

POPULAR MECHANICS

WRITTEN SO YOU CAN UNDERSTAND IT

OCTOBER 1959

35 CENTS

FIRST REPORT
on three new
SMALL CARS:

CHEVROLET CORVAIR

FORD FALCON

PLYMOUTH VALIANT



FALCON



CORVAIR

50 PAGES ABOUT HOMES

PM's Indoor-Outdoor House • Landscaping for Year-Round Effect

USE THE TOOL PROFESSIONALS USE!

ARROW
All-Purpose HEAVY DUTY

STAPLE GUN

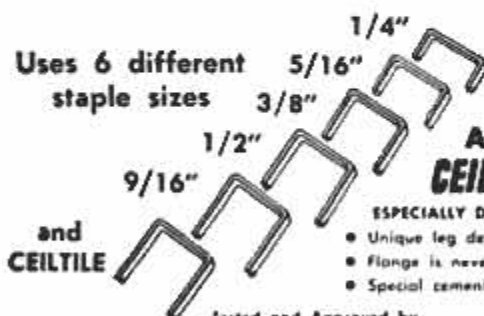

ARROW'S CEILTILE STAPLES!

- ESPECIALLY DESIGNED FOR FASTENING CEILING TILE
- Unique leg design drives flush, holds tight!
 - Flange is never fractured! CEILTILE penetrates perfectly!
 - Special cement coating provides tremendous holding power!

Tested and Approved by Major Ceiling Tile Manufacturers: and other leading manufacturers.



SHOOTS A STAPLE WHEREVER A NAIL CAN BE DRIVEN!



Here's the tool no work bench should be without! Do hundreds of nailing and fastening jobs with this powerful, chrome plated, all steel Arrow Automatic Gun Tacker! Shoots a staple wherever you'd drive a nail! Easier!

Faster! Shoots 100 staples a minute! Cheaper! 100 2-pronged staples cost less than 5c. Arrow's Patented jam-proof mechanism insures a long life of trouble-free performance. Grip it! Feel its perfect balance . . . experience its comfortable shock-absorbing action — and you'll know why Arrow Tackers are the preferred tools of professionals everywhere.

You always have one hand free to hold material!

NEW! MODEL NO. JT.21 JUNIOR STAPLE GUN

For Those Light Household Fastening Chores



This powerful little tool chock-full of quality features never before found in a stapling gun at this amazing low price!

- Unique Safety Compression Handle.
- Safety Lock.
- Non-Jam Loading Mechanism.
- Special Shock-Absorbing Bumper.

- Visual Refill Window.
- Built-in Staple Lifter.
- Loads 100 staples in 2 sizes: 1/4" and 5/16". Locks to fit in pocket for easy carrying. Comes in attractive colors; makes ideal gift for housewife.

Available at leading hardware, lumber, building supply and stationery stores.

ARROW FASTENER COMPANY, INC.
1 JUNIUS STREET • BROOKLYN 12, N. Y.
"PIONEERS AND PACESETTERS FOR OVER A QUARTER CENTURY"

REWARD

Sure as shootin', every man who smokes the new

PHILLIES. CHEROOT

WILL GET A GENUINE REWARD IN SMOKING PLEASURE!

What's more, pardner, these



are MIRACLE MILD

Why these cigars are as smooth and light as the sun settin' over the hills.

BUT DON'T GET CARRIED AWAY UNTIL YOU CARRY AWAY THE HANDY FRESH PACK OF 5 FOR 28 CENTS!

*Slick on the draw
and big as your trigger finger!*



PICK UP A FRESH PACK TODAY



POPULAR MECHANICS®

Address communications to: 200 E. Ontario St., Chicago 11, Illinois. **SUBSCRIPTION SERVICE:** Mail all subscription orders, changes of address, correspondence concerning subscriptions, and Postmaster notices of undeliverable copies to Popular Mechanics, 250 West 55th St., New York 19, N. Y.

Editor

RODERICK M. GRANT

Executive Vice-President

RICHARD E. DEEMS

Publisher

G. HARRY CHAMBERLAINE

Managing Editor

WAYNE WHITTAKER

Assistant Managing Editor

CLIFFORD B. HICKS

Shop Notes and Crafts Editor

JAMES R. WARD

Associate Editors, General Features

ARTHUR R. RAILTON, Automotive
JOHN A. LINKLETTER

Associate Editors, Shop Notes and Crafts

WAYNE C. LECKEY **W. CLYDE LAMMEY**

Radio-Television, Electronics Editor

LOTHAR STERN

Assistant Editors

SHELDON A. MIX, R. B. KIRKPATRICK,
ROBERT I. HULL, JR., General Features
EARL WOBECK, Crafts
JEAN KAVANAUGH, Makeup

Art Staff

FRANK BEATTY, Director

HENRY NEHRBASS, Assistant Director

RICHARD A. POTTS, Art Editor

Eastern Editor

RICHARD F. DEMPWOLFF

Room 4102, Empire State Bldg., New York City 1

Western Editor

THOMAS E. STIMSON, JR.

Suite 1003, 3460 Wilshire Blvd.
Los Angeles 5, Calif.

Advertising Manager

JOSEPH R. BUELL, JR.

Director, Bureau of Information

ALLAN CARPENTER

Advertising Offices

Chicago: 200 E. Ontario St., Whitehall 4-0100;
New York: Empire State Bldg., 350 Fifth Ave.,
Longacre 5-7580; Detroit: General Motors
Bldg., TRinity 5-8711; Cleveland: Hanna
Bldg., 1422 Euclid Ave., PRospect 1-0456; Los
Angeles: 3460 Wilshire, DUmkirk 2-8458; San
Francisco: Russ Bldg., 235 Montgomery St.,
Yukon 2-0823.

Published monthly by Popular Mechanics Company, 200 E. Ontario St., Chicago 11, Ill. Richard E. Berlin, President; Richard E. Deems, Executive Vice-President; Fred Lewis, Vice-President and General Manager; John R. Miller, Vice-President; G. Harry Chamberlaine, Vice-President; G. O. Markuson, Treasurer; H. F. McCauley, Secretary. Single copy in the United States and Canada, 35 cents; subscription rates in the United States and possessions, Canada and countries of the Pan American Postal Union, 1 year \$3.50; 2 years, \$6.00; 3 years, \$8.00. To all other countries add \$1.00 a year over United States prices for overseas postage. If you plan to move, notify us at least 30 days in advance so you will not miss an issue. Give both your old and new addresses. Second-class postage paid at Chicago, Illinois, and at additional mailing offices. Entered as Second Class Matter at Post Office Dept., Canada. Registered as Second Class Matter at the Post Office at Mexico, D.F., Mexico, June 20, 1950. ©1959 by Popular Mechanics Company. All rights reserved. Printed in the United States of America.

FOREIGN EDITIONS:	MECANIQUE POPULAIRE (French)	MECANICA POPULAR (Spanish)	POPULAER MEKANIK (Danish)	POPULAR MEKANIK (Swedish)	POPULARE MECHANIK (German)
-------------------	------------------------------	----------------------------	---------------------------	---------------------------	----------------------------

Volume 112

OCTOBER 1959

Number 4

In This Issue...

Inventors Are NOT Eggheads	97
The New Small Cars—Convair, Falcon, Valiant	106
Sao Paulo—The Detroit of South America	122
Any Old Mother Will Do	130
30,000,000 Ties to Handle	134
Picture Books for the Blind	140

ANNUAL HOUSING SECTION—

The PM Indoor-Outdoor House	144
Will It Increase the Value of Your House?	152
Gas Lamps—the Comeback Kids	156
Electric Heating Is Here to Stay	158
How to Get Your House in Shape to Sell	164
Trends for the Apartment Dweller	166
Parade of Homes	169
Ideas for Home Planners	174
Get in Step With Your Building Code	176
The Test of Good Landscaping	180
Basement Built-ins	188

For the Craftsman...

Cradles for Your Nursery	194
Surgery May Save Your Trees	202
You Can Finish Furniture	210
From Negative to Positive	220
Screwdriving Craftsmanship	229
Showcase of Tools	234
Radio, TV and Electronics	245

Regular Departments...

WHERE-TO-BUY-IT INDEX - - - 92

Know This Old-Timer!	12	An Eye on Space	102
Pioneer of Science	16	Solving Home Problems	206
Detroit Listening Post	90	Shopping for Tools	241
Clinic for Homemakers	252		

Turn to detailed index on page 92. Sources of additional information on items in this issue are shown on the Where-to-Find-It List, available without charge by writing the Bureau of Information, Popular Mechanics, 200 E. Ontario St., Chicago 11, Ill.

Next Month...

DON'T MISS the parade of new cars. All of them will be shown in full color. . . . Also, there's an exciting look at the superairliner of the future. Ten years from now you'll be flying coast to coast in 90 minutes! . . . And, for Christmas planning, there are 19 pages of Christmas gifts you can buy and Christmas gifts you can make

POPULAR MECHANICS

Three fourths of all night driving is now done with the low beam!

The low beam of G-E SUBURBAN Headlamps gives you a "spotlight" effect . . . lets you see better in spite of the other car's lights

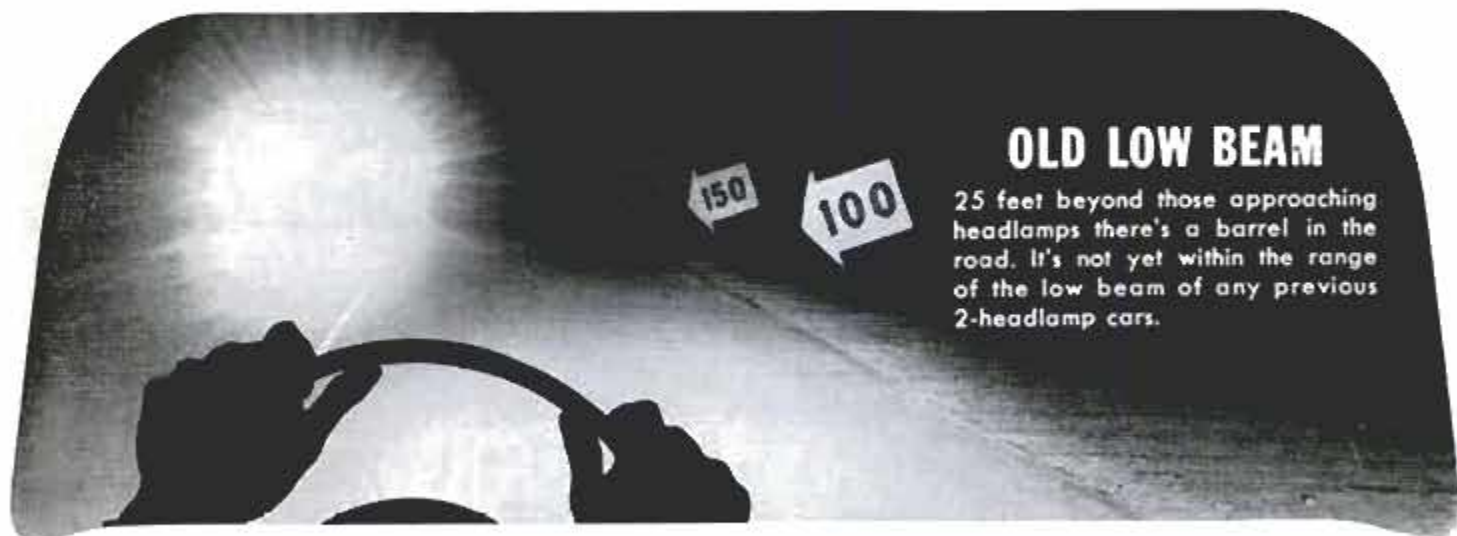

OLD LOW BEAM

25 feet beyond those approaching headlamps there's a barrel in the road. It's not yet within the range of the low beam of any previous 2-headlamp cars.

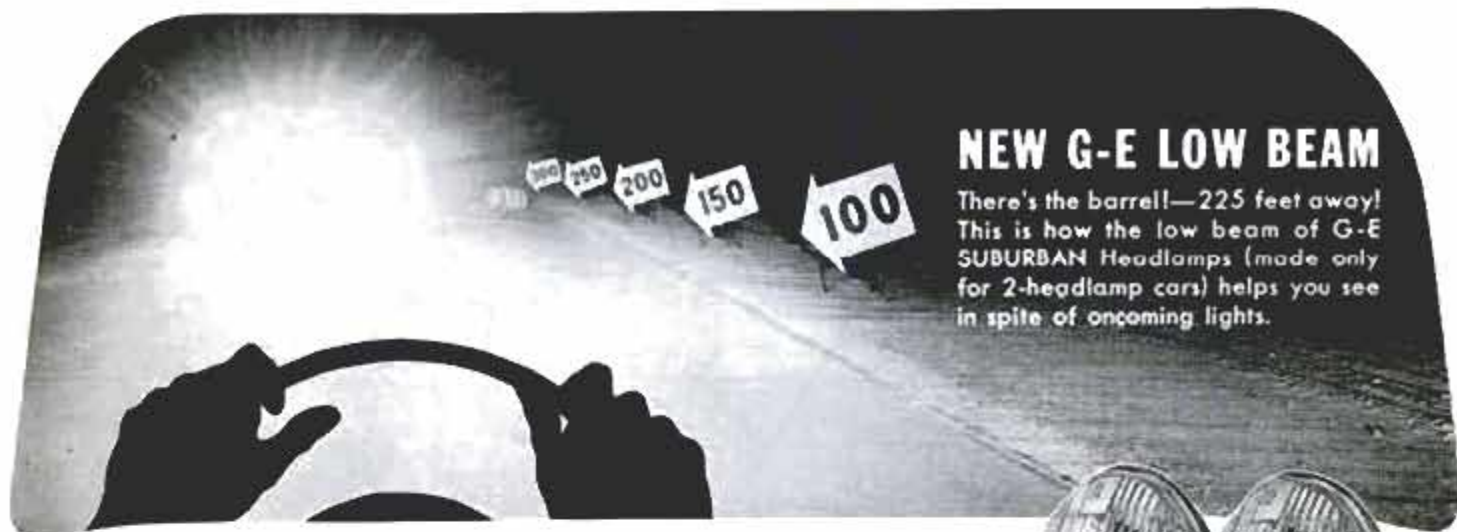

NEW G-E LOW BEAM

There's the barrel!—225 feet away! This is how the low beam of G-E SUBURBAN Headlamps (made only for 2-headlamp cars) helps you see in spite of oncoming lights.

When there wasn't a great deal of nighttime traffic, you used the *upper* beam most often because it pushed a lot more light farther down the road. So, headlamp manufacturers put the upper beam filament on focus for maximum beam control.

Since nighttime traffic has increased tremendously, motorists find they must use the *low beam* more and more. So, General Electric now puts the *low beam* filament on focus to give maximum beam control where it's needed most—to provide a "spotlight" effect which directs more light down the right side of the road. That's why the low beam of new General Electric SUBURBAN Headlamps lets you see past the oncoming car when you're 75 to 200 feet apart. Only General Electric SUBURBAN Headlamps have this feature for 2-headlamp cars. General Electric Company, Miniature Lamp Department M-905, Nela Park, Cleveland 12, Ohio.



ATTENTION ALL OWNERS OF 2-HEADLAMP CARS!

For approximately the same results as the four-headlamp systems in brand new cars (whose low beam filaments are also on focus) . . . have a pair of new G-E SUBURBAN Headlamps installed and aimed today. Tonight you'll see better in spite of the other car's lights.

Progress Is Our Most Important Product

GENERAL  **ELECTRIC**

2 NEW SKIL POWER SAW VALUES!

SAWS 2x6 BOARD IN 14 SECONDS!

The Skil Jig Saw is fastest—cuts anything from wood to steel, any shape from straight lines to circles.

Use the Skil Jig Saw with ease for cutting 2" boards, plywood, plastics, metal, other materials. Veteran power tool user or beginner, you'll get professional results.

With Skil's orbital cutting action, the blade cuts on the up-stroke, moves away from the work on the downstroke to eliminate blade drag. That makes it the fastest cutting jig saw on the market.

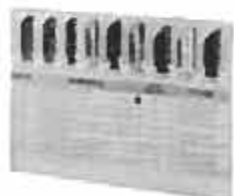
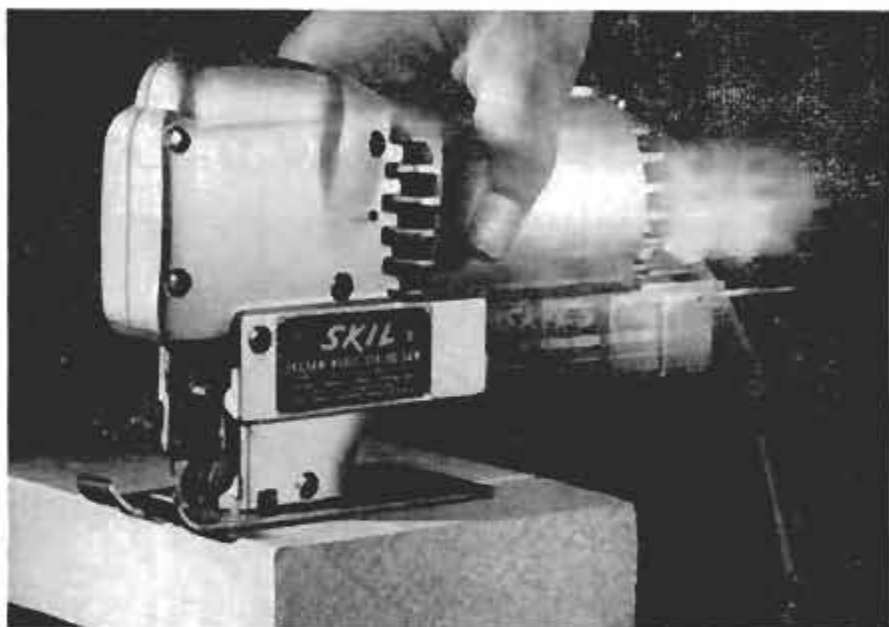

FREE! \$7.50 Value!

Complete 9-blade kit for cutting all materials—metal, wood, plastic—with this Model 514 Jig Saw—all for only \$47.50. Limited time offer, at most Skil dealers.

EXTRA POWER, SPEED, ACCURACY!

This Skilsaw 6½" Power Saw has a rugged 1+ h.p. motor to handle all cuts faster . . . with greater accuracy. Special features include non-binding lower blade guard and safety clutch, which disengages the blade if it jams or binds. Also has easy-to-adjust depth and bevel controls for accurate 45° to 90° cuts.

In short, there are more professional features on this Skilsaw Model 536 than any other saw in its price class.

See your hardware or lumber dealer today and try these two saws. You'll quickly recognize them as outstanding values.



FREE! \$5.45 Value!

One extra combination blade plus accurate rip guide with this 6½" Model 536 Saw—all for only \$49.95. Hurry! Limited time offer, at most Skil Dealers.



... AND SKILSAW POWER TOOLS

Skil Corporation, Chicago 30, Illinois.
Prices higher in Canada.

Road Tests Prove: **RADICALLY NEW**  **LOW PROFILE TIRES**

BEAT DEADLY TIRE HEAT

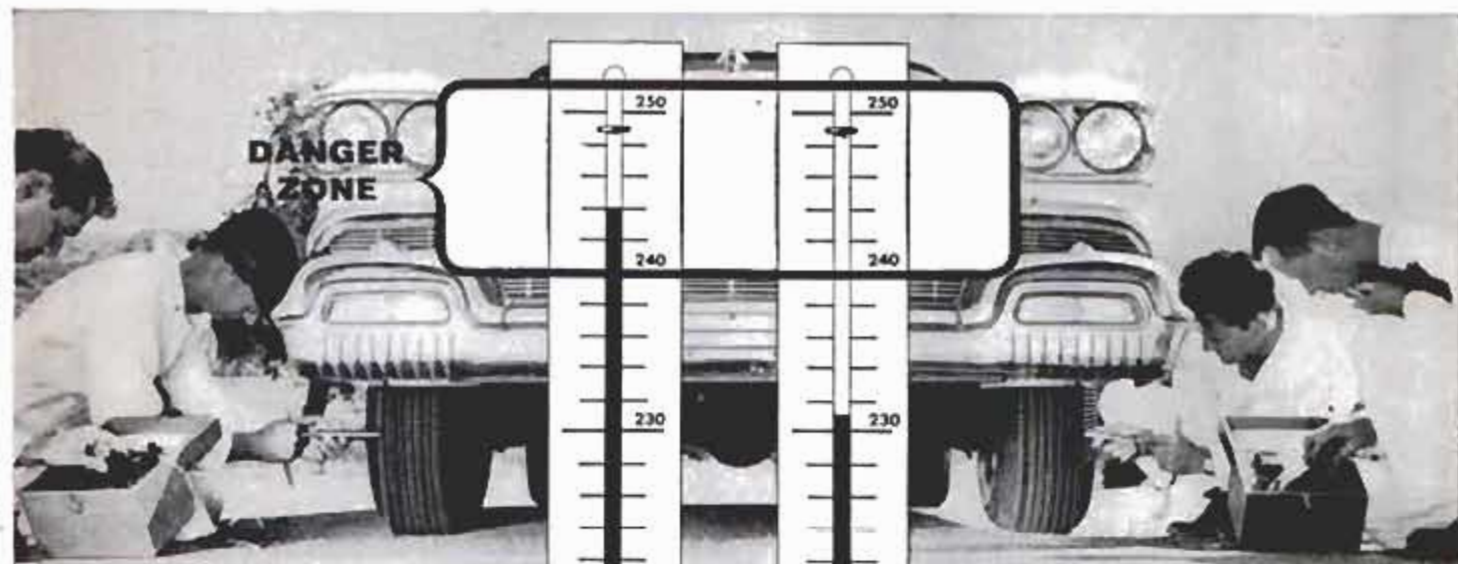

SEE HOW RAPIDLY ORDINARY TIRES GET HOT
—WHILE LOW PROFILE TIRES RUN COOL!

Ordinary tire (at left) and new Low Profile tire (at right) get temperatures taken after running only 29 miles at turnpike speeds.

Constant flexing has already pushed ordinary tire's temperature into the tire-destroying heat danger zone. But new Low Profile Safety-Shape tire is well below the danger zone. Even running hour after hour, U.S. Royal's Low Profile tire stays cool!



NEW LOWER, WIDER TIRES RUN COOLER, ARE SAFER, GIVE UP TO 35% MORE MILEAGE, SAVE GAS—YET COST NO MORE!

Why buy hot-running tires... when now, at down-to-earth prices, you can enjoy the extra safety of tires that beat deadly tire heat!

The above diagram shows Low Profile tires are lower and wider than ordinary tires. Built closer to actual working proportions on the road. So they don't flex as much. Don't strain as hard. Run far cooler than ordinary tires!

They're safer against tire

failure at high speed. Safer on turns. Safer against skids. Safer in emergency stops.

They give longer service. Roll easier—save gas.

U.S. Royal's new Low Profile Safety-Shape tire is now yours at popular prices, at your U.S. Royal Dealer's.

- **MILEAGE**
25% to 35% more mileage
- **HIGH SPEED ENDURANCE**
3 times better
- **TURNPIKE GAS ECONOMY**
6 to 12 extra miles per tankful
- **TURNING EFFORT**
20% more stability on curves
- **SKID RESISTANCE AND TRACTION**—raised 5 to 10%

Effective Immediately in U. S. Royal Tires
A REVOLUTIONARY DISCOVERY IN RUBBER
NO-SHOCK RUBBER

GIVES YOU THE **LUXURIOUS**
RED CARPET RIDE



Smother a million jolts a mile!

U.S. Royal's new super-supple rubber—born of new polymers, new processes, new production techniques—absorbs the "high-frequency" vibrations that cause driving fatigue. Gives you the "big-car" feel!

- No Bounce
- No Sing or Squeal
- Less Scuff
- Soaks Up Vibration
- Wears Longer

U.S. ROYAL TIRES



United States Rubber

Rockefeller Center, New York 20, N. Y.

In Canada: Dominion Rubber Co., Ltd.

See things you never saw before. Visit U. S. Rubber's New Exhibit Hall, Rockefeller Center, New York.

Over the Editor's Desk



To the Editor:

A business that started as a basement hobby of a Beloit College professor is now producing unique electrical specialties for university, industry and government chemical laboratories. Dr. Frederick Mathews, formerly a research chemist in Philadelphia, has abandoned teaching at Beloit, at least temporarily, to devote full time to

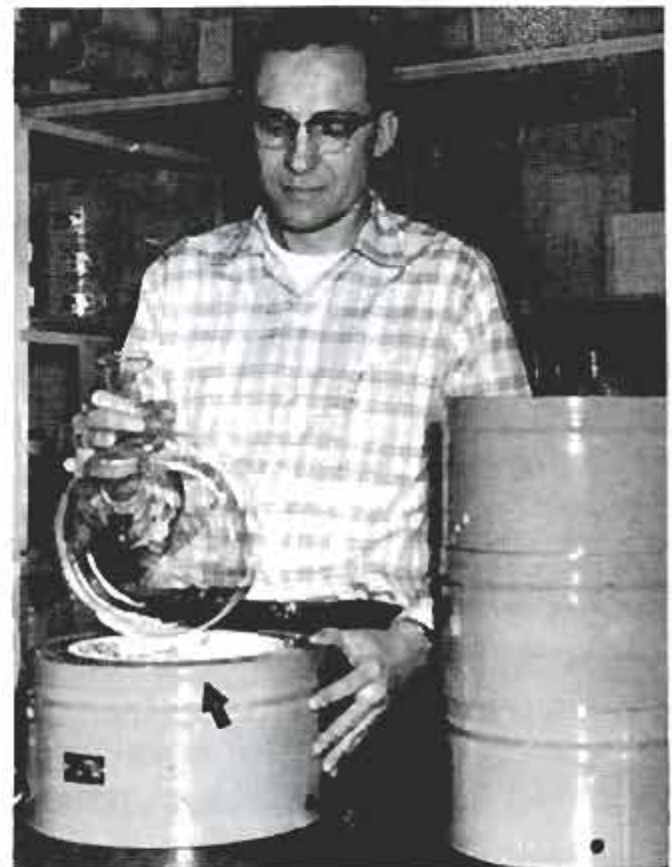

his fledgling business—making electric contour heaters for round-bottom laboratory flasks. Dr. Mathews calls the new heaters, developed to replace Bunsen burners, "studentproof" because they cannot be burned out by distilling the flask dry at too high voltage, cannot be harmed by acids, and they are protected by a durable epoxy paint. The refractory heating shell is built with a special asbestos-cement composition soft enough to be used safely with glass, but fibrous and tough, with high heat conductivity resistant to thermal shock. Dr. Mathews makes the contour heaters in 13 sizes.

Dave Mason,
Beloit, Wis.

☆☆☆

To the Editor:

I am enclosing pictures of the roller coaster I built in 1956. My name is Eugene

(Continued to page 8)



PAINTERS)



sporting goods, exterminators,
printers, plumbers, elevators
whatever you need —

Find it Fast
In The
Yellow Pages



Advertisers displaying this emblem
make your shopping easy.



To those who want to enjoy
an ACCOUNTING CAREER



FREE SAMPLE LESSON

IF you're that person, here's something that will interest you.

Not a magic formula—not a get-rich-quick scheme—but something more substantial, more practical.

Of course, you need something more than just the desire to be an accountant. You've got to pay the price—be willing to study earnestly, thoroughly.

Still, wouldn't it be worth your while to sacrifice some of your leisure in favor of interesting home study—over a comparatively brief period? Always provided that the rewards were good—a salary of \$5,000 to \$10,000 and up?

An accountant's duties are interesting, varied and of real worth to his employers. He has *standing!*

Do you feel that such things aren't for you? Well, don't be too sure. Very possibly they *can* be!

Why not, like so many before you, investigate LaSalle's modern Problem Method of training for an Accounting position?

Just suppose you were permitted to work in an accounting firm under the personal supervision of an expert accountant. Suppose, with his aid, you studied accounting principles and solved problems day by day—easy ones at first—then more difficult ones. If you could do this—and could turn to him for advice as the problems became complex—soon you'd master them all.

That's the training you follow in principle under the LaSalle Problem Method.

Over 4,500 Certified
Public Accountants among
LaSalle alumni

You cover accounting from Basic Accounting right through Principles and Cost Accounting. As you go along, you absorb the principles of Accounting Systems, Federal Income Tax, Certified Public Accountant Training, and prepare for the CPA examinations.

Your progress is as speedy as you care to make it—depending on your own eagerness to learn and the time you spend in study.

Will recognition come? The only answer, as you know, is that success *does* come to the man who is really *trained*. It's possible your employers will notice your improvement in a very few weeks or months. Indeed, many LaSalle graduates have paid for their training—with increased earnings—before they have completed it! For accountants, who are trained in organization and management, are the executives of the future.

Get Free Sample Lesson—Also "Opportunities in Accounting"

For your own good get all the facts about this completely new and modern accounting training. Write for Free Sample Lesson—also latest book "Opportunities in Accounting." They will prove that Accounting offers brilliant futures to those who aren't afraid of serious home study, and will show the wide range of opportunities that exist today. No cost or obligation. If you want a position of higher income, greater prestige and professional standing... MAIL THE COUPON NOW!

Accredited Member, National Home Study Council

LASALLE EXTENSION UNIVERSITY

A CORRESPONDENCE INSTITUTION

417 S. Dearborn St. Dept. 1064HA Chicago 5, Ill.

I want to be an accountant. Send me without obligation, Free Sample Lesson—also "Opportunities in Accounting."

Name..... Age.....

Address.....

City, Zone & State.....

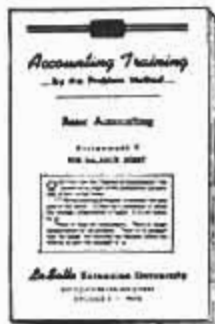



Train AT HOME for a GOOD JOB in **AUTO MECHANICS**

A better job with more pay will mean *better living* for you. It can mean a fine home, a new car, nice vacations, and good educations for the kids. If you would like to earn up to \$125 a week and more—and be able to afford better living, *train yourself* in Auto Mechanics. You can do it with CTI showing you how—and you can learn at home in spare time!

GOOD JOBS ARE WAITING EVERYWHERE because there are over 60 million cars and trucks on the road—7 million new ones each year. One-third are in the heavy-repair classification. Skilled mechanics are needed to keep these cars operating. You can be one of them—make big money, enjoy lifetime security—even open a shop!

EARN AS YOU LEARN just as many CTI students do. They make up to \$15 a week and more in spare time. Some start their own shops by graduation time. CTI Shop-Method Home training, based on resident school practice, makes every step easy.

DIESEL MECHANICS OR BODY-FENDER TRAINING is also yours at no extra cost. A wonderful chance to give yourself a well-rounded education. Only CTI gives you this extra choice! Get the facts: Mail coupon.



YOU PRACTICE WITH THIS TUNE-UP KIT

Kit includes a Compression Tester, a Vacuum Gauge and Fuel Pump Tester, an Ignition Timing Light, and a portable steel case. These professional instruments help you locate engine troubles, let you get useful practice. You keep this kit!

MECHANIC'S TOOLS TOO

You'll use these tools to get real experience. They'll increase your interest, stamp you as a "pro." You'll earn spare time cash with them. No extra cost for tools—you keep them.



MAIL COUPON TODAY!

MAIL TODAY FOR 2 FREE BOOKS

COMMERCIAL TRADES INSTITUTE
1400 Greenleaf Ave., Chicago 26
Dept. A-1156

Send your new Auto Mechanics book and Sample Lesson. BOTH FREE.

Name _____ Age _____

Address _____

City _____ Zone _____ State _____



Paul Clemans and I was only 11 when I built it. I am now 14.

I ordered the wood and got the roller-skate wheels, then started to build my first roller coaster! It took me four days to construct the car and the track. . . . When I set the track out in our back yard, the crowd began to form. Kids from 3 to 13 were there waiting for their first ride. You can bet your bottom dollar that I was the proudest boy in the neighborhood. The top picture is of Judy, my sister, myself, and my brother. They are giving me the shove that I used as power since I didn't make a steep elevation because of the price. The lower picture is an over-all view of my roller coaster, then 93 feet long. The wood cost me \$8.00 and the track

(Continued to page 10)

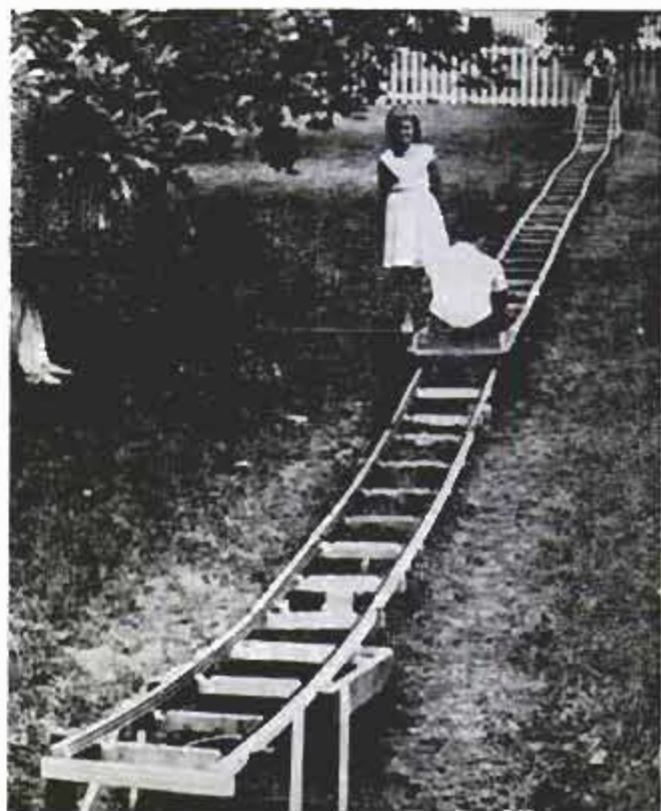

Learn Radio-Television Electronics

by Practicing at Home in Your Spare Time

WITHOUT EXTRA CHARGE YOU GET special NRI kits developed to give you actual practice with Radio-TV receiver or broadcasting circuits and equipment. All equipment is yours to keep.

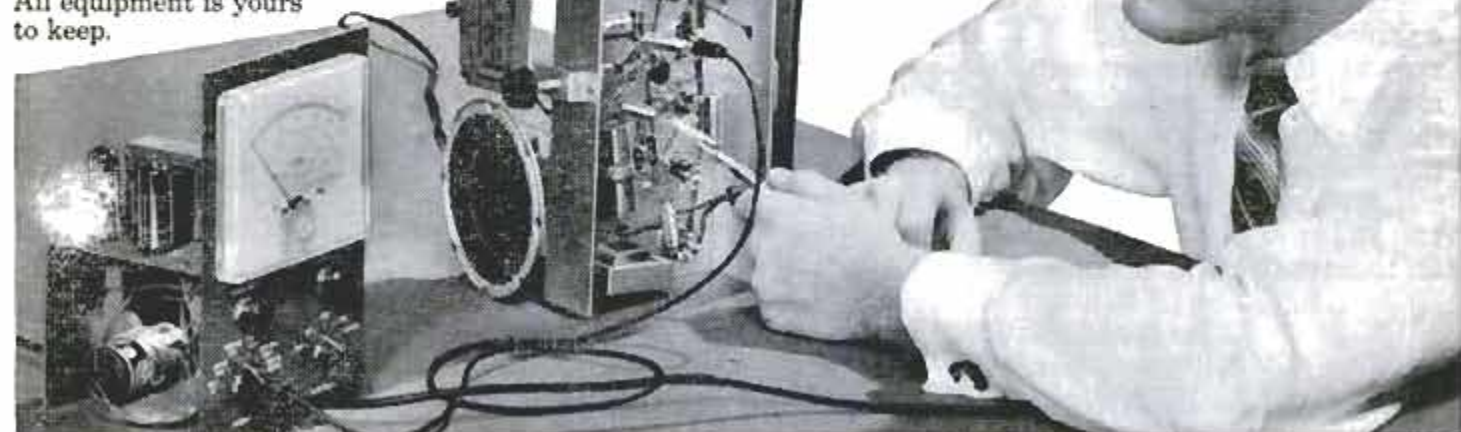

RADIO-TV BROADCASTING (see above) offers important positions as Operators and Technicians. **RADIO-TV SERVICING** Technicians (see below) needed in every community. Their services are respected, their skill appreciated.



Fast Growing Field Offers You Good Pay, Success, Bright Future



J. E. SMITH
founder

Bigger than ever and still growing fast. That's why Radio-TV has special appeal to ambitious men not satisfied with their job and earnings. More than 4,000 Radio and TV stations. More than 150 million home and auto Radios, 40 million TV sets. Color TV promises added opportunities. For the trained man, there are good jobs, bright futures in Radio-TV Servicing or Broadcasting.

Training PLUS opportunity is the ideal combination for success. So plan now to get into Radio-TV. The technical man is looked up to. He does important work, gets good pay for it. Radio-Television offers that kind of work. NRI can supply training quickly, without expense of going away to school. Keep your job while training. You learn at home in your spare time. NRI is the OLDEST and LARGEST home study Radio-TV school. Its methods have proved successful for more than 40 years.

Added Income Soon - \$10, \$15 a Week in Spare Time

Soon after enrolling, many NRI students start to earn \$10, \$15 a week in spare time fixing sets. Some pay for their training and enjoy extra luxuries this way. Some make enough to start their own Radio-TV shops. NRI training is *practical*—gets quick results. Easy to understand, well illustrated lessons teach you basic principles. And you LEARN-BY-DOING by practicing with kits of equipment which "bring to life" things you study.

Find Out What NRI Offers

NRI has trained thousands for successful careers in Radio-TV. Study fast or slow—as you like. Diploma when you graduate. Mail coupon now. Paste it on a postcard or mail in envelope. ACTUAL LESSON FREE. Also 64 page catalog that shows opportunities, shows equipment you get. Cost of NRI courses low. Easy terms. **NATIONAL RADIO INSTITUTE, Dept. 9KA, Washington 16, D. C.**

N.R.I. TRAINED THESE MEN FOR SUCCESS



"I was repairing Radios by 10th lesson. Now have good TV job." M. R. LINDEMUTH, Fort Wayne, Ind.



"Doing spare time repairs on Radio and TV. Soon servicing full time." CLYDE HIGGINS, Waltham, Mass.

"I had a successful Radio repair shop. Now I'm Engineer for WHPE." V. W. WORKMAN, High Point, N. C.



"There are a number of NRI graduates here. I can thank NRI for this job." JACK WAGNER, Lexington, N. C.



VETERANS Approved Under G. I. Bills

SEND FOR BOTH FREE

National Radio Institute

Dept. 9KA, Washington 16, D. C.

Mail me Sample Lesson and 64-Page Catalog FREE. (No salesman will call. Please write plainly.)

Name _____ Age _____

Address _____

City _____ Zone _____ State _____

Accredited Member National Home Study Council



(Continued from page 8)

ran less than 7 cents per foot. Of course, since it was a rather experimental project, I used a very low grade of white pine for both the car and the tracks. The only expensive part of the whole thing was the roller-skate wheels . . .

Gene Clemans,
Lima, Ohio

☆☆☆

Unknown to us at the time, Popular Mechanics played a part in the beginnings of "Unibath," the one-step chemical for photographers reported on page 256 of this issue. We learned about it in this letter:

You might not know that your wonderful magazine, especially an article in 1957, enabled me to meet Mr. H. S. Keelan, who was at that time a research associate at Boston University, employed in developing a combined developer and fixer. This acquaintance, per your wonderful magazine made through your excellent reporting led to a business proposition resulting in the production of Unibath.

James Kunz,
Director of Quality Control,
Cormac Chemical Corp.
80 Fifth Ave.,
New York City

To the Editor:

When Calvin Hostetler had this huge American flag painted on his farm home near Lovington, Ill., when the house was



built in 1897, it created a lot of interest. It still does. Whenever the house was repainted, the flag was part of the decorating job. Now it will be repainted again. Acquisition of Alaska and Hawaii as 49th and 50th states makes the 48-star flag obsolete. Grover Brinkman, Okawville, Ill.

Enjoy
Velvet-Smooth Smoking
-the whole bowl
through!



No wonder Velvet stays smooth and mellow from first puff to last. Velvet's aged burley tobaccos are selected and cut to burn slower and cooler in any pipe, for truly Velvet-smooth smoking.

IN POCKET TINS . . . REGULAR
AND LARGE SIZE HUMIDORS

Spend the rest of your life on Velvet!

How to build a big-pay future in the Air Conditioning and Refrigeration industry with CTI Home Training Kits

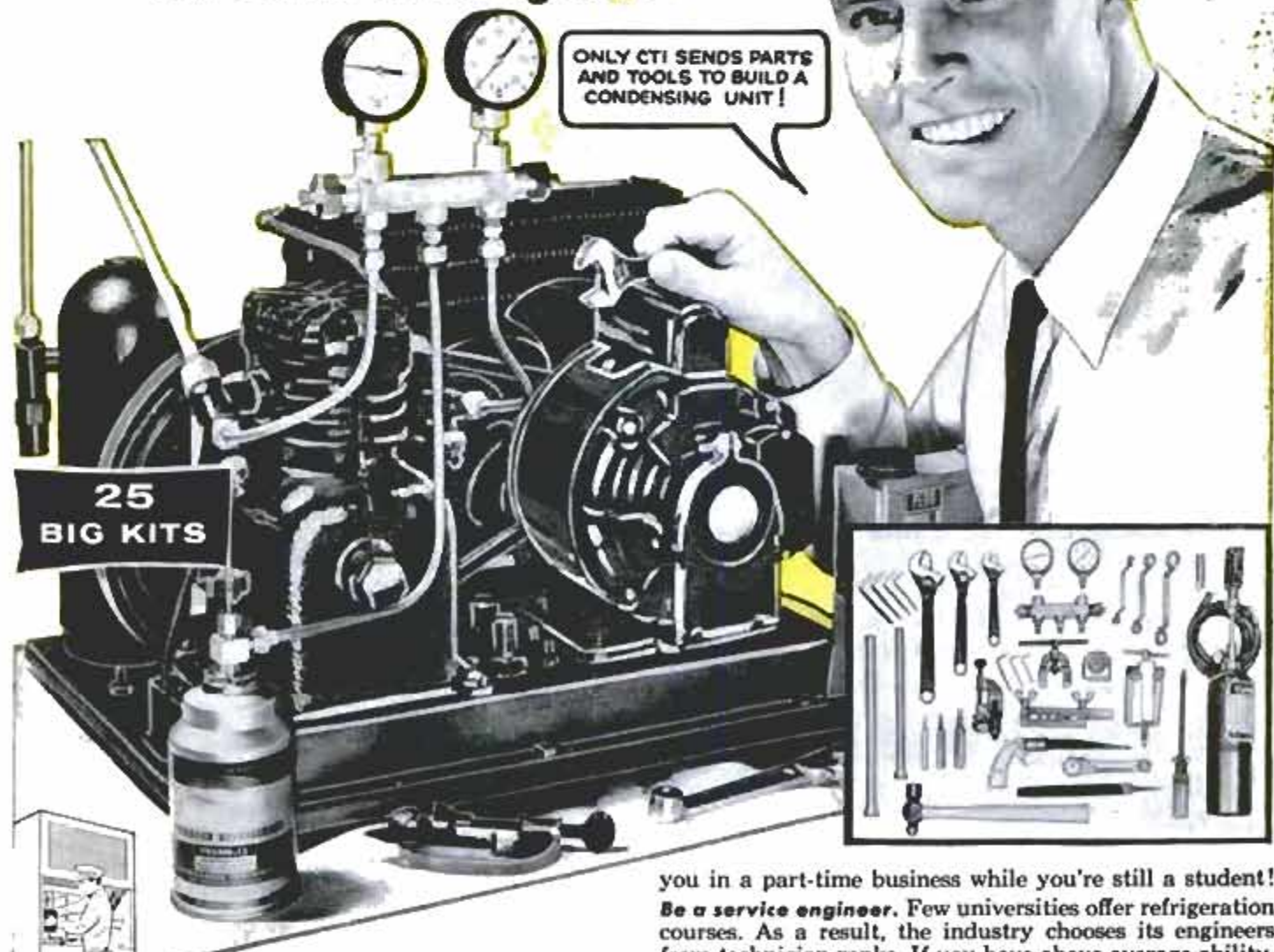

A better job or your own business

The news is spreading fast: America's finest opportunity field is now Air Conditioning and Refrigeration! Today there are over 150 million domestic and industrial units in use. Over 6 million new freezers, refrigerators and air conditioners are manufactured annually. So quickly is the industry expanding that 20,000 service technicians must be trained each year. Yes, air conditioning is a big, uncrowded field where the opportunities are as large as the paychecks!

Learn at home by practicing. It's easy to master this craft. CTI sends you 25 kits of parts and tools to build a heavy-duty, commercial-type, 1/4 h.p. condensing unit (illustrated above). You complete 23 work projects—do 10 trouble-shooting jobs. Then you build an air conditioner, freezer, refrigerator or milk cooler.

Make money as you train. So practical is CTI training that many students earn extra cash fixing and installing. Some make calls on their own; others work for local appliance dealers. CTI training pays its way—actually puts

you in a part-time business while you're still a student! **Be a service engineer.** Few universities offer refrigeration courses. As a result, the industry chooses its engineers from technician ranks. If you have above-average ability, you too may get into planning and estimating—the engineering phase of a great business.

Go in business. This is one of the easiest of all fields in which to start small and grow big. You make friends as you make calls, and build a list of potential customers. You also can sign service contracts with food stores, taverns, motels, restaurants, etc. CTI has special information on how to get started.

Write for new catalog. Your opportunities in the air conditioning and refrigeration industry are thoroughly covered in our big new booklet. *Mail coupon for your free copy.* We'll also send a lesson sample so you can see for yourself how easy it is to learn this top-pay, secure craft. Be sure to mail coupon *today.*—Commercial Trades Institute, Chicago 26, Illinois.

COMMERCIAL TRADES INSTITUTE

1400 GREENLEAF AVENUE
CHICAGO 26, ILLINOIS

DEPT. R-643

Send catalog, *Success in Air Conditioning & Refrigeration*, and Lesson Sample. Both FREE.

Name _____ Age _____

Address _____

City _____ Zone _____ State _____



FIRST GET THE FACTS—THEN DECIDE

Mail Coupon Today for 2 Free Booklets

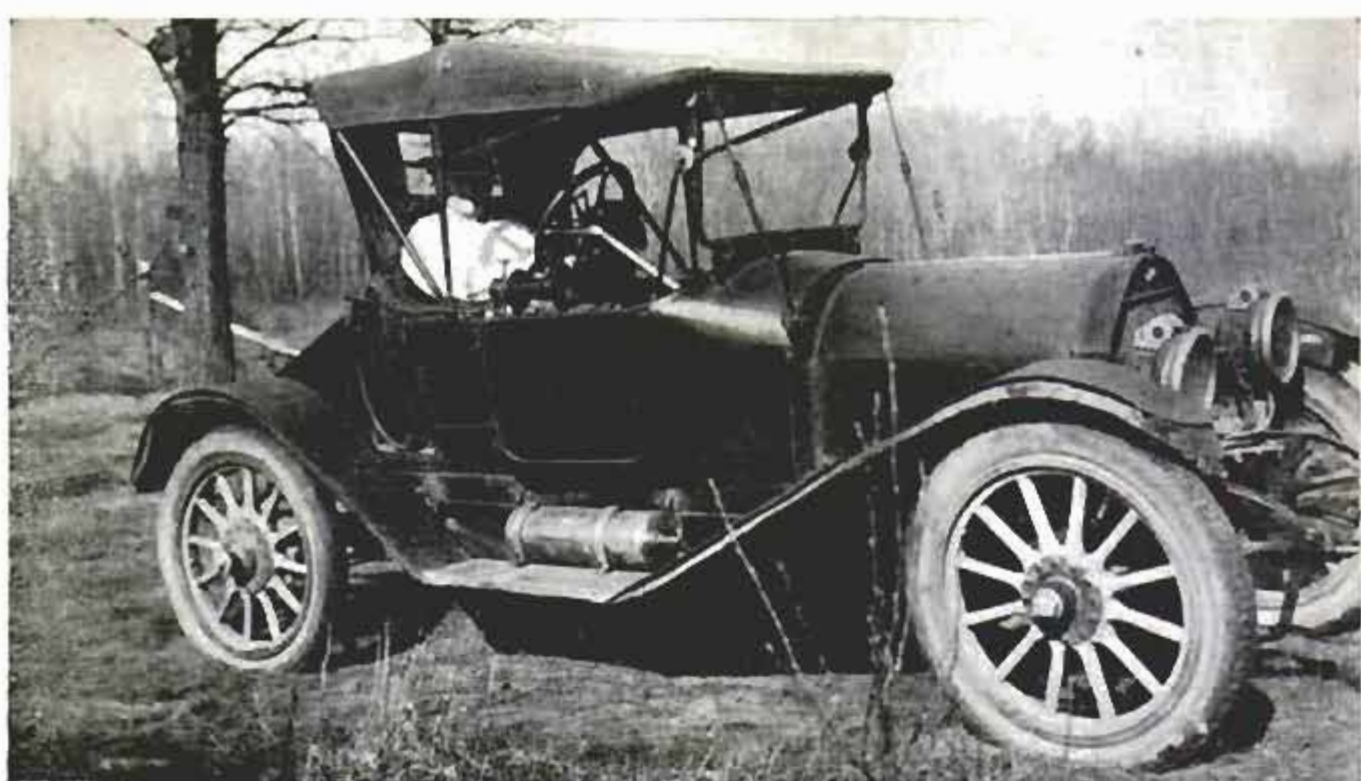

Do You Know This Old-Timer?

This is an old-timer that almost wasn't built. Just 47 cars were turned out in 1907 when the company was rescued by a man who made this car the forefather of a handy little vehicle that was the rage of World

War II. By the time the beauty above was built, he had the company on its feet. The car shown is still owned by John E. Usher, of St. Vital, Man., Can. If you can't name it, turn to page 312.

"EARNED OVER \$2,000.00 IN TEN WEEKS"



You can investigate full time for one company — or earn \$3 to \$10 an hour in *your own business*. No prior experience or higher education needed. And age is no barrier. Here is a field wide open to men 18 to 60.

INVESTIGATE ACCIDENTS. We train you. Then we assist you to step into an excellent position — or to develop your own lifetime business.

A. J. Allen earned over \$2,000 in ten weeks. Gary Williams doubled his former salary. Jessie Hill says "Had I not learned of Universal Schools' Accident Investigator Course I would still be just another time card puncher; but today I have a wonderful position, and I receive \$3.00 an hour plus an expense allowance."

RIGHT NOW the Accident Investigation and Adjusting Field offers you a tremendous future. Here's why: *This vital business distributes more money than any other service industry.* Last year alone over 200 MILLION ACCIDENTS had to be investigated for Insurance Companies, Airlines, Railroads, Steamship Lines, and Government Offices — and the need for trained men is booming!

NOW! FREE Book Gives You All the Facts

Send TODAY for new, illustrated Book mailed FREE. Learn how you can prepare at home in just a few weeks for excellent full time or spare time income. See for yourself how others have doubled and even tripled their earnings. Let us show you how Universal Schools has trained hundreds of men in their own homes spare time — and then helped them add thousands of dollars to their incomes. Absolutely no obligation on your part. No salesman will call. Write at once to me, M. O. Wilson, Universal Schools, 6801 Hillcrest Ave., Dallas 5, Texas.

Mr. M. O. Wilson, Dept. PM-10
Universal Schools, 6801 Hillcrest Ave.,
Dallas 5, Texas

Send me free book on Big Money in Accident Investigating & Adjusting Field. No salesman will call.

Name.....Age.....

Address.....

City.....Zone.....State.....



NOW!
at a price
you can afford!

MAKE MORE MONEY in TELEVISION RADIO-ELECTRONICS

**BETTER...MORE COMPLETE...LOWER COST...
WITH NATIONAL SCHOOLS SHOP-METHOD
HOME TRAINING!**

BETTER... Training that is proved and tested in Resident School shops and laboratories, by a School that is the **OLDEST** and **LARGEST** of its kind in the world.

MORE COMPLETE... You learn **ALL PHASES** of *Television-Radio-Electronics*.

LOWER COST... Other schools make several courses out of the material in our **ONE MASTER COURSE**... and you pay more for less training than you get in our course at **ONE LOW TUITION!**



These
two FREE books will
show you how!

You get all information
by mail... You make
your own decision... at
home! **NO SALESMAN
WILL CALL**



TOP PAY... UNLIMITED OPPORTUNITIES LIFETIME SECURITY CAN BE YOURS!

You are needed in the Television, Radio, and Electronics industry! Trained technicians are in growing demand at excellent pay—in **ALL PHASES**, including Servicing, Manufacturing, Broadcasting and Communications, Automation, Radar, Government Missile Projects.

NATIONAL SCHOOLS SHOP-METHOD HOME TRAINING, with newly added lessons and equipment, trains you in your spare time at home, for these unlimited opportunities, including many technical jobs leading to supervisory positions.

YOU LEARN BY BUILDING EQUIPMENT WITH KITS AND PARTS WE SEND YOU. Your National Schools course includes thorough *Practical* training—**YOU LEARN BY DOING!** We send you complete standard equipment of professional quality for building various experimental and test units. You advance step by step, perform more than 100 experiments, and you build a complete TV set from the ground up, that is yours to keep! A big, new TV picture tube is included at no extra charge.

EARN AS YOU LEARN. We'll show you how to earn extra money right from the start. Many of our students pay for their course—and more—while studying. So can you!

LESSONS AND INSTRUCTION MATERIAL ARE UP-TO-DATE, PRACTICAL, INTERESTING. Every National Schools Shop-Method lesson is made easy to understand by numerous illustrations and diagrams. All instruction material has been developed and tested in our own Resident School Shops, Laboratories and Studios.

SEND FOR INFORMATION TODAY... it can mean the difference between **SUCCESS** and failure for you! Send for your **FREE BOOK** "Your Future in Television-Radio-Electronics" and **FREE Sample Lesson.** Do it **TODAY**, while you are thinking about your future. It doesn't cost you anything to investigate!

GET THE BENEFITS OF OUR OVER 50 YEARS EXPERIENCE

Approved for
GI Training



NATIONAL SCHOOLS
Los Angeles 37, Calif.

YOU GET...

- 19 Big Kits—**YOURS TO KEEP!**
- Friendly Instruction and Guidance
- Job Placement Service
- Unlimited Consultation
- Diploma—Recognized by Industry
- **EVERYTHING YOU NEED FOR SUCCESS!**

SHOP-METHOD HOME TRAINING COVERS ALL PHASES OF INDUSTRY

1. Television, including Color TV
2. Radio AM & FM
3. Electronics for Guided Missiles
4. Sound Recording and Hi-Fidelity
5. FCC License
6. Automation and Computers
7. Radar & Micro-Waves
8. Broadcasting and Communications

NATIONAL TECHNICAL SCHOOLS

WORLD-WIDE TRAINING SINCE 1908

MAIL NOW TO
NATIONAL SCHOOLS, Dept. RB-109
4000 S. FIGUEROA ST., LOS ANGELES 37, CALIF.
Rush free TV-Radio "Opportunity" Book and sample lesson. No salesman will call.

NAME _____ AGE _____
ADDRESS _____
CITY _____ ZONE _____ STATE _____

Check if interested **ONLY** in Resident School training at Los Angeles.
VETERANS: Give date of Discharge _____

RESIDENT TRAINING AT LOS ANGELES

If you wish to take your training in our Resident School at Los Angeles, the world's TV capital, start **NOW** in our big, modern Shops, Labs and Radio-TV Studios. Here you work with latest Electronic equipment - - professionally installed - - finest, most complete facilities offered by any school. Expert, friendly instructors. Personal attention. Graduate Employment Service. Help in finding home near school - - and part time job while you learn. Check box in coupon for full information.



**A HIGHLY
RESPECTED TRADE—
START SOON TO
EARN EXTRA MONEY
IN SPARE TIME**

Learn at Home IN YOUR SPARE TIME to Fix Electrical Appliances

To build a better future, get into a field where there's much important work and the security that comes from knowing a good trade. Servicing electrical appliances offers that OPPORTUNITY. Every wired home has many electrical appliances and millions and millions of new appliances are sold every year. Owners pay well to keep them in repair. That's making a fast-growing need for trained men.

Add To Your Income Starting Soon Need For Service Technicians Increasing

Make extra money in your spare time. Start soon to fix electric toasters, fans, clocks, vacuum cleaners, and other electric appliances for your neighbors and friends. Work in your basement, garage or spare room. It's easy to increase your earning power—to pay for your training many times over—to have extra money to buy things you need.

Learn and Earn with Multi-Use Tester Built with Parts We Send

This course includes the parts to build a portable, sturdy Appliance Tester that helps you locate electrical defects quickly and easily. You use it to learn and do actual electrical appliance repair jobs. If you want better pay learn this good trade. No need to give up your present

job. You can train at home in your spare time for only \$3.00 down and \$6.00 a month. A small price to pay for increased earnings, a more secure future. Paste coupon below on a postal or mail in envelope for free book and sample lesson. Address **National Radio Institute, Dept. AK9, Washington 16, D. C.**

**MAILING THIS
COUPON MAY START
YOU TO SUCCESS**

**LESSON AND BOOK
FREE**



NATIONAL RADIO INSTITUTE, Dept. AK9, Washington 16, D. C.

Please send me Electric Appliance Training lesson and book free. (No salesman will call.)

Name Age

Address

City Zone State

ACCREDITED MEMBER NATIONAL HOME STUDY COUNCIL

Get Ahead Faster

New SUCCESS PROGRAM Gives You Short-Cuts to Executive Skills—at Amazing Low Cost! Takes Minutes a Day!

NOW—in your own home—you can master the fundamentals of success—pave the way to a richer life for yourself and your family. You can benefit from the most practical, scientific plan ever devised to help men increase their earning power. Others have paid hundreds of dollars to learn the tested and proven success secrets available to you in this Program at the low cost of only a few pennies a day.

The New Nelson Doubleday PERSONAL SUCCESS PROGRAM

Month by month, the Nelson Doubleday Personal Success Program will show you how to develop the basic executive abilities that pay such handsome dividends today. One by one you'll acquire the important skills that mark "the man on the way up"—skills in getting along with people—creating new ideas—understanding business figures—winning new friends wherever you go—speaking in public—organizing your time efficiently—writing business letters, reports and memos.

You start with a remarkable memory trainer. Then every 30 days you will receive a new self-training Progress Kit on an essential success subject.

There has never been anything like these "Progress Kits" available—for completeness, authority and detailed step-by-step guidance. Nothing has been left out. The expert business leaders, psychologists and educators who planned the Program have included all the know-how and actual practice you need. Their simplified new self-instruction method enables you to gain "practical experience" in the odd moments that now go to waste every day.

Sample "Memory-Trainer Kit" only 10¢

To introduce you to this new kind of personal achievement plan, Nelson Doubleday offers you a valuable "sample kit" almost as a gift. You'll receive a remarkable 10,000 word handbook—*How To Remember Names and Faces*—that gives you the secrets of professional memory experts. In the first five pages you'll learn one easy trick that will double your memory power—overnight. Soon your new "automatic memory" for names, faces, facts will win new friends, gain recognition on the job.

As with each Progress Kit in the Program, a set of handy practice and application cards accompanies the memory handbook to help you "learn by doing." Slip them into the pocket case provided—for use in your spare moments. They've been scientifically planned to add a "real life" dimension to self-instruction.

Along with your memory training material—as an extra bonus to launch your own Success Program—you will receive a self-evaluation Aptitude Test.

Will you invest 10¢ in your future?

There's plenty of room for you "at the top." Leaders are sought and welcomed more than ever in the business world today. To begin qualifying for the opportunities ahead, accept the valuable introductory package offered by the Personal Success Program for only 10¢. There is no obligation whatever—and no salesman will call. This is merely a "demonstration offer."

If you are delighted with your first kit and wish to continue with the Program, you will receive a new Progress Kit each month, for which you will pay—not the many dollars charged by most "schools"—but only \$1 plus small shipping cost. You stop whenever you like. Mail the coupon today. The Nelson Doubleday Personal Success Program, Garden City, N. Y.

START WITH PRE-TESTED "MEMORY-TRAINER KIT" FOR ONLY 10¢

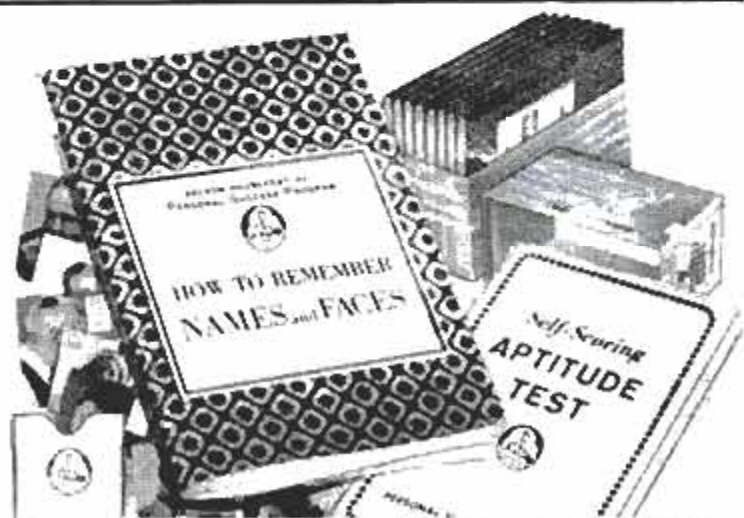

Here's What You Get for only

10¢

1. "HOW TO REMEMBER NAMES AND FACES"—the self-instruction handbook that increases your memory power up to 500% in a few weeks. You possess a skill that's worth a million when you can instantly recall names, faces, facts.

2. POCKET-TRAINER MEMORY CARDS—an exclusive feature of the Personal Success Program that allows you to sharpen your memory with "real life" practice. Handy pocket holder included.

3. HANDSOME DESK FILE—pictured above, for convenient storing of your Progress Kits.

4. FREE BONUS GIFT:

Self-Scoring APTITUDE TEST

Complete 32-page self-evaluator that scientifically reveals to you—and you alone—your present aptitudes, vocational interests, and "hidden potential."



SEND ONLY 10¢ TODAY — STOP WHEN YOU LIKE

**Nelson Doubleday Personal Success Program
Dept. 9-PM-O, Garden City, New York**

I enclose 10 cents to help cover shipping charges. Send me at once my introductory package consisting of 1) handbook "How to Remember Names and Faces" 2) practice and application cards, plus pocket Card Holder 3) handsome desk-top File Case and 4) self-scoring Aptitude Test.

After examining this package, I will decide whether or not I wish to continue with the Program. If not, I will simply let you know. If I do continue you will send me a new Progress Kit each month for only \$1 plus shipping. I am not obligated to take any minimum number of kits, and I am free to stop at any time.

Print Name.....

Address.....

City..... Zone..... State.....

SAME OFFER TO RESIDENTS OF CANADA: Personal Success Program, 105 Bond St., Toronto 2. Offer good in U.S. & Canada only.

remove

GLOP

(SAND, RUST, DIRT, ALGAE, ETC.)

from your household water

Some glop you can see. But most of it you can't until it's trapped in quantity. You just see the dirty work it does . . . a not-quite-clean wash, murky drinking water, etc. That's why every home should have a filter even if the water looks crystal-clear.

The Cuno Aqua-Pure Filter keeps well or city water really crystal-clear. It makes washes cleaner, any cleaning easier. It eliminates most causes of staining and cuts corrosion of kitchen and bathroom facilities. It adds life to pipes and appliances, boosts efficiency of water-treating equipment already installed.

Write today for complete information . . . see your hardware or plumbing dealer . . . and enjoy cleaner water NOW!

**AQUA
=PURE[®]
WATER FILTER**
Pats. Pending

Only **\$28⁵⁰**

with extra cartridge
Quickly, easily installed.



CUNO

**THE CUNO ENGINEERING CORP.,
MERIDEN, CONN.**

The Cuno Engineering Corporation, Dept. PMO,
Meriden, Connecticut

Please send complete information on the Aqua-Pure Filter.

NAME _____

STREET AND NO. _____

CITY _____ ZONE _____

STATE _____

Great Pioneers in Science *Do You Know Them?*

By James S. Thistle

THE SUBJECT of this month's quiz invented the first practical steam engine and saw it come into its own during the Industrial Revolution in England. It was in great demand for pumping purposes in coal mines.

One of the ingenious ideas this inventor had was to rate his engine in terms of "horsepower." He defined one horsepower as the equivalent of the work done in raising 33,000 pounds through a distance of one foot in one minute.

His improved engine became popularly used not only in pumping but as a supplier of power for other machinery. Mass production of the engine followed.

Among this scientist's inventions are a throttle valve, a governor for regulating the speed of steam engines, a copying press and copying ink. He proved also that water is a compound substance, not an element.

*These letters, unscrambled,
spell the name of this
month's Great Pioneer
in Science:*

J A W S E T M A T

(First and Last Names)

Write the correct name here:

Now turn to page 318 for the answer.

POPULAR MECHANICS

NOW READY! McGraw-Hill's New Train-Yourself Course

TELEVISION AND
RADIO REPAIRING

REPAIRING
RECORD CHANGERS

PROFITABLE RADIO
TROUBLESHOOTING

PRACTICAL RADIO
SERVICING

PROFITABLE
TELEVISION
TROUBLESHOOTING

**6 BIG
VOLUMES**
Including
Home Course
Outline!
Shows how
to Get
Ahead Fast.

FIX TV RADIO and RIGHT AWAY RECORD CHANGERS

—even if you've never looked inside a set before!



AT LAST — at Amazing LOW COST — The Most Complete TV-Radio Repair Course Ever Published. TELLS and SHOWS How to Do Every Job Quickly and Easily — Make GOOD MONEY, Full or Spare Time in the BOOMING Repair Business

AFTER 10 YEARS OF PREPARATION — McGraw-Hill's new 6-Volume Course brings you everything you need to know to "cash in" on the TV-RADIO boom. Over 2,350 pages of money-making "know-how" by top factory engineers and electronic experts. **THREE** giant REPAIR MANUALS tell and show how to FIX every trouble the easy way. **TWO** huge TROUBLESHOOTERS tell exactly WHERE to begin, WHAT tools to use, HOW to "polish off" every job. Complete Home Study Volume guides you every step of the way, tells how to get ahead fast as a repairman — build up your own business, full or spare time, for **BIG PROFITS!**

EARN While You Learn

Tested — and now used in top schools, and repair shops — Course volumes are simple enough for green beginners, amazed "pros" with new easy methods. Starts you doing simple repairs — and earning money — from very first chapter. ABC pictures and directions make tougher jobs a "snap." Before you finish you can earn many times its cost.

NO previous training needed. NO complicated formulas. PLAIN ENGLISH

pictures and directions cover ANY job on EVERY set — tubes, circuits, speakers, new a-c/d-c portables, Color TV, even what to charge for every job!

BIG MONEY — Spare or Full Time

Forget lack of experience. Forget your age. Over 40 MILLION TV sets, 130 MILLION radios — and the shortage of repairmen — mean big money for you. Course makes it easy to "cash in," spare time or full, start your own business, enjoy your work and a big bank account!

SEND NO MONEY

Try Course 10 days FREE. (We pay shipping!) If you don't agree it can get you started in a money-making repair business — return it, pay nothing. Otherwise keep it. Earn while you learn; and pay the low cost on easy terms. Mail coupon NOW. McGraw-Hill Book Co., Dept. PM-10, 327 West 41st St., New York 36, N. Y.

Examine
Entire Course
FREE
for 10 Days!

PARTIAL CONTENTS

- 1 Television and Radio Repairing — Testing, repairing, replacing parts, 566 pages, 700 "This-Is-How" pictures, diagrams. By John Markus, Feature Ed., Electronics Magazine.
- 2 Practical Radio Servicing — Easy-to-follow directions, diagrams, drawings — with job sheet for every repair job. 599 pages, 473 illus. By William Marcus, Alex Levy, Electronic Training Experts.
- 3 Profitable Radio Troubleshooting — WHERE to look and WHAT to do for every trouble. How to avoid costly mistakes, handle customers profitably. 330 pages, 153 "how-to" illus. By William Marcus, Alex Levy.
- 4 Profitable TV Troubleshooting — Short-cuts to SPOT and FIX every trouble — fast, for big profits. By Eugene A. Anthony, Service Consultant, General Elec. Co.
- 5 Repairing Record Changers — Step-by-step pictures and directions — how to set up service bench, etc. 278 pages. 202 A-B-C pictures. By Eugene Ecklund, Eng. DuMont Lab., Inc.
- 6 Complete Home Course Outline — Getting started in television and radio servicing. How to get the most out of your Course. How to get ahead PAST. By John Markus.

Free ALL THREE Valuable Repair Aids: TV, RADIO, and CIRCUIT Detect-O-Scopes (Total Retail Value \$3.00)



FREE — whether you keep the Course or not — THREE amazing DETECT-O-SCOPE Charts. TV and RADIO Scopes enable you to spot all tube troubles in a jiffy. CIRCUIT Scope spots all circuit troubles. Make fix-it jobs easier, faster. 16 x 21 inches. ALL THREE (worth \$3.00) yours FREE while they last on this introductory offer.

THIS COUPON SAVES YOU \$11.85

McGraw-Hill Book Co., Dept. PM-10
327 West 41st St., New York 36, N. Y.

Send me — postpaid — for 10 DAYS' FREE TRIAL the 6-Vol. McGraw-Hill TV, Radio and Changer Servicing Course. If okay, I'll remit only \$4.95 in 10 days; then \$5.00 monthly for 5 months. (A total savings of \$11.85 on the regular price of the Course and Detect-O-Scopes.) Otherwise, I'll return Course in 10 days; pay nothing. ALSO send FREE (to keep whether or not I keep the Course) the 3 TV, RADIO, and CIRCUIT DETECT-O-SCOPE CHARTS, — total value \$3.00.

Name

(Please Print Clearly)

Address

City Zone No. State

CHECK HERE if you prefer to enclose first payment of \$4.95 with coupon. Same easy pay plan; same 10-day return privilege for full refund. PM-10

YOU CAN PLAY



ANY INSTRUMENT

... even if you don't know a single note of music now!

IMAGINE! Even if you never dreamed you could play... you can soon surprise your friends with your musical ability.

No special talent or previous training needed. Clear, simple directions tell you exactly what to do, so you can't go wrong! Spend a few minutes a day—and only a few cents per lesson. Teach yourself piano, guitar, accordion, organ, any instrument. Play popular music, hymns, classical, any other music—by note, quickly. Over ONE MILLION students have taken up music this famous way, including TV Star Lawrence Welk.



Stop Cheating Yourself of These Joys!

Popularity! New friends. Gay parties. Good times. Career. Extra Money... understand, appreciate, converse about music. Learn lives and compositions of modern and great masters... Relax! Banish worries and frustrations. Satisfy self-expression, creative urge. Gain self-confidence.

MAIL COUPON FOR FREE BOOK

See for yourself why our method has been successful for 61 years! Read the whole fascinating story of this wonderful method in 36-page illustrated book. For FREE copy, mail coupon.



U. S. School of Music, Studio A3010, Port Washington, N.Y.
(No salesman will call.)



U. S. SCHOOL OF MUSIC

Studio A3010, Port Washington, N. Y.

Please send me your 36-page illustrated Free Book. I'm interested in playing (name instrument) _____

I do I do NOT—have instrument now.

Name _____ Age _____
(please print)

Address _____

City _____ Zone _____ State _____

HOTELS CALL FOR TRAINED MEN

"As a result of Lewis Training, I became Manager of a fine hotel." — M. F. Finch.



"After Lewis Training, I became Assistant in a fine hotel." — Melvin L. Dalrymple.



Record-breaking travel means nationwide opportunities and a sound substantial future for trained men in hotels, motels, clubs, apartment house positions. Fascinating field; fine living; quick advancement. You can qualify at home or through resident classes in Washington. Previous experience proved unnecessary. Placement Service FREE. Write for FREE Book, "Your Golden Opportunity." Approved for ALL Veteran Training
LEWIS HOTEL TRAINING SCHOOL
Desk ER-312, Wash. 7, D.C. 44th Yr.

Write today for FREE BOOK!



STOP FRONT END DRAG on your 4-WHEEL DRIVE with WARN HUBS!

Free-wheeling 2 w.d. with Warn Hubs means big savings in gear, engine, tire wear, gas, plus more pep, performance, power in high and easier steering. Hubs proved in over a billion miles of use. Get drag-free 2-wheel drive or tractive 4-wheel drive automatically, as you shift, with Warn Lock-O-matics; manually with Warn Locking Hubs. Unconditionally guaranteed. Ask your local 4-wheel drive dealer to install Warn Hubs today!

WARN MFG. CO. Riverton Bx 6064-A, Seattle 88, Wn.

JEEP OWNERS

RE-POWER NOW WITH A V-8 OR 6 CYL. ENGINE — USE FORD—CHEV—MERCURY—GMC—PONT—STUDE—DODGE OR PLYMOUTH in Jeeps, Jeepsters, Sta-Wgn, trucks, Kaiser & H. J. cars. Conversion Kits \$45.35 to \$56.90. Want fast action? Give us full information, send \$15.00 Dep. and we will ship correct kit. Bal. COD. Send full amount for prepaid shipment. Wire, phone or write today. Details FREE

HOOSIER MACHINE PRODUCTS CO.

312 S. E. 6th St. Phone CR 6-3442 Pendleton, Oregon

KILLS • • NO CHEMICALS, GASES, ETC.

• MOSQUITOES • MOTHS, MILLERS
• FLIES, GNATS • FISH FLIES, ETC.

OVER 1/2 ACRE HANG IT ANYWHERE
No insect recovery. Harmless. Guaranteed. Built to last 25 years. Beautiful outdoor lighting. Plug into any 110 volt socket.

NO AREA CONTAMINATION
Uses up to 200 watt bulb. Grid cost 10c per month. Complete with fly attractor. Dead insect catcher. Cord, Directions, Etc. Very reasonable price — Write to —
SING SING BUG CHAIR, INC.
Box P 3781, Oak Park 37, Mich.



BOX SIZE - WT. 15X8X10 - 6 LBS.

RUPTURED

BE FREE FROM TRUSS SLAVERY

Surely you want to THROW AWAY TRUSSES FOREVER, be rid of Rupture Worries. Then Why Do you put up with wearing a griping, chafing and unsanitary truss the balance of your life? If you do, it will NOT be through necessity but through choice on your part.

Now there is a new modern Non-Surgical treatment that is designed to permanently correct rupture. These Non-Surgical treatments are so certain, that a Lifetime Certificate of Assurance is given. Write today for our New FREE Book that gives facts that may save you painful, expensive surgery. Tells how non-surgically you may again work, live, play, love and enjoy life in the manner you desire. There is no obligation.
Excelsior Medical Clinic, Dept. H6124, Excelsior Springs, Mo.

LAW TRAINING *for* BUSINESS

[in spare time at home]

Earn LL.B. Degree



Thousands of men and women who never intend to practice are studying Law in spare time at home—not for a legal career but as an aid to business advancement.

Law today is involved in almost every major business decision. In many lines of work it is almost indispensable—credits and collections, accounting, traffic and transportation, employee relations, real estate, insurance, finance, taxation, etc. For all types of work, Law training develops keen, clear, quick, correct, and decisive thinking.

You can study LaSalle's American Law and Procedure right in the privacy of your own home—progressing as rapidly as your time and ability permit. LaSalle has, for over 50 years, helped more than 1,400,000 ambitious people get ahead in the business world. Thousands of letters in our files from grateful students and businessmen who have achieved greater success speak of—better jobs, more money and the satisfaction it brings, prestige and leadership.

A MOST UNUSUAL LAW LIBRARY

This training includes the fourteen-volume LaSalle Law library—AMERICAN LAW AND PROCEDURE, which is the basis of all the instruction service. This library has been compiled by leaders in the field of Law. It covers the whole basic field of Law in an orderly and simple manner that is easy to learn and understand. Collateral reading and printed lectures on legal problems which are furnished at regular intervals throughout the training, supplement the text. Law instructors personally supervise your program from the first assignment to the LL.B. degree or diploma. Under the LaSalle method you deal with legal problems—you learn by doing—actu-

ally solving legal problems—not just memorizing rules.

WRITE TODAY FOR TWO FREE BOOKS

You are determined to get ahead—to prepare for greater future possibilities—and to earn more money. Send the coupon below and find out how to qualify yourself for the many openings available to the Law-trained man. In our FREE books, "Law Training for Leadership" and "Evidence," you will find answers to all your questions about the study of Law and the LaSalle method.

No investment is likely to pay higher returns than an investment in yourself, by enrolling in the American Law and Procedure training. Send coupon today for full information—no obligation, of course.

ACCREDITED MEMBER, NATIONAL HOME STUDY COUNCIL

LaSalle Extension University

A Correspondence Institution

Dept. 1064L, 417 S. Dearborn St., Chicago 5, Ill.

Gentlemen: Please send me your two free booklets, "Law Training for Leadership" and "Evidence," which tell how I may study Law at home and qualify for the LL.B. degree.



Name.....Age.....

Street.....

City.....Zone.....State.....



Tester Checks Plugs Right in the Engine

Spark plugs need not be removed for testing by an electronic device developed by the Champion Spark Plug Company. Designed for service stations, the tester (actually a low-cost, foolproof, lightweight oscilloscope) lets the car owner see for himself the condition of all the plugs while the engine is running. Bright green traces on the hooded screen show the amount of voltage required to fire each plug in order, which indicates whether it is in satisfactory condition, is worn or is misfiring due to fouling. Current for the tester is drawn from the battery of the car, so no self-contained power supply is needed. Only four connections are made and the entire test takes under three minutes. Two cables hook onto the battery terminals, a third taps into the high-tension ignition line and the fourth clamps around the outside of any one of the spark-plug leads. There is only one control to adjust. Even the switching from six to 12-volt batteries is automatic.



Why **WOLVERINE**
Leather gloves
always **DRY SOFT!**

WOLVERINE'S SECRET TRIPLE-TANNING PROCESS TANS NATURALLY TOUGH HORSEHIDE AND PIGSKIN SUPER SOFT TO STAY SOFT—EVEN DRY SOFT AFTER SOAKING.



WOLVERINE OFFERS THE MOST COMPLETE LINE OF HORSEHIDE, PIGSKIN AND BUCKSKIN GLOVES AVAILABLE... ALL LONG ON WEAR... LOW IN PRICE!

Check these features



GREAT GLOVES FOR YARD WORK, ODD JOBS AT HOME! CHOOSE DELUXE FULL GRAIN HORSEHIDE OR BUDGET-MINDED PIGSKIN. (HANDY IN THE CAR, TOO!)



HEAVY WEIGHT SUEDE PIGSKIN PROTECTS HANDS FROM SPARKS, HEAT, GREAT FOR HANDLING ROUGH-FINISH METAL! (EVEN WELDERS USE 'EM!)

ONCE YOU WEAR 'EM, YOU WON'T BE WITHOUT 'EM!
AT STORES EVERYWHERE.

WOLVERINE GLOVES

Wolverine Shoe and Tanning Corp. Rockford, Mich. • Canada: Huck Glove Co., Kitchener, Ont.



RCA INSTITUTES



OFFERS YOU THE FINEST OF HOME STUDY TRAINING



COURSE I
ELECTRONIC FUNDAMENTALS
 COURSE II-T
TV SERVICING
 COURSE II-EA
ELECTRONICS FOR AUTOMATION
 COURSE III-T
COLOR TV

The equipment illustrated and text material you get with each course is yours to keep. Practical work with very first lesson. Courses for the beginner and the advanced student. Pay-as-you-learn. You need pay for only one study group at a time.



SEND FOR THIS FREE BOOK NOW

Resident School courses in New York City offer comprehensive training in Television and Electronics. Day and evening classes start four times each year. Detailed information on request.

ANOTHER WAY RCA SERVES ELECTRONICS THROUGH EDUCATION

RCA INSTITUTES, Inc. Home Study School

A Service of Radio Corporation of America ZPM-109

350 West Fourth Street, New York 14, N. Y.

Without obligation, send me **FREE 64-page CATALOG** on Home Study Courses. No salesman will call.

Name.....
Please print

Address.....

City.....Zone.....State.....

Korean Vets! Enter discharge date.....

CANADIANS — Take advantage of these same RCA courses at no additional cost. No postage, no customs, no delay. Send coupon to:

RCA VICTOR COMPANY, LTD.
 5001 Cote de Liesse Rd., Montreal 9, Que.

To save time, paste coupon on postcard

WHAT SECRET POWER DID THIS MAN POSSESS?



BENJAMIN FRANKLIN
(A Rosicrucian)

WHY was this man great? How does anyone—man or woman—achieve greatness? Is it not by mastery of the powers within ourselves? Know the mysterious world within you! Attune yourself to the wisdom of the ages! Grasp the inner power of your mind! Learn the secrets of a full and peaceful life!

Benjamin Franklin—like many other learned and great men and women—was a Rosicrucian. The Rosicrucians (NOT a religious organization) first came to America in 1694. Today, headquarters of the Rosicrucians send over seven million pieces of mail annually to all parts of the world. Write for YOUR FREE COPY of "The Mastery of Life"—TODAY. No obligation. No salesmen. A non-profit organization. Address: Scribe L.H.D.

THIS BOOK FREE!



The ROSICRUCIANS

SAN JOSE • (AMORC) • CALIFORNIA

—SEND THIS COUPON—

Scribe L.H.D.
The ROSICRUCIANS (AMORC)
San Jose, California
Please send me the free book, *The Mastery of Life*, which explains how I may learn to use my faculties and powers of mind.

Name _____
Address _____
City _____

BETTER YOUR POSITION! IMPROVE YOUR EARNINGS!

BECOME AN ENGINEER!

LEARN ENGINEERING, SCIENCE, MATH at HOME.

- BECOME AN:-
- Electrical Engineer
 - Mechanical Engineer
 - Aeronautical Engineer
 - Civil Engineer
 - Marine Engineer
 - Scientist
 - Technician

Endorsed by leading educators-accredited by the Mathematical Institute-approved by PHI BETA KAPPA scholars. Progress at your own speed and receive your official diploma. Correspondence courses SEND FOR FREE CATALOG!

 **ENGINEERING INSTITUTE OF AMERICA**
Dept. PMA, P.O. BOX 1636, Washington 13, D.C.



WANT MORE MONEY? GET INTO PHOTOGRAPHY

Coast to coast, high-paying jobs in photography are waiting for people with the "know-how" to fill them. You can quickly, easily qualify at home with the world-famous NYI Learn-by-Doing Method. Write today for free catalog. Also resident training in N. Y. 50th Year. Approved for Veterans.

NEW YORK INSTITUTE OF PHOTOGRAPHY
Dept. 49 10 West 33 St. New York 1, N. Y.

make your own Gems 36⁵⁰

The Gem Maker comes complete with all necessary equipment, including a super-charged diamond blade for sawing, and all the wheels for grinding, shaping and polishing; also complete instructions. The complete equipment as shown, less motor and belt for only \$36.50. f.o.b., Burlington, Wisconsin. Write today for information and literature.

B&I MANUFACTURING CO.
Dept. F, Burlington, Wis.



Learn MECHANICAL DENTISTRY

A profession offering unlimited opportunities. Most modern and complete course embracing every branch from Plate to Porcelain Work, which prepares you to work for Dentists or start your own business. Individual instruction—practical training in day or night school. No books—no classes. Catalog upon request.

McCARRIE SCHOOL OF MECHANICAL DENTISTRY
207 N. Broad Street Dept. 93 Philadelphia 7, Penna.

\$1.75 KODACHROME PROCESSING

K 135-20 Exposure Developed and Mounted in slides. . . ONLY

8MM — #459 Movie Film Roll Developed for ONLY

Send for Free Mailer

\$1

THRIFTY DAN—P.O. Box 68, Grand Rapids, Michigan

I'll Send You This Handsome SAMPLE CASE—FREE



and Show You How to Make Up to \$30.00 in a Day

WRITE for this FREE Tailoring Sample Case packed with 100 beautiful, big-value suit and overcoat fabrics. Take orders from friends, fellow-workers, others, for fine quality, made-to-measure clothes. Pocket big cash profits in advance. Because wearing our suits and overcoats brings more orders, we make it easy for you to get your own clothes without ic coat. No experience is needed. **SATISFACTION GUARANTEED. SEND NO MONEY.** Rush your name, address, and age—today!

J. C. FIELD & SON, INC., Harrison & Throp Sts.
DEPT. X-1716 CHICAGO 7, ILLINOIS

DON'T BE HALF-TRAINED! Be A Master Technician

**NOW... ONE
modern master
home training course
IN ALL 3 PHASES**



AIR CONDITIONING - REFRIGERATION ELECTRICAL APPLIANCES

**ALL AT ONE
LOW TUITION**
only National Schools gives
you this complete training
at no extra cost

YOU GET AND KEEP ALL THESE TOOLS AND INSTRUMENTS

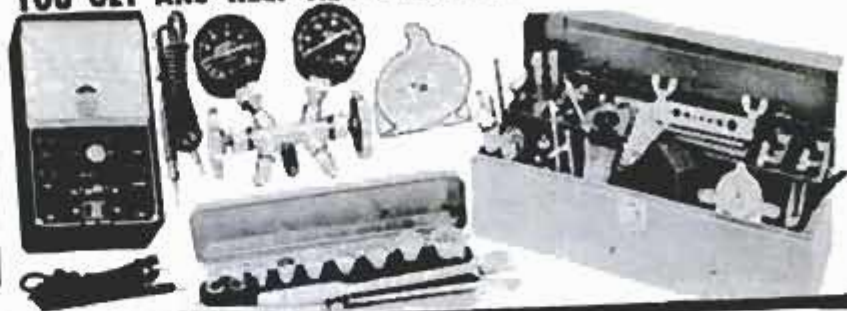

Incomplete training limits your earning power, even disqualifies you for top-pay jobs. The big service companies require complete, all-phase training. If you open your own shop, you'll be called upon to service and repair all types of refrigerators, air conditioners and appliances. With complete training—as only National Technical Schools can give you—you can accept every job, make big profits all year round.

FUTURE BRIGHT FOR TRAINED MASTER TECHNICIANS

Over 30,000 new technicians must be trained annually. You are needed to help service and repair the 50 million air conditioners, refrigerators and electrical appliances that will need fixing this year alone. No wonder the Master Technician has steady work, at high pay, year after year. He can go places in his own business or with a manufacturer, dealer, distributor or department store. Armed with all-phase training, his earning power is unlimited.

JOB TRAINING AT HOME

You get Professional Tools, Precision Instruments, PLUS a Factory-Made APPLIANCE TESTER! A shop-full of PRACTICAL, professional equipment. Use them to conduct over 100 experiments...also in Spare Time Work and ON THE JOB. It is all yours to keep... no EXTRA MONEY DEPOSITS...no EXTRA COST on your equipment kits.

EARN AS YOU LEARN

We show you how. Many of our students pay for their entire course—and more—in Spare Time while learning. So can you. Graduate Advisory Service, too.

**GET THE BENEFIT OF OUR OVER
50 YEARS EXPERIENCE**

**N.T.S. also offers training in
TV - RADIO - ELECTRONICS
and AUTO MECHANICS - DIESEL**



NATIONAL TECHNICAL SCHOOLS
WORLD-WIDE TRAINING SINCE 1905

4000 SO. FIGUEROA ST., LOS ANGELES 37, CALIF., U.S.A.

THE MOST FOR LESS

We give you illustrated Shop-Tested Lessons and Manuals...many other training aids...privilege of CONSULTATION with our instructors and engineers. Every lesson, every manual has been SHOP tested and approved.

ACTUAL LESSON



**SEND FOR
FREE
BOOK AND
ACTUAL
LESSON NOW!**

We'll rush you our big, illustrated OPPORTUNITY BOOK and ACTUAL LESSON, show you how easily you can learn. NO OBLIGATION; no salesman will call. Do it NOW! It costs nothing to find out.

NATIONAL TECHNICAL SCHOOLS
WORLD-WIDE TRAINING SINCE 1905

MAIL NOW TO
National Technical Schools, Dept. CB-109
4000 S. Figueroa St., Los Angeles 37, Calif.
Rush FREE "Opportunity" Book and Actual
Lesson. No Salesman will call.

NAME _____ AGE _____

ADDRESS _____

CITY _____ ZONE _____ STATE _____

Check Here If Interested ONLY in Resident Training at Los Angeles.

RESIDENT TRAINING AT LOS ANGELES

If you wish to take your training in our Resident School at Los Angeles, start NOW in our big modern Shops and Labs. Here you work with latest equipment...professionally installed...finest, most complete facilities offered by any school. Expert, friendly instructors. Personal attention. Graduate Advisory Service. Help in finding home near school...and part time job while you learn. Check box in coupon for full information.

DRAFTSMEN



CASH BIG PAY CHECKS!

Train Now for
more success,
greater security

LEARN AT HOME IN SPARE TIME
(or at college in Chicago)

Check the want ads in any newspaper—SEE the big-pay opportunities open to you as a draftsman. What's more, you can learn this well-paid, prestige profession at home—quickly, easily! No special talent needed. Get complete, step-by-step Chicago Tech lessons in the mail, spend a few pleasant hours studying each week. In a short time you'll be a well-trained draftsman, ready to take your pick of many good jobs. Act now!



Free Information—Mail Coupon Today!

Get **FREE TRIAL LESSON** plus information about C.T.C. practical training. Learn what successful Chicago Tech graduates say about high pay and opportunities in drafting. No charge, or obligation.

CHICAGO TECHNICAL COLLEGE

N-217 Tech Bldg., 2000 So. Michigan Ave.
Chicago 16, Illinois

Mail me **FREE** lesson with facts about big opportunities in **DRAFTING**.

Name _____ Age _____

Address _____

City _____ Zone _____ State _____

EARN \$125 A WEEK AND UP

BE AN AUTO-DIESEL EXPERT—LEARN A TRADE YOU LIKE

You learn fast in our shops because you learn with tools on real equipment. Students short of money may earn most of their expenses by doing part-time work. Experienced instructors explain **WHY** and show you **HOW**, then you **DO IT YOURSELF**. Forty years' experience training men. Successful graduates in 50 states and many foreign countries. Many of our graduates earn \$125 a week and up. Approved for veterans. Day and evening classes. Free bulletin—write today.

NASHVILLE AUTO-DIESEL COLLEGE
226 7th Ave., No., Dept. 86, Nashville, Tenn.

FREE! STAMP BREAKS



FREE—from World's Largest Stamp Firm, the Most Spectacular Offer Ever Made! 115 different genuine foreign postage stamps in all—Includes World's Largest and Smallest stamp **PLUS** fantastic collection of other stamp freaks. Weird designs, glittering colors, peculiar shapes—many from strange, mysterious lands in remote corners of the world—from Aden to Zanzibar! **PLUS** Giant Bonus collection of all-different stamps from other fascinating and exciting parts of the globe. **EXTRA!** Big Bargain Catalog; Collector's Guide; other stamp offers for free consideration. Send 10c for mailing. **ACT NOW!**
H. E. HARRIS & CO., DEPT. F-18, Boston 17, Mass.



SEND **FREE!**
FOR THIS

Make money. Know how to break and train horses or ponies. Write today for this book **FREE**, together with special offer of a course in Animal Breeding. If you are interested in Gaiting and Riding the saddle horse, check here (). Do it today—now.

BEERY SCHOOL OF HORSEMANSHIP
Dept. 11010
Pleasant Hill, Ohio



Intercontinental Marketing Corp.,
45-17 Pearson Street, Long Island City 1, N. Y.

Miniature Battery For Electronic Flash

Less than two inches square, a miniature storage battery delivers four volts and is good for 50 flashes without recharging when used with a photographic electronic-flash outfit. The battery can be recharged overnight without removing it from its housing. It has a total life of 1500 flashes. It is of the lead-acid type but contains a jellied electrolyte in place of the usual liquid.

I WOULDN'T WORK FOR ANYONE ELSE AGAIN IF THEY PAID ME \$500.00 A WEEK!

A strong statement for me to make, isn't it? But that's exactly how I feel! I'm the owner of my own shop now, and there is no other feeling like it in the world! I could kick myself for all the years I wasted, while I plodded along in the same old "blind alley" job. I found the courage to strike out for myself and it's paying off big... not only in hard cash but in the sense of achievement that comes from being my own boss, reaping ALL the rewards of my skills, owning something that I can pass on to my kids. YOU can do the same!

BE YOUR OWN BOSS! If you are satisfied to plod along for the rest of your life as a cog in someone else's wheel, this announcement is not for you. But if you do have the confidence to feel that you too can make a success of a shop of your own... WE CAN HELP YOU make a better life for yourself and your family.



Start YOUR OWN BUSINESS

RADIO & TV REPAIR SHOPS ARE NEEDED



TV RADIO SERVICE LIBRARY

HERE IS LATEST INFORMATION IN A HANDY FORM FOR RADIO AND TELEVISION REPAIRMEN, SERVICEMEN AND STUDENTS

TWO COMPLETE VOLUMES - 1568 Pages - 1083 Illustrations and Diagrams. 1001 Important Facts and Figures on Modern T.V., Radio, Electronic Devices. INCLUDES TRANSISTORS & Transistors Circuits, Rectifiers, Record Changers, P.A. Systems, Phonograph Pick-ups, F.M. Auto Radio, Short Wave.

Basic principles, Construction, Installation, Operation, Troubleshooting, How to get Sharp, Clear T.V. Pictures, Install Aerials, How to Test, Explains COLOR SYSTEMS, Methods of Conversion, Terms, etc. Includes Ultra High Frequency. Quick ready reference or use as a home study course. Only \$8 for BOTH volumes.



CIRCLE No. 3 IN COUPON

Carpentry In Big Demand

CARPENTERS & BUILDERS GUIDES



PRACTICAL STOREHOUSE OF MODERN CONSTRUCTION INFORMATION (4 vol. set) for carpenters and all woodworkers. Explains in easy language and by profuse illustration principles, advances, short cuts, trade secrets, all based on the NEWEST information.

Vol. 1—Tools, steel squares, saw filing, joinery, furniture, etc.; Vol. 2—Builder's mathematics, drawing plans, specifications, estimates, etc.; Vol. 3—House and roof framing, laying out, foundations, etc.; Vol. 4—Doors, windows, stair building, millwork, painting, etc. 4 vols. 1904 Pages. 3700 Illustrations. Whole set only \$8.

CIRCLE No. 8 IN COUPON

A "FIX IT" SHOP PAYS OFF BIG

HOW TO FIX HOME APPLIANCES

REFRIGERATORS TOASTERS IRONERS VACUUMS
WASHERS DRYERS RANGES FREEZERS

Many other GAS AND ELECTRIC APPLIANCES



Handy Reference for Electric & Gas Servicemen, Mechanics, Dealers and Home-owners. Explains clearly and simply how to locate troubles, how to test, reassemble and connect. Wiring diagrams. 1000 Facts. Easy to read. Answers ALL your questions. 864 Pages. Illustrated. Only \$6.

CIRCLE No. 2 IN COUPON

AUTO REPAIR SHOP FOR INDEPENDENCE

WHAT ALL AUTO MECHANICS WANT TO KNOW



This Big Practical Book gives full information, with working diagrams, covering the principles, construction, ignition, service and repair of modern cars, trucks and buses.

Diesel Engines, Hydraulic and Fluid Drives Fully Explained.

A complete guide of 1096 Pages, with over 1500 Illustrations showing inside views of working parts, with instructions for service jobs. Completely up-to-the-minute! Priced at only \$6.



CIRCLE No. 1 IN COUPON

AIR CONDITIONING A GROWING FIELD

REFRIGERATION & AIR CONDITIONING

FOUR BOOKS IN ONE - basic principles, servicing, operation, repair of: 1. Household Refrigeration. 2. Special Refrigeration Units. 3. Commercial & Industrial Refrigeration. 4. Air Conditioning Systems. A GOLD MINE of essential information. Completely up-to-date. 1300 Pages. Fully Illustrated and Indexed. Priced at only \$6.



CIRCLE No. 14 IN COUPON

ADDITIONAL IMPORTANT TITLES

The following Audel Guides are all the best in their fields, written in clear simple fashion, all lavishly illustrated. Circle the numbers wanted in the MAIL ORDER COUPON below. All books are sent for FREE EXAMINATION.

No. 4	HANDY BOOK OF ELECTRICITY. 1230 Pages	5.00
No. 5	TRUCK & TRACTOR GUIDE. 1274 Pages	3.00
No. 6	PLUMBERS & STEAMFITTERS GUIDES. 4 Book Set	8.00
No. 7	PAINTING & DECORATING MANUAL. 464 Pages	3.00
No. 9	DIESEL ENGINE ANNUAL. 640 Pages	3.00
No. 10	WELDERS GUIDE. 608 Pages	3.00
No. 11	MATHEMATICS & CALCULATIONS. 732 Pages	3.00
No. 12	MACHINISTS & TOOLMAKERS HANDBOOK. 1728 Pages	6.00
No. 13	WIRING DIAGRAMS. 204 Pages	2.00
No. 15	ELECTRIC LIBRARY. 7000 Pages. 10 Book Set	30.00
No. 25	BLUE PRINT READING. 448 Pages	2.00
No. 26	MASONRY & BUILDERS GUIDES. 4 Book Set	8.00
No. 27	ELECTRIC MOTOR GUIDE. 1036 Pages	2.00
No. 28	OIL BURNER GUIDE. 416 Pages	2.00
No. 29	SHEET METAL PATTERN LAYOUTS. 1152 Pages	7.50
No. 30	SHEET METAL WORKERS HANDBOOK. 448 Pages	2.00
No. 31	MECHANICAL DRAWING GUIDE. 192 Pages	2.00
No. 32	MECHANICAL DRAWING & DESIGN. 480 Pages	3.00
No. 33	ELECTRONIC DEVICES. 304 Pages	3.00
No. 34	ELECTRICIANS EXAMINATIONS. 272 Pages	2.00
No. 35	ELECTRIC POWER CALCULATIONS. 480 Pages	3.00
No. 36	ELECTRIC DICTIONARY. 9000 Terms	3.00
No. 37	POWER PLANT ENGINEERS GUIDE. 1368 Pages	5.00
No. 38	ENGINEERS AND FIREMANS EXAMS. 384 Pages	2.00
No. 39	OPERATING ENGINEERS LIBRARY. 3 Book Set	12.00
No. 40	PUMPS, HYDRAULICS & AIR COMPRESSORS. 1760 Pages	6.00
No. 41	HOUSE HEATING GUIDE. 1908 Pages	3.00

BUILD A WONDERFUL NEW LIFE AROUND YOUR PRESENT TRADE OR HOBBY...

How do you decide WHICH business to go into? The answer can be found in a SECRET that we have learned over the years. As a general rule you stand the best chance for success in that field where you already possess a skill in your present trade or as a hobby. It's as simple as that...STICK TO YOUR LAST!

HERE'S THE HELP YOU NEED!

You have a trade now (perhaps you're a carpenter)... how much more would you have to learn to run a successful carpentry shop? I'll wager that you could soon be ready to set up your own shop. With the help of AUDEL GUIDES you could be confident of solving any trade problem you have to face! AUDEL GUIDES contain the INSIDE TRADE SECRETS that you need to tackle any job in your field.

SPARE TIME or FULL TIME

Skilled craftsmen are at a premium in America today! If you don't want to make a complete break with your job... try being your own boss in your spare time! Set up a shop in your basement or garage. Let people know you are in business... and watch them beat a path to your door! AUDEL GUIDES will help you and we will be glad to send along FREE with each GUIDE a copy of "Audel's Business Dictionary." You have everything to win and nothing to lose! Send No Money Now - Examine Any Audel Guide Free!

7-DAY FREE EXAMINATION

SEND NO MONEY - Pay the postman nothing! We are glad to send you any of the Audel Guides for absolutely FREE examination in your own home. We take all the risks and leave all the decisions up to YOU. There is no obligation! If you decide to keep the books of your choice you may pay for them under our astounding easy-pay plan of only \$2 a month.

HERE IS ALL YOU DO

IT'S EASY TO ORDER: In the No-Risk Mail Order Coupon at the right just draw a circle around the number of Audel Guides you want us to send you for FREE EXAMINATION. We will send them to you at once to help you build a brighter future by increasing your SKILL. If for any reason at all you are not COMPLETELY satisfied, return the books to us, and that will end the matter! NO STRINGS OR CATCHES TO THIS OFFER.

THEO. AUDEL & CO.

49 West 32nd Street, New York 10, N.Y.



YOURS FREE!
TO HELP YOU GET STARTED

An invaluable aid. Clearly defines all business terms and practices. Yours to keep FREE whether you return the AUDEL GUIDE you order or not.

MAIL THIS NO-RISK COUPON TODAY!

THEO. AUDEL & CO. - Self Improvement Publishers Since 1879 - P10
49 W. 32nd Street, New York 10, N.Y.

Please mail me for 7 days' FREE EXAMINATION the books I have circled at right. I agree to mail \$1 in 7 days on each book or set ordered, and to further mail \$1 a month on each book or set ordered until I have paid the purchase price, plus shipping costs. If I am not completely satisfied with my Audel Guides I may return them.

The FREE "Audel's Business Dictionary" is mine to keep in any event.

NAME _____

ADDRESS _____

OCCUPATION _____

EMPLOYED BY _____

SAVE SHIPPING COSTS! Check here if you enclose complete payment with order. We pay postage charges. You have same return privilege.



YOU
can
acquire

LAW AT HOME!
EARN LL. B. DEGREE

LaSalle's famous Law Library—used as reference in many Law libraries and Law offices—has enabled thousands to master Law surprisingly fast, in spare hours at home, for business and professional advancement.

These 14 remarkable volumes, compiled by leading professors and lawyers, cover the whole basic field of Law in condensed, orderly, simplified manner.

You advance rapidly with this great library, plus special lectures furnished. We guide you step-by-step with personalized Problem Method of instruction...you 'earn by doing'—handling legal problems—not by memorizing rules.

Send for two FREE booklets, "Law Training for Leadership," and "Evidence," answering questions about Law and its value to you. Mail coupon below. No obligation.

Accredited member, National Home Study Council

LA SALLE EXTENSION UNIVERSITY
A Correspondence Institution

417 S. Dearborn St. Dept. 1064L Chicago 5, Ill.

Send me your two FREE booklets described above, without obligation

Name.....Age.....

Street.....

City, Zone & State.....



Big Bag Catches Leaves
"Vacuumed" by Mower

Five full bushels of leaves is the capacity of a big bag developed by Toro Manufacturing Corporation engineers for their Whirlwind mowers. The bag catches leaves that are sucked up by the vacuuming action of the rotary mower and ejected out the side. The six-cubic-foot containers, made of a special cotton cloth, are available in a package that includes two bags plus the mounting rods to fit them to the mower. The bags can be used on the 19 and 21-inch hand-propelled machines and the 21-inch self-propelled model. The manufacturer states that the new Toro mower will vacuum five bushels of leaves—and fill the sack—in one minute.

Supersensitive Radar
"Talks" Missile on Course

Under development for the U. S. Air Force, a supersensitive radar antenna can "talk" to an intercontinental ballistic missile to keep it on its target course. The antenna focuses its electronic radar beam on the flying missile and reports instantly and precisely the position of the missile. An electronic computer makes corrections and feeds them to the radar. The radar then relays them to the missile to assure greatest possible accuracy of flight. Such accuracy is needed since a one-degree launching error could cause the nose cone of an ICBM to miss its target by about 100 miles.

It's EASY to be
Why be Average?

Now you can be dramatically taller...it's just as easy as stepping into a pair of "ELEVATORS"! These amazing shoes instantly add that all-important height you need to make you a BIG man... give you the boost you need to command the respect of everyone! And it's your secret because smartly-styled "ELEVATORS" look and feel just like other fine shoes! TODAY... send for FREE BOOKLET illustrating 34 styles for street, sport and dress. Brockton Footwear, Inc., Dept. 6-109, Brockton 68, Mass.



DRAFTING

LEARN A PROFESSION QUICKLY — IN SPARE TIME AT HOME

MECHANICAL DRAFTING

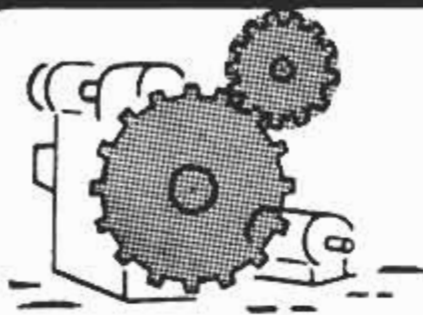

● The automobiles we drive, machinery that produces the might of our nation, household appliances . . . in fact every manufactured product . . . owes its existence to the skill of the mechanical draftsman. His drawings are the language of all engineering professions. Through them, the ideas that becomes tomorrow's way of life are transmitted from creator, to engineer, to production line. The need and importance of this vital link in all industry is constantly growing. C.E.I.'s staff of Licensed Engineers will help you acquire drafting skill in just a few short months. This is the profession that opens the doorway to industrial leadership!

ARCHITECTURAL DRAFTING

● The men who blueprint the American's shelter and living mode are the architectural draftsmen. Their creative, yet practical efforts turn stone, brick, metal, concrete and glass into monumental skyscrapers, beautiful homes, functional factories and specialized commercial structures. A C.E.I. diploma obtained under the guidance of our Registered Architects has opened unlimited career opportunities for thousands of architectural draftsmen. Many of them have gone on to take state examinations and become Registered Architects. If you enjoy seeing your creative ideas permanently recorded in durable construction materials, investigate this profession!

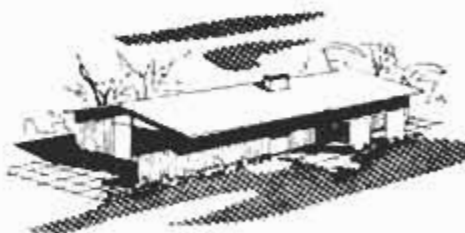

AERONAUTICAL DRAFTING



● A vital part of today's SPACE AGE is the skilled aeronautical draftsman! No profession offers a better viewpoint of the advancing space frontiers than specialized aeronautical and missile drafting. The need for these technically trained men is tremendous . . . is growing daily. If you are the type of man who enjoys the adventure of being in on the beginning of things, if you want big pay, and a position of leadership, C.E.I.'s Aeronautical Drafting course is for you! Under the supervision of a C.E.I. Licensed Engineer, you can become a professional draftsman in a short period of months. Send for a free Success Book and Sample Lesson Now!

PROFESSIONAL SUPPLIES AND EQUIPMENT FREE OF EXTRA COST



FREE →
LESSON AND
SUCCESS
BOOK



Cleveland Engineering Inst., Dept. PM-10J
6300 Euclid Ave. • Cleveland 3, Ohio

Mechanical Architectural Aeronautical

My Name Age

Address

City Zone State

(No Obligation — No Salesman Will Call)

A-2383

**CLEVELAND
ENGINEERING INSTITUTE**
ENGINEERING DRAFTING EXCLUSIVELY

MAIL COUPON NOW! A-1985

Do You Like art?

DRAW FOR MONEY!

Our Simple Method Proves You Can Learn to Draw at Home in Spare Time

YOU can learn Commercial Art, Designing, Illustrating, Cartooning, etc. . . . right at home, in spare time. No previous art training necessary. Soon be your own boss — work at home, pick your own working hours. Or earn big money as staff artist for advertising agency, newspaper, magazine, dept. store, etc. Or make Art a profitable hobby. Earn while you learn. 22-piece art outfit given with your first lesson AT NO EXTRA CHARGE. (School est. 1914.)

FREE BOOK, "ART FOR PLEASURE AND PROFIT." Describes our methods.

Lists opportunities. Tells what our students say. No obligation. So mail coupon at once.



FREE BOOK

Washington School of Art
 Studio 1410, Port Washington, N. Y.
 Send me—FREE—your valuable illustrated Book, "Art for Pleasure and Profit." No obligation. No salesman will call.
 Name..... Age.....
 (PLEASE PRINT PLAINLY)
 Street.....
 City..... Zone..... State.....

"I'M MAKING MORE THAN \$1000 a Month Haven't Touched Bottom Yet!"



—reports Charles Kama, Texas, one of many who are "cleaning up" with orders for PRESTO. Science's New Midget Miracle Fire Extinguisher. So can YOU!



Amazing new kind of fire extinguisher. Tiny "Presto" does job of bulky extinguishers that cost 4 times as much, are 8 times as heavy. Ends fires fast as 2 seconds. Never corrodes.

Guaranteed for 20 years! Over 3 million sold! Sells for only \$4.95.

Show it to civil defense workers, owners of homes, cars, boats, farms, etc., and to stores for resale—make good income. H. J. Kerr reports \$20 a day. Wm. Wydallis \$15.20 an hour. **FREE Sales Kit.** No obligation.

MERLITE INDUSTRIES, Dept. P-15E
 PRESTO DIV., 114 E. 32 St., New York 16, N.Y.
 Canada: Mopa Co., Ltd., 371 Dowd St., Montreal 1, P.Q.

CHRONOGRAPH WATCH



tells the time, measures the distance and the speed of moving objects. It's also a stopwatch — all for only \$9.95. Precision-made with rugged, shock-resistant case, radium hands and numerals, sweep hand. One-year guarantee (excl. parts). Instructions and band included for \$9.95 ppd.

Cryder Sales Corporation, Box 79-C-73, Whitestone 57, N.Y.



119 JIG SAW PATTERNS

FULL-SIZE . . . trace on wood and saw out. Clever, ORIGINAL designs, things you can make to SELL. Wall shelves, lawn signs, planters, book ends, others. **postpaid**

BURGESS VIBROCRRAFTERS, INC.
 Rush \$1 today. DEPT. C-116, Grayslake, Illinois

REAL ESTATE BE A BROKER

PAYS BIG! SEND FOR FREE, BIG, ILLUSTRATED CATALOG NOW! Graduates report making substantial incomes. Start and run your own business quickly. Men, women of all ages, learn easily. Course covers Sales, Property Management, Appraising, Loans, Mortgages, and related subjects. **STUDY AT HOME** or in classrooms in leading cities. Diploma awarded. Write **TODAY** for free book! No obligation. Approved for World War II and Korean Veterans
WEAVER SCHOOL OF REAL ESTATE (Est. 1936)
 2020R Grand Avenue Kansas City, Mo.



LAW FREE BOOK THE LAW TRAINED MAN

Write today for a **FREE** copy of illustrated law book, "THE LAW-TRAINED MAN," which shows how to earn the professional Bachelor of Laws (LL.B.) degree through home study of the famous Blackstone Law Course. All necessary books and lessons provided. Moderate cost; convenient monthly terms. Write for **FREE** law training book today.
Blackstone School of Law, 307 N. Michigan Ave.
 Founded 1890 Dept. 57, Chicago 1, Illinois

BUILD FINE GRANDFATHER CLOCK NOW

The simple sensible **SPEEDE** Red-I-Kut way as thousands have — **FOR YOURSELF OR SELL AT A GOOD PROFIT. SAVE HUNDREDS OF DOLLARS. SHOP TESTED PLANS "SPIRIT OF THE CENTURY"** Narrow waist 33" tall or stately straight side "SPIRIT OF AMERICA." **EASY-TO-FOLLOW photopack PLANS & LIFE SIZE PATTERNS** tell all—plus **MOVEMENT BROCHURE \$40 up**, of heavy brass weight (Kuempel original) Westminster, tube BELL chime, movements, gorgeous bronze-silver **MOVING MOON** dials, 3/4" solid-mahogany Jiffy Joint-Kwik-Bit case kits. Send **\$1.00 today** — Both plans **RUSH \$1.50** as folks have for over forty years.
 Kuempel Chime Clock Works, 22 Kuempel Bldg., Minneapolis 16, Minn.



NEW IDEAL 900

LAWNMOWER SHARPENER

with "Two-Way" Grinding Option means big volume and big profit for you!

Unit sharpens any reel-type mower either by "hook" or "straight-line" method—for top versatility. Gravity feed. Screw-type adjustments. 1/2 h.p. motor. 6-inch grinding wheel. Includes: Bed-knife grinder, reconditioner and Tool Tray.



Write today for full details!

The Fate-Roof-Heath Company, Dept. PM-10, Plymouth, Ohio

MICROSCOPE SLIDES

Fascinating Subjects—Scientifically Prepared

At these low prices you can now afford a complete Aristo-Craft Slides Library. Each set consists of 6 different, exciting slides, packed in book form for easy, quick reference. Each slide is labeled.

SETS: B1-ANIMALS • B2-PLANTS • B3-FIBRES
B4-HAIRS • B5-CRYSTALS • B6-FOODS. SAVE!
LIBRARY of 6 DIFFERENT SETS (36 Slides) —
Only \$3.95 ppd

Send self-addressed and stamped envelope for FREE SLIDES LIST Hundreds of subjects.

POLK'S HOBBIES • 314 5th Ave., (Dept. PM119) N. Y. 1, N. Y.



69c SET Ppd.

MONEY in WORMS

Sell 20,000 fishworms per week @ \$4 per 1000 from a bed 3 feet wide and 8 feet long. We teach you how to raise and where to sell fishworms and crickets. Write for free literature.

CARTER WORM RANCH, PLAINS, GEORGIA

Learn ACCOUNTING Business Administration

Bookkeeping, secretarial and allied subjects at home in your spare time or attend nationally approved resident school. Write for FREE Success Book giving complete details on courses, plans, rates and employment opportunities. G.I. approved. Write Dept. A



Hills BUSINESS UNIVERSITY AND EXTENSION SCHOOL
619 W. MAIN ST. OKLAHOMA CITY 2, OKLAHOMA

Shrinks Hemorrhoids New Way Without Surgery Stops Itch—Relieves Pain

For the first time science has found a new healing substance with the astonishing ability to shrink hemorrhoids and to relieve pain—without surgery.

In case after case, while gently relieving pain, actual reduction (shrinkage) took place.

Most amazing of all—results were so thorough that sufferers made astonishing statements like "Piles have ceased to be a problem!"

The secret is a new healing substance (Bio-Dyne®)—discovery of a world-famous research institute.

This substance is now available in suppository or ointment form under the name Preparation H.® Ask for it at all drug counters—money back guarantee. *Reg. U.S. Pat. Off

94.6% OF BAILEY GRADUATES ARE EMPLOYED AT TOP PAY IN THE FIELDS WHICH THEY WERE TRAINED!



DIESEL-AUTO MECHANICS DESPERATELY NEEDED!

We have a far greater demand for our students than we can fill!

We can show you an actual waiting list of leading companies throughout the world who have tried Bailey graduates—found them outstanding, and are coming back for more!

Bailey Graduates are Successful . . . RECEIVE BIG PAY — HAVE SECURE FUTURE!

The Famous Bailey Course prepares you for BOTH Diesel and Gasoline Mechanics.

This is a must—due to the advent of using Diesel principles, such as 'Fuel Injection' on passenger cars . . . use of gasoline engines for starting Diesel engines, etc. You learn all this at Bailey in the amount of time ordinarily required to learn just one of these subjects, ALL FOR THE PRICE OF ONE.

Don't be satisfied with a 'futureless', one-type job—learn how you can make big money now!

Write today for Free Booklet that takes you on a step-by-step camera tour through our spacious, modern shops—See Bailey students in action as they Learn-by-doing with the Famous Bailey Method of training!

We provide you with housing and part time jobs while in school, plus nation-wide placement service for graduates.

BAILEY Technical SCHOOLS

1634 S. GRAND

ST. LOUIS 4, MO.

MAIL TODAY!

Please mail immediately this free booklet without obligation.

FREE BOOKLET



Name.....

Address.....

City..... State.....

APPROVED FOR VETERAN . . . NON-VETERAN

Check the Kind of Body You Want



Charles Atlas

... and I'll Show You How EASILY You Can Have It!

Just tell me, in coupon below, the kind of body you want—and I'll give it to you SO FAST your friends will be amazed! "Dynamic Tension," my easy, 15-minutes-a-day method, will make your chest and shoulders bulge... arms and legs surge with power... your whole body feel "alive!"

FREE BOOK Learn how I became "World's Most Perfectly Developed Man" — Mail coupon! **CHARLES ATLAS**, Dept. 8K, 115 East 23 Street, New York City 10, N. Y.

CHARLES ATLAS, Dept. 8K, 115 East 23rd St., New York 10, N. Y.

Dear Charles Atlas: Here's the Kind of Body I want: (Check as many as you like)

- | | |
|--|--|
| <input type="checkbox"/> More Weight—Solid—in The Right Places | <input type="checkbox"/> Powerful Arms, Legs, Grip |
| <input type="checkbox"/> Broader Chest, Shoulders | <input type="checkbox"/> Slimmer Waist, Hips |
| | <input type="checkbox"/> Better Sleep. More Energy |

Send me absolutely FREE a copy of your famous book showing how "Dynamic Tension" can make me a new man—32 pages, crammed with photographs, answers to vital questions, and valuable advice. No obligation.

NAME _____ AGE _____
 (please print or write plainly)
 ADDRESS _____
 CITY _____ ZONE _____ STATE _____

UNIMAT



complete machine shop-in-miniature

Converts from lathe to drill press, tool and surface grinding machine, vertical milling machine, or polisher/grinder—in seconds! **\$129.50**

THIS is that jewel of a machine tool you've been looking for—if you're the kind of craftsman, hobbyist, model builder or inventor who demands all-out precision. It's hard to believe that such versatility, such high-level performance could be built into a rugged instrument that measures only 16" from headstock to tail wheel! The basic UNIMAT includes a powerful 3500 RPM motor and everything you need for fundamental machining operations. Advanced workers, of course, will want many of the accessories that make UNIMAT the most practical, all-purpose tool available anywhere in the world! Whether you're a perfectionist or putterer, you'll really enjoy working with UNIMAT. Available at better hardware stores and hobby shops, or WRITE FOR FREE CATALOG AND BUDGET PLAN INFORMATION.

AMERICAN EDELSTAAL, INC. DEPT. 6J
350 BROADWAY ■ NEW YORK 13, N. Y.

WANTED NEW PRODUCTS

We urge manufacturers with products requiring sales representation in the automotive or service-station field to write to us. Inventors, if you have patented items applying to the same sales field, let us know and we'll work out manufacturing and distribution problems for you.

We cover the entire U.S. with an aggressive, reliable force of top-notch sales representatives.

JACK P. HENNESSY COMPANY, INC.
 12 Depot Square • Englewood, New Jersey

TRAINED AND SKILLED MEN IN CLOCK AND WATCH REPAIR

Are Needed in Watchmaking, Electronics, Defense, Aviation, and other technical and precision instrument fields. NOW IS THE TIME TO LEARN THIS VALUABLE TRADE. But, Before You Enroll in Any HOME STUDY Course in Watchmaking, Write for Your Copy of "LEARN THE FACTS." **KANSAS CITY SCHOOL OF WATCHMAKING**
 1226 Admiral Blvd. Kansas City 6, Missouri

"How to Make Money with Simple Cartoons"

A book everyone who likes to draw should have. It is free; no obligation. Simply address **FREE BOOK**

CARTOONISTS' EXCHANGE
 Dept. 910-D Pleasant Hill, Ohio

That Toy Construction Set Has Grown Up

Read What You
Can Do With It Today
in

NOVEMBER

**POPULAR
MECHANICS**

Let me show you how to FIX ANY PART OF ANY CAR

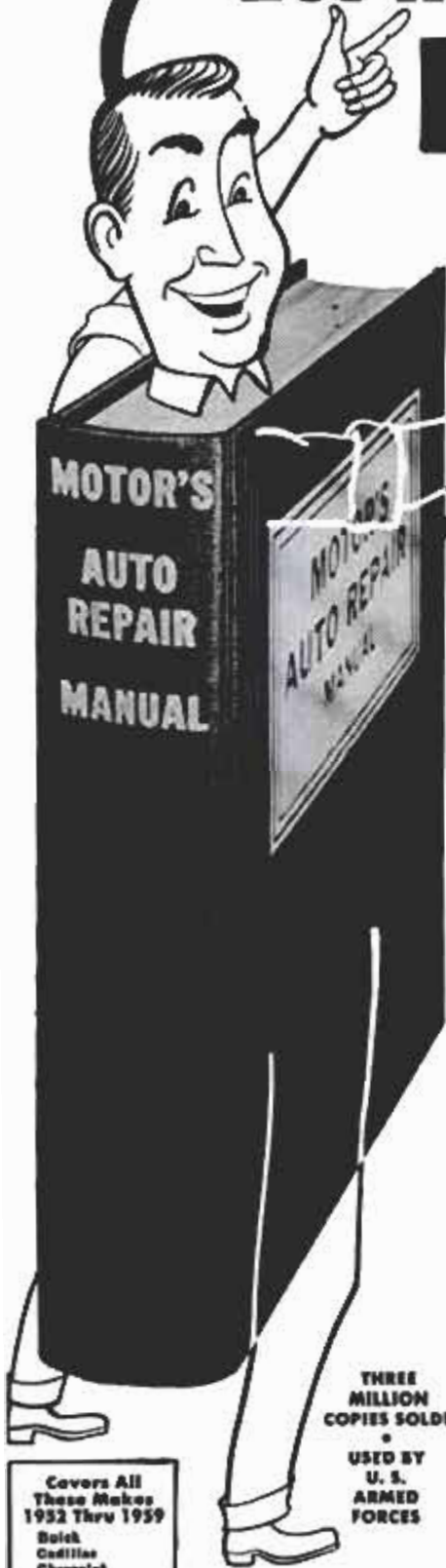

Yes! I'll lead you step-by-step through practically any service or repair job you'll ever face!

I've saved hundreds of thousands of beginner and expert mechanics time, trouble and work! Now let me "whip" your repair jobs on any car listed below!

YES, this famous "Auto Repair Man's Bible" has turned thousands of beginner mechanics into experts. Helped thousands of experts save time, trouble and money "breezing thru" the toughest jobs. Now, the new edition can put YOU right on "top" of practically ANY job on ANY car listed - 1952 thru 1959!

No guess work! No false starts! This giant illustrated guide tells you, then shows you, with crystal-clear pictures and step-by-step directions - how to find the trouble fast - where to start... what tools to use... how to "wrap up" the job "in double-quick time"!

So Simple You CAN'T Go Wrong!

Here's everything you need to know to repair over 1967 car models. Over 1,126 giant pages, 2,850 "this-is-how" pictures, 195 "Quick-Check" charts, 30,000 essential repair specifications, 225,000 service and repair facts. All the instructions and pictures are so complete, so clear that you can't go wrong. That's because your hands are guided by the men who actually build the cars. For this book brings you the time and work-saving methods from 176 Official Shop Manuals!

Everything You Need to Know

Here's complete ILLUSTRATED service, repair and overhaul help on Engines, Automatic Transmissions, Air Suspensions, Ignition, Carburetors, Fuel Pumps, Steering Gears, Brakes, Generators, Distributors, Power Brakes, Power Steering, Voltage Regulators, Starter Switches, etc., etc. Plus a big Trouble-Shooting Section that shows how to spot any one of 2300 car troubles.

No wonder this guide is used by the U.S. Armed Forces and hundreds of thousands of repair men. It's guaranteed to help even a beginner mechanic do a good job. And top-notch mechanics are amazed by the time-saving methods it brings them.

Try It FREE 7 Days

SEND NO MONEY! Just mail coupon. (Paste it to a post-card for fast action.) Use Manual for a week, free. If you don't agree it's the greatest time and work-saver you've ever seen - return book in 7 days and pay nothing. Mail coupon today! **MOTOR BOOK DEPT., Desk 910, 250 West 55th St., New York 19, N.Y. (Schools, Bookstores; Write for discounts.)**

THREE MILLION COPIES SOLD!
USED BY
U. S. ARMED FORCES

Covers All These Makes 1952 Thru 1959

- Buick
- Cadillac
- Chevrolet
- Chrysler
- Clyper
- Continental
- De Soto
- Dodge
- Edsel
- Ford
- Hudson
- Imperial
- Jep
- Lincoln
- Mercury
- Nash
- Oldsmobile
- Packard
- Plymouth
- Pontiac
- Rambler
- Studebaker
- Thunderbird
- Willys

How This Giant Picture Book Helps Other Men:

"Have been using your book on Auto Repair for the past year and feel it is a third man around the shop."
-F. M. Scott, Stearnwood, Wash.

"It sure doesn't take schooling to read it. It's easy to see pictures of every part. Has paid for itself time and again."
-Paul R. Pempfer, Wis.

Some FREE 7-Day Trial on TRUCK REPAIR MANUAL

Covers every job on every popular make truck made since 1952, including GM, Mack and Cummins Diesels. Engines, fuel systems, ignition systems, starters, generators, transmissions, axles, brakes, steering, etc., etc.



All Automatic Transmissions covered in a special big section. NOTE: all pictures shown here greatly reduced in size. Actually this giant book is almost a foot high!



IGNITION - Diagrams, tables and text take the "mystery" out of all ignition systems.



CARBURETORS - You get illustrated step-by-step adjustment procedures for all types of carburetors.

TRY BOOK FREE
for a Whole Week

MAIL COUPON NOW FOR 7-DAY FREE TRIAL (Attach to postcard if more convenient)

MOTOR BOOK DEPT., Desk 910, 250 W. 55th St., New York 19, N. Y.

Rush to me at once (check box opposite book you want):

- MOTOR'S New AUTO REPAIR MANUAL. If O.K., I will remit \$2 in 7 days, \$2 monthly for 3 months and a final payment of \$1.95 (plus 45¢ delivery charge) one month after that. Otherwise I will return the book postpaid in 7 days. (Foreign price, remit \$10 cash with order.)**
- MOTOR'S New TRUCK REPAIR MANUAL. If O.K., I will remit \$2 in 7 days and \$2 monthly for 3 months, plus 45¢ delivery charges, with final payment. Otherwise I will return book postpaid in 7 days. (Foreign price, remit \$11 cash with order.)**

Print Name.....Age.....

Address.....

City.....Zone.....State.....

Check box and save 45¢ shipping charge by enclosing WITH coupon in envelope entire payment of \$7.95 for Auto Repair Manual (or \$9 for Truck Repair Manual.) Same 7-day return refund privilege applies.

Not everyone does as well, but T. N. CODY, who started a business of his own, reports...

For 12 months I've averaged

\$800

per month income

— most of it clear profit for me!

Many men have discovered how to be independent, to be free of layoffs and bosses. C. G. Naples grossed more than \$200 his first week. A father-son combination grossed \$44,000 their second year. H. Lemon says, "I netted \$133 in one 8-hour day."

How much you make depends largely on you. You need no special skill, no large investment. Start part time if you wish.

NO SHOP NECESSARY • Our Electric Deterger shampoos rugs, carpets right on floor—removes dirt and grime and helps to show their natural color and beauty. So efficient and safe it is used by largest railroads and hotels.

This is not a lease proposition. You own the machine, you work when and where you please and all the money you take in is your own. No risk. Machines fully guaranteed.

VON SCHRADER MFG. CO.,
N10 "R" Pl., Racine, Wis.

Without obligation send me **FREE** booklet about your RUG DETERGER and tell me how I can start my own permanent, profitable business.

Mail
Coupon
Today
for
FREE
Book

Name _____
Address _____
City _____ Zone _____ State _____

YOU'D NEVER KNOW I HAD PSORIASIS

For 26 years psoriasis sufferers have learned that Siroil tends to remove unsightly external crusts and scales. If lesions recur, light applications of Siroil help control them. Siroil won't stain clothing or bed linens. Offered on 2-weeks-satisfaction-or-money-refunded basis.

SIROIL

AT ALL
DRUG STORES

Write for new **FREE**
BOOKLET, written by
Registered Physician.

SIROIL LABORATORIES, INC.
Dept. PM-13 Santa Monica, Calif.

Please send me your new **FREE** booklet on PSORIASIS.

NAME _____ Please Print

ADDRESS _____

CITY _____ STATE _____



LIKE WRITING WITH A PENCIL

HANDY-CARVE

HANDY CARVE
BILLFOLD KIT

New **WONDER TOOL** Makes Leatherwork **EASY**

It's Revolutionary — Carve and complete lovely leather designs. All you need is... "HANDY CARVE." No special techniques, no pounding, no hammering, perfect for use in hospitals or where noise is a problem. **HANDY CARVE** has knife edge to cut outline, and spoon-shaped modeler for shading. Billfold kit complete with easy instructions, plus Craftaid for making outlines. **\$2.95**

FREE CATALOG SUBSCRIPTION
TANDY LEATHER CO. (SINCE 1919)
P. O. BOX 791-OT FORT WORTH, TEXAS

SHORTHAND in **6** WEEKS

Famous **SPEEDWRITING** shorthand. 120 words per minute. No symbols; no machines; uses ABC's. Learn at home or through classroom instruction. Lowest cost. For business and Civil Service. 500,000 graduates. Typing available. 37th year. Write for **FREE** booklet. © 1959

Speedwriting
Dept. 1510-9, 55 W. 42 St., New York 36

GET LATEST OFFICIAL AIRCRAFT PHOTOS

SPECIAL INTRODUCTORY OFFER!

- 4 3 1/2 x 5 photos, world's fastest jets.
- 4 3 1/2 x 5 World War II planes.
- 4 3 1/2 x 5 of Rockets, Missiles.
- 1 8x10 Boeing B-52 Jet Bomber.
- 1 8x10 Lockheed F-104A Starfighter.

Only 50c a set. Send \$1 for all 5. (\$2.50 value)

Illustr. CAT. with order. Money back guar.

AVIATION PHOTO EXCHANGE DEPT. PE BOX 7304, LOS ANGELES 3, CALIFORNIA

Print Your Own

Cards, Stationery, Advertising, Circulars, labels, photo and movie titles, church work, tags, etc. Save money. Sold direct from factory only. Raised printing like engraving, too.

Own a Printing Business

Print for Others, Good Profit. Have home shop. Junior press \$16; Senior \$29 up. We supply everything. Easy rules. Pays for self in short time. Write for free catalog of outfits and all details.

KELSEY PRESSES, C-37 Meriden, Conn.

GOVERNMENT OIL LEASES
LOW AS \$1 PER ACRE

You do no drilling, pay no taxes, may realize a king-size profit without ever leaving home. Write for free map and literature.

AMERICAN OIL SCOUTS, Dept. PM
8350 Santa Monica Blvd. Los Angeles 46, Calif.

LEARN WHILE YOU SLEEP!

Experiment in this fascinating, educational new field. Use your phono, recorder or amazing new "Electronic Educator" endless tape recorder. Free catalog lists over 200 unusual tapes, records, equipment for sleep-learning & hypnosis experimenters. **Sleep-Learning Research Ass'n., Box 24-A, Olympia, Wash.**

How Far Away Is Sun? Plot Distance Accurately

Astronomers at Yale University expect to determine accurately the distance to the sun for the first time by using a radiotelescope.

Although the distance is known to be about 93,000,000 miles, it must be plotted with much greater accuracy before space vehicles can navigate safely to other planets. The study is expected to take two years.

To carry out their proposal, the astronomers will use an 84-foot radiotelescope belonging to the Naval Research Laboratory at Maryland Point Observatory, 50 miles south of Washington, D.C.

Technically, astronomers call the distance to the sun the astronomical unit, and it establishes the basic scale of the solar system. The radiotelescope method involves obtaining a precise measurement of the earth's speed in its orbit around the sun, and the astronomical unit can be determined by using this figure in future calculations.

The speed of a rocket leaving earth must be changed from conventional units into a velocity in astronomical units to help calculate the gravitational orbit beyond the immediate vicinity of the earth.

At present, the change to astronomical units is in error, an error of one part in 20,000, the same error as in the present value of the astronomical unit, itself. By using the radiotelescope information, scientists expect to cut down the error in measuring the sun's distance to one part in 280,000. This would mean that the astronomers would be only 300 miles in error in measuring the distance from the earth to the sun.

Two current methods of determining the distance show results differing by 89,000 miles, which is considered an alarming amount.

Just how will the radiotelescope be able to determine the sun's distance with such accuracy?

The telescope's receiving equipment will record, at different times, radio waves from clouds of hydrogen atoms in the space between certain stars. Such measurements will permit scientists to determine the earth's speed in its orbit around the sun. The final step will be to use the earth's speed, along with the time taken for one orbit, to determine the distance to the sun with great accuracy.

NOW...
Train at
home for some
of today's most
spectacular
OPPORTUNITIES

... including
**GUIDED
MISSILE CONTROL**

Nothing else like it! Prepare
in spare time for **REAL EARNINGS** in

RADIO • TELEVISION

Electronics

... the amazing multi-billion dollar opportunity field that's helping pave the way to the exploration of OUTER SPACE. Wonderful choice of opportunities for earning **REAL MONEY** — including Radar, Television, Radio, Automation Electronics, Guided Missile Control, your own business and other interest-packed branches. NOW... get every modern training aid you need at home, including picture-clear **MOVIES**, texts, and 16 shipments of **HOME LABORATORY EQUIPMENT** for needed practical experience.



Employment Service

At no extra cost, all graduates get DeVry Tech's **EMPLOYMENT SERVICE** that has helped thousands of men earn **REAL MONEY!** Often more jobs than grads!

MILITARY SERVICE?

Act now. Get valuable information we have for men facing military service.



JUST "COMMON SENSE" NEEDED TO START

No advanced education or previous technical experience needed. If preferred, you may attend DeVry Tech's well-equipped laboratories in Chicago or Toronto. See for yourself. Mail coupon today.

FREE!

Men 17-55 — get 2 **FREE** booklets, "Come With Us to Outer Space" and "Pocket Guide to Real Earnings." Informative! Fascinating!

MAIL TODAY!

**De Vry
TECH**
Formerly
DeFOREST'S

DeVRY TECHNICAL INSTITUTE

4141 Belmont Avenue,
Chicago 41, Ill., Dept. PM-10-P

2058

I would like your **FREE** booklets and information on how I can prepare to enter **ELECTRONICS**.

Name _____ Age _____

Street _____ Apt. _____

City _____ Zone _____ State _____

Special Offer 25¢

Hear these authentic recordings of dramatic events from



"The Amazing World of Short Wave Listening"

narrated by Alex Dreier, Radio-TV "Man on the Go"

- President's voice from outer space!
- Actual capture of a desperate criminal!
- Radio amateur at Little America!
- Ships at sea . . . aircraft in action!



S-38E
receiver
\$59.95

3 short wave bands plus standard broadcast. Built-in speaker, headset output.

MAIL COUPON TODAY!



hallicrafters...
DEPT. 14, CHICAGO 11, ILL.

Gentlemen: Please rush by return mail my recording, "The Amazing World of Short Wave Listening." I enclose 25¢.

NAME _____

ADDRESS _____

CITY _____

STATE _____

... TURN CONCRETE INTO GOLD!



MAKE UP TO \$75 A DAY IN YOUR OWN BUSINESS

If you want to have your own business — to start a business on your own — here's your big opportunity! New high speed, low cost General block machine produces up to 1,000 concrete blocks a day. Sell all you make to builders, supply houses, and others for homes, factories, buildings, garages. Cash in on the building boom! You can make profits of 100% to 150% — up to \$75 a day! General block machine equipped with 1/2 h.p. electric motor — or can be supplied with gasoline engine — works anywhere, in little space, indoors or out. Operates from ordinary house light socket. Simple, foolproof 3 step operation — so easy a child can do it. Makes superior 3 core blocks any size from 4" to 12". Also makes chimney, ash, corner and other types. Blocks meet any building code anywhere in the country. Materials — sand, water, cement, available anywhere. Simple illustrated operating instructions and mixing formulas for cement and cinder blocks supplied with each machine. Write for FREE folder with full information.

MOTOR DRIVEN

R.L.T. of New York City reports: "MY GENERAL BLOCK MACHINE PAID FOR ITSELF IN FIRST 2 WEEKS!" Hundreds now in use the world over! Write for FREE details today!

EXTRA

Amazing illustrated book gives floor plans for 6 sensational concrete block bungalows. Tells how to lay blocks, lay out building lines, mix concrete, build steps, porch and concrete floors all at great savings. Written by experts. Can save many times the cost of the machine! Get it now! No strings attached. Send \$1.

BOOK SENT FREE IF YOU BUY MACHINE.
\$1 REFUNDED IF YOU BUY LATER.

GENERAL ENGINES CO.

DEPT. M-109, ROUTE 130, THOROFARE, N. J.



Tells How You Can Learn to

FUN! RECREATION! PROFIT!

FREE BOOK

MOUNT BIRDS!

Learn At Home
Men, Boys, Hunters, Fishermen, mount and save your lovely wild-game trophies. Be a Taxidermist. Mount Birds, Animals, Heads, Fish, Ten skins. YOU learn easily, quickly in spare time. Have a grand home-museum. The finest and the greatest hobby known, for sportsmen. Fun, real profits.

FREE BOOK Yes, FREE, Beautiful strange, valuable Book, telling all about Taxidermy. Contains over 100 beautiful game-pictures. And it's yours FREE, if you rush your request. You can mount all kinds of wild-game, and common specimens too. We can positively TEACH YOU. So GRASP this opportunity. RUSH letter or postal for this amazing FREE BOOK. Don't delay. State your AGE. N. W. SCHOOL OF TAXIDERMY, 2510 Elwood Bldg., Omaha 2, Neb.

ELECTRIFY PLAYER PIANOS PUMP ORGANS

YOU CAN QUICKLY END TIRESOME FOOT-PUMPING With a Compact Low-Cost Lee Silent Suction Unit



EASY TO INSTALL
FULLY GUARANTEED
1000'S IN USE



with
LEE MUSIC MFG. CO.
Box 595, Tujunga, Calif.

SUBSCRIBE TO

POPULAR MECHANICS MAGAZINE

SAVE UP TO \$2.40!

Don't miss a single one of the great issues to come. **Subscribe and be sure!**

MAIL THIS COUPON NOW!

POPULAR MECHANICS, Dept. PM-1059
200 East Ontario St., Chicago 11, Illinois

Please enter my subscription to POPULAR MECHANICS Magazine for:

ONE YEAR \$3.50 (Saving me 70c*)

TWO YEARS \$6.00 (Saving me \$2.40*)

Please enclose remittance in full.

Name _____ Please Print

Address _____

City _____ Zone _____ State _____

*All savings based on single-copy price



"Build-It-Yourself" Helicopter

Capable of carrying two passengers, a miniature helicopterlike aircraft can be built from "do-it-yourself" plans. Weighing only 98 pounds, the unpowered craft lifts into the air as it is pulled at a ground speed of 25 miles per hour. The craft can also be towed by a motorboat, attached to a small boat or, in strong wind, flown like a kite on a long rope tied to the ground. An overhead-control stick guides the craft in the air. It can fly of its own power when equipped with a small engine.

Wrought-Iron Oil Pipeline Still in Use After 76 Years

Sections of the world's first oil pipeline, unearthed and moved halfway across the continent, are still in good condition and are being used to carry oil in Oklahoma oil fields. First laid in 1893 between Bradford and Marcus Hook, Pa., the 378 miles of four and five-inch pipe were inspected in 1923 and showed some signs of rust but no pitting. The pipe was sold in the ground that year, and relaid in 1924 in Oklahoma. In 1934 the pipe was again inspected and found in good condition, though steel pipe laid at the same time had to be replaced. The pipe is still in service, handling oil at average pressures of 1000 pounds per square inch. Key to the durability of wrought iron, say metallurgists, is the iron silicate physically entrained in the metal. These nonrusting particles force corrosion to disperse over the iron's surface, where it forms a dense layer which halts further corrosion.

YOU BRIGHTER FUTURE IN AUTO MECHANICS AND DIESEL



Your spare time pays off BIG with our world-famous **SHOP TESTED** Home Training



MAKE YOUR FUTURE AS BRIGHT AS THEIRS

In a matter of months, you can quit your no-future job for a big-pay, big-future career as an Auto-Diesel Mechanic. Free Illustrated Book gives you the facts. Send coupon below. No Obligation. No Salesman will call.

All Phase Training

N. T. S. students become skilled, all-around mechanics. Crystal-clear lessons, Shop-Tested manuals, real professional equipment, make it easy to learn. Big equipment kits, yours to keep. Earn as you learn...we show you how. Graduate Advisory Service.

N.T.S. Training is Better, More Complete, Lower Cost **BETTER...**

Because training is SHOP-TESTED in Resident School Shops & Labs. **MORE COMPLETE...** You learn all phases of Auto Mechanics & Diesel. **LOWER COST...** One low tuition covers entire cost of course and all equipment.

Unlimited Opportunities

Trained mechanics make top money...are in demand at dealer shops, garages, large bus and truck lines, construction projects, government labs, factories, and many others.

YOU GET AND KEEP ALL THIS PROFESSIONAL EQUIPMENT



Motor Analyzing Set



Socket Wrench Set

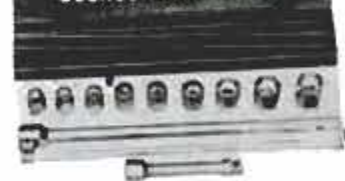

NATIONAL TECHNICAL SCHOOLS

WORLD-WIDE TRAINING SINCE 1909
4000 S. FIGUEROA ST., LOS ANGELES 37, CALIF., U. S. A.

ACTUAL LESSON

FREE!

Illustrated Fact Book & Actual Lesson

Mail coupon now.

Complete TV-Radio Electronics training also available.

RESIDENT TRAINING at Los Angeles!

If you wish to take Resident Training at Los Angeles, in our Big, Modern Shops & Labs, check special box in coupon for full information.

NATIONAL TECHNICAL SCHOOLS

WORLD-WIDE TRAINING SINCE 1909

MAIL NOW TO
NATIONAL TECHNICAL SCHOOLS, Dept. DB-109
4000 S. FIGUEROA ST., LOS ANGELES 37, CALIF.

Send for FREE Auto Diesel Opportunity Book and actual Lesson.

NAME _____ AGE _____

ADDRESS _____



Member



SAVE STRAIN
SAVE SKIN

WITH
Bridgeport
NEOPRENE

CUSHION
GRIP

SCREWDRIVERS

50%
GREATER TURNING
POWER

16 sizes and
styles—Regular
and Phillips.
\$1.00 and \$2.70
At your hardware
store.

- SUPER COMFORTABLE
 - NON-SLIP GRIP
 - UNBREAKABLE HANDLE
 - FULLY GUARANTEED
 - ALLOY STEEL BLADE
- Resilient Neoprene CUSHION GRIP lets you turn screws tighter with less work—and you don't hurt your hands. Tested and approved by Mechanics

Patent No. 2871899

THE BRIDGEPORT HARDWARE MFG. CORP., BRIDGEPORT 5, CONN., U. S. A.

FREE PLAN tells how to start your own business FILING SAWS

Here is a steady repeat CASH business you can start in your own basement or garage in your spare time and make up to \$3 or \$6 an hour. You can file hand, band and both combination and cross-cut circular saws on the Foley Saw Filer. No eyestrain—no experience needed. "The first saw I sharpened with my Foley Filer came out 100%,"—writes Clarence E. Parsons.



Every saw you sharpen with the Foley Saw Filer brings you more customers. "I rented a two-car garage and have all the work I can do"—

Charles H. Smith.

FREE BOOK
Shows How to Start

Foley Price Guide gives saw sharpening charges. Send coupon today. No salesman will call.

Send Coupon for **FREE BOOK**

FOLEY MFG. CO.
1016-9 Foley Bldg., Minneapolis 18, Minnesota.
Send **FREE BOOK**—"Money Making Facts,"
and Time Payment Plan.

Name.....
Address.....



Anderson-Stanley Stamp Co., 4101 W. Grand, Chicago 51.

Foot-Operated Press Prints on Uneven Surfaces

Instructions and other information can be printed on cylindrical surfaces and other odd shapes by a new marking press that uses rubber dies. Cup-shaped objects, spheres and uneven surfaces can be marked. The illustration shows an operator printing a legend on a nine-inch radio speaker. The area that can be printed is 2½ by 5½ inches in the standard model. Practically any material, including wood, plastic, fabrics and metal can be used in the press. It is operated by foot lever and can be adapted to air operation with electrical microswitch control.

Pump Keeps Car Warm After Engine Is Stopped

By circulating hot water through the heater after the engine has stopped, a small electric pump keeps a parked car warm for as long as two hours. Immediately after the engine has been stopped, the water temperature actually rises for 10 or 15 minutes as the block loses its heat. The small pump, which is mounted in the heater-hose network, keeps this hot water moving through the heater so the car's occupants are kept warm without danger of exhaust-fume poisoning from an idling engine.

Harmon & Co., P.O. Box 8026,
Northgate Station, Seattle 55, Wash.

POPULAR MECHANICS

Dowsing "Serves Social Purpose" Say Unbelieving Scientists

Ever hunt for underground water with a divining rod?

Thousands have, and thousands are believers. Now come two scientists who say the art of finding water with a forked stick may have some social purposes but there's no basis for it in science.

In New England, New York and Pennsylvania it's called dowsing. Elsewhere it may be divining, switching, doodlebugging, peach-twig toting or something else. The diviner holds a forked stick, and where there is water beneath, the twig bends downward of its own accord as if to say "Drill here for water."

Evon Z. Vogt, anthropologist at Harvard University, and Ray Hyman, research consultant in behavioral sciences for General Electric Co., in a book on the subject recently published by University of Chicago Press, say that water witching provides a feeling of certainty where scientific advice gives no assurance on hidden sources of water. It relieves a farmer's anxiety about ground water where a geologist might dissuade a farmer from drilling. If the diviner's advice proves correct, his success is remembered and he gains a reputation. Although they consider the practice a form of magical divination, the two scientists conclude that "we do not feel that it is 'superstitious nonsense' that should be stamped out at all costs." It was practiced as far back as the 16th Century, and still is.

Helicopter's Wheel Replaced in Mid-Air

Naval maintenance men replaced a helicopter's wheel while the big aircraft hovered two feet off the ground. The copter, an HO4S, was leaving Chevalier Field, Pensacola, Fla., for Ellyson Field, 30 miles away, when the pilot noticed a wheel rolling down the runway ahead of him. It was his starboard main wheel. He decided to continue on to Ellyson with his load of passengers, since maintenance men there were more familiar with rotary-wing aircraft. At Ellyson the copter hovered close to the ground while the passengers got out. Then, with crash trucking standing by, the ground crewmen attached a spare wheel. Working under the fast-whirling rotor blades and the bulk of the big plane, they needed only 10 minutes to do the job. A chief petty officer who directed the pilot during the operation said that at times—wheels were less than six inches above ground.

These men are getting practical training in ...

ELECTRICITY



ELECTRONICS

ON REAL

Motors • Generators
Switchboards • Controls
Modern Appliances
Automatic Electronic
Control Units

TELEVISION



Radio Electronics

ON REAL

TV Receivers
Black & White and Color
AM-FM and Auto Radios
Transistors • Printed
Circuits • Test Equipment

Train in NEW Shop-Labs of **COYNE**

In Chicago—Electrical and Electronic Center of the World. Prepare for a better job and a successful future in a TOP OPPORTUNITY FIELD. Train on real full size equipment at COYNE where thousands of successful men have trained for 60 years—largest, oldest, best equipped school of its kind. Professional and experienced instructors show you how, then do practical jobs yourself on more than a quarter of a million dollars worth of equipment. No previous experience or advanced education needed. Employment Service to Graduates.

Start Now — Pay Later — Liberal Finance and Payment Plans. Pay most of tuition after graduation. Part-time employment help for students. Choose from nine yearly Starting Dates.

Mail Coupon or Write to Address Below for Free Book—"Guide to Careers." Whether you prefer ELECTRICITY, TELEVISION-RADIO or COMBINED ELECTRONICS TRAINING, which includes both fields, this book describes all training offered.

Information comes by mail. No obligation and NO SALESMAN WILL CALL.

B. W. Cooke, Jr., Pres. Founded 1899

COYNE ELECTRICAL SCHOOL

Chartered as an Educational Institution Not for Profit
1501 W. Congress Pkwy., Chicago 7, Ill., Dept. 79-3C

MAIL COUPON OR WRITE TO ADDRESS BELOW

COYNE ELECTRICAL SCHOOL
New Coyne Building, Dept. 79-3C
1501 W. Congress Pkwy., Chicago 7, Ill.

Send BIG FREE book and details of all the training you offer. However, I am especially interested in:

Electricity Television Both Fields

Name _____

Address _____

City _____ State _____

(I understand no Salesman will call)



FREE!
100
WORLD-WIDE
STAMPS
...just
released!



HURRY! SEND TODAY for colorful, valuable collection of 100 World-Wide stamps. Get new issues of past 12 months. From far corners of the world . . . Ghana, Togo, China, Polynesia, India, Australia, Honduras, Iceland and many others. Wonderful new additions to your collection. All different, all genuine, topicals, pictorials, bi-colors, mint and used. Limited supply. Only one to a collector. Plus free complete, helpful "Stamp Collector's Guide" and other offers for your **FREE** inspection. Send name, address, enclose 10¢ for handling and postage. Garcelon Stamp Company, Dept. PMOX, Calais, Maine

GARCELON STAMP CO., Dept. PMOX
Calais, Maine — Rush **FREE** 100 Different Stamps, Collector's Guide, other offers. Enclosed 10¢ for handling. (PLEASE PRINT).

START YOUR OWN MAIL ORDER HOME BUSINESS

FREE
Publication
SHOWS
YOU
HOW

Get your **FREE** Copy of "How to Make Money in Mail Order" revealing plans on how and where to get best products to sell by mail, how to pocket profits in advance, how to get free ads. Men, women, families, start your own big profit home mail order business without experience or product investment. New Mail Order Exchange Plan helps beginners start. Confidential bulletins show you products to sell by mail, show newest sure-fire mail order techniques. Write today for your **Free** Copy of "How to Make Money in Mail Order." There's no obligation. Airmail reaches us overnight. **MAIL ORDER EXCHANGE, 1717 Westwood, Dept. X25A, Los Angeles 24, California**

INVENTIONS WANTED

If you want to market, or sell, your invention for cash or royalties. Write for our Free Booklet. Send no drawings. We also welcome hearing from firms, or private capital wishing to review inventions in any field. We will be glad to send notice of our clients' inventions.

GLOBAL MARKETING SERVICE

2420 77th Ave. Dept. PD Oakland 5, Calif.

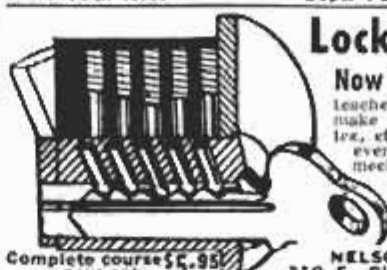

Locksmithing AND KEY MAKING

Now Made Easy! Practical up-to-date course

teaches you how to pick locks, de-code, make master keys, repair, install, service, etc. New self-instruction lessons for every handyman, homeowner, carpenter, mechanic, service station operator, fix-it shop, hardware dealer, gunsmith. 53 easy illustrated lessons. Full price only \$5.95 postpaid; or C.O.D. plus postage. Satisfaction or refund guaranteed.

NELSON-HALL CO., DEPT. KR-2
210 S. Clinton Chicago 6, Ill.

Complete course \$5.95
... now only 3.95

Sworn statement from CHAS. LEMMING reads:

"After starting my own business"



I've averaged \$100 A DAY
—most of it clear profit!"

• If you want to be independent—free from layoffs, bosses—start profitable, year 'round business of your own. Ours is **NOT** a lease proposition. You own the machine, you work when and where you please, and all the money you take in is your own. **FREE** book tells you how.

MAIL COUPON TODAY FOR FREE BOOK

VON SCHRADER MFG. CO.
N10 "D" Pl., Racine, Wisconsin

Without obligation rush your **FREE** booklet about how I can start my own permanent, profitable electric Upholstery Cleaning business.

Name _____

Address _____

City _____ Zone _____ State _____

Not everyone does as well...

Mr. Lemming owns two machines

In city of less than 50,000, Mr. Lemming started his own business after filling in coupon like one below. He averaged \$100 a day during first year, some days \$200. F. E. Doran grossed \$1050 in single month. Geo. Held grossed \$300 in one week.

How much you earn depends largely on you. No special skill, no large investment required for our electric upholstery cleaning machine. Start spare time until full time justified. Hire helpers as needed.

NO SHOP NECESSARY • You clean upholstered furniture on customers' premises—homes, hotels, motels, etc. Auto upholstery, too. No hauling; operate from your home. Watch business grow as satisfied customers tell friends. Supplies cost little, profits high.

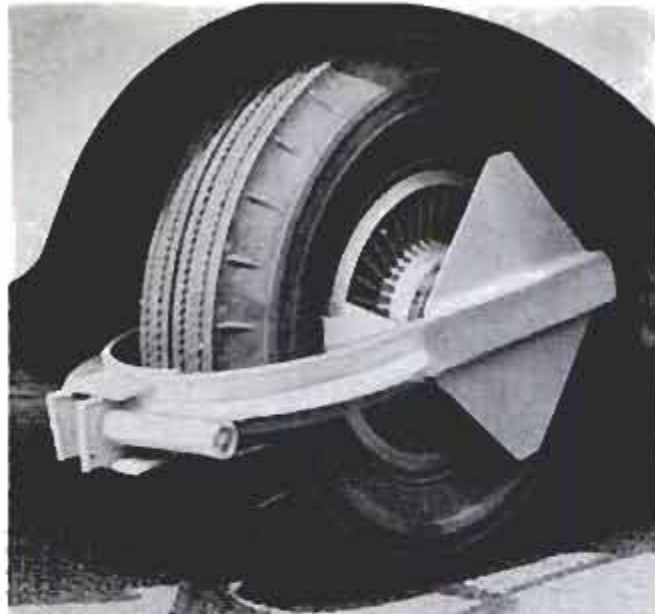

Rhino Products Co., 438 Lipan St., Denver, Colo.

Metal Boot on Wheel Immobilizes Car

Fastened to the front wheel of an automobile, a metal boot prevents the car from being moved. When the car is backed, the boot catches on the bumper; when the car moves forward the boot digs into the pavement. The boot is used by some municipalities and universities to enforce parking regulations. Instead of towing a car away from a no-parking zone, the police officer simply immobilizes the car by means of the boot. The owner can't move his vehicle until the officer returns to the car and unlocks the boot.

Short Radio Waves Cause Plant Mutations

Shortwave radio may become a tool for causing mutations in plants, possibly leading to the development of new varieties of plant life. This suggestion is based on the discovery that short radio waves can be used to cause changes in chromosomes similar to those produced by cosmic rays and X rays. In experiments at the New England Institute for Medical Research, irregular cell divisions and a shortening of chromosomes were observed in garlic root tips that were subjected to radio energy in the megacycle range. The radio energy was "shot" at the root tips in bursts of $\frac{1}{20,000}$ -second to minimize heating. In studies with living protozoa it was found that these microorganisms could move only in the direction of the lines of force while the electric field was on, resuming their random movements when it was switched off. Advantages of the radio system are that extreme power can be used and that it can be controlled very precisely.

Boeing openings offer
ENGINEERS • SCIENTISTS
 outstanding careers,
 wonderful Western living



Supersonic BOMARC in flight

BOMARC is one of the many expanding missile and space-age projects at Boeing that offer engineers and scientists of *all* categories an opportunity to grow in professional stature and to work in a dynamic environment conducive to rapid advancement. Openings, now, in Research, Design, Production, Service.



Lake Washington in Seattle

Boeing is headquartered in Seattle, boating capital of the U.S. and center of world-famous recreation area, noted also for beautiful homes overlooking water and mountain views and top-ranking schools. At Boeing, you and your family will enjoy wonderful Western living at its best!



Write *today* for free 24-page book, "Environment for Dynamic Career Growth." Indicate degree(s) and field of interest. Address: Mr. Stanley M. Little, Boeing Airplane Co. P. O. Box 3822-PMC, Seattle 24, Washington.

BOEING

LOOK!
New!
Improved!



**POCKET-SIZE
BLOW TORCH
only \$2.25**

Now—solder, braze, fix leaks. Do wiring, plumbing, loosen frozen nuts and bolts, 1001 odd jobs. Butane gas blow torch gives intense 3500° pin point flame that lasts ½ hour, turns on or off. Extra "chargers" 49¢ for two. Send \$2.25, check or money order for Jet King Blow Torch with one charger, or send \$2.95 for complete soldering kit: Blow Torch, two chargers, soldering tip, roll of solder. Send coupon now! **Money back guarantee!**

Kidde Manufacturing Co., Inc., 1004 Farrand St., Bloomfield, N. J.

Send me JET KING BLOW TORCHES @ 2.25 ea.*

Send me JET KING SOLDER KITS @ 2.95 ea.*

Send me Boxes of Extra Chargers @ .49 per box.

My check, money order for \$ is enclosed
(*Add \$1.00 Extra per unit for Canada)

NAME

STREET

CITY STATE

**PREPARE FOR BETTER JOB, BIGGER PAY
IN SPARE TIME AT HOME**

Today, choose the job you want—and prepare for it in time you might otherwise waste. Or if you are already in the work you like best, start training now for quicker promotion and increased pay. During the past 62 years AMERICAN SCHOOL has helped ambitious people to reach higher goals. Check subject that interests you and mail coupon for full information.

AMERICAN SCHOOL, Dept. G745, Drexel at 58th, Chicago 37, Ill.

Without obligation, please send FREE and postpaid, full particulars about the subject checked below.

- | | | |
|---|---|---|
| <input type="checkbox"/> Accounting | <input type="checkbox"/> Contracting | <input type="checkbox"/> Mechanical Engineering |
| <input type="checkbox"/> Apprenticeship Courses | <input type="checkbox"/> Diesel Technician | <input type="checkbox"/> Mechanical Technology |
| <input type="checkbox"/> Architects & Building | <input type="checkbox"/> Drafting—Building Trades | <input type="checkbox"/> Metalworking Courses |
| <input type="checkbox"/> Automotive Technician | <input type="checkbox"/> Drafting—Machine Trades | <input type="checkbox"/> Plumbing—Practical |
| <input type="checkbox"/> Better Foremanship | <input type="checkbox"/> Electrical Engineering | <input type="checkbox"/> Private Secretary |
| <input type="checkbox"/> Blueprint Reading | <input type="checkbox"/> Electricity—Practical | <input type="checkbox"/> Retail Merchandising |
| <input type="checkbox"/> Bookkeeping | <input type="checkbox"/> Electronics—Industrial | <input type="checkbox"/> Salesmanship—Outside |
| <input type="checkbox"/> Business Management | <input type="checkbox"/> HIGH SCHOOL COURSES | <input type="checkbox"/> Sheet Metal Work |
| <input type="checkbox"/> Civil Engineering | <input type="checkbox"/> Machinists | <input type="checkbox"/> Tool Making |

NAME

HOME ADDRESS

CITY

AGE

STATE

Accredited Member NATIONAL HOME STUDY COUNCIL

MAIL COUPON NOW

**Social Scientists Seek Answer
To Exploding Population**

About 90 million people, equal to the population of Japan, were added to the earth's population in the last two years. This growth is unprecedented in human history. The populations of some underdeveloped countries are increasing at the rate of three percent or more per year as compared to a rate of 1.7 percent in the United States.

Social scientists say that even if fertility soon begins to decline moderately, the present 2.8 billion people on earth will have multiplied to five or six billion by the end of the century, only 40 years from now. In 600 years, at the present rate of growth, there would be no more than a square yard of earth per person. Something obviously will happen to prevent such overcrowding, points out a United Nations report.

The continuing baby boom is occurring at the same time that famines and epidemic diseases, two things which in the past have periodically decimated human populations, have been brought under increasing control. Food production, housing, schooling and hospital facilities have been improved on a worldwide basis but continue to lag behind the needs of the exploding population. The Population Reference Bureau, Inc., a nonprofit organization that gathers and interprets population data, suggests that means must be found to check fertility so that social progress can catch up. For instance, the problems of chronic poverty and malnutrition have not been solved. Half of the world's children of school-going age are not in school. Housing and its financing are matters of international concern, as are adequate hospital facilities. In short, the Bureau finds that substantial reductions in fertility must occur, especially in underdeveloped countries, before living can be raised much above subsistence levels.

Today 55.2 percent of the people of the world live in Asia, 23 percent in Europe (including Russia), eight percent in Africa, 6.7 percent in North America, 6.5 percent in Latin America, and 0.5 percent in Oceania.

**Test Ceramic Elements
In Atomic Reactors**

Ceramic fuel elements for atomic reactors are being tested at temperatures as high as 5000 degrees F.—one half the surface temperature of the sun—by General Electric scientists.

How You Can Develop a SUCCESS - WINNING VOICE

Put warmth, friendliness and magnetism in your everyday voice. You'll find it worth dollars and cents to you in your business, trade or profession . . . and in social life a persuasive voice, with real character is priceless!

We have been voice-training average men and women (as well as celebrities) since 1916. More than 200,000 members! TV-Star Robert Cummings is one of our celebrity graduates.

FREE BOOK

"Voice Power & Personal Power"
Write today for my big illustrated voice book. Explains all about our amazing method . . . and tells what we can do for you. No cost, no obligation—it's free! Just send me name, address and your age. Book will be mailed at once in plain sealed wrapper. No salesman will bother you.

Eugene Feuchtinger

PREFECT VOICE INSTITUTE
210 South Clinton, Studio KR-2, Chicago 6, Ill.



SCHOOL OPPORTUNITIES

Improve your education, take advantage of school advertising.

115 Volt, A.C., ELECTRIC GENERATORS 60 Cycle, Single Phase, Continuous Duty



750 Watt Cost \$115.00 **\$59.50** fob

1000 Watt Cost \$150.00 **\$79.50** fob

2500 Watt Cost \$285.00 **\$125.00** fob

**BRAND NEW SURPLUS
FULLY GUARANTEED**

Ideal as a permanent or stand-by unit for electricity IDENTICAL to house current. Perfect for farms, camps, aboard ship, oil fields, mines, etc. Easily handles lights, refrigerator, deep freeze, oil burner, radio; power for saws, floodlights, drills, pumps, etc.

All ball bearing. Operates at 3600 R.P.M. Drive with 2 HP to 3 1/2 HP or larger engine—or use power take-off. Voltage self regulating. Standard base mounting. Two outlets. Modern, compact design. Tremendous overload capacity. Operates in either direction!

**SUPPLY LIMITED! ORDER FROM AD
FREE CATALOG OF OTHER SURPLUS, HYDRAULICS**

ROBERTS ELECTRIC CO., Dept. PM-963, 849 W. Grand, Chicago 22, Ill.

FREE ALLIED'S MONEY-SAVING 1960 ELECTRONIC SUPPLY CATALOG

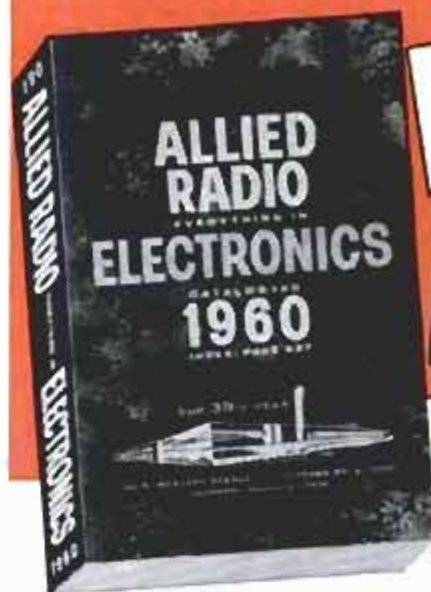

value-packed
SEND FOR IT!

SAVE
ON EVERYTHING
IN ELECTRONICS

EASIEST TERMS
only \$2 down on
orders up to \$50

WORLD'S LARGEST STOCKS

Send for the most widely used buying guide to everything in Electronics for Experimenters, Builders, Amateurs, Servicemen, Engineers and Hi-Fi enthusiasts. Save on:

- KNIGHT-KITS®—Best in Build-Your-Own
- Everything in STEREO HI-FI
- Hi-Fi Music Systems and Components
- Tape Recorders & Phono Equipment
- Public Address & Paging Systems
- TV Tubes, Antennas, Accessories
- Amateur Station Equipment
- Latest Test & Lab Instruments
- Parts, Tubes, Transistors
- Everything in Tools & Technical Books

SAVE on everything in Electronics at ALLIED—get fastest service, expert personal help, guaranteed satisfaction. Send today for your FREE 1960 ALLIED Catalog.

Everything in Electronics
from One Reliable Source

our 39th year

ALLIED RADIO

ALLIED RADIO CORP., Dept. 5-K9
100 N. Western Ave., Chicago 80, Ill.

Rush FREE 1960 ALLIED Catalog.

Name _____

Address _____

City _____ Zone _____ State _____

SEND FOR
FREE
CATALOG





Evinrude Motors, Milwaukee 10, Wis.

All but one of the "big five" are featuring increased horsepower in their top models, with boosts of up to 50 percent. Evinrude's Starflite II, above, develops 75 horsepower and features an automatic choke, double-action shock absorbers, redesigned "Jet Stream" lower unit and a choice of three propellers

OUTBOARDS for 1960

The "big five" outboard motor manufacturers are making news with bigger and better motors for next year. Here's a look at the newest

Johnson's new 75 horsepower Super Sea Horse steps out easily on a big runabout with 10 aboard. New "power package" includes automatic choke, choice of props, new lower unit and shocks

Johnson Motors, Waukegan, Ill.

Leading the Gale line is the 60 horsepower V-Sovereign, an all-new motor from fiber-glass shroud to lower unit

Gale Products, Galesburg, Ill.

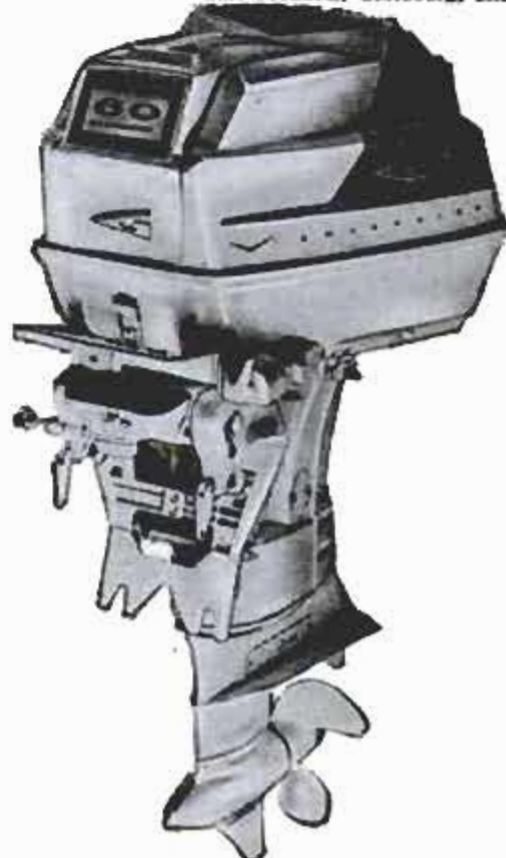



Marine Products Div., McCulloch Corp., Minneapolis 13, Minn.

Newest thing in outboards is the Scott 7½ horse-power motor, smallest and lightest ever offered in or near this power class. Designed for the fisherman, small boat owner, or those who carry their own motor to boat liveries, it's a compact 30 inches long and weighs only 36 pounds — seven inches shorter and 25 pounds lighter than last year's model

Most powerful outboard motor ever put on the market is Mercury's 80 horsepower Merc 800. It boasts an industry top in efficiency with over one horsepower per cubic inch of displacement. The line also has an improved single-lever control unit and better muffling, and offers counter-rotating propellers in their larger motors for torque-free dual installations

Kiekhaefer Corp., Fond Du Lac, Wis.

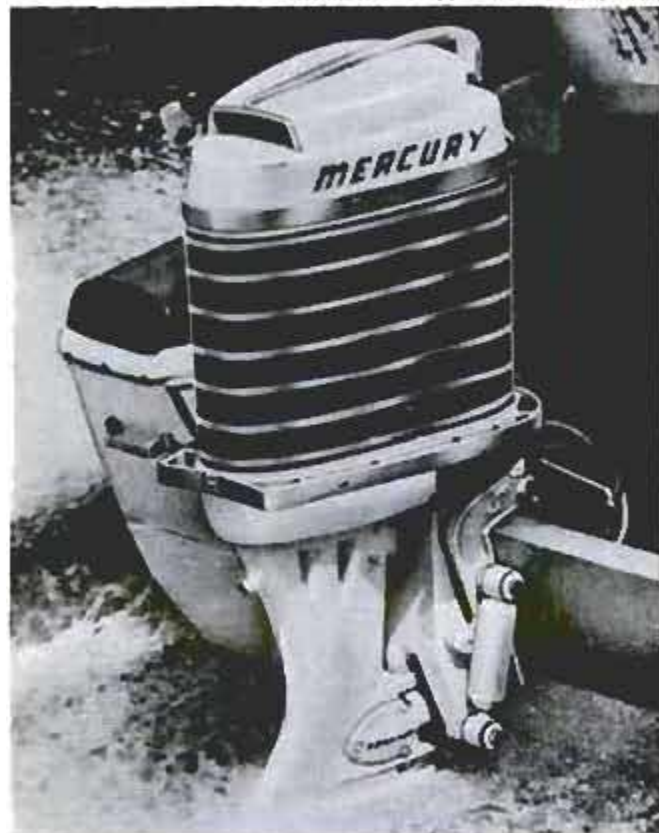

prepare for your career in
**ELECTRONICS
 ELECTRICAL
 ENGINEERING
 RADIO-TV
 COMPUTERS**

At MSOE, you can equip yourself for a career in many exciting, growing fields:
**MISSILES • RADAR • AVIONICS
 AUTOMATION • RESEARCH
 DEVELOPMENT • ELECTRICAL
 POWER • ROCKETRY**

When you graduate from the Milwaukee School of Engineering, you are prepared for a dynamic career as an Electrical Engineer or Engineering Technician. Under a faculty of specialists, you gain a sound technical education in modern, completely equipped laboratories and classrooms. As a result, MSOE graduates are in great demand and highly accepted by industries nationally.

At MSOE, you will meet men from all walks of life and all parts of the country — some fresh out of high school or prep school, others in their twenties — veterans and non-veterans.

You can start school in any one of four quarters and begin specializing immediately. Engineering technicians graduate in 2 years with an Associate in Applied Science degree. For a Bachelor of Science degree in Engineering, you attend 4 years. A 3-month preparatory course also is available.



FREE CAREER BOOKLET!

If you're interested in any phase of electronics, radio or television, be sure to look into the programs of study offered by the Milwaukee School of Engineering. Just mail the coupon.

**MILWAUKEE SCHOOL
 OF ENGINEERING**

Dept. PM-1059, 1025 N. Milwaukee St.
 Milwaukee, Wisconsin

Please send FREE Career Booklet. I'm interested in
 Electronics Electrical Power Television
 Mechanical Engineering Radio Computers
 Electrical Engineering Industrial Electronics

PLEASE PRINT

Name _____ Age _____

Address _____

City _____ Zone _____ State _____

I'm eligible for veterans education benefits

Sunglasses Rest on Bows Of Regular Glasses



K-R Products, P.O. Box 626,
Lincoln 7, Neb.

Featherweight sunglasses without clamps, clips or bows present no problem for persons who wear glasses. Weighing less than four grams, the sunglasses drop or slip behind the lenses of the prescription glasses, with protruding side lips resting on the bows. The sunglasses come in green, amber and smoke tints. Made of plastic, they can be carried in the vest pocket, purse or glove compartment.

Additional Crude Oil Possible With Gamma-Ray Treatment

Prospects of recovering additional crude oil from the ground are seen in experiments by Southwest Research Institute at San Antonio, Tex., which may lead to reduction of viscosity of tar-type crude by gamma-ray treatment.

Shock-Wave Tubes May Power Spaceship

Tubes that duplicate shock waves from the sun may be used to provide thrust to rocket ships in outer space. Such solar shock waves travel at more than a million miles per hour from the sun to the earth. The shock tubes were developed at the Avco-Everett Research Laboratory in Everett, Mass. They produce such high temperatures with small use of power that they also may be used to help harness the power of the hydrogen bomb for peaceful uses. Developer of the electric tube is Dr. Richard Patrick of the laboratory. He describes the operation of the tube in the following way: A rarefied mass of hydrogen gas, confined by a magnetic field at room temperature, is contained in the 30-inch-long tube. A four-billion-watt electrical impulse lasting two-millionths of a second is discharged into the tube. The gas temperature suddenly goes up 1½ million degrees, and the hydrogen atoms are stripped of their electrons, or ionized. In this split second, the hydrogen ions are shoved a million miles per hour and the shock-wave front is produced.



WALBOARD TOOLS

for the DRY-WALL CRAFTSMAN



HAMMER
A versatile striking face, compresses board into perfect dimple for easier "filling", maximum striking power with no bruising or defacing.
No. WH-11 Price \$8.00



UTILITY SAW
An all-around saw: Cuts wood, masonry, wallboard, etc. Heavy duty blade, sharp point for easy penetration without pre-drilling.
No. US-71 Price \$1.95



T-SQUARE
Measuring and cutting true sharp openings, 22½" Head 47½" Blade.
No. TS-31 Price \$9.00



CIRCLE CUTTER
Cuts sharp clean round holes, up to 12" in diameter. One turn of Handle and the Circle is cut.
No. AC-31 Price \$4.00



ROLL LIFTER
Heavy duty corrugated lift-bar with plenty of leverage and foot room. Forces board against wall as it lifts.
No. RL 42 Price \$3.50

If Not Available Locally . . . Order Direct.
Complete catalog available. Write
WALLBOARD TOOL and EQUIPMENT CO.
1708 Seabright Avenue, Long Beach 13, California—Dept. E
Dealer inquiries invited.

ELECTRIC WELD - BRAZE & CUT

REPAIR MOST EVERYTHING MADE OF METAL

Home Appliances, Auto parts, Farm-garden equipment, toys. Make and repair playground equipment, lawn chairs, tables, ornamental iron work, gates, wagons, etc. Solder, heat, bend, and straighten, with terrific heat from arc torch.

Cut and weld up to ¼" steel plate. A million uses for Home, auto, farm, inventors, factories, etc. Works from any home 110 volt plug-in. Complete with dark welder's mask, arc torch, supply of carbon welding and brazing rods and complete Welding Instruction Book. Efficient—durable—1 year guarantee. Wt. only 4 lbs.

SEND ONLY \$3 (cash, ck, mo) and pay postman \$9.95 plus COD postage on arrival or send \$12.95 and we will send postpaid. Ideal gift for mechanically minded home owners, relatives, friends. Order now for early delivery. Available only from:

MIDWAY WELDER Dept. DPM-10 Kearney, Nebraska





.380 BROWNING PISTOL

\$19.95

complete with six accessories

Stock No. X33AW

OUR FABULOUS OVERSEAS PURCHASE! You receive one .380 Cal. postwar Browning pistol made for Royal Swedish officer corps in perfect unissued condition plus 3 clips brand new tooled buff cowhide belt holster, polished leather lanyard, oil and patch case & cleaning rod (all official accessories), a \$60 value. Fires standard U.S. .380 pistol ammo available everywhere.

TO ORDER: Send check, cash or M.O. \$5 deposit for C.O.D. Shipped Exp. Coll. F.O.B. Pasadena. Enclose signed statement: Am not alien, never convicted crime of violence, not under indictment or fugitive. Am 21 or over. Mass., Mo., Mich., N.Y., N.J., N.C., R.I., Omaha, N. Orleans, require permit. In Calif. order thru local dealer. Dealers inquire. **10 DAY MONEY BACK GUARANTEE.**

GOLDEN STATE ARMS CORP.
386 W. Green Street, Pasadena 41, Calif.



FORTUNES IN DIVING

Train at Home in Spare Time

Mail Coupon Today for Amazing Free Booklets

Here is one of the greatest opportunities of our time. Make big money fast in Skin and Lung Diving. Trained divers needed in hundreds of industries and by the government. Build a successful business of your own. Hourly rates among highest paid in any field. Training program by E. R. Cross, world famous master diver.

A Job Waiting for You Just as Soon as You Start Your Training

You can have a job in the big, profitable field of Skin and Lung Diving just as soon as you start your training — a job offering really big pay opportunities. You have a chance to immediately add to your income with good part time earnings — and build up into a full time big money position.

Divemaster—Authoritative Home Training Program

You get thorough, comprehensive training by a man many consider the greatest living authority on Diving. The Divemaster training program is illustrated by hundreds of diagrams, charts, drawings, photographs. Send the coupon for the booklets — see the facts about this program for yourself.

MAPS OF SUNKEN TREASURE

Included in the program are maps of sunken, lost, buried treasure. These large, full size maps in color show location of buried treasure in both hemispheres.

DIVEMASTER

5637 W. 63rd Place, Dept. PM 109, Chicago 38, Ill.

Send me Free Booklets and Information about Diving.

Name Age.....

Address

City State.....



DIPLOMA AWARDED—CERTIFIED MEMBERSHIP CARD

Upon enrolling you receive your card showing you are a Certified Member and are participating in the Divemaster Skin and Lung home training program. Upon graduating you receive a large, beautiful diploma designed in deep blue against a rich gold background.

Free Booklets—Mail Coupon

Big Illustrated FREE Booklets have detailed information about everything used in Skin and Lung Diving. Get the Facts—Mail Coupon Now! DIVEMASTER, Dept. 109, 5637 W. 63rd Place, Chicago 38, Ill.

ENGINEERING DEGREES

EARNED THROUGH HOME STUDY

Mechanical, Civil, Electrical, Electronics, Physics. Also Liberal Arts & Business Administration

PACIFIC INTERNATIONAL COLLEGE OF ARTS & SCIENCES

Primarily a correspondence school — Resident classes also available

5719-T Santa Monica Blvd., Hollywood 38, Calif.



MAKE YOUR FORTUNE

Sell famous Spring-Step Cushion Shoes for all the family—men, women, children and babies! Earn big money daily plus Cash Bonus and Retirement Income with amazing 2-minute demonstration that sells on sight. Big repeat business. Full or spare time. America's Biggest Selection of Shoes for all the family. Free outfit given. No investment ever. Write today.

ORTHO-VENT SHOE CO., Inc.
11910 Brand Road Salem, Virginia



Form Plastic Shapes With PLASTI-FORM

Plasti-Form is an electrically heated forming tool used in forming thermoplastic sheet and in laying up fiberglass cloth over molds to form complex shaped parts, building and repair of fiberglass boats, surfboards, etc. Can also be used to form and repair standard shapes. Ideal as a laboratory or workshop tool and for prototype work. Complete tool as shown consists of heater unit and 5 quick-change heads. Write for Bulletin PF-3.



ONLY \$14.95 p.p.

ERA ENGINEERING INC.

1009 Montana Ave.

Santa Monica, California

LEARN UPHOLSTERY

in your spare time

run your own business AT HOME



FREE TOOLS WITH COURSE!

FREE BOOK with sample lessons

with course

YOU MAKE SLIPPER CHAIR

CLUB CHAIR

OTTOMAN

PLUS SLIP COVERS

Yours to Keep or Sell

BE YOUR OWN BOSS

Earn more from the start! Set up your own profitable business, in your own home, enjoy steady income, independence for life. You're in demand in the booming field of Custom Furniture Upholstery. Right off you start learning and earning with tools, complete frames, fabrics and materials, included FREE with N. Y. State-approved UTS course. You learn skilled professional custom upholstery, reupholstery, furniture finishing, repairs, how to make beautiful slip covers, cushions and draperies. EARN WHILE YOU LEARN, in your spare time AT HOME... the UTS easy way.

FREE ILLUSTRATED BOOK—FREE SAMPLE LESSON Get ready for well-paid job and big profits, from steady work, as your own boss, running your own business. Mail coupon NOW for FREE BOOK! Training in N. Y. School also available. **VET APP'D. ACCREDITED BY N.H.S.C.**

UPHOLSTERY TRADES SCHOOL
Dept. HR-310, 721 B'way, N. Y. 3, N. Y.

Please send me FREE book, "Your New Way to a Successful Career," and FREE sample lesson. No obligation—no salesman will call.
 Home Study Training in N. Y. School

Name
Address
City Zone State
 Check if Korean Veteran



Make "Pro"
Enlargements
in your Home
Tonight!

with a famous

BESELER DARKROOM

... in your own basement, bathroom,
kitchen, closet or clubhouse!

Taking pictures is twice the fun when you make them into giant enlargements. Outfit with lens, chemicals, paper, trays, easel, timer. Beseler 23C Enlarger... if purchased individually, would cost \$287!

DENVER WEST 8206

Complete Outfit

\$195

MAIL THIS COUPON TONITE!

CHARLES BESELER CO.
219 S. 18th St., East Orange, N. J.
Please rush my FREE booklet,
"Fun in the Darkroom."



NAME _____

ADDRESS _____

CITY _____

ZONE _____

STATE _____

©1968, Charles Beseler Company



MUSICAL CHURCH KIT

(Plays Silent Night.) Beautiful all wood 11 inches high. Many lovely features. Regular Retailer \$7.95. Complete Kit \$3.95 P.P. Sell Them!

PILTZECKER IMPORTS, Wood-Ridge, N. J.

High School at Home

MANY FINISH IN 2 YEARS

No classes. No time wasted going to and from school. Progress as fast as your time and abilities permit. Standard H.S. texts supplied. Thousands enroll each year in this 62-year-old school. Send for FREE descriptive booklet.

AMERICAN SCHOOL, Dept. H745
Drexel at 58th St., Chicago 37, Ill.

Without obligation, please send FREE descriptive booklet.

Name _____

Address _____

Accredited Member National Home Study Council



Dial Located in Handset On Latest Bell Telephone

Under test by consumers, a Bell telephone has a dial that is built into the handset. The dial, complete with night light, is expected to be easier to see and to operate than a dial mounted on the phone base. When the handset is placed on the mounting, the telephone takes on an oval configuration. Some 250 of these phones are being installed in New Jersey homes and business places to test public reaction.

Former Luxury Yacht Becomes Fish-Bait Factory

Two California bait-fish suppliers have converted the 65-foot schooner *Hispaniola* to a floating frozen fish-bait plant. They have installed quick-freezing brine tanks and a low-temperature holding room. Independent of shore operations, the suppliers now are equipped for extended cruises along the California coast, where they can catch bait fish, freeze them immediately, and deliver the frozen bait to customers.

Silicon Carbide Tube Would Improve TV

Use of silicon carbide as an electron source may enable scientists to give new electronic tubes the power of vacuum tubes and the minimum heat and greater efficiency of transistors. Such "transistized electronic tubes" would improve TV. The silicon carbide, which would replace the present hot cathode structure as the electron source, would permit a more powerful tube that would emit little heat.



LOCATE HIDDEN TREASURE

JEWELRY, COINS, METALS, MINERALS,
WIRES, PIPE, ETC.

AUTHENTIC U.S. ARMY PORTABLE MINE DETECTOR

ORIG. \$233.00 **\$19.50** BATTERIES \$3.00 EXT.
EXP. CHGS. COLLECT

Model SCR625. Detects objects up to 24" depth. Comes complete in fitted chest with bulbs and instructions. Chest is 28 1/4" long, 15" wide, 8 1/4" deep. Instrument is ideal for electricians, plumbers, utility companies, mineralogists, beach combers, scouts, etc. Like-new condition.

A.M. AIRCRAFT PARTS CO.

307-309 West Broadway, New York 13, N. Y.

the easy way out BUMP-IT door latch



Opening a screen or storm door with your hands full of laundry or packages is easy with a new door-wide bar that has a built-in latching mechanism. A little body pressure anywhere along the length of the anodized aluminum bar and the door unlatches. It can be readily installed on any wood or metal screen-storm door. Beautifully designed, money back guarantee. Price complete \$4.98. Send check or money order.

Dept. PM, 3119 E. 26th St.

HIAWATHA METALCRAFT, INC. Minneapolis 6, Minn.

\$ POPULAR MECHANICS MEANS MORE MONEY IN YOUR POCKETS

POPULAR MECHANICS, the magazine that brings you money-saving ideas now brings you a perfect money-making opportunity.

We are looking for more men and women to introduce our magazines in their neighborhood, to accept orders for Popular Mechanics and other leading publications. If you have been looking for a way to earn a little extra each week—here's the answer!

No waiting for payday, you pocket your earnings right away! No experience necessary, you work when you please, as much as you please, your home is your office, and you are your own boss!

YOU CAN EARN \$10.00, \$25.00, \$50.00 right away with our new Popular Mechanics Subscription Plan. **SEND NOW!**

Popular Mechanics Dept. 1059-B
250 West 55th St., N. Y. 19, N. Y.

Please send me your subscription plan!

Name _____

Address _____

City _____ Zone _____ State _____



YOU can earn more

More money, higher hourly pay, a home or business of your own—all these and many other advantages are yours when you know a specialized trade. You learn to earn big pay in our large, block long, modern equipped Chicago school and shop. Training in Chicago is easier than you think. No previous experience necessary. We help you find part time work and living quarters while you train. Day, evening, or part time courses. Free job placement assistance after you graduate. We have more job openings than graduates to fill them in some trades. You learn by actually using the tools and equipment under personal supervision of skilled technicians. Minimum class room instruction. Greer Shop Training, with 57 years of continuous operation experience, is the largest trade school in the world and is recognized by industry. Greer established 1902.

APPROVED FOR CIVILIANS OR VETS

SHORT TERM DIPLOMA COURSES IN

- DIESEL MECHANICS
- AUTO MECHANICS
- BODY & FENDER REPAIR
- GAS-ARC WELDING
- REFRIGERATION —
AIR-CONDITIONING
- MACHINIST
- ADVANCED MACHINIST —
TOOL & DIE

ENGINEERING COURSES

These courses teach practical and technical phases and lead to a degree. They are designed to prepare men for supervisory positions in Diesel-Automotive and Refrigeration-Air Conditioning fields. Students with high school education, or equivalent, will be accepted.

- DIESEL AUTOMOTIVE ENGINEERING.....27 months
- REFRIGERATION & AIR COND.
ENGINEERING18 months
- WELDING ENGINEERING18 months

Start your career with Greer by checking your interest above and mail coupon for complete information at no obligation.

NAME _____ AGE _____

STREET _____

TOWN _____ STATE _____

BOX J VET

with
GREER shop
training

2236 S. Michigan Ave., Chicago 16, Ill.

8" TILT ARBOR SAW

1959 MODEL
BELOW COST

BLADE TILTS — TABLE STAYS LEVEL

Heavy duty all cast iron and steel construction. Precision ground cast iron table. Price includes massive cast iron mitre gauge and patented motor drive that fits any motor. Cross cuts, rips, bevels, mitres, dadoes, cuts compound angles — everything expected of saws costing four times as much. Depth of cut adjustable; 0" to 2 1/4" — table always level. Send check or M.O. \$2.00 deposits on C.O.D.'s.

Shipped
Complete
as Shown

NOW
\$14⁹⁵
WITH
BLADE



SPECIAL BARGAIN — This saw is our 1959 model. Each saw is brand new — sent to you in factory sealed cartons. Sold and guaranteed direct from the factory to you at a fantastic bargain.

FREE 10 DAY TRIAL — MONEY BACK GUARANTEE

Try this famous saw 10 days. If you are not satisfied that it does the work of any tilt arbor saw, regardless of price, return for immediate money back refund.

Sent Express Collect

We reserve right to refund money if stock is exhausted

AMERICAN MACHINE & TOOL CO.
ROYERSFORD 3, PA.



YOU NEED THIS

FREE GIANT 1960 B-A CATALOG

A Complete Buying Guide for Everything in

**RADIO 1960
TV
ELECTRONICS**

ANNUAL
CATALOG
601

BA
SINCE 1927

Guarantee

204
KING-SIZED
PAGES

EVERYTHING
IN RADIO
TV AND
ELECTRONICS

100'S OF
NEW ITEMS
LISTED HERE
FOR 1st TIME

21 PAGES
OF BARGAINS
NOT IN ANY
OTHER CATALOG

BURSTEIN-APPLEBEE CO.

Dept. PM, 1012 McGee St., Kansas City 6, Mo.

Send Free 1960 B-A Catalog No. 601.

Name.....

Address.....

City..... State.....

SEND
FOR IT
TODAY



"Molectronic" Silicon Crystal Replaces Oscillator

Smaller than the pupil of this girl's eye, this tiny slice of silicon crystal will perform all the functions of a miniature oscillator as a light-sensing device for a satellite telemetry system. A product of Westinghouse solid-state-systems research, it replaces all the transistorized electronic equipment on the table in the foreground, yet will be vastly more reliable because of its simplicity of structure.

Librarian of Future May Be Memory Machine

Library machines that look up references for you and summarize their contents in as many words as you wish are forecast within 20 years. Such an information-retrieval machine would hunt through memory drums on which the complete texts of millions of documents might be stored. It would set aside all references to a desired subject, then assemble the facts from each reference and present them in smooth sentences. The chief stumbling block to such machines at present is that humans must assign subject headings or "descriptors" to the masses of material. This bottleneck could be eliminated by designing another machine, one that would analyze the documents and write descriptions or abstracts of their contents. It is expected that this rudimentary form of translation machine can be perfected long before machines are developed that can make good idiomatic translations.

only 27 months for engineering degree

Realize your dream of becoming a graduate engineer. Then promotion will not pass you by. Share rewards awaiting college men . . . higher income . . . rapid advancement. Important firms visit Tri-State campus to interview seniors. Approved for veterans. *Bachelor of Science Degree in 27 months* in Electrical Engineering with either Electronics or Power major . . . also in Mechanical, Civil, Chemical, Aeronautical Engineering. *In 36 months* a B. S. in Business Administration (General Business, Accounting, Motor Transport Management majors). For earnest, capable students. Small classes. More professional class hours. Well-equipped, new and modernized buildings and labs. Modest costs. Year-round operation. Enter Jan., Mar., June, Sept.

Write J. E. McCarthy, Director of Admissions, for Catalog and Career Book.



TRI-STATE COLLEGE

4109 College Avenue Angola, Indiana

"\$7,108.50 First Year SERVICING RADIATORS!"

— Hank Konter, Newcastle, Wyo. Make good money servicing auto-truck-tractor radiators with new Inland 1-Piece Radiator Shop. Easy to test, clean and repair radiators. Inland, world's largest radiator equipment mfr., trains you free. Small down payment starts you. Proved merchandising assures volume. Profitable dept. for garage or service station. Write INLAND MFG. CO., Dept. PM-10, 1108 Jackson St., Omaha 2, Nebr.



NEW!

MASS PRODUCTION MAKES THESE PRICES POSSIBLE!

Only world's largest boat kit maker can deliver such quality at such prices! Write for free color catalog, kits from \$42.00, Freight included.

12 ft. runabout \$39.50 FREE COLOR CATALOG!



TAFT MARINE WOODCRAFT

Dept. PM-1059 636 39th Ave. N.E. Minneapolis 21, Minn.

250 POWER



Telescope Lens Kit only \$3.49 postpaid

Conquer Space, Explore the Universe, Planets, Moon Craters, New Stars, etc. Complete Lens Kit consists of 80 inch focal length ground and polished objective lens, eyepiece lenses for 50 POWER, 100 POWER, 150 POWER, 200 POWER, 250 POWER, and all necessary lens fittings. Easy to make from simple step by step instructions. (Tripod and mount not included.) Money back guarantee.

BUSSE SALES CO., Hartford, Conn., Dept. PM-80

MEN PAST 40

Afflicted With Bladder Trouble, Pains in Back, Hips, Legs, Nervousness, Tiredness.

If you have these troubles, particularly bladder trouble, then your condition may be traced to Glandular Inflammation . . . a constitutional disease. Neglect of this condition often leads to premature old age and sometimes incurable malignancy.

The Excelsior Medical Clinic has a New Free Book that tells how thousands of men have been successfully treated here at Excelsior Springs for Glandular Inflammation by NON-SURGICAL Methods. They found soothing relief and a new outlook in the future of life.

This Free Book may prove of utmost importance in your life. Write Today. There is no obligation.

Excelsior Medical Clinic, Dept. B6129, Excelsior Spgs., Mo.



MEN! Make up to \$1,000.00 IN A MONTH!

without "SELLING"

Sensational Demand for Low-Priced Fire Alarm PLUS Sure-Fire "No-Selling" Plan Offers Ambitious Men Huge Profit Opportunities

AMAZING NEW INVENTION



Even beginners who never sold anything in their lives are cleaning up unbelievable profits with the first practical effective, low priced Fire Alarm ever invented . . . needed, wanted in homes, factories, offices, stores, on farms, for boats, everywhere. Professional salesmen are making biggest profits in years! Later in this ad I'll tell you about the plan that's producing orders for 1 to 12 Fire Alarms per sale from 8 out of 10 prospects . . . without selling. Here are the facts about the Fire Alarm. It hangs on the wall like a picture—no wiring, no installation. It's always on guard . . . It 'smells' a fire before danger point. When temperature rises, Fire Alarm goes off automatically, howls loud warning that can be heard 1/5 mile, wakes up soundest sleeper, give precious time to put out fire, call fire department, or escape. And it sells for only \$4.95 with profit up to \$2.70 on each one.

Nearest Thing to AUTOMATION SELLING



With our field-tested plan customers sell themselves. No cold canvassing. No hard selling. It's the nearest thing to 'Automation Selling.' Imagine a sales plan even a child can use successfully because the sales tools we give you (and which you leave with your prospects) do all your selling even while you sleep! No room here to give you all the details but if you want big money fast rush the coupon now.

Make This Lighted-Match Demonstration

Sensitive! Lighted match triggers Alarms in 3 seconds.

Free Sales Kit

Send no money. Just rush coupon below for all the exciting moneymaking facts, complete Illustrated Sales Kit, everything you need to make money your first day. Learn how selling only 20 Fire Alarms a day pays

Made \$26.52 in 3 Hours!

"Received first shipment about noon. Worked 3 hours and made \$26.52 profit. It's a terrific seller!" —Stanley

you \$1,080.00 profit in a month. No competition anywhere. Get in on the ground floor now. Rush this coupon.

MERLITE INDUSTRIES, Inc.

(ALARM DIVISION)

114 E. 32nd St., Dept. F-15E

New York 16, N. Y.

ALVIN WESLEY, Sales Manager
Merlite Industries, Inc. (Alarm Division)
114 E. 32nd St., Dept. F-15E New York 16, N. Y.

Rush FREE SALES KIT and full details about your "No-Selling" plan which gives me opportunity to make up to \$1,000.00 in a month without cold canvassing and hard selling —automatically, I am not obligated.

Name _____

Address _____

City _____ Zone _____ State _____

In Canada: Mopa Co., Ltd., 371 Dowd St., Montreal 1, P.Q.

Ice Machine Makes Longer Lasting Snow Cones

Syrup is cooled in same machine that makes snow in the mechanism below. Cold syrup prevents snow cones from melting prematurely

Longer lasting snow cones for the kiddies are turned out by a single-unit snow-making machine. The model combines the snow-making mechanism with syrup containers that are positioned atop the snow compartment to cool the syrup. This produces longer lasting cones because the snow does not melt prematurely when cold syrup is poured over it. Syrup at atmospheric temperature causes the snow to melt quickly. The machine also eliminates the need for a separate syrup-cooling system. Ice is inserted in the top of the machine, which has a capacity of 50 snow cones every 30 seconds.



High-Altitude Radar Photographs Earth

Radar photographs of the earth, that show cities, rivers, islands, mountains and ships, have been made from a balloon soaring 100,000 feet above the earth. The equipment is a modified version of a new Sperry radar system that gives pilots a maplike picture of the earth and that also may be used for all-weather navigation.

Improve Your NIGHT DRIVING Vision INSTANTLY



Now you can IMPROVE your NIGHT vision and ELIMINATE dangerous GLARE at once with this amazing new invention — LITENITE NIGHT DRIVING GLASSES. These remarkable glasses are made of special amber lenses that let through INFRA-RED light. INSTANTLY you see more clearly! Headlamps of oncoming cars look like soft amber lights—yet everything else is in sharp focus. Amazing, unbelievable until you actually put LITENITE on! LITENITES are NOT sunglasses but scientifically developed NIGHT LENSES used by airplane pilots to see more clearly through darkness and haze. (Wonderful also for WALKING at night, TV and night sports. (Glasses can be worn by anyone since they are not prescription.)



NOT THIS — BUT THIS

Beautifully made with 24-KARAT GOLD-PLATED Aviation frame, comfortable temples, adjustable nose-pads, wide-angle lenses. FREE! Rich-looking Leatherette Carrying Case. TRY AT OUR RISK for full week. MONEY BACK if you don't say night driving is a pleasure! Send check or money order — or order COD plus postage.

REGULAR Style only \$2.98. CLIP-ON Style for use over prescription glasses only \$2.25. State STYLE and whether for MAN or WOMAN. DE LUXE Style with large Rhodium-plated frame — \$5.00.

STUYVESANT TRADING CO., INC., Dept. 374
130 W. 42nd St., New York 36, N. Y.



FREE

MUSCLE BUILDING
INFORMATION

Sensational New Methods

Less Time—Less Effort—Better results

BODY-TONE, Box 638, North Miami 61, Fla.

— TIPS & TECHNIQUES —

MACHINE TOOL RECONDITIONING
& THE ART OF HAND SCRAPING (3rd printing)

SEND FOR FREE FOLDER DESCRIBING
ILLUSTRATED MANUAL FOR MACHINISTS

Machine Tool Publications, 382 Holly Ave., Saint Paul 2, Minn.

\$15

HOUR

earn as TAX EXPERT

Our students earn as much as \$3,000 in 3 short months preparing income tax returns in spare time. Also operate lucrative year-round Business Tax Service, Digitized home-office business. Experience unnecessary. We train you; help you start. State approved home training program. Write today for free prospectus.

UNION INSTITUTE, Lakewood, 20D, N. J.

More Comfort Wearing FALSE TEETH

Here is a pleasant way to overcome loose plate discomfort. FASTEETH, an improved powder, sprinkled on upper and lower plates holds them firmer so that they feel more comfortable. No gummy, gooey, pasty taste or feeling. It's alkaline (non-acid). Does not sour. Checks "plate odor" (denture breath). Get FASTEETH today at any drug counter.

OWN a BUSINESS

Be a Specialist in Booming Industry



Get in on the ground floor of a booming \$750 million a year industry. Fill the need in your area for safe, effective "on location" cleaning of carpets and upholstery. Every home houses a customer! We'll train and establish you in YOUR OWN lifetime business! Start part-time if employed. You'll be trained by a nearby dealer and at 50-hr. school to get you quickly established. You provide 6 services to multiply profits. No shop needed. Just 2 jobs a day nets \$8,750.00 first year. We back you with 27 services: counseling, nat'l advg., McCall's, Parents, etc., conventions, advg. kits, others. Booklets explain everything—no obligation, no salesman will call. Send for Free Booklets.

DURACLEAN COMPANY
9-160 Duraclean Bldg., Deerfield, Ill.



Draw CARTOONS

EARN BIG MONEY...

LEARN AT HOME IN SPARE TIME!

No previous training or art ability necessary with the Famous System of Manual Training!*

*U. S. Pat. applied for

Cartoonists are in greater demand than ever before—by magazines, newspapers, movies, television, ad agencies, art studios. As a successful, Continental-trained Cartoonist, your earnings are not limited. A high, professional income and greater personal growth can be yours. The "Famous System of Manual Training" has taught thousands of men and women, now profitably engaged in cartooning. A wonderful pastime or hobby, too. Amuse yourself, your friends.

LEARN FAST—THE MODERN WAY

The Famous System of Manual Training is a unique, new, different concept of art instruction developed by long-experienced,

highly skilled professional cartoonists and instructors. You learn quickly and thoroughly by starting to cartoon immediately, without tedious study or exercises.

EARN WHILE YOU LEARN

Many Continental students start earning a good spare or full-time income after first few lessons. You can work right in your own home, hold your present job, make money at the same time.

The Famous System of Manual Training makes other methods and courses obsolete. Learn rapidly and easily with our modern, streamlined, personalized Method. Approved by educators and cartoonists everywhere.

YOU ARE UNDER ARREST!

Help Bring Crooks to Justice Through Scientific CRIME DETECTION!

We have taught thousands this exciting, profitable, pleasant profession. Let us teach you in your own home. Learn Fingerprinting, Firearms Identification, Police Photography, Secret Service Methods thoroughly, quickly, at small cost. Over 800 of all American Bureaus of Identification employ I.A.S. students or graduates. Write for FREE "Blue Book of Crime."

(A Correspondence School Since 1924)

Institute of Applied Science, 1920 Sunnyside Ave., Dept. 1357, Chicago 40, Ill.

MEN WANTED

Earn \$100 Per
Week and up
AUTO DIESEL
MECHANICS

Master a trade with a future—learn Auto-Diesel mechanics in our shops. You learn with tools on real equipment. Earn while you learn. Many of our graduates earn \$100 per week and up.

No previous experience necessary. Day and night courses. Approved for veterans. Write for free bulletin.

NASHVILLE AUTO-DIESEL COLLEGE

226 7th Ave., N., Dept. 75

Nashville 3, Tenn.



Exclusive Double-Bearing HEAVY-DUTY PUMPS

IRRIGATE • DRAIN • CIRCULATE • SPRAY
Use 1/4 HP motor or larger... 1 HP for up to 7,500
GPH; 1,000 GPH 60" high; or 3,000 GPH from 25' well,
1 1/2" inlet, 1" outlet, Stainless shaft.

TYPE K-2 oil-less bronze bearings. Won't rust... \$10.95

TYPE XB—Ball bearing model... \$12.95

*outpaid if cash with order, then your order today

MONEY BACK GUARANTEE

Centrifugal and Gear Pumps in All Sizes

LABAWCO PUMPS, Belle Mead 2, N. J.

GET INTO ELECTRONICS

V.T.I. training leads to success as technicians, field engineers, specialists in communications, guided missiles, computers, radar, automation. Basic & advanced courses in theory & laboratory. Assoc. degree in 29 mos. B.S. obtainable. ECPD accredited, G.I. approved. Graduates with major companies. Start Feb., Sept. Dorms, campus. H. S. graduate or equivalent. Catalog.

DEPT. D VALPARAISO TECHNICAL INSTITUTE VALPARAISO, INDIANA

MAKE BIG MONEY Selling 100% Waterproof Vulcanized Leather Boot

FREE OUTFIT STARTS YOU! Make \$10 to \$75—as much as \$250 extra per month with Mason's 100% waterproof leakproof LEATHER boot. VULCANIZED seams. Water shedding, "breathing" leather. Guarantees dry feet. Means a mountain of cash profits. One of 230 Mason dress, work, sport styles for men—women, 250,000 pair factory stock. Sizes—2 1/2 to 15...AAAA to EEEE. Send for Free Selling Outfit.

MASON SHOE MFG. CO.
Dept. F-718, Chippewa Falls, Wis.



WE SUPPLY EVERYTHING YOU NEED

You receive the Big Professional Kit of supplies and equipment without extra cost—everything you need during your entire Course. Includes special Articulated Model for drawing any human pose. Valuable later on in your own Studio or Professional Career. Yours as a student.



GET ALL THE FACTS... BIG, COLORFUL BOOK YOURS FREE

Full details of our patented System, plus pages of useful, fascinating information are contained in our Free Catalog... yours for the asking. Use the coupon now.

Investigate and learn what Continental Schools and a Cartooning career can do for you. Full details are free. No obligation whatsoever, and we do not send salesmen. All details come to you by mail for you to read and decide. Write today!



Says P. R. Tilton, N. Y.: "I am especially thankful for your fine training, as it has already enabled me to create cartoons and drawings for a grocery chain for their weekly shopping news." G. Allred, Indianapolis, says: "I didn't believe it was possible to learn so fast. I have sold eight cartoons already—earning enough to pay for the complete course!"



Continental Schools, Inc.

4201 S. BROADWAY, LOS ANGELES 37, CALIF.

CONTINENTAL SCHOOLS, INC.
Dept. A-10 4201 S. Broadway, Los Angeles 37, Calif.
Rush Free Catalog and other information by return mail. No charge or obligation, no salesman will call.

SEND
COUPON FOR
FREE BOOK

NAME _____
ADDRESS _____
CITY _____ ZONE _____ STATE _____

Make Your Own PLYWOOD At a Fraction Of Regular Cost!

NOW for the first time you can learn at home in spare time to make quality plywood, including oak, mahogany, gum—formerly the exclusive products of large mills. Complete illustrated home study course covers every phase. Everything furnished including professional 36 inch press and all materials to make hundreds of feet of plywood. Why continue paying high prices when you can make your own plywood for pennies! Free illustrated brochure explains everything—how by following comprehensive step by step instructions you can master this art.



ROBERT A. ETIEN, B.S.
Graduate wood technologist, outstanding plywood and adhesives specialist, international consultant, authoritative writer in national technical publications, formerly large plywood plant manager. Mr. Etien designed the special press and wrote the comprehensive text for this course.

Fascinating—Profitable

Plywood making at home is now a reality for the first time. Make your own for fun and profit.

Send coupon TODAY!

ETIEN PLYWOOD SCHOOL
P.O. Box 389, Benton, Arkansas

ETIEN PLYWOOD SCHOOL
P.O. Box 389, Benton, Arkansas

Send full information and FREE Plywood sample.

P-10

NAME.....
ADDRESS.....
CITY..... STATE.....

MAKE QUALITY PLYWOOD • SAVE MONEY!

**TWICE
AS
WARM**

as any other
insulation
known to
science



**ORDER
BY MAIL**

\$18.95
+ add 25c for shipping

Wear as lightweight jacket in any weather or as under-shirt in severe weather. 100% premium quality Northern goose Down insulation gives comfort in temperatures from mild to sub-zero and does not cause perspiration as other insulations do. Action-styled tailoring for complete freedom. Silver Sand Rip-Stop nylon with harmonizing knit collar and cuffs.

Sizes S-M-L-XL \$18.95
Matching underpants also available. \$18.95

Add 25c for shipping.

**FREE 48-PAGE
CATALOG**

BEFORE YOU BUY any outdoor clothing, insulated underwear or sleeping bags, GET THE FACTS about insulations. SEND FOR YOUR COPY TODAY.

**ORDER WITHOUT
RISK — COMPARE!**
You'll agree ours is for better quality and value, or return for full refund, including shipping costs both ways.

Eddie BAUER

Seattle 4,
Washington

Dept.
36

CHILD SIZE ELECTRIC MODEL "T"



- For children 4 to 12
- 5 to 7 miles per hour
- Forward and reverse
- 10 to 20 miles per battery charge
- 6 volt auto generator for power—no rewinding

PLANS with full size patterns \$2.00

PARTS—Price list with plans \$32.50 up

COMPLETED CARS—\$105
Fully assembled, ready for 12 volt car battery. F.O.B. Ione, California.

GEBHARDT MODEL CARS
Box 44, Ione, California

Catalog of 2900 Novelties 10c

New Send 10c for amazing catalog of novelties, live animals, scientific supplies, hobbies, funmakers, planes & boats, looms, magic tricks, joke articles, unusual seeds, gadget timesavers, cameras, optical goods, projectors, movies, lucky jewelry, religious novelties, disguises, musical instruments, stamps, coins, puzzles, fortune tellers, radios, auto & bike accessories, telescopes, magnifiers, compasses, banks, smokers' gadgets, artists' supplies, printing sets, engines, motors, shockers, knives, billfolds, guns, rifles, sports, books, games, plants, etc. Send 10c. Dept. 465 Detroit 7, Michigan



BIG EARNINGS WAITING for TYPEWRITER REPAIRMEN

Skilled men are in demand in the new, uncrowded field of typewriter repair. You'll quickly step into a big-pay job or business of your own, full or part time. EARN while learning easily at home under expert guidance. Materials, tools, typewriter supplied. Write TODAY for FREE book.

TYPEWRITER REPAIR SCHOOL, INC.
Dept. K-19, 150 Park Ave., E. Rutherford, N. J.
Lic. by New Jersey Dept. of Educ.

SEND FOR
FREE
BOOK

Typewriter
Supplied

COAST TO COAST IN 90 MINUTES

See the

November Issue

for a

Glimpse of Tomorrow's
**2000 Miles-Per-Hour
Jetliners**



PAY 2 or 3¢ on the DOLLAR

for 1000's of Useful Items of

U.S. GOV'T SURPLUS

AT THE AMAZING PRICES PAID AT GOV'T SURPLUS SALES

Autos.....\$78	Tractors.....\$68
Trucks.....\$212	Motors.....99¢
Boats.....\$5.90	Typewriters \$6.80
Compressors \$9.69	Generators..\$8.78

You BUY DIRECT from U. S. Government at TREMENDOUS savings. Eliminate middlemen—Save BIG MONEY! Pay as LOW as 2¢ on the dollar. Our DIRECTORY Gov't Surplus Sales lists 100's Army, Navy, Air Force Surplus Depots all over the world. BUY JEEPS, sports equipment, hunting, fishing and photographic equipment and supplies, radio, electronic and electrical equipment, trucks, boats, airplanes. Plumbing, hardware, office equipment & supplies. Tools, machinery, furniture. This 1959 book tells how to buy Gov't Surplus DIRECT. No dealer profits to pay. Get on the gravy train NOW! Send \$1 TODAY for "Gov't Surplus DIRECTORY" to AVIATION SURPLUS, Dept. PM-10, Box 789, York, Pa.

75 POWER TELESCOPE 25X-45X-75X \$3.98

NEW 3 in one telescope, 3 variable 25X, 45X-75X magnification. Brass bound. 25 power for ultra bright images. 45 & 75 power for long range. Guaranteed to bring distant stars, moons, objects, sports 75 times closer.

Most powerful scope sold anywhere near this amazing low price. American made, 3 sections. Opens 36", closes 1 ft.; contains 4 ground & polished lenses. Can also be used as powerful compound microscope. Mass production enables us to offer telescope complete at \$3.98 postpaid. Money back guarantee.

CRITERION CO., Dept. PMB-74, 331 Church St., Hartford, Conn.

Better Than Your Own

SHOE STORE AT HOME

No investment, no experience needed. Just show magic cushion comfort to friends, neighbors, co-workers. Advance commissions to \$4.00 a pair, plus Cash Bonus, Paid Vacation, \$25.00 Reward Offer. Outstanding values for men, women, children. Money back guarantee. Shoe samples supplied without cost. Write TODAY for FREE new 84 page catalog and full details.

TANNERS SHOE CO., 395 BROCKTON, MASS.

Two-Eyelet Hit With Cushioned Comfort

ENGINEERING DEGREE IN 27 MONTHS

Students given option of studying engineering under accelerated program leading to Bachelor of Science Degree in 27 months; or the standard four-year program leading to Bachelor of Engineering Degree in 36 months. The B.S. degree in Mathematics, Chemistry, or Physics (including Nuclear Physics) may be earned in 36 months. By attending classes year-round, students can graduate in 3 years and have one year of experience and income in the time usually needed to complete a four-year college course. Preparatory courses. Thorough, practical program. Individualized instruction.

Keeping pace with progress in science and engineering. Campus. Dorms, gym, playing fields. Superior faculty. 2,000 students. New Dana Science Building. Low tuition. Earn board. G.I. approved. Enter December, March, June, September. Students from 48 states, 40 foreign countries. Send coupon for free catalog, full information. Enroll now!

INDIANA TECHNICAL COLLEGE

5109 E. Washington Boulevard, Fort Wayne 2, Indiana

Please send me free information on 27 mo. B.S. DEGREES in:

<input type="checkbox"/> Aeronautical	<input type="checkbox"/> Chemical	<input type="checkbox"/> Civil	<input type="checkbox"/> Electrical
<input type="checkbox"/> Mechanical	<input type="checkbox"/> Electronics		

on 36 mo. B. E. DEGREES in:

<input type="checkbox"/> Aeronautical	<input type="checkbox"/> Chemical	<input type="checkbox"/> Civil
<input type="checkbox"/> Electrical (Power or Electronics)	<input type="checkbox"/> Mechanical	<input type="checkbox"/> Metallurgical

on 36 mo. B.S. DEGREES in:

<input type="checkbox"/> Mathematics	<input type="checkbox"/> Chemistry	<input type="checkbox"/> Physics
--------------------------------------	------------------------------------	----------------------------------

Name _____

Address _____

LEARN MEAT CUTTING AT NATIONAL

Pay After Graduation



The steady dependable trade of Meat Cutting taught easily in 8 short weeks. YOU LEARN BY DOING under actual meat market conditions in big modern school at Toledo.

For beginners or men with experience. Get a profitable store of your own. Remember, PEOPLE MUST EAT! Big pay jobs. Free employment help. Thousands of successful graduates.

Buying, cutting, percentage, pricing, advertising, selling, etc. A complete retail meat education. National School established 36 years. Get National training NOW. Pay your tuition in easy weekly

payments after you graduate. Send coupon for FREE school catalog — TODAY. G.I. approved.

National School of Meat Cutting, Inc., Dept. 50-X, Toledo 4, Ohio

Send me your FREE school catalog on National Training at Toledo in Meat Cutting, Meat Merchandising and Self Service Meats. No obligation. No salesman will call.

Name _____ Age _____

Address _____

City _____ State _____

Approved for Veterans

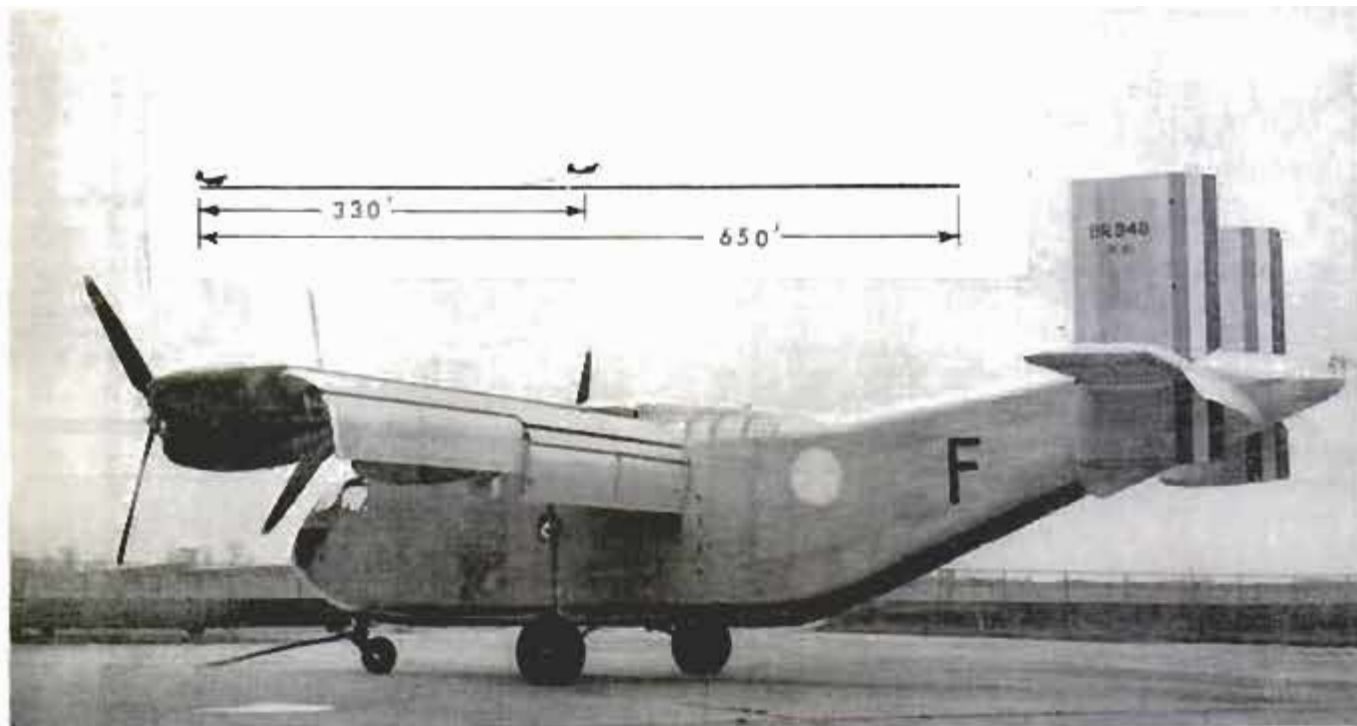

French Plane Can Take Off In 330 Feet

Breguet's 940 airplane, product of the French aircraft company's study of short take-off and landing problems, has cleared a 50-foot obstacle in 620 feet at a climbing rate of 1380 feet per minute. This was done with a total weight of 14,700 pounds. Now Breguet is set to begin production on a

941 model that can get off the ground within 330 to 650 feet, with a maximum weight of 44,000 pounds. The 941 has a reversible pitch-propeller system. This will aid rough-ground landings, where most of the braking action will fall on the propeller.

shaw shoes are designed for men whose feet are part of their job!

Here's a sturdy work oxford, with all the styling, fit and comfort of a dress oxford! Shaw's high value features include full cushion insole heel to toe with metatarsal pad and cushion side arch support . . . oil resistant Neoprene sole . . . steel arch . . . Nylon stitched . . . plus the finest leathers and craftsmanship, in black or Cordovan color. AT STORES EVERYWHERE, or write us for details.



IDEAL FOR mechanics, filling station men, mailmen, factory workers—anyone who wants comfort and style in a work oxford! Also available as high shoe.



ARCH

Today's top values, \$10.95 to \$14.95

M. T. SHAW, INC.
Coldwater, Michigan



"37 Years of Quality Shoemaking"

WHAM-O BLOWGUN SET for target and hunting

This amazing gun has accuracy like a rifle. Compression of breath in barrel gives terrific air power. You won't believe your eyes!



SPECIAL \$1.98 postpaid

Can shoot over 150 ft. Average person can hit a 2" bullseye at 30 ft. Excellent for shooting small game. For target fun with friends, set up in patio garden. Set includes four 5" steel darts, 4 suction-cup target darts, range target. Extra set 10 darts \$1. Satisfaction guaranteed. At sports dealers or send 1.98 to: WHAM-O MFG. CO., Box 10-M, San Gabriel, California

THE BATTERY THAT'S USED IN GUIDED MISSILES NOW RELEASED AS GOVERNMENT SURPLUS

For Photography, Aircraft, Mod-els, Searchlights, Radios, etc. **\$1.95** Post-**EA. paid**

Sintered-plate Nickel-Cadmium alkaline storage batteries designed for "NIKE" Missile and now surplus due to design change. A lifetime battery with no known limit of service (over 5000 recharges on test without loss of capacity). Other features: Virtually indestructible, compact & lightweight, withstands heavy shock and vibration. Flat voltage curve during discharge retains charge year or more, high discharge rate up to 50 amps. for this cell, no corrosive fumes to harm clothing or equipment, spill-proof construction, discharge in any position, indefinite storage without deterioration, operates in temperatures —60° F to +200° F. Each cell is approx. 10 ampere hour capacity. Nominal voltage per cell is 1.2 volts. (A 6 V. battery requires 5 cells.) Cell size 6" H x 2" W. x 1/2" T. Wt. 6 oz. ea. Uses Potassium-Hydroxide (30%) electrolyte. Negligible loss during lifetime service. Add only distilled water once a year. A fraction of Government cost.

Used Test Cells **\$1.95** ea. Postpaid
Brand New Cells **2.95** ea. Postpaid

ALL CELLS GUARANTEED TO YOUR SATISFACTION OR MONEY REFUNDED (LESS POSTAGE).

ESSE RADIO COMPANY, Dept. 2-J
42 W. South Street Indianapolis 25, Indiana

Nutria... NEWEST OPPORTUNITY



New fur-bearing animal now being bred in U. S. Offers huge profits to breeders. This fur is next to Mink NOW in price and will soon surpass it. 15 to 20 young per year. Most easily and economically raised animal known. 1^{1/2}¢ per day to feed. ANY CLIMATE, disease resistant. The Cabana Marrone strain is obtainable ONLY through Cabana Nutria, Inc., and its authorized dealers and distributors. For free booklet and address of Cabana ranch nearest you write:

CABANA NUTRIA, INC.
Dept. 46, 636 W. Lemon Ave., Arcadia, Calif.

PART TIME or FULL TIME... JACK UP YOUR EARNINGS

Write NOW for FREE Brochure on the WIDE OPEN FIELD of **JACK REPAIR BUSINESS**

20 YEARS OF SUCCESSFUL EXPERIENCE CONSOLIDATED FOR YOU. We furnish: Tool set that fits 90% of all jacks, detailed service manuals with 120 exploded drawings, parts lists to fit over 400 different popular hydraulic jacks, suggested sources of potential customers.



BOND TOOL CO. 616 OHIO AVE. WICHITA FALLS, TEXAS

OWN BERETTA WORLD'S FINEST POCKEY PISTOL

Sensational New Low Price Minx 22 Short \$32.00
Tealworth 7 Shot 2 1/4" bb. Auto



New it is possible for anyone to handle an automatic pistol without difficulty. Amazing advanced gun design permits loading without pulling back the slide. Kinged barrel may be loaded as single shot.

FREE! Genuine Leather Holster... Minx 4" bb. \$35.00 (illus)

Order by Mail Today... Send \$5.00 down, Bal. C.O.D.

GODFREY IMPORT Corp., Dept. PM-10, 261 Broadway, N.Y. 7

Since 1854 **YOUR BEST BUY AT DEALERS EVERYWHERE**

Selsi

BINOCULARS • TELESCOPES
MICROSCOPES
BAROMETERS

FREE Selsi ILLUSTRATED CATALOG 'M'

Write today to

SELSI CO., Inc., 29 East 22nd St., New York 10, N.Y.

OVER TWO MILLION MEN CARRY THEIR KEYS ON A Famous KEY-BAK KEY REEL



Carry your keys on a KEY-BAK Key Reel. Keys are safe, handy at your side. Keeps clothing neat, better-fitting (pocket-carried keys bulk up clothing, wear out pockets). KEY-BAK is a pocket-watch size polished chrome reel with 24" long STAINLESS-STEEL chain. KEY-BAK is worn on the belt by hobbyists, handymen, engineers, custodians, janitors, welders, and all who carry keys.

ONLY \$2.95 RETAIL

SAF-T-CHUCK KEY-BAK

— Attach to your drill press. Chuck-key can't be lost. SAF-T-CHUCK KEY-BAK protects against accidents. Write us.



OVER TWO MILLION KEY-BAKS IN USE!

WEST OF MISSISSIPPI LUMMIS MFG. COMPANY, 2242 E. Foothill Blvd. Pasadena, Calif.	EAST OF MISSISSIPPI CTL COMPANY, 1710 W. Stewart Ave. Wausau, Wisconsin
---	--

Make \$20 to \$30 a Day with this new ONE MAN MAIL ORDER BUSINESS



THIS MAN . . .

is taking out of the machine a Plastic Sealing Job—ordered by mail—only 11¢ in material cost brings back \$2.58 in cash by mail. Capacity of machine: \$25.00 profit per hour of operation.

DO PLASTIC LAMINATING AT HOME!

Would you like to get orders and cash from your mailman—then in space of hours make and ship the things people ordered from you? If you have spare time and a little spare room in kitchen, garage, or basement, get the facts about the newest and most fascinating of all home operated businesses. For the first time a simplified machine brings the fabulous profit of **Plastic Sealing and Plastic Laminating** within the reach of the small operator. Any one can learn to operate the machine with a few minutes practice—then

with our **Magic Mail Plan** can get mail orders pouring in daily with cash in every envelope. No canvassing—no selling. We even supply the circulars you mail to bring back cash and orders. Don't waste a minute. Rush your name. We'll send you, **FREE** and postpaid, pictures, prices, details, all the facts you need to start. Mail coupon or send name on postcard. No charge.

Make Thousands of Beautiful Art Creations

COSTUME JEWELRY • CIGARETTE BOXES TRAYS • CANDLESTICKS • COASTERS LAMP BASES • BOOK ENDS...ALL IN SPARKLING COLORED PLASTIC



WARNER ELECTRIC CO., 1512 Jarvis Av. DEPT. L-2-L - CHICAGO 26, ILLINOIS

WARNER ELECTRIC CO., 1512 Jarvis Av. Dept. L-2-L, Chicago 26, Ill.

At no cost to me, please rush complete details postage prepaid, I am under no obligation.

Name _____

Address _____

City _____ Zone _____ State _____

build your own STEREO HI-FI



Actress
Venetia Stevenson,
Warner Bros. Pictures

it's easy, it's fun...

High fidelity STEREO sound can be yours at savings of 50% or more. HEATHKIT step-by-step instructions, written especially for beginners, assure swift and successful assembly. Send today for the FREE catalog listing over 100 easy-to-build HEATHKITS.

HEATH COMPANY
Benton Harbor 17, Michigan

a subsidiary of Daystrom, Inc.

Please send the latest Heathkit Catalog.

NAME _____

ADDRESS _____

CITY _____ ZONE _____ STATE _____

ENGLISH Improve Yours At Home!

Win promotions, new self-confidence, with better command of English. In just 15 minutes a day master the art of "thinking on your feet"; persuasive conversation and letter writing; "short-cuts" to a more powerful vocabulary. Fascinating Sherwin Cody method teaches you at home, in spare time. Send for FREE book describing this famous method. No obligation; no salesman will call. Sherwin Cody Course in English, 5810 Central Drive, Port Washington, N. Y.

NOW

VOLKSWAGEN
RENAULT
ENGLISH FORD
METROPOLITAN
and many others.

SPECIAL

MILESMASTER® 1.5

Enjoy all the famous regulation and filtration action features of Milesmaster—the genuine Fuel Pressure Regulator ... Now, specially engineered

no increase in price ... provides smooth throttle through gears. Stops stalling, flooding, vapor lock and rough idling.

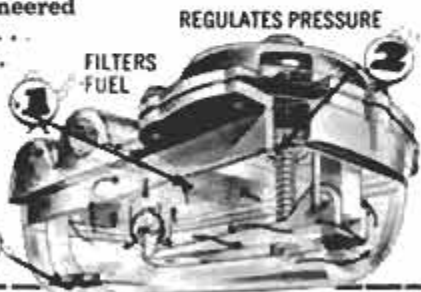

TRAPS METALLIC ABRASIVES

Take this coupon to your dealer—if he can't supply send order to ...

**MILESMASTER, INC., Dept. 105,
1550 E. 74th Place, Chicago 19, Ill.**

MONEY BACK GUARANTEE \$6.95
complete with fittings



MR. WIZARD'S SCIENCE SECRETS

Help your child unravel the mysteries of science. Over 150 experiments by Don Herbert, TV's famed Mr. Wizard. \$2.95

SCIENCE MILESTONES

Dramatic stories of the men whose daring and initiative made scientific history. Enthralling reading for youth and adults alike. \$5.00



HOW-TO-BUILD-IT BOOK FOR BOYS

Crammed with illustrated step-by-step projects covering every field of science and mechanics. A must for every boy. \$2.95

TOYS YOU CAN MAKE

More than 150 simple, easy-to-make toys that you can build from inexpensive materials. \$2.50



★ WHEREVER BOOKS ARE SOLD

OR ORDER DIRECT

Dept. PM-10, Popular Mechanics Press
200 E. Ontario St., Chicago 11, Ill.

Please rush the following books.
My check for \$_____ is enclosed.

- MR. WIZARD'S SCIENCE SECRETS
- SCIENCE MILESTONES
- HOW-TO-BUILD-IT BOOK FOR BOYS
- TOYS YOU CAN MAKE

Name _____

Street _____

City _____ Zone _____ State _____

BVI Painting is Easy! Electric PAINT SPRAYER

with built-in motor
only **\$12.95** complete
Fully Guaranteed

Just plug in, pull trigger and spray paint, varnish, enamel, garden sprays and insecticides, 3 to 7 times faster than painting with a brush! Features sapphire nozzle, instant adjustment for heavy or light spray. Foolproof and trouble-free! Available now at dealers everywhere!

Burgess Vibrocrafters Inc.
Grayslake, Illinois



MONEY FOR YOU... in hidden treasures

Locate buried treasure... coins, gold and silver. New transistorized instruments for greater locating depth, less weight, operates on flashlight batteries. Complete line priced from \$79.50. FREE literature... authentic books of known treasures available. WRITE today.

GOLDAK COMPANY
1542-10 W. Glenoaks Blvd., Glendale, Calif.

\$3.25 OR 2 FOR \$6.00!
With 40 ft. of wire. Additional wire 3¢ ft. **TESTED AND GUARANTEED.** Write for free list of all types of telephones. Shipments FOB Simpson, Pa.
TELEPHONE ENGINEERING CO., Dept. 1089, Simpson, Pa.

STUDY TO BE A DOCTOR of Psychology or Metaphysics

Obtain a Ps.D., M.A.D., or Ph.D. Be a Teacher, Lecturer or Accredited Practitioner. Teach others how to achieve Health, Happiness and Contentment. Chartered by State. Correspondence Courses only. Write for FREE book telling how.

THE NEOTARIAN FELLOWSHIP
Desk B, Pickwick Building Kansas City 6, Missouri

HYDRAULIC JACK REPAIRS

Earn While You Learn at Home
Millions of jacks in gas & auto-service stations, truckers, body-shops, riggers, factories, farms need servicing. We show you HOW—easy step by step directions—what tools to use. **EARN UP TO \$5 an hour.** In spare time, in your own basement or garage. Start your own business NOW. Write for folder No. PM10 & free bonus offer.

Institute of Hydraulic Jack Repair
P.O. Box 50, Bloomfield, N. J.

FIBERGLASS or PLYWOOD

\$41.95 Up, Frt. Pd.
EASY TERMS FREE CATALOG

50 Models
8—18 Ft.



Cruisers, runabouts, convertibles, fishing. Pre-assembled, pre-formed units. Perfect assembly by anyone. Equal factory-built. Save you 1/2 to 3/5. Catalog has natural color photos, details; paint, trailers, accessories, Fiberglass supplies. **WRITE TODAY.**

LUGER BOAT KITS

Dept. B-10, 9200 Access Rd., Minneapolis 20, Minn.

HOW TO MAKE THINGS OF PLASTICS

Complete
Low-Cost
Home Training
Course NOW
Available

There's exciting opportunities for you in Plastic's Fabrication. Fun and relaxation as a hobby! Big money as a spare or full-time business! Course teaches fibreglassing, model building and how to make molded, cast, internally carved colored plastic jewelry, toys, furniture, novelties, signs. Professionally prepared. Used by Industrial Arts Teachers. All materials furnished. For men and women.

Accredited Member National Home Study Council
SEND FOR FREE BOOKLET



INTERSTATE TRAINING SERVICE
Dept. C-3, Portland 12, Oregon
Send Free Booklet on Plastics Home Training Course.

Name _____
Address _____
City _____ Zone _____ State _____

ENGINEERING



Photo of Heald Students in Electrical Laboratory

American Industry Steps Up Its Demand for Trained Engineers. Train Now at Healds

BACHELOR OF SCIENCE DEGREE, 30 MONTHS

Degree Courses:

- Electronic Engineering
- Electrical Engineering
- Highway Engineering
- Mechanical Engineering
- Structural Engineering
- Civil Engineering
- Architecture

Diploma Courses:

- TELEVISION Color TV
- Electronic Technician
- Industrial Electronic Tech.
- Tool & Die Design
- Architectural Drafting
- Mechanical Drafting
- Structural Drafting

Approved for Veterans

Enroll Now for New Term
Heald College Ranks **FIRST** West of the Mississippi in "Who's Who in America"
Send for **FREE** Information
Heald Engineering College
Est. 1883
Van Ness at Post, Dept. P.M.
San Francisco, California

NAME _____
STREET _____
CITY _____
STATE _____

Want **BIG PAY**—
Your Own Business?

Be a

LOCKSMITH



You can quickly step into a well-paid job or start a big-profit business of your own. Shortage of locksmiths means opportunities everywhere, spare-time or full-time.

EARN EXTRA MONEY FROM THE START!

All Special Tools, Supplies Furnished Free

Age, education, minor physical handicaps don't matter in this growing, steady-income trade. You learn fast at home—gain practical experience through well-illustrated lessons. You do real jobs under the personal guidance of experts. Only school of its kind. Licensed State of N. J.; Accredited Nat'l. Home Study Council.

For a future as your own boss, or in a big pay job, send for **FREE** illustrated book. Mail coupon at once. No salesman will call. **Approved for Veterans.**

Locksmithing Institute, Dept. 110-9
150 Park Ave., E. Rutherford, N. J.



Please send **FREE** and without obligation illustrated book.

Name _____

Address _____

City _____ Zone _____ State _____



BARBELLS

**100
POUND
SET
\$12.80**

140-Pound, CHROME DELUXE Barbell-Dumbbell set only **\$19.80**. This is our feature set and is the finest ever manufactured.

Training with adjustable weight is the **BEST** way to keep fit; the **ONLY** way to develop great strength and a perfect body. As the oldest and best equipped barbell company, **BUR** gives value and prices no one can equal.

**SEND FOR FREE CATALOG
BUR BARBELL CO.
Lyndhurst 9, New Jersey**

Extra Plates Only 12c Pound

FINANCIAL HELP TO START YOUR OWN HOME BUSINESS!



Tired of being squeezed between rising prices and a *stationary salary*? Could you use a nice little home-business to bring in *extra income* from your spare time, evenings and week-ends? I can show you *how*—will even *help finance you*, if you're short of cash. Sound unreasonable? Wondering how I can afford to do it? Well, it's simple. The business I'm talking about *uses supplies*. I *make and distribute* those supplies. So do other firms—but I'm willing to gamble that when your business gets rolling you'll rather do business with a *friend* than with strangers who did not show up until you were in the money. I've gambled the same way with hundreds of others, and it has paid off by helping me build the *biggest business of its kind in the world!* The Golden Rule of "do unto others..." *always works* for those who give it a fair trial.

What is this business? It's *printing without a press*, an amazing process I call "Screen Print." With it, you can turn out printing in *gorgeous coloring* that many big shops cannot duplicate, even with presses costing *thousands of dollars!* Yet my equipment (supplied to you with my instructions) *weighs only a few pounds*, can be set up on a *small table* in the corner of your garage, basement, attic, or even a bedroom. You can earn in a *few hours* to print on paper, metal, glass, plastic, leather, cloth, and about anything you can name—even on curved or round surfaces that ordinary printing presses cannot handle at all! And I show you how to get *big-profit orders* from stores, factories, theatres, schools, and practically every type of business or organization for miles around—even by **MAIL ORDER** coast to coast.



JUST SEND ME YOUR NAME & ADDRESS—NO MONEY Remember, I'll help finance you, so *don't worry about the money*—whether you are employed or not. I'm *sure* I can help you get set in a home business that may settle your money problems forever. Just send name and address for **FREE** information, without obligation, **TODAY SURE**.

Mr. C. J. Nowak, President, Screen Print Co., Dept. 210, 15127 S. Broadway, Los Angeles 61, California

Finish HIGH SCHOOL

AT HOME

Complete 4 Years in 12 Months

diploma

Learn More! Earn More!

Enter College, professional or technical schools.

Advance Socially. Live a

Happier, Fuller Life. Individual Courses or complete schedule.

WRITE FOR SCHOOL BULLETIN, Dept. PM105
ACADEMY FOR ADULTS 30 W. Washington Chicago 2, Illinois



SIGN PAINTING

Home-Study Course — Only \$5.95

Teaches you commercial sign painting and sign building as it is being done **TODAY** in leading shops all over the country. Complete practical course for self-instruction. Shows latest methods of truck lettering, office doors, wood letters, reflecting signs, plastic, sprayed signs, gold leaf, silk screen process, up-to-date alphabets, money-making business information, etc.

SATISFACTION GUARANTEED OR REFUND! Contains all the instruction of a high-priced correspondence course. Full price, only **\$5.95**, postpaid. Or C.O.D. plus postage. No risk—order today. Satisfaction or money back! Order "Sign Painting Course," **NELSON-HALL CO., 210 S. Clinton St., Dept. KR-2, Chicago 6, Ill.**



It's FUN to do MAGIC TRICKS

Amaze—mystify—entertain! **500 TRICKS**, 1939 Edition now ready. Contains latest, best magic for pocket, club, stage. Only 10c. **DOUGLAS MAGICLAND, Dept. M. DALLAS TEXAS**



"I sometimes wonder if we'd ever be invited here if I wasn't a handyman!"

Kruger Pistol Bargain \$3.00

.12 CALIBER SINGLE SHOT

.14 MG. POWDER CHARGE

BLUE-BLACK FINISH

Crafted after famous German Luger design. Not an air or CO₂ gun. This is a small bore gun that actually shoots .12 caliber load bullets fired by light 14 mg. powder charge. Beautiful gun, swell for target shooting. 4" steel barrel in knurled styrene stock. Overall length 8 3/4 inches. This amazingly low price is due to ball-and-cap design. Comes with 50 bullets, instructions, and target. Money back if not satisfied.

send \$3 to **KRUGER CORP.**
Kruger Building, Box 51-S, Alhambra, California

ENGINEERING DEGREE IN 27 MONTHS

INDIANA TECHNICAL COLLEGE

B. S. degree (27 mo.); Aero., Chem., Civil, Elec., Mech. & Electronics, B.E. (36 mo.); Aero., Chem., Civil, Elec., Mechanical, Metallurgical, B.S. (36 mo.); Math., Chem., Physics. Prep courses, Demand for grants, Campus, 20 bldgs., dorms, gym, Low rate. Earn board. G.I. appr. Enter Dec., March, June, Sept. 1610 E. Washington Blvd., Fort Wayne 2, Ind. Keeping pace with progress

CONCRETE BLOCK HOME PLANS

\$2500 RANCH HOME



Build your own 25' x 48' Ranch Home complete for \$2500. Liv. room, kit., 3 bedrooms, bath, utility room, fireplace, carport or garage, slab or basement. Blueprints, instructions and material list \$3.00 ppd. Money back guarantee. Other plans—\$1000 Cottage, \$1150 Garage Apt., \$1900 Duplex, \$3500 Cape Cod, \$3800 Ranch Home. Free Folder.

Quality Home Plans Since 1953
MEMBER ARKANSAS HOME BUILDERS ASSOC.
BAILEY BUILDERS 308-B Hiawatha Drive Little Rock, Ark.

FREE TRIAL NEED TO ALL WHO MONEY



I'll help you get extra cash to fill your pocket-book—to live on. Supply my over 200 household products to regular customers. No previous experience or capital needed. I'll send on **free trial** an assortment of fine, full-size products to test and show. Start near your home, full or spare time. Big monthly premiums. Rush your name and home address for outfit. **BLAIR, Dept. 32DT, Lynchburg, Va.**

POPULAR MECHANICS MAGAZINE

now complete on **MICROFILM**

VOLUMES ONE THROUGH NINETY-SIX

Early volumes of POPULAR MECHANICS have been eagerly sought as collector's items. Now the monumental new microfilm collection makes this wealth of reference material available to all libraries.

Begun in 1902 as a weekly, POPULAR MECHANICS was one of the first "picture" magazines. It also pioneered the do-it-yourself idea, and its files contain plans for almost any project desired.

Ninety-six volumes — \$750.00 for the set.

UNIVERSITY MICROFILMS, Inc.

313 North First Street

Ann Arbor, Mich.

ANYONE CAN FIX ANYTHING

WITH



New Magic RUBBER

Repair All Rubber and Fabrics with a Squeeze of the tube.

Tough, elastic rubber in paste form. Seals windshield leaks, repairs convertible tops, awnings, tarps, boots, raincoats, swimming pools, hoses, raincoats, swimming pools, hoses. Dries quickly — permanent, waterproof.

AND **Magic** PLASTIC ALUMINUM

The Amazing Metal Mender with 1001 Uses

Solders, seals, repairs all metal. No heat or tools needed. It's real metal in paste form that can be drilled, filed, tapped, threaded when dry. Waterproof, gasolineproof, heatproof to 600°. For Home, Auto, Boat, Plumbing.

NEW APPLICATOR CAP MAKES SPREADING A SNAP

In 59¢ and \$1.00 sizes at all Hardware, Paint, Department and Auto Supply stores — or send \$1.00 direct to:



Magic

IRON CEMENT CO., INC

5400 Bower Avenue, Cleveland 27, Ohio

FREE! LAFAYETTE'S 1960 CATALOG



304 GIANT-SIZED PAGES

CONTAINS

HUNDREDS OF EXCLUSIVE LAFAYETTE ITEMS NOT IN ANY OTHER CATALOG OR AVAILABLE FROM ANY OTHER SOURCE — SEND FOR YOUR COPY NOW!

See the newest and finest in Stereo Tuners, Amplifiers, Cartridges and Music Systems.

Everything in Electronics

The Complete Catalog Featuring The Best Values Obtainable

LEADERS IN HI-FI

OUR

39th

YEAR

The most complete electronic supply catalog crammed full of everything electronic at our customary down-to-earth money-saving prices.

The largest selection of hi-fi components and systems; greatest savings on Lafayette endorsed "best-buy" complete systems.

EASY PAY TERMS AVAILABLE — 10% DOWN — UP TO 18 MONTHS TO PAY

Lafayette Radio

P.O. BOX 222
JAMAICA 31, N. Y.
DEPT. LJ-9

Send FREE LAFAYETTE Catalog 600

Name.....

Address.....

City..... Zone..... State.....

CUT OUT AND PASTE ON POST CARD



You can make money in

WATCH REPAIR

Learn at home the low cost Sweazey Way

Watch repairing pays up to \$6 an hour, part time watch makers report on survey. Unique and modern Sweazey home study System starts you making repairs right away on Swiss and American watches. Professionally prepared training. No previous experience needed. Special tools provided for practice. Tuition only \$5 a month. Diploma Awarded. Free sample lesson and opportunity book give all facts. Write today. No obligation.

CHICAGO SCHOOL OF WATCHMAKING
2330 N. Milwaukee Ave., Dept. 1109, Chicago 47, Illinois

FREE BOOK and SAMPLE LESSON

CHICAGO SCHOOL OF WATCHMAKING
2330 N. Milwaukee Ave., Dept. 1109, Chicago 47, Illinois
Please rush FREE BOOK and Sample Home Study Lesson.

Name _____ Age _____

Address _____

City _____ Zone _____ State _____

PAINT STRAIGHT or CURVED LINES with Sensational PAINT PEN

DECORATE Furniture, Interiors, Autos, Bikes, Model Planes, Boats, Toys, Linoleums, Wall Board, etc.

PAINTS on wood, glass, plastic, ceramics, metals, fabrics and paper. Use any color paint, glue, tempera, textile paint or underglaze; secure clean, professional decorative lines. No clog or smear.

ORDER NOW Direct or From Your Dealer Only..... **\$1.25**
Other single stripe models:
1/64" 1/32" 3/64" 5/64"
3/32" 1/8" only \$1.75 ea. Extra tips 90c each. Extra 1/4" tip \$1.20.

SPECIAL: Complete Set \$5.00
(Pen and all 7 tips) Only Single Line.

Double Stripe Model—w/s combination \$3.25 C.O.D. Postage Collect.
WENDELL MFG. CO., 4234 LINCOLN AVE., DEPT. 351 CHICAGO 18, ILL.

26 YEARS IN BUSINESS AT THE SAME ADDRESS.

Our entire stock of very slightly used **EXTRA MILEAGE TOP GRADE Tires.** (Written Insurance Guarantee). SEND AD

WHY PAY MORE? UP TO 15,000 MI. Beat the high cost of new tires.

FREE- If you buy 2 or MORE Passenger 4 ply tires, we give One tire, FREE, on Ea. Order, on Request. Does not include W. W. Truck tires or Snow tires.

WRITTEN Guarantee. White walls \$1.00 Extra	
600-16 \$6.92	670-15 \$8.82
600-16(6) 8.62	710-15 6.92
650-16(6) 9.32	760-15 6.92
750-14 7.72	800-15 6.92
800-14 7.72	820-15 6.92
750-16(6) 9.82	700-16(6) 9.92
	700-15(6) \$9.72
	750-16(8) 10.82
	700-17 10.42
	750-17 12.22
	825-20 18.92
	900-20 18.92
	1000-20 19.92
	1100-20 19.92
	1000-22 20.92

"EXTRA SPECIAL" TOP QUALITY all size 4-ply pass. **\$8.72**
FREE TIRE with 2 or more of these.—W.W. \$1.00 Extra.
GIANT TIRE SALE EA.

SNOW TIRES \$7.82 AND \$5.82 ANY SIZE
WHITE WALLS \$2.00 EXTRA
SUBURBANITE OR TOWN & COUNTRY TREAD

Thousands of tires shipped all over the U.S.A. All tires shipped F.O.B. Phila. Send Check or M.O. with this ad. Dept. 2. No C.O.D.
STANDARD 834 N. Broad St., Philadelphia 30, Pa.

NOW THE WORLD'S FINEST POCKET PISTOL CAN BE YOURS!

BRAND NEW .25 AUTOMATIC



Compact! Accurate! Always Dependable! Powerful ammunition available everywhere. A pocket pistol of excellence. Ideal for the Plainclothesman or Home Protection. Reduced from \$32.50. **ORDER NOW!** Send \$10.00—Balance C.O.D.

\$22.50

KENT'S SPORTING GOODS

Dept. P-10 114 E. Roosevelt, Phoenix, Arizona

Say GOODBYE to TV ROOF Antennas!

Just PLUG IN New "SOCKET-ENNA" **\$4.95**



Now you can discard bulky roof antenna or unwieldy indoor antenna. Revolutionary new ELECTRONIC "Socket-Enna" plugs in like electric cord, and turns all your housewiring into huge TV antenna. Brings in good reception from all directions, in almost any area. Fine also for AM-FM and SW radios. Stays out of sight, uses no current. Satisfaction guaranteed or return it in 10 days for full refund.



ZALYTRON TUBE CORP. 220 West 42nd St., New York 36.

Dept. 30-A

NEW! BUILD MUSCLES & HEALTH with BODY BUILDER



Only **\$1.00** Postpaid

This new Chest Pull Body Builder develops powerful he-man muscles F-A-S-T. Ideal for the beginner to give him a real start in championship muscularity and perfect for the more advanced body builder to combine with his regular training for faster, all around muscle growth. Body Builder is wonderful for developing massive arms, shoulders, chest and back. Mail your order today. Only \$1.00 postpaid. No C.O.D.

MEDFORD PRODUCTS, Inc.
Dept. 904E, P. O. Box 39, Bethpage, New York

**After the city,
Before the state
The ZONE keeps your mail
From being late**



The Post Office has divided 106 cities into postal delivery zones to speed mail delivery. Be sure to include zone number when writing to these cities; be sure to include your zone number in your return address — after the city, before the state.

You can make **180 amp. "HUSTLER"**

BIG MONEY

with these **LOW COST WELDERS**

"POWER-WELD" ac power plus dc weld



For a surprisingly low investment you can start a well paying business, doing repairs, construction, metal fabrication, etc. These versatile, low cost Hobart welders are easy to use. Built-in features usually found on larger, more expensive models assure professional results, long life.

The 180 amp. "HUSTLER" is a complete welding package—including accessories. It welds, cuts, burns holes, hard surfaces, and heats metal for bending and forming. Meets REA requirements.

The 200 amp. POWER-WELD furnishes DC current for welding—and simultane-

ously supplies 110/220 v. power for running lights, tools, motors, pumps, sprays, etc. Can also be used as an emergency power source to run brooders, milking machines, etc. Write today for complete details.



HOBART BROTHERS CO., BOX M-109, TROY, OHIO, Phone FE.2-1223

Free! AIRMAIL COLLECTION



Get this spectacular collection of all-different, genuine Airmails from strange, far-away countries in Asia, Africa, Europe, the exotic Orient! World's largest airmail, scarce \$23 stamp, old Zeppelin, many, many others. A truly remarkable collection containing stamps worth up to 30c each at catalog prices! EXTRA: Bargain Catalog PLUS other exciting offers. Send 10c for mailing costs. Act Now!

JAMESTOWN STAMP CO. Dept. F109PM, JAMESTOWN, N. Y.

FREE GERMAN STEEL HUNTING KNIFE



4-INCH BLADE

We give you handiest hunting and fishing knife you've ever had! Has 4-INCH LONG highly tempered steel blade—VERY SHARP! Attractive handle. We send knife FREE to acquaint you with our below-wholesale bargains. Please send 25c for handling. NO LIMIT—but send 25c handling for each knife. Order TODAY! HUNTING KNIFE, Dept. K-441, Box 881, St. Louis, Mo.

PRINTS POSTAL CARDS

Amazing New Advertising Machine!

Learn how businesses are now boosting sales in spite of conditions—with ad messages—printed on government postals with amazing new patented **CARDMASTER**. Guaranteed five years. Low price—sold direct. SEND NAME for FREE illustrated book of money-making ideas and complete unique advertising plans. Send your name today to **CARDMASTER CO.**, 1920 Sunnyside Avenue, Dept. 1210, Chicago 40, Ill.



FREE AMAZING NEW BOOK "HOW TO ANSWER ADS"



Never before have you seen anything like this. Tells you in simple language the correct way to answer ads. Gets you quicker replies—better results, and greater satisfaction. Will save you time and money and it's ABSOLUTELY FREE. No obligation whatever. Every reader of advertising should have this booklet. Send a postcard for your copy NOW. F. W. JOHNSON, Popular Mechanics Magazine, Room 600-A, 204 East Ontario Street, Chicago 11, Ill.

BECOME AN EXPERT IN TRAFFIC and TRANSPORTATION

Traffic men earn \$4,000 to \$10,000 and up. Thousands of firms need experts on rates, tariffs, regulations. We train you thoroughly in spare time at home for executive traffic jobs. Personal training under traffic authorities. Write for free book "Traffic and Transportation."

LASALLE Extension University, 417 So. Dearborn St. A Correspondence Institution Dept. 1064T Chicago 5, Ill.

NO JOB WORRIES

PLASTEX INDUSTRY needs manufacturers on small scale for big production of lamps, clock stands, Art Goods, Novelties in Plastic Marble imitation. No experience necessary. Low material makes regular 10c store sellers. Moulds furnished for fast production. Small investment brings good profit. Big wholesale orders now being placed. Ambitious men have chance for real prosperity and job security. Our NEW FREE booklet will interest and benefit you.

PLASTEX INDUSTRIES, Dept. A, 3400 Third Ave., New York 56, N.Y.

Be a BUILDING CONTRACTOR Earn BIG PAY.



OR HAVE YOUR OWN BUSINESS BUILDING REMODELING HOMES

Learn BUILDING CONTRACTING ESTIMATING in Spare Time at Home!

Men! Fortunes are being made in the billion dollar home building and remodeling field! There are tremendous opportunities for trained builders, estimators and contractors. This field offers fine big-pay jobs and opportunity to build prosperous business of your own! And, you can learn all phases of Building, Contracting and Estimating in your spare hours at home! The American Technical

Society, a not-for-profit educational institution, now offers a simplified home study training program specially planned to give you all the trade related knowledge needed to become an expert in this highly paid field. No classes to attend. Learn in spare hours at home. No interference with present work—learn while you earn. All texts furnished. Low tuition rates. Diploma awarded. Mail coupon for full details.



AMERICAN TECHNICAL SOCIETY, Dept. BH-109, 850 E. 58th Street, Chicago 37, Ill.

Please send me FREE BROCHURE and full information on your complete training program in BUILDING, ESTIMATING and CONTRACTING.

Name _____
Address _____
City _____

Superior's New Model 70 UTILITY TESTER® FOR REPAIRING ALL ELECTRICAL APPLIANCES MOTORS • AUTOMOBILES • TV TUBES

As an electrical trouble shooter the Model 70:



- Will test Toasters, Irons, Broilers, Heating Pads, Clocks, Fans, Vacuum Cleaners, Refrigerators, Lamps, Fluorescents, Switches, Thermostats, etc.
- Will test all TV tubes for open filaments, inter-element shorts, burned out tubes, etc.
- Measures A.C. and D.C. Voltages, A.C. and D.C. Current, Resistances, Leakage, etc.
- Will measure current consumption while the appliance under test is in operation.
- Incorporates a sensitive direct-reading resistance range which will measure all resistances commonly used in electrical appliances, motors, etc.
- Leakage detecting circuit will indicate continuity from zero ohms to 5 megohms (5,000,000 ohms).

As an Automotive Tester the Model 70 will test:

- Both 6 Volt and 12 Volt Storage Batteries • Generators • Starters • Distributors • Ignition Coils • Regulators • Relays • Circuit Breakers • Cigarette Lighters • Stop Lights • Condensers • Directional Signal Systems • All Lamps and Bulbs • Fuses • Heating Systems • Horns • Also will locate poor grounds, breaks in wiring, poor connections, etc.

Model 70 comes complete including 64 page book, only \$15.85

SHIPPED ON APPROVAL NO MONEY WITH ORDER—NO C.O.D.

Try it for 10 days before you buy. If completely satisfied then send \$5.85 and pay balance at rate of \$4.00 per month for 6 months—No Interest or Finance Charge! Add! If not completely satisfied, return to us, no explanation necessary.

MOSS ELECTRONIC, INC., Dept. D-670, 3849 Tenth Ave., New York 34, N.Y.
Please rush Model 70. If satisfactory, I will pay on terms specified. Otherwise I will return tester.

Name _____
Address _____
City _____ State _____

Make \$500 an Hour CASH PROFIT THE DAY YOU START!



START YOUR OWN BUSINESS AT HOME... SHARPEN HOUSEHOLD, GARDEN AND SHOP TOOLS IN SPARE TIME

Now you can turn spare time into Big Cash Profits with new Belsaw Sharp-All. Sharpen knives, scissors, shears, snips, ice skates, mower blades, hedge trimmers, grass whips, axes, chisels, screw drivers, scrapers and saws... just about any household, garden and shop tool. Your own CASH business with no inventory. No calls to make. No experience needed.

Learn how easily you can start your own spare time business. Amazing low cost easy-payment plan. Send postcard for FREE BOOK.

BELSAW SHARP-ALL CO
710 Field Bldg. • Kansas City 11, Missouri



8 FT. SPECIALS - 80c



These GIANT 8 FOOTERS can be yours, while they last, at a fraction of their value. New, genuine neoprene govt. surplus. Great for advertising, you paint your message on 'em, inflate & fly. Attracts crowds to sales, displays, openings, stores, gas stations. Fun at home for young & old and just the thing for any party or school prom. Perfect for beach or picnic. They're BIG, they're FUN, they're useful, so order yours today!

8' dia.-80c ea.... 2 for \$1.50
13' dia.-\$1.95 ea.

Postage pd. on ppd. orders.
Cal. res. add sales tax.

FRANK SALES, Dept. PM1059, 3930 Sunset Blvd., Los Angeles 29, Calif.

AVIATION CAREER

SPECIALIZED EDUCATION / PROFESSIONAL TRAINING... only 16 months to 2 years

Top-pay prestige positions, bright future in aviation. Job opportunities waiting for you as soon as you're ready. Airframe and Powerplant Technician, Aeronautical Engineering Technologist, Business or Executive Pilot. Classes in Miami.

SEND FOR FREE 48-PAGE BOOK

Embry-Riddle Aeronautical Institute
Dept. B Miami, Florida (Founded 1926)

Name.....

Address.....

City.....Zone....State.....

FOCUS YOUR

OR BENJAMIN

SMOOTH BORE BB OR RIFLED 22 - AIR OR GAS GUNS - ROUND LEAD AMMO EFFECTIVE UP TO 100 FT.

AMAZING NEW Line of REPEATERS

WITH THE LATEST IMPROVEMENT IN FAST, SURE, GRAVITY LOADING ACTION AND PIGGY-BACK SHOT MAGAZINE

\$18.95

A Shot is placed in Firing Position each time Bolt is Pulled Back and Closed. Flash Ammo Count on Full View Magazine.



No. 3600 BENJAMIN Super 100 Shot BB Gas Rifle. Non Toxic - Safe - Convenient - Uniform Hi-Velocity Power. —
No. 3620 BENJAMIN Super 85 Shot Cal. 22 Gas Rifle... \$20.95
No. 3100 Super 100 Shot BB Air Rifle. Adj. Shooting Force \$23.95
No. 3120 BENJAMIN Super 85 Shot Cal. 22 Air Rifle... \$25.95

No. 2600 BENJAMIN Super 35-Shot BB Gas Pistol. Safe — No Pumping—Uniform Hi-Power. For Target & Small Game. \$17.95
No. 2620 BENJAMIN 20-Shot Cal. 22 Gas Pistol. Economical. \$19.95
No. 1300 50-Shot BB Air Pistol \$22.50
No. 1320 BENJAMIN 35-Shot Cal. 22 Air Pistol \$24.50

FREE Catalog All Models Benjamin Single Shot & Repeaters—Cal. BB or 177 or 22. Also, Special Hunting & Fishing Knife Offer.

BENJAMIN AIR RIFLE CO., 896 MARION ST., ST. LOUIS 4, MO.

TOOLS WHOLESALE

\$100 PUTS YOU IN BUSINESS

Start your own business, sell tools to your friends and neighbors, or buy tools for your own use and SAVE MONEY \$\$\$

A MILLION DOLLAR INVENTORY AT YOUR FINGERTIPS. NO STOCK TO CARRY. ORDER AS YOU NEED IT.

BUY AT WHOLESALE PRICES. Extra \$25.00 profit on your accumulated purchases, \$1.00 refund on first purchase or refunded if you are not 100% satisfied.

THOUSANDS!! of Nationally Advertised items of Hand Tools, Power Tools, Machinist Tools, Tool Chests, Paint Sprayers, Light Fixtures, Appliances, Guns, Gifts, Toys and other items too numerous to mention.

WE SHIP COAST TO COAST White. Disc. up to 50% off
SILVO HARDWARE CO., Dept. PM10 107 Walnut St., Phila. 6, Pa.

FREE CAREER GUIDANCE BOOKLET



SKILLS for AMERICA

NOW — all in one book! The information you want and need to further your education and increase your earning power. *Skills for America* features articles on correspondence and residence schools by the nation's leading authorities. It tells how to plan your career growth—even contains detailed information on leading schools in your area. Send for your free book today!

POPULAR MECHANICS MAGAZINE, Dept. SFA-109
200 East Ontario Street, Chicago, Illinois

Please send FREE Skills for America book to:

NAME.....

ADDRESS.....

CITY.....STATE.....

Prepare the ALLIED Way for the BEST JOBS in Industry

TRAIN AT HOME
in Your Spare Time
or at Allied Institute
in Chicago

Also
for FREE
SAMPLE LESSON

SEND FOR
FREE
BOOKS

- DRAFTING
- TOOL DIE-DESIGNING
- TOOL-DIE MAKING
- IND. ENGINEERING
- IND. ELECTRONICS
- AIR CONDITIONING
- REFRIGERATION
- AUTO MECHANICS

ALLIED INSTITUTE OF TECHNOLOGY

1338-42 So. Michigan Ave., Dept. PM-109, Chicago 5, Ill.

**GIANT
MAGIC
CATALOG**



1000 TRICKS

ENTERTAIN AND ASTONISH WITH MAGIC

Get your personal copy of this BIG PROFESSIONAL CATALOG. Loaded with magic, tricks, jokes, mysteries, illusions, secrets. You can do them all. Rush name, address and only 25¢ now.

FREE MAGIC TRICK GIVEN WITH EACH CATALOG

House of 1000 Mysteries • 202-5 Pinewood, Trumbull, Conn.

**CUT ANY SIZE — ANY SHAPE
WITH Spearhead Cutter**



Handy pocket size — cuts leather, asbestos, rubber, cork, etc. — round 1/4" to 6" — any size straight and odd shapes.

Send Check or
Money Order!

935
POSTPAID

ZIMMERMAN PACKING — NORWOOD 12, OHIO



TRANSEAL PREVENTS AND STOPS LEAKS IN AUTOMATIC TRANSMISSIONS

Prevents and stops leaks due to drying, hardening or shrinking of transmission seals. Reduces gear and bearing noise... makes shifting quieter faster... smoother.

AT SERVICE STATIONS, GARAGES,
AND AUTO ACCESSORY STORES

RADIATOR SPECIALTY CO.
CHARLOTTE, NORTH CAROLINA

\$1.95

New Table Top Invention Puts You In... PROFITABLE RUBBER STAMP BUSINESS

Home Operators now make **\$9.40 AN HOUR** in business once monopolized by a few big companies

Special rubber stamps bring high prices—cost only pennies to make on new, low-cost table top machine. Run machine on kitchen table using ordinary electrical outlet. Make any kind of stamp. We'll send you free information without obligation about this established, highly profitable business, now open to individuals for the first time. For free information send name today on a post card to Rubber Stamp Div., 1512 Jarvis Ave., Dept. R2L, Chicago 26, Ill.



Now you can fix anything made of metal with
READY MIXED... READY TO USE

Liquid STEEL

IN A TUBE

No more mixing... no tools, heat, or flame. Just squeeze from tube, spread with applicator cap.

Seal and solder holes in gutters & downspouts.

Repair holes and dents in car bodies, gasoline tanks.

Seal leaks in pipes, radiators, containers.

BIG 6 1/2 oz. TUBE

\$1.00

\$1.29 in Canada

★ OTHER FAMOUS **WOODHILL** PRODUCTS

- The Original PLASTIC ALUMINUM
- PLASTIC RUBBER • CHEMSTEEL
- Available at hardware, automotive, paint, variety stores everywhere, or write

The WOODHILL CHEMICAL Co., Cleveland 14, Ohio

"Originators & World's Largest Mfgs. of Plastic Metals"

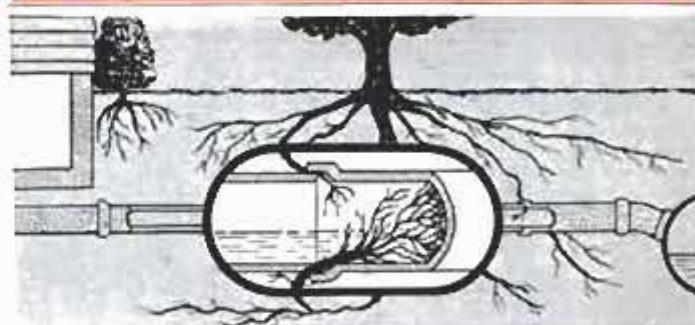

END SEWER-LINE ROOT MESS, SAVE ON COSTLY REPAIRS!

Roots are just naturally thirsty. They force their way through joints in your sewer line, eventually clog it. Toilets and sinks "back up", soon overflow. Now you can avoid costly digging or mechanical cleaning this easy, permanent way.



Pour one box of revolutionary Hercules R-D into toilet bowl. R-D kills and decomposes roots permanently, often overnight. To keep sewer lines root free, apply R-D twice a year. Safe to handle. Safe in septic tanks. Don't wait for trouble. Get R-D now from your plumbing or hardware dealer. It works, or your money back. Only \$3.95 for 2 lb. box. Send for literature.



HERCULES CHEMICAL CO., INC.
416 Broadway, New York 13, N.Y.

AMAZING OPTICAL BUYS

and OTHER SCIENTIFIC BARGAINS



See the Stars, Moon, Planets Close Up! 3" ASTRONOMICAL REFLECTING TELESCOPE

60 to 160 Power — Famous Mt. Palomar Type! An Unusual Buy!



Assembled—Ready to use! You'll see the Rings of Saturn, the fascinating planet Mars, huge craters on the Moon, Star Clusters, Moons of Jupiter in detail. Galaxies! Equatorial mount with lock on both axes. Aluminized and overcoated 3" diameter high-speed f/10 mirror. Telescope comes equipped with a 60X eyepiece and a mounted Barlow Lens, giving you 60 to 160 power. Low-cost accessory eyepiece available for higher powers. An Optical Finder Telescope, always so essential, is also included. Sturdy, hardwood, portable tripod. FREE

with Scope:—Valuable STAR CHART plus 272 page "HANDBOOK OF HEAVENS" plus "HOW TO USE YOUR TELESCOPE" BOOK.
Stock No. 85,050-M \$29.95 postpaid

KNOW THE TRUTH ABOUT POWER. Telescope experts will confirm that an Astronomical Telescope will only give you practical powers to about 50 or 60 times per inch of objective diameter—powers above this only produce empty magnification—make viewing dim, difficult and unsatisfactory.

4 1/4" ASTRONOMICAL TELESCOPE



UP TO 270 POWER!
With this scope you can see everything as above but with greater power plus will split finer stars. Mirror has twice the light gathering power. Mirror guaranteed to give theoretical limit of resolution. Rack and pinion focusing, hardwood tripod, real equatorial mounting—only one adjustment follows stars! Aluminum tube. 4 power finder telescope. 2 standard size eyepieces and mounted Barlow lens give you powers of 40X, 90X, 120X, and 270X. Low-cost accessory eyepiece available for higher powers. FREE with Scope:—Valuable STAR CHART plus 272 page "HANDBOOK OF HEAVENS" plus "HOW TO USE YOUR TELESCOPE" BOOK. Shipping weight 25 lbs.

Stock No. 85,006-M \$74.50 f.o.b.

Same Telescope as above but equipped with Electric Clock Drive—
Stock No. 85-094-M \$111.50 F.O.B. Barrington, N. J.

WAR SURPLUS! — INFRARED SNOOPERSCOPE

Govt. Cost \$900 — Bargain at \$39.50
Converts Infrared to visible light. See in total darkness without being seen. Use in lab, factory, classroom, etc. Completely portable. Operates on two flashlight batteries (not included). Image is quite good, may be made even better by careful focusing. Size 11 1/2" x 8". Weight with carrying case 12 lbs. No infrared light source is furnished. (See below).



Stock No. 85,098-M \$39.50 f.o.b. Barrington, N.J.

INFRARED LIGHT SOURCE AVAILABILITY!

You will need a 6 volt transformer or 6V auto battery to operate.
Stock No. 80,035-M \$10.00 Postpd.

BUILD A SOLAR ENERGY FURNACE

A fascinating new field. Build your own Solar Furnace for experimentation—many practical uses. Easy! Inexpensive! Use scrapwood! We furnish instructions. This sun powered furnace will generate terrific heat—2000° to 3000°. Fuses enamel to metal. Sets paper aflame in seconds. Use our Fresnel Lens—14 3/4" diameter . . . f.l. 14".
Stock No. 70,130-M . . . Fresnel Lens . . . \$ 6.00 Postpd.

BARGAIN! WAR SURPLUS! 7 x 50 MONOCULAR

This is fine quality. American-made Instrument—war surplus! Actually 1/2 of U. S. Govt. 7 x 50 Binocular. Used for general observation both day and night and to take fascinating telephoto shots with your camera. Brand new, \$95 value. Due to Japanese competition we close these out at a bargain price. Directions and mounting hints included.
Stock No. 50,003-M \$15.00 Postpaid

D-STIX CONSTRUCTION KITS

Visualize your ideas. Crystallize your plans. Unique new D-STIX are ideal for "3-dimensional thinking." Colored wood sticks 1/8" thick and "easy-on" rubber joints approx. 3/16" diam. fit together fast—help you work out molecular structures, geometric figures, structural members, shapes, models of all kinds. Ideal for interesting children in developing shapes, structures. Durable kits. Money-back guarantee.
Stock No. 70,209-M (230 pcs) \$3.00 ppd.
Stock No. 70,210-M (370 pcs) \$5.00 ppd.

8 POWER ELBOW TELESCOPE

WAR SURPLUS
\$200 Gov't Cost — Only \$13.50
Big 2" objective, focusing eyepiece 28mm focal length—Amicl erecting system— turret mounted filters, clear, red, amber and neutral—reticle illumination. Sparkling, clear, bright image—6" field / 325 ft. at 1,000 yds.). Focus adjusts 15 ft. to infinity. 28mm f.l. eyepiece alone is worth more than \$12.50.
Stock No. 70,173-M . . . \$13.50 postpaid



MAKE YOUR OWN ASTRONOMICAL TELESCOPE

See December, 1957 issue of POPULAR MECHANICS—Pages 188-192.
4 1/4" MIRROR KIT—Contains ready-to-use 4 1/4" diameter concave, aluminized objective mirror, lenses for 1" focal length eyepiece, and aluminized first surface diagonal mirror.
Order
Stock No. 50,074-M Price \$16.25 postpaid

'FISH' WITH A MAGNET

Go Treasure Hunting On The Bottom

Great Idea! Fascinating fun and sometimes tremendously profitable! Tie a line to our 5-lb. Magnet—drop it overboard in bay, river, lake or ocean. Trawl it along the bottom—your "treasure" haul can be outboard motors, anchors, fishing tackle, all kinds of metal valuables. 5-lb. Magnet is war surplus—Alnico V Type—a terrific bargain. Lifts over 125 lbs. on land—much greater weights under water. Order now and try this new sport.
Stock No. 70,183-M. 5-lb. Magnet. \$8.50 Postpaid
15" x 4" lb. size. Will lift over 250 lbs.
Stock No. 85,088-M \$22.50 F.O.B. Barrington, N. J.
Shipping weight 22 lbs.



NEW BINOCULAR-TO-CAMERA HOLDER

For Exciting Telephoto Pictures
Bring distant objects 7 times nearer with a 35 mm. camera, 7x50 binocular and our NEW BINOCULAR-TO-CAMERA HOLDER. Ideal for long-range shots of wild life, ships, planes, people, etc. Camera and binoculars attach easily. Use any binocular or monocular—any camera, still or movie. Take color or black and white.
Full directions for taking telephoto's.
Stock No. 70,223-M \$11.50 postpaid



Terrific Buy! American Made! OPAQUE PROJECTOR

Projects illustrations up to 3" x 3 1/2" and enlarges them to 4 ft. wide. No film or negatives needed. Projects charts, diagrams, pictures, photos, lettering in full color or black-and-white. Operates on 115 volt, A.C. current. 6-ft. extension cord and plug included. operates on 60 watt bulb, not included. Size 12" x 8" x 4 1/2" wide. Weight 1 lb., 2 oz. Plastic case with built-in handle.
Stock No. 70,199-M \$7.95 Postpaid

NOTICE! EDMUND IS NOW HEADQUARTERS FOR MATH LEARNING AND TEACHING AIDS!

Play This New Game—MATH MAGIC . . . The Fun-Way to Math Skills!
Educator-approved! 3 fascinating games in one! Great fun for the whole family. Increases skill in addition, subtraction, multiplication, division. Includes Dial and Spinner, Numbered Cards, Plastic Tokens, etc.—also rules and directions.
Stock No. 70,204-M \$3.00 Postpaid

MATH IS ESSENTIAL FOR SCIENCE—BUSINESS—COLLEGE! WE HAVE DOZENS OF NEW ARITHMETIC AND MATH GAMES; LEARNING AND TEACHING AIDS. WRITE FOR OUR FREE CATALOG H.

FREE CATALOG-H

100 Pages! Over 1000 Bargains!
Yours for the asking

America's No. 1 source of supply for experimenters, hobbyists. Complete line of Astronomical Telescope parts and assembled Telescope. Also huge selection of lenses, prisms, war surplus optical instruments, parts and accessories. Telescopes, microscopes, satellite scopes, binoculars, infrared sniperscopes, math, learning and teaching aids.
REQUEST CATALOG-H



ORDER BY STOCK NUMBER. SEND CHECK OR MONEY ORDER. SATISFACTION GUARANTEED!
EDMUND SCIENTIFIC CO., BARRINGTON, NEW JERSEY

WORLD'S
BEST
WANT-AD
MEDIUM

CLASSIFIED ADVERTISEMENTS



Advertisements in this section \$1.25 per word, each insertion, minimum 10 words, payable in advance.

To be inserted under proper classification, copy must be in our office the 20th of the second month preceding date of issue

F. W. Johnson, Manager, Classified Advertising

Popular Mechanics Magazine, 200 East Ontario Street, Chicago 11, Illinois

YOU'LL PROFIT

By reading and answering the classified ads in this section. Hundreds of opportunities for you to make and save money

AUTOMOBILES. MIDGET CARS

1959 CATALOG On parts kits for golf buggy or Jr. sports car 25¢. Indus Corporation, 1815 Madison, Indianapolis.

STEERING Wheels, Midgets, etc., \$3.95 up. Literature 10¢. Steerite Products, Dept. PM8, Box 221, Long Branch, N. J.

BOYS Power driven auto, two passenger. Plans, pricelist of parts, 35¢. B. Sypher Co., Sta. P, Toledo, Ohio.

STOLEN Cars impossible. Amazing safety switch. Easily installed. Simple plan. Free details. Sentiff, Box 7305, Chicago 80.

HUNDREDS Of automobile catalogs. American, antique, foreign. Dealer books, glossy photographs, shop manuals. Free motor magazines listed with non-profit organization. Write immediately. Get on free mailing list. Auto Maniacs, Stockbridge, Michigan.

AUTOMOTIVE Books. Send for 1958 general book catalog, 10¢. Popular Mechanics Press, 631 N. St. Clair St., Chicago 11, Ill.

AUTO SUPPLIES AND EQUIPMENT

CRANKSHAFT Grinder. Hand operated. Makes bearings fit without taking engine apart. \$4.00. Literature. L. D. McGee, 719 Cascade St., Wenatchee, Wash.

SPARK Plugs. New 60¢. Guaranteed 10,000 miles. Tell make, model, year. Brooks, Box 218, Evanston, Ill.

MAKE Old cars run like new. Inexpensive. Free details. Newco, Box 164-B, Hinlock Creek, Penna.

SIRENS, Air horns, lights, etc! Catalog 10¢. McCanna, Tarrytown, N. Y.

NEW And used parts at savings. Complete guaranteed parts service for all models cars and trucks, 1924 and later. Largest in the West. Jeep and army parts specialists. Newest type shifting hubs for all jeep and all military and latest production front end drive vehicles. \$27.50 and up. Write. Pioneer Auto and Truck Parts Co., 734 W. 13th Avenue, Denver 17, Colo.

FREE! New catalog. Speed, power, mileage increasing equipment. Discounts! Almquist Engineering, Milford PM5, Penna.

SAVE Money on Jeep and army truck parts. Large inventory. Catalogs for Jeep or G.M.C. owners. American Auto Parts Co., 1830 Locust, Kansas City, Mo.

CLUTCHES And brakes. Ideal for midget cars or motorscooters. Catalog sheets, details 25 cents. Olds Machine Products, 5941 Dixie Hwy., Saginaw, Michigan.

CONVERTIBLE Tops—\$21.50. Jeep tops, \$72.20. Headlinings, \$12.50. Free catalogue. Big Buck, 12 Elliott, Beverly, Mass.

FREE License holder dime postage. Stamps, 116½ Main, Prichard, Alabama.

CHEVROLET V8 engines. Racing equipment. Catalog 50¢. Ledbetter Enterprises, 1015 17th, Texarkana 4, Texas.

1959 EDITION. It's new! It's different! Get world's largest auto accessories and parts catalog, save up to 50%. 356 pages, over 100,000 items for 1920 to 1959 models including Hollywood accessories, custom styling and hi-speed equipment. All parts and accessories for all cars and trucks. We have that hard to get part. Jam packed with bargains. Completely illustrated. Send 25¢ (refundable). J. C. Whitney, 1919-PM-10 Archer, Chicago 16, Ill.

GIANT Auto parts catalog. Thousands special accessories stores don't handle. Gadgets, custom equipment. Send 25¢ (refundable). Newhouse Automotive Industries, 5805-PM-10 Beverly, Los Angeles 22, Calif.

AUTO Shop welding repair training in world's largest non-profit welding school. Low tuition. Free booklet. Hobart Welders, Box M-1091, Troy, Ohio.

BATTERY Charger—build yourself from junk box. Plans \$2.00. Hughes Electronics, Box 143, Farwell, Texas.

SILENCE Hydraulic valve lifter click. Micro-moly guaranteed. \$3.00 profit. Postpaid. Literature. Micro-Moly Products, Garrison 1, Kentucky.

PERMAKROM Bumper refinishing kit does real job restoring chrome finish to bumpers, grill work. Three easy steps. Removes rust in five minutes. Prevents new rust. Coats exposed pits and metal parts, gives chrome brilliant silvery lustre. Simple, economical. Only \$2.00 postpaid. Crafton Company, Dept. PM, 56-20 39th Avenue, Woodside 77, N. Y.

JEOP Owners attention: Free wheeling selective drive hubs for your front drive axles only \$39.95, postpaid. Tractor Supply Company, 2700 North Halsted Street, Chicago, Illinois. Also available at any of our 40 branch stores.

RING—Valve job while driving. \$6.00 postpaid. 8th successful year—over 1,000,000 satisfied users. Yellow Cab test-proven. Free details. Motaloy, Grantham, Penna.

JEOP Owners — V8 conversions. Read Jeep Owners ad, page 18.

END Drugery of tying down car trunk door when loaded. Use our all metal adjustable spring assembly tie-downs. Satisfaction guaranteed. \$2.98 postpaid. Send check or money order to I and R Enterprises, Box 86, Jacksonville Beach, Florida.

DRIVE Fast? Drive safe too with patent pending Safe Speed Indicator. Handsome on dash. \$1.25 ppd. Make and year car. Box 99, Timonium, Maryland.

AUTOMOBILE Body dent pulling tool. \$2.65 complete. Gay, Milton, Indiana.

CAR Burning oil, gas? Losing pep? Try Wonder-Lube. \$2.00 postpaid. Increase battery life with Nu-Power. \$1.00 postpaid. Free information. Money back guarantee. Friendly Products, Box 765, Youngstown 1, Ohio.

TUNE-UP Tips. 1959 edition. Over fifty helpful items to successful tune-ups. Send one dollar to: Modern Automotive School, 323 W. Florence Ave., Los Angeles 3, Calif.

FORD Jeep conversions at half price. Vac-U-Matic Corp., 1-6 Mott St., Ocean-side, New York.

50,000 MILE Guarantee. New fuel pumps. Single \$5.95, double \$9.95, postpaid. Give car, year, model. Ram Fuel Products, P.O. Box 4141, Newark 12, New Jersey.

OLDSMOBILE Owners! Win more drags! Perfect performance! Precise instructions. Learn the secrets! \$2.00. Lehn, Box 3041, Milwaukee, Wisconsin.

AUTO TRAILERS

TRAVEL Trailer blueprints \$2.00. Building guide supply catalog \$1.20. Both \$3.00. Kamcraft, Box 1153, Milwaukee 1, Wis.

CAMP Trailer folding tent. Finest quality sleeps two \$350.00. Telford Trailers, New Lebanon, N. Y.

BUILD Expanding eight foot trailer. Accommodates five. Literature 10¢. Fra-Mar Company, Wilmington, Mass.

ALUMINUM Pickup coach kits. Trailer blueprints. Literature 10¢. Comstock Trailers, Parsons, Kansas.

MOTORCYCLES. BICYCLES. MOTORSCOOTERS AND SUPPLIES

HARLEY-Davidsons — Used bargains. New, used parts, accessories, all models. Bulletin 25¢. Knuth's (Factory Dealer), 1753 Muskego, Milwaukee, Wis.

MOTORCYCLE Parts. New, used. List 25¢. Ballak, 811 N. 9th St. Louis 1, Mo.

RECONDITIONED Motorcycle motors. Chrome accessories. Complete stock Indian parts. Expert rebuilding. Fast service. Indian Motorcycle Sales, Kansas City 27, Missouri.

COMPLETE Hotrod \$25.00; 1954 Whizzer \$20.00; Cushman motorscooter \$25.00; motorcycle \$10.00. Rush 25¢ (35¢ first class mail) for new catalog #963 listing amazing bargains in motors, midget cars, motorcycles, motorbikes, construction plans. Associated, Box 534, Toledo, Ohio.

SEND Cushman, Mustang, or Whizzer camshaft and \$10.00 for racing camshaft. Weber Tool Company, Los Angeles 33, Calif.

NSU Scooters and motorcycles. BMW motorcycle. 2 to 35 h.p. shaftdrive and chaindrive. Butler & Smith, P.O.B. 45, New York City 24.

SEND Cushman, Mustang, or Whizzer camshaft and \$10.00 for racing camshaft. Weber Tool Company, Los Angeles 33, Calif.

CAR Kits, scooters; wheels, sprockets, brakes, steering, etc. List 25¢. Refundable 1st order. Price's, 673 Sycamore St., Oakland 12, Calif.

Briggs \$5. Whizzer motorbike \$25. Servicycle \$45. (Mailorder only.) Send 25¢ (35¢ for first class mailing) for Directory-Catalogue Number 91, listing these and hundreds of other bargains in midget cars, motorscooters, homebuilders parts, plans, etc. Midget Motors Directory, Athens, Ohio.

AVIATION

PROPELLERS. Plans, supplies for airboats and snowplanes. Latest designs, prompt delivery. Catalog 25¢. Banks-Maxwell, Box 3301E, Ft. Worth 5, Texas.

BLUEPRINTS Knight Twister, Heath, Irwin, Flea, Eaglet, Wimpy, Gliders, etc. Circulars illustrating above 30¢. Sport-plane building manual \$1.00. Kamcraft, Box 1153, Milwaukee 1, Wis.

HELICOPTER. Kits, plans. Free brochure. Adams, Box 6042-A, Lakewood, Calif.

FLYING Platform. Three drawings, \$2.00. Rotron, Box 573-A, Bellflower, Calif.

OUTERSPACE Ship X-15. Get genuine glossy 3½ x 5 photo of N. American's newest aircraft plus catalog with thousands of latest jets, missiles, and historical planes. Send 25¢ to U. S. Sea & Air Photos, Box 75084X, Los Angeles 5, California.

RAMJET Helicopter. Build inexpensively. Plans only \$1.00. Wooster Engineering, Box 259-E, Wooster, Ohio.

BUY Gov't surplus: Aircrafts; engines; helicopters; boats; Jeeps; misc. Buy direct now from gov't. Send for "Depot Directory & Procedure" \$1.00. Gov't Surplus Sales, Box 425-PM, Nanuet, New York.

ELECTRICAL SUPPLIES

LAMPS—Parts catalog containing wiring instructions, 25¢. Gyro Lamps, 5208P N.W. 35th Ave., Miami 42, Fla.

ELECTRO-SCRIBE! Engraves all metals, \$2.00. Beyer Mfg., 10511-H Springfield, Chicago 43.

APPLIANCE Parts, accessories wholesale. New enlarged catalogue 25¢. Seco, 26 South 20 Street, Birmingham 3, Ala.

LAMP. Electrical parts, wholesale. Thousands of items for repairing, converting. Catalog 25¢. Brown Lamp, Box 305, Clayton 5, Mo.

WELDING, SOLDERING, PLATING

WELDERS, 110/220, \$39.50. Morris, 1070 Inner Drive, Schenectady 3, New York.

PLATING—Equipment, supplies. Complete line of anodes, solutions. Home workshops, industrial sizes. Hollywood Bronze Supply, Dept. C, 1624 East First, Los Angeles 33, California.

ACETYLENE Welding outfit, new, \$64.50. Arcwelders, \$56.50. Eagle Welding, Dept. PM, 5085 Broadway, Chicago 40, Ill.

FREE Catalog, welders, welder kits. Build 350-ampere welder using aircraft generator, plans 25¢. Agents wanted. Dunbar Manufacturing, Minneapolis 8, Minn.

NEW Fire resistant fabric gauntlet welding glove lasts up to 4 times longer than comparable fabric glove. \$8.25 per dozen or \$4.50 half doz. Postpaid in U.S.A. R. J. Besonen Glove Co., 4226 W. Highland Ave., Milwaukee 8, Wis.

MACHINERY, TOOLS, SUPPLIES

PAINT Sprayer, 7 times faster than brushing. Sensational offer! Free folder. Insc. 1829 S. State, Chicago 16, Ill.

SHEET Metal machines. Brakes: 36", \$37.00. Box: \$95.00; 5' floor, \$80.00. Shears: 7", \$18.50; 24", \$42.00. Free folder. Vyke Mfg. Co., P4158 Jason, Denver 11, Colo.

STOP-Rust — Protect all metal surfaces against rust, acid fumes, salt spray. \$1.50 pint, postpaid. Stop-Rust Co., 1007 Chestnut Street, Chattanooga, Tennessee.

ENGINES, MOTORS, DYNAMOS

REWIND Motors. Simplified instructions and catalog \$1.00. Modern, Box 8715, Kansas City 14, Mo.

negie, Cleveland 3, Ohio.

DIESELS, Gas, gear motors direct. Goins' General Engines, Niland, Calif.

WINDING Data. 275 motors, single and three phase \$1.10. Data Company, 512 Kensington, Kansas City 24, Mo.

ALTERNATING Current generators, 750 watt \$42.50, twincylinder compressors with 1/3 horse \$22.00, motors 1 horse \$38.50. Butler, 1885 Milwaukee, Chicago.

REWIND Motors yourself. Complete instructions \$1.00. Lewis Mfg., Howell, Michigan.

1 HP OE Motor—\$28.95, regular \$75.00 value, in original cartons, 3450 RPM, 1.25 service factor, 115 or 220 single phase, automatic overload protector, drip proof frame, ball bearings, year's warranty from GE, COD \$28.95 plus freight. Cash with order, freight paid Satisfaction guaranteed. Sprayaway Corp., Box 1102, Tulsa, Oklahoma.

BOATS, OUTBOARD MOTORS

MARINE Conversions, Willys to Cadillac, kits and parts. Catalog and conversion hints free. Barr Marine, 2706A Castor Avenue, Philadelphia 34, Penna.

SUBSCRIBE To Government Surplus Weekly. Lists all sales. Buy jeeps, trucks, boats, tents, tires, etc., direct from government. Next 10 issues \$2. Government Surplus, Paxton 20, Illinois.

BOAT Plans—Full size patterns, frame kits. Modern inboards and outboards for amateur builders. Complete new catalog 50¢ or specify requirements. Glen Designs, 9152 Rosecrans, Bellflower, California.

FULL Size, cut-to-shape boat patterns, blueprints, 7½-38 feet. Big new 88 pg. illustrated "Build a Boat" catalog of naval architect-designed cruisers, runabouts, skiffs, outboard boats, sailing, racing, houseboats, 50¢. "How to Build a Boat" booklet, \$2.50. Hardware and Equipment Catalog, \$2.00. Cleveland Boat Blueprint Co., Dept. A-66, Box 1651, Cleveland, Ohio.

FIBERGLAS Permanent boat waterproofing. Special 25% discount. Complete kits, \$9.45 up. Guaranteed materials. Easy application. Full instructions. Free literature. Mail post card. Ajax Plastics, P. O. Box 1323, Fort Worth, Texas.

MARINE Conversions, Ford, Chevrolet, Jeep engines. Catalog 25¢. Lehman Manufacturing Company, 800 Elizabeth Avenue, Linden 4, N. J.

PROPELLERS, Plans, supplies for airboats, snowplanes. Catalog 25¢. Banks-Maxwell, Box 3301F, Ft. Worth 5, Texas.

NEW, Used, rebuilt marine motors. Marine conversions, fittings. Free catalog. Stokes Marine Supply, Dept. 24, Coldwater, Michigan.

SAVE Money. New, used outboard motor parts. Send wants. Stamp appreciated. Outboard Motor Mart, 229-M State, Boston 9, Mass.

THE Steamer Sprague. Big Mama of the Mississippi. World's largest river towboat. Complete history, 106 pictures, 88 pages, \$1.00. P.O. Box 848, Vicksburg, Miss.

PARTS Supplied for all models of Kermath marine engine. Kermath Marine Limited, 930 Millwood Rd., Toronto 17, Ontario.

FREE Catalog! Boat kits, trailers, fiberglass, marine hardware. Luger Industries, Dept. M-10, 9200 Access Rd., Minneapolis 20, Minnesota.

BARGAINS: Small outboard motors. Fall clearance, Box 161-M, Brighton, Mass.

I want to send you proof of the wonderful pulling power of Popular Mechanics classified pages. What's your proposition? Write me today. Include literature if possible. F. W. Johnson, Manager Classified Advertising, Popular Mechanics Magazine, 200 E. Ontario St., Chicago 11, Ill.

ATHLETIC EQUIPMENT, BODY BUILDING COURSES

FREE Muscle building information. Body-Tone, Box 638B, North Miami, Florida.

BARBELLS. Dumbbells. Courses. Booklet 10¢. Good Barbell Co., Siloam Springs, Arkansas.

ual \$3.98. Oriental Book Sales, P.O. Box 1183, Oakland 7, Calif.

FREE 10 Official police Jiu Jitsu home study lessons illustrated copyrighted by world famous military and police instructor. Send 25 cents to cover mailing and handling costs. Jorgensen, Box 5082PM 1059, Seattle 7, Wash.

BIG Strong healthy muscles. 4 courses only 25¢. 12 courses \$2.00. Health wisdom courses \$1.00. Personal supervision. Agents wanted. Results fully guaranteed. Sid's System, PM-2, Southgate, California.

SPORTING GOODS, GUNS, FISHING TACKLE, ARCHERY, TRAPPING

KNIVES, Imported. Worldwide selection of rare daggers, gurrhas, bowies, hunting, throwing knives. Terrific values. Free catalog. Clinton, Mt. Clemens 34, Michigan.

154 PAGE Catalog—A real dream book for fishermen! It's free! Netcraft Company, Dept. B-10, Toledo 13, Ohio.

HOOKS. New stainless steel, barbless, sample 25¢. C. C. Imports, Box 2011, Hanford, Calif.

CLEAN 2000 Fish \$2.00! Nylon scaling attachment fits any electric drill, cleans in seconds. No mess. Jaco, 106 First Avenue, Berea, Ohio.

DISCOUNTS Unlimited! Lyman 4X \$39.95, Weaver K3 \$24.25, Bushnell 4X \$34.50! Guns, successories below wholesale. Catalog 25¢. Discounts Unlimited, Box 38-A, Hastings-on-Hudson, N. Y.

FISHING Equipment at wholesale prices. Send 25¢ (refundable) for lists. Lepden Enterprises, P. O. Box 2608, Jacksonville 3, Florida.

SPEND A buck to get a buck. Try Deer Scent, used by hunters across Canada to attract deer. \$1.00 postpaid, duty free. Gould's Hardware, Woodstock, Ontario, Canada.

10,000 GUNS. Antiques, moderns, swords, armour. Every description. Giant catalog \$1.00. Agramonte's, Yonkers 2 G. N. Y.

LIGHTEST Duck decoy, less than 1st class letter, 3 oz. Flexible foam. Carry 100 easy. Shoot it, can't sink. \$24.00 per doz. Postpaid. Guaranteed satisfaction. Boat Names Company, 3910 East New 40 Hwy, Kansas City, Mo.

MOLDS—For casting your own fishing sinkers. Free illustrated booklet. Reading Instrument Co., Box PM78, Reading, Penna.

CROSSBOWS! Hunting—Bows! Factory prices! Jayco, Box 1355, Wichita, Kansas.

BIG Money raising crickets and 12 inch African fishworms. Free literature. Carter Ranch, Plains, Georgia.

FREE—Wholesale catalog. Beads. Spinners. Lure parts. Sinkers molds. Jigs. Reels. Finnyports (ME), Toledo 6, Ohio.

MOLDS For fisherman's sinkers, jigs, squids, casting and spinning lures. Free catalog. Sweet's Molds, Tonawanda 1, New York.

5000 BARGAINS. Firearms, binoculars, war relics. Catalog 50¢. Smith Firearms, Runnemed, N. J.

AMAZING Wholesale sporting catalog. Save 70%. Tremendous selections, Econ-O-Mart, Whippany 2, New Jersey.

JAP Rifle altering to 30-06, \$6.00, Japshells, \$3.95. Catalog 10¢. T. P. Shop, West Branch 11, Mich.

GUNS, Swords, knives, daggers, flasks. Large list 25¢ coin. Ed Howe, Coopers Mills 52, Maine.

KILL Submersed water weeds which foul up motor propellers, tangle fishing gear, with R-H Weed Rhap-20, Granular 2.4-D. Inexpensive, easy to use, sure results. For free information write Reesor-Hill Corporation, Box 36PM, Jacksonville, Arkansas.

SWAP, photos, movies, slides! Nationwide listing (names-addresses) of amateurs and sportsmen who want to! Your name, interests added to latest listings plus your copy, \$1.25. Ace-List, Box 6022-PS, Minneapolis 10, Minn.

WANTED. Men, women, worm raisers. Sherwood, Dept. P-2A, Monmouth, Maine.

FREE! Valuable fact and picture booklet, "The Amazing Earthworm Business!" Earn thousands \$ in your spare time. Gulf Worm Gardens, Dept. Pl. Bay City, Texas.

BIG Money raising fishworms and crickets. We teach you how to raise and where to sell. Free literature. Medium redworms, 3000, \$5.95; 10,000, \$18.95. Carter Redworms, Plains, Georgia.

RAISE Fishworms and rabbits on \$500 month plan. Free details. White's Rabbitry, Delaware 2, Ohio.

EARN Money at home raising fishworms for us! Backyard, garage, basement. We buy your crop! Inquire: Oakhaven-56, Cedar Hill, Texas.

AFRICAN Giant earthworms, 100—\$2.00, 500—\$7.00. (Dealers quoted.) Ozark Worm Farm-J, Willow Springs, Missouri.

TAXIDERMY

FREE Book tells how you can learn Taxidermy and Tanning. Fascinating, profitable hobby. Send postal. No obligation. State age. Northwestern School, Dept. 2571, Omaha 2, Nebr.

BINOCULARS, TELESCOPES, MICROSCOPES, MAGNIFIERS

BINOCULARS, Telescopes, microscopes; terrific values \$3.98 up. Request free money-saving catalog. Criterion, Dept. P-83, Hartford, Conn.

TELESCOPE Mirrors, lowest price, finest quality. Free bulletin. National Optical Company, 505 New York Avenue, Union City, New Jersey.

REFLECTOR And refractor telescopes, binoculars, microscopes, all sizes. Complete telescope kits, parts, accessories. Free illustrated catalog. Suffolk Science, Mattituck, New York.

REFLECTING Telescope, 60X, completely assembled. Guaranteed observatory clearness. Free information. Skyscope, P.O. Box 55, Brooklyn 28, N. Y.

AMAZING Prices precision binoculars. Folder, "Binocular Selecting," catalog free. Prentiss Importers, Mercury Bldg., West Los Angeles 25, Calif.

DYNASCOPE—Amazing world-famous reflector telescope. Request free brochure. Criterion, Dept. DP-60, Hartford, Conn.

WAR Surplus bargains: millions of lenses, instruments, telescopes, binoculars, components and complete line of astronomical telescope items. World's greatest optical market-place! Send only \$1.00 for beginner's 10-lens kit and big instruction booklet stock 2-CH. Write for catalog CH. Free! Edmund Scientific Co., Barrington, New Jersey.

BUILD Your own reflector telescopes. Complete kits; mirrors, eyepieces, tripods, all other accessories. Request free illustrated literature. Criterion Manufacturing, Dept. DPM-57, Hartford, Conn.

PLANTS, SEEDS, BULBS, NURSERY AND GARDEN SUPPLIES

WORLD'S Greatest cash crop. Free information. Write Ginseng Gardens, Asheville, N. C.

GINSENG, Goldenseal roots bring up to \$14 pound. Full information, F. M. Collins, Viola, Iowa.

GROW Dwarf trees! Instructions and seeds 35¢. Mail Order Specialties, 1439-PM Sabraton Ave., Morgantown, W. Va.

PETS—DOGS, BIRDS, RABBITS, HAMSTERS, ETC.

RAISE Angora, New Zealand rabbits on \$500 month plan. Plenty markets. Free details. White's Rabbitry, Delaware, Ohio.

HUNTERS. Sale price on fine Coon hounds, Fox and Rabbit hounds. Write, Okaw River Kennel, Cowden, Illinois.

GOLDEN Hamsters—Pedigreed breeders \$3.85 pair. Albinos Whitebands. Literature. Moore's Hamster Ranch, Shepherdstown 25, West Virginia.

MAKE Money raising chinchillas, mink, rabbits, cavies for us. Free catalog. Keeney Brothers, New Freedom 2, Penna.

RAISE Rabbits successfully by knowing facts. 48 page illustrated book describing 25 breeds. Housing, feeding, breeding, marketing, etc. Plus bulletin. 25 cents. American Rabbit Association, 36 Arba Building, Pittsburgh, Penna.

HAMSTERS—Ideal pets, \$2.95 pair. Free booklet. Jer-fre's Hamstery, 1447 Apple, Muskegon 13, Michigan.

SKUNKS, Reptiles, hawks, raccoons. Illustrated catalogue, 25¢. Trails End Co., St. Stephen, S. C.

HAMPSTERS—Ideal pets \$2.75 pair. Free literature. H. & H. Hamstery, 551 S. Madison, Nappanee, Indiana.

FUR BEARING ANIMALS

MINK Raising information free. Complete. Lake Superior Mink Farm, Superior, EE1, Wisconsin.

FARMS, FARM LANDS, REAL ESTATE

OPPORTUNITIES! Government land, U. S., Alaska, Canada. Sledge Surveys, Macon, Mississippi.

MR. Property Owner—Want a map of your property? Write Deed-Ettes, Mt. Pocono, Penna.

FREE Strout catalog! Farms, homes, businesses, resorts, retirement properties. Over 3000 values in 16 states. 58 years' service. World's largest! Write Strout Realty, 7-MP S. Dearborn, Chicago 3, Ill.

RETIRE In the country. Only \$3,500 buys Missouri! 40 acres and nice home! Wonderful spot for sportsman. Excellent deer hunting on place, only 3 miles Wappapello Lake. Just 150 yds. off blacktop. 6 miles town. 30 acres tillable, rest wooded, half now pasture, spring branch. See picture in catalog—good 5-room home, electricity, well, flowers, shrubs. Hurry! Only \$3,500, less than half down. Big free fall catalog. Bargains coast to coast! United Farm Agency, 2825-PM Main St., Kansas City 41, Mo.

FLORIDA'S Biggest lot value! No money down! \$5 monthly. Full price only \$133. Between Orlando and Ocala. High, dry, adjoining city, streets, electricity, phones, churches, schools, shopping. In heart of 3000 lakes. World's best fishing! Write for free photos. AC Huysman, Box 467, Bellevue, Florida.

CANADIAN Vacation lands: Full price \$285.00, for 40 acres, \$10.00 month. Suitable cottage sites, hunting, fishing camps. Free information. Land Sales Corporation, 130C Shaftesbury, Downsview, Ontario, Canada.

FISHERMAN'S Paradise—\$10.00 monthly buys 5 acres near Clearwater Lake. Bargain. Free list, Box 425P, Carthage, Missouri.

FLORIDA. Nice homesites, \$345 at \$10 monthly. Folder free. Howard Vernor, DeLand, Florida.

FLORIDA. Beautiful, wooded homesites, \$290, \$10 monthly. Free literature. Wendell Wood, Fountain, Florida.

POULTRY, FARM SUPPLIES

BLACKBREASTED Red game bantams \$5.80 pair. Freshwater's Farms, Mebane 1, North Carolina.

PROFITABLE OCCUPATIONS

BUY Wholesale: 100,000 nationally advertised products. Appliances, cameras, sporting goods, housewares, watches, typewriters, tools, clothing, etc. Discounts to 60%. Buy-Rite, Box 258, Hawthorne 1, New Jersey.

LEARN Piano tuning at home. Free information. American School Piano Tuning, Box 707, Gilroy, Calif.

MAKE Money making new greaseless doughnuts in kitchen. Sell stores. Free recipes. Michael, 3605 South 15th, Minneapolis 7, Minnesota.

BECOME Independent with your own franchise business. Thousands earning handsome incomes. Request interesting facts today. National Franchise Reports, PM-528, 333 North Michigan, Chicago 1.

BIG Money raising fishworms and crickets. Free literature. Carter Wormery, Plains, Georgia.

MAKE Flexible molds. Cast plaques, figurines. Free sample. Tooker, 1045-M Fairview, Hamilton, Ohio.

AUCTIONEERING—Home study course. Diploma granted. Auction School, Ft. Smith, Ark.

SAVE Money! Buy wholesale! Free catalog general merchandise. Norris, 487-M Broadway, New York City.

RAISE Pheasants on \$100 week plan. Little capital and space can make you independent. Free details. Great Central System, Columbus 1, Kansas.

VENDING Machines. No selling. Operate a route of coin machines and earn amazing profits. 32-page catalogue free. Parkway Machine Corporation, Dept. #25, 715 Ensor Street, Baltimore 2, Maryland.

AUTO Parts. I can teach you a life time business. Something different. Men-drifters—don't waste our time. Meyer Bros., 2 Emily St., Dayton 7, Ohio.

RAISE Cash, making candy. "250 Ways" 50¢. Schenck, 717p Penn. Butler, Penna.

MANY Make \$1500.00 per month operating collection office. Free details. Franklin Credit, Roanoke, Virginia.

MAGAZINE Subscriptions. Highest commissions. Bonus. Qualified Agencies, 451-DA Kingston, Brooklyn 25, N. Y.

HOME Mailorder beginner's folio, methods, opportunities, 25¢. Carnahan Bros., 9610 Acacia, Fontana, Calif.

GROW Mushrooms. Cellar, shed and outdoors. Spare, full time, year round. We pay \$4.50 lb. dried. We have 29,000 customers. Free book. Mushrooms, Dept. 99, 2954 Admiral Way, Seattle, Wash.

PHOTOGRAPHY For pleasure or profit. Learn at home. Practical basic training. Long established school. Free booklet. American School of Photography, 835 Diversey Parkway, Dept. 3437, Chicago 14, Illinois.

INDEPENDENT Opportunities. Jobs unlimited. Self improvement. William Dunt-hue, 224 Beach Drive North, St. Petersburg 1, Florida.

WASHING Machines repair book. Step by step pictures, text. Kaye Supply, 5704 Third Ave., Brooklyn 20, N. Y.

NEW Soilers method. Raising night-crawlers, redworms. Three Oaks Ranch, Dresden, Tenn.

MAKE \$2.00 For 3 minutes work repainting and stenciling names on R.F.D. mailboxes. Terrific. Detailed instructions \$1.00. Young, Box 33B, Denville, New Jersey.

PROFITABLE Homework! Telephone surveys! No selling! Nationwide. 5924 Eden prairie, Hopkins, Minnesota.

START A magazine subscription business. Earn generous commissions on Popular Mechanics. Good Housekeeping and all others. Best commissions, bonus, all materials sent free. No experience needed. Write Popular Mechanics, Room 10-P, 250 West 55th St., New York 19, N. Y.

RAISE Fascinating gourds—easy to grow, a wonderful hobby or a profitable commercial business. Details free. Joy-crafts, Box 186-PM, Covina, California.

\$200 WEEKLY Extra introducing buyers to sellers, weekends. Men, women enjoy learning real estate by listening to records. First lecture free. Lee Institute, Brookline, Mass.

BOOKS, PERIODICALS, PICTURES, POSTCARDS

COLOR Picture postcards of Georgia. Mamie's cottage, Augusta, state capital, state flower, etc., 10 all different 50¢. Gareth Thompson, Sale City, Ga.

WRITERS. Get Elements of Style, (just published). Price \$2.25. Writers list free. Kennedy's, 221 Murray Hill Station, N. Y. 16.

OCTOBER 1950

phant set, Brussels Fair, Olympics, Jet Aircraft, Boy Scout, Somali Animals complete. Romania Flags, Togo set, Diamond Popes, U N set, etc., plus big Stamp Dictionary and Approvals. Everything 10¢. Stampex, Box 47-KM, White Plains, N. Y.

222 DIFFERENT Worldwide plus 66 different U.S. 25¢. Unmounted approvals. Casto, Box 357, Dunbar, W. Va.

FREE Gigantic collection, includes U.S.A., British Colonies, foreign. Approvals, Stanley Zajac, 159 Emerson Ave., Toronto, Canada.

FREE! 25 Egypt, 5¢ handling. Approvals, Bellel, Maple Dale, Hazel Park, Mich.

U.S. Stamps, Giant bargain catalogue, 15¢. Raymax, 35-YZ Maiden Lane, N.Y.C. 38.

UNITED Nations. Five different 10¢. Approvals, Anderson, 1112 Harrison, San Francisco 3, Calif.

MEXICO 25 Beautiful 10¢. Approvals, Salzman, Box 702, Berkeley, Calif.

TERRIFIC Value. Eight complete mint sets 10¢ with approvals. Beatties, 58 Glensagar, Islington, Ontario, Canada.

FREE! 50 Different Portuguese; Colorful, inexpensive approvals. Elkhart, Box 33, Elkhart, Indiana.

FREE United States fully illustrated list. First order—10% discount. Simmy, 45-PM Bromfield, Boston, Mass.

GIFT! Tokelau Islands first set to approval applicants. Deane, Box 45-371, Miami, Fla.

50 DIFFERENT Africa 25¢! Approvals, Rowwell, 2425 Maplewood, Royal Oak, Michigan.

100 STAMPS, 15 Cents. Approvals, Mengel, 11 Mansfield, Everett 49, Mass.

LAOS Elephants, 10¢. Approvals, Gebhard, 26 Westwood Drive South, West Orange, N. J.

CLEAR VU mint sheet album. Holds 100 sheets. Black, maroon, green, \$9.95. Slip case \$2.95. US price list free. Sennett, 88 Wyoming Street, Wilkes-Barre, Penna.

25 DIFFERENT Commemoratives 1893 up 10¢. U. S. approvals. K&B, Box 70, Brooklyn 23, N. Y.

BARGAIN US—101 different 25¢, with US. approvals. Stamps, Kennebunk, Maine.

8 DIFFERENT U. S. airmails free! Approvals accompany. Dee, Box 926, Ormond Beach, Florida.

FREE Sample! Interesting, informative, illustrated. National Stamp News, Anderson, South Carolina.

FREE. Valuable collections. Scott's International and Master Global Albums. A gold mine of value all free when you buy our sensational foreign approvals. Topval, Box 486b, Redlands, Calif.

FOREIGN F.D.C.'s mailed direct! Personalized around the world service. Brumsey, 209 Main, Peoria, Ill.

DAMAGED Old U.S. 1/8 catalog, on approval. K. Swartz, Malden Bridge, N. Y.

FREE 50 Worldwide, mailed with inexpensive approvals. University Stamps, P.O. Box 95, Tamiami Station, Miami 44, Florida.

25 DIFFERENT French colonials. All large, including sets, 10¢, approval applicants only. N. Ennis, 66 Mill Street, Arcade, New York.

105 DIFFERENT U.S. stamps 25¢, approvals included. Shelton, Box 907-M, New York 8, N. Y.

TRADE Your duplicates toward our approvals! (Foreign only.) Complete information, 10¢. Variety Stamps, Box 98-P, Newton Highlands 61, Mass.

FREE! Wonderful, new 84 page U. S. catalog. Handling 10¢. Norrisco, Milwaukee 7, Wis.

307 WORLDWIDE Different stamps only 25¢. Approvals. Niagastamp, St. Catharines 671-A, Ontario.

MINT U.S. at face! Older commemoratives only. Send 25¢ for all different packet with first selection mint U.S. approvals. Western, Box 1689P, Salinas, California.

1000 DIFFERENT Worldwide stamps \$1.00. Valued over \$20.00. Universal, Box 6, Kenosha 5, Wisconsin.

tives) 25¢. No approvals. Seidenberg, Appleton, Wisconsin.

FREE! Eight sided stamp, triangle, diamond, midget, mammoth, to approval buyers. Plymouth, Dept. A-9, Bell, Calif.

GIANT Approvals, thousands different, 1¢ and 2¢ each. Wahl's Stamp Exchange, 7008P Farragut, Chicago 31, Ill.

WORLDWIDE, 50 All different, absolutely free. Just to introduce our incomparable approvals. Kent Stamp Company, GPO Box 87, Brooklyn, N. Y.

ALBUM Only 10¢! Hundreds of spaces! Stampmart Company, Hartford 1, Conn.

UNITED States commemorative collection containing 33 different—10¢. Approvals. White, 516-A Avenue L, Brooklyn 30, New York.

SELL Your surplus good grade stamps. Write, describing fully what you have. Vanroy Shirk, Lebanon, Pennsylvania.

AMAZING OFFER! 200 United States stamps — including commemoratives, airmails, high denominations to \$1.00. Only 10¢ to approval applicants! Illustrated bargain lists free. Mystic Stamp Co., Dept. 80, Camden, New York.

100 STAMPS, 10¢ With approvals. Smith, 508A Brooks, College Station, Texas.

OLD Scarce U.S. seconds on approvals. Slight imperfections, lowest prices. Hernefield, Clintonhill Sta., Newark 8, N. J.

100 OLD United States between 1861 and 1935. \$1.00. Roash Stamps, 51 Chestnut, Mansfield, Ohio.

FREE Packet! Angola, Azores, Mongolia, Nepal, Palestine. Fascinating approvals. Coral, Box 7095 (Ludlam), Miami 55, Florida.

225 STAMPS For only 10¢! This mammoth value includes airmails, pictorials; stamps from strange countries cataloging up to 25¢ each! Also approvals. Mystic Stamp Company, Camden 80, New York.

UNITED States price list, 116 pages, price 25¢. Mark Hanna, 335 Fifth Ave., Pittsburgh 22, Penna.

SELL Stamps to our readers. Your ad in this space will be read by thousands of stamp buyers. I'll prove that to you. Write now for Folder "S." P. W. Johnson, Classified Advertising Manager, Popular Mechanics, 200 E. Ontario St., Chicago 11, Ill.

14,000 DIFFERENT! Amazing new plan builds your collection systematically, country by country. Only 50¢ weekly. Free details. L. G. Ware, Stepney 75, Conn.

U. S. Mint flag set, complete, \$1.00. Free list. Brooks, 2323 Avenue X, Brooklyn 35, New York.

INTRODUCING Our better United States approvals, we offer 15 United States stamps including Columbian, Pan-Pacific, famous American, airm, others; only 10¢. Ocean Stamps, Box 64-PM, Brooklyn 29, New York.

103 DIVERSIFIED British colony stamps only 10¢. Approvals. Niagastamp, St. Catharines 671-A, Ontario.

80 DIFFERENT U. S. stamps, includes 19th century, commemoratives, high values. Plus 1943 flag stamp of occupied nations. All for only 25¢. Approvals included. Willett Co., Box 338-C, Yorktown Heights, N. Y.

102 DIVERSIFIED Worldwide stamps 10¢. Approvals. Linstamp, St. Catharines 618, Ontario.

110 INCLUDING Airmails, triangles, U. S. 10¢. Approvals. Stamparee, Box 68, Sierra Madre, Calif.

U. S. Approvals. Low prices. Eagle Stamps, Romine Ave., Pittsburgh 26, Penna.

PENNY Approvals! Regardless catalogue! Kloster, 4164—52nd St., San Diego 5, Calif.

25 DIFFERENT Large American commemoratives 10¢. With approvals. Linstamp, St. Catharines 618-A, Ontario.

INTERESTING Worldwide animal stamp collection 10¢. With approvals. Niagastamp, St. Catharines 671-B, Ontario.

U.S., Canada catalogue now only 20¢. New-Way Stamp, Lawrence (2), Mass.

ECONOMICAL, 1/2¢-3¢ Approvals, 33,000 varieties. Dresel, Box 128-N, West Englewood, New Jersey.

grade approvals. Faith, 1225 Campbell, Alhambra, Calif.

50 LARGE U.S. commemoratives 10¢ with approvals. Jack Clancy, Box 2187, Portland 14, Ore.

300 STAMP Hinges and 25 different Canada free with approvals. Jaydee, 218 Dickinson S.W., Grand Rapids 7, Mich.

U.S. Catalog free. Contains almost 1,000 illustrations; over 10,000 delightful bargains. Stone, 260 Washington, Boston 8, Mass.

1000 DIFFERENT Worldwide with approvals only. Jacobsen, Crompond, N. Y.

77 DIFFERENT U. S.—25¢. Approvals. Utechts, 1143D North Keeler, Chicago 51.

100 DIFFERENT U. S. and foreign 35¢. Richard Powell, 516 Cypress Ave., Lindenvold, N. J.

FREE! Fifty different. Request approvals. John Schuster, 301 Sandpiper, Playa Del Rey, California.

MALTA, 20 Different 25¢. Approvals. Edwin Morr, 1204 Sandusky, Ashland, Ohio.

VALUABLE Packet 10¢, with approvals. Wokasten, Aronica Trailer Ct., Hamburg, N. Y.

RE-GUM Valuable no gum stamps \$1.00 in plastic dispenser. Great Western Stamp, Clackamas, Oregon.

3,000 U. S. Stamps \$1.00. Cozatt, 1916 W. Oklahoma, Enid, Okla.

105 BRITISH Colony stamps, all different 10¢. Approvals. Crown Stamp Company, 901, Virgil, Ontario.

BARGAINS: 324 Stamps 30¢. Bargain lot \$1. Extra special \$2. Giant assortment \$5. High value packet \$3. List samples 10¢. Persile, 436 N. Y. Ave., Brooklyn 25, N. Y.

25 JAPAN Foreign approvals 4¢. Ronald Paul, 33 Altamont Road, Nixon, New Jersey.

MOON Rocket 1959 Czechoslovakian stamp free with approvals. Regal Stamp Co., Box 3064, Birmingham 12, Ala.

FREE United States price list of singles, plate blocks, FDC's. Introductory discount. Bailey, 45-G Bromfield, Boston, Mass.

25 DIFFERENT New Zealand 10¢ only to applicants for our bargain approvals. Smooth Stamp Co., Box 83 (Rugby), Brooklyn 3, New York, Dept. M-Z.

BRITISH, Dutch, colonies, scarce varieties. Prompt service; send postage for free catalogue, over 5,000 offers. Mann, Box 3442, Charlottesville 26, Virginia.

BEAUTIES! Pictorials from Sudan, Andorra, Hong Kong, Iceland, Toga, New Caledonia, San Marino, Singapore, etc. Only 10¢. Approvals. Champlain, Isle La Motte, Vt.

SUPERIOR Worldwide mission mixture. Amazing variety! Six ounces \$1.65. Pound \$3.95. Bay Nielsen, 4545B Harvard, Montreal 28, Canada.

1000 DIFFERENT Stamps free to regular buyers from our price lists. No approvals. Write for details. Lucas Stamps, 612 White, Toledo 5, Ohio.

FREE 80 Page U.S. price list, fully illustrated. Finney, Box 89, El Monte, Calif.

135 DIFFERENT U.S. commemoratives \$1.00; 50, 25¢. Approvals. Harold Holub, 18 East 198 Street, New York 68, N. Y.

FIFTY Different U.S. 15¢ postpaid. Riley, 725 Melody, Metairie, Louisiana.

WOW! 110 All different Germany 10¢. Zeppelins, semi-postals, airmails, high values, etc. Giant catalog. Bargain lists included with beautiful approvals. Jamestown Stamp, Dept. A109PM, Jamestown, N. Y.

100 DIFFERENT Belgium free. UPU, Brussels Fair, railroad stamps free. Approval applicants only. Trylon, Box 2487, Orlando, Florida.

TEN U.S. fifty years old 10¢. Robert Gallup, Albany 1, N. Y.

OUR Specialty, 1000 worldwide stamps \$1.00, 3500, \$3.00. Guaranteed. Harrison's Stamps, 1435 First Ave., Oakland 6, Calif.

BRITISH Colonials — keep our hobby friendly. No high pressure. Approvals to your needs. Premiums, Cubberly, 174 Orange Road, Montclair, N. J.

Box 355, Topeka, Kansas.
50 DIFFERENT Stamps free! Approvals. Marford, Box 48, Queens Village 29, New York.

CANADA: Mint royal visit and seaway, only, 10¢. Approvals. Rheume, 6591 11th Ave., Montreal 36, Canada.

300 MIXED Stamps. Guaranteed catalogue value at least \$7.00! 25¢ to approval applicants only. Bob's Approvals, Dept. M., Box 3045, St. Louis 30, Missouri.

AUSTRALIAN Complete mint Christmas 1958 free. Approvals. Stampport, Cyland, East Palestine 2, Ohio.

55 DIFFERENT U.S. 10¢. Foreign, U.S., British approvals. Jayco, 269 Crescent, Sarnia, Ontario.

KOREA Special, eight different cataloging \$2.00; 15¢ with approvals. Quynn's, Scotland 6, Penna.

BRITISH Empire—111 different, 10¢. Approvals. Farley Stamps, 204 Tanguy, Logansport, Indiana.

FREE Mint set! Approvals accompany. Stampco, 5151 Princeton, Memphis 17, Tennessee.

RUSSIAN Commemoratives, 10¢ with approvals. Schaefer, 16 California Strasse, Wiesbaden, Germany.

MYSTERY Package stamp collection, only 10¢. Hill Company, Box 51, Defiance, Ohio.

FOUR Complete Christmas issues free with interesting approvals. Stamp Imports, Peterborough, Ontario, Canada.

GIGANTIC Collection free. Includes triangles, early United States, animals, commemoratives, British Colonies, high value pictorials, etc. Complete collection plus big illustrated magazine all free. Send 5¢ for postage. Gray Stamp Company, Dept. PM, Toronto, Canada.

FREE 400 Genuine postage stamps! Worth \$10.00 at catalogue prices. Africa, Europe, Asia, British Emp. A fascinating, valuable mixture from foreign convents, banks, etc. Who knows what you will find. Also free helpful collectors handbooks. Adults only. Fine approvals enclosed. Frasek Co., PM, White Plains, N. Y.

FABULOUS Mixture. From banks, shipping co's., imports. Excellent Br. Col., airm. Latins, Asia. 50¢. \$1. \$2, and \$5 lots. Knopp, Box 1381, Bristol, Conn.

TOPS! Free book. "How to Collect Stamps." Send for your copy today. Approvals. Littleton Stamp Co., Littleton, El, N. H.

APPROVAL Applicants! Send 25¢, receive 51 different Canada cataloging \$2.30. Clasper, Box 49, Montgomery, Alberta, Canada.

U.S. Commemoratives: 142 different \$1; 202 different \$2. Moseley, 6 Hanley Downs, St. Louis 17, Missouri.

200 DIFF. Foreign and 300 hinges 25¢. Jim's Stamps, Brocton, New York.

BEAUTIFUL Complete sets, 5 different 10¢. Approvals. R. Grillo, P.O. Box 4028, Norfolk 2, Va.

VATICAN Coronation souvenir—Pope John XXIII card and 10 attractive stamps in protective plastic folder. Story of Vatican and coronation on reverse. A beautiful addition to any collection. 25¢ with approvals. Capital Stamp Co., Ferrysburg 2B, Mich.

FREE—Mint British colonies from Brunei, Solomon Islands, Negri Sembilan, Sarawak, St. Christopher, Nevis, Trengganu, Gilbert Ellice. Free with approvals. Viking, Great Neck 8, N. Y.

1958 LAOS Unesco unused complete, 10¢, or six Greek wind airmails 5¢ to applicants for our progressive approvals. Mark II Stamps, Shop 1517, 6671 Sunset Blvd., Hollywood 28, Calif.

SPORTS! 10 Different. 50 others 10¢ with approvals. Bennett, Candor 3, New York.

CANADA—Fifty different 10¢ to serious approval applicants. Pundy Stamps, Box 431, Saint John, N.B., Canada.

FREE! 33 Somaliland! Paraguay! Greenland! Others. Approvals. Keating, 2520-P Boulevard, Jersey City 4, New Jersey.

FREE! Pictorial packet, with approvals. Conklin, Box 388-PM, Osage, Iowa.

50 CHINA 10¢. Approvals, gifts. Coast, P.O. 2187A, Santa Ana, California.

SPECIAL! Two complete sets, Ceylon, Macao, 15¢ approval applicants. Maerz, 6023 Bowwater Crescent, Bowness, Alta., Canada.

FRANCE-Monaco. Free list. A. Anderson, 1044 Fulton, Fresno 21, Calif.

HONDURAS "Abe Lincoln" bicolored commemoratives, free! Approvals. William Deems, 226m Race, Ravenswood, West Virginia.

SEVENTY-FIVE Different United States. Obsolete and current. 25¢ with approvals. Ed. Keller, Library, Penna.

311 DIFFERENT 25¢. Includes everything: Pictorials, airmails, sets, Vatican, Israel, Philippines, topicals, many others. Approvals included. Century Stamps, Kings Park, New York.

UNITED Nations rare 3¢ cutsquare 10¢! Scarce postcard free. Approvals. Teddie, Crystal Beach, Florida.

FREE! Afghanistan, Bahawalpur, Negri Sembilan, Tanganyika, Thailand. Inexpensive approvals accompany. Nade's, 6316 Crescentville, Philadelphia 20, Pennsylvania.

300 MIXED World famous stamp mixture \$1.25. Stroskey, 223 Market St., Perth-Amboy, New Jersey.

12,000 PENNY Approvals waiting for you. Many from exotic countries, pictorials, airmails, new issues. Tilbury, Box 862, Newark 1, N. J.

1000 FINE Mixed United States stamps 25¢. Wright's, Box 1122, Hagerstown, Maryland.

SEND For our approvals selected to match your collection. You'll be delighted. Laclede Stamps, 4973A Columbia, St. Louis 9, Mo.

UNITED States approval collections. Enclose 10¢. Peterson, 405 Northwestern Bank, St. Paul 1, Minn.

UNITED States. \$1.00 buys four fine unused airmails. #C7-#C10. Approvals accompany. Whiton Paine, Westport 11, Connecticut.

BEAUTIFUL—2¢ Approvals. Thousands varieties! Marshall, Box 451-PB, Long Beach, Calif.

ANTIQUES, RELICS, INDIAN GOODS, CURIOS

FIND Buried battle relics, coins, silverware. Transistorized M-Scope electronic locator. Guaranteed. From \$59.50, easy terms. Free catalog. Fisher Research, Dept. C-1, Palo Alto, Calif.

10 ARROWHEADS \$2.00. Catalog 10¢. Redick, 1061 Geers, Columbus 6, Ohio.

ANTIQUE Firearms. \$12.00 up. Bargain list 25¢. Tontz's, Elsinore, Calif.

ARROWHEADS From Oregon. Four perfect points \$1.00. Box 1757, Rt. 3, Eugene, Oregon.

SCALPING Knife, spearhead, thunderbird \$4.00. Catalog 10¢. Arrowhead, Glenwood, Arkansas.

6 ARROWHEADS \$2.00 List. Smith, 841 N. Tacoma, Indianapolis 1, Indiana.

ANCIENT Grooved stone tomahawk \$3.00. Indian relic list free. Lear's, Glenwood, Arkansas.

SPECIAL: 10 Genuine arrowheads. \$2.00. Stan's, 1054 Lilley, Columbus 6, Ohio.

PRECIOUS STONES, MINERALS

GET Free catalog no serious rockhound, gem cutter, jewelry maker, hobbyist or craftsman can be without. Full of bargains, exclusive items, low prices from largest suppliers and authorities in the field. Free, new catalog just off the press, yours for the asking! Write Grieger's, Dept. C-11, 1633 E. Walnut, Pasadena, California.

TWELVE New Mexico minerals \$2.00, six fluorescents \$1.00, five crystallized minerals \$1.00, fool's gold 35¢. Minerals, Winston, New Mexico.

SAPPHIRE And four more uncut gems, \$1.00. Ten polished gems, baroque-shaped, \$1.00. Free gem list. Lapidary catalogue, 25¢. O'Brien's, 1116M Wilcox, Hollywood 38, Calif.

POLISHED Gem stones sent on approval to collectors, students, schools and hobbyists. New England Gem Co., Dover 1, Mass.

Shop, 201 San Francisco, Santa Fe, New Mexico.

EARTH Science, the rockhounds national magazine. Subscription \$2.00. Sample 35¢. Box 1357-PM, Chicago 90, Ill.

"GEMS & Minerals Magazine," largest rock hobby monthly. Field trips, "how" articles, pictures, ads. \$3.00 year. Sample 25¢. Box 687A, Mentone, California.

4 BEAUTIFUL Specimens. Zinc, lead, calcite, sllgment. \$3.00. Rocks, Box 108, Miami, Oklahoma.

GEMSTONES. Thirty, uncut, gem, mineral book, 400 color illustrations, \$5.00. Reed's, 4930B Palo Alto SE, Albuquerque, New Mexico.

DIAMOND Mines, 50¢ square inch. Land, agents wanted. Box 1702C, Little Rock, Ark.

HOBBIES AND COLLECTIONS

FOR Added interest and enjoyment include items from the Caribbean area in your collection. We provide a wide selection of tropical specimens: corals, preserved fishes, shells, starfish, sea urchins, seeds, and many more specimens from Puerto Rico and the Caribbean sea. We also offer a complete collection of woods from Puerto Rico. Write for further details. Caribbios, P. O. Box #1042, Mayaguez, Puerto Rico.

PROFITABLE. Fascinating hobby 25¢. Obermiller, 4218 Evergreen Rd., Pittsburgh 14, Penna.

COLLECTORS Matchbook covers. 100 different unused, \$1.00. Catalog 25¢. Album \$3.00. Charles Edelman, 1311-C East 84, Cleveland 3, Ohio.

INVENTING Can be an interesting and profitable hobby. Write for complete particulars. Institute of American Inventors, Dept. 40-E 635-F St., N.W., Washington 4, D. C.

NAZI Insignia book. 600 illustrations, \$1.00. 12 Nazi insignia, \$1.00. Hobbyland, Calgary, Canada.

MATCHBOOK Album. Looseleaf pages, expandable, 144 spaces \$1.00 ppd. Match Album, 5056 Armitage, Chicago 39, Ill.

WANTED Old cigarette cards. Write Charles Bray, East Bangor, Penna.

COLLECT Foreign medals, daggers, helmets. Iron Cross with ribbon, \$1.50; Swastika emblem 25¢; catalog 25¢. Hobbies, Box 71-B, Rockaway 94, N. Y.

ANTIQUES Mailorder: moneymaking opportunities: 25¢. Ratnone Publications, Middle Village 79, New York.

CAMERAS, PHOTO SUPPLIES

PHOTOGRAPHY For pleasure or profit. Learn at home. Practical basic training. Long established school. Free booklet. American School of Photography, 835 Diversey Parkway, Dept. 343C, Chicago 14, Illinois.

CAMERAS, Film, projectors—discounts to 40%. Catalog free. Photo Distributors, Box 4203, San Diego 4, Calif.

AGGRESSIVE Photographers! Proven earnings to \$200.00 and more weekly selling photographs! Processing completely eliminated! Send \$1.00 for guaranteed complete instructions: Photographers International, Box D-149, Irvington, N. J.

PHOTO FINISHING

A Triple value. Quality, price, service. Color or black and white, 12 exp. (black and white) 59¢. 20 gift photos \$1.00. Holiday Photos, Dept. 16, Box 666, Denver, Colo.

A 3-In-1 value. Price, quality, service. 20 gift photos, \$1.00. 12 exposure rolls (black and white), 59¢. Color or black and white. Interstate Photos, Dept. 11, Box 15, Aurora, Ill.

KODACHROME Processing by Kodak, 8mm. roll or 35mm., 20 exp., \$1.40. Prompt service. Write for mailers and prices. Color Pix, Dept. P, CPO Box 30, Kingston, N. Y.

TWELVE Exposure rolls 49¢. Wallets 20 for \$1.00. Lincoln Studios, Dept. K, Box 13, Lincoln, Nebr.

ENLARGEMENTS, Heavyweight, six 5x7's or three 8x10's \$1.00. Jack Koons, Huntington Mills, Penna.

chrome \$1.00, 35mm. 20-exposure roll mounted. Kodachrome 20-exposure or 8mm. movie \$1.25. U.S. Color Mart, Box 191, Hartford 1, Conn.

FREE Film kodacolor, black and white, with each roll. Color processing 75¢, color prints 25¢. Black and white 8x 4 1/2, 12x 6 1/2. Reprints 5¢ each. Special offer with this ad included. Weirton Photo, Box 640, Weirton, W. Va.

INTRODUCTORY Special. Processing Kodachrome 8mm movie or 35mm 20 exp. \$1.00. Kodacolor 8 exp. complete \$2.00; 12 exp. \$3.00. Black and white 8 jumbos 40¢. Jumbo reprints 5¢. Quality guaranteed. Prompt service. Write for free mailers. Fast-X-Foto, Box 7A, Jersey City, N. J.

ENLARGEMENTS, Brilliant tone, six 5x7's or three 8x10's \$1.00. Toman, R.3, Palatine, Ill.

SAVE! Photographic Christmas cards. Free mailers. Mail-A-Way, Box 375-A, Fitchburg, Mass.

FREE 5x7. Top quality. Fast service. 8 exposure rolls 40¢, 12 exposure rolls 55¢. Pics Foto, Cambridge, Minnesota.

25 WALLET Size silk finish photos from any picture \$1.00. Original returned unharmed. Studio, Drawer 701D, Springfield, Missouri.

MOTION PICTURES AND SOUND EQUIPMENT

SENSATIONAL Color movies in 8mm full kodak color by professionals. Breathtaking intimate shots of exciting, world famous places. Glamorous Hollywood; fabulous Los Angeles; famous Beverly Hills; exciting Mardi Gras-New Orleans; surfing in Hawaii. 8mm 50-foot color hi-lites \$4.95; 8mm 200-foot color big feature version \$17.50. Send money with orders to Movieland Films, Box 10-M, Van Nuys, California.

SPECIAL Entertainment, 8mm, BXW, \$12.00, 16mm, BXW, \$20.00. Write Tex, Box 368, Terminal A, Toronto, Ont., Canada.

16MM And 35mm sound film, projectors. Savarese, Woodcliff Lake, N. J.

16MM Sound film clearance. Free list. Movocco, Leonard Street, Springfield 4, Mass.

16MM. Sound films. Bargain bulletin. Duquette, 97-T Snow, Fitchburg, Mass.

MOVIE Film! Free catalog! ESO-R, 47th Holly, Kansas City 12, Missouri.

16MM. Sound, projectors, films. Sale, rental, exchange. Visit store or write for catalog. National Cinema, 71 Dey St., New York City.

FREE! Blackhawk's big sale catalog 8mm., 16mm. movies, 2"x2" color slides. Biggest selection anywhere! Projectors, cameras, supplies. Big discounts! Get free, every three weeks, 12-page newspaper size bargain list! Blackhawk Films, Davenport 14, Iowa.

MOVIE Camera film: 8mm. roll \$1.50. 16mm. 100' \$3.00. Free processing. Better Films, 742 New Lots, Brooklyn, N. Y.

16MM. Sound shorts. Tremendous assortment features. \$16.50 up. Used 16 mm. sound projectors. \$79.50 up. Catalog. Abbe Films, 417 West 44th Street, New York City 36.

5,000 8-16MM. Movie films. Free catalogues. International, Greenvale, N. Y.

ENTIRE Life of Christ. 8mm. silent, 16mm. narrated, sacred music for sale. Hemenway Film Co., 424 Little Building, Boston 16, Mass.

8MM-16MM SOUND Films. Entertainment Films, Box 493, Ansonia Station, NYC 23.

10¢ BRINGS Big new cine manual for the 8mm.-16mm. movie maker. Save money on fresh b&w and color movie film, all home processing equipment. Superior, 448 N. Wells, Chicago 10.

COLOR SLIDES

LINCOLN Story, complete in 500 color slides. Catalogue and sample, 35¢. Willems, Box 1515-A, Chicago 90.

COLOR Slides, package of four, 98¢. Rush 35¢ for big catalog, 16,000 subjects. Meston's Travels, 3801Q North Piedras, El Paso, Texas.

COMPLETE Professional music service for songwriters. Colonna Enterprises, Box 888M, Burbank, Calif.

POEMS Wanted immediately for musical setting and recording. Free examination. Rush poems. Songcrafters, Acklen Station, Nashville, Tennessee.

POEMS Wanted for musical setting. Established 1939. URA3, 2181 Bedford Ave., Brooklyn 26, N. Y.

GUITAR Making books, plans, imported woods, tools. List 10¢. Store, 510 East 11th Street, New York 9, N. Y.

SONGPOEMS And lyrics wanted. Mail to: TinPan Alley, Inc., 1650 Broadway, New York 19, N. Y.

POEMS Wanted for musical setting and recording. Send poems. Free examination. Crown Music Company, 49-C West 32 Street, New York 1.

SONGS Into dollars. Share \$33 million dollars yearly for new songwriters, song poets. Any subject, songs composed, published, promoted by largest firm. Information, appraisal free. Send Nordyke Music Publishers, 6000 Sunset, Hollywood 28 PM, California.

POEMS Wanted for musical setting and recording by America's largest song studio. Send poems. Free examination. Five Star Music Masters, 630 Beacon Building, Boston.

ACCORDIONS—Italian manufacturer introduces new models! Authorized dealers throughout United States now offering at introductory price. Do not accept unless it is a Castiglione accordion. Write for free catalog. Castiglione Accordion Company, Box 3862, Detroit 5, Mich.

CHORD Organs—save 1/2. Italian craftsmanship. Play without lessons! Terms. Free trial! Free catalogs. Philharmonic Importers, Department 99-R, 2003 Chicago, Chicago 22.

SWISS Musical movements. Electrical, mechanical. Spielman, 131 West 42nd, New York 36.

ACCORDIONS—1960 Models. Lowest discount prices. Save up to 50%. Free home trial. Trades accepted. Big color catalog free. Accordion Manufacturers, Dept. 109-R, 2003 Chicago, Chicago 22.

SONG Request magazine publishes new songs. Olenik Records, Mount Morris, Michigan.

PHONOGRAPH Records cheap, postpaid. Catalogue. Paramont, Box 2026-M, Pine Castle, Florida.

FREE: "Music Guide" literature. \$50.00 music annually—only \$2.00! Music Guide, 10 Fiske Place, Mount Vernon, N. Y.

SONGWRITERS! Your songs tested, published, recorded; or 25 services. Free details. Iris Music, Box 192, Sun Valley, California.

SWISS Musical movements, \$1.90. Helax, 218 W. 72nd St., New York City 23.

RADIO, TELEVISION AND ELECTRONICS

WORLD'S First 2 station transistorized inter-comm. Write International, 274 Claremont, San Francisco 27, Calif.

SILENCE Television commercials from your easy chair. Simple, inexpensive method any handyman can install. Requires no television experience. \$1 for plans. Harley Stover, 1903 NE 42 Ave., Minneapolis 21, Minnesota.

TUBES Unused. We buy and sell. Have new and used ham gear. Write: P. M. Gensler, 512 Broadway, N.Y.C. 12.

FIX Your own TV the easy way, and save 80%! Send 25¢ for illustrated TV trouble shooter chart showing which tubes to replace. We'll include giant wholesale catalog. Save plenty on parts, receiving and picture tubes. Zalytron Tube Corp., 220-M West 42nd Street, New York City.

CRYSTAL Radio experimenters. Write to Hulet, 305 Hope, Lakewood, New Jersey.

REPAIR Instructions, T.V.s \$2.00, radios \$1.00. DX Radio Coop, Box 5938M, Kansas City 11, Missouri.

HI-FI components, recorders, tap, records. Wholesale catalog free. Electronic World, Inc., 1799M 1st Avenue, New York 28, N. Y.

RECORDERS, HI-FI. Free wholesale catalogue. Carston, 215-PM East 88, New York City 28.

ence course in radio, electronics and television. All new material. Only \$49.50. Formerly sold for over \$300.00. 43 books, over 2000 pages. Limited supply. Write Dept. PM Electronics Training, Box 764, Pittsburgh 30, Penna.

STEREOPHONIC Phonographs, Radios, Recorders, Catalogues 10¢. Tower Distributors, Norristown, Penna.

CONSTRUCTION—Electronic wiring. Free estimates. Send diagrams. Box 314-R4, Kittanning, Penna.

CRYSTAL Radio kit \$1.00; preassembled \$1.25; phone \$1.75; catalogue. Clearco Crystal Co., 2966 N. 4th, Milwaukee 12, Wisconsin.

CODE Learned in minutes! \$1.00. Psycho-code, Box 761, Dept. 10, Berkeley, California.

FREE! Giant wholesale catalog on electronics, hi-fi, transistor, scientific, hobby, optics, photographic, housewares, jewelry, tools, novelties, toys. Write: Lektron, 131M Everett Ave., Chelsea 50, Mass.

TAPE Recorders, Hi-Fi components, sleep learning equipment, tapes. Unusual values. Free catalog. Dressner, 69-02M, 174 St., Flushing 65, N. Y.

AMPEX Tape recorders, components. Boynton Studio, 10-PM Pennsylvania, Tuckahoe, N. Y.

LEARN While asleep with amazing "Electronic Educator" endless tape recorder. Details free. Research Association, Box 24-N, Olympia, Washington.

BUSINESS OPPORTUNITIES

OPERATE Profitable low cost mail order business! Write! Liberty, 210-U Fifth Avenue, New York 10, N. Y.

OPERATE Profitable self-service toy rack route. Free details. Toys, Box 65, Old Hickory, Tenn.

INTERNATIONAL Home import mail-order business! Earnings unlimited. Experience unnecessary. Foreign Traders, 7814 Forsyth, St. Louis 5.

HOW I turned \$1000 into a million—starting in my sparetime, by Nickerson, \$4.95. Battery repair manual \$3.00. Bayer Publications, 938 Betty Avenue, Neenah, Wisconsin.

CASH From sawdust, tin-cans, newspapers. Over 200 methods. Instructions \$1.00. Charles Company, 42-GPN, Norwood, Ohio.

FREE! Valuable fact and picture booklet, "The Amazing Earthworm Business!" Earn thousands \$ in your spare time. Gulf Worm Gardens, Dept. Pl, Bay City, Texas.

DISTRIBUTORS Franchise. Four nationally advertised, trademarked fast money savers sold to auto users, dealers, jobbers, fleets, hardware dealers and jobbers. Over 100% profit. Advertising help launches you into your own business practically overnight. Repeat profits huge. \$10.25 saleable kit \$5.00 (to avoid sample hounds) credited first order. Money back if returned. 4 page Selling Muscle Brochure included free. Service Industries (Rated B-1) 2105-C, E. Somerset St., Philadelphia 34, Penna.

EARN Up to \$30 an hour in your spare time. Just demonstrating and taking orders for the amazing revolving golden beacon. No experience needed. Every store, diner, motel, gas station, etc., are prospects. Send for details free. The Golden Beacon Sales Co., Dept. M., 251 S. 5th St., Philadelphia 6, Penna.

START Your own business on credit (U.S. and Canada). Your own boss, 1383 dealers sold \$5,000 to \$33,500 in 1958. We supply stocks, equipment on credit. 200 home necessities. Sales experience unnecessary. Pleasant profitable business backed by world-wide industry. Write Rawleigh's, Dept. J-U-PPM, Freeport, Ill.

VENDING Machines. No selling. Operate a route of coin machines and earn amazing profits. 32-page catalogue free. Parkway Machine Corporation, Dept. #27, 715 Ensor Street, Baltimore 2, Maryland.

WANTED, Men, women, raise bait for us at home. Full, spare time. Doesn't take up space. We furnish everything. Sherwood, Dept. P-2, Monmouth, Maine.

IMPORT-Export opportunity. Profitable, world-wide, mail-order business from home, without capital; or travel abroad. Established world trader ships instructions for no-risk examination. Experience unnecessary. Free details. Mellinger, X70A, Los Angeles 24.

ACCOUNTANTS. Bookkeepers operate own business using National Tax simplified system. National Tax Service, P.O. Box 1188, Providence 1, R. I.

MAKE Extra money—Big cash commissions plus premiums for you and your customers. Sell advertising book matches. Sensational new tenor, glamour girls, hillbillies; dozens others. All sizes. Quick daily sales; big repeat business. Free master kit makes selling easy. No experience necessary. Superior Match, Dept. MX-1059, 7530 Greenwood, Chicago 19.

LEARN Landscaping and the growing of plants. Start a profitable business part or full time. Free information without obligation. National Landscape Institute, Dept. MC-109, 11826 San Vicente Blvd., Los Angeles 19, Calif.

NEW Home-import mail order profitability! Your mailbox stuffed with money! No selling. No experience. No investment. We supply everything. Free details. Mail Order Distributors (Import Division), 15201 South Broadway, Los Angeles 61A10, Calif.

GAME Warden, government hunter, forestry, park and wildlife services announce job openings. All states. Enjoy outdoor work, good pay, real security. Complete information free! Write Forestry & Wildlife Course, Dept. CC-17A, 1038 S. LaBrea, Los Angeles 19, Calif.

RAISE Angora, New Zealand rabbits on \$500 month plan. Plenty markets. Free details. White's Rabbitry, Delaware, Ohio.

GROW Living miniature forest (only inches high) or orchard that bears tasty tiny fruit. Learn amazing dwarfing secrets! Fascinating hobby! Profitable home-business opportunity! Free seeds and plan. (State your age.) Miniature Nurseries, Dept. OR, Gardena, California.

\$250.00 WEEK Profit possible. Earn at home spare time with fascinating printing method. \$5 starts you. Send no money now. Free confidential facts and valuable samples. Screen-Print OR, Los Angeles 61.

SELL Books by mail. 400% profit. Royal, Box 368-X, Cleveland 27, Ohio.

WHERE To buy newest products. Free details. Domestic, foreign manufacturers. Ardale, 135 Jewell St., Garfield, N. J.

BIG Mail. 25¢ brings you hundreds of moneymaking offers. Linwood Sedgwick, 1114 30th St., Newport News, Va.

OPERATE Profitable mail order business. Splendid opportunity. For details write John Watkins, Box 1, Hackensack, N. J.

WILL You test new items in your home? Surprisingly big pay. Latest conveniences for home, car. Send no money. Just your name. Kristee 111, Akron, Ohio.

MAIL Order guide, rules, laws. Lists 15 mail order publications, 50¢. Curtiss Publications, 312 Olive, Porterville, California.

FORTUNES Made in small sign shops. Strahley, 410 So. Western, Springfield, Ohio.

CALIFORNIA Jobs. Business opportunities. Housing. 45 pages classified. \$1.00 weekly. \$3.00 monthly. Covell, 427 South Olive Street, Los Angeles 13, Calif.

SELL Folios. 200% profits. Sample \$1.00. Wilkinson, 530-f No. Poplar, Centralia, Ill.

YOUR Own home-operated business. Take over your area as our service distributor keeping retail stores supplied. Nationally advertised 30-year-old line pays up to \$20.00 hour. Under \$100.00 for merchandise gets you started. For samples, highly successful plan, write Novo, 3855 Lincoln, Desk H-67, Chicago 13.

STEADY Income by mail. Free kit. Shorelands, Inc., Box 5AE, Plaistow, N. H.

WANTED: Home producers, to be subcontractors. Cast plastic products for manufacturers in our clearing house service. Thousands of easily made items required. Cash in at home, without previous experience. Plastic Service Associates, Dept. 10PM, East Boston 28, Massachusetts.

PROFITABLE Aspects of landscaping. Spare or full time. No involved study. Low investment. Lucrative returns. Details free. A. E. Eldon, Landscaping, RR1 Stratford, Ontario, Canada.

HOMEWORK. \$3.00 Hourly. Typewriter helpful. Business literature and instructions 50¢. Interstate, Del Station, Albany 9, N. Y.

INCREASE Profits. New garden golf motivated archery. Brockway, Box 3924, Portland 8, Oregon.

CANDIED Popcorn and potato chip equipment. Eakins, Box 933-A9, Springfield, Ohio.

EXCEPTIONAL Mailorder opportunity! Write: George Lenhoff, Box 201, Lincoln 1, Nebraska.

PROFITABLE Mailorder business! Write: Cal Enterprises, Box 1592, Beverly Hills, California.

AMAZING Profits manufacturing concrete drain tile! Details free. Ceeten Products, Cornelia, Ga.

OPERATE Profitable mail order business! United Wholesalers, 1265-CR Broadway, New York 1, N. Y.

PLASTERCRAFT Molds, liquid rubber, plasters, flocks, candle supplies. Catalog and manual free. Blue Rapids Supply, Blue Rapids, Kansas.

FRANCHISES Make profits! Have your own profitable franchise business. Opportunities nationwide for distributors, dealers, agency operators. Join thousands of ambitious men throughout America who secure their franchise guidance each month from National Franchise Reports. This pioneer franchise reporting service has been recommended in business books, magazine and newspaper feature articles. It is the authoritative, recognized national clearing house for franchise information. Let NFR assist you in securing a valuable franchise. Write today for interesting, free details of this helpful service. National Franchise Reports, W-528, 333 North Michigan, Chicago 1.

MAILORDER To churches, motels, restaurants, institutions. Complete, individual set-up, not just instructions. Hermes Advertising, 152-C West 42, New York City 36.

OPERATE Profitable mail order business. Write Wayne's Service, 3016-MM Channing N.E., Washington 18, D. C.

FREE Plan and personal help. Retired mail order operator will show you how to start profitable home business. Norris Cole, 217 West 49th, Bradenton, Florida.

"FORTUNES In Formulas." Greatest money-making idea book in the world. 900 pages. \$3.95. Satisfaction guaranteed. Free literature. Rollin Hill, 20-A West Jackson, Chicago 4, Illinois.

I Got rich in the dry cleaning business with no investment, so can you. Free details. Write: Imperial School of Dry Cleaning, Dept. PMC, 1700 Touhy Avenue, Chicago 26, Illinois.

TREMENDOUS Profits by mail! Booklet, literature, 25¢. Labranche, 308 Gagne, Rouyn, Quebec, Canada.

OWN A business. Manufacture building material. Great demand. Particulars free. Morris, 713 So. Wabash, Urbana, Illinois.

MAILORDER. America's most unique no cost plan for beginners. Armstrong's, 154A Darrington St. S.W., Washington 24, D. C.

STRIKE It rich on small home repairs by using set prices. Details free. House Clinic, Dept. P, 7307 Fenton, Dallas 31, Texas.

MANUFACTURE Toys, vinyl dolls, plush animals, houses. 500% profit. 10¢. Benko, 1351 First Ave., New York City 21.

WANT Security? Raise earthworms! 1000, \$6.00. Free booklet with order tells how. Sierra Worm Ranch, Box 2756, Fresno, Calif.

FREE! Name brands catalog! Your own high profit business. Sell name brands, full or part time. No inventory, no investment. More than 2,000 name brand items; lowest wholesale prices. Watches, jewelry, cameras, hi-fi, stereo radios-phonos, appliances, housewares, hardware, power tools, luggage, musical instruments, garden equipment, sporting goods, toys, many others. 8 floors of name brands. Million dollar inventory. Orders shipped complete in 24 hours! Send for free, beautifully illustrated catalog now! Separate wholesale price list. H. B. Davis Corp., Dept. 11, 145 W. 15 St., New York 11, N. Y.

PLATE Baby shoes, jewelry, gifts. Bronze and colored pearl. We finance home businesses. Booklet free. Platex, 11029 South Vermont, Los Angeles 44.

LEARN Sewing machine repairing. To \$125 weekly. Sparetime. Supplies. Add to present business. Shipping from Chicago, New York, Los Angeles. Write today! Taylor Service, Box 2126, San Bernardino, Calif.

IF You like motorcycles and money then send for Harley-Davidson dealership book on how to become a franchised dealer of motorcycles and a new line of motor-scooters. Here's a chance to own your own business with a very modest investment. The youth market is beginning to explode and the next few years promise a chance to cash in on it. Write for free illustrated dealership book today. Harley-Davidson Motor Company, Dept. P, Milwaukee 1, Wisconsin.

EARN Money at home raising fishworms for us! Backyard, garage, basement. We buy your crop! Inquire: Oakhaven 38, Cedar Hill, Texas.

BUY Direct from factories. Appliances, cameras, watches! Free details! Cam Company, 6810PM—20th Ave., Brooklyn 4, N. Y.

BUSINESSES, Resorts, motels, investment property, ranches. Our special service dept. at your disposal. No obligation. World's largest, 58 years' service. Strout Realty, 7-MB S. Dearborn, Chicago 3, Ill.

BIG Money raising fishworms and crickets. Free literature. Carter Farms, Plains, Georgia.

QUICK Profits, with no capital! Take orders for magazines your neighbors like, want. Make cash on the spot! We show how with free kit. Get yours now. Write McGregor Magazine Agency, Dept. 311, Mount Morris, Ill.

OPERATE Mailorder folio business. Free details. Ballard's, 1834 Edgeland, Louisville 4, Ky.

\$34.70 TWO Hours. Manufacturing concrete products. No selling. Carlayne Castings, 1803 Fremont, Rapid City, South Dakota.

TO \$100.00 Weekly. Sparetime, home operated mailorder business. Successful beginner's plan. Everything supplied. Lynn, 10420-M National, Los Angeles 34.

COLORGLAZED Concrete pottery made without molds. Patented method. Cemetery products, novelties, tiles. Basement leak-sealing. Money-making projects. Booklet, details free. Men only. National Potteries Company, Grand Rapids, Minnesota.

PIANO Tuning learned quickly at home. Tremendous field! Musical knowledge unnecessary. Information free. Empire School of Piano Tuning, Champaign, Ill. (Founded 1935).

WANT To make big money at home? \$10.00 profit in an hour possible with invisible mending. Make tears, holes, disappear from clothing, fabrics. Steady year-round demand from cleaners, laundries, homes. Details free. Fabricon, 6234 Broadway, Chicago 40, Illinois.

\$70 WEEKLY—Home, spare time. Simplified mail bookkeeping. Immediate income—easy! Auditax, 34757A, Los Angeles 34.

MAKE Flexible molds. Cast plaques, figurines. Free sample. Tooker, 1045-R Fairview, Hamilton, Ohio.

I Want to send you proof of the wonderful pulling power of Popular Mechanics classified pages. What's your proposition? Write me today. Include literature if possible. F. W. Johnson, Manager Classified Advertising, Popular Mechanics Magazine, 200 E. Ontario St., Chicago 11, Ill.

OPERATE Profitable mailorder business! Write: Bond, 1637-H West Vernon, Phoenix, Arizona.

11,000 NEW Prospects daily. Baby record books, shoes, albums. Sell mailorder. Use our literature. Write: No-Co-Ro, Capitola, California.

COPUBLISH Mail Sale Advertiser. Leading mail order paper. Details, latest copy, dime. Vanroy Shirk, Lebanon, Penna.

FREE Catalog. Contains hundreds of businesses, farms and income properties throughout U.S., Canada. Specify type and location desired. Deal direct with owners. U. I. Buyers Digest, 1608 Hillhurst, Dept. PM-3, Los Angeles 27, Calif.

BRONZE Baby shoes: instructions, equipment and mountings for genuine electroplating process. Largest supplier of all plating equipment, supplies. Free catalog. Hollywood Bronze Supply, Dept. B-3, 1624 East First, Los Angeles 33, Calif.

MAKE \$46 From square foot plywood; jigsaw necessary. Free details. Woodart, Bridgewater, Mass.

MARKETS Everywhere. Make artistic concrete birdbaths, pottery. Best coloring. Home workshop. Hundred varieties. Hollywood Cementcraft, 8527-S Wonderland, Hollywood 46, California.

LIQUID Molding rubber, free sample. Shellcraft supplies. Chaney's, 1907-A East Road, Jacksonville 11, Fla.

FIX Typewriters. Free repair course. Home operated. Remit 25¢ for book explaining free course and agency appointment. Athey, Tarentum, Penna.

MAKE Money by mail! Free details! Hunholz, 902 Eighth, Wamego, Kansas.

MANUFACTURER Fishing lures, plastic, none better. 20 models pennies. Free circular. Quaker, 3514-24 N. Lawrence, Philadelphia 40, Penna.

OPERATE Profitable mail order business. Write Walter Service, 4159A East 112th, Cleveland 5, Ohio.

EARN Good money sharpening chain saws, scissors, cutters, knives. Free manual. Treco, North Tonawanda, N. Y.

RE-Cast junk batteries into new. Latest achievements. Battery Laboratories, Bayou LaBatre, Alabama.

\$100 WEEKLY! Men, women! Work home! Sparetime. Free "Confidential Plan." Scott Sales, Box 388, Great Neck, New York.

IMPORT-Export business made easy. Individual setup service. Not just instructions. Hermes, 152 West 42, New York City 36.

HAVE A profitable business of your own selling the "World's Most Usable Pictorial Bible." Let our 26 years experience help you. International Book Company, Dept. M., P.O. Box 118, Wichita 1, Kansas.

BE Appointed state notary public now. Details. Stationers, 515 East 33rd, Kansas City 9, Missouri.

BAKE New greaseless doughnuts in kitchen. Sell stores. Free recipes. Montgomery, 3605 South 15th, Minneapolis 7, Minnesota.

PROFITABLE Mailorder operation! Write: Vikari, 468PM 3rd Avenue, Salt Lake City 3, Utah.

\$3.00 HOUR—Home, sparetime, assembling pump lamps. Easy. Free details. Ougor, Caldwell, Arkansas.

OPERATE Profitable mail order business. Write Hunt Enterprises, 978 Terrace Dr., Salem, Oregon.

YOUR Own successful business can bring \$1,000 monthly by mail at home. Free details. DeLang Research, Box 52-D, Burlington, Iowa.

YOUR Own business! Sharpening scissors. Steady profits. Blackhawks, Sheldahl, Iowa.

GIANT Homework opportunities 25¢. Kengee, 1105 Morning Glory, Durham, N.C.

"MAILORDER Laws and Regulations" including "Mailorder Rules for Beginners." Explains federal, state and local licenses, taxes, and legal requirements for operating mailorder businesses. \$2.00 postpaid. Tasker, Box 3131, Alexandria, Virginia.

MADE \$10,000 Typing at home. Guaranteed proof. Amazing information 15¢. Lenore Feigen, Box 1125-PM, Oak Park, Illinois.

PLAQUES-Figurines-molds. Free details. Russo, 1196 Brooklyn, Bklyn 3, N. Y.

MOTEL-Resort management. Qualify for hundreds fascinating, leisurely, well-paid executive openings. Learn at home. Free booklet. Motel Managers Training School, PM109, 612 S. Serrano, Los Angeles 5.

CUCKOO Clocks wholesale. Catalog 10¢. Walters Imports, Box 195, Bellevue, Ohio.

"MAIL Order World of Opportunities." Free subscription, details. GPO, Box 972-P, New York 1.

EXPERIENCE Of nation's leading mail order men can be yours! "Money by Mail," \$1.00 ppd. War-Ann, Box 214, Peru, Ind.

EARLY Retirement possible! Unattended coin-operated reducing salons. \$2,975. Trimian, 4812-M Irvington, Houston, Texas.

MANUFACTURING Opportunity—local plants are required to process trademarked building product for regional markets. Basic materials locally available. \$2000 worth of product per week from 3-man crew. Broad markets and generous income potentials. Intensive cooperation in sales development if required. Exclusive manufacturing rights in territory protected by franchise. Investment ranges from \$20,000 to \$30,000, of which about 50% is for machinery. Full information from W. E. Dunn Mfg. Co., 409 24th Ave., Holland, Mich.

GUARANTEED Market. Raise fishworms for us. Free details. Golden Farms, Lubbock 12, Texas.

SPECTACULAR Profits from plastics. Full or spare time. Free details. Trialpha, 7950 Mammoth, Dept. F30, Van Nuys, Calif.

MAILORDER Made to order, everything furnished. Free details. Mailhows, 18 Wagner Pl, Hawthorne 18, N. J.

"50 New Home-business Ideas" booklet, sample free. Spray exotic Velvet-Suede on anything. Flokraft-OR, Los Angeles 61.

"BOOKKEEPING System for Mailorder Beginners." \$1.00. Tasker, Box 3131, Alexandria, Virginia.

MAILORDER Business. No investment. Omaha Envelope, 4721-W California, Omaha 32, Nebraska.

DROPSHIP Buyers' Guide reveals manufacturers mailing single orders using your label. Large profits; no inventory, delivery, packaging headaches. Complete operating instructions. Details free. Rutward, 110 Bryant, Columbia Station, Ohio.

NEED Money! Want security! Independence! Start home mail order business on shoestring. Cox, Saugus 1, Massachusetts.

"EVERYBODY Likes Candy." Make professionally home. (Our 49th year.) Ragsdale Candies, B107, East Orange, New Jersey.

BIG Money refinishing mirrors. Will tell you how and furnish chemicals for silvering 20 square feet \$2.98. Gulf Plating Company, 408 South Royal Street, Mobile, Alabama.

IMPORTERS: Send only \$1.00 for complete list of 42 foreign exporters of good selling, low cost items. Order today! Bob Brock, 1008 East 34th Street, Savannah, Georgia.

DOLLS! Dolls! Dolls! We teach you to repair, make, sell, all kinds. Study at home. Earn while you learn. Free information. Doll Hospital School, Studio PM-109, 11826 San Vicente Blvd., Los Angeles 49, Calif.

PROFIT With Popular Mechanics' subscription plan. No investment, no experience needed. Earnings begin immediately when you obtain subscriptions for Popular Mechanics, Good Housekeeping and others. High commissions, bonus. No experience needed. Deal directly with the publisher. Write Popular Mechanics, Room 10B, 250 West 55th St., New York 19, N. Y.

BE A Manufacturer! Tremendous profit. Start at home spare time. Details free. Pratt Laboratories, Box 6331, Greensboro, N. C.

HELP Yourself! Mailorder! Know the facts: laws, trends, secrets. Everything! 99¢. Customers only! Free advice, product analysis. Ads written professionally. 10¢ word. Minter Enterprises, Box 32PM, Thiensville, Wisconsin.

PROFITABLE Spare time advertising. cities over 50,000. Details, sample \$1.00. Advertising, Box 381, Mobile, Alabama.

PET Cemeteries needed everywhere. Start on shoestring. Sparetime. Tremendous moneymaker. Eye opening information free. John E. Orr Pet Haven Cemetery, Box 1411, Lubbock, Tex.

HELP Others earn money for you. Charles-Ken, Box 394, Hollywood 46, Calif.

MONEY In chemicals. Make own products! Pocket all profits! Others work for you! Valuable starting information, \$1.00. Satisfaction guaranteed. Ranslow Reporters, 51 W. 32nd St., Hialeah, Florida.

WANT To make good money at home for a few hours work? Franchised and no selling. Information free. Marshall's, 4154C Commerce Station, Phoenix, Arizona.

SIX Mailorder magazines, money-making opportunities, 25¢. Thompson, Box 94-PM, Salinas, California.

\$10-\$25 PER Week typing spare time for \$1. Thomas Snapp, Glade Spring, Va.

110 FOREIGN Dropship firms, classified, \$1.00. Henderson, 2620 Rio Vista, Tampa 3, Florida.

MONEYMAKING OPPORTUNITIES

CAKE Decorating, chocolate dipping, professional candymaking, thrilling new home business, hobby. No experience necessary. Your kitchen brings you top money from weddings, birthdays, parties, banquets, all occasions. Learn spare time, your home, any age. Free facts. Candy & Cake, Dept. 513, Fallbrook, Calif.

BIG Money making beautiful pleated skirts with my miracle one-seam instructions. Quick, foolproof. 23" to 33" waist. Only \$1.00. Elizabeth, 1176 East Claremont, Pasadena, California.

VENDING Machines. No selling. Operate a route of coin machines and earn amazing profits. 32-page catalogue free. Parkway Machine Corporation, Dept. #26, 715 Ensor Street, Baltimore 2, Maryland.

MAKE Big easy profits making costume jewelry at home in spare time! Quick, easy to make, easier to sell! Details free! Don-Bar, 3511 W. Armitage, Dept. K-192, Chicago 47, Illinois.

WANTED. Old U.S. stamps. Mail to me for my offer. Dockow, 90 Broadway, Hicksville, N. Y.

START Mailorder correctly. Operate profitably. Guarprod, 2036P 66th, Brooklyn 4, New York.

INVISIBLE Reweaving: \$5 in one hour possible reweaving burns, tears, moth-holes. Spare-full time. Free details. Skil-Weave, Dept. WC-1610, 335 W. Madison, Chicago 6.

TEAR Out this ad, and mail with name, address for big box of home needs and cosmetics for free trial, to test in your home. Tell your friends, make money. Rush name, Blair, Dept. 31CT, Lynchburg, Va.

GENUINE Man-made diamonds \$4.00 per carat. Free literature. Allied Import Co., 1661 University, St. Paul, Minn.

GROW Mushrooms. Cellar, shed and outdoors. Spare, full time, year round. We pay \$4.50 lb. dried. We have 29,000 customers. Free book. Mushrooms Dept.: 173, 2954 Admiral Way, Seattle, Wash.

WEAVE Rugs. Make good profits. No experience necessary! Free catalog, sample card, and low prices on carpet warp, rug filler, looms, parts. Inexpensive beam counter. If you have loom, give make, weaving width please. OR. Rug Company, Dept. 9972, Lima, Ohio.

\$5,000 YEAR Possible. Make new exclusive wood products. Sell by mail. Steady demand. Booklet \$1.00. Gabert, 907 Birch, Eau Claire, Wisconsin.

AMAZING Successes through franchises! Secure your own profitable franchise business. Alert yourself to nationwide opportunities. They are published each month by National Franchise Reports. This is the pioneer franchise reporting service recognized nationally as the clearing house of franchise information. Send today for free, interesting literature. National Franchise Reports, MP-528, 333 North Michigan, Chicago 1.

FREE Catalog. Sell costume, religious jewelry. 200% profit. Sample \$1.00. John Clark, Box 40, New York 12, N. Y.

REPAIR Hydraulic jacks. Illustrated repair manual \$3.98. Free information. Hydraulic Parts Supply, Box 4104, El Paso, Texas.

CIGARETTES: Make 20 plain or filter-tips for 9¢. Facts free. Moberly, Box 821, Owensboro, Kentucky.

\$200.00 MONTHLY. Spare time. With table saw, bandsaw or jigsaw. Write. Holiday House, 7228 4th Plain, Vancouver, Washington.

FREE Home moneymaking plan! Merrill Histand, Box 182F, Hatfield, Penna.

HAVE Big paying home mailorder business! Many new, sparetime moneymaking opportunities now available! Details free! Steininger, Box 181-PM, United, Pennsylvania.

duplicating comic cartoons for advertisers. Adservice, Argyle 1, Wisconsin.

YOUR Own, easy-to-start, home mail-order business, sparetime. Fascinating; profitable! Information free. Alfano, 19-PM Pine, Closter, N. J.

HAMMER? Saw? Drill? \$100 weekly. Jett, Box 422, Escondido, California.

\$340.00 MONTHLY With jigsaw. Details. Elkman, 346F North Summit, Sioux Falls, So. Dak.

BIG Money raising fishworms and crickets. Free literature. Carter Hatchery, Plains, Georgia.

SELL Titania gems. Far more brilliant than diamonds. Catalog 10¢. Diamonite, 2420-M 77th, Oakland 5, California.

BOOKS: Hundreds of subjects. Big 1958 book catalog—10¢. Popular Mechanics Press, 200-BC East Ontario St., Chicago 11.

WIN Contest money. General Contest Bulletin gives hundreds of tips. Lists current contests, rules. Sample magazine 25¢. General Contests, 1609½ East 5th, Duluth 12, Minnesota.

MAKE Money writing short paragraphs. Information free. Barrett, Dept. C-27-D, 7464 No. Clark, Chicago 26.

11 MONEY Making methods. Each worth big money to you. Free details. Griffin, 322 W. State, Ithaca, N. Y.

READ "Progressive Mailtrade," the magazine that tells how to make money by mail. Quarter brings sample and special offer. Progressive Mailtrade, Box 357, Sheboygan, Wisconsin.

BIGGEST Money makers in the field. Acme saw and lawn mower sharpeners. Free literature. Max Mfg. Co., 138 Stockton Ave., San Jose 26, California.

MONEY in your spare time. Become a notary public. One dollar brings full details. JoMar, P.O. Box 142, Baltimore 1, Maryland.

OPERATE Home mail-order business. Vosacek Printing, 4444A Ute, San Diego 17, Calif.

START Big-pay business at home in spare time. No experience needed to operate little table-top machine for bronzing baby shoes. Make \$5.46 profit on every pair. Full particulars free. Send postcard to Mason, 1512 Jarvis, Room CM-2-L, Chicago 26, Ill.

COLLEGE-High school students, junior, senior interested in making extra money. Send us your name, address, college or high school you attend on 4¢ postcard for information. Gerard Rivard, Box 437, Claremont, N. H.

WE Establish you in your own business on our capital. No investment. No experience necessary to start. Part time or full time. Small cities and towns best. Winona Monument Co., Winona, Minn.

ORNAMENTAL Gas yard lights, factory expanding, booming business! Moonlight, 120-F East College, Covina, Calif.

OUTSTANDING Moneymaking spare-time business. Build beautiful outdoor fireplaces or patio planters. Plans \$1.50 each—both \$2.50. AHS, 3181-F Roswell Rd., N. E., Atlanta 5, Ga.

EARN More money! Know and capitalize on your abilities! Eliminate doubt as to your future! Send \$5.00 for comprehensive intelligence test and full analysis. Associated Institute, P.O. Box 4, Manhattan Beach 7, California.

"BUILDING A Fortune Using Common Sense." Send name, address, \$2.00 for booklet. Macvean, 82 Brookview Crescent, Brockville, Ontario, Canada.

MAKE \$5,000 Yearly sparetime raising mink, chinchillas, nutria, etc. Free booklet reveals proved plans. Write: Puss, 588 Mt. Pleasant Road, Toronto 1, Canada.

NOW! A second income in part time mail order business. It's terrific! Free informative literature. Wagner, 110 Calodine, Buffalo 26, N. Y.

MEN — Women! Start money-making plastic laminating business at home in spare time. Material that costs 11¢ brings back \$2.50. No canvassing or selling but mail orders bring in \$20 a day. Write for full particulars free. Rush name on postcard to Warner, Room CL-2-L, 1512 Jarvis, Chicago 26, Ill.

logs. Sample catalog for advertisers 35¢. Marcakis, Box 514, Philadelphia 5, Penna.

UNUSUAL Fees earned managing money-raising campaigns for churches, hospitals, lodges, institutions. Unlimited demand. Three month spare time course backed by thirty-four years experience. Free proof. William Arbogast, 229 East Mason Avenue, Alexandria, Virginia.

MAKE \$5,000-\$15,000 Yearly at home in respectable field. Future growth unlimited! No experience necessary; no public contact; nothing to grow or make. Free expert guidance helps you achieve financial success! Rush \$1.00 today for complete details! Satisfaction or refund. Columbia Enterprises, 9268-PM Piney Branch Road, Silver Spring, Maryland.

WORK At home. We supply everything. \$25-\$50 weekly in spare time. Complete information 10¢. Sufflok Ceramics, 366 Centerport 2, New York.

NEW Soilless method. Raising night-crawlers, redworms. Three Oaks Ranch, Dresden, Tenn.

WANTED Worm raisers. Down-East, Box 149, Bangor 4, Maine.

HAVE Big paying mailorder business! Idea book for beginners, established dealers, only 25¢! Satisfaction guaranteed! Beatty, Box 4754-P, Baltimore 11, Maryland.

HOW To start mailorder business. Taxes, regulations, etc. \$2.00. Freds, 3910 University Avenue, Madison, Wisconsin.

MONEY Making opportunity. New useful invention. Send \$1.00 for sample, refundable. Swan Co., Coronado, Calif.

START A profitable subscription business in spare time! We need men and women (young or old) as representatives for all leading national magazines. Liberal commissions on all subscriptions. Supplies free. No experience needed. Send this ad with your name and address to: Popular Mechanics, Room 10-0, 250 West 55th St., New York 10, N. Y.

EASY To start rubber stamp business at home in spare time. Make up to \$9.80 an hour without experience. Facts free. Write to Roberts, 1512 Jarvis, Room CR-2-L, Chicago 26.

MAKE Humorous signs. Easy, profitable. Free information. Stanmore Sales, Listowel, Ont., Canada.

SELL Information by mail. 10-to-1 profit ratio. Valuable suggestions free. Rawson Wood, 2753-F Fullerton, Chicago 47.

NO Competition. A fortune quickly. Your own business. No investment. Full details only \$5.00. Smutz Company, Box 426-A, Lincoln, Nebraska.

Earn \$3,000.00 for a \$2.00 investment. For information write L. W. Cooke, Box 1581, Steubenville, Ohio.

FORMULAS, PLANS, ETC.

RESILVER Mirrors—make one-way mirrors. Both \$1.00. Kem-Mir, Park Ridge, Illinois.

LATE, Modern manufacturing formulas. List free. Moon Chemical, Martville, New York.

FORMULAS for latest money-making discoveries. New! Good! Valuable literature free! Miller, Chemist, 1517-D, Tampa, Florida.

FORMULAS; All kinds, latest, best. Literature free. Kemixal, Park Ridge, Ill.

OPPORTUNITIES, Unlimited! Latest specialty formulas, analyses, development, consultation. Monthly report of newest products. Exciting details, free. Alpha-Midwest, LaPorte, Indiana.

MANUFACTURING Formulas: Newest products for home, car. Literature free! Write Chemist, Box 337-E, Orrville, Ohio.

PLASTICS

SIMPLIFIED Plastic molding, repairing, trial unit \$2.00. Hallmark Dental Co., Box 1924, Detroit 31, Mich.

PLEXIGLAS. Square foot cost. 1/16", \$1.20; 1/8", \$1.52; 3/16", \$1.86; 1/4", \$2.21; 3/8", \$3.23; 1/2", \$4.36. Colors add 10%. Send 15¢ for postage. Aristocrat Plastics, 23 Sussex Avenue, Newark, N.J.

BOXES, Plastic. Free list. Althor, 170 Bay 23 Street, Brooklyn, N.Y.

time income. Low cost home training now available. Write for free booklet. Interstate Training Service, Dept. D-3, Portland 12, Oregon.

NOW, Electric plastic laminating kit. Profit. Pleasure. Burr, 330 East Center, Kalamazoo, Mich.

SEALED in plastic. Cards, photos, clippings, etc. Burr, 330 East Center, Kalamazoo, Mich.

NEW Liquid casting plastic, clear, colors. Embed real flowers, butterflies, photos, coins. Send 25¢ for two handbooks "How to Cast Liquid Plastics" and "How to Make Extra Money at Home." Castolite, Dept. L-101, Woodstock, Illinois.

EVERYTHING in plastic supplies. Catalog \$1.00. Gel, Box 261, Union, N. J.

NEW Do-it-yourself casting and molding plastics! No experience or machinery necessary. Send 25¢ for big 64 page catalog. Castacraft Corp., Dept. S-22, P.O. Box 555, Palo Alto, California.

PLASTICS—Plexiglas, Polyester, fiberglass, Acetate, supplies. Manufacturers' distributor, sheets, rods, tubes, liquids, coatings, films. Large, small quantities. Complete instructive catalog, 50¢. Details free. Gem-O-Lite, 5529-X Cahuenga Blvd., North Hollywood, California.

PLEXIGLAS Square inch cost postpaid. 1/16"-1¢; 1/8"-1½¢; 3/16"-1¾¢; 1/4"-2¢; 3/8"-3½¢; 1/2"-5¢; 3/4"-7¢; 1"-9¢. Square foot price deduct 20%—color add 15%. Davenport Staple Co., 220 E. 11th, Davenport, Iowa.

CHEMISTRY

FREE Introductory offer. Student chemicals, apparatus, biology supplies. Catalog 25¢. Bio Chemical Products, 30 Somerset St., Belmont 78, Massachusetts.

MICROSCOPE Slides, anatomical. Free list. Bay, 409 Roosevelt, San Francisco 14, California.

AMAZING New book of science experiments, formulas, and catalogue of laboratory supplies. Only 35¢. National Scientific Co., 13 S. Park Avenue, Dept. PM-10, Lombard, Illinois.

EXPERIMENTERS: Terrific bargains galore, catalog 25¢. Hagenow Laboratories, Manitowoc, Wisconsin.

BOOKLETS! Chemistry, Physics, Astronomy, Science, Relativity, Electricity, Radio, Light, Tables, Mathematics. 15¢ each. Franks, 3121 South Racine, Chicago 8.

CHEMICALS And apparatus for industrial, analytical, and private laboratories. Catalog 25¢. Dept. M-50, Biological Supply Co., 1176 Mt. Hope Ave., Rochester 20, N. Y.

ILLUSTRATED Catalog: Chemistry, mineralogy, biology 25¢. Tracey Laboratories, Evanston, Illinois.

CHEMISTRY, Microscopic. Insect, butterflies, rocks, minerals. Sets complete. Literature. Amateur Chemist and Microbiologist, 208 East Eleventh, Kansas City, Mo.

ROCKET Chemicals, supplies, kits, laboratory apparatus. Catalog 25¢ with new illustrated plans. Central Rocket Company, Waupaca, Wis.

APPARATUS Catalog, 232 pages, \$2.00. Laboratory Materials, 7319 Vincennes, Chicago.

CHEMICALS, Supplies catalog 25¢. Laboratory Sales, Box 161-A, Brighton, Mass.

HELP WANTED

NEW MEXICO Tech. Research Division need senior scientists. Apply Campus Station, Socorro, New Mexico. Excellent climate for health seekers.

AGENTS WANTED

SCHOOL Seniors. Be popular with classmates. Have spending money galore. Details free. Craftscards, Box 235-L, Pittsburgh 19, Penna.

EARN \$12,000 Yearly—only two sales daily. World's best seller, The Holy Bible. Illustrated, Protestant or Catholic. Margaret's, P.O. Box 92, Hazleton 7, Penna.

DRESSES 18¢. Blouses 39¢. skirts 69¢ (used). Free catalogue. Ace, 196-PM DeGraw, Brooklyn 31, New York.

BIG Profits. Stamp social security plates, key protectors. Sample 50¢. Catalog free. General Products, 188-PM State, Albany 10, N. Y.

of our new 1959 Christmas and all occasion greeting cards and gifts. Take their orders and earn to 100% profit. No experience necessary. Costs nothing to try. Write today for samples on approval. Regal Greetings, Dept. 151, Ferndale, Michigan.

MEXICAN Art goods! Free sample! Send 14¢ stamps mailing. Sylviak, Apartado 9036, Mexico City.

EASY Handwork makes fast-selling useful articles. Sample free. Sunmade Company, Brockton 64, Massachusetts.

PRINTING. Advertising salesmen—Excellent moneymaking sideline selling decalcomania name plates, small quantities. Automobile initials, sign letters. Free samples. Ralco, XL, Boston 19, Mass.

AGENTS — 300% Profit selling genuine gold window letters; stores and offices. Free samples. Metallic Sign Letter Co., 1217-D West Newport, Chicago.

YOUR Ad in this space will get some good agents for you. Yes, I'll prove it. Write for Folder "A" right now. P. W. Johnson, Classified Advertising Manager, Popular Mechanics Magazine, 200 E. Ontario St., Chicago 11, Ill.

SELL Champion, AC, Autolite spark plugs. Reconditioned, electroplated, guaranteed 10,000 miles. 100% profit. Free sample. Lee Plugs, 1608-E Roberts, Houston 3, Texas.

TREMENDOUS Profits! Every man, woman and child a customer. Used suits \$1.50, pants 35¢, dresses 20¢, shoes 20¢. Operate from store, home, car. Free catalog. Superior, 1250-A Jefferson, Chicago 7.

MONEY-Making opportunities unlimited! Earn good money selling fabulous money-making toys, collector's items, gifts, jewelry, household items, gift wraps, and greeting cards. Reasonably priced. All sell on sight. No big investment. No experience needed. Big illustrated catalog contains 785 money-makers. Write for free catalog. Samples on approval. North Star, 9-735 Finch Bldg., St. Paul 1, Minn.

CHRISTMAS Cards with customer's name imprinted. Broad-appeal personal designs and big-volume business designs all in one attractive presentation album that actually sells for you! These deluxe cards pay deluxe commissions. Earn \$300 to \$500, plus bonuses, easily between now and Christmas, even in spare time. Sales experience unnecessary. Old-established manufacturer. Free sales kit includes sample album and complete, easy-to-follow selling instructions. Send for kit now and pocket profits next week! Write Process Corp., Dept. 4C, 1954 S. Troy, Chicago 23, Ill.

YOUR Own business—Used suits \$1.50; overcoats 65¢; mackinaws 35¢; shoes 12½¢; ladies' coats 30¢; dresses 15¢. Enormous profits. Catalog free. National Mail Order, 2111-AA Roosevelt Road, Chicago 8, Ill.

EARN 173% Profit on \$.25¢ item. Sell new American flag printed in color on parchment paper. Write. New American Flag, 145 Kennedy Street, N.W., Washington 11, D. C.

FOG-STOP Windshield cloth. Instantly removes blurry mist, frost, sleet, snow. Stops windshield fogging. Samples sent on trial. Kristee 65, Akron, Ohio.

SELL Covered wagon lamps. Retail \$9.95 to \$14.95. Wholesale \$6.95. Details free. Garitty, 5011-6 Elton, Baldwin Park, Calif.

DAMASCENE Earrings! Exotic orientalism. Huge profit. Ohga, PM-161 Sigakenkusatu, Japan.

MAKE Your spare time profit time! Over 800 fascinating items! Gifts for men, women, children, the home! Distinctive greeting cards, stationery, toys, novelties, jewelry, cosmetics, gadgets at prices to fit every pocketbook. No minimum order. Make up to 92% profit! Write today for exciting details, colorful catalog. Greetings Unlimited, 9-381 Park Square, St. Paul 1, Minn.

GOLD Or silver letters, numbers. Windows, doors, trucks. 1" to 6". 500% profit. Free samples. Atlas-T, Box 543, Oak Lawn, Ill.

2 SALES Daily make \$150 weekly! Automatic new bed warmer you sleep on; out sells electric blankets 10 ways. 9 of 10 demonstrations sell on assured sales plan. Electro Warmth, Dept. PM-1059, Danville, Ohio.

WHOLESALE Catalog free — shoes, shirts, pants, hosiery, etc. Bostonian, 40-CA Harrison Avenue, Boston 11, Mass.

P.O. Box 27, Albany, N. Y.
\$1,000.00 A Month for making dramatic 3-second demonstration of amazing lightweight Presto fire extinguisher. New chemical used by airforce snuffs out fires instantly. Only \$4.95. Terrific commissions. Millions want it. Free kit. Merlite, 114 E. 32nd, Dept. P-66E, New York 16.

RADIANTLY Beautiful Mexican feather Christmas and greeting folders. 4½"x6½". One dozen assorted with envelopes \$1.95. Mexicana, Dept. 1104, Calexico, Calif.

SEEKING New products? Get my outfit 47 money-making specialties. Latest conveniences for home, car. Send no money. Just your name. Kristee 66, Akron, Ohio.

WANT To make \$20 or more in a day for part or full time route work? Man or woman. Write McNess Co., Freeport 24, Ill.

NEW Soapless dirt solvent. Fireproof. Conquers over 120 cleaning jobs. Sells for 25¢. You make 16¢. Sample free. Service Industries, 2103-07 E. Somerset St., Philadelphia 34, Penna.

MEN-Women agents: Sensational new moneymakers — Beautifully hand-painted, plastic personalized photo enlargements, compacts, rings, bracelets, lockets, etc. Simply take orders, pocket 40% commission. We deliver and collect. Sales outfit free. Novelco, 3343 North Ave., Chicago 47.

BUSINESS Cards wholesale. Details. Ralph Phillips, 702 Briarwood, Garland, Texas.

REAL Diamond rings. Nationally advertised. Sell direct. Make big middleman's profit. No investment. Experience unnecessary. Free catalog, details. Gleamlight, 111-B9, North Columbus, Mount Vernon, N. Y.

\$3.95 AUTOMATIC Fire extinguisher. Details free. Aut-O-Matic, 1737J, East 31st, Denver 5, Colorado.

SELL New 2-year light bulbs to homes, offices, factories. Burns 450% longer than ordinary bulbs or replaced free! "Guaranteed Profit Plan." Details free. Solar Electric Products, 366 Fifth Ave., Dept. 9103, New York.

60% PROFIT On cosmetics. Famous nationally advertised Hollywood cosmetics pay 60%. Make \$25 day up. Hire others. For free samples, details, write: Studio Girl, Glendale, Calif., Dept. J2910G.

BIG Profits selling ties. \$2.00 value. \$6.50 dozen. Free catalog. Empire Cravats, 656—PM Broadway, New York City 12.

BE The Popular Mechanics representative in your neighborhood and earn big profits in your spare time. Write Popular Mechanics, Room 10A, 250 West 55th St., New York 19, N. Y.

BUY IT WHOLESALE

BUY Wholesale; 100,000 nationally advertised products. Appliances, cameras, sporting goods, housewares, watches, typewriters, tools, clothing, etc. Discounts to 60%. Buy-Rite, Box 258, Hawthorne 2, New Jersey.

WHOLESALE: 850,000 items. Supply source directory 25¢. Idealer, Park Ridge, Illinois.

VIBRATING Massage motor, 8 foot U.L. approved cord and switch complete. \$3.98 postpaid. Attach to chair, lounge, etc. Vimco, Inc., Box 498, Centralia, Ill.

CHURCHES. Clubs, salesman discounts to 75%. Catalog \$2.00. Refundable on first order. The Dollar Stretcher, Box 1555, Indianapolis, Indiana.

BULOVA. Benrus watches like new \$4.95 up. Free 32 page illustrated catalog with hundreds of jewelry and gift bargains. Cosmos, New York 35, Dept. 465.

520 PAGE Wholesale catalog free. Save up to 50%. Over 10,000 nationally known products, gifts, toys, jewelry, appliances, radios, tools, sporting goods. Dept. PM, National-Porges Co., 823 W. Jackson Blvd., Chicago, Ill.

HURRY! Tremendous savings, coded discount catalogs. \$1.00. Mullen, Box 178-A, Ballwin, Missouri.

FABULOUS. Wholesale gift catalogue 25¢. Osterhoudt's, Red Oaks Mill Road, Poughkeepsie, N. Y.

OREGON Chain for all chain saws. 25% discount. Write: Barnett Equipment, So. Glens Falls 1, N. Y.

ware, cookware, luggage, binoculars, shavers, radios, phonographs, cameras, projectors, recorders, typewriters, sewing machines, furniture, power tools, toys, sporting goods, watches, diamonds, jewelry, automobiles, etc. Name brands. Huge discounts. Postcard: Selbyco, Decatur 161, Illinois.

USED And new watches \$2 up. Free list. Southern Watches, 5-PM So. Wabash, Chicago 3.

LARGEST Wholesale supply source in U.S.! Furniture, clothing, appliances, housewares, automobiles and accessories, tools, sporting goods, hobby supplies, farm equipment, imports, new products, bargain merchandise. Free details. Associated Wholesalers, Box 2068-DD, Sioux City 4, Iowa.

BUY Wholesale—shoes, shirts, pants, underwear, etc. Free catalog. Bostonian, 40-C Harrison Ave., Boston 11, Mass.

HANDMADE Western boots. Free catalog. Ysleta Boots, Box 815M, Ysleta Station, El Paso, Texas.

WHY Pay retail? You can buy Christmas, personal items wholesale. Name-brands 30-80% off. Catalog \$1.00 deposit. Associates, 631 Stephanie, Battle Creek, Mich.

OLD Wall telephones, working order. Oak cabinets, hand crank for ringing. \$7 each, FOB, Telephone Co., Turtle Lake, Wis.

WHOLESALE! Appliances, housewares, toys, sundries, etc. Multicolor catalogue, 25¢ (refundable). J. P. Frank Co., 1856 Blue Island, Chicago 8, Ill.

FREE Wholesale catalog! Toys, Christmas gifts, appliances, vitamins, health aids. Big savings! Housewares Distributors, 1216-P West 79th Street, Chicago 20, Illinois.

WATCHES. Below wholesale nationally advertised. 17 jewels from \$12.90 Lifetime guarantee. Keystone Industries, 1311 Morse Avenue, Chicago 26, Illinois.

SAVE 60%! Clothing, appliances, etc. United Wholesalers, 1265-M Broadway, New York, N. Y.

SALESMEN—DISTRIBUTORS

MAKE Extra money—Big cash commissions plus premiums for you and your customers. Sell advertising book matches. Sensational new tenoriana, glamour girls, hillbillies; dozens others. All sizes. Quick daily sales; big repeat business. Free master kit makes selling easy. No experience necessary. Superior Match, Dept. M-1059, 7530 Greenwood, Chicago 19.

GET New shirt outfit free; make \$90.00 weekly on 5 average orders a day. Famous quality made-to-measure dress and sport shirts at \$3.95 up sell fast to all men. No experience needed. Full or part time. Write: Packard Shirt Co., Dept. 931, Terre Haute, Ind.

ANYONE Can sell famous Hoover uniforms for beauty shops, waitresses, nurses, doctors, others. All popular miracle fabrics: nylon, dacron. Exclusive styles, top quality. Big cash income now, real future. Equipment free. Hoover, Dept. M-100, New York 11, N. Y.

MAKE Money selling sensational dwarf trees — Bear giant-size apples, peaches, pears. Ornamental. Also Stark-Burbank standard trees, roses, shrubs, vines, etc. Outfit free. Stark, Dept. 30100, Louisiana, Missouri.

SELL Birth perfume. Patent pending. Cosmetics, flavors, incense. Zabe Company, 5512 Kinsman, Cleveland 4, Ohio.

NEW Patented invention a boon to car owners; fantastic sales potential. Write Gregory, 316 Marion Building, Cleveland 13, Ohio.

EARN Extra money, sell miracle metal polish imported from Germany. Make 100% profit. Sample tube, 25¢. Lewis Rand Imports, Narberth, Penna.

\$1,000.000 A Month for making dramatic 3-second demonstration of amazing lightweight Presto fire extinguisher. New chemical used by airforce snuffs out fires instantly. Only \$4.95. Terrific commissions. Millions want it. Free kit. Merlite, 114 E. 32nd, Dept. P-66E, New York 16.

Without any penny cost and agree to show them to friends? You can make up to \$30.00 in a day even in spare time, without canvassing. W. Z. Gibson, Inc., 500 S. Throop St., Dept. W-626, Chicago 7, Ill.

IT Ain't sellin'—Just servicing! Stores make money for you every open hour. Tremendously successful! Free book tells all. Write Novo, 3855 Lincoln, Dept. H-51, Chicago 13.

MAKE Up to \$50.00 a day soliciting delinquent accounts. Terrific commissions. Write today. National Credit, 304Y Pickwick Bldg., Kansas City 6, Mo.

MESSAGE Equipment. Samples at below wholesale. Write for literature. Vimco, Inc., P.O. Box 498, Centralia, Illinois.

CALENDARS, Printing. Bigger commissions. Experience unnecessary. Catalogues furnished. Foester, 1520 Ardmore, Chicago 26.

YOUR Free copy of world's biggest sales magazine tells you how and where to make more money on your own in selling. Write Specialty Salesman Magazine, Desk 5B, 307 North Michigan, Chicago 1.

BIG Profits with America's fastest selling multiple vitamins. Details and sample package \$1.00. Retail \$3.98. Renhill Products Co., Newark 12, N. J.

SELL Reconditioned typewriters, adding machines. Write, Woods Typewriters, Bedford, Penna.

IF You're interested in making money in selling, see the hundreds of exceptional opportunities in Salesmen's Opportunity Magazine. Send name for your copy, absolutely free. Tell us what you're selling now. Opportunity, 848 N. Dearborn, Dept. 17, Chicago 10, Illinois.

SPECIALTY Men. Salesmen. Build permanent income \$50 to \$125 a day, year round! Newly developed filters; approved for all military, residential, commercial, industrial installations. Write for details. Extraer, 1210 Cenevert, Houston 3, Texas.

MAKE Up to \$50.00 a day soliciting delinquent accounts. Terrific commissions. Write today. General Finance, 304V Pickwick Bldg., Kansas City 6, Mo.

BIG Profits in your own "Shoe Store Business"! Free information. Mason Shoe Manufacturing Co., Chippewa Falls K-178, Wisconsin.

BIG Profits selling Bibles, dictionaries, encyclopedias, cook books, others. Free details. Adam, 97 Warren St., N. Y. 7, N. Y.

MAKE Extra money selling advertising matchbooks. Free catalog and sales outfit. Matchcorp., Dept. PM-109, Chicago 32.

LIVING Beauty flower pot holders. 10 for \$1.00. Post paid. Fleshing Mfg. Co., 3240 N.W. 27 Ave., Miami 42, Fla.

1959 HOTTSPARK \$5.50: Starting, pep, mileage 1954 Kaiser, varitypers, IBM's, multiliths, mimeographs, barbells. EG, Elmsford, N. Y.

BUSINESS Representative wanted. \$100 to \$300 weekly commission plus profit sharing bonus. Experience unnecessary. Vital service to business world. Territories now available. Permanent. 30 year old company. Bernard Gelpman, Director, 503C Crawford Building, Kansas City, Mo.

GIVE Away nationally advertised merchandise to make customers, big spare time profits. We pay the bill. Write for demonstration outfit \$5.30 full size. Sayman Home Service. Products on approval for thirty days free trial. Sayman Products, 2101P Locust, St. Louis, Missouri.

EMPLOYMENT INFORMATION

JOBS On ships, \$100 weekly beginners, travel, adventure. Write Seaman's Service, Box 17-M, Brooklyn 8, N. Y.

U. S. Virgins. Booming Caribbean paradise! Facts, contacts; living, retirement, opportunities, vacation. Booklet \$1.00. Airmailed \$2.00. Donrog, 159 Christiansted, St. Croix, Virgin Islands.

LATEST Foreign jobs. Unlimited opportunities. All trades. Certified by America's leading job researcher. Plus, newest South America, Alaska, Canada, Venezuela listings. \$1.00. Universal Research, Box 4912, Baltimore 20, Maryland.

JOBS On ships and yachts traveling foreign countries. Davenport's, 1354-K, G.P.O. New York 1, N. Y.

Without any penny cost and agree to show them to friends? You can make up to \$30.00 in a day even in spare time, without canvassing. W. Z. Gibson, Inc., 500 S. Throop St., Dept. W-626, Chicago 7, Ill.

COPYRIGHTED Reports. Best paying companies, travel, adventure, promotions. Construction, aviation, shipping, oil fields, laborers, clerical, trades, supervisory, factory, unusual opportunities. Skilled, unskilled. Foreign, stateside. Only \$2.00 (\$2.25 airmail) (COD'S accepted). Satisfaction guaranteed. Included free: Special reports on Alaska, Venezuela, South America. Research Services, Meramec Building, St. Louis 3-PM, Missouri.

JOBS Overseas! Write Janacek Development Co., 109 Hub Station, New York 55, N. Y.

FREE Information—U.S.A., overseas jobs. High pay, transportation. Futures, Dept. M, 215 West 34th Street, New York City 1.

COMPETITION To fill 50 vacancies—employees, workmen. Travel Argentina free of charge. Full information and simple examination only \$3.00. J. C. Frick, Correo Central 1231, Buenos Aires, Argentina.

MERCHANT Marine jobs. Top wages. Travel. Details free Captain Box 501-P, Reading, Massachusetts.

FLORIDA Positions. Agency lists, résumé, application helps, \$1.00. Bryan, Box 1011, Winter Park, Florida.

AMERICAN Overseas jobs. High pay. Transportation paid. Men, women, act now! Write today. Free information. Employment Headquarters, 79 Wall Street, Dept. B-1, New York 5.

JOBS In Manhattan—arrange interview by mail. Listing of 100 top companies—\$1.00. Job Hunter, Box 41, New York 91.

DETROIT And Michigan jobs from four largest papers in the state. Send \$1.00. Post Office Box 2713, Detroit 31, Michigan.

HIGH Paying skilled labor jobs. Hollywood movie and TV industry. Carpenters, barbers, electricians, firemen, guards, janitors, secretaries, painters, tailors, many more. 1003 places to apply, and how. \$3.00. Business Information Publishers, Box 1012, Beverly Hills, California.

CLEVELAND Opportunities. Sunday classified, male and female, \$1.00. Groth, 1343 Gladys, Cleveland 7, Ohio.

OPPORTUNITIES Afloat. Jobs on ships. Learn necessary requirements. Write: Kain, 1593-P.G. P.O., New York 1.

AMERICAN Overseas jobs. High pay, men, women. Transportation paid. Free information. Write Transworld, Dept. 19D, 200 West 34th St., New York City.

SPECIAL SERVICES

INFORMATION On anything. Ferguson Research Specialists, 116-14 141 St., South Ozone Park 36, N. Y.

WHAT Do you want to find? If made in U. S. we will locate best source. Mandeville Source Finders, 405 Olympia, Pittsburgh 11, Pennsylvania.

CAN'T Find it? We will. Anything! Bought and sent direct to you. Write Personal Buyer's Service, Box 144, Midtown Station, N. Y. 18, N. Y.

AMAZING Character analysis! \$1. Griscom, Handwriting Identification Expert, Sandy Hook, Conn.

EDUCATIONAL AND INSTRUCTION

OPERATE Restaurant or diner. Free booklet reveals plan. Write School of Restaurant Business, Dept. RC-359, 335 W. Madison, Chicago 6, Illinois.

TIME Study. Key to positive personal profits! Associated Techniques, Box 426, Cedar Rapids, Iowa.

LEARN Asleep or awake. Self-help books, tapes, recordings. Free catalog. Drawer PM-697, Ruidoso, New Mexico.

FINISH High school or grade school at home. Books furnished, diploma awarded. Start where you left school. Write Columbia School, 142c Veterans Blvd., Tucson, Arizona.

DR. Ester C. Swanson, School of Swedish Massage, 3809 Alta Vista, Chicago, Ill.

Without any penny cost and agree to show them to friends? You can make up to \$30.00 in a day even in spare time, without canvassing. W. Z. Gibson, Inc., 500 S. Throop St., Dept. W-626, Chicago 7, Ill.

PROFESSIONAL Investigators. Home study. Badge, certificate, future. Box 41197-F, Los Angeles 41, California.

LEARN Real estate business fast. Unlimited opportunities. Economical home-study course. Particulars free. Gordon-Howard Institute, 320 Glover Building, Kansas City 5, Missouri.

COLLEGE Correspondence courses for Doctor of Psychology, Metaphysics, Divinity. Catalogue. Dr. Dorothy B. Arnheiter, Forest Park, Greenwood Lake, New York.

PORTRAIT Oil coloring. Professional instruction. Modern course. Easy to learn and earn at home, full or part time. Free booklet PM. "Magic of Oil Coloring." Hamilton Studios, Inc., Seaford, New York.

USED Correspondence courses and books sold and rented. Money back guarantee. Catalog free. Courses bought. Lee Mountain, Pisgah, Alabama.

HIGH School diploma at home. Licensed teachers. Approved materials. Southern States Academy, Station E-16, Atlanta, Ga.

EARN Degree. Free bulletin. Home-study only. Midwestern Bible School, 1060 Broadripple, Indianapolis.

BOOKKEEPERS! Increase your earnings! Operate your own simplified "Dollar-A-Week" bookkeeping and tax service. Full or spare time. Details free. No obligation. Ellis, Box 200, Cedar Grove, North Carolina.

EARN While you learn. Auto and diesel mechanics master this top paying trade. Many graduates earn \$100 a week and up. Approved for Korean veterans. For free information write Dept. No. 256, Nashville Auto-Diesel College, Nashville 3, Tenn.

PHYSICAL Therapy and massage. Home training. Practice privately or work with doctors and hospitals. Free catalogue. National Institute, Desk 4, 159 E. Ontario, Chicago, Ill.

INVESTIGATOR Training. Phillips Secret Service System, 1917-B North Kenneth, Chicago 39.

BOOKS. Free general catalog, 100 pages. Text, vocational, educational, instructional subjects. Millions of volumes, new and used. Bargain prices. Books bought. Est. 1902. Long's College Book Co., Dept. PM, Columbus 1, Ohio.

PIANO Tuning pays. Big money in spare time. Learn at home in 30 days. No musical knowledge necessary. Phonograph, records, tools and instructions furnished. Personal instructions available. Free catalog. Capital Piano Tuning School, 3160 S.W. 16th Court, Fort Lauderdale, Fla.

STUDY To be a doctor of psychology, metaphysics, divinity or philosophy. Correspondence courses only. The Neotarian Fellowship, Desk 9, Kansas City 6, Mo.

ENGINEERING And art degrees earned through home study. Electronics, electrical, mechanical, civil, physics, business administration, liberal arts. When writing, specify course desired. Pacific International College of Arts & Sciences, primarily a correspondence school. Resident classes also carried. 5719-B Santa Monica Boulevard, Hollywood 38, California.

BE A real estate broker. Study at home. Write for free book today. GI approved. Weaver School of Real Estate, 2018P Grand, Kansas City, Missouri.

WANT A diesel job? Higher pay? Advancement? We can help you qualify! Complete diesel, tractor and heavy equipment and Cummins Diesel Engine Shop-method home-training courses available. Write today. Interstate Training Service, Dept. B-3, Portland 12, Ore.

DEVELOP Mind power, personality while asleep. Use your phonograph, recorder. Amazing psychological tapes, records now available. Details free. Sleep-Learning Association, Box 24-N, Olympia, Washington.

GO For civil service. Go after a U. S. civil service job by planned preparation for the entrance tests through Franklin Institute's private home study courses. This privately-owned organization offers courses for postal, clerical and other fields. Get information on the civil service appointment system, physical, residence and other requirements, veterans' rights, salaries, vacations, retirement, preparation offered, etc. Free booklet. No obligation. Franklin Institute, Dept. T10, Rochester 4, N. Y.

MOTORBOAT OPERATOR—Get your license now. Complete study course with questions and answers to prepare for the U.S. Coast Guard motorboat operators license examination. Reasonable. Write: Boat Operator School, Box 2601, San Francisco 26, California.

BIG Money—Operate own fix-it shop. Service household appliances, motors, mowers, saws, skates, etc. Free book. Christy Trades School, A-8003, 3214 Lawrence, Chicago 25.

"HOW To Train Horses"—A book everyone who likes horses or ponies should have. Free. No obligation. Simply address Beery School of Horsemanship, Dept. 11010-C, Pleasant Hill, Ohio.

COMPLETE Your high school at home in spare time with 62-year-old school. Texts furnished. No classes. Diploma. Information booklet free. American School, Dept. X745, Drexel at 58th, Chicago 37, Illinois.

PROFITABLE Welding training available Hobart Trade School, Box M-1092, Troy, Ohio, GI approved. Finest equipment in U.S.A. Reasonable prices. Request catalog.

BECOME Average dancer. 20 lessons, \$2! New invention. Satisfaction guaranteed. Castle's, 507 Fifth Ave., N. Y. C. 17.

INVESTIGATORS Course. Free information. Southwestern Institute Criminology, Dept. 1, Box 2117, Lawton, Oklahoma.

FINISH High School at home, spare time. No classes. Diploma awarded. Write for free catalog. Wayne School, Catalog HF-98, 2527 Sheffield, Chicago 14.

LEARN Arc, gas, heliarc welding spare time at home. Big pay trade. Easy practical training covers metallurgy, latest techniques, short cuts, metal repairs, etc. Free booklet. Write Utilities Engineering Institute, Dept. WC-21, 2523 Sheffield, Chicago 14.

PHOTO Retouching, learn at home, big demand. Hedger Retouching Service, 529 East 9th, Loveland, Colorado.

NEW! Your short-cut to mental brilliance "Structuralism." Send \$2 for book to Huron Shores Institute, Box 110, Dept. P, Bad Axe, Michigan.

OIL Coloring photographs—A fascinating hobby or profitable sideline for those with artistic talent. Learn at home. Easy simplified method. Free booklet. National Photo Coloring School, 835 Diversey Parkway, Dept. 3437, Chicago 14.

MASTER Watchmaking at home. Free sample lesson. Chicago School, 2328-YW Milwaukee, Chicago 47.

ENGINEERING Mathematics, Science. Earn your diploma at home. Better your position, improve your earnings. Free literature. Engineering Institute of America, Dept. PM-10, P.O. Box 1636, Washington 13, D. C.

LEARN Civil and criminal investigation at home. Earn steady, good pay. Institute Applied Science, 1920 Sunnywide, Dept. 167, Chicago 40, Illinois.

STUDY For doctor's degree of psychology, metaphysics and divinity. Correspondence courses only. College of Divine Metaphysics, Dept. P-M, 2811 North Illinois, Indianapolis 8, Indiana.

WIN Business success by writing letters that sell. New manual by expert gives you this money-making power. \$2.95 postpaid. Free literature. Christopher Helinger, Court St., East Syracuse, New York.

USED Books, courses. List free. Hutch, 4167 Hemphill, Fort Worth 15, Texas.

CAKE Decorating. Amazing new method. Details free. Decorating Institute, Box 648, Wantagh, N. Y.

SING, Speak with power. Self-training records. Amazing! Canfield, 2018-A Fifth Avenue South, Minneapolis 4, Minnesota.

VOICE Secrets! Nature's phenomena! Free! Studio, 14358NN South Jersey, Norwalk, California.

IT'S Fun learning a language by linguaphone, world's standard conversational method. At home, quickly, easily learn to speak French, Spanish, German, Japanese, Russian, modern Greek—your choice of 34 languages available. It's like living in another country. Complete recorded courses on free trial. Send for free book and details. No obligation. Try, don't buy. Linguaphone Institute, T-83-109 Radio City, New York 20.

FREE Correspondence course in English grammar \$10 deposit required. Details free. Lovelady, 572 Wensley, Elcentro, Calif.

INVESTIGATORS—Fascinating, profitable profession, spare time study. Big pay. Details to open own agency any state. Free booklet. Investigator, Box 490, Times Square Station, New York 36, N. Y.

INEXPENSIVE Correspondence courses. Biochemistry, Naturopathy, Homeopathy. Earl degree. Representatives: Aurean, Central Valley, New York.

RADIO-TV home study for 50 students only. State Technical Institute, Box 8005, Manito Station, Spokane 36, Wash.

DEVELOP Your ability to increase income, win faster promotion, prestige. Authentic methods of leaders revealed. Amazing results. Booklet: 7 free. Personal Advancement Counsellors, 7912 Curragh, Burnaby 1, British Columbia, Canada.

SECRET Investigations. Experience unnecessary. Investigators particulars free. George Wagner, M125 West 86th, New York City 24.

PLAYS, STORIES, MANUSCRIPTS

WANT Your book published? Learn how we publish, advertise, promote, distribute. Many successes. Free booklet PM. Vantage, 120 West 31, New York City. Midwest office: 220 S. Michigan Ave., Chicago, Ill.

ADVERTISING AGENCIES, LETTER WRITERS, FOR ADVERTISERS

BEFORE Advertising—Get Instructive Ad-Guide and newspaper-magazine rate-book, free. Chicago Advertising Agency, Chicago 4.

EMPIRE Advertiser magazine. Low rates, resultful. Sample free. Box FW92, Brooklyn 18, N. Y.

ADVERTISE: 24 Words, 100 Canadian newspapers, \$5.50. Lists free. Advertising Bureau, 10511-C Springfield, Chicago 43.

"AMAZING New Book"—"Profits From Classified Advertising." Tells how and what to advertise. Be sure to read this book before you invest one cent in advertising. Write for your copy now. Just send 10¢ for postage and handling. W. Johnson, Classified Advertising Manager, 202 East Ontario Street, Chicago 11, Illinois.

MAILING Lists most any classification \$5.00 1000. Your circulars mailed with ours \$4.00 1000. Write for our literature. Dixie Mailers, King, N. C.

ADVERTISING, Result-getting ads prepared, placed newspapers, magazines, radio, anywhere! Lowest rates. Catalogue free. Baker Advertising Agency, 189 W. Madison, Chicago 2.

CREATIVE Advertising. Magnetic copy. Dramatic layouts. Moran Agency, Shoemakersville, Pennsylvania.

2742 **RADIO** Stations, addresses. Free advertising under "per inquiry" plan. "Buyers Guide," where to buy anything. Write Barnes, Box 490, Times Square Station, N. Y. 36, N. Y.

NOW Ready: New, amazing Classified Advertising Record Book—prepared especially for classified advertisers. Here is a book that tells you instantly whether or not your advertising in any publication is paying you real results. You can tell immediately how many inquiries each publication produced—how much cash received from every ad. Spaces are provided for the name and address of the publication, date of issue, space used, rate, cost of ad, key number, etc. You have a complete record of each publication right before your eyes. Plenty of space to keep accurate record of 28 separate publications. You can have a copy by sending only 10¢ to cover postage and handling. Send for your copy now. W. F. Johnson, Classified Adv. Mgr., Popular Mechanics Magazine, 204 E. Ontario Street, Chicago 11, Illinois.

CARTOONING, COMMERCIAL ART, SHOWCARD & SIGN PAINTING, TATTOOING

CARTOON Your way to success! Internationally known instructor, Raye Burns, will personally teach you to create original, salable cartoons at home. Cost of course is very low. Write for free details. Raye Burns School, Box 3583-P, Cleveland 18, Ohio.

"HOW To Make Money With Simple Cartoons." A book everyone who likes to draw should have. It is free; no obligation. Simply address Cartoonists' Exchange, Dept. 910-C, Pleasant Hill, Ohio.

ECONOMICAL course offered. Martin, Woodstock 37, Ontario, Canada.

CARTOONING: Step by step course; art materials; magic formula chart \$1.00. Jeb's, Waverly, Missouri.

YOU Can entertain with chalk talks. Catalog 10¢. Balda The Cartoonist, Oshkosh, Wis.

LEARN Sign painting at home. Free talent test. Ben Kerns, Box 812-PM, Greenville, S. C.

LEARN Profitable, fascinating tattooing. Illustrated information \$1. Zeis, 728-C Leslie, Rockford, Illinois.

LEARN Sign painting with fascinating system. Straley, 410 S. Western, Springfield, Ohio.

LEARN To paint signs with our guaranteed 152 lesson home study course covering every phase of sign painting. Details free. Stewart Sign Co., Box 287 M, Pasadena, Calif.

RUBBER STAMPS AND OFFICE SUPPLIES

11¢ A Word, minimum 66¢. Resembles sharpest printing. 1959 Roxy method. Sacrificing our old machine. Engesser, Box 82, St. Peter, Minnesota.

4 **LINES** \$1.00, Plastic case with ink pad. Rayco, 445 Bay, Millbrae, Calif.

INDEXED, Cushioned, 3 lines \$1.00, 4 or 5 lines, \$1.50. Signature stamps, \$3.50. (Script, print, or old English.) Free stock stamp literature. Youngers Stamp Shop, Princeton 4, Iowa.

THREE Line rubber stamp, 1000 embossed business cards, both \$3.75. Reed Press, Mishawaka, Indiana.

POCKET, 3 Lines \$1.00. Guaranteed. W. J. Specialty, 8464 Manhattan, Detroit 11, Michigan.

FREE! Rubber stamp catalog. Many items. Campfield, Box 798, Springfield 1, Mass.

FREE Rubber stamp catalog, Martin, 1425 Major Dr., Jefferson City, Missouri.

THREE Line pocket stamp with pad or office type \$1.00. W. S. Atherton, Box 61, Randolph, Massachusetts.

3 **LINE** Handle stamp \$1.00. Free list. Stamps, Box 711, Denver, Colorado.

THREE Line pocket or handle type, \$1.00. Signature stamp \$3.50. Webb, 146 Fluornoy-Lucas, Shreveport, Louisiana.

TYPEWRITERS, DUPLICATORS, OFFICE DEVICES

RECONDITIONED Typewriters, duplicating, printing devices. \$25.00 up. Supplies. Appliances. DixieGraph, King, N. C.

PRINTING, MULTIGRAPHING, MIMEOGRAPHING, GUMMED LABELS

1000 **BUSINESS** Cards. Raised letters, \$3.95 samples. John H. Taylor, R.D. 2, West Middlesex, Pa.

POSTPAID Printing. Personalized Christmas cards. Samples dime. Cook (PMO) 818 West Gift, Peoria, Illinois.

250 8½x11 **HAMMERMILL** Letterheads \$2.95 250 envelopes \$2.95. Davis, 7609 Spruce Road, Baltimore, 22, Maryland.

OFFSET: Mimeographing; samples, prices, free. Litho, 53 Laurie, Ft. Walton Beach, Florida.

COLORED Or white 8½x11 offset, 1,000, \$5.50; 5,000, \$17. Fast! Also artwork, varityping layout. Promotion, 385-M10 Broadway, New York City 13.

1,000 **BUSINESS** Cards. Raised letters, \$3.95. Samples. Pioneer, PM-10 Island Park, N. Y.

ATTRACTIVE: Stickers, labels, circulars, cards. Samples. Fame, 291 Ellis, San Francisco 2, Calif.

1000 **SIMULATED** Engraved business cards, \$3.99 postpaid. Free samples. Prichard Rubber Stamp Shop, P.O. Box 10604, 116 Main St., Prichard, Alabama.

100 6¾ **ENVELOPES**, 100 5½x8½ letterheads printed, \$2.00. M. Fortney, Route 3, Dillsburg, Penna.

BUSINESS, Personal printing. Reasonable. Free catalog. Andrews Printing, Graham, N. C.

pendence, Mo.

FREE Business printing catalog. Samples. Howprint, 723-C Eunice, Webster Groves 19, Missouri.

100 5½x8½ LETTERHEADS, 100 6¼ Envelopes printed, \$1.90 postpaid. H. Hudson, Centredale 11, R. I.

1000 NAME And address labels \$1.00. Youngers, Princeton 4, Iowa.

LOOK! Only \$3.95 Per 1,000 8½x11; two colors (quantity). Management Aids, Box 1495m, Pittsburgh 30, Penna.

1000 PRINTED 6¼ Envelopes, \$5.95, #10, \$7.95, postpaid. Free price list, other sizes, quantities. Karstan's, 151-39 26 Ave., Flushing 54, New York.

1000 ENGRAVED Letterheads \$17.00 pre-paid. Samples. Allen Press, Fort Edward, New York.

MIMEOGRAPHING—Letters, pricelists, formulas, instructions. Lowest prices. Lem's Letter Shop, 5710 Stanton, Detroit 8.

FREE Catalog postpaid printing, rubber stamps. DM Press, Sebastopol, Calif.

1,000 EMBOSSED Business cards \$3.50 postpaid. Samples. Ellis, 5909 Highlandview, Sylvania, Ohio.

ADS Running under this heading sell printing. Ask me for proof. I'll gladly send you amazing facts. Ask for Folder "P." F. W. Johnson, 200 E. Ontario St., Chicago 11, Ill.

1,000 NAME And address stickers, \$1.00; 8½x11 letterheads, \$5.95; #10 envelopes, \$6.95. Offset Sales, Box 6642, Kansas City 23, Missouri.

1000 EMBOSSED Business cards, \$3.95. Business and social printing catalog, samples. Stationery Sales, Box 113, New Orleans 3, La.

BUSINESS Cards, Printing. Reasonable. Samples. Edmondson, Box 4865-P, Atlanta 2, Georgia.

100 8½x11 LETTERHEADS And 100 6¼ envelopes, carefully printed, \$2.00. Postpaid. Race Printers, Hudson, New York.

HIGHEST Quality photo offset reproductions, imprinting, plates, supplies. Belltree, Box 9035, Chicago 90, Ill.

LOW Cost quality printing! Free literature! Vail, 334, Hicksville, N. Y.

MULTILITHED Sales letters, business forms, low prices, get facts, samples. Perkins Printing Service, Fremont, Nebr.

500 NAME Address labels 50¢. Display Center, So. Lincoln 11, Mass.

FINE Postpaid printing, samples. Space Printers, 2039 Murrayhill, Elmont, N. Y.

TERRIFIC Low prices! Letterheads, envelopes, cards, etc., postpaid to you. Smart designs, fast deliveries. Investigate! Advanced, 1110 East 47th Place, Los Angeles 11, Calif.

PRINTING: All types. Rubber stamps. Office supplies. Bargain prices. Joseph Tymula, Westover Road, Stamford, Conn.

PRINTING OUTFITS AND SUPPLIES

RUBBER Stamp makers supplies. Kiewiet, 2025 Barney Road, Kalamazoo, Michigan.

RUBBER Stamp presses, hydraulic operated, electrically heated. Sizes 5"x8", 8"x12", 10"x15". Starting outfits, supplies. Printing presses, supplies. Custom Manufacturing, 507-P N. Jefferson, Springfield, Missouri.

TYPE For rubber stamp making and printing made from hard foundry metal. Send for free 20% discount catalog. Barco Type Founders, 64 Wagner Dr., Northlake, Ill.

MAKE Your own self-molding rubber stamps and printing cuts. Plexirubber, Argyle 1, Wisconsin.

DO Your own printing. Save money. Simple rules. We supply everything. Print for others; good profit. Raised printing like engraving too. Have home shop. Details free. Kelsey Presses, V-11, Meriden, Connecticut.

PRINTING Presses, type, supplies. Lists 4¢. Turnbaugh Service, Mechanicsburg, Penna.

for big free catalog. Acme Type, 633 Plymouth Court, Chicago.

FOR INVENTORS

INVENTIONS Wanted immediately for promoting on cash or royalty. Patented, unpatented. Free booklet outlines royalty rates, requirements. Write Kessler Corporation, 510-IW, Fremont, Ohio.

NEW Product for sale? Patented or unpatented. Let us submit an effective presentation to national manufacturers. Seaboard Research and Development Corporation, Inc. Mewshaw Building, Glen Burnie, Maryland.

INVENTIONS Wanted for immediate promotion! Patented; unpatented. Casco, 703 Bernley Building, Philadelphia 7, Penna.

ENGINEERING. Development. Drawings. Todd, Consulting Engineer, 424 West 119th Street, New York City 27.

LET Us show you how. Order your copy of "Inventing the Invention" today, \$4.95 postpaid. Eaton Roller & Manufacturing Company, 300 North Meridian, Eaton, Indiana.

INVENTORS—Get the best offer first! Patented or unpatented. Write Carl Sommer, Director, Industrial Invention Sales, 3136-A Sylvania Ave., Toledo 13, Ohio.

INVENTIONS Wanted now by my manufacturer-clients. Patented, unpatented. Write Gilbert Adams, Patent Broker, 80-A Wall Street, Financial District, New York City.

PATENT Searches, including copies of nearest patents, \$6.00. Reports airmailed within 48 hours. More than 100 registered patent attorneys use my service. For free invention protection forms, write Miss Ann Hastings, P.O. Box 176, Washington 4, D. C.

WE Have the markets if you have the ideas. Harvey Engineers, Cambridge 1, Maryland.

PATENT Searches \$3.00. 48-hour service. Free invention protection forms. Write Raymond L. Smith, Patent Searcher, 620 Sheraton Building, Washington 5, D. C.

INVENTORS: Test the commercial value of your patented or unpatented inventions, quickly and inexpensively. Write for free information. Institute of American Inventors, Dept. 40-B, 635-F St., N.W., Washington 4, D. C.

PATENT Searches \$6.00. 48-hour airmail service. Invention protection forms free. Write Patent Engineering Service, 711 14th Street N.W., Washington 5, D. C.

INVENTORS. Don't sell your invention patented or unpatented until you receive our offer. Write Cowgill, Box 298-A, Marion, Ohio.

INVENTORS! Consider our offer first before selling or licensing your invention on a cash or royalty basis. Patented, unpatented. Inventions on Demand, 79 Wall Street, New York 5, N. Y.

HIGHEST Cash, royalties. Inventors having good ideas, write. Inventors Creative Service, 354 South Spring, Los Angeles 13, Calif.

INVENTIONS Sold on percentage basis, searches. Model Prod., Grain Valley 3, Mo.

COLLEGE Trained brokers market your patented, unpatented inventions. Write International Services, 3928-A Lorain, Cleveland 13, Ohio.

INVENTIONS. Ideas, patents wanted for sale development by manufacturers. Cash-royalties. George Spector, Licensed Professional Engineer, Invention Broker, 3615 Woolworth Bldg., New York.

FOUND! Your "open sesame" to selective manufacturers interested in acquiring available inventions. Write: Willard Bott, 2106 Customhouse Sta., San Francisco 26, Calif.

WRITE For information regarding our dignified manner of selling your patent. Reasonable. New Products Development Company, 414 Benson Building, Sioux City, Iowa.

INVENTORS: Save high fees. New "patent kit" now makes it easy. Adren, 806 Wm. Penn Annex, Philadelphia 5, Penna.

office records administered professionally for only \$6.00. For free invention protection forms and dependable service write Washington Patent Office Search Bureau, 1426 G. Street N.W., Washington 5, D. C.

INVENTIONS Pay inventors when profitable sales are certain from constructions soundly patented, and wise steps taken to reach the best markets. I help inventors to make the most profit with low definite fees for all services. Searches \$15. 30 years experience as patent-development engineer, U. S. and foreign patents secured. Joseph O'Brien, 132 Nassau Street, New York 38, N. Y.

INVENTIONS WANTED

FREE List needed inventions. Protection form. Inventors Sales and Engineering Bureau, Dept. 190-D, Box 4973, Washington, D. C.

INVENTIONS. Ideas, patents wanted for sale development by manufacturers. Cash-royalties. George Spector, Licensed Professional Engineer, Invention Broker, 3615 Woolworth Bldg., New York.

INVENTORS. Don't sell your invention patented or unpatented until you receive our offer. Write Cowgill, Box 298-B, Marion, Ohio.

INVENTORS: Hundreds of manufacturers have requested our assistance in locating marketable new products. Complete information free. Institute of American Inventors, Dept. 40-D, 635-F St. N.W., Washington 4, D. C.

INVENTIONS Wanted. Patented; unpatented. Tremendous manufacturers lists. Global Marketing Service, 2420 77th, Oakland 5, California.

INVENTIONS Wanted: Patented, patent pending. 28 years experience promoting inventions. National Service Bureau, 3120 Meramec, St. Louis 18, Mo.

INVENTORS! Consider our offer first before selling or licensing your invention on a cash or royalty basis. Patented, unpatented. Inventions on Demand, 79 Wall Street, New York 5, N. Y.

ARE You interested in offers from reliable manufacturers for your invention? Patented, unpatented. Harvey Engineers, Cambridge, Maryland.

INVENTIONS Wanted now by my manufacturer-clients. Patented, unpatented. Write Gilbert Adams, Patent Broker, 80-B Wall Street, Financial District, New York City.

INVENTIONS Wanted for manufacturers. Free details. Write: Allen, 712 Davis Bldg., Dallas 2, Tex., Dept. B.

CASH Buyers for inventions. Write National Inventors Institute, Box 4125, Washington 15, D. C.

INVENTIONS Wanted for immediate promotion! Patented; unpatented. Casco, 703 Bernley Building, Philadelphia 7, Penna.

WANTED: Patents, patent pending. Eagle Development Co., 4753 Broadway, Chicago.

MANUFACTURING

MODELS—Small lot manufacturing. Metals, plastics, etc. Milburn, Burlington, Kentucky.

MODELS, MODEL SUPPLIES

POWER Models. Unusual steam, gasoline and traction engines; fittings, metals. Accessories—lock washers, socket set screws, rivets. Comprehensive 92 page catalog \$1.00. Chas. Cole, Ventura, Calif.

MODEL Cars run on electrified roadways. Sets, roadways, cars, motors, controls, power packs, supplies. Details free. Electromat Company, Box 13742, Dallas, Texas.

MINIATURE Engines, gas and steam. Build them on your metal lathe using our castings, blueprints. Also available, machined steam engine kits ready to assemble. Illustrated catalogue 25¢. Octura Models, Box 536-PM, Park Ridge, Illinois.

LIONEL Trains. Big discounts. Catalog 25¢. Mack Bros., 2043-P Chicago Ave., Chicago 22.

New England, kits, fittings, plans, books, tools, engines, motors. Illustrated catalog 35¢. James Bliss & Co., Inc., Dept. SM, 342 Atlantic Ave., Boston 10, Mass.

"POWER Drives Handbook"—36 pages illustrating many types motor drives for model autos, boats, displays, turntables, etc. Mail 25 cents cash, returnable first order \$3.00 or more. Wilson's of Cleveland, Dept. PM, 425 Lakeside N.W., Cleveland 13, Ohio.

SCALE Model materials for building model homes and architectural buildings of any type, 1/4" and 1/2" scale. Send 25¢ for catalog. A & B Model Builders, 454-P Donovan Road, Kansas City, Kansas.

ROCKET Supplies—Nozzles, cones, tubes. Specials also made. Catalog 10¢. Sky Mfg., Mineral Point, Penna.

SHIP Model kits and fittings: Fishermen, clippers, frigates, schooners, brigs, tugboats. Also half-hull models for interior decoration. Send 25¢ for 1959 catalog and booklist. Model Shipways, Box 85, Bogota, N. J.

SHIP And yacht model fittings; blueprints. Send 35¢ for illustrated catalog listing hundreds of items. A. J. Fisher, 1002-1 Etowah Ave., Royal Oak, Mich.

FREE List of books, plans for model power boats, planes, race cars. Send stamped, self addressed envelope. Henze's, 30 Main St., Park Ridge, Ill.

HOME CRAFTSMEN

NEW Big illustrated catalog. Supplies for leathercraft, metalcraft and numerous small inexpensive crafts. Prompt shipments. Top values. Latest ideas. Send 10¢ today to J. C. Larson Co., Dept. 9127, 820 S. Tripp, Chicago 24.

LEATHERCRAFT. Send 25¢ for new 160-page catalog of tools, supplies, kits, including metalcrafts, enameling, ceramics, all other crafts. Complete stock. Reasonable. Since 1910. Sax Bros., Dept. PM-10, 1111 N. 3rd, Milwaukee, Wis.

BUY Picture frame moldings at wholesale, actually less than cost of raw lumber. All styles and widths. Free delivery. Write for price list. Chesapeake Picture Frame Co., 511 N. Charles St., Baltimore 1, Maryland.

FREE Illustrated crafts brochure. Leathercraft, tile, coppercraft, woodcraft, Castoglas, etc. Economical easy to make complete kits. Larson Leathercraft, 820 South Tripp, Department 9127C, Chicago 24.

SKIL-CRAFTS—World's finest and largest selection of leathercraft, hobby craft, art & craft supplies. Free billfold or leathercraft kit with first purchase. Send 25¢ latest catalog. Skil-Crafts, Box 167-P, Joplin, Missouri.

FREE. New plans catalog. Make 2400 things. Fun. Profit. Craftplans, 1322-A Wabash, Chicago 5.

UP To \$200, week extra. Turn scrap plywood into beautiful whatnot shelves. How to make and sell. 3 plans \$1.00. Thrifty Wood Mfg. P.O. Box 374, Imperial Beach, Calif.

WORLD'S Largest market, ceramics, leathercraft, woodwork, shellcraft, jewelry, etc. \$2.00. James R. King, P. O. Box 5381, Columbus 19, Ohio.

WOODWORKING Catalog and manual. Brand new 1960 edition! World's largest selection of domestic, imported woods—materials, tools, supplies, do-it-yourself plans, projects, 130 pages, many full color. Send 25¢ (refunded first order). Year's subscription to "Chips and Chats" included free. Constantine, 2050 Eastchester Road, Dept. P-101, New York 61, N. Y.

KNOCKDOWN Cedar chests, also over fifty kits. Catalog 25¢. Giles Kendall Co., Huntsville 2, Alabama.

MAKE Arm chairs that convert into comfortable beds, simple design. Instructions \$1.00. Suroff, 329 E. 54 St., Brooklyn 3, New York.

FREE Leathercraft catalog—quality kits, leather, tools. Handcrafters, Dept. P, Box 427, Montrose, Calif.

MOSAICS—New. Exciting display. 1960 catalog, 25¢ (refunded). Mosaic-Arts Co., 7197-P8, Pittsburgh 13, Penna.

CRAFTS. Free catalog. Leathercraft, mosaics, enameling, metal tooling, stamp engraving, shellcraft, floralcraft, many more. Kit Kraft 2910, Studio City, Calif.

GRANDFATHER Clock movements, case plans, kits. Wholesale catalog 25¢. Mason-Sullivan, Noroton, Conn.

ques, blankets, suspenders, belts, rugs, hats, bags, letters, emblems, flowers, penants, stuffed animals etc. \$2.95 brings big three pound package felt mill ends. Assorted colors. Postpaid. Eastern Mills, Box 154, Chelsea, Mass.

101 PATTERNS Of smart gifts, novelties, shelves, action windmills plus "Make Money Jig Sawing." \$1.00. Mastercraft, 105M, 7041 Olcott, Chicago 31.

STYLECRAFT "Pretraced" leather kits. Handbags, billfolds, filigree belts. Patterns on leather. Just carve, assemble and lace. "Pre-carved" kits also available. Send 25¢ for catalog, free folder. Refunded first order. Apache Leather Company, 2804 E. Washington St., Phoenix, Arizona.

VIOLIN Making supplis. Free catalog. Fred Artindale, Box 71992, Los Angeles 1, Calif.

FREE Booklet! Concrete blockmaker. Mixer plans. Loper, Box 76, Alloway, New Jersey.

NEW Idea plans. Free catalog. Marra, 1337 Kenilworth, Cleveland, Ohio.

SHELLCRAFT Supplies. Lowest prices! Large illustrated catalogue! Shells, designs with instructions. 25¢. Pace's, Box 279, Bradenton, Florida.

ART Metal tooling. Enjoyable, profitable hobby. Big illustrated catalog 10¢. Groundmaster, Boulder, Colo.

ILLUSTRATED Silk screen printing. Instructions, \$1.00. Details free. Pioneer Valley Stencils, Box 162-F, Springfield 1, Mass.

LEARN Art metalcraft and jewelry making. Complete, inexpensive, home training course now available. Special tools and materials furnished. Write for free booklet. Interstate Training Service, Dept. L-3, Portland 12, Oregon.

FREE "Do-It-Yourself" leathercraft catalog. Tandy Leather Company, Box 791-M30, Fort Worth, Texas.

WOODWORKING And cabinetmaking course for beginning and advanced home craftsmen. Only complete low-cost home training program available. Write for free booklet. Interstate Training Service, Dept. G-3, Portland 13, Ore.

FREE! Leathercraft catalog. Hundreds of new items. Write MacPherson Bros. Leather Company, Dept. E, 730 Mission St., San Francisco 3 Calif.

KNOCKDOWN Cedar chests and lumber. Free price list. Bedford Lumber Company, Shelbyville, Tennessee.

REFINISHING? Sanding made easy. Send stamped envelope for free particulars and sanding hints. Write Sanders, Box 248, Hartland, Wis.

BELT Sander—low cost. Easily made from plans. Free literature. Gipple, 121-A School, Buffalo 13, N. Y.

KILN Dried walnut, cherry, etc., hardwoods, blocks, boards and squares. Midland Lumber Company, P.O. Box 262, Savannah, Missouri.

REMODEL Your own home. Save hundreds of dollars. New, amazing book shows you how. Written so you can understand it. Step by step instructions make it easy. Fully illustrated, 400 photographs, hundreds of diagrams, 160 pages. \$3.50. Literature 10¢. Popular Mechanics Press, 200-RH East Ontario St., Chicago 11, Ill.

PATTERNS. Full size. It's easy to make tables, chairs, beds, chests, shelves, workbenches, toys. Santa Claus lawn designs, and many others. Illustrated circular free. Popular Mechanics Press, 200PL East Ontario St., Chicago 11, Ill.

DO IT YOURSELF

FREE "Do-It-Yourself" leathercraft catalog. Tandy Leather Company, Box 791-V32, Fort Worth, Texas.

AT Last. New amazing collection system turns past due accounts quickly into cash. Trial package 25¢. Universal Credit Research, Box 453, Independence Missouri.

LIFETIME Welder from junk. Pain Electric, Rt. 13, Fort Worth 3, Texas.

MAKE-Sell. Christmas decorations, unusual gifts. Idea book plus catalog of available patterns, 50¢. Golden Chain Creations, Box 1560P, Northport, N. Y.

ELECTRIC Laminating kit. Fun or profit. \$14.95. Therm Appliance, St. Charles, Ill.

WATCH Repairing. Information 20¢. Max Present, 24 E. Van Buren St., Chicago 5.

HIGHEST Cash paid for old gold, jewelry, gold teeth, diamonds, watches, silver. Mail articles today. Information free. Chicago Gold Refining Co., 6 E. Monroe, Dept. 1658, Chicago 3.

DIAMOND Substitute! Hard, lustrous, brilliant, inexpensive. Jewelry catalog free. Najecogem, Wheeling, West Va.

WATCH And clock repairing books. Free catalog. North American, 2320-AL Milwaukee, Chicago 47, Illinois.

GOLD. Silver, platinum (in any form), also broken jewelry, watches, spectacles, gold teeth, rings, coins, wanted. Highest cash paid immediately. Information sent free. Wilmot's, 1067-A Bridge, Grand Rapids 4, Mich.

WATCHMAKERS Journal contains instructions on watch repairing. Sample copy 25¢. Dean Co, Box 3218-M, Daytona Beach, Fla.

COSTUME Jewelry supplies, settings, rhinestones, etc. 88 page illustrated catalog. 30¢. Milady, Box 1328, G.P.O., New York City.

10 SWISS Watches \$18.00. Catalog 25¢. Berkowitz, 1150 Castle Hill, New York City 62.

FREE Catalog. Costume jewelry parts. Supplies. Reasonable prices. Fast service. Guaranteed quality. Unique merchandise. Folsom's, Box 52, Medford 55, Mass.

HIGHEST Cash for old gold, jewelry, gold teeth, watches, diamonds, silverware, spectacles, platinum, mercury. Free information. Rose Refiners, Heyworth Building, Chicago 2.

FREE! New supply catalog loaded with moneymaking costume and shell jewelry designs. Modern Craft, Box 11088-JM, Saint Petersburg 33, Florida.

WATCHES. Guaranteed first quality Swiss. Men's, ladies', gold or chrome. 17 jeweled \$9.87. Men's 21 jeweled \$19.64. Many others to choose from. Postpaid airmail from Switzerland. Order from this advertisement or send postal, free literature. Herm Roth, 202-P Pickrelltown Rd., West Liberty, Ohio.

EASY To make costume jewelry. Catalog 10¢. Introductory kit including catalog \$1.00. J & M Novelties, Dept. CL-3, Box 173, Broadview, Ill.

RAZORS, BLADES, SHARPENING

FREE Details. Double action razor blades! North Star, Box 112-M, Cedar Grove, New Jersey.

FOR THE HOME

FOAM Rubber furniture cushions. Factory seconds. 50% discount. Free catalog. Perma-Foam, 390-C Nye Avenue, Irvington, N. J.

TOBACCO, SMOKERS' SUPPLIES

CIGAR Smokers! Stop wasting money on stale, dry cigars. Order factory-fresh quality cigars direct from factory at savings! Millions sold since 1918! Send \$3 for box of 50; \$5.50 for two boxes. Send 25¢ for sample of 3 factory-fresh cigars, postpaid. Order now. Dept. C, Menendez Cigars, 6416 Michigan Ave., St. Louis 11, Mich.

OF INTEREST TO WOMEN

MAKE Money weaving rugs at home for neighbors on \$79.50 Union loom. Thousands doing it. Booklet free. Union Loom Works, Dept. 3, Boonville, N. Y.

SELL Fine fabrics. Get yours wholesale. Box 863, Norwalk, Conn.

DRESSES 24¢. Shoes. 39¢. men's suits. \$4.95. trousers, \$1.20. Better used clothing. Free catalog. Transworld, 164-G Christopher, Brooklyn 12, N.Y.

YOU Can start for Civil Service career through home study. Attractive salaries, benefits. Free booklet. No obligation. Private organization. Franklin Institute, Dept. T12, Rochester 4, N. Y.

GIVE Your home a real treat. Save time and money. Free catalog—68 new and unusual household items. Special offer. Write E'nJ Household Gems, 3 West 29th Street Dept. 9, New York 1, N. Y.

bazaars, gifts, fun! Over 50 fast sellers in "How to Make Sock Toys", \$1 per copy. Clapper Publishing Co., Dept. D10, Park Ridge, Illinois.

TIRED Of looking homemade? Send \$1.00 for professional dressmaking secrets. Elizabeth, Dept. P109, 1176 East Claremont, Pasadena, California.

FUR Capes. Latest styles. \$19.50 up. Free catalog. Rose, 20 W. 27th St., N.Y.C.

IMPORTS! Lacquerware! Catalogs! \$1. Nelson's Imports, 1434 Garnet, San Diego 9, Calif.

COLGATE'S Lustre creme shampoo 4 lbs. \$4.85. Postpaid. Geller, 2089P Matthews 62, N.Y.C.

GUITAR Pin. Colorful. 2 1/4 inches. strings. \$1.00 p.p. Berlow's, 30 McAuliffe Road, Randolph, Mass.

60% PROFIT On cosmetics—Famous nationally advertised Hollywood cosmetics pay 60%! Make \$25 day up! Hire others. For free samples, details, write Studio Girl, Glendale, Calif., Dept. 12910GX.

\$100.00 PRIZE, Doll dressing contest. Box 333 Staten Island 1, N.Y.

HOUSEWIVES, Teachers, students, office workers, if you need extra cash each week but household or other duties prevent you from taking a part-time job, learn how you can earn by accepting orders to Popular Mechanics. Good Housekeeping and all other magazines. No experience needed. Write Popular Mechanics, Room 10W, 250 West 55th St., New York 19, N.Y.

130 SOURCES Will pay cash for over 300 odd, broken, discarded items. Order this exclusive publication now! \$2.00 postpaid. Modern merchandise, Box 77531-PM, Los Angeles 7, Calif.

PERSONAL

LOANS By mail. \$50 to \$600 for any purpose. Employed men and women eligible. Confidential. 2 years to repay. Write for free loan application. American Loan Plan, City National Bldg., Dept. PM-10019, Omaha 2, Nebraska.

REMAILS—Secret, confidential, 25¢. Bulk rate \$3.00 monthly. Steelmaster, Box 524, Findlay, Ohio.

YOUR Handwriting reveals you. Send sample, stamp. Graphoanalyst, 474-PM Siebert, Columbus 6, Ohio.

INCOME Tax figures easily accumulated. Five years in one book. \$2.95. Bryce, 2703 Griswold, Port Huron, Michigan.

BORROW \$100 to \$600 by mail. Quick, easy, private. No co-signers. Repay in 24 small monthly payments. For the amount you want write today to Dial Finance Co., 410 Kilpatrick Bldg., Dept. K-1, Omaha 2, Nebraska.

BIBLE Questions answered. Stamped envelope. Bylon, 17167 Bentler, Detroit 19, Michigan.

FIRE Department Christmas cards. Free brochure. Hobby Mats, Balsam Lake, Wis.

GIPT Problems? Dozens unique ideas 10¢. Keith Armstrong, 711 Seneca, Seattle 1, Wash.

ENJOY Health. Free booklet, Nutrition, 152-PM Kearny, San Francisco, Calif.

ADVENTUROUS? Details for dime. Fred Woodgate, Tamworth, N.W., Australia.

VITAMINS—Send \$1.00 for special introductory 90 day supply Multi-Vites. Similar formulas cost \$3.00 retail. Free catalogue guide-book included. Vitamins, Box 4435-A, Philadelphia 40, Penna.

COBRA, Self-defense street-fighting tricks. Designed to help peaceful adults. \$2. Clarion, Box 9309-S7, Chicago 90.

FALLOUT Shelter. Protect your family! Complete do-it-yourself plans and specifications. \$2.00. U.S. Security Shelter Company, Box 4984, San Francisco.

BORROW By mail \$100-\$600. Anywhere. Air mail service. Postal Finance, Dept. 17-T, 200 Keeline Building, Omaha 2, Nebraska.

REMAILING SERVICE

LOS Angeles confidential address! Remails 25¢. Kent Remailing Service, Box 1976-10, 53.

LA PAZ, Bolivia. Remails \$1.00. Casilla 2959, La Paz, Bolivia.

Details free. Agents since 1950. William McLaughlin 800 Stewart, Columbus 6, Ohio.

LETTERS Remailed 25¢. Ransom, 41 Liberty, Washington Heights, Newburgh, N.Y.

LETTERS Remailed 25¢. Cozatt, 1916 W. Oklahoma, Enid, Okla.

IRAQ Re-airmails, \$1.00. Beautiful viewcards, (5)-\$1.00. Margossian, 66/185-K, Baghdad.

SECRET Mail receiving-forwarding system. \$4 month. Hedgpath, Box 830, Alhambra 23, California.

ALASKA Remails, \$1.00. Replies forwarded. Box 1151, Anchorage, Alaska.

REMAILS 25¢. Monthly \$3.00. Secret. Prompt receiving-forwarding. Lillian's, Box VC3011, No. Hollywood, Calif.

LETTERS Mailed 25¢; forwarded 30¢. Stella M. Lumsden, East 11 Pacific Ave., Spokane 3, Wash.

RENT A confidential remailing, receiving, forwarding address. Details. Fred's, 3910 University Avenue, Madison, Wisconsin.

LETTERS Remailed, anywhere, U.S.A., 25¢. Box 333, Staten Island 1, N.Y.

LETTERS Remailed 25¢. Prestige mailing address. Monthly rates. Consumers Letter Service, Suite 1020, 220 S. State St., Chicago 3, Illinois.

MEXICALI Remails, 25¢. 6 for \$1. Lovelady, 572 Wensley, Elicentro, Calif.

TREASURE FINDERS

METAL Locator kits and assembled models from \$39.90. Transistorized and underwater models available. Free catalog. Electronic Applications, Dept. M, Box 8, Arlington 10, Virginia.

MONEY For you in buried treasure. Coins, gold, silver can be found with Goldak transistorized locators. Five models including underwater locator, priced from \$79.50. Free literature. Authentic books of known treasures available. Goldak Company, 1541 West Glenoaks Blvd., Glendale, California.

TREASURE! Map, handbook 25¢. Locators. Howe, 811 Kansas, Atchison, Kansas.

GOLD-Silver detectors. Geiger counters. Violites for tungsten etc. Best available. Guaranteed. Information free. Detectron, 12970 Bradley Ave., Dept. 20, Sylmar, Calif.

TREASURE Map of all 48 states \$2.00. Map Cache, Box 287d, Burlingame, California.

PROSPECTORS! Learn from experienced geologists how to locate and identify rocks and minerals. A comprehensive home study course designed for anyone interested in exploring for valuable ore deposits. Write now for free literature. Pacific School of Mines, Dept. BAIO, P.O. Box 2538, Palm Springs, Calif.

445 TREASURES, United States map 2x3 feet, plus catalogue, \$1.00. Foul Anchor, Rye 2, N.Y.

FOR SALE—MISCELLANEOUS

WAR Surplus bargains! New government releases arrive constantly. Save up to 80%. Blankets, boots, cots, tents, wearing apparel, etc. Send for free war surplus catalog. Sioux Falls Surplus Store, Sioux Falls, South Dakota.

GOVERNMENT Surplus sales. Latest informative directory \$1. Hoover, 110 Hadson, Westmont, N.J.

FREE Flyer. Electronic and refrigeration surplus. Kurtz, 702 Bay, Staten Island, N.Y.

HEARING Aid batteries, wholesale. Free list. Habs, Box 51, York, Penna.

MAGNETS, New plastic material. Assortment (12) \$1.00. Cosmic Enterprises, 4526 Miller, Gary, Indiana.

MIRROR—Transparent back. Watch, photograph people, secretly. 8"x10", \$2.00; 16"x20", \$5.00. One-Way Mirror, PM-1059, Box 625, Mt. Vernon, N.Y.

WANTED—MISCELLANEOUS

IMMEDIATE Cash for old letters, stamps, coins. Free appraisals. Brooks Stamp Company, 2323 Avenue X, Brooklyn 35, New York.

Box 333, Staten Island 1, N.Y.

TO \$500. Cash for your child's photo. Hundreds used weekly in advertising. Rush \$1. to Herm Roth, 202-PM Pickrelltown Rd., West Liberty, Ohio.

IMMEDIATE Cash for used plating equipment. Send description. Equipment Division, 1624 East First, Los Angeles 33, California.

QUICKSILVER, Platinum, silver, gold. Ores analyzed. Wholesale Terminal, Norwood, Mass.

MISCELLANEOUS

CIVIL Service. Learn about this field of work and how you can prepare yourself by home study for a high entrance mark. Private organizations. Free booklet. No obligation. Franklin Institute, Dept. T11, Rochester 4, N.Y.

SIMPLIFIED, Improved, algebra, mimeographs, windmills. Write: Ziemba, H-6123 Orchard, Dearborn, Mich.

BABY Shoe bronzing kit contains sealer, filler, bronzing powder, bronzing liquid and brush. Complete kit for 2 shoes, price \$1.00. E. Fuller & Co., 1/4 mile south U.S. 41, Route 5 Vincennes, Indiana.

FREE Listings—Buy or sell through Southwestern, 1306 South Darlington, Tulsa 12, Oklahoma.

FREE Catalogue, gifts, household items, toys, electric appliances, etc. Guaranteed. Quality Fair, Box 183, Independence, Mo.

LEARN How to make artificial parts of the body. Free literature. Adele Laboratories, 45-236, Miami, Florida.

MEN! Shave with ease. Free information. Raysol Products, Poplar Bluff, Missouri.

DELICIOUS Citrus fruit, gift packed. Prepaid prices. Varble's, 1505 North Parkwood, Harlingen, Texas.

JAPAN, Buy direct-mail order, kimonoes, dolls, etc. 24 page catalogue, manufacturers' names, addresses. Send \$1.00. Clarence Yamagata, 202 Naka 7, Bldg., Marunouchi, Tokyo.

RECEIVE Magazine samples, mails, catalogues. Bargains from everywhere. Get listed 25¢. Rorick, Cincinnati 26, Ohio.

CIGARETTES: Make 20 plain or filter-tips for 9¢. Facts free. Moberly, Box 915, Owensboro, Kentucky.

WELLS-FARGO Reward posters 12/\$2. Jesse James 50¢. Frontier, North Decatur, Georgia.

DRESSES 18¢. Coats \$1.98, shoes 99¢ (used). Free catalogue. Ace, 196-MP DeGraw, Brooklyn 31, New York.

BOOKS On antiques and their prices. Free circular! P. Warman Publishers, Untontown, Penna.

100,000 PRODUCTS Wholesale—Free catalog! Send postcard: Econ-O-Mart, Whippany 15, New Jersey.

YOUR Name wanted. We'll send 1000 publishers, mailers, wholesalers your name, on our list one year 25¢. Dixie Mailers, King, N.C.

MONEY Making and saving catalogue. Write: Adams, PM 210 5th Avenue, New York 10, New York.

SUPER Memory overnight! Success guaranteed! Bijou, Box 1727-M, Hollywood 28, California.

ORNAMENTAL Iron designs. Book of 1700 beautiful, practical designs for railings, columns, etc. Free literature. Cunningham, 3881 South 3200 West, Salt Lake City 4, Utah.

CESSPOOLS, Septic tanks, clogged drains. How they function and how to keep them working. Free literature. Chemical Cesspool & Drain Cleaning Co., Boston 34, Mass.

MAP Of Lost Dutchman and other legendary mine areas in Superstition Mountains of Arizona. Composed from aerial photography and ground survey. Land marks, trails and springs accurately located. \$2.00. Alan Stirrat, 3510 Clifton, El Paso, Texas.

FACTORY Rejects—plastic raincoats \$1.00 postpaid. State height and weight, men's, ladies', girls', boys'. Whitewater Raincoat Company, Whitewater, Wisconsin.

MAKE Your own will. Legal form only \$1.00. Write, Wills, Box 3826, Oklahoma City 6, Oklahoma.

EASY Shorthand, Glare-Bar night glasses, classic record albums, easy bookkeeping, photo jewelry, toys. House of Brown, P. O. Box 8741, Wash. 11, D. C.

COLLECT Past due accounts with guaranteed system. Write Box 77, Flat River, Mo.

OLD Original 1903 desk telephones. Working order, oak crank ringer, box included. \$5 each. f.o.b. Telephone Company, Turtle Lake, Wis.

WHOLESALE—Appliances, housewares, tools, watches, Catalogue dime. Geo. J. Nelson, 309 So. Jackson, Aberdeen, So. Dak.

RADIATION Fallout shelter plans for basement. Complies with civil defense specifications. \$3.98 complete. Family Fallout Shelters, Inc., 3181-F Roxwell Rd., N.E., Atlanta 5, Georgia.

FEATHER Picture—catalog, papaya seeds. 25c. Frontier, 1104, Calexico, Calif.

FREE! Christmas gift catalog. River Sales, Box 27, Albany, N. Y.

ELECTRO-MAT Foot warmer, 14" x 21" for office or shop, \$7.95 postpaid. Send postal card for free literature or check with order from Southern Industries, Box 545, 1600 Phillips Street, Wilson, N. C.

2 BEDROOM 24 x 24 Frame home for \$1100.00. Plans, materials and itemized price list. Send \$1.00 to Plans, Box 2, Binghamton, New York.

70 BIBLE Lessons, 25¢. Bulletin, Box 87, Cathedral Station, New York City 25.

LET Us tell you how to turn the reading habits of your friends into profit for you. \$10.00, \$25.00 or \$50.00 can easily and quickly be made under our Popular Mechanics subscription plan. No experience needed. Write Popular Mechanics, Room 10M, 250 West 55th St., New York 19, N. Y.

WORLD'S Smallest Bible 50¢. Three \$1.00. Robbins, 443 Encinitas, San Diego 14, California.

GET Samples, opportunities, magazines, catalogs, offers galore! Your name in 5000 big mail directories, 25¢. Results guaranteed. King's, Moorestown, Ontario, Can.

RECEIVE Samples! Bargains! Offers! Mail from everywhere, 20¢. Lee Wierama, Orange City, Iowa.

New FANTASTIC BUSINESS HOBBY

PLASTIC VACUUM FORMING MACHINE "HOBBY-VAC"

A rugged production vacuum-forming machine at a fraction of usual industrial machine cost. No skill required to operate efficiently, only a few minutes of practice.
HOBBY-VAC FORMS, BUBBLE AND BLISTER PACKS, DRAWS UP TO 3" DEEP
 HOBBY-VAC will reproduce from natural objects, such as flowers, shells, letters, etc., or dies, in seconds, for as little as 10c each. No pumps required. Each machine fully equipped and ready to operate on 110 V. outlet and your regular hose-type vacuum cleaner.
 Forms one of a kind or thousands of items in plain or brilliant metallic plastic up to 1/4" thick.
PICTURED ON RIGHT IS THE SMALLEST SIZE HOBBY-VAC
HOBBY-VAC MACHINES AVAILABLE IN THESE SIZES

7"x7" Picture size	6"x8" x up to 3" deep	\$ 39.50
7"x14" " "	6"x13" x up to 3" deep	79.00
10"x14" " "	9"x13" x up to 3" deep	97.00
14"x14" " "	13"x13" x up to 3" deep	160.00

ONLY 39.50



LARGER MACHINES AVAILABLE
 Possibilities are practically unlimited for commercial and industrial purposes. Excellent for producing rugged 3-dimensional parts.

Literature on request. Distributors wanted.

ORBIT of CALIFORNIA 211 Los Molinos, San Clemente, California

SAVE WITH DIRECT MAIL

Shop PM's pages for money-saving direct mail offers



1000 NAME AND ADDRESS LABELS \$1
ANY 3 DIFFERENT ORDERS \$2 ppd.
 Sensational bargain! Your name and address printed on 1000 finest quality gummed labels. Padded! Packed with FREE Plastic GIFT BOX. Use them on stationery, books, cards, etc. 1000 only \$1 ppd.
SPECIAL OFFER — ANY 3 DIFFERENT ORDERS \$2. Satisfaction guaranteed. **HANDY LABELS, 1021 Jasperson Bldg., Culver City 1, California.**

SEWS LEATHER

AND TOUGH TEXTILES LIKE A MACHINE

With **SPEEDY STITCHER** Automatic Sewing Awl, anyone can quickly and skillfully sew or repair anything made of **LEATHER, CANVAS, NYLON, PLASTIC,** or other heavy materials. Sews firm, even lock-stitches like a machine. Gets into hard-to-reach places. Specially made for heavy duty sewing on **LUGGAGE, FOOTWEAR, RUGS, AWNINGS, SAILS, SADDLERY, UPHOLSTERY, OVERALLS, AUTO TOPS, SPORTS GEAR,** and other tough sewing jobs. Here's the handiest tool you'll ever own. Will save you many times its small cost. Comes ready for instant use... complete with both of waxed thread and 3 different types of diamond-pointed needles. Easy-to-follow directions will make you an expert in minutes. Extra needles and waxed thread always available. Save money, send \$1.08 for post-paid delivery. If C.O.D., \$1.08 plus postage. **MONEY BACK GUARANTEE.**



SPORTSMAN'S POST
 366 Madison Ave., Dept. A-81, New York 17

ONLY 1.98



The skilled hand of the German gunsmith is responsible for this .22 caliber, 6-shot repeater automatic with self-ejecting clip. Just 4" long; fits easily into pocket or purse. Ideal for sporting events, stage use.

(Not available to California residents.)

Comes for \$6.95 ppd. from BEST VALUES, Dept. K887, 403 Market, Newark, New Jersey

SAVE 50% AND MORE DURING THIS GREAT SALE



ACCORDEONS 1/2 OFF!

FIVE DAY FREE TRIAL—Easy Terms
 Buy direct from world's largest exclusive accordion dealer. Save 50% or more. Finest imported Italian makes; over 30 models. 5 DAY FREE TRIAL. Lifetime guarantee. Trade-ins accepted. Bonus gifts. Easy terms, low as \$10 monthly. Write today for Big Catalog and Low Wholesale Prices—FREE!

ACCORDION MANUFACTURERS & WHOLESALE OUTLET, 2003 West Chicago Avenue, Dept. R-109 Chicago 22, Illinois
 Please rush color catalog, wholesale price list.
FREE Color Catalog
 Name _____
 Address _____
 City _____ State _____

Heavy Duty Slingshot Kills Small Game



BUILT-
IN
RANGE
FINDER

AMAZING 44 LB. PULL — POWERFUL!

New invention! Extra powerful slingshot gives longer range & accuracy. Extra thick Quadrangular slings with amazing 44 lb. pull! Kills small game, routs pets. Ideal for target practice. Different from light duty slings. Packs terrific wallop! Special cross-bar range finder assures greater accuracy. Same type used on cameras, rifles. Thick leather pouch. Brass riveted slings. Ebony finish wood. Accurate! Powerful! Super silent! Hits like rifle. FREE: 100 Killer Steel Pellets. Sharp cutting edges. Deep penetration! Now half price! Send only \$1 plus 25 cents mailing costs. Special! Extra Pellets, only 75c for 400. Satisfaction guaranteed or money back.

THORESEN INC. Dept. 6-L-943, 585 Water St., New York 2, N.Y.

REG. \$1.98

— NOW —

\$1

FREE

100 KILLER
STEEL PELLETS

\$1 BRINGS YOU \$18

Discover Flok-Kraft and Earn \$\$\$\$\$ AT HOME

Earn up to \$15.00 per hour spare time. Amazing new Velvet-fiber spray instantly makes any object (Lamps, Radio & TV Cabinets, Figurines, Signs, Auto dash boards, toys, furniture, draperies — anything) worth expensive \$\$\$\$\$ prices. . . like magic, you can spray anything with this beautiful new suede-like finish that feels like rich Velvet.

EARN UP TO \$300.00 PER WEEK SPARE TIME

Imagine, materials cost only 3¢ per square foot. Average TV or radio cabinet can be beautifully sprayed with this startling new 3-dimensional Velvet finish in 15 minutes at a cost of only 34¢ in materials. Your charge for this job is at least \$10.00.)

REPRESENTATIVES IN YOUR AREA URGENTLY NEEDED

Own your own business. Work at home in your spare time. Help fill the huge growing demand for this amazing new beautiful Velvet-fiber finish. Orders come from stores, offices, homes, architects, auto dealers, — everywhere. Possible \$20,000,000,000 worth of jobs to be done. Investigate today—be first in your area! Actual samples in 16 Radiant Colors. Brochure of 30 Home Business Opportunities and Confidential Details all sent free! Send No Money. Write: Coast Industries, Los Angeles 61, Calif., Dept. B-10.

THE SOUND OF HIGH FIDELITY



\$3.95

Understand
precise sound reproduction
THE SOUND OF HIGH FIDELITY
tells all. Get yours now.

It's by

POPULAR
MECHANICS

GET THE HABIT OF OUR CLASSIFIED ADS.

Wonderful Opportunities Amazing Bargains

NOW! Shut Out Cold, Wind,
Water, Snow . . . Keep Garage
Warm & Dry ALL WINTER with

FLEXIBLE
RUBBER
GARAGE DOOR
BOTTOM

Don't waste precious heating dollars! Keep winter cold, snow, rain, dust and drafts out—keep heat in with this amazing heavy-duty live rubber weatherstripping. Ingenious front and back lip contour design makes it an automatically perfect closure regardless of shape of floor. Guaranteed never to harden, rot or deteriorate in any fashion. Eliminates forever car-shattering noises, no matter how hard you slam down your overhead garage door. Ideal also for sides of double hung garage doors, barn doors, etc. Can be permanently applied in only 10 minutes—requiring just a hammer—we supply the nails. Complete, simple instructions in plastic pack.

9 foot strip \$2.98 ppd.
16 foot strip \$4.98 ppd.

Famous
Frost King



PLASTIC
STORM
WINDOWS

- Shatterproof
- Waterproof
- Winterproof

720"x36" — 180 sq. ft. — More than enough to winterproof an average house
only \$2.69
plus 31¢ pp. & hdg.

Only pennies per window give you sure-fire protection the year-round. Installs in minutes—no skill needed. All you need is a screw and hammer — we supply all else. Unlike ordinary plastic sheeting, Frost King is expressly designed for storm window use. It seals in heat as it seals out cold, "breathes" with your house. Frost King is unconditionally guaranteed to give you years of satisfactory use under the severest of conditions . . . guaranteed never to shatter . . . unaffected by wind, rain, snow, sleet or dampness.

Versatile, Fully Adjustable WORKBENCH LAMP

For Shop, Inspection
Bench, Machine Tool,
Laboratories

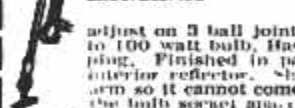

swivels and angles in every conceivable direction. Guaranteed to hold your light exactly where you want it, because 3 arms (2-12" and 1-10") adjust on 3 ball joints. Easy to mount anywhere. Taken up to 100 watt bulb. Has 8-foot long-wearing neoprene cord and plug. Finished in pale green with reflective white enamel exterior reflector. Shade is permanently attached to support arm so it cannot come off or pull the bulb socket out.

the bulb socket out \$5.98 ppd.

Comparable with radios listing at \$75 without batteries!

8 TRANSISTOR "Jewel" POCKET RADIO

MADE IN U.S.A. \$29.95 INCLUDING BATTERIES



JEWEL 8 transistor radio — never before available at this low, low price! Has unbreakable Styrene plastic case — earphone attachment outlet — 3 position metal stand-up easel and carrying handle. Built-in antenna is OMNI-DIRECTIONAL . . . radio plays equally well regardless of position. Powerful 8 transistor superheterodyne circuit, has full tuning range of 540 to 1620 kilocycles. Brings in distant stations without station overlap. Clear, full distortion-free tone that can be turned up to amazingly big volume. Plays in train, plane, car, steel construction buildings — anywhere! Each complete with warranty registration card for factory service and repair in New York City. Limited quantities . . . order NOW for prompt delivery!

LEATHER CARRYING CASE—with snap lock and sturdy leather strap—\$2.49 ppd.
PRECISION PRIVATE EARPHONE ATTACHMENT—\$1.95 ppd.

Send check or money order. If C.O.D. fees extra. Money-back guarantee.

SCOTT MITCHELL HOUSE, INC. Dept. F-10, 415 S. Broadway
Yonkers, New York

Brain-Wave Synchronizer Aids in Hypnosis

Doctors and dentists can use a portable electronic instrument to help them induce the hypnotic state. Called a brain-wave synchronizer, the 117-volt instrument shortens hypnosis-induction time to an average of three minutes. It also helps doctors to lessen resistance and induce a state deep enough for therapy. The synchronizer is effective on groups as well as individuals. With the patient facing the machine, verbal sug-

gestions are made while the dials are turned on and set to the approximate brain frequency. A light flickers at this frequency to aid in induction of hypnosis.

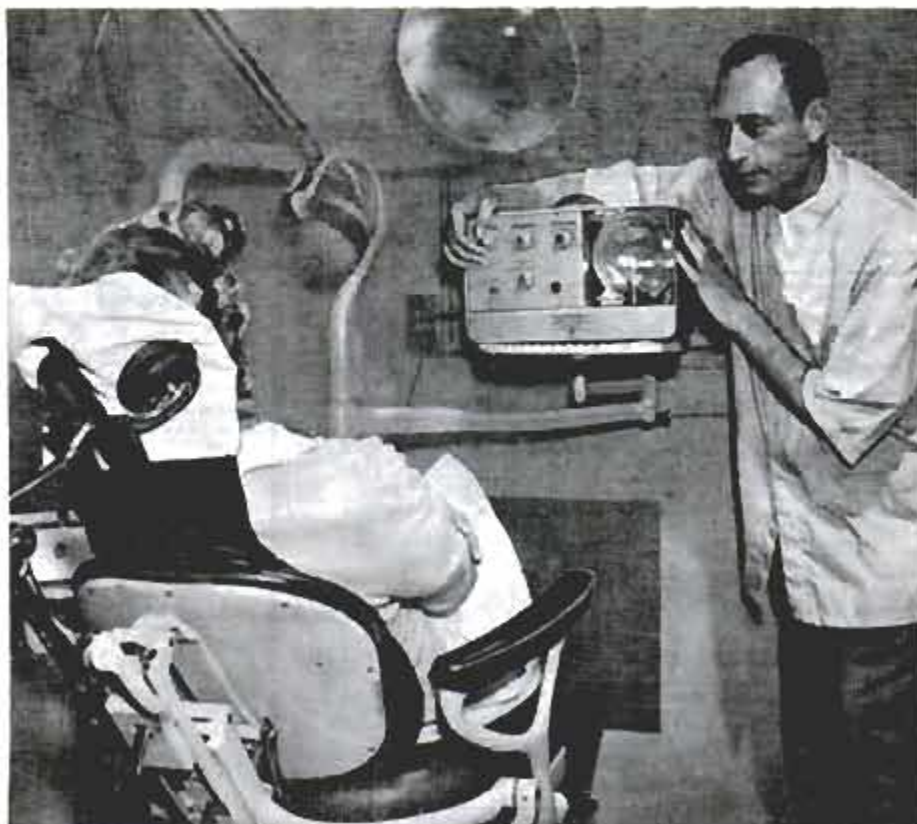

Chemical Stops Ultraviolet Rays

Without stopping visible light, chemical curtains that screen invisible light may soon be available for agricultural and other purposes. A new agent, which can be built into plastic screens, absorbs ultraviolet rays and transforms them into harmless radiation.

NEW... V-Belt Drive Designer for Light Machinery

With this newly-developed **DRIVE DESIGNER**, you can quickly and easily select the proper size V-Belts and pulleys for small machines... such as home workshop tools—electric farm machines—light-duty factory equipment—etc. Highly accurate, simple to use... assures the exact machine speed you want. Send 25¢ for your time-saving **DRIVE DESIGNER** today!



World's Largest Maker of V-Belts

The Gates Rubber Company, Sales Division, Inc. Dept. 15—999 So. Broadway, Denver 17, Colorado

Please send me the new Gates Truflex V-Belt Drive Designer by return mail. I am enclosing 25¢ to cover cost of handling and mailing.

Name..... (Please Print)

Address.....

City..... Zone..... State.....

Gates Truflex V-Belts



Build a Weather-Protected Entrance with **JOHNS-MANVILLE *Corrulux*** shatterproof, translucent building panels

—colorful, distinctive, easy to install

If you can hammer a nail, you can build this attractive entrance shelter in a matter of hours. Colorful *Corrulux* provides diffused glare-free light, adds beauty and value to your home. It is easy to apply with ordinary carpenter's tools.

Send 5 cents (in coin) for detailed construction and materials plan of protected entrance illustrated. Specify Plan No. 4. Send 30 cents for set of 12 plans of practical uses for *Corrulux* around the home (including Plan No. 4).

Johns-Manville, Dept. PM-3, Box 60, New York 16, N. Y. In Canada, Plastic and Allied Building Products, Ltd., Box 250, Dundas, Ontario.

JOHNS-MANVILLE





HIGH WAGES!

High Wages can be yours as an Operating Engineer of heavy construction equipment! Learn NOW to operate our diesel engine bulldozers, draglines, cranes, back hoes, scrapers and motorgraders! Machines of major manufacturers are used in our training program. Contractors are on our advisory staff. Contractors need trained operators and pay high wages to our graduates. We invite comparison and inspection of the nation's original construction equipment operator's training schools. NEW! Announcing resident and non-resident courses in Heavy Construction Management. Write for details.

Budget plan available. VETERANS: Ask about G.I. Benefits

Write TODAY for FREE School Catalog,
no obligation, to either address

THE NATIONAL SCHOOLS of HEAVY EQUIPMENT OPERATION

Dept. D-34

P.O. Box 8415, Charlotte, N. C. • P.O. Box 510, Weiser, Idaho

500 PRINTED NAME & ADDRESS LABELS 25¢



500 Gummed Labels printed with ANY name and address, 25¢ per set! 4 sets (same printing or all different) \$1.00! Padded. Two-tone jewel-type plastic gift boxes only 10¢ extra, 4 for 25¢. Order as many or as few sets and boxes as you want. Only 25¢ per set. Money-back guarantee!

WESTERN STATIONERY, Dept. 820, Topeka, Kan.



SUPER JU JITSU

Now get tough double quick!

A course of instruction in the art of practicing and using this method of applying LIGHTNING-QUICK Super Ju Jitsu. Be Dangerous! These amazing lessons show you how it's done . . . in a big illustrated home-study course. The weapons are just your BARE HANDS—they can be used effectively if you know how and practice the art. Easy to learn; quick. Full 76-lesson course only \$5.95 postpaid—or COD, plus postage. Satisfaction or your money back guaranteed! Order "super Ju Jitsu Course."

NELSON-HALL CO., 210 S. Clinton St., Dept. KR-2, Chicago 6, Ill.

IMPORT PAYS BIG

New World Trade Boom Offers Big Profit Opportunity to Ambitious Men and Women. Learn how to import thousands of products at low foreign prices for buyers in your locality at high U. S. prices—operate a worldwide mail-order Import-Export business from your home. **START WITHOUT CAPITAL** or previous experience. Training includes

shipment to you of many sample imports from 'round the world. Opportunity world travel. Save on personal purchases of Clothes, Tools, Gems, Watches, Cameras, etc. **HERE'S PROOF . . .** an import from overseas **SENT AT OUR COST.** Mail this ad with 25¢ (coin) and we'll rush you this \$2 Nelson Automatic cigarette lighter to convince you of tremendous profits. Send for your lighter and full details showing how to learn World Trade secrets to put you on road to your own Profitable Home Business. (No lighter without this ad—only one to a person.) You can get details alone FREE, but the lighter is actual proof of import values. Either way, **WRITE TODAY!** MELLINGER COMPANY, Dept. X25A, 1717 Westwood, Los Angeles 24, Calif.



HOME PAINTING TIP NO. 49



For neat, professional-looking paint jobs use "SCOTCH" Brand Masking Tape. Sticks tight, stretches to hug curves or irregular surfaces. Paint won't bleed through. When paint has "set" (but not fully dried), "SCOTCH" Masking Tape strips off quickly and easily, leaves a clean sharp edge. An invaluable aid for painting with brush, roller or spray can. Ask for "SCOTCH" Brand Masking Tape in the handy cutter-edge carton—35¢, 69¢, 98¢, \$1.69 sizes—wherever paint is sold!

"SCOTCH" and plaid design are registered trademarks of 3M Co., St. Paul 6, Minn. © 3M Co. 1959.



FREE!

350 BIG PAGES OF BARGAINS LIKE THIS

24 36 JUMBO PAGES MONTH AFTER MONTH

8 TRANSISTOR \$29.95

PORTABLE WITH BATTERY

Versatile! Use anywhere as powerful long distance radio, as portable amplifier for phone — as 2nd half of stereo system. 6 1/2" x 3 1/2" x 1 1/2". Top grain leather case.

- Non Radio
- LP Records
- Power Tools
- Optical Goods
- Test Equipment
- Hi-Fi Components



35¢

NOW AVAILABLE! 1960 GUIDE TO ELECTRONIC PARTS BUYING

300 pages, 8 1/2" x 11", illustrated handbook Articles, engineering data plus buying guide Over 40,000 items. Use coupon to order today!

RADIO SHACK Corporation
730 Commonwealth Ave., Boston 17, Mass.

Please send me:

- | | |
|--|---------------------------------|
| <input type="checkbox"/> FREE Bargain Bulletins for 12 Months | 10M |
| <input type="checkbox"/> FREE Record Flyers for 12 Months | |
| <input type="checkbox"/> 1960 Electronic Buying Guide @ 35¢ | <input type="checkbox"/> Check |
| <input type="checkbox"/> 8 pc. Stereo Package #92LX220 @ \$64.50 | <input type="checkbox"/> M.O. |
| <input type="checkbox"/> 8 Transistor Radio, 90LX696 @ \$29.95 | <input type="checkbox"/> C.O.D. |

Name _____
Street _____
City _____ Zone _____ State _____

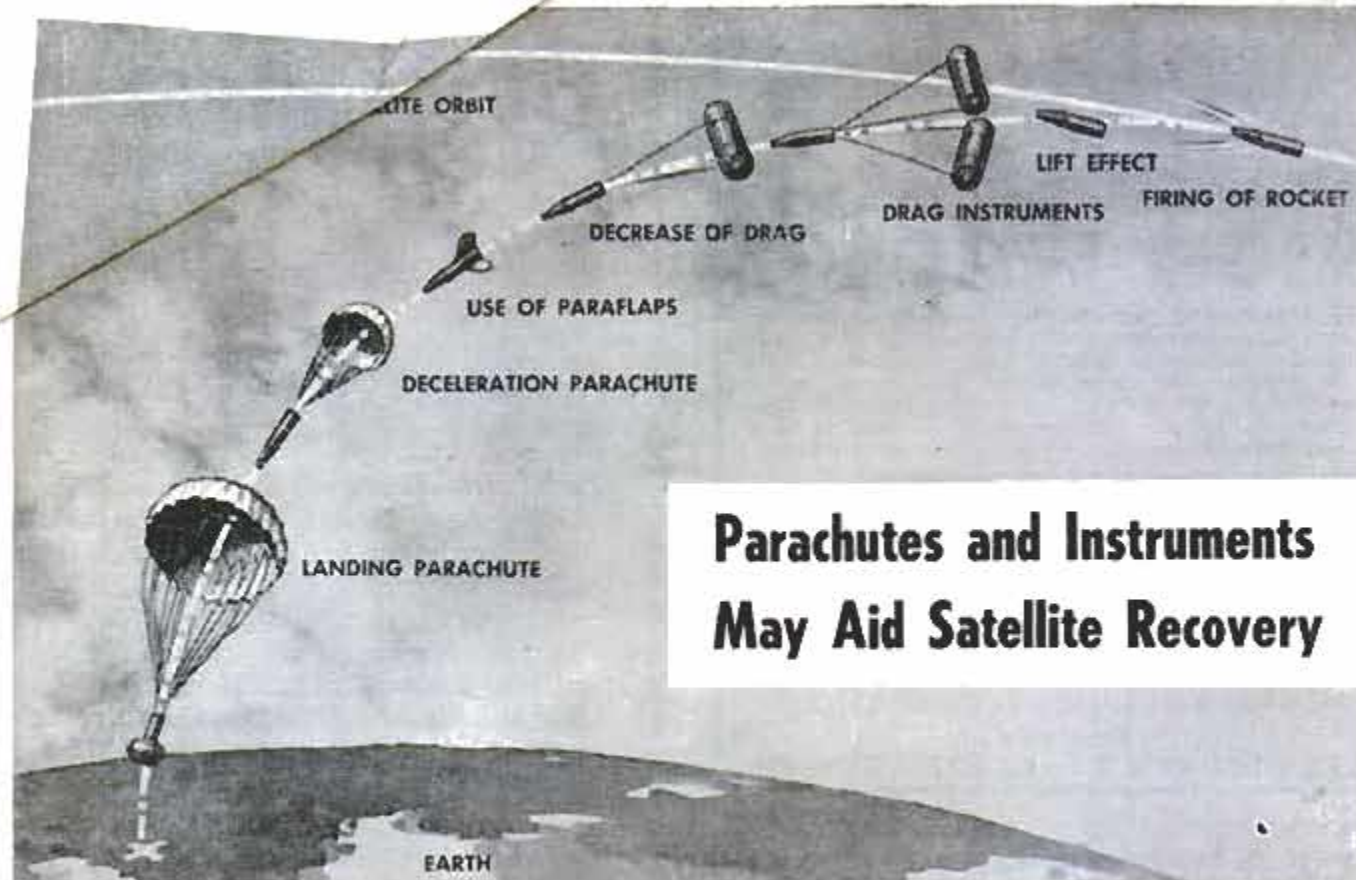

Parachutes and Instruments May Aid Satellite Recovery

Parachutes and drag instruments are expected to aid in the recovery of a manned or instrumented vehicle in orbit, according to Space Recovery Systems, Inc., a newly

formed organization for space research. In one method, the satellite would be slowed down and recovered by drag instruments, paraflaps and finally parachutes.



At Times Like This —
You Need **PLASTIC STEEL**®

80% Steel

When home repair troubles start to pile up . . . don't let it get you down . . . Get **PLASTIC STEEL** the permanent mender with a million uses around the home, garage or farm. **PLASTIC STEEL** fixes practically anything in minutes . . . saves you hundreds of dollars on repair bills.

As easy to use as modeling clay **PLASTIC STEEL** forms to any shape, bonds metals, wood, concrete or glass to itself or each other. Hardens to a steel-like strength in two hours. Can be filed, sanded or painted.

Repairs broken furniture, light fixtures, tools, toys, and appliances without special tools. No heat or pressure required. Seal leaking pipes, tanks, sinks, radiators and furnaces with **PLASTIC STEEL**. Holds under pressure. Won't shrink or expand.

PLASTIC STEEL fixes cracked motor blocks, torn fenders, leaking gas tanks, tractor parts, feed tanks and planting machinery. Unaffected by weather, won't corrode!

PLASTIC STEEL — in the black and yellow package — is available in three convenient home kits — \$1.98, \$1.89 and \$3.95.

At all leading hardware stores.

WRITE FOR FREE HOME REPAIR BOOKLET

DEVCON CORPORATION

176 Endicott Street, Danvers, Mass.



Also available — **NEW Devcon**® Rubber and **Devcon**® Aluminum

GIVE
AMERICAN
CANCER
SOCIETY

GUNK-it-yourself!

Gunk® G.P. removes grease from engines or concrete floors; cleans paint brushes, power mowers, or machinery completely, economically, safely. It's ready-to-use, rinses off with water, won't clog drains. Quart size with handy "Squirt Spout" top speeds application. Insist on the *best* degreaser — the original "**GUNK**" at better automotive supply and hardware retailers everywhere.

REG. TRADE MARK.



GUNK CHICAGO CO., River Forest, Illinois

serving the Midwest and Southwest

RADIATOR SPECIALTY CO., Charlotte, No. Carolina

serving the East, Southeast and far West

NEW **BT₃** ENDS TUNE-UP GUESSWORK!



NEW TUNE-UP CONCEPT BALANCES CARBURETION, COMPRESSION AND IGNITION TO RESTORE *NEW CAR POWER!*

Maintain the new car power, performance and economy that was designed into your GM car. Get a BT-3 tune-up . . . the *balanced* tune-up, three ways.

With this new concept, your compression, ignition and carburetion are checked, adjusted and restored to new car condition. Every replacement part is factory approved. For example, all carburetor parts are genuine parts for Rochester-GM

Carburetors . . . original equipment on more new cars than any other carburetor. And the whole step-by-step, scientific procedure of BT-3 is factory recommended.

Stop wherever you see the BT-3 sign, and enjoy the new car performance that only a balanced tune-up can give. Or if qualified service is your business, contact your nearby UMS distributor to learn how to give BT-3 to your customers.



America's
number one
original equipment
carburetors

ROCHESTER **CARBURETORS**

ROCHESTER PRODUCTS DIVISION OF GENERAL MOTORS, ROCHESTER, NEW YORK

When you want
the finest in Chisels
INSIST ON
SHARK BRAND

THE CHISEL FROM SWEDEN!
Cutting blade
made from world-famous,
tough Swedish Steel.
See Shark Brand at
your hardware dealer.
Write today for this
booklet on the
care and use
of chisels.



Sandvik STEEL INC.
Saw & Tool Division

1704 Nevins Road, Fair Lawn, N. J.
In Canada: P. O. Drawer 1335, Station "O," Montreal 9.

Every Home needs a
RED HEAD
Sprayer



complete kit
less motor
\$44
at your dealers

● Go easy on yourself! Let a Red Head do your chores — spray painting, waxing, greasing, inflating, cleaning, garden spraying, insecticide fogging, many others! Get professional results every time!

Powerful new Red Head outperforms them all, even many large 1/2 hp units! Delivers clean, oil-free air at 3.5 cfm and 50 psi pressure. Only 10" high, weighs under 30 lbs. Use any 1/4 hp or larger motor.

Write for literature today!

JOHNSON SERVICE COMPANY
Compressor Div., Dept. AB
MILWAUKEE 1, WISCONSIN



Tiny Radar Amplifier
Doubles Effective Range

Radar's range can be increased by as much as 100 per cent with the addition of a newly developed parametric amplifier to existing ground and aircraft systems. Called "Paramp," the tiny microwave device boosts the sensitivity of the receiver. It is expected to solve many major problems of air-traffic control in the jet age.



C. L. B. Co., P.O. Box 6031, Houston 6, Tex.

Inertia-Powered Switch
Operates Trailer Light

Equipped with its own battery, a warning light for boat trailers turns on when the car slows down or stops. Inertia of the car slowing down causes a switch to turn on the light. The light has its own battery enclosed in a case mounted behind the reflector. A clamp fastens the light to the trailer. The light is not connected to the car battery or brake mechanism in any way. It thus eliminates the wiring problem when a trailer is used only occasionally.

Ⓛ Powered by a rocket engine, an Air Force test sled traveled 2075 miles per hour, a world speed record for two-railed vehicles.

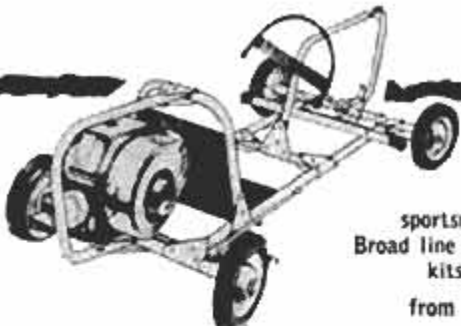

For sportsmen 6 to 60!
Broad line of models —
kits, less motors
from **\$39⁹⁵**

Send 50c for 22-page catalog.
Complete kits with motor from **\$109⁹⁵**

ARNOLD-DAIN CORP.
Box 78, Mahopac, N. Y.
Dealer Territories Available



**Heavy Duty, All Steel
TOOL CHEST**
\$25⁹⁰ F.O.B.
ST. PAUL



WHERE ELSE
can you get 4 drawers with
built-in locking system, sliding
on compound glides—
at this price! Baked blue-gray
enamel. 26" x 12½" x
12¼". Your money back
if not satisfied! Write for
bulletin, describing this
and 12 other models.
HUOT MANUFACTURING CO.
555 No. Wheeler St., St. Paul 4, Minn.

Works in seconds!



**Loosens Rusted Bolts
nuts, screws, "frozen" parts!**

**LIQUID
WRENCH®**
SUPER-PENETRANT

The super-penetrating rust
solvent that quickly loosens
rust and corrosion.

AT ALL HARDWARE AND AUTO STORES
RADIATOR SPECIALTY COMPANY
CHARLOTTE, NORTH CAROLINA

3 oz. CAN
35c

New... for Electric Repairs!



**VACO® No. 1930 P
Terminal Kit**

The ONE tool in this kit cuts and
strips wire, shears 5 sizes
of bolts and crimps all
the new VACO *insu-*
lated solderless
terminals.



SPECIAL OFFER!
Tool, assorted terminals
and FREE pouch... a
\$6.00 value as illustrat-
ed...only \$4.25 prepaid.
At Better Stores Everywhere or Write.

VACO PRODUCTS COMPANY, 323 E. Ontario St., Chicago 11, Illinois

**GUARANTEED...
WON'T
LEAK!**

...yet cool!



Style No.
1188

- Soft, tan Sylflex Vulcanized upper leather *breathes*... lets heat, perspiration out... *won't let water in!*
- Uppers stay *soft* for the life of the shoe
- Heavy corker sole and heel for long wear
- Permacounter heel support... *won't break down*
- Leather laces
- Complete range of sizes and widths

LOOKING for a REGULAR WORK SHOE?

- Town Brown soft, mellow leather upper
- Heavy Neocork sole and heel
- Permacounter heel support
- Leather laces
- Tri-pad arch cushion



Style
841

RANGER
HEAVY DUTY SHOES

"THE GREATEST NAME
IN WORK SHOES"

For name of your dealer write:

ENDICOTT  JOHNSON

Endicott 1, N. Y.



DETROIT LISTENING POST

By Art Railton

IT WAS ACCIDENTAL, no doubt, but it almost looks as though the Big Three got together and divided up the small-car market. These companies, working separately in vacuum-packed secrecy, have come up with cars of such varied personalities that they are almost noncompetitive.

If you like the Falcon, you probably won't like the other two. If you like the Valiant, you probably can't see anything good about the others and so on. There is a wider range of car "personality" among the three small cars than in the entire Chrysler Corporation big-car line, or the General Motors big-car line.

Once the public shows which of the three it likes best, the others will start moving toward it and eventually all will be alike, if history repeats itself. But right now, the choice is wide.

"Compact without discomfort. Spacious, four-passenger body designed for those who prefer a compact car without the discomfort common to the ordinary small car. All-aluminum body. Swivel front seat."

What car of tomorrow is this?

This is a quotation from an advertisement for the Jordan Brougham published in 1918. Apparently, the word "compact" goes back a long, long way—and swivel seats, too.

By January the Falcon and Valiant will both have station wagons. The Valiant's may be announced along with the sedans at the end of October. They won't be available in volume until later, however.

These two can use much of the sedan tooling in the wagon body. The Corvair can't do it that way—everything has to be different (except the chassis). But just because the Corvair will be late with its wagon (due next year) doesn't mean it isn't bullish about the small car.

Some dealers are already planning to set up a separate retail outlet for Corvair, so bright is its future regarded. Within two years, the Corvair will have a range of models extending from the sports car to the truck.

First out (December) may be a sports coupe not too far from the Karmann-Ghia concept (bigger, of course). It will offer a four-speed full-synchromesh transmission (it will be optional on all Corvairs also).

Corvair is out to explode the myth about rear-engine instability that the competition spread around a few months back. There's a hint that it might try to prove the car's stability by winning the sports-car race at Sebring. Rumors are that a low-price fuel injection package is being developed to sell for about \$75 and with it the Corvair may run the wheels off anything in its class at Sebring this December.

You can't go prowling around a Corvair without being reminded of Volkswagen. Certainly Corvair engineers must have had more than a nodding acquaintance with the little German car. Chevrolet is reputed to have bought 25 Volkswagens in the past year and you can be sure they weren't used for door prizes at a dealers' convention.

Now it is Volkswagen's turn to learn. Don't be surprised to see the VW now-vertical fan switched to a horizontal position as in the Corvair. Such a move will reduce height and help wagon design.

What are VW's plans? We don't know, of course, but we can make a few guesses. Now that General Motors has put its stamp of approval on the air-cooled rear engine, VW may be more acceptable than ever, provided it is competitive pricewise.

After all, if the three U. S. small cars have a list price of \$2000, you will soon be able to buy one for \$1850 with the usual discounting by the American car dealer. (Dealers get a 21-percent discount on the small American cars, 24 percent on the big cars.) This would give the VW (a smaller, less desirable package for the average American) a price advantage of only \$150. That may not be enough.

So you might expect VW to bring out an economy version of its present model for about \$1300 at the same time it brings out its new four-door sedan with slightly more engine. When? Soon as possible, we bet.

Meanwhile there's evidence that Corvair plans to cut into VW's commercial business. And station-wagon business, too. The Corvair wagon is expected to be a comfortable, good-looking, low-slung version of the VW Microbus. It will open up a whole new world to the American motoring public. It could be a vacation home on wheels for three weeks a year and a convenient suburban wagon the rest of the time. Family touring will be a delight.

Yes, sir, sense is returning to this, the most esoteric business of all. Sense by the bucketful and we'll all benefit.

DRIVING IS
MORE FUN WHEN
YOU KNOW
YOU'RE HEADED
THE RIGHT WAY



with a NOMAD AUTO COMPASS by

Airguide

On highway, by-way or winding streets, in darkness, rain or daylight, this smartly styled and popular direction guide helps to keep you on the beam. Saves you miles, minutes and temper. Finest Alnico V magnet and exclusive VISI-DOME® dial assure easy steady readings under all conditions. At night just press the button. Self-contained flash cell illuminates dial with a soft green glow. Fits any car. No wiring. Simple to install and adjust. Wonderful gift idea for motorists.

Model No. 79
NOMAD
\$750



Made and
Guaranteed by
Airguide
Instrument
Company,
Chicago 47, Ill.

At better stores everywhere



**FREE
MUFFLER CHECK**
**WE
INSTALL**
AP LONGER LASTING
**MUFFLERS
AND PIPES**

For the longest-lasting mufflers
from the men who know your car
best, look for the AP sign

THE AP PARTS CORPORATION

14-W AP BLDG., TOLEDO 1, OHIO Mufflers and Pipes



Only AP gives you all three: thicker steel, coated steel, "Dri-Flow" design

OCTOBER 1959

"More
shooting fun
for everyone"



SPORTING NEWS PLAYER OF THE DECADE

with Crosman CO₂ Gas Pellguns

"Thanks to Crosman, a whole new, exciting sport has opened up . . . a sport the whole family can enjoy . . . Pellgun shooting. Now you can shoot like I do, in and around your home all year long. It's good recreation when I'm on the road, too. A Crosman Pellgun is both a man's gun and a family gun. They're safe, quiet and easy to handle."

with Hahn CO₂ Gas BB Guns



wholly new BB guns. Feel, look and handle like the famous rifles and revolvers of the Old West . . . with higher BB power and accuracy. True fast draw single action in the revolver . . . authentic lever action in the rifle.

Try these guns at your Crosman Select Dealer, who has a Crosman-Hahn Sales Center. See for yourself the fun that's ahead, when you shoot the Crosman CO₂ gas Powerlet way.

WRITE for free colorful shooting fun literature. Crosman Arms Co., Inc., Dept. CA-17, Fairport, N. Y.

Crosman CO₂ GAS **HAHN**
PELLGUNS BB GUNS

WORLD'S LARGEST MANUFACTURERS OF
CO₂ GAS-POWERED RIFLES AND PISTOLS

IT'S FUN TO BE AN ARMCHAIR ADVENTURER



With a NATIONAL NC-60 SPECIAL Shortwave Radio Receiver you can cross the six continents in the comfort of your favorite chair, visit foreign lands, eavesdrop on aircraft, ships at sea and radio hams. Enjoy standard broadcast too, with this powerful new radio receiver. Suggested price only \$59.95. Write for literature and name of nearest dealer.

JOIN THE NATIONAL ASSOCIATION OF ARMCHAIR ADVENTURERS

SEND 50c for membership certificate and exciting new book on Shortwave Listening. Tells when, where, how to listen, provides log for listing countries you hear. SEND 50c to:

 **NATIONAL RADIO CO., INC.**
MELROSE 76, MASS.

A wholly owned subsidiary of National Company, Inc.



SEAL YOUR DOORS AND WINDOWS
AGAINST COLD, RAIN, WIND AND
DIRT WITH

Bridgeport

INNER-SEAL
WEATHERSTRIPPING
and Cut Your
Fuel Bills, Too!

Made of flexible sponge rubber, reinforced with spring wire and neoprene coated for extra toughness, long-wearing Inner-Seal is easy to put on—you can do-it-yourself with hammer, scissors and tacks. Get INNER-SEAL at your hardware store today! Only 10c a foot.



Write for
FREE FOLDER
"How to
Weatherstrip
Your Home!"
Dept. PM 10

BRIDGEPORT FABRICS, INC.
BRIDGEPORT 9, CONN.

Where-to-Buy-It Index

Annual Housing Section

The P.M. indoor-outdoor house	144
Will it increase the value of your house?	153
Gas lamps—the comeback kids (Falcon Mfg. Co., Inc. P.O. Box 10405, Dallas 7, Tex.; Arkla Air Conditioning Corp., Gaslite Sales Div., Shannon Bldg., Little Rock, Ark.; Bruest, Inc., 20th and Sycamore, Independence, Kans.; Mado Aluminum Products Co., P.O. Box 128, 118 S. Patrick St., Littletown, Penn.; Roberts-Gordon Appliance Corp., 44 Central Ave., Buffalo 6, N. Y.; The East Ohio Gas Co., Public Relations Dept., Cleveland, Ohio; Modern Home Products, Russell, Ill.)	156
Electric heating is here to stay	158
How to get your house in shape to sell	164
Trends for the apartment dweller	166
Parade of homes	169
Ideas for home planners	174
Get in step with your building code	176
The test of good landscaping	180
Basement built-ins	188

Aviation

Fuselage of plane is contoured to eliminate high speed pitch.....	120
Airlines keep stepping ahead.....	129
Giant gas-turbine helicopter will fly for RAF.....	132
Sergeant in air force builds a helicopter.....	136
International version of record-breaking Starfighter.....	143

Ideas for Home Planners

Leather tiles (Kiefer International Products, 240 Front St., Grand Rapids, Mich.)	174
"Flat light bulbs" (Westinghouse Electric Corp., 401 Liberty Ave., Pittsburgh 30, Pa.)	174
Translucent curtain-wall panels (Kalwall Corp., Manchester, N. H.)	174
Built-in-vacuum system (Better Living Specialties, Inc., Providence, R. I.)	174
Powered storage cabinets (General Electric, Appliance Park, Louisville 1, Ky.)	175
Sliding mirror doors (Fleet of America, Inc., 2015 Walden Ave., Buffalo 25, N. Y.)	175

Miscellaneous

Do you know this old-timer?	12
Magazine reproduces sounds with its words	120
Shaft on mower runs lawn tools (Tarpin Engineering Co., Ltd., Ixworth House, Ixworth Place London, S.W.3, England)	121
Any old mother will do	131
Boat mounted on car rolls down the highway.....	133
Carport or utility building comes in kit (Atlantic Industries, P.O. Box 2047, Savannah, Ga.)	133
Anglo-Irish car for U. S. market	137
High-speed fireboat is equipped with radar	137
Adjustable stand holds paper for fast ceiling installation.....	139
One-bath process develops and fixes film (Cormac Chemical Corp., 80 Fifth Ave., New York City 11.)	256
Days are growing longer	294

Science

All-weather TV camera has windshield wiper (Pye Ltd., P. O. Box 49, Cambridge, England).....	132
Machine digs battlefield trench at rate of 12 feet per minute	136

(Continued to page 94)

CONVERT THAT MILITARY RIFLE

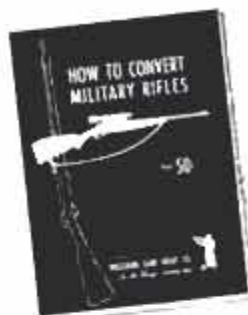

NEW BOOK

Shows You How



'03 Springfield—Before



After

Step by Step Instructions

Shows How To Convert:

Springfield
Enfield
Mauser
A. Krag
N. Krag
6.5 Jap
7.7 Jap
6.5 Carcano
7.35 Carcano
7.62 Russian
S.M.L.E.
Others

The complete "How To" booklet for amateur or expert. Makes custom "sporterizing" of military rifles easy. Tells what the average shooter will require, what accessories are available and how to install them. More than 150 illustrations take you from disassembling through the final finishing. Gives sight combinations, height chart, ammunition to use, etc. Only 50c per copy. If your dealer can't supply, order direct OR send \$1.00 and we will send above booklet plus complete 144 page Shooter's Catalog.

WILLIAMS GUN SIGHT CO.
"On the Range"
7210 Lapeer Road Davison 23, Michigan



WOOD

PLIOBOND

CANVAS

SYNTHETIC RUBBER

"BONDS

PLASTIC

GLASS

ANYTHING

LEATHER

TO

COMPOSITION BOARD

ANYTHING!

STAINLESS STEEL

EASY TO APPLY. PLIOBOND requires no mixing, brushes on, dries rapidly.

EXCELLENT ADHESION. PLIOBOND exhibits exceptional strength — up to 1600 lbs./sq. in. in shear tests.

EXTREMELY DURABLE. PLIOBOND resists age, heat, cold, water, chemicals, oils.

Pliobond
BY
GOODYEAR

Pliobond—T. M. The Goodyear Tire & Rubber Company, Akron, Ohio



WORLD'S LOWEST PRICED CALCULATOR!

NEW! NEW! NEW!

TOM THUMB ADDING MACHINE

With beautiful Leatherette carrying case.
MADE IN AMERICA BY AMERICANS
Beware of cheap imported imitations.
Adds Up To One Billion—1,000,000,000
Subtracts—Multiplies—Divides

Mistake Proof—Positively 100% Accurate—
Lightning Fast—Shock Proof Solid Steel Mechanism

GUARANTEED FOR YOUR LIFETIME

Ideal for Housewives, Shoppers, Students, Engineers and Tax work. Take it to the Super Market—save \$\$\$ every week. We pay postage if you send check, cash or money order—or just send your name & address and pay postman \$1.97 plus postage. Immediate Delivery—10 Day Free Trial—Satisfaction Guaranteed—Money refunded by return mail. Special Gift Offers 2 Machines for only \$3.99. Agents Wanted—Make easy money selling a Top Quality Calculator at our unbelievably low price.

TOM THUMB ADDING MACHINE

P.O. Box 5066, Dept. O-19, Philadelphia 11, Penna.



Not \$3.95 \$2.03 in Penna. including 3% Tax.
But Only **\$1.97**

MAGNETS

We buy and sell permanent magnets of many types, shapes and sizes. If you have surplus magnets, or discontinued items, contact us. If you use magnets send 25c for sample and literature.

RONALD EYRICH, Robin Lane, BROOKFIELD, WISCONSIN

MAKE EXTRA CASH

SHARPENING LAWN MOWERS THE MODERN WAY



\$275.00

F.O.B. Pasadena

Start your own shop! Full or spare time. Earn many dollars in a short time... average \$5.00 per hour. Many mowers need sharpening. With MODERN'S Extra Heavy Duty LAWN MOWER SHARPENER AND BED KNIFE GRINDER you have 6 machines in one. All operations are done quickly and easily. You make money from the start. Write for free details.

MODERN MFG. CO.

160 N. Fair Oaks Ave. Dept. Pasadena, California 10-4

NEW! "ANTISEPTIC GLOVE"

HAND PROTECTION

House • Garden • Workshop • Garage



from oils • dirt • greases • paints • solvents • acids • alkalis • household cleaners • any harsh irritating materials

Three highly successful WEST 'antiseptic glove' PROTECTIVE CREAMS—first formulated for use in industry and now used by hundreds of thousands of working men and women—are now available to you!

You simply apply the appropriate 'antiseptic glove', as directed, before starting any dirty or skin irritating job. These soothing preparations help keep your hands clean, soft and safe by temporarily 'sealing' the pores of your skin. They actually help to condition your skin while preventing the penetration of harsh irritants. They will not stain. They're easily washed off with soap and water—leaving your hands and finger-nails clean and healthy!

WEST PROTECTIVE CREAMS are recommended by leading industrial skin specialists. They're available only from West Chemical Products, Inc., Long Island City, New York—the oldest and largest company of its kind in the world.

Money back guarantee if not completely satisfied.

3 TYPES OF HAND PROTECTION

1—DUST RESISTANT (#211) which protects against dust-borne irritants, viscous oils, dirt, greases, grime, etc.

2—WATER-RESISTANT (#311) which protects against dilute acids, alkalis and water-based irritants such as insecticides, fertilizers, solder flux, wood stains, cutting oils, etc.

3—SOLVENT-RESISTANT (#411) which protects against petroleum hydrocarbons, chlorinated and other type organic solvents, paints, plumbing compounds, glues, etc.

YOU GET ALL 3 in giant 10 oz. tubes

WEST CHEMICAL PRODUCTS, INC.

P. O. Box #29
Long Island City 1, New York

Please send me postpaid WEST'S 'Antiseptic Glove' PROTECTIVE CREAMS #211, #311 and #411. Enclosing Check Money Order for \$2.98 (No C.O.D.'s).

Name _____

Street _____

City & State _____

(This offer is limited to the U.S.)

Only
\$2.98
for all
3 tubes

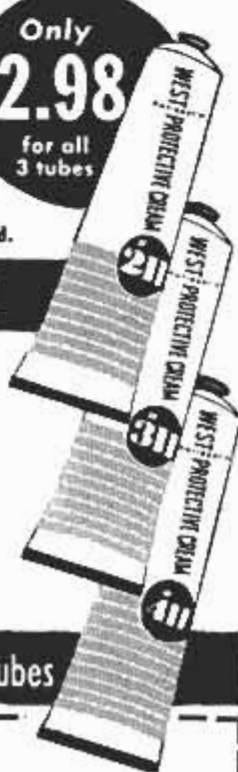

Curtains of air corral herring	138
Palm-size sound meter "maps" factory noise (Mine Safety Appliance Co., 230 N. Braddock Ave., Pittsburgh 8, Pa.)	139
Strips of magnetized plastic seal refrigerator doors	139
Metal made of fibers is 90 percent air	143
Superior bluegrass developed by radiation	143
High-frequency sound waves "see" inside the eye	260

Radio-Television, Electronics

Portable battery-powered TV transmitter and camera (Dage Television Div., Thompson Ramo Wooldridge, Inc., Michigan City, Ind.)	244
Tape-cartridge player (Fidelivox-Fidelipac Div., Waters Conley Co., Inc., of Del., 8225 Christiana St., Skokie, Ill.)	244

Craftsman and Shop Notes Index

Automotive

Blocks with corrugated surface aid installing tire chains	198
Winch mired car to firm ground with Spanish windlass	199
Check for coil polarity	228

House and Home

Solution to a problem corner	193
Smart wall decor for a fireplace	197
Rating numbers taped on TV and radio fuses for easy identification	199
"Bed closet" saves floor space in attic bedroom	205
Silhouettes perk up drab garage	208
V-bottom wood "basket" stacks fireplace logs	208
Plastic cuts greenhouse costs	218

Miscellaneous

Child's king-size whistle made from dowel and hose	198
Windmill-ladder sections used for shelf supports	199
Electrified car lighter becomes novel desk set	200
"Sling" to carry heavy outboard motor easily	201
Helpful hints for duck hunters	205
Hose prevents ice from cracking flagstaff hole	205
Ice-fishing hole kept open with improvised heater	205
Novel cookout trays	208
Fast action avoids stains when tackling food spills	209
Coding micro slides	215
Outlining aids typing stencils	215
Autumn bouquet	216
Swing-away tray clamps to bed rail	217
Loose broom handle tightened by expanding with screw	219
Tractor tire and umbrella make quickie sand box	223
Holding insect on slide	225
Set your own gunights with one shot	225
Farm-built broadcast seeder sows grain and grass seed	228

Photo

Photoflood hanger	209
Camera floor-pod	224
Darkroom rack	224
Thermometer hook	224

Shopping for Tools

Drywall hammer	241
Metal-cutting lathe	241
Reversing transmission	241
Stud locator	241
Circular slide rule	242
Clamp for heavy extension-cord connections	242
Ladder brace	242
Plane attachment	242
Swinging tool tray	242
Bench vise	243

(Continued to page 96)

How to pass a bike down through the family...



Spray on BROMA TOUCH 'N TONE colored aluminum

A good many home-handy people are excited (if the mail is any indication) about spray-on colored aluminum paint. They call it a decorating marvel that's actually fun to use.

Take bikes for example. Big brother's old two-wheeler will look like new in about 30 minutes. Dad's spraying on a gleaming, over-all coat of Broma *Touch 'n Tone*. Small Fry will pass it off tomorrow as a new bike... the colored metallic finish will be the envy of the neighborhood.

Users report that it's no trick now to restore all those hard-to-paint "treasures" around the house. Everything takes on new life and sparkle with colored aluminum paint—lamps, trays, tools, toys, garden furniture, appliances, knickknacks—it's a long list. On rusted areas, many people use a primer such as Master Bronze *Derusto* for longer life.

Available in blue, green, gold and silver, *Touch 'n Tone* is made with Alcoa® Pigments by Master Bronze Powder Company, Calumet City, Ill.



Paint, hardware and building supply dealers everywhere carry colored aluminum paint in spray cans or they can get it for you.

Alcoa does not make paint, but Alcoa Aluminum Pigments are used in most high-quality brands. You should know more about the protective and decorative qualities of aluminum paints and roof coatings. Write today for Alcoa's informative booklets, *Painting With Aluminum* and *Aluminum Roof Coatings Make Time Stand Still*. Use the coupon.

Look for this label... it's your guide to the best in aluminum value



For exciting drama watch "Alcoa Presents" every Tuesday, ABC-TV, and the Emmy Award winning "Alcoa Theatre" alternate Mondays, NBC-TV

Aluminum Company of America
1737-K Alcoa Building, Pittsburgh 19, Pa.

Please send your free booklets:

- Painting With Aluminum*
 Aluminum Roof Coatings Make Time Stand Still

Name _____

Address _____

City _____ Zone _____ State _____

Control unit	243
30-piece drill kit	243
Portable transformer	243
Scriber with magnifier	243

Solving Home Problems

Drinking glass converted to a beaker	206
Electric hedge trimmer	206
Keep paintbrush soft over night.....	206
Clear plastic cap readily seen on cutting razor	206
Skeleton key used as wrench	207
Nontipping child's swing	207
Milk cartons protect tender transplants	207
Box-top thread dispenser	207
Furnace filters	207

Workshop Hints

Battery clip simplifies the grounding of portable tools	197
Bench mount for electric drill permits work to be handheld ..	198
Reference data kept on T-square	198
Cardboard disk protects chuck lathe dog or tool post	201
Lathe carriage used to position the tailstock accurately	201
Hand grip improves scraper	215
Apartment-size tote box	217
Identification marks on plywood scraps indicate type at glance	217
Accurate center-drilling jig	219
Notched wooden spacer block speeds compass adjustment ..	219
Yardstick on workbench edge handy for quick measuring....	219
Food chopper serves as hold-down	223
Depth setting on drill press changed quickly with clips ..	225
"Sanding block" removes paint	225
Magnetized wrench holds screws	228
Turn hardwoods on metal lathe	228
Bore holes straight with this bit guide	232
China-marking pencil doubles as ruling pen	232
Dust collector for home shop	232
Ball thrust bearing for slow-speed shaft	233
Discarded nail set makes tiny pin punch	233
Hole gauge serves as locator for centering dividers	239
Chuck centers long rods in lathe spindle	240
Recording saw-tooth profiles is aid in sharpening	240
Holding nonferrous metals on magnetic chuck	240
Dual chamfering cuts speed production	240
Built-in stop saves fingers	243

NOTICE—It is the intention of this magazine to provide its readers with information regarding the latest developments in the mechanical arts. Except where otherwise indicated, this magazine has no information as to any unexpired patents in respect of the developments reported herein. In the event that commercial use is to be made of any of the developments reported herein, it is suggested that legal counsel be consulted to avoid liability for patent infringement. It is not the purpose of this magazine to encourage patent infringement but, as indicated, it is the intention of this magazine to report on the latest developments in the mechanical arts.

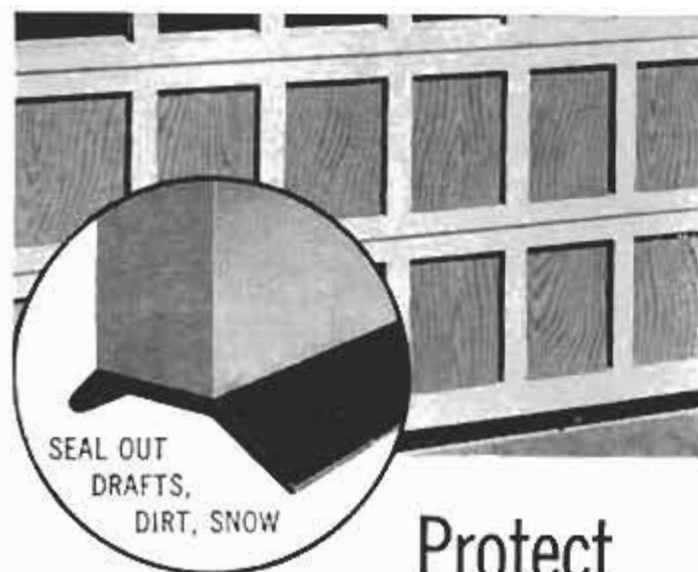

Protect costly garage doors with **StanStrip***

Now . . . for less than \$3.00 . . . in less than 10 minutes . . . you can put StanStrip on an 8-foot overhead garage door. And what a difference it makes!

The thick, rubber "pad" cushions the shock of closing . . . prevents damage to doors, spares the windows, ends the crash of closing.

And, just as important, the double lips of StanStrip flex to follow every irregularity in the floor . . . seal the opening completely against dust and dirt, rain and snow. Your garage stays cleaner, drier, warmer. Your car starts easier in winter.

And does it last! You just can't hurt StanStrip. The special rubber compound was developed from hundreds of formulas tested for this purpose. Stays flexible even in coldest weather. Get StanStrip now at hardware and building supply stores.



SEAL HOME DOORS AND WINDOWS, TOO
Ask for StanSeal,® the grey rubber compound strip that you uncoil and nail as you go. A tight, permanent seal in minutes. You can paint to match the frame.

For the ultimate in door-seal beauty, with no nails showing, get *deluxe* StanSeal. As easy to install and can be painted over, too.

*Trademarks

The Standard Products Co.
PORT CLINTON, OHIO



'America is a Better
America —
thanks to Advertising!



75hp **STARFLITE** **II** with Jetstream drive

Now the wraps are off! We invite you to share the excitement—to see, *try* the sensational new Starflite II—most efficient high performance outboard ever designed!

All the Performance Your Boat Can Use—Starflite II brings to boating entirely new concepts of speed and power, smoothness and reliability. Starflite power makes cruisers scamper like runabouts—Starflite-powered runabouts cruise serenely and economically at speeds other outboards strain to reach!

Outstanding New Features—New automatic

choke, thermostat temperature control, new double-acting shock absorbers, new taper-lock transom brackets—history-making Jetstream Drive with full gearshift. All at no increase in size or weight—all at the lowest cost per horsepower in outboard history!

Preview Showing — 1960 Models—Seven pace-setting new 1960 Evinrudes at your dealer's now...including a fabulous new 40 hp Lark II. New colorful catalog—write: EVINRUDE MOTORS, 4229 N. 27th St., Milwaukee 16, Wisconsin.

JETSTREAM DRIVE BREAKS THE DRAG BARRIER!



Just as jet planes changed shape as greater power boomed them to super-sonic speeds...so has the Starflite II lower unit evolved into a new hydrodynamically designed shape. Jetstream Drive brings to well-designed runabouts the kind of performance formerly limited to lightweight raceabouts and single passenger hulls.

A Division of Outboard Marine Corporation
In Canada: Mfd. by Evinrude Motors, Peterborough

EVINRUDE

FIRST
IN

Get satisfying flavor...So friendly to your taste!

NO FLAT "FILTERED-OUT" FLAVOR!

NO DRY "SMOKED-OUT" TASTE!



You can light
either end!

© A. T. Co.

See how Pall Mall's famous length of fine tobacco travels and gentles the smoke—makes it mild—but does not filter out that satisfying flavor!

HERE'S WHY SMOKE "TRAVELED" THROUGH FINE TOBACCO TASTES BEST



1 You get Pall Mall's famous length of the finest tobaccos money can buy.



2 Pall Mall's famous length travels and gentles the smoke naturally . . .



3 Travels it over, under, around and through Pall Mall's fine tobaccos!

Outstanding . . . and they are Mild!

Product of The American Tobacco Company — "Tobacco is our middle name"



IMPROVED ORGAN CONTROLS

Self-taught organist Ayres built in improved volume controls after manufacturer said it couldn't be done

Inventors Are Not Eggheads

By George X. Sand

GENIAL and soft-spoken Waldemar A. Ayres, 50, of Fort Lauderdale, Florida, looks more like a debonair yachtsman (which he is) than one of the world's foremost inventors, with some 175 patents, issued or pending, to his credit.

His explanation: "The world often thinks of the inventor as an eggheaded, antisocial personality who hides in an ivory tower with his slide rule. This is ridiculous.

"In fact, to be a success the inventor must actually show a genuine interest in, and enjoy close contact with, his fellow man. For the basic aim of inventing is to provide better solutions for human problems. He should bear in mind the admonition which Thomas Mann had inscribed on his tombstone: 'Be ashamed to die until you have

so contributed to the human race that it has been advanced because you lived'."

Ayres, who is listed in *Who's Who in America*, has contributed often and widely for the benefit of his fellow man. During World War II he offered his services to the Sperry Gyroscope Corporation. Within nine months he had devised 28 new inventions, mostly in radar—a word he'd never even heard before. Included were full color radar, three-dimensional (stereo) and anticollision aircraft radar.

Eleven of his inventions were immediately classified as war secrets by the U. S. Government. One of these, the famous radar-guided gliding BAT bomb which the Navy used so effectively against Japanese shipping, became—as far as he can deter-

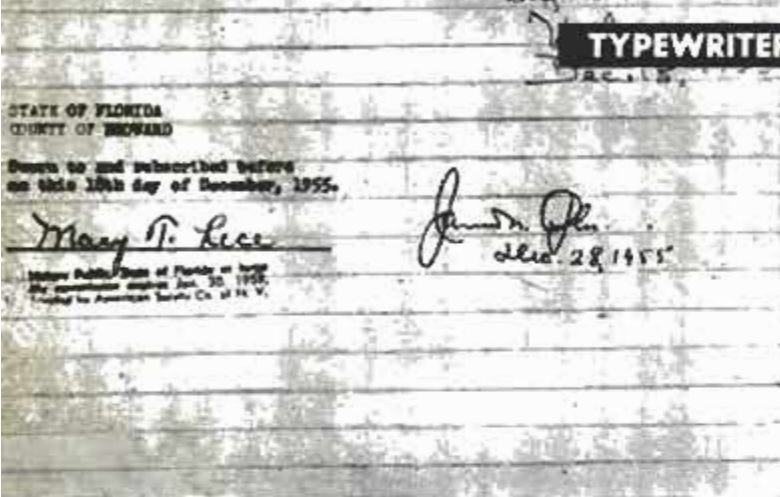
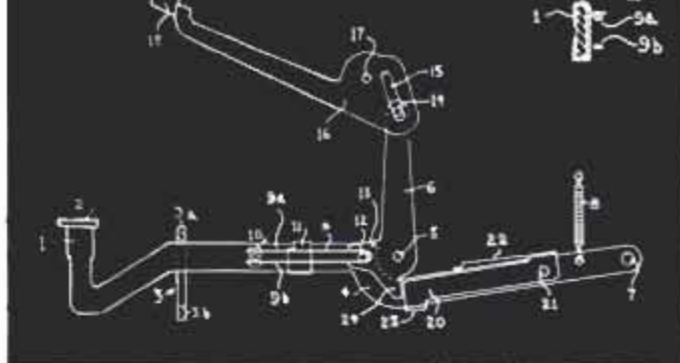
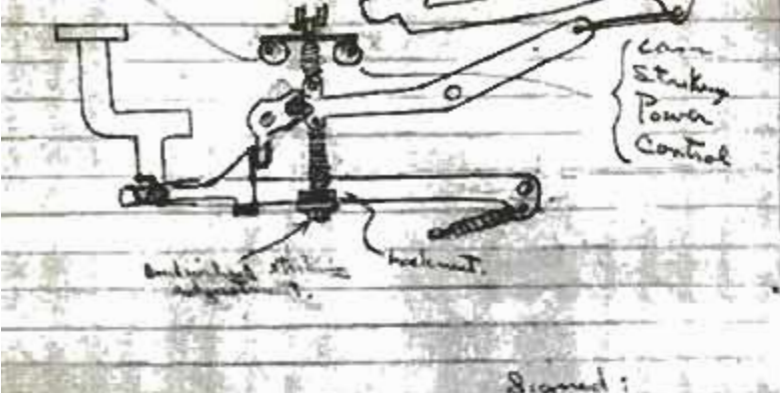

TYPEWRITER-KEY ACTION

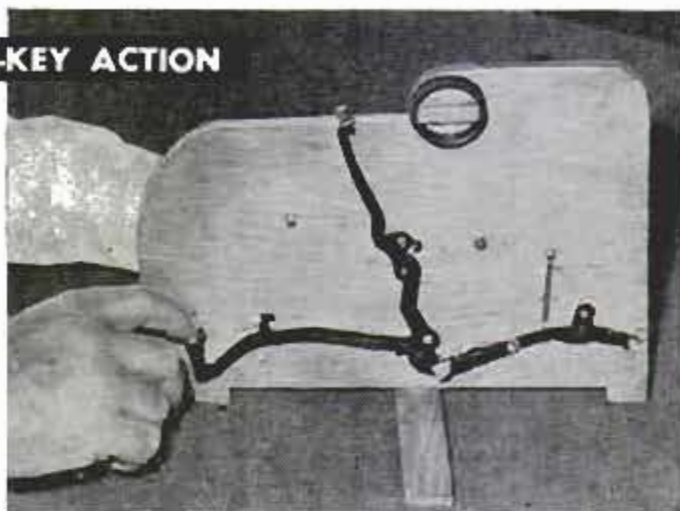

Inventor's progress: Notarized early drawing; sketch for patent application; sales demonstration model

mine—the first electronic self-guided missile for “homing” on enemy targets.

He is the originator of frictional recording for tabulating cards and ledger posting (an improvement over the conventional punched-card methods). He is credited with developing the world's first nonprofessional small camera for three-dimensional pictures which do not require a stereoscope for viewing. While employed by the White Sewing Machine Company (he'd had no sewing-machine experience whatever) he soon built a new machine which incorporated 141 improvements into

the company's product, 30 of them patentable, in spite of the fact he'd found some 20,000 sewing machine patents already issued in Washington for this extremely worked-out field.

He has also invented such unusual things as underwater swimming gloves for divers, a plastic paper clip that won't rust and stain, a bow tie with grippers that prevent it from coming loose at one's collar, and a novel “puffer” device which milady can use in the sanctity of her boudoir to “powder her bare back in areas ordinarily inaccessible.”

Duplicating attachment built into Polaroid camera makes on-the-spot copies without copying device

Built-in gyroscopic stabilizer eliminates jiggling image in glasses of over eight-power magnification

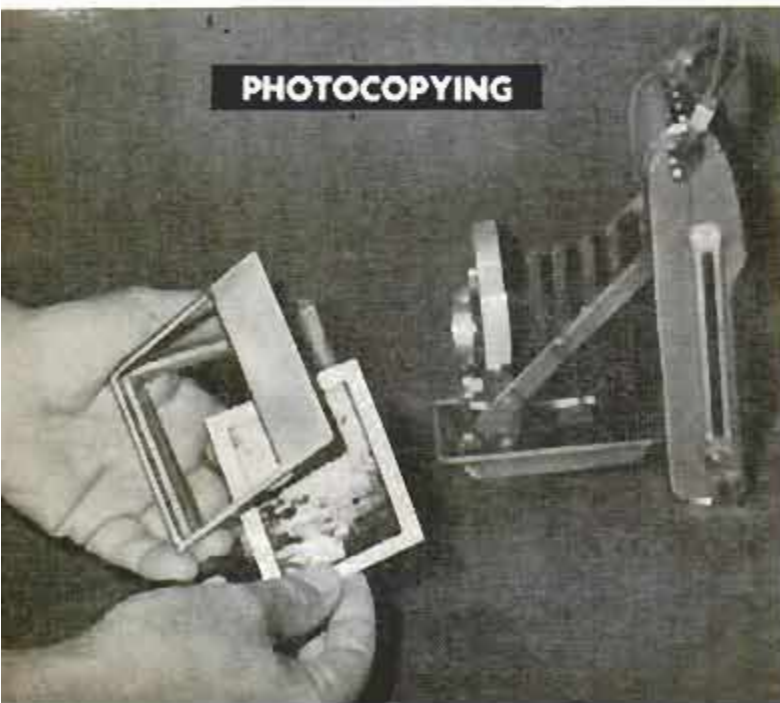

PHOTOCOPYING

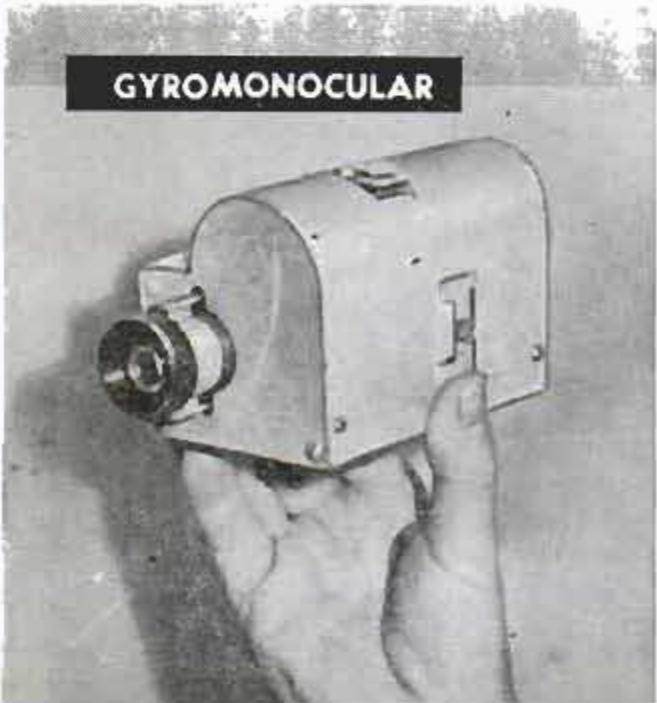

GYROMONOCULAR



Mr. and Mrs. Ayres didn't like the skin-diving gloves available; invented the collapsible gloves shown

There are certain steps which the would-be inventor should follow to insure his greatest chance for success, says Waldemar Ayres. Consider how the veteran completed these successive steps while perfecting a new typewriter keyboard action:

(1) *Judging the need.* Unless you can honestly see a genuine requirement for the product, forget it, he urges. You likely will not earn enough from it to pay for the energy, time and money invested. "It is said less than five percent of the approximately 80,000 U. S. patents that are annually applied for earn enough to pay their patenting costs. Main reason for this is the inventors failed to spend as much thought in selecting what to invent as they did later in solving their inventing problems."

In the case of his new typewriter-key action, preliminary research had revealed people bought electric typewriters mainly to enjoy the perfectly even blackness of printing such machines provided. Yet some 65 percent of the typewriters being sold were still manually operated. Ayres reasoned that if he could cause the conventional machines to type with the same evenness of the electrics a real need could be met.

(2) *State the problem.* The successful inventor learns to first write out his problem, fully and clearly. This initial record, incidentally, can in time become part of your "Invention Disclosure." It can be quite informal, so long as it clearly states what you intend to do, and how you hope

to do it. Since all U. S. patents are issued on the basis of dates, it is quite possible to lose your entire invention by being a *single day* behind a competitor who may have the same invention in mind. So be sure to date this original paper and have it notarized, even should it be hastily written upon the back of an envelope (as has sometimes been done). More on this later.

"Write down *all* the objectives, even if you haven't the faintest idea how you will achieve them," says Ayres. "Aim high, at what you feel would be the ultimate achievement. If it be a complex problem list the major elements and their dependent elements. This will serve to reduce the one large problem into a series of smaller ones that you can more successfully overcome, one at a time.

"Tackle the major elements first, since your solution to these will often modify the subsidiary considerations accordingly. Don't hesitate to invest considerable thought at this stage, since it can save you much trouble later. This careful stating of the problem at the outset will often carry you a long way toward its solution."

Ayres' problem was briefly this: Unevenness of typing resulted because the typist invariably struck some keys harder than others. Hence, he would have to design a key action that would produce letters and numerals of the same blackness on the paper even though the keys be struck unevenly.

(3) *Acquaint yourself with the materials*



and forces involved. Obviously, you must study and provide yourself with a working knowledge of the things you will be working with. If you intend to invent or improve something mechanical you must have a knowledge of mechanisms; and the same for chemical and other fields. Wally Ayres went to a large typewriter repair company in his city and borrowed an old key action. He removed one key and mounted this on a small piece of plywood breadboard so that when he depressed the key the associated linkage operated and caused the lone type face to strike a small cross-sectional piece that he'd cut from a discarded roller and mounted in proper position on the board.

He played with this gadget. Here before him, then, were the materials, the forces he would have to work with.

(4) *Arrive at a solution, striving for as many alternative methods as possible.* This is your chance to let your imagination roam, to show your originality. It is surprising, the veteran inventor says, how many of us, by the time we become adults, are conditioned to standardized thinking as a result of reading, watching movies and TV and talking with others. "Originality is the ability to climb out of these ruts of thought and explore new possibilities," he says. "Thinking of alternative solutions, then selecting the best working and least expensive answer to the problem, is one of the *principal* things we can do to insure success in inventing."

He recommends playing chess and reading science fiction as a stimulus to the would-be inventor to develop imagination and originality. The former recreation invites you to continually work out various alternative combinations of moves. ("Definitely a form of inventing!") And the second pastime not only encourages exploring unusual fields of thought, it also teaches the reader a surprising amount of science.

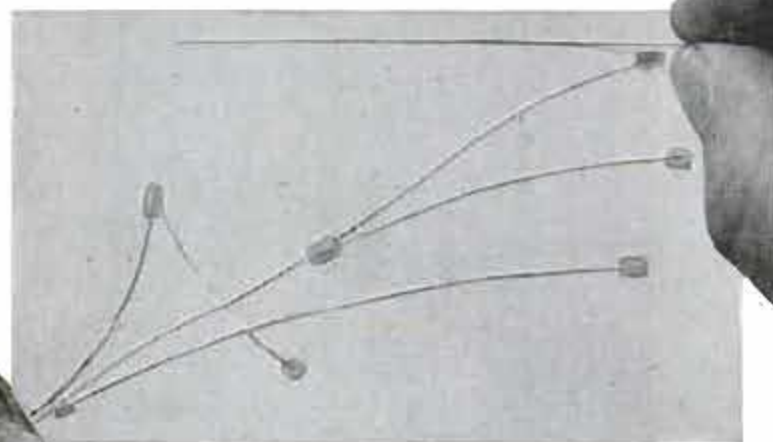

Using special magnifying glasses, Ayres works on hair-sized glass tubing shown in center. Below, Mrs. Ayres inspects a 3-dimensional photograph made through his lenticular stereoscopic lens screen



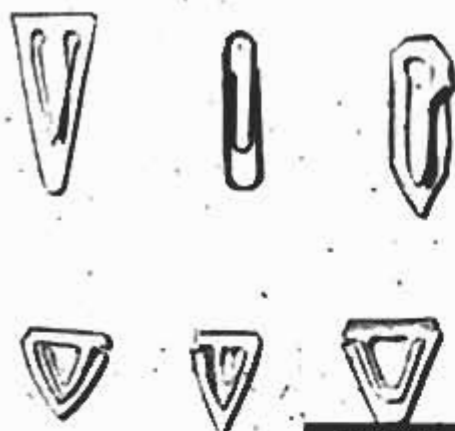

PAPER CLIPS

Seven styles of plastic paper clip were considered before choosing the final design for patenting

Another helpful device, he says, is to repeatedly state your problem to your subconscious mind, particularly just before going to sleep, since this portion of the brain seems to work a 24-hour-daily shift and can often solve problems for us without our being aware of the process. Sometimes it may take months, of course.

To avoid risk of being charged with "abandonment" of your invention idea you should now be doing some work on it (that you can prove) at least every two months until you are ready to file for a patent.

After considering many alternatives Ayres arrived at this conclusion with regard to his typewriter problem: In the



NONSLIP TIE

Bow-tie wearer Ayres didn't like the clips on his ties; invented a successful nonslip collar clip

ordinary "momentum" machines it wasn't how far, but how fast one pushed the key that determined the blackness of the typing. You always push the same distance. If these principles could be reversed, therefore, so that the force delivered to the striking key is a function of how far, and not how fast you push it, and since you are always going to push it the same distance, you should be able to achieve printing uniformity.

A simple rubber band had helped him arrive at this conclusion. If he pulled the band back a given distance, then released it, it would snap against an obstruction

(Continued on page 302)

Every inventor's objective—proof of his issued patent. This is the patent for a 360-degree movie lens

UNITED STATES PATENT OFFICE
324216
CYCLORAMA OPTICAL SYSTEM
William A. Ayres, New York, N. Y., applicant by International Business Machines Corporation, New York, N. Y., a corporation of New York
Submitted October 4, 1955; Serial No. 523,297
1 Claim, 105, 16—55

This invention relates to improved means for recording and projecting cyclorama and/or moving pictures.

An object of the invention is the provision of a reflector or mirror reflector in position to be associated with a camera in order to take pictures of a cyclorama 360° around of scenes that are recorded and projected.

Another object of the invention is the provision of a reflector or mirror reflector associated with a camera or projector to determine selectively the upper and lower limits of working areas of a projected and projected horizontal band substantially a complete vertical range of light ray heights.

A feature of the invention is the association of a camera lens with a reflector to view it or use with a camera or projector associated to a horizontal band.

Further and other objects of the present invention will be understood and made clear in the following description and claims and in the drawings which show by way of illustration a preferred embodiment and the objects thereof and which I have contemplated of applying the principles. Other modifications of the invention encompassed by the claims or equivalents may be used and structural changes may be made to those shown in the drawings without departing from the present invention and within the scope of the appended claims.

In the drawings:
FIG. 1 is a perspective view showing the structure of a cinematograph reflector with a camera or projector.
FIG. 2 is a plan view of the reflector shown in FIG. 1.
FIG. 3 is a perspective view of the camera or projector associated with the reflector shown in FIG. 1.
FIG. 4 is a perspective view of the camera or projector associated with the reflector shown in FIG. 1.

The invention relates to improved means for recording and projecting cyclorama and/or moving pictures. An object of the invention is the provision of a reflector or mirror reflector in position to be associated with a camera in order to take pictures of a cyclorama 360° around of scenes that are recorded and projected. Another object of the invention is the provision of a reflector or mirror reflector associated with a camera or projector to determine selectively the upper and lower limits of working areas of a projected and projected horizontal band substantially a complete vertical range of light ray heights. A feature of the invention is the association of a camera lens with a reflector to view it or use with a camera or projector associated to a horizontal band. Further and other objects of the present invention will be understood and made clear in the following description and claims and in the drawings which show by way of illustration a preferred embodiment and the objects thereof and which I have contemplated of applying the principles. Other modifications of the invention encompassed by the claims or equivalents may be used and structural changes may be made to those shown in the drawings without departing from the present invention and within the scope of the appended claims. In the drawings: FIG. 1 is a perspective view showing the structure of a cinematograph reflector with a camera or projector. FIG. 2 is a plan view of the reflector shown in FIG. 1. FIG. 3 is a perspective view of the camera or projector associated with the reflector shown in FIG. 1. FIG. 4 is a perspective view of the camera or projector associated with the reflector shown in FIG. 1.

OPTICAL SYSTEM PATENT

FIG. 1. FIG. 2. FIG. 3. FIG. 4.

1955 105
William A. Ayres

AN EYE ON SPACE

By Dr. Dan Q. Posin

PROFESSOR OF PHYSICS, DE PAUL UNIVERSITY
SCIENTIFIC CONSULTANT AND ADVISOR, COLUMBIA BROADCASTING SYSTEM

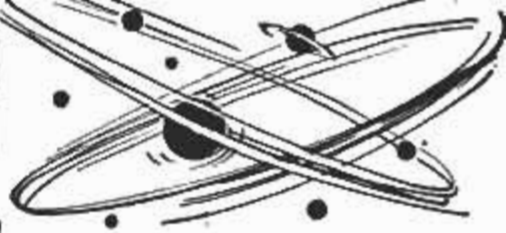

WHAT IS THAT THING paddling around out there?" a friend asked the other day. "This paddle wheel satellite gizmo has four paddles, but where's the water to paddle, or the air?"

It isn't paddling anything. It just looks like a paddle wheel. The paddles are fixed to a more or less spherical body, a bit elongated. It's 26 inches across the stomach, and 29 inches tall. The thing weighs 142 pounds.

The paddles themselves are studded with solar batteries for recharging the ordinary chemical batteries of the satellite. Each paddle has 2000 solar batteries—1000 on each side. So a total of 8000 sunlight-snatching devices are supplying the rejuvenating power for the orbiting paddle wheel.

This is not the first time that solar batteries have been installed in a satellite. However, this installation is really knocking on big time.

Solar batteries make use of the basic principle that sunlight can be converted into electricity. The mechanism of conversion is something like this: From sand we extract pure silicon; this silicon, in its molten condition, is given a pinch of a special impurity — arsenic for example (but not old lace). Then, upon cooling, we have a crystal of what we might call "poisoned silicon." From the crystal we slice a wafer, and this is coated with a thin layer of boron. If sunlight now falls on the crystal, electrons in droves are knocked off the silicon atoms, and this flow of electrons is electricity. The solar battery can last hundreds of years, and thus is an instrument which extracts the free gift of radiance from space for the uses of man.

The launching of the paddle-wheel satellite was accomplished by a three-stage Thor-Able rocket, with a horizontal take-off speed of about 22,000 miles per hour. Since even 18,000 miles per hour would have been sufficient to orbit the satellite, the excess of 4000 miles per hour produced an overshooting effect, resulting in a very elongated orbit. A launching at still greater speed could make a satellite have such a long elliptical orbit that it would enclose the moon in its journey. And a still higher launching speed would produce an open curve—that is, the satellite would escape the Earth for keeps. The paddle-wheel satellite goes out to about 25,000 miles at its furthest from the Earth, and comes in closer than 150 miles at its nearest. It transmits the findings of about 15 major experiments. Investigation is being

made of the radiation belts around Earth, the magnetic field of our planet, the electrical condition of our planet, cloud cover, communication through space, the nature and intensity of cosmic rays, and the amount of space dust and particles.

Meanwhile, of course, other successful launchings have been made. Capsules similar to the "home" of the first astronaut have been fired into orbit, although attempts to recover them, at the moment of this writing, have failed. But the heavens are opening up. Here we come!

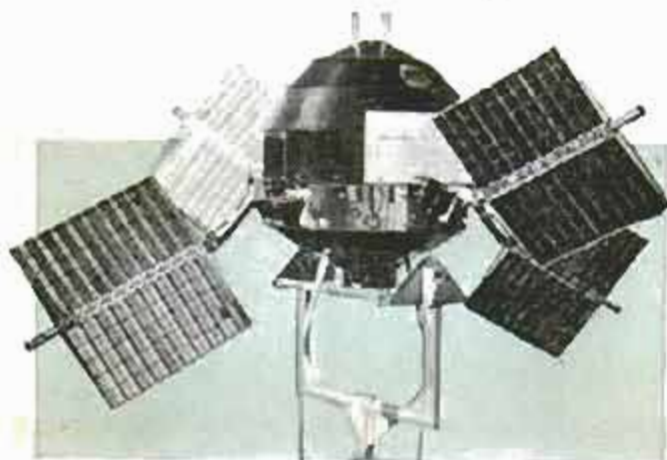



Chevrolet has restyled its rear for 1960. Toned down are the sweeping fins, and the teardrop taillights are gone



Chevrolet Tones Down Its Flash a Bit

CONTINUING its basic chassis without major changes, Chevrolet restyled its front and rear to look a little less rash.

To increase trunk-loading convenience, the rear-deck sill has been lowered 1.5 inches. Brakes have been improved. The front wheel cylinders are larger. A new parking brake uses a ratchet application so a second stroke can be taken if necessary to hold the car on steep inclines or if

the brakes are somewhat out of adjustment.

Engine changes are in the interest of economy. The standard V8 now has a low-lift camshaft. The carburetor is recalibrated for more miles per gallon. High-performance engines are virtually unchanged. Fuel injection is available only on the Corvette (which is unchanged this year).

The four-speed handshift is available as an option for all passenger cars.

Chevrolet offers three wagons. Continued is its rear-facing third seat. Pictured is the Nomad model





Pontiac

Pontiac gets a completely new grille shaped like a V. Transmission hump has been reduced. The steering wheel is one inch smaller on the Bonneville, half inch on the standard models

SPORTING both a classic and a racy look, Pontiac has new sheet metal front and rear. Continued is the optional V8 economy engine with a new miserly two-barrel carburetor. The rear-axle ratio is lowered for economy. Pontiac now has a horizontal speedometer, and there's a new series, the Ventura, with two hardtop models.

.....

OLDSMOBILE is 2.1 inches shorter in the 98 and 0.8 in the other series. It's lighter by 15 to 25 pounds. An economy engine available for the "Dynamic 88" operates on regular gas. New is a three-seat wagon with a rear-facing third seat that folds into the floor effortlessly. Olds also has a new instrument cluster.



Oldsmobile

Olds has removed its fins. It looks lower, sleeker. The rear doors open five inches wider for easier entry. A lower axle ratio provides more economy, and the transmission hump in the front floor has been lowered



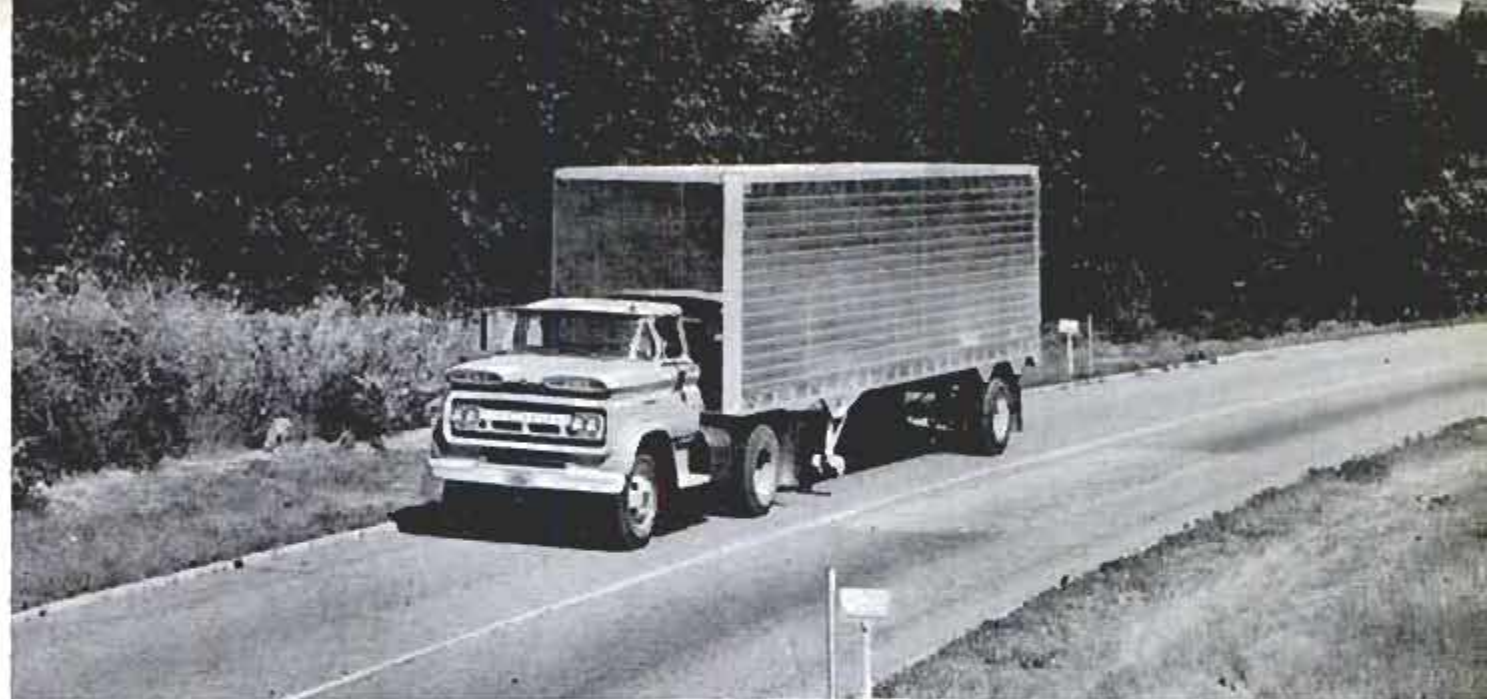

Styling is new, but the big news is chassis where passenger-car comfort is added to trucks as big as this

Chevrolet Trucks Get Independent Front Suspension

Pickups are as much as seven inches lower due to frame kickup. Loading is easier. No step is needed to get into seat so floor is now full width



TRUCK DRIVERS can now smile at bumps, forget about pitch and sway. Chevrolet has independent front suspension, first ever offered on an American truck.

It comes on all sizes from the small, light pickup to the huge semitrailer. The only exceptions are the four-wheel-drive models and the forward-control trucks used for around-town deliveries.

Front springs are torsion bars that run longitudinally alongside the frame members. Ball joints are used in front.

At the rear, coil springs come on trucks up through the $\frac{3}{4}$ -ton size, leaf springs are on the 1 and $1\frac{1}{2}$ -tonners, while the big jobs have a new variable rate, two-stage leaf spring that provides a smooth unloaded ride yet can handle heavy loads.

Left, light-duty rear suspension. Note frame kickup. Right, heavy-duty front suspension with torsion bars

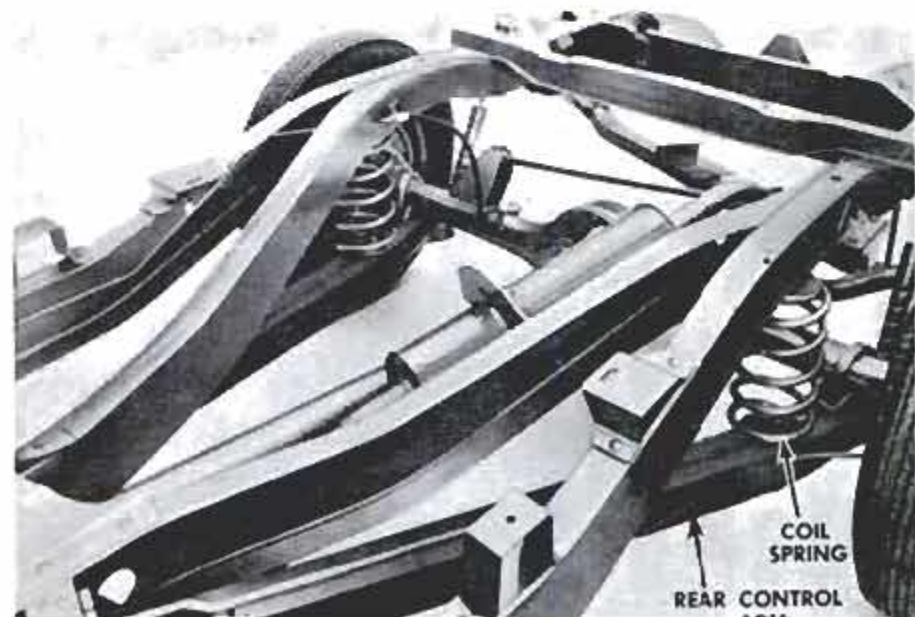

Here They Are: **AMERICA'S**

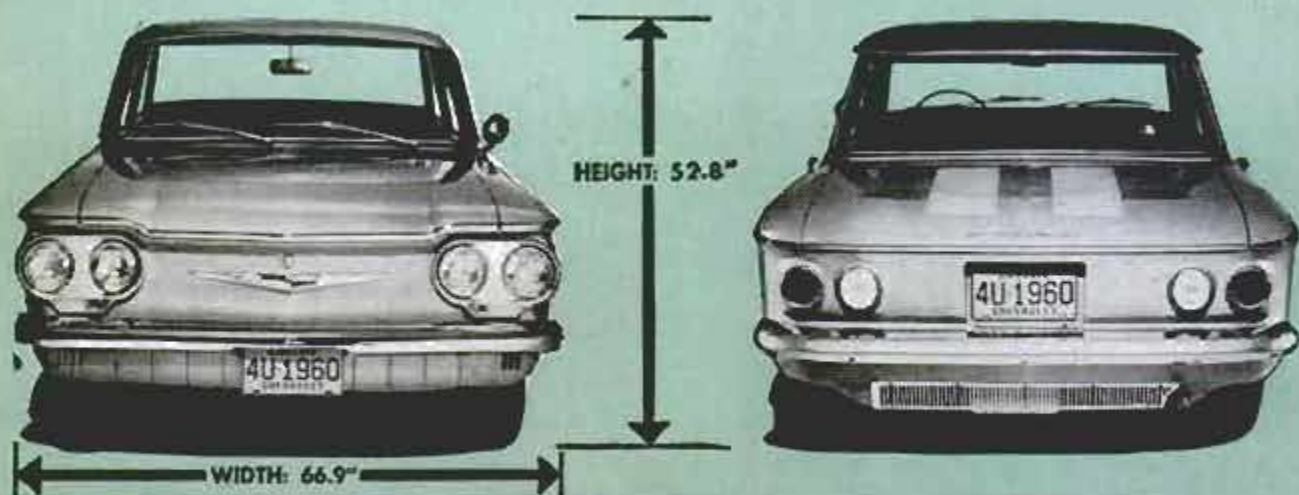

Taking the bold approach, the Chevrolet Corvair offers more innovations than any car ever to come out of Detroit. It's a fresh, new design on the American scene.

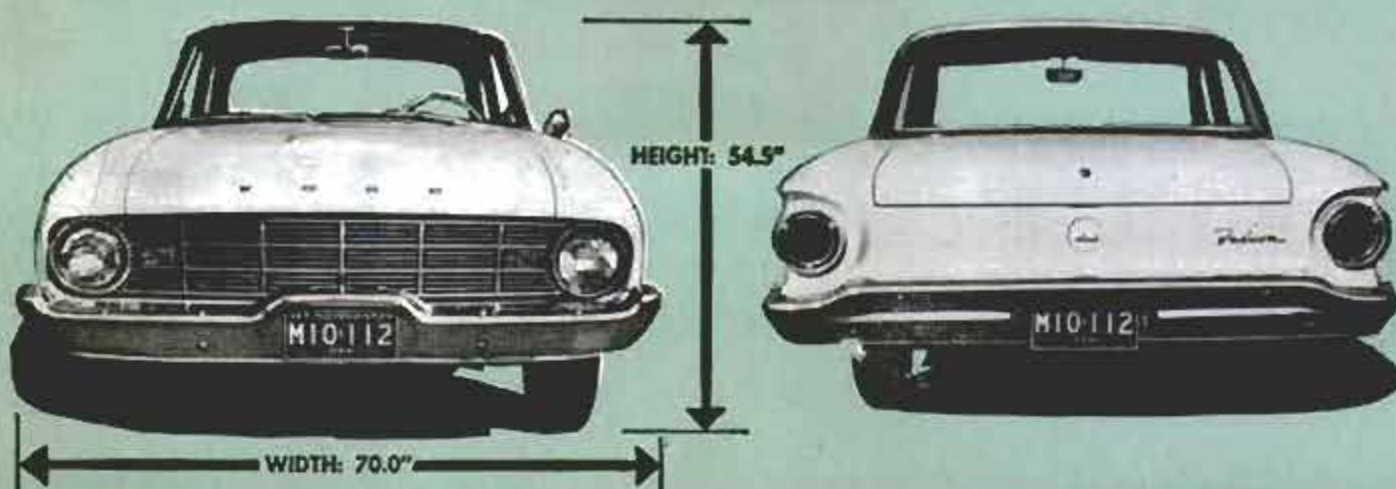

Playing the game conservatively, the Ford Falcon has a simple, conventional design. No rash innovations here. It is time-tested and even its styling is quiet, dignified.

Still under wraps, the Valiant has been "styled" more than the others. It looks bigger, more luxurious, less like an economy car. It has some bold engineering ideas.

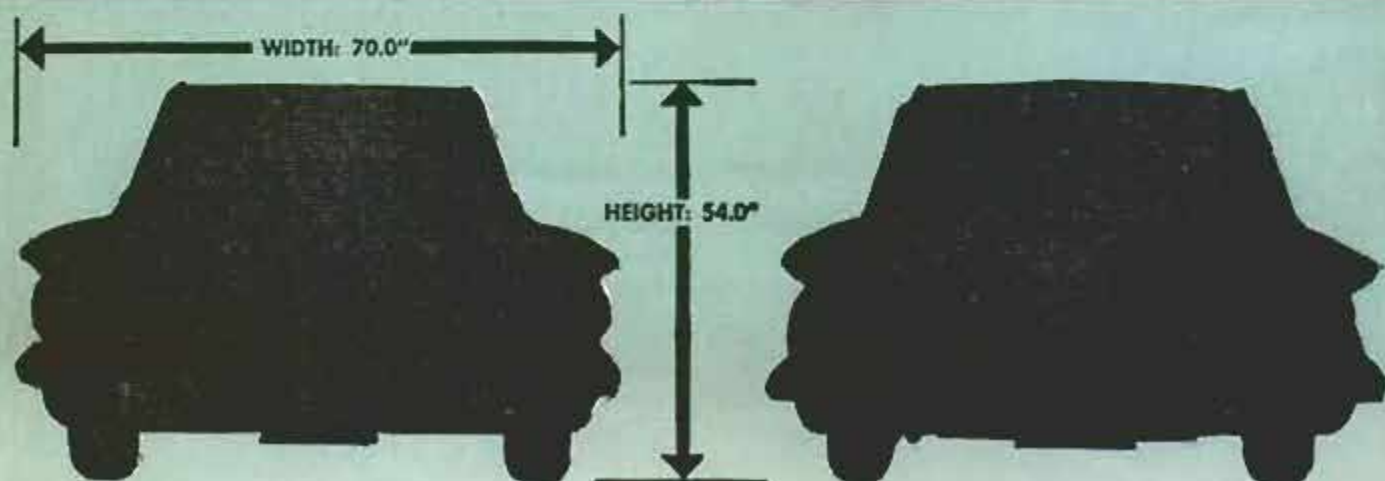

NEW SMALL CARS

By
Art
Railton

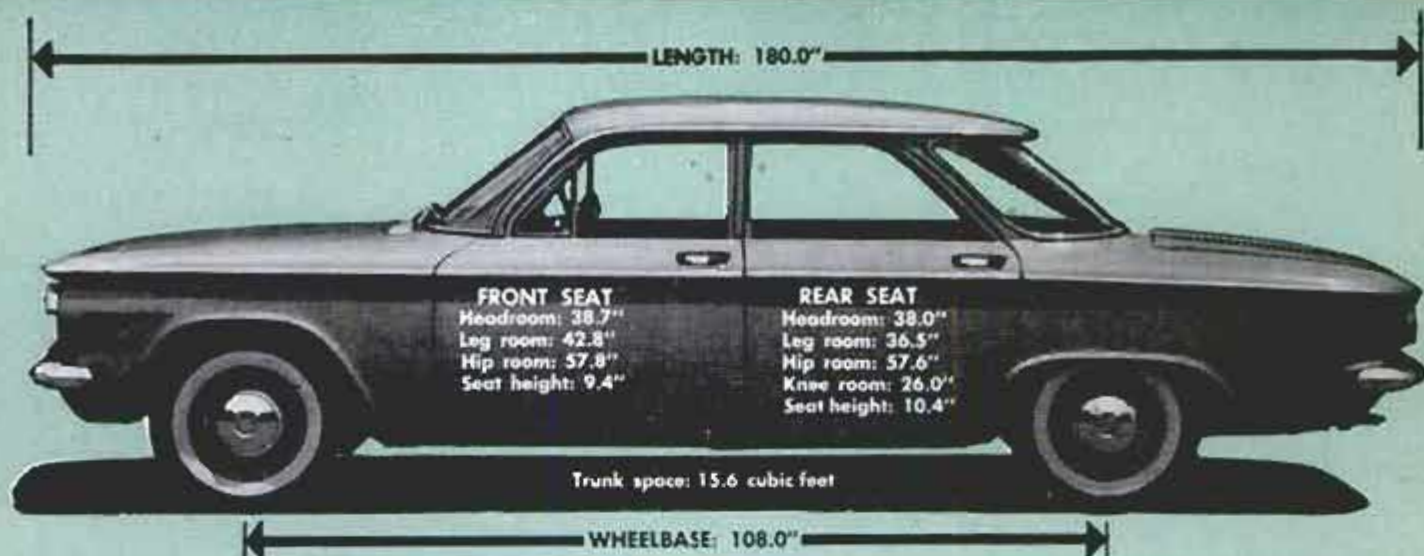

TURN PAGE FOR MORE DETAILS ON THE **Corvair**

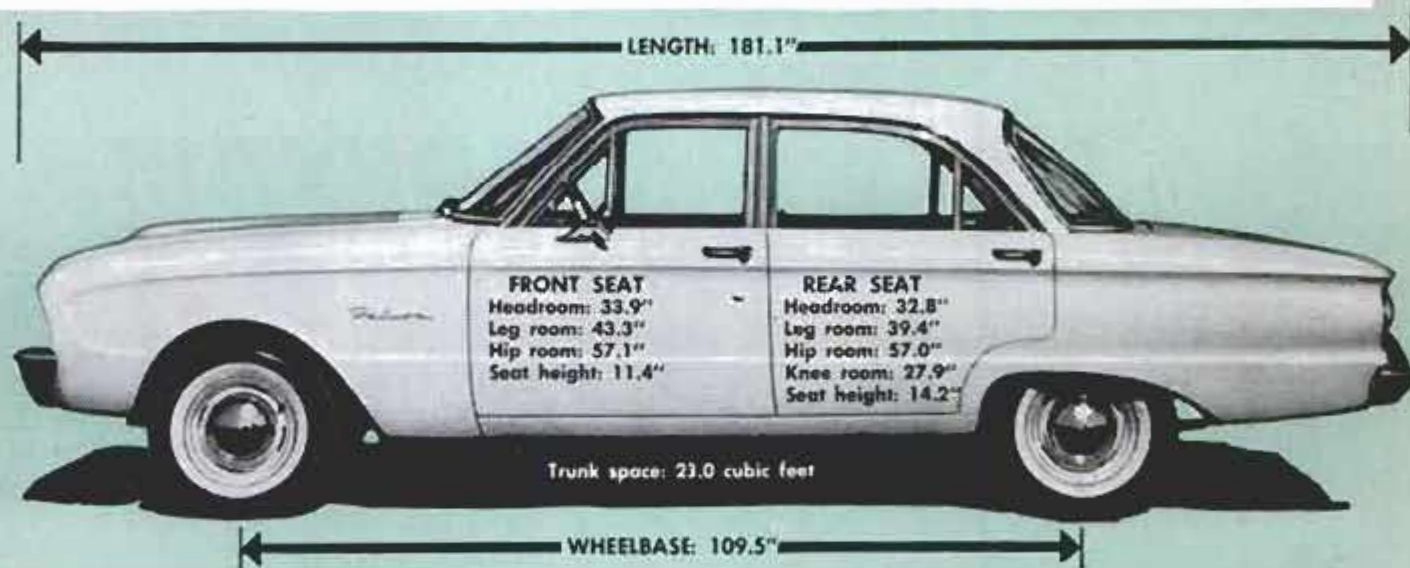

SEE PAGE 112 FOR MORE DETAILS ON THE **Falcon**

SEE PAGE 116 FOR MORE DETAILS ON THE **Valiant**





Stylists have given the car a conventional look despite its rear engine. Only one body style, a four-door sedan, is available now

CORVAIR —

REVOLUTIONARY, BOLD, daring — these words fit the Chevrolet Corvair.

Here is the most radical engineering design to come down the American road since the car pushed the horse out of the barn.

It has an air-cooled, rear-mounted, horizontal-opposed, six-cylinder engine made with plenty of aluminum to keep it lightweight.

It has independent suspension on all four wheels. It has a rear-mounted transaxle, with a minimum of unsprung weight.

Its neat-and-tidy engine is designed for accessibility. Every part (except the starter) is right out where you can get at it once you lift the rear deck lid (or is it the hood?).

Displacement is 140 cubic inches; bore is 3.375 inches; stroke is 2.60 inches; compression ratio is 8.0 to 1 and the engine thrives on regular gasoline.

Above, with automatic transmission, shift lever is in the dash. Left, a rear engine allows a flat floor with lots of leg room





Top, without fins or razzmatazz, the car has a well-tucked-in look, especially in back. Only the louvers atop the rear deck indicate a rear-mounted engine



Left, luggage goes in front. Visible are spare tire and gas-fired heater. Right, optional rear seat folds to convert back compartment into vast luggage area

The Bold One

It develops 80 horsepower at 4400 revolutions per minute and will drive the car 80 miles per hour all day without strain.

Although *PM* has made no tests (these will come later) at this writing, the car is expected to average between 22 and 25 miles per gallon.

The lightweight engine does not have an aluminum block, as early reports suggested. Actually, it does not have a block at all, in the usual sense. Instead, its aluminum-alloy crankcase is the engine's main structural element. It is made in two halves and bolted together. A sheet-steel oil pan goes on the bottom and an aluminum cover goes on the top to form the engine's central structure.

Three cast-iron cylinders lie flat on each side and are bolted into a unit by an aluminum cylinder head. The whole structure is covered by a sheet-metal shroud that directs cooling air from a horizontally mounted blower down over the finned cylinders and out the back end.

The blower is driven by a long fanbelt that comes up from a crankshaft pulley and makes a right-angle turn over two more pulleys to drive the blower shaft.

The body is 180 inches or exactly 15 feet long. Wheelbase is 108 inches. The car turns in a 39-foot circle.



Gas-tank filler pipe is in left front fender. Tank is under the floorpan. Below, there's more luggage space behind the rear seat. Note amount of leg room



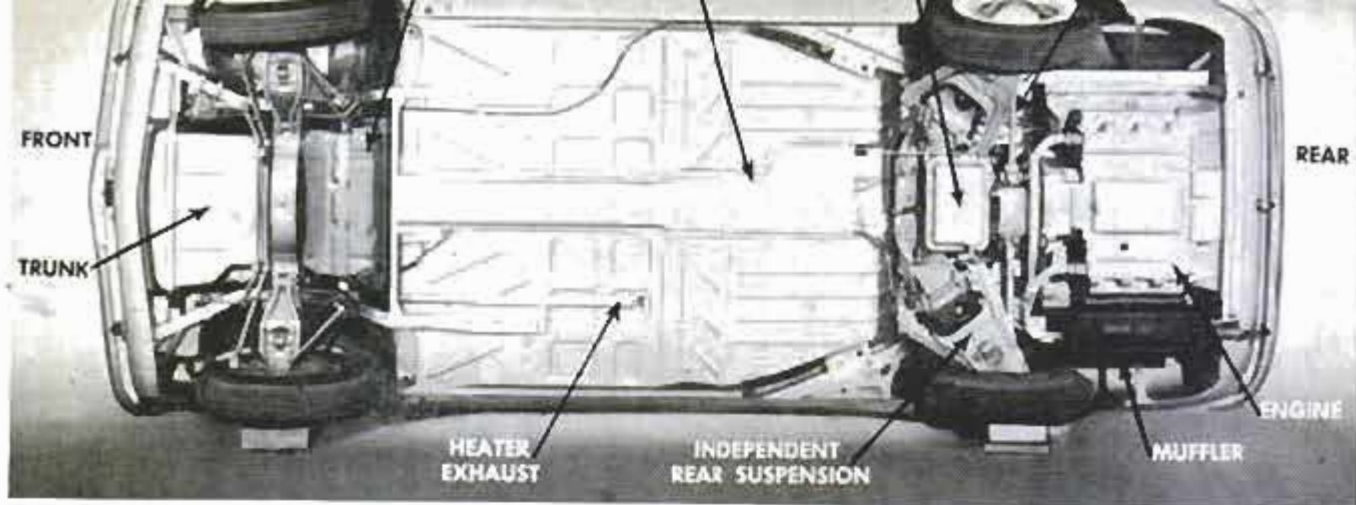

Here's a pavement view of the Corvair. Black line snaking along top of floorpan is the speedometer cable

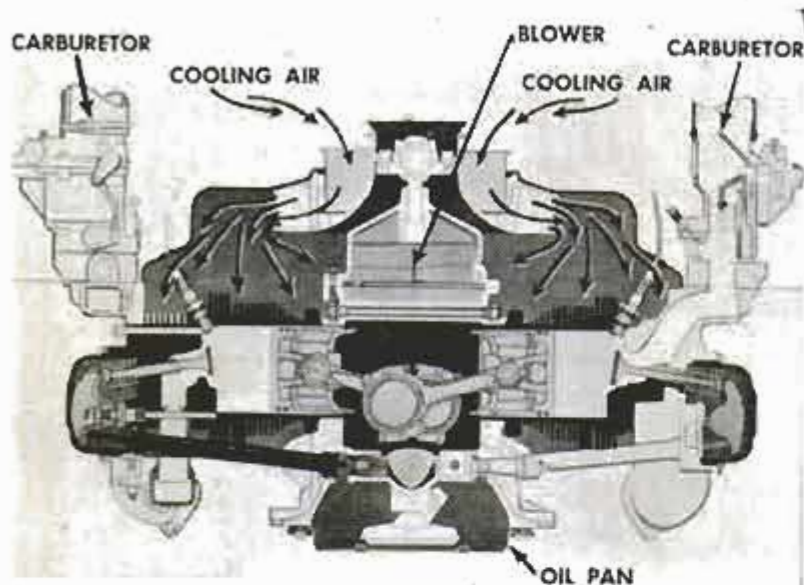

Above, arrows show how blower forces air over finned iron cylinders. Below, the engine as it appears in the "trunk"

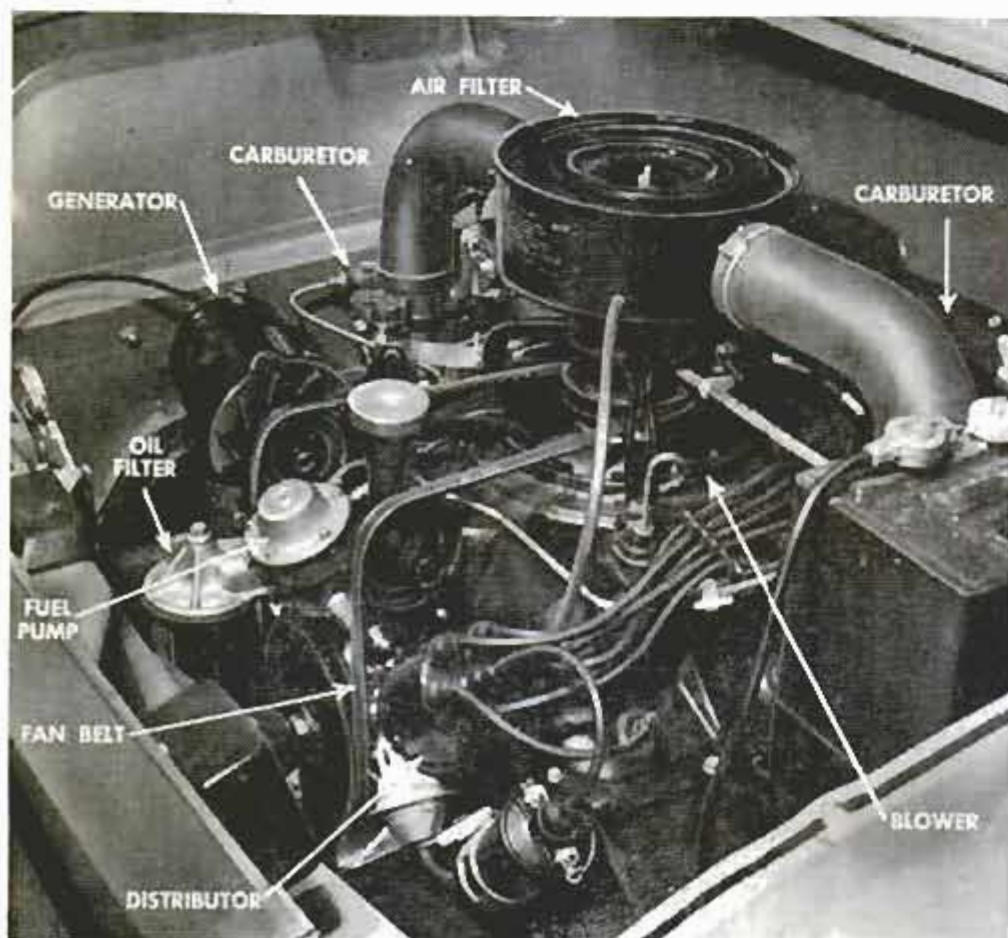

And it is low. Over-all height, unloaded, is 52.8 inches, which means that a tiny five-foot girl towers over it.

Yet, it is a six-passenger design. It is minus some width by big-car standards, but in other dimensions it is right up there with its big brothers. Seat cushions are high and well padded across their entire width, because of the absence of a tunnel.

The floor is flat, front and rear, except for a one-inch bulge that you can hardly see. Inside this tunnel are all the control linkages, brake lines, fuel lines and electrical harness. The underside is flat and clean, which cuts wind resistance sharply.

Being air-cooled, it needs no radiator (except a small oil cooler inside the engine), no hoses, no water pump, no anti-freeze, no water at all.

Two transmissions are offered: A two-speed automatic and a three-speed handshift, synchromesh in second and third. The short, positive shift lever of the handshift box is mounted on the floor. The automatic transmission is controlled by a stubby lever that sticks out of the dashboard. Instead of moving the pointer, you move the quadrant behind it.

The heater is gas-burning and delivers heat in 30 seconds.

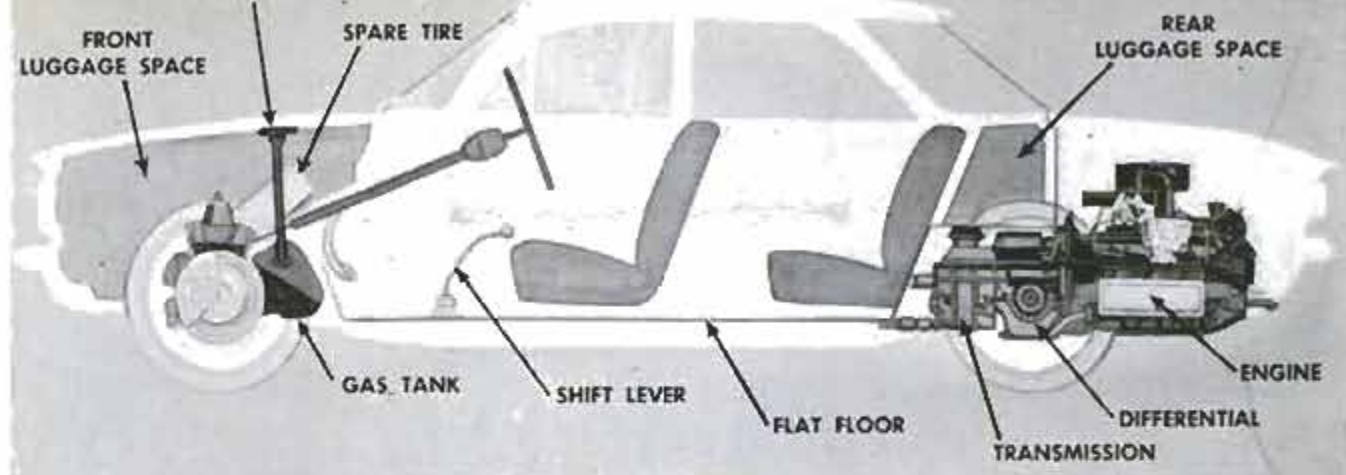

Gas tank is under floorpan, protected by the front suspension. Floor-mounted shift lever works crisply

Gasoline is carried in an 11-gallon tank mounted just behind the front suspension members and down below the floorpan where it is safe from damage in either a front or rear collision. The filler pipe comes up through the left-front fender.

Luggage space is no more than adequate. A rear-engine design does not provide the same amount of luggage space per inch of over-all length as a front-engine design. The Corvair has two luggage bins—one under the front hood contains 11.3 cubic feet and another behind the rear seat has 4.3 cubic feet. Optional is a folding rear seat which converts the entire back compartment into a flat floor.

Coil springs are used on all four wheels. Body construction is of the unit type, completely welded. Anticorrosion treatment includes the use of a high-zinc-content coating prior to welding in such critical spots as sills. In addition, a wax-base aluminum-flake compound is forced inside sills and other critical areas after welding to seal and coat places where condensation is likely to collect. Chevrolet considers this treatment superior to the dipping process used by other unit-body builders.

One often-overlooked advantage of the air-cooled engine is its rapid warmup. The automatic choke goes off much sooner than with water-cooled engines, saving fuel on short runs in winter.

Incidentally, the Corvair has two carburetors — one for each bank of three cylinders. One centrally mounted air cleaner is used and the automatic choke operates on the air-cleaner intake rather than at the carburetor as is customary.

How does the Corvair ride and drive?

It is amazingly quiet. There is none of the engine clatter common to air-cooled foreign engines (the hydraulic tappets are responsible for most of this quietness). There is an absence of vibration, ride is

(Continued to page 300)

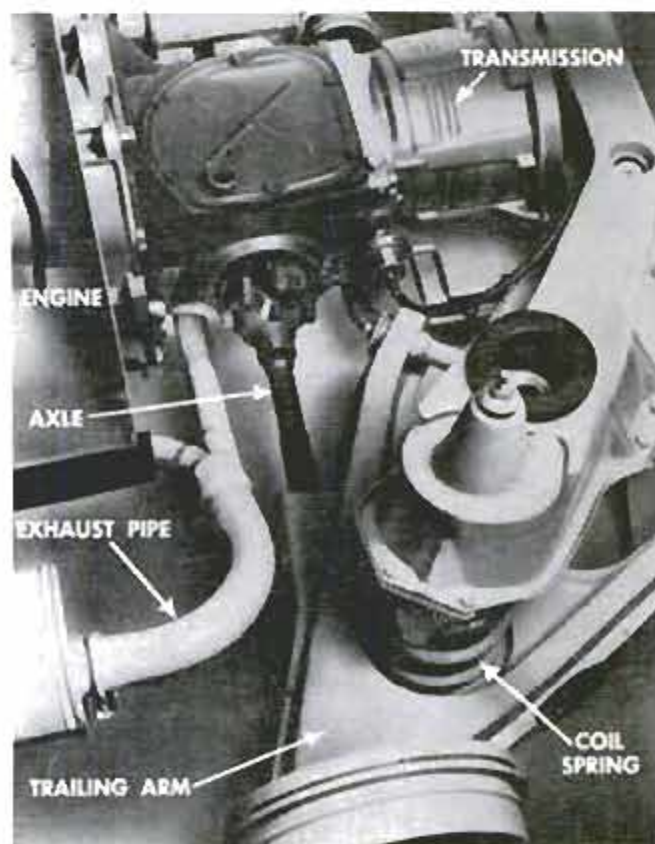

Above, rear suspension with automatic transmission. Below, under-floor control tunnel carries (left to right) shift rod, accelerator cable, parking-brake cable, two fuel lines, brake line, wiring harness

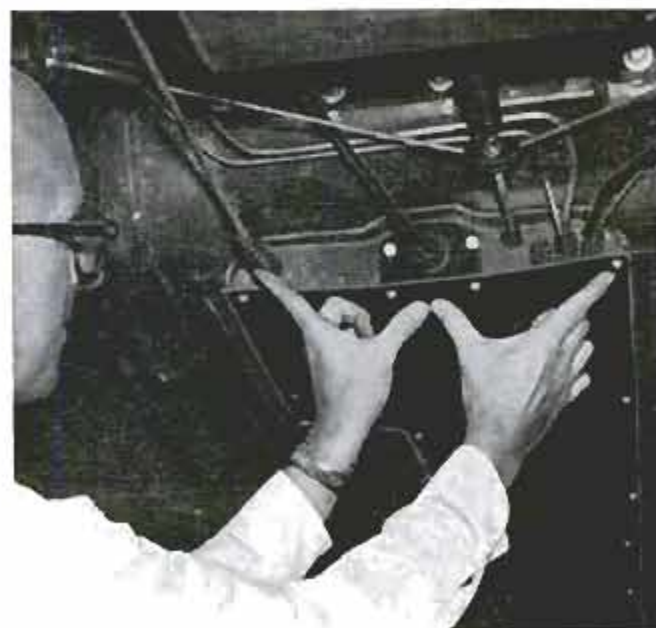



Only 181.1 inches long, the Falcon comes as a four-door sedan and two-door. Wagons will be along later

FALCON—The Conventional One

CONVENTIONAL, SENSIBLE and simple—these are the words for the Ford Falcon. Every effort has been made to keep the car as troublefree and as uncomplicated as possible.

Even the styling is in character. Side panels are decorated only by neat, trim sculpturing that runs from headlights to neat, circular taillights. The grille is a simple oval with single headlights (here again evidence of the keep-it-simple philosophy).

Front fenders bolt on separately (despite the fully unit body) and can be replaced quickly if damaged. The heater is as uncomplicated as a fresh-air heater can be.

Yet there is no evidence of skimping. In-

terior details are well done. Upholstery is luxurious to the touch and narrow-pleated in the expensive style. The ash tray, for example, moves in and out on nylon slides to add to the luxury feel.

The front seat feels deep and comfortable and has lots of plastic foam in it. The roof panel is well padded to keep the interior quiet and give a "big" atmosphere to the interior. Even the sun visors are held fast at each end in the best money-is-no-object tradition. Certainly it has no sensation of austerity.

What's under the hood?

There is a six-cylinder inline overhead-valve engine designed especially for the car. It is water-cooled. It has a cast-iron

Solid and roomy, the Falcon body is unitized. High-mounted coils are used in the new front suspension

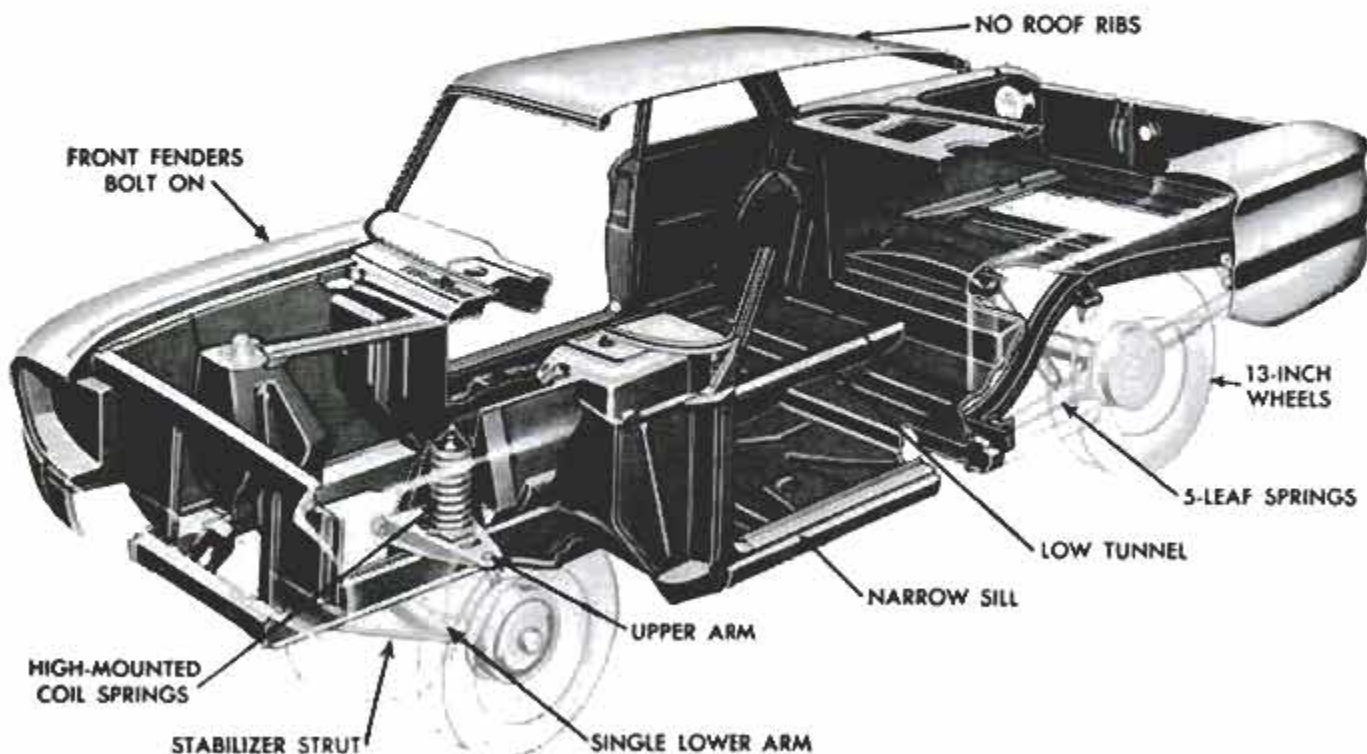



From the rear, the Falcon has a characteristic Ford look. Right, diagram of the car's brand-new engine

block and cylinder head. Displacement is 144.3 cubic inches, the bore is 3.5 inches and the stroke 2.5 inches. Horsepower is rated as 90 at about 4200 revolutions per minute. Compression ratio is 8.7 to 1.

Unlike the air-cooled Corvair engine (which is similar in displacement, having 140 cubic inches), the Falcon engine uses very little aluminum. The only place where the light metal is used is in the flywheel housing. Ford engineers claim that the use of aluminum to reduce engine weight is much overrated. If they had made the Falcon engine of aluminum, they say, it would weigh only 40 pounds less than it does.

With normal accessories, with oil, water

Below, dash design is pleasing, yet simple and the nonwrap windshield gives lots of entry room, right

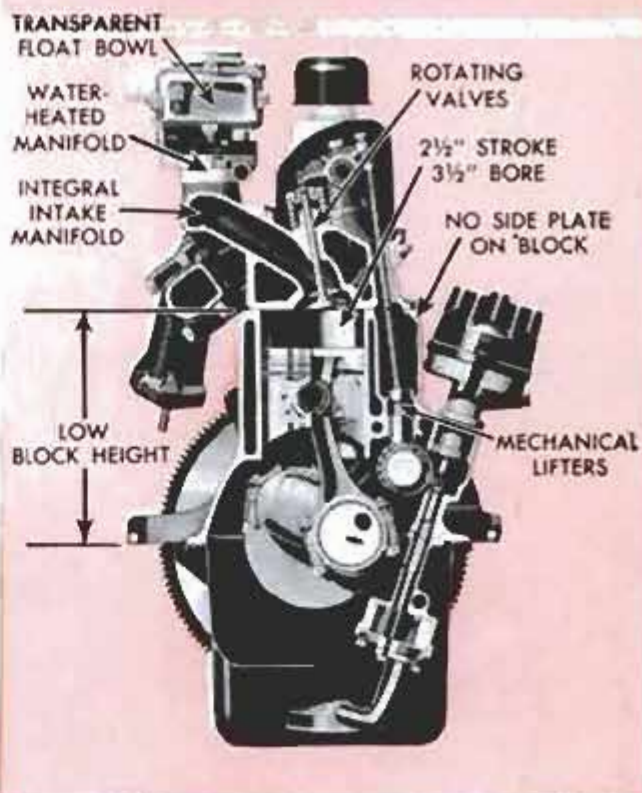



Instruments are well planned. Gas and temperature gauges are needles, the others are warning lights



Above, the spare is flat in the trunk, yet there's ample room for any except the most heavily bagged. Below, it's amazing how simple an engine can be and how accessible. It's a mechanic's dream



and radiator included, the Falcon engine in running condition weighs only 379 pounds. The Chevrolet Corvair engine, which uses considerable aluminum, in the same condition weighs 343 pounds, only 36 pounds less.

Being conventional in layout, the Falcon has a driveshaft that runs through a low tunnel, which does not intrude into the passenger space as much as you would expect in a car only 54.5 inches high.

The engine design is ingenious, being made for lightness and simplicity. Unlike the other two small cars, the Falcon's engine stands upright (the Corvair's is flat, the Valiant's is tilted).

The block is very low, making it an extremely rigid package. The intake manifold is cast as an integral part of the cast-iron cylinder head. There are no gaskets to install or leak. The manifold looks like a length of pipe plugged at each end. Each cylinder has its own intake port.

The exhaust manifold bolts on in a conventional manner.

Valves use mechanical lifters and are rotating in the usual Ford setup.

The interior of the car is amazingly roomy with seats of excellent height (highest of the three cars, see page 107 for comparisons). Even in the center over the driveshaft tunnel there is ample padding. Headroom, too, is excellent. No crossribs are used in the roof which is rigid enough without them. As a result, there is more room for heads. This left no convenient central spot on which to mount the dome-light (normally a hump on a crossrib) so it is attached above the windshield.

You will be surprised at the ease of entry and exit. Because there is no wrap-around windshield, there is no dogleg to bang your knee on in front and the rear doors open wide for rear-seat entry.

On two-door models (it comes as a two-door and four-door) the door extends all the way back to the forward edge of the rear seat so entry to the back is unhindered.

A fairly high lip runs across the back, but it does not interfere with loading into the well-planned and roomy trunk. The spare tire lies flat. Usable trunk space is 23.0 cubic feet (see page 107 for comparisons).

Weight of the four-door is about 2320 pounds. No station wagons are available yet, but they will be along come winter.

The optional automatic transmission is a scaled-down Fordomatic and has two speeds. The handshift gearbox is synchromesh in second and third and the shift lever is mounted on the floor.

Front suspension is a new design that has at least 50 percent less unsprung weight

(Continued to page 326)

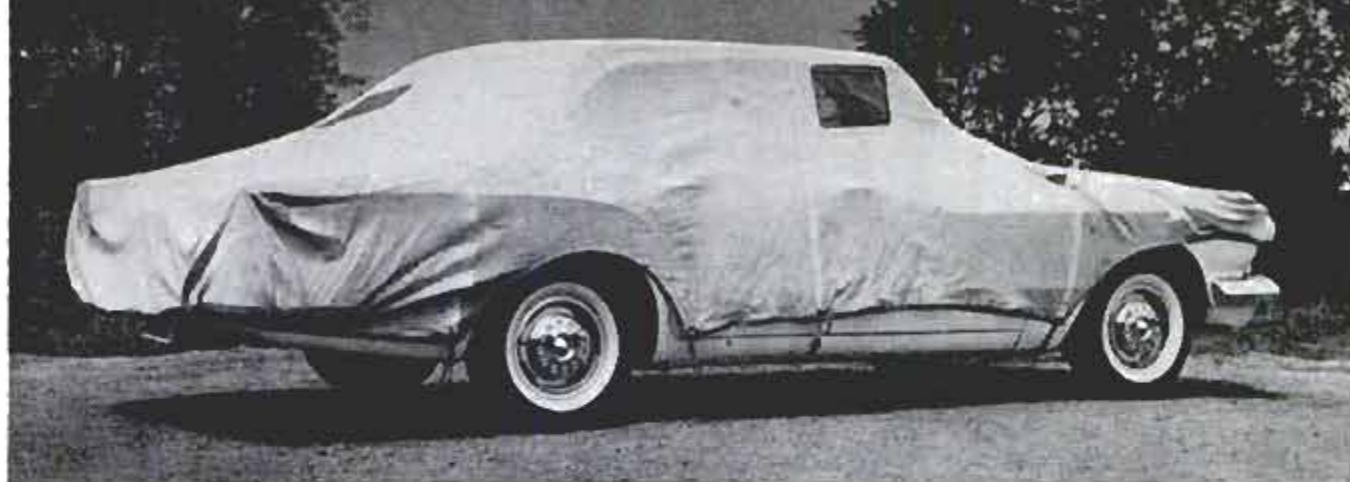

Until next month when photographs can be shown, this under-wraps view of the Valiant will have to suffice

VALIANT—The Stylish One

CRISP, CONTINENTAL and muscular —these words fit the Valiant.

Unfortunately, this month we cannot print full photographs of the car. The release date is not until late in October. Next month, however, we will have complete photographic coverage of the Valiant and all other 1960 cars in full color.

How does the Valiant look? As you will see in the silhouettes and dimensions on pages 107 and 115, it is slightly larger than either of the others. Its styling makes it appear bigger than it really is. Seen alone, it has none of the small, economy-car look. It was proportioned and sculptured to avoid this.

Over-all length is 184.0 inches. Wheelbase is only 106.5 inches. A four-door three-seat station wagon (there's a two-seat wagon also) is slightly longer, being 185.1 inches over-all. No two-door model is offered.

All are 70 inches wide and 54 inches high, over-all.

The front grille is an open-mouth, functional air intake covered with aluminum mesh. The Valiant emblem in the center serves as a hood release as well.

The hood slopes downward sharply to give the front a lunging, eager look, that tends to accentuate its muscularity.

Photographs of the Valiant have been printed prematurely elsewhere. Such pictures have been in our possession for some weeks under a pledge that they be kept confidential until Chrysler Corporation's release date, Oct. 25. While others have broken this promise, *Popular Mechanics* has decided to keep its pledge. You'll see the Valiant here next month.—The Editor



Rear end of the Valiant. Spare fits in a floor well. Trunk lid slopes down sharply from window to bumper

Comparison of a VW, a Valiant and a 1959 Plymouth. Bulge on Valiant rear deck is the dummy spare-tire cover

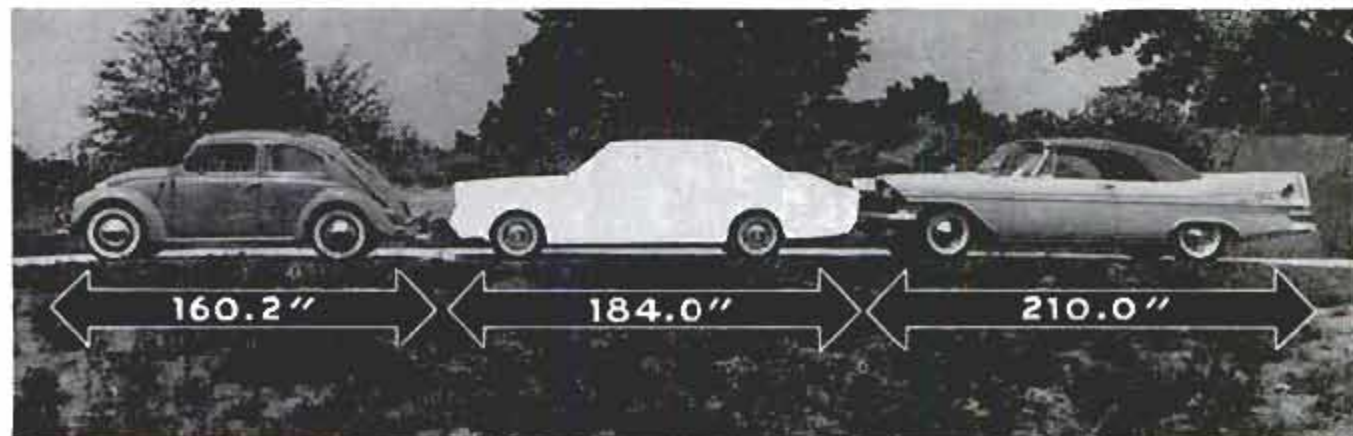



Valiant's unit body has no frame, the welded sheet metal providing the structure. Front fenders bolt on

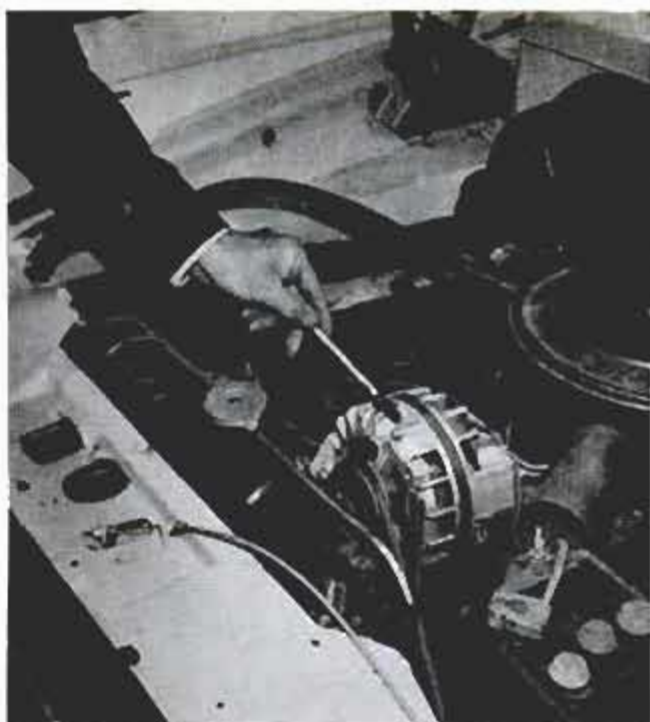

Instead of a generator, Valiant has an alternator. Smaller, lighter, simpler, it charges even on idle

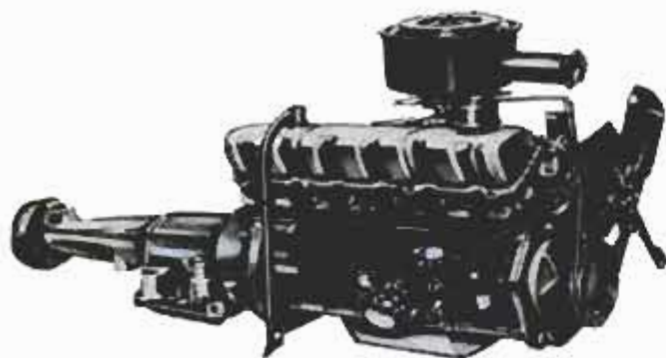

Engine tilts 30 degrees to the right. Transmission slants to the left to permit tunnel to be lowered

Cutaway of overhead-valve six, showing 30-degree slant. Upright carburetor has long, tuned manifold

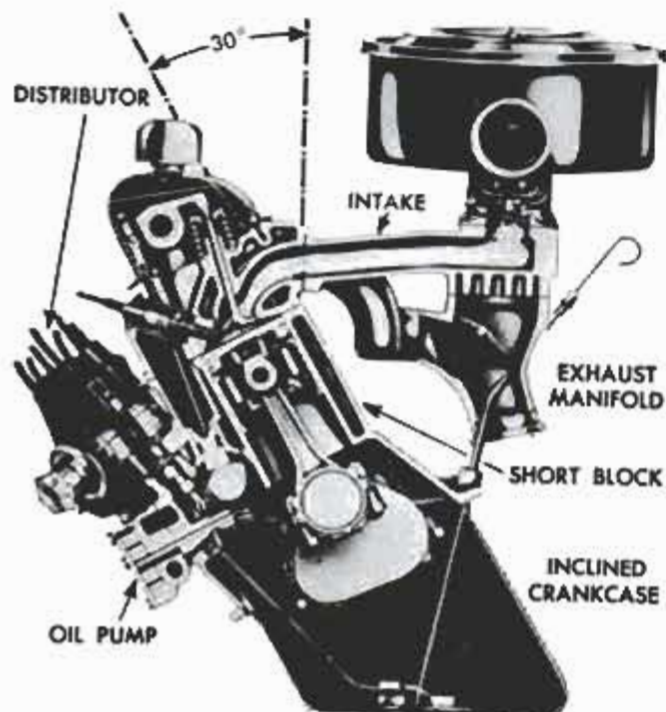

Roof pillars are slender. Windows and doors extend high into the roof, which is creased along its edges both for styling and engineering reasons. The creases cover the roof ribs which go up into the sheet metal instead of hanging down, thus allowing more headroom and higher door openings. You won't bump your head getting into this car.

Wheel openings are round and large—all four of them.

It is a six-window body, there is a side window behind the rear door. Forward and side visibility is excellent, but the high rear window limits rear vision somewhat, especially close in.

The back end slopes downward from the roof to the bumper without any horizontal surfaces anywhere. It's called a semifast back. The trunk lid has an imitation spare-tire cover, the only artificial styling trick on the car. Taillights are simple ovals that cant outward diagonally to make the body seem wider, lower.

Every effort has been made to put each inch of width into the interior. Doors have been kept as thin as possible. Nowhere is there any excess fat. There is more interior width per exterior inch in this car than in any Chrysler ever built. It is additional evidence of the trend toward sensible designs in automobiles.

What's under the Valiant sheet metal? It has a unit body from bumper to bumper without the stub front frame of the bigger Chrysler cars. Suspension is typically Chrysler with torsion bars in front, leaf springs in the rear. It, alone among the

(Continued to page 314)



Despite altered front, Imperial retains its character. The Le Baron below has a smaller rear window

Imperial

Imperial offers further comfort with redesigned seats that increase interior room and have six inches of foam rubber. Among its innovations are a flattened steering wheel for more knee room and powered window vents. It is the only Chrysler car not unit-constructed.



1960 Chrysler Features

Although only the Imperial can be shown in pictures this month, many details of the 1960 Chrysler Corporation cars have been released for publication.

Most important is the fact that these 1960 Chrysler Corporation cars, from the Valiant to the Imperial, are the first cars to be designed with the full-time help of electronic "brains."

Through thousands of calculations on IBM machines, Chrysler engineers determined exactly where the welds should go, where the bracing should go, what gauges of metal were needed to make the body solid, quiet and durable, before the first prototype model was built.

A major achievement was the precise location of the three mounts for the Valiant engine. The usual cut-and-try method was entirely eliminated. The machines calculate exactly how much vibration will result for every possible engine-mount location and combination of locations. Engineers can select spots in which vibrations

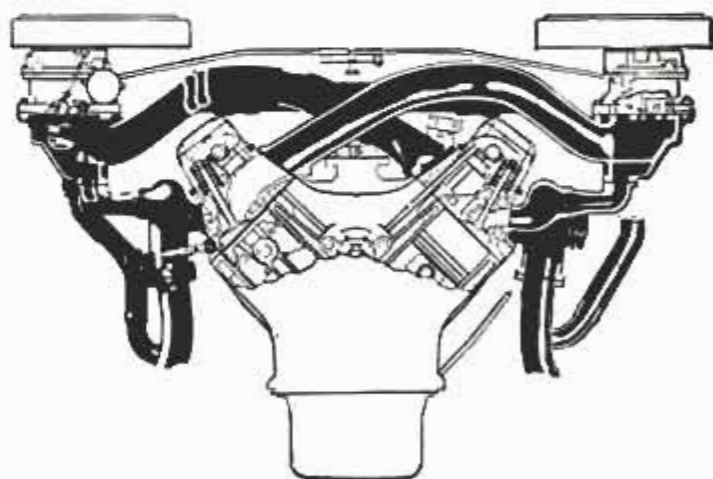

Ram manifolds in Dodge V8 have these 30-inch tubes. Below, Plymouth Fury offers a flattened steering wheel





Above, dotted lines show last year's body, solid lines this year's. Deep footwells increase room and the narrower posts and roof make entry easier. Below, plastic figure is used to test out a 1960 Dodge front seat



Now you can play standard 45-r.p.m. records in your car with this automatic changer

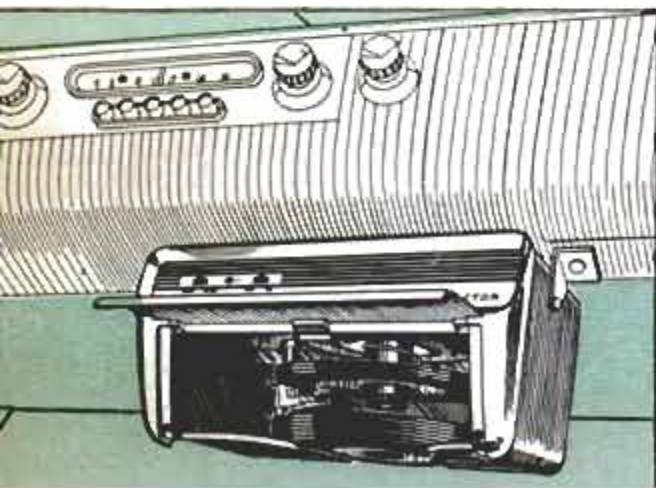

are at a minimum. It is estimated that it would have taken one man 165 years to complete the same calculations the IBM machine had to make in solving this problem—and that is one man with an electric calculating machine, not just a slide rule.

As a result, the 1960 Chrysler cars came out of the prototype shop "cleaner" engineerwise than any cars the Corporation has ever designed. They were "right" from the start. Previously, proving-ground tests were relied upon to show up necessary changes. Under the new "elimination by calculation" system, virtually no changes were necessary after proving-ground tests were completed.

What this means to you is that the very first Chrysler cars off the assembly line will be as perfect as the cars previously were after several months of production. The troubles that usually show up early in the run have been licked at the start, say Chrysler engineers.

The new unit body (shared by all cars from Plymouth up through the Chrysler) offers more interior room, thanks to its lower floorpan, narrower center posts and shallower roof. An in-

(Continued to page 322)

Running under the floor mat, a flexible cable moves the swivel seat in and out as the door is opened. The sketch shows how

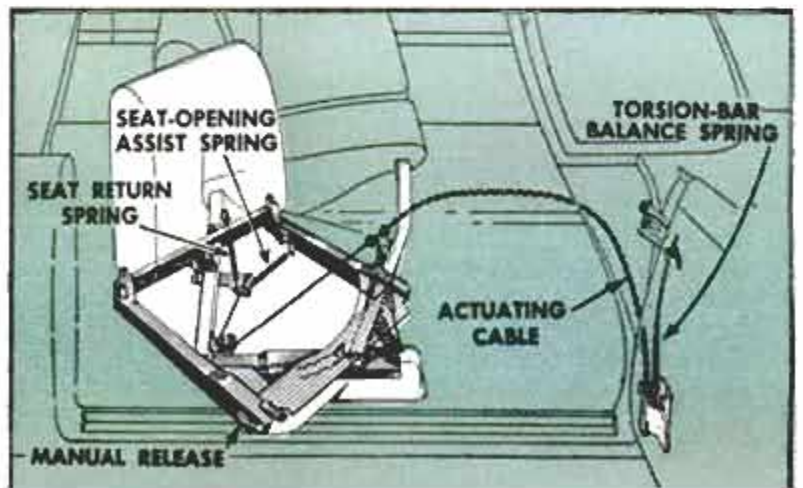



Saunders-Roe "Hovercraft" is 30 feet long, 24 feet wide, weighs 3½ tons and has passed its flight tests

Tests Indicate Bright Future for "Air Sleds"

Development of ground-effect machines—vehicles which operate on a cushion of compressed air—is progressing rapidly, with military, commercial and private experimenters racing to build a practical machine. The "air sleds," which "fly" a

few inches above any smooth surface by sliding on a bubble of downward-ducted air, are not related to the helicopter or ducted flying fans, since they depend entirely on the effect of their downthrust against a surface. (The other, higher-flying

craft get their lift from the down-wash of their rotors. They require bigger engines and rotors, and are much more expensive to operate.) Shown here are two leading examples—the British Saunders-Roe SR-N1 "Hovercraft," above, and the "Aeromobile," designed and built by Dr. W. R. Bertelson of Neponset, Ill., for his own use—to speed his rounds over rough country roads. Both machines have been tested at speeds up to 40 miles per hour and over both land and water. Dr. Bertelson plans to market a similar small sled; Saunders-Roe Ltd., encouraged by the SR-N1 tests, are planning a cross-channel ferry. The 100-ton vehicle would carry 300 passengers and 30 tons of cargo at speeds up to 90 knots. Another proposed design is a 400-ton unit that can carry 160 tons of payload over water, ice or land.





In recording, ink-coated sheet is placed under plate on machine, and recording arm revolves under sheet



From originally recorded sheet, hundreds of extra copies can be reproduced as is done on mimeograph



Magazine reader listens to machine play sounds of Prince Akihito's wedding as recorded in publication



Sheets in album have pictures on one side, recording on other. Sheets are removed and played by machine

Magazine Reproduces Sounds With Its Words

There's a Japanese magazine that can boast listeners as well as readers. In magnetically treated pages, it has introduced a new audible-reproduction system that can provide sound effects for its articles. One page of the publication, for example, has photographs of Niagara Falls and London's Big Ben on one side, and a block of solid brown ink on the other. The page is torn out and placed, brown side down, in a specially made machine called a Synchro-

reader, which "plays" the page much like phonograph records. Out of a speaker come the sound of the Niagara's tumbling waters and Big Ben's mighty gongs, just as recorded on the scene. The process of printing with sound costs publishers about three cents for each page and is done by impressing one side of a sheet with special ink from a plate produced from a master recording. The special ink used in this printing contains magnetized iron.

Fuselage of Plane Is Contoured to Eliminate High-Speed Pitch



Unique design is featured in the Air Force's newest supersonic airplane, the T-38 Talon trainer. As shown in the rollover in the photograph, the forward underbelly has fuselage contouring as a trimming device to eliminate high-speed pitch. Another feature is the flat underside of the after-body, which enables engineers to simplify landing-gear door operation, design of access doors and speed brakes, and actuation of the horizontal stabilizer.



Left, flexible shaft powers the hedge trimmer. Right, rotary tiller is lightweight and easy to handle

Shaft on Mower Runs Lawn Tools

WITH THE AID of a new flexible shaft, homeowners in England can use their power mowers for several other jobs. The shaft is adaptable to most makes of mowers. It is driven by belt from an auxiliary pulley mounted on the engine output shaft. Several attachments can be powered by the flexible shaft, including a hedge trimmer, chain saw, rotary-garden tiller, grass trimmer, grinder-sander and pruning saw. Slip-on couplings permit the operator to change rapidly from one attachment to another. No tools are required to connect the shaft or the attachments.

Center right, grass cutter and trimmer will handle high grass and weeds. Right, chain saw, operated by the idling mower, cuts through branch. Attachments can be changed quickly





South America's greatest industrial center, Sao Paulo has been called the fastest growing city in the world

Sao Paulo — the Latin ~~Chicago~~ Detroit

BRAZIL

SAO PAULO •
RIO DE
JANEIRO

By
Thomas E. Stimson, Jr.

IF YOU COULD whisk a North American to the city of Sao Paulo in Brazil and then ask him where in the world he was, chances are his reply would be something like this:

"Somewhere in the United States, I think. Probably in California. I don't recognize these beautiful buildings but they're spanking new and modern in style, and the people, stores and traffic all seem familiar."

Resembling a typical North American city in more ways than one, Sao Paulo has often been called the Chicago of South America. From a climatic standpoint it is

more like Los Angeles. But its burgeoning automobile industry may soon bring Sao Paulo the name of "the Latin Detroit."

Automobiles of both European and North American lineage are on their way to a boom in Brazil. A five-year-old car costs as much as a new car in the United States, chiefly because of high import duties. This government philosophy is intended to spur domestic manufacture, and the idea is working. Foreign manufacturers are moving into the Sao Paulo area with money and know-how and have erected assembly plants that are already producing. Ford is building trucks in Sao Paulo. In the outlying suburb of Sao Bernardo do Campo, Willys-Overland is building Jeeps, Volkswagen is completing a new factory, Simca is already in operation and Mercedes-Benz is building both cars and trucks and adding to its plant facilities. Chevrolet and Inter-

Lined-up Jeeps await delivery outside the Willys-Overland of Brazil factory at Sao Bernardo do Campo, Sao Paulo's industrial suburb. This expanding plant will soon be producing 250 Jeeps, cars and station wagons per day



Willys four-door sedan, last built in the United States in 1955, goes into production late in 1959 at Willys-Overland of Brazil to compete with European manufacturers for the expanding South American auto market



Administration building of the new Fiat plant at Sao Bernardo do Campo. Brazil used high import duties to induce domestic industrial development by foreign manufacturers who would otherwise import their products



Daimler-Benz plant manufactures Mercedes-Benz cars and trucks. Other foreign automobile manufacturers in the Sao Bernardo do Campo industrial suburb include Chevrolet, Ford, International Harvester, Simca, Volkswagen



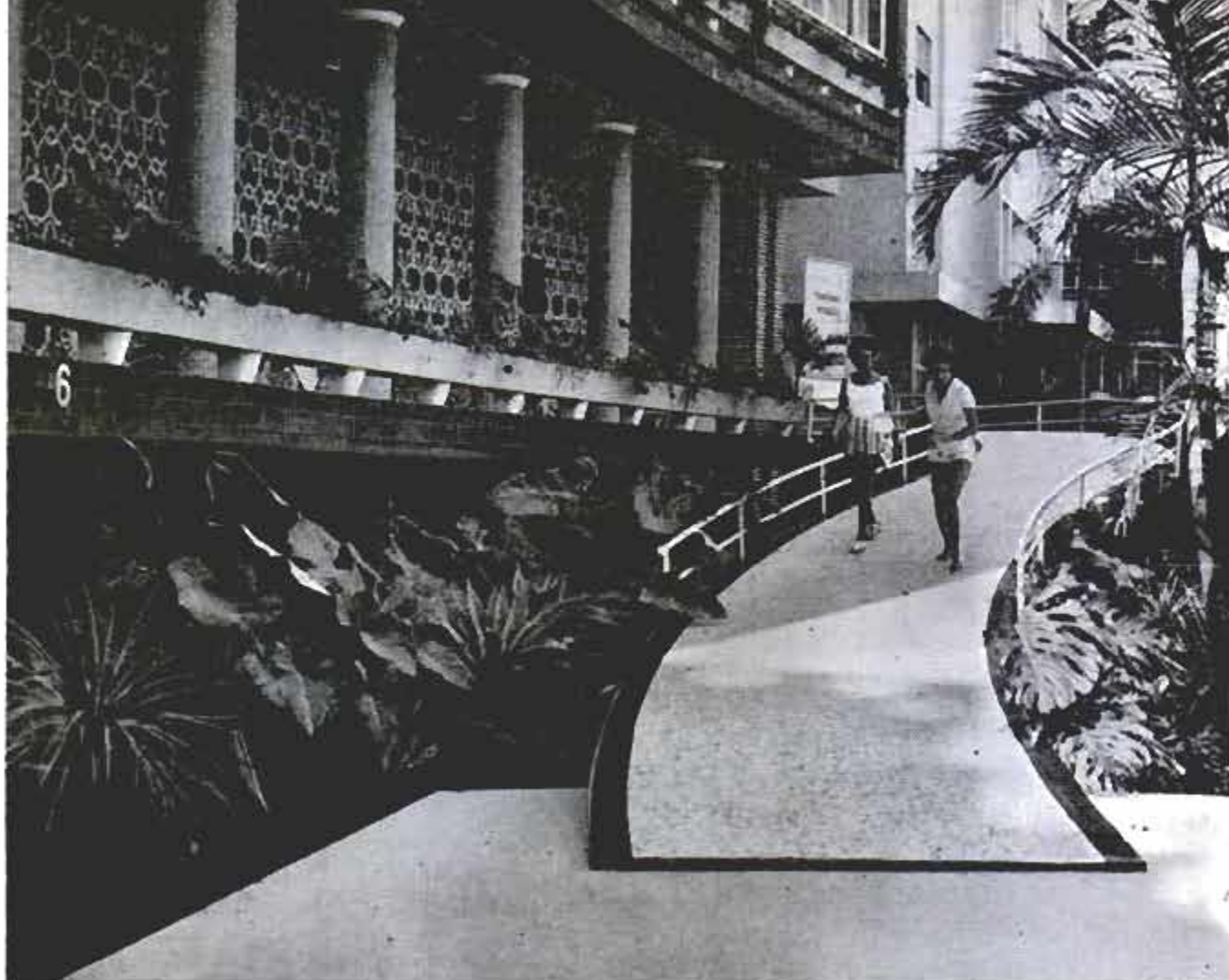

Sweeping concrete entrance ramp leads into one of the modern apartment buildings on the beach at Santos

national Harvester are building trucks at still other nearby locations.

These assembly plants expect to turn out 250,000 vehicles in 1960. Not an impressive figure? Not until you realize that there were no more than 750,000 automotive vehicles in all of Brazil a year ago. From

next year onward the production figures will spiral up. As an indication of this, Willys-Overland do Brasil no sooner had begun production than the company found it would not be able to keep up with demand. Result: Another half-million square feet of new space is being rushed to

Entrance to one of the large private clubs in Sao Paulo, and a view of its huge swimming pool at right





Downtown street in Sao Paulo shows parks, tree-lined sidewalks as well as well-planned, separated streets

completion, including a press plant, axle and transmission plant, and storage buildings in addition to a cafeteria, hospital and administration offices. With these new facilities it will be possible to produce 104 Jeeps, 62 Jeep station wagons and 84 passenger cars per day. This passenger car is based on the relatively small four-door Willys sedan which was last built in the United States in 1955. It will compete with the European cars in the South American market.

There are some strange paradoxes in this fast-growing city. It is not a tourist center, but there are some 4000 North Americans in town. Brazil is rich in iron and coal, yet an X-ray look at those skyscrapers, the pride of Sao Paulo, would show that almost none has a steel skeleton. Most are of reinforced concrete.

Another oddity, and one reason for Sao Paulo's industrial boom, is its plentiful power. Clever engineering has taken advantage of a unique topographical situation: Rivers that originate only a few miles from the Atlantic flow inland instead of draining directly into the ocean. This is because at the Atlantic coast just 40 miles east of the city the ground rises abruptly in a cliff-like escarpment from sea level to more than 3000 feet, then slopes downward toward the interior. To develop

Huge office building under construction reflects Brazilian mastery of reinforced-concrete architecture





Seemingly impossible shapes molded in concrete form the roof garden of another Santos beach apartment



power, the engineers reversed the flow of one river by a system of dams and pumping plants and used it as a canal to draw water from a larger river that it joins. Now the diverted water flows eastward, is impounded in reservoirs. From the reservoirs it plunges down to sea level, in its fall spinning the turbines of the largest powerhouse in South America. Most of the power is developed underground in the second-largest underground generating plant in the world. The power cavern, hewn from solid rock, is 395 feet long and 130 feet high, contains six generator sets of more than 65,000 kilowatts each. Total capacity of this Cubatao plant is 864,000 kilowatts.

Less familiar to North Americans than Rio de Janeiro, Sao Paulo is Brazil's largest city and Latin America's greatest industrial center, its population of 3,200,000 being surpassed in all Latin America only by Mexico City and Buenos Aires. The state of Sao Paulo, of which the city is capital, is about the size of Arizona and has some 10 million inhabitants. Principal agricultural state in Brazil, Sao Paulo produces 45 percent of the country's coffee, 60 percent of its cotton and large percentages of sugar cane, potatoes, citrus and bananas.

Half a dozen cities of 100,000 population lie within a 60-mile radius of Sao Paulo city and in these industrial suburbs are such diverse industries as glass and ceramics, rayon, plas-

Penstocks at Cubatao are only a small part of the 864,000 kilowatt Sao Paulo-Santos generating system



Apartment building roof garden boasts a gracefully-beamed concrete abstraction for a decorative sunshade

tics, paint, refrigeration and pharmaceuticals. This one dynamic city and its satellites produce one third of the national income and pay 43 percent of Brazil's income taxes. The Paulistas boast that their city uses 40 percent of Brazil's industrial electricity, produces 46 percent of the national industrial product, is the banking capital of Brazil, has three universities, four TV stations, and in its environs are 40 percent of the newspapers of Brazil and 44 percent of the radio stations.

From 1940 to 1950 Sao Paulo was the fastest-growing city in the world and it hasn't begun to slow down yet. Industry is expanding more than 10 percent per year. New homes are being completed every six to eight minutes. The downtown skyline sprouts new shapes every time you look at it.

And all those 20 and 30-story skyscrapers have frames of reinforced concrete (concrete columns and beams poured around smooth steel reinforcing rods $\frac{1}{2}$ to $1\frac{1}{2}$ inches in diameter) with curtain walls of brick or hollow tile. A 45-story building using this technique is under construction, a 56-story building is planned. No steel beams. Why?

Visiting engineers can hardly believe their eyes when they inspect an overhead canopy of solid reinforced concrete only five inches thick, cantilevered 10 feet over a sidewalk. Or a corner column for an office building that is neither round or square but $7\frac{1}{2}$ by 36

View from the roof of a tall apartment building shows window-walls and planting ledges provided for tenants





Spectacular reinforced concrete beach house perches on a boulder overlooking the ocean near Santos

inches, a shape designed to provide more inside space.

Here is the explanation. Dr. Oscar Niemeyer, Brazil's leading architect, studied reinforced concrete under the famous Corbusier in Paris during the 20s, saw that it was ideally suited to conditions in Brazil and arranged for Le Corbusier to found a school there. This influence had a chain reaction. With steel expensive and hard to get and earthquakes no particular problem, reinforced concrete became standard.

Brazil is still a steel-importing country despite the fact that probably one fifth of the world's best iron ore is located in the state of Minas Gerais, north of Rio de Janeiro. In southern Brazil are coal re-

serves estimated at five billion tons. Coal and ore are brought together at Volta Redonda, near Rio, at the largest steel mill in Latin America. Steel production was recently stepped up to 2 million tons per year, is being increased still more but demand is so great that importation must continue for years to come.

Where there are automobiles, good roads are needed but only a small percentage of Brazil's 200,000 miles of roads are paved. An improvement program is under way and several thousand miles of roads are being paved each year, and a start has been made on a toll superhighway network. The unimproved roads are one reason for

(Continued to page 299)

Ferry across Santos harbor docks sideways to allow the whole load of cars to drive ashore at once





This mobile set of covered passenger steps automatically unwinds and rewinds a gold carpet as it approaches and leaves the side of the plane. Used by Continental Airlines for its Boeing 707s, the unit is directed from top platform by a ramp agent

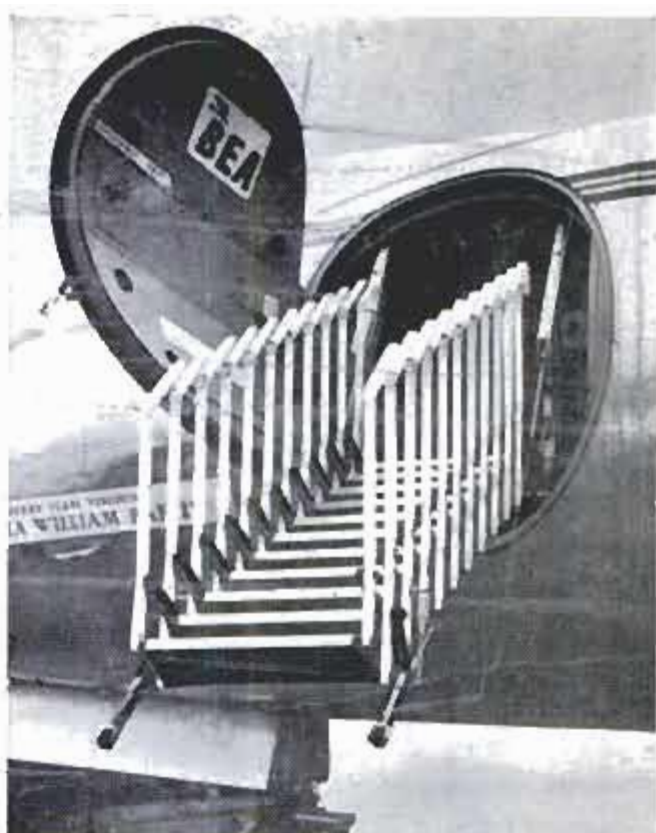

Hydraulically operated, this folding stairway has been fitted to the British Viscount to take the place of a ramp. When the plane is ready for takeoff, the steps fold inside, taking little room. Called an "Airsclator," the unit is made of light alloy

Airlines Keep Stepping Ahead

Tub-shaped baggage containers have been developed by United Air Lines for its new DC-8 Jet Mainliners. Made of lightweight glass fiber, the preloaded containers match the contour of cargo compartments in the underside of the plane. The containers are cradled in carts for towing by tractor to and from planes



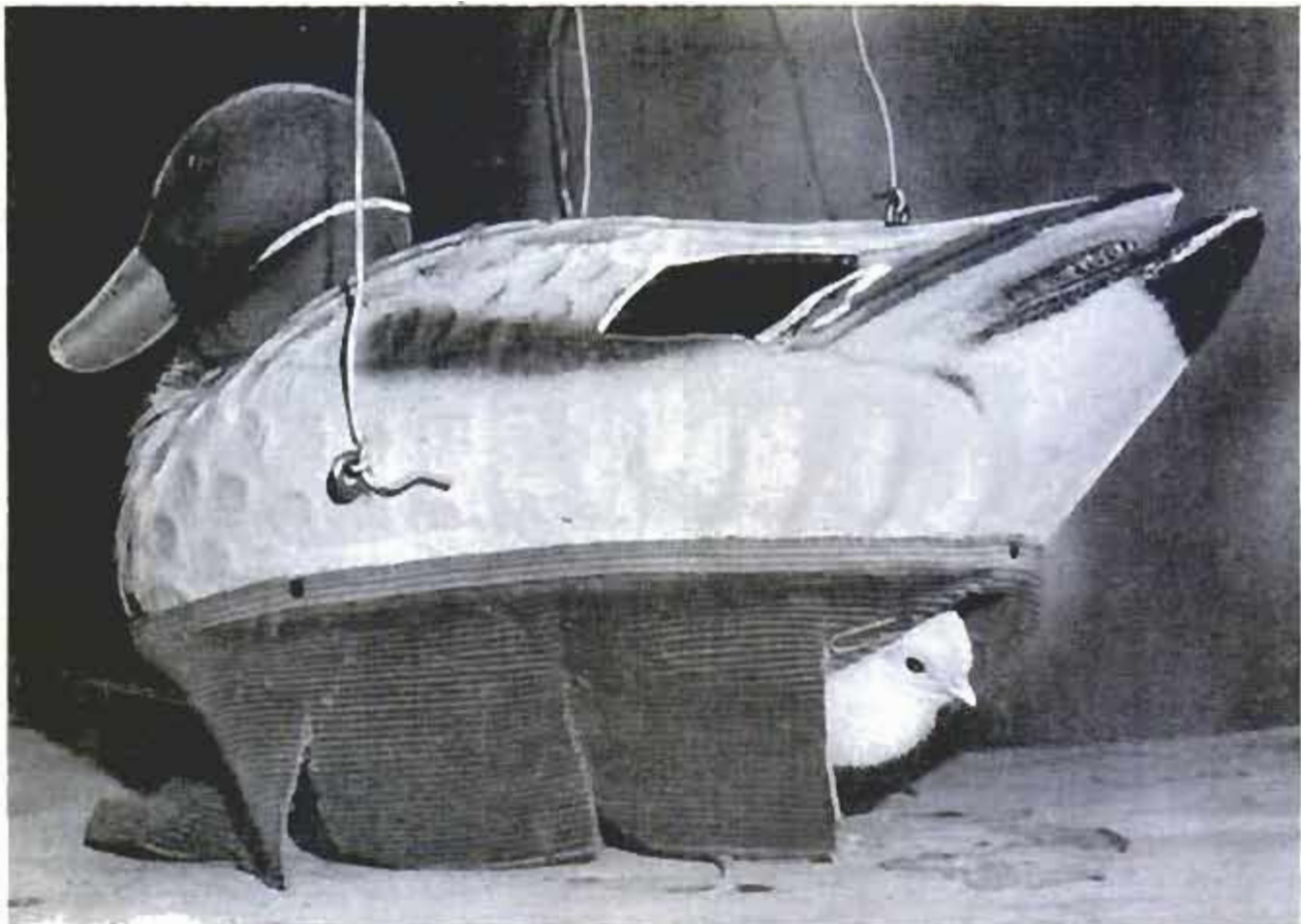

Nestling under mom gives any chick a mighty safe and cozy feeling. Trouble is, this little fellow doesn't know that "mom" is a duck decoy. If the newborn chick sees the decoy first, and it moves—it's mom!

Any Old Mother Will Do

Stuffed fowl is wired for sound to become another substitute mother. Experiments show that the chicks respond more quickly to objects emitting a sound

This is rear view of feeding apparatus. Chicks get feed through holes covered by colored disks. They cluster at red disk, showing definite color preference

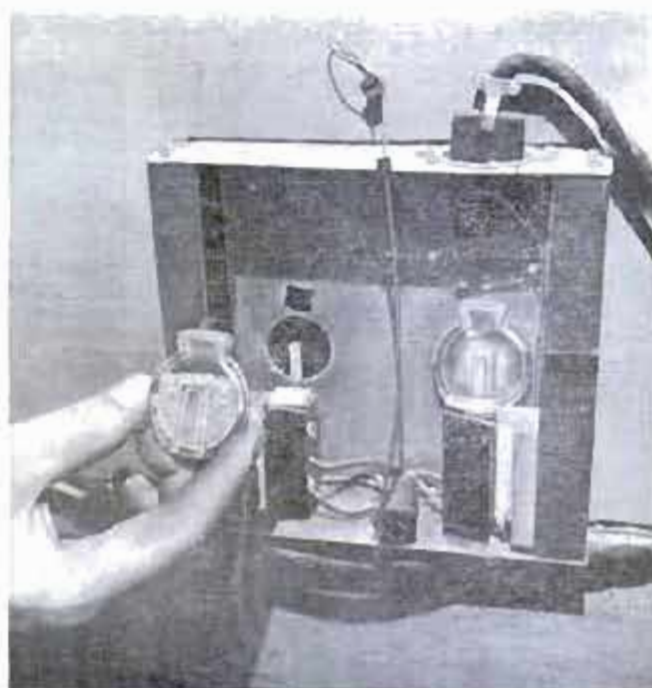

JUST HOW SMART is a baby chick? Not very smart, according to the experiments of Dr. Eckhard Hess, Associate Professor of Psychology at the University of Chicago. As a matter of fact, a baby chick can't tell the difference between its own mother and a rubber ball, as long as the ball moves. Dr. Hess conducted a series of experiments to find out how chicks react to different colors, sounds and stimuli. He rigged up stuffed fowl, decoys and rubber balls so they would move. He discovered that any such object which was dangled in front of the chick as soon as it came out of its shell became the little creature's mother. The chick would follow the object and try to nuzzle under it or against it for security. The texture of the make-believe mother didn't seem to make much difference, so long as the object moved. In other experiments, Dr. Hess found that the chicks have a definite preference for certain colors, particularly yellow and red, and that certain sounds make them neurotic. He administered tranquilizers to reduce early fear responses and to make the chicks more impressionable. After living with their decoy mothers for a while, some of the chicks preferred the artificial mom to the real thing. Purpose of the research? To learn how chicks could live more happily, and thereby produce more eggs. ★ ★ ★

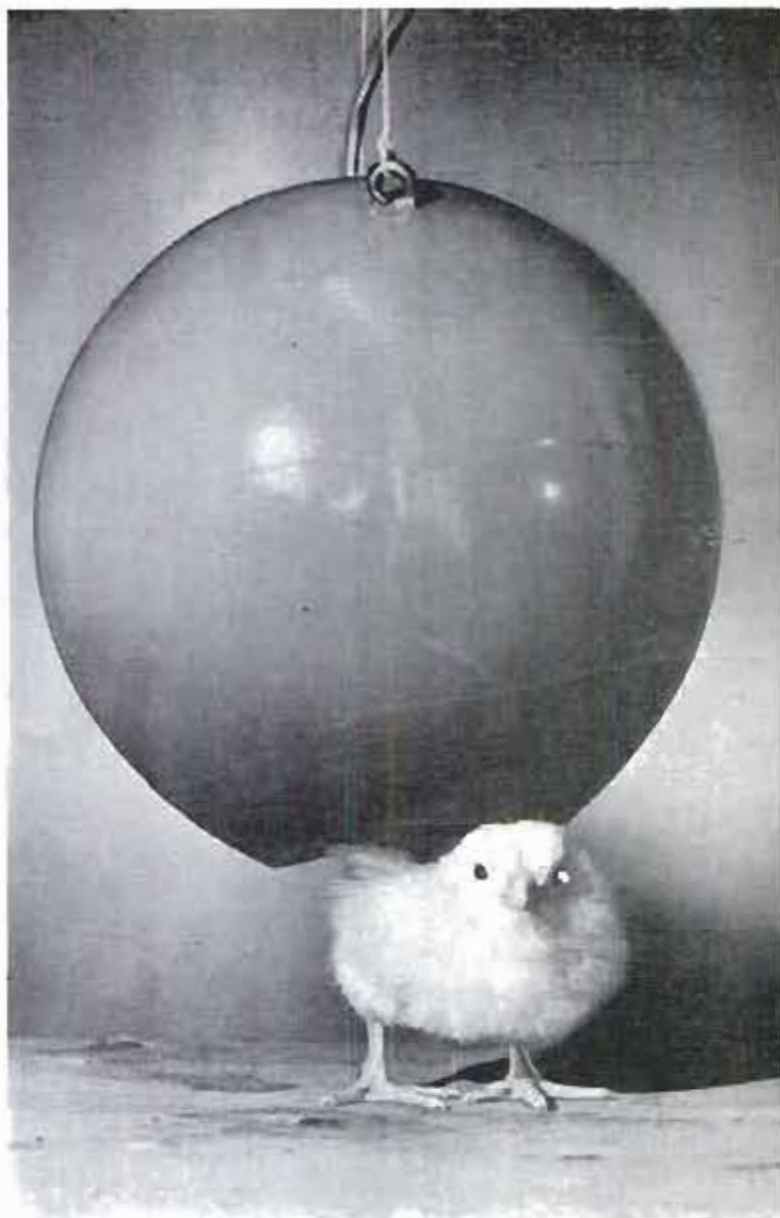

"Mother!" peeps the chick, and immediately nestles up against a rubber ball. Dr. Hess believes chick is looking for security

Technician applies colored head, tail and wings to rubber ball. Chick preferred the unimproved model

Dr. Hess stands at control panel, watching through one-way glass as chicks become familiar with "mother"

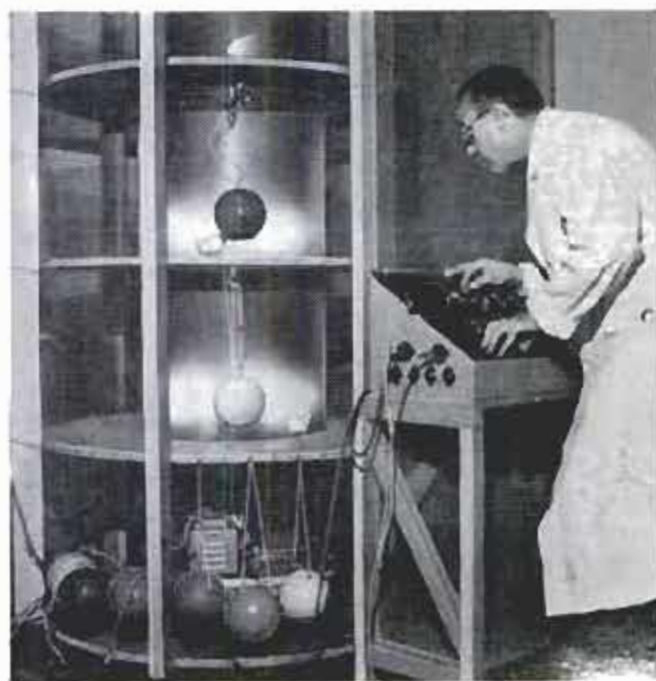
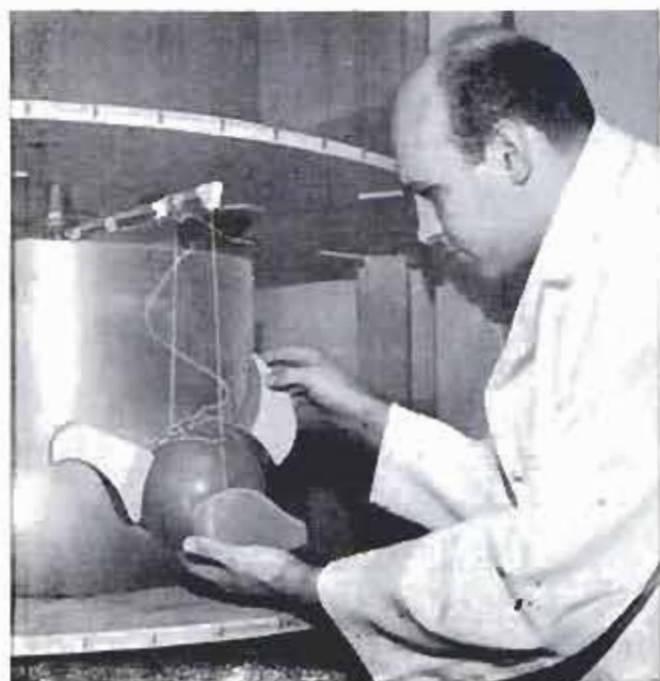



Giant Gas-Turbine Helicopter Will Fly for RAF

Britain's Royal Air Force will soon have the largest helicopter in Europe. The gas-turbine, tandem-rotor Bristol 192 is 54 feet long. It has been designed for troop and freight transport, search and rescue operations, and ambulance and supply-dropping work. The big twin-engine aircraft can

carry 25 men and has a concentrated-load freight capacity of 4000 pounds; the distributed-load limit is 6000 pounds. A synchronizing shaft interconnects the two engines, keeping the rotors in the correct phase relationship and permitting both to operate on one engine in an emergency.



All-Weather TV Camera Has Windshield Wiper

Equipped with a windshield wiper, a completely enclosed television camera was displayed at the Industrial Photographic and Television Exhibition in London. For use in a closed-circuit system, the all-weather apparatus can be proofed against noise, heat and cold, according to the manufacturers. It is designed to operate under climatic conditions found anywhere in the world.

Number, Please!

Whenever you write us to

- Renew your subscription
- Change your address
- Order your own or a gift subscription

... In fact, whenever you write us,

PLEASE INCLUDE YOUR CITY POSTAL ZONE NUMBER IN YOUR ADDRESS

*This insures better delivery.
It helps you and it helps the postman.*



CARPORT OR UTILITY BUILDING COMES IN KIT

Galvanized-steel add-a-section buildings are assembled from packaged sectional units. With all parts pre-cut and pre-punched, drilling and cutting at the site is eliminated. And to change the design you merely add another prefabricated section. In the photo above, a storage room of 60 square feet accompanies the carport that

has a 22-gauge steel roof. The structures can be left open or enclosed with siding, and can be painted and insulated. Windows and doors may be located where desired. The structures are designed for use as garages, cottages, repair shops, barbecue shelters, field houses and playhouses. Ordinary hand tools erect structures.

Boat Mounted on Car Rolls Down the Highway

Modified to fit over a Crosley chassis, a boat hull makes a combination rolling advertisement and company car for W. E. West, California boat dealer. Licensed as a conventional auto, the rig cost \$2000 to

build, including the original car. Proof of its effectiveness came when a local newspaper columnist complained about meeting a boat that was rolling down the highway just like an automobile.



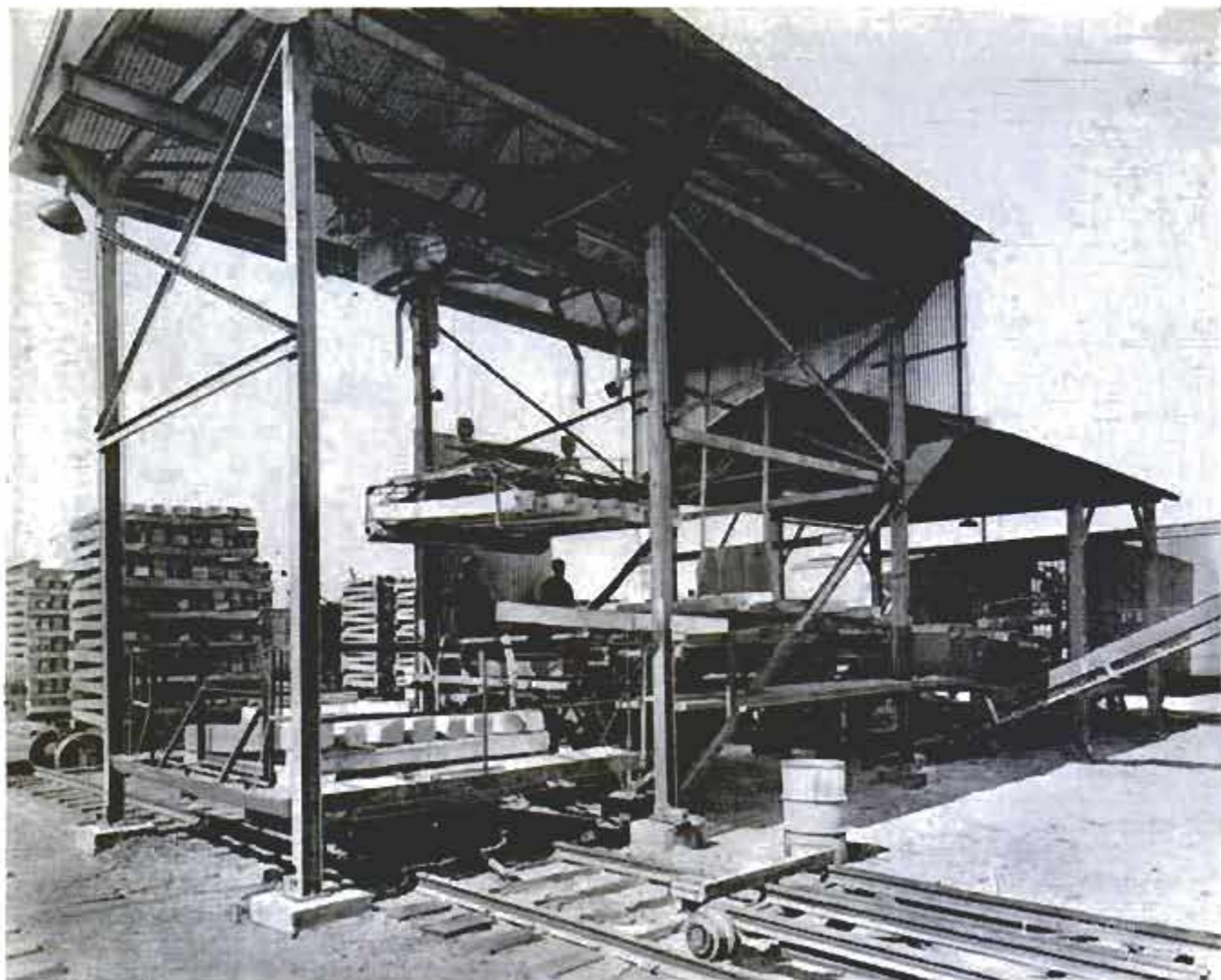

Machinery has replaced manual labor in handling of railroad ties. Here ties are moved on monorail from boxcar to tram

30,000,000 Ties to Handle

By Guy Browning Arthur

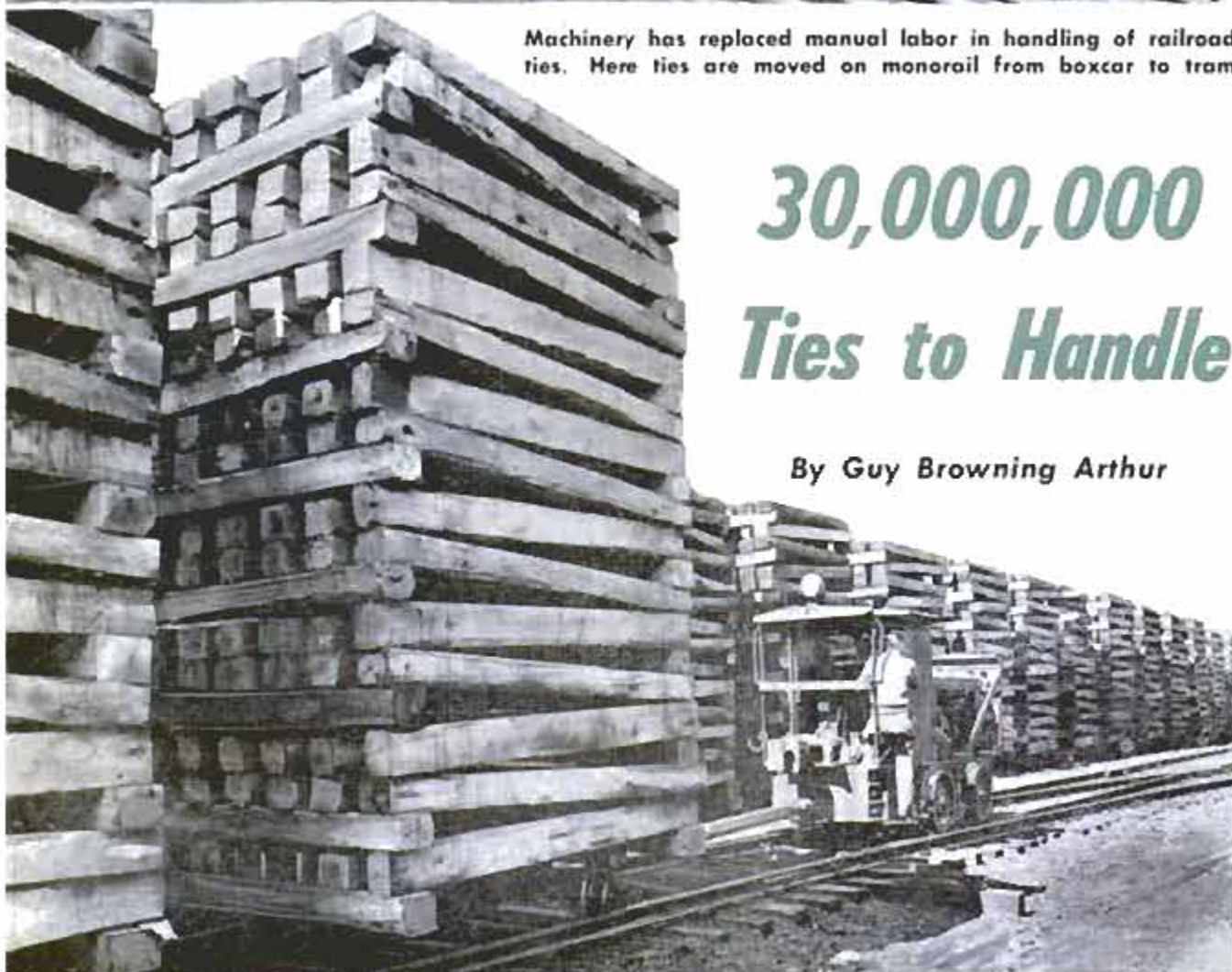

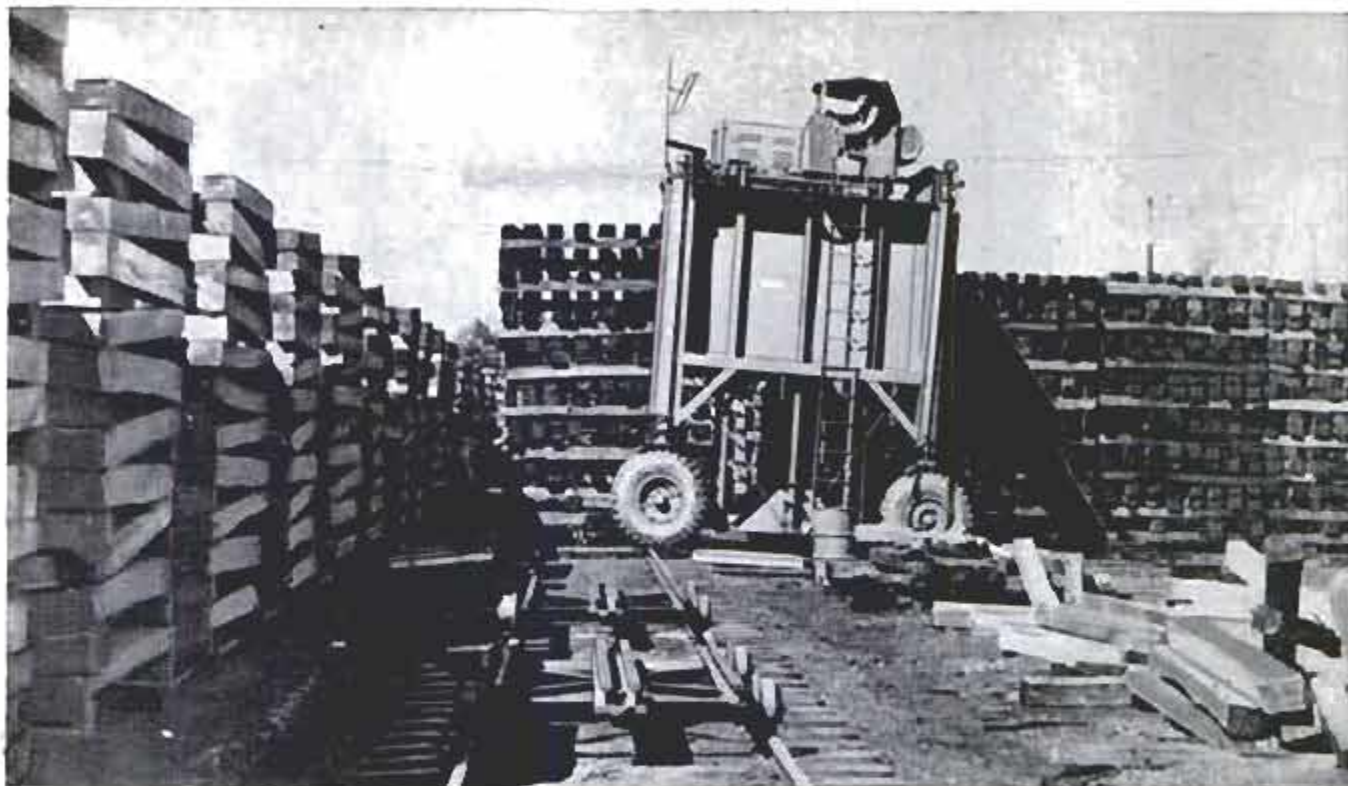

Ross Carrier descends from track after placing a rick of 127 dry ties on tram car. Once, each tie was carried by one man

With electronic unit around his neck, workman controls movements of boom, grapple

As grapple hoists unit of eight ties and stringer, hooks catch ends of the stringer

THE RAILROADS use about 30 million cross-ties every year. When wood was cheap, and labor easily recruited, the frequent replacement of ties was a commonplace item in railroad costs. About 50 years ago maintenance men began to show that the waste in using untreated ties could not be justified. Demands on roadbeds were becoming more exacting, with heavier, faster trains.

Paralleling this development, processes for preserving wood were perfected. Today practically all ties are treated to make them last longer, reducing the number of replacements.

The Southern Wood Preserving Company's plant at East Point, Ga., handles 300,000 to 400,000 green and dry ties a year. Until the invention and installation of special labor-saving devices, every tie was carried by hand, unloaded from cars, ricked in the yard, moved from the ricks to tram cars on tracks 120 feet apart, and unloaded from these cars for cutting to length, adzing and boring. Each

(Continued to page 296)





Machine Digs Battlefield Trench at Rate of 12 Feet Per Minute

Soldiers of the future may have their foxholes and trenches dug for them—and much faster than they could do the job themselves. Designed to provide rapid protection for troops, a mechanical ditch dig-

ger can dig a trench four feet deep and two feet wide at the rate of 12 feet per minute. The machine has been undergoing tests at the Army Research and Development Center in Ft. Belvoir, Va.



Sergeant in Air Force Builds a Helicopter

Using material and equipment bought from salvage yards, an Air Force staff sergeant built his own helicopter. And it flies. The craft seats one person and is powered by a 72-horsepower engine. According to Larry Henderson, the 25-year-old builder, it cruises at 80 miles per hour and has a top speed of 110. The eight-foot-long craft, which took almost six months to build, has a fuel capacity of five gallons, weighs approximately 280 pounds and has a 16,000-foot ceiling. The sergeant estimates that he spent about \$300 and almost 600 hours on his homemade helicopter, which he values commercially at \$1700. Nicknamed "Ginny," copter can stay aloft for one hour and 15 minutes.



High-Speed Fireboat Is Equipped With Radar

Custom-built for high speed fire fighting and rescue work in the San Diego harbor area, the 32-foot *Point Loma III* is driven by three engines totaling 750 horsepower and

is capable of 40 knots. Other equipment includes radar, radio, 300-gallon-per-minute pumps to aid sinking boats, and bow and stern lights for night rescue work.

Anglo-Irish Car For U. S. Market

Aimed at the American export market, the Shamrock sports sedan will be assembled in Ireland from parts and materials made in England. The body is all plastic; the prototype shown here demonstrates the removable canopy that quickly transforms it into a hardtop. A four-seater, it has a four-cylinder overhead-valve engine, an American 12-volt electrical system, and a 98-inch wheelbase. The price in England is \$2500, which includes high local taxes which wouldn't apply to the American market. The manufacturer plans to demonstrate the car in California.



Curtains of Air Corral Herring

FISHERMEN in Maine are using air curtains to corral herring catches. Their success was first anticipated in research of the U. S. Bureau of Commercial Fisheries during the past two years. The equipment consisted mainly of a 1200-foot length of flexible plastic pipe with holes drilled at one-foot intervals, and two compressors supplying air at each end. The researchers learned that they could herd herring right into waiting seines. Setups made during six nights yielded 5350 bushels of herring. Aerial observations were made to locate the herring schools. The fish moved down channel as usual until they came to an air curtain. Rather than pass through the air, they moved along it to the point where the seine was attached. It was learned that difficult conditions such as deep water, boat traffic, swift tides or debris, which often make it impossible to use nets and other seine gear, have no effect on the use of an air curtain. By using the air curtain, sizeable catches of herring were corralled where no fish had been caught for several weeks. The fish, valued at one dollar per bushel, were worth about twice the cost of the major components of the equipment. The pipe, weighted with lead to make it sink, is laid by boat and retrieved with a power-driven hose reel. The compressors are mounted on separate vessels.



Above is Boothbay Harbor in Maine, showing air-bubble curtains. Sketch below shows how curtains are laid. Herring move along curtains rather than go through them—and end up in seines

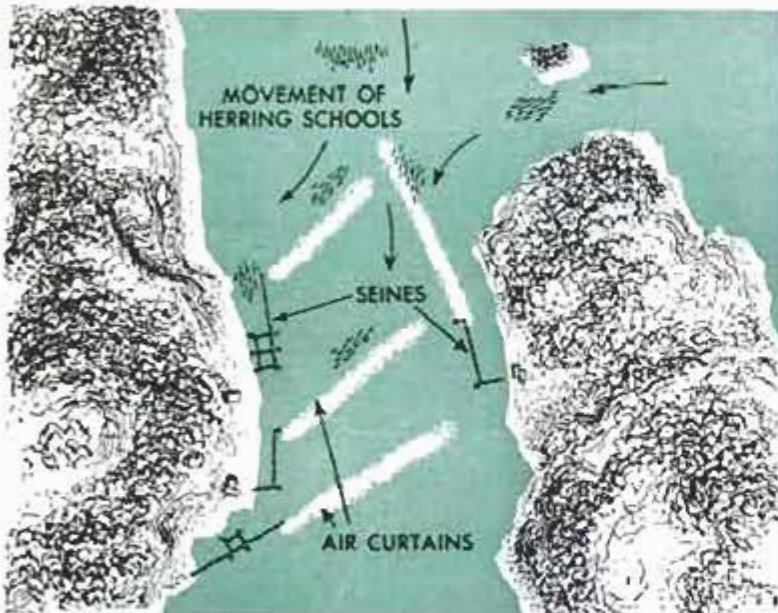

Pipe, laid by boat, is supplied with air by two compressors driven by 26-horsepower air-cooled engine and 52-horsepower diesel

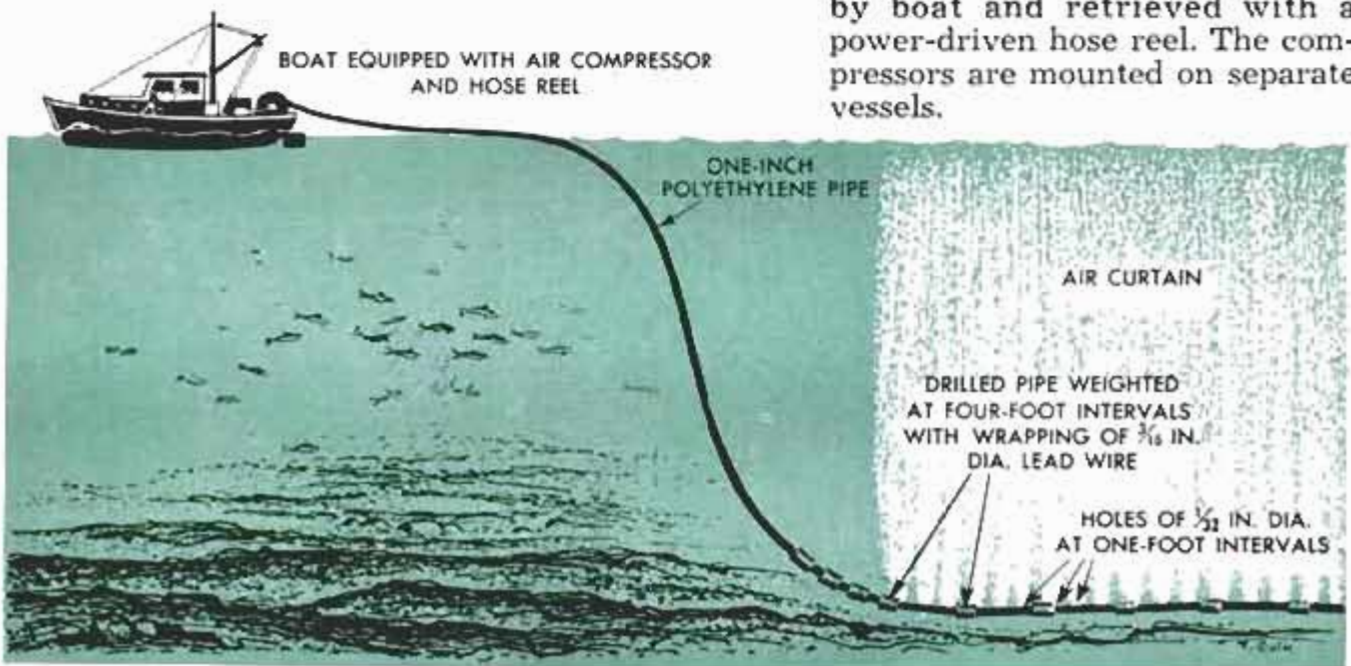



Strips of Magnetized Plastic Seal Refrigerator Doors

Magnetized plastic strips have been developed for sealing refrigerator doors. The magnets are produced by melting vinyl resin with plasticizers, and mixing this compound with metallic powder. The mixture is shaped and run through a magnetic field.



Adjustable Stand Holds Paper For Easy Ceiling Installation

If you're going to decorate a room all by yourself you can get a "hand" from an adjustable stand that does two things: It holds paper close to the ceiling while you're working it into place, and it holds paint and tools. It is attached to a stepladder.

Palm-Size Sound Meter "Maps" Factory Noise

Designed for rapid measurement of sound levels, a palm-size noise-survey meter can help establish noise-contour "maps" in large industrial plants. Weighing only 12 ounces, and about the size of an electric shaver, the instrument shows sound-pressure levels in the range of 75 to 140 decibels. This covers noise levels from busy street corners to the painful noise levels in the test cell of an aircraft-engine plant. Two models, one for measuring hearing-damage noise and the other for acoustical engineering studies, are available.





PICTURE BOOKS FOR THE BLIND

Miss Elsey Taft, retired teacher, began illustrating books in Braille as a hobby. Now it's a business

By Joseph E. Brown

IN 1849, the invention of a blind French science teacher named Louis Braille became a beacon to others whose world is perpetual night. In the 110 years since, Braille's system of punched-dot lettering has opened vast new vistas in education, information and entertainment for millions who "read" with their fingertips.

Now an American woman has made a significant improvement upon the revolutionary system Braille perfected. She has added illustrations to his words.

The inventor of this process, called Braille Illustrated, is a retired New York schoolteacher named Elsey Taft who now lives in La Jolla, Calif. She began experimenting with the process last December as a hobby. The hobby now has catapulted itself into a full-time task, bringing Miss Taft out of retirement to provide picture books, wall-size relief maps and other educational tools for sightless children and adults.

Braille Illustrated, which Miss Taft has patented, is basically a simple process, a refined variation of the same molding fundamentals used by hundreds of American industrial firms. A raised impression is fashioned over an outline of a picture on heavy Manila paper. A sheet of plastic is placed over this die, inserted in an oven and baked under vacuum. Then the plastic is allowed to cool and re-harden. The result is a



Completed Braille illustrated page (background) and plastic page (foreground) are shown together. The figures on Manila paper were formed from scraps



House on this page from illustrated book is made in relief from scraps of cloth, wood and toothpicks



Sightless boy "reads" illustrated book with finger tips. Typed text allows sighted reader to follow

plastic mold that reproduces the original picture image.

One day last December, while casting about for a hobby, Miss Taft visited Edward K. Duffy, a friend who operates a restaurant in La Jolla. In his spare time, Duffy serves as one of several hundred Braille transcribers in the United States. He urged she consider this as a hobby, too.

Duffy showed her two basic tools he used: a handheld, oblong wood and metal "slate" to clamp the Braille paper in place, and an awl-like punch or stylus, used to stamp embossed dots in uniform rows through tiny windows in the slate. In Braille, variations of only six dots, punched in squares, can form almost every letter, phrase, sentence and punctuation mark in any language.

Miss Taft was enthusiastic. She enrolled in a class and soon became a rapid transcriber.

On this finished plastic page, various textures of house construction stand out in relief. Story is told in Braille dots at top of page. Demand for Braille Illustrated far exceeds supply, and Miss Taft hopes to expand

"The idea for adding pictures came after I had completed several books," she says. "The books are a Godsend to the blind, especially to young sightless children. They are an important link with the sighted world." But to a former schoolteacher, who realized the value of illustrations to a child, the lack of pictures to implement these words was saddening.

Transforming her La Jolla living room into a makeshift workshop, she set about to correct the situation.





Miss Taft inspects illustration embossed in plastic. Figures are "read" with fingertips by blind

First, she studied several illustrated children's books, selected one she felt best suited as a pilot project, and obtained permission to reproduce it in the new medium.

Sighted Person Can Follow

Miss Taft decided upon a 14 by 14-inch page as a standard size for the Braille work because translating into the raised-dot system required more space than normal printing in the original. Each page of the text was retyped and pasted on the left side of facing pages in the new Braille edition. This permitted a sighted person to follow the text with a blind reader who "read" the corresponding dots with his finger tips.

Each page contained one illustration. On heavy Manila paper, selected because of its ability to withstand the heat of an oven used in a later phase, she traced an outline of the illustration.

Now came the most difficult part of the process—creating a raised die from this outline. Just any material wouldn't do. It had to withstand the oven's heat and pressure and at the same time relay to the touch the impression that the artist, for a sighted reader, achieved with colors and dimensional effects.

Miss Taft began experimenting with various bits of material. She tested scraps of cloth of various textures and thicknesses, a gob of plaster-repair compound, tiny pebbles (to represent boulders), glue, toothpicks, fluffs of cotton for hair, grains of rice and wheat, sand, salt and other



Stylus is used to punch dots through Braille transcription slate. At left is transcription guidebook

odds and ends. These she placed, layer upon layer, over the picture outline.

Gradually, the two-dimensional picture assumed a three-dimensional look. In a typical illustration, for example, cloth and cotton on the die represented a small boy's clothing and hair, a pebble became the boulder on which he sat; toothpicks cut in miniature brick shape formed the chimney of a house, and a scattering of grain was glued into place as a lawn.

The dies finished, Miss Taft fastened a sheet of transparent plastic over each page and inserted them in an oven. Subjected to heat and vacuum pressure, the plastic melted into the tiny impressions formed by the cloth, cotton, toothpicks and grain. These were allowed to cool and harden.

Result Is Durable

The result was a durable plastic reproduction of the original illustration that could be read with sensitive fingertips.

The first book, Miss Taft admits, was crude. But despite its minor flaws it was an immediate smash hit with sightless youngsters at the Blind Recreation Center in San Diego. They hungered for more.

Miss Taft widened her field of ideas. More advanced books were transformed into plastic. By trial and error, she discovered new materials that would stand up under the oven's heat, and more accurately translate to the sightless the impression the artist tried to convey.

Other projects followed. The most am-

(Continued to page 284)

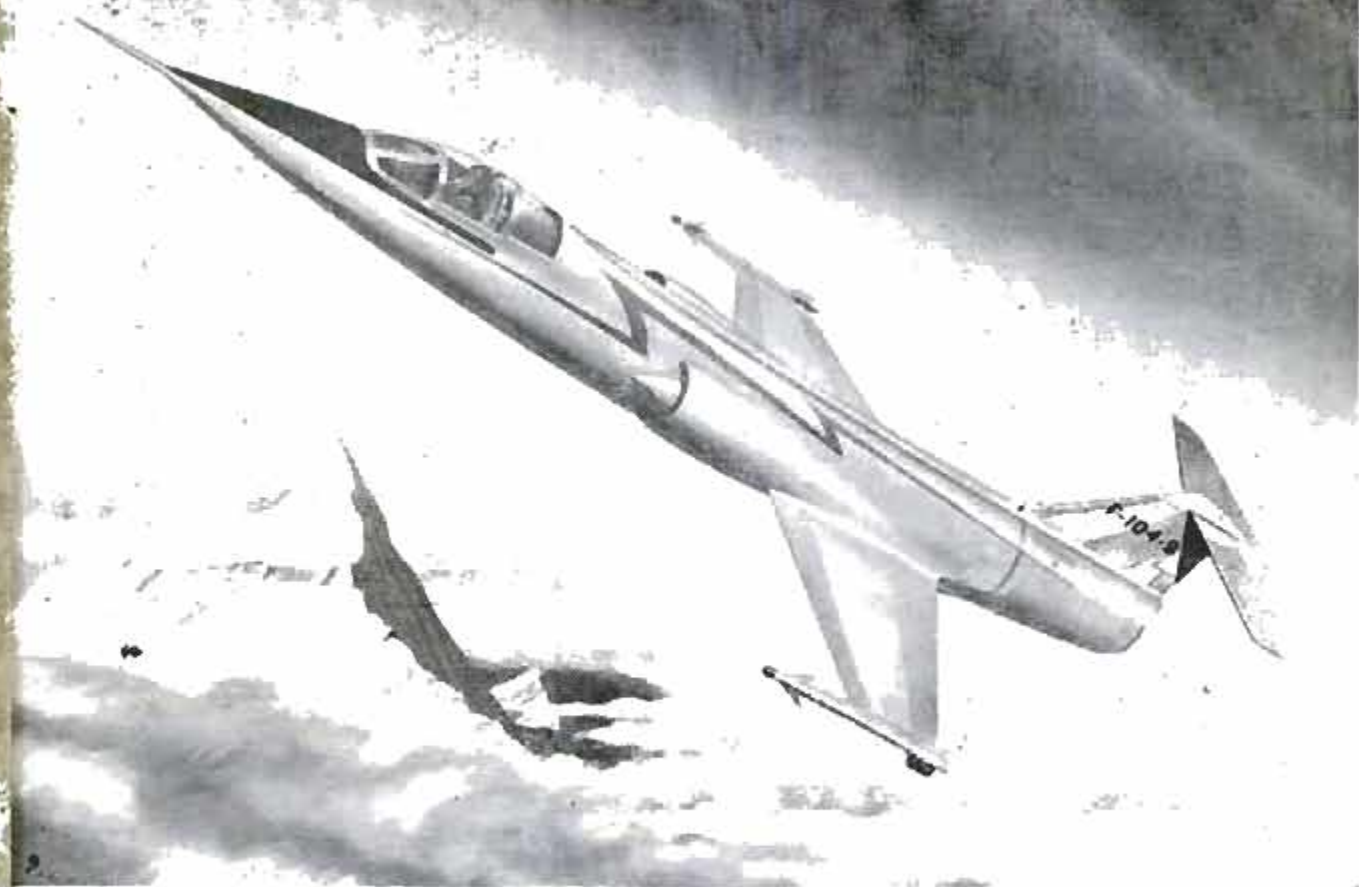

International Version of Record-Breaking Starfighter

Defense of our allies will soon be strengthened by the addition of Lockheed's new F-104-9 Starfighter, shown here in an artist's drawing. This international version of the famed Starfighter has been planned specially to meet foreign nations' economic

and military requirements for a supersonic front-line fighter. It will be armed with two wing-tip Sidewinder guided missiles. Existing Starfighters hold the world's records for speed (1404 miles per hour) and altitude (91,243 feet).

Metal Made of Fibers Is 90 Percent Air

Fiber metal, a new product that looks and feels like solid sheet metal but is 90 percent air, has been developed at the Illinois Institute of Technology. The material is made of thin metal fibers bonded together by heat. Its high strength and low weight make it practical for aircraft and rocket use. In another form, it may be used as a filter for liquids and gases.

Superior Bluegrass Developed by Radiation

U. S. Department of Agriculture scientists have produced a strain of Merion bluegrass that resists stem rust. Success over the rust, considered a major disease of Merion blue, was achieved by treating seed with thermal-neutron radiation. Plants from the treated seed produced a second generation of more than 3000 individuals, of which one line of 10 plants remained free of stem rust and continued to grow throughout the season.



The 50-page housing section that follows is devoted to your home—whether it be in the dream stage, in need of refurbishing or remodeling, or just in need of fresh ideas here and there to make it more livable. We think you will be as enthused as we are over the PM Indoor-Outdoor House. It was designed especially for our readers by the noted Chicago architect, Edward D. Dart, A.I.A.

—THE EDITORS

The PM Indoor-Outdoor House



DESIGN A HOUSE with no 'indoors' or 'outdoors,'" we asked. "Design a house with no real separation between the two; a house that flows from Dad's easy chair right on out to the patio, diving board or rose garden. At the same time, insure privacy wherever it's needed."

These were our instructions to Edward D. Dart, one of the nation's leading architects.

How well did Dart fill the bill? Take a look at the magnificent home shown on the following pages—and judge for yourself. We think you'll agree that the "PM Indoor-Outdoor House" is one of the finest small-home designs ever presented, a home ideally suited to informal living. And who doesn't want to live informally, inside and out, these days?

Actually, this "small home" isn't so small. *Inside* the house there are 1555 square feet of living area; *outside* there are as many square feet as you wish to include, for in this home you don't live inside or outside, but all over the place.

Despite its comfortable size, the home carries no sky-high price tag. Building costs vary widely across the



Family room is fine for TV viewing and informal dining. With wall-doors open at both ends, it becomes a porch

country, but the *PM* Indoor-Outdoor House is *relatively* inexpensive because of Dart's choice of construction materials. These include used brick and, in some spots, rough-sawn redwood board-and-batten siding.

On these pages we show the house wrapped around a small pool. Dart emphatically points out though, that the house, as situated on the lot, lends itself just as readily to a big patio or an informal garden. What are your family's hobbies? How many children do you have? What are their ages? How many green thumbs in the family? These are factors which should be considered in planning the outdoor portion of the home, factors that will determine whether a pool, patio or garden is best.

Ed Dart is a quiet, highly imaginative young man who knows what it means to live indoors and out. The prize-winning architect has two children who keep him busy all around his home and yard in Barrington, Ill. From practical experience Ed knows that a satisfying family life can't be limited by a doorway between indoors and out. Activities will overflow the house no matter how it's designed. Dart's philosophy, therefore, is to *include the outdoors in the plan.*

A home, Dart says, is inevitably a place of conflicting activities.

"A house belongs to the family," he explains, "and the family is made up of persons of varying ages, interests and activities. It's inevitable that these diverse factors frequently conflict.

"Take a good look at how a home is used. Actually you require three different houses. There are times when the whole family is together; the house must open out spaciouly to handle everyone at once. This is house number one. There are times when certain age groups get together—for adult or teen-age parties—while other members of the family not only seek but need a retreat. House number two. Then there are times when everyone in the family needs a pocket of complete isolation to sleep, to study, to avoid arguments or just to daydream. House number three.

"Thus each family needs three houses in one. Some homes serve these multiple needs with great adaptability, others very awkwardly."

The *PM* Indoor-Outdoor House is a fine solution to the three-in-one problem. The house for absolute privacy (the bedrooms) forms a separate wing. The house for all

Complete plans for the *PM* Indoor-Outdoor House are available. The package consists of four complete sets of working drawings, two sets of specifications, materials list, cost breakdown and estimating guide. The plans are detailed for construction both with and without a basement. Reverse plans are available upon request. The cost of the complete building package is \$39.00. Write: Plans Department, *Popular Mechanics Magazine*, 200 E. Ontario St., Chicago 11.

70' LOT

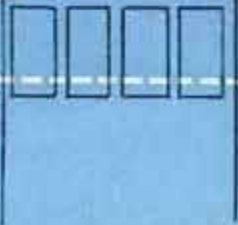
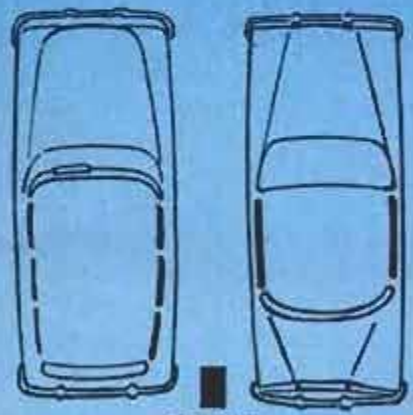
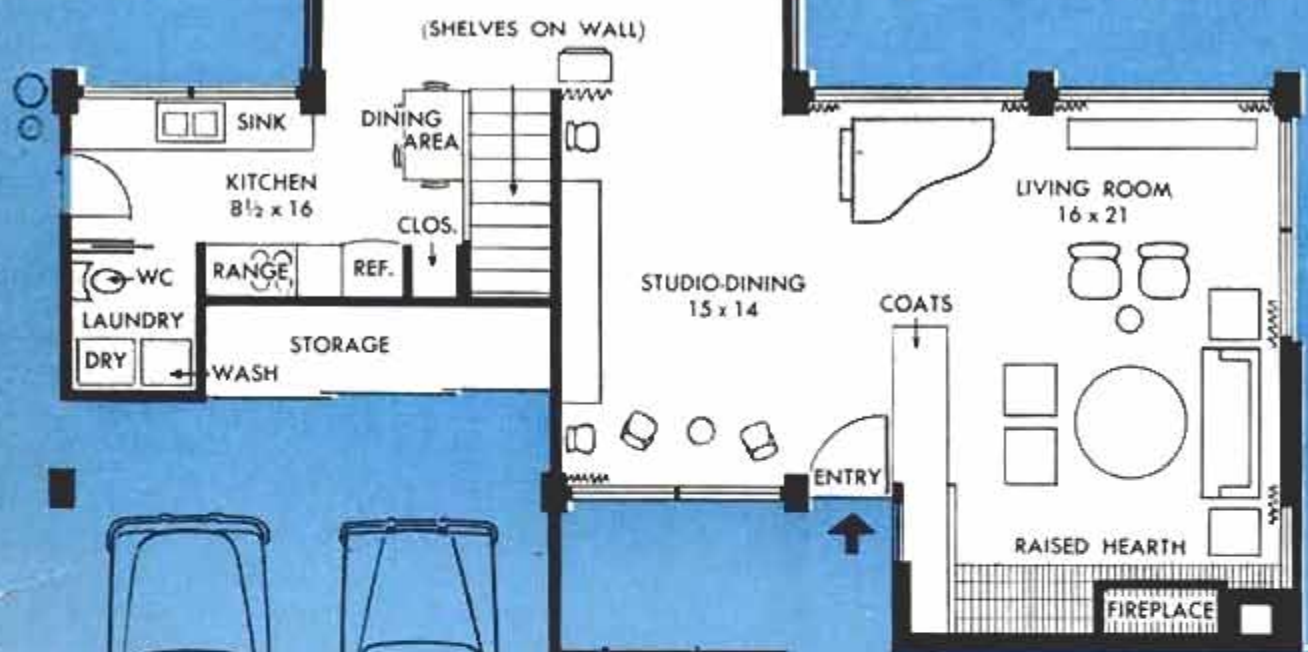
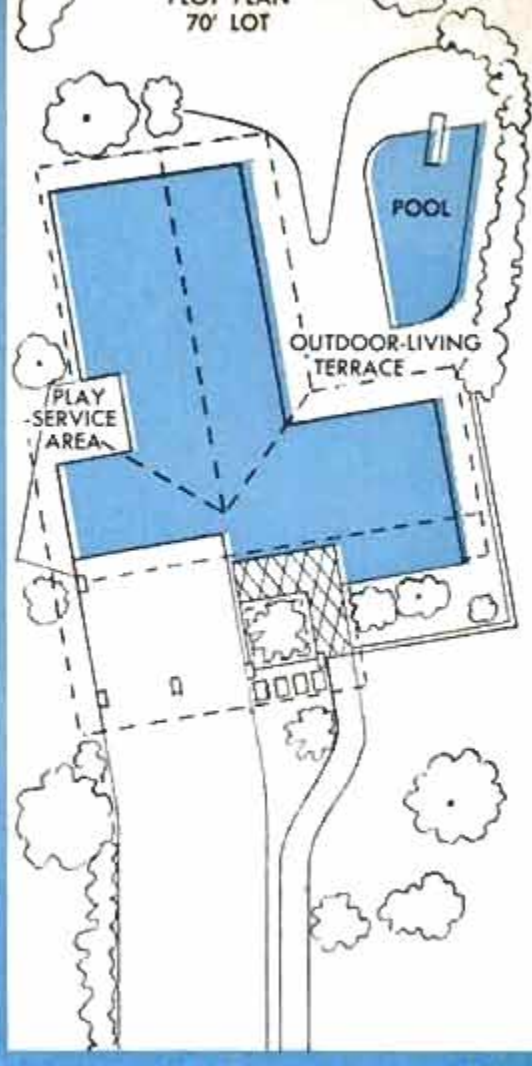



Living room features big fireplace wall, with built-in desk and storage on the right, a skylight overhead

the family (the family room-porch-kitchen and the whole outdoors) offers plenty of space for combined activities. The house for entertaining (the expandable living room) also offers ready access to the outdoors.

Take a closer look at the plan of the Indoor-Outdoor House. As you approach, the most striking feature is the mass of masonry that forms one corner of the house. The shrimp color of the used brick provides a warm contrast with the long, low roof, shingled with cedar shakes, that overhangs the home on every side. The masonry theme is repeated periodically across the front by brick pillars that support the roof.

The carport has plenty of room for two cars. Built into one wall is ample storage space for garden tools, lawn mowers, baseball gloves, doll buggies, car wax, used boomerangs and other oddments that don't seem to have a natural place in most houses. Incidentally, Dart designed the carport so it could be converted into a garage by enclosing the sides. "The front of the house will look just as good either way," he says.

From the carport you enter the house either by the side or front door. Both doors are a few steps away, and both are protected from the elements by the big roof overhang. As you walk over to the front door you pass an attractive planter with a tree that grows right through the roof.

Upon entering the house, you can't help but be impressed by the size of the front "hall." Actually this is the most unique room of the house and an innovation in small-home design. Dart calls it the studio-

dining room. Its flexibility is tremendous. First it serves as an entry—a foyer which is a far cry from the crowded vestibules found in most homes. The coat closet on the right goes only part way to the ceiling, so there is no psychological barrier between this room and the living room. Second, it serves as a dining room for entertaining and for somewhat formal family dinners. (Dart considers most dining rooms space-wasters, which is the reason for the flexibility of this room.) Finally, if you are entertaining several guests, this room becomes a natural enlargement of the living room without any preparation, as a glance at the floor plan will show.

A magnificent fireplace with a truly generous raised hearth is the focal point of the living room. One corner of the room has a built-in desk and storage space for books, games and the hi-fi. A skylight in the roof over this corner sheds light dramatically down the mass of the fireplace.

The combination family room-porch is ready-made for family dining, TV viewing and all manner of activities for the kids. Dart considers this room the real nucleus of the home, with all other activities radiating from it like spokes from a hub. The two exterior walls consist of sliding glass doors, one leading to a play and service area off the kitchen, the other to the patio-pool area. Thus with two doors open the room becomes a "porch" smack in the middle of the house. The room also serves as a buffer between the bedroom area and the living room.

A stairway to the basement (optional) is
(Continued to page 286)

*Ask yourself this question
before investing time and money
in a home-improvement project:*

WILL IT INCREASE THE VALUE OF YOUR HOUSE?

THE NEXT TIME you plan to improve your home, ask yourself this question: Am I doing it merely to change the looks of things? If your answer is yes, then give your plans further consideration.

You don't want just a change—you want the time and money you spend to be an investment that will increase the value of your home.

For example, increasing the number of circuits in your home is a modest improvement that will make your house worth more if you should sell it.

On the other hand, removing bedroom ceiling lights and rewiring their wall switches to control bedside lamps is an improvement that is a matter of taste.

Some people prefer ceiling lights in bedrooms; some do not. The house is worth exactly the same either way.

Before beginning any home remodeling, whether it be indoors or outdoors, you should consider these three questions:

- Will the improvement increase your home's livability? The investment is not worthwhile unless you will enjoy it.
- Will it increase the house's market value if and when you sell? Well-chosen improvements can be worth more later than they cost right now.
- To what extent will the improvement increase maintenance? A large formal garden or an elaborate game room may increase property value, but excessive main-

Lightweight brick makes fireplace attractive. The brick is applied with a special adhesive, using a putty knife





Separating the living room from the entranceway are permanent dividers that are an excellent investment

tenance may outweigh this advantage.

After considering these questions, you must decide what improvements you want. One room in the house that should be given priority is the kitchen. Anything that will save work there will certainly increase the value of your home. Good investments are all of the latest mechanisms such as electric dishwasher, garbage disposer and built-in oven. A counter-top range is a definite asset, providing extra storage space beneath. New cabinets add color and storage space. An exhaust fan helps keep the kitchen fresh, especially after cooking and baking.

An attractive bathroom is always of value to your home. Plenty of counter and cabinet space is a big asset in a bathroom. Convenient in any bedroom is a closet lavatory, complete with wash bowl, mirror cabinet and storage space.

If your house has a fireplace, it should be made as attractive as possible. Prospective buyers like a large, eye-

appealing fireplace. One method is to cover the surface with a thin brick that can be put on with adhesive. The cost is small compared to the significant increase in value.

If yours is a large living room, dividers can conveniently adapt it for two-room purposes, while adding shelves or storage.

Outdoor fencing—for privacy and wind protection, for appearance, for protecting children and pets—increases the value of your property

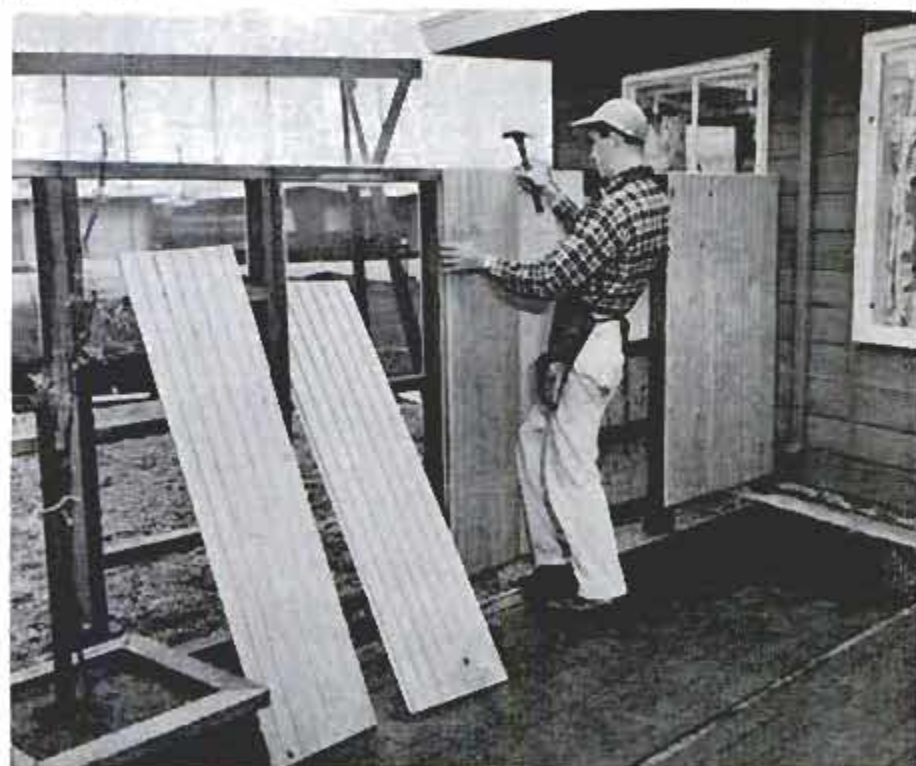



Most-for-your-money home has a modern bathroom complete with good lighting, electric heater



Bathroom capacity of a home can be increased by installing a lavatory in the master bedroom closet

Outdoor landscaping poses less of a planning problem because time works with you. Bare-root trees and one-gallon shrubs are inexpensive and soon grow to be worth many times their cost.

Often during outdoor planning you may find that appearance means more than livability or minimum maintenance. This is because a home that is attractively landscaped draws admirers and instantly adds to the value of your home. Proper shrub-

bery and permanent rather than annual plantings mean a better looking front yard the year around. Permanent sprinkler installed in the lawn not only are convenient but are an excellent investment.

There are innumerable ways to improve the back yard, but most effective in increasing property value are conveniences such as patios, masonry barbecues and roofed, screened-in patios. An outdoor pool may be expensive, but today it is a

BACK-YARD IMPROVEMENTS

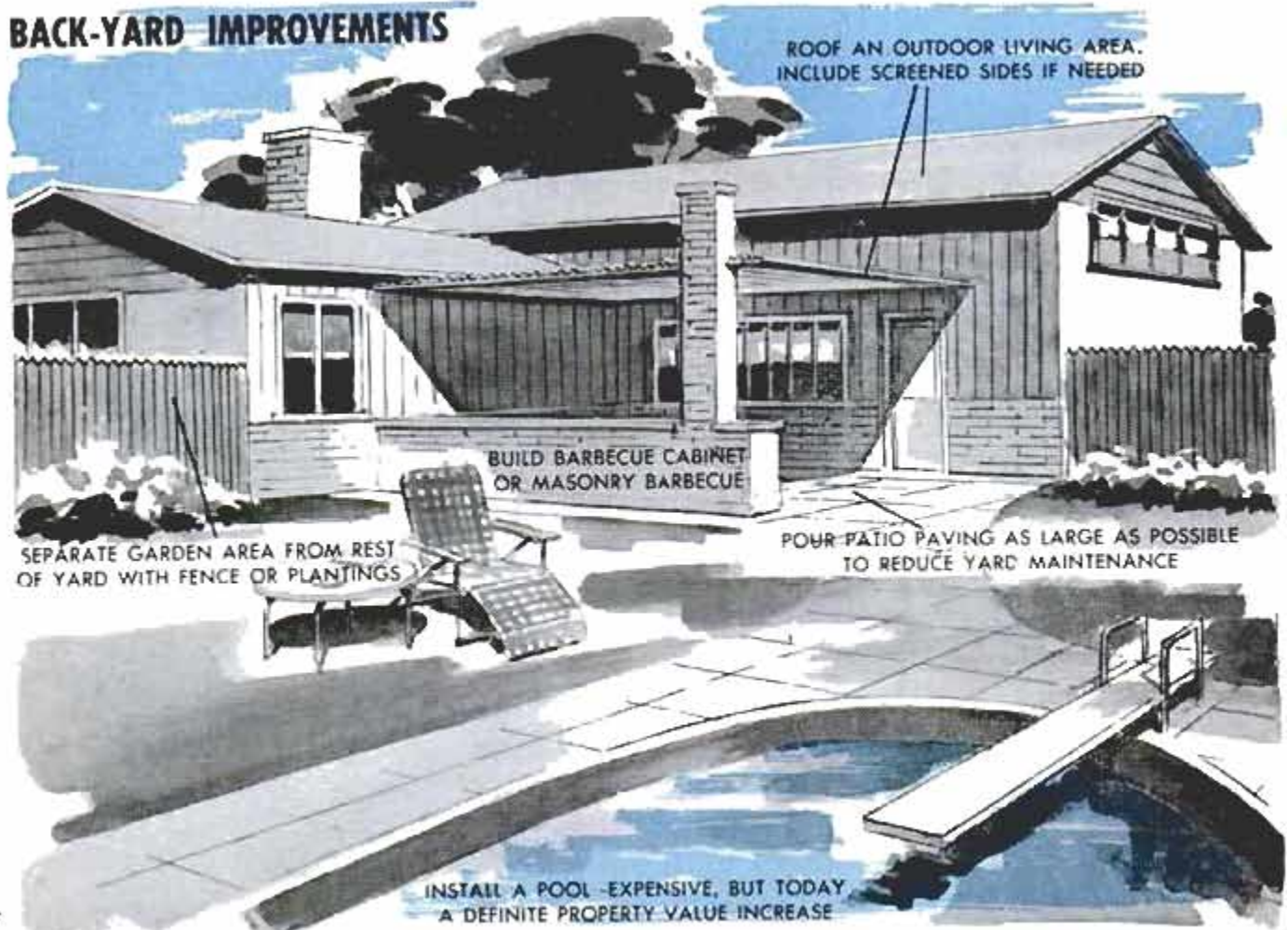

ROOF AN OUTDOOR LIVING AREA.
INCLUDE SCREENED SIDES IF NEEDED

BUILD BARBECUE CABINET
OR MASONRY BARBECUE

SEPARATE GARDEN AREA FROM REST
OF YARD WITH FENCE OR PLANTINGS

POUR PATIO PAVING AS LARGE AS POSSIBLE
TO REDUCE YARD MAINTENANCE

INSTALL A POOL - EXPENSIVE, BUT TODAY
A DEFINITE PROPERTY VALUE INCREASE



Facilitating kitchen work with dishwasher, garbage disposer and built-in oven adds much to value of house

definite property-value asset. All of these items are part of the outdoor way of life now so popular. Any homeowner making these improvements will be paid well for his labor.

When you sit down to plan your home improvements, remember to ask yourself whether you're merely making change for change's sake or if you are increasing the value of your home. ★ ★ ★

FRONT-YARD IMPROVEMENTS

PRESERVE SIDING AND TRIM WITH PAINT FOR THE TYPE OF MATERIAL

TUCKPOINT BRICKWORK

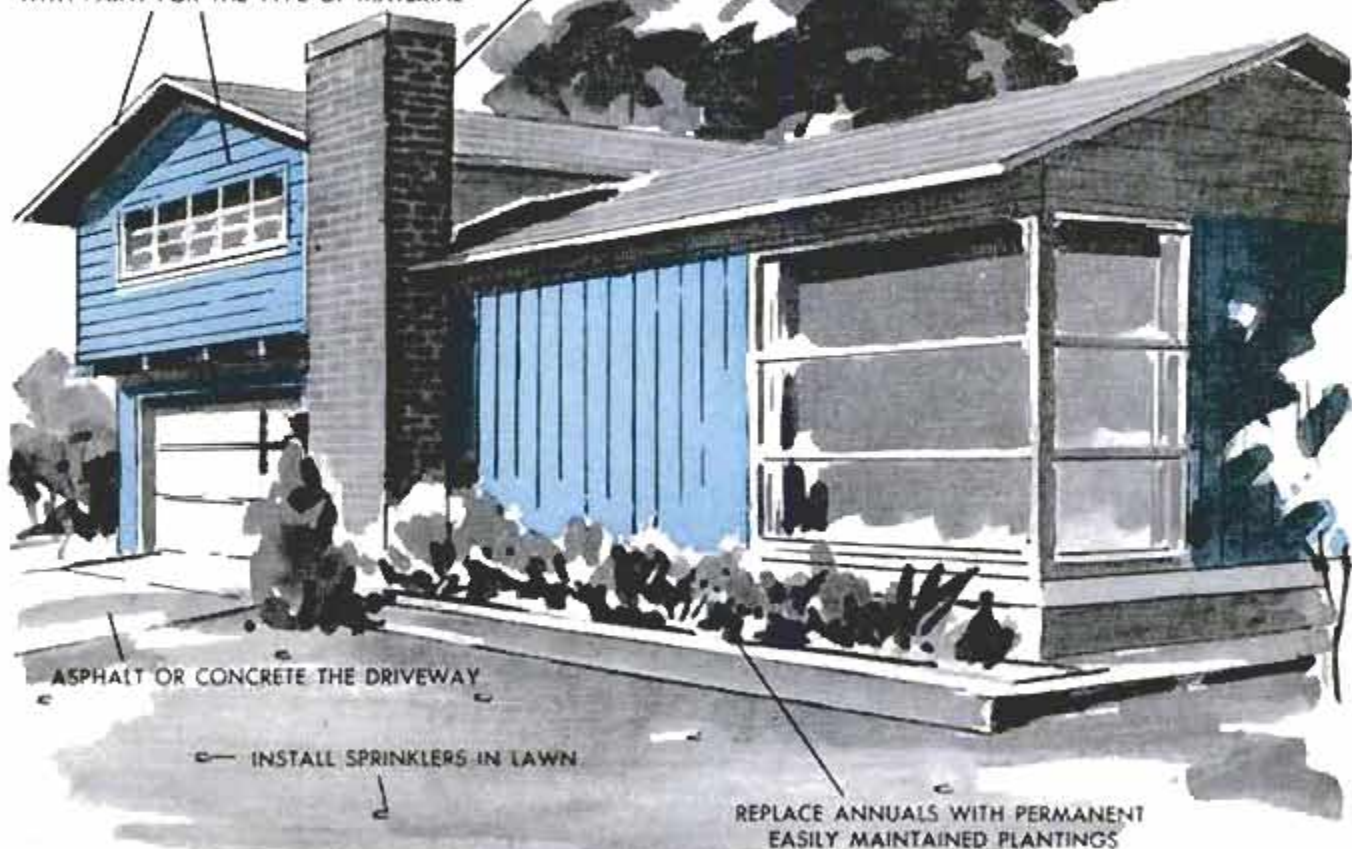

ASPHALT OR CONCRETE THE DRIVEWAY

INSTALL SPRINKLERS IN LAWN

REPLACE ANNUALS WITH PERMANENT EASILY MAINTAINED PLANTINGS



Hadeo Aluminum Products photo

Gas lamps, gaining wide acceptance throughout the country, come in many styles and find a variety of uses. Here an outdoor lamp serves as a light for a front yard. Name plate is conveniently attached to the post. Gas lamps can operate on natural gas, butane or propane

GAS LAMPS-- The Comeback Kids

Adding a modern touch to gas lighting are the futuristic shades atop these lamps. Gas lamps, emitting a moonlike glow of light, provide an attractive lighting system for the outdoor swimming pool

Veeder photo





Hastings-Willinger and Associates photo

ARKLA 7

The traditional look of the gas lamp above produces a pleasing effect in decorating the front yard of this modern ranch home. Photo at right shows another type of lamp that is more conventional in design

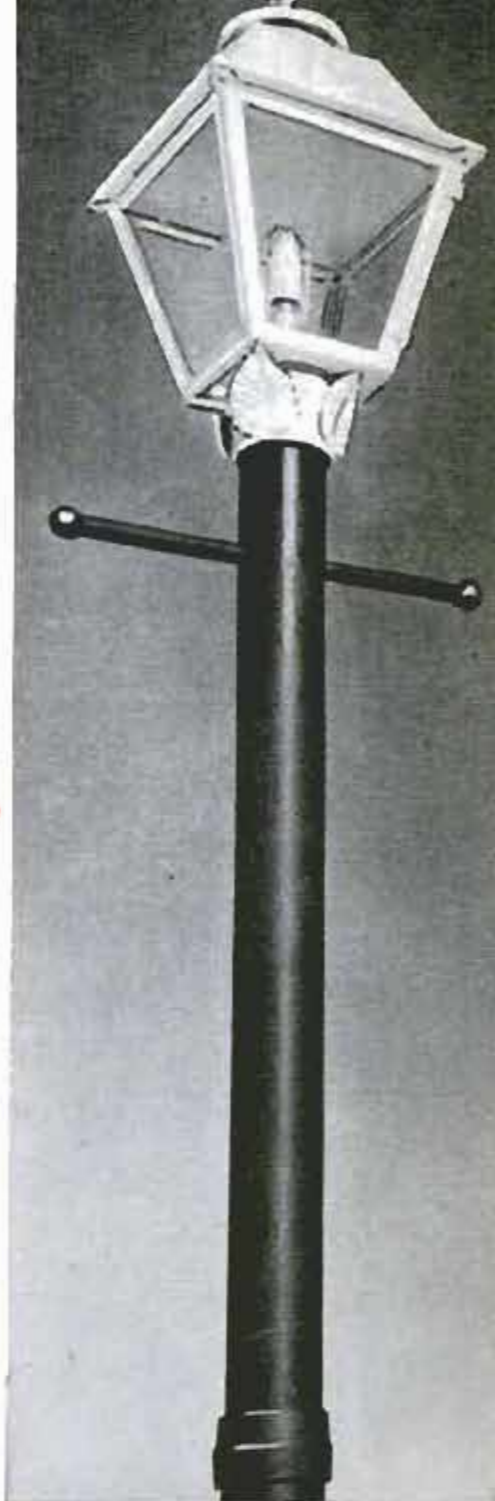

Modern Home Products photo

GAS LAMPS. mementos of the days when grandpa watched his first electric light with awe, once again are brightening parks and patios across the nation. Started as a promotional stunt by the gas industry, gas lighting has become a fad of ever-spreading proportions.

Lighting a suburban area in Albuquerque, N.M., and marking runways at the North Little Rock, Ark., airport are two modern uses for this ancient light. A swank restaurant in Greenwich, Conn., is using nothing but gas lamps for interior and exterior lighting. A 180-home site in North Olmsted, Ohio, has gas-lighted streets.

The fad has spread to residential living, too. Along driveways, in front and back yards, beside patios, gas lamps are emitting a soft glow, inoffensive to neighbors, unappealing to insects, and economical to pocketbooks—and giving homes a traditional look that grandpa thought he'd never see again when he saw his first electric bulb. ★ ★ ★



ELECTRIC HEATING



IS HERE TO STAY

By Richard Dempewolf

A CROSS THE TOP of the country, from Oregon to Maine, a new kind of house has been appearing. From outside, the only tip-off is the fact that it has no chimney. Inside, though, it's a different story. Last Fall, when most of us busily checked the oil supply and wondered if the furnace and burner should be cleaned before the first frigid gales swept the temperature down the chute, the owner of the new chimneyless home just "tuned in" a comfortable climate on a set of wall dials and forgot about it. He did it with about the same ease you'd tune in a station on your radio—adjusting a dial in each room for whatever temperature he wanted to maintain.

Some of the unique heating systems in these houses use electric coils hidden away behind wall panels, strung around the baseboards or buried in the ceiling plaster. Warmth from the coils toasts inhabitants much the same way a slice of bread is warmed in a toaster—except that most of these house-heating coils never get too hot to touch. Other systems involve heat pumps, which operate like your kitchen refrigerator in reverse. In still other houses, big electric furnaces provide central warm-air heat.

Until recently, such glamorous things as radiant, electric glass panels, ceiling coils and heat pumps were considered useful for taking the morning chill off the air in

southern climates. Up North, they were used occasionally as supplemental heat in apartment bathrooms and chilly corners during winter. What's more, if you were like most people, you figured that using electric heat was like owning a yacht—nice if you could afford it.

All this is changing. Electric heating—for any place in the country—is on the way. Last year, in Chicago's suburban St. Charles, a developer named Ray Borovicka built his revolutionary "Skyline Estates"—some 250 houses heated exclusively with electricity. In an area noted for howling blizzards, whistling gales and temperatures that plummet below zero, owners of the new \$15,000 to \$16,000 dwellings have considerable praise for their electric heating systems, which are largely Hotpoint's baseboard resistance units. Typical comment after two rugged winters: "We love it. It's clean, noiseless and warms the house in a hurry. We don't get any hot or cold spots, and there are no drafts. Best of all, each room has its own control. We can keep the living room at 70 degrees and the bath at 80, while the bedrooms stay as cool as we want them—usually 65—for comfortable sleeping."

In New York City, two new apartment developments boast rooms individually heated by some 3000 "radiant" electric glass panels. All across the country—North as

←Electric baseboard heating now can keep a home comfortable even in northern climates. Slots allow air to circulate through heating elements. Below, sketch shows the different types of electric heat for homes

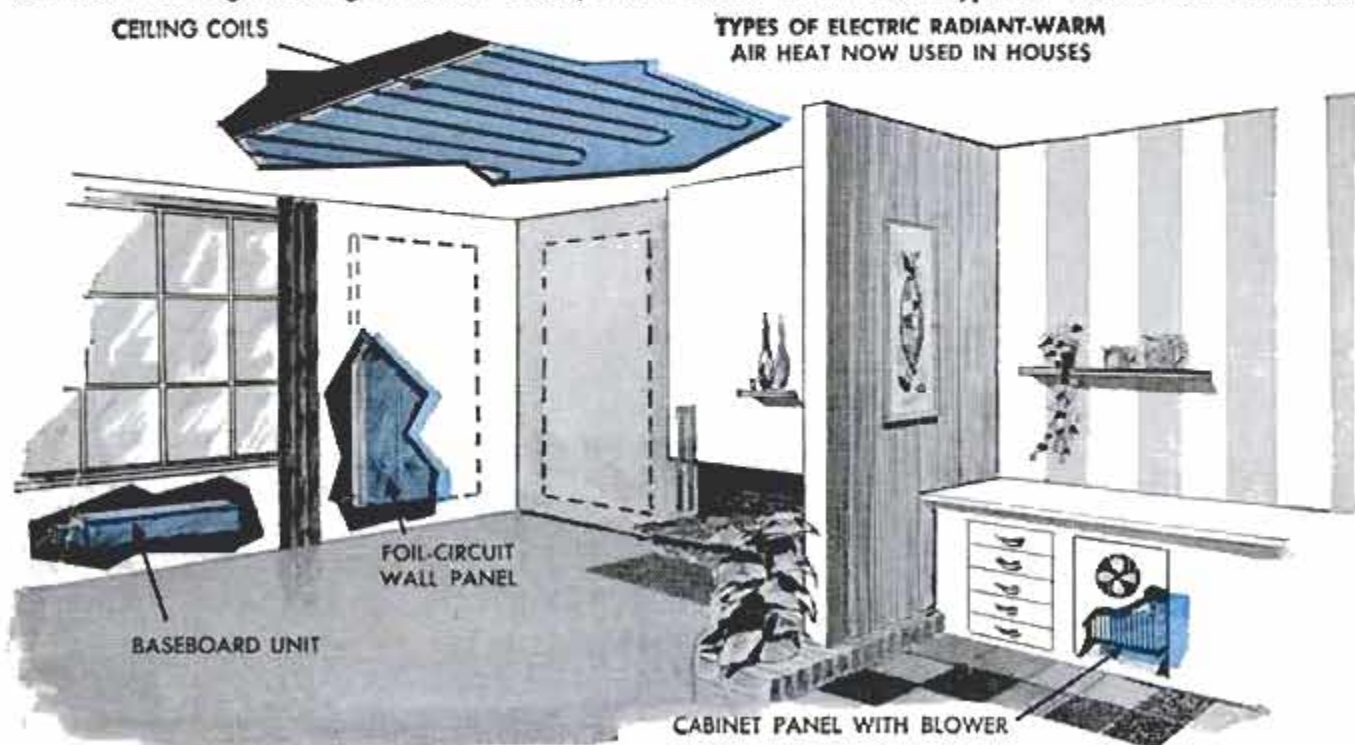

well as South—hotels and motels are installing individual electric units that can be adjusted by the transient tenant to suit his whims, without upsetting the heat balance in any other room. "We eliminated the cost of vents, chimneys and central boiler," says an Ohio motel keeper who installed 1500-watt wall heaters in each of his 20 units. "We have no smoke or fumes, and the furnishings stay cleaner longer. Besides, the customers like it."

Some applications of electric heat are uniquely appropriate. In Cleveland, an outdoor-theater operator installed 500 in-car heaters that keep him in business all winter. And in northern Michigan, eight million crickets are kept vivacious with voltage in a cricket hatchery. The owner, who sells his crop for bait, discovered that nine Electromode, three-kilowatt electric heaters would keep his charges at a chirpy 90 degrees all winter, at a cost only slightly above the previous heating system that had depleted them due to fumes.

Rapid Growth of Electric Heating

Five or six years ago, fewer than 100,000 homes were heated electrically. Today, more than half a million houses are being warmed with it—50,000 of them newcomers this year alone. While that's still a minute fraction of America's 46 million heated homes, C. J. Witting, vice president of Westinghouse's consumer products division, estimates that in 10 years the national figure for electric heat will jump eight times. By 1978, he figures, electrically heated dwellings in this country will number 20,000,000.

Although electric heating comes in a wide variety of units and systems, there are only two basic types: electrical resistance and heat pump. Resistance systems are the simplest in principle. They carry an electric



Washington Water Power Co. photo

Latest thing in electric heating is a paper coated with foil "busses." Entire floor will be a "radiator" current through wires or conductive particles that glow with heat like your toaster. In some cases, the wires are buried in the ceiling plaster, in the walls or concrete floor. This is called electric panel heating. Baseboard electric heaters circle the base of the room just as any baseboard radiator would. There are small units that can be built into a wall or cabinet—some with fans and some without—and portable units that can be carried from room to room and plugged into any outlet. One outfit is making a sandwich wall panel with an alumi-

HOW HEAT PUMP FURNACE WORKS

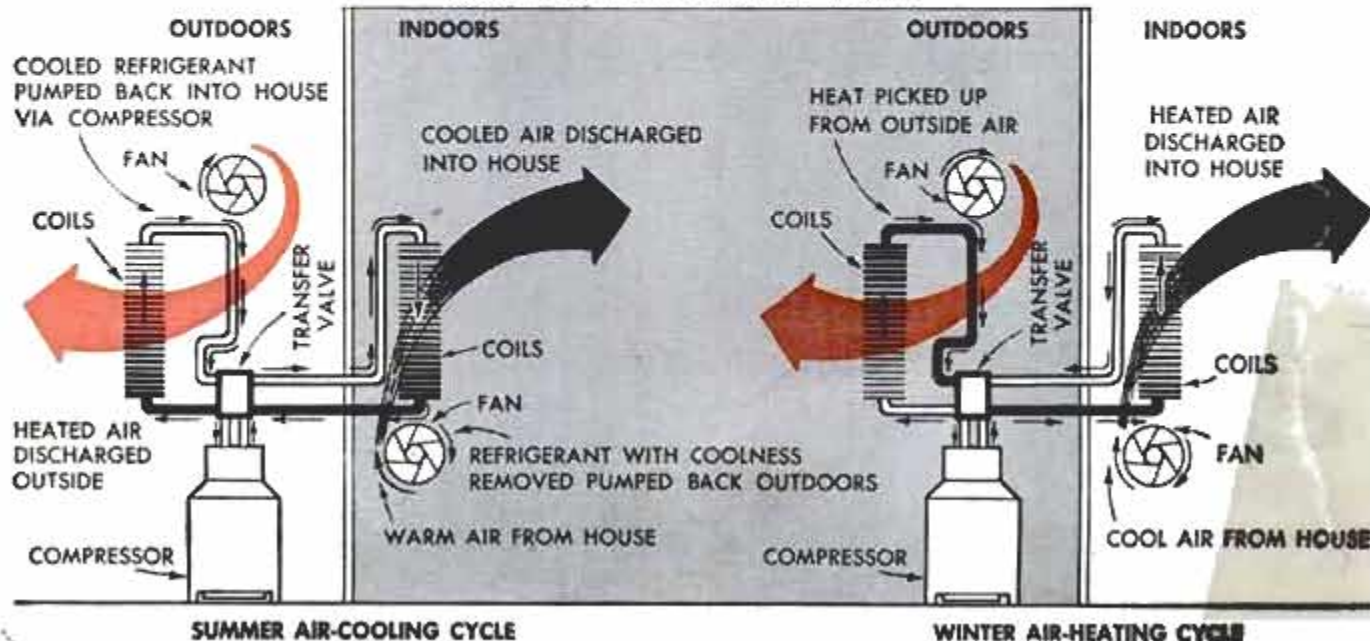

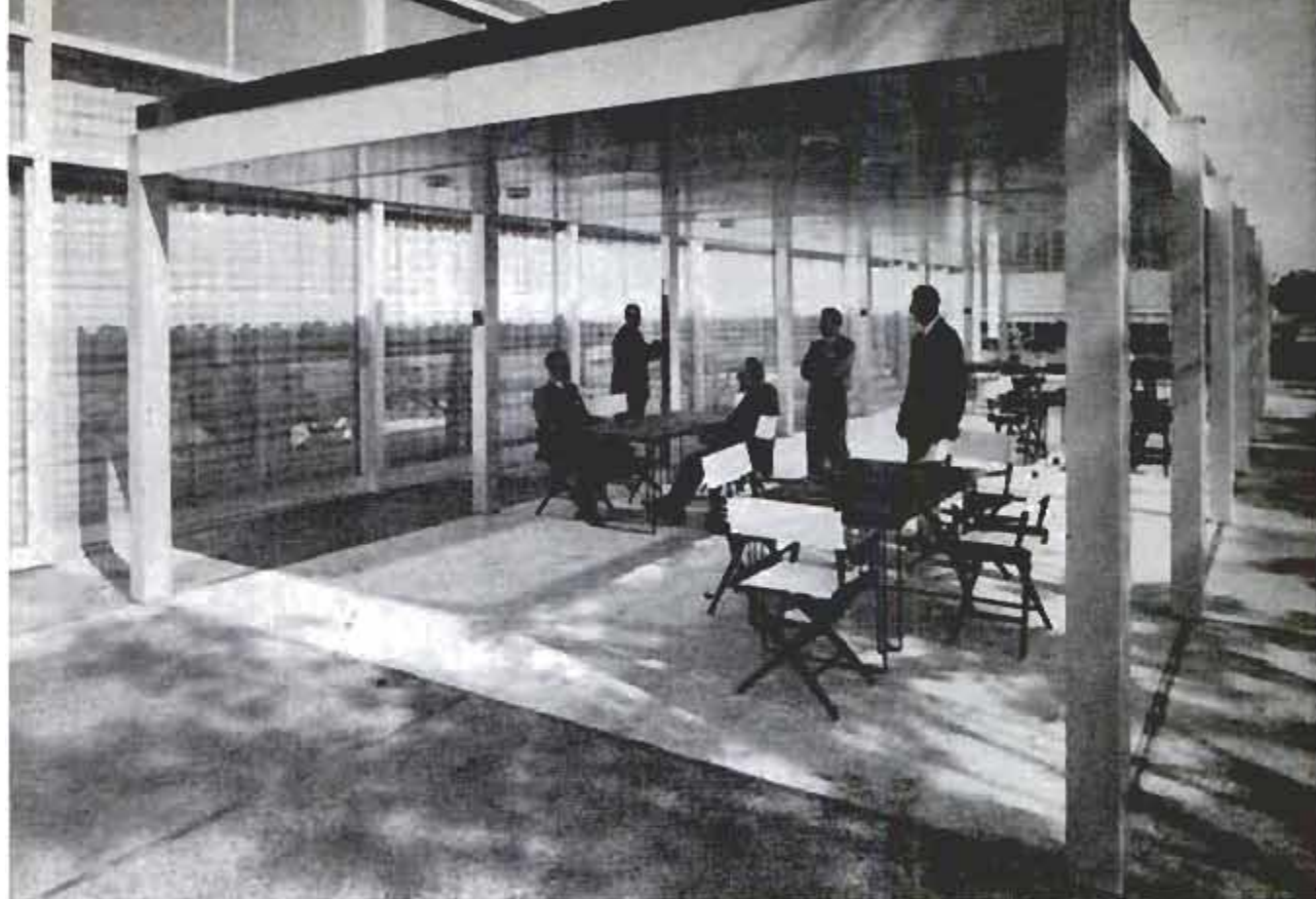

Washington Water Power Co. photo

Pavilion has conductive paper above ceiling and i. floor. It is comfortable even in cool weather

num screen—heating element fused to the inner face. It has a core of paper honeycomb and can be installed in any wall. Another buries its heating grid in a board covered with vinyl plastic for an interior wall finish.

Resistance appears to be the kind of electric heat that is giving birth to the most spectacular developments in electrical home heating. Indeed, resistance units account for an estimated 90 percent of all installations to date. Among the trickiest new wrinkles in the field is an electrically conductive paper, called Cellotherm, developed by Robert Smith-Johannsen of Niskayuna, N. Y. The material, which looks like ordinary building paper, is laminated between microscopic-thin layers of plastic insulation. Copper foil strips along the edges act as busses to carry the current through the sheet. The big rolls of Cellotherm are simply applied to ceilings, walls or floor—beneath the finished surface—just as you would apply a building paper. When tied in to the electrical service and energized, the paper radiates a gentle warmth into the room from its entire surface.



Most expensive electric house-heating system is the heat pump, shown here as installed in fireplace of Florida dwelling. It cools in summer as well as heats in winter. System works much like refrigerator or air-conditioner. In winter, however, cold air is pumped out of house, and heat is discharged into house



In the hidden ceiling-coil system, resistance coils are stapled in place on an unfinished ceiling



Coils are covered with plaster. Radiant heat warms plaster finish and radiates gently throughout room

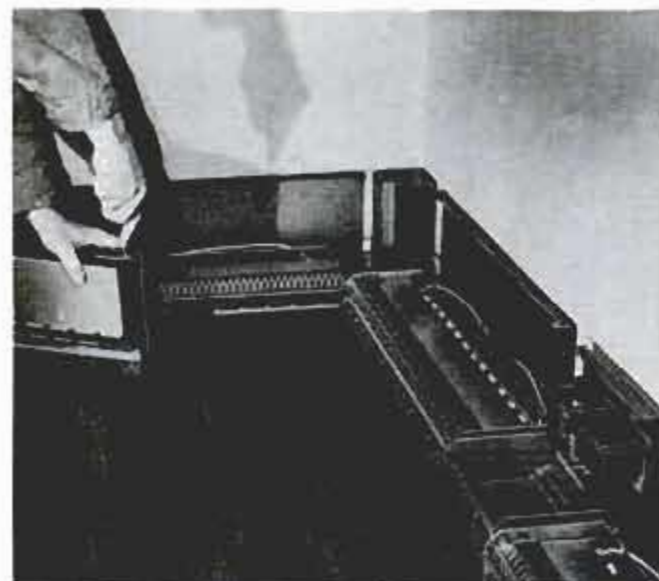

Electric baseboard heating comes in sections to fit any contour. Below, experimental Westinghouse panels not only heat the room but also cool and light it

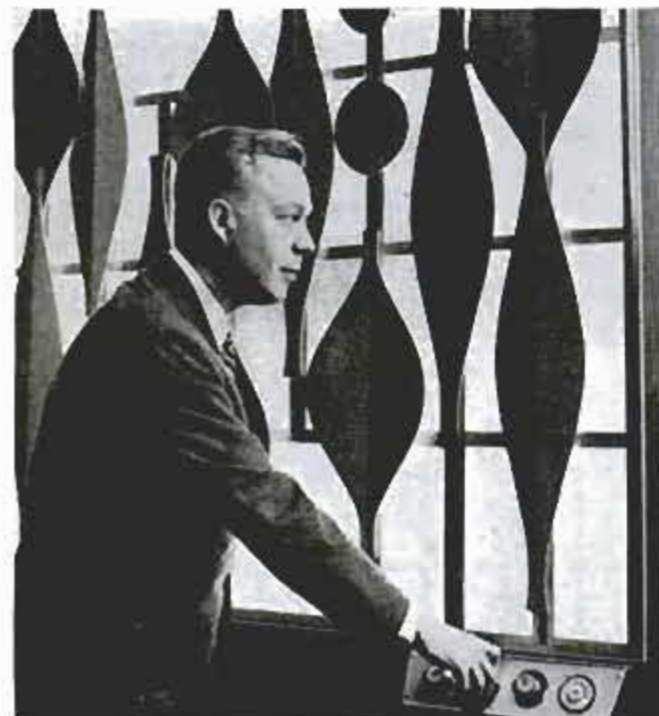

Johannsen, who expects to market his brain child soon, sees a tremendous future for it as a "snow melter" for driveways, airport runways and sidewalks, as well as for food-warming tables, industrial pipes and so on. But used in a living room, on all sides, it will provide a draftless, mysterious heat source as congenial as a summer day. One test installation in the ceiling and floor of an open dining pavilion in Spokane, Wash., enables patrons to eat outdoors comfortably even in winter.

Many panel-type resistance units are commonly called "radiant heaters." They're not, in most cases. Most resistance heaters warm the air in a room by convection, and the warm air, in turn, warms you. True radiant heat is reflected heat that will warm anything solid (including people) that it bounces against, without warming the surrounding air: something like the glare of a flashlight, which lights up objects it hits, but not the night. Under real radiant heat, you could be comfortably warm in a room where the air was near freezing temperature.

One of the many problems with this tricky heating method is that you can't control it with ordinary thermostats, which only work when air temperature changes. But equipment manufacturers are hot on the trail of some combination radiant-convective heaters for tomorrow's "all electric" house. Several outfits already produce panel units in a large assortment of sizes. They look like nothing more than plate glass in a metal frame. These heaters are actually tempered glass backed by a thin, electrically conductive coating. Thin, silver-foil strips on each side of the panel carry the current, and the entire glass sheet becomes

(Continued to page 288)

HOW MUCH CAN YOU AFFORD TO PAY?



BIGGEST QUESTION confronting the house hunter is "How much can I afford to pay each month on a mortgage?"

To help the prospective buyer, *Popular Mechanics* presents a chart that relates monthly housing expense to monthly take-home pay. Prepared by the Federal Housing Administration, this chart is based on the FHA's nationwide figures from 1955 through 1957. It should be understood that this chart is not the final criterion in judging a mortgagor's ability to pay. It is only a guide. The FHA has found that rules of thumb, such as 25 percent for housing expense or 2½ times income as a safe purchase price, are unreliable.

To use the chart, first find the heavy black median line. This represents the median housing expense for borrowers at each income level. Let's say your monthly take-home pay (after income-tax deduction) is \$650. Checking the chart, you'll find that the median for borrowers with that amount of income is about \$122, which means that this is about how much you can afford to pay per month for housing.

The chart also shows how housing expense for any one income group varies

above or below the median. For example, 25 percent of the borrowers with take-home pay of \$500 a month, who finance their homes with insured mortgages, assume monthly housing expenses ranging from \$108 to slightly less than \$120.

FHA techniques for analyzing mortgage risks, developed over 25 years, are based on three estimates: 1. the prospective mortgagor's dependable, continuing income; 2. the cost of occupying the property; and 3. all debts, living costs and other financial demands.

In estimating the cost of occupying a property ("what you can probably pay per month" in the chart below), home buyers sometimes make the mistake of thinking only in terms of mortgage payments and taxes. Actually the cost of home ownership and occupancy generally involves, in addition to these, the mortgage-insurance premium, hazard-insurance premium, maintenance and repairs, and utilities.

It is important that the estimate of prospective housing expense be compared with the housing expense that the borrower is accustomed to paying.

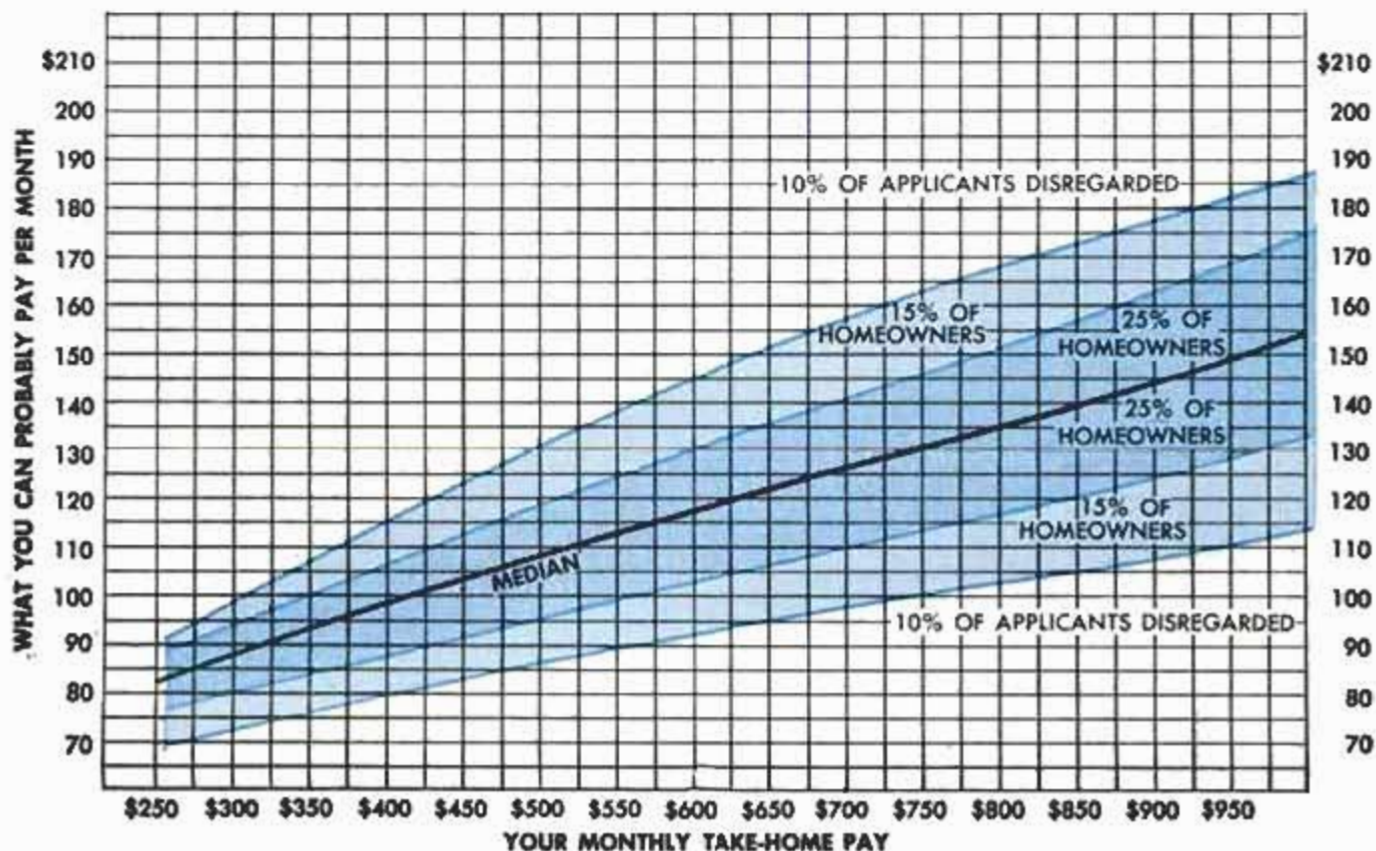

HOW TO GET YOUR HOUSE



CLEAN OUT ATTIC, BASEMENT, GARAGE



CLEAN UP THE FURNACE



KEEP YARD IN TOP SHAPE



PAINT FRONT DOOR AND SHUTTERS

EACH YEAR millions of Americans play a gigantic game of musical chairs. Last year, for example, a restless 33 million citizens packed up their belongings and moved to a new home, leaving their old abode as a "new home" for others.

Perhaps you are perfectly happy in your present home; you may plan to stay there the rest of your life. This may well happen, but the odds are against it. Figures show that the "average" family—if there is such a thing—moves once every five to six years.

Even though you have no intention of selling your house at the moment, the information on these two pages may be useful in the future. These tips on selling your home come from real-estate brokers—professionals in the business of getting prospects to sign on the dotted line.

These experts say the first thing to do is take an hour's time to tour your home as a stranger. Drive down the street as though you were a prospective buyer. What is your first impression? Does the house look attractive and homey? Now walk through every room, analyzing all the home's good points and bad. List the assets—you know them better than anyone else—for the realtor. On another sheet list the liabilities, along with any good arguments he can use to overcome these drawbacks.

It doesn't usually pay to make major and expensive alterations to a house in order to sell it. Usually such alterations will not increase the selling price proportionately.

Inside the house, the most important thing to do is to *emphasize spaciousness throughout*. A buyer likes to think he is getting a lot of house for the money. You can increase the *feeling* of spaciousness in a good many ways. Clean out the attic, basement and garage, disposing of everything you don't intend to move with you and packing everything you won't need until you're settled in your new home.

Remove out-of-season clothing from the closets and pack or store it elsewhere. Uncrowded closets can convert a looker into a buyer. Remove all other out-of-season items from the house and yard, such as boating equipment and garden furniture in wintertime, skis and duck decoys in the summer.

Have a talk with the kids, if they're old enough to understand what's going on. If possible, find them a parking place for their bicycles outside of the garage, and insist that they keep their toys in their rooms whenever

IN SHAPE TO SELL



the house is being shown. Toys can give an appealing touch to a child's room, but the same toys underfoot can make the house seem crowded.

If your basement is dark and gloomy, make it seem larger by renting a sprayer and spraying the ceilings and walls a light color. Use a water-mixed vinyl or similar paint to get a good one-coat finish.

Suggest easy family living inside the house. If you have a fireplace, clean it out and lay some logs. To the buyer the sight will inspire a mental picture of a pleasant evening in front of the fire.

The most important room in the house is the kitchen, from the standpoint of selling. Glamorize it in any way you can. Give cabinets a new coat of paint. It may pay you to replace worn countertops.

Repair the little things that the buyer is sure to notice. A loose porch step or a leaky faucet can profoundly affect the buyer's attitude, whether he knows it or not. Also, clean the furnace. For some obscure reason, men always look at the furnace of a home in the same way they kick the tires of an automobile.

When you show the house, have the windows sparkling clean and the drapes and shades open. This will make the rooms seem larger.

Outside the house, *suggest pleasant living, not work*. A lawn that needs mowing or a sidewalk that needs shoveling suggests hard work. Hire such work done if you must vacate the house before selling. If planting beds are overgrown and ragged, trim them back.

Repainting the exterior is debatable, but one thing you can do is repaint the exterior doors, particularly the front door. It welcomes any visitor, including the buyer. Make it an appealing welcome.

Federal tax laws allow you to deduct all fix-up costs made within 90 days before selling your home. Keep receipts and a record of all such expenses.

Last but not least, if you turn the home over to a realtor, *let him show it without interference*. Selling is his business. He's much more likely to make a sale if you let him handle prospects himself. ★★★



REDECORATE KITCHEN



SPRAY-PAINT BASEMENT



LET REALTOR SHOW HOUSE

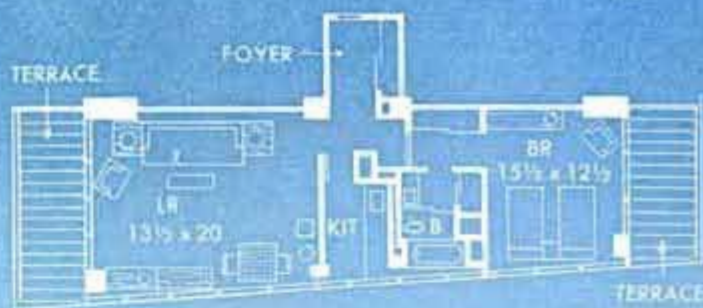
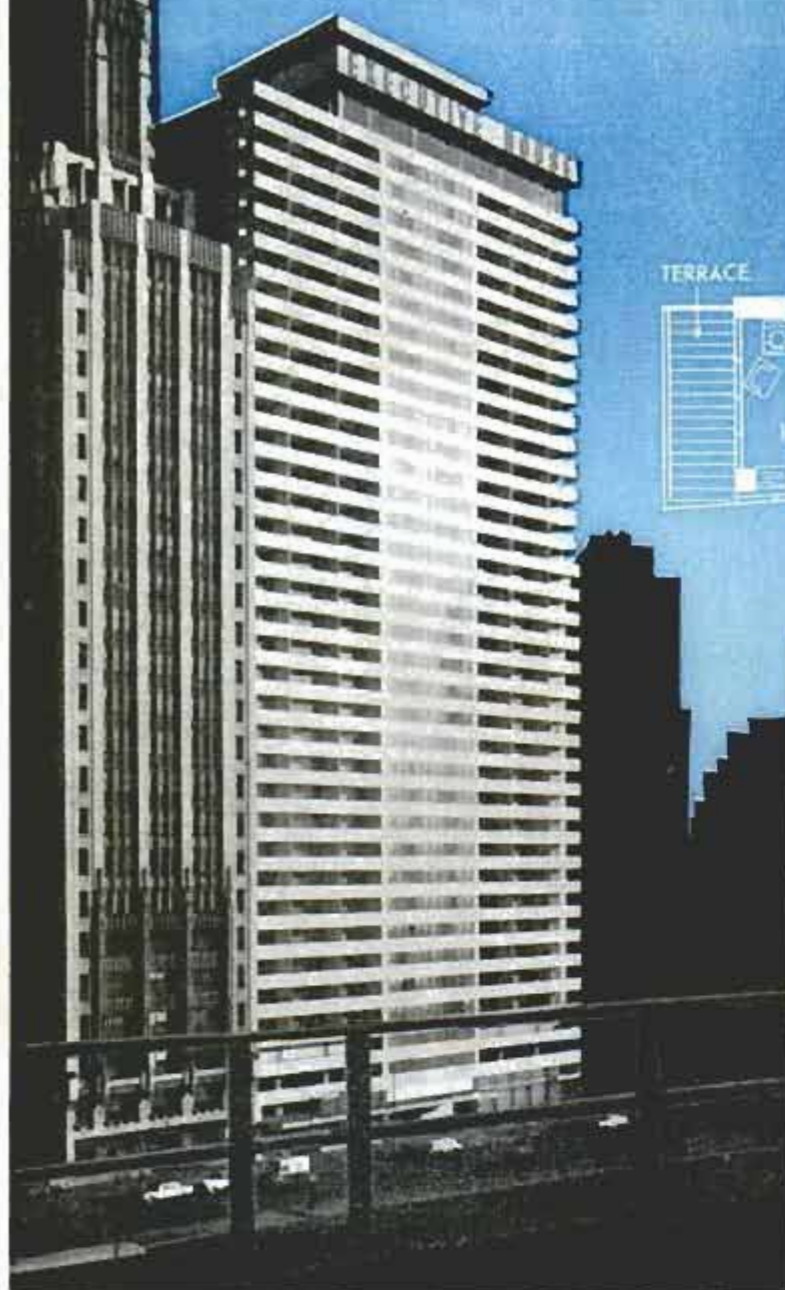

New Concepts in Hotel Living . . .

RISING 40 STORIES above Chicago's Wacker Drive, the Executive House offers a new idea in hotel service with 448 suites and rooms for ultra-comfortable living and business entertaining on a daily or long-term basis. Designed by architect Milton M. Schwartz, the stainless-steel-clad skyscraper features accommodations from single studios to suites (plan above). There are kitchenettes in all units, 6 by 20-foot balconies in most. On top is a night club and restaurant, at ground level a 200-car garage.

Winner of a Merit Award from the American Institute of Architects, the Executive House reflects the trend of combining home and business functions under one roof.

Bill Engdahl, Hedrich-Blessing photos

Chicago's Executive House combines downtown-hotel convenience with apartment comforts. Living rooms, below, are designed to double for business entertaining; kitchen, bar and bedroom make the suite (floor plan above) a complete living unit or a self-contained "branch office" during conventions or shows





And New Efficiency From an Old Idea

CLASSIC ROW-HOUSE construction has long been a European favorite, is being widely used by American architects for areas where maximum families-per-acre coverage is necessary without resorting to towering "highrise" apartments. In the Drexel House and Gardens Project in Chicago, architect Bertrand Goldberg simplified design and construction and built 64 three-bedroom units which sold for a low \$12,900.

Despite the high land usage in this development, the use of interior courts and grille-walled patios provides a private outdoor area for each unit. Projecting roof and side walls add to the privacy as well as contributing to the striking over-all design. The development has won several awards and is being held up as an excellent example for future urban redevelopment or for suburban development in areas where a space problem exists.

Construction is almost entirely of concrete blocks and reinforced-concrete roofs and floors. Even the gridded privacy screens are side-laid concrete blocks.

Walled patios, projecting roof and walls give rowhouse units privacy. Through-wall concrete masonry (right) cuts costs, adds permanence. Units are compact, but there's plenty of room inside (see plan)



MORE APARTMENTS...



Split-level units in Loma Palisades project are clustered around landscaped courts; \$13,000,000 co-op was designed specifically for permanent tenants with children, features 25 pools, 10 fenced playgrounds



Interior of Loma Palisades apartment looks out over attractive patio; San Diego climate permits outdoor living year 'round. Santa Monica Biltmore, below, is built around a big swimming pool and patio that are the focal point for all apartments



EVEN IN Southern California, where they think in terms of open spaces rather than in terms of crowded urban areas, multiple-unit construction is increasing as land costs rise. One of the trend-setters in the West is the Los Angeles firm of Palmer & Krisel, which designed the Loma Palisades, a 1062-unit co-op project in San Diego.

Designed for Family Living

To attract permanent tenants with families, Palmer & Krisel built in maximum space and privacy, with split-level units in clusters of eight and twelve. Each unit has a patio or balcony and built-in appliances, and the project has 25 swimming pools and 10 fenced playgrounds—features that would be expensive extras to the private homeowner.

Another of the firm's projects reflects an opposite trend, this one in urban living. The Santa Monica Biltmore is an 80-unit building that was conceived as an apartment hotel, but was changed to an apartment building with a patio and pool in which units are leased to adults only.

The apartment architect today must be more than a designer of sectioned structures—he must provide adequate space with storage, built-ins, parking and outdoor-living areas to compete with home builders, and must provide all those features within the rigid budget set by the rental standards that will control future income.

PARADE OF HOMES

Outstanding homes from across the country, selected for their excellent design, livability and reasonable price



WHERE LAND for building is at a premium, the measure of a good architect can be his ability to design for problem lots. Here's an excellent design by Tacoma architect Marshall Perrow, built on a slope overlooking Puget Sound. A "two stage" house built for \$24,000, it's planned with the living area on the upper floor; the space below can be finished later if it's needed. Decks and sunshades provide plenty of outdoor-living space

VIEW FROM THE STREET belies the living space inside; the 1800-square-foot main floor has a bath and a half and three bedrooms; 800 square feet of deck. The lower floor has equal space and can be finished into two more bedrooms and a bath, but serves as a playroom and utility area until it's needed. Construction is wood frame with grooved fir plywood siding which is carried through the entryway and repeated in interior paneling. An interesting economy note is that the builder used $\frac{3}{4}$ -inch plywood for concrete forms, then reused the plywood for subflooring



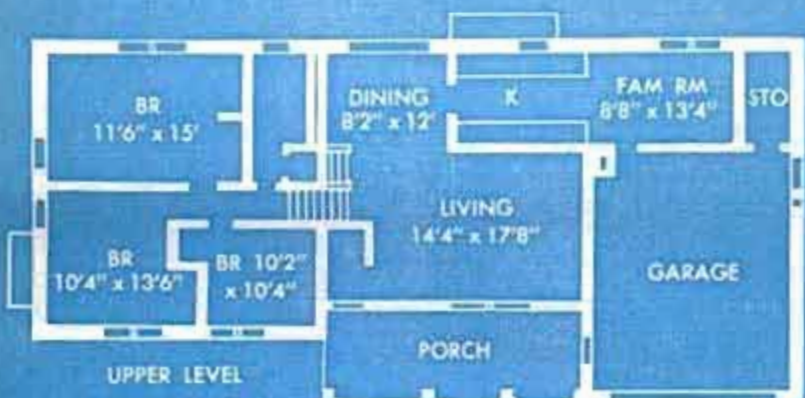
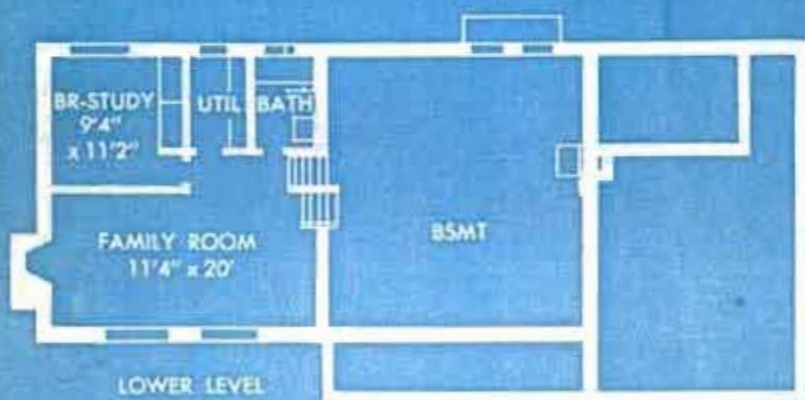

A LEADING MIDWESTERN builder, Gerholtz Community Homes of Flint, Mich., developed this popular side-to-side split-level home with architect Irving E. Palmquist and designer Richard B. Pollman. Called the Rockcreek Executive, the home has two full baths, four bedrooms, a two-car garage and a large patio, and is being built in several variations to sell from \$21,950 up. The price includes a long list of unusual extras — complete comfort conditioning; double-glazed windows, all appliances, carpeting and drapes; and complete sodding and landscaping. There are 1860 square feet of living area, excluding the basement and garage. The two variations shown above demonstrate how the trim—shutters, porch posts and other small but important touches—can add a traditional look to a good contemporary plan



LARGER and more costly than the other homes on these pages, the Tom Seidel home in Los Angeles presented such a good example of contemporary California architecture that we've included it. The Los Angeles architects, Holmes and Sellery, placed the master bedroom and parents' area into a second-floor "ivory tower," away from the other activities in the home, which are at ground level. The use of balconies, terrace and pool provide ideal outdoor living possibilities; deck serves as shelter for terrace. Construction is concrete block, redwood trim

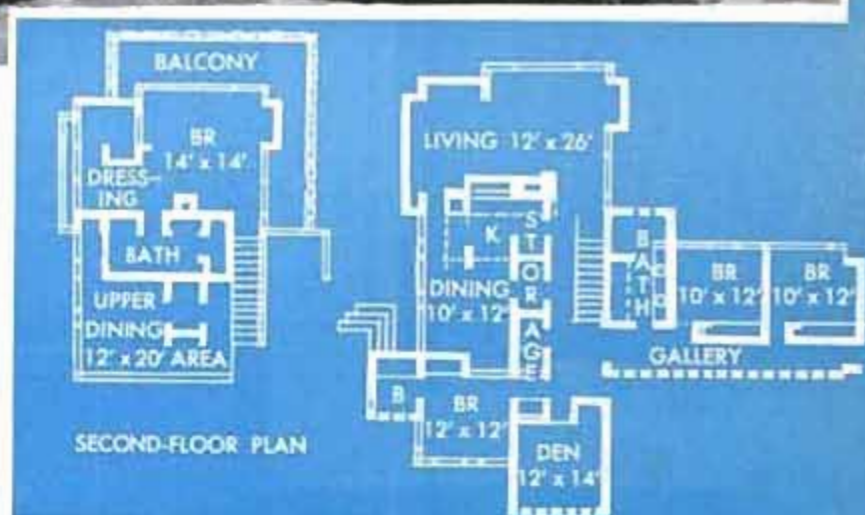

ANOTHER builder's house, this time from the South, is the "Accent" house built by Fox & Jacobs Construction Company, Dallas, Tex. All masonry, the home covers 1375 square feet of living area plus 454 square feet of garage and storage, and sells for \$15,300 with year-round air conditioning, carpeting, dishwasher, garbage disposer, built-in range, oven, hood and several other extras. The Accent home proved popular with Texans — a 500-unit section sold out completely in less than three weeks

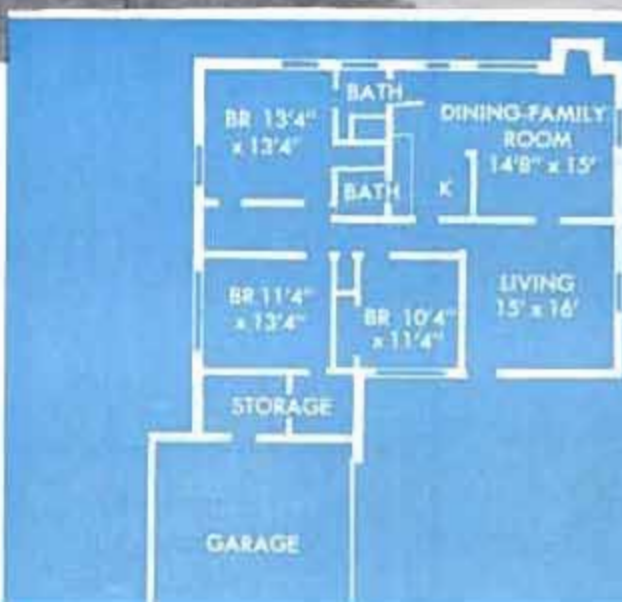



DESIGNED FOR FLORIDA, but a good house in any state, the Century was developed by Cross and Wilkinson of Bradentown, Fla., for Designer Builders' Bayshore Gardens development in Sarasota. This compact home has three bedrooms in its 940 square feet of living space, which is supplemented by 442 square feet of carport, storage and screened patio. It sold for \$11,950 in a planned community with a boat basin, beaches and many recreational facilities usually associated with resorts. The construction is mostly concrete masonry — blocks on three sides, concrete brick and plywood siding on front elevation



"SOUTHWEST TRADITIONAL" is the best term to describe the home of Mr. and Mrs. Harry Hilson in Tucson, Ariz. Designed by architect Charles E. Cox, the home features three bedrooms and two full baths in its 1550 square feet, and cost approximately \$16,000. Construction is 4 by 8 by 16-inch concrete blocks with "weeping" mortar joints, which soften the large masonry areas and blend very well with the textures of redwood siding, shake-shingled roof

ANOTHER houserol of ideas is the Richard Cornelle home in San Mateo, Calif., by architects Anshen & Allen. Base of the U-shaped plan is formed by a big all-purpose room which combines open kitchen, dining area, living room and family room, with access to terraces on each side. Between the arms of the U is a skylighted court, screened from the adjacent carport

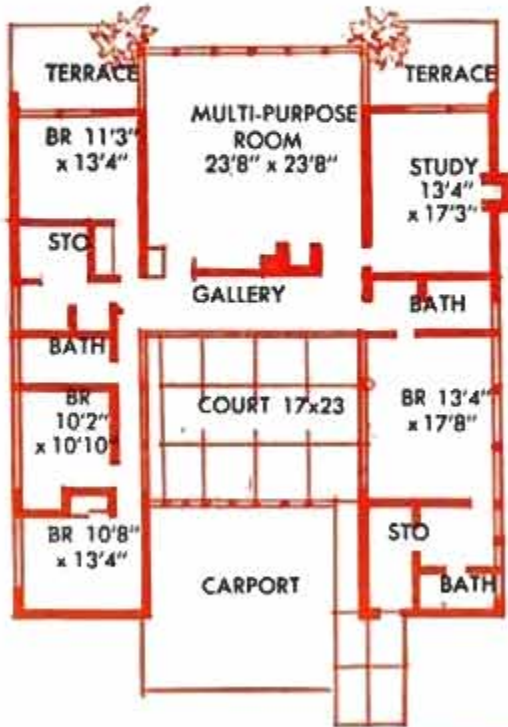

UNUSUAL front-to-rear split level, designed by Rudolph A. Matern & Associates, was built in Riverton, N. J., by Strausman Construction Company. Its 1200 square feet, excluding the full basement under the living level, includes three bedrooms and a bath and a half. The price, including landscaping, built-in range and oven and other extras but excluding the land, was \$14,490; construction is wood frame with brick veneer, asbestos shingle, siding

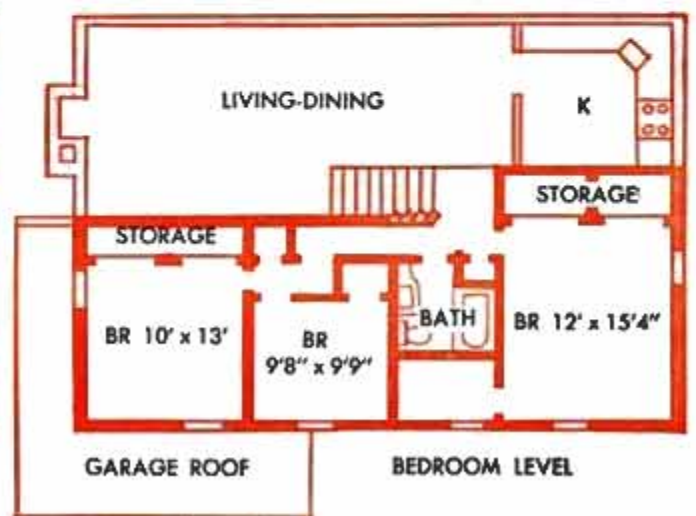



LEATHER TILES for floors or walls are installed like any other tiles. Surfaced with durable, slip-proof lacquer, pigskin tiles come in $4\frac{1}{2}$ by $4\frac{1}{2}$ or $4\frac{1}{2}$ by 9-inch sizes either with straight or with beveled edges



"FLAT LIGHT BULBS," soon in production, will have many uses in architectural lighting. The inch-thick fluorescent glass plates produce a diffused light with almost no heat. They draw very little power

IDEAS FOR HOME

TRANSLUCENT CURTAIN-WALL PANELS of reinforced plastic and aluminum come prefabricated and fit quickly into floor and ceiling tracks. Doors, windows and color patterns can be built in to suit individual plan



BUILT-IN VACUUM SYSTEM for homes makes cleaning quick, quiet and dustless. Heavy-duty unit is installed in the basement; vacuum is "piped" to rooms. Lightweight hose plugs into convenient wall sockets



POWERED-STORAGE CABINETS slide up and down as needed, disappear when not in use. Operated by a silent electric-drive unit, they allow maximum storage in kitchens without wall space; on the market by 1960



PLANNERS



SLIDING MIRROR DOORS can be installed in bypass, pocket or face-track mountings. They are available in door sizes or floor-to-ceiling size, and can be mirrored on both sides for between-room installations



Request Jan 1960

After checking patio wall with his pocket rule, building inspector explains to owner that wall must be lowered. It is a foot higher than legal limit allows, and it shields next-door neighbor's back yard



By Richard T. Morris

CHIEF BUILDING INSPECTOR,
CITY OF LOS ANGELES

as told to James Joseph

GET IN STEP WITH YOUR BUILDING CODE

In erecting roof and wall, homeowner unwittingly built a "room." This violates window minima in rooms off patio



Here, inspector discovers that center beam is unsupported. Two boards are hanging in midair





In yard above, the cabana wall is too high. Usually, back-yard walls may be no more than six feet in height. Furthermore, cabana is built too close to property line. This violates building code's side-yard law

HOME CRAFTSMEN by the thousands—perhaps you among them—are right now pouring countless dollars and as many hours into home-improvement projects doomed to destruction.

Typical is the Illinois homeowner who labored a month of Sundays erecting a six-foot wall around his front yard. When irate neighbors complained, harried building inspectors had no choice but to ask him to lop off 18 decorative inches—to bring his craftsmanship within the 42-inch legal limit. He'd have conserved both muscle and money had he checked *first* with his local building office.

In New York, a homeowner converted his garage to a maid's quarters and ran afoul of a law common to most towns and cities. Unwittingly, he'd created a multiple dwelling in a neighborhood zoned for single-family homes. He was ordered to return the building to "original condition"—a garage. A moment's inquiry would have put his project in line with the building codes and saved him \$3000.

More costly was the conduit-caused fire in Maryland which gutted a \$30,000 home. Insurance sleuths voided the owner's policy—as they could by terms of its small print—when they discovered he'd installed the wiring without benefit of an electrical inspection. For \$3—the price of a permit—he could literally have saved his house.

In California, a couple invested three

This vent for gas furnace was installed too close to valley flashing. Rainwater coursing along flashing might seep into vent and douse flame in furnace



You'll probably need a building permit if:

1. Your home addition is valued over \$100 (figuring your labor at going local rates).
2. The addition changes your home's use or "occupancy," say from a single to multiple-family dwelling.
3. You add a garage or convert the one you have to another use.
4. You wall in, roof or attach a patio to your house.
5. The pool you're building is deeper than 24 inches.
6. You build a retaining wall over four feet high.
7. You plan to install plumbing or electricity, either inside or outside your home.
8. Your barbecue's chimney is more than six feet high.
9. You drill a well or put in a lawn-sprinkler system.
10. You build a carport.
11. Your radio or TV antenna, tower or flagpole exceeds 45 feet in height.
12. The garden house you plan (lath house or pergola) has a floor area greater than 400 square feet.
13. Awnings or canopies extend 12 feet or more from your home's exterior walls.
14. You plan to install or alter street curbs or sidewalks.

weeks and \$900 in a home-crafted room addition. Scarcely had they applied the last coat of paint than they received orders to demolish it. The new room, though expertly built, pre-empted the space which by law must be left between neighboring dwellings.

"Building codes?" shrugged the unhappy homeowners. "Why, we thought they applied only to contractors."

On the contrary, there's hardly a home project which isn't ruled, one way or another, by local building codes. True, you may not always need a *building permit*. But you always need to know the law—the *building code*.

What's more, if yours is among the 850 cities in 42 states operating under the "Uniform Building Code" (or the 150 southern municipalities using the "Southern Standard Code"), you'll likely need a permit *before* beginning any project which (1) changes the use or "occupancy" of your home; (2) costs more than about \$100, figuring your own labor at local rates (some cities tab costs on the basis of \$10 a square foot); (3) involves electricity or plumbing.

Free Information

Regardless of the project, it's a safe bet that before you pick up trowel or hammer you should pick up the phone and dial your local building office. Moreover, building inspectors have at finger tip a whole

glossary of how-to-build-it information that's yours, free for the asking.

Maybe you're wondering whether the rafters of that detached garage you're planning should be two by fours or two by sixes. The building inspector knows, and advises you to buy two by sixes because he knows your local code.

What's the concrete formula for post-supporting piers under that patio roof you hanker to build? Within seconds the inspector's back on the phone with the answer: "One part cement, three parts sand, four parts gravel."

Or perhaps it's a retaining wall you're planning. The building office will give you the rough specifications, may even send an inspector out to the house to size up your problem. You pay nothing for do-it-yourself information, and but a modest fee for plan checking and building permits, if they're required.

How modest? Well, many building offices charge as little as \$3 to check over plans for projects valued at \$1000 and more. Once plans are approved, you pay another \$5 to \$6 for a permit, which gives you the green light to unlimber shovel and saw.

You've spent but \$8 or \$9, yet bought a bargain: the round-the-clock services of your building department.

As your project progresses, an inspector will check it over. He may suggest money-saving changes and labor short cuts. To-



Inspector notes cold joint in concrete foundation. Fault occurs when too much time elapses between pours

gether, you and the inspector will see the job through. Nor will you be asked to pay a cent more for all these services which, if you contracted them out, would likely run \$10 to \$15 per hour. Your original fee—\$8 to \$9 for the average home project—covers the works, and as many on-the-spot visits as you need to finish the job.

Unhappily, many home craftsmen who could most benefit from the inspector's years of do-it-yourself know-how neglect to ask his advice before taking tools in hand.

Recently, for example, I surveyed a residential tract whose \$15,000 to \$20,000 homes had been built within the past two years. Their owners, with incomes in the \$6000 to \$10,000 bracket, had money to spend—and they'd spent it putting up patios, fences and new room additions. Not one had bothered to apply for a building permit. Nor, for that matter, for construction advice. Small wonder that fully 11 percent of the home projects violated building codes, violated them enough to warrant citations.

One homeowner had installed a dozen light switches, every one of them illegal under the local code (they'd been ruled "not acceptable" by the fire marshal who blamed them for scores of fires).

Another had built a retaining wall with

insufficient reinforcement to hold back a hill which threatened, even as I looked over the job, to bury his house.

Still another had crafted a barbecue in his front yard, a site illegal under most zoning regulations.

(Continued to page 273)

Looking out for homeowner's interests, inspector makes sure contractor understands window minima





Good landscaping is as tidily decorative with its basic evergreens under snow as it is in summer when flowering shrubs bloom (opposite page)

THE TEST OF GOOD LANDSCAPING THAT YEAR-ROUND EFFECT

By **Harold O. Klopp**
LANDSCAPE ARCHITECT

TOO BAD you can't see the place in another six weeks, when the 'mums are in bloom."

"Sorry the yard's such a mess—you should have seen it last month when the spring bulbs were at their peak."

If you're an apologetic gardener who constantly hears himself making remarks like these in spite of the fact that you work like a demon with hose, fertilizer, trowel and seed catalogue, you have lots of company. Chances are you're the victim of an easily remedied deficiency suffered by all but the professionals and a relatively few

knowledgeable amateur gardeners: There's something basically wrong with your landscaping.

The traditional "flower garden," grown in precision-edged patches cut out of the lawn and banked with assorted annuals so everyone can see the display of color each summer, presents one of the toughest maintenance jobs possible. What's worse, the carefully cultured blooms are gone in a few months. During the remainder of the year the "garden" is a patch of scraggly brown stems intermingled with a spattering of struggling green plants, unreachable



Landscaped by the author, the home of John Hedberg in Arlington, Ill. (above), reveals a summer dress of low foundation plantings with a few tall shrubs for accent. Sweeping pavements and broad, curving beds make for eye appeal and easy care. Ground cover borders beds for horizontal balance. Below, spring blossoms in an Elgin, Ill., year-round garden (snowed in at left) provide a riot of color against evergreen shrubs



MID-SOUTH



Year-round beauty, requiring little care, can be achieved in any climate by careful planning and by using trees, shrubs and hardy year-round flowering plants. In the mid-South garden above, azaleas blaze against a pattern of dogwood and redbud trees. The Southwest garden, below, features a spectacular array of blooming cactus, providing an intriguing texture even during nonblooming periods

SOUTHWEST

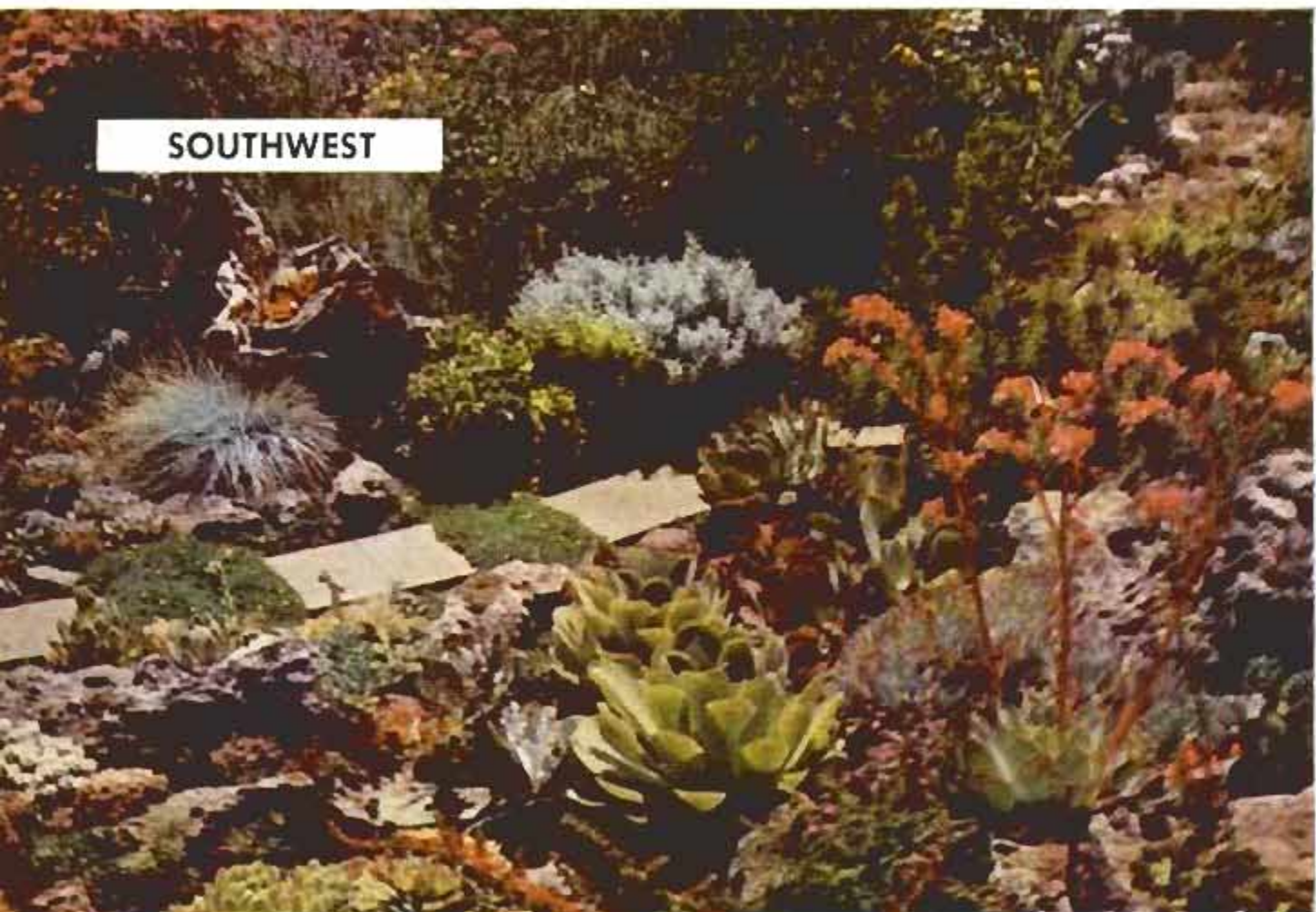

NEW ENGLAND



Red and gold sugar maples are at their flamboyant best during New England fall (above), but their decorative beauty in spring and summer, shading the lawns, is matched in winter when black branches make patterns on the snow. Simple evergreens planted near houses relieve austerity of these yards in winter. Below, the profusion of color surrounding a West Coast home all year is achieved with geraniums, Scotch broom, white roses

WEST COAST

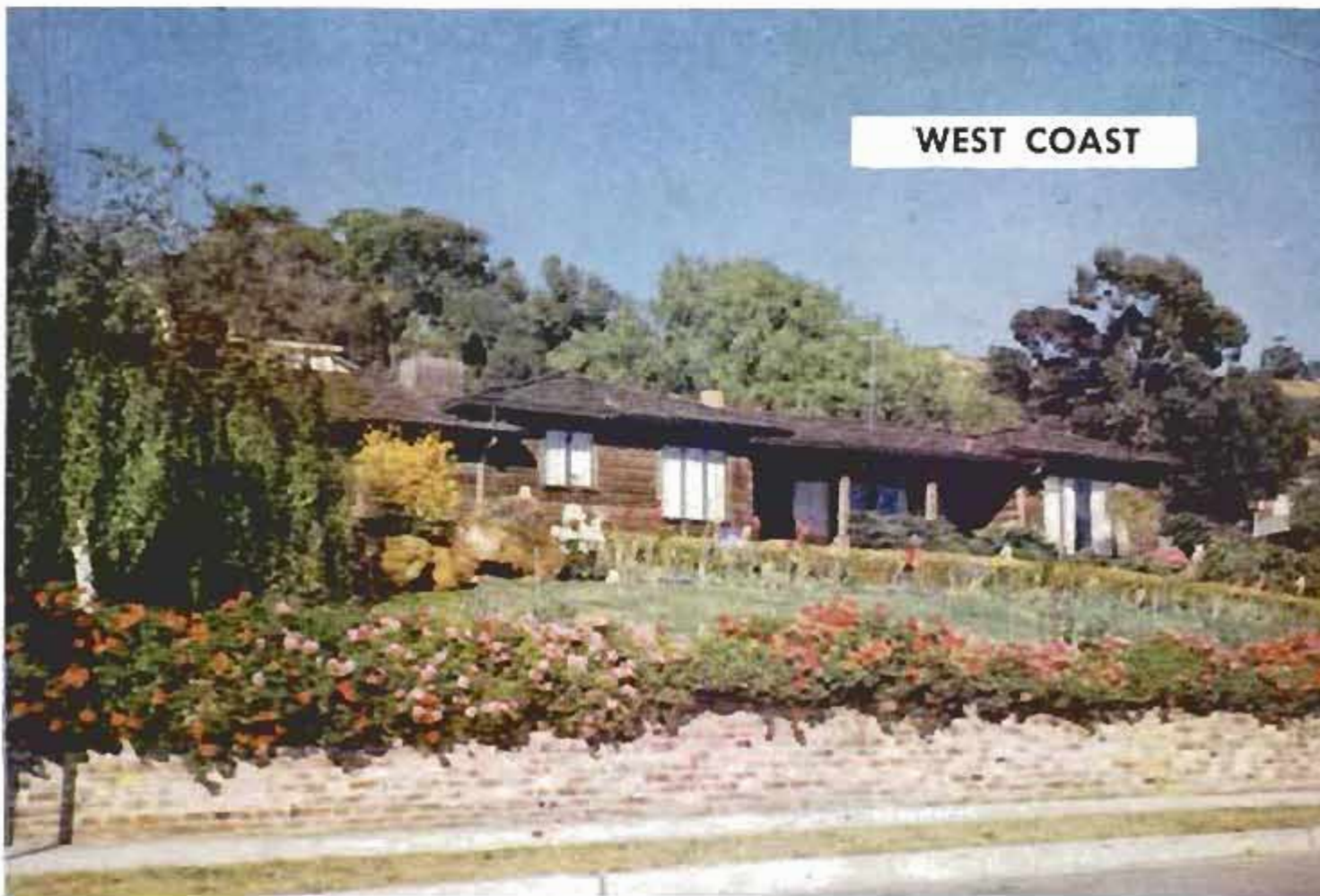



Modern patio landscape designed for *Popular Mechanics* by the author emphasizes easy maintenance and graceful lines. Generous curves provide drama. Interest is added by dual level and low brick wall. Paved area eliminates mowing, creates separate lounging terrace. Paved mowing strips eliminate trimming. Ground cover, evergreens, flowering shrubs and trees complete effect

CHART FOR YEAR ROUND BEAUTY

NORTHERN AREAS

Trees

Evergreen

- Norwegian spruce
- Blue spruce
- Douglas fir
- Canadian hemlock
- White pine
- *Red pine
- Eastern red cedar
- *Juniper

Deciduous

- American maple
 - *Japanese maple
 - *Japanese cherry
 - *Chestnut
 - Alder
 - *Amalanchier (Juneberry)
 - Birch
 - *Redbud
 - *Flowering dogwood
 - Hawthorn
 - *Beech
 - *Silverbell
 - *Magnolia
 - Flowering crab
 - Weeping and corkscrew willow
- *Asterisks above indicate trees equally desirable in South.

Shrubs

Evergreen

- *Azalea
- *Catawba rhododendron
- *Japanese andromeda
- *Mountain laurel
- *Dwarf Japanese yew
- Horizontal juniper
- Mugo pine
- *Arborvitae

Deciduous

- Dogwood (red)
- *Pagoda dogwood
- *Cornelia cherry
- *Cottoneaster
- Russian olive
- Euonymus alatus
- Witchhazel
- *Oregon grape holly
- Sumac
- Buffaloberry
- Wayfaring tree
- Nanny berry
- Blackhaw
- Warminster broom
- Viburnum carlesi

Ground Covers

Sun or Shade

- Ajugga geneuensis
(evergreen—blue flower)
- Euonymus radicans
(evergreen—white-orange berries)
- Iberis sempervirens
(evergreen—white flower)
- Vinca minor (periwinkle)
(evergreen—blue flower)
- Hedera helix baltica
(evergreen—inconspicuous flower)
- Violets
(perennial—white and blue flower)
- Sedums
(perennial—various flowers)
- Euonymus colorata
(perennial—variegated leaf)

Shade Only

- Pachysandra (evergreen)
- Lily of the valley
(Perennial—white bell)

Sun Only

- Creeping thyme
(perennial—white, lavender blue flower)
- Lonicera japonica
(perennial—pink flower)
- Rose wichuriana
(perennial—white flower)
- Rosa Max Graf
(perennial—silver-pink flower)

SOUTHERN AREAS

Trees

Evergreen

- Cedrus
- Cypress
- Pinus excelsa
- English yew

Deciduous

- Southern hackberry
- Ginkgo
- Japanese honey locust
- Sweet-gum
- Magnolia
- Oak
- Kadsura tree

Shrubs

Evergreen

- Pyracanthus
- Buxus
- Carolina rhododendron
- Camellia japonica
- Holly
- Abelia

Deciduous

- Cork maple
- Deutzia
- Hibiscus
- Tennessee false indigo
- Beauty fruit
- Blue spirea
- Sweet fern
- Daphne
- Jasmine

weeds and inevitable sprays of thriving crabgrass. More often than not, the space it occupies, chosen for display from the street, walk or kitchen window, is lawn area that you and the kids could use for lounging or play.

Oddly enough, in most cases it is easier to have a garden you'll be intensely proud of not just three months a year, but virtually all year 'round; one that will make the most of your yard space so everyone can enjoy it. In such a garden, plants that have finished blooming form decorative green banks as a backdrop for other blooms that are on the way. It can, in fact, look like the corner of a lavish estate all the time. And the most startling fact is that all this can be meticulously maintained in a fraction of the time you would have to spend on frustrating flower patches.

The simple secret is landscaping — in a word, planning. Good planning calls for a

written list of all your family needs and desires. Talk it over and get everyone's ideas. A contemporary garden is not just something to look at from the street. It is for people—a place they can use and enjoy. It can and should be a part of outdoor living for every member of the family.

Careful selection of plantings, plus a few techniques we'll discuss in this article, can make it possible to organize your beds so that you won't be a slave to a garden that never looks right. Whatever you do, don't go out and haphazardly buy flowers, shrubs and trees. What should you do, then?

First, make a scale map of your property on graph paper, indicating the position of your house on the plot. All trees, rocks, embankments, slopes and the direction of any view worth emphasizing come next. These are all natural features that can be exploited in a garden, even though some of those rocks and ridges may seem like ob-



Rocky outcrop in the garden can become part of the decorative scheme with interesting rock plants such as "hen and chicken" cluster. Quarter is for size



Effective use of *euonymus colorata* variegated as a ground cover around a curious birdbath adds a spot of texture to make an interesting garden corner



Many ground covers have blossoms or fruits that spatter color across broad areas, such as the berry-laden *euonymus radicans* vegetus, above. Below is *vinca minor* (periwinkle), favorite in sun or shade



stacles at first. Sedums, mosses, perennial rock plants and small horizontal evergreens can make a high point of interest out of an ugly rock.

As you chart these features, try to visualize your yard in areas that can be set apart by plants, with perhaps the addition of a few strategically placed shrubs such as yews, junipers, dwarf Japanese maples and the like. Be careful of towering vertical varieties, since they tend to create a "fence" or "hedge" unless expertly treated as accent units, or for special purposes.

Once you've determined the likeliest positions for these first planting beds, use bold, sweeping lines in outlining their contours. Growing shrubs and plants will soon overrun sharp curves, wiggles and angled corners. Long, bold curves tend to maintain their over-all design.

In plotting the "area divisions" of your land, these are things to consider:

Privacy. You'll want a section of lawn where you can sit, entertain and perhaps barbecue a picnic supper without making it necessary for the neighbors to see and hear everything that's going on. They may not enjoy it any more than you. This is





Combinations of ground-hugging plants make for interesting variety, such as the Queen Anne's lace mixed in with *ajuga genevensis* in garden above



Points of high interest in a garden can be created with simple ingredients shown here—a rock, a *funkia spectabilis*, *euonymus colorata variegated* and ferns

one place where tall, screening evergreen shrubs and trees—such as juniper, rhododendron, cedar and hemlock—can provide a gracefully curving wall of informal privacy, creating a secluded nook without presenting the cold, formidable barrier of a high wall or fence. Banked with low flowering shrubs, border perennials or, even better, low ground cover to mark the contour of the bed, such a green wall can present all the cool seclusion of a forest glen. A tiny pool, or even the grill itself set on a flagged dais a few inches higher than the lawn can provide a fine center of interest in such a quiet corner.

Play area. The kids have to have their fun, so don't cheat them out of their place in the sun. Somewhere, allow for a broad sweep of tough lawn where badminton can be set up, croquet wickets staked out or a bow and arrow range contrived. It should

(Continued to page 258)

Deft artistic touch may be applied to a garden with a single accent tree like the lacy corkscrew willow shown at right



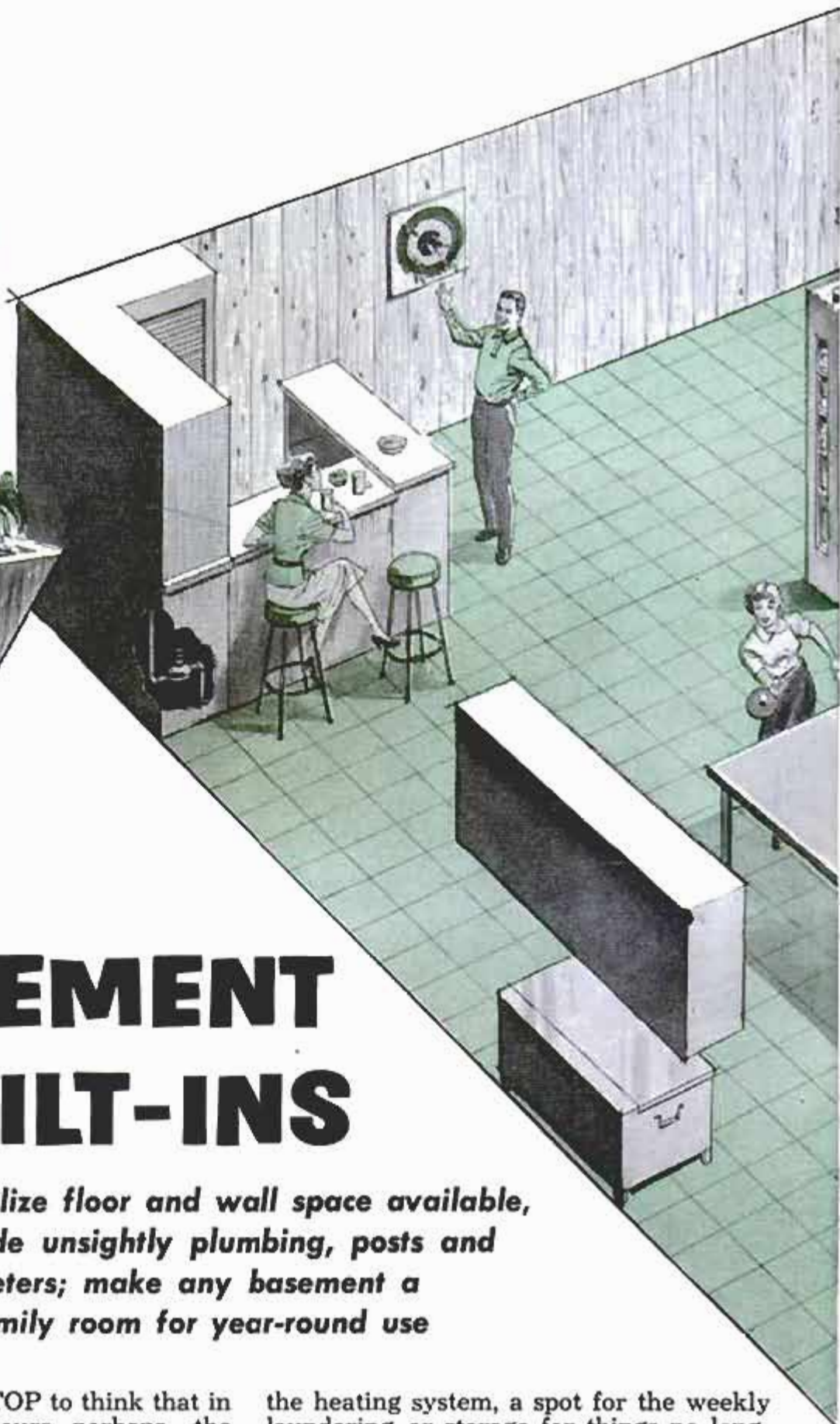

BASEMENT BUILT-INS

*utilize floor and wall space available,
hide unsightly plumbing, posts and
meters; make any basement a
family room for year-round use*

DID YOU EVER STOP to think that in many homes, yours perhaps, the basement floor area is the same as that of the house? If yours is an older home, the basement floor area may be only half that of the house, or even less, but it's still a valuable part of the property. In most homes the basement remains just about as it was when the house was built, nothing more than a plain utility room, a place for

the heating system, a spot for the weekly laundering, or storage for things no longer wanted upstairs. Perhaps there are shelves along the walls somewhere and possibly there's left-over space for a workbench and a few household tools. And that's about all. But with a bit of simple planning it can be something else.

What you plan depends to some extent on the size of the basement, the height

If your basement is rectangular in shape and average size, you may find it possible to follow through with many of the suggested built-ins pictured below and on the opposite page. Note that several of these are arranged to house meters, water heater, furnace

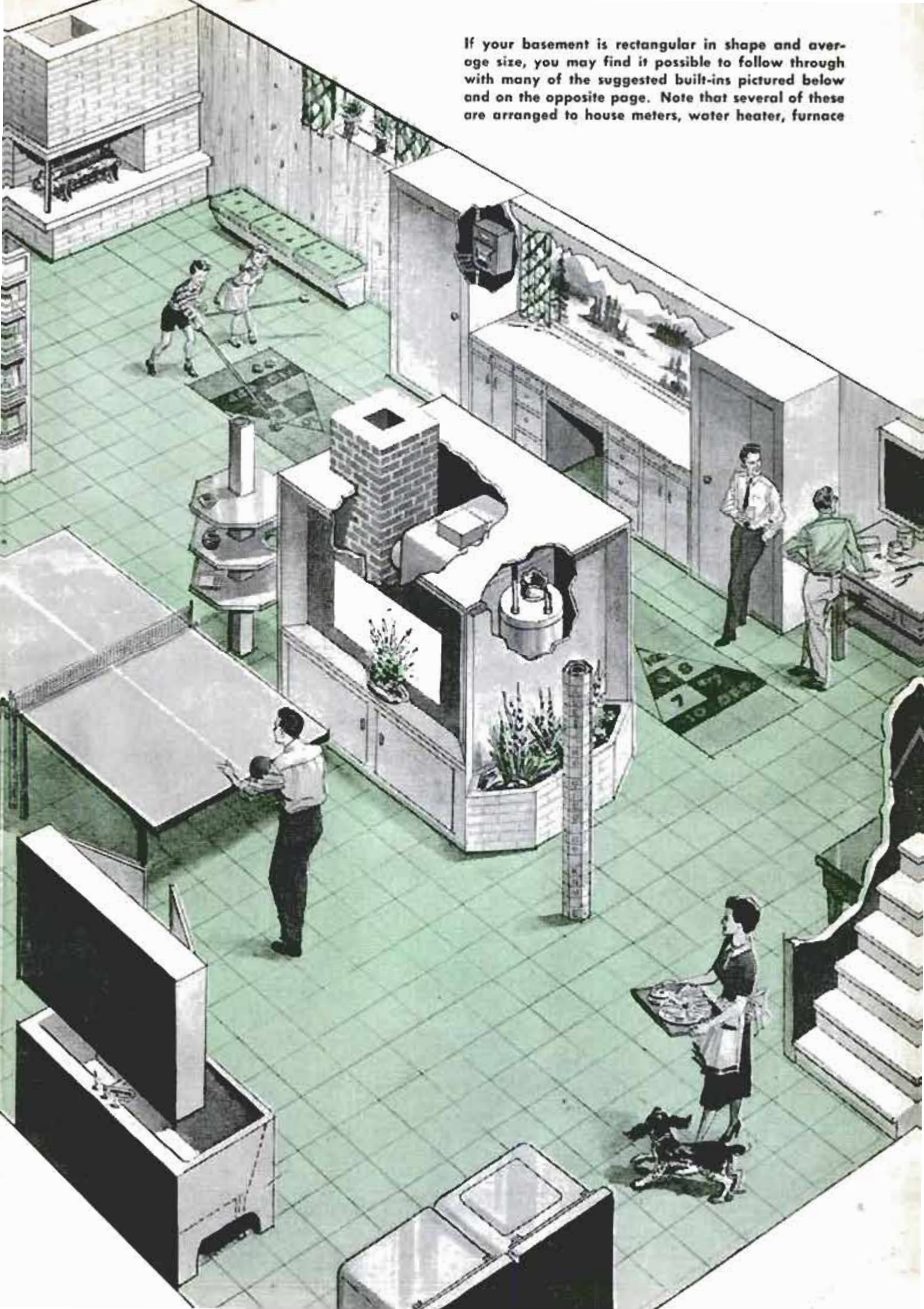

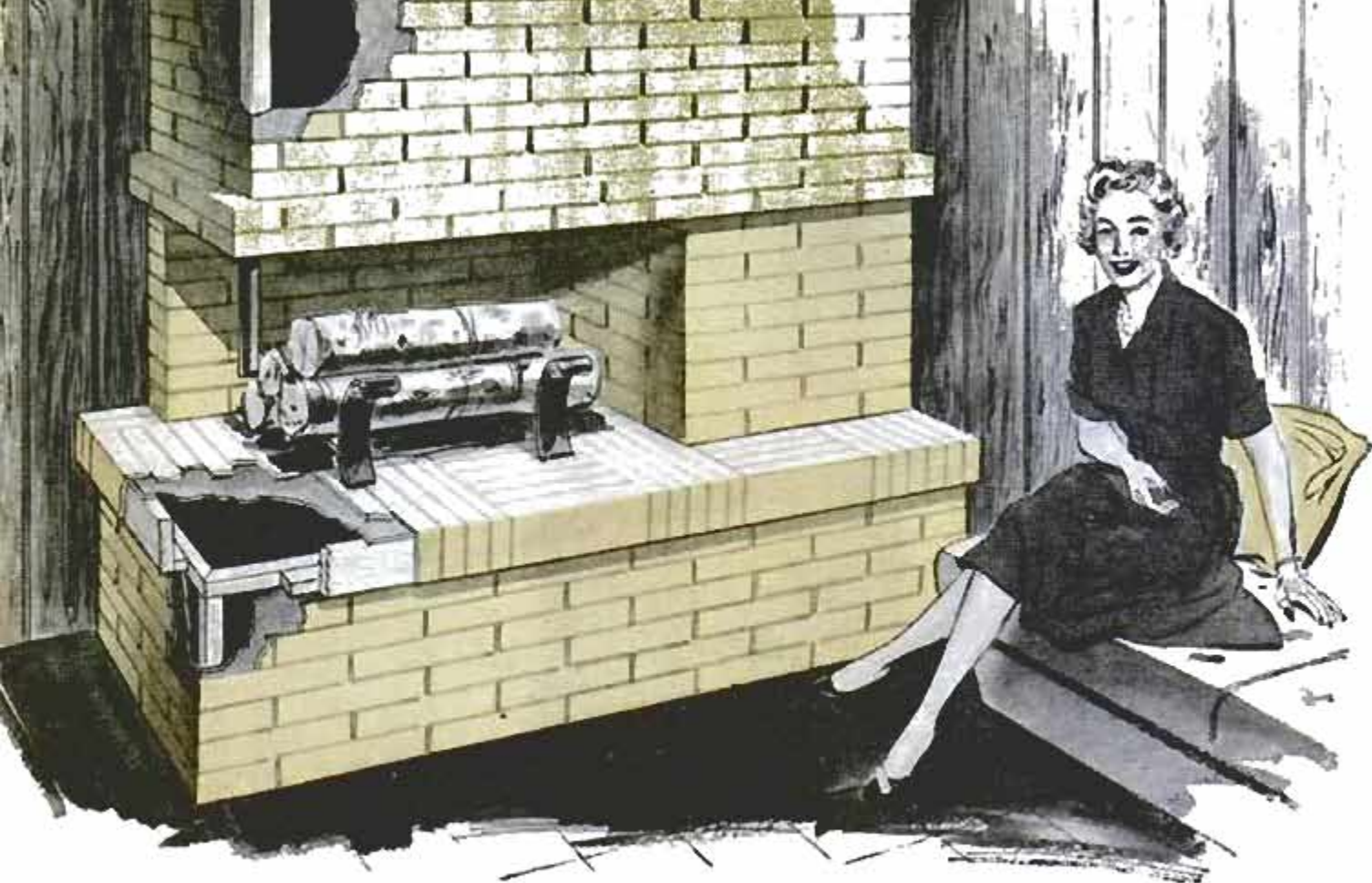

from floor to joists, and whether or not it is a square, rectangular or L-shaped room. Also, the location of the laundry tubs (or the washer-dryer units), the gas, water and electric meters and the location of the furnace or boiler and the chimney are factors to be considered. The center beam and supporting posts also will enter into the planning in the final decorative stages.

If the room is rectangular or square and open without any load-bearing partitions, then it usually is best to plan a single room rather than partitioning into two or more rooms, especially if the floor space is comparatively small. If the room is quite large or is L-shaped, planning should take this into account. It's always a good idea to make a simple sketch to scale, say

1 in. to 1 ft., of the floor area. On this, locate the center beam and supporting posts, the furnace or boiler, chimney, stairway, drains, meters and so on until you have included all the utilities and other items that must remain in place. Then mark the tentative locations of such built-in units as space will permit. If the furnace is near the center of the room, then you may wish to plan an island-type enclosure as suggested in the drawings on preceding pages. In planning such an enclosure it is essential to provide access doors and reduce the fire hazard to the minimum with an asbestos lining. The air requirements of the fuel burner also must be considered. If the basement affords a long, unbroken wall space, plan a hobby or study center

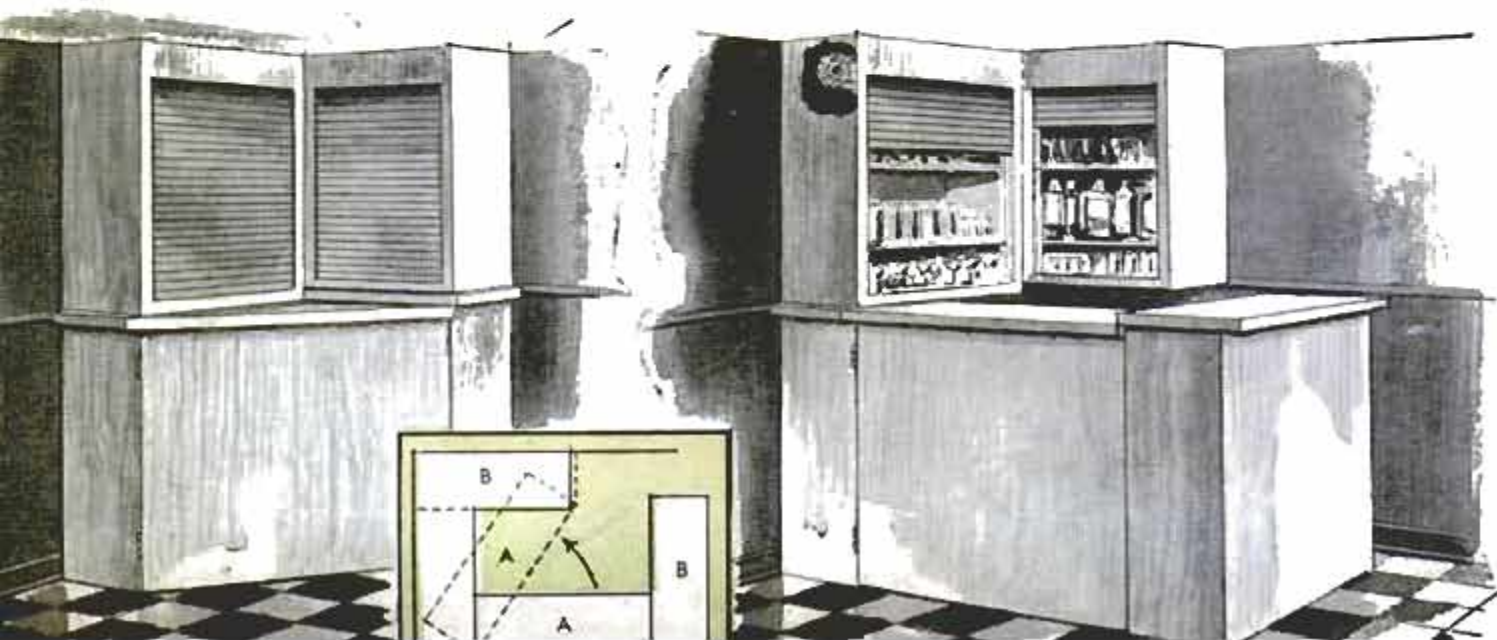

with a suitable wall mural, also a desk-table with plenty of drawer and cabinet storage space. Floor-to-ceiling storage cabinets at the ends of the desk-table can provide additional storage space. Perhaps one or the other can be made to house one of the meters, or other fixed object, as suggested in the illustrations.

A refreshment bar and a real or false fireplace have decorative values that should always be kept in mind when planning. In a rectangular room the corners are likely locations, but don't rule out the possibility of locating one or the other or both on the wall spaces. A real fireplace is, of course, a job for your mason contractor. Let him plan and build it. Just tell him where you want it and let him take it from there. But the ornamental fireplace you can build yourself, using any of the ornamental brick coverings that suits your fancy. It's a fairly simple job to frame such a structure and apply the coverings as suggested in one of the illustrations.

When planning the size, location and construction of hanging wall cabinets, floor-to-ceiling storage cabinets, a refreshment bar, a center island and an ornamental fireplace, plan to use the plywoods and the wood-grained or plain hardboards as building materials. These cut easily and assemble quickly into cabinets, tables, doors and also can be used as wall paneling, especially the grained types.

The refreshment bar can be made to

fold into a corner as suggested in one of the illustrations which shows open and closed views and indicates the manner in which the two-piece bar can be made to fold. The corner cabinet can be made with rolling shutters of the tambour type, or you can use sliding glass panels.

If the basement stairway is built against a wall, give special attention to the space under the stair. Enclosed it may afford space for storage of power tools such as a circular saw or wood lathe, a drill press and possibly a small band saw. Or you may find you can utilize the space available to better advantage by building the workbench under the stair and storing small tools in shallow wall cabinets with sliding doors. In this plan, power tools on rolling stands can be arranged along a wall out of the way when not in use. The stairway itself can be enclosed as in a well, or it can be left open and provided with an ornamental rail with square or turned balusters.

Wall, floor and ceiling treatment offers considerable latitude and choice of materials. Paneling of solid woods for the walls is a popular choice, but any of the wood-grained hardboards make a good substitute. Ceiling tile in various colors, types and patterns are available from your local building-materials dealer, also complete instructions for application. You'll also want to think about flush-lighting fixtures in the ceiling, spotlighting a dart

Give special attention to space under basement stairway. In nearly all instances it can be utilized for storage of power tools, hobby supplies, canned fruit, vegetables, anything that requires closed storage space. Or, perhaps you can put the space to better use for a built-in workbench and tool panels

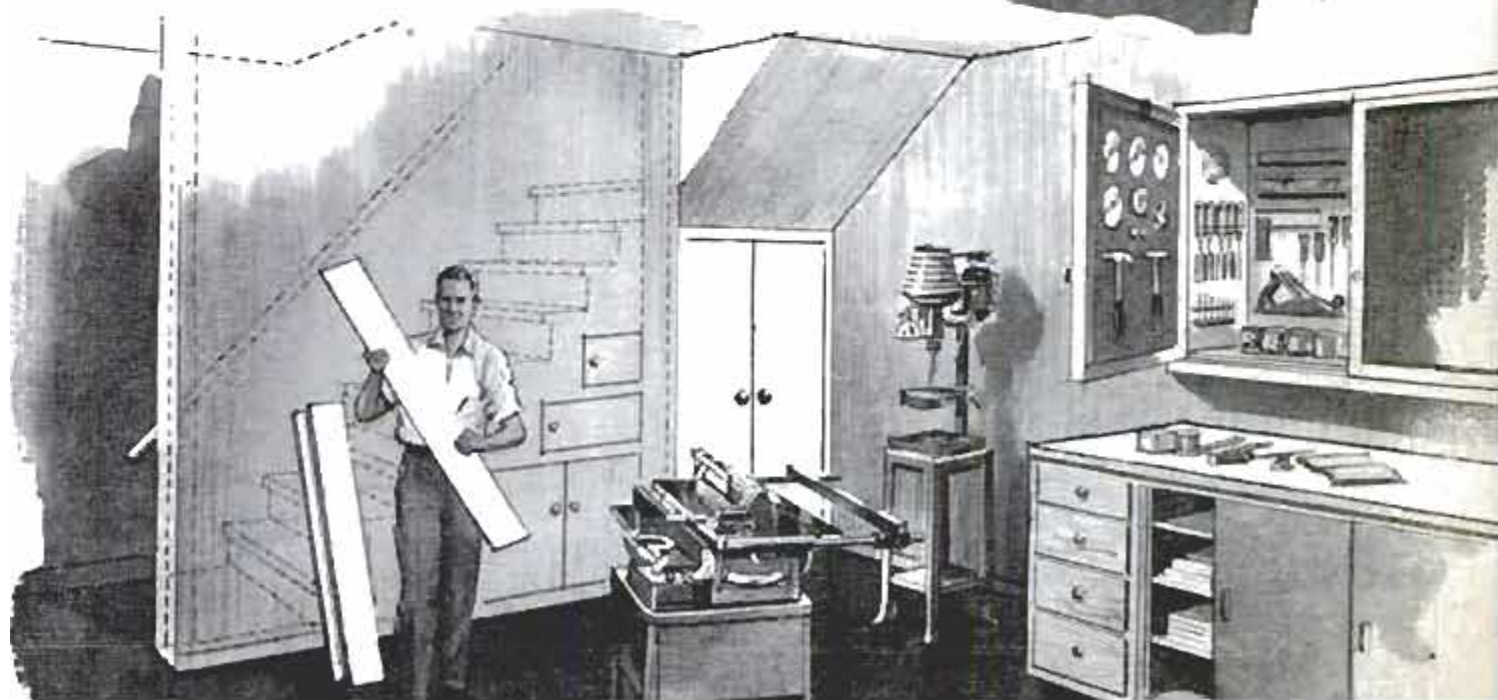



board, floodlighting the shuffleboard area, the workbench and individual power tools and possibly the wall mural. If you plan to use asphalt floor tile be sure to follow in all details the manufacturer's instructions for laying asphalt tile below grade.

Wall treatment calls for some careful thought. If the room is rectangular it generally is best to panel only two of the walls with wood or a wood-grained hardboard. Walls to be paneled should be coated with a masonry waterproofer or with hot asphalt before attaching furring strips and paneling. If wood paneling is used it's a good idea to coat the backs of the boards with shellac or an oil paint to prevent absorption of moisture.

Accompanying illustrations suggest methods of decorating supporting posts. The supporting beam, warm-air ductwork and plumbing that run below the floor joist require individual treatment. Before beginning work it's important to check all governing provisions of your local building code. ★ ★ ★

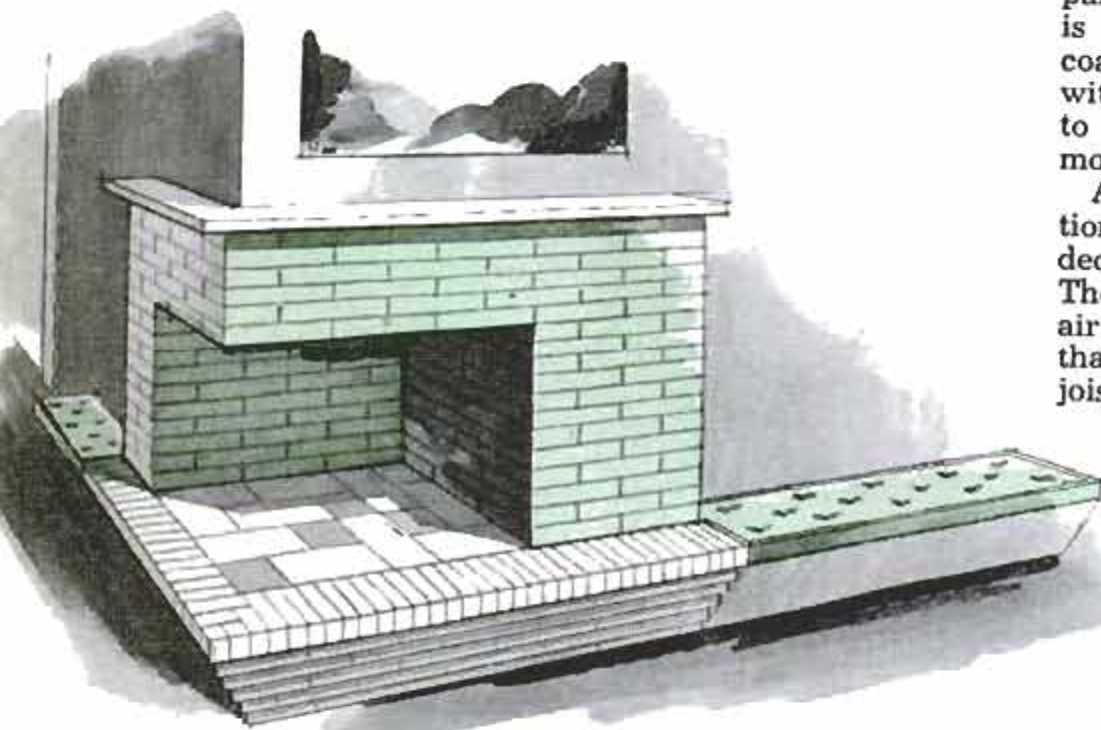

Above and below are suggested variations of the fireplace and hobby center shown on preceding pages. Here the fireplace is built on an outside corner and the hobby center across the end of a narrow room. You may find these better suited to the space

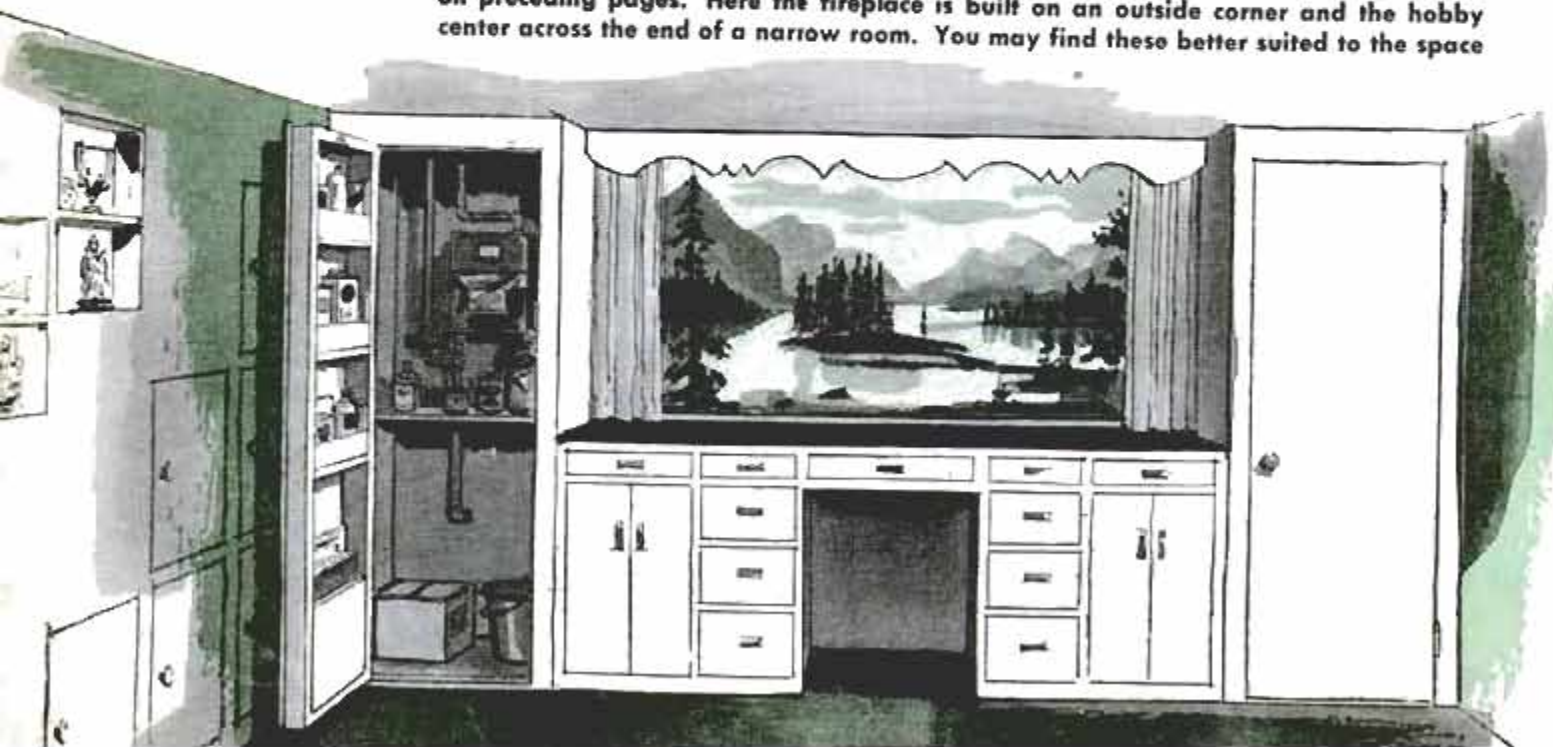

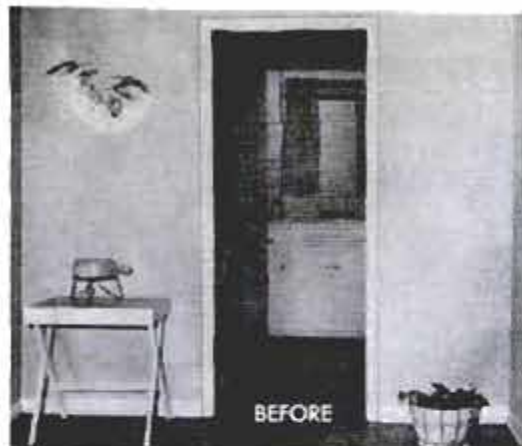

SOLUTION TO A PROBLEM CORNER

WHERE standard-size furniture appears too large, too wide or just plain out of place when furnishing a problem corner, the man with a home workshop can custom-tailor such corners. As an example of what can be done, the before and after photos show a problem area which faced Grover C. Henley of Jacksonville, Fla., and how he solved it. His clever solution of grouping overhead bookshelves, a desk and a storage cabinet around a kitchen doorway could very well be adapted to a similar situation by simply altering the dimensions.

The cabinet and kneehole desk were made of $\frac{3}{4}$ -in. fir plywood and assembled as shown in the drawing. The bookshelves were 1 x 8 boards supported by quarter-round cleats at one end and 1-in. dowels at the other. At the dowel ends, the shelves are anchored to the dowel posts by driving finishing nails through the edge and into the dowel. Both cabinet and desk tops could be covered with plastic laminate if desired. Contact cement makes it easy for anyone to apply this sheet plastic. After it is applied to each top surface, quarter-round is used to add a finish where the surfaces join the wall. One prime coat and two regular coats of white enamel will give a fine finish. On veneer-faced plywood, the edges would be taped and a varnish finish applied.

G. B. Tripp, Jacksonville, Fla.
OCTOBER 1959

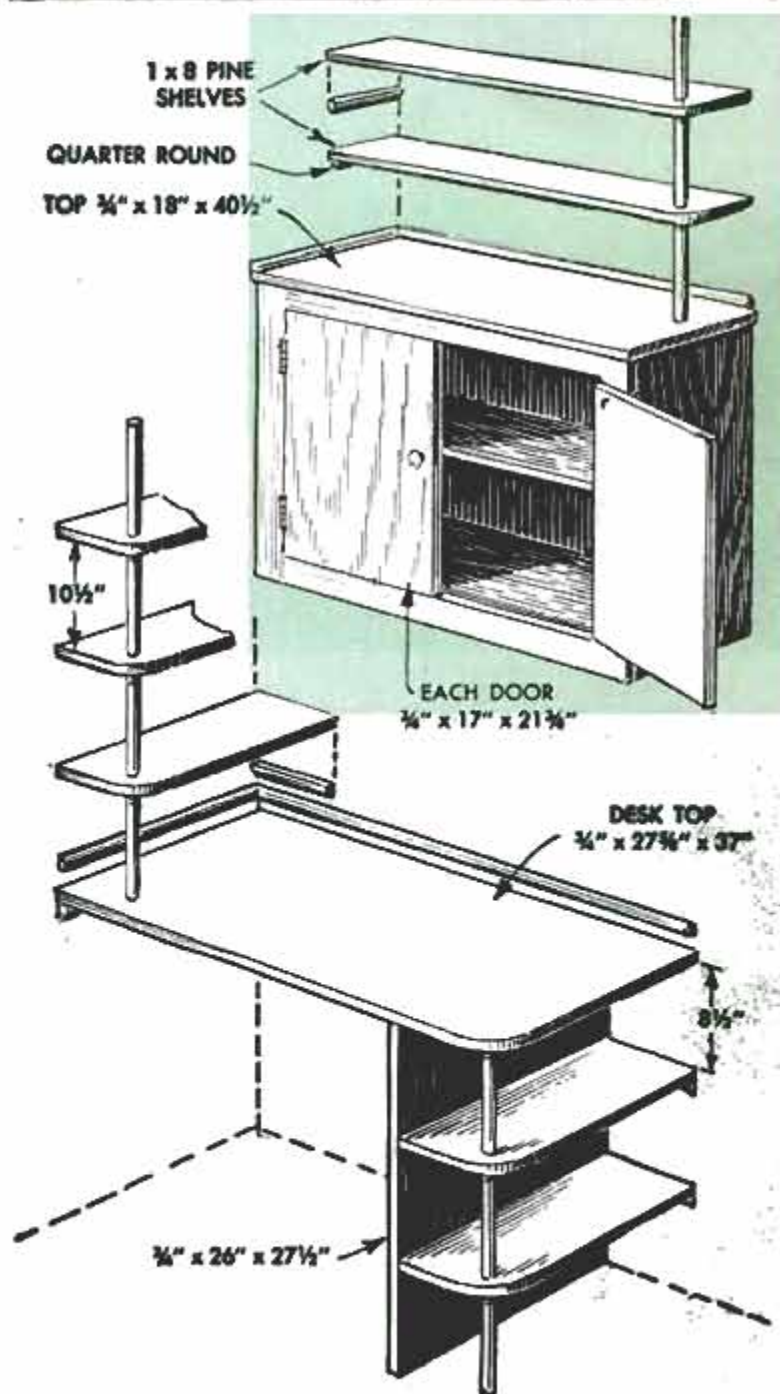



Designed by D. E. Boetman

CAR-BED CRADLE

Plywood

- 2 pcs. $\frac{3}{4}$ " x 18" x 21"—Cradle ends
- 1 pc. $\frac{3}{4}$ " x 17 $\frac{1}{4}$ " x 35 $\frac{1}{4}$ "—Bottom

Hardwood

- 2 pcs. $\frac{3}{4}$ " x 1 $\frac{1}{2}$ " x 36"—Top side rails
- 2 pcs. $\frac{3}{4}$ " x 2" x 36"—Bottom side rails
- 2 pcs. 1 $\frac{5}{8}$ " x 1 $\frac{5}{8}$ " x 38"—Posts
- 1 pc. $\frac{3}{4}$ " x 3" x 38"—Stretcher
- 2 pcs. $\frac{3}{4}$ " x 4" x 24"—Cross feet
- 2 pcs. $\frac{3}{4}$ " x 7" x 7"—Post braces
- 2 pcs. 1 $\frac{1}{2}$ " x 1 $\frac{1}{2}$ " x 3 $\frac{1}{2}$ "—Pins

Miscellaneous

- Dowels, nails, screws, glue, wooden buttons, plastic clothesline

EARLY AMERICAN CRADLE

Plywood

- 1 pc. $\frac{3}{4}$ " x 19 $\frac{1}{2}$ " x 37 $\frac{3}{4}$ "—Bottom

Hardwood

- 2 pcs. $\frac{3}{4}$ " x 15 $\frac{3}{4}$ " x 44"—Sides
- 1 pc. $\frac{3}{4}$ " x 19 $\frac{3}{4}$ " x 20 $\frac{3}{4}$ "—Headboard
- 1 pc. $\frac{3}{4}$ " x 17 $\frac{1}{4}$ " x 20 $\frac{3}{8}$ "—Footboard
- 2 pcs. $\frac{3}{4}$ " x 7 $\frac{1}{2}$ " x 33"—Rockers
- 1 pc. $\frac{3}{4}$ " x 3 $\frac{1}{4}$ " x 35 $\frac{1}{4}$ "—Stretcher
- 2 pcs. $\frac{3}{4}$ " x 1 $\frac{1}{4}$ " x 39 $\frac{3}{4}$ "—Molding
- 2 pcs. $\frac{3}{4}$ " x 1 $\frac{1}{4}$ " x 21 $\frac{1}{4}$ "—Molding
- 1 pc. $\frac{1}{4}$ " dowel 40" long—Gluing pins

MISCELLANEOUS

- Screws, nails, glue

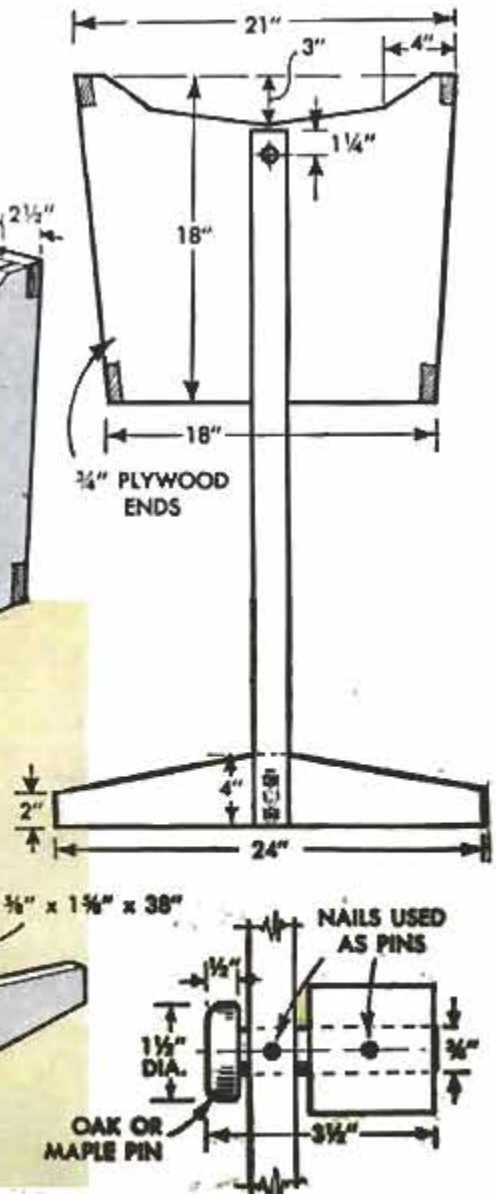
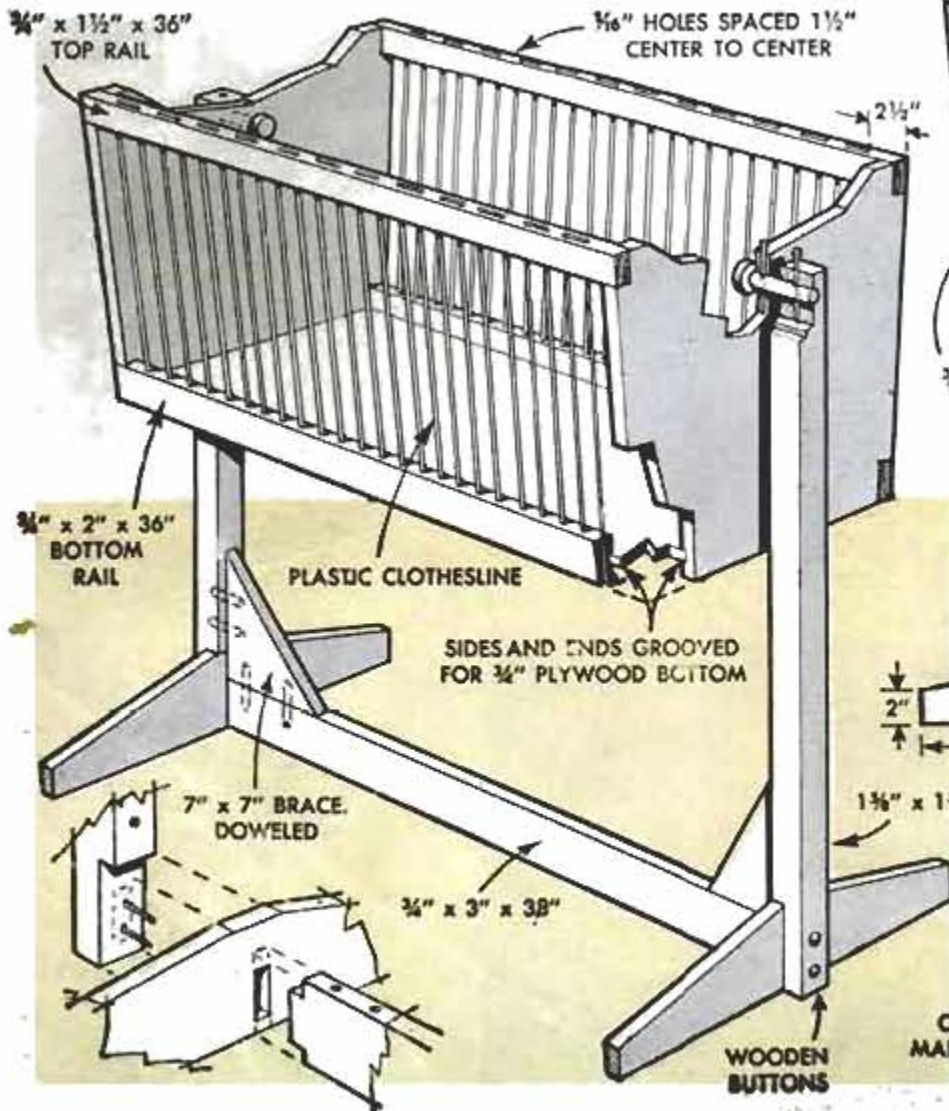

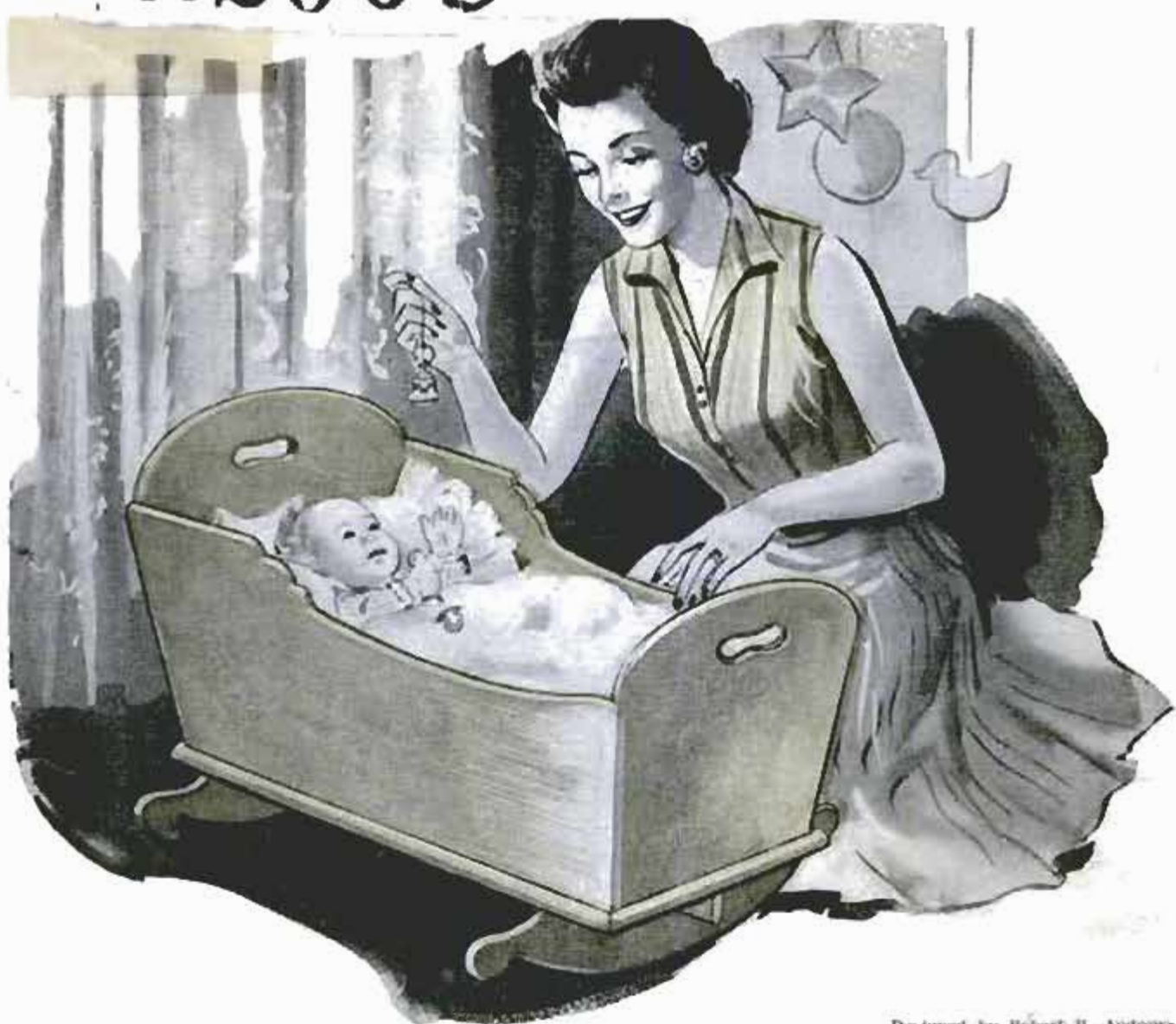

Designed by Robert P. Andrews

CRADLE FOR THE NURSERY

YOU'LL want to be ready for that new arrival and if the blessed event is your first and there is no hand-me-down crib to use, why not surprise mom and the new infant with a cradle? You have a choice of two designs, one traditionally colonial, the other a novel portable affair that rocks in a sturdy floor stand and doubles as a car bed.

Construction of the latter is fully detailed in the drawings on the facing page. The cradle itself rocks, or pivots, on two loose-fitting wooden pins. Two sets of cross pins lock the wooden pins in place, as well as the cradle. Pulling out the cross pins permits the wooden pins to be removed when the cradle is to be detached from the stand and used as a car bed. If you have no way of turning the pins, they can be improvised by using short lengths of $\frac{3}{4}$ -in. dowel and attaching drawer

knobs to the ends. The open sides of the cradle are laced with plastic clothesline through holes spaced $1\frac{1}{2}$ in. apart in the top and bottom rails. Start lacing at the bottom so that the knot in the cord will be hidden. The lacing actually should be done last, after the cradle has been painted. Decals, along with colored clothesline, will help doll it up. The cradle is designed to take a standard bassinet mattress.

The Early American cradle is equally simple to build and is of a size comparable to a six-month crib. To be authentic, it should be made of solid maple stock rather than plywood, and you may find it necessary to glue up pieces to obtain the widths required for the various parts. Also, solid stock permits the edges to be shaped to simulate wear. This is done with a coarse rasp, then a file and finally sandpaper. Full-size paper patterns should be

made from the squared magazine patterns. You will notice that the headboard is somewhat larger than the footboard. Dowels are used to fasten the side members to the head and footboards, while screws are used to fasten the bottom, the screw heads later being concealed by a mitered molding. Holes for dowel pins are bored before the edges of the work are rounded and after the sides have been glued and clamped to the ends. You will notice in the section detail that shallow rabbets are made along the slanted edges of the side members. These serve to keep the parts from shifting when clamping pressure is applied, as well as make a better joint. The holes for the dowel pins are bored 2 in. deep into the ends, then the pins are coated with glue and driven in place. When the glue has dried, a rasp is used to round the edges and the ends of the dowels at the same time. Four dowels are used along each joint. The edges of the jigsawed hand holes are worked round with a half-round file and sandpaper. The rocker assembly, consisting of two rockers and a connecting stretcher, is assembled as a separate unit and attached to the cradle with glue and screws driven down through the bottom. Note that the stretcher is half-lapped into the rockers. After sanding, the cradle can be stained, shading from a deep tone in the corners to a lighter tone in the middle of the sides and ends. Final coating can be either lacquer or varnish to give a satin finish. ★ ★ ★

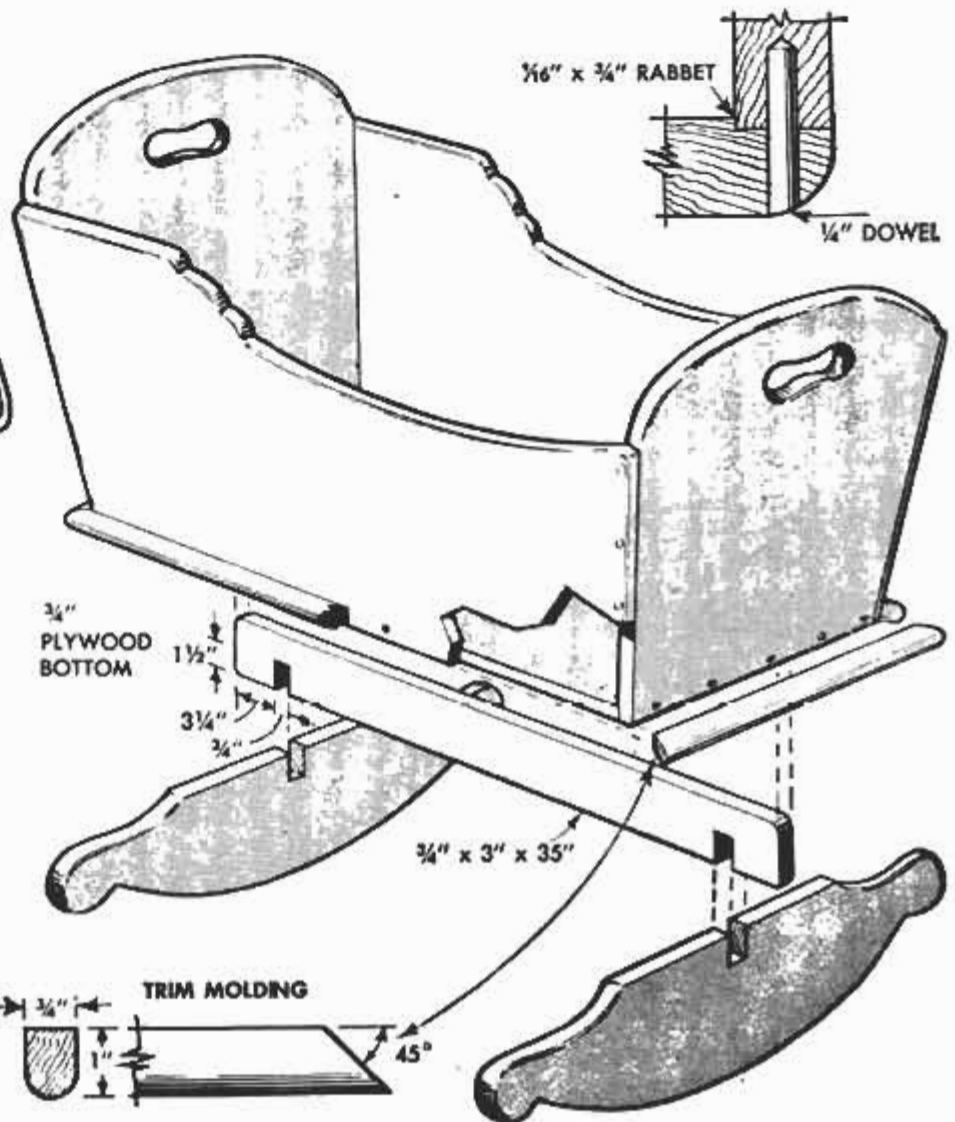
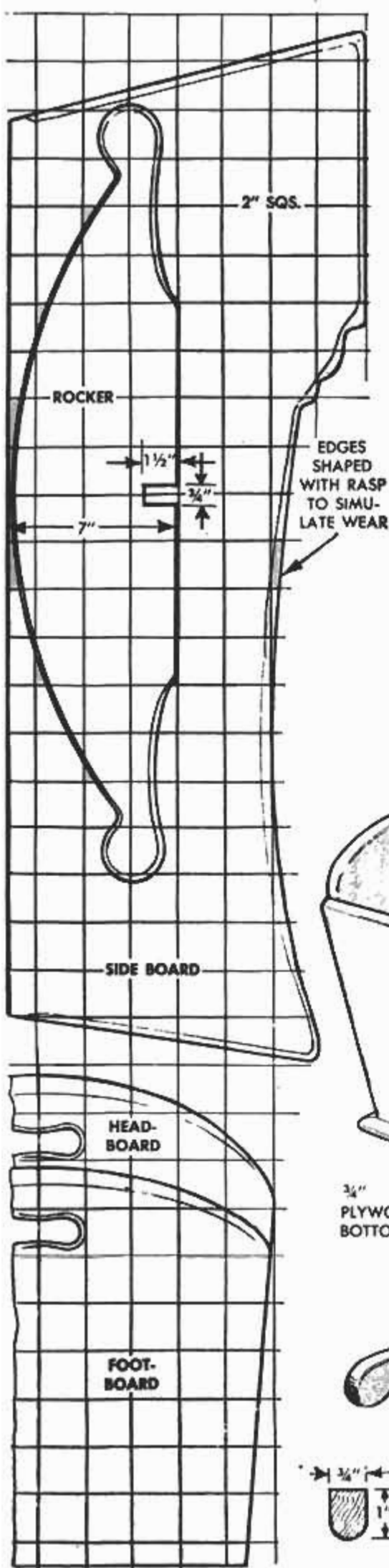

Smart Wall Decor for a Fireplace

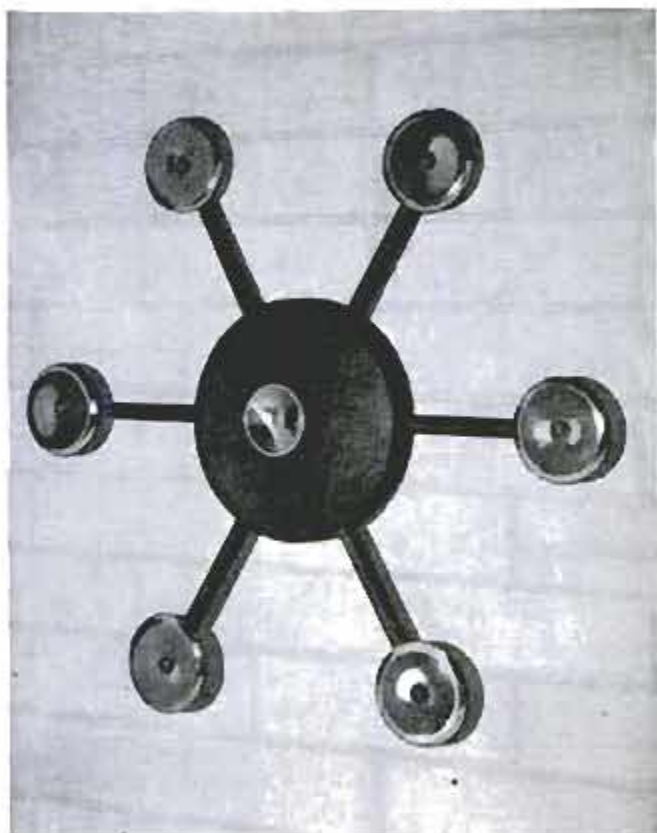
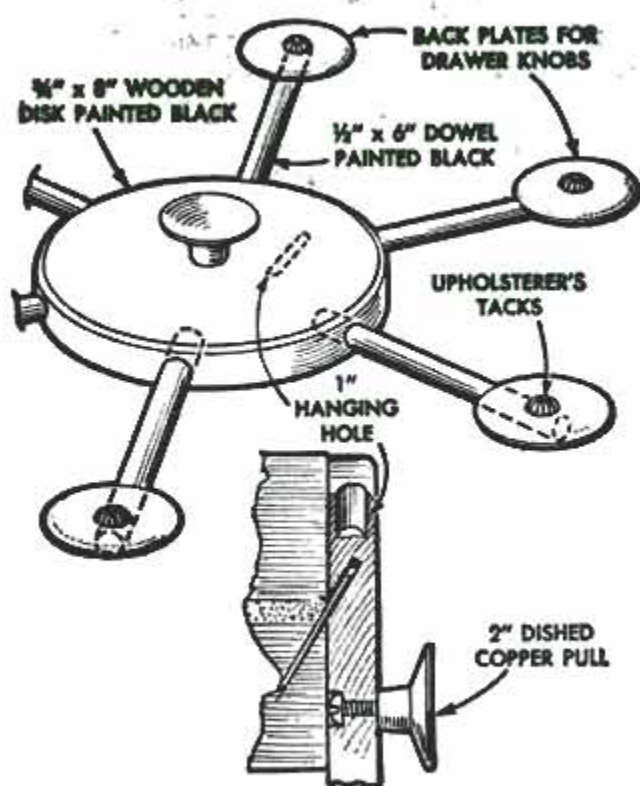

While especially striking when mounted on the face of a fireplace, this modern version of a sunburst ornament will become a stunning conversation piece when hung on any wall. The original was done in black and copper but you can choose brass or chrome since the metal parts are standard doorknobs and knob backplates that come in a choice of plated finishes. The backplates are flat 2 $\frac{3}{4}$ -in. metal disks that normally are used with the knobs but which can be purchased separately. Small holes are made in the center of the disks for fancy upholstery tacks which are used to attach the backplates to the ends of six dowel spokes radiating from an 8-in. wooden disk. Holes for the dowels are bored in

the disk 1-in. deep and equidistantly around the edge and the dowels are glued in place. A hole is drilled in the center of the wooden disk for a 2-in. metal knob and then all the wooden parts are painted flat black. If your hardware store does not carry upholstery tacks that match the finish of the backplates, go to a local upholsterer. He will have some called Metaline, which are enameled and are available in almost any color imaginable. Position the backplates so that the tacks enter the dowels about $\frac{1}{4}$ in. in from the ends. The completed ornament is hung flat against the wall on a nail driven at an angle to engage a slanting hole in the disk.—Ruth O'Donnell Geissler, Green Bay, Wis.

Battery Clip Simplifies the Grounding of Portable Tools

When the three-prong adapter plug on a portable electric drill must be removed to permit the tool to be plugged in at another location, the "grounding" of the adapter each time is made easy if a small battery clip is fastened to the grounding wire. The clip makes it a simple task to attach the wire in a jiffy to the outlet box, armored cable or other suitable ground by merely clamping the clip to it. All of your portable electric tools should be grounded before using them to avoid the possibility of serious and sometimes fatal shock. The clip permits the adapter plug to be stored with the tool by clipping it to the cord.





Child's King-Size Whistle Made From Dowel and Hose

Your youngsters will love this kingsize whistle that can be made in a few minutes from a short piece of garden hose and a length of $\frac{5}{8}$ -in. dowel. After both parts are cut and notched as shown in the detail at left, the dowel piece is inserted in the whistle and positioned to produce the desired pitch. This is done by sliding the dowel slowly in or out while blowing into the whistle. A length of bamboo pole may be used in place of garden hose, fitting it with a dowel of the required size.

Reference Data Kept on T-Square

Drafting and engineering reference data can be kept conveniently at hand for the draftsman by gluing decimal equivalents, conversion tables, etc. to the T-square blade as shown at right. If the data is only for temporary use, it can be affixed to the T-square with rubber cement for easy removal. Tables of permanent nature should be given a protective coating of clear lacquer or plastic spray.

R. Hanscom, Elmhurst, Ill.

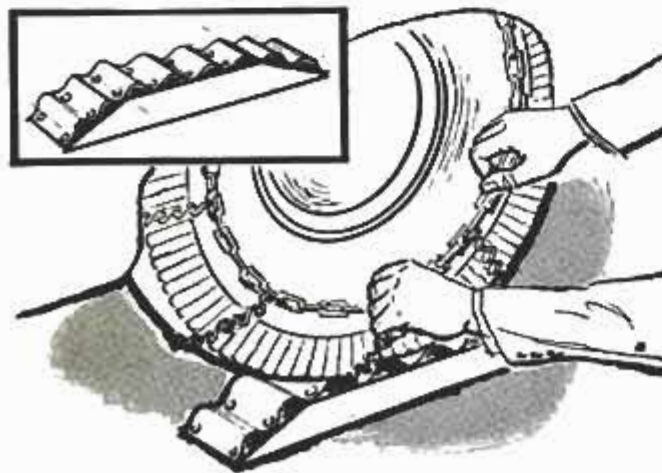
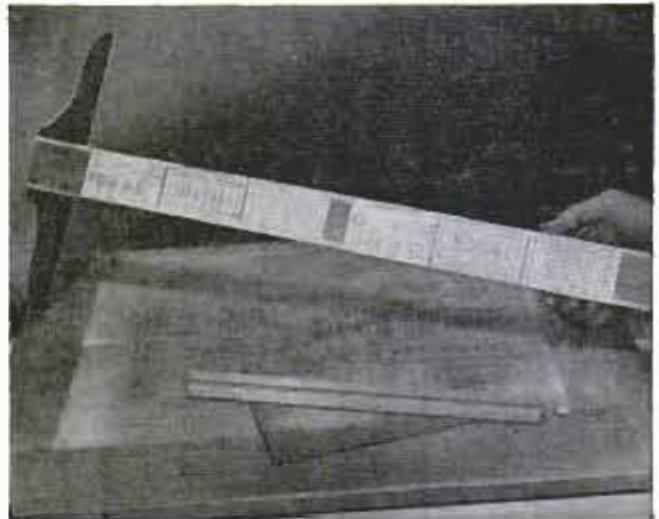

Blocks With Corrugated Surface Aid Installing Tire Chains

Installing car-tire chains is a snap when a block having a strip of corrugated sheet metal nailed to it as shown, is provided for each wheel. Before the car is backed on the blocks, the chains are placed on them so that the cross links lie in the corrugations. The chains then are fastened in place without moving the car since the corrugations permit free movement of cross links when drawing the chains tight.

Bench Mount for Electric Drill Permits Work to be Handheld

Bench-mounting attachments available for some electric drills are a good investment since they permit the use of both hands for steadying work. This is especially helpful when working on small pieces as shown in the photo at right. If a bench mount is not available for a drill you now have, one can be made from two lengths of flat steel shaped and bolted together to provide a clamp at one end to hold the tool and a T-shaped bracket at the other end for bolting to a bench.

—Louis Reitz, Bourbon, Mo.

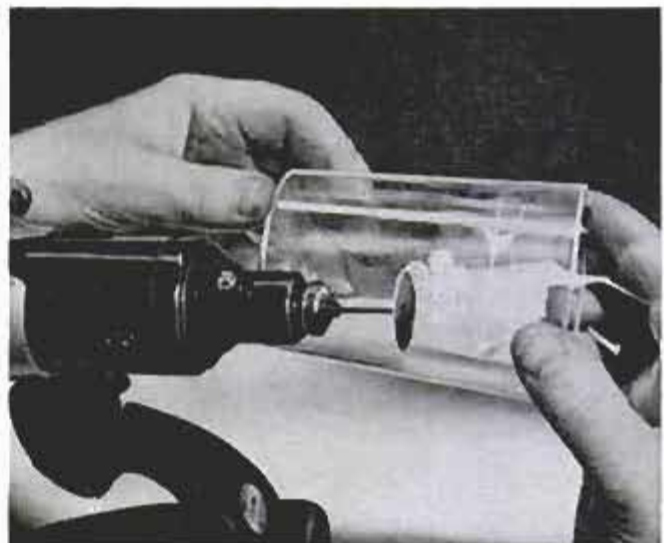



Winch Mired Car to Firm Ground With Spanish Windlass

Campers who drive their cars off the road and get bogged down need not fear being stranded far from help if they have enough rope or chain to set up a Spanish windlass. The windlass is used to winch the car to firm footing as illustrated. To do this, a small log is placed upright in a shallow hole dug next to a tree to which it is linked with a rope as shown. One end of a tow rope is then tied to the car and the other end is wound on the log, after a

loop is tied on the end. A stout pole inserted in the loop is used as a lever to operate the windlass.

E. V. Reyner, Salinas, Calif.

Rating Numbers Taped on TV and Radio Fuses for Easy Identification

To avoid installing the wrong size circuit fuse in a TV or radio set when tiny fuses for more than one set are kept on hand, one homeowner attaches paper tabs to them listing identifying data. The data for each fuse is lettered in black ink on a strip of paper that is wrapped around the glass part and held in place with cellophane tape as indicated in the photo at right. This is done under a good light soon after the fuses are purchased, using a magnifying glass to read the amp. rating and type numbers stamped on the metal ends of the fuses. Then, when a fuse is needed in a hurry, there is little chance of selecting the wrong one. Always unplug a TV set when replacing the fuse.—R. Hanscom, Elmhurst, Ill.



Windmill-Ladder Sections Used for Shelf Supports

Ladder sections from a dismantled windmill were found by one farmer to make excellent floor-to-ceiling shelf supports for workshop storage of spare parts. The ends of a pair of ladder sections of equal length were drilled to take one screw each and then bent at right angles to provide a means of fastening them to the shop floor and ceiling as shown at right. The shelf supports can be easily removed for use in another location if desired. The planks used for shelves are not fastened in place.

G. E. Hendrickson, Argyle, Wis.

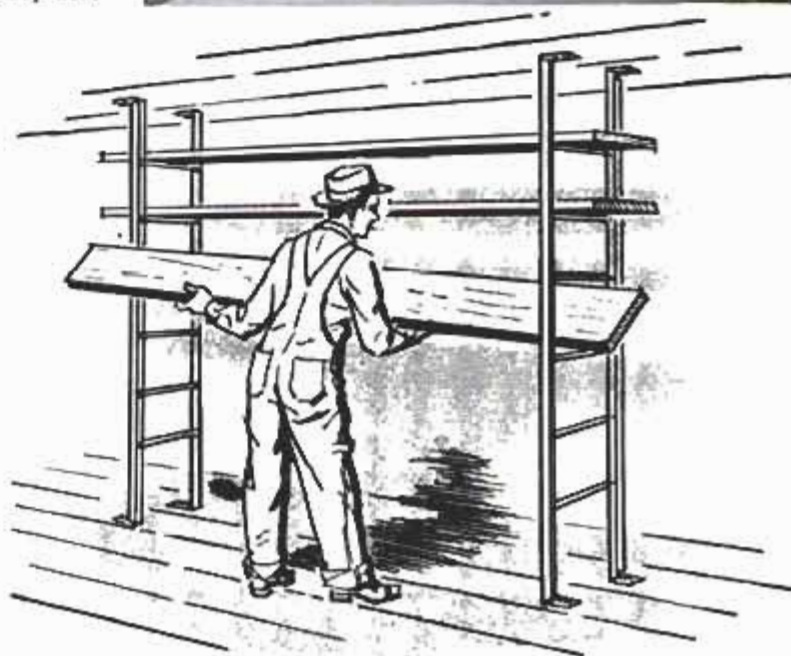

ELECTRIFIED CAR LIGHTER BECOMES NOVEL DESK SET



DESIGNED for use in the home or office, this cigarette lighter and ash tray share a handsome mahogany cabinet that any smoker would be proud to own. What's more, the lighter never runs out of fluid because it is a car cigarette lighter that uses house current converted to 6-v. by a transformer. The parts of this easy one-evening project consist of a car-lighter assembly, a 6-v., 10-amp. transformer, 6-v. indicator light, push-button switch and a glass ash tray. The top, sides and ends of the cabinet are cut from $\frac{1}{2}$ -in. stock, rabbeted and glued together as indicated. A bottom cover of $\frac{1}{8}$ -in. hardboard is screwed in place after the unit is completed. The ash tray is kept in place by a $\frac{1}{4}$ -in.-deep recess cut in the cabinet top to take its base. Operation of lighter is the same as in a car installation, except that a switch is provided to permit turning off the current when it is not in use.

C. A. Phillips, Corning, N.Y.

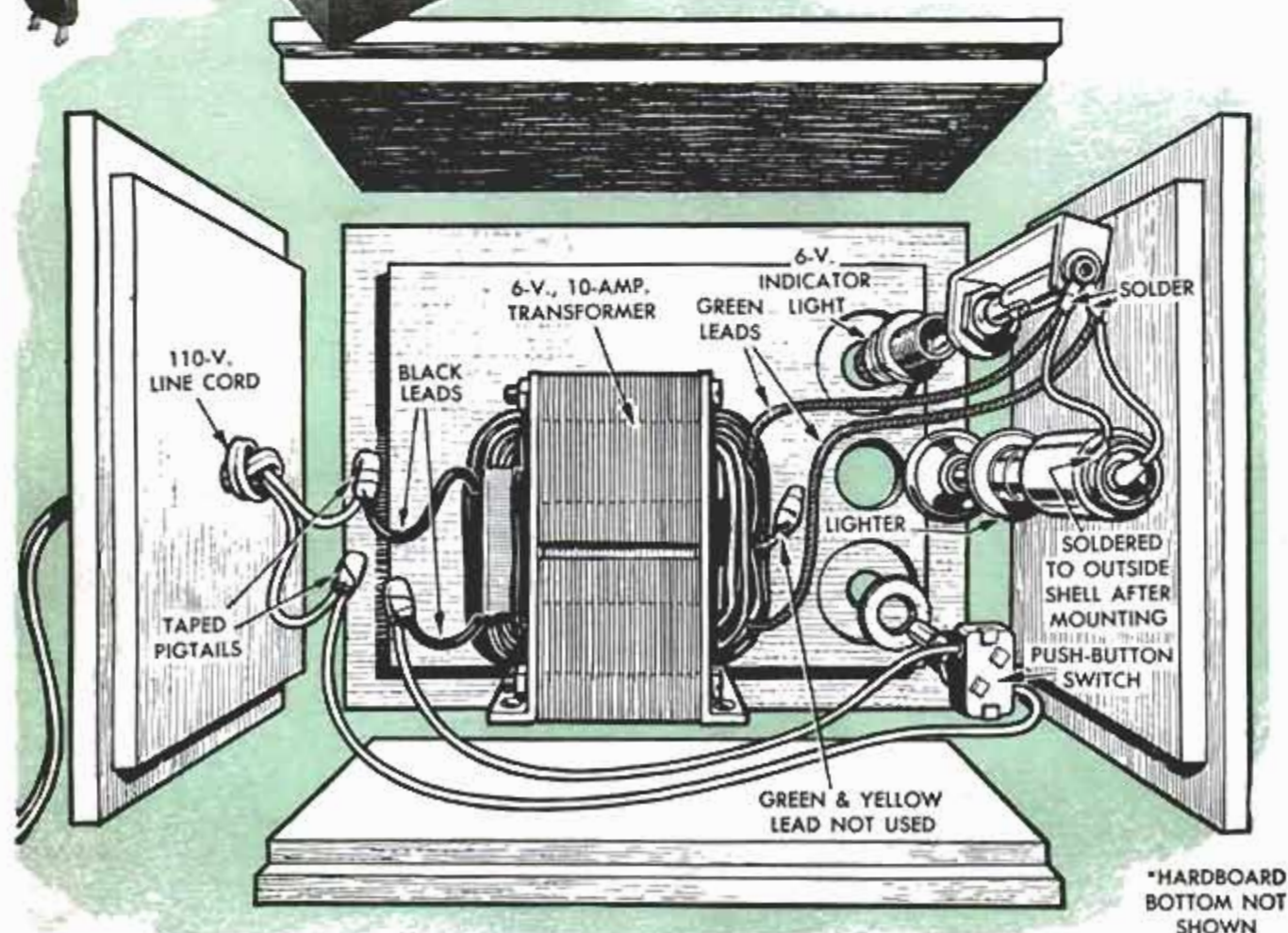

"Sling" to Carry Heavy Outboard Motor Easily

By using this carrier, two men can carry a heavy outboard motor easily and place it in the bottom of a boat, or the back of a car to keep it from bouncing around over rough roads. The carrier is made from $\frac{1}{2}$ -in. pipe and short pieces of 2x4s. The motor is tied down with turnbuckles anchored to the carrier with pipe clamps and a heavy spring. If a bender is not available for shaping the pipe, tamp it full of sand and then bend it around some object that has approximately the desired radius. The sand will prevent buckling.

L. A. Wilke, Austin, Tex.

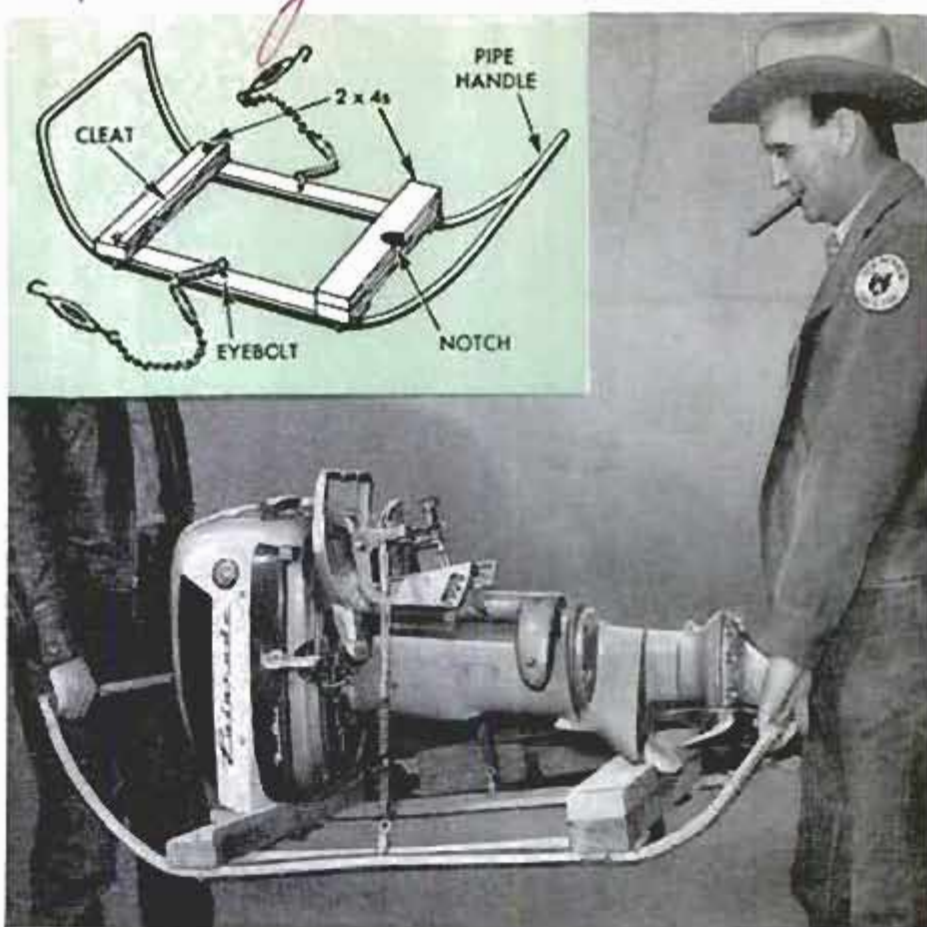

Model Builders, when tying the many fine lines needed to make the shrouds of authentic ship models, can save time by substituting lightweight nylon fishing line for the thread that came with the model kit. The

nylon line is laid out on an assembly board in the usual way, but joined lines need not be hand tied. Nylon melts under heat and permanent joints are made by touching each joint with a soldering iron.

Cardboard Disk Protects Chuck Lathe Dog or Tool Post

A student, or even an experienced operator for that matter, may accidentally allow the compound rest or tool post to strike a spinning lathe chuck. To serve as a reminder to avoid such an accident, try fitting a white cardboard disk over the face of the chuck. The disk has two cross slots cut in the center to form four points, which hold it in place.

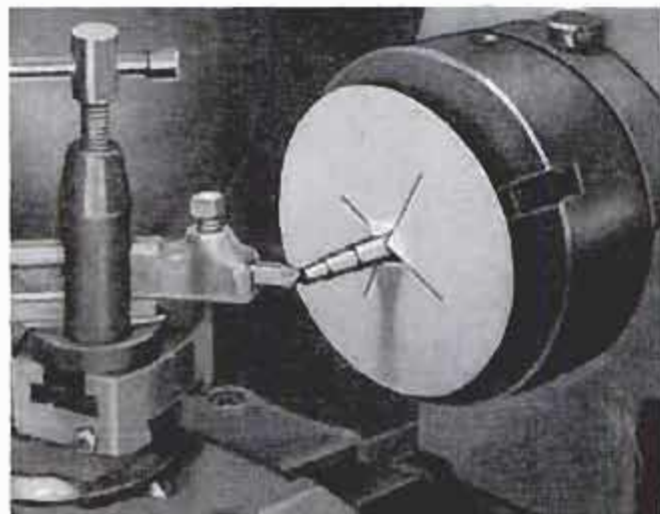

Lathe Carriage Used to Position The Tailstock Accurately

A quick method of positioning a lathe tailstock is to use the carriage to slide it into position. By connecting the tailstock to the carriage with a removable wire clip, it can be positioned with one hand while the work, especially if it is heavy or unwieldy, is held with the other hand. The tailstock then may be moved in either direction to engage the work.



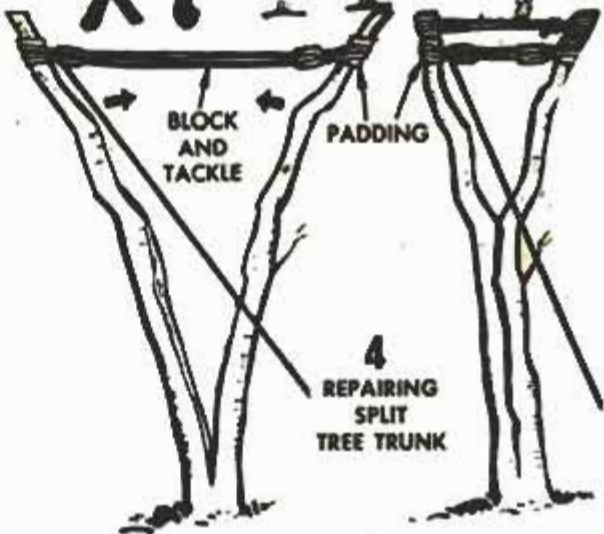

SURGERY

By Earle W. Gage

USE OF PROPER "surgical methods" when pruning or repairing tree damage is nearly as important for survival of the tree as it is for treating human ailments requiring surgery. Tree bark serves the same primary function as the skin covering your body in that it protects underlying tissue from attack by micro-organisms that exist in the atmosphere. Illustrated and explained in this article are the procedures for treating successfully most of the injuries that might possibly occur to your trees, including the proper way to prune them.

Fungi Cause Most Trouble

Most of the ills that beset trees are caused by fungi, the spores of which find suitable conditions for incubation and development in sap that flows from exposed wood whenever there is a break in the bark. That is why it is important to treat such areas as soon as possible after the injury. The procedure is the same regardless of the nature of the wound, whether it be a gouge, an amputated limb, an infected cavity, or very serious damage such



Above left, badly split tree need not be cut down. After pulling split parts together and bolting them in place, tree will remain alive and grow stronger

Center left, after removing loose fragments from surfaces of break, antiseptic is applied, followed by coating of asphalt to prevent fungus infection

Left, trunk is drilled through at right angles to surfaces of break to take threaded rod which holds trunk together permanently when screwed in place

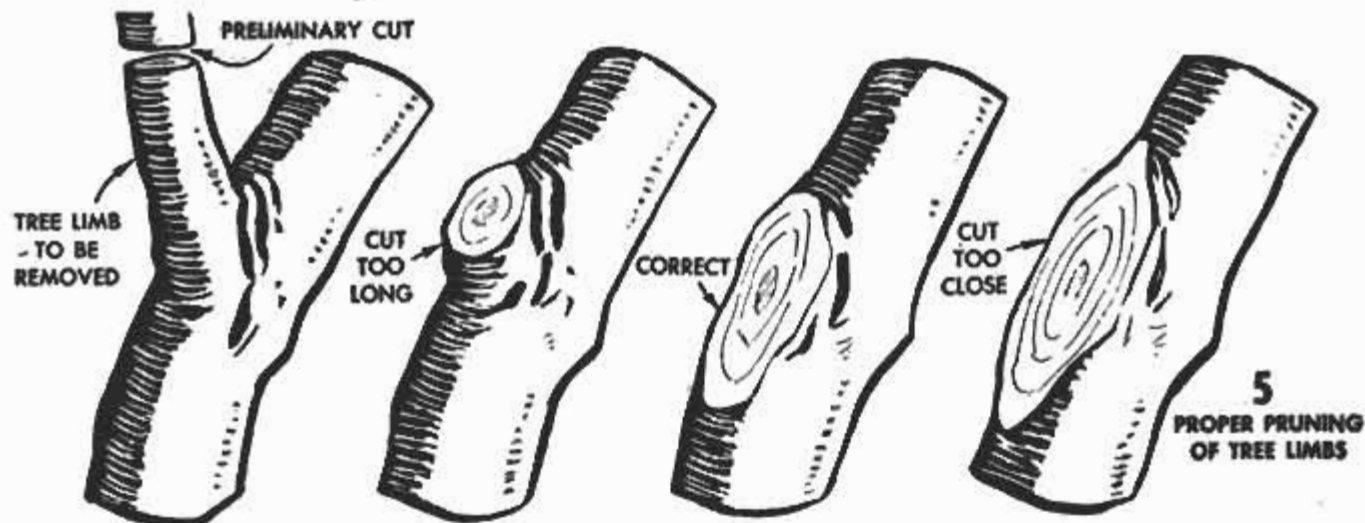

MAY SAVE YOUR TREES

as a split down the entire trunk, as shown in Fig. 1. First remove loose fibers and dead tissue. Then saturate the exposed surfaces with an antiseptic, especially the outer growth since it is the sapwood that is most susceptible to infection. This can be a 1-to-1000 solution of bichloride of mercury; a copper sulfate solution, made by dissolving 1 oz. of copper sulfate in 1 qt. of wood alcohol; or creosote. If a mercury solution is used, handle it with care. It is a deadly poison and is harmful to skin and metals. After sterilizing the wound, give it a waterproof coating of chromate asphalt. Inspect large wounds each spring and apply a fresh coat of asphalt if needed.

A valuable shade or fruit tree that is badly split down the trunk, Fig. 1, can usually be saved, if it is repaired promptly. Begin by cutting away all loose fragments. Then sterilize the exposed surfaces and coat them with asphalt as in Fig. 2. Connect a block and tackle to the largest branches growing from the trunk and pull them together as in Fig. 4. Secure the limbs in

position with a Manila rope to prevent the parts of the split from spreading when the tackle is removed. Note that soft padding is placed between the rope and bark at points of contact to avoid crushing the bark. Remove the rope when the repair is completed. Next drill holes through the trunk at right angles to the surfaces of the break, Fig. 3, to take threaded steel rods like the ones shown in Fig. 7. (The latter shows an example of "preventive medicine," the rods being used to reinforce a weak crotch that might have split at a time of stress.) If the bit you have is not long enough to pass through the trunk to be drilled, weld a steel rod on the end of it. Holes must be slightly smaller than the rods used. They should be spaced close enough to draw the split parts tightly together.

When installing a rod, tap it in the hole for a depth of about 1 in. and then screw the rod in the rest of the way, using a pipe wrench for leverage as in Fig. 6. Cut off the unused part with a hacksaw. Both ends should be within the bark layer to permit





the wounds to heal over and conceal the rod. At strategic places, such as at the upper end of a split trunk, the rod should have a washer and nut on each end as in Fig. 8. This eliminates the possibility of the screw thread slipping out of the hole, as when considerable pressure is brought to bear by a windstorm, or from the weight of fruit or snow.

A cavity in a tree trunk or limb offers an ideal breeding ground for fungi, especially when its position is such that water enters and remains there. To eliminate this threat to the life of a tree, it is necessary to remove all dead matter from the cavity and prepare it for a concrete filling, a procedure which is not too unlike that of filling a tooth. When removing decayed wood from a cavity, use outside-ground gouges having curved cutting edges. Keep them very sharp so as not to tear the delicate cambium tissue (the layer between wood and bark in which almost all growth takes place). Be sure to cut away all discolored and water-soaked heartwood since fungi thrive in this medium, which cannot be disinfected. Trim the bottom of the cavity so that water will drain out, yet leave enough of a pocket or recess to hold the concrete filling. Next disinfect and coat the cavity walls in the manner suggested for treating exposed wood. When filling a large cavity, such as the one shown, it is necessary to drive 3-in. common nails halfway into the wood. Spaced as shown, the nails hold the concrete in place when hard. Use 1 part cement to 3 parts sand for small cavities, substituting fine gravel for the sand when filling large ones. The mortar should be stiff so that it remains in place when troweled into vertical cavities. However, a very large cavity requires a temporary retainer consisting of a piece of screening held in place by wires as shown in Fig. 9. The wires and screening are removed when the concrete has set, at which time a thatch of tar-paper strips is cut to fit the opening and attached to it by pushing nails into the soft concrete. The tar paper protects the somewhat porous concrete from rain, keeping it in good condition for a long time.

The proper way of pruning a tree is detailed in Fig. 5. For large limbs especially, it is important to make a preliminary cut a short distance above the final cut. This prevents the severed limb from tearing bark off the trunk, or from producing a shattered, porous cut that would soak up water and invite infection. A close cut is neat looking and it permits cambium to produce a covering of bark. A cut that is made too close leaves an unnecessarily large wound. ★ ★ ★

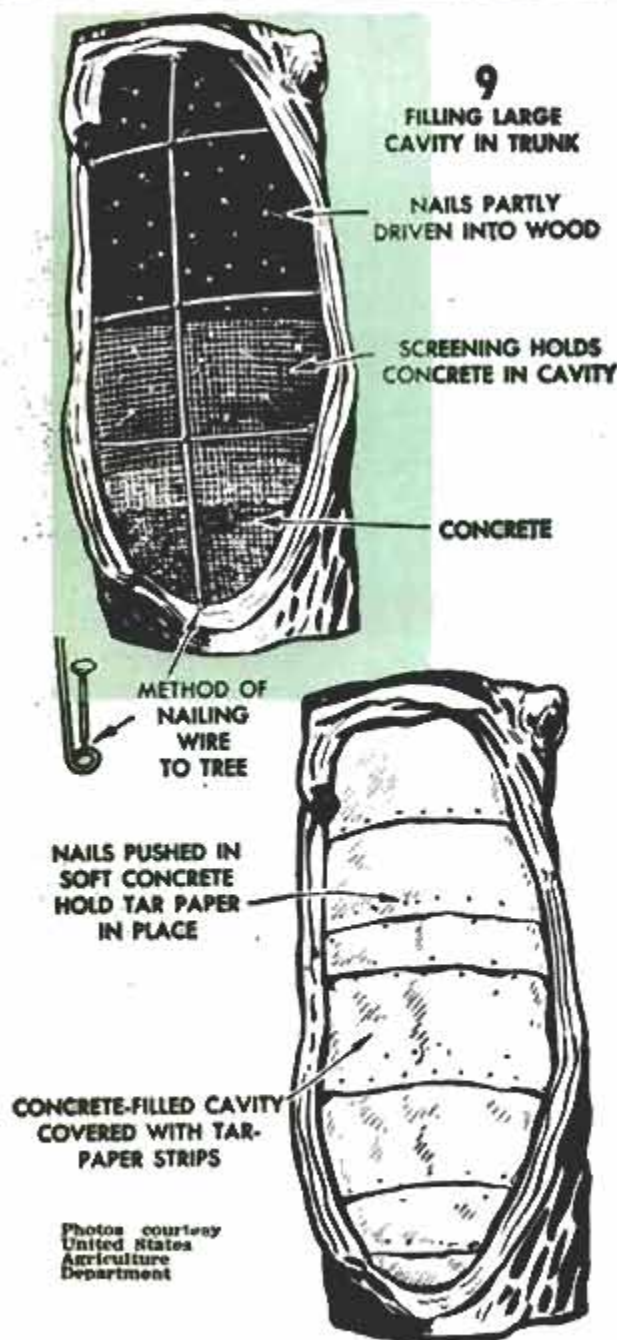

Ice-Fishing Hole Kept Open With Improvised Heater

To prevent a fishing hole from freezing over during the night, one ice-fishing enthusiast places a lighted kerosene lantern in a 5-gal. paint pail, which then is allowed to float in the hole. A 2-in. layer of gravel in the pail serves as ballast to keep it upright in a strong wind and prevent the lantern from sliding to one side. The improvised heater is effective, except in very cold weather. The glow from the light also serves as a warning to skaters, enabling them to see the danger spot in time to avert a collision.

G. E. Hendrickson, Argyle, Wis.

Helpful Hints for Duck Hunters

Chest-high waders are expensive duck-hunting accessories that are well worth repairing to delay the time when they must be replaced by new ones. Most cracks, tears and punctures can be repaired on the spot with an inner-tube patching kit. It is a good idea to reinforce weakened places with large, vulcanized patches. When waders are no longer repairable, cut them off at the ankles and use the bottom for ankle-length rubbers. The tops may be used to protect clothing when changing a tire on the road. They also make excellent rain pants for use on a boat, or when hunting in wet underbrush.

Save the wings from ducks shot in the fall and use them for making realistic-looking training aids for a retriever. When doing this, chop the wings off close to the body and store them in a dry place. Then tape four wings to a small, cork-filled boat fender so that the heavier parts point toward the ends of the fender, making the dummy slightly dumbbell shaped. Such a dummy approximates the size of a duck's body, encouraging a dog to take a proper hold on it.—D. Duffy, Clintonville, Wis.

Hose Prevents Ice From Cracking Flagstaff Hole

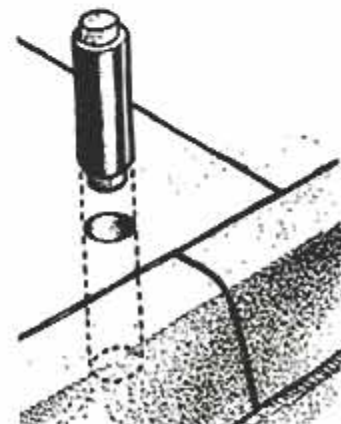

If water is allowed to collect in a flagstaff hole in a curb, it may crack the concrete upon freezing. To prevent this, plug both ends of a length of hose and keep it in the hole as indicated.



"Bed Closet" Saves Floor Space In Attic Bedroom

When an attic is converted to bedrooms without raising the roof, more usable floor space can be gained by providing a storage recess or cabinet in each room to take a single bed of the type mounted on rollers as shown below. Vertical clearance of 2 ft. is provided so that a bed may be rolled into it when made up. Note that insulation board is used to line the recess. The latter can be left open at the front, or fitted with a door as shown. To insure ventilation, perforated hardboard could be used for the door. Extra guest beds may be kept in such enclosures, ready to use when the need arises, but completely out of the way when not in use to leave more space for play, sewing or other uses.

N. M. Pittman, Overton, Tex.

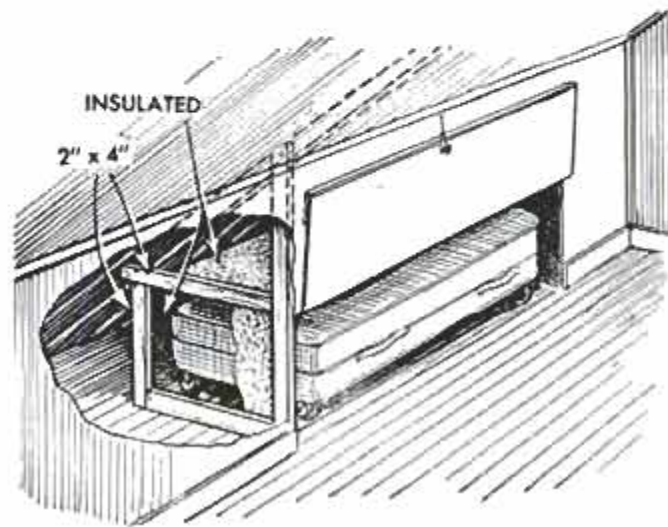



Solving HOME PROBLEMS



1. ANY DRINKING GLASS can be quickly converted to a beaker by slipping a rubber "spout" over the rim. The latter is a 2-in. section of motorcycle inner tube which is cut to the shape shown to form a pouring lip when the band is stretched over glass

2. THE CHANCE of accidentally cutting the cord on an electric hedge trimmer is lessened when a spiral wrapping of adhesive tape is wound around the cord. The white tape makes the cord stand out in sharp contrast, and thus, is much easier to see

3. TO KEEP A BRUSH soft overnight during a paint job, or for a longer period, wrap aluminum foil around the bristles to form a self "container." Add a little solvent and seal shut by crimping foil around handle. The stored brush will stay soft for several days

4. IT TAKES GOOD EYESIGHT sometimes to spot the clear-plastic protective cap on the cutting head of a razor when it is removed. To make it readily seen when laid on any surface, paint a narrow stripe of nail polish across the top of the plastic cap

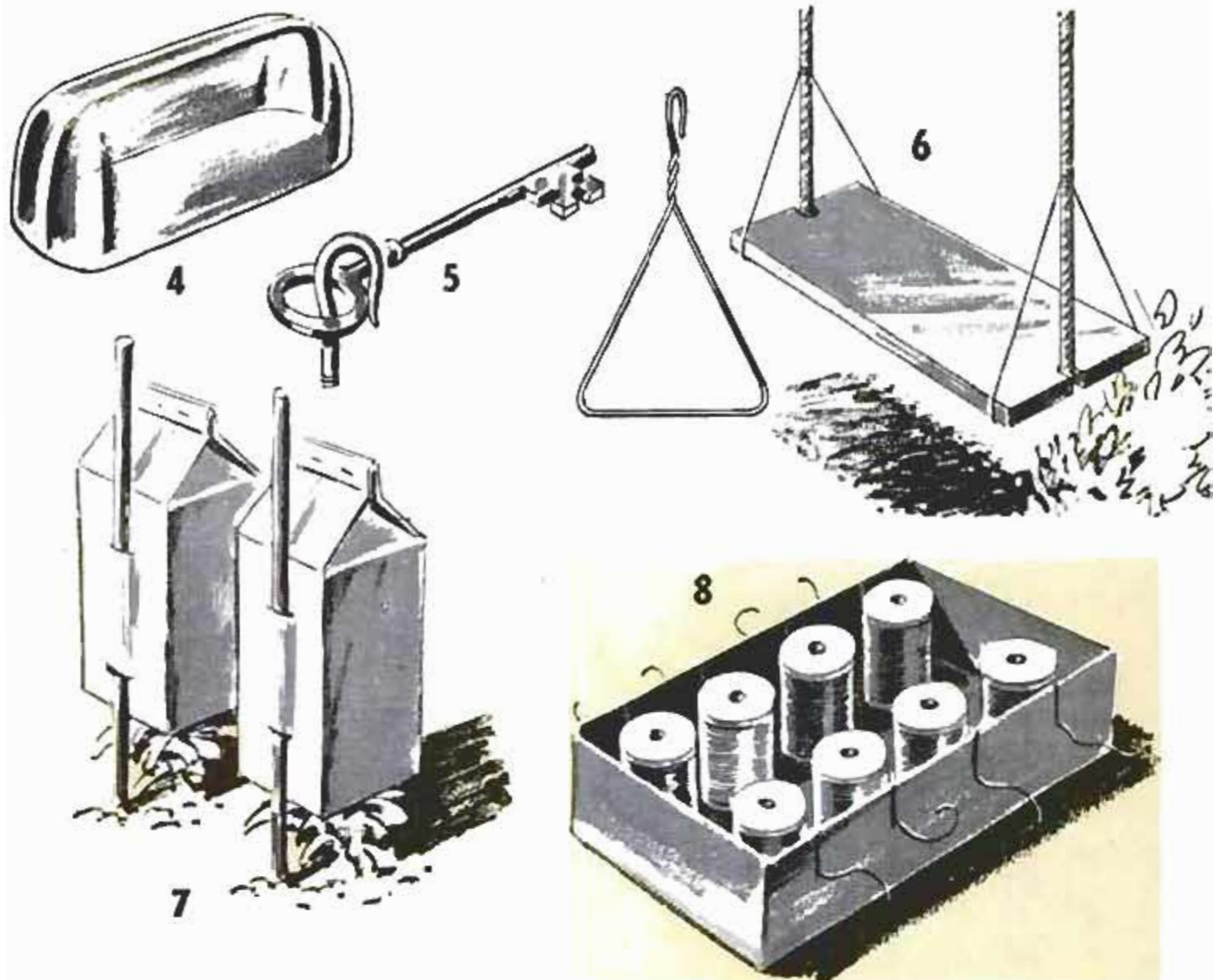

5. WHEN THE HOUSEWIFE is without the proper tool for driving cup or screw hooks, she will find that the skeleton key from a door lock makes a good substitute for the purpose. After the hook is started, the key is slipped over it and then used like a wrench

6. THE SEAT BOARD of a child's swing can be made nontipping with a couple of wire coat hangers. Bend the hangers triangular-shape to slip over the ends of the board and then bind the straightened hook ends to the swing rope with several turns of tape

7. MILK CARTONS with the bottoms cut out make dandy temporary hoods for protecting tender transplants from early frost or wilting sun. The cartons are supported over the plants by sticks which are inserted through slits cut in the sides of cartons

8. BOX-TOP THREAD DISPENSER will keep a number of spools of thread tangle-free when the bottom of a candy box is slitted and the thread is pulled out through the slits. Thread ends are always left protruding after use. The box cover holds ends secure

9. FURNACE FILTERS are easily cleaned with your vacuum cleaner if a window screen is placed over the filter to prevent the suction from dislodging the glass-wool fibers. The screen also permits the nozzle to slide without catching in holes in filter

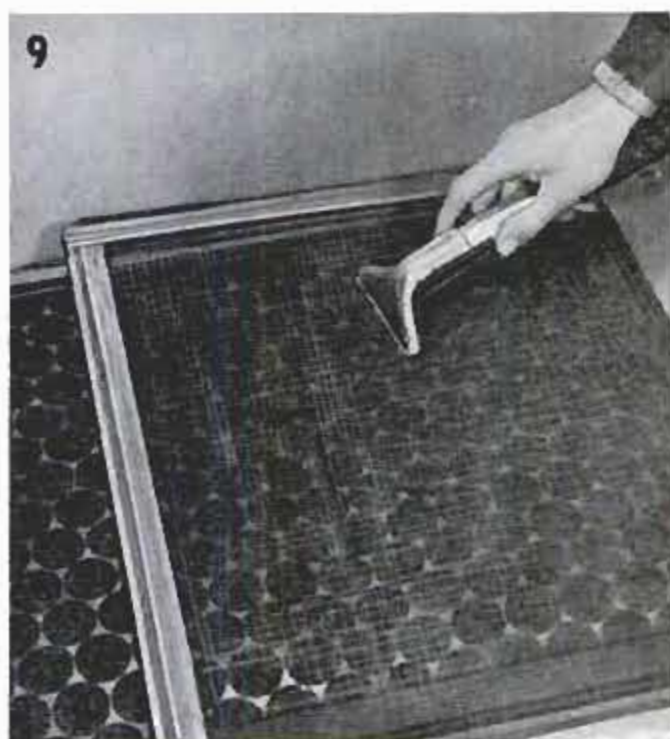

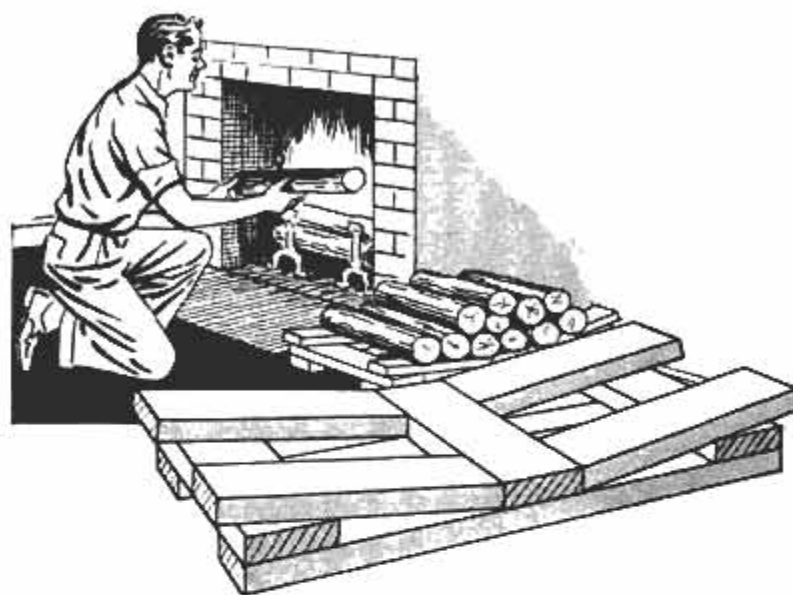

V-Bottom Wood "Basket" Stacks Fireplace Logs

While somewhat crude for use in your living room, this simple fuel rack is ideal for keeping logs neatly piled near a fireplace in your recreation room. Featuring a V-bottom which makes the logs roll toward the center as they are used, the rack is formed by stacking nine 2 x 4 blocks in the manner shown. You have a choice of tossing the blocks in the fire along with the last log, or making the rack a permanent one by nailing the blocks together and painting.

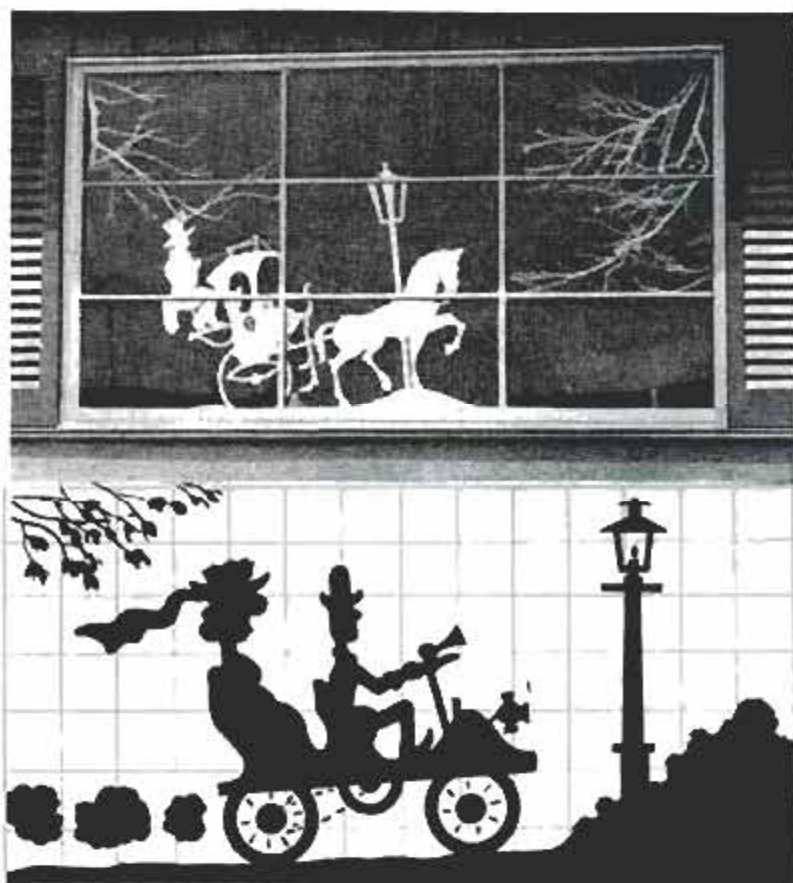

Silhouettes Perk Up Drab Looking Garage

A new fad that is becoming popular in California is the painting of silhouettes on the windows of garages to relieve their plain uninteresting look. The silhouettes are painted directly on the glass by pasting a suitable pattern on the outside of the glass and copying it by painting the outline on the inside. Patterns of horse-and-buggy scenes, as well as early-model autos, are preferred for silhouettes, although almost any magazine illustration will do when enlarged by the square method. The silhouettes are done in white paint to show up against the darkened interior. Actual tree branches, sprayed white, can be used in conjunction with the silhouette as shown in the photo.



Novel Cookout Trays

Ideal for outdoor cookouts to tote a sizzling hamburger or barbecue, these shovel-like trays will provide your guests with a safe way to carry a paper plate in one hand while they grab a Coke with the other. Varnished and decorated with appropriate decals, the trays are something that can be quickly mass-cut from scraps in your wood box. If you wish, a hole can be cut in one end of the tray to accommodate a drinking glass. The handles are cut from 1-in. wood and attached to the plywood trays with two flatheaded screws.

Ted Fenn, Skokie, Ill.

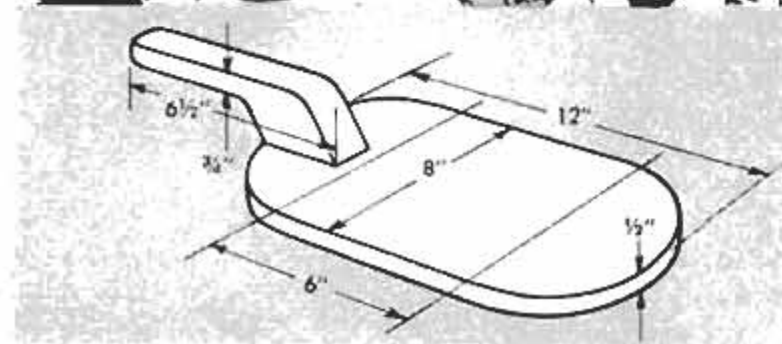

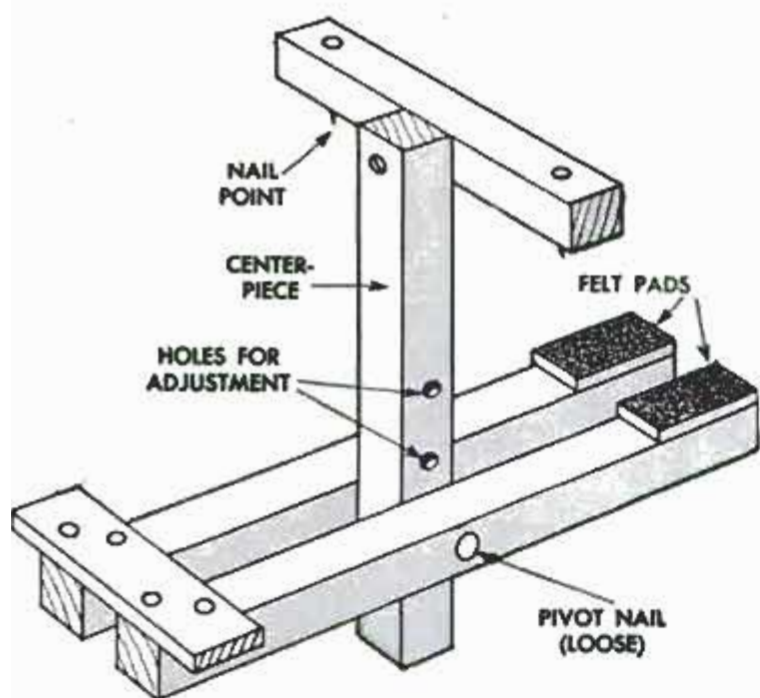

PHOTOFLOOD HANGER



Where to clamp a photoflood overhead poses a problem for most home photographers when there are no light stands at hand. Equally perplexing is how to hang a backdrop without driving nails into the woodwork. I was faced with these problems until I made a couple of these self-locking brackets which are designed to clamp to door or window trim and provide a support for clamping a photoflood or hanging a curtain. As shown in the detail, the bracket is adjustable to fit different-size trim and padded to prevent marring it.

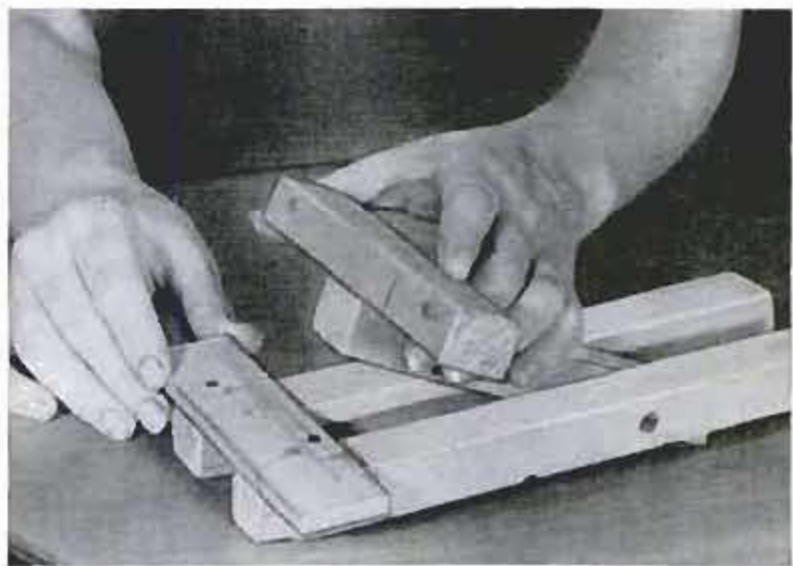

Fast Action Avoids Stains When Tackling Food Spills

If used in time, say technicians of the National Institute of Rug Cleaning, the following two formulas will remove nearly all food stains from rugs and carpets: Formula No. 1 consists of neutral soapless detergent, 1 teaspoonful, lukewarm water, ½ pint. Formula No. 2 consists of white vinegar, 1 teaspoonful, lukewarm water, 3 teaspoonfuls.

As with all food spills, the spot first should be sponged with lukewarm water. Then the remover is applied with an eyedropper and the spot wiped from the outer edge toward the center before finally blotting. Use formula No. 1 first in treating all

food stains. Then if the stain remains, use formula No. 2. Where both formulas are used, dry the spot by absorbing the moisture into thicknesses of paper towels held in place by flat weights. The secret of successful application is to avoid excessive use. Application of either formula to the extent of soaking the back of the rug may result in staining the carpet brown. Likewise, if too much dry-cleaning fluid is used, the fluid may deteriorate the latex backing used in many rugs. To remove butter and other fat stains, apply dry-cleaning fluid with an eyedropper and sponge with white unstarched cloths.

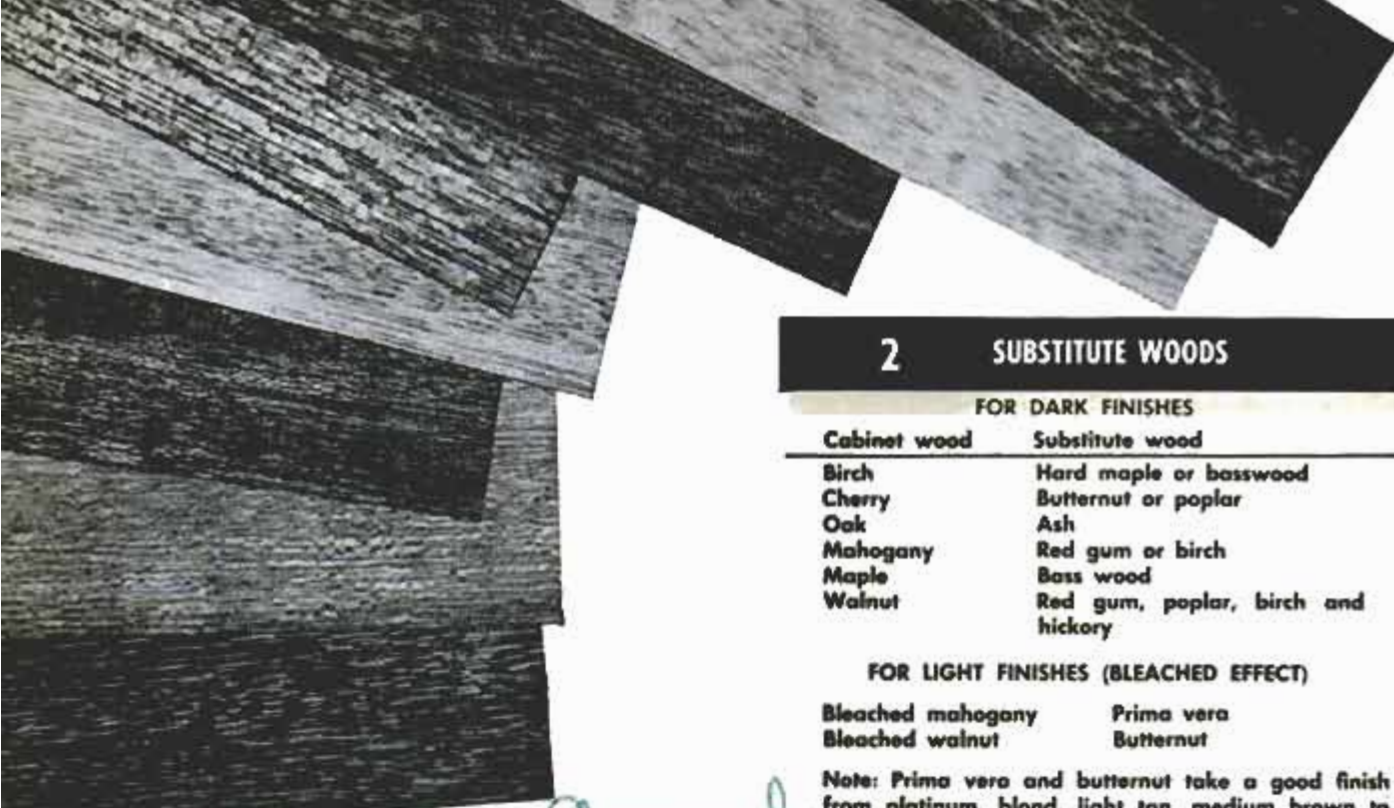

2

SUBSTITUTE WOODS

FOR DARK FINISHES

Cabinet wood	Substitute wood
Birch	Hard maple or basswood
Cherry	Butternut or poplar
Oak	Ash
Mahogany	Red gum or birch
Maple	Bass wood
Walnut	Red gum, poplar, birch and hickory

FOR LIGHT FINISHES (BLEACHED EFFECT)

Bleached mahogany	Prima vera
Bleached walnut	Butternut

Note: Prima vera and butternut take a good finish from platinum, blond, light tan, medium brown to dark finishes of mahogany and walnut

1

CAUSES OF FINISH FAILURES

- 1—Inferior or defective lumber
- 2—Excessive moisture in wood
- 3—Dents, scratches, tool marks, glue spots and stains on work
- 4—Insufficient or improper sanding of wood before finishing
- 5—Presence of sanding dust on surfaces when finishing
- 6—Dust in air settles on surfaces of work while and after finishing
- 7—Wrong temperature and humidity
- 8—Inadequate illumination
- 9—Finishing in direct sunlight
- 10—Poor grade of finishing materials
- 11—Old, spoiled finishing materials
- 12—Incompatibility of materials
- 13—Wrong type of brush
- 14—Improperly cleaned brushes
- 15—Poor brushing technique causing brush marks, skipped areas, runs, sags, and pileup in corners
- 16—Air bubbles in shellac, sealer, varnish, and lacquer
- 17—Faulty spray-gun technique
- 18—Wrong spraying consistency
- 19—Improper adjustment of spray gun
- 20—Insufficient drying between coats
- 21—Improper sanding between coats
- 22—Wrong rubbing and polishing materials
- 23—Faulty rubbing and polishing

YOU CAN

Haste trips up most beginners when finishing furniture. Passing over important little steps in surface preparation is the biggest mistake. Take it easy and you'll find that you can finish furniture beautifully the very first time

By E. R. HAAN

PART 1

ADDING THE BEAUTIFUL finishes which give that store-bought look to home-built furniture is a part of furniture making that throws the average home craftsman for a loop. And yet, it actually requires far less skill than the cabinetry. The cause of most finish failures on the part of the home craftsman is haste. In his eagerness to complete the piece and put it in use, the tendency is to overlook many seemingly unimportant little steps and, consequently, his efforts to produce a fine piece of furniture, finish-wise, result in disappointment. In addition to impatience, other causes of finish failures that plague the beginner are given in Fig. 1.

61" Shopnotes Annual



Delta photo

FINISH FURNITURE

Starting Out Right

A transparent finish emphasizes both the beauty and the defects of wood. Therefore, when building fine furniture to be so finished, select each piece of wood carefully and avoid that which has undesired knots, mineral streaks, sap and heartwood. As it is impossible to obtain lumber without any defects at all, enough should be purchased so that undesired areas can be cut out as waste. For exacting standards in fine cabinet work this may mean a waste of 30 to 40 percent. Where economy must be considered, it is possible to cut costs by using certain substitute woods as listed in Fig. 2, and finish them to resemble the more expensive ones.

Finishing nails should be set below the wood surface and the holes filled with wood putty as in Fig. 3. Sunken screwheads can be concealed with "boat plugs" which show surface grain as in Fig. 4. You can cut these from relatively thin wood by using a "hole punch" of proper size to assure a perfect fit. Such plugs should match the wood grain around the holes. Glue them in place and sand them flush after the glue has dried.

Take care to avoid glue stains as they prevent uniform staining. Remove un-

avoidable glue drops with a sharp wood chisel or scraper, then sand the surface smooth. To eliminate shallow dents, moisten them and then apply a warm iron as in Fig. 5. If the dent does not raise enough, make several razor slits with the grain and then repeat the process.

Sanding Prior to Finishing

Much time and effort can be saved by using power sanders, a belt sander, Fig. 6, for heavy cutting, and a reciprocating pad sander, Fig. 7, for fine finishing. The pad sander is better for cutting off fine ends of wood fibers but is not intended for heavy work. Three grades of sandpaper, coarse, medium and fine, as recommended by the machine manufacturers, are used successively to produce a perfectly smooth and scratch-free surface.

When hand-sanding wood, you also use three grades of open-coat aluminum-oxide abrasive paper, Fig. 8, detail A. Use No. 1/0 to remove tool marks and light glue spots, No. 3/0 to level and smooth and No. 6/0 to produce the final smooth finish. For flat surfaces you should hold the sandpaper on a wooden block or other type of holder. The block or holder shown in detail B, has a felt

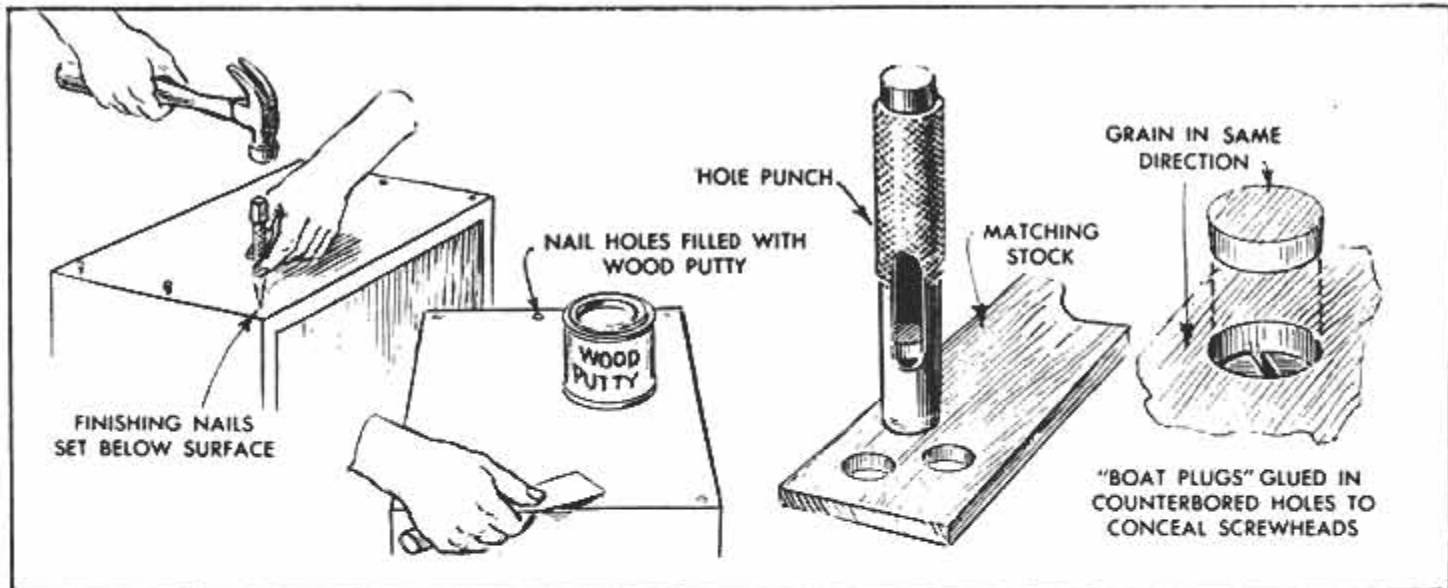

3 WAYS TO CONCEAL NAILHEADS

4 AND FLATHEAD WOOD SCREWS

backing. For curved surfaces, hold the sandpaper on a 1/2-in.-thick felt pad as in detail C. For small-radii molding always use a finger behind the paper to make it conform to the curvature. For sanding many pieces of similar molding you can make a sanding block having the same contour, as in detail D.

Always sand with the wood grain to avoid cross scratches that are hard to remove. Pressure should be light, letting the grit do the work. Slightly bevel, or break, all sharp edges with two or three strokes of No. 6/0 sandpaper, but not more than this as the edge then will become noticeably rounded. A sharp edge causes finishing material to build up on either side of it but prevents good coverage on the edge itself.

Fuzzy grain that remains on some woods after sanding is removed by first applying a glue size (glue, 1 oz. and water, 1 pt.), letting it dry for 24 hours and then sanding. After the bare wood on any furniture job has been completed, dust off all surfaces with a soft brush or use a vacuum cleaner with a small brush attachment.

Room Conditions for Finishing

Many home craftsmen do their finishing under adverse room conditions of temperature, humidity, air circulation, cleanliness and illumination. Temperature should be 70 deg. F. or more. Humidity should not exceed 90 percent as this greatly prolongs drying time and much more dust than normal will settle and spot the finish.

There should be a constant change of air. This equalizes inside and outside humidity and eliminates volatile vapors that may be harmful to breathe and are a fire hazard as well. Too fast a change of air should be avoided as it raises dust. When using a spray gun, a discharge fan and a respirator for the worker are necessary.

Lighting above and on the side of the work as in Fig. 9 (top) should be adequate so that the application of finishing materials can be seen by slight reflection, and thus can be controlled. Finishing and drying should never be done in direct sunlight as this may cause haze and discoloration. The room should be as free as possible of dust. A room that is separate from the workshop is best. Fine finishing never should be attempted outdoors or in an open garage or workshop that is exposed to even a slight wind. This invariably results in a ruined, dust-speckled finish.

Plan on using only the best finishing materials available. Price often is a good criterion. Use fresh materials, avoiding the temptation to economize by using the contents of an opened can over three months old. Old material may never dry,



5 REMOVING SHALLOW DENTS

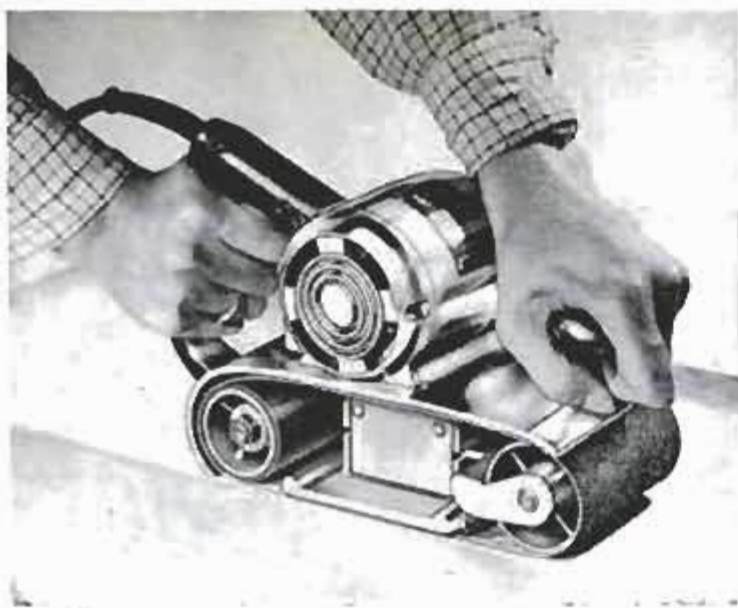

6 BELT SANDER FOR HEAVY CUTTING

Skill photo



7 PAD SANDER FOR FINE FINISHES

Miller Falls photo

may contain dust deposited in it by a previously used brush, may be oxidized and covered with a skin, may have undergone chemical changes so that a resulting finish will be cloudy.

One kind of finishing material may have a formulation not compatible with another. For example, the solvent of a sealer or top coat applied on a stain or primer may cause the stain to bleed or prevent it from drying. A lacquer top coat should never be applied over a pigmented oil stain, nor over varnish, although varnish can be applied over lacquer. Some materials serve as both sealer and top coat, and are not compatible with regular varnishes and lacquers.

Tips on Brushes and Spray Guns

Using the right kind and size of brush

contributes to better work. A soft, long-bristle brush, 2 to 3 in. wide, is best to apply sealer, varnish and lacquer. An inexpensive soft brush, 2 or 3 in. wide, is adequate for applying stain. A stiff-bristle brush, 3 to 4 in. wide is best for applying filler. Get good quality brushes.

Many finish failures are caused by improper cleaning and storage of brushes. They should be cleaned immediately after using them. Brushes used for stain and filler are cleaned with turpentine, benzine or white gasoline. Those used for varnish are cleaned with turpentine or special solvent used for some varnishes, but never with benzine or white gasoline, which causes the varnish to curdle and form small particles that come off in subsequent jobs. Brushes for shellac are cleaned with wood

8 SANDING BLOCKS AND PADS FOR FLAT AND CONCAVE SURFACES

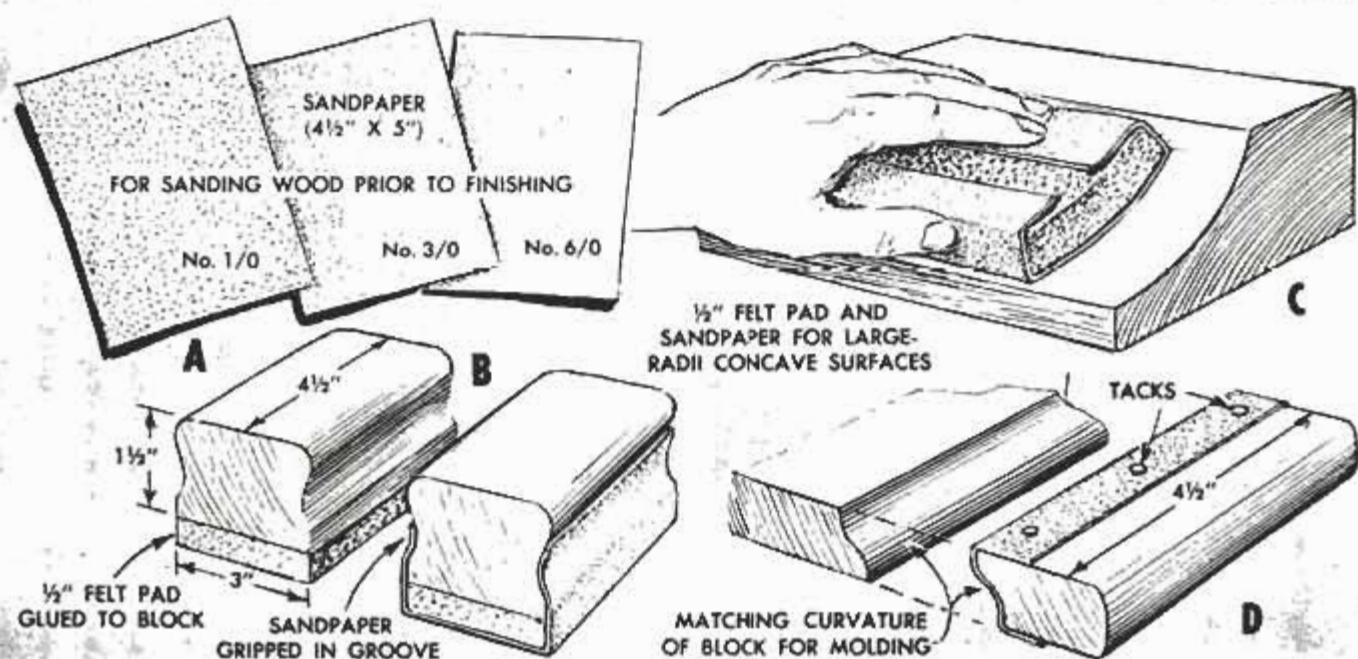

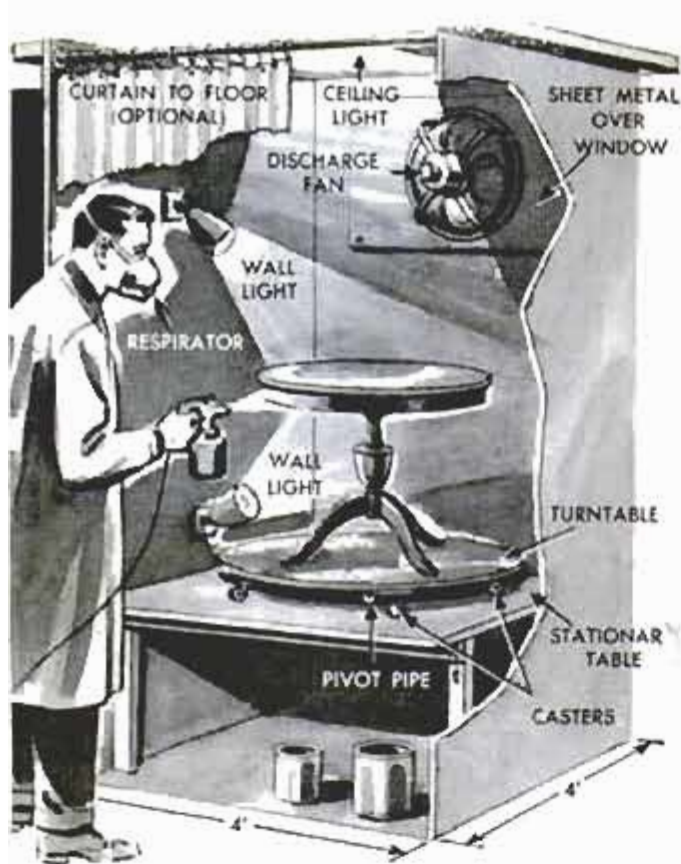

9 SPRAY BOOTH AND SPRAYING TECHNIQUES

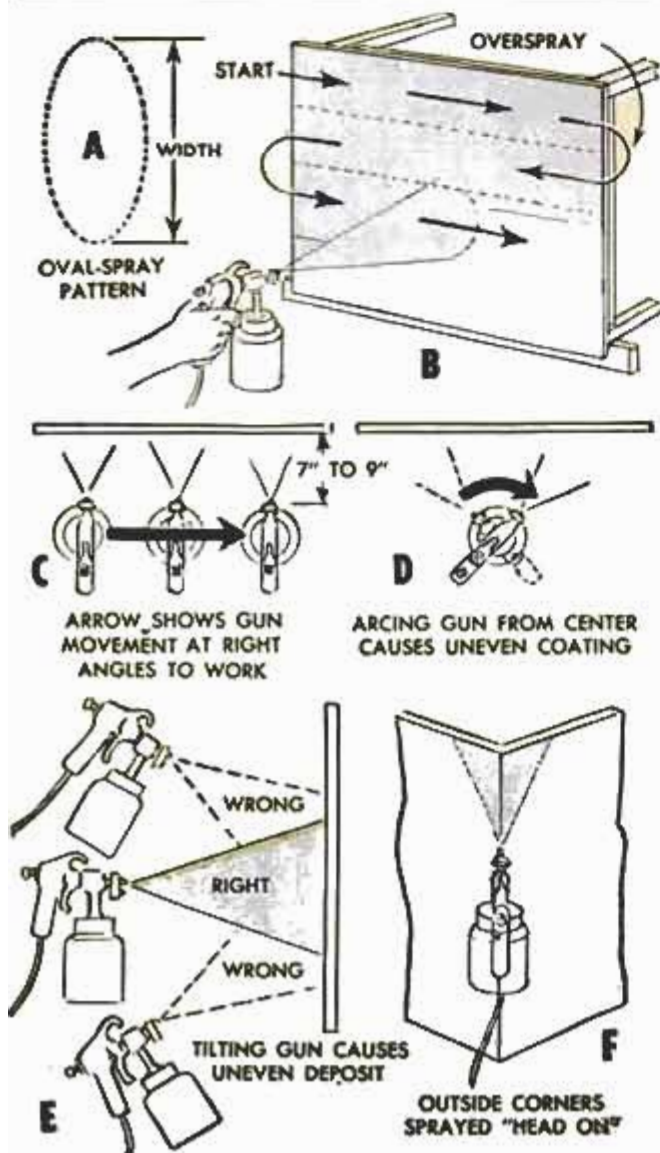

alcohol, and those for lacquer and lacquer sealer are cleaned with lacquer thinner.

To clean a brush properly, submerge it in solvent suitable for material in the brush, working this well into the bristles with your fingers as in Fig. 10. Repeat the process with fresh solvent until the brush is cleaned thoroughly. Shake the brush to throw out dirty solvent each time. Then straighten out the bristles by combing with a wire brush and wrap the brush in aluminum foil for storage as in Fig. 11.

The same solvents are used for cleaning a spray gun, which should be cleaned immediately after use. Clean the cup first, then pour in fresh solvent and spray this through the nozzle. Next, unscrew the nozzle to inspect it and the orifices for cleanliness. If the orifices are clogged, disassemble the gun and submerge the parts in solvent until the orifices are clean. Don't push wire through the orifices.

Any finishing materials should be stirred to mix the ingredients and produce the right consistency. Shellac, sealer, varnish and lacquer are stirred carefully to avoid forming air bubbles which are transferred to the work surface and may cause tiny craters. The brush is dipped into the liquid about one third of its bristle length, and then is drawn over the can rim to remove the excess. In large half-empty cans the brush can be slapped against the inside to do this.

Shellac, varnish and lacquer are "flowed" on with a full brush, first with long and slightly overlapping strokes in the grain direction, then with light cross strokes for uniform spreading, and finally with light finishing strokes with the grain.

Spraying Technique

A spray booth equipped with a fan to discharge the fumes, a turntable and suitable lighting, as shown in Fig. 9, is highly desirable. The average home spray gun op-

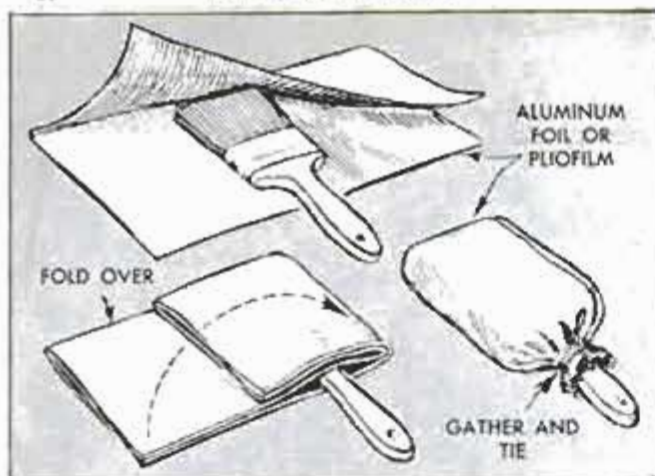

erates on a pressure of about 35 lbs. p.s.i., which permits spraying of liquids having about 20 percent solid material. Spray guns working on 90 to 110 lbs. of pressure can spray from 35 to 45 percent solid material in liquids. Finishing materials are brought to proper spraying viscosity by adding solvent. Then they are strained through a 60-mesh wire screen before being used.

The gun nozzle is adjusted to spray a fan pattern 5 to 6 in. wide, detail A, Fig. 9, when holding the gun from 7 to 9 in. from the surface. For each 10 lbs. of additional pressure, the gun is held 1 in. farther away. Holding the gun too close results in an uneven coating that has ripples and runs. Holding it too far away results in a dry, sandy spray with excessive dusting.

Always start spraying a vertical surface at the top and work downward with successive cross strokes as in detail B. Pull the gun trigger just before the spray hits the work, and release it just after it passes the work. You can spray the two vertical edges before making the horizontal strokes to minimize over-spraying. Always spray full wet coats just short of running.

Keep the spray axis at right angles to the work and at a uniform distance from it as in detail C. Arcing the gun from a central position, detail D, results in a heavier deposit at the center frequently causing runs. Holding the gun downward produces a heavier deposit at the upper fringe of the spray pattern, and holding it upward will make a heavy deposit at the lower fringe, detail E.

In spraying horizontal surfaces, you start at the edge nearest you and proceed to the farthest edge with successive horizontal strokes. Then the spray dust that lands on the uncoated surface will be dissolved by a full spray stroke. Reversing this procedure will cause spray dust to settle on the finished surface. Outside corners are sprayed head-on as in Fig. 9, detail F, with the nozzle set horizontally to produce an even deposit. ★ ★ ★

Outlining Aids Typing Stencils

When typing advertising copy on a stencil, it is easy to type within ruled-off areas if their limits are marked off on the cushion sheet between the stencil and the backing sheet. If you outline the areas with black ink, ruling them directly on the cushion sheet, you will be able to see the lines clearly through the stencil.

—G. E. Hendrickson, Argyle, Wis.



Coding Micro Slides

Identifying micro slides becomes a simple job when you are able to write the code number or letters directly on the glass. This can be done with a lead pencil if a roughened spot is made on the glass. A quick way to sand a spot on a number of slides is to cover the end of a dowel with fine emery cloth and chuck it in a drill-press. A roughened spot can be "ground" in a few seconds by a mere touch of the abrasive.

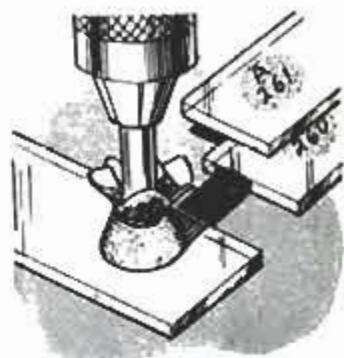

Hand Grip Improves Scraper

Since downward pressure is required when using a paint scraper, particularly when the blade begins to dull, you'll find that a knob added to the handle over the blade end provides a most convenient handhold. A drawer pull will serve as a suitable knob which is easily attached to the wooden handle.



AUTUMN BOUQUET

FROM AN ODD COLLECTION of dried egg shells, seed pods, a fruit jar and some left-over paint and varnish, you can create an artificial autumn bouquet for your table that is a thing of beauty. The bouquet part, consisting of milkweed and honey-locust pods, cattails and bittersweet, is gathered along roadsides, pastures and fence rows. Milkweed pods may be glued shut at the seams to retain the seeds or they may be removed. In the latter case, the open pods are painted inside and out in such colors as white, gold, silver, gray-green and shades of red and orange. The cattails should be cut with long stems and shellacked or varnished lightly to seal the seeds and preserve the original coloring. Bittersweet should be hung stem-end-up to dry for at least two weeks. Clay is used to bed the bouquet in the bottom of the jar vase. The method of decorating the latter is explained in the photos below.

Jean Lyon, Cedar Rapids, Ia.



Above, the fruit jar is decorated by first coating with thick shellac and then rolling it in crushed eggshells while tacky. Eggshell surface and remaining bare spots are then coated with flat-finish paint, or enamel



Below left, cattail seed pods are coated with varnish to prevent the millions of tiny seeds from floating about. Below right, when seeds are removed from milkweed pods, both inside and outside of pods are painted



Apartment-Size Tote Box

Although he has no need for as complete a toolbox as his homeowners cousin, the apartment dweller has need for a tuck-away fix-it box that will hold an assortment of tacks, screws and nails needed from time to time to fix a curtain bracket, hang a picture or fix a wobbly chair. Made like a suitcase from pine and hardboard, this box stands open for convenient access and provides shallow drawer space for sandpaper, glue and other items too large to fit in the jars. — Eli Raymond, New Bedford, Mass.

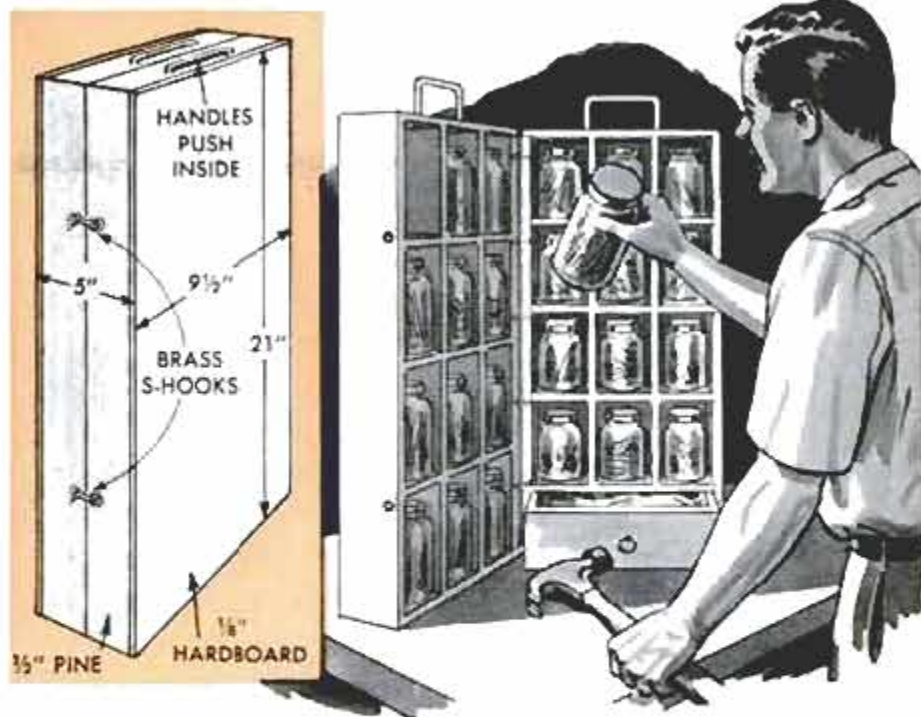

Identification Marks on Plywood Scraps Indicate Type at Glance

Once cut from the main panel, leftover scraps of waterproof plywood lose their identity as to their type. Consequently, it is a good practice to mark such pieces right away so there is no chance of getting them confused with nonwaterproof type. A "W" marked in pencil on one or both sides will tell you at a glance.

Richard Hanscom, Elmhurst, Ill.

When applying board sheathing diagonally, start a short distance from a corner, say about 6 ft. You'll find it easier to establish a 45-deg. angle, and short cutoffs can later be used up nicely in filling out the corners.

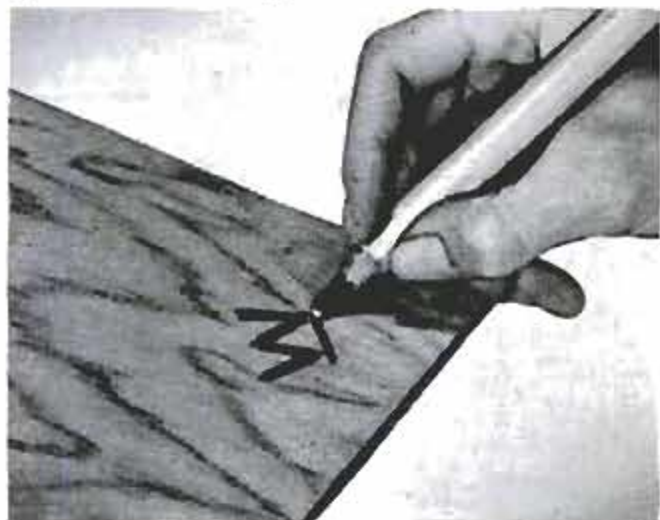

Swing-Away Tray Clamps to Bed Rail

Featuring a pivoted arm which clamps to the bed rail, this convenient tray can be easily swung away with little effort by the patient. The tray is a disk of plywood which is supported by bending a kink in the tubular arm as shown by the dotted lines. The clamp rides the rail and is clamped by a hook which is tightened with a wingnut. A piece of rubber tubing makes the hook nonmarring.

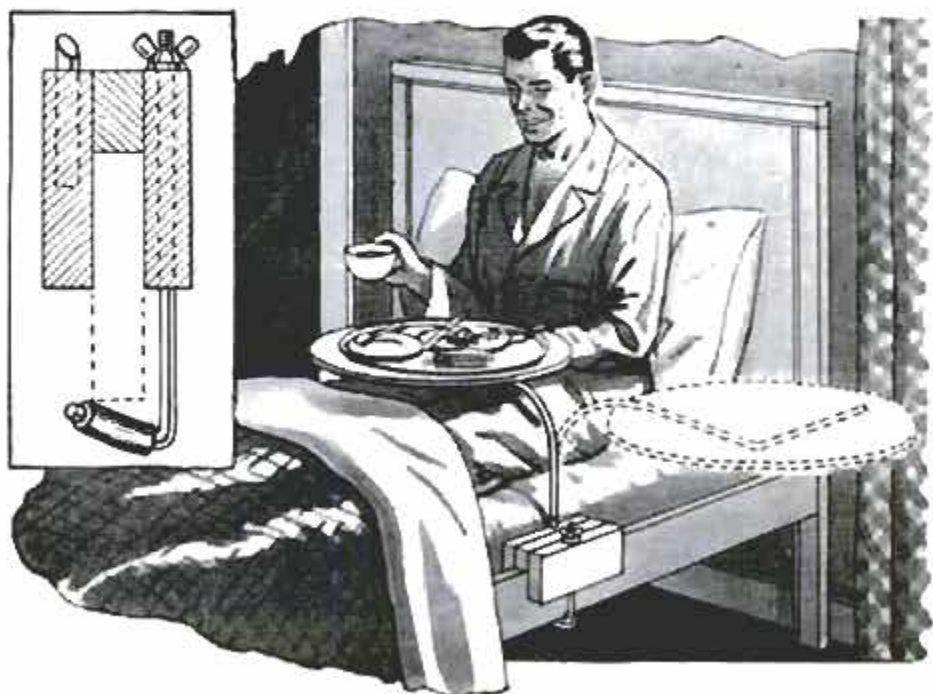

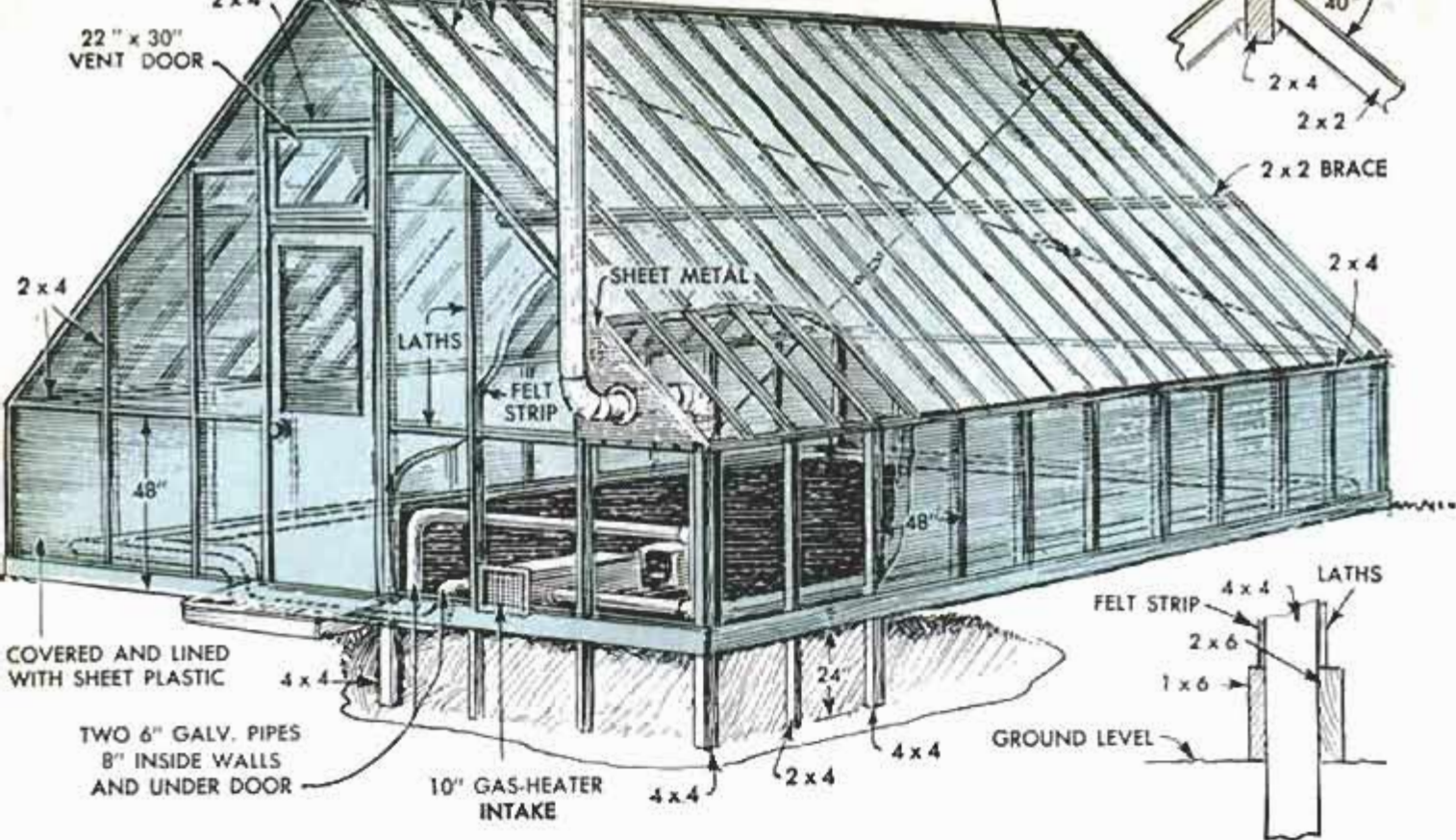

Plastic Cuts Greenhouse

By H. H. Slawson



LOWER ORIGINAL construction costs plus moderate maintenance expenses, for greenhouses used by either commercial or home flower growers, are promised by innovations in a structure designed and built by horticulturists at the South Dakota Agricultural College. Polyethylene-plastic film is used in place of the glass used in conventional greenhouses. Cost of the plastic for the 18 x 40-ft. structure built at the college was 45 dollars. Material for a home-size unit would be correspondingly less costly. To construct the walls 4 x 4s were sunk in the ground every 8 ft., with 2 x 4s centered between each pair. The corner posts are 4 x 4s. Across the top of these vertical members, which project 4 ft. above the ground and extend 2 ft. into the ground, are nailed 2 x 4s. At ground level, outside the walls, are nailed 2 x 6s, while a 1 x 6 is nailed to the inside of the wall opposite each exterior member. All wood contacting the ground is treated with wood preservative. The roof of the building consists of 2 x 2 rafters fitted against a 2 x 4 ridgepole. A 2 x 2 longitudinal is positioned at right angles to the rafters on each side of the roof, and lengths of 9-ga. wire are fitted through screw eyes and tightened by turnbuckles to form an X-brace on each side of the

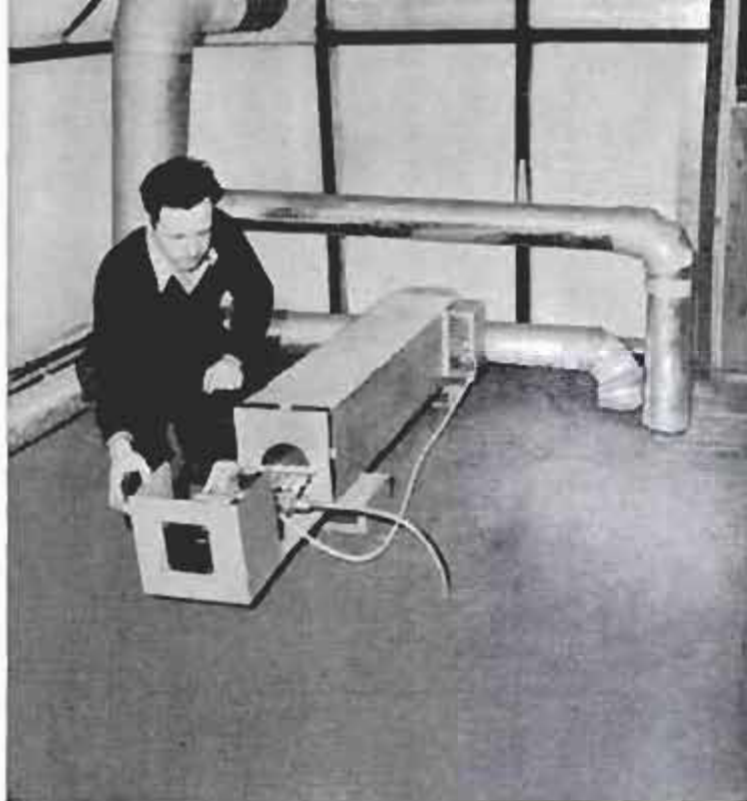

Costs

roof as indicated. Rough spots and slivers are removed or sanded before applying the sheet plastic, to minimize the chance of tearing it. The outside layer of polyethylene plastic is 3 mils (.003 in.) thick, stapled in place with laths nailed over it as added reinforcements. The inside layer of plastic is .0015 in. thick, strips of 2-in.-wide roofing felt being used rather than laths. Heat for the greenhouse is supplied by an LP gas heater, the heat being forced through metal ducts positioned 8 in. inside the walls, with the bottom duct 4 in. above the floor. The ducts run underground inside the door. A commercial version of the greenhouse has a concrete floor, with the furnace in an enclosure outside the greenhouse to conserve floor space. A home greenhouse also could have a concrete floor, with a small oil space heater to maintain temperature. The plastic deteriorates during the summer and must be replaced annually, but the college figures that, for a commercial establishment, its replacement cost is less than the cost of replacing broken glass. Also, with the continual improvement in plastics, it is quite possible that a material will be developed that will last much longer. Replacement of the plastic is made in fall, when the weather is fair. The 50-in.-wide material is lapped 3 in., for a tight, strong joint that keeps heat and humidity inside. ★★★

OCTOBER 1959

Yardstick on Workbench Edge Handy for Quick Measuring

Keyhole slots cut near the ends of a yardstick will permit it to be attached to the edge of a workbench, for measuring pieces of material. Round-headed screws hold it in place, yet allow it to be removed.

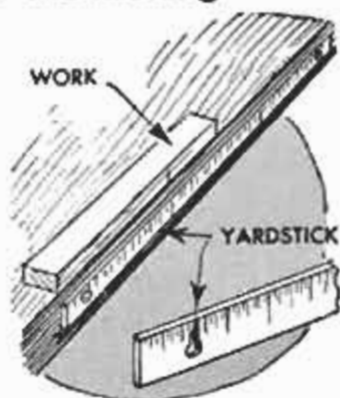

Notched Wooden Spacer Block Speeds Compass Adjustment

Fitted over the threaded adjusting rod of a compass, a notched spacer block permits quick adjustment to a small radius without the need for turning the adjusting nut to the full length of the screw.

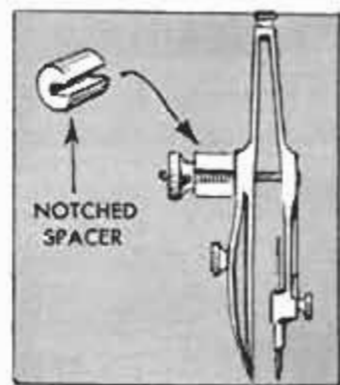

Loose Broom Handle Tightened By Expanding With Screw

When the wooden handle of a broom or brush becomes loose because the threads on the end have worn, it can be re-tightened by splitting the handle end and driving a screw into it.

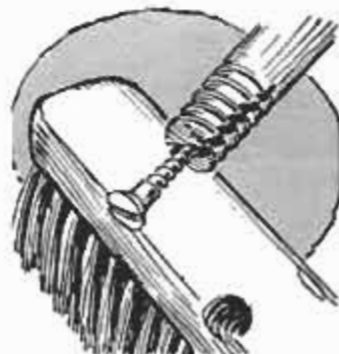

Accurate Center-Drilling Jig

Accurate center-drilling of small-diameter rods and tubes is assured with a jig made of two square nuts in which V-notches are filed. A hole of the desired diameter is drilled in one to guide the drill bit; the second nut holds the work level.

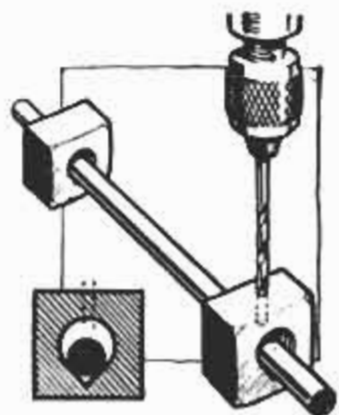



FROM NEGATIVE

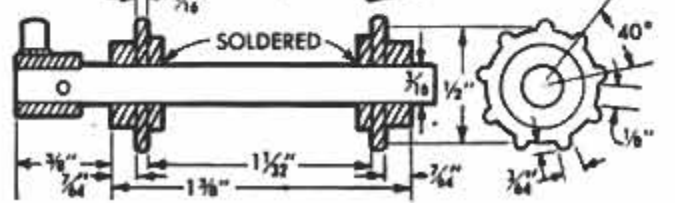
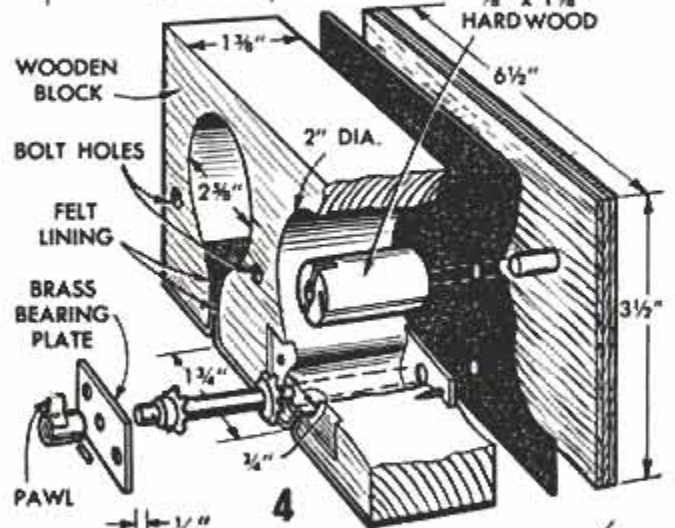
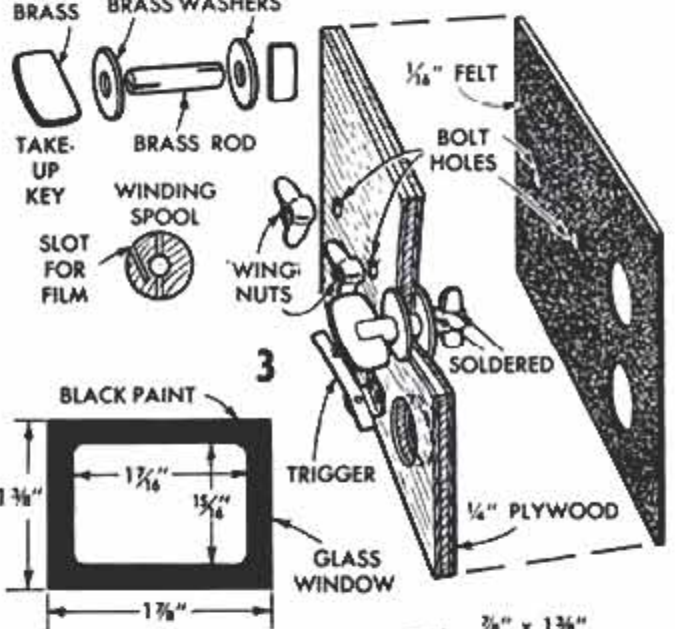
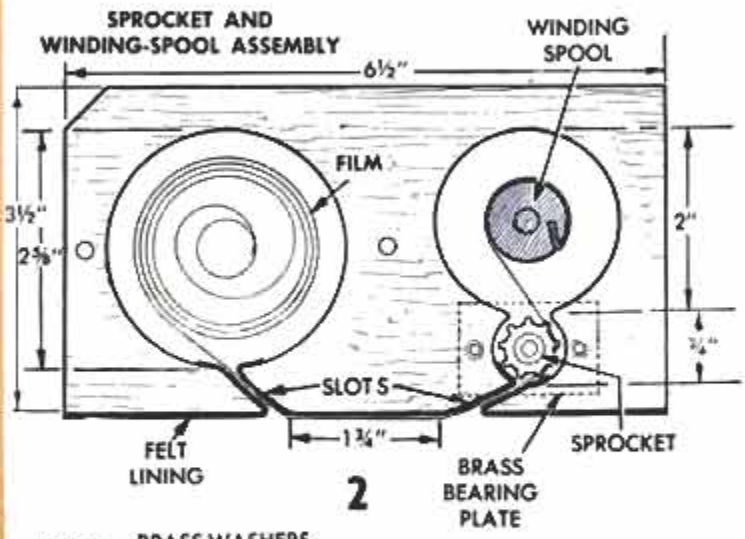
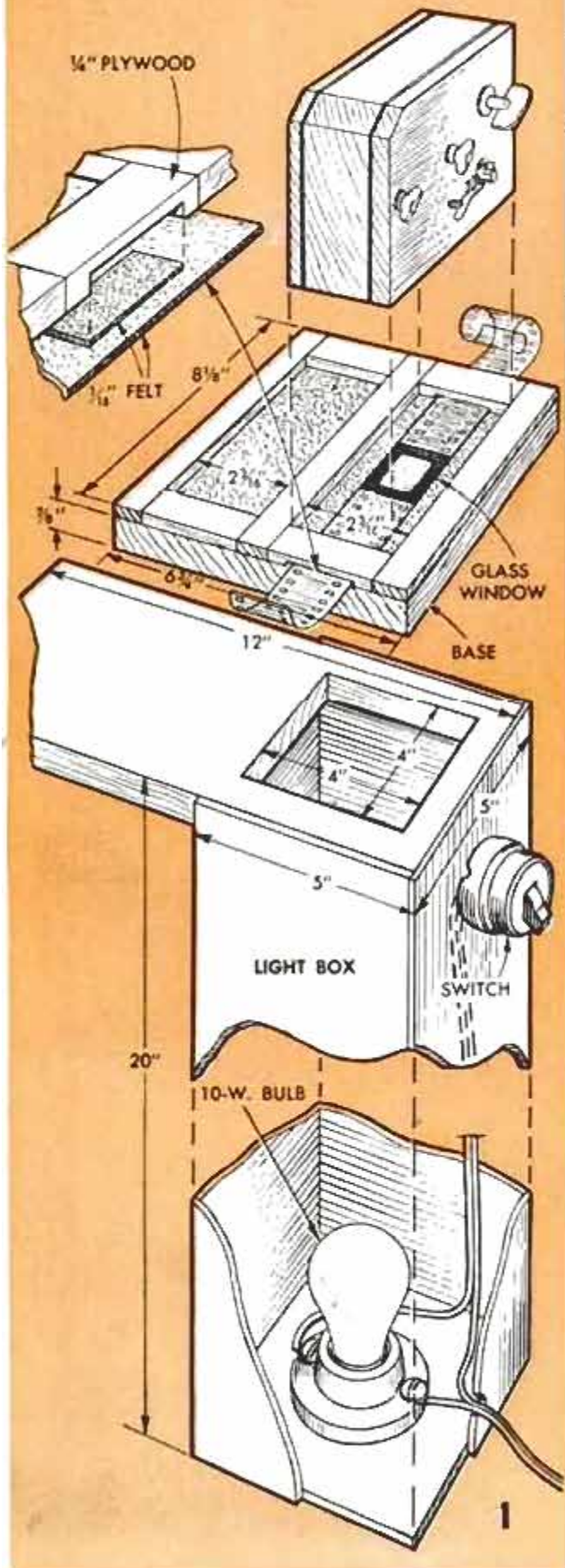

TO POSITIVE

MANY 35 mm fans do not realize that black-and-white negatives can be "reversed" for viewing in a projector like any regular color transparency. Actually, the printing of such positives is as simple and inexpensive as making prints, the main difference being that film is used instead of paper. As for equipment, it requires a film printer, or a printing frame which is designed to print several exposed negatives at one time.

There are several such printers on the market, three of which are pictured in Figs. 6, 7 and 8, which range in price as well as versatility. Some require accessory light sources; others have a built-in light. All have light-tight magazines for holding the raw film. Some have "click stops" for proper movement of the negative and raw film. Still other printers feature a light dimmer to compensate for variances in negative densities.

If you wish, you can save the price of a printer by making the one detailed in Figs. 1, 2, 3 and 4. It consists of a light box which supports a recessed base in which a film magazine rests. One recess has an aperture, or window, over which the

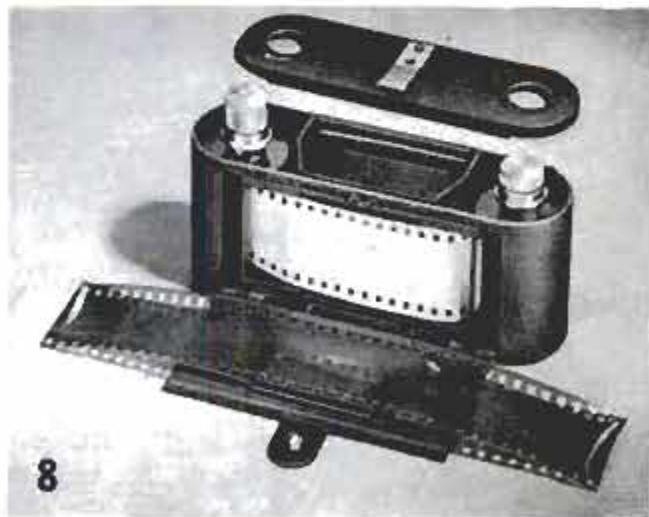
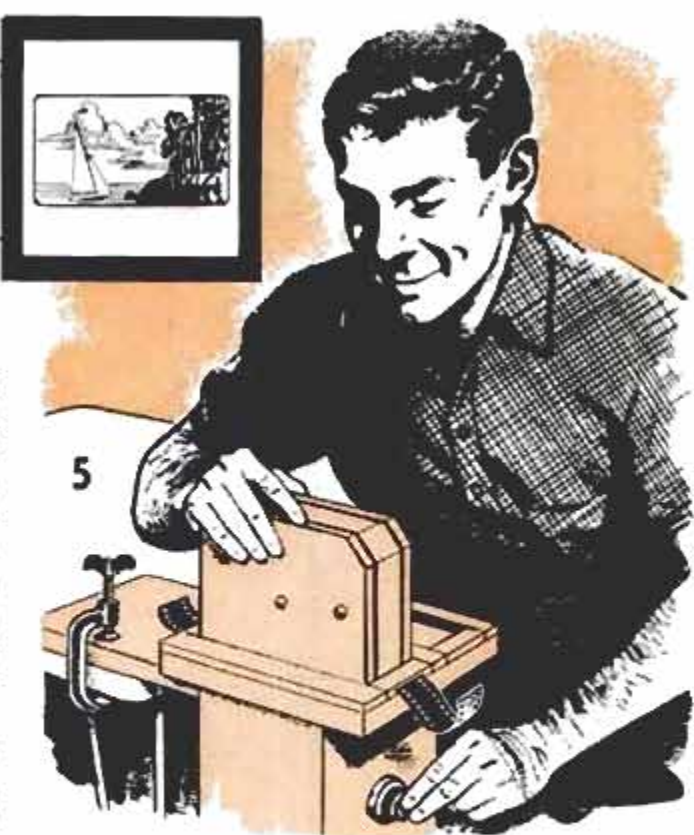



Commercially available printers, such as this one from France, make little work of transferring your prize black-and-white negatives into sparkling positives, ready for projection

negative is placed for printing. The second recess is provided for holding the film magazine while the film strip is being advanced for the next exposure. The film magazine in which raw film is placed, consists of a 1 $\frac{3}{8}$ -in.-thick core which is sandwiched between outer layers of felt and $\frac{1}{4}$ -in. plywood. Fig. 2 shows how openings in the core permit the raw film to be wound through felt-lined slots onto a sprocket and takeup spool. One side of the film magazine is removable for loading and is held by two wing nuts. The take-up key for the

winding spool is detailed in Fig. 3, which also shows how the key is assembled to engage a slot in the end of the winding spool. A pawl on the sprocket shaft is provided to limit the advance of the raw film as it is wound from one frame to the next, and a spring-actuated trigger, engaging the pawl, permits it to be released for advancing the film. Fig. 4 shows how the pawl is pinned to the end of the shaft. The completed printer is held to the edge of a table with a C-clamp, Fig. 4, when being used.

Generally speaking, any good negative will produce a good positive. However, there are pitfalls that the beginner must avoid. Dust is one. A dust particle, unperceptible to the naked eye, becomes readily noticeable when enlarged 40 times. For this reason, it is most important to keep both the raw film and the negative free of dust when printing positives. To make a positive from a negative, you must use positive film, such as Kodak fine-grain positive film P402. This can be purchased in 100-ft. rolls. Whether only part or

all of the film is used at one loading, the amount used must be developed at one time. If you use a commercial printer, the film magazine is loaded according to manufacturer's instructions. If you have made your own printer, the film is placed in the magazine in the manner shown in Fig. 2. In each case, loading of the magazine must be done in total darkness to protect the film. With the magazine loaded, select a negative of normal density and place it against the positive film. Be sure that the emulsion sides of both films (the positive

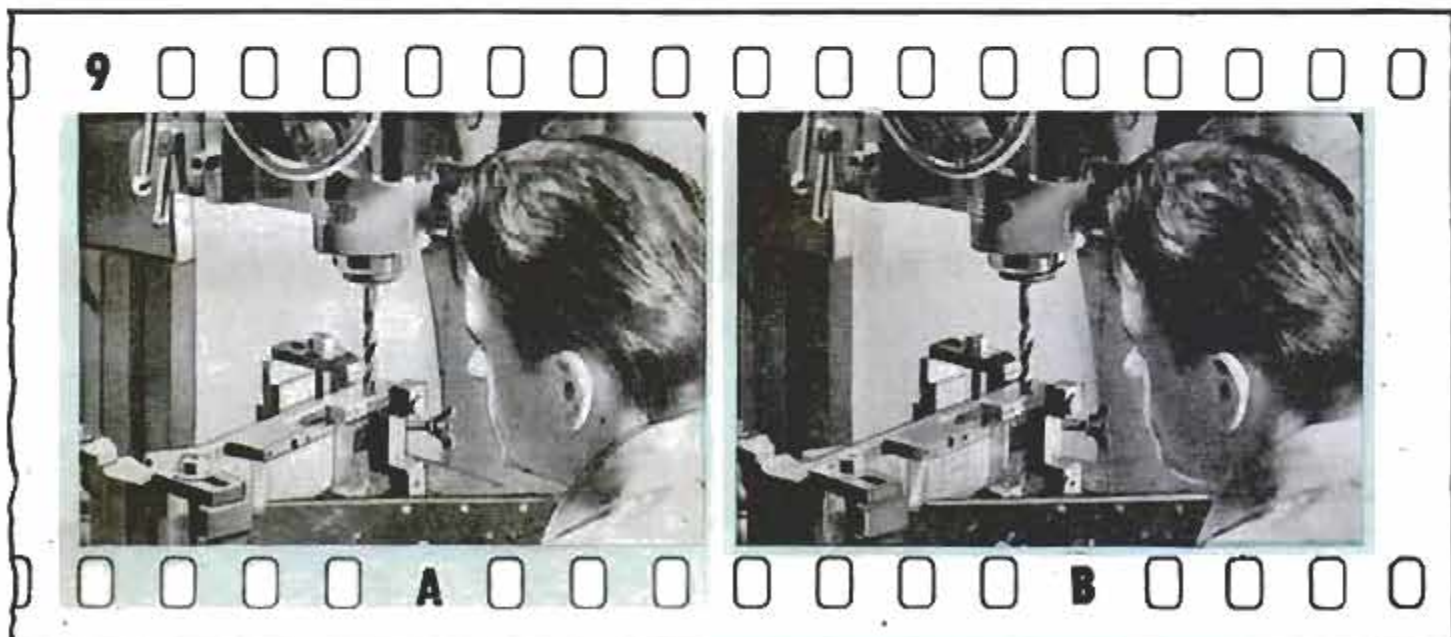

and the negative) are placed back to back and that both films are firmly in contact. Start your series of test shots with a one-second exposure. Then advance the positive film only and expose the same negative again for an interval of two seconds. Repeat this procedure for four, six and eight-second exposures, advancing just the positive film with each exposure. This operation, naturally, must be done in a dark-room, or in a room or closet made light tight. In operating your home-built printer, set the loaded magazine in the rear compartment of the base. Then fit your negative strip over the glass window in the front recess of the base. To expose the film or make a positive print, the magazine is lifted from the rear recess to the front recess and the lamp in the light box is turned on for the required number of seconds. The film in the magazine is advanced one frame, the magazine itself is removed and returned to the rear recess, after which the negative is shifted over the window. These specific steps are repeated in printing each frame individually in the negative strip. Where only a portion of the full roll of positive film is used, that portion can be cut from the roll and removed and the rest rethreaded onto the take-up spool.

In developing your test exposures to determine the correct exposure time, run them through D-11 developer for 11 min., then rinse, fix, wash and dry as done in normal procedures. Now compare your exposures with the examples shown in Fig. 9, exposure A being underexposed, B being normal and C overexposed. Positives that are near normal are placed in cardboard mounts and projected on a screen for study. Those considered under or overexposed are discarded and the exposure of the perfect positive remembered when making positives of the rest of your negatives. ★★



Tractor Tire and Umbrella Make Quickie Sand Box

If you can lay your hands on a discarded tractor tire, you have the makings of a ready-made sand box. And by driving a length of pipe in the center of it to hold an umbrella, you can protect young castle builders from the hot sun. The umbrella would have to be one you didn't care much about since the handle must be cut off in order to stick it into the pipe.

Food Chopper Serves as Hold-down

Think twice before you toss out that old food chopper. The clamp part of it will prove useful in your workshop. Sawed off at the point indicated, you'll find that the fork foot of the clamp is especially handy for holding two pieces of work in alignment for soldering the abutting ends.

Alexander P. Truchot, Choteau, Mont.

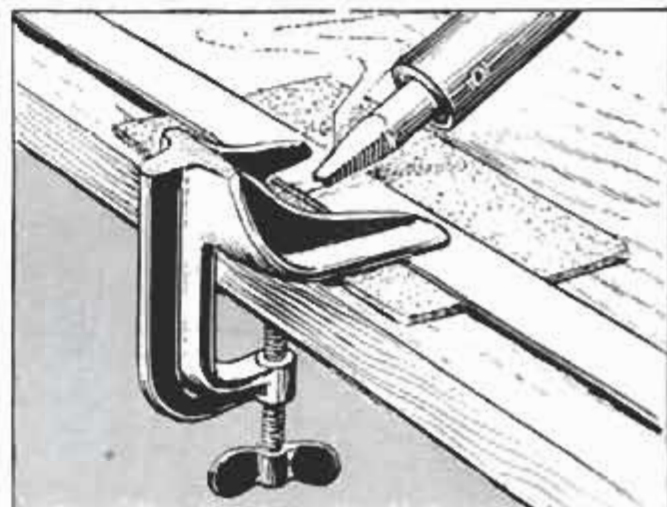
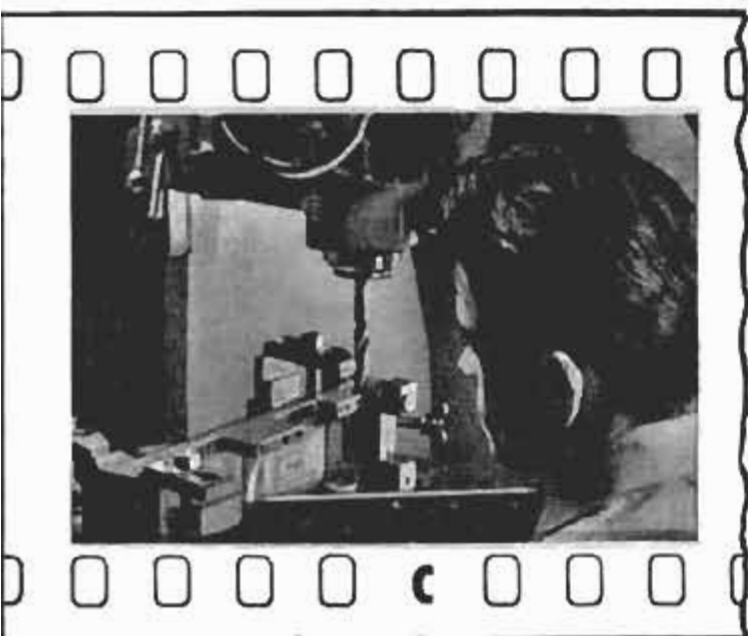

Camera Floor-Pod

An indispensable accessory for shooting low-angle movie scenes is a camera floor-pod like this one. Being nothing more than a board measuring 5 x 10 in. and fitted with a $\frac{1}{4}$ -20 bolt for attaching the pan head, it is an accessory that is easily made and one which will provide firm support for low panning shots. The hole for the bolt head should be countersunk on the underside of the board so the bolt head will be flush with the surface. Where steeper low-angle shots are required than are possible with the tilt head, the front end of the wooden base can be blocked up with a book or other flat object which will provide stable support to prevent rocking.

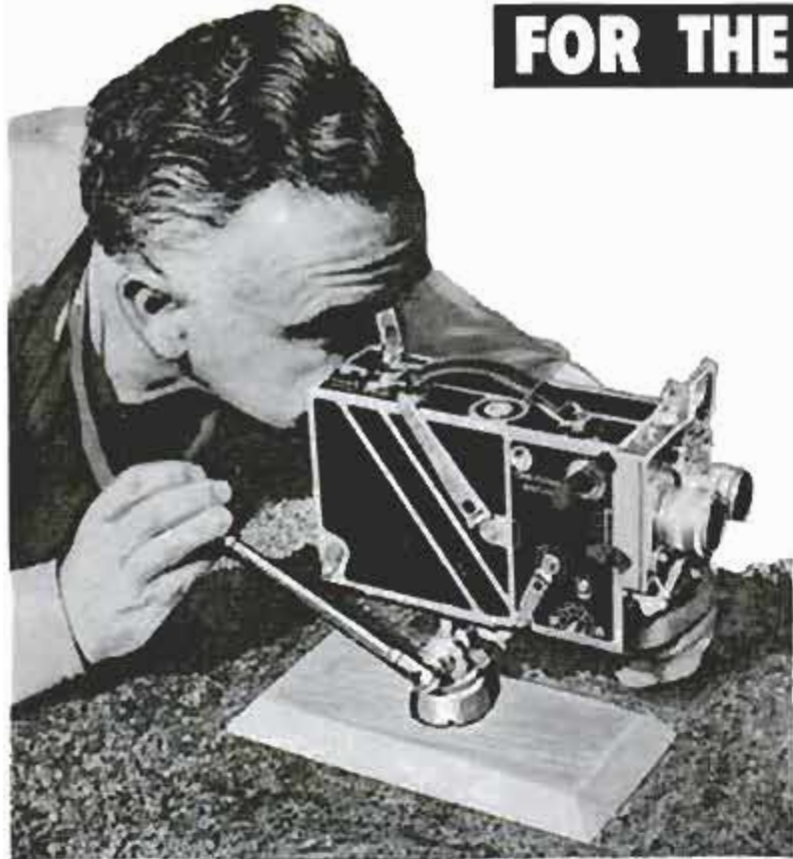

Darkroom Rack

Stirring rods, print tongs, thermometers, as well as film clips, can all be stored in neat orderly array in this simple darkroom wall rack. It's something you can make in a few minutes' time from scraps of $\frac{1}{2}$ -in. wood. The tongs are held in notches by wedging 3-in. lengths of plastic knitting needle crosswise in the ends of the tongs. These crosspins also serve as stops in preventing the tongs from slipping into the tray when resting them on the edge. Holes are provided for holding the stirring rods and thermometers, and a block positioned below the holes provides a support on which to rest. Nails driven into the edge of the block serve to hold a few film clips.

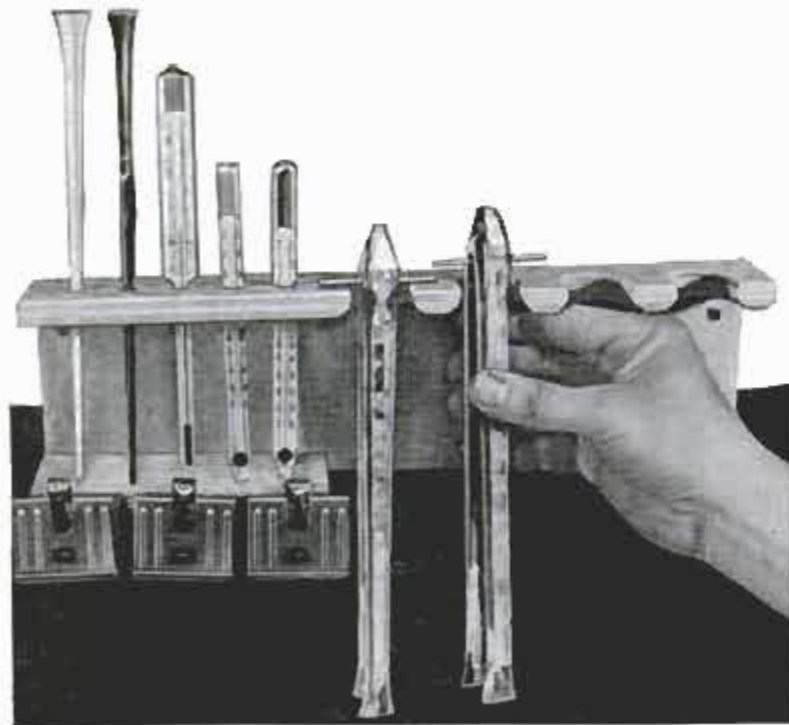

Thermometer Hook

Resting a thermometer on the edge of a developing tray to check the temperature of the solution usually results in the thermometer rolling into the tray. One way to prevent this is to slip a rubber fuller ball part way over the end of the thermometer so it will hook over the edge of the tray. The fuller ball will also serve as a knob to give you a better grip. It will be necessary to enlarge the hole in the ball to suit the particular thermometer.

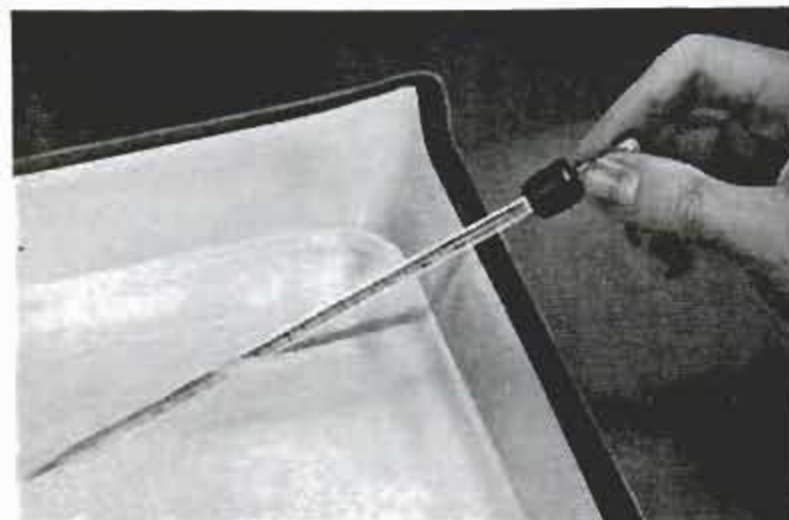



Set Your Own Gunsights With One Shot

Instead of setting gunsights by the trial-and-error method, take a few minutes and do the job accurately, as illustrated. First, clamp the gun securely in position. A bench vise on a firm support, such as a post or solid table, will do nicely. Then, place the target about 100 ft. from the gun, farther if the gun is high-power. Align the target in the gun sights and secure it so it will

not move from impact with a bullet. Fire the gun. Now, without moving the gun or target, align the sights with the bullet hole in the target, making the adjustment for either a fine or coarse sight as desired. Observe all safety precautions and make the setup so there is no possibility of injuring animals or humans.

H. S. Robbins, San Antonio, Texas.

Holding Insect on Slide

To examine a small insect under a microscope, cover it on the slide with a small watch crystal. This will keep the specimen in place without misshaping it.

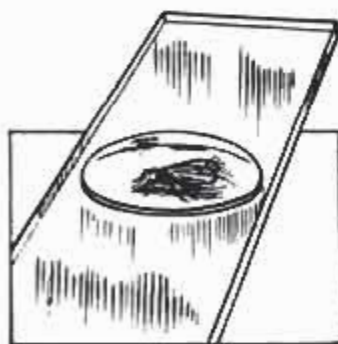

"Sanding Block" Removes Paint

To remove peeling paint, use a block of wood wrapped with fairly small wire as indicated. This provides a "sanding block" that will not clog.

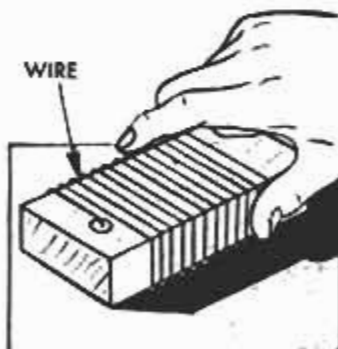

Depth Setting on Drill Press Changed Quickly With Clips

When it is necessary to drill to several different depths on duplicate work, snap-on clips that fit over the drill-press depth stop will permit quick and accurate adjustment of the setting. Cut from light sheet metal, the clips are shaped to a press fit on the stop. They may be of any desired length and, for quick identification, the length may be stamped on them.

To remove stamps from envelopes try a steam iron. Lay a piece of dry white cotton cloth about 4 in. square over the stamp to be removed. Place the iron over the cloth and press the steam button. In about 10 seconds remove the iron without releasing the steam button. Lift the cloth and the stamps will come off undamaged.

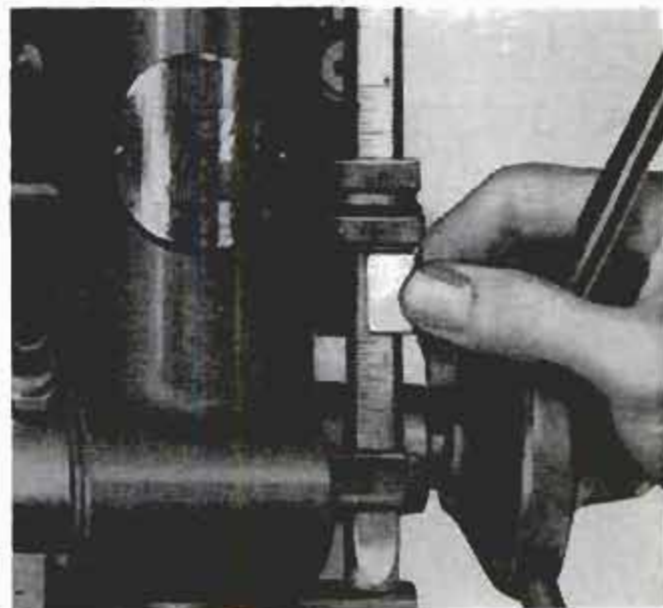

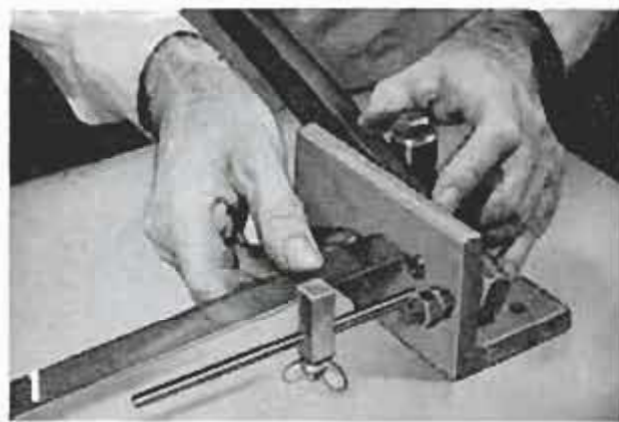

Cutter has adjustable stop for cutting duplicate parts from rods or wire. Has also a novel lever guide which is made in the form of an eccentric. Arrangement allows adjustment to maintain uniform contact of dies and to compensate for wear

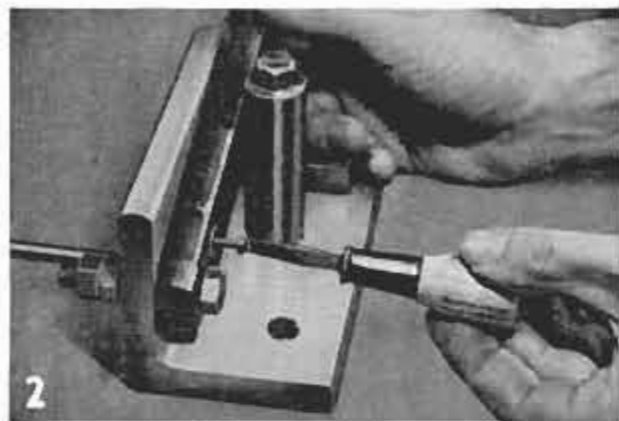

By tapping the fixed die, Fig. 6, small screws and stove bolts can be cut to required length without damaging threads. Note eccentric guide

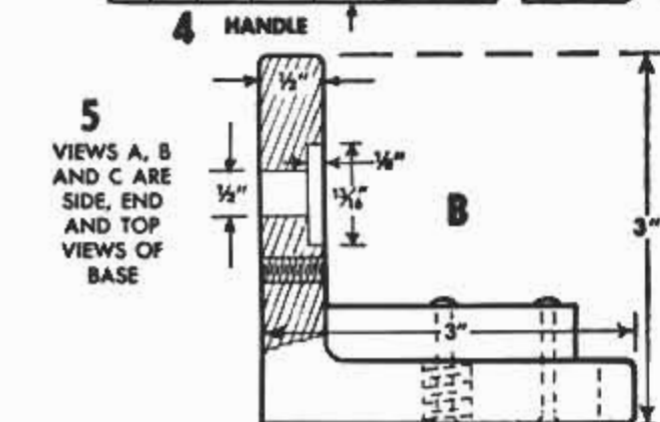
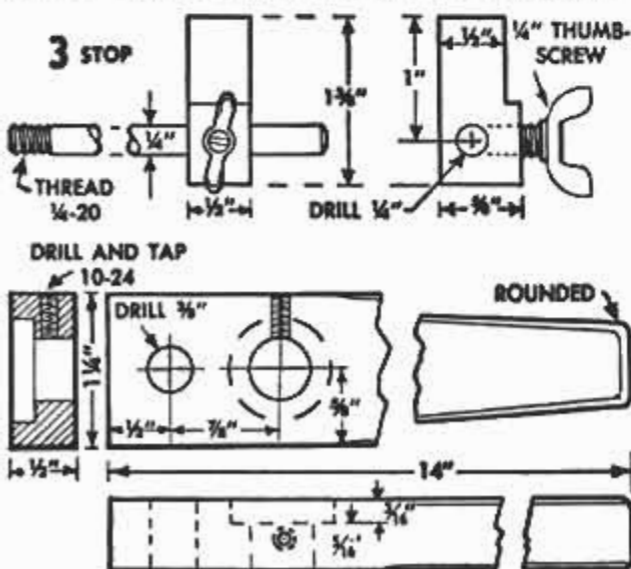

ROD AND BOLT

Makes a clean, square cut on round stock up to 3/16 in. in dia. Adjustable stop assures duplicate lengths

NO EXPERIENCED shop man likes the job of cutting duplicate lengths from light rod stock with a hacksaw; or cutting small bolts to a required length by the same means. In both instances the parts must be finished with a file or grinder if accurate work is to be produced. This shop-made rod and bolt cutter turns the trick with one stroke of a lever and no final finishing of the cut ends is necessary.

As you will see from the detailed parts, the cutter is a simple gadget assembled from stock materials quite readily available. Made as detailed, the unit features an adjustable stop, Fig. 1, for cutting to duplicate lengths, and also a tapped die, Figs. 2 and 6, for cutting screws, bolts and threaded rods. By using a tapped die, bolts, screws and threaded rods can be cut clean and square, with little or no crushing of threads.

Fig. 3 details the adjustable stop; Fig. 4, the handle, and Fig. 5, views A, B and C, the frame, or base. This is made from a length of heavy steel angle and is drilled, counterbored and tapped on both webs as indicated. In use, the unit ordinarily is clamped to the bench top, but mounting holes for bolts can be drilled as in Fig. 5,

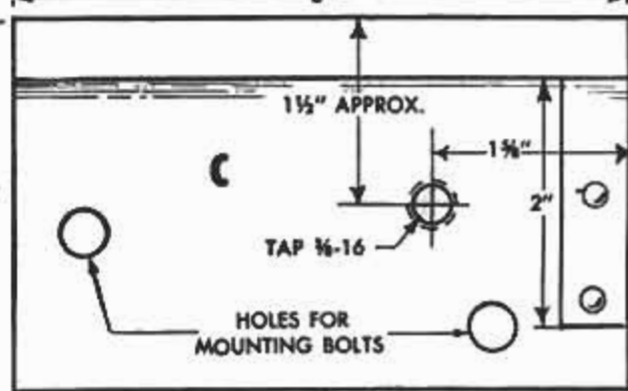
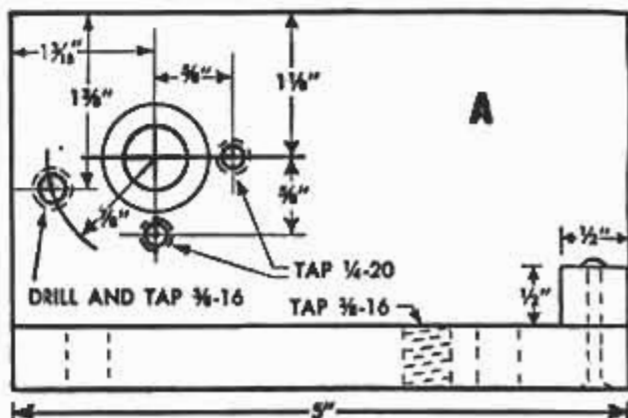

CUTTER FOR YOUR SHOP

detail C. The diameter and location of these holes are, of course, optional.

The handle and one web of the base are drilled and counterbored to take the shouldered dies in a light push fit. Fig. 7 details one way of making the counterbores on a drill press, using a $\frac{1}{2}$ -in. boring bar and a fly cutter. As detailed, the cutter is mounted about $\frac{5}{8}$ in. from the end of the bar, thus permitting the end to serve as a pilot.

The dies are turned from tool steel, the faces being ground and polished after hardening. Only the dies made for cutting bolts and screws are tapped, of course. The rod and wire-cutting dies have straight holes, the holes in the fixed dies being only slightly larger than the diameter of the stock to be cut. It's a good idea to have an assortment of dies so the stock of varying sizes can be handled without the necessity of making up sets of dies for each job.

Note in the assembly view below that the lever guide is made in the form of an eccentric. This arrangement provides a means of maintaining the dies in sliding contact throughout the cutting stroke. The eccentric also provides an adjustment to compensate for wear. ★ ★ ★

By
Walter E.
Burton

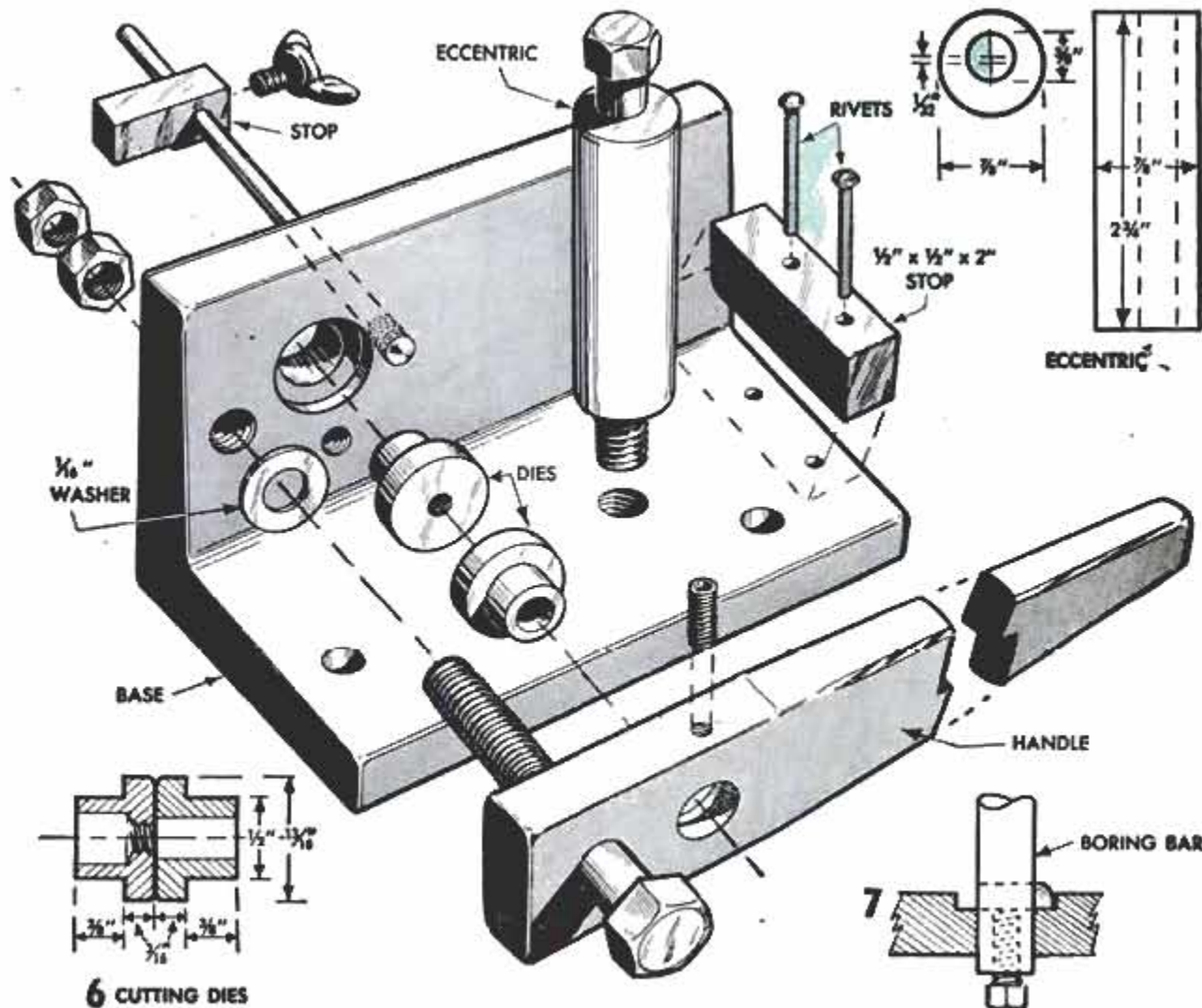

Farm-Built Broadcast Seeder Sows Grain and Grass Seed



At a tractor speed of 4 m.p.h. and a broadcast reach of 30 ft. or more, this seeding unit can really cover ground. That's what counts at seeding time. The specially built hopper has a capacity of 14 bu. A smaller hopper about 1 ft. square, centered in the larger hopper, holds grass seed which is sown along with the grain. Both are connected to the seeding unit which is adapted from the parts of an older type endgate seeder. The seeding unit is driven from the tractor-belt pulley by a crossed flat belt and a reduction of 5 to 1 is made by roller chain from the driven pulley to the gear-wheel shaft of the seeder. The entire unit is carried on channel-steel extensions bolted to the side members of the tractor frame. When grass seed is sown along with grain, make sure by test that the grass seeding unit is feeding the correct amount.

Check for Coil Polarity

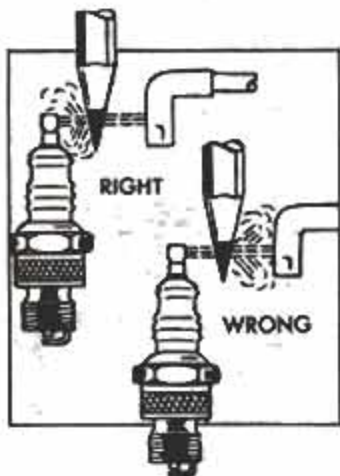

Incorrect coil polarity can affect engine performance. Here's a quick check: With the engine running, hold a pencil point between a detached ignition cable and a spark plug as indicated. Details show correct and incorrect spark flare.

Magnetized Wrench Holds Screws



Starting socket screws in hard-to-reach places is easy when you use an Allen wrench that has been magnetized as shown in the photo at left. Do the same with a screwdriver, which makes it easy to pick up and start small steel screws.

Turn Hardwoods On Metal Lathe

Hardwood turnings, especially cylindrical and tapered forms, can be made very accurately on a metal lathe. You'll need a sharp gouge, a holder that fits in the tool post and wood-turning centers. Or, use the 3-jaw chuck as a live center as pictured. The holder, cut from a steel bar, is about 5 in. long and of a sectional size that will fit in the tool post. Holes are drilled and tapped in one edge to take screws holding the clamping piece.

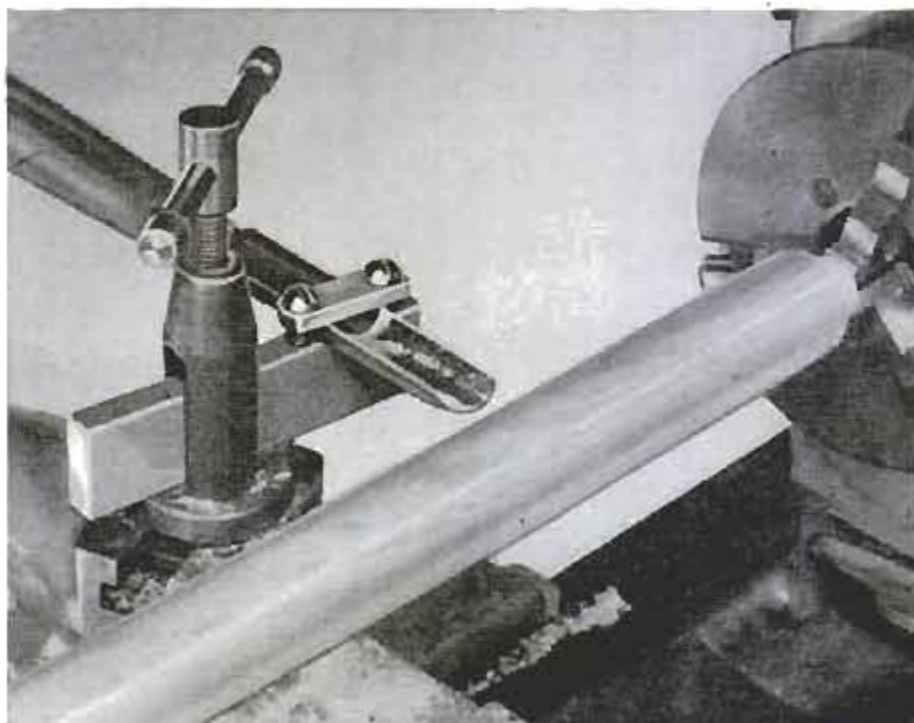

SCREWDRIVING CRAFTSMANSHIP

NEARLY ALL TYPES of craftwork in wood, in which parts must be assembled into a unit, call for the use of wood screws in some part of the construction. It's important to select the right screw and driver for the job to be done. Wood screws most commonly used are those of the regular type having a single slot, Figs. 6 and 18. The two most commonly used drivers are known as the wing and cabinet types, Fig. 10. All other types are simply variations of the basic types.

Figs. 1, 2 and 3 show the importance of selecting a driver having a bit of the correct width and thickness. In Fig. 1, detail A shows the proper width. In detail B, Fig. 2, the correct thickness is shown, and Fig. 3, detail C shows what happens to the screw slot if the blade is too narrow, or is tilted, or has damaged corners. Also, the upper details in Fig. 3 show how the surface of the work can be damaged if the screw is seated with a blade that is too wide. If the blade is too thin or too narrow for the job, you may twist it as in the upper detail, Fig. 2.

Wing-type drivers are preferred for driving flathead screws that seat flush with the surface. Cabinet-type drivers are used when driving screws into counterbored holes, and often when driving round and ovalhead screws, Fig. 7. Spiral ratchet drivers, Fig. 4, speed up the job of driving a great number of screws, as in boatbuilding. Much the same is true of the driver bit designed for use with a brace, detail A, Fig. 5. When space is limited, a ratchet driver of the type shown in detail B, Fig. 5, is used. The cabinet driver also is made in a very small size, detail D, Fig. 5.

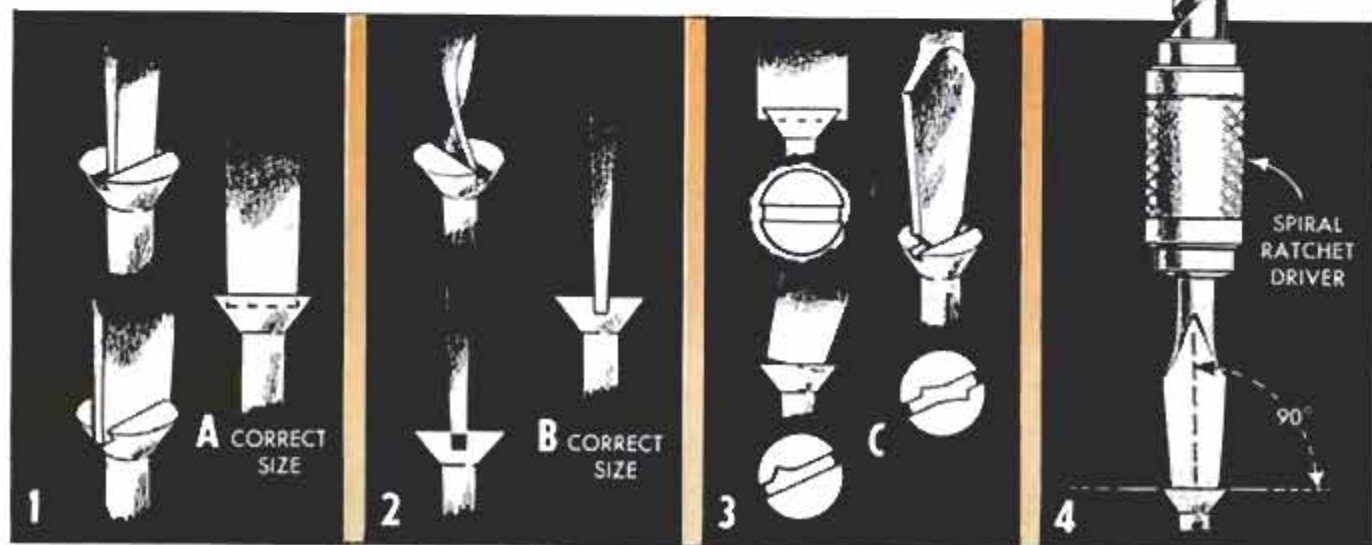

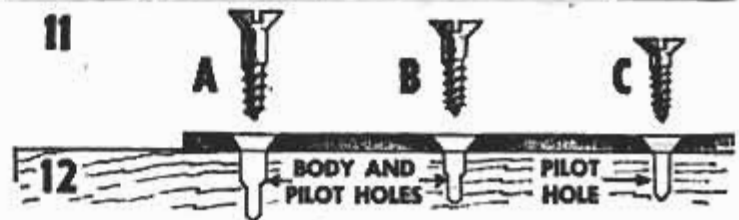
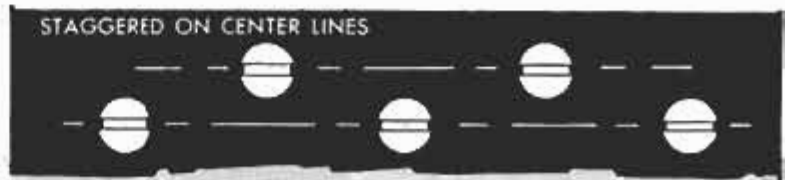
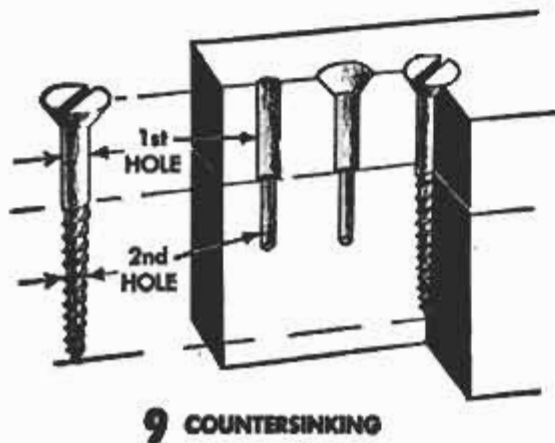
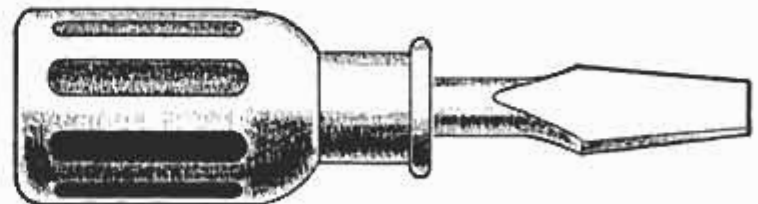
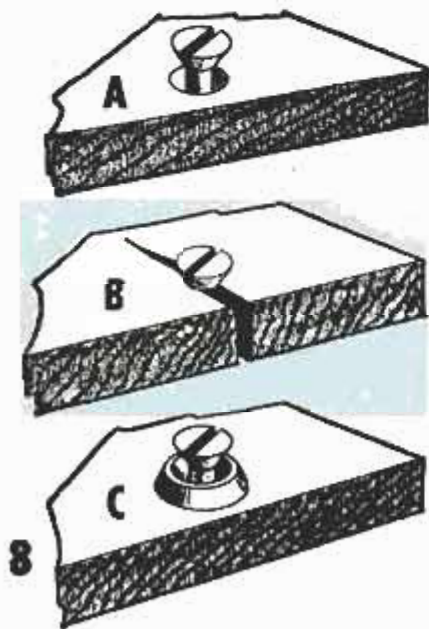
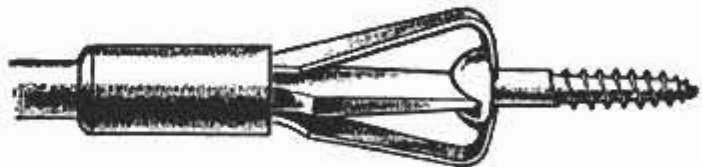
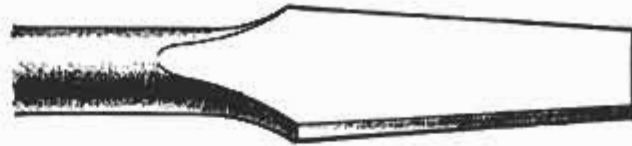
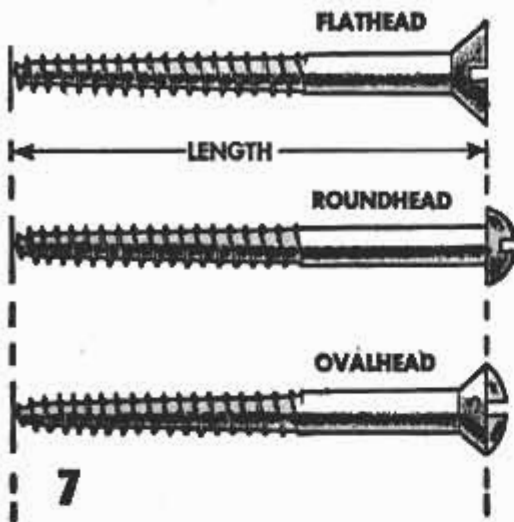
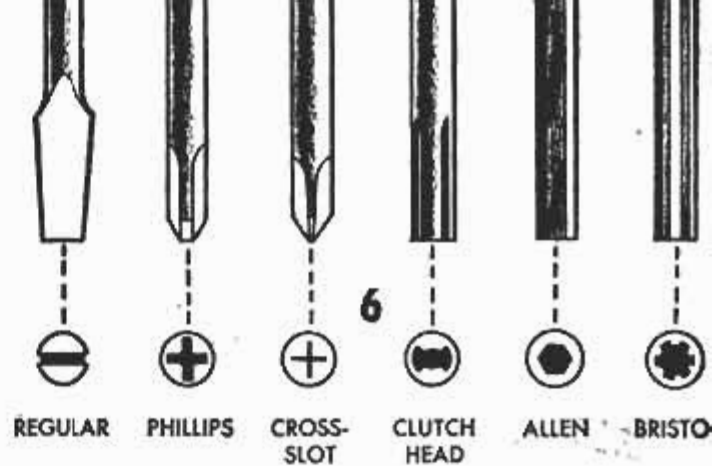
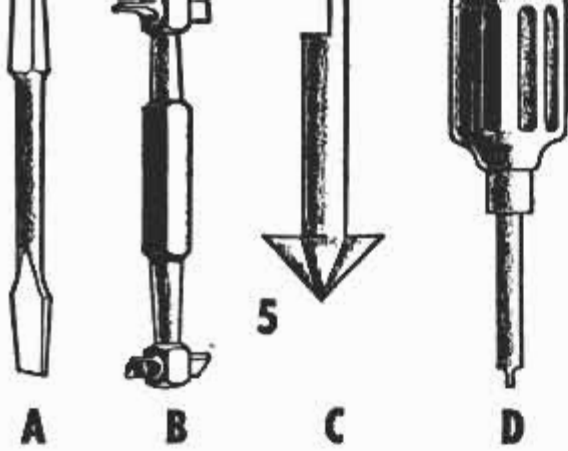

Flathead screws should be countersunk, detail A, Fig. 8, or run down on finishing washers, detail C. Driving a flathead screw without countersinking may result in splitting, detail B. Countersinking can be done with a rose countersink, Fig. 5, detail C, or with a combined countersink and drill, Figs. 14 and 15. The rose countersink is available in two types, one for use in spiral-ratchet drivers and some types of push drills, having a notched shank, Fig. 5. The other type has a squared shank for use in a bit brace. The combination unit drills the body hole and pilot hole and runs the countersink in one operation, Figs. 9, 14 and 15. By adjusting a stop on some types, the tool also will run down a counterbore for a wooden plug, Fig. 15. It is designed to be driven by a 1/4-in. portable drill. Each unit is marked with the number and length of the screw for which it is intended.

Good work calls for a screw of the proper type and length. In Fig. 16, details A, B and C, the screw in detail C is the correct length and is properly countersunk. In Fig. 17, details A, B and C, the longer screw, detail B, would normally be used for maximum strength in softwood. For hardwood the screw in detail C would be about right for average work. For fastening metal to wood, Figs. 12 and 13, screws A and B in Fig. 12 will give the greatest holding power and resistance to shearing strains if the body and pilot holes are drilled to the correct size. When the work requires that screws be driven in line near the edge of the stock on a spacing of 1 in. or less, it's best to stagger the line as in Fig. 11 to avoid any possibility of splitting the stock.

Fig. 18 shows representative sizes of wood screws which are numbered from 1 to 18 inclusive. The table gives the body diameter in inches and indicates the twist, drill size, also the auger bit number. * * *

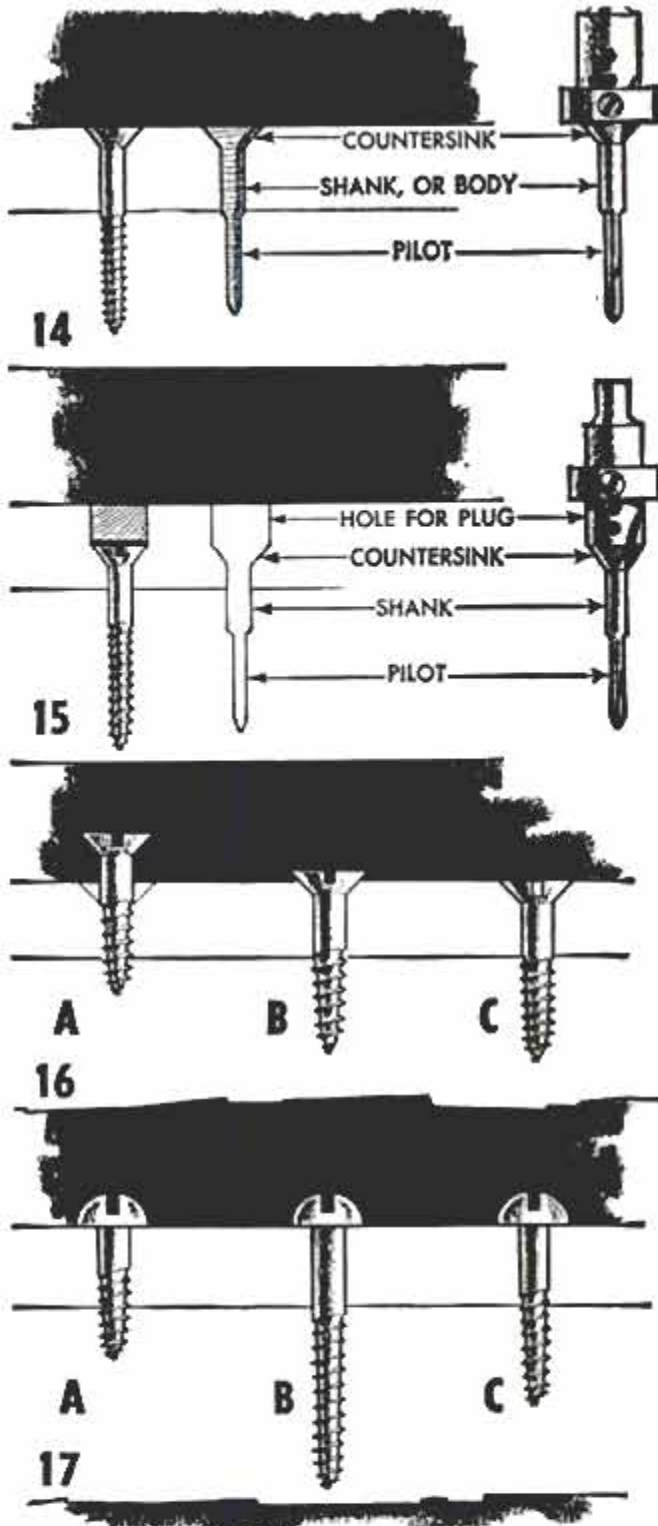

NUMBER OF SCREW	1	2	3	4	5	6	7	8	9	10	12	14	16	18
BODY DIAMETER	3/64	3/32	3/16	1/8	5/32	3/16	1/4	5/16	3/8	7/16	1/2	5/8	3/4	7/8
TWIST-DRILL SIZE 1 (SEE FIG. 9) AUGER-BIT NUMBER	3/64	3/32	3/16	1/8	5/32	3/16	1/4	5/16	3/8	7/16	1/2	5/8	3/4	7/8
							3	3	3	3	4	4	5	5
TWIST-DRILL SIZE 2 (SEE FIG. 9) AUGER-BIT NUMBER		3/16	3/8	1/2	5/8	3/4	7/8	1	1	1	2	2	3	3
													3	3
														4

NOTE—SOME FRACTIONAL SIZES GIVEN ARE ONLY APPROX. ALL FRACTIONAL SIZES IN INCHES

Dust Collector For Home Shop

Obsolete vacuum cleaners, usually available from dealers, provide a means of equipping home-shop machines with individual dust collectors. All you need are the motor, fan and housing, and the dustbag. With these parts at hand and in reasonably good condition, it usually is possible to devise a fitting, or adapter, for almost all the common shop machines. On many old cleaners the fan housing comes with a flange to which a simple adapter, such as a piece of plywood or sheet metal, can be attached. This usually can be bolted or screwed to some part of the machine in a position to permit the cleaner fan to operate.



China-Marking Pencil Doubles as Ruling Pen

When you need a drawing that will withstand shop handling without becoming illegible, draw the outlines with a china-marking pencil rather than a lead pencil. By sharpening the "lead" of the marking pencil frequently you can do almost as accurate work as with a ruling pen and you will save the time of inking, which is a factor to be considered when time is limited.

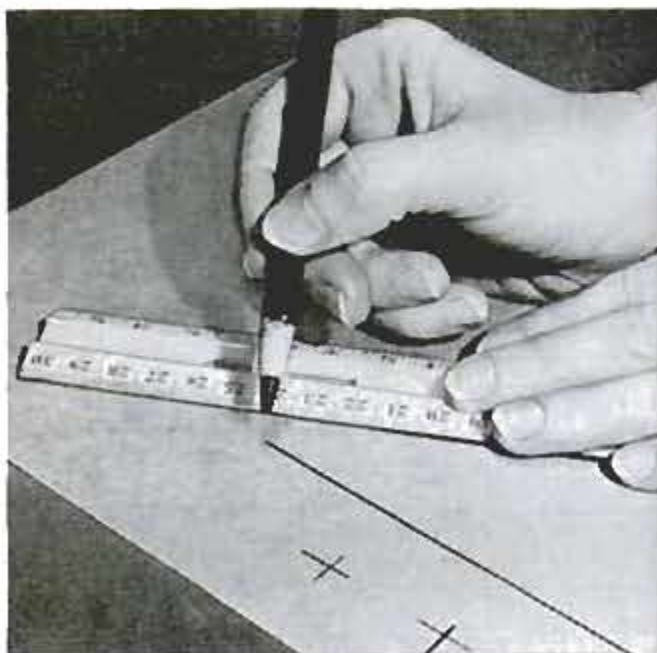

Bore Holes Straight With This Bit Guide

Even highly skilled craftsmen look upon the boring of a hole perpendicular to the surface of the work with some misgiving. In guiding the bit by eye alone, a true hole is largely a matter of luck. Cut a corner from a shoebox, cut away the bottom at the corner as indicated and attach to the work with tape. This gives you a two-way guide for holding the bit true.

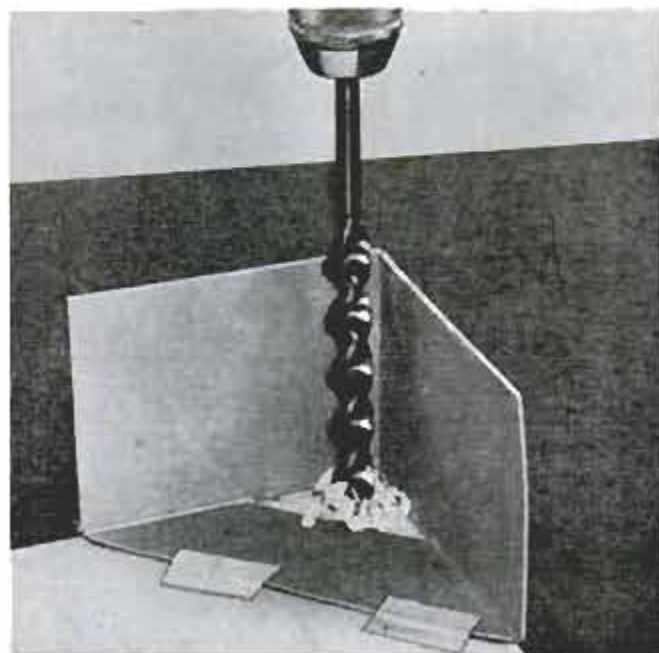

Built-In Stop Saves Fingers

If you've ever had a drill bit seize suddenly, causing the work to spin with the bit, you can fully appreciate the convenience and safety of this spring-actuated stop. The stop not only steadies the work when drilling, it can prevent a painful injury to the fingers of the hand holding the work. The stop pin is $\frac{1}{4}$ in. in dia. and it projects about $\frac{1}{4}$ in. above the table when in working position. One end is drilled and tapped for a 10-32 screw by means of which it is attached to a flat spring. The spring is attached to the underside of the drill-press table with a stove bolt and spacer. Drill a $\frac{3}{16}$ -in. hole about $2\frac{1}{2}$ in. to the left of the center hole in the table to take the stop pin. Location of the hole for the stovebolt, also length of the spring, are determined by the size of the table and position of the slots.

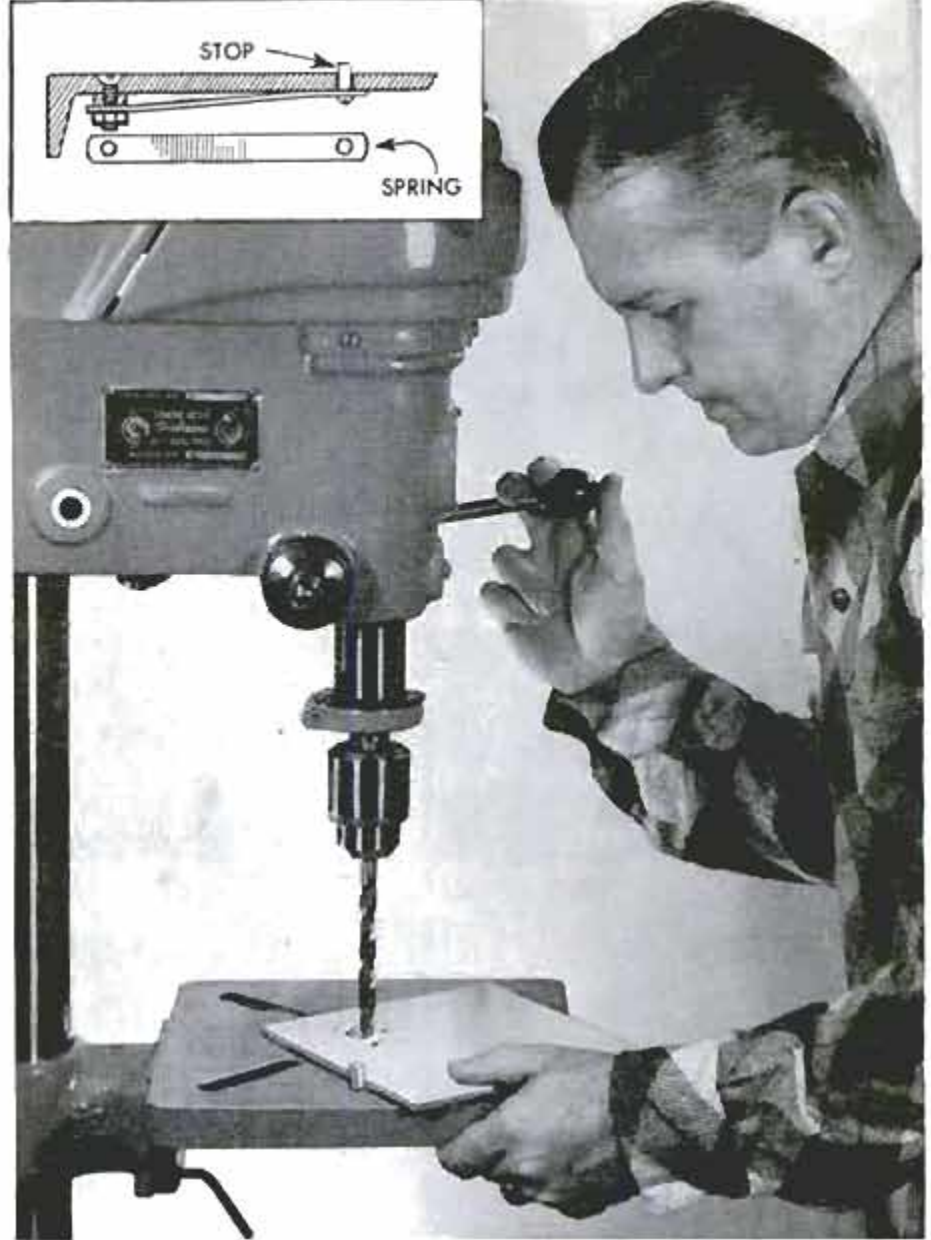

Ball Thrust Bearing For Slow-Speed Shaft

Experimental models, mockups of machine assemblies and temporary fabrications for display purposes often require special bearings that permit close adjustment and easy assembly. One simple bearing which served these purposes is detailed below. It will take both end and side thrust, can be adjusted to eliminate end play and is quickly assembled and disassembled.

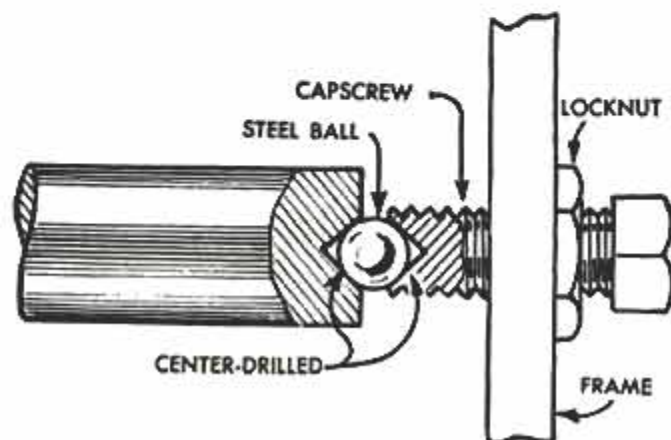

Discarded Nail Set Makes Tiny Pin Punch

Shanks of broken or damaged nail sets and center punches are utilized to make useful pin punches in small sizes. First, the part is annealed so that it can be drilled to take a steel dowel or a length of drill rod of the required diameter. The dowel or drill rod should be a press-fit in the hole. The detail shows the shank counterbored but this is not essential.

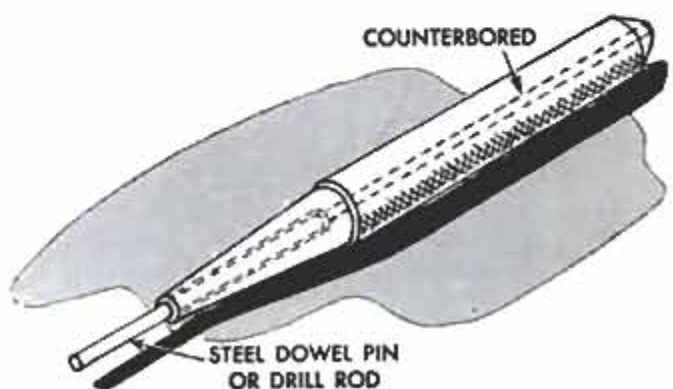

POPULAR MECHANICS SHOWCASE OF TOOLS

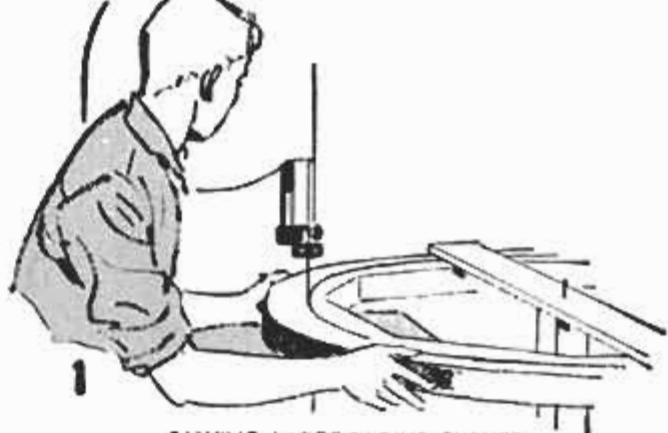

SAWING LARGE-RADIUS CURVES

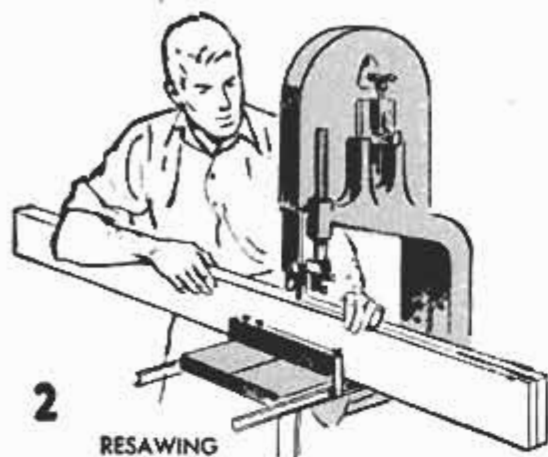

RESAWING

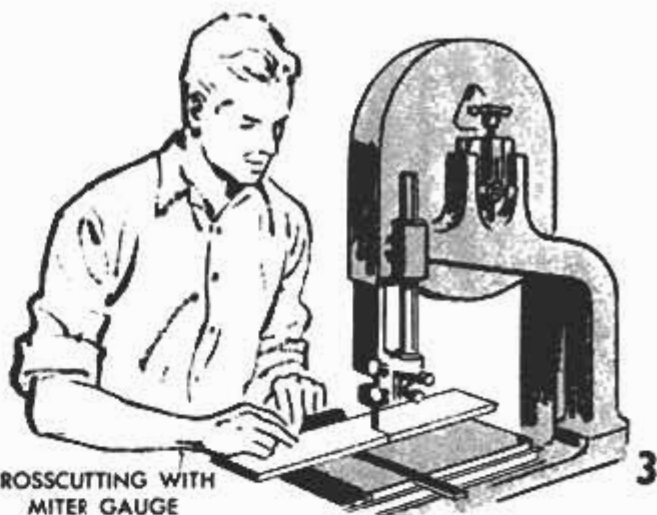

CROSSCUTTING WITH
MITER GAUGE

BANDSAWS FOR YOUR WORKSHOP

By E. R. Haan

NEXT TO THE CIRCULAR SAW and drill press, a bandsaw rates third in importance in the average home shop, school shop or custom woodworking shop. Fitted with the correct blade a bandsaw will cut almost anything. Most of the smaller machines will cut materials up to 6 in. or more in thickness. Using an endless blade the cut can be made only from the edges of the material, but internal cuts started from a hole drilled in the waste can be made with machines fitted with electric blade-welding equipment. Figs. 1 to 6 show various common operations that illustrate the cutting capacity of small bandsaws.

A two-wheeled bandsaw is a simple, durable machine, its principal parts being arranged as in Fig. 7. Some late-model bandsaws in the smaller sizes have a welded steel frame, rather than the cast-iron frame shown in Fig. 7. Some small bandsaws are made with three wheels, Fig. 8, a wheel arrangement that provides greater capacity with less height. Also, on some of the smaller machines the motor is directly connected to the lower wheel spindle, eliminating a belt drive. Others, having a belt drive, are fitted with a gear-reduction

unit giving a wide range of wheel speeds for wood and metal cutting.

On all two-wheeled machines the upper, or idler, wheel can be adjusted for proper blade tension and also tilted to track the blade, Fig. 13. In Fig. 13 the upper wheel is purposely shown without the guard. The table is slotted to the center to permit removal and replacement of blades. Some small machines have the tables grooved for a miter gauge. The table is mounted on trunnions so that it can be tilted for sawing bevels, Fig. 5. The usual range of tilt is 45 deg. forward and 10 to 15 deg. in the opposite direction. There also are machines made with stationary tables and pivoted frames which permit frame, wheels and blade to tilt while the table remains level.

The diameter of the band wheels indicates the size of the machine, just as the swing of a lathe determines its size. As an example, a bandsaw with 14-in. wheels is referred to as a 14-in. bandsaw. Also, the table size usually is quite closely related to the wheel diameter, that is, a 14-in. bandsaw generally has a table approximately 14 in. square.

A 12-in. bandsaw normally requires a

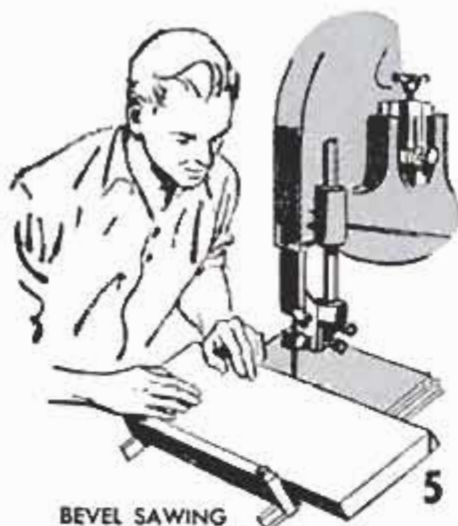
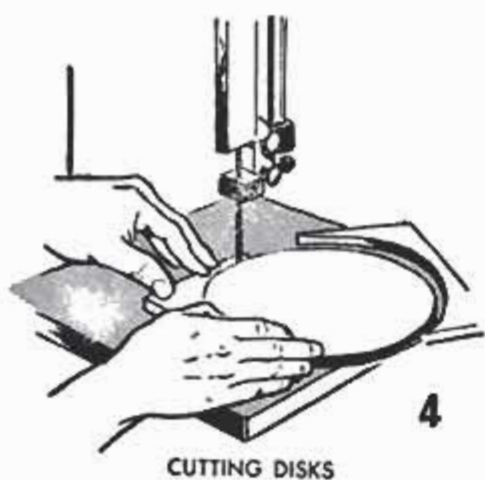
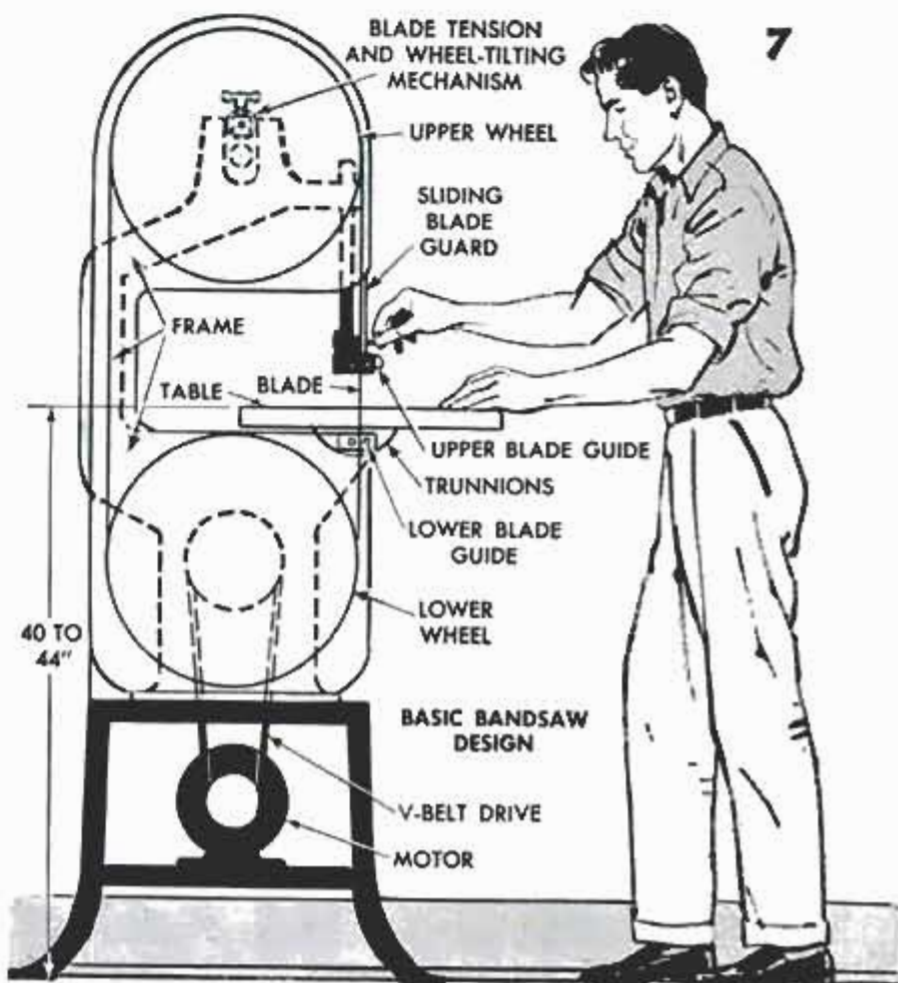

Photo courtesy Delta Power Tool Div., Rockwell Mfg. Co.

IN 12 TO 18-IN. SIZES

$\frac{1}{8}$ -hp., 1725-r.p.m. motor for average work. A 14-in. machine is generally supplied with a $\frac{1}{2}$ -hp. motor. Pulleys recommended for woodcutting bandsaws in the smaller sizes usually give a wheel speed of about 600 r.p.m. On a 14-in. machine this gives a blade speed of about 2200 feet per minute (f.p.m.). Bandsaws designed for woodcutting can be fitted with metal-cutting blades and a simple countershaft arrangement as in Fig. 9 to reduce blade speed to 250 f.p.m., or less.

Small bandsaws are designed for blades ranging from $\frac{1}{8}$ to $\frac{3}{4}$ in. in width. The width of the blade determines the minimum cutting radius it will take without binding and heating, Fig. 10. Spring-tempered blades, Fig. 11, can be resharpened with a file, but





BOICE-CRANE CO.



SEARS, ROEBUCK & CO.

DELTA POWER TOOL DIV.
ROCKWELL MFG. CO.

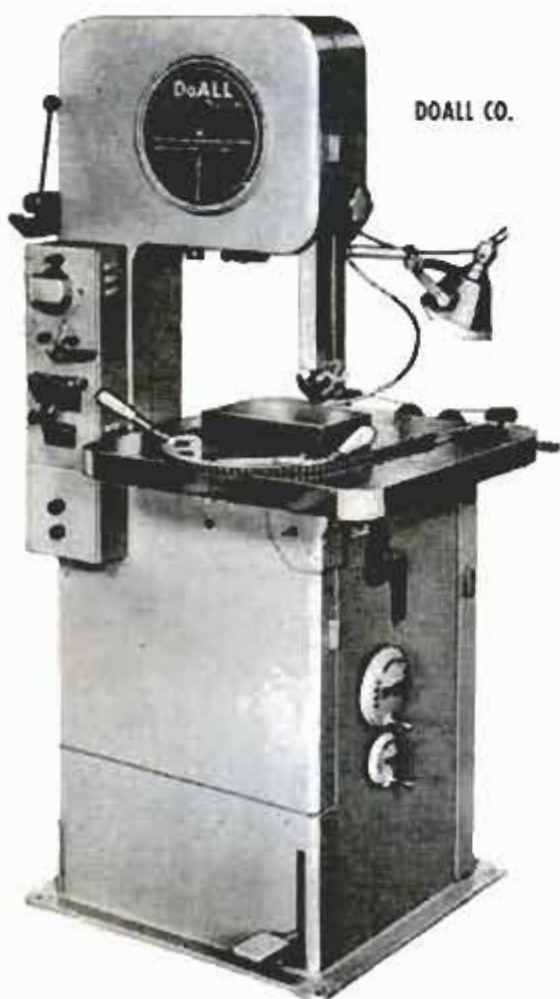

DOALL CO.

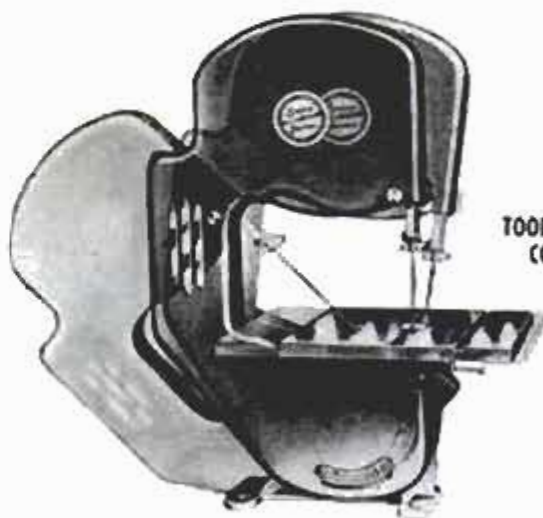

TOOLCRAFT
CORP.



SPRUNGER BROS.,
INC.

POWERMATIC
MACHINE CO.

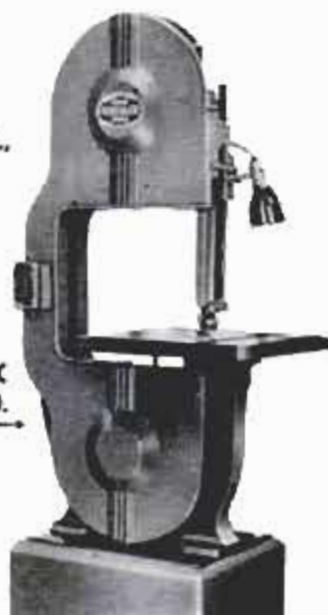

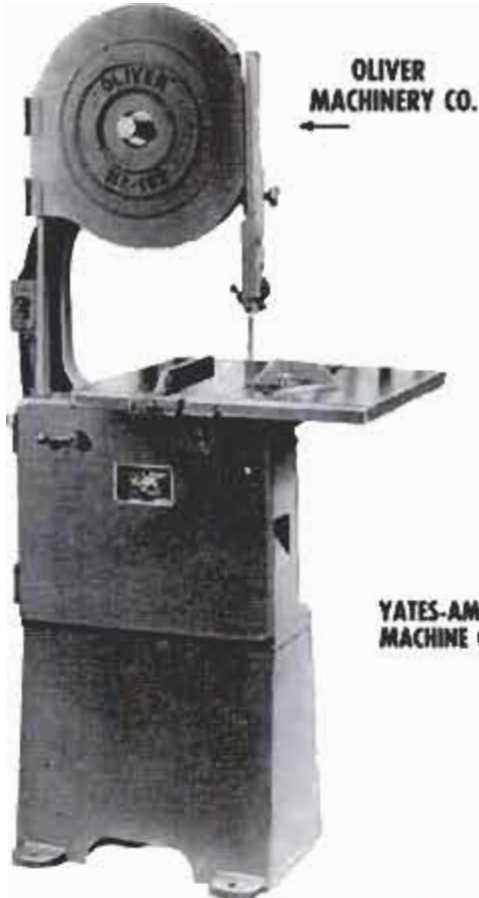

GENERAL SPECIFICATIONS OF BANDSAWS SHOWN (All dimensions in inches)

Trade Names, Manufacturers and Catalogue Number	Size	Throat Cap.	Max. Depth of Cut	Table Size	Table Tilt	Blade Speed (f.p.m.)	Blade Length	Over-All Size		
								Width or Depth	Length	Height
Atlas Press Co. 912	12	12	6-1/4	14 x 14	45 R.	2052	83	14	22-1/4	35-9/16 less stand
Boice-Crane Co. 2300	14	13-1/2	2-3/4	15 x 15-1/2	45 R. 10 L.	92 to 4100	98	27	29	67 on stand
"Craftsman" 1042B Sears Roebuck & Co.	12	12	6	12-1/2 x 14-3/16	45 R.	2165	80	14-3/16	22-7/8	37 less stand
"Darra-James" 512 Toolkraft Corp.	12	12-1/4 to 15-3/8	8	10 x 11	Body tilts					
"Delta" 28-100 Rockwell Mfg. Co.	10	9-5/8	6-1/4		45 R.	2400	71-3/4	10-5/8	18-1/4	32-3/4 less stand
DoAll Co. 16M	16	15-1/4	12	24 x 24	45 R. 10 L.	50 to 5200	122	13-1/2	21-3/4	34-3/8 less stand
Duro Metal Products Co. K-3021	12	12	5-1/8	13 x 13	45 R.					35 less stand
Gilliom Power Tools 471-A	12	12-1/4	6	18 x 18	45 R.	1800	78			
Oliver Machinery Co. 192	18	17-3/4	10	20 x 23-1/2	45 R.	264 & 8500	114			
Powermatic Machine Co. 140	14	13-3/4	7-1/2	16 x 16	45 R. 10 L.	3000	99-1/2	23	33	48 less stand
"Pow-Kraft" 2325 Montgomery Ward Co.	9	9	4	10 x 10	45 R.		60	16	20	68-1/2 on stand
Sprunger Bros. Inc.	14	14	6-1/2	14 x 14	45 R.	2600	94	14	25	42 less stand
"Walker-Turner" 3210 Rockwell Mfg. Co.	14	14	7	16 x 16	45 R. 10 L.	180 to 4550	96-5/8	23-3/4	28-1/2	69-1/2 on stand
Yates-American Machine Co. J-114	14	13-3/4	6-1/2	14 x 14	45 R. 10 L.	3850	91			



**GILLIOM
POWER
TOOLS**

Bandsaw is supplied as parts kit, right. Frame, guards, table, are made from plywood by purchaser of the kit

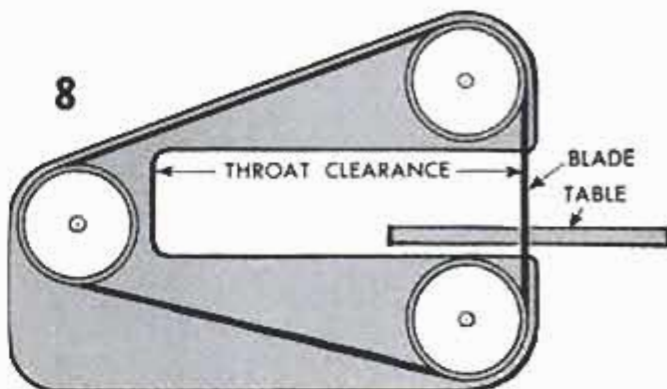
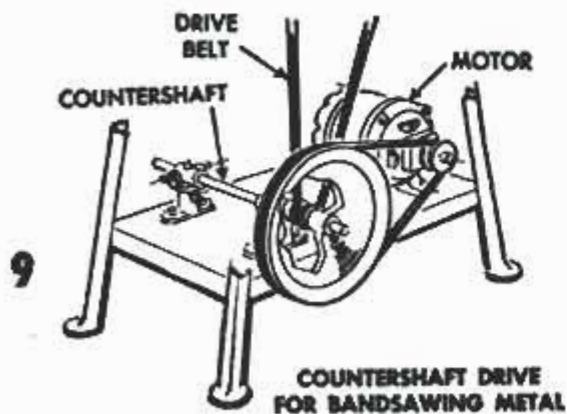
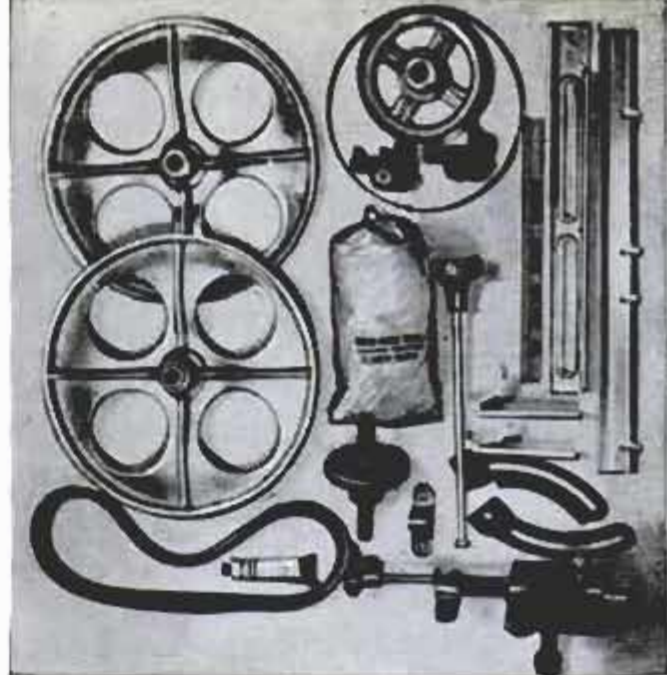

THREE-WHEELED BANDSAW GIVES GREATER THROAT CLEARANCE IN PROPORTION TO HEIGHT

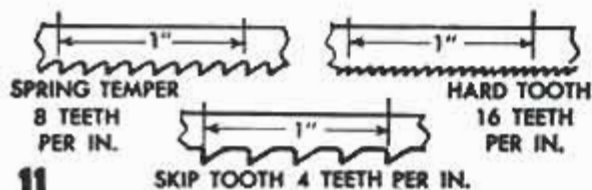
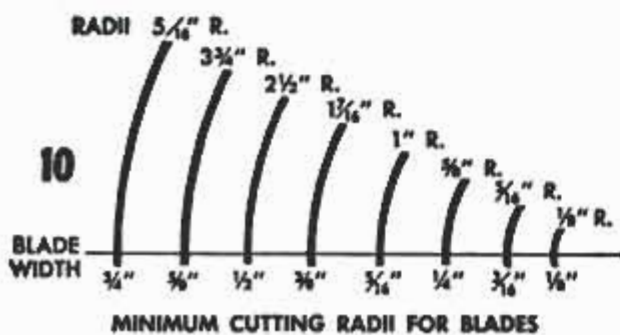

the hard-tooth, flexible-back blade is a disposable type which is discarded when the teeth are dulled by long use. The skip-tooth blade, Fig. 11, is also a hard-tooth blade. It generally is used for cutting wood, plastic, fiber and soft metals. For cutting the harder metals hard-tooth blades having 8 to 24 teeth per inch generally are used.

There are three different types of tooth-set, known as alternate, raker and wave, Fig. 12. In the first, alternate teeth are set in opposite directions. In the raker set, one tooth, the raker tooth, is unset between pairs of teeth set in opposite directions. In the wave set alternate groups of teeth are set in opposite directions. Spring-temper blades generally are supplied with alternately set teeth, suitable for woodcutting. The other two types are metal-cutting blades.

To install a new blade, or change blades on a bandsaw, open or remove the wheel guards as in Fig. 15. If changing blades, or replacing a blade with one of the same width and tooth type, leave the blade guides, Fig. 14, set just as they were, both above and below the table. Release the tension so that the blade can be removed

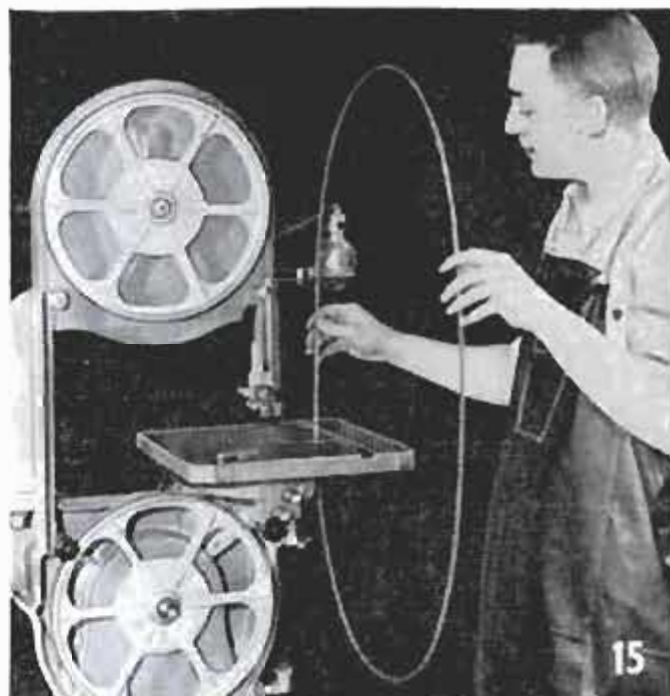
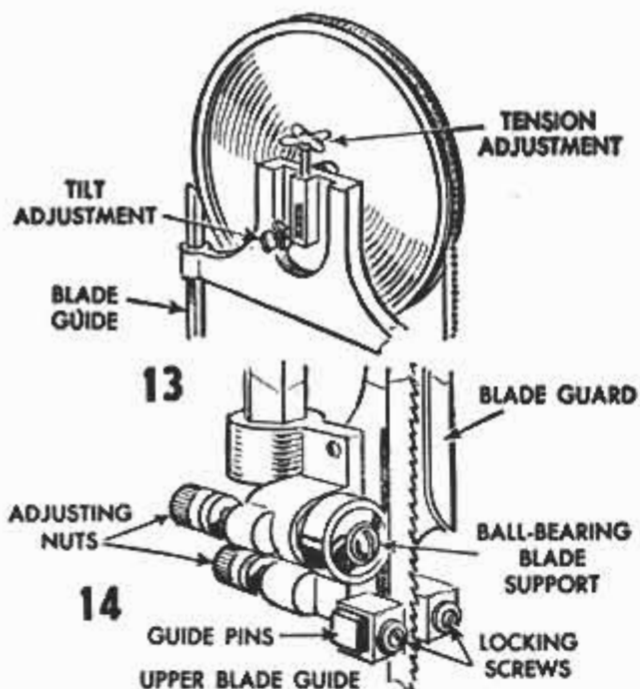

from the wheels. Remove the alignment pin to clear the blade slot. Place the new blade on the wheels and tighten the tension screw just enough to take out the slack. Then turn the wheels slowly by hand, making sure that the blade enters the guides. If the blade runs off center tilt the upper wheel to center it. Then bring it to operating tension and note the position of the back of the blade in relation to the roller supports, Fig. 14. Some small bandsaws are fitted with backing pins instead of rollers but the requirements for blade position are the same. With the blade moving slowly (the wheels being turned by hand) the rollers above and below the table should clear the back of the blade about $\frac{1}{64}$ in. Now start the motor and check both rollers. They should not rotate when the blade is running idle under power. If the machine is equipped with backing pins, the

back of the blade should clear each pin by about $\frac{1}{64}$ in.

Next, check the guide pins, Fig. 14. These should be spaced to clear the blade by approximately the thickness of a single sheet of newspaper. The gullets between the teeth should be flush with the outer edges of the pins when the latter are correctly set both for clearance and for position with reference to the blade. If a blade is simply replaced by another of the same width and tooth characteristics and the new blade is correctly tracked it is not likely that the pins and rollers will need resetting but, of course, the setting should be checked. After the blade has been correctly aligned replace the table insert and alignment pin. When a bandsaw must stand idle for long intervals it is a good idea to reduce the blade tension well below that normally indicated for operation. ★ ★ ★

Hole Gauge Serves as Locator For Centering Dividers

There are times when remembering a simple kink can save hours on the job. Here's an instance where a quick improvisation did the trick. The work required that the machined rim of a hollow boss be scribed concentrically. At hand were a center punch, a telescoping gauge and a pair of dividers. A light punch mark was centered on the head of the gauge which was then centered in the opening to provide support for one leg of the dividers. Then the machined surface of the boss was coated with a marking fluid, the dividers placed in position and the required line scribed on the work as a center line for locating a row of holes.—Bruce D. Stewart, Winder, Ga.

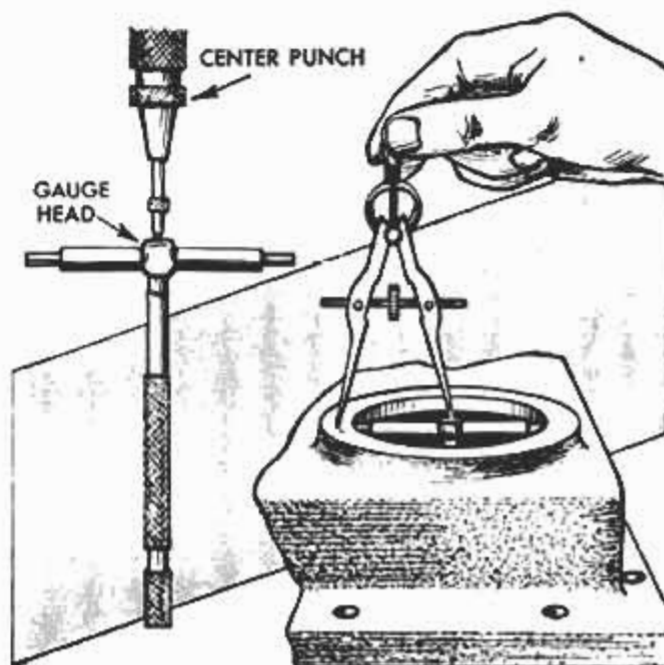

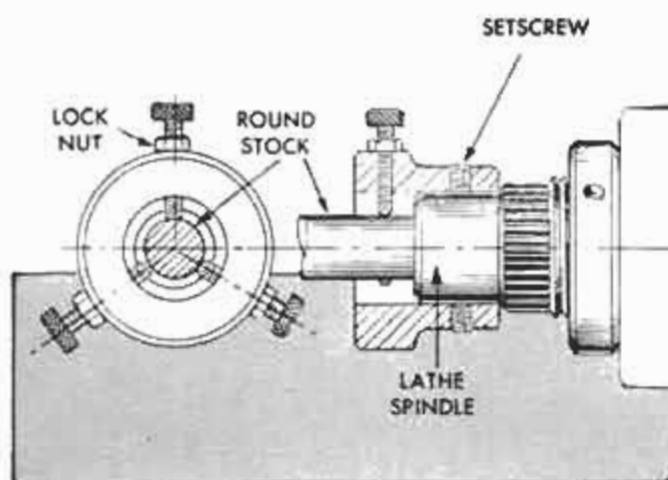

Chuck Centers Long Rods In Lathe Spindle

Machinists in a small shop developed this support, or chuck, for centering long rods at the left end of the lathe spindle. The chuck not only prevents wear of the spindle bore, it also eliminates the annoying whip and clatter of the rod as it rotates. As will be seen from the detail, the chuck body is bored to a slip-fit over the projecting end of the spindle and is fitted with three knurled thumbscrews spaced equidistantly and provided with locknuts.

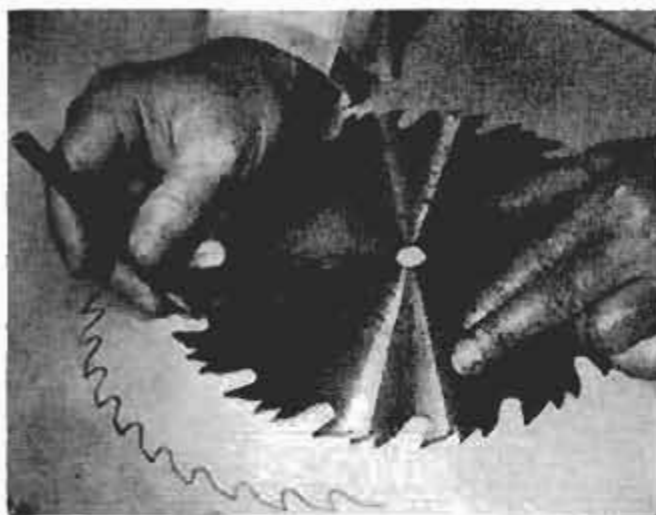

Recording Saw-Tooth Profiles Is Aid in Sharpening

Holding saw teeth to the original shape when filing is no simple trick unless you provide yourself with something to go by. This is especially true of the newer tooth shapes and those combination blades having cutting teeth and rakers spaced by deep gullets. One simple way of preserving the original profiles of the teeth is to lay the new blade on a sheet of heavy white paper and trace the profiles with a pencil having the lead sharpened to a point. Keep handy for reference when filing the blades.

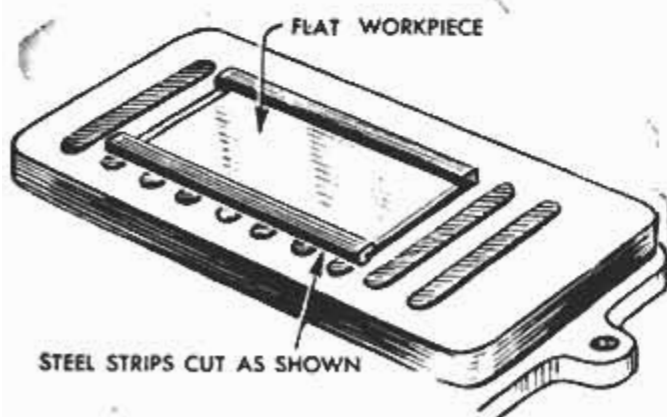

Holding Nonferrous Metals On Magnetic Chuck

Good shop men usually can come up with a solution for almost any problem posed by a custom job. Here's an example. The job called for V-grooving a number of flats of a nonferrous alloy. No vise large enough to hold the workpieces was available so rabbets were milled on two pieces of tool steel, the depth of the rabbets being made about .005 less than the thickness of the workpieces. These strips served as holders for each workpiece on a magnetic chuck.

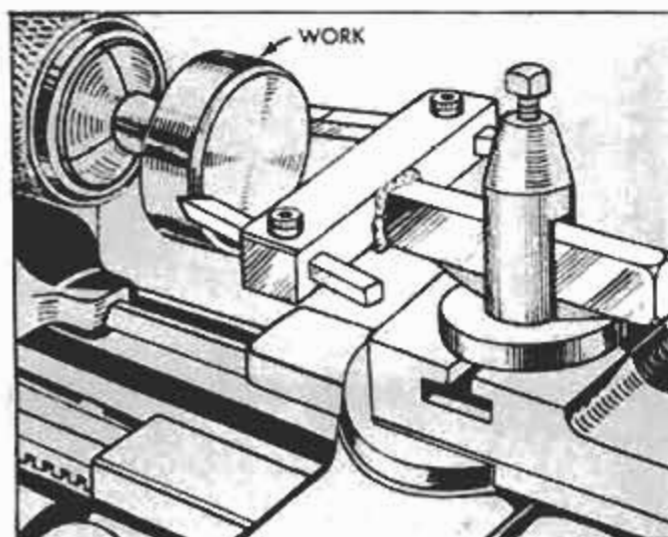

Dual Chamfering Cuts Speed Production

This chamfering tool cuts two ways, speeds the job of chamfering, or breaking, corners on duplicate workpieces. Movement of the lathe carriage is reduced to one short stroke. The tool also can be altered to make simultaneous cuts on two corners, as on a shouldered workpiece. It consists of a T-shaped holder designed to fit in the tool post. Holes are drilled at a 15-deg. angle through the crossbar of the tee and then broached to take $\frac{1}{4}$ or $\frac{3}{8}$ -in.-square cutting tools.

Frank L. Rush, Columbus, Ohio.

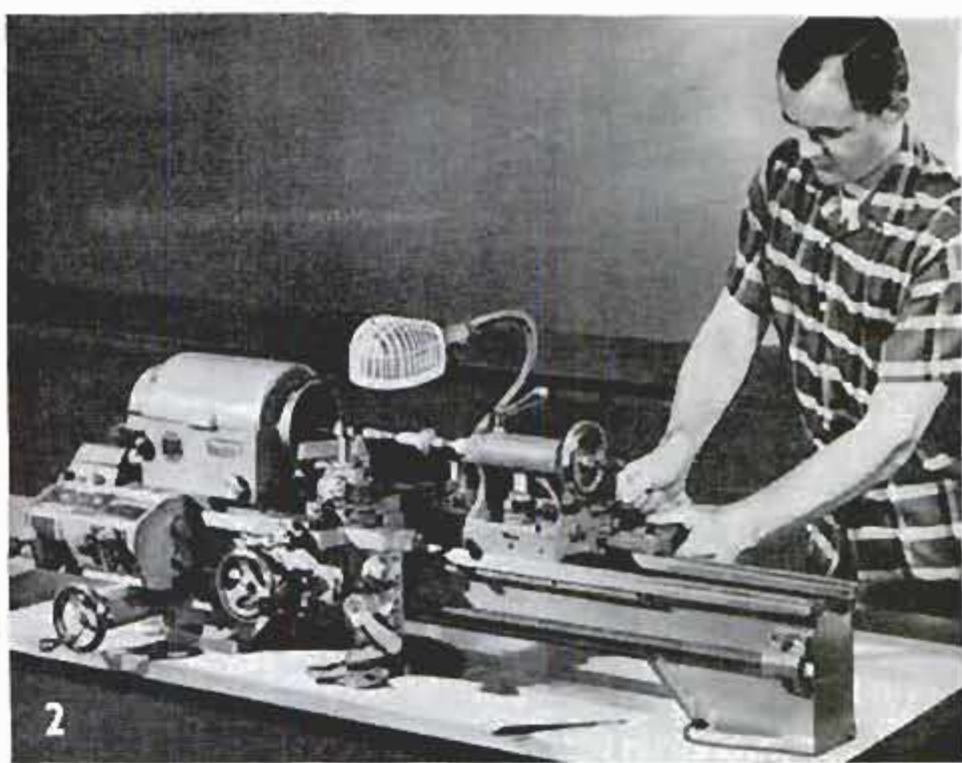

SHOPPING FOR TOOLS

1. DRYWALL HAMMER is especially made for the purpose. Head is shaped to permit driving nail close to ceiling board. Scored face of poll is designed to make a dimple of the correct depth without breaking facing paper or cracking off edge of board. Cushion grip of nylon won't loosen or wear out

Estwing Mfg. Co., Rockford, Ill.

2. METAL-CUTTING LATHE swings 10 in. over bed and is equipped with variable-speed drive that can be preset for high and low speed limits in direct or gear drive. Spindle speed range is from 50 to 1500 r.p.m. Collet capacity is $\frac{3}{4}$ in. Hole through spindle is $\frac{13}{16}$ in. in dia. Has ball-bearing spindle

Delta Power Tool Div., Rockwell Mfg. Co.,
452 N. Lexington Ave., Pittsburgh 8, Pa.

3. REVERSING TRANSMISSION weighs only 7 lb., has one forward, one reverse speed and neutral. Unit is regularly furnished with shift lever and an 8-tooth roller-chain sprocket. Designed for use with engines up to $5\frac{1}{2}$ hp. Suited to riding lawn-mower drives and other small vehicles requiring 2 $\frac{3}{8}$:1 ratio

V. B. Foote Foundry Co., P. O. Box 2214,
Flt. Dearborn Station, Dearborn, Mich.

4. STUD LOCATOR, or jig, simplifies setting and nailing of studding on 16-in. centers. Made of heavy-gauge steel, jig positions individual stud on sole plate and holds it securely as end is toenailed in place. The base of the jig serves as a spacer; twice its length centers the stud 16 in. from the preceding one

James & Edwards, Inc., Floral Park, N. Y.

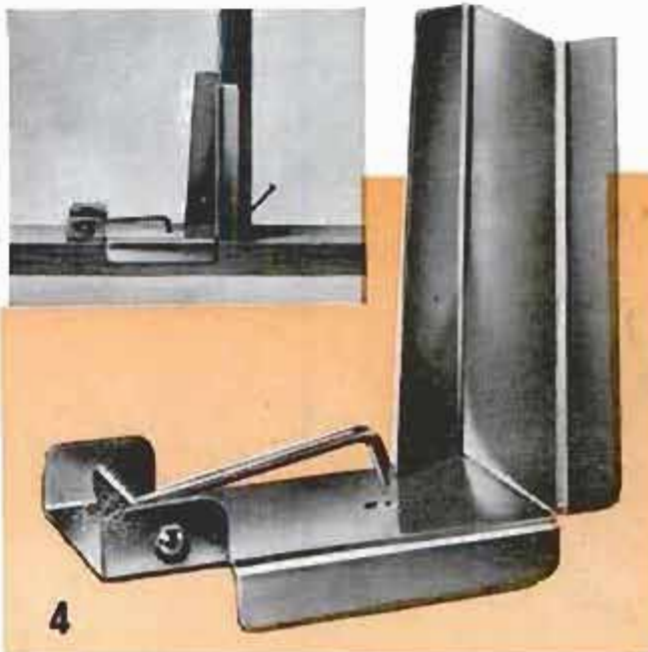

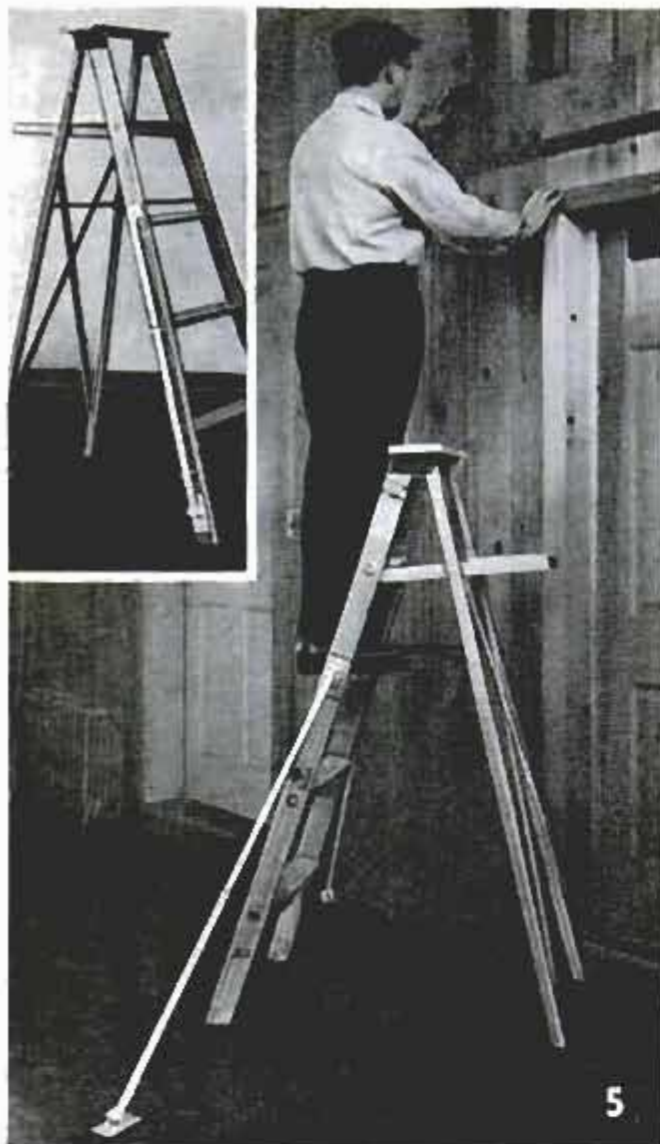

5. LADDER BRACE fits ladders having flat side rails. Telescoping braces prevent the ladder from tipping, even when it must be placed on a sloping grade. Base plates of braces have deeply corrugated rubber pads that won't slip, even on smooth surfaces.
Robbie Durrell, Inc., 278 E. State St., Westport, Conn.

6. CIRCULAR SLIDE RULE is pocket-size, does simple mathematical calculations accurately. Handy for engineers, builders and others who must make rapid and accurate calculations in the field. Complete easy-to-follow instructions supplied with each rule
General Industrial Co., 57-18 Elston Ave., Chicago 30

7. CLAMP prevents heavy extension-cord connections from pulling apart when in use. Prevents power interruptions and damage to cord and plug. Widely used by builders and others who must operate portable electric tools at a distance from power source
Drumcliff Co., Towson 4, Md.

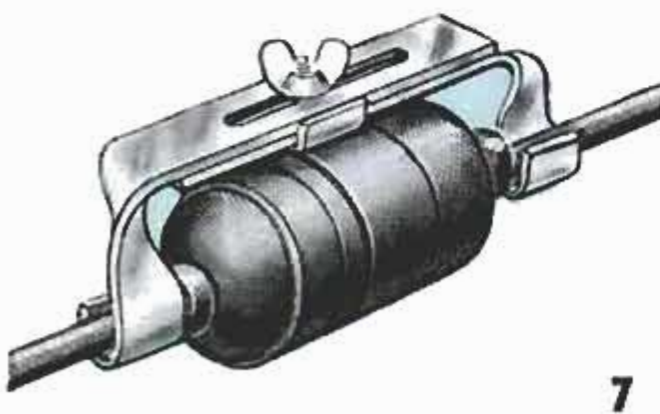

8. PLANE ATTACHMENT for router motor makes high-speed power plane for planing doors and window sash to size. Planes up to 2 in. wide and 3/32 in. deep at one pass. Fence is adjustable to 45 deg. for bevel cuts. Cutter and arbor are standard equipment
Black & Decker Mfg. Co., Towson 4, Md.

9. SWINGING TOOL TRAY attaches to the column of a drill press, keeps chuck wrench, vise, oil can, drills and miscellaneous tools always at hand when needed. Steel tray is circular, with a rim 3/4 in. high and 12 in. in dia. Tray rotates, also pivots on arm
B & I Mfg. Co., Burlington, Wis.





10

10. PORTABLE TRANSFORMER makes it possible to thaw frozen water pipes by using domestic 110 or 220-v. 60-cycle, single-phase a.c. There are three thawing steps: high, medium and low. Furnished complete with 10-ft. power cord, two 20-ft. thawing cables
Hobart Bros. Co., Hobart Square, Troy, Ohio

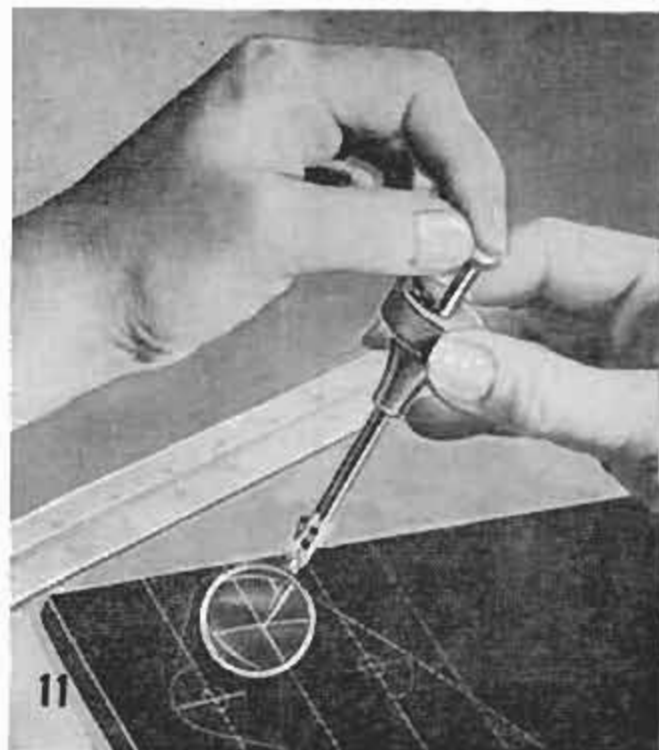

11

11. SCRIBER WITH MAGNIFIER is a four-in-one tool consisting of striker, center punch, magnifier and scribe. Makes layout easier for machinists, designers, tool- and diemakers, modelmakers and hobbyists. Tool is available with carbide-tipped scribe
The Langley Corp., San Diego, Calif.

12. CONTROL UNIT is easily attached to any hand trowel or wooden float, permits finishing of concrete slabs from standing position outside forms. Trowel or float remains level regardless of angle of handle. Can be used with handle of any convenient length
Ed Kearney Enterprises, P. O. Box 1152, San Jose, Calif.

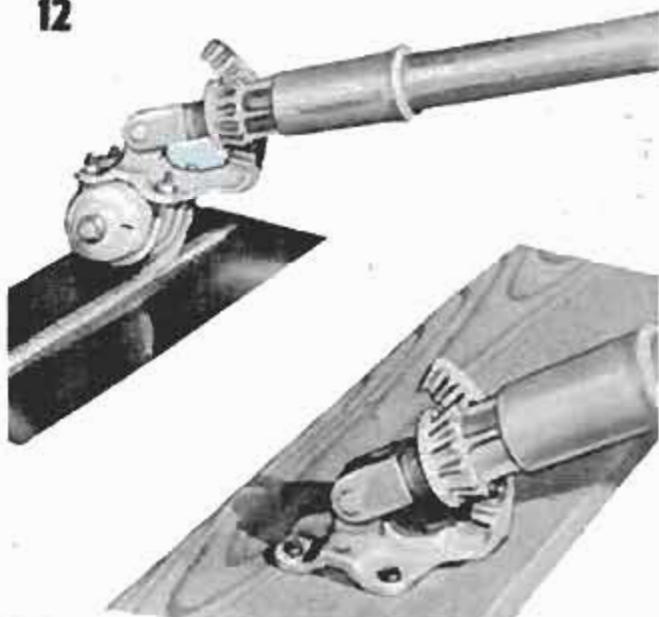

12

13. 30-PIECE DRILL KIT is a handyman's power workshop that includes 1/4-in. portable electric drill and all accessories necessary for drilling, sanding, polishing, buffing and grinding, plus a 21-piece socket-wrench set. Metal carrying case also included
Cummins Portable Power Tool Co.,
Div. of John Oster Mfg. Co., Milwaukee, Wis.



13

14. BENCH VISE features a rotating, turret-type rear jaw having four working faces and a machined flat on the top. Spring-loaded stop locates the turret at any one of the four positions. Holds round, flat and irregular shapes. Can also be used as machine vise
Roto Products Co., 1823 N. Church St., Rockford, Ill.

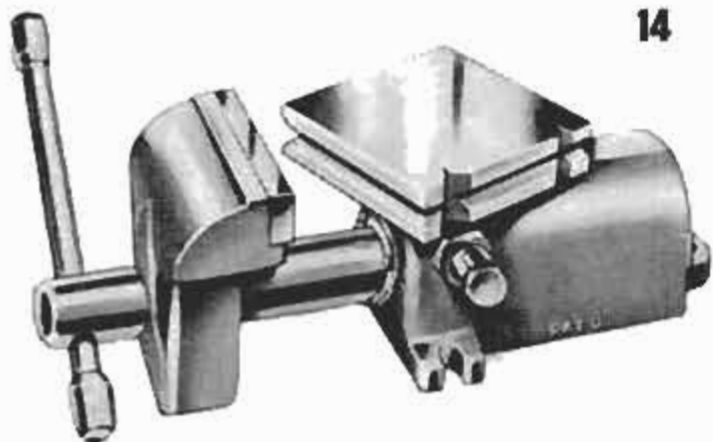

14

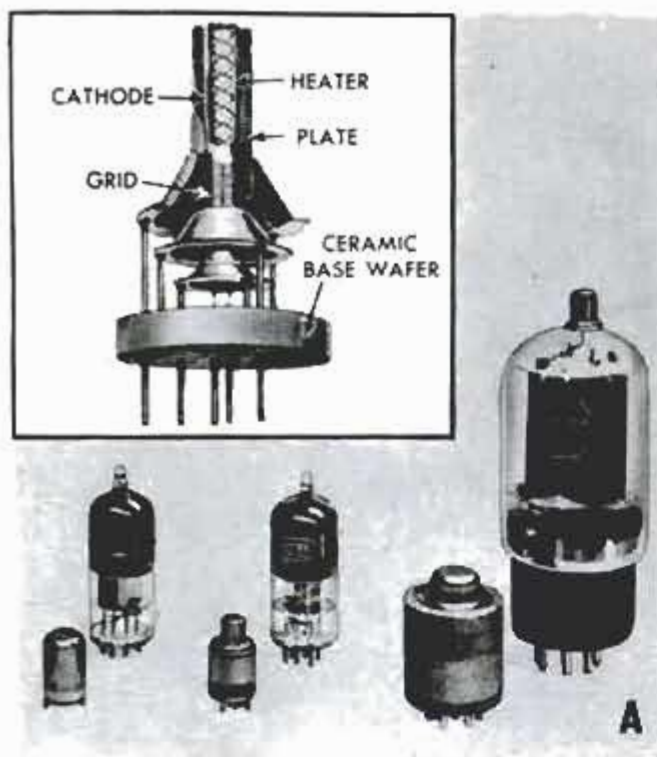

... IN THE NEWS

A.—A "new look" in electron tubes. Dwarfed by their present-day counterparts, RCA's newly developed triodes, tetrodes and beam-power tubes will go into limited production in 1960. Simplified construction, see inset, improves ruggedness and reliability and lowers cost while small size and greater efficiency are expected to cause a revolution in electronics

B.—and still smaller. Micromodular construction has resulted in a 6-transistor radio which fits into a teaspoon with room to spare. Sponsored by the U.S. Army, new miniaturization concept was developed primarily for the military but may also be applied to products for home, commerce and industry

C.—More compact than the Walkie-Talkies of World War fame, Dage's new battery-powered TV system combines fully automatic camera and transmitter in a two-unit, 16-lb. package. System has half-mile range—is designed for military and commercial use

D.—Latest in hi-fi tape reproducers, the Stereophonic Fidelivox makes prerecorded tapes even easier to handle and play than ordinary records. Tape magazine eliminates tape threading or rewinding—plays continuously until removed from the machine. Requires separate stereo amplifier and speaker system

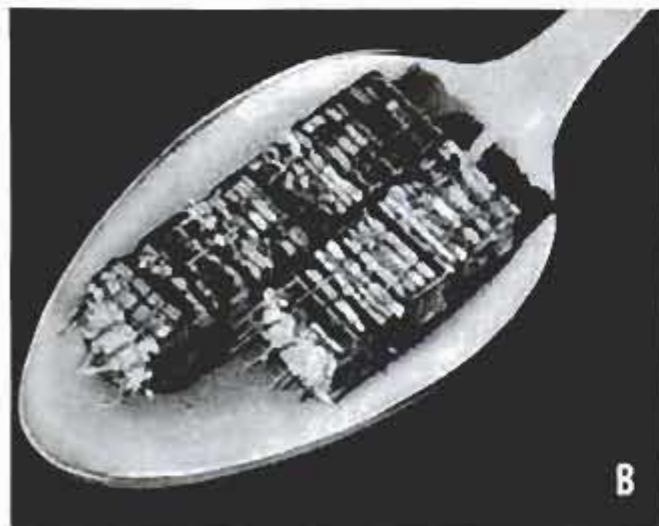



FOR BETTER STEREO

“Third Channel” Fills Hole in the Middle

By Norman Kramer

ASST. CHIEF ENGINEER, KNIGHT ELECTRONICS CORP.

THE SEARCH for “perfection” goes on. Hi-fi has replaced the ordinary radio and phonograph, and stereo is rapidly replacing hi-fi. The phrase “high fidelity” itself is giving way to “stereo fidelity” which, today, represents the ultimate in the reproduction of sound and music in the home. But despite the excellent quality of today’s stereo records (and tapes), despite the near-flawless reproduction available from modern high-fidelity components, even the three-dimensional magic of present-day two-channel stereo does not always satisfy the requirements of the critical listener.

It is generally agreed that two-channel stereo can produce amazingly lifelike results—provided that the two speakers are properly spaced, about 7 to 9 feet apart, and the listener remains in a relatively small area midway between and approximately 12 to 15 feet away from the speakers. This forms a triangle in such a way that the listener sees an angle of 30 deg. to 40 deg. between the speakers.

Unfortunately, room decor frequently places the listener in some position other than this ideal stereo triangle. Moving further away from the speakers, however, causes a fusion of the two dissimilar signals and results in considerable loss of the stereo effect. Conversely, approaching closer to the speakers causes an over-separation which often gives the distinct impres-

sion of two separate orchestras playing in opposite corners of the room; leaving a sort of void, or hole, in the middle.

Even at the proper distance, the hole-in-the-middle effect is often present due to recording defects, such as intentionally over-separated records; or merely because of the psychological effect of actually seeing two speakers. Whatever the cause, the hole in the middle could be eliminated by moving the two speakers closer together, but such a remedy has several disadvantages. Not only does it mar the stereo effect for listeners farther away, it also converts the center section of the orchestra into a sort of “no man’s land”—an area in which the performers seem to be picking up their instruments and moving about from side to side as the listener himself varies his position with respect to the center line between the speakers. In addition, reducing the distance between the speakers reduces the effective spread of the orchestra so that the feeling of spaciousness associated with listening to a live performance is severely restricted.

The “Third Channel”

Ideally, it would be desirable to place the two speakers far enough apart to maintain the full stereo effect at the maximum distance from the speakers, at the same time filling in the space between the speak-

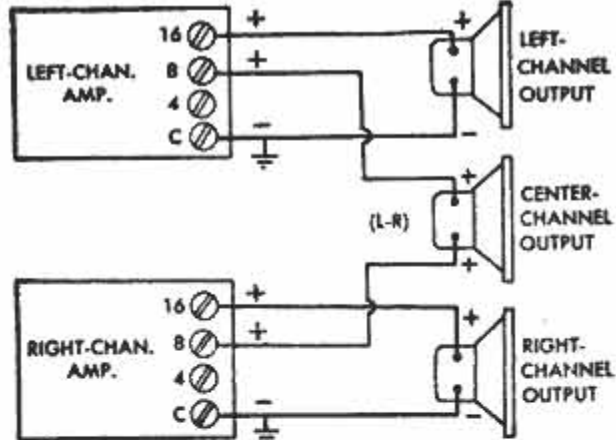
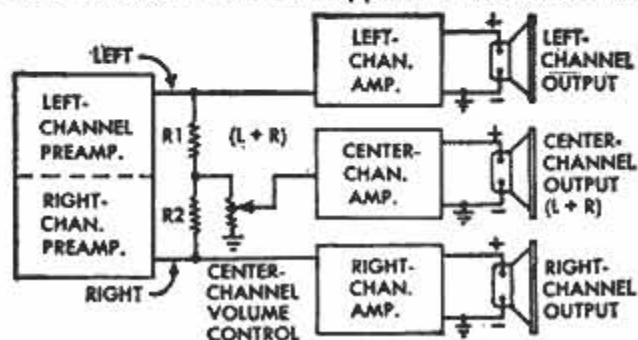

Fig. 1. Center-channel output obtained by the subtraction method. Note that like signals in left and right channels cancel in center-channel output

Fig. 2. Center-channel output obtained by an addition. Resistors provide interchannel isolation but cause blended mixture to appear at volume control



ers and stabilizing the positions of the center-stage instruments for the close-up listener. This effect can be accomplished by placing a third speaker midway between widely separated end speakers and feeding it with a signal which is either the sum of, or the difference between, the two stereo signals. This results in a simulated third channel which increases the size of the stereo listening area, focuses the center-stage performers and fuses the two halves of the orchestra into an integrated unit without compromising the stereo effect.

The various schemes for obtaining such a "third channel" have in common the principle that if two microphones are correctly placed, their combined output will correspond to the output of a single microphone placed midway between the two. This condition can be duplicated without the use of an actual center microphone merely by taking a portion of signal from each of the two stereo amplifier channels and applying the combined signal to a centrally placed speaker.

The "Difference" Method

An early and popular approach to obtaining this simulated third channel is illustrated in Fig. 1. With this method the two stereo speakers are connected to the amplifier output terminals in the conventional manner, while the center speaker bridges the two amplifiers by being con-

nected across the lower impedance output taps of the two transformers.

The operation of this circuit becomes obvious if we consider the voltages appearing at the 8-ohm transformer taps when a stereo signal is applied. Let's assume, first, that the signals applied to the two amplifiers are identical in frequency and amplitude. Under this condition, which corresponds to that of a monophonic signal at the amplifier input, the voltages at the output of the amplifier will also be identical in phase and amplitude at any instant of time. And, if voltages at both 8-ohm amplifier taps are always the same, there can be no voltage across the center speaker. For monophonic input signals, therefore, and for any like portions of a stereo signal, the center speaker will remain mute.

With substantially different signals in the left and right amplifiers, the instantaneous voltages at the 8-ohm amplifier taps will not be the same, so that a voltage difference will appear across the center speaker. This difference between the two signals, therefore, will be reproduced by the center speaker.

Being activated by the difference component of a stereo signal, the center speaker will adequately fill the hole in the middle. This method of obtaining center fill, however, does have some disadvantages. For the reproduction of a monophonic signal, the center speaker serves no useful purpose. And, because only the difference component of a stereo signal is reproduced in the center speaker, the latter could not be employed as a possible remote monophonic reproducer without some loss of audio quality.

The Addition Method

A method of obtaining the third channel by a summation process is illustrated in Fig. 2. Here, mixing takes place in the output of a stereo preamplifier across a common resistor—the center-channel volume control.

Since both the left and the right portions of the stereo signal appear across this volume control, they are effectively added at the input of the center-channel amplifier and reproduced by the center speaker. Resistors R1 and R2 provide the necessary isolation between the left and right-channel amplifiers to eliminate the possibility of cross-talk. The volume of the center speaker is adjustable to provide just the right amount of center-fill signal and, since the center speaker reproduces the entire stereo signal, it can be used remotely as a monophonic reproducer for both stereo and monophonic signals.

This method has the disadvantage of requiring a third power amplifier as well as

a third speaker. It is frequently prohibitive from a standpoint of cost and space considerations.

Another approach to the summation process appears in Fig. 3. Here the mixing takes place at the grid of an amplifying tube in a stereo preamplifier. Several hi-fi equipment manufacturers have used this method in commercially available preamplifiers. Such units are supplied with a third output jack labeled, appropriately, "third-channel output." Like the circuit in Fig. 2, this method too requires a separate third-channel power amplifier and has the same advantages and disadvantages.

No Third Amplifier

Still another approach for achieving the third channel by the summation method was developed by the author. This method, illustrated in Fig. 4, is incorporated in the Knight 40-watt stereo amplifier kit, but can be easily adapted for nearly any stereo amplifier or to two separate amplifiers being used for stereo purposes. It has the advantage of providing full monophonic output from the third speaker, from either a monophonic or stereophonic input signal, without the need for a third power amplifier. The only requirements for proper operation of this circuit are that the secondary windings of both output transformers are provided with a 4-ohm tap, and that all speakers used have voice-coil impedance in excess of 4 ohms.

With this method, mixing is achieved entirely in the output transformers. It should be noted that the 4-ohm transformer taps, rather than the common leads, are grounded. Since the 4-ohm taps, electrically speaking, are the center taps of the secondary transformer windings, the transformers are connected in a sort of push-pull arrangement for monophonic signals and for like components of a stereo signal. This condition is depicted in Fig. 4, which shows the instantaneous polarity across the two output-transformer windings for similar applied signals. When the third speaker bridges the amplifier outputs as shown, the top end of the speaker goes positive while its bottom end goes negative with respect to the grounded center tap. The third speaker, therefore, receives the sum of the voltages appearing across half of each transformer winding. Since these voltages are equal and in phase, the speaker produces an output which is equal in intensity to that of each end speaker.

If, as in stereophonic program material, the signals from the two amplifiers are not identical, the volume of the center speaker may be slightly less than that of the end speakers. In all cases, however, the third speaker will reproduce the combined signal

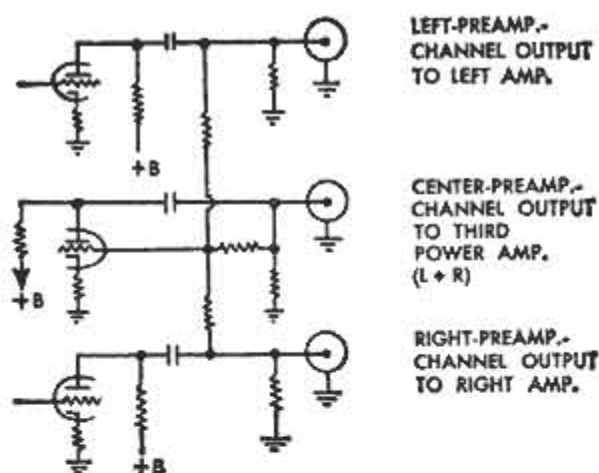
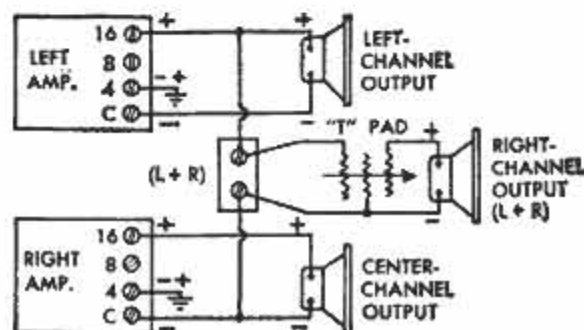

Fig. 3. One approach for obtaining a center-channel output, by mixing the left and right signals directly in the preamplifier, employs extra tube

Fig. 4. Center-channel output obtained by mixing in output transformers. Like signals in left and right channels do not cancel in the center-channel speaker



of the two stereo channels with no frequency discrimination.

Used as a center-fill speaker only, the volume of the third speaker need not be as great as that of the end speakers. In fact, its output should be only loud enough to effectively fill in the space between the other two. For this reason, a T-pad, which acts as a volume control for the third speaker only, is connected to this unit. This permits independent control of center-speaker volume for any desired degree of center fill. The correct amount depends, of course, on the distance between the end speakers, the size of the listening room and, to some extent, on the position of the listener.

Modifying Existing Amplifiers

Virtually any existing stereo amplifier, or two amplifiers used in a stereo set-up, can be modified easily and inexpensively for this type of three-channel operation. The necessary modifications are illustrated in Fig. 5. The original circuit is shown in black while the required changes and additions are superimposed in green ink.

In most hi-fi or stereo amplifiers, the "common" (black) output-transformer leads are connected to the "common" (C) terminals of the speaker terminal strips,

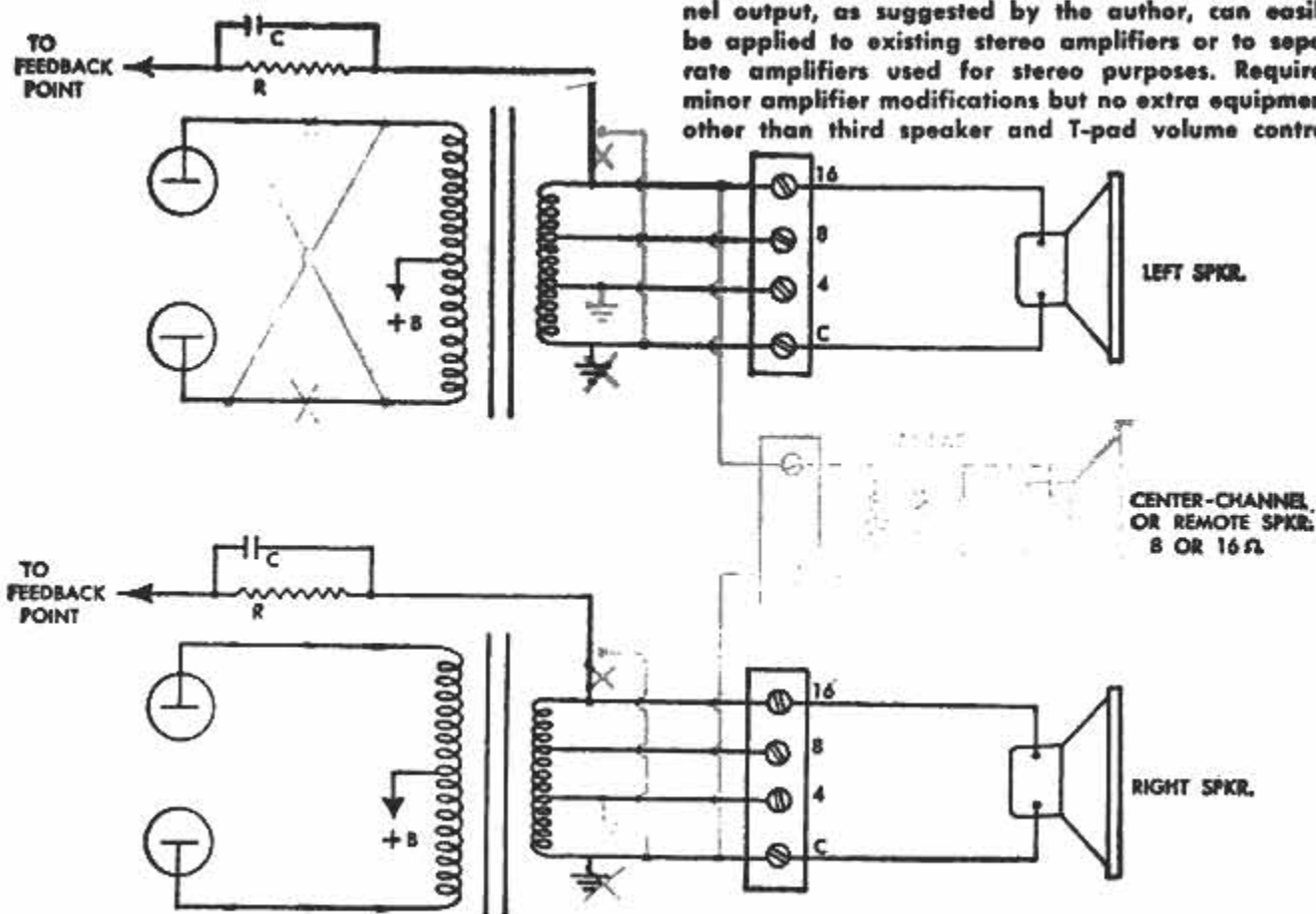

Fig. 5. Additive method for obtaining center-channel output, as suggested by the author, can easily be applied to existing stereo amplifiers or to separate amplifiers used for stereo purposes. Requires minor amplifier modifications but no extra equipment other than third speaker and T-pad volume control

with wires running from these terminals to grounded points on the amplifier chassis. The first step is to remove the ground wires from the C terminals and to solder these to the 4-ohm terminals instead. The black transformer leads must remain connected to the C terminals. (In cases where the black transformer leads are connected directly to the chassis, these must be resoldered to the C terminals of their respective speaker terminal strips.) The external designations of the terminal strips remain as they are and the two end speakers will remain connected to the same terminals as before.

Having made the above change, the feedback voltage, which normally exists between the 16-ohm tap and ground, will have been altered. Usually, feedback is obtained through an R-C network connected from the 16-ohm tap to the cathode of some previous amplifier stage. Under such conditions, changing the ground connection, as described, reduces the feedback to half its original value. To restore the original amount of feedback, each feedback resistor (R in Fig. 5) should be replaced with a resistor having half the original value.

In experimenting with a number of different stereo amplifiers, the author found that some operated extremely well after the above changes were made. Others, how-

ever, notably those with less inherent stability, began to oscillate at very high or very low frequencies. In such cases stability was restored by removing the feedback network from the 16-ohm tap and soldering it, instead, to the C terminal; a change which reduces the inherent source capacity of the feedback circuit, thereby favoring amplifier stability under feedback conditions.

This modification, though it doesn't change the amount of feedback, does change its phase from negative to positive—a condition which must be corrected. This can easily be done by reversing the primary winding of the output transformer. Merely unsolder the output-tube plate and interchange the wires.

Connecting the third or center-channel speaker system (after equipping it with a T-pad to match its impedance) from the 16-ohm terminal of one speaker terminal strip to the C terminal of the other completes the conversion.

Remote Hi-Fi

If the third speaker is used for center fill only, a relatively inexpensive unit will provide satisfactory results. However, the possibility of using this speaker as a high-

(Continued to page 256)

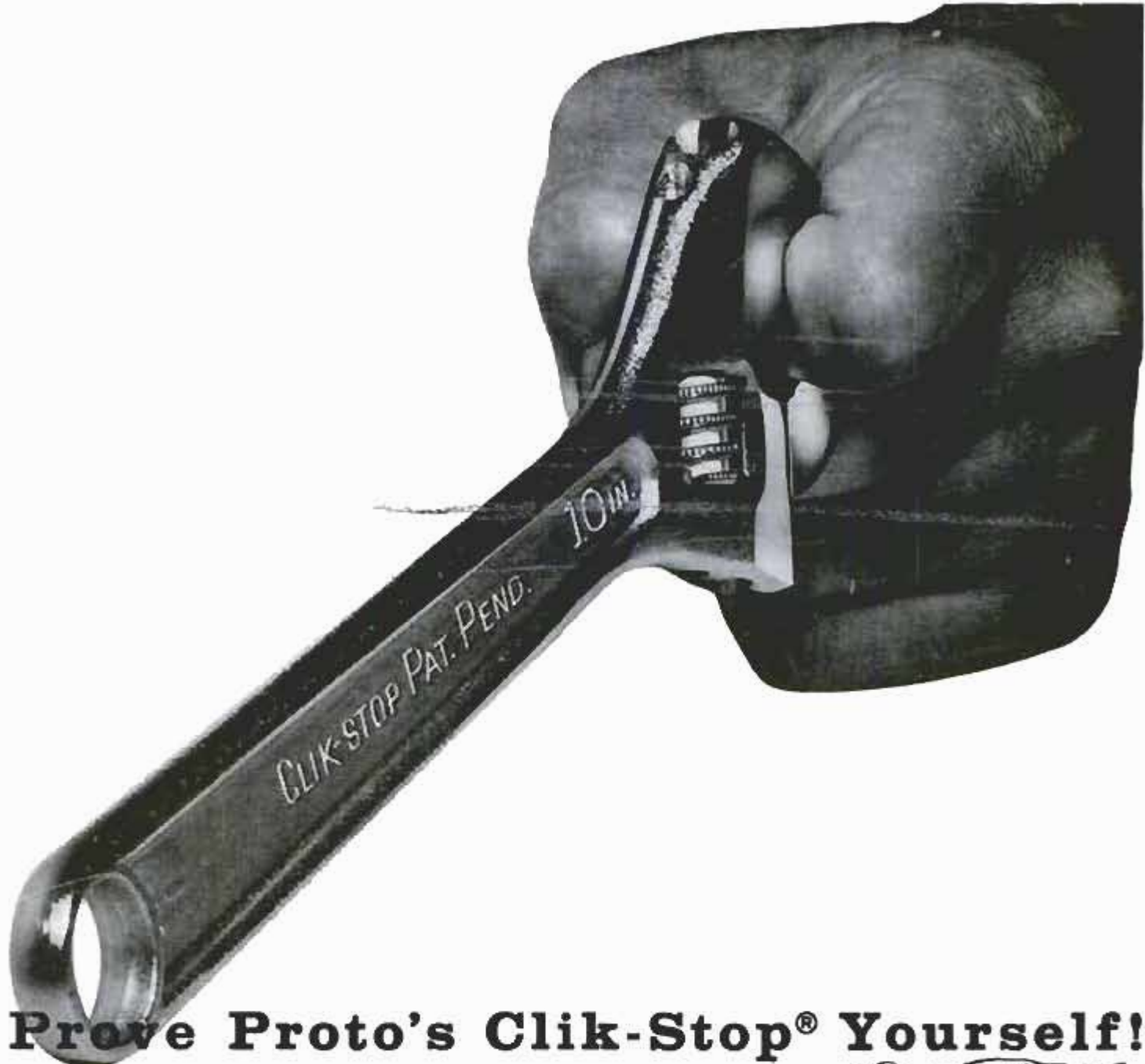

Prove Proto's Klik-Stop® Yourself!

Tighten a Klik-Stop® on your finger.



Now try to turn its Golden Knurl. You can't. Because the weight of the suspended handle alone keeps it locked. That's why the harder you pull, the tighter it locks... *automatically*. That's why Proto's Klik-Stop is safest to use. It won't change when laid aside; doesn't need resetting every time you go back to the same size fitting; it locks where you set it... *automatically*. Yet, when not under pressure, this same golden knurl turns smooth as silk to adjust to any opening size. Use it like an ordinary adjustable wrench. No buttons or gadgets to push. Saves you from busted knuckles and more serious accidents. All Proto Tools... more than 2,172 of them... are guaranteed to do their job. At your Proto Dealers, including Hardware, Builders Supply and Auto Parts stores all over the country. Buy Klik-Stops in: 4", 6", 8", 10", 12", 16", 20" sizes. Chrome or Black Industrial Finish.

2202 Santa Fe Avenue, Los Angeles 54, California
502 Allen Street, Jamestown, New York
1702 Oxford East, London, Ontario, Canada



DIVISION OF



Now! Shoot perfectly exposed movies

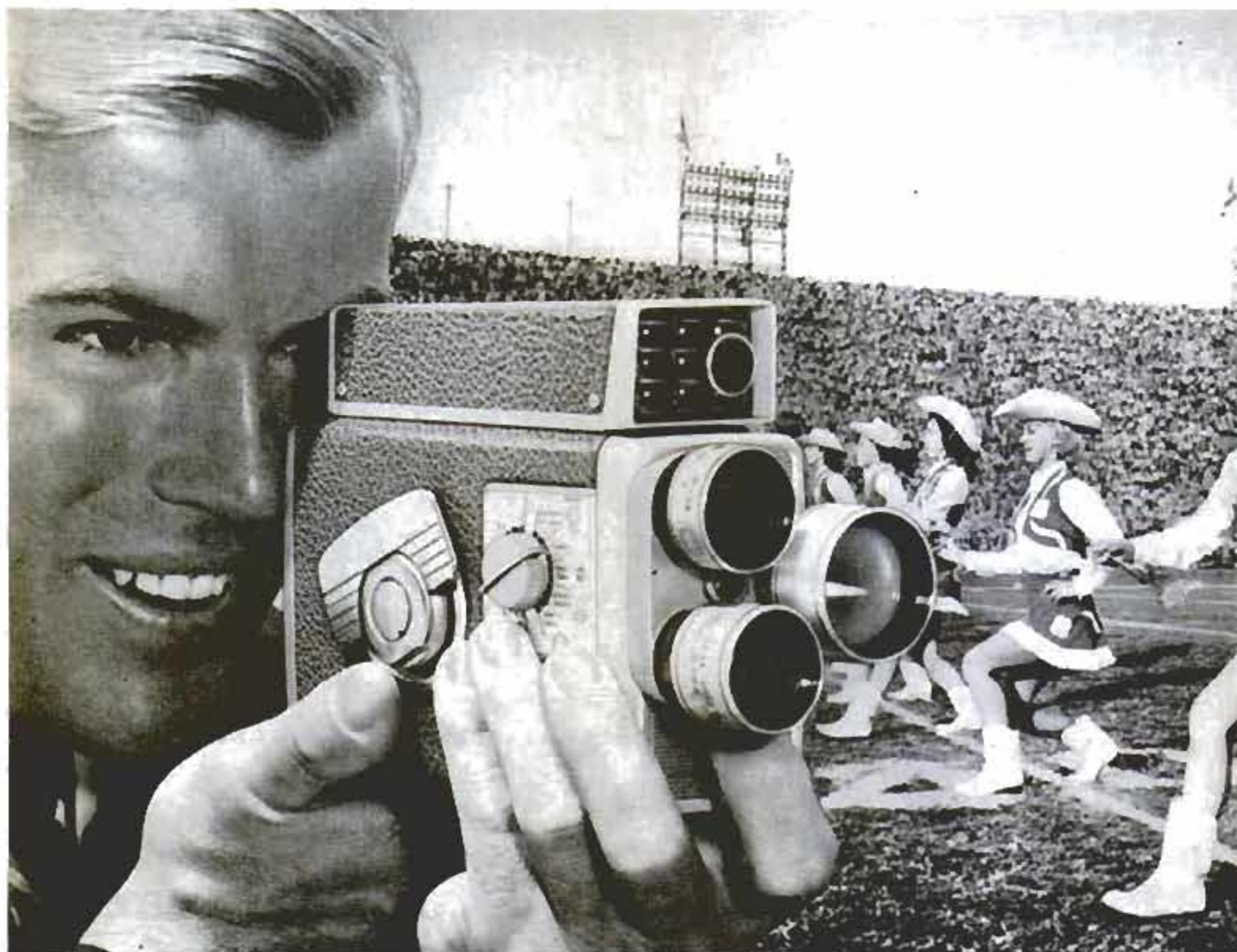

Get all the action, all the color . . . with the Kodak Cine Scopometer Camera, Turret $f/1.9$. \$99.50

Enjoy action-packed movies at a budget price—with 8mm Brownie Movie Equipment!



Brownie Movie Camera, Turret $f/1.9$. Three-lens range at a 1-lens price. Twist the turret for normal, wide-angle, or telephoto shots—and more exciting movies! Fast $f/1.9$ lens system gets bright, clear movies even on dull days. Only \$67.50, or as little as \$7 down.



Brownie 500 Movie Projector gives you brilliant 4-foot-wide screenings from a distance of only 16 feet. Accepts 400-foot reels for uninterrupted half-hour shows. Shows reverse action, "stills." Easy to load, easy to run. Only \$79.50 or as little as \$8 down.

...and show them automatically!



Kodak turret camera with built-in meter shows you when exposure setting is correct! New Kodak projector threads itself automatically . . . right onto the take-up reel!

Now you can make 8mm color movies and know they'll come out beautifully every time. Shoot in dazzling sunlight. In deep shadow. Even indoors. Yet you never have to guess at the right exposure setting. Here's how:

Aim the Kodak Cine Scopemeter Camera at your subject. Automatically, the built-in exposure meter measures the light. As the meter pointer moves, you see it move—right in your viewfinder. Just position the pointer by turning a knob and—presto—you've set the lens!

Move from sunlight to shade, and back again, changing your lens opening *while you shoot*. You never have to stop shooting to check exposure. For special effects such as sunsets you can set your lens independent of the meter reading.

And you can get three kinds of movie shots—normal, wide-angle, or telephoto—with just a flip of the turret. Other features include built-in Skylight and Type A filters . . . easy loading . . . fast $f/1.9$ lens

system. All for only \$99.50, or as little as \$10 down at most dealers.



Show your movies automatically with the amazing new Kodak Cine Showtime Projector, Model A20. It threads itself from start to finish! Simply place your film leader at the top sprocket feed . . . the Showtime takes over from there. Threads right onto the take-up reel, starts your show automatically.

New high-lumen projection lamp provides brilliant screenings up to 5 feet wide. 400-foot reel capacity gives you uninterrupted half-hour shows. Price: only \$137.50, or as little as \$13.75 down at most dealers.

Ask your Kodak dealer to demonstrate this camera-projector team for you.

Prices are list and are subject to change without notice.

See Kodak's "The Ed Sullivan Show" and "The Adventures of Ozzie and Harriet"

EASTMAN KODAK COMPANY
Rochester 4, N. Y.

Kodak
TRADEMARK



SUPREME VERSAMATE

Versamate . . . a wonderful tool that fits any power drill—reduces speed to give seven times more power. Drives screws of all sizes. Inexpensive extras make it a nut and bolt driver, heavy-duty drilling unit. See your tool dealer today!



\$9.95

For Portable Drill Users...

CHOOSE THE ATTACHMENTS THAT DO THE BIG JOBS!

Versamatic triples portable drill usefulness. *Reverses!* Drives and removes screws, nuts, bolts. Boosts power 7 times. Set includes regular and Phillips-type bits, and 1/4" square drive adapter. For heaviest drilling jobs in steel and concrete, add a 1/2" Supreme Brand Chuck.

\$14.95



SUPREME VERSAMATIC



**SUPREME PRODUCTS
CORPORATION**
2222 S. Calumet, Chicago 16
Div. of A. S. R. Products Corp.

Clinic for Homemakers



As a service to our readers in solving the hundreds of problems pertaining to a home—inside or out—the editors of *Popular Mechanics* invite you to present your problems to The Clinic Editor for help and advice. Address your questions to The Clinic Editor, *Popular Mechanics Magazine*, 200 East Ontario Street, Chicago 11, Ill.



Defective Plaster Patch

Q—I've just painted a room which has always been papered. I had to patch one large crack and several smaller ones. Now, after applying two coats of paint the patches still show. On the large crack the paint appears to have dried flat. What's the most likely cause and what can I do about it now?

—H.D., Fla.

A—Usually there are two main reasons for plaster patches showing through paint: (1) The patching material may not be precisely flush with the surrounding surface, causing a shadow to be cast. (2) The new patching material may be more porous than the regular plaster and thus absorb more of the oil in the paint, giving it the appearance of drying flat. On such a patching job painters usually size the patches when dry, or spot them with the same paint that is to be applied to the wall. In some instances it is best to apply an undercoater to the new plaster patches and allow it to dry before finishing the job. White shellac also can be used. In your case it would probably be best to spot the patches then finish up by painting the wall one extra coat. This treatment should hide the patches effectively.



Solvent Aids Floor Sanding?

Q—Isn't there some way of preventing the abrasive from clogging when sanding a floor with a sanding machine? I've been told that ordinary kerosene would do it, but I'm afraid to use it because of the fire hazard. What about carbon tetrachloride, is it safe to use?—E.H., Ark.

A—Do you use an open-coat abrasive for the first time over? And do you run the sander at an angle with the boards? As a rule this simple procedure will minimize the trouble you are experiencing. You're right in assuming that use of kerosene would be hazardous. Should the abrasive strike a nail in the flooring, the resulting sparks might ignite kerosene.

(Continued to page 254)



What will the 1960 cars be like? One thing's certain: most makers of cars *and* trucks will use Champions!

Q. Why do 17 out of 21 U.S. truck manufacturers specify Champion spark plugs?

A. Because they know full-firing Champions are *dependable*. To get this dependable performance—plus extra mileage—in your car, put in new Champions every 10,000 miles.

World's favorite spark plug—engineered for every car built by Ford Motor Company, General Motors, Chrysler, American Motors, Studebaker-Packard and every major foreign maker.



New Dexall Brush Cleaner

- Cleans hardened paint brushes easily
- Cleans all types of bristles
- Nonflammable — re-usable

*Snaps paint-hardened brushes
back to life!*



DESHLER PRODUCTS, INC.
Deshler, Ohio



Tough seal lasts for years!

New Dexall Caulking Compound

- Caulks stucco, wood, concrete, brick, stone
- Permanently elastic
- Easy-to-use cartridges

At paint and hardware stores everywhere.

(Continued from page 252)

Carbon tetrachloride is not flammable but it does pose a health hazard. In fact, any common solvent may be a health hazard in degree in any closed room. For this reason we could not recommend their use for the purpose you have in mind. Rather we would suggest that you equip the machine with a coarse, open-coat abrasive, make each pass of the machine at an angle with the floor boards, and do not attempt to remove all the old varnish the first time over. If you permit the machine to move over the floor quite rapidly there will be less tendency to clogging of the abrasive as less heat will be generated on each pass. Go over the floor rapidly in one direction, then once again at a different angle with the boards. Finish the rough cutting with the grain of the wood. Then, with the wood exposed, finish with a finer abrasive.



Insects on Fresh Paint

Q—Last fall I painted two houses and on one I had trouble with small insects alighting on the fresh paint and sticking fast like flies on flypaper. Next time I want to avoid this trouble as the insects can completely ruin a good paint job. Can you tell me how?

S.L., Ill.

A—Some painters troubled in this manner mix a small quantity of insect repellent with the paint. We understand that it's quite effective. However, we could not recommend the procedure without reservation as it is possible that ingredients of some insect repellents might affect the durability of house paints. In most localities trouble with insects can be avoided by painting only during or after periods of settled weather as the drying conditions are usually ideal and insects ordinarily give very little trouble, especially during the morning hours. Under good drying conditions the paint will set insect-free in an hour or so.

Ice Dam on Roof

Q—My home has a low-pitched roof and last winter the ceiling plaster was damaged by water which evidently leaked through the roof just above the eaves. On going into the attic at the time I first noticed the damp spots on the ceilings, I found that water was dripping from the roof boards near the lower ends of the rafters. I'm puzzled. Where does the water come from?—G.M., N.Y.

A—Condensation is always a possibility, but judging from your description of the trouble we think it more likely that an ice dam forms on the roof just above the eaves. Heat loss to the attic and the warmth of the sun during the clear days melts the snow on the roof. Water from the melting snow is trapped by the dam and seeps under the shingles and through the roof boards, as you have observed. Perhaps the simplest way to prevent this trouble is to install electric heating cables (lead-covered) along the eaves. Heat from these cables will melt the snow that collects at this point and prevent the formation of a dam.

Determining Length of V-Belt

Q—I want to change the pulley sizes on a home-shop power tool, but I don't know how to determine the correct length of V-belt. Is there a formula for figuring the belt length, or must this be determined by measurement?—C.D., Vt.

A—One fairly accurate method is simply to measure around the outside of the V-pulleys with a flexible steel rule. Of course, this must be done with the pulleys on the shafts on which they are to be operated. Or, cut two pieces from the old belt, each one to a length that will reach slightly more than half way around each of the pulleys. Tape the pieces in place on the pulleys and measure around the pulleys as before. This method is somewhat more accurate. You can compute the length of belt required by adding the diameters of the driving and driven pulleys and multiplying by 1.57. Then add twice the distance between the centers of the pulleys when mounted. The final figure is the length of belt required.

Exclusive features never before offered!

ALL-NEW IN EVERY WAY



DEWALT®

**POWER
SHOP***

Model 925



NEW!
EXTRA BIG CAPACITY

9" saw cuts 2½" deep
rips 24" wide

Patented totally-
enclosed motor

DELIVERS

MORE THAN 2 H. P.

includes exclusive built-in
ROTO-GRIP motor brake†
(stops motor instantly)



NEW Exclusive ROTO-GRIP
motor brake



NEW Totally-enclosed
direct-drive motor

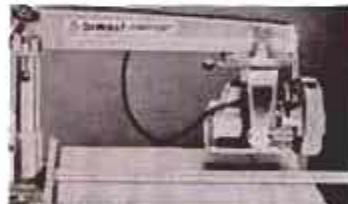

NEW Weldwood® Lebanex
Drop-leaf Table



NEW Exclusive new
cut-off scale

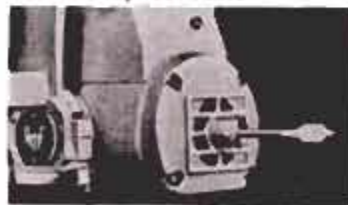

NEW Use of low-cost
right hand tools



NEW Safety "CAM"
Key Switch, built-in

Go to your nearest DeWalt dealer and see a free demonstration of DeWalt's great new Model 925. It's loaded with EXTRA VALUE features you've been waiting for! You can own this incomparable new DeWalt with all its exclusive features at no extra cost. See it now!

LOW BUDGET TERMS EVERYWHERE!

as low as \$2.50 per week

*T. M. DeWalt Division

†Patent Pending

DeWALT, Dept. PM-910, Lancaster, Pa.

- Please send me FREE CATALOG of the new DeWALT POWER SHOP.
 Send name of my nearest DeWALT dealer.

Name _____

Address _____

City _____ State _____

For a tight grip
in tight places...



The "Mighty Midget"

CHANNEL LOCK

No. 424

This "mighty midget" is a natural for a tight grip on small work in hard-to-get-at places. Only 4-1/2" long... drop forged from high grade steel. Four exclusive Channellock precision grooved jaw adjustments... capacity to 1/2". Skilled mechanics say it's one of the handiest pliers in their kits. You'll say so, too!

CHAMPION DEPARTMENT TOOL COMPANY • MEADVILLE, PA.

ASK YOUR TOOL SUPPLIER
FOR A CHANNELLOCK No. 424



Be sure it's a genuine CHANNELLOCK
Look for the trademark on the handle

"Third Channel" Fills Hole in the Middle

(Continued from page 248)

fidelity monophonic reproducer in some other room of the house should not be overlooked. For such applications, the quality of the reproduced sound will be limited only by the quality of the components, and the third speaker should match the performance of the rest of the system.

Additional versatility can be obtained by connecting two 8-ohm speakers in series in a third-channel hookup. One of these could then be used for center fill and the other as a remote monophonic reproducer. Two 16-ohm speakers connected in parallel could be used for this application with only a slight reduction in acoustical power due to the impedance mismatch.

The need for a third channel reproducer is still a highly controversial issue. Some stereo listeners, perhaps those with ideally placed speakers and a concentrated listening area, insist that there is no conscious feeling of sound separation with two-channel reproduction. Others, enough of them to influence the design of stereo equipment, insist that a third speaker can add greatly to the depth, realism and spaciousness of stereophonic sound. The simplicity and low cost of the method described above should enable every interested stereo fan to—"judge for himself." ★ ★ ★

One-Bath Process Develops and Fixes Film

With a new chemical solution the photographer can process his film in a single bath. The bath cuts developing time from the usual 50 to 60 minutes to 10 to 15 minutes. According to the manufacturer, the photographer no longer needs to go through the three-stage operation of developer, short-stop and hypo. Now he places the film or print in one bath and it is automatically developed. It can be left in the bath as long as the photographer wishes with no fear of overdeveloping. One drawback, however, is that contrast cannot be controlled. Solution temperature is not critical. Processing can take place at any temperature above 68 degrees F. Final washing in flowing water takes five minutes. The bath contains a special chemical to prevent prints from bleaching or turning yellow.

☐ Foam mattresses for cattle, covered with a tough plastic immune to water rot, have been designed by an English farmer who got tired of the high cost of straw bedding.



PAINT NEWS

NEW DU PONT

LUCITE ACRYLIC HOUSE PAINT

TRADEMARK

LASTS 50% LONGER

DRIES IN 30 MINUTES

Here's the greatest paint discovery since Du Pont quick-drying auto finishes: Du Pont "Lucite" Acrylic House Paint. It's so durable it lasts 50% longer than ordinary paints... can save you hundreds in repainting costs. An acrylic emulsion, it is recommended for use only over No. 38 Blister Resistant Wood Primer on new wood or on old surfaces with the finish completely removed.

SOLVES BLISTERING PROBLEM

For a long time blistering has been home owners' most serious paint problem. Until now, it has been an almost insolvable, recurring predicament. The combination of No. 38 Primer and "Lucite" Acrylic House Paint can give unprecedented protection against blistering because it is chemically engineered to al-

low moisture vapor to breathe through while shutting out water penetration.

EASIEST PAINT TO APPLY

"Lucite" Acrylic House Paint flows on more smoothly, evenly than any paint you ever used. Dries in 30 minutes—ready for a second coat in one hour! You save time and money by avoiding the usual ladder shifting that is necessary. One coat covers, two give maximum protection and durability. Water is all you need for thinning. Soap and water clean your brushes.

COMES IN MANY COLORS

"Lucite" Acrylic House Paint is available in white and 16 beautiful colorfast colors. This amazing new paint and primer are ready for delivery now at your Du Pont Paint Dealer's. You'll find his name in the Yellow Pages.

Buy the paint that's worth the work! Your time is too valuable to risk on "bargain" paints. Buy Du Pont Paint and you know you're getting the most modern finishes made... and that the beauty will last. Du Pont Paint Chemistry assures you of that.



Better Things for Better Living
... through Chemistry

MILD LITTLE CIGARS

NO NEED
TO INHALE
TO ENJOY THEM

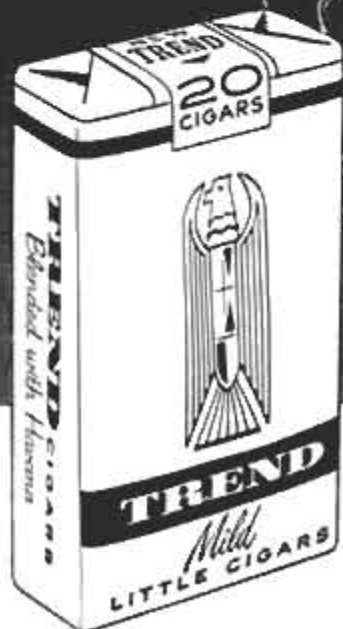

35c
Humidor pack
of 20

TREND

- Long enough for complete satisfaction . . . short enough to enjoy *any* time.
- 100% cigar tobaccos—with uniform tobacco wrapper.
- No need to inhale to enjoy them.

Try them today . . . the *milder* little cigars in the *modern* size. Carton includes free cigar holder.



Tipt

New Filter Tip Little Cigar

40c Humidor Pack of 20

Filter-tip protection . . . true cigar flavor . . . convenient modern size.

STEPHANO BROTHERS
(Cigar Division) Phila. 7, Pa.

PIONEER IN MODERN LITTLE CIGARS

The Test of Good Landscaping . . .

(Continued from page 187)

be spacious enough for a good game of three-cornered "catch," and can be marked off by natural contours or suggestively defined by small beds with tough bordering shrubs.

Utility. Drying area, burning area, off-street parking space, storage nooks for building materials and compost, space for a small vegetable or fruit garden, all should be worked into the master plan with careful thought to convenience as well as design.

There are many ways to separate even a small yard into areas, but the best way is to utilize the natural formations on the land. Be sure to take advantage of those variations in grade, even if the grade change is only 6 inches in 50 feet. Flat ground or a flat slope is monotonous and hard to landscape, whereas great interest can be created if you're lucky enough to have uneven ground. Even the tiniest slope can be terraced with low-lying, curved walls of flagstone or thin random slabs of shelf rock, creating unique and pleasing garden areas on separate levels.

Fences, Walks, Patios . . .

This brings up the all-important matter of fences, walks, driveways, patios, tool sheds and other architectural structures. These form the main framework of your garden and should be handled carefully. You can make them assets or eyesores. A rough-hewn rail fence, brick or stone wall banked with shrubs and perennials, or laced with ivy can incorporate itself beautifully into almost any garden. A well-designed tool house, nestled in flowering shrubbery and graced with an inviting brick or flagstone walk can look as though it belongs in the garden.

Walks, drives and patios should fit into the garden design, and not be set apart by traditional hard, straight lines of squared-off paving. If such paving is already in, pave additional areas to give pleasing lines and curves. Try not to break up these lines in disjointed segments. Tie in your walks, driveway and garden planting areas with generous, graceful curves which are far more restful to the eye. And be sure to take into consideration the color in your paving material, gravel and outside painted surfaces just as carefully as you would handle an indoor color scheme. In selecting your flowering shrubs and perennial plants for the beds, keep in mind the colors that the blossoms will impose against these backgrounds.

(Continued to page 260)

EASY TO AFFORD...



the things you've always wanted!

built on your **YUBA**



Mark 5



Any room of your house . . . every member of the family . . . will benefit from Dad's new SHOPSMITH. Home-fixing . . . from simple tables to intricate cabinetry . . . is money-saving with this quality multi-purpose tool. Amazingly versatile, SHOPSMITH—at 1/3 the cost—does everything AND MORE than a shop full of single-purpose power tools!

SHOPSMITH is the *practical* power tool for novice or craftsman, proved by well over a quarter-million owners. See your nearest SHOPSMITH dealer, Montgomery Ward store or write Dept. SPM-10 for literature.

SHOPSMITH
makes a wonderful gift
... is a wonderful
gift-maker!

NOW! Complete Shop in 1 Tool for only \$299.50



9" Saw



12" Sander



34" Lathe



Unlimited
Horizontal Drill

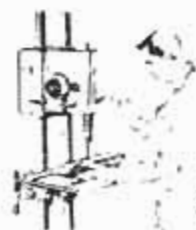

16 1/2"
Vertical
Drill Press

YUBA POWER PRODUCTS, INC.

800 EVANS ST., CINCINNATI 4, OHIO

A Subsidiary of

YUBA CONSOLIDATED INDUSTRIES, INC.

YUBA

One of the most important factors in a garden is ease of maintenance. The traditional garden, with its great variety of plants, set out in formal stylized symmetry in a vast profusion of color, made for plant material (largely annuals and potted plants), set out in formal stylized symmetry in a vast profusion of color, made for the highest and most expensive maintenance. The modern garden we're talking about makes use of evergreens, flowering shrubs, ground covers that perpetuate themselves year after year, plus a few well-spaced masses of blooming plants (largely perennial) for dramatic effect. Easy maintenance doesn't just happen. It must be planned. While there is no 100-percent workfree garden, there are degrees of care that certain types of planting require.

Here's a rule-of-thumb list for guidance:

Easy maintenance: Paving, gravel and flagstone in heavily used areas; trees; slow-growing shrubs; ground covers where grass is hard to grow and to create borders.

Medium maintenance: Lawn, perennial flowers.

Heavy maintenance: Annuals, tubed plants, vegetables.

Keeping your maintenance to a minimum comes with experience, but there are

many pitfalls you can avoid at the outset by proper planning. The use of paved terraces in garden areas can eliminate a lot of mowing. Many materials are used today which are highly decorative and interesting. Flagstone, of course, is handsome but expensive. However, I have seen gravel used with great effectiveness. Broken chunks of concrete can be cleverly arranged in random paving. Some western gardens have terraces paved with natural round disks sliced from the trunks of redwood trees. Easterners could do the same with cedar. Old used pink brick set in a bed of sand can make a handsomely textured terrace pavement.

Paved mowing strips along the planting beds eliminate the need to hand trim the lawn edges. Made of stone slabs, clay tile or brick, such edgings will enhance any garden.

Low walls of brick or dry stone construction look as though they belong in a garden. So do paddock-type or rough-hewn rail fences. And don't overlook the decorative value of oddly shaped boulders, a low table made of natural rock slab or an interesting piece of driftwood made into a table or bench. Best of all, such items decorate the garden without the perpetual trimming required by hedges and shrubs. If you must

(Continued to page 262)

Decorate • Personalize • Protect

Bright Ideas 24 Hours a Day. Versatile, beautiful by day, 3M Reflective Products reflect with exceptional brilliance at night. It's fun to design markings that literally "pop" out of the dark . . . reflect up to 100 times brighter than white paint. Easy to apply reflective markings let you decorate, personalize, and protect countless items. Available from auto accessory, hardware, and other fine stores.

brilliant red—day and night

SCOTCHLITE REFLECTIVE TRIM

Easy to apply, press-on "Scotchlite" Trim prevents accidents with highly visible markings for autos, trailers, etc. Use this durable material to decorate, personalize, and protect your property 24 hours a day!

chrome by day—white at night

CHROMELITE REFLECTIVE TRIM

New—attractive chrome trim offers highly visible reflective protection at night. Attractive trim presses-on, protects outboard motors, boats, trailers, cars, bicycles, wheeled toys, lawn furniture.

"brush-on" bright reflection

REFLECTO-LITE REFLECTIVE COATING

Handy household item. Simply brush-on like paint . . . on curbs, driveway markers, trees, posts, docks, mail boxes, whatever you want to stand out in any light beam. Reflects brilliant white at night!





Free Plans from Masonite for your favorite **christmas figures**

Decorate your yard and your home with bright, colorful Christmas figures. It's easy and fun with our free plans and sturdy Masonite® hardboard panels. Make a jolly Santa...his prancing reindeer...a Nativity scene...choirboys, carolers, angels...and a dozen other joyous themes.

You don't have to be an artist! The plan folder explains all: how to make the cutouts any size you like, what colors to paint them, how to stand them in the ground or attach

them to the house. You'll like working with sturdy, split-proof Masonite panels, too. They're smooth and grainless, without knots. They take paint or enamel beautifully. And they'll laugh at the weather for many Yuletides to come.

See your local lumber dealer today for your free Christmas plan. Many are offering special prices on Masonite panels in sizes 1' x 4', 2' x 4', 3' x 4' and 4' x 4'. Or send the coupon today—we'll rush the free plan folder to you.

MASONITE 
CORPORATION

®Masonite Corporation—manufacturer of quality panel products.

MASONITE CORPORATION
Dept. PM-10, Box 777, Chicago 90, Ill.

In Canada: Masonite Corporation, Gatineau, Quebec
Please send me your free Christmas plan folder and full information about Masonite outdoor panels.

Name _____
Address _____
City _____ State _____
Zone _____ County _____

AUTO-LITE[®]

RESISTOR SPARK PLUGS WITH

POWER TIP



AT LOW SPEEDS
Power Tip is hot to burn
fouling deposits away clean.

AT HIGH SPEEDS
Power Tip is cool to check
costly pre-ignition.

**"FIRE UP" AT
ALL SPEEDS
WITH
AUTO-LITE[®]
POWER TIP**



*— the spark plug that cleans
itself while you drive!*

have a hedge, make it of hardy evergreens, in the North, or of slow-growing evergreens in the South, so trimming is necessary only once or twice a year.

Terracing, besides breaking up your garden into pleasant-looking sectors, creates easier maintenance, so pay careful attention to grade.

In selecting your shrubs and plants, remember that they all will grow. So check the mature height and spread of each variety before you put it in, and plant it with proper spacing to allow for growth. This way, they'll take care of themselves and you won't spend the rest of your life transplanting or trimming to keep the place from going to jungle. This can be time-consuming, frustrating and expensive, since transplanting is difficult.

Plan Ahead

Another important item to cut down on future labor is proper soil preparation *before* you begin your beds. It's much easier to mulch and fertilize a bed when it is barren than later on, when the plants are deeply rooted. Once a well-prepared bed is planted, a minimum of cultivating each spring and fall will keep it rich and loamy.

Things to avoid assiduously if you want an easy-to-maintain garden: formal design, sharp curves, straight lines and isolated shrubs.

Probably one of the most satisfying solutions to good landscape design, easy maintenance and a year-round effect is ground cover. For years, such ground covers as pachysandra and periwinkle were considered only as substitutes for grass in places too shady to grow lawn. Today, most good landscape architects hungrily seek new varieties, along with the tried and true varieties, to create vast areas of interesting form, line and texture that will stay green 12 months a year.

Ground Cover Is Versatile

Some of the things you can do with a ground cover are truly amazing. A few years back, attempts to achieve a balance between the height of a house and its setting resulted in a moustache of foundation plantings that soon towered to second floor windows, crowding for space and crying for a saw. Today, horizontal balance is achieved with large masses of ground cover planted in wide, generous beds, with a few accent trees or shrubs strategically spotted in an attractively textured mat of thick ground cover. These ground-hugging plants can also be used effectively in garden beds to pull scattered plantings together.

(Continued to page 264)

BUILDING CABIN**BUILDING FENCE****CUTTING FIREWOOD****FELLING TREES**

Now You Can Do Any Job, Anywhere, Anytime with One Saw...

NEW EXCLUSIVE WRIGHT® POWER BLADE SAW

No other saw like it! Replaces Chain,
Hand, Buck and Crosscut Saws

Fast, powerful, versatile—the Wright Power Blade Saw is all you need to build a cabin, duck blind, boat pier, fence, raft, outdoor furniture. It also prunes trees, cuts firewood...does any cutting job. Drops 20" trees with a single cut...yet follows a chalkline for precision cutting and leaves a smooth mill-edge. Narrow $\frac{3}{16}$ " cut.

Gasoline engine starts instantly in any weather, in any position. Safety trigger stops engine instantly, automatically, if saw is dropped. Special Chromeweld Power Blade stays sharper longer. Needs no accessories. And it's so safe anyone can use it.

WORLD'S SAFEST POWER SAW
NO DANGEROUS CHAIN

ONLY **\$189⁵⁰** Including 20" blade
F.O.B. Sheboygan, Wis.
Price applies in U.S. only.



THOMAS INDUSTRIES INC.
WRIGHT SAW DIVISION
410 S. Third Street
Louisville 2, Ky.



Save up to \$100 by building a log cabin with the Wright Saw. Send 10¢ for "HOW-TO-DO-IT-PLANS" and booklet "Build the Easy Way With Wright Saw."

MAIL THIS COUPON TODAY!

THOMAS INDUSTRIES INC.
Wright Saw Division
410 S. Third St., Louisville 2, Ky., Dept. PM-10
I enclose 10¢ for "HOW-TO-DO-IT-PLANS" and illustrated "Build the Easy Way With Wright Saw" booklet.

Name.....

Address.....

City..... Zone..... State.....

Five yews, for instance, planted like a row of periods, will suddenly melt into a beautifully textured unit design if a bed of ajugga surrounds them. Points of high interest in a garden can be created by a few simple, easy-to-maintain types of ground cover. *Euonymus colorata*, a boulder, a funkia and a couple of ferns can make a magazine picture out of an ugly stone jutting from the lawn. Ground covers, besides their decorative function, still serve well in places too shady or sour for grass to grow—such as under trees, under eaves where rainwater drips and creates bare spots, in hard-to-mow places, on steep embankments to hold soil together. Anywhere you use them, try to create interesting patterns and use the vertical accent of a tree, shrub or boulder here and there to break the horizontal monotony.

In Color All Year

Virtually all the plants we've discussed here will keep their form and color through all the seasons. Many evergreen shrubs, such as the japonicas and laurels, provide a mass of exotic blooms each spring as a bonus, and so do many ground-cover plants (see chart). There is hardly a season, in fact, when you can't have some blossoms blazing away in your year-round landscaped garden. Even in northern winters, the little erica carnea King George—a one-foot-high evergreen—bursts into five months of continuous bloom that more often than not has a blanket of snow for a background. Even without such spectacular plants, the stark, lacy branches of a white birch, a sugar maple, a dogwood or a pin oak tree can be a decorative asset to a snowbound northern garden that is well landscaped and held together with evergreens.

In spring, of course, masses of color burst from an endless assortment of easily maintained shrubs, trees and perennial plants. Clumps of forsythia light up the dark evergreens like spots of bright sunshine; dogwoods, fruit trees and lilacs spatter color against the sky; japonicas and deciduous shrubs are puffballs of bloom; borders come alive with bulb plants (planted in clusters amid decorative boulders); peonies make their dramatic debut, and even some ground covers become beds of solid blossom. In springtime a year-round garden is at its colorful height.

Summer finds blossoms on some rhododendron varieties and althea (*hibiscus syriacus*). Hundreds of perennial flowers (planted in masses of single varieties for dramatic effect) make it possible for even the busiest homeowner to enjoy a display

of color in a well-planned garden throughout the summer with a minimum of care.

Fall, for some obscure reason, is thought by most northern people to be limited to chrysanthemums. This is far from true. 'Mums are a great asset to any year-round garden, since their leafy foliage forms a soft green cover all summer. But a carefully landscaped garden of trees, shrubs and perennials can literally burn with a wide variety of other blossoms through the chilly months. The blazing colors of turning leaves on maples, oaks, euonymus shrubs, dogwoods, can be fringed with hardy flaming asters, bronze heleniums, monkshoods, Japanese anemones, tall hibiscus or mallow. One group of clematis (*heracleifolia davidiana*), and crocus-like colchicums will bloom well into October as far north as the Canadian border.

There are many other late-blooming shrubs and perennials if you take the trouble to seek them out. But none will look like much unless your garden is planned to make the most of each seasonal display. That means good landscaping. At the risk of some repetition, these are the inside tips that are the key to achieving a garden with a year-round effect:

- Use of bold forms in planting lines.
- Skillful use of evergreen materials.
- Choice of plants with interesting form, texture, branching or bark.
- Utilization of every change in the grade of your land.
- Use of trees and tall shrubs for accent in design.
- Attention to color of architectural materials (paint, brick, etc).
- Attention to overhead branches for sky pattern, light and shadow.
- Attention to lines and patterns created by walks, drives and patios.

★ ★ ★

High-Frequency Sound Waves "See" Inside the Eye

Areas inside and behind the eye, previously inaccessible without surgery, can now be examined through a new technique using harmless high-frequency sound waves. Foreign bodies that are invisible to X rays may also be seen. Key advantage of the diagnostic apparatus is that it may be used to visualize diseases in eyes that cannot be examined by X rays and other existing instruments. An "ultrasonic locator" at the heart of the new equipment sends forth a burst of sound waves that penetrates the tissues. A microphone picks up echoes reflected from the tissues. The echoes are converted to electrical energy, then displayed on a radar-indicator tube. The picture is similar to that seen on television.



1050

STEELMASTER



"BIG 6"

3008



299

1722



3006

41

SU

STEELMASTER Hammer. The finest ever made. All steel. 16 oz. \$4.99

"BIG 6" 6 ft. folding rule with extra strength, long life \$1.98

299 Utility Knife cuts wallboard, linoleum, cardboard \$1.00

41 Push Drill for pilot holes 8 points in handle. \$6

1050 "Chalk-O-Matic" 50 ft. chalk line reel for accurate marking. \$1.69

64 Chisel Set. 1/4", 1/2", 3/4", 1" sizes. Finest chisel \$12.00

1722 Phillips Screw Driver



8 ft. Pacemaker Tape Rule
Fall Special only 98¢
with free carpenter's pencil



Combination Square
Regularly \$2.25
Fall Special only \$1.88



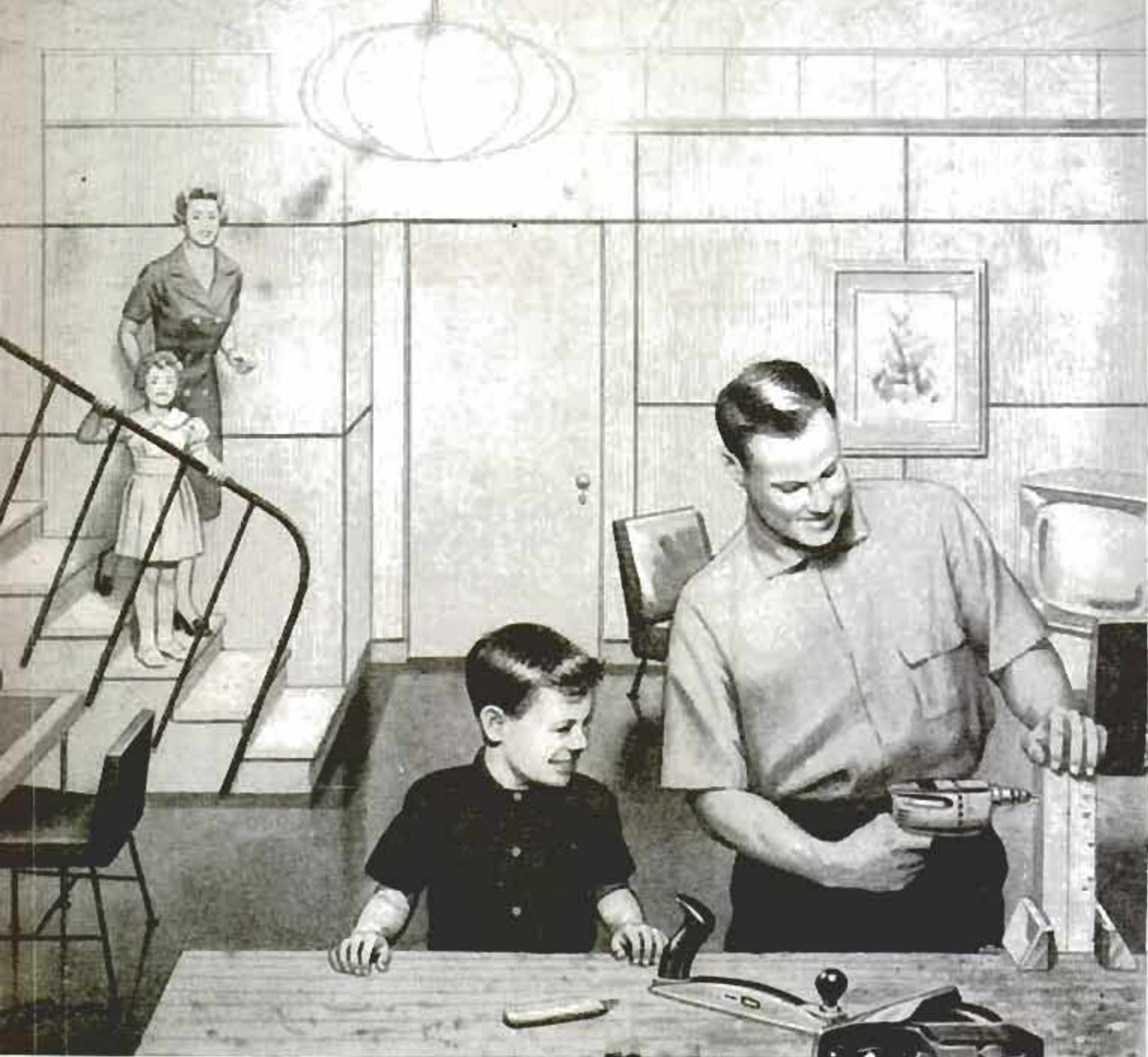

Better your home on your own

Your home is surely your prize possession. In dollars it is probably your biggest asset. It is wrapped around the other precious stuff of your life—the people, things and memories you love. Whatever you do to “better your home”—especially “on your own”, will build its value in every important sense of the word.

STANLEY

AMERICA BUILDS BETTER AND LIVES BETTER WITH STANLEY
This famous trademark distinguishes over 20,000 quality products of The Stanley Works, New Britain, Conn.—hand tools • electric tools • builders hardware • industrial hardware • drapery hardware • automatic door controls • aluminum windows • stampings

Get in Step With Your Building Code

(Continued from page 179)

"But," complained the householder, "it's my property, and I'll build my barbecue any darn place I please."

And people did, a short 25 years ago. They also built apartments next door to snug little bungalows. Nor was it uncommon for a 10-foot wall to rise, blocking both the view and light from a neighbor's house. You've seen such neighborhoods in the older parts of town. But you wouldn't want to live there, much less own one of the houses.

Building codes exist for your protection and safety—and for your neighbor's, too.

Recently, a homeowner hired a contractor to add a \$5000 den. Luckily, before the contractor reached the plastering stage an alert inspector discovered that he'd set the room's girders on hollow concrete blocks. The added weight of the plaster, which often doubles the framed-in weight, would have crushed the blocks, wrenching the room out of shape and the plaster off the walls.

Wincing the appreciative homeowner, "if it hadn't been for that inspector and the building codes, I'd have had nothing for my \$5000 but a roomful of cracked plaster."

He might also have been left with a den whose windows (distorted in their frames) wouldn't open, and whose chimney, its flue lining cracked, might have set his house afire.

The inspector, and the rule book he carries, protect *you* from *your neighbor*, as well. In most cities the fellow next door can't build a barbecue without a spark-arrestor atop its chimney (sparks would threaten your home). Nor can he encroach upon your property line (he's got to leave a reasonable and specified "side yard" between his house and yours). Neither can he own a swimming pool unless he encloses it with a fence, its gate rigged with a kid-proof lock (thus, by law, he's required to protect *your* children from drowning as well as his own).

Set up in 1927 (and updated every three years), the Uniform Building Code is framed on the time-tested premise that if for safety's sake a brick chimney requires a fire-clay flue in Denver, the same lining is as necessary in Des Moines.

Manual for Homeowners

Most homeowners don't realize, however, that the Code is one of the most comprehensive do-it-yourself manuals ever compiled. It spells out specifically, for example, what kind of materials should go into your

(Continued to page 274)

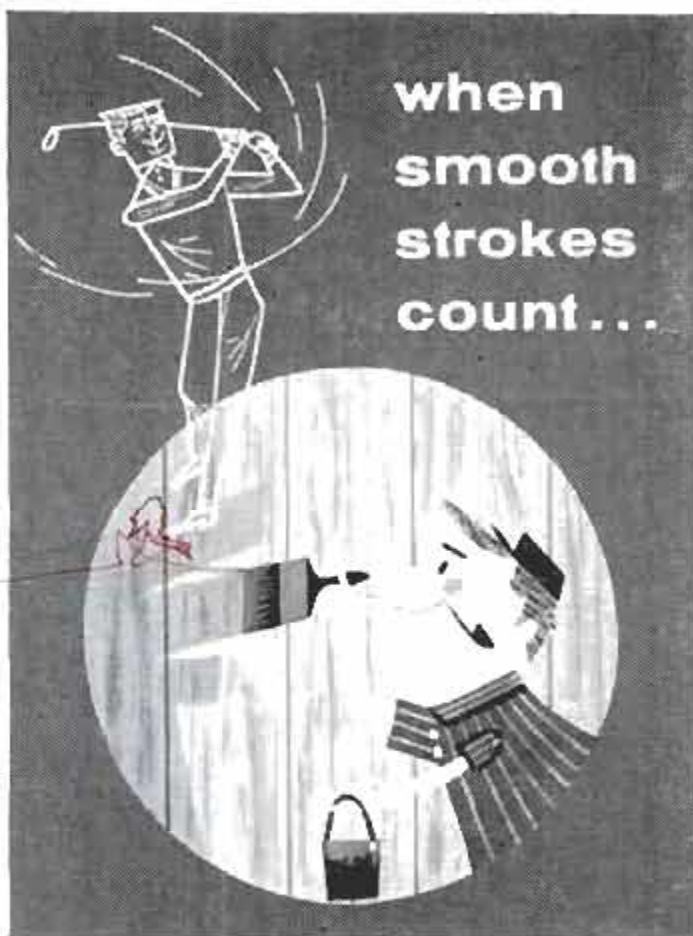

count on

BAKER SMOOTH STROKE BRUSHES



The "pro's" agree — the smoother the stroke, the better the result. Get professional results with Baker 'smooth stroke' Paint Brushes and Rollers. You'll dip less, cover more, get neater, better-looking jobs. And, you'll save lots of time and money, too!

FREE! 32-page book tells you "How To Do A Good Paint Job" with brush and roller. Write to Baker Brush Co., Inc., 83 Grand Street, New York 13, N. Y.

TAPERED TYNEX OR PURE BRISTLE
AMERICA'S FINEST PAINTING TOOLS

©1959, Baker Brush Co., Inc.

HERE IT IS.
PARDNER

the new
lever action



Polomin

MODEL

400



22 caliber . . . 20-shot . . .
hammerless . . . tubular magazine . . .

**ultra-modern version
of the glamorous
western rifle \$68⁰⁰**

Shoots all Short, Long and Long Rifle cartridges. Has tubular magazine and Mossberg's new, precision, AC-KRO-GRUV rifling. Hammerless lever action is velvet smooth, lightning fast. Better see your Mossberg dealer promptly for this one, pardner!



Side plate removed to expose action. Note simplicity of mechanism and ease of access for cleaning.

FREE: Send for catalog
O. F. Mossberg & Sons, Inc.
99710 St. John Street
New Haven 5, Connecticut

Mossberg
for accuracy

house, how its foundation should be laid, and the set back it must have from the street.

Nor is the code, as some have complained, either complex or contradictory. On the contrary, it's written as much for the do-it-yourselfer as for the contractor.

Let's see, for example, what the Code has to say, in part, about windows—a section that's typical, and applicable to hundreds of home projects.

"Windows. All living rooms, kitchens and other rooms used for living, eating or sleeping purposes shall be provided with windows with an area not less than twelve square feet (12 sq. ft.) nor one-eighth of the floor area of such room. Not less than one half such area shall be openable."

Ironically, though the regulation is set down in plain language, it's one of the most frequently violated. Let's see why. Suppose you decide to add a den to your living room. The living room is 12 by 12 feet, or 144 square feet, and the contractor, abiding by the rules, installed 18 square feet of windows ($\frac{1}{8}$ the floor area, the legal minimum for a room this size).

But in cutting the door between the new den and living room you use half the room's former window area. You've violated the code, and also health and safety statutes. There's one obvious solution, of course: Install additional living-room windows, at least the minimum amount.

Just as commonly the window minima are violated when the owner of a U-shaped bungalow roofs and walls in what was once his patio and converts it into a den or bedroom. The windows in the three walls which now open onto the enclosed room are no longer "windows." Because they aren't, it's more than likely that the rooms they once brightened have less than minimum window area.

Are the window minima, and scores of minima like them justified? If you've been house shopping lately, I think you'll agree they are. You didn't carry a measuring tape as you went house to house, nor did you stop to measure window area. You didn't because you *knew* the house had been built to code specifications (thus had windows enough for light and health). Nor did you have to crawl beneath the house to check sewer connections. Neither did you chip off a hunk of foundation to have it lab-analyzed for strength. The code, in effect, had done that for you.

The code does more. In laying down zoning regulations, it protects your investment, insures that a foundry won't blight your neighborhood. Further, it guarantees that the neighbors won't turn their homes

(Continued to page 276)

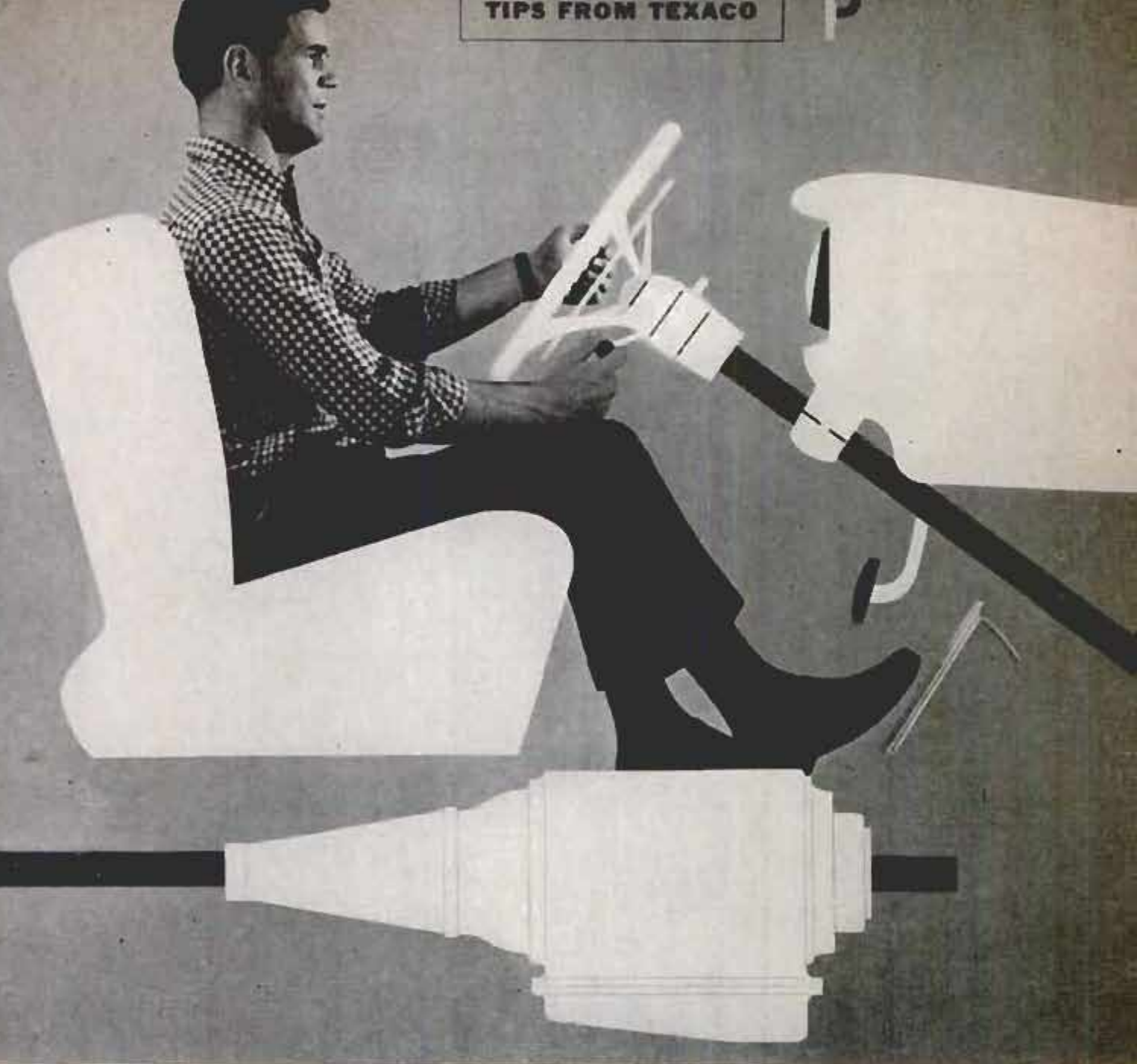

How to care for your automatic transmission

1 Apply your parking brake or keep your foot firmly on foot brake before starting engine or shifting automatic transmission from neutral into any driving range.

2 When a red light stops you on an upgrade, apply either parking or foot brake, then shift transmission into neutral. For a wait of only a minute or two it's permissible to push the gas pedal down just enough to make the engine "hold" the car on the grade.

3 When driving downhill, never shift into neutral and allow your car to coast. This is illegal, and also dangerous.

4 Make sure you are completely stopped before shifting from "drive" to "reverse."

5 When you leave your car, make sure ignition is turned *off* and key removed, the parking brake set tight, and gear selector set at "park" or "neutral."

6 Never have car pushed or towed without first making sure the procedure being used is correct for *your* make of car.

7 Be sure you're using the finest automatic transmission fluid money can buy... and that fluid is up to proper level. No problem when you're a Texaco motorist. For Texaco Dealers service your car with Texaco Texamatic Transmission Fluid and they are trained to check fluid level regularly.



into motels or boarding houses. And, by the same token, neither can you.

Frequently, home owners run afoul of zoning laws because they don't understand the terms.

Front yard requirements: In a single-family residential zone (applicable to most of us) all homes must be set back a specified minimum and maximum distance from the front property line. In effect, front yards must have about equal depth (though this may vary under some codes as much as 10 feet).

Suppose that the minimum setback for houses in your block is 22 feet. Your house, however, is set 25 feet back from the front property line. You'd like to extend the dining room six feet into the front yard. Will the code permit a six-foot extension? Probably not, though you'd likely be allowed to add three feet, bringing your house within the 22-foot setback minimum.

Side yards: Most codes require that you have an open space—a side yard—between your house and the neighbors'. The side yard usually applies only to your house (but not, for example, to the garage). Some codes require a five-foot side yard (thus, 10 feet between houses). Some say the side yard must be no less than 10 percent of your lot width.

Your lot, let's say, is 50 feet wide. By

the 10 percent rule, the open spaces on either side of your house must each be five feet wide.

More often than any other, homeowners violate the side-yard code. They extend den, patio, kitchen or dining room, closing this "breathing space" between their house and a neighbor's.

Rear yard: Just as the code specifies front-yard depth and width of side yards, it may also rule that your backyard be at least 25 feet deep (from the rear property line). Some codes specify a backyard "not less than 25 percent of the lot's depth."

There are exceptions, however, to even the code's most rigid edicts. The exceptions are necessary because, for one thing, there may be several types of lots—inside lots, corner lots, reverse corner lots and key lots—in the same block.

Side-Yard Construction

Regardless of lot type, some building may be permitted even in side yards. A carport, for example, is often permissible in a side yard so long as the structure is but one story high, not more than about 20 feet in length, and is entirely open on at least three sides (save for necessary supporting columns).

An attached garage may also be located

(Continued to page 278)

Trap household odors and dust...
SAVE MONEY, too!

RP EZ KLEEN
WASHABLE, ALUMINUM

FURNACE FILTERS

Economical because they're WASHABLE. As easy as rinsing a dish... collected dust, dirt, pollen and water soluble adhesive flush off with water.

Amazing adhesive REMOVES ODORS, DUST. Super Filter Coat adhesive, in two types of spray containers, traps and holds odors and dirt... has built-in detergent to simplify washing. Restores like-new efficiency to filter.

Long-lasting ALUMINUM won't rust, makes cleaning easier... lasts for years and years of clean filter service... and improved furnace operation.

ASK YOUR DEALER

IN CANADA: Hicks-Baker Ltd., Winnipeg • Spall-Bowman, Ltd., Guelph

RESEARCH PRODUCTS Corporation • Dept. 227, Madison 1, Wisconsin

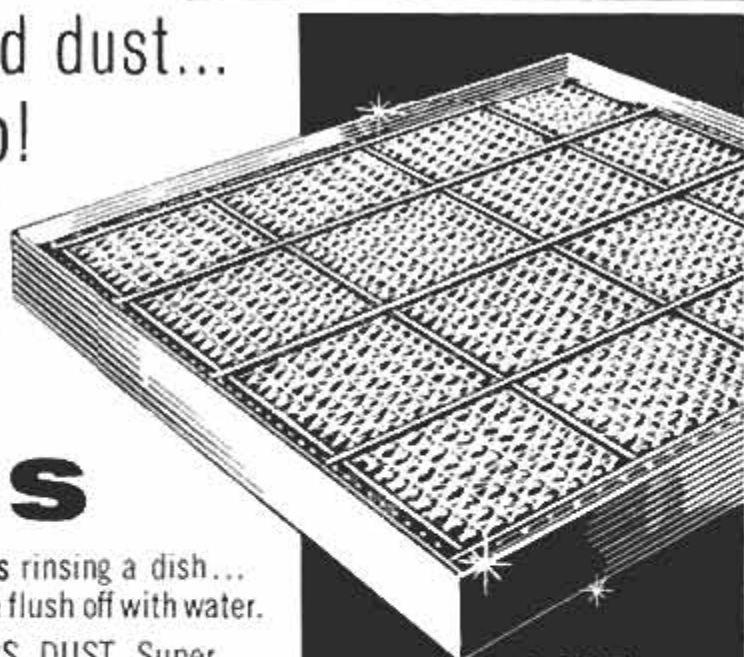

As low as \$1.95

for popular sizes

Write For
FREE BOOKLET

Complete information on
what to look for in an
air filter.



*"I'm the only one in the family that can't use the **Dremel!**"*

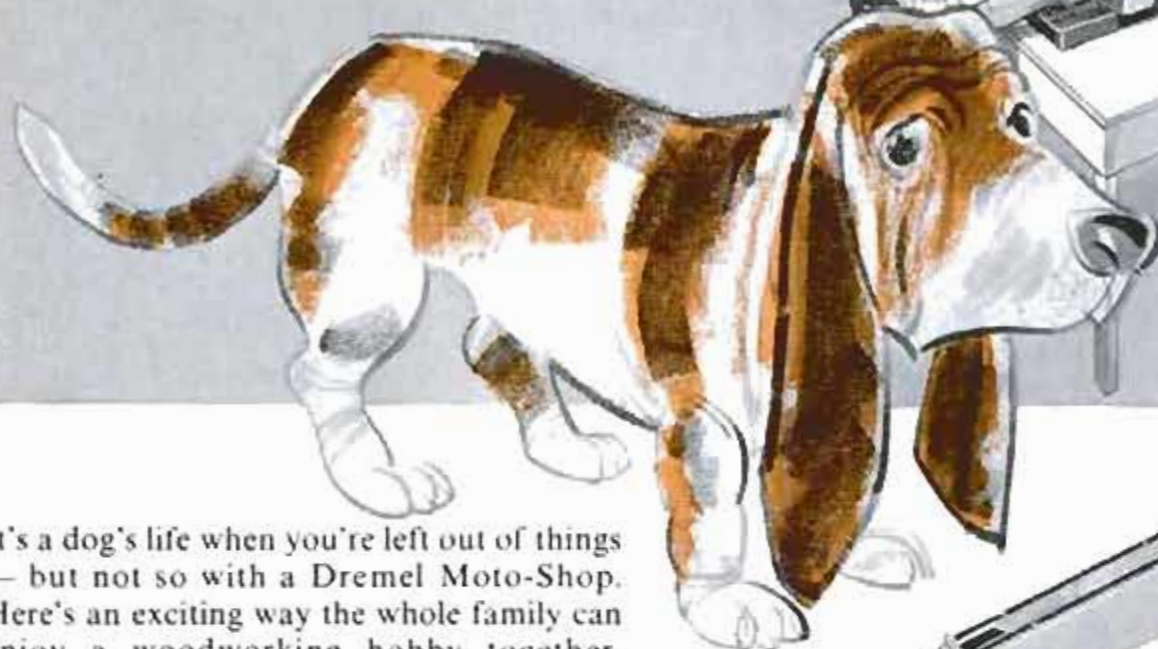

It's a dog's life when you're left out of things — but not so with a Dremel Moto-Shop. Here's an exciting way the whole family can enjoy a woodworking hobby together. Teaches children to be creative and helps cut down the TV habit.

Not a cumbersome cast iron model, but sturdy, lightweight, portable — and safe. Unique blade guard protects even the littlest hands. Simple operation — make gifts, toys, furniture, practical items for the home.

Treat your whole family to a Dremel Moto-Shop. America's most popular and useful multi-purpose tool.

- Large capacity — Has 15" throat — cuts 1 1/4" wood, light metal, tile, plastics.
- Powerful ball bearing motor — not a vibrator. 3,450 strokes per minute.
- 4-way blade holder — saws in any direction.
- Lightweight, sturdy — easy to carry or store away.
- Tilting table — Tilts 45° for angle and bevel cuts.
- Adjustable table — Raises or lowers to new blade area.
- Economical — Self contained — no extra motor — no belts or pulleys.

A complete power workshop in 1 compact portable unit. Two models to meet any family's need.

Model 571 Moto-Shop. Includes 15" Jig Saw with disc sander attachment only as shown above . . . \$33.95

Model 572 Deluxe Moto-Shop. Includes 15" Jig Saw with disc sander, grinding wheel and guard, wire and cloth buffing wheels, a 12 piece accessory set, and 30" flexible shaft (grinds, drills, carves, polishes, engraves, sands, sharpens) . . . \$49.95

Ask your Power Tool Dealer for a Demonstration

WRITE FOR FREE LITERATURE

DREMEL MFG. CO. Dept. 119K Racine, Wis.



DREMEL POWER SANDERS — All Dremel Sanders have it — *Straight-Line Action!* Means you sand with-the-grain, get the smoothest finish. No swirl marks, no scratches. Three models — from \$14.85 to \$37.50.



DREMEL MOTO-TOOL KITS — A compact, pocket-size machine shop. Grinds, polishes, carves, sharpens, drills, engraves. For fine detail work at home or shop. Speed range from 25,000-27,000 rpm. Prices, \$14.85 to \$27.50.



DREMEL MOTO-SAW — The scroll saw everyone can use skillfully. Cuts the most intricate designs accurately at 7200 strokes per minute. Saws 3/4" wood, light metal, plastics, floor and wall tile. Model 203 . . . \$6.85.

in a front yard (though usually it must be set back at least five feet from the property line).

Cornices, sills, canopies and other architectural projections (but not bay windows) may often extend into a side yard. One code says, "but they may not project more than two inches for each one foot of side-yard width."

There's scarcely a project around the home which doesn't fall under your building code. You can, for example, fence your yard without getting a permit. Regardless, its height and placement must hew to the code. Generally you can build platforms, walks and driveways as long as they're not over two feet above ground nor constructed over the basement. You can put up flagpoles, towers and radio antennas, but they can't be over 45 feet high, nor attached to a building. You can build patios, yet they must comply with the code.

To help the homeowner comply, many cities have compiled easy-to-understand fact sheets. Among the dozen fact sheets available at no cost to the homeowner in Los Angeles, some detail minimum specs for low retaining walls, foundations and even one and two-story houses. One, for example, explains allowable fence heights on residential lots. Drawings simplify and interpret the code, telling the do-it-yourselfer all he needs to know about fences. (If yours is an "inside" lot set between adjacent lots, your front-yard fence may be no more than 42 inches high. But you may fence your backyard to a height of six feet).

Another fact sheet tells you how to build a detached garage. Drawings show how supporting posts should be centered, how many nails of what size must be used, and where. You're told, for example, that corner braces should be one by sixes. These are *minimum* requirements. If you want to use more than the required five eight-penny nails to secure the braces, you may. But you can't use less and stay within the code.

Instructions for Patio

Still another fact sheet for do-it-yourselfers explains how to put up a patio addition. Drawings indicate, for example, that you should use four by four-inch posts to support the patio's roof. And further, that the posts should be set on 12 by 12 by 12-inch concrete piers.

Building inspectors have made it unnecessary for you to thumb thru the 300 pages of the "Uniform Building Code." You're handed the rules on a single instruction sheet.

Nor does your building department stop there in catering to the fellow who hankers to build. Some inspection offices supply ready-made plans for projects ranging from two-story houses to fireplaces. You simply fill in the blanks with your project's dimensions and ask the inspector to approve them.

Filing for a building permit is almost as easy. Either by mail or in person you make application, detailing what it is you want to build. You may be told that your project doesn't require a permit (in which case, the inspector simply explains the code, hands you a fact sheet covering your project and sends you home to start work).

If a permit is required, you'll be asked to draw a plot plan (the scale usually $\frac{1}{8}$ to $\frac{1}{4}$ inch to the foot). For simple home-projects (a breezeway, attached patio or remodeling) the building office may accept your own or a draftsman's plans, or plans from a magazine. Some offices, as I've mentioned, have plans already drawn which need only the insertion of your project's measurements. For elaborate or complex construction—anything "major"—you need an architect's plans and services.

For the average home project such as an attached patio, the building office will need a week for plan checking. If corrections are warranted, they'll be noted. And you'll be told to correct your drawings and return them for another look.

Once plans are approved and you've paid the plan-checking fee, you'll be issued a building permit. The permit fees, like local codes, vary. The average cost on a \$1000 project shouldn't exceed about \$6.

With your permit—your green light to build—you'll be given an inspection record card. The card is posted on your project, and must be available to the inspector.

Visits by Inspector

Modest home projects—a retaining wall, for example—may require only two visits by the inspector: one when you have the forms built and reinforcing steel installed, and another when the wall is finished.

Major projects require at least four checks of your workmanship and progress.

Foundation inspection is made *after* you've dug trenches for the foundation, have erected forms and installed reinforcing steel, but *before* you've poured concrete.

Framing inspection is made *after* all wood roof, wall and floor framing, fire-blocking and bracing are complete and all pipes, rough plumbing, chimneys, wiring and vents are in, but *before* you've placed any interior wall covering (rough-in plumbing and electrical work require, un-

(Continued to page 282)



EXTRA BLOWOUT PROTECTION: Nylon has lasting strength to guard against blowout. Nylon protects against the four kinds of unseen tire damage that can lead to sudden tire failure: (1) heat, (2) bruising from bumps, (3) moisture, (4) flexing. All tire makers use nylon cord in their better tires. Why risk a dangerous blowout? Have your tires checked regularly. And whenever you buy new tires, be sure they're made with nylon cord.

THE SAFEST, STRONGEST TIRES ARE MADE WITH

NYLON

LOOK FOR THE NYLON IDENTIFICATION ON TIRE SIDEWALL.



BETTER THINGS FOR BETTER LIVING... THROUGH CHEMISTRY

YOUR SAW



Cat. No. 34-004
Delta Homecraft
9" Tilting Arbor Circular Saw equipped
with Extension Wings and Steel Stand.

**OWN THE FINEST
RIGHT FROM THE START**

—AND AT A BIG

\$21⁰⁰ Saving

(Slightly higher in the West)

IS WORTH \$21⁰⁰

WHEN YOU TRADE IT ON THE FAMOUS DELTA 9" CIRCULAR SAW

Here's a once-in-a-lifetime opportunity to trade slow, old fashioned hand sawing for fast, easy, accurate cutting—and start your home workshop with the best!

You can get a liberal trade-in allowance for your old saw (*any kind, regardless of condition*) toward the purchase of a new Delta 9" Tilting Arbor Circular Saw.

You'll be proud to own this saw, with its New Advanced Design styling, clean lines and handsome mottled grey finish. And you'll like the

ruggedness, built-in precision and safety features you get—the kind of quality you find only in Delta Industrial Tools. But, best of all, you'll enjoy the satisfaction of owning the finest of its kind—a power tool backed by over 30 years of engineering skill and experience. Why be satisfied with anything less?

Hurry—offer limited—see your Delta Dealer (he's listed under "TOOLS" in the Yellow Pages) or visit your leading Department, Hardware or Building Supply Store.

FREE! New Deltacraft Library Catalog

Lists titles and contents of every volume in the famous Deltacraft Library—one source for all the power tool information you'll want to have in your workshop. For your FREE copy, write: Rockwell Manufacturing Company, Delta Power Tool Division, 502K N. Lexington Ave., Pittsburgh 8, Pa.

DELTA POWER TOOLS

another fine product by

ROCKWELL



Anchor wood or metal to concrete or steel with one light tap!



Anchoring 2x4 partition plate to basement floor.

Remington Mighty-Mite® Stud Driver is a cost- and time-saving fastening tool with a hundred uses! One light hammer tap on firing pin permanently anchors furring strips, partition plates, electrical outlets to concrete or steel with special Remington Studs. Scientifically graded 22 caliber Power Loads furnish exact driving force needed. No pre-drilling. See your dealer today or send coupon for full details. **Only \$39.95**

Most dealers also have a tool-rental plan.

HERE'S HOW THE "MIGHTY-MITE" WORKS



UNSCREW upper assembly, drop a Remington "Power-Guide" Stud into barrel, insert chamber bushing and proper 22 caliber Power Load.



REPLACE handle-grip assembly, position tool and press firmly over work. Tap firing pin with a light hammer and the job's done!

Remington 

Remington Arms Company, Inc.
Industrial Sales Division, Box J-8
Bridgeport 2, Connecticut

Please send full information about the cost- and time-saving "Mighty-Mite" Stud Driver.

Name _____

Address _____

City _____ State _____

der most codes, the services of a licensed plumber or electrician).

Plastering inspection is made after all exterior, fire-resistive and structural plaster backing is in place but before you apply plaster or stucco.

Final inspection is made after your project is completed and ready for occupancy.

Nor should the home craftsman be vexed if the inspector spots a code violation and asks that it be corrected. The fact is that licensed contractors and professional craftsmen who've been years at their trades are almost as often found in error as the fellow putting up his first project. The inspector isn't infallible either.

Classic is the swank men's club in Oakland, Calif., which was completed some years ago, ready for tenants, before it was discovered that the contractor had forgotten to install bathrooms (nor had the building inspector been more perceptive).

More recently, a contractor putting in massive concrete piers for a multimillion-dollar university building couldn't savvy the architect's logic in designing some one size, and some another. Unhappily for the over-zealous construction man, the architect was on firm engineering ground. The contractor built all the piers alike—a boner far more costly than any homeowner's.

The fact is that homebuilders are often excellent craftsmen. Yet too often they transgress the code, jeopardizing the very projects on which they've spent months of effort and hundreds of dollars.

Not long ago I was summoned to a home on the complaint of a neighbor who objected to "what the people next door have done to their garage."

The people next door had done wonders. They'd converted the garage to a paneled den, its glass doors opening onto a patio.

They'd also broken half a dozen laws. They hadn't bothered to get a building permit (their project's evaluation exceeded \$100). Just as unwittingly, they'd violated one of the most basic of residential codes: Having converted their garage, they'd literally put the family cars out on the street. Yet the code demanded garaging of one kind or another for the car.

Even after they'd paid a fine for building without a permit, the homeowners had to choose between returning the garage to original use or investing in a detached garage. Luckily, they had space enough for the detached unit. But the fine, construction corrections and the new garage cost them hundreds of dollars.

To get in step with their codes they'd have needed to spend only a dime—the price of a phone call to their local building office.

★ ★ ★

How safe are your shock absorbers?



Shock absorbers are as important to *safety* as they are to comfortable riding. They stabilize your car, keep wheels from bouncing off the road, prevent erratic steering and side sway.

Shocks wear so gradually that you aren't aware of ride deterioration. Sometimes, it takes an accident caused by loss of control to point up the danger of worn shocks. Don't wait for that to happen.

If your speedometer now reads more than 20,000 miles, there's a good chance you're already driving on "dead" shocks—shock absorbers that are worn to the danger point. And dead shocks are deadly!

Replace worn shocks with new Monro-Matics today. They're the only shock absorbers with automatic adjustment for all roads and loads. Installed in just 30 minutes at your garage or service station.

TAKE THE 60-DAY FREE RIDE!

Have a set of Monro-Matic shock absorbers installed today, and try them for 60 days. If you're not completely satisfied, for *any* reason, return them for a full refund and re-installation of your old shocks!

MONRO-MATIC

SHOCK ABSORBERS



Mail this coupon for a free booklet showing how shock absorbers contribute to driving safety.

MONROE AUTO EQUIPMENT CO.

Monroe, Michigan
Dept. ST-13

Name _____

Address _____

City _____ Zone _____ State _____

MONROE AUTO EQUIPMENT CO. • World's largest maker of Ride Control Products, including **LOAD-LEVELERS***
In Canada, **MONROE-ACME LTD.**, Toronto, Ont. • In Mexico, **MEX-PAR**, Box 28154, Mexico City

*Trademark

Picture Books for the Blind

(Continued from page 142)

bitious was a wall relief map of the world, complete in detail down to identification of countries in Braille lettering, major mountain ranges, rivers and oceans.

Miss Taft chose pieces of variously textured cloth to separate the countries and make them distinguishable by touch. Russia and her satellite nations, for instance, were patterned in corduroy. West Germany was represented by smooth muslin. Plaster was used to form mountain ranges.

The map was made in sections because of the limit of the molding oven. When baked, cooled and hardened, the plastic sections were glued together and stapled on a plywood backing.

The possibilities of future projects appear limited only by the imagination of a creative mind. Miss Taft, an oil and water-color hobbyist, envisions the day when famous works of art may be reproduced in Braille for sightless art lovers to "see" for the first time.

Today, it is estimated, there are about 6000 sightless children under the age of seven, and more than 300,000 blind or partially blind persons above that age, in the United States alone. In the world, the

number of sightless has been variously estimated between seven and fourteen million.

Like the Braille system in its baptismal years, Miss Taft's picture process is not without its mechanical problems. They will have to be solved before mass production is attempted.

For example, the die materials must withstand the molding oven's heat without catching fire and must yield their surface configuration on the plastic. Miss Taft says only about ten copies can be obtained from each die before it is unfit for use.

The response to the new process has expanded a onetime hobby into what is now a full-time occupation. Friends are sending Miss Taft all sorts of new materials (A recent donation yielded two gunny-sacks!). When she develops a faster system for making the dies, and is able to obtain more copies in the baking process, she hopes to expand the ideas beyond the Southern California area, where the demand for Braille Illustrated now is far beyond the supply.

Like the invention of a determined Frenchman a little more than a century ago, Miss Elsey Taft's hobby has lighted another candle in a darkened world. ★★ ★

I MADE THIS TABLE WITH ARDOR E-Z



FOLDING LEG BRACKETS

America's Most Mechanically Efficient Hardware

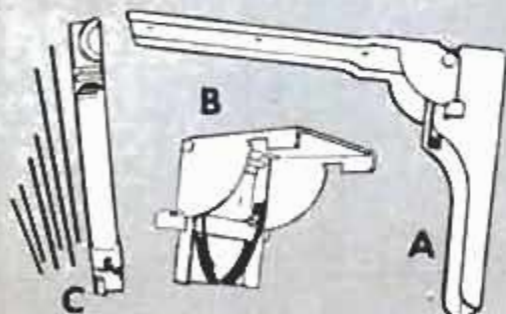

(A) E-Z Heavy duty one piece Folding Shelf Bracket for wall hung, drop-leaf snack bars, work tables, long shelves etc. Fits flush without framing. Exclusive positive spring lock. Set of 2, only \$3.95.



(B) E-Z One piece Folding Leg Bracket for ping-pong tables, banquet tables, game tables or any type folding leg table, as well as for wall hung shelves and desks. Positive spring lock. Set of 4 and screws \$3.95.



(C) E-Z Bendit Tool has no moving parts. Shapes Aluminum wire into hooks for 1/8" and 1/4" pegboard. Tool and supply of wire 98c.



E-Z Products available everywhere. If dealer can't supply you, write for nearest one.

**ARDOR
MFG., INC.**

611 SOUTH WASHINGTON
ROYAL OAK, MICH.

**INTRODUCTORY
SALE
'TIL OCT. 31'**

SAVE 1/3 AT SEARS

on New CRAFTSMAN Karbo Grit Tools!

Amazing Karbo Grit Tools never wear out! Their grits are made from diamond-hard Tungsten Carbide, permanently brazed on steel! Karbo Grit Tools cut and smooth all woods, plastics, Formica, plywood, plaster, composition, hardboard, fiber glass, aluminum, brass, wallboard, and laminates. Easy to clean with wire brush or gum remover. Free booklet describing advantages and uses of Karbo Grit Tools included with every purchase.



8-inch diameter
\$3.98
will be
5.98

KARBO GRIT RIM CUTTING WHEEL

- 6 1/2-inch diameter 2.65 will be 3.98
Designed to cut with extra speed. Leaves an exceptionally smooth, finished surface.
- 7 1/2-inch diameter 3.32 will be 4.98
1/4-1/2-inch center hole
- 8-inch diameter 3.66 will be 5.49
1/4-1/2-inch center hole
- 10-inch diameter 5.98 will be 8.98
3/4-1 1/4-inch center hole

KARBO GRIT ABRASIVE SANDING WHEEL #3000

Hundreds of tungsten carbide particles are brazed to the edge and sides of the wheel. That means you can saw, dado, shape, sand, and plough all on the same blade! Safe to use, too, because there are no teeth to snag or drag! Designed especially for bench and radial arm saws. Knockout bushed to fit 5/8-1 1/2 inch center hole. 10-inch diameter 6.65 will be 9.98



Karbo Grit 10-inch Flat File 1.32 will be 1.98
Files in any direction. Coarse on one side—medium on the other. Wide-spaced grits give self-cleaning action. Wood handle. #3001
10-inch Half-Round Blade. **1.32** will be 1.98
Medium or coarse grit. 3/4" radius #3003

Karbo Grit 5-inch Sanding Disc.... 1.19
will be 1.79
For rotary motion sanders. Sands twice as fast as sandpaper. Eliminates changing of wornout, torn sandpaper. Available in fine, medium or coarse. #3007.



6-inch diameter 1.26 will be 1.89
Fine, medium or coarse.

Karbo Grit Rasplane Blade (Half Round)
86¢ will be 1.29

Smooths wood with grain or against it. #3006
Flat. #3016..... 86¢ will be 1.29

Karbo Grit Sanding Sheet 65¢ will be 98¢
2 3/4 x 8 inch Fine, medium or coarse. #3004
3 3/4 x 9 inches..... 92¢ will be 1.39
Fine, medium or coarse. #3005

Karbo Grit Hand Sander 92¢ will be 1.39
Outlasts hundreds of sandpaper sheets. 2 3/4 x 5 1/2-inch platen with felt back-up pad. Fine or medium grit. #3002

Karbo Grit Vixen Blade 1.19 will be 1.79
For auto body work. Available in fine, medium or coarse. #3009

Make Sears your headquarters for abrasive and sanding tools. Buy Craftsman Karbo Grit Tools at your nearest Sears Retail Store or from your Sears Catalog, by mail, phone or at your nearest Sears Catalog Sales Office.

SATISFACTION GUARANTEED OR YOUR MONEY BACK

© SEARS, ROEBUCK AND CO.





BUILD THE BEST!

build quality money-saving

knight-kits®

A PRODUCT OF ALLIED RADIO



see them all in
ALLIED'S
1960 ELECTRONIC
SUPPLY CATALOG

FREE

build your own...
it's easy...it's fun!

SAVE UP TO 50%

HI-FI
KITS



INSTRUMENT
KITS



HOBBY KITS



HAM
KITS

world's
largest
stocks

See the 1960 KNIGHT-KIT line—available only from ALLIED. KNIGHT-KITS are lowest in cost, convenience-engineered for easiest assembly—the only kits with money-back guaranteed specifications. Send today for the 1960 ALLIED Catalog—select your KNIGHT-KITS—and...

**SAVE ON EVERYTHING
IN ELECTRONICS**

Get more for your money in Stereo hi-fi systems and components; save on recorders and tape; Amateur station equipment; TV tubes, antennas, accessories; test instruments; electronic parts, tubes, transistors, tools, books. Send today for your **FREE 1960 ALLIED Catalog!**

EASIEST TERMS
only \$2 down on
orders up to \$50

FREE
catalog

ALLIED RADIO

100 N. Western Ave., Dept. 24-K9, Chicago 80, Ill.

Rush **FREE 1960 ALLIED Catalog**

Name _____

Address _____

City _____ Zone _____ State _____

The PM Indoor-Outdoor House

(Continued from page 151)

located between the kitchen and the family room.

Efficiency is the keynote of the kitchen itself. In a relatively small area there's an efficient food-preparation area, a table for a quick breakfast, a laundry room and even a toilet near the side door (a must for children).

Feature for Mom

Any mother will appreciate one feature of the house above all others: From the kitchen, without moving anything but her head, she can keep a supervisory eye on the play yard outside, the family room-porch and even the patio just beyond. Thus she has complete control over the natural play areas. Furthermore the basement stairway is only two or three steps away. Strangely enough, despite the view, the kitchen has its own form of privacy. Work counters a mess? They are completely screened from the dining area and even from the eating area on the family room-porch.

In the sleeping wing are a large master bedroom and two smaller bedrooms. One feature of the master bedroom that Dad will like (Mom, too!) is the dressing alcove including basin, toilet and shower. And take a look at the generous closet.

One entire wall of the master bedroom is glass. As a matter of fact, Dart obviously uses huge expanses of glass to achieve the feel of the outdoors inside the house. Every room, with the sole exception of the kitchen, has at least one entire wall of glass. When you're inside, the outdoors seems part of the room. When you're outside, there is no visual barrier to the interior.

But even outdoors, there's a need for privacy. The design of the house and its placement on the lot (see page 150) lends itself to privacy. The house itself visually shelters the patio-pool area. A landscaping screen along the lot line can insure complete privacy if desired.

The house has one big plus that isn't apparent at a glance: It's expandable. To a growing family this can be of great importance. Additional bedrooms can be added by extending the bedroom hall. The master bedroom then becomes a child's room, and at least two additional rooms can be added. A glance at the floor plan will indicate how readily this can be done.

That's the PM Indoor-Outdoor House. Ed Dart calls it one of the finest he has ever designed for privacy and fine living, outside or in. We think you'll agree. ★ ★ ★

SEARS CUTS PRICES

Special
'til
Oct. 31

on CRAFTSMAN Cutting Tools!

SAVE
MORE
THAN
HALF!



Only
\$9.99
complete

CRAFTSMAN MOLDING CUTTER HEAD AND BITS SET

23-piece set includes plastic storage kit, tempered steel cutter head with safety lock, spacer washers, bushings to fit 1/2", 5/8" or 3/4" arbors and 6 sets of tool steel blades (3 bits to a set):

1-in. Planer and Jointer, Cabinet Door Lip Cutter, 3-Bead (1/4-in.) Cutter, Base Molding Cutter, Glue Joint Cutter, Combination Cove and Bead Cutter (5/8-in.).

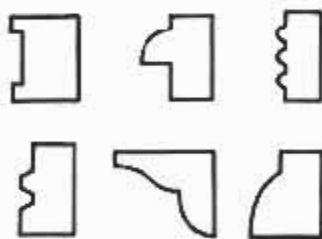

If bought separately, would total \$21.69

© 1959, SEARS, ROEBUCK AND CO.

SAVE \$2 ON ALL CRAFTSMAN TUNGSTEN-CARBIDE-TIPPED BLADES



Tungsten-carbide-tipped blades are the best long-term buy you can make! They provide 20 times longer sharp blade life than conventional blades. For every type and size of electric hand or bench saw.

Here are typical savings!

dia.	arbor	reg. price	sale price
6 3/4"	3/4" x 3/4"	\$ 8.95	\$6.95
8"	3/2" x 3/8"	\$ 9.95	\$7.95
10"	1" x 3/4" x 3/8"	\$11.95	\$9.95

Make Sears your saw blades headquarters. The selection is complete—the prices are below all comparable-quality blades sold elsewhere. Buy Craftsman Blades at the Craftsman Home Workshop Display at your nearest Sears Retail Store... or order from Sears Catalog, by mail, phone or at your nearest Sears Catalog Sales Office.

BUY TWO AND SAVE! CRAFTSMAN KROMEDGE BLADES



2 for **\$3.88** or \$2.19 each.

6 3/4" & 6 1/2"	reg., \$2.29
7 1/2"	reg., \$2.49
8"	reg., \$2.50
8" Crosscut	reg., \$2.50
8" Rip	reg., \$2.50
8" Combination	reg., \$2.50

10" Blades

2 for **\$5.99** \$3.29 each

Buy any of the above blades in 10" size for only \$3.39 each or 2 for \$5.99 (reg. price, \$3.79)

SEARS
ROEBUCK AND CO.

SATISFACTION GUARANTEED OR YOUR MONEY BACK

*Reach
for
America's
favorite
extension
rule*



Next time you see a carpenter, plumber, steam fitter, sheet-metal worker at work, take a look at his rule.

Ten to one you'll see a Lufkin Red End . . . and often it will be the handsome X-46, with 6" brass extension slide.

Men who do quality work prefer quality tools. They like the old-fashioned character of a natural finish as used on the X-46 . . . the quality-look of gleaming joints and strike plates . . . the precision-look of sharp graduations.

Pick up an X-46 at your hardware store. One close look at it, and you'll want it. Buy it right then.

*You'll find a world of
LUFKIN measuring tools
at your hardware store.*



LUFKIN RED END RULES
TAPES • PRECISION TOOLS

Electric Heating Is Here to Stay

(Continued from page 162)

one solid heating element. Such units become warm, but not too hot to touch, and can be used as highly decorative wall panels. Although these elements produce some true radiant infrared heat, most of their work is done by air-warming convection.

Panel Will Heat, Cool and Light

Most fabulous harbinger of things to come, along this line, is Westinghouse's full-scale wall panel that promises to light tomorrow's house while also heating and cooling it. Still a laboratory guinea pig, the hot-cold glass wall (or ceiling) works from a set of dials that controls its temperature from a low of 55 degrees to a high of 120 F., and changes the color or intensity of its glowing "electroluminescent" light at will. "Your living room could be flooded with white or gold light during the day," explains C. J. Witting, "then converted to soft blue tones for evening." The entire unit operates from tiny thermoelectric cells that are a part of the artistic design superimposed on the huge decorative panels.

More complex than the electric-resistance house heater is the heat pump. This gadget is nothing more than the familiar air-conditioner, designed to work both ways. In summer, the pump cools your house by extracting heat from the air inside your home and pumping it outside where a heat exchanger gives up the heat to the outside air. An electric refrigerator does the same thing, and if you don't believe it, just slip your hand behind the box sometime when it's working.

In winter, the refrigeration cycle on the heat pump is simply reversed. Heat is extracted from the outside air (just as a refrigerator extracts heat from the ice-cube compartment), and is circulated back into the house. Even in zero weather, there's enough heat in the outside air so that, when passed through the unit's compressor, it yields enough warmth to raise the temperature inside the house. Actually, heat pumps can be rigged to draw heat from underground water supplies, and even from deep dry wells drilled in the earth.

Big advantage in heating with a heat pump is that simply by throwing a switch it provides cooling in summer. New, glamorous units, with remote compressors that can be located in a garage or other out-of-the-way spots, are designed for recessed installations in walls and book cabinets. They look no more obvious than a recessed steam radiator. One disadvantage of this

(Continued to page 294)

TRULY NEW...ALL NEW...from **YUBA**
SAWSMITH Radial Arm Saw

with the
BIG 5
 exclusive features

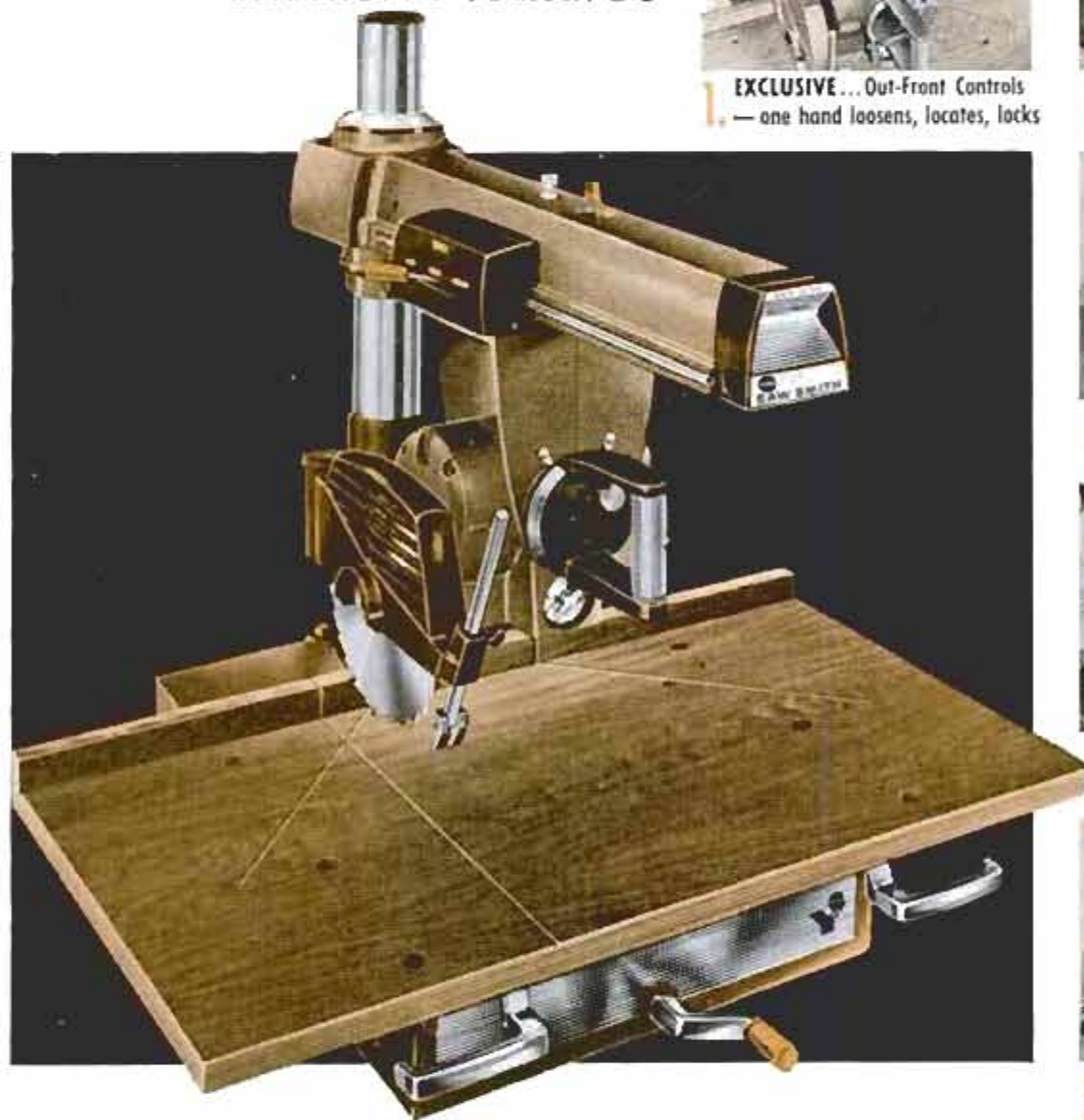

1. **EXCLUSIVE... Out-Front Controls**
 — one hand loosens, locates, locks



2. **EXCLUSIVE... Vari-Speed Drive**
 — 7 speeds, not just one



3. **EXCLUSIVE... Switch-Over Blade**
 — puts all cuts fully on table



4. **EXCLUSIVE... one-piece Sliding Table**
 — no fence-fumbling



5. **EXCLUSIVE... Coil Cord** — safely and always out-of-the-way

Now... do it *yourself*—do it better—on a SAWSMITH. It's the newest radial arm saw... *does* so much more but costs *no more*. The exclusive Big 5 features put new ease into every phase of woodworking. SAWSMITH makes home craftsmanship so simple you do a professional job the *very first time!*

You just decide and guide. SAWSMITH furnishes skill and precision for *fourteen* basic operations, does hundreds of jobs... enables you to convert instantly

from one operation to the next. It's the *only* saw with the right speed for every power sawing job—from softest pine to toughest oak.

Whether you're a hobby-man or handyman, you'll find SAWSMITH a revelation in time and money-saving... a responsive tool for creative man-type talent.

See it at your dealer or Montgomery Ward store. For literature on SAWSMITH's exclusive BIG 5 features and 25 extra values, write Dept. RPM-10.

Manufacturers
 of world-famous
 SHOPSMITH Mark 5

YUBA POWER PRODUCTS, INC.
 800 EVANS ST., CINCINNATI 4, OHIO
 A Subsidiary of
YUBA CONSOLIDATED INDUSTRIES, INC.



Your
invitation
to outboard
living

1960

**9 Great New Models —
6 to 80 hp. — New Single-
Lever Remote Controls!**

Hanker for the scent of pine on a mountain lake or the salty tang of an ocean breeze? Mercury gives you a new definition of outboard living. Fishing, skiing or cruising, you'll command the world's most advanced outboards — *all-new* from controls to props! Your Mercury dealer is ready to open the doors to adventure for you *today!*

- **Powerful Sixes** — 80 hp Merc 800, 70 hp Merc 700, 60 hp Merc 600, World's most powerful family outboards.
- **Fabulous Fours** — 45 hp Merc 400, 35 hp Merc 300. Smoothness and fuel economy unmatched by "big-bore" twins.
- **Trim Twins** — 22 hp Merc 200, 15 hp Merc 150, 10 hp Merc 100, with automatic transmission. 6 hp Merc 60, Push-Button Drive!



MERCURY

World's No. 1 Outboard!



NEW SINGLE-LEVEL REMOTE CONTROL FOR TWINS, FOURS AND SIXES! *One* hand commands Mercury power, with the world's fastest, safest, easiest-to-operate remote controls — combine throttle, forward, neutral and reverse. Six cylinder model controls incorporate starting as well!

NEW FIXED JET CARBURETORS ON EIGHT MODELS! Eliminate troublesome high-speed needle valves, guarantee efficient carburetion throughout the speed range; no adjustments except idle, as on your car!

NEW PROP-JET EXHAUST! On 80 and 70 hp models and *Glide-Angle* Twins, submerges exhaust noise and fumes under water, far aft of boat.

NEW IN-LINE ENGINES! Modern small-bore, short-stroke design that delivers the most horsepower per pound, per cubic inch.

NEW COLOR SCHEME, CLASSIC STYLING! Clean and compact, Mercury's prestige styling is the most distinctive and functional of any outboard line! Cowls are aluminum and stainless steel for longer life, lasting beauty.



Presenting The Magnificent New

merc 800

80 hp Six-in-Line . . . new leader of the world record line!

Write for free catalog.
Address Dept. PM-10





Fly the
**WORLD'S
FAVORITE**

powered models—with
the world's easiest starting engines!

Thimble-Drome

Ready-to-Fly Models

IF YOU LIKE SPEED, you'll like model flying... the Thimble-Drome way. On the end of a control line, Thimble-Drome's LI'L STINKER or SUPER CUB 105 going 45 feels like it's doing 150 mph! Even if you're a beginner a Thimble-Drome flight tested plane will let you perform realistic flight maneuvers, loops and wing-overs, after just a few practice flights. And there are no hours of tedious construction—Thimble-Drome planes are fully assembled, ready-to-fly!



"Li'l Stinker"

Fully assembled—
with engine



\$9.00
Sug.
Ret.

YOU CAN ACTUALLY FLY IT IN YOUR BACKYARD! The world's first ready-to-fly biplane, Thimble-Drome's LI'L STINKER, has a wingspan of only 10 in., fuselage of 9 1/2 in.! Yet every detail is complete—wing struts, covered landing gear, wing and body realism. The engine is the world's smallest—Thimble-Drome's fabulous PEE WEE .020 with displacement of less than 1/50th of a cu.in.—the size of a pencil eraser!



Super Cub 105

Civil Air Patrol
Fully assembled—
with engine

\$8.00
Sug.
Ret.

WORLD'S LARGEST SELLING MODEL PLANE. Thimble-Drome's model of the PIPER SUPER CUB 105 has outsold all other models because it starts faster, flies better, and lands more smoothly. Beautiful chrome yellow plastic, contrasting blue struts and tail, enclosed cabin, official C-A-P insignia, Thimble-Drome .049 BABE BEE engine... a BIG 17 1/2 inch beauty!



Thimble-Drome
GLOW FUEL
for finest
performance
PINT 95¢ ... 1/2 PINT 50¢

CHOOSE FROM THESE and other flight-tested Thimble-Drome models at your favorite hobby counter.

If not available locally
order from factory. No C.O.D.'s, please.

FREE full color 12-page
packet catalog P M 10

L. M. COX MANUFACTURING CO., INC.
P. O. BOX 476A • SANTA ANA, CALIF.

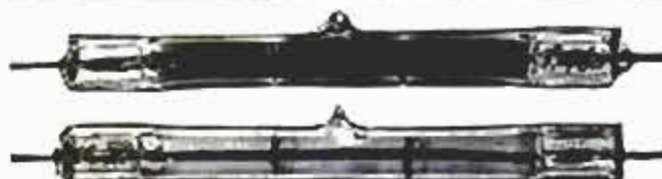

Iodine Prevents Lamps From Growing Dim

New tubular quartz lamps won't blacken because they have an iodine cycle that re-deposits the evaporated filament. The lamp is 200 times smaller than the standard industrial lamp but gives 10 percent more light in its life because it never dims. The lamp at the top had no iodine and darkened after two hours. The one at the bottom included iodine and was clear after 1000 hours.

Tire Never Needs Air

Made entirely of wire, a new tire will be used on space vehicles passing through the thermal barrier on re-entry into the air-mass. The tire can withstand temperatures in the 1000 to 2000-degree F. range.

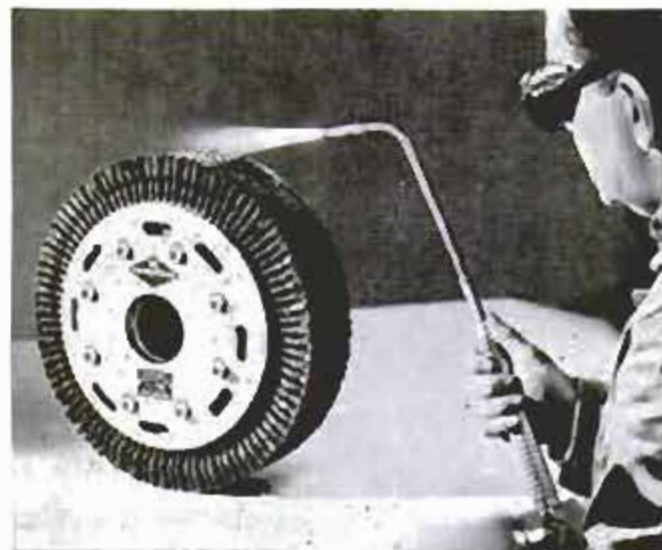



SPORTSTER

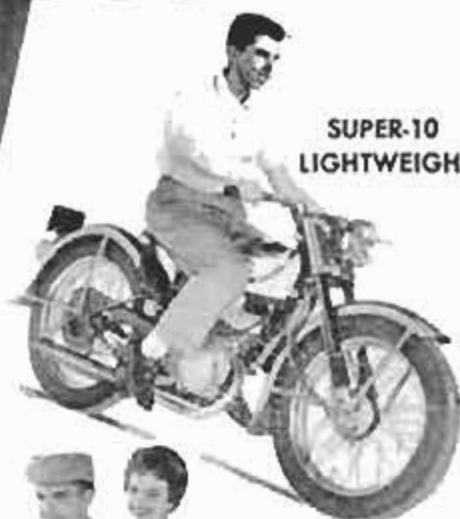

SUPER-10
LIGHTWEIGHT



TOPPER



DUO-GLIDE

Choose
your
FUN
RIDE

from Harley-Davidson's "all-round" line for '60

DUO-GLIDE — Harley-Davidson's finest is the luxury cruiser of motorcycles. Smoothest ride on two wheels. Newly styled and engineered for 1960. Available in the FL series or super-powered FLH models.

SPORTSTERS — H Model (shown) for highways or byways — rough going or smooth. Also Sportster CH for "driving" through the rough in "off-the-road" competition.

NEW SUPER-10 LIGHTWEIGHT — Harley-Davidson's newest wheels for the young and young at heart. Ideal for work, school and play. Exciting new styling. Up to 80 miles per gallon.

NEW TOPPER SCOOTER — Tops all others in beauty and performance. Fashioned in gleaming chrome and fiberglass. No shifting

Harley-Davidson

MILWAUKEE 1, WISCONSIN

Perfect Mating of Man and Machine

or clutching with *Scotaway* drive. Low center of gravity makes for easy handling.

In '60 more than ever before, there's a Harley-Davidson for every purse . . . every purpose. We've added the new *Super-10* Lightweight and *Topper* Scooter. We've made the famous *Duo-Glide* and *Sportster* better than ever. See the all 'round line for '60 at your dealer's now. He'll show you how easy it is to own a Harley-Davidson with his easy-pay plans. Or mail the coupon for free, colorful folders.

HARLEY-DAVIDSON MOTOR CO.

Dept. P, Milwaukee 1, Wisconsin

Please send me information on

Duo-Glides Sportsters Super-10 Topper

Name.....Age.....

Address.....

device is the fact that the colder it gets, the less heat becomes available to a heat pump operating on outside air. Hence, in colder climates, heat pumps must generally be augmented with some resistance heaters as well.

Electric heating can be as elaborate as you want it. If you like central heat, you can get that with electricity, too, plus all kinds of fancy wrinkles.

Several familiar furnace companies are producing electric furnaces with resistance elements in modules for any heat output needed up to 123,000 British Thermal Units. Such electric units, which sit in the basement like any furnace, deliver warm air through ducts to various rooms in the house. Some even come in modular sections. If you want central air conditioning, just add it to the pile. The cooling coil fits right into the furnace assembly, while compressor units are located somewhere outdoors. Electrostatic air filters can be clipped into place just as easily to remove the dust from your house, if you're interested. And if controlled humidity is important, you can slip an electric humidity-control in the assembly whenever you want.

Set it and Forget it

Besides doing away with things like soot, chimneys, cumbersome radiators and expensive steam-fitting, electric house heating has a number of appealing advantages. Its inherent automatic features make it possible to set it once and forget it for a season. Some of the new control panels for complete home systems look like small radios recessed in the wall, and are easily set with dial controls. Their flexibility goes beyond "zone heating," to allow control of heat for each room in the house individually. When you want heat, there's no muss or fuss. Just flick a switch. The heat is clean, flameless and hence requires no oxygen supply. Resistance units are completely noiseless, and even heat pumps are reasonably quiet.

Until now, the one big disadvantage has

been operating cost. Much of the steam behind the geysering growth of electric heat comes from special low rates many power companies have established to encourage its growth. In the Chicago area, Commonwealth Edison cut its rates 30 percent for all owners of electrically heated homes. As a result, the annual cost of heating those new three-bedroom houses in St. Charles is about \$240. Heating with gas or oil in the same area would cost between \$125 and \$150.

Most power companies are enthusiastic about electric heating because it helps balance their load output. The boom in air conditioning has put their peak loads in summertime, while in winter they have more generating capacity than customers can use. Heating a three-bedroom house around Chicago with resistance units takes about 16,000 kilowatt hours per year, and that's a lot of juice.

Actually, while resistance heating systems are far cheaper than any other to install (about half the cost of conventional systems), they are far and away the most expensive to operate. Heat-pump systems can cost several times more than even an oil or gas-fired system (steampipes, radiators, chimney and all), but they use considerably less operating current. The Carrier Corporation estimates that in Portland, Ore., at the going utility rate, it costs \$113 annually for a 1200-square-foot house to be cooled in summer and warmed in winter with its heat-pump system. In Roanoke, Va., where utility rates are higher and temperatures more moderate, the same service would cost \$266.

And, for all electric heating systems, the house must be adequately sealed with vapor barriers and additional insulation to prevent heat loss—all of which bumps up the price of this new luxury.

But as rates are whittled down, and manufacturers devise more ingenious and less voracious juice-gobbling units, there's little doubt that electric home heating will become more and more popular. Already there's no doubt that it's here to stay. ★★★

Days Are Growing Longer

If a clock had been set at the time of the birth of Christ and kept running accurately through the past 2000 years, it would be two hours fast today, report two California geophysicists. Following a line of investigation started by the 18th century English astronomer Edmund Halley, Professors Walter H. Munk and Gordon J. F. MacDonald have calculated that our days are growing longer at the rate of one hundred-

thousandth of a second each day. The cause of this phenomenon is the gradual slowing of the earth's rotation. The calculations were made by measuring successive transits of the sun or a star across the zenith. The most-popular explanation for the slowdown is that the ocean tides cause a loss of energy, but Munk and MacDonald disagree, though they have not yet found any other explanation.

For that "FACTORY FINISH"



**PORTER-CABLE
ALL-PURPOSE
BELT
SANDER
KIT
A 4-STAR
TOOL!**

The most versatile sander you can own. The Porter-Cable Belt Sander not only gives you "professional finishes" — fast . . . it is a real time-saver for heavy stock removal, fine cabinet work, home remodeling, paint and varnish removal, boat work, rubbing, polishing, sharpening, etc. Extra quality features include: precision spur gears, ball bearing construction, and neoprene-covered drive pulley. A professional-quality tool especially priced for home craftsmen and hobbyists.



Ideal for sanding broad surfaces. With correct abrasive, sander quickly fits doors, storm screens.



Quickly removes paint or varnish. With felt and canvas belts, it does a professional job of polishing and rubbing.



With Bench Stand, sands curved edges, small pieces. Also sharpens knives, chisels, tools.

**BIG 10-PIECE KIT
FOR ONLY \$59⁹⁵**



Reg. \$67.50 Model 165P Kit includes 2 1/2" x 21" Belt Sander, heavy-duty Bench Stand with miter gauge, abrasive belt, felt belt, canvas belt, 4 rubbing and polishing compounds, and "The Finishing Touch" — how-to-do-it booklet.

Porter-Cable
Quality Power Tools

**LIMITED OFFER!
ORDER YOUR SANDER KIT NOW!
SEND NO MONEY!
TAKE SIX MONTHS TO PAY!**

PORTER-CABLE MACHINE CO.

9140 Marcellus Street, Syracuse 4, N. Y.

I wish to order the tools checked below. I agree to pay my Porter-Cable Dealer full price or down payment indicated upon receipt of tool, and the balance in monthly installments shown below.

	Price	Down Payment	Balance Monthly for 6 months
Model 165P Kit	\$59.95	\$11.00	\$8.65*

*Includes Service Charge

This offer good only in U.S.A., Hawaii and Alaska. State and local taxes applicable. (Void where prohibited, license required or otherwise restricted.)

Name _____

Address _____

City & State _____

CRESCENT ADJUSTABLE WRENCHES



Crescent offers unequalled value, performance and selection in Adjustable Wrenches. Choose CRESTOLOY for greatest strength and finest finish in 4" to 24" sizes, single and double end patterns; CRESCENT for toughness and durability at lesser cost in 4" to 18" sizes. Also insulated handles on the 12" CRESTOLOY. See CRESTOLOCK, the new locking adjustable wrench.

Sold by hardware dealers everywhere.



Crescent is our trade-mark, registered in the United States and abroad, for wrenches and other tools. Sold by leading distributors and retailers everywhere and made only by

CRESCENT TOOL COMPANY, JAMESTOWN, N. Y.

30,000,000 Ties to Handle

(Continued from page 135)

tie was carried by one man, moved to the processing end of the plant in the same manner, and from there to shipment.

Rising wages and the increasing difficulty of finding men strong enough to carry ties weighing 200 to 275 pounds forced all wood-preserving companies to think of mechanical handling. A group of devices was designed to reduce manual labor.

The operations may be briefed in this order: (1) unloading green ties from box cars, (2) sawing to length, (3) drying in the yard, (4) adzing and boring and, finally, (5) preservation and shipping.

Green ties are ricked in the yard for drying, and each tie loses about 50 pounds of moisture. This opens the grain for deep penetration of the preserving liquids. Free circulation of air through the ricks is imperative, and eight ties are placed in each layer, with wide spaces between them. A stringer tie is laid crosswise under one end of each layer, first at one end and then at the other, providing still more air spaces.

The basic idea is to lift a layer of ties, complete with its stringer, as a unit.

Car Unloader

A heavy, three-legged frame is mounted on a concrete foundation alongside the track. It has a retractable boom mounted at the top, which is moved in and out with a motor mounted on the frame. For raising and lowering the load, another motor, with a cable drum, is mounted on the rear end of the boom.

When a car is placed, the boom is projected to reach the far end of the load.

A grapple, designed to pick up five or six ties, is lowered over the pile. The hooks of the grapple naturally swing in to catch, and drop over the ends of the ties. The hooks dig into the ties and lift. The load is racked back along the boom, and the boom is retracted until it can be thrust through the far door of the car. The boom is then racked forward until the load is outside the car. Then the load is turned and lowered and the grapple releases the ties on a chain conveyor.

All movements of the boom and grapple are controlled by a workman by means of an electronic unit slung round his neck.

Chain Conveyor

The chain conveyor carries the ties crosswise. As they move along they are engaged by guides that arrange them in position to be cut to length by a saw. A cam arrangement, with a following dog, is timed

(Continued to page 298)

8 WAYS TO REDUCE COSTS AND INCREASE QUALITY IN BUILDING YOUR NEW HOME

For certain applications, the *lowest-cost materials* you can use are the *highest quality* products in their field. This is true of Homasote products—by their very nature and by their wide variety of sizes, forms and thicknesses. Here are some of the savings possible—compared with other standard building materials—on a 3-bedroom house with 1200 square feet of exterior wall surface...

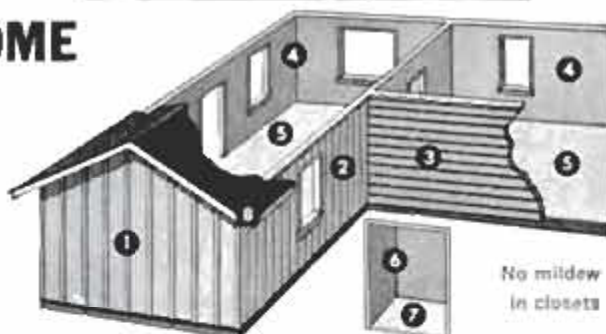

REDUCE YOUR COSTS BY \$515 TO \$1712	1 Homasote Board-and-Batten	2 Homasote Grooved Vertical Siding	3 Homasote 12" Siding
4 Homasote Interior Walls	\$220 to \$1092	\$175 to \$1048	\$110 to \$ 983
5 Homasote Sub-Flooring	297 to 480	297 to 480	297 to 480
6 Closet Walls	34 to 40	34 to 40	34 to 40
7 Closet Floors	29 to 46	29 to 46	29 to 46
8 Facia and Rake Molds	11 to 14	11 to 14	11 to 14
	34 to 40	34 to 40	34 to 40
	\$625 to \$1712	\$580 to \$1668	\$515 to \$1603

Further savings occur, because Homasote methods also reduce application costs.

FREE—HOMASOTE'S COST-REDUCTION ANALYSIS. Send us the plan for your new home—without cost or obligation. We will show you just how these savings can be effected—in your area—on your particular house. Your plan

will be treated confidentially and returned to you. Or—for further details—send 10¢ for the 72-page Homasote Handbook.

Remember— Homasote products increase the quality, comfort and life of your home—as well as reducing the original cost. Kindly address Dept. K-1.

HOMASOTE COMPANY

TRENTON 3, NEW JERSEY

Homasote of Canada, Ltd., 224 Merton Street, Toronto 12, Ontario



GENUINE ALNICO MAGNETS

AMAZING, PERMANENT, NON-ELECTRIC, HIGHLY PRACTICAL. Conduct interesting experiments. Hundreds of uses. Retrieve valuable steel items such as guns, tackle from fresh or salt water; tools from tanks & drains. **GUARANTEED.** Try any magnet one week.

- MONEY BACK IF YOU ARE NOT WELL-PLEASED**
- M-710 (Wt. 53 oz.) Has pull of 225 lbs. on steel block... \$18.00
 - M-625 (Wt. 70 oz.) Has pull of 125 lbs. on steel block... \$10.00
 - M-575 (Wt. 18 oz.) Has pull of 75 lbs. on steel block... \$ 7.00
 - M-500 (Wt. 13 oz.) Has pull of 50 lbs. on steel block... \$ 5.00
 - M- 90 (Wt. 5 oz.) Has pull of 15 lbs. on steel block... \$ 3.50
 - M-102 Pocket Magnet. 5 lb. pull. 2 for \$ 1.50
 - M- 47 Hot Pad Magnets. 10 for \$1.00... 50 for \$ 4.87
 - M- 35 Hobbyist assortment of 8 magnets... \$ 2.00

Send M.O. or check. We pay postage. Sorry no C.O.D.'s.
MIAMI MAGNET COMPANY, 3240 N. W. 27TH AVE., MIAMI 42, FLORIDA

POWERFUL!

Man, here's *light!* 1/4-mile beam—15,000 beam candle power. Compact, easy to carry, built to last! Uses two 6-volt batteries. See your dealer. **\$6.75** less batts.



Delta POWER-KING ELECTRIC LANTERN

HANG FIXTURES SECURELY... USE MOLLY Screw Anchors and JACK NUTS

PERFECT FASTENERS to hold anything on walls, floors, ceilings

With Molly you can install fixtures exactly where you want—not just where studs are. Won't pull through. Spider backing reinforces area in which used. Fixtures can be removed and replaced in same anchor. Easy to install without disfiguring wall. Inexpensive, guaranteed. Ask your hardware dealer for genuine Molly—the name is stamped on the cap.

New JACK NUTS HOLD IN HOLLOW-CORE FLUSH DOORS
Now you can fasten fixtures securely to flush doors! Jack Nuts need only 1/4" expansion space, grip any material up to 3/4" thick.

EXPANDS BEHIND WALL
MOLLY Corp. • 200 N. 5th St. • Reading, Pa.

Enclosed is \$1.00 for sample box of (check one) Mollys Jack Nuts

NAME _____
ADDRESS _____
CITY _____ ZONE _____ STATE _____

STOP WINDOW DRAFTS

do-it-yourself
in just minutes

with

Mortite WINDOW WEATHERSTRIP

everything you need...
no tacks or tools
required

only
29¢



JUNIOR BOX 29¢, gives you enough for a single window. For 5 to 6 windows, ask for the **BARGAIN BOX** at only \$1.39.

MORTITE is the unique "FINGERTIP" weatherstrip. Simply press into place—it adheres to any clean, dry surface. Use it around drafty windows—Government reports show cracks and crevices are responsible for up to 25% heat loss in the average home. Use it around uneven screens to keep insects out. Use it as a sealer, gasket, caulker, plugger-upper... there are hundreds of uses around the home, farm, shop, cottage.

- Works equally well inside or out.
- Never cracks, chips or peels.
- Can be painted over.
- Stays soft—unrolls like a ribbon.
- Easily removed—leaves no marks.

LOOK FOR "FINGERTIP" MORTITE
AT YOUR NEARBY HARDWARE
OR BUILDING SUPPLY STORE.

Seals cold out! Seals heat in!

**JUNIOR
BOX**



**BARGAIN
BOX**



Another Home-Saver Product by

Mortell
COMPANY
KANKAKEE, ILLINOIS

with lugs on the chain so the ties move past the circular saw about 30 inches apart.

After this the ties must be spaced on the chain so that when they are placed in the rick there will be free circulation of air. This spacing is done by cams, and dogs on the chain, which retard the forward motion of a tie until it is properly spaced.

The most ingenious trick is getting the stringer tie turned and moved into position under the end of a layer of ties. It is lowered from its preceding position on the crosswise chain on gravity rollers, and then pulled around into place under the end of the layer on a drag chain.

Lifting the Unit of Ties

Another grapple, larger than the one used for unloading cars, is designed for this special "lift." It has extra hooks on all four corners. When the grapple lifts, the hooks catch the ends of the ties in the layer, and also the ends of the stringer. The complete unit is moved outward on a monorail and lowered onto a tram car. The next unit is laid in the opposite direction. A complete rick of 127 ties is thus built up on the car.

The tram train is pulled to the drying yard, where the ricks are taken from the cars. The rick is moved as a unit by a Ross Carrier, or straddle truck. The straddle truck mounts and crosses the railroad track to stand over the rick of ties. It lifts the rick, backs off the track, and moves the rick to its place in the yard. After drying, the ricks are moved out of the drying yard in the same way, and hauled to the adzing and boring machine.

Planning and Results

The new system has brought many gains. A tie yard, for example, is commonly laid out with tram tracks 120 feet apart. For a man carrying a tie, this meant a maximum distance of 60 feet.

Injuries to tie carriers have been eliminated. A number of men used to develop bad sacroiliacs, injured shoulders and other ailments. Lost-time accidents have been greatly reduced in number.

Costs are reduced to negligible amounts for gasoline, oil and electricity. Maintenance expense has been very low. All these charges, along with interest and depreciation, come to seven or eight cents a tie on an output of 300,000 ties. ★★★

☞ If mosquitoes find you especially tasty, it may be that you've been eating bananas. A Philippine researcher says mosquitoes crave serotonin and norepinephrine, and can detect these two chemicals in your perspiration or blood stream if you have recently eaten a banana.

Sao Paulo — the Latin Detroit

(Continued from page 128)

popularity of the Jeep, which is even used for taxi service in some rural areas. Lacking enough good roads, and with some areas entirely without roads, Brazil has relied heavily on air transportation and is reputed to be second only to the United States in volume of air traffic. This despite the fact that flights on many routes terminate before dark for want of airway radio aids and night-landing facilities. Sao Paulo's principal airport is the busiest in Brazil, one of the few equipped for night operations, and is served by 25 airlines of which 14 operate international flights. This one airport handles nearly 8000 scheduled commercial flights per month, carrying 100,000 passengers and 4,000,000 pounds of cargo.

Seaport 40 Miles Away

Forty miles from Sao Paulo is its seaport, Santos, Brazil's busiest. More than 5000 ocean ships clear the port annually with more than 8,000,000 tons of cargo. The cities were first connected by railroad, more recently by a high-speed divided highway. Pipelines climb the coastal escarpment and carry to Sao Paulo the fuel oil and gasoline once moved inland by rail, but the railroad hardly notices this lost business. It is so busy it has put back into service some of the ancient wood-burning locomotives that first hauled trains over its tracks. On the same rails today you are apt to see modern diesel engines, conventional steam locomotives and the early wood-burners all at work.

Sao Paulo may be chilly and damp in winter while sea-level Santos enjoys a year-round tropical climate and so has become, with its adjoining beach communities, a year-long resort area. A typical Paulista business man sends his family to Santos for the winter and joins them on weekends.

The cosmopolitan nature of its population is one reason for its vitality. Sao Paulo began as a Jesuit mission in 1553, became a village in 1660, attained the status of a city in 1711. Beginning about 1870, waves of immigrants from Italy, Germany, Japan, Spain and Portugal moved into the area. A small percentage came from the United States, a number of southern families moving to Sao Paulo after our Civil War. The Paulista today is described as highly industrious, individualistic and independent.

The 4000 North American citizens resident in Sao Paulo are mostly employed by United States companies that have invested a billion dollars in industry here. The Sao



STOP DOOR DRAFTS

do-it-yourself
in just minutes
with

FOAMFLEX[®] DOOR WEATHERSTRIP

everything you need
to do the job . . .
even the nails

only
\$2.29

Famous FOAMFLEX consists of closed-cell, positively non-absorbent vinyl foam permanently bonded to clear wood moulding. New, exclusive "offset" design of foam edge provides perfect 2-WAY airtight seal . . . against the door and against the door-stop! With only hammer and saw, anyone can install in only 10 minutes. Package contains more than enough to weatherstrip the average door—two 7' lengths, one 3' length, instruction sheet, package of nails.

Patent Pending

- Stops wind, rain, snow.
- Silences closing doors.
- Can be painted without hardening.
- Stays flexible even at 50° below zero.
- Fits tight, even against warped surfaces.

LOOK FOR THIS DISPLAY CARTON AT YOUR FAVORITE
HARDWARE OR BLDG. SUPPLY STORE.

Seals cold ou! Seals heat in!

Another Home-Saver Product by

Mortell
COMPANY
KANKAKEE, ILLINOIS

NEW KLEIN PLIERS

make electronic wiring easier

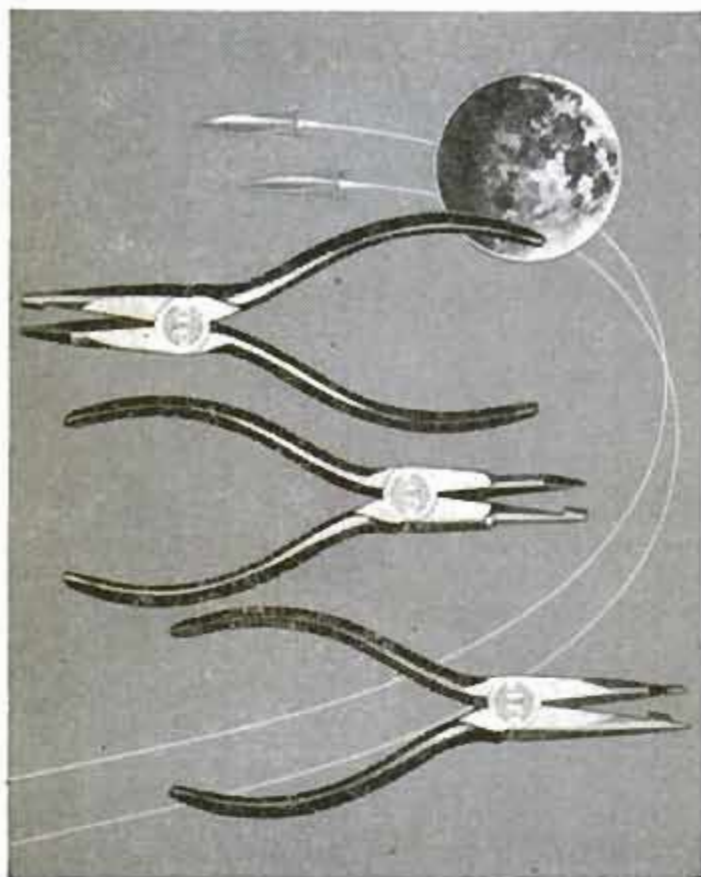

These three shear cutting pliers cut flush and hold clipped end of sheared wire firmly. Available with spring to hold jaws open.

260-6 All-Purpose Electronic Plier
Length, 6 $\frac{3}{8}$ "

261-6 Needle Nose Electronic Plier
Length, 6 $\frac{3}{8}$ "

208-6 PC Shear Cutting Plier with knife at tip—Length, 6 $\frac{3}{8}$ "



Write for Catalog 101A, which shows the complete line of Klein Pliers, including many recently developed pliers.

Mathias KLEIN & Sons
Established 1857 Chicago, Ill., U.S.A.
7200 McCORMICK ROAD • CHICAGO 45, ILLINOIS



Pau American Chamber of Commerce is 40 years old. The Economics Officer of the American Consulate at Sao Paulo answers inquiries about living conditions and trade opportunities. Prospective emigrants to Brazil should remember that while some Brazilians speak English and Spanish, Portuguese is the common language. And they should know that today inflation is such a problem that newcomers may find it hard to make ends meet on an income that would be considered adequate in the United States. One utility company, for example, had to grant its employees a 35 percent wage increase in the last year.

One information brochure for newcomers has other words of caution: It's safer to boil drinking water. Wash leafy vegetables with chemicals before cooking. Bus transportation in Sao Paulo sometimes finds rush hour queues standing in line for an hour. Electric power in residential areas, advertised as 110 volts, may fluctuate between 90 and 135 volts. Water pressure varies. And you may wait a year to have a telephone installed.

But these are the growing pains of a growing city. Sao Paulo and Brazil itself are growing so fast that everything cannot keep up the pace. But it is a progressive pace, and Sao Paulo is racing into a dynamic future. ★ ★ ★

Corvair—The Bold One

(Continued from page 111)

surprisingly soft yet not hammocky. The body generally feels solid, substantial despite its smallness. Entry room is good, especially in front where there is no wraparound windshield to interfere.

Cornering is a pleasant experience. It does it flat and with confidence. There is no apparent tendency to oversteer. It does feel slightly different from a front-engine car, but there are no new skills to learn.

Even braking is fun. From high speeds, there is no dip, the car simply squats down and grabs hold of the pavement.

Seat design is good, although shorties may have trouble seeing over the steering wheel. There are no intrusions by front-wheel housings into the front compartment.

No power assists are available and none seems necessary. Steering is light and, although not extremely fast, is quick enough to give the car an agile character. There is no wheel fight in chuckholes or soft shoulders. Shifting with the floor-mounted stick is a pleasure.

For years, it was felt that rear engines would not work in wheelbases over 100 inches. They said it couldn't be done, but Chevy seems to have done it here. ★ ★ ★

NEW! MARLITE RANDOM PLANK

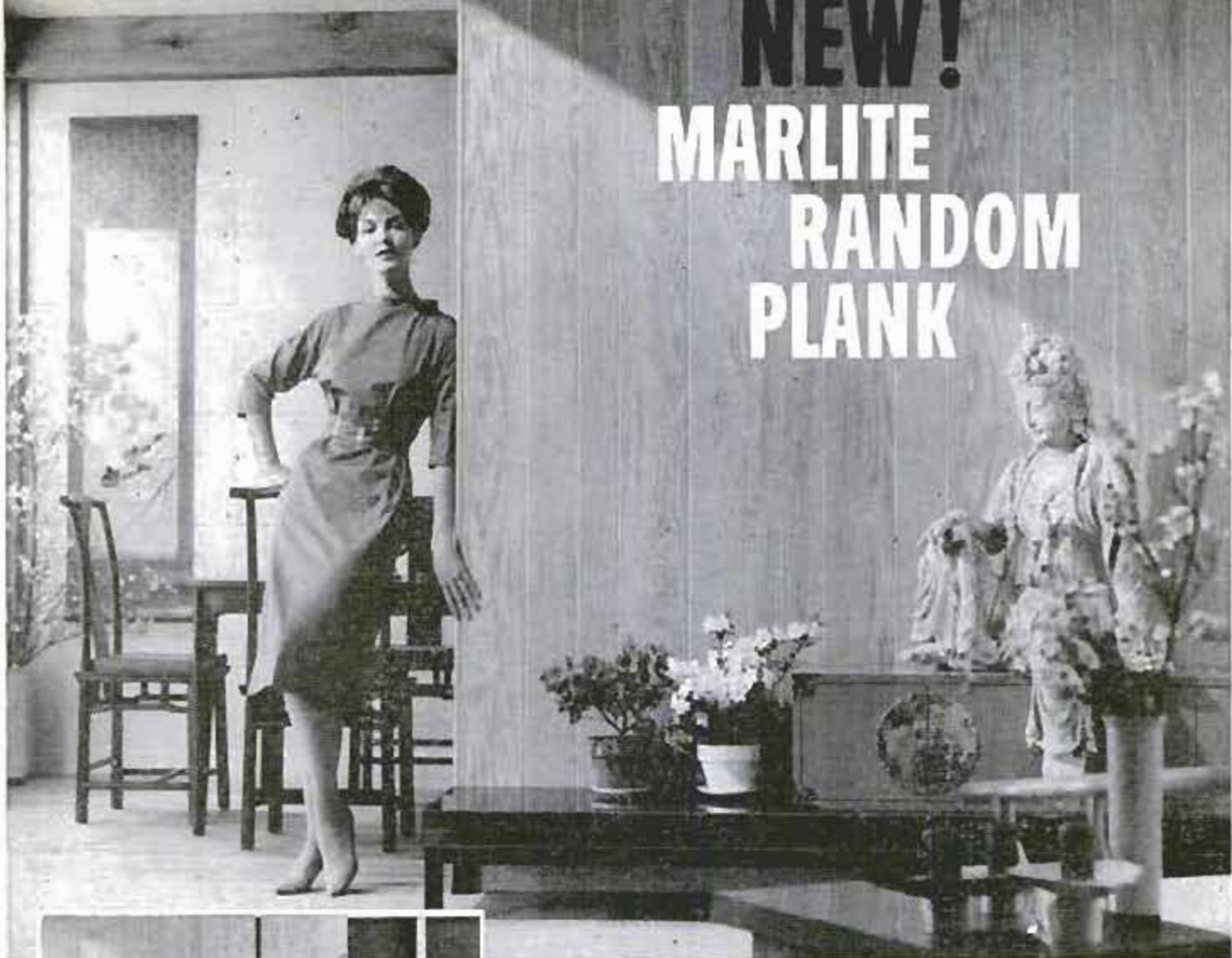

Tongued and grooved Random Plank goes up fast over furring strips or existing walls. Planks for a 12' x 8' wall cost as little as \$52!

Marlite[®]
plastic-finished paneling

*beautiful wood-grain paneling
you can install yourself!*

You can add extra luxury to any room with new Marlite Random Plank. The 16-inch-wide planks with modern random grooves are eight feet long, 1/4-inch thick—tongued and grooved for easy installation. Six new Trendwood hues (Danish Birch, English Oak, Swedish Cherry, Italian Cherry, Swiss Walnut, American Walnut) capture the beauty of fine hardwoods. And Marlite's baked melamine plastic finish requires no painting or further protection; resists stains and mars; cleans with a damp cloth. See your building materials dealer, or mail coupon below.

Marlite Division of Masonite Corporation
Dept. 1042, Dover, Ohio

FREE! Please send full-color folder and do-it-yourself instructions on new Marlite Random Plank.

Name _____

Address _____

City _____ State _____



ANOTHER QUALITY PRODUCT OF MASONITE[®] RESEARCH

Cut it with WISS



As versatile as they are powerful, Wiss Snips are an all-purpose cutting tool no home work bench should be without. Above: No. V-13, seven-inch pocket size \$2.50. Others from 8" to 17" in aviation, combination, and solid steel styles. At hardware and department stores.

WISS SNIPS CUT EVERYTHING!



Cut Tile



Cut Leather



Cut Fish and Poultry



Cut Fencing and Screens

J. WISS & SONS CO., NEWARK 7, N. J.
World's Largest Manufacturer of Shears, Scissors, Pinking Shears, Skalloping Shears, Metal Cutting Snips and Garden Shears

Inventors Are Not Eggheads

(Continued from page 101)

with a given amount of force. It made no difference whether he pulled it back quickly or slowly each time he let it go, it always struck with the same force.

Keeping this observation in mind he proceeded to build up a key action that would remain locked during the initial depressing of the key. He arranged for this original finger energy to be stored in a spring. Then, as one approached the end of the finger stroke, the mechanism unlatched automatically—after which it was this same spring that drove the type. Thus, the same striking force was delivered each time.

Notarize All Changes

(5) *Complete the Invention Disclosure.* Very likely by this time you will have incorporated several changes and improvements into your originally written plan how to solve your invention problem. It is important that the original disclosure be followed by supplementary disclosures describing such changes, each such notarized disclosure clearly referring to its predecessors, to make a connected series.

A vital part of Ayres' invention disclosure in this case was several samples of uneven printing, both originals and carbons, that were made on an ordinary machine to compare them with the even typing available from his improved system. In the case of the ordinary machine carbons became illegible in spots in some cases after the fourth copy sheet, whereas his copies remained easily readable and uniform. These printing samples were likewise each carefully dated and notarized.

"Studied All Means"

"I've studied all the available means for legalizing conception dates of inventions and I cannot overemphasize the value of a simple notarization," says Waldemar Ayres. "There are those persons who erroneously believe they can accomplish the same thing by mailing themselves a copy, then leaving the envelope unopened. However, when the self-addressed envelope reaches you it is quite apt to have a cancellation date stamped on it that is illegible. Too, in court a good opposition attorney could claim you had steamed the envelope open and changed its contents.

"Some inventors depend upon ordinary witnesses for proof. But you may not know where to find these again when the need arises. (It may be several years later that

(Continued to page 304)

Now for the first time!
SOLDER ALUMINUM
EASILY, INEXPENSIVELY
with Reynolds new
soldering brush kit

At last, you can do a first-class soldering job on aluminum, right in your own workshop—produce strong, clean, corrosion-resistant joints with Reynolds new soldering brush kit. The secret lies in the stiff fibre glass brush which abrades the aluminum oxide on the metal surface so solder can be readily bonded to the bare aluminum. Soldering is fast, easy, economical . . . no flux required. See your local dealer or send check or money order for \$1.98 to: Mailing Services, Dept. PM, P. O. Box 5027, Richmond 20, Va. Be sure to print name and address plainly. Do it today!

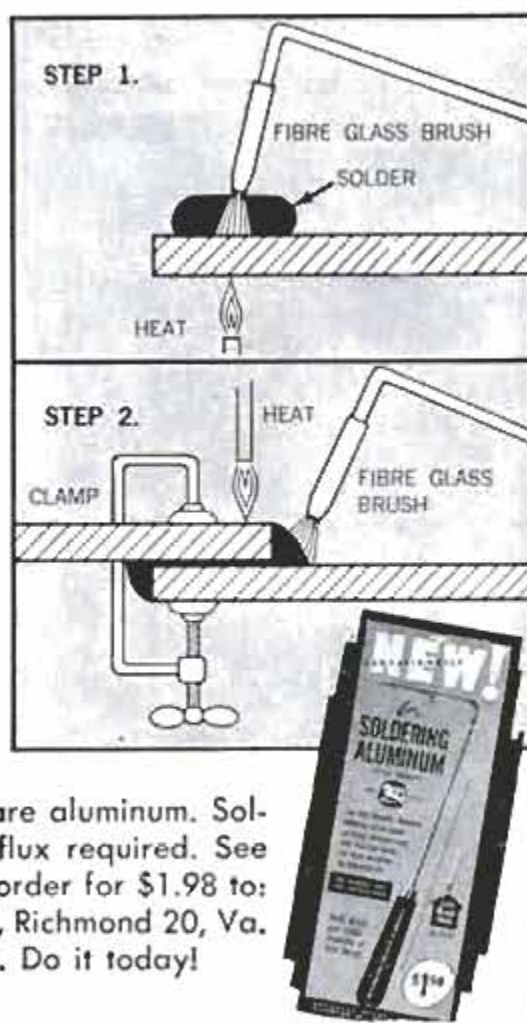

For a cleaner . . . healthier home

AIR FILTERS

should be changed regularly!

ECONOMIZE

buy a season's supply! Get a



Contains permanent metal frame and four filter changes. Frame lasts the life of your furnace . . . save the frame cost with every filter change. Replacement filter kit contains six changes for the same price as the original kit. You save 1/3!

COMPLETELY SANITARY! The MICROMAT Filter is chemically treated to control germs and bacteria! Does a superior job of removing dirt, pollen, other impurities from the air . . . keeps your home cleaner, healthier . . . saves fuel and service calls!

There's a MICROMAT Sanitary Air Filter for all warm air furnaces, central heating and cooling systems, and room air conditioners. Ask for Micromat at your favorite Hardware or Building Supply store. If there is no dealer near you, or he cannot supply you — order your MICROMAT Sanitary FILTER KIT direct — only \$4.60 postpaid. Send check or M.O. and filter size, to:



COMPLETE KIT ONLY
\$4.60

Microtron
CORPORATION
 Box 2092 • CHARLOTTE, N. C.



GRAVELY
makes leaves
VANISH!

ROTARY MOWER—LEAF MULCHER

- Mulches 30" width! . . . Twice the power of ordinary mulchers . . . gets rid of leaves fast! . . . 6.6 HP at 2600 RPM.
- New Steering Sulky, New Optional Starter, New Rotary Cultivator—30 attachments for year-round work. Snowblower, Snow Plow, Chain and Circular Saws for Fall and Winter jobs . . . Finance Plan available!

Write today for FREE 24-page "Power vs Drudgery" Booklet!

GRAVELY TRACTORS, INC.
 BOX 601-K DUNBAR, W. VA.

FIELD-TESTED SINCE 1922

"Pays Off" in your workshop . . .

Cummins

"Circle of Power"

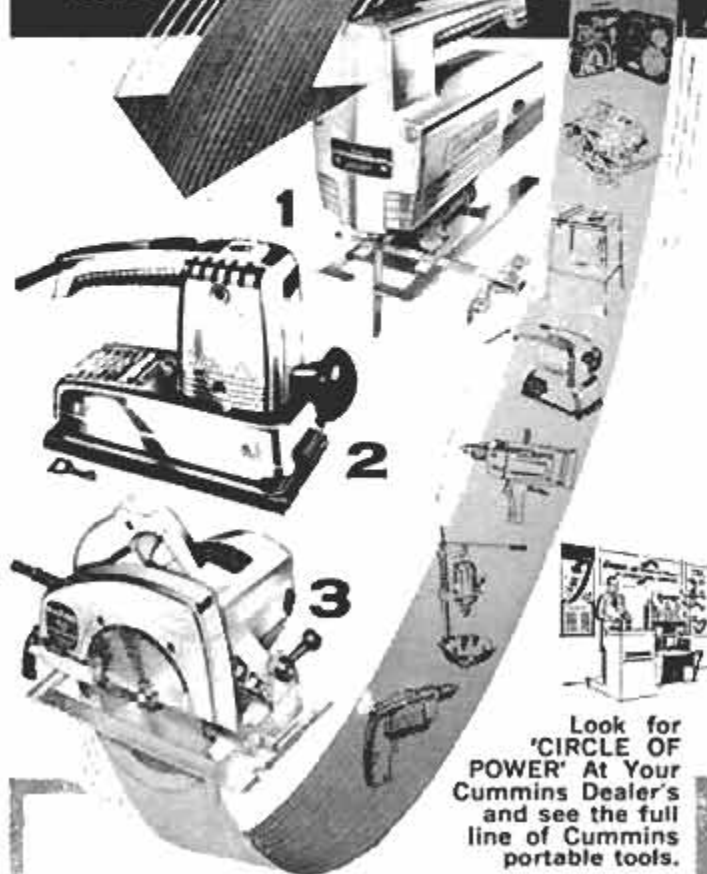

Look for
**'CIRCLE OF
POWER'** At Your
Cummins Dealer's
and see the full
line of Cummins
portable tools.

**A Complete Line of Portable
Electric Tools . . . With Pay-Off
Power for Everyone!**

King-size performance — budget-size cost! Quality-built Cummins "Circle of Power" Tools mean versatility for most home workshop, maintenance and repair jobs . . . reliability with rugged Cummins-built motors. See the "Circle of Power" display at your Cummins dealer's now!

- 1** Cummins Sabre-Jig Saw\$44.95
NO VIBRATION! Seven saws in one — cuts 2" dressed lumber at 45°, cuts plywood, plastics, leather, even metal. Accurate control.
- 2** Cummins Double-Action Sander \$49.95
TWO SANDERS IN ONE! Get orbital and straight-line sanding at the turn of a key for beautiful professional-quality finishes.
- 3** Cummins 727-01 MAXAW\$49.95
7 INCH CUTTING CAPACITY! Magic-pivot for deeper angle cuts with blade to spare; makes all cuts in 2" dressed lumber.

Cummins Portable Tools

5055 N. Lydell Ave., Milwaukee 17, Wis.
Prices slightly higher in Canada

Division of **John Deere** MANUFACTURING CO.



an invention is challenged.) They may be dead. Their memories may prove poor, or the opposition lawyer may trip them up. In any event, you'll likely have to pay their expenses to come and testify. On the other hand, the notary public's presence is seldom required in court. He need know nothing about the mechanism or inventing. All you want from him is his certification that the papers in question were shown him by you, a person who had identified himself, on the date that his signature and seal confirms."

Witness Can Help

It is a good idea at this time, too, to have several persons observe your invention in operation, he says. Have notarized statements signed by them to this effect. Try to attach a picture of the invention to each statement and have the notary's seal include a portion of each such photo, too. It will be even better if one of these witnesses is a recognized authority in the field in which you've invented. (Ayres took his improved key action back to the typewriter store from whose repair department he'd originally gotten the parts and the much-impressed owner gave him a letter stating that it was "the first major improvement of the manual typewriter in 50 years.")

(6) *Have a patent search made.* By this time your library research and perhaps guarded questioning of others may have encouraged you to believe there exists no other invention like yours. Next step will be to hire a patent attorney to confirm this by making a "preliminary novelty search" in the Washington, D. C. patent office. In most cases, if the "art" be fairly simple, such a novelty search can be made for about \$50. You should instruct the attorney not to make any additional expenditures without first getting your approval.

Get Copies of Other Patents

"He will provide you with copies of issued U. S. patents closest to your invention, together with a written opinion analyzing your own chance for getting worthwhile invention claims," says Ayres. "The extent of this analysis will, of course, be limited by the small amount you are authorizing him to spend. However, it should be understood that no search made in the patent office is ever complete, even should you spend millions, since under U. S. patent law an invention has to be 'new everywhere in the world,' must never have been 'published,' even in mimeographed likeness, and no one could possibly prove such a worldwide claim."

Your brain child may infringe upon one

(Continued to page 306)

CART-BUILDERS! REDUCTION STEERING UNIT!

CAST ALUMINUM • MACHINE-CUT GEARS • PRECISION-ENGINEERED • EASILY INSTALLED • MOUNTING PADS ROTATE 360° • FOR ALL CARTS OR CHUGS.

ALSO AVAILABLE: Ball joints, clevises, 3/8" diameter tie rods, complete set.....\$4.95
1/2" diameter steering column, 2 feet long.....\$1.00



\$1495

Fully Guaranteed

A complete line of engines, wheels, drive-wheels, tires and automatic clutches.

When ordering, pay 50% down, balance C.O.D. Postage on parts prepaid only if purchase-price is paid in full. Order now for immediate delivery in time for Christmas.

MANUFACTURERS - DISTRIBUTORS - DEALERS - PRICES ON APPLICATION. Get full particulars about the number of attractive dealer-jobber openings now available to qualified, established wheel-goods and automotive parts distributors.

Send 25 cents for illustrated booklet describing complete line of parts and accessories.

Write to:

Redon MFG. CO.

Department M, P.O. Box 792, Minneapolis 40, Minn.



AXLES AND PEDALS:

3/8" rear axle for 31" tread and 2 1/2" hubs, with castellated nuts.....\$2.95

Cast aluminum anti-slip foot pedals... (as illustrated) \$6.95 pr.

AUTOMOTIVE FRONT END: 1/2" steering column, 22" long • 10" cast aluminum steering wheel • Heavy-weight spindle brackets with 3/8" diameter spindles, castellated nuts • Front end 1 1/4" square tubing—31-inch tread • Tie rods. **COMPLETE PACKAGE.....\$24.95**
Less steering wheel.....\$19.95

JOINT AND SHARPEN ALL SAWS



SUPER FILER NO. 9

SO EASY to joint and file saws like new. Two hardened steel rollers keep teeth same height. All teeth cut, saw runs true and smooth. \$2.95 ppd.

"TRU-CIRCLE" SAW SET
Automatically sets teeth at 10° or more. \$2.95 ppd.

send for **FREE CATALOG**

A. D. McBURNEY, 5908 Hollywood Blvd., Hollywood 28, Calif., Dept. 1-105



SUPER FILER NO. 11

For both hand and circular saws. Steel rollers give all teeth correct height, pitch and bevel. \$9.95 ppd.

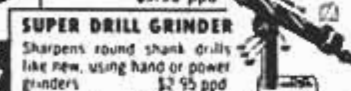

SUPER DRILL GRINDER
Sharpens round shank drills like new, using hand or power grinders. \$2.95 ppd.

WELD BRAZE 4WAY
SOLDER CUT ONLY \$14.75
f.o.b. factory

Acclaimed by thousands of Homeowners, Mechanics and Hobbyists as the welder of 1001 uses. Easily operated from properly wired 110 volt AC or DC line. The ideal gift with a life-long use....Order today on 10 day money back guarantee.

FOUR-WAY WELDER CO., Dept. F2-K
1810 S. Federal St. • Chicago 16, Ill.



WELDER
Complete with Twin Carbon Arc Torch and accessories... to handle all metal-craft work.

why **deft** WOOD FINISH

in a spray can?



The Deft 16 oz. Aerosol Spray Can belongs in every home and workshop. It is especially convenient for touch-ups and fast finishing where brushing is difficult, such as carved details, shutters and small projects. If stain is desired, surface may be stained, wiped and immediately finished using Deft spray can. A light mist spray protects brass, other hardware and tools against tarnish and corrosion.

Deft, the complete interior wood finish in one can, is also available in gallons, quarts, pints and half-pints... wherever paints are sold.

Write for Free Deft 6-step simplified finishing chart.

DESMOND BROS. Box 2216, Torrance, California

FUEL BILLS GET FAT when insulation goes flat!



Get it up to the proper fuel-saving level

INSULATE with ZONOLITE®

Fuel bills zoom if attic is uninsulated or if old insulation's played out... shrunk...skimpy! Zonolite vermiculite pours easily between joists; fills uniformly to plug heat leaks and cut fuel bills as much as 40%! It's fire-proof, rotproof and verminproof; never settles or loses efficiency. Guaranteed for the life of the building. Send for FREE booklet.



ZONOLITE COMPANY, Dept. PM-109
135 S. La Salle Street, Chicago 3, Illinois
Send me free booklet HI-110, "Homeowners' Guide to Insulation." No obligation.

Name _____
Address _____
City & Zone _____ State _____

AT LUMBER OR BUILDING SUPPLY DEALERS

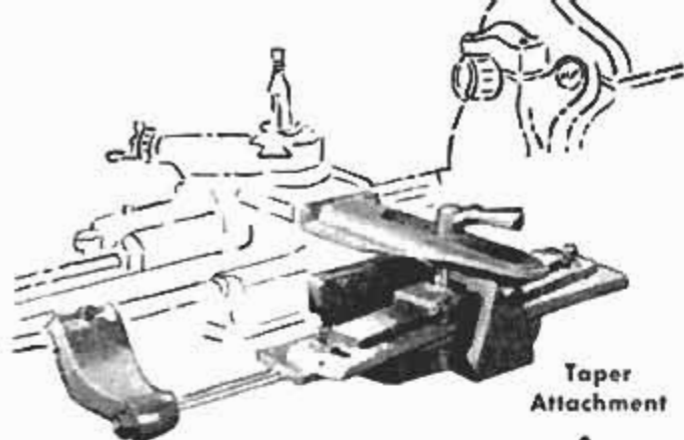

Taper Attachment

Get
More Work
out of
Your Lathe

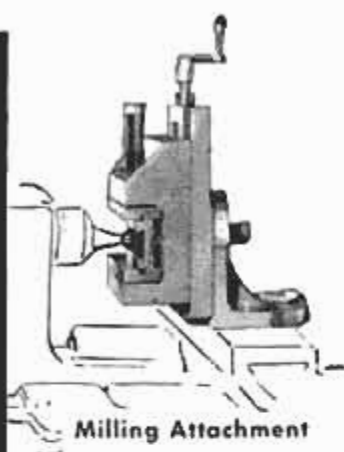

Milling Attachment



Steady Rest



External Grinder



Live Centers



Handlever Collet Attachment

Use South Bend Attachments to...

Cut Machining Time • Simplify Difficult Jobs
Speed up Tooling • Handle More Types
of Jobs • Perform Non-lathe Operations

Write for complete information
on the largest selection of lathe attachments,
tools and accessories made.

SOUTH BEND LATHE

South Bend Lathe, Inc., South Bend 22, Indiana

Builders of Lathes, Milling Machines,
Shapers, Drill Presses, Pedestal Grinders

Up to 24 months to pay



or more patents already issued, in which case your attorney may recommend that you "design around" these conflicts.

(7) *Build a working model.* You will stand a better chance of getting a patent—and successfully defending it in court later, if necessary—if you will build a working model. Too, in the case of a prospective manufacturer for your product, "seeing is believing." He will have difficulty with a "paper patent" when he tries to visualize changes he may wish to make in styling and production economies. Don't underestimate the importance of attractive appearance, since women shoppers do about 80 percent of the buying in the U. S.

Don't Forget Working Model

A working model is important, also, since it constitutes what is known legally as a "reduction to practice." The law requires that the model be capable of performing all the functions which the complete device would perform. Ayres' single type-writer-key action failed to meet this requirement, since it could type only the letter "y." He and his attorney maintained "diligence," however, by promptly applying for a patent, since this constituted the necessary legal "constructive reduction to practice."

"A great problem — often harder than making the invention itself—is getting the thing sold," says Ayres.

There are several reasons for this, he explains. One is the "NIH Factor" or "not invented here" stigma. It seems that many potential manufacturers, perhaps often unconsciously, are reluctant to invest in something they didn't think of themselves. "It is much as though you, an outsider, were to walk into their plant and say, 'Here, I'm offering you something you weren't smart enough to figure out yourselves'."

Make Your "Product" Attractive

Another big obstacle is that such concerns are understandably reluctant to gamble on expensive changes that will usually be necessary in their production, advertising, merchandising and other programs. You must offer a product so attractive they will still want it, despite such drawbacks.

The inventor has three possibilities, in the following order of financial importance: for earning a return from his patent:

(1) He can *practice his own invention*, that is, go into the business of manufacturing and selling his device. This involves the highest risk, but also the highest potential return. It calls for being a good

(Continued to page 308)

CUT PERFECT HOLES & DISCS with
ARCO HOLE-SAW
Fits Any Electric Drill!

Now Available with Regular or
**BRAND NEW EXTRA
 LONG SAWBLADES!**



**NEW HEAVY-DUTY
 DESIGN PERMITS
 CUTTING STEEL &
 ALL OTHER METALS,
 WOOD, PLASTICS,
 WALLBOARD, etc.**

"Slug-Ejector" pops out discs immediately—works 3-times faster than other makes! 7 highest quality Metal Cutting Blades easily exchanged to cut 1", 1 1/4", 1 1/2", 1 3/4", 2", 2 1/4" & 2 1/2" holes thru 3/4" stock. No. 650 **\$7.95**
 No. 652—as above but with 2 1/4" Extra Long Blades to cut thru any 2" stock. Incl. 3/8" drill bit with 1/4" shank **\$11.95**

At your dealer or order direct on our **20-DAY MONEY BACK GUARANTEE**. Send check, M.O. (ppd), COD + post.

ARCO ARROW METAL PRODUCTS CO.
 Dept. PM-10, 421 W. 203rd St., N. Y. 34, N. Y.

HOW TO PROTECT YOUR INCOME!
Earn Extra Money With A Rapid

**SHEAR SHARPENER
 AND
 KNIFE SERRATOR**



Easy to operate—professional-type sharpener does a perfect job in just 2 minutes on all types scissors and shears, including pinking shears. Knife guide puts proper edge on any blade. Knife serrating attachment puts saw tooth edge on hard or soft steel blades. Quick profits from homes, dressmakers, barbers, restaurants, hotels, butchers, etc. No experience needed. Big opportunities with this precision ball bearing machine. Has 1/2 h.p. motor. A money-making investment—write for **FREE FOLDER PM-7**

BEAVER MFG. CO P.O. BOX 434, 800 So. Isis Ave.
 Inglewood, Calif.

FREE AMAZING NEW BOOK
"HOW TO ANSWER ADS"

how to
 answer
 ads

Never before have you seen anything like this. Tells you in simple language the correct way to answer ads. Gets you quicker replies—better results, and greater satisfaction. Will save you time and money and it's **ABSOLUTELY FREE**. No obligation whatever. Every reader of advertising should have this booklet. Send a postcard for your copy **NOW**, F. W. JOHNSON, Popular Mechanics Magazine, Room 600-A, 204 East Ontario Street, Chicago 11, Ill.



**Have fun removing
 paint and varnish**

KWIK



So quick and easy! Just brush on to remove all types of paint, enamel, varnish, lacquer . . . even synthetics. Off comes paint in 5 to 15 minutes. Safe, too. Non-flammable. No acid or alkali. At better hardware, paint and marine dealers.

CHEMICAL PRODUCTS COMPANY, INC.
 Aberdeen, Maryland

**The New, Big
 12-INCH
 Groove Joint
 Plier...**



**SUCCESSOR
 TO THE PIPE
 WRENCH**

DIAMOND

*"There is nothing
 finer than
 a DIAMOND"*



The hardest
 gripping,
 handiest all-
 around tool in

the kit. Jaws open
 parallel 2 1/8 inches.

Beautifully nickel chrome

plated. Ask your hardware or auto supply dealer for this handy new tool, the **DIAMOND HL112** . . . For long time satisfactory service, be sure of the **DIAMOND** trademark used for years on Diamalloy Adjustable Wrenches. Made in the U.S.A., and only by

DIAMOND TOOL

and Horseshoe Co.

DULUTH, MINNESOTA  TORONTO, ONTARIO

EST. 1908

Manufacturers of the finest forgings for fifty years.

FREE bit holder



with 6-piece Greenlee **ZIP BIT** set

Get this handy new set of wood-boring power bits with FREE metal bit holder. Keeps bits protected and in order . . . gives instant size selection. Holds up to 11 bits. Comes to you free with set of six GREENLEE ZIP BITS sizes $\frac{3}{8}$ ", $\frac{1}{2}$ ", $\frac{5}{8}$ ", $\frac{3}{4}$ ", $\frac{7}{8}$ ", 1".

Set with free holder, only **\$3.90**

ZIP BIT has nonslip **HEX SHANK** BORES IN ANY WOOD, AT ANY ANGLE, ANY SPEED

- Hex shank gives positive, nonslip drive . . . added strength
- Hex shank chucks quickly, accurately in any $\frac{1}{4}$ " or larger electric drill
- Cutting edges easily re-sharpened
- Heat-treated for long life

See your hardware or building supply dealer now for ZIP BITS with free bit holder.



GREENLEE TOOL CO.

1843 Columbia Ave., Rockford, Illinois

businessman as well as a good inventor. Many people are not both.

(2) He can license his invention on a royalty basis to some other person or concern who will undertake the business risks of production, promotion, inventory maintenance and all the rest that is involved in placing a new product on the market. If the product is successful the inventor gets the agreed-upon royalty for as long as it is kept on the market. Should it fail, however, his licensee quickly stops payment of the royalties. ("In which case, if your contract is properly drawn, you resume ownership and are free to offer it elsewhere.") This method couples less income for the inventor with less risk.

If You Wish, Sell It Outright

(3) He can sell his patent outright. This offers the least risk — but also the least profit. The purchaser now takes all the risk, giving the inventor an agreed-upon cash payment.

Most U. S. patents are exploited in the second category above. Royalties range from $\frac{1}{2}$ percent to 20 and more, although 5 percent of the net return is the most common. This is not as little as may seem at first glance, since today a corporation is considered to do well to earn a net return of 10 percent.

Is inventing worth the effort, despite such obstacles? "Certainly," says the genial Ayres who today owns his own yacht, is his own boss. "I feel certain there is, and always will be, opportunity for individuals despite the current team-research methods of many of today's big businesses. It's true that the wire paper clip, crimped bottle cap and other simple yet tremendously successful innovations may have already been invented, but many others are waiting. Consider the recent hula-hoop craze. I understand the originator made a million dollars from that thing, and it was utterly unpatentable!"

"What Does Everyone Need?"

Wally Ayres reiterates that the prospective inventor must ask himself "What is it that the people need?" In this connection he recently discovered that the sale of binoculars dropped off sharply for power greater than eight. It is physically impossible for the average person to hold a stronger glass in his hands without having the image "jiggle." Binoculars on the market today are the same as those invented 75 years ago. You guessed it . . . Ayres got busy and designed a gyroscopic stabilization system that permits use of higher

(Continued to page 310)

CHEVROLET
PONTIAC
OLDSMOBILE
BUICK
CADILLAC
GMC TRUCKS

*all
a*

START WITH DELCO DC-12

DRY

CHARGE

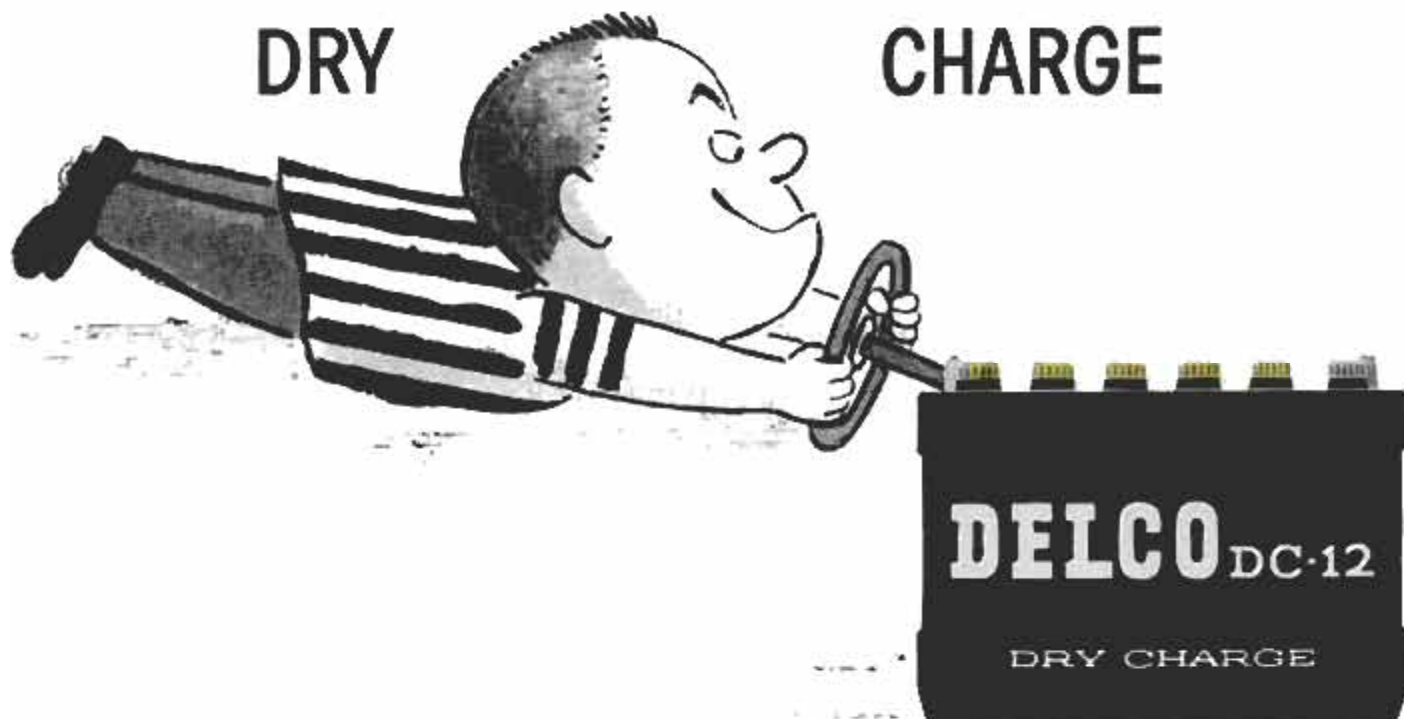

In a mere ten years the electrical requirements of automobiles have tripled! And the only batteries that can meet this increased demand for power are those which are specifically designed for the job. The Delco DC-12 is!

It's a hard-working dry charge battery built to handle the extra demands of high compression engines and power equipment. Moreover, it's the only battery designed and manufactured by an automobile producer. These are important reasons why, when you replace, you should ask for a Delco DC-12—the 100% fresh battery that is factory installed on almost half of the new cars built.



GENERAL MOTORS STARTS WITH DELCO BATTERIES

Brand-New Show — Brand-New Star — "The Art Carney Show" — NBC-TV

OCTOBER 1959

NEW!

P & C **CLIK-STOP**

THE ADJUSTABLE WRENCH THAT **NEVER SLIPS!**

ACTUAL
SIZE
8" WRENCH

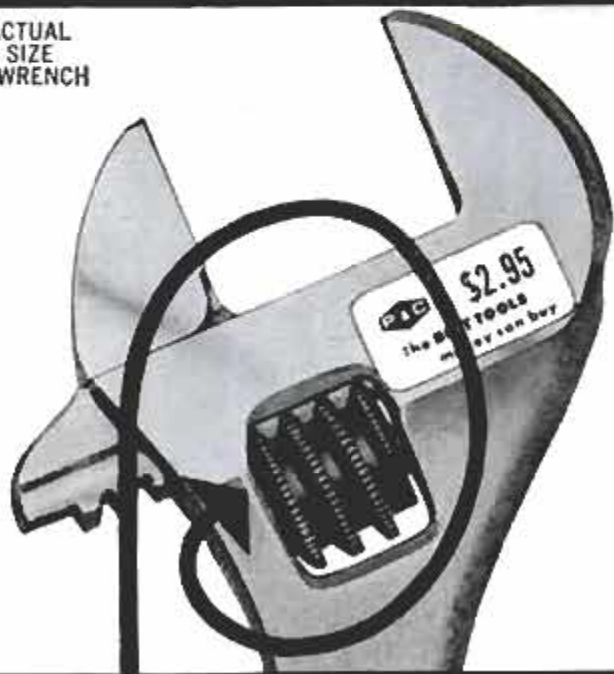

Locking Feature is Automatic Ends Knuckle Skinning While Working

This is not just another adjustable wrench. The jaws on a P & C Clik-Stop can't work loose or creep open . . . ever. Gear teeth on bottom of knurl lock against immovable meshpoints when the wrench is in use. Yet the knurl adjusts easily to any setting.

Each Clik-Stop wrench is chrome plated, made of alloy steel, scientifically heat treated and guaranteed.

The Clik-Stop adjusts to any size opening and is available in 4" through 20" sizes at more than 14,000 stores.

You'll find the Clik-Stop adjustable wrench in hardware stores displaying the colorful blue and white P & C Merchandiser.



P & C **TOOL COMPANY**

Portland 22, Oregon

Subsidiary of Pendleton Tool Industries, Inc.
In Canada, Box 366, London, Ontario

powers. He has applied for a patent to protect his work on this project.

Again looking close to home, Wally analyzed the spinet-model electric organ which he enjoys playing in the main cabin of his boat. (No one has yet figured out how he got this big instrument inside without first disassembling it, since the cabin doors and windows are too small.) The inventor had taught himself to play this tone-wheel-type organ but felt he could do better if he were able to control separately the volumes of the upper and lower keyboards.

He asked the selling dealer to make this change for him. He was told it would be impossible. He then asked if he could borrow a circuit diagram of the organ. It was given to him.

Ayres Makes Some Changes

Ayres then proceeded to make the changes he wanted. He went a step farther, too. Displeased with even the concert model's 81 preset combinations ("Only about 60 per cent of which could be used in various combinations, since some of the tones were too low with others too loud"), he effected a second circuit improvement on his spinet organ which now permits him to use a full hundred such possible cross-combinations—all with ample volumes, easily controlled. The organ people asked how he did this. Ayres won't tell them.

"That's why I constantly advise young inventors to take nothing for granted," he observes in conclusion. "Work it out for yourself."

He cites as another example the time an employer assigned him the job of developing a circular movie theater film-projection system that would permit those in the audience to view moving pictures going on about them simultaneously in all directions just as they might observe real life objects outside.

It had been suggested that a cluster of 10 movie cameras be used to make the original life-as-is pictures, each pointing outward from the center and spaced 36 degrees apart. Wally was told to develop a device that would keep the films synchronized so they could be properly shown by 10 correspondingly mounted projectors inside the circular theater.

Synchronization Impossible

Ayres, however, pointed out this would be impossible since operation was intended 14 hours daily, for months on end, and the films were bound to break. This would hopelessly upset the synchronization.

One day, after giving the problem considerable thought, he walked into his boss's

(Continued to page 312)

See what you can do...easily, quickly ...with a SWINGLINE STAPLE GUN!

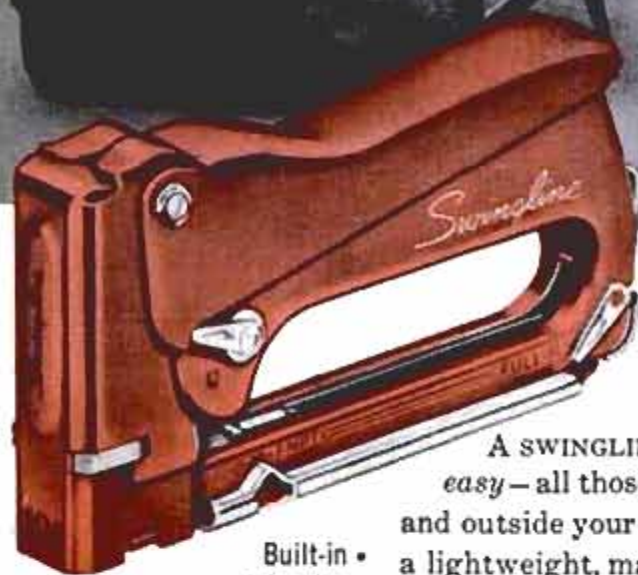
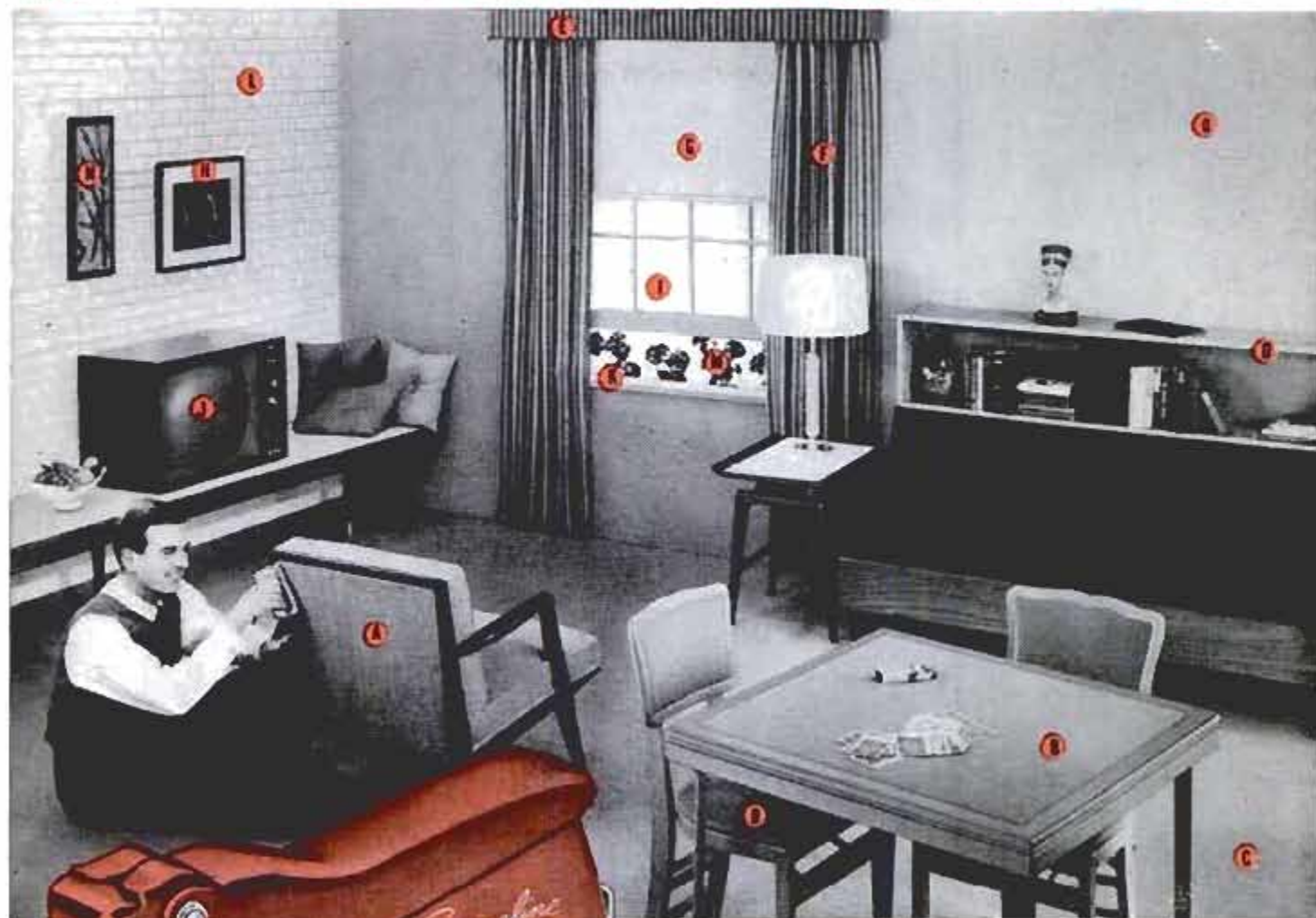

ONLY \$ **4.95** with
PUSH-BUTTON
LOADING

- Built-in extractor
- Handle lock
- Push-button loading
- Rugged, heavy-duty steel construction
- Load indicator
- Open channel takes 2 staple sizes: 1/4" and 5/16"

A SWINGLINE staple gun makes *immediately possible*—and *easy*—all those time consuming, hard-to-do chores both inside and outside your home. This is a lightweight, maneuverable, *precision* tool that's so easy to operate even a housewife can use it. Drives those staple-nails flush and holds 'em tight! The price? A hard-to-believe \$4.95—that's all! Your choice of Gray, Red or Green. Insist on a SWINGLINE staple gun—with push-button loading—at better hardware, department, stationery stores!

CHECK THIS LIST

- A—upholstering furniture
- B—recovering card table and chairs
- C—installing carpeting
- D—shelf trimming
- E—valances
- F—hanging drapes
- G—window shades
- H—matting pictures
- I—window screens
- J—attaching TV antenna
- K—weather stripping
- L—installing plastic wall brick
- M—making window boxes
- N—wall decorations
- O—insulating
- And hundreds of other uses.

FREE! Send for Booklet "Tips for Tacking" How to do many stapling jobs.



Swingline INC. Long Island City 1, New York
World's Largest Manufacturer of Staplers For Home and Office!

Shake hands with a JET ROCKET

\$4²⁵

You can feel the dynamic power and balance in this famous tool. You'll enjoy the aliveness of the JET ROCKET as it centers the power of your swing and smoothly absorbs impact shocks.

Head is permanently locked to tubular-steel handle. Comfortable cushion grip won't slip, even when wet. Shake hands with a JET ROCKET at your favorite hardware store today. True Temper, 1623 Euclid Avenue, Cleveland 15, Ohio.

Also see the ROCKET® at \$5.25, with polished octagon head—it's the carpenters' favorite. ROCKET and JET ROCKET are excellent nail pullers.

TRUE TEMPER

THE RIGHT TOOL FOR THE RIGHT JOB

office with a soup ladle in hand. He invited his superior to hold the big spoon inverted over his head and observe how reflections from the four office walls could be viewed simultaneously as reflections on the outside of the soup ladle's curved surface. "My suggestion is that we both photograph and project a moving picture against a similar curved reflector, thereby beaming the scene in all directions at once," he said.

His boss was agreeable but two of the country's foremost optical experts promptly told Wally this couldn't be done. When horizontal objects were in focus the vertical plane objects would be out of focus, and vice versa, they warned. Nevertheless, starting once more with a crude working model (this one he built around the mirrored globe of a secondhand lawn ornament which he bought for \$3), Ayres finally built a cycloramic optical system and projecting device (U. S. Pat. Nos. 2,244,235 and 2,304,434) which preceded the popular Cinerama-type "wide screen" moving pictures we enjoy today, nearly a decade later.

"Both those 'experts' knew more about optics than I'll likely ever know—but they were both wrong on one little point," says the inventive genius in retrospect. "They were both convinced that a camera lens couldn't be stopped down sufficiently to insure sharp focus in both the horizontal and vertical planes, and still pass sufficient light to properly expose the film at the speed necessary for movies.

"Obviously, they both had accepted this belief as truth, without ever taking a camera in hand to make sure. And that one little point made them wrong." ★ ★ ★

Construction has begun on a generating plant near Healdsburg, Calif., which will tap live steam trapped underground to produce 12,500 kilowatts of electric power.

Do You Know This Old-Timer?

(answer to quiz, page 12)



1910 Overland

CASITE'S 3-ZONE engine protection

Guaranteed Protection for your car's power and performance

The technical staffs of Casite and its parent organization, Hastings Manufacturing Company, specialize in just one thing—the maintenance of automotive engines. Working together, these experienced scientists and engineers have utilized the latest chemical discoveries to improve car performance, combat engine deterioration and wear.

Use these new Casite products with confidence. Results are guaranteed, or double-your-money back!

1
for the
FIRING
ZONE

2
for the
FRICION
ZONE

3
for
AUTOMATIC
TRANS-
MISSIONS



IMPROVED CASITE . . . FOR THE FIRING ZONE

The nation's favorite "Tune-up in a can" now vastly improved with spark plug and carburetor cleaner and acid inhibitor. Recommended for use in the gas tank or carburetor air intake to free valves and rings and clean carburetor and spark plugs. Also for use in crankcase oil for quicker starting, less start-up wear and to break-in new or rebuilt engines. List price \$1.25.

CASITE 3-C . . . FOR THE FRICTION ZONE

A new heavy duty crankcase concentrate that protects your car's engine. Added to your motor oil, it gives you a tougher oil that won't thin out—oil that cushions the load on every working part—cuts friction and wear. Casite 3-C, with Barimen, stops hydraulic lifter noises, quiets and smooths the engine. It cleans the engine, and keeps it clean. Protects against acid, rust and corrosion, too. List price \$1.50.

CASITE "SMOOTH-SEAL" . . .

For smooth, quiet, leak-proof performance, Smooth-Seal reduces jerks and roughness in automatic transmissions. Stops and prevents leaks due to hardening or shrinking of the transmission seals. Reduces shock and wear, enables delicate parts to last longer. List price \$1.95.

use all **3** to keep your engine and automatic transmission clean . . . friction free . . . at peak operating efficiency.

HASTINGS MANUFACTURING COMPANY • HASTINGS, MICHIGAN
Casite Additives, Piston Rings, Oil Filters, Spark Plugs



Don't Break Glass



When driving glaziers' points (or even brads) into window, picture or mirror frames, the tool to use is a Red Devil Glaziers' Hammer which s-l-i-d-e-s across the glass. Costs \$3.75 but may save you a trip back to the glass dealer.



You don't have to buy machinery to keep your floors beautiful. Thousands of dealers are ready to rent you a Red Devil Floor Polisher for around a dollar a day—and to sell you one if you like it, for as little as \$54.95.



We're still in business even though this 1-dollar Red Devil Utility Knife does the jobs of many of our other tools—and almost as well. Blade locks in 6 different positions to cut, scrape, clip, score, carve most anything with ease.



Don't make a mess trying to scrape moldings and odd shapes with an ordinary scraper. Red Devil's No. 310 has 4 different shapes and sizes of blades—for the best \$3.55 you ever spent.

It's always best to buy where Red Devil Tools are sold, for wider choice, top quality, correct "how-to" advice. 4574

Free booklet, "How To Maintain Wood Floors." Address Dept. B-10

Red Devil Tools.

Union, N. J., U. S. A.

World's largest manufacturer of painters' and glaziers' tools.



KIT BOATS Boat Plans Patterns Frame Kits



SAVE 2/3

FREE FREIGHT CREDIT TERMS

KIT CATALOGS—Over 50 Models—Pre-assembled, Runabouts, Cruisers, Fishing (8' to 19'). Anyone can assemble. Complete Marine Accessories, Fiberglass plastics, trailers, paint, etc. Also CATALOG on 50 Modern Plans and Patterns. Prefab Frame Kits—All types best for the amateur builder.

Tonawanda 11, N.Y.

SEND US FOR 2 COLORED CATALOGS—NOW

Craig Craft Name _____ City _____
Address _____ State _____

Valiant—the Stylish One

(Continued from page 116)

new small cars, offers power steering and power brakes.

The engine is a brand-new overhead-valve six of 171.0 cubic inches. Bore is 3.40 inches, stroke is 3.125 inches. Compression is 8.5 to 1.

Horsepower is not available at this time, but it is expected to be about 100. Gasoline economy is estimated at about 25 miles per gallon, although PM's tests will come in a later issue.

Unusual is the fact that the engine lays over on its right side 30 degrees to permit a lower hood line and give a lower center of gravity. The lower hood line means less frontal area, which means less wind resistance, more economy, better high-speed performance.

Because of the laid-over design, intake manifolding has been stretched out. Fuel distribution is improved by a long-branch manifold design (called a "bunch of bananas" by Valiant engineers), which permits intake-manifold tuning.

The carburetor is located on the high side of the engine. Plugs, fuel pump, distributor and oil filter are on the lower left side along the fender well and remain surprisingly easy to get at from above.

The transmission is tilted in the opposite direction to increase interior room and permit a lower hump in the front floor. The power train is familiarly called the "corkscrew" by engineers because of its design.

Outstanding among the Valiant innovations is the generator, which is an AC alternator. This is a new generating system and is expected to spread to all Chrysler cars in a year. It is smaller, lighter and simpler. It requires less maintenance. But best of all, it provides excellent charging while the engine is idling, unlike the DC generator which usually does not produce any current at idle.

No current regulator is needed because the alternator is self-regulating. The design does not require a cutout, because the silicon-diode rectifiers prohibit a reverse current flow. The only external component is a simple voltage regulator.

Optional in the Valiant is a three-speed automatic transmission with pushbuttons. It is the only three-speed automatic offered in the new small cars. With it, the car should have excellent stoplight getaway even though it is undoubtedly the heaviest of the three (no weight is available at this writing but the guess is that it weighs about 2500 pounds).

The handshift transmission has a floor-
(Continued to page 320)

What
glue
for



Speedy squeeze bottle. No muss, no fuss. Dries fast, clear and strong! Building or fixing, best all-purpose glue you can buy.

Send stamped, self-addressed envelope for Free copy of "Elmer's Guide to Good Gluing". Write Elmer, The Borden Company, Dept. 106, 350 Madison Avenue, New York 17, N. Y.
BORDEN'S PRODUCTS FOR THE HOME HANDYMAN

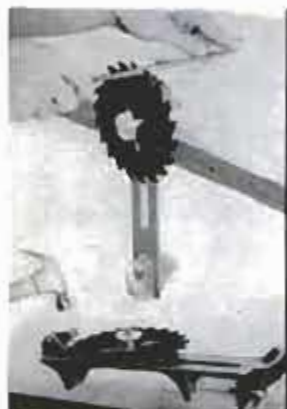

Now! You can keep your circular-saw blades in "new" condition by using the "Sharp-Set." This tool was designed to set teeth precisely and keep the blade under proper tension regardless of size for filing. Available direct from factory. \$19.95

Prepayment saves C.O.D. and postage charges. California residents add 4% sales tax.

Calgo Manufacturing
89 N. Santa Anita Av.—Pasadena, Cal.

BRONZE FOUNDRY



Schools • Home Workshops • Inventors
Make your own castings of aluminum, copper, bronze, silver. Foundry sets are available in three sizes including 2400 Deg. F. blast Furnaces. \$26.50; \$33.50; and \$46.00 f.o.b. Marysville. Write for Free Circular.

KANSAS CITY SPECIALTIES CO. DEPT. P-10, P. O. BOX 6022, MARYSVILLE, KANSAS



Onan Emergency Electric Plants



PORTABLE MODELS
500 to 10,000 watts. Supply plug-in power anywhere!

Start automatically when high-line power is cut off, supply current for lights, heating system, freezer, water pump, stove, all appliances and machines. Prevents losses and hardships. Plant stops automatically when power is restored. Compact, easy to install. 500 to 200,000 watts A.C. Priced from \$319.00.

Write for Free Folder

D. W. ONAN & SONS INC.
3315 UNIVERSITY AVE. S.E. • MINNEAPOLIS 14, MINN.

New

RIGID

No. E-110 Offset Hex Wrench

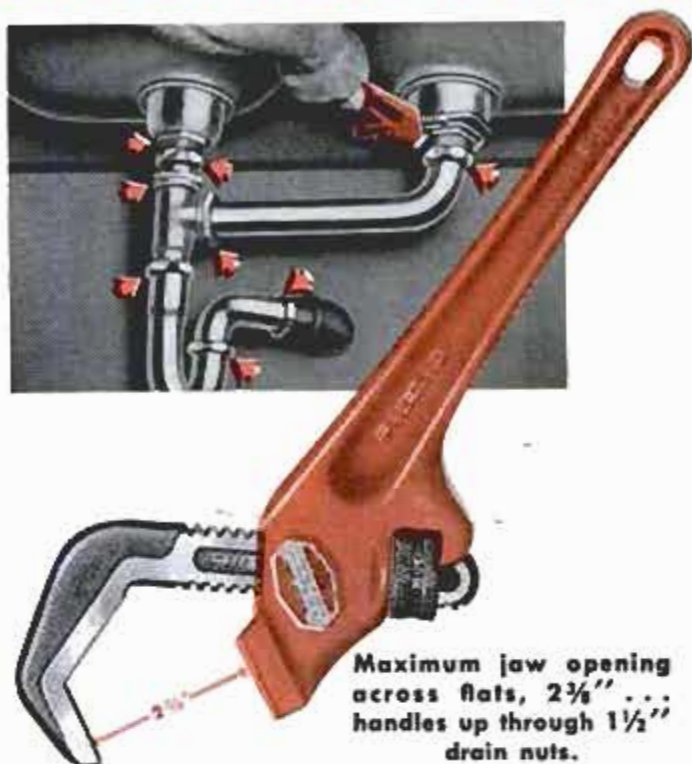

Maximum jaw opening across flats, 2 3/4" . . . handles up through 1 1/2" drain nuts.

Extra-wide Jaw Opening . . . Short Handle make work easy on sink and tub drain nuts!

Here's a real time saver. This latest addition to the RIGID Hex Wrench line is especially designed with an extra-large opening offset jaw that gives easy-on, non-slip grip on sink and tub drain nuts . . . all other hard-to-get-at nuts and fittings. Thin, smooth jaws slip into tightest places . . . won't mar highest chrome finish. Short handle makes work easy in close quarters. Multi-sided grip allows extra leverage . . . no more rounded nut shoulders or bruised knuckles.

Famous heavy-duty RIGID construction. Alloy malleable housing guaranteed against warping or breaking. Comfort-grip handle has handy hang-up hole.

Save time on sink and tub repairs. Buy a RIGID No. E-110 Hex Wrench at your Dealer's!

RIGID

The Ridge Tool Company • Elyria, Ohio, U.S.A.

here for the
first time
anywhere—
elegance with economy



Impala Sport Coupe—one of 16 fresh-minted '60 Chevrolets you can choose from.

SUPERLATIVE '60 CHEVROLET

Here's new gem-bright beauty, new room to sprawl in and sit tall in. New lean-muscled engine economy, new spirit and silence in its going. For fineness of features, for precise craftsmanship—for all the things that make a car good to own—the '60 Chevrolet stands alone in its price field.

Just wait till you see it. Everything about the '60 Chevy, every styling accent, every engineering detail, has been polished and refined to a degree of perfection never before thought possible of a car in Chevrolet's price class.

Picture practicality and economy combined with the luxury and hushed comfort usually associated with high-priced cars. That's Chevy! You have to see it up close to appreciate its fine

workmanship. You have to take a turn behind the wheel to know its astonishing smoothness and almost total absence of road hum and vibration. We'll admit our enthusiasm's showing just a bit—but once you've dropped into your dealer's we're sure yours will be, too. *There's nothing like a new car—and there's never been a new car like this '60 Chevrolet!* . . . Chevrolet Division of General Motors, Detroit 2, Michigan.

NEAREST TO PERFECTION A LOW-PRICED CAR EVER CAME!

NOW!
THE REVOLUTIONARY
Corvair
BY CHEVROLET
WITH THE ENGINE IN THE
REAR WHERE IT BELONGS
IN A COMPACT CAR! ★ ★ ★



*You have your choice of two Corvairs—
this one's the de luxe Corvair 700.*

The only American car with an airplane-type horizontal engine!
The only American car with independent suspension at all 4 wheels!
The only American car with an air-cooled aluminum engine!

The rumors about this one were right—but they didn't go far enough. Because here, for the first time, is a truly compact, economical American car that retains the ride and 6-passenger comfort you're used to in a big one. The key to this small miracle: America's first and only *rear-mounted aluminum engine*—a revolutionary 6-cylinder power plant that combines compactly with the transmission and drive gears in one lightweight package. You'll get up to 30% more miles to a gallon and—because this engine is *air cooled*—you'll never have to fuss with antifreeze.

Corvair's size—almost 5 inches lower, 2½ feet shorter, 1,300 pounds lighter than conventional sedans—makes it a joy to jockey through traffic and park in tight spots. Yet its unique Unistrut Body by Fisher offers plenty of room for 6 broad-shouldered passengers. And, thanks to Corvair's rear engine, the floor is practically flat, front and rear, so there's generous foot room. Shifting engine weight to the rear also adds extra ground-gripping traction and gives better compact car

handling and braking. And with *independent suspension at all 4 wheels*, Corvair rivals much more costly cars in the poised, unruffled way it rides.

A price your budget will appreciate. Wonderfully practical as all these advances sound, you'll find the most practical thing about this new Corvair is its price. Make it a point to visit your Chevrolet dealer soon—and see what a wealth of engineering a modest amount of your money buys! . . . *Chevrolet Division of General Motors, Detroit 2, Michigan.*

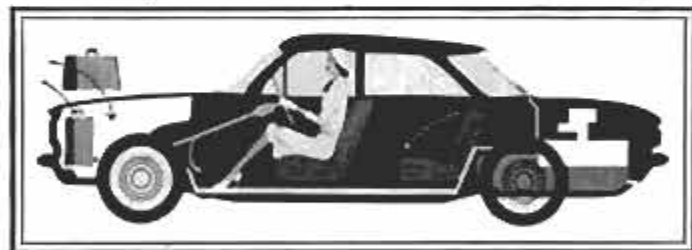

THE FLOOR IS PRACTICALLY FLAT—Trunk's up front. Lightweight rear engine is world's first production 6 with ultra-smooth power of horizontally opposed pistons. Pure and simple as modern architecture. **THERE'S NOTHING LIKE A NEW CAR—AND NO COMPACT CAR LIKE THE CORVAIR . . . by CHEVROLET!**

CUT-TO-FIT HOMES CUT BUILDING COSTS

CHOICE OF 57 DESIGNS

ORDER NOW

SAVE UP TO 1/3



Build your own home and save the builders' profit—plus savings in lumber and labor with Sterling Ready-Cut-Homes. Anyone can assemble with simple, easy to follow plans furnished. Every house complete with all lumber, roofing, nails, glass, hardware, paint, doors and windows marked ready to erect. Freight paid. Complete building plans ready for filing at low cost. Sold separately if desired. Write today!

PRICED FROM \$2150 up

Five Easy Payment Plans

Send 25c for NEW COLOR CATALOG

INTERNATIONAL MILL AND TIMBER CO.
DEPT. PM109 BAY CITY, MICHIGAN



700 Watt Light Plant

PUSH BUTTON START

115 v. 60 cyc. AC Powered by a rugged 2.2 HP. easy starting Briggs engine. No wiring necessary! Just plug in and operate. Plenty of current for any oil burner, freezer, brooder, emergency lights, etc. which require up to 700 watts. Ideal for television and radios. Complete with voltmeter and built-in winding to charge 6 V. auto batteries. (Item 24) Wt. 75 lbs. Easily fits in car trunk. Be prepared!

\$143.50

If storm knocks out power lines. Reg. \$275.
1200 Watt Plant (Item 45) same as Item 24 but lacks generator and engine with 30% greater output. \$199.50

HEAVY DUTY D-C ARC WELDER

Use as portable or shop welder. Up to 100 amp. Sinter Made for years of trouble-free, continuous service. Will handle light or heavy jobs. Easily welds up to 3/4" plate using 1/4" rods. Built-in air cooling system. Arc is easy to strike and hold, because of specially designed arc stabilizer. Hi-lo switch and dial control gives wide range of welding heats. Run welder at 2600 rpm with tractor, jeep or 1 1/2 hp. gas engine, or 7 hp. and triple V belt or flat pulley. You can pay more, but you can't buy a better welder. Wt 110 lbs.

\$119.50

WELDING KIT Two 10 ft. leads, welding helmet, electrode holder, ground clamp. Sold only with welder at \$10.50

(Item 10) Easily installed in furnace pipes. Forces even heat to all rooms. Over range removes kitchen smoke and odors. Powerful, continuous duty motor. 110-120v. AC. Mount in wall or ceiling to ventilate any area. Quiet, super-efficient fan moves huge volume of air. (400 to 600 CFM.)

HEATING & VENTILATING FAN



8" Pipe, wt. 5 lb. \$7.85
9" Pipe, wt. 6 lb. \$8.85
10" Pipe, wt. 7 lb. \$8.85
12" Pipe, wt. 8 lb. \$9.85

HEAVY DUTY FAN. Semi-enclosed motor, suitable for spray booths, restaurant exhausts, poultry houses, etc. 10" Fan, wt. 8 lbs. (Item 10E) \$11.95
12" Fan, wt. 10 lbs. (Item 10D) \$12.95

HIGH SPEED BARN FAN similar to above, but larger, high speed motor moves huge volume of air.
12" Fan (item 10F) \$14.95
14" Fan (item 10G) \$17.95

Heats instantly anything from a cup of water to a washtub full. Heats much faster than any stove. Terrific for coffee, tea, soup, etc.—great too for laundry, dishes and baths. Made of unbreakable shock proof "Nyalite." Simple and cheap to operate—just plug it in. 1200 watts, 115 v. A.C. Money back guarantee, Item 856. Shipped prepaid \$3.95 only



FAUCET WATER HEATER

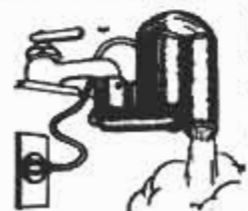

Instant hot water for just pennies—You just slip MASTER MECHANIC'S new Faucet Water Heater over any faucet—plug it in a wall outlet and you've got steaming hot water instantly for dishes, shaving, washing baby's bottle, etc. Simple and safe—operates on ordinary 110 v. house current—costs only 2 1/2 cents per hour for hot water. Ideal for homes, shops, cabins, trailers, etc. Easily regulated from lukewarm to full hot. Fully guaranteed. (Item 408) Wt. 2 lbs. \$4.95
Factory price

Send 10c for 100 page Catalog—FREE with order. Prices f.o.b. factory—Send check or M.O.

MASTER MECHANIC MFG. CO., Dept. A109 Burlington, Wis.

1001 FIX-IT USES



INDIANA LABORATORIES Elkhart, Indiana

This Month's "Great Pioneer in Science"

(Page 16)



James Watt (1736-1819)

Everything for the Craftsman!



WRITE FOR NEW 132 PAGE

WOOD AND HOME WORKSHOP CATALOG

**Finest Domestic and Imported Woods
... Mouldings, Hardware, Tools ...
ALL AT LOW MONEY - SAVING PRICES!**

Your complete wood buying guide and project book. Craftsman is your best, most complete source of finest kiln-dried domestic and rare imported woods, beautiful wood inlays, colorful bandings, matched plywoods, embossed mouldings, carved ornaments, newest woodworking tools, "hard to find" cabinet hardware and fittings... more than 1500 items! Packed with newest scroll saw patterns, project ideas and money making plans. Enclose 25c (refunded with first order) to help pay mailing, handling cost. Write:

NEW!!

- Mosaic Tile Kits
- Period Clock Kits
- New Line of Metal Legs
- Over 1,500 Items!

**CRAFTSMAN WOOD SERVICE COMPANY, Dept. A-10
2729 SOUTH MARY STREET - CHICAGO 8, ILLINOIS**

DO MORE PLANING JOBS WITH LOW COST BELSAW



Exclusive MONEY-MAKING Features: Full 12 1/4" x 6" capacity • Power feeds at 14" to 34" a minute • Provides for Grinding Knives in the Cutter-head • Attachments for Jointing, Rabbeting, Tongue, Matching, Groove. Convert low cost rough lumber into high priced stock. Easy to make flooring and popular patterns. Send Today for FREE Literature and Prices.

**LOW DOWN
PAYMENT
EASY TERMS**

Belsaw Machinery Co., 2050 Field Bldg., K.C. 11, Mo.

DRAINS cellars, cisterns, wash tubs; \$7.95 IRRIGATES - CIRCULATES - SPRAYS



1,001 uses. Stainless shaft. Won't rust or clog! Use 1/8 HP motor or larger... 3/4 HP for up to 3000 GPH; 450 GPH 80" high; or 1800 GPH from 25' well. 1" inlet; 3/4" outlet. Coupling included free. \$7.95.

CELLAR DRAINER KITS (less motor)
"Low Boy" 13" high, 1500 GPH \$12.95
"High Boy" 32" high, 3000 GPH \$15.95
Postpaid if cash with order. **MONEY BACK GUARANTEE**
LABAWCO PUMPS, Belle Mead 7A, N. J.

REPAIR FOR YOUR B&D TOOLS



For genuine B&D repairs check Yellow Pages under "Tools-Electric" for address of nearby Black & Decker

FACTORY SERVICE BRANCH

Free tool inspection when requested • Genuine B&D parts used • Factory-trained technicians • Standard B&D Guarantee at completion of recommended repairs • Fast service, reasonable cost, always.

Or write for address of nearest of 48 branches to: *The Black & Decker Mfg. Co., Dept. S5010, Towson 4, Md.*

Black & Decker
QUALITY ELECTRIC TOOLS

THROW OUT

Model No. 520
20" x 8 1/2" x 13"



Model MC-28
28" x 9" x 8"

Write For Name of
Nearest Dealer

These famous Kennedy tool chests in brown, ripple baked enamel. See them at your dealer's NOW.

YOUR OLD CHEST for a new KENNEDY journeyman

- 7 lined drawers, top storage, heat- and moisture-proof
- Rugged steel construction . . .



Compound
Drawer Slides



Bar
Lock

benchmate

- Machinist chest designed as a base for the JOURNEYMAN
- Large enough to hold 24" scale and 1/2" drill



Kennedy Manufacturing Company
Van Wert 2, Ohio

**STOP
THAT
DRAFT!**



Seal with DAP.

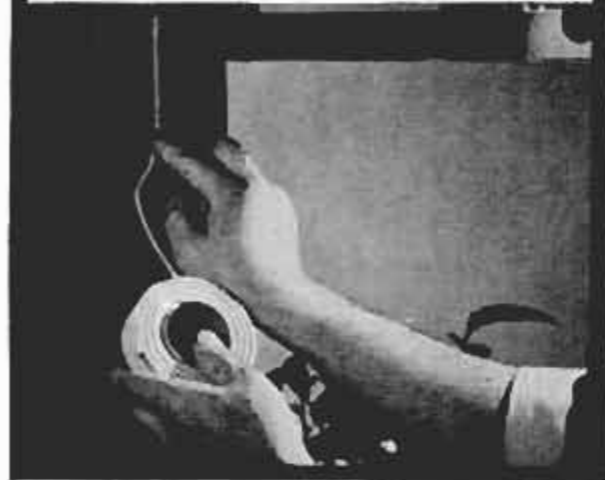

DAP Rope Caulk makes a perfect weatherstrip. Keeps out air, water, dust, insects—saves heat. Just press into place with fingers. Easy to remove. Get DAP Rope Caulk at hardware, paint and building supply dealers.

Write for free do-it-yourself folder.

DAP



DICKS-ARMSTRONG-PONTIUS, inc. • Dayton, Ohio.

TRADE SECRETS REVEALED HOW TO TURN CONCRETE INTO GOLD



You've seen them all over the country . . . concrete bird baths, garden seats, flower boxes, appealing statuary, and many other items that add charm around the house and lawn. They're made by enterprising people, just like you, from our COPYRIGHTED ALUMINUM MOLDS. It's easy. It's fun. It's profitable.

Send \$2.00 today for this 82-page "How to" book. 20 pages of clear instructions. Valuable trade secrets. Over 250 items beautifully pictured (with description, dimensions, and prices of molds). Rushed to you by first class mail.

CONCRETE MACHINERY CO., INC.
HICKORY 4, NORTH CAROLINA

Name _____

Address _____

**HOW TO
TURN
CONCRETE
INTO
GOLD**

mounted shift lever that goes through the gears like that hot knife in butter. It makes gear shifting what it should be—the most pleasant activity in driving.

Trunk room is abundant, largest of the group, due to the semifast back. The spare tire is carried flat in a floor well. The gas tank is forward of the well (under the floorpan, of course) and is kidney-shaped to fit neatly between the well and the rear-axle housing. It holds 13 gallons.

Head room and legroom are good. Being a front-engine design, there is a driveshaft hump in the floor, but it is narrow and low so the seats are comfortable all the way across. The dashboard has no horizontal shelf on top to reflect sunlight. It slopes sharply downward from the windshield, adding to the roominess of the front seat.

Instruments are mounted in two large circles beneath an overhanging shroud. All are gauges except the oil-pressure light.

Front-seat access is excellent as there is no wrap-around windshield to interfere. Seats, front and rear, are comfortably high and the rear floor has a deep stepdown with plenty of foot room.

Now for a few driving impressions based on a limited test:

The car is very responsive (the one I drove had handshift transmission plus power steering). It is as agile and nimble as many cars much smaller and lighter. Power steering is typically Chrysler with precise, light control at all times. Manual steering (which I did not try) is 23 to 1, fast by American standards.

Most pleasing of all is the sporty feel of the floor-mounted shift lever. The knob is right where your hand rests on it naturally. Running up and down the gears is a delight. These three new small cars all have floor-mounted shift levers that work beautifully and they may reverse the trend toward automatic transmissions for all cars.

Ride is excellent. The body is tight and rattlefree with no sheet-metal flutter. All three of these cars will add new standards to the American car market that will cause the big cars much concern.

Altogether, this Valiant (and it should not be called the Plymouth Valiant despite the label on the cover of this issue—it is simply the Valiant) is the small car that feels biggest, most luxurious and least like an economy car. There's no hint of austerity here. Items like door handles and window cranks are solid, heavy, rich-looking. They feel good to the touch. Dash styling is substantial. No penny-pinching is evident anywhere.

Whether it has too much muscle, too much weight, too much styling to satisfy the market remains to be seen. ★ ★ ★

SNOW REMOVAL is faster, easier, more economical



WITH **MONARCH Power Hydraulic CONTROLS** that **LIFT** and **LOWER** the snow plow...

...Automatically!



DYNA-MIGHT

MODEL HEP

You operate the snow plow right from the truck or jeep cab with Monarch Controls. Instant, automatic lifting or lowering that saves time, does the job more efficiently. See your dealer or write for illustrated folder.

HY-LO-JACK - HY-LO-JEEP

FAN-BELT DRIVEN



MONARCH

MONARCH ROAD MACHINERY COMPANY
1331 MICHIGAN ST., N.E., • GRAND RAPIDS 3, MICHIGAN



Now!
A Wood Boring Drill Set
with an extra wide range from $\frac{1}{4}$ " to $1\frac{1}{4}$ "
Yours for only \$2.75

New 10 piece set fits all $\frac{1}{4}$ " electric drills and drill presses. Bore faster, cleaner, truer holes in wood, plastics, panelboard, plaster, compositions. New plastic case gives you permanent, moisture resistant container for your bits. Hardened tool steel — rugged construction. Sold at leading hardware stores.

Set includes universal shank and wrench.

Buy the **Parker Line**

PARKER MANUFACTURING CO.
WORCESTER 1, MASS., U. S. A.

OCTOBER 1959

For home handy-men everywhere!

md handi-pegs Aluminum

Sturdy, Extruded Aluminum Track with Adjustable Pegs



Use anywhere! Keeps everything neat and handy. Simple to install. Fasten track in place. Insert pegs wherever needed. Packaged in complete sets.



md Adjustable Shelf STANDARDS & BRACKETS

Quick, easy way for you to add shelves—anywhere! Sturdy, ornamental and practical. Just select shelf height—and hook in brackets!

At Leading Hardware & Lumber Dealers

MACKLANBURG-DUNCAN CO. OKLAHOMA CITY, OKLAHOMA

EXTERIOR FIR PLYWOOD BOAT PLANS

Only **25¢** ea.

Big, fully-illustrated, step-by-step plans make it easier than ever to build your own boat. Designed by top marine architects. Every model has been thoroughly tested for ease of construction and seaworthiness.

OUTBOARDS

11' (Plan 35) Fast, roomy car-top utility model.

13' (Plan 40) Great for skiing. High freeboard for open water. Double cockpits seat 6.

CABIN CRUISERS

18' (Plan 60) Trim lines. Easy to build for size.

20' (Plan 65) Sleeps 2, has galley, head.

SAILBOATS

8' (Plan 75) Build as dinghy or sailing pram.

15' (Plan 80) Fast, seaworthy knockabout.

Plans Only 25¢ Each. Order by number. (Offer good USA only)
DOUGLAS FIR PLYWOOD ASSOCIATION, Dept. 9, Tacoma, Wn.

Use only Exterior plywood (EXT-DFPA®) for boats. Comes in several sizes, grades—including premium quality solid-core "Marine Exterior" for hull construction.



Remove old

PAINT



*Wash it off! Scrape it off!
It's easy either way with*

HEAVY-BODIED KLEAN-STRIP



One application of Heavy-Bodied Klean-Strip will easily and quickly peel off several layers of paint or any other finish. Semi-paste consistency makes it ideal for use on overhead or vertical surfaces. Non-inflammable, needs no neutralizer or afterwash.

THE KLEAN-STRIP CO., INC.
2340 S. Lauderdale, Memphis, Tenn.



WOOD FOLDING DOORS

ASH • BIRCH • OAK • PINE • PHILIPPINE
MAHOGANY • AMERICAN WALNUT

HERE'S AN IDEA—Use PELLA WOOD FOLDING DOORS with their natural beauty of wood as room dividers, closures for closets, utilities, storage areas. Save floor and wall space. Easily installed. Order unfinished and save. Distributors in U.S. and Canada.

CLIP AND MAIL TODAY!
ROLSCREEN COMPANY, Dept. KC-49, Pella, Iowa
Please send free 6-page Folder on PELLA
WOOD FOLDING DOORS.

NAME _____

ADDRESS _____

CITY & ZONE _____

STATE _____

1960 Chrysler Features

(Continued from page 118)

tensive rustproofing process has been developed for these bodies.

Each body is given three metal-cleaning baths, seven anticorrosive dips, seven spraying operations and seven external paint finishing operations. Inside and outside, the metal is coated to prevent corrosion.

Ram manifolding, available on certain high-performance engines, increases power as much as 19 percent between 20 and 50 miles per hour. Sonic impulses traveling inside 30-inch-long manifold tubes create pressure pulses that ram outside air into the cylinders giving much greater power in the middle-speed ranges.

Optional on several models is a rectangular steering wheel that provides added room between the bottom of the wheel and the seat cushion. Steering with it is something like juggling a cigar box, but you soon get used to it.

Available again after an absence of a few years is the Chrysler record player that mounts below the dashboard. This new model plays regular 45-r.p.m. records so you can use the same records you play at home. The earlier version required specially cut disks.

Swivel seats have been improved. As you swing open the door, the seat pivots out automatically so it is ready for you to plunk into. When you close the door after getting out of the car, the seat swings itself back into place as you close the door. A flexible cable actuates the seat.

Instrument panels on the Chryslers and Imperials are illuminated by a no-glare light source called electroluminescent (EL) lighting. It is produced by sending electricity through phosphor. It is a low-level light, yet is extremely visible in the dark. The numerals and letters on the dials are backlit by flat, thin EL lamps that produce a blue-green light. Moving across the dial faces are pointers that glow in contrasting colors and are EL lamps themselves.

The new lamps are virtually unbreakable and give maximum light for over 10,000 hours. They never burn out suddenly, but simply get dimmer. At 40,000 hours, they produce about half of their original light intensity.

Also new at Chrysler is the overhead-valve six-cylinder engine that is used by Valiant, Plymouth and Dodge Dart. For details on this exciting new engine design turn to the article in this issue on the Valiant. ★ ★ ★

for power tools to your liking

SAY

WEN

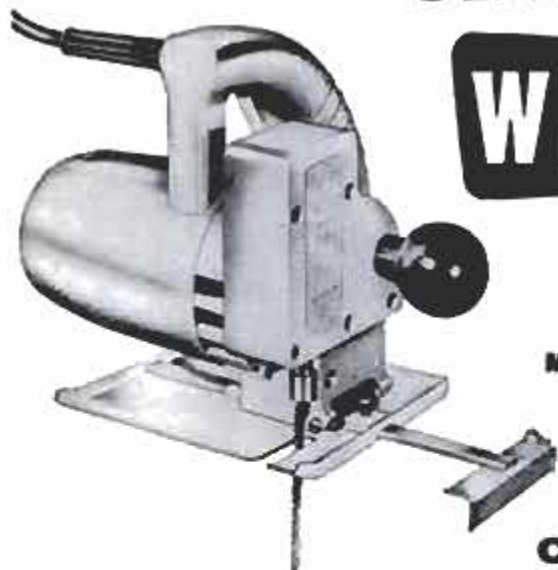

MODEL 909

ONLY

½ H.P. SOUPED-UP SABRE SAW \$44.95

Only portable electric saw that can cut 4x4's at 45°, 6" board or log, yet cut any pattern, too! Cuts up to ½" steel, 2" pipe. Complete with rip guide, circle cutter, 45° tilting base plate and 7 blades.

Say WEN for Drills, Solder Guns, Sanders
8818 NORTHWEST HIGHWAY, CHICAGO 31
EXPORTED BY: SCHEEL INTERNATIONAL, CHICAGO

FREE! BELT HOLSTER NOW WITH EVERY EVANS TAPE

Sizes from 6 ft. to 12 ft.



CLIPS ON BELT!

Holster, worth 50c, free now at your hardware dealer, when you buy an Evans "high visibility" push-pull or power pocket tape. Metal-reinforced, vinyl-covered holster provides great new on-the-job convenience—clips to the belt, you can measure "from the hip." At your dealer only.

Evans RULE CO.

Factories at:
Elizabeth, N. J. and Montreal, Que.

PLUMB PERMABOND™

Keeps Handles Tight *permanently*

*Permabond
is the red
material in
the eye of
the tool*

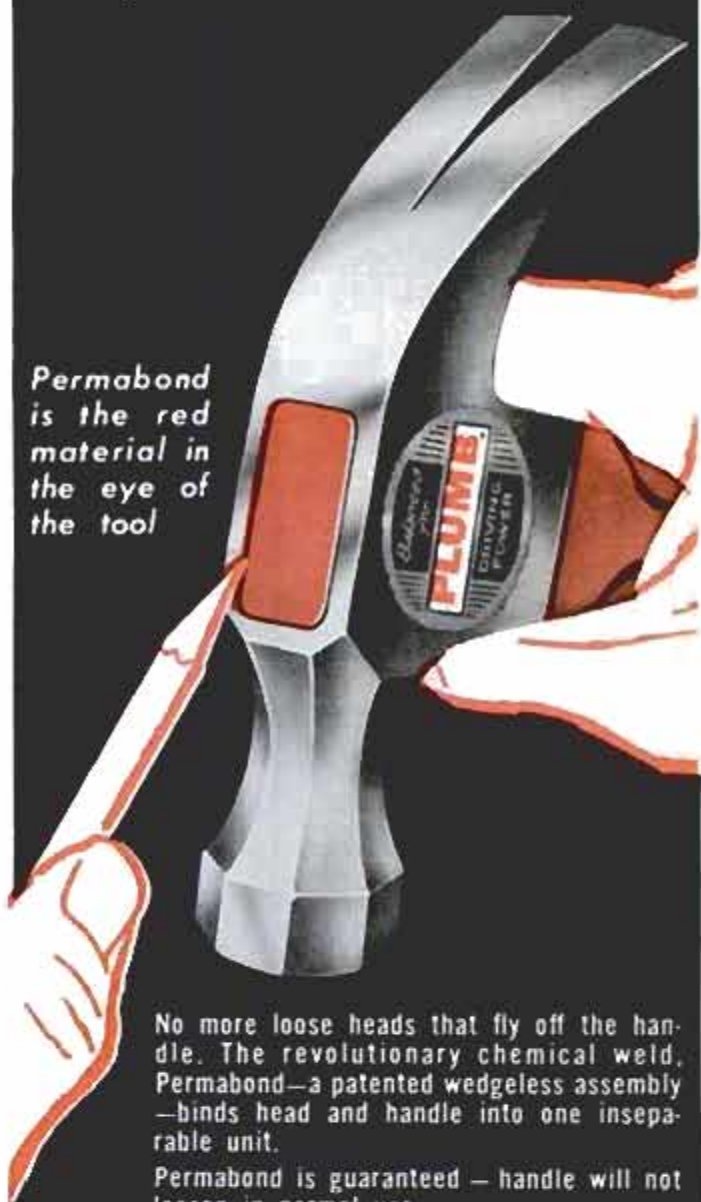

No more loose heads that fly off the handle. The revolutionary chemical weld, Permabond—a patented wedgeless assembly—binds head and handle into one inseparable unit.

Permabond is guaranteed—handle will not loosen in normal use.

Only PLUMB TOOLS Are PERMABOND ASSEMBLED

Fayette R. Plumb, Inc. • Phila. 37, Pa.
HAMMERS • HATCHETS • AXES • FILES

Big Reason Why AC Spark Plugs Must Be the Best!

AC-Pioneered Insulator

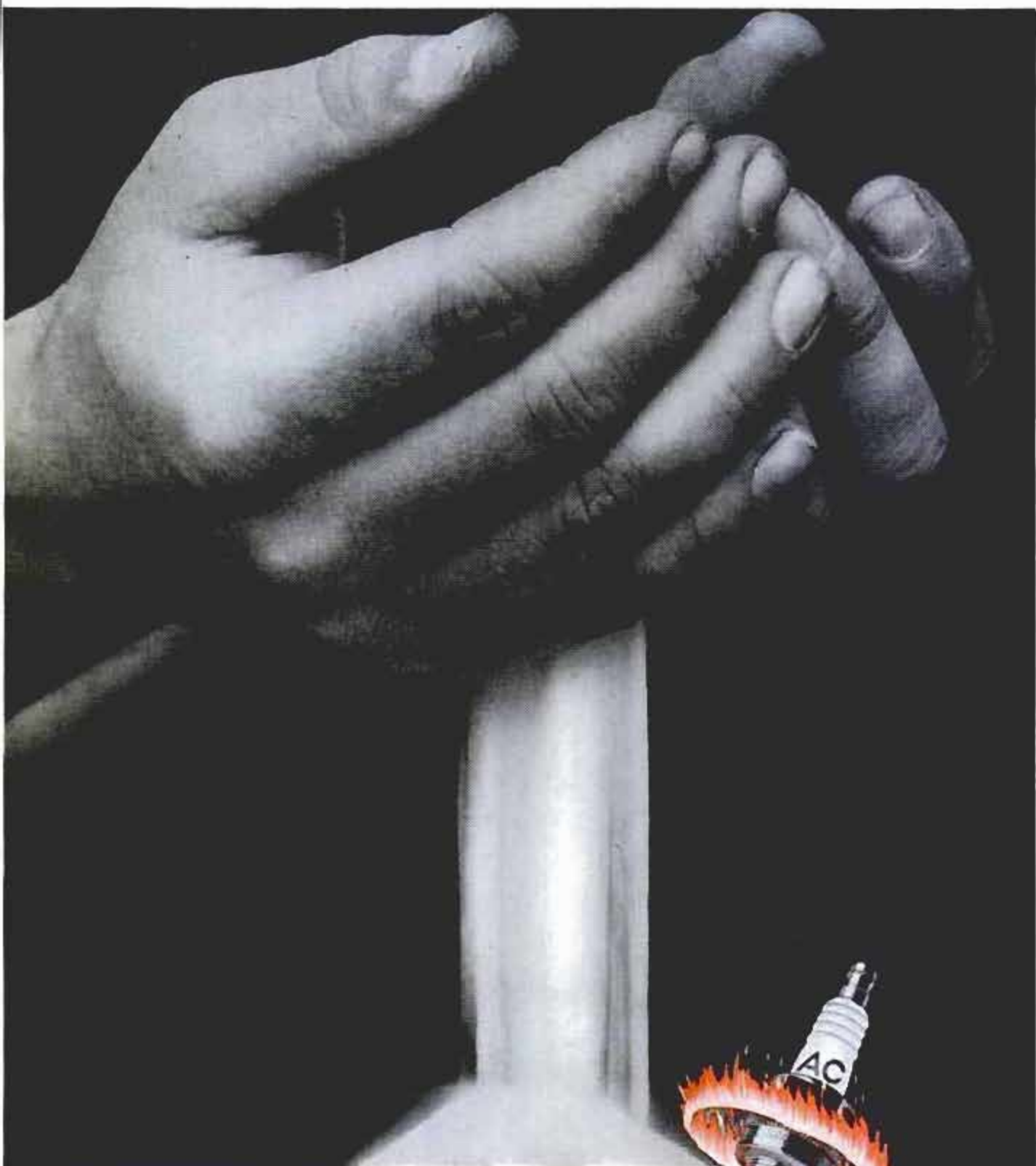

They **must** be the best! **New**

Now Available at 302,000 Service Stations, Garages, Car Dealers, Farm Implement Dealers and Marinas

Leads Field in Quality!

ALUMINUM OXIDE—WHAT IT IS. The fine, white powder shown opposite is aluminum oxide. It is the basic material of the ruby, emerald and sapphire. It is made artificially from bauxite, the raw material of aluminum, and it is from this material that AC forms its spark plug insulators of gem-like hardness. AC pioneered and perfected the idea of aluminum oxide for spark plug insulators and uses it by the carload for the millions of AC Spark Plugs made for original equipment and replacement. Each carload is laboratory tested to rigid standards of quality and reliability.

SECRET FORMULA MAKES THE DIFFERENCE. AC ceramic specialists experimented with scores of formulae before they settled on the one considered ideal. From it came an insulator able to take higher stresses, and with longer life, greater resistance to breakage and better insulating characteristics than any previous material.

TESTING TO INSURE HIGHEST QUALITY. In the Kodak shadowgraph, at high magnification, insulators are given a highly accurate dimensional check. Further, samples of finished insulators are tested to withstand a 600 pound tensile pull that is well beyond the strength of other makes. There are weight tests, density checks and thermal expansion and conductivity tests. In total, some 116 reliability tests are given to AC Spark Plugs.

GEMS IN EVERY SENSE. The ruby, emerald and sapphire are nature-processed aluminum oxide. AC Spark Plug insulators are man-processed aluminum oxide. In the gems, a trace of impurity lends color. AC insulators are pure white and have no crystalline fracture pattern. They are truly gems—but yours at a price far less than a gem, and no more than that of ordinary spark plugs.



AC SPARK PLUG  THE ELECTRONICS DIVISION OF GENERAL MOTORS

Pictures at right show how AC's exclusive Hot Tip is deeply recessed to clear the centerwire while ordinary tip hugs the centerwire. Graph shows the Hot Tip's faster-heating, faster-cooling action. Fast heating prevents fouling. Fast cooling prevents pre-ignition.

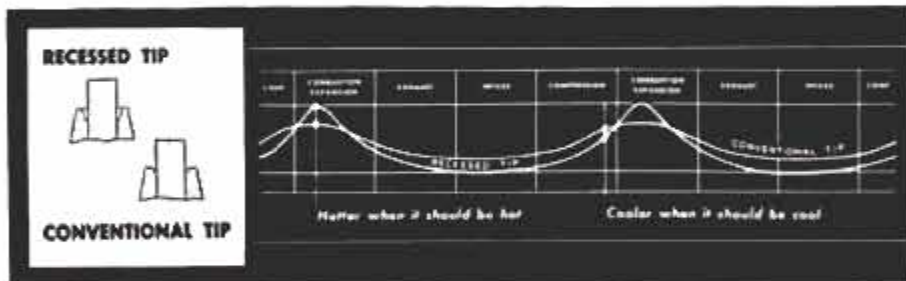

Fire-Ring Spark Plugs

AC PRESENTS THE ART CARNEY SHOW, NBC-TV, NOVEMBER 13

*It's like employing
your own personal mechanic
to keep your engine
always at its best*



The superior lubricating qualities of Kendall SuperB mean less wear, less need of repair. Oil and gas mileage go up. Noise level goes down. Driving is more economical, more enjoyable with this All-Weather SAE 10W-30 oil refined from the choicest 100% Pennsylvania Crude Oil — richest in the world.

Ask your favorite dealer
for it now



KENDALL REFINING COMPANY
BRADFORD, PENNA.

Falcon—the Conventional One

(Continued from page 114)

than a standard design. The result is a quiet, bump-smoothing suspension that takes tar strips quieter than many bigger cars. Only a single lower arm is used instead of the usual A-frame. The coil spring is mounted above the upper control arm (which is of a conventional design) and extends upward almost as high as the hood-line.

Steering is by recirculating balls and is extremely light. It is slower than you might expect on such a small car, the over-all ratio being 27.0 to 1. Turn-circle diameter is 37.7 feet, curb to curb, very good for a 109.5-inch wheelbase.

As for the way the car feels when you drive, many of the points have already been discussed. The outstanding impression is the car's extreme quiet and complete lack of harshness. The 13-inch wheels seem to roll over irregularities without the slightest fuss. No wheel fight is apparent even under extreme conditions.

There is absolutely no sensation of smallness about the car once you sit behind the wheel. Every effort was made to have it ride and handle like a big car. This, perhaps, is the reason why it does not seem as nimble as you might expect for a car this size.

Seats are high. Visibility front and rear is excellent. The hood slopes down sharply and the road is visible.

Instruments are in excellent taste and simple and straightforward in styling. The wipers work in unison, clearing an uninterrupted section all the way across the glass.

PM did not run any economy test on the Falcon (that will come in a later issue when we can test a production model, not a handbuilt prototype), but gas economy is expected to be at least 25 miles per gallon.

Altogether this is a comfortable, pleasant machine. It may not be exciting in the design sense to the same degree that the Corvair is, but it is an excellent solution to the problem that America wants answered: How to get sensible transportation without too much unnecessary expense. ★ ★ ★

Heat From Electric Fields Kills Weevils, Beetles, Borers

Heat from radio-frequency electric fields takes only seconds to kill rice and granary weevils, flour beetles and other grain borers in wheat bins, and does not damage the wheat.

G.-1 150-250 amp 30V New \$17.95 used \$9.95
 G.E. 200 amp 30 Volt Good Cond. \$13.95
 R-1 300 amp G.E. new \$24.50 Good C. 15.50

Accessories Kit For Arc Welder for above generators has helmet, gloves, elect. holder, volt. reg. rheostat, voltmeter, Ground Clamp, cable & switch. \$19.50.
 With G.E. 200 amp. gen. \$26.00.
 with 166-250 amp gen. \$33.50

New Reactor Coil Arc Stabilizer with 4 S Copper for R-1. P-1. G-1 & ACDC. Wt. 11 lbs. \$10.95. Incl. engine throttle solenoid control \$14.95

AC-DC WELDER KIT #511 G.E. Generator. Makes 1250 Watts AC light plant and 200 amp. DC welder and battery charger. Includes all items listed in accessories kit. AC-DC generator & instr. \$38.50

Complete Pk. Accessories For welding & battery Chg. including Reactor coil arc stabilizer \$29.50. With 300 amp gen. \$45.50. With 200 amp gen. \$39.95. With 166-250 amp \$39.45

3-V Belt Pulley Kit fits all gen. has 2 ball bearings blocks. H. speed bearings 3-V-pulley, shaft 8" L & flex coupling \$17.50

New, throttle, Solenoid & idling device for all gens., 1" travel \$7.50
 Welding Cable 00" 50' \$12.95 100' \$24.50

NEW HYDRAULIC PUMP - MOTOR SYSTEM KIT

Offers fluid drive of varying power consist of 2 new Vickers p.d.s. pumps ea. .410 cu. in. rev. 3750 RPM 1000 PSI 375 GPH where one pump is belt driven as motor, 1 four way c. valve with variable speed control, reservoir, filter, gauge, hose fittings & instr. Valued \$98.10, with manual control kit price \$49.95 including 12-24VDC Solenoid control \$57.50

Dual Power battery motors kit Excellent for golf cart, winch, etc., fully reversible, runs on 24-12VDC kit, includes 2 motors each 334 HP 250 amp 2300 RPM, 2 relays, switch, 2 flex. couplings with speed reducers 10:1 & all cable valued \$73.20 wt. 55 lbs. price \$32.50 2 kits \$59.00

New Linear Actuator 5 1/4" travel & 1 1/2 HP DC motor \$8.95. Rotary pump 180GPH 200PSI 20" vacuum \$7.95

SAVE ON SURPLUS MOTORS

H.P. 24-12V.D.C. Shaft (+15%)
 Delco 1/4 8.4 amp 5/16"x1" \$5.95 2/10.50
 Bendix 1/4 8 amp 5/16"x1" 4000 RPM \$6.50
 Gear Red mtr 27:1 or 51:1 1/5 HP 3800 RPM \$4.85
 Peaco 3/4 HP 2300 RPM 1 1/2"x2" \$9.95 2/817.50
 with 10:1 speed red. & flex coupling \$14.75

NEW HYDRAULIC CYLINDERS

Air or Oil	Bore	Stroke	Shaft D.A.	2000 PSI
#607	1 1/2"	4 1/2"	1 1/4"	5 lbs \$4.35
#300	2 3/8"	9 1/4"	1"	7 lbs \$10.95
#511	3 1/2"	2 1/2"	1 1/4"	15 lbs \$24.50
#127	4 1/2"	10 1/4"	1 3/4"	16 lbs \$27.50

NEW HYDRAULIC SYSTEM KIT

#400 K. Heavy duty Power Driven. Rated 14,000 lbs. lift. Consists of 2 D.A. hyd. cylinders, 3" bore x 24" stroke, each rated 7000 lbs. with 1000 P.S.I., 1 four way hyd. control valve with built in relief #821, 1 Vickers hyd. pump, 400 G.P.H., 150" P.S.I., 3750 RPM, 1 hyd. 2 gal. reservoir, 1 Purolator hyd. filter, 1 gauge 0-2000 P.S.I. all hose & fittings. Value \$184.10, save \$90.00. Kit price \$94.10. Kit with two #511 cyl. \$79.95

HYDRAULIC PUMP BARGAINS 1500 P.S.I.

Type	RPM	GPH	Reversible	Price
Vickers PP	3750	375		\$17.50
Peaco gear	3750	198		\$ 9.95
Peaco gear	4500	270		\$12.99
Stratopower P. disp.	450 cu. in.			\$15.50
Bendix Vac. Air	15 cu. ft. M.	4700 RPM 10"		\$22.50 used \$12.95

GENERAL SALVAGE CO. CHECK OR M.O.
 2922 E. 27 St., Dept. 109, Kansas City 27, Mo.

use the solder that most home owners use!



KESTER SOLDER

For your electrical work, radio-TV, do-it-yourself projects always use the best . . . KESTER SOLDER. Send for FREE 16-page book that tells you how!

KESTER SOLDER COMPANY
 4251 Wrightwood Avenue • Chicago 39, Illinois
 OVER 60 YEARS' EXPERIENCE IN SOLDER AND FLUX MANUFACTURING

WHY GET LOST?



A dependable HULL COMPASS will keep you "on course" wherever you go . . . strange cities, new neighborhoods . . . at junctions and detours. A color to match your car or boat. \$5.95 to \$7.50. At your dealer. Write for literature



HULL MFG. CO., P.O. Box 246-D-10, Warren, O.

SPLIT SHUTTER?



NOW YOU SEE IT! NOW YOU DON'T!

Weather-resistant Plastic Wood won't crack or crumble. Easy to sand, paint or varnish.



For surest results always use GENUINE

PLASTIC WOOD

Handles like putty—hardens into wood!

CHECK YOUR TIRES . . . YOUR LIFE DEPENDS ON THEM!

Ideal for home workshop

Dillon FORCE GAUGE



Indispensable for the plant

INSTANTLY MEASURES } **COMPRESSION TENSILE TORQUE**

Over 100 different ways to use—measuring pressure in vises, drills, arbor presses, between rollers, etc.

- Portable. Compact. Fits into "tight" spaces.
- Accurate to within 1% of full scale capacity.
- 12 capacities from 0-10 to 0-50,000 lbs.
- Accommodates wide variety of attachments.
- Available as combination push-pull model.
- Red maximum pointer registers peak loads.
- Optional switch controls mechanisms.
- Shockless mechanism for rough jobs.
- Jewelled dial indicator repeats perfectly.
- Flexes millions of cycles without damage.

W.C. Dillon & CO., INC. 14600 Keswick Street, Van Nuys 20, Calif.

FREE! Write for illustrated catalog & price list



Any man will enjoy new

AIRGRATE.

YELLOW-BOLE

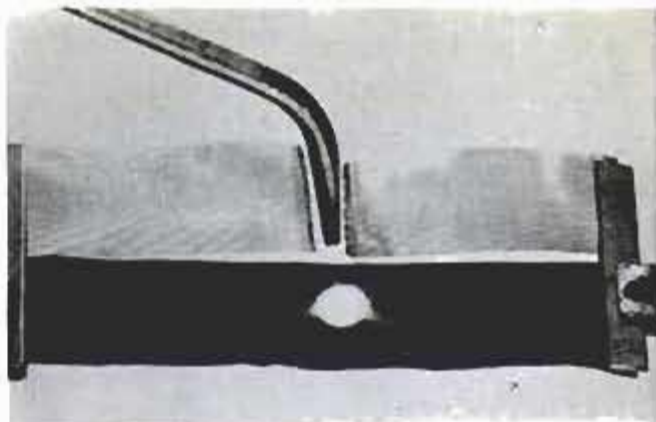

Growth Industries Group, Inc., 100 William St., New York City.

Graphite Cloth

Ordinary cloth is converted into a flexible graphite fabric by a complex thermochemical process developed by National Carbon Company. The crystalline structure of the cloth is changed to that of graphite similar to that used for electric-furnace electrodes. Any textile form, including yarns, braids and felts, woven or knit, can be converted. Graphite textiles have no melting point and become stronger at high temperatures until 6600 degrees F. is reached, at which point they vaporize. They are self-lubricating and are resistant to attack by acids, alkalis and organic compounds except those of a high oxidizing nature.

Mammoth Water Distiller Also Produces Electricity

Largest of its kind in the world, a water plant for converting sea water to fresh water has been constructed on the semi-arid Dutch island of Aruba off the Venezuelan coast. The \$11,000,000 structure is the first ever built to combine production of usable electricity with the distillation of salt water. The plant can supply 2,700,000 gallons of fresh water a day, more than enough for the island's 55,000 inhabitants.

1. Smokes sweeter!

Imported briar bowl lined with *real honey*. Starts caking the instant you light up. Hence, no break-in.



2. Smokes drier and healthier!

Metal grate condenses moisture, tars, nicotine. No wet heel.



3. Smokes cooler!

Air-vented chamber draws in fresh air. Aluminum fins and shank throw off heat, cool the smoke.

Famous honey-lining!

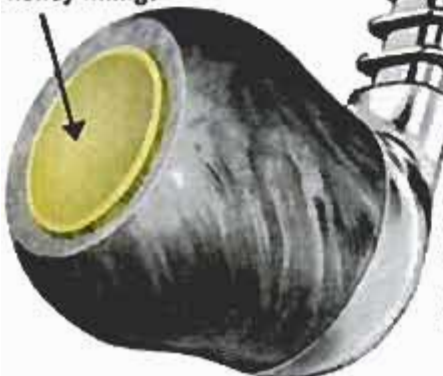

\$295

Extra interchangeable bowls — \$1.50 each

"Icepak" Set—Airograte Yellow-Bole Pipe plus two extra bowls, \$5.95

Other Yellow-Bole Pipes, also of imported briar \$1.50 to \$4.95

Send for FREE FOLDER, YELLOW-BOLE PIPES, INC., Dept. Y64, N.Y. 22

KEEP CAR PERFORMANCE LIKE NEW—REPLACE WORN PARTS

ONE Clark adjustable HOLE-CUTTER does the work of a whole drill set!

Mail Orders Postpaid.

Cuts wide range of diameters in WOOD, METAL, PLASTICS, etc.!



Order today or ask your dealer!

Clark Adjustable Hole Cutter cuts any diameter within its range merely by resetting blade! Indispensable for woodworkers, cabinetmakers, autobody shops, sheetmetal workers, radio and electronic chassis jobs, hobbyists, craftsmen, etc. Excellent gift item! All blades High-Speed tool steel.

TWO SIZES: Model 100 — 3/8" to 1 1/2". Price \$4.50. Extra Blade \$2.00. Model 101 — 1" to 2 1/2". Price \$5.75. Extra Blade \$2.80. Complete kit: both models in attractive box. Price \$11.50.

Robert H. Clark Company

9330 Santa Monica Blvd., Beverly Hills, California

Got a "WABBLY" in your home?

A "Wabby" is that faucet handle or shower handle with broken threads or chipped, rusty chrome—that old worn out handle on the laundry tub or kitchen sink... any broken or unsightly faucet handle. If you've got such a "Wabby" in your place, don't wait another minute—REPLACE IT WITH PERMA-FIT REPLACEMENT HANDLES

FITS 'EM ALL!

You can install a Perma-Fit in just about two minutes flat without anything but a wrench or pair of pliers. It's as simple as A B C and they will probably outlast your plumbing!



Beautifully proportioned in heavy chrome—as modern as tomorrow. Just \$1.49 per pr. for lever type and \$1.89 per pr. for cross type (list f.o.b.) at your hardware, dept. store, or plumbing supply dealer.



ACME BRASS MANUFACTURING CO.
1826 GLENDALE BLDG., LOS ANGELES 28, CALIFORNIA

MAKERS OF PERMA-FIT HANDLES AND VALVESTREAM SHOWERHEADS
"Products for lifetime service."

SPRAY AWAY SQUEAKS

in Home
on metal and wood
window and screen
channels, casement
windows, drawer guides, etc.



and Auto
on weather
stripping, trunk
seals, hood
lacings, etc.



NEW! SIL-GLYDE®

lubricating compound with Silicone



Here's the easy way to lubricate otherwise hard-to-reach areas. A push of the button stops squeaks on friction surfaces; makes sliding surfaces work easier. Water repellent and freeze-proof; works from -20° F. to +400° F. 6-oz. aerosol only \$1.49. Also in 1½-oz. tube (89c) for those who prefer squeeze-on application. At hardware, auto supply, sporting goods stores and service stations.

S-251
AGS American Grease Stick Co. • Muskegon, Mich.

BARGAIN-PRICED EQUIPMENT FOR YOUR WORKSHOP, HOME, FARM, FACTORY!

Portable! Compact! Lightweight —
Weights only 61 lbs.!

1000 WATT A.C. POWER PLANT



**Briggs & Stratton
Gas Engine Driven**
Handles electric saws, pumps, floodlights, pipe threaders, benders, drills, lights, refrigerator, oil burner, radio, deep freeze, etc.
BRAND NEW . . . FULLY GUARANTEED!

1000 watt continuous duty, 115 volt, 60-cycle, single phase, A.C. Easy starting 2¾ H.P. Briggs & Stratton engine, 4 cycle, air cooled with automatic recoil rope starting. Operates at 3600 R.P.M. Equipped with standard double outlet receptacle with overload fuse protection. Economical—runs 3 hrs. per 1 gal. gas. Dim.: 20½" L. x 12" W. x 16" H. Shpg. wt., 73 lbs. F.O.B. Chicago.

No. 1008-B \$159.50

A.C. VOLTMETER

0-150 Volts

Simpson Model #56. 3½" round flange mounting. Black Bakelite case. Postpaid. No. 580 \$5.00



PRESSURE GAUGE

0-200 P.S.I. scale



U.S. Gauge Co. Model #4½AD-6977. 4½" dia. white face; cast iron case. Rear flange mounting. ½" pipe thread bottom connection. 6" O.D., 2½" deep. Postpaid. No. 566 \$5.95

OBERDORFER BRONZE CENTRIFUGAL PUMP

FOR: Fluid Transfer, Sprinkler Boost, Circulating Marine Coolant.

Designed for continuous, heavy service. Carbon bearings require no lubrication. For direct or belt-drive with speeds up to 3450 R.P.M. All bronze housing and impeller with ½" stainless steel shaft. Has ¾" inlet and outlet. Pump delivers maximum 4.25 gals. per min., 20 ft. head, at 3450 R.P.M. Requires up to ¼ H.P. Motor. Postpaid.



No. 481
NOW \$8.95 Each
Two for \$17.00

Regularly ~~\$26.50~~

BLOWER WITH MOTOR



24 volt electric motor driven blower has 1¼" dia. inlet, 1¾" dia. outlet. Can be used on 32 volt systems for even greater output. Dim.: 5" L. x 3¾" W. x 3½" H. Postpaid. No. 551 \$3.95

WRITE TODAY for your FREE GROBAN CATALOG! New Fall edition now available containing hundreds of surplus and newly manufactured items!

GROBAN SUPPLY CO.

1139 South Wabash Ave. Dept. PM-10
Chicago 5, Illinois Webster 9-3793



At Times Like This — You Need **PLASTIC STEEL**®

80% Steel
When home repair troubles start to pile up . . . don't let it get you down . . . Get **PLASTIC STEEL** the permanent mender with a million uses around the home, garage or farm. **PLASTIC STEEL** fixes practically anything in minutes . . . saves you hundreds of dollars on repair bills.

As easy to use as modeling clay **PLASTIC STEEL** forms to any shape, bonds metals, wood, concrete or glass to itself or each other. Hardens to a steel-like strength in two hours. Can be filed, sanded or painted.

Repairs broken furniture, light fixtures, tools, toys, and appliances without special tools. No heat or pressure required. Seal leaking pipes, tanks, sinks, radiators and furnaces with **PLASTIC STEEL**. Holds under pressure. Won't shrink or expand.

PLASTIC STEEL fixes cracked motor blocks, torn fenders, leaking gas tanks, tractor parts, feed tanks and planting machinery. Unaffected by weather, won't corrode!

PLASTIC STEEL — in the black and yellow package — is available in three convenient home kits — \$1.98, \$1.89 and \$3.95. At all leading hardware stores.



WRITE FOR FREE HOME REPAIR BOOKLET
DEVCON CORPORATION
176 Endicott Street, Danvers, Mass.

Also available — **NEW Devcon**® Rubber and **Devcon**® Aluminum

GUNK-it-yourself!

Gunk® G.P. removes grease from engines or concrete floors; cleans paint brushes, power mowers, or machinery completely, economically, safely. It's ready-to-use, rinses off with water, won't clog drains. Quart size with handy "Squirt Spout" top speeds application. Insist on the *best* degreaser — the original "GUNK" at better automotive supply and hardware retailers everywhere. © REG. TRADE MARK.



GUNK CHICAGO CO., River Forest, Illinois
Serving the Midwest and Southwest
RADIATOR SPECIALTY CO., Charlotte, No. Carolina
Serving the East, Southeast and far West

GIVE AMERICAN CANCER SOCIETY



PUSH-BUTTON GARDEN & LAWN PROTECTION

...with a Hayes spray gun

\$2.95 and up

Simply press down the button on a Hayes garden hose sprayer to start spraying garden chemicals. It's the quick, easy way to control insect pests that eat into leaves and flowers, sap plant vitality and damage your garden.

The Hayes mixes, proportions and applies spray materials automatically — using the water power from your garden hose. Hayes spray guns are approved by leading manufacturers of garden chemicals. At nursery and hardware dealers.

- **Hayes Garden Sprayers.** For insecticides, fungicides, crabgrass killers, fly, ant and termite control. In 1½, 3, 4, 6 and 12 gallon sizes.
- **Hayes Lawn Sprayers.** For fertilizers, lawn moth solutions, fungicides, weed killers, herbicides, etc. In 3 models.

FREE! 16-pg. booklet on garden and lawn care. Write Dept. M. HAYES SPRAY GUN CO.—World's Largest Manufacturer of Garden Hose Sprayers—98 N. San Gabriel Blvd., Pasadena, Calif.

NOW! HOME CRAFTSMEN CAN OWN THIS PROFESSIONAL ARC WELDER

EASY TERMS
ONLY \$98.50
F. O. B.

Now you can own a Trindl full 125 amp Industrial Welder at a price far less than smaller machines. With a Trindl 125A you can weld metals up to ½ inch thick. Operates off either 110 or 220 volt line, properly wired, 16 heat stages from 20 to 125 amps. Make and repair anything of metal around the home, garage, farm or shop, like a professional. No previous experience or training needed. Full "do-it-yourself" instructions with each machine. Complete only \$98.50 f.o.b. factory, or write for details. Trindl manufactures a complete line of heavy duty welding machines. Dealer inquiries invited.

TRINDL PRODUCTS Ltd., Dept. T2-K
1807 So. Clark St., Chicago 16, Ill.



Guaranteed
12 MONTHS
IN
CONTINUOUS
OPERATION



FREE
WRITE FOR
COMPLETE
DETAILS AND
EASY PAY PLAN

new • fast • easy • economical



way to
STOP DRAFTS
 and **QUIET**
NOISY DOORS
 with **ROBERTS**
DRAFSTOP
WEATHERSTRIPPING

Weatherstripping

Door Bottom

Just cut to fit and nail on door jamb. Made of Poly-vinyl foam permanently bonded to clear grain wood molding. Non-absorbing foam can be painted, resists weather and wear. Stops dust, drafts and water, quiets door slam—blends with door frame. Complete kit only \$1.95 suggested retail.

Easy to install, fits snugly. Unique automatic spring action clears carpets and door mats. Made of durable silver satin anodized aluminum. Nylon stop-roller provides positive closing, draft-tight seal. Complete kit only \$2.95 suggested retail.

a product of the big **R**...at your dealer's or

write Dept. PM109

THE ROBERTS CO. 600 NO. BALDWIN PARK BLDG. CITY OF INDUSTRY, CALIF.

QUALITY PRODUCTS FOR HOME AND INDUSTRY FOR OVER 20 YEARS

STAR HACK SAW BLADES

STAR

Hack Saw Blades and Frames

...used throughout industry

STAR Moly

★ For better, faster metal cutting in your home work-shop or on the job, use the ★
 ★ Hack Saw Blades preferred by people who know — Star. "Handy-Pak" convenience, with card holding one or two blades, makes storing and handling easier and safer. Cards give valuable and helpful tips on metal cutting. 1493 ★

Star "Lever-Lock" Hack Saw Frames

- ★ automatically position and tension blade.
- ★ high-strength tempered steel back.
- ★ perfectly balanced to make cutting easier.

At all leading hardware stores—be sure and ask for STAR
 Send 10¢ in coin for information-filled booklet on metal cutting.

★ **CLEMSON BROS., INC.** Middletown N.Y., U.S.A. ★

New Homelite



Chain Saw



ONLY

\$153⁵⁰

COMPLETE, F. O. B. FACTORY

The new Homelite BUZ is the first direct-drive chain saw to give you quality performance at a price everyone can afford... only \$153.50 complete, F. O. B. Factory!

It cuts 16" trees in 16 seconds, fells trees up to 3 feet in diameter. Light 19 pounds (less bar and chain) are easy to handle on any cutting job or carry to a campsite. Famous Homelite short-stroke engine and diaphragm carbureter give you full cutting power in any position. Flush-cut handle lets you cut level with the ground.

Ask your Homelite dealer for a free demonstration.

Send 10¢ for informative 16-page booklet "A Man's Guide To Chain Saws."



HOMELITE
 A DIVISION OF TEXTRON
 INC.
 610 RIVERDALE AVE.,
 PORT CHESTER, N.Y.

THINK FIRST OF QUALITY... THINK FIRST OF HOMELITE

Dress up your front door
with a new

kwikset ENTRANCE HANDLE LOCKSET



Distinguished styling,
simple to replace existing
lockset, dependable
construction, moderate price.
Write for FREE catalog.

kwikset **K** **locksets**

America's largest selling
residential locksets

KWIKSET SALES AND SERVICE COMPANY

A subsidiary of
The American Hardware Corporation
Anaheim, California

"NEW"
SENSATIONAL
RECHARGEABLE LIFETIME
FLASHLIGHT BATTERY

CONTAINS OWN CHARGER

PLUG IN 110 VOLT AC, RECHARGE OVERNIGHT.
NO DAMAGE IF CHARGED LONGER. 10 RECHARGES
COST 1¢



FITS STANDARD LIGHT • REPLACES 2 DRY CELLS



Designed by
SONOTONE CORP.
FOR MILITARY USE
NOW AVAILABLE
TO YOU

\$7.95
RECHARGEABLE

RUGGED BUILT:
No Corrosion
No harm to equipment
Operating Temperature
range -40° to +160°

AERO Quality SALES COMPANY

13711 E. SEVEN MILE, DETROIT 5, MICHIGAN
Sonotone Factory Agents and Distributors

Send Free with this order Sonotone Aircraft Battery Color Brochure
 Cash Check Money Order C.O.D. Quantity _____

NAME _____

ADDRESS _____

CITY _____ STATE _____

Ideal Gift, especially for the person that has everything



TO CRAFTSMEN EVERYWHERE
THIS LABEL MEANS

**QUALITY AND
PERMANENCE**

For every fastener application that calls for permanence, Southern makes a quality screw to fit the job. There are no better screws made than U.S.A.-made Southern Screws.

Specify "Southern Screws"

Buy 'em by the box and save!

**SOLD THROUGH LEADING HARDWARE
AND BUILDING SUPPLY DEALERS.**

Wood Screws • Tapping
Screws • Stove Bolts •
Machine Screws & Nuts •
Carriage Bolts • Hanger
Bolts • Dowel Screws •
Wood Drive Screws



Gestetner Duplicator Corp., 216-222 Lake Ave., Yonkers, N. Y.

Duplicator Copies Artwork On Mimeograph Stencils

Charts, drawings, photographs and other printed matter now can be reproduced automatically on mimeograph stencils by use of an electronic machine. The original copy is fastened to one roller on the desk-size duplicator and the blank stencil to a second roller. When the current is switched on, the original is reproduced on the stencil in a few minutes. The stencil then can be used to make as many copies as desired. Paste-up layouts can be reproduced on the duplicator the same way.

SURPLUS SALE

GOVT. SURPLUS
EXCESS INVENTORY
BANKRUPT STOCK

SPECIAL OF THE MONTH!

GOVT. FIRE EXTINGUISHER

● Item #120. New Govt. genuine Phister pressurized carbon-tet extinguisher. Ideal for homes, garages, factories, offices, farms.

● Consists of 2 gal. steel cylinder with 1-gal. carbon-tet, pressurizing pump, pressurizing valve, pressure gauge, 24" hose, nozzle.

● To use simply open valve, compressed air throws powerful stream. No need to invert. Renew air pressure by operating pump or at filling station. Refill carbon-tet readily available. Size 25"x7"x7". Wt. 35 lbs. Govt cost \$89.50. SALE..... \$19.95 FOB



BATTERY HYDRAULIC PUMP

● Item #220. New electric hydraulic pump. Use on lift trucks, loaders, etc.

● Operates on 12 or 5 24-v DC, 1000 p.a.i. 1 to 3 rpm. Inlet and outlet ports, 3/4". 14 female threaded. Size 15"x7"x6". 35 lbs. Cost Govt. \$175. SALE..... \$16.95 FOB

115-V to 34-V TRANSFORMER

● Item #1522. New, Ideal for DC battery gear motor and DC winch shown in this ad.

● 115 volts to 34 volts at 85 amp. 8"x10"x6". Wt. 48 lbs. Cost \$45. SALE..... \$17.95 FOB



ELECTRICAL-ELECTRONIC BUYS

Typical surplus items in our '59 catalog:

- Radiation Geiger Tubes, cost \$20. \$.79
- 905 Cathode Ray Tubes, cost \$52.50 4.91
- G.E. Telechron Clock Timer..... 5.97
- Army HS-30 Head Sets, cost \$10.50 1.75
- AC Voltmeter, 0-150-v..... 3.55

FREE CATALOG Electronics, Power Tools, Binoculars, Hydraulics, Power Plants, Air Compressors and thousands of other items.

SURPLUS CENTER
LINCOLN, NEBR DEPT 812

12-V DC ROBOT CONTROL MOTOR

● Item #522. Powerful DC unit. Geared motor operates lever. Use to operate remote valves, throttles, levers, steering, doors, switches, open-close drapes, etc. Govt. cost \$47.50. SALE..... \$5.95 FOB

STANDARD DIAL PHONE

● Item #715. Modern dial phone. Use for extension to main line on private system. Work on any system. Govt. cost \$25. SALE..... \$9.95 Ppd



MIRACLE EPOXY LIQUID METAL

● Item #1725. Marvelous new Epoxy chemical metal bonds to any surface. Big writeup in LIFE and HEADERS DIGEST. Consists of 2 chemicals in self-measuring tubes. Squeeze out the correct amount of each, then apply. Dries steel-hard in 50 minutes. Can be sanded, drilled, tapped, etc. One ton strength. Bonds objects in glass, steel, brass, plastics, wood, aluminum, etc. Kit of 2 self-measuring tubes. \$3.95 Ppd.

FARMER-CONTRACTOR PUMP

● Item #200. 2 1/2" size, 16,500 gph. New ball-bearing centrifugal irrigation-contractor pump. 280 gpm. 45 ft. head. 6" pulley. 2 1/2" intake, 2" discharge. Wt. 37 lbs. Govt. cost \$98. SALE..... \$49.50 FOB



GOLF and PERSONNEL CAR MOTOR

● Item #573. Amazing buy! Use for golf cars, factory personnel cars.

● Powerful expensive ball-bearing gear reduction motor runs on any 6-v or 12-v storage battery. Powerful high torque. Shaft speed 150-300 rpm. Full instr. Easily reversible. Wt. 34 lbs. Size 7 1/2"x9"x14". Est. \$250. Govt. cost \$250. SALE..... \$19.46 FOB



STORAGE BATTERY WINCH

● Item #311. Powerful fully reversible ball-bearing gear reduction winch, 1000-2000 lb. pull. Use on 6 or 12-v battery. Holds 40' of 1/4" cable. For trucks, docks, boats. Govt. cost \$280. SALE..... \$46.71 FOB



AIR COMPRESSOR BARGAINS

● For painting, cleaning, tires, termite, Assemble own outfit.

● Item #450. Deluxe Kit. Compressor, tank, gauge, regulator, paint gun, relief valve, fittings, hose, instructions. List \$52. SALE..... \$43.91 FOB.

● Air Components. Compressor 1-cyl. \$19.35. Air tank, \$10.90. Regulator \$3.95. Pop-off \$1.95. Press. Gauge \$1.89. Finest Paint Gun \$11.50. Auto Switch \$4.75. All Ppd. in US.

HYDRAULIC EQUIPMENT BARGAINS

Savings to 80%. Build loaders, diggers, presses, etc. All brand new.

- Hydraulic Hand Pump & Cyl. \$29.87 FOB
- Control Valve, 1 or 2 way... 18.00 Ppd
- Tractor Pump 1000 psi... 45.50 Ppd
- 2-Way Cyl. 1 1/2" bore, 11" stroke 9.87 FOB

Get catalog, many items.

CONTRACTORS LEVEL-TRANSIT

● Item #804. Leading make, brand new latest model level-transit with tripod and case. Used by leading builders, schools, etc. 12-X scope, high accuracy. Use as level or transit. \$69.95 Ppd. Limited time offer.

● Many other instrument buys.



INVALID CHAIR—BOY'S AUTO MOTOR

● Item #576. Marvelous ball bearing battery (6 or 12 v.) electric gear reduction motor. Makes wonderful amazing electric drive for boy's auto, invalid's chair, etc. Also useful for factory electric lifts—trucks, etc.

● Gear ration 33 to 1. High torque. Finest precision gears. Fully reversible. Buy or the year. Size 15 1/2"x5 1/4". Wt. 27 lbs. Est. Govt. cost over \$295. SALE..... \$15.79 FOB



Sharpen All Circular Saws with QUICK-WAY

Model PG12 \$19.95 Postage-Paid

IDEAL for home-workshops; carpenters, contractors, QUICK-WAY unit precision sharpens, joints, gums and retools all circular saws to 12" diameter. Fits all bench, table and radial saws. Thousands of satisfied users. Send for Circular Make money sharpening saws. Order today \$19.95 postage-paid. Complete Unit with Grinder Wheel. No Extras to Buy. Patented.

FREE Saw Set with Initial Order

QUICK WAY SAW CO., 136 Tompkins Street, Cortland, N.Y.



KING MIDGET

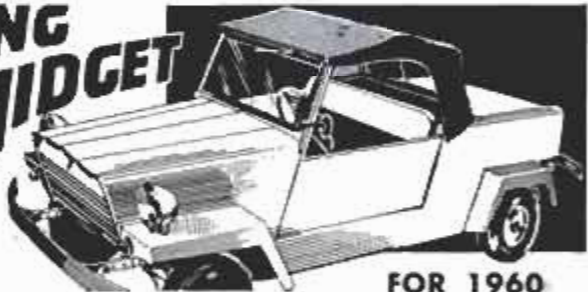

FOR 1960

More aluminum, lighter weight, better performance, beautiful styling. Still Worlds Lowest Priced Car. Drive it for 75c a week. Rider Agents Wanted. If no dealer near you send 25c for 32 page picture book, full details, dealer price. Or send \$1 (refunded first order) for this and Service Manual plus Repair Manual and 15 5 x 7 photos of car and factory.

MIDGET MOTORS CORPORATION, ATHENS 1, OHIO

ATTENTION! Farmers, Hobbyists, Do-it-yourselfers! ADD THIS LOW-COST, AUTOMATIC STARTING CLUTCH TO YOUR GASOLINE-ENGINE DRIVES

Permits instant, easy engine starts, even in cold weather. Stops wear and equipment damage caused by overloads.

Here's a safety and convenience feature anyone can install on pumps, compressors, sprayers, mowers, and other engine- or motor-powered equipment. Automatic clutch disengages the drive when your engine is stopped or throttled low. No-load starts are fast and easy. Centrifugal clutch engages automatically at proper engine speed. You can control engagement and release with the gas throttle. Installs easily—just slip over drive shaft and tighten setscrew. Drive pulley is machined right into clutch housing. Write for free booklets Fairbanks, Morse & Co., Magneto Division, Beloit, Wisconsin.

FAIRBANKS-MORSE
A name worth remembering when you want the BEST

Six models for 1 to 10 hp engines, 3 hp motors. Standard A-B pulley-groove. Engagement speeds, 1450 to 3100 rpm.

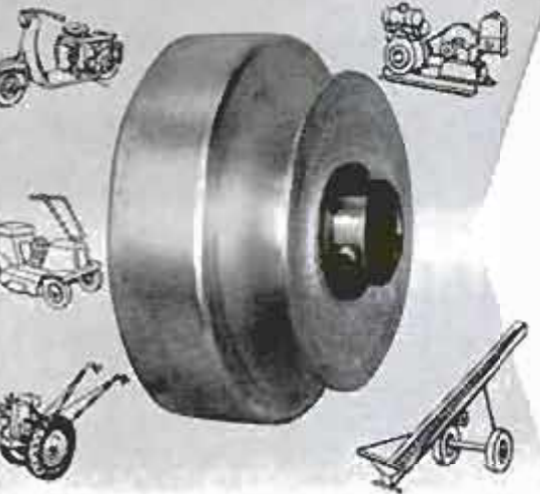

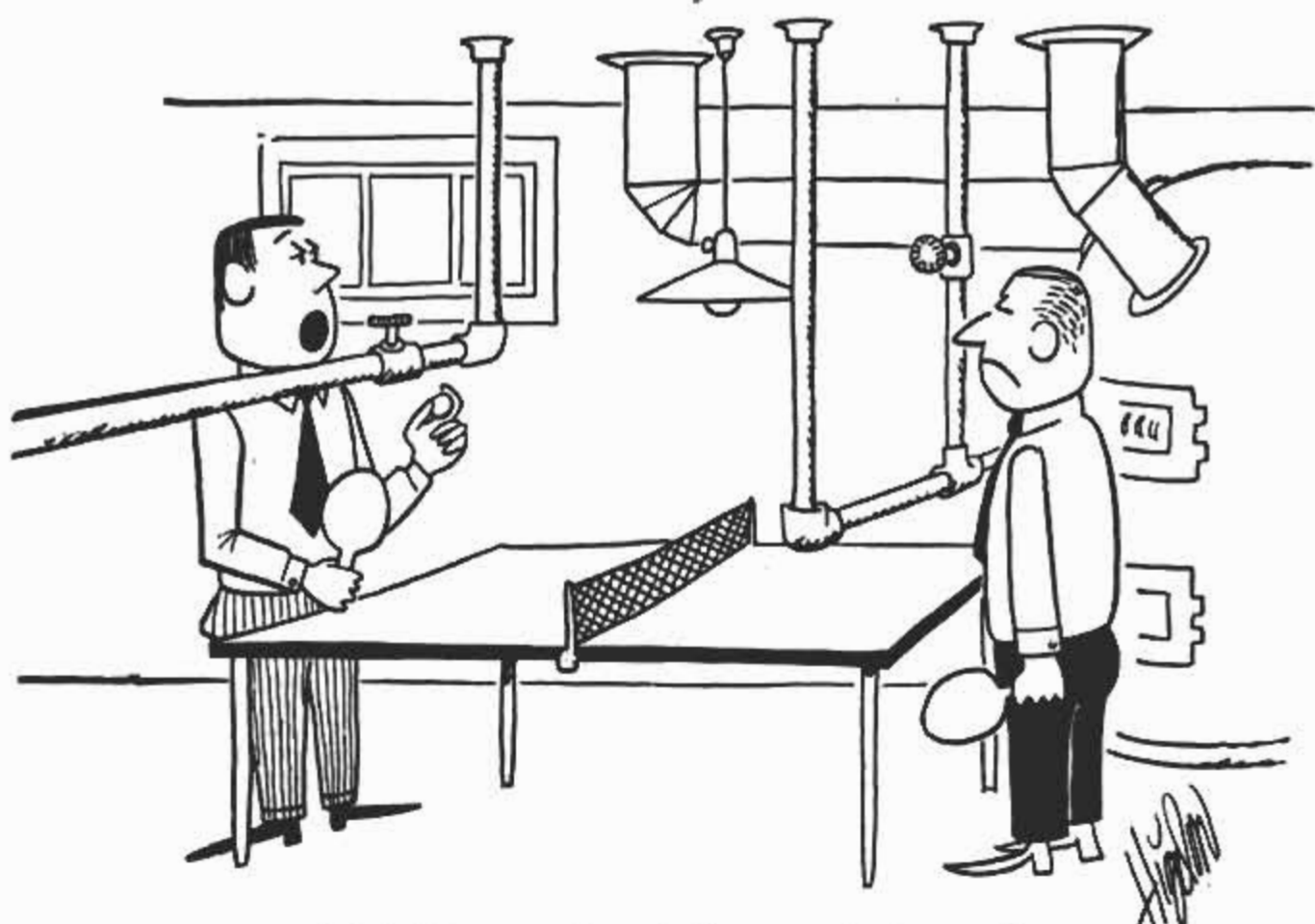

"First, let me run through the ground rules . . ."

More cutting power ✓
for 1/4" electric drills

Irwin Speedbor "88"
most revolutionary bit in years

➔ Irwin's Exclusive Hollow Ground Point and spade-type cutters bore faster, deeper, cleaner with less power. Try the Speedbor "88" in your small 1/4" electric drill or drill press and see. Get smooth, effortless cutting action in hard or soft woods, plaster, plywood, plastics — even hardrock maple! Forged in one piece from solid bar of high carbon steel, hardened full length to stay sharp. And remember . . . the hollow ground point is exclusive with Irwin's Speedbor "88". Buy individual sizes or sets from your independent hardware dealer.

No. 886-R plastic roll set of 6, sizes 3/8" to 1", only \$4.50



75¢
each
1/4" to 1"
\$1.25
each
1 1/8" to 1 1/2"

IRWIN
Wilmington, Ohio

• the original solid center auger bit
• screw drivers • screw driver bits

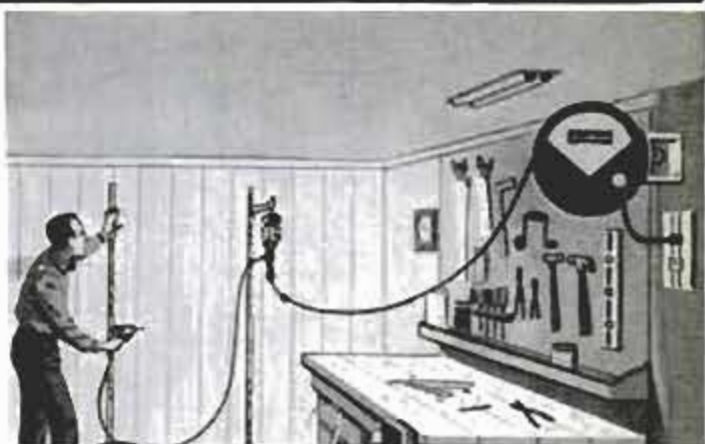

MODEL 500
\$8.95

Light and power
when and where
you want it . . .
AUTOMATICALLY!

Modern, convenient • 20-foot cord pulls out to any desired length, locks, retracts into case automatically • phenolic pistol grip handle has built-in electric outlet for power tools and appliances • mounts easily on wall or ceiling.

New HANDY-LITE REEL

by *Cordomatic*®

17th and Indiana Avenue, Philadelphia 32, Pennsylvania
Available at all Hardware and Department Stores

DC JET GENERATOR ARC WELDING KIT Complete with GE Type CM-77 Generator (30 volts D.C., 400 Amp., 3000 RPM up; ampere rating is for continuous duty, intermittent amperage is 500 to 600 amps.), also 2 rheostats, 1 voltage regulator, 1 voltmeter, 1 electrode holder, 2 ea. 25 ft. lengths No. 0 welding cable, 1 welder's mask, 1 toggle switch, 10 lb. vacuum packed 1/8 in. welding rods, pair welder's gloves & spline coupling. All units guaranteed pre-tested. Wt. 110 lbs. Approx. GOVT. COST \$700. All items, now only **\$64.50**.

*G.E. Generator noted above can be purchased separately. Makes deluxe heavy-duty welder comparable to the finest commercial welders available. Wt. 90 lbs. Approximate GOVT. COST \$400. Gen. alone — **\$49.50**.

ECLIPSE ARC WELDING KIT with built-in internal cooling fan. Complete with P-2 Generator (200-250 AMP. rating, continuous duty; 24 to 32 volt output; speed 5000 RPM), also voltage regulator, ammeter, shunt, voltmeter, rheostat, switch, electrode holder, welder's mask, 50 ft. heavy-duty welding cable, pair welder's gloves, 10 lb. vacuum packed 1/8 in. welding rod and wiring diagram. All units guaranteed pre-tested. Weight 60 lbs. Approx. GOVT. COST \$450. All items, now only **\$47.50**.

*P-2 Generator noted above can be purchased separately. One of finest D.C. gen. for arc welding purposes. Wt. 50 lbs. Approx. GOVT. COST \$300. Gen. alone — **\$29.50**.

OXYGEN BREATHING SUPPLY UNIT. Designed for the Air Force for high altitude flying, also ideal for medical purposes. Compact, portable; could save your life in the event of a heart or asthma attack. Complete with steel oxygen bottle, cylinder pressure gauge, demand type reg., oxygen flow blinker, 36" hose and face mask. Shpg. wt. 20 lbs. Tested, checked and filled. Approx. GOVT. COST \$250. NEW. **\$39.95**.

SENSITIVE ALTIMETER in 20 ft. increments, 0 to 35,000 ft. (inches of Mercury). Famous Pioneer. Tested & inspected in our own instrument lab. Guaranteed perfect. Approx. GOVT. COST \$150. Wt. 2 lbs. **\$14.50**.

SOUTH WIND HEATER & ACCESSORIES
Mfd. for govt. antarctic expeditions for jeeps and half-tracks. Heating unit puts out over 20,000 B.T.U.'s. Burns any type gas, 6 volt system. Fuel consumption extremely low, 1 gal. per 8 hrs. Terrific for trucks, loads, tractors... farms, warehouses, ranches, boat houses, cabins, etc. Complete with service & installation manuals and over 360 components. Approx. GOVT. COST \$550. Shpg. wt. 120 lbs. gross. NEW. **\$39.95**. Limited quantity.

WELDING CABLE DOUBLE-O, heavy-duty, neoprene jacket, fiberglass insulation. Will handle 400 amps. or better. NEW. Approx. GOVT. COST \$40. 50 ft. lengths — **\$12.50**... 100 ft. lengths — **\$24.00**.

140-1 REDUCTION GEAR For beaching boats, winches, hoists. Ideal for motor in golf or boy's electric car. DC motor & clutch. Easily reversible wiring diagram furnished. Hi torque, 1st speed. Runs on 6-12 or 24 V. Wt. 65 lbs. gross. Approx. GOVT. COST \$300. Like NEW, **\$12.00**. Matched splined gear for above — **\$3.00** ea.
*225-1 Reduction Gear — **\$13.50**

BENDIX GEROTOR PUMP & MOTOR — NEW!
Use wherever fluid pumping required. Excellent for hydraulic installations. Has 3/4" pipe connections, built-in relief valve adjustable up to 1500 lbs. Max. cap. 6 GPM. 1 1/2 H.P., 24 V. motor. Use on 12 to 36 V. Approx. GOVT. COST \$350. **\$8.75**.

ELECTRIC PUMP WITH CONTROL UNIT
Runs on 12 or 24 V. Centrifugal type. Draws 5.2 AMPS. Has built-in removable filtering screen. Great for bilge, circulating or sump pump... ball tanks, etc. Pumps 500 GPH. Complete with on and off switch rheostat, 2 speeds (hi & lo). Mfd. by Ingersoll-Rand. Shpg. Wt. 7 lbs. Approx. GOVT. COST \$195. NEW **\$8.95**.

NEW 1960 CATALOG! Tremendous catalog — our biggest ever — fully illustrated — 1000s of bargains in war surplus & other items. Send 25c in coin for your copy today! Where ppd. indicated applies to US only. Other prices FOB Culver City, Cal. Send cash, check, money order. 50% den. COD.

AIRBORNE SALES CO., INC. DEPT. PM 1059
8501 Steller Drive, Culver City, Calif.

BUY GREAT NECK HAND TOOLS
... for long-lasting performance



CHROME PLATED ADJUSTABLE TUBULAR HACK SAW

GREAT NECK SAW MFRS., Inc.
MINEOLA, N. Y. — SEE YOUR LOCAL STORE

Frantz Miracle ENGINE GUARD
PROTECTS ENGINE & BEARINGS

Automatically stops engine if oil pressure becomes dangerously low or when vehicle has major accident. All internal combustion engines. Easily installed. Satisfaction guaranteed. When ordering give make vehicle, no. of cyl., 6 or 12 volt Batt.

\$8.50

FRANTZ MIRACLE PRODUCTS CORP.
YOSEMITE BLVD. MODESTO, CALIF.

STOP that **DRAWER** from **STICKING**
Easy—Quick—Forever!

WITH **Roll-eez** **ROLLER BEARINGS FOR WOODEN DRAWERS**

Eliminates friction of wood-against-wood, keeps drawers in proper alignment. Makes wooden drawers work like magic — *even in hot, humid weather!* Made with improved NYLON rollers mounted on steel frames. Each drawer set includes simple instructions and nails. Anyone can apply. Ideal for furniture as well as built-ins. Used by cabinetmakers to provide lasting convenience in homes of every price range.

49¢ SET FOR ONE DRAWER

At Hardware, Lumber and Building Supply Stores.

JOBBER DEALERS WRITE

Building? Remodeling? Insist on Roll-eez for Better Drawer Action — Lowest Cost!

Junior-Pro Prod. Co., Dept. M, 118 E. Marceau, St. Louis 11, Mo.

CASH FILING SAWS

Make from \$3 to \$6 an hour spare time or start a full time business with the

FOLEY SAW FILER

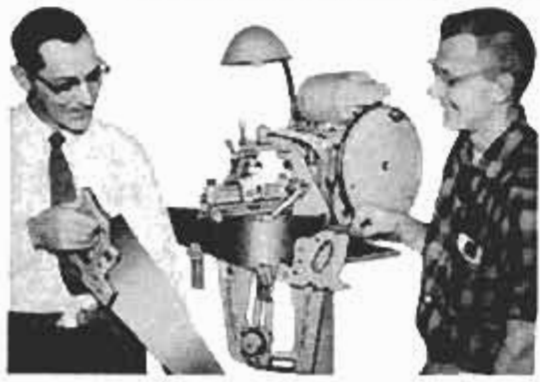

Here is a steady repeat CASH business you can start at home. No experience is necessary to turn out perfect cutting saws. With the new 1959 Foley Saw Filer you can file hand, band and both "combination" and cross-cut circular saws. Easy to operate — no eyestrain. You will find you can make from \$3 to \$6 an hour — \$20 to \$30 a week in spare time as a starter.

FREE BOOK
"MONEY MAKING FACTS" shows you how to get plenty of saws to file. Time payments if desired. Send coupon today — no salesman will call.

FOLEY MFG. CO., 1043-9 Foley Bldg. Minneapolis 18, Minn.

Send me free book "MONEY MAKING FACTS" and Time Payment plan.

Name _____
Address _____
City _____ State _____



75 Mounted Wheels & Miniature Cutters. Regular \$11.00 value **\$4.50** P.P.
For cutting and grinding on paid wood, metal or plastic. Includes 25 mtd. wheels and points on 3/32" shanks; 24 miniature cutters on 3/32" shanks; 25 short shank min. cutters. Will fit all electric drills and hand grinders.

FLEXIBLE SHAFT—ONLY \$6.50 P.P.
Fits all electric drills & hand power tools 3/32" long. Oilite bearings. Core of specially wound, high carbon steel wire in flexible steel casing. Will accommodate tool shafts up to 1/4" dia. For lathes, electric drills, etc.

2 DRUM SANDERS With 12 bands in Assorted Grits. 1/2" dia. x 1" long on 1/4" arbor with **\$1.50 P.P.**
One drum, 1" dia. x 1" long on 1/4" arbor with 6 extra sleeves **\$1.00 P.P.**

2 Carbon Steel Wood Bits for Brace. Assorted sizes. 3/32" to 5/8", for drilling on wood or metal. **\$1.75 P.P.**
18 Assorted Drills. From 1/16" to 1/2" high speed steel and carbon. Only **\$3.95 P.P.**

10 HIGH SPEED STEEL REAMERS—Straight and Taper Shanks— all brand new and in excellent condition. Reg. \$25.00 **\$4.50** value. 10 for **\$45.00**

2 Circular saws. On 2 Mandrels—all at one low price. 1" diameter saws on 1/4" Mandrels. For cutting wood, plastic or soft metals. **\$1.50 P.P.**
No C.O.D.'s. Catalog 10 cents

SEHN-SCH SUPPLY CO. 7331 COLLEGE GROVE AVE. DEPT. PM-21 CHICAGO 19, ILL.

12 MOUNTED WHEELS and points on 1/4" Shank \$2.95
36 for **\$7.50 P.P.**
For grinding on plastic, wood, soft & hard metals. Regular Value \$8.40. 12 Mounted points on 3/32" shank **\$2.50**; 12 mtd. wheels on 1/4" shank **\$3.60**.

ADAPTER CHUCK With 2 interchangeable collets, opening from 3/32" to 6, on 1/4" mandrel. Price each only **\$1.50 P.P.**

Adapter Chuck. From 60 to 80 on 3/32" Mandrel. **\$1.00 P.P.**
7 H.S. and carbon drills from 6" to 12" in length. Assorted sizes up to 1/4" diam. for drilling in hard to reach places. A reg. **\$1.95 P.P.** \$10.00 val. for only **\$1.95 P.P.**

12 India Silicon Carbide and Arkansas Stones— Squares, Rounds, Triangles. An assortment from 3/4" long to 6" long. Fine, medium and coarse. A real **\$9.00** value. **\$4.25 P.P.**

30 Assorted Drills. Hi-speed steel & carbon. Up to 1/4" dia. **\$2.75 P.P.**

32 H.S. steel drills. Threaded shanks from 3/32" to 1/4". Reg. **\$9.50** **\$2.00 P.P.** value, only

18 Rotary Cutters **\$5.85 P.P.**

\$13.50 Value. Assorted size cutters on 1/4" or 3/32" shank. Will fit all hand grinders. Ideal for cutting wood, metal, or plastic.

**See the
NEW CARS
in Full Color
SPECIAL
in the
NOVEMBER ISSUE
of
POPULAR
MECHANICS**

YOUR CHOICE  **A style and size to fit your exact needs. Free Catalog.**
GERSTNER TOOL CHESTS
459 Columbia St., Dayton 7, Ohio

 **REPLACE YOUR WORN-OUT WOODEN HATCHWAY...**

 **with an all-steel BILCO basement door**

... and your basement entrance will be weathertight, good-looking — for a lifetime. A spring-balanced Bilco door floats open at a touch . . . locks securely . . . costs so little. And you can install it yourself — in just a few hours!

Bilco
AMERICA'S FINEST BASEMENT DOOR

The Bilco Co., Dept. R-910
New Haven 5, Conn.
Please send me your free illustrated folder and name of local dealer.

NAME _____
ADDRESS _____
CITY _____ ZONE _____ STATE _____

MAKE HOME IMPROVEMENTS NOW

IS THIS OFFER TOO GOOD TO BE TRUE?

We Pay All Freight For Your FREE Home Trial!

GRINDER
SANDER
30" LATHE
8" TILTING TABLE SAW
HORIZONTAL DRILL PRESS



It's true. We pay all freight for your FREE home trial. Factory to you only \$79.95. Handles big jobs. 100% ball bearing. Think of the fun you'll have and the money you'll save with your own workshop. Only \$10 down delivers \$79.95 Supershop prepaid to your home. Write for full details, color brochures, FREE home trial plan. Mail postcard now.

**Power Tools Division
UNITED INDUSTRIES, Inc.**
124 Yates Ave., Beloit, Wisc.



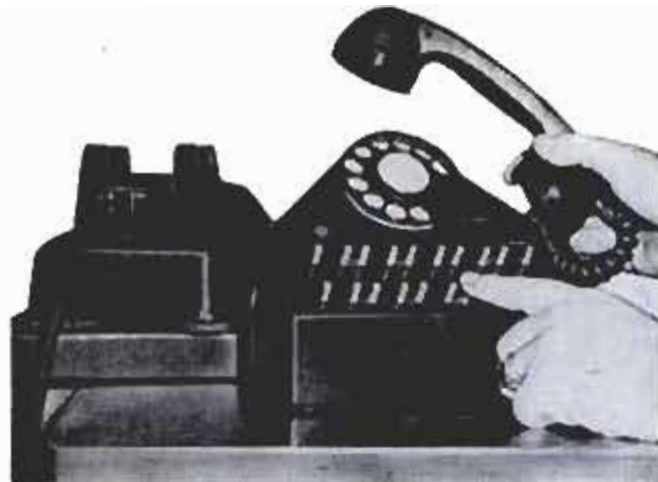

William Esty Co., 100 E. 42nd St., New York City 17

Preset Telephone Numbers Dialed by Push Button

Between 20 and 40 telephone numbers can be dialed automatically by pushing the appropriate buttons on a desk unit developed in Europe. The user presets the numbers to be retained by the instrument. After that, a number can be reached by pressing one button. The numbers can be replaced and any telephone number can be called at any time by standard dialing methods. The automatic equipment will "remember" any combination of digits up to 15.

BUILD 'EM YOURSELF



with **DOT**

TEENUTS®

and **EASI-BILD® PATTERNS!**

TEENUTS... the flush-mounting, "can't-slip" nut that needs no washer... is now specified in 10 popular Easi-Bild patterns! Get them both at Hardware, Variety and Lumber stores!

*T. M. Reg. U. S. Pat. Off.

Columbia* Fastener Company

Chicago 8, Illinois

SAVE 50% ON PHILIPPINE MAHOGANY

Take advantage of our Boatload Purchases. Ideal for paneling Dens, Office, Hotel, etc. This select Luan Philippine Mahogany meets the most rigid specifications. It is a rich golden color - rotary cut for beauty of grain. Both sides sanded and ready to use. Bonded with the finest resins. Two types to choose from; 1. Plain surface or 2. 'V' grooved in random widths.



FREE SAMPLE ON REQUEST!

AS LOW AS
1/4" thick PLYWOOD (Min. order 8 sheets)
SIZE SURFACE Price each
3' x 6' Plain \$1.89
3' x 7' Plain 2.19

1/4" thick PLYWOOD (Minimum order 4 sheets)
SIZE SURFACE Price each
4' x 7' Plain \$4.49
4' x 7' 'V' grooved 4.89
4' x 8' Plain 4.79
4' x 8' 'V' grooved 5.29

FIBERGLASS PANELING - Flat or corrugated. In most colors. 90¢ sq. ft. vol. Free samples, sq. ft. **39¢**

100-200-300X MICROSCOPE

An ideal Gift for Student, Amateur Scientist, etc. Has fine precision ground and polished lenses. Triple revolving lens objective turret allows choice of 100X, 200X or 300 power magnification. Has right and left hand rack & pinion adjustment. All-metal body inclines through 90°. Has large stage and sub-stage mirror. Complete with fitted case.
Regular Palley Catalog Price \$7.95... **NOW... ONLY 5.88**



DUAL EYEPIECE 60-600X 3 TURRET MICROSCOPE

HAS 60 - 120 - 200 - 300 - 400 & 600 POWER MAGNIFICATION WITH ILLUMINATED SUB-STAGE MIRROR and TRIPLE TURRET
Change magnification with a simple shift of the dual eyepiece turret. No loss of focus - no readjustment. Has precision ground & polished lenses. Triple revolving turret has 6X, 20X and 40X objective lenses. Dual eyepiece has 10X and 15X lenses. NEW patented sub-stage has battery operated light - no external light source is necessary. Large sub-stage has a revolving, variable iris. Body is ALL-METAL, designed to incline 90°. Comes complete with fitted case and 12 slides described below. Ideal for Student, Home Lab, etc.

12 SLIDES FREE! INCLUDE INSECTS - POLLEN SPORES, ETC.

12 DIFFERENT PREPARED SLIDES Free with purchase of above microscope. 12 Slides purchased separately... \$2.95

4 inch IMPORTED SLIDE RULE

Non-warping bamboo with scales on a white nitrate face. Face scales are A, B, C, D and K. Other side has S, L & T scales. In Case. **2.95**

5 inch IMPORTED SLIDE RULE

Same scales as above rule... **3.95**

AIR FORCE CRASH HELMET

ONLY 6.95
\$2.00 EXTRA with Earphones
Just purchased from Gov't at tremendous savings. Has rugged outer shell padded inside with foam rubber. Size: Small, Large. Ideal for Auto, Boat or Cycle racing. \$85 val.



PROFESSIONAL DRAFTETTE

Scientifically designed. Ideal for use in Classroom, Art Studio, Workshop, Office, Home, etc. Easily fits in a briefcase. Has 3" and 5" scale calibrated in .0005 of an inch. Made of black anodized aluminum. Weights 2 1/2 lbs. Comes with 11" x 17" drawing board. **6.95**

NEW FOLDING PARATROOP MACHETE AND HOLSTER

Has special blade that folds into handle, when open, blade is locked in position. Blade is finest blood steel with razor sharp, ground and honed edge. O. A. open length 17". Blade lgh. 8". **2.89**
Leather Holster... **1.50**

2000 PSI HYD. HAND PUMP

A 2000 PSI hvy. duty steel cylinder. Good for hydraulic press. Has a 2-1/2" bore, 7" stroke, 1-5/8" shaft, 19" lgh. Cost Gov't approx. \$270.00
Palley Cat. price \$12.75 **9.95**
Cat. No. H-24D

1500 PSI HYD. HAND PUMP

1500 PSI type with built-in check valve. Displaces .19GPM at 30 cycles per min. Capacity 1.5 cu. in. per stroke cycle. Reg. Palley price \$12.75 **8.95**

64 PG. IMPORT CATALOG

Packed with import bargains for Home or Patio. Includes New Hydraulic Equipment Supplement.
Send 25¢ to cover the cost of handling and mailing.

HYD. 4-WAY VALVE

H-V7A-1 **Now 3.95**
A spring loaded, poppet type valve. Pressure balanced. Off in neutral. Has 1/4" tube ports. Cost Gov't approx. \$38.

Send check or M.O. 1/2 deposit with C.O.D. All items shipped postage or freight collect.
palley's 2263 E. Vernon Ave., Dept. PM-109 Los Angeles 58, California

SAVE your foundation

PROTECT basement from flooding

GUARD against lawn erosion

only **\$2⁹⁵**
at hardware stores

RAIN-X-IT*

flexible downspout
extender

Attached in seconds
to any downspout elbow
with adjustable stainless
steel collar.

Unrolls
by itself when
it rains.

Rolls up
out of the way.

Do-it-yourself STORM WINDOWS and STORM DOORS

Each Storm-Lite Window Kit contains weather-resistant clear plastic sheet, fiber molding strips and nails. At your hardware store, only 31c per window.



GLAZE

poultry houses, farm buildings, sheds, porches, breezeways, garages and greenhouses with

R-V-LITE*

Flexible
WINDOW MATERIALS

Ask at your hardware store

*Registered trade-mark of Arvey Corporation, Chicago 18, Ill.

**ALL
NEW!**

1960 Edition of Constantine's WOODWORKING CATALOG & MANUAL



Get the biggest Constantine Catalog & Manual—2000 items! World's largest source since 1812 for rare imported and domestic woods in veneers, lumber, plywoods, bandings, inlays, mouldings, carvings... hard-to-find hardware, new solid brass hardware, wood finishing and upholstery supplies, patterns, tools, woodworking materials—at bargain prices! Also exclusive Inlaid-Wood-Picture Kits... Identification Chart of 60 rare woods in color... inspiring projects, plans, etc. For all-new 1960 Catalog & Manual, send 25c (refunded on first order). Write today!

FREE—Year's subscription to "Chips & Chats" brings news of exciting woodworking ideas and latest offerings... Free with Catalog!

ALBERT CONSTANTINE AND SON, INC
2050 Eastchester Rd., Dept. P-5
New York 61, N. Y.

The second most important tool...
for every
woodworking shop

A VERSATILE

W&H

MOLDER-PLANER

is second only
to a saw... it
molds, planes and rabbets.
"Your savings pile up as your
shavings pile up."



Thousands
in Use!

**SEND FOR
FREE BROCHURE**

WILLIAMS & HUSSEY MACHINE CORP.
CLINTON ST., MILFORD, NEW HAMPSHIRE

CHRISTMAS GIFT IDEAS?

Watch for them

NEXT MONTH

Gifts You Can Make

Gifts You Can Buy

FOR TOP POWER FOR THE JOB!



FOR HOME CRAFTSMEN

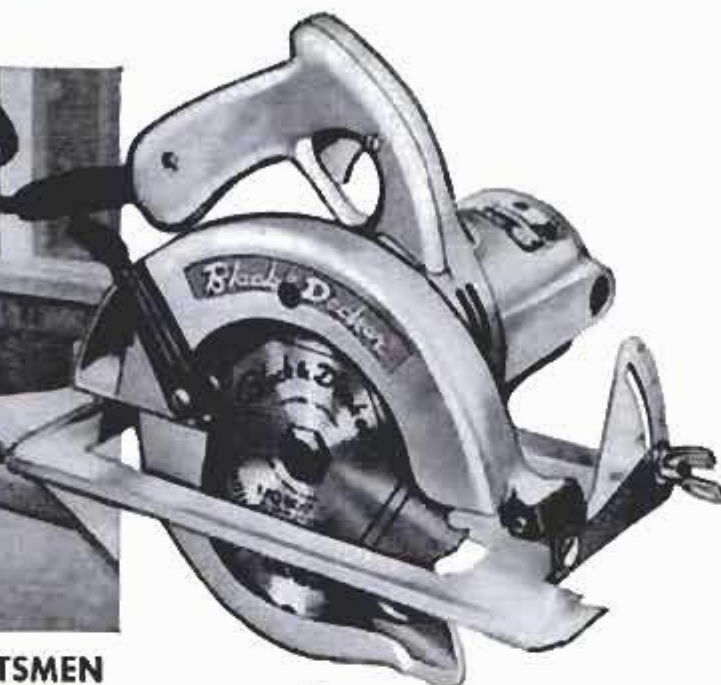

New B&D 6 1/2" Utility Saw

SPECIAL INTRODUCTORY PRICE

\$45⁹⁵

After December 25, 1959, \$49.95

Quality at low price! With new sawdust ejector and calibrated depth adjustment *plus* all the features of heavy-duty models! Cuts to 2 3/32" at 90°, 1 13/16" at 45°. Perfect model for small budgets, now specially priced for limited time!



FOR THE PROFESSIONAL

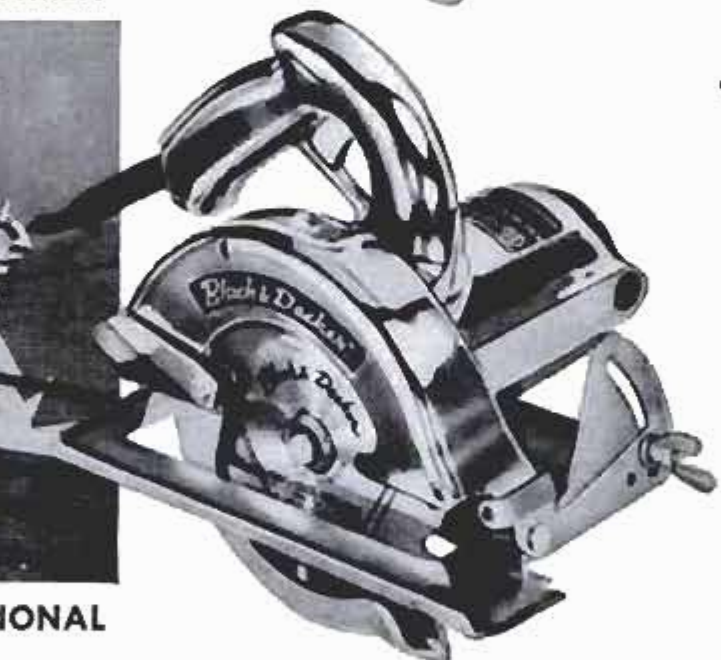

Job-tested B&D 6 1/2" H. D. Saw

ONLY **\$69⁵⁰**

Top quality in a lightweight, heavy-duty saw . . . for use portably or in a saw table. Provides power to spare for any sawing job; cuts through a 2 x 4 at 45°. Cuts to 2 5/32" at 90°, 1 7/8" at 45°.



Black & Decker

Towson 4, Md.

"TOP 10" SAWS

On the job at America's top ten construction projects



7 1/4" HEAVY-DUTY SAW



8" HEAVY-DUTY SAW



8 1/4" HEAVY-DUTY SAW



9 1/4" HEAVY-DUTY SAW

BIG MONEY BY 35



We're willing to wager that, given the proper guidance and training, you can at least double your present income within the next few years.

We'll put up three interesting and valuable books to help prove this point.

One is the gold-mine of helpful career tips, "How to Succeed."

Another is a handbook outlining opportunities in your particular field of interest (see list in coupon below).

The third is a sample lesson in Basic Mathe-

matics which demonstrates how easily yet how thoroughly I.C.S. helps you master a subject.

These books will be especially useful to you if you are between 20 and 35—provided you want to enjoy the rewards of success before you reach middle age. Actually, the famous I.C.S. method of "Success Conditioning" knows no age limit. It's never too late to learn.

Hurry up your future! Mark and mail the coupon today.

For Real Job Security—Get an I. C. S. Diploma!

I. C. S., Scranton 15, Penna.

Accredited Member,
National Home Study Council

INTERNATIONAL CORRESPONDENCE SCHOOLS



BOX 04626K, SCRANTON 15, PENNA.

(Partial list of 258 courses)

Without cost or obligation, send me "HOW to SUCCEED" and the opportunity booklet about the field BEFORE which I have marked X (plus sample lesson):

- | | | | | |
|--|--|--|--|---|
| <p>ARCHITECTURE and BUILDING CONSTRUCTION</p> <ul style="list-style-type: none"> <input type="checkbox"/> Air Conditioning <input type="checkbox"/> Architecture <input type="checkbox"/> Arch. Drawing and Designing <input type="checkbox"/> Building Contractor <input type="checkbox"/> Building Estimator <input type="checkbox"/> Carpenter Builder <input type="checkbox"/> Carpentry and Millwork <input type="checkbox"/> Carpenter Foreman <input type="checkbox"/> Heating <input type="checkbox"/> Painting Contractor <input type="checkbox"/> Plumbing <input type="checkbox"/> Reading Arch. Blueprints <p>ART</p> <ul style="list-style-type: none"> <input type="checkbox"/> Commercial Art <input type="checkbox"/> Magazine Illus. <input type="checkbox"/> Show Card and Sign Lettering <input type="checkbox"/> Sketching and Painting <p>AUTOMOTIVE</p> <ul style="list-style-type: none"> <input type="checkbox"/> Automobile <input type="checkbox"/> Auto Body Rebuilding and Refinishing <input type="checkbox"/> Auto Engine Tuneup <input type="checkbox"/> Auto Technician | <p>AVIATION</p> <ul style="list-style-type: none"> <input type="checkbox"/> Aero-Engineering Technology <input type="checkbox"/> Aircraft & Engine Mechanic <p>BUSINESS</p> <ul style="list-style-type: none"> <input type="checkbox"/> Accounting <input type="checkbox"/> Advertising <input type="checkbox"/> Business Administration <input type="checkbox"/> Business Management <input type="checkbox"/> Cost Accounting <input type="checkbox"/> Creative Salesmanship <input type="checkbox"/> Managing a Small Business <input type="checkbox"/> Professional Secretary <input type="checkbox"/> Public Accounting <input type="checkbox"/> Purchasing Agent <input type="checkbox"/> Salesmanship <input type="checkbox"/> Salesmanship and Management <input type="checkbox"/> Traffic Management <p>CHEMICAL</p> <ul style="list-style-type: none"> <input type="checkbox"/> Analytical Chemistry <input type="checkbox"/> Chemical Engineering <input type="checkbox"/> Chem. Lab. Technician <input type="checkbox"/> Elements of Nuclear Energy <input type="checkbox"/> General Chemistry <input type="checkbox"/> Natural Gas Prod. and Trans. <input type="checkbox"/> Petroleum Prod. and Engr. <input type="checkbox"/> Professional Engineer (Chem) <input type="checkbox"/> Pulp and Paper Making | <p>CIVIL ENGINEERING</p> <ul style="list-style-type: none"> <input type="checkbox"/> Civil Engineering <input type="checkbox"/> Construction Engineering <input type="checkbox"/> Highway Engineering <input type="checkbox"/> Professional Engineer (Civil) <input type="checkbox"/> Reading Struc. Blueprints <input type="checkbox"/> Sanitary Engineer <input type="checkbox"/> Structural Engineering <input type="checkbox"/> Surveying and Mapping <p>DRAFTING</p> <ul style="list-style-type: none"> <input type="checkbox"/> Aircraft Drafting <input type="checkbox"/> Architectural Drafting <input type="checkbox"/> Drafting & Machine Design <input type="checkbox"/> Electrical Drafting <input type="checkbox"/> Mechanical Drafting <input type="checkbox"/> Sheet Metal Drafting <input type="checkbox"/> Structural Drafting <p>ELECTRICAL</p> <ul style="list-style-type: none"> <input type="checkbox"/> Electrical Engineering <input type="checkbox"/> Elec. Engr. Technician <input type="checkbox"/> Elec. Light and Power <input type="checkbox"/> Practical Electrician <input type="checkbox"/> Practical Lineman <input type="checkbox"/> Professional Engineer (Elec) <p>HIGH SCHOOL</p> <ul style="list-style-type: none"> <input type="checkbox"/> High School Diploma | <ul style="list-style-type: none"> <input type="checkbox"/> Good English <input type="checkbox"/> High School Mathematics <input type="checkbox"/> High School Science <input type="checkbox"/> Short Story Writing <p>LEADERSHIP</p> <ul style="list-style-type: none"> <input type="checkbox"/> Industrial Foremanship <input type="checkbox"/> Industrial Supervision <input type="checkbox"/> Personnel-Labor Relations <input type="checkbox"/> Supervision <p>MECHANICAL and SHOP</p> <ul style="list-style-type: none"> <input type="checkbox"/> Diesel Engines <input type="checkbox"/> Gas-Elec. Welding <input type="checkbox"/> Industrial Engineering <input type="checkbox"/> Industrial Instrumentation <input type="checkbox"/> Industrial Metallurgy <input type="checkbox"/> Industrial Safety <input type="checkbox"/> Machine Shop Practice <input type="checkbox"/> Mechanical Engineering <input type="checkbox"/> Professional Engineer (Mech) <input type="checkbox"/> Quality Control <input type="checkbox"/> Reading Shop Blueprints <input type="checkbox"/> Refrigeration and Air Conditioning <input type="checkbox"/> Tool Design <input type="checkbox"/> Tool Making <p>RADIO, TELEVISION</p> <ul style="list-style-type: none"> <input type="checkbox"/> General Electronics Tech. | <ul style="list-style-type: none"> <input type="checkbox"/> Industrial Electronics <input type="checkbox"/> Practical Radio-TV Eng'g <input type="checkbox"/> Practical Telephony <input type="checkbox"/> Radio-TV Servicing <p>RAILROAD</p> <ul style="list-style-type: none"> <input type="checkbox"/> Car Inspector and Air Brake <input type="checkbox"/> Diesel Electrician <input type="checkbox"/> Diesel Engr. and Fireman <input type="checkbox"/> Diesel Locomotive <p>STEAM and DIESEL POWER</p> <ul style="list-style-type: none"> <input type="checkbox"/> Combustion Engineering <input type="checkbox"/> Power Plant Engineer <input type="checkbox"/> Stationary Diesel Engr. <input type="checkbox"/> Stationary Fireman <p>TEXTILE</p> <ul style="list-style-type: none"> <input type="checkbox"/> Carding and Spinning <input type="checkbox"/> Cotton Manufacture <input type="checkbox"/> Cotton Warping and Weaving <input type="checkbox"/> Loom Fixing Technician <input type="checkbox"/> Textile Designing <input type="checkbox"/> Textile Finishing & Dyeing <input type="checkbox"/> Throwing <input type="checkbox"/> Warping and Weaving <input type="checkbox"/> Worsted Manufacturing |
|--|--|--|--|---|

Name _____ Age _____ Home Address _____
 City _____ Zone _____ State _____ Working Hours _____ A.M. to P.M. _____
 Occupation _____

Canadian residents send coupon to International Correspondence Schools, Canadian, Ltd., Montreal, Canada. . . . Special low monthly tuition rates to members of the U. S. Armed Forces.

"I was ashamed to always be so tired!"



I ALWAYS felt simply "run-down." People were thinking of me as a "spoil-sport." I didn't know why until my doctor put me wise. He told me that I acted like a man much older than myself, and explained why I felt "tired," why my energy was slipping away, why my wife and family were beginning to think of me as a worn-out man.

He told me how a vitamin-mineral deficiency could bring on these symptoms, and suggested that I add a good food supplement to my diet.

Well, I put off doing anything about my condition — until one day I read the Vitasafe ad in a magazine offering a 30-day trial supply of high-potency Vitasafe C. F. Capsules! I figured I had nothing to lose, so I mailed the coupon. When my trial supply arrived, I began taking one Capsule a day. In a short time, I began to feel like a new man. My pep and energy increased, I continued with the Vitasafe Plan — and I felt stronger — more energetic!

Today, no one thinks of me as a "worn-out old man." I feel peppier and more energetic than I have in years. And you may, too! Accept this no-risk offer as I did by mailing the postcard today!

A dramatization posed by professional model.

MILLIONS
HAVE READ
TRUE-TO-LIFE
VITASAFE
STORIES
LIKE
THESE ...

"Our
It's hard to believe I got home from back at her! We that we suddenly ing up! There was that both of us al each other's nerve

Our family doctor probably saved our healthy people, he and over-tired bed deficiency. This could tense and short tem

To correct this condition Vitasafe High-Potency had more pep, more improved. Instead of other's arms.

If you or your wife you used to have. nervous and bad-tem you owe it to yourself Potency Capsules.

FREE 30 days supply High-Potency Capsules LIPOTROPIC FACTORS, VITAMINS and MINERALS

Safe, Nutritional Formula Containing 27 Proven Ingredients: Glutamic Acid, Choline, Inositol, Methionine, Citrus Bioflavonoid, 11 Vitamins (Including Blood-Building B12 and Folic Acid) Plus 11 Minerals

To prove to you the remarkable advantages of the Vitasafe Plan . . . we will give you, without charge, a 30-day free supply of high potency VITASAFE C.F. CAPSULES so you can discover for yourself how much stronger, happier and peppier you may feel after a few days' trial! Just take one of these capsules each day supplies your body with over twice the minimum daily requirement of Vitamins A, B1, and D — five times the minimum adult daily requirement of Vitamin B-1, and the concentration recommended by the Food and Nutrition Board of the National Research Council for the other four important vitamins! Each capsule contains an amazing Vitamin B-12, a remarkable nutrient that helps nourish your body organs. Vitasafe Capsules also contain Glutamic Acid, an important protein constituent derived from natural wheat gluten. And now, to top off this exclusive formula each capsule also brings you an important amount of Citrus Bioflavonoid. This formula is so complete it is available nowhere else at this price!

You can use these Capsules confidently because U. S. Government regulations demand that you get exactly what the label states — pure, safe ingredients. The beneficial effects of these ingredients have

been proven time and time again.

**WHY WE WANT YOU TO TRY
A 30-DAY SUPPLY — FREE!**

So many otherwise normally healthy people have already tried VITASAFE C.F. CAPSULES with such outstanding results . . . so many have written in telling us how much better they felt after only a short trial . . . that we are absolutely convinced that you, too, may experience the same feeling of improved well-being after a similar trial. In fact, we're so convinced that we're willing to back up our convictions with our own money. You don't spend a penny for the vitamins! All the cost and risk are ours.

**HOW AMAZING PLAN SLASHES
VITAMIN PRICES**

With your free 30-day supply of Vitasafe High-Potency Capsules you will also receive complete details regarding the benefits of an amazing new Plan that provides you regularly with all the factory-fresh vitamins and minerals you will need. By participating in the Vitasafe Plan now you are never under any obligation! When you have received your first 30-day trial supply, simply take one VITASAFE Capsule every day to prove that this formula can help you as it is helping so many others. But you remain the sole judge. If you are not completely satisfied, and do not wish

to receive any additional vitamins, simply let us know by writing us before the next monthly shipment — or you can use the handy instruction card we will provide — and no future shipments will be sent. Yes, you are under no purchase obligation

A VITASAFE PLAN FOR WOMEN

Women may also suffer from lack of pep, energy, and vitality due to nutritional deficiency. If there is such a lady in your house, you will do her a favor by bringing this announcement to her attention. Just have her check the "Woman's Plan" box in the postcard.

tion ever; you may cancel future shipments at any time!

But if you are delighted — as so many people already are — you don't do a thing and you will continue to receive fresh, additional shipments regularly every month — for just as long as you wish, automatically and on time — at the low Plan rate of only \$2.78 plus a few cents shipping for each full month supply. You take no risk whatsoever — you may drop out of this Plan any time you wish without spending an extra penny, by simply notifying us of your decision a few days before your next monthly shipment. Take advantage of our generous offer! Mail postcard NOW.

Mail Postcard To **VITASAFE CORPORATION, 43 West 61st Street, New York 23, N.Y.**
or when in New York visit the **VITASAFE PHARMACY, 1860 Broadway at Columbus Circle**

Two Soldering Temperatures make this
the world's greatest soldering gun value!



Weller®

**DUAL HEAT
SOLDERING GUN KIT**

Features the new Weller Dual Heat Gun—most advanced soldering tool on the market. Not only does the heat and spotlight come on instantly when trigger is pulled, but 2 trigger positions give 2 soldering temperatures. You can switch instantly to high or low heat as your job requires.

Kit also includes
cleaning brush,
soldering aid
and solder

\$795
MODEL
8200K

**2 TRIGGER
POSITIONS**
give low 90-watt
and high 125-watt
heat at tip

Don't settle for less than these Weller Gun Features

DUAL HEAT Saves time, adds convenience and increases tip life. You use high heat only when necessary.

LONG LIFE TIP Utilizes copper for superior heat transfer, plus iron plating for durability and long life.

INSTANT HEAT Pull the trigger and tip heats instantly—no waiting. Release and heat goes off.

LONG REACH Slips easily into tight spots and makes soldering easier. Tip can also be bent, if desired.

SPOTLIGHT Prefocused to throw a beam of light right where you're soldering. No flashlight needed.

RUGGED HOUSING Streamlined design. Perfectly balanced. Pistol grip lets you guide the gun easily.

You can make every kind of cut with a
WELLER SABRE SAW

Cuts through plywood, composition board, aluminum, plastics, etc. Even makes its own starting hole for inside cuts. And it's portable—use it anywhere. Exclusive strain-relief design eliminates blade breakage. Lubricated for life. 3 different blades included.

MODEL 800

\$1995



AT YOUR HARDWARE OR HOBBY DEALER • WELLER ELECTRIC CORP., EASTON, PA.