

# POPULAR MECHANICS

WRITTEN SO YOU CAN UNDERSTAND IT

SEPTEMBER 1959

35 CENTS

MILES PER GALLON

## WHICH FOREIGN CAR IS BEST FOR YOU?

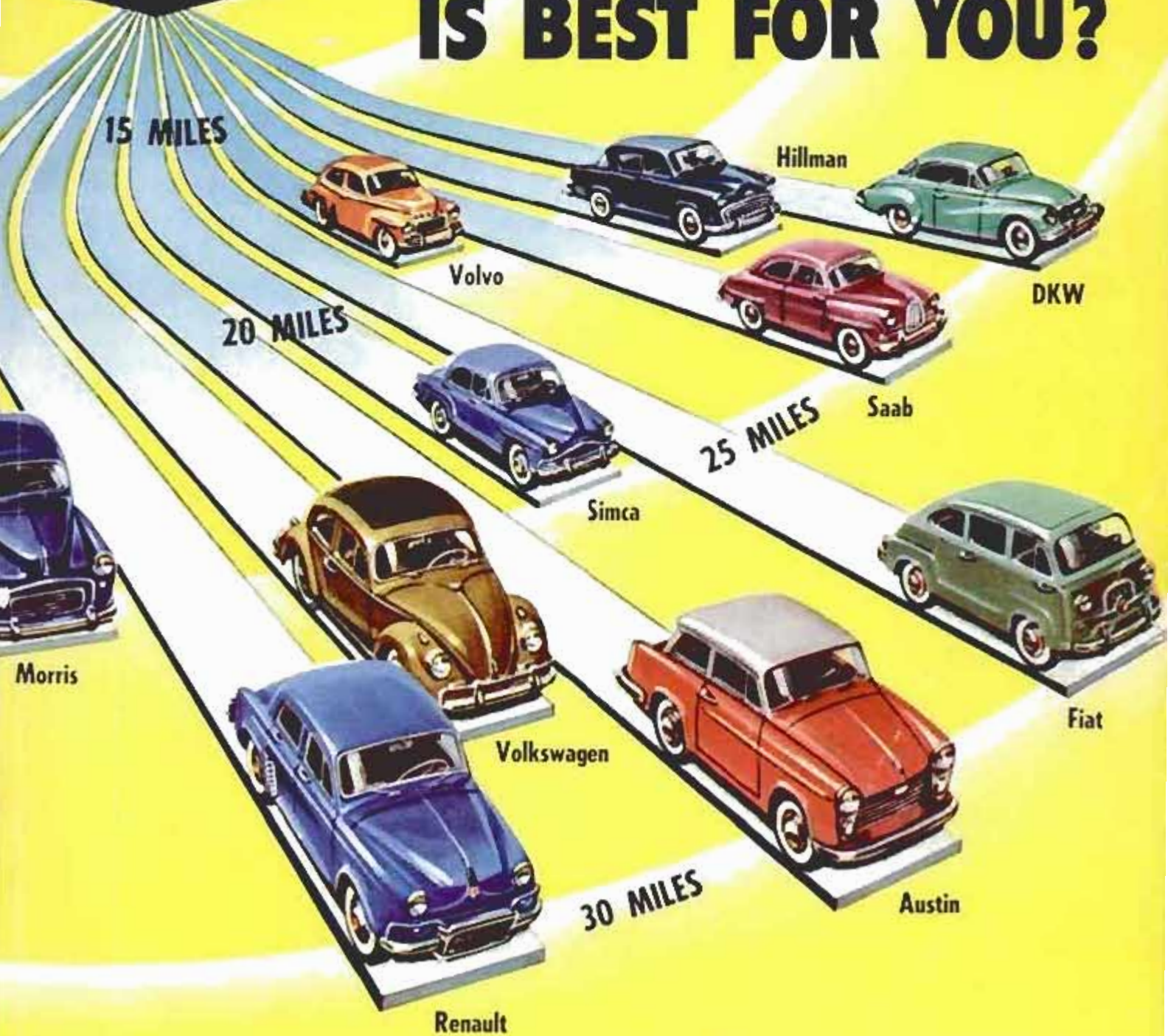

# HOW AMERICA'S NUMBER ONE CARBURETOR TESTS TROUBLE OUT, BUILDS RELIABILITY IN!



The GM Desert Proving Grounds simulate the most severe summer conditions. At the same time, other parts of the country are chosen to reproduce winter and extreme altitude conditions.



Rochester-GM Carburetors keep pace with the latest advances in fuel to give you years' ahead performance and economy on today's cars and on models of the future.



Quality is carefully controlled at every stage of manufacture to assure trouble-free performance of every Rochester-GM Carburetor and assure that every gallon of gas does a lot more work.

Rochester-GM Carburetors must perform in all 50 states, twelve months of the year, regardless of weather conditions. To do this, trouble is tested out through millions of rugged test miles, simulating conditions in every part of the country. And, through research and careful quality controls, the makers of Rochester-GM Carburetors build reliability in! The results: the same dependable performance in June as in January. To keep this carburetor in top operating condition, it's important to see your factory-trained Rochester-GM Carburetor specialist for periodic maintenance. See him today, and see the difference. *Rochester Products Division of General Motors, Rochester, New York.*



Rochester-GM Carburetor specialists are taught the expert techniques of maintaining your Rochester-GM Carburetor in training schools throughout the country.

**ROCHESTER CARBURETORS**



America's  
number one  
original equipment  
carburetors

# INDIAN TERRITORY



AND WE MEAN CIGAR STORE INDIAN TERRITORY...  
A LAND THAT'S BEEN INVADED BY A WONDERFUL NEW CIGAR

# PHILLIES. CHERROOTS



The smoke signal you get from Gheroots is

## MIRACLE MILD

Whoop it up with a cigar that's new in size and shape

*Slick on the draw  
and big as your trigger finger!*



Scout around for 28 cents and buy the handy fresh pack of 5



# STEP UP TO PROTO

Here are 4 of the many job-planned tool sets waiting for you at your Proto Dealers, including Hardware, Builders Supply, and Auto Parts stores all over the country.

## SET NO. 9910

Matched Set of the most useful basic tools.

Contents:  $\frac{3}{8}$ " Sq. Dr. Ratchet,  $7\frac{1}{2}$ " Ext., 12" Ext., 12" Hinge Hdle. Sockets, 12 Pt.— $\frac{3}{8}$ ,  $\frac{7}{16}$ ,  $\frac{1}{2}$ ,  $\frac{9}{16}$ ,  $\frac{5}{8}$ ,  $\frac{1}{2}$ " Sq. Dr. Ratchet, 5" Ext., 10" Ext., 15" Hinge Hdle. Sockets, 12 Pt.— $\frac{1}{2}$ ,  $\frac{9}{16}$ ,  $\frac{3}{8}$ ,  $\frac{1}{16}$ ,  $\frac{3}{4}$ ,  $\frac{13}{16}$ ,  $\frac{7}{8}$ ,  $\frac{15}{16}$ , 1,  $1\frac{1}{16}$ ". Combination Wrenches:  $\frac{3}{8}$ ,  $\frac{7}{16}$ ,  $\frac{1}{2}$ ,  $\frac{9}{16}$ ,  $\frac{5}{8}$ ,  $\frac{11}{16}$ ,  $\frac{3}{4}$ ,  $\frac{13}{16}$ ,  $\frac{7}{8}$ ". Tool Box w/Tote Tray.

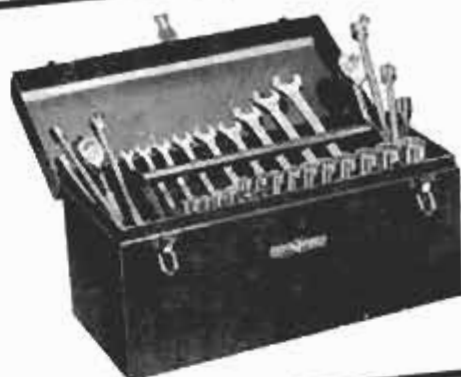

## SET NO. 5200ABM

Complete Metric Socket Set with special features.

Contents: 5026-HP Patented Spark Plug Socket, 14mm, with Rubber Insert.  $\frac{3}{8}$ " Sq. Drive, 12-Pt. Sockets: 8, 9, 10, 11, 12, 13, 14, 15, 16, 17, 18, & 19 Millimeters, Ratchet, 2 Extensions, Hinge Hdle., U-Joint, Speeder, Steel Box.

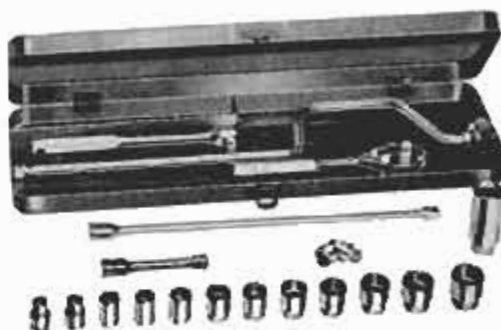

## SET NO. 1200F

Master Set of famous Proto Combination Wrenches.

Contents: Opening Sizes— $\frac{5}{16}$ ,  $\frac{3}{8}$ ,  $\frac{7}{16}$ ,  $\frac{1}{2}$ ,  $\frac{9}{16}$ ,  $\frac{5}{8}$ ,  $1\frac{1}{16}$ ,  $\frac{3}{4}$ ,  $\frac{13}{16}$ ,  $\frac{7}{8}$ ,  $1\frac{1}{16}$ , 1,  $1\frac{1}{16}$ ,  $1\frac{1}{8}$ ,  $1\frac{1}{4}$ ". Vinyl Kit.

## SET NO. 4700B

Midget Socket Set for all kinds of light work.

Contents: 6-Pt. Sockets:  $\frac{7}{32}$ ,  $\frac{1}{4}$ ,  $\frac{9}{32}$ ,  $\frac{5}{16}$ ,  $\frac{11}{32}$ ,  $\frac{3}{8}$ ,  $\frac{7}{16}$ ". 8-Pt. Sockets:  $\frac{1}{4}$ ,  $\frac{5}{16}$ ". Ratchet, Socket Driver,  $\frac{5}{8}$ ", T-Handle, Steel Box.



**NOTE:** Proto guarantees the performance and quality of every tool.

2202 Santa Fe Ave., Los Angeles 54, California  
502 Allen St., Jamestown, N.Y.  
1702 Oxford East, London, Ontario, Canada



# POPULAR MECHANICS®

Address communications to: 200 E. Ontario St., Chicago 11, Illinois. **SUBSCRIPTION SERVICE:** Mail all subscription orders, changes of address, correspondence concerning subscriptions, and Postmaster notices of undeliverable copies to Popular Mechanics, 250 West 55th St., New York 19, N. Y.

*Editor*  
**RODERICK M. GRANT**

*Executive Vice-President*  
**RICHARD E. DEEMS**

*Publisher*  
**G. HARRY CHAMBERLAINE**

*Managing Editor*  
**WAYNE WHITTAKER**

*Assistant Managing Editor*  
**CLIFFORD B. HICKS**

*Shop Notes and Crafts Editor*  
**JAMES R. WARD**

*Automotive Editor*  
**ARTHUR R. RAILTON**

*Associate Editors, Shop Notes and Crafts*  
**WAYNE C. LECKEY**      **W. CLYDE LAMMEY**

*Radio-Television, Electronics Editor*  
**LOTHAR STERN**

*Assistant Editors*  
**SHELDON A. MIX, R. B. KIRKPATRICK,**  
**ROBERT L. HULL, JR., General Features**  
**EARL WOBCEK, Crafts**  
**JOHN DALEN, Makeup**

*Art Staff*  
**FRANK BEATTY, Director**  
**HENRY NEHRBASS, Assistant Director**  
**RICHARD A. POTTS, Art Editor**

*Eastern Editor*  
**RICHARD F. DEMPEWOLFF**  
Room 4102, Empire State Bldg., New York City 1

*Western Editor*  
**THOMAS E. STIMSON, JR.**  
Suite 1003, 3460 Wilshire Blvd.,  
Los Angeles 5, Calif.

*Advertising Manager*  
**JOSEPH R. BUELL, JR.**

*Director, Bureau of Information*  
**ALLAN CARPENTER**

*Advertising Offices*  
Chicago: 200 E. Ontario St., Whitehall 4-0100;  
New York: Empire State Bldg., 350 Fifth Ave.,  
Longacre 5-7580; Detroit: General Motors  
Bldg., TRinity 5-8711; Cleveland: Hanna  
Bldg., 1422 Euclid Ave., PRospect 1-0456; Los  
Angeles: 3460 Wilshire, DUmkirk 2-8458; San  
Francisco: Russ Bldg., 235 Montgomery St.,  
Yukon 2-0823.

Published monthly by Popular Mechanics Company, 200 E. Ontario St., Chicago 11, Ill. Richard E. Berlin, President; Richard E. Deems, Executive Vice-President; Fred Lewis, Vice-President and General Manager; John R. Miller, Vice-President; G. Harry Chamberlain, Vice-President; G. O. Marquon, Treasurer; R. V. McCauley, Secretary. Single copy in the United States and Canada, 35 cents; subscription rates in the United States and possessions, Canada and countries of the Pan American Postal Union, 1 year \$3.50; 2 years, \$6.00; 3 years, \$8.00. To all other countries add \$1.00 a year over United States prices for overseas postage. If you plan to move, notify us at least 30 days in advance so you will not miss an issue. Give both your old and new addresses. Second-class postage paid at Chicago, Illinois, and at additional mailing offices. Entered as Second Class Matter at Post Office Dept., Canada. Registered as Second Class Matter at the Post Office at Mexico, D.F., Mexico, June 20, 1950. ©1959 by Popular Mechanics Company. All rights reserved. Printed in the United States of America.

FOREIGN EDITIONS:	MECANIQUE POPULAIRE (French)	MECANICA POPULAR (Spanish)	POPULAER MEKANIK (Danish)	POPULAR MEKANIK (Swedish)	POPULARE MECHANIK (German)
Volume 112	SEPTEMBER 1959			Number 3	

## In This Issue...

PM Salutes Igor Sikorsky	73
The Other Side of Paradise	84
Which Foreign Car Is Best for You?—Part II	96
Jungle Road Knives Through the Last Frontier	105
The Palace That's Painted With Corn	114
Musical House for a Musical Family	126
A Child in a Giant's World	132
The "Squash Bug" Searches for Pay Dirt	136
Get Ready for the Next Flood	141
Radio, TV and Electronics	149

## For the Craftsman...

Table for Your Lamp	154
Dumb-Waiter—a Home "Workhorse"	158
Home Uses for Urethane Foam	162
Lower Your Boating Bill	170
Painting Over New Plaster	177
Why a Compression Test?	188
Now They're Using Chemicals	198

## Regular Departments...

WHERE-TO-BUY-IT INDEX	68
Old-Timer Quiz	14
Pioneer of Science	20
An Eye on Space	81
Detroit Listening Post	82
What's New for Your Home	122
Solving Home Problems	166
Shopping for Tools	206
Clinic for Homemakers	212

Turn to detailed index on page 68. Sources of additional information on items in this issue are shown on the Where-to-Find-It List, available without charge by writing the Bureau of Information, Popular Mechanics, 200 E. Ontario St., Chicago 11, Ill.

## Next Month...

**HOMES, HOMES, HOMES . . .** Leading off our annual Home Section is the exciting PM Indoor-Outdoor House, designed by one of the nation's leading architects. We think you'll agree it's one of the finest houses ever presented. Also in the big 50-page Home Section you'll find 11 other articles ranging from tips for home planners to "Landscaping for Year-Round Effect" . . . And watch the October issue for your first look at the details on the first of the Detroit small cars



**EXTRA BLOWOUT PROTECTION:** Nylon has lasting strength to guard against blowout. Nylon protects against the four kinds of unseen tire damage that can lead to sudden tire failure: (1) heat, (2) bruising from bumps, (3) moisture, (4) flexing. All tire makers use nylon cord in their better tires. Why risk a dangerous blowout? Have your tires checked regularly. And whenever you buy new tires, be sure they're made with nylon cord.

**THE SAFEST, STRONGEST TIRES ARE MADE WITH NYLON**

LOOK FOR THE NYLON IDENTIFICATION ON TIRE SIDEWALL.



BETTER THINGS FOR BETTER LIVING... THROUGH CHEMISTRY



## Now! For the man who can't afford battery failure!

Auto-Lite sta-ful with Power Bond is the battery for the man who *must* be there, who can't afford to trifle with time, who just can't afford battery failure. Power Bond, an exclusive Auto-Lite development, eliminates plate-destroying vibration, a major cause of battery failure.

Auto-Lite sta-ful with Power Bond needs

water only 3 times a year in normal car use because it has the sta-ful extra liquid reserve above the plates. Power Bond is so good that it is registered in your name at the factory. It is the leader of a top-quality, top-value family of Auto-Lite Batteries made for both the new 12- and the older 6-volt automotive electrical systems.



HERE'S THE TOUGHEST TEST ever made on batteries! Both Auto-Lite sta-ful with Power Bond and ordinary batteries were clamped to this vibrating machine and tested for power loss at specific time intervals. See the amazing results . . .

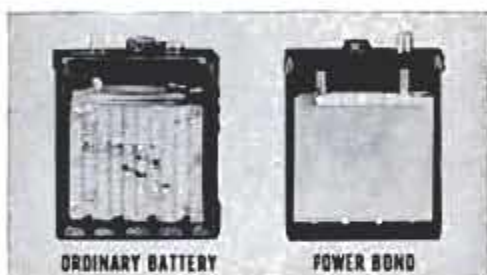

Ordinary battery plates (left) have lost vital power-producing materials and failed after only 55 hours of vibration testing. But the amazing Auto-Lite sta-ful with Power Bond (right) shows no damage at all after 1000 hours in the same test. Plates are still intact and delivering full starting power!



# AUTO-LITE. sta-ful. with POWER BOND.

DRY CHARGED . . . FRESH WHEN YOU BUY! FOR MOST 12-VOLT SYSTEMS

# Over the Editor's Desk



Add the urge to travel—whether it's on a sidewalk or a tollway, a chain of lakes or the sky—to the built-in ingenuity of the do-it-yourself addict and you come out with a variety of interesting vehicles. From our editor's mailbag we collected the homemade craft pictured with the paragraphs that follow:

## Big Jeep

Inspired by an article in *PM* of September, 1957, George C. Henderson of Detroit built this special Jeep station wagon.



It has front-wheel drive, 100-inch wheelbase, four-wheel hydraulic brakes, direction signals "and all the usual trimmings." Mr. Henderson reports 20 miles per gallon with the four-cylinder engine. He changed the gears in the axle from 5.38 to 4.56 to 1 ratio, which reduces the r.p.m. somewhat and saves gasoline. The project cost \$420, not counting about 60 days of labor for which Mr. Henderson did not charge himself as, he writes, "I am on Social Security so I have nothing to do."

☆

## Little Jeep

Another Jeep—this a father-and-son project—was adapted by Milton Pirett of



(Continued to page 8)

Enjoy Velvet-Smooth Smoking  
-the whole bowl through!



Velvet-smooth smoking is milder smoking — cool and comfortable — from first puff to last. Velvet's aged burley tobaccos are selected and cut to burn slower and smoother in any pipe.

**Spend the rest of your life on Velvet!**

IN POCKET TINS,  
REGULAR  
AND LARGE SIZE  
HUMIDORS

© 1959 LIGGETT &  
MYERS TOBACCO CO.



# A BETTER JOB MORE MONEY



## LEARN ACCOUNTING...

### SEND FOR FREE SAMPLE LESSON

You need no special talents to be a success in Accounting. You do not even need a preliminary knowledge of bookkeeping. All you need is the will to win—the will to work—and if you apply yourself you, too, can get into the bigger-money class.

Demand for Accountants far exceeds the supply—and this demand is increasing every day. A capable accountant should never have any trouble getting a job—and at better than average earnings.

We train you from the ground up—Basic Accounting right through Accounting Systems and Federal Income Tax. Then CPA Training to prepare for the CPA examinations.

#### Why Be Satisfied with Your Present Job?

Why accept mediocre pay when right in your own home you can acquire the necessary training to advance rapidly in the profitable, growing field of Accounting.

#### Take the Short Cut

**The LaSalle Problem Method**  
Under the LaSalle Problem Method you can acquire a thorough knowledge of Accounting—you can master its fundamental principles—and become

expert in the application of those principles. You learn by doing—and without losing any time from your present work.

Your training is directly under the supervision of a competent staff of Certified Public Accountants and accounting experts—and you can master Accounting as rapidly as your time and ability permit.

#### Free Sample Lesson

Send the coupon today—our FREE booklet "Opportunities in Accounting" will be sent promptly along with a sample lesson. It explains fully how we train you from the ground up—or from where you are now—according to your individual needs.

Get all the facts. The cost is low—terms easy. Don't pass this page without tearing out the coupon and mailing it promptly. It can be the means of your success—more money—a better job. Get our FREE booklets and judge for yourself.

ACCREDITED MEMBER,  
NATIONAL HOME STUDY COUNCIL

FIFTY YEARS OF  
QUALITY TRAINING

LSU

SEND FOR FREE BOOK

OVER 4,500 CPAs HAVE BEEN  
TRAINED BY THE FAMOUS LASALLE  
**PROBLEM METHOD**



### LaSalle Extension University

—A Correspondence Institution—

Dept. 964H, 417 S. Dearborn St., Chicago 5, Ill.

Please send me, free of all cost or obligation, a sample lesson in Accounting...also, your latest illustrated book, "Opportunities in Accounting."

Name.....

Address.....

City, Zone, State.....

(Continued from page 6)

Damascus, Md., from plans he found in the *PM* book, "The Boy Mechanic." The Piretts made changes in the steering mechanism to achieve a closer turn with a simple auto-type cable steering. They added a 1-1.5 hp. Briggs and Stratton engine with hand throttle and clutch, and positive-action brakes, both clutch and brakes having foot pedals. The motor is rear-mounted, and the ratio from motor to wheel is 9 to 1.



### It Follows Him Around

Master Sgt. Lawrence D. Cox started building an airplane in 1953. He was on



duty, then, at Elmendorf Air Force Base, Alaska. He finished it five years later at Walker Air Force Base, N. Mex. Our last report was that it was being dismantled for transfer to Pease Air Force Base, N. H. Sergeant Cox estimates he spent about \$800 for material and power plant, but he can't guess the man-hours invested. All parts except the engine, engine mounts, tail wheel, hubs and propeller were handmade. The plane has been given a federal certificate of airworthiness.



### Detroit Supplied the Parts

Nick Kuntz of Flasher, N.D., built this tractor from an assortment of parts most



(Continued to page 10)

**NOW! 10 Times Faster than Hand Raking**  
*Rid your lawn of grass clippings, leaves, all debris the easy way... as you stroll*



**Parker**  
LAWN SWEEPERS

**75 YEARS**

Parkerette  
20" and 28" sweep

Your new Diamond Jubilee Parker sweeps your lawn in *one-tenth* the time of old-fashioned hand raking, folds for easy storage. There's a wonderful Parker lawn sweeper waiting for you at your hardware garden supply or department store.  
**Ask for a FREE DEMONSTRATION.**

--	--	--	--	--

Springfield Homemaster Electro-Sweep Suburbanite Pelican cart

**THE PARKER SWEEPER COMPANY**  
SPRINGFIELD, OHIO

Cast your ballot for a successful future!

# 258 I.C.S. COURSES



I.C.S. is the oldest and largest correspondence school. 258 courses. Business, industrial, engineering, academic, high school. One for you. Direct, job-related. Bedrock facts and theory plus practical

application. Complete lesson and answer service. No skimping. Diploma to graduates.

Send for the 3 free booklets offered below and find out how I.C.S. can be your road to success.

## ACCOUNTING

Accounting  
Auditing  
Bookkeeping & Cost Accounting  
General Accounting  
Junior Accounting  
Practical Accounting  
Public Accounting

## ADVERTISING

Advertising  
Advertising Production  
Direct Mail Advertising  
Magazine & Newspaper Advertising

## ARCHITECTURE AND BUILDING CONSTRUCTION

Architectural Drawing & Designing  
Architectural Interiors  
Architecture  
Building Contractor  
Building Contractor with Drawing  
Building Estimator  
Building Maintenance  
Carpenter-Building  
Carpenter Foreman  
Carpentry & Millwork  
House Planning  
Lumber Dealer  
Mason Foreman  
Painting Contractor  
Reading Arch. Blueprints  
Reading Struct. Blueprints

## ART

Advertising Layout & Illustration  
Amateur Artist  
Commercial Art  
Commercial Cartooning  
Fashion Illustrating  
Figure Drawing & Painting  
Magazine Illustrating  
Show Card & Sign Prod'n  
Show Card Writing  
Sign Painting & Designing  
Sketching & Painting

## AUTOMOTIVE

Auto Engine Tune-up  
Automobile  
Automobile Body Rebuilding and Refinishing  
Automobile Electrical Technician

Automobile Technician  
Diesel Engines  
Diesel-Gas Motor Vehicle Engines  
Gas Engines  
Internal Combustion Engines

## AVIATION

Aero-Engineering Technology  
Aircraft & Engine Mechanic  
Aircraft Mechanic  
Aviation Engine Mechanic  
Reading Aircraft Blueprints

## BUSINESS

Business Administration  
Business Correspondence  
Business Law  
Business Management  
Business Management & Marketing  
Business Management & Production  
Canadian Business Management  
Clerk-Typist  
Commercial  
Condensed Business Practice  
Federal Tax Course  
Managing a Small Business  
Office Administration for Engineers  
Office Management  
Professional Secretary  
Programming for Digital Computers  
Purchasing Agent  
Retail Business Management  
Retail Merchandising  
Shorthand  
Stenographic  
Typewriting

## CHEMICAL

Analytical Chemistry  
Chemical Engineering  
Chemical Engineering Unit Operation  
Chemical Laboratory Technician  
Chemical Prod'n Foreman  
Elements of Nuclear Energy  
General Chemistry  
Industrial Analytical Chemistry  
Industrial Chemistry  
Paper Making  
Professional Engineer—Chemical  
Pulp & Paper Engineering

Pulp & Paper Making  
Pulp Making

## CIVIL ENGINEERING

Bridge & Building Foreman  
Civil Engineering  
Construction Engineering  
Highway Engineering  
Mine Surveying & Mapping  
Principles of Mapping  
Principles of Surveying  
Professional Engineer—Civil  
Railroad Engineering  
Roadmaster  
Sanitary Engineering  
Section Foreman  
Sewage Plant Operator  
Structural Engineering  
Surveying and Mapping  
Water Works Operator

## DRAFTING

Aircraft Drafting  
Architectural Drafting  
Drafting & Machine Design  
Electrical Drafting  
Electrical Engineer Drafting  
Industrial Piping Drafting  
Junior Mechanical Drafting  
Mechanical Drafting  
Sheet Metal Drafting  
Structural Drafting

## ELECTRICAL

Design and Construction of Overhead Power Lines  
Elec. Appliance Servicing  
Electrical Contractor  
Electrical Eng'g (Power Plant option—Electronic option)  
Electrical Engineering Tech.  
Electrical Instruments  
Electric Light & Power  
Electric Motor Repairman  
Electrical Operating Eng'r  
Hydroelectric Power Plant Equipment  
Industrial Electrical Eng'g  
Lighting Technician  
Power-House Electric  
Practical Electrician  
Practical Lineman  
Principles of Steam-Electric Power Plants  
Professional Engineer—Electrical  
Reading Electrical Blueprints  
**HIGH SCHOOL**  
Good English

High School Business  
High School College Prep (Arts)  
High School College Prep (Engineering & Science)  
High School General  
High School Mathematics  
High School Secretarial  
Letter Writing Improvement  
Short Story Writing

## LEADERSHIP

Industrial Foremanship  
Industrial Supervision  
Personnel-Labor Relations  
Supervision

## MECHANICAL

Industrial Engineering  
Industrial Instrumentation  
Junior Mechanical Engineer  
Mathematics and Mechanics for Engineers  
Mechanical Engineering  
Professional Engineer—Mechanical  
Quality Control

## PETROLEUM

Natural Gas Production & Transmission  
Oil Field Technology  
Petroleum Production  
Petroleum Prod'n Eng'g  
Petroleum Refinery Operator  
Petroleum Refining  
Petroleum Technology

## PLASTICS

Plastics Production Foreman  
Plastics Technician

## PLUMBING, HEATING, AIR CONDITIONING

Air Conditioning  
Air Conditioning with Draw's Air Conditioning  
Maintenance  
Domestic Heating with Oil & Gas  
Domestic Refrigeration  
Heating  
Heating & Air Conditioning  
Heating Drawing & Estimat'g  
Plumbing  
Plumbing Drawing & Estimating  
Plumbing & Heating  
Plumbing & Steamfitting

Practical Plumbing  
Refrigeration  
Refrigeration & Air Conditioning  
Steamfitting

## RAILROAD

Air Brake Equipment  
Car Inspector & Air Brake Diesel Electrician  
Diesel Engineer & Fireman  
Diesel Locomotive  
Diesel Machinist  
Railroad Administration  
Railroad Car Repairer

## SALESMANSHIP

Creative Salesmanship  
Marketing  
Real Estate Salesmanship  
Retail Salesmanship  
Sales Management  
Salesmanship & Sales Management

## SHOP PRACTICE

Boilermaking  
Electric Welding  
Forging  
Foundry Practice  
Gas and Electric Welding  
Gas Welding  
Heat Treatment of Metals  
Industrial Metallurgy  
Inspection and Physical Testing of Metals  
Machine Shop Inspection  
Machine Shop Practice  
Machine Shop Practice & Toolmaking  
Metallurgical Engineering Technology  
Practical Millwrighting  
Reading Shop Blueprints  
Resistance Welding Technology  
Rigging  
Safety Eng'g Technology  
Sheet Metal Worker  
Tool Designing  
Tool Engineering Technology  
Toolmaking  
Welding Engineering Technology

## STEAM AND DIESEL POWER

Combustion Engineering  
Power Plant Engineering

Stationary Building Eng'g  
Stationary Diesel Eng'g  
Stationary Diesel-Electric Engineering  
Stationary Fireman  
Stationary Steam Eng'g  
Steam Engine Operation

## TEXTILES

Carding and Spinning Supervisor  
Carding Technician  
Cotton Manufacturing  
Cotton Warping & Weaving Supervisor  
Cotton Warping & Weaving Technician  
Hosiery and Circular Knitting  
Loom Fixing Supervisor  
Loom Fixing Technician  
Spinning Technician  
Synthetic Fabric Manufacturing  
Synthetic Fabric Warping & Weaving  
Synthetic Yarn Throwing & Warping  
Textile Designing  
Textile Engineering  
Textile Finishing & Dyeing Supervisor  
Textile Finishing & Dyeing Technician  
Textile Mill Supervisor  
Woolen Manufacturing  
Worsted Manufacturing

## TRAFFIC

Motor Traffic Management  
Railroad Rate Clerk  
Traffic Management

## TV-RADIO-ELECTRONICS

Gen'l Electronics Technician  
Industrial Electronics  
Practical Radio-TV Eng'g  
Radio Operating  
Radio Servicing  
Radio Servicing with Practical Training  
Radio & TV Servicing  
Radio & TV Servicing with Practical Training  
Servicing Electr'n'c Devices  
Servicing Sound Equip't  
Practical Telephony  
TV Receiver Servicing  
TV Technician

For Real Job Security—Get an I. C. S. Diploma! I. C. S., Scranton 15, Penna.

Accredited Member,  
National Home Study Council

## INTERNATIONAL CORRESPONDENCE SCHOOLS



BOX 84626J, SCRANTON 15, PENNA.

Without cost or obligation, send me "HOW TO SUCCEED," the opportunity booklet about the field I have indicated below, and a sample lesson (Math.)

Name of the course in which you are interested \_\_\_\_\_

Your Name \_\_\_\_\_ Age \_\_\_\_\_ Home Address \_\_\_\_\_

City \_\_\_\_\_ Zone \_\_\_\_\_ State \_\_\_\_\_ Working Hours \_\_\_\_\_ A.M. to \_\_\_\_\_ P.M.

Occupation \_\_\_\_\_ Canadian residents send coupon to International Correspondence Schools, Canadian, Ltd., Montreal, Canada. . . . Special low monthly tuition rates to members of the U. S. Armed Forces.

# Still dreaming about a good job and more pay?



## WAKE UP TO YOUR OPPORTUNITIES IN Auto Mechanics

### PRACTICAL NEW WAY TO TRAIN AT HOME

Don't rely on *luck* to make your dreams come true! Be practical and depend on *training*. As a skilled man, you can step into a good, top-pay job—enjoy security—and even open a shop. Your best bet is to become an auto mechanic. *That's the big opportunity field today.* Over 60 million cars and trucks are on the road, and all require maintenance. At least one-third are in the heavy-repair class. There's so much work that 50,000 mechanics are needed! It's easy to learn this trade at home. Find out how by mailing coupon below.

**EARN MONEY IN SPARE TIME** as you train. Many students repair cars for neighbors; others get jobs in local garages; some open shops by the time they graduate. You can learn-and-earn because CTI offers practical Shop-System training.

**DIESEL MECHANICS OR BODY-FENDER REBUILDING** is included at no extra cost. Only CTI offers this extra choice. Get this fully-rounded mechanic's training. Send coupon for two free books.

**YOU PRACTICE WITH THIS TUNE-UP KIT**  
Kit includes a Compression Tester, a Vacuum Gauge and Fuel Pump Tester, an Ignition Timing Light, and a portable steel case. These professional instruments help you locate engine troubles, let you get useful practice. You keep this kit!

**MECHANIC'S TOOLS TOO**  
You'll use these tools to get real experience. They'll increase your interest, stamp you as a "pro." You'll earn spare time cash with them. No extra cost for tools—you keep them.

**MAIL COUPON TODAY!**

**MAIL TODAY FOR 2 FREE BOOKS**

COMMERCIAL TRADES INSTITUTE  
1400 Greenleaf Ave., Chicago 26  
Dept. A-1147

Send your new Auto Mechanics book and Sample Lesson. BOTH FREE.

Name \_\_\_\_\_ Age \_\_\_\_\_  
Address \_\_\_\_\_  
City \_\_\_\_\_ Zone \_\_\_\_\_ State \_\_\_\_\_



(Continued from page 8)  
of which originated in Detroit, Flint and South Bend automobile factories. The front end, for example, started with a Model T and the differential was borrowed from a 1947 Studebaker. From axle to axle center measures 48 inches. With a Briggs and Stratton motor, and with an independent power takeoff for a rotary mower, the tractor really works.

### Crusette, British Style

Back in May 1954 we published plans for building the "Crusette," a 12-foot utility outboard. J. J. Nichols, one of our readers in Willenhall, Staffordshire, England, liked it and built the boat with modifications to



suit his needs. His "Willy Nick" is 14 feet long and accommodates six passengers. He added the fins as an afterthought and reports his boat makes seven to eight knots.

### "The Spook" Has Four Legs

Sixteen-year-old Jerry Ewing of Culver, Ind., wanted to build something "just to be different." He came up with a quadricycle, but it didn't start that way. It began with an old bike frame stretched out to a one-seat bicycle with a 9-foot 3½-inch wheelbase. Nicknamed "Long John," it



(Continued to page 12)



POSED BY PROFESSIONAL MODELS

## The story of Argie Taylor and his successful career that can be yours



SERVICING RADIO AND TELEVISION SETS OFFERS GOOD PAY, PRESTIGE.

Today, people in Glasgow, Ky., respect Argie Taylor, depend on his services, pay him well. He is his own boss. He uses a station wagon in his business, his wife drives a Cadillac and they have just bought a 9 room brick home. Argie Taylor is a trained Radio-Television Technician. He owns the largest Radio Television Servicing business in his area.

But it wasn't always this way. Taylor was just a worker in a textile factory struggling to make ends meet. He knew he had to learn more to earn more. And he did something about it. He mailed a coupon like the one below, then enrolled with NRI.

Taylor is just one of thousands who have made better lives for themselves and their families with NRI training. Wishing means failure. It takes action to win success. You don't need a college degree to achieve a successful career in the fast growing field of Radio Television Electronics. For more than 40 years NRI has been training men at home, in spare time. NRI is the oldest and largest home study Radio TV school.

This is the age of Electronics—but only the beginning. There are growing opportunities for high pay, interesting careers in Radio, TV, Hi-Fi Servicing—Broadcasting Stations—Plane, Train, Ship Communica-



THE GROWING FIELD OF ELECTRONICS NEEDS MORE TRAINED TECHNICIANS

tions—Commercial 2 Way Radio—Electronics in Radar, Rockets, Missiles—Electronics in offices and plants.

Soon after enrolling many NRI students add to their income fixing sets for friends and neighbors. Easy-to-understand lessons show you the "how" and "why." Without extra charge NRI sends Training Kits to give you practical experience. Keep your job while learning. No need to go back to school. But you must act to get ahead. Take the first step now. Mail coupon for Sample Lesson and Catalog. Both FREE. Low monthly payment plan. Address **NATIONAL RADIO INSTITUTE, Dept. 9JA, Washington 16, D. C.**



BROADCASTING STATIONS PAY ENGINEERS WELL FOR INTERESTING JOBS

**NATIONAL RADIO INSTITUTE**  
Dept. 9JA, Washington 16, D.C.

Please mail me Sample Lesson and 64 page Radio Television Electronics Catalog FREE. (No salesman will call. Please write plainly.)

Name..... Age.....

Address.....

City..... Zone..... State.....

ACCREDITED MEMBER NATIONAL HOME STUDY COUNCIL

didn't quite satisfy him, so he produced "The Spook" from four bicycle frames and an assortment of old pipe. Its wheelbase is 6½ feet and its width 4½ feet, with pedals and relaxed seating for two. Both rear wheels have brakes. And, Jerry adds, it doesn't cost a drop of gasoline!



### Watch 'er Climb a Hill!

This "hot rod" is proudly driven by 10-year-old Landy Dale Schubert of Tacoma, Wash., whose dad built it for him. Landy says it has everything—lights, horn, clutch, differential, brakes, coil springs and a



front-mounted motor. Writes young Mr. Schubert: "It will climb a steep hill."



### Back-Yard Racer

This three-wheeler has a lot of background. Chassis and wheels once belonged to a 1946 Cushman ice-cream scooter. The rest, auto junkyards; the rear end is a



1941 Ford hood cut in half and welded. The sides, sheet metal. The grille, aluminum. The front, once a Dodge truck hood. The seat came from a Crosley station wagon. Joseph DeBellis of W. Moorestown, N.J., who built it for his 11-year-old son, says it can do 25 to 30 miles per hour on a straightaway and he provided a small track in his back yard for the boy and his pals.

*Comforting Facts  
about  
**WOLVERINE  
WORK SHOES***

WOLVERINE SHELL HORSEHIDES ARE THE LONGEST WEARING ... EASIEST WEARING WORK SHOES YOU CAN STEP INTO

WOLVERINE'S 50 YEAR OLD SECRET TRIPLE TANNING PROCESS KEEPS THESE TOUGH SHELL HORSEHIDE LOGGER BOOTS SOFT

THEY CAN TAKE RUGGED WEAR, TOO, AND GIVE YOUR FOOT PLENTY OF MUCH NEEDED PROTECTION

EVEN IF YOU SPEND DAY AFTER DAY IN THE MUD, WOLVERINE WORK SHOES WILL NOT HARDEN OR CRACK ... BUT WILL DRY SOFT & FLEXIBLE

**PLUS THESE COMFORT FEATURES—**

Sweat Proof Leather Insoles  
• Triple Ribbed Steel Shank • Tapered Backstay • Outside Counter Pocket.

**WOLVERINE**  
ROCKFORD, MICHIGAN

SERVICE OXFORDS  
WORK SHOES • BOOTS  
SAFETY SHOES

# INVENTORS

Learn how to protect your invention. The U. S. Patent Laws provide that any new and useful art, machine, article of manufacture, or composition of matter, or any new and useful improvement thereof, may be patented if the act of invention is involved. Therefore, every inventor with a valuable invention should take advantage of the Patent Laws and proceed for patent protection in order to safeguard his rights.

A patent gives the inventor the exclusive right to prevent others from making, using, or selling the invention claimed in the patent for a period of seventeen years.

The Patent Laws were enacted for the benefit of the inventor to give him protection for the features of his invention which are patentable. These features must be properly and concisely set forth and claimed in a formal application for patent, in order to comply with the requirements of the Patent Laws. For that reason, unless the inventor is familiar with patent matters, he should engage a competent registered patent attorney or agent to represent him. We are registered to practice before the U. S. Patent Office and are prepared to serve you in the handling of your patent matters.

A specially prepared booklet entitled "Patent Guide for the Inventor", containing detailed information with respect to patent protection and procedure, together with a "Record of Invention" form will be promptly forwarded to you without obligation upon request.

---

**CLARENCE A. O'BRIEN & HARVEY JACOBSON**

*Registered Patent Attorneys*

**91-J DISTRICT NATIONAL BUILDING**

**WASHINGTON 5, D. C.**

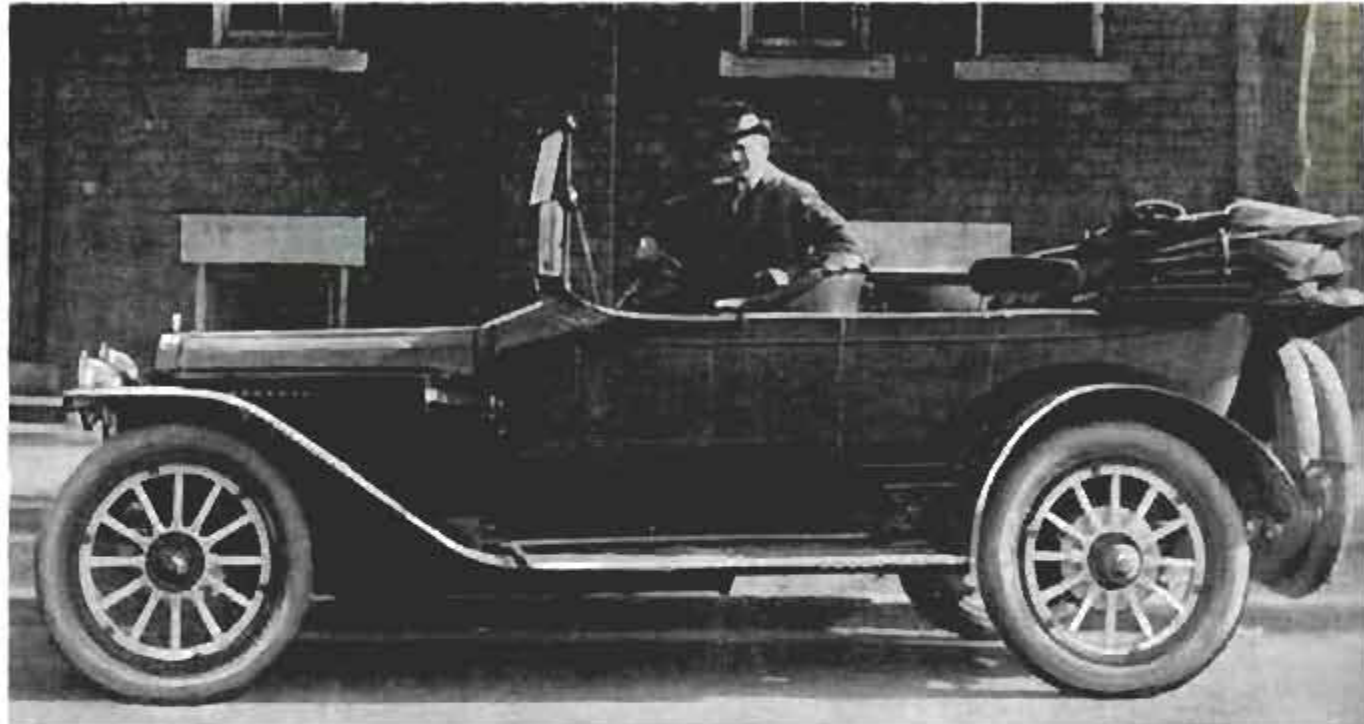

## Do You Know This Old-Timer?

Think cars are too big today? What about this seven-passenger touring car? A man could be proud of this giant as he sat high up, lord of all he surveyed. None of that worm's-eye view of things that we get from today's underslung models. It was

practical, too. Under its hood an air compressor stood ready to inflate those tremendous 37-inch tires should one go flat, as it usually did. The top, big as a tent, could be put up and down by one man, or so they said. The make? See page 222.



## BENDIX ELECTRIC FUEL PUMP PROVED AT

*150° above zero and 65° below zero*

In government-supervised tests, the Bendix\* Electric Fuel Pump worked perfectly in temperatures ranging from +150°F. to -65°F.—a record no other fuel pump anywhere near its price class could match. This best-on-the-market Bendix pump prevents vapor lock, delivers a constant flow of fuel. You'll *start* and *go* better in any weather with Bendix.

\*REG. U.S. PAT. OFF.

**Bendix-Elmira**  
Eclipse Machine Division  
Elmira, N. Y.





# A Practical New Way to End Your Job Worries!

TRAIN AT HOME FOR A SUCCESSFUL FUTURE IN  
**AIR CONDITIONING**  
AND REFRIGERATION



R. C. ANDERSON  
President

If you want an interesting job that pays real well and offers year-round work—get into Air Conditioning and Refrigeration! It's a big, uncrowded field that is well-established—yet growing fast! Each year over 20,000 newly-trained mechanics are needed. No wonder! Today there are 150 million units in use—and each year over 6 million new air conditioners, refrigerators and freezers are manufactured. All units need periodic service and repair. The pay? It ranks with the best!

Refrigeration mechanics is an easy trade to learn... Especially when you get your training through CTI. You can learn at home in spare time by practicing with commercial equipment. Get all the facts about this wonderful new way to acquire a highly-profitable technical education. Mail coupon today for fact-filled free booklets. No obligation whatever.



## Easy Way to Start a Business

Own a business—and enjoy independence. Thrill to the satisfaction of being the boss. Give orders—not take them! The refrigeration field is ideal for getting started on your own. You can make friends as you make service calls. In time, you'll have a list of potential customers. You can also sign service contracts with food stores, taverns, restaurants, etc. Thousands of CTI graduates have their own successful small shops.

## Get Into Auto Air Conditioning

Experts say that over 400,000 air conditioners are to be installed in autos this year. The field is growing very fast. Already auto shops are advertising for skilled air conditioning mechanics. Opportunities are excellent for starting repair shops. Some day, air conditioners will be standard equipment on cars. So get in on the ground floor now. Our catalog has information on this specialized, profitable field. It's worth looking into.



## TYPICAL LETTERS FROM SUCCESSFUL STUDENTS

"I have been very busy. Had an offer to work for an appliance dealer but it looks like I'll be in business for myself before long."  
—Frank Fuller, Wells, N. Y... "Am now working in the field. Earn \$40 more per month than before."  
—Frank Krotzer, Houston, Texas... "I not only got a job, but today am foreman, earning \$60 a week more than before I enrolled."  
—E. E. Hughes, Chicago... "Have my own business. Only problem is: Too much business!"  
—Conrad King, Cynthia, Ky. You can do as well as these men!

**FIRST GET THE FACTS—THEN DECIDE**  
Mail Coupon Today for 2 Free Booklets

25  
BIG KITS

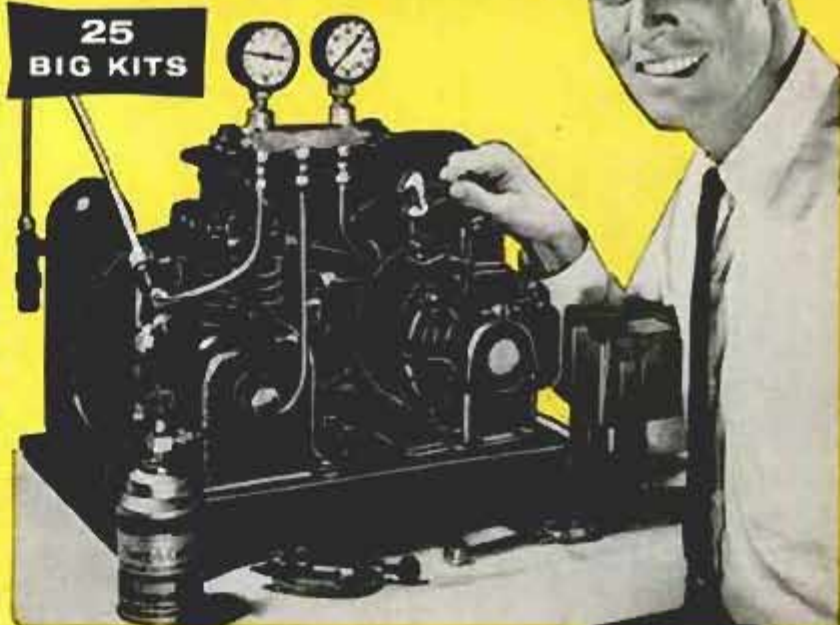

## You Get Experience as You Train Because You Practice with Commercial Equipment

Another CTI first! You learn by practicing—you get experience as you train—because CTI sends you 25 kits. You get all parts and tools to build a heavy-duty, commercial-type, 1/4 h.p. condensing unit (illustrated above.) You build an air conditioner, freezer, refrigerator, or milk cooler. You complete 23 field-type projects—do 10 service and trouble-shooting jobs! You "boil down" years of apprentice-like training into months. Kit training perfects your skill, provides practical knowledge, assures useful experience, and helps you learn faster! CTI makes your home a training center.

## Earn Extra Cash in Spare Time as You Train

Because CTI training is so practical, you'll soon be making profitable service calls. Perhaps you'll work "on your own." Or, you may prefer to get a part-time job with a local appliance dealer or air conditioning contractor. You can add to your income this way. With extra cash, you can buy additional shop equipment, pay your tuition, even bank money. Be sure to mail coupon for complete details. Act today!—Commercial Trades Institute, Chicago 26, Illinois.

## COMMERCIAL TRADES INSTITUTE

1400 GREENLEAF AVENUE  
CHICAGO 26, ILLINOIS

DEPT. R-636

Tell me how I can qualify for a better job or a business of my own. Send booklet, *Success in Air Conditioning & Refrigeration*, and Lesson Sample. Both FREE.

Name \_\_\_\_\_ Age \_\_\_\_\_

Address \_\_\_\_\_

City \_\_\_\_\_ Zone \_\_\_\_\_ State \_\_\_\_\_





### Make Extra Money in Spare Time

Build your own spare time business. Turn your "nothing-to-do" hours into cash to buy extras you'd like to have.



### Save - Fix Your Own Appliances

Money spent on Appliance Repairs mounts up. Fix your own. Save it - could soon offset low cost of NRI training.



### Build a Business of Your Own

As an Electrical Appliance Technician you can be your own boss. Enjoy independence, security.



### Independent Income during Slack Times, Layoffs, After Retirement

Have an important skill that is always in demand. There is no age limit.

# Be an Electrical APPLIANCE TECHNICIAN

## Step Up Your Income Train at Home in Spare Time

Want more cash? More interesting work? Greater security for your future? Find out what Electrical Appliance Servicing offers you.

## Add a New Skill... Important in a Growing Field

The Electrical Appliance industry is big and growing fast. Many millions of appliances are sold every year. Electric refrigerators, irons, toasters, washing machines were considered luxuries not many years ago. Today they are necessities in millions of homes. The Electrical Appliance Technician is the key man in this field now because most homes have a dozen or more appliances that need servicing and repair. Owners pay well for it. As an Electrical Appliance Technician you can enjoy the good income and the independence of a businessman.

## Earn Soon... Start While Learning

Soon after enrolling, many ad \$10 to \$15 a week to their income fixing appliances for friends and neighbors. Many have paid for their training and built up to their own full time business this way.

## Appliance Tester Furnished No Extra Charge

NRI training methods are thoroughly proven. We've had more than 40 years experience - have successful graduates all over the country. NRI instructors are expert, know how to train you. You get carefully planned, easy-to-understand lessons. You also build a quality tester. Use it to make tests, locate appliance troubles, earn extra money, get practical experience starting soon after enrolling.

Electrical Appliance Servicing offers you many spare time and full time opportunities. Mail the coupon now. Get a Sample Lesson and Catalog FREE. Low payment plan. NATIONAL RADIO INSTITUTE, Dept. AJ9, Washington 16, D. C.

## National Radio Institute

WASHINGTON 16, D. C., FOUNDED 1914

### LESSON and BOOK FREE

NATIONAL RADIO INSTITUTE  
Dept. AJ9, Washington 16, D. C.

Please send me sample lesson of your Electrical Appliance Training and Catalog FREE. (No salesman will call.)

Name \_\_\_\_\_ Age \_\_\_\_\_

Address \_\_\_\_\_

City \_\_\_\_\_ Zone \_\_\_\_\_ State \_\_\_\_\_

ACCREDITED MEMBER NATIONAL HOME STUDY COUNCIL



# INVENTORS

If you believe that you have an invention, you should find out how to protect it. The first step is to have a search made of the prior pertinent U. S. patents. If a report on this search indicates that the invention appears patentable you can apply for a patent, and the specifications and claims should be prepared.

The firm of McMorrow, Berman & Davidson, with offices in Washington, D. C., is qualified to take the necessary steps for you. We can make a preliminary search on your invention, advise you whether we think it can be patented, and prepare your application for patent.

Unless you are fully familiar with the U. S. Patent Laws, we recommend that you engage the services of a Registered Patent Attorney to protect your interests. The patent laws are *your* laws. A patent gives you the right to prevent others from making, using or selling the invention claimed in your patent for a period of 17 years.

Use these patent laws for your protection. Investigate whether your invention can be patented. If you have what you believe to be an invention, we suggest that you have this firm make a search for you.

*Send for a copy of our Patent Booklet entitled "How To Protect Your Invention," containing information about patent protection and patent procedure. Along with this we will also send you an "Invention Record" form, for your use in writing down and sketching details of your invention. We will mail them promptly. No obligation. They are yours for the asking.*

## McMORROW, BERMAN & DAVIDSON

*Registered Patent Attorneys*

**PATENTS • COPYRIGHTS • PATENTS**

**135-D VICTOR BUILDING, WASHINGTON 1, D. C.**

# DRAFTSMEN



**CASH BIG  
PAY CHECKS!**

**Train Now for  
more success,  
greater security**

**LEARN AT HOME IN SPARE TIME  
(or at college in Chicago)**

Check the want ads in any newspaper—SEE the big-pay opportunities open to you as a draftsman. What's more, you can learn this well-paid, prestige profession at home — quickly, easily! No special talent needed. Get complete, step-by-step Chicago Tech lessons in the mail, spend a few pleasant hours studying each week. In a short time you'll be a well-trained draftsman, ready to take your pick of many good jobs. Act now!



**Free Information—Mail Coupon Today!**

Get FREE TRIAL LESSON plus information about C.T.C. practical training. Learn what successful Chicago Tech graduates say about high pay and opportunities in drafting. No charge, or obligation.

## CHICAGO TECHNICAL COLLEGE

M-217 Tech Bldg., 2000 So. Michigan Ave.  
Chicago 16, Illinois

Mail me FREE lesson with facts about big opportunities in DRAFTING.

Name \_\_\_\_\_ Age \_\_\_\_\_  
Address \_\_\_\_\_  
City \_\_\_\_\_ Zone \_\_\_\_\_ State \_\_\_\_\_

## WANTED!

**Mechanically Inclined  
Men to Qualify for**



**CUMMINS DIESEL  
FACTORY TRAINING**

If you are interested in High Pay Jobs and Advancement in the Diesel field... here's your opportunity! Qualified Factory-Trained men are in demand by highway builders, diesel manufacturers, truck line operators everywhere. Interstate can help you qualify for tuition-free Cummins factory training and big pay diesel jobs! Write for complete information about Cummins-approved home training.

**Get the Facts Today!**

**WRITE INTERSTATE TRAINING SERVICE**  
Dept. A-3, Portland 12, Oregon

RUSH information about Cummins tuition-free Factory Training and approved Home Study programs.

Name \_\_\_\_\_  
Address \_\_\_\_\_  
City \_\_\_\_\_ Zone \_\_\_\_\_ State \_\_\_\_\_



Pocket Size—Loose Leaf

# LEFAX

TECHNICAL DATA BOOKS

\$125  
each

Printed on loose leaf, 6 hole, 6 3/4"x3 3/4" bond paper, each book contains about 140 pages of technical data, condensed, accurate, essential, for engineer, technical worker, teacher, student, business man

Architecture	Surveying	Machinist's Data	Radio
Home Heating	Tables	Mech. of	Television & FM
Illumination	Highway Eng'g.	Materials	Electricity, AC
Electrician's	General Math	Pwr. Trans.	Electricity, DC
Data	Math Tables	Mach.	AC Motors and
Builder's Data	Physics	Thermo. Tbls.	Generators
Lumber Data	Trig-Log Tables	& Charts	Conversion Tabl.
Air Conditioning	Gen'l Chemistry	Phys. & Thermo-	Steel Forms
Building Constr.	Chemical Tables	dynamic Data	Welding Data
Reinf. Concrete	Analytic Chem.	Metallurgy	Transformers,
Piping Data	Mech'l Drawing	Hydraulics	Relays & Meters
Surveying	Machine Design	Metals	

Write for FREE catalogs (2000 listings). See how helpful LEFAX can be to you. Send \$1.25 book, or \$6 for any five books to

**LEFAX PUBLISHERS, Dept. PM-99, PHILADELPHIA 7, PA.**

## Make '5 an Hour CASH PROFIT

**THE DAY YOU START!**

**Start your own business at Home...  
Sharpen Household,  
Garden and Shop  
Tools in Spare Time.**



Turn spare time into Big Cash Profits with new Belsaw Sharp-All. No experience needed to sharpen knives, scissors, shears, ice skates, mower blades, hedge trimmers, axes, chisels and circular saws... Learn how easily you can start your own spare time business. Amazing low cost easy-payment plan. Send Postcard for FREE BOOK. **BELSAW SHARP-ALL CO 710 Field Bldg., Kansas City 11, Mo.**

## 250 POWER.....



**Telescope Lens Kit**

only \$3.49  
postpaid

Conquer Space, Explore the Universe, Planets, Moon Craters, New Stars, etc. Complete Lens Kit consists of 80 inch focal length ground and polished objective lens, eyepiece lenses for 50 POWER, 100 POWER, 150 POWER, 200 POWER, 250 POWER, and all necessary lens fittings. Easy to make from simple step by step instructions. (Tripod and mount not included.) Money back guarantee.

**BUSSE SALES CO., Hartford, Conn., Dept. PM-79**

## MAKE TREMENDOUS PROFITS

Have fun! Earn Big Money! Cast plaster figurines, bookends, plaques, novelties at home in your spare time with X.L. rubber molds! NO EXPERIENCE NEEDED! Models and rubber for 3 molds, only \$1.50 ppd. Send 25c (refunded with order) for 40 page catalog now! **PLASTIC ARTS STUDIO 3403 S. MADISON, DEPT. PM2 MUNCIE, INDIANA**

## GOVERNMENT OIL LEASES LOW AS \$1 PER ACRE

You do no drilling, pay no taxes, may realize a king-size profit without ever leaving home. Write for free map and literature.

**AMERICAN OIL SCOUTS, Dept. PM  
8350 Santa Monica Blvd. Los Angeles 46, Calif.**

## RUPTURED

### BE FREE FROM TRUSS SLAVERY

Surely you want to THROW AWAY TRUSSES FOREVER, be rid of Rupture Worries. Then Why Do you put up with wearing a griping, chafing and unsanitary truss the balance of your life? If you do, it will NOT be through necessity but through choice on your part.

Now there is a new modern Non-Surgical treatment that is designed to permanently correct rupture. These Non-Surgical treatments are so certain, that a Lifetime Certificate of Assurance is given. Write today for our New FREE Book that gives facts that may save you painful, expensive surgery. Tells how non-surgically you may again work, live, play, love and enjoy life in the manner you desire. There is no obligation.

**Excelsior Medical Clinic, Dept. H6124, Excelsior Springs, Mo.**

**NOW!**  
at a price  
you can afford!

# MAKE MORE MONEY in TELEVISION RADIO-ELECTRONICS

**BETTER...MORE COMPLETE...LOWER COST...  
WITH NATIONAL SCHOOLS SHOP-METHOD  
HOME TRAINING!**

**BETTER...** Training that is proved and tested in Resident School shops and laboratories, by a School that is the **OLDEST** and **LARGEST** of its kind in the world.

**MORE COMPLETE...** You learn **ALL PHASES** of *Television-Radio-Electronics*.

**LOWER COST...** Other schools make several courses out of the material in our **ONE MASTER COURSE**... and you pay more for less training than you get in our course at **ONE LOW TUITION!**



These **FREE** books will show you how!

You get all information by mail... You make your own decision... at home! **NO SALESMAN WILL CALL**

**TOP PAY... UNLIMITED OPPORTUNITIES  
LIFETIME SECURITY CAN BE YOURS!**

You are needed in the Television, Radio, and Electronics industry! Trained technicians are in growing demand at excellent pay—in **ALL PHASES**, including Servicing, Manufacturing, Broadcasting and Communications, Automation, Radar, Government Missile Projects.

**NATIONAL SCHOOLS SHOP-METHOD HOME TRAINING**, with newly added lessons and equipment, trains you in your spare time at home, for these unlimited opportunities, including many technical jobs leading to supervisory positions.

**YOU LEARN BY BUILDING EQUIPMENT WITH KITS AND PARTS WE SEND YOU.** Your National Schools course includes thorough *Practical* training—**YOU LEARN BY DOING!** We send you complete standard equipment of professional quality for building various experimental and test units. You advance step by step, perform more than 100 experiments, and you build a complete TV set from the ground up; that is yours to keep! A big, new TV picture tube is included at no extra charge.

**EARN AS YOU LEARN.** We'll show you how to earn extra money right from the start. Many of our students pay for their course—and more—while studying. So can you!

**RESIDENT TRAINING AT LOS ANGELES**

If you wish to take your training in our Resident School at Los Angeles, the world's TV capital, start **NOW** in our big, modern Shops, Labs and Radio-TV Studios. Here you work with latest Electronic equipment—professionally installed—finest, most complete facilities offered by any school. Expert, friendly instructors. Personal attention. Graduate Employment Service. Help in finding home near school—and part time job while you learn. Check box in coupon for full information.

**LESSONS AND INSTRUCTION MATERIAL ARE UP-TO-DATE, PRACTICAL, INTERESTING.** Every National Schools Shop-Method lesson is made easy to understand by numerous illustrations and diagrams. All instruction material has been developed and tested in our own Resident School Shops, Laboratories and Studios.

**SEND FOR INFORMATION TODAY**... it can mean the difference between **SUCCESS** and failure for you! Send for your **FREE BOOK** "Your Future in Television-Radio-Electronics" and **FREE Sample Lesson**. Do it **TODAY**, while you are thinking about your future. It doesn't cost you anything to investigate!

**GET THE BENEFITS OF OUR OVER  
50 YEARS EXPERIENCE**

Approved for  
GI Training



**NATIONAL SCHOOLS**  
Los Angeles 37, Calif.

**YOU GET...**

- 19 Big Kits—**YOURS TO KEEP!**
- Friendly Instruction and Guidance
- Job Placement Service
- Unlimited Consultation
- Diploma—Recognized by Industry
- **EVERYTHING YOU NEED FOR SUCCESS!**

**SHOP-METHOD HOME TRAINING  
COVERS ALL PHASES OF INDUSTRY**

1. Television, including Color TV
2. Radio AM & FM
3. Electronics for Guided Missiles
4. Sound Recording and Hi-Fidelity
5. FCC License
6. Automation and Computers
7. Radar & Micro-Waves
8. Broadcasting and Communications

**NATIONAL TECHNICAL SCHOOLS**  
WORLD-WIDE TRAINING SINCE 1905

**MAIL NOW TO**  
**NATIONAL SCHOOLS, Dept. RB-99**  
4000 S. FIGUEROA ST., LOS ANGELES 37, CALIF.  
Rush free TV-Radio "Opportunity" Book and sample lesson. No salesman will call.

NAME \_\_\_\_\_ AGE \_\_\_\_\_  
ADDRESS \_\_\_\_\_  
CITY \_\_\_\_\_ ZONE \_\_\_\_\_ STATE \_\_\_\_\_  
 Check if interested **ONLY** in Resident School training at Los Angeles.  
VETERANS: Give date of Discharge \_\_\_\_\_



# Boeing openings offer **ENGINEERS** outstanding careers



BOMARC is one of many expanding missile and space-age projects at Boeing that offer engineers of all categories an opportunity to grow in professional stature and to work in a dynamic environment conducive to rapid advancement. Openings are available now in Research, Design, Production and Service.



Analog computer installation used to simulate missile trajectory, ground control and terminal guidance. Boeing missile openings include assignments on BOMARC, and on Minuteman solid-propellant intercontinental ballistic missile system. Other long-range opportunities are available on advanced jet aircraft and space vehicle projects.



Write today for free 24-page book, "Environment for Dynamic Career Growth." Indicate degree(s) and field of interest. Address: Mr. Stanley M. Little, Boeing Airplane Co., P. O. Box 3822-PMB, Seattle 24, Washington.

## **BOEING**

Seattle • Wichita • Cape Canaveral

## Great Pioneers in Science *Do You Know Them?*

—By James S. Thistle—

THIS "WIZARD" was considered so stupid by his teacher that his mother removed him from school three months after he started. Despite his ill-starred attempt at formal education, however, he came to be regarded as the greatest inventor in history. More patents were issued to him than to any other inventor—in all, about 1100 to 1200.

The first to record and reproduce sound, he won his greatest fame for his invention of the electric light bulb in 1879. Some ten years later he produced motion pictures, which led to the birth of the movie industry. The electronic tube used in radio, the long-distance telephone and the X ray all came about through his discovery of the flow of electrons from hot filaments.

This inventor perhaps did more than any other to make our daily lives easier and happier.

*These letters, unscrambled,  
spell the name of this  
month's Great Pioneer  
in Science:*

## **ITSOHANDSOME**

(First and Last Names)

*Write the correct name here:*

Now turn to page 231 for the answer.



# LET RCA TRAIN YOU IN ELECTRONICS

*RCA Institutes celebrates Fifty Years of Electronic Training by introducing its newest Home Study Course . . .*

## **ELECTRONICS FOR AUTOMATION**

. . . Now you have *four* comprehensive courses for your electronic training . . . from basic electronic theory to the more advanced principles of color TV and Automation.

### Electronic Fundamentals



### Electronics for Automation

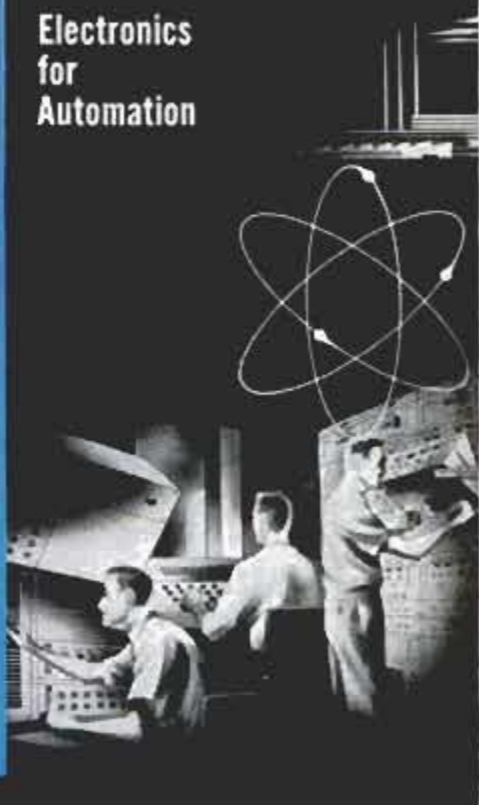

### Television Servicing



### Color Television



Practical work with the very first lesson. Pay-as-you-learn. You need pay for only one study group at a time.

### **RCA INSTITUTES, Inc.** Home Study School, Dept. PM-99

A Service of Radio Corporation of America

350 West Fourth Street, New York 14, N. Y.

Without obligation, send me the FREE catalog of Home Study Courses. No salesman will call.

Name  Please print

Address

City  Zone  State

Korean Vets! Enter Discharge Date

**CANADIANS** — Take advantage of these same RCA courses at no additional cost. No postage, no customs, no delay. Send coupon to: RCA Victor Company, Ltd., 5001 Cote de Liesse Rd., Montreal 9, Quebec  
To save time, paste coupon on postcard.

Send for our  
64 page Home  
Study Catalog

**FREE!**



RESIDENT SCHOOL offers Technical Institute and Vocational School Courses in Electronics. Day and Evening classes start 4 times each year. Resident School Catalog sent free on request.

# "MADE \$1200 ON ONE JOB"

Some make more, some less...

## We help you start Your Own All-Year Business

**Make BIG Money!** With our easily operated, highly efficient wall washer, G. H. Jones made \$1200 on one school job. E. L. Goss took in more than \$10,000 in one year. E. C. Taber wrote, "I made \$400 gross in two weeks." And no wonder...this machine washes walls 6 times faster and better than by hand—with no mess...no drop cloths.

**Your Money-Making Opportunity** • We want more men to go into this profitable business for themselves and enjoy independence—freedom from layoffs and bosses. Customers everywhere—homes, offices, schools, churches, hotels, etc. How much you earn depends largely on you. What you take in is mostly profit. No need to rent shop or office; operate from home. Start spare time until full time is justified.

**Lose No Time — Send Coupon Today for All the Facts**

**FREE BOOK! MAIL COUPON TODAY!**

**VON SCHRADER MFG. CO.**

910 "W" Pl., Racine, Wisconsin

Send at once (no obligation) your FREE booklet containing information about your WALL WASHING MACHINE and how I can start my own permanent, profitable business.

Name \_\_\_\_\_

Address \_\_\_\_\_

City \_\_\_\_\_ Zone \_\_\_\_\_ State \_\_\_\_\_

.....

## Hotels Call for Trained Men



You can qualify at home, or through resident classes in Washington for a well-paid position in hotels, motels, clubs, and apartment house projects. Thousands of Lewis graduates, both young and mature, "making good" everywhere. Get into this fast-growing field offering sound, substantial opportunities, fine living, luxurious surroundings. Previous experience proved unnecessary. Registration in Lewis Nationwide Placement Service FREE. Send today for FREE Book, "Your Golden Opportunity."

**An Accredited School of N.H.S.C.**  
**Course Approved for ALL Veteran Training.**

LEWIS HOTEL TRAINING SCHOOL  
Room E0-349, Washington 7, D. C. **43** SUCCESSFUL YEARS

# realize your dream

Become a graduate engineer. Then promotion will not pass you by. Share rewards awaiting college men . . . higher income, rapid advancement. Important firms interview seniors here regularly. Approved for veterans.

## Graduate Engineer in 27 months

B. S. degree in Electrical Engineering (with either Electronics or Power major), also in Mechanical, Civil, Chemical, Aeronautical Engineering. In 36 Months a B. S. in Business Administration (General Business, Accounting, Motor Transport Management majors). For earnest, capable students. Small classes. More professional class hours. Mature students. Well-equipped labs. Modest costs. Year-round operation. Enter Jan., Mar., June, Sept. Write J. E. McCarthy, Director Admissions, for Catalog and "Your Career" Book.



## TRI-STATE COLLEGE

499 College Avenue

Angola, Indiana



## 1000 NAME AND ADDRESS LABELS \$1

ANY 3 DIFFERENT ORDERS \$2 ppd. Sensational bargain! Your name and address printed on 1000 finest quality gummed labels. Padded! Packed with FREE Plastic GIFT BOX. Use them on stationery, books, cards, etc. 1000 only \$1 ppd. SPECIAL OFFER — ANY 3 DIFFERENT ORDERS \$2. Satisfaction guaranteed. HANDY LABELS, 921 Jasperson Bldg., Culver City 1, California.



## make your own Gems 36<sup>50</sup>

The Gem Maker comes complete with all necessary equipment, including a super-charged diamond blade for sawing, and all the wheels for grinding, shaping and polishing; also complete instructions. The complete equipment as shown, less motor and belt for only \$36.50, f.o.b., Burlington, Wisconsin. Write today for information and literature.

**B&I MANUFACTURING CO.**  
Dept. P. Burlington, Wis.



# MONEY in WORMS

Sell 20,000 fishworms per week @ \$4 per 1000 from a bed 3 feet wide and 8 feet long. We teach you how to raise and where to sell fishworms and crickets. Write for free literature. CARTER WORM RANCH, PLAINS, GEORGIA



## HYDRAULIC JACK REPAIRS

### Earn While You Learn at Home

Millions of jacks in gas & auto-service stations, truckers, body-shops, riggers, factories, farms need servicing. We show you HOW—easy step by step directions—what tools to use. EARN UP TO \$5 an hour, in spare time, in your own basement or garage. Start your own business NOW. Write for folder No. PM9 & free bonus offer.

### Institute of Hydraulic Jack Repair

P.O. Box 50, Bloomfield, N. J.

## Million Dollar Inventory — All Famous Brands



SAVINGS NEVER LESS THAN 50%, UP TO 70% OFF REGULAR PRICES HEADQUARTERS FOR ALL SPORTS CAR TIRE SIZES  
➔ SEND FOR YOUR FREE CATALOG! ➔

**RELIABLE TIRE CO.** • 728 MORGAN BLVD. CAMDEN 4, N. J.



# Here is the little table-top machine that can set you up in a money-making business of your own—at home—in your spare time

## FREE!

Just send

me your name on the coupon and I'll tell you all about the newest and most fascinating home-operated business you ever heard of. For the first time, you can get a simplified little table-top machine that can bring you fabulous profits in Plastic Sealing and Plastic Laminating. Any man or woman regardless of age, education or experience can learn the work in a few minutes and turn out professional jobs AFTER ONE HOUR'S PRACTICE!

11¢ for Material  
**\$2.58 BACK**  
**BY MAIL**

This man is taking out of his machine a Plastic Sealing job ordered by mail. He paid only 11¢ for material, yet he'll get back \$2.58 ... by mail.

**Capacity of Machine**  
**\$25.00 PER HOUR**  
**OF OPERATION**



This picture shows a snapshot sealed in Plastic for life-time protection.

Gives lifetime protection to photos, identification cards, discharge papers, driver's licenses, Social Security cards and all kinds of documents and papers that people want to protect against wear and damage.

There are no "hooks" in my offer to send you complete information about the wonderful new kind of business—absolutely free. There are no strings attached. You pay me nothing for this information—now or any other time. Now read on this page the amazing story of Plastic Laminating—and how any ambitious man can get started in this fabulous business—right in his own home—in his spare time.

BY M. R. WARNER

Plastic Laminating suddenly has become the most fascinating of all home-operated businesses. And now—to put this business within reach of all comes a simplified little table-top machine that can bring fabulous profits to the man who owns and operates it. The machine itself is so small that it can be set up in a corner of your kitchen, basement or garage. And any man or woman, regardless of age, education or experience can start to turn out professional, saleable work the very day he or she starts to operate the machine.



## A Fortune in Plastic Sealing

The beauty of the Plastic Laminating business is this: there is no house-to-house canvassing required—no face-to-face selling. In every city, town and village, there are hundreds of people looking for a way to protect valuable cards, photo-

graphs, documents and valuable papers against wear, soil and other damage. I show you how to contact all these people with my *Magic Mail Plan*. With this Plan you sit at home, open envelopes the mailman delivers and take out money and orders. The simplicity of this Plan will amaze you.

## No Home Business Like It

But my *MAGIC MAIL Plan* is only ONE of eight different ways you can make money in Plastic Laminating. The opportunities are so great it is impossible to give you full details here. Before you can get any idea of the size of the market and your place in this sensational business you must read all the facts. I want to send this information to you free so you can see for yourself how easy it is to do the work—and how simple. All you do is put plastic sheets into your little machine and take out a fortune. If this machine printed actual money it could hardly be more profitable!

And here's something else. You do not have to depend on orders from your own locality alone. I show you how you can get money and business from every State in the Union—how you can achieve personal independence without study or previous experience in this field.

## I Send All Facts Free

Never before, to the best of my knowledge, has an opportunity like this been offered to the spare time home operator. It is a spare time business to start, but it can easily be expanded into a full time business as the profits increase. So don't lose a minute. Mail the coupon to me right away. I will send complete information back to you by the next mail—free and postage prepaid—together with all information about the table-top Plastic Laminating machine, complete and fully illustrated.

Remember—there is not a penny's cost to you for this information. You pay nothing for it—now or any other time. No salesman will call. So get full details on this exciting opportunity—right away.

**M. R. WARNER, 1512 Jarvis Avenue,  
Dept. L-2-K, Chicago 26, Illinois**

Dear Mr. Warner:

Please send me complete illustrated information about your little Table-top Plastic Laminating Machine and how I can use it to get started in a profitable one-man business of my own—at home—in spare time. Everything you send me now is free. I pay nothing for it now or any other time. It is understood and agreed no salesman will call.

**M. R. WARNER**

**1512 Jarvis Ave., Dept. L-2-K  
Chicago 26, Illinois**

Name.....

Address.....

City.....Zone.....State.....

My name is Charles Atlas. I can't promise you'll win the title of "World's Most Perfectly Developed Man" as I did. But I do believe I can make a powerful He-Man of you -- in a very short time. You can prove it to yourself -- at my risk. My big free book tells how to do it.



26 YEARS IN BUSINESS AT THE SAME ADDRESS.  
Our entire stock of very slightly used  
**EXTRA MILEAGE TOP GRADE** Tires,  
(Written Insurance Guarantee). SEND AD  
**WHY PAY MORE?** UP TO 15,000 MI.  
Beat the high cost of new tires.

**FREE-** If You buy 2 or MORE Passenger 4 ply tires, we give One tire, FREE, on Ed. Order, on Request. Does not include W. W. Truck tires or Snow tires.

**WRITTEN Guarantee.** White walls \$1.00 Extra

600-18	\$6.92	670-15	\$6.82	700-15(6)	\$9.72	750-20(8)	\$12.42
600-18(6)	8.82	710-15	6.92	750-16(8)	10.82	825-20	18.92
650-16(6)	9.32	760-15	6.92	750-17	10.42	900-20	18.92
750-14	7.72	800-15	6.92	750-17	12.22	1000-20	19.92
800-14	7.72	820-15	6.92	850-20	10.02	1100-20	19.92
750-16(6)	8.82	700-16(6)	9.92	700-20	11.82	1000-22	20.92

"EXTRA SPECIAL" TOP QUALITY all size 4-ply pass. FREE TIRE with 2 or more of these.—W.W. \$1.00 Extra. **\$8.72 EA.**  
**GIANT TIRE SALE**

**SNOW TIRES \$7.82 AND \$5.82 ANY SIZE**  
WHITE WALLS \$2.00 EXTRA  
SUBURBANITE OR TOWN & COUNTRY TREAD  
Thousands of tires shipped all over the U.S.A. All tires shipped F.O.B. Phila. Send Check or M.O. with this ad. Dept. 2. No C.O.D.  
**STANDARD 834 N. Broad St., Philadelphia 30, Pa.**

**WARN HUBS CUT HIGHWAY MILEAGE COSTS of 4-WHEEL DRIVES!**

With Warn Hubs, your 4-wheel drive reels off highway miles fast in free-wheeling 2 w.d., takes the rough stuff in 4 w.d. as usual. With the front drive standing still in 2 w.d. there is no gear wear or whine—vehicle has amazing pep, handling ease. Use 2 or 4 w.d. as needed, automatically with Warn Lock-O-matics, manually with Locking Hubs. Unconditionally guaranteed. See your local 4 w.d. dealer soon!

WARN MFG. CO., Riverton Bx 6064-A, Seattle 88, Wn.

**JEEP OWNERS**

RE-POWER NOW WITH A V-8 OR 6 CYL. ENGINE — USE FORD—CHEV—MERCURY—GMC—PONT—STUDE—DODGE OR PLYMOUTH  
In Jeeps, Jeepsters, Sta-Wgn, trucks, Kaiser & M. J. cars.  
Conversion Kits \$45.35 to \$56.90. Want fast action? Give us full information, send \$15.00 Dep. and we will ship correct kit. Bal. COD. Send full amount for prepaid shipment. Wire, phone or write today. Details FREE

**HOOSIER MACHINE PRODUCTS CO.**  
312 S. E. 6th St. Phone CR 6-3442 Pendleton, Oregon

**EARN MORE BE A TAX EXPERT**

Earn lucrative fees preparing income tax returns in your spare time during 3 month busy season every year or operate profitable Business Tax Service for year-round income. No experience needed. We train you at home. Low cost State Approved Course. Write for free prospectus. No agent will call.

**UNION INSTITUTE LAKEWOOD 20C NEW JERSEY**

**FREE GERMAN STEEL HUNTING KNIFE**

**4-INCH BLADE**

We give you handiest hunting and fishing knife you've ever had! Has 4-INCH LONG highly tempered steel blade—VERY SHARP! Attractive handle. We send knife FREE to acquaint you with our below-wholesale bargains. Please send 25c for handling. NO LIMIT—but send 25c handling for each knife. Order TODAY!  
**HUNTING KNIFE. Dept. K-426. Box 881. St. Louis, Mo.**

**KILLS . . .**

- Mosquitoes
- Flies, Gnats
- Moths, Mollars
- Fish Flies, etc.

**OVER 1/4 ACRE**  
No insect recovery, harmless, guaranteed! Luxury unit. Beautiful outdoor lighting.

**No Area Contamination**  
Use up to 200 watt bulb, grid operation less than 10c month. Anodized aluminum hood. Built to last 25 years.

**Plug into any 110V A.C. Socket**  
Complete with fly attractor, hook on dead insect catcher, good cord, directions. Guaranteed. Very reasonable price. Write for complete details—

**SING SING BUG CHAIR, INC.**  
Box P3781, Oak Park 37, Mich.

**HANG ANYWHERE**

**NO CHEMICALS SMELLS GASES**

**BOX SIZE—WT. 12x16x6 9 lbs.**



**FREE BOOK** Mail coupon now for free 32-page book. Tells how I can give you "Stand-Out" muscles — how "Dynamic Tension" can make you a new man — confident, popular, successful. Rush coupon to me personally: **CHARLES ATLAS, Dept. 8J, 115 E. 23 St., N.Y. 10.**

**CHARLES ATLAS, Dept. 8J, 115 East 23rd St., New York 10, N. Y.**

Dear Charles Atlas — Here's the Kind of Body I Want: (Check as many as you like)

<input type="checkbox"/> Slimmer Waist, Hips	<input type="checkbox"/> More Powerful Arms, Grip
<input type="checkbox"/> Broader Chest, Shoulders	<input type="checkbox"/> More Powerful Legs
<input type="checkbox"/> More Weight, Solid	<input type="checkbox"/> Better Energy, Sleep

Send me, absolutely FREE, a copy of your famous book showing how "Dynamic Tension" can make me a new man. 32 pages, crammed with photographs, answers to vital questions, and valuable advice. No obligation.

Name.....Age.....  
(Please Print or Write Plainly)

Address.....

City.....Zone...State.....

**"I'M MAKING MORE THAN \$1000 a Month Haven't Touched Bottom Yet!"**



—reports Charles Kama, Texas, one of many who are "cleaning up" with orders for PRESTO. Science's New Midget Miracle Fire Extinguisher. So can YOU!



Amazing new kind of fire extinguisher. Tiny "Presto" does job of bulky extinguishers that cost 4 times as much, are 8 times as heavy. Ends fires fast as 2 seconds. Never corrodes.

**Guaranteed for 20 years! Over 3 million sold! Sells for only \$4.95.**

Show it to civil defense workers, owners of homes, cars, boats, farms, etc., and to stores for resale — make good income. H. J. Kerr reports \$20 a day. Wm. Wydallis \$15.20 an hour. **FREE Sales Kit. No obligation.**

**MERLITE INDUSTRIES, Dept. P-15D**  
PRESTO DIV., 114 E. 32 St., New York 16, N.Y.  
Canada: Mopa Co., Ltd., 371 Dowd St., Montreal 1, P.Q.

# DON'T BE HALF-TRAINED! Be A Master Technician

**NOW... ONE**  
modern master  
home training course  
**IN ALL 3 PHASES**



## AIR CONDITIONING - REFRIGERATION ELECTRICAL APPLIANCES

**ALL AT ONE  
LOW TUITION**  
only National Schools gives  
you this complete training  
at no extra cost

**YOU GET AND KEEP ALL THESE TOOLS AND INSTRUMENTS**



Incomplete training limits your earning power, even disqualifies you for top-pay jobs. The big service companies require complete, all-phase training. If you open your own shop, you'll be called upon to service and repair all types of refrigerators, air conditioners and appliances. With complete training—as only National Technical Schools can give you—you can accept every job, make big profits all year round.

### FUTURE BRIGHT FOR TRAINED MASTER TECHNICIANS

Over 30,000 new technicians must be trained annually. You are needed to help service and repair the 50 million air conditioners, refrigerators and electrical appliances that will need fixing this year alone. No wonder the Master Technician has steady work, at high pay, year after year. He can go places in his own business or with a manufacturer, dealer, distributor or department store. Armed with all-phase training, his earning power is unlimited.

### THE MOST FOR LESS

We give you illustrated Shop-Tested Lessons and Manuals...many other training aids...privilege of CONSULTATION with our instructors and engineers. Every lesson, every manual has been SHOP tested and approved.

### JOB TRAINING AT HOME

You get Professional Tools, Precision Instruments, PLUS a Factory-Made APPLIANCE TESTER! A shop-full of PRACTICAL, professional equipment. Use them to conduct over 100 experiments...also in Spare Time Work and ON THE JOB. It is all yours to keep...no EXTRA MONEY DEPOSITS...no EXTRA COST on your equipment kits.

### EARN AS YOU LEARN

We show you how. Many of our students pay for their entire course—and more—in Spare Time while learning. So can you. Graduate Advisory Service, too.

### GET THE BENEFIT OF OUR OVER 50 YEARS EXPERIENCE

**N.T.S. also offers training in  
TV - RADIO - ELECTRONICS  
and AUTO MECHANICS - DIESEL**



MEMBER



**NATIONAL TECHNICAL SCHOOLS**  
WORLD-WIDE TRAINING SINCE 1905

4000 50. FIGUEROA ST., LOS ANGELES 37, CALIF., U. S. A.

### RESIDENT TRAINING AT LOS ANGELES

If you wish to take your training in our Resident School at Los Angeles, start NOW in our big modern Shops and Labs. Here you work with latest equipment...professionally installed...finest, most complete facilities offered by any school. Expert, friendly instructors. Personal attention. Graduate Advisory Service. Help in finding home near school...and part time job while you learn. Check box in coupon for full information.



**SEND FOR  
FREE  
BOOK AND  
ACTUAL  
LESSON NOW!**

We'll rush you our big, illustrated OPPORTUNITY BOOK and ACTUAL LESSON, show you how easily you can learn. NO OBLIGATION; no salesman will call. Do it NOW! It costs nothing to find out.

**NATIONAL TECHNICAL SCHOOLS**  
WORLD-WIDE TRAINING SINCE 1905

MAIL NOW TO  
National Technical Schools, Dept. CB-99  
4000 S. Figueroa St., Los Angeles 37, Calif.  
Rush FREE "Opportunity" Book and Actual Lesson. No Salesman will call.

NAME \_\_\_\_\_ AGE \_\_\_\_\_

ADDRESS \_\_\_\_\_

CITY \_\_\_\_\_ ZONE \_\_\_\_\_ STATE \_\_\_\_\_

Check here if interested ONLY in Resident Training at Los Angeles.

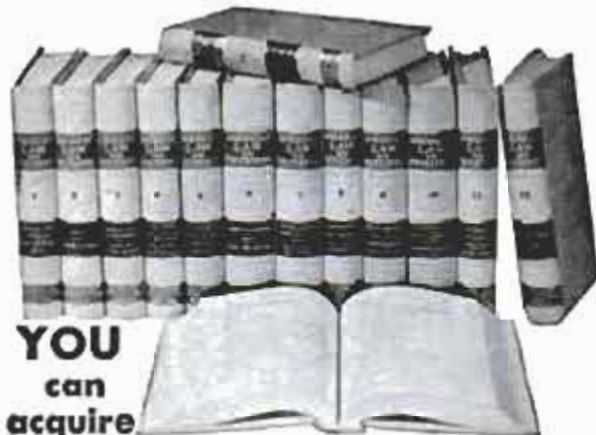

**YOU  
can  
acquire**

**LAW AT HOME!  
EARN LL. B. DEGREE**

LaSalle's famous Law Library—used as reference in many Law libraries and Law offices—has enabled thousands to master Law surprisingly fast, in spare hours at home, for business and professional advancement.

These 14 remarkable volumes, compiled by leading professors and lawyers, cover the whole basic field of Law in condensed, orderly, simplified manner.

You advance rapidly with this great library, plus special lectures furnished. We guide you step-by-step with personalized Problem Method of instruction...you 'earn by doing—handling legal problems—not by memorizing rules.

Send for two FREE booklets, "Law Training for Leadership," and "Evidence," answering questions about Law and its value to you. Mail coupon below. No obligation.

Accredited member, National Home Study Council

**LA SALLE EXTENSION UNIVERSITY  
A Correspondence Institution**

417 S. Dearborn St. Dept. 964L Chicago 5, Ill.

Send me your two FREE booklets described above, without obligation

Name.....Age.....

Street.....

City, Zone & State.....

**SAVE 75%  
ON**



**WORK CLOTHES!**

**SURPLUS STOCK FROM MIDWEST SUPPLY FIRM!**  
Terrific values you've got to see to believe!

**SHIRTS 79c**

Made to sell for 2.99! Now only 4 for \$2.99

What a buy! 4 for the price of one! These shirts, though used, are washed, sterilized and ready for long, tough wear. In blue, tan or green. Send neck size, 1st and 2nd color choice.

**PANTS to match Unbelievable Bargains!** Sold for 3.95. Now only 4 for \$3.75

Send waist measure and inside leg length.

**COVERALLS... wear 'em used and save plenty!** Originally 6.95. Now only 3 for \$6.75

Send chest measurement.

**SHOP COATS... fully reconditioned.** Take advantage of this rock-bottom price. Send chest measurement. Now only 3 for \$5.00

**SATISFACTION GUARANTEED!** Your money back if you can beat these bargains anywhere! You can't lose so order TODAY for immediate delivery! Send \$1.00 deposit on C. O. D. orders. Add 25¢ postage and handling on prepaid orders.

**GALCO SALES CO. Dept. 139**  
7120 Harvard Ave. • Cleveland 5, Ohio

**95% PROFITS  
YEAR 'ROUND**

Be your own boss. Operate a **SIMPLEX** lawn-mower sharpening service in your community. One compact machine grinds all mowers, sharpens cutlery. Low investment, 95% profit. Pays for itself in average month.

**SIMPLEX**

**-4 Machines in One!**  
**Reel Grinder**—sharpens any mower reel in or out of mower.  
**Bed Knife Grinder**—grinds with either round or cup wheel.



**Rotary Blade Grinder**—hollow grinds any rotary mower blade.  
**Cutlery Knife Grinder**—sharpens cutlery, tools, scissors.

Send for free, money-making details!

The **FATE-ROOT-HEATH Company** • Dept. PM-9, Plymouth, Ohio

**75 POWER TELESCOPE \$398**  
25X-45X-75X

**NEW** 3 in one telescopes, 3 variable 25X, 45X-75X magnification. Brass bound. 25 power for ultra bright images. 45 & 75 power for long range. Guaranteed to bring distant stars, moons, objects, sports 75 times closer. Most powerful scope sold anywhere near this amazing low price. American made, 3 sections. Opens 36", closes 1 ft.; contains 4 ground & polished lenses. Can also be used as powerful compound microscope. Mass production enables us to offer telescope complete at \$3.98 postpaid. Money back guarantee.

**CRITERION CO., Dept. PMB-73, 331 Church St., Hartford, Conn.**



**"\$10,784 IN ONE YEAR"**

**SERVICING RADIATORS!**

—Sidney Rad. Shop, Sidney, Mont.  
Make good money servicing auto-truck-tractor radiators. Easy to learn. Inland, world's largest radiator equip. mfr., offers complete package—equipment merchandising, "Pay-for-itself" Purchase Plan, free training. Small down payment on equipment starts you. Profitable dept. for garage or service station. Write:

**INLAND MFG. CO., Dept. PM-9, 1108 Jackson St., Omaha 2, Nebr.**

**TRAINED AND SKILLED MEN IN  
CLOCK AND WATCH REPAIR**

Are Needed in Watchmaking, Electronics, Defense, Aviation, and other technical and precision instrument fields. NOW IS THE TIME TO LEARN THIS VALUABLE TRADE. But, Before You Enroll in Any HOME STUDY Course in Watchmaking, Write for Your Copy of "LEARN THE FACTS."  
**KANSAS CITY SCHOOL OF WATCHMAKING**  
1226 Admiral Blvd. Kansas City 6, Missouri

**GET INTO ELECTRONICS**

V.T.I. training leads to success as technicians, field engineers, specialists in communications, guided missiles, computers, radar, automation, Basic & advanced courses in theory & laboratory. Assoc. degree in 20 mos. B.S. obtainable. ECPD accredited. G.I. approved. Graduates with major companies. Start Sept., Feb. Dorms, campus, H. S. graduate or equivalent. Catalog.  
**VALPARAISO TECHNICAL INSTITUTE**  
DEPT. D VALPARAISO, INDIANA

**WORLD'S LOWEST PRICED CALCULATOR!** Not \$3.95 \$2.03 in Penna. including 3% Tax.  
NEW! NEW! NEW!  
**TOM THUMB ADDING MACHINE** But Only \$1.97  
With beautiful Leatherette carrying case. MADE IN AMERICA BY AMERICANS. Beware of cheap imported imitations. Adds Up To One Billion—1,000,000,000. Subtracts—Multiplies—Divides.  
Mistake Proof—Positively 100% Accurate—Lightning Fast—Shock Proof Solid Steel Mechanism.  
**GUARANTEED FOR YOUR LIFETIME**  
Ideal for Housewives, Shoppers, Students, Engineers and Tax work. Take it to the Super Market—Save \$\$\$ every week. We pay postage if you send check, cash or money order—or just send your name & address and pay postman \$1.97 plus postage. Immediate Delivery—10 Day Free Trial—Satisfaction Guaranteed money refunded by return mail. Special Gift Offer: 2 Machines for only \$3.49. Agents Wanted—Make easy money selling a Top Quality Calculator at our unbelievably low price.  
**TOM THUMB ADDING MACHINE**  
P.O. Box 5066, Dept. S-19, Philadelphia 11, Penna.

# WHEN YOU TALK...DO PEOPLE LISTEN?

*A Message from Dr. D. Alan Walter*

"You probably know—and perhaps have envied—people who never seem at a loss for words. In business, they always seem able to express opinions in words that carry weight and build a reputation for sound judgment. At social affairs, they talk easily and entertainingly whatever the conversation turns to. And whenever they talk, people listen.

"Why? What do they have that makes them both interesting and impressive? The answer is something we can all acquire—broad knowledge—and the quickest, surest, easiest way of adding to your knowledge is by having a set of the Encyclopaedia Britannica in your home. With this great storehouse of information at your fingertips, you will soon acquire the habit of 'looking it up in Britannica' and thus acquire the command of language . . . the interesting information . . . the authoritative knowledge that makes people listen when you talk."

Brand new edition

## ENCYCLOPAEDIA BRITANNICA

now available direct from the publisher on

### Book a Month Payment Plan

you get all 24 volumes now—pay later!

The latest edition of Britannica—the most respected treasure of knowledge ever published—is the biggest and greatest in our almost 200-year publishing history. An enormous printing materially reduces our costs and under an unusual direct-from-the-publisher plan, we pass these savings on to you. All 24 handsome volumes will be delivered to your home NOW direct from the publisher. You pay later at a cost so low it is as easy as buying a book a month!

#### Equivalent to a library of 1,000 books

The Encyclopaedia Britannica is the most valuable gift you can give yourself and your family—the priceless gift of knowledge. Information on every subject significant to mankind is contained in the new edition. It is equivalent to a library of 1,000 books, bringing you the knowledge and authority of world-recognized leaders in every field.

The new Britannica almost "televizes" information to you, with 25,042 magnificent photographs, maps, and drawings. In every respect, Britannica is the most complete reference set published in America, containing 27,357 pages, and over 38,000,000 words.

#### Symbol of a good home

Benjamin Franklin said: "An investment in knowledge pays the best in-



terest," and Britannica gives you the accumulated knowledge of the world in clear, easy-to-read language and superb illustrations. It is essential in every home where education is valued and respected.

#### Preview Booklet Offered FREE

Simply fill in and mail the coupon today, and we will send you . . . without cost or obligation . . . a copy of our beautiful, new booklet which contains an exciting preview of the latest edition of Encyclopaedia Britannica. Send no money—not even for postage. It's yours, absolutely free! However, since this offer is necessarily limited, please mail the coupon today before it slips your mind.

#### MAIL COUPON NOW for FREE BOOKLET



ENCYCLOPAEDIA BRITANNICA, DEPT. 12-J  
425 N. Michigan Avenue, Chicago 11, Illinois

Please send me, free and without obligation, your colorful Preview Booklet which pictures and describes the latest edition of ENCYCLOPAEDIA BRITANNICA. Also include complete information on how I may obtain this magnificent set, direct from the publisher, on the Book a Month Payment Plan.

Name \_\_\_\_\_ Please Print

Address \_\_\_\_\_

City \_\_\_\_\_ Zone \_\_\_\_\_ State \_\_\_\_\_

In Canada, write E. B. Ltd., Terminal Bldg., Toronto, Ont.

# Inventors

If you consider your invention valuable, take these necessary preliminary steps promptly to protect it by applying for a United States patent.

Sketch and describe your invention. (For convenience in starting action on your invention, use "Evidence of Invention" form offered below.)

Sign, date and have this invention disclosure witnessed by two people capable of understanding your invention.

Have us make a preliminary search among U. S. patents already granted for similar types of invention. We then prepare a report for you on the probable patentability of your invention and recommend your further course of action.

This firm is registered to practice before the U. S. Patent Office. We are available to assist you in the preparation and prosecution of your application for patent.

We shall be glad to send you promptly and without obligation, an instructive booklet—"Patent Protection for Inventors"—and our convenient "Evidence of Invention" form.

**VICTOR J. EVANS & Co.** *Merlin M. Evans*  
REGISTERED PATENT ATTORNEY  
530-K MERLIN BUILDING, WASHINGTON 6, D. C.

## RUN A BIG-MONEY DINER

I'll show you how to start with little or no capital ...

I show you how to get started just as I did; where to locate, 7 ways to get capital, money making methods, even how to run a sandwich business right out of your own home with only a few dollars investment. Write for free details. **Ken Kessler.**

**School of Restaurant Business**  
335 W. Madison Street, Dept. R359, Chicago 6, Ill.



## BRONZE FOUNDRY



Schools • Home Workshops • Inventors

Make your own castings of aluminum, copper, bronze, silver. Foundry sets are available in three sizes including 2400 Deg. F. blast furnaces. \$26.50; \$33.50; and \$46.00 f.o.b. Marysville. Write for Free Circular.

**KANSAS CITY SPECIALTIES CO.** DEPT. P-9, P. O. BOX 6022, MARYSVILLE, KANSAS

**ENGINEERING  
DEGREE IN  
27 MONTHS**

B. S. degree (27 mo.): Aero., Chem., Civil, Elec., Mech. & Electronics.  
B. E. (36 mo.): Aero., Chem., Civil, Elec., Mechanical, Metallurgical, B.S. (36 mo.): Math., Chem., Physics.  
Prep courses. Demand for grads. Campus. 20 bldgs.; dorms, gym. Low rate. Earn board. G.I. appr. Enter Sept., Dec., March, June. Catalog. 1699 E. Washington Blvd., Fort Wayne 2, Ind. Keeping pace with progress

**INDIANA TECHNICAL COLLEGE**

## Next Month...

## FIRST OF THE NEW SMALL CARS!

Talked about for months, they make their debut in the October issue—the new "babies" of the Chevrolet, Ford and Plymouth lines

**BVI****Painting is Easy!  
Electric PAINT  
SPRAYER**

only **\$1295** complete  
with built-in motor  
Fully Guaranteed



Just plug in, pull trigger and spray paint, varnish, enamel, garden sprays and insecticides, 3 to 7 times faster than painting with a brush! Features sapphire nozzle, instant adjustment for heavy or light spray. Foolproof and trouble-free! Available now at dealers everywhere!

Burgess Vibrocrafters Inc.  
Grayslake, Illinois

**REAL ESTATE  
BE A BROKER**

**PAYS BIG! SEND FOR FREE, BIG, ILLUSTRATED CATALOG NOW!** Graduates report making substantial incomes. Start and run your own business quickly. Men, women of all ages, learn easily. Course covers Sales, Property Management, Appraising, Loans, Mortgages, and related subjects. **STUDY AT HOME** or in classrooms in leading cities. Diploma awarded. Write TODAY for free book! No obligation.

**FREE BOOK TELLS NOW**

Approved for World War II and Korean Veterans  
**WEAVER SCHOOL OF REAL ESTATE (Est. 1936)**  
2020R Grand Avenue Kansas City, Mo.

**BECOME AN EXPERT IN  
TRAFFIC**

Traffic men earn \$4,000 to \$10,000 and up. Thousands of firms need experts on rates, tariffs, regulations. We train you thoroughly in spare time at home for executive traffic jobs. Personal training under traffic authorities. Placement counsel and help. Write for free 48-page book "Traffic Management—the Fast Growing Profession."

**LASALLE Extension University, 417 So. Dearborn St.**  
A Correspondence Institution Dept. 964T Chicago 5, Ill.

**'How to Make Money with  
Simple Cartoons'**

A book everyone who likes to draw should have. It is free; no obligation. Simply address **FREE BOOK**

**CARTOONISTS' EXCHANGE**  
Dept. 99-D Pleasant Hill, Ohio

**After the city,  
Before the state  
The ZONE keeps your mail  
From being late**



The Post Office has divided 106 cities into postal delivery zones to speed mail delivery. Be sure to include zone number when writing to these cities; be sure to include *your* zone number in *your* return address — after the city, before the state.

SEPTEMBER 1959

29

**AUTO MECHANICS AND  
DIESEL**

Your spare time  
pays off **BIG**  
with our world-famous  
**SHOP TESTED**  
Home Training



**MAKE YOUR FUTURE AS  
BRIGHT AS THEIRS**

In a matter of months, you can quit your no-future job for a big-pay, big-future career as an Auto-Diesel Mechanic. Free Illustrated Book gives you the facts. Send coupon below. No Obligation. No Salesman will call.

**All Phase Training**

N. T. S. students become skilled, all-around mechanics. Crystal-clear lessons, Shop-Tested manuals, real professional equipment, make it easy to learn. Big equipment kits, yours to keep. Earn as you learn...we show you how. Graduate Advisory Service.

**N.T.S. Training is Better,  
More Complete, Lower Cost  
BETTER...**

Because training is **SHOP-TESTED** in Resident School Shops & Labs. **MORE COMPLETE...** You learn all phases of Auto Mechanics & Diesel. **LOWER COST...** One low tuition covers entire cost of course and all equipment.

**Unlimited Opportunities**

Trained mechanics make top money...are in demand at dealer shops, garages, large bus and truck lines, construction projects, government labs, factories, and many others.

**YOU GET AND KEEP ALL THIS  
PROFESSIONAL EQUIPMENT**



**Motor Analyzing Set**



**Socket Wrench Set**

**NATIONAL TECHNICAL SCHOOLS**

WORLD-WIDE TRAINING SINCE 1905  
4019 S. FIGUEROA ST., LOS ANGELES 37, CALIF., U. S. A.



**FREE!**  
Illustrated Fact Book  
& Actual Lesson

Mail coupon now.

Complete TV-Radio Electronics training also available.

**RESIDENT TRAINING  
at Los Angeles!**

If you wish to take Resident Training at Los Angeles, in our Big, Modern Shops & Labs, check special box in coupon for full information.

**NATIONAL TECHNICAL SCHOOLS**

WORLD-WIDE TRAINING SINCE 1905

MAIL NOW TO  
**NATIONAL TECHNICAL SCHOOLS, Dept. DB-99**  
4000 S. FIGUEROA ST., LOS ANGELES 37, CALIF.

Send for **FREE** Auto Diesel Opportunity Book and actual Lesson.

NAME \_\_\_\_\_ AGE \_\_\_\_\_

ADDRESS \_\_\_\_\_

CITY \_\_\_\_\_ ZONE \_\_\_\_\_ STATE \_\_\_\_\_



Member





# BE YOUR OWN MUSIC TEACHER

Send for Free Book Telling How Easily You Can Learn Piano, Guitar, Accordion, ANY Instrument This EASY A-B-C Way



NOW IT'S EASY to learn music at home. No tiresome "exercises." No teacher; just START RIGHT OUT playing simple pieces. Thousands now play who never thought they could. Our pictured lessons make it easy as A-B-C to learn to play popular music, hymns, classical, and any other music. Low cost. One million students including TV Star Lawrence Welk. (Our 61st year.)

### Mail Coupon for FREE BOOK

Find out why our method can teach you quickly, easily, inexpensively. Write for FREE Book. No obligation. No salesman will call. Mention favorite instrument. Mail coupon today.

**U. S. SCHOOL OF MUSIC**  
Studio A309,  
Port Washington, N. Y.



U. S. SCHOOL OF MUSIC, Studio A309, Port Washington, N. Y. Please send me Free 36-page Illustrated Book. I would like to play (Name instrument).

Instrument \_\_\_\_\_ Have you Instrument? \_\_\_\_\_  
Name \_\_\_\_\_ (Please Print)  
Address \_\_\_\_\_  
City \_\_\_\_\_ Zone \_\_\_\_\_ State \_\_\_\_\_

## LEARN WOODWORKING AT HOME

### Complete Home Training Course in Woodworking and Cabinetmaking Now Available

Today—it's easy to acquire the skills and craftsmanship of fine woodworking and cabinetmaking with Interstate's complete "shop method" course. Prepared by expert instructors, the course consists of 22 profusely illustrated training manuals



containing more than 1100 pages of instruction. Covers all phases of woodworking, including selection of woods, planning and laying out projects, correct use and care of all hand and power tools, joint making, cutting, assembling, finishing, simple upholstery, etc. Over 75 learn-by-doing instruction projects give work bench training and experience in actual construction. Course is approved for beginners and professionals alike.

**SEND FOR FREE BOOKLET TODAY**

### INTERSTATE TRAINING SERVICE

Dept. F-3, Portland 12, Oregon

Please send free booklet and information on your complete course in Woodworking and Cabinetmaking.

Name \_\_\_\_\_  
Address \_\_\_\_\_  
City \_\_\_\_\_ Zone \_\_\_\_\_ State \_\_\_\_\_

## ELECTRONIC ENGINEERING



TRAIN IN FLORIDA

FOUNDED 1894

### DEGREE IN 24 MONTHS

Electronic engineers are urgently needed in Florida — the Nation's Electronic and Missile center. VA approved. Send for Free Catalog.

**MASSEY TECHNICAL INSTITUTE**  
BOX 3305B JACKSONVILLE 6, FLA.

## OWN a BUSINESS!



**We'll Train and Establish You**  
Start part-time if employed. You'll be trained by a nearby dealer and at 5-day training school. As a carpet-upholstery cleaning expert, you provide 6 services to multiply profits and customer satisfaction. No shop needed. Just 2 average jobs a day nets \$8,750 first year. We help build your business with 27 continuous services: counseling, nat'l advertising (McCalls, Parents, House Beautiful, others), newspaper ads mats, etc. Send for FREE booklets. DURACLEAN CO., 9-169 Duraclean Bldg., DEERFIELD, ILLINOIS

### MASS PRODUCTION MAKES THESE PRICES POSSIBLE!

Only world's largest boat kit maker can deliver such quality at such prices! Write for free color catalog, kits from \$42.00. Freight included.



12 ft. runabout \$99.50  
FREE COLOR CATALOG!

**TAFT MARINE WOODCRAFT**  
Dept. PM-959 636 39th Ave. N.E. Minneapolis 21, Minn.

## NEW! FABRIC ADHESIVE

• **SUPER QUICK** Repair tents, boat covers, awnings, tarpaulins, and  
• **ECONOMICAL** all other canvas products. Send \$2.95 today for  
• **WATERPROOF** complete kit and instructions. Results guaranteed.  
**ALL WEATHER PRODUCTS, Box 194, Dunellen, N. J.**

**IF YOU HAVE WEEKEND OR EVENING SPARE TIME**

### MAKE up to \$20.00 HOUR ... NO SELLING ... JUST SERVICING

Even if you have a steady job, you can take over your area as a Novo Service Distributor. Keep retail stores supplied with nationally-advertised Novo Humorous Greeting Cards on weekends, or evening hours. **NO SELLING.** Just put racks in stores **ON CONSIGNMENT** and keep them filled. **MAKE 66 2/3% MARKUP** ... up to \$20.00 and more in an hour.

**FREE** Big 32-Page Book describing highly successful plan. Also samples... **ALL FREE, no obligation.** Write today to: **Novo Card Publishers, Inc., Dept. G-18 3855 LINCOLN AVENUE, CHICAGO 13, ILLINOIS**

## MEN PAST 40

**Afflicted With Bladder Trouble, Pains in Back, Hips, Legs, Nervousness, Tiredness.**

If you have these troubles, particularly bladder trouble, then your condition may be traced to Glandular Inflammation ... a constitutional disease. Neglect of this condition often leads to premature old age and sometimes incurable malignancy.

The Excelsior Medical Clinic has a New Free Book that tells how thousands of men have been successfully treated here at Excelsior Springs for Glandular Inflammation by **NON-SURGICAL Methods.** They found soothing relief and a new outlook in the future of life.

This Free Book may prove of utmost importance in your life. Write Today. There is no obligation. **Excelsior Medical Clinic, Dept. B6129, Excelsior Spgs., Mo.**



# Train NOW as **HEAVY EQUIPMENT OPERATORS**

PUT YOURSELF IN THE DRIVER'S SEAT!

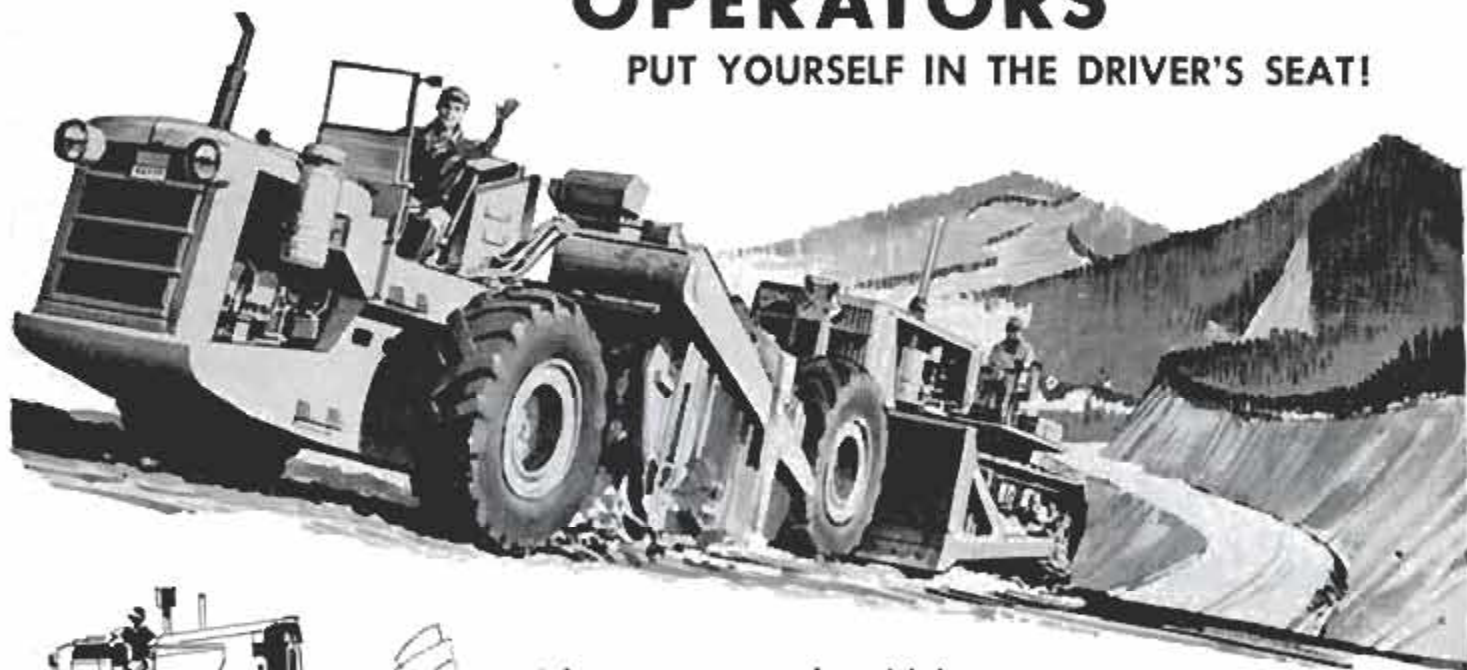

The most tremendous highway building program in history is under way... bridges, dams, houses, factories, are springing up all across the nation... The construction industry is booming as never before. And *You* can have a box seat for this greatest show on earth!

## **EXPERIENCE UNNECESSARY — APPLY NOW**

You will be trained thoroughly for modern heavy equipment operation. Learn to master heavy equipment such as: tractors, scrapers, graders, carry-alls. Engineering fundamentals... blueprint reading... operating controls... diesel engine operation... highway construction, etc.

If you are between 17 and 45, you can get into Heavy Equipment NOW — regardless of your present position, training or income. Nationwide placement service available upon completion. We help you with financing.

**SEND FOR FREE INFORMATION**

### **HEAVY EQUIPMENT TRAINING**

Northwest Schools, Inc. (Dept. M-3)  
1221 N. W. 21st Avenue • Portland 9, Oregon

Rush information without obligation.

Name \_\_\_\_\_

Address \_\_\_\_\_

City \_\_\_\_\_ State \_\_\_\_\_

Phone \_\_\_\_\_ Age \_\_\_\_\_

Education \_\_\_\_\_ Hours Worked \_\_\_\_\_



## Multi-Million Dollar Business Now Being Split Up Among Home Operators in Small Communities

### Inexpensive Table Top Machine Pays Profits UP TO \$9.20 AN HOUR



The multi-million dollar Rubber Stamp Business is now being taken over by small home operators throughout the U.S. Men and Women who operate this inexpensive machine can turn out large numbers of Rubber Stamps with special wording of all kinds. Only 27¢ worth of material makes a stamp that sells for \$1.80. The machine is easy for anyone to operate. It molds as many as six Rubber Stamps at a time, each with different wording such as names, addresses, notices, stock numbers, prices and other 'copy' needed by offices, factories and individuals. At full capacity, it can earn as much as \$9.20 an hour for the operator! You don't need experience to get into this big profit business at home. We supply everything, including complete instructions and eight ways to get orders for stamps coming in fast. Start making up to \$9.20 in one hour right away. We'll mail full particulars FREE; no salesman will call. Be first in your locality. Rush coupon.

**RUBBER STAMP DIV. 1512 Jarvis Avenue, Dept. R-2-K, Chicago 26, Ill.**

#### RUBBER STAMP DIV., Dept. R-2-K 1512 Jarvis Ave., Chicago 26, Ill.

Please mail all facts showing how I can get started in the profitable Rubber Stamp business at home in spare time. Everything you mail me is FREE and no salesman will call.

NAME .....

ADDRESS .....

CITY ..... Zone ..... STATE .....

## AVIATION CAREER

### SPECIALIZED EDUCATION / PROFESSIONAL TRAINING... only 16 months to 2 years

Top-pay prestige positions, bright future in aviation. Job opportunities waiting for you as soon as you're ready. Airframe and Powerplant Technician, Aeronautical Engineering Technologist, Business or Executive Pilot. Classes in Miami.

#### SEND FOR FREE 48-PAGE BOOK

Embry-Riddle Aeronautical Institute  
Dept. B Miami, Florida (Founded 1926)

Name .....

Address .....

City ..... Zone ..... State .....

## Catalog of 2900 Novelties 10c

Send 10c for amazing catalog of novelties, live animals, scientific supplies, hobbies, funmakers, planes & boats, looms, magic tricks, joke articles, unusual seeds, gadget timersavers, cameras, optical goods, projectors, movies, lucky jewelry, religious novelties, disguises, musical instruments, stamps, coins, puzzles, fortune tellers, radios, auto & bike accessories, telescopes, magnifiers, compasses, banks, smokers' gadgets, artists' supplies, printing sets, engines, motors, shockers, knives, billfolds, guns, rifles, sports, books, games, plants, etc. Send 10c.

JOHNSON SMITH & CO. Dept. 796 Detroit 7, Michigan

### ELECTRIC MOTOR KIT AS LOW AS 20c

Used by Science Classes, Schools, Model Builders Speedy, Dynamo-type Motor. Drives models. Runs up to 8000 rev. per min. Understand motors, generators, electro-magnetism, current flow, etc. All parts completely finished. Easy & fun to assemble in a few minutes. Metal base, 6-bar laminated armature. Illustrated directions. About 2-in. high. 35c each Postpaid. 10 or more 25c each. 100 or more, 22 1/2c each. 500 or more only 20c each.

JOHNSON SMITH CO. Dept. 796 Detroit 7, Mich.

## SEWS LEATHER

### AND TOUGH TEXTILES LIKE A MACHINE

With SPEEDY STITCHER Automatic Sewing Awl, anyone can quickly and skillfully sew or repair anything made of LEATHER, CANVAS, NYLON, PLASTIC, or other heavy materials. Sewa firm, even lockstitches like a machine. Gets into hard-to-reach places. Specially made for heavy duty sewing on LUGGAGE, FOOTWEAR, RUGS, AWNINGS, SAILS, SADDLERY, UPHOLSTERY, OVERALLS, AUTO TOPS, SPORTS GEAR, and other tough sewing jobs. Here's the handiest tool you'll ever own. Will save you many times its small cost. Comes ready for instant use... complete with bobbin of waxed thread and 3 different types of diamond-pointed needles. Easy-to-follow directions will make you an expert in minutes. Extra needles and waxed thread always available. Save money, send \$1.98 for post-paid delivery. If C.O.D., \$1.98 plus postage. MONEY BACK GUARANTEE.



#### SPORTSMAN'S POST

366 Madison Ave., Dept. A-89, New York 17

ONLY 1.98



FREE CATALOG

### ADD UP TO 25 POUNDS of SOLID MUSCLES

or you pay NOTHING

\$10 BODY MOLD course included FREE with DAN LURIE BARBELLS. Only DAN LURIE BARBELLS and "Body Mold" courses produce such amazing results. 15 minutes a day can make you a bigger man. Send today for details. Order now at lowest factory price.

50 lb. set \$8.98 & 100 lb. set \$14.98  
150 lb. set \$21.98 & 200 lb. set \$27.98  
Semisteel sets approx. 10% higher. Extra wts. 1.4c per lb. Send 50¢ cash, balance C.O.D. P.O.B. Plant

DAN LURIE BARBELL CO., 52-M9 Bristol St., Dept. 959J, Bklyn. 12, N. Y.

## "YOU ARE UNDER ARREST!"

### Help Bring Crooks to Justice Through Scientific CRIME DETECTION!



We have taught thousands this exciting, profitable, pleasant profession. Let us teach you in your own home. Learn Finger Printing, Firearms Identification, Police Photography, Secret Service Methods thoroughly, quickly, at small cost. Over 800 of all American Bureaus of Identification employ I.A.S. students or graduates. Write for FREE "Blue Book of Crime."

(A Correspondence School Since 1916)

Institute of Applied Science, 1920 Sunnyside Ave., Dept. 1356, Chicago 40, Ill.

## YOUR OWN BUSINESS with BIG EARNINGS in..



### ELECTRIC APPLIANCE REPAIRING

50,000,000 Families Are Your Prospects! Repair electrical appliances for friends and neighbors. Service electrical equipment in stores, etc. Earn up to \$5.00-\$8.00 an hour or more! New shop method home study training. Electronic Kit makes it now possible. Rush name for FREE Book, and Special PAY LATER form. CHRISTY TRADES SCHOOL, 3214 W. Lawrence Ave., Dept. A-8403, Chicago 25.

## LAW FREE BOOK



Write today for a FREE copy of illustrated law book. "THE LAW TRAINED MAN," which shows how to earn the professional Bachelor of Laws (LL.B.) degree through home study of the famous Blackstone Law Course. All necessary books and lessons provided. Moderate cost; convenient monthly terms. Write for FREE law training book today.

Blackstone School of Law, 307 N. Michigan Ave. Dept. 56, Chicago 1, Illinois

Founded 1890

Be a  
**LOCKSMITH!**  
EARN WHILE  
YOU LEARN  
Send for  
FREE BOOK

Big opportunities in this fascinating, profitable trade. Earn quickly—step into a well-paid job or start a business of your own, full or part time. Learn easily at home, all materials and special tools supplied.

Write NOW for FREE book!

LOCKSMITHING INST., Dept. 109-9, 150 Park Ave., E. Rutherford, N. J. Licensed by State of N.J. Vet Approved

## Learn BAKING At Home

Baking is one of America's high industries in wages. Nearly depression-proof. Thorough basic home course lays sound foundation. If you have aptitude, write for FREE BOOKLET, "Opportunities in Commercial Baking."

National Baking School, 835 Diversay Pkwy., Dept. 1358, Chicago 14, Illinois



CHOOSE THE PROFESSION WITH A FUTURE... LEARN

# DRAFTING

AT HOME... QUICKLY... EASILY... IN SPARE TIME...

## JOIN THE SPACE AGE ENGINEERING TEAM!

You, too, can become a key man on the modern engineering team. The draftsman is the vital communication link between engineers and technicians. All commercial projects start on the draftsman's drawing board!

**HERE IS YOUR CHANCE!** No matter where you live... no matter what your present job is... you too, like many of today's industrial leaders, can use drafting as your springboard to success. Never before has there been such a demand and respect for skilled draftsmen. No profession has a brighter future! Draftsmen get top pay... are in line for promotion to executive positions.

**NO EXPERIENCE NEEDED.** C.E.I.'s modern drafting courses are the finest, practical, thorough home study training available. They are fully illustrated, prepared especially for Home Study.

**EARN WHILE YOU LEARN!** Keep your present job while learning drafting at home in spare time. Many students, as they advance in their C.E.I. course, use their drafting skill to increase their present income.

**ACT NOW! INSURE YOUR FUTURE!** C.E.I.'s faculty of licensed engineers and registered architects will guide you each step of the way. Find out how a C.E.I. Diploma can open doors for you... bring you a richer life... greater security... big pay... the respect of your employer and people in your community. **MAIL THE COUPON NOW!**

COMPLETE  
EQUIPMENT  
FREE OF  
EXTRA COST

**VETERAN APPROVED!**

free

LESSON  
AND  
SUCCESS  
BOOK

Approved Ohio State  
Dept. of Education



**CLEVELAND  
ENGINEERING INSTITUTE**  
ENGINEERING DRAFTING EXCLUSIVELY

## You Too, Can Have:

- MORE MONEY
- PROFESSIONAL RATING
- BIG PAY JOBS
- BRIGHT FUTURE
- JOB SECURITY
- SUCCESS

C.E.I.'s Drafting Course has helped me in many ways: It has raised my education rating and technical classification and has boosted my income.



J. F. Balschun, Canal Zone



C.E.I.'s Home Study Course made it possible for me to secure valuable training while keeping my full time job to meet living expenses. C.E.I. training made my present job possible and doubled my pay.

Wm. M. Willis, Iowa

I advise everyone interested in the highly specialized field of drafting to start your top caliber course at once! C.E.I.'s course has increased my income 92%. The ceiling of the salary and position of experienced draftsmen is unlimited.



Paul W. Marrone, Fla.

Your course has made my present position possible. It has also enabled me to study engineering in college evening courses. My C.E.I. diploma was accepted in place of high school credits which I lacked.

J. Jakubowski, Michigan

These are only a few of hundreds of letters of appreciation in C.E.I.'s files

## MAIL COUPON NOW!

CLEVELAND ENGINEERING INST. DEPT. PM-9J  
6300 Euclid Ave. Cleveland 3, Ohio

Mechanical  Aeronautical  Architectural

MY NAME \_\_\_\_\_ AGE \_\_\_\_\_

ADDRESS \_\_\_\_\_

CITY \_\_\_\_\_ STATE \_\_\_\_\_

No Obligation — No Salesmen A-2327

# AUDELS GUIDES

FOR

## MECHANICS & ENGINEERS

### EARN MORE...LEARN MORE

No. 1	AUTOMOBILE MECHANICS GUIDE. 1696 Pages.....	\$ 6.00
No. 2	HOME APPLIANCE SERVICE GUIDE. 864 Pages.....	6.00
No. 3	TV & RADIO SERVICE LIBRARY. 2 Book Set.....	8.00
No. 4	HANDY BOOK OF ELECTRICITY. 1520 Pages.....	5.00
No. 5	TRUCK & TRACTOR GUIDE. 1376 Pages.....	5.00
No. 6	PLUMBERS & STEAMFITTERS GUIDES. 4 Book Set.....	8.00
No. 7	PAINTING & DECORATING MANUAL. 464 Pages.....	3.00
No. 8	CARPENTERS & BUILDERS GUIDES. 4 Book Set.....	8.00
No. 9	DIESEL ENGINE MANUAL. 640 Pages.....	3.00
No. 10	WELDERS GUIDE. 608 Pages.....	3.00
No. 11	MATHEMATICS MADE EASY. 752 Pages.....	3.00
No. 12	MACHINISTS & TOOLMAKERS HANDBOOK. 1728 Pages.....	6.00
No. 13	WIRING DIAGRAMS. 304 Pages.....	2.00
No. 14	REFRIGERATION & AIR CONDITIONING. 1360 Pages.....	6.00
No. 15	ELECTRIC LIBRARY. 10 Volume Set.....	20.00
No. 25	BLUE PRINT READING. 448 Pages.....	3.00
No. 26	MASONS & BUILDERS GUIDES. 4 Book Set.....	8.00
No. 27	ELECTRIC MOTOR GUIDE. 1056 Pages.....	5.00
No. 28	OIL BURNER GUIDE. 416 Pages.....	2.00
No. 29	SHEET METAL PATTERN LAYOUTS. 1152 Pages.....	7.50
No. 30	SHEET METAL WORKERS HANDY BOOK. 448 Pages.....	2.00
No. 31	MECHANICAL DRAWING GUIDE. 192 Pages.....	2.00
No. 32	MECHANICAL DRAWING & DESIGN. 480 Pages.....	3.00
No. 33	ELECTRONIC DEVICES. 304 Pages.....	3.00
No. 34	ELECTRICIANS EXAMINATIONS. 272 Pages.....	2.00
No. 35	ELECTRIC POWER CALCULATIONS. 480 Pages.....	3.00
No. 36	ELECTRIC DICTIONARY. 9000 Terms.....	3.00
No. 37	POWER PLANT ENGINEERS GUIDE. 1568 Pages.....	5.00
No. 38	ENGINEERS AND FIREMANS EXAMS. 544 Pages.....	2.00
No. 39	OPERATING ENGINEERS LIBRARY. 3 Book Set.....	12.00
No. 40	PUMPS, HYDRAULICS & AIR COMPRESSORS. 1760 Pages.....	6.00
No. 41	HOUSE HEATING GUIDE. 1008 Pages.....	5.00

#### 7-DAY FREE EXAMINATION

SEND NO MONEY — Pay the postman nothing! We'll send you any of the Audel Guides for FREE examination in your home. If you decide to keep the books you may pay for them under our easy-pay plan of only \$2 a month.

#### HERE IS ALL YOU DO

IT'S EASY TO ORDER: In the No-Risk Mail Order Coupon below you need only draw a circle around the number of Audel Guides you want. We will send them to you at once. If you are not completely satisfied, return the books to us.

## MAIL THIS COUPON TODAY!

THEO. AUDEL & CO. — Self Improvement Publishers Since 1879  
49 W. 23rd Street, New York 10, N. Y.

P9

Please mail me for 7 days' FREE EXAMINATION the books I have circled. I agree to mail \$2 in 7 days on each book or set ordered, and to further mail \$2 a month on each book or set ordered until I have paid the purchase price, plus shipping costs. If I am not completely satisfied with my Audel Guides I may return them.

NAME \_\_\_\_\_

ADDRESS \_\_\_\_\_

OCCUPATION \_\_\_\_\_

EMPLOYED BY \_\_\_\_\_

1 2 3 4 5 6 7 8 9 10 11 12 13 14 15 25 26  
27 28 29 30 31 32 33 34 35 36 37 38 39 40 41

SAVE SHIPPING COSTS! Check here if you enclose complete payment with order. We pay postage charges. You have same return privilege.



**Nutria.... NEWEST OPPORTUNITY**

New fur-bearing animal now being bred in U. S. Offers huge profits to breeders. This fur is next to Mink NOW in price and will soon surpass it 15 to 20 young per year. Most easily and economically raised animal known. 1 1/2¢ per day to feed. ANY CLIMATE. disease resistant. The Cabana Marrone strain is obtainable ONLY through Cabana Nutria, Inc. and its authorized dealers and distributors. For free booklet and address of Cabana ranch nearest you write:

**CABANA NUTRIA, INC.**  
Dept. 46, 636 W. Lemon Ave., Arcadio, Calif.

Build the best portable **EICO** ALL-TRANSISTOR RADIO RA-6 KIT \$29.95 WIRED \$49.95

Includes leatherette case, less 9V battery.



Easy fun! 6-transistor superhet has high sensitivity & selectivity. Push-pull audio, 6" speaker for big-set sound. Send for FREE catalog on STEREO hi-fi, "ham" gear & test instruments, KITS & Factory-Wired.

EICO, 3300 N. Blvd., L. I. C. I. N. Y. Dept. PM-9 Add 5% in West.

## STUDY TO BE A DOCTOR

### of Psychology or Metaphysics

Obtain a Ps.D., Ma.D., or Ph.D. Be a Teacher, Lecturer or Accredited Practitioner. Teach others how to achieve Health, Happiness and Contentment. Chartered by State. Correspondence Course only. Write for FREE book telling how.

#### THE NEOTARIAN FELLOWSHIP

Desk B, Pichwick Building Kansas City 6, Missouri

# \$ POPULAR MECHANICS MEANS MORE MONEY IN YOUR POCKETS

POPULAR MECHANICS, the magazine that brings you money-saving ideas now brings you a perfect money-making opportunity.

We are looking for more men and women to introduce our magazines in their neighborhood, to accept orders for Popular Mechanics and other leading publications. If you have been looking for a way to earn a little extra each week—here's the answer!

No waiting for payday, you pocket your earnings right away! No experience necessary. you work when you please, as much as you please, your home is your office, and you are your own boss!

YOU CAN EARN \$10.00, \$25.00, \$50.00 right away with our new Popular Mechanics Subscription Plan. SEND NOW!

Popular Mechanics Dept. 959-B  
250 West 55th St., N. Y. 19, N. Y.

Please send me your subscription plan!

Name \_\_\_\_\_

Address \_\_\_\_\_

City \_\_\_\_\_ Zone \_\_\_\_\_ State \_\_\_\_\_



**FREE OUTFIT STARTS YOU  
IN BIG MONEY  
JACKET & SHOE BUSINESS**



We furnish everything FREE to set you up in a profitable spare time Jacket and Shoe Business. You never invest one cent. Top men make \$5 to \$10 per hour. Just 2 orders a day for these INSULATED Jacket and boot combinations pay you up to \$660 monthly EXTRA CASH! Amazing INSULATED INTER-LINING keeps wearer warm at below zero. Used by U.S. Army to keep men comfortable in Korean winters. Holds body heat in, is light — not bulky. You make money with over 190 styles: dress, sport, work shoes for men and women. Never sold by stores. You get steady profits from repeat orders. Save money on Your and family's jackets and shoes. Be first in your area . . . send for FREE OUTFIT today.

**MASON SHOE, Dept. F-717, CHIPPEWA FALLS, WIS.**

**BRAND NEW Snow or Regular TIRES—CHEAPER**

than retreads—dollar for dollar—mile for mile!  
Made by one of the world's largest mfgs.

**HOOD** World famous for stability & safety. Passenger, Truck, Bus, Trailer, Farm, Foreign Cars, Rayon, Tyrex, Nylon, Black or White, Tube Type or Tubeless—Factory guaranteed. All over USA.

**SEND FOR FREE CATALOG NOW** and be set for winter!

Showing all sizes and our amazingly low prices!

**MARY BLATT** 6th & Spring Garden St. Philadelphia, Pa.

"The name to trust in Tires"

Before you buy any tire get our LOW PRICES first!



**LEARN LANDSCAPE GARDENING**

A thorough, interesting home study course for those who wish to become LANDSCAPERS, GARDENERS, DESIGNERS, etc., for profit or pleasure. Write today for FREE INFORMATION to:

**NATIONAL LANDSCAPE INSTITUTE**  
Dept. M-99 11826 San Vicente Blvd. Los Angeles 49, Calif.

**SIGN PAINTING**

Home-Study Course — Only \$5.95

Teaches you commercial sign painting and sign building as it is being done TODAY in leading shops all over the country. Complete practical course for self-instruction. Shows latest methods of truck lettering, office doors, wood letters, reflecting signs, plastics, sprayed signs, gold leaf, silk screen process, up-to-date alphabets, money-making business information, etc.

**SATISFACTION GUARANTEED OR REFUND!**

Contains all the instruction of a high-priced correspondence course. Full price, only \$5.95, postpaid. Or C.O.D. plus postage. No risk—order today. Satisfaction or money back! Order "Sign Painting Course." NELSON-HALL CO., 210 S. Clinton St., Dept. JR-2, Chicago 6, Ill.



**Finish HIGH SCHOOL**

**AT HOME**  
Complete 4 Years in 12 Months  
diploma



Learn More! Earn More!  
Enter College, professional or technical schools.

Advance Socially. Live a Happier, Fuller Life. Individual Courses or complete schedule.

WRITE FOR SCHOOL BULLETIN, Dept. PM-99

**ACADEMY FOR ADULTS** 30 W. Washington Chicago 2, Illinois

**NOW...  
Train at  
home for some  
of today's most  
spectacular  
OPPORTUNITIES**

**... including  
GUIDED  
MISSILE CONTROL**

Nothing else like it! Prepare in spare time for REAL EARNINGS in

**RADIO • TELEVISION**

**Electronics**

... the amazing multi-billion dollar opportunity field that's helping pave the way to the exploration of OUTER SPACE. Wonderful choice of opportunities for earning REAL MONEY — including Radar, Television, Radio, Automation Electronics, Guided Missile Control, your own business and other interest-packed branches. NOW . . . get every modern training aid you need at home, including picture-clear MOVIES, texts, and 16 shipments of HOME LABORATORY EQUIPMENT for needed practical experience.

**JUST "COMMON SENSE" NEEDED TO START**

No advanced education or previous technical experience needed. If preferred, you may attend DeVry Tech's well-equipped laboratories in Chicago or Toronto. See for yourself. Mail coupon today.



**Employment Service**

At no extra cost, all graduates get DeVry Tech's EMPLOYMENT SERVICE that has helped thousands of men earn REAL MONEY! Often more jobs than grads!

**MILITARY SERVICE?**

Act now. Get valuable information we have for men facing military service.



Come With Us to OUTER SPACE

**FREE!**

Men 17-55—get 2 FREE booklets, "Come With Us to Outer Space" and "Pocket Guide to Real Earnings." Informative! Fascinating!

**MAIL TODAY!**

**DeVRY TECHNICAL INSTITUTE**

4141 Belmont Avenue, Chicago 41, Ill., Dept. PM-9-P 2058

I would like your FREE booklets and information on how I can prepare to enter ELECTRONICS.

Name \_\_\_\_\_ Age \_\_\_\_\_

Street \_\_\_\_\_ Apt. \_\_\_\_\_

City \_\_\_\_\_ Zone \_\_\_\_\_ State \_\_\_\_\_

**De Vry  
TECH**

Formerly DeFOREST'S



# Draw CARTOONS

**EARN BIG MONEY...**

**LEARN AT HOME IN SPARE TIME!**

**No previous training or art ability necessary with the Famous System of Manual Training!\***

\*U. S. Pat. applied for

Cartoonists are in greater demand than ever before—by magazines, newspapers, movies, television, ad agencies, art studios. As a successful, Continental-trained Cartoonist, your earnings are not limited. A high, professional income and greater personal growth can be yours. The "Famous System of Manual Training" has taught thousands of men and women, now profitably engaged in cartooning. A wonderful pastime or hobby, too. Amuse yourself, your friends.

**LEARN FAST—THE MODERN WAY**

The Famous System of Manual Training is a unique, new, different concept of art instruction developed by long-experienced,

highly skilled professional cartoonists and instructors. You learn quickly and thoroughly by starting to cartoon immediately, without tedious study or exercises.

**EARN WHILE YOU LEARN**

Many Continental students start earning a good spare or full-time income after first few lessons. You can work right in your own home, hold your present job, make money at the same time.

The Famous System of Manual Training makes other methods and courses obsolete. Learn rapidly and easily with our modern, streamlined, personalized Method. Approved by educators and cartoonists everywhere.

**WE SUPPLY EVERYTHING YOU NEED**

You receive the Big Professional Kit of supplies and equipment without extra cost—everything you need during your entire Course. Includes special Articulated Model for drawing any human pose. Valuable later on in your own Studio or Professional Career. Yours as a student.



**GET ALL THE FACTS... BIG, COLORFUL BOOK YOURS FREE**

Full details of our patented System, plus pages of useful, fascinating information are contained in our Free Catalog... yours for the asking. Use the coupon now.

Investigate and learn what Continental Schools and a Cartooning career can do for you. Full details are free. No obligation whatsoever, and we do not send salesmen. All details come to you by mail for you to read and decide. Write today!



Says P. R. Tilton, N. Y.: "I am especially thankful for your fine training, as it has already enabled me to create cartoons and drawings for a grocery chain for their weekly shopping news." G. Allred, Indianapolis, says: "I didn't believe it was possible to learn so fast. I have sold eight cartoons already—earning enough to pay for the complete course!"

**Continental Schools, Inc.**

4201 S. BROADWAY, LOS ANGELES 37, CALIF.

CONTINENTAL SCHOOLS, INC.

Dept. A-9, 4201 S. Broadway, Los Angeles 37, Calif.

Rush Free Catalog and other information by return mail. No charge or obligation, no salesman will call.

NAME \_\_\_\_\_  
ADDRESS \_\_\_\_\_  
CITY \_\_\_\_\_ ZONE \_\_\_\_\_ STATE \_\_\_\_\_



**SEND COUPON FOR FREE BOOK**

# Prepare the ALLIED Way for the BEST JOBS in Industry

**TRAIN AT HOME**  
in Your Spare Time  
or at Allied Institute  
in Chicago

Also for FREE  
SAMPLE LESSON

SEND FOR  
**FREE**  
BOOKS

- DRAFTING
- TOOL DIE-DESIGNING
- TOOL-DIE MAKING
- IND. ENGINEERING
- IND. ELECTRONICS
- AIR CONDITIONING
- REFRIGERATION
- AUTO MECHANICS

**ALLIED INSTITUTE OF TECHNOLOGY**

1338-42 So. Michigan Ave., Dept. PM-99, Chicago 5, Ill.

# INVENTORS

U. S. Patents protect your inventions. Our free book of "Instructions on Patent Procedure for Inventors," also "Certificate of Invention" form sent without obligation.

**C. A. SNOW & CO.**

REGISTERED PATENT ATTORNEYS

428 SNOW BUILDING WASHINGTON 1, D. C.

# INVENTORS

Whether an invention is patentable can be substantially determined by a search of the U. S. Patent records. Without obligation, write for information explaining the steps you should take to secure a patent.

**JOHN N. RANDOLPH**

Registered Patent Attorney

801 Victor Building, Washington 1, D.C.

# INVENTORS

Send for  
**PATENT INFORMATION**  
Book and  
**INVENTOR'S RECORD**  
without obligation

**GUSTAVE MILLER**  
99-PM WARNER BUILDING  
WASHINGTON 4, D.C.

**REGISTERED PATENT ATTORNEY**

ASSOCIATE EXAMINER  
U.S. PAT. OFF. 1922-1929  
Patent Attorney & Advisor  
U. S. NAVY DEPT. 1930-1947  
**PATENT LAWYER**

# INVENTORS NEEDED AT ONCE

If you have an invention you wish to sell outright or license on royalty, write us at once. We are seeking inventions of household items, games, toys, sports items, tools, and mechanical and technical devices. Patented or unpatented. For further information and free brochure outlining manufacturers' requirements, royalty rates, send name (no drawings, please) on letter or postcard at once.  
**KESSLER CORPORATION, Dept. D-59, Fremont, Ohio**

# INVENTORS

**PROTECT YOUR INVENTION BY A U. S. PATENT. SEND FOR FREE "INVENTION RECORD" FORM AND "PATENT INFORMATION EVERY INVENTOR SHOULD HAVE."**

**CARL MILLER**

REGISTERED PATENT ATTORNEY

WOOLWORTH BLDG., 36th FLOOR, 99A  
NEW YORK CITY

COVERS ALL THESE MAKES  
— ALL MODELS, 1952 THRU 1959

Buick	De Soto	Jeep	Plymouth
Cadillac	Dodge	Lincoln	Pontiac
Chevrolet	Edsel	Mercury	Rambler
Chrysler	Ford	Nash	Studebaker
Clipper	Hudson	Oldsmobile	Thunderbird
Continental	Imperial	Packard	Willys

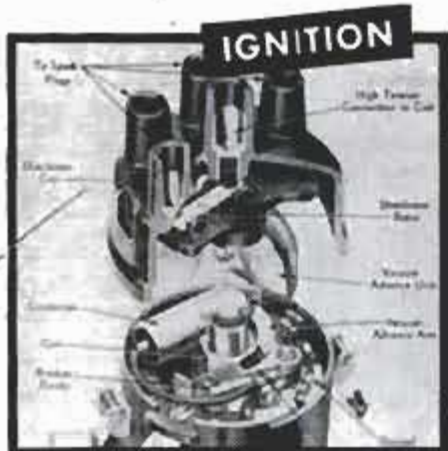

Clear photos, cutaway drawings and diagrams, plus know-how directions make every part of any ignition system crystal-clear.

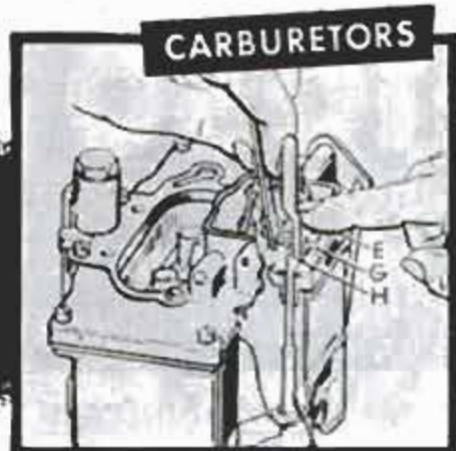

No more guesswork. You get illustrated, step-by-step procedures for all types of carburetors.

# Let Factory Experts Show You HOW TO FIX ANY PART OF ANY CAR

3 MILLION COPIES SOLD! USED BY U. S. ARMED FORCES

**This Famous "Auto Repair Bible" Turns Beginner Mechanics Into Experts—Saves Experts Time, Trouble, Money**

SUPPOSE crews of trained factory experts were ready to guide your hands as you start to fix any part of any car. If they told you EXACTLY WHAT TO DO, couldn't you "wrap up" any repair job—quickly, easily, right? That's exactly the kind of expert guidance you get in MOTOR'S new AUTO REPAIR MANUAL!

### YOU CAN'T GO WRONG!

With clear illustrations and step-by-step instructions, these experts show you how to "breeze through" any job on any car listed—1952 thru 1959. Even if you're a beginner, this famous Manual can show you how to fix cars the way the EXPERTS do. Tells you WHERE to start, what TOOLS to use, guides you every STEP of the way!

You get practical how-to-do-it procedures—worked out by AUTOMOTIVE ENGINEERS—from 176 official Shop Manuals, hundreds of factory bulletins, boiled down in simple, easy-to-follow language. 1,120 giant pages, 2,850 "This-is-How" pictures, 195 Quick-Check Charts — 30,000 essential repair specifications. Over 225,000 service and repair facts. Instructions and pictures are so clear you can't go wrong!

### 3 BOOKS IN 1

You actually get three complete "show-how" books in one giant handy, indexed volume:

1. Complete TROUBLE-SHOOTER SECTION spots more than 2,300 car troubles, helps you find the "bugs" fast.

2. HOW TO SERVICE, REPAIR ALL CAR PARTS—Transmissions, Air Suspension Systems, Rear Ends, Generators and Regulators, Fuel Pumps, Ignition Systems, Overdrives, Automatic Transmissions, Brakes, Rings, Water Pumps, Distributors, Dash Gauges, Power Steering, Power Brakes, etc., etc.

3. STEP-BY-STEP INSTRUCTIONS AND PICTURES on each specific car make and model—covers over 1,960 car models—1952 thru 1959.

PLUS Factory Specifications and Adjustment Tables, Tune-up Charts, Overhauling and Replacement facts—and MUCH MORE! Used by Armed Forces, hundreds of thousands of auto service men.

### TRY BOOK FREE 7 DAYS

Send no money! Just mail coupon (paste it to a postal card for faster action). Use Manual for a week, free. Unless you agree that it is the greatest time and money-saver you've ever seen, return it in 7 days—and you won't owe a cent! Mail coupon today! Address: MOTOR Book Dept., Desk 91A, 250 West 55th St., New York 19, N. Y. (SCHOOLS, BOOKSTORES: Write for discounts.)



**FREE 7-DAY TRIAL**  
Return and Pay Nothing if Not Delighted

**MAIL COUPON NOW FOR 7-DAY FREE TRIAL**  
(Attach to postcard if more convenient)

MOTOR BOOK DEPT., Desk 91 A, 250 W. 55th St., New York 19, N. Y.

Run it to me at once (check box opposite book you want):

MOTOR'S New AUTO REPAIR MANUAL. If O.K., I will remit \$2 in 7 days, \$2 monthly for 2 months and a final payment of \$1.95 (plus 45¢ delivery charge) one month after that. Otherwise I will return the book postpaid in 7 days. (Foreign price, remit \$10 cash with order.)

MOTOR'S New TRUCK REPAIR MANUAL. If O.K., I will remit \$3 in 7 days, and \$2 monthly for 2 months, plus 45¢ delivery charge with final payment. Otherwise I will return book postpaid in 7 days. (Foreign price, remit \$11 cash with order.)

Print Name..... Age.....

Address.....

City..... Zone..... State.....

Check box and save 45¢ shipping charge by enclosing WITH envelope entire payment of \$7.95 for Auto Repair Manual or \$9 for Truck Repair Manual. Same 7-day return-refund privilege applies.

Same FREE 7-Day Offer on MOTOR'S Brand-New TRUCK REPAIR MANUAL

Covers EVERY job on EVERY gasoline-powered truck made since 1952—PLUS GM, Mack and Cummins Diesels. Over 3,000 illustrations; over 300,000 facts. Check proper box in coupon for FREE 7-DAY TRIAL.

Amazed Self and Friends—  
"I amazed myself and my friends, too. Now do jobs that stumped me before."—Michael Balitsky, Newark, N. J.

So Complete and Easy to Understand — "So complete, easy to understand—have done jobs with Manual I would not have attempted without it."—C. L. Vanerstrom, Mich.



Some make more, some less:

# \$1050

## gross in single MONTH in my own business

F.E. DORAN  
reports:



### Start your own business!

Here's YOUR chance to start a money-making, year 'round business of your own and make the success you've dreamed about.

G. R. Adcock took in \$102 in one day. O. W. Hare landed a \$750 hotel job. J. S. Corbit grossed \$279.50 his first month. Homes, hotels, offices, clubs, offer you big profit possibilities. Auto upholstering also.

**NO SHOP OR OFFICE NECESSARY** - You clean furniture on customers' premises. No hauling, no high rents. Supplies inexpensive; you operate from your own home. What you take in is mostly profit.

If you want to be your own boss—free from lay-offs and strikes, we will help you to start and succeed.

This is not a lease proposition. You own the machine, you work when and where you please and all the money you take in is your own.

**VON SCHRADER MFG. CO.**  
910 "D" Pl., Racine, Wisconsin

Without obligation rush your FREE booklet about how I can start my own permanent, profitable electric Upholstery Cleaning business.

Mail  
Coupon  
Today  
for  
FREE  
Book

Name \_\_\_\_\_  
Address \_\_\_\_\_  
City \_\_\_\_\_ Zone \_\_\_\_\_ State \_\_\_\_\_

## Learn to MOUNT BIRDS



**Yan SKINS, Make Up FURS**  
Be a Taxidermist. We teach you at Home. Mount Birds, Animals, Pets, Game Heads, Fish. Save your hunting trophies; decorate home and den. **MAKE MONEY** Mount and Krome-tan for others. Big spare-time profits. **FREE BOOK** 100 game pictures 48 pages - Hunters. Get this wonderful book. It's Now Free. Send postcard TODAY. State AGE. **NORTHWEST TAXIDERM SCHOOL** Dept. 2509 Omaha, Nebraska

## 8 FT. SPECIALS - 80c



These GIANT 8 FOOTERS can be yours, while they last, at a fraction of their value. New, genuine neoprene govt. surplus. Great for advertising, you paint your message on 'em, inflate & fly. Attracts crowds to sales, displays, openings, stores, gas stations. Fun at home for young & old and just the thing for any party or school prom. Perfect for beach or picnic. They're BIG, they're FUN, they're useful, so order yours today!

8' dia.-80c ea. . . . 2 for \$1.50  
13' dia.-\$1.95 ea.

Postage pd. on ppd. orders.  
Cal. res. add sales tax.

FRANK SALES, Dept. PM959, 3930 Sunset Blvd., Los Angeles 29, Calif.

## MAKE YOUR OWN POOL TABLE

Easy, detailed plans for this 4'x7' pool table enables you to build it for less than \$80.00 completed. These plans provide for the best-playing qualities of a nonwarping bed, rubber cushions, and enclosed ball returns. Table is engineer-designed for maximum accuracy with sturdy folding legs and leveling devices. The plans are complete and easy-to-follow. We also offer a kit of accessories: the best rubber cushions, deluxe lath-turned balls, cues, good quality suede billiard cloth, ball triangle, chalk, rubber cement, etc.



Easy, inexpensive entertainment is yours. Send \$3.00 for complete plans today. Satisfaction guaranteed.

**MAR-BER COMPANY, Box 475, Massena, New York**



## BIG EARNINGS WAITING for TYPEWRITER REPAIRMEN

Skilled men are in demand in the new, uncrowded field of typewriter repair. You'll quickly step into a big-pay job or business of your own, full or part time. **EARN** while learning easily at home under expert guidance. Materials, tools, typewriter supplied. Write TODAY for FREE book.

**TYPEWRITER REPAIR SCHOOL, INC.**  
Dept. J-19, 150 Park Ave., E. Rutherford, N. J.  
Lic. by New Jersey Dept. of Educ.

## MEN WANTED

Earn \$100 Per  
Week and up  
**AUTO DIESEL  
MECHANICS**

Master a trade with a future—learn Auto-Diesel mechanics in our shops. You learn with tools on real equipment. Earn while you learn. Many of our graduates earn \$100 per week and up. No previous experience necessary. Day and night courses. Approved for veterans. Write for free bulletin.

**NASHVILLE AUTO-DIESEL COLLEGE**  
226 7th Ave., N., Dept. 73 Nashville 3, Tenn.



## SUPER JU JITSU

Now get tough double quick!

A course of instruction in the art of practicing and using this method of applying **LIGHTNING-QUICK** Super Ju Jitsu. Be Dangerous! These amazing lessons show you how it's done . . . in a big illustrated home-study course. The weapons are just your **BARE HANDS**—they can be used effectively if you know how and practice the art. Easy to learn; quick. Full 76-lesson course only \$5.95 postpaid—or COD, plus postage. Satisfaction or your money back guaranteed! Order "Super Ju Jitsu Course."

**NELSON-HALL CO., 210 S. Clinton St., Dept. JR-2, Chicago 6, Ill.**

## FIX OUTBOARD MOTORS

## POWERMOWERS, AND ALL SMALL 2 & 4-CYCLE GASOLINE ENGINES

**MAKE EXTRA MONEY**—or, repair your own equipment and **SAVE!** Fully illustrated, easy-to-understand, Home Study Course. Write today for **FREE** information.

**LINCOLN TECHNICAL INSTITUTE**  
SUITE 9-E, 472 MARKET STREET, NEWARK 5, N. J.





## Beauty by Colorcrete Can Earn High Incomes



Beautifying buildings by Colorcrete is a business opportunity awaiting men of modest capital everywhere. Owners of homes, stores, motels, schools — almost any type of construction—are looking for means to give lifetime eye-appeal to drab or dirty concrete, stucco and similar masonry surfaces. Colorcretors can do such jobs, in little time and at little cost, and pocket generous profits. Colorcrete is a cementitious material, applied by air pressure. Tough, tenacious, enduring; 30 colors. Investigate this low-investment enterprise by writing for the Opportunity Book.

COLORCRETE INDUSTRIES, INC.  
570 Ottawa Ave., Holland, Mich.

### COLORCRETE

## TOOLS WHOLESALE

**\$100 PUTS YOU IN BUSINESS**

Start your own business, sell tools to your friends and neighbors, or buy tools for your own use and **SAVE MONEY \$\$\$**

A MILLION DOLLAR INVENTORY AT YOUR FINGERTIPS. NO STOCK TO CARRY. ORDER AS YOU NEED IT.

THOUSANDS!! of Nationally Advertised items of Hand Tools, Power Tools, Machinist Tools, Tool Chests, Paint Sprayers, Light Fixtures, Appliances, Gums, Gifts, Toys and other items too numerous to mention.

**WE SHIP COAST TO COAST**  
Wholesale Disc. up to 50% off

BUY AT WHOLESALE PRICES. Extra \$25.00 profit on your accumulated purchases. \$1.00 refund on first purchase or refunded if you are not 100% satisfied.

Dept. PM-9  
**SILVO HARDWARE CO., 107 Walnut St., Phila. 6, Pa.**

## Be A FLORIST

Thousands of money making opportunities full or part time. Many start business in own home. Flower arrangement included to enable you to make professional corsages, sprays, etc. Professional material supplied with Home Study Training. Write for FREE Book.

NATIONAL FLORAL INSTITUTE

Studio M-99 11826 San Vicente Blvd. Los Angeles 49, Calif.

## I'll Set You Up For Life In Your Own BIG PAY SHOE BUSINESS

With The ONE Shoe Line that Serves Everyone  
From Baby to "Pop" and "Mom"



Only 8 orders a day can make you up to \$32.00 a day, \$180.00 a week, \$600.00 a month. It's no trick at all to make big money full or Spare Time with America's most comfortable shoes. Amazing new "Spring-Step" cushion design proves it by actual demonstration. Over 200 styles for men, women, boys, girls and infants! Profits are BIG—repeat orders sure and easy. No experience needed. No investment. Everything furnished free, including finest sales outfit and actual demonstrators. Send today for Free Outfit.



Amazing 2-Minute  
Demonstration  
Does Your Selling  
Job for You FAST!  
I Give producers  
Their Own Shoes  
AS A BONUS!

ORTHO-VENT SHOE CO.

1199 BRAND ROAD  
SALEM, VIRGINIA

These men are getting  
practical training in ...

## ELECTRICITY



### ELECTRONICS

**ON REAL**

Motors • Generators  
Switchboards • Controls  
Modern Appliances  
Automatic Electronic  
Control Units

## TELEVISION



### Radio Electronics

**ON REAL**

TV Receivers  
Black & White and Color  
AM-FM and Auto Radios  
Transistors • Printed  
Circuits • Test Equipment

Train in NEW Shop-Labs of

## COYNE

In Chicago—Electrical and Electronic Center of the World. Prepare for a better job and a successful future in a TOP OPPORTUNITY FIELD. Train on real full size equipment at COYNE where thousands of successful men have trained for 60 years—largest, oldest, best equipped school of its kind. Professional and experienced instructors show you how, then do practical jobs yourself on more than a quarter of a million dollars worth of equipment. No previous experience or advanced education needed. Employment Service to Graduates.

Start Now — Pay Later — Liberal Finance and Payment Plans. Pay most of tuition after graduation. Part-time employment help for students. Choose from nine yearly Starting Dates.

Mail Coupon or Write to Address Below for Free Book — "Guide to Careers." Whether you prefer ELECTRICITY, TELEVISION-RADIO or COMBINED ELECTRONICS TRAINING, which includes both fields, this book describes all training offered.

Information comes by mail. No obligation and  
**NO SALESMAN WILL CALL.**

B. W. Cooke, Jr., Pres. Founded 1899

**COYNE ELECTRICAL SCHOOL**

Chartered as an Educational Institution Not for Profit  
1501 W. Congress Pkwy., Chicago 7, Ill., Dept. 69-3C

**MAIL COUPON** OR WRITE TO ADDRESS BELOW

COYNE ELECTRICAL SCHOOL  
New Coyne Building, Dept. 69-3C  
1501 W. Congress Pkwy., Chicago 7, Ill.

Send BIG FREE book and details of all the training you offer. However, I am especially interested in:

Electricity  Television  Both Fields

Name \_\_\_\_\_

Address \_\_\_\_\_

City \_\_\_\_\_ State \_\_\_\_\_

(I understand no Salesman will call)





# Be Your Own Art Teacher

**IT'S EASIER THAN YOU THINK!**

**D**RAWING at top shows how to use guide lines to proportion average female head. Art instruction has been simplified same way in our famous home study course. Now you can learn commercial art, cartooning, lettering, fashion, TV, etc. . . . right at home, in spare time. No previous art training necessary. Soon be your own boss. Or earn big money as staff artist for advertising agency, newspaper, magazine, etc. Earn while you learn. 22-piece art outfit given with first lesson **AT NO EXTRA COST.**

**FREE BOOK** describes our methods. Lists opportunities. Quotes students. No obligation, no salesman will call. Just clip this ad, fill out, and mail to: **Washington School of Art, Studio 149, Port Washington, N. Y. (Established 1914)**

Name.....Age.....  
(PLEASE PRINT)  
Address.....  
City.....Zone...State.....



# HIGH WAGES!

High Wages can be yours as an Operating Engineer of heavy construction equipment! Learn NOW to operate our diesel engined bulldozers, draglines, cranes, back hoes, scrapers and motorgraders! Machines of major manufacturers are used in our training program. Contractors are on our advisory staff. Contractors need trained operators and pay high wages to our graduates. We invite comparison and inspection of the nation's original construction equipment operator's training schools. **NEW!** Announcing resident and non-resident courses in Heavy Construction Management. Write for details.

Budget plan available. **VETERANS:** Ask about G.I. Benefits

**Write TODAY for FREE School Catalog,**  
no obligation, to either address

## THE NATIONAL SCHOOLS of HEAVY EQUIPMENT OPERATION

Dept. D-32

P.O. Box 8415, Charlotte, N. C. - P.O. Box 510, Weiser, Idaho



# ACCORDIONS 1/2 OFF!

**5 DAY FREE TRIAL—EASY TERMS**

Buy direct from world's largest exclusive accordion dealer. **Save 50% off mfr's list prices!** Famous Italian makes; over 50 models. **5 Day FREE TRIAL.** Double Guarantee. Trade-ins are accepted. Bonus gifts. Easy terms, low as \$10 monthly. **FREE** catalog and low discount prices—write **Accordion Manufacturers & Wholesalers Outlet** 2093 W. CHICAGO AVE., DEPT. R-99, CHICAGO 22, ILL.

# LEARN UPHOLSTERY

in your spare time  
run your own  
business  
AT HOME



FREE TOOLS  
WITH COURSE!

**FREE  
BOOK**  
with  
sample  
lessons

with course

**YOU MAKE**

**SLIPPER  
CHAIR**

**CLUB  
CHAIR**

**OTTOMAN**

**PLUS  
SLIP COVERS**

**Yours to Keep  
or Sell**

### BE YOUR OWN BOSS

**Earn more from the start!** Set up your own profitable business, in your own home, enjoy steady income, independence for life. **You're in demand** in the booming field of Custom Furniture Upholstery. **Right off you start learning and earning** with tools, complete frames, fabrics and materials, included **FREE** with N. Y. State-approved UTS course. You learn skilled professional custom upholstery, reupholstery, furniture finishing, repairs, how to make beautiful slip covers, cushions and draperies. **EARN WHILE YOU LEARN,** in your spare time **AT HOME**. . . the UTS easy way.

**FREE ILLUSTRATED BOOK - FREE SAMPLE LESSON**  
Get ready for well-paid job and big profits, from steady work, as your own boss, running your own business. Mail coupon NOW for **FREE BOOK!** Training in N. Y. School also available. **NET APPV'D. ACCREDITED BY N.H.S.C.**

**UPHOLSTERY TRADES SCHOOL**  
Dept. HO-310, 721 B'way, N. Y. 3, N. Y.

Please send me **FREE** book, "Your New Way to a Successful Career," and **FREE** sample lesson. No obligation—no salesman will call.  
 Home Study  Training in N. Y. School

Name.....  
Address.....  
City.....Zone...State.....  
 Check if Korean Veteran

# \$3.25 OR 2 FOR \$6.00!

With 40 ft. of wire. Additional wire 3c ft. **TESTED AND GUARANTEED.** Write for free list of all types of telephones. Shipments FOB Simpson, Pa.  
**TELEPHONE ENGINEERING CO., Dept. 989, Simpson, Pa.**

# FREE AMAZING NEW BOOK "HOW TO ANSWER ADS"



Never before have you seen anything like this. Tells you in simple language the correct way to answer ads. Gets you quicker replies—better results, and greater satisfaction. Will save you time and money and it's **ABSOLUTELY FREE.** No obligation whatever. Every reader of advertising should have this booklet. Send a postcard for your copy **NOW.** **F. W. JOHNSON, Popular Mechanics Magazine, Room 600-A, 204 East Ontario Street, Chicago 11, Ill.**

# High School at Home

## MANY FINISH IN 2 YEARS

No classes. No time wasted going to and from school. Progress as fast as your time and abilities permit. Standard H.S. texts supplied. Thousands enroll each year in this 62-year-old school. Send for **FREE** descriptive booklet.

**AMERICAN SCHOOL, Dept. H645**  
Drexel at 58th St., Chicago 37, Ill.

Without obligation, please send **FREE** descriptive booklet.

Name.....  
Address.....  
Accredited Member National Home Study Council

start a big profit business  
with a small investment  
**EARN UP TO  
\$200 a DAY**

Manufacturing Exciting New  
**RAINBOW ROCK**  
Concrete Slump Brick  
in your back yard

Earn big building boom profits with Rainbow Rock, the colorful new building brick that's taking the country by storm. Sell all you can make to contractors, builders, building supply houses. **RAINBOW ROCK CUTS LABOR COSTS BY 1/3!** Amazing low cost machine makes modern slump brick 24" long (3 times the length of ordinary brick) in a variety of widths and pastel colors . . . up to 1500 bricks a day! **NEEDS NO SPECIAL SKILL.** Operates indoors or out. Full instructions and valuable mixing formulae supplied. **YOU CAN START EARNING BIG MONEY NOW. PAY AS YOU PROFIT!** A limited number of machines available on easy payment terms. **NOW** is the time to start. Write today for free literature and full information.

**GENERAL ENGINES CO., INC.**  
Dept. M-99 — Route 130,  
Thorofare, N. J. • Tildon 5-5401



**STEEL PIER SENSATION**  
Luxurious RAINBOW ROCK fireplace wall in living room of the "Home of the Century" in Atlantic City, N. J.'s Steel Pier . . . acclaimed by over 500,000 Summer, 1953 visitors as the most beautiful they'd ever seen. Endorsed by the Pier's famous architect, William F. B. Koelle.



Makes beautiful, decorative fences, garden walls, garages, outside walls, room separators, etc.

**You Can Have a  
HE-MAN VOICE**

**STRENGTHEN** your voice this tested, scientific way. Yes—you may now be able to improve the **POWER** of your speaking and singing voice . . . in the privacy of your room! Self-training lessons, mostly silent. No music required.

**FREE BOOKLET**

Write today for Eugene Feuchtinger's great booklet "How to Develop a Successful Voice." It's absolutely **FREE!** You must state your age. Booklet mailed postpaid in plain sealed envelope. No salesman will bother you. Send your name and age **RIGHT NOW!**  
Perfect Voice Institute, 210 S. Clinton St., Studio JR-2, Chicago 6, Ill.



**MAKE BIG MONEY**

**MAKING COSTUME JEWELRY AT HOME!**

Thrilling spare-time, **MONEY-MAKING** hobby! Make newest, beautiful jeweled earrings, necklaces, bracelets, pins, pendants, cuff links, tie clips! Quick, easy to make—easier to sell to friends, neighbors, stores, at big profit! Details **FREE!**

**DON-BAR CO., Dept. J-19**  
3511 W. Armitage Ave., Chicago 47, Ill.



**New HOME-IMPORT  
BUSINESS!**

Men - Women. We show you how to import big-profit items at amazing low foreign prices (examples at left). Your home is your office. Get list of 157 Imports **FREE!** Full or spare time business by Mail Order. Or take volume orders from stores. Import jewelry, clothing, sporting goods, hardware, etc. **NO EXPERIENCE OR INVESTMENT IN PRODUCTS NEEDED.** Without obligation send today for complete details and list of 157 imports **FREE!** Air mail reaches us over night. **THE MELLINGER CO.,** 1717 Westwood Boulevard, Dept. X259, Los Angeles 24, California.



Clocks 65¢  
in Germany—  
\$5 value  
in U.S.A.

**94.6% OF BAILEY  
GRADUATES ARE EMPLOYED  
AT TOP PAY IN THE FIELDS  
WHICH THEY WERE TRAINED!**



**DIESEL-AUTO MECHANICS  
DESPERATELY NEEDED!**

We have a far greater demand for our students than we can fill!

We can show you an actual waiting list of leading companies throughout the world who have tried Bailey graduates — found them outstanding, and are coming back for more!

**Bailey Graduates are Successful . . . RECEIVE BIG PAY — HAVE SECURE FUTURE!**

The Famous Bailey Course prepares you for **BOTH Diesel and Gasoline Mechanics.**

This is a must—due to the advent of using Diesel principles, such as 'Fuel Injection' on passenger cars . . . use of gasoline engines for starting Diesel engines, etc. You learn all this at Bailey in the amount of time ordinarily required to learn just one of these subjects, **ALL FOR THE PRICE OF ONE.**

Don't be satisfied with a 'futureless', one-type job — learn how you can make **big money now!** Write today for Free Booklet that takes you on a step-by-step camera tour through our spacious, modern shops — See Bailey students in action as they Learn-by-doing with the Famous Bailey Method of training!

We provide you with housing and part time jobs while in school, plus nation-wide placement service for graduates.

**BAILEY Technical SCHOOLS**

1634 S. GRAND ST. LOUIS 4, MO.

**MAIL TODAY!**

Please mail immediately this free booklet without obligation.

**FREE BOOKLET**



Name \_\_\_\_\_

Address \_\_\_\_\_

City \_\_\_\_\_ State \_\_\_\_\_

**APPROVED FOR VETERAN . . . NON-VETERAN**

# Count on COMFORT

All Day . . . Every Day



**RED WING SHOES** ... for Men in Uniform



A real treat for working feet!

Walk better—work better—feel better in Red Wing Shoes. "Tailored to your feet"—to give you tops in comfort and wear. "Sweat-Proof" leather insoles—Black Dresides uppers—nailless construction—"Traction-Tred" cushion wedge crepe soles.

See your Red Wing Dealer or write for his name

**RED WING SHOE COMPANY**

197 Main Street • Red Wing, Minnesota

**BUY IT! TRY IT!**

SATISFACTION GUARANTEED OR MONEY REFUNDED!  
"REDWING WEDGIES"

SEE AD ON THIS PAGE



- \* 101 OXFORD \$14.98
- 102 HI-SHOE \$15.98
- 195 CHUCKA \$15.98

Immediate Delivery  
Sizes 6-14  
in A to EE

(Black Only) C.O.D.  MONEY ORDER  FREE CATALOGUE

**WASSERMAN SHOE CO., INC.** 24 E. Livingston Ave. Columbus 15, Ohio

Size \_\_\_\_\_ Width \_\_\_\_\_ Send me \_\_\_\_\_ Prs. checked \_\_\_\_\_

Name \_\_\_\_\_ Address \_\_\_\_\_

City \_\_\_\_\_ State \_\_\_\_\_



For extra income or career... learn

# WATCH REPAIRING

at home the low cost Sweeney Way

Modern, simplified shop method starts you making repairs right away on Swiss and American watches. No previous experience needed. No age limit. Low terms. FREE sample lesson without obligation. Write today.

**CHICAGO SCHOOL OF WATCHMAKING**

2330 N. Milwaukee Ave. Dept. 199 Chicago 47, Ill.



## BARBELLS

100 POUND SET \$12.80

140-Pound, CHROME DELUXE Barbell-Dumbbell set only \$19.80. This is our feature set and is the finest ever manufactured.

Training with adjustable weight is the BEST way to keep fit; the ONLY way to develop great strength and a perfect body. As the oldest and best equipped barbell company, BUR gives value and prices no one can equal.

SEND FOR FREE CATALOG  
**BUR BARBELL CO.**  
Lyndhurst 9, New Jersey



## DRAINS IRRIGATES - CIRCULATES - SPRAYS \$7.95

1,001 uses. Stainless shaft. Won't rust or clog! Use 1/6 HP motor or larger... 3/4 HP for up to 3000 GPH! 450 GPH 80' high; or 1800 GPH from 25' well, 1" inlet; 3/4" outlet. Coupling included free. \$7.95. HEAVY DUTY BALL-BEARING PUMP. Up to 2,500 GPH or 3,000 GPH from 25' well, 1 1/4" inlet; 1" outlet. \$12.95. Postpaid if cash with order. MONEY BACK GUARANTEE. Centrifugal and Gear Pumps in All Sizes. LABAWCO PUMPS, Belle Mead 7, New Jersey



## MECHANICAL DENTISTRY

To make Crowns, Plates, Bridgework, etc., for Dentists. Easy practical way to learn mechanical dentistry at home in spare time. FULL EQUIPMENT OF TOOLS AND MATERIALS INCLUDED WITH COURSE. Low tuition. Easy terms. Write for FREE BOOK about this money making profession that is not affected by machine age.

McCARRIE SCHOOL OF MECHANICAL DENTISTRY  
207 N. Broad St., Dept. 92, Philadelphia 7, Pa.

## SHORTHAND IN 6 WEEKS

Famous SPEEDWRITING shorthand. 120 words per minute. No symbols; no machines; uses ABC's. Learn at home or through classroom instruction. Low cost. 500,000 graduates. For business and Civil Service. Typing available. 36th Year. Schools in over 400 cities. Write for FREE booklet.

**Speedwriting**  
Dept. 1509-9  
55 W. 42 St., N.Y. 36, N.Y.

**6 WEEKS**



## BE THE CENTER OF THE CROWD!

Free illustrated comic book, "The Center of the Crowd", shows you how a guitar means quick social success!

name \_\_\_\_\_  
address \_\_\_\_\_  
city \_\_\_\_\_ zone \_\_\_\_\_ state \_\_\_\_\_

clip and mail this coupon today to "Guitars For Fun",  
1005 Madison Street, Oak Park, Ill.

# Shrinks Hemorrhoids New Way Without Surgery Stops Itch - Relieves Pain

For the first time science has found a new healing substance with the astonishing ability to shrink hemorrhoids and to relieve pain - without surgery.

In case after case, while gently relieving pain, actual reduction (shrinkage) took place.

Most amazing of all - results were so thorough that sufferers made astonishing statements like "Piles have ceased to be a problem!"

The secret is a new healing substance (Bio-Dyne\*) - discovery of a world-famous research institute.

This substance is now available in suppository or ointment form under the name Preparation H.\* Ask for it at all drug counters - money back guarantee. \*Reg. U.S. Pat. Off

**Learn ACCOUNTING**  
Business Administration

Bookkeeping, secretarial and allied subjects at home in your spare time or attend nationally approved resident school. Write for FREE Success Book giving complete details on courses, plans, rules and employment opportunities. G.I. approved. Write Dept. A

**Hills BUSINESS UNIVERSITY AND EXTENSION SCHOOL**  
619 W. MAIN ST. OKLAHOMA CITY 2, OKLAHOMA

## DOLLS! DOLLS! DOLLS!

LEARN world's most fascinating business. We teach you to repair, make, sell all kinds of Dolls and accessories. Study at home. Earn while you learn. Start your own business part or full-time. We show you how. FREE booklet without obligation.

**THE DOLL HOSPITAL SCHOOL**  
STUDIO M-99

11826 San Vicente Blvd. Los Angeles 49, California

**Locksmithing AND KEY MAKING**  
Now Made Easy! Practical up-to-date course teaches you how to pick locks, de-code, make master keys, repair, install, service, etc. New self-instruction lessons for every handyman, homeowner, carpenter, mechanic, service station operator, fix-it shop, hardware dealer, gunsmith. 52 easy illustrated lessons. Full price only \$5.95 (postpaid) or C.O.D. plus postage. Satisfaction or refund guaranteed.

**NELSON-HALL CO., DEPT. JR-2**  
210 S. Clinton Chicago 6, Ill.

Complete course \$5.95  
... now only \$3.95

**FUN TO BUILD!  
FUN TO FLY!**

You, too, can now build and fly the famed **Bensen** COPTER GLIDER

Simplest aircraft known of helicopter type. Professionally designed for "do-it-yourself" hobbyist. Costs little to build, nothing to fly. Thousands built and flown here and abroad. Send just \$1 for 3-view drawings, specs, in-flight photo and illustrated booklet.

Send \$1 **BENSEN AIRCRAFT CORP., Dept. PM-99G**  
P.O. Box 2746, Raleigh, N.C.

Name \_\_\_\_\_  
Address \_\_\_\_\_

# FREE CAREER BOOKLET

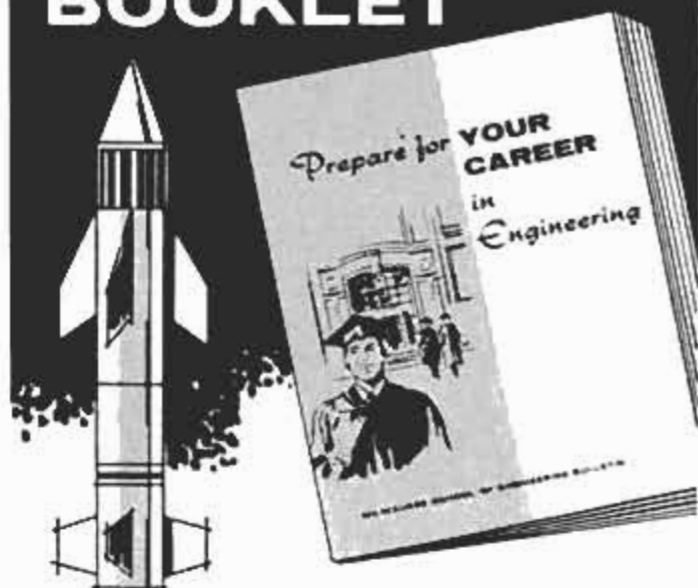

To guide you to a successful future in

## ELECTRONICS RADIO-TV COMPUTERS ELECTRICAL ENGINEERING

This interesting pictorial booklet tells you how you can prepare for a dynamic career as an Electrical Engineer or Engineering Technician in many exciting, growing fields:

**MISSILES • AVIONICS • AUTOMATION  
SALES • DEVELOPMENT  
ELECTRICAL POWER • ROCKETRY  
RADAR • RESEARCH**

Get all the facts about job opportunities, length of study, courses offered, degrees you can earn, scholarships, part-time work - as well as pictures of the Milwaukee School of Engineering's educational and recreational facilities. No obligation - it's yours free.

### MILWAUKEE SCHOOL OF ENGINEERING

#### MAIL COUPON TODAY!

**Milwaukee School of Engineering**  
Dept. PM-959, 1025 N. Milwaukee St., Milwaukee, Wis.

Please send FREE "Your Career" booklet  
I'm interested in

Electronics  Radio-TV  Computers  
 Electrical Engineering  Mechanical Engineering

Name \_\_\_\_\_ Age \_\_\_\_\_  
PLEASE PRINT

Address \_\_\_\_\_

City \_\_\_\_\_ Zone \_\_\_\_\_ State \_\_\_\_\_

I'm eligible for veterans education benefits.  
Discharge date \_\_\_\_\_ MS-117

# FINANCIAL HELP TO START YOUR OWN HOME BUSINESS!



Tired of being squeezed between rising prices and a *stationary salary*? Could you use a nice little home-business to bring in *extra income* from your spare time, evenings and week-ends? I can show you *how*—will even *help finance* you, if you're short of cash. Sound unreasonable? Wondering how I can afford to do it? Well, it's simple. The business I'm talking about uses supplies. I *make and distribute* those supplies. So do other firms—but I'm willing to gamble that when your business gets rolling you'll rather do business with a *friend* than with strangers who did not show up until you were in the money. I've gambled the same way with hundreds of others, and it has paid off by helping me build the *biggest business of its kind in the world!* The Golden Rule of "do unto others..." *always works* for those who give it a fair trial.

What is this business? It's *printing without a press*, an amazing process I call "Screen Print." With it, you can turn out printing in *gorgeous coloring* that many big shops cannot duplicate, even with presses costing *thousands of dollars!* Yet my equipment (supplied to you with my instructions) *weighs only a few pounds*, can be set up on a *small table* in the corner of your garage, basement, attic, or even a bedroom. You can earn in a *few hours* to print on paper, metal, glass, plastic, leather, cloth, and about anything you can name—even on curved or round surfaces that ordinary printing presses cannot handle at all! And I show you how to get *big-profit orders* from stores, factories, theatres, schools, and practically every type of business or organization for miles around—even by *MAIL ORDER* coast to coast.



### JUST SEND ME YOUR NAME & ADDRESS—NO MONEY

Remember, I'll help finance you, so *don't worry about the money*—whether you are employed or not. I'm *sure* I can help you get set in a home business that may settle your money problems forever. Just send name and address for *FREE* information, without obligation. *TODAY SURE.*

Mr. C. J. Nowak, President, Screen Print Co., Dept. 29, 15127 S. Broadway, Los Angeles 61, California

## PREPARE FOR BETTER JOB, BIGGER PAY IN SPARE TIME AT HOME

Today, choose the job you want—and prepare for it in time you might otherwise waste. Or if you are already in the work you like best, start training now for quicker promotion and increased pay. During the past 62 years AMERICAN SCHOOL has helped ambitious people to reach higher goals. Check subject that interests you and mail coupon for full information.

AMERICAN SCHOOL, Dept. G645, Drexel at 58th, Chicago 37, Ill.

Without obligation, please send *FREE* and postpaid, full particulars about the subject checked below.

<input type="checkbox"/> Accounting	<input type="checkbox"/> Contracting	<input type="checkbox"/> Mechanical Engineering
<input type="checkbox"/> Apprenticeship Courses	<input type="checkbox"/> Diesel Technician	<input type="checkbox"/> Mechanical Technology
<input type="checkbox"/> Architecture & Building	<input type="checkbox"/> Drafting—Building	<input type="checkbox"/> Metalworking Courses
<input type="checkbox"/> Automotive Technician	<input type="checkbox"/> Drafting—Machine	<input type="checkbox"/> Plumbing—Practical
<input type="checkbox"/> Better Foremanship	<input type="checkbox"/> Electrical Engineering	<input type="checkbox"/> Private Secretary
<input type="checkbox"/> Blueprint Reading	<input type="checkbox"/> Electricity—Practical	<input type="checkbox"/> Retail Merchandising
<input type="checkbox"/> Bookkeeping	<input type="checkbox"/> Electronics—Industrial	<input type="checkbox"/> Salesmanship—Outside
<input type="checkbox"/> Business Management	<input type="checkbox"/> HIGH SCHOOL COURSES	<input type="checkbox"/> Sheer Metal Work
<input type="checkbox"/> Civil Engineering	<input type="checkbox"/> Machinist	<input type="checkbox"/> Tool Making

NAME \_\_\_\_\_ OCCUPATION \_\_\_\_\_ AOV \_\_\_\_\_  
 HOME ADDRESS \_\_\_\_\_ STATE \_\_\_\_\_  
 CITY \_\_\_\_\_ ACCREDITED MEMBER NATIONAL HOME STUDY COUNCIL

MAIL COUPON NOW



Lawn-All Corp., Midland Park, N. J.

## Power Lawn Roller

Without any muscle strain you can roll steep grades and freshly seeded areas with a new powered lawn roller. A two-horsepower gasoline engine provides the power. The roller is 24 inches wide.

## Screen for Garage Door

You can convert a garage into a patio or indoor-outdoor family room by fastening a new glass-fiber screen to the top and side frames of the garage door. The screen is designed for a garage with an overhead door. A zipper along one side permits entry and exit. The screen also can be fastened to the door with snappers. When the door is raised, the screen goes up with it.

Norton Screen Co., Inc., 1610 W. 89th St., Chicago 20.



# LEARN MEAT CUTTING

AT NATIONAL  
Pay After Graduation



The steady dependable trade of Meat Cutting taught easily in 8 short weeks. YOU LEARN BY DOING under actual meat market conditions in big modern school at Toledo.

For beginners or men with experience. Get a profitable store of your own. Remember, PEOPLE MUST EAT! Big pay jobs. Free employment help. Thousands of successful graduates.

Buying, cutting, percentage, pricing, advertising, selling, etc. A complete retail meat education. National School established 36 years. Get National training NOW. Pay your tuition in easy weekly

payments after you graduate. Send coupon for FREE school catalog — TODAY. G.I. approved.

**National School of Meat Cutting, Inc., Dept. 50-W, Toledo 4, Ohio**

Send me your FREE school catalog on National Training at Toledo in Meat Cutting, Meat Merchandising and Self Service Meats. No obligation. No salesman will call.

Name \_\_\_\_\_ Age \_\_\_\_\_

Address \_\_\_\_\_

City \_\_\_\_\_ State \_\_\_\_\_

Approved for Veterans

## MAKE EXTRA CASH

SHARPENING LAWN MOWERS THE MODERN WAY



\$275.00  
F.O.B. Pasadena

Start your own shop! Full or spare time. Earn many dollars in a short time... average \$5.00 per hour. Many mowers need sharpening. With MODERN'S Extra Heavy Duty LAWN MOWER SHARPENER AND BED KNIFE GRINDER you have 6 machines in one. All operations are done quickly and easily. You make money from the start. Write for free details.

**MODERN MFG. CO.**  
160 N. Fair Oaks Ave. Dept.  
Pasadena, California 10-4

## CONCRETE BLOCK HOME PLANS

\$1000 COTTAGE



Build your own 22'x26' cottage complete for \$1,000. Slab floor, beamed ceiling. Contains Liv. Rm., kitchen, two bedrooms, bath and fireplace. Blueprints, instructions and material list \$2.00 ppd. Money back guarantee. Other plans—\$1150 Garage Apt., \$1900 Duplex, \$2500 Ranch Home, \$3500 Cape Cod, \$3800 three bedroom, two bath, family room Ranch Home.

Illustrated Folder, "How To Build Your Own Block Home," plus Plan Folder, 10c.  
**BAILEY BUILDERS, 308-A Hiawatha Drive, Little Rock, Ark.**

## ENGINEERING



Photo of Heald Students in Electrical Laboratory

American Industry Steps Up Its Demand for Trained Engineers. Train Now at Healds

**BACHELOR OF SCIENCE DEGREE, 30 MONTHS**

Degree Courses:

- Electronic Engineering
- Electrical Engineering
- Highway Engineering
- Mechanical Engineering
- Structural Engineering
- Civil Engineering
- Architecture

Diploma Courses:

- TELEVISION  Color TV
- Electronic Technician
- Industrial Electronic Tech.
- Tool & Die Design
- Architectural Drafting
- Mechanical Drafting
- Structural Drafting

Approved for Veterans

Enroll Now for New Term

Heald College Ranks FIRST West of the Mississippi in "Who's Who in America"

Send for FREE Information

**Heald Engineering College**

Est. 1863

Van Ness at Post, Dept. P.M. San Francisco, California

NAME \_\_\_\_\_  
STREET \_\_\_\_\_  
CITY \_\_\_\_\_  
STATE \_\_\_\_\_

WORLD FAMOUS

# Black Forest

FORMERLY \$3.95

# FREE

# 88¢

plus 12¢ postage

**Leather Sheath**

World's most fabulous hunting knife! Over 100,000 sold for \$3.95. Now this genuine Black Forest Knife yours for only 88 cents. Extra thick, high carbon tempered Korium Steel—can cut thru metals! Sharp enough to shave with. Gives lifetime of rugged service. Hundreds of uses: Skins moose, rabbit, deer; scales fish; cuts hemp, wire, underbrush, branches—even metals! Carves roasts, turkey, steak. Also use for impressive den decoration. 10 inches over-all. Hand forged by legendary sword makers proud of their ancient craftsmanship. Send only 88¢ plus 12¢ postage for prompt delivery. 100% satisfaction guaranteed or money back.

**THORESEN Inc., Dept. 6-K-76**  
585 Water Street, New York 2, N. Y.

10 INCHES

**CUTS METAL**  
Supply limited. Rush today!

# ENGINEERING

## DEGREE IN 27 MONTHS

Students given option of studying engineering under accelerated program leading to Bachelor of Science Degree in 27 months; or the standard four-year program leading to Bachelor of Engineering Degree in 36 months. The B.S. degree in Mathematics, Chemistry, or Physics (including Nuclear Physics) may be earned in 36 months. By attending classes year-round, students can graduate in 3 years and have one year of experience and income in the time usually needed to complete a four-year college course. Preparatory courses. Thorough, practical program. Individualized instruction.

**Keeping pace with progress in science and engineering**  
Campus. Dorms, gym, playing fields. Superior faculty. 2,000 students. New Dana Science Building. Low tuition. Earn board. G.I. approved. Enter September, December, March, June. Students from 48 states, 40 foreign countries. Send coupon for free catalog, full information. Enroll now!

## INDIANA TECHNICAL COLLEGE

599 E. Washington Boulevard, Fort Wayne 2, Indiana  
Please send me free information on 27 mo. B.S. DEGREES in:

Aeronautical  Chemical  Civil  Electrical  
 Mechanical  Electronics

on 36 mo. B. E. DEGREES in:  
 Aeronautical  Chemical  Civil  
 Electrical (Power or Electronics)  Mechanical  Metallurgical

on 36 mo. B.S. DEGREES in:  
 Mathematics  Chemistry  Physics

Name \_\_\_\_\_

Address \_\_\_\_\_



# FREE

## MUSCLE BUILDING INFORMATION

Sensational New Methods

Less Time—Less Effort—Better results

BODY-TONE, Box 638, North Miami 61, Fla.



## Become A - - -

# BUILDING CONTRACTOR!

MAIL COUPON for FREE BROCHURE

Simplified home study training program. Learn every phase of building, estimating, contracting. Fortunes are made in this line of work every year. Use spare hours—no interference with present work. Diploma awarded. Low tuition rates.

**AMERICAN TECHNICAL SOCIETY**  
Dept. BH-99, 850 E. 58th Street, Chicago 37, Ill.

Please send me your FREE Brochure and full details of your building, estimating and contracting training program.

Name \_\_\_\_\_

Age \_\_\_\_\_

Address \_\_\_\_\_

City \_\_\_\_\_

State \_\_\_\_\_



# YOU'LL SEE THE NEW CROP OF CARS

*starting in the*  
**OCTOBER ISSUE**

*Don't miss it!*

## FREE CATALOG of SURPLUS EQUIPMENT

• Generators • Motors • Hydraulics • Much more

Every machine below wholesale cost!

ROBERTS ELECTRIC, 849 W. Grand, Dept. PM-949, Chicago 22

## BE A MAGICIAN!

Get started today! Become a popular man of mystery. Earn and learn in spare time. Magic is fun and profitable too. Be the Life of the Party. Astonish your friends!

RUSH 25c now for

PROFESSIONAL MAGIC CATALOG

160 pages thick • 800 illus. • 1000 Mysteries

Also Jokes, Puzzles, Secrets, Illusions.

FREE MAGIC TRICK INCLUDED

HOUSE OF 1000 MYSTERIES • 202-20 PINWOOD • TRUMBULL, CONN.



EASIER  
THAN  
YOU  
THINK!

IT'S  
FUN



# LOOK

AT THE AMAZING PRICES  
PAID AT GOV'T SURPLUS SALES

Autos.....\$78	Tractors.....\$68
Trucks.....\$212	Motors.....99c
Boats.....\$5.90	Typewriters \$6.80
Compressors \$9.69	Generators \$8.78

# PAY 2 or 3¢ on the DOLLAR

for 1000's of Useful Items of  
**U.S. GOV'T SURPLUS**

You BUY DIRECT from U. S. Government at TREMENDOUS savings. Eliminate middlemen—Save BIG MONEY! Pay as LOW as 2¢ on the dollar. Our DIRECTORY Gov't Surplus Sales lists 100's Army, Navy, Air Force Surplus Depots all over the world. BUY JEEPS, sports equipment, hunting, fishing and photographic equipment and supplies, radio, electronic and electrical equipment, trucks, boats, airplanes. Plumbing, hardware, office equipment & supplies. Tools, machinery, furniture. This 1959 book tells how to buy Gov't Surplus DIRECT. No dealer profits to pay. Get on the gravy train NOW! Send \$1 TODAY for "Gov't Surplus DIRECTORY" to AVIATION SURPLUS, Dept. PM-9, Box 789, York, Pa.



# EARN \$125 A WEEK AND UP

## BE AN AUTO-DIESEL EXPERT — LEARN A TRADE YOU LIKE

You learn fast in our shops because you learn with tools on real equipment. Students short of money may earn most of their expenses by doing part-time work. Experienced instructors explain WHY and show you HOW, then you DO IT YOURSELF. Forty years' experience training men. Successful graduates in 50 states and many foreign countries. Many of our graduates earn \$125 a week and up. Approved for veterans. Day and evening classes. Free bulletin-write today.  
**NASHVILLE AUTO-DIESEL COLLEGE**  
226 7th Ave., No., Dept. 86, Nashville, Tenn.



## WANT MORE MONEY? GET INTO PHOTOGRAPHY

Coast to coast, high-paying jobs in photography are waiting for people with the "know-how" to fill them. You can quickly, easily qualify at home with the world-famous NYI Learn-by-Doing Method. Write today for free catalog. Also resident training in N. Y. Our 50th Year. Approved for Veterans.

**NEW YORK INSTITUTE OF PHOTOGRAPHY**  
Dept. 49 10 West 33 St. New York 1, N. Y.

*Beautiful  
Modern  
Custom*

## METAL SIGNS

Lowest Cost... for Use Anywhere. All Sizes All Colors. (Agents Wanted... Big Profits!)  
Saturday Roll-Your-Own Signs, Dept. A, Cottleville, Mo.

## ENGINEERING DEGREES EARNED THROUGH HOME STUDY



Mechanical, Civil, Electrical, Electronics, Physics. Also Liberal Arts & Business Administration  
**PACIFIC INTERNATIONAL COLLEGE OF ARTS & SCIENCES**  
Primarily a correspondence school — Resident classes also available  
5719-T Santa Monica Blvd., Hollywood 38, Calif.

## FORTUNES IN DIVING Train at Home in Spare Time

Write Today for Amazing Free Booklet

Here is one of the greatest opportunities of our time. Make big money fast in Skin and Lung Diving. Trained divers needed in hundreds of industries and by government. Build a successful business of your own. Hourly rates among highest paid in any field. Training program by E. R. Cross, world famous master diver. Get the facts now. Mail coupon for **FREE BOOKLET TODAY!**

**DIVEMASTER, Dept. PM-99**  
5637 W. 63rd Place, Chicago 38, Ill.

Send me free information about Diving.

Name \_\_\_\_\_ Age \_\_\_\_\_

Address \_\_\_\_\_

City \_\_\_\_\_ State \_\_\_\_\_

# FREE ALLIED'S MONEY-SAVING 1960 ELECTRONIC SUPPLY CATALOG

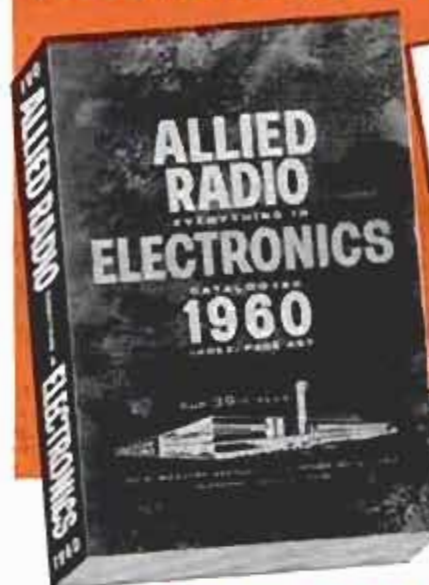

value-packed  
SEND FOR IT!

SAVE  
ON EVERYTHING  
IN ELECTRONICS

EASIEST TERMS  
only \$2 down on  
orders up to \$50

## WORLD'S LARGEST STOCKS

Send for the most widely used buying guide to everything in Electronics for Experimenters, Builders, Amateurs, Servicemen, Engineers and Hi-Fi enthusiasts. Save on:

- KNIGHT-KITS—Best in Build-Your-Own
- Everything in STEREO HI-FI
- Hi-Fi Music Systems and Components
- Tape Recorders & Phono Equipment
- Public Address & Paging Systems
- TV Tubes, Antennas, Accessories
- Amateur Station Equipment
- Latest Test & Lab Instruments
- Industrial Electronic Supplies
- Parts, Tubes, Transistors, Tools & Books

SAVE on everything in Electronics at ALLIED—get fastest service, expert personal help, guaranteed satisfaction. Send today for your **FREE 1960 ALLIED Catalog.**

Everything in Electronics  
from One Reliable Source

our 39th year

## ALLIED RADIO

- ALLIED RADIO CORP., Dept. 5-J9
- 100 N. Western Ave., Chicago 80, Ill.
- Rush FREE 1960 ALLIED Catalog.

Name \_\_\_\_\_

Address \_\_\_\_\_

City \_\_\_\_\_ Zone \_\_\_\_\_ State \_\_\_\_\_



SEND FOR  
FREE  
CATALOG



GET READY FOR THE SPACE and SCIENCE ERA! SEE SATELLITES, MOON ROCKETS CLOSE-UP

# AMAZING OPTICAL BUYS

and OTHER SCIENTIFIC BARGAINS



## See the Stars, Moon, Planets Close Up! 3" ASTRONOMICAL REFLECTING TELESCOPE

60 to 160 Power — Famous Mt. Palomar Type! An Unusual Buy! Assembled—Ready to use! You'll see the Rings of Saturn, the fascinating planet Mars, huge craters on the Moon, Star Clusters, Moons of Jupiter in detail. Galaxies! Equatorial mount with lock on both axes. Aluminized and overcoated 3" diameter high-speed f/10 mirror. Telescope comes equipped with a 60X eyepiece and a mounted Barlow Lens, giving you 60 to 160 power. Low-cost accessory eyepiece available for higher powers. An Optical Finder Telescope, always so essential, is also included. Sturdy, hardwood, portable tripod. Valuable STAR CHART and 272-page "Handbook of Heavens." Stock No. 85,050-M.....\$29.95 postpaid



**KNOW THE TRUTH ABOUT POWER.** Telescope experts will confirm that an Astronomical Telescope will only give you practical powers to about 50 or 60 times per inch of objective diameter—powers above this only produce empty magnification—make viewing dim, difficult and unsatisfactory.

## 4 1/4" ASTRONOMICAL TELESCOPE! UP TO 270 POWER!

With this scope you can see everything as above but with greater power plus will split finer stars. Mirror has twice the light gathering power. Mirror guaranteed to give theoretical limit of resolution. Rack and pinion focusing, hardwood tripod, real equatorial mounting—only one adjustment follows stars! Aluminum tube. 6 power finder telescope. 2 standard size eyepieces and mounted Barlow lens give you powers of 40X, 90X, 120X, and 270X. Low-cost accessory eyepiece available for higher powers. Free handbook and Chart. Shipping weight 25 lbs. Stock No. 85,006-M \$74.50 f.o.b.



Same Telescope as above but equipped with Electric Clock Drive— Stock No. 85-094-H.....\$111.50 F.O.B. Barrington, N. J.

## WAR SURPLUS! — INFRARED SNOOPERSCOPE

Govt. Cost \$900 — Bargain at \$39.50 Converts infrared to visible light. See in total darkness without being seen. Use in lab, factory, classroom, etc. Completely portable. Operates on two flashlight batteries (not included). Image is quite good, may be made even better by careful focusing. Size 11 1/2" x 8". Weight with carrying case 12 lbs. No infrared light source is furnished. (See below). Stock No. 85,098-M.....\$39.50 f.o.b. Barrington, N.J.

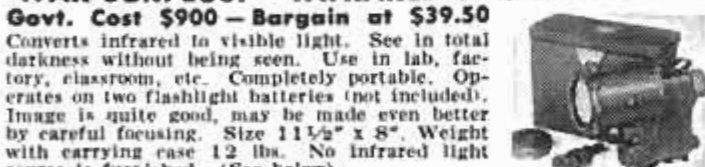

**INFRARED LIGHT SOURCE AVAILABILITY!** You will need a 6 volt transformer or 6V auto battery to operate. Stock No. 80,035-M.....\$10.00 Pstpd.



## Terrific Buy! American Made! OPAQUE PROJECTOR

Projects illustrations up to 3" x 3 1/2" and enlarges them to 4 ft. wide. No film or negatives needed. Projects charts, diagrams, pictures, photos, lettering in full color or black-and-white. Operates on 115 volt, A.C. current. 6-ft. extension cord and plug included, operates on 60 watt bulb, not included. Size 12" x 8" x 4 1/2" wide. Weight 1 lb., 2 oz. Plastic case with built-in handle. Stock No. 70,199-H.....\$7.95 Postpaid

**BARGAIN! WAR SURPLUS! 7 x 50 MONOCULAR** This is fine quality, American-made instrument — war surplus! Actually 1/2 of U. S. Govt. 7 x 50 Binocular. Used for general observation both day and night and to take fascinating telephoto shots with your camera. Brand new, \$95 value. Due to Japanese competition we close these out at a bargain price. Directions and mounting hints included. Stock No. 50,003-M.....\$15.00 Postpaid



## D-STIX CONSTRUCTION KITS for Science Fans, Hobbyists

Visualize your ideas. Crystallize your plans. Unique new D-STIX are ideal for "3-dimensional thinking." Colored wood sticks 1/8" thick and "easy-on" rubber joints approx. 3/16" diam. fit together fast—help you work out molecular structures, geometric figures, structural members, shapes, models of all kinds. Ideal for interesting children in developing shapes, structures. Durable kits. Money-back guarantee. Stock No. 70,209-M (230 pcs).....\$3.00 ppd. Stock No. 70,210-M (370 pcs).....\$5.00 ppd.

## 8 POWER ELBOW TELESCOPE

WAR SURPLUS  
\$200 Gov't Cost — Only \$13.50  
Big 2" objective, focusing eyepiece 28mm focal length—Amiel erecting system—turret mounted filters, clear, red, amber and neutral—reticle illumination. Sparkling, clear, bright image—6° field (325 ft. at 1,000 yds.). Focus adjusts 15 ft. to infinity. 28mm f.l. eyepiece alone is worth more than \$12.50. Stock No. 70,173-M.....\$13.50 postpaid



## MAKE YOUR OWN ASTRONOMICAL TELESCOPE

See December, 1957 issue of POPULAR MECHANICS—Pages 188-192. 4 1/4" MIRROR KIT—Contains ready-to-use 4 1/4" diameter concave, aluminized objective mirror, lenses for 1" focal length eyepiece, and aluminized first surface diagonal mirror. Order Stock No. 50,074-M.....Price \$16.25 postpaid

## 'FISH' WITH A MAGNET

Go Treasure Hunting On The Bottom

Great idea! Fascinating fun and sometimes tremendously profitable! Tie a line to our 5-lb. Magnet—drop it overboard in bay, river, lake or ocean. Trawl it along the bottom—your "treasure" haul can be outboard motors, anchors, fishing tackle, all kinds of metal valuables. 5-lb. Magnet is war surplus—Alnico V Type—a terrific bargain. Lifts over 125 lbs. on land—much greater weights under water. Order now and try this new sport. Stock No. 70,183-H. 5-lb. Magnet.....\$8.50 Postpaid 15 1/4 lb. size. Will lift over 250 lbs. Stock No. 85,088-M.....\$22.50 F.O.B. Shipping weight 22 lbs. Barrington, N. J.



## NEW BINOCULAR-TO-CAMERA HOLDER

For Exciting Telephoto Pictures

Bring distant objects 7 times nearer with a 35 mm. camera, 7x50 binocular and our NEW BINOCULAR-TO-CAMERA HOLDER. Ideal for long-range shots of wild life, ships, planes, people, etc. Camera and binoculars attach easily. Use any binocular or monocular—any camera, still or movie. Take color or black and white.



Full directions for taking telephoto's. Stock No. 70,223-M.....\$11.50 postpaid

## BUILD A SOLAR ENERGY FURNACE

A fascinating new field. Build your own Solar Furnace for experimentation—many practical uses. Easy! Inexpensive! Use scrapwood! We furnish instructions. This sun powered furnace will generate terrific heat—2000° to 3000°. Fuses enamel to metal. Sets paper aflame in seconds. Use our Fresnel Lens—14 3/4" diameter... f.l. 14". Stock No. 70,130-M.....Fresnel Lens \$ 6.00 Pstpd.



## HAND SIGHTING LEVEL

Described in Popular Mechanics

March 1958 issue, page 212

Sight it like a Telescope. Gives you a level line of sight, for laying out gardens, drives, new construction, ditches, etc. Complete instructions included. Stock No. 105-H.....\$2.50 postpaid



## BARGAIN-PRICED STETHOSCOPE

For Hobbyists, Motor Mechanics Schools

A real stethoscope at half the usual cost! Ideal for home craftsmen, hobbyists, motor repairmen. Listen to running machinery. Check on hard-to-hear motor noises, leakage of gas, air or fluid. Pick up heart beats of animals, insect noises, other "unhearable" sounds. Splendid for experiments, classroom use, animal husbandry. Hours of educational fun for adults, students and children. Excellent for auto repair, do-it-yourself projects. Sensitive, yet sturdily made to stand hard use. Money-back guarantee. Stock No. 50,223-M.....\$2.95 Postpaid



## FREE CATALOG-H

100 Pages! Over 1000 Bargains!

Yours for the asking

America's No. 1 source of supply for experimenters, hobbyists. Complete line of Astronomical Telescope parts and assembled Telescope. Also huge selection of lenses, prisms, war surplus optical instruments, parts and accessories. Telescopes, microscopes, satellite scopes, binoculars, infrared sniperscopes, math, etc.



REQUEST CATALOG-H

ORDER BY STOCK NUMBER . SEND CHECK OR MONEY ORDER . SATISFACTION GUARANTEED!

**EDMUND SCIENTIFIC CO., BARRINGTON, NEW JERSEY**

**WORLD'S  
BEST  
WANT-AD  
MEDIUM**

# CLASSIFIED ADVERTISEMENTS



Advertisements in this section \$1.25 per word, each insertion, minimum 10 words, payable in advance.

To be inserted under proper classification, copy must be in our office the

20th of the second month preceding date of issue

F. W. Johnson, Manager, Classified Advertising

Popular Mechanics Magazine, 200 East Ontario Street, Chicago 11, Illinois

## YOU'LL PROFIT

By reading and answering the classified ads in this section. Hundreds of opportunities for you to make and save money

### AUTOMOBILES, MIDGET CARS

**AUTOBODY** Repairs. Spot painting, dents, scratches, rust holes, customizing tricks. Do it yourself. No power tools required. Instruction book containing 30 actual step by step photographs plus diagrams shows exactly how. Save money. \$3.00 postpaid. Bodyshop, Box 912, Bluefield, W. Va.

**FULL** Color post card photos of antique and classic cars. 25 for \$1. Specify series 1, 2, 3 or 4 (all different). Free list. L. I. Auto Museum, 29 Museum Sq., Southampton, N. Y.

**CONFIDENTIAL.** Used car dealer's auction report current wholesale prices. Over 500 cars listed, 1949 to 1959, all makes, models, American and foreign, \$1.00. King Auto Report's, Box 112, Pleasantville, New Jersey.

**10 RARE** Foreign car catalogs for one dollar bill. Richard Veen, Wibe-Mora, Sweden.

**HUNDREDS** Of automobile catalogs—American, antique, foreign; dealer books, glossy photographs; shop manuals; free motor magazines listed by non-profit organization. Write immediately. Get on free mailing list. Auto Maniacs, Stockbridge, Mich.

**1959 CATALOG** On parts kits for golf buggy or Jr. sports car 25¢. Indus Corporation, 1815 Madison, Indianapolis.

**AUTOMOTIVE** Books. Send for 1958 general book catalog. 10¢. Popular Mechanics Press, 631 N. St. Clair St., Chicago 11, Ill.

### AUTO SUPPLIES AND EQUIPMENT

**FOREIGN** Car owners; free illustrated catalogue imported accessories and tools. Wilco, Box 1128-M, Rochester 3, N. Y.

**AUTO** Shop welding repair training in world's largest non-profit welding school. Low tuition. Free booklet. Hobart Welders, Box M-991, Troy, Ohio.

**CRANKSHAFT** Grinder. Hand operated. Makes bearings fit without taking engine apart. \$4.00. Literature. L. D. McGee, 719 Cascade St., Wenatchee, Wash.

**1959 EDITION.** It's new! It's different! Get world's largest auto accessories and parts catalog, save up to 50%. 356 pages, over 100,000 items for 1920 to 1959 models including Hollywood accessories, custom styling and hi-speed equipment. All parts and accessories for all cars and trucks. We have that hard to get part. Jam packed with bargains. Completely illustrated. Send 25¢ (refundable). J. C. Whitney, 1919-PM-9 Archer, Chicago 16, Ill.

**FREE**—Details, literature. Proven sales plan. Unduplicated, 99¢ necessary auto accessory. Early sales nearly two million. Major wholesalers: national chains; 30 states. First offer to independent jobbers, direct salesmen. Income potential \$50.00 day. Sample 50¢. Allied Industries, 515 W. Broadway, Winona, Minnesota.

**GIANT** Auto parts catalog. Thousands special accessories stores don't handle. Gadgets, custom equipment. Send 25¢ (refundable). Newhouse Automotive Industries, 5805-PM9 Beverly, Los Angeles 2, Calif.

**PARTS** Model A. Free list. Matco, Box 135, San Pedro, Calif.

**1909-1934 FORD** Parts. Illustrated catalogue 50¢. Mark Auto, Box 9A, Layton, New Jersey.

**SPARK** Plugs. New 60¢. Guaranteed 10,000 miles. Tell make, model, year. Brooks, Box 218, Evanston, Ill.

**MAKE** Old cars run like new. Inexpensive. Free details. Newco, Box 164-B, Hunlock Creek, Penna.

**RING-Valve** job while driving, \$6.00. (8th successful year.) Yellow Cab test-proven. Free details. Motaloy, Grantham, Penna.

**AUTO** Repair, step by step assembly by photography, every nut, bolt and gasket. State make and model. Mail \$1.00 cash to: Foley, 15234 Euclid, Alken Park, Michigan.

**REPLACE** Burned-out spark plugs with revolutionary fire injectors that outlast your car, mower, tractor, outboard. No cleaning, adjusting ever. Increases horsepower, mileage. Free particulars. Holt, Box G, Highlands, N. C.

**AUTHENTIC** Looking decal and wallet card proclaim your vehicle to have a certified speed exceeding 130 MPH. Both for \$1.00. Fool everyone. Fiberglass Shop, Box 25, Ft. Lauderdale 5, Fla.

**SIRENS,** Air horns, lights, etc! Catalog 10¢. McCanna, Tarrytown, N. Y.

**BATTERY** Charger, plans, 25¢. Venus Engineering, P.O. Box 121, San Bruno, Calif.

**FLUORESCENT** "Wind Sock." Your friends will see you instantly with this bright-colored fluorescent "Wind Sock" on your auto antenna. Send \$1.00. Post Office Box 2724, Las Vegas, Nevada.

**JEOP** Owners—V8 conversions. Read Jeep Owners ad, page 24.

**NEW** And used parts at savings. Complete guaranteed parts service for all models cars and trucks, 1924 and later. Largest in the West. Jeep and army parts specialists. Newest type shifting hubs for all Jeep and all military and latest production front end drive vehicles, \$27.50 and up. Write, Pioneer Auto and Truck Parts Co., 734 W. 13th Avenue, Denver 17, Colo.

**FREE!** New catalog. Speed, power, mileage increasing equipment. Discount! Alquist Engineering, Milford PMS, Penna.

**SAVE** Money on Jeep and army truck parts. Large inventory. Catalogs for Jeep or G.M.C. owners. American Auto Parts Co., 1830 Locust, Kansas City, Mo.

**MINIT** Mitt. New patented, car washing glove. Acrilan faced, complete with standard hose fitting. Prepaid \$1.98. Agents attention. 1006 N. Cedar, Ottawa, Kansas.

**RING-Valve** job while driving, \$3.98. Unconditionally guaranteed. Mota-Nu. Box 8236, Fort Worth, Texas.

**CHEVROLET** V8 engines. Racing equipment. Catalog 50¢. Ledbetter Enterprises, 1015 17th, Texarkana 4, Texas.

**NOW**—Run your car without spark plugs. Get up to 31 more h.p., 8 more m.p.g. using regular gas. L. Silver, 5 Paxton, Framingham, Mass.

**SEND** Cushman, Mustang, or Whizzer camshaft and \$10.00 for racing camshaft. Weber Tool Company, Los Angeles 33, Calif.

**FOREIGN** And American speedometers, tachometers, temperature gauges, clocks repaired recalibrated. Minimum \$5.00. Maximum \$7.50. Guaranteed. Send to Mack Instrument Service, 18141 Mack, Detroit 15, Michigan.

**AUTO** Window decals, 49 states, Washington, D.C., Scotland, Ireland, France, Australia, Mexico, Japan, Korea, Guam, Puerto Rico, Habana, Bermuda, Hawaii, Canada, Army, Navy, AF, CG, Marines, Rotary, Lions, Mason, Shriner, Kiwanis, Medical, Moose, Elks, K of C, VFW, Baseball Clubs, United Nations, US-Confederate-Pirate Flags, 15¢ each. Rockland Decal, Box #504, Nyack, New York.

**MEN!** Motor fouled, burn oil, valves click? Save dollars with "Trucker's Secret." Guarantees better performance. \$2.00 postpaid. Random, 212E Newcastle, Syracuse 4, New York.

**SUN** Portable carburetor tester for automobiles, trucks. List \$120.00. Net \$45.00. Condenser tester \$5.00. Wilt Surplus, 7829 So. Racine Ave., Chicago 20, Illinois.

### AUTO TRAILERS

**CAMP** Trailer folding tent. Finest quality. Sleeps two, \$350.00. Free literature. Telford Trailers, New Lebanon, N. Y.

**BUILD** Expanding eight foot trailer. Accommodates five. Literature 10¢. Framar Company, Wilmington, Mass.

**ALUMINUM** Pickup coach kits. Trailer blueprints. Literature 10¢. Comstock Trailers, Parsons, Kansas.

**TRAVEL** Trailer blueprints \$2.00. Building guide supply catalog \$1.20. Both \$3.00. Kamcraft, Box 1153, Milwaukee 1, Wis.

### MOTORCYCLES, BICYCLES, MOTORSCOOTERS AND SUPPLIES

**MIDGET** Car \$15, Cushman motorscooter \$15, less engine. Whizzer engine \$10, Briggs \$5, Whizzer motorbike \$25, Servicycle \$45. (Mailorder only.) Send 25¢ (35¢ for first class mailing) for Directory-Catalogue Number 91, listing these and hundreds of other bargains in midget cars, motorscooters, homebuilders parts, plans, etc. Midget Motors Directory, Athens, Ohio.

**WHIZZER Motors, \$20.00;** midget race car reasonable; motorscooter \$6.00; Cushman two-speed \$20.00. Send 25¢ (35¢ first class mail) for catalog #33 jammed with sensational bargains in wheels, motors, motorscooters, midget cars, motorbikes, construction plans, etc. Gail, 1313 Jefferson, Toledo, Ohio.

**HARLEY-Davidsons** — Used bargains. New, used parts, accessories, all models. Bulletin 25¢. Knuth's (Factory Dealer), 1753 Muskego, Milwaukee, Wis.

**MOTORCYCLE Parts.** New, used. List 25¢. Ballak, 811 N. 9th, St. Louis 1, Mo.

**WORLDWIDE Motorcycle Club** literature free. Send stamp. Worldwide Motorcycle Club, Department A, Box 20749, Los Angeles 6, California.

**RECONDITIONED Motorcycle motors.** Chrome accessories. Complete stock Indian parts. Expert rebuilding. Fast service. Indian Motorcycle Sales, Kansas City 27, Missouri.

**HOP-Up guide** tells how to modify motorcycles and motorscooters for more acceleration, power, speed! \$1.00. Advance Engineering, Box 2274, Dallas 21, Texas.

**1000 MOTORCYCLE Bargains** — Parts equipment, repossessed automobiles. Catalog 35¢. Bunico, 146-PM, Covington, Virginia.

### AVIATION

**HELICOPTER.** Kits, plans. Free brochure. Adams, Box 6042-A, Lakewood, Calif.

**FLYING Platform.** Three drawings, \$2.00. Rotron, Box 573-A, Bellflower, Calif.

**OUTERSPACE Ship X-15.** Get genuine glossy 3½ x 5 photo of N. American's newest aircraft plus catalog with thousands of latest jets, missiles, and historical planes. Send 25¢ to U. S. Sea & Air Photos, Box 75084X, Los Angeles 5, California.

**AIRBOATS.** Plans, kits, propellers. Catalog and 3 view drawings, \$2.00. Miller Industries, 2229 Hasley, Oklahoma City 20, Oklahoma.

**SEE Jet propulsion work.** Jet propelled plane kit. Aluminum. Flies 6 minutes 2 cents fuel, captive flight. Lasts lifetime. Assemble 15 minutes. Complete, pylon, injector, one hour's fuel. \$4.95 postpaid, check, M.O. Happy Hollow Ranch, 505 Shady, Fayetteville, Arkansas.

**SKY Jeep kits, plans; details, dollar.** \$75.00 builds man carrying flying saucer; drawings, dollar. \$50.00 builds F-104; drawings, dollar. Gyro-copter flight manuals, dollar. McCulloch engine manuals, dollar. Sky Jeep Manufacturing, Box 48, Chandler, Arizona.

**PROPELLERS.** Plans, supplies for airboats and snowplanes. Latest designs, prompt delivery. Catalog 25¢. Banks-Maxwell, Box 3301E, Ft. Worth 5, Texas.

**BLUEPRINTS Knight Twister, Heath, Irwin, Flea, Eaglet, Wimpy, Gliders, etc.** Circulars illustrating above 30¢. Sport-plane building manual \$1.00. Kamcraft, Box 1153, Milwaukee 1, Wis.

### ELECTRICAL SUPPLIES

**ELECTRO-SCRIBE!** Engraves all metals, \$2.00. Beyer Mfg., 10511-H Springfield, Chicago 43.

**APPLIANCE Parts, accessories** wholesale. New enlarged catalogue 25¢. Seco, 26 South 20 Street, Birmingham 3, Ala.

**LAMP.** Electrical parts, wholesale. Thousands of items for repairing, converting. Catalog 25¢. Brown Lamp, Box 305, Clayton 5, Mo.

**SAFCORDE:** End burned out fuses and octopus connections, without costly rewiring. Free brochure. Safco, 18 Wagner Pl., Hawthorne 18, N. J.

**LAMPS**—Parts catalog containing wiring instructions, 25¢. Gyro Lamps, 5208P N.W. 35th Ave., Miami 42, Fla.

### WELDING, SOLDERING, PLATING

**ACETYLENE Welding outfits,** new \$54.50, arcwelders \$56.50. Eagle Welding, Dept. P.M., 5085 Broadway, Chicago 40, Ill.

**WELDERS.** 110/220, \$39.50. Morris, 1070 Inner Drive, Schenectady 3, New York.

**PLATING Equipment, supplies.** Complete line of anodes, solutions. Home workshops, industrial sizes. Hollywood Bronze Supply, Dept. C, 1624 East First, Los Angeles 33, California.

### MACHINERY, TOOLS, SUPPLIES

**WHOLESALE Tool catalog.** Free. Tools Unlimited, Box 235A, Vandalia, Ohio.

**PAINT Sprayer,** 7 times faster than brushing. Sensational offer! Free folder. Inasco, 1829 S. State, Chicago 16, Ill.

**CUT Glass easy** with "Zip-Cutter," guides and measures while cutting. Guaranteed \$1.00. Zipcutter, 4555P Riverside, Dayton 15, Ohio.

### ENGINES, MOTORS, DYNAMOS

**DIESEL Injector parts and fuel pumps** wanted. GM51-53-71-110. Bares, 7120 Carnegie, Cleveland 3, Ohio.

**DIESELS, Gas, gear motors direct.** Goin's General Engines, Niland, Calif.

**WINDING Data,** 275 motors, single and three phase \$1.10. Data Company, 512 Kensington, Kansas City 24, Mo.

**ALTERNATING Current generators,** 750 watt \$42.50, twincylinder compressors with 1/3 horse \$22.00, motors 1 horse \$38.50. Butler, 1885 Milwaukee, Chicago.

**REWIND Motors yourself.** Complete instructions \$1.00. Lewis Mfg., Howell, Michigan.

### BOATS, OUTBOARD MOTORS

**FREE Catalog!** Boat kits, trailers, fiberglass, marine hardware. Luger Industries, Dept. M-9, 9200 Access Rd., Minneapolis 20, Minnesota.

**FORDS And Jeeps 100%** marine engines with famous Convo-Kits. Deluxe catalogue 25¢ coin. Oscomotors, 3627B Lawrence, Philadelphia 40, Penna.

**MARINE Conversions,** Willys to Cadillac, kits and parts. Catalog and conversion hints free. Barr Marine, 2706A Castor Avenue, Philadelphia 34, Penna.

**FOLDING Boats.** Imported, unsinkable, 8 models. Sail, paddle, motorboat. Free catalog PM, Pioneer Folding Boats, 206 East 86 Street, New York.

**SUBSCRIBE To Government Surplus Weekly.** Lists all sales. Buy jeeps, trucks, boats, tents, tires, etc., direct from government. Next 10 issues \$2. Government Surplus, Paxton 20, Illinois.

**BOAT Plans**—Full size patterns, frame kits. Modern inboards and outboards for amateur builders. Complete new catalog 50¢ or specify requirements. Glen Designs, 9152 Rosecrans, Bellflower, California.

**FULL Size, cut-to-shape boat patterns,** blueprints, 7½-38 feet. Big new 88 pg. illustrated "Build a Boat" catalog of naval architect-designed cruisers, runabouts, skiffs, outboard boats, sailing, racing, houseboats, 50¢. "How to Build a Boat" booklet, \$2.50. Hardware and Equipment Catalog, \$2.00. Cleveland Boat Blueprint Co., Dept. A-66, Box 1651, Cleveland, Ohio.

**FIBERGLAS Permanent boat waterproofing.** Special 25% discount. Complete kits, \$9.45 up. Guaranteed materials. Easy application. Full instructions. Free literature. Mail post card. Ajax Plastics, P. O. Box 1323, Fort Worth, Texas.

**MARINE Conversions.** Ford, Chevrolet, Jeep engines. Catalog 25¢. Lehman Manufacturing Company, 400 Elizabeth Avenue, Linden 4, N. J.

**PROPELLERS.** Plans, supplies for airboats, snowplanes. Catalog 25¢. Banks-Maxwell, Box 3301F, Ft. Worth 5, Texas.

**NEW, Used, rebuilt marine motors.** Marine conversions, fittings. Free catalog. Stokes Marine Supply, Dept. 24, Coldwater, Michigan.

**WATERPROOF Tail light stop-directional-license plate.** Cast aluminum anodized, \$10.95 factory. Postpaid. No (c.o.d.'s) Strang Electric, Hawthorne, California.

**LIGHT Weight imported outboard 1½-5½ hp.** Lasts a lifetime. No maintenance, corrosion free instant starting. British Seagull. Brochure and prices. Henry Co., Box 1632, Fort Myers, Florida.

**I want to send you proof of the wonderful pulling power of Popular Mechanics classified pages.** What's your proposition? Write me today. Include literature if possible. P. W. Johnson, Manager Classified Advertising, Popular Mechanics Magazine, 200 E. Ontario St., Chicago 11, Ill.

### ATHLETIC EQUIPMENT, BODY BUILDING COURSES

**YOURS**—A body like a Greek god! Startling, amazingly quick new method explained in free literature. Send name and address to: DeVel-O-Flex, 3607 W. Magnolia Blvd., Burbank, Calif.

**FREE Muscle building information.** Body-Tone, Box 638B, North Miami, Florida.

**BARBELLS.** Dumbbells. Courses. Booklet 10¢. Good Barbell Co., Siloam Springs, Arkansas.

### SPORTING GOODS, GUNS, FISHING TACKLE, ARCHERY, TRAPPING

**SPEND A buck to get a buck.** Try Deer Scent, used by hunters across Canada to attract deer. \$1.00 postpaid, duty free. Gould's Hardware, Woodstock, Ontario, Canada.

**10,000 GUNS.** Antiques, moderns, swords, armour. Every description. Giant catalog \$1.00. Agramonte's, Yonkers 2-G, N. Y.

**NEW Fountain pen pellet gun.** Made of steel, \$2.65 post paid. Circular, B. Sypher Co., Sta. F, Toledo, Ohio.

**BIZIBUG**—New action! More bass! Free literature and introduction offer. Shaw Tackle Company, Dept. E, Rt. 2, Montevallo, Alabama.

**DISCOUNTS Unlimited!** Weaver K2.5, K3, \$24.25; 7x25 Binoculars \$24.25; Bushnell 4X \$34.50, FN rifles, \$99.50; Marlin Levers, \$59.00; scopes, reloading equipment below wholesale. Catalog 25¢. Discounts Unlimited, Inc., Box 38 A, Hastings-on-Hudson, N. Y.

**M-1 Garands \$100.00; M-1 Carbines \$85; Disco,** 2503 N. 3, Milwaukee, Wisconsin.

**ARMY Wool cushion sole heavy sox.** Slight imperfections, 5 pairs \$2 ppd. Roxy-James Hosiery Mill, Chattanooga 4, Tennessee.

**LIGHTEST Duck decoy,** less than 1st class letter, 3 oz. Flexible foam. Carry 100 easy. Shoot it, can't sink. \$24.00 per doz. Postpaid. Guaranteed satisfaction. Boat Names Company, 5910 East New 40 Hiway, Kansas City, Mo.

**CATCH More fish.** All seasons. Unique method guaranteed. Free details. Plumer, 151 W. Quackenbush, Dumont, N. J.

**MOLDS**—For casting your own fishing sinkers. Free illustrated booklet. Reading Instrument Co., Box PM78, Reading, Penna.

**CROSSBOWS! Hunting**—Bows! Factory prices! Jayco, Box 1355, Wichita, Kansas.

**BIG Money raising crickets and 12 inch African fishworms.** Free literature. Carter Ranch, Plains, Georgia.

**FREE**—Wholesale catalog. Beads, Spinners, Lure parts, Sinkers, molds, Jigs, Reels, Finny sports (ME), Toledo 6, Ohio.

**KILL Submersed water weeds** which foul up motor propellers, tangle fishing gear and choke irrigation ditches with R-H Granular Weed Rhap-20. Inexpensive, easy to use, sure results. For details write Reasor-Hill Corporation, Box 36PM, Jacksonville, Arkansas.

**MOLDS** For fisherman's sinkers, jigs, squids, casting and spinning lures. Free catalog. Sweet's Molds, Tonawanda 1, New York.

**5000 BARGAINS.** Firearms, binoculars, war relics. Catalog 50¢. Smith Firearms, Runnemed, N. J.

**AMAZING Wholesale sporting catalog.** Save 70%. Tremendous selections. Econ-O-Mart, Whippany 2, New Jersey.

**JAP Rifle altering to 30-06,** \$6.00. Japshells, \$3.95. Catalog 10¢. T. P. Shop, West Branch 11, Mich.

**GOLFERS!** Beat bragging buddies. Substitute off-center golf ball. It slices, hooks; wobbles like crazy on green. 75¢, 3 for \$2.00. Wilson \$1.25 golf balls, 3 for \$2.25. Hilarious business cards each order. 25¢ postage. Hall, 212C Newcastle, Syracuse 4, New Ycrk.

**GUNS, Swords, knives, daggers, flasks.** Large list 25¢ coin. Ed Howe, Coopers Mills 52, Maine.

**EARTHWORMS, CRICKETS, FROGS**

**BIG** Money raising fishworms and crickets. We teach you how to raise and where to sell. Free literature. Medium redworms, 3000, \$5.95; 10,000, \$16.95. Carter Redworms, Plains, Georgia.

**WANTED.** Men, women, worm raisers. Sherwood, Dept. O-2A, Monmouth, Maine.

**"EARTHWORMS For Profit"**—Exciting new (1959) 128 page manual, profusely illustrated, \$50.00 worth of vital growing, advertising, marketing, money-making information on Redworms and African night-crawlers; \$2.00, postpaid. Money-back guarantee! Free literature. Shields Publications, Box 358-A, Mountain Home, Ark.

**RAISE** Fishworms and rabbits on \$500 month plan. Free details. White's Rabbitry, Delaware 2, Ohio.

**EARN** Money at home raising fishworms for us! Backyard, garage, basement. We buy your crop! Inquire: Oakhaven-56, Cedar Hill, Texas.

**AFRICAN** Giant earthworms, 100—\$2.00, 500—\$7.00. (Dealers quoted.) Ozark Worm Farm-J, Willow Springs, Missouri.

**TAXIDERMY**

**FREE** Book tells how you can learn Taxidermy and Tanning. Fascinating, profitable hobby. Send postal. No obligation. State age. Northwestern School, Dept. 2571, Omaha 2, Nebr.

**BINOCULARS, TELESCOPES, MICROSCOPES, MAGNIFIERS**

**DYNASCOPE.** Amazing world-famous reflector telescope. Request free brochure. Criterion; Dept. DP59, Hartford, Conn.

**REFLECTOR** Telescope kits direct from factory. From \$7.75. Other optical do-it-yourself kits. Free booklet. Esco Products, Oakridge, New Jersey.

**BUILD** Your own reflector telescopes. Complete kits; mirrors, eyepieces, tripods, all other accessories. Request free illustrated literature. Criterion Manufacturing, Dept. DPM 56, Hartford, Conn.

**BINOCULARS** \$2.00 Postpaid. Unconditional Guarantee. Young, 17 May, Sharon, Mass.

**TELESCOPE** Mirrors, lowest price, finest quality. Free bulletin. National Optical Company, 505 New York Avenue, Union City, New Jersey.

**BINOCULARS.** Telescopes, microscopes. Terrific values \$3.98 up. Request free money-saving catalog. Criterion, Dept. P 82, Hartford, Conn.

**REFLECTOR** And refractor telescopes, binoculars, microscopes, all sizes. Complete telescope kits, parts, accessories. Free illustrated catalog. Suffolk Science, Mattituck, New York.

**WAR** Surplus bargains: Millions of lenses instruments, telescopes, binoculars, components and complete line of astronomical telescope items. World's greatest optical market-place! Send only \$1.00 for beginner's 10-lens kit and big instruction booklet Stock 2-CH. Write for catalog CH free! Edmund Scientific Co., Barrington, New Jersey.

**REFLECTING** Telescope, 60X, completely assembled. Guaranteed observatory clearness. Free information. Skyscope, P.O. Box 55, Brooklyn 28, N. Y.

**AMAZING** Prices precision binoculars. Folder. "Binocular Selecting," catalog free. Prentiss Importers, Mercury Bldg., West Los Angeles 25, Calif.

**PLANTS, SEEDS, BULBS, NURSERY AND GARDEN SUPPLIES**

**GINSENG.** Goldenseal roots bring up to \$14 pound. Full information, F. M. Collins, Viola, Iowa.

**GROW** Dwarf trees! Instructions and seeds 35¢. Mail Order Specialties, 1439-PM Sabraton Ave., Morgantown, W. Va.

**WORLD'S** Greatest cash crop. Free information. Write Ginseng Gardens, Asheville, N. C.

**FUR BEARING ANIMALS**

**MINK** Raising information free. Complete. Lake Superior Mink Farm, Superior, E.E. Wisconsin.

**PETS—DOGS, BIRDS, RABBITS, HAMSTERS, ETC.**

**HUNTERS.** Sale price on fine Coon hounds, Fox and Rabbit hounds. Write, Okaw River Kennel, Cowden, Illinois.

**GOLDFISH** Die? They can live for years in a bowl. Complete instructions 50¢. Belltree, Box 9035, Chicago 90, Illinois.

**GOLDEN** Hamsters—Pedigreed breeders \$3.85 pair. Albinos Whitebands. Literature. Moore's Hamster Ranch, Shepherdstown 25, West Virginia.

**RAISE** Rabbits. Most profitable way! Particulars free. Grinsteads, Edwardsville, Illinois.

**MAKE** Money raising chinchillas, mink, rabbits, cavies for us. Free catalog. Keeney Brothers, New Freedom 2, Penna.

**STRAIGHT** Cooners! World's oldest kennel. Combination hounds, rabbit, fox, beagles, deerhounds, bird dogs. Puppies of all breeds. Prices reasonable. Trial. Free catalogue. Raccoon Mountain Kennels, Box 464, Boaz, Alabama.

**HAMSTERS.** Pairs, Golden \$2.75. Albinos, Whitebands, Creams, \$3.75. Free literature. Edgewater Hamstery, 106 Carter, Goshen, Indiana.

**RAISE** Angora. New Zealand rabbits, fishworms on \$500 month plan. Free details. White's Rabbitry, Delaware, Ohio.

**EARN** \$10,000 Yearly raising Angora rabbit wool for us. Information 25¢ coin. American Angora Company, Malta 12, Montana.

**RAISE** Rabbits successfully by knowing facts. 48 page illustrated book describing 25 breeds. Housing, feeding, breeding, marketing, etc. Plus bulletin. 25 cents. American Rabbit Association, 36 Arba Building, Pittsburgh, Penna.

**HAMSTERS**—Ideal pets, \$2.95 pair. Free booklet. Jer-fre's Hamstery, 1447 Apple, Muskegon 13, Michigan.

**SKUNKS,** Reptiles, hawks, raccoons. Illustrated catalogue, 25¢. Trails End Co., St. Stephen, S. C.

**FARMS, FARM LANDS, REAL ESTATE**

**RIVER** Farm with herd. Scenic 158 acres with 1/2 mile frontage on one of Ozarks most beautiful fishing streams! Owner includes 23 good dairy heifers for \$11,500! Electric-lighted 7-room 4-bedroom home, running water indoors, pretty view. Barn needs repair, 2 small poultry houses, etc. 40 tillable valley land acres, rest mostly wooded pasture, stream and spring. Only 3/4 mile to village. Quick-sale price, only \$11,500 with cattle! New free fall catalog. Bargains coast to coast! United Farm Agency, 2825-PM Main St., Kansas City 41, Mo.

**FLORIDA'S** Biggest lot value! No money down! \$5 monthly. Full price only \$133. Between Orlando and Ocala. High, dry, adjoining city, streets, electricity, phones, churches, schools, shopping. In heart of 3000 lakes. World's best fishing! Write for free photos. AB Huysman, Box 467, Bellevue, Florida.

**OZARKS** Homes, farms. Sizzling fresh list bargains \$1.00. Ozarker, 420 Chestnut, Springfield, Mo.

**BUY** Low cost farms direct from owners! Latest catalog \$1.00. Or subscribe \$3.00 per year. Land Bargains, Dept. 9, Live Oak, Florida.

**OPPORTUNITIES!** Government land. U. S., Alaska, Canada. Sledge Surveys, Macon, Mississippi.

**MR.** Property Owner—Want a map of your property? Write Deed-Ettes, Mt. Pocono, Penna.

**CANADIAN** Exclusive vacation-sporting club grants members free cottage site, usage all facilities. Annual membership \$10.00. Throughout Canada excellent vacation, fishing, hunting areas. Free information. Vacation Acres, 82 Acton, Downsview, Ontario, Canada.

**FREE** Bargain list! Choice properties in Central Florida. Claren L. Brady, Realtor, 307 W. Colonial Drive, Orlando, Florida.

**FREE** Strout catalog! Farms, homes, businesses, resorts, retirement properties. Over 3000 values in 36 states. 58 years' service. World's largest! Write Strout Realty, 7-MP S. Dearborn, Chicago 3, Ill.

**FLORIDA'S** Nice homesites, \$345 at \$10 monthly. Folder free. Howard Vernor, DeLand, Florida.

**FARM MACHINERY AND SUPPLIES**

**SENSATIONAL** Garden tractor. Hoes between plants and rows, including strawberries. Eliminates hand hoeing. Standard in size, yet entirely different. Patent 2742840. Also tills. Fantastic offer to first few inquiries. Auto Hoe, DePere 68, Wis.

**PROFITABLE OCCUPATIONS**

**INVESTIGATE** Accidents—Earn \$125 week to start. Claim investigators are urgently needed to investigate more than 490,000 accidents daily. Work full time for insurance company, railroad, steamship line, or government office. Or step into your own profitable spare time business. No experience needed. Free book, now! Universal Schools, T-9, Box 8202, Dallas 5, Texas.

**MAGAZINE** Subscriptions: highest commissions. Bonus. Qualified Agencies, 451CA Kingston, Brooklyn 25, N. Y.

**BASIC** Typewriter repair, sources. Free information, sample. Box 1435, Lancaster, Penna.

**BUY** Wholesale: 100,000 nationally advertised products. Appliances, cameras, sporting goods, housewares, watches, typewriters, tools, clothing, etc. Discounts to 60%. Buy-Rite, Box 258, Hawthorne 1, New Jersey.

**WASHING** Machine repair book. Details free. Kay Washing Machine Supply, 5704 Third Ave., Brooklyn 20, N. Y.

**CYPRESS** Knees. Prices quoted. Sample \$2.00. Tom Gaskins, Palmdale, Fla.

**PROFIT** From large selection of franchises available your territory. Free information rushed. Franchise Previews 25W, 1218 Standard Building, Cleveland 13.

**LEARN** Piano tuning at home. Free information. American School Piano Tuning, Box 707, Gilroy, Calif.

**YOUNG** Jumbo frogs for stocking lakes or ponds. Raising very profitable. Nu-Tex Frog Farm, 4014 Mueller, Corpus Christi, Tex.

**\$400.00** MONTHLY Raising worms, soil-less method. Three Oaks Ranch, Dresden, Tenn.

**START** A magazine subscription business. Earn generous commissions on Popular Mechanics, Good Housekeeping and all others. Best commissions, bonus, all materials sent free. No experience needed. Write Popular Mechanics, Room 9-P, 250 West 55th St., New York 19, N. Y.

**MAKE** Money making new greaseless doughnuts in kitchen. Sell stores. Free recipes. Michael, 3605 South 15th, Minneapolis 7, Minnesota.

**EARN** \$240.00 A month at home. Spare time doing only two \$5.00 invisible mending jobs a day. Big money paid for service that makes cuts, tears disappear from fabrics. Steady demand. Details free. Fabricon, 6236 Broadway, Chicago 40, Ill.

**BECOME** Independent with your own franchise business. Thousands earning handsome incomes. Request interesting facts today. National Franchise Reports, PM-528, 333 North Michigan, Chicago 1.

**HOME** Mailorder beginner's manual, methods, opportunities, 25¢. Carnahan Bros., 9610 Acacia, Fontana, Calif.

**WE** Pay \$3.50 lb. dried. Grow mushrooms. Cellar, shed and outdoors. Spare, full time, year round. We pay \$3.50 lb. Free book. Mushrooms, Dept. 99, 2954 Admiral Way, Seattle, Wash.

**BIG** Money raising fishworms and crickets. Free literature. Carter Wormery, Plains, Georgia.

**MAKE** Flexible molds. Cast plaques, figurines. Free sample. Tooker, 1045-M Fairview, Hamilton, Ohio.

**AUCTIONEERING**—Home study course. Diploma granted. Auction School, Ft. Smith, Ark.

**SAVE** Money! Buy wholesale! Free catalog general merchandise. Norris, 487-M Broadway, New York City.

**RAISE** Pheasants on \$100 week plan. Little capital and space can make you independent. Free details. Great Central System, Columbus 1, Kansas.

\$200 WEEKLY Extra introducing buyers to sellers, weekends. Men, women enjoy learning real estate by listening to records. First lecture free. Lee Institute, Brookline, Mass.

### BOOKS, PERIODICALS, PICTURES, POSTCARDS

OUT-Of-print books at lowest prices! You name it, we find it! Fast service. No obligation. International Bookfinders, Box 3003-PM, Beverly Hills, Calif.

FREE Catalog! 1001 fascinating books! Treasure-Site, 6990 Aberdeen, Upper Darby, Penna.

TRADE. Buy, sell books, magazines, etc. in "bookworms" bargain magazine" 25¢. Brown, 6376 Windsor Lane, San Jose, California.

FREE Catalog. Latest books. All subjects. Fast service. Shorelands, Inc., Box 5-AC, Plaistow, N. H.

FREE Catalog 1001 subjects. Arrow Publishing, 4555P Riverside, Dayton 15, Ohio.

10¢ BOOKS. Thousands subjects. 2 catalogs, dime! Carlton's, 3007 Wharton, Philadelphia 46.

ROPE, Nylon or polyethylene wholesale prices. Wolfe Specialties Inc., 350 Stanford, Akron 14, Ohio.

10¢ BOOKS! Tons of titles! Sensational subjects! Three catalogs (books and bargains), two dimes, refundable. Bargains, 1323-PM Chaparral, Corpus Christi, Texas.

HOW To Think Your Way To Fame And Fortune. Send 25¢ to Avalon, 322 W. Van Buren, Chicago 7, Illinois.

1000 "HOW To" books. Catalog 25 cents. Artcraft, Baldwin, Maryland.

BRITISH Book bargains—Any subject. Catalogues free. Transatbooks, Wantagh, N. Y.

SCIENCE-Fiction book bargains. List free. Werewolf Bookshop, Verona, Penna.

FREE Catalog. Self-help books. Write: Wilshire, 8721 Sunset, Los Angeles 46P.

BOOKFINDERS! All subjects. Send wants! Jaher Book Service, 183 Hazelwood Drive, Westbury, N. Y.

"SCIENCE Milestones." Records march of science starting 400 years before Christ, right up to date. Amazing facts revealed. 312 pages packed with startling information that will thrill you. A real history of science. \$5.00. Literature free. Popular Mechanics Press, 200-SM East Ontario St., Chicago 11, Ill.

EXCITING Catalog packed with books covering most everything. Think of it—From cover to cover you will find described and illustrated hundreds of books telling how to fix and how to build almost anything. How to remodel your home; do your own decorating, plumbing, electrical work, carpentry, painting, furniture making and refinishing. How to build your own home workshop tools. Best books on welding, hobbies, homecraft. Send now for 1958 book catalog—only 10¢. Popular Mechanics Press, 200-BC E Ontario St., Chicago 11, Ill.

### GAMES, TOYS, NOVELTIES

PLAY New casino. Improve your arithmetic. Instruction booklet 10 cents. Allen Badler, 2063 East 18th St., Brooklyn 29, N. Y.

### MAGIC TRICKS, PUZZLES, JOKER NOVELTIES

WORLD Famous giant professional magic and fun catalog (160 pages) now only 25¢. Free trick given. House of 1000 Mysteries, 202BD Pinewood, Trumbull, Connecticut.

MAKE Hole in paper 3"x4", fit over body. Information \$1.00. D. Mellow, Box 195 Times Square Sta., New York City 38, N. Y.

ARTIFICIAL Chocolates like real. Sample 15¢. Display Center, So. Lincoln 11, Mass.

MAGIC Tricks book \$1. Be party live-wire. Free catalogue. Mandel, 1200-PM Avenue H, Brooklyn 30, New York.

FOUR Clever new practical jokes \$1.00. Dept. P.M. Box 423, Connersville, Indiana.

FREE "Top Hat Topics" booklets containing exclusive tricks we manufacture and sell. Visit the world's most modern magic shop. Lou Tannen, 120 W. 42 Street, New York 36, N. Y.

3100 NOVELTIES. Jokes, tricks, gadgets, funmakers, hobbies. Big catalog 10¢. Johnson-Smith, D-498, Detroit 7.

500 TRICKS—1959 Edition now ready! Contains latest, best magic for pocket, club, stage. Only 10¢. Douglas Magicland, Dept. M, Dallas, Texas.

WORLD'S Finest professional magic. Joker novelties. Giant illustrated catalog 10¢. Top Hat, Evanston 12, Illinois.

3000 TRICKS. Pocket, parlor, stage. World's finest magic catalog (408 pages), \$2.50. Kanter's, M-1311 Walnut, Philadelphia 7.

### COINS, TOKENS, CURRENCY

LINCOLN Cents: 1913-S, 1926-S, 1923-S, 1924-S, 1921-S, 1927-S, 1928-S, 1933-D. Complete lot only \$3.00. Berry, Box 306, Westminster, Calif.

BRILLIANT Uncirculated United States five dollar gold pieces, \$15.00. Twenty dollar, fine, \$45.00. Rare Coin Company, 31 North Clark St., Chicago 2, Ill.

"EAGLET" Numismatic Magazine, 35¢, subscription \$3.00 year. Dept. P, 229 South 11th, Newark 7, N. J.

1959 GIANT U. S. coin catalogue 25¢. Ace, 107 N. Dearborn, Chicago 2.

LARGEST Coin magazine, 200 pages, 40¢. Scrapbook, 7320-J Milwaukee, Chicago 31.

RAREST CO mint dollar 1885 uncirculated \$5.00. Illustrated catalogue 25¢. Schultz, Salt Lake City 10, Utah.

INDIAN Cent plus Bargain Lists 10¢. Hutchinson's, Box 4747, Philadelphia 34, Penna.

SIXTEEN Page price list of U.S.A. and Canadian coins free. Selling prices on thousands of coins and supply items. Bryson Inc., 612A White, Toledo 5, Ohio.

STARTER Collections, 20 different Indian cents, \$2.50, 13 different liberty nickels \$2.50, 20 different Barbour dimes in folders, postpaid \$5.00. Prager, 470 27th Avenue, San Francisco, Calif.

COMPLETE U.S. coin list, 10¢ (refundable). Bonus offer included! Economy Sales, 156-C Dean, Mansfield, Mass.

SPECIAL \$1.00, 20 page bargain list, 7 different Indian cents, album. Hobby Sales, Box 4054, St. Paul, Minnesota.

EIGHT Different Indian cents \$1.00. Collector's Bargains, New Hope, Penna.

DELUXE 32 Page U.S. catalog 10¢. Contains almost 100 illustrations; over 5,000 delightful bargains. Stone, 260 Washington, Boston 8, Mass.

LET'S Get acquainted special—Scarce Lincoln Cents 1909vdb, 1916, 1921s, 1923s, 1924s 25¢ each or all five \$1.00. Free price lists with order. Reynolds Coin Shop, Kresge Bldg., Flint 2, Michigan.

44 ASSORTED Coins, \$1.00. 44 assorted bills \$1.00. Oddehon, Box 482, St. Louis, Mo.

RARE Coin guide and new penny in clear plastic 20¢. Campbell's, 1714 Broadway, Mattoon 7, Ill.

FREE List! U. S. coins. Lowest prices! Hugh's Coins, Hickory, N. C.

GOLD Uncirculated: Fives \$13.00; Tens \$23.95; Twenties \$41.95. Cook, Box 181, Jackson 5, Mississippi.

TWELVE Different barber dimes \$2.00. Bargain lists free. Sayers, 100 Unaka, Johnson City, Tennessee.

BRILLIANT Uncirculated Mexican silver dollars 50¢ each, three for \$1.00. Bargain list with order. Universal Services, Box 675, San Antonio 6-D, Texas.

FOREIGN Coin, banknote and large illustrated coin list for 4¢ postage. Bargains: Indian head cent, 10¢; wooden nickel, 10¢; Chinese dollar, 53¢. Approvals included with every order. Tatham Coin Company, Springfield 30, Massachusetts.

10 DIFFERENT Indian pennies — \$1.00. 8 different Liberty head nickels \$1.00. I. Doktor, P.O. Box 35151, Los Angeles 35, Calif.

RARE Unc. 1899-P silver dollar, each \$5.00. Butts, East F, Torrington, Wyo.

FREE! Copy Canadian Bulletin. Year \$1.00. Marles, Box 833, Calgary, Canada.

BUS Tokens-nickel, roll of 50. \$1.00. 500 postpaid \$6.00. William Lawson, Grafton, W. Va.

32 PAGE Catalogue, coins "wanted" list, 25¢. Refundable, Jolie, Roslyn Heights, N. Y.

GLITTERING 1959 Proof set encased in beautiful lucite paper weight \$9.85. Queen Elizabeth coronation proof set in box \$11.95. Gigantic bargain catalogue \$1.00 (deductible \$10.00 order). Guidebook \$1.75; Canadian catalogue \$1.50; World coin book \$4.00. Bebee's, 4514 North 30th, Omaha 11, Nebraska.

LINCOLNS 1911D, 1913D, 1933D, 1939D, 35¢ each, 1910S, 1912D, 1913S, 1915S, 1922D, 1926S, 1931D 75¢ each. All \$6.25 postpaid. Free list. United, 101 Cranston, Providence, R. I.

### STAMP COLLECTING

WOW! 110 All different Germany 10¢. Zeppelins, semi-postals, airmails, high values, etc. Giant catalog, bargain lists included with beautiful approvals. Jamestown Stamp, Dept. A99PM, Jamestown, N. Y.

QUALITY Packet, all different, \$10.00 catalog, plus surprise gift only \$1.00. Also approvals. Satisfaction guaranteed. Robert Bedford, Box 6111, Minneapolis 24, Minnesota.

FREE! Colorful 215-different stamp collection! With adult, bargain approvals. Rush 10¢ postage. Philatelics, Dept. RE, New Paltz, N. Y.

BEAUTIFUL Honduras set six "Lincoln" mints plus same on cover \$1.00! Busson, Apartado 544, Tegucigalpa, Honduras.

AIRMAILS: World wide selection, including first complete German airport set. Only a dime with approvals. Boger, Box 152, North Wales, Penna.

GIANT-Size issues collection: Laos Elephant set, Brussels Pair, Olympics, Jet Aircraft, Boy Scout, Somali Animals complete, Romania Flags, Togo set, Diamond Popes, U N set, etc., plus big Stamp Dictionary and Approvals. Everything 10¢. Stampex, Box 47-KM, White Plains, N. Y.

FREE Stamp wallet-perforation gauge sent new approval applicants. Robert J. Clark, P. O. Box 28-P, Wilmette, Illinois.

222 DIFFERENT Worldwide plus 66 different U. S. 25¢. Unmounted approvals. Casto, Box 357, Dunbar, W. Va.

FREE Gigantic collection, includes U.S.A., British Colonies, foreign. Approvals. Stanley Zajac, 159 Emerson Ave., Toronto, Canada.

FIRST Day cover approvals! Artcraft, Artmaster, included free: valuable airmail flight cover, Myers, Coopersburg, Penna.

FREE! 25 Egypt, 5¢ handling. Approvals, Bellet, Mapledale, Hazel Park, Mich.

JAMAICA, 25 Different 20¢. Approvals. Edwin Morr, 1204 Sandusky, Ashland, Ohio.

DEALERS—Wholesale list. Postage 4¢. Frank, 5031 Queensberry, Baltimore 15, Maryland.

CUBA, 100 Different plus free illustrated catalog, \$1.00 bill. Venecia, Obispo 518, Habana.

GAZA War three different rare covers \$2. Nussbaum, P.O.B. 337, Ramatgan, Israel.

U.S. Stamps. Giant bargain catalogue, 15¢. Raymax, 35-VZ Maiden Lane, N.Y.C. 38.

COLLECTORS! British colonial sets at wholesale. Free list. Fischer, 1530 Metropolitan, New York 62, N. Y.

SCOTT'S #834, \$5.00 Coolidge 50¢ with U.S. approvals. Emge, 1647 Pontiac, Denver 20, Colorado.

UNITED Nations. Five different 10¢. Approvals, Anderson, 1112 Harrison, San Francisco 3, Calif.

ISRAEL 10 Different free to approval applicants. Morrel, 203 Fenimore St., Brooklyn 25, N. Y.

MEXICO 25 Beautiful 10¢. Approvals. Salsman, Box 702, Berkeley, Calif.

MYSTERY Bag stamp collection, only 10¢. Hill Company, Box 51, Defiance, Ohio.

TERRIFIC Value. Eight complete mint sets 10¢ with approvals. Beatties, 58 Glenagar, Islington, Ontario, Canada.

**FREE!** Giant bargain catalog—New edition listing thousands of bargains including U. S. and B. N. A. stamps, packets, mixtures, albums, accessories and supplies; sent with beautiful approvals. Jamestown Stamp, Dept. E99PM, Jamestown, N. Y.

**HITLER** Head's—18 different 10¢. Approvals. Jewell's Stamps, Tamaqua, Penna.

**FREE!** 33 Somaliland! Jugoslavia! Hailaya! Others. Approvals. Heating, 2520-P Boulevard, Jersey City 4, New Jersey.

**MINIATURE** Sheets 3 Latin American \$1.00. Satisfaction guaranteed. Altair, Box 272, El Segundo, Calif.

**FREE!** 50 Different Portuguese; Colorful, inexpensive approvals. Elkhart, Box 33, Elkhart, Indiana.

**DIAMOND**, Triangle, Timor, topicals. 44 all different 10¢ with approvals. Carpenter, Box 310, Claremont, Calif.

**FREE** United States fully illustrated list. First order—10% discount. Simmy, 45-PM Bromfield, Boston, Mass.

**GIFT!** Tokelau Islands first set to approval applicants. Deane, Box 45-371, Miami, Fla.

**135 DIFFERENT** U. S. commemoratives \$1.00; 60, 30¢. Carstamps, 739 Ordway, Freeport, Illinois.

**FREE!** 6 Greek wind airmails to purchasers of our reasonably priced approvals. Ask about profit sharing plan. Mark II Stamps, Shop 1517, 6671 Sunset Blvd., Hollywood 28, Calif.

**U. S. Mint** sheet. #948, 20¢. Approvals. Kopkin, Box 133, Brooklyn 14.

**2 OZS.** Unsorted foreign, 35¢. Includes pictorials. Knopp, Box 1381, Bristol, Conn.

**POLAND** 25 Different 10¢. approvals. Iray, Box 114, Boston 34, Mass.

**50 DIFFERENT** Africa 25¢! Approvals. Rowswell, 2425 Maplewood, Royal Oak, Michigan.

**100 STAMPS**, 15 Cents. Approvals. Mengel, 11 Mansfield, Everett 49, Mass.

**LAOS** Elephants, 10¢. Approvals. Gebhard, 25 Westwood Drive South, West Orange, N. J.

**TERRIFIC!** Penny approvals. Thousands varieties! Marshall, Box 451-PG, Long Beach, Calif.

**500 WORLDWIDE** Mixture 30¢. Nice variety. Monjar, Fairmount, Cincinnati 14, Ohio.

**400—2x4 POSTMARKS** For \$1.00. Cozatt, 1916 West Oklahoma, Enid, Oklahoma.

**SUPERB** Collection 100 world-wide, 10¢. Approvals. Jackson, Newfoundland, Ky.

**GERMANY**, Hitler's commemorative collection. Free! Approvals. William Deems, 226k Race, Ravenswood, West Virginia.

**CLEAR VU** mint sheet album. Holds 100 sheets. Black, maroon, green. \$9.95. Slip case \$2.95. US price list free. Sennett, 88 Wyoming Street, Wilkes-Barre, Penna.

**ENJOY** Stamp collecting! Write for "Penny-provals." Penny-proval Service, New York Building, Saint Paul, Minnesota.

**125 DIFFERENT** 5¢ With British empire approvals. Mokwa, 2855 W. Byron, Chicago 18.

**FOUR** Complete Christmas sets free with attractive approvals. Stamp Imports, Peterborough, Ontario, Canada.

**33 DIFFERENT** Greece only 10¢ with approvals. Eppley, Box 301, Bensenville, Illinois.

**25 DIFFERENT** Commemoratives 1893 up 10¢. U. S. approvals. K&B, Box 70, Brooklyn 23, N. Y.

**TERRIFIC!** 50 Australia plus complete Russian set! 10¢. Outstanding approvals. Westgate, 5A Centre, Hempstead, New York.

**48 DIFF.** Selected Scandinavian, Greenland, Iceland. \$1.00. Brage, Taastrup, Denmark.

**BARGAIN US**—101 different 25¢. with US. Approvals. Stamps, Kennebunk, Maine.

**50 ALL** Different South America 10¢ with attractive approvals. Superior Stamps, Box 53, Dept. 48, Cathedral Station, New York 25, N. Y.

**MILLION** Stamps on approval! 2¢ each! Send for thrilling, giant selection! ABC Stamp Company, San Francisco 1-AA, California.

**8 DIFFERENT** U. S. airmails free! Approvals accompany. Dee, Box 926, Ormond Beach, Florida.

**1000 DIFFERENT**, \$1.00 With approvals. Louis Golden, 6721 Eastwood, Philadelphia 49, Pennsylvania.

**FREE Sample!** Interesting, informative, illustrated. National Stamp News, Anderson, South Carolina.

**FREE.** Valuable collections. Scott's International and Master Global Albums. A gold mine of value all free when you buy our sensational foreign approvals. Topval, Box 486b, Redlands, Calif.

**FOREIGN P.D.C.'s** mailed direct! Personalized around the world service. Brumsey, 209 Main, Peoria, Ill.

**SUPERB** 25¢ Packets. All stamps off paper. Limit eight different packets. Low priced approvals. Arkay Stamps, 1705 Acacia, Alhambra, Calif.

**DAMAGED** Old U.S. 1/8 catalog, on approval. K. Swartz, Malden Bridge, N. Y.

**FREE** 50 Worldwide, mailed with inexpensive approvals. University Stamps, P.O. Box 95, Tamiami Station, Miami 44, Florida.

**SURPRISE!** 45 Different with general foreign approvals. Bert Collier, Chamblee, Ga.

**25 DIFFERENT** French colonials. All large, including sets, 10¢. approval applicants only. N. Ennis, 66 Mill Street, Arcade, New York.

**105 DIFFERENT** U.S. stamps 25¢, approvals included. Shelton, Box 907-M, New York 8, N. Y.

**TRADE** Your duplicates toward our approvals! (Foreign only.) Complete information, 10¢. Variety Stamps, Box 98-P, Newton Highlands 61, Mass.

**FREE!** Over 100 different, \$2.50 value, including space satellite, Israel, British, U. S., first U. N., Siberia. Approvals, catalogue. Send 25¢ for mailing. Gatewood, Box 346, Winston-Salem, N. C.

**FREE!** Wonderful, new 84 page U. S. catalog. Handling 10¢. Norrisco, Milwaukee 7, Wis.

**307 WORLDWIDE** Different stamps only 25¢. Approvals. Niagastamp, St. Catharines 671, Ontario.

**MINT** U.S. at face! Older commemoratives only. Send 25¢ for all different packet with first selection mint U.S. approvals. Western, Box 1689P, Salinas, California.

**1000 DIFFERENT** Worldwide stamps \$1.00. Valued over \$20.00. Universal, Box 6, Kenosha 5, Wisconsin.

**60 DIFFERENT** U. S. (30 commemoratives) 25¢. No approvals. Seidenberg, Appleton, Wisconsin.

**FREE!** Eight sided stamp, triangle, diamond, midget, mammoth, to approval buyers. Plymouth, Dept. A-9, Bell, Calif.

**GIANT** Approvals, thousands different, 1¢ and 2¢ each. Wahl's Stamp Exchange, 7008P Farragut, Chicago 31, Ill.

**WORLDWIDE**, 50 All different, absolutely free, just to introduce our incomparable approvals. Kent Stamp Company, GPO Box 87, Brooklyn, N. Y.

**ALBUM** Only 10¢! Hundreds of spaces! Stampmart Company, Hartford 1, Conn.

**UNITED** States commemorative collection containing 33 different—10¢. Approvals. White, 516-A Avenue L, Brooklyn 30, New York.

**SELL** Your surplus good grade stamps. Write, describing fully what you have. Vanroy Shirk, Lebanon Pennsylvania.

**AMAZING OFFER!** 200 United States stamps—including commemoratives, airmails, high denominations to \$1.00. Only 10¢ to approval applicants! Illustrated bargain lists free. Mystic Stamp Co., Dept. 80, Camden, New York.

**100 STAMPS**, 10¢ With approvals. Smith, 508A Brooks, College Station, Texas.

**OLD** Scarce U.S. seconds on approvals. Slight imperfections, lowest prices. Hernefield, Clintonhill Sta., Newark 8, N. J.

**100 OLD** United States between 1861 and 1935, \$1.00. Roush Stamps, 51 Chestnut, Mansfield, Ohio.

**FREE** Packet! Angola, Azores, Mongolia, Nepal, Palestine. Fascinating approvals. Coral, Box 7095 (Ludlam), Miami 55, Florida.

**225 STAMPS** For only 10¢! This mammoth value includes airmails, pictorials; stamps from strange countries cataloging up to 25¢ each! Also approvals. Mystic Stamp Company, Camden 80, New York.

**UNITED** States price list, 116 pages, price 25¢. Mark Hanna, 335 Fifth Ave., Pittsburgh 22, Penna.

**SELL** Stamps to our readers. Your ad in this space will be read by thousands of stamp buyers. I'll prove that to you. Write now for Folder "S." F. W. Johnson, Classified Advertising Manager, Popular Mechanics, 200 E. Ontario St., Chicago 11, Ill.

**14,000 DIFFERENT!** Amazing new plan builds your collection systematically, country by country. Only 50¢ weekly. Free details. L. G. Ware, Stepney 75, Conn.

**U. S. Mint** flag set, complete. \$1.00. Free list. Brooks, 2323 Avenue X, Brooklyn 35, New York.

**INTRODUCING** Our better United States approvals, we offer 15 United States stamps including Columbian, Pan-Pacific, famous American, airs, others; only 10¢. Ocean Stamps, Box 64-PM, Brooklyn 29, New York.

**103 DIVERSIFIED** British colony stamps only 10¢. Approvals. Niagastamp, St. Catharines 671-A, Ontario.

**80 DIFFERENT** U. S. stamps, includes 19th century, commemoratives, high values. Plus 1943 flag stamp of occupied nations. All for only 25¢. Approvals included. Willett Co., Box 338-C, Yorktown Heights, N. Y.

**25 ATTRACTIVE** Pictorials worldwide different 10¢. Approvals. Linstamp, St. Catharines 618-B, Ontario.

**102 DIVERSIFIED** Worldwide stamps 10¢. Approvals. Linstamp, St. Catharines 618, Ontario.

**110 INCLUDING** Airmails, triangles, U. S., 10¢. Approvals. Stamparee, Box 68, Sierra Madre, Calif.

**U. S. Approvals.** Low prices. Eagle Stamps, Romine Ave., Pittsburgh 26, Penna.

**PENNY** Approvals! Regardless catalogue! Kloster, 4164—52nd St., San Diego 5, Calif.

**25 DIFFERENT** Large American commemoratives 10¢. With approvals. Linstamp, St. Catharines 618-A, Ontario.

**25 U.S. Commemoratives** 10¢ with approvals. Colonial Stamp Mart, RD. 1, Box 458, Kingston 8, N. Y.

**INTERESTING** Worldwide animal stamp collection 10¢. With approvals. Niagastamp, St. Catharines 671-B, Ontario.

**U.S., Canada** catalogue now only 20¢. New-Way Stamp, Lawrence (2), Mass.

**508 DIFFERENT** Worldwide from Madagascar, Macao, Guinea, etc., cataloguing over \$15 only 35¢. Approvals. Littleton Stamp Company, Littleton Q1, New Hampshire.

**ECONOMICAL** 1/2¢-3¢ Approvals. 33,000 varieties. Dresel, Box 128-N, West Englewood, New Jersey.

**5 BEAUTIFUL** Different complete sets, 10¢. Approvals. R. Grillo, P.O. Box 4028, Norfolk 2, Va.

**LAOS** Elephants, only 10¢ with better grade approvals. Faith, 1225 Campbell, Alhambra, Calif.

**100 EXCITING** Flags. All nations. Correct colors 10¢ to approval buyers. Belmont Stamps, Washington 15, D. C.

**50 LARGE** U.S. commemoratives 10¢ with approvals. Jack Clancy, Box 2187, Portland 14, Ore.

**300 STAMP** Hinges and 25 different Canada free with approvals. Jaydee, 218 Dickinson S.W., Grand Rapids 7, Mich.

**U.S. Catalog** free. Contains almost 1,000 illustrations; over 10,000 delightful bargains. Stone, 260 Washington, Boston 8, Mass.

**1000 DIFFERENT** Worldwide with approvals only. Jacobsen, Crompond, N. Y.

### ANTIQUES, RELICS, INDIAN GOODS, CURIOS

**SCALPING** Knife, spearhead, thunderbird \$4.00. Catalog 10¢. Arrowhead, Glenwood, Arkansas.

6 ARROWHEADS \$2.00 List Smith, 841 N. Tacoma, Indianapolis 1, Indiana.

ANCIENT Grooved stone tomahawk \$3.00. Indian relic list free. Lear's, Glenwood, Arkansas.

10 ARROWHEADS \$2.00. List 10¢. Redick, 1061 Geers, Columbus 6, Ohio.

SPECIAL: 10 Genuine arrowheads, \$2.00. Stan's, 1054 Lilley, Columbus 6, Ohio.

### PRECIOUS STONES. MINERALS

FOSSILS, 15 Classified, \$2.00, 50 classified, \$7.50. List, Pioneer Museum, Burnet, Texas.

SAPPHIRE And four more uncut gems, \$1.00. Ten polished gems, baroque-shaped, \$1.00. Free gem list. Lapidary catalogue, 25¢. O'Brien's, 1116M Wilcox, Hollywood 38, Calif.

POLISHED Gem stones sent on approval to collectors, students, schools and hobbyists. New England Gem Co., Dover 1, Mass.

SEMI-Precious uncut gems. Ten different for \$1.00. Request list 2¢. Prospectors Shop, 201 San Francisco, Santa Fe, New Mexico.

EARTH Science, the rockhounds national magazine. Subscription \$2.00. Sample 35¢. Box 1357-PM, Chicago 90, Ill.

OUT Gems, make jewelry—For profit or fun. 100 page magazine tells how: where to get supplies. Sample 25¢ or request free literature. Lapidary Journal, Del Mar 2, Calif.

'GEMS & Minerals Magazine,' largest rock hobby monthly. Field trips, 'how' articles, pictures, ads. \$3.00 year. Sample 25¢. Box 687A, Mentone, California.

### HOBBIES AND COLLECTIONS

COLLECTORS Matchbook covers. 100 different unused, \$1.00. Catalog 25¢. Album \$3.00. Charles Edelman, 1311-C East 84, Cleveland 3, Ohio.

AUTHENTIC Costumes, 1800's and early 1900's. Belle Antiques, Galion, Ohio.

COLLECT Military medals. Iron Cross with ribbon, \$1.50. Purple Heart, \$1.00. Swastika emblem 25¢. Catalog 25¢. Hobbies, Box 71-B, Rockaway 94, New York.

MATCHBOOK Album. Looseleaf pages, expandable. 144 spaces, \$1.00 ppd. Match Album, 5056 W. Armitage, Chicago 39.

CYPRESS Knees. Prices quoted. Sample \$2.00. Tom Gaskins, Palmdale, Fla.

FABULOUS Art color prints—look and feel like canvas! \$1.00 each. 4 different \$3.00. Guaranteed. Vanguard, 5880-V Hollywood Blvd., Hollywood 28, Calif.

INVENTING Can be an interesting and profitable hobby. Write for complete particulars. Institute of American Inventors, Dept. 40-E 635-F St., N.W., Washington 4, D. C.

NAZI Insignia book. 600 illustrations, \$1.00. 12 Nazi insignia, \$1.00. Hobbyland, Calgary, Canada.

### CAMERAS. PHOTO SUPPLIES

20% DISCOUNT All cameras and supplies. Send check, we pay postage. Rembrandt Camera, Sharon, Penna.

PHOTOGRAPHY For pleasure or profit. Learn at home. Practical basic training. Long established school. Free booklet. American School of Photography, 835 Diversey Parkway, Dept. 343C, Chicago 14, Illinois.

NEW German, Japanese top name cameras at world's lowest prices! Free lists. Gieralt Import, 859 North Paulina, Chicago 22.

UNDERWATER Shutterbugs—build your own custom camera case. Instructions & parts list free. Dive-Rite, Box 3445, Long Beach, Calif.

### PHOTO FINISHING

QUALITY Photofinishing, reasonable prices built our reputation. 19 years experience. Jumbo prints 5¢. Other prices equally low. We pay postage both ways. Free enlargement. Save on color, too. Write for free mallers. Mailbox Photo, Box 99A, Hamilton, Ohio.

8 MM Kodachrome, 20 exp. Kodachrome and Ektachrome processing \$1.19. Rembrandt Camera, Sharon, Penna.

BEAUTIFULLY Colored 8x10 enlargement photo or negative \$1.00. 3 same pose \$2.50. Dick's Studio, Louisville 12, Ky.

A Triple value. Quality, price, service. Color or black and white, 12 exp. (black and white) 59¢. 20 gift photos \$1.00. Holiday Photos, Dept. 16, Box 666, Denver, Colo.

NEGATIVES Enlarged 8x10 50 cts. Cooke Potolab, 1547 Cahuenga, Hollywood 28, Calif.

100 PHOTOSTAMPS Reproduced from your photograph or negative \$1.50. Dealers welcome! Chesley Distributors, 2339 University Avenue, San Diego 4, California.

A 3-in-1 value. Price, quality, service. 20 gift photos, \$1.00. 12 exposure rolls (black and white), 59¢. Color or black and white. Interstate Photos, Dept. 11, Box 15, Aurora, Ill.

ENLARGEMENTS, Professional, six 5x7's or three 8x10's \$1.00. Toman, R3, Box 303, Palatine, Ill.

KODACOLOR 12 Prints guaranteed from any roll \$2.50. Trial offer with this adv. Reprints 20¢ each. Eli Photo Service, Box 1873PM, New Haven, Conn.

KODACHROME Processing by Kodak, 8mm. roll or 35mm., 20 exp., \$1.40. Prompt service. Write for mallers and prices. Color Pix, Dept. P, CPO Box 30, Kingston, N. Y.

TWELVE Exposure rolls 49¢. Wallets 20 for \$1.00. Lincoln Studios, Dept. K, Box 13, Lincoln, Nebr.

ENLARGEMENTS, Heavyweight, six 5x7's or three 8x10's \$1.00. Jack Koons, Huntington Mills, Penna.

FAST Film service. Kodachrome processing only 75¢. Prints only 25¢. Black and white: 8 exposure 40¢; 12 exposure 60¢; 20 exposure \$1.00. Reprints 5¢. Kodachrome, Anscochrome, Ektachrome. Mounted \$1.35. Finest quality. Mail Order Photo Service, Box 297, Watertown, Wisconsin.

TWO Beautiful prints from each picture on roll 8 exposures 45¢; 12 exposures 55¢. Thirty-eight years of satisfied customers. Quick service. Lens Photos, Dept. J-4, Janesville, Wis.

COLOR Processing! Anscochrome, Ektachrome \$1.00, 35mm. 20-exposure roll mounted. Kodachrome 20-exposure or 8mm. movie \$1.25. U.S. Color Mart, Box 191, Hartford 1, Conn.

### MOTION PICTURES AND SOUND EQUIPMENT

16MM Sound film clearance. Free list. Movoco, Leonard Street, Springfield 4, Mass.

16mm SOUND—Silent. Free list. Torrington, Box 74636-M, Los Angeles 4, Calif.

PROFESSIONAL Color movies, Europe, Russia, America. Descriptive lists 25¢. Minimum order \$25. Box P-664, Meriden, Conn.

16MM. Sound films. Bargain bulletin. Duquette, 97-T Snow, Fitchburg, Mass.

MOVIE Film! Free catalog! ESO-R, 47th Holly, Kansas City 12, Missouri.

16MM. Sound, projectors, films. Sale, rental, exchange. Visit store or write for catalog. National Cinema, 71 Dey St., New York City.

FREE! Blackhawk's big sale catalog 8mm., 16mm. movies, 2"x2" color slides. Biggest selection anywhere! Projectors, cameras, supplies. Big discounts! Get free, every three weeks. 12-page newspaper size bargain list! Blackhawk Films, Davenport 14, Iowa.

MOVIE Camera film: 8mm. roll \$1.50. 16mm. 100' \$3.00. Free processing. Better Films, 742 New Lots, Brooklyn, N. Y.

16MM. Sound shorts. Tremendous assortment features, \$16.50 up. Used 16 mm. sound projectors, \$77.50 up. Catalog. Abbe Films, 417 West 44th Street, New York City 36.

5,000 8-16MM. Movie films. Free catalogues. International, Greenvale, N. Y.

### COLOR SLIDES

LINCOLN Story, complete in 500 color slides. Catalogue and sample, 35¢. Willems, Box 1515-A, Chicago 90.

COLOR Slides, package of four, 98¢. Rush 35¢ for big catalog, 16,000 subjects. Meston's Travel, 3801P North Piedras, El Paso, Texas.

### MUSIC & MUSICAL INSTRUMENTS

ACCORDIONS—1960 Models. Lowest discount prices. Save up to 50%. Free home trial. Trades accepted. Big color catalog free. Accordion Manufacturers, Dept. 99-R, 2003 Chicago, Chicago 22.

SONGWRITERS! A publishing house for amateurs. Songs published, recorded. Free music. Free lyric course. Amateur Songwriters Association, 1356 Hancock Street, Quincy, Mass.

COMPLETE Professional music service for songwriters. Colonna Enterprises, Box 888M, Burbank, Calif.

ACCORDIONS. Wholesale to everyone. Save up to 60%. All national known brands. Free catalogue. Del Principe, 29 South Cicero, Chicago 44.

ELECTRIC Guitars, amplifiers, wholesale. Free catalog. Carvin PMM, Covina, California.

SONGWRITERS. With publisher contacts, want song ideas. Share royalties. No fees. Send poems: Songwriters' Associates, 1650 Broadway, New York City 19-G.

POEMS Wanted immediately for musical setting and recording. Free examination. Rush poems. Songcrafters, Acklen Station, Nashville, Tennessee.

POEMS Wanted for musical setting. Established 1939. URAB, 2181 Bedford Ave., Brooklyn 26, N. Y.

GUITAR Making books, plans, imported woods, tools. List 10¢. Store, 510 East 11th Street, New York 9, N. Y.

SONGPOEMS And lyrics wanted. Mail to: TinPan Alley, Inc., 1650 Broadway, New York 19, N. Y.

POEMS Wanted for musical setting and recording. Send poems. Free examination. Crown Music Company, 49-C West 32 Street, New York 1.

SONGS Into dollars. Share \$33 million dollars yearly for new songwriters, song poets. Any subject, songs composed, published, promoted by largest firm. Information, appraisal free. Send Nordyke Music Publishers, 6000 Sunset, Hollywood 28 PM, California.

POEMS Wanted for musical setting and recording by America's largest song studio. Send poems. Free examination. Five Star Music Masters, 630 Beacon Building, Boston.

SONG Request Magazine publishes new songs. Pays royalties. Subscription two dollars per year. Olenik Records, Mount Morris, Michigan.

### RADIO, TELEVISION AND ELECTRONICS

FIX Your own TV the easy way, and save 80%! Send 25¢ for illustrated TV trouble shooter chart showing which tubes to replace. We'll include giant wholesale catalog. Save plenty on parts, receiving and picture tubes. Zalytron Tube Corp., 220-M West 42nd Street, New York City.

CRYSTAL Radio experimenters. Write to Hulet, 305 Hope, Lakewood, New Jersey.

PICTURE Tube booster: Extend life of your old TVPicture Tube. Install yourself; guaranteed or refund. For parallel or series circuits. \$2.98 prepaid. P. P. Day Co., Highland, N. Y.

STEREOPHONIC Phonographs. Radios. Recorders. Free catalogues. Towers, R-1, Norristown, Penna.

REPAIR Instructions, T.V.s \$2.00, radios \$1.00. DX Radio Coop, Box 5935M, Kansas City 11, Missouri.

HI-FI components, recorders, tap, records. Wholesale catalog free. Electronic World, Inc., 1799M 1st Avenue, New York 28, N. Y.

TUBES-TV, radio, transmitting, special purpose types. Bought, sold, exchanged. Send details to Barry Electronics Corp., 512 Broadway, New York 12, N. Y.

ELECTRIC Guitars, amplifiers, wholesale. Free catalog. Carvin, PMR, Covina, California.

RECORDERS, HI-FI. Free wholesale catalogue. Carston, 215-PM East 88, New York City 28.



**TAPE** Recorders, Hi-Fi components, sleep learning equipment, tapes. Unusual values. Free catalog. Dressner, 69-02M, 174 St., Flushing 65, N. Y.

**AMPEX** Tape recorders, components. Boynton Studio, 10-PM Pennsylvania, Tuckahoe, N. Y.

**LEARN** While asleep with amazing "Electronic Educator" endless tape recorder. Details free. Research Association, Box 24-N, Olympia, Washington.

**2-TRANSISTOR** Wrist radios including earplug, \$9.95. Kiktavi Imports, 6612 Kalaniana'ole, Honolulu, Hawaii.

### BUSINESS OPPORTUNITIES

**BECOME** Finance specialist. Handsome profits. Tucker Associates, 3633 Warder N. W., Washington 10, D. C.

**CANDIED** Popcorn and potato chip equipment. Eakins, Box 933-A9, Springfield, Ohio.

**EARN** \$100.00 Weekly part time from your arm-chair and in one year you'll receive a free trip to Europe for two. No selling. No mailorder. Pan Pacific, TDC, Box 595, Laguna Beach, Calif.

**EXCEPTIONAL** Mailorder opportunity! Write: George Lenhoff, Box 201, Lincoln 1, Nebraska.

**OPERATE** Collection agency. Gold mine opportunity. Lifetime business. Be respected. Franklin Credit, Roanoke, Va.

**JAPAN** Contacts. 145 manufacturing exporters, Japan and Honk Kong trade journal information. Asia opportunities, \$1.00 today. Nippon Annai, Box 6266, Spokane 28, Washington.

**PROFITABLE** Mailorder business! Write: Cal Enterprises, Box 1592, Beverly Hills, California.

**CASH** From sawdust, tin-cans, newspapers. Over 200 methods. Instructions \$1.00. Charles Company, 42-GPM, Norwood, Ohio.

**WANT** To make good money at home for a few hours work? Franchised and no selling. Information free. Marshall's 4154B Commerce Station, Phoenix, Ariz.

**AMAZING** Profits manufacturing concrete drain tile! Details free. Ceeten Products, Cornelia, Ga.

**OPERATE** Profitable low cost mail order business. Write: Liberty 210-R Fifth Avenue, New York 10, N. Y.

**LIQUID** Marble. Colorful, glossy! Molded, brushed, sprayed! Particulars free. Marbleizing Service, Edwardsville, Illinois.

**OPERATE** Profitable mail order business! United Wholesalers, 1265-CR Broadway, New York 1, N. Y.

**GLASHEEN** Window cleaning concentrate. Easiest money maker in years. Two vials of crystals that make six quarts and plastic spray bottle for \$1.98. Your cost \$1.76 per case of twenty-four. (Exclusive territory can be arranged.) Glasheen Company PM1, Box 240, Lancaster, Ohio.

**MAKE** Extra money—Big cash commissions plus premiums for you and your customers. Sell advertising book matches. Sensational new tenor, glamour girls, hillbillies; dozens others. All sizes. Quick daily sales; big repeat business. Free master kit makes selling easy. No experience necessary. Superior Match, Dept. MX-959, 7530 Greenwood, Chicago 19.

**FLOK-KRAFT** Christmas trees! Earn big profits spraying ordinary cheap trees into beautiful, colorful, "cashmere-soft" specimens that bring 10 times original tree cost. Be first your area this Christmas. Free sample and booklet showing "50 Other Ways to Earn Big Flok-Kraft Profits." Flok-Kraft, SRX, Los Angeles 61.

**GAME** Warden, government hunter, forestry, park and wildlife services announce job openings. All states. Enjoy outdoor work, good pay, real security. Complete information free! Write Forestry & Wildlife Course, Dept. CC-179, 1038 S. LaBrea, Los Angeles 19, Calif.

**PLASTERCRAFT** Molds, liquid rubber, plasters, flocks, candle supplies. Catalog and manual free. Blue Rapids Supply, Blue Rapids, Kansas.

**CONVERT** Furniture to slenderizer-massager. Agents wanted. Details free. Ardale, 135 Jewell St., Garfield, N. J.

**FRANCHISES** Make profits! Have your own profitable franchise business. Opportunities nationwide for distributors, dealers, agency operators. Join thousands of ambitious men throughout America who secure their franchise guidance each month from National Franchise Reports. This pioneer franchise reporting service has been recommended in business books, magazine and newspaper feature articles. It is the authoritative, recognized national clearing house for franchise information. Let NFR assist you in securing a valuable franchise. Write today for interesting, free details of this helpful service. National Franchise Reports, W-528, 333 North Michigan, Chicago 1.

**WANTED**, Men, women, raise bait for us at home. Full, spare time. Doesn't take up space. We furnish everything. Sherwood, Dept. O-2, Monmouth, Maine.

**MAILORDER** To churches, motels, restaurants, institutions. Complete, individual set-up, not just instructions. Hermes Advertising, 152-C West 42, New York City 36.

**SHINE** Shoes without polish. New invention. Lightning seller. Shoes gleam like mirror. Samples sent on trial. Kristee 110, Akron, Ohio.

**MOTEL-Resort** management. Qualify for hundreds fascinating, leisurely, well-paid executive openings. Learn at home. Free booklet. Motel Managers Training School, PM109, 612 S. Serrano, Los Angeles 5.

**\$250.00 WEEK** Profit possible. Earn at home spare time with fascinating printing method. \$5 starts you. Send no money now. Free confidential facts and valuable samples. Screen-Print SR, Los Angeles 61.

**START** Your own business on credit (U.S. and Canada). Your own boss. 1383 dealers sold \$5,000 to \$33,500 in 1958. We supply stocks, equipment on credit. 200 home necessities. Sales experience unnecessary. Pleasant profitable business backed by world-wide industry. Write Rawleigh's, Dept. I-U-PPM, Freeport, Ill.

**GROW** Living miniature forest (only inches high) or orchard that bears tasty tiny fruit. Learn amazing dwarfing secrets! Fascinating hobby! Profitable home-business opportunity! Free seeds and plan. (State your age.) Miniature Nurseries, Dept. SR, Gardens, California.

**IMPORT-Export** opportunity, profitable, world-wide, mail-order business from home, without capital; or travel abroad. Established world trader ships instructions for no-risk examination. Experience unnecessary. Free details. Mellinger, X709, Los Angeles 24.

**NATURAL** Molding rubber, extra thick. Free sample. W. Wooley, 1016-A Donald, Peoria, Illinois.

**OPERATE** Profitable mail order business. Write Wayne's Service, 3016-MM Channing N.E., Washington 18, D. C.

**"MAILORDER** Laws and Regulations," "Mailorder Rules for Beginners," "Selling Information by Mail," "Simplified Mail-order Bookkeeping System." \$1.00 each. Helpful books explaining different licenses, taxes, legal requirements, etc. (Catalogue free.) Tasker, Box 3131, Alexandria, Virginia.

**FREE** Plan and personal help. Retired mail order operator will show you how to start profitable home business. Norris Cole, 217 West 49th, Bradenton, Florida.

**OPPORTUNITIES** Galore, profitable & exciting. Details free. Watson Variety Sales, 261-C Watson Blvd., Pittsburgh 14, Penna.

**NEW** Big profit dealership mail-order plan builds your own business. Send \$1.00 (refundable) for details. Cecil Dykes, Block City, Church Hill, Tennessee.

**YOUR** Own home-operated business. Take over your area as our service distributor keeping retail stores supplied. Nationally advertised 30-year-old line pays up to \$20.00 hour. Under \$100.00 for merchandise gets you started. For samples, highly successful plan, write Novo, 3855 Lincoln, Desk G-67, Chicago 13.

**"FORTUNES** In Formulas." Greatest money-making idea book in the world. 900 pages. \$3.95. Satisfaction guaranteed. Free literature. Rollin Hill, 20-A West Jackson, Chicago 4, Illinois.

**MONEY** At home raising fishworms for us. Down-East, Box 149, Bangor 3, Maine.

**WORK** At home. We supply everything. Send for free details. Suffolk Ceramics, 366, Centerport 1, N. Y.

I Got rich in the dry cleaning business with no investment, so can you. Free details. Write: Imperial School of Dry Cleaning, Dept. PMC, 1700 Touhy Avenue, Chicago 26, Illinois.

**HEAVY** Brown 9x12 envelopes for mailing folios, manuscripts, photographs, etc. 24 for \$1.00, 100 for \$4.00. Sample free. Tasker, Box 3131, Alexandria, Virginia.

**WANTED**: Home producers, to be subcontractors. Cast plastic products for manufacturers in our clearing house service. Thousands of easily made items required. Cash in at home, without previous experience. Plastic Service Associates, Dept. 9PM, East Boston 28, Massachusetts.

**TREMENDOUS** Profits by mail! Booklet, literature. 25¢. Labranche, 308 Gagne, Rouyn, Quebec, Canada.

**OWN** A business. Manufacture building material. Great demand. Particulars free. Morris, 713 So. Wabash, Urbana, Illinois.

**MAILORDER**, America's most unique no cost plan for beginners, Armstrong's, 154A Darrington St. S.W., Washington 24, D. C.

**\$3.00 HOURLY**, Typewriter required. Confidential homework literature 35¢. Interstate, Del Station, Albany 9, N. Y.

**STRIKE** It rich on small home repairs by using set prices. Details free. House Clinic, Dept. P, 7307 Fenton, Dallas 31, Texas.

**NEW** Home-import mail order profitability! Your mailbox stuffed with money! No selling. No experience. No investment. We supply everything. Free details. Mail Order Distributors (Import Division), 15201 South Broadway, Los Angeles 61A9, Calif.

**PLASTICS**, Import-export, mail order businesses offered in new three-in-one money-making opportunity. Send for free details. No obligation. Trialpha, 7950 Mammoth Ave., Dept. P39, Van Nuys, Calif.

**COLOR**-Lighted water fountains beautify lawns, gardens, patios, commercial displays. Littleford Products, 6271 Truitt, Salisbury, Maryland.

**IMPORT** Direct through German, Japanese agents. Lowest prices; fastest service. Guaranteed contacts, \$1.00. David Henderson, 2620 Rio Vista, Tampa 3, Florida.

**MAIL** Order Guide, rules. Lists publications, 50¢. Curtiss Publications, 312 Olive, Porterville, Calif.

**MANUFACTURE** Toys, vinyl dolls, plush animals, houses, 500% profit. 10¢. Benko, 1351 First Ave., New York City 21.

**INTERNATIONAL** Home import mail-order business! Earnings unlimited. Experience unnecessary. Foreign Traders, 7814-BJ Forsyth, St. Louis 5.

**WANT** Security? Raise earthworms! 1000, \$6.00. Free booklet with order tells how. Sierra Worm Ranch, Box 2756, Fresno, Calif.

**MAKE** Durable building plastic easily. Beautiful, 101 uses. 800% profit. Bays Laboratory, Keams Canyon, Arizona.

**OPERATE** Fabulous mailorder business from home. Start on special easy payment plan. Amazing details free. Baker, Box 108-P, Sugar Land, Texas.

**PLATE** Baby shoes, jewelry, gifts. Bronze and colored pearl. We finance home businesses. Booklet free. Platex, 11029 South Vermont, Los Angeles 44.

**PROFIT** With Popular Mechanics' subscription plan. No investment, no experience needed. Earnings begin immediately when you obtain subscriptions for Popular Mechanics, Good Housekeeping and others. High commissions, bonus. No experience needed. Deal directly with the publisher. Write Popular Mechanics, Room 9B, 250 West 55th St., New York 19, N. Y.

**LEARN** Landscaping and the growing of plants. Start a profitable business part or full time. Free information without obligation. National Landscape Institute, Dept. MC-99, 11826 San Vicente Blvd., Los Angeles 49, Calif.

**APPOINTING Distributors.** In Midwest, west and some eastern areas. New proven repeat consumer product group by reputable company. Marketing methods and company support takes advantage of current radio and television advertising. Territories have annual profit potential of \$20,000 to \$50,000. Prefer aggressive individual capable of expanding to full potential. Must have modest working capital. Write for details. F. A. Products, 600 So. Michigan, Chicago 5, Illinois.

**IMPORT** For profit. Our facilities at your service. Free air mail particulars. Boisclair Buyer's Service, Box 377, Gelsenkirchen, Germany.

**FRANCHISED Dealerships** available. The Putt-Nik Fun Cart. Most competitively priced and popularly accepted of all carts. Nationally advertised. Write now to Putt-Nik Sales, Inc., 1430 West Peachtree St., Atlanta 9, Ga. Manufactured by Cummings Enterprises, Washington, Ga.

**SIX Mailorder trade magazines,** 25¢. Thompson, Box 94-PM, Salinas, California.

**DOLLS! Dolls! Dolls!** We teach you to repair, make, sell, all kinds. Study at home. Earn while you learn. Free information. Doll Hospital School, Studio PM-99, 11826 San Vicente Blvd., Los Angeles 49, Calif.

**FREE.** New, profitable imprint circulars. Possible \$5.00 monthly bonuses! Details, 10¢. Jones, Box 78-22, Brooklyn 33, N. Y.

**FREE!** Name brands catalog! Your own high profit business. Sell name brands, full or part time. No inventory, no investment. More than 2,000 name brand items; lowest wholesale prices. Watches, jewelry, cameras, hi-fi, stereo radios-phonos, appliances, housewares, hardware, power tools, luggage, musical instruments, garden equipment, sporting goods, toys, many others. 8 floors of name brands. Million dollar inventory. Orders shipped complete in 24 hours! Send for free, beautifully illustrated catalog now! Separate wholesale price list. H. B. Davis Corp., Dept. 11, 145 W. 15 St., New York 11, N. Y.

**MAILORDER!** Succeed with your own guaranteed profit mail order business. No inventory. We dropship and show you how to make big profits. Write Gifftime, 919 Walnut, Dept. GPM, Philadelphia, Penna.

**LEARN** Sewing machine repairing. To \$125 weekly. Sparetime. Supplies. Add to present business. Shipping from Chicago, New York, Los Angeles. Write today! Taylor Service, Box 2126, San Bernardino, Calif.

**IF** You like motorcycles and money then send for Harley-Davidson dealership book on how to become a franchised dealer of motorcycles and a new line of motor-scooters. Here's a chance to own your own business with a very modest investment. The youth market is beginning to explode and the next few years promise a chance to cash in on it. Write for free illustrated dealership book today. Harley-Davidson Motor Company, Dept. P. Milwaukee 1, Wisconsin.

**EARN** Money at home raising fishworms for us! Backyard, garage, basement. We buy your crop! Inquire: Oakhaven 38, Cedar Hill, Texas.

**BUY** Direct from factories. Appliances, cameras, watches! Free details! Cam Company, 6810PM-20th Ave., Brooklyn 4, N. Y.

**BUSINESSES,** Resorts, motels, investment property, ranches. Our special service dept. at your disposal. No obligation. World's largest. 58 years' service. Strout Realty, 7-MB S. Dearborn, Chicago 3, Ill.

**BIG** Money raising fishworms and crickets. Free literature. Carter Farms, Plains, Georgia.

**QUICK** Profits, with no capital! Take orders for magazines your neighbors like, want. Make cash on the spot! We show how with free kit. Get yours now. Write McGregor Magazine Agency, Dept. 311, Mount Morris, Ill.

**OPERATE** Mailorder folio business. Free details. Ballard's, 1834 Edgeland, Louisville 4, Ky.

**\$34.70 TWO** Hours. Manufacturing concrete products. No selling. Carlayne Castings, 1803 Fremont, Rapid City, South Dakota.

**TO \$100.00 Weekly.** Sparetime, home operated mailorder business. Successful beginner's plan. Everything supplied. Lynn, 10420-M National, Los Angeles 34.

**COLORGLAZED** Concrete pottery made without molds. Patented method. Cemetery products, novelties, tiles. Basement leak-sealing. Money-making projects. Booklet, details free. Men only. National Potteries Company, Grand Rapids, Minnesota.

**PIANO** Tuning learned quickly at home. Tremendous field! Musical knowledge unnecessary. Information free. Empire School of Piano Tuning, Champaign, Ill. (Founded 1935).

**WANT** To make big money at home? \$10.00 profit in an hour possible with invisible mending. Make tears, holes, disappear from clothing, fabrics. Steady year-round demand from cleaners, laundries, homes. Details free. Fabricon, 6234 Broadway, Chicago 40, Illinois.

**\$70 WEEKLY**—Home, spare time. Simplified mail bookkeeping. Immediate income—easy! Auditax, 34757A, Los Angeles 34.

**MAKE** Flexible molds. Cast plaques, figurines. Free sample. Tooker, 1045-R Fairview, Hamilton, Ohio.

**I** Want to send you proof of the wonderful pulling power of Popular Mechanics classified pages. What's your proposition? Write me today. Include literature if possible. F. W. Johnson, Manager Classified Advertising, Popular Mechanics Magazine, 200 E. Ontario St., Chicago 11, Ill.

**INCOME** With garden golf. Motivated archery ranges. Brockway, Box 3924, Portland 8, Oregon.

**OPERATE** Profitable mailorder business! Write: Bond, 1637-H West Vernon, Phoenix, Arizona.

**11,000 NEW** Prospects daily. Baby record books, shoes, albums. Sell mailorder. Use our literature. Write: No-Co-Ro, Capitola, California.

**COPUBLISH** Mail Sale Advertiser, leading mail order paper. Details, latest copy, dime. Vanroy Shirk, Lebanon, Penna.

**FREE** Catalog. Contains hundreds of businesses, farms and income properties throughout U.S., Canada. Specify type and location desired. Deal direct with owners. U. I. Buyers Digest, 1608 Hillhurst, Dept. PM-3, Los Angeles 27, Calif.

**BRONZE** Baby shoes; Instructions, equipment and mountings for genuine electroplating process. Largest supplier of all plating equipment, supplies. Free catalog. Hollywood Bronze Supply, Dept. B-3, 1624 East First, Los Angeles 33, Calif.

**MAKE \$46** From square foot plywood; jig saw necessary. Free details. Woodart, Bridgewater, Mass.

**MARKETS** Everywhere. Make artistic concrete birdbaths, pottery. Best coloring. Home workshop. Hundred varieties. Hollywood Cementcraft, 8527-S Wonderland, Hollywood 46, California.

**LIQUID** Molding rubber, free sample. Shellcraft supplies. Chaney's, 1907-A East Road, Jacksonville 11, Fla.

**FIX** Typewriters. Free repair course. Home operated. Remit 25¢ for book explaining free course and agency appointment. Athey, Tarentum, Penna.

**MAKE** Money by mail! Free details! Hunholz, 902 Eighth, Wamego, Kansas.

**MANUFACTURER** Fishing lures, plastic, none better. 26 models pennies. Free circular. Quaker, 3514-24 N. Lawrence, Philadelphia 40, Penna.

**OPERATE** Profitable mail order business. Write Walter Service, 4159A East 112th, Cleveland 5, Ohio.

**EARN** Good money sharpening chain saws, scissors, cutters, knives. Free manual. Treyco, North Tonawanda, N. Y.

**ROBINSON'S** Sewing Machine Service Manual. 579 illustrations. 144 pages. Earn to \$5 per hour. Price \$6.25. Lee Robinson, Book Nook Bldg., Walla Walla, Wash.

**RE-Cast** junk batteries into new. Latest achievements. Battery Laboratories, Bayou LaBatre, Alabama.

**\$100 WEEKLY!** Men, women! Work home! Sparetime. Free "Confidential Plan." Scott Sales, Box 388, Great Neck, New York

**IMPORT-Export** business made easy. Individual setup service. Not just instructions. Hermes, 152 West 42, New York City 36.

**HAVE** A profitable business of your own selling the "World's Most Usable Pictorial Bible." Let our 26 years experience help you. International Book Company, Dept. M., P. O. Box 118, Wichita 1, Kansas.

**MAIL** Order business. Avoid losing money through errors of judgement. Read, "I was wrong about that", by Arthur Sizemore. Send for free copy. John Bishop, Box 153B, Ojai, California.

**BE** Appointed state notary public now. Details. Stationers, 515 East 33rd, Kansas City 9, Missouri.

**BAKE** New greaseless doughnuts in kitchen. Sell stores. Free recipes. Montgomery, 3605 South 15th, Minneapolis 7, Minnesota.

**PROFITABLE** Mailorder operation! Write: Vikari, 468PM 3rd Avenue, Salt Lake City 3, Utah.

**\$3.00 HOUR**—Home, sparetime, assembling pump lamps. Easy. Free details. Ougor, Caldwell, Arkansas.

**ADVERTISING** Line, markup plus production commission. Cooke Company, 3-1 Chome Yurakucho, Chiyodaku, Tokyo, Japan.

**OPERATE** Profitable mail order business. Write Hunt Enterprises, 978 Terrace Dr., Salem, Oregon.

**YOUR** Own successful business can bring \$1,000 monthly by mail at home. Free details. DeLang Research, Box 52-D, Burlington, Iowa.

**YOUR** Own business! Sharpening scissors. Steady profits. Blackhaws, Sheldahl, Iowa.

**RAISE** Angora, New Zealand rabbits, fishworms on \$500 month plan. Free details. White's Rabbitry, Delaware, Ohio.

**WHOLESALE** Catalog free — shoes, shirts, pants, hosiery, etc. Bostonian, 40-CA Harrison Avenue, Boston 11, Mass.

**GIANT** Homework opportunities 25¢. Kengee, 1105 Morning Glory, Durham, N.C.

#### MONEYMAKING OPPORTUNITIES

**WEAVE** Rugs. Make good profits. No experience necessary! Free catalog, sample card, and low prices on carpet warp, rug filler, looms, parts, inexpensive beam counter. If you have loom, give make, weaving width please. OR. Rug Company, Dept. 9972, Lima, Ohio.

**\$5,000 YEAR** Possible. Make new exclusive wood products. Sell by mail. Steady demand. Booklet \$1.00. Gabert, 907 Birch, Eau Claire, Wisconsin.

**AMAZING** Successes through franchises! Secure your own profitable franchise business. Alert yourself to nationwide opportunities. They are published each month by National Franchise Reports. This is the pioneer franchise reporting service recognized nationally as the clearing house of franchise information. Send today for free, interesting literature. National Franchise Reports, MP-528, 333 North Michigan, Chicago 1.

**MAKE** Big easy profits making costume jewelry at home in spare time! Quick, easy to make, easier to sell! Details free! Don-Bar, 3511 W. Armitage, Dept. J-192, Chicago 47, Illinois.

**HOME** Mail business. Magazine 35¢. Davies, Box 54PM, Hammond, Ind.

**CAMERA** Profits. Five plans, photo markets Only \$1.00. Grote, P. O. Box 266, Bronx 51, New York.

**\$150.00-\$200.00 WEEK** Repairing typewriters. Send \$3.95 for course. Typewriter, Box 317, Walden, N. Y.

**FREE** Catalog. Sell costume, religious jewelry. 200% profit. Sample \$1.00. John Clark, Box 40, New York 12, N. Y.

**REPAIR** Hydraulic jacks. Illustrated repair manual \$3.98. Free information. Hydraulic Parts Supply, Box 4104, El Paso, Texas.

**CIGARETTES:** Make 20 plain or filter-tips for 3¢. Facts free. Moberly, Box 831, Owensboro, Kentucky.

**\$200.00 MONTHLY.** Spare time. With table saw, bandsaw or jig saw. Write. Holiday House, 7228 4th Plain, Vancouver, Washington.

**FREE Home money-making plan!** Merrill Hilstad, Box 182F, Hatfield, Penna.

**PRACTICAL Mallorder.** Start small. Money-maker, 722 East Silver Spring, Milwaukee 17, Wisconsin.

**EARN \$5,000-\$15,000 Yearly** at home in respectable field. Only 3 hours weekly attention needed. No public contact, no experience necessary. Exceptional but true. Rush \$1.00 for complete detailed plan. Satisfaction or refund. Columbia Enterprises, Ltd., 9268-PM Piney Branch Road, Silver Spring, Maryland.

**HAVE Big paying home mallorder business!** Many new, sparetime moneymaking opportunities now available! Details free! Steinger, Box 181-PM, United, Pennsylvania.

**SELL To stores.** Big profits. Samples \$1.00. Refunded first order. Creative Products, Box 423, Connerville, Indiana.

**FORTUNE.** Bronzing baby shoes, growing miniature trees, manufacturing rubber stamps. All instructions, \$1.00. Davis & Sons, Box 1511, Levelland, Texas.

**BIG Profits** from amazing catalog plan. Work home. Rowe, 2317P Marshall, Chicago 23, Ill.

**WIN Contests.** Latest contests, helps. Contests, 25 Earl, Red Bank, N. J.

**NEW Publishing franchise plan.** Highly profitable, continuous income. Full-sparetime, men-women. Operate from home. No capital, equipment, experience needed. Free details on exclusive rights. Calendar, 181-5 Apple Tree, Winnetka, Illinois.

**START A profitable subscription business** in spare time! We need men and women (young or old) as representatives for all leading national magazines. Liberal commissions on all subscriptions. Supplies free. No experience needed. Send this ad with your name and address to: Popular Mechanics, Room 9-0, 250 West 55th St., New York 10, N. Y.

**INVISIBLE Reweaving:** \$5 in one hour possible reweaving burns, tears, moth-holes. Spare-full time. Free details. Skill-Weave, Dept. SC-169, 335 W. Madison, Chicago 6.

**START Big-pay business** at home in spare time. No experience needed to operate little table-top machine for bronzing baby shoes. Make \$5.46 profit on every pair. Full particulars free. Send postcard to Mason, 1512 Jarvis, Room CM-2-H, Chicago 26, Ill.

**EASY To start rubber stamp business** at home in spare time. Make up to \$9.80 an hour without experience. Facts free. Write to Roberts, 1512 Jarvis, Room CR-2-H, Chicago 26.

**SNAKES** Are worth up to \$25.00, each. Lizards \$8.00. Turtles \$25.00. Toads and frogs \$1.75. We buy all kinds, sizes. Full details and collectors brochure 25¢. Biological Exchange, 1211L Wagner Lane, El Paso, Texas.

**WE Pay \$3.50 lb. dried.** Grow mushrooms. Cellar, shed and outdoors. Spare, full time, year round. We pay \$3.50 lb. Free book. Mushrooms, Dept. 173, 2954 Admiral Way, Seattle, Wash.

**EARN Money evenings** copying and duplicating comic cartoons for advertisers. Adservice, Argyle 1, Wisconsin.

**YOUR Own, easy-to-start, home mail-order business.** Sparetime. Fascinating; profitable! Information free. Alfano, 19-PM Pine, Closter, N. J.

**HAMMER? Saw? Drill?** \$100 weekly. Jett, Box 422, Escondido, California.

**\$340.00 MONTHLY** With jigsaw. Details. Elkman, 346F North Summit, Sioux Falls, So. Dak.

**BIG Money raising** fishworms and crickets. Free literature. Carter Hatchery, Plains, Georgia.

**SELL Titania gems.** Far more brilliant than diamonds. Catalog 10¢. Diamonite, 2420-M 77th, Oakland 5, California.

**BOOKS;** Hundreds of subjects. Big 1958 book catalog—10¢. Popular Mechanics Press, 200-BC East Ontario St., Chicago 11.

**WIN Contest money.** General Contest Bulletin gives hundreds of tips. Lists current contests, rules. Sample magazine 25¢. General Contests, 1609½ East 5th, Duluth 12, Minnesota.

**MAKE Money writing** short paragraphs. Information free. Barrett, Dept. C-27-D, 7464 No. Clar., Chicago 26.

**MEN — Women!** Start money-making plastic laminating business at home in spare time. Material that costs 11¢ brings back \$2.50. No canvassing or selling but mail orders bring in \$20 a day. Write for full particulars free. Rush name on postcard to Warner, Room CL-2-H, 1512 Jarvis, Chicago 26, Ill.

**11 MONEY Making methods.** Each worth big money to you. Free details. Griffin, 322 W. State, Ithaca, N. Y.

**READ "Progressive Mailtrade,"** the magazine that tells how to make money by mail. Quarter brings sample and special offer. Progressive Mailtrade, Box 357, Sheboygan, Wisconsin.

**BIGGEST Money makers** in the field. Acme saw and lawn mower sharpeners. Free literature. Max Mfg. Co., 138 Stockton Ave., San Jose 26, California.

**MONEY In your spare time.** Become a notary public. One collar brings full details. JoMar, P.O. Box 142, Baltimore 1, Maryland.

**CATHOLIC Religious articles** including large Catholic Bible. 50% discount. Start your own business. Catholic Guild, 11 Harding Ave., White Plains, N. Y. Samples and kit \$1.00.

**OPERATE Home mail-order business.** Vosacek Printing, 4444A Ute, San Diego 17, Calif.

**TWO Hundred dollars per week lifetime income.** Self-employment, security, independence, free guidance. Five dollars starts you. MacRay Chemicals, Littleton 1, New Hampshire.

### FORMULAS, PLANS, ETC.

**LATE, Modern manufacturing formulas.** List free. Moon Chemical, Martville, New York.

**FORMULAS For latest money-making discoveries.** New! Good! Valuable literature free! Miller, Chemist, 1517-D, Tampa, Florida.

**FORMULAS;** All kinds, latest, best. Literature free. Kemixal, Park Ridge, Ill.

**OPPORTUNITIES, Unlimited!** Latest specialty formulas, analyses, development, consultation. Monthly report of newest products. Exciting details, free. Alpha-Midwest, LaPorte, Indiana.

**6 LOW-Cost, high profit formulas.** Proven money makers! Ford Chemical Co., Box 8665, University Station, Knoxville, Tennessee.

### PLASTICS

**MAKE, Sell signs** (plastic letters). Dixie, Lakeland, Fla.

**LAMINATING Supplies.** Price list free. Solomonson, 46 Cornhill, Boston 8, Mass.

**NEW Liquid casting plastic, clear, colors.** Embed real flowers, butterflies, photos, coins. Send 25¢ for two handbooks "How to Cast Liquid Plastics" and "How to Make Extra Money at Home." Castolite, Dept. K-101, Woodstock, Illinois.

**SIMPLIFIED Plastic molding, repairing.** trial unit \$2.00. Hallmark Dental Co., Box 1924, Detroit 31, Mich.

**NEW Do-it-yourself casting and molding plastics!** No experience or machinery necessary. Send 25¢ for big 64-page catalog. Castacraft Corp., Dept. O-22, P.O. Box 555, Palo Alto, California.

**PLEXIGLAS.** Square foot cost, 1/16", \$1.20; 1/8", \$1.52; 3/16", \$1.86; 1/4", \$2.21; 3/8", \$3.23; 1/2", \$4.36. Colors add 10%. Send 15¢ for postage. Aristocrat Plastics, 23 Sussex Avenue, Newark, N.J.

**BOXES, Plastic.** Free list. Althor, 170 Bay 23 Street, Brooklyn, N.Y.

**LEARN Plastics fabrication** for spare time income. Low cost home training now available. Write for free booklet. Interstate Training Service, Dept. D-3, Portland 12, Oregon.

**NOW, Electric plastic laminating kit.** Profit. Pleasure. Burr, 330 East Center, Kalamazoo, Mich.

### CHEMISTRY

**LABORATORY Chemicals and apparatus.** Catalog 50¢. Atlas Chemicals, Box 22, Rupert, Idaho.

**FREE Introductory offer.** Student chemicals, apparatus, biology supplies. Catalog 25¢. Bio Chemical Products, 30 Somerset St., Belmont 78, Massachusetts.

**NEW 52 Page science catalog.** Prices reduced 30%. Catalog 25¢. Winn Chemicals, 124M West 23 St., New York 11.

**EXPERIMENTERS:** Terrific bargains galore, catalog 25¢. Hagenow Laboratories, Manitowoc, Wisconsin.

**AMAZING New book of science experiments, formulas, and catalogue** of laboratory supplies. Only 35¢. National Scientific Co., 13 S. Park Avenue, Dept. PM-9, Lombard, Illinois.

**BOOKLETS:** Chemistry, Physics, Astronomy, Science, Relativity, Electricity, Radio, Light, Tables, Mathematics. 15¢ each. Franks, 3121 South Racine, Chicago 8.

**CATALOG, 3000 illustrations.** \$2.00. Laboratory Materials, 7315 Vincennes, Chicago, Illinois.

**ROCKET Chemicals, supplies for amateur research.** Catalog 25¢. Central Rocket Company, Box 890, Waupaca, Wis.

**CHEMICALS And apparatus for industrial, analytical, and private laboratories.** Catalog 25¢. Dept. M-50. Biological Supply Co., 1176 Mt. Hope Ave., Rochester 20, N. Y.

**ILLUSTRATED Catalog:** Chemistry, mineralogy, biology 25¢. Tracey Laboratories, Evanston, Illinois.

### HELP WANTED

**SENIOR Metallurgist** in the field of research in physical metallurgy dealing with studies of transient loads having high magnitude and short duration. A better understanding is being sought of shock wave transfer and fracture mechanics, particularly in the light metals. Permanently established research program. Located in town of 6000 pop. Excellent year-round climate with exceptional outdoor recreational facilities. Write Personnel Manager, New Mexico Institute of Mining and Technology, Campus Station, Socorro, New Mexico.

### AGENTS WANTED

**CUSTOMER—Making gift free!** Introduce thrilling, new Christmas card line by giving friends fine, imported gifts for only 39¢. Easily make \$50 to \$250 spare time. Experience unnecessary. 2 assortments on approval. Name-imprinted samples and gift free. Midwest, 1113 Washington, Dept. 443-L, St. Louis 1, Mo.

**NEW Car thief signal.** Lightning seller. Samples sent on trial. Northwest Electric, 225, Mitchell, S. Dak.

**EXCITING New jewelry item.** Tremendous profits. Complete details free. Blyt-mann Company, Box 2401-A, San Francisco 26, California.

**CHRISTMAS Cards** with customer's name imprinted. Broad-appeal personal designs and big-volume business designs all in one attractive presentation album that actually sells for you! These deluxe cards pay deluxe commissions. Earn \$300 to \$500, plus bonuses, easily between now and Christmas, even in spare time. Sales experience unnecessary. Old-established manufacturer. Free sales kit includes sample album and complete, easy-to-follow selling instructions. Send for kit now and pocket profits next week! Write Process Corp., Dept. 4B, 1954 S. Troy, Chicago 23, Ill.

**MEN! Make extra money** selling fast-selling line; reasonably priced toys, gift wraps, greeting cards, collector's items, household gadgets. Work your own hours. Extra income without changing jobs. Take orders from colorfully illustrated free catalog of 785 money-makers. No big investment. No experience needed. Samples on approval. Write: North Star, 9-734 Finch Bldg., St. Paul 1, Minnesota.

**EASIEST \$60 To \$160 you'll ever make!** Exciting new Southern Beauty Christmas cards; \$1 ceramic gifts pay huge profits. Free 25th anniversary personalized album, samples on approval. Special anniversary free gift offer. Write Southern, 478 N. Hollywood, Dept. P-63, Memphis.

**MAKE \$1,000 Before Christmas!** Over 800 best-selling items! Gifts for men, women, children, the home! Distinctive greeting cards, stationery, jewelry, cosmetics, mechanical gadgets, novelties, household helps, toys, games at prices to fit every pocketbook. No minimum order. Samples on approval. Make up to 92% profit! Write today for free details. Greetings Unlimited, 9-380, Park Square, St. Paul 1, Minn.

**60% PROFIT** On cosmetics — Famous nationally advertised Hollywood cosmetics pay 60%. Make \$25 day up. Hire others. For free samples, details, write Studio Girl, Glendale, Calif. Dept. 1299G.

**MAKE Money 50% faster!** Keep 75¢, not 50¢, on \$1.25 Christmas card assortment; \$75.00 on hundred. 250 best assortments, gifts, \$1 up. Free samples 59 imprinted cards. Gift bonuses. Approval samples. Free gift offer. Creative. 4401 Cermak, Dept. 507-L, Chicago 23.

**SELL Portraits** painted in oils. Write Portraits, 402-D Hazlett, Baltimore 29.

**150% PROFIT** Selling amazing Spark Booster: Pep up cars, trucks, tractors like new! Install in one minute. Instantly improves performance; mileage; prevents plug fouling! Guaranteed \$2.00 postpaid. Broehm Products, M-2569 North 12th Street, Milwaukee 6, Wisconsin.

**BIG Profits** selling unique dictionary. Write Harrigan, 97 Warren Street, New York 7, N. Y.

**MAKE Extra money fast**—Show friends, others big value \$1.00-\$1.25 Christmas, year round greeting card assortments, gift wrappings, exciting gifts, household items, costume jewelry, stationery, toys. Profits to 100%. Bonus to 7%. Write for newest assortments on approval, free album name imprinted Christmas cards, free gift offer, details. Hedenkamp, 361 Broadway, Dept. PM-60, New York.

**EARN To \$25,000** first year selling phonograph records. Our new plan shows how. Boone's, 6647 Michigan, Chicago 37.

A Blizzard of winter sales, sell greatest idea yet for winter driving. Amazing Ice-Trak-Shon stones give traction to spinning wheels on ice and snow. Every car owner a prospect, a natural for volume service-shop sales. Now is the time to get going. Introduce yourself to wide line of product opportunities with our organization. \$1 brings you eye-catching sales sample, complete facts. Write Chemical Institute America, 14 Longworth St., Newark 2, N. J.

**2 SALES Daily** make \$150 weekly! Automatic new bed warmer you sleep on; out-sells electric blankets 10 ways. 9 of 10 demonstrations sell on assured sales plan. Electro Warmth, Dept. PM-959, Danville, Ohio.

**DAMASCENE Earrings!** Exotic orientalism. Huge profit. Ohga, PM-160, Sigakenkusatu, Japan.

**SCHOOL Seniors.** Be popular with classmates. Have spending money galore. Details free. CraftsCards, Box 235-L, Pittsburgh 19, Penna.

**EARN \$12,000 Yearly**—only two sales daily. World's best seller. The Holy Bible. Illustrated, Protestant or Catholic. Margareta's, P.O. Box 92, Hazleton 7, Penna.

**DRESSES 18¢, Blouses 39¢, skirts 69¢ (used).** Free catalogue. Ace, 196-PM DeGraw, Brooklyn 31, New York.

**BE The Popular Mechanics** representative in your neighborhood and earn big profits in your spare time. Write Popular Mechanics, Room 9A, 250 West 55th St., New York 19, N. Y.

**QUICKEST Money** with new Christmas cards. Show free sample exclusive 21-card \$1.25 assortment; make 75¢ on each, \$45.00 on only 60. Over 400 assortments, gifts, \$1 up. Leading \$1 box on approval. Personal album free. Cardinal, 1400 State, Dept. 51-G, Cincinnati 14.

**RUN A Spare-time** greeting card and gift shop at home. Show friends samples of our new 1959 Christmas and all occasion greeting cards and gifts. Take their orders and earn to 100% profit. No experience necessary. Costs nothing to try. Write today for samples on approval. Regal Greetings, Dept. 151, Ferndale, Michigan.

**MEXICAN Art goods!** Free sample! Send 14¢ stamps mailing. Sylviak, Apartado 9036, Mexico City.

**LORD'S Prayer** sachets—Lord's Prayer beautifully printed on gilt-edged envelope containing finest oil-base sachet in assorted popular fragrances. A self-seller. Send \$1. for sample dozen, refundable on your first order. Make up to 300% profit, and more! Canham Sachets, 257 South State Street, Elgin, Illinois.

**BIG Profits.** Stamp social security plates, key protectors. Sample 50¢. Catalog free. General Products, 188-PM State, Albany 10, N. Y.

**EASY Handwork** makes fast-selling useful articles. Sample free. Sunmade Company, Brockton 64, Massachusetts.

**PRINTING, Advertising** salesmen—Excellent moneymaking sideline selling decalcomania name plates, small quantities. Automobile initials, sign letters. Free samples. Raico, XL, Boston 19, Mass.

**GOLD Or silver** letters, numbers. Windows, doors, trucks. 1" to 6". 500% profits. Free samples. Atlas-T, 544 West 79th, Chicago 20.

**AGENTS — 300% Profit** selling genuine gold window letters; stores and offices. Free samples. Metallic Sign Letter Co., 1217-D West Newport, Chicago.

**YOUR Ad** in this space will get some good agents for you. Yes, I'll prove it. Write for Folder "A" right now. F. W. Johnson, Classified Advertising Manager, Popular Mechanics Magazine, 200 E. Ontario St., Chicago 11, Ill.

**YOUR Own business**—Used suits \$1.50, overcoats 65¢, mackinaws 35¢, shoes 12½¢, ladies coats 30¢, dresses 15¢. Enormous profits. Catalog free. Nathan Portnoy Associates, 2109-AA Roosevelt Road, Chicago 8.

**SELL Champion, AC, Autolite** spark plugs. Reconditioned, electroplated, guaranteed 10,000 miles. 100% profit. Free sample. Lee Plugs, 1608-E Roberts, Houston 3, Texas.

**TREMENDOUS Profits!** Every man, woman and child a customer. Used suits \$1.50, pants 35¢, dresses 20¢, shoes 20¢. Operate from store, home, car. Free catalog. Superior, 1250-A Jefferson, Chicago 7.

### BUY IT WHOLESALE

**BUY Wholesale:** 100,000 nationally advertised products. Appliances, cameras, sporting goods, housewares, watches, typewriters, tools, clothing, etc. Discounts to 60%. Buy-Rite, Box 258, Hawthorne 2, New Jersey.

**NEW Multicolor** wholesale catalog! Housewares, appliances, clothing, silverware, cookware, luggage, binoculars, shavers, radios, phonographs, cameras, projectors, recorders, typewriters, sewing machines, furniture, power tools, toys, sporting goods, watches, diamonds, jewelry, automobiles, etc. Name brands. Huge discounts. Postcard: Selbyco, Decatur 160, Illinois.

**FREE—500 Address** labels. Details, catalog 25¢ deposit. Pink-Paw Co., 1038 Hickory, Altus, Oklahoma.

**VIBRATING** Massage motor, 8 foot U.L. approved cord and switch complete, \$3.98 postpaid. Attach to chair, lounge, etc. Vimco, Inc., Box 498, Centralia, Ill.

**CHURCHES, Clubs, salesmen** discounts to 75%. Catalog \$2.00. Refundable on first order. The Dollar Stretcher, Box 1555, Indianapolis, Indiana.

**SALE.** Most items under wholesale. Catalog 25¢, refunded first order. Charles Carnus Co., Manistique, Mich.

**OREGON Chain** for all chain saws. 25% discount. Write: Barnett Equipment, So. Glens Falls 1, N. Y.

**ELECTRIC** Guitars, amplifiers, wholesale. Free catalog. Carvin PMW, Covina, Calif.

**BOOTS.** Handsome western styles. Free catalog. Austin Boot Co., Box 5303J, El Paso, Tex.

**USED** And new watches \$2 up. Free list. Southern Watches, 5-PM So. Wabash, Chicago 3.

**LARGEST Wholesale** supply source in U.S.! Furniture, clothing, appliances, housewares, automobiles and accessories, tools, sporting goods, hobby supplies, farm equipment, imports, new products, bargain merchandise. Free details. Associated Wholesalers, Box 2068-DD, Sioux City 4, Iowa.

**HANDMADE** Wellington and cowboy boots. Free catalog. Ysleta Boots, Box 815, Ysleta, Texas.

**BUY Wholesale**—shoes, shirts, pants, underwear, etc. Free catalog. Bostonian, 40-C Harrison Ave., Boston 11, Mass.

### SALESMEN—DISTRIBUTORS

**ANYONE** Can sell famous Hoover uniforms for beauty shops, waitresses, nurses, doctors, others. All popular miracle fabrics: nylon, dacron. Exclusive styles, top quality. Big cash income now, real future. Equipment free. Hoover, Dept. L-100, New York 11, N. Y.

**BUSINESS Representative** wanted, \$100 to \$300 weekly commission plus profit sharing bonus. Experience available. Vital service to business world. Territories now available. Permanent, 30 year old company. Bernard Gelpman, Director, 503C Crawford Building, Kansas City, Missouri.

**MAKE Extra money**—Big cash commissions plus premiums for you and your customers. Sell advertising book matches. Sensational new tenorrama, glamour girls, hillbillies; dozens others. All sizes. Quick daily sales; big repeat business. Free master kit makes selling easy. No experience necessary. Superior Match, Dept. M-959, 7530 Greenwood, Chicago 19.

**AMAZING** Invention stops slamming, banging doors! Big profits easy with lowest priced hydraulic door check for all type doors! 10-Second demonstration sell it. Kant-Slam, Dept. M-14, Bloomfield, Ind.

**MAKE Extra money** selling advertising matchbooks. Free catalog and sales outfit. Matchcorp, Dept. PM-99, Chicago 32.

**GET New shirt** outfit free; make \$90.00 weekly on 5 average orders a day. Famous quality made-to-measure dress and sport shirts at \$3.95 up sell fast to all men. No experience needed. Full or part time. Write: Packard Shirt Co., Dept. 930, Terre Haute, Ind.

**WILL You** wear new suits and topcoats without one penny cost and agree to show them to friends? You can make up to \$30.00 in a day even in spare time, without canvassing. W. Z. Gibson, Inc., 500 S. Throop St., Dept. X-626, Chicago 7, Ill.

**MAKE Up to \$50.00** a day soliciting delinquent accounts. Terrific commissions. Write today. National Credit, 304Y Pickwick Bldg., Kansas City 6, Mo.

**MASSAGE Equipment.** Samples at below wholesale. Write for literature. Vimco, Inc., P.O. Box 498, Centralia, Illinois.

**BIG Profit** repeats for years when you wholesale Night Shine reflectorized, adhesive backed letters. Millions in use but surface barely scratched. Sales kit and samples free. Scanlan, Box 3456, Chicago 54.

**WILL You** test new items in your home? Surprisingly big pay. Latest conveniences for home, car. Send no money. Just your name. Kristee 36, Akron, Ohio.

**SELL Chalkpad.** The chalk writing surface with a thousand uses. Sample 99¢. Details free. Endur, 721 Goshen, Visalia, Calif.

**CALENDARS, Printing.** Bigger commissions. Experience unnecessary. Catalogues furnished. Foester, 1520 Ardmore, Chicago 26.

**IT Ain't sellin'**—Just servicing! Stores make money for you every open hour. Tremendously successful! Free book, tells all. Write Novo, 3855 Lincoln, Dept. G-5, Chicago 13.

**YOUR Free copy** of world's biggest sales magazine tells you how and where to make more money on your own in selling. Write Specialty Salesman Magazine, Desk 5B, 307 North Michigan, Chicago 1.

**WANTED.** Fire extinguisher salesman. Huge profits. Out-O-Matic, 1737D East 31st, Denver 5, Colo.

**MAKE Money** selling sensational dwarf trees—Bear giant-size apples, peaches pears. Ornamental. Also Stark-Burbank standard trees, roses, shrubs, vines, etc. Outfit free. Stark, Dept. 30190, Louisiana, Missouri.

**BIG Profits** with America's fastest selling multiple vitamins. Details and sample package \$1.00. Retail \$3.98. Renhill Products Co., Newark 12, N. J.

**SELL No-Hoze,** the world's easiest car wash. 200% profit. Washes any car clean, regardless of mud or dirt coverage. No hosing, no rinsing. Polishes chrome. Wipe on—wipe off. That's all. Self dries. Car will never need re-waxing or re-painting. \$1.50 for 8 oz. bottle with sales plan. Postpaid. Money back guarantee. Reliable Laboratories, 3238 Fenkell, Detroit 38, Michigan.

**300% PROFIT** Selling at shows. 70% to stores. Eyeshield Co., 12 Pearl Street, Brookline 46, Mass.

**SERVICE Stations** and mechanics buy our product because it earns them \$10.50 per hour. Write. Certified Products 209, Louisville 11, Ky.

**EXCLUSIVE Territories** available. New fall line of advertising specialties and gifts calls for expansion of sales force. Our sales-tested advertising promotions stimulate business and build sales for our customers. Opportunity for a fascinating, lucrative career; no age limits, full or spare time to start. Year around business; sell now for Christmas delivery. Salesbuilders, Inc., W. P. Galer, 312 E. Court, Cincinnati 2, Ohio.

**ADVERTISING Salesmen.** New, exclusive items. Details free. Johnny Publishers, Box 423, Connersville, Indiana.

**SELL Birth perfumes, cosmetics, flavors, incense.** Zabe Company, 5512 Kinsman, Cleveland 4, Ohio.

**IMBED** in plastic. Sea life. Make pictures from shells, etc. Easy, pleasant. Creative designs, instructions, materials, kits. Mosaic kits from \$5.00 prepaid. Also mail order products. Agents wanted, distributors, salesmen. Free literature. Return if not pleased. Adele Lab Inc., 45-236, Miami, Florida.

**SELL** Reconditioned typewriters, adding machines. Write, Woods Typewriters, Bedford, Penna.

**IF** You're interested in making money in selling, see the hundreds of exceptional opportunities in Salesmen's Opportunity Magazine. Send name for your copy, absolutely free. Tell us what you're selling now. Opportunity, 848 N. Dearborn, Dept. 17, Chicago 10, Illinois.

**EARN** Big commission full or part time. Build profitable business of your own selling America's largest line low priced business printing. 360 page catalog samples hundreds of items used daily by business people. Advertising specialty line features imprinted ball pens low as \$9.95 for 100. Calendars low as \$5.95 for 100. Free sales kit. National Press, Dept. 8, North Chicago, Ill.

**SPECIALTY Men. Salesmen.** Build permanent income \$50 to \$125 a day, year round! Newly developed filters; approved for all military, residential, commercial, industrial installations. Write for details. Extraer, 1210 Chenevert, Houston 3, Texas.

**MAKE** Up to \$50.00 a day soliciting delinquent accounts. Terrific commissions. Write today. General Finance, 304V Pickwick Bldg., Kansas City 6, Mo.

#### EMPLOYMENT INFORMATION

**WANT** Free overseas job information? Write: Employment Headquarters, 79 Wall Street, Dept. 8-E, New York 5.

**FLORIDA Positions.** Agency lists, resumé application helps, \$1.00. Bryan, 2621 N. Charles St., Baltimore, Maryland.

**"HOW To Get Job You Want."** Free details. Thomas J. Surface, Director, Roanoke, Virginia.

**JOBS** On ships, \$100 weekly beginners, travel, adventure. Write Seaman's Service, Box 17-M, Brooklyn 8, N. Y.

**LOS ANGELES** Largest Sunday classified, \$1.00. Martin, 5837 Carlton Way, Hollywood 28, Calif.

**U. S. Virgins.** Booming Caribbean paradise! Facts, contacts; living, retirement, opportunities, vacation. Booklet \$1.00. Airmailed \$2.00. Donrog, 159 Christiansted, St. Croix, Virgin Islands.

**FREE** Employment information. J.S.P. Co., P.O. Box 646, Scranton 2, Penna.

**BOOMING** Southwest! Sunday classified, two large cities, \$1.00. Neibaur, Box 1161, Farmington, New Mexico.

**LATEST** Foreign jobs. Unlimited opportunities. All trades. Certified by America's leading job researcher. Plus, newest South America, Alaska, Canada, Venezuela listings, \$1.00. Universal Research, Box 4912, Baltimore 20, Maryland.

**"OPPORTUNITIES Afloat."** High paying jobs on ships. Details free. P. Kain, 1593-N, G.P.O., New York 1, N. Y.

**AMERICAN** Overseas jobs. High pay, men, women. Transportation paid. Free information. Write Transworld, Dept. 18D, 200 West 34th St., New York City.

**OVERSEAS** Jobs. High pay, free travel. Complete survey \$1.00. Included free: "Directory of American Companies in Sixty Countries." Hill Publications, P.O. Box 26-P, Massapequa Park, New York.

**BOOMING** Arizona, fabulous Phoenix. Unlimited employment, housing, business opportunities. Latest information dollar. Arizona remains 25¢. Arizona Opportunities, Box 48, Chandler, Arizona.

**HOLLYWOOD** Jobs. Where to apply. Listings: Motion Pictures, \$1.50; Television, \$2.00; Talent Agencies, \$1.00; Advertising Agencies, \$1.00; or all 4 lists, \$4.00. Business Information Publishers, Box 1012, Beverly Hills, California.

**JOBS** On ships and yachts traveling foreign countries. Davenport's, 1354-K, G.P.O. New York 1, N. Y.

**NEW** York Times Sun. Classified Airmailed \$1. American, Box 1054, NYC 1.

**FOREIGN** Jobs—Latin America, Alaska, Canada, up to \$1500 monthly. Up-to-date 1959 foreign service directory gives complete information; hot list of firms hiring for military and civilian construction, aircraft, oil, exporters-importers, mining. How-when-where to apply, 11th successful year. \$1.00. Global Reports, Box 8873-S, Los Angeles 8, Calif.

**COPYRIGHTED** Reports. Best paying companies, travel, adventure, promotions. Construction, aviation, shipping, oil fields, laborers, clerical, trades, supervisory, factory, unusual opportunities. Skilled, unskilled. Foreign, stateside. Only \$2.00 (\$2.25 airmail) (COD'S accepted). Satisfaction guaranteed. Included free: Special reports on Alaska, Venezuela, South America. Research Services, Meramec Building, St. Louis 5-PM, Missouri.

**JOBS** Overseas! Write Janacek Development Co., 109 Hub Station, New York 55, N. Y.

**FREE** Information—U.S.A., overseas jobs. High pay, transportation. Futures, Dept. M, 215 West 34th Street, New York City 1.

#### SPECIAL SERVICES

**SELL.** Learn real estate! Have office in your home. Excellent booklet 50¢. Endsley & Co., 46 N. Whittier Place, Indianapolis 19, Indiana.

**INFORMATION** On anything. Ferguson Research Specialists, 116-14 141 St., South Ozone Park 36, N. Y.

**WHAT** Do you want to find? If made in U. S. we will locate best source. Mandeville Source Finders, 405 Olympia, Pittsburgh 11, Pennsylvania.

**TRANSLATIONS.** All languages! Fast air mail. Box 1895, Dallas 21, Texas.

**OIL** Painted portraits 8"x10" made from snap shot. Beautiful work done by oriental master painters in Japan. \$9.95. Send money order and snap shot. Foreign Import Mail Co., Dept. 8, Live Oak, Florida.

#### EDUCATIONAL AND INSTRUCTION

**SELL** Slide rules to college students! Hoffman, 622M, Passaic, New Jersey.

**GO** For civil service. Go after a U. S. civil service job by planned preparation for the entrance tests through Franklin Institute's private home study courses. This privately-owned organization offers courses for postal, clerical and other fields. Get information on the civil service appointment system, physical, residence and other requirements, veterans' rights, salaries, vacations, retirement, preparation offered, etc. Free booklet. No obligation. Franklin Institute, Dept. S10, Rochester 4, N. Y.

**PROFITABLE** Welding training available Hobart Trade School, Box M-992, Troy, Ohio. GI approved. Finest equipment in U.S.A. Reasonable prices. Request catalog.

**DRAFTING** Pays big money. Leads to top positions in automotive, aeronautical, construction, mechanical fields. Learn at home in spare time. All equipment supplied. Pay later plan. Free book. Christy Trades School, CD-4503, 3214 Lawrence, Chicago 25.

**DRAFTING**—Design, Electronic, Mechanical, Architectural, Structural, Estimating, Surveying, Mathematics. 8-months days, prepares position engineering-architectural-electronic industries. Veteran approved. State licensed. Start Mondays. Mondell Institute, 230 West 41st, New York, 50 years placing thousands drafting-design-engineer positions.

**MEMORY** Improvement! Earn more money! Impress everyone with an extraordinary memory! Amazing results regardless of age or education. Complete home study course, consisting of ten lessons from America's oldest memory school. Write for brochure to Dr. Bruno Furst, Director, School of Memory and Concentration Dept. P-5, 365 West End Avenue, New York 24, N. Y.

**LEARN** By ear with Dormiphone. While you slumber, the amazing new scientific invention works for you. Revolutionary Dormiphonic tools give you a shortcut to learning languages, correct speech; memorizing facts, figures; relaxation, habit training. Saves your time, effort. So simple to use, Children benefit. Used by educators, psychologists. Write today for fascinating free book. No obligation. Modernophone, Inc., 320-099 Radio City, New York 20.

**FINISH** High School at home, spare time. No classes. Diploma awarded. Write for free catalog. Wayne School, Catalog HF-97, 2527 Sheffield, Chicago 14.

**USED** Correspondence courses, educational books bought, sold, rented. Catalog. Vernon, Summerville, Ga.

**BIG** Money—Operate own fix-it shop. Service household appliances, motors, mowers, saws, skates, etc. Free book. Christy Trades School, A-7903, 3214 Lawrence, Chicago 25.

**COMPLETE** Your high school at home in spare time with 62-year-old school. Texas furnished. No classes. Diploma. Information booklet free. American School, Dept. X645, Drexel at 58th, Chicago 37, Illinois.

**BECOME** Tax consultant. Graduates earn \$1,000-\$3,000 every tax season preparing returns evenings. State approved. Union Institute, Lakewood 2C, N. J.

**LEARN** Another language at home, easily, quickly, naturally with Linguaphone. The world's standard conversational method. You learn to speak French, Spanish, German, Japanese, Modern Greek—any of 34 modern languages available on life-like conversational recordings. It's like living in another country. Complete language course available on free trial. Send for free book and details of free trial. No obligation. Linguaphone Institute, T-83-099, Radio City, New York City 20.

**DRAFTING.** Design, blueprint reading. Good paying. Easy to learn at home. Minimum age 17. Write Utilities Engineering Institute, Dept. TC-18, 2525 Sheffield, Chicago 14.

**LEARN** Civil and criminal investigation at home. Earn steady, good pay. Institute Applied Science, 1920 Sunnyside, Dept. 166, Chicago 40, Illinois.

**DIESEL!** Learn to operate, maintain and overhaul all type engines—spare time. Write for free book. Utilities Diesel Training, Dept. DC-70, 2521 Sheffield, Chicago 14.

**"HOW To Train Horses"**—A book everyone who likes horses or ponies should have. Free. No obligation. Simply address Beery School of Horsemanship, Dept. 1109, Pleasant Hill, Ohio.

**MASTER** Watchmaking at home. Free sample lesson. Chicago School, 2328-YV, Milwaukee, Chicago 47.

**HELP** Yourself to abundant living. Our courses have aided students to richer, fuller lives. Learn secret of contentment, happiness. Earn degrees Ps.D., Ms.D. Write for free book. College of Universal Truth Correspondence School, 23-C E. Jackson, Chicago.

**OPERATE** Restaurant or diner. Free booklet reveals plan. Write School of Restaurant Business, Dept. RC-359, 335 W. Madison, Chicago 6, Illinois.

**TIME** Study. Key to positive personal profits! Associated Techniques, Box 426, Cedar Rapids, Iowa.

**LEARN** Asleep or awake. Self-help books, tapes, recordings. Free catalog. Drawer PM-697, Ruidoso, New Mexico.

**USED** Correspondence courses, educational books, satisfaction guaranteed. Catalog 10¢ refundable. Courses bought. Bayles, 78-B Courtright, Wilkes Barre, Penna.

**FINISH** High school or grade school at home. Books furnished, diploma awarded. Start where you left school. Write Columbia School, 142c Veterans Blvd., Tucson, Arizona.

**EARN** College degree through correspondence. Golden State University, 2100-AI Magnolia, Burbank, California.

**LEARN** Tile setting at home. Free details. American Institute of Tile Setting, Box #217, Oakland 4, California.

**DR.** Ester C. Swanson, School of Swedish Massage, 3809 Alta Vista, Chicago, Ill.

**LEARN** Picture framing. Professional methods. Mail or shop training. Fine Arts School, 821 Hay, Fayetteville, N. C.

**ENGINEERING, Mathematical Science.** Earn your diploma at home. Better your position, improve your earnings. Free literature. Engineering Institute of America, Dept. PM-9, P.O. Box 1636, Washington 13, D. C.

**BECOME Average dancer—20 lessons, \$2!** New method. Satisfaction guaranteed! Castle, 507 Fifth Avenue, New York City 17.

**MILLIONS Of sewing machines need repair.** Train at home for this high paying trade. For information write: Sincere Training Schools, Box 10014, Phoenix, Arizona.

**LEARN Piano tuning at home!** Only \$32.95 including tools. Write TuneCraft, Box 5074-M, St. Paul, Minnesota.

**\$10,000 YEARLY Specializing.** Renault or Volkswagen. Sample diploma, information, dollar. Foreign Mechanics School, Box 48, Chandler, Arizona.

**INEXPENSIVE Correspondence courses.** Divinity, Theology, Philosophy. Earn degree. Colleges U.S.A., abroad. Aureba, Central Valley, New York.

**HOME Study illustrated welding book \$1.00.** Welding School, Galion, Ohio.

**LEARN Auto electrical systems and tune-up.** Up-to-date home study course. Details from Modern Automotive School, 323 W. Florence, Los Angeles 3, Calif.

**PIANO Tuning pays.** Learned easily at home. GI approved. 59th year. Free booklet. Niles Bryant School, Dept. P. 3731 Stockton, Sacramento 20, Calif.

**PROFESSIONAL Investigators.** Home study. Badge, certificate, future. Box 41197-F, Los Angeles 41, California.

**LEARN Real estate business fast.** Unlimited opportunities. Economical home-study course. Particulars free. Gordon-Howard Institute, 320 Glover Building, Kansas City 5, Missouri.

**MANY Make \$1500.00 per month operating collection office.** Free details. Franklin Credit, Roanoke, Virginia.

**COLLEGE Correspondence courses,** for Doctor of Psychology, Metaphysics, Divinity. Catalogue. Dr. Dorothy B. Arnheiter, Forest Park, Greenwood Lake, New York.

**PORTRAIT Oil coloring.** Professional instruction. Modern course. Easy to learn and earn at home, full or part time. Free booklet PM. "Magic of Oil Coloring." Hamilton Studios, Inc., Seaford, New York.

**CAPITALIZE On your aptitudes!** Locate your potential! Know your I.Q. Free I.Q. test and information. Associated Institute, Box 4, Manhattan Beach 1, California.

**USED Correspondence courses and books sold and rented.** Money back guarantee. Catalog free. Courses bought. Lee Mountain, Pisgah, Alabama.

**HIGH School diploma at home.** Licensed teachers. Approved materials. Southern States Academy, Station E-16, Atlanta, Ga.

**EARN Degree.** Free bulletin. Home-study only. Midwestern Bible School, 1060 Broadripple, Indianapolis.

**BOOKKEEPERS! Increase your earnings!** Operate your own simplified "Dollar-A-Week" bookkeeping and tax service. Full or spare time. Details free. No obligation. Ellis, Box 200, Cedar Grove, North Carolina.

**EARN While you learn.** Auto and diesel mechanics master this top paying trade. Many graduates earn \$100 a week and up. Approved for Korean veterans. For free information write Dept. No. 256, Nashville Auto-Diesel College, Nashville 3, Tenn.

**PHYSICAL Therapy and massage.** Home training. Practice privately or work with doctors and hospitals. Free catalogue. National Institute, Desk 4, 159 E. Ontario, Chicago, Ill.

**INVESTIGATOR Training.** Phillips Secret Service System, 1917-B North Kenneth, Chicago 39.

**BOOKS.** Free general catalog. 100 pages. Text, vocational, educational, instructional subjects. Millions of volumes, new and used. Bargain prices. Books bought. Est. 1902. Long's College Book Co., Dept. PM, Columbus 1, Ohio.

**PIANO Tuning pays.** Big money in spare time. Learn at home in 30 days. No musical knowledge necessary. Phonograph, records, tools and instructions furnished. Personal instructions available. Free catalog. Capital Piano Tuning School, 3160 S.W. 16th Court, Fort Lauderdale, Fla.

**STUDY To be a doctor of psychology,** metaphysics, divinity or philosophy. Correspondence courses only. The Neotarian Fellowship, Desk 9, Kansas City 6, Mo.

**ENGINEERING And art degrees earned** through home study. Electronics, electrical, mechanical, civil, physics, business administration, liberal arts. When writing, specify course desired. Pacific International College of Arts & Sciences, primarily a correspondence school. Resident classes also carried. 5719-B Santa Monica Boulevard, Hollywood 38, California.

**BE A real estate broker.** Study at home. Write for free book today. GI approved. Weaver School of Real Estate, 2018P Grand, Kansas City, Missouri.

**WANT A diesel job? Higher pay? Advancement?** We can help you qualify! Complete diesel, tractor and heavy equipment and Cummins Diesel Engine Shop-method home-training courses available. Write today. Interstate Training Service, Dept. B-3, Portland 12, Ore.

**DEVELOP Mind power, personality while asleep.** Use your phonograph, recorder. Amazing psychological tapes, records now available. Details free. Sleep-Learning Association, Box 24-N, Olympia, Washington.

#### PLAYS. STORIES. MANUSCRIPTS

**"MY Tales of the Desert,"** 25 episodes, \$1. Special 10 day offer 50¢. Get this amazing book. Ben Arid, 7th St., Hermosa Beach, California.

**WANT Your book published? Learn how** we publish, advertise, promote, distribute. Many successes. Free booklet PM. Vantage, 120 West 31, New York City. Midwest office: 220 S. Michigan Ave., Chicago, Ill.

#### ADVERTISING AGENCIES, LETTER WRITERS, FOR ADVERTISERS

**LISTS: Very young women, men.** Details from Semmelrogh, 2008 West 4th, Duluth, Minn.

**ADVERTISE: 24 Words, 100 Canadian** newspapers, \$5.50. Lists free. Advertising Bureau, 10511-C Springfield, Chicago 43.

**"AMAZING New Book"—"Profits From Classified Advertising."** Tells how and what to advertise. Be sure to read this book before you invest one cent in advertising. Write for your copy now. Just send 10¢ for postage and handling. W. Johnson, Classified Advertising Manager, 202 East Ontario Street, Chicago 11, Illinois.

**MAILING Lists most any classification \$5.00 1000.** Your circulars mailed with ours \$4.00 1000. Write for our literature. Dixie Mailers, King, N. C.

**ADVERTISING.** Result-getting ads prepared, placed newspapers, magazines, radio, anywhere! Lowest rates. Catalogue free. Baker Advertising Agency, 189 W. Madison, Chicago 2.

**CREATIVE Advertising.** Magnetic copy. Dramatic layouts. Moran Agency, Shoemakersville, Pennsylvania.

**NOW Ready: New, amazing Classified Advertising Record Book—prepared especially for classified advertisers.** Here is a book that tells you instantly whether or not your advertising in any publication is paying you real results. You can tell immediately how many inquiries each publication produced—how much cash received from every ad. Spaces are provided for the name and address of the publication, date of issue, space used, rate, cost of ad, key number, etc. You have a complete record of each publication right before your eyes. Plenty of space to keep accurate record of 28 separate publications. You can have a copy by sending only 10¢ for cover postage and handling. Send for your copy now. W. P. Johnson, Classified Adv. Mgr., Popular Mechanics Magazine, 204 E. Ontario Street, Chicago 11, Illinois.

#### CARTOONING, COMMERCIAL ART, SHOWCARD & SIGN PAINTING, TATTOOING

**"HOW To Make Money With Simple Cartoons."** A book everyone who likes to draw should have. It is free; no obligation. Simply address Cartoonists' Exchange, Dept. 99-C, Pleasant Hill, Ohio.

**CARTOONING Pays big.** Free booklet. Cartoonist's Agency, 210 5th Ave., New York 10, N. Y.

**"KEY To a Cartoon Career."** If you like to draw, write for this free book to: Bureau of Cartooning, 3123 North End Station, Colorado Springs, Colorado.

**YOU Can entertain with chalk talks.** Catalog 10¢. Balda The Cartoonist, Oshkosh, Wis.

**LEARN Sign painting at home.** Free talent test. Ben Kerns, Box 812-PM, Greenville, S.C.

**LEARN Profitable, fascinating tattooing.** Illustrated information \$1. Zeis, 728-C Leslie, Rockford, Illinois.

**LEARN Sign painting with fascinating system.** Straley, 410 S. Western, Springfield, Ohio.

#### RUBBER STAMPS AND OFFICE SUPPLIES

**INDEXED, Cushioned, 3 lines \$1.00, 4 or 5 lines, \$1.50.** Signature stamps, \$3.50. (Script, print, or old English.) Free stock stamp literature. Youngers Stamp Shop, Princeton 4, Iowa.

**THREE Line rubber stamp, 1000 embossed business cards, both \$3.75.** Reed Press, Mishawaka, Indiana.

**3 LINE Pocket or handle \$1.00.** McDonough, Box #2, East Lynn, Mass.

**YOUR Name, address, 3 lines 75¢.** Calnoco, 4052-40 St., San Diego 5, California.

**POCKET, 3 Lines \$1.00. Guaranteed.** W. J. Specialty, 8464 Manhattan, Detroit 11, Michigan.

**FREE! Rubber stamp catalog.** Many items. Campfield, Box 798, Springfield 1, Mass.

#### TYPEWRITERS, DUPLICATORS, OFFICE DEVICES

**RECONDITIONED Typewriters, duplicating, printing devices, \$25.00 up.** Supplies. Appliances. DixieGraph, King, N. C.

#### PRINTING, MULTIGRAPHING, MIMEOGRAPHING, GUMMED LABELS

**EMBOSSER Letterheads, envelopes, 100 each, \$3.00.** Estimates, anything. Universal Arts, Scotch Plains, New Jersey.

**1000 SIMULATED Engraved business cards, \$3.99 postpaid.** Free samples. Prichard Rubber Stamp Shop, P.O. Box 10604, 116 Main St., Prichard, Alabama.

**100 6 3/4 ENVELOPES, 100 5 1/2 x 8 1/2 letterheads printed, \$2.00.** M. Fortney, Route 3, Dillsburg, Penna.

**CARDS. Exclusive but not expensive.** Folder, samples. Graphic Press, 2921 East 40th Street, Tacoma 4, Wash.

**100 ENVELOPES Printed, your name, address, \$1.00.** Womble's, Siler City, N. C.

**FREE Sample cardboard cut-out letters.** Many colors, sizes. Set of 180, \$1.00. Mutual Aids, Dept. 280, 1946 Hillhurst, Los Angeles 27, California.

**BUSINESS. Personal printing.** Reasonable. Free catalog. Andrews Printing, Graham, N. C.

**1000 NAME Labels, \$1.00.** Plastic case free. Eugene Barbosa, 704 Hanover, Liverpool, N. Y.

**1,000 BUSINESS Cards.** Raised letters, \$3.95. Samples. Pioneer, PM-9, Island Park, N. Y.

**PRINTING—Reasonable prices, fast service, guaranteed.** Fred, Box 623, Independence, Mo.

**1000 EMBOSSER Business cards, \$3.99.** Fast! Accurate! Literature. Samples. Krug, 667 McAllister, San Francisco 2, California.

**FREE Business printing catalog.** Samples. Howprint, 723-C Eunice, Webster Groves 19, Missouri.

**250 TRANSPARENT Plastic business cards, \$6.00.** Unusual samples 10¢. Glover, 142-15 119th, Jamaica 36, N. Y.

**COLORED Or white 8x11 offset, 1,000, \$5.50; 5,000, \$17.** Fast! Also artwork, variety layout. Promotion, 385-M9 Broadway, New York City 13.

**100 5 1/2 x 8 1/2 LETTERHEADS, 100 6 3/4 Envelopes printed, \$1.90 postpaid.** H. Hudson, Centredale 11, R. I.

**1000 NAME And address labels \$1.00.** Youngers, Princeton 4, Iowa.

**MIMEOGRAPHING**—High quality, reasonable prices. Free samples, pricelists, Mail-Me-Mimeo, 920 Vanburen, Milwaukee 2.

**LOOK!** Only \$3.95 Per 1,000 8½x11; two colors (quantity). Management Aids, Box 1495m, Pittsburgh 30, Penna.

**POSTPAID**, Low priced printing. Business letterheads, envelopes, cards. Samples. Press, Weaubleau, Missouri.

1000 PRINTED 6½ Envelopes, \$5.95, #10, \$7.95, postpaid. Free price list, other sizes, quantities. Karstan's, 151-39 26 Ave., Flushing 54, New York.

1000 ENGRAVED Letterheads \$17.00 pre-paid. Samples. Allen Press, Fort Edward, New York.

1000 PERSONALIZED Address labels 95¢. Curtis Singleton, 501 Poplar, Cincinnati 15, Ohio.

1,000 BUSINESS Cards, simulating engraving, \$2.99 postpaid. The Graphic Garret, P. O. Box 9312, Rosslyn Station, Arlington 9, Va.

1,000 STATEMENTS, \$5.40. Salesman's discount, 50%. Cassell, Romeo 213, Michigan.

1,000 NAME And address labels \$1.00 in plastic box. Free catalogs. Rubber stamps, personalized items. Heights Industries, Capitol Heights 27, Maryland.

**BUSINESS Cards**, reasonable, free samples. Ford, 15 John Avenue, Elmont, New York.

**DISTINCTIVE**, Low-cost business printing. Catalog, samples free. Biggerstaff Press, Box 1351, Chapel Hill, N. C.

**MIMEOGRAPHING**. Amazingly fast, inexpensive. Free samples. Fuesing, 6522 West Center, Milwaukee 10.

**MIMEOGRAPHING**—Letters, pricelists, formulas, instructions. Lowest prices. Lem's Letter Shop, 5710 Stanton, Detroit 8.

FREE Catalog postpaid printing, rubber stamps. DM Press, Sebastopol, Calif.

1,000 EMBOSSED Business cards \$3.50 postpaid. Samples. Ellis, 5909 Highlandview, Sylvania, Ohio.

**ADS** Running under this heading sell printing. Ask me for proof. I'll gladly send you amazing facts. Ask for Folder "P." F. W. Johnson, 200 E. Ontario St., Chicago 11, Ill.

1,000 NAME And address stickers, \$1.00; 8½x11 letterheads, \$5.95; #10 envelopes, \$6.95. Offset Sales, Box 6642, Kansas City 23, Missouri.

## PRINTING OUTFITS AND SUPPLIES

**MAKE** Your own self-molding rubber stamps and printing cuts. Flexirubber, Argyle 1, Wisconsin.

**DO** Your own printing. Save money. Simple rules. We supply everything. Print for others; good profit. Raised printing like engraving too. Have home shop. Details free. Kelsey Presses, V-11, Meriden, Connecticut.

**PRINTING Presses**, type, supplies. Lists 4¢. Turnbaugh Service, Mechanicsburg, Penna.

**RUBBER Stamp presses**, hydraulic operated, electrically heated. Sizes 5"x8", 8"x12", 10"x15". Starting outfits, supplies. Printing presses, supplies. Custom Manufacturing, 507-P N. Jefferson, Springfield, Missouri.

**TYPE** For rubber stamp making and printing made from hard foundry metal. Send for free 20% discount catalog. Barco Type Founders, 64 Wagner Dr., Northlake, Ill.

## PATENT ATTORNEYS

**INVENTORS**: Learn how to protect your invention. Unless the inventor is familiar with patent matters, he should engage a competent registered patent attorney or agent to represent him. We are registered to practice before the U.S. Patent Office and prepared to serve you in handling your patent matters. "Patent Guide for the Inventor" containing detailed information concerning patent protection and procedure with "Record of Invention" form will be forwarded to you upon request, without obligation. Clarence A. O'Brien & Harvey Jacobson, Registered Patent Attorneys, 91B-G District National Building, Washington, D. C.

**INVENTORS**—If you believe that you have an invention, you should find out how to protect it. The firm of McMorow, Berman & Davidson is qualified to take the necessary steps for you. Send for copy of our Patent Booklet "How to Protect Your Invention" and "Invention Record" form. No obligation. McMorow, Berman & Davidson, Registered Patent Attorneys, F34-S Victor Building, Washington 1, D. C.

"INVENTOR'S Guide" and "Record of Invention" free on request. Frank P. Ledermann, Registered Patent Attorney, 154 Nassau Street, New York City.

**INVENTION Record** form free and "Patent Information Every Inventor Should Have." Carl Miller, Registered Patent Attorney, Woolworth Building, New York.

**INVENTORS**: Without obligation, write for information explaining the steps you should take to secure a patent. John Randolph, Registered Patent Attorney, 803 Victor Bldg., Washington 1, D. C.

C. A. Snow & Co.—M427, Snow Building, Washington 1, D. C. Registered Patent Attorneys. Write for information.

**INVENTORS**—Take these preliminary steps toward patent protection. Sketch and describe your invention. Sign, date and have this disclosure witnessed by two people who understand your invention. Have us make a preliminary search among U.S. patents already granted for similar types of invention. We report on the probable patentability of your invention and recommend your further course of action. Write for our instructive booklet, "Patent Protection for Inventors" and convenient "Evidence of Invention" disclosure form. Victor J. Evans & Co., 531-K, Merlin Building, Washington 6, D. C.

## FOR INVENTORS

**INVENTIONS** Wanted for immediate promotion! Patented; unpatented. Casco, 703 Bernley Building, Philadelphia 7, Penna.

**INVENTORS**—This firm is registered to practice before the United States Patent Office and available to assist you in the preparation and prosecution of your patent application. "Patent Protection for Inventors" booklet containing detailed information sent promptly upon request. No obligation. Victor J. Evans & Co., 532-K, Merlin Building, Washington 6, D. C.

**ENGINEERING**. Development. Drawings. Todd, Consulting Engineer, 424 West 119th Street, New York City 27.

**LET** Us show you how. Order your copy of "Inventing the Invention" today. \$4.95 postpaid. Eaton Roller & Manufacturing Company, 300 North Meridian, Eaton, Indiana.

**INVENTORS**—Go; the best offer first! Patented or unpatented. Write Carl Sommer, Director, Industrial Invention Sales, 3136-A Sylvania Ave., Toledo 13, Ohio.

**INVENTIONS** Wanted now by my manufacturer-clients. Patented, unpatented. Write Gilbert Adams, Patent Broker, 80-A Wall Street, Financial District, New York City.

"INVENTOR'S Guide" sent free. Frank P. Ledermann, 154 Nassau Street, New York 38, N. Y.

**PATENT Searches**, including copies of nearest patents, \$6.00. Reports airmailed within 48 hours. More than 100 registered patent attorneys use my service. For free invention protection forms, write Miss Ann Hastings, P.O. Box 176, Washington 4, D. C.

**WE** Have the markets if you have the ideas. Harvey Engineers, Cambridge 1, Maryland.

**PATENT Searches** \$6.00. 48-hour service. Free invention protection forms. Write Raymond L. Smith, Patent Searcher, 620 Sheraton Building, Washington 5, D. C.

**INVENTORS**: Information on patent procedure furnished on request, without obligation. John Randolph, Registered Patent Attorney, 802 Victor Bldg., Washington 1, D. C.

**INVENTORS**: Test the commercial value of your patented or unpatented inventions, quickly and inexpensively. Write for free information. Institute of American Inventors, Dept. 40-B, 635-F St., N.W., Washington 4, D. C.

**INVENTION Record** form free and "Patent Information Every Inventor Should Have." Carl Miller, Registered Patent Attorney, Woolworth Building, New York.

**PATENT Searches** \$6.00. 48-hour airmail service. Invention protection forms free. Write Patent Engineering Service, 711 14th Street N.W., Washington 5, D. C.

**INVENTORS**. Don't sell your invention patented or unpatented until you receive our offer. Write Cowgill, Box 298-A, Marion, Ohio.

**INVENTORS!** Consider our offer first before selling or licensing your invention on a cash or royalty basis. Patented, Unpatented. Inventions on Demand, 79 Wall Street, New York 5, N. Y.

**HIGHEST Cash**, royalties. Inventors having good ideas, write. Inventors Creative Service, 354 South Spring, Los Angeles 13, Calif.

**INVENTORS** If you believe that you have an invention, you should find out how to protect it. The firm of McMorow, Berman & Davidson is qualified to take the necessary steps for you. Send for copy of our Patent Booklet "How to Protect Your Invention" and "Invention Record" form. No obligation. McMorow, Berman & Davidson, Registered Patent Attorneys, F34-R Victor Building, Washington 1, D. C.

**INVENTORS**: Learn how you can protect your invention. A specially prepared booklet "Patent Guide for the Inventor" containing detailed information concerning patent protection and procedure together with "Record of Invention" form will be promptly forwarded to you upon request, without obligation. We are registered to practice before the United States Patent Office and are prepared to serve you in the handling of your patent matters. Clarence A. O'Brien & Harvey Jacobson, Registered Patent Attorneys, 91A-G District National Building, Washington, D. C.

**INVENTORS**—Send for free Patent Information book and Inventor's Record. Registered Patent Attorney, Associate Examiner. Patent Office 1922-29, Patent Attorney & Advisor, Navy Department 1930-47. Gustave Miller, 99A, Warner Building, Washington 4, D. C.

**FREE Patent searches**, how I make my own safely, thru 2,675,000, from Berwyn, Limited, booklet \$1. Satisfaction guaranteed. Kubas, 3748 South Home Avenue, Berwyn, Illinois.

**INVENTIONS** Sold on percentage basis, searches. Model Prod., Grain Valley 3, Mo.

**COLLEGE** Trained brokers market your patented, unpatented inventions. Write International Services, 3928-A Lorain, Cleveland 13, Ohio.

**PATENT Drawings** your inventions made by our experts. Reasonable costs. Patent Service Associates, Haverhill, New Hampshire.

## INVENTIONS WANTED

**INVENTORS**—Do you want to sell or license your invention on cash or royalty basis? Write Kessler Corporation, 59-IW, Fremont, Ohio.

**LARGEST** Nationally known manufacturers of housewares, toys and novelties desires patented or unpatented inventions in the above fields. Cash or royalty basis. E-Z-For Corporation, 4422-28 N. Broadway, Chicago 40, Illinois.

**CASH Buyers** for inventions. Write National Inventors Institute, Box 4125, Washington 15, D. C.

**SUPERIOR Promotions**. Patented; unpatented inventions. Information booklet, free. Superior, 338-344 North Rodeo, Beverly Hills, Calif.

**INVENTIONS** Wanted for immediate promotion! Patented; unpatented. Casco, 703 Bernley Building, Philadelphia 7, Penna.

**INVENTIONS**. Ideas, financed, promoted. Details free. World, 3422 Olive, St. Louis 3, Mo.

**FREE List** needed inventions. Protection form. Inventors Sales and Engineering Bureau, Dept. 199-D, Box 4973, Washington, D. C.

**WANTED**: Patents, patent pending. Eagle Development Co., 4753 Broadway, Chicago.

**INVENTORS!** Don't sell your invention patented or unpatented until you receive our offer. Write Cowgill, Box 298-B, Marion, Ohio.

**INVENTORS:** Hundreds of manufacturers have requested our assistance in locating marketable new products. Complete information free. Institute of American Inventors, Dept. 40-D, 635-F St. N.W., Washington 4, D. C.

**INVENTIONS Wanted, Patented; unpatented.** Tremendous manufacturers lists. Global Marketing Service, 2420 77th, Oakland 5, California.

**INVENTIONS Wanted:** Patented, patent pending. 28 years experience promoting inventions. National Service Bureau, 3120 Meramec, St. Louis 18, Mo.

**INVENTORS!** Consider our offer first before selling or licensing your invention on a cash or royalty basis. Patented, Unpatented. Inventions on Demand, 79 Wall Street, New York 5, N. Y.

**ARE You interested in offers from reliable manufacturers for your invention?** Patented, unpatented. Harvey Engineers, Cambridge, Maryland.

**INVENTIONS Wanted now by my manufacturer-clients.** Patented, unpatented. Write Gilbert Adams, Patent Broker, 80-S Wall Street, Financial District, New York City.

**INVENTIONS Wanted for manufacturers.** Free details. Write: Allen, 712 Davis Bldg., Dallas 2, Tex., Dept. B.

### PATENTS FOR SALE

**ONE Piece wire, lifetime clothespin, turtle grip jaws.** Holds blankets, rugs, etc., without slipping. Model sent on request. William Hietala, Poplar, Wis.

**FOR Sale—Exclusive manufacturing and distribution rights to hand cultivating tool; U. S. Patent No. 2,504,746.** McFarland, 448 Harrison, Greenville, Ohio.

**PATENTED Hedge comb for sale.** Used to comb clipped hedges or bushes. Keeps hand away from sharp edges or thorns avoiding injury to hand. John V. Reidmiller, Box 83, Wayne, N. J.

**MILLIONS Of cars, new & used, can get more engine protection with permanent combination oil gauge & filter.** New inexpensive invention. \$50,000 & royalties. Write Mr. Gilbert Adams, 15 Park Row, New York, N. Y.

### MANUFACTURING

**MODELS, Tools, dies, product manufacturing.** Raydie, 248-F Interstate, Addison, Illinois.

**ALUMINUM Castings made.** Nobco, 151 N. Pasadena Ave., Pasadena, California.

**MODELS—Small lot manufacturing.** Metals, plastics, etc. Milburn, Burlington, Kentucky.

**WANTED—Four new non-food items related to outdoor living.** Sell through supermarkets under our nationally advertised brand. P.O. Box 4127, Station A, Dallas, Texas.

### MODELS, MODEL SUPPLIES

**SHIP Models.** Most complete line in New England, kits, fittings, plans, books, tools, engines, motors. Illustrated catalog 35¢. James Bliss & Co., Inc., Dept. SM, 342 Atlantic Ave., Boston 10, Mass.

**"POWER Drives Handbook"—36 pages illustrating many types motor drives for model autos, boats, displays, turntables, etc.** Mail 25 cents cash, returnable first order \$3.00 or more. Wilson's of Cleveland, Dept. PM, 425 Lakeside N.W., Cleveland 13, Ohio.

**SCALE Model materials for building model homes and architectural buildings of any type, 1/2" and 1/4" scale.** Send 25¢ for catalog. A & B Model Builders, 454-P Donovan Road, Kansas City, Kansas.

**ROCKET Supplies—Nozzles, cones, tubes.** Specials also made. Catalog 10¢. Sky Mfg., Mineral Point, Penna.

**SHIP Model kits and fittings:** Fishermen, clippers, frigates, schooners, brigs, tugboats. Also half-hull models for interior decoration. Send 25¢ for 1959 catalog and booklist. Model Shipways, Box 85, Bogota, N. J.

**SHIP And yacht model fittings; blueprints.** Send 35¢ for illustrated catalog listing hundreds of items. A. J. Fisher, 1002-1 Etowah Ave., Royal Oak, Mich.

**POWER Models.** Unusual steam, gasoline and traction engines, fittings, metals. Displacement and mechanical lubricators. Comprehensive 92 page catalog \$1.00. Chas. Cole, Ventura, Calif.

**ROCKETS You can build.** Instruction sheet 15 drawings based on over 500 flights. 50 cents. Missiles, P.O. Box 90391, Los Angeles 45, Calif.

**FREE List of books, plans for model power boats, planes, race cars.** Send stamped, self addressed envelope. Heuze's, 30 Main St., Park Ridge, Ill.

**MODEL Boat fittings.** Precision imported hand crafted, not diecast or plastic. Clearly illustrated 56 page catalogue \$1.00. Ocutra Models, P.O. Box 538-WP, Park Ridge, Illinois.

**COMPLETE working model.** Old English fairground 30x13 ft. with organ music, lighting, hundreds of carved figures. A magnificent show. \$2500. Salt, 43-A, Winchester Rd., Southampton, England.

**ROCKET Plans.** Two-stage rocket, 6 mile altitude, instrumented payload, parachute recovery. Catalog \$2.00. Missile Research and Development Centre, Box 1124, Orlando, Florida.

### HOME CRAFTSMEN

**SHELLCRAFT Supplies.** Lowest prices! Large illustrated catalogue! Shells, designs with instructions. 25¢. Pace's, Box 279, Bradenton, Florida.

**FREE! New supply catalog loaded with moneymaking costume and shell jewelry designs.** Modern Craft, Box 11088-HK, Saint Petersburg 33, Florida.

**CRAFTS.** Free catalog. Leathercraft, mosaics, enameling, metal tooling, stamp engraving, shellcraft, floralcraft, many more. Kit Kraft 299, Studio City, Calif.

**ILLUSTRATED Silk screen printing.** Instructions, \$1.00. Details free. Pioneer Valley Stencils, Box 162-F, Springfield 1, Mass.

**101 PATTERNS Of smart gifts, novelties, shelves, action windmills plus "Make Money Jig Sawing."** \$1.00. Mastercraft, 95M, 7041 Olcott, Chicago 31.

**NEW Big illustrated catalog.** Supplies for leathercraft, metalcraft and numerous small inexpensive crafts. Prompt shipments. Top values. Latest ideas. Send 10¢ today to J. C. Larson Co., Dept. 9027, 820 S. Tripp, Chicago 24.

**LEATHERCRAFT.** Send 25¢ for new 160-page catalog of tools, supplies, kits, including metalcrafts, enameling, ceramics, all other crafts. Complete stock. Reasonable. Since 1910. Sax Bros., Dept. PM-9, 1111 N. 3rd, Milwaukee, Wis.

**KILN Dried walnut, cherry, etc., hardwoods.** Blocks, boards and squares. Midland Lumber Company, P.O. Box 262, Savannah, Missouri.

**BIG Sample amazing new "fix-anything" adhesive.** Rush dime to Handyman, 1503A Madison, Evanston, Ill.

**FREE Sample epoxy cement described July Popular Mechanics.** Scheid Labs., 3008A, Montrose, Chicago 18.

**ART Metal tooling.** Enjoyable, profitable hobby. Big illustrated catalog 10¢. Groundmaster, Boulder, Colo.

**MOSAICS New 1960 illustrated catalog and instructions.** 25¢ (refunded). Mosaic Arts Co., 7197-P7, Pittsburgh 13, Penna.

**LEARN Art metalcraft and jewelry making.** Complete, inexpensive, home training course now available. Special tools and materials furnished. Write for free booklet. Interstate Training Service, Dept. L-3, Portland 12, Oregon.

**2430 FULL Size patterns.** Free catalog. Craftplans, 1322-A Wabash, Chicago 5.

**FREE "Do-It-Yourself" leathercraft catalog.** Tandy Leather Company, Box 791-M30, Fort Worth, Texas.

**WOODWORKING And cabinetmaking course for beginning and advanced home craftsmen.** Only complete low-cost home training program available. Write for free booklet. Interstate Training Service, Dept. G-3, Portland 13, Ore.

**FREE! Leathercraft catalog.** Hundreds of new items. Write MacPherson Bros. Leather Company, Dept. E, 730 Mission St., San Francisco 3, Calif.

**KNOCKDOWN Cedar chests and lumber.** Free price list. Bedford Lumber Company, Shelbyville, Tennessee.

**FREE Leathercraft catalog.** Quality kits, leathers, tools. Handicrafters, Dept. F, Box 427, Montrose, California.

**REMODEL Your own home.** Save hundreds of dollars. New, amazing book shows you how. Written so you can understand it. Step by step instructions make it easy. Fully illustrated. 400 photographs, hundreds of diagrams. 160 pages. \$3.50. Literature 10¢. Popular Mechanics Press, 200-RH East Ontario St., Chicago 11, Ill.

**PATTERNS.** Full size. It's easy to make tables, chairs, beds, chests, shelves, workbench, toys, Santa Claus lawn designs, and many others. Illustrated circular free. Popular Mechanics Press, 200PL East Ontario St., Chicago 11, Ill.

### DO IT YOURSELF

**GRANDFATHER Clock movements, case plans, kits.** Wholesale catalog 25¢. Mason-Sullivan, Noroton, Conn.

**HARD Water problems solved!** Build proven inexpensive softener! Capacity tables, drawings, directions \$1.00. Starr, Freeland 1, Michigan.

**FREE "Do-It-Yourself" leathercraft catalog.** Tandy Leather Company, Box 791-V32, Fort Worth, Texas.

**LIFETIME Welder from junk.** Fain Electric, Rt. 13, Fort Worth 3, Texas.

**LIFETIME Welder from junk.** Fain Electric, Rt. 3, Fort Worth 3, Texas.

### WATCHES, OLD GOLD, JEWELRY

**COSTUME Jewelry supplies, settings; rhinestones, etc.** 88 page illustrated catalog. 30¢. Milady, Box 1328, G.P.O., New York City.

**HIGHEST Cash paid for old gold, jewelry, gold teeth, diamonds, watches, silver.** Mail articles today. Information free. Chicago Gold Refining Co., 6 E. Monroe, Dept. 1558, Chicago 3.

**WATCHMAKERS' Jewelers', lapidaries' Catalog 25¢.** Bengal, 8910 Venice, Culver City, California.

**WATCH And clock repairing books.** Free catalog. North American, 2320-AK Milwaukee, Chicago 47, Illinois.

**WATCHMAKERS' Tools, materials, supplies, watches.** Catalog. Gales, Box 1000, Chicago 90, Illinois.

**SWISS Watches from importer, \$2.95 up.** Catalog. Transworld, 565 5 Ave., New York City.

**10 SWISS Watches \$18.00.** Catalog 25¢. Berkowitz, 1150 Castle Hill, New York City 62.

**GOLD Coins wanted.** Highest cash prices paid immediately for gold coins, silver, gold, platinum scrap, any shape or form. Send 50¢ cash or money order for our premium guide booklet of United States, Canadian coins. A must for accurate dealer prices. Write: Wilmot's, 1067-AZ Bridge, Grand Rapids 4, Michigan.

**FREE Catalog.** Costume jewelry parts. Supplies. Reasonable prices. Fast service. Guaranteed quality. Unique merchandise. Palsom's, Box 52, Medford 55, Mass.

**HIGHEST Cash for old gold, jewelry, gold teeth, watches, diamonds, silverware, spectacles, platinum, mercury.** Free information. Rose Refiners, Heyworth Building, Chicago 2.

### FOR THE HOME

**FOAM Rubber furniture cushions.** Factory seconds. 50% discount. Free catalog. Perma-Foam, 390-C Nye Avenue, Irvington, N. J.

### OF INTEREST TO WOMEN

**YOU Can start for Civil Service career through home study.** Attractive salaries, benefits. Free booklet. No obligation. Private organization. Franklin Institute, Dept. S12, Rochester 4, N. Y.



**STAMPED Linens** for embroidery or painting. Buy direct from manufacturer and save. Send for free catalog. Merrilee, 16 West 19th St., Dept. 593, New York 11, N. Y.

**60% PROFIT** On cosmetics. Famous nationally advertised Hollywood cosmetics pay 60%. Make \$25 day up. Hire others. For free samples, details, write: Studio Girl, Glendale, Calif. Dept. 1299GX.

**FREE Brochure!** Perfumes! France's finest! Glamorize economically! Save \$12.00 an ounce! Gale Denise Company, 2293 Darlington Drive, Augusta 6, Georgia.

**BEAUTIFUL Skin** yours. For free booklet write Nuvo, 1039 Nostrand, Brooklyn 25, N. Y.

**HOUSEWIVES, Teachers, students, office workers,** if you need extra cash each week but household or other duties prevent you from taking a part-time job, learn how you can earn by accepting orders to Popular Mechanics, Good Housekeeping and all other magazines. No experience needed. Write Popular Mechanics, Room 9W, 250 West 55th St., New York 19, N. Y.

**MAKE Money** weaving rugs at home for neighbors on \$79.50 Union loom. Thousands doing it. Booklet free. Union Loom Works, Dept. 3, Boonville, N. Y.

**SELL Fine fabrics.** Get yours wholesale. Box 863, Norwalk, Conn.

**DRESSES 24¢; Shoes, 39¢; men's suits, \$4.95; trousers, \$1.20.** Better used clothing. Free catalog. Transworld, 164-G Christopher, Brooklyn 12, N. Y.

### PERSONAL

**BIBLE Questions** answered. Stamped envelope. Bylon, 17167 Bentler, Detroit 19, Michigan

**FIRE Department Christmas cards.** Free brochure. Hobby Mats, Balsam Lake, Wis.

**BORROW \$50 To \$600** by mail. Quick, easy, private. No co-signers. Repay in 24 small monthly payments. For the amount you want write today to Dial Finance Co., 410 Kilpatrick Bldg., Dept. J-1, Omaha 2, Nebraska.

**GIFT Problems?** Dozens unique ideas 10¢. Keith Armstrong, 711 Seneca, Seattle 1, Wash.

**BORROW** By mail. \$100-\$600. Anywhere. All mail service. Postal Finance, 200 Keeline Building, Dept. 17R, Omaha 2, Nebraska.

**CONFIDENTIAL Remailing** service 25¢, monthly \$3.00. Hill's, Box 895-PM, Flint 1, Michigan.

**LOANS** By mail. \$50 to \$600 for any purpose. Employed men and women eligible. Confidential. 2 years to repay. Write for free loan application, American Loan Plan, City National Bldg., Dept. PM-90A, Omaha 2, Nebraska.

**ENJOY Health.** Free booklet. Nutrition, 152-PM Kearny, San Francisco, Calif.

**ALASKA.** America's last frontier. Fish-wildlife, opportunities, settlement, employment, housing. Info. \$1.00. Alaskan Information, 2731 So. Homan, Chicago 23, Ill.

**WHAT Day** of the week? Years 1753 to 2000. Send year, month and date. self-addressed envelope and \$1.00. Apple, 310 E. Hendrix, Greensboro, N. C.

I Can teach you how to be born again free. Send stamped envelope. Personal Evangelism, P.O. Box 3161, Knoxville, Tenn.

**ADVENTUROUS?** Details for dime. Fred Woodgate, Tamworth, NSW, Australia.

### REMAILING SERVICE

**CONFIDENTIAL Letters** 25¢. Monthly \$2.00. Weintraub's, Box 1481, New Orleans 5, Louisiana.

**OKLAHOMA City,** remails 25¢. Monthly \$3.00. Sheehan, Box 3826, Oklahoma City 6, Oklahoma.

**MIAMI,** Hollywood and West Hollywood, Florida, remails 25¢, monthly \$3.00. Classified, \$1.25. Scenic cards, 10¢. M. Rea, 7191 N. West 26 St., West Hollywood, Florida.

**LOS Angeles** confidential address! Remails 25¢. Kent Remailing Service, Box 1976-10, 53.

**REMAILS 25¢; Forwarding \$3.00** monthly. James T. Stephens, Box 1434, Atlanta 1, Georgia.

**RENT** A confidential remailing, receiving-forwarding address. Details free. William McLaughlin, 800 Stewart, Columbus 6, Ohio.

**OZARKS Stamped,** remailed 25¢. Name, address, stamp, beautiful scrip \$2.00. Fastamp, 420 Chestnut, Springfield, Mo.

**SECRET Mail** receiving-forwarding system, \$4 month. Hedgpath, Box 830, Alhambra 23, California.

**ALASKA Remails,** \$1.00. Replies forwarded. Box 1151, Anchorage, Alaska.

**REMAILS 25¢, Monthly \$3.00.** Prompt receiving-forwarding. Lillian's, Box VC-3011, No. Hollywood, Calif.

**LETTERS Mailed 25¢; forwarded 30¢.** Stella M. Lumsden, East 11 Pacific Ave., Spokane 3, Wash.

**RENT, Confidential** postal mailing. Receiving address. \$3 per month. Fred's, 3910 University Avenue, Madison, Wisconsin.

### TREASURE FINDERS

**PLUMBERS, Electricians, coin collectors,** get "Metal Locating Kinks" 25¢. IGWTP, Williamsburg, New Mexico.

**METAL Locator** kits and assembled models from \$39.90. Transistorized and underwater models available. Free catalog. Electronic Applications, Dept. M, Box 8, Arlington 10, Virginia.

**MONEY** For you in buried treasure. Coins, gold, silver can be found with Goldak transistorized locators. Five models including underwater locator, priced from \$79.50. Free literature. Authentic books of known treasures available. Goldak Company, 1541 West Glenoaks Blvd., Glendale, California.

**GOLD-Silver detectors.** Geiger counters. Violites for tungsten, etc. Best available. Guaranteed. Information free. Detectron, 5528 Vineland Ave., Dept. 18, North Hollywood, Calif.

**GHOST Towns** Old West, 3x2 foot map, 85 sites. \$1.00. Poul Anchor, Rye 2, N. Y.

**TRANSISTORIZED M-Scope** unexcelled detecting treasures, gold, silver, etc. Lightweight, supersensitive, dependable. From \$59.50. Easy terms. Free catalog. Fisher Research, Dept. C-1, Palo Alto, Calif.

**TREASURE! Map, handbook 25¢.** Locators. Howe, 811 Kansas, Atchison, Kansas.

**TREASURE Map** of all 48 states \$2.00. Map Cache, Box 287, Burlingame, California.

### FOR SALE—MISCELLANEOUS

**CYPRESS Knees.** Prices quoted. Sample \$2.00. Tom Gaskins, Palmdale, Fla.

**FREE Flyer.** Electronic and refrigeration surplus. Kurtz, 702 Bay, Staten Island, N. Y.

**POCKET Size** booklet started thousands. Profitable character analysis work. \$1.00. Satisfaction guaranteed. Lucas System, 2419 Sunset, Los Angeles 26, California.

**MIRROR—Secretly** watch, photograph people through transparent back. 8" x 10", \$2.00; 16" x 20", \$5.00. One-Way Mirror, PM-959, Box 625, Mt. Vernon, N. Y.

**HEARING Aid** batteries, wholesale. Free list. Habs, Box 51, York, Penna.

### WANTED—MISCELLANEOUS

**IMMEDIATE Cash** for used plating equipment. Send description. Equipment Division, 1624 East First, Los Angeles 33, California.

**QUICKSILVER,** Platinum, silver, gold. Ores analyzed. Wholesale Terminal, Norwood, Mass.

### MISCELLANEOUS

**DELICIOUS Citrus** fruit, gift packed. Prepaid prices. Varble's, 1505 North Parkwood, Harlingen, Texas.

**CIVIL Service.** Learn about this field of work and how you can prepare yourself by home study for a high entrance mark. Private organization. Free booklet. No obligation. Franklin Institute, Dept. S11, Rochester 4, N. Y.

**PERSONALIZED Gifts,** stationery, jewelry. Free catalog. MacLeif, 105A Canal, New York City 2.

**JAPAN:** Buy direct-mail order, kimono, dolls, etc. 24 page catalogue, manufacturers' names, addresses. Send \$1.00. Clarence Yamagata, 202 Naka 7, Bldg., Marunouchi, Tokyo.

**FREE Literature.** 100 correspondence cards personalized \$1.00. Abell, P.O. Box 571, Findlay, Ohio.

**BORED? Read "Letters to the Editor"** Magazine 25¢. Periodicals, 6376 Windsor Lane, San Jose, California.

**RECEIVE Magazine** samples, mails, catalogues. Bargains from everywhere. Get listed 25¢. Rorick, Cincinnati 26, Ohio.

**KEY-Sleeves** (trademark) fit over teeth of your keys. Prevents holes in pockets. Write on them, for labelling. Retain one, reminds you of loaned keys. Durable. Good feel. Money-back guarantee. 50 for \$1., postpaid. NLS Company, Box 34-PM, New York City 35, N. Y.

**CIGARETTES:** Make 20 plain or filter-tips for 9¢. Facts free. Moberly, Box 916, Owensboro, Kentucky.

**COLGATES Lustré** Creme shampoo 4 lbs. \$4.85 postpaid. Geller, 2089 Matthews, New York 62, New York.

**"HERE I Fell Asleep"** stamped in gold on genuine leather book mark (6 1/2 x 2"). 25¢ each or 5 for \$1.00. Handsome design. Orders promptly filled. Order from Books Unlimited, 249 Broad Ave., Palisades Park, N. J.

**SWAP—Read "Trading Post Magazine,"** 10¢. Thorne's, B-525, Dewey, Jackson, Michigan.

**RECEIVE Samples,** magazines, catalogues. 10¢. Star Service, B-7092, San Antonio 10, Texas.

**LOVERS Knots** of unusual designs! True symbols of secure love! Lifetime gifts! Jewelry manufacturer sells direct to you! Send for free folder. Fredericks, 1223 National Newark Building, Newark, New Jersey.

**WELLS-FARGO** Reward posters 12/¢. Jesse James 50¢. Frontier, North Decatur, Georgia.

**DRESSES 18¢, Coats \$1.98, shoes 99¢** (used). Free catalogue. Ace, 196-MP DeGauw, Brooklyn 31, New York.

**LET Us** tell you how to turn the reading habits of your friends into profit for you. \$10.00, \$25.00 or \$50.00 can easily and quickly be made under our Popular Mechanics subscription plan. No experience needed. Write Popular Mechanics, Room PM, 250 West 55th St., New York 19, N. Y.

**FREE—Lifetime** gift free! Write Capitol Enterprises, Box 5150, Washington 19, D. C.

**BOOKS** On antiques and their prices. Free circular! P. Warman Publishers, Uniontown, Penna.

**100,000 PRODUCTS** Wholesale—Free catalog! Send postcard: Econ-O-Mart, Whippany 15, New Jersey.

**YOUR Name** wanted. We'll send 1000 publishers, mailers, wholesalers your name, on our list one year 25¢. Dixie Mailers, King, N. C.

**MONEY Making** and saving catalogue. Write: Adams, PM 210 5th Avenue, New York 10, New York.

**SUPER Memory** overnight! Success guaranteed! Bijou, Box 1727-M, Hollywood 28, California.

**MAKE Your own will.** Legal form only \$1.00. Write, Willis, Box 3826, Oklahoma City 6, Oklahoma.

**LUMINOUS Stars** printed on clear plastic, form a "See thru" map for easy star identification. Twelve maps systematically covers entire sky. All American Ephemeris Navigational Stars included. 1960 co-ordinates. Set of 12 maps \$4.95 postpaid. Broders Maps, 1368 McAllister St., San Francisco 15, California.

**ORNAMENTAL Iron** designs. Book of 1700 beautiful, practical designs for railings, columns, etc. Free literature. Cunningham, 3881 South 3200 West, Salt Lake City 4, Utah.

**CESSPOOLS,** Septic tanks, clogged drains. How they function and how to keep them working. Free literature. Chemical Cesspool & Drain Cleaning Co., Boston 34, Mass.

# YOU can earn more

More money, higher hourly pay, a home or business of your own—all these and many other advantages are yours when you know a specialized trade. You learn to earn big pay in our large, block long, modern equipped Chicago school and shop. Training in Chicago is easier than you think. No previous experience necessary. We help you find part time work and living quarters while you train. Day, evening, or part time courses. Free job placement assistance after you graduate. We have more job openings than graduates to fill them in some trades. You learn by actually using the tools and equipment under personal supervision of skilled technicians. Minimum class room instruction. Greer Shop Training, with 57 years of continuous operation experience, is the largest trade school in the world and is recognized by industry. Greer established 1902.

APPROVED FOR CIVILIANS  OR VETS

## SHORT TERM DIPLOMA COURSES IN

- DIESEL MECHANICS
- AUTO MECHANICS
- BODY & FENDER REPAIR
- GAS-ARC WELDING
- REFRIGERATION —  
AIR-CONDITIONING
- MACHINIST
- ADVANCED MACHINIST —  
TOOL & DIE

## ENGINEERING COURSES

These courses teach practical and technical phases and lead to a degree. They are designed to prepare men for supervisory positions in Diesel-Automotive and Refrigeration-Air Conditioning fields. Students with high school education, or equivalent, will be accepted.

- DIESEL AUTOMOTIVE ENGINEERING ..... 27 months
- REFRIGERATION & AIR COND.  
ENGINEERING ..... 18 months
- WELDING ENGINEERING ..... 18 months

Start your career with Greer by checking your interest above and mail coupon for complete information at no obligation.

NAME \_\_\_\_\_ AGE \_\_\_\_\_

STREET \_\_\_\_\_

TOWN \_\_\_\_\_ STATE \_\_\_\_\_

BOX 1 \_\_\_\_\_  VET

with  
**GREER** shop  
training

2236 S. Michigan Ave., Chicago 16, Ill.

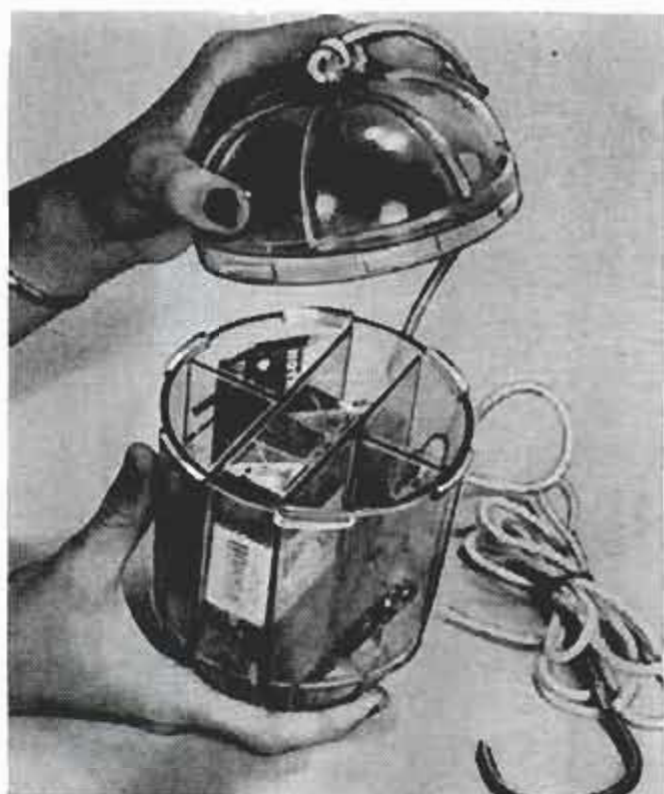

"Tackle Buoy", New Idea Sporting Goods, Inc.,  
Post Office Box 401, Bay City, Texas

## Floating Tackle Box

Nine compartments for tackle, cigarettes and other gear make this floating plastic tackle box a handy fisherman's accessory. Lanyard doubles as a stringer, or lets a wading angler trail the box from his belt.

## Long Reach for Fishermen

Anglers have a 10-foot reach with a new landing net. This permits a bridge fisherman to reach down into the water to land his catch. The handle of the net is made in sections which screw together. The hoop of the net can be locked at any angle to the handle. Included with the net is a gaff hook.



Gutert Quality Products, Inc., 117  
W. Keefe Ave., Milwaukee 12, Wis.



## Telephone Set In One Piece

Swedes have begun using a one-piece telephone. Speaker and receiver are combined in a lightweight unit that can stand on a table. The dial is built into the bottom plate and is available to the caller when he picks up the phone.

**GET INTO  
THE BOOMING  
BUILDING INDUSTRY**

**WRITE FOR FREE BOOKLET**

**Become an Expert Building Contractor  
Learn Quickly in Spare Time. ATS Home  
Training Helps You Go Up to Big Pay**

Job opportunities are great for Estimators, Contractors, Builders. Succeed in your own Home Building and Remodeling Business in this multi-billion dollar industry. Start with small, profitable remodeling jobs go on to bigger jobs. No previous experience or advanced education needed. Easy to understand pictorial methods of this not-for-profit organization prepares for advancement in all branches of building industry. Learn Blue Print Reading, Carpentry, Masonry, installing and designing plumbing, wiring and estimating, house planning, construction financing, etc. Write for FREE booklet today—no obligation.

**AMERICAN TECHNICAL SOCIETY, Dept. BH959  
850 EAST 54TH ST., CHICAGO 37, ILL.**



**WHAM-O**

**\$1.50**

40 LB  
PULLY

HITS LIKE A RIFLE—  
KILLS RABBITS, SQUIRRELS

Powerful, silent, accurate  
For hunting, target,  
routing pests.

Sportsman's choice  
and world  
winner



**HUNTING  
SLINGSHOT**

Heavy duty T ash stock,  
40 heavy steel balls, extra rubber,  
target, adapter for shooting arrows.

**GUARANTEED.** Professional model of  
Nat'l Slingshot Assn. At dealers, or write

**WAMO MFG. CO., Box 15, P. San Gabriel, Calif.  
FREE catalog on crossbows, knives, games, pistols, etc.**



**MONEY in FLORISTRY!**  
For Men, Women, Families

Growing demand everywhere for Flower Designers—men, women, any age. Big pay, full or part time. Or open your own Flower Shop. No big investment—high profits! We train you at home, spare time, supply professional design materials. Earn while learning.

**10 WAYS TO MAKE MONEY AT HOME WITH FLOWERS**—Flowers costing pennies wholesale or from your garden bring dollars as corsages, wedding bouquets, funeral pieces, etc. Orders come from friends, neighbors, churches, hotels. Or grow flowers to sell to florists. Easy, profitable. Professional florists offer instruction, guidance—including "10 Ways to Make Money at Home with Flowers." **FREE details and Lesson in professional Flower Arranging.** No obligation. Write today. Floral Arts Center, Dept. 20 3570 W. First St., Los Angeles 4, California

**WHY GET LOST?**

A dependable HULL COMPASS will keep you "on course" wherever you go... strange cities, new neighborhoods... at junctions and detours. A color to match your car or boat. \$5.95 to \$7.50. At your dealer. Write for literature



HULL MFG. CO., P.O. Box 246-D-9, Warren, O.

**START YOUR OWN  
MAIL ORDER  
HOME BUSINESS**

**FREE  
Publication  
SHOWS  
YOU  
HOW**

Get your **FREE COPY** of "How to Make Money in Mail Order" revealing plans on how and where to get best products to sell by mail—how to pocket profits in advance—how to get free ads. Men, women, families, start your own big profit home mail order business without experience or product investment. New Mail Order Exchange plan helps beginners start. Confidential bulletins show you products to sell by mail, show newest sure-fire mail order techniques. Write today for your **FREE COPY** of "How to Make Money in Mail Order." There's no obligation. Air mail reaches us overnight.

**MAIL ORDER EXCHANGE**  
3717 Westwood, Dept. X259, Los Angeles 24, Calif.

**WOOD**  
**PLIOBOND**  
**CANVAS**  
**SYNTHETIC RUBBER**  
**"BONDS"**  
**PLASTIC**  
**GLASS**  
**ANYTHING**  
**LEATHER**  
**COMPOSITION BOARD**  
**TO**  
**ANYTHING!**  
**STAINLESS STEEL**

**EASY TO APPLY.** PLIOBOND requires no mixing, brushes on, dries rapidly.

**EXCELLENT ADHESION.** PLIOBOND exhibits exceptional strength—up to 1600 lbs./sq. in. in shear tests.

**EXTREMELY DURABLE.** PLIOBOND resists age, heat, cold, water, chemicals, oils.



*Pliobond*  
BY  
**GOOD YEAR**

Pliobond—T. M. The Goodyear Tire & Rubber Company, Akron, Ohio



Jack's former job was a hard, unrewarding one.



Jack greets his family after a day at the office.

# THE JACK EVANS STORY

Jack's home-study assignments proved to be the best preparation for future progress in his chosen field.

*B. Richard*



Jack Evans is a successful young man by anyone's standards—a beautiful wife, two fine children, an attractive home, a good job, an unlimited future. Jack Evans has everything an ambitious young man could want.

But it wasn't always this way with Jack. He wasn't "born with a silver spoon in his mouth." Everything he has today he worked for—and most of all he studied for it, building a background in his field that served as a base for his "future unlimited."

Jack graduated from Lincoln High School in Lincoln, Illinois in 1950. He had a steady job lined up and planned to marry his high school sweetheart just as soon as he saved some money. Just as it did with thousands of others, the Korean conflict interfered with Jack and his plans, and his marriage was postponed for several years while he was overseas.

When Jack left the service he thought he "had the world by the tail"—a good job waiting for him, newly-married to an attractive wife, and it didn't matter much that he and his wife lived with her par-



This attractive home is a direct result of the increased earning power education brought him

## ... **FUTURE UNLIMITED**

ents. It was inconvenient—sure, but Jack was ambitious. He was sure that in a short time he would be able to afford an apartment of his own or maybe even a small home.

But the coming of his first child upset Jack's dreams. It became more and more difficult to stretch his pay check out from one week to the next. These were tough times for both Jack and his wife. Chances for a home of their own seemed farther away than ever—his rosy future seemed to be fading more and more out of reach. Raises weren't forthcoming, and his job as an accounting clerk with a good-sized local manufacturer seemed to be leading him exactly nowhere.

Although Jack didn't know it at the time, he was approaching a decisive turning point in his career . . . a point at which he came to realize that all the hard work in the world would be of little help to him in his present job. He knew he'd stay right at the same desk for years to come without much increase in income.

Exactly how or when Jack arrived at his decision isn't important; the fact was, Jack came to realize that in order to achieve his

(Continued to page 260)

As Senior Accountant, Jack's earning power has increased greatly along with more responsibilities



AMAZING 6-SECOND **HERCULES**

# SWIF SOLDER

REAL SOLDER (NOT A GLUE). JUST SQUEEZE ON AND HEAT... 42% FASTER THAN WIRE SOLDER\*

Squeeze on Hercules SWIF Solder and heat... even a match will work when you solder wires with SWIF. SWIF solders copper, brass, iron, steel, silver, zinc, tin, etc. Plumbers, electricians and electronics men choose SWIF because it gives them a real 50/50 tin-lead solder in time-saving, easy-to-use paste form. One tube of SWIF does the work of 3 to 4 times as much ordinary solder. Each tube comes with a free Do-it-Yourself Solder Leaflet that shows how to use SWIF for so many jobs.

\*Test report available on request



Hobbies & Crafts    Electrical Wiring    Plumbing & Repairs

ONE HANDY TUBE MAKES HUNDREDS OF CONNECTIONS... ONLY **69c** 

Also available with acid flux in 4 oz., 1/2 lb., 1 lb. and 3 lb. containers. **HERCULES CHEMICAL CO., INC.**, 416 Broadway, New York 13, N.Y.

## ENGINEERING

HOME STUDY COURSES

Courses written by world authorities in all branches of engineering and science. Step-by-step instructions using methods proved successful by thousands of our graduates. One hour each day in your spare time will start you off to higher pay, security and prestige. Fill in the coupon to-day and indicate the course of interest. We will send you a complete outline of the course with a booklet describing the Institute and our advanced teaching methods.

CIVIL ENG.  
SURVEYING  
ARCHITECTURE  
FORESTRY  
STRUCTURAL  
MECHANICAL ENG.  
INDUSTRIAL ENG.  
REFRIGERATION  
DRAFTING  
ELECTRICAL ENG.  
RADIO  
ELECTRONICS  
TELEVISION  
AERONAUTICAL ENG.  
HIGH SCHOOL  
CHEMICAL  
MATHEMATICS  
ACCOUNTING

### MAIL THE COUPON TODAY

Canadian Institute of Science & Technology Ltd.,  
727 Century Bldg., 412, 5th St. N.W., Wash., D.C.

NAME.....

ADDRESS.....

CITY..... STATE.....

COURSE OF INTEREST.....

Canadians: Send to C.I.S.T., 727 Garden Bldg.,  
263 Adelaide St. W., Toronto, Ont.



# C. I. S. T.

# Where-to-Buy-It Index

## Automotive

Do you know this old-timer?	14
Flexible spout dispenses car polish (Skil Corp., 5033 Elston, Chicago 30)	72
Right-hand drive car used to check meters	92
Italian auto-top tent fits any car	92
V8 truck engine: 150,000 miles without overhaul	104
Transistor car radio built into mirror (W. Ramseier & Co., S.A. Geneva, Switzerland)	111
One hand-lever controls speed and gears of tractor (Tractor and Implement Div., Ford Motors Co., Birmingham, Mich.)	124
"Squashed up" car solves parking headache (Scootacars Ltd., 125 Jack Lane, Leeds 10, England)	129
Converter cuts exhaust (Ford Motors Co., 477 Madison Ave., New York City 22)	135
Mailman covers route in homemade truck	135
Seat on truck bumper speeds up street striping	146

## Aviation

Loader for superplanes	112
Remember this old-timer? It's back as a crop duster (Kelleit Aircraft Corp., Box 35, Willow Grove, Pa.)	119
"Pitcher" huris bomb away from plane (Republic Aviation Corp., Conklin St., Farmingdale, L.I., N. Y.)	124
Computers to plan air trips? (John W. Grewell, System Planning Div., Federal Aviation System, Las Vegas, Nev.)	148

## Missiles and Rockets

Earth-burrowing rocket?	111
Huge "balloon" will shelter largest missiles	125
Earthbound "spaceship" tests control systems	129
Huge antenna tracks missiles	140

## Miscellaneous

Portable power winch handles many jobs (Easy Go Products, Inc., P.O. Box 37, Kenmore, Wash.)	91
"Sixth finger" on glove serves as trap for ball (Rawlings Sporting Goods Co., 2300 Delmar Ave., St. Louis, 66)	91
Step-up trampoline serves as diving board	91
Germ killer	92
Fluorescent-tube research produces new designs and single socket (Lamp Div., Westinghouse Electric Corp., Bloomfield, N. J.)	92
Nylon church	93
Bike with detachable bar serves brother and sister (Westfield Mfg. Co., Westfield, Mass.)	111
Jar of fibers filters water (Cuno Engineering Corp., Meriden, Conn.)	111
Foam strip saves finish (United Mineral and Chemical Corp., 16 Hudson St., New York City 13)	112
Clear chemical coating protects color transparencies (Polaroid Enterprises, 307 W. 38th St., New York City 18)	113
Television cameras identify workers (General Precision Labs, Inc., Pleasantville, N. Y.)	115
Superfast movie camera photographs bubbles on propeller	117
World's smallest watch?	118
Pedal blocks on trike never scrape sidewalk (Marlex Mfg. Co., 415 Wells St., Caro, Mich.)	119
Everything but the apple built into teacher's desk (American Seating Co., Grand Rapids, Mich.)	120
Chart light for boats also lights cigarettes (N. A. Taylor Co., Inc., Gloversville, N. Y.)	120
Playground goes modern	121
Two-volt replaceable cells build marine battery (Sweinhart Equipment Sales, Inc., 2900 E. Olympic, Los Angeles 23, Calif.)	128
Horizontal pipes improve organ tone	129
Old trolleys attract fish to once-barren waters	130
Machine pruning cuts cost	134
Sidewalks steam-cleaned	134
Elevator on wheels raises loads anywhere	139
German locomotives trade coal for oil	139
Vacuum attachment speeds barber's work	139
Vinyl plastic lamps inflate like balloons (Wonderland Lamps, Marede Mfg. Co., Inc., 4855 E. 10th Ct., Hialeah, Fla.)	139
London schoolchildren tap out tunes on water-filled bottles	140
"Toothpaste tube" method forms intricate metal shapes (Alcoa Aluminum Co. of America, 1501 Alcoa Bldg., Pittsburgh 12)	146
Moving aerial sidewalk links hotel with annex	147
Motorized gantry crane retrieves landing craft	148
"Ten day wonder" silo is Europe's largest	148

## Science

An Eye on Space	81
Radioactivity in milk measured by detector	112
Electronic typewriter operates by light beam	118
IBM cards rule mill rolling aluminum slabs (Aluminum Co. of America, 1501 Alcoa Bldg., Pittsburgh 19, Pa.)	124
Midjet computer aids engineer (Electronic Assoc. Inc., Long Branch, N. J.)	140
Infrared analyzer spots air pollution	147
Radiation monitor room built from armor plate (General Electric Co., Richland, Wash.)	148
Worldwide TV programs may bounce off moon	222

(Continued to page 70)

# 5 reasons why ACCOUNTING

FINE CAR



A NICE HOME



offers you

## MORE MONEY and SUCCESS



**SEND FOR FREE  
SAMPLE LESSON**

**REASON #1.** If you were an expert accountant right now, chances are you would find yourself in one of the best paid fields of business.

**REASON #2.** The demand for accountants is great—everywhere. All businesses must have trained accountants to cope with ever-growing requirements. It's a field offering wide opportunity—always—to the man who knows.

**REASON #3.** You can fit into any business, anywhere in the country—because accounting principles are universal. Think what this means in terms of security and independence!

**REASON #4.** Accounting is open to all. Any man or woman of good intelligence, who enjoys figure work and is willing to follow LaSalle's systematic "problem method" plan, can rapidly qualify for a highly profitable, enjoyable lifetime career . . . and he doesn't have to finish his training before beginning to "cash in."

**LASALLE**  
417 S. Dearborn St.,  
CHICAGO 5, ILL.

**REASON #5.** Without losing a day from your present work, you can prepare in spare hours at home, at low cost, under LaSalle's step-by-step "Problem Method" of "learning by doing." This famous plan accounts for LaSalle's remarkable record of having trained one out of every 13 of all Certified Public Accountants in the U. S. . . . and of having put many thousands of others into high-paying careers.

**Send today for Free Sample Lesson** and "Opportunities in Accounting." Learn about the several great fields of opportunity . . . and LaSalle's time-tested plan for helping men and women to rapid advancement, higher income and greater prestige. The coupon below will bring this information to you—without cost or obligation.

**Accredited Member, National Home Study Council**

**SEND FOR FREE BOOK**



**LaSalle Extension University**  
A Correspondence Institution

Dept. 964 HB, 417 S. Dearborn St., Chicago 5, Ill.  
Please send me, free of all cost or obligation, free sample lesson and your latest book, "Opportunities in Accounting."

Name.....Age.....

Address.....

City, Zone, State.....

## FREEZER TIP NO. 43



Seal in freshness and flavor of pies and baked goods with "SCOTCH" Brand Freezer Tape. Fruit pies are better when frozen unbaked. Cream pies: bake as usual but freeze without meringue. Moisture-resistant "SCOTCH" Freezer Tape sticks in freezing cold to saran and other films, to foil or paper. Tape is a label, too . . . you can write on it! Get "SCOTCH" Brand in handy cutter-edge carton—in thrifty 35¢ or 98¢ rolls.

Don't run short . . .  
**BETTER BUY TWO!**

Made by  
Minnesota Mining & Mfg. Co.  
St. Paul 6, Minn.  
© 3M Co., 1958



## "THE-THINKING MAN'S GUIDE" STOP FISHING BUNDLY



Locate your fish in  
Muddy water, fresh or  
salt water, or ANY  
kind of water with a

### LOWRANCE FISH LO-K-TOR

Condition of the water makes no difference. The Lowrance portable Fish LO-K-TOR is not a gimmick or gadget, or a pig in a poke, but a proven modern electronic instrument that sends and receives sonar signals through the water, which indicate on the scope whether it is a single fish or a school. You still gotta locate 'em before you can catch 'em (any good fisherman knows that). Shows condition of bottom and how deep down to 80 ft. Transistorized and operates on two regular six-volt lantern batteries. Light and compact (wt. 10 lbs). See your sporting goods or marine dealer, or write for FREE literature. Price complete with batteries and special boat bracket



**\$148<sup>50</sup>** F. O. B.  
Joplin, Mo.

**LOWRANCE ELECTRONIC MFG. CORP.**

Dept. 899 Ph.: Mayfair 3-3643 Joplin, Mo.

**DEALER INQUIRIES INVITED**

## What's New for Your Home

Automatic ironer	122
Electrically powered baby cradle	122
Salad maker	122
Automatic washing tool	123
Liquid charcoal lighter	123
Battery-powered mixer	123
Dialed vegetable slicer	123
Spiral utility rack	123

## Radio-Television, Electronics

Kit-built hi-fi trims stereo costs (Heath Company, Benton Harbor, Mich.)	149
Zener-regulated power source	152

## Craftsman and Shop Notes Index

### Automotive

Store paper towels for car use in wax-paper container	173
Holder on glove-compartment lid keeps pen and pencil handy	173
Corrosion of battery terminals prevented by small copper piece	181
Plastic sheet under automobile-seat cover protects upholstery	181
Spark plugs provide lifting rings for hoisting motor from chassis	181
Spark plug short-circuited by deteriorated boot	181
Auto cleanliness extended to include underhood area	191
Inexpensive breakdown insurance provided by spare fan belt	191
Installation date on battery is preventive maintenance	191
Straight pin used as gauge to set spark-plug gap	191

### Farm

Closed gates permit open doors	175
Tractor attachment applies waste oil to control road dust	175
Ladder bolted to combine hopper permits easier inspection	185
Tandem tractors with one operator pull double load	187

### House and Home

Tape protects decorative nails	156
Bookcase "guards" stairwell	157
Home-movie trick	160
Helpful home kinks	161
Methods of making yardlight posts	161
Rustic signpost	165
Bench legs adjusted with leg screws	176
Oriental planter	184
Expanded garage houses second car and boat	180
Shingles dip-painted before applying	194

### Miscellaneous

Screening assures sharp focus	161
Gluing hints	168
Modified desk drawer provides added support to slide	185
Mock automobile crash makes eye-catching roadside sign	185
Make her a play sink	186
Curtain rod holds paint sign	156
Paper "seals" masonry wall	161

### Shopping for Tools

Sanding block	206
Kitchen mixer converts to portable electric drill	206
Portable belt sander has two speeds	206
Ball and roller-bearing cleaner	207
Leg brackets	207
Spiral burnisher	207
Self-chaiking line	207
Torque adapter	208
Welding gun	208
Framing square	208
Sub-fractional horsepower gearmotor	208
Hand screwdriver	208
Portable electric paint remover	208

### Solving Home Problems

Portable barbecue grill made shockproof	166
Tapering edges improve door bolt	166
Clothing easily removed from closet	166
Novel pool caddy for your sewing box	166
Teakettle used for melting and pouring paraffin	167
Sewing buttons on heavy garments made easy	167
Holder for storing electric razor	167
Keeping track of a house key	167
Convenient hanging file made from envelopes	167

(Continued to page 72)

**NOTICE**—It is the intention of this magazine to provide its readers with information regarding the latest developments in the mechanical arts. Except where otherwise indicated, this magazine has no information as to any unexpired patents in respect of the developments reported herein. In the event that commercial use is to be made of any of the developments reported herein, it is suggested that legal counsel be consulted to avoid liability for patent infringement. It is not the purpose of this magazine to encourage patent infringement but, as indicated, it is the intention of this magazine to report on the latest developments in the mechanical arts.



# only one coat?

Certainly,  
it's that  
wonderful  
colored  
aluminum  
paint!



Mrs. Johnson chose Antique White. Weather-Foil also comes in Berkshire Green, Alpine Blue, Sierra Red. Made by Phelan-Faust Paint Manufacturing Co., St. Louis, Missouri.

## St. Louis homeowner restores old roof with Phelan's Weather-Foil

Mrs. Virginia Johnson of St. Louis County, Missouri, had a problem. What to do about an old, weathered roof that leaked? A friend told her about Phelan's *Weather-Foil*, one of the time-proved, colored aluminum coatings made with ALCOA® Pigments.

Mrs. Johnson checked with her painter, found that *Weather-Foil* is economical and durable—told him to get on with it. Here are the results: New appearance for the entire property, nail holes plugged and small cracks sealed and a weather-proof surface that should add five to ten years to the roof's life.

Tough, fibered coatings like *Weather-Foil* protect in any climate—will not run or crack—stay firm on top, flexible and pliant underneath—cover 75 to 150 sq ft per gallon. And the aluminum flakes turn back much of the sun's heat, help keep interiors comfortable in summer.

Coatings like *Weather-Foil* with their fade-proof colors stay new-looking for years. In fact, weathering actually intensifies the colors. One coat hides any roof surface—built-up composition, asphalt shingles, tar paper, slate—even well-

cleaned, rusty metal. And patched roofs can now be made uniform in color with *Weather-Foil*.

ALCOA does not make roof coatings, but we will be happy to refer you to reputable manufacturers who do. Send for our booklets, *Painting With Aluminum* and *Aluminum Roof Coatings Make Time Stand Still*. Use the coupon.



Look for this label . . .  
it's your guide to the best  
in aluminum value

For exciting drama watch "Alcoa Presents" every Tuesday, ABC-TV, and the Emmy Award winning "Alcoa Theatre" alternate Mondays, NBC-TV

Aluminum Company of America  
1737-J Alcoa Building, Pittsburgh 19, Pa.

Please send your booklets:

- Painting With Aluminum*  
 *Aluminum Roof Coatings Make Time Stand Still*

Name \_\_\_\_\_

Address \_\_\_\_\_

City \_\_\_\_\_ Zone \_\_\_\_\_ State \_\_\_\_\_

## Workshop Hints

Glass gutter scores metal to assure sharp bend	156
Wrench-and-clamp storage rack	156
Screws stored with faceplate	161
Calipers used to measure flanged parts and cylindrical grooves	164
Cork sheet cushions steel stock to stop drill-press chatter	164
Tape "locks" micrometer on desired setting	164
Bench stop pivots in slot	169
Methods of holding polished tubing for cutting	169
Razor-blade "chisel" is aid in scribing and mortising small hinges	169
Storage cups for brads	169
Keep grounding adapter handy by taping it to three-prong plug	173
Wire stripping easy with adapted pliers	173
Efficient edge clamp is improvised from wire and turn-buckle	175
Guard protects blades of paint scraper	176
Lead-shot "lock washer" in acorn nut	176
Magnetic holder for drill-chuck key	176
Rope "clamped" quickly with tubing	176
Strap clamp for special machining	176
Springs hand-wound on bolt "mandrel"	187
Gap spark plugs with care	190
Accurate centerpunch layout assured with simple jig	194
Sheet-metal cutting tool shaped from auto valve	194
Track-mounted hoist for the workshop	195
Router plane	196
Adjustable jig for accurate scribing of parallel lines	197
Holder for small twist drills	197
Strips of masking tape indicate lengths of bolts	197
Rubber band acts as holder for tailstock wrench	204
Simple lathe attachment reclaims cutting oil for reuse	204
Squaring bracket aids work setup	204
One-piece follower rest travels with tool post	205
Clamping collar of hardwood supports drill-press table	205
Shop-made lathe steady rest for large-diameter work	205

## Flexible Spout Dispenses Car Polish

Featured on a seven-inch electric car polisher is a flexible spout that automatically dispenses liquid polish and cleaner onto the surface to be polished. A press of the thumb on the trigger pumps liquid through the

spout, which is 9½ inches long. According to the manufacturer, the flexible nozzle will not scratch the car should it brush against the painted surface. Capacity of the dispenser is sufficient to polish one car. The polish dispensing handle is available as an accessory for most makes of polishers.



# SAVE UP TO 1/2 ON FINE ITALIAN

# CHORD ORGANS

Buy Direct-From-Importer... GET BIG DISCOUNTS

PLAY ON SIGHT! NO LESSONS NEEDED!

Here's the new musical instrument sensation that's suddenly captured the entire country! You and the children can play old and new songs in just a matter of minutes!... thanks to the famous DA-MAR System, included FREE! Makes music fun right from the start. Brings the whole family closer together as everyone joins in playing everything from hit tunes to lovely hymns. Best of all... you actually save 1/2 off mfr's list prices... buying direct from the importer. Pay only a small amount down... the rest just pennies a day!

### HAND CRAFTED IN ITALIAN TRADITION OF QUALITY

Many domestic-made Electric Chord Organs use inferior plastic reeds... but every Philharmonic reed is made of finest, carefully treated Swedish Stainless Steel for superbly richer tonal quality and volume. Your Philharmonic Electric Chord Organ is largely hand crafted, just as any outstanding instrument should be! A giant in performance—yet it's light in weight, fully portable. Choose from a wide selection of models, including Piano-Keyboard model for those with piano background. DOUBLE GUARANTEED. Get new FREE Color Catalog and lowest Direct Importer-to-You Discount Prices. Rush Coupon...

ELECTRICALLY OPERATED—JUST PLUG IN AND PLAY



EASY TERMS  
SMALL DOWN PAYMENT  
BALANCE only  
PENNIES A DAY

### FREE BONUS GIFTS

- Big Solo Kit...with special easy-play arrangements of favorite songs.
- Plastic Protective Cover
- Expandable Music Portfolio
- Chemically Treated Polishing Cloth
- DOUBLE GUARANTEE...gives you 100% certified protection.

Rush coupon for details

## 5 DAY FREE HOME TRIAL

Try it—play it—enjoy it in your own home on 5-FULL DAYS' FREE TRIAL. Only then can you appreciate how much fun the Philharmonic can bring into your home. Details free.

**PHILHARMONIC ORGAN CORPORATION**  
Dept. R-99, 2003 West Chicago Avenue, Chicago 22, Illinois

**FREE!** GET COLOR CATALOGS AND DIRECT IMPORTER-TO-YOU DISCOUNT PRICES

Philharmonic Organ Corporation—Dept. R-99  
2003 W. Chicago Avenue, Chicago 22, Ill.  
Rush Color Catalogs and Lowest Discount Prices

NAME \_\_\_\_\_  
ADDRESS \_\_\_\_\_  
CITY \_\_\_\_\_ ZONE \_\_\_\_\_ STATE \_\_\_\_\_

get a real head start in work you like!

choose  
qualify  
know  
... before  
enlistment

It's up to you! The Army's new "Choose-it-Yourself" System lets you choose your vocational training before you enlist! Here's how it works:

**1. CHOOSE** . . . before enlistment!

Choose your training from fields like Metal Working, Electronics, Motor Maintenance, Guided Missiles, Radar & TV Repair—and many more.

**2. QUALIFY** . . . before enlistment!

Next you take aptitude and physical examinations to qualify for the training you've chosen.

**3. KNOW** . . . before enlistment!

If you qualify, you know you'll get the training you like. Your choice is written into your future Army record—guaranteed before you enlist.



AND THERE'S NO OBLIGATION! Choose, qualify and know—without the slightest obligation to enlist. You get the Army training you like—guaranteed in writing—or you don't enlist! This week, see your Army recruiter and choose from his complete list of available fields.

CHOOSE IT  YOURSELF VOCATIONAL TRAINING SYSTEM  
**US ARMY**

**You can't miss with Lucky Strike.**

You're sure of its tobacco—fine, mild, golden-rich.

You're sure of its taste—full, fresh, unforgettable.



Outdoors  
or indoors,  
you enjoy  
the taste.

Get the genuine article ...

Get the honest taste  
of a **LUCKY STRIKE**

© A. T. Co.

Product of *The American Tobacco Company*—“Tobacco is our middle name”

# PM Salutes Igor Sikorsky

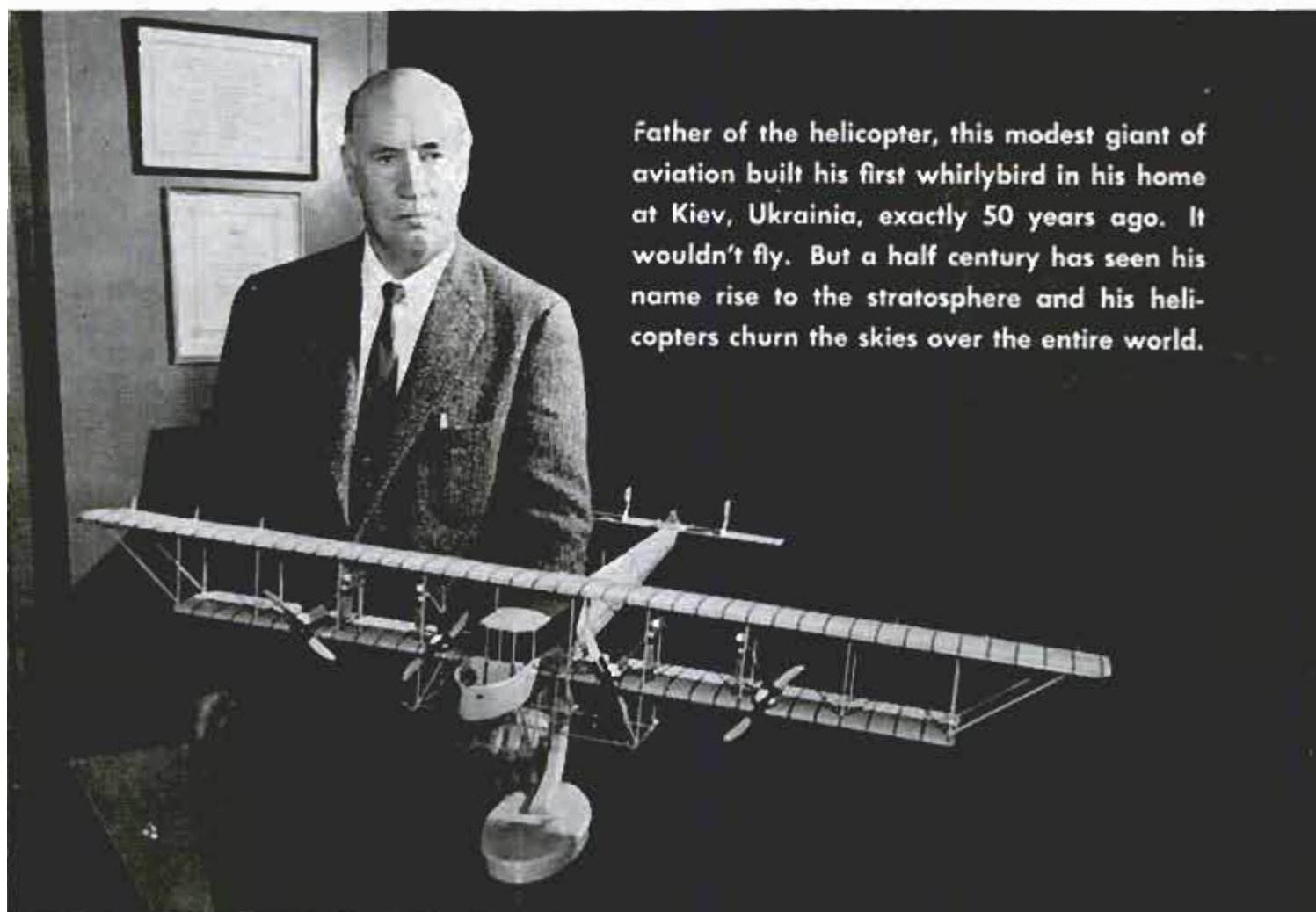

Father of the helicopter, this modest giant of aviation built his first whirlybird in his home at Kiev, Ukrainia, exactly 50 years ago. It wouldn't fly. But a half century has seen his name rise to the stratosphere and his helicopters churn the skies over the entire world.

*By Richard F. Dempewolff*

**O**NE OF THE wildest-looking contraptions ever designed to defy gravity in a big way hoisted itself by its bootstraps straight up off the test aprons of United Aircraft's "Sikorsky Division" in Stratford, Connecticut, a few weeks ago. Like some dinosaur-size three-headed dragonfly, the 80-foot, 10-ton helicopter rose gently under the spinning umbrella of a five-bladed "fan" 72 feet in diameter. Skimming slowly a few feet above the ground, it paused and hovered above an eight-ton steel assembly to which several men hitched a steel cable dangling from the craft. As if toting a feather, the huge whirlybird lifted the mass of steel and made off with it.

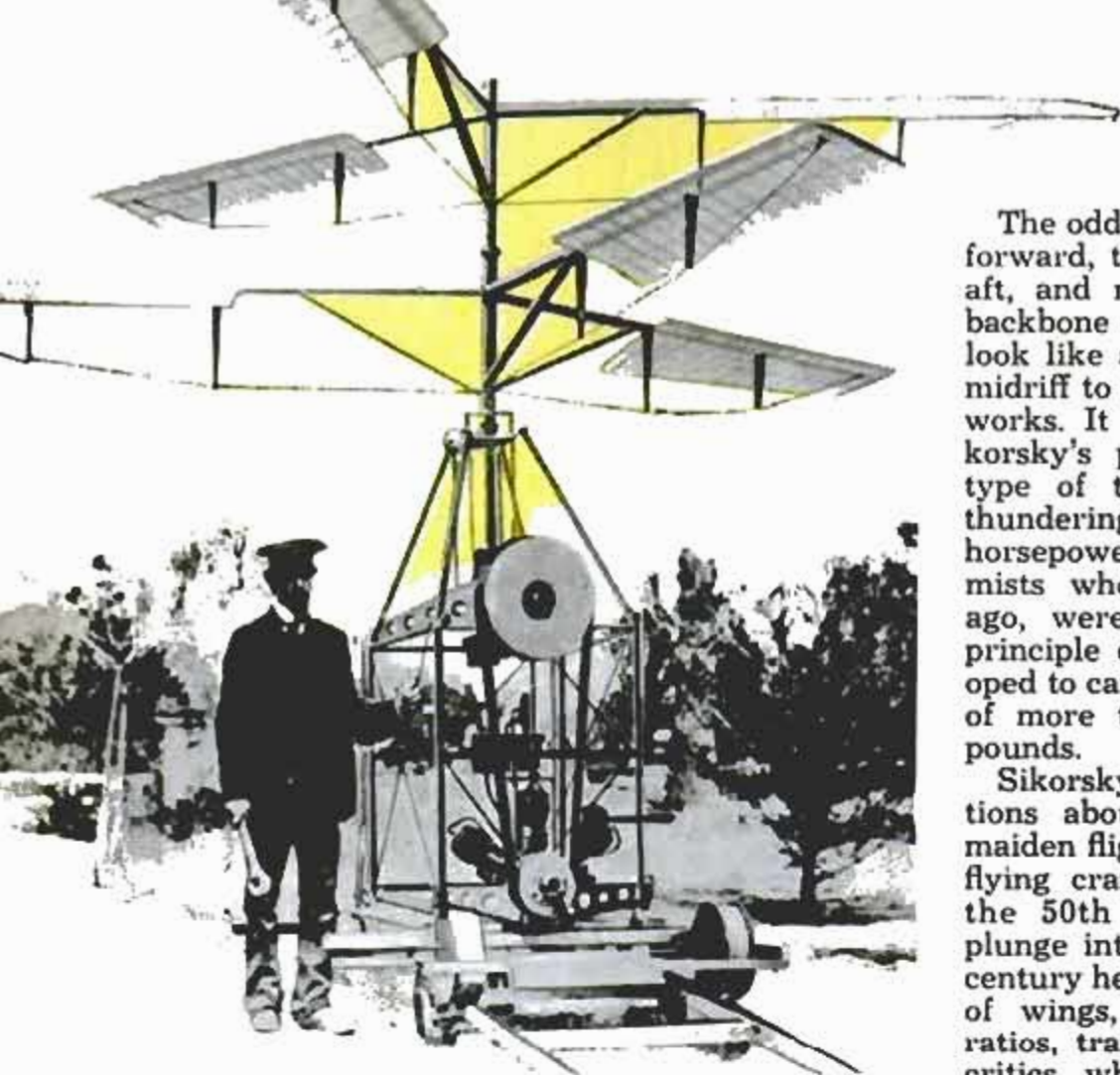

This was the beginning. By 1909, at the age of 20, Sikorsky had built two helicopters. The first wouldn't fly. The second lifted its own weight, 400 pounds, but the pilot's weight was too much

The odd craft, with deep cabin forward, towering tail assembly aft, and nothing but a skinny backbone connecting them, may look like a big fish that lost its midriff to a passing shark, but it works. It is Igor Ivanovich Sikorsky's production-line prototype of the "flying crane"—a thundering, twin-engined, 3600-horsepower answer to the pessimists who, only a few years ago, were sure the helicopter principle could never be developed to carry a practical payload of more than a few thousand pounds.

Sikorsky is used to dire predictions about his ventures. The maiden flight of his "impossible" flying crane this spring marks the 50th anniversary of his plunge into aviation. For half a century he has wallowed in a sea of wings, struts, lift-to-weight ratios, transmission grease, and critics who said "it can't be done." He emerges today, at the age of 70, dripping with honors, fame and a string of successes that, one by one, have silenced the critics—well-meaning and otherwise. His eyes still light with an amused twinkle when he recalls that his first attempt, as a

Czar Nicholas of Russia is greeted by Sikorsky on observation deck of the world's first four-engine plane



19-year-old, to build a vertical-lift aircraft inspired a prominent aeronaut of the day to write an article on the subject, entitled: "The Wrong Way."

The first helicopter, built in a room of the Sikorsky family home in Kiev, Ukraine, where the inventor was born on May 25, 1889, was hardly recognizable as an aircraft. It had a wooden frame, like a big box. On one side was a 25-horsepower motor; on the other a seat. On two vertical tubular shafts, one inside the other, were mounted a pair of counter-rotating two-bladed rotors supported by piano wires, by means of which the young inventor could adjust the pitch of the blades. A belt drive on wooden pulleys turned the 15-foot fans. "It's true that it did not fly," he admits, with a faint note of sympathy for the little machine, "but it tried to."

Actually, the roaring, shuddering rig developed 357 pounds of lift—just 100 pounds shy of its own weight. A second copter, one year later, was able to lift its own 400 pounds but couldn't manage with the pilot aboard. With more power, and better rotors, Sikorsky thought he might do it. But reliable power in those days was a myth, and intuition told him the time was not

right for real success with the helicopter. Sikorsky's intuition is something he respects with a feeling akin to reverence. So helicoptering was shelved temporarily. He turned to the more popular wings and propellers that seemed likely to carry men aloft sooner.

When young Sikorsky entered the field in 1908, real flying was just a furrow on the brows of competent engineers, and a gleam in the eyes of many dreamers. The Wright brothers, Bleriot and a handful of others

This was really flying. The four-engine Grand of 1913 had an open balcony in front of its glassed-in cabin

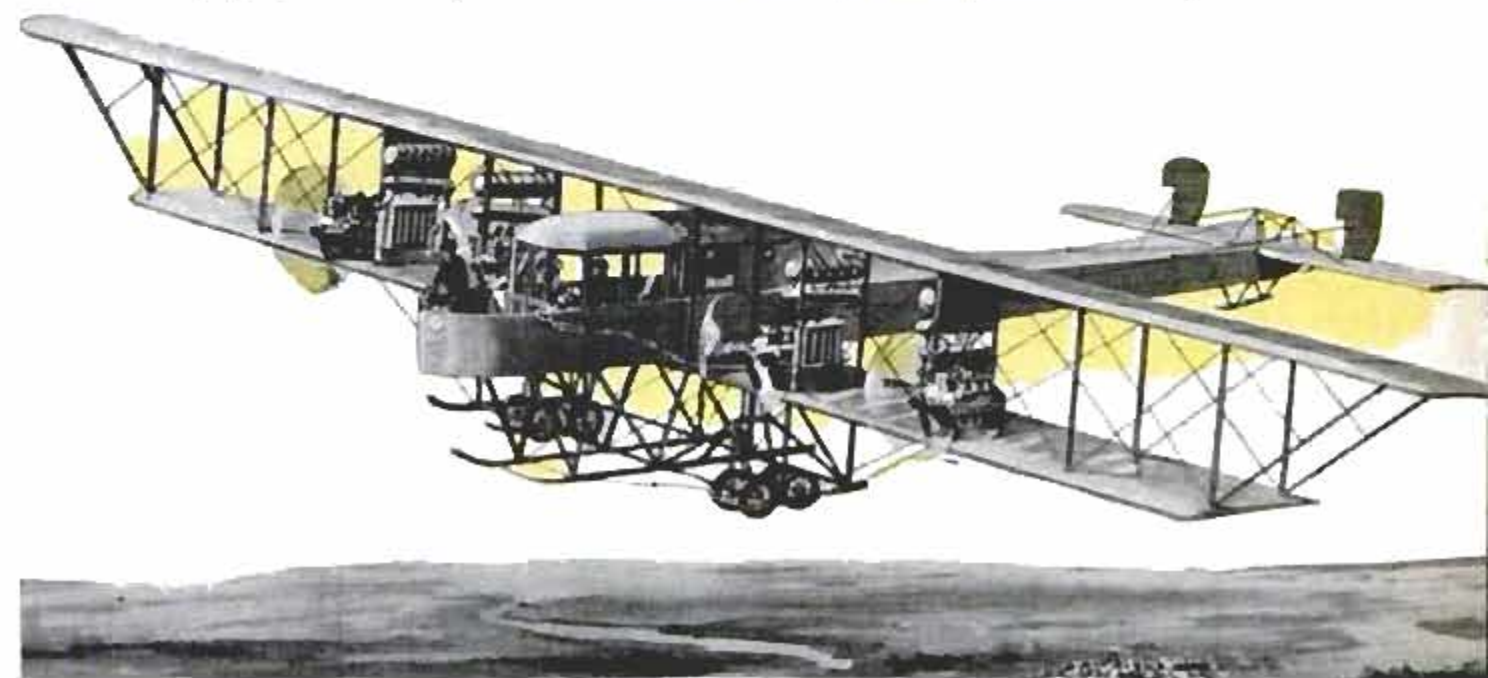

1959: Sikorsky's S-60 "sky-hook," revolutionary flying crane without a cargo cabin. It can carry a six-ton load



1914: the Ilya-Mourometz-B, used for observation and patrol in World War I, lands with men atop fuselage

had constructed aeroplanes that managed to sputter and wobble through the air for a matter of minutes instead of seconds. But most of the motorcycle racing drivers and mechanics who turned to "flying" for added thrills and chills in and around Paris—hub of the budding aviation business—were content to "rouler" their quivering contraptions. This consisted of flapping along a pasture runway and hopping precariously five feet off the ground occasionally. The "planes" were wood with sized-fabric coverings, Sikorsky recalls, and the experienced pilot was one who had "broken plenty of wood in the field."

Engines were complex, temperamental collections of moving parts that coughed, spluttered and stalled out, or refused to start at all. While scouting a suitable motor for his first helicopter, Sikorsky asked one Paris "expert" (an impressive wood-breaker) which engine was best. "None is best, they're all bad," he was told. "Then which is least bad?" the inventor persisted. "The one with the least parts," was the prompt answer. This advice led Sikorsky to the Anzani, a simple, three-cylinder development of a motorcycle engine, which not only powered most of his first aircraft, but also carried Louis Bleriot safely across the English Channel on his famous flight.

For two years, working day and night with the help of volunteer schoolmates from the Kiev Polytechnic Institute, young Igor set out to master the problem of flight. A generous Sikorsky family backed its respect for his ideas by financing him with hard-earned savings, and finally mortgaged the house to keep him going.

First try was the S-1, a fragile-looking pusher-type biplane with bicycle-wheel landing gear. It would taxi erratically across the meadow, but stolidly refused to fly. "The aerodynamics were pure guesswork, and we needed more power," Sikorsky shrugs. Undaunted, the little band of students and craftsmen went back to the drawing board.

Using S-1's wings and a bigger Anzani power plant up forward, a new S-2 took shape. Sikorsky put in days of ground maneuvering to "feel out" the controls. Then, one morning he gave it full throttle, found himself in the air—and in an odd predicament: "Never having been in the air," he explains, in a masterpiece of understatement, "it became necessary to learn quite quickly how to fly." He did.

But after half a dozen short hops totaling eight minutes of flight in as many days, S-2 finally soared 80 feet in the air, stalled out and splattered itself in a thousand splinters across a ravine. Sikorsky, unhurt, crawled from the debris and went back to sketching new plans.

One by one, "S" planes were built and improved. S-5, a big 50-horsepower biplane built of homemade parts, plumbing hardware, motorcycle wheels, kitchen-door springs (for shock absorbers) and more family loans, really flew. In it, Sikorsky won his first pilot license.

A year later, at the age of 22, he broke the world's flying record for speed (70 miles per hour) in his S-6-A, and swept the field at the Moscow Aircraft Exhibition. As a result, the Russian Baltic Railroad Car Factory signed him up as designer and



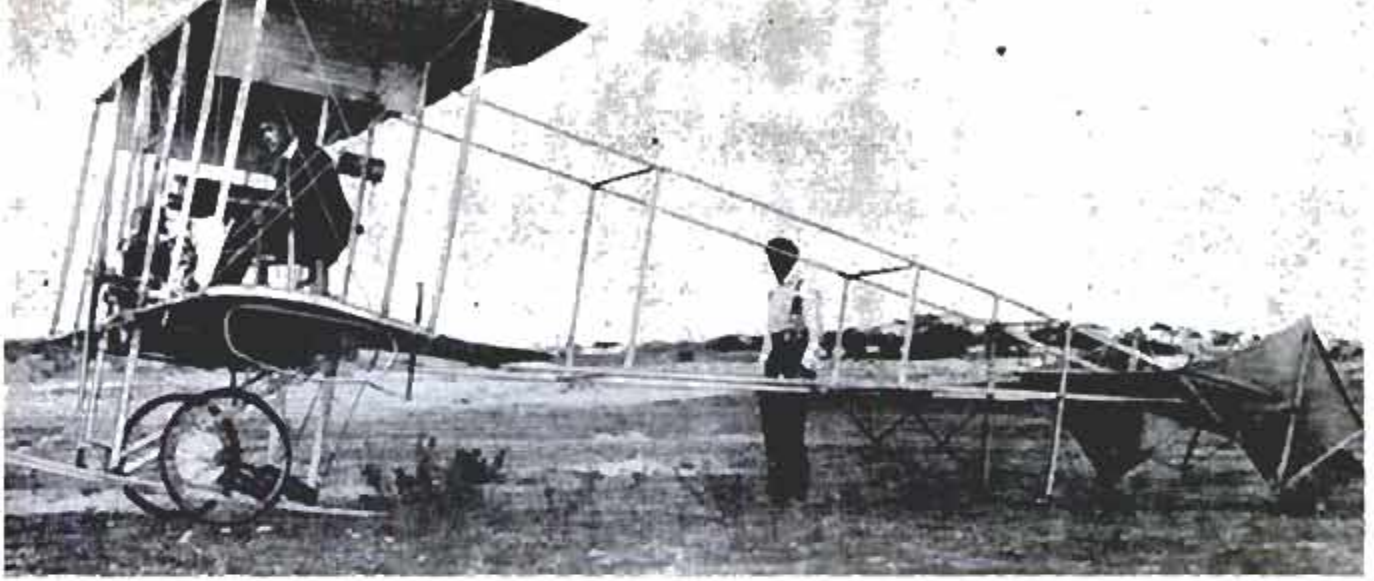

Sikorsky is at the controls of his first successful airplane. It flew for eight minutes in eight tries, then crashed from 80 feet. Its bicycle-wheel undercarriage had shock absorbers adapted from kitchen-door springs



First Sikorsky plane built in America was the S-29, its frame of angle iron and pipe salvaged from junk yards. It crashed on its maiden flight due to overload of passengers he hadn't the heart to refuse a ride

The S-29 was salvaged and sold in 1923 and newer versions began to make money for the inventor's small aircraft company. The S-38, below, a sturdy twin-engine seaplane, became highly popular in the late 1920s





chief engineer of aircraft—with orders to produce at least one new plane design each year.

Young Igor was in his element. His first design, he calmly announced, was to be the biggest, most thundering airplane ever created. It would have not one, but *four* engines. A closed cabin—unheard of then—would envelop pilot and passengers in luxuriously paneled, windproof comfort. There would be outside observation decks.

Before *The Grand* was even on paper, headshakers and wags predicted its doom: "It will never fly. Four engines are totally unmanageable. The wings are completely wrong. Even Nature has set a limit on the weight of flying creatures, or the ostrich would fly. No airplane can ever lift so much weight."

Sikorsky's thin, drooping moustache, gentle eyes and his famous fedora hat with brim turned up fore and aft, give him more the look of a pensive professor than a canny

Sikorsky uses a telephone to coach the pilot flying his first military helicopter at Bridgeport, Conn.

Three tail rotors provided stability and control for early version of the VS-300, one of Sikorsky's first

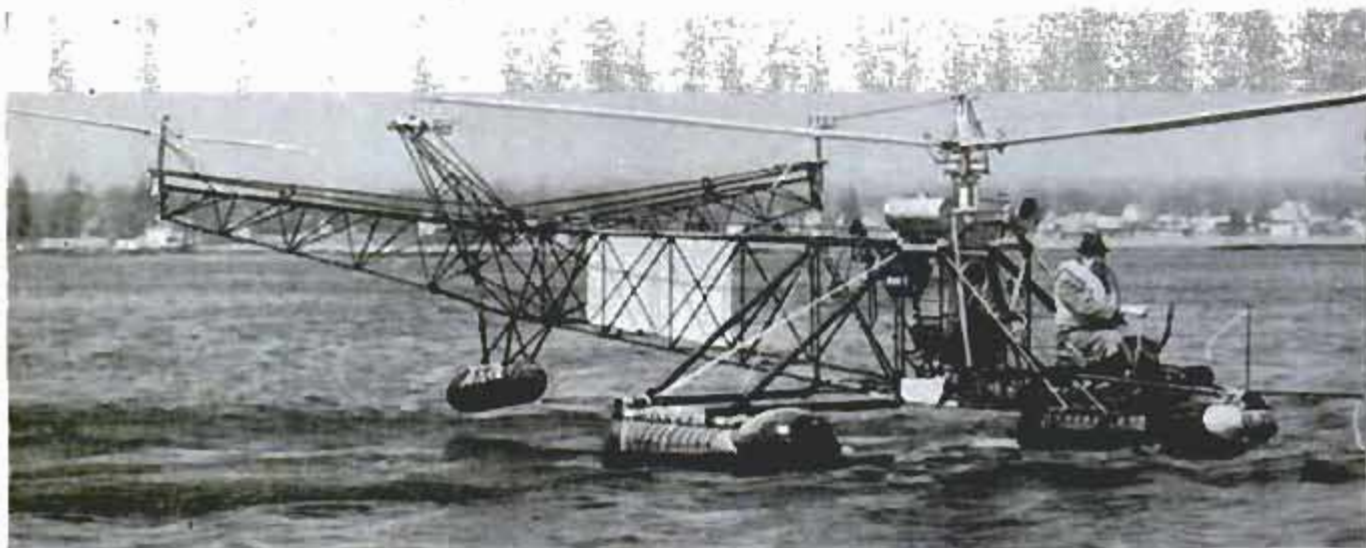



First serious bid for vertical flight was the VS-300, shown above still anchored to the ground for safety

genius with a genuine love of people, who probably has more practical aeronautical engineering tucked away than any man alive. Fellow workers, however, are well aware of the stubborn tenacity and lion-hearted courage with which he can tackle an idea he feels is right. Critics of *The Grand* were quietly ignored unless they had constructive offerings. "Most were guessing," he says. "They did not know. I did not know, either, but my intuition told me it would fly—why not?"

Igor Sikorsky believes that "intuition" includes the practical ability to visualize a finished structure and its capabilities before it is born—plus the rare insight to fit the "vision" into its proper place in time. While *The Grand* was a-building, he prowled the factory after hours, meditating over the parts of the big plane as they took shape. "In those days," he explains,

"it was believed that to lift more pounds you simply increased wing area regardless of shape. So, a short, broad wing then should lift as much as a long thin wing of the same area. One night when everyone had gone home, I looked at the broad, short wings for *The Grand*. I did not like the 'feel' of them, and so we changed them to long and narrow. This horrified many people. Today we know that 'lift' comes from the vacuum formed by air rushing over the top of the wing—and the more leading edge, the greater the lifting surface. Then, we knew no such aerodynamics, but my intuition said those stubby wings would not work, and it was right."

Needless to say, *The Grand*, first four-engined plane in history, flew. In it, Sikorsky made some of aviation's first real cross-country flights, tried blind flying (without instruments), and stood on the

Fame came with the 40-passenger flying boat used by Pan-American Airways on its pioneer overseas routes





Full-size model shows what 1960 travelers can expect. The S-61 gas-turbine craft will carry 25 passengers

outside observation decks to marvel at the cloud forms sailing past. More four-engined "Ilia Mourometz" planes followed *The Grand*, and made a historic record in Russian sorties over Germany during World War I.

In 1919, after the Red Revolution, Sikorsky, bereft of all possessions, left his country for France. A year later he migrated to the United States to endure a stretch of "starvation days" for several years.

By 1923, with a handful of Russian refugee friends who pooled their meager assets, he was building another plane. The

S-29, a sturdy twin-engine craft, was born in an abandoned barn near Roosevelt Field on Long Island—and slowly grew from an assortment of bits salvaged from junk yards. Because of too many over-used parts, plus the fact that Sikorsky hadn't the heart to put off the hoard of "volunteer" passengers (most of whom helped build the ship) for the maiden hop, S-29 labored into the air and promptly crashed.

But no crash ever did more than delay Sikorsky. Within months, more subscriptions and hard work had put the battered plane back in the air. Captain Roscoe

(Continued to page 224)

The hull of this turbine-driven amphibious whirlybird, unveiled this year, weighs less than the land type



# AN EYE ON SPACE

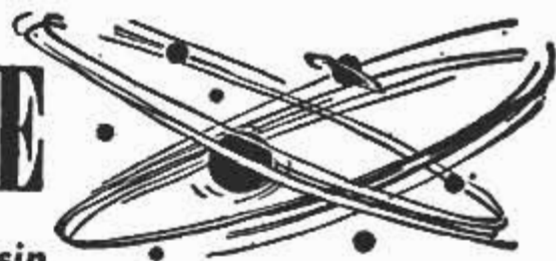

By Dr. Dan Q. Posin

PROFESSOR OF PHYSICS, DE PAUL UNIVERSITY  
SCIENTIFIC CONSULTANT AND ADVISOR, COLUMBIA BROADCASTING SYSTEM

ONCE UPON A TIME some Earthlings invented the idea of an "atom."

"The atom is an tiny particle in a great emptiness," said the Greek thinkers. "Here is an atom, there is another. They are in nothing—in an emptiness, in a void. Sometimes they get together and make big things, like cats and trees. But in general there is only the atom in a void." Clearly, as far as the atom is concerned, the Greeks had a void for it.

Later, other scientists said, "The atom doesn't really exist, but the idea is useful. It helps us understand nature."

Then one day a scientist announced, "Remember those 'imaginary' atoms? Well, I just broke one."

So Earthlings now were confronted with real atoms in a void. But of course the void still remained, as empty as ever. "The vacuum," said Earthlings only a few years ago, "is a pure nothing. You pump out the air and then you have it—you have nothing. You have emptiness."

But is the void a void? Recently scientists have been learning some facts about the void that are just as startling as those they learned about the atom, facts that may be of untold significance as Earthlings start their exploration of space.

It turns out, for example, that the void has magnetism in it. Some of the magnetism is unchanging, like that of a bar magnet; some of it varies like the magnetism produced when a current varies. In addition to magnetism, the void is also filled with electrical fields, some unchanging, some varying. Electrical and magnetic fields travel through space together, each giving rise to the other in an unending cycle of death and regeneration.

Where do the electromagnetic fields come from? They come from the stars, from lightning on the planets Earth and Jupiter, and from the great turmoil of galaxies in collision. We know, for example, that the electromagnetic energy emitted in *one second* from a pair of galaxies in collision could supply all the energy needs of the planet Earth for *one trillion years*—if all this energy could be captured.

The vast void—the vacuum—also is filled with X rays from the sun and from other stars, sunlight, starlight and cosmic rays, which are tiny electrical particles and bursts of energy or gamma rays.

Einstein, moreover, showed that *matter itself* can be converted into energy, into waves of electricity, magnetism, light, X rays and gamma rays. Thus matter may be converted into waves, travel through the vacuum, and be plucked out of it for use as matter elsewhere!

Though an Earthling may pump the gross matter out of a confined space (a laboratory instrument, for example), that space still has matter in it, matter in its wave form. This matter is impalpable to the touch and is unaffected by the instrument's pump, but it is there, *and is extractable*.

So Earthlings are beginning to understand that the "empty" space is alive and hopping with energy. Soon they may learn how to extract great quantities of energy for extended space flights, learn to pick up energy from the "nothing" along the route. And they may learn, too, how to send vast energies through the emptiness to manmade devices soaring through the heavens.

"Matter" now is understood to be concentrated or "frozen" energy. Man may transform the matter of rocks, gases, liquids, portions of the moon, an asteroid or a planet, into wave energy through the processes of fusion or fission, or by the total annihilation of substance.

# Where Should A Small Car's Engine Be?



## IN FRONT?

**T**HE BATTLE RAGES. Detroit is watching the most vicious infighting in years. Not in a generation have companies taken such potshots at each other.

**At issue: Front versus rear engines.**

The battle is to prove one right, the other wrong; one stable, the other unstable. Nobody seems willing to admit that both may be right, that there's room for both.

So rough and tumble has it become, so rabbit-punchy are the blows, that even anonymous mailings are being used. Unsigned material arguing against the rear engine has been mailed to auto writers in plain envelopes with no clue as to the sender.

**The knifing started a few months ago when Ford used TV commercials to prove that arrows go straighter when the heavy end is in front rather than in the rear.**

Chrysler, ostensibly to sell Simcas, distributed pamphlets entitled, "The Advantages of Front-Engine Cars."

Presidents of both Chrysler and American Motors issued statements that their cars have and will continue to have engines in front "where they belong."

Chevrolet, its future wedded to the rear-engine Corvair, saw the climate growing inhospitable. There was too much at stake here to remain silent, so Chevrolet presented its case. After all, neither Ford nor Chrysler had even seen the Corvair much less driven one. Declaring a design unstable simply from rumor is far from scientific, Chevrolet felt.

**Speaking for Chevrolet was Maurice Olley, former director of research and development and now an independent consultant, recognized as an authority on suspension systems.**

Olley's main point is that a light, economical car should be designed from scratch to provide the same ride, the same handling, the same braking when loaded as when the driver is alone in the car. It should not be simply a big car scaled down because of the difference in the weight-to-load ratio.

In the big domestic car with 4000 pounds total weight, adding either 150 pounds (driver alone) or 800 pounds (four riders and luggage) makes comparatively little difference, the total package being so heavy. But in a small 2400-pound car, those 800 pounds amount to 33 percent, a more serious problem. Anybody who has ridden in an imported light car is aware of the ride differences when unloaded and when heavily loaded.

As for weight distribution, here, too, things are different in small cars. A conventional front-engine light car with 55 percent of its empty weight on the front wheels may have as much as 55 percent of its weight on the rear wheels when fully loaded. This is because most of the payload rests on the rear axle.

**For this reason, Olley explains, Chevrolet decided to give the new car the same weight distribution empty as loaded. It was designed with a 40-percent-front, 60-percent-rear distribution when empty since passengers and luggage add weight to a car in about that proportion. The Corvair has a 40-60 distribution whether empty, partially loaded or full. Handling and ride are the same at all times.**

Can a car with a heavy rear end be stable on the highway?

Ford says it cannot and uses a tail-heavy arrow wobbling in flight to prove it. In a car that has more weight in back, side forces from cornering and from cross winds generate a centrifugal force that may make a car hard to control. The car tends to "steer" itself deeper into the corner, making it necessary for the driver to turn the wheels in an opposite direction to correct this "oversteer." This is the classic argument against rear-engine cars.

In addition, some argue that the absence of a heavy, solid engine in front of the driver makes the car less safe, that rugged engine mounts absorb collision energy and prevent injuries. One Chevrolet competitor explains it by saying that "the sheet steel of the body can absorb relatively little energy and collapses like an accor-



## IN REAR?

dion. When this occurs, the impact is carried directly to the passenger compartment."

Olley makes no claim at being a safety expert, but he does say that some experts believe crumpling sheet metal will prevent, not cause, personal injuries by absorbing much of the force that now throws the passengers through the windshield.

As for the rear-heavy car being stable on the highway, Olley says the wobbling arrow proves nothing. Cars don't operate in free air. A car must run on wheels, must turn corners, stop safely and go up hills on ice. An arrow needs none of these attributes.

You make a rear-heavy car stable, Olley says, by following two rules: Don't overload the rear tires (if you do, the car has no firm fulcrum to turn on and it wanders); the other is that the front end must have slightly less cornering power than the rear end. Both of these requirements are satisfied by new tire engineering. Low-profile, long-cord tires, mounted on wide rims, have cornering power more nearly proportional to load than was possible three years ago. The lightly loaded front wheels have less cornering power than the heavily loaded rear wheels; therefore they have a slightly bigger slip angle in front than in the rear, giving the car a desirable sense of direction and providing the important margin of "understeer." There is no "oversteer" in the Corvair, Olley says.

The problem of not overloading the rear tires is solved by giving them about 10 pounds more air pressure than the front tires (16 pounds in front, 26 pounds in rear). Wheels, incidentally, are 13-inches (on the Falcon and Valiant also).

How can engineers argue that rear-heavy cars are unstable, says Olley, when almost all the station wagons with more than two persons in them are rear-end heavy? What about a Greyhound Scenicruiser which carries 72 percent of its weight on the rear and is as stable as a battleship?



## DETROIT LISTENING POST

By Art Railton

Ford's reply is that back in 1953 this same Maurice Olley (then a Chevrolet executive) delivered an SAE paper in which he stated that rear-engine cars "are a poor bargain, at least in the form in which they are at present built . . . it appears impossible to make a car with heavily loaded rear tires handle safely in a wind even at moderate speeds."

Olley admits to have held this opinion in 1953, but says tires are different today. Anyhow, he adds, everybody should learn something in six years if he intends to stay up-to-date.

In stating the advantages of the rear engine, Olley released many details about the Corvair (although Chevrolet claimed he was discussing a "hypothetical" car).

It has a flat six-cylinder aluminum engine that weighs about half as much as a standard cast-iron V8. Its flat design makes it wide and low, so wide that it won't fit in the narrow canyon between the front pivoting wheels, but does fit neatly between nonsteering rear wheels.

Cooling is by fan only (the fan is laid horizontally atop the engine to reduce height and permit a low rear deck). The engine gets the same amount of cooling whether the car is moving or stopped. No power is lost pushing air through a radiator and under the hood. Olley says it takes 25 horsepower at 75 miles per hour to push air through what he calls "the cave of winds" under the hood of a front-mounted water-cooled engine. There's none of this waste in the Corvair.

Being air-cooled, it requires no radiator, no hoses, no water pump, and in winter no antifreeze. He did not mention that it does have an oil radiator and that a tiny portion of the cooling, therefore, is by liquid, in this case, engine oil.

With the engine-transmission package at the rear, the floor hump is eliminated. Good seat height and legroom are available across the full seat width. The car can be made lower without sacrificing headroom. Springing is by coils on all

(Continued to page 256)

# *The Other Side of*

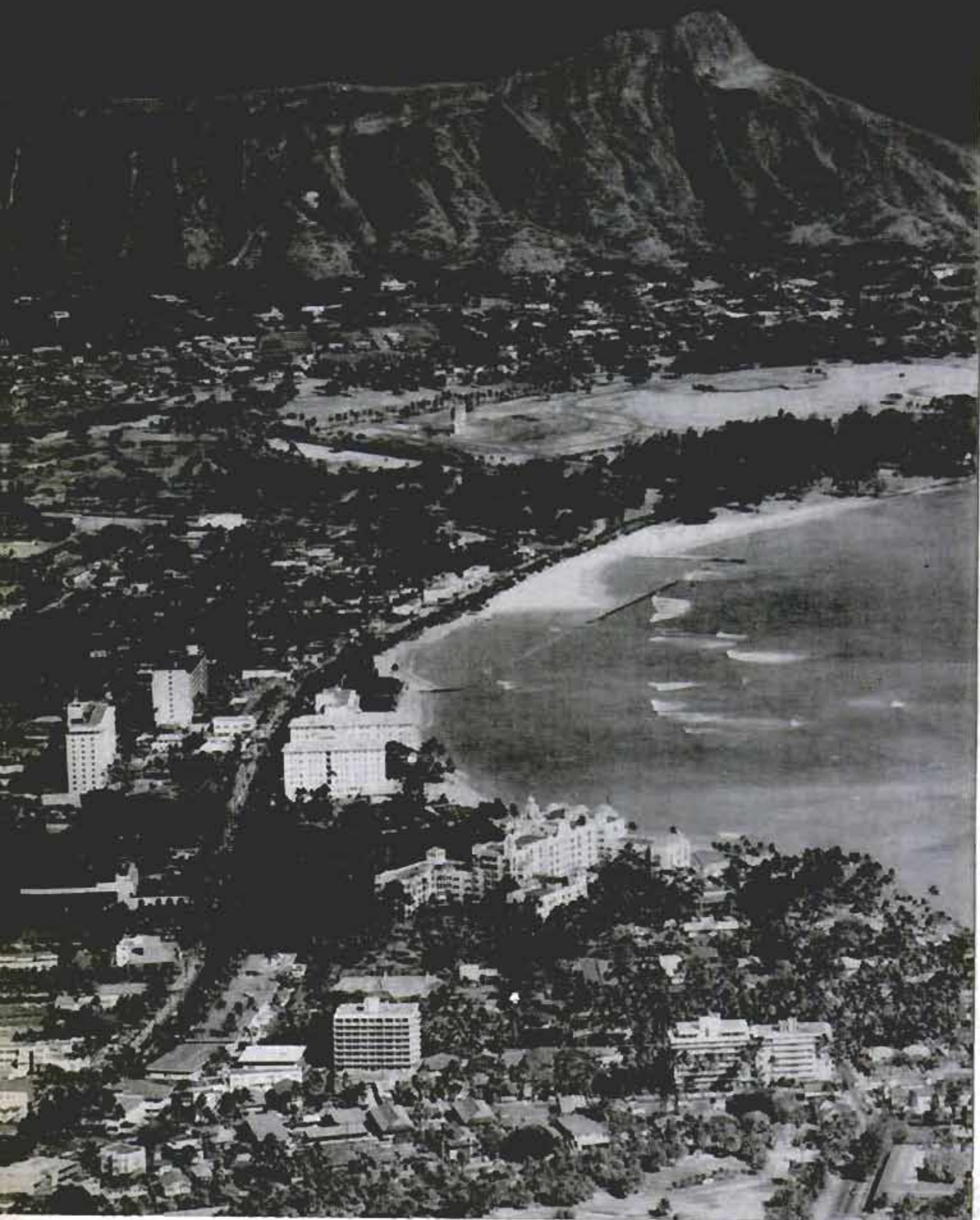



# Paradise

**There is more to our 50th state than the hula, the beach at Waikiki, palms, volcanoes and tourist dreams. There is industry and agriculture, too**

**By Richard M. Botts**

**T**AKE A CHUNK of lava and coral about the size of Connecticut, put it in the middle of the Pacific Ocean, add some year-round balmy weather, season it with a good crop of tourists, toss in some Federal spending and top it off with an industrious and highly mechanized agricultural and industrial economy and you have Hawaii—our newest, boomiest, 50th state.

Actually, when we say Hawaii, we really mean a series of five big islands and a lesser number of smaller ones that lie in a close-knit nest some 2300 miles off the California Coast. The heaviest population concentration is on the Island of Oahu, where Honolulu and Waikiki Beach are

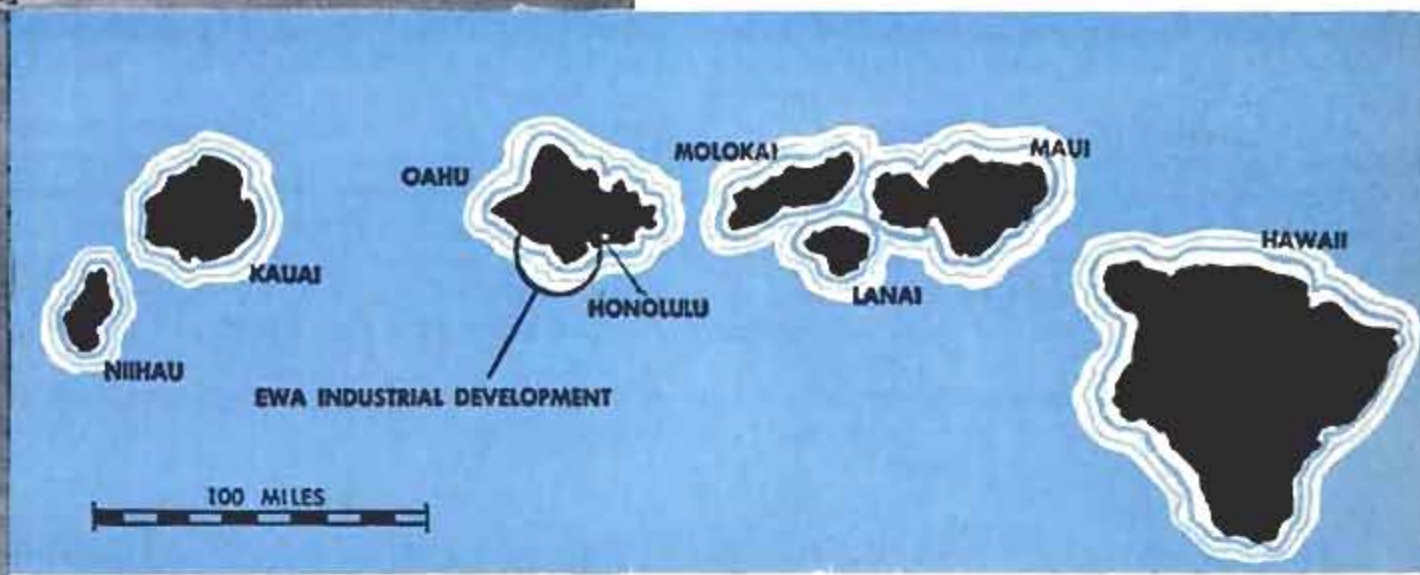

located; to the northwest is the island of Kauai, to the southeast are Molokai, Maui and the volcanic island of Hawaii.

However, the newcomer who arrives in Hawaii and expects to find grass shacks and natives sleeping under coconut trees is in for a rude awakening. Instead of grass shacks, the visitor finds modern buildings, up-to-date roads and a jam of new cars. Instead of sleepy natives, the visitor is greeted by aggressive, modern, wide-awake businessmen. Push aside the curtains a bit more and you'll find that Hawaii's booming economy is mainly built on sugar, pineapples, Federal spending and a seven-month-long tourist season. Its drive is sustained by a growing population that includes native Hawaiians; ex-Yankee



whalers who dug in their roots over 100 years ago; Chinese, Japanese and Koreans who emigrated from the Far East; and a host of other nationalities. Such a melting-pot population seems to bring out the best in each group and the result is a colorful and dynamic economy. Today's Hawaii has one of the highest standards of living in the world—its agricultural workers are the highest paid in the world, and the natives claim that as the 50th state it will have the largest area of any state in the Union, although they admit there is an awful lot of it under the Pacific Ocean.

Strangely enough, it is the weather that makes two of Hawaii's most important industries—agriculture and tourism—possi-

ble. The Hawaiian Islands lie in an area of the tropics that is quite similar to Cuba or Acapulco, Mexico, but the heat and humidity of similar tropical areas are not Hawaii's problem because of two things—first, the waters from the Bering Sea to the north lower the temperature of the ocean area of Hawaii some 10 degrees below that of other regions of similar latitude and, second, the persistent trade winds “air condition” the islands to an average 78 degrees in summer and 72 in winter. Thus Hawaii's crops grow 12 months a year and the sugar and pineapple industry can work on a year-round basis; and tourism booms with a “two season” year—a haven for those escaping the winter cold, and an





Arrive in Hawaii expecting to see grass shacks and sleepy natives, and you'll be surprised by scenes like these: Efficient mechanized equipment helping raise pineapples (above left), sugar cane (below left), and papayas (below); the ancient hulas being performed for modern TV cameras (below right); bustling modern shops along Waikiki Beach (right); a modern factory producing textiles in native motifs (above right); even the traditional catamarans (above) have gone modern with moonlight sails and all the dinner-aboard frills of the large ocean-going cruise ships





Henry Kaiser's new Hawaiian Village Hotel stands on a section of Waikiki that was a swamp in 1954

attraction for visitors who want to get away from the mainland's summer heat!

Agriculturally, you will find a hustle and bustle and a mechanical efficiency that doesn't quite fit into the picture of Polynesian tranquillity. The two main sources of agricultural income in Hawaii are sugar and pineapples, and these bring in more than \$260,000,000 a year. Lesser sources such as coffee, and newer industries such as macadamia nuts, papayas for export, flowers, passion fruit and guava products make up an additional \$50,000,000 a year.

These industries are still in the "infant" stage of growth, but have considerable promise of expanding over the years ahead. The sugar plantations in Hawaii are all very efficiently operated. Because of a remarkably high degree of mechanization and fertilization, plus top management and constant research for better cane varieties and agricultural practices, Hawaiians are able to produce an astonishing 10 tons of sugar per acre.

In the cane fields, huge cranes with specially equipped "grabs" pick up chunks of

A third of the newest state's population lives in Honolulu, where the Aloha Tower (at left, below) stands on the waterfront to greet visitors

Industrialist Kaiser came to visit but stayed to develop





**Rugged Koolau Range separates Oahu's windward and leeward sides, but is being pierced by highway tunnels**

newly harvested cane and toss them into tremendous trucks which road off down the highway to the mill. The mills are modern and up-to-date, some even employing a complete hydro-separator system so that the cane wash water can be used again and again while the remaining soil-laden water is pumped onto rocky areas to produce new soil and agricultural land.

Sugar is not alone in its progress toward mechanization. Out on the pineapple fields, huge loaders move through the fields picking up the ripe pineapples on long con-

veyor belts and transporting them swiftly up a chute onto waiting trucks which whisk them to the canneries. Speed in this industry is a "must," as the ripe fruit must be packed within 48 hours after picking or it will spoil. One of the biggest unsolved headaches—how to plant the pineapple slip mechanically rather than by stoop labor—is expected to be solved soon.

### **Industry in Paradise**

On the industrial side of the picture, Hawaii's construction work will rise from

**Construction is booming all over Hawaii, and particularly around Honolulu and Waikiki. The \$16,000,000 Ala Moana Shopping Center, shown below, will be one of the world's largest; it's almost a self-contained city**





Honolulu is only nine airline hours from the West Coast; four-hour jet service will start late this year

Hawaii's standard of living is among the world's highest—the booming economy and growing population have meant many vast new housing developments like this one near Honolulu

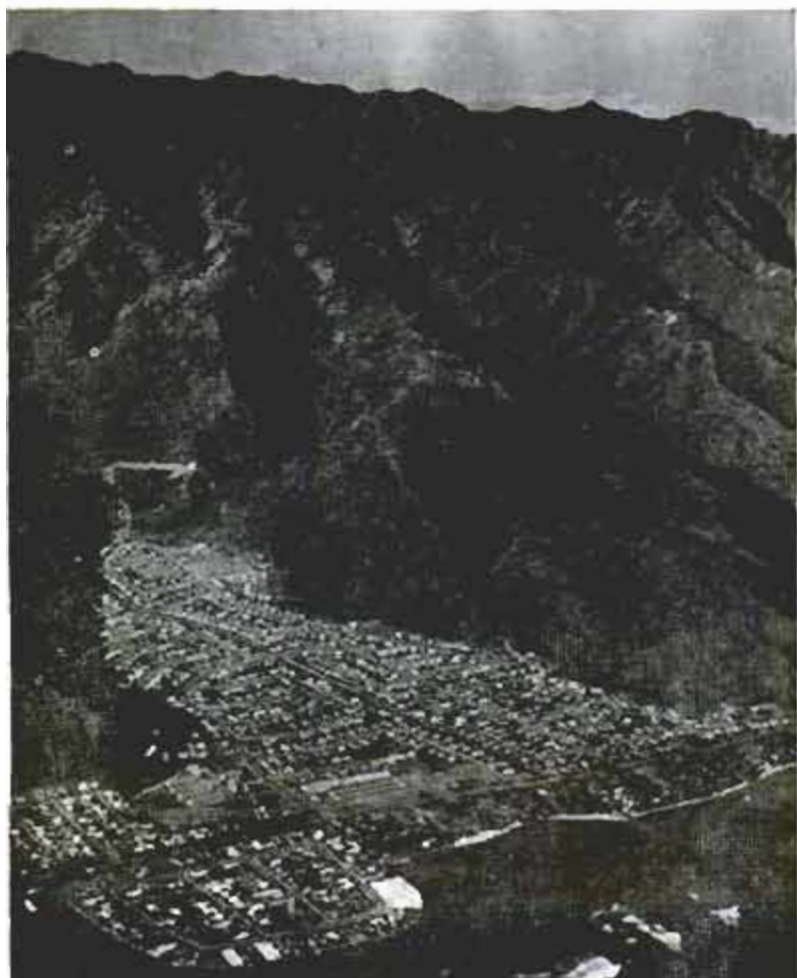

the \$94,000,000 scored in 1955 to about \$200,000,000 in 1959. Most of the construction boom however has been on the island of Oahu, with very little spilling over to the neighbor isles. Take the Waikiki area, for instance, where construction is going on at a rapid pace. Prior to World War II it took five to seven days to reach Hawaii by ship from the West Coast; after the war the airplane gradually reduced this distance to the present nine hours. Now the dawning jet age will put Hawaii only four hours away from the West Coast and eight to nine hours from New York! The tourist industry which has been building up at a 25 percent-a-year rate is expected to take a big jump, and Waikikians are expanding in every direction to take care of this expected surge of tourists.

One who visualized the coming tourist rush was Henry J. Kaiser. Coming to Hawaii in 1954, he fell in love with Hawaii and decided not to miss the coming boom. Taking a small undesirable and half-submerged area of Waikiki, he put men and bulldozers to work

(Continued to page 248) 253



### Step-up Trampoline Serves as Diving Board

You can enjoy springboard diving, even from a float or raft, with this portable diving trampoline with a built-in ladder and diving platform. It's made of tubular steel with a double nylon bounce pad.



### "Sixth Finger" on Glove Serves as Trap for Ball

Fielders are now hauling in baseballs with a six-fingered glove. The "sixth finger," interlaced to the thumb and index finger, is actually a web that moves with the thumb and traps the ball.

### Portable Power Winch Handles Many Jobs

You can now move dirt loads or launch your boat in hard-to-reach fishing spots with a power winch that can be taken anywhere you go. The winch, equipped with a 1.75-horsepower gas engine, weighs 75 pounds. In use, it is fastened to any convenient tree or post, or anchored to a steel pin that is available. A hook on the end of the steel cable fastens onto posts, logs, rocks or cars that are stuck.



### Computer May Cut Air Accidents

Mid-air collisions may be prevented by a new traffic-control computer developed for the Air Force. The computer can check a pilot's flight plan to see if it conflicts with other flights, track the flight itself by periodic position reports from the pilot and automatically warn the pilot of any deviation from his course.

□ World production of food grains is increasing, but the increase is not enough to keep up with population growth.





## Right-Hand Drive Car Used to Check Meters

Police in Los Gatos, Calif., are checking parking meters with a small car equipped with right-hand drive and removable right front door. Eye-pins replace hinge-pins, making it convenient to attach or detach the door. Battery and radio parts ride in the car trunk.

## Fluorescent-Tube Research Produces New Designs and Single Socket



Fluorescent tubes that can be connected to a single socket like an ordinary incandescent bulb have been developed by Westinghouse engineers. The new design has a base at one end only and requires no wiring or socket at the other end. Another new design in fluorescent lamps is a U-shaped tube that has some of the advantages of a single base, since all wiring is confined to one end of the fixture. Neither design is on the market yet.

## Tiny TV Camera Can Be Swallowed

Medical patients may soon be asked to swallow a tiny television camera. The camera, which weighs only a quarter of an ounce, flashes clear pictures of internal organs on a screen. Expected to aid the fight against cancer, the camera was developed by members of the University of Melbourne (Australia).

## Italian Auto-Top Tent Fits Any Car, Makes "Canvas Bedroom" for Two



Demonstrated at the Rome (Italy) Fair, compact sleeping tent mounts on any car top like a conventional luggage carrier, but opens up and out to make a two-man tent.

## Germ Killer

Fabrics can be permanently germ-proofed by dipping in a chemical solution soon to be marketed. The compound, an improved colloidal silver nitrate, can also be used for washing floors, walls and equipment, for sterilizing fruits and vegetables, and for killing moss and algae.



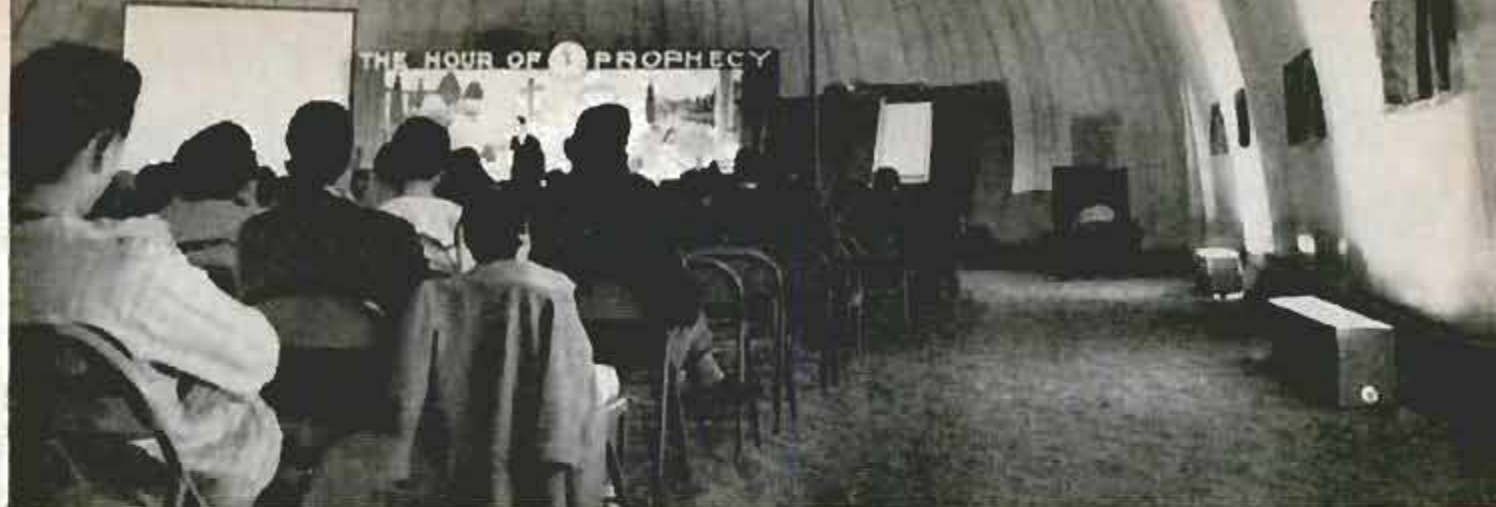

## Nylon Church

RELIGIOUS revivals are being held in a nylon structure supported by air coming from two blowers. The church can be inflated in 17 minutes and can house more than 1000 persons. Covered inside and out with a thin coating of vinyl, the structure is 125 feet long, 65 feet wide and 30 feet high when expanded. Sand is placed in a canvas trough around the edge of the nylon, and the trough is laced up. This weight keeps the edges down snugly in winds up to 70 miles per hour. Packed up, the church makes a bundle small enough to fit on the back of a truck.

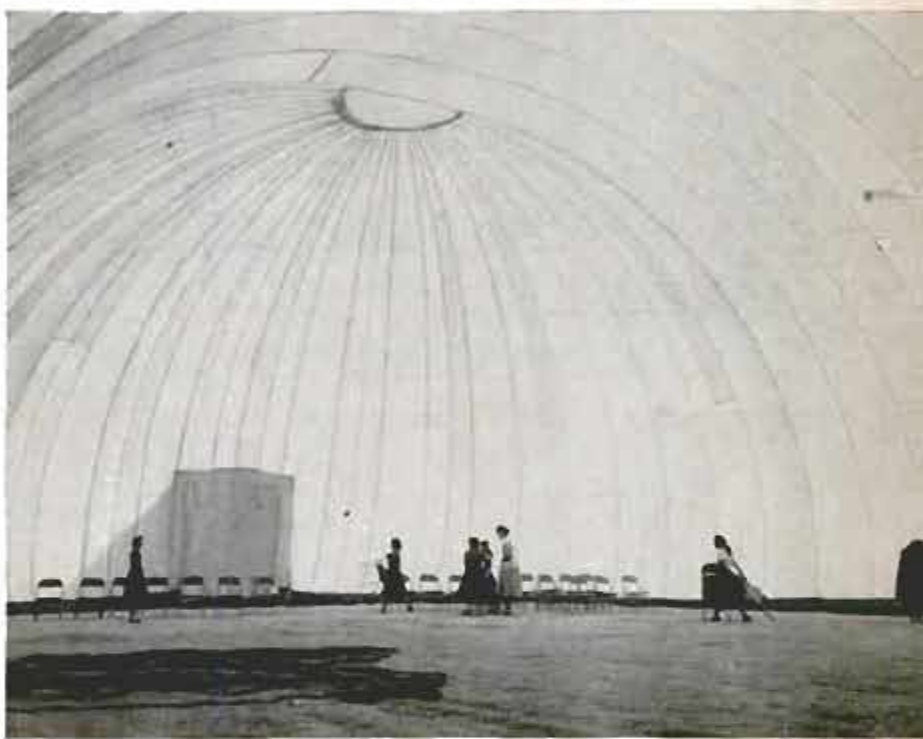

POWER WAS SUPPLIED BY THE LEGS OF ONE MAN

HAESSLI-VILLINGER WHICH MADE SEVERAL SHORT FLIGHTS



DESIGN FOR A MAN-POWERED AIRCRAFT BY SHENSTONE. SPAN 60 FEET. GROSS WEIGHT WITH TWO MEN: 485 POUNDS



ALTERNATE POSITION OF PROPELLER

PILOT USES LEGS FOR PROPULSION AND ARMS FOR CONTROL

CREWMAN USING ARMS AND LEGS FOR PROPULSION

PROPELLER DRIVING RING

GEARBOX

ALTERNATE POSITION FOR PROPELLER



EXTREME LIMIT OF MAN'S MUSCLE POWER IS OF SHORT DURATION. GRAPH SHOWS HORSEPOWER IN RECORD PERFORMANCES DEVELOPED BY CYCLISTS

MUSCLE POWER DEPENDS ON ADEQUATE OXYGEN SUPPLY TAKEN INTO LUNGS AND TRANSPORTED TO BLOOD STREAM. GRAPH SHOWS POWER OF MAN

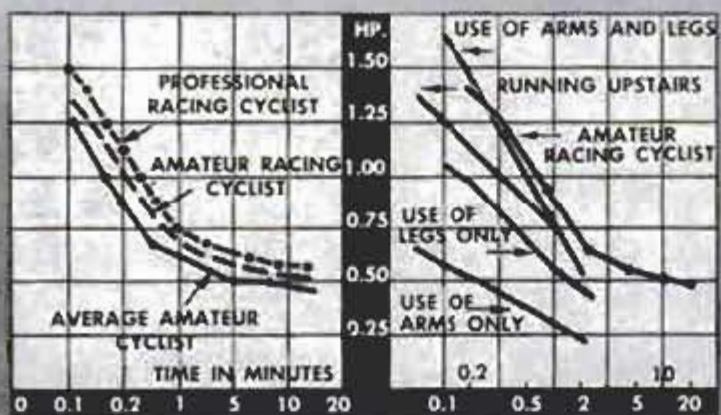

2 HP. FOR 30 SECONDS  
 0.9 HP. FOR ONE MINUTE  
 0.6 HP. FOR FIVE MINUTES  
 AN ESTIMATE OF DURATION OF FLIGHT ACCORDING TO THE AMOUNT OF ENERGY USED BY MAN  
 PROVIDING CREW WITH EXTRA OXYGEN, FLIGHT MAY BE PROLONGED FROM 10 TO 60 MINUTES  
 SCALE RANGES FROM ONE TO 60 MINUTES

NONWEILER'S DESIGN FOR A MAN-POWERED AIRCRAFT

PILOT USING LEGS FOR PROPULSION AND ARMS FOR CONTROL

CREWMAN USING ARMS AND LEGS FOR PROPULSION

LIGHTWEIGHT TWO-BLADED PROPELLER

RUDDER

LIGHTWEIGHT WHEELS MAY BE PROVIDED

A DESIGN BY LIPPISCH WHICH GIVES GOOD AERODYNAMICS FOR LIGHT WEIGHT

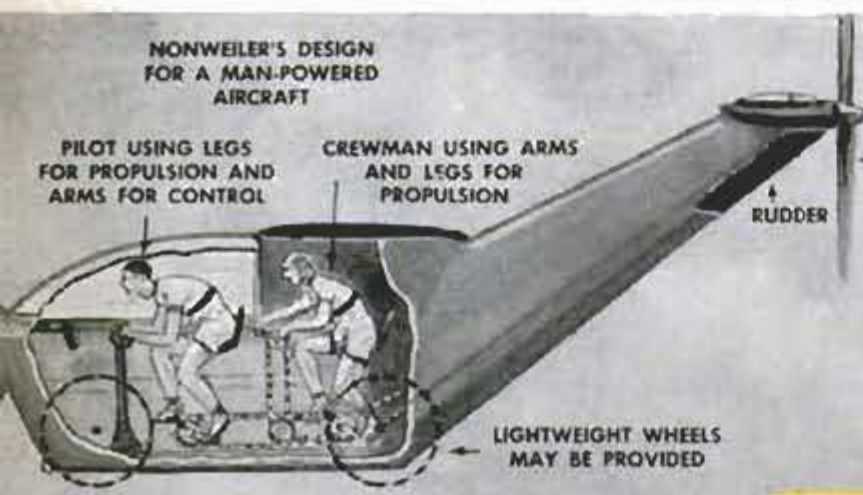

CLUTCH

VARIABLE GEARBOX WITH BRAKE

THE HOLLOWAY POWER-STORAGE UNIT TO ASSIST IN TAKE-OFF

RUBBER CORD

GEARBOX

HOLLOW SHAFT

LEG DRIVE

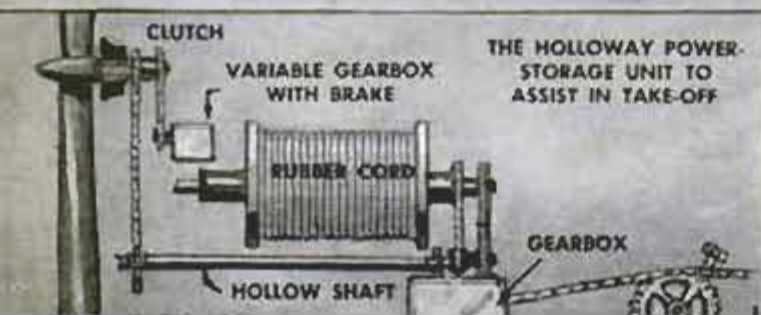

Diagrams show some principal designs proposed for the "flying bicycle," and breakdown of horsepower capable of being developed when man uses his own muscle power. Pedal-power, similar to that generated when riding a bike, would keep the vehicle in flight. Detail at lower left shows power-storage unit to assist in take-off

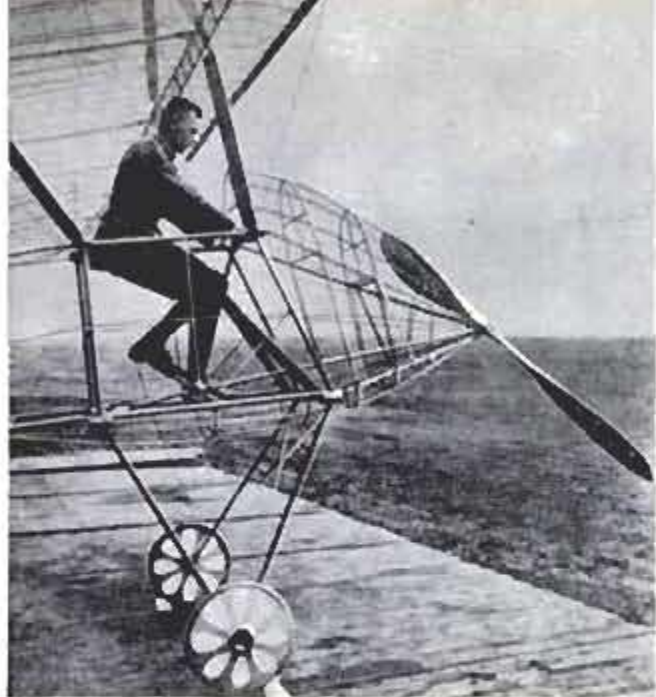

Early German man-powered craft was one of many designed, but few ever left ground



Dr. W. R. Wilkie (on machine) helps aviation scientists test amount of horsepower man can produce and for how long

## Here Comes The Flying Bicycle!

Copyright photos by Bernsen's International Press Service

**I**T MAY LOOK like a step backward, but man may soon be flying through the air on a pedal-powered vehicle—the flying bicycle. Dr. W. R. Wilkie, of the University College of London, after a series of tests, concludes “man-powered flight is possible.” He says that power required for men to fly is 0.4 horsepower, a level man can maintain for 5 to 30 minutes. The Aeronautical Society has given approval of plans to build a craft that will fly on the power developed by the arms and legs of two crewmen. Such a vehicle will be light with minimum drag, maximum lift. A power-storage unit or simple launching will get it off the ground. ★ ★ ★

One of the most notable of the manually powered craft built in Germany before the war was the Haessler-Villinger. This cockpit view shows how pedals produced lift. Craft is expected to be basis for designs of the future

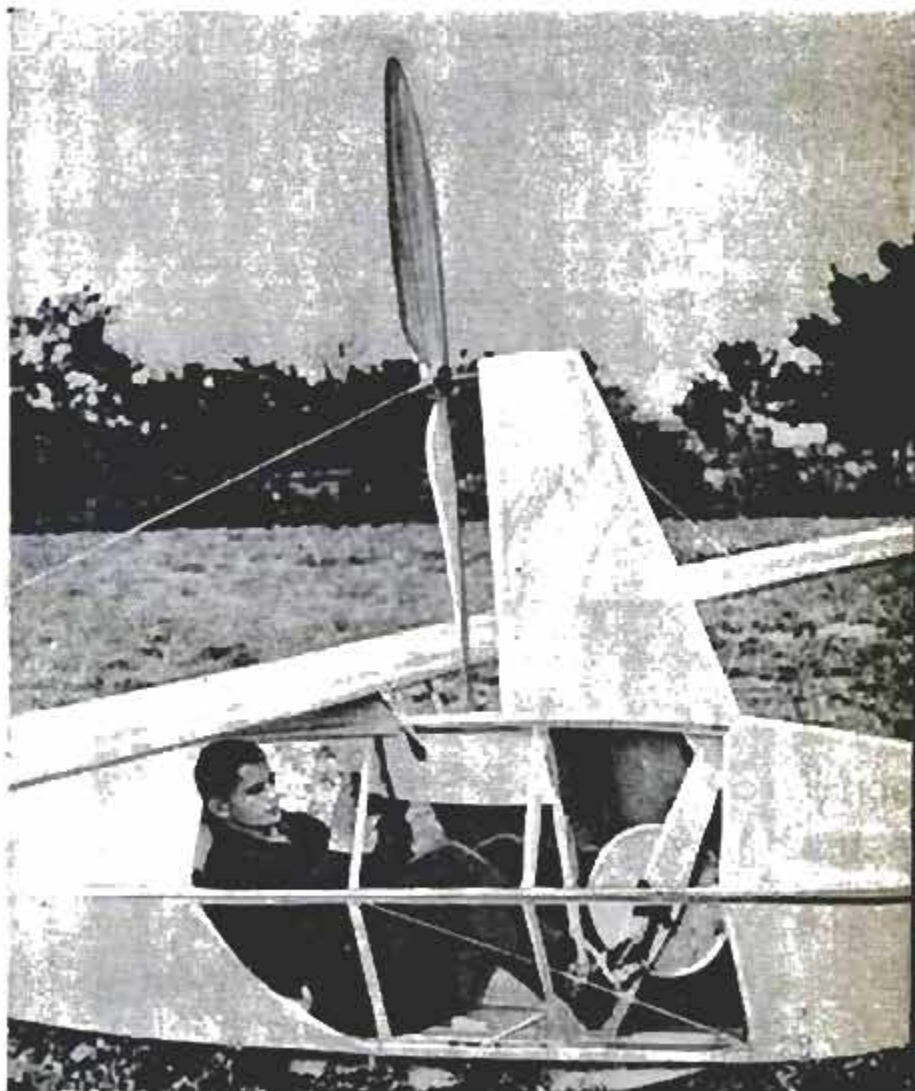



DKW



FIAT



HILLMAN



MORRIS



RENAULT



AUSTIN

# Which Import

**O**KAY, SO YOU'VE decided to take the bold step—to buy an imported car. About a half-million Americans are making such a decision this year, so you're not alone.

But what next? Which car is best for you? Imported cars offer as much variety of design as American cars do similarity.

You can buy four-cylinder engines, three-cylinder, two-cylinder, water-cooled, air-cooled, two-cycle, four-cycle engines; coil-spring suspension, leaf-spring, torsion-bar, swing axles, unit bodies, frames, semi-units—just about any design in the textbook.

So what do you do? How do you make up your mind?

*Popular Mechanics* surveyed 2000 owners of 10 representative foreign cars—10 cars high among the best sellers, 10 cars representative of the variety of designs.

We asked the owners to tell you about their cars, to tell what they like and don't like. *PM's* test engineer, Dale Kelly, put the 10 cars through a standard test to get

performance data that you can use to make valid comparisons.

Right off, we might as well dispose of styling since this is important in the choice of any car (although perhaps less important to the foreign-car buyer).

Styling is an individual problem. Nobody can help you here. If you don't like the way a car looks, if you don't think you will ever like the way it looks, obviously that car is not for you. It may not be scientific to judge a car by its looks, but it's more rational than it sounds. You wouldn't buy a suit you didn't like to look at, nor should you buy a car that you don't like to look at.

Probably the most important single item to remember in buying a car (and one often overlooked) is the availability of good service and parts.

This is especially true of a foreign car. Many independent garages refuse to repair an imported car, many don't have ready access to a parts source for imports. Some will tackle a repair job but do not know how properly to complete it. Many



## How Do Owners Rate Them Over-All?



	Excellent	Average	Poor
Saab	96.9%	0.0%	3.1%
Volkswagen	94.0%	3.6%	2.4%
Volvo	93.3%	6.7%	0.0%
Renault	85.4%	13.8%	0.7%
DKW	85.4%	12.2%	2.4%
Austin	82.6%	17.4%	0.0%
Fiat	78.7%	20.2%	1.1%
Morris	76.9%	19.4%	3.7%
Hillman	70.6%	26.1%	3.3%
Simca	64.6%	28.3%	7.1%



SAAB



SIMCA



VOLKSWAGEN

# Is Best For You?

By Arthur R. Railton



VOLVO

first-time imported-car owners have been soured on the product because of an aggravating delay in parts and service. They were completely happy with the car itself, but parts and service difficulties turned them against it.

Let's face it, there are some "minuses" that you agree to accept when you buy an import. They include a less-roomy, often-cramped rear seat. They include luggage space that is adequate for the efficient packer, but allows no room for excess (in some cars even such "necessities" as a set of golf clubs and cart can't be carried). Accessories may not be as refined or as reliable as you are accustomed to (things like windshield wipers, heaters, defrosters, turn signals, rear side windows that don't go down, door locks). Acceleration and top speed are probably slower than you are used to, especially when fully loaded (an exception may be the Volvo).

But to compensate for these minor annoyances (and they may seem major to some), you get some advantages.

Included are lower first cost (sometimes as much as \$600 under the cheap American cars), lower operating cost (25 or more miles per gallon over-all), a minimum of the petty "bugs" that often accompany a more complex machine, a smaller dollar loss in depreciation each year, easier parking, more nimbleness in traffic, more room in the garage, and an opportunity once again to putter around with the mechanism yourself (however, some makes, like VW, frown on tinkerers).

You may also want to remember that Detroit's answers to the foreign car (the Corvair, Falcon and Valiant) will be out within a month or two. You may want to wait for them. However, they will not be directly competitive with most of these imports—they are larger, faster, more expensive, more stylish (and can be bought with automatic transmissions, incidentally).

With this general introduction, let's look at each of the 10 cars (alphabetically) and try briefly to report what *PM* learned about them from owners.

## Which Gives Best Gas Mileage Over-All?

	Miles Per Gallon*
Austin A40 2 dr. sedan-wagon	32.0
Renault Dauphine 4 dr. sedan	31.5
Fiat Multipla 4 dr. station wagon	31.0
Volkswagen 2 dr. sedan	28.0
DKW 2 dr. Hardtop	26.0
Saab 2 dr. sedan	26.0
Morris Minor 1000 2 dr. sedan	26.0
Simca Aronde 4 dr. sedan	25.0
Hillman Minx 4 dr. sedan	22.0
Volvo 2 dr. sedan	20.0

\*Based on a 50-mile road test, combining city and country driving.





# Which Owners Are Most Satisfied?



## NEXT CAR WILL BE:

	Same Make	Other Foreign	U. S. Make	Undecided
Volkswagen	49.1%	16.6%	14.8%	19.5%
Volvo	47.5%	18.5%	4.7%	29.3%
Austin	40.0%	20.0%	4.0%	36.0%
Saab	35.9%	27.2%	4.6%	32.3%
DKW	35.7%	23.8%	16.7%	23.8%
Fiat	30.9%	21.2%	14.9%	33.0%
Renault	30.5%	19.8%	16.3%	33.4%
Morris	19.4%	34.9%	17.1%	28.6%
Hillman	15.5%	29.5%	18.0%	37.0%
Simca	14.1%	20.2%	20.2%	45.5%

### British Austin

Owners of the British Austin are well pleased. None rates the car poor over-all (the only other car that can boast this unblemished record is Volvo). Austin dealers also are given a high rating by the owners with 66.7 percent describing dealer service as excellent.

Forty percent of the owners will buy an Austin again and another 20 percent intend to stay in the foreign-car market. Only four percent plan to buy an American car next time, 36 percent still are undecided.

Engineer Dale Kelly tested the brand-new Austin A40, a two-door sedan that looks much like a small station wagon. Italian styling gives it quite different appearance from previous Austins.

The A40 racked up the best over-all gas economy of all 10 cars, averaging 32 miles per gallon. It is important to remember that Kelly's over-all gas test includes considerable stop-and-go driving and is designed to be representative of the driving an owner would do. All the cars tested will average more miles per gallon than the

Kelly figures on long trips or at constant speeds—the economy figure given here will come close, however, to what you can expect to get in normal everyday use.

Luggage capacity of the A40 is about average with four persons in the car (average for a European car, that is, about half that of an American trunk). With only two in the car and with the back seat folded, capacity is greater than in a standard domestic trunk.

Here are quotations describing the likes and dislikes most frequently mentioned by the owners:

"Cost of operation is about 1.3 cents per mile. I get 27.5 miles per gallon."—Illinois sales manager.

"Handles well on slippery roads. Drove it every day this winter without one bad slide."—Pennsylvania engineering assistant.

"Smaller size for easier parking on streets and in garage. Also easier to keep looking nice. Washing and polishing easy. Not smothered in chrome."—California salesman.

### HOW ACCURATE ARE THE SPEEDOMETERS?

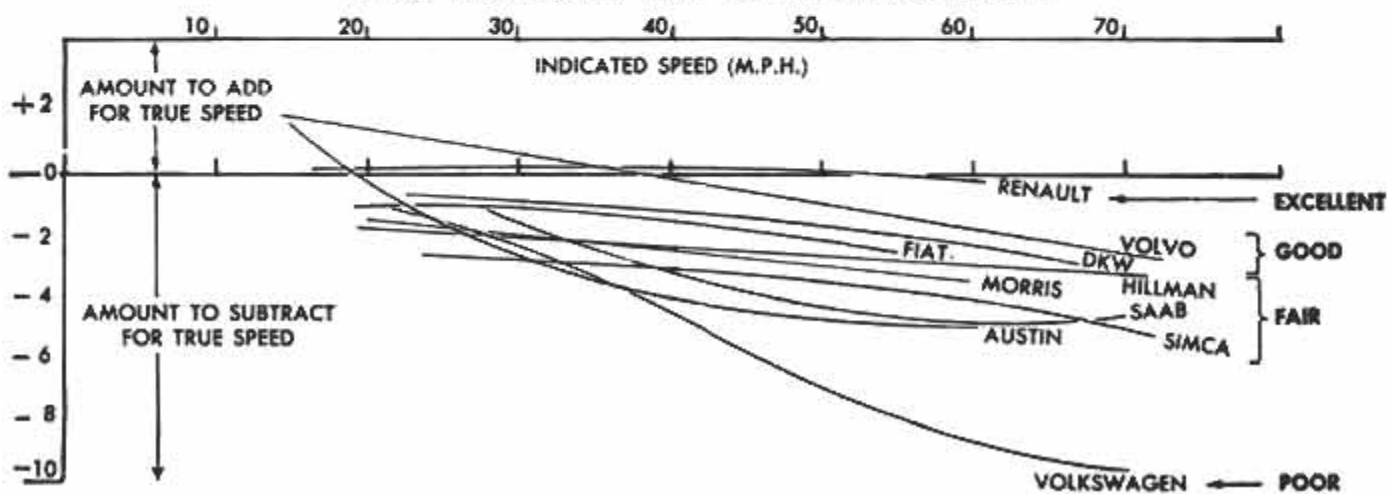

# Which Car Accelerates Fastest?



	0-40*	0.50*	0.60 <sup>0</sup>
Volvo	6.5	9.5	14
Simca	11.0	16.5	26.5
Saab	11.5	18.0	27.0
DKW	13.0	20.0	31.0
Volkswagen	13.5	21.5	41.0
Austin	14.0	21.0	34.0
Renault	14.0	21.0	.....
Morris	14.5	21.0	.....
Hillman	14.5	21.5	35.0
Fiat	25.0	50.0	.....

\*Figures are seconds representing conservative driving based on "red-line" acceleration.



"Neat interior workmanship."—California electrical supplier.

"Troublefree. 12-month warranty. Less depreciation."—Illinois executive.

"Would like more miles per gallon. I get 22 miles over-all."—Illinois salesman.

"Sluggish on acceleration for passing."—California insurance man.

"Had trouble getting parts on a highway breakdown on a holiday."—California teacher.

## German DKW

Owners of the German DKW don't seem to be bothered by the fact that its engine is a two-stroke design. This design has no valves (in the usual sense) and, like an outboard motor, it requires the addition of lubricating oil in the gasoline. Only one owner seems to feel it is troublesome enough to mention.

The car's front-wheel drive gives it excellent traction on ice and snow. It is larger than most of the other cars discussed here; only the Volvo is longer.

Its dealers do not rate very high with

owners. Only 45.2 percent are rated excellent, 14.3 percent are described as poor. Inadequate service is the most frequently mentioned complaint with 21.4 percent of the owners mentioning it. Economy of operation is the best-liked feature with 73.8 percent mentioning it.

Kelly's test of the two-door hardtop model showed an over-all gas economy of 26 miles per gallon. Luggage space is about half that of a 1959 American car. Its turn-circle diameter was the biggest of the 10 cars due to its larger size and to the front-wheel drive which limits wheel-turn. The DKW, in fact, requires more room to turn around than a 1959 Ford or Chevrolet.

This car is an excellent over-the-road car, providing a comfortable, quiet ride at relatively high speed. Among its advantages is a steering wheel that locks with the ignition, to discourage thieves. Among its disadvantages are rear-hinged doors that open at the front and will be whipped open by the wind if accidentally unlatched when the car is moving.

Here are some quotations from owners:

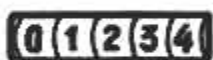

## ARE ODOMETERS ACCURATE?

For a true 100 miles, odometer read:

Austin	100
DKW	100
Morris	100
Saab	100
Simca	100
Renault	98
Fiat	102
Hillman	103
Volkswagen	103
Volvo	104



## HOW MANEUVERABLE?

Minimum turning circle diameter:

Fiat	28.5
Renault	31.0
Volkswagen	33.0
Morris	34.0
Simca	34.0
Volvo	35.0
Hillman	35.5
Austin	36.5
Saab	37.0
DKW	41.5



## WHAT ARE THEIR TOP SPEEDS?

Over 70 m.p.h.

Volvo  
Simca  
Hillman  
DKW

About 70 m.p.h.

Saab  
Austin  
Morris  
Volkswagen  
Renault

About 55 m.p.h.

Fiat



# How Do Owners Rate Their Dealers?



	Excellent	Average	Poor
Saab	73.0%	19.1%	7.9%
Volkswagen	66.7%	29.0%	4.3%
Austin	66.7%	25.0%	8.3%
Morris	55.9%	32.3%	11.8%
Fiat	53.8%	31.2%	15.0%
Renault	52.6%	32.8%	14.6%
Hillman	45.4%	41.2%	13.4%
DKW	45.2%	40.5%	14.3%
Volvo	42.9%	47.9%	9.2%
Simca	31.9%	44.7%	23.4%

"Most of all I like the over-all economy: low depreciation, gas, servicing and repair bills."—California salesman.

"Solid feel. Trunk lid operates like a refrigerator door and doors close without slamming."—California office worker.

"Comfortably holds four adults. Has large trunk. Keeps up with traffic even in the mountains with full load."—California electronics technician.

"Not enough dealers across the country for service on long trips."—California owner.

"Oil-gas combination makes tanking up a project. Difficult to change gears on occasion."—Ohio recreation consultant.

"Expected to get 32 miles per gallon, but get only 23."—California businessman.

"It hurts when you drive in for service and the service manager says: 'Another one of those foreign jobs. What a waste of time.'"—Illinois general manager.

"As it has front-wheel drive, I have had some trouble with tire wear and vibration."—Montana student.

"Heater takes too long to throw heat."—Missouri paymaster.

"Insatiable appetite for spark plugs."—California painter contractor.

## Italian Fiat

Fiat has such a wide variety of models that it is impossible to describe them all. Most popular at the moment is the 600, the smallest of the 10 cars surveyed. The 600 comes as a two-door sedan or as an unbelievably roomy Multipla body which will seat six persons arranged two-two-two, as in a bus. Kelly tested the Multipla. It averaged 31.0 miles per gallon over-all, ranking near the top in economy, just below Austin and Renault.

Luggage space is equal to the American standard with four persons in the car and is unbelievably spacious with only two aboard. The body style, however, is not designed for comfort nor speed. The front seat is directly over the front wheels but the ride is remarkably comfortable despite this. Getting in and out is apt to be awk-



# How Dependable Are These Cars?



## Broke Down on the Road:

Volkswagen	3.6%
Fiat	5.3%
Hillman	5.8%
Renault	5.8%
Volvo	5.8%
Austin	8.0%
Morris	8.7%
DKW	9.5%
Saab	10.9%
Simca	11.1%



# What About Luggage Space?

Number of one-cubic-foot cartons it will carry:\*

Fiat	15
Hillman	8
Volvo	8
Austin	6
DKW	6
Simca	6
Renault	5
Volkswagen	5
Saab	4
Morris	3

\*Average number of cartons for low-priced 1959 American cars is 14.



ward, especially for women. However, anybody who wants a versatile, multipurpose car for hauling either children or commodities around town, will be interested in the Multipla.

Owners rate the Fiat about average, with 78.8 percent calling it excellent. Dealer service, too, rates about average among the 10 cars. The most-frequently mentioned complaint of the owners is lack of power (this refers to the small 600 and the even smaller 500—the larger models would be more adequate).

Turn-circle diameter of the Multipla 600 is the smallest of all cars tested. Top speed is about 55 miles per hour, the only car not in the about-70-mile-per-hour range. This speed limitation is for the Multipla body and is not typical of all Fiats, not even of all 600 models.

Fiat doors open from the front, a feature which some owners find undesirable.

You can buy a Fiat with either front engine or rear engine, with either air cooling or water cooling. Fiat builds everything

from a sports car to a six-cylinder sedan, and is the biggest company in Italy.

Here are some comments from owners: "Gas bill dropped from about \$42 per month to only \$14."—South Carolina insurance man.

"Good handling. Surprisingly good road car although you have to plan your trips with a time-allowance factor."—Oklahoma clerk.

"Maneuverable. Easy to park."—New York psychologist.

"Well-made inside and out. Very comfortable, even on long trips."—Florida secretary.

"This Multipla is very versatile. Seats six. Able to haul bulky things like chairs, large boxes of food. A new car for \$1900, 35 miles per gallon."—Arizona engineer.

"Needs just a few more horsepower. Not much more, but for passing and climbing hills. It now has 22, think 28 would be fine."—Arizona supervisor.

"Not enough trunk space in the two-door 600."—Texas engineer.

## DO OWNERS FEEL SAFER IN THEM?

PERCENT OF OWNERS WHO SAY THEY DO:

DKW	95.2%
Volvo	95.1%
Austin	92.0%
Saab	90.6%
Renault	85.1%
Morris	83.8%
Hillman	83.5%
Volkswagen	83.2%
Simca	81.8%
Fiat	80.8%

## ARE THEY THE ONLY CAR?

ONLY CAR IN FAMILY:

Volvo	63.1%
Austin	60.0%
Saab	59.4%
Simca	57.6%
Renault	53.9%
Hillman	52.9%
Morris	52.4%
Fiat	45.8%
Volkswagen	41.3%
DKW	40.5%

## OWNED FOREIGN CAR BEFORE?

No, this is first import:

Renault	91.5%
Fiat	86.2%
Simca	85.9%
DKW	78.6%
Hillman	77.7%
Morris	77.1%
Volkswagen	74.3%
Austin	68.0%
Volvo	65.1%
Saab	61.0%

# WHAT DO OWNERS LIKE AND

<b>AUSTIN</b> Best-Liked Features	<b>DKW</b> Best-Liked Features	<b>FIAT</b> Best-Liked Features	<b>HILLMAN</b> Best-Liked Features	<b>MORRIS</b> Best-Liked Features
Economy of operation .80%	Economy of operation .73.8%	Economy of operation .89.4%	Economy of operation .83.4%	Economy of operation .84.7%
Handling ease .68%	Ease of handling .54.8%	Handling ease .53.2%	Handling ease .67.0%	Handling ease .64.7%
Easy to park .44%	Workmanship .23.8%	Easy to park .36.2%	Easy to park .37.1%	Easy to park .24.8%
Workmanship .24%	Easy to park .21.4%	Riding comfort .17.0%	Workmanship .16.5%	Workmanship .18.1%
Most-Frequent Complaints	Most-Frequent Complaints	Most-Frequent Complaints	Most-Frequent Complaints	Most-Frequent Complaints
None at all .20%	None at all .30.9%	None at all .35.1%	None at all .29.3%	None at all .31.4%
Not enough gas economy .12%	Inadequate service .21.4%	Insufficient power .21.3%	Inadequate service .16.6%	Insufficient power .16.2%
Insufficient power .8%	Not enough gas economy .16.7%	Not enough room .10.6%	Uncomfortable riding .10.7%	Uncomfortable riding .13.3%
Inadequate service .8%	Insufficient power .14.3%	Inadequate service .8.5%	Not enough room .10.0%	Not enough room .11.4%

"Heater puts little heat in front, too much in rear. Experienced mechanics and parts not readily available except in large cities."—Illinois soldier.

"Side winds give trouble. Tend to toss it about."—Ohio laboratory worker.

"Front doors open at front."—Oklahoma cable splicer.

## English Hillman

Hillman was one of the first European cars sold in the United States after World War II. However, despite its early start, it does not seem to have developed its service facilities as well as some latecomers.

Owners rate the car low on the list with 70.6 percent rating it excellent over-all; only one car ranked lower.

Dealer service also rates surprisingly low in view of the long time it has been sold over here. Only 45.4 percent describe the dealer service as excellent (three cars rank below it in this department).

Kelly's test of the Hillman Minx sedan shows an average over-all gasoline economy of 22.0 miles per gallon. Its luggage capacity is highest of all the sedan bodies tested.

A variety of Hillman models is available, including a handsome convertible and a roomy 4-door station wagon. All are closer to the American design and "feel" than any of the other nine cars tested.

Here are some quotations from owners:  
"Gas bill cut from \$40 to \$12 a month."—Pennsylvania mill superintendent.

"Pleasure to drive a car in which you don't have to break your neck in parking or any other maneuver."—Oklahoma draftsman.

"Exceptional coachwork and painstaking care during manufacture. I like a well-built piece of machinery."—Illinois serviceman.

"Handles well at high speeds. I drive 70 all the time."—Missouri cameraman.

"Surprising comfort for a small car. Four can sit comfortably with as much leg-room as in rear of American cars."—Missouri accountant.

"No esthetic fakery."—Texas psychiatrist.

"Despite fact that dealers claim they carry parts, it has been 10 weeks since a switch mechanism was ordered and to date it has not arrived."—California businessman.

"Not as comfortable as American cars. Shift works opposite."—Louisiana physician.

"Should have more headroom."—North Carolina teacher.

"Gas mileage is lower than anticipated. I average 20 miles per gallon over-all."—Georgia assistant superintendent.

## British Morris

Morris owners, like most imported-car owners, rank economy of operation as best-liked feature, with handling ease second. Kelly's test shows the Morris averaging 26.0 miles per gallon over-all, about midway in the lineup.

The most-frequent complaint is that the car has insufficient power, say 16.2 percent of the owners. This probably refers to the over-50-mile speeds because below that, the Kelly test shows the Morris as about average.

Dealers are rated high by the owners, with 55.9 percent describing them as excellent to rank fourth among the 10 cars surveyed.

Over-all, the Morris ranks eighth with 76.9 percent of the owners calling it excellent.

Of all 10 cars surveyed, the Morris perhaps comes as close as any to the sports-car feel so dear to many foreign-car owners. Its steering is precise, its suspension firm. Torsion bars are used in front, steering is by rack and pinion. If you'd like an intro-

# DISLIKE ABOUT THESE CARS?

RENAULT	SAAB	SIMCA	VOLKSWAGEN	VOLVO
<b>Best-Liked Features</b>	<b>Best-Liked Features</b>	<b>Best-Liked Features</b>	<b>Best-Liked Features</b>	<b>Best-Liked Features</b>
Economy of operation .88.6%	Handling ease . . . . .68.8%	Economy of operation .72.7%	Economy of operation .85.1%	Economy of operation .70.9%
Handling ease . . . . .60.2%	Economy of operation .67.2%	Handling ease . . . . .55.5%	Handling ease . . . . .62.9%	Handling ease . . . . .66.0%
Easy to park . . . . .29.1%	Road-ability . . . . .28.1%	Easy to park . . . . .34.4%	Workman-ship . . . . .29.3%	Workman-ship . . . . .37.9%
Initial low cost, depreciation . . .15.8%	Workman-ship . . . . .26.6%	Workman-ship . . . . .16.2%	Easy to park . . . . .26.4%	Easy to park . . . . .12.6%
<b>Most-Frequent Complaints</b>	<b>Most-Frequent Complaints</b>	<b>Most-Frequent Complaints</b>	<b>Most-Frequent Complaints</b>	<b>Most-Frequent Complaints</b>
None at all .32.6%	None at all .23.4%	None at all .18.2%	None at all .27.6%	None at all .27.2%
Not enough room . . . . .13.5%	Insufficient power . . . . .15.6%	Inadequate service . . .23.2%	Heater . . . . .19.2%	Inadequate service . . .16.5%
Heater . . . . .13.5%	Small rear window . . .10.9%	Not enough room . . . . .17.2%	Insufficient power . . . . .13.8%	Noisy engine . . . . .10.2%
Too light; road sway . 9.2%	Inadequate service . . . 9.4%	Not enough gas economy . . . . .10.1%	Too light; road sway .13.8%	Uncomfortable riding . 9.7%

duction to the sports-car way of life on a budget and have a family to accommodate, try the Morris.

Here are some quotations from owners:

"My monthly gasoline bill has been cut by two-thirds."—California office clerk.

"Easy to park and drive in heavy traffic. I honestly feel safer in my small foreign car than in the larger American car I once owned."—Maine secretary.

"Most of all I like the sports-car steering. Easy to handle."—Pennsylvania laborer.

"Care in workmanship. Little or no worry as to maintenance except prescribed in manual. Complete booklet."—Pennsylvania salesman.

"Low initial cost. I would not have been able to afford a new American car."—Rhode Island teacher.

"Now we take trips just for the fun of riding."—Colorado teacher.

"Not enough pickup for passing purposes."—Texas telephone man.

"Bumpy ride."—Illinois welfare worker.

"I am six feet tall and my left leg is a bit cramped."—Washington, D.C., detective.

"Poor heating system, especially defrosting."—Pennsylvania purchasing agent.

"Poor dealer service. Inability to get parts promptly. I tore a door panel two months ago and am still waiting."—California reporter.

## French Renault

Renault is breaking into the imported-car market fast and furiously. In the few years the Dauphine (which was designed for the American market) has been available its sales have soared until this year it is right on Volkswagen's tail for first place.

It is creating many new customers for imported cars, ranking highest among first-foreign-car owners, with 91.5 percent of Renault owners stating that it is their first foreign make.

Over-all, it rates just above the middle

of the scale with 85.4 percent describing it as excellent. It has a flattering "poor" rating, less than one percent of owners rating it as poor.

Dealers rank average, with 52.6 percent described as excellent, placing them sixth in order in the 10 makes.

Best-liked feature, say the owners, is gasoline economy with 88.6 percent mentioning it. Kelly's over-all gasoline mileage for the Dauphine is 31.5 miles per gallon, to place it second on the list, just below Austin.

Most-frequent complaint of Renault owners is that there is not enough room and that the heater is not adequate for cold weather (both being mentioned by 13.5 percent).

Here are some quotations from owners:

"I like its economy. Gas mileage good. I get 33 miles per gallon. Oil changes cost 50 cents. Grease job about 15 cents. I do it myself."—Ohio clerk.

"Convenience and ease of operation. Feels as if you jump in and are halfway to your destination before you could get our old sedan out of the garage and turned around."—Virginia federal employee.

"Car is a part of you. Like putting on a pair of pants."—Indian tool designer.

"Handles better on bad roads than some of our cars. Better traction. Takes corners easier."—Michigan machinist.

"Good construction with practically no rattles. Finish excellent."—Arkansas pilot.

"Should improve front legroom. Do away with wheel wells."—Delaware lab worker.

"Inadequate heating system for below-zero temperatures."—Maine owner.

"Too light. Sounds like a tin can when doors are closed."—Tennessee teacher.

"Swerves in gusty wind."—Rhode Island technical specialist.

(Continued to page 248)



Left, the 305-cubic-inch V6, smallest of the line. Right, the 702-inch V12, made by tandemming two V6s

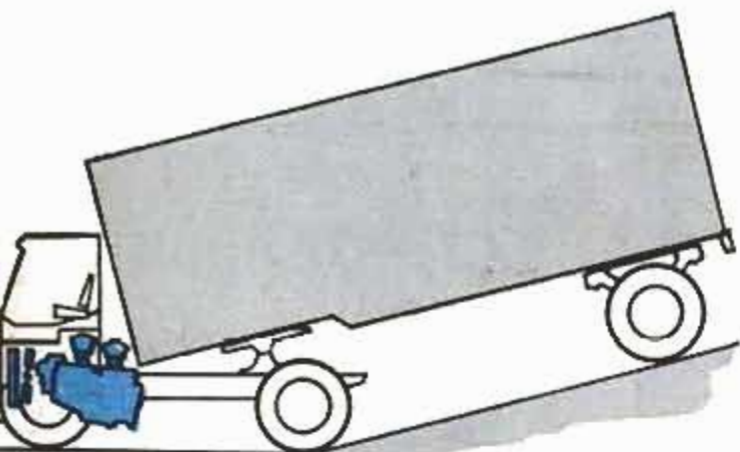

Even in undercab rigs, the big V12 retains clearance for sharp ramps. Shorter V6 fits neatly inside cab confines

With a 60-degree design, the narrow V6 fits between frame rails, leaving lots of steering room. Spark plugs are easy to reach from top of engine, valve lifters can be removed without taking off cylinder heads

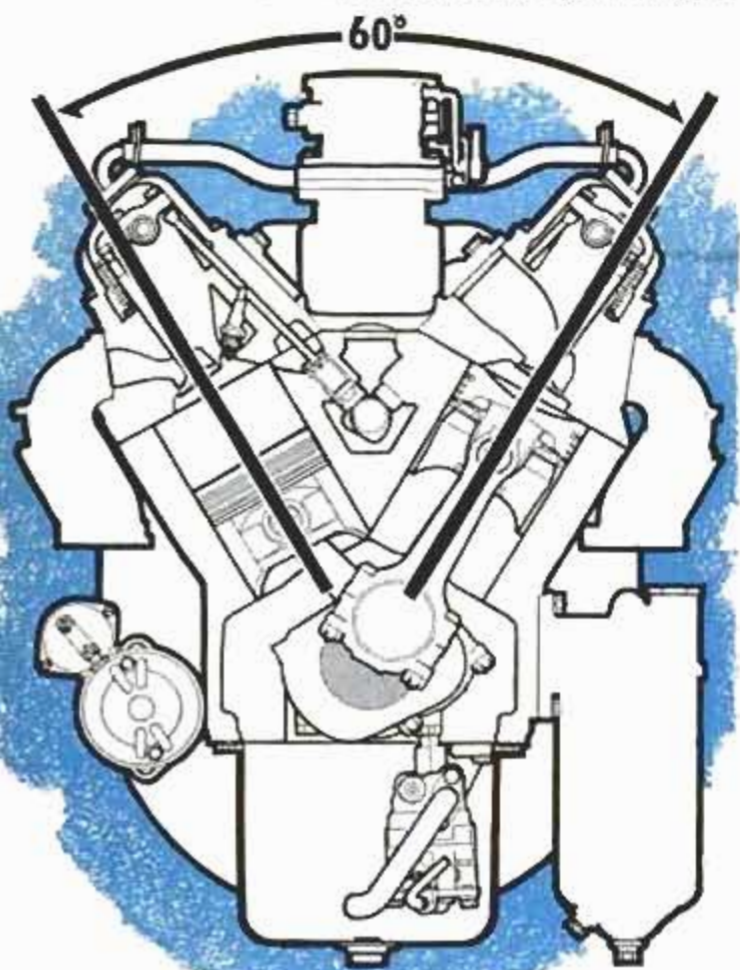

## V6 Truck Engine: 150,000 Miles Without Overhaul

WITH THREE TIMES the durability of present designs, a new V6 gasoline engine for trucks is expected to cut into the popularity of the diesel among truckers.

The engines have a potential of over 150,000 miles of continuous use without major overhaul. Because the engines develop peak torque at much less than full throttle, valve life is increased sharply and fuel consumption is decreased.

Maximum torque is developed at 1400 revolutions per minute, compared with about 2500 for a typical V8 design.

Developed by GMC Truck and Coach Division, the V6 design is also used on a 12-cylinder power package by combining two V6 engines, one behind the other.

Three sizes are to be built: 305, 351 and 401 cubic inches. The V12, called the Twin-Six, has 702 cubic inches.

Some features of the design include full-length water jackets through which three times more water circulates than in previous designs, an oil pump that moves twice as much oil as previously, a camshaft-lobe dip pocket for instant lubrication on starting, and ease of access to such parts as spark plugs and valve lifters.

Bottom view of block shows offset arrangement of banks. All engines are oversquare with short strokes

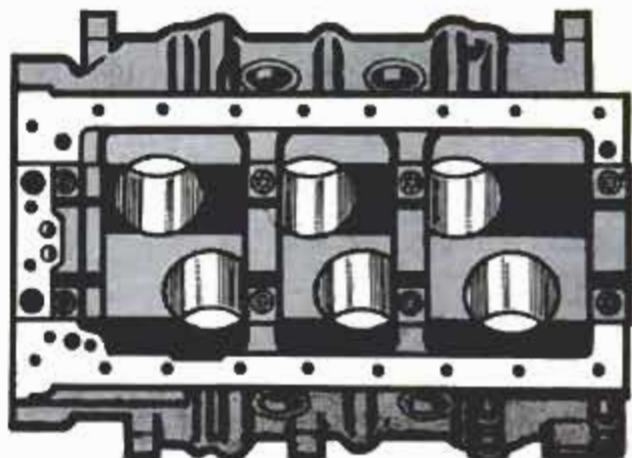

*With machetes, bulldozers and hand axes an army of 5000 men is carving a 1400-mile highway to pierce the Amazon heartland*



# ***JUNGLE ROAD KNIFES THROUGH THE LAST FRONTIER***

*By Thomas E. Stimson, Jr.*

**T**HE WORLD'S greatest jungle, the "green hell" of the Amazon that has withstood civilization for centuries, is finally being conquered.

The latest step in the conquest is a road that connects the Amazon basin for the first time with the rest of Brazil. The jungle highway starts at Belem near the mouth of the Amazon and stretches 1400 miles south, connecting with roads that lead to Sao Paulo and Rio de Janeiro. The

highway will be ready for traffic in 1960.

The Amazon is the region where you find grasshoppers as large as sparrows, flies that blister you when they bite, and the annoying "sweat bees" that have no sting, but instead, crawl through your hair and under your clothes and into your nose and ears. There are basilisk lizards that walk upright on their hind legs, vampire bats and deadly bushmaster snakes. There are anaconda snakes up to 40 feet long.

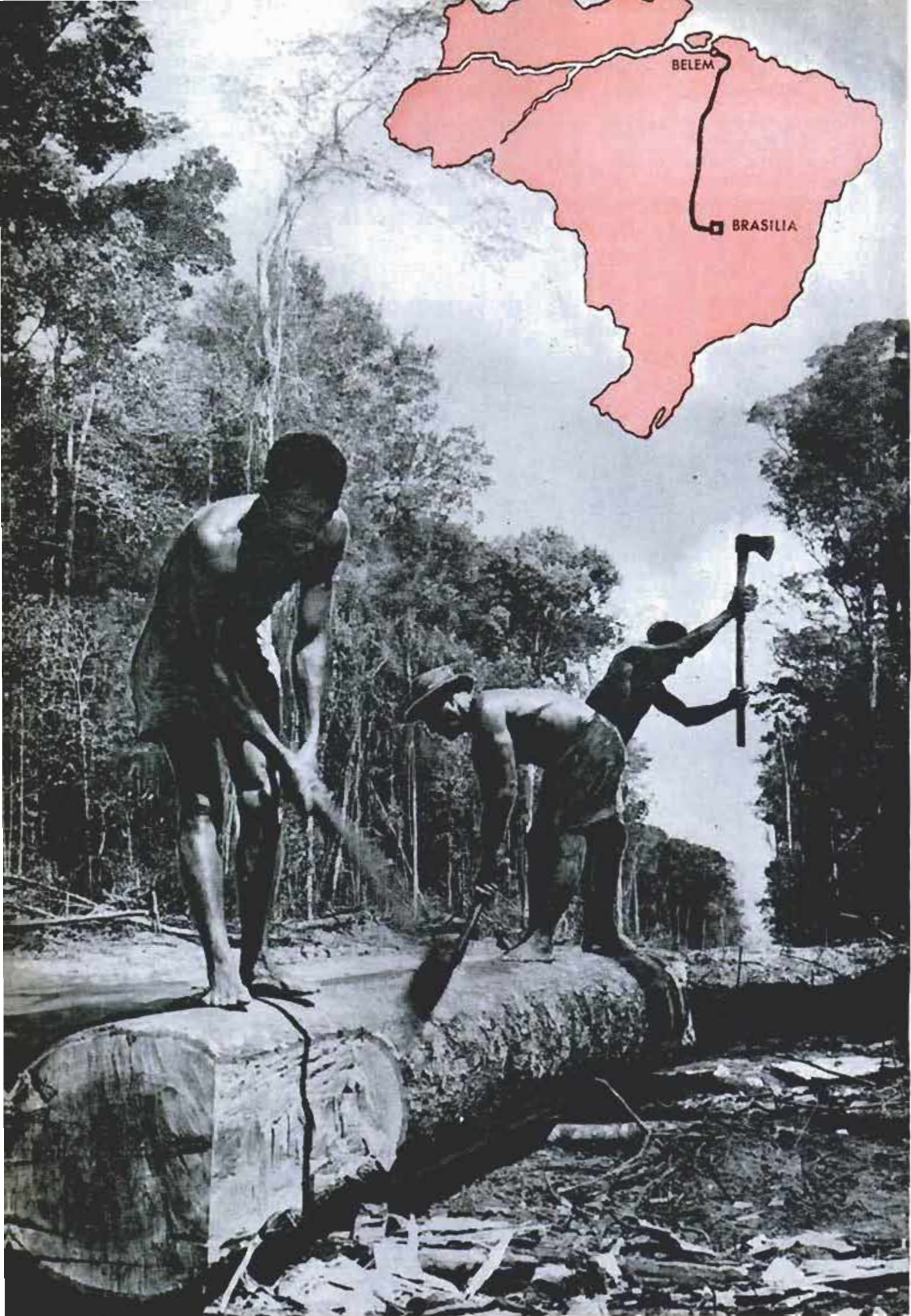

In the rivers are nine-foot catfish, electric eels and ferocious piranha fish that can strip the flesh from a swimmer.

Some native tribes in the upper watershed still use blowguns, and darts that are tipped with curare. Possibly true, possibly untrue, is the story that members of the savage Bat Tribe paint their bodies purple and their hair yellow when on headhunting expeditions.

The Amazon is the world's greatest river, with a flow equal to 20 Mississippi. It drains three million square miles of territory, an area larger than Europe, and its mouth is 20 times wider than the English channel. Ocean ships can steam for days upstream.

The hot, humid equatorial climate, the dense jungles, and such diseases as malaria and yellow fever are reasons why the Amazon watershed, encompassing 59 percent of Brazil's area, contains less than seven percent of the country's population.

Yet today, tourists who left New York less than 24 hours before are sightseeing at Manaus, the ancient rubber capital halfway up the river. At Porto Velho, literally twice as remote, a man by the name of Resky is agent for such luxuries as movie cameras and refrigerators. Daily airline schedules connect the principal towns.

In its drive to develop this last frontier, Brazil has created a special Amazonian commission known as SPVEA and has provided it with funds for fighting disease, reducing malnutrition, raising standards of living and developing potential industries. Participating in the program are such agencies as the United Nations and Rockefeller's International Basic Economy Corporation.

The new road is part of the development plan. To draw attention to the importance of this trans-Brazilian highway, SPVEA is rushing completion of the road to coincide with the opening of the new national capital at Brasilia next spring. An army of 5000 men is at work on the road today, some with hand implements, some at the controls of modern heavy-



Tree is rolled away after toppling across the roadway. Thirty subposts are being set up along the road for maintenance



Farmer uses empty paper cement bags for house roof. Rains harden small amounts of remaining cement to make sound roof

Along the roadway are jungle gasoline stations which consist of a barrel of gasoline which is pumped by hand into vehicle



Left, road workers use axes to cut timber for a bridge from the trunk of a tree



Party of local "caboclos" or small farmers prepare for a hunting expedition in the jungle. Most of them carry muzzle-loading shotguns. They keep their dogs on short leashes to "prevent fights"

Workers haul water atop their heads to camp after using the unfinished roadway as a trail to the nearest stream. Road is costing about \$35,000,000



duty, fast-moving roadbuilding equipment.

To get the story of this jungle highway I recently flew from Belem to a short dirt strip where I joined U.S. Ambassador Ellis O. Briggs on an inspection tour of one of the road camps. Later I returned to the same area in a little jungle-hopping Cessna and grabbed a ride on a supply truck for a trip along the road itself.

Among other passengers on the truck were half a dozen "caboclos" who were going hunting. These local people exist mainly on mandioca, corn and bananas that they grow in small clearings; most of them had never seen a truck or an automobile until the road was cut through their area.

What interested me was the muzzle-loading shotguns that some of them carried. The old weapons were fired by means of a percussion cap. There was no way of telling their age, but each gun was in fine shape, clean and oiled.

The hunters had a few dogs with them. An odd thing was that these dogs had claws that were long and pointed, almost needle-sharp. Living in the jungle, they never encountered hard ground or pavement that would blunt their claws.

Every dog was held tightly on a short leash, and I wondered why. My interpreter explained that otherwise the fierce beasts would try to kill each other.

The stretch of road that I traveled crosses an area explored only from the air in the past, and our truck made one stop at a new camp that had just been built by





Although many primitive building tools are used in construction of the road, modern equipment such as graders and bulldozers cut down the banks to widen roadway in preparation for paving it

people from the famed tropical zoo at Belem. They had gone into the unknown area on the chance that they could find new specimens. Already they had discovered a previously unknown variety of the toucan, a large-billed fruit-eating bird.

For lunch at the camp I had my first taste of mandioca, the starchy root of the cassava plant that is one of the chief foods of the Amazon. The substance looks like ground-up wood and that's exactly how it tastes.

It was raining in the late afternoon when we returned to the Cessna and the clouds were down in the treetops. We were weathered in and had to spend the night at the airstrip, sleeping in hammocks. To pass the evening we drove along a Jeep trail to the town of Irituia, an old river settlement that is served by a small cargo boat that occasionally comes up the river from Belem. Irituia is progressive. Its dirt streets are now lighted by street lamps that consist of naked 100-watt bulbs hanging from wires.

About a century ago an attempt was made to build a railroad in one part of the Amazon country, but the project had to be abandoned because the company ran

Airplane follows the road to one of the temporary landing strips which have been built every 50 miles along the road





Once on the dirt strips, the larger aircraft are turned around by hand. Planes often bog down in mudholes

out of men. Disease took its toll almost at the rate of one man for every railroad tie.

How, then, can a highway be built in virtually the same area? The answer is that conditions have changed and are still changing. First of all, the road commission and the contractors are using local labor, the small farmers who live in the jungle and are accustomed to its conditions. For another thing, sanitation has been improved vastly. The anopheles mosquito, the malaria carrier, is being eliminated. DDT has been so successful against mosquitos

that the number of malarial people in some small towns has dropped from an original 80 percent to less than two percent. Drinking water that is taken from muddy streams is boiled. Other health measures are being taken.

On the road itself there is a rolling hospital in the form of a large truck, complete to X-ray machine and operating table. It is used for emergency operations and for diagnosing illness; if necessary, a patient can be flown by light plane to the nearest

(Continued to page 242)

Temporary strips are used to drop food to workers. Below, men pick up bags of mandioca and corn



## Jar of Fibers Filters Water

Rust, sand and other dirt particles that sometimes reach household water supplies can be eliminated with a filter that fits on the cold-water pipe. The filter, consisting of cylindrical fibers housed in a plastic jar, is said to withstand temperatures up to 100 degrees F. To change a cartridge, the main valve above the filter is closed. Filters usually last about six weeks and are good until there is a noticeable drop in water pressure at the outlets.



## Bike With Detachable Bar Serves Brother and Sister

One bicycle manufacturer has found a way to end brother-sister squabbles over the same bike. The answer? A detachable bar that converts a girl's bike into a boy's bike. The bar can be used on a 20-inch size bike by connecting one end under the seat and the other to the handle-bar brace. According to the manufacturer, the bar fits securely enough to lift the bicycle. There's no need for the boy and girl to fight; they can both take their turns and feel right at home.



## Transistor Car Radio Built Into Mirror

Combined with the rear-view mirror, an all-transistor car radio is now being offered in Switzerland. No outside antenna is needed, but the radio requires an external speaker.

## Earth-Burrowing Rocket?

Have the Russians developed an underground rocket that burrows irrigation and pipeline tunnels? A Hungarian magazine recently reported that such rockets had been developed by Soviet engineers in a mountainous area near Afghanistan. American experts believe that the "rocket" must be similar to the well-known spalling equipment which uses oxygen-fed flame to flake away rock. They speculate that the Russian machine must have several flame-cutting heads.





### Loader for Superplanes

German inventiveness has come through with a practical method for hoisting heavy cargo up to the doors of today's super-size airplanes. A hydraulic loader lifts heavy loads in seconds. Resembling a huge ironing board in its raised position, the new elevator-on-wheels easily hoisted a Volkswagen sedan during a demonstration at Rhine-Main airport in Frankfurt, West Germany. The loader is capable of lifting a cargo of 3½ tons as high as 12 feet.



### Foam Strip Saves Finish

You can cushion any household item to prevent it from scratching a tabletop by applying strips of urethane foam plastic to the base. The stripping, ¾ inch wide and ¼ inch thick, is coated on one side with pressure-sensitive adhesive. It can also be used as weather stripping around doors, ventilators, and air conditioners.



### Radioactivity in Milk Measured by Detector

Scientists at the Los Alamos Scientific Laboratory use a large radiation detector to measure minute quantities of radioactive materials in milk. Dry-milk samples from 47 U. S. cities, 12 in Canada and 13 in other countries are studied to detect cesium-137, a major constituent of fallout from nuclear explosions. The detector can also measure the radioactivity in humans. Scientists say the machine has shown that the cesium count is high among humans in the same areas where it is high in the milk. Cesium's fallout partner is strontium-90. Cesium-137, however, enters body muscles and can damage reproductive organs, while strontium-90 damages mostly bone cells and is almost incapable of genetic injury. About 840 people were measured in the counter last year.



## Television Cameras Identify Workers

Closed-circuit television cameras are helping factory guards identify employees entering an auxiliary gate 350 feet away. Cameras at the gate pick up pictures of each worker which are shown on two television screens at the main gatehouse. One shows a split-screen image of the worker's face and badge. The other keeps him in sight as he passes through the turnstile in either direction. When proper identification has been made, the guard presses a button to open the electrically operated gate. An intercom system is used to answer any questions. Installed at the Gulf Oil Corporation refinery in Philadelphia, the system permits some 150 employees more convenient access to their working area, as they do not have to pass through the main gate. It also eliminates use of extra guards to watch the auxiliary entrance.



## Clear Chemical Coating Protects Color Transparencies

Color transparencies or black-and-white negatives can be protected permanently from air, moisture, heat, dust, wear and finger marks by dipping them in a new chemical coating. The coating also overcomes the tendency of film to become brittle with age. The slide is simply dipped into the liquid with tweezers and allowed to dry for about 45 minutes. The cost is less than a cent a slide, and the coating will neither distort the picture nor change color values. The coated film can be cleaned in hot water.



# THE PALACE THAT'S PAINTED WITH CORN

Oscar Howe, outstanding Indian artist, supervises work on his corn mosaics for the Mitchell Corn Palace

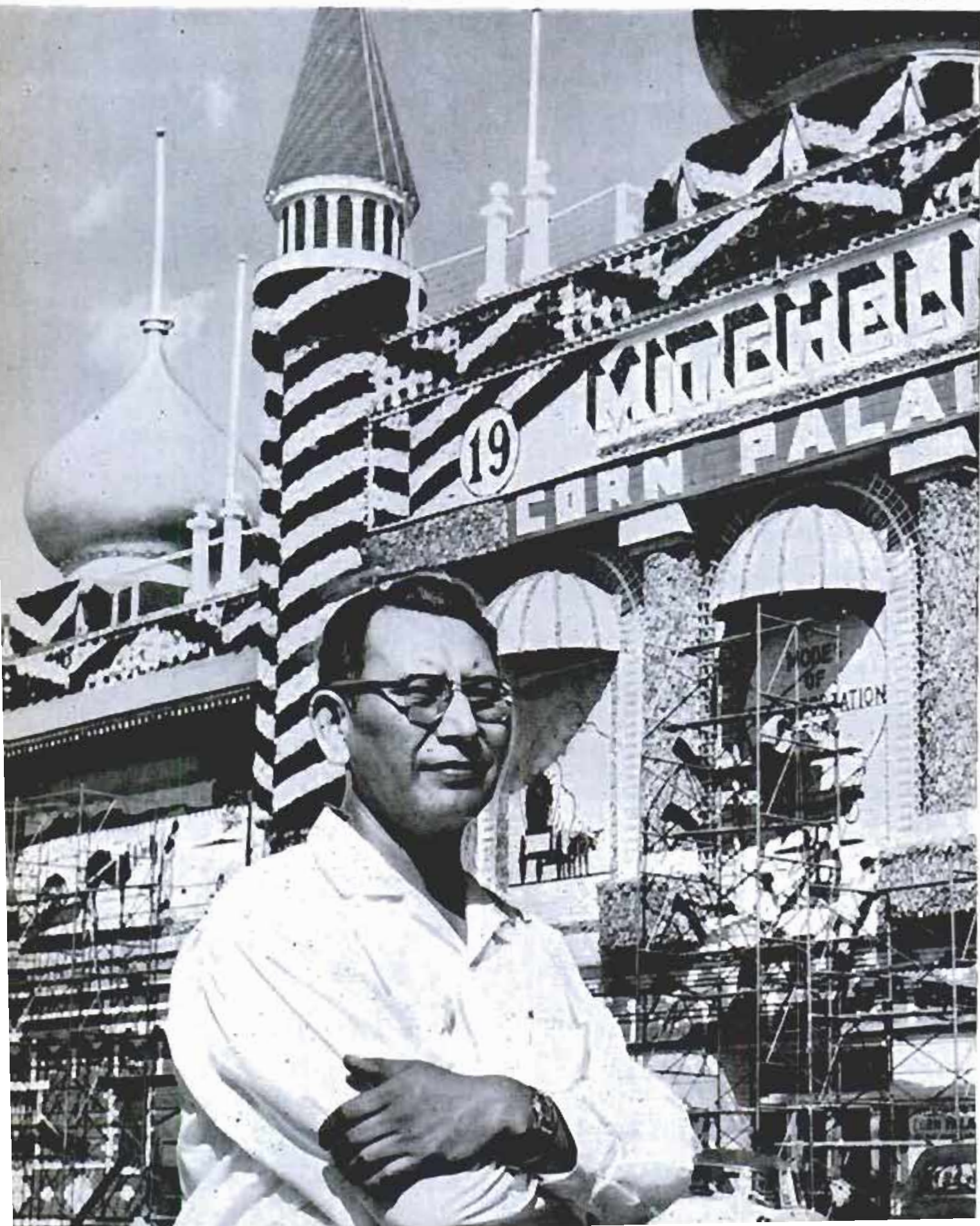

**WORLD'S ONLY CORN PALACE"** has been a trademark of Mitchell, S. D. since 1892, when two public-spirited citizens sparked a drive to build a cultural center for their growing city. Their earliest structure was a simple frame building decorated in geometric patterns with the dif-

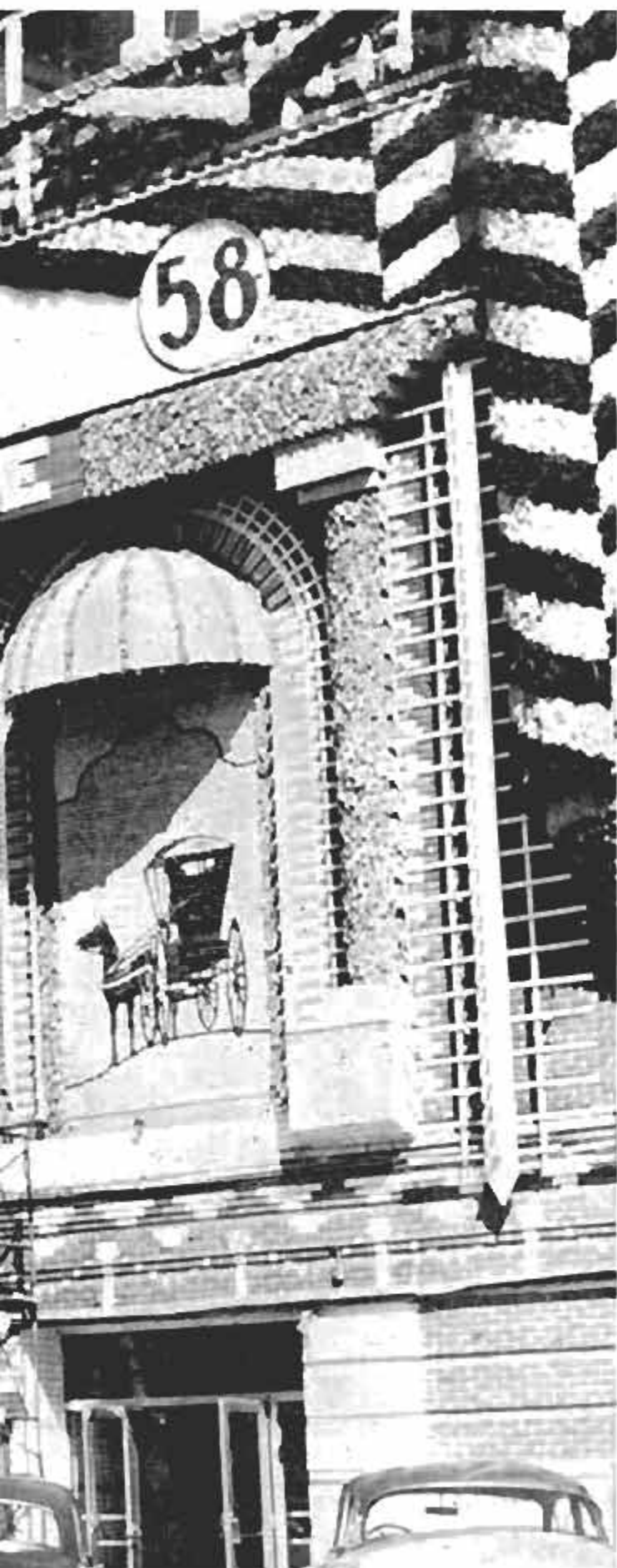

ferent-colored corn grown in their area, but they dreamed of a building outstanding enough to be an attraction in itself. Those early ambitions were realized in the now-famous Byzantine structure which lures tourists from all over the country, and their early attempts at decoration are still reflected in the patterns of its brickwork.

But the most remarkable—and popular—feature is the practice of decorating the palace with colored corn, which has continued through the years and has developed into one of the most-unique mosaics in architecture.

### Indian Designs Panels

Since 1948, the big annual job of designing the 11 decorative panels on the two street sides of the building has been entrusted to the only Sioux Indian artist in the Middle West, Oscar Howe of Vermillion, S. D., who is recognized as outstanding among the 100 American Indian artists.

An art instructor at South Dakota University, Howe has won national awards in all major Indian art competitions, and his paintings are on exhibition in most major cities in the United States and in several foreign countries. In 1948, while teaching art at Dakota Wesleyan University in Mitchell, he was called in by the Corn Palace decorating committee when William Kearney, who was in charge of the decorations for years, fell ill and could not carry on. He has been designing the corn mosaics ever since.

### Designs Follow Regional Themes

Three of the mosaic panels are 30 feet long and the remaining eight are 12 feet long. All are 12 feet high. All are keyed to an annual theme based on local life or history. The mosaics are executed in ears of red, yellow, brown, blue, white and calico corn grown especially for that purpose; in some years the job has required as many as a thousand bushels of corn. Great bunches of yellow-ear corn and dyed cornhusks complete the decoration of the building, which is timed for completion for the Corn Palace Festival, held during the fourth week in September each year.

The first three years after taking over the job, Howe designed the mosaics showing Indian culture. Next came scenes from the history of South Dakota; then themes based on the state's agricultural, business, religious and social life; one based on the 75th anniversary of the founding of Mitchell and an athletic theme. Then came the series shown on these pages—modes of transportation from 1892 to 1958.

Working in his home studio, Howe designs each year's new panels to scale, painting them in the bold corn colors that will



Heidi Howe watches husband finish a mosaic scale drawing

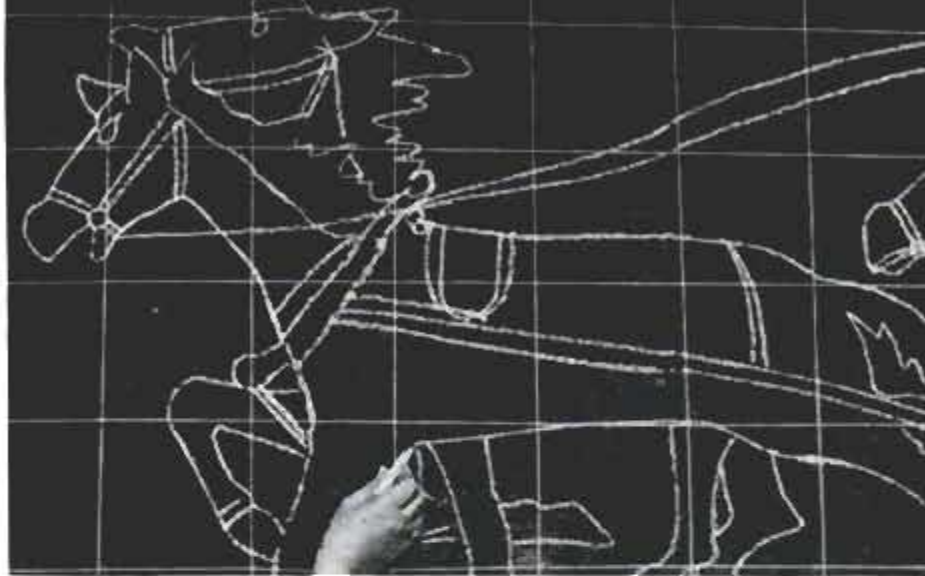

Hardest part of the job—Howe enlarges the scale drawing to a full-size pattern in chalk on gridded roofing paper to guide his workmen

be used. After his proposed designs have been approved by the palace decorating committee, he begins the hardest part of the job—enlarging the sketches to full-size patterns for the decorating crew.

Working on a wall in the Mitchell Armory, he repeats the designs in chalk on

gridded-roofing paper, using the familiar craftsman's method of transferring squares. Each color section is marked for the color to fill it, so the workmen's job is much like working on a do-it-yourself oil painting with color-coded canvas.

The workmen attach those "black prints"

Workmen attach scale drawings to Corn Palace wall; mosaic this size will take about a week to finish

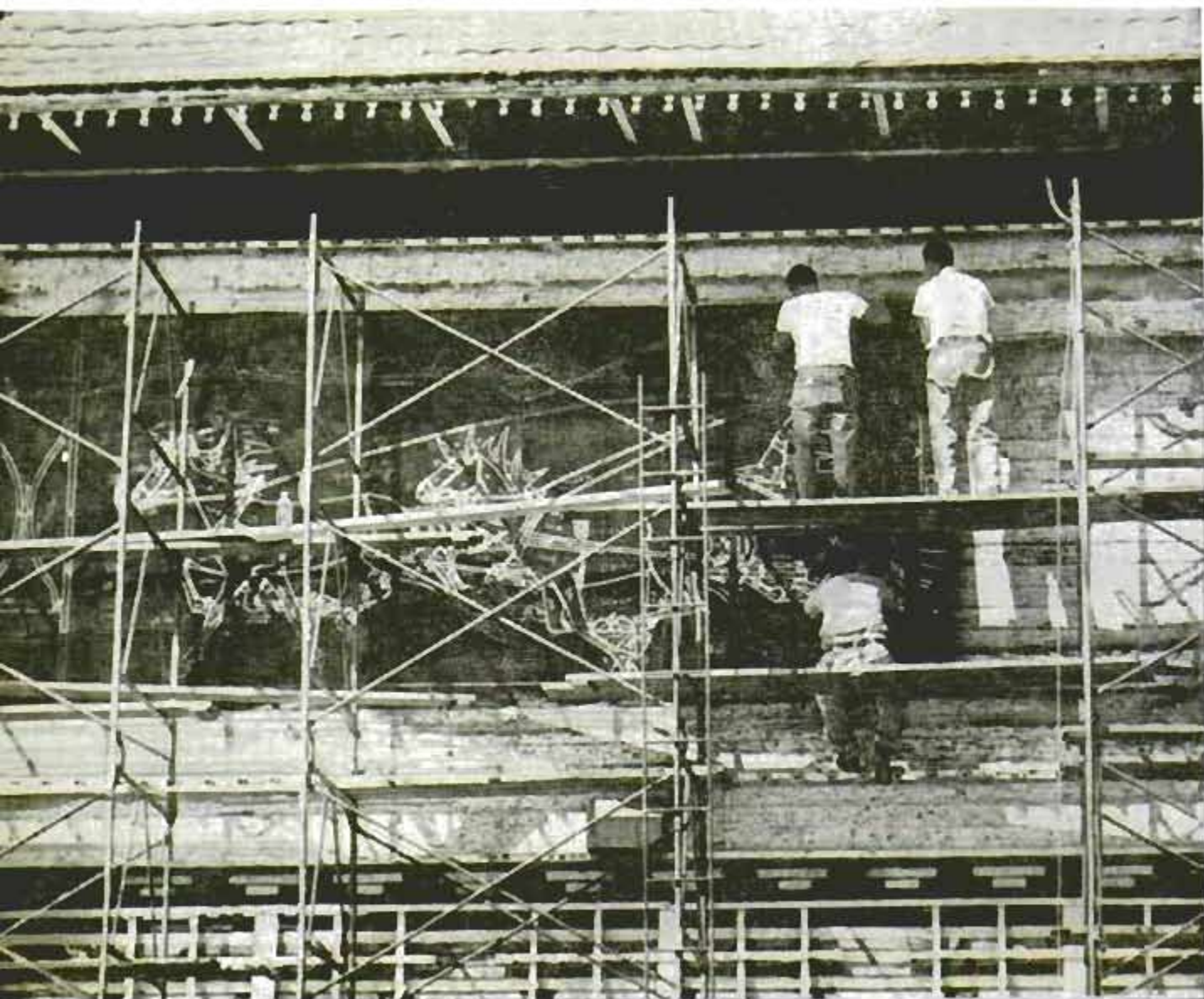





**Decorations** Foreman Sid Grinde splits the corn ears as needed to fill in the design



Following Howe's full-scale drawing and color guide, workmen nail split ears over pattern. Background is always yellow

to the assigned panels, and then begin nailing split ears of colored corn over the pattern, using three or four nails to each ear to hold it securely in place. It takes the crew about a week to finish one of the big panels, though several are worked on at the same time. Ordinary yellow field

corn is used for the background and is nailed in place first. Then the colored details are added. By the last week in September, the new mosaics are completed and the Corn Palace — perhaps the most colorful building in the Midwest—is ready for the festival. ★ ★ ★

**South wall of the Palace shows finished mosaic depicting modes of transportation from 1892 to 1958**





### Electronic Typewriter Operates by Light Beam

Remotely controlled to allow use by paraplegic patients, an electric typewriter is operated by directing a headlamp beam against a keyboard of photoelectric cells. Using neck and head muscles, which have the greatest residual control, some patients can type up to 30 words per minute and can communicate though otherwise paralyzed.



### World's Smallest Watch?

Believed to be the world's smallest timepiece, this tiny watch, mounted like a gemstone in a gold ring, was one of the displays at the 1959 Basel Watch Fair held by Swiss watch manufacturers.

### Superfast Movie Camera Photographs Bubbles on Propeller

Working at a shutter speed of one million frames per second, a camera developed by the California Institute of Technology has photographed the life history of the cavitation bubbles which cause metal fa-

tigue in ship propellers. The bubbles collect on fast-moving metal in water and create pressure waves of several thousand pounds per square inch when they break, causing strains that disintegrate the metal.

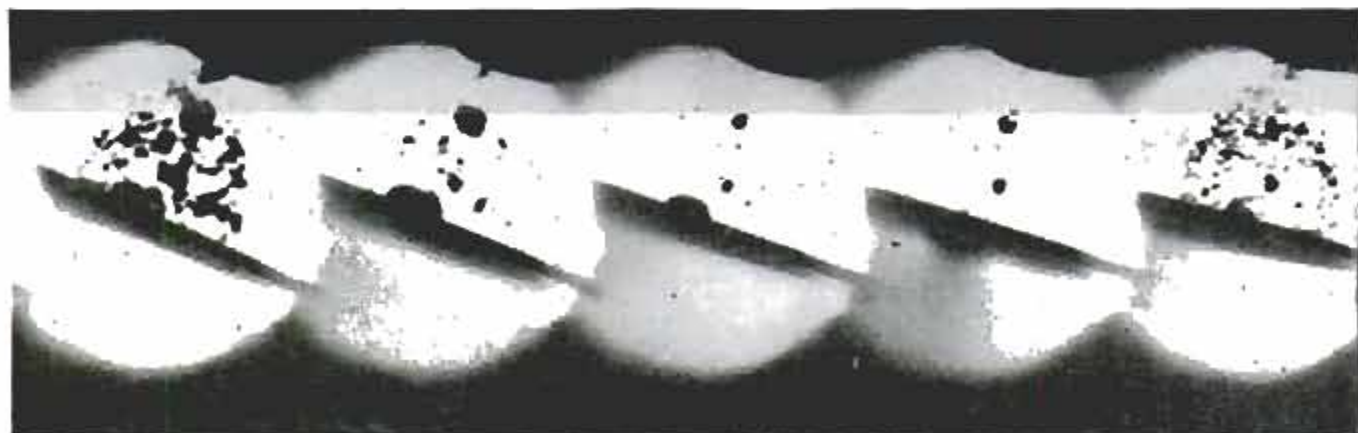



## Remember This Old-Timer? It's Back as a Crop Duster

Growth of agricultural aviation has revived interest in the 20-year-old Kellett autogiro. In crop-spraying operations it can fly close to the ground at speeds as low as 22 miles per hour, whereas most fixed-wing aircraft have a minimum speed of 70 miles per hour. The autogiro is comparatively inexpensive, and a qualified pilot can learn to fly it in three hours. Powered

by a 225-horsepower engine, it has a cruising speed of 100 miles per hour and a service ceiling of 14,000 feet. Take-off requires no runway, and landing can be accomplished in an area only slightly larger than the diameter of the rotors. In addition to agriculture, the craft can be used in power-line and pipeline inspection, aerial photography, forest-fire patrol and forest seeding.

## Pedal Blocks on Trike Never Scrape Sidewalk

Raising pedal height  $2\frac{1}{2}$  to 3 inches without decreasing lower pedal clearance, a new tricycle-pedal extension allows small children to ride big tricycles, increasing the useful life of the trike by at least two years. The pedals are kept in position by a tube which slides over a piston-type rod attached to the handle bars.

### *Number, Please!*

Whenever you write us to .

- Renew your subscription
- Change your address
- Order your own or a gift subscription

... In fact, whenever you write us,

**PLEASE INCLUDE YOUR CITY POSTAL ZONE NUMBER IN YOUR ADDRESS**

*This insures better delivery  
It helps you and it helps the postman.*



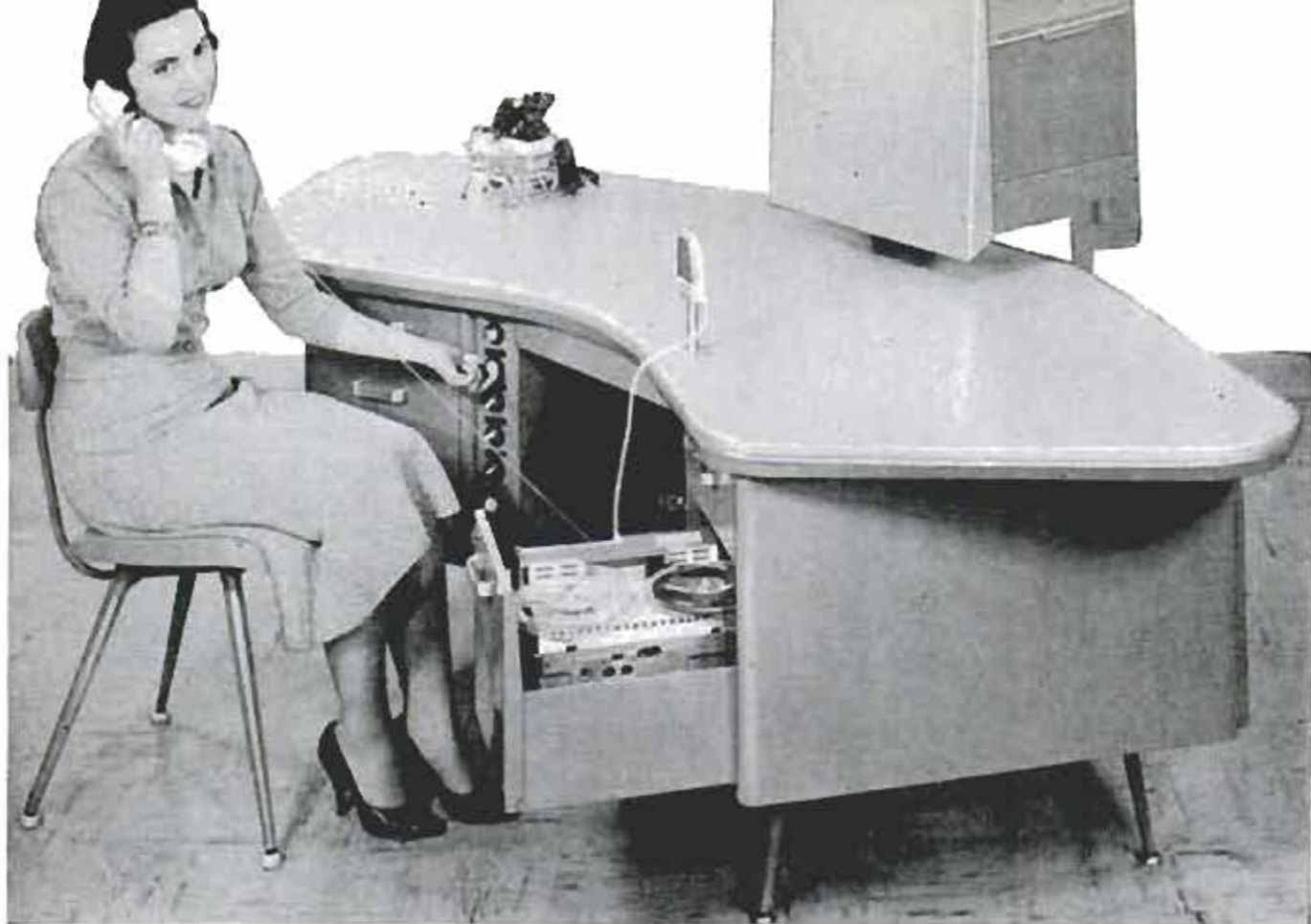

## Everything But the Apple Built Into Teacher's Desk

Designed for education of the future, an experimental teacher's desk has a built-in television set and gives the instructor electronic aids for her class. The TV set, adaptable for closed-circuit and direct telecasts, fits beneath the top of the desk when not in use. To bring it into position, the teacher presses a switch and it rises to the top of the desk with the 21-inch screen facing the students. Another switch puts it away. Electronic controls close the draperies and turn off lights. The desk also contains a tape recorder and a telephone.



## Chart Light for Boats Also Lights Cigarettes

Installed on the dashboard of your boat, a chart light also serves as a cigarette lighter. A chrome mounting plate simplifies installation. While reading a map or chart, the boater flips the switch on the cockpit light. When not being used as a light, the mechanism pulls out like an ordinary car lighter. It comes in both 6 and 12-volt models.

☐ In 1960, the United States plans to launch about 15 satellites and space probes and 100 sounding rockets.





Girl can easily balance herself on wooden ball, since it can move only backward and forward while following spiral rail



Kimpel designed this game for table or sickbed. Object is to hit other person's ball

## Playground Goes Modern

RECREATIONAL equipment in Ulm, Germany has a new look. Designed by an architect named Joachim Kimpel, it stresses function and mechanics, and pushes psychology into the background. Kimpel's innovations include a climbing arch, a Ferris wheel that requires the body weight of just three passengers to keep it going, and a tug-of-war game in which contestants pull on rings instead of rope. The children of Ulm like the toys so much they call Kimpel their "Uncle Joachim."

Ferris wheel runs on three childpower. In tug-of-war, youngsters grab hold of rings



# WHAT'S NEW FOR Your Home

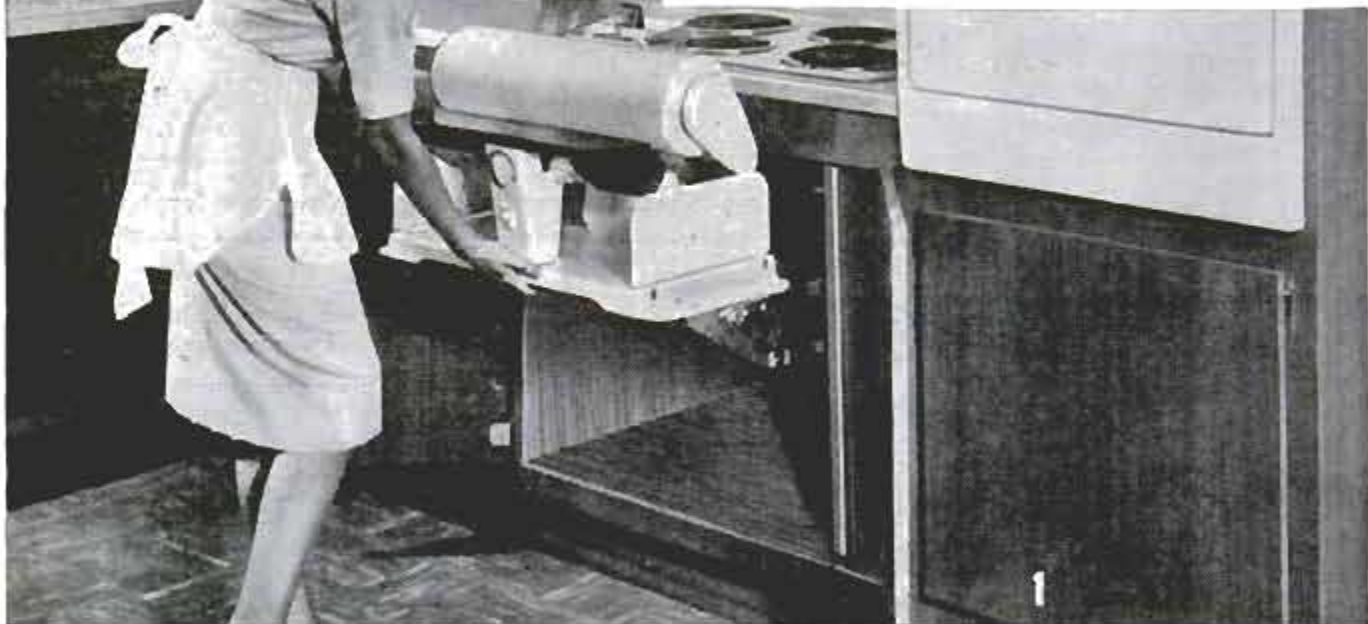

**1. AUTOMATIC IRONER** can be installed in any standard base cabinet now popular in kitchens. When installed, the ironer pulls up easily into working position. A slight push, after releasing catch, causes it to ease down slowly and disappear in the cabinet where it remains unseen when not in use

Ironrite, Inc., Mount Clemens, Mich.

**2. ELECTRICALLY-POWERED BABY CRADLE**, bottom left, eliminates rocking baby to sleep. When turned on, mechanism starts a gentle rocking motion and plays Brahms' Lullaby. Other attachments convert it into a nursery for play. A detachable horse replica converts combination cradle and nursery into a hobbyhorse

Stauffer Reducing, Inc., 1919 Vineburn Ave., Los Angeles 32, Calif.



**3. SALAD MAKER** comes equipped with five rust-resistant interchangeable steel disks that help prepare vegetables or fruits, nuts and cheese, from coarsely chopped to powder-fine. The mechanism slices, chops, shreds, grates and will even shave ice

Mouli Mfg. Corp., 91 Broadway, Jersey City 6, N. J.





4

**4. AUTOMATIC WASHING TOOL** turns water on and off without using nozzle. Turned on at faucet, water stops at sponge head, which connects to hose. When sponge is pressed lightly to surface water flows

Hopkins Mfg. Corp., Emporia, Kans.



5

**5. LIQUID CHARCOAL LIGHTER** causes stubborn charcoal to burn instantly for outdoor parties. Packed in a no-leak, no-spill, pushbutton can, the foam is sprayed over the grill and spreads flame over entire cooking surface

Defiance Corp., 170 E. Vernor Hwy., Detroit 1, Mich.

**6. BATTERY-POWERED MIXER**, right, can take care of small mixing chores around the house, boat or camping site. Useful for mixing chocolate drinks, eggs, baby foods or salad dressings, the mixer operates on a flashlight battery

Jet Corp. of America, Commercial Trust Bldg., Philadelphia 2, Pa.



6

**7. DIALED VEGETABLE SLICER** is equipped with one straight and one corrugated-steel blade. Dial on the machine adjusts the thickness of each slice. Vegetable is pushed forward by guard and slices drop into plate at end

Popeil Eros., Inc., 14 N. Sangamon, Chicago 7

**8. SPIRAL UTILITY RACK** stretches across any door without nails or screws and provides extra hanging space for towels, laundry, clothing, household accessories and tools. It fits all standard doors, even sliding doors, from 22 to 36 inches wide

Direct Promotions, 114 E. 32nd St., New York City 16



7

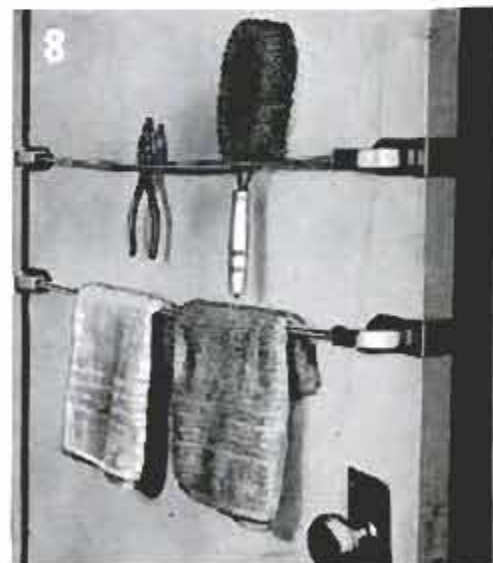

8



## One Hand-Lever Controls Speed and Gears of Tractor

Drivers of the new Ford tractors can change gears and speeds with just one hand lever. There's no clutch pedal, and changes can be made while the tractor is in motion. Ten forward speeds, two reverse

speeds and a "neutral" and "park" position are provided. Gear ratios and ground speeds show on a lighted dial. Forward speeds range from .6 mile per hour to more than 18 miles per hour.

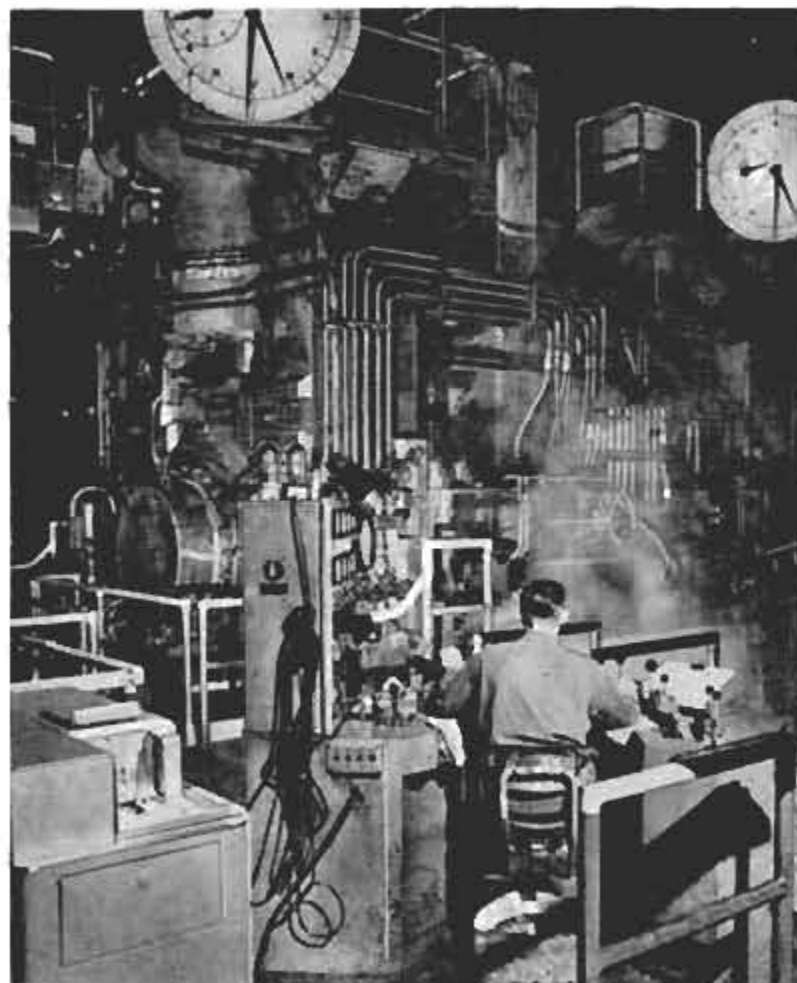

## IBM Cards Rule Mill Rolling Aluminum Slabs

Aluminum billets are worked into slabs on the first electronically controlled rolling mill to be used in the light-metal industry. An automatic system, following instructions on IBM cards, establishes mill speed and roll opening for a 160-inch reversing mill. The breakdown mill rolls 16-inch-thick billets into 3 to 4-inch slabs.

## "Pitcher" Hurls Bomb Away From Plane

Dropping bombs from supersonic fighter-bombers such as the Air Force F-105 presents a problem, since air pressure at speeds up to Mach II can force the bomb back into the bomb bay or bounce it against the belly of the aircraft. Republic Aviation has found one solution after 18 months of testing. A pneumatic-tube bomb "pitcher" uses 30,000 pounds of air pressure to throw the bomb clear at any speed.



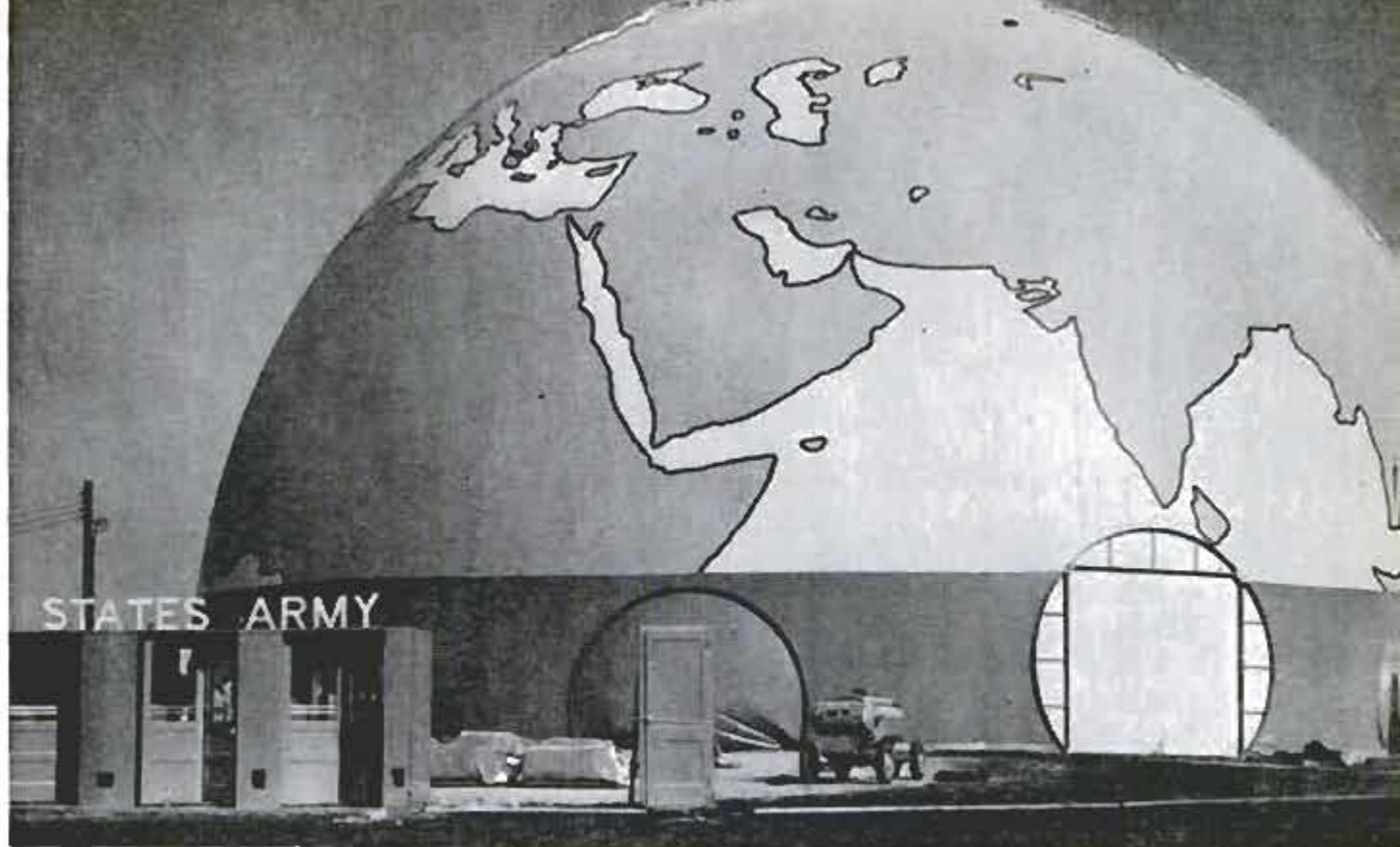

Fully inflated, the "Pentadome" will hold even the largest missiles in horizontal or vertical position

## Huge "Balloon" Will Shelter Largest Missiles

NINE STORIES HIGH and covering 17,500 square feet but erected in a single day, a huge air-supported structure is designed to shelter missile-maintenance operations. Made of 18,000 square yards of fabric, the shelter has no framework. It requires 1,060,000 cubic feet of air for support, but at only .03 pound per square inch pressure. Walk-in doors allow easy access; large loads enter through a 100-foot air lock. The completely portable structure forms the nucleus of a five-section shelter unit being tested by the Army Ordnance and Missile Departments.

Twelve electric-powered centrifugal blowers move a quarter-million cubic feet of air per minute to fill and support the huge vinyl-coated nylon envelope

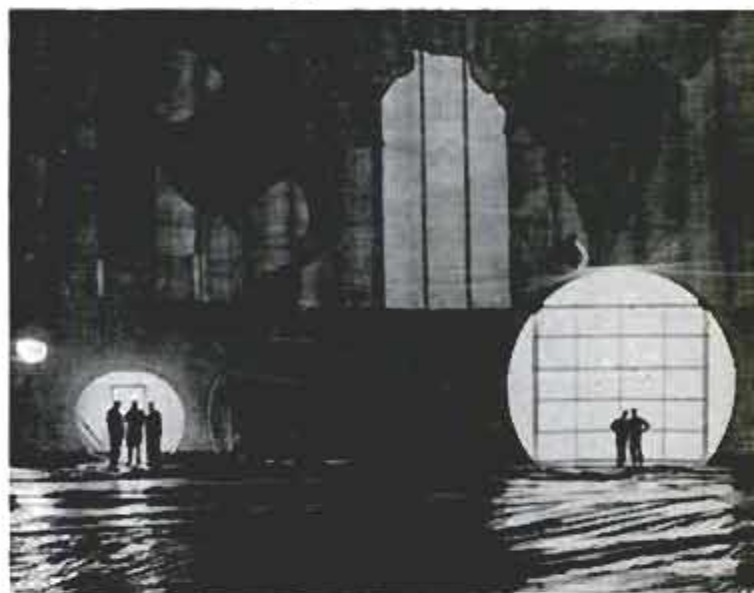



Dorothy Collins makes test recording in husband Raymond Scott's home recording studio as Scott works dials

## MUSICAL HOUSE FOR

**T**HE HOUSE WHERE Composer Raymond Scott, Singer Dorothy Collins and their two children live in Manhasset, N. Y., is not a home in any ordinary sense. It is a 32-room musical labyrinth, and a testament to Scott's electronic genius.

A self-taught audio engineer, Scott has filled many of the rooms with electronic instruments that have confounded highly trained experts in his field. He uses them in his composing and recording chores.

Scott, who composes everything from musical scores for films to singing commercials, was formerly with "Hit Parade" where his wife still performs as a singer. Scott's creative talent for musical innovation has become well known through the Raymond Scott quintet, which has pioneered in unconventional sounds for more than a decade.

To create these sounds, Scott has developed some unusual electronic instruments which, along with a recording studio, a film projection room and a ham-radio setup,

make his home a musical showplace.

One of his instruments, called a "clavivox," is a piano-type keyboard instrument with two unusual features. First, it can slide smoothly in pitch from any note on the keyboard to any other without a break or hesitation. Secondly, it uses two foot pedals to make a humanlike vibrato control. It is said to be the only instrument that can produce this combination of effects, and very nearly duplicates the human voice.

For writing film scores, Scott has developed an instrument which he calls the "videola." From its place on top of the living-room piano, the mechanism operates a movie film in a projection room in another part of the house by remote control.

The movie is flashed on a television screen on the piano, so that Scott can watch the film as he composes appropriate music. A recording apparatus is hooked up to the videola, as well, so that he can stop, play back, listen, rub out and rewrite.

Scott also holds a patent on an automatic scanning radio, which tunes in on stations around the country and changes frequency by itself at any given interval, enabling him to catch most of the nation's disc-jockey shows in a brief span and find out what tunes are being played.

Among other instruments which Scott has developed are a device that automatically finds a selection in a particular recording tape and continues to repeat it as long as he wants it repeated, and a remote control instrument that enables him to make recorder selections from another part of the house.

Along with these special developments, Raymond's and Dorothy's mansion contains a completely equipped recording studio, a film-projection room and, in the basement, an immense workshop and storeroom, where all of the electronic innovations have been made.

In fact, Scott employs a full-time engineering assistant whose job it is to help build and maintain the equipment which he is constantly creating. The exact value of the electronic installations is unknown, but Scott estimates that it would cost him a "couple of



Dorothy and daughter Debbie listen as Scott explains the intricacy of equipment which he developed for his own needs

*By Alan D. Haas*

## A MUSICAL FAMILY

A Scott invention, the "clavivox" is a keyboard instrument that sounds quite similar to human voice

Another Scott specialty, the "videola" flashes movie film on TV screen to help musician write score





A ham-radio enthusiast, Scott has a complete radio unit for tuning in worldwide amateur broadcasts



Scott hears nation's hit tunes with automatic scanning radio that picks up stations around country

hundred thousand dollars" to replace them.

Scott's house has neither a hi-fi nor a stereophonic system because he thinks that "adequate modern-day reproduction" is all that is required. He believes that "in these days of elaborate high-fidelity installations,

there is too great an emphasis on the method of reproduction rather than what is being reproduced."

As might be expected, the Scott household, which includes Elizabeth, 1, Debbie, 4 and Dorothy, is filled literally with music. Dorothy can usually be found in the recording studio trying out a new tune, listening to a playback or trying to get her husband to explain what all the dials are for.

Despite her musical training, she confesses that she is mystified by a good part of the equipment which has turned her household into a conservatory of music. Debbie, already showing signs of following the family tradition, plays the piano remarkably well for her age. Elizabeth has not yet shown any preference for an instrument, but is rapidly developing into a good listener—she has very little choice.

Despite the many demands of their busy careers (Scott is writing a musical play along with producing television commercial jingles), Raymond and Dorothy have kept their family life alive, with music as the binding force. The Scotts are definitely in tune with each other. ★ ★ ★



Scott uses microscope to see that grooves are cut correctly on test record made in his home studio

## Two-Volt Replaceable Cells Build Marine Battery

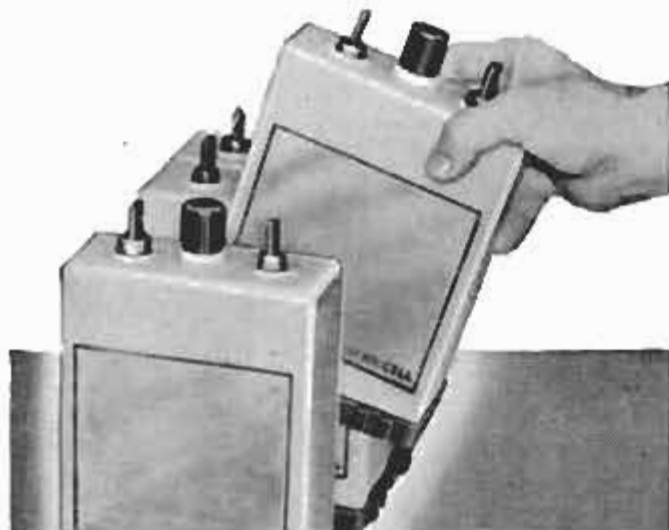

Now you can buy marine batteries with replaceable cells. Each of the interlocking plastic-case cells produces two volts, and groups of them can be arranged in nearly any configuration desired. Use of selenium in the battery units eliminates the problem of sulphation, which kills many conventional cells. The selenium also permits easier flow of current and maintains the battery charge during periods of idleness. Over-all weight of the battery is reduced by the use of plastic cell cases, plus selenium in the power circuits.

## Earthbound "Spaceship" Tests Control Systems

Balanced on a near-frictionless air bearing and moved by blasts of compressed gas, a reaction-control simulator was built by aircraft engineers to study the problems of controlling vehicles in airless space where conventional aircraft control surfaces are useless. By regulating the force and direction of the gas jets, the operator can turn the simulator into various positions of pitch, roll and yaw, duplicating many of the conditions expected in controlled space flight. In addition to the gas-jet systems, methods of control by flywheel inertia and gyroscopes will also be tried. Different sizes and weights of vehicles can be simulated by weighting the framework.

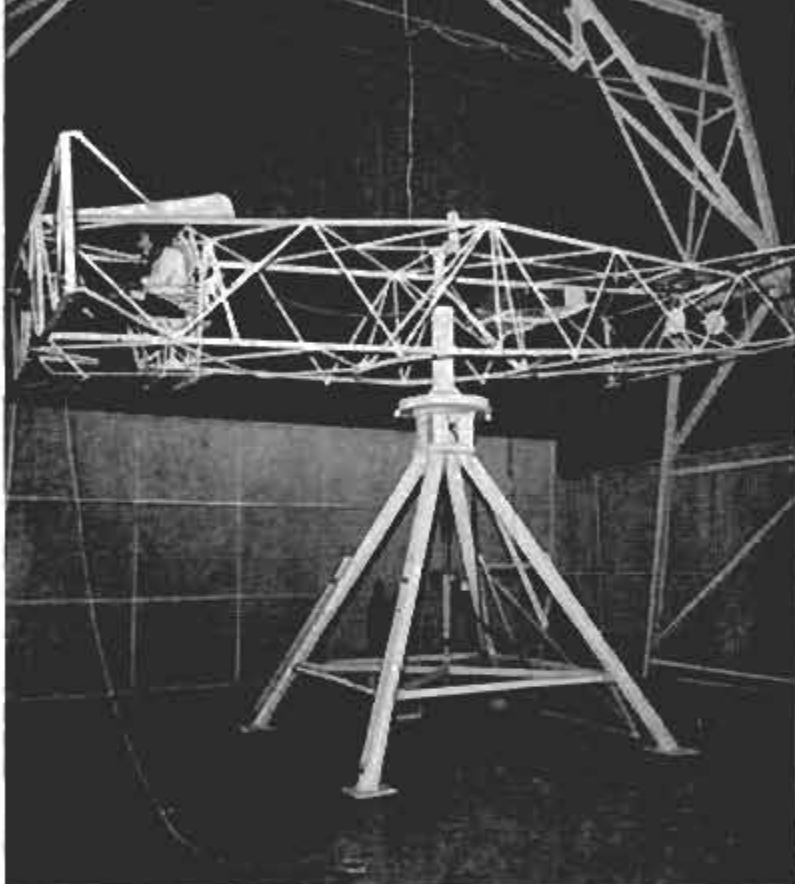

## "Squashed Up" Car Solves Parking Headache

Britain's auto market offers a plastic three-wheeler that can be parked in six feet of curb space. Called "Scootacar," the tiny vehicle has handle-bar steering and an eight-horsepower engine. It seats two adults in front and two children in back. Top speed is 50 miles per hour.



## Newsprint From Eucalyptus

Newsprint is now being manufactured from eucalyptus wood in Tasmania. The mill at Boyer is Australia's only newsprint plant and is reputed to be the only place in the world where hardwood is processed into newsprint.

## Horizontal Pipes Improve Organ Tone

Persons going into the newly rebuilt St. Matthias Church in West Germany for the first time are mildly taken aback when they notice the unusual arrangement of organ pipes. When the church was restored after destruction in World War II, a new set of pipes, called "Spanish trumpets," was placed horizontally instead of vertically. The arrangement is said to improve the tonal quality of the instrument significantly.

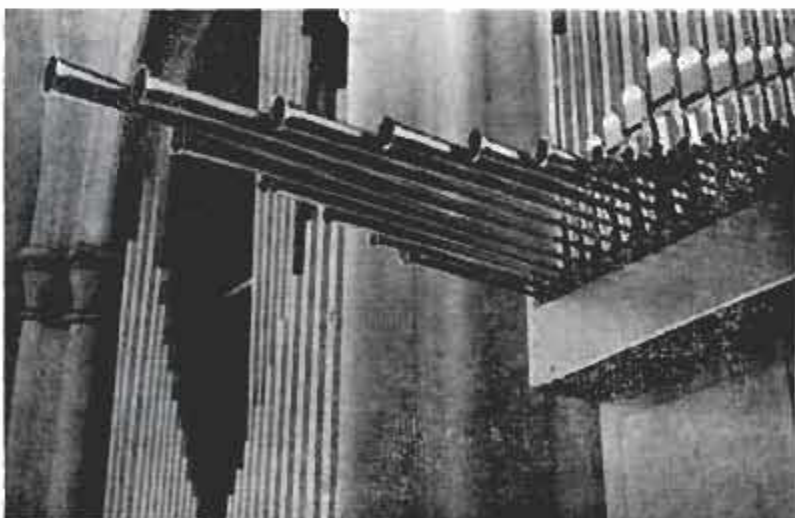

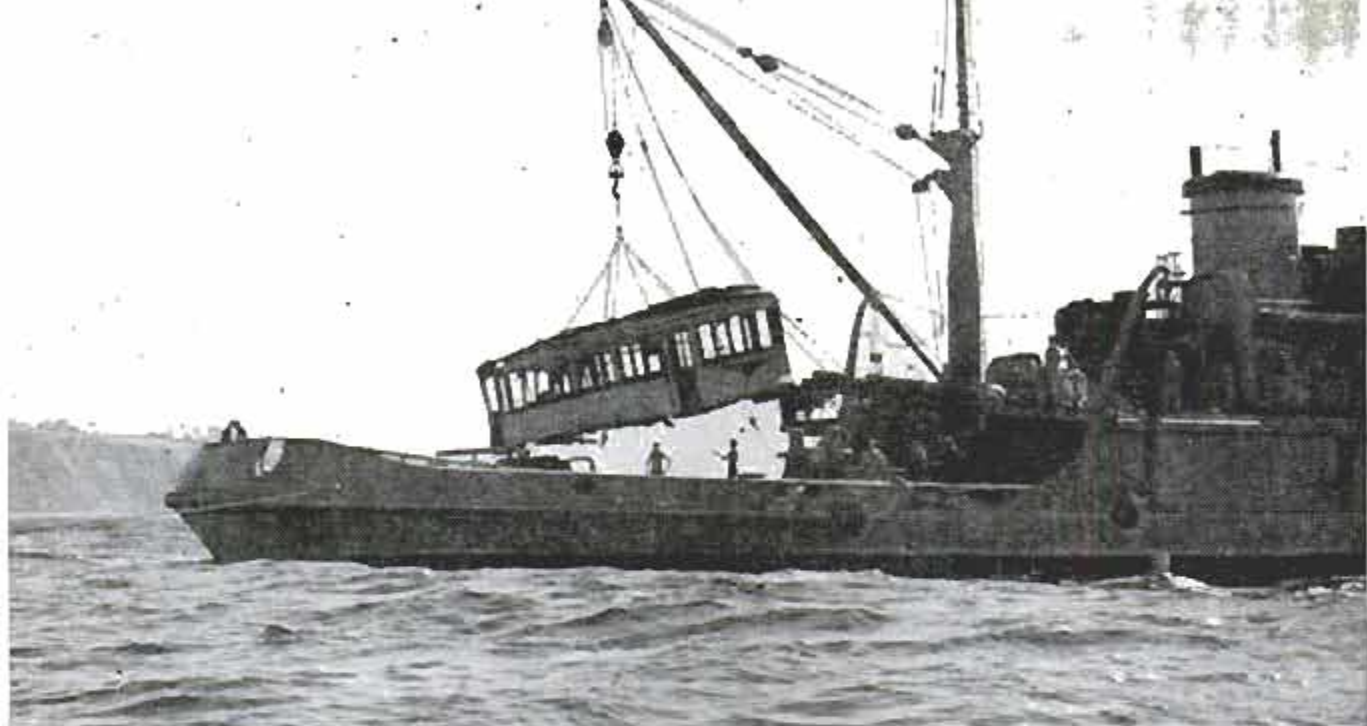

Derrick on a Navy tug hoists junked trolley car. It will be lowered into water as home to attract fish

## Old Trolleys Attract Fish to Once-Barren Waters

RELICS FROM TROLLEY LINES are proving to be castles for fish. Biologists on the West Coast have found that junked streetcars make attractive homes for fish in waters where they failed to gather before. Diving biologists, aware that fish congregate around wrecked ships, created an artificial reef from half a dozen six-ton streetcars by sinking them in 60-foot-deep

ocean waters off the Redondo-Palos Verdes coastline in Southern California. The result? Curious fish, among them, perch, kelpfish, seabass and yellowtail, have made the trolleys their homes. The trolleys were moved to the site by barge, then transferred to a Navy tug. A derrick lowered each trolley into the water—apparently to the delight of the fish.

One by one, a half dozen six-ton streetcars are placed in 60-foot-deep waters, forming an artificial reef

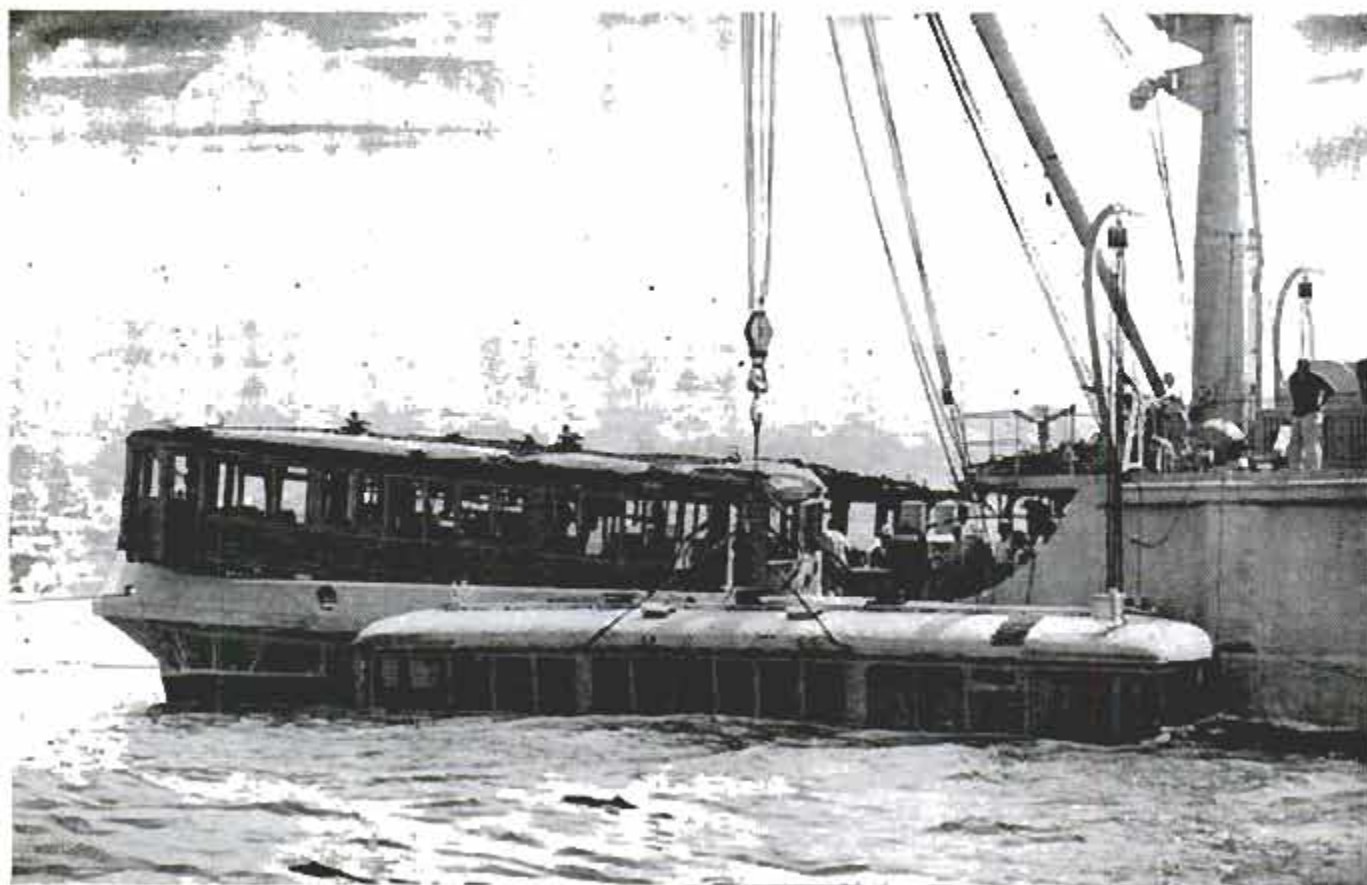

# Coming Next Month

## Annual **HOME** Issue

50 Exciting Pages  
of NEW IDEAS

The  
Indoor—



—Outdoor  
House



Planned around a swimming-pool patio, with strategically placed glass walls, uniquely spacious areas for luxurious modern living, and fresh ideas in every room, this beautiful home was designed by the nationally famous architect Edward V. Dart, with *Popular Mechanics* readers specifically in mind.

### FOUR PAGES OF FULL-COLOR VIEWS OF THIS HOME— *Along With Many Other Outstanding Features:*

- Ten simple things you can do to increase the value of your home
- Exciting news about the latest in home heating — electricity
- Tips on year 'round landscaping in all areas of the nation
- Putting your house in shape to sell
- How building codes affect wings and additions you plan to build
- How to estimate what YOU can afford to pay for a new house
- Parade of new ideas in home plans from all areas of the country
- How to hide basement eyesores

### PLUS A HOARD OF NEW IDEAS FOR HOMEOWNERS



Giant "father" turns from newspaper to look at tot, who is wandering through exhibit designed for adults

## A CHILD IN A GIANT'S WORLD

**H**OW DOES IT FEEL to live in a child's world where people are giants, furniture is mountainous and distances are vast? In Nottingham, England, architect Paul Ritter has built an exhibit with furnishings  $2\frac{1}{2}$  times their normal size. Adults wander-

ing through the exhibit get a striking lesson in how the world appears to their youngsters. Occasionally it alters their "point of view" toward child rearing. And when a *real* three-year-old appears on the scene, as shown here, he's truly in a giant's world.



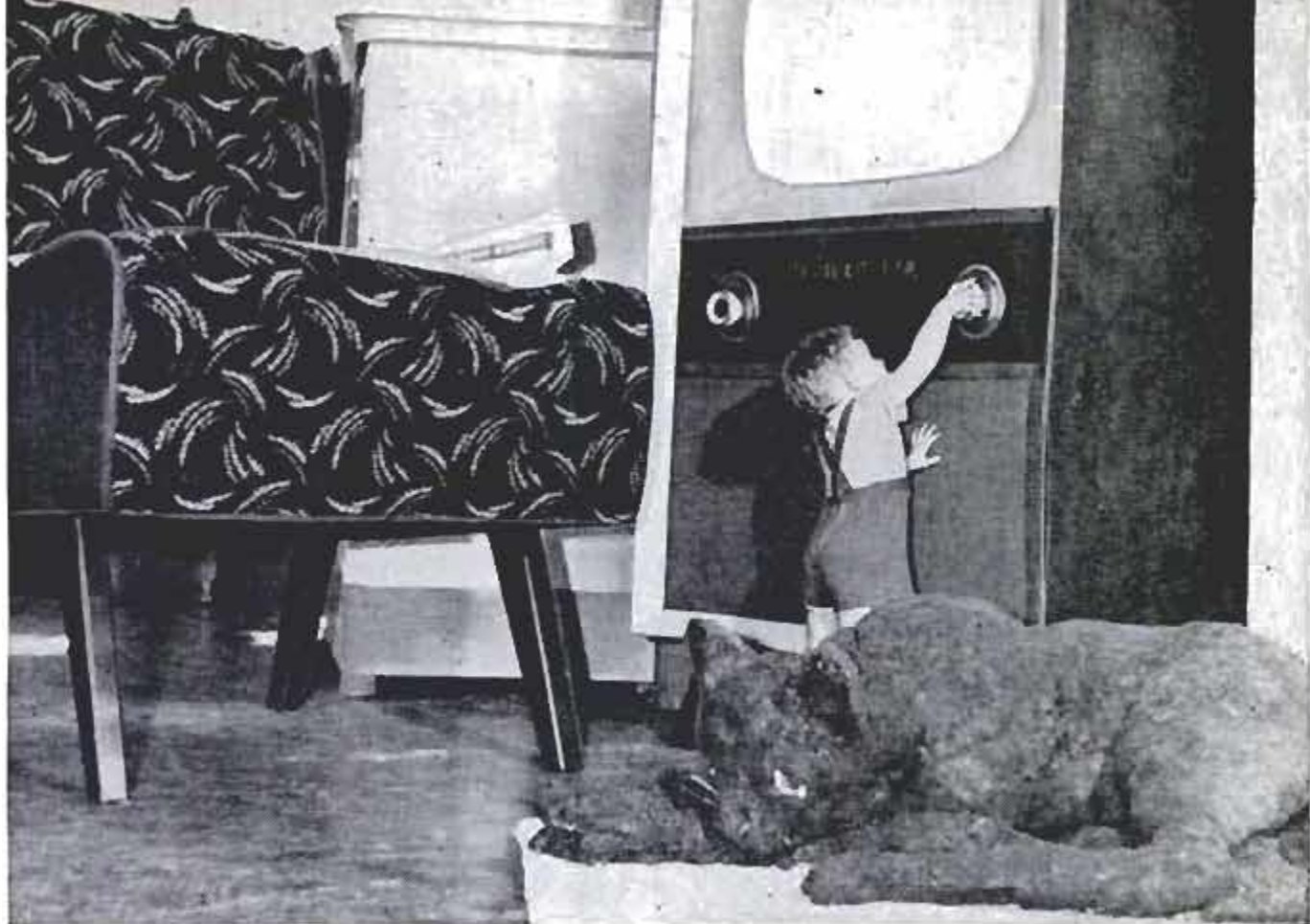

Three-year-old edges past terrifying tabby and stands on tiptoe to fiddle with "big screen" television set



To a tot, "small" household items are huge, and he sees bottom of a table more frequently than the top

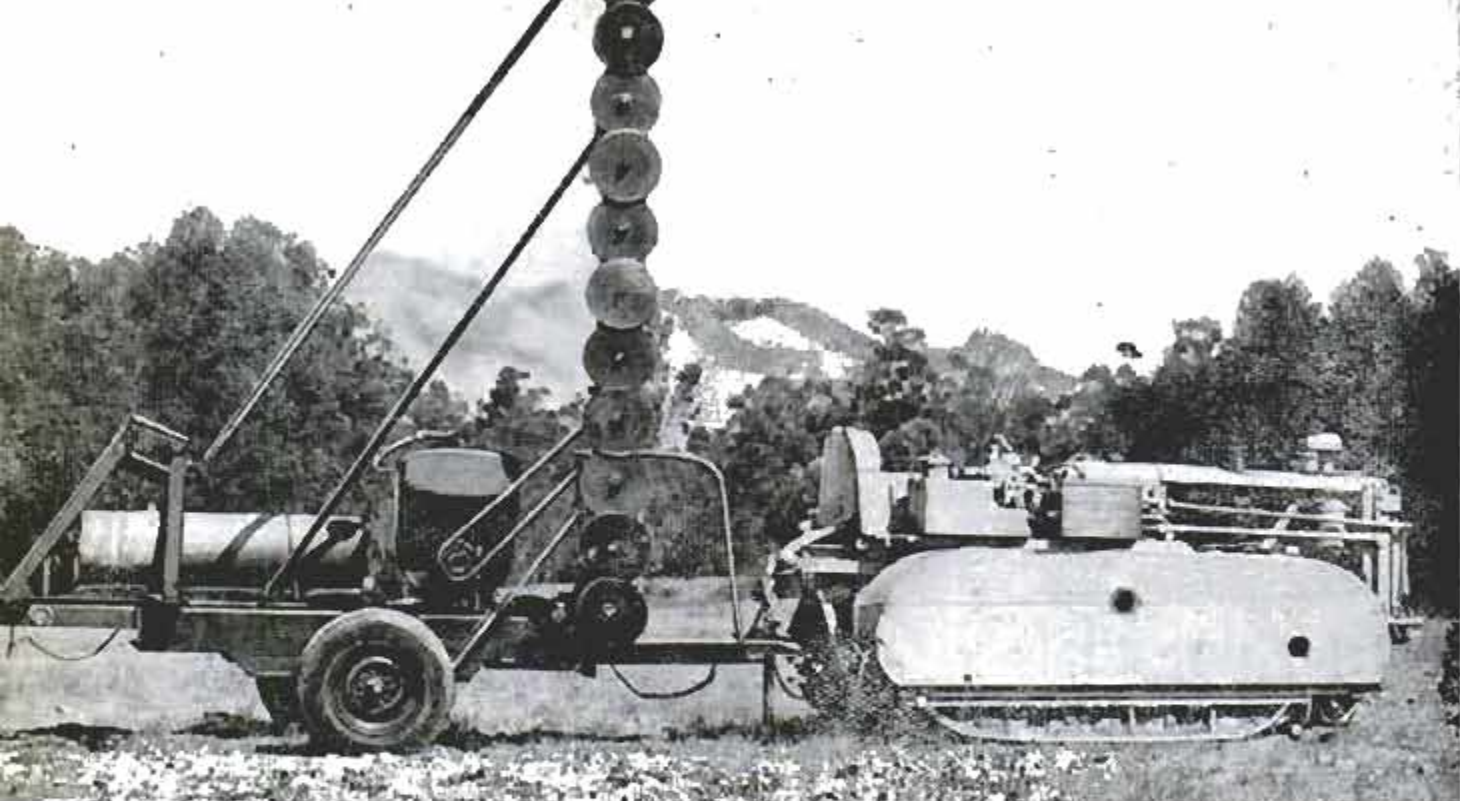

### Machine Pruning Cuts Cost

Hedging and topping machines are cutting citrus-pruning costs by 30 to 50 percent. The hedger shown above has twelve 14-inch saws and can prune lemons, oranges or grapefruit on two sides of a row at the rate of  $\frac{3}{4}$  to 1 acre per hour. At the left is a heavy-duty topping machine. The orange tree being topped has had four to five feet cut off.



### Sidewalks Steam-Cleaned

Downtown sidewalks in San Jose, Calif. have been steam-cleaned by two portable, oil-fired rigs that create steam in burners. Chemical detergents and caustics are added to the steam. Gums and tars on the walk are loosened by a solution composed of five chemicals. Then the steam operation cleans and bleaches the walk. Power is supplied by generators on the rigs.



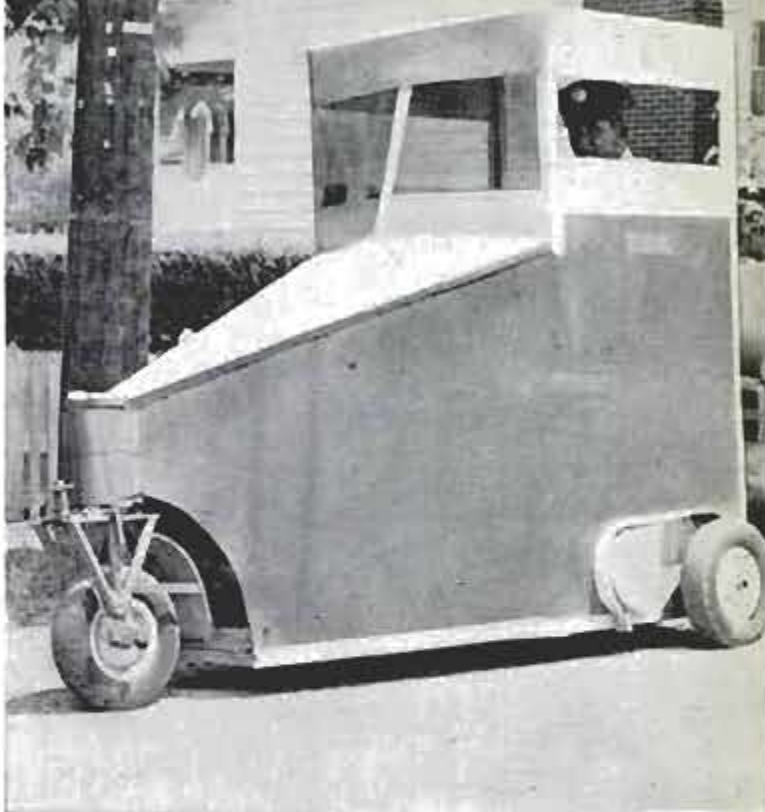

### Mailman Covers Route In Homemade Truck

Delivering the mail each day doesn't tire the legs of a Falmouth, Ky., letter carrier. He rides over his route in a miniature homemade truck. Put together from scrap parts of machinery, and powered by a 6.8-horsepower, air-cooled engine, the little truck was built with an eye on practicality. It has plenty of space for packages, the mail bag and a seat for the driver. The frame, made of one-inch galvanized pipe, is covered with strips of hardboard and aluminum. The steering system consists of a steering rod connected to a worm gear from a washing machine, which is attached to the front wheel.

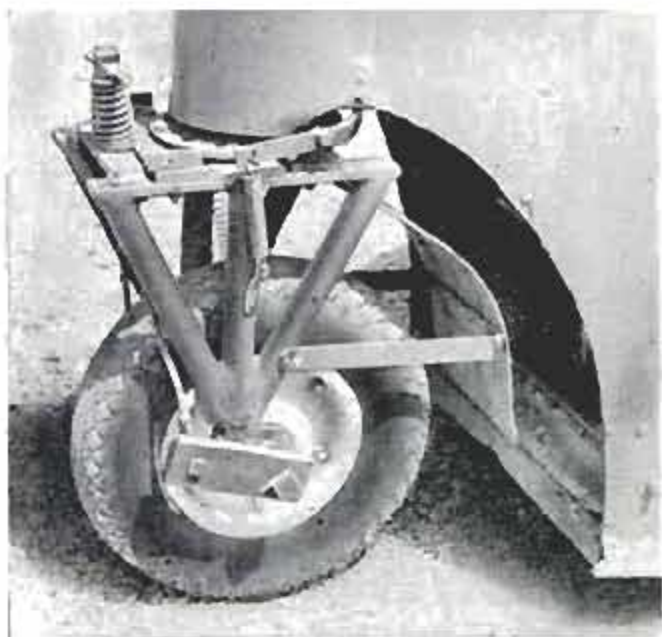

### Converter Cuts Exhaust

Automobiles can now be equipped with a catalytic converter that reduces exhaust hydrocarbons, which are believed to contribute to smog formation. The muffler contains pellets coated with vanadium pentoxide, which eliminate a major part of the unburned hydrocarbons in the flow of exhaust gases. The device has standard exhaust and tail pipes.

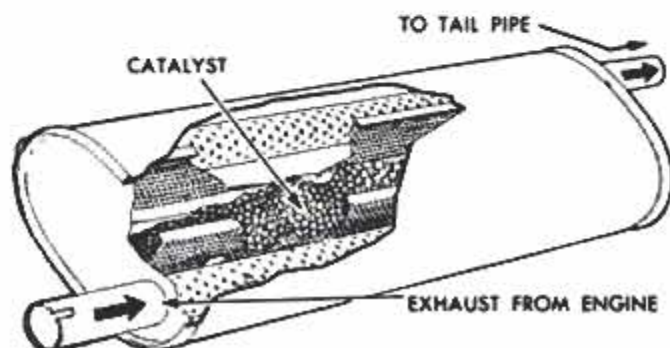



Geological Survey party heads for testing ground in station wagon and "Squash Bug," a mobile laboratory

By  
Sterling  
Gleason

# THE "SQUASH BUG"

Dr. E. H. Bailey, left, geologist in U.S.G.S. party, sieves test sample that assistant has pulverized



**I**F YOU THINK the day of great bonanzas is past, the geologists and chemists of the U. S. Geological Survey have a surprise for you.

They're field-testing mineral-locating techniques that will open up a new frontier for prospecting—the uncounted "blind" ore deposits that show no visible clue at the surface.

U.S.G.S. is gunning not merely for individual ore bodies but for vast metal-rich districts that will be prime hunting grounds like yesterday's Cripple Creek and Mother Lode areas. Its geologists point out that we're still getting most of our key metals from last century's discoveries, made at spots where certain old formations lay exposed to view. Tomorrow's great strikes must come through new techniques that can penetrate below the surface.

U.S.G.S. is using new organic reagents that undergo remarkable changes of color when microscopic amounts of metal are added to them. At present most of the reagents are handled by highly skilled chemists, but, already, simplified kits that almost anyone can learn to use are on the market



Metal traces can be found almost anywhere. Twigs may contain telltale traces of metals below surface

# SEARCHES FOR PAY DIRT

for prospecting for copper, lead and zinc. A similar kit is standard equipment among Canadian prospectors combing the North Woods for nickel.

Geochemical prospecting is based on the principle that metals are scattered widely throughout the earth's crust. Metal traces can be found almost anywhere—if you have means of detecting them.

Gold? The world's full of it. There's probably some flowing out of your kitchen faucet. Simply boil down from one to forty billion gallons of tap water and you may recover an ounce of the precious metal.

Copper? You don't have to mine it; it's all about you. Almost any igneous rock, or soil derived from it, contains about 70 parts to the million.

Aluminum is so common that soils generally average about 81,000 parts per million.

Uranium, mercury and platinum, however, you'll find in only a few parts to the billion.

You might suppose this abundance of clues would prove confusing, but U.S.G.S. finds that with the new geochemical

Careful use of complex reagents by U.S.G.S. teams gives delicate, incredibly sensitive tests for metals



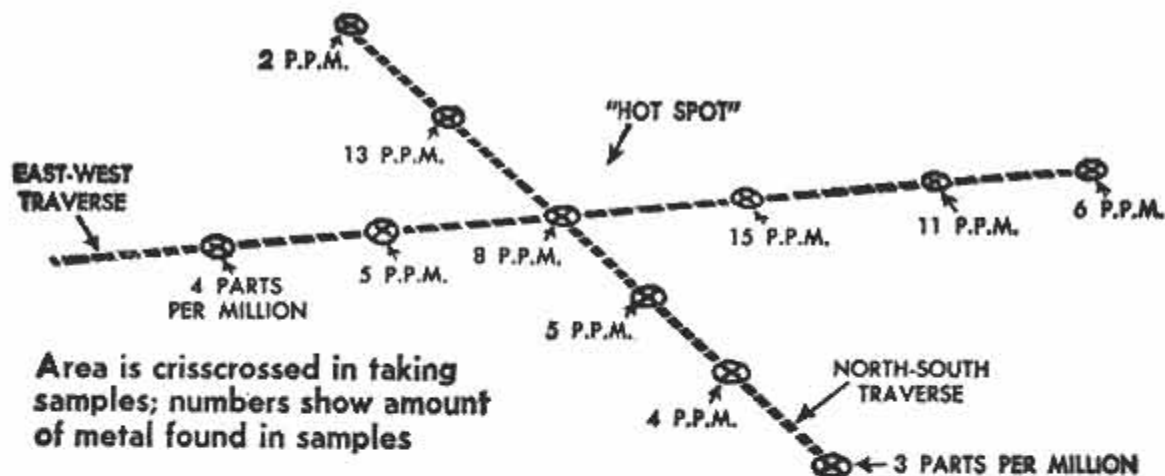

wizardry, "blind" ore deposits are no longer so blind. Leakage from the depths seems to be common, sometimes carried through cracks caused by earth movement, freezing and thawing; sometimes waterborne by deep springs. Plant roots help by probing to bring up metals they need for growth, concentrating them in their leaves.

So U.S.G.S. is putting geologists and chemists into the field to perfect its colorimetric techniques. They are picking leaves of "loco weed," snipping pine needles and twigs of birch and juniper, scooping sand from stream beds, filling bottles with water from streams and bogs, spooning up weathered rock that by ordinary assays would appear barren. Systematically mapping these leakage traces, they can pick up "hot" trails leading to the parent ore bodies.

Recently I drove over a narrow road into

a range of mountains east of Lovelock, Nevada. A squat green truck stood on a promontory overlooking a vast plain that showed light-colored trails on its surface. These marked the dusty progress of trucks, some carrying high-grade iron ore, some carrying diatomaceous earth.

The green truck, I knew, was the "Squash Bug," the dream buggy of the U.S.G.S. geochemical section. It is a modern traveling laboratory for the new magic. It carries a generator, butane tank, ultraviolet lamp, a supply of highly purified water, and an extensive complex of shelves and racks holding bottles, beakers, filters and funnels. In this mobile field center a vast amount of testing is done in a short time.

I shook hands with Frederick N. Ward, geochemist. "This is a rich district," he ob-

(Continued to page 216)



To identify an unknown metal found in a sample, U.S.G.S. teams compare the color of the sample with standard reagent

## Vinyl Plastic Lamps Inflate Like Balloons

Made of tough vinyl film and purchased in a flat, deflated shape, the shade of this hanging lamp is inflated to shape by a mouth valve at the bottom, then hung from a rim at the top. The doughnut-shaped plastic "balloon" forms different shapes, depending on the amount of inflation. Quick and easy to assemble and hang, the lamp is ideal for outdoor use for patio parties, but can be used anywhere in the home. It comes with complete hardware and a six-foot cord, ready to hang. Tests for safety and durability showed that a 40-watt bulb could burn inside for six weeks without discoloring or overheating the plastic; bulb heat is diffused through a "chimney" at the top of the shade.



## Elevator on Wheels Raises Loads Anywhere

For direct loading of trucks or railroad cars, or materials handling to any high level, an elevating platform on wheels has been developed by a German firm. Working like a forklift with a platform, the elevator can be rolled into position, loaded and raised to any desired level. Hinged side plates stand up to form sides, fold down to bridge the gap when level is reached.



## Vacuum Attachment Speeds Barber's Work

Welded to his clippers, a vacuum attachment cuts haircut time in half and catches the clippings, in E. V. Wilson's barber shop in Judsonia, Ark.

## German Locomotives Trade Coal for Oil

Thirty big coal-burning locomotives of the German Federal Railway have been modernized by installing oil burners in their fireboxes and converting the coal tenders to fuel tanks. Results have been so good that the railway plans more conversions.





## Huge Antenna Tracks Missiles

Enemy missiles would be detected and tracked while still over enemy territory by a series of huge tracking antennas designed and built by Goodyear Aircraft for the Air Force's ballistics missile early warning system. A cutaway drawing of the installation is shown at left. The pedestal supporting the antenna is three stories high, and the protective radome is large enough to encircle a two-story house on a 100-foot lot.



## Midget Computer Aids Engineer

Ninety-five percent of the routine mathematical operations encountered by an engineer in normal design work can be performed by a transistorized analog computer. With the new computer, an engineer can work out, electronically, problems in addition, subtraction, multiplication, division, integration and other mathematical operations. In addition to making scientific calculations, the device will be used as an educational tool.

## London Schoolchildren Tap Out Tunes on Water-Filled Bottles



Hitting the bottle is the favorite pastime of some 200 pupils at a school in London. But no one is shocked, for the bottles contain only water, and they're hit with small wooden hammers by the youngsters. The bottles are filled with different amounts of water to produce different musical notes when struck. Each youngster has a bottle and two mallets. Clanking his instrument on signal, each player helps to make a tune, and learns elementary music as well.





# ***Get Ready for the Next Flood***

***—remembering disasters of recent years, the State of California has organized a school for flood fighters who'll be alert and trained if the rivers boil over again***

***By Leo Rosenhouse***

**N**ATURE'S unsavory reputation for going on a flood rampage, often with little or no warning, is well known to the men who work for California's Department of Water Resources at the state's Flood Operations Center in Sacramento.

These workers recall the Christmas flood of 1955 and grimly label it to be the worst disaster to strike at the West in recent years. Within a period of nine days, more than two thirds of the Golden State was drenched by upwards of 40 inches of rain, pushed by wind velocities reaching 110 miles per hour.

When it was all over, Californians were staggered by a death toll that topped 100 lives, and by property losses that skyrocketed well above the \$200,000,000 mark. But the flood damage that caused such devastation could have been far worse were it not for the efforts of thousands of flood fighters and levee patrols who sandbagged

and also guarded the flooding streams.

Mindful of the lessons learned from that terrible disaster, the California Department of Water Resources has lately set up a unique outdoor school for flood fighters in which engineers and other personnel whose job it is to battle and control floods can get themselves prepared for any forthcoming wet threat that may be among nature's bag of tricks.

Experts say the school will possibly save the West untold millions of dollars in conservation of property, and will also save lives.

Already, more than 200 engineers, men experienced in hydraulics, have been schooled in flood fighting by a "dry run" technique consisting of open-air classes held on sunny days and conducted by state flood-control experts. Classes are held at a riverbank laboratory along the Sacramento River, just west of Sacramento.



Students watch demonstration of how to fill mud box. Box is two parallel wooden walls held together with cross beams and stakes. Mud boxes hold back flood waters and take place of sand bags when solid fill is scarce

The school for flood fighters, which has attracted students from all parts of the nation, stresses preparedness and know-how in respect to floods. Classes look more like a get-together of shirt-sleeved office workers than the serious meeting of hydraulic engineers and other water-resource experts.

Because these men have dealt with flood problems most of their professional years, instructors find it takes but one day or more to brief them on emergency flood-control methods. The lessons learned aren't quickly forgotten. Most of the men respect the capricious behavior of a stream or river reaching flood stage, and are eager to tame high water.

"The purpose of the school is to train our engineers who may be called upon in a flood emergency to go out and offer advice and assistance to local flood fighters," says Carl Werner, chief of flood control operations.

"Much of the training is fundamental and easy to grasp. But, we can't afford to

assume that all of our engineers who might be summoned in a flood emergency fully understand this work. Hence, the training school for flood fighters."

### Controlling an Angry Stream

Flood-control operations men recently completed construction of a 50-foot training levee to demonstrate ways that engineers can safely control the angry behavior of a stream at flood level. Simulated situations encountered during the high-water season along California's rivers and lakes have been duplicated on this levee. These include sand boils, levee overflow and levee erosion.

Students are referred to as trainees, and in their "dry run" training learn how to cope with flood problems by actually playing a realistic role as flood fighters. They build and operate devices that successfully control water during a flood emergency. These devices may consist of something as simple as a sandbag, and training may involve the making of a sand-boil chimney



Practice session: Trainees learn how to prevent wave wash, which exists when waves, pushed by wind, strike at levee slope and tend to erode it. Panels laid on earth and held down by sand bags help prevent washout



**Operation of sand-bag chimney is explained to trainees. Device reduces flow of water and sand from boiler**

with filled bags or extend to the operation of mammoth earth-moving bulldozers and steam shovels.

Instruction at the school for flood fighters begins with a refresher course during the first few hours of school, when teachers review the ABCs of flood prevention. Trainees are reminded that preflood preparations are still the best insurance against trouble with high water during the rainy season.

The trainees are instructed how to clear

brush, trees and wild growth from levees that confine a tricky river; how to seal and fill animal burrows, caves and holes; how to repair and bond broken drains and levee structures and keep them in working order. Trainees are even lectured on the severe damage that livestock often cause to a delicate levee system.

Many an engineer at school is surprised to learn that wallowing pigs frequently pit the crown or slope of a fresh earth levee, leading to large holes and washouts during

**Real thing:** When washout was detected along Cache Creek levee shortly before it became raging torrent, technique taught at flood-fighter school came into play. Flood fighters quickly laid planks over eroded area





After break of Feather River, Yuba City, Calif., suffered big flood on Christmas, 1955. When Cache Creek threatened its levee on February 24, 1958, below, experts watched rise of stream to determine amount of wave wash occurring against levee. Truck carries public address system and flood lamp for night work





When Cache Creek reached critical flood stage, workers patrolled bank, feeling for washouts with feet

high-water flows. They are told that cows are also guilty of breaking down a levee with their hoofs and body weight. Advice is given to keep livestock off levees and restrict them by fencing.

At the school for flood fighters, trainees are taught that levee failures are the major reason for floods and most of the lessons are dedicated to correction of this problem.

Boils are a common cause of levee collapse and are usually caused by levee leaks produced by burrowing animals, mostly rats and gophers. Pressure produced by high water against a levee causes water to be "piped" through or under the burrowed hole with sufficient velocity to carry free-earth material toward the land side of the levee.

The condition causes a critical flood situation when sand and other material is suspended in the discharging water. It makes the levee subject to rapid deterioration and quick collapse.

### Sacks of Sand Do the Job

To control a boil, engineers are advised to build up a watertight ring around the boil with sacks of sand until material is no longer discharged from the boil. This procedure causes a decrease of velocity on part of the inrushing water and stops dangerous erosion within the levee. When several boils occur at once, flood experts advise that a sack sublevee be built around the nest of boils to a height that none of the boils will discharge with enough velocity to move earth material from the levee foundation. When time is too short for the use of sacks, an earthen cofferdam may be created by heavy equipment instead.

Spouting sand boils were partially responsible for the tragic Yuba City disaster during the Christmas flood of 1955. The Yuba and Feather Rivers licked frantically at the tops of the levees that were holding back these wild rivers. The breakthrough came as the river water made a sneak attack underneath the levee through undetected rodent holes.

When the levee broke, it did so with such suddenness that it seemed to explode! The roar of the collapse of the protective earth mound was heard in Yuba City. Minutes later, a gigantic crest of water rushed the snug town of 4000 persons, crushing homes, ripping up streets and wiping out dozens of lives.

"Sometimes men assigned to flood-control duty don't even have the know-how to fill a sand bag properly," explains Joseph Burns, a state hydraulic engineer assigned to help instruct trainees at the school for flood fighters.

"Sandbags should be but one third or one half filled to be truly useful," states Burns. "Put more sand into a bag than that and the average man has trouble lifting it. We teach that one end of the bag must be loose and free of sand so it can fold or lap snug against another bag. The lapping of one bag upon another makes an effective water seal."

Burns points out that the flood-control center maintains a stockpile of burlap sacks in strategic locations throughout the waterways of California.

"Even if we did run short of bags, we can always count on the farmer," says Burns. "Whenever a levee threatens to

(Continued to page 232)



## Seat on Truck Bumper Speeds Up Street Striping

By mounting an implement seat bracket to the front bumper of a truck, the city of Newark, California, has increased the speed of its walking striping machine from three to seven miles per hour. The flag in front lets the truck driver follow the old line

while the striping operator guides his machine from his bumper seat. Since it's not attached to the truck, the striping machine can be easily swung around to paint crosswalks and parking lines. It also has a hopper to drop reflecting beads into the wet paint.

## "Toothpaste Tube" Method Forms Intricate Metal Shapes

Lateral impact extrusion, a process that combines extrusion and forging, is now in use for cold-forming intricate parts in one stroke of an impact press. Lateral extrusion produces a sideward flow of metal as well as the usual forward and reverse flow,

and results in products with wrought-metal strength, but in intricate patterns and to very close tolerances. It is especially well-suited to production of parts where projections radiate from a hub, as in the steering wheel core shown at right below.

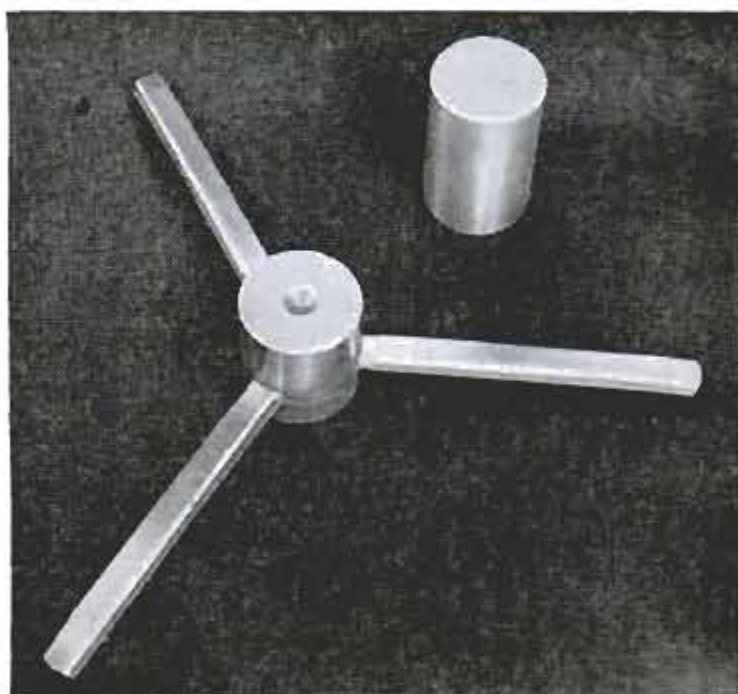
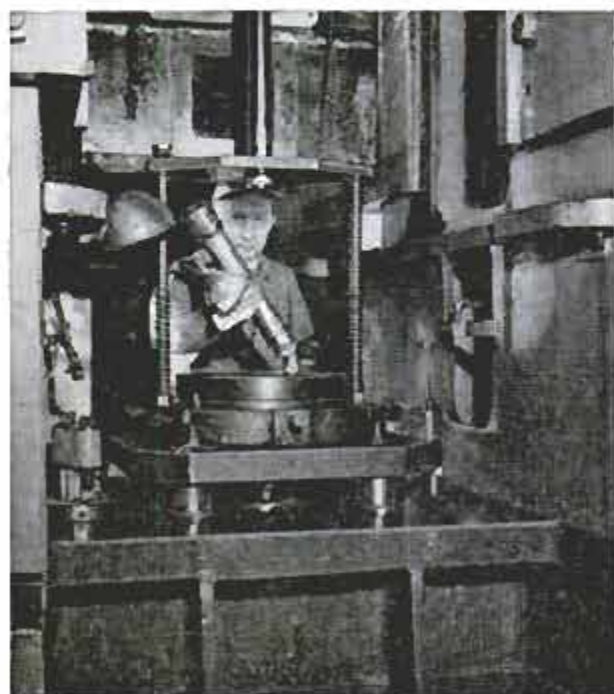



## Moving Aerial Sidewalk Links Hotel with Annex

Spanning a busy intersection in downtown San Diego, Calif., a moving aerial sidewalk connects a large hotel with its motel annex 250 feet away, and allows guests and service employees to go from one building to the other without crossing the street. Designed by an elevator manufacturer, the sidewalk has two channels moving in opposite directions and separated by an island. High safety-glass panels on the outer edges protect passengers from winds while allowing a view of the business district below.



Union Tribune Pub. Co., San Diego, Calif.

## Infrared Analyzer Spots Air Pollution

Carbon monoxide and other air pollutants are now being measured at streetside by the Department of Air Pollution of New York City. The department uses an infrared analyzer which can pick up and analyze automobile exhaust products in amounts as small as one part per million parts of air. The analyzer works with two infrared beams, one passing through a polluted air sample, the other through a comparison cell. Contamination is measured by the resistance to the beam as it passes through the sample.





## Motorized Gantry Crane Retrieves Landing Craft

Designed to straddle landing craft in the surf and carry them to repair shops ashore, this new landing-craft retriever is essentially a self-propelled gantry crane capable of standing in ten feet of water and of lifting 70 tons. The unit is 25 feet high and 36 feet wide, but has no steering system. It is steered by varying the speed of the wheels, which are individually powered and controlled.

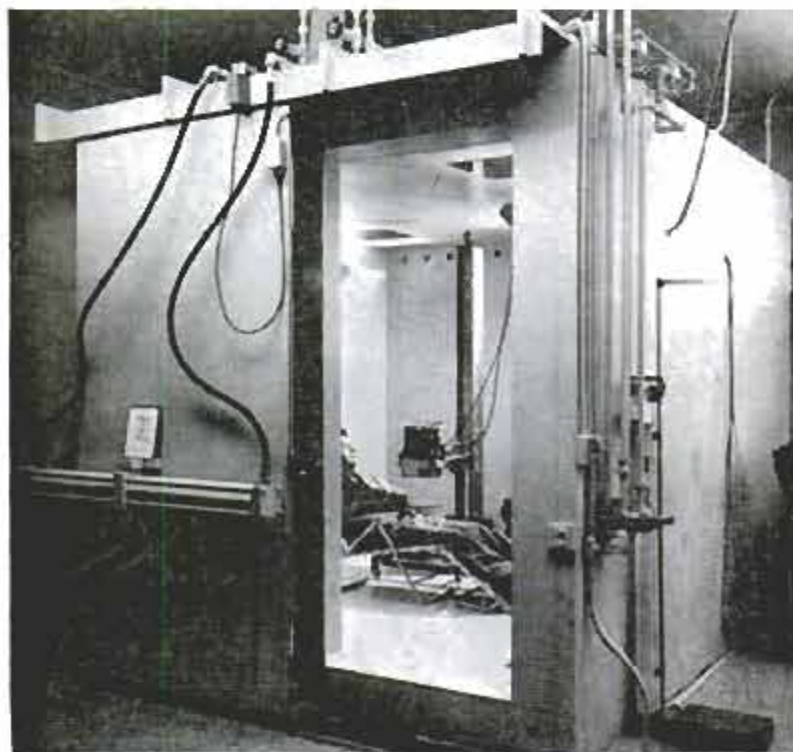

## Radiation Monitor Room Built From Armor Plate

Ten-inch-thick steel plates, intended for a World War I battleship that was never built, were used to build a gamma-ray-proof room at the Hanford atomic plant in southeastern Washington. The steel, found in an Eastern shipyard, was chosen for its extremely low background radiation level (newer steel contains some radioisotopes from fallout). The room contains monitoring equipment used to test for radioactivity in the bodies of the plant's employees, and must be shielded from external radiation, since the equipment is sensitive enough to detect one microcurie of radiation, and its precise measuring ability would be upset by any outside radiation.



## "Ten Day Wonder" Silo Is Europe's Largest

Completed in only ten days, Europe's biggest silo towers high above the landscape at Corbehem, France. Built on 98 columns of prestressed concrete sunk 45 feet in the ground, it is 105 feet high and 102 feet in diameter, and will hold 25,000 tons of sugar.

## Computers to Plan Air Trips?

Air-safety experts foresee the day when computers will determine the best flight plan for a pilot who is planning a trip. The computers will analyze the weather, take into account the existing traffic, and come up with the route and altitude to be used.



# RADIO TV HI-FI

ELECTRONICS



## KIT-BUILT HI-FI TRIMS STEREO COSTS

By *Lothar Stern*

**H**OW MUCH of a complete stereo hi-fi system can you build yourself? Virtually all of it—thanks to a brand-new kit which supplies everything from an amplifier to a complete cabinet, in knocked-down easily assembled form.

The Heath Stereo System Package is new in a number of ways. It is the only complete stereo system available in kit form. It is the first kit which contains a set of components, each specifically designed to match the characteristics of the others. And it is the first system of any type to employ the CBS Laboratories-developed 2-in-1 amplifier circuit, which permits the amplification of a two-channel stereo signal in a single amplifier. The result is a system whose cost (not counting your own labor) compares with that of "commercial grade" stereo, but whose performance rivals that of more expensive, high-fidelity installations.

Stereophonic sound requires two signals, each independently amplified, and each reproduced through a separate speaker. For high fidelity, each speaker must reproduce

the entire range of sound frequencies, from the lowest bass to the highest treble.

But wide-range speaker systems are expensive. What's more, proper reproduction of low frequencies demands relatively large speakers and enclosures which often present decorating problems. To circumvent these problems, the Heath Package follows the industry-wide trend towards the use of a "satellite" speaker system.

The satellite speaker system makes use of the experimentally proven fact that low audio frequencies are nondirectional and add nothing to the three-dimensional effect of stereophonic sound. In the Heath system, frequencies below 250 cycles are separated from both the left and the right stereo signals and are channeled to a single 8-in. low-frequency speaker which is mounted in the main cabinet. The remainders of the left and right signals, which carry the actual stereo information, are applied to separate left and right satellite speakers.

Since the satellites do not reproduce very low frequencies, they need not be as large or as expensive as full-range speakers.

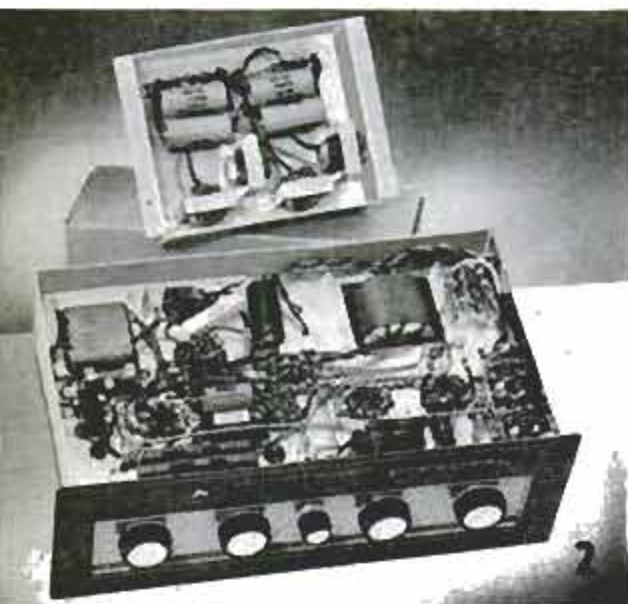

Electronic components of kit, Fig. 1, include preassembled record changer with stereo cartridge, parts for amplifier and speaker network, and 3-unit speaker system. Under-chassis views of amplifier and speaker network, Fig. 2, illustrate wiring simplicity made possible by new 2-in-1 amplifier circuit

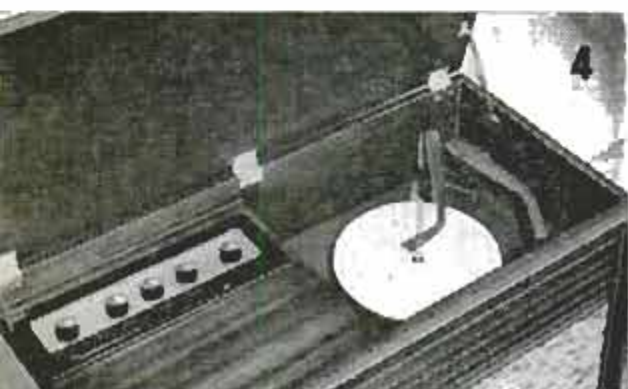
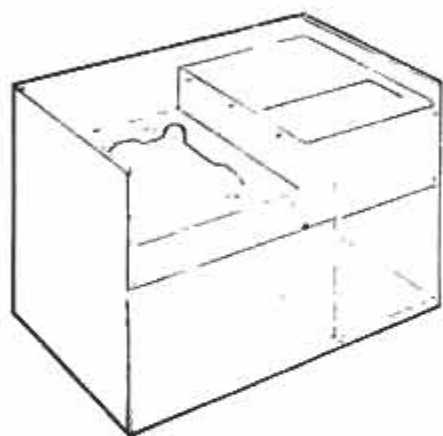

Similarly, since the woofer (the low-frequency speaker) need not handle the high frequencies, it can be designed especially for optimum response to the bass tones without the compromise usually involved in the design of a full-range speaker. The result is a space-saving, money-saving stereo speaker system capable of excellent performance.

But the really big difference between the Heath system and that of other manufacturers is in the stereo amplifier. Until the development of the CBS Laboratories' circuit, it was generally believed that the amplification of a stereo signal demanded two separate amplifiers. High-fidelity considerations made push-pull output stages and high-quality output transformers mandatory for each channel. The CBS circuit is unique in that it employs only a single push-pull output stage with an additional, inexpensive matrix transformer to provide the advantages of push-pull amplification for *both* stereo signals.

### How It Works

To understand the operation of the CBS circuit we must first take a quick look at how stereo records are made. In the universally adopted Westrex recording method, a cutting stylus is energized by signals from two magnetic elements. The signal applied to the left element drives the cutter into the right groove wall at a 45-deg. angle, while a signal applied to the right element drives the cutter into the left groove wall at a similar angle. The two magnetic elements are connected out of phase, so

Cabinet construction, Fig. 3, simplified by pre-cut, specially grooved panels, requires no special tools or clamps. Finished unit, Fig. 4, is attractive and functional. Amplifier panel reserves space for possible later addition of radio tuner

that a positive voltage on the left forces the cutter deeper into the right-hand wall, while a positive signal on the right tends to lift the cutter out of the left groove wall.

If identical signals are applied simultaneously to each of the two elements, as shown in Fig. 5A, the downward force of the left signal is completely canceled by the upward force of the right signal and no angular motion can result. But, while the vertical components of the two signals cancel, the horizontal components are in the same direction. These, therefore, combine to drive the cutter in a purely lateral (side-to-side) direction.

Now let's reverse the phase of the right signal so that this will tend to move the cutter deeper into the left groove wall, Fig. 5B. Under such conditions, the horizontal components of the two forces will cancel, while the vertical components will add vectorially to move the cutter in an up-and-down direction only.

Neither of the above conditions is likely to occur in a true stereo recording. Normally, the two signals, like the two images of a stereo picture, will be similar but not identical. Such a condition is illustrated in Fig. 5C. In this case, the vertical components of the two forces, not being equal, do not cancel entirely, so that the resultant groove will be displaced vertically as well as horizontally.

Note, however, that the horizontal displacement, representing the *sum* of the horizontal components of the left and right signals ( $L+R$ ), is by far the stronger of the two. The smaller vertical displacement represents the *difference* between the two vertical components ( $L-R$ ), and provides only the stereo information.

The stereo pickup-cartridge is essentially the same as the cutter except that it performs the cutter's function in reverse. Instead of converting two electrical signals into mechanical stylus motion, the reproducing stylus is mechanically activated by the groove displacement and converts this into corresponding electrical signals.

Fig. 5D shows the electrical output from the two pickup elements resulting from a stylus displacement as in Fig. 5C. Each element produces a signal which is the result of two forces—a large horizontal force and a small vertical one. The net effect is as though each element actually produced two signals corresponding in phase and amplitude to the individual forces.

It is interesting (and important) to note that the elements of the pickup are connected *in phase*, as compared to the *out-of-phase* connection of the cutter elements. Thus, while two identical signals at the cutter produce a horizontal groove displacement, the latter produces two out-of-

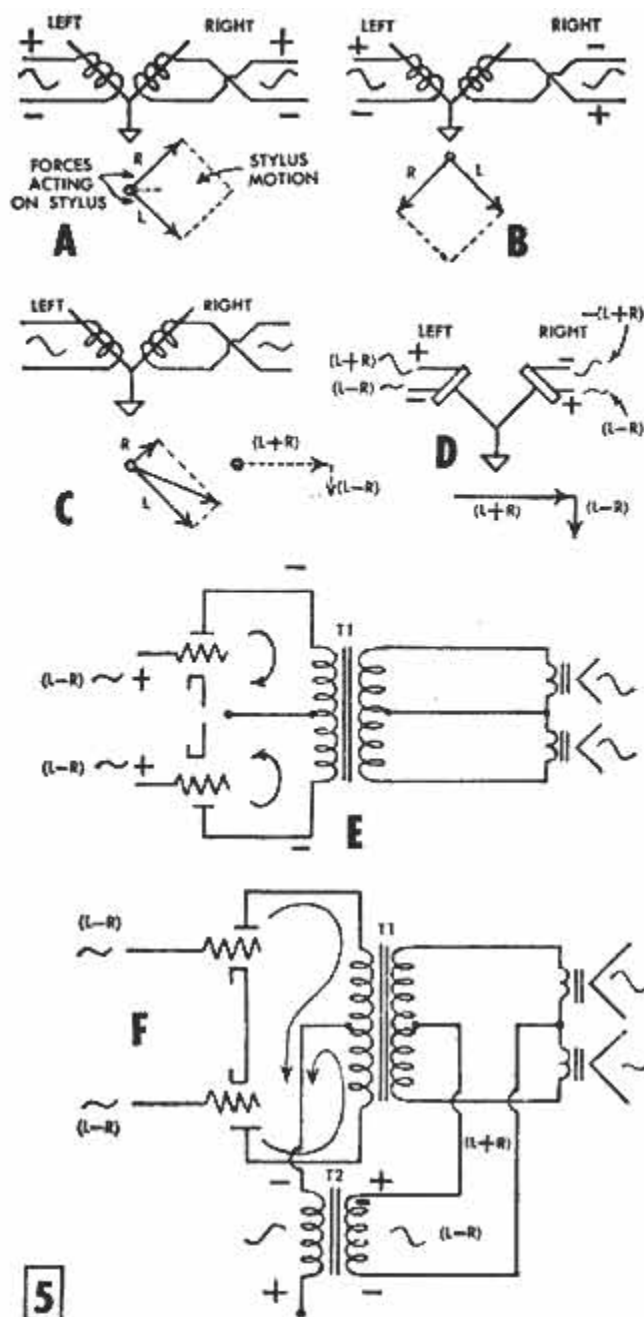

phase signals from the pickup elements. Conversely, while two out-of-phase cutter signals produce a vertical groove, such a groove produces two in-phase signals from the pickup elements.

Now let us apply the signals from the two pickup elements to opposite grids of a standard, push-pull-connected output stage, Fig. 5E, and determine the results. The two out-of-phase signals,  $(L+R)$  and  $-(L+R)$ , which are the result of the identical portions of the stereo signals, meet the requirements for push-pull amplifier action and cause a signal to be induced in the secondary winding of output transformer T1. If two speakers are connected as shown, each speaker will receive the same signal and produce the same sound.

The smaller signals,  $(L-R)$ , which are the result of differences between the applied stereo signals, are in phase at the grids of the tubes. These, therefore, pro-

(Continued to page 238)

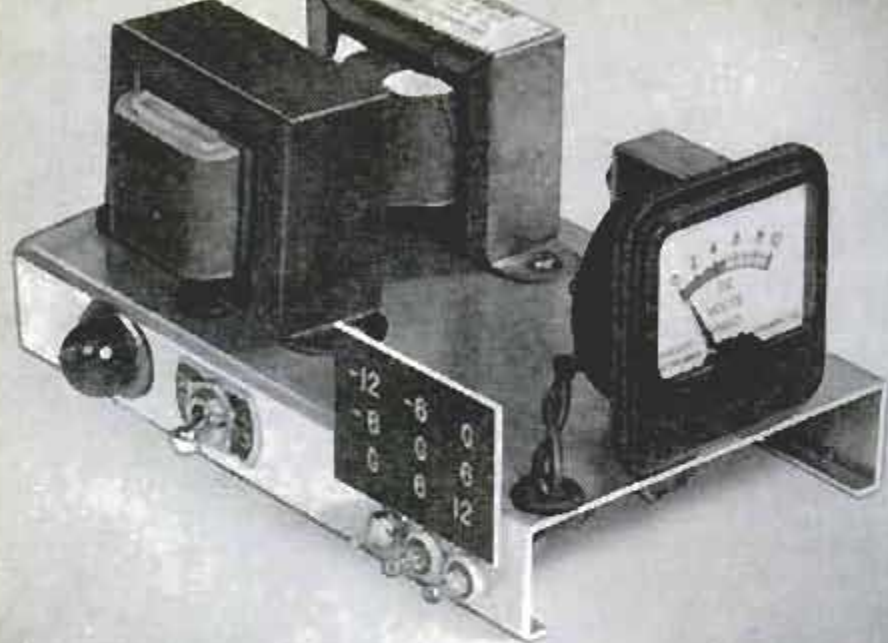

*For Transistor Experimenters*



# Zener-Regulated POWER SOURCE

By Paul E. Mix

PROBABLY the greatest advantage of transistors over vacuum tubes is their ability to operate at low voltages and currents. This characteristic makes them ideal for portable, battery-operated electronic equipment, but it is precisely this advantage which becomes a major source of annoyance to hobbyists experimenting with new transistor circuits. All too frequently, troubles attributed to faulty circuit design are eventually traced to weak or defective batteries being used as a source of power. The obvious solution to this headache is to replace the batteries on your workbench with an electronic power supply capable of dependable, continuous operation.

The power supply presented here is unique in that it presents a number of *regulated* output voltages especially designed to operate, service and test low-power and medium-power transistor circuitry. It permits a steady current drain which is greater than that available from flashlight cells and mercury batteries, yet, like a set of new batteries, it maintains a constant output voltage, regardless of load current, over the regulated range.

Low-voltage regulation is made possible by the unique properties of silicon diodes, two of which are employed in this power supply. If such diodes are biased in the reverse direction, they represent virtually an open circuit until the applied voltage

becomes high enough to cause the diode to "break down." This is called the Zener voltage. When this voltage is exceeded, the Zener diode conducts heavily. Its action, therefore, is exactly like that of a gas-tube regulator except that breakdown of a diode can occur at a much lower voltage. The special Zener diodes have accurately repeatable breakdown points which make them ideally suited as low-voltage regulators.

The power supply used here employs a conventional, full-wave rectifier circuit, see Fig. 1, followed by a pi-shaped L-C filter consisting of C1, CH1 and C2. Two Zener diodes with breakdown voltages of about 6 volts are connected in series across the output. By connecting the load circuit to the appropriate output terminals, output voltages of 6, 12, —6 and —12 volts, at currents up to 140 ma., can be obtained.

Output meter, M, connected across one of the Zener diodes, serves as an overload indicator. Since the output voltage drops and the Zeners fail to regulate when the circuit is overloaded, see Fig. 3, the meter provides a visual indication and warning of excessive current drain. Slight overloads corresponding to about a ½-volt drop on the meter may be tolerated, but prolonged operation at an overload condition should be avoided.

Construction of the power supply, as illustrated in Fig. 2, is not difficult. The rectifier diodes, D1 and D2, the Zeners, Z1 and

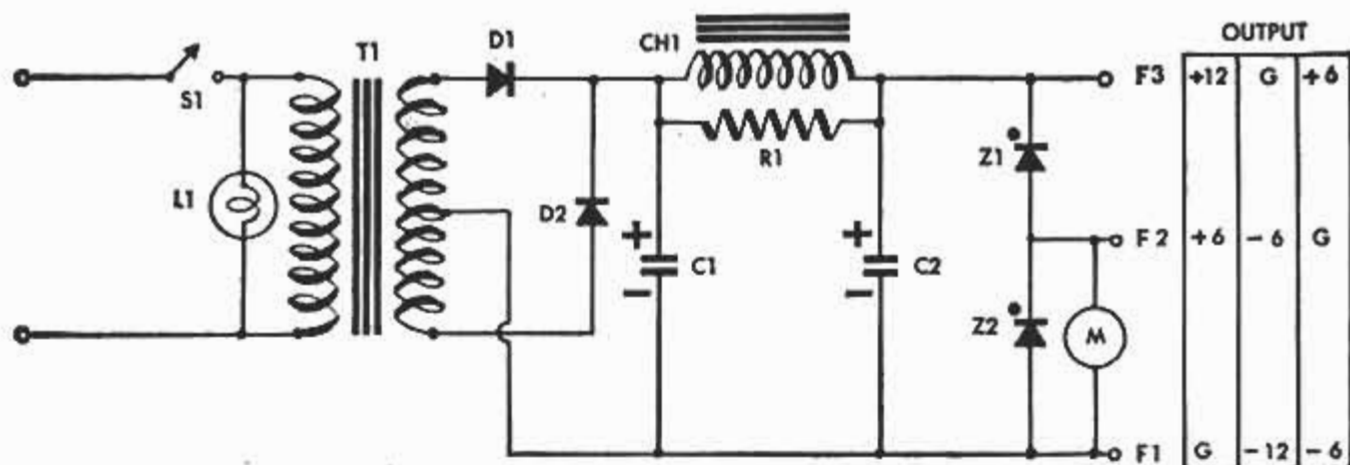

Fig. 1. Schematic wiring diagram of Zener-regulated power supply for experimental transistor circuits

Z2, and the filter capacitors, C1 and C2, are premounted with the aid of "flea clips" on a  $2\frac{1}{2} \times 3\frac{1}{4}$ -in. perforated Bakelite board. After the board is completely wired, including all leads underneath, as indicated by the dashed lines in Fig. 2, it is mounted to the main chassis with machine screws and nuts. Extra nuts between the board and the chassis serve as spacers to keep the flea clips from shorting out against the bottom of the chassis.

The remainder of the parts are fastened directly to the chassis and rubber grommets are employed to pass the wires from transformer T1, filter choke CH1 and the meter to their connecting points underneath. A knot in the line cord, just inside the chassis, serves as a strain relief.

Three insulated feed-through bushings provide readily accessible output-voltage terminals. None of these is grounded to the power-supply chassis so that any one of them may be used as the "common" terminal for the external load circuit. This permits either a positive or a negative voltage to be applied to the load. It is a good idea, however, to label the positive and negative terminals of the supply in some manner to prevent the inadvertent application of incorrect voltage polarity to the load. This is important because transistors are likely to be damaged by the application of "reverse" voltage.

Another safety precaution is the inking of the 0-5-volt portion of

(Continued to page 236)

Fig. 2. Pictorial diagram. Keep diodes insulated from each other and from other circuit parts. Mount meter above chassis

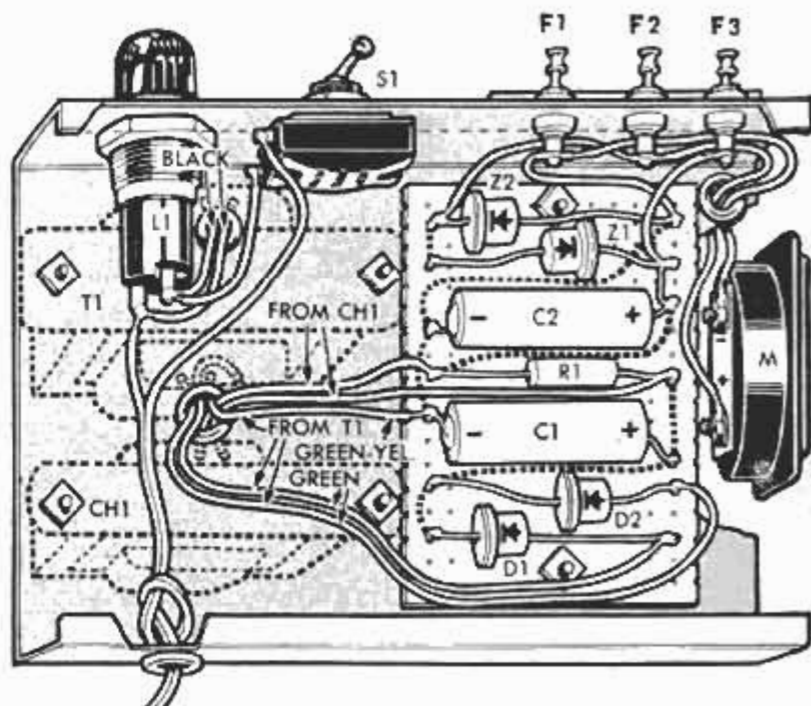
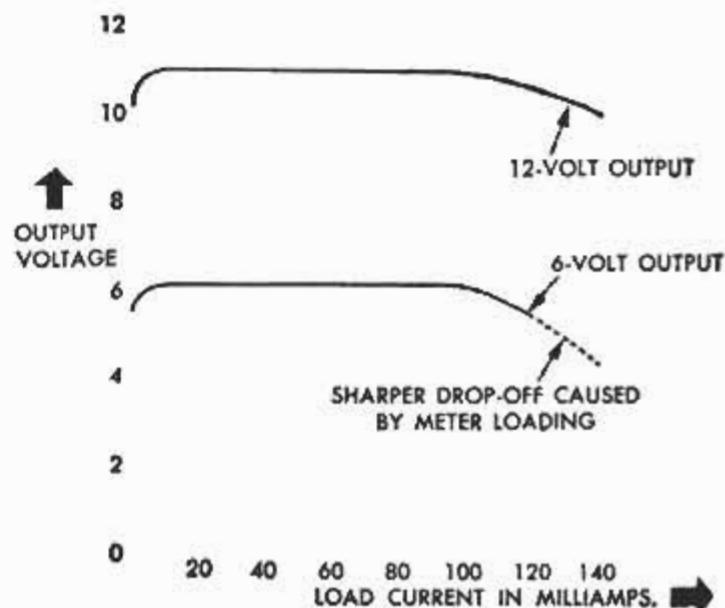
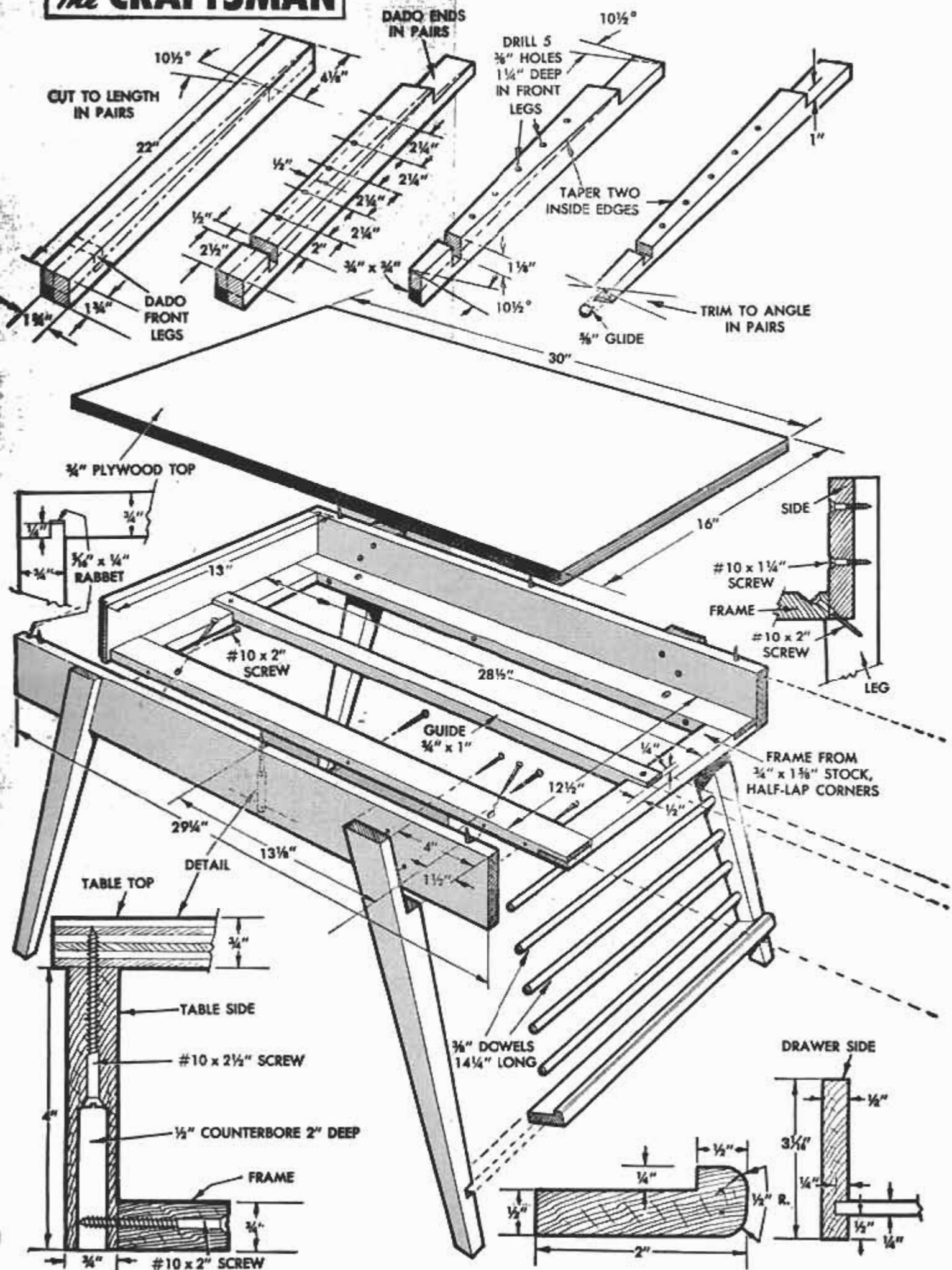

Fig. 3. Regulation curves show output voltage vs. load current







# TABLE FOR YOUR LAMP

By John Bergen

**F**EATUREING a magazine rack and a king-size drawer, this smart lamp table, with its straight lines, can be made with not much more than a hammer and a saw. In fact, the only other tools actually required are a brace and bit to bore the dowel and screw holes and a screwdriver to drive the screws. Start out by making the half-lapped frame first, then add the 4-in. aprons to three sides. Screw the 1-in.-wide drawer guide to the frame, then the table top. Screws in 2-in.-deep counter-bored holes in the aprons fasten the latter.

The legs are tapered on two inside adjacent faces only, and the half-lapped notches, as well as the dowel holes and tray dadoes, are cut before the legs are tapered. The legs are splayed in just one direction, and the tray and dowels, of course, must be in place before the front legs can be attached. The drawer front is rabbeted to lap the frame rail at the front and the ends of the aprons. The rest of the drawer is made in typical drawer fashion, running grooves for the bottom and gluing a runner to the underside to ride on the 1-in. guide. Allow sufficient clearance so the drawer will slide freely (and for possible swelling). While the drawer dimensioned is 16 in. long, it can be made the length of the table.

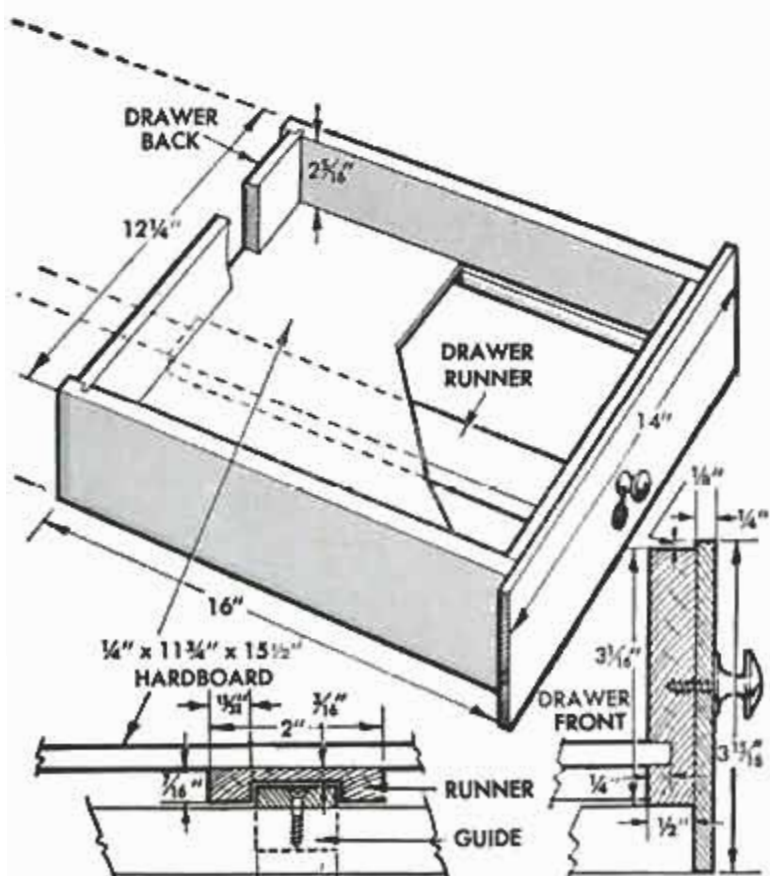



### Curtain Rod Holds Paint Sign

In schools and other public buildings, and in homes, too, when floors are to be painted or varnished and doors are left open for more ventilation, an effective method of displaying warning signs is on adjustable curtain rods. Suction cups screwed to the ends of the rods hold them between the jambs. Positioned so it is waist high to an adult, such a sign will be near the eye level of youngsters who would be most likely to run into a room without noticing that work was being done on the floor.

G. E. Hendrickson, Argyle, Wis.

### Tape Protects Decorative Nails

Prevent damage to furniture nails, or other types of nails with decorative heads, by crossing two strips of adhesive tape on the face of the hammer. This will not impair the striking impact of the hammer.

M. Robert Beasley, Jackson, Mich.

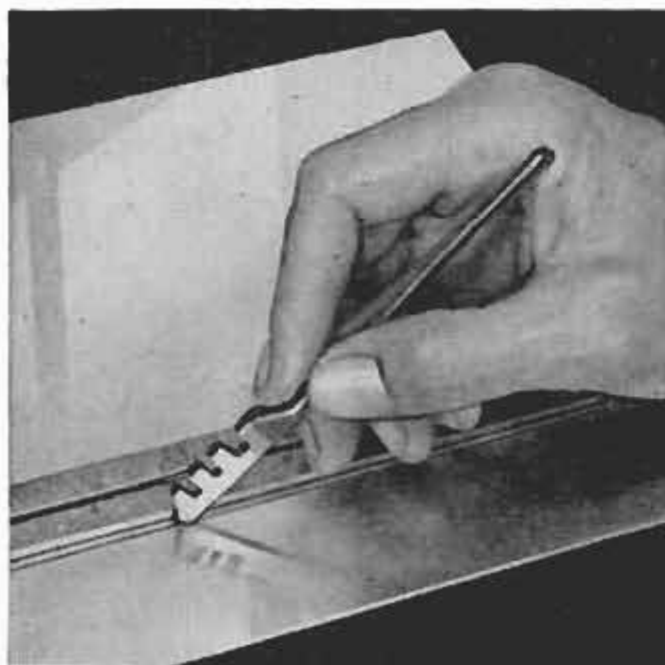

### Glass Cutter Scores Metal To Assure Sharp Bend

When a clean, sharp bend is desired in soft sheet metal, such as aluminum, copper or zinc, first score along the line of the bend with a wheel-type glass cutter. Use a straightedge to guide the cutter, making sure the straightedge is heavy enough so it does not flex sideways under pressure. Make the first pass with the cutter fairly light, then increase the pressure on succeeding passes until the score is deep enough to assure a sharp bend. It is best to clamp the straightedge in position to make certain that it does not shift away from the line. Heavy cardboard can be scored in a similar manner when it is to be bent at sharp angles to form a container, or perhaps a model for school work.

H. Hanscom, Elmhurst, Ill.

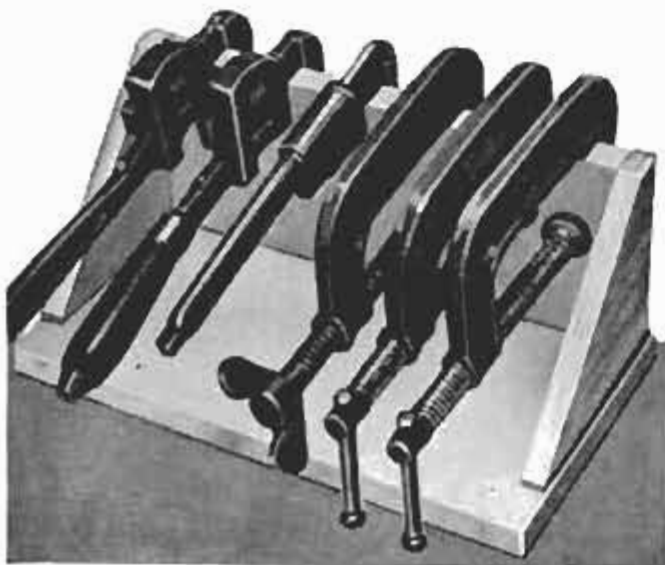

### Wrench-and-Clamp Storage Rack

Pipe wrenches, adjustable wrenches and C-clamps that too often become a jumbled mess in a toolbox or workbench drawer are stored neatly on this simple rack. Size and type of wrench or clamp are seen readily, and the fact that a tool is missing can be noted at a glance. The original rack has a 7 x 13-in. base of 1-in. stock with a 6 x 13-in. back. Two triangular pieces of 1/2-in. plywood are used for endpieces. Dimensions of the rack can be changed to suit, and scrap pieces of almost any kind of lumber or plywood of 1 in. or less can be used. The rack can be screwed to a bench top or left semiportable.





**By Grover Brinkman**

RAILINGS at the tops of stairwells tend to weaken with age, and can present a serious hazard, especially if there are active children or elderly people in the home. An excellent way of making this area safer is to replace the railing with a bookcase, which not only is stronger than the railing, but adds beauty and utility as well. Any style of bookcase can be used, as long as it is assembled strongly and fastened solidly to floor and wall. The unit shown has a rounded end on the top, with rounded shelves below to match. The lower end of the dowel that supports the shelves has a blind hole in it to receive a smaller dowel that fits in another blind hole in the floor. Any vertical member that is likely to be grasped by anyone ascending or descending the stairs should be reinforced also, to eliminate any chance of accidents. All joints of the bookcase should be screwed and glued, and provision should be made to permit driving screws through the base of the unit into the floor. Screw anchors are used to fasten the end

of the bookcase to the wall. The back, or stairwell side, of the bookcase is closed by a sheet of hardboard or plywood, to prevent books or other objects from being pushed through and dropping down the stairway. As an added safety feature, a small night light can be installed on the end of the bookcase close to the floor.

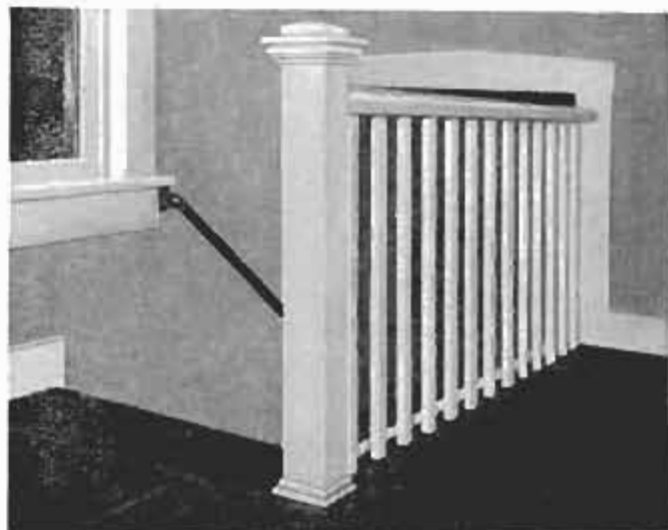

# DUMB-WAITER

## A HOME "WORKHORSE"

IS IT A "back breaking" job to "man-handle" objects up to your attic for storage? Does washday mean an aching back and tired feet for your wife, from carrying soiled laundry from the second floor down to a ground-floor utility room or basement laundry room? When it is necessary to carry awkward, heavily laden trays of refreshments to a basement recreation room, does this area sometimes seem more of a disadvantage than a place for fun? All these problems can be eliminated by installing a dumb-waiter. For some years these home "workhorses" have been considered rather old fashioned. They were replaced in some homes by a laundry chute that gives soiled laundry a one-way ride—down. When washed and ironed, the clothing had to be carried back upstairs. In many homes entrance to the attic is gained by using a "disappearing stairway" that folds up against the ceiling, out of the way. While this type of stairway saves space and is adequate to permit a person to walk up to the attic, it sometimes presents a problem when heavy items must be taken to the attic for storage.

For all these reasons the dumb-waiter is making a comeback. More and more of the units are being included as an accessory in new homes, and many are being installed in older homes. In new construction, architectural design permits the dumb-waiter to be installed so it takes a minimum of space, as in Fig. 2. Clever remodeling can produce the same space-saving result when a dumb-waiter is installed in a home that already is built, Fig. 1. Note in Fig. 1 that the dumb-waiter serves two floors and the basement. Food prepared in the kitchen is sent to the basement recreation room by means of an access door to the dumb-waiter shaft positioned at countertop height for convenience. Soiled laundry from the bedrooms and bathroom on the second floor is sent to the basement laundry room with the same ease. In some modern homes the automatic washer and dryer are located in the kitchen to minimize steps and eliminate the need for going up and down the basement stairs. The dumb-waiter in Fig. 1 could serve any of these situations equally well. While Fig. 1 does not show the dumb-waiter going to the attic, it would be a simple matter to extend the shaft to the



roof to permit delivering items to the attic area.

Dumb-waiters can be manually operated. An endless pull rope is run over a pulley, or sheave, at the top of the shaft to permit the sheave to be rotated. On an axle, or shaft, with the driving sheave is a traction sheave over which is run a rope from the top of the dumb-waiter car to a counterweight that moves up and down in the shaft, opposite in direction to the movement of the car. Counterweights are used with manually operated dumb-waiters to assure ease of operation. They usually consist of flat plates of metal sliding between guides on one side of the dumb-waiter shaft. Weight of the counterweight must be just slightly more than the combined weight of the dumb-waiter car and the maximum normal weight of material that is expected to be carried in the car. To stop and hold the dumb-waiter car at any position, a brake is required. For the manually operated dumb-waiter a mechanically actuated brake is located on the same shaft as the pull and traction sheaves. This brake usually is operated by pulling on a cord that can be reached from any floor served by the dumb-waiter. The brake consists of a drum keyed to the shaft, with brake shoes held stationary on supporting members. The action of this brake is much like the parking brake located on the driveshafts of some makes of automobiles.

In line with the modern trend toward electrically powered appliances in the home and motor-driven garage doors, the most popular types of dumb-waiters are those driven by electric motors. In these types simply pressing a button brings the dumb-waiter car to any floor, pressing another sends it on to any floor. Brakes used on the powered dumb-waiters are operated by solenoids that release the brake when power is applied to move the car. When the electricity is shut off by any of a number of switches in the circuit, heavy springs clamp the brake shoes on a drum and hold the car in position. Other features of electrically driven dumb-waiters are interlock latches on the doors at each floor, that prevent the car from being moved until the door is closed again. Upper and lower-limit switches stop the car at the highest and lowest doors, prevent the car from running past either of these openings, Figs. 3 and 4. Dumb-waiters of the types shown in Figs. 3 and 4 can be purchased as complete units and have such safety features as a slack-cable safety switch that prevents the car from dropping should the cable break or become slack. Fig. 2 demonstrates one type of installation where the upper door is fitted out of the way beneath a kitchen counter. This setup would be used



Photo courtesy Filinchbaugh-Murray Corp.  
Car of this commercial unit is lined with laminate to resist wear and make interior easy to wipe clean

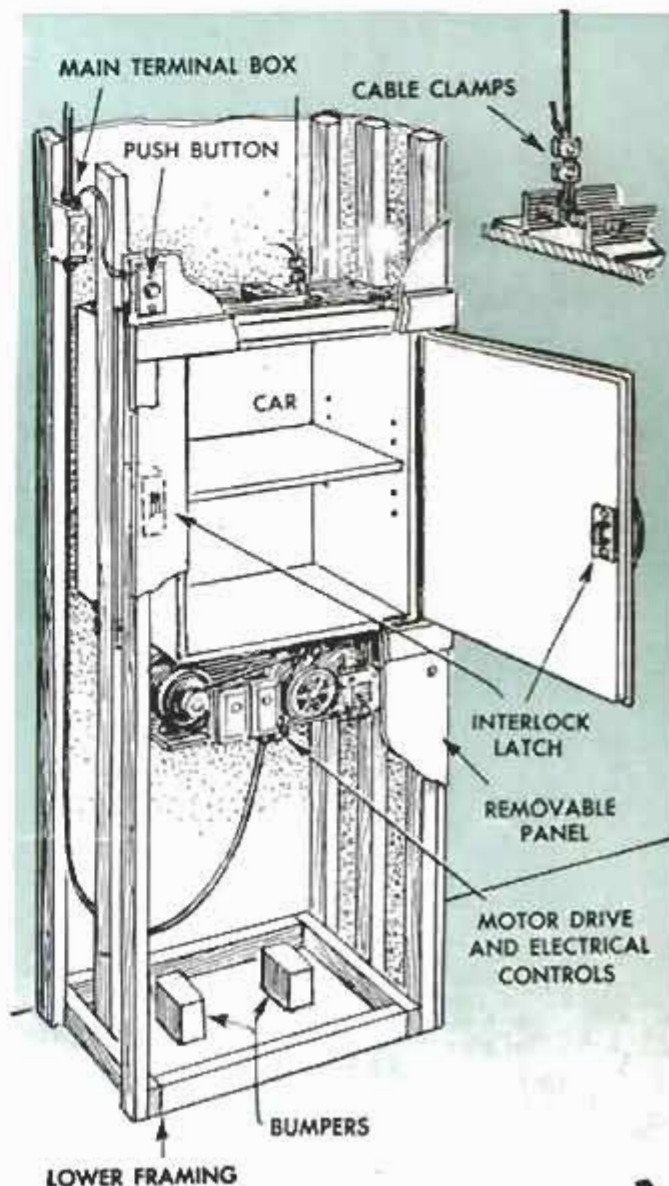

in a one-floor home with a basement. That carload of food is going to make the gang in the basement recreation room very happy, and the party-dressed hostess will not have to make several tiring and hazardous trips up and down the basement stairs.

Whether the dumb-waiter is a manufactured unit, or one assembled from parts purchased at an elevator-supply house and installed by a home craftsman, certain factors must be considered. The car of the dumb-waiter must be large enough to carry the loads it is intended to carry, yet it must not be so large that the required shaft takes up too much space in the home. Manufactured units of the types shown in Figs. 3 and 4 have the electric motor and other mechanism on the bottom of the car, traveling up and down with the car. Some types require the motor and mechanism to be at the bottom of the shaft; others, at the top. In the latter case it is necessary to have ample space above the car when it is at its uppermost limit, to accommodate the mechanism. Manually operated dumb-waiters usually have the mechanism at the top. Not only must there be room for this mechanism, but it should be readily accessible for servicing.

The car of the dumb-waiter is not simply suspended in the shaft on a cable, but must be positioned in wooden or metal guides that run the full length of the shaft. These guides prevent the car from twisting or tipping and becoming jammed in the shaft. In manually operated dumb-waiters there must be stops to prevent the car from contacting the mechanism at the top or the bottom of the shaft. If the mechanism is at the top of the shaft, springs or a cushioning device are located in the bottom of the shaft to prevent the car from striking heavily against the bottom of the shaft. The precautions also are necessary in dumb-waiters powered by electricity. In case of the failure of a limit switch the car must not be permitted to jam against the top of the shaft, nor the bottom. In the case of dumb-waiters of the type shown in Figs. 3 and 4, there must be an access door near the lower end of the shaft to permit servicing the motor and mechanism. This usually consists of a removable panel screwed in place for neat appearance and to facilitate quick removal. ★ ★ ★

### Home-Movie Trick

When a home-movie script calls for a closeup of an effervescent drink, the bubbling effect can be simulated realistically with a headache tablet. Drop it in a glass of water and begin shooting as it starts to dissolve.

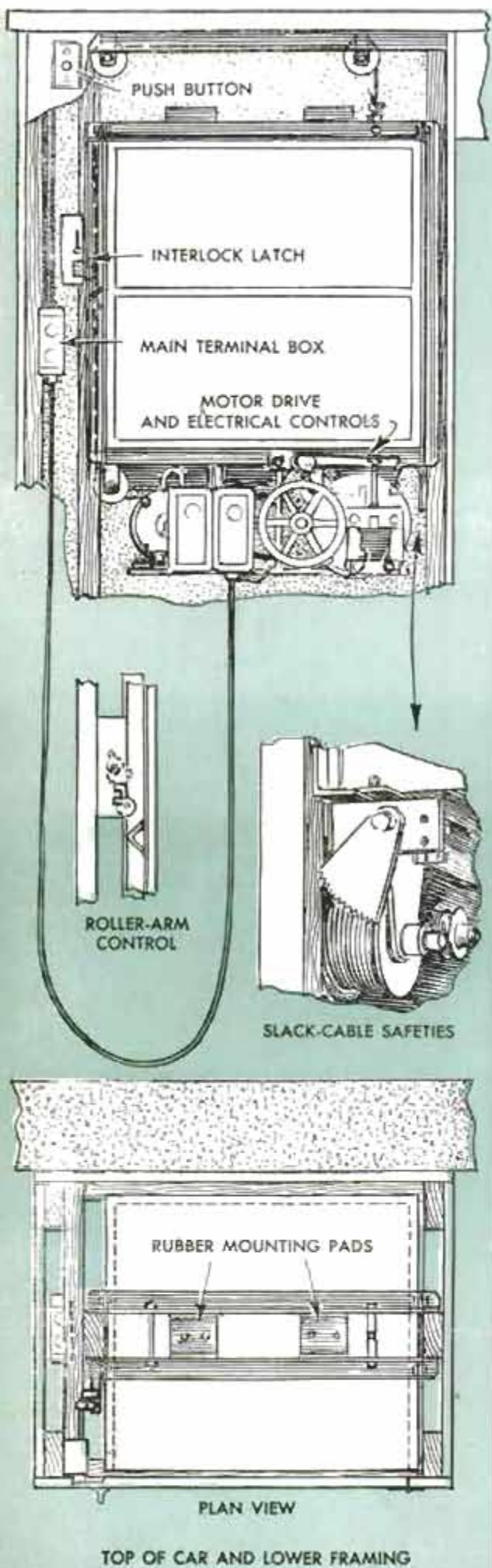

## Methods of Making Yardlight Posts

Here are three ways to fit a wire inside the wooden column of an outdoor light. First, as in A, build the column as a hollow post, using 1-in. lumber. Second, as in B, cut grooves in two pieces of lumber, then join them together. Last, as in C, cut a deep groove, insert the wire, then seal with a wooden strip. — William B. Eagan, Floyds Knobs, Ind.

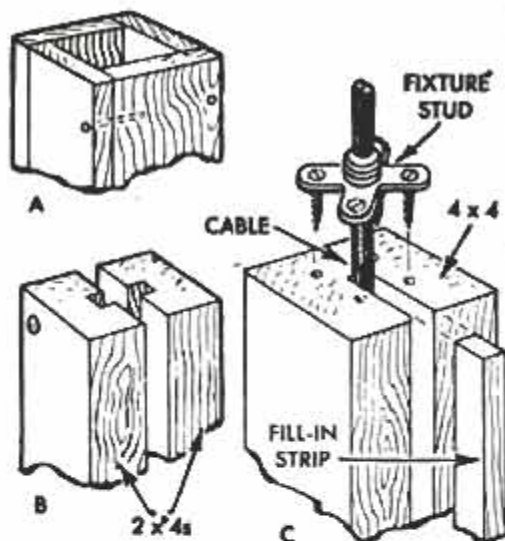

## Paper "Seals" Masonry Wall

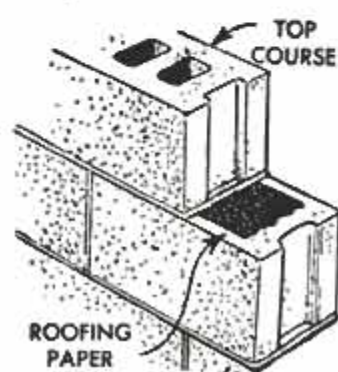

When the last course of a block wall is to be filled with concrete, lay a strip of tar paper on the preceding course. Cut the paper 1 in. narrower than the block to assure a good bond.

## Screws Stored With Faceplate



Tape will keep screws at hand for attaching work to a lathe faceplate. Just insert the screws in the holes and place strips of tape across heads to hold them in place when plate is hung up.

## Helpful Home Kinks

☐ Stains on a sink or bathtub can be removed with a paste made of hydrogen peroxide and cream of tartar.

☐ Paint lap marks that sometimes show on a ceiling after it has been painted are caused by the edge of the paint starting to dry on one section before the next section is started. To avoid this, paint as rapidly as possible and keep the sections to a size that will permit starting the second section before the first has started to dry.

☐ Time and effort can be saved when painting a basement floor by using a paint roller fastened to a mop handle to eliminate the need for kneeling or bending down to contact the floor. Some manufacturers supply paint rollers with hollow handles that are threaded to receive handles supplied by the same company.

☐ When using quick-drying lacquers and spray paints, extra precautions should be observed. These paints should never be used near any kind of flame, such as gas stoves or heaters with pilot lights because the solvents are highly flammable.

☐ Electric food mixers are oiled more efficiently by inserting a toothpick in the tiny oilholes and letting a drop or two of oil run down it into the holes.

## Screening Assures Sharp Focus

Cut to the size of a negative, a piece of window screening makes a good focusing device for use in the negative holder of an enlarger. Its uniform over-all pattern can be brought into focus quickly, and it shows a brighter image than the usual focusing negative. If there is doubt about the covering power of a particular lens, screen shows immediately whether all of the format can be focused sharply or not.

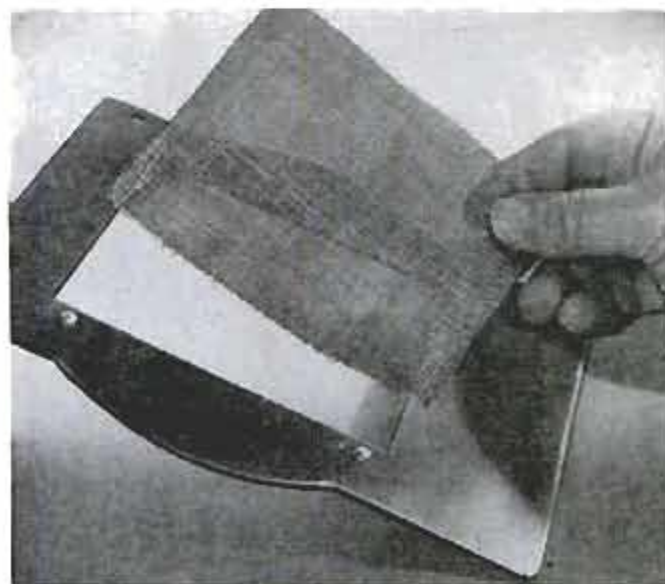

# HOME USES *for* URETHANE FOAM

*Urethane foam is strong, odorless, washable, noncombustible and can be cut easily to any desired form*



*By Jerry Parker*

**A**VAILABLE in a variety of colors in the form of sheets, slabs and adhesive-backed strips, urethane foam is ideal for many cushioning applications. Sheets may be cut with a sharp knife or scissors. Slabs that are 3 in. thick, or more, may be cut with a knife, or with a bandsaw when round shapes are to be cut as in the photo on the opposite page, top right. The material may be cemented, nailed, stapled or sewed, depending upon the means of attachment that best suits the needs of a situation.

Squares of 5-in.-thick charcoal-colored foam make comfortable seats for Oriental-style novelty parties, below left. Stacked, they can be used as a hassock. Use the slab material to reupholster furniture, or to turn a wide window ledge or raised hearth into a cozy seat.

Above, a sheet of 1-in. foam provides a comfortable pad for an outdoor lounge. The material is weatherproof, need not be covered and may be machine or hand washed when soiled. A disk of 1/4-in. foam on a turntable, drawing at left, protects



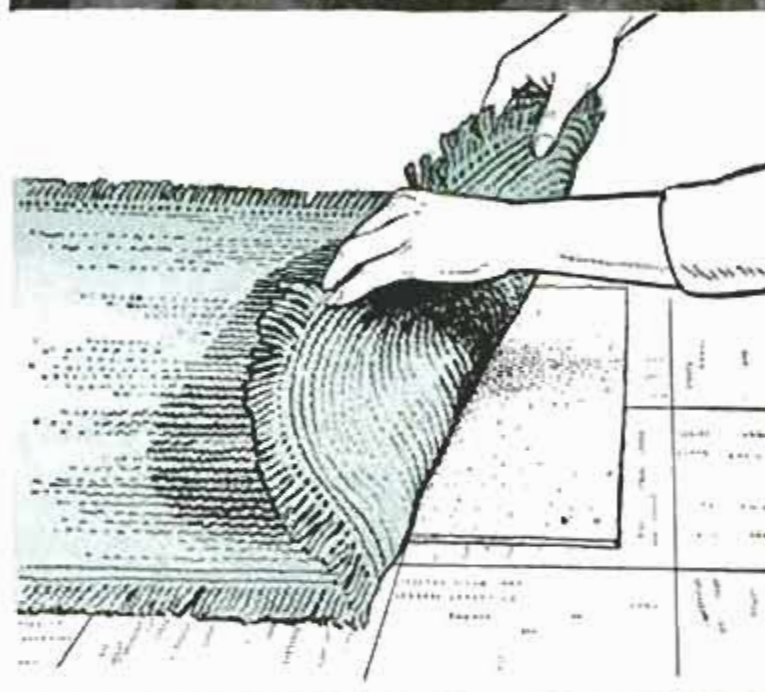
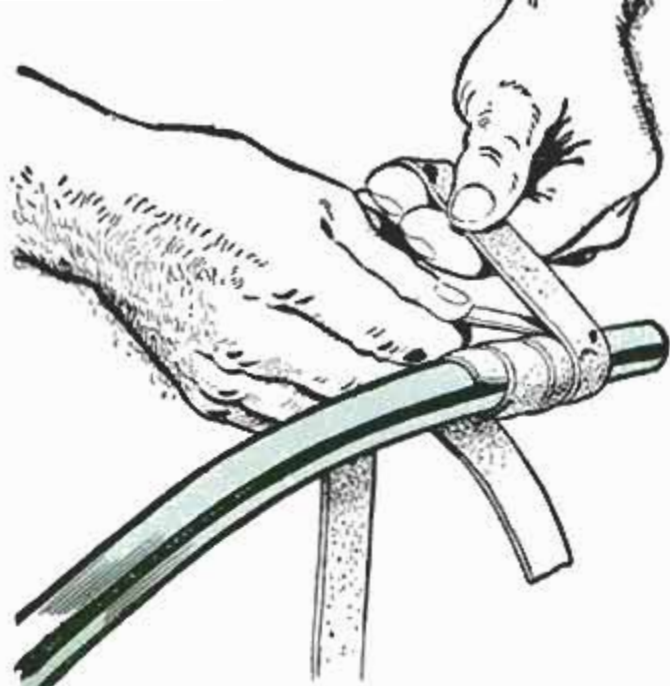

records and prevents them from slipping. The  $\frac{1}{8}$ -in.-thick foam sheets can be made into beautiful draperies that have high insulating value. Use these thin sheets also for headboard padding, place mats, shelf lining and holiday trimming. Use sheet foam to tame a throw rug that is inclined to send you reeling now and then. Simply place a  $\frac{1}{4}$ -in. sheet under the rug as in the drawing at right center of this page.

Nonslip handle grips that are easy on the hands may be made from adhesive-backed foam strips for garden implements and tools, as shown in the drawing at top left. Above, such strips also make nonslip pads for lamp bases, bric-a-brac, telephones and other items that have a tendency to scratch tabletops or to creep. Sharp edges on furniture that is moved about frequently, such as the teacart shown at right, can be covered with foam strips to provide "crash pads." ★★★



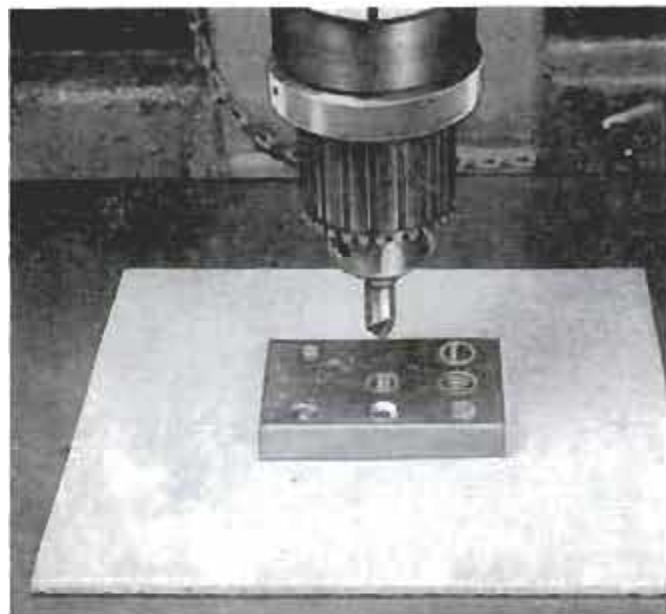

## Cork Sheet Cushions Steel Stock To Stop Drill-Press Chatter

When countersinking holes in flat-steel pieces on a drill press, tendency of the bit to chatter can be stopped by cushioning the work on a sheet of  $\frac{1}{8}$ -in. cork as shown in the photo at left. The cork absorbs the vibrations created by the action of the bit as it cuts into the metal, thereby eliminating the noise. Without the cork, or some other material that is equally as soft but firm, the piece being drilled simply vibrates against the drill-press table and the bit. Operate the drill press at its lowest speed; use a cutting oil and a very light feed.

H. J. Gerber, Stillwater, Okla.

## Calipers Used to Measure Flanged Parts and Cylindrical Grooves

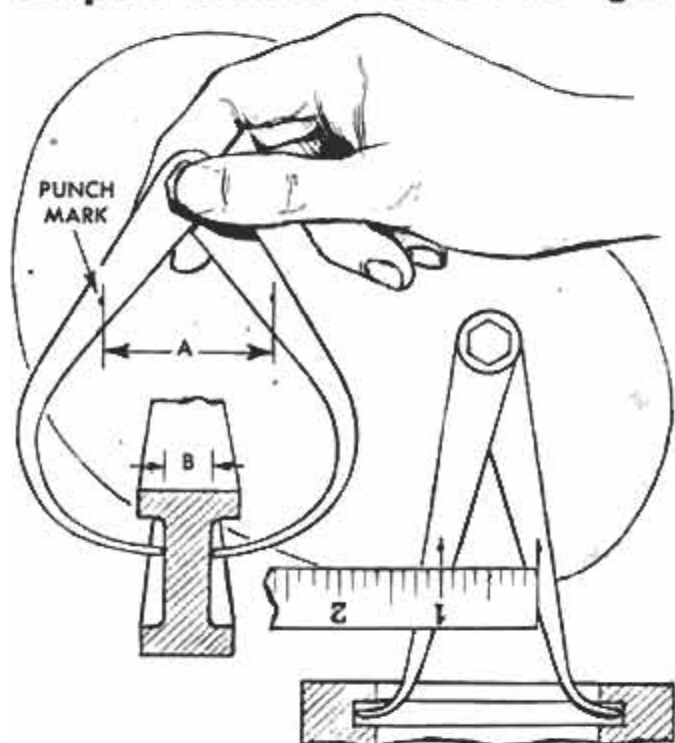

Here is a way of using calipers for odd measuring jobs, such as determining the thickness of the web of an I-beam, or the diameter of an inside circular groove. An outside caliper is used for the former, an inside caliper for the latter. To do this, first make prick-punch marks high up on the flat sides of the legs to serve as reference points when transferring a dimension from the part to be measured as shown. Then, in the case of an I-beam, the legs of the instrument are closed on the web surfaces and distance "A" is measured with a machinist's scale. Next the caliper is removed and closed to distance A again. The span between caliper tips is then measured to get distance "B," web thickness. Measuring the diameter of an inside groove cut in a cylindrical piece is accomplished in a similar manner, using an inside caliper as indicated in the detail.

C. W. Woodson, Chicago



## Tape "Locks" Micrometer On Desired Setting

To use a small micrometer not having a spindle lock, as a gauge for continuous checking at the same setting, as when production work is being inspected, use the method of "locking" shown in the photo. A wide strip of cellophane tape, wrapped around the barrel of the micrometer so that it overlaps the calibrated thimble, holds the instrument at the desired setting until removed. When a micrometer is to be locked in this manner for a long time, the tape should be replaced occasionally to prevent the adhesive from drying out and sticking to the metal.

H. Hanscom, Elmhurst, Ill.



A SIGNPOST, by its homey, inviting charm, helps to identify the owner of the property on which it stands. Some posts simply give the name and house number in bold letters on an attached board. Others are more original and colorful, giving only a hint of the family name. For example on the board shown, the name "Trotter" is illustrated by a trotting horse painted on it.

The rustic post shown is sturdy, easy to make and inexpensive. The upright and crossarm are cut from a 16-ft. length of 4 x 6-in. fir. A pattern of shallow grooves chiseled on it with a  $\frac{3}{4}$ -in. gouge as shown in the photo below, right, gives the post a hand-hewn appearance. When cutting the notches for fitting the crossarm, make a series of sawcuts in the wood to be removed and chisel it out as in the photo below, left. The lower portion of the post is finished off as detailed. Assemble the post as shown and stain it as desired. An electric light and a mailbox may be attached to the post if desired.



By  
*William Palmer*

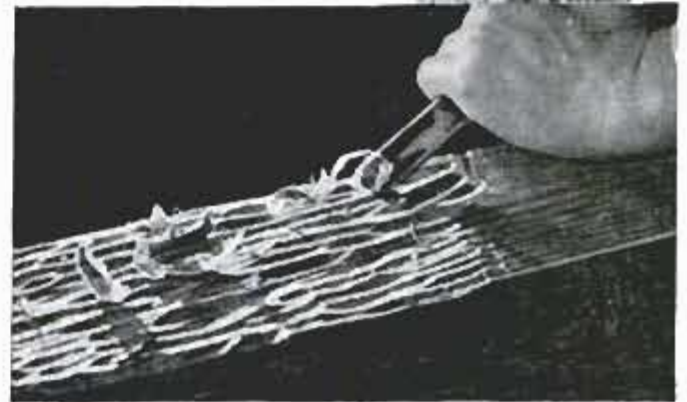
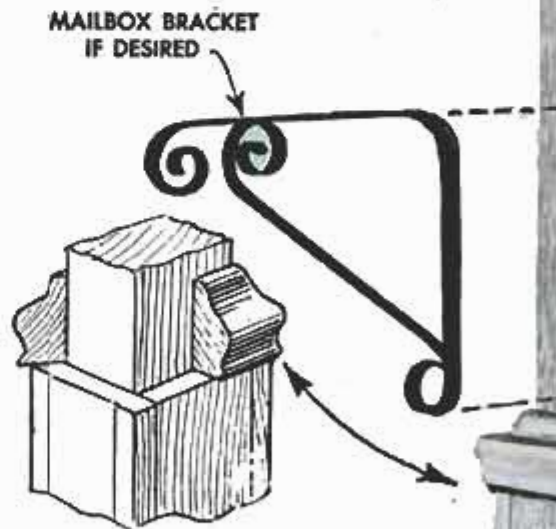
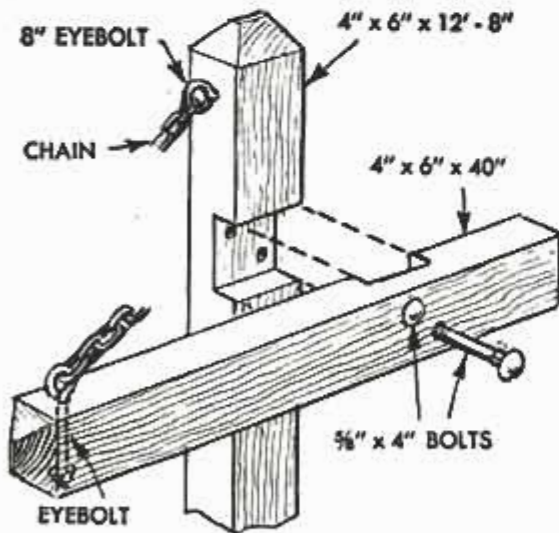

# Solving Home Problems



A **GROUND WIRE** attached to a portable barbecue having a motor-driven spit, will safeguard the chef from possible shock when operating the grill on damp ground or wet surface. Such a wire can be clamped to the metal grill and to a nearby sill cock. A short circuit, resulting from worn insulation, could cause a fatal shock if grill is not properly grounded

**WHEN A DOOR BOLT** won't align with the opening in the striker plate, simply taper the top and bottom edges of the bolt with a file. This is better than enlarging the hole in the plate and will alleviate any future misalignment trouble caused by the settling of either the door or the doorframe

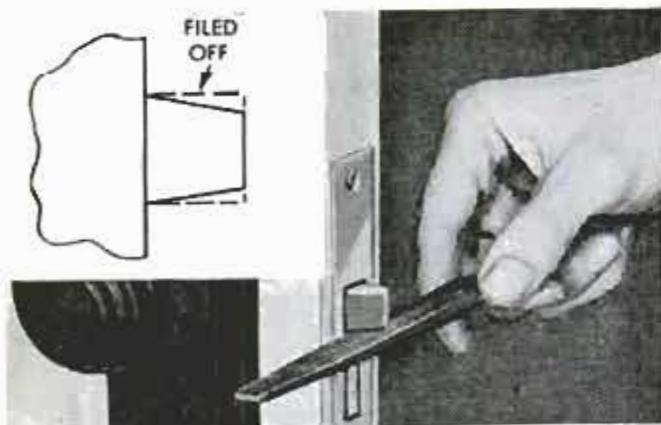

**IN CASE OF FIRE**, when it might be expedient to act in a hurry in saving clothing, it is wise always to see that coat hangers in a closet all face the same way on the rod. This permits the clothing to be grabbed in armloads and lifted off quickly



**NOVEL SPOOL CADDY** for your sewing box is improvised from a discarded table-tennis paddle. Spindles for the thread spools are provided by driving nails through the paddle from the back. Small corks nailed to the handle will store thimbles

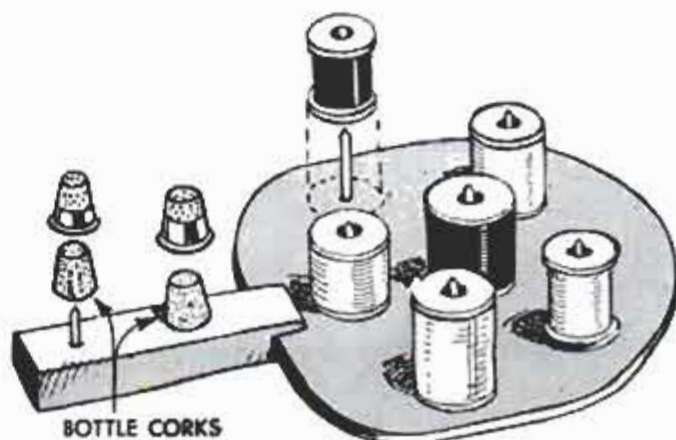

**IF YOU FOLLOW** the common practice of putting homemade jelly in tumblers and then sealing with paraffin, a teakettle will be found the safest utensil for melting and pouring the paraffin. A length of string placed across each tumbler beforehand will provide a handy built-in handle later for removing the paraffin from the top of the jar

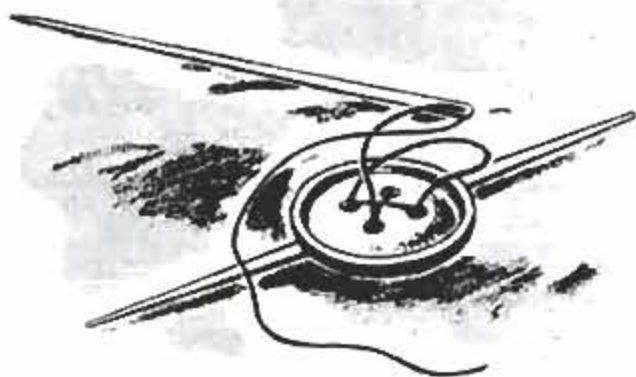

**SEWING BUTTONS** on heavy garments so they will be less difficult to button is accomplished by inserting a toothpick between the button and the cloth after the first loop stitch is made. A less tightly sewed button results, since the toothpick adds slack

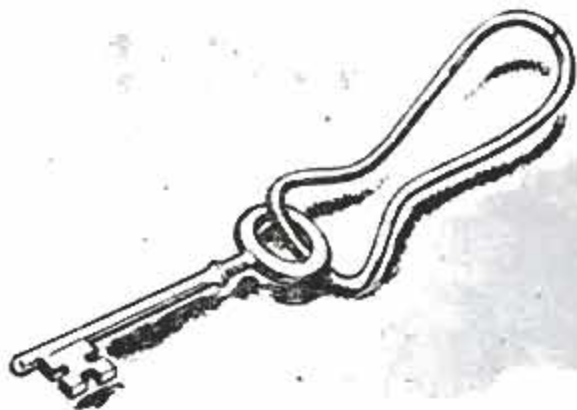

**KEEPING TRACK** of a house key is less trouble when it is attached to a large ring. A cap-bottle opener is ideal for this as it not only makes the key more easy to find, but being with the key, the opener is always at hand in the pocket for use at a picnic

**NEAT HOLDER** for storing an electric razor in a medicine cabinet can be made from a metal adhesive-bandage box. Cut the box down so it measures 1 3/4 in. high and then cover the sharp edges, as well as the rest of the box, with colored tape

**BY CLIPPING THE FLAP** of one envelope to the metal clasp of the other, several Manila envelopes ganged together in this manner will make a convenient hanging file for sorting clippings. It's easy to detach any of the envelopes at any time from the group

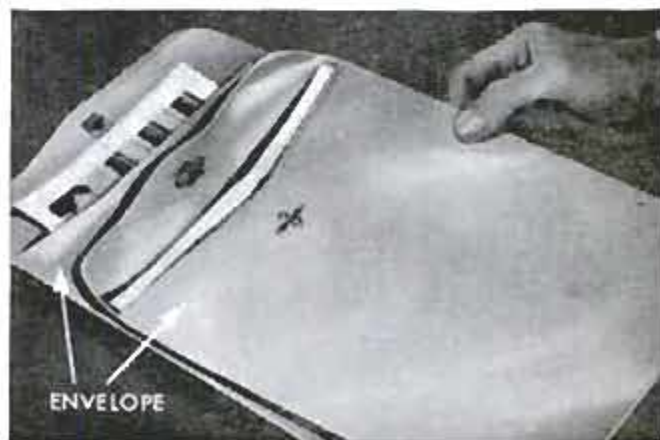



## GLUING HINTS



1. An easy way of attaching a letter or other insignia to a sweater is to spread white plastic glue on the back of the insignia and press it onto the garment with a warm electric iron. Either cloth or felt insignia may be attached in this manner



2. Loose crossrail of a chair can be reglued without having to pull members of the joint apart. First drill a small hole in the leg to take the tip of a plastic glue-bottle spout as shown. With the spout held firmly in the hole, squeeze the bottle to force glue into the joint, wiggling the members to get an even distribution of glue. Wipe off excess glue and fill the hole with plastic wood tinted to match

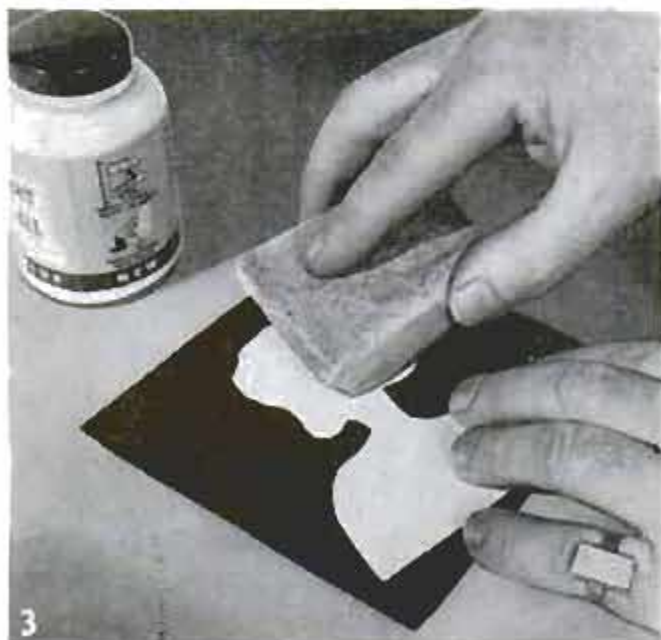

3. When gluing unglummed labels and decorations cut from thin paper, dampen them with a sponge immediately before applying the glue to assure a neat job. The moisture-expanded paper contracts as it dries, leaving a smooth, wrinkle-free appearance

4. Here is an easy way of relieving glue pressure in a dowel joint without having to cut a groove or flat surface on one side of the dowel. Wrap a length of lightweight thread around the dowel to be glued, apply glue and insert it as shown. Excess glue can flow through the spaces made by the thread which then becomes saturated and flattened. This method does not reduce contact surfaces as when a dowel is grooved or flattened, resulting in a stronger joint

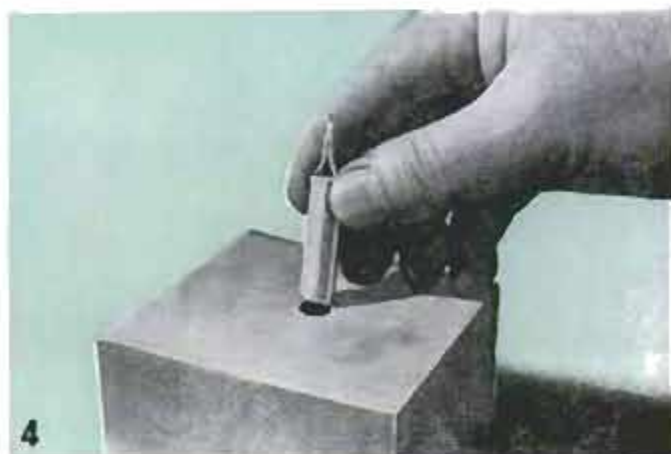

## Methods of Holding Polished Tubing For Cutting

There are two ways to cut polished tubing cleanly and squarely without marring the highly-finished surface, both of which allow the work to be held securely in a vise. By one method, the tubing is pressed over the extending end of a snug-fitting wooden plug, such as a dowel, and then clamped between the vise jaws. The cut is made with a fine-tooth hacksaw, sawing through both tubing and wooden plug. This prevents burring by slowing the cutting action of the blade, resulting in a fine cut. A second method is to clamp the tubing between split halves of a bored block and to saw through both as before.

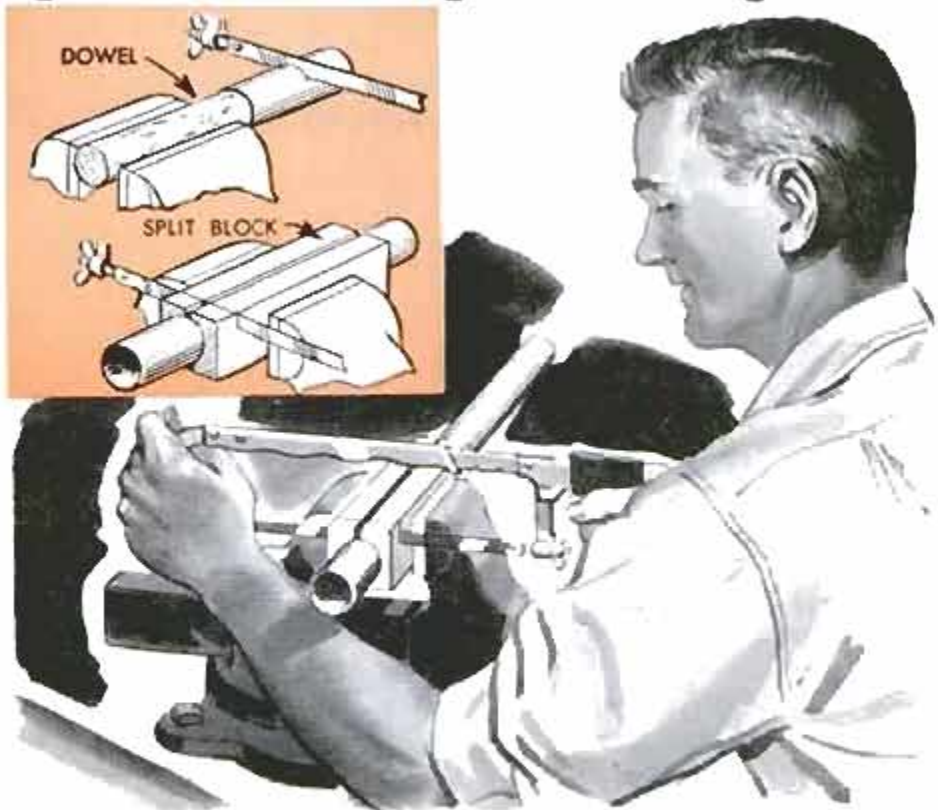
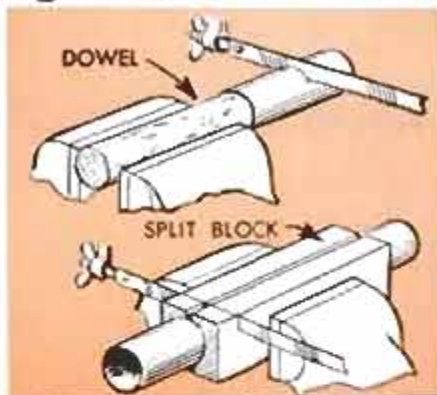

### Bench Stop Pivots in Slot

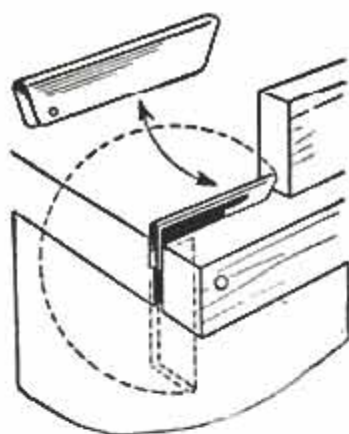

Bent double, a sheet-metal strip, pivoted by a nail in a slot cut in the edge of your workbench, provides a simple workstop when edge planing. Stop swings down below surface of bench completely out of the way when not being used.

### Storage Cups For Brads



Picking up that last tack or tiny brad from a round-bottom container is far easier than from a square-bottom one. You'll find that the halves of a couple of hollow-rubber balls, tacked to a board, make perfect storage cups.

### Razor-Blade "Chisel" Is Aid When Scribing and Mortising Small Hinges

When cutting mortises for small butt hinges, you may find that a single-edge razor blade is easier to handle than a chisel in outlining the mortise. Having a wedge-shaped cutting edge, the razor blade makes a clean square cut with very little pressure. The reinforced back of the blade permits it to be tapped lightly with a hammer to outline mortise, after which a series of cuts, made across the mortise to the required depth, permits the waste to be neatly pared away, either with the razor blade or with a regular chisel. You'll find, too, that a razor blade is an ideal tool to use in scribing around the hinge when marking its location on the edge of the door. It will give a precise guide line to follow.

Henry Hanscom, Elmhurst, Ill.





Above, "boatport" attached to garage is easy to build. Roof consists of metal roofing fastened to frame of 2 x 4s, one side of which is supported by 2 x 4 nailed to garage, other side by pipe supports

Below, in addition to providing an inexpensive permanent shelter and adequate circulation of air, boatport leaves ample clearance on all sides of boat for doing maintenance work during lay-up period



Providing a good shelter and proper care at lay-up time is a sure way to

## LOWER

**W**HEN IT'S TIME to call it quits for another boating season, give your boat and equipment a break with proper lay-up and winter protection. A muster of all hands for a weekend of touching up paint, and thorough cleaning of boat, motors and equipment before storing them in a dry place will pay big dividends next spring. While inside storage is no problem for a boat that is small enough to keep in the garage, cruisers and heavy runabouts usually require a special shelter. This can take the form of a rigid shelter, such as the "boatport" illustrated on this page, or it can be a tarpaulin lashed down on top of the boat. Since the latter usually restricts air circulation, which encourages dry rot in a wooden hull, it is recommended that the rigid type of shelter be used. The latter not only costs less than a good tarpaulin, but it will last much longer. Being entirely free of contact with the boat, there is also ample space for doing repair and maintenance work during lay-up, Fig. 3.

Attached to one side of the garage, the boatport is easy to build, requiring only metal roofing, framing, and pipe supports for the open side as shown in Figs. 1 and 2. A 2 x 4 nailed to the side of the garage provides support for the other side of the roof. A receptacle can be installed on the outside of the garage and tapped into the garage wiring for the convenience of running power tools and for lighting.

A proper lay-up procedure should begin with a thorough scrubbing of the hull and



# YOUR BOATING

# BILL

By  
F. C. Clark, Jr.

superstructure. Be sure to scrub the bottom as soon as the boat is removed from the water. If you wait until the marine growth on the hull becomes dry, it is very difficult to remove. If the boat is to be stored on a trailer, the trailer should be completely serviced before loading. Clean and repack wheel bearings, Fig. 4, lubricate hitch parts, Fig. 5, winch, springs, keel rollers and other moving parts. Whether a boat is stored on a trailer or on a cradle, it must have well distributed support points (keel rollers and bunks or cradles) to prevent the weight of the boat from forcing the hull out of shape. Good tire care requires that the trailer axle be blocked up to take the weight off the tires.

Next tend to the power plant. Motors that have been operated in salt water should be flushed with fresh water. An easy way of doing this for an outboard motor not recommended to be flushed with a hose is to run it in a 50-gal. steel drum of water while the motor is still on the boat, Fig. 6. To flush an inboard engine, connect one end of a garden hose to the intake side of the water pump and place the other end in a container with enough water for a few minutes' running time. Next drain the cooling system according to the directions given in your owner's manual. For an outboard this usually involves setting the motor in a vertical position and rotating the flywheel manually several times. To prevent formation of gum deposits in the fuel system, drain the lines and carburetor. Re-

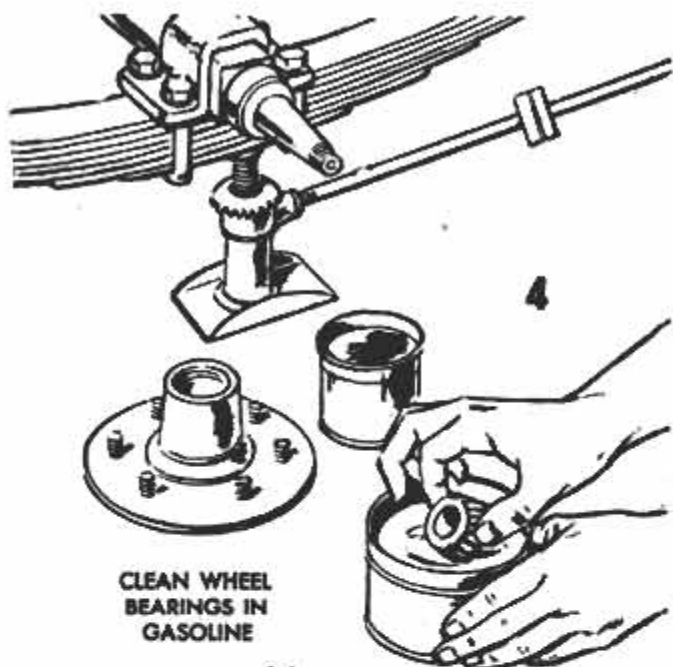



Above, to clear salt water from motors, run them in drum of fresh water while still mounted on transom

Below, small amount of motor oil squirted in cylinder through spark-plug hole retards rust during lay-up

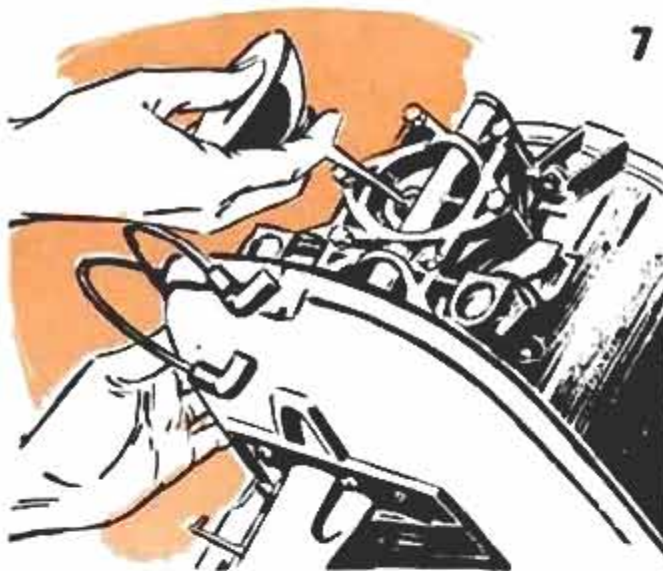

Below, use torque wrench to tighten cylinder-head bolts; be careful not to exceed recommended pressure



move the carburetor sediment bowl and wipe it clean. Use benzine to clean the filter element.

Another important job is to clean the spark plugs. With the plugs removed, squirt some clean motor oil into the openings, rotating the engine crankshaft several times to distribute the oil evenly. Coat throttle-linkage joints with grease to protect them from corrosion. Cylinder-head bolts may have loosened. Use a torque wrench to tighten them, Fig. 8, so the correct pressure can be applied as recommended by the manufacturer. Don't forget to drain and refill the lower-unit gear case. After you have completed servicing the motor, wipe a film of oil on all exterior parts and store it upright in a dry place. At the same time, don't forget to give the starting battery proper care during its hibernation period. Keep the battery in a cool, dry place and charge it as necessary, Fig. 9.

Turning to the interior of the boat, first remove all unattached equipment, gear and supplies to permit a thorough cleaning. Set these things aside for proper storage in the garage or house. A lightened boat will reduce the chances of hull members warping while the boat is in dry storage. Then clean the inside of the boat thoroughly, using detergents and cleaners that are not harmful to the surfaces to be cleaned. Be sure the bilges are free of gasoline and grease. Remove the drain plug when washing the interior and drain all cleaning solutions. Check over lines and anchors, being sure the rope is dry before storing it. Inspect the steering cable for worn spots. Additional cable guides may be necessary to avoid chafing. While performing all these prestorage jobs, it's a good idea to make a list of things you need to replace or add to the boat for the coming season. Keep the list handy so you will be reminded to tend to items as time and budget permit.

★ ★ ★

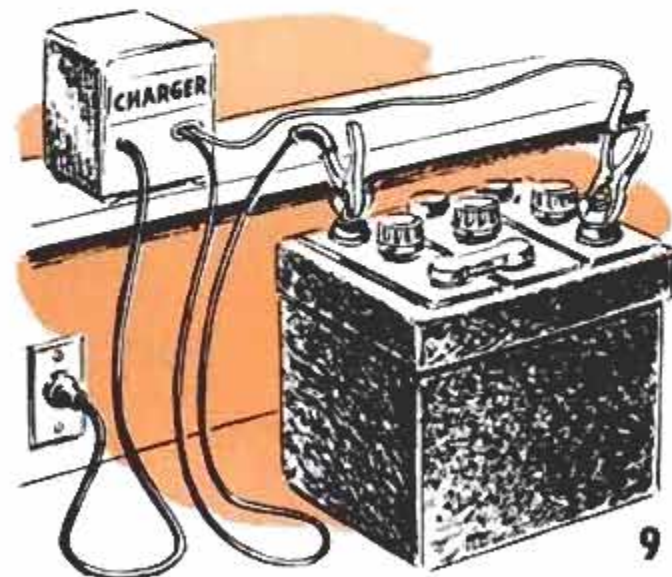



## Wire Stripping Easy With Adapted Pliers

You can do a better and faster job of stripping insulation from light-gauge wire when several turns of wire are wound around one jaw of the pair of long-nose pliers used for this purpose as shown in the photo. Acting as a stop, the wire prevents the cutting edges of the pliers from severing more than the insulation. The size and location of the wire turns determine the clearance between the cutting edges when the jaws are closed.

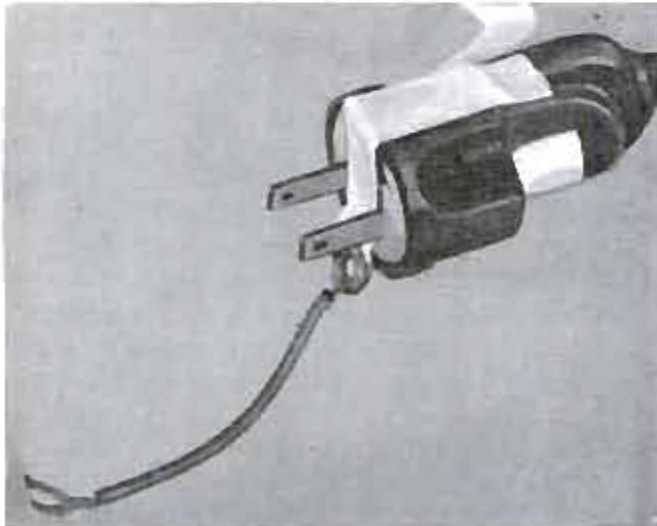
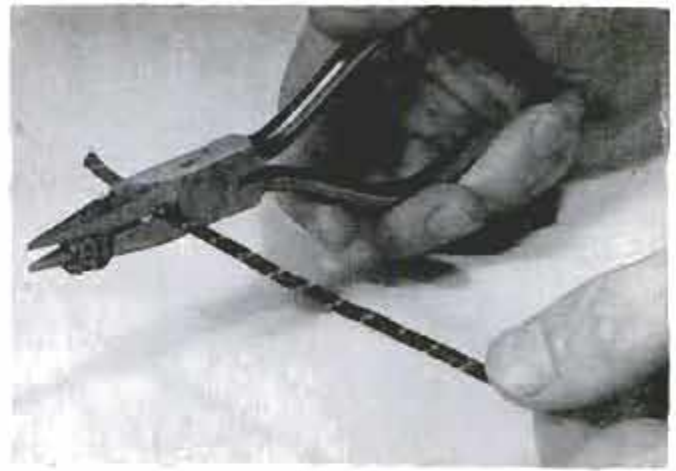

## Keep Grounding Adapter Handy By Taping It to Three-Prong Plug

To assure that a grounding adapter that converts a 3-prong plug into a 2-prong plug is always conveniently at hand, one home craftsman taped the two together as shown in the photo at left. This is done by first applying a strip of tape that is long enough to overlap both plugs when centered between the prongs of the 2-prong plug. Then another strip is wrapped around the 3-prong plug circumferentially to overlap the ends of the first strip.

R. Hanscom, Elmhurst, Ill.

## Holder on Glove-Compartment Lid Keeps Pen and Pencil Handy

Here is a tip for motorists who are irked by having to search the glove compartment whenever they need a pen or pencil. Simply cement a small plastic holder to the lid of the compartment as shown in the photo at the right. The holder takes no usable space and always keeps a pen and pencil handy for instant use. Such holders are available at most stationery and variety stores.

Arthur R. Tanner, Jr., Poughkeepsie, N. Y.

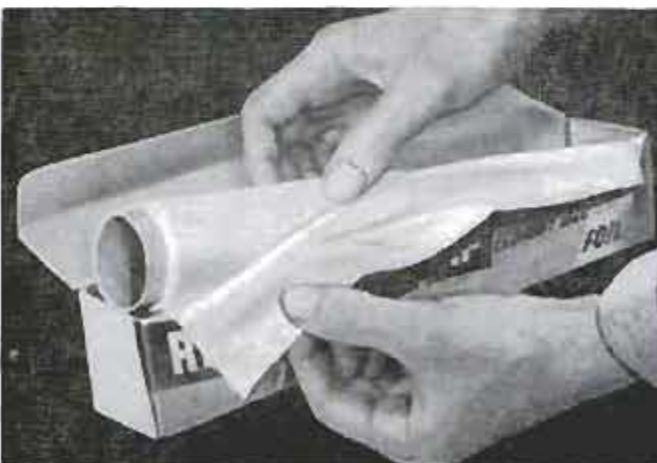
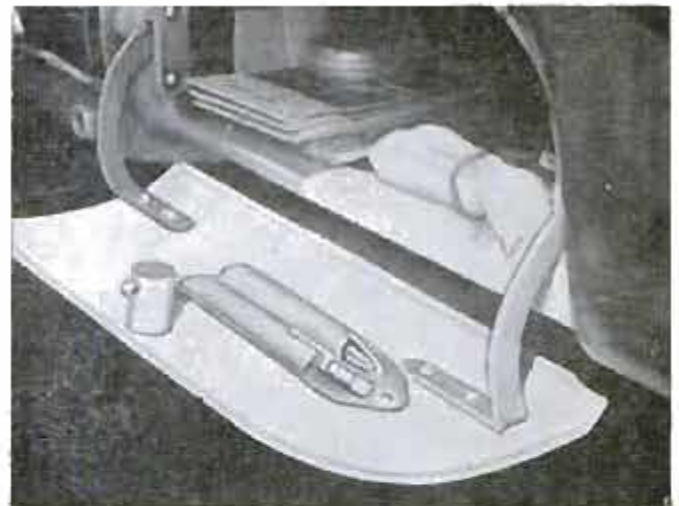

## Store Paper Towels for Car Use In Wax Paper Container

Rolled paper towels are kept conveniently at hand by a motorist who rolls them on an empty tube from an aluminum foil or wax-paper container. Enough towels are rolled on a tube to permit replacing it in the container for clean, neat storing under the front seat. The metal edge attached to most lids of such containers provides an easy means of tearing off towels when needed for cleaning the windshield, wiping hands and many other uses.



Creosoted poles braced with 2 x 4s form the framework of this corncrib that is divided lengthwise into three sections. The center section can be used for storing baled hay or straw, machinery or loads that might be caught in a rain. Siding extends about 4 ft. down from the roof for weather protection; below that the walls are covered with war-surplus steel matting. The roof is galvanized sheeting.

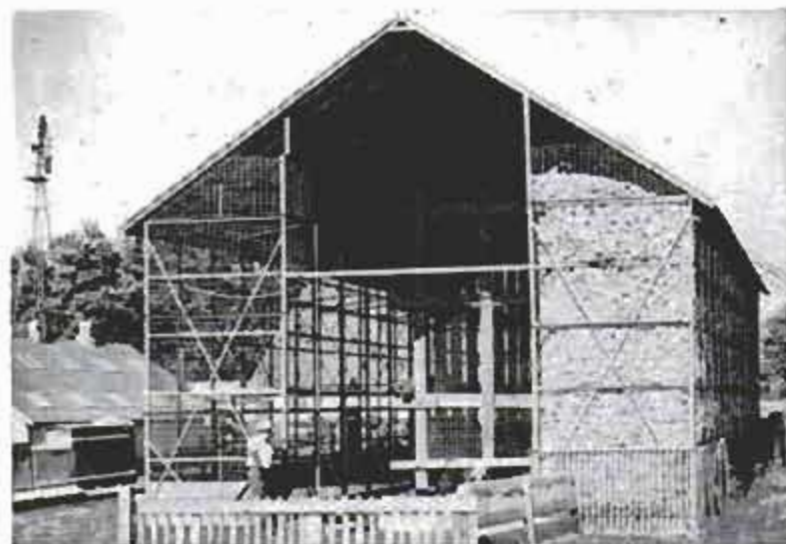

When necessary, ear corn also is stored in the center section of this welded-steel crib, increasing the capacity of 10,000 bushels. The walls of the crib were welded as units on the ground, then lifted upright with block and tackle. Steel brace rods and connecting corner angles then were welded in place. Rafters also are welded steel angles to which is attached corrugated galvanized roofing. Welded-wire mesh covers the walls from roof to ground on the side sections.

## IDEAS IN CORNCRIBS



This combination hog shed and corncrib saves time and labor at feeding time, as ear corn is scooped through outside doors by farmer on catwalk, and dropped to the concrete floor of the pen below. The catwalk consists of planks nailed to alternately projecting floor joists. A scoop is located at the ladder which provides access to the catwalk at the far end of the building.



Building a 5000-bu. corncrib against the wall of the cattle shed reduced cost for both structures. Salvaged electric-line poles are set in concrete to provide both roof supports and wall members. Spaced slats are nailed to the poles several feet above the ground, with a number of doors positioned 4 ft. above the ground. Above this the walls are covered with wire fencing. A catwalk makes shifting the elevator easier.

## Closed Gates Permit Open Doors

Hung across the driveway of the granary this pair of heavy gates can be closed when the large sliding doors are open. This allows free circulation of air through the building for drying a fresh crop, while keeping out stray livestock. Gateposts are lengths of heavy steel pipe sunk in concrete. They are positioned far enough out from the building so that the gates in no way interfere with the sliding doors. When the gates are open, as shown, they are hooked to stops in the concrete.

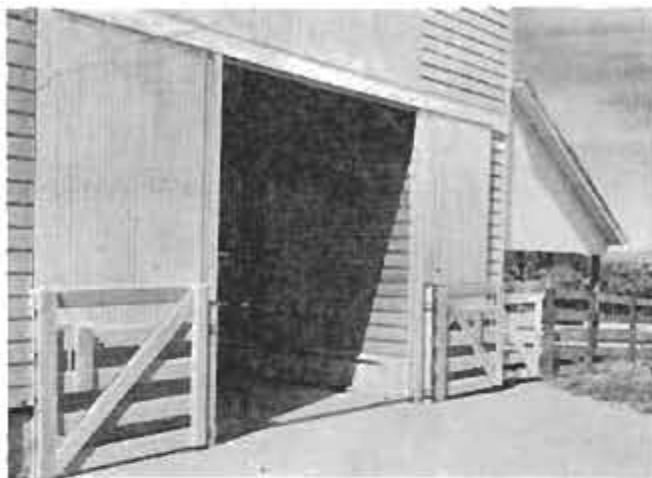

## Tractor Attachment Applies Waste Oil to Control Road Dust

In Des Moines County, Iowa, Jack Gibson controls the dust on the road that passes his farmhouse by applying crankcase drain oil. Built in the farm workshop, and mounted on the rear of a tractor, the applicator consists of a steel oil drum fitted with a T-shaped assembly of pipe and fittings. The crossbar of the tee has  $\frac{1}{4}$ -in. holes drilled in it every  $1\frac{1}{2}$  in. Control of the oil flow is by a valve in the pipe between the oil drum and the crossbar. The tractor is driven at 2 m.p.h. when applying the oil.—A. M. Wettach, Mt. Pleasant, Ia.



## Efficient Edge Clamp Is improvised From Wire and Turnbuckle

If you do not have enough clamps, or if a clamp of sufficient size is not available, one can be improvised from a length of heavy wire and a turnbuckle. Extend the turnbuckle its full length and draw the wire as tight as possible when fitting it in the eyes of the turnbuckle. If the object to be clamped has a finished surface, use wooden blocks to prevent the wire from damaging it. A piece of thin plywood or hardboard should be placed also between the turnbuckle and the work, to protect the finish. Tremendous pressure can be applied with this improvised clamp, so it is best to use less force than would seem necessary.

Ken Murray, Colon, Mich.



☞ Use olive oil to loosen quickly a piece of paper stuck to a polished table top.



### Lead-Shot "Lock Washer" in Acorn Nut

Lead shot can be used to lock an acorn nut on a bolt or threaded shaft when the threaded portion is too short to permit using a lock washer. Enough pieces of shot are fitted in the nut so that when they are crushed by the nut, they jam it in place, but still permit the face of the nut to bear firmly against the object to be held.



### Magnetic Holder for Drill-Chuck Key

Placed against the column of a drill press, a high-strength-alloy horseshoe magnet provides a handy means of keeping track of a chuck key. Should the key be used on more than one machine, it is a simple matter to transfer both the key and magnet to a different location.

Walter E. Burton, Akron, Ohio



### Guard Protects Blades of Paint Scraper

You can eliminate the need for sharpening the blades of a paint-scraping tool of the type indicated, every time it is used, with this guard. It is made by slitting a length of small-diameter hose. When carried in a toolbox or dropped in a drawer with other tools, the guard will prevent the blades from becoming dull and nicked.



### Bench Legs Adjusted With Lag Screws

If the concrete floor of the basement or garage where you plan to locate a workbench is not level, you still can have a wobble-free work surface by using lag screws as leg levelers. Turning the screws in or out with a wrench does the leveling. To prevent splitting the legs, drill adequate-size pilot holes.

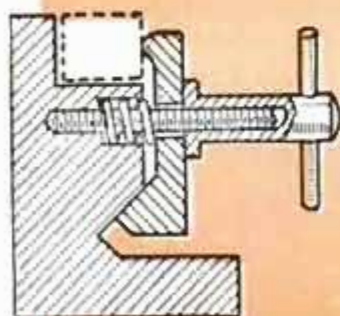

### Strap Clamp for Special Machining

When it was necessary to machine the top surfaces of a number of pieces, one workman made the strap clamp shown. Because of the angled lower edge of the clamp, tightening it causes it to pull downward as well as holding laterally against the fixture. The spring on the clamp screw assures quick releasing.

Federico Strasser, Santiago, Chile.



### Rope "Clamped" Quickly With Tubing

Short sections of copper or aluminum tubing provide a quick method of securing light ropes in loops, "whipping" the loose ends of the rope to prevent it from unraveling, and for splicing lengths of the rope together. The tubing is slipped over the rope, then both are placed in a vise and the tubing is flattened so the rope is clamped.



# Painting Over New Plaster

By E. R. Haan

**B**EFORE you start spreading gay colors on the interior walls of your new home, just make sure that the plaster is actually ready for painting in respect to dryness and surface condition. Then you can be reasonably certain that the paint job will be uniform in appearance and free from blemishes.

Too much dampness in new plaster may delay the painting or influence the selection of paint. Surface conditions, such as soft spots, chalkiness, efflorescence and the presence of hairline cracks, should be corrected. These conditions also may be influential in the paint selection.

## Dryness of Plaster

If you are intending to use alkyd or oil-base paint, dryness of plaster is of utmost importance. For many years painters followed the rule of waiting six months to two years before applying oil-base paint to interior walls. Today, however, improved formulation of both plaster and paint have shortened this waiting period. For average conditions of varying humid-

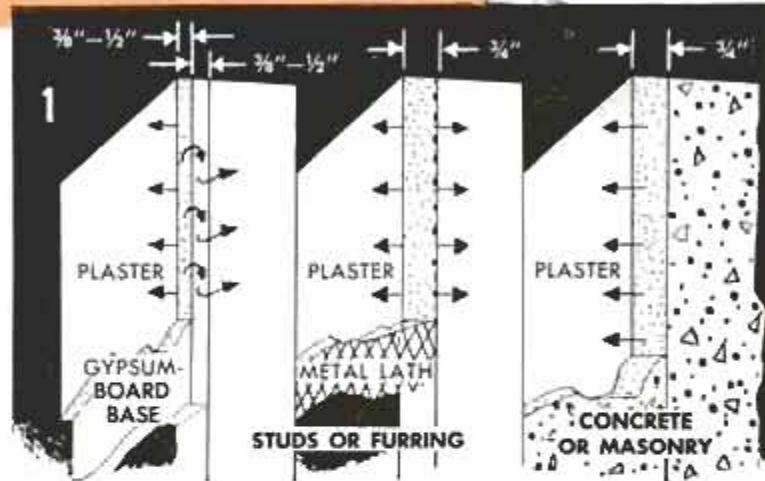

ity, a 60 to 90-day drying period often is recommended. But when the relative humidity is not over 40 percent, and the temperature is not less than 50 deg. F., plaster on partitions or furred walls often dries sufficiently in three or four weeks. Dry air absorbs large quantities of moisture from plaster quickly, but humid air, which is already loaded with moisture, retards drying time considerably.

The drying rate of plaster varies with the type of wall construction. There is

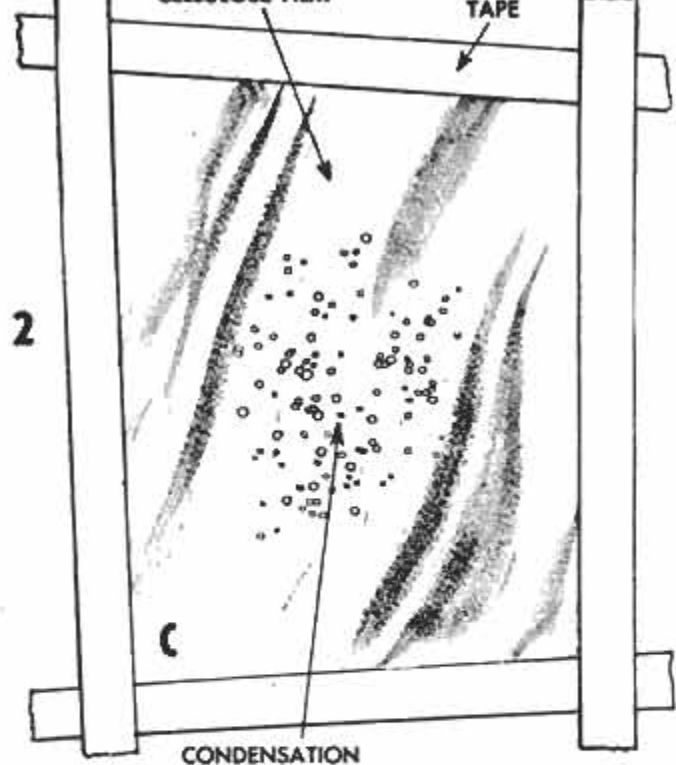
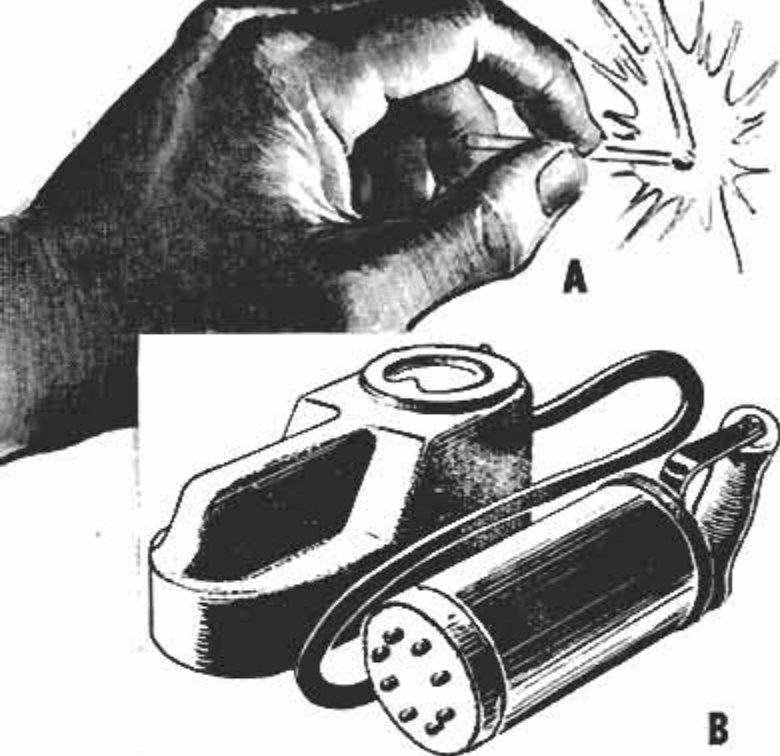

less water to evaporate from a plaster coating on a gypsum-board base, Fig. 1, than from a thicker three-coat plaster covering on expanded metal lath. Plaster on frame partitions or that applied to a base over furring, dries from both sides. The slowest to dry is plaster applied directly to concrete or masonry.

#### Tests for Plaster Dryness

To determine accurately how dry plaster is, and whether it can be painted, professional painters often make use of a moisture meter, such as pictured in Fig. 2, detail B. Homeowners, however, can make other simple tests. If a match fails to ignite when struck on plaster, it is an indication that it is still too damp for the application of an alkyd or oil-base primer. Another test consists of taping a small sheet of cellophane or celluloid loosely to the wall, sealing the edges all around with strips of masking tape. If any condensation appears on the inside surface of the sheet in the course of a few days, the plaster is too damp for an alkyd or oil-base primer.

#### Painting Damp Plaster

When it is necessary to paint damp plaster, a single coat of water-base paint, preferably of the latex variety, usually will adhere but may not give the desired coverage. A single coat will still permit evaporation of moisture in the plaster to continue. Two coats of latex paint should not be applied to a damp wall since the paint film then becomes a moisture barrier, preventing further evaporation from the plaster. Moisture remaining in the

plaster builds up pressure under the paint and may cause it to loosen in spots unless sufficient evaporation occurs from the opposite side. Therefore, the second coat of paint is applied after the wall has dried completely. The pigments in some paints react to the alkali which is drawn out of the plaster by the moisture, resulting in spottiness.

#### Dry-outs and Sweat-outs

Some soft spots in plaster that have white, chalky surfaces are known as "dry outs." These are caused by too-rapid evaporation of water before the plaster has set. This condition can be remedied by spraying the area repeatedly as necessary with a solution of alum, 1 lb., dissolved in water,  $\frac{1}{2}$  gal., or equivalent proportions. A hand-operated garden sprayer can be used to apply it as in Fig. 4. The added moisture promotes crystallization.

Other soft spots known as "sweat outs" are damp and somewhat dark in shade as indicated in Fig. 3. These are caused by too-slow drying which allows the water to remain in the plaster after it has set. The condition sometimes can be improved by drying the wall with heat, or by applying lacquer to surface-harden these spots and permit painting. If this does not help, it may be necessary to remove the soft plaster and replace it.

#### Efflorescence and Chalkiness

Efflorescence, shown in Fig. 5, is a thin deposit of soluble salts from concrete or masonry to which plaster is sometimes applied, and is brought to the plaster surface by moisture. When such deposits are



3 "SWEAT OUT"—DAMP, SOFT SPOT, SOMEWHAT DARK



5

found, they are brushed off repeatedly over a period of time until they no longer reappear. Brushing is done dry, without any water. If necessary to paint over efflorescence, it should be done with latex paint. Similar white deposits on a plaster surface often result from water leaking through it, originating from a roof or wall leak. This can be stopped only by finding the leak and repairing it permanently.

Plaster that has a dull, nonreflective surface may be covered with a white, chalky film which rubs off easily. This condition is quite common and causes paint to peel. The chalky film is brushed off and then an alkyd or oil-base primer is used. A water-base paint will not adhere to a surface covered with this powder.

#### Oil Spots and Hairline Cracks

Any apparent grease or oil on plaster should be removed with a cloth saturated with white gasoline or benzine. When dry, the spot is washed with a detergent solution and then allowed to dry before painting. Sometimes hairline cracks develop in the finish coat of plaster and do not show up until the wall is painted. Such cracks can be filled with Spackle, using a putty knife on smooth plaster or a stiff-bristle brush on rough plaster. On smooth plaster, the Spackle is sanded when dry. Hairline cracks often can be obscured with a heavy-bodied paint over the primer.



4  
"DRY OUT"—  
SOFT AND CHALKY WHITE

#### Painting

The first coat of paint is a primer sealer. This renders the plaster surface uniform so that there will not be varying spots of sheen and dullness. When using an alkyd or oil-base primer, it should be allowed to dry for at least a week before the top coat is applied. If the latter is applied too soon, peeling may result. An oil-base finish paint can be applied over a latex primer, but will not adhere properly to other water-base paints. It is important to mix the paint thoroughly before application and to keep it well stirred to assure good coverage and uniformity of color.

\*\*\*



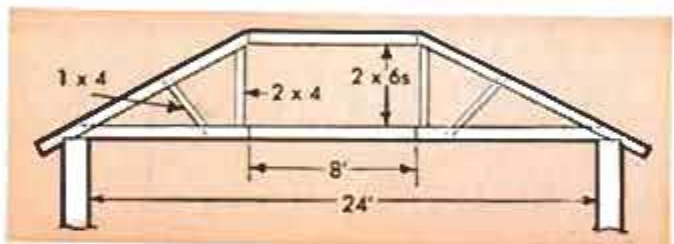
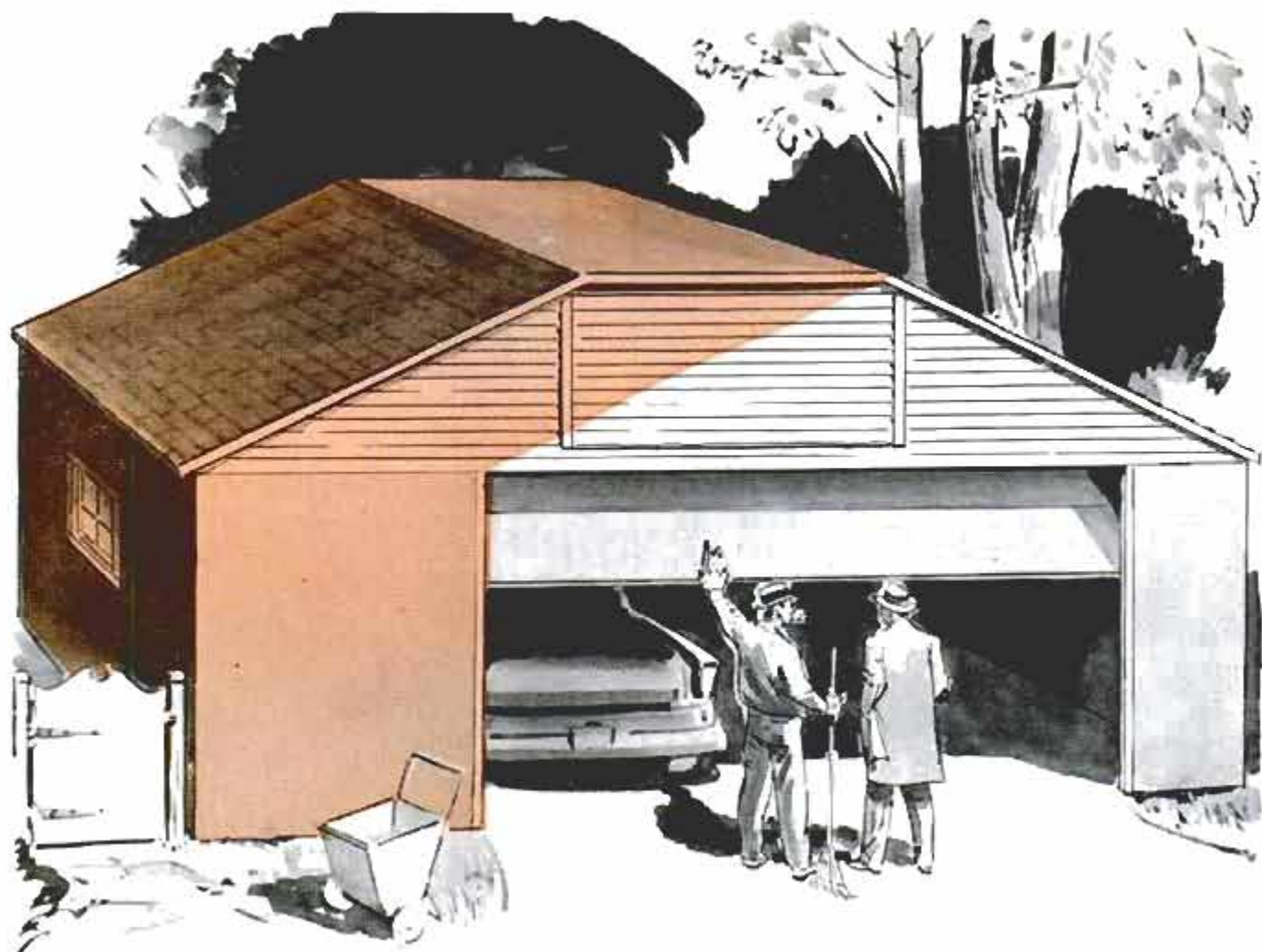

## Expanded Garage Houses Second Car and Boat

IF A WIDER late-model car is crowding your one-car garage; if you need room for a second car, or simply require more storage space, then do as Everett Hedgcock of East Peoria, Ill., did and expand the garage. First step is to pour a new footing level with the old. The roof is shored up and separated at the ridge. Front and side walls then are pulled down, the loose half of the roof being supported on the back wall and shores, and new walls are built on the new footings. The free half of the roof now is moved to position on the new walls. In the original job, 2 x 4 rafters were spaced on 2-ft. centers as were the roof beams. A 2 x 6 was spiked to each rafter, and lengths of 2 x 4s joined them to the separated roof sections. Between the roof sections a length of 2 x 6 was positioned horizontally. The result is a sort of truss. An advantage of this type of construction is that an 8-ft.-wide deck is formed between the roof halves. Using a "haymow type" door at the front of the garage permits this deck to be used for storage of a boat. A doubled 2 x 8 header, set on edge and even with the top course of blocks, is used across the door opening to support the end truss.



## Spark Plugs Provide Lifting Rings For Hoisting Motor From Chassis

When it is necessary to pull a motor from a car, two spark plugs altered as indicated will provide lifting rings for the chain hoist. Just remove the insulators from the plugs and substitute short pieces of rod. Form an eye on one end and peen the other end, after inserting the rod into the plug to keep it from slipping out. Hook a cross chain into each eye and then hook the hoist chain into this chain.

Robert Beasley, Jackson, Mich.

**Keep windows open** during and immediately after using a washing machine, dryer or other moisture-releasing machine, and you will be less likely to have excessive humidity in your home.



## Plastic Sheet Under Automobile-Seat Cover Protects Upholstery

Woven plastic, fiber or cloth seat covers for cars protect the seats from surface dirt, but dust and spilled liquids will penetrate the covers and soil the seats. To avoid this, place a sheet of plastic film under the cover next to the seat. This will catch any liquid or dust that penetrates the cover, and is especially desirable if you have small children riding in the car. There are many types of plastic sheets suitable for this purpose. Be sure the plastic is worked carefully over the seat and tucked well in under the cover so that it will stay in place.



## Corrosion of Battery Terminals Prevented by Small Copper Pieces

If you have experienced difficulty by having car-battery terminals corrode, try this stunt, which some filling stations in Texas use. Just insert a small piece of copper into the soft covering on the battery close to each terminal as indicated.

—C. V. Harris, Cincinnati, Ohio.

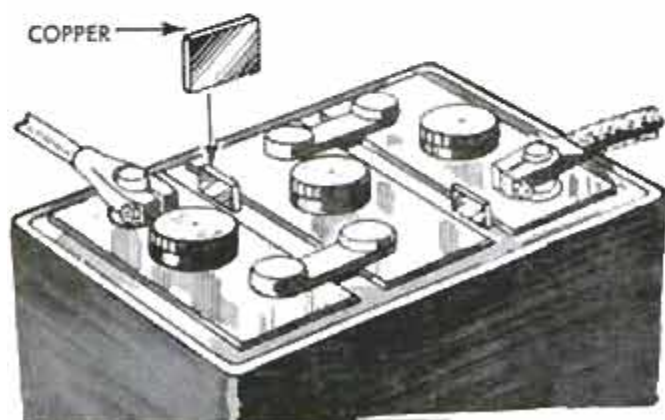

## Spark Plug Short-Circuited By Deteriorated Boot

According to Champion Spark Plug Company, spark plugs can be shorted by cracks in the rubber boots used to protect them against moisture. The photo shows such a plug. Note on the insulator how a carbonized path has been formed through the crack in the boot.

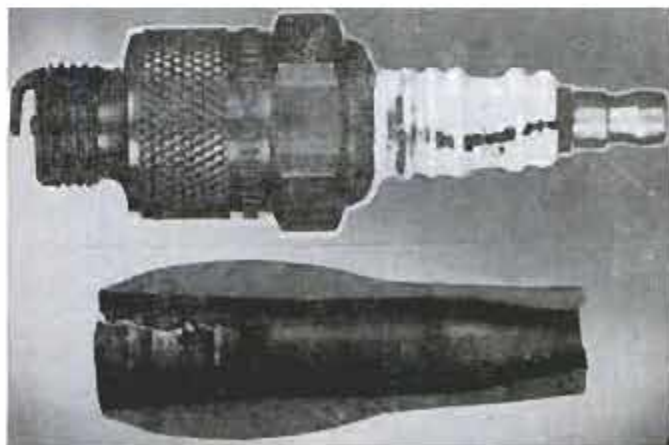

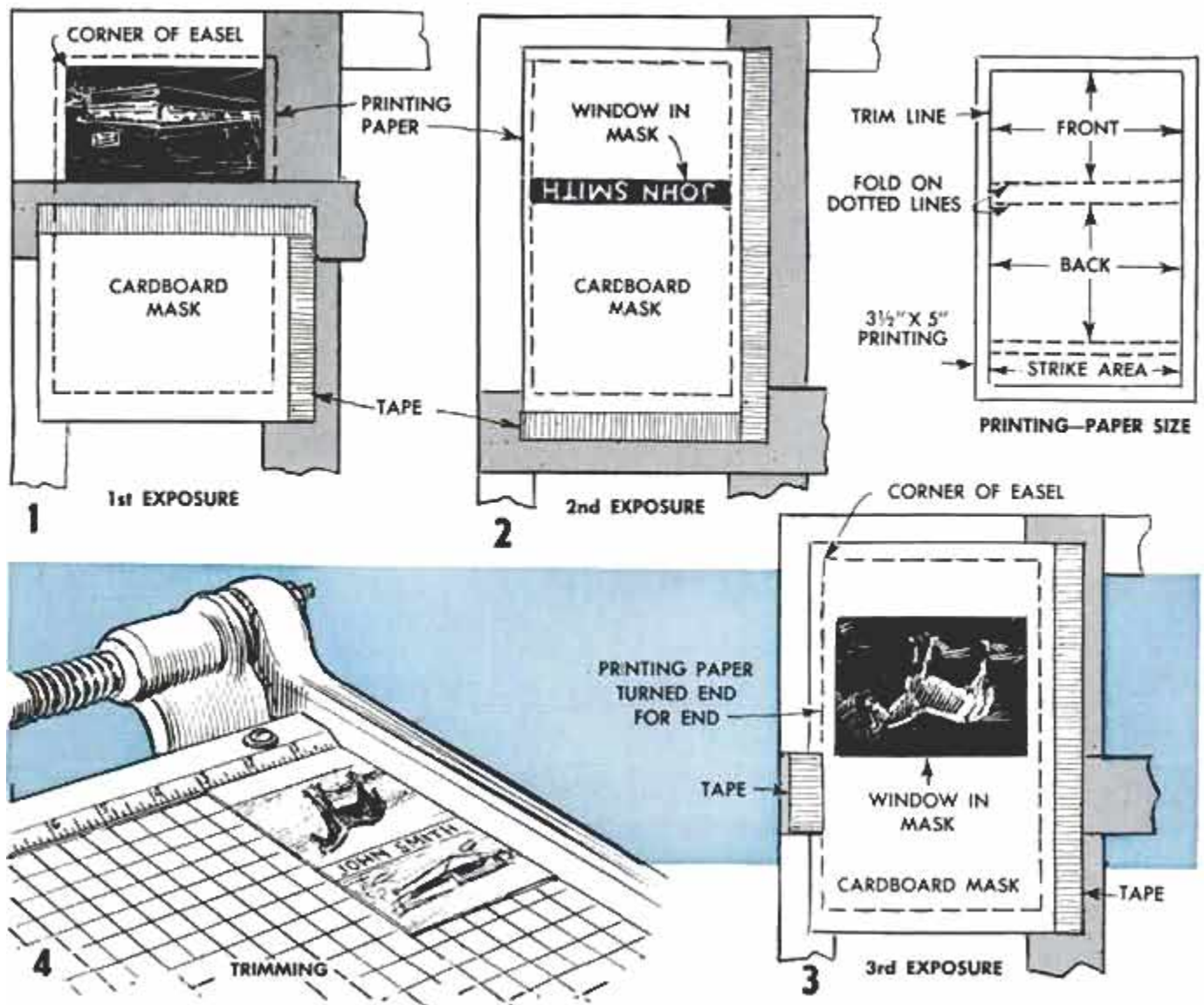

# CONVERSATION COVERS

By Hartwell J. Kennard

**P**ERSONALIZING your matchbooks with pictures of your children, home or trophy-winning trotter is sure to bring exciting comment from your friends when handed out as mementos. Any amateur photographer who has a darkroom and an enlarger can make photographic matchbook covers and have a lot of fun doing so.

The first step is to remove the cover from a book of matches and use it as a pattern in cutting the printing paper to size. The example given above is for king-size book matches which require 3-in.-wide covers. Notice that a border equal to the margins produced by your enlarger easel is allowed all around the paper for later trimming the covers to size. All your printing paper should be cut to size from double-weight matte or glossy stock.

While the steps pictured here show how you can print two pictures and a message or name on a cover, you can vary the procedure and limit the printing to a

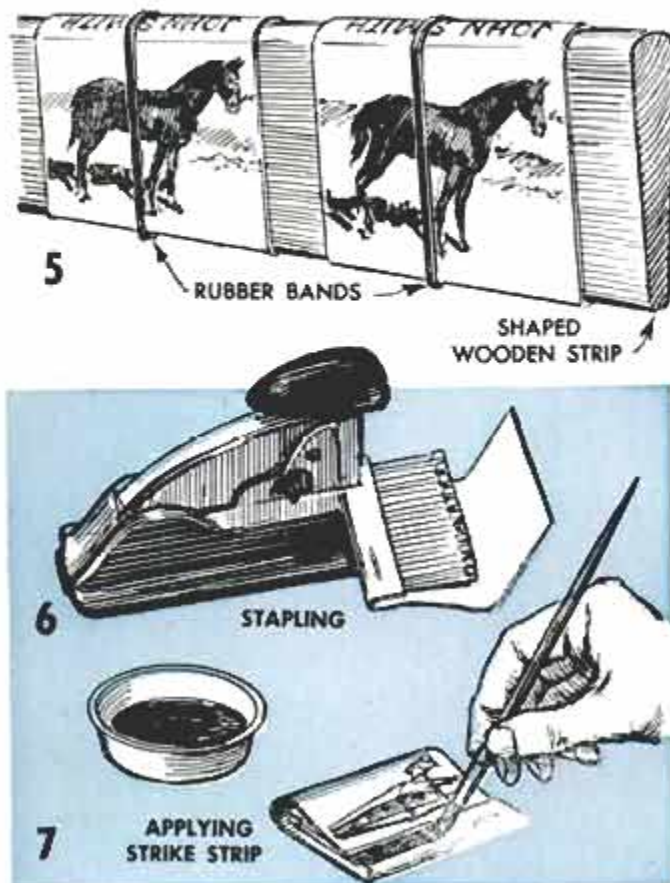



## FOR YOUR MATCHBOOKS

single picture, positioned either vertically or horizontally on the cover. Cardboard masks are used to protect the printing paper during the three separate exposures. The front of the cover is exposed first and a mask is taped to the enlarger easel in the manner shown in Fig. 1. The negative is focused within the established margins and in an upside-down position. The negatives used should be of fairly equal density and it is best to make a test strip beforehand to determine the proper printing exposure. All the covers are exposed before the setup is disturbed and the paper is put back in a light-tight box while the easel is masked off for the second exposure. It is important, of course, to keep track of the part already exposed to later avoid double printing. A window is made in the second mask for printing a name or message across the fold of the cover, and Fig. 2 shows how it is taped to the easel to protect the rest of the cover while the second exposure is made. The third exposure is made with a mask

like that shown in Fig. 3. A window in the mask is positioned to allow space below it for adding a striking surface on the cover. In making the third exposure, the paper is placed end for end in the easel.

With the third exposure completed, all the covers can now be developed, fixed, washed and immersed in a print-flattener solution. After partial drying, the covers are trimmed, Fig. 4, and then "wrapped" around a wooden slat in the manner shown in Fig. 5. The wedge-shape slat should approximate the size and shape of the match filler to which the covers will be stapled. The covers are held on the slat with rubber bands and left to dry. The match fillers are obtained by taking matchbooks apart and stapling your photo covers to the fillers as in Fig. 6. A strike-surface mixture that can be painted on the covers is made by mixing amorphous (red) phosphorus, 10 parts, oxide of manganese, 8 parts and glue, 4 parts. The ingredients listed may be purchased from any chemical-supply house. ★ ★ ★

# Oriental Planter



By  
**Harry Zidman**

HERE IS A SMALL PLANTER with personality. It has two shelves that serve as pagodalike verandas on which Japanese figurines are placed, giving it the appearance of an Oriental import. Constructed of  $\frac{1}{4}$ -in. plywood, except for the basket-weave side panels, the planter can be made in a few hours. Glue only is used for fastening the joints. Before cutting the shelves to shape, make a full-size pattern from the squared half-pattern shown below. Cut and sand all parts before starting the assembly work. The sides are completely assembled before gluing them in place. To do this, drill holes in facing edges of the top and

bottom members to take the dowel ends, spacing the holes 1 in. on centers. Next cut  $\frac{1}{16}$ -in.-deep grooves in facing edges of the side members to take the ends of the veneer strips. After gluing the dowels and endpieces to the bottom piece, slide each of the veneer strips in place so that they pass on alternate sides of the dowels as shown. To make this job easier and to prevent cracking the strips, soak them in hot water for 5 min., before using. When the last strip is in place on each side, glue the top member to the ends and dowels. Enamel the box red, the base black and coat the rest with clear spar varnish.

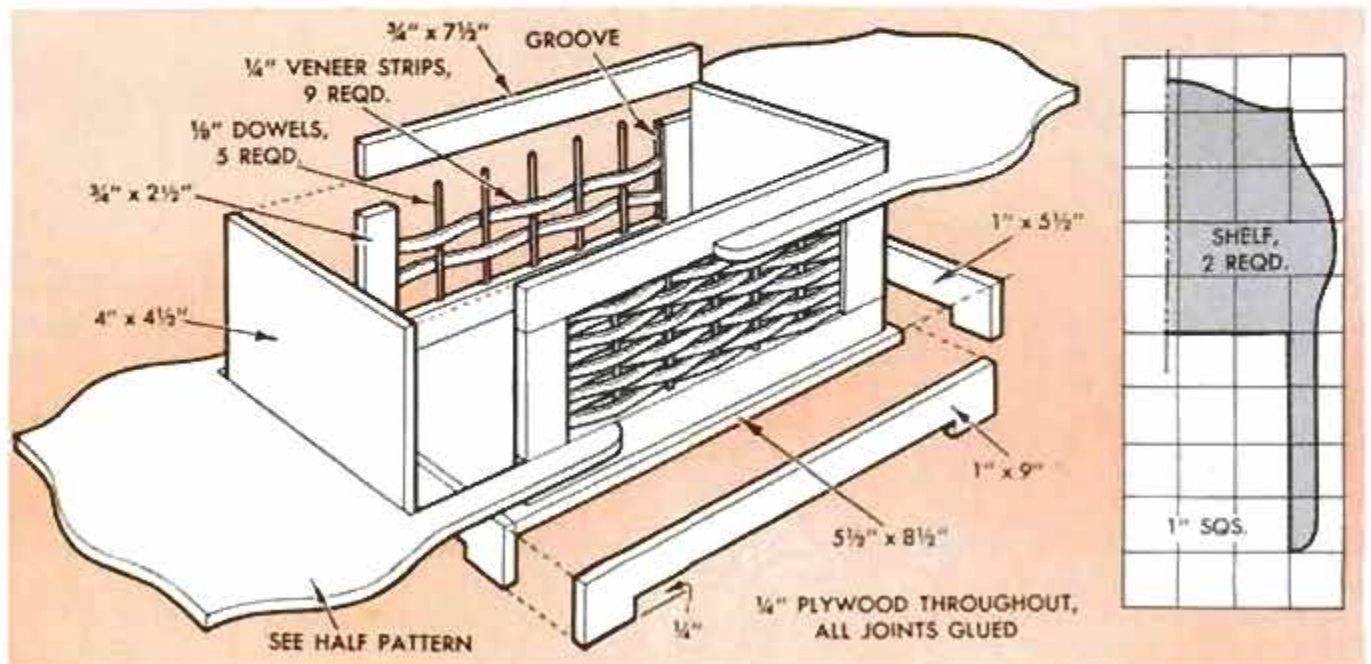

## Ladder Bolted to Combine Hopper Permits Easier Inspection

Checking the amount and quality of the grain in a combine grain hopper can be done more quickly and with less chance of barked shins when a ladder is bolted to the hopper as shown. A section of wind-mill ladder could be used, or a ladder could be bolted or welded together from lengths of steel angle. Spacers are used between the tank and the ladder to provide ample toe room. Bottom rung of the ladder is positioned high enough to clear any normal obstructions.

A.M. Wettach, Mt. Pleasant, Iowa.

Handling spark-plug leads roughly, if they are of the resistance type used in most late-model cars, can cause trouble. These leads consist of a carbon-impregnated conductor with an insulating cover. Short lengths of wire are forced into each end of the conductor to make contact with the connectors. To prevent pulling the wire from the conductor, grasp the molded spark-plug cap, twist it to loosen it from the plug porcelain, then pull it free.



## Modified Desk Drawer Provides Added Support to Slide

When the dictation slide of a desk is used frequently for supporting a typewriter or adding machine, it can be given added rigidity by using the drawer beneath it as a brace. Fit a wooden turn button on the inside surface of the drawer front as shown, so that it projects just enough to support the slide firmly. Locate the pivot of the turn button so that the portion projecting upward is longer than the lower part. This will assure that the upper end will drop down, but will not allow the opposite end to pivot up enough to lock the drawer when it is shut.

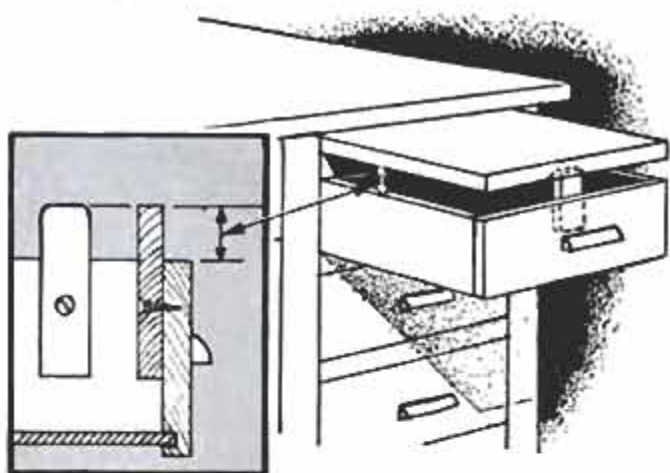

## Mock Automobile Crash Makes Eye-Catching Roadside Sign

Need an "attention getter" for a roadside business? Try this traffic-stopping "auto crash," actually a car cut in half and fitted flush against a wall. What appears to be broken siding is just a painted pattern. Keep the car clean and polished and air in the tires to maintain an authentic look.

Grover Brinkman, Okawville, Ill.

☞ Two or three clamp-type trousers hangers do a much more effective job of holding a heavy blanket on a clothesline for drying or airing as they grip more strongly over greater area than pins, and leave no marks.



# Make Her a Play Sink

By Russ Whitaker

WHEN THE FUTURE housewife in your family decides to wash her own dishes after a tea party with her friends or dolls, do not discourage her because the kitchen sink is out of reach unless she has a chair on which to stand. Instead, build her a sink of her own that is just the right size not only for washing dishes but for preparing food as well. It is a cabinet sink, so there is room for storage of dishes, utensils and perhaps a few staples such as cocoa, sugar and canned milk. No dimensions are given, as the sink must be tailor-made for a specific child. A frame for the sink top is made of 1 x 2 furring strips. It is covered with a sheet of 3/16-in. hardboard, and an opening is cut in the center to accommodate a plastic dishpan. The rest of the cabinet also is made of 3/16-in. hardboard, except for the shelves that are lengths of 1 x 12 pine. A strip of 1 x 2 also is used on the lower edge of the back panel between the cabinets to act as a stiffener. The sink is painted with white enamel. For an added touch of realism the top can be covered with plastic laminate.

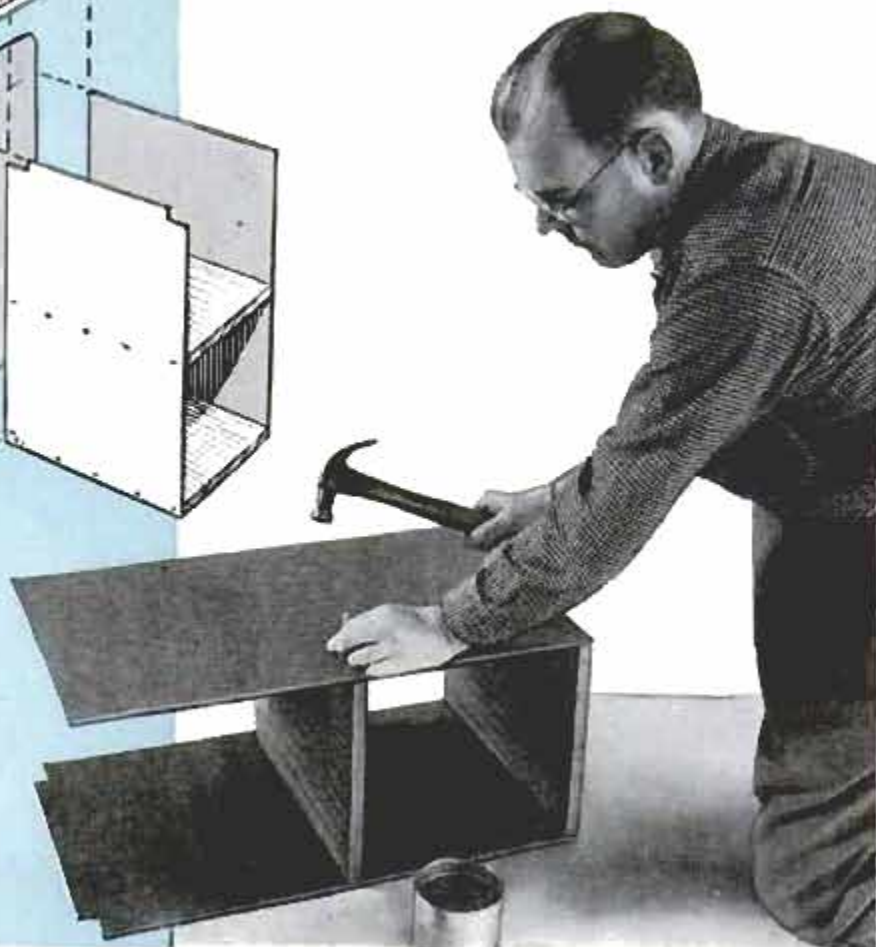
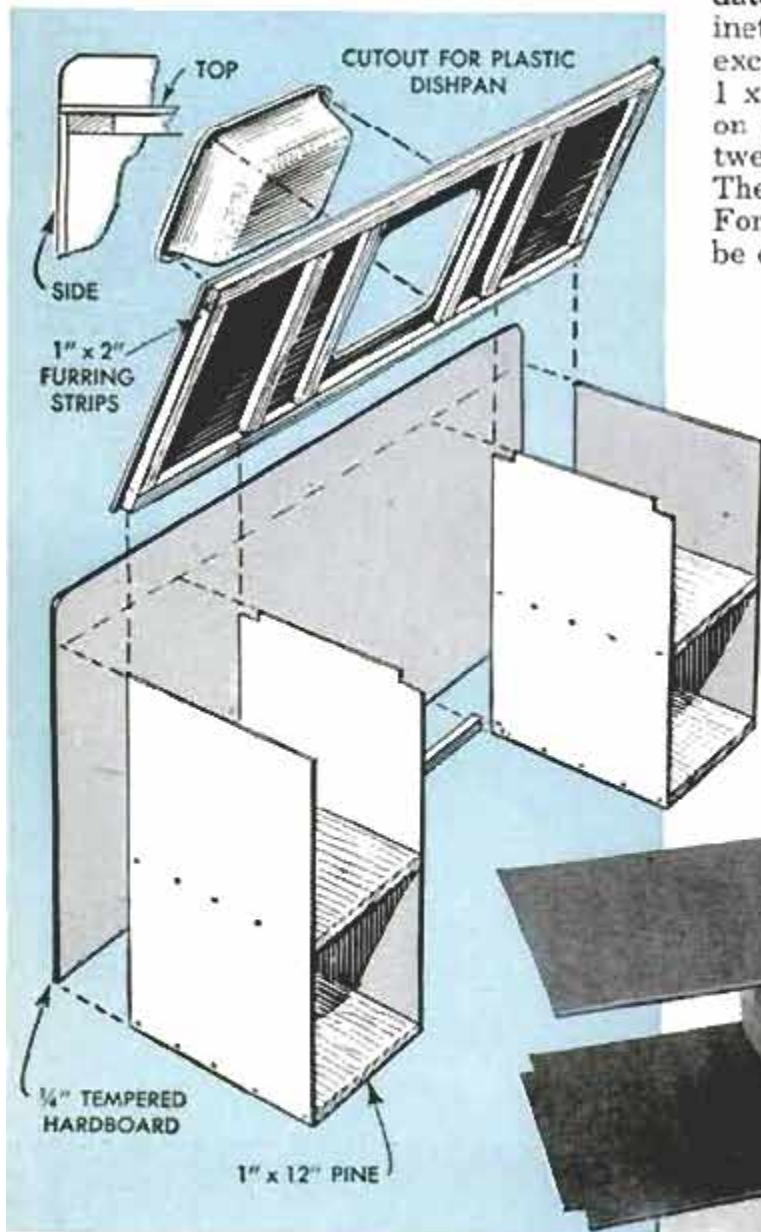

## Springs Hand-Wound On Bolt "Mandrel"

When a number of small-diameter springs, ( $\frac{3}{8}$ -in. in this case) were required, one hobbyist used a bolt as a winding mandrel. The head of the bolt is cut off and a hole drilled in the unthreaded portion. One end of the spring wire is wedged in the hole by a pin tapped into it. After the spring is wound, the wire is cut at both ends and the spring is "unscrewed" from the bolt. The wire is held under constant tension as it is wound.—Charles A. Oldroyd, Lancashire, England.

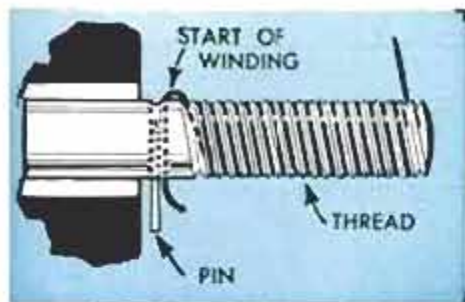

## Locknuts Hold Mower Adjustment

Spacing between the reel and cutter bar on a reel-type lawn mower is adjusted by means of two screws at each end of the blade. Once adjustment is made, the two screws are tightened against the blade so they apply pressure against each other to prevent them from rotating. Vibration, or a blow against the blade, sometimes will loosen the screws, and the setting of the blade will change. To prevent this, fit a locknut on each of the screws. After an adjustment is made, hold the screws with a screwdriver and tighten the nuts.

☐ Light frequent clippings are better than infrequent heavy cuttings to keep a hedge neat in appearance.

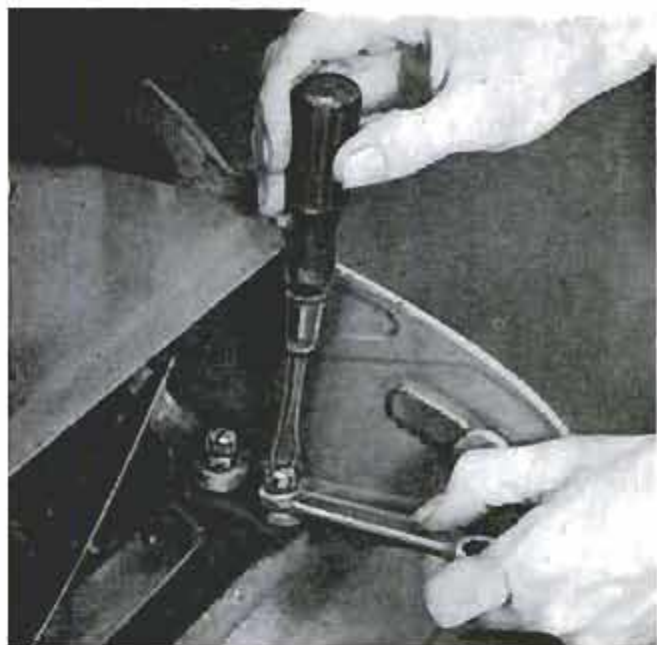

## Tandem Tractors With One Operator Pull Double Load

Two tractors coupled together help this Illinois farmer compensate for the manpower shortage at spring planting. Front wheels are removed from the rear tractor and its frame is pivoted to the drawbar of the front tractor with a ball joint. This assures easy maneuvering of the tandem unit at the headlands and also achieves a more uniform distribution of weight on the drive wheels.



**D**ESPITE THE ARRAY of electronic instruments now available to an auto mechanic for testing ignition and carburetion, and even valve action, he still uses a simple instrument to determine accurately the mechanical condition of an engine. A compression tester, essentially an air-pressure gauge, is used before a tuneup to let a mechanic know ahead of time whether a particular engine will run smoothly after the job is done.

When a cylinder shows a below-specification compression, accurate tests can be made to determine what component or components of that cylinder are malfunctioning and need repair or replacement. A pressure tester used by some professional mechanics consists of a device that fits the spark-plug hole to permit applying air pressure to a cylinder after the piston is brought to top dead center and both valves are closed. A gauge in this device then tells the percentage of drop in air pressure—loss of efficiency—which indicates the seriousness of the malfunction. At the same time, air leaking from various parts of the engine pinpoint the malfunctioning components. Air hissing from the carburetor shows that an intake valve is leaking, Fig. A. If air escapes from the exhaust pipe, an exhaust valve is leaking, allowing air to enter the exhaust manifold and pass through the exhaust system, Fig. B. If the sound of escaping air is heard at the oil-filler pipe, it means air is leaking past worn piston rings and entering the crankcase. New rings, and probably a complete engine overhaul, are indicated by this air leak. As a final check, the radiator cap is removed and the water inspected for air bubbles. Their presence means a crack in



## WHY A

the head or block, or a leaking head gasket. If two adjacent cylinders have a uniformly low compression reading, it is a good indication that the head gasket is leaking between them. A home mechanic can make a pressure tester by breaking the insulator from a spark-plug base and brazing a tire valve to it. Also, there is available a manufactured unit that has a spark-plug thread on one end and an air valve on the other. This unit is available in various sizes, and

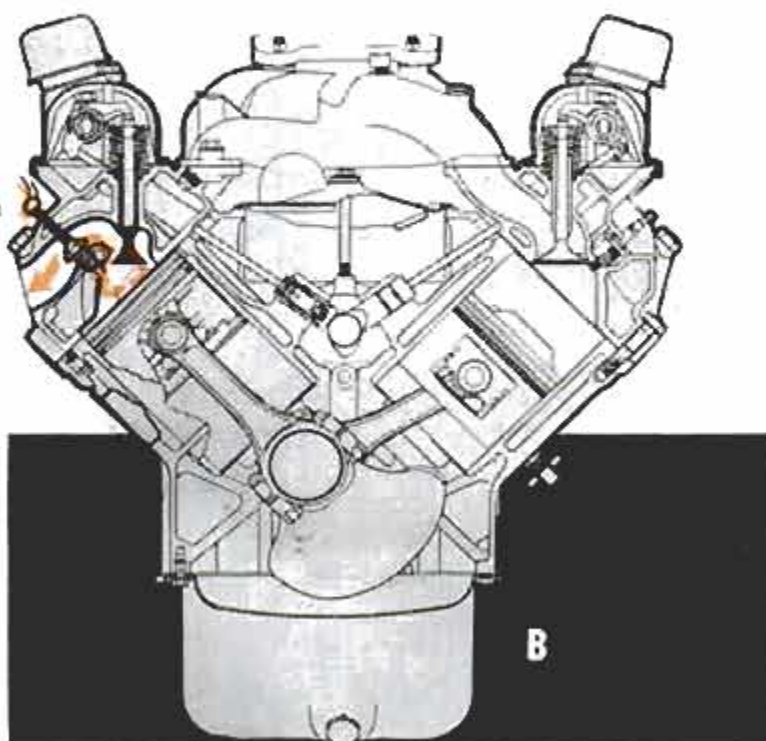
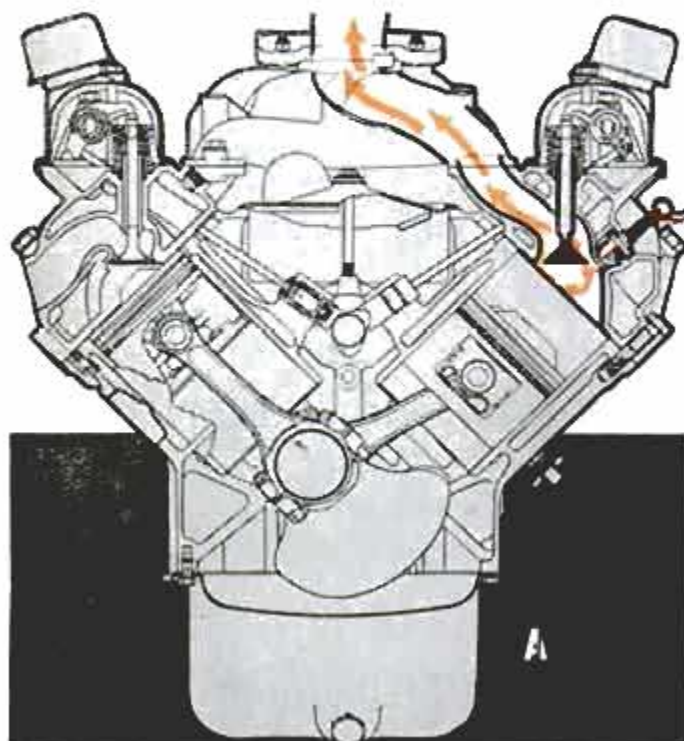



BURNED, PITTED OR  
WARPED VALVES

WORN PISTON RINGS,  
PISTONS AND CYLINDERS

WARPED HEAD OR  
LEAKING GASKET

# COMPRESSION TEST?

By Ed Packer

an extension tube can be used with it for engines that have deeply recessed heads, to permit connecting an air hose.

While pressure is produced in an auto engine by the upstroke of a piston, there also is a vacuum produced by the downstroke of the piston. This condition of negative pressure exists in the intake manifold through which the fuel-air mixture is pulled from the carburetor. As pressure,

or compression, is a factor of engine operation, so is vacuum. However, while compression is the result strictly of mechanical conditions, vacuum may be affected by carburetion and ignition. Thus, while a low and steady reading on a vacuum gauge can indicate low compression, it also can mean late ignition timing. A floating motion of the gauge needle from right to left means that a rich air-fuel mixture is present in the intake manifold. The rest of the vacuum-gauge readings show strictly mechanical faults inside the engine and, in some cases, will verify a diagnosis made with a compression tester.

One example has just been stated, that of low vacuum agreeing with low compression. Another would be a three or four-point intermittent drop of the vacuum-gauge needle indicating sticky valves. If a compression test of one or more cylinders gave a moderately high reading on the first compression stroke of the engine, but did not increase, this also could indicate sticky valves. Usually the compression pressure will build up several pounds with each stroke. Generally, three compression strokes will produce the maximum pressure possible, although if an engine is worn, several strokes are required to pump oil to the rings to seal them enough to build up additional compression.

A number of factors must be remem-

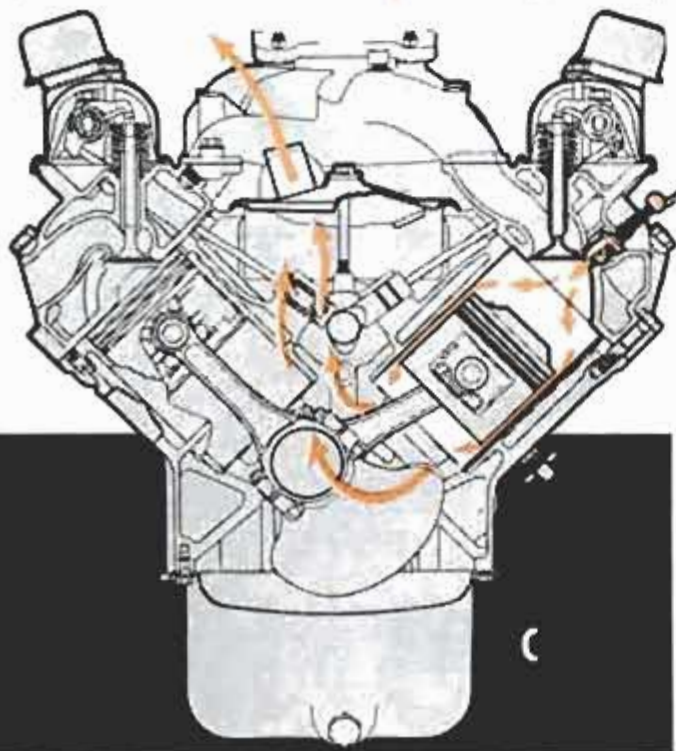



RAPID VIBRATION OF NEEDLE AT IDLE SPEED INDICATES WORN INTAKE-VALVE GUIDES.

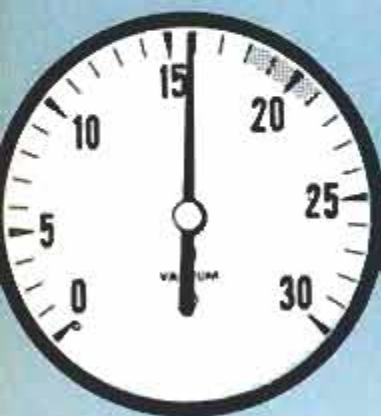

LOW AND STEADY READING INDICATES LOW COMPRESSION, AIR LEAKS OR LATE IGNITION TIMING.



RAPID VIBRATION OF NEEDLE WHEN ENGINE IS ACCELERATED INDICATES WEAK VALVE SPRINGS.



FLOATING MOTION OF NEEDLE FROM RIGHT TO LEFT INDICATES RICH FUEL MIXTURE.



THREE OR FOUR-POINT INTERMITTENT DROP OF NEEDLE INDICATES STICKY VALVES.

bered by the home mechanic when making tests of an engine. Because compression ratios have been increasing each year, compression pressures at cranking speed also have increased. Where 120 lb. once was considered high, 150 lb. and up now are considered normal. The manufacturer's specifications must be checked to determine the proper pressure. Because of the original high pressures, many engines will start easily and run smoothly when they are several pounds under the specified compression pressure. However, if there is a variation between cylinders of more than 10 lb., the engine will not run smoothly and there is a good chance that the engine will not start readily. Generally such a variation indicates the need for a valve grind.

Another reason for checking manufacturer's specifications is that vacuum readings will vary greatly between engines. So-called "low vacuum" engines will have a normal reading of 16 to 17 in. of vacuum as compared to most engines that have a reading of 22 to 23 in. of vacuum. The variation occurs because of camshaft design. If there is a large overlap in valve timing—that is, the intake and exhaust valves are open at the same time a greater number of degrees of crankshaft rotation—manifold vacuum will be low. These low-vacuum engines usually are rated at high horsepower. Engines of the "economy" type have mild camshaft grinds that produce a high vacuum in the intake manifold. Cars that have electric windshield wipers do not have a readily accessible vacuum line for attaching a vacuum gauge, but whether the engine is a V8 or inline type there is a pipe plug somewhere in the intake manifold. This plug is removed and replaced with a short length of pipe or a fitting to permit attaching the hose of a vacuum gauge. If a car has vacuum-operated windshield wipers, and there is a vacuum-booster pump—it will be combined with the fuel pump—the booster must be disconnected when taking vacuum readings. If this is not done, the gauge readings will be false, as the vacuum indicated will be that produced by the booster pump, rather than by the engine. ★ ★ ★

### Gap Spark Plugs With Care

When checking and setting the electrode gap on a spark plug, avoid exerting any pressure on the center electrode. Pressure on the center electrode, according to Champion Spark Plug Company, may damage the seal, causing compression leaks and pitting and burning of the plug shell. Always use a spark-plug tool and exert pressure only on the ground electrode.

## Straight Pin Used as Gauge To Set Spark-Plug Gap

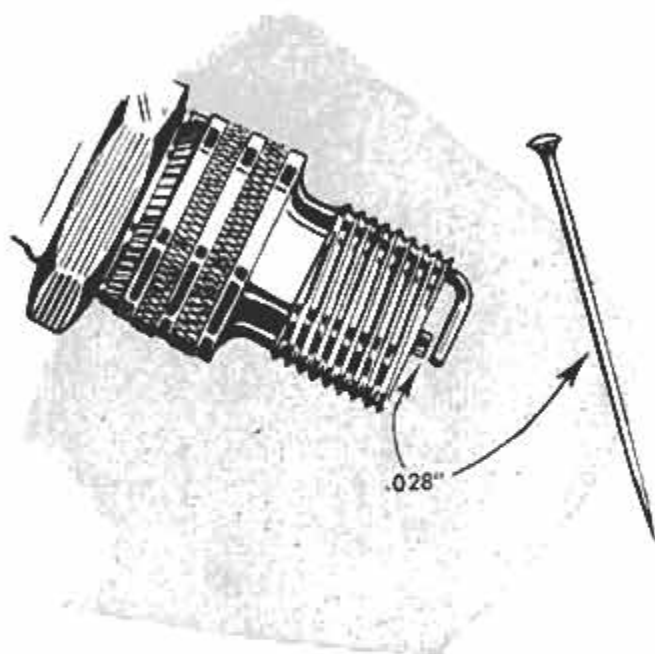

If the spark-plug gap for the engine of your car is .025 and no gauge is available, you can set the gap quite accurately by using a straight pin. The shank of a standard-size straight pin measures a uniform .028 in., thus if the plug gap is adjusted so the pin fits snugly in the gap, it will be nearly correct. When testing the gap with the pin, hold it lightly so that you can readily "feel" the correct measurement of the gap.

## Inexpensive Breakdown Insurance Provided by Spare Fan Belt

Kept in the trunk of your car, a spare fan belt or belts, if required, is inexpensive insurance against a breakdown miles from any garage. The big engines in modern cars will overheat quickly without the water pump in operation, and the many accessories will drain a battery in a short while if the generator is not being driven by the engine.



## Installation Date on Battery Is Preventive Maintenance

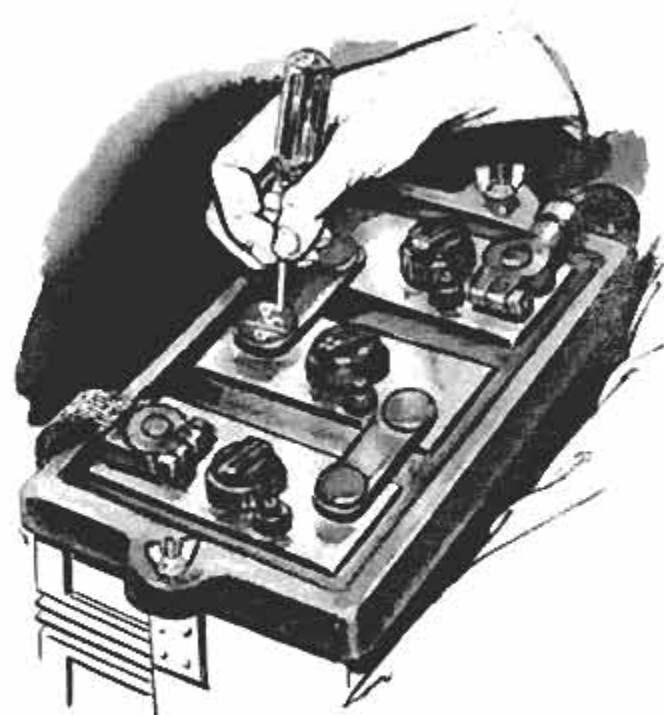

Both for purposes of checking the guarantee and to assure dependable car operation, it is wise to date the battery the day it is installed. If you have trouble with the battery a quick glance will tell you how long it has been in service. Also, if the date shows the guarantee is about to expire, it is time to buy a new battery.

## Auto Cleanliness Extended To Include Underhood Area

Whenever you wash your car, go a step further and clean under the hood. Wipe the oil and dirt from the air cleaner, then use the same cloth to clean the battery top. Discard this cloth, as it will have acid on it. Use a vacuum cleaner to blow through from the back of the radiator core to remove debris and insects.

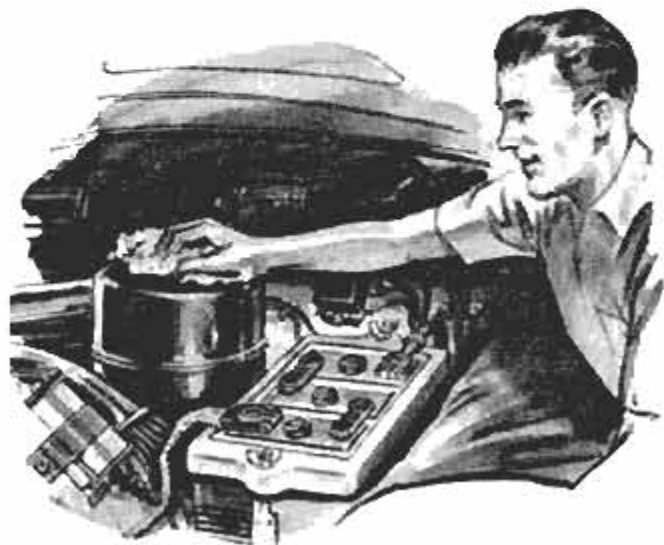

WHITE CAST IRON



1

GRAY CAST IRON



2

LOW-CARBON STEEL



3

HIGH-CARBON STEEL



4

HIGH-SPEED STEEL



5



STREAM

SHAFT

FORK

SPRIGS

DASHES

APPENDAGES

BUD.  
BREAK. ARROW

14

15

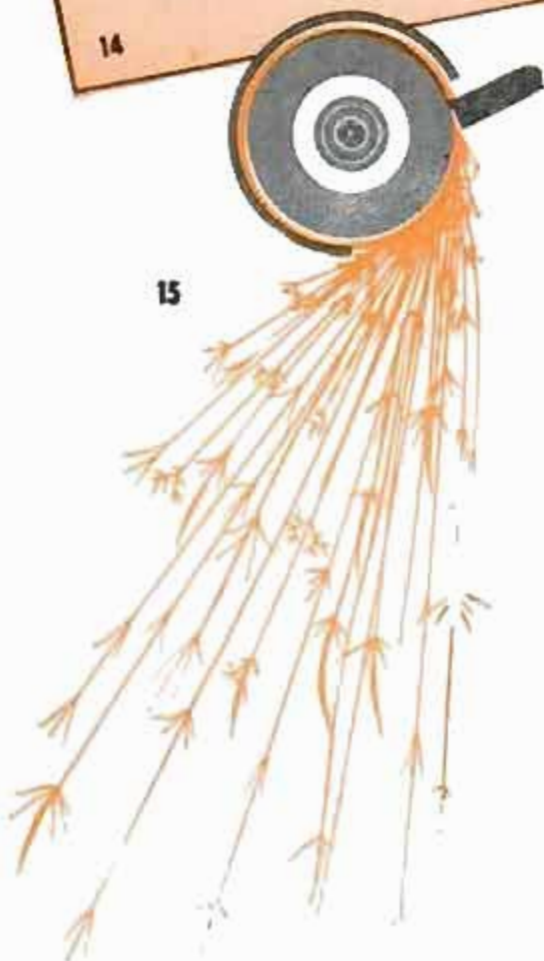

## SPARK CHARACTERISTICS

1. **WHITE CAST IRON.** Length of spark stream is about 20 in. Volume is small, color straw-yellow. Sprigs are small, repeating
2. **GRAY CAST IRON.** Spark stream is straw-yellow, length about 25 in. Sprigs are small, repeat along length of each streamer
3. **LOW-CARBON STEEL.** Color is white, spark stream moderately large. Length is 60 to 70 in. with forks, appendages
4. **HIGH-CARBON STEEL.** Stream is white, of fairly large volume with numerous small, repeating sprigs. Length 50 to 55 in.
5. **HIGH-SPEED STEEL.** Spark stream averages 60 in. long. Individual streamers are small, straw-yellow with only a few forks
6. **STAINLESS STEEL.** Stream is moderate in volume, straw-colored near wheel and white near end. Streamers end usually in forks
7. **TUNGSTEN (CHROMIUM).** Stream is of small volume, 35 in. or so in length, red near wheel, white near ends. Forks are repeating
8. **WROUGHT IRON.** Stream is yellow, about 65 in. in length. Volume is fairly large, streamers ending in forks, appendages
9. **MALLEABLE IRON.** Length, volume of stream is moderate, straw-yellow turning to white, ending in small, repeating sprigs
10. **NITRIDED (ALLOY STEEL).** Stream is large with curving streamers up to 50-60 in. long, white and ending generally in forks
11. **ALLOY (COBALT, CHROMIUM, TUNGSTEN).** Volume of stream is generally small with short streamers, usually red near wheel
12. **TUNGSTEN CARBIDE (CEMENTED).** Stream is very small, rarely more than 3 in. long and is light orange throughout length
13. **NICKEL.** Volume of stream is very small with occasional wavy streamers 2 to 3 in. long. Color is orange throughout

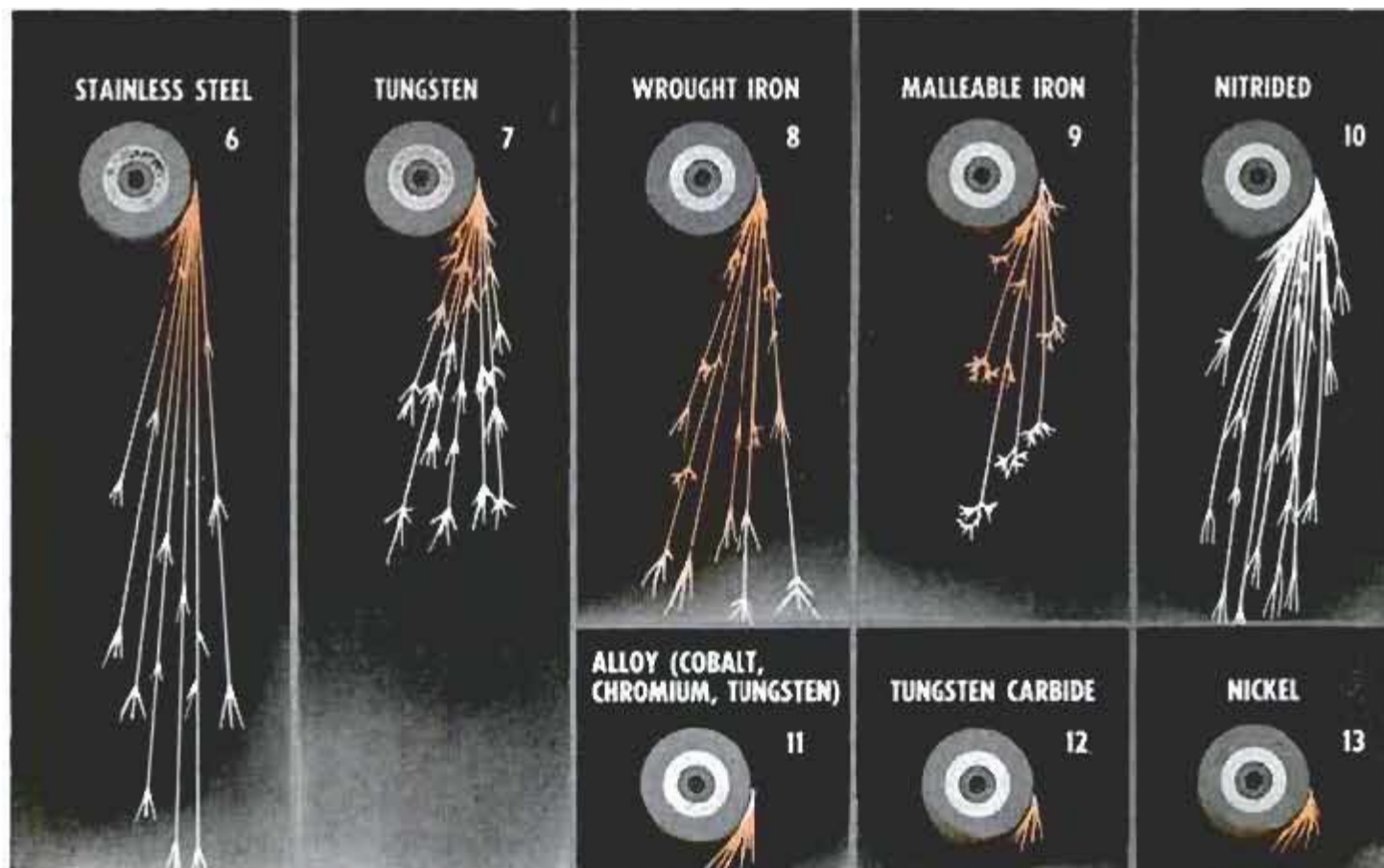

## SPARK STREAMS IDENTIFY METALS

By C. W. Woodson

**S**PARK TESTING is a quick method often used in shops and also by junk dealers and others for identifying unclassified metals. When testing is done by an operator experienced in "reading" the spark patterns the method has proved quite accurate.

The work can be done on any ordinary bench or pedestal grinder having a wheel speed of 3450 r.p.m. The pedestal grinder is, of course, best as it is possible to judge the length of the spark stream, as well as its characteristics, to better advantage. The grade of the abrasive wheel used can vary, as the important characteristics of the spark patterns of different metals will not be appreciably affected. However, in most cases, the degree of coarseness of the wheel will vary the length of the spark stream to some extent. As a rule a coarse wheel will give a longer spark stream with a given metal than will a fine wheel. The latter will throw a somewhat shorter stream but the sparks will have essentially the same characteristics. The wheel should be dressed before being used for spark testing. The test piece should be clean.

Pressure of the test piece against the face of the wheel should be light to moderate. Heavy pressure will cause the test piece to heat rapidly. This will increase the volume

of the spark stream and in some instances may affect the pattern, giving the effect of a higher carbon content in the test piece than it actually contains.

Locate the grinder so that the spark stream can be viewed against a dark background. Although in many instances the test piece can be held on the tool rest as in Fig. 15, it may be advisable, when testing metals giving off long spark streams, to remove the tool rest and shift the guard so that the test piece can be touched to the bottom of the wheel. This will result in a horizontal spark stream and may give a more accurate measure of its true length. To assure a normal spark pattern in which the bursts can be closely observed, make sure that the stream is not deflected by drafts. Air currents from a fan also will affect the formation of the sparks.

Fig. 14 details the common forms of sparks, or spark bursts, which ordinarily appear in the spark streams from various metals. Figs. 1 to 13 inclusive detail the appearance of spark streams from test pieces of the common metals. Due to the limitations of printing these cannot be taken as precise representations. The details are intended only to indicate in a general way the volume and character of the streamers and spark bursts.



## Shingles Dip-Painted Before Applying

If you plan on painting or staining shingles before applying them, deeper penetration of the stain can be had by dipping them individually. Stain need not be thinned for dipping, but paint should be reduced with a quart of thinner to a gallon of paint. Use an old tub or pail and fill it so the shingles will be stained 2 in. beyond the area to be exposed to the weather. Drive a small nail through the thin part of each shingle, at an angle, so it can be hooked over a clothesline. Shingles should be thoroughly dry before nailing in place.—R. Dillon Kiniry, Woburn, Mass.

## Accurate Center-Punch Layout Assured With Simple Jig

Making a center-punch layout on metal can be done more quickly and accurately with the aid of this simple jig. It is bent from light sheet metal in the form of a modified try-square as indicated, the leg, or flange, being shaped to fit the thickness of the metal. After the jig is bent to shape, a square is used to mark a line of equally spaced holes that are drilled to a size just large enough to accommodate the point of the center punch. Locating the holes a definite distance from the edge of the jig will permit it to be used also for spacing the punch marks.

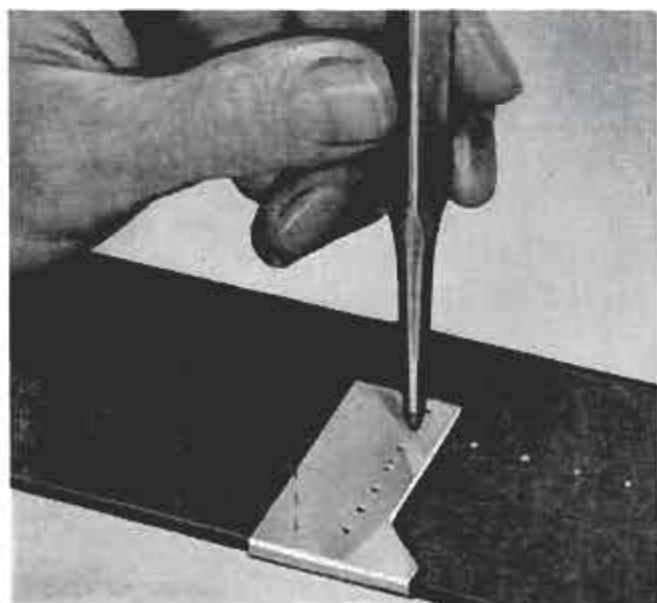

## Sheet-Metal Cutting Tool Shaped From Auto Valve

Irregular curves can be cut in fairly heavy sheet metal with this cutting tool which is shaped from the exhaust valve of an auto engine. The valve is refaced to a knife edge, then a flat is ground on one side to provide a hammering surface. A wooden file handle is modified to accommodate the valve stem and the tool is complete. Use an exhaust valve in preference to an intake valve, as the former is of tougher steel and will hold a cutting edge longer. Discarded valves can be obtained from the scrap container at any service garage.—H. J. Gerber, Stillwater, Okla.



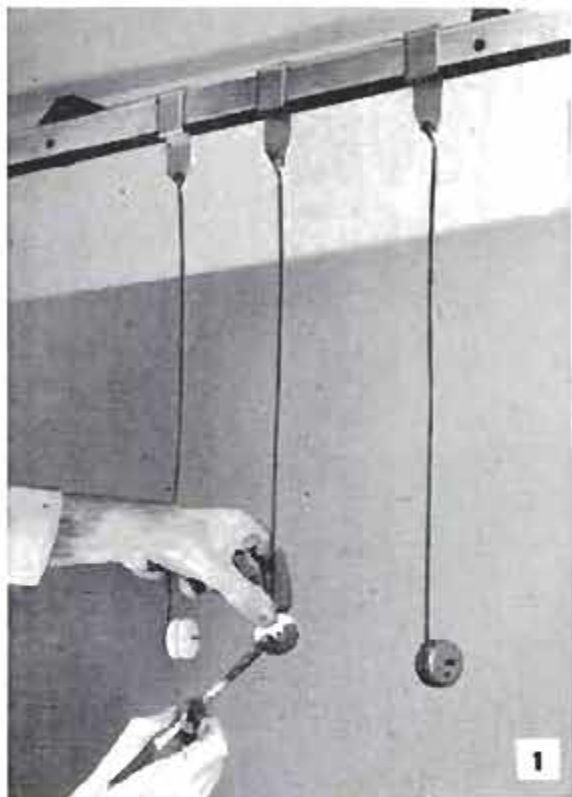

## TRACK-MOUNTED HOIST FOR THE WORKSHOP

THIS HOIST when attached to the ceiling over your workbench in the manner shown in Fig. 2, provides the equivalent of a third hand for holding various work. To accommodate a number of lightweight pieces of work for painting or other purposes, U-shaped clips to which lengths of wire are attached are provided as in Fig. 1. The clips are forced from  $\frac{1}{8}$  x 1-in. lengths of aluminum, allowing sufficient clearance for a sliding fit. Also, objects having a clamping device on them, such as the photofloodlamp in Fig. 4, can be clamped on the track when an overhead position is desired for the work.

The track is made from a  $\frac{3}{4}$  x  $\frac{3}{4}$  x 54-in. length of steel angle to which a  $\frac{5}{8}$  x  $1\frac{1}{16}$  x 54-in. length of hard maple is bolted as in Fig. 3. The track mounts consist of L-shaped brackets bolted on the back of the track and screwed to ceiling joists as indicated. The roller-equipped hanger for the hoist is made as detailed in Fig. 3. The rollers consist of two short lengths of  $\frac{1}{2}$ -in. rod center drilled to take  $\frac{1}{4}$ -in. bolts, and  $\frac{1}{4}$ -in. washers that are clamped against the roller ends when assembled to serve as flanges. The Z-shaped bracket from which the hoist is suspended is formed so that the lower flange is aligned vertically with the centers of the rollers. Any light-duty block and tackle may be used as a hoist, or it can be assembled from a length of rope and two single-pulley blocks equipped with becketts.

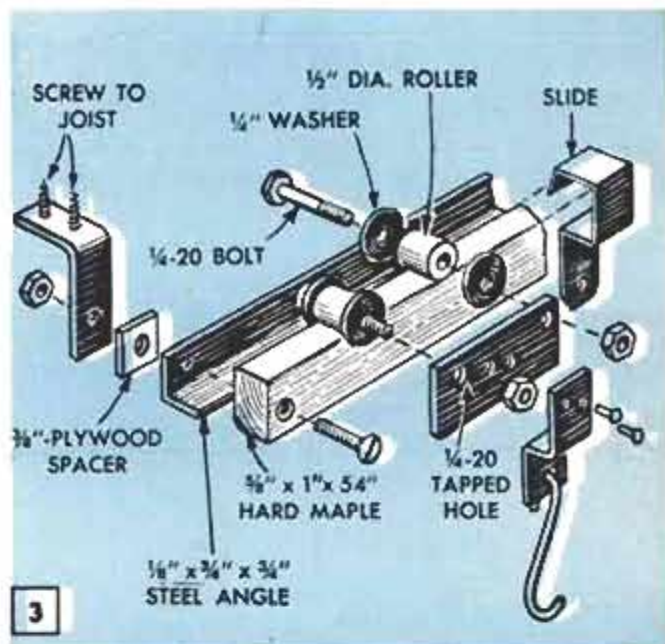

Below, photoflood lamp clamped on track provides ideal overhead lighting arrangement when photographing material or project displayed on workbench top



# ROUTER PLANE

**Has Adjustable Cutter  
Made from Stove Bolt**

By C. W. Woodson

SMOOTHING AND TRUING the bottom surfaces of sawed or chiseled grooves and mortises, whether they have closed or open ends, Fig. 2 and 3, is a simple job with this shop-built router plane. The cutter blade of the router is an ordinary  $\frac{1}{4}$ -in. flat-headed steel bolt, the head of which is filed at a 2-deg. angle so it presents a sharp, curved edge to the wood, Fig. 4. Two locknuts position the cutter for depth below a base cut from  $\frac{5}{8}$  or  $\frac{3}{4}$ -in. plywood. The blade is centered in the base, which measures  $7\frac{1}{2} \times 9$  in., Fig. 5. It can be made smaller or larger to suit individual requirements. Handles for the plane are cut from  $\frac{3}{4}$ -in. plywood or 1-in. hardwood. The latter is preferred, as it is easier to round and shape the wood to form a comfortable hand grip. Handles can be shaped by using the squared pattern in Fig. 4, or, if you have a favorite plane, its handle can be traced and used as a pattern. Countersunk, flatheaded screws are driven through from the underside of the base to attach the handles. A counterbore is required to recess the lower locknut on the blade. A wooden disk and a metal washer aid in holding the cutter firmly in place. The plane, Fig. 1, is used in a manner similar to that of a regular plane, except that two hands are used.

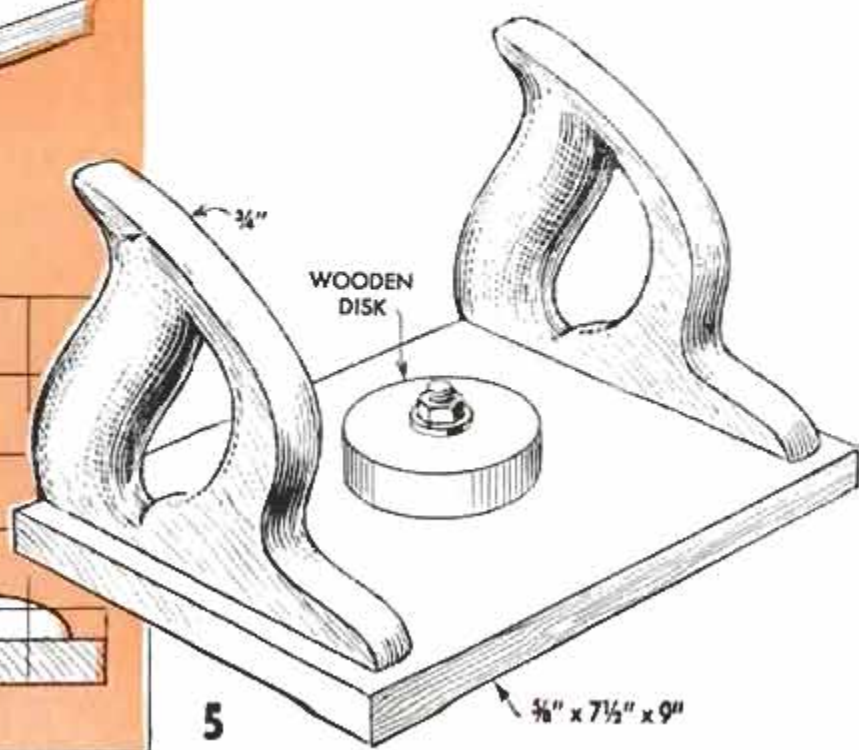
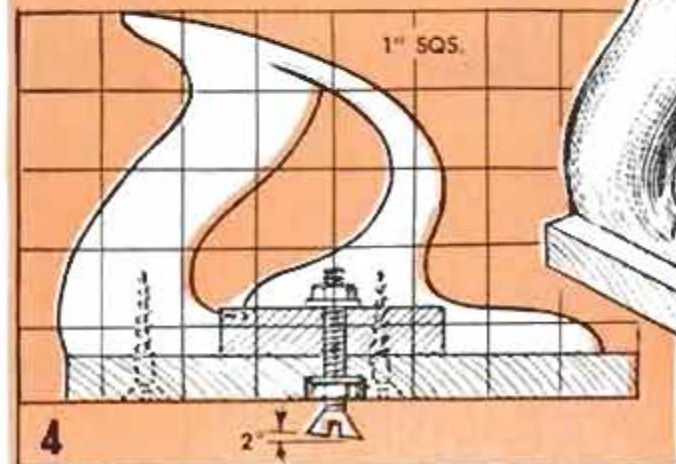
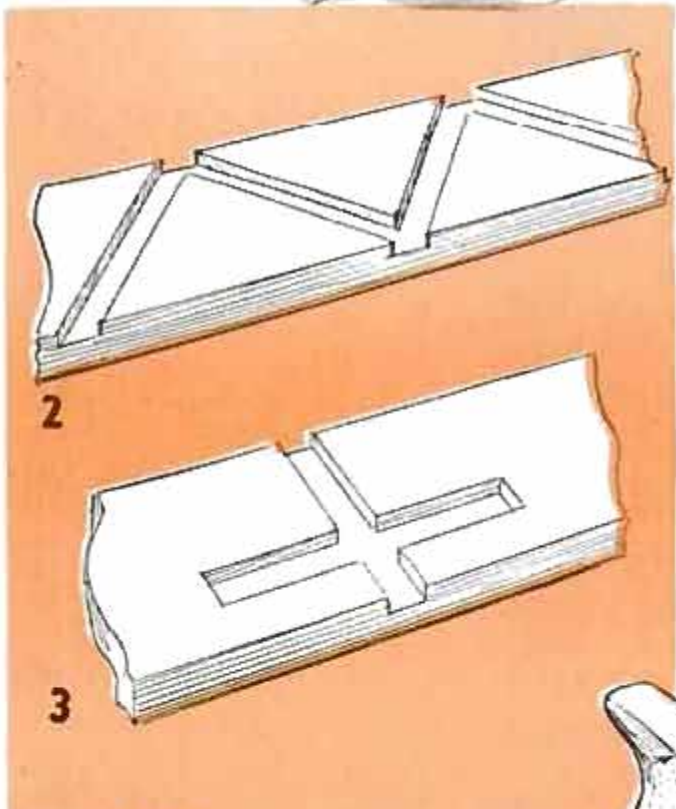



## Strips of Masking Tape Indicate Lengths of Bolts

Bolts, capscrews and other stock items kept in bins or stacked drawer units are easily checked for desired length by means of strips of tape attached to the drawer fronts. Without opening the drawers, the strips show the exact length of the bolts or screws. When desirable, other data pertaining to the contents can be lettered on the tape in ink. Strips are easily removed when bin contents are changed.

A coping saw fitted with a fine blade having 32 teeth per inch is just the thing to cut plastic tile, especially where you have to make short-radius cuts in fitting the tile around bathroom fixtures or pipes that come through the wall. Beeswax or paraffin rubbed on the sides of the blade will prevent it from binding in those short-radius cuts.



## Holder for Small Twist Drills

Remove the elements from a radio-tube base and you have a handy holder for those small twist drills that are so easily lost in a drawer or toolbox. Cut a strip of corrugated paper to a width slightly greater than the depth of the base. Roll the strip into a core to fit snugly inside the base. This will form pockets in which the drills can be arranged in order. Mount on a discarded tube socket screwed to the tool panel, or drill 6 holes in a suitable block to take the base prongs.



## Adjustable Jig for Accurate Scribing of Parallel Lines

This simple jig offers a fast and reasonably accurate means of scribing parallel lines on round and square stock. It's adjustable to suit varying widths and diameters. Consists of two threaded scribers with hardened points, two slotted bars, or carriers, two guides and the necessary thumbscrews. The scribers are turned through tapped holes in the slotted bars and are held in the desired position with locknuts. Slots in the bars permit adjustment, parallelogram-fashion, for varying sizes of work.

Bruce D. Stewart, Winder, Ga.

Those unsightly worn spots on the floor-mats of your car can be quite neatly repaired with shoe soles of the type having one face coated with an adhesive.

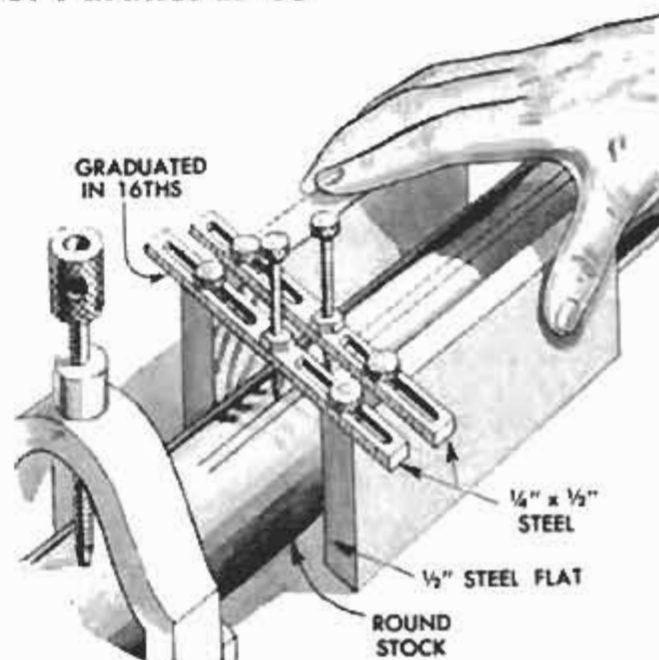

Two views below show how pattern is used for scribing mastic, also how mastic is cut

Left, this glass tube is the tool tip through which chemicals that do the actual cutting are conducted to the surface of workpiece

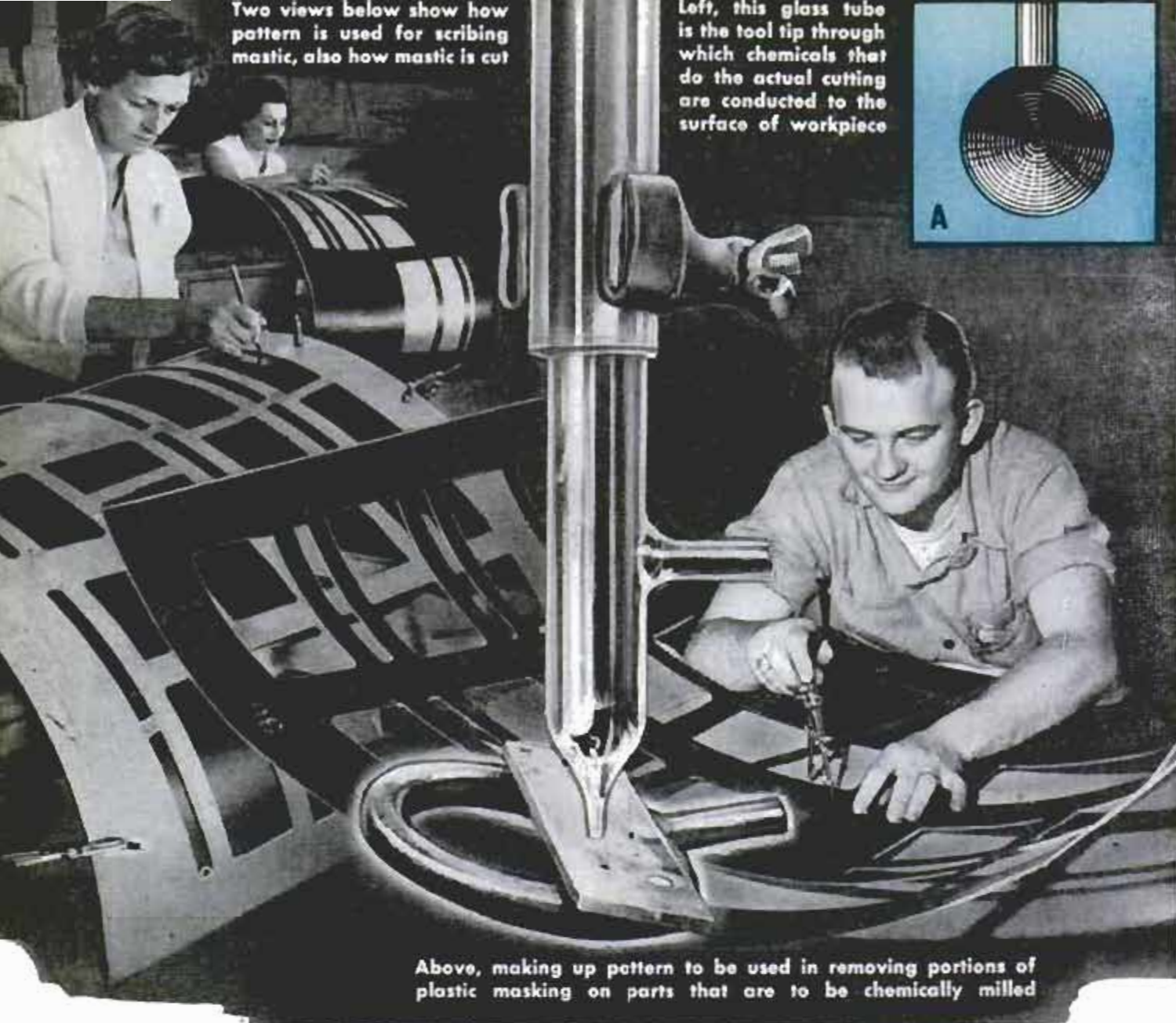
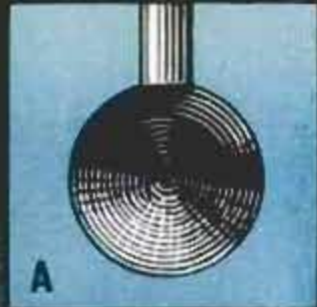

Above, making up pattern to be used in removing portions of plastic masking on parts that are to be chemically milled

### to drill, shape, mill, sharpen, superhard metals on tight production

**T**ODAY METALLURGISTS are developing fantastically tough metals for use in such new power units as rocket motors, jet turbines and atomic-pile plumbing. These metals withstand heat that would erode ordinary steels to dust, or reduce them to liquids in seconds. Some must not only withstand rock-melting heat, they must also take explosive impact without shattering or crumbling, and resist the corrosive action of newly developed chemical fuels.

These new metals, many of which ordinary tools will not even scratch, posed what at first appeared to be unsolvable machining problems. In early experimental work, special machining methods with

specially developed cutting tools were tried and discarded as the operations soon proved to be impractical, or too time consuming to be fitted into any modern production schedule. It was then that engineers remembered acids that erode, or "eat" into and through metals by chemical action. They came up with "liquid tools" that would machine almost anything machinable, and do the job on schedules that matched, and in some instances exceeded, the fastest methods developed in shops for work on the common metals.

For example, Engineer **E. V. Howe** of General Electric's Schenectady, New York, laboratory demonstrates the speed and precision of liquid tools on an alloy bar of



Spiral gear with lower portion chemically polished in minutes. Hand honing would take hours



Early laboratory setup for electrolytic milling. Work is rotated by geared motor under glass "tool" at right side of apparatus

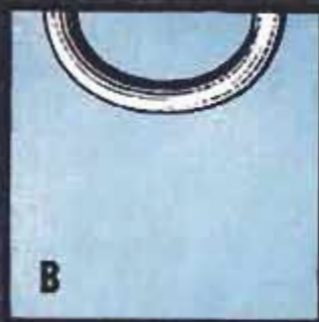

B

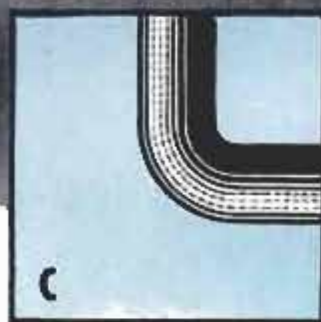

C

Grooves, contours are cut in superhard metals to precise dimensions. Work is simply turned under tool

Details A to D show graphically hole-forming versatility of electrolytic, or chemical, milling. Detail E shows how contours are formed by multiple jets

# CHEMICALS

## clean and polish schedules

cobalt and tungsten carbide, one of the toughest of the tough metals. In this he has drilled two precision holes experimentally. The first one took nearly three days by conventional methods. The second hole went through in 15 minutes. Using liquid tools Howe can drill a hole in from one face of the work and enlarge it within the material; drill in and out on the same face of the stock; drill in on one face and out on an adjacent face, or drill a hole to a given diameter and degree of taper. See the details A to D inclusive. Hard alloys can be machined all over, grooved and shouldered to precise dimensions. By arranging tool tips side by side in a suitable holder as in detail E, almost

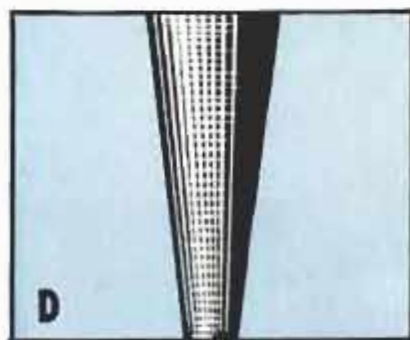

D

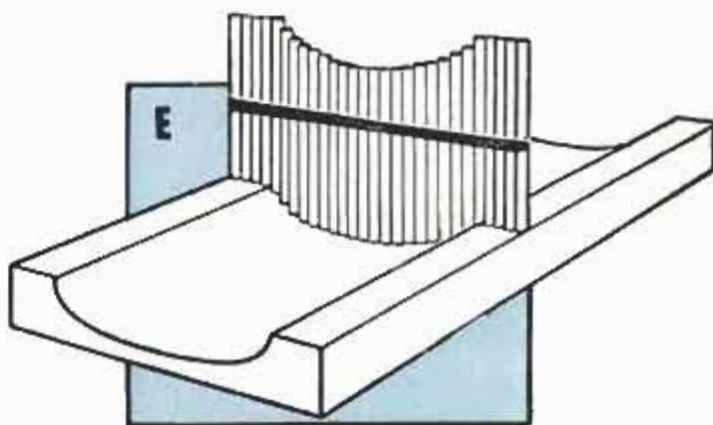

E

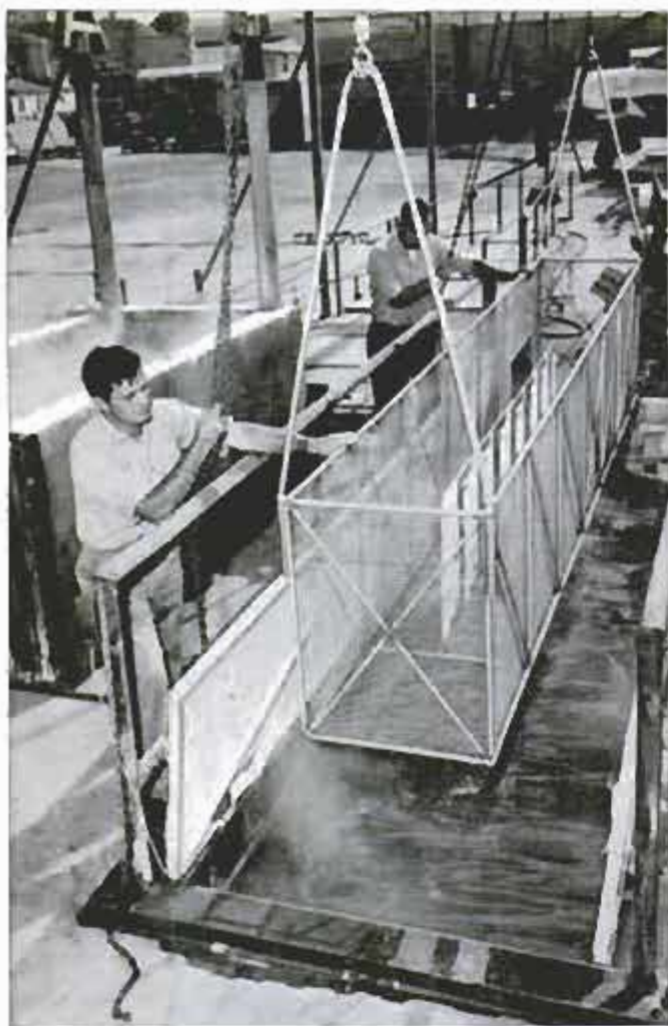

Large sheets of metal to be chem-milled are placed in a carrier and lowered into a tank containing liquid "tool." Time of immersion is closely controlled

Small parts are worked with the setup shown diagrammatically below. Here glass tip is used to concentrate work of liquid tool, as in drilling a hole

any desired contour can be machined on the face of the stock. Finished work can be given a polish which equals or exceeds in brilliance and smoothness that produced by ordinary methods of grinding and polishing. In many instances this can be accomplished in a fraction of the time required by conventional methods.

Described in simplest terms the process is electroplating in reverse. Particles of metal are removed from the work, which serves as the anode, and deposited on a cathode. Electrically charged combinations of sulphuric, hydrochloric and hydrofluoric acids with addition of various salts (electrolyte) are pumped through a system like that diagrammed below. The electrolyte, flowing through a shaped glass tube under closely controlled conditions, removes tiny particles of metal from the workpiece. The glass tube, which is necked down to form a small orifice at the tip, never touches the work. It serves only to direct the flow of the electrolyte which does the cutting. By using single or multiple glass tips in varying sizes and arrangements it is possible to duplicate almost any ordinary machining cut in the hard metals. In hole drilling and in certain other cuts, computing the speed with which the liquid cuts through the metal indicates the rate at which the tip must be advanced to produce a hole of a given diameter or a cut of a given depth. Curved holes, right-angle turns within the material, and other penetrations are made by using curved glass tips, flexible tips, or tips made with jets, or orifices, located on the side rather than at the end. According to the engineers who have carried out the extensive

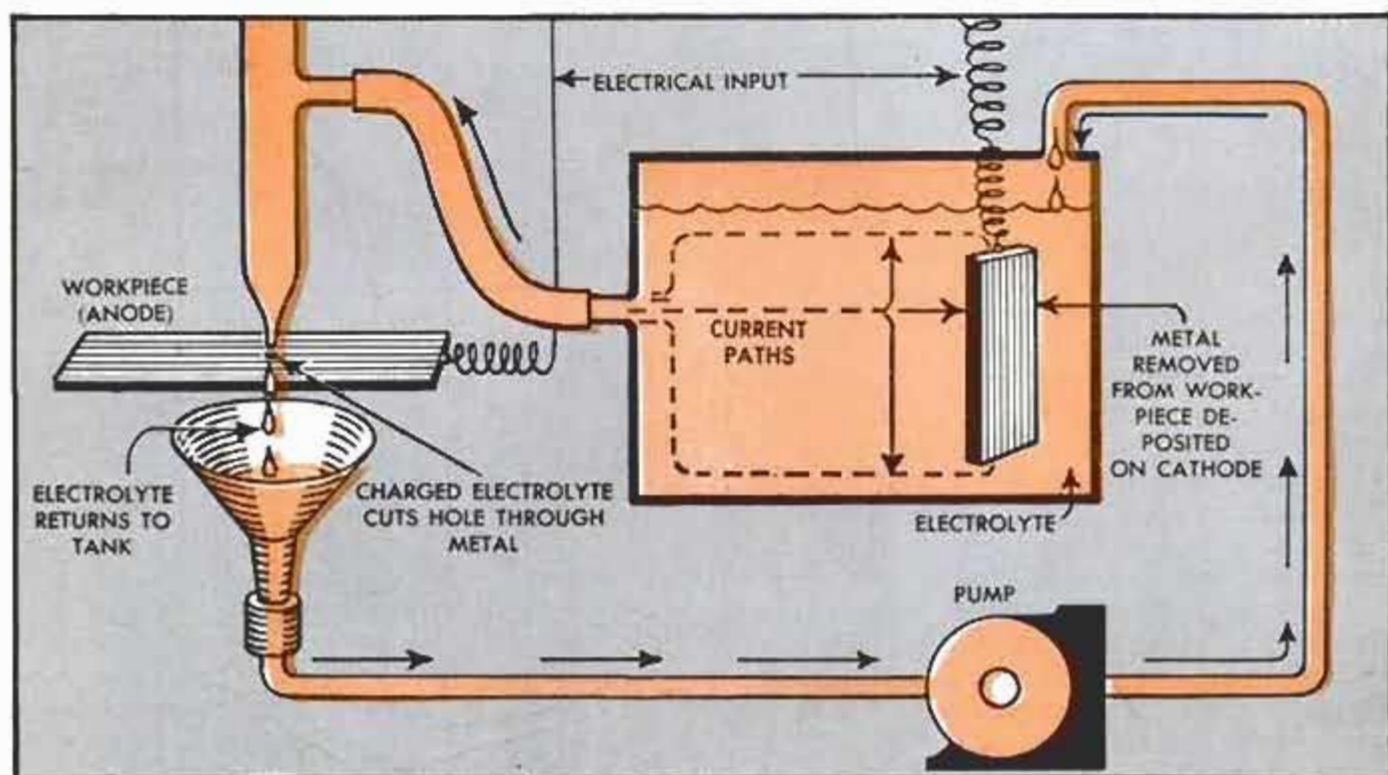

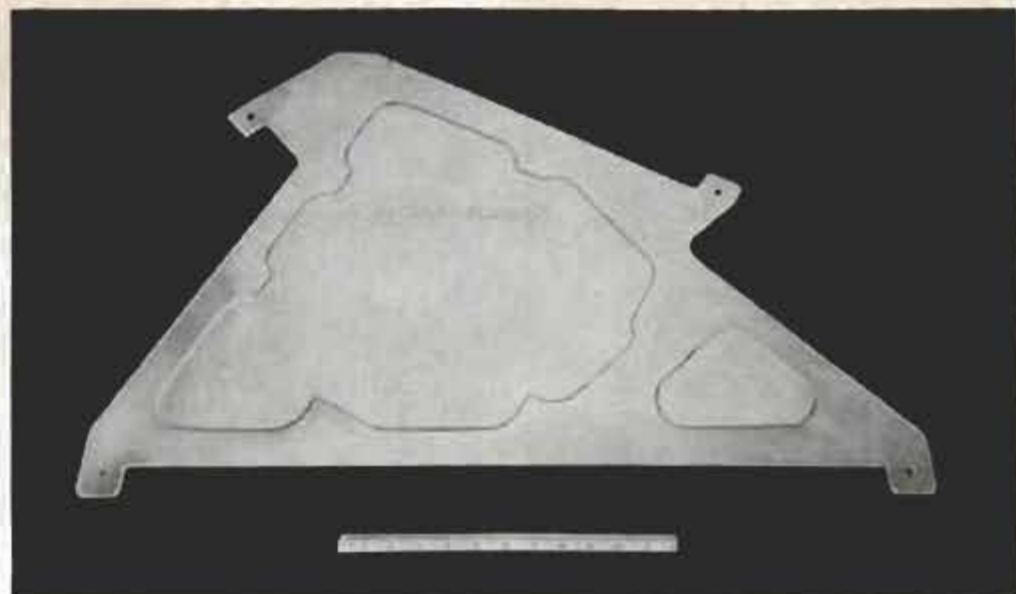

Left, spiral grooves cut on the outside of a rocket nozzle by chemical milling. The grooves serve as coolant passages after outer skin is attached. Right, recesses chem-milled in panel of thin sheet metal

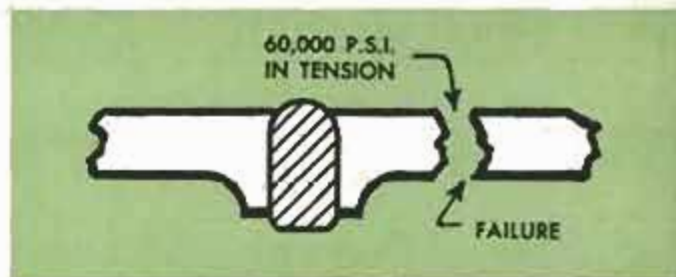
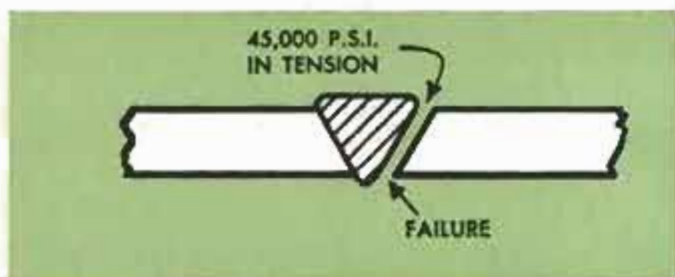

Aluminum sheet fails at weld under tension. Sheet has not been milled. Compare with detail at right

Sheet similar to that at left milled after welding does not fail at weld, even under greater tension

Tanks sufficiently large for immersing large aircraft parts are located as pictured. Overhead hoists are provided for lowering and raising carriers in which parts are placed. Immersion time is controlled

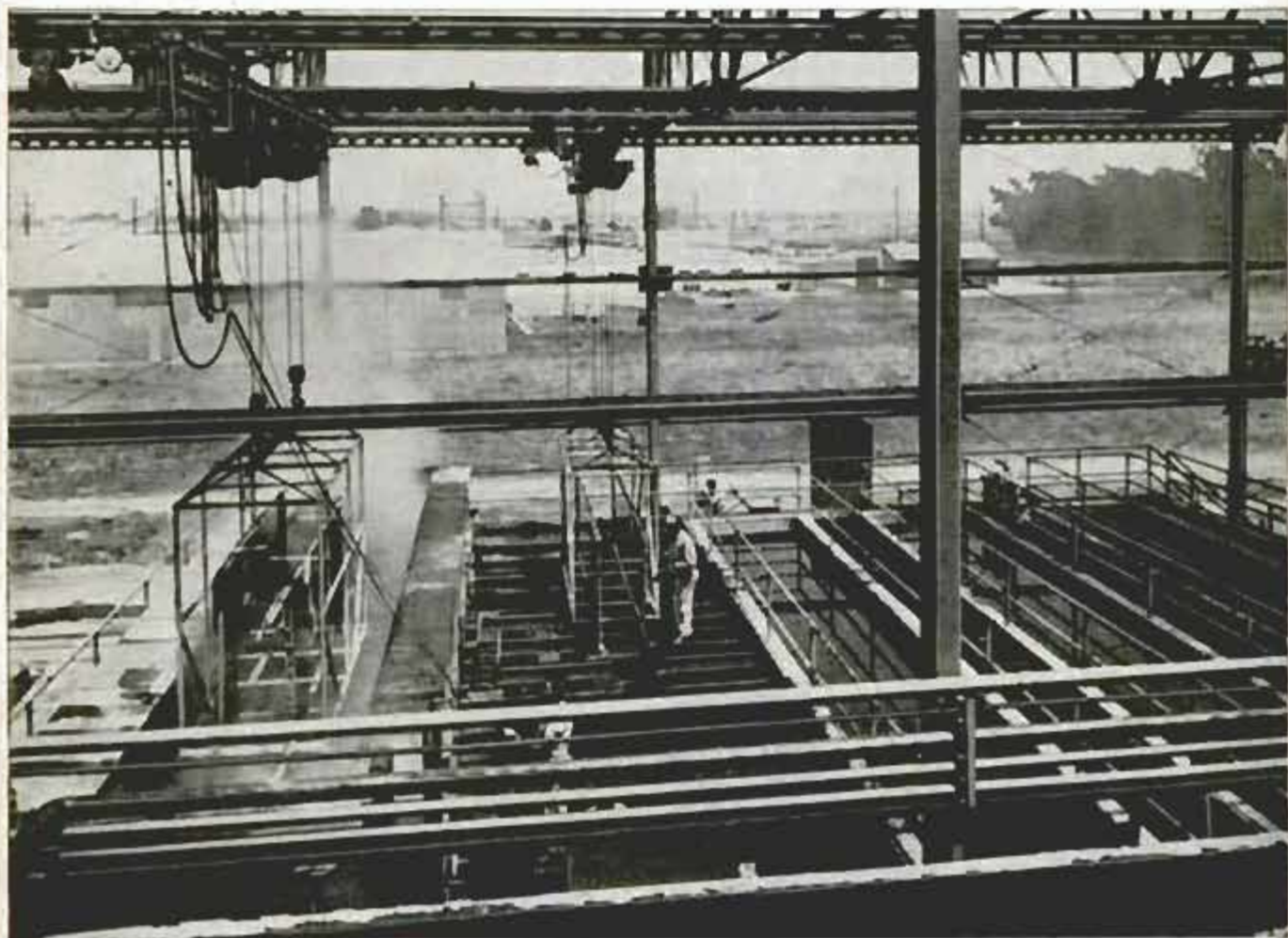



Left, examples of electrolytic drilling and recessing in superhard metals. Cord shows how hole was drilled in from surface and out on adjacent side. Right, micrometer is used to check thickness after chem-milling

experimental work, the trick in attaining precise and uniform results is to determine the proper electrolyte for a given metal and then combine this with an electrical charge of just the right density.

By slowing or speeding up the progress of the tip at a constant rate, it is possible to "drill" holes to a uniform taper of almost any degree required. Once a uniform cutting rate has been established with a given setup, it is possible to duplicate certain parts to a semifinished or finished state with an accuracy comparable to those mass-produced by conventional methods from common materials.

Another process, similar in principle but differing in application, has been developed. Instead of confining the cutting action of the chemical tool to a very small area as is done in drilling and other operations with a glass tube, or jet, the material to be machined or milled is coated with a plastic masking, as the first step. The plastic coating is then cut away, using a pattern, or template, as a guide to those portions of the metal which are to be cut away. The workpiece is then lowered into a tank containing the chemical "tool," which cuts away the exposed portions of the metal, leaving uncut those sections protected by masking. The time of immersion is determined by a preset timing device. At the end of the predetermined period the work is lifted from the bath automatically. It is then rinsed in a neutralizing bath.

This simple method of cutting through

and recessing metals is now widely used by manufacturers in making huge airframes and also highly specialized parts for rockets. Not only does this new technique of milling with chemicals, or chem-milling, as it has come to be called, create shapes that are difficult or even impossible to machine by conventional methods, it produces many parts faster and cheaper than can be produced with ordinary machine tools. It has been found possible by these new methods to hold work to tolerances that compare favorably with conventional manufacturing practices. As a result chem-milling has been applied not only to the shaping and machining of superhard metals but to the softer metals such as aluminum, magnesium and carbon steels. Castings and forgings of some types are now shaped with chemical tools. Steel shipping containers, radar aerials, pump impellers, even decorative metal panels have been produced. Experimental work has been done in the field of reconditioning and sharpening edge tools.

At present the field of chem-milling still is greatest in the aircraft industry where machining speeds and weight reduction are of prime importance. As an example, every pound that can be removed from the parts of a rocket without impairing efficiency and necessary strength gives the missile an additional three miles of altitude with a corresponding increase in range. Tubing conveying fuel in rocket engines is first bent to the required shape and then is chem-milled to minimum wall

thickness. The ends of the ducts, which require extra strength for clamps, are masked during the milling process and retain their original thickness. As much as 20 lb. per missile can be saved in this way. Similarly, 100 lb. of unneeded metal is milled from bulkhead rings of the Lockheed Constellation series of aircraft, a saving that wasn't practical before chem-milling was developed, because of the high cost.

"Chemical milling had only a few uses when we developed it five years ago," says Manuel C. Sanz, chief of materials research at the missile division of North American Aviation. "Then we found we could do a number of tricks with it.

"We can taper the thickness of a sheet of metal simply by lowering the sheet very slowly into the chemical bath, a metering hoist lowering it at a preset rate. The depth of cut depends on immersion time so a very smooth taper is produced. A somewhat similar effect is obtained by

lowering the sheet in a series of steps, or by progressive unmasking.

"To produce a crowned shape we rotate a part and slowly immerse it at the same time. The outer edges are in the bath longer than the material near the center, hence more metal is removed from the edges.

"Of course, there are things that chemical milling can't do. It isn't going to put any standard tool out of business. But in its special fields it has been estimated that \$30,000 worth of chem-milling equipment can do the same amount of work as three milling machines costing perhaps \$600,000."

One of the greatest advantages of the process of chem-milling is that very thin material can be worked on one or both sides without any danger of distortion due to stress, or warping due to heat. This permits working complex shapes and intricate patterns at great savings over stamping, which calls for costly dies and a large investment in individual machines. ★ ★ ★

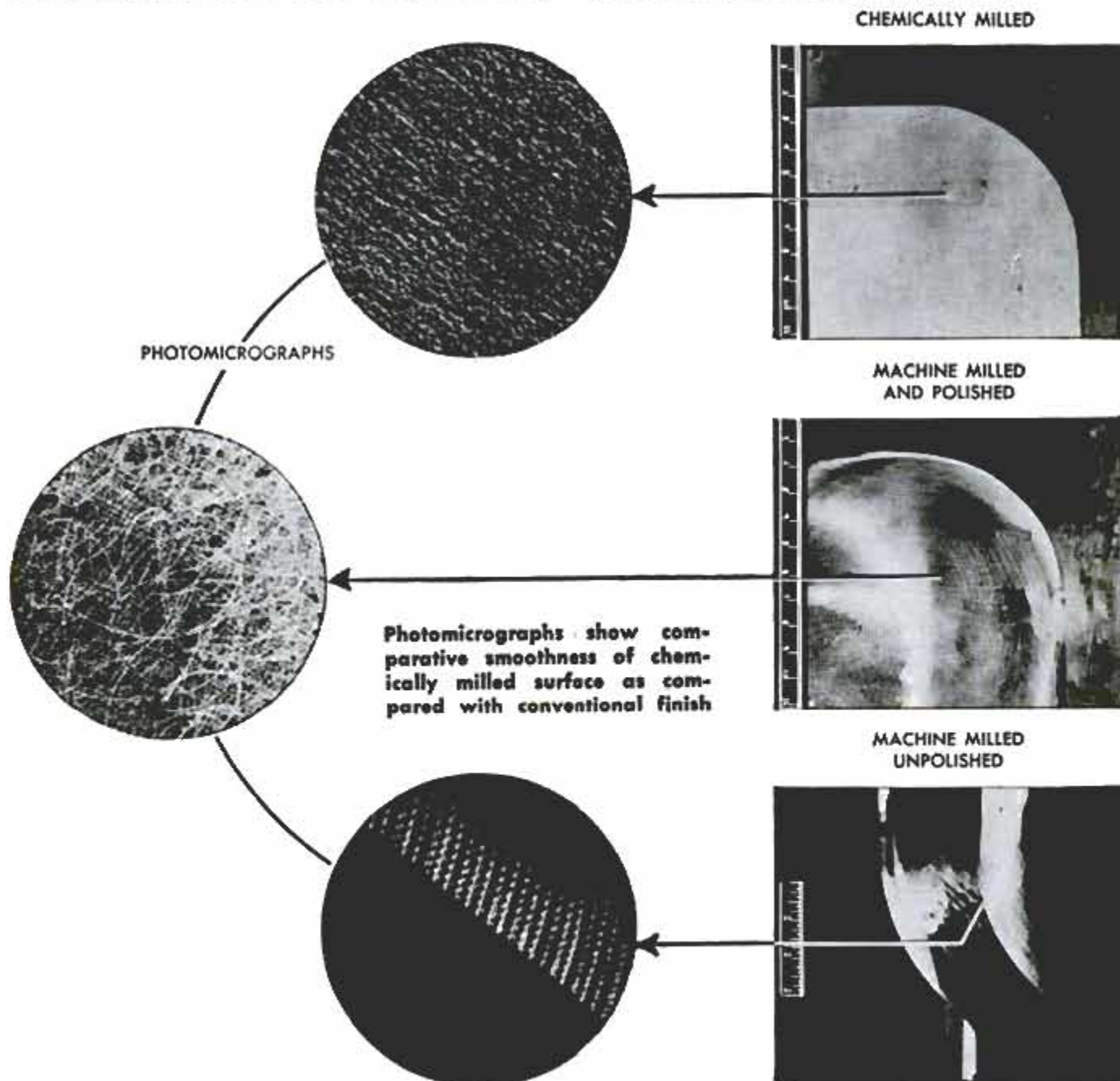

## Squaring Bracket Aids Work Setup

When setting up work in a milling vise there are times when you could use three hands, one to hold the square, one to hold the work against the square and one to tighten the vise. A fixed square, or squaring bracket, attached to the fixed jaw of the vise will eliminate the problem quite effectively. Mill a short length of steel angle all over and attach it to the fixed vise jaw with a socket-head set-screw. True the square with a dial-type indicator, tighten the screw and there you are.

## Rubber Band Acts As Holder For Tailstock Wrench

If you have trouble keeping track of the tailstock wrench—even the socket-type wrench can get mislaid or fall to the floor occasionally—just loop a heavy rubber band over the wrench and the nut as pictured. The band won't interfere with the regular use of the wrench and it will always be at hand when you have use for it.

Beeswax or soap applied to a grinding wheel will prevent it from clogging when grinding aluminum or other soft metals.



## Simple Lathe Attachment Reclaims Cutting Oil for Reuse

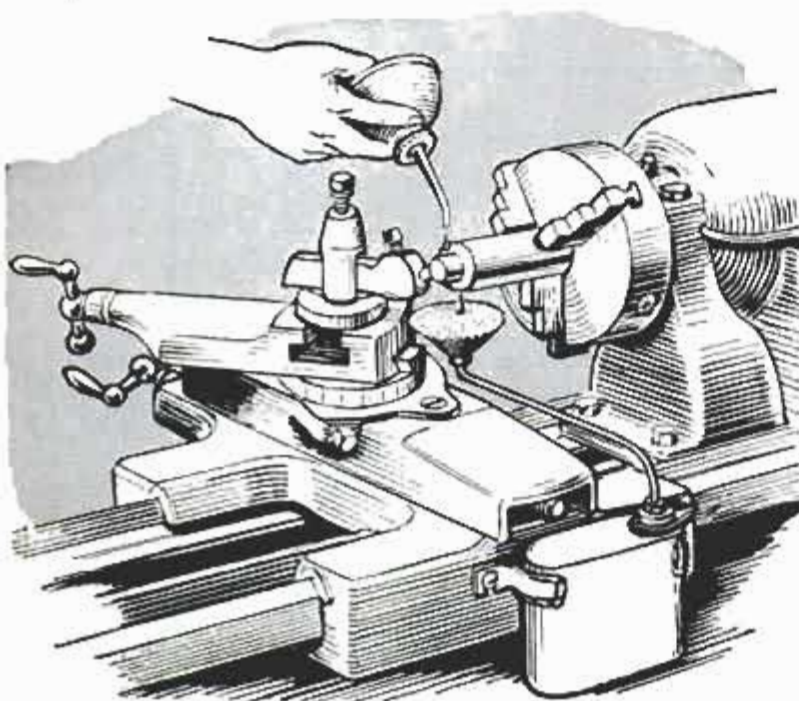

In shops where volume or nature of the work does not warrant fitting lathes with cutting-oil circulators, it still is possible to reclaim the small quantities of oil that may be used. A simple shop-made attachment that travels with the carriage can be put together in a few minutes, using an oval-shaped can with screw cap, a short length of tubing and a small funnel. Thread one end of the tubing and attach to the screw cap with two nuts. Screw cap onto the can and attach the can to the back of the carriage. Cut the neck from the funnel and solder the funnel to the free end of the tubing. Cover the funnel with fine screen to catch the metal chips.



## One-Piece Follower Rest Travels With Tool Post

This follower rest was improvised to handle a special job which involved the running of a long shoulder cut to approximately half the length of small-diameter stock. This made it essential that the rest follow the tool closely to prevent score and chatter marks. To meet these requirements, the rest detailed was made from a piece of brass about  $\frac{3}{16}$  in. thick, the lower edge being milled and filed to give the shape indicated. It is then bent so that when placed in the tool post between the toolholder and the clamping screw it will bear on the work just back of the cutting tool.

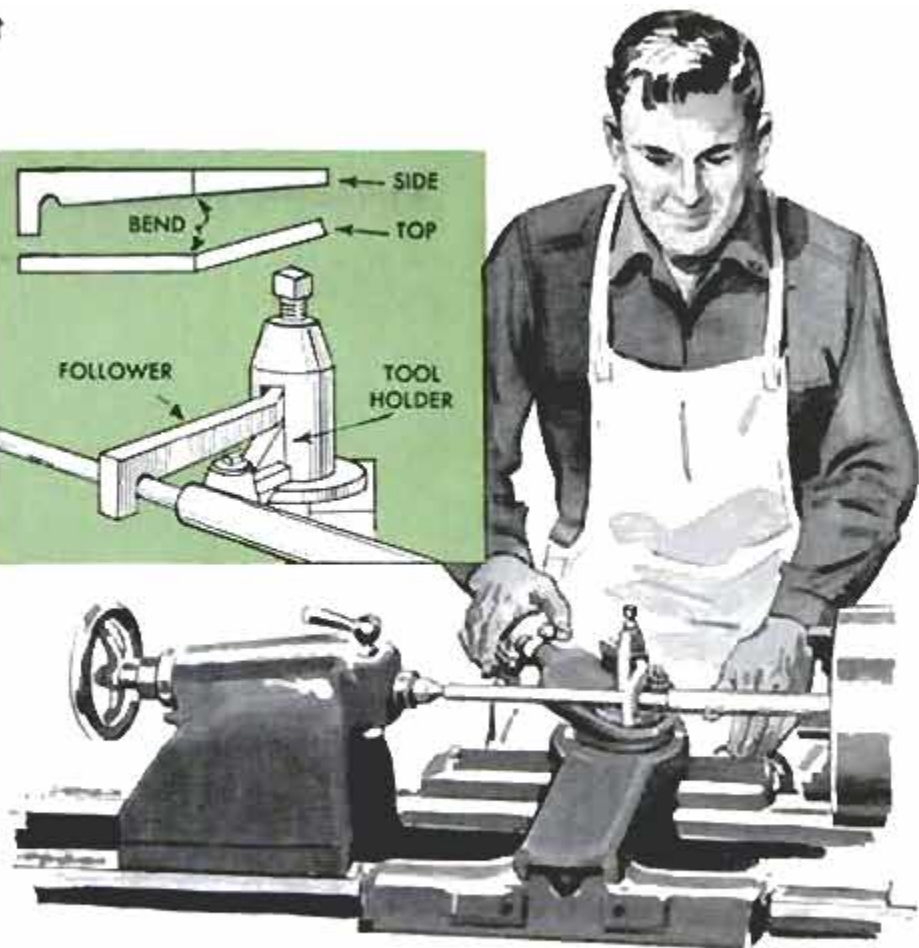
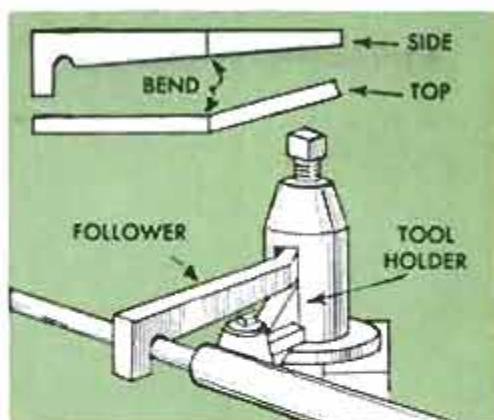

## Clamping Collar of Hardwood Supports Drill-Press Table

Ever have the drill-press table slide without warning to the lower end of the column? It can happen and there's only one sure way to prevent it. That's by means of a clamp collar, or pinch clamp, on the column below the table collar. Such a clamp can be made from hardwood or plywood, whichever material you happen to have at hand. Shape the collar as indicated in the photo, fit it with a small bolt and wing nut so that it can be clamped tightly to the column at any point.



## Shop-Made Lathe Steady Rest For Large-Diameter Work

In one custom shop a job called for an internal groove to be cut near the ends of several pieces of tubing, each about 8 in. long. The diameter of the tubing being greater than the capacity of the regular steady rest, it was necessary to make a rest from structural-steel angle. One web of the angle was bandsawed to a radius slightly less than the outside diameter of the tubing. It was then bolted to the lathe bed and finished with a fly cutter held in the chuck.

C. W. Woodson, Chicago



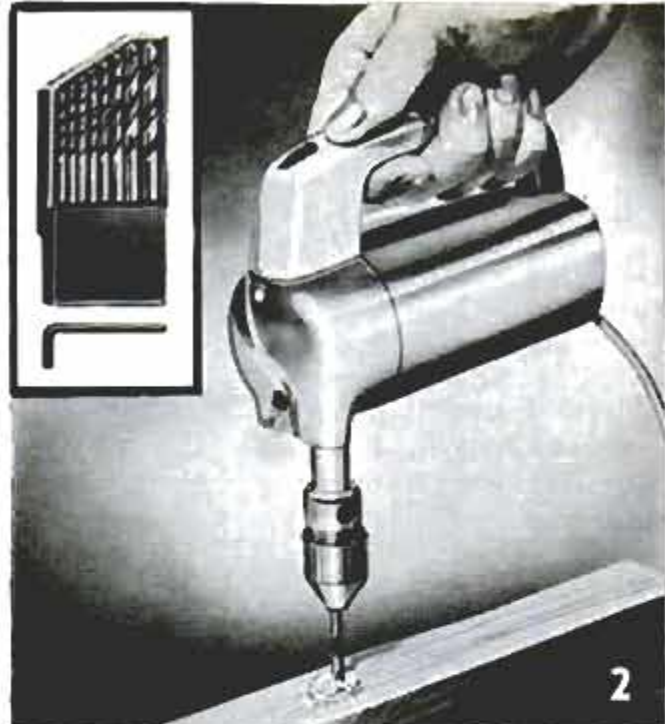

# SHOPPING FOR TOOLS

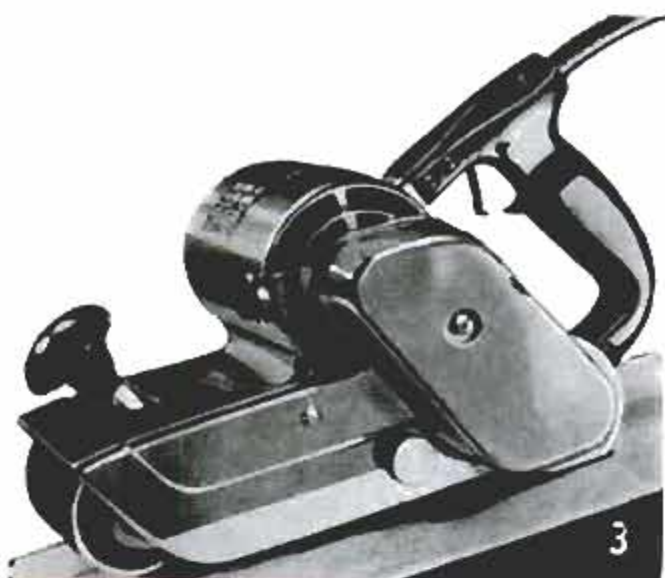

**1. SANDING BLOCK** has the same feel and is of the same general size and shape as the ordinary hand-sanding block, but it's fitted with a sheet-metal pad coated on one face with tungsten-carbide abrasive. Sheet-metal pad won't tear or buckle and score surface. Individual abrasive grains are permanently affixed. Comes in two grits, No. 80 and 150

Millers Falls Co., Greenfield, Mass.

**2. ADAPTER** converts a kitchen mixer to a 1/4-in. portable electric drill. Conversion is accomplished by removing regular beater and inserting adapter. Assembly consists of adapter, key chuck and a set of 9 twist drills in sizes ranging from 1/16 to 1/4 in. Adapter is made in sizes and types to fit all standard mixers of stationary and portable types

G. K. Stewart Co., 183 M<sup>h</sup> Curve Blvd., St. Paul 5, Minn.

**3. PORTABLE BELT SANDER** has two speeds, one for smoothing rough materials and one for finishing. High-speed position of switch gives a belt speed of 1100 feet per minute (f.p.m.). On the slow-speed setting the belt travels 800 f.p.m. Abrasive belt is 4 in. wide, covers a large area at one pass over work. Handle is molded plastic, shaped for easy grip

Skill Corp., 5033 Elston Ave., Chicago 30

**4. BALL AND ROLLER-BEARING CLEANER** combines cleaning action of both solvent and air under pressure. Handles any antifriction bearing from the smallest up to 5 in. in diameter, without disassembling or removing seals or shields. Cleaning solution is continuously filtered to remove all particles larger than 1/2 micron in size. Takes bench space -18 x 30 in.

Bearing Inspection, Inc., 3311 E. Gage Ave.,  
Huntington Park, Calif.

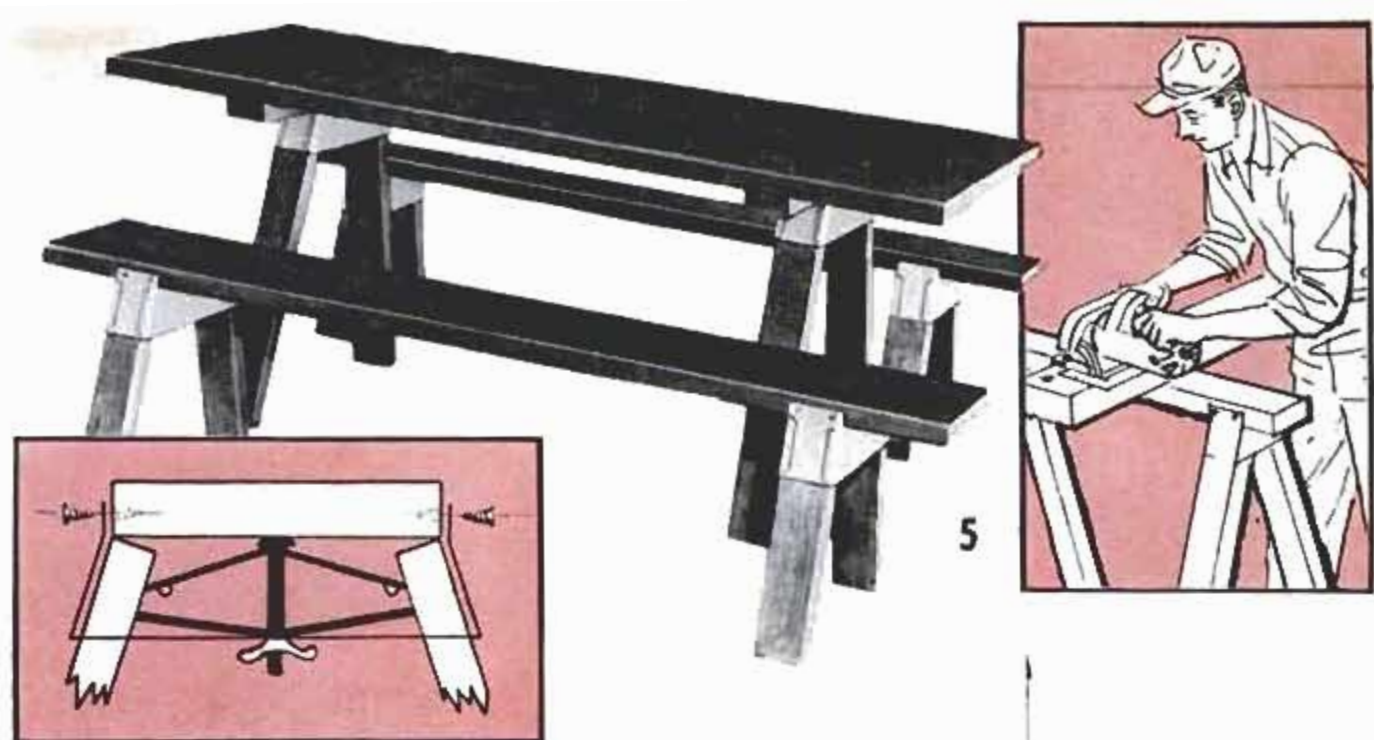

**5. LEG BRACKETS** are used in making sawhorses, benches, scaffolds and tables. No mitering cuts are necessary when making any of these units. Brackets come in different widths to suit the purpose. As an example, for benches, stools and low scaffolds the brackets take a standard 2 x 12 for the top and use 2 x 4 legs. One sawhorse bracket accommodates 2 x 4 legs and a 2 x 8 horizontal member. Another bracket available takes 2 x 4 legs and a 2 x 4 top member. Legs are removed by loosening wing nut as in detail

Saturn Mfg. Corp., P.O. Box 592, Topeka, Kans.

**6. SPIRAL BURNISHER** follows the reamer to produce a perfect hole to extremely close tolerances without waves or a trace of chatter marks. It does not remove stock as does a reamer but produces a combined burnishing and compression action as it is rotated. This action stresses the material being worked beyond its elastic limit as the tool is fed into the reamed hole. Stock sizes range from 1/16 to 1 in.

Shearcut Tool Co., 7045 Darby Ave., Reseda, Calif.

**7. SELF-CHALKING LINE** comes in 50 and 100-ft. lengths, in a specially designed plastic case, or housing, which can serve as a plumb bob. Universal hook at free end of line can be attached to any projection or slot for one-man operation. Rewind handle folds into case for carrying in pocket or toolkit. Case is easily refilled with powdered chalk in colors

The Stanley Works, 111 Elm St., New Britain, Conn.

**8. TORQUE ADAPTER** converts any 1/4, 3/8 or 1/2-in. portable drill into an efficient torque wrench. Torque on the three sizes is adjustable, ranging to 120 lb. for the 1/2-in. drill, 540 lb. for the 3/8-in. drill and 960 lb. for the 1/4-in. drill. Slip clutch releases automatically when desired torque is reached. Square driver takes common sizes of wrench sockets for driving nuts and all types of machine screws

Stockholm Tool Co., 270 E. Mound St., Columbus 15, Ohio

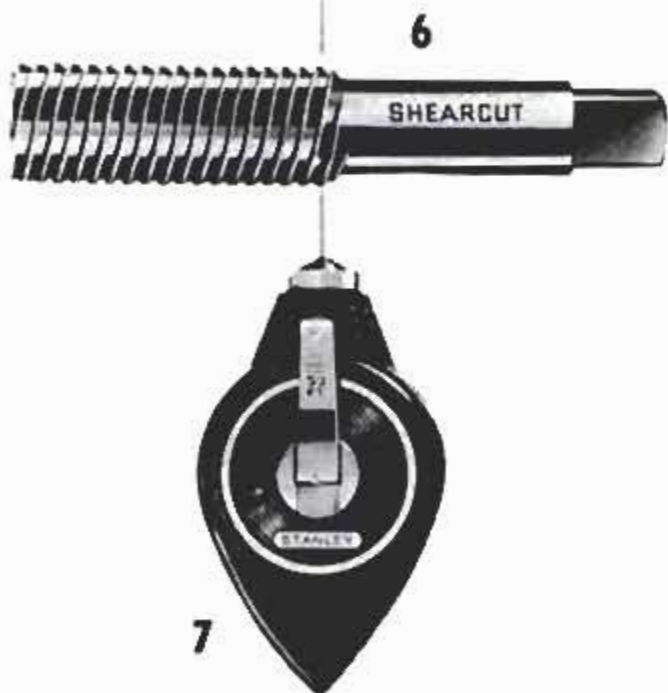



9

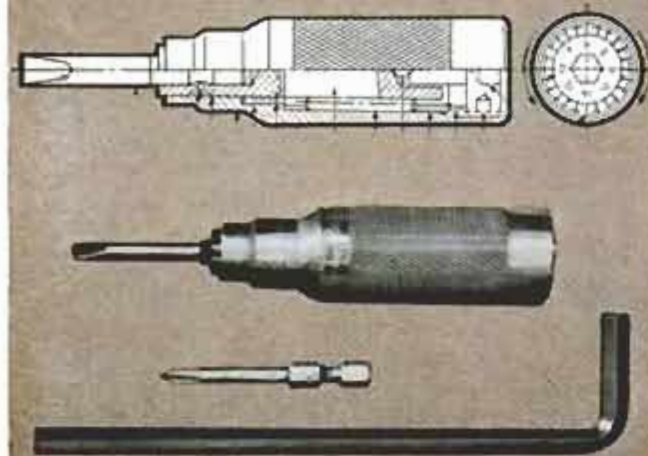

12



13



10

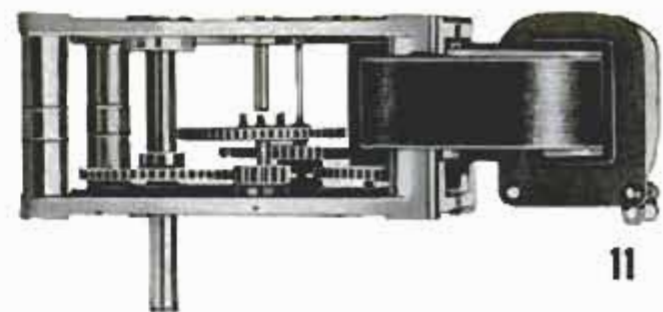

11

**9. WELDING GUN** handles studs through  $\frac{1}{2}$  in. in diameter, weighs less than 4 lb. and is only 9 in. long. Body of gun is of durable plastic. A comfortable pistol grip gives the operator close and positive control of placement and welding of the studs. Positive balance reduces operator fatigue, increases output and the accuracy and quality of the work

Nelson Stud Welding Div., Gregory Industries, Inc., Lorain, Ohio

**10. FRAMING SQUARE** simplifies rafter layout, makes it easy to cut braces that fit, serves as a T-square, T-bevel, and as a level for plumbing wall framing. It can be set for marking any angle up to 45 deg. and can be set at 90 deg. to serve as a steel square. It's lightweight, easy to handle and stores readily in any toolkit. Graduations are clear and sharp

Squangle Corp., 6406-17th St. S.W., Lynnwood, Wash.

**11. SUB-FRACTIONAL HORSEPOWER GEARMOTOR** is directly connected to a gear train designed to convert low-power electrical input into slow-speed, high-torque output. It's built to give long and reliable service in the operation of animated advertising displays, various types of control devices, also vending and coin-operated amusement machines of various types

Multi-Products Co., 2052 Grove Ave., Racine, Wis.

**12. HAND SCREWDRIVER** works to a preset torque in a range of 0 to 25 inch-pounds. It is designed for precision assembly, production and maintenance jobs where air or electrically powered drivers cannot be used due to space requirements or safety regulations. Typical applications are assembly of industrial instruments, aircraft controls, appliance controls

Scully-Jones & Co., 1901 S. Rockwell St., Chicago 8

**13. PORTABLE ELECTRIC PAINT REMOVER** takes off old paint and varnish in one pass. Controlled depth of cut leaves a uniformly flat surface ready for repainting or refinishing. Disks are faced with tungsten-carbide abrasive, the grains being spaced to prevent clogging. Its use for paint removal eliminates fire hazards present when a blowtorch is used

Porter-Cable Machine Co., 128 Exchange St., Syracuse, N. Y.



Champion-equipped outboards run smoothly. Test at Marineland, Fla., proves they don't even frighten fish.

- Q. Why does every major manufacturer of outboard motors use Champion spark plugs?
- A. Because Champions deliver the quick starts and dependable performance outboard owners want. For performance like this in your *car*, put in Champions every 10,000 miles. You'll save gas, too!

*World's favorite spark plug—engineered for every car built by Ford, General Motors, Chrysler, American Motors, Studebaker-Packard and every major foreign maker.*



# Now... a camera built to THE KODAK SIGNET 80

Whether you work in wood, metal, or plastic . . . skin-dive or study the stars . . . specialize in sports cars or specimen roses . . . aircraft models or model rail layouts . . . electronic experiments or action photography . . . *this Kodak Signet 80 Camera should be your teammate and companion.*

It has a part to play . . . making your hobby better—more rewarding.

Precision camera? Yes. Expert's camera? Yes—but you don't have to be an expert to operate it. Kodak, in the American tradition, has created

a camera with all the features the experts demand—but easy-to-use in every feature.

See the superb new Kodak Signet 80 Camera at your photo dealer's. Examine the interchangeable lenses. Test the photoelectric meter, the "natural-size" finder, unique new "injection" loading, the connectors for both flashbulbs *and* electronic flash. It's *the* camera to team up with your hobby. Yours for only \$129.50, with 50mm *f*/2.8 lens—or as little as \$12.95 down.

**Here are a few ways the Signet 80 Camera can make any hobby richer, more rewarding . . .**



You get needle-sharp pictures with the coupled rangefinder—2½ feet to infinity! Couples to all lenses.



You shoot exactly what you see, with the brilliant big-as-life viewfinder. Image is life-size!



You read exposure easily—with ultra-sensitive photoelectric meter! Sets for all films.



You change lenses instantly—switch to wide-angle or telephoto. Just drop in, start shooting!



You pull in faraway scenes, take candid portraits with the telephoto lens. (90mm *f*/4, \$69.50)



You capture the broad sweep of a scene with the wide-angle lens. (35mm *f*/3.5, \$57.50)

**EASTMAN KODAK COMPANY •**

# team up with your hobby...

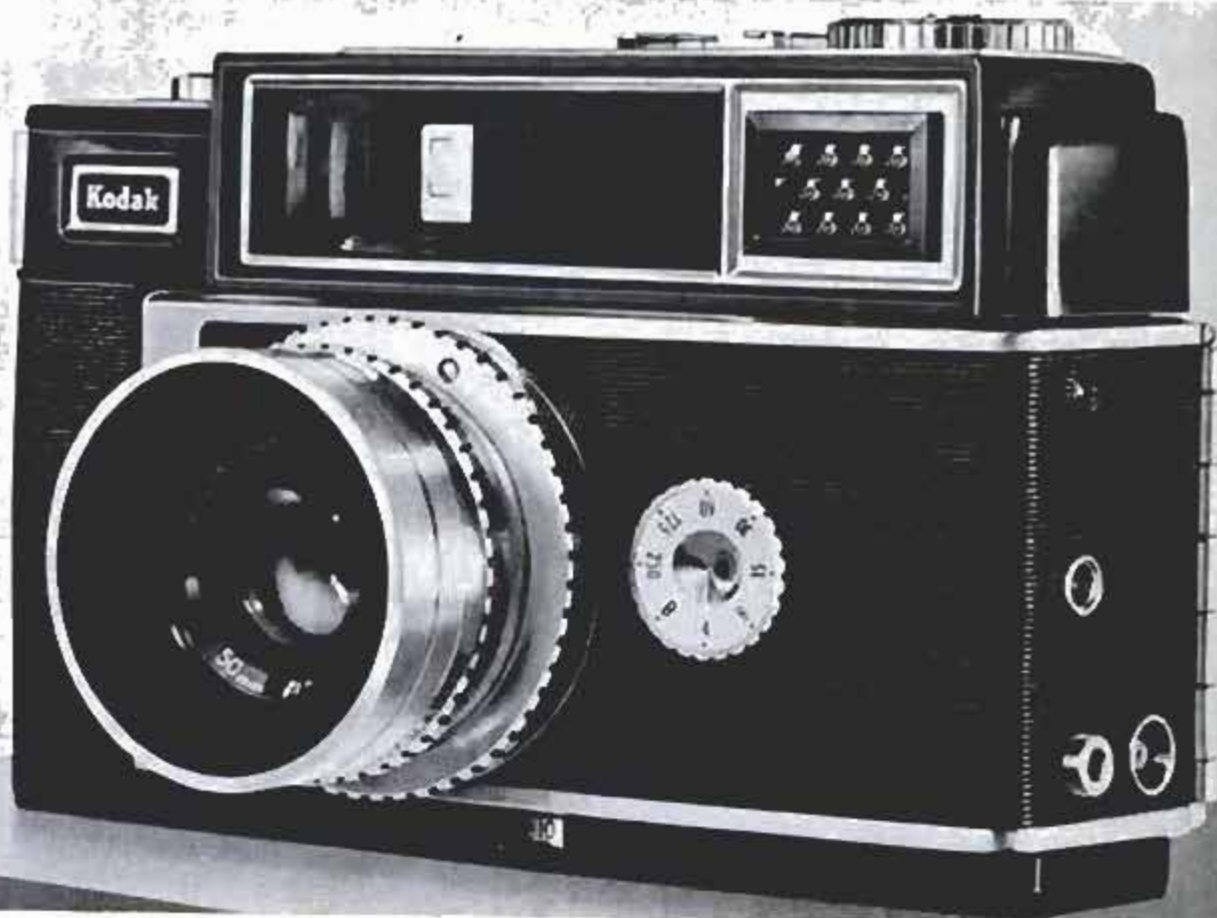

Want to shoot the moon? To team up your new Signet 80 with a telescope, write our Sales Service Division for "Astrophotography With Your Camera," Pamphlet C-20.

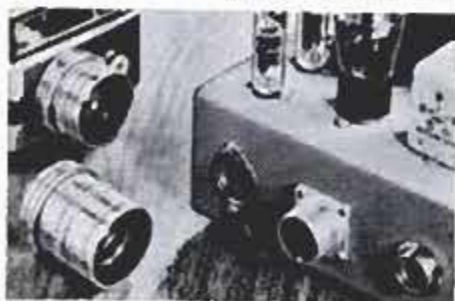

Near or far, you capture extra detail with Signet 80 rare-element-glass lenses. Superb for color.



You load film fast—drop it in, close the camera. You can do it with one hand, blindfold!



You can make ultra-close-ups of specimens with low-cost Kodak Portra Lenses. Quick, easy.



Multi-Frame Finder tells instantly which lens fits the scene best. (\$17.50)



You click off rapid-sequence shots with thumb-action film advance. Sets shutter too, counts shots.

See Kodak's "The Ed Sullivan Show" and "The Adventures of Ozzie and Harriet"

(Prices are list, include Federal Tax, are subject to change without notice)

**Kodak**  
TRADEMARK

Rochester 4, N.Y.

SEPTEMBER 1959



## SUPREME VERSAMATE

Versamate . . . a wonderful tool that fits any power drill—reduces speed to give seven times more power. Drives screws of all sizes. Inexpensive extras make it a nut and bolt driver, heavy-duty drilling unit. See your tool dealer today!



\$9.95

For Portable Drill Users...

# CHOOSE THE ATTACHMENTS THAT DO THE BIG JOBS!



\$14.95

Versamatic triples portable drill usefulness. *Reverses!* Drives and removes screws, nuts, bolts. Boosts power 7 times. Set includes regular and Phillips-type bits, and 1/4" square drive adapter. For heaviest drilling jobs in steel and concrete, add a 1/2" Supreme Brand Chuck.

## SUPREME VERSAMATIC



**SUPREME PRODUCTS  
CORPORATION**  
2222 S. Calumet, Chicago 16  
Div. of A • S • R Products Corp.

# Clinic for Homemakers



As a service to our readers in solving the hundreds of problems pertaining to a home—inside or out—the editors of *Popular Mechanics* invite you to present your problems to The Clinic Editor for help and advice. Address your questions to The Clinic Editor, *Popular Mechanics Magazine*, 200 East Ontario Street, Chicago 11, Ill.

### Restoring Oil Painting



**Q**—How does one go about restoring an oil painting which is quite old? I doubt if it is valuable but it is old and very much cherished, as it has been in the family for so many years. It is rather dingy in appearance and is covered with the dust and grime of years. Is there a safe solvent that can be used to clean and restore it to its original appearance? — D. G., Wash.

We'd suggest that you consider giving the job to a professional restorer who will have the opportunity to examine the painting and determine what procedures are safe and effective. However, if you wish to attempt the work yourself, we have one suggestion which may prove successful. Fold a clean, soft cloth to make two or three thicknesses that will cover the painting. Then dip the cloth in lukewarm, soft water and wring out until it no longer drips. Spread the damp cloth over the painting and press into contact. Allow the cloth to remain in place for five or ten minutes, then lift it off, rinse thoroughly and repeat the procedure. Several applications should remove most of the accumulated dust. Special care must be taken not to get the surface of the painting unduly wet. After it dries thoroughly it can be brightened with an application of copal varnish applied with a fine-bristle brush or better, sprayed on. Do not use any synthetic, clear finishes as these may contain solvents that will soften the oil paints used originally.

### Tool Selection For Home



**Q**—I would like to purchase hand tools for household use. I'm a new homeowner and I've thought it best to purchase tools only as I need them, gradually acquiring a complete set in this way. But I'd like to see a representative selection listing those tools likely to prove most useful over a period of time. — L. R., N. Y.

**A**—You are correct in the assumption that it is best to purchase tools only as the need develops. In any selection there are always a few tools that

(Continued to page 214)





## PONTIAC IS THE ONLY CAR WITH WIDE-TRACK WHEELS

Wide-Track Wheel design brings car and road into a new relationship. The wheels of a Pontiac are farther apart, widening the stance but not the car. There's a feeling of complete control, road-holding response. You're steadier, more secure, balanced. It's the automotive advancement of the year and one of the big reasons Pontiac is now first in sales in its price class. Hasn't the day come for you to drive this sleek beauty? The keys are waiting at your nearest dealer.

PONTIAC MOTOR DIVISION • GENERAL MOTORS CORPORATION



### THE WIDE-TRACK STORY

Pontiac wheels are five inches farther apart. This widens the stance, not the car. Lower center of gravity makes the car grip the road. Lean and sway disappear. You get safer cornering, easier handling, a steadier, balanced, smoother ride.

PONTIAC! AMERICA'S NUMBER ① ROAD CAR!

You'll agree—  
it's the  
**HANDIEST  
PLIER  
OF THEM  
ALL**

**CHAN NEL LOCK**

**No. 420**

You'll like the all 'round usefulness of the Channellock No. 420 . . . its terrific gripping power . . . its quick, non-slip adjustability up to 1-3/4" size. And you'll find it easy to use in hard-to-get-at places because of its compact design. Mechanics everywhere say no other plier does so many jobs so well. You'll say so, too!

**CHAMPION DEARMENT  
TOOL COMPANY  
MEADVILLE, PENNSYLVANIA**



**ASK YOUR  
TOOL SUPPLIER  
FOR  
CHANNELLOCK  
PLIERS**

**Be sure it's a genuine CHANNELLOCK  
Look for the trademark on the handle**

(Continued from page 212)

will get more general use than others, but as a rule those not used so often will pay for themselves in time. Following is a list of hand tools selected on the basis of all-around home use but not necessarily calculated to cover all probable requirements:

Ripsaw, 26-in. blade (5 to 6 points per in.)	Jack plane, 14-16-in. frame
Crosscut saw, 24-in. blade (12 points per in.)	Level, aluminum frame, 18 to 24 in.
Compass saw	Cabinet scraper
Coping saw	Twist drills, 1/32 to 1/4 in. by 32nds
Hacksaw	Expansive bit, 7/8 to 1 1/2 in.
Combination square with scribe	4 flat files with handles (selected according to requirements)
Miter box, 26-in. back-saw (optional)	Combination pliers (slip-joint, side-cutting)
Ratchet screwdriver	Long-nose pliers
Hand drill, 1/4-in. chuck cap.	Tin snips
Combination ollstone	Ripping bar, 18 to 24 in.
Ratchet bit brace, 10-in. sweep	Marking gauge
Auger bits, 1/4 to 3/4 in. rising by 8ths or 16ths	Folding rule, 6-ft.
Rosehead countersink	Adjustable wrench (two or three sizes according to requirements)
Nail set	Pipe wrench, for pipe up to 2 in.
Nail (curved-claw) hammer 13-Oz. head	Spokeshave
Block plane	
Smooth plane, 8-in. frame	



**Refinishing Cherry**

**Q**—I have a chest of drawers which I've always thought was walnut wood. After removing the old finish preparatory to refinishing, I found that it is not walnut at all. A friend who knows wood says it is cherry. I want to refinish it to look like walnut. Can this be done successfully?  
C. S., Ala.

**A**—Selected pieces of cherry can be finished in a very close imitation of genuine walnut. You do not describe the chest in detail but if we can assume that all exposed parts are of cherry, then it should be possible to refinish the chest to appear as walnut. First, do a thorough job of sanding, using several grades of sandpaper and finishing up with the finest 8/0 grade. Follow sanding with a pigmented-walnut stain, applying and reapplying and wiping until you get the color that will match a finished sample of genuine walnut. It is not necessary to use a filler on cherry. Allow the stain to dry at least 24 hr. or more. Then go over the stained surfaces very lightly with fine steel wool, dust off and apply a sealer. When the sealer is dry, sand it lightly with fine sandpaper and dust off the surfaces. Follow with a water-white lacquer, applying with a spray gun rather than a brush. You can usually rent a sprayer from your local paint dealer. Spray on two thin coats of lacquer, allow to dry 24 hrs., then go over the surfaces with fine steel wool, 3/0 or 4/0 grade.

**Paint Peels From Window Casings**

**Q**—I have an older home and my problem is paint peeling from the window casings. What causes this and what can be done to prevent it?  
A. E., Minn.

**A**—You do not describe the windows or say whether the walls are insulated, but we think it likely that peeling of the paint is caused by moisture entering the window-weight wells from the room side and passing through the casings to the paint film. This could cause peeling of the paint as you describe. Basically, the trouble is due to the high humidity of the air in the rooms during the colder months. Anything you can do to lower this will, of course, help to mitigate the trouble. Although we hesitate to suggest it due to the labor involved, removing the casings and priming the back faces with an oilbase paint will tend to prevent peeling of paint on the exterior surfaces.

# FORMER SERVICEMEN: TAKE A FRONT ROW SEAT IN THE NEW AGE OF SPACE

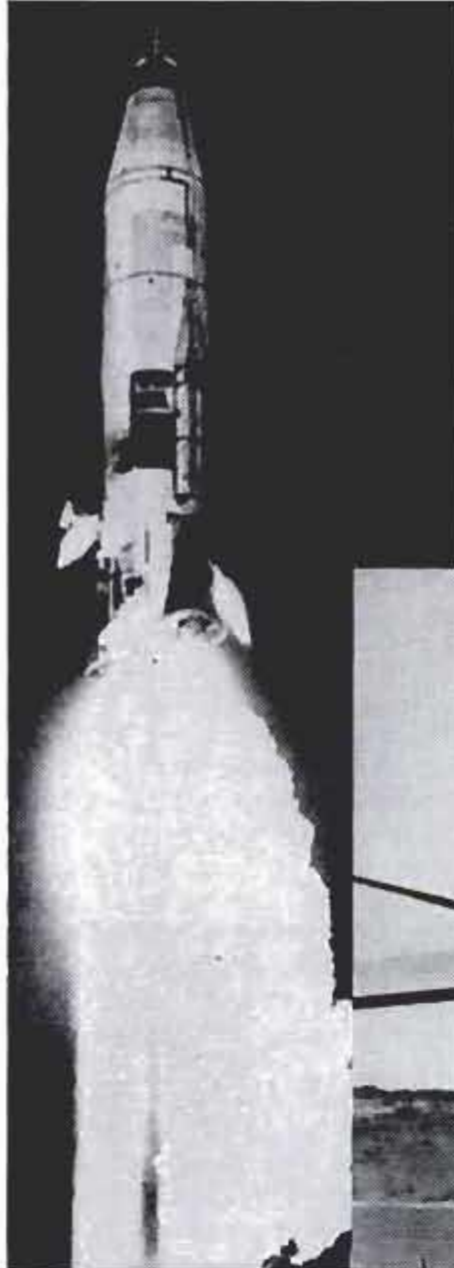

## AS A SPECIALIST IN THE U.S. AIR FORCE

If you have a technical skill, make the most of it, where the Age of Space is *now*—in the U.S. Air Force. You'll work with the latest equipment, learn the latest advances of your specialty. What's more, you'll hold down an *important*, responsible job, and you can look forward to a future that's guaranteed. But the time to act is now, while your skill is at peak value. See your local Air Force Recruiter, or mail the coupon.

**PASTE ON POSTAL CARD AND MAIL TO:**

Prior Service Information, Dept. MM-99  
Box 7608, Washington 4, D. C.

Please send me more information on the Air Force Prior Service Program.

Name \_\_\_\_\_

Address \_\_\_\_\_ Age \_\_\_\_\_

City \_\_\_\_\_ Zone \_\_\_\_\_ State \_\_\_\_\_



THE FUTURE BELONGS  
TO THE AIRMAN

# Meet a Great New Semi- Automatic .22—from Marlin!



Here's the only rifle that gives you the advantages of semi-automatic action—18 shots as fast as you can pull the trigger!—combined with the extra accuracy of Marlin's exclusive Micro-Groove Rifling! It's the new Marlin Model 99! Chambered for .22 Long Rifle cartridges, the Model 99 has a solid receiver top drilled and tapped for an adapter base for tip-off scope mounting. It's a rugged, ready-for-action sporter, weighs only 5¼ pounds. Priced at \$39.95, **only \$4.00 down payment** under Marlin's Pay-Later Plan. Ask your dealer about the low combo price of the Model 99 with Marlin Micro-Vue 4-Power Scope—you save \$4.95.

*Prices subject to change without notice*

## Marlin G-99 Micro-Groove Rifles

Marlin Firearms Company, New Haven, Conn.

Please send me the Marlin illustrated catalog, 24 page Target & Game Record Book, plus a Home and Field Rustopper Kit. 25¢ enclosed for handling and mailing.

NAME \_\_\_\_\_

ADDRESS \_\_\_\_\_

CITY \_\_\_\_\_

ZONE \_\_\_\_\_

STATE \_\_\_\_\_

## The "Squash Bug" Searches for Pay Dirt

(Continued from page 138)

served. "Did you notice the mercury retorts at the cinnabar mines in this range? We're mapping it geochemically, using a new technique. Already we've found we can detect mercury ore bodies hundreds of feet down by sampling on the surface."

Voices came from behind us. Three figures were coming down the trail. In the lead was Dr. E. H. Bailey, the party's geologist. Two young men carrying racks of small cardboard cylinders were introduced as M. Kyi Soe and Khin Maung Nyo, here from Burma to study geochemical techniques with U.S.G.S.

### Silk Cloth Is Sieve

Nyo sieved the fine soil of one sample through a silk cloth, then dumped a measured amount into a test tube with acid to "digest" it for the color tests to follow. Soe emptied plant leaves into platinum dishes and ashed them over a butane flame. We watched Ward transfer one sample to a colorimetric tube containing a measure of yellowish acid, add a few drops of one reagent, then a dash of another. Soon the yellow color was topped by a rapidly forming layer of red.

"This is a general test for heavy metals such as copper, lead or zinc," Ward explained. "If there's no reaction, we go no further. But we're getting a positive reaction, so let's see what we have."

To more of the sample he added other reagents. The solution turned gray, then blue, finally pinkish.

"Copper!" pronounced Ward. "Now, how much?"

### Color Indicates Amount of Metal

He passed the sample along a rack of fluid-filled tubes, each representing the color produced by a known amount of metal.

"Gray would mean four micrograms of copper per million parts; blue means five. Our sample has changed from blue to purple, but it hasn't quite turned red, it's pink—so we know we have a little more than five but not quite six micrograms. This color-matching is certainly faster than juggling laboratory balances!"

He quickly ran another test whose blue-green reaction at the finish indicated a small quantity of zinc. A test for lead was negative.

Ward explained that the first of these "miracle reagents" was reported in 1878 by

(Continued to page 218)

# RADICALLY NEW U. S. ROYAL LOW PROFILE SAFETY SHAPE TIRES

BEAT DEADLY HEAT, GIVE UP TO 35% MORE MILEAGE, SAVE GAS — YET COST NO MORE!

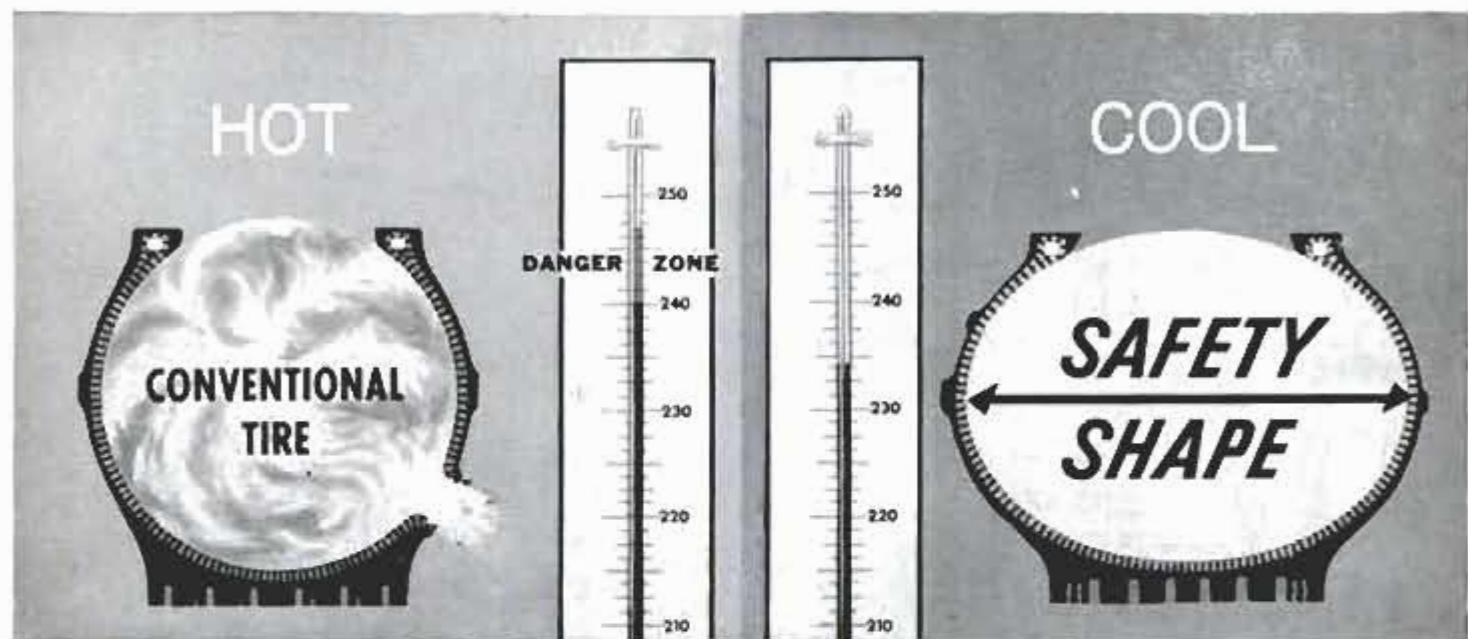

HEAT HATES TIRES... WEARS 'EM OUT... BURNS 'EM OUT... BLOWS 'EM OUT! BUT NEW SAFETY-SHAPE TIRES DON'T FLEX AS MUCH, DON'T WORK AS HARD, RUN COOLER, LAST LONGER!

## CONVENTIONAL TIRE

In world's largest tire "torture chamber", U. S. Royal tests tires 24 hours a day, 279 million miles a year. Above, a conventional tire fails on a high-speed test wheel after only 72 minutes. *Murdered by heat!*



## SAFETY-SHAPE TIRE

New U. S. Royal Low Profile *Safety-Shape* tire passes "torture test" in a breeze. Keeps running hour after hour at high speeds. Lower, wider construction means less flexing, less heat, triple the high-speed endurance!



As your tires revolve, they constantly *flex*. This creates heat that can *murder* your tires. (*It's like bending a paper clip to and fro... the metal gets hot and finally snaps!*) U. S. Royal beats the heat with a new type of tire—the Low Profile *Safety-Shape* tire. This lower, wider tire doesn't flex as much as conventional tires. Runs cooler. Stays below the crucial heat danger zone. Gives up to 35% more miles. This easier-rolling tire *even cuts your gas bills!* Yet it costs no more than conventional tires. Ask your U. S. Royal Dealer.

**5 WAYS  
BETTER THAN  
CONVENTIONAL  
TIRES!**

**MILEAGE** — 25% to 35% more mileage  
**HIGH-SPEED ENDURANCE** — 3 times better  
**TURNPIKE GAS ECONOMY** — 6-12 extra miles per tankful  
**TURNING EFFORT** — 20% more stability on curves  
**SKID RESISTANCE AND TRACTION** — Raised 5% to 10%

# U. S. ROYAL SAFETY 1<sup>ST</sup> TIRES



## United States Rubber

Rocketfeller Center, New York 20, N. Y. In Canada: Dominion Rubber Company, Ltd.

# SPECIAL OFFER

FROM DU PONT



## 6 CAR WASHES ONLY 25¢

(90¢ VALUE)

Safe for all cars! Will not streak!

Du Pont Car Wash is the faster, safer way to wash your car. Won't harm wax, drains dry without wiping. One packet does entire car.

TEAR OFF END TAB AND MAIL WITH 25¢



New Quick-Grip "Duco" Cement holds better, dries fast. Mends 1,001 things—china, wood, metal, paper, glass, leather.



Better Things for Better Living... through Chemistry

Du Pont Car Wash Offer  
Dept. 110, Wilmington 98, Del.

I enclose 25¢ in coin and end tab from a "Duco" Cement carton. Please send me 6 packets of Du Pont Car Wash.

Name \_\_\_\_\_

Address \_\_\_\_\_

City \_\_\_\_\_ State \_\_\_\_\_

a chemist named Fischer. Apparently useless, it was forgotten until another chemist—also named Fischer—found the old report and noted that the reagent showed two highly important properties: It was both metal-hungry and color-sensitive.

This Cinderella compound, dithizone, became a sensation, for with proper coaxing it could be made to react with any of 17 metals, tinting a solution with color or producing a bright-hued precipitate. And the color was automatically linked with the metal that caused it!

### Colors Detect 30 Metals

Other researchers plied the entire list of metals with other organic reagents, thereby raising to 30 the number of metals that can be detected by the color tests.

U.S.G.S., familiar with the problems of prospecting parties that must carry their gear into roadless deserts and mountains, knew that the complex laboratory apparatus should be reduced to something closely resembling Junior's chemistry set. Its "idea men" replaced glass bottles with unbreakable polyethylene, found safe, inexpensive substitutes for temperamental reagents and dangerous acids; replaced delicate weighing operations with routines as simple as shaking a cocktail. Samples were identified on the spot by matching colors against reference standards.

These methods were taken into the field for tests against known ore bodies, then into totally unmapped areas. One team sampled waters of a bog in New York, found it zinc-rich and tracked the source down to springs bubbling up from deep ore bodies. In Alaska another team improvised a rapid way to sample soil beneath the all-concealing tundra, punching through masses of tangled roots and arctic moss with a sharpened pipe.

### Standardize Techniques

Waving his hand at the equipment ranged along the Squash Bug's let-down workbenches, Ward explained: "We're using this luxury-type mobile lab to standardize our techniques and get the kinks out of them. Then everything will be stripped down to the real back-pack equipment that can go out to the far places. A two-man team will be able to go anywhere and run their own tests instead of waiting weeks for assays to tell them whether they're on the right track."

Nearby, Dr. Bailey spread out a field-reconnaissance map.

"What we look for," he said, "is an 'anomaly'—a spot showing above-average

(Continued to page 220)

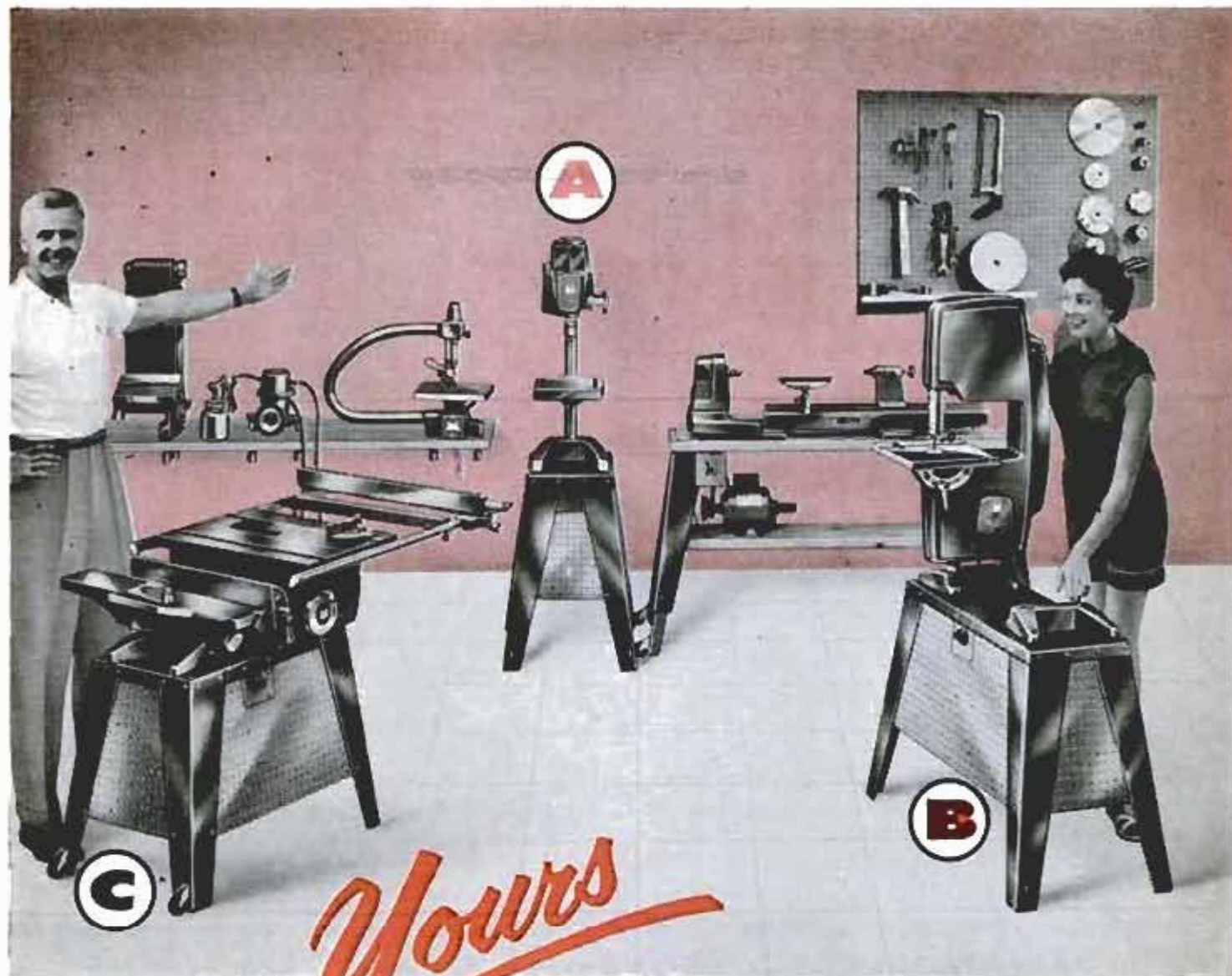

**THIS BEAUTIFUL SHOP**  
as easy as **A·B·C·D!**

**A**

SINGLE TOOL,  
SINGLE STAND

**B**

SINGLE TOOL,  
DOUBLE STAND

**C**

DOUBLE TOOL,  
DOUBLE STAND

**D**

COMPLETE SHOP  
ON 3 STANDS and  
1 WALL SHELF

**with YUBA'S exclusive "BUILD-UP" Plan**

Your needs and your budget determine your "BUILD-UP" to a really complete shop of magnificent MAGNA power tools! With your first MAGNA tool, choose either single or double stand (the cost's the same). To start, select:

- Tilt Arbor Saw • Jointer • Bandsaw • Jigsaw
- Belt Sander • Lathe • Drill Press • Compressor-Sprayer

With the double stand, your second tool cost is LOW . . . you already have stand and double-shaft motor! Simply mount any second tool and it's ready for use instantly.

The complete MAGNA shop fits in minimum space with minimum investment. Only 3 double stands needed for utmost versatility.

MAGNA tools are the practical approach to space and cost problems.

Write Dept. MPM-9 for your copy of the new YUBA A · B · C · D folder.



Manufacturers of the  
world-famous  
SHOPSMITH Mark 5

**YUBA POWER PRODUCTS, INC.**  
800 EVANS ST., CINCINNATI 4, OHIO  
A Subsidiary of  
**YUBA CONSOLIDATED INDUSTRIES, INC.**



readings. So, to get a quick picture of the general average, the metallic 'background,' we first cover the territory fast, sampling at long intervals.

"Only samples that show more than twice the background value are significant. If we find a cluster of high readings in our mapping we know we've found a metal-rich anomaly.

"For instance, the cobalt background in the Blackbird district of central Idaho is about 10 parts per million, but detailed sampling outlined an area three miles long and nearly a mile wide where the content climbed to 100. This cobalt-rich area will provide a good hunting ground for prospectors.

### Scientists Work in Pairs

"We generally work in pairs. The chemist runs the tests and the geologist interprets results and relates them to geological features such as faults, favorable structures and so on. Together they quickly reject ground that proves unfavorable, and space the samples closer over favorable areas."

Next problem, Dr. Bailey explained, is to get an idea of the shape of the anomaly. Is it a straight line, hinting at leakage of metals up through a fault or fissure? Is it a fan spreading out from the base of a cliff,

perhaps from a lode exposed by erosion? Or perhaps a fan-shaped train of ore fragments strewn by an ancient glacier? A water-borne trail of metal can be traced upstream just as the old-time prospector followed traces of gold to the lode.

In flat country, a circular ring or "halo" suggests an ore deposit at the bull's eye—often a spot where molten rock pushed up from the depths, its metal-rich vapors forcing their way out around the fringe of the deposit.

### Not Really Looking for Ore

The Geological Survey does not hunt ore, although its field men have turned up many a new deposit. Its job is to find out more about the earth, its structure, the forces that are changing it, and the way its mineral treasures are distributed. The Survey pioneers in developing basic scientific knowledge.

Already some of the new tools forged by this research are being put to work. In Africa, geochemists are handling more than 100,000 samples per year in a combing of the Rhodesian copper-belt soils, searching for chromium, cobalt, nickel and even the blue Kimberlite clay, source of Africa's diamonds. An oil company sampled waters of 467 lakes in Maine, locating three promis-

(Continued to page 222)

## Decorate • Personalize • Protect

**Bright Ideas 24 Hours a Day.** Versatile, beautiful by day, 3M Reflective Products reflect with exceptional brilliance at night. It's fun to design markings that literally "pop" out of the dark . . . reflect up to 100 times brighter than white paint. Easy to apply reflective markings let you decorate, personalize, and protect countless items. Available from auto accessory, hardware, and other fine stores.

brilliant red—day and night

### SCOTCHLITE REFLECTIVE TRIM

Easy to apply, press-on "Scotchlite" Trim prevents accidents with highly visible markings for autos, trailers, etc. Use this durable material to decorate, personalize, and protect your property 24 hours a day!

chrome by day—white at night

### CHROMELITE REFLECTIVE TRIM

New—attractive chrome trim offers highly visible reflective protection at night. Attractive trim presses-on, protects outboard motors, boats, trailers, cars, bicycles, wheeled toys, lawn furniture.

"brush-on" bright reflection

### REFLECTO-LITE REFLECTIVE COATING

Handy household item. Simply brush-on like paint . . . on curbs, driveway markers, trees, posts, docks, mail boxes, whatever you want to stand out in any light beam. Reflects brilliant white at night!

MINNESOTA MINING AND MANUFACTURING COMPANY

... WHERE RESEARCH IS THE KEY TO TOMORROW





YOUR FIRST  
PIPEFUL TELLS YOU  
WHY AMPHORA OUT-  
SELLS ALL OTHER  
IMPORTED TOBACCOS  
COMBINED



# AMPHORA

Make your next pipeful AMPHORA, the even-burning, longer lasting, gentle blend from The Netherlands, available in pouch or tin, at tobacco counters everywhere.



## KING MIDGET



FOR 1959

More aluminum, lighter weight, better performance, beautiful styling. Still Worlds Lowest Priced Car. Drive it for 75c a week. Rider Agents Wanted. If no dealer near you send 25c for 32 page picture book, full details, dealer price. Or send \$1 (refunded first order) for this and Service Manual plus Repair Manual and 15 5 x 7 photos of car and factory.

MIDGET MOTORS CORPORATION, ATHENS 1, OHIO

use the solder  
that most  
home owners  
use!



## KESTER SOLDER

For your electrical work, radio-TV, do-it-yourself projects . . . always use the best . . . KESTER SOLDER. Send for FREE 16-page book that tells you how!

KESTER SOLDER COMPANY

4251 Wrightwood Avenue • Chicago 39, Illinois

OVER 60 YEARS' EXPERIENCE IN SOLDER AND FLUX MANUFACTURING

**NOW!** a hi-compression  
staple gun  
for only  
**\$4.95**



With Exclusive  
Push-button Loading  
and Built-In  
Staple Extractor.

Indispensable for home use...and never before priced so low! This compact, all steel, powerful SWINGLINE 101 staple gun is ideal for insulation, carpentry, upholstery, screening, wire fencing, plus thousands of other uses. Handle locks to fit pocket. Lightweight, maneuverable, jam-proof! Staple sizes  $\frac{1}{4}$ " ,  $\frac{3}{16}$ ". Send for FREE book—"Tips for Tacking".

*Swingline*® INC.

Dept. M99 Long Island City 1, New York

# A New Precision Instrument for Leveling and Incline Measurement

HOPPY

**SPLIT  
IMAGE  
TRANSIT**



Only  
**\$6.95**

**Accurate,  
Inexpensive,  
Simple to Operate**

Optional—  
also  
available  
for the  
thousands  
of Hoppy  
Transits  
now in use—  
sturdy carry-  
ing case \$3.25

*Easy as a camera to operate! One man—ALONE—  
can do leveling and incline measuring. Accurate to  
a fraction of an inch. Many uses on the job and  
around the house.*

Carpentry Leveling	Contour Plowing	Guttering
Patio & Terracing	Brick Laying	Drainage
Duct Installation	Yard Grading	Masonry
Foundation Work	Irrigation	ETC.

*Guaranteed Product Satisfaction*



If not available at your Building Supply or  
Hardware Dealer, write directly to:

**HOPKINS MANUFACTURING CORP.**  
Dept. PM-7 Emporia, Kansas

**Another Quality Product by HOPPY**

ing grounds for lead, silver, zinc and copper. A two-man team in Finland is sifting clues from the fine sands left by melting glaciers, and is prospecting for bog-covered ores by analyzing peat.

The great bonanzas seem to be concentrated in certain metal-rich "provinces" that may extend over hundreds of square miles. For instance, the tin in most soils and rocks averages about 60 parts in a million, but there's an extensive area in Malaya and Indochina where this background rises to 100 or even 2500 parts.

One of the big jobs of geochemistry is to block out promising areas for tomorrow's treasure-hunting. U.S.G.S. believes, for example, that the whole great Appalachian region of eastern United States can now be explored economically to reveal possible treasures buried under hundreds of feet of barren rock and soil. After all, radioactive "hot spots" marked from the air by U.S.G.S. geologists in the West's great canyons led prospectors to some of the world's greatest uranium deposits—and geochemistry doesn't require the use of an airplane! ★★★

## Worldwide TV Programs May Bounce Off Moon

TV programs from overseas may someday be bounced off the moon before they reach your receiver. British communications experts recently used the moon to reflect a radio signal to this country. They believe that a regular ultra-high-frequency radio link may be established within three years, using this method. A similar TV connection is expected by 1964, but not until a new "narrow band" transmission system can be developed. In the meantime, 100-foot metal-plastic balloons could be used to reflect the present "wide band" frequencies.

## Do You Know This Old-Timer?

(answer to quiz, page 14)

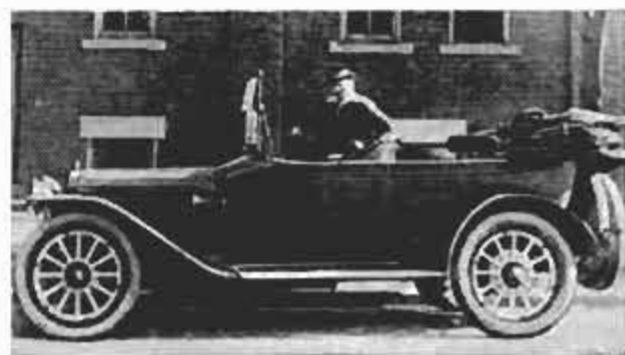

**1913 Winton Six**

# MECHANIC'S FAVORITE!

Here's the number one choice—



It's the Huot Model 100 DeLuxe Chest—custom designed for mechanics who want the finest protection plus maximum accessibility for fine tools. Eleven drawers—seven of them cork-lined for protection. Three heavy-duty drawers for large tools—1 extra deep drawer for power tools. Single latch locks entire cabinet. Two-tone oil-resistant finish. *Free bulletin describes 12 tool chests.*

**HUOT MFG. CO.**

555 No. Wheeler Street, St. Paul 4, Minnesota

## "THINGS TO MAKE ON TOOLS YOU OWN"

Handsome DELTA hard bound book illustrates and clearly describes a wide selection of useful projects designed to be built on each of the basic tools you own—only \$1.00. Send for FREE folder on complete Delta Library; Rockwell Manufacturing Company, Delta Power Tool Division, 502J N. Lexington Avenue, Pittsburgh 8, Pa.

## DO MORE PLANING JOBS WITH LOW COST BELSAW



Exclusive MONEY-MAKING Features: Full 12 3/4" x 6" capacity • Power feeds at 14" to 34" a minute • Provides for Grinding Knives in the Cutter-head • Attachments for Jointing, Rabbeting, Tongue, Matching, Groove. Convert low cost rough lumber into high priced stock. Easy to make flooring and popular patterns. Send Today for FREE Literature and Prices.

LOW DOWN  
PAYMENT  
EASY TERMS

Belsaw Machinery Co., 2050 Field Bldg., K.C. 11, Mo.

GET IMPROVED CAR PERFORMANCE . . .

# IMPROVED GASOLINE ECONOMY

. . . with an AC ACon-O-Mizer!

The AC ACon-O-Mizer controls fuel flow for maximum acceleration and high speed operation—saves fuel, reduces flooding and stalling!

Installed between fuel pump and carburetor and actuated by vacuum from the manifold, the AC ACon-O-Mizer regulates fuel pressure under all driving conditions, senses increased power requirements and provides maximum pressure when you need it! Constant, accurate regulation of fuel flow gives you greater fuel economy!

ACon-O-Mizer Only

**\$9<sup>90</sup>**

At Your Nearby Service Station, garage or General Motors Dealer.



**ACon-O-Mizer**

AC Spark Plug ⚙ The Electronics Division of General Motors

## When you do-it-yourself...

# CONOLITE®

*makes it easy to do!*



When your home-needs re-doing, do-it-yourself with CONOLITE—the beautiful, hard-surface plastic laminate for sink tops, tables, bars, and walls!

Your reliable Lumber and Paint Dealers have many rich patterns and wood grains now. *So cover your home with exciting Conolite color today!*

economical • flexible, easy to handle • adheres to wood or metal • comes in rolls • less trimming, no seams • chip, heat & stain resistant

**CONTINENTAL CAN COMPANY**

**CONOLITE DIVISION**

WILMINGTON, DELAWARE

SEPTEMBER 1959



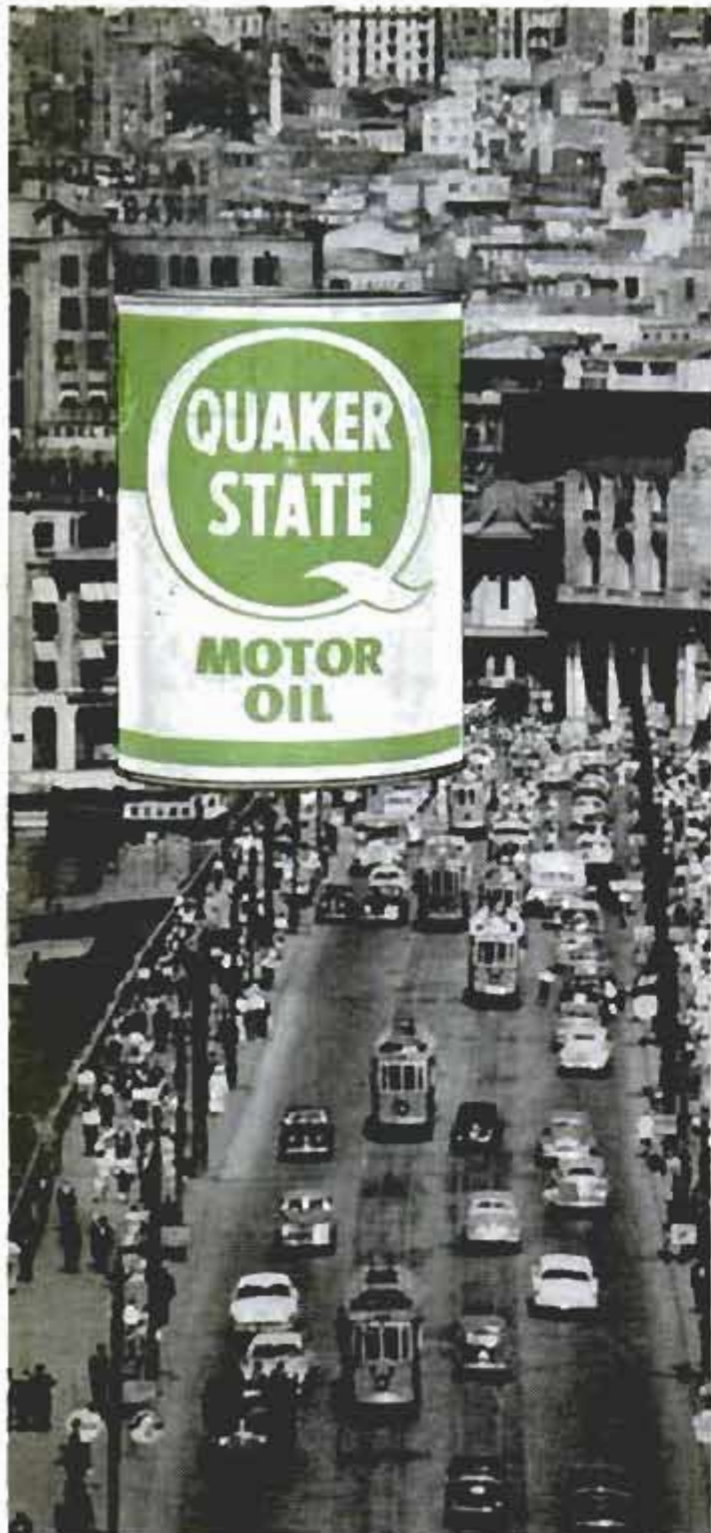

GALATA BRIDGE, ISTANBUL, TURKEY

**On tour or around town, drive with Quaker State, the pure Pennsylvania oil that's fortified to stop both corrosive and erosive engine wear. In countless dynamometer tests and in millions of crankcases the world over, Quaker State has proved that it stops harmful deposits and acid action, keeps engines newer longer! For long-lasting protection against engine wear, specify Quaker State.**

**QUAKER STATE OIL REFINING CORPORATION, OIL CITY, PA.**

Member Penn. Grade Crude Oil Assn.

1859—100th Anniversary of Drake Oil Well—1959  
and Founding of the Petroleum Industry

## PM Salutes Igor Sikorsky

(Continued from page 80)

Turner bought it, and the little Sikorsky group was in business. A clutter of aircraft, emblazoned with Sikorsky's "Winged S" began to fill the skies—training planes, seaplanes, twin-engined craft. Finally, under the banner of United Aircraft, which absorbed his little company, came the great fleet of four-engined flying boats that carried the Winged S, via Pan-American Airways, to the corners of the earth.

Unhappily, according to Eugene Wilson, then vice-president of United, Sikorsky's flying boats proved that four-engined aircraft could safely hop the oceans in one leap—"and so paved the way for their replacement by land planes." Worse, a depression was in progress. In 1938, Wilson was ordered to tell Sikorsky to close up shop. Appearing at Wilson's office for this doleful meeting, Igor bowed from the waist, as is his custom, and blandly suggested that, far from ceasing research, it was United's responsibility to aviation to push on. "I seriously recommend as the subject of our research," he said, "the return to my first love, the helicopter . . . While admittedly radical, and perhaps impossible," he continued, waving aside protests about finances, "the helicopter is entirely rational." He quietly pointed out that a helicopter required no prepared landing field, would never compete with the airplane, and would be "used" not to destroy lives, but to save them.

Sikorsky got his financing and plunged into work on his now famous VS-300. The problems were staggering. One incidental trouble with a single-rotor helicopter is that as the rotor spins, the craft tends to

(Continued to page 228)

Sikorsky shows his friend Henry Ford the VS-300, first commercially built model of the helicopter





## handiest glue around the house

Speedy squeeze bottle. No muss, no fuss. Dries fast, clear and strong! From furniture to scrap-books, best all-purpose glue you can buy. Send stamped, self-addressed envelope for Free copy of "Elmer's Guide to Good Gluing". Write Elmer, The Borden Company, Dept. 9G, 350 Madison Avenue, New York 17, N. Y.

**BORDEN'S PRODUCTS FOR THE HOME HANDYMAN**



### Exclusive Double-Bearing HEAVY-DUTY PUMPS

IRRIGATE • DRAIN • CIRCULATE • SPRAY

Use 1/4 HP motor or larger . . . 1 HP for up to 7,500

GPH; 1,000 GPH 60' high; or 3,000 GPH from 25' well.

1 1/4" inlet; 1" outlet. Stainless shaft.

TYPE X—2 oil-less bronze bearings. Won't rust. . . . \$10.95

TYPE XB—Ball bearing model. . . . \$12.95

Postpaid if cash with order. Rush your order today

**MONEY BACK GUARANTEE**

Centrifugal and Gear Pumps in All Sizes

**LABAWCO PUMPS, Belle Mead 2, N. J.**



**FORGET  
ABOUT  
COSTLY  
UPKEEP!**

## SPECIFY: **ALSCO** **ALUMINUM SIDING**

exclusive  
**BAK-R-FOAM\***  
Insulation  
saves up to 30%  
on fuel bills.  
\*Pat. Pend.

Heavy gauge aluminum is protected with two coats of baked enamel. Almost cares for itself. Nearly 50 color combinations available.

Send for complete information on AlSCO Aluminum Siding, including colors.

ALSCO Aluminum Building Products, Dept. AS-57, Akron 8, O.

## HERE'S A MONEYMAKER FOR YOU!

make from \$3 to \$6 an hour  
with the **FOLEY SAW FILER**

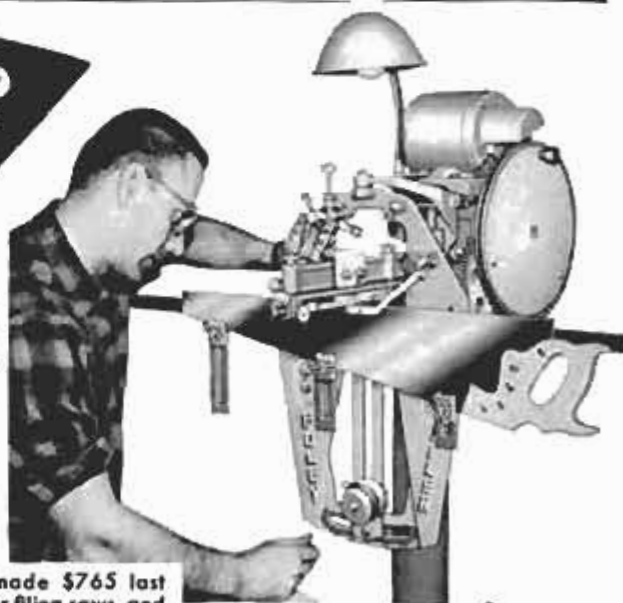

### HERE'S PROOF

"When Mr. Patrick got his Foley Saw Filer in March 1946 he made a good and wonderful investment. He has done so well that we bought a house and paid for it; bought a new car, built an addition to our house. Nicest of all, it's all paid for." Mrs. Leslie Patrick.

"I made \$765 last year filing saws, and it sure comes in handy. I do this work in my spare time." —James B. Williams

"Last year's profit amounted to \$3,000. Not so bad for a one-man outfit." —Charles C. Hough.

"I have done 4 or 5 thousand saws in my spare time in the 4 1/2 years since I got the outfit, and they are all coming back with repeat orders." —Len Crego.



Ask yourself these three questions: 1. Do I really want to get ahead *faster*? 2. How can I do it? 3. Am I willing to *use* my spare time? If you answer "Yes" to questions 1 and 3—then we have a positive answer for you on No. 2. Men make from \$3 to \$6 an hour sharpening hand, band and circular saws with Foley Saw Filers. No experience needed, to turn out sharp, smooth-cutting saws with this automatic machine. Start in spare time—no canvassing.

### HERE'S THE WAY TO START

Read "Money Making Facts"—shows you how others have added hundreds or thousands of dollars to their incomes in this steady, repeat, CASH business. Start your *own* business in your basement or garage, no overhead, small investment. With *Time Payment Plan* the Foley can more than pay for itself out of profits. Send for "Money Making Facts"—mail coupon now. No salesman will call.

FOLEY MFG. CO., 916-9 Foley Bldg., Minneapolis 18, Minn.

Send me free book "MONEY MAKING FACTS" and Time Payment Plan.

NAME \_\_\_\_\_

ADDRESS \_\_\_\_\_



"HARRY DOESN'T MIND OUR USING HIS DEN. HE'S DOWNSTAIRS WITH HIS NEW MILLERS FALLS SAW."

## Talk about Power... these saws

Choose from  
**5 GREAT  
 MODELS**



Write for Free Folders  
**MILLERS FALLS COMPANY**  
 Dept. PM-30  
 Greenfield, Mass.



**800 Heavy Duty**  
 8 1/4" • 2.0 HP • \$95.00

A Contractor's Special that's a real standout. Tremendous power and cutting capacity.



**747 Heavy Duty**  
 7 1/4" • 2.0 HP • \$84.50

An outstanding Builder's Buy, ideal for every type of work. Lightweight, easy to handle.

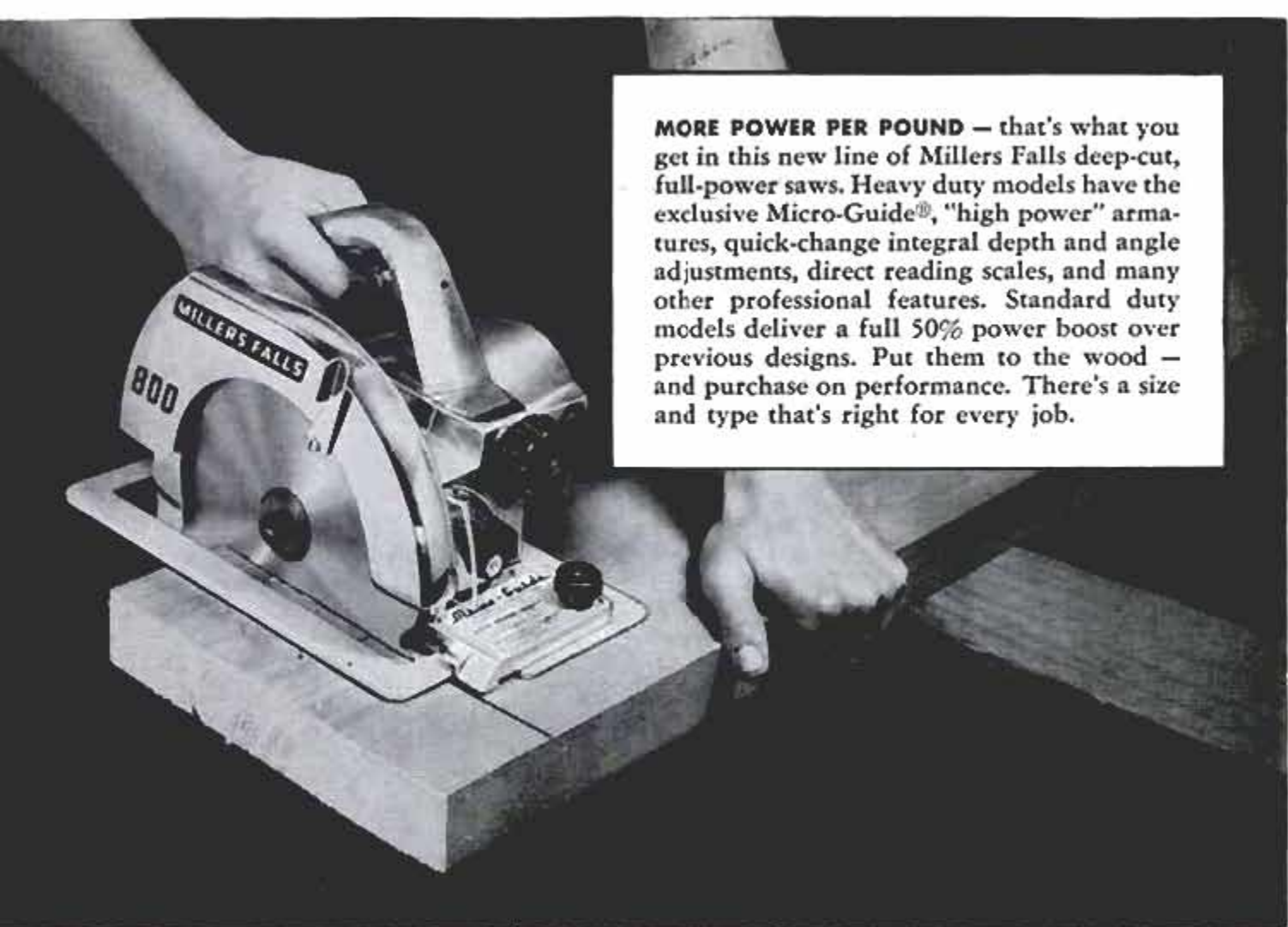

**MORE POWER PER POUND** — that's what you get in this new line of Miller Falls deep-cut, full-power saws. Heavy duty models have the exclusive Micro-Guide®, "high power" armatures, quick-change integral depth and angle adjustments, direct reading scales, and many other professional features. Standard duty models deliver a full 50% power boost over previous designs. Put them to the wood — and purchase on performance. There's a size and type that's right for every job.

have it **IN SPADES!**



**646 Heavy Duty**

**6½" • 1.5 HP • \$69.50**

An amazing all-purpose performer. Special base permits sawing in very close quarters.



**727 Standard Duty**

**7" • 1.5 HP • \$74.50**

A rugged Carpenter's Model with ample capacity as well as perfect, easy-to-use balance.



**626 Standard Duty**

**6½" • 1.0 HP • \$54.50**

Swings through every common cut including tough compound mitres in 2-in. dressed lumber.

spin in the opposite direction. Sikorsky solved this with a vertical tail rotor at the end of a long, skeletal fuselage. Another built-in headache of a rotor is that as the copter moves forward, the blade moving forward gets increased lift from the additional wind it encounters, while the blade sweeping backward gets even less than it would in still air. Result, the helicopter promptly turns turtle. To offset this disastrous effect, Sikorsky's odd-looking crate employed a hinge-like device that allowed each blade to increase lift on the back-sweep, and decrease its angle of attack on the forward sweep.

To steer his odd-looking birdcage, and make it move in any direction, he employed cyclical pitch—a mechanical blade-pitch control, activated by the control stick in the cabin. When the stick was pushed to the right, for instance, each blade of the rotor, as it swept through an arc on the right side of its circle, would automatically decrease its pitch (and lifting power) and the helicopter would fall away in that direction.

On top of all this, he introduced a system similar to that on a variable-pitch airplane propeller. When he wanted to rise vertically, his rotor blades tilted sharply, to take big bites of air; for hovering and moving straight and level, they flattened out.

When he was finished, the hub for the rotor of the VS-300 looked like a transmission case for a truck. But within a few months the rickety-looking framework of pipes was aloft, with Sikorsky sitting stiffly on the forward platform, in overcoat and fedora, patiently learning how to fly it.

About this time, the inventor prepared a movie for his colleagues at United as a sort of "progress report." Everyone was properly impressed, and it wasn't until later that it suddenly struck Wilson the movies showed Igor hovering, backing down, and weaving sideways—but not in one frame had the crazy machine moved forward. He called the inventor about it. "Oh yes, I know," Sikorsky told him seriously. "That is a problem we have not solved yet."

"The trouble," he explains today, "was a matter of turbulence. We were experimenting with two horizontal tail rotors at that time, and whenever we moved forward, the poor tail rotors would run right into the wash from the main rotor, and we would get bumped around very badly. But we solved that by putting the rear rotors on a high tower, above the wash."

By 1942, the VS-300 had proved itself. It also proved that the helicopter could, indeed, gentle itself into a patch of lawn no

bigger than the sweep of its rotors, and take off straight up from it. It could move into a tight spot and back out, or sneak sideways. It could hang in the air inches from the ground to take on or disgorge passengers or cargo—and light out again without having set a wheel on the floor.

Since then, "Igor's nightmare," as it was surreptitiously dubbed at first, has grown into an aerial workhorse with, he firmly believes, its greatest future still ahead. Short-haul whirlybird airlines from city rooftops to outlying airports already thrive in New York, Chicago and West Coast cities. Sabena operates a copter line between nearby cities in Belgium and Holland. Big choppers are airlifting giant steel towers into remote spots on craggy mountains for power lines. They haul tons of wet cement into inaccessible wildernesses, hover while they pour it into foundation forms, then make off, bucket dangling, for another load for all the world like a swarm of giant wasps building a nest.

Thousands of Sikorsky S-55s saw duty in the Korean war, chopping over the battlefields to save an estimated 15,000 lives. The whirlybirds have lifted disaster victims from the sea, plucked broken humans from mountain crags and flood-ravaged canyons. New uses for the strange craft crop up daily. Farmers use it for safe and sane crop dusting. Nut grove planters can harvest pecan crops by flying over the trees with a helicopter and beating the fruit to the ground with the breeze from the big blades.

Today, half a dozen big companies turn out helicopters of all descriptions. Twin-bladed "flying bananas," auto-rotating gyrodynes, big ones and little ones fill the skies—largely because Igor Sikorsky insisted on "the wrong way."

Where do we go from here? Unique helicopter configurations for the world of tomorrow are hidden away in the Sikorsky "dreams and schemes" department. "One day," predicts the inventor, "you will see helicopters, with automatic detachable hooks dangling under them. They will be 'elevators' for small airplanes—hoisting them from small parking places in forests or jungles and releasing them at high altitudes. They could also hook such planes in mid-air, and lower them into areas where they could otherwise never land."

Sikorsky believes the future lies with single-bladed helicopters. "One woman in the kitchen is enough," he says. "If you want to lift a bigger payload—use a bigger bladed rotor." He does admit, however, that multirotored copters may find specialized uses.

(Continued to page 230)





*Firestone tires pass the world's toughest trials on the world's fastest tracks.*

***Firestone proves why in the 7 toughest types of testing!***



*Firestone tires give you the safety and mileage you need for today's turnpikes.*

## **CHAMPION ON TRACK...AND TURNPIKES, TOO!**

*Test-proved Firestone Rubber-X\* is the best-proved material in tires.*

Only Firestones are tough enough to pass every blazing trial in *all seven* types of tire testing—on speedways, turnpikes and proving grounds, in city driving, on gravel and dirt by-paths, over twisting mountain grades and on roasting desert roads. Firestone combines scientific testing in complex laboratories with all-weather research on every type of road and on Firestone's 170-m.p.h. test track, the fastest in the world. To measure tires for safety, stability, mileage and other factors that affect your driving, engineers run them for millions of miles under calculated conditions of tire-torturing extremes. Such research helped bring you speedway-proved S/F (Safety-Fortified) cord—and Firestone Rubber-X, the longest-wearing rubber ever used in Firestone tires. Since it costs no more to get best-proved Firestone tires, why take less or pay more? Buy them on convenient terms if you wish at your nearby Firestone Dealer or Store.

*\*Firestone Rubber-X is compounded specifically for each type of Firestone tire*

# **Firestone**

**BETTER RUBBER FROM START TO FINISH**

Copyright 1959, The Firestone Tire & Rubber Company



**tailor-make wrenches  
on the job...**

WITH  
**Williams Supersockets®**



**YOU CAN TAILOR-MAKE WRENCHES** for any job...big or small...hand or power...in a matter of seconds. From tiny assemblies to massive structural work, Williams broad line of Supersockets®, Power Drive Sockets and Superector® Wrenches covers the full range of openings from 3/16" to 4-5/8" for hex and square nuts.

At Leading Industrial, Auto and Hardware Dealers  
WRITE FOR CATALOG 503

BETTER  
TOOLS

**WILLIAMS**

FOR BETTER  
WORK

**J. H. WILLIAMS & CO.**

Division of United-Greenfield Corporation  
419 VULCAN STREET, BUFFALO 7, N. Y.

His twin-engined S-56, capable of carrying 30 passengers, is already in military service and is the monster from which his new flying crane was developed. A sleek S-61, powered by twin jet engines, seats up to 25 people in a comfortable boat-like amphibious body.

#### Apply Jets to Rotor

"Jets may be applied to rotor tips for better performance," he says. "And you will see great advancement made in flying cranes—for hoisting movable-pod buildings to battlefields and construction sites, as well as lifting great steel assemblies to places no crane can reach."

What about those ducted fans, and flying platforms? Sikorsky shrugs. "Any decent propeller will provide a lift," he says noncommittally. "Even an indecent one. But there are great difficulties with control. If the fan stops," he points out with a humorous twinkle in his eye, "you then have a choice. I call it the 'two Ps'—for 'parachute or pray.' And you pray not for your safety but for your ultimate destination."

As for the convertiplanes, they will have a limited place, he thinks. But for people who want to go straight up—properly—Sikorsky is strictly a helicopter addict. ★★

Trap household odors and dust...  
SAVE MONEY, too!

**RP EZ KLEEN®**  
WASHABLE, ALUMINUM

## FURNACE FILTERS

Economical because they're WASHABLE. As easy as rinsing a dish... collected dust, dirt, pollen and water soluble adhesive flush off with water.



Amazing adhesive REMOVES ODORS, DUST. Super Filter Coat adhesive, in two types of spray containers, traps and holds odors and dirt...has built-in detergent to simplify washing. Restores like-new efficiency to filter.

Long-lasting ALUMINUM won't rust, makes cleaning easier...lasts for years and years of clean filter service...and improved furnace operation.

ASK YOUR DEALER

IN CANADA: Hicks-Baker Ltd., Winnipeg • Spall-Bowman, Ltd., Guelph  
RESEARCH PRODUCTS Corporation • Dept. 227, Madison 1, Wisconsin

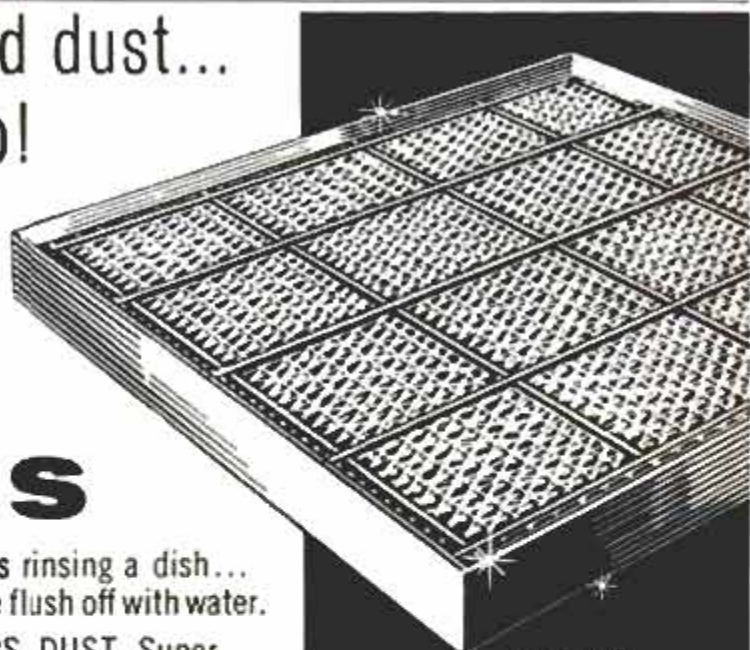

As low as **\$1.95**

for popular sizes

Write For  
**FREE BOOKLET**

Complete information on  
what to look for in an  
air filter.



Everything for the Craftsman!



WRITE FOR NEW 132 PAGE

# WOOD CATALOG

AND HOME WORKSHOP

Finest Domestic and Imported Woods

... Mouldings, Hardware, Tools ...

ALL AT LOW MONEY-SAVING PRICES!

Your complete wood buying guide and project book. Craftsman is your best, most complete source of finest kiln-dried domestic and rare imported woods, beautiful wood inlays, colorful bandings, matched plywoods, embossed mouldings, carved ornaments, newest woodworking tools, "hard to find" cabinet hardware and fittings... more than 1500 items! Packed with newest scroll saw patterns, project ideas and money making plans. Enclose 25¢ (refunded with first order) to help pay mailing, handling cost. Write:

Upholstery Materials:  
New Tools; Lamp Parts;  
Metal and Wood Legs;  
Cabinet Hardware;  
Music Boxes; Archery  
and Water Ski Kits.  
Over 1500 Items

CRAFTSMAN WOOD SERVICE COMPANY, Dept. A-9  
2729 SOUTH MARY STREET - CHICAGO 8, ILLINOIS



## PEEL OFF PAINT



- Remove old finishes easier, faster
- Non-inflammable and needs no afterwash
- For wash-off or scrape-off use

### Heavy-Bodied KLEAN-STRIP

PAINT REMOVER

THE KLEAN-STRIP CO., INC.

2340 S. Lauderdale, Memphis 6, Tenn.

## This Month's "Great Pioneer in Science"

(Page 20)

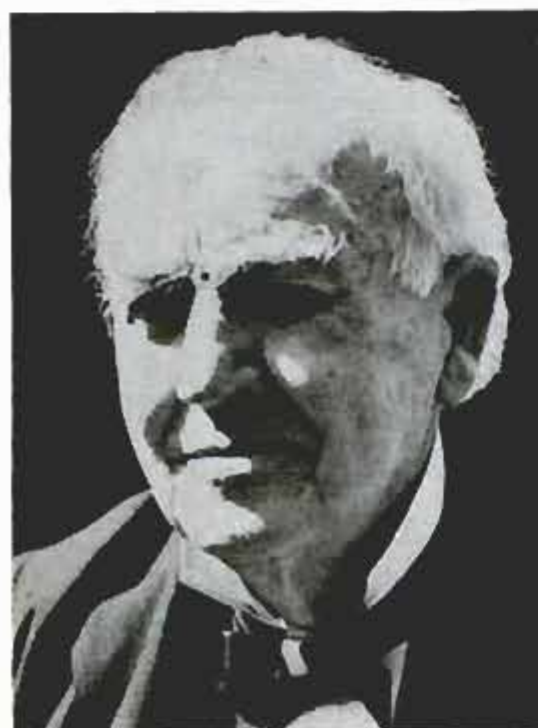

Thomas Edison (1847-1931)

# HOW FLEET OWNERS GET 200,000 MILES FROM STOCK ENGINES



Truck and cab operators replace key parts . . .  
get like-new engines for worry-free driving

Let's say you've got a good car you'd like to keep. Trouble is, it burns too much oil . . . can't get by a gas pump; and at traffic lights, you're left behind in a cloud of exhaust. Well, owners of fleet cars with stock engines *just like yours* know what to do. Invest in an engine overhaul, replace key parts like bearings and rings, and get a car that runs as good as new!

### WHEN TO OVERHAUL?

Worn engine bearings are easy to diagnose. Among other things, they cause oil burning, engine misfiring and knocking, poor gas mileage, sluggishness and loss of power. Spot the symptoms in your own car? You need an overhaul, and new Federal-Mogul engine bearings.

### WHAT TO REPLACE?

An "overhaul" without new engine bearings is no bargain—you can tell after a few miles. Then you put up with it, or pay to do the job over. So make it *right* the first time! It costs just a few dollars more, and it's worth every cent of it.

### WHY FEDERAL-MOGUL?

Your engine depends on bearings—main, connecting rod and crankshaft. Federal-Mogul bearings are the world standard for quality and precision. Yet it *costs* no more to use the best! Ask your mechanic.



## FEDERAL-MOGUL SERVICE



Division of Federal-Mogul-Bower Bearings, Inc. • Detroit 13, Michigan

# POCKET-SIZE BLOW TORCH

(BUTANE GAS)

only \$2.25

Sweats pipe! Do your own plumbing repairs! Jet King "sweats" joints in copper tube up to one-half inch diameter.



Solders wire! Do your own TV, radio repair! Jet King solders in a jiffy, lets you do fine work in close quarters.



Repairs jewelry! Pin-point flame of Jet King Blow Torch lets you do delicate work safely, surely, and simplifies repair or making of jewelry.

Now—solder, braze, fix leaks. Do wiring, plumbing, loosen frozen nuts and bolts, 1001 odd jobs. Butane gas blow torch gives intense 3500° pin-point flame that lasts ½ hour, turns on or off. Extra "chargers" 49¢ for two. Send \$2.25, check or money order for Jet King Blow Torch with one charger, or send \$2.95 for complete soldering kit: Blow Torch, two chargers, soldering tip, roll of solder. For sale at hardware, auto accessory, and plumbing supply stores, or send coupon below.

Money back guarantee

Kidde Manufacturing Co., Inc., 904 Farrand St., Bloomfield, N.J.

Send me \_\_\_\_\_ JET KING BLOW TORCHES @ 2.25 ea.\*

Send me \_\_\_\_\_ JET KING SOLDER KITS @ 2.95 ea.\*

Send me \_\_\_\_\_ Boxes of Extra Chargers @ .49 per box.

My check, \_\_\_\_\_ money order, \_\_\_\_\_ for \$ \_\_\_\_\_ is enclosed  
(\*Add \$1.00 Extra per unit for Canada)

NAME \_\_\_\_\_

STREET \_\_\_\_\_

CITY \_\_\_\_\_ STATE \_\_\_\_\_

## Get Ready for the Next Flood

(Continued from page 145)

give way, farmers appear with their own supply of sacks and they also manage to bring along plenty of tarps, duck canvas and plastic haystack covers that can be used in an emergency. Farmers are good flood fighters. They know that high water can ruin a year's work in a matter of minutes."

Flood-conscious trainees are taught to use bales of hay, stacks of tree limbs and small trunks, or any other available material when caught in a flood crisis where there is too little time to get a supply of sacks.

### Wave Wash Erodes Levee

Frequently, flood conditions arise from an erosion of a levee due to action of a swift current of water against an earthen levee. This is called wave wash and usually gets started when a high wind forms pounding waves on the water.

The school for flood fighters advises students that they must patrol levee banks and test for slope erosion by actually wading along a submerged slope and feeling for the beginning of a washout with their feet. Trainees are cautioned to wear life jackets during this operation and seek the extra protection of a lifeline anchored to the shore.

Detection of washouts calls for the placing of wooden panels against the eroded area to halt further wave-wash erosion. Another method is heavy cotton bagging when available, or the placement of sandbags directly in the washout.

### They Go Right to the Trouble Spot

Engineers can usually go right to a trouble spot on a levee even when most of the water side of the levee is flooded. They know that erosion occurs the fastest at the ends of the levee dikes; on road-crossing ramps, and in areas where pipes and other structures penetrate the levee.

There are times when flooding of land occurs simply because the builders of the levee failed to estimate properly the high-water elevation of the adjacent body of water. Low levee sections cause many millions of dollars of damage annually throughout the country.

Trainees are taught to use emergency methods to provide additional topping on a low levee. Using the sack method, they are instructed to lay one layer of sacks one third to one half full of sand in stretcher-wise fashion on the crown of the levee; the second layer goes crosswise, and so on.

(Continued to page 234)

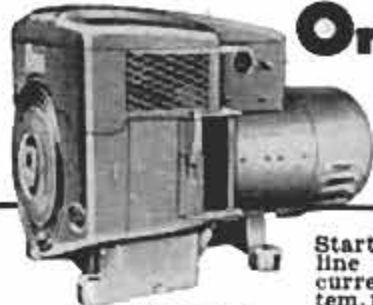

## Onan Emergency Electric Plants

Start automatically when high-line power is cut off, supply current for lights, heating system, freezer, water pump, stove, all appliances and machines. Prevents losses and hardships. Plant stops automatically when power is restored. Compact, easy to install. 500 to 200,000 watts A.C. Priced from \$319.00.

### PORTABLE MODELS

500 to 10,000 watts. Supply plug-in power anywhere!

Write for Free Folder

**D. W. ONAN & SONS INC.**  
3313 UNIVERSITY AVE. S.E. • MINNEAPOLIS 14, MINN.

**BUILD FINE GRANDFATHER CLOCK NOW**

The simple sensible **SPEEDE Red-i-Kut** way as thousands have — **FOR YOURSELF OR SELL AT A GOOD PROFIT, SAVE HUNDREDS OF DOLLARS. SHOP TESTED PLANS "SPIRIT OF THE CENTURY"** Narrow waist 43" tall or stately straight side "SPIRIT OF AMERICA," **EASY-TO-FOLLOW photopack PLANS & LIFE SIZE PATTERNS** tell all—plus **MOVEMENT BROCHURE \$4.00** up, of heavy brass weight (Kuenpel original) Westminster tube **BELL chime, movements, gorgeous bronze-silver MOVING HOON dials, 3/4" solid-mahogany Jiffy Joint-Kwik-Bit case kits. Send \$1.00 today — Both plans RUSH \$1.50 as folks have for over forty years.**

Kuenpel Chime Clock Works, 22 Kuenpel Bldg., Minneapolis 16, Minn.

**Print Your Own**

Cards, stationery, circulars, etc. Save money. Print for Others, Good Profit; easy rules sent. Raised Printing like engraving. (on Junior press \$13; Senior \$29 up. Sold direct from factory only. We furnish everything. Write for free details.)

**KELSEY PRESSES, Y-37 Meriden, Connecticut**

# Watch for PM's Indoor-Outdoor House

a color feature in the October issue.

It's designed for you by a noted architect

SEPTEMBER 1959

**CUT CLEAN, ROUND HOLES QUICKLY and SAFELY with**



**Starrett**

**SAFE-FLEX**

HIGH SPEED

WELDED EDGE

**HOLE SAWS**



You can cut perfect holes, at minimum cost, from 9/16" through 6" in diameter in steel, brass, bronze, cast iron, aluminum, wood and plastics with STARRETT SAFE-FLEX High Speed Welded Edge HOLE SAWS. Easy to use with portable power tools, lathes, drill presses or other machine tools. They are made of high speed steel with a shatterproof body and rigid steel cap. Equipped with a 1/4" pilot drill and a choice of 7/16" or 5/8" hexagon or 1/4" round shank.

Starrett also makes a complete line of finest quality Hacksaws, Band Saws and Band Knives for every cutting purpose. See them at your Industrial Supply Distributors, Hardware Tool Store or send for **BIG, FREE STARRETT CATALOG**. It describes and illustrates these and over 3,000 other Starrett Tools. Send the coupon today.



THE L. S. STARRETT COMPANY  
Dept. AP, Athol, Mass., U. S. A.

Please send my free copy of the big new Starrett Catalog No. 27.

Name.....

Occupation.....

Address.....

City.....Zone.....State.....



**...with less oil and gas!**

Don't put up with poor performance and big oil and gas bills just because your car's no longer new. You can restore its lost pep and power and prevent excessive oil and gas consumption, with a Hastings re-ring job.

The sooner you act, the less it will cost. See your motor specialist the minute oil-pumping warns you there's trouble ahead. When he recommends new piston rings ask him for Hastings. They're engineered exclusively for replacement service . . . to provide the additional lubrication worn engines need . . . to stop oil-pumping, save gasoline, restore lost performance.

Get new car power and performance from your present car—with Hastings. Truly your best investment for many thousands of extra miles of trouble-free driving pleasure.

 **HASTINGS**

**PISTON RINGS**

**TOUGH** on oil pumping **GENTLE** on cylinder walls

**HASTINGS MANUFACTURING COMPANY  
HASTINGS, MICHIGAN**

Piston Rings, Casite, Oil Filters, Spark Plugs

Each layer provides three to four inches of topping. Trainees are told that this method can successfully raise a levee surface by as much as three feet and is likely to avert a flood!

Flood fighters are told to use lumber combined with sack topping to hold back water in low-levee areas. Stakes are driven into the river side of the levee crown, and panels are then nailed to them from the land side of the stakes. This wall is then backed with sandbags or tamped with earth.

### Mud Boxes Help

Mud boxes are yet another method used by flood-fighting experts in taming a cresting river. Two parallel wooden walls are placed near the waterward side of the levee crown and filled with available material. The walls are boxlike, being up to 24 inches in height and 30 inches wide. They are valuable in flood control when the fill material turns soupy. They can also take a liquid fill when sand or soil is scarce, but only if the boxes are lined with canvas or burlap material.

Construction methods are but one of the very important means of flood control. The other vital phase of work emphasized by the school for flood fighters is the organized levee patrol.

Trainees supervising flood-control crews on their own home ground must send out patrols to seek trouble spots along the levees. The trainee has to be able to judge the number of men he can spare for a patrol during emergency periods, how much equipment the patrols should carry and where to stockpile tools and supplies so they can be reached with the least delay.

In addition, trainees are instructed to learn what facilities in the community can be used during a flood. They must know the extent of their personal authority, for sometimes, in order to prevent widespread flooding, engineers have to divert a stream across private property, thus damaging a limited area to save a larger region.

The trainees are told how far they can legally proceed to control a flood and what help they may expect from other agencies and private citizens when aid must be commandeered.

### Effectiveness of Training Proves Self

The effectiveness of the training provided by the school for flood fighters became well known to Western hydraulic engineers as a result of the recent Cache Creek incident, occurring just a few weeks after the California Department of Water Resources

gave its employees the initial course in flood fighting.

Cache Creek, a small stream emptying into the Sacramento River below the town of Knight's Landing, had been deluged by eight inches of rain within two days. On February 24, 1958, a radio-operated measuring gauge on the banks of the creek tele-metered a warning to the operations center at Sacramento that the stream was about to overflow.

The water rise had been so sudden, engineers suspected that the warning equipment had gone haywire, and made telephone contact with a flood lookout in the area.

The lookout, a woman rancher, waded through three feet of water covering her fields in order to reach a manually operated gauge on the Cache Creek levee. The gauge confirmed the previous report, and the brave woman also advised that the creek might leave its banks in a sudden rush.

### Residents in Danger

Immediately in danger were 300 residents in the nearby town of Yolo, plus countless ranches, farms, two major highways and a main railway line.

Classroom technique turned to practice as flood-control experts rushed 200 men to the creek and used most of the flood-combat methods described in this article. Even though added rainfall caused further rise in the creek, it was declared safe within 24 hours.

The incident proved that, given ample time to reach a danger area, flood fighters with know-how can avert disaster, often under seemingly hopeless odds.

The state has since installed a radio-warning system along many of its treacherous streams, relaying river levels on a timed basis to the Flood Operations Control Center in Sacramento.

California hopes it will never again have to face a catastrophic flood such as the one that occurred during the Christmas season of 1955. Should threat of a major water invasion again occur, residents now have the assurance that they will be protected by men who received their training at the school for flood fighters.

In this respect, Californians are receiving the best flood security available anywhere within the nation. ★ ★ ★

☞ Scientists are studying earth vibrations recorded throughout the International Geophysical Year to determine whether Antarctica is a single continent or separate land masses.

Your  
dipstick  
**PROVES**  
the  
difference  
in filters



Hastings Oil Filter Cartridges keep oil clean from filter change to filter change, when replaced as normally recommended.\*

That's because only Hastings has Densite filtering material, which traps and holds even the most microscopic dirt particles. The dipstick test proves it!

Just ask for Hastings—next filter change. Be sure of clean oil *all* the time.

\*Proved by tests conducted in accordance with U. S. Bureau of Standards.

U. S. Patent Numbers 2,797,811 2,584,771



**HASTINGS**  
**OIL FILTER  
CARTRIDGES**

HASTINGS MANUFACTURING COMPANY  
HASTINGS, MICHIGAN

Oil Filters, Casite, Piston Rings, Spark Plugs

the meter scale with red ink. This portion of the scale indicates an excessive overload condition, and its emphasis in this manner will show at a glance when too much current is being drawn from the supply.

With all wiring completed, the power supply should operate the instant that the line cord is plugged into the wall socket and the switch, S1, is turned on. When this is done, the pilot lamp should light and the meter pointer should rise to a value between 5.5 and 6.5 volts, depending on the particular characteristics of the Zener diode it shunts. Because such diodes are selected to break down within  $\pm 10\%$  of their



**This point lets you bore holes up to 1 1/2" with small electric drill**

**It's hollow ground to bore cleaner, faster at any angle**

**NOW YOU CAN** increase the boring range of your small electric drill or drill press. New Irwin Speedbor "88" bits bore faster, cleaner holes up to 1 1/2" in any wood. 1/4" shank chucks perfectly. No wobble, no run-out. Sharp cutting edges on Irwin exclusive hollow ground point start holes faster, permit spade-type cutters to bore up to 5 times faster. All Irwin Speedbor "88" wood bits are forged from single bar of special bit steel, tempered full length and machine-sharpened for extra accuracy, longest life. 17 sizes, 1/4" to 1 1/2". Buy individually or in sets from your Irwin hardware or building supply dealer.

**Only 75c each, sizes 1/4" to 1"**

**Only \$1.25 each, sizes 1 1/8" to 1 1/2"**

**IRWIN SPEEDBOR "88" WOOD BITS**  
at Wilmington, Ohio, since 1885

#### LIST OF MATERIALS

S1=s.p.s.t. toggle switch; L1=NE-51 neon bulb w. Dialco No. 931 panel assembly; T1=filament transformer, sec. winding 26.5 VCT/.6A., Thordarson 21F27; D1, D2=germanium rectifiers, G.E. 1N91; C1, C2=100 mfd./25-v. electrolytic capacitors; CH1=filter choke, 2.3 hy./150ma., 60 ohms, Stancor C2304; Z1, Z2=Zener diodes, IRC IZ5.6; M=0-10-VDC meter, Emico RF-2C; F1, F2, F3=insulated feed-through bushings, "USECO" 1432 or similar; R1=220-ohm resistor, 2 watts; aluminum chassis, 6 1/4 x 4 x 1; perforated bakelite board, 2-7/16 x 3 3/8, Lafayette MS-304; "flea clips", (2 pkgs.) Lafayette MS-263; line cord w. a.c. plug; rubber grommets (4).

rated voltage, output-voltage variations within this range may be considered normal.

In use, the Zener diodes cease to regulate when the load current reaches a value of approximately 140 ma. This is the overload point and any attempt to draw more current will result in a rapid drop of output voltage, as indicated on the meter. Actually the voltage begins to drop at a somewhat lower load current but the drop does not become excessive until overload current is being drawn.

Circuit components have been selected with care and should not be replaced with units having different specifications. Any change in the d.c.-resistance value of filter choke, CH1, in the resistance of R1, or in the voltage output of the transformer, T1, will affect the maximum amount of current which can be drawn from the supply. As designed, the unit provides a safety factor of at least 10 percent beyond that which is built into the components themselves by the manufacturers. Properly used, it will provide reliable operation over a long period of time. ★ ★ ★

☞ Persons born deaf are likely to have frequent, vivid dreams in three-dimensional color, say scientists who have interviewed totally deaf students at Gallaudet college for the deaf at Washington, D. C.

**only a screw holds like a screw**



Whether you're repairing, refitting, remodeling or working on a completely new project, nothing can substitute for the permanent holding power of a Southern quality screw. Stock up now on Southern Screws with the sharpest gimlet points and the smoothest cutting threads you can buy. Southern screws start right, drive right, hold tight. Buy 'em by name—buy 'em by the box and save!

Sold Through Leading Wholesale Distributors, also Leading Hardware and Building Supply Dealers.



- Wood Screws
- Topping Screws
- Machine Screws & Nuts
- Stove Bolts
- Hanger Bolts
- Carriage Bolts
- Dowel Screws
- Wood Drive Screws



**NOW**

*Multi-Color  
Painting  
is easy  
for anyone!*



• Low-cost PRESSURE MAID Paint Sprayer with special spray cap for MULTI-COLOR paints is ideal for do-it-yourself projects. Rugged, portable, trouble-free. Complete — ready to spray. Piston-type, direct-drive, single cylinder compressor. 1/3 h.p. 110 Volt AC motor.

Write for new Bulletin PM 500 today!

The Campbell-Hausfeld Co.

1046-C Railroad Ave., Harrison, Ohio



**CAMPBELL-HAUSFELD**



## GENUINE ALNICO MAGNETS

AMAZING, PERMANENT, NON-ELECTRIC, HIGHLY PRACTICAL. Conduct interesting experiments. Hundreds of uses. Retrieve valuable steel items such as pins, tackle from fresh or salt water; tools from tanks & drains. **GUARANTEED.** Try any magnet one week. Money back if you are not well-pleased.

- No. M-710 (Wt. 53 oz.) Has pull of 225 lbs. on steel block... \$18.00
- No. M-625 (Wt. 70 oz.) Has pull of 125 lbs. on steel block... \$10.00
- No. M-575 (Wt. 18 oz.) Has pull of 75 lbs. on steel block... \$7.00
- No. M-500 (Wt. 13 oz.) Has pull of 50 lbs. on steel block... \$5.00
- No. M-300 Kit of Flat Bars 5 Pairs (10 Magnets)... \$3.00
- No. M-250 Kit of Round Rods 5 Pairs (10 Magnets)... \$2.50
- No. M-17 Flat Pad Magnets, 10 for \$1.00... 50 for \$4.87
- No. M-35 Hobbyist assortment of 8 small magnets... \$1.50

Send M.O. or check. We pay postage. Sorry no C.O.D.'s.

MIAMI MAGNET COMPANY, 3240 N.W. 27th Ave., Miami 42, Fla.

## ALL NEW! 1960 Edition of Constantine's WOODWORKING CATALOG & MANUAL



Get the biggest Constantine Catalog & Manual — 2000 items! World's largest source for rare imported and domestic woods in veneers, lumber, plywoods, bandings, inlays, mouldings, carvings... hard-to-find hardware, new solid brass hardware, wood finishing and upholstery supplies, patterns, tools, woodworking materials — at bargain prices! Also exclusive Inlaid-Wood-Picture Kits... Identification Chart of 60 rare woods in color... Inspiring projects, plans, etc. For all-new 1960 Catalog & Manual, send 25c (refunded on first order). Write today!

**ALBERT CONSTANTINE & SON, INC.**  
2050 Eastchester Rd., Dept. M-5  
New York 61, N. Y.

**FREE**—Year's subscription to "Chips & Chats"... brings news of exciting woodworking ideas and latest offerings... Free with Catalog!

**BROKEN  
GLASS?**



Replace with **DAP**



DAP "33" Glazing Compound is your best way to set glass in wood or metal sash—or to replace dried-out putty that lets windows leak air and water. Works easily, lasts longer. Get DAP "33" and other nationally advertised DAP products at your hardware, paint or building supply dealers. Write for free do-it-yourself folder.

**DAP**

CAULKING COMPOUNDS  
GLAZING COMPOUNDS  
TUB AND TILE SEALER  
SPACKLING COMPOUND

DICKS-ARMSTRONG-PONTIUS, inc. • Dayton, Ohio.

**TOOL  
CARE**



Give your precision tools the care they deserve—in a Gerstner Chest. Free Catalog.

**GERSTNER TOOL CHESTS**  
459 Columbia St., Dayton 7, Ohio

## 3 ways to make **BIG MONEY** in ARC WELDING

... and have a paying business of your own

Welding is in big demand throughout the country. You can step into the picture and cash in on the constantly growing need for emergency repair work and construction projects. Choose the equipment experts prefer—Hobart! You'll turn out topnotch,

professional work with the ① 180 amp. all-around AC transformer model ② 100 amp. home work shop model, or ③ 200 amp. AC power/DC welder combination, that welds or runs tools, lights, motors, etc. Write for complete details — no obligation.

**HOBART BROTHERS CO., BOX M-99, TROY, OHIO, Phone FE 2-1223**



Shop Type AC Transformer



Home Work Shop Model



DC Welder and AC Power Combination

duce equal and in-phase plate currents which cancel each other in the primary of T1 and produce no voltage in the secondary.

In Fig. 5F, a special matrix transformer, T2, has been added to the previous circuit. Although the L-R signals produce no voltage in T1, they do cause a voltage drop across the primary of T2 which is induced in the secondary winding of this transformer. With the secondary windings of the two transformers interconnected as shown, the (L-R) signal is effectively in series with both the (L+R) and  $-(L+R)$  signals of T1. Being in phase with one of these, and out of phase with the other, it restores the stereo difference to the two push-pull-amplified sum signals applied to the individual speakers.

The complete schematic of the Heath amplifier, less power supply, is shown in Fig. 6. The output stage, which follows the theory outlined above, is preceded by three stages of voltage amplification. These provide sufficient gain to permit a .1-volt input signal to drive the amplifier to its rated power output of 10 watts.

The power supply, a transformer-powered, full-wave doubler, employs two silicon rectifiers in a cool-running, well-regulated circuit.

### Advantages and Limitations

As an integrated stereo-phono system, The Heath Stereo Package leaves little to be desired. The amplifier has a flat ( $\pm 1\frac{1}{2}$  db.) frequency response from 30 to 16,000 cycles, with less than 2% harmonic distortion over the entire range at a 9-watt power output level. The quality of the other electronic components—the CBS ceramic stereo cartridge and the special

Jensen speakers—complements that of the amplifier.

But the system has its disadvantages. Despite the fact that the amplifier has two "tuner" input jacks and a "stereo tuner" selector-switch position, it is doubtful that present AM-FM stereo broadcasts will provide satisfactory stereo reproduction. Since the separate radio signals are not likely to have the exact phase relationships required for proper operation of the amplifier, stereo reproduction of this type would appear to be strictly accidental. On the other hand, radio reception from a monophonic radio tuner, either FM or AM, is excellent, and stereo by proposed FM multiplex methods is entirely possible. If stereo multiplexing replaces FM-AM stereo broadcasts, as it may well do in the near future, this amplifier system will be fully compatible.

A second limitation is the lack of a preamplifier which prohibits the use of the amplifier in conjunction with microphones or tape decks unless a suitable preamplifier is added separately. A limited number of input jacks and selector-switch positions restricts the use of the amplifier to one stereo-phono pickup plus one additional monophonic signal source, such as radio tuner, TV tuner, etc. In short, the stereo package lacks the versatility associated with "components" high fidelity.

But these shortcomings are important only where future expansion of the basic system is contemplated. For anyone interested principally in stereo-phono reproduction, with the possible later addition of an FM-AM (nonstereo) tuner, the new kit provides a worthwhile construction project—a low-cost means towards true stereo fidelity. ★ ★ ★

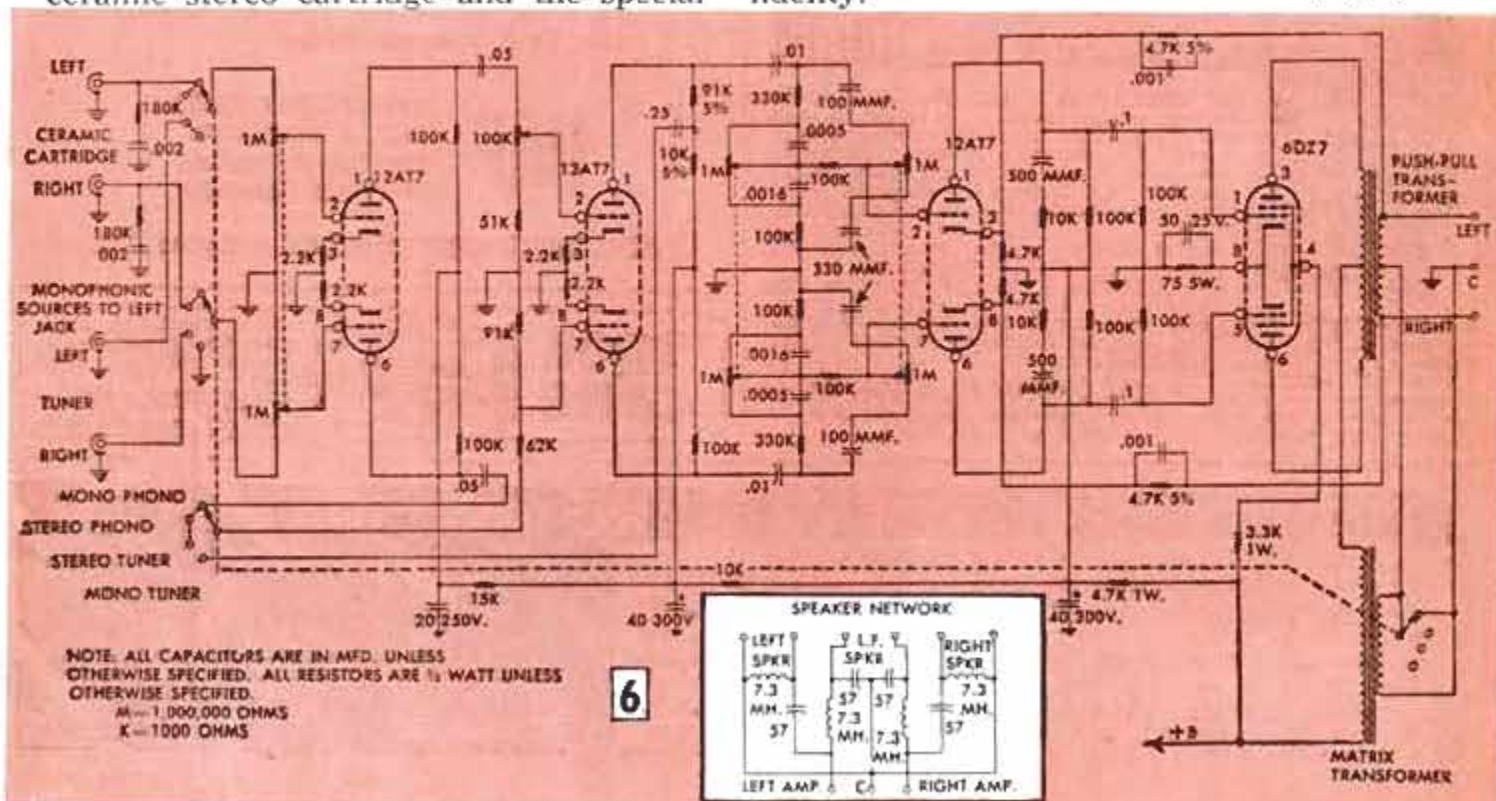



At Times Like This —  
**You Need PLASTIC STEEL®**

80% Steel

When home repair troubles start to pile up . . . don't let it get you down . . . Get PLASTIC STEEL the permanent mender with a million uses around the home, garage or farm. PLASTIC STEEL fixes practically anything in minutes . . . saves you hundreds of dollars on repair bills.

As easy to use as modeling clay PLASTIC STEEL forms to any shape, bonds metals, wood, concrete or glass to itself or each other. Hardens to a steel-like strength in two hours. Can be filed, sanded or painted.

Repairs broken furniture, light fixtures, tools, toys, and appliances without special tools. No heat or pressure required. Seal leaking pipes, tanks, sinks, radiators and furnaces with PLASTIC STEEL. Holds under pressure. Won't shrink or expand.

PLASTIC STEEL fixes cracked motor blocks, torn fenders, leaking gas tanks, tractor parts, feed tanks and planting machinery. Unaffected by weather, won't corrode!

PLASTIC STEEL — in the black and yellow package — is available in three convenient home kits — \$1.98, \$1.89 and \$3.95. At all leading hardware stores.



WRITE FOR FREE HOME REPAIR BOOKLET  
**DEVCON CORPORATION**  
 176 Endicott Street, Danvers, Mass.

Also available — NEW Devcon® Rubber and Devcon® Aluminum

**FREE!**  
**BELT HOLSTER**  
 NOW WITH EVERY  
**EVANS TAPE**

Sizes from 6 ft. to 12 ft.



CLIPS ON BELT!

Holster, worth 50¢, free now at your hardware dealer, when you buy an Evans "high visibility" push-pull or power pocket tape. Metal-reinforced, vinyl-covered holster provides great new on-the-job convenience — clips to the belt, you can measure "from the hip." At your dealer only.

**Evans RULE CO.**

Factories at:  
 Elizabeth, N. J. and Montreal, Que.

SEPTEMBER 1959

Small  
 Lathe  
 with a

**BIG  
 Reputation**

for Dependability and Accuracy

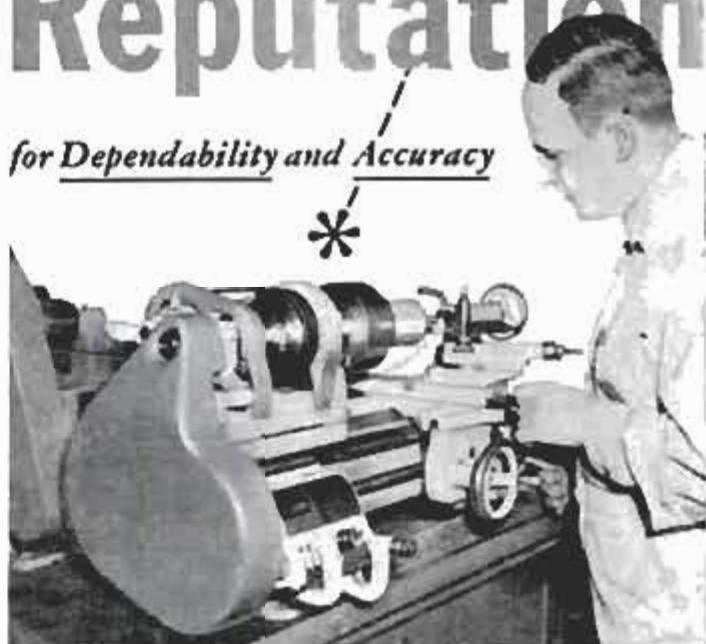

- \* Always ready to go . . .
- \* Run every day, for years—still going strong . . .
- \* No doubts, No worries—if the job goes on the South Bend, delivery's on time . . .

**THAT'S DEPENDABILITY**

- \* The FINISH so FINE, just wash and deliver—grinding or lapping seldom necessary . . .
- When tolerances are tight, "South Bend" does the job . . .

**THAT'S ACCURACY**

- \* Dependable and Accurate—that's how South Bend lathes are built . . . So say thousands of South Bend 9' lathe owners . . . Compared with all others—They're your best lathe investment.

**OVER 140 MODELS—FROM \$280.00**

Write for free catalog

**SOUTH BEND**

**LATHE, Inc.**

**SOUTH BEND 22, INDIANA**

Builders of Lathes, Milling Machines,  
 Shapers, Drill Presses, Pedestal Grinders



Up to 24  
 months to pay.

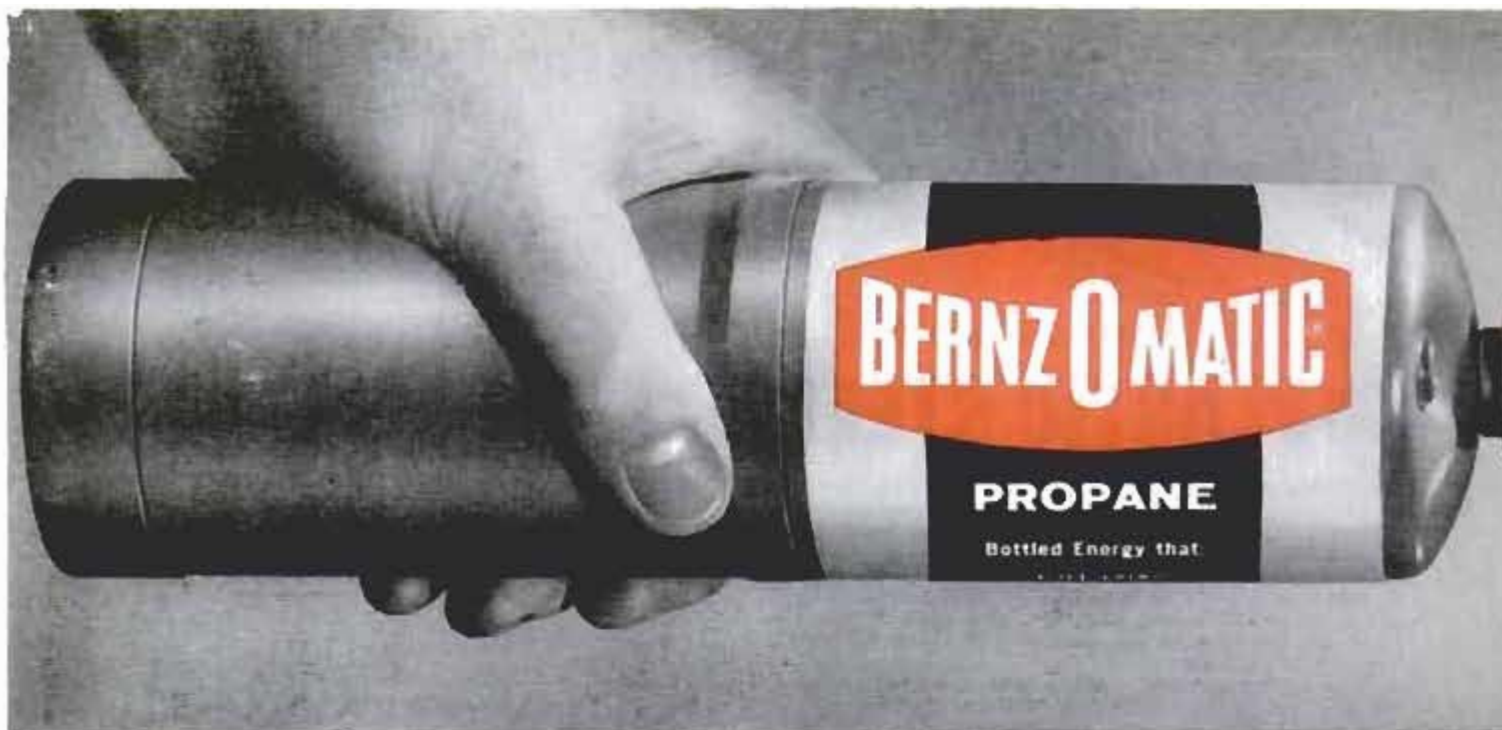

# Now—handiest tool

## *Do 101 jobs with the blue-hot*

Five minutes after you use this new tool you'll wonder how you ever did without it!

Now, with the flick of a match, you install asphalt tile, thaw frozen pipes, solder tools and toys, remove old paint, solder copper tubing — do hundreds of jobs around your home — with the easy-to-use Bernz-O-Matic Torch!

There's no filling! No spilling! No pumping! No priming! Just screw the burner unit onto the safe UL-approved, disposable fuel cylinder — and your Bernz-O-Matic Torch is ready! It lights instantly!

And every job you do . . . like antiquing furniture . . . costs you only pennies. A Bernz-O-Matic fuel cylinder lasts up to 15

hours with pencil-type flame. Replacement cylinders available from any hardware store. Cost only \$1.94.

Torch units like the one shown above are \$6.95. Torch kits with soldering tip, utility burner and flame spreader — or a complete kit with sturdy metal carrying case and handy sparker — are also available . . . up to \$9.95.

Ask your hardware dealer to demonstrate the most do-everything tool since your electric drill . . . The Bernz-O-Matic Propane Torch. And while you are there, be sure to enter your name in the big Family Sweepstakes of 1001 Prizes.

The Otto Bernz Co., Inc., Rochester, N. Y.



**SWEATS  
COPPER TUBING**



**THAWS  
PIPES**



**SOFTENS  
TILE**



**ANTIQUES  
FURNITURE**

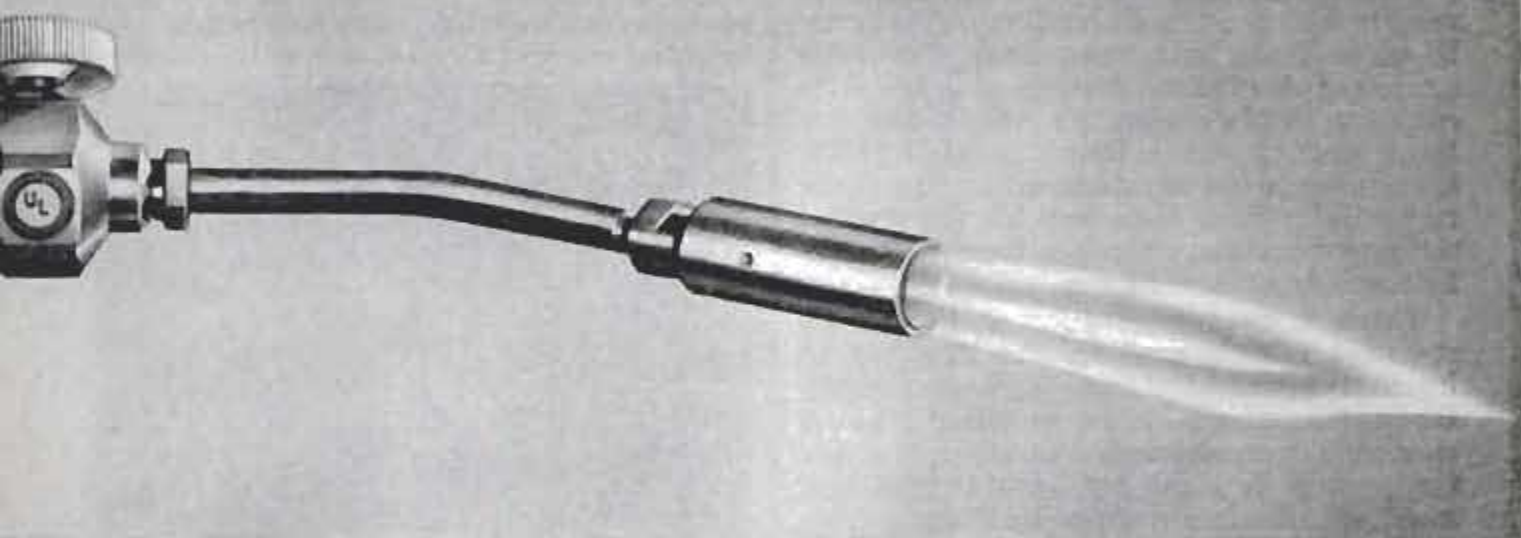

since the electric drill  
flame of a Bernz-O-Matic Torch

# Family Sweepstakes\*

1001 prizes...just enter your name at your hardware store to win.

2 expense-paid trips for two to Mexico City and Acapulco as first prizes.

**PLUS:** 10 Fedders Air Conditioners — 10 Scott Outboard Motors — 10 Motorola Stereo Hi Fi — 10 Shopsmiths — 50 Lionel Train Sets — 202 Bernz-O-Matic Ceramic

Grilles — 101 Stanley Sabre Saws — 101 Jefferson Golden Hour Clocks — 101 Bernz-O-Matic Two-Burner Camp Stoves — 101 Hamilton Beach Fry Pans — 101 Westinghouse Spoutless Coffee Makers — 101 Bernz-O-Matic Lanterns — 101 Bernz-O-Matic Single-Burner Camp Stoves.

\*Drawing subject to all Federal, State, and Local laws and regulations.



REMOVES  
PAINT



LIGHTS  
CHARCOAL FIRES



## Jungle Road Knives Through The Last Frontier

(Continued from page 110)

large town for extended treatment. One of the first chores in building the road was to clear small landing strips every 50 miles or so. Temporary only, the strips are rough and often muddy. All are suitable for single-engine aircraft, a few are large enough for a lightly loaded DC-3. Staple foods are air-dropped at the strips in partially filled bags that hit the ground without bursting, then are trucked to the intermediate road camps.

There is no refrigeration at the camps so meat is delivered on the hoof, to be butchered when the camp cooks are ready for it. Sometimes when no other meat is available, a camp sends a few men out into the jungle to hunt for land turtles and monkeys. Each is a welcome dish.

The road doesn't run through dense jungle from one end to the other, of course. Only the northern several hundred miles are in the equatorial rain forest. Farther south the road climbs to higher ground and the jungle diminishes to heavy brush, sometimes to open plains.

The jungle portion of the highway runs through gently rolling country that was hardly a challenge to the engineers until

they sized up the whole job. Then they realized the magnitude of the task. The close-growing trees had to be cut down one by one. Some are softwood, others are so hard they dull the saw. Each has its

Worker holds a land turtle, which furnishes the meat for supper at one of the workers' roadside campsites



## EVERY BOAT OWNER



## NEEDS WOOD SCRAPERS

Take advantage of this timely opportunity to own a set of three excellent wood scrapers. One each 2½", 1⅝" and 1" with double-edge steel blades, plus 9 extra blades. Included is the FLETCHER No. 250 scraper with the instantaneous blade changing device.

Ask your dealer for the FLETCHER 3 S Wood Scraper Kit. If he cannot supply you, order direct at \$2.25 per set, prepaid, if check or P.O. Money Order accompanies your order.

**THE FLETCHER-TERRY CO., DEPT. P**  
FORESTVILLE, CONNECTICUT

painting is  
**6 TIMES  
FASTER!**  
with the new  
**POWER AIRE**



You can spray a chair in less than 5 minutes, save up to 85% painting time on any job, with the new, hi-speed Power Air Sprayer. Takes drudgery out of painting furniture, fences, porches, siding, etc. Perfect too, for insecticide fogging, garden sprays, waxing, greasing, inflating, cleaning. Handles heavy or light paints, enamels, chemicals. So handy you'll use it for 101 chores around home, shop, farm.

Outperforms them all — even many larger units. *Power Aire* is the most efficient sprayer made—delivers full 3.5 cfm and 50 psi, yet weighs under 30 lbs. Only 10" high. Easily portable — use it anywhere.

37 other models from \$30.  
Write for literature today!



Compressor Div., Dept. X,  
Milwaukee 1, Wis.



**JOHNSON  
SERVICE  
COMPANY**  
See your dealer

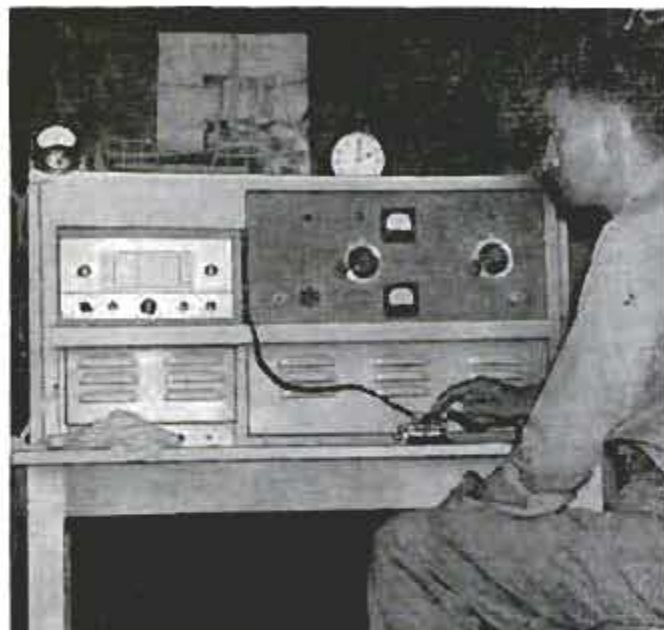

Isolated road camps report to headquarters by radio. Radio above is located in a covered truck at a camp

own tangle of lianas, woody vinelike growths that may be 100 feet long and 3 inches in diameter. After being cut, trunks and debris had to be bulldozed into piles and burned, or shoved off the road, and the stumps had to be dynamited or pulled out by tractors. The ground itself was a mass of roots, which had to be bladed out.

Small jungle streams every mile or so

were crossed by small bridges or by fills and culverts. Two major rivers are being spanned by steel-and-concrete bridges.

The cleared roadway is 81 feet wide and is to be improved with a 22-foot-wide asphalt pavement in the center that will be suitable for truck traffic. The road is costing some two and a half billion cruzeiros, about \$35,000,000 in U. S. currency. This sounds fantastically cheap, but labor is inexpensive and no right-of-way had to be purchased.

Keeping the road open for traffic is going to be a never-ending battle in the jungle area. New growth will spring up rapidly along the sides, old roots will force their way up through the pavement. For a time, falling trees occasionally will block the road. Torrential rains will erode the fills and wash out some of the stream crossings. The road commission knows what it is up against. It is establishing 30 sub posts along the road simply for maintenance.

No other roads that would tap other parts of the Amazon basin are planned for a long time. Some parts of the region are too swampy, other parts are flooded annually. For the single route the road to Belem, known as the "gateway to the Amazon," was the best choice, since the river itself is a cheap and dependable highway

(Continued to page 244)

## 8 WAYS TO REDUCE COSTS AND INCREASE QUALITY IN BUILDING YOUR NEW HOME

For certain applications, the *lowest-cost materials* you can use are the *highest quality* products in their field. This is true of Homasote products—by their very nature and by their wide variety of sizes, forms and thicknesses. Here are some of the savings possible—compared with other standard building materials—on a 3-bedroom house with 1200 square feet of exterior wall surface...

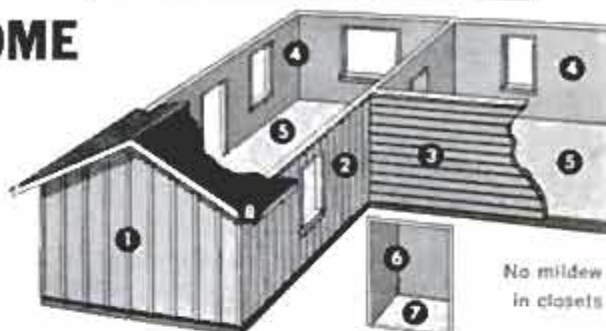

### REDUCE YOUR COSTS BY \$515 TO \$1712

- 4 Homasote Interior Walls
- 5 Homasote Sub-Flooring
- 6 Closet Walls
- 7 Closet Floors
- 8 Facia and Rake Molds

#### 1 Homasote Board-and-Batten

\$220 to \$1092
297 to 480
34 to 40
29 to 46
11 to 14
34 to 40

\$625 to \$1712

#### 2 Homasote Grooved Vertical Siding

\$175 to \$1048
297 to 480
34 to 40
29 to 46
11 to 14
34 to 40

\$580 to \$1668

#### 3 Homasote 12" Siding

\$110 to \$ 983
297 to 480
34 to 40
29 to 46
11 to 14
34 to 40

\$515 to \$1603

Further savings occur, because Homasote methods also reduce application costs.

**FREE—HOMASOTE'S COST-REDUCTION ANALYSIS.** Send us the plan for your new home—without cost or obligation. We will show you just how these savings can be effected—in your area—on your particular house. Your plan

will be treated confidentially and returned to you. Or—for further details—send 10¢ for the 72-page Homasote Handbook.

**Remember—Homasote products increase the quality, comfort and life of your home—as well as reducing the original cost.**

Kindly address Dept. J-1.

# HOMASOTE COMPANY

TRENTON 3, NEW JERSEY

Homasote of Canada, Ltd., 224 Merton Street, Toronto 12, Ontario



# NEW!

## P & C **CLIK-STOP**

THE ADJUSTABLE  
WRENCH THAT  
**NEVER SLIPS!**

ACTUAL  
SIZE  
8" WRENCH



### Locking Feature is Automatic Ends Knuckle Skinning While Working

This is not just another adjustable wrench. The jaws on a P & C Clik-Stop can't work loose or creep open . . . ever. Gear teeth on bottom of knurl lock against immovable meshpoints when the wrench is in use. Yet the knurl adjusts easily to any setting.

Each Clik-Stop wrench is chrome plated, made of alloy steel, scientifically heat treated and guaranteed.

The Clik-Stop adjusts to any size opening and is available in 4" through 20" sizes at more than 14,000 stores.

You'll find the Clik-Stop adjustable wrench in hardware stores displaying the colorful blue and white P & C Merchandiser.



## P & C **TOOL COMPANY**

Portland 22, Oregon

Subsidiary of Pendleton Tool Industries, Inc.

In Canada, Box 366, London, Ontario

to the rest of the region. Cargoes that come down the river by boat will be transferred to trucks at Belem, while manufactured goods that the trucks bring up from the south will be transhipped to the river boats at the same point.

In the past the only way to move goods between the Amazon and the populated southern portion of Brazil was by small, slow ocean vessels that operated on infrequent schedules. Trucks will make the one-way trip in seven or eight days.

Brazil nuts, rubber and other vegetable products and hardwoods will be among the commodities that will be carried south. The rubber, incidentally, is being gathered once more from the wild trees in the jungle instead of from the plantations that were started a number of decades ago. The reason is that the native trees are spaced so far apart in the jungle that a tree disease can't jump from one rubber tree to the next. In the open plantations, with the trees growing close together, disease literally spreads like wildfire. Today, disease-resistant strains of rubber trees are being sought so that the plantations can be re-established.

### Resources Not Yet Realized

Brazil doesn't yet know the measure of the natural resources that exist in the Amazon area. Gold and diamonds have been mined in quantities. What is said to be the largest high-grade deposit of manganese ore in the world was discovered relatively recently near Macapa, north of the river's mouth, and now is being worked. Most Brazilians are sure that large deposits of petroleum exist in the region, although the few exploratory holes that have been drilled in the watershed so far were dry.

Not even the amount of commercial timber in the basin is known. A forest inventory is being taken now, and some 37 million acres have been surveyed by means of aerial photographs. From the pictures, the amount of softwoods and hardwoods can be estimated. Some 350 different species of trees have been identified and the list is not complete. At Santarem, 700 miles up the river, a training center to demonstrate modern sawmill techniques has been established.

SPVEA expects that pulp and paper mills will be built to use the softwoods, and various agencies are studying the best uses that can be made of the hardwoods. In some of the upper plateau forest areas as much as 80 percent of the species are "sinkers," so heavy that they sink to the bottom when dropped in a river. Some of the wood is so dense that it resists all or-

(Continued to page 246)



The second most important tool...  
for every  
woodworking shop

A VERSATILE

## W&H MOLDER-PLANER

is second only  
to a saw... it  
molds, planes and rabbets.  
"Your savings pile up as your  
shavings pile up."



SEND FOR  
FREE BROCHURE

WILLIAMS & HUSSEY MACHINE CORP.  
CLINTON ST., MILFORD, NEW HAMPSHIRE

## Now NINE "MFG" Beauties

all featuring the famous, tough  
MOLDED FIBER GLASS lapstrake hull



Write today for literature  
MOLDED FIBER GLASS  
BOAT COMPANY  
71 Fourth Ave., Union City, Pa.

- two all-fiberglass 17-footers from \$995
  - four mahogany-decked 15-footers from \$525
  - one colorful fiberglass-decked 15-footer \$625
  - two mahogany-trimmed 13-footers from \$325
- Prices f.o.b. factory

**GIVE**  
AMERICAN  
CANCER  
SOCIETY

OVER TWO MILLION MEN CARRY THEIR KEYS ON A

## Famous KEY-BAK



Wear it on your belt. STAINLESS-STEEL chain 24" long, reels in keys. Keeps them handy; safely at your side. Pocket-watch size. Chrome finish. Buy KEY-BAK Key-Reel from your dealer or order direct.

WEST LUMMIE MFG. CO. PASADENA, CALIF.  
EAST CTL COMPANY, WAUSAU, WISCONSIN



The Modern PLASTIC  
for lasting Home Repairs

PERMANENTLY mends cracks or holes in wood, tile, stone or plaster. Sticks and stays put—Does not chip, shrink or fall out. Easy to use. Economical. Mold it, chisel it, polish or paint it. The big 4-lb. can is obtainable from your lumber, paint or hardware dealer at \$1.40; or will be shipped direct postpaid (in U. S.) for \$1.75. Complete satisfaction guaranteed or your money refunded.

DONALD DURHAM CO.  
Box 804-T Des Moines, Iowa



**TOO  
BAD!**

There goes her new fall outfit and there goes his hunting trip, because they've got trouble—the kind of engine trouble that *really costs*. And too bad for it all *could have been avoided* if they had used Wynn's Friction Proofing.

Smart motorists (people who like to avoid engine repairs) have their engines cleaned and flushed with Wynn's Motor Cleaner. Then after the crankcase is drained and re-filled, they make sure the attendant adds a pint of Wynn's Friction Proofing for Auto Engine. That keeps it clean and trouble free—*makes all cars run better, longer.*



THE Proof IS IN THE Performance!

Also available in Canada and everywhere in the free world.

Wynn Oil Company • 1151 West 5th Street • Azusa, Calif. • U.S.A.

# COLUMBIA®

MADE IN U.S.A.

HIGH SPEED STEEL

## TWIST DRILLS

SOLD INDIVIDUALLY  
AND IN AMERICA'S WIDEST  
ASSORTMENT OF SETS



Columbia's exclusive plastic cases easily fit the palm of your hand when closed... when opened they become unusually handy bench stands. Made in 7, 10, 13, 15, 29 piece High Speed Drill Sets. Also 1/4" Shank High Speed and Corbide Tipped Drills to 1/2".



ONLY COLUMBIA HIGH SPEED DRILLS  
OFFER YOU ALL THESE HIGH QUALITY FEATURES  
AT LOWEST AMERICAN MADE PRICES

- Easier to guide
- Less vibration
- Less trouble starting holes
- Minimum breakage
- Little tendency to "walk"
- Increased accuracy
- Greater rigidity
- Withstand heavier feed pressure

WRITE TODAY FOR ILLUSTRATED FOLDER AND PRICES

Ask for Columbia Drills at your local Hardware Store

**COLUMBIA DRILL COMPANY**  
463 WEST ONTARIO ST., CHICAGO 10, ILL.

dinary tools. An example is the abiorana tree. A saw that cuts through 100 inches of cedar in a given length of time can cut no more than six and a half inches of abiorana in the same length of time.

Many of the hardwoods are excellent as decorative flooring, and for industrial flooring that receives hard use. Practical ways of slicing or veneering the wood are being sought, so that hardwood surfaces may be applied to soft woods.

Under SPVEA the capacities of the electric power plants in several of the major Amazon cities have been increased, preparatory to greater industrialization. Soil studies are being made so that the commercial production of jute, black pepper, cocoa, rubber and other commodities can be increased. Cattle raising is contemplated for some areas. A large fishery industry is being promoted, and better air and river transportation is planned. The number of rural schools is being increased. There are more health centers.

One of the SPVEA officials at Belem summed up the whole program for me in a few words.

"Exploited in the past," he said, "the Amazon region now is being developed for the future." ★ ★ ★



## LICKITY LOG SPLITTER

Ends Wood  
Splitting Drudgery

Hydraulic power splits profits from waste wood  
• 7 HP trailer model • Two speed • auto shift  
• auto stroke. Power "squats" to receive large diameter logs without "dead" lift—eighteen ton smooth hydraulic force cuts right through knots, 26" stroke handles up to 30" length, any diameter. Your name on a postal card will bring literature.

THE WACO AIRCRAFT CO., Dept. D, Troy, Ohio

FREE THE HISTORY OF  
THE COMPASS  
SEND FOR YOUR COPY

New **DINSMORE**  
*Celebrity*  
COMPASSES

in Beautiful GOLD or SILVER

A jeweled, precision instrument—designed for modern cars. Full, indirect illumination. Sharp, clear letters. Silver or gold Celebrity models \$6.95, standard models \$5.45, illuminated \$6.45  
**APPROVED BY AUTO MAKERS**  
Fine Quality Compasses for over 31 Years

**DINSMORE INSTRUMENT CO.**  
1802-37 Kelso St., Flint 1, Michigan



Write  
for Folder

THE ORIGINAL PACKAGED  
**BOAT KITS**

• World's Largest Line—New Fiberglass Hulls. Over 200 styles Boats-Kits, Formed-Hulls, Semi & Custom finished. All types: Prams, Cruisers, Racers, Inboards, Outboards. Easy to build. Professional results. Dealers - Agents Inquire.  
**Send 25¢ for 3-Color Catalogs** 52 pg. Kit Catalog plus 20 pg. Hardware and 8 pg. Armor Glass books.  
(SPECIAL OFFER)  
All 3-colored CATALOGS plus "Boating Handbook"... all for \$1.

CREDIT  
TERMS

MADE ONLY BY *Custom Craft*



★ **BOAT  
PLANS, PATTERNS  
FRAME PACS**

• Over 400 Plans-Patterns, Frame Pak Kits, Prams, Kayaks, Racers, Runabouts, Catamarans, Cruisers - In- Outboards (6' to 40') Wood, Plywood and Steel. **Send 35¢ for 120 pg. Plan Catalog.** Catalog plus "Boat Building Handbook"... Send \$1.00.

Buffalo 7L, N. Y.

## WELD IN A JIFFY! IT'S DYNAMIC \$38.50 F.O.B.



Now any one can weld, cut, braze or solder almost any metal quick, safe and easy with this professional type welder. Make repairs in home or shop and farm; repair auto bodies and fenders, build wrought iron furniture, railings, fences, etc.—1001 metal items. No previous experience necessary. Designed to operate on any properly wired 110 V. A.C. line. Order today! Literature on larger industrial equipment on request.

**DYNAMIC WELDER COMPANY, 1808 S. Federal St., Dept. D2-J, Chicago 16, Ill.**

**EASY  
PAY PLAN**

Low down payment. Pay as you USE. Money back guarantee. Act now!

**SEND ONLY \$6.00**

CHECK CASH or M.O. PAY  
POSTMAN BALANCE  
PLUS CHARGES 1 YEAR  
GUARANTEE 10 DAY  
MONEY BACK  
TRIAL

**FOCUS YOUR**  **on BENJAMIN**  
**AMAZING NEW**  
**Line of REPEATERS**

**\$18.95**

SMOOTH BORE BB OR RIFLED 22 - AIR OR GAS GUNS - ROUND LEAD AMMO EFFECTIVE UP TO 100 FT.

WITH THE LATEST IMPROVEMENT IN FAST, SURE, GRAVITY LOADING ACTION AND PIGGY-BACK SHOT MAGAZINE

A Shot is placed in Firing Position each time Bolt is Pulled Back and Closed. Flash Ammo Count on Full View Magazine.



- No. 3600 BENJAMIN Super 100 Shot BB Gas Rifle. Non Toxic - Safe - Convenient - Uniform Hi-Velocity Power. →
- No. 3620 BENJAMIN Super 85 Shot Cal. 22 Gas Rifle . . . \$20.95
- No. 3100 Super 100 Shot BB Air Rifle. Adj. Shooting Force \$23.95
- No. 3120 BENJAMIN Super 85 Shot Cal. 22 Air Rifle . . . \$25.95
- No. 2600 BENJAMIN Super 35 - Shot BB Gas Pistol. Safe - No Pumping - Uniform Hi-Power. For Target & Small Game. \$17.95
- No. 2620 BENJAMIN 20 - Shot Cal. 22 Gas Pistol. Economical. \$19.95
- No. 1300 50 - Shot BB Air Pistol \$22.50
- No. 1320 BENJAMIN 35 - Shot Cal. 22 Air Pistol \$24.50

**FREE** Catalog All Models Benjamin Single Shot & Repeaters - Cal. BB or 177 or 22. Also, Special Hunting & Fishing Knife Offer.  
**BENJAMIN AIR RIFLE CO., 896 MARION ST., ST. LOUIS 4, MO.**

## PROTECT YOUR CAR WITH

Latest and best automotive products - you'll find them advertised in PM.



Pyralgas Industries, 3010 Montrose, Chicago 18

### Key on Two Tubes Dispenses Adhesive Mix

Two-part epoxy solder is now dispensed by turning a key that extends across both tubes. The simultaneous ejection of resin and hardener assures exact proportioning. The caps of the twin tubes have different sizes and threading to eliminate "cap freezing." The solder is a permanent adhesive for use on metal, wood, glass, ceramics, concrete, hard rubber and glass fibers. It hardens to a metal-like state in about four hours, and can be drilled, sawed, sanded and finished as metal can.



**TWELVE NEW DIAL TEST INDICATORS,** new Vernier Calipers, new Flat-Rod Depth Mike, new 5-Power Magnifier and many more new and improved precision tools with exclusive features are pictured and described in this new Lufkin catalog.

**GET THIS CATALOG TODAY** from your industrial supply house or by using the coupon below.

**LUFKIN RULE COMPANY  
 SAGINAW, MICHIGAN**

Please rush me a copy of "New Lufkin Tools".

Name \_\_\_\_\_

Address \_\_\_\_\_

City and State \_\_\_\_\_

# "MY PRINCIPAL 'TOOL KIT' FOR BUILDING MY 6-ROOM HOUSE WAS VISE-GRIP"

The True Story of  
Marcel Lacasse, St. Johns, Quebec



"I'm a do-it-yourselfer just completing my 6-room bungalow. Lack of funds kept me from buying a home builder's tool kit. Instead, I bought two Vise-Grips which have helped me everywhere—in plumbing, electrical work, carpentry! Vise-Grip is truly many tools in one."

## WISE-GRIP Does More Jobs Easier than Any Other Tool

You'll find *hundreds* of uses for powerful, all-purpose Vise-Grip. It's a pliers, wrench, clamp, hand vise, wire cutter—all in one tool! Ask for the new Vise-Grip with Easy Release. Only \$2.15 to \$2.95 at your hardware store.



**PETERSEN MFG. COMPANY**

Dept. PM-9, DeWitt, Nebr.

## GUNK-it-yourself!

Gunk® G.P. removes grease from engines or concrete floors; cleans paint brushes, power mowers, or machinery completely, economically, safely. It's ready-to-use, rinses off with water, won't clog drains. Quart size with handy "Squirt Spout" top speeds application. Insist on the *best* degreaser—the original "GUNK" at better automotive supply and hardware retailers everywhere. ® REG. TRADE MARK.



GUNK CHICAGO CO., River Forest, Illinois  
serving the Midwest and Southwest  
RADIATOR SPECIALTY CO., Charlotte, No. Carolina  
serving the East, Southeast and far West

## Which Import Is Best for You?

(Continued from page 103)

"Dealers don't seem to be equipped with necessary metric tools. High cost of replacement parts: \$32 for front bumper assembly."—Louisiana retired Navy officer.

"Frequency of having to shift gears due to small engine."

Washington, D. C. clerk

### Swedish Saab

Saab carries off top honors in two departments. In over-all rating, the Swedish car is rated excellent by an overwhelming 96.9 percent of the owners. No owner rates it average and 3.1 percent rate it poor.

Dealers rate high with Saab owners also, as 73.0 percent describe them as excellent to put Saab at the head of the list. Only 7.9 percent of the dealers are rated poor.

Saab owners are the only ones who rate handling ease above economy of operation in the best-like list. Roadability is also ranked high by the owners and so is riding comfort.

Complaints include insufficient power with 15.6 percent mentioning it and poor rear vision through its high, narrow rear window, 10.9 percent mentioning this.

Many of the Saab owners have had foreign-car experience before. Only 61.0 percent list it as their first imported car, the smallest percentage among the 10 cars.

Kelly's test put Saab in third place in acceleration, fractionally behind the Simca. Over-all gas mileage in the Kelly test shows 26.0 miles per gallon, tying for fifth place with the DKW (which uses a similar engine) and the Morris. The Saab engine is a three-cylinder, two-stroke design and it has front-wheel drive. This provides excellent roadability and traction in bad weather and as a result the Saab is a frequent rally winner both in this country and Europe.

Some owners (7.8 percent) do complain about the fact that oil and gas must be mixed due to the two-stroke design. This is a minor inconvenience that you may want to consider when buying a car.

Trunk space on the Saab is limited sharply by the "fast back" styling. However, the rear seat is designed to be removed easily to open into the trunk so long loads can be carried.

Turn-circle diameter is also larger than most other cars due to the front drive.

Here are comments from Saab owners: "Handling ease. Front-wheel drive is terrific. Gives a sense of security while turning."—Wisconsin druggist.

"Economical to run, license and repair.

(Continued to page 250)

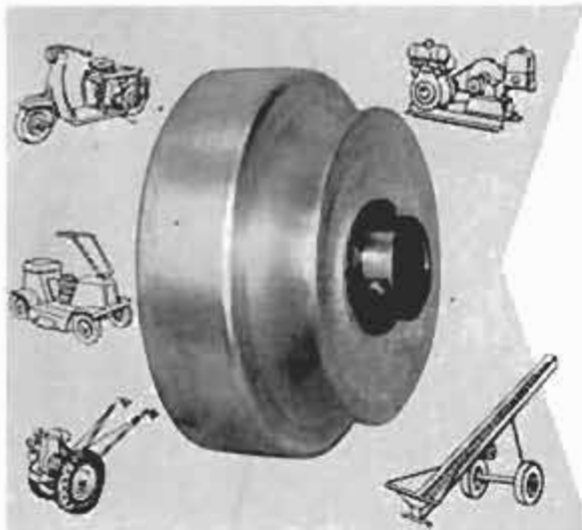

## ATTENTION! Farmers, Hobbyists, Do-it-yourselfers! ADD THIS LOW-COST, AUTOMATIC STARTING CLUTCH TO YOUR GASOLINE-ENGINE DRIVES

Permits instant, easy engine starts, even in cold weather. Stops wear and equipment damage caused by overloads.

Here's a safety and convenience feature anyone can install on pumps, compressors, sprayers, mowers, and other engine- or motor-powered equipment. Automatic clutch disengages the drive when your engine is stopped or throttled low. No-load starts are fast and easy. Centrifugal clutch engages automatically at proper engine speed. You can control engagement and release with the gas throttle. Installs easily — just slip over drive shaft and tighten setscrew. Drive pulley is machined right into clutch housing. Write for free booklet: Fairbanks, Morse & Co., Magneto Division, Beloit, Wisconsin.



**FAIRBANKS-MORSE**

A name worth remembering when you want the BEST!

Six models for 1 to 10 hp engines, 3 hp motors. Standard A-B pulley-groove. Engagement speeds, 1450 to 3100 rpm.

(Item 24)



### 700 Watt Light Plant PUSH BUTTON START

115 v. 60 cyc. AC Powered by a rugged 2.2 HP, easy starting Briggs engine. No wiring necessary; just plug in and operate. Plenty of current for any oil burner, freezer, brooder, emergency lights, etc. which require up to 700 watts. Ideal for television and radios. Complete with voltmeter and built-in winding to charge auto batteries. Item 24) Wt. 75 lbs. Easily fits in car trunk. Be prepared if storm knocks out power lines. Reg. \$275. . . .

**\$143.50**

1200 Watt Plant (Item 45) same as Item 24 but larger generator and engine with 50% greater output. . . . . **\$199.50**

We make all sizes up to 25,000 watts. Send 10c for catalog

**MASTER MECHANIC MFG. CO., Dept. A-99 Burlington, Wis.**

## FREE AMAZING NEW BOOK "HOW TO ANSWER ADS"



Never before have you seen anything like this. Tells you in simple language the correct way to answer ads. Gets you quicker replies—better results, and greater satisfaction. Will save you time and money and it's ABSOLUTELY FREE. No obligation whatever. Every reader of advertising should have this booklet. Send a postcard for your copy NOW. F. W. JOHNSON, Popular Mechanics Magazine, Room 600-A, 204 East Ontario Street, Chicago 11, Ill.

**WELD BRAZE  
SOLDER CUT**



Acclaimed by thousands of Homeowners, Mechanics and Hobbyists as the welder of 1001 uses. Easily operated from properly wired 110 volt AC or DC line. The ideal gift with a life-long use. . . . Order today on 10 day money back guarantee.

**FOUR-WAY WELDER CO., Dept. F2-J  
1810 S. Federal St. • Chicago 16, Ill.**

**4WAY  
ONLY  
\$14.75  
f.o.b. factory**

**WELDER**  
Complete with  
Twin Carbon Arc  
Torch and ac-  
cessories . . . to  
handle all metal-  
craft work.

**HUNTER TOOLS**

# DON'T DROP SCREWS!

USE AN AUTOMATIC

## Magic-Tip

SCREW HOLDING SCREWDRIVER

**HOLDS... DRIVES... REMOVES SCREWS**

YOUR DEALER HAS ALL SIZES

**FREE ILLUSTRATED CATALOG**  
HUNTER TOOLS • 8851 ALBERTS  
SANTA FE SPRINGS, CALIF

## Lub-a-Spray

**DRY LUBRICANT**

ALL-PURPOSE GRAPHITE

NO MESS, GREASE or STAIN

One puff from this handy dispenser provides lubrication for doors, windows, locks, appliances — dozens of hard to get at places!

Lub-a-Spray is oilless, odorless, weatherproof — lubricates metal, wood, leather, rubber, plastic.

At Hardware, Sports, Dept. Stores, Service Stations.

PAPEL MANUFACTURING COMPANY • MILWAUKEE 1, WIS.

# Converting to STEREO?

Change for the Better  
Change to **V-M**



**The Stereo Record Changer With Transcription Turntable**  
Performance Quality stereo reproduction starts with the record changer. Depend on

V-M for precision performance — as so many leading manufacturers do. V-M Stere-O-Matic® Automatic four-speed record changer, Model 1201, with stereo cartridge and stylus, dual outputs and stereo/monaural switch. Model 1202, with four-pole motor and plug-in head for GE and other magnetic stereo or monaural cartridges. Both available on matching base pan as Models 1226 and 1228. See your dealer now.

the **Voice** of **Music**  
\* V-M OF V-M CORP.

V-M CORPORATION • BENTON HARBOR, MICHIGAN  
World Famous for the Finest in Record Changers.  
Phonographs and Tape Recorders

I get 28 miles per gallon."—Illinois owner.

"Marvelous in snow and on slippery roads. Hardly ever skids and when it does the front wheel drive straightens it right out. Small size makes it perfect for traffic driving."—Maine teacher.

"Quality and workmanship. More custom-made feeling."—New Hampshire city planner.

"Small size allows plenty of space on narrow city streets or winding country roads."—Rhode Island bank officer.

"More comfortable to sit in than an American car."—Massachusetts student.

"Could use about 15 more horsepower."—New York test pilot.

"Poor visibility to the rear. Also fuel goes into gas tank too slowly due to oil-mixing chamber."—Iowa photographer.

"Have to depend on only one dealer. There aren't enough in the area I might wish to drive in."—Virginia analyst.

"Little crowded in rear seat on long trips."—New York engineer.

### French Simca

Simca, which is sold by franchised Chrysler dealers, is a good test case on what normally happens when dealers are unfamiliar with a car. At the time of the survey, Chrysler dealers were comparatively new at the imported-car business.

The result shows up sharply in the survey of owners. Simca dealers are rated poorest of all with only 31.9 percent of the owners describing their dealers as excellent and 23.4 percent describing them as poor.

As Chrysler mechanics become more familiar with the Simca this will, no doubt, improve. Training programs are underway.

Simca is now offering some new models which are more up-to-date in styling although the mechanical parts are changed very slightly. There is one important change in the station wagon. At present the wagon is built on a heavy-duty truck-type chassis and is not as comfortable as most Americans prefer. The new wagon, out this month, will be softer riding and more like a sedan in passenger comfort.

Simca is second only to Volvo in acceleration and rates fourth in maneuverability. It is attracting many new owners to the foreign-car field, ranking third among first-time owners.

Economy of operation is easily the best-liked feature with 72.7 percent listing it first. Kelly's economy test shows the Simca averaging 25.0 miles per gallon over-all, eighth in the lineup. The most-frequent complaint of owners is poor or inadequate service and, as mentioned above, this could very well be a temporary

condition due to the transfer of franchises to Chrysler Corporation dealers just prior to our survey.

Here are some comments from owners:

"Economy of operation and initial cost. Also the way it takes curves on mountain roads."—Tennessee auto jobber salesman.

"Pleased with maneuverability around city. Find myself getting to and from calls more quickly now."—Iowa minister.

"Ability to park in congested places."—Ohio welder.

"Solid structure of the body with very few rattles."—Kentucky supervisor.

"Smooth riding."—Nebraska inspector.

"Low depreciation. Lack of unnecessary gadgets to get out of order. Simple to lubricate and wash."—Texas serviceman.

"Scarce parts. Poor instruction to dealers on proper maintenance. I know as much as the service man does about the car."—Indiana accountant.

"Too little legroom in front and rear. Only fair visibility."—Delaware salesman.

"Gas mileage not as good as expected. I get 26.4 miles per gallon."—Texas clerk.

"Somewhat underpowered."—Montana civil engineer.

"Noisier than U.S. cars. More vibrations. Synchronous roar at certain speeds (28 and 45 miles per hour)."—Delaware chemist.

"Rear doors don't open wide enough. Pedals too close together."—Ohio teacher.

### German Volkswagen

Still leading the sales race among imports (a position it has held for several years), Volkswagen is evidence of the fact that cars don't necessarily have to be stylish to be in demand.

With a body style only slightly different from what it was 20 years ago, the VW is still the imported car most wanted by the public. As a result, its resale value is artificially high—sometimes higher than its new price.

For example, a tabulation of the wholesale auction prices of used 1959 Volkswagens all over the country showed the average price was 10 percent greater than the average retail price. One-year-old Volkswagens wholesaled at auction for 94 percent of the new retail price, two-year-old models for 81 percent of the new retail price.

(By way of comparison, the Renault Dauphine wholesale prices were 77 percent of retail in the current-model year, 63 percent for one-year-old models and 52 percent for two-year-old models).

Dealers rank high among Volkswagen owners with 66.7 percent described as excellent. Owners report fewer poor Volkswagen dealers than for any other make—

(Continued to page 252)



# EXTRA POWER, SPEED, ACCURACY!

Skilsaw 6½" Power Saw has rugged 1+ h. p. motor, built-in safety clutch. Cuts 2" boards at 45°.

There are more professional quality features on the Skilsaw Model 536 than any other saw in its price class. Yet, because of Skil's ever-increasing production, you can now own this versatile saw at a new low price—only \$49.95. Special features like its non-binding lower blade guard and Vari-

Torque, which disengages the blade if it jams or binds, makes it the safest saw to use. Then add these other top features—easy to adjust depth and bevel controls for accurate 45° to 90° cuts, plus a powerful motor rated at over 1 horsepower—and you have your best buy in power saws.

**FREE!** \$5.45 Value



extra blade and rip guide with 6½" Model 536 (illustrated). Hurry! Limited time offer.



**NEW, LOW-COST ½" DRILL.** The Skil ½" Model 503 is your biggest drill value. Extra power from big 2.5 amp motor to drive new Skil Snap/Lock Sander, Jig Saw, 5" Circular Saw and Hedge Trimmer that snap on or off drill in 3 seconds. Only \$16.95.



**PROFESSIONAL-TYPE SANDER.** Over 25 sq. inches of sanding surface to quickly smooth down large areas. Use it to sand wood, wall board, plaster or remove paint and varnish. End sanding boredom and get professional results on every job. Only \$49.95.



**...and Skilsaw power tools**

SKIL Corporation, 5033 Elston Ave., Chicago 30, Illinois

only 4.3 percent rate dealers poor.

Over-all, the Volkswagen ranks second only to Saab, as 94.0 percent of the owners call the car excellent. In reliability, the German air-cooled rear-engined car rates highest with only 3.6 percent experiencing a road breakdown.

Best-liked feature of the VW is gasoline economy. Kelly's test rates the Volkswagen fourth in over-all gasoline mileage with 28.0 miles per gallon.

Luggage space is small in the Volkswagen; only the Saab and Morris have less.

Chief complaint among the owners is the inadequacy of the heater, followed by a lack of power at higher speeds. Kelly's test shows the VW rates fifth among the 10 cars in acceleration for speeds up to 50 miles per hour. Above that speed, it is seventh on the list.

Here are some quotations from VW owners:

"Economy. Took 1535-mile trip, spent \$15.10 for gas and oil."—Ohio engineer.

"Have owned two other VWs. Drove them over 58,000 miles, total cost under three cents a mile."—Vermont lawyer.

"Handling. Terrific traction in snow and mud. Fun to drive."—North Dakota owner.

"Skilled workmanship." — Mississippi school teacher.

"Convenient to park. A real timesaver in traffic."—South Carolina engineer.

"Low initial cost. High trade in."—Texas personnel counselor.

Rides as good or better than any American car I have been in." — Oklahoma oil-field worker.

"Heater not very good with weather around zero."—Wyoming electronics man.

"About eight more horsepower would give that extra push on hills and passing." Alabama design engineer.

"Sways when driving in gusty winds." Tennessee house builder.

"Front seats are fine but back seat not roomy enough for long hauls."—Kentucky college professor.

"Speed range between stop and five miles per hour awkward because first gear is not synchromesh."—Virginia sailor.

"Air-cooled engine noisy." — Indiana professional musician.

### Swedish Volvo

Biggest of the 10 cars under study, the Swedish Volvo is also the most powerful. It accelerates better than twice as fast as most of the other nine cars. Its top speed is well over 70 miles per hour.

As you would expect, gasoline economy suffers somewhat as a result. Nevertheless, economy of operation is still the best-liked feature with 70.9 percent of the own-

ers mentioning it. Kelly's economy run shows the Volvo averaging 20.0 miles per gallon over-all, ranking tenth on the list.

Most frequently mentioned complaint among Volvo owners is inadequate dealer service, with 16.5 percent of the owners mentioning it. Only 42.9 percent of the owners rate their dealers excellent, 47.9 percent rate them average and 9.2 percent describe them as poor.

Over-all, the owners rate Volvo high: 93.3 percent describe it as excellent, 6.7 percent as average; none call it poor.

Its index of reliability is also high with only 5.8 percent of the owners having had a breakdown on the road. Only two cars rate higher, Volkswagen and Fiat.

Nearly half of the owners will buy another Volvo (47.5 percent). Volvo has apparently been the most convincing of all imported cars as only 4.7 percent of its owners intend to buy an American car next time, the lowest percentage in the survey.

This car is relatively heavy with a sturdy, well-built feeling (only the Hillman Minx is heavier.)

Here are comments from Volvo owners: "Economy. I get 20 miles per gallon in town, 30 on trips. Have driven it up to 95 miles per hour and it was not wide open." North Carolina collector.

"Superior workmanship. Everything fits, everything works properly. No rattles. A solid feeling."—Illinois professor.

"Ease of handling. Also the fact that it is not as tiny as some foreign cars."—Rhode Island bookkeeper.

"Corners well. Have driven nothing like it. Goes when needed."—Indiana engineer.

"Low depreciation."—Illinois technician.

"Everything seems to be where you can see and get at it for making any repairs." Maine retired owner.

"Spare parts sometimes are difficult to obtain. But has improved greatly since 1955 when I brought my first imported car. Most gas stations now know how to lubricate them."—Washington, D. C. owner.

"Ride isn't as smooth and comfortable as in a big car and there isn't as much room inside."—Missouri lithographer.

"Gas tank too small. Holds only 9½ gallons. A 12-gallon tank would be much better."—Missouri highway engineer.

"Takes too long to warm up in winter. Heater isn't quite large enough for below-zero weather."—Indiana steelworker.

There it is, the story of 10 well-known and representative imported cars — the cars that forced Detroit to look into the "compact car" market.

It is fair to say that generally these imported-car owners seem happier than a

(Continued to page 254)



USE LUBRIPLATE  
ON CATCHES AND HINGES  
TO CHASE THE SQUEAKS  
THE GREASEMAN MISSES



**TRY LUBRIPLATE!** It's a new, white and clean, semi-fluid lubricant that stays put. Stops squeaks, prevents rust and corrosion. Works wonders on your car and around your home.

• In handy 25¢, 50¢ and \$1.00 tubes at Sporting Goods, Hardware, Marine and Auto Supply Stores.

• Dealers write to LUBRIPLATE DIVISION, Fiske Bros. Refining Co., Newark 5, N. J.

**LUBRIPLATE**  
THE MODERN LUBRICANT

## BOAT PLANS PATTERNS AND FRAME KITS



Build your own "dream boat" from FULL SIZE PATTERNS or FRAME KITS. Send 50¢ TODAY for large illustrative catalog covering all '59 styles of inboards and outboard designs.

**GLEN L.**  
9152T ROSECRANS  
BELLFLOWER, CALIFORNIA

## MAKE HOME IMPROVEMENTS NOW

### FREE POWER TOOL CATALOG

Get the right tool for the job! Write:

World's largest  
maker of  
electric tools

**Black & Decker®**  
Dept. MO99, Towson 4, Maryland

## NO JOB WORRIES

PLASTEX INDUSTRY needs manufacturers on small scale for big production of Lamps, Clock Stands, Art Goods, Novelties in Plastic Marble imitation. No Experience necessary. 1/2¢ material makes regular 10¢ store sellers. Moulds furnished for fast production. Small investment brings good profit. Big wholesale orders now being placed. Ambitious men have chance for real prosperity and job security. Our NEW FREE booklet will interest and benefit you.

**PLASTEX INDUSTRIES, Dept. A**  
3400 Third Ave. New York 56, N.Y.

# Cut it with WISS



Cut Metal, Vinyl, Leather—practically anything—with versatile Wiss V-13 "Mighty Midget" Snips. Only 7" long, \$2.50. Others 8" to 17" in aviation, combination, and solid steel styles. At hardware and department stores.

## OTHER FINE WISS CUTTING TOOLS

### GRASS SHEARS

No. 701  
\$2.75



Easiest cutting, fastest cutting grass shears you've ever used, with molded vinyl handle grips and special closing latch. Others from \$1.39 to \$4.95.

### PRUNERS

No. 907-G  
\$3.25



Wiss Hy-Power Pruners, with new vinyl grips, cut toughest limbs, protect your hands. 7-inch pocket size. \$3.25 wherever garden tools are sold.

## J. WISS & SONS CO., NEWARK 7, N. J.

World's Largest Manufacturer of Shears, Scissors, Pinking Shears, Skalloping Shears, Metal Cutting Snips and Garden Shears

## NEW ENGINEERING DISCOVERY

Saves Up To  
**25% on Gasoline!**

*Reduces driving fatigue!*

## NEW ELECTRONIC

# GLIDE CONTROL\*

*The only dependable  
low-cost constant speed  
control for any car.*



**STOPS WASTEFUL  
"PEDAL PALPITATION"**

**MAKES VACATION, CROSS-COUNTRY  
AND THRUWAY DRIVING A CINCH!**

Can be installed in ANY car in less than one hour!  
Safe toe-tip control...like dimming your headlights!

GLIDE CONTROL retails for only \$29.50—pays back its full cost within a few months in gasoline savings. If your dealer doesn't handle GLIDE CONTROL, send coupon today for full details. Prices slightly higher in Canada.

\*Trade Mark



**GLIDE CONTROL CORP.** Dept. PM-9  
1608 Centinela Ave.  
Inglewood, Calif.

Please rush full details on GLIDE CONTROL performance.

Name \_\_\_\_\_

Address \_\_\_\_\_

City \_\_\_\_\_ State \_\_\_\_\_

I am a (check one)  Distributor  Retailer  Private car owner

similar sample of American-car owners. However, not all are happy and there is no guarantee that you will be.

Don't buy any of these cars (or any U. S. car) without a reasonable road test in which you ride and drive the car yourself. To be happy with an imported car, you must get used to a new method of driving. If you are not willing to learn to drive the way the cars are designed to be driven, don't buy one.

Good luck. Look carefully and choose well. ★★★



Carol Westlake Originals, Fort Lauderdale, Fla.

## Pads Aid Nonswimmers

Children can learn to swim with the aid of a two-piece plastic-foam body support. Helpful in overcoming fear of water, it holds the body in the swimming position and allows freedom of arms, legs and neck. It is adjustable for children aged two to six.



America is a Better  
America —  
thanks to Advertising!

## ELECTRIC WELD - BRAZE & CUT

REPAIR MOST EVERYTHING MADE OF METAL

Home Appliances, Auto parts, Farm-garden equipment, toys. Make and repair playground equipment.



Lawn chairs, tables, ornamental iron work, gates, wagons, etc. Malters, heat, bend, and straighten, with terrific heat from arc torch.

Cut and weld up to 1/2" steel plate. A million uses for home, auto, farm, inventors, factories, etc.

Works from any home 110 volt plug-in. Complete with dark welder's mask, arc torch, supply of carbon welding and brazing rods and complete Welding Instruction Book. Efficient—durable—1 year guarantee. Wt. only 4 lbs.

SEND ONLY \$3 postage on arrival or send \$12.95 and we will send postpaid. Ideal gift for mechanically minded home owners, relatives, friends. Order now for early delivery. Available only from:

MIDWAY WELDER Dept. DPM-9 Kearney, Nebraska

## TRANSEAL

PREVENTS AND STOPS LEAKS IN AUTOMATIC TRANSMISSIONS

Prevents and stops leaks due to drying, hardening or shrinking of transmission seals. Reduces gear and bearing noise... makes shifting quieter faster... smoother.

AT SERVICE STATIONS, GARAGES, AND AUTO ACCESSORY STORES

RADIATOR SPECIALTY CO.  
CHARLOTTE, NORTH CAROLINA



### CHANGE SPARK PLUGS REGULARLY

# 20 Ways to Increase the Value of Your Home!

One of the special features written to guide you . . . in next month's 50-page annual Home Section



## What on earth Is a Grady Wedge?



A Red Devil Grady Wedge driven into the end of axe or hammer handle keeps the head on tight, safe. Your hardware dealer has 8 different sizes, from 4¢ to 14¢ each—or a handy bag of 5 most-useful sizes for 28¢. Cheap life insurance!



Nothing Sharper Than Razor Blades for scraping stickers off windshields, paint off windows or what have you? But why shed blood when 29¢ buys you this Red Devil "Red Hed" that's easy to grasp, retracts blade with a thumbstick. Spare blades, 5 for 15¢, colored red to warn when business edge is exposed.



Scraping Is Easier Than You Thought when you use the right Red Devil Scraper for the job. Professionals know this, so we make 18 different sizes, shapes, and kinds to keep 'em happy. The best stores carry all, priced from 40¢ to \$4.95, and will tell you which to use.



Linoleum Cuts Like Butter with a Red Devil Linoleum Knife. A whiz for cardboard, opening boxes, cutting roofing material. Worth 60¢ to have one "just in case", but if you're choosy, Red Devil dealers have 7 different styles for which you can pay as much as \$1.15.

It's always best to buy where Red Devil Tools are sold, for wider choice, highest quality, and correct "how-to" advice.

Free booklet, "How To Prepare Surfaces For Finishing." Address Dep't. B-9



## Red Devil Tools.

Union, N. J., U. S. A.

World's largest manufacturer of painters' and glaziers' tools.

## TURN CONCRETE INTO GOLD



You've seen them all over the country—concrete bird baths, garden seats, flower boxes, appealing statuary, and many other items that add charm around the house and lawn. They're made by enterprising people, just like you, from our COPYRIGHTED ALUMINUM MOLDS. It's easy. It's fun. It's profitable.

Send \$2.00 today for this 62-page "How to" book, 30 pages of clear instructions. Valuable trade secrets. Over 250 items beautifully pictured (with description, dimensions, and prices of molds). Rushed to you by first class mail.

CONCRETE MACHINERY CO., INC.  
HICKORY, NORTH CAROLINA

Name \_\_\_\_\_

Address \_\_\_\_\_

HOW TO  
TURN  
CONCRETE  
INTO  
GOLD



## NEW MARLITE RANDOM PLANK

*beautiful wood-grain paneling  
you can install yourself!*

Add extra luxury to any room with new Marlite Random Plank. The 16"-wide planks are 1/4" thick, tongued and grooved for easy installation. Six exclusive new Trendwood finishes capture the beauty of fine woods in a random-width paneling effect. And Marlite's baked plastic finish resists stains and mars, requires no painting or further protection. See your building materials dealer or write for free decorating book. Marlite Division of Masonite Corp., Dept. 942, Dover, O.

5942

**Marlite** plastic-finished paneling

ANOTHER QUALITY PRODUCT OF MASONITE® RESEARCH

### HOME PROJECTS

**NEED A HELPING HAND**

with **ARDOR E-Z PRODUCTS**



### E-Z FOLDING SHELF BRACKETS

Attach to top, no framing needed. Fits flush to wall. Supports heavy loads. Ideal for snack bars, work tables, drop leaf shelves. Has exclusive positive spring lock. Set of 2, only \$3.95.

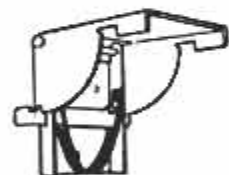

### E-Z FOLDING LEG BRACKETS

For ping-pong tables or any type folding leg table and drop leaf shelves. Positive spring-lock. Set of 4 with screws, \$3.95.

### E-Z BENDIT TOOL

No moving parts. Shapes wire hooks for 1/8" and 1/4" peg-board. Tool with supply of aluminum wire 98c.

IN CANADA:

Mallory Hdwe. Products, Ltd.  
Blenheim, Ontario



**ARDOR**  
MFG., INC.

611 SOUTH WASHINGTON  
Royal Oak, Michigan

## Where Should a Small Car's Engine Be?

(Continued from page 83)

four wheels, with swing axles in the rear.

Front tires (carrying only 40 percent of the weight) are lightly loaded, making steering light without power assist. Because the front tires carry low air pressure, there is less road shock transmitted to the steering wheel. The tires envelop road bumps more gently, flowing over them, rather than bouncing.

When you apply the brakes, a sharp shift of weight to the front wheels takes place in any car, front or rear-engined. With the engine in front, the heavy front end becomes even heavier. The front brakes have to do most of the work. The rear wheels are so unloaded that they would lock if set up to do their share.

As the rear-engine car shifts its weight forward in braking, it creates a balanced load with about equal work being done by all four wheels. Braking is faster, safer. Brake linings and tires will wear longer.

You can't spin the rear wheels either. Acceleration is better for any given amount of torque. On ice and snow there is no need for chains. The wheels won't spin out easily.

What about safety? Much has been said about the forward location of the gas tank and its vulnerability in collisions. The tank, Olley explains, is mounted behind the front suspension elements and beneath the fire wall. It is protected from either front or rear-end collisions. There is no exhaust pipe near it, nothing to heat it (a fact that wastes gasoline by vaporization in conventional designs). Vapor lock and percolation will be unheard of, the entire fuel system remaining cool always.

The heater, Olley explains, is gas-fired and mounted under the hood. It provides heat within seconds. The air-cooled engine itself heats faster than a water-cooled engine and the automatic choke goes off faster, saving gas in winter.

Finally, Olley says, the rear flat engine has its parts out in the open so service can be quick and simple. Spark-plug removal, point adjustment, fuel-pump overhaul, carburetor adjustment, all are made without delays caused by inaccessibility.

Olley compared the accessibility of the Corvair engine to that of the Volkswagen. He didn't mention that there are a lot of design borrowings from Volkswagen and that, in effect, it could be called an Americanized, up-to-date version of the German engine.

One point where the rear engine is less desirable, even Olley might be willing to admit, is in luggage space. There just isn't the room for luggage under the hood that there is under the rear deck. Like the Volkswagen, the Corvair also has a spot behind the rear seat for luggage, but this is neither large nor convenient.

Don't let the arguments about the location of the engine obscure the fact that this upcoming rear-engine design is a major engineering achievement. It is no secret that the American public has come to feel that salesmen and stylists rule the roost. This radical, exciting new rear-engine design may well restore the public's faith in our engineers. It will stop the battle cry that all cars are alike. It could make those critics who think only Europeans can engineer cars swallow their words.

After all, the proof of the pudding is in the eating. And, having driven both the Corvair and the Falcon, I can say that in both cases, the eating is good—very good indeed.

So don't let the propaganda from either side obscure the facts. Don't prejudge the cook before you taste the pudding. Wait until you've driven the small cars yourself and decide—that makes sense, just as much sense as these small American cars will make to a waiting public. ★ ★ ★



"Listen closely to the last movement . . . and you'll hear the conductor's asthma!"

## Tops for Sportsmen

# HOMELITE



# CHAIN SAW



AS LOW AS

**\$169<sup>50</sup>**

F.O.B. FACTORY

- perfect for firewood, building cabins or shelters
- easy to use
- easy to carry
- fells trees up to 3 feet in diameter
- cuts 18" trees in 18 seconds
- only 18 pounds†

†Less bar and chain

As little as \$3.60 weekly after small down payment

# HOMELITE

A DIVISION OF TEXTRON INC.

609 RIVERDALE AVENUE, PORT CHESTER, NEW YORK

Dealerships available in some selected areas. Write for details.

In Canada: Terry Machinery Co., Ltd.

# CUTS GAS BILLS

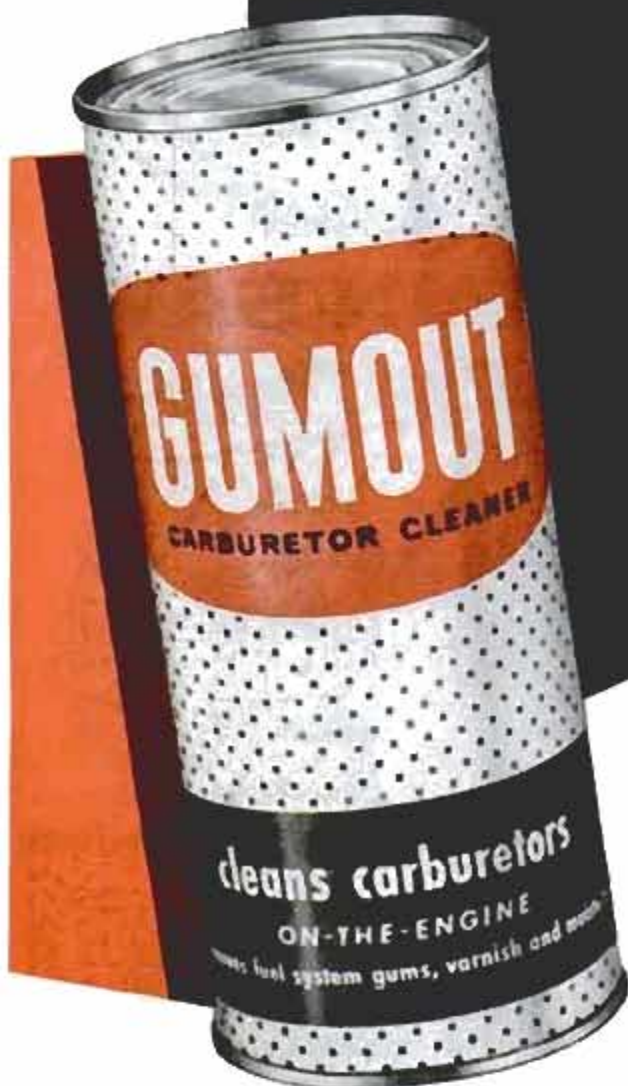

**EVERY MILE YOU DRIVE** adds dirt and gum to your carburetor. This build-up can reduce gas mileage as much as 10%. And at today's prices that costs you about 3c a gallon.

You can easily beat this problem by cleaning your carburetor with Gumout. Simply add a can of Gumout to your gas tank. It cleans the carburetor as you drive.

You'll get smoother engine performance and, best of all, you'll get more miles for your gasoline dollar. Gumout is sold by most service stations and auto supply stores.

**GUMOUT • CLEVELAND 4, OHIO**

## The Other Side of Paradise

(Continued from page 90)

and performed "magic." Lagoons appeared where once there was only mud; sandy beaches were built on coral reefs and fill; swimming areas popped up where once there were only rocks. Giant coco palms were magically planted overnight by huge cranes and then sometimes just as magically disappeared to make room for some new project. And in the middle of all this, Kaiser's Hawaiian Village grew and continues to grow upward and outward.

And further out in Waikiki you'll find that the cooperative apartment idea has just recently caught on. Along the shores of Waikiki all the way to the lee of Diamond Head, a good many apartment houses are under construction or in the planning stage.

Move a few miles away from Waikiki toward Honolulu itself, and you'll see one of the largest shopping centers in the world under construction. Costing over \$16,000,000, the Ala Moana Shopping Center will be virtually a self-contained city.

Industrially, Hawaii is not impressive when compared to many large mainland areas, but it is growing rapidly. Hawaii's new industrial area is mostly on Oahu, spreading from Honolulu harbor towards the newly developed Ewa area past Pearl Harbor. Here in the Ewa area, Standard Oil of California has already broken ground for Hawaii's first oil refinery. Standard plans to bring in oil from the Middle East and unload the oil at the \$40,000,000 plant by means of an unusual undersea submarine cable.

Nearby, construction has already begun on the first steel plant in the islands. Hawaiian Western Steel will for the most part turn out reinforcing bars. And in the same area Henry J. Kaiser has completed plans for a dust-free cement plant to take care of Hawaii's growing construction needs. In the same area, the 1200-acre Campbell Industrial Park is now partially completed; eventually it will grow to around 2400 acres. This area has been specially designed and planned to attract large and small industrial concerns to Hawaii. Plans call for a barge harbor, too, and later a deep-water harbor will be dredged. Another, and yet untouched, industry is the production of aluminum from Hawaii's vast bauxite deposits. This seems a long way in the future, but perhaps not so far as we might believe, for as one of Hawaii's leading economists sums it up: "Statehood will interest big mainland capital in investing in Hawaii. We look for vast industrial growth; the boom has just begun." ★ ★ ★

## G. E. AIR COMPRESSOR



Item #461—High pressure. 2 cyl. 2 stage air comp. rated 1000 P.S.I. output. Driven by 1/2 H.P., 27 volt D.C., 17 amp. motor. 14" L. x 9 1/2" H. Shp. wt. 15 lbs. U. S. Gov't paid \$296.

OUR PRICE F.O.B. Chicago ..... **\$15.00**

High pressure Air Receiver Tank for compressor. 2 lbs. .... **\$4.00**  
 PRESSURE GAUGE 0 to 2500 P.S.I. **\$1.50 ea.**

## FREE! New, Big GROBAN Catalog

Value-packed pages of war surplus and newly manufactured equipment—Bargains for farm, home, factory, workshop! WRITE TODAY for your free copy!

## STEEL TANKS

Ideal for compressors, tire inflators, floats, buoys, pulsation chambers, hydraulic reservoirs, fuel containers, fluid and milk containers, etc. • Strong! • Light-weight! • Used as aviators' oxygen bottles.

### BARGAIN-PRICED FOR FAST SELLING!



Item #391—Type D-2—carbon steel—Capacity—500 cu. in. (approx. 2 gals.) 450 lbs. P.S.I. 1 1/2" port at each end. 24" length 6 1/2" dia.

Postpaid..... **\$6.95 ea.**  
 2 for **\$12.50**

Item #63—Type G-1—stainless steel—Capacity—2100 cu. in. (approx. 450 P.S.I. 1/4" port at each end. 24" length 12" dia. Wgt. 19 lbs.

F. O. B. Chgo..... **\$14.95 ea.**  
 2 for **\$27.00**

## GROBAN SUPPLY COMPANY

Dept. PM-9 • 1139 S. Wabash Ave. • Chicago, Ill.  
 WEBster 9-3793

## ADJUSTABLE MITER BOX & CORNER CLAMP

2 TOOLS IN ONE

### No. 44 COMBINATION MITER BOX AND CORNER CLAMP

Holds the wood and holds your saw. Uses any hand saw for accurate cuts from 0° to 180°. Full 3" capacity. Sides of joints exposed for nailing, gluing.

**\$2.75 ppd.**

Adjusts to any angle!

No. 33 Works the same as No. 44, but without saw guide adjustment.

**\$1.75 ppd.**

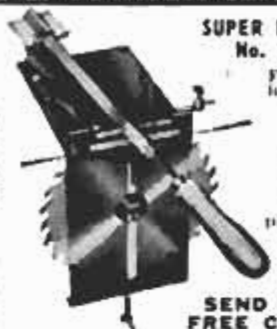

### SUPER FILER No. 11

For both hand and circular saws. Steel rollers give all teeth correct height, pitch and bevel.

**\$9.95 ppd.**

SEND FOR FREE Catalog.

A. D. McBurney, 5908 Hollywood Blvd., Hollywood 28, Calif. Dept.: A-99



The skilled hand of the German gunsmith is responsible for this .22 caliber, 6-shot repeater automatic with self-ejecting clip. Just 4" long, fits easily into pocket or purse. Ideal for sporting events, stage use.

(Not available to California residents.)

Comes for **\$6.95 ppd.** from

BEST VALUES, Dept. K855, 403 Market, Newark, New Jersey

## POWER TOOLS MAKE YOUR WORK EASY



## garage DOOR?

**QUICK!** Get it moving and keep it running smoothly with dependable 3-IN-ONE. Lubricates, cleans, prevents rust. On sale everywhere.

## 3-IN-ONE OIL

REGULAR • OIL SPRAY • ELECTRIC MOTOR



## New Self-locking perforated board fixtures DOUBLE YOUR STORAGE SPACE without remodeling!



Just insert Easy Hang fixtures into perforated board. They automatically lock into position. Ideal way to double your storage space in closets, playroom, kitchen, workshop. Fast! Low cost!

Dozens of styles and sizes.

Free, new idea folder tells all!

## Turnbuckle's, Inc.

Turnbuckles Inc., Dept. PM, Box 333, Michigan City, Ind. Rush free folder showing how to double my storage space.

Name \_\_\_\_\_  
 Address \_\_\_\_\_  
 City \_\_\_\_\_ State \_\_\_\_\_

Get in the Air with the  
**FLYING TIGERS!**



**PILOT YOUR OWN  
AUTHENTIC SCALE MODEL**

## **Thimble-Drome**

### **P-40 FLYING TIGER**

The **QUALITY** engine-powered replica of  
most famous fighting plane of  
the past quarter-century!

**DETAIL-FOR-DETAIL** "big plane realism"—true P-40 "combat" maneuverability—this is what you'll find in the Thimble-Drome P-40 **FLYING TIGER**, most accurate, most complete ready-to-fly model airplane you've ever seen! You'll be joining the attack with the famous American Volunteer Group, clearing the skies over the Burma Road, when you have this fast realistic "fighter" at the end of your control lines.

**EXCEPTIONAL FLYABILITY.** Thimble-Drome **FLYING TIGER** is extremely stable and easy to fly, yet controls are so sensitive you can fly it in hot, or bring it in for normal 3-point landing, or let it down easily on the verge of a stall, as you choose. The engine—a special **SUPER BEE**—is the easiest starting, most powerful for its size, and is available only in the Thimble-Drome **FLYING TIGER**.

**FLY IT NOW!** Because L. M. Cox is the **WORLD'S LARGEST MANUFACTURER** of ready-to-fly models and engines, the Thimble-Drome **FLYING TIGER** can be yours at an unbelievably low price. Get ready for the next good model flying day. Visit your favorite hobby counter and get your Thimble-Drome **FLYING TIGER** now.

If not available locally,  
order from factory. No C.O.D.'s.



P-40  
**FLYING TIGER**  
Fully assembled—  
with engine  
**\$10.00**

Big 20" wingspan

**FREE** full color 12-page  
pocket catalog **PMB**

**L. M. COX MANUFACTURING CO., INC.**  
P. O. BOX 476A • SANTA ANA, CALIF.

... **Future Unlimited**

(Continued from page 67)

ambitions for more responsibility, more salary, a more challenging job he had to learn more about accounting. When he noticed a correspondence school ad in a national magazine, he clipped the coupon and sent for information on correspondence courses in accounting.

Just to be sure of the school, he dropped by Lincoln High School to see if he could get background information. He found the high school placement advisor well-informed. The advisor gave the correspondence school the highest of recommendations and commended Jack for his initiative in taking home-study training.

In a short time he received complete information on courses available to him and, for a moderate cost, he enrolled in the basic accounting course. It didn't take Jack long to get back into the groove of studying, especially since he could apply the subject matter of his lessons to his job at the office. Two or three hours of studying and working on assignments three nights a week was an effort, but it was an effort Jack found well worth making. His assignments were graded and corrected by a qualified accountant employed by the school. Jack's assignments weren't perfect by any means, but penciled comments by his instructor in the margin of his corrected assignments and the correct solution returned in the mail let him know exactly where he stood.

Jack tried never to make the same mistake twice. The more he studied and the more assignments he turned in, the more interested he got in his profession. Taking instruction at home let him set his own "classroom" hours. Illness and vacation time didn't hold him back, and he found that by keeping up with his study assignments his grades stayed high.

After the completion of his fifth lesson, Jack received a letter from the school offering to send progress reports to the Chief Accountant who was his superior at work. Jack was only too happy to take advantage of this offer because he knew it would mean more rapid advancement for him if his boss was regularly informed of the courses he was taking and of his progress throughout his course of study.

Jack continued his part-time studies for about a year. He found that the Chief Accountant enthusiastically received progress reports from the school; so much so, in fact, that he often talked assignments



and lessons over with Jack. During a year Jack had taken a number of courses and the Chief Accountant knew he was ready for added responsibility, a chance to put his newly-acquired skills to work.

And so Jack was promoted to General Ledger Clerk with almost a 50% increase in salary. He was able to afford an apartment of his own and still save money toward the home he and his wife looked forward to so eagerly.

But for Jack this wasn't enough; he wanted more knowledge, and he continued to take courses of a more advanced nature. He talked things over with the Controller who headed the Accounting Department of his firm, and it was decided that the company would pay part of his tuition. The Controller knew by this time that Jack was an ambitious young man, a man looking for more responsibility—a man who, more than anything else, wanted to improve himself and, in so doing, was making himself more and more valuable to the company. For Jack now it was only a matter of time, study and hard work. He continued his instruction in accounting for two years and took a good share of the courses offered by the school. He broadened his knowledge and applied it directly to his job.

Also, he took advantage of an offer on the part of the school to provide consultation on some of the job problems that were now Jack's responsibility. This free advice, given by a qualified group of practical accountants and Certified Public Accountants employed by the school, was studied and considered by the whole Accounting Department. It was a valuable "extra" resulting from Jack's studies and it increased all the more Jack's importance to the department.

In about two years' time Jack, now 28 years old, received another promotion; this time to Chief Accountant with additional supervisory responsibility. In his spare evenings he is still taking advanced accounting courses and preparing for the future. His brand new, brick, ranch-style home in one of the most pleasant sections of Lincoln is a source of pride and satisfaction to him and his wife. Now, there is ample room for his children to grow and play.

Jack's wife, who had a yen for interior decoration, was able to furnish and decorate her house in just the way she'd always wanted. Jack's well-stocked workshop gives him a chance for relaxation

(Continued to page 262)



In these days of nuclear power, monkeys in orbit and dogs in space suits, some hands never use their skill. And honestly, it isn't always easier or faster to use power tools where hand power will do . . . and it's often not as satisfactory. Take screw driving for example.



There's a Stanley screw driver that's exactly right for every screw and a "Yankee" push drill that's exactly right for preparing any pilot hole. Here are a few that are favorites with tool users.



"Yankee" No. 41 Push Drill is a precision tool with 8 drill points from 1/16" to 11/64" in the magazine handle. A real mechanic's tool. Only \$6.95 complete.



"Yankee-Handyman" No. 46 Push Drill is a popular priced tool with 4 drill points in magazine handle. Makes quick work, easy job of small holes. Only \$3.98.

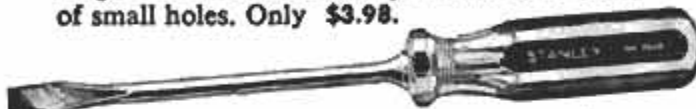

Stanley "100 Plus" Screw Drivers are the finest screw drivers made. They can take it. Bolster type blade strengthens bar against prying strains. Available in sizes and styles for every need from \$1.00 to \$2.85.

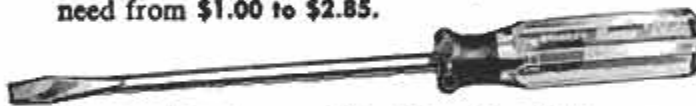

Stanley-Handyman "Cushion-Core" Screw Drivers are just right for home use. Red core in handle resists pounding. Available in sizes and styles for every need from 49¢ to \$1.10.

Remember the name Stanley when you buy tools. Stanley is the tool box of the world.

STANLEY TOOLS,  
Division of  
The Stanley Works,  
New Britain, Conn.

**STANLEY**



NOW AVAILABLE TO PUBLIC...

## UNIVERSAL METAL POLISH DEVELOPED FOR SCIENCE AND INDUSTRY

Secret of Boyer's Metal Polish is a universal "rouge" that has an almost magic effect on dull, rusty or tarnished metal. It's particularly useful for polishing cars (no better chrome polish made!) tools, plumbing fixtures, aluminum, metal trim, copper and brass ornaments. If not yet available at your hardware or auto supply dealer's, write for generous 16 oz. can. Special Offer! Large, soft polishing cloth free with order. Send \$1.00 to:

BOYER CHEMICAL CO., Dept. A, 1611 Church St., Evanston, Ill.



## LUGER BOAT KITS

DEPT. B-9

9200 Access Road, Minneapolis 20, Minn.

FIBERGLASS  
or PLYWOOD

50 Models; 8' to 18'  
\$41.95 up; frt. pd.  
Easy Terms

FREE CATALOG



Stylish cruisers, runabouts, convertibles, fishing. Pre-assembled, and pre-formed units assure perfect assembly by anyone! Equal factory-built. Save you 1/2 to 3/4. FREE CATALOG has natural color photos, details, accessories, trailers, paint, Fiberglass supplies. WRITE TODAY.

## NEW... V-Belt Drive Designer for Light Machinery

With this newly-developed DRIVE DESIGNER, you can quickly and easily select the proper size V-Belts and pulleys for small machines... such as home workshop tools—electric farm machines—light-duty factory equipment—etc.

Highly accurate, simple to use... assures the exact machine speed you want. Send 25¢ for your time-saving DRIVE DESIGNER today!



World's Largest Maker of V-Belts

The Gates Rubber Company, Sales Division, Inc.  
Dept. 15—999 So. Broadway, Denver 17, Colorado

Please send me the new Gates Truflex V-Belt Drive Designer by return mail. I am enclosing 25¢ to cover cost of handling and mailing.

Name..... (Please Print)  
Address.....  
City.....Zone.....State.....

**Gates Truflex V-Belts**

and the constructive spare-time work he enjoys so much.

Jack and his family have a full life. No question about it, today he does "have the world by the tail". He's a respected executive in his company in a well-paid position. He's young for the job he holds. but to Jack and his superiors, age alone doesn't make for success, and they know that experience alone without added knowledge and ambition can mean very little.

That's why Jack is now the youngest of three men being considered for the Assistant Controllorship of his company. The present Controllor is moving up to Vice President status and it is necessary to train a replacement. Jack has proved himself beyond doubt as a man who knows his job and knows thoroughly the latest methods and accounting techniques. A young man — yes. But a man with a "future unlimited".

If your situation is similar to Jack's, regardless of the trade or skill you're interested in, why not take your first step toward a "future unlimited"? Send for your free career guidance booklet, SKILLS for AMERICA today, and Popular Mechanics will see that you receive all the information you need from the nation's best resident and home-study schools.

POPULAR MECHANICS MAGAZINE, Dept. SFA-99  
200 East Ontario Street, Chicago, Illinois

Please send FREE Skills for America book to:

NAME.....

ADDRESS.....

CITY.....STATE.....



MOTOR CURE

**stops**

**...oil burning!**

**SAFE, PURE PETROLEUM  
BASE SEALANT**

Just pour in motor oil, MOTOR CURE, with exclusive "Cushion Plating Action" oil plates, fills in and seals in and around the rings and cylinder bores—and all internal engine parts. Oil cannot bypass rings and OIL BURNING STOPS! MOTOR CURE'S lasting oil film seal raises compression • increases oil pressure • quiets tappets, valves and lifters • ends cold, dry starts • seals out friction • improves oil viscosity • assures 100% lubrication at all times. **MONEY BACK GUARANTEE** \$1.95 16 fl. oz.

**TRANS-CURE**

**stops transmission leaks!**

• Prevents seals from drying, hardening or shrinking . . . Keeps seals soft and pliable . . . Swells and coats around seals and gaskets. TRANS-CURE improves performance and smoothness. One can in transmission oil assures **NO SLIP — NO JERK — NO HOWL — NO GRIND!**

BOTH MOTOR CURE and TRANS-CURE are backed by \$250,000 Products Liability Policies with one of the world's largest insurance companies.

Get MOTOR CURE and TRANS-CURE at your nearest service station, garage or auto accessory store. Or write to



**MONEY BACK  
GUARANTEE**  
\$2.45 16 fl.  
ozs.

Kapra Corp., 2329 S. Michigan, Chicago 16, Ill.

INVEST IN



**SAFE AS AMERICA**



**Wood Carvers!**

"HERE'S THE  
NEWEST  
IN THE  
CARVING FIELD!  
\$10.95 PER SET!  
OVERALL LENGTH OF  
EACH TOOL 6 1/2".  
PLASTIC HANDLES



6 PIECE CARVING SET

Most Complete Line of Chisels and Gouges

CATALOG  
AVAILABLE!"

**BUCK BROS. INC.**  
RIVERLIN WORKS • MILLBURY, MASS.

SEPTEMBER 1959

**8" TILT ARBOR SAW**  
1959 MODEL  
**BELOW COST**

**BLADE TILTS —  
TABLE STAYS LEVEL**

Heavy duty all cast iron and steel construction. Precision ground cast iron table. Price includes massive cast iron mitre gauge and patented motor drive that fits any motor. Cross cuts, rips, bevels, mitres, dadoes, cuts compound angles — everything expected of saws costing four times as much. Depth of cut adjustable; 0" to 2 1/4" — table always level. Send check or M.O. \$2.00 deposits on C.O.D.'s.

Shipped  
Complete  
as Shown

NOW  
**\$14.95**  
WITH  
BLADE

**SPECIAL BARGAIN** — This saw is our 1959 model. Each saw is brand new — sent to you in factory sealed cartons. Sold and guaranteed direct from the factory to you at a fantastic bargain.

**FREE 10 DAY TRIAL — MONEY BACK GUARANTEE**

Try this famous saw 10 days. If you are not satisfied that it does the work of any tilt arbor saw, regardless of price, return for immediate money back refund.

Sent Express Collect

We reserve right to refund money if stock is exhausted

**AMERICAN MACHINE & TOOL CO.**  
ROYERSFORD 63, PA.

**FREE! LAFAYETTE'S  
1960  
CATALOG**



**304 GIANT-SIZED PAGES**

**CONTAINS**

HUNDREDS OF EXCLUSIVE LAFAYETTE ITEMS NOT IN ANY OTHER CATALOG OR AVAILABLE FROM ANY OTHER SOURCE — SEND FOR YOUR COPY NOW!

Everything In Electronics

See the newest and finest in Stereo Tuners, Amplifiers, Cartridges and Music Systems

• TAPE RECORDERS • PUBLIC ADDRESS SYSTEMS • AMATEUR EQUIPMENT • INDUSTRIAL SUPPLIES • RADIO & TV TUBES AND PARTS • INSTRUMENTS • TELESCOPES, BINOCULARS, MICROSCOPES & CAMERAS

**LEADERS IN HI-FI**

The most complete electronic supply catalog crammed full of everything electronic at our customary down-to-earth money-saving prices.

OUR

**39th**

YEAR

The largest selection of hi-fi components and systems; greatest savings on Lafayette endorsed "best-buy" complete systems.

**EASY PAY TERMS AVAILABLE —  
10% DOWN — UP TO 18 MONTHS TO PAY**

**Lafayette Radio** P.O. BOX 222  
JAMAICA 31, N. Y.  
DEPT. LI-9

Send FREE LAFAYETTE Catalog 600

Name.....

Address.....

City..... Zone..... State.....

CUT OUT  
AND PASTE  
ON POST  
CARD

263



## Amphibious "Hovercraft" Rides on Cushion of Air

Newest development in the fast-growing field of air-cushion vehicles, the Swiss-designed "Ilen" rests on Lake Zurich during tests. Designed to carry 12 passengers over water or land, the craft operates on a

power-driven cushion of air which is sucked in through the six vents in the bow, then diverted downward to provide lifting power. Since there's no contact with the surface, the craft rides very smoothly.



One of our BEST Values!  
**2.9 AMP HEAVY DUTY**  
**1/4" RAM DRILL**  
 with Jacobs Geared Chuck & Key

Reg. \$39.95—Our Price **\$14.95**  
 plus 50c pp. & hdg.

Ask any expert and he'll always say "RAM for Heavy Duty Work." Not just an ordinary 2, 2 1/4 or 2 1/2 amp unit, but a powerful full 2.9 AMP. drill to do every heavy duty job in home, shop or industry. Built to take years of rough-tough use. Newer, more rugged motor gives 1/2" capacity in hard wood and 1/4" capacity in steel with a full load speed of 1200 R.P.M. Durable, mirror finished, lightweight aluminum housing. Features Universal, series wound AC-DC motor; heavy duty multiple thrust ball bearings; automatic release trigger switch with locking pin; 6 ft. 2 conductor, UL approved cord and plug. Standard 115 V. AC-DC. This powerhouse measures 9" in length yet weighs only 3 1/2 lbs. If you've ever needed a drill or find that your present 1/4" job just won't do the things you expect of it, ORDER THIS 2.9 AMP. 1/4" RAM DRILL TODAY! Limited quantities.

### Bigger Drills at Lower Price!



4 pc.  
**High Chrome**  
**SPEED SET**  
 Reg. \$42.50  
 NOW  
**\$9.95**  
 plus 50c  
 pp. hdg.

Another of Scott Mitchell's famous tool bargains! The original \$42.50 price is right on the package, but you pay only \$9.95! The reason? A large tool wholesaler needed warehouse room badly. So he closed out a large quantity of these high quality drill sets to us! A wonderful buy for advanced hobbyists, carpenters, construction workers, factories, machine shops! Made of high quality, specially hardened steel, with turned down shanks to fit all 1/2" electric drills. Zip through hardwoods, aluminum, iron, plastics, even the toughest steel! Sizes 5/8", 3/4", 7/8", 1". Come in numbered pocket, snap closure tool roll. Extra Special! 11 Pc. Set. Reg. \$99.50. NOW ONLY \$29.95 plus \$1 pp. hdg. Name features as 4 pc. set. Sizes 9/16", 5/8", 11/16", 3/4", 13/16", 7/8", 15/16", 1", 1 1/8", 1-3/16", 1 1/4".



AMAZING BLOCK & TACKLE  
 • PORTABLE—weighs 13 ozs.  
 fits in pocket!  
 One Hand Operation  
 • POWERFUL—lifts up to  
 1000 pounds!

For  
 • HUNTERS • HANDYMEN  
 • FARMERS • TRUCK DRIVERS  
 • YACHTSMEN • MOTORISTS

The great strength, small size, complete portability of the Mid-Net Babe Block & Tackle gives it many uses. In car, home, factory farm. For sportsmen: loading deer, boats, etc. For lifting heavy articles anywhere! Best grade aluminum. Steel axles. Lubricated for life! Two lifting slings, top and bottom. Heavy welded steel rings. Slings can be doubled for extra strength. With 60 ft. nylon cord. 5-1 ratio, 1000 lb. test. Carrying bag, instructions, 1 yr. guarantee. **\$9.95** ppd.

Also Available—Tiny Babe: Lifts up to 2000 lbs. With 100 ft. nylon cord. 7-1 ratio, 2000 lb. test. 15 oz. wt. Twice as powerful **\$12.95** ppd. as \$9.95 model only.

Send Check or M.O. C.O.D. fee extra **MONEY BACK GUARANTEE**

**SCOTT-MITCHELL HOUSE, INC.** Dept. F-9, 415 S. Broadway  
 Yonkers, New York

## SAVE WITH DIRECT MAIL

Shop PM's pages for money-saving direct mail offers

**POPULAR**  
**MECHANICS**  
 MAGAZINE

now complete on  
**MICROFILM**

### VOLUMES ONE THROUGH NINETY-SIX

Early volumes of POPULAR MECHANICS have been eagerly sought as collector's items. Now the monumental new microfilm collection makes this wealth of reference material available to all libraries.

Begun in 1902 as a weekly, POPULAR MECHANICS was one of the first "picture" magazines. It also pioneered the do-it-yourself idea, and its files contain plans for almost any project desired.

**Ninety-six volumes — \$750.00 for the set.**

**UNIVERSITY MICROFILMS, Inc.**

313 North First Street

Ann Arbor, Mich.



## An Easy Way to Earn EXTRA MONEY For Your NEW CAR!

POPULAR MECHANICS—the magazine that helps you to *save money* on hundreds of projects—now offers you an opportunity to earn *extra money* as a spare-time or full-time subscription representative for POPULAR MECHANICS and *all other* leading national magazines.

Thousands of men, and women too, are earning substantial sums daily through this pleasant, convenient and profitable work. What *they* are doing, you can do too, just as easily and successfully. The rapidly growing interest of men in all kinds of practical crafts has created millions of potential subscribers for POPULAR MECHANICS—one of the easiest of all magazines to sell.

### MAIL THE COUPON NOW!

Few ways of earning extra money at home are so convenient to engage in, so easy to start, so certain to add worthwhile amounts to your personal or family income. Let us send you complete details of our plan, free supplies—everything you need to start earning extra money at once.

POPULAR MECHANICS, Dept. 959  
250 West 55th St., New York 19, N. Y.

Please send me, without obligation, complete details of your subscription plan.

NAME \_\_\_\_\_

ADDRESS \_\_\_\_\_

CITY & ZONE \_\_\_\_\_

STATE \_\_\_\_\_

SEPTEMBER 1959

Now you can fix anything made of metal with  
READY MIXED . . . READY TO USE

# Liquid STEEL

### IN A TUBE

No more mixing . . . no tools, heat, or flame. Just squeeze from tube, spread with applicator cap.

Seal and solder holes in gutters & downspouts.

Repair holes and dents in car bodies, gasoline tanks.

Seal leaks in pipes, radiators, containers.

BIG 6½ oz. TUBE \$1.00

\$1.29 in Canada

★ OTHER FAMOUS **WOODHILL** PRODUCTS

- The Original PLASTIC ALUMINUM
- PLASTIC RUBBER • CHEMSTEEL
- Available at hardware, automotive, paint, variety stores everywhere, or write

The WOODHILL CHEMICAL Co., Cleveland 14, Ohio

"Originators & World's Largest Mfgs. of Plastic Metals"



**FREE!**  
350 BIG PAGES  
OF BARGAINS  
LIKE THIS

24-36 JUMBO PAGES  
MONTH AFTER MONTH

- Ham Radio
- LP Records
- Power Tools
- Optical Goods
- Test Equipment
- Hi-Fi Components

COMPLETE HI-FI \$64.50  
STEREO SYSTEM

2 speakers, 2 cabinets, stereo amplifier, 4-speed changer with cartridge and base. No extras to buy.

Because Radio Shack has millions of mail order customers, Radio Shack gets first offerings from manufacturers needing cash, first refusal on closeouts, first choice on new items! All these opportunities are passed along to Radio Shack customers in our Bargain Bulletins and Record Flyers. To be "in the know", just fill in and mail the coupon!



35c

350-PAGE  
COMPLETE GUIDE  
TO ELECTRONIC  
PARTS BUYING

Profusely illustrated 8½" x 11" book with authoritative articles plus a complete hi-fi and electronic catalog issued in September

RADIO SHACK Corporation  
730 Commonwealth Ave., Boston 17, Mass.

- Please send me:
- |  |                                 |
|--|---------------------------------|
| <input type="checkbox"/> FREE Bargain Bulletins for 12 Months    | 9M                              |
| <input type="checkbox"/> FREE Record Flyers for 12 Months        | <input type="checkbox"/> Check  |
| <input type="checkbox"/> 1960 Electronic Buying Guide @ 35c      | <input type="checkbox"/> M.O.   |
| <input type="checkbox"/> 8 pc. Stereo Package #92LX220 @ \$64.50 | <input type="checkbox"/> C.O.D. |

Name \_\_\_\_\_  
Street \_\_\_\_\_  
City \_\_\_\_\_ Zone \_\_\_\_\_ State \_\_\_\_\_

# Nonswimmers Row Themselves With Paddles on Ball

Want to have fun in the water even though you can't swim a stroke? There's a new recreational device that makes it possible for nonswimmers to stay afloat and move about in the water. It consists of paddles attached to a plastic ball. All you have to do is grasp the paddle handles and start paddling. The ball keeps you from sinking, the paddles keep you moving.

## Is the Earth Warming Up?

Army researchers are analyzing air bubbles trapped in ice 1000 years ago to determine whether their carbon-dioxide content is less than that of today's atmosphere. Cores were drilled as deep as 1345 feet in Greenland and Antarctic ice for the study. If the analysis demonstrates increasing carbon dioxide in recent years, industrialization would be suspected as the cause, and the effect would be a warming of the earth.



## BUILD 'EM YOURSELF

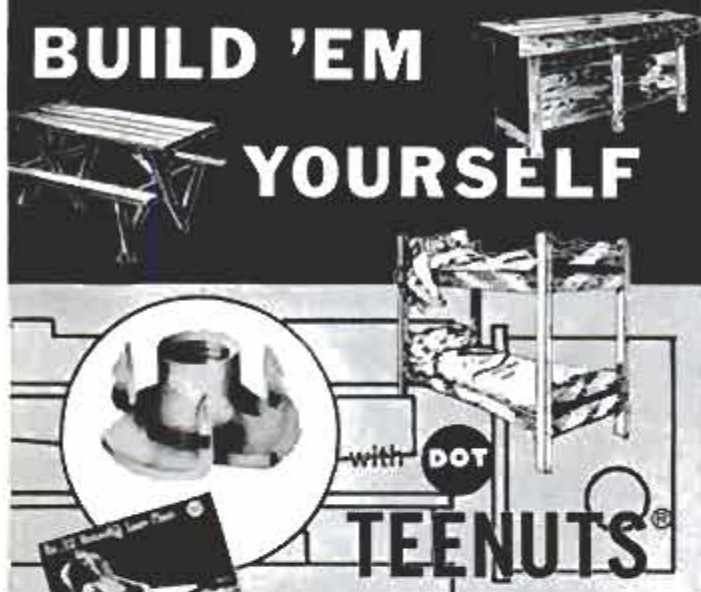

and  
**EASI-BILD' PATTERNS!**

TEENUTS... the flush-mounting, "can't-slip" nut that needs no washer... is now specified in 10 popular Easi-Bild patterns! Get them both at Hardware, Variety and Lumber stores!

\*T. M. Reg. U. S. Pat. Off.

**Columbia Fastener Company** Chicago 8, Illinois

## DREMEL MOTO-TOOL THE "POCKET SIZE MACHINE SHOP"

Handiest tool you'll ever own. Its high speed is ideal for precision grinding, polishing, carving, drilling, engraving, de-burring, sharpening, and hundreds of other household and workshop uses. Eliminates time-consuming hand work — gives the finished job a professional look. Weighs only 13 oz.—handles easily as a pencil. Does fine detail work with pin point accuracy. Fastest, most powerful tool of its kind — develops 27,000 RPM. Widely used by tool and die makers, model builders, craftsmen, lab technicians, repair men, gun smiths, schools, etc.

SEE YOUR DEALER or write for FREE catalog on the complete Dremel line of power tools.



MODEL No. 1.....\$14.85  
MOTO-TOOL MODEL No. 2.....\$19.95  
MOTO-TOOL KIT No. 1.....\$23.50

MOTO-TOOL KIT No. 2 (as shown) Incl. Model No. 2 Moto-Tool, 23 accessories (high-speed steel cutters, grinding wheels, etc.) in a sturdy storage case.....\$27.50

QUALITY POWER TOOLS SINCE 1934

**DREMEL MFG. CO.** Dept. 119J, RACINE, WIS.

POPULAR MECHANICS

GIGANTIC  
SAVE-TO-70%

# MAIL SALE

WAR SURPLUS  
EXCESS INVENTORY  
BANKRUPT STOCK

## AIR COMPRESSOR BARGAINS



For painting, cleaning, tires, control termites. Assemble your own outfit and save money. Lowest prices in U.S.

- Item 450. DeLuxe Kit. Compressor, tank, gauge, regulator, paint gun, relief valve, fittings, hose, instructions. List \$52. SALE... \$39.49 FOB
- Air Components. Compressor 1-cyl. \$19.95; Air tank, \$8.79; Regulator \$3.95; Pop-off \$1.95; Press. Gauge \$1.89; Finest Paint Gun \$11.95; Auto Switch \$4.75. All Ppd. in U. S.

## STORAGE BATTERY WINCH

Powerful fully reversible ball-bearing gear reduction winch. 1000-2000 lb. pull. Use on 6 or 12-v battery. Holds 40' of 1/4" cable. For trucks, docks, boats. Govt. cost \$280... \$46.75 FOB



## ELECTRIC CAR MOTOR



Item 572. Runs on 6 or 12 volt batt. Powerful gear reduction. Reversible. Cost \$295. SALE \$22.75

## SPEED REDUCER

80-to-1 gear reduction unit. 8 roller bearings, multiple gears. Reduces standard motor to 21 rpm - increases torque. Winches, revolving signs, door openings, etc. Govt. cost \$60. SALE \$8.98 Ppd.



## AC WATER PUMP

Item 246. Gorman-Rupp pump driven by 115-v. 60-c AC motor. 500 gph. 1" hose slips over inlet and outlet. 7 1/2" x 4 1/2" x 4 1/2". Wt. 5 lbs. List \$25. SALE \$8.95 Ppd.

## SPECIAL OF THE MONTH!

### WELDING GENERATOR

Famous new condition P-1 220-250 amp. aircraft generator. Makes excellent welder, power plant, fast battery charger. 200-250 amp 30-v 2500-4500 Reg. price \$18.95. SALE, limited time only... \$14.95 FOB



### DIAL PHONE

Modern hi-efficiency attractive dial phone. Use for extension to main line on private system. Use several for complete private system, etc. Complete with ringer, dial, etc. Work on any system. Govt. cost \$25.00. SALE... \$9.95 Ppd.



Item 715  
ORDER FROM AD or get free catalog.  
**BURDEN SALES COMPANY**  
811 West "O" St., Lincoln, Nebraska

## GET THE HABIT OF READING OUR CLASSIFIED ADS.

Wonderful Opportunities Amazing Bargains



Stimulating, adventure-packed reading for young boys and girls

A perfect blending of scientific information and exciting adventure. Each book \$2.95. At your bookstore, or order direct from Popular Mechanics, 200 E. Ontario Street, Chicago 11, Illinois.

## SPEED MARK SQUARE

NO OTHER SQUARE OFFERS THESE FEATURES

- 16" OC tongues for fast layout work
- No accumulative error on long runs
- Slots with numbered pitches Protractor stamped in body
- No memorizing the steps in using a square
- Slots allow for finding or marking center lines
- Scale reading from "on center line" Fits in tool box
- Runs are clearly marked with pitch figures
- Body equals width of a 2x4

REDUCES LAYOUT TIME  
SIMPLIFIES RAFTER CUTTING

PATENTS PENDING



Only \$6.95 prepaid

HIGH QUALITY STEEL  
GROUND ACCURATE  
NICKLE PENETRATE FINISH  
WHITE STAMPED NUMERALS  
COMPLETE INSTRUCTIONS  
WRITE DIRECT TO:

SATURN MFG. CORP.  
Box 592 - TOPEKA, KANSAS

SPEEDMARK Squares go through seventeen different steps in manufacturing to insure an accurate high quality tool.

## Superior's New Model 70 UTILITY TESTER\* FOR REPAIRING ALL ELECTRICAL APPLIANCES MOTORS • AUTOMOBILES • TV TUBES

As an electrical trouble shooter the Model 70:



- Will test Toasters, Irons, Broilers, Heating Pads, Clocks, Fans, Vacuum Cleaners, Refrigerators, Lamps, Fluorescents, Switches, Thermostats, etc.
- Will test all TV tubes for open filaments, intermittent shorts, burned out tubes, etc.
- Measures A.C. and D.C. Voltages, A.C. and D.C. Current, Resistances, Leakage, etc.
- Will measure current consumption while the appliance under test is in operation.
- Incorporates a sensitive direct-reading resistance range which will measure all resistances commonly used in electrical appliances, motors, etc.
- Leakage detecting circuit will indicate continuity from zero ohms to 5 megohms (5,000,000 ohms).

As an Automotive Tester the Model 70 will test:

- Both 6 Volt and 12 Volt Storage Batteries
- Generators
- Starter Distributors
- Ignition Coils
- Regulators
- Relays
- Circuit Breakers
- Cigarette Lighters
- Stop Lights
- Condensers
- Directional Signal Systems
- All Lamps and Bulbs
- Fuses
- Heating Systems
- Horns
- Also will locate poor grounds, breaks in wiring, poor connections, etc.

Model 70 comes complete including 64 page book, only... \$15.95

**SHIPPED ON APPROVAL  
NO MONEY WITH ORDER - NO C. O. D.**

Try it for 10 days before you buy. If completely satisfied then send \$3.95 and pay balance at rate of \$4.00 per month for 8 months - No Interest or Finance Charge Added! If not completely satisfied, return to us, no explanation necessary.

MOSS ELECTRONIC, INC., Dept. D-659  
3849 Tenth Ave., New York 34, N.Y.

Please rush Model 70. If satisfactory, I will pay in terms specified. Otherwise I will return tester.

Name \_\_\_\_\_  
Address \_\_\_\_\_  
City \_\_\_\_\_ State \_\_\_\_\_  
All prices incl. F.O.B. N. Y. C.



*Speedy Sprayer*

## sprays paint

7 times faster than hand brushing!

And what a finish . . . smooth, flawless, no brush strokes. So easy — just pull the trigger. Speedy Sprayer is a real professional tool. Paints anything, toy to a house. A must for every workshop. Operates with any 1/4 or 1/2 hp motor. 890 OUTFIT, less motor, \$42.50

Mobile Wheel Kit, \$7.50 extra

**W. R. BROWN CORP.**

Specialists in Portable Sprayers for 38 Years  
2635 N. Normandy Ave. • Chicago 35, Ill.

FREE! "How to Spray" booklet and catalog. Write!

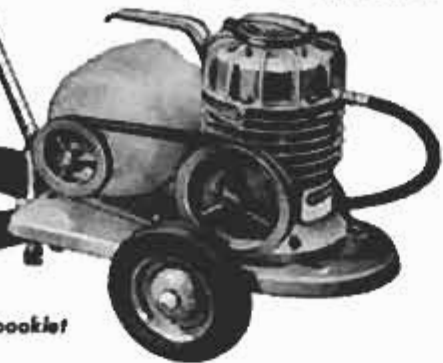

new • fast • easy • economical



way to  
**STOP DRAFTS**  
and **QUIET**  
**NOISY DOORS**  
with **ROBERTS**  
**DRAFSTOP**  
**WEATHERSTRIPPING**

Weatherstripping

Door Bottom

Just cut to fit and nail on door jamb. Made of Poly-vinyl foam permanently bonded to clear grain wood molding. Non-absorbing foam can be painted, resists weather and wear. Stops dust, drafts and water, quiets door slam — blends with door frame. Complete kit only \$1.95 suggested retail.

Easy to install, fits snugly. Unique automatic spring action clears carpets and door mats. Made of durable silver satin anodized aluminum. Nylon stop-roller provides positive closing, draft-tight seal. Complete kit only \$2.95 suggested retail.

a product of the big **R** . . . at your dealer's or

write Dept. PM 99

**THE ROBERTS CO.**  
600 NO. BALDWIN PARK BLVD.  
CITY OF INDUSTRY, CALIF.

QUALITY PRODUCTS FOR HOME AND INDUSTRY FOR OVER 20 YEARS



TOM  
HENDERSON

"Junior, I thought I told you to stay in your room!"



**WAR SURPLUS** AS OTHER BARGAINS **SAVE 90%**



**SOUTH WIND HEATER & ACCESSORIES**

Mtd. for govt. antarctic expeditions for jeeps and half-tracks. Heating unit puts out over 20,000 B.T.U.'s. Burns any type gas. 6 volt system. Fuel consumption extremely low, 1 gal. per 8 hrs. Terrific for trucks, boats, tractors... farms, warehouses, ranches, boat houses, cabins, etc. Complete with service & installation manuals and over 360 components. Approx. GOVT. COST \$550. Shpg. wt. 120 lbs. gross. NEW. \$39.95. Limited quantity.



**R1 GENERATOR - 300 AMP.**

Make your own arc welding and battery charging unit. Terrific source of power for all 24-32 V. equipment. Simple installation with our wiring diagram. All generators pre-tested in our own shop. Approx. GOVT. COST \$400. Like NEW. \$16.50.

**GENUINE P1 GENERATOR - 200-250 AMP.** Use for same purposes as above. Approx. GOVT. COST \$250. Like NEW. \$14.50.



**DOUBLE-V SPLINE 3" PULLEY** For P-1, R-1, GE Gen. shown above. Heavy-duty machine-broached steel. Heavily constructed, will handle any job. Set screw locked. Shpg. Wt. 3 lbs. NEW. \$5.95.

**ACCESSORIES FOR BUILDING ARC WELDER** for above generators consisting of VOLTAGE Regulator, 300 AMP. ammeter, 300 AMP. shunt, heavy-duty welder's gloves, 50' welding cable, electrode holder, rheostat, welder's helmet (hood type), Giant Toggle Switch. All 9 items - Approx. GOVT. COST \$150. Like NEW - Complete \$21.50.



**BENDIX GEROTOR PUMP & MOTOR - NEW!**

Use wherever fluid pumping required. Excellent for hydraulic installations. Has 3/4" pipe connections, built-in relief valve adjustable up to 1500 lbs. Max. cap. 6 GPM. 1 1/2 H.P., 24 V. motor. Use on 12 to 36 V. Approx. GOVT. COST \$350. \$8.75.



**ELECTRIC PUMP WITH CONTROL UNIT**

Runs on 12 or 24 V. Centrifugal type. Draws 5.2 AMPS. Has built-in removable filtering screen. Great for bilge, circulating or sump pump... bait tanks, etc. Pumps 500 GPH. Complete with on and off switch rheostat, 2 speeds (hi & lo). Mfd. by Ingersoll-Rand. Shpg. Wt. 7 lbs. Approx. GOVT. COST \$195. NEW \$8.95.



**140-1 REDUCTION GEAR**

For beaching boats, winches, hoists. Ideal for motor in golf or boy's electric car. DC motor & clutch. Easily reversible wiring diagram furnished. Hi torque, 1° speed. Runs on 6-12 or 24 V. Wt. 65 lbs. gross. Approx. GOVT. COST \$300. Like NEW, \$12.00. Matched splined gear for above - \$3.00 ea. \*225-1 Reduction Gear - \$13.50



**WELDING CABLE DOUBLE-O**

heavy duty, neoprene jacket, fiberglass insulation. NEW. Approx. GOVT. COST \$40. Will handle 400 amps. or better. 50' lengths \$14.50. 100' lengths \$26.00.

**NEW 1960 CATALOG!**

Tremendous catalog - our biggest ever - fully illustrated - 1000s of bargains in war surplus & other items. Send 25c in coin for your copy today! Where sppd. indicated applies to US only. Other prices FOB Culver City, Cal. Send cash, check, money order. 50% dep. COD.



**AIRBORNE SALES CO., INC. DEPT. PM 959**

8501 Steller Drive, Culver City, Calif

**ONE Clark adjustable HOLE-CUTTER**  
does the work of a whole drill set!

Mail Orders Postpaid.  
Cuts wide range of diameters in WOOD, METAL, PLASTICS, etc.!



Order today or ask your dealer!

Clark Adjustable Hole Cutter cuts any diameter within its range merely by resetting blade! Indispensable for woodworkers, cabinetmakers, autobody shops, sheetmetal workers, radio and electronic chassis jobs, hobbyists, craftsmen, etc. Excellent gift item! All blades High-Speed tool steel.

TWO SIZES: Model 100 - 5/8" to 1 1/2". Price \$4.50. Extra Blade \$2.00. Model 101 - 1" to 2 1/2". Price \$5.75. Extra Blade \$2.80. Complete kit: both models in attractive box. Price \$11.50.

**Robert H. Clark Company**

9330 Santa Monica Blvd., Beverly Hills, California

**THE SOUND OF HIGH FIDELITY**



\$3.95



Understand

precise sound reproduction  
**THE SOUND OF HIGH FIDELITY**  
tells all. Get yours now.

It's by



**REPLACE YOUR WORN-OUT WOODEN HATCHWAY...**

with an all-steel **BILCO** basement door



... and your basement entrance will be weathertight, good-looking - for a lifetime. A spring-balanced Bilco door floats open at a touch... locks securely... costs so little. And you can install it yourself - in just a few hours!

**Bilco**

The Bilco Co., Dept. R-99  
New Haven 5, Conn.

Please send me your free illustrated folder and name of local dealer.

NAME \_\_\_\_\_  
ADDRESS \_\_\_\_\_  
CITY \_\_\_\_\_ ZONE \_\_\_\_\_ STATE \_\_\_\_\_

AMERICA'S FINEST BASEMENT DOOR



The Fixlife Co., Loudonville, Ohio

The object of the game is to stay on the spinning float—but it's just as much fun if you fall off

## Floating Merry-Go-Round Spins and Tips Swimmers

Rotating freely around a rigid anchor rod, a new variation of the swimming float provides a ride like a playground carousel when a wheel on top is pulled. The seven-foot reinforced-plastic disk is also supported by the anchor rod, so it can't sink, but bobs and tips from side to side; the greater the load, the more it bobs.



**LINZER HERE**

means  
**QUALITY HERE**

and  
**PERFECTION  
HERE**

It's false economy to use anything but a LINZER quality brush... for LINZER Flo-Controlled Brushes retain their "active bristle" life for years. No matter how often you use a LINZER, you will never be troubled with brush marks or bristle fall-out.

Send 10¢ for latest "Painting Hints" Book

AS ADVERTISED IN  
**LIFE**

**DAVID LINZER & SONS, INC.**  
10-20 Astor Place, New York 3, N.Y.

**LINZER**  
Brushes  
GUARANTEED QUALITY SINCE 1897

**SUBSCRIBE TO**

**POPULAR  
MECHANICS  
MAGAZINE**

**SAVE UP TO \$2.40!**

Don't miss a single one of the great issues to come. *Subscribe and be sure!*

MAIL THIS COUPON NOW!

**POPULAR MECHANICS, Dept. PM-959**  
200 East Ontario St., Chicago 11, Illinois

Please enter my subscription to **POPULAR MECHANICS Magazine** for:

**ONE YEAR \$3.50** (Saving me 70c\*)

**TWO YEARS \$6.00** (Saving me \$2.40\*)

Please enclose remittance in full.

Name \_\_\_\_\_ Please Print

Address \_\_\_\_\_

City \_\_\_\_\_ Zone \_\_\_\_\_ State \_\_\_\_\_

\*All savings based on single-copy price



**AT LAST!**

**RE-PLATE CHROME YOURSELF WITHOUT EQUIPMENT NOT A PAINT OR POLISH — A TRUE REPLATING PROCESS**

Amazing and wonderful **INSTANT CHROME PLATE** is absolutely guaranteed to restore brilliant gleam to rusted, nicked, and dull bumpers, metal trim, other chrome. Easily applied with a cloth—replate an entire bumper in 10 minutes! (Job would cost \$35 at a plating shop.) Also works on wood or plastic. Nothing like it. Order now!

**SEND NO MONEY!**

Just pay postman (plus usual COD charges;) or remit with order, we ship postpaid. Money-back guarantee!

**THE KROME PLATE CO.**  
Box 609, Dept. DM,  
EVANSTON, ILL.

**SPECIAL Complete INSTANT CHROME KIT**

(ample for average car) **\$3.00**  
Two for **\$5.00**

RETAIL PRICE \$125.00  
**FACTORY TO YOU \$79.95**

**SUPERSHOP** includes precision-built 8" tilting table saw, vertical and horizontal drill press, 30" lathe, sander, grinder. 100% BALL BEARING. Write for FREE catalog, full details, trial plan.



Power Tools Division  
123 YATES AVENUE  
BELOIT, WISCONSIN

**SHARK Brand Swedish Steel CHISELS**

SEE THEM AT YOUR DEALER

Send for Free "How to Use" Booklet 1704

**Sandvik STEEL INC.**  
SAW & TOOL DIVISION  
NEVINS RD. FAIR LAWN, N. J.

**20 Yr. Warranty!**

**REX WATER HEATERS**

BEST BY SERVICE TEST FOR OVER 50 YEARS

Write for your nearest dealer's name.

**The CLEVELAND HEATER CO.**  
2311 Superior • Cleveland 14, Ohio



**Loosens Rusted Bolts nuts, screws, "frozen" parts!**

**LIQUID WRENCH SUPER-PENETRANT**

The super-penetrating rust solvent that quickly loosens rust and corrosion.

AT ALL HARDWARE AND AUTO STORES  
RADIATOR SPECIALTY COMPANY  
CHARLOTTE, NORTH CAROLINA

**SAVE 50% ON IMPORTED LUAN MAHOAGANY PLYWOOD**

Take advantage of our **Boatload Purchases**. Ideal for paneling Dens, Office, Hotel, etc. This select Luan Philippine Mahogany meets the most rigid specifications. It is a rich golden color — rotary cut for beauty of grain. Both sides sanded and ready to use. Banded with the finest resins. Two types to choose from: 1. Plain surface or 2. 'V' grooved in random widths.

**1/8" thick PLYWOOD** (Min. order 8 sheets)  
**AS LOW AS**  
SIZE SURFACE Price each  
3' x 6' Plain \$1.89  
3' x 7' Plain 2.19

**1/4" thick PLYWOOD** (Min. order 4 sheets)  
SIZE SURFACE Price each  
4' x 7' Plain \$4.49  
4' x 7' 'V' grooved 4.89  
4' x 8' Plain 4.79  
4' x 8' 'V' grooved 5.29

**FIBERGLASS PANELING** — 8 sq. ft. Flat or ripple. Greatest variety of color. 39¢ sq. ft.



**FREE SAMPLE ON REQUEST**

**SAVE! SPECIAL PALLEY 2-TANK DIVING UNIT**

Allows approx. 1 hour diving time. Has two 22 cu. ft. tested tanks, shut-off valves, air hoses, dilutor-demand type regulator plus harness, safety belt and weight belt. Equal to an \$80.00 unit. **SAVE!**  
**NOW ONLY \$45.95**

**PALLEY ONE-TANK SKIN DIVING KIT**

Has 38 cu. ft. tested and dated Air Tank — allows approx. 45 minutes of diving time. Complete with shut-off valve, web cradle and harness, air hoses, dilutor-demand regulator, connector assembly, mouth piece, weight belt — all you need for underwater fun. Cat. No. PSD-11 **39.95**

**CORNELIUS AIR COMPRESSOR**

A three-stage AIRFORCE SURPLUS Air Compressor. Ideal for filling underwater diving tanks (such as shown above). Has a built-in 1/3 HP, 27 V. DC electric motor. Will develop 1500 PSI or reset to 2000 PSI. Will deliver .4 CFM. Used but excellent. 110V. TRANSFORMER to provide 24V. AC current for above unit. **NOW \$32.50**

**FOR EXPERIMENTS & INDUSTRY! GYRO STABILIZER**

With simple adaptation this unit can be made to serve as an auto-pilot on any size pleasure boat. A hydraulic system or mechanical linkage system may be used. Gyro operates from 12 or 24 volt electrical source. The gyro has a 6" diameter gyrotor wheel, bubble level, reduction gear train and servo motor. When the gyro deviates the servo motor is set in operation causing the hydraulic or mechanical mechanism to function. Originally used on military aircraft. **COST GOV'T APPROX. \$7500**  
**NOW ONLY \$22.95**

**FAMOUS NORDEN M-9 BOMB SIGHT**

Here it is! The super-secret Norden Bomb-sight of WW2 fame. Brand new and in working condition. Loaded with precision parts, gears, optical systems, electrical gyro, **Only \$37.50**  
Ideal for use in aerial, fish "planting" or glider "bombing" contests. Cost Gov't approximately \$6000.00

**18 to 1 Ratio Midget Hoist**

Has 24 volt universal motor. Will operate on 115 volts AC when used with transformer (see below). The motor turns 9000 RPM & is reversible. Gear ratio is 18-to-1. Power take-off shaft turns 500 RPM. A limit switch may be used to set length of travel or eliminated for continuous use. Also has a magnetic clutch. **NOW ONLY \$9.95**  
115/24 VOLT TRANSFORMER for above. Step-down 115 to 24 volt. \$3.45

**ATTENTION INDUSTRIAL BUYERS**

Genuine Vickers Electro-Hydraulic Hoist Drive Assembly. Complete with...  
1. 20HP, 220/440 V. AC, 3phase motor.  
2. Vickers 1000 PSI Hydraulic Pump — 11.5 to 20 GPM capacity.  
3. Remote operation control system.  
4. Two Vickers Hyd. Motor & Valve assem.  
5. 46 gallon reservoir.  
Sell ALL or parts. Write for info. **\$1500**  
Cost \$9000. Complete unit's now...

Send check or M.O. 1/2 deposit with C.O.D. All items shipped postage or freight collect.

**palley's** 2263 E. Vernon Ave., Dept. PM-99  
Los Angeles 58, California

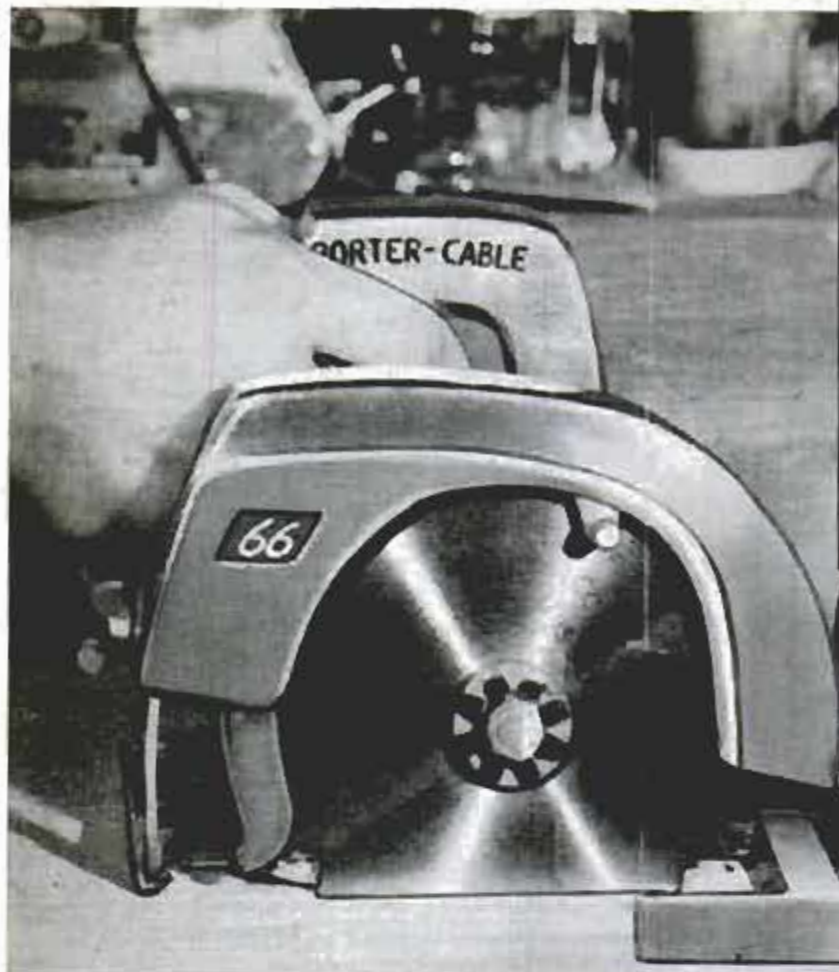

Porter-Cable  
**CIRCULAR SAWS**  
 have  
*Power-Plus  
 Accuracy!*

This 6½" Saw is loaded with many of the exclusive features found on Porter-Cable professional models. You can make every possible cut, including 45° angles on 2 x 4's! Has instant depth and bevel adjustments . . . self-lubricating bearings . . . weighs only 8½ lbs.

**A 3-STAR TOOL**

Safety Kickproof Clutch  
 "No-Drag" Telescoping Guard  
 Cuts 2 x 4's at 45°

MODEL 66 Only **\$39<sup>95</sup>**

MODEL 146A

**\$74<sup>95</sup>**



6½" Heavy-Duty Porter-Cable Saw. Here is a professional saw at a low price. It's light in weight yet a powerhouse. Carpenters pick this model every time for speed and accuracy of cut!

**A  
 5-STAR  
 TOOL**

- ★ Ball bearings throughout
- ★ Exclusive gear lubricator
- ★ Safety Kickproof Clutch
- ★ Blower Clears Line as Cut
- ★ Calibrated Depth, Bevel Sets

**Limited offer! Order your saw now!  
 Send no money! Take 6 months to pay!**

Porter-Cable Machine Co., 9149 Marcellus Street  
 Syracuse 4, N. Y.

I wish to order the tools checked below. I agree to pay my Porter-Cable Dealer full price or down payment indicated upon receipt of tool, and the balance in monthly installments shown below.

	Price	Down Payment	Balance Monthly for 6 months
Model 66 Saw	\$39.95	\$9.00	\$5.50*
Model 146A Saw	\$74.95	\$18.75	\$9.95*

\*includes service charge

Name \_\_\_\_\_  
 Address \_\_\_\_\_  
 City & State \_\_\_\_\_

**Porter-Cable**  
*Quality Power Tools*

**PORTER-CABLE MACHINE COMPANY**  
 9149 Marcellus Street, Syracuse 4, N. Y.

# THE MAILMAN

REMEMBER THE MORNING I FOUND ANDY SHOLL TRYING TO TAKE ON THE WHOLE NEIGHBORHOOD...



ALL RIGHT, BOYS, WHAT'S THE TROUBLE?

THEY CALLED MY POP A "MUSCLE HEAD" JUST 'CAUSE HE NEVER FINISHED SCHOOL



...DY! YOU'VE  
...N FIGHTING  
...AIN! OH, IF  
...Y WE COULD  
...AVE THIS  
...GHBORHOOD

MAYBE THIS  
WILL HELP...  
IT'S FROM  
INTERNATIONAL  
CORRESPONDENCE  
SCHOOLS



SURE ENOUGH, WITHIN A FEW WEEKS I BEGAN TO DELIVER MORE LETTERS AND PACKAGES FROM I.C.S.

WE'RE KEEPING YOU BUSY THESE DAYS. ANDY'S FATHER IS TAKING A CORRESPONDENCE COURSE, YOU KNOW



A SMART MOVE FOR ANY MAN!

IT WASN'T LONG BEFORE I BEGAN TO NOTICE CHANGES IN THE SHOLL'S HOME. LITTLE THINGS. NEW CURTAINS. FLOWER BOXES. FRESH PAINT. AND THEN, ONE MORNING...

LOOK, MR. MCCURDY. HOW DO YOU LIKE OUR NEW CAR?

WOW! THAT'S A BEAUTY!



GOSH, ANDY, WILL YOUR POP TAKE US FOR A RIDE IN IT?

NEW WEEKS LATER, MRS. SHOLL TOLD ME AS I CAME UP THE STEPS...

...S ANDY TOLD YOU THE NEWS? ...RE MOVING. MR. SHOLL IS ...NG TRANSFERRED. HE'S TO BE ...ECTION LEADER IN THE NEW ...LDALE PLANT. HERE'S OUR ...NEW ADDRESS



WELL, I'M REAL HAPPY FOR YOU. BUT I'M GOING TO MISS ANDY—AND THAT I.C.S. MAIL



IT WAS YOU AND I.C.S. THAT MADE IT ALL POSSIBLE. WE

I'VE SEEN IT HAPPEN OFTEN. I.C.S. NOT ONLY CAN CHANGE PEOPLE'S ADDRESSES, IT CAN CHANGE THEIR WHOLE WAY OF LIVING.

IF YOUR LETTER CARRIER IS LIKE ME, HE'LL BE GLAD TO TAKE A LETTER THAT HAS THE I.C.S. COUPON INSIDE. IT REALLY STARTS THINGS!



**FILTER-BLEND** here

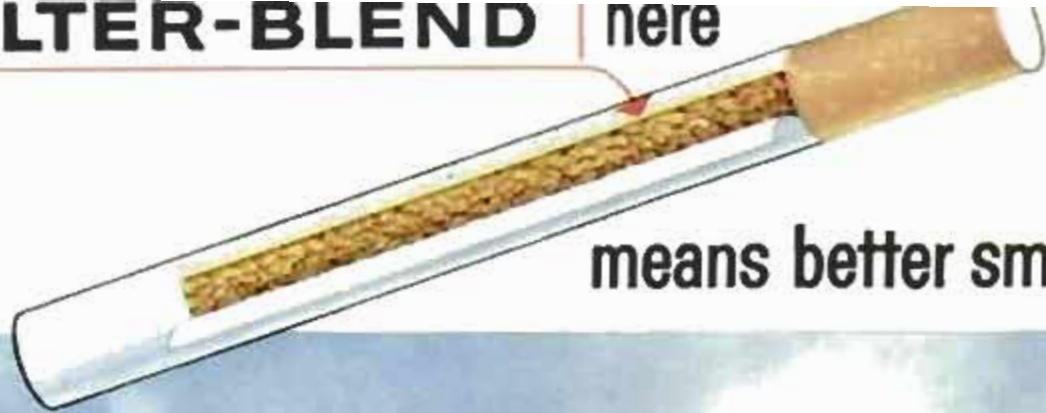

means better smoking here

*It's what's  
up front  
that counts!*



**FILTER-BLEND** ahead of the filter—  
that's the **WINSTON** secret

FILTER-BLEND is a mighty good reason for you to switch to Winston, because it means tobaccos *specially processed for filter smoking*. No other filter cigarette has it. Smoke Winston and you'll agree . . .



America's  
best-selling  
filter  
cigarette!

**WINSTON TASTES GOOD** like a cigarette should!

R. J. REYNOLDS TOBACCO CO., WINSTON-SALEM, N. C.