

POPULAR MECHANICS

MAGAZINE

WRITTEN SO YOU CAN UNDERSTAND IT

REG. U.S. PAT. OFF.

*Launching Ramp
for Skiers—Page 156*

10 Best Boating Vacations

BUILD YOUR OWN PONTOON BOAT

Owners Report on the

BUICK

**I Teach Kids to Swim
in One Lesson**



WIN!

THE FABULOUS EVINRUDE DREAMBOAT

Hit of the New York and Chicago boat shows
... powered by two 35 hp Evinrude Larks!

**ENTER THE EVINRUDE DREAMBOAT
CONTEST—FEB. 21-MARCH 22**

Here's a prize to stir your Gypsy blood! A gay and glamorous "houseboat-of-the-future" by noted designer Brooks Stevens. Custom built and luxuriously fitted to accommodate your entire family. Powered to perfection with two famed Evinrude Larks. This answer to your dreams may be as close as your Evinrude dealer. Drop in and pick up a contest entry form.

A visit will reward you in other ways—it's Evinrude Dealer Boat Show time! A wonderful time to see the latest boats on display and the finest motors in 50 years. See these remarkable new Evinrudes with *sound-sealed cushioned power*... and *thermostat temperature control*... most efficient boat power yet produced!

Take the family to visit "dreamboat land" at your Evinrude dealer. They'll share the fun—and can help you win!

A Division of Outboard Marine Corporation
In Canada: Mtd. by Evinrude Motors, Peterborough



EVINRUDE

QUIET OUTBOARD MOTORS

HOW TO ENTER!

1. Go to your nearest Evinrude dealer (look for his name under "Outboard Motors" in the yellow pages).
2. Pick up rules and entry blank.
3. Complete this statement in 50 words or less: "People who own an Evinrude get more fun out of life. I'd like to own a '59 Evinrude because."
4. Mail official entry blank to "Evinrude Contest."

33 PRIZES... FOUR WEEKLY CONTESTS!

FIRST PRIZE: Fabulous Evinrude "Dreamboat" houseboat... hit of the New York and Chicago Boat Shows... powered by two Evinrude 35 hp Larks.

4 SECOND PRIZES—one each week for 4 weeks: Evinrude V-4 50 hp Starflite motor plus \$1,500 in credit at your dealer for the family boat of your choice and accessories up to that amount.

NEXT 28 PRIZES—7 each week for 4 weeks: 3rd Prize: 50 hp Evinrude Four-Fifty motor; 4th Prize: 35 hp Lark; 5th Prize: 35 hp Big Twin; 6th Prize: 18 hp Fastwin; 7th Prize: 10 hp Sportwin; 8th Prize: 5½ hp Fisherman; 9th Prize: 3 hp Lightwin

SPECIAL BONUS PRIZE: If you buy a 1959 Evinrude motor during the contest period and become a winner—we'll pay you the full value of the motor you bought in addition to the prize.

"MIRACLE MILD" PHILLIES

Now - The Best Selling Blunts in the U.S.A.

The advertisement features a central image of a pack of Phillie Blunts. The pack is white with a black spine that says "PHILLIES" vertically. The top of the pack says "BLUNT" in large black letters. A circular window shows four blunts with "PHILLIES BLUNT" labels. A black price tag in the upper right corner of the pack says "NOW 39¢". Below the window is a large orange oval with "PHILLIES" in white. At the bottom of the pack, it says "MIRACLE MILD" and "Blended with Havana" in a cursive font. A large, detailed image of a single blunt is positioned horizontally across the bottom of the pack. To the right of the pack is a black and white photograph of a man in a suit holding a large trophy.

"MIRACLE MILD" Phillies Blunts — the first cigar mild enough for all smokers. Never before has smoking offered so much pleasure for so little cost. Pick up a pack today!

NEW LOW PRICE!

5 for 39¢

Other Phillies sizes . . .

IMPERIALS—DOUBLE PERFECTOS—KING SIZE—2 for 25c • PERFECTOS—10c • PANATELLAS—5 for 39c • JUNIOR PHILLIES 5c

MARCH 1959

This One



1

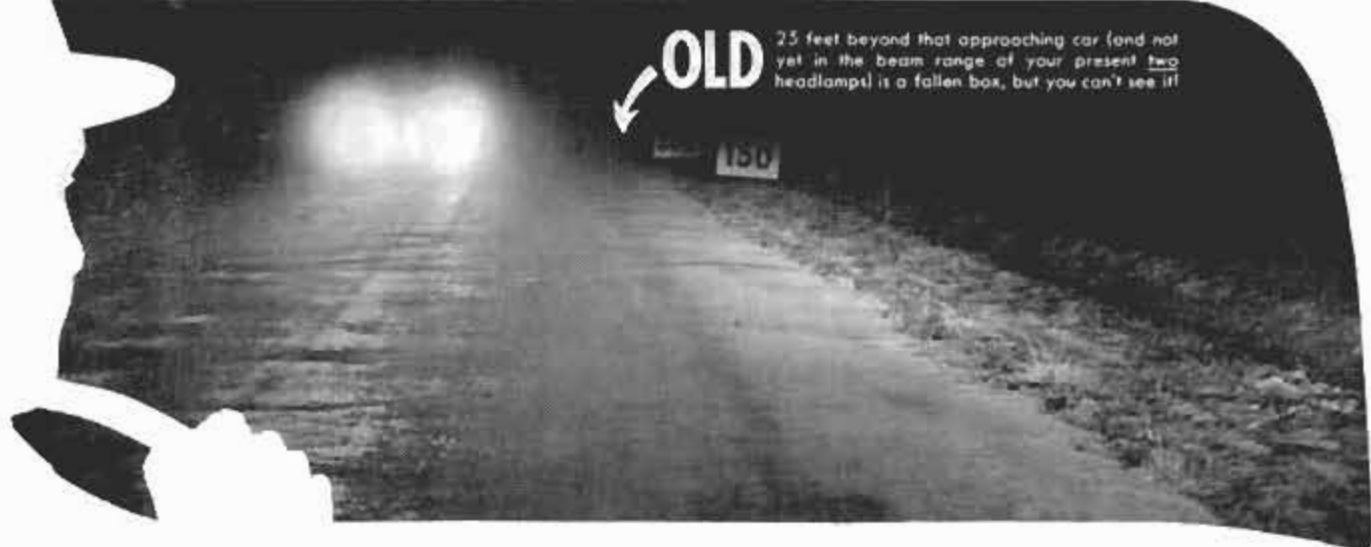

OLD

25 feet beyond that approaching car (and not yet in the beam range of your present two headlamps) is a fallen box, but you can't see it!

See better in spite of the other car's lights!



NEW

There's the box 200 ft. ahead! This is how a pair of new G-E SUBURBAN Headlamps helps you see better against oncoming cars' lights!

Get NEW G-E SUBURBAN Headlamps with the "built-in spotlight" effect in the low beam

... especially designed for all cars with two headlamps

Only the new General Electric SUBURBAN Headlamps have the low beam filament *optically centered* in the reflector. Because this filament is on focus, it provides *twice* as much light in the "spotlight" area—with ample light to the sides of the road—and with no added drain on the battery.

The additional light enables you to see better beyond the oncoming car in

spite of *its* lights—when both cars are from 75 to 200 feet apart. And it helps you recover your vision more quickly after the other car goes by.

See the dramatic difference; get G-E SUBURBAN Headlamps. Have a pair installed and aimed now. General Electric Co., Miniature Lamp Dept., Nela Park, Cleveland 12, Ohio.



Special low beam filament shield lets you see better in fog, rain or snow. The upper beam reaches far and wide for safer driving on the open road.

Get a pair today

Progress Is Our Most Important Product

GENERAL  ELECTRIC

Popular Mechanics Magazine

Registered in U. S. Patent Office and Canada

Address all communications to: 200 E. Ontario St., Chicago 11, Ill.

Editor
RODERICK M. GRANT

Executive Vice-President
RICHARD E. DEEMS

Publisher
G. HARRY CHAMBERLAINE

Managing Editor
WAYNE WHITTAKER

Assistant Managing Editor
CLIFFORD B. HICKS

Shop Notes and Crafts Editor
JAMES R. WARD

Associate Editors, General Features
ARTHUR R. RAILTON, Automotive
KENNETH N. ANDERSON

Associate Editors, Shop Notes and Crafts
WAYNE C. LECKEY **W. CLYDE LAMMEY**

Radio-Television, Electronics Editor
LOTHAR STERN

Assistant Editors
SHELDON A. MIX, General Features
JAY W. HEDDEN, EARL WOBEC, Crafts
JOHN DALEN, ARLENE HIRSCH, Makeup

Art Staff
FRANK BEATTY, Director

HENRY NEHRBASS, Assistant Director
RICHARD A. POTTS, Art Editor

Eastern Editor
RICHARD F. DEMPEWOLFF
Room 4102, Empire State Bldg., New York City 1

Western Editor
THOMAS E. STIMSON, JR.
Suite 1003, 3400 Wilshire Blvd.
Los Angeles 5, Calif.

London Manager
DOUGLAS W. WEDDERSPOON
Eagle House, Jermyn St.,
London S.W. 1, England

Director, Bureau of Information
ALLAN CARPENTER

Advertising Offices
Chicago: 200 E. Ontario St., Whitehall 4-0100;
New York: Empire State Bldg., 350 Fifth Ave.,
Longacre 5-7580; Detroit: General Motors
Bldg., TRinity 5-8711; Cleveland: Hanna
Bldg., 1422 Euclid Ave., PRospect 1-0456; Los
Angeles: 3460 Wilshire, DUmkirk 2-8458; San
Francisco: Russ Bldg., 235 Montgomery St.,
Yukon 2-0823.

Published monthly by Popular Mechanics Company,
200 E. Ontario St., Chicago 11, Ill. Richard E.
Berlin, President; Richard E. Deems, Executive
Vice-President; Fred Lewis, Vice-President and
General Manager; John R. Miller, Vice-President;
G. Harry Chamberlaine, Vice-President; G. G. Mar-
kison, Treasurer; R. F. McCauley, Secretary;
Joseph R. Buell, Jr., Advertising Manager. Single
copy in the United States and Canada, 35 cents;
subscription rates in the United States and pos-
sessions, Canada and countries of the Pan Amer-
ican Postal Union, 1 year \$3.50; 2 years, \$6.00;
3 years, \$8.00. To all other countries add \$1.00
a year over United States prices for overseas
postage. If you plan to move, notify us at least
30 days in advance so you will not miss an
issue. Give both your old and new addresses.
Entered as Second Class Matter, September 15,
1903, at the Post Office at Chicago, Illinois, under
Act of March 3, 1879. Entered as Second Class
Matter at Post Office Dept., Canada, Registered
as Second Class Matter at the Post Office at
Mexico, D.F., Mexico, June 20, 1950.
Copyright 1959 by Popular Mechanics Company.
Copyright under International Copyright Union.
Copyright in France. All rights reserved under
Pan-American Copyright Union. Printed in the
United States of America.

MARCH 1959

FOREIGN EDITIONS: MECANIQUE POPULAIRE (French) MECANICA POPULAR (Spanish) POPULAER MEKANIK (Danish) POPULAR MEKANIK (Swedish) POPULARE MECHANIK (German)

Volume 111

MARCH 1959

Number 3

In This Issue...

High-Voltage Rainmakers	-	-	-	81
Owners Report on the '59 Buick	-	-	-	90
Teach the Kids to Swim in One Lesson	-	-	-	97
They're Testing Tomorrow's Homes	-	-	-	102
Seagoing Saucers Ahead?	-	-	-	110
Canada's Fabulous Submarine Killer	-	-	-	113
A Prefab Tunnel Conquers a Tough River	-	-	-	122
You Ought to Keep a Bee	-	-	-	130
Foolmaster to the Hounds	-	-	-	140

ANNUAL BOATING SECTION—

10 Best Boating Vacations	-	-	-	144
What's New in Boats	-	-	-	151
Outfitting Your Boat	-	-	-	154
What's New in Water Skiing	-	-	-	156
Versatile Pontoon Boats—Part I	-	-	-	158
The Right Propeller Wins	-	-	-	164

For the Craftsman...

Sportsman's Showcase	-	-	-	168
"Jack-in-the-Box" Trailer Becomes Vacation Home	-	-	-	178
Modeling the French Chebec—Conclusion	-	-	-	186
"Sound Diagnosing" Engine Troubles	-	-	-	197
Your Lathe Drives This Jigsaw	-	-	-	201
Use a Wood Rasp	-	-	-	205
Radio, TV and Electronics	-	-	-	213

Regular Departments...

WHERE-TO-BUY-IT INDEX	-	-	-	74		
Across the Editor's Desk	-	-	6	What's New for Your Home	-	120
Pioneers of Science Quiz	-	-	16	Solving Home Problems	-	174
Detroit Listening Post	-	-	106	Shopping for Tools	-	209
Keeping up With the Atom	-	-	108	Radio, TV and Electronics	-	213
Clinic for Homemakers	-	-	218			

Turn to detailed index on page 74. Sources of additional information on items in this issue are shown on the Where-to-Find-It List, available without charge by writing the Bureau of Information, Popular Mechanics, 200 E. Ontario St., Chicago 11, Ill.

Next Month...

You'll find OUTDOOR LIVING featured on 16 pages, including four in full color, with intriguing do-it-yourself projects that range from a barrel-type Dutch oven to a swank lawn cabana with full entertainment facilities. Other highlights are a redwood patio with a cantilever roof and, for the boating family, a foldup "house." . . . Now that the experts have had their say about the new cars, read the owners' verdicts on the '59 CHEVROLET, FORD, PLYMOUTH



THERE'S A BIG DIFFERENCE IN PERFORMANCE TODAY

and Plymouth's got it!... let these experts tell you how!

"MAY PROVE TO BE THE ONLY '59 CAR WHICH HAS ACTUALLY IMPROVED PERFORMANCE... BEST CAR OF THE LOW-PRICED 3... A GREAT PERFORMANCE CAR... I DROVE THIS PLYMOUTH FLAT-OUT... AND THERE WASN'T THE SLIGHTEST SIGN OF OVERHEATING OR BREAKDOWN."

Tom McCahill, Mechanix Illustrated.

"... PROBABLY THE HOTTEST OF THE STANDARD PASSENGER SEDANS... TO BE FULLY APPRECIATED, MUST BE DRIVEN... QUICKEST CAR ON

THE ROAD IN FURY FORM WITH THE BIG ENGINE... GREAT HANDLING... MAY EVEN SURPASS SOME SPORTS CARS..."

Motor Life.

"IT'S QUITE A PACKAGE... CORNERING QUALITIES... DESERVE AN 'EXCELLENT' RATING WHEN COMPARED TO ANYTHING OTHER THAN A FULL-FLEDGED SPORTS CAR."

Ray Brock, Hot Rod Magazine.

"THIS YEAR'S 'HOT ONE' MAY BE THE 1959 PLYMOUTH."

Arthur R. Railton, Popular Mechanics.

And these are only a few of the raves! See your Plymouth dealer for FREE "Experts Folder" with more enthusiastic quotes. See and try the optional *New Golden Commando 395 V-8*... biggest engine in the low-price field. Discover all the news about the **BIG DIFFERENCE IN PERFORMANCE** among low-price cars for 1959!

So much the same in price... so different on the road

Plymouth

As a former serviceman, your skill could be valuable to the U.S. Air Force. If so, the Air Force has an important job and a guaranteed future waiting for you in this new Age of Space. You'll work with the most modern equipment and learn the newest techniques of your specialty. And don't forget: your previous service counts toward rank, pay and retirement income. Talk it over with your local Air Force Recruiter, or mail the coupon.

**FORMER SERVICEMEN:
YOUR EXPERIENCE
CAN MEAN A
GUARANTEED
FUTURE
IN THE
NEW AGE OF SPACE**



BE A SPECIALIST IN THE U.S. AIR FORCE



**THE FUTURE BELONGS
TO THE AIRMAN**

PASTE ON POSTAL CARD AND MAIL TO:

Prior Service Information, Dept. PM-13321
Box 7608, Washington 4, D. C.

Please send me more information on the Air Force Prior Service Program.

Name _____

Address _____ Age _____

City _____ Zone _____ State _____

ACROSS THE DESK



spot after his sensational solo drive from Paris to Bordeaux and return in 1895. The huge monument, with a fine bas-relief showing Levassor's arrival, is still there, though few guide books mention it. There's a bus stop nearby and a vast number of motor vehicles buzz past it every 24 hours, but few of the hurrying drivers and riders ever seem to pause to acknowledge their debt to Levassor.

"I, for one, believe you have put the credit finally where it belongs when you have credited Levassor with 'inventing' the automobile. True, Benz and Daimler merit all the honors that have been accorded them for pioneering in the installation of internal-combustion engines in road and rail vehicles and in boats, but it was Daimler's good friend Levassor who spent month after month with various arrangements of the several component parts of the motor vehicle until he found the one which worked best. That combination—engine in front, gearbox and clutch next in line, then drive-shaft and differential, and finally the driving-axles—introduced the automobile as we know it.

"The publication, *Paris Match*, reported the other day that the French equivalent of our Society of Automotive Engineers has just proposed that an automobile museum

(Continued to page 8)

"Heroic Years"

The color paintings that highlighted our annual Automobile Section in January under the title "Heroic Years of the Automobile" have brought flattering comments and many requests for the "pin-up" reprints. One of the interesting letters came from Christy Borth of the Automobile Manufacturers Association, who helped uncover the historical material with Art Railton, Automotive Editor. From Borth's letter to Railton we quote:

"Congratulations! Your handling of 'Heroic Years of the Automobile' in the January, 1959, edition of *PM* leaves nothing to be desired. Orchids, too, to Robert Korta for excellence in capturing the spirit of the four great events of the automobile's infancy in his paintings.

"I suppose you know that around 1907 the people of Paris subscribed to a monument at the Porte Maillot commemorating that exciting moment when Emile Constant Levassor arrived at the finish line at that

Hair problem got you out on a limb?

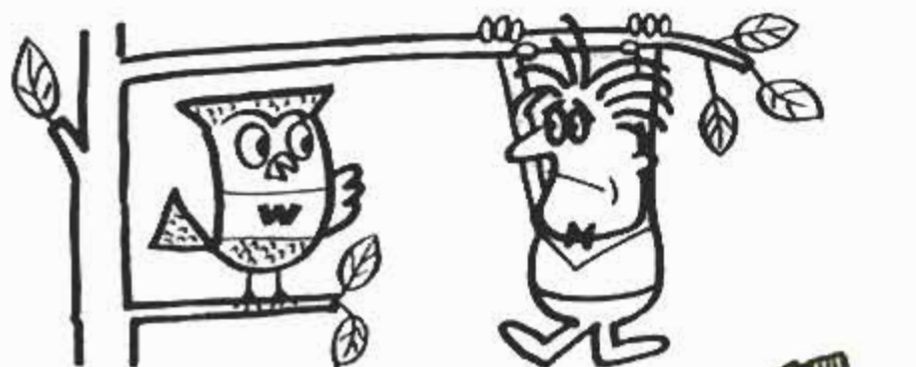

Get Wildroot Cream-Oil Charlie!



Just a little bit of Wildroot and... WOW!





YOU Can Prepare Rapidly as an EXPERT BOOKKEEPER



FREE SAMPLE LESSON

IF that's what you want, here's something that will interest you—a short course to quickly prepare you for your start in a successful accounting career. Not a magic formula—not a get-rich-quick scheme—but something substantial, and practical.

Of course, you need something more than just the desire. So, wouldn't it be well worth your while to use some of your leisure time in interesting home study—over a comparatively brief period? Always provided that the rewards were good and thousands upon thousands have found it so.

A Bookkeeper's or Accountant's duties are interesting, varied and of real worth to his employer. He has important standing with his employer.

Why not, like so many before you, investigate LaSalle's modern Problem Method of training for an Accounting or Bookkeeping position?

Through more than 50 years' experience in training hundreds of thousands of successful accountants, including nearly 5,000 CPA's, we have developed a practical training in sound accounting principles and practices, designed to prepare you rapidly for countless numbers of high-paying bookkeeping and accounting positions.

You, Too, Can Succeed

The success of LaSalle graduates has resulted from their knowledge and application of the principles acquired through Basic and Practical Accounting. Principles of Accounting and Cost Accounting training, offered in our step-by-step accounting plan. Federal Income Tax is included to qualify you for the many opportunities available to bookkeepers and accountants with this valuable knowledge.

Success in mastering the training is assured through the guidance of expert accountants and CPA instruc-

tors. You complete the lessons right in your own home. in your spare time, advancing as rapidly as your time and ability permit. Low cost-easy terms.

Will recognition come? The only answer, as you know, is that success *does* come to the man who is really trained. It's possible your employers will notice improvement in a very few weeks or months. Indeed, many LaSalle graduates have paid for their training—with increased earnings—before they have completed it!

Get Free Sample Lesson—Also "Opportunities in Accounting"

For your own good get all the facts about this short course in modern accounting training. Write for Free Sample Lesson—also latest book "Opportunities in Accounting." They will prove that Accounting offers a brilliant future to you and will show the wide range of opportunities that exist today. No cost or obligation. If you want a position of higher income and greater prestige...MAIL THE COUPON NOW!

**ACCREDITED MEMBER,
NATIONAL HOME STUDY COUNCIL**

LEU

SEND FOR FREE BOOK



LaSalle Extension University

—A Correspondence Institution—
Dept. 364H, 417 S. Dearborn St., Chicago 5, Ill.

Please send me, free of all cost or obligation, a sample lesson in Accounting...also, your latest illustrated book, "Opportunities in Accounting."

Name.....Age.....

Address.....

City, Zone, State.....

America Is Short 100,000 Auto Mechanics!

WHY NOT
BE ONE?



**It's easy to train at home for a
TOP-PAY JOB with a BIG FUTURE!**

Stop worrying because you need a better job—or because you need more pay! Over 100,000 jobs are waiting right now for newly-trained auto mechanics. Here's why: There are 60 million cars and trucks on the road—and one-third need heavy repairs. Over 7 million new vehicles are made annually—also need service. No wonder the demand is big for auto mechanics—why pay is tops, work is steady!

YOU CAN LEARN AUTO MECHANICS in months, at home in spare time. Let CTI train you with its famous Shop Method. It's easy. It's fast. *Mail coupon for free details.*

You Practice with Tune-Up Kit and Tools

(Included with training)

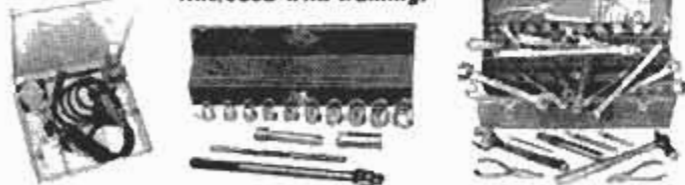

CTI training is practical. You get a valuable Tune-Up Kit, the kind that experienced mechanics use to locate engine troubles. You receive a Compression Tester; Vacuum Gauge & Fuel Pump Tester; Ignition Timing Light; portable steel case. You also get a set of professional mechanic's tools, including socket set with extension. You'll use instruments and tools to practice, to make repairs, to earn money as you train. (Note: Diesel Mechanics or Body-Fender Repair instruction too—at no extra cost.)

Many Students Make Money as They Train

Soon after they begin training, many students fix cars for others. They not only acquire useful experience—they also earn money. Their earnings help pay tuition, buy shop equipment, start many in business. *Mail coupon for details.*

COMMERCIAL TRADES INSTITUTE

1400 GREENLEAF AVENUE DEPT. A-1030
CHICAGO 26, ILLINOIS

Send booklet, *Big Money in Auto Mechanics*,
and *Sample Lesson*. BOTH FREE.

Name _____ Age _____

Address _____

City _____ Zone _____ State _____



(Continued from page 6)
be established in Paris. The *Conseil Municipal de Paris* and the French Republic both promised support. The sponsors point out that Paris is the proper place for such a museum, not only because of Levassor's pioneering, but also because it was there. In 1768, that Captain Nicolas Joseph Cugnot, ordnance officer under Louis XV, successfully ran his invention, the steam-powered artillery tractor which was the grandsire of all self-propelled vehicles.

"I hope that your article and Korta's paintings may play important parts in augmenting the plan to get this museum created in Paris. Nothing, in my opinion, would be more fitting and proper than for a groundswell of American public opinion to manifest itself in favor of this plan, for surely no other people on this earth have reaped greater rewards from the widespread use of motor vehicles than have we here in the United States.

Christy Borth,
Assistant to the
Managing Director,
Automobile Manufacturers
Association,
Detroit, Mich."

☆

Your 1959 Parade of Cars (January PM), which I thought was fine generally, specifically put the Rambler in a bad light price-wise.

It showed the price of a Super Rambler V8 as \$2398 with a footnote stating "for Sixes subtract about \$120."

This is correct, but your readers may not know that Rambler also offers, in the six-cylinder line only, a Deluxe model that sells for \$2098.

Russell Martin,
Miner Motor Sales,
Willimantic, Conn.

☆

There are also the dissenters. Roy Ferrer, Los Angeles, writes:

"I wish to take exception to a statement in the section '1895—Paris-Bordeaux-Paris: Levassor's Triumph.' Mr. Railton writes: 'This first speed event of all time proved the superiority of the gasoline engine.'

"This statement in my opinion is both erroneous and ambiguous. It did not prove the superiority of anything. I think it did prove that Monsieur Levassor was either a very good mechanic or machinist, or that he had good men working for him.

"All down the line before and since in automotive history, steam cars have time and time again proved their superiority. If

(Continued to page 10)

Learn Radio-Television

Servicing or Communications by Practicing at Home in Spare Time

N.R.I. SENDS kits with which you practice building circuits common to Radio and TV sets. You LEARN-BY-DOING to locate Radio-TV troubles. As part of N.R.I. Servicing Course, you build Vacuum Tube Voltmeter and AC-DC receiver. Use VTVM to conduct experiments, earn extra money fixing sets in spare time.



RADIO-TV BROADCASTING (see above) offers important positions as Operators and Technicians. **RADIO-TV SERVICING Technicians** (see below) needed in every community. Their services are respected, their skill appreciated.



Fast Growing Field Offers You Good Pay, Success, Bright Future



J. I. SMITH
founder

Bigger than ever and still growing fast. That's why Radio-TV has special appeal to ambitious men not satisfied with their job and earnings. More than 4,000 Radio and TV stations. More than 150 million home and auto Radios, 40 million TV sets. Color TV promises added opportunities. For the trained man, there are good jobs, bright futures in Radio-TV Servicing or Broadcasting. Training PLUS opportunity is the ideal combination for success. So plan now to get into Radio-TV. The technical man is looked up to. He does important work, gets good pay for it. Radio-Television offers that kind of work. NRI can supply training quickly, without expense of going away to school. Keep your job while training. You learn at home in your spare time. NRI is the **OLDEST** and **LARGEST** home study Radio-TV school. Its methods have proved successful for more than 40 years.

Added Income Soon - \$10, \$15 a Week in Spare Time

Soon after enrolling, many NRI students start to earn \$10, \$15 a week in spare time fixing sets. Some pay for their training and enjoy extra luxuries this way. Some make enough to start their own Radio-TV shops. NRI training is *practical*—gets quick results. Easy to understand, well illustrated lessons teach you basic principles. And you LEARN-BY-DOING by practicing with kits of equipment which "bring to life" things you study.

Find Out What NRI Offers

NRI has trained thousands for successful careers in Radio-TV. Study fast or slow—as you like. Diploma when you graduate. Mail coupon now. Paste it on a postcard or mail in envelope. **ACTUAL LESSON FREE.** Also 64 page catalog that shows opportunities, shows equipment you get. Cost of NRI courses low. Easy terms. **NATIONAL RADIO INSTITUTE, Dept. 9CA, Washington 16, D.C.**

N.R.I. TRAINED THESE MEN FOR SUCCESS



"I was repairing Radios by 10th lesson. Now I'm Engineer for WHPE." **M. R. LINDEMUTH, Fort Wayne, Ind.**



"Doing spare time repairs on Radio and TV. Soon servicing full time." **CLYDE HIGGINS, Waltham, Mass.**

"I had a successful Radio repair shop. Now I'm Engineer for WHPE." **V. W. WORKMAN, High Point, N.C.**



"There are a number of NRI graduates here. I can thank NRI for this job." **JACK WAGNER, Lexington, N.C.**



VETERANS Approved Under G. I. Bills

SEND FOR BOTH FREE

National Radio Institute

Dept. 9CA, Washington 16, D.C.

Mail me Sample Lesson and 64-Page Catalog FREE. (No salesman will call. Please write plainly.)

Name _____ Age _____

Address _____

City _____ Zone _____ State _____

Accredited Member National Home Study Council



We Help Men Build Lifetime Businesses



W. Lookiebill (St. Louis): My 28th year! Began during depression and built business on good service.



M. Lyons (Chgo.): 3rd year should hit \$100,000; 2nd was \$60,000; 1st \$40,000. Hdqtrs help make it possible.

D. Chilcott (N. Platte): Duraclean says you can gross \$9.00 per hour. I gross up to \$12.00. Many dealers do much better.



E. Roddey (Hamp-ton, Va.): Have earned as much as \$485 in one day. My 9th year and business keeps growing.



You, too, can enjoy the financial Independence of your own business

Join the thousands of opportunity-minded men like those pictured above who are sharing in the profits that Duraclean and this remarkable home-furnishings cleaning field make possible. We can help you to make more money in one of the fastest-growing industries today . . . one which the Dept. of Commerce estimates as having a \$750 million dollar a year potential. Every building houses a customer!

We will train you to become a cleaning specialist, show you the proven methods for building business, and then back you with over 27 continuous services to help assure your growth.



Arlis Wilson of Tulsa says: "As a Duraclean Dealer, I have the ideal setup. I am operating my own business, yet have at my disposal a staff of experienced men at headquarters who will gladly help me on a moment's notice."

Start Part-Time if now employed and build it into a full-time operation as thousands of Duraclean Dealers have done. No shop needed. We help finance reliable men.

FIVE WAYS TO MAKE MONEY:

You provide 5 different services, thereby multiplying profits on most jobs. **Duraclean:** unique absorption method of cleaning rugs, carpets and upholstery which eliminates harmful scrubbing, soaking and shrinkage. This process is so safe it has been awarded the Parents' Magazine Seal. Other vital services are **soil retarding, mothproofing, flameproofing, and spotting.** Just 2 average jobs a day nets \$8,750 first year.



WE HELP YOU GROW: Duraclean's growth depends on your success; thus, Headquarters provides all the help possible to assure your success. When you phone or write, our staff of specialists give you prompt, expert counsel. What's more, you're kept up-to-date, first hand, on all phases of your business through our comprehensive 5-day training school, national conventions and regional conferences. We back you with National Advertising in leading consumer and trade magazines, provide newspaper ads, direct mail materials, copyright and trademark protection, a monthly sales-building magazine plus a host of others.

Mail coupon for free booklets and complete details on a dealership in your town.

DURACLEAN CO., 9-163 Duraclean Bldg., Deerfield, Ill.

"OWN A BUSINESS" COUPON

Duraclean Co., 9-163 Duraclean Bldg., Deerfield, Ill.

Without obligation, please rush me free booklets giving me full details of how I may OWN a growing, lifetime business.

Name.....

Address..... County.....

City..... State.....

(Continued from page 8)

they had had the concentrated engineering spent on them that the internal-combustion cars had, there probably would be very few i.c. cars in use today."

No fan is more devoted than the steam-engine fan. Nevertheless, Mr. Railton comments, "historical fact is that in 1895 steam cars which had been built for years were trounced by a whole raft of primitive, imperfect gasoline cars. From that day until this the steam car has never been a threat. It may be some day, but at the moment it is not."

☆ ☆ ☆

To the Editor:

I have been reading your magazine for a good many years, and have found some good ideas in it.

I am enclosing a snapshot of an outboard motor I built from a Crosley car engine.

It was put on an Evinrude lower-end unit, it has a dry oil sump under the motor and two U.S. carburetors.

It does about 30 m.p.h. on a 15-foot boat.
Chas. Wells,
London, Ontario

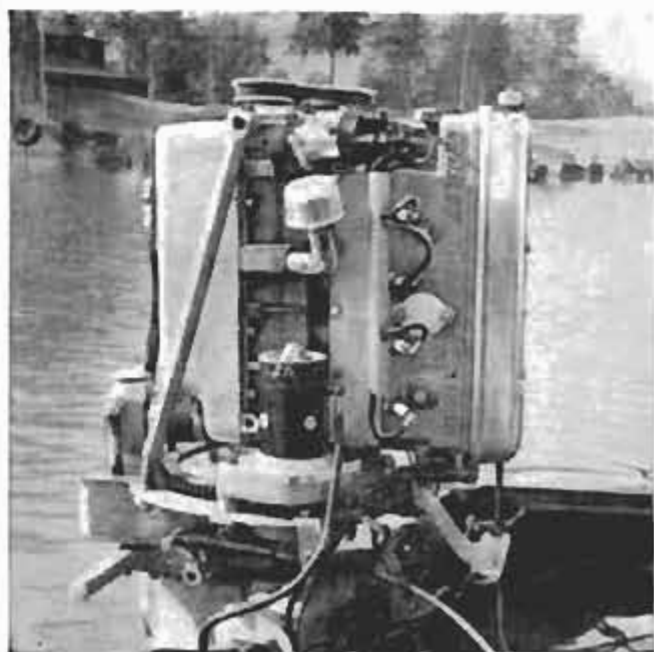

☆ ☆ ☆

Next time a tornado heads for your town—and we hope you never have this opportunity—get out your camera before you duck for cover. Weather bureau scientists are making a study of tornadoes and applying photogrammetric methods (aerial mapping). They will welcome as many photographs of a single tornado as possible, taken from all angles, whether by professional or

(Continued to page 14)

INVENTORS

Learn how to protect your invention. The U. S. Patent Laws provide that any new and useful art, machine, article of manufacture, or composition of matter, or any new and useful improvement thereof, may be patented if the act of invention is involved. Therefore, every inventor with a valuable invention should take advantage of the Patent Laws and proceed for patent protection in order to safeguard his rights.

A patent gives the inventor the exclusive right to prevent others from making, using, or selling the invention claimed in the patent for a period of seventeen years.

The Patent Laws were enacted for the benefit of the inventor to give him protection for the features of his invention which are patentable. These features must be properly and concisely set forth and claimed in a formal application for patent, in order to comply with the requirements of the Patent Laws. For that reason, unless the inventor is familiar with patent matters, he should engage a competent registered patent attorney or agent to represent him. We are registered to practice before the U. S. Patent Office and are prepared to serve you in the handling of your patent matters.

A specially prepared booklet entitled "Patent Guide for the Inventor", containing detailed information with respect to patent protection and procedure, together with a "Record of Invention" form will be promptly forwarded to you without obligation upon request.

CLARENCE A. O'BRIEN & HARVEY JACOBSON

Registered Patent Attorneys

91-C DISTRICT NATIONAL BUILDING

WASHINGTON 5, D. C.

Obviously, We Didn't Know This Old-Timer!

On page 44 of our January 1959 issue we ran the photograph of an old car loaded down with camping gear shown below and asked: "Do you know this old-timer?" On another page we identified it as a 1919 Ford. Readers from all over the country wrote to tell us how wrong we were. Here are some of the letters:



We said it was a 1919 Ford, but it's a 1917 Chevrolet 490



This is a 1919 Ford

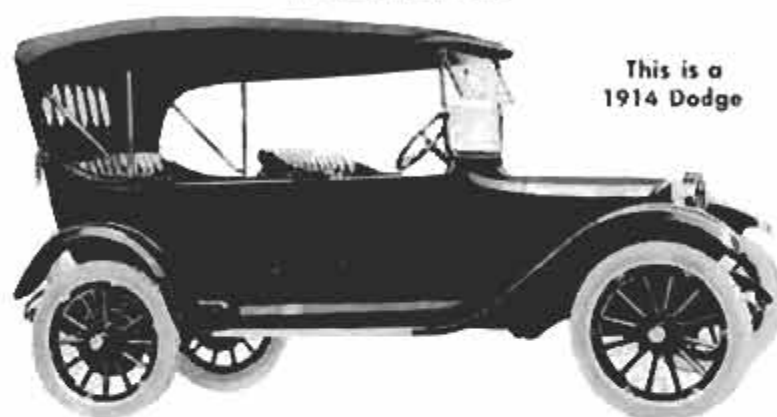

This is a
1914 Dodge

This is a
1915 Chevrolet
490



The old-timer on page 44 is certainly not a 1919 Ford. It is a 1917 Chevrolet 490. I, as a boy of 15, drove this car over hill and dale and am well acquainted with its details.

A. G. Bussey,
Los Angeles, Calif.

He is absolutely right—ED.

You say the old-timer is a 1919 Ford but that it's not a Ford top. The reason for the top not being a Ford top is because the car is a 1918 Chevrolet 490.

Delbert D. Daniel,
San Jose, Calif.

I don't know the exact year, but I believe it was one of the first cars built by Dodge.

C. F. Grazioso,
Clifton, N. J.

Compare the photograph with any 1916 Dodge stock touring car. Also compare with any 1916 to 1922 Ford. You will readily agree that it is a 1916 stock Dodge. I should know, I owned one.

William B. Baker,
Council Bluffs, Iowa

Body resembles a Ford but the front fenders, lights and radiator are those of a Dodge. The wheel size is also that of a Dodge with demountable rims. If the Ranger was not standing in front of the steering wheel and windshield I would have more clues.

T. A. Parker,
Brady, Tex.

Just to keep the record straight, this couldn't be a Ford, even a highly rebuilt one. It most probably is a model 490 Chevrolet, about a 1917. And the top is okay.

Cornelius W. Hauck,
Cincinnati, Ohio

The headlights are set up too high and are mounted on U-brackets. The visors on the front of the fenders are rather long. My guess is that the car is a Chevrolet. I hope you continue these old photos.

Henry A. Parker, Jr.,
Johnson, Vt.

NOW Men 17 to 55 who want to earn MORE MONEY!

GET THIS VALUABLE **FREE** POCKET **GUIDE**

THAT'S PACKED WITH TIPS FOR EARNING **Real Money!**

Looking for an unusual chance to prepare to bring home a REAL PAY CHECK? Like to have what it takes to drive home a sleek new car? Want a job that's REALLY INTERESTING—that has a GREAT FUTURE? Or perhaps you want to ADD TO YOUR PRESENT INCOME?

Then mail the coupon today. Get the SURPRISING FACTS about one of the most remarkable opportunities of its kind to prepare in your spare time at home for a real job in the vast, multi-billion dollar field of

RADIO-TELEVISION- ELECTRONICS

where so many exciting . . . marvelous things are happening.

See how you can get the VERY HELP YOU NEED—easy-to-read, picture-illustrated lessons . . . fascinating "learn-by-seeing" movies . . . even a home laboratory of equipment for "do it yourself" experience. And to top it all, the BEST IS YET TO COME!

**OFTEN MORE JOBS FOR OUR GRADUATES
THAN WE CAN FILL**



This remarkable industrial training organization has already recommended graduates to OVER 8,000 companies in the Radio-Television-Electronics field. Upon graduating, you get the same effective EMPLOYMENT HELP that has already enabled thousands of men to enjoy REAL EARNINGS.

"BUT WHAT DO ALL OF THESE WONDERFUL ADVANTAGES COST?"

Here's more GOOD NEWS! The plan is operated to make it convenient for almost any ambitious man to get started! The cost is nominal—in fact, a happy surprise to many men. So much is happening you should know about, MAIL THE COUPON TODAY!

If you leave home, you can get all of your training in some of the finest training laboratories of their kind—in Chicago or Toronto. Write for details.

DeVRY TECHNICAL INSTITUTE

4141 BELMONT AVENUE CHICAGO 41, ILLINOIS
Formerly DeFOREST'S TRAINING, Inc.

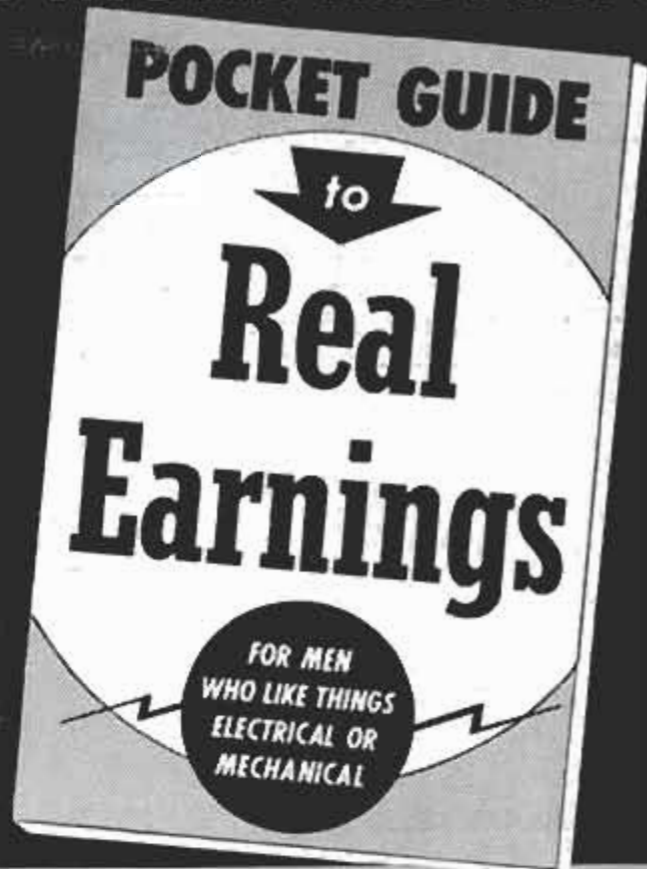

Nothing Else Like It!

"Wonderfully helpful" . . . "Some of the best tips on earning REAL MONEY I've ever come across." That's what many men are saying about this remarkable free guide.

- ★ **YOU'LL DISCOVER** the TEN LITTLE WORDS THAT MAY BOOST YOUR INCOME.
- ★ **YOU'LL SEE** that if you're an average, normal man, you have MORE THAN ENOUGH BRAINS to prepare to earn and enjoy some REAL MONEY—and likely in the very area you live.
- ★ **YOU'LL FIND OUT** about some amazing new job developments in one of the greatest opportunity fields of our time—wonderfully interesting, down-to-earth, REAL MONEY JOBS you may readily train for in your spare time at home.
- ★ **YOU'LL SEE** that you DON'T HAVE TO BE TOPS IN MATH . . . that you DON'T NEED AN ADVANCED EDUCATION.
- ★ **IN FACT**, if there are a lot of things you want these days but just DON'T HAVE THE MONEY—fill in, mail the coupon below NOW! I think what we have for you will really surprise and please you—including this valuable new POCKET GUIDE TO REAL EARNINGS.

MAIL TODAY FOR FREE FACTS

DeVry Technical Institute
4141 Belmont Ave., Chicago 41, Ill., Dept. PM-3-P
Please give me a FREE copy of your unusual booklet, "Pocket Guide to Real Earnings," and tell me how I may prepare to enter one or more branches of Electronics.

NAME _____ AGE _____

STREET _____ PLEASE PRINT _____ APT. _____

CITY _____ ZONE _____ STATE _____

Check here if subject to military training.

DeVry Tech's Canadian Training Center is located at
626 Roselawn Avenue, Toronto 12, Ontario

2052



STEP INTO A INDEPENDENT FUTURE

— WITH NO INVESTMENT!



FULL
OR
PART
TIME



... Quik-Chek, world's leader in self-service tube testing and replacement tubes, offers an opportunity to establish your future in a dignified profession with unlimited prospects!

BE FIRST IN YOUR AREA WITH THIS TV-RADIO TUBE TESTER BUSINESS

Everything INCLUDED

You get: handy, lightweight carrying case, famous Quik-Chek tube tester (nationally advertised), starter stock of various type TV-radio tubes, adv. literature, Quik-Chek Agency sales manual; even business stationery. In addition, you receive the help of our area supervisor-distributor to insure your success.

All you need is a good reputation and the Quik-Chek Portable Tester Kit. There is a tremendous market in your area... waiting for the right man! The fact is that in four cases out of five YOU can put TV sets back into good working order right in your neighbors' homes — just by testing tubes and replacing them from your Quik-Chek kit! Your profit: \$1.25 to \$8.00 per service-sale! Build goodwill and a solid future at the same time.

RIGHT FROM YOUR OWN HOME! It is not necessary to set up a store, shop or office. No overhead whatsoever. Whatever you earn is all your own. We help you get started with everything you need: including a starter kit of tubes. As tubes are sold we supply you with additional stock... at amazing wholesale discounts!

NO TECHNICAL EDUCATION NEEDED! This is not a course of instruction; it is an opportunity. Anyone with a grammar school education can qualify. We ship the entire kit without charge on loan. All we ask is that you be of good character, are able to furnish good references, and willing to demonstrate your sincerity. Get the full facts on this amazing opportunity that may never again be repeated. Write today for the FREE FOLDER.

QUIK-CHEK CORP.

World's Leader in
Self-Service Tube Testers

TELL-ALL FOLDER FREE!

QUIK-CHEK, Dept. PM-359
5212 Pulaski Ave., Philadelphia 44, Pa.
Send free folder, "Your Next Step into a Business of Your Own," and details of the Quik-Chek Agency offer.

Name _____
Address _____
City _____ Zone _____ State _____

amateur photographers. With enough different views they can measure the storm in three dimensions. Prints may be mailed to Severe Local Storm Research Unit, Office of Meteorological Research, Weather Bureau, Washington 25, D.C. Mark pictures as to date, time and place, and indicate if you wish them returned.



To the Editor:

One of the top attention-getters at Paradise Airport, just outside Phoenix, Ariz., is the single-seat monoplane constructed by Ken Bowser and Gailord Barker, of Phoenix.

Using no plans, but improvising as they went along, the amateur fliers built a plane which has passed CAA specifications. They introduced many new ideas and managed to buy and salvage pieces from other planes and remodel them.

The plane has a length of 16 feet, modified Luscombe wings which were 35 feet long originally and now are 23.7 feet.

Designed by the two fliers, the throttle is ball-jointed with swivel, which results in no binding. The straps are mounted in the frame and the stick is a push rod with ball-bearing operation, making it easy to handle.



The tubular steel for the fuselage ranges from 3/8 to 1 1/4 inch and was put together by welder Barker. The gasoline tank mounted ahead of the pilot can haul 16 gallons. The plane burns about 4 1/2 gallons to the hour and is powered by a 65 horsepower Continental.

The gear is a Cessna type but cut down, and the heater system was built by the flying team.

Capable of flying at a top speed of 100 miles per hour, the plane can land and take off at around 60 miles per hour and it has gone over 13,000 feet.

Henry F. Unger,
Phoenix, Ariz.

(Continued to page 78)

**THIS is how you train at home
to become a SERVICE ENGINEER
in the Air Conditioning and
Refrigeration industry...**

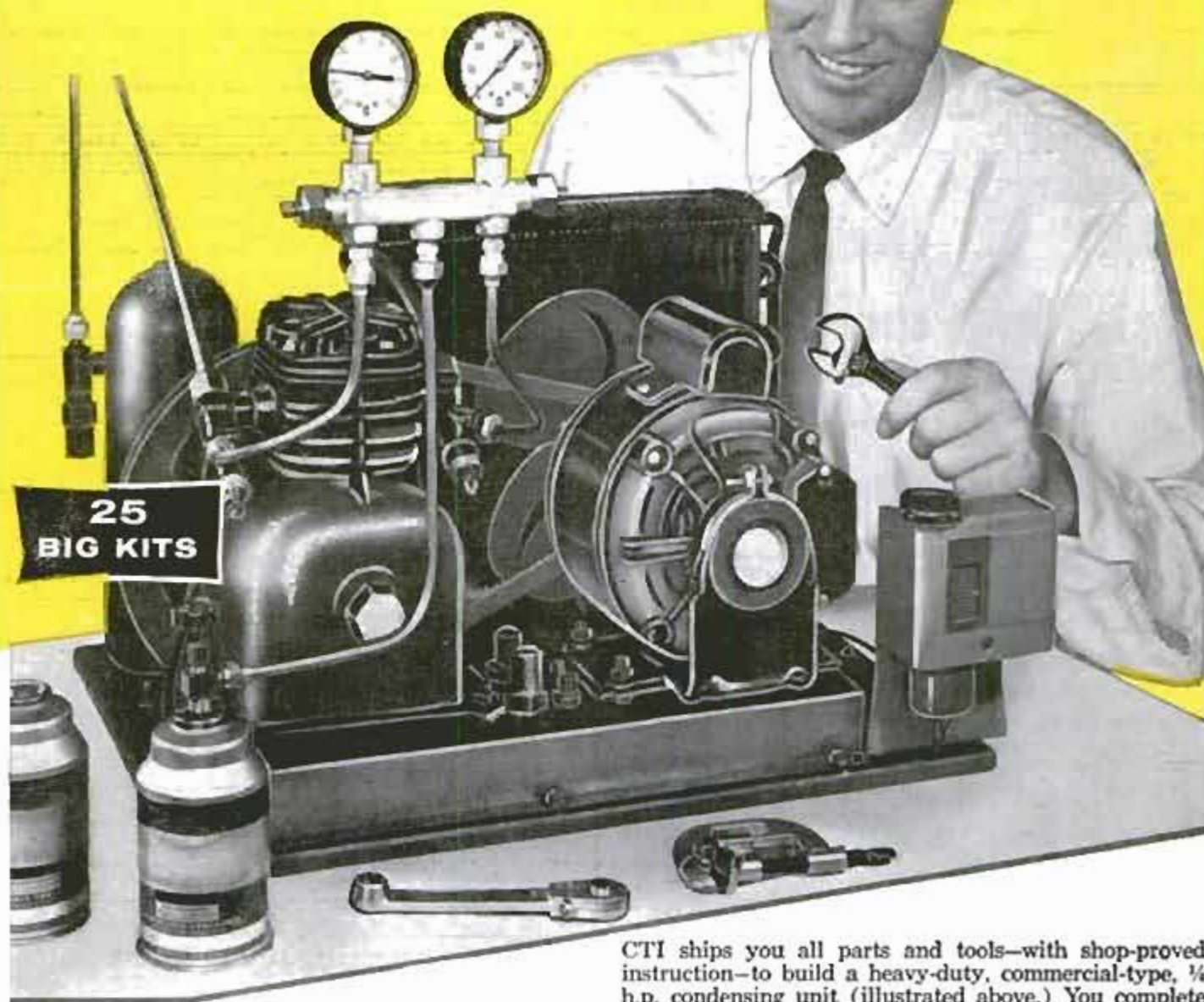

An old industry offers bright new opportunities

Almost any industry has jobs for men with special skills. In many cases, good pay and steady work are the rule. Yet—would you be happy in being a repairman all your life? Wouldn't you rather have a job that presents a *challenge*—still *bigger money*—an opportunity to *grow*?

Listen, if you are ambitious to *keep climbing*: The air conditioning and refrigeration industry is growing so fast that 20,000 newly-trained technicians are needed each year. They can come only from the technical schools. Because installation and repair work is important, graduates may expect high pay and security right from the start. That's not all. *A well-trained technician has a great opportunity to develop into a Service Engineer.* As a matter of fact, 90 percent of all refrigeration engineers are former repairmen!

If you seek a *career*, not just a job, get into air conditioning and refrigeration. Your first step is to gain skill and knowledge. Learn at home by practicing with 25 big kits that CTI sends. Acquire experience as you train.

CTI ships you all parts and tools—with shop-proved instruction—to build a heavy-duty, commercial-type, 1/4 h.p. condensing unit (illustrated above.) You complete 23 field-type projects—do 10 trouble-shooting jobs. You make home a training center!

So practical is CTI training that many students earn extra cash in spare time soon after they start. They make calls on their own, or get part-time jobs with local appliance dealers or air conditioning contractors.

But read the complete story. It is told in a new CTI catalog. *Just fill out and mail coupon below for your copy.* Sample lesson included. No cost nor obligation—Commercial Trades Institute, Chicago 26, Ill.

COMMERCIAL TRADES INSTITUTE

1400 GREENLEAF AVENUE
CHICAGO 26, ILLINOIS

DEPT. R-559

Send catalog, *Success in Air Conditioning & Refrigeration*, and
Lesson Sample. Both FREE.

Name _____ Age _____

Address _____

City _____ Zone _____ State _____



Do-it-yourself—



**clean your
carburetor...
increase
your gas
mileage**

Gum and varnish deposits build up faster than you think in your carburetor. This kills carburetor efficiency and cuts gas mileage 10% or more. At today's prices, that's a loss of about 3c a gallon.

It's easy to avoid this waste by using Gumout to clean your carburetor. Just add Gumout to your gas tank. Gumout, a special solvent, cleans the fuel lines and carburetor while you drive.

Gumout is used and recommended by carburetor specialists. Try Gumout for smoother engine performance and more miles per gallon of gasoline.

Sold by service stations and auto supply stores everywhere.

GUMOUT DIVISION
Pennsylvania Refining Co.
2671 Lisbon Road
Cleveland 4, Ohio



Great Pioneers in Science Do You Know Them?

—By James S. Thistle—

VULCANIZATION of rubber came about by accident. Its developer accidentally spilled some crude rubber and sulphur on a hot stove. The rubber became smooth, elastic and temperature-resistant. At last he had discovered the process that led to the founding of the American rubber industry.

His road to success, however, was not a smooth one. He was unable to get anyone to invest in his experiment. He was also involved in many patent suits, which drained him financially. Finally, in 1852, his legal claim to his discovery was upheld in the famous India Rubber Case.

Daniel Webster represented him in court, but his fee of \$250,000 was more than our scientist ever earned from his researches in science. He went to England and France, established a manufacturing firm that shortly failed. In spite of all his efforts, he died in debt, but others made fortunes from his patents.

*These letters, unscrambled,
spell the name of this
month's Great Pioneer
in Science:*

SHALERODCOYRAGE

(First and Last Names)

Write the correct name here:

Now turn to page 236 for the answer.

POPULAR MECHANICS

INVENTORS

If you believe that you have an invention, you should find out how to protect it. The first step is to have a search made of the prior pertinent U. S. patents. If a report on this search indicates that the invention appears patentable you can apply for a patent, and the specifications and claims should be prepared.

The firm of McMorrow, Berman & Davidson, with offices in Washington, D. C., is qualified to take the necessary steps for you. We can make a preliminary search on your invention, advise you whether we think it can be patented, and prepare your application for patent.

Unless you are fully familiar with the U. S. Patent Laws, we recommend that you engage the services of a Registered Patent Attorney to protect your interests. The patent laws are *your* laws. A patent gives you the right to prevent others from making, using or selling the invention claimed in your patent for a period of 17 years.

Use these patent laws for your protection. Investigate whether your invention can be patented. If you have what you believe to be an invention, we suggest that you have this firm make a search for you.

Send for a copy of our Patent Booklet entitled "How To Protect Your Invention," containing information about patent protection and patent procedure. Along with this we will also send you an "Invention Record" form, for your use in writing down and sketching details of your invention. We will mail them promptly. No obligation. They are yours for the asking.

McMORROW, BERMAN & DAVIDSON

Registered Patent Attorneys

PATENTS • COPYRIGHTS • PATENTS

1357 VICTOR BUILDING, WASHINGTON 1, D. C.

OPTICAL BARGAINS

REPLICA GRATING — LOW, LOW COST

It's here—after decades of effort! Replica Grating—on film—at very low price. Breaks up white light into full spectrum colors. An exciting display, 13,400 lines per inch. Diffraction Grating has been used to answer more questions about the structure of the material world and the universe than any other single device. Use it for making spectroscopes, for experiments, as a fascinating novelty. First time available such large size—so cheaply. Comes in clear-plastic protector.

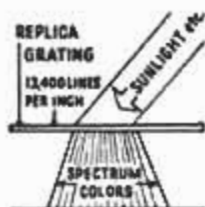

Stock No. 50,202-M . . . Includes 2 pieces 8" x 5 1/2"—1 transmission type, 1 reflecting type \$2.00 Postpd.
Stock No. 50,180-M . . . 1 piece transmission type 8 in. x 6 ft. \$5.95 Postpd.
Stock No. 50,203-M . . . 1 piece reflecting type 8 in. x 6 ft. \$10.95 Postpd.

SALE! TERRIFIC WAR SURPLUS BARGAIN! AERIAL CAMERA LENSES



Gov't. Cost \$1218—Now Low as \$39.50 Used Made by B & L and E.K.—24" F.L. f/6. In 23" long Lens Cone. Use as long range. Big Bertha Telephoto lens—for Richest field (wide field, low power) telescope, etc. Lenses are 4" dia.—precision 4-element type. Aero Tessar and Aero Ektar. Easily removed. Diaphragm f/6 to f/22 is included. Opens approx. 1" to 3 1/2". Lens and cone—wt. 25 lbs. Sturdy carrying trunk—wt. 26 lbs.

Stock No. 85,059-M 24", used. Price \$39.50 f.o.b. Utah
Stock No. 85,060-M 24", new. Price \$59.50 f.o.b. Utah

SPECIAL! SPECIAL!

Complete Optical Kit! Build a 6" Reflecting Telescope! (Described in Mech. Illus. Feb. & March 1958 issues)

Consists of plate glass mirror blank; tool; 2 finely ground and polished lenses to make 1/2" F.L. eyepiece; first surface diagonal mirror; magnifying lens; 8 abrasives; pitch.

Stock No. 70,154-M . . . \$9.00 Postpaid
Stock No. 70,004-M . . . Deluxe Kit with Pyrex mirror blank—1" eyepiece lenses. \$11.95 Postpaid

WRITE FOR FREE CATALOG "H"!

Complete Line of Astronomical Telescope Parts and Assembled Telescopes. Also huge selection of lenses, prisms, war surplus optical instruments, parts and accessories. Telescopes, microscopes, hand Spectroscopes, Sniperscopes, binoculars, etc. Request Catalog "H"!

ORDER BY STOCK NUMBER (SEND CHECK OR MONEY ORDER) SATISFACTION GUARANTEED!
EDMUND SCIENTIFIC CO., BARRINGTON, N. J.

Bean's

Free Catalog

Just Off the Press



Fully illustrated 100 pages, shows three hundred and seventy-five items of interest to both men and women—special fishing tackle, footwear, clothing, leather and canvas specialties, many of our own manufacture.

L. L. Bean, Inc., 61 Main St., Freeport, Maine
Mfrs. Fishing and Camping Specialties

High School Course at Home

Many Finish in 2 Years

If you did not or cannot finish high school, here is your opportunity. Study in spare time at home. Go as rapidly as your time and abilities permit. Course equivalent to residential school—prepares for college exams. Standard texts supplied. Credit for subjects already completed. Single subjects if desired. Diploma awarded. Be a High School graduate. Start studies now. Free Bulletin. Write today.

AMERICAN SCHOOL, Dept. H345

Drexel at 58th, Chicago 37, Illinois

Accredited Member NATIONAL HOME STUDY COUNCIL

Sworn statement from CHAS. LEMMING reads:

"After starting my own business



I've averaged \$100 A DAY

—most of it clear profit!"

• If you want to be independent—free from layoffs, bosses—start profitable, year 'round business of your own. Ours is NOT a lease proposition. You own the machine, you work when and where you please, and all the money you take in is your own. FREE book tells you how.

Not everyone does as well...

Mr. Lemming owns two machines

In city of less than 50,000, Mr. Lemming started his own business after filling in coupon like one below. He averaged \$100 a day during first year, some days \$200. F. E. Doran grossed \$1050 in single month. Geo. Held grossed \$300 in one week.

How much you earn depends largely on you. No special skill, no large investment required for our electric upholstery cleaning machine. Start spare time until full time justified. Hire helpers as needed.

NO SHOP NECESSARY • You clean upholstered furniture on customers' premises—homes, hotels, motels, etc. Auto upholstery, too. No hauling; operate from your home. Watch business grow as satisfied customers tell friends. Supplies cost little, profits high.

MAIL COUPON TODAY FOR FREE BOOK

VON SCHRADER MFG. CO.
310 "D" Pl., Racine, Wisconsin

Without obligation rush your FREE booklet about how I can start my own permanent, profitable electric Upholstery Cleaning business.

Name _____
Address _____
City _____ Zone _____ State _____



LET RCA TRAIN YOU IN ELECTRONICS

RCA Institutes celebrates Fifty Years of Electronic Training by introducing its newest Home Study Course . . .
ELECTRONICS FOR AUTOMATION

. . . Now you have *four* comprehensive courses for your electronic training . . . from basic electronic theory to the more advanced principles of color TV and Automation.

Electronic Fundamentals



Electronics for Automation

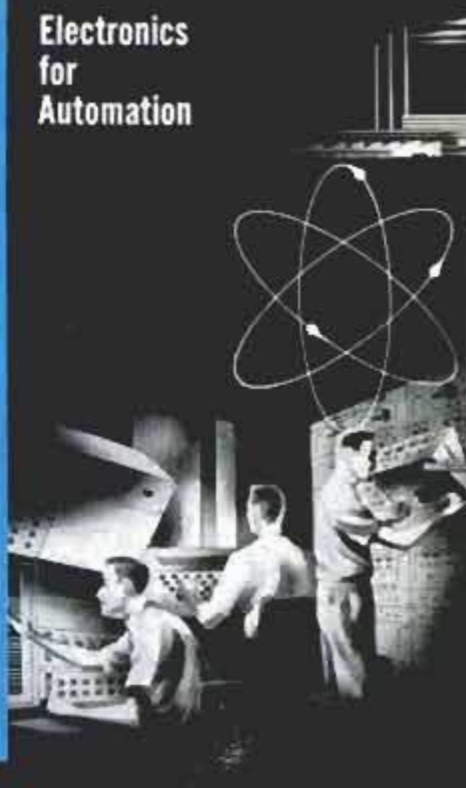

Television Servicing



Color Television



Send for our
64 page Home
Study Catalog

FREE!

RESIDENT SCHOOL offers Technical Institute and Vocational School Courses in Electronics. Day and Evening classes start 4 times each year. Resident School Catalog sent free on request.



Practical work with the very first lesson. Pay-as-you-learn. You need pay for only one study group at a time.

RCA INSTITUTES, Inc. Home Study School, Dept. PM-39

A Service of Radio Corporation of America

350 West Fourth Street, New York 14, N. Y.

Without obligation, send me the FREE catalog of Home Study Courses. No salesman will call.

Name Please print
Address
City Zone State
Korean Vets! Enter Discharge Date

CANADIANS — Take advantage of these same RCA courses at no additional cost. No postage, no customs, no delay. Send coupon to: RCA Victor Company, Ltd., 5001 Cote de Liesse Rd., Montreal 9, Quebec
To save time, paste coupon on postcard

Inventors

If you consider your invention valuable, take these necessary preliminary steps promptly to protect it by applying for a United States patent.

Sketch and describe your invention. (For convenience in starting action on your invention, use "Evidence of Invention" form offered below.)

Sign, date and have this invention disclosure witnessed by two people capable of understanding your invention.

Have us make a preliminary search among U. S. patents already granted for similar types of invention.

We then prepare a report for you on the probable patentability of your invention and recommend your further course of action.

This firm is registered to practice before the U. S. Patent Office. We are available to assist you in the preparation and prosecution of your application for patent.

We shall be glad to send you promptly and without obligation, an instructive booklet—"Patent Protection for Inventors"—and our convenient "Evidence of Invention" form.

VICTOR J. EVANS & Co. *Merlin M. Evans*
REGISTERED PATENT ATTORNEY
530-C MERLIN BUILDING, WASHINGTON 6, D. C.

ACCORDION PRICES SMASHED



SAVE 50% AND MORE DURING THIS GREAT SALE

5 Days' FREE TRIAL

Hurry! Get in on these sensational accordion values. America's largest exclusive accordion dealer selling out finest brand new accordion overstock! Fabulous savings. Leading brands in more than 30 new models. Small down payment. Easy terms. Trade-ins accepted. Chance of a lifetime.

FREE for promptness . . .
• FREE Lessons
• Music Stand
• Deluxe Case
• Lifetime Guarantee

FREE COLOR CATALOG & Wholesale Prices

Learn how easily you may own and play a fine accordion. Rush name and address for big FREE Color Catalog and new low wholesale price list. No obligation. WRITE TODAY!

ACCORDION MANUFACTURERS AND WHOLESALERS OUTLET
2003 W. CHICAGO AVE., Dept. R-39, CHICAGO 22, ILLINOIS

FREE OUTFIT STARTS YOU IN BIG MONEY SHOE BUSINESS!

We furnish everything FREE to set you up in your own profitable full or spare time shoe business. Just 3 easy sales a day brings up to \$84 a week EXTRA! Repeat orders mean big, steady profits. No experience or investment needed. You feature over 150 fast-selling styles in dress, sport, work shoes for men, including beautiful Nylon mesh shoes with Air Cushion innersoles. Also special kinds of shoes for different occupations. Amazing range of sizes and widths. Fit customers stores are unable to take care of. Start now by selling to friends, neighbors, relatives. Everyone is your prospect. Send postcard Today for FREE Selling Outfit!



Mason Shoe Mfg. Co., Dept. F-422, Chippewa Falls, Wis.



MECHANICAL DENTISTRY

To make Crowns, Plates, Bridgework, etc., for Dentists. Easy practical way to learn mechanical dentistry at home in spare time. FULL EQUIPMENT OF TOOLS AND MATERIALS INCLUDED WITH COURSE. Low tuition. Easy terms. Write for FREE BOOK about this money making profession that is not affected by machine age.

MCCARRIE SCHOOL OF MECHANICAL DENTISTRY
207 N. Broad St., Dept. 86, Philadelphia 7, Pa.

REAL ESTATE BE A BROKER

PAYS BIG! SEND FOR FREE, BIG, ILLUSTRATED CATALOG NOW! Graduates report making substantial incomes. Start and run your own business quickly. Men, women of all ages, learn easily. Course covers Sales, Property Management, Appraising, Loans, Mortgages, and related subjects. STUDY AT HOME or in classrooms in leading cities. Diploma awarded. Write TODAY for free book! No obligation.

Approved for World War II and Korean Veterans
WEAVER SCHOOL OF REAL ESTATE (Est. 1936)
2020R Grand Avenue Kansas City, Mo.



MEN PAST 40

Afflicted With Bladder Trouble, Pains in Back, Hips, Legs, Nervousness, Tiredness.

If you have these troubles, particularly bladder trouble, then your condition may be traced to Glandular Inflammation . . . a constitutional disease. Neglect of this condition often leads to premature old age and sometimes incurable malignancy.

The Excelsior Medical Clinic has a New Free Book that tells how thousands of men have been successfully treated here at Excelsior Springs for Glandular Inflammation by NON-SURGICAL Methods. They found soothing relief and a new outlook in the future of life.

This Free Book may prove of utmost importance in your life. Write Today. There is no obligation.

Excelsior Medical Clinic, Dept. B6129, Excelsior Spgs., Mo.

DON'T BE HALF-TRAINED! Be A Master Technician

NOW... ONE
modern master
home training course
IN ALL 3 PHASES



AIR CONDITIONING - REFRIGERATION ELECTRICAL APPLIANCES

**ALL AT ONE
LOW TUITION**
only National Schools gives
you this complete training
at no extra cost



**YOU GET
AND KEEP
ALL THESE
TOOLS
AND
INSTRUMENTS**

Incomplete training limits your earning power, even disqualifies you for top-pay jobs. The big service companies require complete, all-phase training. If you open your own shop, you'll be called upon to service and repair all types of refrigerators, air conditioners and appliances. With complete training—as only National Technical Schools can give you—you can accept every job, make big profits all year round.

FUTURE BRIGHT FOR TRAINED MASTER TECHNICIANS

Over 30,000 new technicians must be trained annually. You are needed to help service and repair the 50 million air conditioners, refrigerators and electrical appliances that will need fixing this year alone. No wonder the Master Technician has steady work, at high pay, year after year. He can go places in his own business or with a manufacturer, dealer, distributor or department store. Armed with all-phase training, his earning power is unlimited.

THE MOST FOR LESS

We give you illustrated Shop-Tested Lessons and Manuals...many other training aids...privilege of CONSULTATION with our instructors and engineers. Every lesson, every manual has been SHOP tested and approved.

JOB TRAINING AT HOME

You get Professional Tools, Precision Instruments, PLUS a Factory-Made APPLIANCE TESTER! A shop-full of PRACTICAL, professional equipment. Use them to conduct over 100 experiments...also in Spare Time Work and ON THE JOB. It is all yours to keep...no EXTRA MONEY DEPOSITS...no EXTRA COST on your equipment kits.

EARN AS YOU LEARN

We show you how. Many of our students pay for their entire course—and more—in Spare Time while learning. So can you. Graduate Advisory Service, too.

GET THE BENEFIT OF OUR OVER 50 YEARS EXPERIENCE

**N.T.S. also offers training in
TV - RADIO - ELECTRONICS
and AUTO MECHANICS - DIESEL**



MEMBER



NATIONAL TECHNICAL SCHOOLS

WORLD-WIDE TRAINING SINCE 1905

4000 SO. FIGUEROA ST., LOS ANGELES 37, CALIF., U. S. A.

RESIDENT TRAINING AT LOS ANGELES

If you wish to take your training in our Resident School at Los Angeles, start NOW in our big modern Shops and Labs. Here you work with latest equipment...professionally installed... finest, most complete facilities offered by any school. Expert, friendly instructors. Personal attention. Graduate Advisory Service. Help in finding home near school...and part time job while you learn. Check box in coupon for full information.



**SEND FOR
FREE
BOOK AND
ACTUAL
LESSON NOW!**

We'll rush you our big, illustrated OPPORTUNITY BOOK and ACTUAL LESSON, show you how easily you can learn. NO OBLIGATION; no salesman will call. Do it NOW! It costs nothing to find out.

NATIONAL TECHNICAL SCHOOLS

WORLD-WIDE TRAINING SINCE 1905

MAIL NOW TO
National Technical Schools, Dept. CB-39
4000 S. Figueroa St., Los Angeles 37, Calif.
Rush FREE "Opportunity" Book and Actual Lesson. No Salesman will call.

NAME _____ AGE _____

ADDRESS _____

CITY _____ ZONE _____ STATE _____

Check here if interested ONLY in Resident Training at Los Angeles.

DRAFTSMEN



CASH BIG PAY CHECKS!

Train Now for
more success,
greater security

LEARN AT HOME IN SPARE TIME
(or at college in Chicago)

Check the want ads in any newspaper—SEE the big-pay opportunities open to you as a draftsman. What's more, you can learn this well-paid, prestige profession at home — quickly, easily! No special talent needed. Get complete, step-by-step Chicago Tech lessons in the mail, spend a few pleasant hours studying each week. In a short time you'll be a well-trained draftsman, ready to take your pick of many good jobs. Act now!



Free Information—Mail Coupon Today!

Get FREE TRIAL LESSON plus information about C.T.C. practical training. Learn what successful Chicago Tech graduates say about high pay and opportunities in drafting. No charge, or obligation.

CHICAGO TECHNICAL COLLEGE

C-217 Tech Bldg., 2000 So. Michigan Ave.
Chicago 16, Illinois

Mail me FREE lesson with facts about big opportunities in DRAFTING.

Name _____ Age _____

Address _____

City _____ Zone _____ State _____



HIGH WAGES!

High Wages can be yours as an Operating Engineer of heavy construction equipment! Learn NOW to operate our diesel engined bulldozers, draglines, cranes, back hoes, scrapers and motorgraders! Machines of major manufacturers are used in our training program.

Contractors need trained operators and pay high wages to our graduates.

We invite comparison and inspection of the nation's original construction equipment operator's training schools.

NEW! Announcing resident and non-resident courses in Heavy Construction Management. Write for details.

VETERANS: Ask about G.I. Benefits

Write TODAY for FREE School Catalog,
no obligation, to either address

**THE NATIONAL SCHOOLS of
HEAVY EQUIPMENT OPERATION**

Dept. D-27

P.O. Box 8415, Charlotte, N. C. - P.O. Box 510, Weiser, Idaho

WAR SURPLUS BARGAINS

WAR SURPLUS BARGAINS

5500,000.00 INVENTORY
for QUICK LIQUIDATION

Surplus items — hundreds of them for home, shop, factory, farm and outdoor use. New items, used items, reconditioned items—all at tremendous savings—All priced for quick sale.

Page After Page of Values

This big catalog shows page after page of amazing money saving values. Write for your copy today. Send 10c to cover postage, mailing, etc. Write today! SEND TODAY FOR YOUR COPY

10c

STARK'S 212 W. Madison St.
Dept. PM-593
CHICAGO 6, ILL.

**STOP FRONT DRIVE DRAG
ON YOUR Jeep**

PROVEN IN OVER A BILLION MILES OF SERVICE!

Warn Hubs on your 4 w.d. give double-duty value — economical, free-wheeling 2 w.d. (with added pep!), normal 4 w.d. — automatically with Lock-O-Matics, manually with Warn Locking Hubs. See your 4 w.d. dealer!

WARN HUBS WARN MFG. CO., Inc.
Riverton Box 6064-A3
Seattle 88, Wash.

JEEP OWNERS

RE-POWER NOW WITH A V-8 ENGINE — Use

FORD • CHEVROLET • MERCURY

in 2 or 4 Whl-Dr. Jeeps, Jeepsters, Sta-Wgn, Trucks, M. J. and Kaiser cars. Conversion Kits \$43.25 to \$59.85. If you want fast action tell us which engine you wish to use, give us year, Model (2 or 4 Whl-Dr) of your vehicle. Send Min. \$15.00 Dep. and we will ship correct kit, Bal. COD. Send full amt. for Prepaid shipment. Wire, phone or write for free details. Also Kits for FORD 6 engine.

HOOSIER MACHINE PRODUCTS CO.
312 S.E. 6th St. Phone CR 6-3442 Pendleton, Oregon, U.S.A.

MONEY in WORMS

Sell 20,000 fishworms per week @ \$4 per 1000 from a bed 3 feet wide and 8 feet long. We teach you how to raise and where to sell fishworms and crickets. Write for free literature.

CARTER WORM RANCH, PLAINS, GEORGIA

GET INTO ELECTRONICS

V.T.I. training leads to success as technicians, field engineers, specialists in communications, guided missiles, computers, radar, automation. Basic & advanced courses in theory & laboratory. Assoc. degree in 26 mos. H.S. obtainable. ECPD accredited, G.I. approved. Graduates with major companies. Start Sept., Feb. Dorms, campus, H. S. graduate or equivalent. Catalog.

VALPARAISO TECHNICAL INSTITUTE
DEPT. D VALPARAISO, INDIANA

Million Dollar Inventory — All Famous Brands

TIRE SALE

AT LESS THAN WHOLESALE!

SAVINGS NEVER LESS THAN 50% UP TO 70% OFF REGULAR PRICES
HEADQUARTERS FOR ALL SPORTS CAR TIRE SIZES
SEND FOR YOUR FREE CATALOG!

RELIABLE TIRE • 728 MORGAN BLVD.
CO. CAMDEN 4, N. J.

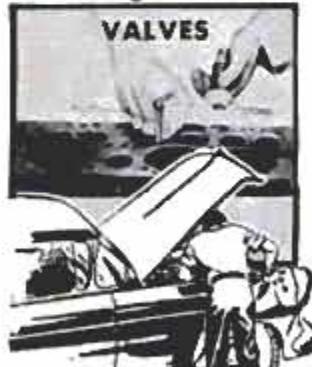
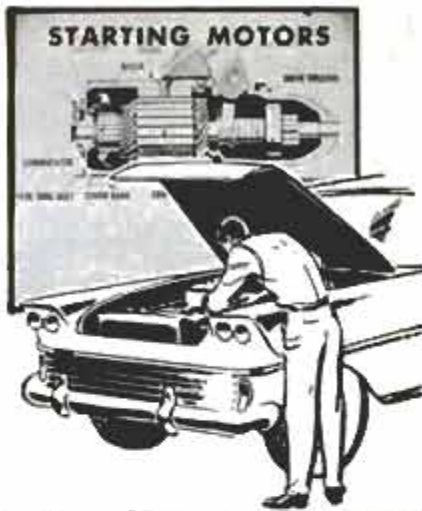

Thousands now find it a cinch to FIX ANY PART OF ANY CAR

Now — Whether You're a Beginner or Expert Mechanic
You, too, Can "Lick" ANY Auto Repair Job —
With 2,900 "This-Is-How" Pictures, 225,000 Service and
Repair FACTS, ABC Factory-Expert Methods

YES, this famous "Auto Repair Man's Bible" has turned thousands of beginner mechanics into experts. Helped thousands of experts save time, trouble and money "breezing thru" the toughest jobs. Now, the new edition can put YOU right on "top" of practically ANY job on ANY car listed — 1952 thru 1959!

No guess work! No false starts! This giant illustrated guide tells you, then shows you, with crystal-clear pictures and step-by-step directions — how to find the trouble fast — where to start... what tools to use... how to "wrap up" the job "in double-quick time!"

So Simple You CANT Go Wrong!

Here's everything you need to know to repair over 600 car models. Over 1,100 giant pages, 2,900 "this-is-how" pictures, 291 "Quick-Check" charts, 23,436 essential repair specifications, 225,000 service and repair facts.

All the instructions and pictures are so complete, so clear that you can't go wrong. That's because

your hands are guided by the men who actually build the cars. For this book brings you the time and work-saving methods from 176 Official Shop Manuals!

Everything You Need to Know

Here's complete ILLUSTRATED guidance on Automatic Transmissions, Air Suspensions, Ignition, Carburetors, Fuel Pumps, Steering Gears, Brakes, Generators, Distributors, Power Brakes, Power Steering, Dash Gauges, Voltage Regulators, Starter Switches, etc., etc. Plus a big Trouble-Shooting Section that shows how to spot any one of 2300 car troubles.

No wonder this guide is used by the U.S. Armed Forces and hundreds of thousands of repair men. It's guaranteed to help even a beginner mechanic do a good job. And top-notch mechanics are amazed by the time-saving methods it brings them.

Try it FREE 7 Days

SEND NO MONEY! Just mail coupon. (Paste it to a postcard for fast action.) Use Manual for a whole week, free. If you don't agree it's the greatest time and work-saver you've ever seen—return book in 7 days and pay nothing. Mail coupon today! MOTOR Book Dept., Desk 913, 250 West 55th St., New York 19, N. Y. (Schools, Bookstores: Write for discounts.)

"Have been a mechanic 23 yrs. Manual still takes me out of tight spots. It's a gem! I'm glad to be introduced to average person."



—V. Laurin, Nev.

"Never know anything about repairing cars until I got this book. It's paid for itself many times and more again."



—P. Pomper, Wis.

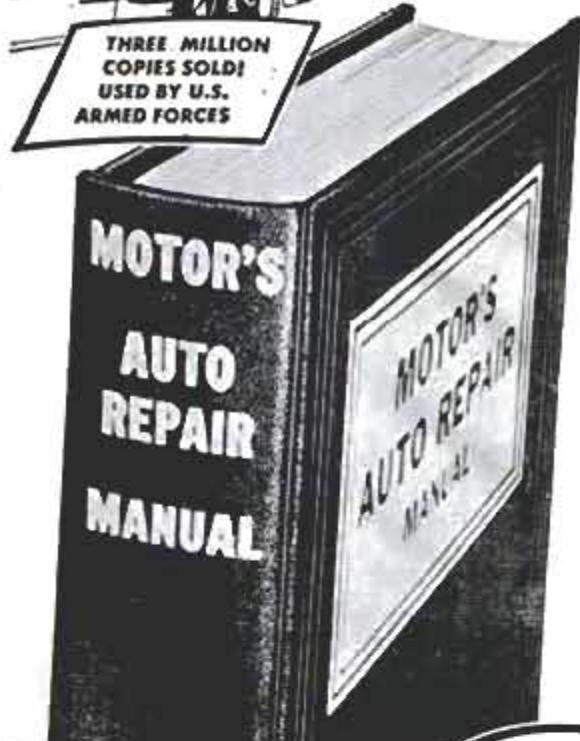

THREE MILLION COPIES SOLD!
USED BY U.S. ARMED FORCES

COVERS ALL THESE MAKES 1952 Thru 1959

Buick	Edsel Ford	Oldsmobile
Cadillac	Ford	Packard
Chevrolet	Hudson	Plymouth
Chrysler	Imperial	Pontiac
Clipper	Jeep	Rambler
Continental	Lincoln	Studebaker
De Soto	Mercury	Thunderbird
Dodge	Nash	Willys

TRY BOOK
FREE
FOR A WHOLE WEEK

Same FREE 7-Day Trial on TRUCK REPAIR MANUAL

Covers every job on every popular make truck made since 1952, including GM, Mack and Cummins Diesels. Engines, fuel systems, ignition systems, starters, generators, transmissions, axles, brakes, steering, etc., etc. For FREE TRIAL, check box in coupon.

MAIL COUPON NOW FOR 7-DAY FREE TRIAL
(Attach to postcard if more convenient)

MOTOR BOOK DEPT.
Desk 913, 250 W. 55th St., New York 19, N. Y.

Rush to me at once (check box opposite book you want):

MOTOR'S New AUTO REPAIR MANUAL. If O.K., I will remit \$2 in 7 days, \$2 monthly for 3 months and a final payment of \$1.95 (plus 45¢ delivery charges) one month after that. Otherwise I will return the book postpaid in 7 days. (Foreign price, remit \$10 cash with order.)

MOTOR'S New TRUCK REPAIR MANUAL. If O.K. I will remit \$3 in 7 days and \$2 monthly for 3 months, plus 65¢ delivery charges with final payment. Otherwise I will return book postpaid in 7 days. (Foreign price, remit \$11 cash with order.)

Print Name.....Age.....

Address.....

City.....Zone.....State.....

Check box and save 45¢ shipping charge by enclosing WITH coupon in envelope entire payment of \$1.95 for Auto Repair Manual (or \$9 for Truck Repair Manual.) Same 7-day return refund privilege applies.

YOU
can
acquire

LAW AT HOME! EARN LL. B. DEGREE

LaSalle's famous Law Library—used as reference in many Law libraries and Law offices—has enabled thousands to master Law surprisingly fast, in spare hours at home, for business and professional advancement.

These 14 remarkable volumes, compiled by leading professors and lawyers, cover the whole basic field of Law in condensed, orderly, simplified manner.

You advance rapidly with this great library, plus special lectures furnished. We guide you step-by-step with personalized Problem Method of instruction...you *earn by doing*—handling legal problems—not by memorizing rules.

Send for two FREE booklets, "Law Training for Leadership," and "Evidence," answering questions about Law and its value to you. Mail coupon below. No obligation.

Accredited member, National Home Study Council

LA SALLE EXTENSION UNIVERSITY A Correspondence Institution

417 S. Dearborn St. Dept. 364L Chicago 5, Ill.

Send me your two FREE booklets described above, without obligation

Name.....Age.....

Street.....

City, Zone & State.....

ADD INCHES TO HEIGHT

without
anyone knowing
how you did it!

Change to

THE ORIGINAL AND BARKING
ELEVATORS
HEIGHT-INCREASING SHOES
"YOUR PERSONAL PEDICEL"
A TRADE MARK OF STONE-TARLOW, INC., N.Y.



Within seconds you can "grow" almost 2 inches taller, with amazing "ELEVATORS" height-increasing shoes! Everyone will notice how much better you look, but only you will know that you are wearing "ELEVATORS"! They look—they feel—like any other fine, smart shoes.

Over 30
styles.
Most
styles
\$25.95

Write for FREE BOOKLET today!
STONE-TARLOW SALES CORP.
Dept. 6-39, Brockton 68, Mass.



"I'M MAKING MORE THAN \$1000 a Month



C. KAMA



Haven't Touched Bottom Yet!

—reports Chas. Kama, Texas, one of many who are "cleaning up" with orders for PRESTO, Science's New Midget Miracle Fire Extinguisher. So can you! Amazing new kind of fire extinguisher. Tiny "Presto" does job of bulky extinguishers that cost 4 times as much, and are 8 times as heavy. Ends fires fast as 2 seconds. Never corrodes. **GUARANTEED for 20 years!** Over 3 million sold! Sells for only \$4.95.

Show it to civil defense workers, owners of homes, cars, boats, farms, etc. and to stores for re-sale—make good income. H. J. Kerr reports \$20 a day. Wm. Wydallis, \$15.20 an hour. Write for FREE Sales Kit. No obligation. **MERLITE INDUSTRIES, Dept. P15W, Presto Div., 114 East 32nd Street, New York 16, New York** IN CANADA: Mops Co., Ltd., 371 Dowd Street, Montreal 1, P. Q.

SHORTHAND in

6
WEEKS

Famous SPEEDWRITING shorthand, 120 words per minute. No symbols; no machines; uses ABC's. Learn at home. Easiest to learn, write and transcribe. Lowest cost. For business and Civil Service. 100,000 graduates. Typing available. 36th year. Write for FREE booklet.

© 1959

Speedwriting
Dept. 1503-9, 55 W. 42 St., New York 36



Mr. "N" Made \$9,700 Last Year By Selling Just 20 KEEP/SAFEs a Month!

Like Mr. "N" you can profit with KEEP/SAFE—the fine personal safe that undersells all others. Only safe sold direct. 95% of homes, farms and small businesses are prospects. \$30 to \$71 profit per sale, plus bonuses up to \$12 a safe. Choice territory, chance to become district agent. **FREE DEMONSTRATOR!** Get details, giving address including county.

JOHN D. BRUSH & CO., INC.
575 West Ave. Rochester 11, N. Y.

FIX OUTBOARD MOTORS

POWERMOWERS, AND ALL SMALL 2 & 4-CYCLE GASOLINE ENGINES

MAKE EXTRA MONEY—or, repair your own equipment and SAVE! Fully illustrated, easy-to-understand, Home Study Course. Write today for FREE information.

LINCOLN TECHNICAL INSTITUTE
SUITE 3-E, 472 MARKET STREET, NEWARK 5, N. J.

FALSE TEETH

That Loosen Need Not Embarrass

Many wearers of false teeth have suffered real embarrassment because their plate dropped, slipped or wobbled at just the wrong time. Do not live in fear of this happening to you. Just sprinkle a little **FASTEETH**, the **alkaline** (non-acid) powder, on your plates. Holds false teeth more firmly, so they feel more comfortable. Does not sour. Checks "plate odor" (denture breath). Get **FASTEETH** at drug counters everywhere.

GREATEST
ADVANCE IN
SHOP-METHOD
HOME TRAINING

EARN MORE MONEY...GET INTO TELEVISION ELECTRONICS-RADIO

Learn ALL 8 PHASES in ONE MODERN HOME-STUDY COURSE
At Home - In Spare Time

YOU GET ALL THIS NEWEST PRACTICAL EQUIPMENT

- Parts to build a modern TV set, including all tubes plus a large screen Picture Tube
- Parts to build a powerful Superhet Receiver, standard broadcast and short wave
- Parts to conduct many experiments and build Continuity Checker, RF Oscillator, TV Circuits, Audio Oscillator, TRF Receiver, Signal Generator
- A Valuable Professional Multitester

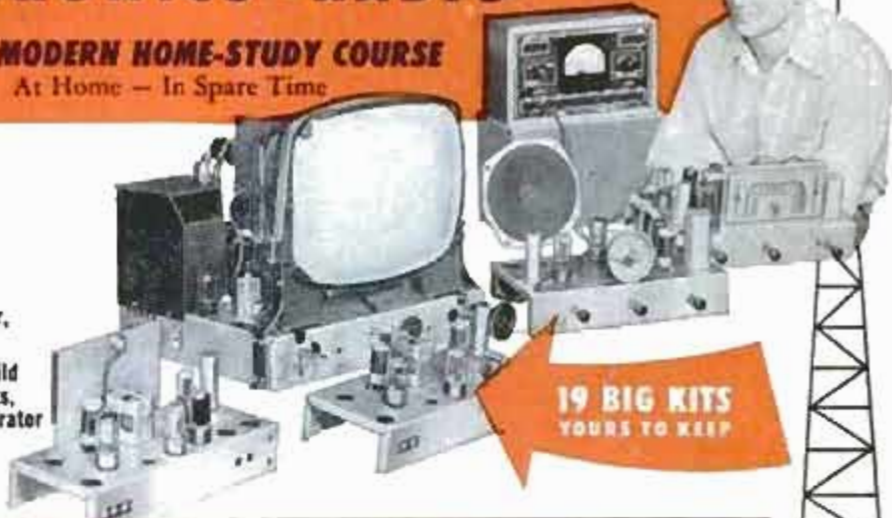

19 BIG KITS
YOURS TO KEEP

YOUR NATIONAL SCHOOLS TELERAMA COURSE COVERS ALL 8 PHASES

1. TELEVISION, INCLUDING COLOR TV
2. RADIO, FM AND AM
3. INDUSTRIAL ELECTRONICS
4. SOUND RECORDING AND HI FIDELITY
5. PREPARATION FOR FCC LICENSE
6. AUTOMATION
7. RADAR AND MICRO WAVES
8. COMMUNICATIONS

YOU ARE NEEDED IN THE TELEVISION-ELECTRONICS-RADIO INDUSTRY!

You can build a secure future for yourself if you get into Electronics NOW! Today's shortage of trained technicians creates tremendous opportunities. National Schools Shop-Method trained technicians are in constant and growing demand for high-pay jobs in Broadcasting and Communications, Electronic Research, Servicing and Repair, and many other branches.

Let National Schools, a Resident Technical School for over 50 years train you for today's unlimited opportunities in electronics! Our Shop-Method trains you to be a MASTER-TECHNICIAN. Completely up to date, developed by experienced instructors and engineers, your Telerama Course will teach you all phases of the industry quickly, clearly and correctly. You can master the most modern projects, such as Color TV, printed circuits - even prepare for FCC License without taking a special

course. You can handle sales, servicing, manufacturing, or make good money in your own business. SEND FOR FACTS TODAY!

EARN AS YOU LEARN. Many of our students earn their entire tuition and more in Spare Time jobs we show them how to do while learning.

YOU GET EVERYTHING YOU NEED - Clear, profusely illustrated lessons, shop-tested manuals, modern circuit diagrams, practical job projects - all the valuable equipment shown above

- many other materials and services
- consultation privilege with our qualified staff, and Graduate Employment Service. **EVERYTHING YOU NEED** for outstanding success in Electronics.

RESIDENT TRAINING AT LOS ANGELES

If you wish to take your training in our Resident School at Los Angeles, the world's TV capital, start NOW in our big, modern Shops, Labs and Radio TV Studios. Here you work with latest Electronic equipment - professionally installed - finest, most complete facilities offered by any school. Expert, friendly instructors. Personal attention. Graduate Employment Service. Help in finding home near school - and part time job while you learn. Check box in coupon for full information.



MEMBER



FREE! Fully illustrated "Career" Book in TV-Radio-Electronics. PLUS actual sample lesson - yours at no cost, no obligation. CLIP COUPON NOW - MAIL IT TODAY!

APPROVED FOR G.I. TRAINING

NATIONAL SCHOOLS

4000 S. FIGUEROA ST., LOS ANGELES 37, CALIF.

NATIONAL SCHOOLS

TECHNICAL TRADE TRAINING SINCE 1905
LOS ANGELES 37, CALIFORNIA

GET FAST SERVICE - MAIL NOW TO OFFICE NEAREST YOU!

NATIONAL SCHOOLS, DEPT. RB-39
4000 S. FIGUEROA ST., LOS ANGELES 37, CALIF.

Rush free TV-Radio "Opportunity" Book and sample lesson. No salesman will call.

NAME _____ AGE _____

ADDRESS _____

CITY _____ ZONE _____ STATE _____

Check if interested ONLY in Resident School training at Los Angeles.
VETERANS - Give date of Discharge _____

FREE! 100 WORLDWIDE STAMPS
... just released!



Send today for 100 scarce, beautiful stamps — FREE! Get newest issues of last 12 months, including United Arab Republic, Belgian Atomium, Morocco, Zanzibar — everywhere. So new, some are not cataloged yet. All different, genuine, mint and used, bi-colors, pictorials, topicals. This FREE Worldwide collection has never been offered before. Supply limited, one packet per collector. Send for this rare offer today, plus helpful "Collector's Guide" and other offers for free inspection. Rush name, 10c for handling to GARCELON STAMP CO., Dept. PM3W Calais, Maine.

GARCELON STAMP CO. Dept. PM3W, Calais, Maine
Rush FREE 100 Different Stamps, Collector's Guide, other offers.
Enclosed 10¢ for handling. (PLEASE PRINT)

Make \$500 an Hour CASH PROFIT THE DAY YOU START!



START YOUR OWN BUSINESS AT HOME... SHARPEN HOUSEHOLD, GARDEN AND SHOP TOOLS IN SPARE TIME

Now you can turn spare time into Big Cash Profits with new Belsaw Sharp-All. Sharpen knives, scissors, shears, snips, ice skates, mower blades, hedge trimmers, grass whips, axes, chisels, screw drivers, scrapers and saws... just about any household, garden and shop tool. Your own CASH business with no inventory. No calls to make. No experience needed.

Learn how easily you can start your own spare time business. Amazing low cost easy-payment plan. Send postcard for FREE BOOK.

BELSAW SHARP-ALL CO
719 Field Bldg. • Kansas City 11, Missouri



realize your dream

Become a graduate engineer. Then promotion will not pass you by. Share rewards awaiting college men... higher income, rapid advancement. Important firms interview seniors here regularly. Approved for veterans.

Graduate Engineer in 27 months

B. S. degree in Electrical Engineering (with either Electronics or Power major), also in Mechanical, Civil, Chemical, Aeronautical Engineering. In 36 Months a B. S. in Business Administration (General Business, Accounting, Motor Transport Management majors). For earnest, capable students. Small classes. More professional class hours. Mature students. Well-equipped labs. Modest costs. Year-round operation. Enter June, Sept., Jan., Mar. Write J. E. McCarthy, Director Admissions, for Catalog and "Your Career" Book.



TRI-STATE COLLEGE

439 College Avenue

Angola, Indiana



LEARN TV REPAIR IN ONE SHORT WEEK!

Now, after 5 years research — a streamlined training system! Earn up to \$150 weekly, in just 7 days. No expensive training, equipment, or long study. Learn to service TV sets instead of building them! Most practical method yet — developed by leading scientists with cooperation of major TV mfg.s! Send for details and FREE SAMPLE LESSON. Use it on your set — repair it! — convince yourself! Write: TV SERVICING SYSTEMS Dept. C-173, 1038 S. La Brea, Los Angeles 10, California

FREE Photo Book Catalog

Only complete catalog of photographic books available. Over 500 titles — international selections — on every phase of photography. Covers 35mm, Reflex, Color, Portraiture, Optics, Photo-journalism, etc. — for amateurs and press! 24 big pages. Write today.

AMPHOTO, Inc. DEPT. PM, 33 WEST 60TH STREET, NEW YORK 23, NEW YORK

WHOLESALE Electric Guitars - Parts - Factory to You

Professional electric solid body Spanish guitars, amplifiers, electric bass, double-necks, triple-necks, tone changers, double-neck Spanish, electric mandolin, pickups. Parts to outfit your own. 1959 Models wholesale — Free catalog.



CARVIN CO., Box 287, PM-3, Covina, Calif.

TASOPE PHOTO-ENGRAVING PLANTS



Material Cost Of This Cut 3/4c Selling Price \$1.00 And Up

Establish your own profitable PHOTO-ENGRAVING business. Make cuts for newspapers, printers, and advertisers. Make etched name plates, plaques, etc. Instructions furnished, no experience necessary. Sold direct from factory since 1931. First five hundred cuts sold locally or by mail will pay for plant and pay you well for your time. Write for FREE catalog.

TASOPE, DEPT. PM3, AURORA, MO.

RUPTURED

BE FREE FROM TRUSS SLAVERY

Surely you want to THROW AWAY TRUSSES FOREVER, be rid of Rupture Worries. Then Why Do you put up with wearing a griping, chafing and unsanitary truss the balance of your life? If you do, it will NOT be through necessity but through choice on your part.

Now there is a new modern Non-Surgical treatment that is designed to permanently correct rupture. These Non-Surgical treatments are so certain, that a Lifetime Certificate of Assurance is given. Write today for our New FREE Book that gives facts that may save you painful, expensive surgery. Tells how non-surgically you may again work, live, play, love and enjoy life in the manner you desire. There is no obligation. Excelsior Medical Clinic, Dept. H6124, Excelsior Springs, Mo.

SOWING PENNIES

**to Harvest Dollars
when they are needed**

How hundreds of far-sighted men are using spare hours now to assure themselves of a ready made income in the event of lay-offs or recessions that might affect their jobs.



All over the country it's happening. You may even know some of the men who already have started home operated businesses of their own in their spare hours. They keep their jobs. The "boss" doesn't know they are planning for independence. They do not have any heavy investments in equipment or inventory, because they buy their raw materials as they are needed. They have no overhead expense because they operate their businesses from their homes.

Yet hundreds are quietly developing a second source of income—an extra income right now for their spare hours; and a business that can be quickly expanded if it were ever necessary to look to it for complete support.

These "little" home businesses are little only in the sense that they require little capital to start and run, and they require little time on the part of the owner. The margins of profit in some of them are so fantastic as to be almost unbelievable—far greater than those usually enjoyed by big investment manufacturing.

And, there are many kinds and types. For the man who is mechanically inclined there are businesses in which he can use his hands as well as his head. For those who have no aptitude with tools there are small manufacturing operations that are almost automatic in their production methods.

One of the features found in many of these businesses is a wide and ready market for the product. Usually it is a product too small in total national market to attract the attention or envy of the big investors. So, the danger of competition from big operators is absent. Usually it is a product that enjoys a neighborhood demand so that good markets are found in any size community from the small town to the neighborhoods of the big city. Usually the cost of the raw materials is only about one tenth the selling price. One such product costs 11c for raw materials, yet sells readily for \$1.00. Another sells for \$6.50, yet the raw materials cost only 55c. Still another returns \$1.80 for each 27c worth of raw materials.

In the same way that history had its "Minute Men", quietly trained and ready at a moment's notice, so today, we have a constantly growing number of "Ready Men." They are working at steady jobs in offices, stores, factories, gas stations. They have a regular income now—an income that only a few months ago was considered both regular and dependable. But when the signs went up, they started quietly to prepare for independence. They are ready. They have mastered the details of their businesses. They have been making twenty, thirty,

forty, or more dollars a week as extra money—now—sometimes with others in the family helping. They have established the outlets for their products. But, more important than their present extra income, they are ready, overnight, to give their full time and to expand their businesses into full-fledged operations at increased income.

The fear of layoffs is gone from their hearts. The worried look induced by threats of recession has vanished from their faces. They face the future with confidence because they have sown the pennies that will be reaped as dollars when more dollars are needed—they have attained a sense of personal independence that puts them above worry and fear.

What are these businesses? There are a number. One that is especially interesting and that you can own outright for less than \$175.00 is the manufacture of a product used in quantity in every office and factory in the nation—and by millions of individuals.

The product is light in weight and can be delivered to customers by mail for just the cost of a few stamps. And 27c worth of material, to which you add nothing but your own time, brings back \$1.80 in cash at retail. The entire "factory" takes so little space that it can be operated on a table top in any spare room, the basement or garage and it is such a simple process that even the junior members of the family can help. The equipment is supplied by The Warner Electric Company who also give seven different methods of selling the output. These methods include a plan by which others sell your product so there is no canvassing needed on your part; another plan by which you sell by mail.

Complete information concerning this and other businesses is free. Information is mailed, postage prepaid, to anyone who is interested. There is no obligation and, since the company has no salesmen, you are not bothered by anyone trying to "sell" the equipment. On the basis of the information mailed, you decide in the quiet of your own home whether you are interested.

It is not necessary to write a letter. Just send your name and address on a postcard and say you want complete free information on various home businesses offered by Warner Electric Company. Address your card to Warner Electric Company, Dept. R-2-A, at 1512 Jarvis Avenue, Chicago 26, Illinois. You may want to plan a degree of security for the future that is not experienced by men who depend upon the ups and downs of others' businesses for their livelihood.



MEN! Make up to
\$1,000⁰⁰
IN A MONTH!

without "SELLING"

Sensational Demand for Low-Priced Fire Alarm PLUS Sure-Fire "No-Selling" Plan Offers Ambitious Men Huge Profit Opportunities

AMAZING NEW INVENTION



Even beginners who never sold anything in their lives are cleaning up unbelievable profits with the first practical effective, low priced Fire Alarm ever invented . . . needed, wanted in homes, factories, offices, stores, on farms, for boats, everywhere. Professional salesmen are making biggest profits in years! Later in this ad I'll tell you about the plan that's producing orders for 1 to 12 Fire Alarms per sale from 8 out of 10 prospects . . . without selling. Here are the facts about the Fire Alarm. It hangs on the wall like a picture—no wiring, no installation, it's always on guard . . . It 'smells' a fire before danger point. When temperature rises, Fire Alarm goes off automatically, howls loud warning that can be heard 1/5 mile, wakes up soundest sleeper, give precious time to put out fire, call fire department, or escape. And it sells for only \$4.95 with profit up to \$2.70 on each one.

Nearest Thing to AUTOMATION SELLING

With our field-tested plan customers sell themselves. No cold canvassing. No hard selling. It's the nearest thing to 'Automation Selling.' Imagine a sales plan even a child can use successfully because the sales tools we give you (and which you leave with your prospects) do all your selling even while you sleep! No room here to give you all the details but if you want big money fast, rush the coupon now.

Make This Lighted-Match Demonstration

Sensitive! Lighted match triggers Alarms in 3 seconds.

you \$1,080.00 profit in a month. No competition anywhere. Get in on the ground floor now. Rush this coupon.

MERLITE INDUSTRIES, Inc.

(ALARM DIVISION)

114 E. 32nd St., Dept. F-15W

New York 16, N. Y.

ALVIN WESLEY, Sales Manager
 Merlite Industries, Inc. (Alarm Division)
 114 E. 32nd St., Dept. F-15W, New York 16, N. Y.

Rush FREE SALES KIT and full details about your "No-Selling" plan which gives me opportunity to make up to \$1,000.00 in a month without cold canvassing and hard selling—automatically. I am not obligated.

Name _____

Address _____

City _____ Zone _____ State _____

In Canada: Mopa Co., Ltd., 371 Dowd St., Montreal 1, P.Q.

TIRE SALE

FREE PASS. TUBE

25 YEARS IN BUSINESS AT THE SAME ADDRESS

Seeing is believing—IF YOU GO SHOPPING YOU'LL END HERE. Be Wise, try one! You'll buy more. GUARANTEE given with each used tire sold. SEND AD.

600x16	\$4.72	670x15	\$4.72	650x16(6)	\$8.42	800x15	\$6.22
600x16(6)	7.62	710x15	4.72	750x16(6)	8.72	820x15	6.42
850x14	7.52	760x15	4.72	640x15	5.32	700x16(r)	8.72
750x14	7.52	800x14	8.72	1100x29	19.52	1100x22	20.32
700x18(6)	\$9.92	700x20	\$10.92	750x17	\$13.72	825x20	\$19.52
750x18(8)	11.62	750x20(10)	15.22	600x20	9.92	900x20	19.72
700x17	10.92	750x20(8)	13.32	650x20	11.32	1000x20	19.92

12 MOS. WRITTEN GUARANTEE. WHITE WALLS \$1.00 EXTRA

"EXTRA SPECIAL" TOP QUALITY all size 4-ply pass. FREE TIRE with 2 or more of these. W.W. \$8.82
 \$1.00 Extra — GIANT TIRE SALE. EA.

Thousands of tires shipped all over the U.S.A. All tires shipped F.O.B. Phila. Send Check or M.O. with this ad. Dept. 2. No C.O.D.
STANDARD 834 N. Broad St., Philadelphia 30, Pa.

MEN WANTED

Earn \$100 Per Week and up

AUTO DIESEL MECHANICS

Master a trade with a future—learn Auto-Diesel mechanics in our shops. You learn with tools on real equipment. Earn while you learn. Many of our graduates earn \$100 per week and up. No previous experience necessary. Day and night courses. Approved for veterans. Write for free bulletin.

NASHVILLE AUTO-DIESEL COLLEGE

226 7th Ave., N., Dept. 75

Nashville 3, Tenn.

Secrets of VENTRILOQUISM Now Revealed!



Easy to learn in 60 to 90 days with our Home Study Course. RESULTS GUARANTEED. Make Money! Be Popular! Have Fun! Big Opportunity! Radio, Television, Stage Appearance! For FREE information regarding price and terms WRITE. You must state your age. Dummy Catalog 25c. MAHER HOME COURSE OF VENTRILOQUISM Box 36, Studio PM-3, Kensington Station Detroit 24, Michigan

make your own Gems 36⁵⁰

The Gem Maker comes complete with all necessary equipment, including a super-charged diamond blade for sawing, and all the wheels for grinding, shaping and polishing; also complete instructions. The complete equipment as shown, less motor and belt for only \$36.50, f.o.b. Burlington, Wisconsin. Write today for information and literature.

B&I MANUFACTURING CO.
 Dept. P. Burlington, Wis.



SEND FOR THIS FREE!

Make money. Know how to break and train horses or ponies. Write today for this book FREE, together with special offer of a course in Animal Breeding. If you are interested in Gaiting and Riding the saddle horse, check here (). Do it today—now.

BERRY SCHOOL OF HORSEMANSHIP
 Dept. 1103 Pleasant Hill, Ohio

SEWS LEATHER

AND TOUGH TEXTILES LIKE A MACHINE

With SPEEDY STITCHER Automatic Sewing Awl, anyone can quickly and skillfully sew or repair anything made of LEATHER, CANVAS, NYLON, PLASTIC, or other heavy materials. Sewa firm, even lock-stitches like a machine. Gets into hard-to-reach places. Specially made for heavy-duty sewing on LIGGAGE, FOOTWEAR, BAGS, AWNINGS, NAILS, SADDLERY, UPHOLSTERY, OVERALLS, AUTO-TOPS, SPORTS GEAR, and other tough sewing jobs. Here's the handiest tool you'll ever own. Will save you many times its small cost. Comes ready for instant use . . . complete with bobbin of waxed thread and 3 different types of diamond-pointed needles. Easy-to-follow directions will make you an expert in minutes. Extra needles and waxed-thread always available. Save money, send \$1.98 for post-paid delivery. If C.O.D., \$1.98 plus postage. MONEY BACK GUARANTEE.



SPORTSMAN'S POST
 366 Madison Ave., Dept. A-88, New York 17

ONLY **1⁹⁸**

Shrinks Hemorrhoids New Way Without Surgery Stops Itch—Relieves Pain

For the first time science has found a new healing substance with the astonishing ability to shrink hemorrhoids and to relieve pain—without surgery.

In case after case, while gently relieving pain, actual reduction (shrinkage) took place.

Most amazing of all—results were so thorough that sufferers made astonishing statements like "Piles have ceased to be a problem!"

The secret is a new healing substance (Bio-Dyne*)—discovery of a world-famous research institute.

This substance is now available in suppository or ointment form under the name Preparation H.* Ask for it at all drug counters—money back guarantee. *Reg. U.S. Pat. Off



**EXACT REPLICA
U. S. MARINE
GRENADE**
As Used in Hand Combat

Get a real bang when you toss this replica of a Marine grenade. Startle ex-G.I.'s. Explodes automatically 4 seconds after pulling pin as it strikes ground. Can't break. Heavy gauge steel firing mechanism. Uses standard caps. Can be exploded over and over. Real collector's item. Comes complete with instructions. Send \$1.98 plus 25c shipping charge—cash, check or money order to: Standard American Suppliers, Inc. Grenade Dept. PM-3, One Park Ave., New York 16, N. Y.

Renew roofs in your neighborhood! Average \$189 PROFIT a week

Right in your neighborhood there are dozens of homes that need to be re-roofed. With new Quikspray Unit, you can spray up to 3 roofs a day with colored aluminum roof coating. Excellent money . . . either full or part time. Write for free booklet "How to Quikspray Roofs."

QUIKspray, INC., Box 327A, Port Clinton, Ohio

Learn ACCOUNTING

Business Administration

Bookkeeping, secretarial and allied subjects at home in your spare time or attend nationally approved resident school. Write for FREE Success Book giving complete details on courses, plans, rates and employment opportunities. G.I. approved. Write Dept. A.

Hills **BUSINESS UNIVERSITY AND
EXTENSION SCHOOL**
619 W. MAIN ST. OKLAHOMA CITY 2, OKLAHOMA

Do you have a "RICH MAN'S" FOOT?



SAVE on SIZES 10 to 16 — AAA to EEE

We specialize in LARGE SIZES ONLY—sizes 10 to 16; widths AAA to EEE. Dress, sport, casual and work shoes; golf shoes; insulated boots; sock slippers; rubbers; overshoes; shoe trees. Also sport shirts in your exact, extra-long sleeve length. Enjoy perfect fit in your hard-to-find size at amazingly low cost. Satisfaction Guaranteed. Sold by mail only. Write for FREE Style Book TODAY!

SEND FOR
FREE
CATALOG

KING+SIZE, INC. 187 Brockton, Mass.

MARCH 1959

Prepare for today's top
opportunity field...

ELECTRICITY ELECTRONICS

ON REAL

Motors • Generators
Switchboards • Controls
Modern Appliances
Automatic
Electronic
Control Units



Train in NEW Shop-Labs of

COYNE

in Chicago—Electronic Center of the World. Prepare for a better job and a successful future in TOP OPPORTUNITY FIELD—Electricity-Electronics—a field that offers a world of opportunities now and in the years ahead. In industry—in the home—New developments and fabulous growth are creating increasing job opportunities. AUTOMATION ELECTRONICS—one of the more recent applications of Electricity-Electronics—promises to create additional demands for trained Electrical-Electronics men such as we have never seen. Send coupon or write to address below for details.

YOU TRAIN IN CHICAGO—on real full size equipment at COYNE where thousands of successful men have trained for over 60 years—largest, oldest, best equipped school of its kind. Professional and experienced instructors show you how, then do practical jobs yourself on more than a quarter of a million dollars worth of equipment. No previous experience or advanced education needed. **Start Now—Pay Later**—Liberal Finance and Payment Plans. Pay most of tuition after graduation. Part-time employment help for students. Employment Service to Graduates.

NEW HOME OF COYNE



Send For Free Book, "Guide to Careers" and all information will come by return mail. NO OBLIGATION AND NO SALESMAN WILL CALL. so mail coupon in envelope—paste on postal card or write to address below.

B. W. COOKE JR., Pres.

COYNE
ELECTRICAL SCHOOL

FOUNDED 1899

Chartered as an Educational Institution Not For Profit
1501 W. Congress Pkwy., Chicago 7, Ill., Dept. 39-3E

MAIL COUPON OR
WRITE TO ADDRESS BELOW

COYNE ELECTRICAL SCHOOL
New Coyne Building Dept. 39-3E
1501 W. Congress Pkwy., Chicago 7, Ill.

Send FREE book, "Guide to Careers" and details of training you offer in Electricity-Electronics.

Name _____

Address _____

City _____ State _____

(I understand no Salesman will call)



EARN MORE - LEARN AUTO DIESEL MECHANICS

OR TRAIN WITH OTHER GREER DIPLOMA COURSES

- | | |
|------------------------------------------------|---------------------------------------------|
| <input type="checkbox"/> AUTO MECHANICS | <input type="checkbox"/> REFRIGERATION |
| <input type="checkbox"/> DIESEL MECHANICS | <input type="checkbox"/> AIR CONDITIONING |
| <input type="checkbox"/> BODY & FENDER REPAIR | <input type="checkbox"/> MACHINIST TRADE |
| <input type="checkbox"/> GAS-ARC WELDING | <input type="checkbox"/> ADVANCED MACHINIST |
| <input type="checkbox"/> PIANO TUNING & REPAIR | |

Skilled men are needed in every part of the country. Earn top pay in established shops or start your own business. Greer's expert instruction and actual shop training teaches you how. You learn by doing—quick, easy courses using the latest tools and equipment. Day, evening and part time instructions available.

Job placement and convenient living accommodations are yours while training. Contact GREER'S FREE JOB PLACEMENT SERVICE when you enroll if you wish part time or full time employment.

ENGINEERING DEGREE COURSES

- | |
|--------------------------------------------------------------------------|
| <input type="checkbox"/> DIESEL AUTOMOTIVE ENGINEERING 27 MONTHS |
| <input type="checkbox"/> REFRIGERATION & AIR COND. ENGINEERING 18 MONTHS |
| <input type="checkbox"/> WELDING ENGINEERING 18 MONTHS |

All Courses Approved Civ. or G.I.

Please rush me free literature on the trade indicated, at no obligation.

NAME _____ AGE _____

STREET _____

TOWN _____ ZONE _____ STATE _____

Established 1902

GREER SHOP TRAINING

Box C, 2236 S. Michigan Ave.
Chicago 16, Illinois

AMAZING STAMP OFFER!

Free

TO GET NAMES FOR OUR MAILING LIST

- 1 WORLD MAP**—authentic 3 ft. sq. Mercator projection map, used by air and sea navigators—yours FREE!
- 2 STAMP FINDER**—identifies stamps around the world—no matter how strange their script letters—yours FREE!
- 3 ENCYCLOPEDIA OF STAMP-ISSUING COUNTRIES**—Tells area, location, population, parent country, etc.—yours FREE!



Also FREE: 30 MUCH-WANTED FOREIGN STAMPS

Now you can identify even the strangest stamps—at a glance—with this GIANT world map and stamp guide. Opens up to 3 SQUARE FEET to make a big handsome wall map you'll be proud to display in your room. THE PHILATELIC WORLD MAP & GUIDE is well-known among stamp fans all over the country. Complete and up-to-date. Locates the tiniest, most remote stamp-issuing countries in the world. While our supply lasts—we'll send it to you FREE. But that's not all! You also get—FREE—30 colorful foreign stamps—from exciting, far-off places like San Marino, Djibouti, etc. Included is Chi-

nese anti-Communist stamp with face value of \$10,000 in Nationalist money! Also interesting stamp offers for your inspection. No obligation. But hurry. Offer may be withdrawn at any time. Send your name and address, with 10c to cover postage and handling, to LITTLETON STAMP CO., Dept. 9-PM-3, Littleton, New Hampshire.



G-5

The Bird Bath, above, sells for \$6.50. Cost of materials and labor: \$2.25. Mark-up, \$4.25

Spare-Time Income from Gardencrete

Wherever there's a pride of home, there's a place for Gardencrete. That's why the sales field is so broad, and so rich in profit potentials.

Gardencrete is basically made of cement and sand, then Colored in a choice of 30 attractive colors that stay new. Easily washed or scrubbed. Beautify lawn and garden.

On a small investment for molds and Color-glazer you can develop a line of products that sell for two or three times your cost of materials and labor. Easily made in shed or garage.

Write for book "Make Money." Describes equipment and gives figures on costs and selling prices on dozens of different items.

COLORCRETE INDUSTRIES, INC.
710 Ottawa Ave., Holland, Mich.



SCIENTIFIC CRIME DETECTION



IT'S EASY TO LEARN

Let us teach you in your own home. Learn Finger Printing, Firearms Identification, Police Photography, Criminal Investigation Methods thoroughly, quickly, at small cost. Over 800 Bureaus of Identification in the U. S. employ I. A. S. students or graduates. Write today, stating age.

INSTITUTE OF APPLIED SCIENCE, 1920 Sunnyside Ave., Dept. 1353
(A Correspondence School Since 1916) Chicago 40, Ill.

MONEY in DONUTS

Make new greaseless donuts. Start in kitchen. No smoke. Sell stores. HALF PROFIT. Cash daily. Free recipes. No obligation. Write! MARTIN RAY CO., 3605 SO. 15th AVENUE. MINNEAPOLIS 7, MINN.

DRAINS cellars, cisterns, wash tubs; **\$7.95**
IRRIGATES - CIRCULATES - SPRAYS

1,001 uses. Stainless shaft. Won't rust or clog! Use 1/6 HP motor or larger... 3/4 HP for up to 3000 GPH; 450 GPH 80' high; or 1800 GPH from 25' well. 1" inlet. 3/4" outlet. Coupling included free. \$7.95.

CELLAR DRAINER KITS (less motor)

"Low Boy"—15" high, 1500 GPH	\$12.95
"High Boy"—32" high, 3,000 GPH	\$15.95

Postpaid if cash with order. **MONEY BACK GUARANTEE**
LABAWCO PUMPS, Belle Mead 7A, N. J.

ARTHRITIS—RHEUMATISM VITAL FACTS EXPLAINED

FREE DESCRIPTIVE BOOK

How crippling deformities may be avoided. This amazing FREE BOOK explains why ordinary methods give only temporary relief—if that. Describes a drugless method of treatment successfully applied in thousands of cases. Write for this 36-page FREE BOOK today. No obligation.

BALL CLINIC, DEPT. 756, EXCELSIOR SPRINGS, MO.

NO JOB WORRIES

PLASTEX INDUSTRY needs manufacturers on small scale for big production of Lamps, Clock Stands, Art Goods, Novelties in Plastic Marble imitation. No Experience necessary. 1/2¢ material makes regular 10¢ shiny sellers. Molds furnished for fast production. Small investment brings good profit. Big wholesale orders now being placed. Ambitious men have chance for real prosperity and job security. Our NEW FREE booklet will interest and benefit you.

PLASTEX INDUSTRIES, Dept. A
3400 Third Ave. New York 56, N.Y.

How To Stumble Upon A Fortune in GEMS

All over the U.S.—Diamonds, Pearls, Amethysts, Opals, Garnets, Jade, Rubies, Topaz, Sapphires, Turquoise, Zircons, and other Precious and Semi-Precious Stones are Waiting to be Picked Up!...

Here is Exactly HOW and WHERE to Find Them...

Next time you trip on a rock—examine it carefully. You may have "walked into" a real fortune—unexpectedly.

In a single year, over half a MILLION dollars worth of stones were found by week-end gem hunters. A youth pitching horseshoes in an open lot picked up a stone and kept it in his pocket for 15 years before he discovered it was the largest alluvial diamond ever found in the U.S.A. ... 84.46 carats in weight.

Two salesmen went gem-hunting on vacation and found a small pocket of "Tourmaline," a semi-precious, crystal gemstone, worth \$13,500.

Are You "Passing Up" Real GEMS Near Your Home?

Valuable gems are all around us—half hidden by surface dirt and other rock. Perhaps in an abandoned quarry near your home, a river bottom, a rocky hillside, a beach, or an old cave. If you know WHERE to look and how to RECOGNIZE the more precious stones—you can enjoy an educational hobby that can pay off BIG.

Now you can enjoy and profit by gem-hunting—no matter where you live in

the U.S.! Brand-new book, "Gem Hunter's Guide" tells all you need to know. Exactly where

to find scores of precious and semi-precious gems. Where to find rich PEARL-bearing mussels. Complete town-by-town and county-by-county index helps you plan week-end and one-day gem hunting. How to recognize each variety.

53 Gem Stones Shown in Natural Color

These full-size photos make it easy to identify gem discoveries as they occur in nature. Simple tests you can give the rocks you find, plus 800 locations where gem materials

have been found all over U.S.A. and a special chapter on how to identify quickly 75 different and valuable gemstone varieties. Contains almost 200 pages packed with interesting illustrations, photos, maps, etc.

SEND NO MONEY!

Examine FREE for 5 Days

SEND NO MONEY. Just fill out and mail the coupon below. We will send the "Gem Hunter's Guide" for you to examine Free for 5 days entirely at our own risk and expense. If you decide to buy the book, it may be the richest investment you ever made. In a single day, it may pay you back many thousands of times its small cost. So rush coupon NOW for 5 days' FREE examination in your own home.

Science & Mechanics Magazine
450 East Ohio Street, Chicago 11, Illinois

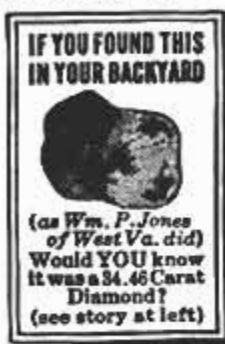

Do You Know that.....

- Big, valuable, perfect Pearls have been found in many sections of the U.S.?
- 48,000 Diamonds have been found in Arkansas alone?
- A Diamond weighing over 20 carats was found in Va.?
- A vast region surrounding the Great Lakes holds the greatest store of Diamonds yet to be found in the U.S.?
- Gem sapphires are found in Colorado, Idaho, Montana, and North Carolina?
- For every diamond already found in this country, there are thousands more yet to be found?
- A cowboy found an Opal worth \$280,000.00?
- Mid-west streams have produced as much as half a million dollars worth of pearls in a single year?
- 10-pound Turquoise nugget, believed largest ever found, discovered recently in one of our western states?
- Valuable Gems are discovered in all parts of the U.S.—even in New York City area?



tells you:

MANY WAYS to test rocks to see how valuable they are; the color tests, hardness and specific gravity tests

HOW to plan a week-end gem-hunting trip

LOCATIONS where gem materials are found in EACH State—complete town and county index; with 81 detailed road maps giving gem-material locations

WHERE rubies are found in Georgia, Idaho, New Jersey and No. Carolina

How to make the drab rocks glisten like

magic with "black light"

HOW TO IDENTIFY over 75 different gem materials by hardness, composition, color, luster, cleavage, associated rocks, etc.

METHODS for classifying gems by families.

WHERE big diamonds, pearls and rubies have been found in the U.S.

A SIMPLE PLAN for finding and harvesting pearl-bearing mussels

THAT GEM QUALITY emeralds may be found in Maine, Massachusetts, New Mexico, Nevada, and North Carolina

... ALSO special full-color portfolio shows 53 gem materials in their natural state.

Science & Mechanics Magazine, Dept. 196 450 EAST OHIO STREET, CHICAGO 11, ILL.

Please send me—for 5 days' FREE EXAMINATION—a copy of the "Gem Hunter's Guide" packed with pictures, maps, charts, expert advice telling where gems may be found. Unless completely satisfied with the book at the end of 5 days' examination I may return it and owe nothing. Otherwise, I will keep it and send you only \$3.95, plus 50c to cover postage and handling charges.

Name _____

Address _____

City, Zone & State _____

SAVE 50c POSTAGE AND HANDLING CHARGES... by enclosing only \$3.95 WITH this coupon. Then WE will prepay ALL delivery charges. Return book within 5 days for full refund if not delighted.



PLAY RIGHT AWAY ANY INSTRUMENT

—even if you don't know a single note now!

NOW it's EASY to learn ANY instrument. No boring exercises. Even if you don't know a single note now you can play delightful pieces — from your FIRST lesson! BY NOTE. Make amazing progress. No special "talent" needed. Learn at home in spare time. Without a teacher. Low cost! Soon you can play popular music, hymns, classical and any other music. Over 1,000,000 students, including Lawrence Welk.

FREE BOOK. Send this ad with your name and address filled in below, to: **U. S. SCHOOL OF MUSIC, Studio A303, PORT WASHINGTON, N. Y.** (No obligation, no salesman will call.)

Name _____
Address _____
Be Sure to Include Zone No., if any.



DON'T PAY FOR THESE GREAT SHOES!



GET THEM WITHOUT COST AS A REWARD — PLUS —
THE CHANCE TO "BE BOSS" OF YOUR OWN \$10,000 A YEAR SHOE BUSINESS!
Brand new plan! You can earn marvelous new shoes instead of paying for them — and develop an extra income for life! Sell friends Work, Dress, Casual Shoes and Boots in spare time. Revolutionary new leather soles guarantee twice the wear! Simple 2-finger demonstration of patented AIR CUSHION comfort makes shoe selling a snap! We back you with over a quarter million pairs in stock. Sizes 4 to 18, widths AAAA to EEEE Also earn Advance Commissions to \$5.00 a pair, plus Big Bonus. No experience, no investment. Shoe samples supplied.
SEND FOR NEW OUTFIT!
Everything you need to succeed in an independent business of your own will be rushed to you — without obligation. You can't lose — write today!

CHARLES CHESTER SHOE CO.
Dept. C-593, Brockton 64, Mass.

Over 180 Styles for Men, Women and Children

WORLD'S LOWEST PRICED CALCULATOR! NOT \$3.95
NEW! NEW! NEW!
TOM THUMB ADDING MACHINE
But Only **\$1.97**
\$2.00 in Penna. including 5% Tax



With beautiful Leatherette carrying case. **MADE IN AMERICA BY AMERICANS.** Beware of cheap imported imitations. **ADDS UP TO ONE BILLION — 1,000,000,000. SUBTRACTS — MULTIPLIES — DIVIDES** Mistake Proof • Positively 100% Accurate • Lightning Fast • Shock Proof Solid Steel Mechanism • **GUARANTEED FOR YOUR LIFETIME.** Ideal for Housewives, Shoppers, Students, Engineers and Tax work. Take it to the Super Market — Save \$ \$ every week. We pay postage if you send check, cash or money order — or just send your name & address and pay postman \$1.97 plus postage. Immediate Delivery — 10 Day Free Trial — Satisfaction Guaranteed or money refunded by return mail.
SPECIAL GIFT OFFER — 3 Machines for only \$4.99
AGENTS WANTED — Make easy money selling a Top Quality Calculator at our unbelievably low price.
TOM THUMB ADDING MACHINE
P.O. BOX 5066 Dept. M-19 Philadelphia 11, Penna.

"MINIATURE MACHINE SHOP
No Bigger Than A Typewriter, Outperforms Machines Many Times its Size!"
That's what a popular publication says about UNIMAT in their 3 page feature story in the May issue. If you want a reprint of this story plus complete information about this amazing 10 in 1 combination precision tool write to:
AMERICAN EDELSTAAL, Inc.
UNIMAT DIV., DEPT. 339, 350 BROADWAY, NEW YORK 13



A TRADE THAT PAYS IN MANY WAYS
CLOCK AND WATCH REPAIR
Wide Choice of Opportunities in Precision Instrument Fields for the Trained, Skilled Watchmaker.
Aviation, Electronics, Defense, and other Technical Fields. Watchmakers are Rated High by Industrial Personnel
Write today for your Copy of "THE VITAL ROLE OF THE WATCHMAKER IN DEFENSE."
KANSAS CITY SCHOOL OF WATCHMAKING
1226 Admiral Blvd. Kansas City 6, Missouri

75 POWER TELESCOPE \$3.98
25X-45X-75X
NEW 3 in one telescopes, 3 variable 25X, 45X-75X magnification. Brass bound. 23 power for ultra bright images 45 & 75 power for long range. Guaranteed to bring distant stars, moons, objects, sports 75 times closer.
Most powerful scope sold anywhere near this amazing low price. American made, 5 sections. Opens 36", closes 1 ft.; contains 4 ground & polished lenses. Can also be used as powerful compound microscope. Mass production enables us to offer telescope complete at \$3.98 postpaid. Money back guarantee.
CRITERION CO., Dept. PMB 67, 331 Church St., Hartford, Conn.



EARN WHILE YOU LEARN
SEND FOR FREE BOOKLET

Be a LOCKSMITH
Learn fascinating, profitable trade from experts in spare time at home! Age no disadvantage. Year 'round, steady income. Full or part time. Practical, illustrated lessons. Make money even while learning! All materials and special tools supplied.
LOCKSMITHING INSTITUTE, Dept. 103-9
150 Park Ave. East Rutherford, N. J.
Lic. by N. J. State Board of Ed. Apprvd. for Vets



HYDRAULIC JACK REPAIRS
Earn While You Learn at Home
Millions of jacks in gas & auto-service stations, truckers, body-shops, riggers, factories, farms need servicing. We show you HOW — easy step by step directions — what tools to use. **EARN UP TO \$5 an hour**, in spare time, in your own basement or garage. Start your own business NOW.
Write for folder No. PM-3 & free bonus offer.
Institute of Hydraulic Jack Repair
P.O. Box 50, Bloomfield, N. J.



RUPTURE!
An amazing Air-Cushion Invention allows body freedom at work or play. Light, neat, cool, sanitary. Durable, cheap. Day and night protection helps Nature support weakened muscles gently but surely. No risk. Sent on Trial! Write NOW for free Booklet and Proof of Results. All correspondence confidential.
BROOKS COMPANY, 143 State St., Marshall, Mich.



MAKES OVER \$1,000 A MONTH IN BUSINESS WITH MAYFLOWER



G. ROBINSON

Yes, George Robinson made over \$12,000 last year as a Contract Truckman for Aero Mayflower Transit Company, Inc., world-famous household goods mover. He says he has not only paid for two tractors, but has a new car, complete new furniture, and has built substantial bank account since joining Mayflower's contract fleet in 1953. He's just one of many successful van operators enjoying a profitable business in partnership with Mayflower.

You, too, can have this great opportunity! Our business has increased every year; we need additional tractor owners, 23 years or older to go into business for themselves with Mayflower. We furnish company paid training as needed at no cost. All you need to become independent businessman is a 1955 or newer model tractor titled in your name that meets Interstate Commerce Commission safety requirements. Also personal references. Write A. G. Davis, Box 161, Indianapolis 6, Indiana. No obligation.

Learn at Home in your spare time to Fix Electric Appliances



Better Pay—More Opportunities

Get into a field where there is important work and opportunity for the trained man. Millions of electric appliances are sold every year. Every wired home now has an average of 8. Many of them need service and repair. Owners pay well to have them fixed quickly, properly. This is your opportunity for a better job, your own part time or full time business. NRI can give you the training you need, at home, in your spare time.

Spare Time Earnings Start Soon

Soon after starting you will be able to earn extra cash fixing toasters, clocks, fans, vacuum cleaners, etc., for neighbors and friends. Keep your job while learning and earning. Put spare time to work for you. Work in your basement, garage, spare room. You'll be amazed how easily, quickly you, too, can start earning many extra dollars. NRI shows you how. Even before you finish training your spare time earnings may pay for the course and equipment.

NRI Sends Tester to Learn and Earn

You need proper equipment to service today's automatic appliances. With this course you get parts to build professional type, multi-use Appliance Tester. You learn to use it. Takes guess work out of servicing. Mail coupon for FREE book and Sample Lesson. See how easy it is to learn. Find out about NRI—a school that for more than 40 years has been training men, through home study, for success, good pay jobs. Our reputation, record, experience back up this course. Write now to: National Radio Institute, Dept. AC9, Washington 16, D. C.

FREE Lesson and Book
Mail this NOW!

NATIONAL RADIO INSTITUTE
Dept. AC9, Washington 16, D.C.

Send me Lesson and Book Free. No Salesman will call.

Name _____ Age _____

Address _____

City _____ Zone _____ State _____

ACCREDITED MEMBER NATIONAL HOME STUDY COUNCIL

DIVING SPECIALISTS

Commercial, military and sports diving equipment.
New and surplus shallow water and deep water types.

WHOLESALE AND RETAIL

Write for interesting catalog — 20c

M & E MARINE SUPPLY COMPANY
P. O. Box 601Y Camden, New Jersey



HOME-IMPORT BUSINESS

Men, women. Make big profits buying low cost imports abroad (see examples at left) and selling to friends, stores or by mail order. Famous world trader guides you—shows you how to find thousands of exotic imports for full or spare time business, how to pocket profits in advance on foreign drop shipment plan. Full details FREE! Airmail reaches us overnight. Write Today!

MELLINGER CO., 1717 Westwood
Dept. X253. LOS ANGELES 24, CALIFORNIA



Interesting—Educational—Easy-To-Build PORTABLE TRANSISTOR RADIO KIT

Complete—Nothing Else to Buy—
No Soldering—Screwdriver Only Tool Needed

Here's a challenge and an opportunity for every youngster to build a quality, portable transistor radio that is guaranteed to give amazingly clear reception even from distant stations. This is not an ordinary "crystal set" but a carefully engineered unit utilizing the Germanium Diode developed for radar plus the Transistor for superior amplification of sound.

A screwdriver is the only tool needed. It's simple to follow the step-by-step assembly instructions. The kit contains all necessary components plus a "Trans-Assembly Template." Gift boxed. Buy several for your own youngster and lads and lassies as a really educational gift. **\$7.95** ppd

Send check or money order. If COD, fees extra. **MONEY BACK GUARANTEE**

- Penlite Batteries—Last 1000 hours
- Simple to Assemble
- Personal Portable Radio with Case
- Complete with Professional Earphone
- Guaranteed to Operate

SCOTT MITCHELL HOUSE, INC. Dept. F-3, 415 S. Broadway, Yonkers, New York

Not everyone does as well, but T. N. CODY, who started a business of his own, reports...

For 12 months I've averaged

\$800

per month income

— most of it clear profit for me!

Many men have discovered how to be independent, to be free of layoffs and bosses. C. G. Naples grossed more than \$200 his first week. A father-son combination grossed \$44,000 their second year. H. Lemon says, "I netted \$133 in one 8-hour day."

How much you make depends largely on you. You need no special skill, no large investment. Start part time if you wish.

NO SHOP NECESSARY • Our Electric Deterger shampoos rugs, carpets right on floor—removes dirt and grime and helps to show their natural color and beauty. So efficient and safe it is used by largest railroads and hotels.

This is not a lease proposition. You own the machine, you work when and where you please and all the money you take in is your own. No risk. Machines fully guaranteed.

Mail
Coupon
Today
for
FREE
Book

VON SCHRADER MFG. CO.,
310 "R" Pl., Racine, Wis.

Without obligation send me FREE booklet about your RUG DETERGER and tell me how I can start my own permanent, profitable business.

Name _____
Address _____
City _____ Zone _____ State _____

Learn To **MOUNT BIRDS**

Tan SKINS, Make Up FURS

Be a Taxidermist. Double your hunting fun. We teach you at home. Mount Birds, Animals, Pets, Heads and Fish. Save your hunting trophies! Decorate home and den. **MAKE MONEY**. Mount and Krome—fun for others. Big sparetime profits. **INVESTIGATE TODAY.**

FREE BOOK with 100 game pictures, 48 pages. Hunters, get yours! It's Now Free.

Send postal card TODAY—This Minute! State your AGE. NORTHWESTERN SCHOOL OF TAXIDERMISTRY, Dept. 2503, Omaha, Nebr.



OPERATE EARTH MOVING EQUIPMENT



Learn to operate bulldozers, cranes, motor scrapers, crawler tractors, draglines, off-highway dump trucks, etc. on 1,700 acre Green Training Area 60 miles S.W. of Chicago, Ill., on Route 66. Courses include operation, equipment care, preventive maint., stake marking, etc. Minimum classroom instruction. You learn by actually operating the equipment. 200 hour 7.5 week complete course in the operation of bulldozers, loaders, scrapers, dump and off-highway trucks as low as \$375. Classes start every Monday. Reserve your space today. Approved for vets and civilians.

MECHANIC TRAINING

Complete Mechanics Course covering Diesel engine transmissions; torque converters; fuel injection systems; track assemblies; final drive assemblies; steering systems; jitters; rollers; power transfer systems; cable control systems; hydraulic control cylinders & welding pertaining to heavy equipment such as bulldozers, scrapers, loaders, off-highway trucks, etc. Course time—540 hours—10 weeks to 13 1/2 weeks. Convenient payment plan. Write for details. Approved for vets and civilians.



Greer TECHNICAL INSTITUTE
ATT: M. C. Hutch, Box 276, East Troy, Ill.

Electronic Engineering in Florida

DEGREE IN 24 MONTHS

Electronic engineers are urgently needed in Florida—the nation's electronic and missile center. Train for these top-pay jobs at Massey Tech while you enjoy pleasant living in Florida. Accredited electronic engineering degree in only 24 months. Also, short residence and homestudy courses for electronic, radio and TV technician job training. VA Approved.



Send for fact-packed booklet. Learn how you can qualify for top-pay electronic jobs in Florida.

MASSEY TECHNICAL INSTITUTE, Inc.
P.O. BOX 3008B - JACKSONVILLE 6, FLORIDA

KITBOATS Boat Plans Patterns Frame Kits



KIT CATALOGS—Over 50 Models—Pre-assembled, Runabouts, Cruisers, Fishing (8' to 19'). Anyone can assemble. Complete Marine Accessories, Fiberglass plastics, Trailers, Paint, etc. Also Catalog on 50 Modern Plans and Patterns, Prefab Frame Kits—SEND 10c FOR 2-COLORED CATALOGS

CRAIG-CRAFT, Tonawanda 1L, N.Y.

TAPE RECORDERS



HI-FI COMPONENTS
Sleep Learn Kits

MERITAPE
Low cost, high quality recording tape, in boxes or cans.

UNUSUAL VALUES FREE
1959 CATALOG

DRESSNER, 69-02MA 174 St., Flushing 65, N.Y.

PLEASE SEND ME



for the time checked.
I am enclosing . . .

- 1 year \$3.50
- 2 years \$6.00

name _____
address _____
city _____ zone _____ state _____

Hand this order to your newsdealer or send it to
POPULAR MECHANICS
200 East Ontario St. Chicago 11, Ill.

EARN \$100 A WEEK AND UP

BE AN AUTO-DIESEL MECHANIC — EARN WHILE YOU LEARN

Many of our graduates earn \$100 a week and up. You learn fast in our school and shops because you learn with tools on real equipment. Experienced instructors explain WHY and show you HOW, then you DO IT YOURSELF. One of the best equipped technical schools in the United States. Thirty-nine years' experience training men. Successful graduates in 48 states and many foreign countries. Approved for veterans. Day and evening classes. Free bulletin—write today.

NASHVILLE AUTO-DIESEL COLLEGE
226 7th Ave. N., Dept. 86, Nashville, Tenn.

Better Than
Your Own

SHOE STORE AT HOME

No investment, no experience needed. Just show magic cushion comfort to friends, neighbors, co-workers. Advance commissions to \$4.00 a pair, plus Cash Bonus, Paid Vacation, \$25.00 Reward Offer. Outstanding values for men, women, children. Money back guarantee. Shoe samples supplied without cost. Write TODAY for FREE new 84 page catalog and full details.

TANNERS SHOE CO., 129 BROCKTON, MASS.



Two-Eyelet
Hit With
Cushioned
Comfort

WESTERN MERCHANDISE

- BOOTS • SADDLERY EQUIPMENT
- HATS • SADDLES
- WESTERN WEAR • CHAPS

56
PAGE
FREE
CATALOG

LARGEST WESTERN STORE IN TEXAS

All Merchandise Fully Guaranteed
810 MAIN
P. O. BOX 1785-LT
FORT WORTH, TEXAS

Silver Spur

Everything YOU WANT TO KNOW ABOUT INDOOR & OUTDOOR Fireplaces AND BARBECUES

76 PAGES — 220 ILLUSTRATIONS

A complete handbook of designs, layouts, plans, equipment... everything in indoor and outdoor fireplaces and barbecues. Only \$1 ppd. Send for yours now!

The **Majestic Co., Inc.**
540 Erie St., Huntington, Indiana



MARCH 1959

CARPENTERS AND BUILDERS GUIDES



PRACTICAL STOREHOUSE OF MODERN CONSTRUCTION INFORMATION 4 set sets for carpenters and all woodworkers. Explains in easy language and by precise illustration principles, advances, short cuts, frame stresses, air-based on the NEWEST information.

Vol. 1 — Tools, steel square, saw, framing, joinery, furniture, etc.; Vol. 2 — Builders' mathematics, drawing plans, specifications, estimates, etc.; Vol. 3 — House and tree framing, laying out, foundations, etc.; Vol. 4 — Doors, windows, stair building, millwork, painting, etc. 4 vols. 1904 Pages. 3700 Illustrations. Whole set only \$5.

CIRCLE NO. 8 IN COUPON



TV TELLS HOW TO ANSWER RADIO RADIO TV QUESTIONS SERVICE LIBRARY

HERE IS LATEST INFORMATION on radio from our own RESEARCH AND REVISION REPAIRMEN, SERVICEMEN AND ENGINEERS.

TWO COMPLETE VOLUMES—1568 Pages—1085 Illustrations and Diagrams. 1001 Important Facts and Figures on Modern T.V. Radio.

Electronic Devices. INCLUDES TRANSISTORS & Transistors Circuits, Rectifiers, Record Changers, P.A. Systems, Phonograph Pick-ups, F.M. Auto Radio, Short Wave.

Basic principles, Construction, Installation, Operation, Repairs, Troubleshooting. How to get Sharp, Clear T.V. Pictures. Install Antennas. How to Test. Explains COLOR SYSTEMS, Methods of Conversion, Terms, etc. Includes Ultra High Frequency. Quick ready reference or use as a home study course. Only \$4 for BOTH volumes.

CIRCLE NO. 3 IN COUPON

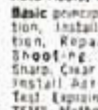

MATHEMATICS MADE EASY

A COMPLETE HOME STUDY COURSE — Starting with the first principles of arithmetic, advancing step by step through the various stages of mathematics, including the rules and calculations for mechanical and electrical problems. New EASY correct methods. Includes plane and solid geometry, trigonometry, algebra, calculus, etc. Practical tests, reference tables and data. How to use slide rule. 752 Pages. 550 Illustrations. Priced at only \$3.

CIRCLE NO. 11 IN COUPON

WELDERS GUIDE

Covers ELECTRIC, Oxy-acetylene, Thermit, Disinert welding for sheet metal, spot and pipe welds, pressure vessels and aluminum, copper, brass, bronze and other metals. Air-plane work, surface hardening, hard facing, cutting, brazing, etc. 658 Pages. Fully illustrated. Only \$3.

CIRCLE NO. 10 IN COUPON

ADDITIONAL IMPORTANT TITLES

Audel Guides are the best in their fields, written in clear simple fashion, lavishly illustrated. Circle numbers wanted in the MAIL ORDER COUPON at right. All sent for FREE EXAMINATION.

No. 1	AUTOMOBILE MECHANICS GUIDE, 1092 Pages	\$6.00
No. 3	TRUCK & TRACTOR GUIDE, 1376 Pages	5.00
No. 6	PLUMBERS & STEAMFITTERS GUIDES, 4 Book Set	8.00
No. 7	PAINTING & DECORATING MANUAL, 464 Pages	2.00
No. 9	DIESEL ENGINE MANUAL, 640 Pages	2.00
No. 13	WIRING DIAGRAMS, 304 Pages	2.00
No. 14	ELECTRIC LIBRARY, 7000 Pages, 10 Book Set	20.00
No. 23	BLUE PRINT READING, 448 Pages	3.00
No. 24	MASONRY & BUILDERS GUIDES, 4 Book Set	8.00
No. 27	ELECTRIC MOTOR GUIDE, 1036 Pages	3.00
No. 29	SHEET METAL PATTERN LAYOUTS, 1132 Pages	7.50
No. 30	SHEET METAL WORKERS HANDBOOK, 464 Pages	1.00
No. 31	MECHANICAL DRAWING GUIDE, 192 Pages	3.00
No. 32	MECHANICAL DRAWING & DESIGN, 480 Pages	3.00
No. 33	ELECTRONIC DEVICES, 304 Pages	2.00
No. 34	ELECTRICIAN EXAMINATIONS, 272 Pages	2.00
No. 35	ELECTRIC POWER CALCULATIONS, 480 Pages	2.00
No. 36	ELECTRIC DICTIONARY, 9000 Terms	3.00
No. 37	POWER PLANT ENGINEERS GUIDE, 1368 Pages	3.00
No. 38	ENGINEERS AND FIREMANS EXAMS, 344 Pages	2.00
No. 39	OPERATING ENGINEERS LIBRARY, 3 Book Set	12.00
No. 40	PUMPS, HYDRAULICS & AIR COMPRESSORS, 1790 Pages	9.00
No. 41	HOUSE HEATING GUIDE, 1008 Pages	3.00

MAIL THIS COUPON TODAY!

THEO. AUDEL & CO. — Self Improvement Publishers Since 1879 P3
49 W. 23rd Street, New York 10, N.Y.

Please mail me for 7 days' FREE EXAMINATION the books I have circled at right. I agree to mail \$2 in 7 days on each book or set ordered, and to further mail \$2 a month on each book or set ordered until I have paid the purchase price, plus shipping costs. If I am not completely satisfied with my Audel Guides I may return them.

NAME _____

ADDRESS _____

OCCUPATION _____

EMPLOYED BY _____

1 2 3 4 5 6 7 8 9 10 11 12 13 14 15 25 26
27 28 29 30 31 32 33 34 35 36 37 38 39 40 41

SAVE SHIPPING COSTS! Check here if you enclose complete payment with order. We pay postage charges. You have same return privilege.

REFRIGERATION & AIR CONDITIONING

FOUR BOOKS IN ONE — basic principles, operating, operation, repair of 1. Household Refrigeration 2. Special Refrigeration Units 3. Commercial & Industrial Refrigeration & Air Conditioning Systems 4. GOLD MINE of essential information. Completely up-to-date. 1300 Pages. Fully illustrated and indexed. Priced at only \$5.

CIRCLE NO. 15 IN COUPON

NEW MACHINISTS AND TOOLMAKERS HANDBOOK

MODERN MACHINE SHOP MANUAL. 5 PRACTICAL BOOKS IN ONE. New from cover to cover. Tells how to set up and operate lathes, screw and milling machines, shapers, drill presses and all other machine tools. A COMPLETE INSTRUCTOR AND REFERENCE BOOK. 1728 Pages. Fully illustrated. Priced at only \$6.

CIRCLE NO. 4 IN COUPON

HOME APPLIANCES

HOW TO FIX Refrigerators Dryers Vacuums Washers Freezers Toasters Ranges

Many other GAS and ELECTRIC APPLIANCES

Handy Reference for Electric & Gas Servicemen, Mechanics, Dealers and Homeowners. Explains clearly and simply how to locate troubles, how to test, reassemble and connect. Wiring diagrams. 1000 facts. Easy to read. Answers All your questions. 854 Pages. Illustrated. Only \$5.

CIRCLE NO. 2 IN COUPON

PRACTICAL ELECTRICITY

A COMPLETE HANDBOOK — Quick, simplified, ready reference. Complete instruction and practical information on the rules and laws of electricity — Maintenance of Machinery — A.C. and D.C. Motors — Armatures — Wiring Diagrams — House Lighting — Power Wiring — Meters — Batteries — Transformers — etc. — Simple to understand. 1120 Pages. 2800 Illustrations. Priced at \$5.

CIRCLE NO. 12 IN COUPON

OIL BURNERS

New, complete, explaining in detail both domestic and industrial oil burners. Includes electrical hook-ups and wiring diagrams. Fully covering the theory, construction, installation, operation, testing, servicing and repair of all equipment. Indexed for ready reference. Over 416 Pages. 320 Illustrations and Diagrams.

Only \$2 — **CIRCLE NO. 25 IN COUPON**

7-DAY FREE EXAMINATION

SEND NO MONEY — Pay the postman nothing! We are glad to send you any of the Audel Guides for FREE examination in your home. We take all the risks and leave the decisions to YOU. There is no obligation if you decide to keep the books you may pay for them later. Our outstanding easy-pay plan of only \$2 a month.

HERE IS ALL YOU DO

IT'S EASY TO ORDER: In the No-Risk Mail Order Coupon just draw a circle around the number of Audel Guides you want us to send for FREE EXAMINATION. We will send them to you at once to help you build a brighter future by increasing your skill. If for any reason at all you are not COMPLETELY satisfied, return the books, and that will end the matter!

LEARN PLASTICS FABRICATION AT HOME!

Complete
Low-Cost
Home Training
Course NOW
Available

There's exciting opportunities for you in Plastics Fabrication. Fun and relaxation as a hobby! Big money as a spare or full-time business! Course teaches you how to make molded, cast, internally carved colored plastic jewelry, toys, furniture, novelties, signs. Professionally prepared. Used by Manual Training and Industrial Arts Teachers. Earn as you learn. All materials furnished. For men, women. Accredited Member National Home Study Council



SEND FOR FREE BOOKLET



INTERSTATE TRAINING SERVICE
Dept. C-3, Portland 12, Oregon
Send Free Booklet on Plastics Home Training Course.

Name _____
Address _____
City _____ Zone _____ State _____

make it with 60c worth of sand & cement!

SELL IT FOR \$2000

every home a prospect for these "LIFETIME"

CONCRETE INCINERATORS

Make big profits manufacturing rust proof, fire proof, almost indestructible concrete incinerators in your own backyard or garage... full or part time. Sell to home-owners, hardware, department and garden supply stores. Phila. manufacturer doing big volume with Sears, Roebuck; large department stores. Easy to follow instructions and all needed equipment supplied. Exclusive protected franchise—No competition! Territories going fast. Write immediately for full details.



Dept. PM-39, T. C. TOR
318 Roncoax Ave., Delanco, N.J.

Gentlemen:
Rush full information about your concrete incinerator protected franchise offer

Name _____
Street No. or R.D. _____
City _____ Zone _____ State _____

INVENTORS

PROTECT YOUR INVENTION BY A U. S. PATENT. SEND FOR FREE "INVENTION RECORD" FORM AND "PATENT INFORMATION EVERY INVENTOR SHOULD HAVE."

CARL MILLER
REGISTERED PATENT ATTORNEY
WOOLWORTH BLDG., 36th FLOOR, 39A
NEW YORK CITY

INVENTORS

Whether an invention is patentable can be substantially determined by a search of the U. S. Patent records. Without obligation, write for information explaining the steps you should take to secure a patent.

JOHN N. RANDOLPH
Registered Patent Attorney
801 Victor Building, Washington 1, D.C.



INVENTORS

U. S. Patents protect your inventions. Our free book of "Instructions on Patent Procedure for Inventors," also "Certificate of Invention" form sent without obligation.

C. A. SNOW & CO.
REGISTERED PATENT ATTORNEYS
428 SNOW BUILDING WASHINGTON 1, D. C.

TELLS HOW TO SELL YOUR INVENTION

If you have an invention that you believe has merit, write us at once for copy of copyrighted booklet "How to Go About Selling Your Invention." We work with manufacturers, and booklet reveals present markets, qualities of a saleable invention, current royalty rates being paid by manufacturers. Booklet is FREE, is offered to encourage new ideas we might submit to manufacturers. Just send name (no drawings, please) to Kessler Sales Corporation, Dept. D-53, Fremont, Ohio

INVENTORS

Send for
PATENT INFORMATION
Book and
INVENTOR'S RECORD
without obligation
GUSTAVE MILLER
39-PM WARNER BUILDING
WASHINGTON 4. D.C.

REGISTERED PATENT ATTORNEY
ASSOCIATE EXAMINER
U.S. PAT. OFF. 1022-1929
Patent Attorney & Advisor
U. S. NAVY DEPT. 1030-1047
PATENT LAWYER



National Society for
Crippled Children and Adults
2023 W. Ogden Ave.
Chicago 12, Ill.

REPAIR WATCHES

Like an Expert
The Sweazey Home Study Way

Learn the same methods professional watchmakers use. The unique Sweazey System starts you repairing Swiss and American watches right away. No previous experience needed. This simplified, modern home training costs less than 17c a day. Free sample lesson. No obligation. Write today.

Chicago School of Watchmaking

2330 N. Milwaukee Ave., Dept. 139, Chicago 47, Ill.

SIGN PAINTING

Home-Study Course - Only \$5.95

Teaches you commercial sign painting and sign building as it is being done TODAY in leading shops all over the country. Complete practical course for self-instruction. Shows latest methods of truck lettering, office doors, wood letters, reflecting signs, plastics, sprayed signs, gold leaf, silk screen process, up-to-date alphabets, money-making business information, etc.

SATISFACTION GUARANTEED OR REFUND!
Contains all the instruction of a high-priced correspondence course. Full price, only \$5.95, postpaid. Or C.O.D. plus postage. No risk—order today. Satisfaction or money back! Order "Sign Painting Course," NELSON-HALL CO., 210 S. Clinton St., Dept. 2CR-2, Chicago 6, Ill.





DO MAGIC

JUST LIKE PROFESSIONAL MAGICIANS

IT'S EASIER THAN YOU THINK
THRILL, ASTONISH AND AMAZE OTHERS
WITH YOUR SENSATIONAL MAGIC

RUSH 50c NOW - TODAY FOR
PROFESSIONAL MAGIC CATALOG

160 Pages • 800 Illustrations • 1000 Mysteries!

HOUSE OF 1000 MYSTERIES • 202A PINWOOD TR. • Trumbull, Conn.

Learn BAKING At Home

Baking is one of America's high industries in wages. Nearly depression-proof. Thorough basic home course lays sound foundation. If you have aptitude, write for **FREE BOOKLET**, "Opportunities in Commercial Baking."

National Baking School, 835 Diversy Pkwy., Dept. 1353, Chicago 14, Illinois



LAW

FREE BOOK

THE LAW TRAINED MAN

Write today for a **FREE** copy of illustrated law book, "THE LAW TRAINED MAN," which shows how to earn the professional Bachelor of Laws (LL.B.) degree through home study of the famous Blackstone Law Course. All necessary books and lessons provided. Moderate cost; convenient monthly terms. Write for **FREE** law training book today.

Blackstone School of Law, 307 N. Michigan Ave.
Founded 1890 Dept. 53, Chicago 1, Illinois

WHY DEPEND ON SOCIAL SECURITY!



ADD TO YOUR INCOME • UP TO \$5.00/HR. SHARPENING ALL TYPES OF LAWN MOWERS

Modern Manufacturing's precision Lawn Mower Sharpener and Bed Knife Grinder makes it easy for you to earn extra cash on a full or part time basis. Many mowers need sharpening. Do it in your basement or garage. Anyone can learn to operate this sharpener. Write today for free brochure. Dept. 10

MODERN MFG. CO.

160 N. Fair Oaks Ave.
Pasadena, Calif.

\$27500
F.O.B. Pasadena

Hey SKINNY!



...YER RIBS ARE SHOWING!



I Can Make YOU a New Man, Too In Only 15 Minutes a Day!

PEOPLE once laughed at my skinny 97-lb. body. I was ashamed to strip for sports. Girls made fun of me behind my back. THEN I discovered "Dynamic Tension." It made me such a complete specimen of manhood that I hold the title, "The World's Most Perfectly Developed Man."

What's My Secret?

When you look in the mirror and see a healthy, husky, handsome, fellow smiling back at you—you'll be amazed at how fast "Dynamic Tension" GETS RESULTS. It's the easy, NATURAL method you can practice in your own room — JUST 15 MINUTES EACH DAY. No gadgets to fool with. You simply use the dormant muscle-power in your own body—watch it grow into solid LIVE MUSCLE. See your shoulders broaden . . . your scrawny chest swell with inches of new muscle . . . those spindly legs and arms bulge with new power . . . and your whole body starts to feel "alive," full of zip and go!

FREE My 32-Page Illustrated Book Just Mail the Coupon

Send NOW for my famous book showing how "Dynamic Tension" can make you a new man. 32 pages, packed with photographs, valuable advice, answers many vital questions. This book is a real prize for any fellow. Yes, I'll send you a copy absolutely FREE. Just glancing through it may change your life. Rush coupon to me personally: **CHARLES ATLAS, Dept. 8C, 115 East 23rd St., New York 10, N. Y.**



CHARLES ATLAS, Dept. 8C, 115 East 23 St., New York 10, N. Y.

Send me — absolutely FREE — a copy of your famous book, showing how "Dynamic Tension" can make me a new man, 32 pages, crammed with photos, valuable advice. This book is mine to keep, and sending for it does not obligate me in any way.

Name _____ Age _____
(Please print or write plainly)

Address _____

City _____ Zone _____ State _____

Free! SCARCE TRIANGLE COLLECTION



Start TODAY to enjoy an exciting new hobby! Get this big, valuable collection of gorgeous, multi-colored triangle shaped postage stamps... brought to you from strange and mysterious lands in the wilds of Africa, enchanting Europe, exotic Latin America, etc. All genuine, all different—picturing man-eating reptiles, jungle birds, action-packed sports, ancient clipper ships; PLUS scarce airmails, fabulous commemoratives, giant and midget-sized stamps. EXTRA! Bargain Catalog, "Collector's Manual" plus other exciting offers for your inspection. Enclose 10c for mailing costs. Supplies limited. ACT NOW!

JAMESTOWN STAMP CO. Dept. H39PM, JAMESTOWN, N. Y.
RUSH my Free "Triangle" Collection and other offers. I enclose 10c for mailing costs.

Name
Address
City & State

MANUFACTURE THIS BEAUTIFUL CONCRETE OUTDOOR FIREPLACE

Right In Your Own Backyard

\$4.00 Worth of Sand & Cement produces this Attractive Fireplace.



Sells on Sight from \$60. to \$80. Easy to start your own Profitable Business.

The General Fireplace Molds and Process are the most amazing and foolproof ever invented. Simple to operate. Two men can produce five fireplaces a day.

BIG DEMAND!!

Sell all you produce to Department Stores, Homeowners, Parks, Nurseries and Picnic Groves. Fireplaces sell on sight. No experience necessary. We supply full operating instructions and equipment plus the know-how that spells BIG PROFITS. This is an outstanding opportunity for men of vision and small capital to get into a busy rich paying field. Don't delay, be the only exclusive manufacturer in your own home town. Mail coupon at once for full details as to how you can reserve your territory. Molds sold only on exclusive franchise.

GENERAL ENGINES CO., Inc., Dept. M-39
ROUTE 130, THORFARE, N. J.

Mr. Tor of Philadelphia writes: Sold 250 in first 4 months. Selling to Sears Roebuck, John Wanamaker, and Gimbel Bros. in Philadelphia area.

Name
Address
City Zone
State

NEW WONDER AUTO GLAZE

with Miracle DOW CORNING 200 Fluids

Gives You \$55.00 a Day Clear Profit . . . on Your Own Exclusive Route!



FREE SAMPLE

GUARANTEED to outshine, outlast and outperform ANY wax polish on the market today—or money back! FAST, REPEAT SELLER! Needed by 45,000,000 car owners. Demonstrates like magic. Just apply, wipe off. No hard rubbing. Keeps car and chrome like new for months! OVER 175% PROFIT! Retail \$2.00 pint (year's supply). Your profit can be over \$1.35 each pint. FREE SAMPLE sent to try on your car. Rush name for FREE sample and money-making details. No Obligation! Exclusive Franchises Available

ROYALTONE PRODUCTS CORP., Dept. P-3
1035 E. 10th St., Brooklyn 30, N. Y.



BARBELLS

140-Pound, CHROME DELUXE Barbell-Dumbbell set only \$19.80.

This is our feature set and is the finest ever manufactured.

Training with adjustable weight is the BEST way to keep fit; the ONLY way to develop great strength and a perfect body. As the oldest and best equipped barbell company, BUR gives value and prices no one can equal.

SEND FOR FREE CATALOG

BUR BARBELL CO.
Lyndhurst 9, New Jersey



MASTER MIND!

LEARN SHORT-CUT MATHEMATICS

Juggle figures, do baffling number tricks. Make people gasp at your marvelous lightning-quick mind. Multiply 4 figures by 4 figures without using old-fashioned multiplication! Big cloth-bound volume! fully illustrated course for self-instruction.

SHARPEN UP YOUR BRAIN POWER

Includes worked-out problems, answers, etc. Sensational bargain. Only \$3.95 postpaid or COD plus postage. Satisfaction guaranteed or refund. Order this amazing "Short-Cut Mathematics" today!

NELSON-HALL CO., 210 S. Clinton St.
Dept. 3CR-2 Chicago 6, Ill.

\$3.95 Complete



MONEY FOR YOU...

in hidden treasures

Locate buried treasure... coins, gold and silver. New transistorized instruments for greater locating depth, less weight, operates on flashlight batteries. Complete line priced from \$79.50. FREE literature... authentic books of known treasures available. WRITE today.

GOLDAK COMPANY
1042-3 W. Glenoaks Blvd., Glendale, Calif.

200 Amp. PORTABLE GASOLINE ENGINE WELDER

Government Cost \$2,940.00

Yours \$189.50

Most compact welder obtainable for the big jobs in out of the way places. Generator is capable of delivery of double overload or continuous service at 200 Amps. use up to 1/4" welding rod. Engine is manufactured by Ranger Aircraft and is a 2 cylinder, 4 cycle 10 H.P. at 3200 RPM. Fully governed for varying loads. You need to supply only cables and electrodes for welding. Units weigh approx. 150 lbs. (less oil & gasoline) and are approx. 22" W x 33 1/2" L x 17" H. All units used but guaranteed and checked before shipment. Parts available both new and used. Engine sold separately (attach your own P-2 or R-1 generator) checked and tested \$125.

JEFFERSON AIR DEPOT P. O. Box 798 N.M.S.
Madison, Indiana



FOCUS YOUR  **ON BENJAMIN**

SMOOTH BORE BB OR RIFLED 22—AIR OR GAS GUNS—ROUND LEAD AMMO EFFECTIVE UP TO 100 FT.

AMAZING NEW Line of REPEATERS

WITH THE LATEST IMPROVEMENT IN FAST, SURE, GRAVITY LOADING ACTION AND **PIGGY-BACK SHOT MAGAZINE**

A Shot is placed in Firing Position each time Bolt is Pulled Back and Closed. Flash Ammo Count on Full View Magazine.

18.95



No. 3600 BENJAMIN Super 100 Shot BB Gas Rifle. Non-Toxic—Safe—Convenient—Uniform Hi-Velocity Power—

No. 2600 BENJAMIN Super 35-Shot BB Gas Pistol Safe—No Pumping—Uniform Hi-Power. For Target & Small Game. \$17.95

No. 2620 BENJAMIN 20-Shot Cal. 22 Gas Pistol. Economical. \$19.95

No. 1300 50-Shot BB Air Pistol \$22.50

No. 1320 BENJAMIN 35-Shot Cal. 22 Air Pistol \$24.50

FREE Catalog All Models Benjamin Single Shot & Repeaters—Cal. BB or 177 or 22. Also, Special Hunting & Fishing Knife Offer.

BENJAMIN AIR RIFLE CO. 896 MARION ST., ST. LOUIS 4, MO.

WANT MORE MONEY? GET INTO PHOTOGRAPHY



Coast to coast, high-paying jobs in photography are waiting for people with the "know-how" to fill them. You can quickly, easily qualify at home with the world-famous NYI Learn-by-Doing Method. Write today for free catalog. Also resident training in N. Y. 49th Year. Approved for Veterans.

NEW YORK INSTITUTE OF PHOTOGRAPHY

Dept. 49 10 West 33 St. New York 1, N. Y.

ENGINEERING DEGREE IN 27 MONTHS

B. S. degree (27 mo.): Aero., Chem., Civil, Elec., Mech. & Electronics. B. E. (36 mo.): Aero., Chem., Civil, Elec., Mechanical, Metallurgical, B. S. (36 mo.): Math., Chem., Physics. Prep courses. Demand for grads. Campus. 20 bldgs.; dorms, gym. Low rate. Earn board. G.I. app. Enter March, June, Sept., Dec. Catalog. 1639 E. Washington Blvd., Fort Wayne 2, Ind. Keeping pace with progress

INDIANA TECHNICAL COLLEGE

MAKE TREMENDOUS PROFITS

Have fun! Earn Big Money! Cast plaster figurines, bookends, plaques, novelties at home in your spare time with X.L. rubber molds! NO EXPERIENCE NEEDED! Molds and rubber for 3 molds, only \$1.50 ppd. Send 25c (refunded with order) for 40 page catalog now!

PLASTIC ARTS STUDIO 3403 S. MADISON, DEPT. PM2 MUNCIE, INDIANA

"\$10,784 IN ONE YEAR NEW!"

SERVICING RADIATORS!

—Sidney Radiator Shop, Sidney, Mont. Make good money servicing auto-truck-tractor radiators with new Inland 3-Piece Radiator Shop. Easy to test, clean and repair radiators. Inland, world's largest radiator equip. mfr., trains you free. Small down payment starts you. "Pay-for-itself" Purchase Plan. Profitable dept. for garage or service station. Write for free information!



INLAND MFG. CO.
Dept. PM-3
1108 Jackson St., Omaha 2, Nebr.

HI-POWER BINOCULARS

50¢

SEE UP TO 18 MILES

POST PAID UNIT \$10 & CUSTOMER

Powerful folding Opera Glasses fit into pocket or purse. Center eye piece adjustment. Worth many times low introductory price. Comparable to models selling for \$4.95.

BRUCE SALES CO.
121 E. 24 St., Dept. B-300
New York, N. Y.



Send cash, check or money order. Sorry, no C.O.D.'s.

Only \$6⁰⁰ starts you in **TELEVISION and RADIO**

Learn in spare time at home to fill the best paying jobs—my new, faster way!



We're making it easier than ever to become a well paid Radio-TV Service Technician the proved 'Learn-by-Doing' Sprayberry way!



Get valuable shop bench practical experience fast with expertly engineered kits you'll assemble.

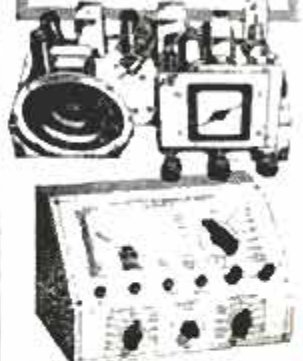

EARN WHILE YOU LEARN!

Trained Radio-Television Service Technicians are needed at once by the thousands! If you are looking for better pay, a bright future and interesting work . . . there's a place for you in Radio and Television. Be ready to step into a good paying job in 10 months or less . . . or your own profitable business! Train at home in spare time. I'll help you earn extra money while you train . . . doing instructive radio service jobs. Our new tuition terms are more liberal than ever . . . only \$6 starts you towards success in this booming field!

25 KITS OF RADIO-TV PARTS

In addition to modern lessons, you train with actual parts and equipment. Build the famous Sprayberry Training Television Set, Multi-Range Tester, 2-Band Radio, Test Equipment—all yours to keep. Get latest training on Color TV, Transistors, Hi-Fi and UHF Conversions!

SEE HOW EASILY YOU CAN LEARN

See for yourself . . . in actual pictures and descriptions . . . what Sprayberry Radio-Television Training offers you. Backed by almost 30 years of training experience. Three training plans to suit your exact needs. Rush coupon today for big new catalog and sample lesson. No obligation; no salesman will call.

SPRAYBERRY ACADEMY OF RADIO-TV
1512 Jarvis Ave., Dept. 10-3, Chicago 26, Ill.



FREE 60 Page Catalog and Sample Lesson

Sprayberry Academy of Radio-Television
1512 Jarvis Ave., Dept. 10-3, Chicago 26, Ill.
Please rush catalog on your ALL-NEW Radio-Television Training Plans. I understand this does not obligate me. No salesman will call. Include Sample Lesson FREE.

Name _____ Age _____
Address _____
City _____ Zone _____ State _____



**10,000 HAPPY
TOMORROWS IN FLORIDA
FOR A 4c STAMP TODAY!**



CAPE CORAL gives you more of what you look to Florida for. That's why thousands of families have already invested over \$9,000,000 in homesites there. Just a 4c stamp brings you all the facts about this exciting new waterfront community!

- CAPE CORAL challenges comparison!
 - CAPE CORAL invites inspection!
- CAPE CORAL, on Florida's beautiful Gulf Coast, is offered and sold on merit alone—for as little as \$20 down and \$20 per month!

Send for and read the
"Cape Coral Story" →

It's yours for the asking
ABSOLUTELY FREE
Send no money, please!



CHAMBER OF COMMERCE MEMBER
Lee County and Ft. Myers
Dade County • Florida State

.....MAIL THIS COUPON TODAY!.....

Gulf Guaranty Land & Title Co., Dept. MS3

1771 N. Tamiami Trail, Fort Myers, Florida

Please rush my **FREE** copy of "The Cape Coral Story" in full color.

Name.....

Address.....

City.....

Zone.....

State.....

"SEE" YOUR FISH
Before you catch'em with
a Fish **LO-K-TOR**

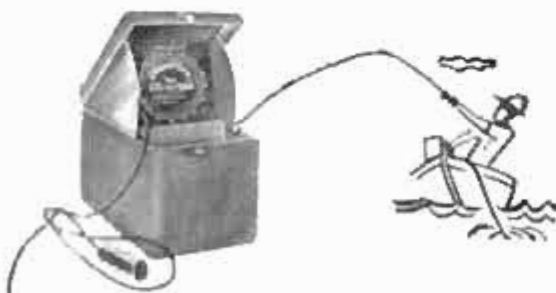

**DON'T WASTE TIME
GUESSING... KNOW!**



The Lowrance Portable Fish LO-K-TOR (wt. 10 lbs.) shows if there is a single fish or a school; how deep they are up to 80 ft.; the slope of the bank; if the bottom is rocky, muddy or brushy. Eliminate "blind fishing" . . . you'll catch more and get a bigger thrill out of fishing because the sonar scope will show you where they are. Use in any type boat. Transistorized; uses two lantern-type batteries. Operates in salt water, too. Excellent navigation aid in foggy weather, unfamiliar waters. If your dealer does not have, write for **FREE** literature, or order direct: price includes LO-K-TOR complete with batteries and special boat bracket. **\$148.50**

Plus Postage

LOWRANCE SALES CO.

112½ E. 13th, Dept. 839, Joplin, Mo.

DEALER INQUIRIES INVITED

Beauty...

backed by
**SCIENTIFIC
MARINE
ENGINEERING**



Every Penn Yan is built to scientific principles of marine design. As a result, Penn Yans are superbly maneuverable,

fast, durable and safe. They are built—as they have been for nearly 40 years—to give greater satisfaction longer.



Free Brochure describes complete new line. Write Penn Yan Boats, Inc., 34th St., Penn Yan, N. Y.

Penn Yan Boats

ART **LEARN AT HOME!**

Enjoy glamorous high-pay career or profitable hobby. Learn Commercial Art, Illustrating, Cartooning, Fashion Art, Lettering, T.V., etc. We train you at home, in spare time. 22-yr. art outfit given with first lesson at no extra cost. Write for **FREE** Book describing easy low-cost method. No obligation. No salesman will call on you. Washington School of Art, Studio 143, Port Washington, N. Y. (Estab. 1914)



SUPER JU JITSU

Now get tough double quick!

A course of instruction in the art of practicing and using this method of applying **LIGHTNING-QUICK** Super Ju Jitsu. Be Dangerous! These amazing lessons show you how it's done . . . in a big illustrated home-study course. The weapons are just your **BARE HANDS**—they can be used effectively if you know how and practice the art. Easy to learn; quick. Full 76-lesson course only \$5.95 postpaid—or COD, plus postage. Satisfaction or your money back guaranteed! Order "Super Ju Jitsu Course."

NELSON-HALL CO., 210 S. Clinton, Dept. SCR-2, Chicago 6, Ill.

SPARE-TIME MONEymAKING OPPORTUNITIES

READ OUR CLASSIFIED ADS

HUNDREDS OF BARGAINS

AMAZING OFFERS



216 Sq. Ft. PLASTIC

Regular price of 9 x 12-ft. heavy transparent plastic cloth is \$1.00 — our special **LOW Sale price, TWO FOR \$1.00!**

PERFECT COVER for cars, boats, buggy, appliances, bicycles, lawn furniture, etc. Protects rugs, furniture and floors when painting. Make into aprons, tablecloths, lampshades, appliance covers, etc. Waterproof, greaseproof, dirtproof—clean with damp cloth. Each cover is full one piece, no seams! Send \$1.00 plus 25¢ for post. & hdlg. for two 9x12 Cloths. Money-back guarantee.

L & M CO., Dept. PL-267, Box 881, St. Louis, Mo.



\$25.85

OUR GUNSMITH'S SPECIAL SPORTER

Stock No. R210 with open sight
Fully sporterized, ready for the field, and \$80 value for only \$25.85.
OUR GUNSMITH'S SPECIAL CAL. 30 (7.5mm SWISS) is the product of two great nations: Switzerland's famed army rifle was designed and developed by the world's foremost ballistics experts and adapted for sporting use in this country by Golden State Arms.

FREE!
40 rds. ammo. Test fire at no cost!

Over 15,000 of these fine Carbinas have been sold already! A 12-shot bolt action sporter perfect for all big game. Our gunsmith machines and precision crown walnut to sporter contours, rebeds the harralid action perfectly, checks head space, trigger pull (20oz. light crisp.) Bores are perfect.

EXTRA AMMO. .30 cal (7.5mm SWISS) Soft nose hunting ammo, 40 rd. Box \$5.00

TO ORDER: Send check, cash or M.O. \$10 deposit for C.O.D. Shipped R.R. Ex. charges collect F.O.B. Los Angeles, California resident, add 1% state tax.

GOLDEN STATE ARMS CORP.

306 WEST GREEN STREET, PASADENA 142, CALIFORNIA

Prepare for your career in **METALLURGY** **INDUSTRIAL ENGINEERING** **AIR CONDITIONING** **MECHANICAL ENGINEERING**

Missiles or machinery, rockets or refrigeration, MSOE equips you for a career in many fields:

**PRODUCT DESIGN • RESEARCH
DEVELOPMENT • QUALITY CONTROL
TIME STUDY • PURCHASING
SALES ENGINEER**

When you graduate from the Milwaukee School of Engineering, you are prepared for a dynamic career as a Mechanical Engineer or Engineering Technician. Under a faculty of specialists, you gain a sound technical education in modern, completely equipped laboratories and classrooms. As a result, MSOE graduates are in great demand and highly accepted by industries nationally.

At MSOE you will meet men from all walks of life and all parts of the country — some fresh out of high school or prep school, others in their twenties — veterans and non-veterans.

You can start school in any one of four quarters and begin specializing immediately. Engineering technicians graduate in 2 years with an Associate in Applied Science degree. For a Bachelor of Science degree in Engineering, you attend 4 years. A 3-month preparatory course also is available.



If you're interested in any phase of metallurgy, air-conditioning or mechanical engineering, be sure to look into the programs of study offered by the Milwaukee School of Engineering. Just mail coupon.

FREE CAREER BOOKLET

MILWAUKEE SCHOOL OF ENGINEERING

Dept. PM 359, 1025 N. Milwaukee St., Milwaukee, Wis.

Please send FREE Career Booklet. I'm interested in

- Mechanical Engineering Air Conditioning
 Industrial Engineering Metallurgy
 Electrical Engineering

Name _____ Age _____

Address _____

City _____ Zone _____ State _____

I'm eligible for veterans education benefits.

MS-112

BE AN INDIVIDUALIST!

Free COLORFUL BROCHURE tells how you, too, can add your own personality to prized possessions with a smartly crafted custom made-to-order inexpensive "Prestige Plate"

Write today to
PRESTIGE PLATES, INC., 805 Colorado Ave., Avon Ohio

MAKE \$5⁰⁰ AN HOUR IN SPARE TIME BIG, EASY "AT HOME" PROFITS—METALIZING

It's so easy to earn Big Money right at home in fascinating new spare time business. Little easy-to-run table-top machine returns Cash Dollars for a few cents cost. We furnish everything to put you in business for yourself, "eternalizing" baby shoes, and other keepsakes. Write TODAY for full facts FREE. No salesman will call on you. No obligation.

WARNER ELECTRIC, 1512 Jarvis, Dept. M-2-C, Chicago 26, Ill.

INVESTIGATE ACCIDENTS

Train quickly in your own home for repeat income in the exciting, secure Claim Investigation and Claim Adjusting field. Our students and graduates are already earning \$4, \$5, \$6 an hour extra SPARE TIME — and up to \$10,000 a year Full Time. You need NO prior experience or higher education. Your age does NOT matter.

HERE IS YOUR CHANCE FOR ACTION AND REAL JOB SECURITY

As a trained Claim Investigator you will (1) INVESTIGATE FACTS and (2) DISTRIBUTE MONEY as the representative of wealthy organizations.

No other business offers you greater opportunities for success and security. Here's why: The huge, rapidly expanding Claim Investigation and Adjusting Profession right now distributes more money than any other service industry. And it's growing fast. Over 200 MILLION ACCIDENTS must be investigated this year for Insurance Companies, Airlines, Railroads, Steamship Lines, and Government Offices.

MAIL NOW for FREE BOOK →

SEND TODAY for Big, FREE, Illustrated Catalog. Learn the exciting facts about Universal Schools' low cost training. No obligation. No salesman will call. GI APPROVED.



UNIVERSAL SCHOOLS

6801 Hillcrest Ave.
Dept. PM-3, Dallas 5, Texas

Please rush me your FREE book on Claim Investigation. This does not obligate me and no salesman will call.

Name _____ Age _____

Address _____

City _____ Zone _____ State _____

Approved by Government for Korean Veterans

YOU CAN BE AN AUTO REPAIR SPECIALIST in 3 WEEKS

— NO CORRESPONDENCE COURSES —

GUARANTEED RESULTS! 9 out of 10 A. M. I. Graduates go to work as journeymen in the trade!

AUTO MECHANICS INSTITUTE

4931 South Vermont • Los Angeles 37, Calif.

INDUSTRY APPROVED

WRITE FOR FREE COUNSELING AND INFORMATION ON COURSES

- SUN TUNE-UP
- BEAR ALIGNMENT
- AUTOMATIC TRANSMISSIONS
- BODY & FENDER
- AMMCO BRAKES
- CLAYTON DYNAMOMETER
- FOREIGN CARS
- ENGINES
- AUTO AIR CONDITIONING

I'll Send You This Handsome SAMPLE CASE—FREE



and Show You How to Make Up to \$30.00 in a Day

Mail coupon for this Free Tailoring Sample Case packed with 100 beautiful, big-value suit and overcoat fabrics. Take orders from friends, fellow-workers, others, for fine quality, made-to-measure clothes. Pocket big cash profits in advance. Because wearing our suits and overcoats brings more orders, we make it easy for you to get your own clothes without the cost. No experience is needed. **SATISFACTION GUARANTEED. SEND NO MONEY.** Just fill out and mail coupon—today!

J. C. FIELD & SON, Harrison & Throop Streets DEPT. L-1716 CHICAGO 7, ILLINOIS

J. C. FIELD & SON, Dept. L-1716 Harrison & Throop Sts., Chicago 7, Ill.

Dear Sir: I WANT A MADE-TO-MEASURE SUIT TO WEAR AND SHOW, without paying 1c for it. Rush details and Sample Kit of actual fabrics. **ABSOLUTELY FREE.**

NAME.....AGE.....

ADDRESS.....

CITY.....STATE.....

Finish HIGH SCHOOL

AT HOME

Complete 4 Years in 12 Months

diploma

Learn More! Earn More!

Enter College, profes-

sional or technical schools.

Advance Socially. Live a

Happier, Fuller Life. Individual Courses

or complete schedule.

WRITE FOR SCHOOL BULLETIN, Dept. PM-35

ACADEMY FOR ADULTS 30 W. Washington Chicago 2, Illinois

\$3.25 OR 2 FOR \$6.00

With 40 ft. of wire **TESTED AND GUARANTEED**

Write for free list of all types of telephones.

Shipments F.O.B. Simpson, Pa.

TELEPHONE ENGINEERING CO., Dept. 389, Simpson, Pa.

FREE GIANT NEW 1959 B-A CATALOG



180 KING-SIZED PAGES

EVERYTHING IN RADIO TV AND ELECTRONICS

100'S OF NEW ITEMS LISTED HERE FOR 1st TIME

21 PAGES OF BARGAINS NOT IN ANY OTHER CATALOG

BURSTEIN-APPLEBEE CO.

Dept. PM, 1012 McGee St., Kansas City 6, Mo.

Send Free 1959 B-A Catalog No. 591.

Name.....

Address.....

City.....State.....

SEND FOR IT TODAY



YOUR GIFT TO EASTER SEALS

assures continued skilled service to all the crippled

National Society for Crippled Children and Adults
2023 W. Ogden Ave.
Chicago 12, Ill.

QUICKIE TV TROUBLE FINDER



If your TV is providing weird sights, or none at all, your trouble is probably a lifeless tube, or one so weak it doesn't do the job. To detect the dead tube with the Quik-Chek detector, you just dial your trouble and test all of the tubes that are concerned with that particular problem. Detectors cost 39c, are produced by the **Quik-Chek Corp.**, Dept. P-39, 5212 Pulaski Ave., Philadelphia 44, Pa.

MASS PRODUCTION MAKES THESE PRICES POSSIBLE!



Only world's largest boat kit maker can deliver such quality of such prices! Write for free color catalog, kits from \$42.00, frt. inc. 12 ft. runabout \$99.50 frt. inc. **FREE COLOR CATALOG!**

TAFT MARINE WOODCRAFT
Dept. PM-359 626 39th Ave. N.E. Minneapolis 21, Minn.

MAIL ORDER BUSINESS

How to Start a Profitable Business of Your Own at Home or in a Small Office. Annual new instruction course shows you how to run a good mail order business, spare time or full time. Up-to-date, practical training—a true business of the best plans and practices being used TODAY by successful operators. Only \$5.95. Complete—Satisfaction Guaranteed! This is BIG. You get 24 money-making lessons in 3 separate volumes, all in one shipment. You must be satisfied or your money back immediately. Full price only \$5.95, postpaid—or C.O.D. plus postage. Nothing more to pay! Order "Mail Order Course" today. Nelson-Hall Co., 210 S. Clinton St., Dept. 9CR-2, Chicago 6, Ill.



LOWEST PRICED .22 Cal. REVOLVER AVAILABLE

NEW! 6 Shot .22 Short Double Action ONLY \$15.98 —\$29.95 Value

Only Godfrey Guns could find a genuine .22 Cal. Revolver today for \$15.98. Small "Puppy" .22 Cal. REAL Revolver can be slipped into your pocket or car. Can be used for hunting or trapping! Solid steel barrel gives close-up accuracy. Quick-grip handles. A fast loading double-action. Just pull the trigger to fire...



FREE! Box of .22 Short Cartridges with all orders.

Order by Mail Today... Send \$3.00 down, Bal. C.O.D.

GODFREY IMPORT CORP., Dept. PM3, 261 Broadway, N. Y. 7

HANDWRITING ANALYZE

You can analyze handwriting—at home, in your spare time. No interference with job or social life. Win more pay, social recognition, prestige! Men and women both needed now. Complete lesson and answer service. Personalized instruction. Handsome, suitable-for-framing Diploma to graduates!

I.G.A.S. Write now for three free services: (1) Sample 16-page Lesson (2) Free Entrance Examination (3) Full Color 48-page Success Book. Absolutely No Obligation. Adults only.

INTERNATIONAL GRAPHO ANALYSIS SOCIETY, INC. SPRINGFIELD, MISSOURI

FREE THE HISTORY OF THE COMPASS SEND FOR YOUR COPY

New DINSMORE Celebrity COMPASSES

in Beautiful GOLD or SILVER

A jeweled, precision instrument—designed for modern cars. Full, indirect illumination. Sharp, clear letters. Silver or gold Celebrity models \$6.95, standard models \$5.45, illuminated \$6.45 **APPROVED BY AUTO MAKERS**

Fine Quality Compasses for over 31 Years

DINSMORE INSTRUMENT CO.
1802-25 Kelso St., Flint 1, Michigan



Write for Folder



ME—in a Rut? —COULD BE!

YES—you may be in a rut—just getting by—and not fully realizing it.

Every day you stay in that rut you "dig deeper"—make it harder and harder to get out.

So today while you think of it, take stock of yourself—are you getting ahead as fast as you should—are you satisfied to go along in a small job at small pay the rest of your life?

Hundreds of thousands of our students have won promotion and more money—and the prestige and happiness that success brings—perhaps we can help you.

DON'T LIMIT YOURSELF

For more than 50 years over 1,400,000 ambitious men and women have turned to LaSalle training for more money, larger success in life, and greater job security.

Better investigate—the coupon below is for your convenience. Just check the field of your choice and we'll send you without obligation full information on that field—the requirements and opportunities.

Take the first step to get out of that rut—make more money—get a better job.

Accredited Member, National Home Study Council

MAIL THIS COUPON TODAY

LASALLE Extension University

A Correspondence Institution

417 S. Dearborn St., Dept. 364R, Chicago 5, Ill.

Please send me your free book on the field I have marked below and full information about your spare-time training.

- | | |
|---------------------------------------------------|------------------------------------------------------|
| <input type="checkbox"/> Accounting | <input type="checkbox"/> Foremanship |
| <input type="checkbox"/> Law: LL.B. Degree | <input type="checkbox"/> Stenographic-Secretarial |
| <input type="checkbox"/> Business Management | <input type="checkbox"/> Stenotype-Machine Shorthand |
| <input type="checkbox"/> Traffic & Transportation | <input type="checkbox"/> Sales Training |
| <input type="checkbox"/> Industrial Management | |

Name.....Age.....

Address.....

City.....Zone.....State.....

Pocket Transistor Radio

"Hit Parade"
Mighty Midget



\$7.95

Low Price!
Smart Design!

Marvelous Reception!

size of cigaret package, yet thrilling performance. Weighs only 3 ounces. Listen while traveling, at ball game, in home or office or school. Includes Hi-Fi speaker-phones for private listening. Modern two-tone moulded plastic case, red with gold metal grille. Complete broadcast band. On-off switch on end. Uses standard penlight cells (included). Guaranteed. **\$7.95** Complete, ready for immediate playing. Postpaid Only...
JOHNSON SMITH & CO. Dept. 770 Detroit 7, Michigan



Catalog of 2900 Novelties 10c

New Send 10c for amazing catalog of novelties, live animals, scientific supplies, hobbies, funmakers, planes & boats, looms, magic tricks, joke articles, unusual seeds, gadget timesavers, cameras, optical goods, projectors, movies, lucky jewelry, religious novelties, disguises, musical instruments, stamps, coins, puzzles, fortune tellers, radios, auto & bike accessories, telescopes, magnifiers, compasses, banks, smokers' gadgets, artists' supplies, printing sets, engines, motors, shockers, knives, billfolds, guns, rifles, sports, books, games, plants, etc. Send 10c.
JOHNSON SMITH & CO. Dept. 770 Detroit 7, Michigan

They
All Came to
Admire!

The crowds are gathering around the new Arkansas Traveler Fiber lapstreak boats. Join them at your Dealer's — or write for free catalog on the 25 aluminum and fiber glass models for '59.

ARKANSAS TRAVELER BOATS
2006 E. 14th St. Little Rock, Ark.



arkansas traveler
THE QUALITY NAME IN BOATS—ALUMINUM—FIBER GLASS



OWN YOUR OWN BUSINESS

Free folder tells how!
Build and operate this
profitable roadside stand—
seasonal or year 'round.
Mail coupon now.



RICHARDSON Corporation
Dept. PM-3, P.O. Box 790, Rochester 3, N.Y.
Please send me FREE folder on your tested,
franchised refreshment stand.

Name.....
Address.....
Place.....

Nutria.... **NEWEST**
OPPORTUNITY

New fur-bearing animal now being bred in U. S. Offers huge profits to breeders. This fur is next to Mink NOW in price and will soon surpass it. 15 to 20 young per year. Most easily and economically raised animal known. 1 1/2c per day to feed. ANY CLIMATE. disease resistant. The Cabana Marrone strain is obtainable ONLY through Cabana Nutria, Inc., and its authorized dealers and distributors. For free booklet and address of Cabana ranch nearest you write:

CABANA NUTRIA, INC.
Dept. 46, 636 W. Lemon Ave., Arcadia, Calif.

MAGNIFYING GLASSES FOR CRAFTSMEN

with **POCKET CLIP**
Pen-Like CASE

only **\$3.98**

Make fine repairs, adjustments, read fine print, blue prints, instructions, etc. . . with new style import glasses . . . fit all heads and permits looking over or under without stumbling. For folks without astigmatism or eye disease. **10 DAYS TRIAL—Money Back Guarantee. SAVE COD postage. SEND only \$3.98 TODAY! State Age.**

DALO IMPORT Dept. 4333 N. Crawford Ave. Chicago 41, Ill.
603

Break
the
grip
of the
crippler

ARTHRITIS

95% PROFITS YEAR 'ROUND

Be your own boss. Operate a SIMPLEX lawnmower sharpening service in your community. One compact machine grinds all mowers, sharpens cutlery. Low investment, 95% profit. Pays for itself in average month.

SIMPLEX — 4 Machines in One!

Reel Grinder—sharpens any mower reel in or out of mower.
Bed Knife Grinder—grinds with either round or cup wheel.
Rotary Blade Grinder—hollow grinds any rotary mower blade.
Cutlery Knife Grinder—sharpens cutlery, tools, scissors.



Send for Simplex Brochure today!

THE FATE-ROOT-HEATH COMPANY

Dept. PM-3, Plymouth, Ohio

'How to Make Money with Simple Cartoons'



A book everyone who likes to draw should have. It is free; no obligation. Simply address

FREE BOOK

CARTOONISTS' EXCHANGE
Dept. 93-D Pleasant Hill, Ohio



NEW CAR THIEF SIGNAL

Lightning Seller
Samples for Trial

NORTHWEST ELECTRIC
Dept. 12, Mitchell, S. Dak.

GIANT 6 FOOTERS 59¢



FOR PARTIES AND FUN

YOUR MESSAGE HERE

FOR ADVERTISING

A special purchase makes it possible to offer these GIANT 6 FOOTERS at a fraction of their value. New, genuine neoprene govt. surplus. Great for advertising, you paint your message on 'em, inflate & fly. Attracts crowds to sales, displays, openings, stores, gas stations. Fun at home for young & old and just the thing for any party or school prom. Perfect for beach or picnic. They're BIG and they do a BIG job! Order yours today!

6' — 59¢ ea. 2 for \$1
8' Specials — \$1.25 each — 5 for \$6
13' — \$1.95, 15' — \$2.95, 18' — \$3.95

Postage pd. on p.p.d. orders.

Cal. res. add sales tax.

FRANK SALES • Dept. PM359
3930 Sunset Blvd., Los Angeles 29, Cal.

ENGINEERING



Photo of Heald Students in Electrical Laboratory

American Industry Steps Up Its Demand for Trained Engineers. Train Now at Heald's

BACHELOR OF SCIENCE DEGREE, 27 MONTHS

Degree Courses:

- Radio-Electronic Eng.
- Electrical Engineering
- Highway Engineering
- Mechanical Engineering
- Structural Engineering
- Civil Engineering
- Architecture

Diploma Courses:

- TELEVISION Color TV
- Radio-Electronic Tech.
- Industrial Electronic Tech.
- Tool & Die Design
- Architectural Drafting
- Mechanical Drafting
- Structural Drafting

Approved for Veterans

Enroll Now for New Term

Heald College Ranks FIRST West of the Mississippi in "Who's Who in America"

Send for FREE Information

Heald Engineering College

Est. 1862

Van Ness at Post, Dept. P.M. San Francisco, California

NAME _____
STREET _____
CITY _____
STATE _____

SHOOTERS



better shooting at less cost

● **Handbook of Cast Bullets:** All about making your own bullets—for the first time available in a single book. Hundreds of bullet designs, metals, lubricants, powders, moulds. Sample articles: TIPS ON CASTING BULLETS • BULLETS IN SHOTGUNS • BULLETS OF THE CIVIL WAR • SELECTING YOUR GUNPOWDER. Over 400 drawings and photos, 230 pages.

● **Lyman Reloading Handbook:** Basic ammunition book for every shooter—the reloader's bible. All reloading steps, recommended loads for hundreds of bullet designs. Articles packed with practical tips on reloading for hunting and target shooting, by gun editors of Outdoor Life, Sports Afield, Field and Stream, and other experts. Over 280 illustrations—200 pages.

See your sporting goods dealer, or order direct—each book only \$2.00 postpaid. Write to Dept. 143

RELOADING EQUIPMENT • SIGHTS • SCOPES • SHOTGUN CHOKES

Lyman

THE LYMAN GUN SIGHT CORP. WINDLEFIELD, CONN.

Superior's New Model 70 UTILITY TESTER® FOR REPAIRING ALL ELECTRICAL APPLIANCES MOTORS • AUTOMOBILES • TV TUBES

As an electrical trouble shooter the Model 70:



- Will test Toasters, Irons, Broilers, Heating Pads, Clocks, Fans, Vacuum Cleaners, Refrigerators, Lamps, Fluorescents, Switches, Thermostats, etc.
- Will test all TV tubes for open filaments, inter-
element shorts, burned out tubes, etc.
- Measures A.C. and D.C. Voltages, A.C. and D.C.
Current, Resistances, Leakage, etc.
- Will measure current consumption while the
appliance under test is in operation.
- Incorporates a sensitive direct-reading resis-
tance range which will measure all resistances commonly used in electrical appli-
cances, motors, etc.
- Leakage detecting circuit will indicate
continuity from zero ohms to 5 megohms
(5,000,000 ohms).

As an Automotive Tester the Model 70 will test:

- Both 6 Volt and 12 Volt Storage Batteries • Generators • Starters •
Distributors • Ignition Coils • Regulators • Relays • Circuit Breakers •
Cigarette Lighters • Stop Lights • Condensers • Directional Signal Systems •
All Lamps and Bulbs • Fuses • Heating Systems • Horns • Also will locate
poor grounds, breaks in wiring, poor connections, etc.

Model 70 comes complete including 64 page book, only \$15.85

SHIPPED ON APPROVAL
NO MONEY WITH ORDER—NO C.O.D.

Try it for 10 days before you buy. If completely satisfied then send \$8.85 and pay balance at rate of \$4.00 per month for 3 months — No Interest or Finance Charges Added! If not completely satisfied, return to us, no explanation necessary.

MOSS ELECTRONIC, INC., Dept. D-580
3849 Tenth Ave., New York 34, N.Y.

Please return Model 70. If satisfactory, I will pay as terms specified. Otherwise I will return tester.

Name _____

Address _____

City _____ Zone _____ State _____

All prices net, F.O.B., N. Y. C.

EASY, QUICK WAY TO SKIN FISH



... for cooking, freezing or filleting
Skin fish — don't just scale 'em. Use the time-tested Townsend Fish Skinner. Send for **FREE FOLDER**. Learn how it eliminates messy flying scales, reduces fish-cleaning time. Skins all fish — smooth or scaly, large or small. Precision-built. **Money-back guarantee.** No tackle box complete without one. Smart gift for everyone who fishes. See your dealer. If he can't supply you, send order to Townsend Engineering Co., 2447 Hubbell, Des Moines, Iowa.

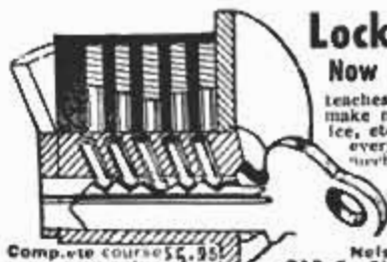

Complete course \$5.95
... now only \$3.95

Locksmithing AND KEY MAKING

Now Made Easy! Practical up-to-date course

teaches you how to pick locks, de-code, make master keys, repair, install, service, etc. New self-instruction lessons for every handyman, homeowner, carpenter, mechanic, service station operator, fix-it shop, hardware dealer, gunsmith. 53 easy illustrated lessons. Full price only \$5.95 postpaid or C.O.D., plus postage. Satisfaction or refund guarantee.

Nelson-Mail Co., Dept. CR-2
210 S. Clinton Chicago 6, Ill.



ADD UP TO 25 POUNDS of SOLID MUSCLES or you pay NOTHING

\$10 BODY MOLD course included FREE with DAN LURIE BARBELL'S. Only DAN LURIE BARBELL'S and "Body Mold" courses produce such amazing results. 15 minutes a day can make you a bigger man. Send today for details. Order now at lowest factory price.

50 lb. set \$8.98 • 100 lb. set \$14.98
150 lb. set \$21.98 • 200 lb. set \$27.98
Semisteel sets approx. 10% higher. Extra wts. 14¢ per lb. Send 50¢ cash, balance C.O.D. P.O.B. Plant, DAN LURIE BARBELL CO., 32M-2 Bristol St., Dept. 950C, Bldg. 12, N.Y.

After the city,
Before the state
The ZONE keeps your mail
From being late



The Post Office has divided 106 cities into postal delivery zones to speed mail delivery. Be sure to include zone number when writing to these cities; be sure to include *your* zone number in *your* return address — after the city, before the state.

TAKE UP SLACK TIME — MAKE EXTRA MONEY FIX SMALL AIR COOLED ENGINES

2nd Printing 3rd Edition. 12 Models Added

GET THE SMALL ENGINES SERVICE MANUAL Edited by Engineers and Professional Mechanics CONTAINS: 23 makes, 6 more than in 2nd Edition, including Lawn Boy, Lycoming and the famous Italian Vespa Scooter engine. Also British J.A.P.

NEW AUTHORITATIVE SECTIONS COVER: Gas Engine Fundamentals, Troubleshooting and servicing of ignition and carburetor equipment plus a SECTION ON TROUBLESHOOTING FOR BEGINNERS.

246 pages of practical, down-to-earth information on 2 and 4 cycle engines, 1, 2, and 4 cylinder models. Parts information on more than 17,000 items. Fit and clearances . . . over sizes and undersizes . . . addresses of Parts Distributors . . . Tool requirements. Order now. Price \$4.65. Satisfaction guaranteed or your money back. Send check or money order. Clip this.



SMALL ENGINES SERVICE MANUAL 1014 Wyandotte Street, Dept. G-1, Kansas City 5, Mo.

HOW TO GROW

ORCHIDS

AT HOME

"Most enjoyable hobby I know. People drive 100 miles to see this plant . . . 10 flowers 8 1/2 inches across."
TWO MURRY, Miss

Learn Special Conditions of Light, Temperature & Humidity Needed!

WORLD'S MOST THRILLING HONEY - PROFITABLE HOME BUSINESS SUCCESSFUL HOME GROWER offers COMPLETE illustrated instructions. Tells HOW TO START. Tells easy thing you need to know about growing Cattleyas, Cymbidiums, Dendrobiums and many others. Many Dishes GROW WITHOUT SOIL, get food from the air. Includes from include new BLOOMINGEST DRENCH PLANT FREE! Kit petals and 3 months Subscription to the "Orchidist," the "house-ho" publication for home orchid growers. WRITE TODAY! A special order form on request.

TROPICAL FLOWERLAND Dept. 313, 100 S. Vermont, Los Angeles 4, Cal



STUDY TO BE A DOCTOR of Psychology or Metaphysics

Obtain a Ps.D., Ms.D., or Ph.D. Be a Teacher, Lecturer or Accredited Practitioner. Teach others how to achieve Health, Happiness and Contentment. Chartered by State. Correspondence Courses only. Write for FREE book telling how.

THE NEOTARIAN FELLOWSHIP

Desk 8, Pickwick Building Kansas City 6, Missouri



For Many Uses!

Metal Turning Lathe

Only \$49.95

F.O.B. Lansing, Ill.

15 1/4" bed with 4 1/2" swing
7" between centers.

Satisfaction Guaranteed.

FREE FOLDER

Write for it today!

Rosemoor Manufacturing Co.
Box 147J, Lansing, Ill.

TERMITES?

GET RID OF THEM YOURSELF!

Don't pay up to \$300 and more to get rid of termites or prevent infestation. Do-it-yourself — Easily! Quickly! Inexpensively with "TERM-OUT" solution. Send 10¢ for fact-filled handbook.



COMPASS RESEARCH

701-A INVESTMENT BLDG., PITTSBURGH 22, PA.



INVENTORS

I shall be pleased to furnish you, upon request, with full information relative to patent procedure—without any obligation on your part.

PATRICK D. BEAVERS

Registered Patent Attorney

934 Victor Building

Washington 1, D.C.

MARCH 1959



POWERHOUSE German TELESCOPE!

225 TIMES BIGGER AREA! 5 SYNCHRONIZED LENSES
75,000 people gladly paid \$4.98—now price slashed to only \$2.98—while our supply lasts. The Powerhouse is new and excitingly different. Most low cost telescopes use 2 lenses—but the new Powerhouse uses 5—yes, 5 synchronized Rothlar lenses—all ground and polished with meticulous care. They are not glued, but anchored in sturdy steel rings. The draw tubes are heavy duty metal. All this means greater power and greater clarity . . . far greater range than you ever dreamed possible. And you get no blur, no cloudiness, no distortion, thanks to the 5 lens system that develops a 225 times area magnification.

When first you look through your Powerhouse, you will gasp with disbelief at the wonders it reveals. Yet it is true—so very true! The distant

worlds and towns, the people and natural views are real and the amazing Powerhouse draws them closer! Far closer than a deluxe 7 x 50 binocular costing \$250 can ever do. Imagine it—you get a 225 times greater area. You smash thru space barriers. Examine the new Powerhouse, try it by night or day; enjoy it for 10 days—without risk or obligation of any kind. Explore the heavens on a clear night. It must thrill and satisfy you in every way. Otherwise, return it after the 10 day period.

RUSH ORDER NOW

Save 40%—rush your order now. Remember: We reserve the right to refuse orders received after this sale. Powerhouse Telescopes make wonderful gifts. Order for self and for gift giving.

No. 430 Telescope \$2.98

75,000 Sold at \$4.98



Sold Only By Mail
Only By Thoresen's
585 Water Street, New York 2, N. Y.

THORESEN, Inc., Dept. 6-C-430
585 Water Street, New York 2, N. Y.

Rush Powerhouse German Telescope at REDUCED price of \$2.98. My money back if I'm not satisfied.

Check, cash, m.o. enclosed.
 Send postage paid.

Send COD plus fee & Postage (enclose \$1 deposit).

Print Name _____
& Address _____

ENGINEERING

DEGREE IN 27 MONTHS

Students given option of studying engineering under accelerated program leading to Bachelor of Science Degree in 27 months; or the standard four-year program leading to Bachelor of Engineering Degree in 36 months. The B.S. degree in Mathematics, Chemistry, or Physics (including Nuclear Physics) may be earned in 36 months. By attending classes year-round, students can graduate in 3 years and have one year of experience and income in the time usually needed to complete a four-year college course. Preparatory courses. Thorough, practical program. Individualized instruction.

Keeping pace with progress in science and engineering
Campus, Dorms, gym, playing fields. Superior faculty, 2,000 students. New Dana Science Building. Low tuition. Earn board G.I. approved. Enter March, June, Sept., Dec. Students from 48 states, 40 foreign countries. Send coupon for free catalog, full information. Enroll now!

INDIANA TECHNICAL COLLEGE

539 E. Washington Boulevard, Fort Wayne 2, Indiana
Please send me free information on 27 mo. B.S. DEGREES in:

Aeronautical Chemical Civil Electrical
 Mechanical Electronics

on 36 mo. B. E. DEGREES in:

Aeronautical Chemical Civil
 Electrical (Power or Electronics) Mechanical Metallurgical

on 36 mo. B.S. DEGREES in:

Mathematics Chemistry Physics

Name _____

Address _____

FLY YOUR OWN Bensen HELICOPTER

Simple to fly — build it yourself, with engine or as inexpensive glider type which can be mounted on floats or boat. Order 3-

view drawing, specs and photo of Glider for \$1 or motor powered Gyro-Copter \$2. Building plans and kits also available.

Send \$1 or \$2

BENSEN AIRCRAFT CORP., Dept. PM-39
P.O. Box 2746, Raleigh, N. C.

Name _____

Address _____



PRICE REDUCED on .22 CAL. GERMAN AUTOMATIC PISTOLI

\$6.98 and \$7.98 elsewhere—our price only \$4.99! Famous .22 cal. German 6-shot repeater. For fun, sports, protection against prowlers. Fires only blanks. No permit needed. Self-ejecting clip. Safety catch. Cleaning brush. Deluxe handle, 4 inches long. Shipped anywhere except to N. Y. & Calif. Shipped Railway Express Collect. Money back guarantee. Order direct from importer.

4.99

THORESEN, Inc., Dept. 6-C-1110 585 WATER STREET, NEW YORK 2, N. Y.

AVIATION CAREER

SPECIALIZED EDUCATION / PROFESSIONAL TRAINING... only 16 months to 2 years

Top-pay prestige positions, bright future in aviation. Job opportunities waiting for you as soon as you're ready. Airframe and Powerplant Technician, Aeronautical Engineering Technologist, Business or Executive Pilot. Classes in Miami.

SEND FOR FREE 48-PAGE BOOK

Embry-Riddle Aeronautical Institute
Dept. B Miami, Florida (Founded 1926)

Name _____

Address _____

City _____ Zone _____ State _____

The Most Fascinating Book About the Automobile Ever Printed!

Popular
Mechanics

AUTO ALBUM

The Motor Car in Picture
and Story from
1769 to 1952



You'll Find...
the Answers... the Fascinating Stories...
in the AUTO ALBUM

Who built the first horseless carriage?
Who obtained the first U.S. patent on an automobile?
Where did the name "automobile" come from?
Are you familiar with the workings of the Stanley Steamer... the "electric" ... the famous Ford Model T?

Do you know when the first Indianapolis race was won... by whom... at what speed?
Do you know the story of Henry Ford, Barney Oldfield, Ransom Olds, Walter Chrysler, W. C. Durant and other automotive giants?

**166 Illustrations Including
94 Old-Time Cars — 22 Auto
Ads of By-Gone Days!**

Here is a book you can't help enjoying and wanting, whether or not you have, or ever will own, an automobile. It is the fascinating, thrilling and informative story of the horseless carriage from the first gasoline-propelled buggy to a forecast of the atomic car of the future.

Popular Mechanics AUTO ALBUM by Throm and Crenshaw presents America's first cars and the pioneering men who made them; the scrambled start and the development of the fabulous auto industry; the story of automobile racing; the growth of the Nation's highways. It is a book that just had to be published.

**To Read... to Enjoy...
to Remember!**

More than one-half of the book is pictures, most of them action pictures, from photos of old-time cars in operation. Other pictures show race cars from 1911 to 1951; early auto advertising, picturing 32 cars priced from \$375 to \$6000; tri-cycle autos, wind wagons, auto cycles and other automotive oddities. A roll call of horseless carriages is included — the names of more than 2000 cars made in the United States.

Gift Book of the Year

Get the fascinating AUTO ALBUM for yourself today. Send it as a gift to friends and business associates. Order on coupon below. Money refunded if you are not entirely pleased.

Cloth
Binding



Use Coupon to Get AUTO ALBUM

POPULAR MECHANICS PRESS, 200 E. Ontario, Chicago 11

Send at once postpaid _____ copies of Popular Mechanics AUTO ALBUM at \$3.50 each. Remittance enclosed. Send COD. I will pay postman plus charges. I understand books are returnable in 7 days for full refund if I am not pleased.

Name _____

Address _____

City _____ Zone _____ State _____

LEARN MEAT CUTTING AT NATIONAL

Pay After Graduation



The steady dependable trade of Meat Cutting taught easily in 8 short weeks. YOU LEARN BY DOING under actual meat market conditions in big modern school at Toledo.

For beginners or men with experience. Get a profitable store of your own. Remember, PEOPLE MUST EAT! Big pay jobs. Free employment help. Thousands of successful graduates.

Buying, cutting, percentage, pricing, advertising, selling, etc. A complete retail meat education. National School established 36 years. Get National training NOW. Pay your tuition in easy weekly

payments after you graduate. Send coupon for FREE school catalog — TODAY. G.I. approved.

National School of Meat Cutting, Inc., Dept. 50-P, Toledo 4, Ohio

Send me your FREE school catalog on National Training at Toledo in Meat Cutting, Meat Merchandising and Self Service Meats. No obligation. No salesman will call.

Name _____ Age _____

Address _____

City _____ State _____

Approved for Veterans

DO YOU WANT HELP FOR A MORE PROSPEROUS FUTURE?

by A. J. ABARSI

Is job insecurity one of your major problems? Has your life been filled with a series of unsuccessful attempts to get out of a rut? Are your cash reserves low, are you facing worrisome debts? Do your desires for your family and for yourself end up at a brick wall? Then, probably at this very minute, like thousands of others, you're at a crossroads in your life, and you don't know where to turn.

GET OUT OF THE RUT!

Consider the life of a manufacturer. The manufacturer is the one who makes the very first, the surest profit on any product. It's the manufacturer who states who is to be hired and who is to be fired. He's the one who sets costs, who makes up sales policy and who says who may and who may not sell his goods. No matter where he goes, he has the admiration and the respect of his fellow man. He is a solid citizen with success in his background and security in his future.

However, to the average person, manufacturing brings up pictures of huge industrial plants with smoking stacks and with thousands of employees. Yet, recent figures from the Department of Labor and the U. S. Chamber of Commerce reveal that the total amount of small manufacturers, with limited facilities, still makes them the dominant factor on the American Industrial Scene.

Perhaps the thought of becoming a manufacturer never crossed your mind. You could think only of a big investment, a specialized knowledge of the technique of manufacturing, big weekly payrolls, lots of money tied up in equipment and tools. Even before you investigated the field of manufacturing, you thought that it was not for you.

TAKE THE RIGHT CROSSROAD!

There is a wide open field in one particular phase of manufacturing which you can enter immediately. You'll need no costly plant or factory. Your inventory can be held down to a bare minimum. You probably already own the required tools. AND THE KNOWLEDGE THAT YOU NEED TO ENTER THIS SPECIALIZED FIELD OF MANUFACTURING CAN BE ACQUIRED QUICKLY WITH ALMOST NO EFFORT ON YOUR PART!

Still more important, within weeks, you'll be in a position to fill orders that will come to you . . . but you need to spend no money on advertising, because advertising on a National Scale is already in force. You can have a sales staff anxious to turn business over to you. You'll have access, at no cost, to every possible aid and assistance that you'll ever require. Within a short while you'll be the manufacturer of products that have a ready market because the users of the products which you will be making welcome your services—services that are unobtainable in 97% of all communities except the largest of cities—if you can find them!

But there is still one more point that must be stressed. You can start manufacturing right now, in your home—in your garage, your attic, even in your kitchen. AND YOU CAN START IN YOUR SPARE TIME. There is no need, no necessity for you to leave your present job. Keep on earning your regular salary, but make extra

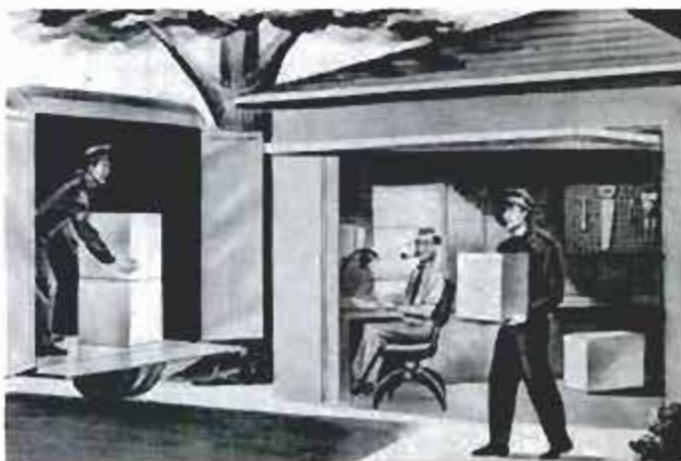

money in your spare time until you decide that the security and the success that you and your family so richly deserve will come solely from full-time manufacturing.

STOP RUNNING DOWN BLIND ALLEYS

Surely you want to know a great deal more about this opportunity that is now within your grasp. Fill in the coupon and mail it. By acting now, you will have a chance, within days, of seeing how you, too, can become a manufacturer. You will see all the facts which will help you to make up your own mind. At your own convenience, at your leisure, and without obligation, you will determine for yourself whether or not you are fitted to move up in society.

A. J. Abarisi
807 Sunset Blvd., Dept. A-3, Los Angeles, Calif.

Certainly, Mr. Abarisi, I'm interested in knowing how I can improve both my financial and my social standing by becoming a manufacturer. Please send me FREE, and with no obligation on my part, all the information.

NAME _____

ADDRESS _____

CITY _____ ZONE _____ STATE _____

UNUSUAL TELESCOPE BUYS.

See the Stars, Moon, Planets Close Up!
3" ASTRONOMICAL REFLECTING TELESCOPE

60 to 160 Power — Famous Mt. Palomar Type! An Unusual Buy!
 Assembled—Ready to use! You'll see the Rings of Saturn, the fascinating planet Mars, huge craters on the Moon, Star Clusters, Moons of Jupiter in detail, Galaxies! Equatorial mount with lock on both axes. Aluminized and overcoated 3" diameter high-speed f/10 mirror. Telescope comes equipped with a 60X eyepiece and a mounted Barlow Lens, giving you 60 to 160 power. Low-cost accessory eyepiece available for higher powers. An Optical Finder Telescope, always so essential, is also included. Sturdy, hardwood, portable tripod. Valuable STAR CHART and 272-page "Handbook of Heavens." Stock No. 85,050-H. \$29.95 postpaid



KNOW THE TRUTH about power. Telescope experts will confirm that an Astronomical Telescope will only give you practical powers to about 50 or 60 times per inch of objective diameter—powers above this only produce empty magnification—make viewing dim, difficult and unsatisfactory.

4 1/4" ASTRONOMICAL TELESCOPE! UP TO 270 POWER!

With this scope you can see everything as above but with greater power plus will pick finer stars. Mirror has twice the light gathering power. Mirror guaranteed to give theoretical limit of resolution. Rack and pinion focusing, hardwood tripod, real equatorial mounting—only one adjustment follows stars. Aluminum tube. 4 1/4" power finder telescope. 2 standard size eyepieces and mounted Barlow lens give you powers of 40X, 90X, 120X, and 270X. Low-cost accessory eyepiece available for higher powers. Free handbook and Chart. Shipping weight 25 lbs. Stock No. 85,006-H. \$74.50 f.o.b.



WRITE FOR FREE CATALOG "H"!

Complete Line of Astronomical Telescope Parts and Assembled Telescopes. Also huge selection of lenses, prisms, war surplus optical instruments, parts and accessories. Telescopes, microscopes, Hand Spectroscopes, Sniperscopes, binoculars, etc. Request Catalog "H"!

ORDER BY STOCK NUMBER SEND CHECK OR MONEY ORDER SATISFACTION GUARANTEED
EDMUND SCIENTIFIC CO., BARRINGTON, N. J.

PREPARE FOR BETTER JOB, BIGGER PAY IN SPARE TIME AT HOME

Today, choose the job you want—and prepare for it in time you might otherwise waste. Or if you are already in the work you like best, start training now for quicker promotion and increased pay. During the past 62 years AMERICAN SCHOOL has helped ambitious people to reach higher goals. Check subject that interests you and mail coupon for full information.

AMERICAN SCHOOL, Dept. G345, Drexel at 58th, Chicago 37, Ill.

Without obligation, please send FREE and postpaid, full particulars about the subject checked below.

<input type="checkbox"/> Accounting <input type="checkbox"/> Apprenticeship Courses <input type="checkbox"/> Architecture & Building <input type="checkbox"/> Automotive Technician <input type="checkbox"/> Better Foremanship <input type="checkbox"/> Blueprint Reading <input type="checkbox"/> Bookkeeping <input type="checkbox"/> Business Management <input type="checkbox"/> Civil Engineering	<input type="checkbox"/> Contracting <input type="checkbox"/> Diesel Technician <input type="checkbox"/> Drafting—Building <input type="checkbox"/> Drafting—Machine <input type="checkbox"/> Electrical Engineering <input type="checkbox"/> Electricity—Practical <input type="checkbox"/> Electronics—Industrial <input type="checkbox"/> HIGH SCHOOL COURSES <input type="checkbox"/> Machinists	<input type="checkbox"/> Mechanical Engineering <input type="checkbox"/> Mechanical Technology <input type="checkbox"/> Metalworking Courses <input type="checkbox"/> Plumbing—Practical <input type="checkbox"/> Private Secretary <input type="checkbox"/> Retail Merchandising <input type="checkbox"/> Salesmanship—Outside <input type="checkbox"/> Sheet Metal Work <input type="checkbox"/> Tool Making	TRADES <input type="checkbox"/> <input type="checkbox"/> <input type="checkbox"/> <input type="checkbox"/> <input type="checkbox"/> <input type="checkbox"/> <input type="checkbox"/> <input type="checkbox"/> <input type="checkbox"/> <input type="checkbox"/>
NAME _____ OCCUPATION _____ HOME ADDRESS _____ CITY _____ STATE _____ AGY _____ Accredited Member NATIONAL HOME STUDY COUNCIL			

MAIL COUPON NOW



TOOLS WHOLESALE

\$100 PUTS YOU IN BUSINESS

Start your own business, sell tools to your friends and neighbors, or buy tools for your own use and SAVE MONEY \$\$\$

A MILLION DOLLAR INVENTORY AT YOUR FINGERTIPS. NO STOCK TO CARRY. ORDER AS YOU NEED IT.

Send \$1. for Tool Catalog today. BUY AT WHOLESALE PRICES. Extra \$25.00 profit on your accumulated purchases. \$1.00 is refunded if you are not 100% satisfied with our offer.

THOUSANDS!! of Nationally Advertised items of Hand Tools, Power Tools, Machinist Tools, Tool Chests, Paint Sprayers, Light Fixtures, Appliances, Guns, Gifts, Toys and other items too numerous to mention.

WE SHIP COAST TO COAST Wholesale Discounts up to 50% OFF

SILVO HARDWARE CO., Dept. PM-3 107 Walnut St., Phila. 6, Pa.



\$ POPULAR MECHANICS MEANS MORE MONEY IN YOUR POCKETS

POPULAR MECHANICS, the magazine that brings you money-saving ideas now brings you a perfect money-making opportunity.

We are looking for more men and women to introduce our magazines in their neighborhood. to accept orders for Popular Mechanics and other leading publications. If you have been looking for a way to earn a little extra each week—here's the answer!

No waiting for payday. you pocket your earnings right away! No experience necessary. you work when you please. as much as you please. your home is your office. and you are your own boss!

YOU CAN EARN \$10.00, \$25.00, \$50.00 right away with our new Popular Mechanics Subscription Plan. SEND NOW!

Popular Mechanics Dept. 359-B
 250 West 55th St., N. Y. 19, N. Y.

Please send me your subscription plan!

Name _____
 Address _____
 City _____ Zone _____ State _____

"ALL ABOUT BOATS"



A New PM Book to Help you Build, Sail, Maint-in and Enjoy the Boat You've Always Wanted

Now enjoy the pleasures of hunting, fishing, swimming and skin diving as never before—complete with your own beautiful boat! This new PM book makes it all possible—how to build the boat of your choice easily, accurately and quickly—even with few tools and little experience! Contains five different designs. Everything is completely planned for you, from forming of the keel to the last coat of varnish and paint. All you do is follow simple step-by-step instructions and show-how photos and drawings, with full materials list and helpful building hints. In addition, you become an expert on all phases of boat styles, operation and maintenance, seamanship, safety and weather. This book is by far the most complete, authoritative manual on boats and boating ever compiled at this low price. Your money back if not pleased. Send for your copy today, only.....

\$2.95

- Sec. 1—Types: outboard cruisers and utilities, inboards, sailboats, etc.
- Sec. 2—How and whether to buy or build
- Sec. 3—Motors, inboard and outboard; how to buy
- Sec. 4—Plans: 11' 6" skiff, 15' outboard utility, 20' cabin cruiser, 15' sailboat, 13' outboard runabout
- Sec. 5—Seamanship, boat handling
- Sec. 6—Boat care and maintenance
- Sec. 7—Motor care and repair
- Sec. 8—How to get the most fun from your boat

POPULAR MECHANICS PRESS, Dept. 359
200 E. Ontario St., Chicago 11, Ill.

NEW! Completely UP-TO-DATE!

Manual for PLYMOUTH OWNERS



COVERS ALL MODELS 1941 to 1957. Gives you more from your Plymouth for less. So accurate mechanics can use it... so simple a woman can understand it

Now fix it yourself and save money on Plymouth repairs. With this Popular Mechanics book you prevent trouble... enjoy care-free driving... increase trade-in value... get sparkling performance... and avoid major repairs by fixing minor troubles before they get serious. Not just a re-hash of service manuals, but a completely updated version of the famous 1950 PM book written by automotive expert Ed Paetzer, with the assistance of the Chrysler Corporation. Covers latest Plymouth features: power brakes, torque bar suspension, automatic transmission, tubeless tires, air conditioning, etc. Motor specifications are given for all models 1941-57. Contains 272 pages, more than 350 photos, diagrams, tables, charts, breakdown drawings, plus clear, non-technical directions that make all repairs as simple as ABC. Shows you how to diagnose troubles by feel, sound, sight, smell and performance.

MONEY BACK IF IT DOESN'T SAVE MORE THAN IT COSTS!

One minor repair will save the cost ten times over. Read it. Then you decide. If you don't see that you'll save more than the cost, send it back for refund. **SEND NO MONEY.** Send postcard. Ask for PLYMOUTH Manual. Postman will deliver C.O.D. for \$3.95 plus postage. Or, save postage by sending \$3.95 with order. Save its cost on your next repair. Send today.

POPULAR MECHANICS PRESS
Dept. 359, 200 E. Ontario St., Chicago 11, Illinois



YOU BRIGHTER FUTURE IN AUTO MECHANICS AND DIESEL



Your spare time pays off **BIG** with our world-famous **SHOP TESTED** Home Training



MAKE YOUR FUTURE AS BRIGHT AS THEIRS

In a matter of months, you can quit your no-future job for a big-pay, big-future career as an Auto-Diesel Mechanic. Free Illustrated Book gives you the facts. Send coupon below. No Obligation. No Salesman will call.

All Phase Training

N. T. S. students become skilled, all-around mechanics. Crystal-clear lessons. Shop-Tested manuals, real professional equipment, make it easy to learn. Big equipment kits, yours to keep. Earn as you learn... we show you how. Graduate Advisory Service.

N.T.S. Training is Better, More Complete. Lower Cost BETTER...

Because training is **SHOP-TESTED** in Resident School Shops & Labs. **MORE COMPLETE...** You learn all phases of Auto Mechanics & Diesel. **LOWER COST...** One low tuition covers entire cost of course and all equipment.

Unlimited Opportunities

Trained mechanics make top money... are in demand at dealer shops, garages, large bus and truck lines, construction projects, government labs, factories, and many others.

YOU GET AND KEEP ALL THIS PROFESSIONAL EQUIPMENT



Motor Analyzing Set



Socket Wrench Set



NATIONAL TECHNICAL SCHOOLS

WORLD-WIDE TRAINING SINCE 1905
4000 S. FIGUEROA ST., LOS ANGELES 37, CALIF., U. S. A.

FREE!

Illustrated Fact Book & Actual Lesson

Mail coupon now.

Complete TV-Radio Electronics training also available

RESIDENT TRAINING at Los Angeles!

If you wish to take Resident Training at Los Angeles, in our Big, Modern Shops & Labs, check special box in coupon for full information.

NATIONAL TECHNICAL SCHOOLS

WORLD-WIDE TRAINING SINCE 1905

MAIL NOW TO
NATIONAL TECHNICAL SCHOOLS, Dept. DB-39
4000 S. FIGUEROA ST., LOS ANGELES 37, CALIF.
Send for FREE Auto-Diesel Opportunity Book and Actual Lesson.

NAME _____ AGE _____

ADDRESS _____

CITY _____ ZONE _____ STATE _____



Member





PAY 1¢ on the DOLLAR for 1000's of Useful Items U.S. GOV'T SURPLUS

LOOK AT THESE LOW PRICES

Jeeps . . . \$223 Tractors . . . \$68
Trucks . . \$212 Motors . . . 99c
Boats . . \$5.90 Airplanes . . \$366
Fork-lifts, \$197 Typewriters, \$6.80
Hydraulic cylinders \$1.01 • Gear
Reducers 97c • Transmissions \$7.80
-Paid at Govt. Surplus Sales

Eliminate the middleman—Save big money! Buy direct from U. S. Government at TREMENDOUS savings. Pay as low as 1c on the dollar or less. Our Directory Govt. Surplus Sales lists 100's of Army, Navy, Air Force, and other government surplus depots. Many of them right in your own back yard. Buy sports equipment, hunting, fishing and photographic equipment and supplies, radio, electronic and electrical equipment, trucks, boats, jeeps, airplanes. Plumbing, hardware, office equipment supplies, Power tools, machinery, furniture. Directory is indexed for quick information. Answers your questions. Tells you how to buy. Get on the gravy train while you can. Send \$1 for "Govt. Surplus Directory" to— Aviation Surplus, Dept. PM-3, Box 789, York, Pa.



Become A . . . BUILDING CONTRACTOR! MAIL COUPON for FREE BROCHURE

Simplified home study training program. Learn every phase of building, estimating, contracting. Fortunes are made in this line of work every year. Use spare hours—no interference with present work. Diploma awarded. Low tuition rates

AMERICAN TECHNICAL SOCIETY
Dept. BH-39, 850 E. 58th Street, Chicago 37, Ill.

Please send me your FREE Brochure and full details of your building, estimating and contracting training program.

Name _____ Age _____

Address _____

City _____ State _____



LEARN UPHOLSTERY

in your spare time
run your own
business
AT HOME



FREE BOOK
with
sample
lessons

with course

YOU MAKE
SLIPPER
CHAIR



PLUS
SLIP COVERS
Yours to Keep
or Sell

BE YOUR OWN BOSS

Earn more from the start! Set up your own profitable business, in your own home, enjoy steady income, independence for life. You're in demand—in good times and bad—in the booming field of Custom Furniture Upholstery. Right off you start learning and earning with tools, complete frames, fabrics and materials, included FREE with N. Y. State-approved UTS course. You learn skilled professional custom upholstery, reupholstery, furniture finishing, repairs, how to make beautiful slip covers, cushions and draperies. EARN WHILE YOU LEARN, in your spare time AT HOME... the UTS easy way.

FREE ILLUSTRATED BOOK - FREE SAMPLE LESSON

Get ready for well-paid job and big profits, from steady work, as your own boss, running your own business. Mail coupon NOW for FREE BOOK! Training in N. Y. School also available.

APPROVED FOR VETERAN TRAINING

UPHOLSTERY TRADES SCHOOL
Dept. HC-310, 721 B'way, N.Y. 3, N. Y.

Please send me FREE book, "Your New Way to a Successful Career," and FREE sample lesson. No obligation—no salesman will call.
 Home Study Training in N. Y. School

Name _____ Please Print Plainly

Address _____

City _____ Zone _____ State _____

Check if Korean Veteran

GUARD YOUR FAMILY FIGHT CANCER WITH A CHECKUP AND A CHECK

AMERICAN CANCER SOCIETY

start a big profit business
with a small investment
EARN UP TO
\$200 a DAY

Manufacturing Exciting New RAINBOW ROCK Concrete Slump Brick in your back yard

Earn big building boom profits with Rainbow Rock, the colorful new building brick that's taking the country by storm. Sell all you can make to contractors, builders, building supply houses. RAINBOW ROCK CUTS LABOR COSTS BY 1/3! Amazing low cost machine makes modern slump brick 24" long (3 times the length of ordinary brick) in a variety of widths and pastel colors . . . up to 1500 bricks a day! NEEDS NO SPECIAL SKILL. Operates indoors or out. Full instructions and valuable mixing formulae supplied. YOU CAN START EARNING BIG MONEY NOW. PAY AS YOU PROFIT! A limited number of machines available on easy payment terms. NOW is the time to start. Write today for free literature and full information.

GENERAL ENGINES CO., INC.
Dept. MR-39 — Route 130,
Thorofare, N. J. - Tilden 5-5401



STEEL PIER SENSATION
Luxurious RAINBOW ROCK fireplace wall in living room of the "Home of the Century" in Atlantic City, N. J.'s Steel Pier... acclaimed by over 500,000 Summer, 1953 visitors as the most beautiful they'd ever seen! Endorsed by the Pier's famous architect, William F. B. Koelle.



Makes beautiful, decorative fences, garden walls, garages, outside walls, room separators, etc.

Amazing HOLESAW saws any shape hole

FITS ALL
1/4 INCH
DRILLS

\$1
ONLY

Insert this amazing Hole Saw in chuck of your 1/4-inch power drill. Bore thru material as usual with steady, easy pressure. Enlarge the hole by moving this hole saw in widening circles. You saw ANY shape hole with full saw stroke and just light pressure. Easily bores thru wood, plastic, plaster, plywood, etc. Cuts circles, triangles, zig-zags—in fact, any shape you may dream up—in SECONDS. Fine quality alloy steel gives long service. Send \$1 for prompt delivery. Satisfaction guaranteed or money back. Over 250,000 sold! Get yours now!



THORESEN, INC.
Dept. 6-C-42
585 Water St.
New York 2, N.Y.

\$1 BRINGS YOU \$18

Discover Flok-Kraft and Earn \$\$\$\$\$ AT HOME

Earn up to \$15.00 per hour spare time. Amazing new Velvet-fiber spray instantly makes any object (Lamps, Radio & TV Cabinets, Figurines, Signs, Auto dash boards, toys, furniture, draperies—anything) worth expensive \$\$\$\$\$ Prices . . . like magic, you can spray anything with this beautiful new suede-like finish that feels like rich Velvet.

EARN UP TO \$300.00 PER WEEK SPARE TIME

Imagine, materials cost only 1/2¢ per square foot. (Average TV or radio cabinet can be beautifully sprayed with this startling new 3-dimensional Velvet finish in 15 minutes at a cost of only 3/4¢ in materials. Your charge for this job is at least \$10.00.)

REPRESENTATIVES IN YOUR AREA URGENTLY NEEDED

Own your own business. Work at home in your spare time. Help fill the huge growing demand for this amazing new beautiful Velvet-fiber finish. Orders come from stores, offices, homes, architects, auto dealers—everywhere. Possible \$25,000,000.00 worth of jobs to be done. Investigate today—be first in your area! Actual samples in 16 Radiant Colors. Booklet of 50 Home Business Opportunities and Confidential Details all sent free! Send No Money. Write: Coast Industries, Los Angeles 61, Calif., Dept. B-3.

FORTUNES IN DIVING Train at Home in Spare Time

Write Today for Amazing Free Booklet

Here is one of the greatest opportunities of our time. Make big money fast in Skin and Lung Diving. Trained divers needed in hundreds of industries and by government. Build a successful business of your own. Hourly rates among highest paid in any field. Training program by E. R. Cross, world famous master diver. Get the facts now. Mail coupon for FREE BOOKLET TODAY!

DIVEMASTER, Dept. PM-39
5637 W. 63rd Place, Chicago 38, Ill.

Send me free information about Diving.

Name _____ Age _____

Address _____

City _____ State _____

TRAIN AT HOME

in Your Spare Time or in
the Great Allied School

1338-42 South Michigan Ave.
Chicago 5, Ill.

DRAFTING—All Branches
• Mech. • Structural • Aeronautical

ENGINEERING
• Industrial Engineering
• Tool Engin. & Designing

ELECTRONICS

AUTO MECHANICS

AIR CONDITIONING
Refrigeration — Heating & Cooling

TOOL & DIE MAKING
Machinist Trade

Choose the
Allied Way for Best Pay

SEND FOR
FREE
BOOKS

Prepare for the best jobs in your spare time at home. With ALLIED'S practical home study program you can progress so rapidly that big new opportunities will soon be open to you. Students planning a career in engineering can begin their training in short courses at Home or at Allied Institute and continue progressively toward an Engineering Degree in 31 months. Allied is approved by Industry, National Home Study Council, Department of Education, Office of Public Instruction, State of Illinois, U. S. Department of Justice.

ALLIED INSTITUTE OF TECHNOLOGY,
1338-42 South Michigan Ave., Dept. PM-39, Chicago 5, Ill.

Send me without obligation information on your courses:

- | | |
|-------------------------------------------------|--------------------------------------------|
| <input type="checkbox"/> MECHANICAL DRAFTING | <input type="checkbox"/> AUTO MECHANICS |
| <input type="checkbox"/> STRUCTURAL DRAFTING | <input type="checkbox"/> ELECTRONICS |
| <input type="checkbox"/> AERONAUTICAL DRAFTING | <input type="checkbox"/> AIR CONDITIONING |
| <input type="checkbox"/> INDUSTRIAL ENGINEERING | <input type="checkbox"/> REFRIGERATION |
| <input type="checkbox"/> TOOL & DIE DESIGNING | <input type="checkbox"/> TOOL & DIE MAKING |
| <input type="checkbox"/> HOME STUDY | <input type="checkbox"/> RESIDENT |
| <input type="checkbox"/> VETERAN | <input type="checkbox"/> NON-VETERAN |

NAME _____ AGE _____

ADDRESS _____

CITY _____ COUNTY _____ STATE _____

YOUR NEIGHBORHOOD NEEDS AN ELECTRICAL APPLIANCE



TROUBLE SHOOTER

Men needed to repair and service all kinds of Electrical Appliances—AUTOMATIC WASHERS - DRYERS - IRONS - VACUUMS - TOASTERS - REFRIGERATORS - FANS - HOME FREEZERS - AIR CONDITIONERS —home and industrial motors, etc.—also home and industrial wiring.

Big, Year-'Round Profits!
HELP US FILL HUGE DEMAND

MODERN BIG PROFIT ONE-MAN BUSINESS YOURS AT HOME — SPARE OR FULL TIME.

No previous experience needed. New, visual "Shop-Practice" method quickly shows you how. Hundreds of plain-as-day "How to" photos and drawings make it easy. A corner of garage, porch, attic, or basement is all the space needed. No costly leases—no big overhead. We show you how to make business come to you.

NEW 30-DAY INCOME PLAN!

Shows you how to start your own Big Profit Business without investment—no big overhead

Send for this FREE BOOK! AIR MAIL COUPON NOW!



BIG MONEY, SECURE FUTURE—INDEPENDENCE.
F. V. in N. Y. says, "I made \$800 in 3 months while studying." T. E. H. in W. Va. says, "Made \$14 a day while learning."
EVERYTHING FURNISHED—including BIG TOOL KIT Instructions are complete and include a Tool Kit and Appliance Tester. Everything furnished to help you build your own big-profit business at home. Our new 30-day income plan shows you how to start making money almost at once. Send no money—just your name and address on coupon below. I will rush you FREE complete success plan with full details. Do it NOW—BE FIRST!

PACIFIC TRAINING SCHOOL, Dept. PM593
11029 So. Vermont Ave., Los Angeles 44, Calif.

PACIFIC TRAINING SCHOOL, Dept. PM593
11029 So. Vermont Ave., Los Angeles 44, Calif.

Gentlemen: Rush me postpaid your FREE plan for success in the Appliance Repair Business and the Free Book Entitled "The Appliance Repair Business and You" and remember I am under no obligation.

Name _____
Address _____
City _____ Zone _____ State _____

AMAZING NEW PERSONAL POCKET RADIO



GUARANTEED—FOR YOUR LIFE!
FOR AS LONG AS YOU OWN IT! NO TUBES, BATTERIES, TRANSISTORS OR ELECTRICAL PLUG-INS NEEDED! Will never run down or burn out! SMALLER THAN A PACK OF CIGARETTES! RECEIVES LOCAL RADIO STATIONS—ANYTIME—ANYWHERE YOU GO! Easy thumb tuner. NO DANGLING EARPHONES. HAS BUILT-IN SPEAKER PHONE! Black gold plastic cabinet, semi-conductor wave detector. NOT IMPORTED. MADE

AND GUARANTEED BY AMERICANS—You can always get service, (thru, OK, mail) and pay postman \$4.00 C.O.D. postage on arrival or send \$6.00 for postpaid delivery. SENT COMPLETE READY TO LISTEN WITH LIFE GUARANTEE—NOTHING EXTRA TO BUY EVER! FREE LONG DISTANCE ANTENNA if you order now. Available only from MIDWAY COMPANY Dept. WPM-3 KEARNEY, NEBRASKA

WHAM-O AUSSIE BOOMERANG Special 98¢



Exciting Sport **98¢** postpaid
GUARANTEED TO RETURN
NO SPECIAL SKILL REQUIRED Terrific fun to throw! For young and old alike. Scientific airfoil design makes it return unfaillingly. Crafted from tough plastic. 15 inches across. Practically indestructible. At dealers or send to: WHAM-O MFG. CO., Box 17-E, San Gabriel, California

The skilled hand of the German gunsmith is responsible for this .22 caliber, 6-shot repeater automatic with self-ejecting clip. Just 4" long, fits easily into pocket or purse. Ideal for sporting events, stage use.



(Not available to California residents.)
Comes for \$6.95 ppd. from **BEST VALUES**
Dept. G-511, 403 Market, Newark, New Jersey

CHEMISTRY

FREE Earn DIPLOMA in less than a year! Chemistry, Physics, Science, Mathematics, Microscopy and 30 other courses! Send for free catalog. **FREE COURSES TO ELIGIBLE STUDENTS!**
NATIONAL SCHOOL OF CHEMISTRY
Dept. A, P.O. Box 606, Redwood City, Calif.



SAVE WITH DIRECT MAIL

Shop PM's pages for money-saving direct mail offers



180 amp. "HUSTLER" is easy to operate—even for beginners, yet its performance delights the most experienced operators. It's a complete welding package Start a profitable business of your own (including accessories) that welds, cuts, burrs holes, hard surfaces, and heats metal for bending and forming. And it meets REA requirements.

There's **BIG MONEY** in ARC WELDING Start Today!

200 amp. "POWER/WELD" supplies both power and DC welding current simultaneously. This low cost unit is the only one of its kind. It lets you use all types of Gas drive...welds anywhere! Runs tools! electrodes to weld, and at the same time run lights, tools, motors, pumps, sprays, etc. Can also be used as emergency power unit.



HOBART BROTHERS COMPANY, BOX M-39, TROY, OHIO, Ph. FE 2-1223

**WORLD'S
BEST
WANT-AD
MEDIUM**

CLASSIFIED ADVERTISEMENTS



Advertisements in this section \$1.25 per word, each insertion, minimum 10 words, payable in advance.

To be inserted under proper classification, copy must be in our office the

20th of the second month preceding date of issue

F. W. Johnson, Manager, Classified Advertising

Popular Mechanics Magazine, 200 East Ontario Street, Chicago 11, Illinois

YOU'LL PROFIT

By reading and answering the classified ads in this section. Hundreds of opportunities for you to make and save money

AUTOMOBILES, MIDGET CARS

HUNDREDS Of automobile catalogs—American, antique, foreign; dealer books, glossy photographs, shop manuals; free motor magazines listed by non-profit organization. Write immediately; get on free mailing list. Auto Maniacs, Stockbridge, Mich.

TEN Complete illustrated automobile driving lessons prepared by Automobile Driving Aids, Inc., Box 6A, Turtle Creek, Penna. \$1.00, no c.o.d.'s.

MIDGET Car. Plans and pricelist of parts 35¢. B. Sypher Co., Sta. P., Toledo, Ohio.

NEW 1959 Automobiles—To 25% off retail. Meder, 550-PM Fifth Avenue, New York City 36.

HOT Cart racer—\$129.00 up. 2 to 4 hp. Wheel options. Free folder. Dept. 23, Box 9405, Richmond 28, Virginia.

GRAB This info! Dealers' cost 1959 cars. Reports covering all models and accessories 50¢ each. State make. Autoforms, Box 15-1A, Tonawanda, N. Y.

"AUTO Dealer Costs" lists dealer cost American, foreign cars, accessories, 1959 edition. \$2.00. Hanner Sale, Lincoln 4, Nebraska.

QUARTER Midgets. 300 racing parts in stock. 1959 catalog "M." 25¢. Steen's, 19 East Valley, Alhambra, California.

SMALL-Scale electric car: Build it yourself, easily! Plans \$2.00, literature 10¢. Magnuson Co., San Diego 15, Calif.

BOYS! Build real gas powered midget car! Plans 35¢. Al Huckabay, C.O.P., S.H., Stockton 4, Calif.

FULL Color post card photos of antique and classic cars. 25 for \$1, specify series 1, 2, 3 or 4 (all different). Free list. L. I. Auto Museum, Southampton, N. Y.

AUTOMOTIVE Books. Send for 1958 general book catalog. 10¢. Popular Mechanics Press, 631 N. St. Clair St., Chicago 11, Ill.

GOOD News for go-karters. Now available. Do-it-yourself 12-tooth $\frac{3}{8}$ " p. sprocket type automatic clutch with $\frac{1}{2}$ " or $\frac{3}{8}$ " bore. Installs on engine for direct drive to wheel. Only \$12.50 postpaid. Send check or money order. Satisfaction guaranteed. Mercury Clutch, Dept. pm, 1261 Camden Ave., S.W. Canton, Ohio.

AUTO SUPPLIES AND EQUIPMENT

RING-Valve job while driving. \$6.00. Free details. Motaloy, Grantham, Penna.

REVOLUTIONARY Gasoline saver device! Particulars, send 10¢, refundable. Grable Enterprises, 26314 Normandy, Roseville, Michigan.

SAVE Money on Jeep and army truck parts. Large inventory. Catalogs for Jeep or G.M.C. owners. American Auto Parts Co., 1830 Locust, Kansas City, Mo.

HIGHWAY Safety flares! 15-minute, red! Patented! Self-standing! 3/\$2.98. Grifco, 613 Latham, Wynnewood, Penna.

AUTO Shop welding repair training in world's largest non-profit welding school. Low tuition. Free booklet. Hobart Welders, Box M-391, Troy, Ohio.

SPARK Plugs half price. Send for selection chart, 10¢. Shelb Thompson, Box 175, Wilmington, Ohio.

NEW And used parts at savings. Complete guaranteed parts service for all models cars and trucks, 1924 and later. Largest in the West. Jeep and army parts specialists. Newest type shifting hubs for all jeep and all military and latest production front end drive vehicles, \$27.50 and up. Write. Pioneer Auto and Truck Parts Co., 734 W. 13th Avenue, Denver 17, Colo.

FREE! New catalog. Speed, power, mileage increasing equipment. Discounts! Almqvist Engineering, Milford PM5, Penna.

BARGAIN. Exciting Little Library booklets. 25¢ each. How to use tools, painting, welding, home improvement, games, models, plastics, lamp making, glass blowing, boats, photographs. Free Little Library catalog. Popular Mechanics Press, 200-LB East Ontario St., Chicago 11.

PROFIT! Battery repair manual \$3.00. Bayer, 938P Betty, Neenah, Wis.

1959 GIANT Auto parts catalog. Thousands accessories stores don't handle. Gadgets, custom equipment. Send 25¢ (refundable). Newhouse Automotive Industries, 5805 PM-3 Beverly, Los Angeles 22, Calif.

AMAZING Discovery. Master Glaze, puts brilliant glass like surface on cars. Free sample, information. Big commissions. Master Glaze, Dept. 902, 7720 Harwood, Milwaukee, Wis.

1959 EDITION. It's new! It's different! Get world's largest auto accessories and parts catalog, save up to 50%. 308 pages, over 85,000 items for 1920 to 1959 models including Hollywood accessories, custom styling and hi-speed equipment. All parts and accessories for all cars and trucks. We have that hard to get part. Jam packed with bargains. Completely illustrated. Send 25¢ (refundable). J. C. Whitney, 1919PM-3 Archer, Chicago 16, Ill.

CRANKSHAFT Grinder. Hand operated. Makes bearings fit without taking engine apart. \$4.00. Literature. L. D. McGee, 719 Cascade St., Wenatchee, Wash.

REPAIR Tubeless tires permanently! Complete kit, \$4.50. Ten day money-back guarantee. Walter Badowski, 17 Worthington St., Roxbury 20, Mass.

FREE Literature. Metal emblems, souvenir decals. Box #504, Nyack, New York.

JEOP Owners—V-8 conversions. Read Jeep Owners ad, page 22.

1909-1934 FORD Parts. Illustrated catalog 50¢. Mark, Layton, New Jersey.

ENGINE Hot? Radiator dirty? Cool and clean while driving. Proven water filter and conditioner. Satisfaction guaranteed. Free literature. Rahl Co., Box 5303J, El Paso, Tex.

AUTO TRAILERS

BUILD It yourself. Sleek, compact Jet Wing touring trailer. Sleeps five, cooking and eating space. Only 12 feet long. Sketches \$1.00. Complete plans \$2.00. William A. Smith, 18503 Burnham, Lansing, Illinois.

TRAILER Building guide supply catalog \$1.20. Blueprint booklet floor plan 60¢. Komcraft, Box 1153, Milwaukee 1, Wis.

BUILD Expanding eight foot trailer. Accommodates five. Literature 10¢. Fra-Mar Company, Wilmington, Mass.

FLEXI-Trailer—Box, flat, boat or camping. Converts in 60 seconds! Plans \$3.00. Write for details. Outdoor Industries, R. 4, Excelsior, Minn.

MODERN Travel trailer kits and plans. Literature 10¢. Jer-D Trailer Company, 14260 Livonia Crescent, Livonia, Mich.

CAMP Trailer, collapsible, sleeps 4. Simplified plans \$1.00, complete. Musnug, Box 74, Bethel, Connecticut.

MOTORCYCLES, BICYCLES, MOTORSCOOTERS AND SUPPLIES

MODIFY Your motorcycle or motor-scooter for more acceleration, power, speed. New manual tells how! Guaranteed! \$1.00. Advance Engineering, Box 2274, Dallas 21, Texas.

ORDER Autosol for blue exhaust pipes, aluminum chrome. \$1.00 postpaid. H. C. Barnes, 175 Morgan St., Rockford, Ill.

1000 MOTORCYCLE Bargains. Motors, parts, equipment. Catalog 25¢. Bunico, 146-XK Covington, Virginia.

HARLEY - Davidsons — Used bargains. New, used parts, accessories for all models. Bulletin, catalog 25¢. Knuth's (Factory Dealer), 1753 Muskego, Milwaukee, Wis.

RECONDITIONED Motorcycles and motors. Chromium accessories. Complete stock Indian parts. Expert rebuilding. Fast service. Indian Motorcycle Sales, Kansas City 27, Missouri.

RACING Power cams for Cushman, Whizzer, Mustang, Hiawatha, Continental. Send your cam and \$10. Weber Cams, Box 33175, Los Angeles 33, Calif.

DOODLEBUG Motorscooter \$35. Servicycle \$18, midget car \$45. Whizzer motor-bike, 2 extra engines \$50, electric outboard \$5, engines \$2.50 up. (Mailorder only). Send 25¢ (35¢ for first class mailing) for directory-catalogue number 88 just out, listing these and hundreds of other bargains in midget cars, motorscooters, home-builders parts, plans, etc. Midget Motors Directory, Athens, Ohio.

MOTOR-Bike from bicycle easy. Plans \$1.00. Jenks Rides, Audubon, Iowa.

MOTORCYCLE Parts. New, used. List 25¢. Ballak, 811 N. 9th, St. Louis 1, Mo.

WHIZZER Motors, \$20.00; midget race car reasonable; motorscooter \$6.00; Cushman two-speed \$20.00. Send 25¢ (35¢ first class mail) for catalog #33 jammed with sensational bargains in wheels, motors, motorscooters, midget cars, motorbikes, construction plans, etc. Gail, 1313 Jefferson, Toledo, Ohio.

AVIATION

BOOKS, Aviation. Free catalog. Aero Publishers, 2162-PM3 Sunset, Los Angeles 26, California.

BUY Gov't surplus—Aircrafts, fuselages, engines, helicopters, boats, jeeps, radio-telephones, misc. Buy direct now from gov't. Send for "Depot Directory and Procedure" \$1.00. Brody, Box 8-PM, Sunny-side 4, New York City.

ROCKET Amateur's Guidebook. 24 pages. New. Valuable guidance in your research, design, construction, career. \$1.00. Space Products, Dept. PM, 38 E. 57th St., New York 22, N. Y.

HELICOPTER, Kits, plans. Free brochure. Adams, Box 6042-A, Lakewood, Calif.

FLYING Platform. Three drawings, \$2.00. Rotron, Box 573-A, Bellflower, Calif.

AVIATION Surplus bargain catalogue. One dime. Box 22PM9, Thomasville, Penna.

PROPELLERS, Plans, supplies for air-boats and snowplanes. Latest designs, prompt delivery. Catalog 25¢. Banks-Maxwell, Box 3301E, Ft. Worth 5, Texas.

BOOKS: Hundreds of subjects. Big 1958 book catalog—10¢. Popular Mechanics Press, 200-BC East Ontario St., Chicago 11.

ELECTRICAL SUPPLIES

LAMP, Electrical parts, wholesale. Thousands of items for repairing, converting. Catalog 25¢. Brown Lamp, Box 305, Clayton 5, Mo.

LAMPS—Parts catalog containing wiring instructions. 25¢. Gyro Lamps, 3438P N.W. 54 Street, Miami, Fla.

FREE Instrument screwdriver! Just send postcard. Hurry, while supply lasts. Laircraft, Box 5008-BA, Detroit 35, Michigan.

ELECTRIC Pencil: Engraves all metals \$2.00. Beyer Mfg., 10511-H Springfield, Chicago 43.

RELAYS, Custom made switch stacking, voltage. \$1.75 to \$3.00. Write: Ranco, Box 6161, Chicago 80, Ill.

REPLACEMENT Parts, all rectifiers, DC power supplies. Build-it-yourself kits for all applications. Electrical Division, 1624-J East First, Los Angeles 33, Calif.

APPLIANCE Parts wholesale. Catalogue 25¢. Sielco, 26 South 20 Street, Birmingham 3, Alabama.

APPLIANCE, Lamp parts, wiring devices. Wholesale prices. Catalog '50¢. Lamp Specialties, 322 Washington St., Newark 2, N. J.

HOUSE Wiring—Electrical repairs. Booklet. Send for 1958 general book catalog. 10¢. Popular Mechanics Press, 633 N. St. Clair St., Chicago 11.

WELDING, SOLDERING, PLATING

BUILD 350 Ampere welder from surplus. 25¢ brings guaranteed plans with factory discount welder catalog. LeJay Manufacturing, Dept. 525, Asheville, North Carolina.

ACETYLENE Welding outfits, new \$54.50, arcwelders \$56.50. Eagle Welding, Dept. P.M., 5085 Broadway, Chicago 40, Ill.

FREE Catalog, welders, welder kits. Build 350-ampere welder using aircraft generator, plans 25¢. Agents wanted. Dunbar Manufacturing, Minneapolis 8, Minn.

IT'S Amazing! Your own welder from household parts. Instructions \$1.00. Bee Enterprises, Box 102, Boulder, Colorado.

ARC Welders, electric, four sizes. Dealerships open. Lorson Electric, Inc., Hope, Kansas.

WELDING Regulator and torches. Repair or exchange. \$7.50 to \$10.00 each. Welding Headquarter, 2425 Milwaukee Ave., Chicago 47.

WELDERS, 110/220, \$39.50. Morris, 1070 Inner Drive, Schenectady 3, New York.

PLATING Equipment, supplies. Complete line of anodes, solutions. Home workshops, industrial sizes. Hollywood Bronze Supply, Dept. C, 1624 East First, Los Angeles 33, California.

MACHINERY, TOOLS, SUPPLIES

FREE Instrument screwdriver! Just send postcard. Hurry, while supply lasts. Laircraft, Box 5008-BB, Detroit 35, Michigan.

POWERED Portable concrete and mortar mixers. Free literature. Beran Mfg. Co., 906 Duiling, San Antonio 10, Texas.

FLASHLIGHT Adapter—Charges batteries. \$1. Morris, 1070 Inner Drive, Schenectady, N. Y.

MATERIAL, Metals, plastics, etc., fabrication. Supplier, Box 35B, Bloomfield, N. J.

WHOLESALE Tool catalog. Send \$1.00. Yuhns, P.O. Box 5363, Detroit 11, Mich.

SURVEYING INSTRUMENTS

NEW And guaranteed factory rebuilt transits and levels, sale or rent, with purchase option. We will repair, trade or buy old instruments. Write for list M-93. Warren-Knight Co. (Manufacturers of Surveying Instruments), 136 N. 12th St., Philadelphia 7, Penna.

ENGINES, MOTORS, DYNAMOS

REWIND Your own motors. It's easy. Simplified method. Only \$1.00. Bee Enterprises, Box 102, Boulder, Colorado.

WINDING Data. 275 motors, single and three phase, \$1.10. Data Company, Box 7631, Kansas City 28, Mo.

REWIND Motors yourself. Complete instructions \$1.00. Lewis Mfg., Howell, Michigan.

ALTERNATING Current generators 750 watt \$42.50, twin cylinder compressors with 1/2 horse \$22.00, motors 1 horse \$38.50. Butler, 1885 Milwaukee, Chicago.

ENGINES—Buda, Commando, Invader, Packard. Max Goin, 1044 W. 7th, San Pedro, Calif.

DIESEL Injector parts and fuel pumps wanted. GM51-71-110. Bares, 7120 Carnegie, Cleveland 3, Ohio.

ENGINES, Midgets, motorbikes kits. Catalog 25¢. Loren Products, Danville, Illinois.

MINIATURE Gov. surplus PM motor. Two inches long. 24V. Ideal for models \$1.50, postpaid. Lee Industrial Surplus, 28180 Van Born, Inkster, Mich.

BOATS, OUTBOARD MOTORS

FULL Size, shape-cut boat patterns, blueprints, 7 1/2-38 feet. Send 50¢ for 88-page illustrated "Build a Boat" catalog of all types, naval-architect-designed, boats. "How to Build a Boat" booklet, \$2.50. "Hardware and equipment," \$2.00. Cleveland Boat Blueprints, Dept. A-66, Box 1651, Cleveland, Ohio.

MARINE Conversions. Ford, Chevrolet, Jeep engines. Catalog 25¢. Lehman Manufacturing Company, 800 Elizabeth Avenue, Linden 4, N. J.

HYDRAULIC Steering. New, guaranteed. Easy installation, outboard and inboard boats. Also, waterproof trailer lights. Hulse Industries, P.O. Box 1163, Palos Verdes Estates, California.

ROPE, Nylon or polyethylene wholesale prices. Wolfe Specialties Inc., 350 Stanford, Akron 14, Ohio.

I Want to send you proof of the wonderful pulling power of Popular Mechanics classified pages. What's your proposition? Write me today. Include literature if possible. F. W. Johnson, Manager Classified Advertising, Popular Mechanics Magazine, 200 E. Ontario St., Chicago 11, Ill.

PROPELLERS, Plans, supplies for air-boats, snowplanes. Catalog 25¢. Banks-Maxwell, Box 3301F, Ft. Worth 5, Texas.

SAVE Money. New, used outboard motor parts. Send wants. Stamp appreciated. Outboard Motor Mart, 229-M State, Boston 9, Mass.

NEW, Used, rebuilt marine motors. Marine conversions, fittings. Free catalog. Stokes Marine Supply, Dept. 24, Coldwater, Michigan.

BOAT Plans—Full size patterns, frame kits. Modern inboards and outboards for amateur builders. Complete new catalog 50¢ or specify requirements. Glen Designs, 9152 Rosecrans, Bellflower, California.

BOAT Leaking? Make it dry. Fiberglass covering kits, molding supplies. Aqua Glas, Box 99, Altadena, Calif.

FIBERGLAS Permanent boat waterproofing. Special 25% discount. Complete kits, \$9.45 up. Guaranteed materials. Easy application. Full instructions. Free literature. Ajax Plastics, Dept. PM, P.O. Box 1323, Fort Worth, Texas.

BUY Direct from the factory. Custom made Core-Glass and Fiberglass boats. Fishing and runabout models 14 to 18 ft. Boat trailers 400# to 2000# capacity. Tremendous savings on complete package of boat, motor and trailer. Free wholesale catalog. Osage Manufacturing Co., Box 117M, Osage, Minn.

ALUMINUM Pontoon sailboat, 14', \$1000. Photo, inf. 25¢. H. Ankrom, 8. Main St., Washington C. H., Ohio.

SENSATIONAL New flying outboard. Patented, safe, profitable. See Agents Wanted.

FORDS And Jeeps 100% marine engines with famous Convo-Kits. Deluxe catalogue 25¢ coin. Oscomotors, 3627B Lawrence, Philadelphia 40, Penna.

MARINE Conversions, Willys to Cadillac, kits and parts. Catalog and conversion hints free. Barr Marine, 2706A Castor Avenue, Philadelphia 34, Penna.

FREE Catalog! Boat kits, trailers, fiberglass, marine hardware. Luger Industries, Dept. M-3, 9200 Access Rd., Minneapolis 20, Minnesota.

EPOXY Fiberglass "speedkit"—Best for your boat! Free catalog tells why. Write today! Outdoor Industries, Excelsior, Minn.

WATER Ski—Floating plastic rope. Anchor rope. Tremendous savings. Earl Stephenson, Box 7152, Kansas City 13, Mo.

EMERGENCY Boat bailer. Manual centrifugal action pumps 6 g.p.m. easily. \$3.65 cash or m.o. Mashrow Products, Box 605, Hurst, Texas.

FIBERGLAS Boat covering, wholesale prices. Free literature and samples. Selfert's Box 31M, DePere, Wis.

PLANS, Patterns, catalogs: Powerboat 50¢, sailboat 25¢. Outboard motors \$70.00 up. Marinecraft, Box 161-M, Brighton, Mass.

BUILD Boat trailers. Pleasure, profit. Circulars illustrated. 6 models 25¢. Kamcraft, Box 1153, Milwaukee 1, Wis.

ATHLETIC EQUIPMENT, BODY BUILDING COURSES

4 MUSCLE Courses 25¢. Fully guaranteed, 12 courses \$2.00. Personal supervision. Sid's System, Southgate, Calif.

FREE Muscle building information. Body-Tone, Box 638B, North Miami, Florida.

SPORTING GOODS, GUNS, FISHING TACKLE, ARCHERY, TRAPPING

KILL Submersed water weeds which foul up motor propellers, tangle fishing gear and choke irrigation ditches with R-H Granular Weed Rhap-20. Inexpensive, easy to use, sure results. For details write Reasor-Hill Corporation, Box 36PM, Jacksonville, Arkansas.

MOLDS For fisherman's sinkers, jigs, squids, casting and spinning lures. Free catalog. Sweet's Molds, Tonawanda 1, New York.

5000 BARGAINS, Firearms, binoculars, war relics. Catalog 50¢. Smith Firearms, Runnemed, N. J.

AMAZING Wholesale sporting catalog. Save 70%. Tremendous selections. Econ-O-Mart, Whippany 2, New Jersey.

JAP Rifle altering to 30-06, \$6.00. Japshells, \$3.95. Catalog 10¢. T. P. Shop, West Branch 11, Mich.

MACHINE Guns, cannons, rifles. Surplus military arms, ammunition, accessories. Profusely illustrated catalog 50¢. Service Armament Co., Fort Lee Road, Bogota 8, N. J.

FISHERMEN! Our new sputnik, buck-tail, spinning popper. All for \$2. Bentley, Chicago 11.

CROSSBOWS! Hunting—Bows! Factory prices! Jayco, Box 1355, Wichita, Kansas.

BIG Money raising crickets and 12 inch African fishworms. Free literature. Carter Ranch, Plains, Georgia.

GUNS, Swords, knives, daggers, flasks. Large list 25¢ coin. Ed Howe, Coopers Mills 52, Maine.

HOW To catch fish with smell, 25¢. Johnson's, 312 Lake Avenue, Ithaca, New York.

10,000 GUNS! Swords, Kentuckies, Colts, Lugers, hunting guns! Bargain catalog 50¢. Agramonte's, Yonkers 2-G, N. Y.

FREE—Wholesale catalog. Beads, Spinners, Lure parts, Sinkers molds, Jigs, Reels, FinnySports (ME), Toledo 6, Ohio.

CAMPING Equipment, tents; world's largest selection. Send 25¢ for 160 page catalogue—handbook—camp site directory. (Print name and address). Morsan, 10-21R 50th Ave., Long Island City 1, N. Y.

IMPROVED Slingshot \$1.00, new type hamburger press \$1.00. Postpaid. Hanson Mfg., 2435 Skyline Drive, Eugene, Oregon.

UNBREAKABLE Polyethylene water bottle, holds sixteen ounces, very light in weight. \$1.00 postpaid. Harris, 433 W. 9th Street, Cincinnati 3, Ohio.

FREE Catalog illustrates hundreds of hunting, camping, fishing items. Imported and domestic. Terrific values. Write J. D. Clinton, Mt. Clemens 21, Mich.

SHOOT In your basement or garage. Free "Hints for a Home Range." Detroit Bullet Trap Co., 9447 Seymour, Schiller Park, Illinois.

WOODBURNING Folding stoves. Lightweight. Sturdy. Models \$28-\$39. Campstoves, Lovell, Wyoming.

YELLOW Tail and salmon jigs. Solid cast aluminum. Twelve types. \$2.00 each. \$18.00 per dozen. Catalog free. Dooley, 2350 Curry, Long Beach, Calif.

SPECIAL! To all gun lovers! 5 year subscription to The Gun Digest, only \$10.00 postpaid. Lifetime \$50.00. Start with either 1959 or 1960 edition. At your local dealer or order by mail from the publisher, Gun Digest Company, Dept. PM3, Chicago 6, Ill.

RAP-A-Rod—An excellent tool for wrapping fishing rods and golf clubs with a professional finish. Only \$6.45. 9045 16th Ave. S.W., Seattle 6, Wash.

EARTHWORMS, CRICKETS, FROGS

FREE Folder. Make money raising worms. Maxwell, Rt. 2, Irving, Tex.

FINEST Red hybrid worms. 1000, \$4.50; 5000, \$19.50 postpaid. Satisfaction guaranteed. Campbell's Fishbait, Fort Payne, Alabama.

\$1,000 MONTHLY Possible raising earthworms. African giants. Backyard, garage, basement. Complete illustrated booklet explains raising, feeding, packing, marketing. Only 25¢. Ozark Worm Farm-J, Willow Springs, Missouri.

EARN Money at home raising fishworms for us! Backyard, garage, basement. We buy your crop! Inquire: Oakhaven-56, Cedar Hill, Texas.

BIG Money raising fishworms and crickets. We teach you how to raise and where to sell. Free literature. Bedrun redworms, 3000, \$6.50; 10,000, \$19.95. Carter Redworms, Plains, Georgia.

DO-It-Yourself booklets. 32 different home and hobby projects. Send for 1958 book catalog 10¢. Popular Mechanics Press, 631 N. St. Clair St., Chicago 11.

BINOCULARS, TELESCOPES, MICROSCOPES, MAGNIFIERS

REFLECTOR Telescopes from Esco. Assembled and "do-it-yourself" telescopes from \$7.50 (3") to \$175 (12"). Complete line of optics and accessories. Send for free illustrated booklet. Esco Products Company, Oak Ridge, New Jersey.

LOOK—No hands. Powerful 10 diopter stand magnifier, adjustable lens. \$4.25. A. C. Fitzgerald, Box 1764, Longview, Tex.

BINOCULARS, Telescopes, microscopes, terrific values \$3.98 up. Request free money-saving catalog. Criterion, Dept. P76, Hartford, Conn.

TELESCOPES—Reflector, reflector, kits and accessories. Free illustrated booklet. Dell Optics Co., Limited, Dept. PM, 329-55th Street, West New York, New Jersey.

TELESCOPES, Binoculars— all sizes. Complete optics, parts, accessories for telescopes. Free catalog. Suffolk Science, Mattituck, New York.

DYNASCOPES—Sensational new reflector telescopes. Send for details. Criterion Co., Dept. DP53, Hartford, Conn.

REFLECTING Telescope, 60X, completely assembled. Guaranteed observatory clearness. Free information. Skyscope, P.O. Box 55, Brooklyn 28, N. Y.

WAR Surplus bargains: Millions of lenses, instruments, telescopes, binoculars, components and complete line of astronomical telescope items. World's greatest optical market-place! Send only \$1.00 for beginner's 10-lens kit and big instruction booklet stock 2-CH. Write for catalog CH free! Edmund Scientific Co., Barrington, New Jersey.

BUILD Your own reflector telescopes. Complete kits: Mirrors, eyepieces, tripods, all other accessories. Request free illustrated literature. Criterion Manufacturing, Dept. DPM 50, Hartford, Conn.

SPECIAL Winter sale, precision binoculars. Amazing prices. Folder "Binocular Selecting," catalog free. Prentiss Importers, Mercury Bldg., West Los Angeles 25, Calif.

PLANTS, SEEDS, BULBS, NURSERY AND GARDEN SUPPLIES

RAISE Your shrubs, trees from seed. Free planting guide, price list. Woodlot Seed Co., Norway 9, Michigan.

WORLD'S Greatest cash crop. Free information. Write Ginseng Gardens, Asheville, N. C.

WONDER Ruber roses, 5 stems, \$1.00. All colors. Box 855, Grover City, Calif.

GINSENG, Goldenseal. Roots bring up to \$14 pound. Full information. F. M. Collins, Viola, Iowa.

CASTINGS (Earthworm manure) give plants new life. 2½ quarts \$2.00. Terra-Vermis Gardens, Allegan, Michigan.

GROW Dwarf tree! Instructions and seeds 35¢. Mail Order Specialties, 1439PM-8 Sabraton Ave., Morgantown, W. Va.

PETS—DOGS, BIRDS, RABBITS, HAMSTERS, ETC.

MAKE Money raising chinchillas, mink, nutria, rabbits, cavies for us. Free catalog. Keeney Brothers, New Freedom 2, Penna.

HAMSTERS— Ideal pets, \$2.95 pair. Free booklet. Jer-Fre's Hamstery, 2216 East Broadway, Muskegon 13, Mich.

RAISE Rabbits on \$500 month plan. Plenty markets. Free details. White's Rabbitry, Delaware, Ohio.

GOLDEN Hamsters— Pedigreed breeders \$3.85 pair. Literature. Moore's Hamster Ranch, Shepherdstown 25, West Virginia.

EARN \$10,000 Yearly raising Angora rabbit wool for us. Information 25¢ coin. American Angora Company, Malta 12, Montana.

RAISE Rabbits successfully by knowing facts. 48 page illustrated book describing 25 breeds. Housing, feeding, breeding, marketing, etc. Plus bulletin. 25 cents. American Rabbit Association, 36 Arba Building, Pittsburgh, Penna.

SKUNKS, Reptiles, hawks, raccoons. Illustrated catalogue, 25¢. Trails End Co., St. Stephen, S. C.

HAMSTERS—Golden: young, \$3.00 pair; fully-developed, \$4.00 pair. Adironack Hamstery, Prospect 20-C, New York.

MONKEYS, Snakes, lizards, turtles. Foreign and domestic. Illustrated animal-bird list 15¢. Reptile list 10¢. Wild Cargo, West Hollywood, Florida.

FLYING Squirrels. Fine healthy stock. Thirteen years breeding and selling them. Send 10¢ for literature, prices and pictures. Greensons Flying Squirrel Ranch, 905 N. Monroe St., Arlington, Va.

HAMSTER— Pairs, golden \$2.75, albinos \$3.75. Free literature. Edgewater Hamstery, 106 Carter, Goshen, Indiana.

RAISE Rabbits. Send 35¢, free stock offer, marketing, housing information. Johnson, 683, Kansas City 41, Missouri.

RAISE Rabbits! Profitable Angoras, Chinchillas, Particulars free. Grinsteads, Edwardsville, Illinois.

FERRETS, Red fox \$6.00, skunks \$10.00. Young June delivery. Live delivery guaranteed. Alley Fur Farm, Sewal, Iowa.

INSTRUCTIONS On care of live reptiles with price list, 25¢ stamps or coin. Snake Farm, Laplace, Louisiana.

RACCOONS, Skunks, squirrels, birds, turtles, frogs, snakes. Catalog 10¢. Ray Singleton, Interbay Station, Tampa, Fla.

FUR BEARING ANIMALS

MINK Raising information free. Complete. Lake Superior Mink Farm, Superior, Eel, Wisconsin.

CASH in raising nutria, rabbits. Bob Madsen, Lyndon 2, Illinois.

NUTRIA. Lacosta, Brunett of the finest. Hawkeye Nutria Farm, Kalona, Iowa.

FARMS, FARM LANDS, REAL ESTATE

\$9 ACRE Timbered retirement investment lands. Listings free. Address: Armstrong's, Shook, Missouri.

HOMESITES \$15 Monthly— California's finest garden section. Morro Bay's scenic shores. Wonderful fishing, boating. Fertile soil, softest water, temperate climate, congenial community. Free literature. Richard Otto, Department M, San Luis Obispo, California.

FLORIDA. Nice homesites, \$345 at \$10 monthly. Folder free. Howard Vernor, DeLand, Florida.

CANADIAN Tax sale lands, average price four dollars an acre. Small monthly payments. Farms, timber, hunting and fishing camps, minerals. Limited number of properties. Write at once for free catalogue. Tax Sale Service, Room 105, 120 Bloor Street, West, Toronto 5, Canada.

\$10 DOWN, \$10 Monthly buys your home-site in central Florida's finest retirement and vacation community in the high ridge section near Sebring. On 84 square mile Highlands Lake. Free community parks and beaches. Get free color brochures, house plans; learn how we help you plan, finance, build your low cost, tax-exempt home. Write Florida Realty Bureau, Inc., Dept. EZ, Lake Placid, Fla.

CENTRAL Florida lakefront home sites. \$795 at \$15 monthly. Literature. Grace Parker, Paisley, Florida.

FLORIDA 2½ Acres, near Gulf; 50 foot elevation. \$795.00; \$15.00 down and month. Russell Hancock, Realtor, Brooksville, Florida.

FREE Strout catalog! Farms, homes, businesses, resorts, retirement properties. Over 3000 values in 36 states. 58 years' service. World's largest! Write Strout Realty, 7-MP S. Dearborn, Chicago 3, Ill.

LAKEFRONT, Highway, acreage and trailer lots, from \$295.00. Fifteen central Florida developments. Monthly terms. Box 2005, DeLand, Florida.

OPPORTUNITIES! Government land. U. S., Alaska, Canada. Sledge Surveys, Macon, Mississippi.

\$6,100 ORCHARD Near the sea! Creek-front 21 acres near Oregon's beautiful coast, only \$1,600 down! On U. S. 101 highway, only ½ mile high school, 4 miles town. All level tillable acreage, now in woven wire fenced pasture. Nice orchard, 26 apple trees, 20 plums, 2 pears. Cozy little home needs some finishing work, running water in. 36-ft. barn. For relaxed and enjoyable living, own this at \$6,100, only \$1,600 down. Free spring catalog, bargains coast to coast! United Farm Agency, 2825-PM Main St., Kansas City 41, Mo.

FLORIDA. Fine \$580 homesites, predevelopment price \$290, \$10 monthly. High, dry 80-foot lots, beautifully wooded. Famous Gulf resort area. Money-back guarantee. Wendell Wood, Fountain, Fla.

FLORIDA'S Biggest lot value! No money down! \$5 monthly. Full price only \$133. Between Orlando and Ocala. High, dry, adjoining city, streets, electricity, phones, churches, schools, shopping. In heart of 3000 lakes. World's best fishing! Write for free photos. Abel Huysman, Box 467, Belleview, Florida.

FLORIDA Land buyers. Avoid mistakes. Get the facts. \$1.00 to Bobbitts, 1725 Powhatan, Petersburg, Virginia.

FLORIDA'S Biggest lot value! No money down! \$5 monthly. Full price only \$133. Between Orlando and Ocala. High, dry, adjoining city, streets, electricity, phones, churches, schools, shopping. In heart of 3000 lakes. World's best fishing! Write for free photos. Abel Huysman, Box 467, Belleview, Florida.

FLORIDA Land buyers. Avoid mistakes. Get the facts. \$1.00 to Bobbitts, 1725 Powhatan, Petersburg, Virginia.

FLORIDA'S Biggest lot value! No money down! \$5 monthly. Full price only \$133. Between Orlando and Ocala. High, dry, adjoining city, streets, electricity, phones, churches, schools, shopping. In heart of 3000 lakes. World's best fishing! Write for free photos. Abel Huysman, Box 467, Belleview, Florida.

FLORIDA Land buyers. Avoid mistakes. Get the facts. \$1.00 to Bobbitts, 1725 Powhatan, Petersburg, Virginia.

FLORIDA'S Biggest lot value! No money down! \$5 monthly. Full price only \$133. Between Orlando and Ocala. High, dry, adjoining city, streets, electricity, phones, churches, schools, shopping. In heart of 3000 lakes. World's best fishing! Write for free photos. Abel Huysman, Box 467, Belleview, Florida.

FREE Florida Silver Springs Ocala folder. Homesites \$595.00. \$10.00 month. Write Silver Springs, 366-WP Eight Mile, Detroit 20, Michigan.

FLORIDA 75x100' Access to Lake Josephine near Sebring. \$10 mo. Free brochure. Eastern Enterprises, 325 E. 15th St., Hialeah 1, Fla.

TEXAS Resort lands offer unusual investment opportunities. Write for free folder. Hugh Matlock, Dept. GM34, Pipe Creek, Texas.

FARM MACHINERY AND SUPPLIES

SENSATIONAL Garden tractor. Hoes between plants and rows, including strawberries. Eliminates hand hoeing. Standard in size, yet entirely different. Patent 2742840. Also tills. Fantastic offer to first few inquiries. Auto Hoe, DePere 68, Wis.

POULTRY, FARM SUPPLIES

BABY Chicks, heavies. \$6.90, 100. Browsers \$4.90. Leghorn pullets \$20.00. Diamond Chickery, New Castle, Del.

PROFITABLE OCCUPATIONS

PROSPECTORS! Learn from experienced geologists, how to locate and identify rocks and minerals. A comprehensive home study course designed for anyone interested in exploring for valuable ore deposits. Write now, for free literature. Pacific School of Mines, Dept. CC, Box 2538, Palm Springs, California.

INVESTIGATE Accidents—Earn \$750 to \$1,000 month. Thousands of airlines, insurance companies, steamship lines urgently need claim investigators. We train you home spare time. Placement counsel and help. Free book! No obligation. Write: Universal Schools, T-3, Box 8202, Dallas 5, Texas.

MAGAZINE Subscriptions—Largest commissions. Bonus. Qualified Agency, 451VA Kingston, Brooklyn 25, N. Y.

400 JOB Ideas for retirement income. New 96-page book shows how, where to find satisfaction and security. Practical guidebook. Send \$3 for postpaid copy. Wayside Press, Mendota 5, Illinois.

HOME Mailorder beginner's manual, opportunities, 25¢. Carnahan Bros., 9610 Acacia, Fontana, Calif.

\$200 WEEKLY Extra introducing buyers to sellers, weekends. Men, women, enjoy learning real estate by listening to records. First lecture free. Lee Institute, Brookline, Mass.

\$340.00 MONTHLY With jigsaw. Details. Elkman, 346X North Summit, Sioux Falls, So. Dak.

BE In television. Anyone, anywhere. Non-technical. Exciting part time, full time careers. Free information. Telewriters, 23 Monterey Avenue, Dayton 19, Ohio.

MAGNETIZER Permanently magnetizes screwdrivers, etc. \$2.00 postpaid. Kublak, Huntingdon Valley, Penna.

CHARACTER Analysis. Free brochure. Lucas System, 2419 Sunset, Los Angeles 26, California.

CONSTRUCTION Workers! Big jobs breaking soon. Foreign, domestic, all sections. Send \$1.00 for copyrighted publication. Construction Scout News, Dept. DA, P. O. Box 457, Glen Burnie, Maryland.

GENERAL Electric motored basement sump pump, all bronze, 1/2 h.p., 3,000 g.p.h., \$27.95. Flo-Dri Pump Co., New Castle, Indiana.

BIG Money raising fishworms and crickets. Free literature. Carter Wormery, Plains, Georgia.

EARN \$240.00 A month at home, spare time doing only two \$5.00 invisible mending jobs a day. Big money paid for service that makes cuts, tears disappear from fabrics. Steady demand. Details free. Fabricon, 6236 Broadway, Chicago 40, Ill.

WHY Worry about work? Escape jobs forever! Retire securely now. Lead leisurely life. Unusual new book shows how. Postcard brings details free. Belmont, Wyckoff 156, New Jersey.

MAKE Flexible molds. Cast plaques, figurines. Free sample. Tooker, 1045-M Fairview, Hamilton, Ohio.

BUY Wholesale 100.000 nationally advertised products. Appliances, cameras, sporting goods, housewares, watches, typewriters, tools, clothing, etc. Discounts to 80%. Buy-Rite, Box 253, Hawthorne 103, New Jersey.

MUSHROOMS Quicker, easier, cheaper. "Magic" preplanted trays. Newest facts free. Spawn \$1.00. Luxur, 641 South 19th, Newark 3, N. J.

AUCTIONEERING—Home study course. Diploma granted. Auction School, Ft. Smith, Ark.

MONEY Plans! "Secret Journal." Grandpa, two daughters made \$2500 first month! Work home. Publiccos, Oceanside, Calif.

BAKE New greasless doughnuts in kitchen. Sell stores. Free recipes. Michael Ray, 3605 South 15th, Minneapolis 7, Minn.

FREE Book "505 Odd Successful Businesses." Work home. Pacific, Oceanside, Calif.

SAVE Money! Buy wholesale! Free catalog general merchandise. Norris, 487-M Broadway, New York City.

BECOME Independent with your own franchise business. Thousands earning handsome incomes. Request interesting facts today. National Franchise Reports, PM-528, 333 North Michigan, Chicago 1.

FREE Book "990 Successful, Little-Known Businesses." Work home. Plymouth, 1610-43 Street, Brooklyn 4, N. Y.

RAISE Pheasants on \$100 week plan. Little capital and space can make you independent. Free details. Great Central System, Columbus 1, Kansas.

SHARPEN Scissors, pinkers. Inexpensive machine. Sharpening supplies. Blackhaws, Sheldahl, Iowa.

WE Pay \$3.50 lb. dried. Grow mushrooms. Cellar, shed and outdoors. Spare, full time, year round. We pay \$3.50 lb. Free book. Mushrooms, Dept. 99, 2954 Admiral Way, Seattle, Wash.

788 HOMEWORKER'S Markets. Details, 25¢. Bryant, R. 2-PM, Lawrenceburg, Ky.

BOOKS, PERIODICALS, PICTURES, POSTCARDS

FLYING Saucers are real! 50¢. 40 pages. Stendik, Box 657, Waterloo, Iowa.

BUILD Small boats. Send for 1958 general book catalog. 10¢. Popular Mechanics Press, 633 N. St. Clair St., Chicago 11.

FREE Catalog. Self-help books. Write: Wilshire, 8721 Sunset, Los Angeles 46P.

"SCIENCE Milestones." Records march of science starting 400 years before Christ, right up to date. Amazing facts revealed, 312 pages packed with startling information that will thrill you. A real history of science. \$5.00. Literature free. Popular Mechanics Press, 200-SM East Ontario St., Chicago 11, Ill.

BOOKFINDERS! All subjects. Send wants! Jaher Book Service, 183 Hazelwood Drive, Westbury, N. Y.

OUT-Of-print books at lowest prices! You name it, we find it! Fast service. No obligation. International Bookfinders, Box 3003-PM, Beverly Hills, Calif.

BRITISH Book bargains—Any subject. Catalog free. Transbooks, Box 1-PLG, Wantagh, N. Y.

FREE Catalog! 1001 subjects! Treasure-Site Books, 6990 Aberdeen, Upper Darby, Penna.

SHIPS Original photographs. Lists 10¢. Scozzafava, 1648 59th St., Brooklyn 4, N. Y.

LOCATE Any book! No obligation. Aardvarks Search Service, Fredonia, Penna.

NEW Book tells how to plan for retirement. \$1.00 postpaid. Retirement, Box 326, Fresno 8, California.

EXCITING Catalog packed with books covering most everything. Think of it—From cover to cover you will find described and illustrated hundreds of books telling how to fix and how to build almost anything. How to remodel your home; do your own decorating, plumbing, electrical work, carpentry, painting, furniture making and refinishing. How to build your own boat, home workshop tools. Best books on photography, welding, hobbies, homecraft. How to make a home freezer. Send now for 1958 book catalog—only 10¢. Popular Mechanics Press, 200-BC E. Ontario St., Chicago 11, Ill.

GAMES, TOYS, NOVELTIES

NINE Word games—"Blocks of Fun." Fulop, 69 Northwest Sixth Street, Miami 32, Florida.

CORKBALL—Fascinating St. Louis game. Rules and instructions 25¢. Spell's, 3721 Watson, St. Louis, Mo.

WHOLESALE Toys, catalogue 10¢. Harold Osterhout, Red Oaks Mill Road, Poughkeepsie, N. Y.

SEND \$1 For your name beautifully molded in metal. Reversed for inscribing name on valuables; use as conversational piece. Lewisco, 144 Roberts, Glenside, Penna.

MAGIC TRICKS, PUZZLES, JOKER NOVELTIES

500 TRICKS, Douglas famous catalog just 10¢. This book of 120 pages describes magic tricks for pocket, parlor and stage. Magicians, both professional and amateur depend on Douglas for fast service. Amaze your friends. Send 10¢ today. Douglas Magicland, Dept. (M), Dallas, Texas.

COMPLETE Coin and card tricks outfit \$1.00. Sinta, 22790 Rausch, East Detroit, Michigan.

TWO Fabulous tricks plus catalogue \$1.00. Lachter, 151-71 25th Ave., White-stone 57, N. Y.

PUZZLERS, Win \$1000. Details free. Chegwidan, Box 182M, Dover, New Jersey.

HOUSE Of 1000 mysteries! Famous coast to coast! Professional magic! Pocket tricks! Secrets! Illusions! Mind reading! Mysteries Joke novelties! New giant surprise catalog! 160 pages! 800 illustrations! Rush 50¢ now for de luxe edition and free magic trick! Vick Lawton, 202Z Pine-wood, Trumbull, Conn.

FREE Catalog! Magic—Houdini escapes. Write: Magician Heaney, Oshkosh, Wis.

MAGIC Locostick. Appears to obey spoken commands. No skill required. Satisfaction guaranteed. \$1.00 postpaid. Arrowhead Novelty Co., P.O. Box 227P, Redlands, Calif.

FUNNIEST Ever gag cards. Sixty \$1.00. Gags, Box 126, Ivyland, Penna.

"VENTRILLO," Voice-thrower 25¢. Ventriloquist puppet 75¢. Box 971-PM, Philadelphia 5.

VENTRILLOQUISM, easiest method. Details free. Smith, 2125 N. Bigelow, Peoria, Ill.

3100 NOVELTIES, Jokes, tricks, gadgets, funmakers, hobbies. Big catalog 10¢. Johnson-Smith, D-491, Detroit 7.

WORLD'S Finest professional magic, Joker novelties. Giant illustrated catalog 10¢. Top Hat, Evanston 12, Illinois.

BE A magician! Large professional catalog of latest tricks. 35¢. Ireland, C-109 North Dearborn, Chicago 2, Illinois.

SMOKEBOMBS, Gigantic! 25¢. 7—\$1.00. (Nonpoisonous.) 4463-PM Greene, Philadelphia 44.

STINKBOMBS, Super-potent! 50¢/\$1.00, 300/\$5.00. "Amerotrix," Philadelphia 44.

PROFESSIONAL Catalog, 175 pages, 25¢. Williams, 900 Plymouth, Ellwood City, Penna.

NOVELTIES, Tricks, magic. Free price list. Behnke Sales, Box 273, Temple City, Calif.

3000 TRICKS, Pocket, parlor, stage. World's finest magic catalog (408 pages), \$2.50. Kanter's, M-1311 Walnut, Philadelphia 7.

COINS, TOKENS, CURRENCY

LINCOLN'S 1910S, 1913S, 1922D, 1926S, 1931D. 60¢ each postpaid. Free list. United, 101 Cranston, Providence 7, R. I.

INDIAN Head cents, two different only 10¢. Approvals. Littleton Coin Company, Littleton R1, New Hampshire.

OLD Money wanted. Will pay \$1,000.00 for 1894 dime, S. mint, \$5,000.00 for 1913 Liberty head nickel (not buffalo). Big premiums paid for all rare coins. Send 5¢ for large coin folder. May mean much profit to you. Numismatic Co., Box 750-A, Costa Mesa, Calif.

NEWS! Bargains! Canadian bulletin 10¢. Marles, Box 833, Calgary, Canada.

WANTED Urgently! Coins! Now we pay even higher prices! Confidential 1959 buying guide, \$1.00. Sullivan, 128-TT Frontier Bldg., St. Paul 1, Minn.

INVESTORS: Proof sets 1959, \$2.49; 1958, \$2.94; 1957, \$2.94; 1956, \$3.94; 1955, \$5.94; 1954, \$6.94; 1953, \$11.94. Seven sets \$36.29 postpaid. Sayge, Mt. Carmel, Penna.

REVISED U. S. coin price list. Bargains. Only 25¢. Huber, National Bldg., Minneapolis, Minnesota.

FREE List! U. S. coins. Best prices. Hugh's, Box 361-HI, Hickory, N. C.

20 PAGE Coin bargain list, 10 Indian cents, \$1.00. Maurice's 18 Orme, St. Paul 16, Minn.

TWELVE Different Barber dimes \$2.00. Bargain lists free. Sayers, 1000 Unaka, Johnson City, Tennessee.

DELUXE 32 Page U. S. catalog 10¢. Contains over 100 illustrations; 5,000 delightful bargains. Stonie, 260 Washington, Boston 8, Mass.

TWENTY Different Indian cents \$2.50; ten different \$1.00. Collector's Bargains. New Hope, Penna.

"EAGLET" Numismatic Magazine, 35¢ subscription \$2 year. 229 South 11th, Newark 7, N. J.

GET Profit and pleasure in collecting old coins. Send 20¢ for 68-page illustrated coin catalog. You'll be delighted with it. Send for it now. B. Max Mehl, Box 750-B, Costa Mesa, Calif. Oldest rare coin establishment in U. S. Established 59 years.

44 DIFFERENT Coins, \$1.00. 44 different bills, \$1.00. Oddehon, Box 482, St. Louis, Mo.

1959 GIANT U. S. coin catalogue 25¢. Ace, 107 N. Dearborn, Chicago 2.

LARGEST Coin magazine, 200 pages, 40¢. Scrapbook, 7320-J Milwaukee, Chicago 31.

RAREST CO mint dollar 1885 uncirculated \$5.00. Illustrated catalogue 25¢. Schultz, Salt Lake City 10, Utah.

BARGAINS, U. S. coins: 1893 Columbian world's fair half dollar, \$1.00. Ten different Indian pennies, 75¢. Two-cent piece, and 3-cent piece, \$1.00. Gold ¼ eagle, \$9.00. Gold ½ eagle, \$12.50. Beautiful coin bracelet, \$1.00. Many coins available. What do you need? Rare Coin Company, 31 North Clark, Chicago 2.

COMPLETE United States coin bargain lists, Indianhead cent, 10¢. Economy Sales, 156-A Dean, Mansfield, Mass.

INDIAN Cent plus Bargain Lists 10¢. Hutchinson's, Box 4747, Philadelphia 34, Penna.

SIXTEEN Page price list of U.S.A. and Canadian coins free. Selling prices on thousands of coins and supply items. Bryson Inc., 612A White, Toledo 5, Ohio.

COLLECTORS Items: United Nations medallion, solid goldene bronze 1¼" diam. Front shows U.N. buildings, back U.N. pledge. America's famous dollar that George Washington threw across Rappahannock! Piece of eight of pirate fame! Solid German silver. Buried treasures map shows where now being recovered, also other locations. Only \$1.00 each, 3 for \$2.75, 6 for \$5.00 ppd. Hano, 1598 Third Ave., New York City 28. (Dealers wanted.)

LINCOLN Cents: 1910-S, \$1.25; 1911-S, \$2.75; 1912-S, \$2.25; 1913-S, \$1.50; 1915-S, \$1.50; 1926-S, \$1.00; 1923-S, \$1.00. Condition fine. Berry, Box 306, Westminster, California.

WANTED—Coins. Send 10¢ for buying list. Holcomb, 4127½ Centinela Ave., Los Angeles 66, California.

"BRILLIANTIZE" Coins safely, \$1.00 prepaid. Amazing, guaranteed. Stephenson's, Ames, Iowa.

STARTER Collections. 20 different Indian cents, \$2.50, 13 different liberty nickels \$2.50, 20 different Barbour dimes in folders, postpaid \$5.00. Prager, 470 27th Avenue, San Francisco, Calif.

UNCIRCULATED Silver dollars, 1879-O through 1885-O, \$2.50 each. Butts, East F, Torrington, Wyo.

LINCOLN, Indian, Canadian cents, buffalo nickels. Bargain lists 10¢. Hughes, 21 Ottawa, Grand Rapids, Michigan.

SEND \$2.00 And receive 19th century silver dollar and Indian head penny. Etna Elliott, P.O. Box 351, Reno, Nevada.

20 DIFFERENT Indian nickels, \$2.00. Catalogue, 15¢. Fred Buza, Stevens Point, Wisconsin.

\$4,000.00 FOR 1913 Liberty head nickel, Uncirculated dollars: 1804-1839, 1893-S, 1895-P, 1903-O pay \$100.00-\$5,000.00. Certain dates Lincoln cents before 1932, \$125.00; flying eagle cents, \$500.00; Indian cents, \$175.00; dimes before 1943, \$2,000.00; quarters before 1924, \$1,500.00; half dollars before 1929, \$3,000.00; 2¢ pieces, \$125.00; 3¢ pieces, \$150.00; half-dimes, \$1,500.00. Hundreds of others worth \$10.00, \$1,000.00, Canadian coins, 1921, 5¢ silver, \$100.00, 1875 quarters, \$100.00, 1921, 50¢, \$750.00. Wanted: 20¢ pieces, gold coins, paper money, etc. Our large illustrated guarantee buying-selling catalogue, giving complete allcoin information, send \$1.00. Purchase catalogue before sending coins. Worthycoin Corporation (K-288-C), Boston 8, Massachusetts.

1959 CANADA, Newfoundland, coin buying catalogue. Huge listings paper money, gold, silver. Sent postpaid 25¢ coin. Stern Co., McIntyre Bldg., Winnipeg, Canada.

WORLD'S Greatest 92-page bargain catalog \$1.00. (Deductible first \$10.00 order). Beautiful uncirculated sets, in albums, Jefferson nickels \$41.00; Roosevelt dimes \$15.95. Franklin ½, \$37.50. Bebee's, 4514 North 30th, Omaha 11, Nebraska.

LARGE Cent \$1.00, 3 different \$2.75. Price list 10¢. R&M Coins, DeLanco, New Jersey.

12 GENUINE Foreign coins, bills, 25¢. Interesting lists. Musser, Box 505-B, Dunbar, West Virginia.

10 DIFFERENT Choice Indian cents, \$1.00; large lists, curious coin, 10¢. Elliott, 235 Juniper, Coraopolis, Penna.

CASH For Canadian, American coins. Catalogue values we pay, 50¢ postpaid. Bourse, Box 274, Ft. Wayne, Ind.

STAMP COLLECTING

224 DIFFERENT For only 25¢! New Caledonia, Brunel, Ethiopia, Timor included plus 88 flags of world. Bargain approvals sent. Rush 25¢. Ask for lot FO-32. Zenith, 81 Willoughby, Brooklyn, N. Y.

FIFTEEN Different sport topicals 10¢. Approvals accompany. Smith, 6 Green-croft, Champaign, Illinois.

GOOD Mixture large U. S. commems, 200, \$1.00 postpaid. No approvals. O. Murer, 1244 North Dearborn, Chicago 10.

ANDORRA, Ifni, Lundy, Oceania, Re-union, etc., assortment 10¢. With approvals. Jebramek, Box 566, Terminal A, Toronto, Canada.

100 DIFFERENT U. S.—50% approvals. Utechts, 1143D North Keeler, Chicago 51.

U. S. 100 Different 20¢ with approvals. White Mountain Stamps, U2, Bethlehem, N. H.

TERRIFIC Stamp bargain! Israel, Iceland, Vatican assortment—Plus exotic triangle set. Also fabulous British Colonial accumulation. Plus large stamp book. All four offers free. Send 10¢ to cover postage. Empire Stamp Corp., Dept. PM, Toronto, Canada.

FREE! 19 Different Bavaria plus world's only octagonal stamp, plus Abyssinia Red Cross set; to those requesting approvals. C. R. Cleveland, 806 North Humphrey, Oak Park, Illinois.

508 DIFFERENT Worldwide from Mada-gascar, Macao, Guinea, etc., cataloguing over \$15 only 35¢. Approvals. Littleton Stamp Company, Littleton Q1, New Hampshire.

FREE! Giant bargain catalog—New edition listing thousands of bargains including U. S. and B. N. A. stamps, packets, mixtures, albums, accessories and supplies; sent with beautiful approvals. Jamestown Stamp, Dept. E39PM, Jamestown, N. Y.

COLLECTION 100 Different United States stamps. Contains commemoratives, airmails, regular issues, high denominations, including some over 70 years old. Worth over \$1.00 but our price only 20¢ with approvals. Sandman, Littleton T1, New Hampshire.

U. S. Stamps. Giant bargain catalog 15¢. Raymax, 35-VZ Maiden Lane, New York City 38.

150 DIFFERENT Stamps from 150 different countries, only \$1.00 with approvals. Ray Roberts, 3694 Sunset, Markham, Ill.

FREE Mint set! Approvals accompany. Stampco, 5151 Princeton, Memphis 17, Tennessee.

MIXTURES — 1000 Foreign or United States, \$1.00 each. Missions Warehouse, Box 386, St. Petersburg, Florida.

50 ADEN To Russia, cat. over \$1, only 25¢, with approvals. Herget, 2884 Bailey, Buffalo 15, N. Y.

50 BEAUTIFUL Birds 35¢. Outstanding! Bonus plan approvals. Dee, Box 926, Ormond Beach, Florida.

WORLD Approvals ½ catalogue, 21 Elgin St., Brantford, Ontario, Canada.

U. S. Mint souvenir sheet #948, 20¢ Approvals. Kopkins, B-133, Brooklyn 14.

FREE—Mint British colonies from Brun-nel, Solomon Islands, Negri Sembilan, Sarawak, St. Christopher, Nevis, Trengganu, Gilbert Ellice. Free with approvals. Viking, Great Neck 8, N. Y.

FOREIGN Mint. New issues on approval. Adults preferred. Friendly Dealer, 56 Miracle Lane, Loudonville, N. Y.

STAMP Finder enabling you instantly to identify all difficult stamps and the countries they come from, world map locating stamp issuing countries, and encyclopedia of collecting terms all for only 5¢. Approvals. Goliath, Bethlehem K1, New Hampshire.

DEALERS—Wholesale list. Postage 4¢. Frank, 5031 Queensberry, Baltimore 15, Maryland.

WOW! 110 All different Germany 10¢. Zeppelins, semi-postals, airmails, high values, etc. Giant catalog, bargain lists included with beautiful approvals. Jamestown Stamp, Dept. A39PM, Jamestown, N. Y.

"ELEPHANTS Of Laos"—Three brilliant mint pictorials, portraying elephants in life-like multicolor, 10¢. Approvals. Gustave Gebhard, 26 Westwood Drive South, West Orange, New Jersey.

100 DIFFERENT Belgium free. UPU, Brussels fair, railroad stamps free. Approval applicants only. Trylon, Box 179-P, Forest Hills 75, N. Y.

FREE! Wonderful, new \$4 page U. S. catalog. Handling 10¢. Norrisco, Milwaukee 7, Wis.

307 WORLDWIDE Different stamps only 25¢. Approvals. Niagastamp, St. Catharines 671, Ontario.

MINT U.S. at face! Older commemora-tives only. Send 25¢ for all different packet with first selection mint U.S. approvals. Western, Box 1689P, Salinas, California.

1000 DIFFERENT Worldwide stamps \$1.00. Valued over \$20.00. Universal, Box 6, Kenosha 5, Wisconsin.

12,000 PENNY Approvals waiting for you. Many from exotic countries, pictorials, airmails, new issues. Tilbury, Box 862, Newark 1, N. J.

100 DIFFERENT Austria 10¢. Approvals. Aronson, Box F, Newton Centre 59, Mass.

FREE! Newfoundland, Israel, animals, birds, sports, Pipex; with approvals. Tropicana, Box 449M, Hollywood, Florida.

BEAUTIES! Pictorials from Andorra, Iceland, Monaco, New Caledonia, Togo, San Marino, Singapore, etc. Only 10¢. Approvals. Champlain, Isle La Motte, Vermont.

FREE! 25 Egypt, 5¢ handling, approvals. Bellet, Mapledale, Hazel Park, Mich.

FREE 60 Different stamps to collectors requesting approvals. Stanley Zajac, 159 Emerson Ave., Toronto, Canada.

U. S. commemoratives: 141 different \$1; 201 different \$2. Moseley, 6 Hanley Downs, St. Louis 17, Missouri.

PRE-1888 U.S. — Two free copies, with approvals. Collier, Chamblee, Ga.

1959 U. S. catalog free. Contains almost 1000 illustrations, over 10,000 delightful bargains. Stone, 260 Washington, Boston 8, Mass.

TERRIFIC Value. Eight complete mint sets 10¢ with approvals. Beatties, 58 Glenagar, Islington, Ontario, Canada.

FREE! 50 British Empire, 5¢ handling. Approvals. Kensington Stamps, Buffalo 15, N. Y.

FREE—Your choice any volume Scott's International albums. 1959 Scott's complete catalogues, even Master Global albums free when you buy our sensational foreign approvals. Bargain Stamps, Redlands, Calif.

50 CHINA 10¢ Approvals, gifts. Coast, P.O. 2187A, Santa Ana, California.

FREE! Eight sided stamp, triangle, diamond, midget, mammoth, to approval buyers. Plymouth, Dept. A-9, Bell, Calif.

GIANT Approvals, thousands different, 1¢ and 2¢ each. Wahl's Stamp Exchange, 7008P Farragut, Chicago 31, Ill.

SUPERIOR Worldwide mission mixture. Amazing variety! Six ounces \$1.50. Pound \$3.75. Bay Nielsen, 4545B Harvard, Montreal 28, Canada.

MEXICO, 25 Beautiful 10¢. Approvals. Salsman, Box 702, Berkeley, Calif.

50 DIFFERENT Stamps free! Approvals. Marford, Box 48, Queens Village 29, New York.

FREE 1958 Illustrated U. S. price list. H & S, 45-PM Bromfield, Boston, Mass.

TRADE Your duplicates toward our approvals! (Foreign only.) Complete detailed information, 10¢. (Refundable.) Variety Stamp Service, Box 98-P, Newton Highlands 61, Mass.

60 DIFFERENT U. S. (30 commemoratives) 25¢. No approvals. Seidenberg, Appleton, Wisconsin.

HONG Kong, 25 different, 25¢. Foreign approvals. Spicka, 518 No. 85th, Omaha 14, Nebraska.

1000 DIFFERENT, \$1.00 With approvals. Louis Golden, 6721 Eastwood, Philadelphia 49, Pennsylvania.

WORLDWIDE, 50 All different, absolutely free, just to introduce our incomparable approvals. Kent Stamp Company, GPO Box 87, Brooklyn, N. Y.

ALBUM Only 10¢! Hundreds of spaces! Stampart Company, Hartford 1, Conn.

ECONOMICAL 1/2¢-3¢ Approvals, 33,000 varieties. Dresel, Box 128-N, West Englewood, New Jersey.

UNITED STATES commemorative collection containing 33 different—10¢. Approvals. White, 516-A Avenue L, Brooklyn 30, New York.

SELL Your surplus good grade stamps. Write, describing fully what you have. Vanroy Shirk, Lebanon, Pennsylvania.

AMAZING Offer! 200 United States stamps — including commemoratives, airmails, high denominations to \$1.00. Only 10¢ to approval applicants! Illustrated bargain lists free. Mystic Stamp Co., Dept. 80, Camden, New York.

100 STAMPS, 10¢ With approvals. Smith, 508A Brooks, College Station, Texas.

OLD Scarce U.S. seconds on approvals. Slight imperfections, lowest prices. Herfield, Clintonhill Sta., Newark 8, N. J.

100 OLD United States between 1861 and 1935, \$1.00. Roush Stamps, 51 Chestnut, Mansfield, Ohio.

10 CANAL Zone 25¢. Approvals. Merkel Stamps, 30 Grandview, South Hadley Falls, Mass.

FREE Sample! Interesting, informative, illustrated. National Stamp News, Anderson, South Carolina.

FREE Packet! Angola, Azores, Mongolia, Nepal, Palestine. Fascinating approvals. Coral, Box 7095 (Ludlam), Miami 55, Florida.

TWO \$5.00 U. S. postage stamps free to approval buyers. Send dime for postage, details. Irwin Stamp Co., Box 11-55, Brooklyn 30, N. Y.

135 DIFFERENT U. S. commemoratives \$1.00; 50, 25¢. Approvals. Harold Holub, 18 East 198th St., New York 68, N. Y.

TERRIFIC U. S. list free! Bailey, 45 Bromfield, Boston 8-O, Mass.

225 STAMPS For only 10¢! This mammoth value includes airmails, pictorials; stamps from strange countries cataloging up to 25¢ each! Also approvals. Mystic Stamp Company, Camden 80, New York.

WEIRD Diamond shape coffee stamps. Lovely flower triangle! First American big commemorative. Greenland, idol dancer, etc. Free with approvals. Capital Stamp Co., Ferrysburg 2, Mich.

UNITED States price list, 116 pages, price 25¢. Mark Hanna, 335 Fifth Ave., Pittsburgh 22, Penna.

INTRODUCING Our better United States approvals, we offer 15 United States stamps including Columbian, Pan-Pacific, famous American, airs, others; only 10¢. Ocean Stamps, Box 64-PM, Brooklyn 29, New York.

SELL Stamps to our readers. Your ad in this space will be read by thousands of stamp buyers. I'll prove that to you. Write now for Folder "S." F. W. Johnson, Classified Advertising Manager, Popular Mechanics, 200 E. Ontario St., Chicago 11, Ill.

14,000 DIFFERENT! Amazing new plan builds your collection systematically, country by country. Only 50¢ weekly. Free details. L. G. Ware, Stepney 75, Conn.

U. S. Mint flag set, complete, \$1.00. Free list. Brooks, 2323 Avenue X, Brooklyn 35, New York.

FREE 50 Worldwide introducing inexpensive approvals. University Stamps, P.O. Box 95, Tamiami Station, Miami 44, Florida.

40,000 VARIETIES Available on approvals, 1/4¢ upwards. Keigwin, Box 933B, Daytona, Florida.

STAMP Zoo including kookaburra, zabu, kangaroo, koalabear, rhinoceros 10¢. Approvals. Linstamp, St. Catharines 618-A, Ontario.

FREE! Over 100 different, \$2.50 value, including space satellite, Israel, British, U. S., first U. N., Siberia. Approvals catalogue. Send 25¢ for mailing. Gatewood, Box 346, Winston-Salem, N. C.

103 DIVERSIFIED British colony stamps only 10¢. Approvals. Niagastamp, St. Catharines 671-A, Ontario.

FREE — Your choice of 100 different Canada, 100 different Philippines, or 100 different from 100 different countries, each collection over \$5.00 catalogue value, when you buy our sensational foreign approvals. Topval, Box 486, Redlands, California.

80 DIFFERENT U. S. stamps, includes 19th century, commemoratives, high values. Plus 1943 flag stamp of occupied nations. All for only 25¢. Approvals included. Willett Co., Box 338-C, Yorktown Heights, N. Y.

102 DIVERSIFIED Worldwide stamps 10¢. Approvals. Linstamp, St. Catharines 618, Ontario.

FIRST U.N. set. Among world's prettiest. Only 10¢. Approvals. Welles, Box 1246-R, New York City 8.

FREE! 50 Different Portuguese; Colorful, inexpensive approvals. Elkhart, Box 33, Elkhart, Indiana.

333 DIFFERENT Stamps only 25¢ with approvals. Finney, Box 89, El Monte, Calif.

INTERESTING Packet free. Approvals. Farley Stamps, 204 Tanguy, Logansport, Indiana.

EXCITING Strange countries packet. Free with approvals! Saxon, Orange, California.

LOOK! Six different Queen Elizabeth mint sets! Basutoland, Malta, Virgins, etc. 21 bicolors 25¢! Attractive approvals! Gannon Stamps, Box 931, Canton 1, Ohio.

SOUVENIR Sheets Czechoslovakia 1937 plus Japan 1947, 10¢ with approvals. Kingman, 30 Empire, Yonkers 4, N. Y.

FREE! Pictorial packet, with approvals. Conklin, Box 388-PM, Osage, Iowa.

FREE—100 Different foreign, with approvals. Dunning, 1634 Chippendale, Houston 18, Texas.

50 DIFFERENT Large U. S. commemoratives 10¢ with approvals. Jack Clancy, Box 2187, Portland 10, Ore.

110 INCLUDING Airmails, triangles, U. S., 10¢. Approvals. Stamparee, Box 68, Sierra Madre, Calif.

WORLDWIDE Stamps 1100 — \$1.00, includes pictorials, commemoratives. No approvals follow. Harrison's Stamps, 1435 First Avenue, Oakland 6, Calif.

U. S. Approvals, Low prices. Eagle Stamps, Romine Ave., Pittsburgh 26, Penna.

CEYLON! Fourteen beautiful bi-colored (80¢ value), only 10¢ with temptingly priced approvals. Bischmann's, 118 Mississippi Ave., Joliet, Illinois.

BEAUTIFUL 2¢ Approvals! Thousands varieties! Marshall, Box 451-PN, Long Beach, Calif.

FREE! 105 Different worldwide with approvals. Martin, 2102 Bentley, Los Angeles 25.

NEW 1959 U. S. and Canada catalogue only 20¢. New-Way Stamp, Lawrence 2, Mass.

1000 MIXED, Includes pictorials, 50¢. Knopp, Box 1381, Bristol, Conn.

PENNY Approvals! Regardless catalogue! Kloster, 4164—52nd St., San Diego 5, Calif.

FREE! Fifty different stamps. Adult approval applicants. Norge, Ho-Ho-Kus, N. J.

25 DIFFERENT Commemoratives 1893 up 10¢. U. S. approvals. K&B, Box 70, Brooklyn 23, N. Y.

25 SPAIN Plus Nigeria, Bavaria, Indonesia, 10¢ with approvals. Poster, Box 183, Muskegon Heights, Michigan.

FREE! 53 Different. Approvals. J. Schuster, 301 Sandpiper, Playa Del Rey, California.

ISRAEL 10 Different free to approval applicants. Morrel, 203 Fenimore St., Brooklyn 25, N. Y.

SWEDEN Calling. 200 different Swedish stamps \$1.00. John Allgren, Box 436, Gothenburg 1, Sweden.

20 BRITISH Pictorials 10¢. Approvals. Van, Box 981, Columbus, Miss.

300 DIFFERENT Given free with approvals. Particulars. Windsor Stamps, 8834 Cornell Avenue, Chicago 17.

EXCEPTIONAL! Old U.S., flags, presidents, commemoratives with approvals, free gift, 10¢ handling. Metropolitan Stamps, Box 312UD, Jackson Heights, N. Y.

FREE 200 Different stamps! Gift magnifier! Free "PhotoNotes" subscription! Approvals. Rush 10¢ postage. Philatelics, Dept. RA, New Paltz, N. Y.

U. S. Mint #907-928 face plus 2¢ each, #929-1125 plus 1¢. Wilhelm, 16566 Mendota, Detroit 21, Michigan.

500 WORLDWIDE Mixture. Big variety 30¢. Monjar, Fairmount, Cincinnati 14, Ohio.

AMERICAN Commemoratives; beautiful colonial sets; Asian topical mixture 5¢. Approvals. Bristols, Canton Center, Conn.

90,000 STAMPS Sale. Bargain 40¢. Big lot \$1. Extra special \$2. Giant assortment \$5. Persil, 436 New York Ave., Brooklyn 25, N. Y.

U. S. 60 Different 20¢. 60 different commemoratives 40¢. Both 50¢. Jim's Stamps, Brocton, New York.

GIANT Diamond, midget triangle, Timor, 15 beautiful topicals, 26 others, 10¢ with approvals. Carpenter, P.O. Box 310, Claremont, Calif.

SAMPLE Pound drying paper, chemically pure, stamps flat, clean, dry, long life, brilliant. Method included. Zoul, 261 Magnolia, Orange, Calif.

YOUR Collection a winner. The award ten scarce foreign. Cat. \$2. Handling 10¢. Approvals. Reid, 441 N. 6, Allentown, Penna.

WHOLESALE Lots: No "Iron Curtain" junk or "kiddie" material. All different. Made for resale. Sample \$1.00. Cadet, Selden, N. Y.

111 DIFFERENT Worldwide stamps, 10¢. 88 different U. S. 25¢. Approvals. Plaza, Box 275, Pottsville 2, Penna.

THE Gods of Ancient Greece; Russia Sputnik; U.S. national parks; Israel; U.N.; sets; packets; surprises; free with purchases. Approvals. Stamp Farm, M2-11, Oxford, Wis.

UNITED STATES, \$1.00 buys four fine unused airmails. #C7-#C10. Approvals accompany. Whiton Paine, Westport 11, Connecticut.

1000 UNITED STATES on paper 60¢. 4000 for \$2.00. No approvals. Ace Stamps, Jamesburg, N. J.

FREE! Somaliland! Philippines! Caledonia! Others. Approvals. Keating, 2520-P Boulevard, Jersey City 4, New Jersey.

WANTED—Stamp collections, accumulations. Murray Gold, 62-95P Saunders, Rego Park 74, N. Y.

UNITED States commemoratives, 100 diff., \$1.00; 150, \$1.50; 200, \$2.50. 2122 Anderson, Falls Church, Virginia.

PRICE List, foreign and U. S. No approvals. Stamps, 5000 Miami, St. Louis 9, Mo.

1000 DIFFERENT Worldwide with approvals. Alfred Jacobsen, Crompond, New York.

1000 DIFFERENT Stamps free to regular buyers from our price lists. No approvals. Write for details. Lucas Stamps, 612 White, Toledo 5, Ohio.

U. N., Israel, Ghana, Vatican stamps included in packet of 50 different worldwide, free to approval buyers. 10¢ handling. Conquistador, 2627 Troy Rd., Schenectady 9, N. Y.

HUNGARY, Latest bicolored flower triangles, free! Approvals. William Deems, 226F Race, Ravenswood, West Virginia.

11 MADEIRA, 25¢. Approvals! Price-lists! Rowswell, 2425 Maplewood, Royal Oak, Michigan.

FREE! Negrisembilian, Saudi-Arabia, Thailand, Nepal, Tasmania. Inexpensive approvals accompany. Nade's, 6316 Crescentville, Philadelphia 20, Pennsylvania.

U.S. seconds on approval. Slight flaws, bargain prices. Swartz Stamps, Malden Bridge, N. Y.

MINT Airmails. Thirty-three different, 10¢. Approvals. Valley's, Box 414PM, Spring Valley, California.

37 DIFFERENT Mint Vaticans \$1.00. Approvals. Jewels Stamps, Tamaqua, Penna.

250 STAMP Hinges and 20 different Canada free with approvals. Jaydee, 218 Dickinson S.W., Grand Rapids 7, Mich.

SWAP Your extra stamps by mail. One collector's address and details 20¢. Correspondents' Exchange, Box 212, Crescent Beach, S. C.

ROOSEVELT Memorial; Egyptian jets; Croatian legion in action; U.S. Norse-American; grab bags; new issue sets; free with purchases. Approvals. Stamp Farm, M2-12, Oxford, Wis.

U.S. Bargain, 100 different 25¢, 55 different commemoratives 25¢, both 40¢, with U.S. approvals. Stamps, Kennebunk, Maine.

2 HAWAII Classics or 25 exciting Soviet Russia 10¢. Approvals. Belmont Stamps, Washington 15, D. C.

MINT UNR set free with approvals. W-B Stamps, Wilkes-Barre, Penna.

UNITED States approvals. Select copies, used—mint. Kingsbury, Groton, Vermont.

ICELAND 10 Different beautiful stamps for only 10 cents to applicants for our good old fashioned approvals. Old Colony Stamp Co., Dept. A, Milford, Connecticut.

BETTER Grade U.S. Low prices. List free. National, Box 60, Boston 1, Mass.

LARGE U.S. commems. on paper, \$4.75 per pound; \$9.00 per two pounds. Satisfaction guaranteed. Wm. Rice, 87 Washington Ave., Kingston 37, N. Y.

AMAZING Profits made investing in unused commemorative postage stamps, with as little as \$2.50 weekly. No experience necessary. Professional advice free to clients. Vatican City "Vacant Seat" (Stamps issued after death of Pope Pius XII) increased from 20¢ to \$1.50 in 30 days. Complete details \$1.00. Satisfaction or refund. Columbia, 8203-ME Grubb, Silver Spring, Maryland.

FREE! Giant British Empire collection, hard-to-get new issues. Plus free "Empire bonus packet" (Coronations, jubilees, royal visits). Collector's guide, unusual approvals. 10¢ for handling. Garcelon Stamp Co., Calais 2, Maine.

ANTIQUES, RELICS, INDIAN GOODS, CURIOS

4 SELECTED Arrowheads \$1.00. Smith, 841 N. Tacoma, Indianapolis, Indiana.

WANTED — Axes, ceremonials, arrowheads, spears, pipes. Cash for collections. Magaw, 1513 Ohio, McKeesport, Penna.

ANCIENT Grooved stone tomahawk \$3.00. Indian relic list free. Lear's, Glenwood, Arkansas.

PRECIOUS STONES, MINERALS

CUT Gems, make jewelry—For profit or fun. 100 page magazine tells how: where to get supplies. Sample 25¢ or request free literature. Lapidary Journal, Del Mar 2, Calif.

"GEMS & Minerals Magazine," largest rock hobby monthly. Field trips, "how" articles, pictures, ads. \$3.00 year. Sample 25¢. Box 687A, Mentone, California.

SAPPHIRE And four more uncut gems, \$1.00. Ten polished gems, baroque-shaped, \$1.00. Free gem list. Lapidary catalogue, 25¢. O'Brien's, 1116M Wilcox, Hollywood 38, Calif.

SEMI-Precious uncut gems. Ten different for \$1.00. Request list 2¢. Prospectors Shop, 201 San Francisco, Santa Fe, New Mexico.

EARTH Science, the rockhounds national magazine. Subscription \$2.00. Sample 35¢. Box 1357-PM, Chicago 90, Ill.

GEMSTONES, Thirty, uncut, \$4.00. Minerals. Lists. Reed's, 4930B Palo Alto, S.E., Albuquerque, New Mexico.

ROCKHOUNDS—Visit rockhound paradise. Circular. Heike's Agate Shop, Wenona, Illinois.

FREE Wholesale list #111, faceted stones for jewelry, rings, etc. Lowest prices. Portland Stone & Lapidary Co., 510 S. W. Third Avenue, Portland 4, Oregon.

DIAMONDS — Lowest wholesale prices, direct from Belgium's world-leading market. Save up to 43%. Tax free. Lloyds insured. Write airmail for free, illustrated catalog. Royal Diamond Exporters, 103-B Rue Royal, Brussels, Belgium.

10 APACHE Tears (obsidian). Satin finish, \$1.00. Arizona Apache Tear Co., 2502 No. 32nd St., Phoenix, Arizona.

FIND Hidden treasures in your own backyard, spare time, weekends. Get free information about sources, bargains, vital data from the jewelry industry's biggest suppliers. Write for free booklet! Grieger's, Dept. A-89, Pasadena 4, California.

OPALS—Uncut Australian, three ounces \$5.00. Western Rocks, 20385 Stanton, Castro Valley, California.

CORES From Texas oil wells 1½-2 miles deep! Anhydrite, limestone, shale, salt, oil saturated sandstone. Fascinating, unusual display! Five specimens. All different. Send \$1.00. Cores, 2711 Brookhollow, Tyler, Texas.

18 COLORFUL And basic U.S. mineral specimens attractively boxed. Descriptive folder \$1.00 prepaid. Included free dinosaur bone pocket piece. Rock Haven Mineral Co., Dept. B-3, Whitefield, N. H.

HOBBIES AND COLLECTIONS

INVENTING Can be an interesting and profitable hobby. Write for complete particulars. Institute of American Inventors, Dept. 40-E 635-F St., N.W., Washington 4, D. C.

COLLECTORS Matchbook covers, 100 different unused, \$1.00. Catalog 25¢. Album \$3.00. Charles Edelman, 1311-C East 84, Cleveland 3, Ohio.

DO-It-Yourself booklets, 32 different home and hobby projects. Send for 1959 book catalog 10¢. Popular Mechanics Press, 631 N. St. Clair St., Chicago 11.

NAZI Swastika armband and catalog, \$1.00. Hobbies, Box 71B, Rockaway Park 94, N. Y.

NAZI Insignia book, 600 illustrations, \$1.50. 12 Nazi insignia, \$1.00. Hobbyland, Calgary, Canada.

RARE, Tropical seashells. Eight \$2.00, named. Buy, sell. Free list, Edward Dunav, 229 S. 9th, Philadelphia 7, Penna.

WANTED Cigarette, tobacco cards. Write Charles Bray, East Bangor, Penna.

REPAIR Your own television. Profitable. Experience not essential. Literature free. Sentinel Electric Company, 32 E. Concord, Kansas City 12, Mo.

CAMERAS, PHOTO SUPPLIES

PHOTOGRAPHY For pleasure or profit. Learn at home. Practical basic training. Long established school. Free booklet. American School of Photography, 835 Diversey Parkway, Dept. 3431, Chicago 14, Illinois.

FREE! Free! 72 page photographic bargain catalog. Thousands of new and used bargains, photographic equipment and supplies. Dept. 1-B3, Central Camera Company, 230 S. Wabash Ave., Chicago, Ill.

BUY Cameras-supplies wholesale, save up to 40%, all leading brands. Argus Matchmatic C3 outfit \$52.10 (list \$74.95). Send for free price list now. East Coast Photo Suppliers, 516 5th Ave., New York 36, N. Y.

PHOTO FINISHING

TRIAL 8 Jumbo roll 35¢. 12—50¢. Western Photo, PM39, Box 298, San Francisco 1.

Hi-Gloss prints, 3¢. Photos, P.O. Box 342, Oshkosh, Wis.

KODACHROME Processing by Kodak. 8mm. roll or 35mm., 20 exp., \$1.50. Prompt service. Write for mailers and prices. Color Pix, Dept. P, CPO Box 30, Kingston, N. Y.

KODACOLOR Trial offer: Enlarged color prints from your Kodacolor negatives, 15¢ each with this advertisement. Bell Color, Dept. PM, Englewood, New Jersey.

8-HOUR Service on deluxe jumbo prints. 8-exposure roll developed and 8 jumbo prints 40¢. 12 exposure 55¢. 16 exposure 70¢. 35mm. 20 exposure 75¢. 36 exposure \$1.25. Jumbo deckle reprints 5¢ each. Contact prints made if specified. Bay Photo Service, P.O. Box 210, Oakland, California.

TWELVE Exposure rolls 49¢. Wallets 20 for \$1.00. Lincoln Studios, Dept. K, Box 13, Lincoln, Nebr.

ENLARGEMENTS, Heavyweight, six 5x7's or three 8x10's \$1.00. Jack Koons, Huntington Mills, Penna.

SUPERIOR Quality. Prompt service. 8 jumbos in album 40¢. 16 contacts 50¢. Jumbo reprints 5¢. Satisfaction guaranteed. Also complete color film finishing service. Write for free circulars and mailers. Fast-X-Photo, Box A, Jersey City, N. J.

BEAUTIFULLY Colored 8x10 enlargement \$1.00; 8 jumbo prints 35¢; 12. 50¢. Dick's Photo, Louisville 12, Ky.

\$1.00 20X 35MM., 120, 127 Slides or 8mm. movies. Complete price list on request. Glendel Photo, Box 701, Hutchinson, Kans.

MOTION PICTURES AND SOUND EQUIPMENT

ROSE Parade 1959 in color, 8mm. 50', special \$4.95. Complete Parade, 200', \$17.50. Finest photography. Rose Parade Movies, Box 10M, Van Nuys, Calif.

5,000 8-16MM. Movie films. Free catalogues. International, Greenvale, N. Y.

FREE Catalog. Save dollars. Fresh 8mm., 16mm, b&w and color film. Home processing equipment. Superior Bulk Film Company, 448 No. Wells, Chicago 10.

16MM. Sound, projectors, films. Sale, rental, exchange. Visit store or write for catalog. National Cinema, 71 Dey St., New York City.

SOUTHSEAS — 2x2 Colorslides. Catalogue, sample, 36¢. Avery Coloralides, 4818A Placidia, North Hollywood, Calif.

SENSATIONAL Offer. 8mm. 50 ft. movies. Reg. \$1.95, only \$1.00. Comedies, cartoons, travel, animals, airplanes. Send \$1.00 each. Home Movies, Box 10M, Van Nuys, Calif.

16MM. Sound films. Bargain bulletin. Duquette, 97-T Snow, Fitchburg, Mass.

FREE! Blackhawk's big sale catalog 8mm., 16mm. movies, 2"x2" color slides. Biggest selection anywhere! Projectors, cameras, supplies. Big discounts! Get free, every three weeks, 12-page newspaper size bargain list! Blackhawk Films, Davenport 14, Iowa.

MOVIE Camera film: 8mm. roll \$1.50, 16mm. 100' \$3.00. Free processing. Better Films, 742 New Lots, Brooklyn, N. Y.

BOOKS; Hundreds of subjects. Big 1958 book catalog — 10¢. Popular Mechanics Press, 200-BC East Ontario St., Chicago 11.

16MM. Sound and silent, 100 feet \$1.00. Features \$15.00 and up. Minot Films, Inc., Milbridge, Maine.

GIANT Bargain bulletin 16mm. sound films from "movie capital." Entertainment, religious, educational. Gaines, Box 36378-PM, Los Angeles 36.

16MM. And 35mm. sound films, projectors. Savarese, Woodcliff Lake, N. J.

MOVIE Film! Free catalog! ESO-R, 47th Holly, Kansas City 12, Missouri.

8MM.-16MM. movies (sound). 35mm. slides. Huntton Rentals, Bellows Falls, Vermont.

8, 16, 35MM. Films, proj., equip. Used. Joseph Macrie, 249 Bellevue, Hammonton, N. J.

8MM.-16MM. sound shorts. Also tremendous assortment full length features as low as \$15.00. Used 16mm. sound projectors our specialty, \$79.50 up. Send for 1959 catalog. Abbe Films & Equipment Co., Dept. PM359, 417 West 44th Street, New York 36. Plaza 7-2219.

MUSIC AND MUSICAL INSTRUMENTS

NEW Pianos \$395.00. Photo 25¢. James, 5758 Magnolia, Riverside, Calif.

GUITAR Making books, plans, imported woods, tools. List 10¢. Store, 510 East 11th Street, New York 9, N. Y.

SONGPOEMS And lyrics wanted. Mail to: TinPan Alley, Inc., 1650 Broadway, New York 19, N. Y.

POEMS Wanted for new songs and recording. Immediate consideration. Send poems. Songcrafters, Box 6145, Acklen Station, Nashville, Tenn.

POEMS Wanted for musical setting and recording by America's largest song studio. Send poems. Free examination. Five Star Music Masters, 630 Beacon Building, Boston.

POEMS Wanted for musical setting and recording. Send poems. Free examination. Crown Music Company, 49-C West 32 Street, New York 1.

SONG Poems wanted. Free examination. Send poems. McNeil, Master of Music, 1112 PM Wilshire, Santa Monica, Calif.

ACCORDIONS — 1959 Models. Lowest wholesale prices. Save up to 75%. Free home trial. Trades accepted. Big color catalog free. Accordion Manufacturers, Box R 2003 Chicago, Chicago 22.

ELECTRIFY Player pianos and reed organs. Lee Mig., 10630 Hillhaven, Tujunga, Calif.

ELECTRIC Guitars, amplifiers, wholesale. Free catalog. Carvin P.M.M., Covina, California.

WANTED! Poems, lyrics, songs, ideas. Bengol, 93 Jefferson, Chelsea 50, Mass.

ACCORDIONS, Wholesale to everyone. Save up to 60%. All national known brands. Free catalogue. Del Principe, 29 South Cicero, Chicago 44.

SONGS Into dollars. Share \$33 million dollars yearly for new songwriters, song poets. Any subject, songs composed, published, promoted by largest firm. Information, appraisal free. Send Nordyke Music Publishers, 6000 Sunset, Hollywood 28 PM, California.

VIOLINMAKERS, Repairers. Fine tone wood, and all violin supplies. Send for free wholesale new price list. International Sales, 414-MPM E. Baltimore St., Baltimore 2, Maryland.

SONGWRITERS! Don't mail poems or songs anywhere! Write for safe procedure! Song Service P, 333 West 56th, New York City 19.

1959 ACCORDIONS Wholesale — 10 day trial. Free catalog. American Accordion Center, 5329 PM-39 Belmont, Chicago.

POPULAR Piano—Beginner's course with instruction record. \$3.00. Kunkle, Box 542, Kent, Ohio.

VIOLIN Makers supplies. Free catalog. 309 W. Fourth, Los Angeles 13.

SONG Request magazine publishes new songs. Send fifty cents for copy. Olenik Records, Mount Morris, Michigan.

ACCORDION Teachers buy at distributors' prices. Accordion Importers, 7445 East Seven Mile, Detroit, Michigan.

SAXOPHONES, Clarinets, trumpets, trombones from factory. Save 50%. Free catalog. Libro Music Center, 591 Chapel St., New Haven, Conn.

RADIO, TELEVISION AND ELECTRONICS

TWO-Way radio for everyone. Unlimited uses. No operator's license needed for new Class "D" citizens band at 27 megacycles. Inexpensive, even home-made equipment is usable. Complete "Class D Report" \$1.00. Human, 6 Berkshire, Worcester, Mass.

KITS: Shortwave radio \$3.50; crystal radio 75¢. Alliance, 2059 60th, Brooklyn 4, N. Y.

TELEVISION Tubes wholesale. Free price list. Edison Tube Co., Menlo Park, N. J.

CRYSTAL Radio experimenters. Write to Hulet, 305 Hope, Lakewood, New Jersey.

NEW 1959 World's largest electronic catalog. 1536 pages. Weighs 7 lbs. \$3.50. Your \$3.50 refunded on purchase of \$25.00 or more. Spera Electronics, 37-10 33 St., Long Island City, N. Y.

ELECTRIC Guitars, amplifiers, wholesale. Free catalog. Carvin, PMR, Covina, California.

HI-FI components, recorders, tape records. Wholesale catalog free. Audio Fair, 1799M 1st Avenue, New York 28, N. Y.

GOVERNMENT Surplus radios, parabolic reflectors, snooperscopes, mine detectors, parts. Catalog 10¢. Meshna, Maiden 48, Mass.

RECORDERS, HI-FI Free wholesale catalogue. Carston, 215-PM East 88, New York City 28.

TAPE Recorders, HI-FI components, sleep learning equipment, tapes. Unusual values. Free catalog. Dressner, 69-02M, 174 St., Flushing 65, N. Y.

FIX Your own TV the easy way, and save 80%! Send 10¢ for new, illustrated TV trouble shooter chart showing which tubes to replace, for all common TV picture troubles. We'll include latest wholesale tube price list free. Zalytron Tube Corp., Dept. PM, 220 West 42nd Street, New York City.

CRYSTAL Radio kit \$1.00; preassembled \$1.25; phone \$1.75; catalogue. Clearco Crystal Company, 2966 No. 4th, Milwaukee 12, Wisconsin.

15 TESTED One-tube circuits, 25¢. Laboratories, 1131-C Valota, Redwood City, California.

SAVE Money on all types radio and TV tubes! 100% guaranteed! Brand new! Write United Radio, Box 1000, Newark, N. J.

FREE Instrument screwdriver! Just send postcard. Hurry, while supply lasts. Laircraft, Box 5008-BC, Detroit 35, Michigan.

AMPEX Tape recorders, components, Boynton Studio, 10-FM Pennsylvania, Tuckahoe, N. Y.

SIMPLE Television repairs. Marvelous booklet or book. Send for 1958 general book catalog. 10¢. Popular Mechanics Press, 633 N. St. Clair St., Chicago 11.

BE A radio, TV announcer, disc-jockey! Make over 500 dollars per week! Top D-J gives complete short cut course for only one dollar. Tells all! Where and how to get first job in broadcasting. Rush one dollar to Your Broadcasting Voice, Box 36, Lexington 73, Massachusetts.

RECORDERS, Tapes, stereo components. Dealer prices, catalogue. ElSCO, 270-B Concord, West Hempstead, N. Y.

CONVERT Light to electricity with photocells. Information free. Write John C. Reynolds, P.O. Box 24106, Los Angeles 24, California.

BUSINESS OPPORTUNITIES

MAKE Extra money—Big cash commissions plus premiums for you and your customers. Sell advertising book matches. Sensational new tenorina, glamour girls, hillbillies; dozens others. All sizes. Quick daily sales; big repeat business. Free master kit makes selling easy. No experience necessary. Superior Match, Dept. MX-359, 7530 Greenwood, Chicago 19.

INTERNATIONAL Mailorder business made easy. Individual setup service, not just instructions. Hermes, 152 West 42, New York City 36.

START Your own business on credit (U.S. and Canada). Your own boss. 1425 dealers sold \$5,000 to \$32,000 in 1957. We supply stocks, equipment on credit. 200 home necessities. Sales experience unnecessary. Pleasant profitable business backed by world-wide industry. Write Rawleigh's, Dept. C-U-PPM, Freeport, Ill.

START Profitable home mimeographing service! Write: Mozelle's Mimeo Shop, Bonham, Texas.

"50 NEW Home-Business Ideas" booklet, sample free. Spray exotic Velvet-Suede on anything. Flokcraft-MH, Los Angeles 61.

IMPORT-Export opportunity, profitable, world-wide, mail-order business from home, without capital; or travel abroad. Established world trader ships instructions for no-risk examination. Experience unnecessary. Free details. Mellinger, X703, Los Angeles 24.

GROW A living miniature forest or orchard (only inches high) that bears tasty tiny fruit at home. Learn amazing dwarfing secrets! Fascinating hobby. Profitable home-business opportunity. Free seeds and plan. (State your age.) Miniature Nurseries, Dept. MH, Gardena, California.

MOLDED Monuments. Terrific profits. No machinery. Local material. One man operation. Granitex Monuments, Dyersburg, Tenn.

\$250.00 WEEK Profit possible. Earn at home spare time with fascinating printing method. \$5 starts you. Send no money now. Free confidential facts and valuable samples. Screen-Print MH, Los Angeles 61.

WOMEN'S Wear store managers. Exclusive. No investment. Browning's, Box 355, Broken Arrow, Oklahoma.

BE A home manufacturer. Make the highest profits. Our sales organization gets the orders, helps sell your products. Build luggage and cases for 1001 needs. We supply instructions, supplies, everything. Work full, sparetime. Details free. Abarsi, 807-S3 Sunset Blvd., Los Angeles 12, Calif.

GROW Expensive herbs for us! Big profits home-business of your own. Year around profitability! We supply everything necessary! Send for free rare seeds and revealing plan. (State your age.) National Herb Exchange, Dept. MH, Gardena, Calif.

INVISIBLE Reweaving: \$5 in one hour possible reweaving burns, tears, moth-holes. Spare-full time. Free details. Skill-Weave, Dept. SC-163, 335 W. Madison, Chicago 6.

CLEANS Windows without mess. Strange dry cleaning-cloth. Replaces liquids. Windows gleam. Samples sent on trial. Kristee 107, Akron, Ohio.

MONEY In mailorder. 5 guaranteed plans. Egert's, Box 7M, Wayne, N. J.

LEARN Professional TV servicing in one week! Fabulous new simplified system. No big expense. No studying. No tools or equipment. Spare, full time. Own your own big profit business! Save! Amazing but true! Free! Write, TV Systems, Dept. CC-173, 1028 So. LaBrea, Los Angeles 19, Calif.

RECENTLY Published. Modern "Manufacturing Formulary." Contains a wealth of information on the composition and manufacture of foods, household, veterinary preparations, cosmetics, vitamins, etc., packaging and labeling. Information, literature free. E. J. Belanger, 4035 N. Central Park Ave., Chicago 18, Ill.

SERVICE Stores with novelty toy displays part or full time. (Small investment triples yearly). Fried, Incorporated, Box 22PM, Brooklyn 25, N. Y.

EARN Money raising fishworms for us! Inquire: Oakhaven-38, Cedar Hill, Texas.

CANDIED Popcorn and potato chip equipment. Eakins, Box 933-A9, Springfield, Ohio.

BUSINESSES, Resorts, motels, investment property, ranches. Our special service dept. at your disposal. No obligation. World's largest. 58 years' service. Strout Realty, 7-MB S. Dearborn, Chicago 3, Ill.

GUARANTEED Market! Earn ready cash raising fishworms for us! Backyard, garage, basement! We buy your crop! Exciting details free! Oakhaven-38, Cedar Hill, Texas.

\$400.00 MONTHLY Raising giant tropical worms. Odorless, soilless method. Charlie Morgan, Box 116E, Bushnell, Florida.

BIG Money raising fishworms and crickets. Free literature. Carter Farms, Plains, Georgia.

SELLING By mail fascinating. Profitable. Free information. Alfano, 19 Pine, Closter, New Jersey.

EVERYBODY Likes candy. Make professionally home. Instruction, tools, supplies. Details free. (Our 49th year.) Ragsdale Candies, B107, East Orange, New Jersey.

QUICK Profits, with no capital! Take orders for magazines your neighbors like want. Make cash on the spot! We show how with free kit. Get yours now. Write McGregor Magazine Agency, Dept. 311, Mount Morris, Ill.

OPERATE Mailorder folio business. Free details. Ballard's, 1834 Edgeland, Louisville 4, Ky.

\$20.00 PROFIT Per hour! Homes, offices, insurance companies pay big money for invisible carpet reweaving. Makes cuts, holes, tears, disappear from expensive rugs and carpets. Brand new industry. Huge, unfulfilled demand. All trade secrets revealed. Details free. Carpeton, 1201D Rosemont, Chicago 40, Illinois.

MUSHROOMS Quicker, easier, cheaper. "Magic" preplanted trays. Newest facts free. Spawm \$1.00. Luxur, 641 South 19th, Newark 3, N. J.

BRUSH Plating outfits for plating articles in the home and shop. No tanks necessary, silvering mirrors, spare or full time. Free particulars. Gunmetal Co., Ave. H, Decatur, Ill.

QUICK Money! "Repairing Car Batteries." At home! Easy too! Free details! Batteryman, Penrose, Colorado.

LEARN Sewing machine repairing. To \$125 weekly. Sparetime. Supplies. Add to present business. Shipping from Chicago. New York, Los Angeles. Write today! Taylor Service, Box 2126, San Bernardino, Calif.

FREE "Franchise profit letter" describes nationwide opportunities. Exclusive distributorships, dealerships, agency operations. Write today. National Franchise Reports, W-528, 333 North Michigan, Chicago 1.

BOOMING Business. Ground floor opportunity. Free booklet. Stone-Craft, Box 856-A, St. Louis, Mo.

\$34.70 TWO Hours. Manufacturing concrete products. No selling. Carlayne Castings, 1803 Fremont, Rapid City, South Dakota.

TO \$100.00 Weekly. Sparetime. Home operated mailorder business. Successful beginner's plan. Everything supplied. Lynn, 10420-M National, Los Angeles 34.

CAMERA Owners! Earn \$50.00 week-ends! Instructions \$1.00, information free! Kline, 935-PM North Austin, Chicago 51, Illinois.

COLORGLAZED Concrete pottery made without molds. Patented method. Cemetery products, novelties, tiles. Basement leak-sealing. Money-making projects. Booklet, details free. Men only. National Potteries Company, Grand Rapids, Minnesota.

PIANO Tuning learned quickly at home. Tremendous field! Musical knowledge unnecessary. Information free. Empire School of Piano Tuning, Champaign, Ill. (Founded 1935).

WANT To make big money at home? \$10.00 profit in an hour possible with invisible mending. Make tears, holes, disappear from clothing, fabrics. Steady year-round demand from cleaners, laundries, homes. Details free. Fabricon, 6234 Broadway, Chicago 40, Illinois.

\$70 WEEKLY—Home, spare time. Simplified mail bookkeeping. Immediate income—easy! Auditax, 34757A, Los Angeles 34.

MINK Raising information free. Complete. Lake Superior Mink Farm, Superior, E.E.I., Wisconsin.

MAKE Flexible molds. Cast plaques, figurines. Free sample. Tooker, 1045-R Fairview, Hamilton, Ohio.

NATURAL Molding rubber, extra thick. Free sample. W. Wooley, 1016-A Donald, Peoria, Illinois.

I Want to send you proof of the wonderful pulling power of Popular Mechanics classified pages. What's your proposition? Write me today. Include literature if possible. P. W. Johnson, Manager Classified Advertising, Popular Mechanics Magazine, 200 E. Ontario St., Chicago 11, Ill.

INCOME With garden golf. Motivated archery ranges. Brockway, Box 3924, Portland 8, Oregon.

YOUR Own high profit business. Sell name brands, full or part time. No inventory, no investment. More than 2,000 name brand items; lowest wholesale prices. Watches, jewelry, cameras, hi-fi radios, phonos, appliances, housewares, hardware, power tools, luggage, musical instruments, garden equipment, sporting goods, toys, many others. 8 floors of name brands. Million dollar inventory. Orders shipped complete within 24 hours! Send for free, beautifully illustrated catalog now! Separate dealer price list. H. B. Davis Corp., Dept. 11, 145 W. 15 St., New York 11, N. Y.

OPERATE Profitable mailorder business! Write: Bond, 1637-H West Vernon, Phoenix, Arizona.

RAISE Rabbits on \$500 month plan. Plenty markets. Free details. White's Rabbitry, Delaware, Ohio.

MONEY Plans! "Secret Journal." Grandpa, two daughters made \$2500 first month! Work home. Publicco, Oceanside, Calif.

11,000 NEW Prospects daily. Baby record books, shoes, albums. Sell mailorder. Use our literature. Write: No-Co-Ro, Capitola, California.

BAKE New greaseless doughnuts in kitchen. Sell stores. Free recipes. M. Ray, 3605 South 15th, Minneapolis 7, Minnesota.

PLATE Baby shoes, jewelry, gifts, bronze and colored pearl. Free booklet. Platex, 11029 South Vermont, Los Angeles 44.

COPUBLISH Mail Sale Advertiser, leading mail order paper. Details, latest copy, dime. Vanroy Shirk Lebanon, Penna.

FREE Catalog. Contains hundreds of businesses, farms and income properties throughout U.S., Canada. Specify type and location desired. Deal direct with owners. U. I. Buyers Digest, 1608 Hillhurst, Dept. PM-3, Los Angeles 27, Calif.

BRONZE Baby shoes; instructions, equipment and mountings for genuine electroplating process. Largest supplier of all plating equipment, supplies. Free catalog. Hollywood Bronze Supply, Dept. B-3, 1624 East First, Los Angeles 33, Calif.

FREE Book "505 Odd, Successful Businesses." Work home. Pacific, Oceanside, Calif.

FREE Folio "\$5,000-\$45,000. Unlimited Vacations." No merchandise. Unknown! Work home, sparetime! Haylings, Carlsbad, Calif.

MAKE \$46 From square foot plywood; jig saw necessary. Free details. Woodart, Bridgewater, Mass.

GROW Orchids at home. Profitable, fascinating. Successful home grower explains special light, temperature and humidity conditions orchids need. Free! Full details. Orchids, 100 S. Vermont, Los Angeles 4.

REBUILD Batteries; repair dolls; make rubber stamps. "75 Ideas" free. Universal, Box 1076-A, Peoria, Ill.

BUY Direct from factories—Appliances, cameras, watches! Free details! Cam Company, 6810PM—20th Ave., Brooklyn 4, N. Y.

PLASTERCRAFT Molds, liquid rubber, plasters, flocks, candle supplies. Catalog and manual free. Blue Rapids Supply, Blue Rapids, Kansas.

LIQUID Molding rubber, free sample. Shellcraft supplies. Chaney's, 1907-A East Road, Jacksonville, Fla.

\$5,000 YEARLY. Spare time at home. Nothing to buy. No local selling. Dignified. Guaranteed. Home Harvest, 1933 Lakeview Road S.W., Albuquerque, N. Mex.

MARKETS Everywhere. Make artistic concrete birdbaths, pottery. Best coloring. Home workshop. Hundred varieties. Hollywood Cementcraft, 8527-S Wonderland, Hollywood 46, California.

WHOLESALE Catalog — Shoes, shirts, pants, underwear, hosiery, etc. Bostonian, 14-CA Dock Square, Boston 8, Mass.

FREE 50 Proven moneymaking plans! Planrite, 1817A Illinois, Wheaton, Ill.

RAISE Earthworms for profit. Write for free folder. Angler's P.O. Box 265, Malibu, Calif.

MAILORDER To motels, restaurants, churches, institutions. Complete individual setup, not just instructions. Hermes Advertising, 152-C West 42, New York City 36.

FIX Typewriters. Free repair course. Home operated. Remit 25¢ for book explaining free course and agency appointment. Athey, Tarentum, Penna.

MAKE Money by mail! Free details! Hunholz, 902 Eighth, Wamego, Kansas.

START Profitable mail order business. Home operated. Everything furnished. Wayne's Service, 3016 Channing N.E., Washington 18, D. C.

WE Pay \$3.50 lb. dried. Grow mushrooms. Cellar, shed and outdoors. Spare, full time, year round. We pay \$3.50 lb. Free book. Mushroom, Dept. 172, 2954 Admiral Way, Seattle, Wash.

REPAIR Hydraulic jacks, earn high wages. Complete illustrated course \$3.98. Hydraulic Parts Supply, Box 8695B, Brightwood 11, D. C.

MANUFACTURER Fishing lures, plastic, none better. 20 models pennies. Free circular. Quaker, 3514-24 N. Lawrence, Philadelphia 40, Penna.

\$100 WEEKLY! Men, women! Work home! Sparetime! Free "confidential plan." Scott Sales, Box 388, Great Neck, New York.

OPERATE Profitable mail order business. Write Walter Service, 4159A East 112th, Cleveland 5, Ohio.

START Your own profitable doll hospital, repair-supply and accessory business. Excellent full or part-time money-maker. Send \$1.00 for comprehensive catalogue. Grand Wig Co., Inc., 139 Fifth Avenue, Dept. P.M., New York 10, N. Y.

YOUR Own home-operated business! Take over your area as our service distributor keeping stores supplied. Nationally advertised 29-year-old line pays you 66 2/3% mark-up. Less than \$100 for merchandise starts you. For samples, highly successful plan, write Novo, Inc., 1168-F Milwaukee, Chicago 22, Ill.

SELL By mail. Work home. Everything furnished. Irvin, Box 603, R-9, Oklahoma City 10, Okla.

SIXTEEN. Yes \$16.00 starts profitable home business. Send \$1.00 for samples. Fully secured. G. VanKoersel, 1339 Peoria W., Phoenix, Arizona.

MAKE Money installing home burglar; fire alarms. Simple diagrams 25¢. Amora Products, 7648 Sunset, Elmwood Park 35, Ill.

OWN Your own business applying aluminum siding. Solupak Co., 1620 Plymouth, Minneapolis 11, Minnesota.

SHELLCRAFT—(Make \$5 items for \$1 investment). Complete "Home-Business in a Package." Revealing instructions, business plan and materials to make over \$50.00 worth of jewelry of all kinds. Only \$9.95 postpaid. Money back guarantee. Handicrafts, 1423 S. Sunrise Way, Dept. P-3, Palm Springs, Calif.

FANTASTIC Profit making hostess aprons designed by leading fashion creator available on exclusive franchise basis. Write to Jobs, Dept. M-2, Box 125, Rugby Station, Brooklyn 3, N. Y.

WE'RE Seeking successful part-time, spare-time, money-making occupations, hobbies, ideas. Cash dividends paid. Inquire Idea Dividends, Dept. PM1346, 125 West 41 St., New York City.

FREE Big mail. Exciting opportunities. Buntun Industries, Box 354A, Philadelphia 5, Penna.

EASILY Possible to earn a dollar every ten minutes with an Acme saw or lawn-mower sharpener. For free literature and terms write Max Mfg. Co., 138 Stockton Ave., San Jose 26, California.

OPERATE Your own home mail order business, it's profitable. Write. Webb Imports, Pico Rivera, Calif.

"MAILORDER Laws and Regulations" and "Mailorder Rules for Beginners." Learn about necessary licenses, different taxes, legal requirements, etc. Both books, \$2.00. Tasker, Box 313f, Alexandria, Va.

INTERNATIONAL Home import mail order business! Experience unnecessary. Earnings unlimited. Free import bulletin. Foreign Traders, 7814-BG Forsyth, St. Louis 5.

EARN \$50 Daily! Incredible! Genuine handmade \$10.00 wallets. Only \$1.50! Free leather sample. Rush! Walletco, Nestor, Calif.

CAMERA Profits! Earn \$50.00 weekly spare time. Instructions \$1.00. Details free. Wilson, Box 965M, Evanston, Ill.

VENDING Directory 197 manufacturers. Only \$1. Vicoa, 79 Wall, New York City 5.

HOME Binocular repair. Profitable! 108-page manual. Lesson-plates, details, free. Waldeyer, 404 20th Ave., San Francisco 21, Calif.

\$100.00 WEEKLY Raising earthworms! Free information. Alamo Earthworms, 425 Oaknoll, A, San Antonio 1, Texas.

MAIL Order opportunity magazine, 10¢. Fireside Shopper, 9430 St. Cyril, Detroit 13, Michigan.

WANTED: Home producers, to be subcontractors. Cast plastic products for manufacturers in our clearing house service. Thousands of easily made items required. Cash in at home, without previous experience. Plastic Service Associates, Dept. 3-PM, East Boston 28, Massachusetts.

SELL Imports! Details, big mail, 30¢. Gem, Eagles Mere, Penna.

NEW Home-import mail order profitability! Your mailbox stuffed with money! No selling. No experience. No investment. We supply everything. Free details. Mail Order Distributors (Import Division), 15201 South Broadway, Los Angeles 61A3, Calif.

PURCHASE Your snow cone machine direct from manufacturer. All prices and sizes. P.O. Box 7803, Dallas, Texas.

COSTS 8¢—Retail \$1.00. Needed automotive product. You manufacture, distribute, easily. Everything furnished. Wilson, 505-F, Princeton, W. Va.

A & W franchises available U.S.A. and Canada for popular A & W root beer. Want to own your own business? Make money, have time to enjoy it. Financing available on credit approval. Write A & W Root Beer Co., Box 1039 PMM, Santa Monica, Calif.

CASH From sawdust, tin-cans, newspapers. Over 200 methods. Instructions \$1.00. Charles Company, 42-GPE, Norwood, Ohio.

EARN Good money sharpening chain saws, scissors, cutters, knives. Free manual. Treyco, North Tonawanda, N. Y.

ALASKA Profitable business opportunity. Investments, history and resources. Excellent book for businessman or student. Send \$1.00 to Educational Book, P.O. Box 12535, Lakewood, Atlanta 15, Georgia.

GET Into booming mail order the professional way. We supply everything. Big profits. Write: Sigma Enterprises, Box 3509, Cleveland 18, Ohio.

MAILORDER Business. No investment. Omaha Envelope, 4721-W California, Omaha 32, Nebr.

IMPORTERS Guide and directory of foreign manufacturers, \$2.00. Wolfe, Route 4, Warren, Ohio.

MADE \$10,000 Typing at home. Guaranteed proof. Amazing information 15¢. Lenore Felgen, Box 1125-PM, Oak Park, Illinois.

SIX Mailorder magazines, articles, tips, sources, moneymaking opportunities, 25¢. Thompson, Box 94-PM, Salinas, California.

MANUFACTURE Concrete drain tile with simple machine. Profitable! Easy! Circular free. Ceeten Products, Cornelia, Ga.

LIQUID Marble—Colorful, glossy! Molded, brushed, sprayed! Particulars free. Marbleizing Service, Edwardsville, Illinois.

ROBINSON'S Sewing Machine Service Manual. 579 illustrations. 144 pages. Earn to \$5 per hour. Price \$6.25. Lee Robinson, Book Nook Bldg., Walla Walla, Wash.

YOUR Own successful business can bring you \$20,000 a year regularly, by mail at home. Know-how is important, investment isn't. Get free details, then decide. DeLang Research, Box 52-D, Burlington, Iowa.

\$1 PAYS \$16.00. Enclose \$1 bill, receive charges prepaid materials for making \$16.00 worth sensational new tire cleaning discovery. Lifetime opportunity. Money-back guarantee. Watts Products, 4809 Poplar Level Rd., Louisville 13, Ky.

BOSS Your own home business. Profits 1200% to 3000%! Make, distribute stunning Shellcraft jewelry. Sells itself wherever displayed. Big repeat demand. Details free! Shellcraft, Dept. A, Box 804, Panama City, Florida.

LEARN Upholstering. Supply sources. Free information. Write Shelton, Box 5101, Nashville, Tenn.

MAIL Order opportunities galore! Details free! Write: Mail Order Publications, 5204 37th Street North, St. Petersburg 14, Florida.

MONEYMAKING OPPORTUNITIES

MAKE Big easy profits making costume jewelry at home in spare time! Quick, easy to make; easier to sell! Details free! Don-Bar, 3511 W. Armitage, Dept. C-192, Chicago 47, Ill.

MAILORDER Beginners. Sell our manual. Million prospects. Free guidance. Thayer Products Co., Bath, Maine.

MAKE And save money. Beautiful, imported "Black Forest" cuckoo clocks. Hand carved wood case. Price \$23.77 each. \$30.00 up retail. Cash or money order. Mauzy, 2915 Clairmont Ave., Birmingham 5, Ala.

AMAZING Money making mail order opportunity. Experience unnecessary. Free details. Write Richton, 231 Wyoming, Maplewood 22, New Jersey.

INVISIBLE Reweaving: \$5 in one hour possible reweaving burns, tears, moth-holes. Spare-full time. Free details. Skill-Weave, Dept. SC-163-A, 335 W. Madison, Chicago 6.

BE Appointed state notary public now. Details. Stationers, 515 East 33rd, Kansas City 9, Missouri.

\$340.00 MONTHLY With jigsaw. Details. Elkman, 346F North Summit, Sioux Falls, So. Dak.

AMAZING Magazine with moneymaking suggestions. Sample 10¢. Pinkerton, 1738-B North West 12th, Oklahoma City 6.

BIG Profits making flowers. Beginner's outfit, \$1.10. Hauser House, Box 6524-P, Phoenix, Arizona.

ASTOUNDING Profit raising earthworms. Details free. Raising instructions 25¢. C. Barnes, Box 135, Pulaski, Tenn.

FREE Imports from overseas. Particulars free. Henry Bassen, Importer, 828 Fullerton, Chicago 14, Ill.

EASY To start rubber stamp business at home in spare time. Make up to \$9.80 an hour without experience. Facts free. Write to Roberts, 1512 Jarvis, Room CR-2-A, Chicago 26.

SELL The new \$29.95 Regina adding machine. Everyone a prospect. Write for free information. Holes-Webway Co., St. Cloud, Minnesota.

FREE Plan and help. Start home mail order business. In 1952 I was almost broke. Today I own \$18,000 home, drive Cadillac, have bank account. Anyone can do this. Norris Cole, 217 West 49th, Bradenton, Florida.

SNAKES Are worth up to \$25.00 each, lizards \$8.00, turtles \$25.00, toads and frogs \$1.75. We buy all kinds, sizes. Full details and collectors brochure 25¢. Biological Exchange, 1211L Wagner Lane, El Paso, Texas.

MAKE Money writing short paragraphs! No tedious study. I tell you what to write, where and how to sell; and supply list of editors buying from beginners. Many small checks add up quickly. Write to sell, right away. Send for free facts. Benson Barrett, Dept. C-27-A, 7464 Clark, Chicago 26.

BIG Money raising fishworms and crickets. Free literature. Carter Hatchery, Plains, Georgia.

START Big-pay business at home in spare time. No experience needed to operate little table-top machine for bronzing baby shoes. Make \$5.46 profit on every pair. Full particulars free. Send postcard to Mason, 1512 Jarvis, Room CM-2-A, Chicago 26, Ill.

MEN—Women! Start money-making plastic laminating business at home in spare time. Material that costs 11¢ brings back \$2.50. No canvassing or selling but mail orders bring in \$20 a day. Write for full particulars free. Rush name on postcard to Warner, Room CL-2-A, 1512 Jarvis, Chicago 26, Ill.

EARN Cash at once, sending us easy orders for magazines your friends, neighbors want. Instant profits! We show how. For free kit, everything you need, write McGregor Magazine Agency, Dept. 321, Mount Morris, Ill.

HOW To make money—Over 150 plans \$1. Catlin, 68 North Ellsworth, San Mateo 8, California.

AMAZING Successes through franchises! Become exclusive franchise holder your territory. Information rushed. National Franchise Reports, MP-528, 333 North Michigan, Chicago 1.

WIN Contests. Complete information, 10¢. Spence, Box 11569, St. Petersburg, Fla.

MUSHROOMS Quicker, easier, cheaper. "Magic" preplanted trays. Newest facts free. Spawn \$1.00. Luxur, 641 South 19th, Newark 3, N. J.

JOIN The prosperity parade with a mail order bookshop in your own home. Valuable information free. Practical Publications, 3974-F Milwaukee, Chicago 41, Ill.

SELL Titania gems. Far more brilliant than diamonds. Catalog 10¢. Diamonite, 2420-M 77th, Oakland 5, California.

SELL Information by mail. 10-to-1 profit ratio. Valuable suggestions free. Rawson F. Wood, 3974 Milwaukee, Chicago 41.

EARN Money evenings copying and duplicating comic cartoons for advertisers. Adservice, Argyle 1, Wisconsin.

BOOKS: Hundreds of subjects. Big 1958 book catalog—10¢. Popular Mechanics Press, 200-BC East Ontario St., Chicago 11.

WIN Contest money. General Contest Bulletin gives hundreds of tips. Lists current contests, rules. Sample magazine 25¢. General Contests, 1609½ East 5th, Duluth 12, Minnesota.

FREE Folio "\$5,000-\$45,000. Unlimited vacations." No merchandise. Unknown! Work home, sparetime! Haylings, Carlsbad, Calif.

MAKE Money, operating mail order business, selling business cards. Vosacek Printing, 4444A Ute, San Diego 17, Calif.

CIGARETTES—Improved roller makes 20 for 9¢. Facts free. Moberly, Box 821, Owensboro, Kentucky.

READ Progressive Mailtrade, the magazine that tells how to make money by mail. Dime brings sample and special offer. Progressive Mailtrade, Box 357, Sheboygan, Wisconsin.

WE Pay \$3.50 lb. dried. Grow mushrooms. Cellar, shed and outdoors. Spare, full time, year round. We pay \$3.50 lb. Free book, Mushrooms, Dept. 173, 2954 Admiral Way, Seattle, Wash.

OPPORTUNITIES. Unlimited. 100 selected, small manufacturing opportunities. Exciting details, free. Alpha-Midwest, LaPorte, Indiana.

HAMMER? Saw? Drill? \$100 weekly. Jet, Box 422, Escondido, California.

\$3.00 HOURLY, Sparetime. Typewriter required. Confidential home-setup 35¢. Interstate, 37 Besch, Albany 9, N. Y.

A Store of your own. How to obtain and operate without capital told in revealing booklet. \$2.00 postpaid. 10 day money back guarantee. Charles Cammer, 2711 De LaVine, Santa Barbara, Calif.

LONGINES, Hamilton, Benrus, Gruen, Bulova, and Elgin. One of the world's largest suppliers of new and rebuilt watches. Lowest prices. Ladies' and men's. \$6.95 up. Write for catalog. Mars Watch Co., Dept. 11-C, 421 S. Los Angeles St., Los Angeles 13, Calif.

"COLLECTIONS Unlimited" offers fascinating agency proposition! Extraordinary. Box 1346-PM, Denver 1.

PROFITABLE Unique coin jewelry. Easily made. Instructions \$1.00. Albert, 809 San Luis Rey, San Diego 8, Calif.

FREE Gift 5 money making plans. Discount catalogue. Coupons worth \$10.00. All \$1.00. Edith's Service, Box 984, Globe, Ariz.

BIG Money in imported paintings. Buy direct at low low prices. Free details. Hrebenyar Company, 4436-C Hamilton Scipio Road, Hamilton, Ohio.

SELL Books by mail. 400% profit. Royal, Box 388-X, Cleveland 27, Ohio.

LEARN Managing money-raising campaigns for churches, hospitals. Handsome fees. Free proof. John Arbogast, 229 East Mason Avenue, Alexandria, Virginia.

FABULOUS Opportunities still exist. Learn to buy and sell real estate for profit. Egan, 17579 Ohio, Detroit 21, Michigan.

\$20 DAILY Spare time plating baby shoes, jewelry, novelties. Free details. Jo-Ca Electroplater, 7840-D Northwest Sixth Court, Miami 50, Florida.

MAILORDER Success secrets revealed by new magazine. Free details. Mailorder Income, 2639-23 Howard, Chicago 45, Ill.

RECEIVE Magazines, samples, mail, catalogs, offers, from everywhere. Get listed. \$1.00. Helen T. Todd, 107-A Pardee St., San Antonio 10, Texas.

RAISE Earthworms for health and profit. Free literature. Edith, Terra-Vermis, Allegan, Michigan.

MONEY Maker—A travel business you can run from your home. Practically no investment. No experience required. W. Anderson, 3933-PM No. Clarendon, Chicago 13, Ill.

\$200.00 DAILY Potential guaranteed! Sawdust product, demanded everywhere! Retraining, sacrificing formula at \$1.00. Starduster, Hendersonville, Tennessee.

MAKE Money gathering herbs, roots, barks, moss, cones, flowers, leaves, etc. Free folder. Kelley, B-10-M, Looneyville, West Virginia.

HOME Mail order sales. We love money, do you? Sell my booklet, "Successful Job Interviewing" 100% profit each. Take advantage of present unemployment. Sample, instructions, \$1.00, satisfaction guaranteed. Box 717, Endicott, N. Y.

START A profitable subscription business in spare time! We need men and women (young or old) as representatives for all leading national magazines. Liberal commissions on all subscriptions. Supplies free. No experience needed. Send this ad with your name and address to: Popular Mechanics, Room 3-0, 250 West 55th St., New York 19, N. Y.

BEGIN Immediately. Make money from empty cigarette packs. Complete instructions. \$1.00. Kokinda, Simpson Avenue, Duryea, Pennsylvania.

FORMULAS, PLANS, ETC.

4 PROFITABLE And useful formulas \$1.00. John Palmer, Box 294, Sacramento Calif.

CAST Plastic opaque. Guaranteed. Write Plastic, 2875 N. Elston Ave., Chicago 18, Illinois.

FORMULAS: All kinds, latest, best. Literature free. Kemixal, Park Ridge, Ill.

LATE, Modern manufacturing formulas. List free. Moon Chemical, Martville, New York.

FORMULAS For latest money-making discoveries. New! Good! Valuable literature free! Miller, Chemist, 1517-D, Tampa, Florida.

PLASTICS

LAMINATING Plastics. All types plastic sheets, vinylite, acetate, plexiglas. Free catalogue. Arthur Blank & Co., 44 Cummington, Boston 15, Mass.

NEW Liquid casting plastic, clear, colors. Embed real flowers, butterflies, photos, coins. Send 25¢ for two handbooks "How to Cast Liquid Plastics" and "How to Make Extra Money at Home." Castolite, Dept. C-101, Woodstock, Illinois.

PHOTO-Seal. Complete electric laminating kit for wallet size photos, cards. \$14.95. Refills available. Therm Appliance, St. Charles, Illinois.

LAMINATING Supplies. Free price list. Solomson, 46 Cornhill, Boston 8, Mass.

BOXES. Plastic. Free list. Althor, 170 Bay 23 Street, Brooklyn, N. Y.

LEARN Plastics fabrication for spare time income. Low cost home training now available. Write for free booklet. Interstate Training Service, Dept. D-3, Portland 13, Ore.

NOW — Electric plastic laminating kit. Burr, 330 East Center, Kalamazoo, Mich.

NEW Do-it-yourself casting and molding plastics! No experience or machinery necessary. Send 25¢ for big 64 page catalogue. Castacraft Corp., Dept. C-22, P.O. Box 555, Palo Alto, California.

PLEXIGLAS. Square foot cost. 1/16", \$1.20; 1/8", \$1.52; 3/16", \$1.86; 1/4", \$2.21; 3/8", \$3.23; 1/2", \$4.36. Colors add 10%. Send 15¢ for postage. Aristocrat Plastics, 23 Sussex Avenue, Newark, N. J.

CHEMISTRY

MICROSCOPE Slides, anatomical. Free list. Bay, 409 Roosevelt, San Francisco 14, California.

EXPERIMENTERS: Bargains galore catalogue, 25¢ (refundable). Hagenow Laboratories, Manitowoc, Wisconsin.

CHEMICALS And apparatus for industrial, analytical, and private laboratories. Catalog 25c. Dept. M-50, Biological Supply Co., 1176 Mt. Hope Ave., Rochester 20, N. Y.

ILLUSTRATED Catalog: Chemistry, mineralogy, biology 25¢. Tracey Laboratories, Evanston, Illinois.

AMAZING New book of science experiments, formulas, and catalogue of laboratory supplies. Only 25¢. National Scientific Co., Dept. PM-3, 11 E. St. Charles Road, Lombard, Illinois.

350 SCIENCE Pocket-books! Comprehensive catalog, 25¢. Details. Fabian's, 4370-P Clark, Montreal 18, Canada.

CHEMISTRY Catalog, 25¢. Experiment book, 25¢. Laboratory Sales, Box 161-A, Brighton, Mass.

VISUALIZED Chemistry-science books! Information free. Franks, 3121 South Racine, Chicago 8.

AGENTS WANTED

FREE Sample! Beautiful feather pictures. Send 14¢ stamps mailing. Sylviak, Apartado 9036, Mexico 1, D. F.

BUY Wholesale — Shoes, shirts, pants, underwear, etc. Complete catalog. Bostonian, 14-C Dock Square, Boston 8, Mass.

WHOLESALE Jewelry closeouts! Catalogue! A&S Distributors, 677 Washington, Norwood, Mass.

MAKE Money selling bumper signs, decals. Box 2223, Paterson, New Jersey.

SALON Reducing tables, rollers, belts, cushions, slant boards. Coin timers factory. Mary-Mac, 1012 Powhattan St., Dallas 2, Tex.

EARN \$12,000 Yearly Only two sales daily. World's best seller, The Holy Bible. Illustrated. Protestant or Catholic. Margaret's, P.O. Box 92, Hazleton 7, Penna.

EASY Handwork makes fast-selling useful articles. Sample free. Sunmade Company, Brockton 64, Massachusetts.

BE The Popular Mechanics representative in your neighborhood and earn big profits in your spare time. Write Popular Mechanics Magazine, Room 305M, 200 E. Ontario St., Chicago 11.

GOLDMINE Of 600 money makers. Free copy. Specialty Salesman Magazine, Desk 5B, 307 North Michigan, Chicago 1, Ill.

PRINTING, Advertising salesmen—Excellent moneymaking sideline selling decalcomania name plates, small quantities. Automobile initials, sign letters. Free samples. Ralco, XL, Boston 19, Mass.

GOLD Or silver letters, numbers. Windows, doors, trucks, 1" to 6". 500% profits. Free samples. Atlas-T, 544 West 79th, Chicago 20.

AGENTS — 300% Profit selling genuine gold window letters; stores and offices. Free samples. Metallic Sign Letter Co., 1217-D West Newport, Chicago.

YOUR Ad in this space will get some good agents for you. Yes, I'll prove it. Write for Folder "A" right now. F. W. Johnson, Classified Advertising Manager, Popular Mechanics Magazine, 200 E. Ontario St., Chicago 11, Ill.

YOUR Own business — Used suits \$1.50, overcoats 65¢, mackinaws 35¢, shoes 12 1/2¢, ladies coats 30¢, dresses 15¢. Enormous profits. Catalog free. Nathan Portnoy Associates, 2109-AA Roosevelt Road, Chicago 8.

CASH Commissions at once, taking orders for magazines every family wants! No experience needed. For free money-making kit, with everything you need, write McGregor Magazine Agency, Dept. 301, Mount Morris, Ill.

RUN A spare-time greeting card and gift shop at home. Show friends samples of our wonderful new 1959 all-occasion greeting cards and gifts. Take their orders and earn up to 100% profit. No experience necessary. Costs nothing to try. Write today for samples on approval. Regal Greetings, Dept. 31, Ferndale, Michigan.

MAKE \$50-\$300 Quickly, easily, showing outstanding all occasion, Easter cards, costume jewelry, gifts, imprinted stationery, household items. Costs nothing to try. Bonus to 7%. Special plan for churches, organizations. Write for best-sellers on approval. Free surprise gift offer, money-making details. Hedenkamp, 361 Broadway, Dept. PM-55, New York City.

SHINE Cars without polish. New invention. Lightning seller. Cars gleam like mirror. Samples sent on trial. Kristee 61, Akron, Ohio.

SELL Miculite coatings or lubricants. Guaranteed. Some commissions 50%. Miculite, Box 8335, Fort Worth, Texas.

NEW Car thief signal. Lightning seller. Samples sent on trial. Northwest Electric, 108, Mitchell, S. Dak.

\$1,000.00 A Month for making dramatic 3-second demonstration of amazing lightweight Presto fire extinguisher. New chemical used by airforce snuffs out fires instantly. Only \$4.95. Terrific commissions. Millions want it. Free kit. Merlite, 114 E.32nd, Dept. P-66W, New York City 16.

\$10.80 PUTS You in business. Take in \$24.00. Get 24 8-oz. bottles guaranteed vanilla flavoring. Repeat orders. F.o.b. Betty Cunningham Co., Box 1, New London, Ohio.

FLYING Outboard. \$1500, car needed. Box 291, Dana Point, California.

TURN Your spare time into cash! No "selling" needed with items like these; you just sit back and take orders during your spare time! Over 700 fascinating items: Gifts, gadgets, toys, greeting cards, and novelties that sell themselves on sight. Write today for details and free, colorful catalog. Samples on approval. Greetings Unlimited, 9-311 Park Square, St. Paul 1, Minnesota.

60% PROFIT On cosmetics — Famous nationally advertised Hollywood cosmetics get 60%. Make \$25 day up. Hire others. For free samples, details, write Studio Girl, Glendale, Calif. Dept. 1293G.

SEEKING New products? Get my outfit 47 money-making specialties. Latest conveniences for home, car. Send no money. Just your name. Kristee 60, Akron, Ohio.

IMPORT Dropship franchise. Personalized and advertising cigaret lighter line. Nice profit. Details \$1.00 (credited towards first order.) Write Cooke & Co., 3, 1-PM, Chome Yurakucho Chiyodaku, Tokyo, Japan.

SELL. Profitable imports. Literature free. Dale, 1959 Clays Mill Rd., Lexington, Ky.

SELL Champion, AC, Autolite spark plugs. Reconditioned, electroplated, guaranteed 10,000 miles, 100% profit. Free sample. Lee Plugs, 1608-E Roberts, Houston 3, Texas.

"BEST-Gro" plant food is a necessity that brings repeat business, generous profits! Mail \$2.00, refundable, for sales pack. Dealer's prices. Best's Nursery, Kissimmee, Florida.

DAMASCENE Earrings! Exotic orientalism. Huge profit. OHGA, PM141, Sigakenkusatu, Japan.

GET Into toys! Gunsmoke—Matt Dillon cowboy vest, top seller. Many other products. Styleco, Dept. 889, Cincinnati 10, Ohio.

WANTED Fire extinguisher salesman. Huge profits. Out-o-Matic, 1737 W. E. 31st, Denver 5, Colo. ☐

BUY IT WHOLESALE

ILLUSTRATED Wholesale merchandise catalog 25¢. Staffords, 806 N. Emerson, Indianapolis 91.

FREE! Beautiful sample doll, authentic sleeping eyes, with wholesale discount catalogue, 50¢. Refunded \$5 order. Amazing savings. Thousands of items. Pecks, 501 South 8th, Independence, Kansas.

DIAMOND Rings! Below wholesale, catalogue. Distributors, Box 106Z, Hudson, New York.

HANDMADE Western boots. Free catalogue. Hall Boots, Box 7074, El Paso, Texas.

AMAZING Savings. Wholesale catalogue \$1.00, refundable. Coleman's Personal Shopping Service, Wayland, N. Y.

ACCORDIONS Wholesale! Save 1/2. Home trial. Free catalog. Accordion Warehouse, Dept. 39-RW, 2003 Chicago, Chicago 22.

TREMENDOUS Savings. Large wholesale catalog. \$1.00 (refundable). Robert Barcker, Dewey Rd., Amherst, Ohio.

BUY Wholesale: 100,000 nationally advertised products. Appliances, cameras, sporting goods, housewares, watches, typewriters, tools, clothing, etc. Discounts to 80%. Buy-Rite, Box 258, Hawthorne 104, New Jersey.

USED And new watches \$2 up. Free list. Southern Watches, 5-PM So. Wabash, Chicago 3.

MOST Unusual catalog—Gift included. 25¢ (refundable). Seegay, Box 10126, San Antonio 21, Texas.

ELECTRIC Guitars, amplifiers, wholesale. Free catalog. Carvin PMW, Covina, Calif.

LARGEST Wholesale supply source in U.S.! Furniture, clothing, appliances, housewares, automobiles and accessories, tools, sporting goods, hobby supplies, farm equipment, imports, new products, bargain merchandise. Free details. Associated Wholesalers, Box 2068-DD, Sioux City 4, Iowa.

PLYWOOD Wholesale. Fir or hardwoods. Send 20¢ for price lists. Lewis, Box 172, Medford, Oregon.

I Can get it for you wholesale! Clothing, appliances, household goods. Even automobiles. Free information on our service. Frank's, Box 547, Paducah, Kentucky.

RONSON And Zippo type lighters. \$5.50 dozen postpaid. Midwest Imports, 430 South, Springfield, Missouri.

BIG Multicolor wholesale catalog! Housewares, appliances, clothing, silverware, cookware, luggage, binoculars, shavers, radios, phonographs, cameras, projectors, recorders, typewriters, sewing machines, furniture, power tools, toys, sporting goods, watches, diamonds, jewelry, automobiles, etc. Name brands. Huge discounts. Postcard: Selbyco, Decatur 154, Illinois.

SELLING Out many items less than wholesale. Catalog 10¢. Cewaco, 5921 Lowell Road, Everett, Wash.

JEWELRY. Watches, perfume, pricelist 25¢. 3208 Oriole, San Jose, California.

BUY Wholesale! Tremendous discounts available! United Wholesalers, 1265-M Broadway, New York 1, N. Y.

SALESMEN—DISTRIBUTORS

\$1,000.00 A Month for making dramatic 3-second demonstration of amazing lightweight Presto fire extinguisher. New chemical used by airforce snuffs out fires instantly. Only \$4.95. Terrific commissions. Millions want it. Free kit. Merlite, 114 E. 32nd, Dept. P-66W, New York City 16.

GET New shirt outfit free! Make \$90.00 weekly on 5 average orders a day. Famous quality made-to-measure dress and sport shirts at \$3.95 up sell fast to all men. No experience needed. Full or part time. Write: Packard Shirt Co., Dept. 841, Terre Haute, Ind.

AD Match sales! Your own business, without investment! Sell for world's largest direct selling manufacturer of advertising matchbooks. Big spot cash commission. Start without experience. Our tested sales kit tells you where and how to get orders. Men, women, part or fulltime. Match Corporation of America, Dept. PM-39, Chicago 32.

AMAZING Opportunity. New low priced fire alarm protects homes, farms, offices, factories, etc. No wiring, hangs like picture. Pays up to \$1,100 a month. Free kit. Merlite (Alarm Div.), 114 E. 32nd St., Dept. F-66W, New York 16, N. Y.

MAKE Big profits calling on business men. Free details. Box 77A, Flat River, Mo.

SELL New 49 star flag. Wales Manufacturing, 47 W. 63, New York City 23.

SELL Utility jeeps, wagons. Big demand, high profit. Send 10¢ for folder and prices. Custom Car Company, Rockford, Illinois.

\$6.73 PROFIT On every sale of lightning portable adding machines, retail \$14.95. Wide market. Full details, actual size. Color photo free. Lightning Adding Machine Sales Company, 2306A West Slauson Avenue, Los Angeles 43, California.

MAKE Extra money—Big cash commissions plus premiums for you and your customers. Sell advertising book matches. Sensational new tenoramas, gamon, girls, hillbillies; dozens others. All sizes. Quick daily sales; big repeat business. Free master kit makes selling easy. No experience necessary. Superior Match, Dept. M-359, 7530 Greenwood, Chicago 19.

MY Free outfit puts you in a fine business! Just 8 easy orders a day brings you up to \$960 extra a month in big money shoe business! Complete line air cushion shoes for men, women. Rush postcard for powerful free selling outfit! Mason, Chippewa Falls K-136, Wisconsin.

WILL You wear new suits and topcoats without one penny cost and agree to show them to friends? You can make up to \$30.00 in a day even in spare time, without canvassing. J. C. Field & Son, Inc., Dept. L-1826, Harrison & Throop Sts., Chicago 7, Ill.

I'LL Send you free stocking sample newest advancement in hosiery since nylon. Patented, full-length. Stays up over-the-knee without supporters, without girdle! Nationally advertised price \$1.95. Make money introducing to friends at \$1.00 pair. American Mills, Dept. 674, Indianapolis, Ind.

CALENDARS. Advertising novelties, matches. All styles, including religious, varnished. 12 sheet, girls. Hundreds of advertising novelties, book matches, etc. Fleming Calendar Co., Sales Division, 6539 Cottage Grove, Chicago 37, Ill.

BIG Money making opportunity. Exclusive line uniforms, jackets, pants, shirts, coveralls, sportwear. Advertising embroidered. Every business prospect. Get selling outfit free! Master Co., Dept. K-21, Ligonier, Indiana.

ANYONE Can sell famous Hoover uniforms for beauty shops, waitresses, nurses, doctors, others. All popular miracle fabrics: Nylon, dacron. Exclusive styles, top quality. Big cash income now, real future. Equipment free. Hoover, Dept. C-100, New York 11, N. Y.

SALESMEN—Big money every day showing nationally known drain cleaner. No chemicals. Nothing like it. Minute demonstration. Commissions paid daily. Sample furnished. Campbell Co., (Est. 1928), Rochelle 604, Illinois.

IF You're interested in making money in selling, see the hundreds of exceptional opportunities in Salesmen's Opportunity Magazine. Send name for your copy, absolutely free. Tell us what you're selling now. Opportunity, 848 N. Dearborn, Dept. 17, Chicago 10, Illinois.

TAKE Over your area—Agents, dealers, farmers, make \$125 up weekly selling nationally advertised Campbell's Go-Green liquid fertilizer concentrates. No investment. Everything free. Campbell Co., (Est. 1928), Rochelle 5, Illinois.

INCREASE Your earnings by applying time proven sales methods. The selling plan in "The Magic Key to Selling" has greatly increased the earnings of thousands of salesmen. Send \$4.98 today for this effective selling plan. Satisfaction guaranteed. Specialty Sales Consultants, P.O. Box 222, Muncie, Indiana.

"SPIRITUAL Birth certificates." It's new, marvelous, unique, exclusive, fascinating, beautiful, copyrighted. Market goal 125,000,000 certificates. Possibly \$70.-000,000 retail sales. Franchise available to qualified jobbers, distributors, salesmen, etc. Write Spiritual Birth Certificates, Red Springs, North Carolina.

SELL Australian boomerang. Information and sample \$2.00. Far Horizons Imports, Box 252, Felton, Calif.

\$10,000 A Year selling steel shelving, parts bins-cabinets-shop equipment. Sold everywhere! Terrific commissions. Free 32-page catalog. Jobber discounts. BFC Corporation, 2800 E. Hedley, Philadelphia 37, Penna.

IT Ain't sellin'—Just servicing! Take over your area as our service distributor keeping retail stores supplied. Nationally advertised 29-year-old line pays you 66 2/3% mark-up. For samples and highly successful plan, write Novo, Inc., 1166-T Milwaukee, Chicago 22, Illinois.

100% PROFIT. Fast easy money! Take orders for Sweet Georgia Brown cosmetics. Colored people buy quick. Free sample. Valmor, Dept. TD, 2451 Michigan, Chicago 16.

EMPLOYMENT INFORMATION

MIAMI Opportunities. \$1 for ads. Maco, 864 W. 73rd Pl., Hialeah, Fla.

AMERICAN Overseas jobs. High pay, men, women. Transportation paid. Free information. Write Transworld, Dept. 12D, 200 West 34th St., New York City.

JOBS On ships. Write for free information. World Wide Seamens Service, Box 1445-PM, New York 1, N. Y.

LOS Angeles employment, housing, business opportunities \$1.00. Hall, Box 4011, N. Hollywood, Calif.

WANT A good job? High pay? Overseas—U.S.A.? Free information. Employment Headquarters, 79 Wall Street, Dept. 340, New York City 5.

500 NAMES, Addresses of U. S. firms operating overseas. Send \$2.00. Fileco, 1456 Jones, San Francisco 9.

RUN Profitable advertising business. Particulars free. Industrial, 82 Pioneer, Dayton, Ohio.

MEN, Women. U. S. A., foreign jobs. High pay. Construction, clerical, supervisory, shipping, aviation, oilfields, etc. Skilled, unskilled. Free transportation, adventure, promotions. Unusual opportunities. Complete information plus worldwide project listings. Only \$2.00 (\$2.25 airmail). Satisfaction guaranteed. International Reports, Dept. E, P.O. Box 621, San Jose, California.

CALIFORNIA Jobs and pay rates. New 48-page book lists firms, jobs, wage and salary information. Valuable sample employment tests, essential job-getting information. Send \$1. Periday Co., Box 331, Inglewood, California.

MERCHANT Marine jobs. Top wages. Ship's captain reveals how to join. Beginners book \$2.00. Details free. Captain, Box 501-P, Reading, Massachusetts.

JOB Hunters—Procedure booklet, secrets; \$1.00. Counseleers, 514 Forest, Collinsville, Illinois.

ALASKA Hourly scale: Laborers \$4.16; truck drivers \$4.45; carpenters \$4.38; plumbers \$5.00; electricians \$5.00. Construction projects awarded over \$335,000, -000.00. Names and addresses of companies hiring; total contract awarded; location; wage scale; also information regarding homesteading. Send \$1.00 to Alaska Employment Opportunities, Box 1032, Anchorage, Alaska.

JOBS Overseas! Write Janecek Development Co., 109 Hub Station, New York 55, N. Y.

INFORMATION—U.S.A. overseas jobs. High pay, transportation. Futures, Dept. M, 215 West 34th Street, New York City 1.

FOREIGN Jobs—Latin America, Alaska, Canada, up to \$1500 monthly. Up-to-date 1959 foreign service directory gives complete information; hot list of firms hiring for military and civilian construction, aircraft, oil, exporters-importers, mining. How-when-where to apply. 11th successful year. \$1.00. Global Reports, Box 8873-S, Los Angeles 8, Calif.

JOIN The merchant marine. For information write Box 4092, Jacksonville 1, Fla.

ALASKA Information. Unlimited opportunities. Homesteading, employment. 25¢. Haase, De Forest, Wisconsin.

JOBS \$400 Month. Merchant marine. Write: Box 1804-T, Paterson, N. J. Beginners only.

FOREIGN Employment information. Make big money in Europe, Africa, South America, Canada, Alaska, Far East. Transportation paid. Construction workers, clerks, truck drivers, etc. Travel, adventure. Complete information application blanks, sent by return mail. Send \$2.00 to Foreign Bureau, P.O. Box 512, New Orleans, Louisiana.

WHY Worry about work? Escape jobs forever! Retire securely now. Lead leisurely life. Unusual new book shows how. Postcard brings details free. Belmont, Wyckoff 157, New Jersey.

COMING To Florida? Send for complete report, jobs, salaries, cost of living. Information you need. \$2.00. Survey, 904 Chamber of Commerce Bld., Miami 32, Fla.

JOBS—High pay; U.S.A., So. America, the Islands. All trades. Many companies pay fare. Write Dept. 71J, National Employment Information, 1020 Broad, Newark, N. J.

COPYRIGHTED Reports. Best paying jobs with travel, adventure, promotions. Construction, aviation, shipping, oilfields, laborers, clerical, trades, supervisory, factory, unusual opportunities. Skilled, unskilled. Foreign, stateside. Men, women. Only \$2.00 (\$2.25 airmail) (c.o.d.'s accepted), including registration-advisory service. Satisfaction guaranteed. Included free: Special reports on Alaska, Venezuela, South American opportunities, husband and wife foreign jobs. Research Services, Suite 514-PM Meramec Building, St. Louis 5, Missouri.

JOBS, Ships, \$100 weekly beginners. Travel, adventure. Details free. Seaman Service, Box 17-M, Brooklyn 8, N. Y.

BEAUTIFUL Virginia! Jobs available. Sunday classifieds \$1.00. Information, 38 Richland, Newport News, Virginia.

SOUTHERN California jobs, housing, business opportunities. Classifieds \$1.00. C. A. Stumpf, 1881 Palmer Court, Long Beach, California.

NEWEST Foreign jobs to \$16,000. Latest listings. Bonuses, travel adventure. Canada, Japan, Europe, Africa. 12 years job researching. Men, women all trades. Plus free information on Venezuela, South America, Alaska. Only \$1.00. Universal Research, Box 4912, Baltimore 20, Md.

PROVEN Method brings best jobs! T. J. Surface, Director, Roanoke, Virginia.

ALASKA — Complete job information. Current employment report \$1.00. Alaska Unlimited, Box 197, Ketchikan, Alaska.

JAPAN! Many hi-paying jobs available. Full details (complete coverage) \$2.00. K. Wats, C.P.O. Box 903, Tokyo.

RAPIDLY Developing British Columbia frontier offers exciting new life, unlimited opportunities, numerous occupations. L. Matte, 385U Winnipeg, Prince George, B.C., Canada.

JOBS on ships and yachts traveling foreign countries. Davenport's, 1354, G.P.O., New York 1, N. Y.

SPECIAL SERVICES

DEEDS Plotted. Write to Burt D. Horn, Mt. Pocono, Penna.

INFORMATION On anything. Ferguson Research Specialists, 116-14 141 St., South Ozone Park 36, N. Y.

AUTHORS And songwriters. Get published. Postcard brings free details. Ace Service, Box 1161, Warwick Station, Newport News, Virginia.

BORROW Business magazine articles, free list. Keith's, Box 453, Ottawa, Can.

WHAT Do you want to find? We will locate best sources for you. Reasonable fee. Mandeville Source Finders, 405 Olympia, Pittsburgh 11, Pennsylvania.

EDUCATIONAL AND INSTRUCTION

LEARN Piano tuning at home! Only \$29.95 including tools. Write Musical Enterprises, Box 5074-M, St. Paul, Minnesota.

FINISH High School at home, spare time. No classes. Diploma awarded. Write for free catalog. Wayne School, Catalog HF-92, 2527 Sheffield, Chicago 14.

MASTER Watchmaking at home. Free sample lesson. Chicago School, 2328-YP Milwaukee, Chicago 47.

LEARN By ear with Dormiphone. While you slumber, the amazing new scientific invention works for you. Revolutionary Dormiphonic tools give you a shortcut to learning languages, correct speech, memorizing facts, figures; relaxation, habit training. Saves your time, effort. So simple to use, children benefit. Used by educators, psychologists. Write today for fascinating free book. No obligation. Modernophone, Inc., 320-039 Radio City, New York City 20.

MANY Make \$1500.00 per month operating collection office. Free details. Franklin Credit, Roanoke, Virginia.

LEARN Civil and criminal investigation at home. Earn steady good pay. Institute Applied Science, 1920 Sunnyside, Dept. 163, Chicago 40, Ill.

BECOME Tax consultant. Licensed home training. Union Institute, Hoboken 2W, N. J.

UNIVERSAL Language. 33 letter alphabet \$1. Adam-man, 6111, Cleveland 1, Ohio.

DRAFTING, Design, blueprint reading. Good paying. Easy to learn at home. Minimum age 17. Write Utilities Engineering Institute, Dept. TC-16, 2525 Sheffield, Chicago 14.

BOOKKEEPING Made easy. Simplified course. Record keeping for your business. Includes "Bookkeeping—Budgeting for Housewife." \$1.98 postpaid. Edgemont Sales, Whitesboro 1, New York.

"HOW To Train Horses"—A book everyone who likes horses or ponies should have. Free. No obligation. Simply address Beery School of Horsemanship, Dept. 1103-C, Pleasant Hill, Ohio.

COMPLETE Your high school at home in spare time with 62-year-old school. Texts furnished. No classes. Diploma. Information booklet free. American School, Dept. X345, Drexel at 58th, Chicago 37, Illinois.

HELP Yourself to abundant living. Our courses have aided students to richer, fuller lives. Learn secret of contentment, happiness. Earn degrees Ps.D., Ms.D. Write for free book. College of Universal Truth Correspondence School, 23-C E. Jackson, Chicago.

USED Correspondence courses and books sold and rented. Money back guarantee. Catalog free. Courses bought. Lee Mountain. Pisgah, Alabama.

PROFESSIONAL Investigators correspondence school. Badge, diploma, future. Box 41197, Los Angeles 41, Calif.

EARN Degrees by correspondence courses: Associate of Arts, Bachelor of Arts also Bachelor of Science in Business Administration. Pacific International College of Arts and Sciences, primarily a correspondence school. Resident classes also carried. 5719-D Santa Monica Blvd., Hollywood 38, California.

1959 INDUSTRY Training. Home-study. Drafting, design, electronics. Aero Tech. 2166-PM Sunset Blvd., Los Angeles 26, Calif.

ENGINEERING Degrees earned through home study. Electronics, electrical, mechanical, civil, physics. When writing, specify course desired. Pacific International College of Arts & Sciences primarily a correspondence school. Resident classes also carried. 5719-B Santa Monica Blvd., Hollywood 38, California.

HIGH School diploma at home. Licensed teachers. Approved materials. Southern States Academy, Station E-16, Atlanta, Ga.

SECRET Investigations. Experience unnecessary. Investigators particulars free. George Wagner, M125 West 86th, New York City 24.

SING, Speak with power. Self-training records. Amazing! Canfield, 2018-A Fifth Avenue South, Minneapolis 4, Minnesota.

BE An investigator. Write for free details. State age. National Detective Academy, Dept. P, P.O. Box 1082, Scottsdale, Arizona.

EARN Degree. Free bulletin. Home-study only. Midwestern Bible School, 1060 Broadripple, Indianapolis.

STUDY To be a doctor of psychology, metaphysics, divinity or philosophy. Correspondence courses only. The Neotarian Fellowship, Desk 9, Kansas City 6, Mo.

STUDY For Doctor's degree of psychology, metaphysics and divinity. Correspondence courses only. College of Divine Metaphysics, Dept. P-M, 2811 North Illinois, Indianapolis 8, Indiana.

WANT A diesel job? New opportunities to increase income. Higher pay. More money. We can help you qualify. Tools. Shop method home training. Write today! Diesel, Tractor, Heavy Equipment Division, Interstate Training Service, Dept. B-2, Portland 13, Oregon.

BOOKKEEPERS! Increase your earnings! Operate your own simplified "Dollar-A-Week" bookkeeping and tax service. Full or spare time. Details free. No obligation. Ellis, Box 300, Cedar Grove, North Carolina.

LEARN Appliance service and repair. Motors, washers, refrigeration, cleaners, everything. Free booklet. Armstrong, 11027-A South Vermont, Los Angeles 44.

BE A real estate broker. Study at home. Write for free book today. OI approved. Weaver School of Real Estate, 2018P Grand, Kansas City, Missouri.

EARN While you learn. Auto and diesel mechanics master this top paying trade. Many graduates earn \$100 a week and up. Approved for Korean veterans. For free information write Dept. No. 256, Nashville Auto-Diesel College, Nashville 3, Tenn.

PHYSICAL Therapy and massage. Home training. Practice privately or work with doctors and hospitals. Free catalogue. National Institute, Desk 4, 159 E. Ontario, Chicago, Ill.

INVESTIGATOR Training. Phillips Secret Service System, 1917-B North Kenneth, Chicago 39.

LEARN Blueprint reading at home. Insure your job. Higher income and advancement. Madison Technical School, 118 Meriham Drive, Dept. PM, Madison 5, Wisconsin.

ELECTRONICS — Television. Expert technician salaries \$150.00-\$200.00 weekly. Earn while you learn. Free job placement. Ages 18-55. Information free. Universal Electronics, 324 East Tenth, Kansas City, Missouri.

STUDY Dianetics and Scientology. Start your course at home. Teaches you how to control and handle your fellow man and your own thinkingness, reactive mind, and body. Be clear. Write today for information and enrollment. Academy of Scientology, 1812 19th St., N.W., Washington 9, D. C.

BOOKS. Free general catalog, 100 pages. Text, vocational, educational, instructional subjects. Millions of volumes, new and used. Bargain prices. Books bought. Est. 1902. Long's College Book Co., Dept. PM, Columbus 1, Ohio.

LEARN While asleep with your recorder. phonograph or amazing new "Electronic Educator" endless tape recorder. Details free. Research Association, Box 24-N, Olympia, Washington.

VOICE Secrets! Information! Free! Studio, 14356R South Jersey, Norwalk, California.

HOME Study courses. Revolutionary new method. Choose from over 80 subjects. Free bulletin. Automent, Inc., 2166 Market, San Francisco 14, Calif.

TIMESTUDY, Key to positive personal profits! Associated Techniques, Box 426, Cedar Rapids, Iowa.

CASH For correspondence courses (Buyers and sellers.) Gem, Dept. 3-M, Linwood, New Jersey.

USED Correspondence courses, educational books. Satisfaction guaranteed. Catalog 10¢ refundable. Courses bought. Bayles, 78-B Courtright, Wilkes Barre, Penna.

SCIENCE Of getting things done: Short, sizzling, powerpacked for immediate results. For executive or housewife. Frameable. \$1.00 per copy. Pan Pacific Services, 521 Pine, Seattle 1, Washington.

EARN Doctorate—Homoeopathy, science. Correspondence. College abroad. Representatives: Aured, Central Valley, New York.

PIANO Tuning pays. Big money in spare time. Learn at home in 30 days. No musical knowledge necessary. Phonograph, records, tools and instructions furnished. Personal instructions available. Free catalog. Capital Piano Tuning School, 3160 S.W. 16th Court, Fort Lauderdale, Fla.

MATHEMATICS. Home study. Elementary through university levels. UCSM, Philadelphia 26, Pennsylvania.

SWEDISH Massage. Home study. Diploma. Swanson's Illinois Licensed School, 3809 Alta Vista, Chicago.

BLUEPRINT Reading. practical home study course. Gassin, Box 20591, Los Angeles 6, Calif.

WELDERS Earn big money. Easy to learn arc, gas, automatic welding. Non-profit school, low tuition, GI approved. Free booklet. Hobart Welding School, Box M-392, Troy, Ohio.

LEARN Mineralogy and lapidary art at home. Diploma course. Earn big profits making costume jewelry. Free catalog. Mineral Science Institute, Desk 2, 159 East Ontario, Chicago 11.

SELF Mental mastery! New health! New beauty! Specify need. The Leavitt Science, Clinton, Illinois.

ANALYZE Handwriting for profit, pleasure, self-understanding. TV, radio, newspaper columns, teaching, lecturing, court work, counseling. Men, women, spare time up to \$50 an hour. Amazing opportunities. Sample lesson free. Must be 21. IOAS, Inc., 47, Springfield 4, Missouri.

AN Efficient and powerful subconscious mind; also doctor's degrees in Psychology, Metaphysics, and Divinity can be yours. Gain peace, health, plenty, Correspondence. Institute of Metaphysics, Dept. PM, 1250 Indiana Street, Birmingham 14, Ala.

PLAYS, STORIES, MANUSCRIPTS

WANT Your book published? Learn how we publish, advertise, promote, distribute. Many successes. Free booklet PM. Vantage, 120 West 31, New York City. Midwest office: 220 S. Michigan Ave., Chicago, Ill.

WANTED: Book manuscripts, all subjects considered. Greenwich Book Pub., Attn. Mr. Zealand, 489 Fifth Ave., New York City.

ADVERTISING AGENCIES, LETTER WRITERS, FOR ADVERTISERS

MAILING Lists most any classification \$5.00 1000. Your circulars mailed with ours \$4.00 1000. Write for our literature. Dixie Mailers, King, N. C.

NOW Ready: New, amazing Classified Advertising Record Book—prepared especially for classified advertisers. Here is a book that tells you instantly whether or not your advertising in any publication is paying you real results. You can tell immediately how many inquiries each publication produced—how much cash received from every ad. Spaces are provided for the name and address of the publication, date of issue, space used, rate, cost of ad, key number, etc. You have a complete record of each publication right before your eyes. Plenty of space to keep accurate record of 28 separate publications. You can have a copy by sending only 10¢ to cover postage and handling. Send for your copy now. W. F. Johnson, Classified Adv. Mgr., Popular Mechanics Magazine, 204 E. Ontario Street, Chicago 11, Illinois.

ADVERTISE: 24 Words, 100 Canadian newspapers \$5.50. Lists free. Advertising Bureau, 10511-C Springfield, Chicago 43.

CALIFORNIA Birth lists, gummed labels, \$7.00, 1,000. Willard's, 12663 Ralston, San Fernando, Calif.

FREE! 1959 Advertisers Rate and Data Directory. 52 pages! E. H. Brown Advertising Agency, 20 N. Wacker, Chicago 6.

ADVERTISING. Result-getting ads prepared, placed newspapers, magazines, radio, anywhere! Lowest rates. Catalogue free. Baker Advertising Agency, 189 W. Madison, Chicago 2.

"AMAZING New Book"—"Profits From Classified Advertising." Tells how and what to advertise. Be sure to read this book before you invest one cent in advertising. Write for your copy now. Just send 10¢ for postage and handling. W. Johnson, Classified Advertising Manager, 202 East Ontario Street, Chicago 11, Illinois.

ADVERTISING Ratebook leading newspapers, magazines, free. Chicago Advertising Agency, Chicago 4.

WE Place advertising in all newspapers and magazines at lowest possible rates. Write us. Polger Advertising Company, 410 South Michigan Avenue, Chicago 5, Illinois.

CARTOONING, COMMERCIAL ART, SHOWCARD & SIGN PAINTING, TATTOOING

"HOW To Make Money With Simple Cartoons." A book everyone who likes to draw should have. It is free; no obligation. Simply address Cartoonists' Exchange, Dept. 93-C, Pleasant Hill, Ohio.

HOW To draw. 46 lesson course, \$2.00 postpaid. Simmons, Box 4462, Philadelphia 40.

CARTOON Your way to success! Internationally known instructor, Raye Burns, will personally teach you to create original, salable cartoons at home. Cost of course is very low. Write for free details. Raye Burns School, Box 3583-P, Cleveland 18, Ohio.

YOU Can entertain with chalk talks. Catalog 10¢. Balda The Cartoonist, Oshkosh, Wis.

LEARN Sign painting at home. Free talent test. Ben Kerns, Box 812-PM, Greenville, S.C.

LEARN Sign painting with fascinating system. Straley, 410 S. Western, Springfield, Ohio.

LEARN Profitable, fascinating tattooing. Illustrated information \$1. Zeis, 728-C Leslie, Rockford, Illinois.

RUBBER STAMPS AND OFFICE SUPPLIES

PLASTIC Case rubber stamps, 3 lines \$1.00. Floyd Smith, 14213 Courtland Ave., Cleveland 11, Ohio.

HANDLE Type—3 lines \$1. Dean-PM, 1189 N. Grand, Baldwin, N. Y.

FREE! Rubber stamp catalog. Many items. Campfeld, Box 798, Springfield 1, Mass.

POCKET, 3 Lines \$1.00. Guaranteed. W. J. Specialty, 8464 Manhattan, Detroit 11, Michigan.

3 LINES 75¢. Knob handled, cushioned. Satisfaction guaranteed. Clancy, 304-P Swan, Providence 5, R. I.

3 LINES 75¢; 1000 Embossed business cards \$3.00; 1000 8½x11, offset printing \$6.75 up. Economy, Box 3853, Hilltop, Milwaukee 5.

PENCILS! Printed with your firm name, address or any name, slogan. Office quality, rubber erasers. In lots of three gross \$4.70 per gross, five gross \$6.45 per gross, ten gross \$8.25 per gross. Postpaid. Milwaukee Pencil Company, 2720 North 48th, Milwaukee 10, Wisconsin.

THREE Line stamp \$1.00. 4 line \$1.25. Broad Stamp Co., Box 866, Lexington, Ky.

TYPEWRITERS, DUPLICATORS, OFFICE DEVICES

DUPLICATORS Delivered anywhere in Canada for \$63, in U.S.A. for \$48. Free details. Permo Seal Sales, Box 205A, Grand Centre, Alberta, Canada.

RECONDITIONED Typewriters, duplicating, printing devices. \$25.00 up. Supplies. Appliances. DixieGraph, King, N. C.

PRINTING, MULTIGRAPHING, MIMEOGRAPHING, GUMMED LABELS

PRINTING: All types. Rubber stamps. Office supplies. Bargain prices. Joseph Tymula, Westover Road, Stamford, Conn.

EMBOSS Letterheads 8½x11, 1000, \$14.75. Samples. Printshop, 17030 Miles, Cleveland 28, Ohio.

SALESBOOKS. One time carbon forms, continuous business forms. Box 502, Great Neck, N. Y.

FREE Catalog postpaid printing, rubber stamps. DM Press, Sebastopol, Calif.

MIMEOGRAPHING—Letters, pricelists, formulas, instructions. Lowest prices. Lem's Letter Shop, 5710 Stanton, Detroit 8.

MIMEOGRAPHING And copy writing. Letters, circulars, composed. Inexpensive. Write Fuesing, 6522 West Center, Milwaukee 10, Wisconsin.

1000 GUMMED Labels, 3 lines \$1.00. Free pocket knife. General Supply, Box 128, Depew, N. Y.

LOW Cost business printing. Samples, prices free. Chicago Mail Service, 192-A North Clark, Chicago 1.

1,000 NAME And address labels in plastic box \$1.00. Heights Industries, Capitol Heights 27, Md.

CATALOGUES Printed 1½¢ apiece, free price list. Copen Press, 105 Court Street, Brooklyn, N. Y.

OFFSET Printing: 24 hour service. Only 67½¢ per 100 8½x11. (Minimum order 1,000.) National Letter, 308 West 43 St., New York City 36.

BUSINESS Cards 1000—\$2.95. Fast service. Other quality printing low prices. Tribune, Green Forest, Arkansas.

BUSINESS, Personal printing. Reasonable. Catalog. Press, Box 1, Weaubleau, Missouri.

HAMMERMILL Bond! 125 8½x11 note-heads, 125 #10 envelopes. Up to 4 lines. 3" wide copy, our layout, \$3.25 postpaid. Prompt, neat work. Catalog for stamp. Camellia Printing Co., 915B 18th St., Sacramento 14, Calif.

1,000 BUSINESS Cards. Raised letters, \$3.50. Samples. Pioneer, PM-3, Island Park, N. Y.

FINE Printing: Offset, letterpress, from \$5.00 per thousand. Flexart, 59 Elm, Stonington, Conn.

FREE Unusual catalog. Business, personal printing. Bariskill, 1715 Julian, El Cerrito, California.

100 6¾ ENVELOPES, 100 5½x8½ Letter-heads quality printed, \$2.35. Millard Fortney, R3, Dillsburg, Penna.

1,000 BUSINESS Cards—Processed embossed, \$3.50. Two color \$4.50. Bodie, Wise Road, East Hebron, New Hampshire.

BUSINESS Printing. Catalog, samples free. Howprint, 723-G Eunice, Webster Groves 19, Missouri.

POPULAR Priced printing. Indigo Press, 5800 Indigo Road, Richmond 30, Va.

GUMMED Name and address labels, 1000, \$2.00 postpaid. Joe J. Jemec, Star Rt. 3, Hibbing, Minn.

5,000 COLORED Circulars—\$39. Complete: Art, copy, layout, printing. Promotion-M3, 385 Broadway, New York City 13.

QUALITY Offset prices free. Industrial, 82 Pioneer, Dayton, Ohio.

\$2.89 THOUSAND—Business cards (pre-paid-postpaid) samples. Wayside, Livermore, California.

FREE Literature personalized stationery items, envelopes, labels, cards, name plates. Myers Company, 1228 Adams, Owosso, Michigan.

SUPERIOR Mimeographing, quality printing, free samples. Vincent Printing, Skippers, Virginia.

BUSINESS Cards with glamour. Reasonable. Samples. Mention business. Heaven's, Colmar, Penna.

BUSINESS Printing, rubber stamps. Inexpensive. Free! Literature, samples. Hildreth, 1047 Inner, Schenectady 3, New York.

100 WATERMARKED 8½x11 Letterheads and 100 6¾ envelopes \$2.00 postpaid. Samples. Hussey Printing, Abbeville, Miss.

1000 GENUINE Engraved 8½x11 letter-heads, \$16.00 postpaid. Hamilton, 4341 Meade, Chicago 34.

EMBOSS Letterheads, envelopes, 100 each, \$3.00. Universal Arts, Scotch Plains, New Jersey.

YOUR Name and address printed on gummed labels 500-3 lines \$1.00. 15¢ each extra line. ½x1½. Print clearly. No c.o.d.'s. Addison Mail Order, PMB-3, 1840 Addison, Chicago 13.

FREE Catalog, amazing printing bargains. Quality Imprints, Box 859, North Miami, Florida.

1,000 NAME And address stickers, \$1.00; 8½x11 letterheads, \$5.95; #10 envelopes, \$6.95. Offset Sales, Box 6642, Kansas City 23, Missouri.

MIMEOGRAPHING. Offset printing, lettershop services. Samples. Pennway, Drawer 1470, Scranton, Penna.

BUSINESS Printing. Reasonable. Samples. H & H Print, 67 Ashland, Medford 55, Mass.

FREE Printing catalog. 1000—8½x11 photo offset, \$5.50. Rich, 67 Cheyenne, Springfield, Mass.

PRESS Printed signs, 7x11 15¢ each, over 10. Freidman, 79 White Beeches, Dumont, N. J.

QUALITY Printing—Letterpress, offset. 1000 business cards \$3.25, card case included, prepaid. Literature, samples free. Schlake, D-4, Alexandria, Kentucky.

1000 BUSINESS Cards, raised printed, \$3.98 postpaid. Free samples. Free estimates on anything printed. Cardcrafters, 135 South Cherry, Galesburg, Ill.

ADS Running under this heading sell printing. Ask me for proof, I'll gladly send you amazing facts. Ask for Folder "P." F. W. Johnson, 200 E. Ontario St., Chicago 11, Ill.

PRINTING OUTFITS AND SUPPLIES

MIMEOGRAPHS, \$9.95 Up. New. Guaranteed. Price list free. Independent Distributor, 1055 48th St., Oakland 8, Calif.

MAKE Your own self-molding rubber stamps and printing cuts. Plexirubber, Argyle 1, Wisconsin.

DO Your own printing. Save money. Simple rules. We supply everything. Print for others; good profit. Raised printing like engraving too. Have home shop. Details free. Kelsey Presses, V-11, Meriden, Connecticut.

RUBBER Stamp making presses, hydraulic operated, electrically heated. Sizes 5"x8", 8"x12", 10"x15", starting outfits. All kinds supplies. Custom Manufacturing, 507-P N. Jefferson, Springfield, Mo.

PATENT ATTORNEYS

INVENTORS—Take these preliminary steps toward patent protection. Sketch and describe your invention. Sign, date and have this disclosure witnessed by two people who understand your invention. Have us make a preliminary search among U.S. patents already granted for similar types of invention. We report on the probable patentability of your invention and recommend your further course of action. Write for our instructive booklet, "Patent Protection for Inventors" and convenient "Evidence of Invention" disclosure form. Victor J. Evans & Co., 531C Merline Building, Washington 6, D. C.

INVENTORS: Learn how to protect your invention. Unless the inventor is familiar with patent matters, he should engage a competent registered patent attorney or agent to represent him. We are registered to practice before the U. S. patent office and prepared to serve you in handling your patent matters. "Patent Guide for the Inventor" containing detailed information concerning patent protection and procedure with "Record of Invention" form will be forwarded to you upon request—without obligation. Clarence A. O'Brien & Harvey Jacobson, Registered Patent Attorneys, 91-B-A District National Building, Washington, D. C.

"INVENTOR'S Guide" and "Record of Invention" free on request. Frank P. Ledermann, Registered Patent Attorney, 154 Nassau Street, New York City.

INVENTION Record form free and "Patent Information Every Inventor Should Have." Carl Miller, Registered Patent Attorney, Woolworth Building, New York.

INVENTORS—If you believe that you have an invention, you should find out how to protect it. The firm of McMorro, Berman & Davidson is qualified to take the necessary steps for you. Send for copy of our patent booklet "How to Protect Your Invention" and "Invention Record" form. No obligation. McMorro, Berman & Davidson, Registered Patent Attorneys, 134-A Victor Building, Washington 1, D. C.

C. A. Snow & Co.—M427, Snow Building, Washington 1, D. C. Registered Patent Attorneys. Write for information.

INVENTORS: Without obligation, write for information explaining the steps you should take to secure a patent. John Randolph, Registered Patent Attorney, 803 Victor Bldg., Washington 1, D. C.

FOR INVENTORS

INVENTORS! Have you good patentable ideas? Write Mr. Metzler, 11 West 42nd, New York.

SAVE High fees! Apply for a patent yourself. New do-it-yourself kit now makes it easy. Free registration form. Miss Claire Arden, 806 Wm. Penn Annex, Philadelphia 5, Penna.

FREE—"Vital Information Every Inventor Needs Before Selling Invention." Brown, 141-A Broadway, New York City.

LOSE Your patent? Patent reinstatement guaranteed. Draftsman fee only. \$12.50 up. Pacific Patent Co., 2570 Marshall Dr., Palo Alto, Calif.

INVENTORS—Send for free Patent Information book and Inventor's Record. Registered Patent Attorney, Associate Examiner, Patent Office 1922-29, Patent Attorney & Advisor, Navy Department 1930-47, Gustave Miller, 39A Warner Building, Washington 4, D. C.

FREE Invention record form, and list of needed inventions. Keep your idea secret until recorded. We search patent office, and report, advising most profitable procedure. Patent Sales Bureau, Box 4973, Washington 8, D. C.

INVENTORS: Where to offer your invention. Particulars from Location Service Bureau, Box A37, Almond, Wis.

INVENTIONS Wanted now by my manufacturer-clients. Patented, unpatented. Write Gilbert Adams, Patent Broker, 80-A Wall Street, Financial District, New York City.

"INVENTOR'S Guide" sent free. Frank P. Ledermann, 154 Nassau Street, New York 38, N. Y.

PATENT Searches, including copies of nearest patents, \$6.00. Reports airmailed within 48 hours. More than 100 registered patent attorneys use my service. For free invention protection forms, write Miss Ann Hastings, P.O. Box 176, Washington 4, D. C.

WE Have the markets if you have the ideas. Harvey Engineers, Cambridge 1, Maryland.

INVENTION Record form free and "Patent Information Every Inventor Should Have." Carl Miller, Registered Patent Attorney, Woolworth Building, New York.

INVENTORS. Don't sell your invention patented or unpatented until you receive our offer. Write Cowgill, Box 298, Marion, Ohio.

PATENT Searches \$6.00. 48-hour service. Free invention protection forms. Write Raymond L. Smith, Patent Searcher, 620 Sheraton Building, Washington 5, D. C.

INVENTORS: Information on patent procedure furnished on request, without obligation. John Randolph, Registered Patent Attorney, 802 Victor Bldg., Washington 1, D. C.

INVENTORS: Test the commercial value of your patented or unpatented inventions, quickly and inexpensively. Write for free information. Institute of American Inventors, Dept. 40-B, 635-F St., N.W., Washington 4, D. C.

PATENT Searches \$6.00. 48-hour airmail service. Invention protection forms free. Write Patent Engineering Service, 711 14th Street N.W., Washington 5, D. C.

INVENTIONS Pay inventors when profitable sales are certain from constructions soundly patented, and wise steps taken to reach the best markets. I help inventors to make the most profit with low definite fees for all services. Searches \$15. 30 years experience as patent-development engineer, U. S. and foreign patents secured. Joseph O'Brien, 132 Nassau Street, New York 38, N. Y.

INVENTORS—If you believe that you have an invention, you should find out how to protect it. The firm of McMorro, Berman & Davidson is qualified to take the necessary steps for you. Send for copy of our patent booklet "How to Protect Your Invention" and "Invention Record" form. No obligation. McMorro, Berman & Davidson, Registered Patent Attorneys, 134-B Victor Building, Washington 1, D. C.

INVENTORS: Learn how to protect your invention. Unless the inventor is familiar with patent matters, he should engage a competent registered patent attorney or agent to represent him. We are registered to practice before the U. S. patent office and prepared to serve you in handling your patent matters. "Patent Guide for the Inventor" containing detailed information concerning patent protection and procedure with "Record of Invention" form will be forwarded to you upon request—without obligation. Clarence A. O'Brien & Harvey Jacobson, Registered Patent Attorneys, 91A-A District National Building, Washington, D. C.

INVENTORS—This firm is registered to practice before the United States Patent Office and available to assist you in the preparation and prosecution of your patent application. "Patent Protection for Inventors" booklet containing detailed information and steps to take toward patent protection sent promptly upon request. No obligation. Victor J. Evans & Co., 532-C Merline Building, Washington 6, D. C.

LET Us build your model. Henry Herman, 350 Hewes, Brooklyn 11, N. Y.

INVENTIONS WANTED

INVENTORS—Turn your talents into immediate cash! Join Inventors of America. Write National Headquarters, 3136-A Sylvania Avenue, Toledo 13, Ohio.

INVENTORS. Don't sell your invention patented or unpatented until you receive our offer. Write Cowgill, Box 298, Marion, Ohio.

INVENTORS: Hundreds of manufacturers have requested our assistance in locating marketable new products. Complete information free. Institute of American Inventors, Dept. 40-D, 635-F St. N.W., Washington 4, D. C.

INVENTIONS Wanted. Patented; unpatented. Tremendous manufacturers lists. Global Marketing Service, 2420 77th, Oakland 5, California.

INVENTIONS Wanted: Patented, patent pending. 28 years experience promoting inventions. National Service Bureau, 3120 Meramec, St. Louis 18, Mo.

INVENTORS: Have you tried to sell your invention without success? Contact us, we succeed where others fail. Chapman, 5250 W. Montrose Ave., Chicago 41, Ill.

INVENTIONS Wanted for manufacturers. Free details. Write: Allen, 712 Davis Bldg., Dallas 2, Tex., Dept. B.

INVENTIONS Bought and sold. Write: Your I.D.E.A., Incorporated, Box 8627, Oklahoma City, Oklahoma. Bonded and licensed.

ARE You interested in offers from reliable manufacturers for your invention? Patented, unpatented. Harvey Engineers, Cambridge, Maryland.

INVENTIONS Wanted now by my manufacturer-clients. Patented, unpatented. Write Gilbert Adams, Patent Broker, 80-S Wall Street, Financial District, New York City.

INVENTIONS Needed immediately for manufacturers. For additional information write Kessler Corporation, 53-1W, Fremont, Ohio.

SUPERIOR Promotions. Patented; unpatented inventions. Information booklet, free. Superior, 338-344 North Rodeo, Beverly Hills, Calif.

FREE—"Vital Information Every Inventor Needs Before Selling Invention." Brown, 141-A Broadway, New York City.

PATENTS FOR SALE

RETRACTABLE Stabilizer fin for water skis. Royalties or outright. Information, D. L. Durley, 1809 Wychwood St., Toledo 13, Ohio.

MANUFACTURING

DESIGNERS, Manufacturers. Industrial decalcomanias, bumper signs. Lowest prices. Modra Sales, Grafton, Wisconsin.

GENUINE Buckskin coats, jackets, shirts, gloves. Northwestern Buckskin, Merrill 1, Wisconsin.

CUSTOM Models, parts, tools, instruments. Henry Herman, 350 Hewes, Brooklyn 11, N. Y.

MODELS—Small lot manufacturing. Metals, plastics, etc. Milburn, Burlington, Kentucky.

DESIGNING, Tools, dies, models, manufacturing. Bald Knob Products, 1640 Lionel, Cincinnati 14, Ohio.

MODELS, MODEL SUPPLIES

SCALE Model materials for building model homes and architectural buildings of any type, 1/4" and 1/8" scale. Send 25¢ for catalog. A & B Model Builders, 454-F Donovan Road, Kansas City, Kansas.

MINIATURE Engines, gas and steam. Build them on your metal lathe using our castings, blueprints. Also available, machined steam engine kits ready to assemble. Illustrated catalogue 15¢. Octura Models, Box 536-PM, Park Ridge, Illinois.

SHIP And yacht model fittings: blueprints. Send 35¢ for illustrated catalog listing hundreds of items. A. J. Fisher, 1002-1 Etowah Ave., Royal Oak, Mich.

ROCKET Supplies. Nozzles, nose cone, tubes, fuse. Send 10¢ for catalog to Alana Manufacturing Company, Mineral Point, Penna.

SHIP Model kits and fittings: Fishermen, clippers, frigates, schooners, brigs, tugboats. Also half-hull models for interior decoration. Send 25¢ for 1959 catalog and booklist. Model Shipways, Box 85, Bogota, N. J.

SHIP Models. Most complete line in New England, kits, fittings, plans, books, tools, engines, motors. Illustrated catalog 35¢. James Bliss & Co., Inc., Dept. SM, 342 Atlantic Ave., Boston 10, Mass.

ROCKET Plans, photographically illustrated directions sent with new supply catalog 25¢ (refundable). Central Rocket Company, Waupaca, Wisconsin.

"POWER Drives Handbook"—36 pages illustrating many types motor drives for model autos, boats, displays, turntables, etc. Mail 25 cents cash, returnable first order \$3.00 or more. Wilson's of Cleveland, Dept. PM, 425 Lakeside N.W., Cleveland 13, Ohio.

SCALE Mechanical drawings every type ever used, steam, diesel, turbine, electric, Union Pacific, \$3. UP Motive Power, 2666 Farnam, Omaha, Nebraska.

POWER Models. Unusual steam, gasoline and traction engines, fittings, metals. Four cylinder gasoline engine. Comprehensive catalog \$1.00. Chas. Cole, Ventura, Calif.

ROCKETS! Five new plans including fuel formulae. 1. Two stage, 4.5 mile altitude. 2. Parachute return, 21" length. 3. Electrical ignition, 1.5 mile altitude. 4. 1,600' altitude. Less than \$1.00 builds it. 5. Fiber tube construction, experimental design. Any two, \$1.00. All five, \$2.40. Joe Krohn, Carleton College, Northfield, Minn.

AIRPLANES, Railroad, boats, military, automobiles, chemistry, art, craft, electricity; dozens more. Beautiful full color catalog 10¢. Carpenter, 1337 Fargo, Chicago 26, Ill.

LIQUID Rocket. 75 lb. thrust, 6' long. Complete plans \$2.00. Missile Research, Station 1, Provo, Utah.

ROCKETS! Seven different blue-prints. Plus instrumentation, fuel directions. \$1.00. Rocketry, Spencer, Iowa.

BIG, Colorful model airplane catalog only 10¢! Pictures, descriptions of over 133 planes, missiles, racing cars, supplies. 24 color-printed pages! Send dime to Comet, Dept. S, 501 W. 35th, Chicago.

HOME CRAFTSMEN

BOAT Lumber, furniture woods. Free list, 10484 Maria, Cincinnati 31, Ohio.

FREE Bargain catalog—Fluorescent fixture kits, fixtures, parts. Shoplite, 650M Franklin, Nutley 10, New Jersey.

FREE. New catalog 2430 artist-drawn patterns. Craftplans, 1322-A Wabash, Chicago 5.

MOSAIC Kits and supplies. 600 fabulous coffee table and mural kits from \$6.95. Imported glass tile sample, brochure, instructions 50¢. Free price list. Mosaics, Box 25282, Los Angeles 25, California.

105 JIGSAW Patterns plus alphabets \$1. Jigcraft, O'Fallon 53, Missouri.

NEW Big illustrated catalog. Supplies for leathercraft, metalcraft and numerous small inexpensive crafts. Prompt shipments. Top values. Latest ideas. Send 10¢ today to J. C. Larson Co., Dept. 8527, 820 S. Tripp, Chicago 24.

LEATHERCRAFT, Mosaics, enameling, art materials, 24 other crafts. 60 page catalog 25¢. Kit Kraft, 293, Studio City, Calif.

KNOCKDOWN Cedar chests, also over fifty kits. Catalog 25¢. Giles Kendall Co., Huntsville 2, Alabama.

FREE! Leathercraft catalog. Hundreds of new items. Write MacPherson Bros. Leather Company, Dept. E, 730 Mission St., San Francisco 3, Calif.

FREE "Do-it-yourself" leathercraft catalog. Tandy Leather Company, Box 791-Y28, Fort Worth, Texas.

WOODWORKING And cabinetmaking course for beginning and advanced home craftsmen. Only complete low-cost home training program available. Write for free booklet. Interstate Training Service, Dept. G-3, Portland 13, Ore.

LEARN Art metalcraft and jewelry making. Complete, inexpensive, home training course now available. Special tools and materials furnished. Write for free booklet. Interstate Training Service, Dept. L-3, Portland 13, Oregon.

FREE Seashells catalog. Instruction book 35¢. Secor's, Bradenton, Florida W.

REMODEL Your own home. Save hundreds of dollars. New, amazing book shows you how. Written so you can understand it. Step by step instructions make it easy. Fully illustrated, 400 photographs, hundreds of diagrams. 180 pages, \$3.50. Literature 10¢. Popular Mechanics Press, 200-RH East Ontario St., Chicago 11, Ill.

FREE Leathercraft catalog. Quality kits, leathers, tools. Handicrafters, Box 427, Montrose, California.

STYLECRAFT "Pretraced" leather kits. Handbags, billfolds, filigree belts. Patterns on leather. Just carve, assemble and lace. "Pre-carved" kits also available. Send 25¢ for catalog, free folder. Refunded first order. Apache Leather Company, 2804 E. Washington St., Phoenix, Arizona.

BUILD Your own 6x48 belt sander. bench-type, with end and side fence. Unfinished stock available. Plans \$1.00. O. Gipple, 121 School St., Buffalo 13, N. Y.

LEATHERCRAFT. Send 10¢ for new 102-page catalog of tools, supplies, kits including metalcrafts, enameling, ceramics, all other crafts. Complete stock. Reasonable. Since 1910. Sax Bros., Dept. PM-3, 1111 N. 3rd, Milwaukee, Wis.

101 PATTERNS Of smart gifts, novelties, shelves, action windmills plus "Make Money Jig Sawing." \$1.00. Mastercraft, 35M, 7041 Olcott, Chicago 31.

FREE Details, natural wood bricks, make with table saw. Holiday House, 7225 "L" 4th Plain, Vancouver, Washington.

KNOCKDOWN Cedar chests and lumber. Free price list. Bedford Lumber Company, Shelbyville, Tennessee.

16 LAWN Chairs, 22 tables, benches, trellises. Plans and necessary patterns. \$1.00. Mastercraft, 33M, 7041 Olcott, Chicago 31.

WHITTLING Figures: \$1.00 set. Dae Co., Box 219, Baraboo, Wisconsin.

WALNUT, Maple and cherry squares. One free when you buy two. Limited time. Free list. Midland Lumber Co., P.O. Box 262, Savannah, Missouri.

\$50.00 WEEKLY Making Formica knock-down furniture. Details and plans. Write Woodcrafters Supply, Box 844, Evergreen Park, Ill.

DO IT YOURSELF

PLAYER Piano repair manual explanations and illustrations \$2.00. Hefe, Box 56, Riverdale Station, Dayton 5, Ohio.

TOOLMAKERS: Build your own vernier height gage. Terrific savings: Kits, plans, graduated scales. Free information. Henn Industries, 1341 Cloverfield Ave., Dayton 29, Ohio.

SPORTSMEN, Inventors, hobbyists can make and repair anything with cold welding. Complete assembly \$2.98. Chemweld, Pollock, Idaho.

MAKE Efficient air compressor from gas engine. Plans \$1.00. D & W Engineering, P.O. Box 301, Hertford, N. C.

6x8' UTILITY House. Build for under \$100.00. Plans, materials list \$2. Smith, Box 4165, Pensacola, Florida.

EVERLASTING Welder from junk. Pain Electric, R13, Ft. Worth 5, Texas.

GRANDFATHER Clock movements, barometers, blueprints, kits. Wholesale catalog 25¢. Mason-Sullivan, Noroton, Conn.

WATCHES, OLD GOLD, JEWELRY

COSTUME Jewelry supplies, settings, rhinestones, etc. 88 page illustrated catalog. 25¢. Milady, Box 1328, G.P.O., New York City.

FREE Catalog. Costume jewelry parts. Supplies. Reasonable prices. Fast service. Guaranteed quality. Unique merchandise. Folsom's, Box 52, Medford 55, Mass.

HIGHEST Cash for old gold, broken jewelry, gold teeth, watches, diamonds, silverware, spectacles, platinum, mercury. Free information. Rose Refiners, Heyworth Building, Chicago 2.

WATCHBANDS Repaired, lengthened or shortened, \$2.00 per band. Federal Band Co., Box 3244, So. El Monte, California.

WATCHMAKERS', Jewelers', requirements: Watchmaking courses from \$25.00. Catalog (100+ pages) 25¢. Bengale Wholesale, Culver City, California.

HIGHEST Cash paid for old gold, jewelry, gold teeth, diamonds, watches, silver. Mail articles today. Information free. Chicago Gold Refining Co., 6 E. Monroe, Dept. 1258, Chicago 3.

WATCH And clock repairing books. Free catalog. North American, 2320-AC Milwaukee, Chicago 47, Illinois.

FACETED Birthstone rings. Free brochure. Lapidex, 514 Forest, Collinsville, Illinois.

WATCHMAKERS Journal contains instructions in watch repairing. Sample copy 25¢. Dean Co., Box 3218-M, Daytona Beach, Fla.

CASH Dollars paid for old gold, broken jewelry, gold teeth, watches, platinum, etc. Regardless of condition. Mail articles today. We guarantee highest prices. Eastern Refiners, 102 Pine Street, Bristol, Conn.

FREE Folder costume jewelry supplies. Modern Craft, Box 11088-H, St. Petersburg 33, Florida.

TOBACCO. SMOKERS' SUPPLIES

CIGARS 5 1/4" Hand made clear Havana. Box 50, \$6.75 or 5 samples 75¢. Prepaid. Money back guarantee. Jack Catani, 2306 North Habana, Tampa 7, Florida.

FOR THE HOME

WEATHERVANES, Cupolas, yard numbers, post signs, estate signs. Free catalog. Home Industries, 330 Athens Street, Jackson, Ohio.

FOAM Rubber furniture cushions. Factory seconds, 50% discount. Free catalog. Perma-Foam, 390-C Nye Avenue, Irvington, N. J.

OF INTEREST TO WOMEN

HOUSEWIVES, Teachers, students, office workers, if you need extra cash each week but household or other duties prevent you from taking a part-time job, learn how you can earn by accepting orders to Popular Mechanics. Good Housekeeping and all other magazines. No experience needed. Write Popular Mechanics, Room 3W, 250 West 55th St., New York 19, N. Y.

HOUSEWIVES Wanted! Big money. Spare or full-time cake decorating and candy making. Turn your kitchen into a gold mine. Complete instruction, learn and earn at home. Write for free facts: Candy and Cake, Dept. 273, Fairbrook, California.

60% PROFIT On cosmetics — Famous nationally advertised Hollywood cosmetics pay 60%. Make \$25 day up. Hire others. For free samples, details, write Studio Girl, Glendale, Calif. Dept. 1293G.

DRESSES 24¢; Shoes 39¢; men's suits \$4.95; trousers \$1.20. Better used clothing. Free catalog. Transworld, 164-S Christopher, Brooklyn 12, N. Y.

SELL Fine fabrics. Get yours wholesale. Box 863, Norwalk, Conn.

COLGATE'S Lustre-Creme shampoo 4 lbs. \$4.85 postpaid. Geller, 2089P Matthews, 62, New York City.

BUTTON Hole worker \$1.00. Guaranteed. Martin, Lawson St., Martinsville, Va.

AMAZING Offer on Bible stories, with photographs, and artistic masterpieces. Free circular. Webster's Products, P.O. Box 508, Centralia, Wash.

SELF-Watering planter. Red or black, 24K gold decorated. \$3.50 postpaid. Greenwood Co., North Hills, Penna.

SEASHELL Earrings 50¢. Catalog 25¢. White's, Box 512, Clearwater, Florida.

FREE Sample razor blade, from Germany. Revolutionary accomplishment. First time in U.S.A. Agents wanted. Paul Weil, Dept. 41, Box 157, New York City 31.

"8 MISTAKES Parents Make." Every parent should have this new book about child training. It is free; no obligation. Simply address Parents Association, Dept. 673, Pleasant Hill, Ohio.

PERSONAL

BORROW \$50 To \$600 by mail. Quick, easy, private. No co-signers. Repay in 24 small monthly payments. For the amount you want write today to Dial Finance Co., 410 Kilpatrick Bldg., Dept. C-1, Omaha 2, Nebr.

FALSE Teeth stained? Don't wait another minute. New "extain" safely removes stain and deposits. 3 mo. supply \$1.00. Arlo Industries, Box 3073A, San Antonio 11, Tex.

BORROW By mail. \$100-\$600. Anywhere. Air mail service. Postal Finance, 200 Keeline Building, Dept. 917C, Omaha 2, Nebraska.

TRADE With our 50,000 customers. We act as agents. Give full description of offering. Name item you seek in return. Trader's Exchange, Dept. P-1, Box 125, Rugby Station, Brooklyn 3, N. Y.

LOANS By mail. Borrow \$50 to \$500 for any purpose. Employed men and women eligible. American Loan Plan, City National Bldg., Dept. PM-3, Omaha 2, Nebr.

SEVEN Lost mines, during seventy years three losers still living. Two dollars buys my story. F. H. Zimmerman, Box 5263, Long Beach 5, Calif.

ENJOY Health. Free booklet. Nutrition, 152-PM Kearny, San Francisco, Calif.

BIBLE Questions answered. Stamped envelope. Bylon, 17167 Bentler, Detroit 19, Michigan.

MEXICAN Information. Any subject. Suarez, Box 2104, Mexico City, Mexico.

RETIREMENT And independence, now! Regardless of age or wealth. Enjoy life. Future Plans, Box 76-C, Tarzana, Calif.

REMAILING SERVICE

PALM Beach remains 25¢. Receiving-forwarding \$3 monthly. Confidential. Enterprises, 615 El Prado, West Palm Beach, Florida.

HOLLYWOOD, Las Vegas, New York City. Confidential address \$3.00 month. Remains 25¢. Hall, Box 4011, N. Hollywood, Calif.

MINNESOTA Remains 25¢, monthly \$3.00, classifieds \$1.00. Smith, Box 2115, North Mankato, Minn.

REMAILING-Receiving-forwarding \$3.00 monthly. Details free. Beasley, 1829-H Claiborne, Richmond 20, Va.

SECRET Mail address, \$3 month. Hedgpath, Box 830, Alhambra 23, Calif.

HOUSTON Remains 25¢. Monthly \$3.00. Remailing Services, Box 12112, Houston, Texas.

REMAIS 25¢. Monthly \$3. Rex Co., Box 5831, Baltimore 8, Maryland.

RENT A confidential mailing receiving-forwarding address. Agents since 1950. Details free. William McLaughlin, 800 Stewart, Columbus 6, Ohio.

REMAIS 25¢. Forwarding. \$3.00 month. Sund, 3602 Ferdinand, Tacoma 7, Wash.

REMAIS 25¢. Receiving, forwarding. Kusz, Box 206, Station B, Hamilton, Ont., Canada.

FORWARDING \$3.00 Monthly, remailing 25¢. Wellsdon 35-28 163 St., Flushing, N. Y.

CONFIDENTIAL Remailing, receiving-forwarding. \$3.00 monthly. J. Albert Green, Box 2353, Colorado Springs, Colo.

LETTERS Remailed 25¢. Confidential receiving address \$3.00 month. Bonded. Pan Pacific Services, 521 Pine, Seattle 1, Washington.

RE-Airmails \$1.00. Monthly \$3.00. Confidential. Laubscher, 77 Ooster Street, Ladybrand, South Africa.

CANADA'S Capital remains 25¢. Keith's, Box 453, Ottawa, Canada.

SECRET Hawaiian address. Use our address as your address. \$3.00 month. Fobel, 617-S Kuaaina, Kailua, Hawaii.

JORDAN, Syria, Lebanon, Spain, France. Remains 60¢. Postcards available. Worldwide (159 cities), 58 East Eleventh, Columbus 1, Ohio.

REMAIS, 25¢. Receiving-forwarding. \$3.00. Hale, Box 1, Glenmont, N. Y.

CALIFORNIA Remains 25¢. Forwarding \$3.00 month. Reliable Service, Box 95, Orange, California.

MAIL Received-forwarded, 25¢ letter, \$3.00 monthly. Gillespie, 6619 Meadowlawn, Houston 23, Texas.

TREASURE FINDERS

GOLD-Silver detectors. Geiger counters. Violites for tungsten, etc. Best available. Guaranteed. Information free. Detectron, 5528 Vineland Ave., Dept. 6, North Hollywood, Calif.

UNDISCOVERED Wealth! Transistorized M-scope detects gold, silver, jewelry, etc. Lightweight, guaranteed. From \$59.50, easy terms. Free catalog. Fisher Research, Dept. C-1, Palo Alto, Calif.

MAP 445 Treasures, \$1.00. Free catalogue treasure books. Foul Anchor, Rye 2, N. Y.

TREASURE! Exciting handbook 25¢. Locators. Howe, 811 Kansas, Atchison, Kansas.

NEW-Extremely light weight economical transistorized metal detectors. Waterproof search head. Kit or assembled models. Geiger counters and mineralights. Free literature. Electronic Applications, Dept. M, P.O. Box 8, Arlington, Virginia.

FIND Buried treasure, gold and silver, with Goldak's sensational 3 1/2 lb. "find-it" locator, only \$64.50. Write for free literature on complete line of mineral, metal locators; Geiger and scintillation counters. Goldak, 1541 W. Glenoaks Blvd., Glendale, Calif.

FOR SALE—MISCELLANEOUS

POCKET Size Pilefilm cover protects against radioactive fallout, \$2 postpaid. Free information on defense against atomic attack with order. Atomic Aid, 215 West 34th Street, New York City 1.

BUY Government surplus bargains! Complete information \$1.00. Surplus, Box 2115, North Mankato, Minn.

PORCUPINE Quills. Doz. \$1.00 U. S. Albion Keneipp, St. Ignatius, Mont.

HEATERS, Southwind, for cars, buses, space. Complete winterization kit, \$325, while they last, \$99.50. Ketcham's, Chicago 43, Ill.

HEARING Aid batteries, wholesale. Free list. Habs, Box 51, York, Penna.

WANTED—MISCELLANEOUS

GOLD, Silver, platinum, old jewelry, diamonds, watches, spectacles, wanted. Highest prices paid immediately. Information free. Wilmo's, 1067 W. Bridge, Grand Rapids 4, Michigan.

QUICKSILVER, Platinum, silver, gold. Ores analyzed. Wholesale Terminal, Norwood, Mass.

MISCELLANEOUS

EXTRAORDINARY Opportunity! Retire now! Lead leisurely life. Remarkable book shows how. Free details. Belmont, Wyckoff 158, New Jersey.

CIGARETTES—Improved roller makes 20 for 9¢. All types pipe tobaccos. Facts free. Moberly, Box 910, Owensboro, Ky.

RECEIVE Magazine samples, mails, catalogues. Bargains from everywhere. Get listed 25¢. Rorick, Cincinnati 26, Ohio.

100,000 PRODUCTS Wholesale—Free catalog! Send postcard: Econ-O-Mart, Whippany 15, New Jersey.

CESSPOOLS, Septic tanks, clogged drains. How they function and how to keep them working. Free literature. Chemical Cesspool & Drain Cleaning Co., Boston 34, Mass.

YOUR Name wanted. We'll send 1000 publishers, mailers, wholesalers your name, on our list one year 25¢. Dixie Mailers, King, N. C.

SUPER Memory overnight! Success guaranteed! Bljou, Box 1727-M, Hollywood 28, California.

HOW To remodel, basement, attic. Booklet or book. Send for 1958 book catalog—10¢. Popular Mechanics Press, 633 N. St. Clair St., Chicago 11.

BOOKS On antiques and their prices. Free circular! P. Warman Publishers, Uniontown, Penna.

70 BIBLE Lessons, 25¢. Bulletin, Box 87, Cathedral Station, New York City 25.

LEARN Furniture refinishing, matching colors, etc. Fundamental instructions two dollars. Donovan, P.O. Box 161, Dearborn, Michigan.

FREE Postal scale, to introduce amazing Vim-Vitamins. \$2.00. Vitadenda, Box 806, Guttenberg, N. J.

TATTOOS Removed safely, \$1.00. Complete details. Anderson (PM-1), Box 837, Toledo 1, Ohio.

JAPAN: Buy direct, mail-order, 26 page catalogue, kimono, dolls, etc., manufacturers' listings, business informations. Send \$1.00. Clarence Yamagata, 202 Naka 7 Bldg., Marunouchi, Tokyo.

LARGE Ant farm. Fun, exciting, fascinating. \$2.98 postpaid. Hays, 1307 Sunset, West Palm Beach, Florida.

GENUINE \$3 Bill, authentic reproductions, 50¢. Three, \$1.00. McWhorter, 38 Richland, Newport News, Virginia.

100% PROFIT On vitamins. Details, Lindstroms, 48 Boylston, Cambridge, Mass.

MAILBOX Nameplates. Free catalog. Name-address stencil \$1.00. Moore Sales, 14008 Tacoma, Detroit, Mich.

SAY It on a grain of rice! Your message in micro-writing. Most unusual gift idea in years. For details write: Rice, Box 237, Portland, Texas.

BUILD Barbecue. Complete plans. Booklet or book. Send for 1958 book catalog—10¢. Popular Mechanics Press, 633 N. St. Clair St., Chicago 11.

FREE Vitamin catalogue—Feel younger, work better, look better. Guard your health. Quality capsules, potent formulas, like doctors, hospitals buy. Buy direct, save! Vitacenter, Drawer 2318-P, Detroit 31.

STAGE Money, \$10,000.00, 25¢; \$100,000.00, \$1.00. Glauser, 6005 Summerdale, Philadelphia 49, Penna.

BUY Wholesale! Tremendous discounts available! United Wholesalers, 1265-G Broadway, New York 1, N. Y.

EPOXY Compound, "fixes anything"; auto bodies, engines, tanks, toys, plumbing, china. "Metal Plastic" hardens like steel, machinable. Send \$1.75—6 oz.; \$2.00—1 lb. Metal Plastic, Box 1934, Erie, Penna.

YOUR Name on our giant mailing list, brings you moneymaking and other mail offers galore. Send 25¢ today. Direct Mail Service Co., P.O. Box PM581, Bakersfield, Calif.

FLORIDA, Miami Beach, Coral Gables confidential. Information, fruit, souvenirs, hotel stationery, etc. 25¢ plus. Driftwood Apts. #4, 820 N.W. 18 Place, Miami, Fla.

SPONSOR Nationally advertised name brands. Your merchandise free. No selling. Catalog and trade stamps only 25¢. Miracle Plan Company, 410 S. Williams, Amarillo, Texas.

"GEOMETRIC Designs" for tile patterns, inlays, patios, brickwork, mosaics and many others. How to use and modify to produce hundreds of variations. \$2.00. Creative Products Corp., Box 258, Cathedral Station, New York 25, N. Y.

MONEY Making and saving catalogue. Write: Adams, PM 210 5th Avenue, New York 10, New York.

ADS Running under this heading sell printing. Ask me for proof. I'll gladly send you amazing facts. Ask for Folder "P." F. W. Johnson, 200 E. Ontario St., Chicago 11, Ill.

NEW! Send 25¢ for Klein's bargain sports catalog containing hundreds of great values in fishing tackle, camping, new and used guns, etc. Klein's, Dept. PM-3, Chicago 6, Ill. When in Chicago show Klein's 5 Chicago stores for sport.

PHOTO-Copy important papers, letters, 50¢. Three for \$1. Guaranteed. Robbie, Box 3596, Oklahoma City 6, Oklahoma.

CHARM—Emblem free catalogue. Fraternal, religious, weddings, anniversaries, zodiac, etc. 14K gold, sterling silver. Newport Jewelry Co., 63 Washington Street, Providence 3, R. I.

PERSONALIZED Hand-tooled leather goods. Designed for modern living. Wonderful gifts. Free catalog. Piel, 4724-PMA North Drake, Chicago 25, Ill.

If You Want To STOP SMOKING

Airline Pilot Tells How!



Roger Don Rae is a senior pilot for TWA. He says: "Bantron allowed me to stop smoking without noticing it. Today I am free of the habit. I tell all my friends who want to stop smoking—try Bantron!"

Here at last is a safe, new product, developed at a great American University, that has helped thousands stop smoking. In a series of clinical tests, published in a leading Medical Journal*, scientists reported that 4 out of 5 men and women who wanted to quit smoking stopped within 5 days when they took Bantron.

And the Bantron way is so easy and pleasant! Just take 3 Bantron tablets a day, after meals, for four days. Then only 2 a day until all desire to smoke leaves you. 80% are "Free" in 5 to 10 days.

Taken as directed Bantron is perfectly safe. It acts as a substitute for the nicotine in your system which gives you a craving for tobacco. Now at drug stores without prescription. Price \$1.25.

*Copies available to doctors on request.

Bantron

BRAND

Smoking Deterrent Tablets
A Campana Product

TURN CONCRETE INTO GOLD



You've seen them all over the country—concrete bird baths, garden seats, flower boxes, appealing statuary, and many other items that add charm around the house and lawn. They're made by enterprising people, just like you, from our COPYRIGHTED ALUMINUM MOLDS. It's easy. It's fun. It's profitable.

Send \$2.00 today for this 82-page "How to" book, 30 pages of clear instructions. Valuable trade secrets. Over 250 items beautifully pictured (with description, dimensions, and price of molds). Rushed to you by first class mail.

CONCRETE MACHINERY CO., INC.
HICKORY, N. NORTH CAROLINA

Name _____
Address _____

HOW TO
TURN
CONCRETE
INTO
GOLD

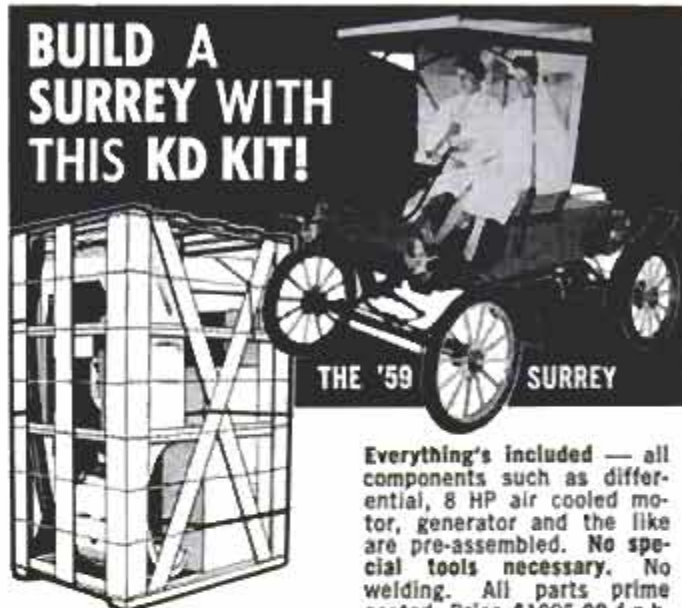

THE '59 SURREY

You can build the 1959 Surrey—the full-size old-fashioned car that's taking the country by storm—with this easy-to-assemble KD kit!

Everything's included — all components such as differential, 8 HP air cooled motor, generator and the like are pre-assembled. No special tools necessary. No welding. All parts prime coated. Price \$1095.00 f.o.b. Canton. Build a Surrey for yourself or for profitable re-sale! KD kits available at your local Surrey dealer or write DYER PRODUCTS, Dept. M, Canton 1, Ohio.

HOW TO PUBLISH YOUR BOOK

Join our successful authors in a complete publishing program: publicity, advertising, lovely books. Send for FREE manuscript report and copy of How To Publish Your Book.

COMET PRESS BOOKS
Write Dept. PM-3
200 Varick Street, New York 14

Carbon Monoxide Detector Records Poison Percentage

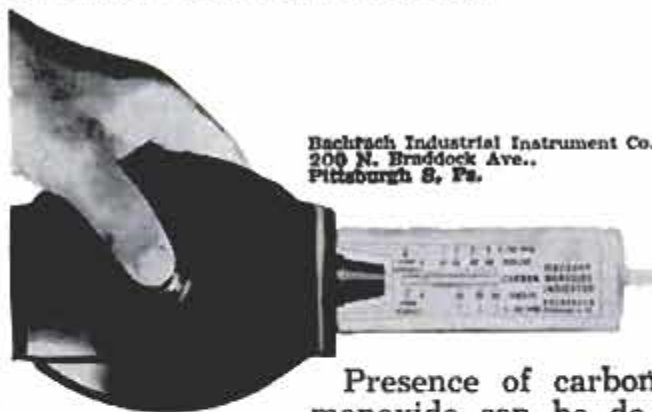

Bachrach Industrial Instrument Co.
200 N. Braddock Ave.,
Pittsburgh 8, Pa.

Presence of carbon monoxide can be determined quickly with a pocket-size gauge that indicates the percentage of the poisonous gas on a scale. A replaceable glass tube containing a yellow gel is inserted in the device and a controlled-volume sample is drawn into the tube by depressing, then releasing a button. The percent of carbon monoxide is indicated by the length of brownish-gray stain that appears in the tube.

☐ In the known universe there are millions of planets that probably support life similar to that on earth, according to Dr. Melvin Calvin, University of California chemist and researcher in photosynthesis.

NOW — ESPECIALLY NOW — BIG MONEY WAS NEVER SO EASY TO MAKE WITH A PRODUCT FOR WHICH THERE IS A CRYING NEED!

Today It is Reasonable for You to Expect to Make Easily up to \$1,000 a Month With Motor Overhaul



Today when millions of car owners all over America are trying to economize and to get the most out of their cars, you can cash in on the undisputed demand for a product which saves money for motorists on gas and oil and repairs, and which extends the life of their car engines. In this period of economy-mindedness, is it any wonder that MOTOR OVERHAUL, which does all this, is a life-saver for the millions who are holding on to their present autos . . . and is a source of rich rewards for salesmen from Maine to California?



You, yourself, know folks are holding on to their present cars nowadays. Autos, which have seen better days, are still operating and will continue to do so for some time. What better time than now to sell these millions of older-car owners a product which will give their automobiles greater money-saving efficiency and freedom from costly repairs? And, with cars costing as much as they do today, new-car owners are eager for money-saving economies, too. If MOTOR OVERHAUL is added at every oil change right from the start, it retains new-car power longer, cuts down wear, extends the life of the engine for years. YOU can be the man to pick up these customers (there must be plenty in your neighborhood alone) and make yourself a pretty penny. You can do it with MOTOR OVERHAUL. You can prove to motorists that for only \$2.98 MOTOR OVERHAUL will give their old autos new-car power and smoothness, phenomenal gas and oil savings and no costly repairs. There's a crying need for this kind of product, and you can cash in on it with MOTOR OVERHAUL; there's nothing else like it on the market. Truck fleet operators, taxi companies, police and fire departments buy 6 to 12 dozen cans at a time. Tremendous repeat orders come automatically because MOTOR OVERHAUL is added at every oil change. You'll be in a big-paying business you can run year after year in just your spare time. And you can reasonably expect earnings of up to \$1,000 a month and even more.

All these sensational claims for MOTOR OVERHAUL have been certified by an outstanding Independent Testing Laboratory after actual road tests. It proves, beyond a shadow of a doubt, that MOTOR OVERHAUL makes old motors run like new, with new-car power, smoothness and economy, giving thousands of EXTRA repair-free, trouble-free miles of driving to even the oldest cars. With this kind of proof, making sale after sale is a cinch. And getting automatic repeat orders is also a sure thing.

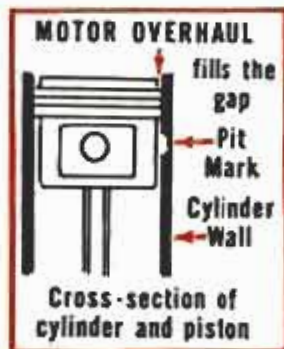

Here's How Motor Overhaul Works

MOTOR OVERHAUL is a magnetized metallic liquid, which, when added to your crankcase oil, travels with it into the cylinders. It fills pits, scratches and cracks in the cylinder wall and, because MOTOR OVERHAUL is magnetized it clings there, creating a glass-smooth surface that re-seals the gap between cylinder wall and piston ring. Engine is "tight" again . . . oil no longer enters combustion chamber (where it would be burned away) . . . compression, power and peppy response increase dramatically . . . in mere minutes!

Look How Motor Overhaul Gives Old Autos New-Car Power!

- 1. INCREASES MOTOR COMPRESSION UP TO 58%.** In minutes, the Laboratory Test Car delivered 58.26% more compression. Motors 100,000-miles-old regain new-car power like magic.
- 2. INCREASES GAS MILEAGE UP TO 54%.** The Laboratory Test Car ran 54.12% more miles per gallon. Savings on gas can run to hundreds of dollars a year.
- 3. INCREASES OIL-SAVING EFFICIENCY UP TO 900%.** No more oil needed between oil changes. Laboratory Test Car "burned" a quart every 300 miles before MOTOR OVERHAUL . . . now never needs oil added . . . saves 67 quarts a year.
- 4. MAKES ENGINES RUN SMOOTHER AT ONCE.** Immediately, rings and cylinders fit tightly again, friction-drag reduced. Motor "knock" disappears while car is driven — at once.
- 5. EXTENDS LIFE OF ENGINE FOR YEARS.** Laboratory Report shows: when MOTOR OVERHAUL is added every 1,500 to 2,000 miles with oil change, new-motor action will continue.

Read What Amazed Motorists Report!

Stopped Using Oil. My 1940 Nash used 3 or 4 quarts of oil every 100 miles. I added Motor Overhaul and in just a few miles it stopped using oil, easier to start, more power. I recommend Motor Overhaul 100% to anyone needing a ring job.
Bernie Robinson, Ind.

100,000 Miles; Motor Never Apart. I have a Chevrolet truck which has 100,000 miles on it, and motor has never been apart, thanks to Motor Overhaul.—R. C. Colgan, Vermont

Daring "YOU BE THE JUDGE" GUARANTEE Clinches Sales!

Tell customers: "Try MOTOR OVERHAUL in your engine. See, hear, feel the improvement. Then, if **IN YOUR OWN OPINION**, you aren't getting the amount of improvement you expected, return the empty can and get all your money back. **YOU BE THE JUDGE!**" Customers order at once on this wide-open guarantee . . . and fewer than 1% ever ask for money back. Yet, even on these few we back you up and refund the wholesale price you paid for the cans returned. Over 99% satisfied customers . . . who'll give you repeat orders if you simply follow them up!

FREE! Big Profit Sales Kit and Sensational Laboratory Report

You have to see the almost fantastic MOTOR OVERHAUL results to believe them. Mail the coupon below for big Illustrated Sales Kit, including customer circulars, big-profit plan and actual copy of the Certified Independent Laboratory Report . . . plus "YOU-Be-The-Judge" Guarantee—all sent FREE, with no obligation at all. Mail coupon today and see what big money, what easy money, is in store for you!

POPE CHEMICAL CO.

114 East 32nd Street, Dept. T-3
New York 16, New York

POPE CHEMICAL CO., Dept. T-3
114 East 32nd St., New York 16, N.Y.

PROVE TO ME I can make up to \$1,000 a month and more with amazing new MOTOR OVERHAUL. Rush FREE Big Illustrated Sales Kit, with Certified Independent Laboratory Test Report, "YOU-Be-Judge" Guarantee, money-making plans. I am not obligated.

Name _____

Address _____

City _____ State _____

**94.6% OF BAILEY
GRADUATES ARE EMPLOYED
AT TOP PAY IN THE FIELDS
WHICH THEY WERE TRAINED!**



**DIESEL-AUTO MECHANICS
DESPERATELY NEEDED!**

We have a far greater demand for our students than we can fill!

We can show you an actual waiting list of leading companies throughout the world who have tried Bailey graduates — found them outstanding, and are coming back for more!

Bailey Graduates are Successful . . . RECEIVE BIG PAY — HAVE SECURE FUTURE!

The Famous Bailey Course prepares you for BOTH Diesel and Gasoline Mechanics.

This is a must—due to the advent of using Diesel principles, such as 'Fuel Injection' on passenger cars . . . use of gasoline engines for starting Diesel engines, etc. You learn all this at Bailey in the amount of time ordinarily required to learn just one of these subjects, **ALL FOR THE PRICE OF ONE.**

Don't be satisfied with a 'futureless', one-type job — learn how you can make big money now!

Write today for Free Booklet that takes you on a step-by-step camera tour through our spacious, modern shops — See Bailey students in action as they Learn-by-doing with the Famous Bailey Method of training!

We provide you with housing and part time jobs while in school, plus nation-wide placement service for graduates.

BAILEY Technical SCHOOLS

1634 S. GRAND ST. LOUIS 4, MO.

MAIL TODAY!

Please mail immediately this free booklet without obligation.

FREE BOOKLET



Name.....

Address.....

City..... State.....

APPROVED FOR VETERAN . . . NON-VETERAN

Where-to-Buy-It-Index

Automotive

Glass-fiber hubcaps for autos (Colorado Fiberglass Co., 4200 Madison St., Denver, Colo.) 80
 Detroit Listening Post..... 106
 Miniature bus for small riders..... 118
 Air-conditioned cab cools combine operator (International Harvester Co., 180 N. Michigan Ave., Chicago, I.)..... 143
 Automatic nose for alcohol would warn "lit up" driver 249

Aviation

Here's Convair 880—the fastest jet transport in the world? (Convair, Div. of General Dynamics Corp., San Diego 12, Calif.) 87
 Workhorses of the air (Vertol Aircraft Corp., Morton, Pa.) 100
 Hiller's tilt-wing transport is largest of VTOL aircraft (Hiller Aircraft Corp., 1350 Willow Road, Palo Alto, Calif.)..... 107
 Rotating chute reduces glide and drops to ground vertically (Pioneer Parachute Co., Inc., Manchester, Conn.; Barish Assoc., 224 E. 38th St., New York City)..... 109
 Superhot jet tests missile materials..... 127
 Power-steering in jet plane aids pilot on ground (Republic Aviation Corp., Farmingdale, Long Island, N. Y.) 249

Boating and Fishing

Paper sailboat (Hinde and Dauch, Div., West Virginia Pulp and Paper Co., Sandusky, Ohio)..... 136
 Scientists lure fish by feeding them a line—of chatter..... 139
 One small boat tows 5146 pounds of skiers..... 143
 What's new in boats..... 151
 Outfitting your boat?..... 155
 What's new in water skiing..... 157

Construction

Prefab house has aluminum exterior (National Homes Corp., Lafayette, Ind.) 86
 Powerhouse inside mountain has six-mile "waterfall"..... 101
 Huge flying crane can haul power-line towers—or houses (Sikorsky Aircraft, Div., United Aircraft Corp., Stratford, Conn.) 129
 Double-furnace system gives better zone control (American Standard, Air Conditioning Div., 40 W. 40th, N. Y. C.)... 129
 Prefab panels make "dome" cabin (Pease Woodwork Co., 900 Forest Ave., Hamilton, Ohio)..... 137
 Hydraulic door closer resists push of wind (Illinois Lock Co., 800 S. Ada St., Chicago 7)..... 256

Miscellaneous

Tiny projection lamp produces top screen brilliance (Sylvania Electric Products, Inc., 1740 Broadway, New York City 19) 87
 Glass-fiber heater made of thin sheet (Hunting Mhoggias, Ltd., Luton, England)..... 87
 Ruler rolls on drawing paper to make parallel lines (J.C. Neville Ltd., London, England)..... 107
 Orbiting "satellite" (Wen-Mac Corp., 11511 Tennessee Ave., Los Angeles, Calif.)..... 112
 Cadets read signal lights to learn what to wear..... 112
 Basketball goal can be adjusted to suit boy's height (Lindcraft Corp., Cape Girardeau, Mo.)..... 112
 Goliath goes anywhere (Pacific Can and Foundry Co., Renton, Wash.) 127
 San Francisco says "welcome" with billboard of flowers.... 128
 Man with a high calling—He's a TV steeplejack..... 134
 Tilting operating table aids veterinary surgeons..... 136
 Torpedo resists jamming..... 136
 Bread from miniature bakery tests new varieties of wheat. 138
 Earth gives boost to three Alaskan cities..... 238
 Push-button coffee servers for hotel and motel units (Morning Coffee, Inc., San Diego, Calif.)..... 242
 Basketball players evaluated by electronic computer 246
 Mechanical globe "stops" sun on any day of year (P. H. Hagner, 1010 Navarro St., San Antonio 5, Tex.) 248
 Table-model chord organ can be played in seconds (Magnus Organ Corp., Public Relations; Roger D. Isaacs, Robert V. Hudson, 75 E. Wacker Dr., Chicago) 263

Science

Transmitter in scanning system weighs 2½ ounces 86
 From outer space—Voices today, TV tomorrow..... 88
 An eye on space..... 96
 Sensitive tube "sniffs" smoke to set off warning (Minneapolis Regulator Co., Research Center, Hopkins, Minn.)..... 107

(Continued to page 76)



NEW! DO-IT YOURSELF!

MAGIC PRINTING OUTFIT

PRINT UP TO 5 COLORS AT ONE TIME

You can print postcards, invitations, labels... anything up to 5 colors at one time. No skill needed. You'll do a perfect job the very first time! No limit - print drawings, lettering, typewriting, etc. Instructions and FREE sample typewritten master included! Make your own masters easily and professionally on a typewriter, freehand or by tracing drawings, type, etc. Prints up to 35 copies in 3 minutes - in all 5 colors. Pays for itself the first job!

Do It Yourself For Fun & Profit

PRINT ON ANY PAPER Invitations Menus Notices Club Bulletins Postcards Thank You Notes Greeting Cards Letterheads

YOU SAVE \$\$\$

To save you \$\$\$ in shipping charges, we've omitted one item, something you have or can purchase in any drug or variety store for about 25c. Otherwise it's complete. Low cost supplies always available.

HUGE SUPPLY OF PAPER INCLUDED

Hundreds of postcards, gummed labels, white bond, stock for informals, tickets, etc. Assorted colors. Worth many times the low \$3.95 price.

order today - airmail reaches us overnight

INTERNATIONAL INDUSTRIES

321 JASPERSON BLDG., CULVER CITY, CALIFORNIA

TEST-RIDE the

'59 TRIUMPH

FREE . . . WITHOUT OBLIGATION



Phone or write your nearest Triumph dealer today. He'll quickly arrange a free demonstration ride on a brand-new Triumph motorcycle. Once you sample its powerful, precision performance, you'll know why Triumph's World Record Line for '59 sets a new mark in motor-cycling pleasure. Triumph outperforms anything on two wheels - tops in speed, maneuverability, handling ease and economy. Test-drive the '59 Triumph yourself!

Model shown is
BONNEVILLE T-120
40 cu. in. (650 c.c.) OHV

FREE Please send me the new 1959 full-color Triumph catalog showing your complete range of models with specifications.

Check here if you wish name, address and telephone number of your nearest Triumph dealer sent by return mail. Dept. P.

In the West: Johnson Motors, 267 W. Colorado St., Pasadena 1, Cal.
In the East: The Triumph Corp., Towson, Baltimore 4, Md.

Name.....Age.....
Street.....
City.....State.....
Telephone Number.....



CANVAS

SYNTHETIC RUBBER



PLASTIC

GLASS



LEATHER

COMPOSITION BOARD



STAINLESS STEEL

EASY TO APPLY. PLIOBOND requires no mixing, brushes on, dries rapidly.

EXCELLENT ADHESION. PLIOBOND exhibits exceptional strength - up to 1600 lbs./sq. in. in shear tests.

EXTREMELY DURABLE. PLIOBOND resists age, heat, cold, water, chemicals, oils.



Pliobond
BY
GOOD YEAR

Pliobond - T. M. The Goodyear Tire & Rubber Company, Akron, Ohio

Free!

ALLIED'S

MONEY-SAVING 1959

ELECTRONIC SUPPLY CATALOG

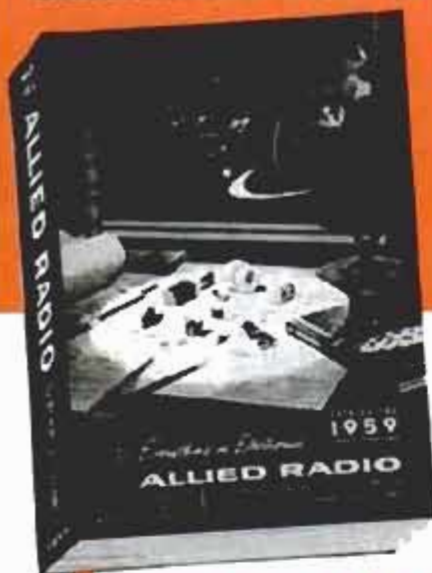

452

value-packed pages

send for it!

SAVE

ON EVERYTHING IN ELECTRONICS

EASY TERMS AVAILABLE

WORLD'S LARGEST STOCKS

Here is the complete guide to everything in Electronics for Experimenters, Builders, Amateurs, Servicemen, Engineers and Hi-Fi enthusiasts:

- Amazing Build-Your-Own KNIGHT-KITS
• Everything in STEREO HI-FI
• Hi-Fi Music Systems & Components
• Recorders & Phono Equipment
• Public Address & Paging Systems
• TV Tubes, Antennas, Accessories
• Amateur Station Equipment
• Latest Test & Lab Instruments
• Industrial Electronic Supplies
• Parts, Tubes, Transistors, Tools & Books

SAVE on everything in Electronics at ALLIED—get fast, dependable service, expert personal help, guaranteed satisfaction. Send today for your FREE 1959 ALLIED Catalog.

Everything in Electronics From One Reliable Source

OUR 38th YEAR

Send for FREE Catalog

ALLIED RADIO

ALLIED RADIO, CORP., Dept. 5-C9 100 N. Western Ave., Chicago 80, Ill.

Rush FREE 1959 ALLIED 452-Page Catalog

Name

Address

City Zone State

(Continued from page 74)

Table listing various articles and their page numbers, including 'Brr! Magnet helps approach absolute zero', 'Seagoing saucers ahead', 'Tank could produce weightless sensation', etc.

What's New for Your Home

Table listing home-related articles and their page numbers, including 'Floor flusher washes away dust, litter', 'Bowl holder handy with electric mixer', etc.

Radio-Television, Electronics

Table listing radio and television related articles and their page numbers, including 'Go behind the scenes to look ahead in electronics'.

Craftsman and Shop Notes Index

Automotive

Table listing automotive-related articles and their page numbers, including 'Vacuum tests wiper motor', 'Using antifreeze second season can damage cooling system', etc.

Boating

Table listing boating-related articles and their page numbers, including 'Outboard can't slip off boat when chained to transom', 'Grease fittings on wheel hubs ease boat-trailer servicing', etc.

Farming

Table listing farming-related articles and their page numbers, including 'Tractor hitch pin has hook to lift towing tongue', 'High-lift jack handles farm jobs', etc.

House and Home

Table listing house and home-related articles and their page numbers, including 'Finishing quarter-round molding', 'Cupola with bandstand motif', etc.

Lawn and Garden

Table listing lawn and garden-related articles and their page numbers, including 'Coating inside of metal planters prevents corrosion', 'Jig for spacing fence pickets', etc.

(Continued to page 80)

NOTICE—It is the intention of this magazine to provide its readers with information regarding the latest developments in the mechanical arts. Except where otherwise indicated, this magazine has no information as to any unexpired patents in respect of the developments reported herein.

NEW! 16 FT. MOLDED FIBERGLASS BOAT KITS



EASILY ASSEMBLED IN ONE EVENING!
SAVE UP TO 60%
FREIGHT PAID! FULLY GUARANTEED!

EASY TERMS!
No need to pay extra for a fiberglass boat just because of additional expense of factory assembly. With Luger's simplified, patented assembly procedure, anyone can easily assemble the 3 basic 1-piece molded units (deck, hull, upper bow) into a super-strong, professionally finished, 1-piece fiberglass boat. No need to pay dealer profit either. Buy Luger Fiberglass Boats factory-direct. Luger pays the freight! No hand finishing. Lustrous colors molded in. 3 exciting models. WRITE FOR FREE FULL-COLOR CATALOG.

LUGER INDUSTRIES INC., Dept. GE-3
9200 Access Road, Minneapolis 20, Minn.

"HOW TO HAVE MONEY TO RETIRE ON"

This exciting new book reveals the many ways Financial Experts, Real Estate Authorities, Retirement Counselors put their money to work. YOU TOO can use their methods to BUILD WEALTH and INDEPENDENCE even though your savings may now be small. Learn how, and watch your savings multiply. Written in easy to understand language exactly what you can do to MAKE YOUR SAVINGS WORK FOR YOU. START NOW. Money back guarantee. Send only \$2.00 to —

A. A. KLUTE CO. Dept. PM-1 7527 Wise Ave. St. Louis 17, Mo.

IN SPRING, A YOUNG MAN'S FANCY TURNS ... CAN BE WRONG TURNS

He needs a HULL AUTO COMPASS, the original motoring guide, that reveals wrong turns, the instant they happen, for thousands of motorists every day. \$5.50 and \$6.95. At your dealer's or write for literature.

FAMOUS COMPASS MAKERS FOR MOTORISTS AND BOATERS

HULL MFG. CO., P.O. BOX 246-D-3, WARREN, OHIO



WHEELS! WHEELS! Complete Line

new high speed wheels with Timken roller or ball bearings, pneumatic and zero pressure, tube or tubeless, demountable or single hubs, all sizes and types, light or heavy duty for use on trailers for boats, campers, luggage, all portable equipment, auto midget cars, dollies, concrete mixers, go carts, etc. Low cost direct from manufacturer at fraction of retail prices. For colored illustrated booklet of full line and prices send \$1.00 — Upon first order \$1.00 will be refunded.

HOUSE OF WHEELS c/o WRIGHT'S ENGINEERING
4785 WIGHTMAN ST. SAN DIEGO 5, CALIFORNIA



Get into... PLASTIC LAMINATING AT HOME!

Get ORDERS and CASH from your mailman—do work in SPARE TIME at home — or expand into FULL TIME business. Send coupon for Free facts about the newest and most fascinating of all home operated businesses. For the first time a simplified machine brings the fabulous profits of Plastic Sealing and Plastic Laminating within the reach of the small operator. Anyone can learn to operate the machine with a few minutes practice — then with our Magic Mail Plan can get mail orders pouring in daily with cash in every envelope. No canvassing—no selling. We even

Make up to \$5 an Hour..
MAGIC MAIL PLAN!

THIS MAN ...
... is taking out of the machine a Plastic Sealing Job — ordered by mail — only 11c in material cost brings back \$2.58 in cash by mail. Capacity of machine: \$25.00 profit per hour of operation.

Make Thousands of Beautiful Art Creations
COSTUME JEWELRY • CIGARETTE BOXES
TRAYS • CANDLESTICKS • COASTERS
LAMP BASES • BOOK ENDS...ALL IN
SPARKLING COLORED PLASTIC

supply the circulars you mail to bring back cash and orders. Don't waste a minute. Rush your name. We'll send you FREE and postpaid, pictures, prices, details, and all the facts you need to start. Mail coupon or send name on postcard. No charge. Warner Electric Co., 1512 Jarvis Av., Dept. L-2-C, Chicago 26, Ill.

WARNER ELECTRIC CO., 1512 Jarvis Av.
Dept. L-2-C, Chicago 22, Ill.
At no cost to me, please rush complete details postage prepaid. I am under no obligation.

Name _____
Address _____
City _____ Zone _____ State _____

HOME PAINTING TIP NO. 49



For neat, professional-looking paint jobs use "SCOTCH" Brand Masking Tape. Sticks tight, stretches to hug curves or irregular surfaces. Paint won't bleed through. When paint has "set" (but not fully dried), "SCOTCH" Masking Tape strips off quickly and easily, leaves a clean sharp edge. An invaluable aid for painting with brush, roller or spray can. Ask for "SCOTCH" Brand Masking Tape in the handy cutter-edge carton—35¢, 69¢, 98¢, \$1.69 sizes—wherever paint is sold!



"SCOTCH" and plaid design are registered trademarks of 3M Co., St. Paul 6, Minn. © 3M Co. 1959.

Lub-a-Spray

DRY LUBRICANT

ALL-PURPOSE GRAPHITE NO MESS, GREASE or STAIN

One puff from this handy dispenser provides lubrication for doors, windows, locks, appliances — dozens of hard to get at places. Lub-a-Spray is oilless, odorless, weatherproof — lubricates metal, wood, leather, rubber, plastic. At Hardware, Sports, Dept. Stores, Service Stations.

PANEF MANUFACTURING COMPANY • MILWAUKEE 1, WIS.

To the Editor:

What are probably the world's only naked footprints in bronze are embedded in concrete in the Plains Indian Sign Language Memorial at the small prairie settlement of Browning, Montana, agency for the Blackfeet Indian Reservation.

In 1930 the last of the Indian sign talkers of the West met in council. For days they talked, never uttering a word. Almost every Indian tribe of the West had its own

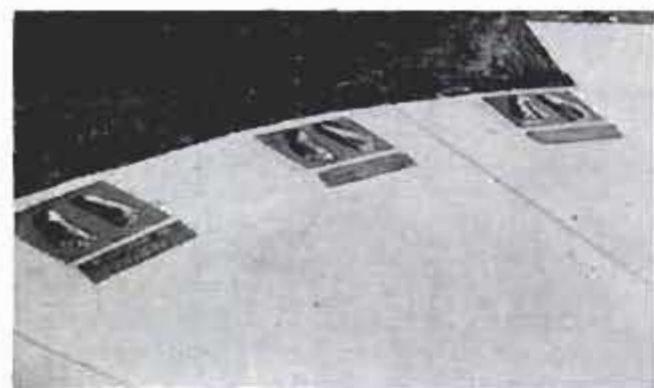

language; communication between the many tribes was achieved by means of signs, something like the white man's deaf-and-dumb talk of today.

The red men sign-talkers were all old then. They are dead now, and the sign language has disappeared. The only complete record available was taken at the council, on film, for the Smithsonian Institution in Washington, D. C.

After the council was over, the sign talkers, most of them chiefs, had their footprints taken, cast in bronze, and set in a concrete circle which stands today before

the Museum of the Plains Indian on the outskirts of Browning.

Eric Thane,
Helena, Mont.

☆ ☆ ☆

Dane Builds PM Cruiser

It appears to be literally true that a good man can build a *Popular Mechanics* boat with one hand. The feat was accomplished at Copenhagen, Denmark, by Kaj Niels Andreasen, a lithographer, who has only one hand. From plans for the 25-foot cruiser *Sea Craft*, published in our March 1948 issue and later appearing in our Danish-Norwegian edition published at Copenhagen, Mr. Andreasen built "the most beautiful ship you can imagine" of mahogany. The task took seven years, and every part was handmade. The ship has a six-cylinder engine capable of cruising at 13 knots.

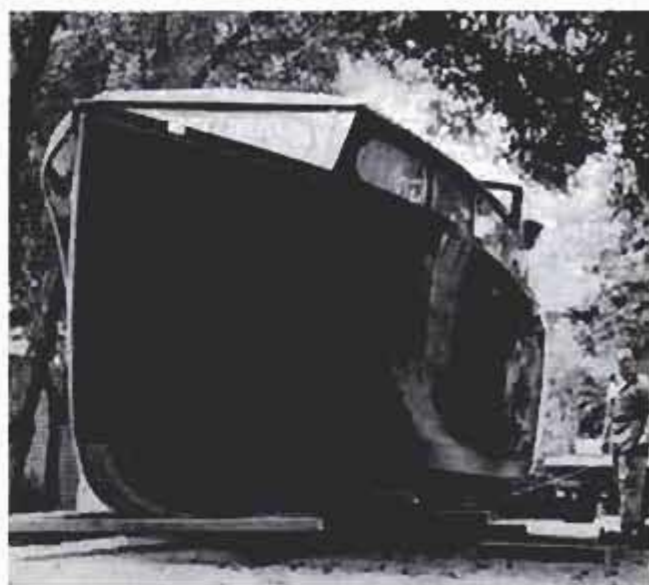

HOW AMERICA'S NUMBER ONE CARBURETOR TRAINS AN ARMY OF SERVICE EXPERTS!



Wherever you go, you'll find Rochester-GM Carburetor specialists who can quickly and accurately diagnose and correct trouble to save you time and money.



Qualified instructors with vast automotive experience train mechanics in every phase of carburetion, in the fastest, surest way to service Rochester-GM Carburetors.



Up-to-the-minute bulletins keep these specialists fully qualified at all times to assure the most efficient operation of your Rochester-GM Carburetor.

Each month a trained army of Rochester-GM Carburetor specialists graduate from General Motors Training Centers and Rochester-GM Carburetor Field Schools all over the country. This training in carburetor repair and adjustment makes them qualified to maintain Rochester-GM Carburetors at peak efficiency. There's a Rochester-GM specialist in your neighborhood. Look him up for new-car performance. Or, if you are a mechanic interested in receiving Rochester-GM Carburetor training in your area *free of charge*, write to: Rochester Products Division of General Motors, Rochester, New York.

Each month a trained army of Rochester-GM Carburetor specialists graduate from General Motors Training Centers and Rochester-GM Carburetor Field Schools all over the country. This training in carburetor repair and adjustment makes them qualified to maintain Rochester-GM Carburetors at peak efficiency. There's a Rochester-GM specialist in your neighborhood. Look him up for new-car performance. Or, if you are a mechanic interested in receiving Rochester-GM Carburetor training in your area *free of charge*, write to: Rochester Products Division of General Motors, Rochester, New York.



General Motors Training Centers offer mechanics professional methods of maintaining carburetors at peak efficiency. Night Field Schools are arranged for those unable to attend day classes.

ROCHESTER CARBURETORS



America's
number one
original equipment
carburetors

Look for **LUFKIN** tape rules

FIVE FEET OUT —
STILL WON'T BUCKLE

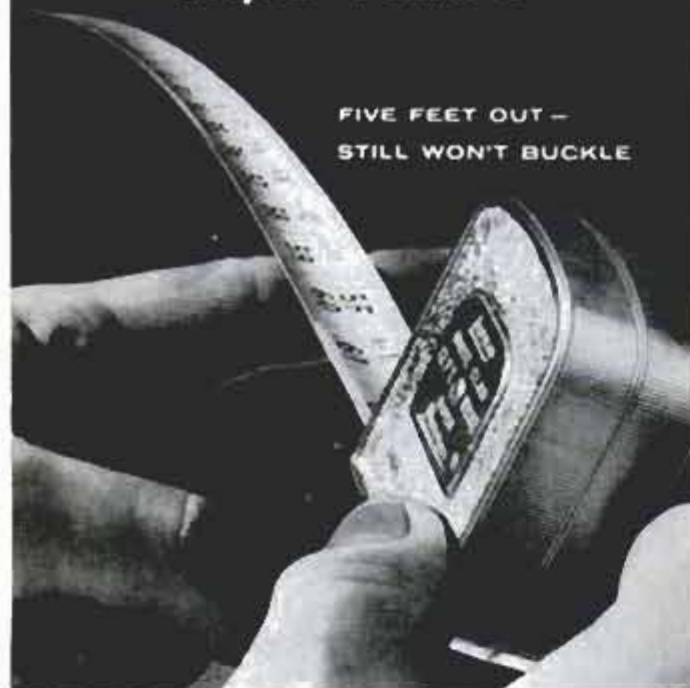

3/4" SUPER MEZURALL

In the photo above, five feet of the steel blade are extended, yet the blade hasn't buckled.

And look at all these other features!

- Easy-to-read, black markings
- Shows both total inches — and feet and inches
- Self-adjusting hook, 2" case for inside measuring
- Blades quickly, easily replaced

Lufkin White Clad® Mezurall tape rules are available in both Regular 1/2" and Super 3/4" widths, with 6', 8', 10' and 12' lengths.



You'll find a world of Lufkin measuring tools at your hardware store.

LUFKIN TAPE RULES
TAPES RULES PRECISION TOOLS

(Continued from page 76)

Miscellaneous

Night sky reproduced on bedroom wall.....	182
Plastic squeeze bottles "pump" air and liquid soap.....	185
Cover on flash reflector reduces light intensity for close-ups.....	185
Ornamental brass box for small parts.....	193
Auxiliary stop aids cutting paper in darkroom.....	200
Gasket in pouring spout eliminates need for extra cap.....	200
Positions on opposite sides of wall located with magnet.....	200
Check rulings before converting your gun.....	212

Shopping for Tools

Portable power unit.....	209
Tapping attachment.....	209
Low-voltage lighter.....	209
Mandrel takes new blades and other circular-saw attachments.....	210
Handled pad for wide range of abrasives.....	210
Miter guide for handsaw.....	210
Spade, or wing, type bits.....	210
Lock washer.....	210
Siphon-feed spray gun.....	210
Toolholder has swiveling head.....	210
Storage rack for screws.....	210
Lifter for cinder and concrete blocks.....	210
Bench-type hot stamping press.....	210

Solving Home Problems

Store pan lids, pie tins on rack.....	174
Keep medicine spoon off night stand or dresser.....	174
Inverted ashtray makes base for figurine.....	174
Cake candles won't tip.....	174
Threading a curtain rod.....	174
Instructions to your cleaner.....	175
Score a wooden ruler.....	175
Cotton gloves make ladder-top pads.....	175
Thimble stores needles.....	175
Paper doilies make attractive ornaments.....	175
Glycerin will stickproof a glass stopper.....	175

Tools

Deburring tool from can-opener.....	170
Auxiliary drill-press table fitted with stop pins.....	177
Cork "handle" for drill bit.....	182
Three-on-one T-wrench.....	182
Improvised ball-bearing center fits drill chuck or tailstock.....	192
Wrench for worn-shanked taps.....	192
Flat-steel hook on bow saw increases its usefulness.....	196
Guard for glass-cutter wheel.....	203
Shop-made expanding mandrel.....	203
Sanding drums improvised with glue and abrasives.....	204

Workshop Hints

Dowels handsawed accurately with rubber-faced guide.....	173
Storage wall for small parts.....	176
Square aids in cutting accurate miters with handsaw.....	177
Sawhorse from windmill ladder.....	182
Steel-ball locator removed from machine casting.....	192
Flattened shanks hold bolts.....	192
Threading short pipe nipples.....	196
Steel balls extend pin punch.....	203
Magnets hold scale on machine.....	208
Rod gauges planer knives.....	208
Alter duplicate key to fit lock.....	212

Glass-Fiber Hubcaps for Autos

Automobile hubcaps made of glass fiber have now been perfected. They are said to be resistant to rust. Lightweight and striking in appearance, the hubcaps have a layer of gold or silver glitter just below the outside surface. They will fit all cars.

Ever wanted to design your own car? Chevrolet lets you come awfully close—with a choice of nine engines, five transmissions, two suspension systems, regular or Positraction rear axles, special cams, solid or hydraulic valve lifters, two air-conditioning systems, even Fuel Injection. You name it, chances are Chevy has it. Here's an example of what we mean:

“I ‘built’ my Chevy to handle like
a sports car . . . for five!”



“Take a young architect (that’s me) with a Corvette appetite, a one-car budget and a family of wife, three kids and a puppy, and you’ve got *frustration*.

“That is, you did—until Chevy came out with that terrific four-speed floor-shift gearbox.* The minute I heard that, I knew Chevy had given me the makings of a *family* sports car that would be the greatest!

“Here’s how I ‘designed’ the sweetest handling five-seater that ever came down the pike: First, an Impala two-door sport coupe. Then the 290-h.p. Fuel Injection V8* and, buttoned on right behind it, that *great* four-speed box. (That’s the Corvette transmission, you know, with synchro on all *four* gears and that solid, direct floor shift.) The driveline ends up with Chevy’s limited-slip Posi-

traction* rear axle to give me real glued-to-the-road traction on gravel, mud or whatever.

“Seat belts, of course, and those optional nylon tires. But I wouldn’t add a thing to the genuine road car feeling of Chevy’s Full Coil suspension and Ball-Race steering. I’ve let a lot of my sports car friends drive the Impala and you ought to see the look on their faces after a couple of blocks. Man, I never thought a sedan could feel like *this!*”

It’s a fact; here’s a car you really can tailor to your measure. Why don’t you sit down now and make an outline of what your “ideal” car would be like—we’ll bet there’s a Chevy that fits the specifications like a glove! . . . Chevrolet Division of General Motors, Detroit 2, Michigan.

*Optional at extra cost.



Get the genuine article

Get the honest taste of a LUCKY STRIKE



Honest taste is the true, full, generous taste of fine tobacco. And you get it every time in a Lucky Strike.



HIGH-VOLTAGE RAINMAKERS

By
Richard F. Dempewolff

DO RAINDROPS and other precipitation in a thunderstorm generate the tremendous electrical charges that enable it to produce sparks several miles long? Or do vast electrical fields generated by other forces in a growing thunderhead create the raindrops? If electricity comes first, as scientists Dr. Bernard Vonnegut and Charles B. Moore suspect, small generating plants may be able to "broadcast" an electrical charge into the free air, influence electrification of clouds and possibly stimulate rainfall in many places where it's needed.

For several years, Vonnegut and Moore, two prominent young scientists working out of Arthur D. Little Laboratories in Cambridge, Mass., have been chasing big black cumulus clouds to probe their secrets. From the 10,300-foot summit of Mount Withington in New Mexico—a thunderhead "factory" that

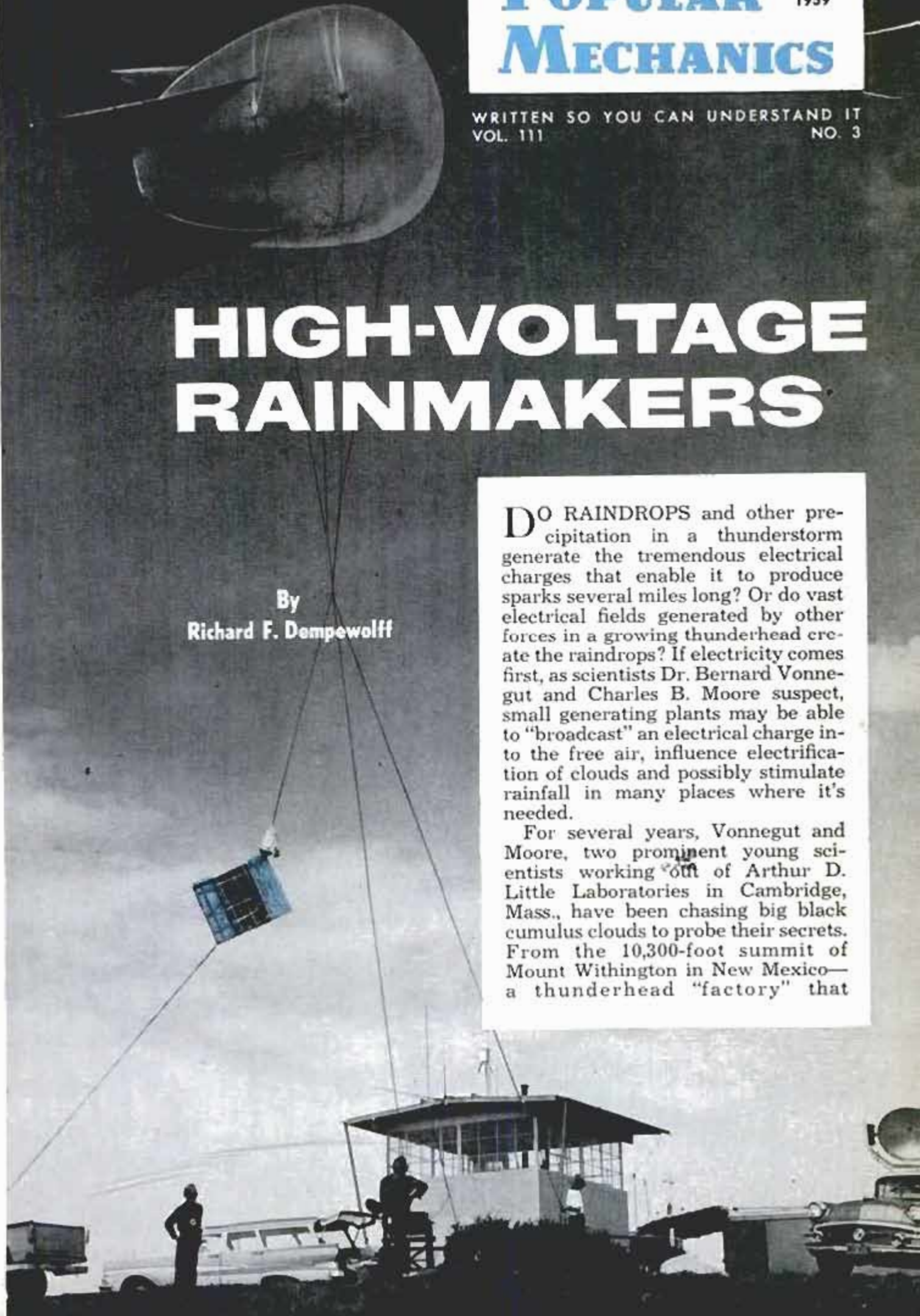

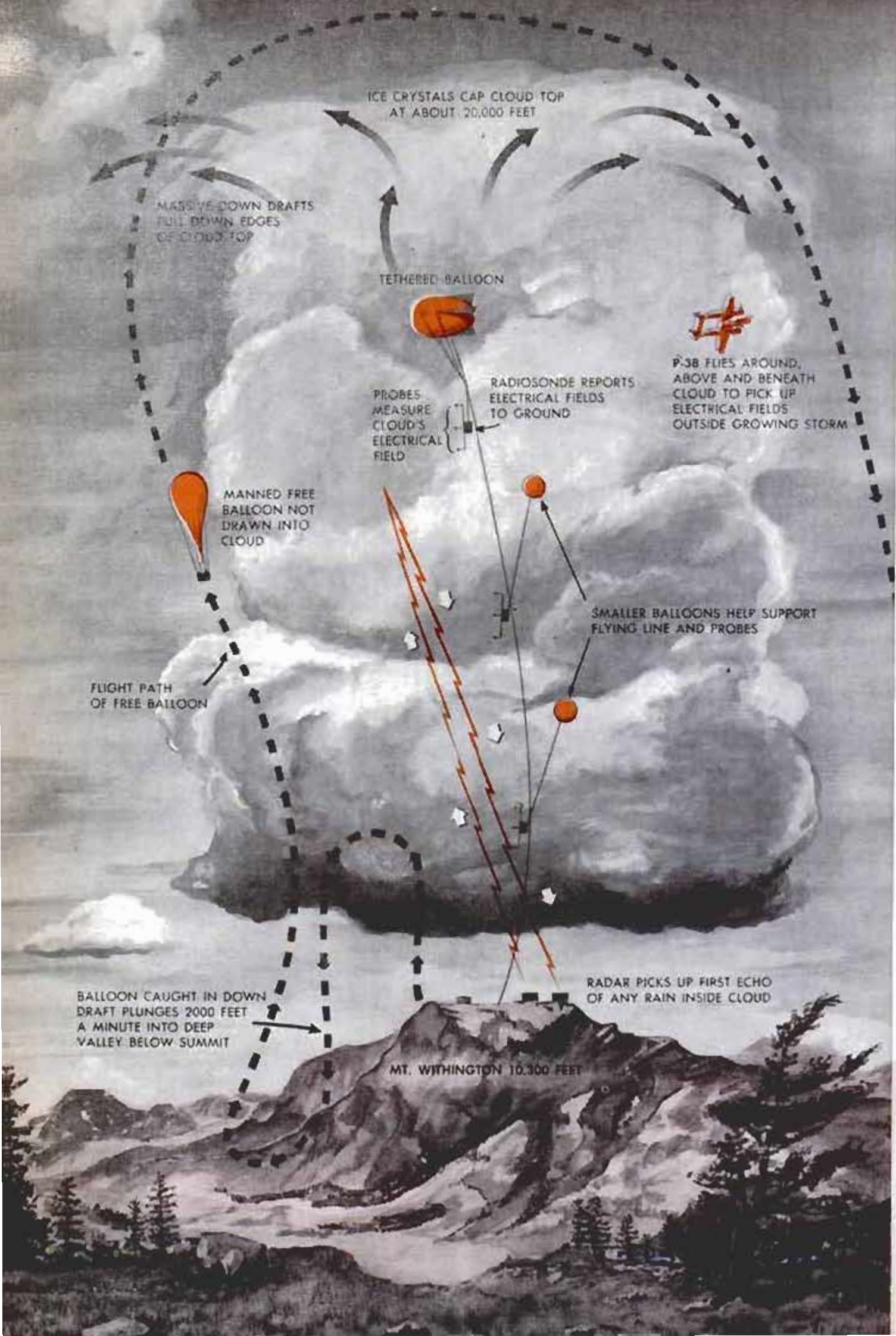

ICE CRYSTALS CAP CLOUD TOP AT ABOUT 20,000 FEET

MASSIVE DOWN DRAFTS FILL DOWN EDGES OF CLOUD TOP

TETHERED BALLOON

P-38 FLIES AROUND, ABOVE AND BENEATH CLOUD TO PICK UP ELECTRICAL FIELDS OUTSIDE GROWING STORM

PROBES MEASURE CLOUD'S ELECTRICAL FIELD

RADIOSONDE REPORTS ELECTRICAL FIELDS TO GROUND

MANNED FREE BALLOON NOT DRAWN INTO CLOUD

SMALLER BALLOONS HELP SUPPORT FLYING LINE AND PROBES

FLIGHT PATH OF FREE BALLOON

BALLOON CAUGHT IN DOWN DRAFT PLUNGES 2000 FEET A MINUTE INTO DEEP VALLEY BELOW SUMMIT

RADAR PICKS UP FIRST ECHO OF ANY RAIN INSIDE CLOUD

MT. WITHINGTON 10,300 FEET



P-38 airplane, with special weather instruments mounted on probe, is used in studies of thunderstorms

produces walloping rumpers nine out of every ten days in summer—their tethered balloons, trailing pigtailed instruments to measure electrical fields, soar through the vitals of developing storms. Their radar, perched on the mountain, sweeps the cloud curtain above it for an "X ray" glimpse of the first sign of rain formation. Meanwhile, an airplane, bristling with probes, roars above, through and beneath the towering cumulus columns to measure the horizontal and vertical electrical fields inside and around the storm cloud.

Twice, on a flimsy plywood platform slung beneath a giant free balloon, Moore and two other scientists have sailed through the frightening up-and-down drafts of growing black thunderheads to observe first-hand the machinery of developing storms.

Last summer, as a result of what they discovered, the meteorologists set out across the prairie with a truckload of innocuous-looking equipment. At a ranch near Jacksboro, Tex., they quietly set about rigging a simple experiment with startling implications. On 30-foot telescoping TV masts, they strung a slender wire four miles across the prairie. Using a portable generator, they shot a high-voltage direct-

current charge through their "aerial." At night, faintly visible coronas glowed along the length of the wire as fast ions sprayed out into the atmosphere and were carried off downwind. "We found," says Vonnegut, "that the negative space-charge we were introducing reversed the normal fair-weather field for four or five miles downwind. When low cumulus clouds were growing above this region of artificially electrified air, we found that the electrical fields beneath such clouds were far more strongly reversed than elsewhere. There appears little doubt that our artificially produced charge was entering these small clouds."

Even more interesting is the fact that during April and May of last year, while the experiment was in full swing, vast areas of east Texas, downwind of the unique power line, experienced unusual torrential downpours. Vonnegut cautions that those rains probably bear no relation to the space-charge experiment, but, he admits, "we are presently so ignorant of the process governing rainfall distributions that we should not entirely dismiss the possibility of a relationship."

Since 1953, when he wrote a paper on his thunderstorm ideas, Vonnegut has been in



Silvered hemisphere is used as wide-angle lens for pictures of sky. Camera records cloud conditions

what he calls "an amiable scientific controversy" with most of his fellow scientists. Nearly all of them hew to half a dozen generally accepted, though unproven, theories. "One of these ideas," Vonnegut explains, "is that falling raindrops capture ions, become charged themselves and electrify the cloud. Another popular theory is that the storm becomes electrified by the collision of ice particles and snowflakes rubbing together. The shattering of ice crystals, break-up of raindrops in updrafts, the riming process on hail particles, and voltages produced in the freezing process itself—all these have been given credit for doing the job." In each case, he points out, rain or other precipitation is assumed to come first, and electrification of the storm afterward. What might happen inside a cloud if things happened to work the other way around?

In his laboratory, Vonnegut has set up a simple gadget, first devised in 1879, to show visitors just that. He turns a petcock on a fine nozzle, and a vertical fountain of almost misty droplets sprays upward. He rubs a pocket comb on his sleeve, then holds it a few inches from the spray. Instantly,

ELECTRICAL PRIMING OF CLOUDS

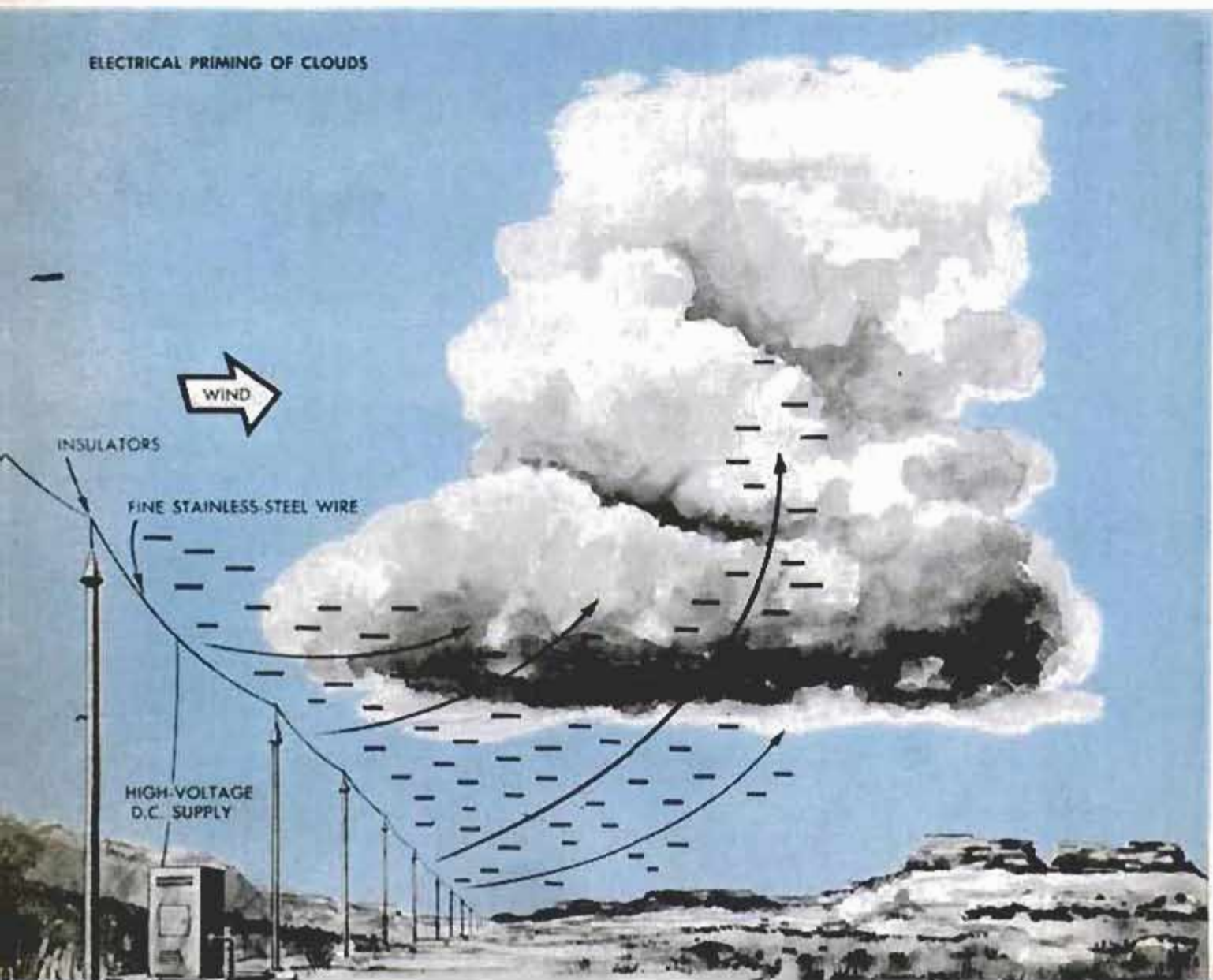



Unable to stay close to thunderhead top, balloonists soared 29,000 feet before they could start earthward

the fine moisture particles, brought under the influence of the tiny static field set up by the comb, coalesce into big drops, and the fountain becomes a short column of water spattering "rain" around itself.

Vonnegut's hunch is that a similar phenomenon probably is what makes a thunderstorm "rain." But if so, then how does the cloud become electrified to start with? The lower atmosphere blanketing the earth, he explains, always carries what physicists know as a "fair-weather space charge" of positive electricity. Dr. Vonnegut thinks that air containing this charge may rise into a small cumulus cloud on convection currents, weakly electrifying it. This weak field, he says, would cause a conduction current to flow around the cloud, bringing an opposite charge to the cloud surface. Downdrafts on the cloud's surface would carry these negative particles into the lower part of the cloud, and a continuous current would begin to flow from the upper atmosphere into the lower reaches of the cloud. As the cloud grows, so do the charges, and the developing storm becomes a sort of snowballing, mammoth Van de Graaff generator. Finally, masses of cloud particles, caught in the vast electrical field, coalesce into sheets of rain and fall earthward. Meanwhile the charges continue to build on roaring convection currents until they sizzle themselves away in lightning strokes.

To prove beyond doubt whether electricity or precipitation occurs first in a moving, growing cloud isn't easy. However, betting

that they'd come up with some answers if they could measure the field in and around a developing thunderhead, and watch for the first sign of rain with radar, Vonnegut and Moore went cloud-chasing. While their radar sets, perched on top of Mount Withington, peered into the hearts of passing cumulus clouds, the two meteorologists explored the electrical mysteries of the clouds with a wide assortment of ingenious equipment.

From Airplane to Balloon

One of the first tools was a little Beechcraft Bonanza that sprouted glass-fiber fishing rods from its wingtips, belly and back. On the rod tips, radioactive probes picked up the faintest space-charge variations as the plane flew along, registering the "tickle" on an electrometer in the cabin. "We got some interesting readings," Vonnegut says, "but the plane was too light. It finally lost its engine and landed on the desert. So we went to tethered balloons, on which we rigged radiosondes."

Designed by Moore, these polyethylene teardrop-shaped balloons sporting fins, carried measuring devices 20,000 feet above sea level, up into the cores of developing thunderheads. A P-38 Weather Bureau plane flew over each guinea-pig cloud at the same time, measuring the electrical field above the growing storm. Down on the mountain peak, a screen-walled "Faraday Cage," resembling somebody's back porch, measured the constantly changing

(Continued to page 252)



Ezra Stoller photos



Prefab House Has Aluminum Exterior

Buyers of prefabricated homes can now look at houses featuring bake-finished aluminum siding and roofing. It is estimated that the owner of one of these houses can save \$4000 in maintenance and repairs over a span of 20 years. The aluminum exterior is backed with gypsum, which is fastened to a conventional wall with insulation, interior sheathing and two by four-inch studs.

Transmitter in Scanning System Weighs 2½ Oz.

Tiny and compact, the transmitter in a television-type scanning system designed by Navy scientists to picture the moon weighs just 2½ ounces. The crystal-stabilized transmitter is capable of a 50-watt output, to transmit a television picture 240,000 miles. The scanning system itself weighs eight pounds.



Here's Convair's 880—the Fastest Jet Transport in the World?

At 615 miles per hour, Convair's 880 is said to be the world's fastest jet transport. It carries 88 first-class passengers in a two-abreast seating arrangement. Basically a medium-range airplane, the gold-striped

880 is able to operate from nearly every airport in the world that has been accommodating four-engine transports. Seven international airlines have placed orders for the new jet airliner.

Tiny Projection Lamp Produces Top Screen Brilliance

Your eight-millimeter movie projector can now be equipped with a 150-watt lamp that is said to produce screen brilliance surpassing that of 750-watt lamps. Only $3\frac{3}{8}$ inches tall, it supplements a curved, built-in reflector with a low-voltage operation and rugged filament structure.



Glass-Fiber Heater Made of Thin Sheet

Ability to generate nonincandescent heat evenly over any area is the feature of a new heating element developed by a British manufacturing firm. Made of glass fiber, the material is in thin-sheet form and can be shaped and laminated for many uses. It can be used in portable heaters, hot plates, ovens, and can also be incorporated in room baseboards to replace radiators.



From Outer

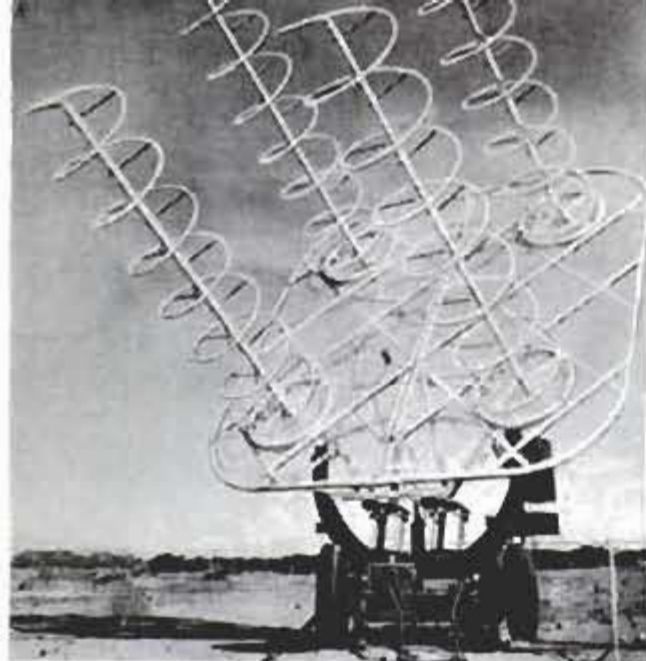

Spiral antenna transmits messages to space vehicle

INSTRUMENT PACKAGE EMBEDDED IN SHOCKPROOF PLASTIC DUPLICATED IN FAIRING ON EACH SIDE OF ATLAS

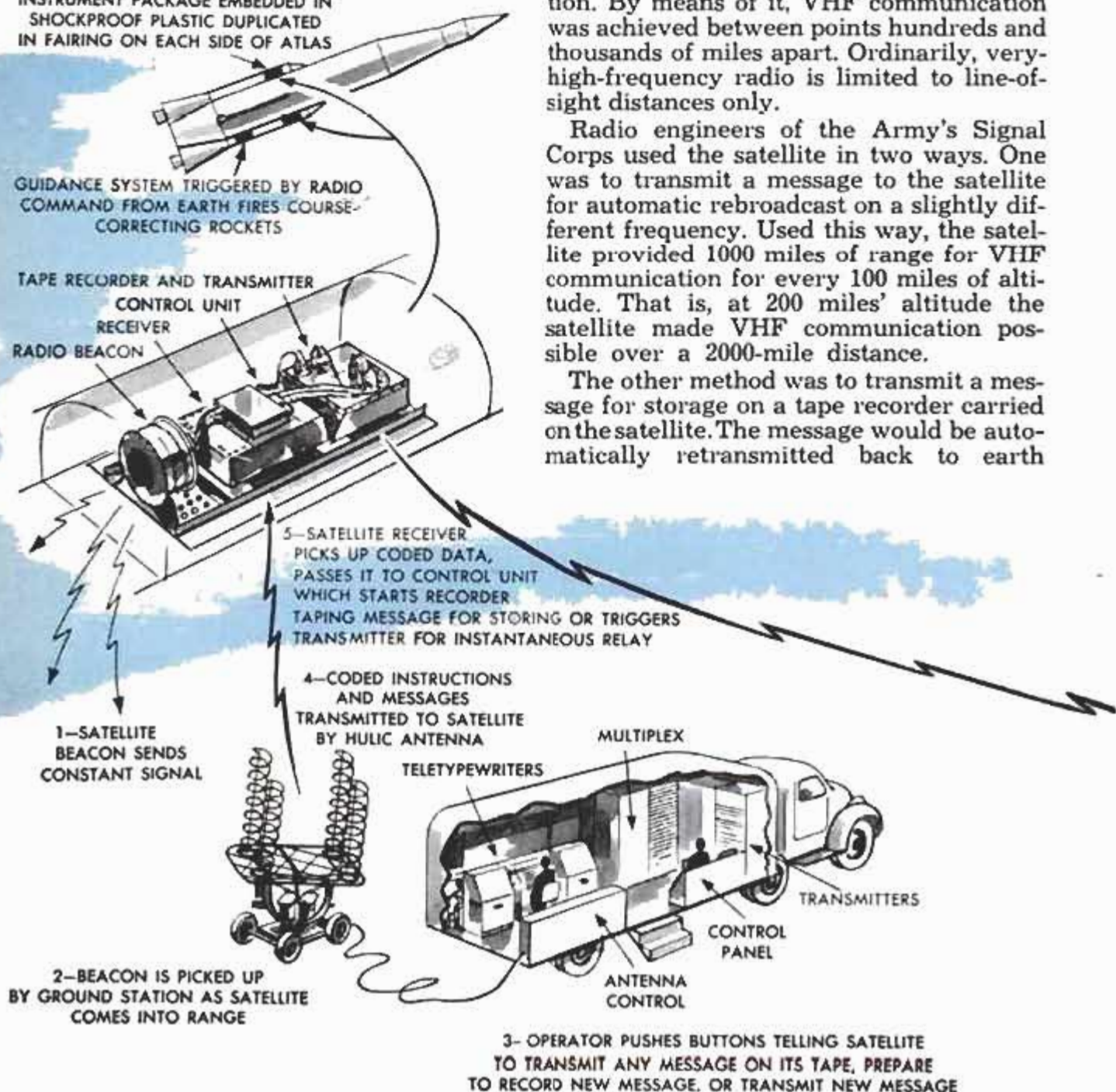

WHEN OUR "talking" Atlas satellite of December rammed its 8750-pound shell into a looping orbit around the earth, like a ball on the end of a string, its greatest significance to rocketeers lay in its tiny package of "brains." Not only did the 85-foot rocket's tricky communications system receive, remember, and return verbal messages from space to earth, but it was steered en route by radio signals from the ground.

Known as SCORE (for Signal Communications by Orbiting Relay Equipment) this satellite was a high-flying radio-relay station. By means of it, VHF communication was achieved between points hundreds and thousands of miles apart. Ordinarily, very-high-frequency radio is limited to line-of-sight distances only.

Radio engineers of the Army's Signal Corps used the satellite in two ways. One was to transmit a message to the satellite for automatic rebroadcast on a slightly different frequency. Used this way, the satellite provided 1000 miles of range for VHF communication for every 100 miles of altitude. That is, at 200 miles' altitude the satellite made VHF communication possible over a 2000-mile distance.

The other method was to transmit a message for storage on a tape recorder carried on the satellite. The message would be automatically retransmitted back to earth

Space— Voices Today, TV Tomorrow

whenever a ground station interrogated the satellite. Messages on seven teletypewriter channels in addition to voice could be stored this way. Sometimes a stored message would be "unloaded" to another ground station on the same pass around the earth, sometimes it would be held for a number of revolutions before a ground station interrogated the satellite and caused the message to be transmitted from it. All the Signal Corps experiments worked perfectly.

Clustered before their complex instrument panels, Air Force ballistic-missile experts watched as the Atlas roared out of this world. Each time the rocket veered from the trajectory that would send it into orbit, a series of coded orders, radioed skyward by earthbound human monitors, flashed through a miniature receiver aboard the space vehicle. They were relayed instantly to a decoder that translated the electronic beeps to course commands. Switches closed, valves opened, and small rockets burst into flame, nudging the nose of Atlas back toward its globe-circling course. According to the Air Force's ballistic-missile chief, Gen. Bernard Schriever, it was the first time any satellite rocket was steered into orbital trajectory by radio guidance. Until now, all our space vehicles have had built-in gyro-electronic guidance. Once off the pad, they were on their own.

The unique communications system carried by Atlas points the way to space relay networks that may soon make it possible to send microwave-radio and TV signals to any point on earth from a single ground station. It proved the feasibility of reconnaissance satellites (now a-building) that will gather and store pictures and data as they hurtle along, and transmit their coded information to ground stations at radioed command.

Heart of Atlas' big secret was a 150-pound communications payload consisting of two identical miniature radio stations. Fitted snugly in faired housings on each side of the big rocket, the briefcase-size units included flush-mounted flat antenna, receiver, control unit, tape recorder and transmitter. Each set could pick up, store and relay messages from ground stations.

Why two? "If one failed, the other could take over," explains S. W. Spaulding, engineer at RCA's Astro-Electronic Laboratories where many of the components were designed and built in conjunction with U. S. Army Signal Corps scientists. Wisdom of the twin units was proven when one of the two sets went dead shortly after the Atlas took off. President Eisenhower's famous Christmas message from space was handled by the alternate set.

Here's how the tricky system worked:

(Continued to page 244)

6—AS SATELLITE COMES WITHIN RANGE OF NEXT STATION, OPERATOR INSTRUCTS IT TO PLAY BACK RECORDING, ALSO FEEDS IT NEW DATA FOR RELAY.

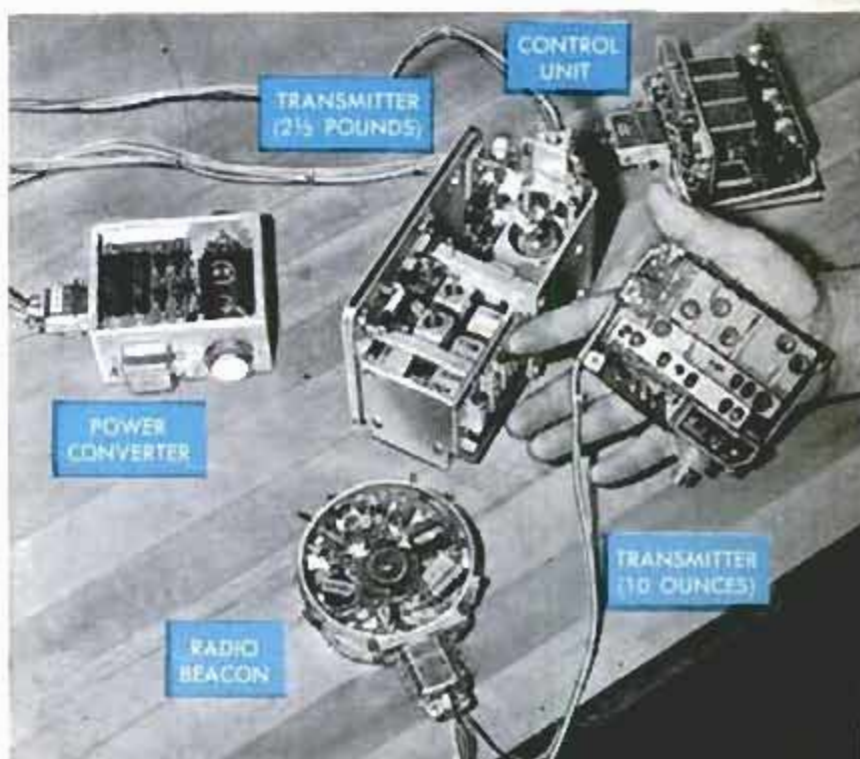



Buick's straight-line speedometer is probably the longest in the industry



Trunk is ample, but deck slants so sharply to rear that two-suiter case must be placed in extreme forward position to allow lid to close



Tunnel under center of rear seat allows about one inch of padding

MARGINAL COMMENTS
BY ART RAILTON
PM'S AUTO EDITOR

There must have been a big bumptiousness market a few years ago when Buick was in third place in sales. Public taste apparently changed sharply in '57.

In all cars, the center seat is to this generation what the rumble seat was to the '20s—the mother-in-law seat.

BUICK HAS NEW PERSONALITY; HERE'S HOW OWNERS LIKE IT

WHEN BUICK says it's new, it means it. The all-newness includes the way it drives, the way it sits and the way you feel inside it.

It's a whole new personality.

How does this new personality appeal to long-time Buick owners? To find out, *PM* surveyed 1000 owners of 1959 Buicks, asking them what they think about the new car. The answer: They like the big change.

"Both my husband's family and mine have had Buicks for years. We deferred getting a new car for two years as we didn't care for the previous Buick styling. This year's is just right. Sweeping lines, but not too severe. It certainly has eye appeal. Some have told us it looks like a plane taking off as we drive away."—Wyoming housewife.

And the new look seems to appeal to the "conquest" buyer—the man who traded a different make:

"I traded a 1956 Mercury. This is the first good-looking Buick I have ever seen. In previous years, Buick was too bumptious, too heavy looking, poor taste in general."—Rhode Island retired owner.

What single feature do the owners like most? Surprisingly, it is not styling. The most often mentioned feature is Buick's handling ease, next comes riding comfort and third is the new styling.

But there are some complaints also. Topping the list of don't-likes is the high center hump in both front and rear floors which makes the center of the seats uninhabitable for any long period. Second most frequent complaint is the difficulty of getting in and out of the low-slung



Sure, I love my Buick's

- Ease of handling, say 49.5% of the owners
- Comfortable ride, say 47.1% of the owners
- Beautiful styling, say 41.9% of the owners
- Power and performance, say 28.9% of the owners
- Excellent brakes, say 14.6% of the owners

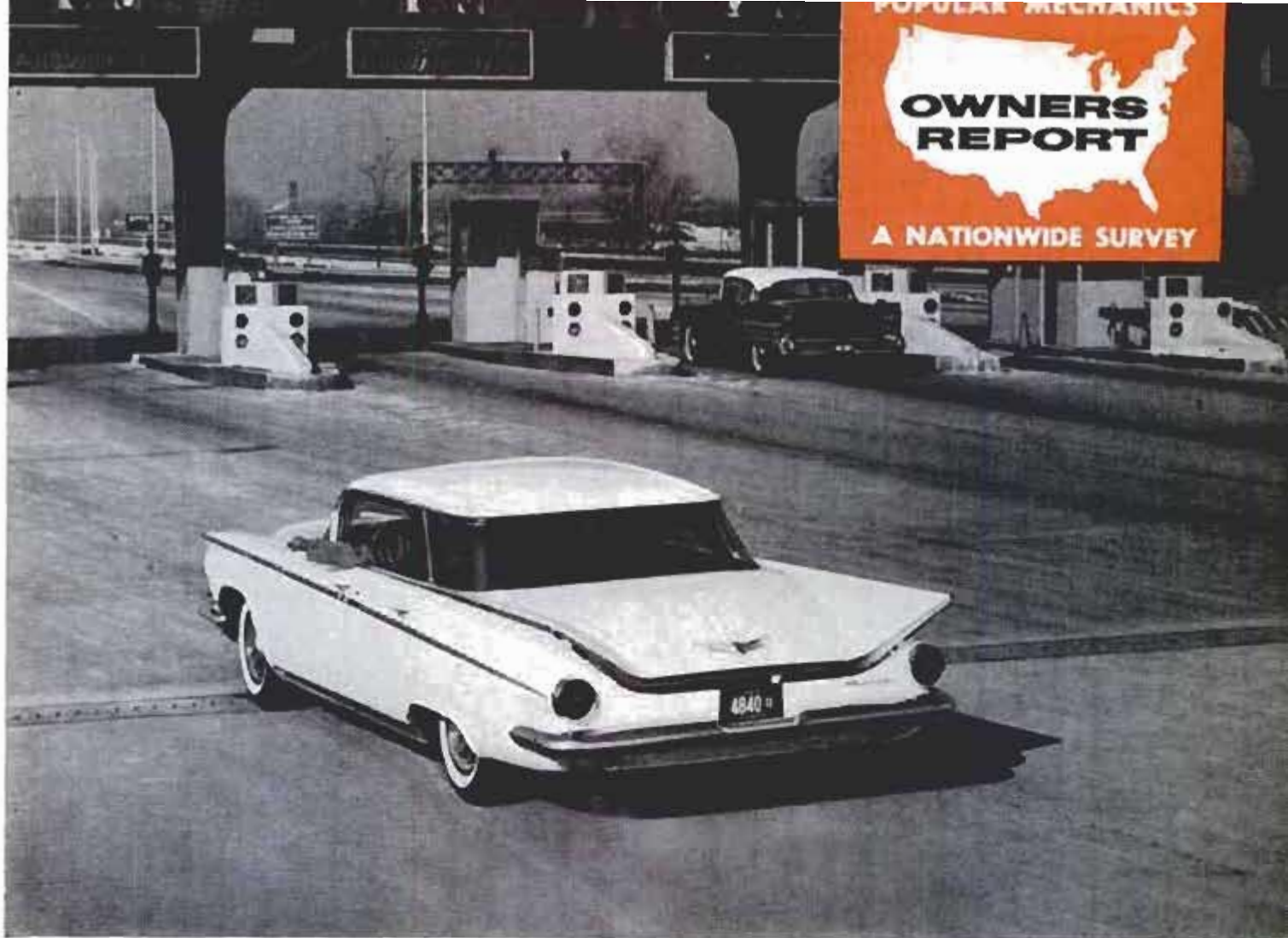

body. Third is a bothersome and, some owners say, dangerous reflection on the inner surface of the windshield when the sun shines on the shelf over the dashboard.

Best-liked Features

Here, in order of frequency of mention, are the Buick's best features as described by the owners:

"Handles lightly in the city and performs like a heavy car on the highway."—Kansas government worker.

"Steering improved to the point that it feels like power-assisted equipment although it isn't in my car."—California wholesale clerk.

"New power steering is exceptional. Good handling. Hardly know it is a Buick, so different is it."—California aircraft inspector.

"Comfortable, buoyant ride."—Maryland accountant.

← *It's good news that poor workmanship (usually a major complaint in an all-new year) is far down on the list in 8th place.*

← *If you think Buicks still drive the way they used to, you're in for a surprise. Gone is the ponderosity of the past. Now you can aim it into the eye of a needle.*

But, I don't like

Driveshaft tunnel, say 25.2% of the owners

Getting in and out, say 15.2% of the owners

Sun glare on top of dash, say 12.8% of the owners

Low front seat, say 8.8% of the owners

Its length, width, lowness, say 7.3% of the owners



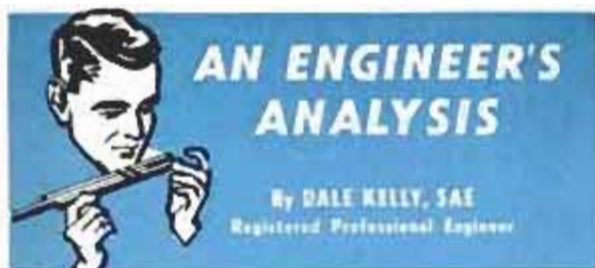

1959 BUICK INVICTA TEST

MODEL TESTED: Four-door hardtop with four-barrel carburetor, dual exhaust, Twin Turbine transmission, power brakes and steering.

Rear-axle ratio: 3.23 to 1. Wheelbase: 123.5 inches. Tires: 7.60 by 15. Weight: 4546 pounds with gas tank half full (54 percent on the front wheels, 46 percent on the rear).

Mileage on car at time of test: 450 miles. Barometer: 29.1 inches. Temperature: 73 deg. F. Payload: 200 lbs.

ACCELERATION TIME FROM STANDING START (in seconds)



Ignition timed for:	0 to 20	0 to 40	0 to 60	0 to 80	1/4 mile
Regular gasoline	2.2	6.3	11.2	17.5	18.3
Premium gasoline	2.1	5.8	10.3	17.0	17.7
Super-premium gasoline.....	No improvement				

(Gasoline used had following octane ratings by Research method: Regular 90, Premium 99; Super-premium 105.)

FUEL ECONOMY (miles per gallon)



Ignition timed for:	Steady 30 m.p.h.	Steady 50 m.p.h.	Steady 70 m.p.h.	Traffic Route
Regular gasoline.....	16.0	15.8	13.3	9.0
Premium gasoline	16.5	15.4	13.5	9.3
Super-premium gasoline.....	Not tested			

(In traffic test, car makes 10 full stops per mile and is driven fast enough to average 15 miles per hour.)

ESTIMATED AVERAGE ANNUAL GASOLINE BILL: \$237 for 10,000 miles

(Based on use of premium gasoline at 33 cents a gallon.)

SPEEDOMETER ERROR (miles per hour)



Speedometer reading.....	20	30	40	50	60	70	80
True Speed.....	19	29	38	47	56	65	73

ODOMETER ERROR (miles traveled)

Odometer registered 105 miles for an actual distance of 100 miles.



DRIVER'S VISION

Driver could see part of road 18 feet in front of car, full width of road 24.5 feet in front of car.



GROUND CLEARANCE (unloaded car)

Worst dip that could be crossed.....26-ft. radius
Worst hump that could be crossed.....18-ft. radius
Deepest rut that could be negotiated.....7.5 in.
Curb clearance for door opening.....14.8 in.

STEERING

Steering wheel turns for 50-ft. circle...1.5 turns
Curb-to-curb turn-circle diameter.....44.0 feet
Wall-to-wall turn-circle diameter.....46.5 feet
Steering-wheel turns, lock-to-lock.....3.6 turns

CENTER OF GRAVITY: 21.0 inches

TRUNK CAPACITY

12 cartons (one cubic foot each)

WATER RESISTANCE: Fair

Splash-pan test: No leaks
High-pressure test: Leaks under both front doors

OBSERVATIONS

Speedometer has an open, legible scale, but the one in the test car was not particularly accurate. Gasoline gauge monitored a dwindling supply of fuel accurately down to almost the last gallon (1.5 gallons, to be exact). Excessive chrome around instruments seriously interferes with legibility.

Engine had an oil-wetted air cleaner, which

is standard equipment on this engine. Optional at extra cost is the more modern, more efficient dry paper filter (an item which is standard on many cars).

Transmission is very smooth, going from standstill to top speed with no jerk or apparent shifts.

Dale Kelly, SAE



Owners like Buick's handling ease most. Its power steering is light and the big car is surprisingly nimble

"My job takes me all over New England. I average between 800 and 1000 miles per week. I travel over the roughest roads, taking short cuts between towns. Buick takes these back-country roads like they were superhighways. Most comfortable car I have ever driven."—Rhode Island salesman.

"I especially like the styling better than the 1958 design because of the lack of so much chrome and gingerbread."—New York secretary.

"It will last stylewise, it's so new. I had a 1954 Buick and never felt my car was outmoded until I saw the 1959 Buick."—California Navy man.

"A complete departure in styling. Rakish and very sporty looking."—New York salesman.

Now the Complaints

Buick owners are enthusiastic, but most of them admit the car has a fault or two (however, 24.3 percent of them register no complaints at all).

Here, in order of frequency, are the top five complaints as described by the owners:

"Where the drive shaft goes under the seat cushions, it is like sitting on a rail."—Wisconsin salesman.

"If more than four persons are in the car, the center passengers must sit on the drive-shaft housing which can be felt under the padding."—Wisconsin clerk.

"This is really a four-passenger car although it is a four-door hardtop. Center of seats very uncomfortable."—Missouri salesman.

"Difficult to get out of back seat of this four-door hardtop. Especially for ladies. Legs hit the rocker panels on outside and dirt rubs off on stockings. Not too difficult for men."—Minnesota retired owner.

"It is so hard to get in and out of the station wagon."—Ohio housewife.

← Over smooth roads, test car almost floated. On washboard, considerable rear-wheel hop and chatter. Crossing railroad tracks, reaction is sharp and noisy, but not at all unpleasant.

← What about the guy who had just bought a '58 Buick?

← How much more would you pay for a car without a center hump? \$100? It could be done for that, say engineers, but they doubt that you'd pay that much.

← Apparently, in the back seat of a car at least, it's a man's world!

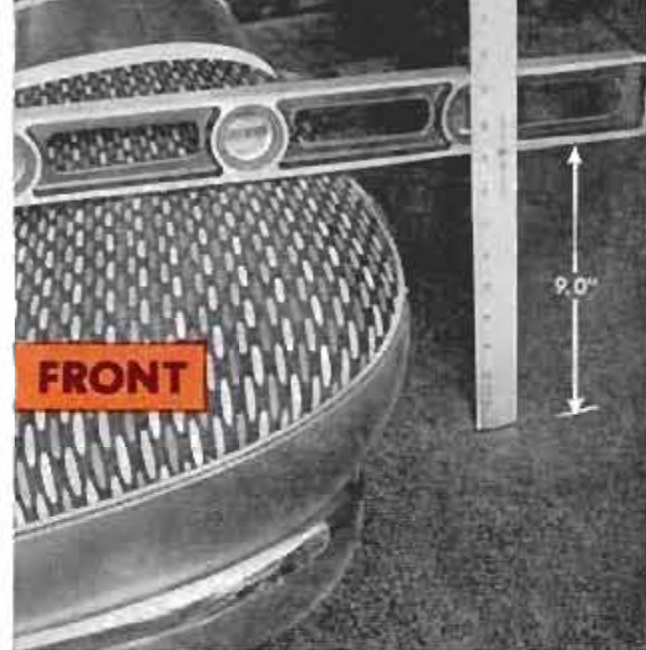
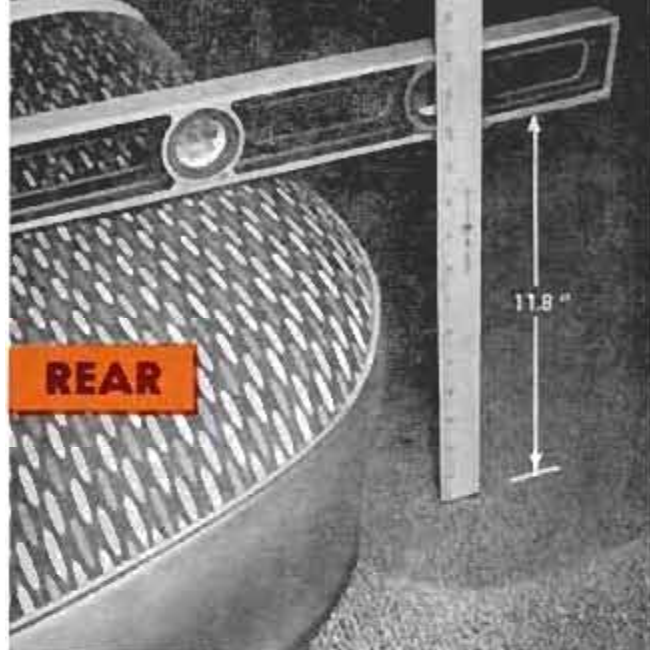

Rear-seat riders (if no more than two of them) have best seat in house. Deep stepdown in floor gives them a high cushion and toe space under front seat. Those in front have no stepdown and sit almost on floor

One auto company released a series of photos showing how to get into its cars gracefully. The secret: Stern first.



"There must be a more ladylike way of entering the car. It seems awfully awkward to enter the front seat, especially with a tight skirt."—Ohio Fisher Body employee.

Everybody from eye doctors to filling-station men dislikes wrap windshields, yet they get bigger, curvier and more horizontal. Sun glare is just one more reason why they are a mistake.



"Windshield gives back a terrible reflection in sunshine. Dash lights at night also reflect on windshield unless practically turned off. I consider this a safety hazard."—Wisconsin manufacturer's representative.

"Dashboard shelf is of a leatherette which reflects in driver's eyes when sun shines on it. It gives the effect of a dirty windshield and could hamper vision on a bright day."—Wisconsin soldier.

Front seat is so low a short driver can't see right-front fender. We're being forced into buying power-seat options.



"Driving into sun, the high blue cowl and slanted windshield reflects a blue haze on glass, cutting visibility."—Illinois owner.

"Front seat seems too low. Right leg gets tired on long trips."—Georgia tugboat captain.

"It's like sitting on the floor."—North Dakota businessman.

"Low front seat and high front fender limit visibility on right-hand turns."—Illinois clerk.

"A low car has many road advantages, but they are far offset by the discomfort of such low seats. Legs tire much quicker on long trips."—West Virginia retailer.

Turn circle is larger by two feet than in 1957. This is progress?



"Too big! Too long, wide and low. Hard to find parking area large enough. It takes up most of my garage. Hard to make U-turn."—Illinois salesman.

"Extreme width at fins and long rear overhang make sharp turns out of narrow garage difficult."—Illinois sales manager.

If men were as critical of clothing as they are of cars, they wouldn't wear the anachronistic felt hat. It makes even less sense than lower cars.



Suggestions for Industry

Each owner is asked to make one suggestion to the whole industry (not simply to Buick). The one most frequently suggested is, as you might expect, to provide increased gas economy. Second is to lower horsepower, third is to make cars shorter, narrower.

"Increase gas mileage and lower horsepower. Small cars are going to take over if this isn't done, I believe."—West Virginia branch manager.

"Raise the roof. My hat is worn and torn."—New York insurance salesman.

"Too much fins, too much glass, too long and too wide. Give us a car that is more durable."—Georgia tire retailer.

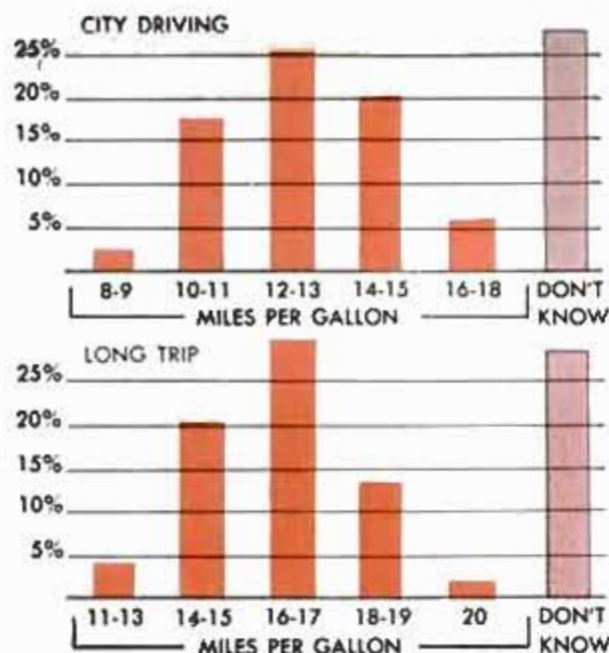

Bars in charts above show what Buick owners claim to be getting in gasoline mileage. Over-all average is probably between 13 and 15 miles per gallon. Right, extended fin can hit the vertical post before rear bumper when car is on a slant as at curbing



"What would be wrong with making a Chevrolet of about 100 horsepower, as big as a Rambler, but almost identical in styling to the Impala? They will never do this, but it would be nice."—Georgia businessman.

"The auto companies must sample teen-agers rather than the people who can afford to buy new cars when they ask about styling. I have no sympathy for the dilemma of the auto companies. I have been in business for nearly 30 years. At least 90 percent of my friends feel as I do. Why are cars so long and so low? The whole thing is ridiculous."—Illinois corporation president.

"Not enough attention is paid to the comfort of seats."—California general contractor.

(Continued to page 258)

← Don't ever say "never," my teacher used to say. And this fellow is in for a pleasant surprise come autumn.

← Why? Because they sell, that's why. Did you ever see a corporation president in a small car?

SUMMARY OF BUICK OWNERS' OPINIONS:

OVER-ALL RATING: Excellent 79.5% Average 18.8% Poor 1.7%

Best-liked features

Handling ease	49.5%
Riding comfort	47.1%
Exterior styling	41.9%
Power, performance	28.9%
Excellent brakes	14.6%
Good visibility	14.3%

Most-frequent complaints

None at all	24.3%
Center hump in floor	25.2%
Hard to get in, out	15.2%
Sun reflection dash	12.8%
Seats too low	8.8%
Too wide, too low, too long	7.3%
Heater-blower arrangement	6.1%

Had trouble with engine?

No trouble	87.9%
Some trouble	11.2%
Considerable trouble	0.9%

What was trouble?

Pings, knocks	5.8%
Carburetor, poor idle	3.0%
All others less than	1.0%

How is dealer service?

Excellent	53.1%
Average	29.4%
Poor	7.5%

Would buy from him again?

Yes, would	51.7%
No, would not	6.4%
Don't know, no answer	41.9%

What make was traded?

Buick	67.9%
Another GM make	14.6%
Ford Motor make	10.0%
Chrysler Corp. make	4.8%
All other makes	1.2%
No trade, no answer	4.5%

What other car owned?

Another Buick	4.3%
Another GM make	12.8%

Ford Motor make	8.5%
Chrysler Corp. make	4.5%
Independent make	4.3%
Foreign make	1.5%
No other car, no answer	64.1%

What make will buy next time?

Another Buick	68.7%
Another GM make	3.3%
Ford Motor make	2.1%
Chrysler Corp. make	1.2%
All other makes	1.0%
No answer, don't know	23.7%

Approve of industry styling?

Yes, approve	86.9%
No, disapprove	1.5%
No answer	11.6%

One suggestion for industry?

More gas economy	18.5%
Less horsepower, speed	11.6%
Smaller cars	9.1%
Better workmanship	5.2%
Easier in and out	3.3%

AN EYE ON SPACE

By Dr. Dan Q. Posin

PROFESSOR OF PHYSICS, DEPAUL UNIVERSITY
SCIENTIFIC CONSULTANT AND ADVISOR, COLUMBIA BROADCASTING SYSTEM



THE UNITED STATES has a plan to put a man into orbit. According to plan, the man will go around the earth 15 times or more before he comes down again, safely. McDonnell Aircraft Company now is designing and will build the capsule which is to carry the space adventurer around the world—not in 80 days, but in little more than 80 minutes.

The capsule with occupant will be launched by an Atlas ICBM. This rocket, using two booster engines and one sustaining engine, has been able in the past to develop more than 350,000 pounds of thrust. To increase the total thrust to more than 1,000,000 pounds, more booster rockets will be clustered around the main shell, thus permitting a substantial payload to go into orbit—a capsule containing a Daniel Boone of space.

The capsule will be guided into the chosen orbit by ground-radio equipment. If, by any chance, a mishap occurs on the way up, it will be possible to separate the capsule and bring it back by parachute.

After a series of successful orbitings, the spaceman will be able to fire a braking rocket in the direction of flight, the recoil destroying most of his forward speed. After a period of free fall, a series of parachutes will bring the traveler down to the surface, where radio signals will reveal his position. The capsule will be buoyant, should it land in the water.

The flight path, at about 125 miles above the earth's surface, will lead through the atmospheric fringe, and could permit orbiting for several weeks, should the spaceman begin to like his work and decide to remain aloft. Sufficient medical data will have been gathered, however, in the course of merely 15 or 30 orbital trips (a day or two).

The speed in orbit will be something like the 18,000 miles per hour we've heard and read so much about. But this 18,000 is not a magic or absolute number. At a greater distance from the earth, the speed can be less. Obviously this is so because the earth's gravitational pull is less at greater distances, and the satellite can laze along, experiencing only a relatively mild curving effect. At the distance of the moon, a satellite can lope along at a mere 2000 miles per hour. And, in fact, the moon does just that.

It is not difficult to calculate the speed which any satellite must have in order to orbit at any distance from the earth. For example, at 4000 miles from the earth's center (that is, a little above the earth's surface), the speed for orbiting is about 18,000 miles per hour; at 16,000 miles from the earth's center, the orbiting speed would be 9000 miles per hour, and at 36,000 miles the orbiting speed would be 6000 miles per hour.

In this connection, our spaceman could have a very interesting capsule journey around the equator at a distance of about 22,000 miles from the earth's surface (26,000 miles from the earth's center). At this distance the orbiting speed would be about 7000 miles per hour. And at this speed, the orbiting capsule would be turning in space at *exactly the same rate as the surface of the earth below*. Thus an orbiting spaceman at 22,000 miles above the equator would be constantly poised above the same spot on earth. It might even be the spaceman's house. It would be as though a man sat on a flagpole 22,000 miles tall—with the minor difference that there would be no flagpole!

Teach the Kids to Swim in One Lesson

By
Emmett Gowen

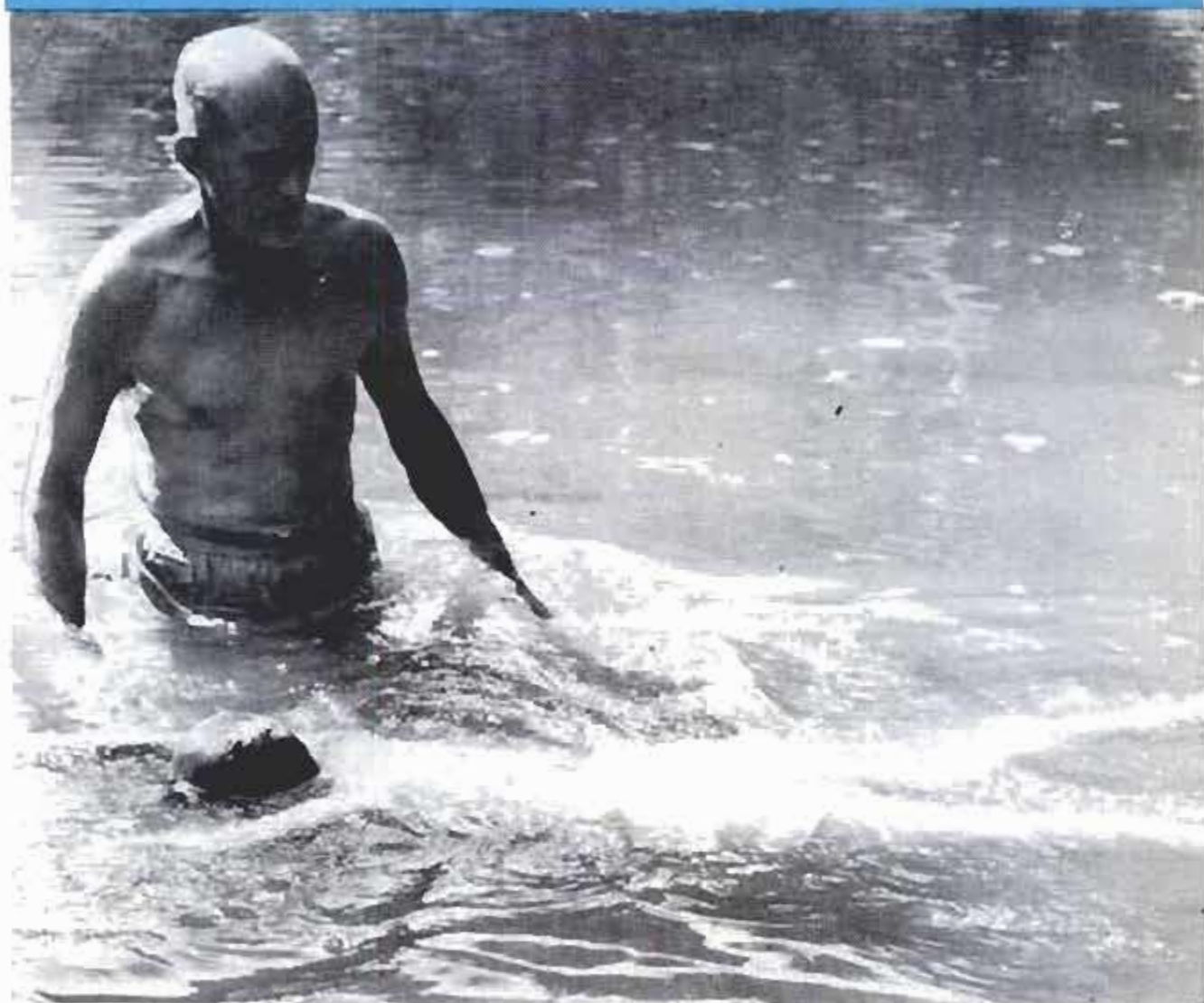

The author starts a 10-year-old nephew out with his first step in learning to swim, the dead-man's float

IT IS POSSIBLE to teach almost any non-swimmer to swim in one lesson. There are but three basic ideas to put across, three things for the pupil to do. When he does the three together, he's swimming.

First, have your pupil do the dead-man's float. Chances are he can already do this, for it is nothing but lying in the water, face downward. Small children often learn this in the bathtub. When asked to do it in a pool or lake, though, many kids are horrified at the idea of putting their faces in

the water. So if you want to see how quickly you can teach someone to swim, I'd suggest you choose a boy about 10 years old who has decided he *wants* to learn. It helps if your word has authority with him. He must believe that if he does as you say, he will be able to swim as soon as he has gone through the three steps. These steps shouldn't take longer than a half hour.

Have him do the dead-man's float a few times. Then, step two, instruct him to make swimming motions with his arms. Do this a



Still doing "dead-man's float," Coleman advances to second step—making swimming motions with his arms

few times, and make sure that the motions strike downward so that there will be a lifting effect. It is best to keep the whole thing as simple as possible, so say nothing, yet, about kicking the feet. That can come later. Just convince the pupil that (1) if he does the dead-man's float and (2) pulls with his arms, he will move through the water.

Now you add the third step. Do the dead-man's float, pull forward and down with the arms, and try while doing this to peep up out of the water. Anyone who has not swum before will tend to exaggerate this motion. The thing that can hold any beginner back is the impulse to get as much of himself as possible above water—with the result that he loses the flotation he had when lying barely awash. In trying to get too high out of the water, he sinks

himself. So your advice to just peep out is a trick to get only the nose and mouth out of the water.

Once he is floating, propelling himself, and has his face up high enough to breathe, he's swimming.

Good swimming instructors use these three basic steps in their teachings, but they don't put it all into one lesson or half an hour. I noticed this many years ago when I used to go swimming in a hotel pool. A woman was taking swimming lessons there, and I noticed that the instructor used several lessons on nothing but the dead-man's float, then spent several more having the woman swim with her face underwater. Finally he had her raise her face, and she was swimming.

I applied the observation to teaching six of my seven nieces and nephews to swim.



Still floating, and propelling self with arms, Coleman raises nose, mouth above water—but not too high

But I didn't see any reason to string out the lessons. I proceeded quickly.

There were, I found, variations in the aptitude of individuals. Iris was never fond of playing in water, had no desire to learn to swim, and when pressed asserted positively that she did not want to learn to swim. She has not learned to this day. Nona, strong-willed and inclined from earliest childhood to test everything with her own intelligence, would not listen. She asserted she would learn by herself, so she went into the water and fought it until she half-drowned herself and was weak with exhaustion, and getting nowhere. Finally she considered trying my method. She did the dead-man's float, pulled her hands against the water, raised her face and was swimming.

Travis and Jeanine were impressed, al-

most hypnotically. It took no more than half an hour to teach them to start swimming. It was in salt water, which is more buoyant than fresh water, and neither of them will ever believe that there is anything difficult to learn about swimming.

Sandra learned by herself. Three children older than she already knew how to swim, and wanted to go to the deep hole in the creek. She was only about five, and I had not yet tried to teach her. We just put a kapok life preserver on her and let her paddle along while we swam. One day, when the life preserver had become waterlogged, Sandra unconsciously began swimming against its dead weight. After we threw the life preserver away, she paddled around the deep water much faster.

Karen would not do the dead-man's float.

(Continued to page 238)

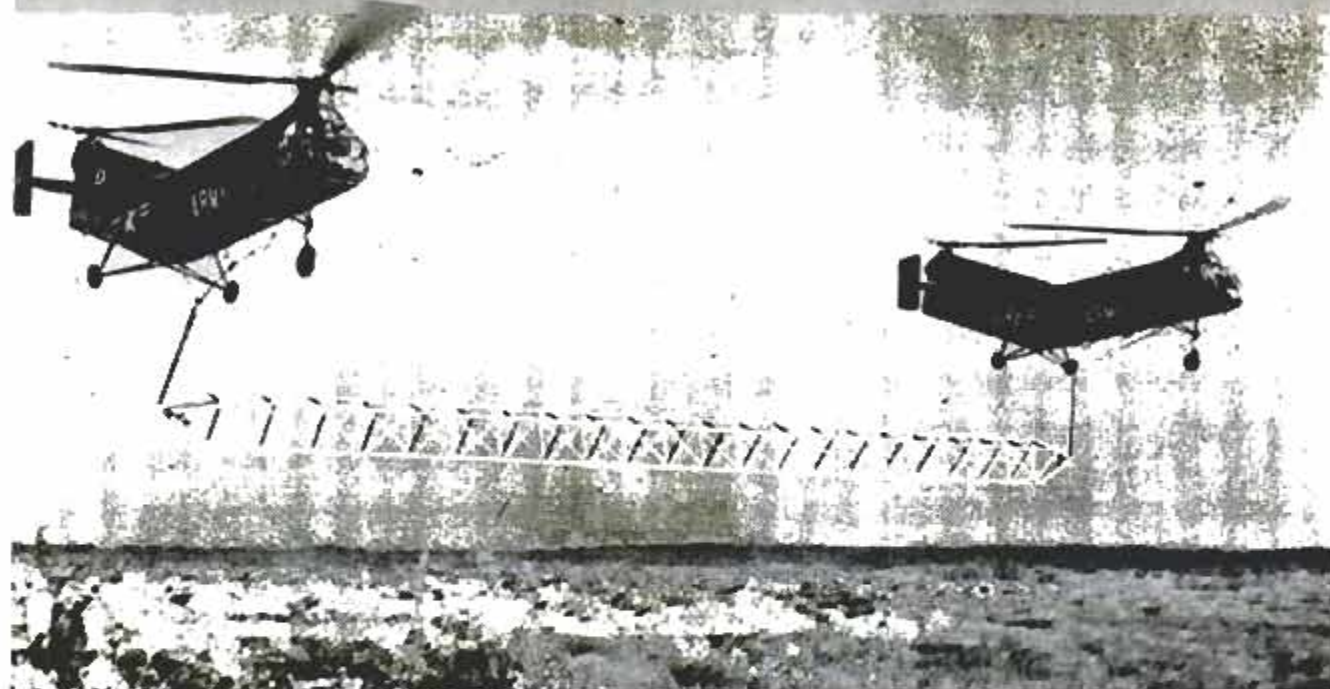

Workhorses of the Air

HELICOPTERS can be harnessed in teams of aerial workhorses, providing tremendous lifting power for short-haul delivery of heavy military vehicles and materiel to advanced combat areas. The copters can be harnessed in teams of two, three, four, five or six. Their heavy cargo, such as a 13,000-

pound truck, is attached by cables to aluminum-alloy spreader-frames. Ends of the frames are fastened together and the copters are attached to the frames by suspension cables. Each frame is 113 feet long and weighs 400 pounds. Vertol Aircraft developed the method for the Army.

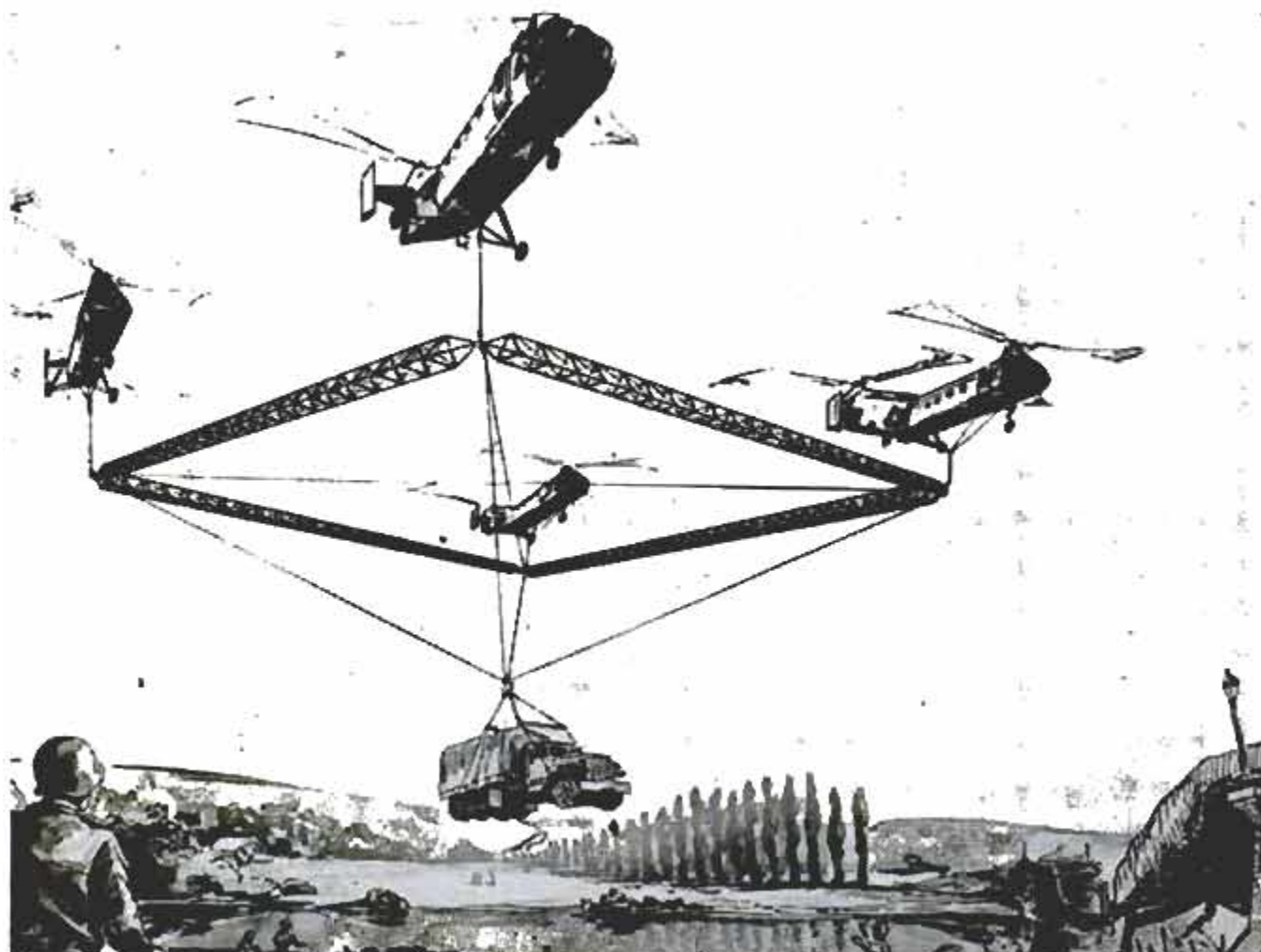

Powerhouse Inside Mountain Has Six-Mile "Waterfall"

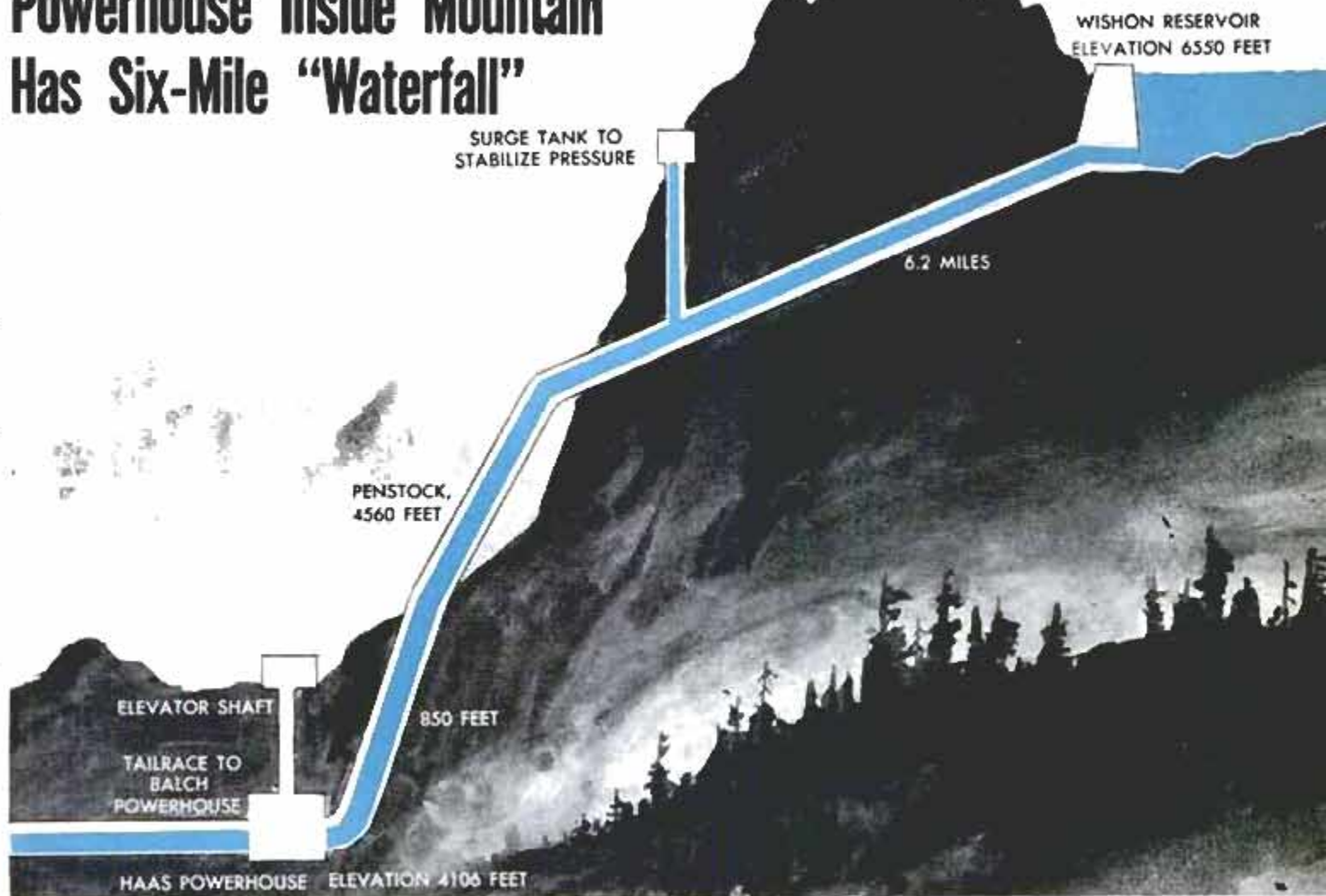

Profile sketch illustrates the flow of water to underground Haas powerhouse from High Sierra reservoir

BURIED 427 FEET in the solid granite of the Sierra Nevada Mountains of California is a hydroelectric installation as big as a 10-story building. The huge underground Haas powerhouse contains two generators with a capacity of 128,000 kilowatts. The installation is part of the Kings River hydroelectric system of the Pacific Gas and Electric Company. Water to operate the turbines comes from the Wishon Reservoir, which is over a mile high in the Sierras. The water flows six miles through a 13-foot horseshoe tunnel cut in the rock. The end of the tunnel connects with a steel penstock that carries the water 4560 feet above ground to another granite tunnel through which the water plunges 850 feet, almost straight down, to the turbines. After falling 14 times the height of Niagara Falls, the water rifles into the turbines with a pressure measuring 72 tons per square foot. The nozzle speed of the water jets hitting the turbine cups is 261 miles per hour. Then the water flows through a tailrace to produce more power in other generators downstream. Granite that was cut from where the tunnels and the powerhouse are now located was used in construction of the Wishon Reservoir Dam.

Interior view of underground powerhouse during installation of generators. Walls are solid granite



They're Testing

Walls without studs, roofs without rafters and windows without sashes are among construction ideas for houses of the future that should give you more for your money

By Kenneth Anderson

WHEN YOU SHOP for a new home in the rapidly approaching "space age," the real-estate salesman might mention the advantages of wiring trees, slotted splines or expandable polystyrene in stress skins. But he won't be using doubletalk. The words already are part of the vocabulary of home builders who are experimenting with revolutionary techniques and materials that should result in better houses for less money in the next few years.

Right now the National Association of Home Builders Research Institute is conducting tests with the first two of a planned series of houses incorporating new developments in aluminum, gypsum, plastics, plywood, steel, concrete and other building products.

The research houses which have been built so far, at South Bend, Ind., and Knoxville, Tenn., would not appear out of place in any neighborhood of inexpensive new homes. They are attractive three-bedroom, basementless houses. Both were erected by prominent home builders—Martin L. Bartling, Jr., constructed the Knoxville research house and Andrew S. Place built the South Bend home. Both have modern floor plans and might carry a price tag of around \$13,500, if you could buy them.

The most startling feature of the South Bend research house is a steep-pitched shelter over the driveway. This structure, linked to the family room-kitchen area by a breezeway, is called a "garport, since it is a cross between a carport and garage." A "traffic stopper" on the Knoxville research house might be the wind-sheltered patio. It extends in an L-shape around the exterior of the kitchen and family room. The patio receives additional sunlight through an exposed portion of the ribbed-aluminum roof.

More significant, probably, are some of the features that are not discernible in a view from the street. Even from inside the South Bend research house, for example, you are not aware that the six-room structure, with approximately 1200 square feet of floor space, was assembled without a single stud, joist or rafter. The outside walls, interior walls and roof are made of sandwich panels with a "filling," or core, of foamed plastic.

The panels, also known as stress skins, have never been used before in building a house. They are made by placing two sheets of conventional building material, such as gypsum board or plywood, in a form and filling the 2¼-inch space between the sheets with expandable polystyrene. The polystyrene, which bears the trade name of Dylite, foams

Interior doors of NAHB research house at South Bend, top left, are eight feet high and close on hardware mounted on wall, beneath electric switch plate. Center photo shows cross-sections of a gypsum interior wall panel and a plywood roof panel, both filled with foamed plastic. Left, workmen at Knoxville site install hardboard wall panel on sill plate



Tomorrow's Homes

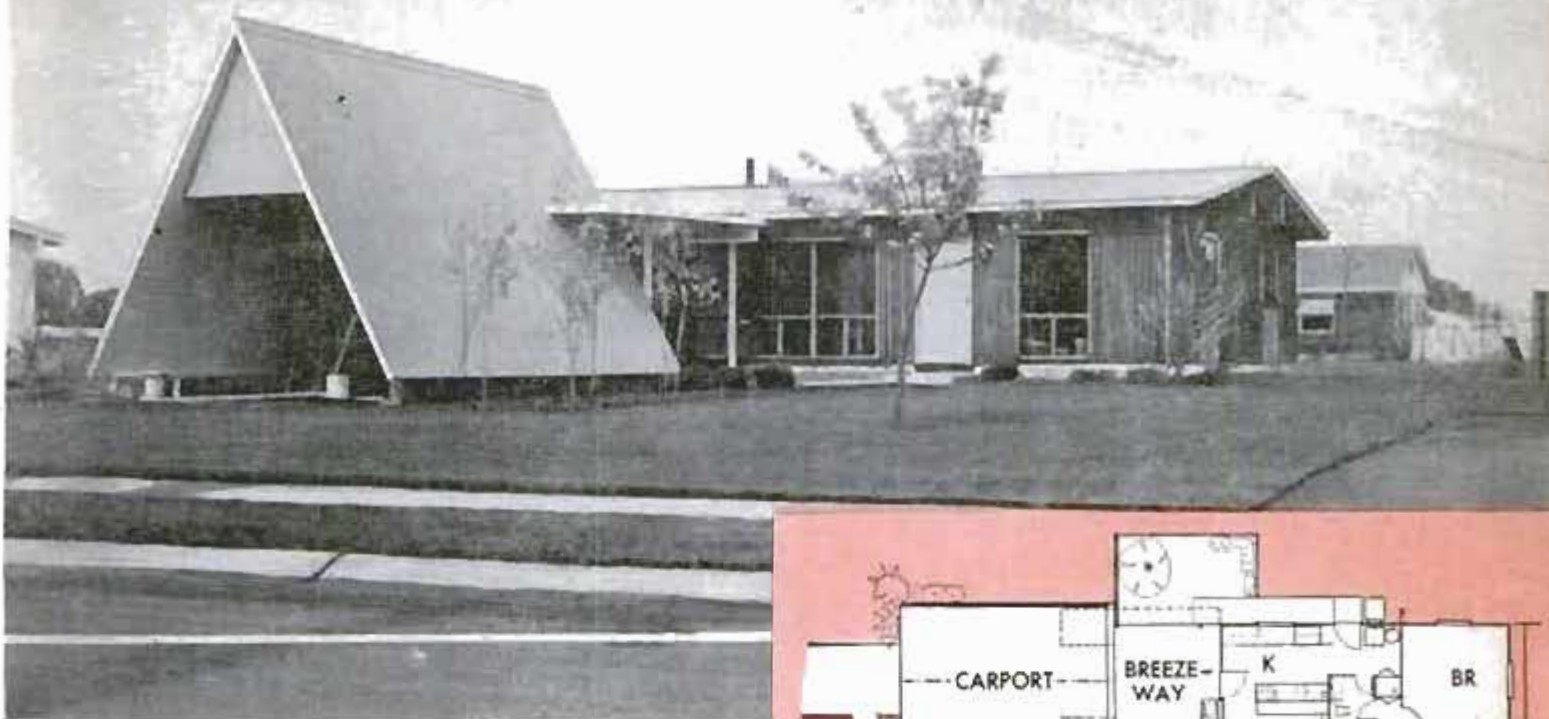

South Bend research house is 36½ feet by 32½ feet, features steep-pitched "garport" of sandwich panels

in the space and forms a bond with the surface material, which in the case of exterior wall panels may be Douglas Fir plywood on one side and "combed" redwood plywood on the other.

The tiny beads of Dylite feel like pieces of popcorn if you squeeze them between your fingers. As insulating material, the plastic is rated excellent. Heat loss through the sandwich panels is about half that of walls built with conventional framing methods. And the panels have a tremendous load-bearing capacity. Builders of the home estimate the studless walls could

Knoxville research house is 36 feet 8 inches long by 28 feet 8 inches wide and has sheltered patio

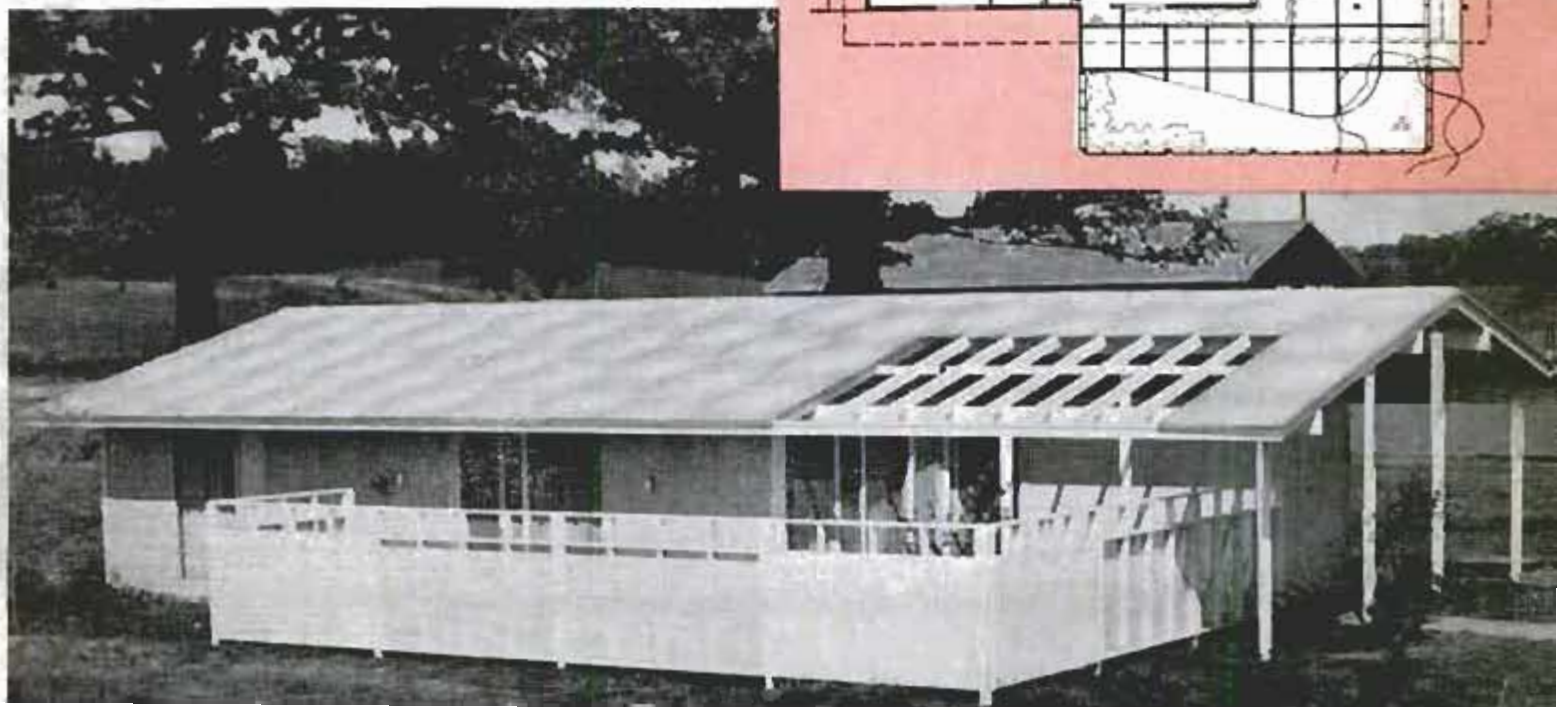
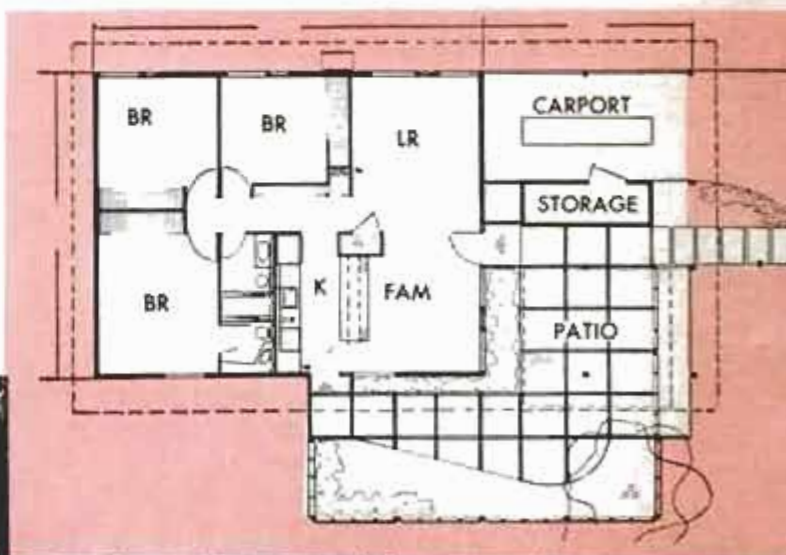
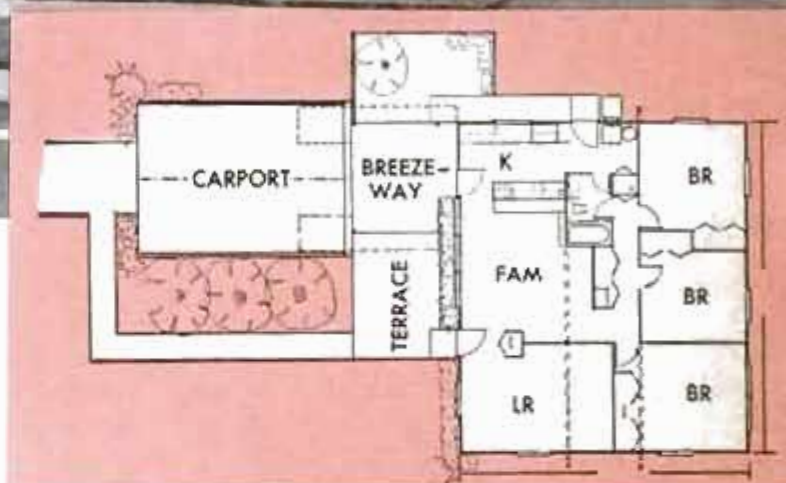



First of plastic-core roof panels is put on South Bend house, which five men erected in one working day

support a roof covered with wet snow 40 feet deep, if the roof weren't deflected by the weight.

The panels for the South Bend research house were produced in four-foot modules. But, eventually, they may be produced in any length that can be shipped. And when the homeowner of the future wants to add a room to his house, he may simply order sandwich panels to match the dimensions of the room and cut out holes for the doors and windows.

The stress-skin panels with foamed plastic cores are lightweight. The 4-inch thick roof panels, 18 feet long and 4 feet wide, weigh 190 pounds and can be handled by two men.

Exterior and interior walls of the Knoxville research house were assembled from factory-built panels of hardboard. The inside surfaces of the wall sections are plastic-coated and the exterior surfaces are finished with a new kind of outside paint which may not have to be renewed for 20 years. The hardboard wall panels also have built-in insulation, are lightweight and can be erected quickly by a small crew of workmen. (The entire research house at South Bend was erected by five men in one working day.)

Both the South Bend and Knoxville houses make use of aluminum as roof coating and fascia strip. On the Knoxville project, ribbed aluminum sheets, measuring 4 by 18 feet, were fastened to plywood sheathing. The aluminum is expected to help insulate the house and to eliminate periodic replacement of shingles, as is nec-

essary with today's conventional houses.

Some new ideas in plumbing also are getting a practical test in the two research homes. At Knoxville, all-plastic plumbing was installed, along with a new type of toilet and a garbage disposer that greatly reduce the amount of water consumed. In the South Bend research house, the plumbing is a simplified package of pipes concealed under the kitchen sink. Since the bathroom adjoins the kitchen, all the sewage and water-supply pipes are located next to the common wall. Even the stack is one solid pipe that can be disconnected under the sink counter and pulled up through the roof. Copper tubing was used in the South Bend house, with the explanation that copper will bend if the structure settles and plumbing failures caused by sagging walls and floors will be eliminated. The copper tubing is four times lighter than the type usually recommended for home plumbing.

The bathtub was installed on a platform six inches above the floor. This idea, it is hoped, will prove attractive to a mother of small children. She won't have to bend over so far to scrub the toddlers.

Many of the ideas being tested by the NAHB are simple cost-cutting methods. For example, hiding the seams between wall and ceiling panels is expensive. In the South Bend house little or no effort is made to conceal the seams. The builder explains, "there's no heat loss through them and they don't leak, so let them show."

The interior walls are plastic coated and the interior doors are eight feet high. For people who have spent most of their lives

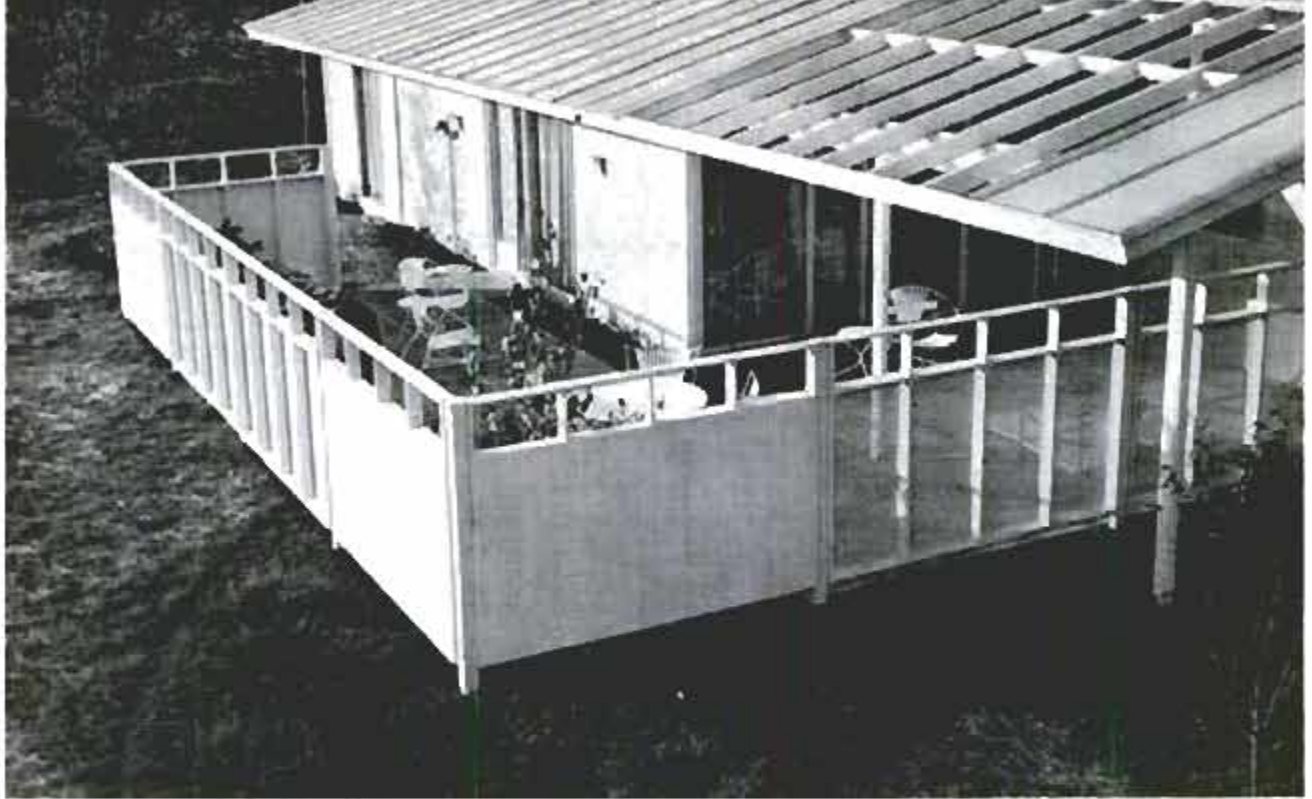

Close-up of house at Knoxville shows use of 18-foot aluminum roofing sheets combined with fascia strip

opening and closing six-foot eight-inch doors, the eight-foot doors may seem unnecessarily large. But the oversize door reduces the cost of framing doorways; the conventional door casing is eliminated. There is, instead, a vinyl closing strip along the edge of the wall.

Windows in the South Bend house are sashless. They are simply plates of glass that slide in the grooves of a wood casing. Hardware mounted directly on the glass permits the windows to be locked shut or partly open. The heat loss through the sashless window reportedly is 72 percent less than through awning-type windows.

Still other ideas being tested for the homes of tomorrow are very thin hardwood flooring—African oak $\frac{3}{16}$ inch thick—and a pre-assembled electrical wiring system called a “wiring tree.”

Kitchen cabinets in the Knoxville house are made of hardboard and mounted on slotted splines. Cabinets in the South Bend house can be opened either from the kitchen or from the family room.

These aren't just demonstration houses. They actually serve as laboratories for the NAHB Research Institute. And from these laboratories will come tomorrow's houses—with better materials, methods and values. ★ ★ ★



Sashless windows lock closed or partly open with twist of wrist. Kitchen cabinets, below, can be opened from family room

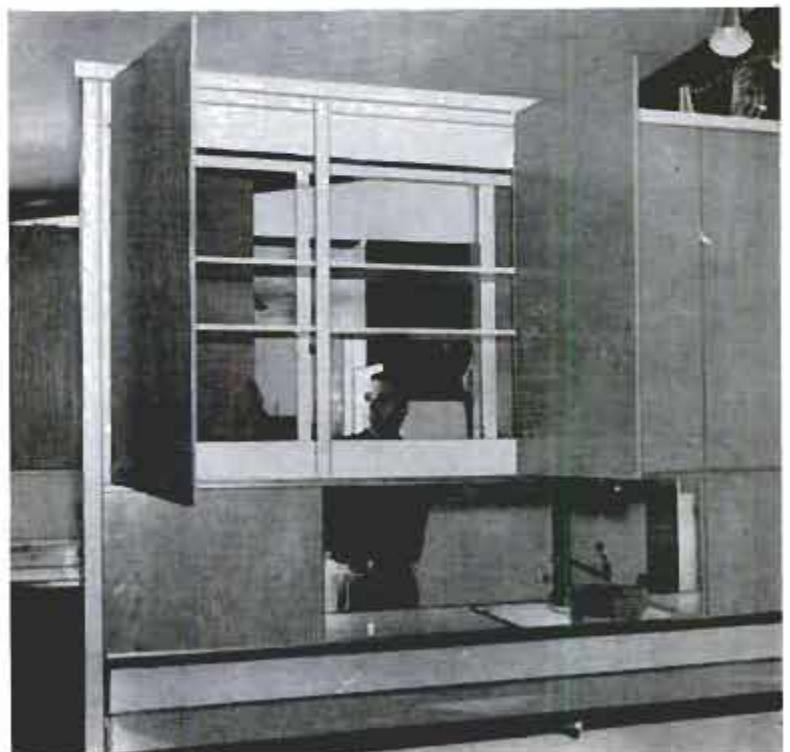

L around. The next three years will be the most exciting since they stopped putting flower vases in sedans.

By 1962 the three top-selling cars will be makes that aren't even on the street today (except as prototype test cars in deep disguise).

The Big Three's upcoming smaller cars could account for at least 40 percent of all domestic cars sold in 1962. If so, drastic changes are certain. At least one and, quite possibly, two medium-price makes in each family of cars will vanish. Do your own forecasting as to which will be first to go.

"Nothing in the past three months has occurred to discourage GM's move toward small cars," is the way Frederic G. Donner, top man at General Motors carefully understated it at the Chicago Auto Show.

The bold plan of the automobile industry is to produce a durable, dependable automobile of such simple mechanical design that you can work on it yourself. This will bring the do-it-yourself movement back into the home garage. (Hurray! shout millions of enthusiasts to whom tinkering with the car is not only money saving, but relaxing.)

Of course, there will always be the bigger, luxury-type car for those who demand it and can afford it. This may even become the second car in the family. The mass market is expected to be for a transportation vehicle.

Must Be Exciting

These smaller cars must not fail to be exciting, say the planners. They must provide the same fun-to-drive that foreigners have taught Americans to expect in small cars. They must provide a pride of ownership based on exciting engineering, exciting handling instead of the rapidly disappearing size-prestige symbol.

If reports are right, the GM small car does all this and more. Test drivers say that the rear-engine machine (rumored to be disguised under a foreign-car body) goes up and down winding mountain roads faster than any mass-produced car in the world. Weight distribution is the key to its fine handling. The supposedly inherent oversteer of the rear-engine design has apparently been licked by GM's lightweight power package. The car is expected to clip the tart tongues of the "Detroit iron" cult of critics.

There may be three shades of small-car opinion. GM is emphasizing engineering innovations. Ford seems to be betting on conventionality, reliability and miles per gallon. Chrysler is rumored to feel that visual excitement or styling is as important (perhaps even more so) as mechanical ex-



By Art Railton

citement. These are far too generalized statements to be taken literally; no company puts all its efforts in one area. However, they do describe the over-all impression one gets.

Chevrolet dealers apparently are not going to market the GM small car. Best bet is that the choice plum fell into Pontiac's lap, with a possibility that Buick will be cut in also. If so, this explains why Pontiac and Buick dealers were given the Vauxhall and Opel. Their two-year experience with the imports gives them an advance feeling of the small-car business. Once the new GM car is out, these two "naturalized" imports are expected to return quietly home.

If you want to speculate on what the rear of the 1960 Cadillac will look like, study the \$13,000 Italian-built Cadillac Brougham. Its tailfins are subdued, but stylish. And in good taste—no rocketry there. The 1960 Cadillac will copy them.

Exciting Truck Engine

Big news for truckers will break this fall. Here also, GM will make a bold advance. It will introduce a spectacular V6 engine for its truck line. The shorter, more powerful engine will fit neatly under the floor of the close-coupled tractor cars. It is an attempt (and a successful one, say insiders) to make the gasoline engine as long-lived and as cheap to maintain as the diesel, without the diesel's initial higher cost. It will run 200,000 miles without an overhaul.

Is it suitable for passenger cars? Experts say it is not. A V6 takes up more vertical space than a V8 because of its 60-degree configuration. It is also longer for the same reason. These are two dimensions that are critical in cars. The big virtue of the V6 shape is its narrowness. In an under-cab-engine design, width is a critical item, but not in today's automobiles.

Anyway, the new V6 is water-cooled and cast iron, much too old-fashioned to be exciting in the years ahead. GM has the upcoming air-cooled aluminum flat six to power its passenger cars until the turbine takes over. ★ ★ ★



Hiller's Tilt-Wing Transport Is Largest VTOL Aircraft

At 16½ tons, Hiller Aircraft Corporation's X-18 "Propelloplane" is the largest VTOL (vertical take-off and landing) craft yet built. The tilt-wing transport can also operate as an STOL (short take-off and landing) or a conventional airplane, depending on the length of runway. The X-18 is an intermediate-range transport.

Sensitive Tube "Sniffs" Smoke To Set Off Warning

Prevention of fire and explosion disasters was given an assist by the development of an ultraviolet-sensitive tube that responds simultaneously to flame, smoke and combustible vapors. The four-inch, black tube, developed by the Minneapolis-Honeywell Regulator Company, is shown here at the center of an experimental detector. As a demonstrating scientist lights his pipe, the tube illuminates the "fire" and "smoke" indicators. The "vapor" indicator notes the presence of gases in the beaker.



Ruler Rolls on Drawing Paper To Make Parallel Lines

Introduced recently in England is an instrument designed to aid draftsmen and artists in drawing horizontal or vertical lines. The device consists of a ruler that is attached to a roller housing. The roller housing contains a scale for measuring the distances between horizontal and vertical lines. By inserting the pencil point in holes in the ruler, the instrument can be used to draw parallel vertical lines. The roller has serrated metal ends to prevent slipping.

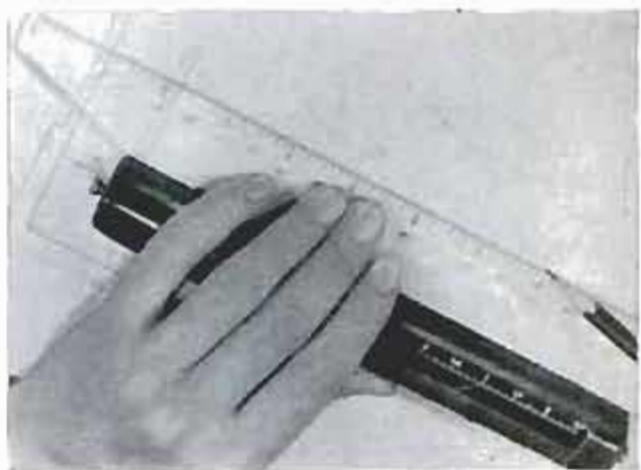

Keeping up with the ATOM

NOW THE TINY ATOM has been put to work weighing the contents of loaded freight cars. The photo at right shows an experimental "atomic scale" developed by the New York Central.

Between the freight car's wheels is a lead-shielded box containing Cobalt 60, a material which emits gamma rays. Suspended above the car is a scintillation counter which measures the gamma rays reaching it.

As a freight train passes over the box, the gamma rays penetrate each car. The car absorbs a certain amount of the rays depending upon the weight of its contents. The measurements are fed into an electronic computer which then calculates the weight of the car and records the answer on a graph or printed tape.

The atomic scales can be used to weigh entire trains without uncoupling the cars, as present systems require. Although the system is not yet accurate to within two tenths of one percent, as required for billing purposes, additional improvements may permit such pinpoint accuracy.

☆☆☆

ARE THERE ATOMIC particles with negative mass? The discovery of such strange particles would be fascinating, for it would be akin to the discovery of an object that would fall up instead of down!

There is evidence that "falling up" electrons exist. Experiments in this field have been performed at the Princeton Laboratories of the Radio Corporation of America. The experiments uncovered evidence that some electrons inside crystals of germanium rotate in a direction just opposite to that of positive-mass electrons.

The negative-mass electron might be compared to an object that would move the wrong way when pushed. If such strange electrons could be attained in quantity, they would signal a major breakthrough in solid-state physics.

☆☆☆

DEER ANTLERS can offer mute testimony to the increase in fallout.



Studies have been made of deer that normally graze on upland pastures which are known to contain relatively high levels of fallout. This analysis indicates that there has been about a tenfold increase in radioactivity since 1952.

Also, British scientists are undertaking a study of the effects that fallout may have on wildlife. Recent reports indicate some mysterious changes. For example, migratory birds have arrived to winter in Africa wearing the next season's breeding plumage, and some birds arriving in Britain, also with unseasonal plumage, have been found to be more radioactive than normal birds. British scientists suspect that radioactivity may have upset the birds' sexual cycle.

☆☆☆

THE TOM THUMB instrument below is said to be the world's smallest neutron detector. Developed by Westinghouse, its function is to map the pattern of neutrons inside the core of a nuclear reactor.

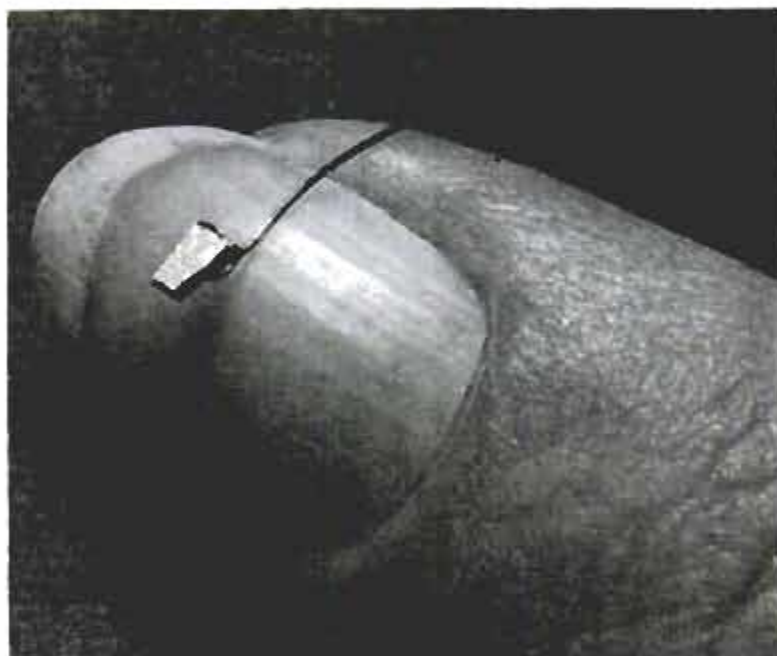



Rotating Chute Reduces Glide And Drops to Ground Vertically

Safer and more accurate parachuting may result from a chute equipped with four cloth blades that spin like a helicopter's rotor. Still being tested, the chute greatly reduces shock on opening, and all but eliminates glide, thus making it possible to drop personnel or cargo vertically. The chute is also intended for missile recovery and braking of high-speed aircraft. Rotation of the blades creates a vortex of air around the tips, increasing the drag area and enlarging the chute's size. The corners of the blades are attached to nylon suspension lines drawn together at a swivel, which has an attachment for personnel, cargo, missiles or aircraft.



Brrr! Magnet Helps Approach Absolute Zero

Temperatures within a thousandth of a degree of absolute zero can be maintained with the help of an electromagnet. A substance to be tested is placed in a container inside a helium bath and the whole apparatus lowered into the magnet's core. Liquid helium lowers the temperature of the

substance and most of the random motions of its molecules cease. Meanwhile, the magnetic field has aligned the molecules in orderly fashion. When the magnet is turned off, the molecules try to return to a disordered state. Expending energy, they become colder still.

On floor above giant magnet, scientist places test apparatus in container holding liquid-helium bath

Scientists inspect magnet. Tubes, left, keep magnet cool with 2200 gallons of kerosene per minute



SIDE VIEW OF "MARINE FLYING SAUCER"



GREATEST CUSHION PRESSURE IS IN CENTER OF SHIP. IT IS RETAINED THERE BY FORE-AND-AFT BLASTS FROM FANS



VIEW OF UPPER DECK

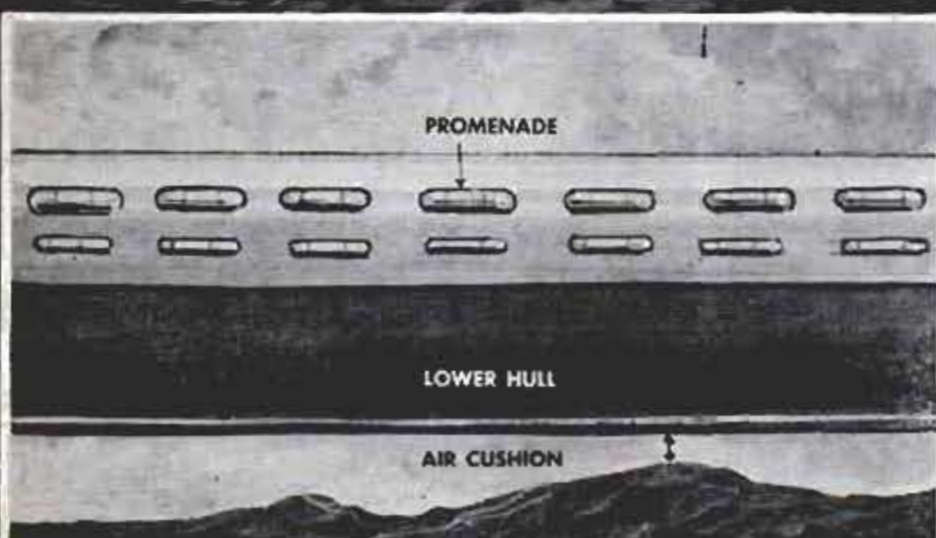
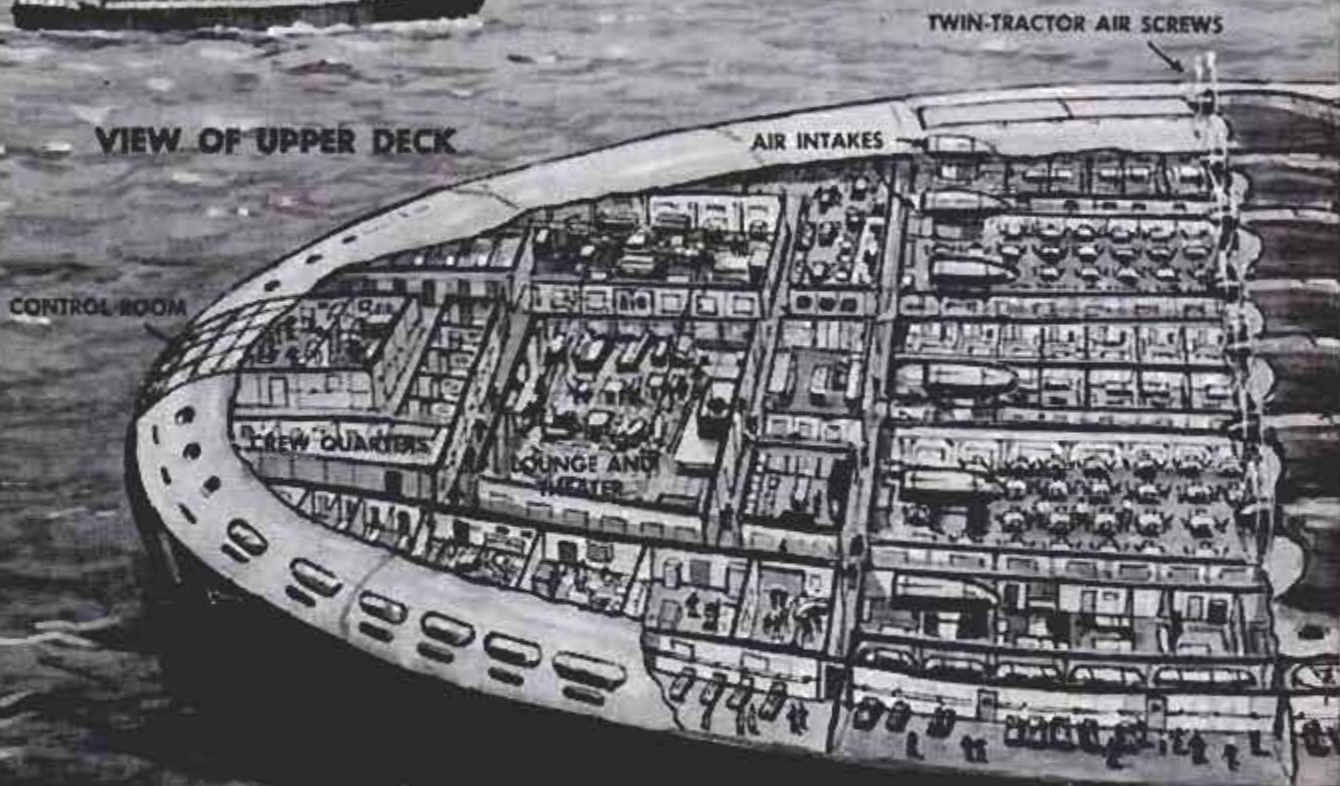

AVERAGE HEIGHT OF ATLANTIC WAVES: 8 FT. AVERAGE HEIGHT OF ATLANTIC WAVES IN GALE: 18 FT. SHIP WOULD BE HELD APPROXIMATELY 8 FEET ABOVE ALL CRESTS. BECAUSE SHIP HAS NO DIRECT CONTACT WITH SEA, IT REMAINS STABLE IN ALL WIND AND SEA CONDITIONS

OCEAN VOYAGERS may some day travel on a vessel that rides a few feet above water and crosses the sea at 100 knots. Such a vessel would look like the marine "flying saucer" shown on these pages, which was designed by Swiss engineer Carl Weiland and drawn for *Popular*

PROPULSION UNITS

AIR INTAKE

CABINS

AIR CUSHION DUCTS

FUEL

SEAGOING SAUCERS AHEAD?

AIR INTAKES

CABINS

FINS AND RUDDERS

SWIMMING POOL

CABINS

PROMENADE

WEIGHT OF SHIP: 40,000 TONS
PASSENGER ACCOMMODATIONS: 1000
DIAMETER: 330 FT.
SPEED: 100 KNOTS

VIEW FROM BOTTOM, SHOWING
MOTORS AND PRESSURE-CUSHION FANS

MAXIMUM CUSHION-
PRESSURE AREA

Mechanics by the British artist, G. H. Davis. Skimming the surface as a hydroplane does, the vessel would ride on a cushion of high-pressure air created by huge fans fore and aft. The vessel's circular design would reduce to a minimum the escape of air from the cushion. ★ ★ ★

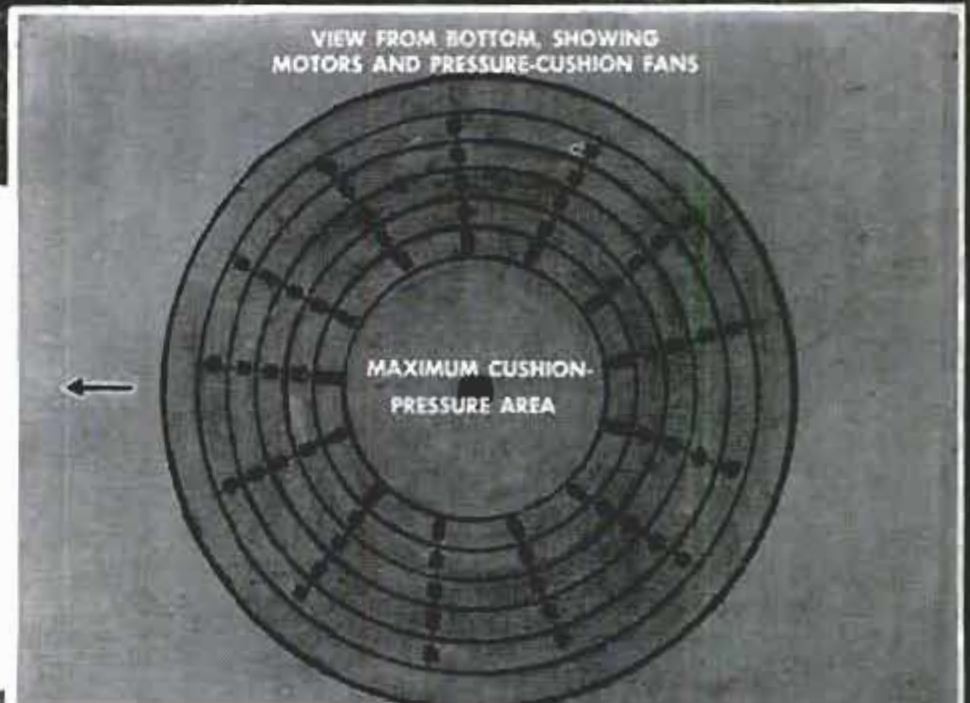



Orbiting "Satellite"



Model plane enthusiasts can fly a new "satellite" either in free flight or on a tether in "controlled orbit." The model consists of whirling vanes mounted around a gas engine. In free flight on a calm day the model will rise more than 1000 feet straight up. On a control line it can be made to "orbit" above the head of the flier.



Cadets Read Signal Lights To Learn What to Wear

Combinations of colored lights tell Air Force Academy cadets which uniform to wear at the next formation. From a control room, the signals are flashed on electronic panels located on hall ceilings throughout cadet quarters. The system replaces the traditional flag-and-yardarm method used at other service academies.

Number, Please!

Whenever you write us to

- Renew your subscription
- Change your address
- Order your own or a gift subscription

. . . In fact, whenever you write us,

PLEASE INCLUDE YOUR CITY POSTAL ZONE NUMBER IN YOUR ADDRESS

*This insures better delivery.
It helps you and it helps the postman.*

Basketball Goal Can Be Adjusted to Suit Boy's Height

Fathers may now buy a basketball goal that can "grow" with their sons. It can be adjusted from seven feet up to ten—regulation height. Designed for garages and other

buildings, the goal is extended far enough out so that a player can dribble in for an under-the-basket shot without bumping into the building.





All photos by Canadian National Defence

HMCS *Restigouche* pauses at gun wharf in her home port, Halifax. Rounded edges of deck shed atomic fallout

Canada's Fabulous Submarine Killer... HMCS *Restigouche*

By Wayne Whittaker

WHEN YOU STEP ABOARD Her Majesty's Canadian Ship *Restigouche*—regarded by Navy men on a couple of continents as the hottest thing in antisubmarine warfare—you are immediately impressed with the ship's resemblance to her enemy. The rounded decks and sleekly contoured hull make the ship look like a cross between a high-riding submarine and a destroyer.

When I boarded this new destroyer escort at Halifax, Nova Scotia, she had just come in from her first trials in the North Atlantic. The captain of the ship, Comdr. John W. McDowall, and his ordnance officer, Lt. Comdr. Richard J. F. Donnithorne, pointed out that this vessel, and others of its class, would be in the first line of defense against missile-launching enemy sub-

marines—even in areas of atomic fallout.

"The *Restigouche* can proceed for days if necessary through radioactive fallout," said Comdr. McDowall as he led the way

Crew is proud of this new twin-mounted 3-inch .70-caliber antiaircraft gun; it can be fired remotely



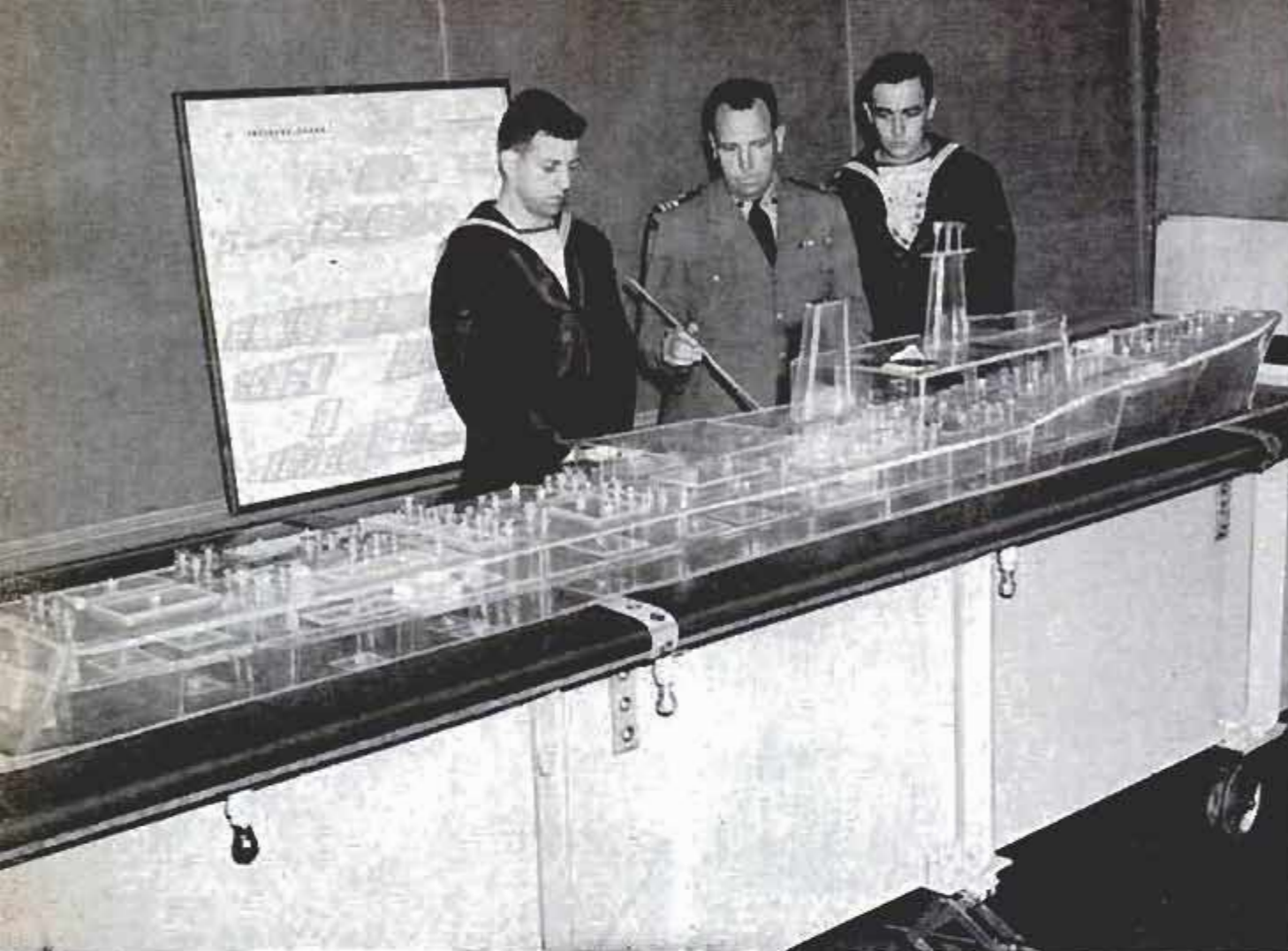

Lt. Comdr. Ian C. Martin uses \$50,000 transparent model of *Restigouche* in tank to show ship's stability

along the spotless decks of the 366-foot ship. "The ship can be sealed airtight and the air recirculated as in a submarine."

A gesture by Lt. Comdr. Donnithorne included the radar masts and aft guns. "We also have the latest equipment in sonar, as well as electronically controlled mortars and homing torpedoes," he said. "You know, it's only proper that the home port of the *Restigouche* should be Halifax." He pointed to the harbor bustling with naval craft and ocean liners. At one end of the long inlet that forms the harbor is a protected basin and at the other a widening blue expanse to the open sea. "Many of the biggest convoys of World War II were made

up here at Halifax. This place is antisubmarine minded."

Comdr. McDowall chuckled. "I guess some people have been surprised that the Canadian Navy has developed such a lethal ship as HMCS *Restigouche*. It was a case of our sitting back in the weeds and taking the best ideas from the British and United States navies. Then, with some of our own Canadian gadgets, we put together the finest submarine killer afloat. This little ship has \$6,000,000 worth of special equipment."

As we proceeded across decks, down passageways and up ladders, we were joined by Lt. Comdr. Jacques P. Coté, the ship's executive officer, who filled us in on the

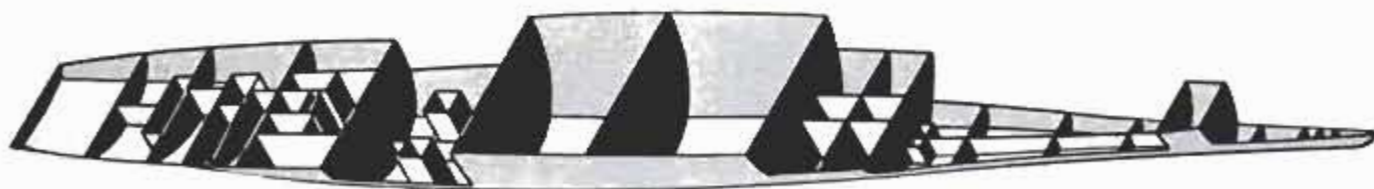

Drawing shows crosswise bulkheads that add greatly to ship's stability if struck by torpedo. The *Restigouche* will not list more than 18 degrees either way. Below, colored area can be flooded before sinking plus section just aft of diagonal lines in center; when critical center section is flooded the ship rolls over and sinks



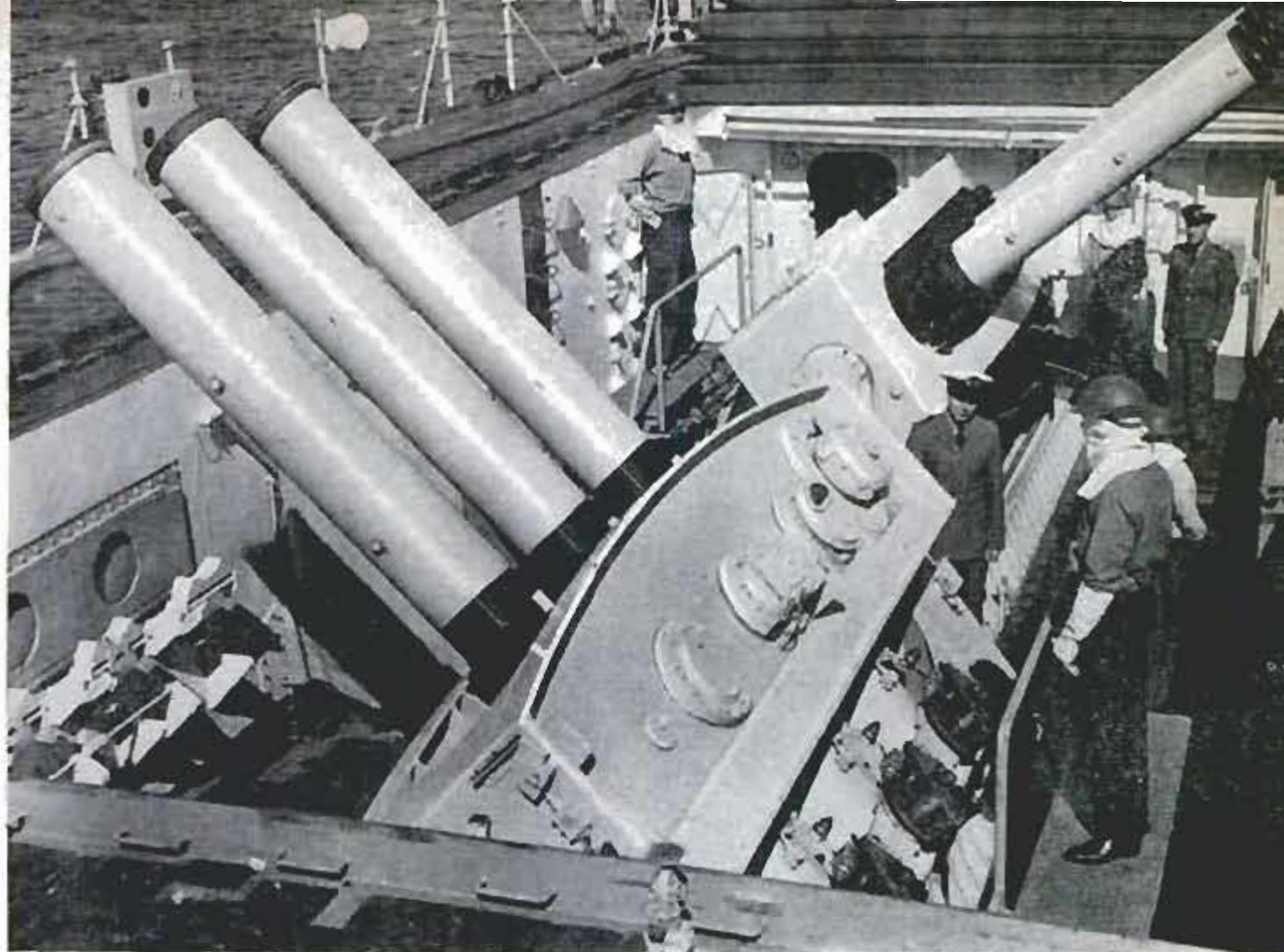

Two triple-mounted 12-inch mortars that replace "ashcans" of World War II are housed in the aft hatch

history of HMCS *Restigouche* and her place in the St. Laurent class of postwar destroyer escorts. Built by Canadian Vickers Limited in Montreal, there were to be 14 ships in the class which took its name from the first ship, HMCS *St. Laurent*. The *Restigouche* (named for a river in the maritime province of New Brunswick) is No. 8, but so many improvements have been incorporated in her design and armament that the other six ships now nearing completion will be known as members of a special *Restigouche* class. All 14 destroyer escorts have a displacement of 2900 tons and the same geared steam turbines and twin propellers which provide a speed of "over 25 knots." How much faster than that



Right, crew handles a deadly homing torpedo. Below, ship gives itself shower to wash off atomic fallout





Left to right, Lt. Comdr. Coté, member of crew and Comdr. McDowall on the bridge



Cutaway shows: 1. Food storage and refrigeration; 2. Gunner's store; 3. Diving-gear store; 4. Naval store; 5. Water ballast tank; 6. Fresh-water tank; 7. Mess; 8. Water-ballast tank; 9. Fuel tank; 10. Foremast; 11. Electrical workshop; 12. Boiler room; 13. Engine room; 14. 3"/50 magazine; 15. Pump; 16. Fuel tanks; 17. Cofferdam; 18. Small-arms magazine; 19. Fog-oil tank; 20. Steering-gear compartment; 21. Provision room; 22. Refrigeration units; 23. Mortar hatch; 24. 3"/50 twin gun; 25. Single Bofors; 26. Torpedo house; 27. 27-foot motor boat; 28. Funnel; 29. Radar room; 30. Ward room; 31. Sonar room; 32. Radio rooms; 33. Operations room (C.I.C.); 34. Gunnery remote control; 35. HF/DF loop; 36. Radar; 37. Bridge; 38. 3"/70 twin gun

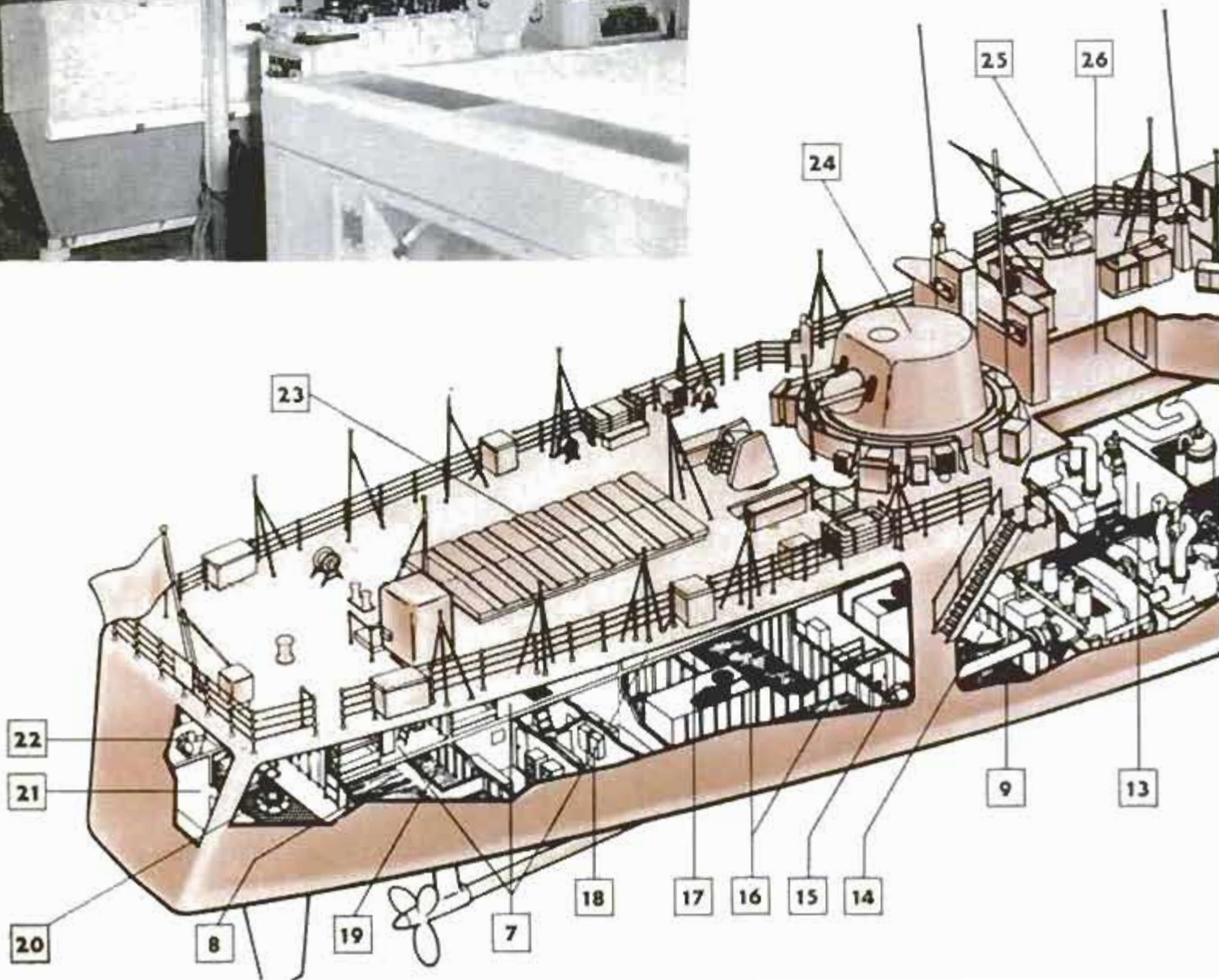

Right, view from forward deck shows .70-caliber guns and officer leaning from remote visual-control post

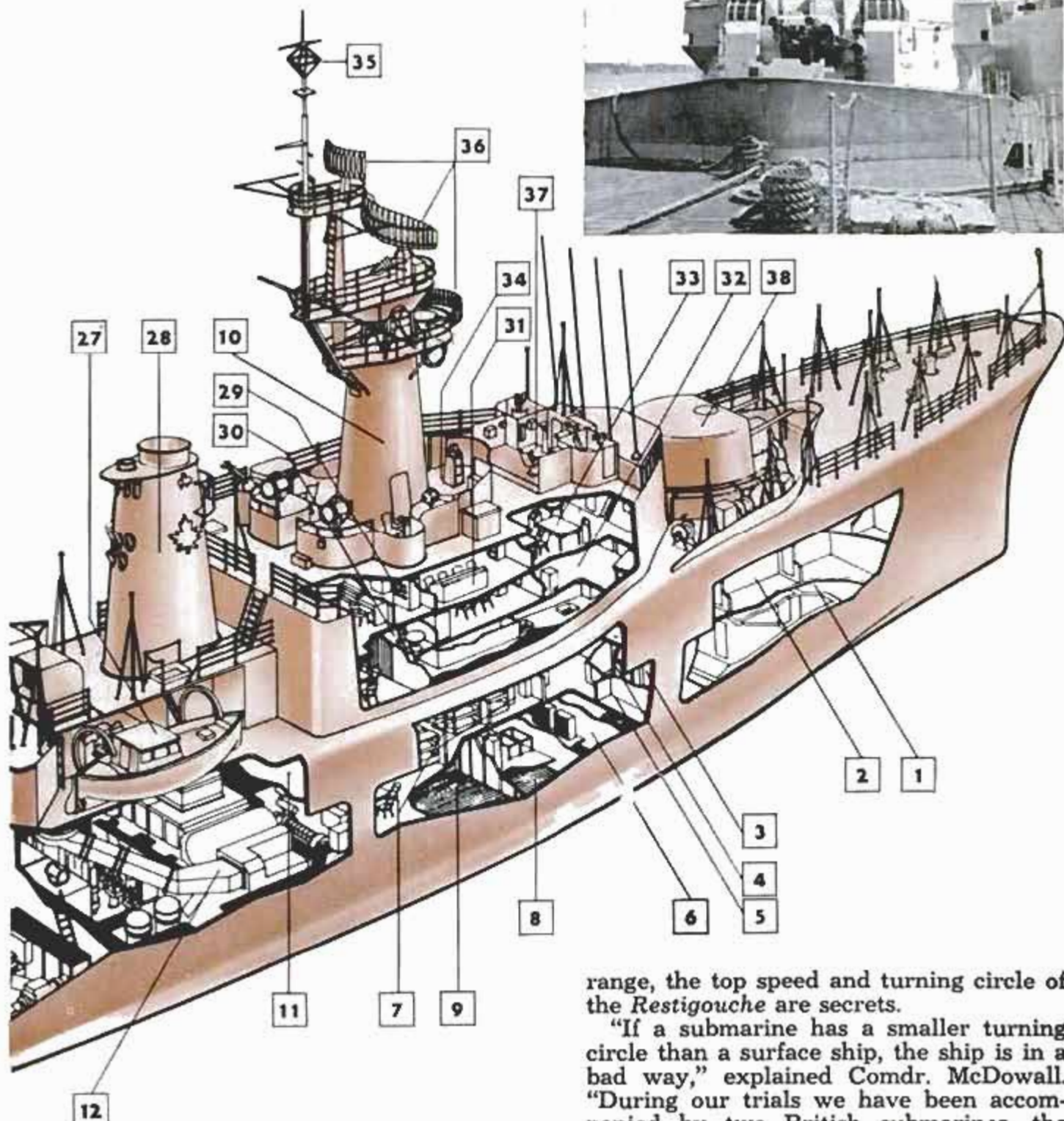

the ships will travel is anybody's guess, but when an earlier ship of the St. Laurent class worked out with the speedy United States atomic submarine *Nautilus* she was reported to have done "very well." Along with other such items as radar and sonar

range, the top speed and turning circle of the *Restigouche* are secrets.

"If a submarine has a smaller turning circle than a surface ship, the ship is in a bad way," explained Comdr. McDowall. "During our trials we have been accompanied by two British submarines, the *Alcide* and the *Ambush*. These subs are manned partially by Canadians."

"Our playmate subs have plenty of respect for the *Restigouche*," said Lt. Comdr. Donnithorne. "We can hunt down a submarine whether it's submerged, on the

(Continued to page 230)



Dubbed the "Little Hound Line," this scale-model bus is 3 feet 5 inches wide and 4 feet 4 inches high

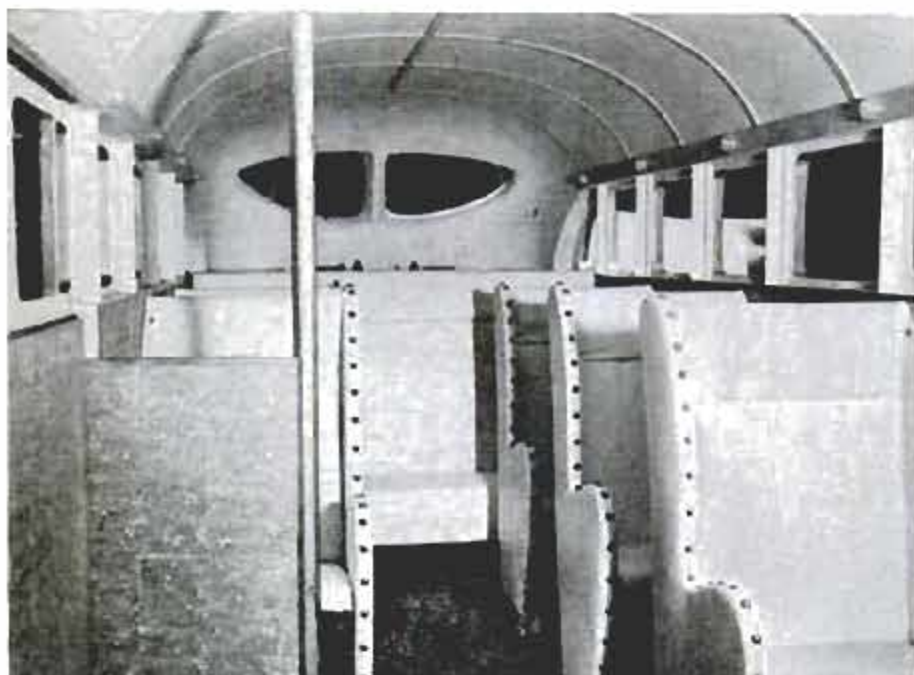

Interior of bus shows five single seats and one wide seat at the rear. There are six dome lights above the windows on each side. Photo below shows Crosley steering assembly, transmission lever and other controls

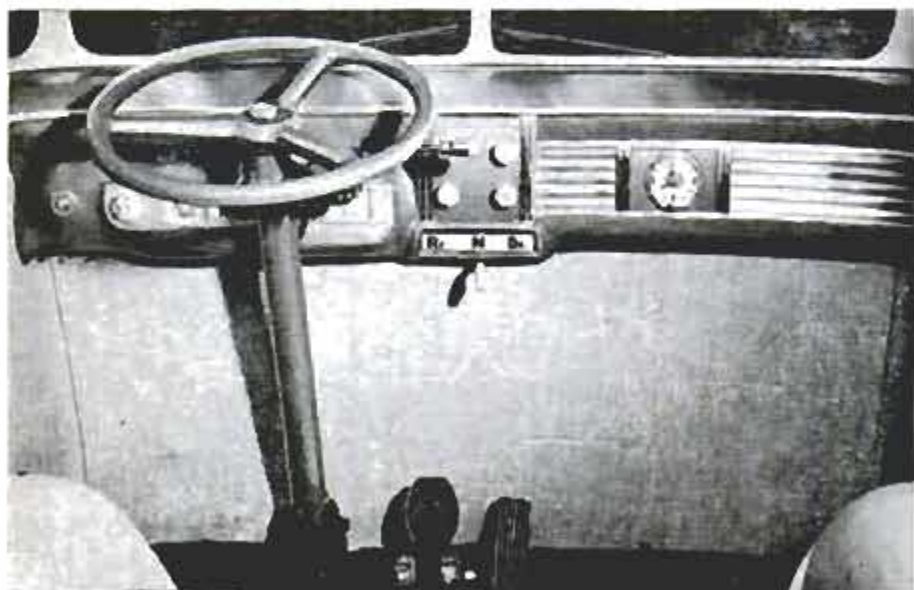

Miniature Bus For Small Riders

EIGHT CHILDREN and one adult, the driver, can ride in a miniature bus constructed by L. A. Beretta of Lexington, Mo., from sheet aluminum and parts of cars and farm machinery. The tiny bus, a scale model of the type used by one of the cross-country buslines, has a top speed of 25 miles per hour. It's powered by an eight-horsepower engine and has an automatic transmission that works through a centrifugal clutch. The midget bus is 4 feet 4 inches high, has a wheelbase of 83 inches and weighs 1280 pounds. Beretta spent three years of his spare time on the project, plus \$475 for materials. He did all work himself, except for welding the frame. The springs came from a hay baler and from a mower. The bus has tractor headlights, fender parking lights from a 1941 Ford and directional lights converted from the parking lights of a 1941 Chevrolet. License-plate holders serve as side windows.

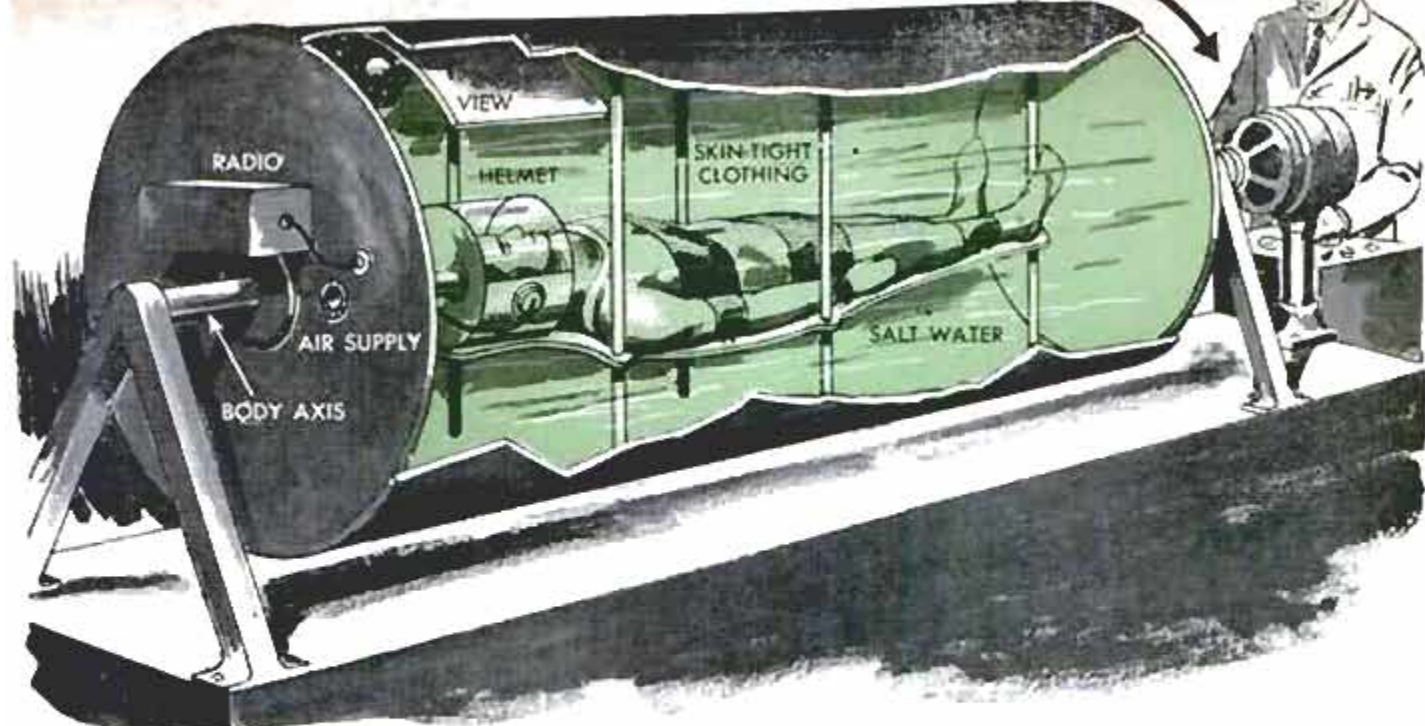

Tank Could Produce Weightless Sensation

Scientists could experience the feeling of weightlessness with inexpensive equipment in an earthbound laboratory, according to Dr. H. J. Muller of Indiana University. Dr. Muller, a Nobel Prize-winning zoologist, said an apparatus could be constructed similar to a mechanism used for nullifying gravity in studies on plants. The subject, in skin-tight clothing, would be immersed in a tank in a salt solution having the same specific gravity as the body. The tank would spin around a horizontal axis to "disengage" the balancing apparatus in the subject's ears. A transparent helmet would provide a means for breathing and talking, and a fixed "view" in relation to the subject would prevent any sensation of motion.

Portable Shortwave Radio Transmitter Controls Tower Crane

With portable equipment carried by an operator on the ground, all of the operations of a giant tower crane can be handled by remote control. The portable equipment includes a set of controls and a transmitter that emits ultrashort radio waves. The unit broadcasts 36 separate frequencies, each of which controls some action of the 200-foot crane. The frequencies are tuned so they do not interfere with each other and up to 12 of the control frequencies can be transmitted at the same time. A radio receiver on the crane contains 36 relays, each tuned to one of the frequencies. So-called dead-man controls automatically stop the crane if the load is too heavy or the crane travels too far. Both the crane and remote-control unit were developed in Germany.



WHAT'S NEW FOR Your Home



FLOOR FLUSHER washes away dust, litter and leaves. The nozzle is mounted on a wheel and rides an inch above ground. Its tiny opening provides forceful stream and cuts down on water bills. Handle is four feet high
Magie Hostess Corp., 36th and Bennington, Kansas City 29, Mo.

BOWL HOLDER gives housewives "third hand." Especially handy when electric mixer is being used, it permits tilting of bowl. Holder adjusts to fit any size bowl and has three-point legs tipped with rubber cushions. It can hold potted plants, hot dishes
Milwaukee File Co., 1567 W. Pierce St., Milwaukee 4, Wis.

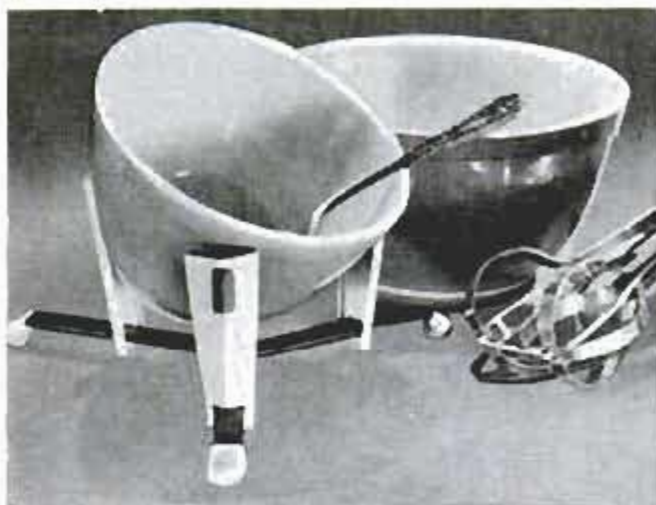

WOVEN WOODEN SHADE, used with sliding glass doors, provides privacy and blocks harsh sunlight and glare. Combination folding door and drapery can be opened from either side with fingertip action. Even when fully drawn, shade permits air to circulate through door into room, at the same time softly diffusing outdoor light. Easily cleaned, it comes in 12 colors
Consolidated General Products, Inc., 24th and Nicholson, Houston 8, Tex.

DRINKING BUBBLER can be attached to kitchen and bathroom faucets and outdoor outlets. A flip of the lever sends gentle stream of water upward. Easily installed to aerator-type faucets, fountain attachment does not interfere with use of sink
Hawa Drinking Faucet Co.,
Fourth and Page, Berkeley 10, Calif.

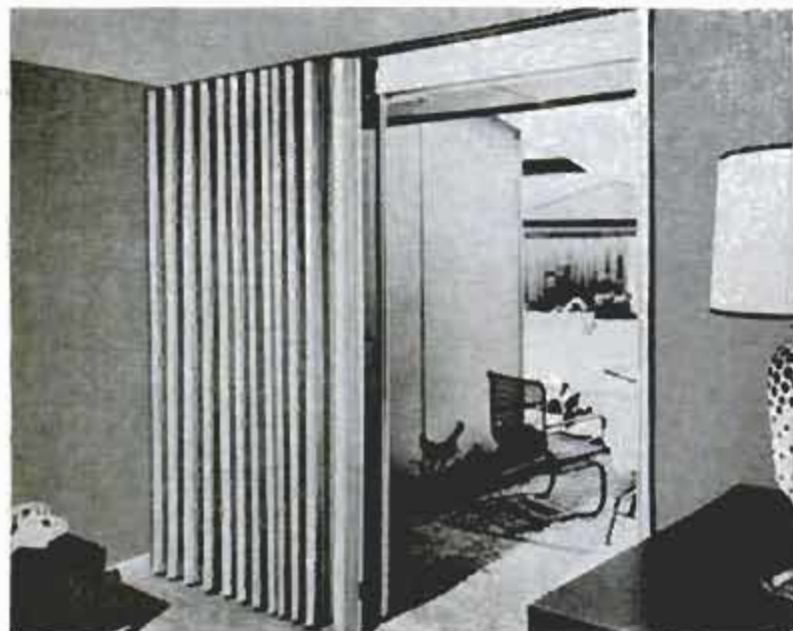

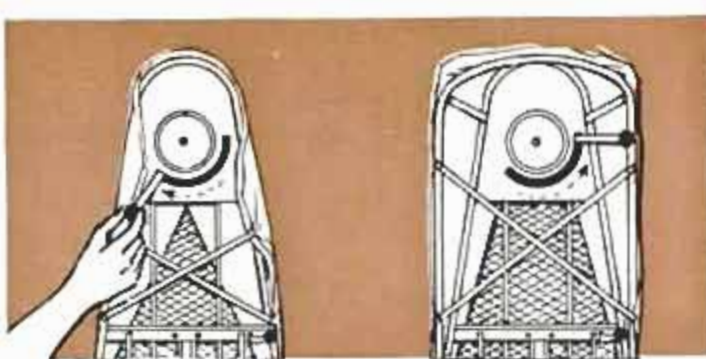

IRONING BOARD has adjustable tapered, squared-off ends—the latter for such items as bedspreads, sheets and curtains. Board has mesh top for cooler, drier ironing and is equipped with wheels that lock into place. It also has 12 different positions in height—from 23 to 36 inches—to permit sit-down ironing

The J. R. Clark Company, Reading, Pa.

PLASTIC DIFFUSERS take glare away from fluorescent light fixtures. Made of rigid vinyl, diffusers are snapped into aluminum tracks that are screwed to cornices or ceilings. Designed for one-man installation, they resist flame and can be cleaned with soap and water. Diffusers come in several different types

Lam, Inc., Wakefield, Mass.

WINDOW GREENHOUSE enhances beauty of home inside and out and enables gardener to grow plants and flowers throughout year. Thin but sturdy aluminum framing provides big glass area. Top panel is hinged for ventilation. Framing will not rust, rot, warp, shrink or swell. Unit available for any size window

Emerson Industries, Inc., 122 Adams Ave., Hempstead, Long Island, N. Y.

WALL FIXTURES can be adjusted six ways: up and down, in and out, and from side to side. Designed in wide variety of styles, fixtures have inner glass plate that prevents shades from discoloring because of heat. "Tableless lamps" are especially suitable in room where added table would crowd other furniture

Globe Lighting Products, Inc., 10 East 40th St., New York City



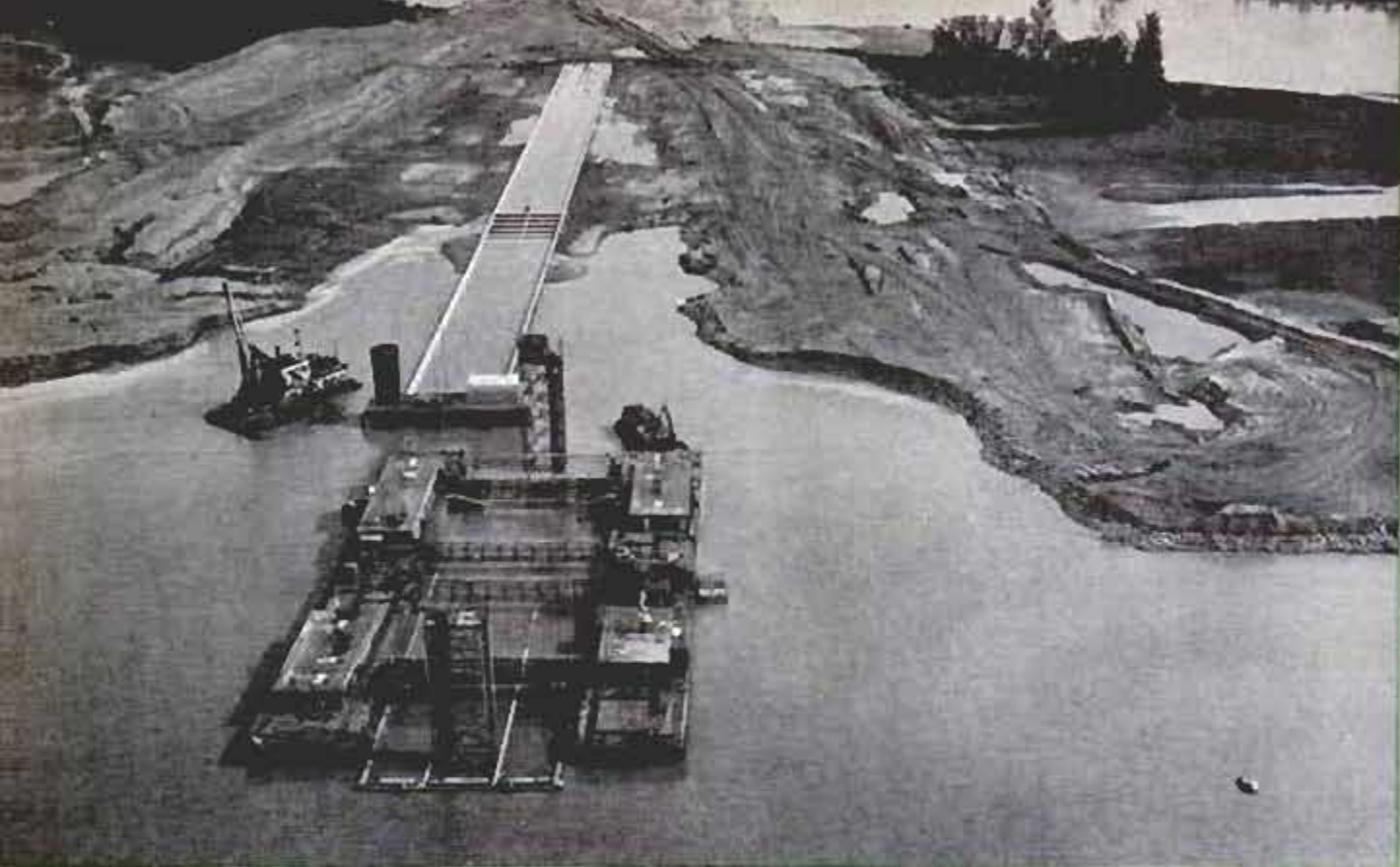

Four steel scows ease a prefab section of the tunnel into position for sinking—six inches per second

A Prefab Tunnel Conquers a Tough River

Six sections of tunnel (lower right) were prefabricated in 40-foot drydock; then floated to positions

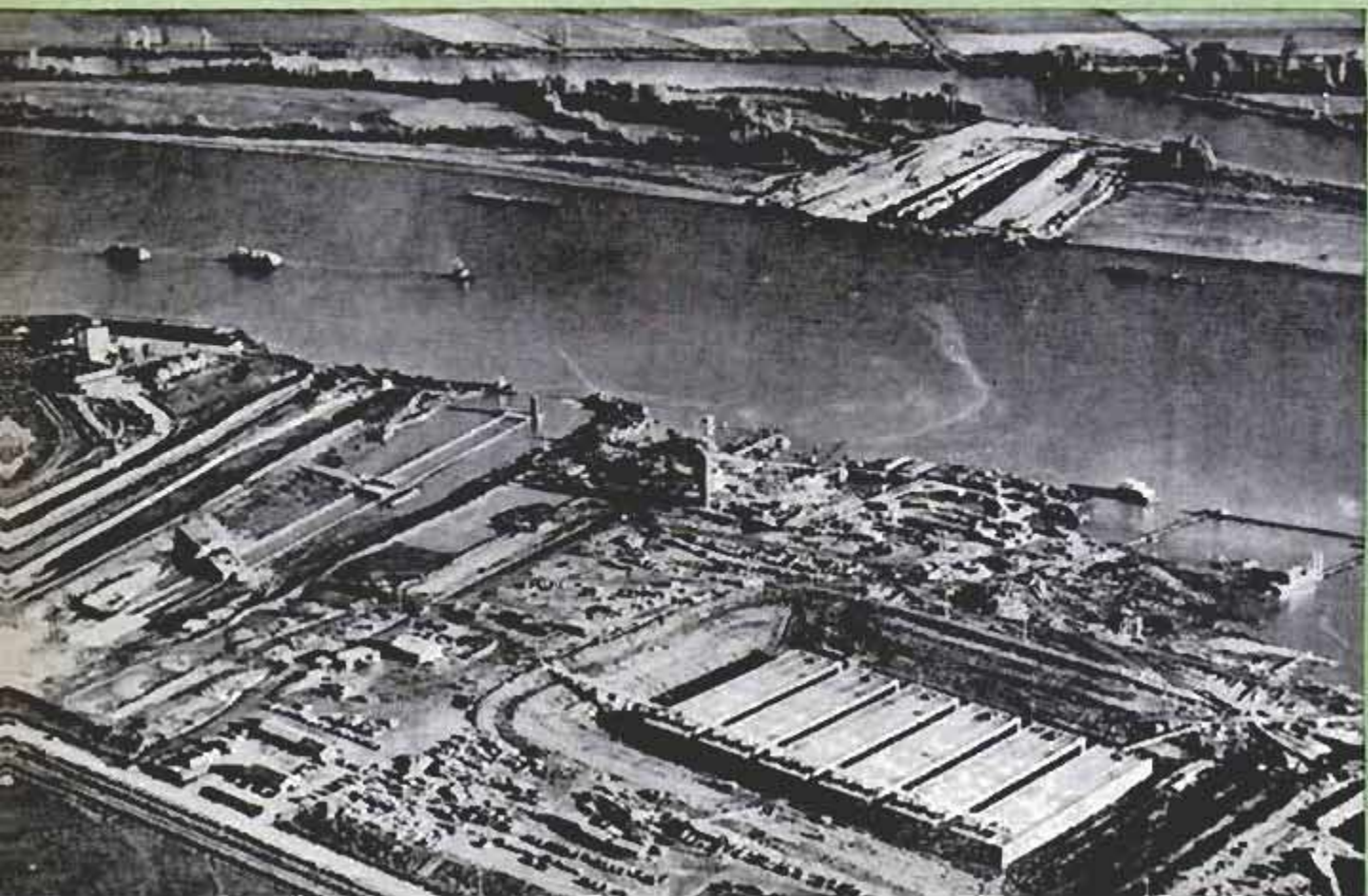



Shafts 70 feet high were fitted to the sections before sinking. Right, dotted lines show main traffic route via tunnel

By Carson Kerr

THE BIG RIPPLE ROCK blast attracted more attention, but future historians will probably attach much more significance to the comparatively quiet completion of the Deas Island Tunnel under British Columbia's treacherous Fraser River. The scenic surroundings of Vancouver — mountains north and east, ocean on the west and river to the south—give Canada's third largest city a setting second to none, but also complicate access to it. Traffic has demanded more southerly approaches, but the scenic features have presented the most problems.

For years, experts have felt that the only possible supplement to the one existing highway bridge at New Westminster, 10 miles up-river, was additional ferry service. At any feasible crossing point adjacent to the city the Fraser is subject to tides, has constantly shifting sand dunes beneath the surface, is bordered by large peat bogs, and frequently feels the force of earthquakes.

After decades of deliberation, a bridge

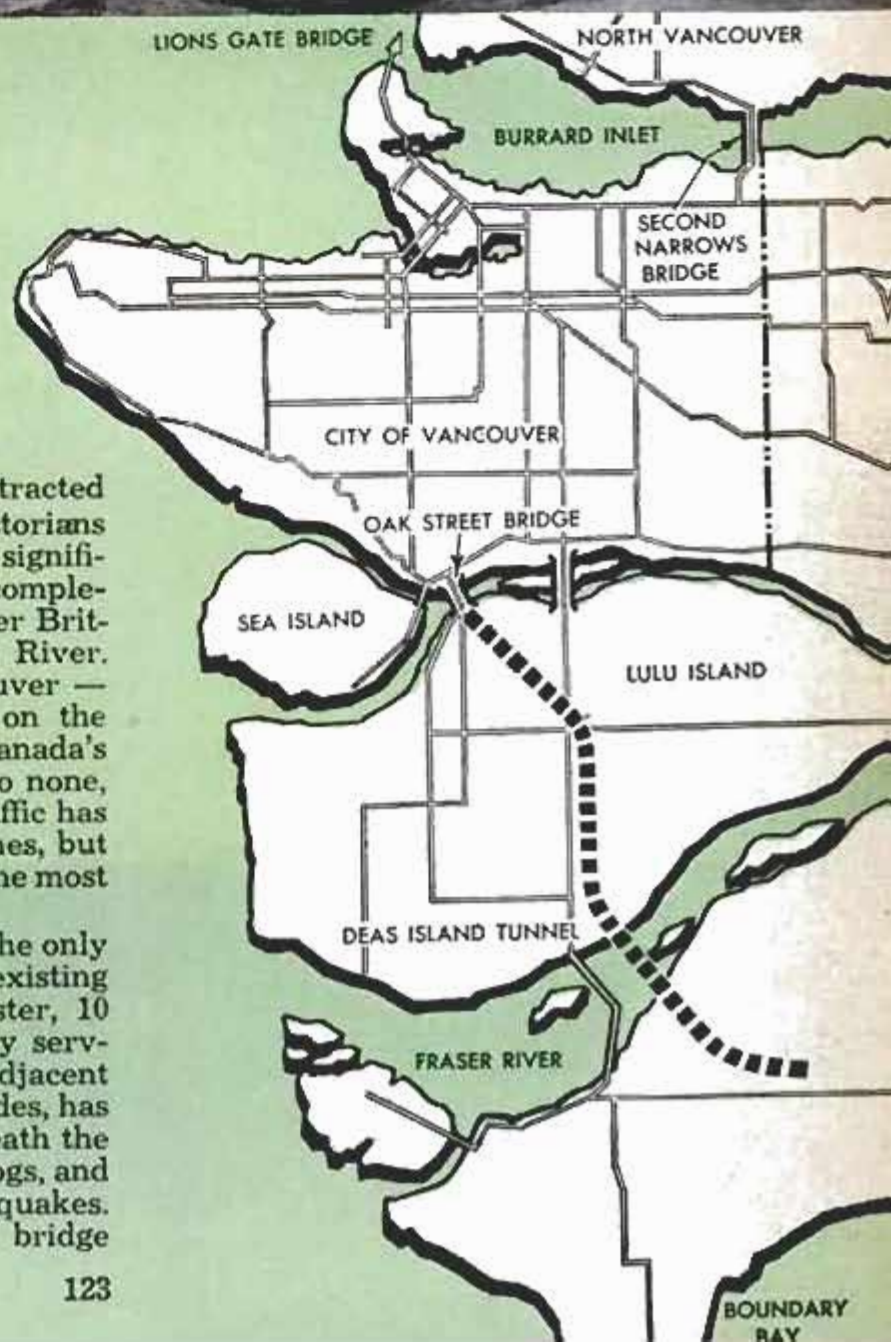



Divers played important part in helping position the sections

had been ruled out, for two reasons: It was almost impossible to find firm foundation for one lofty enough to provide clearance for the ocean-going freighters that frequent the river route; also, a high bridge would create a hazard to aircraft using Vancouver Airport on nearby Sea Island. A solution to the problems was finally found in going under, instead of over, the river. But it was by no means a simple one. History was made last year with a unique prefabricated tunnel, first of its kind in

Strips of bituminous material are sealed for waterproof cover

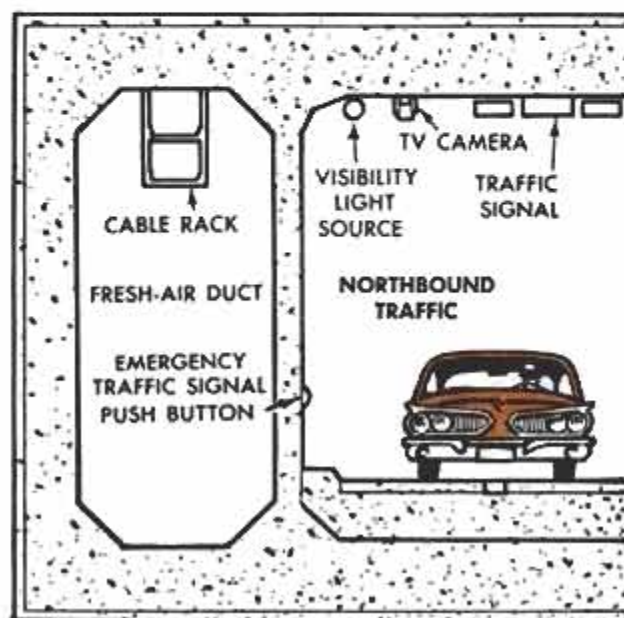
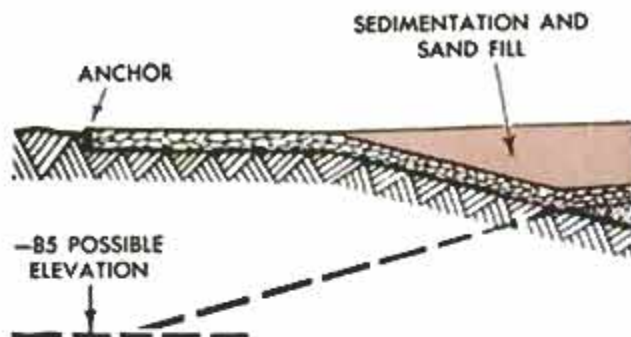
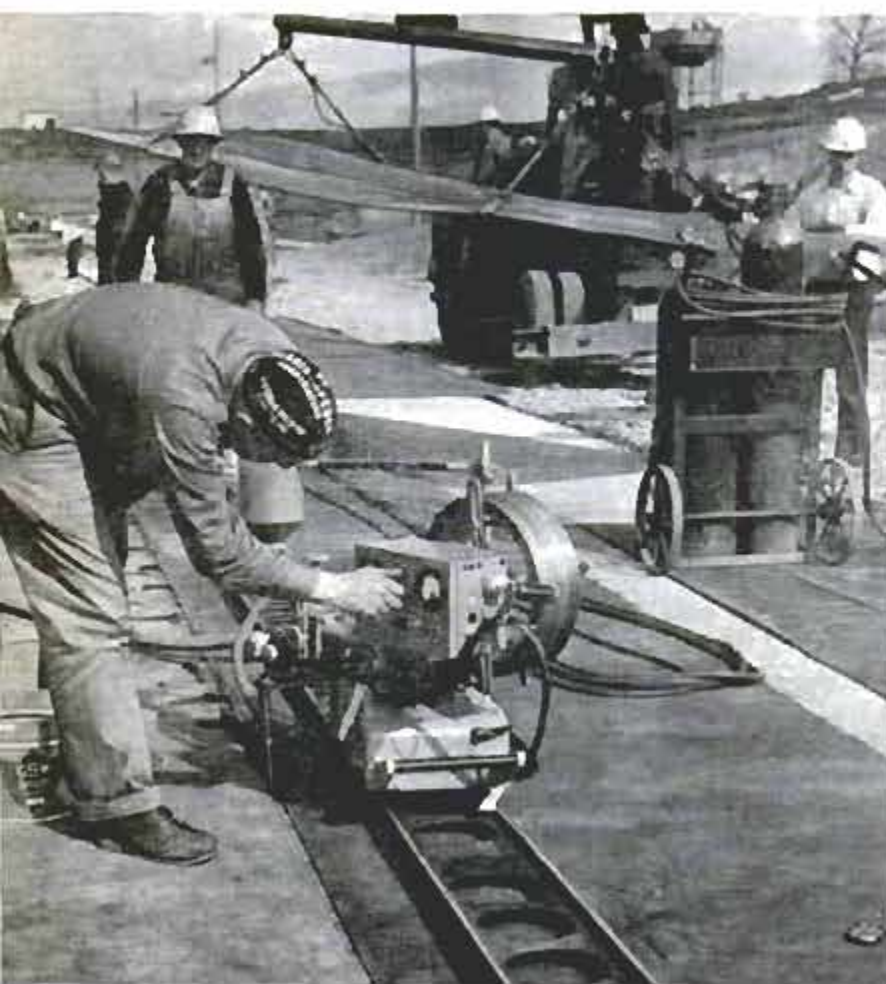

North America and second in the world, and the mighty Fraser met its match in the combined engineering and construction skills of man.

The tunnel was one of the most complex construction jobs ever undertaken, according to project manager Ole H. Bentzen. A Danish engineer, Bentzen represents the Foundation of Canada Engineering Corporation, which shared credit for the project with Christiani & Neilsen of Canada, designers of the famous Maas Tunnel under Rotterdam Harbor.

"The Fraser River is under the double influence of tides and mountain freshets," Ole observes. "The flow varies from 12 feet per second to almost-still water. Work had to be done at extreme low tide and when velocity dropped below two feet per second. We were limited to a period from the beginning of winter to mid-April, because at any other time the river was unmanageable. Most of the critical work was done 'blind,' in heavy rain, high winds or dense fog. The river was so muddy that contractors had to rely on instru-

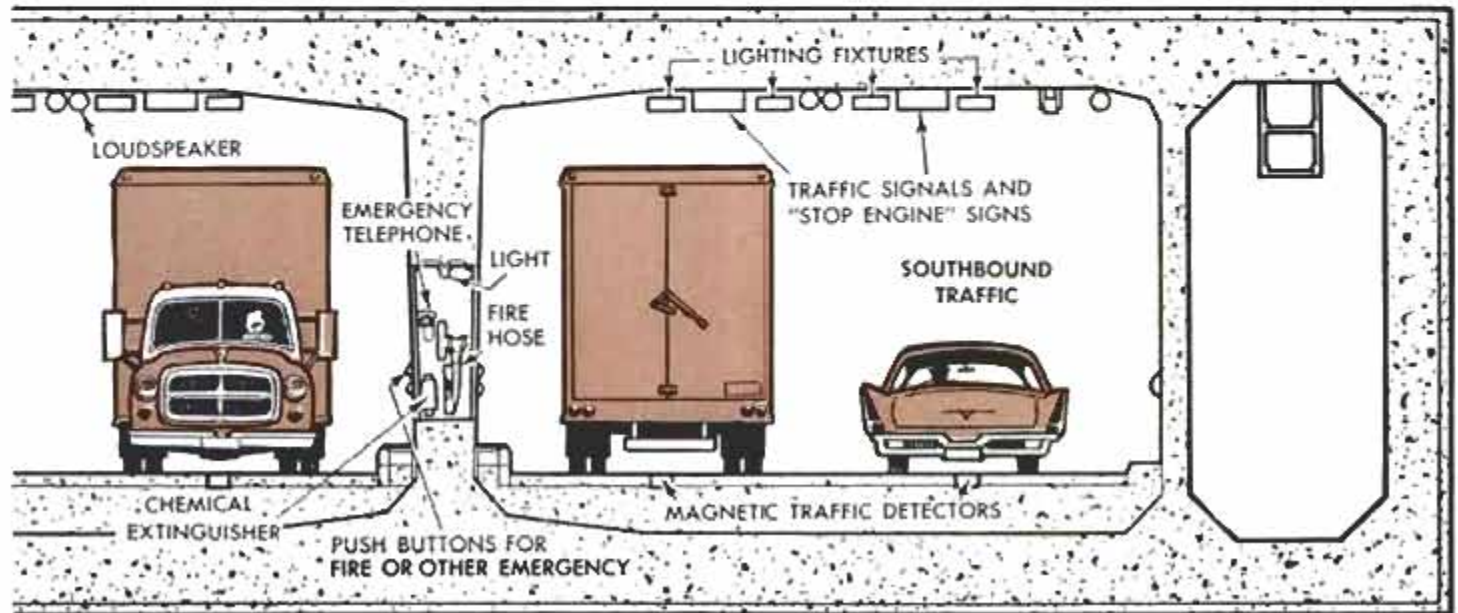
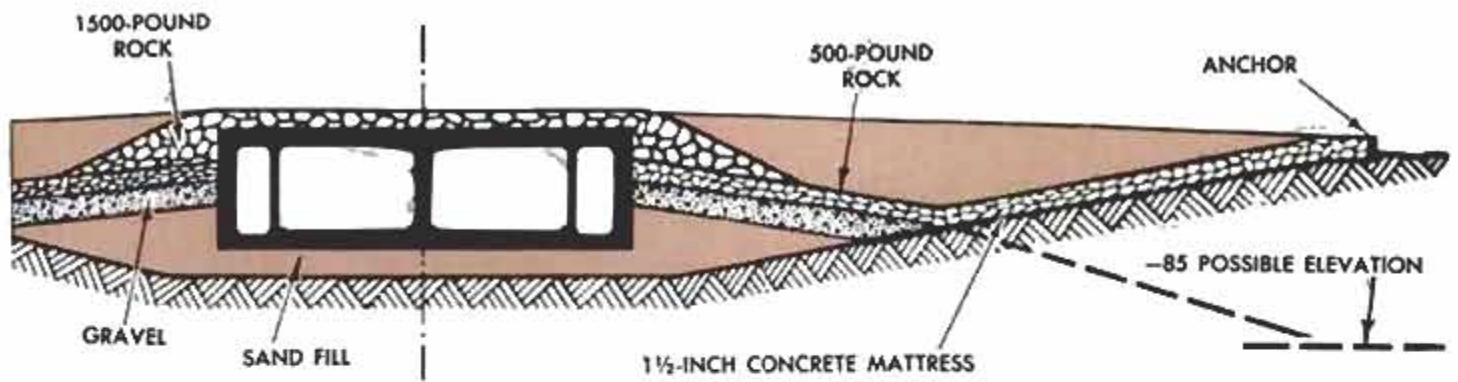

ments and the verbal reports of divers. We'd hoped to achieve accuracy within one quarter of an inch; we actually made it plus or minus one eighth. Before the last section was sealed in place, I'd almost worn out my knuckles knocking on wood."

Crossing only a short distance from where the river pours into the Pacific, the new tunnel is 25 miles from the Canada-U.S. border, and is linked to Highway 99 to the south and the Trans-Canada High-

way to the east. It connects Lulu Island (from which two bridges lead to Vancouver) with the mainland, and cuts across the end of Deas Island, after which it has been named. Together with its approaches, it is 8000 feet in length with 2100 feet of tunnel. The two 24-foot roadway tubes are 60 feet beneath the surface at the lowest point, allowing navigable water with a depth of more than 40 feet above.

Although it was patterned after the Maas

Concrete sections nearing completion in drydock; each is 344 feet long, 24 feet high and weighs 18,500 tons



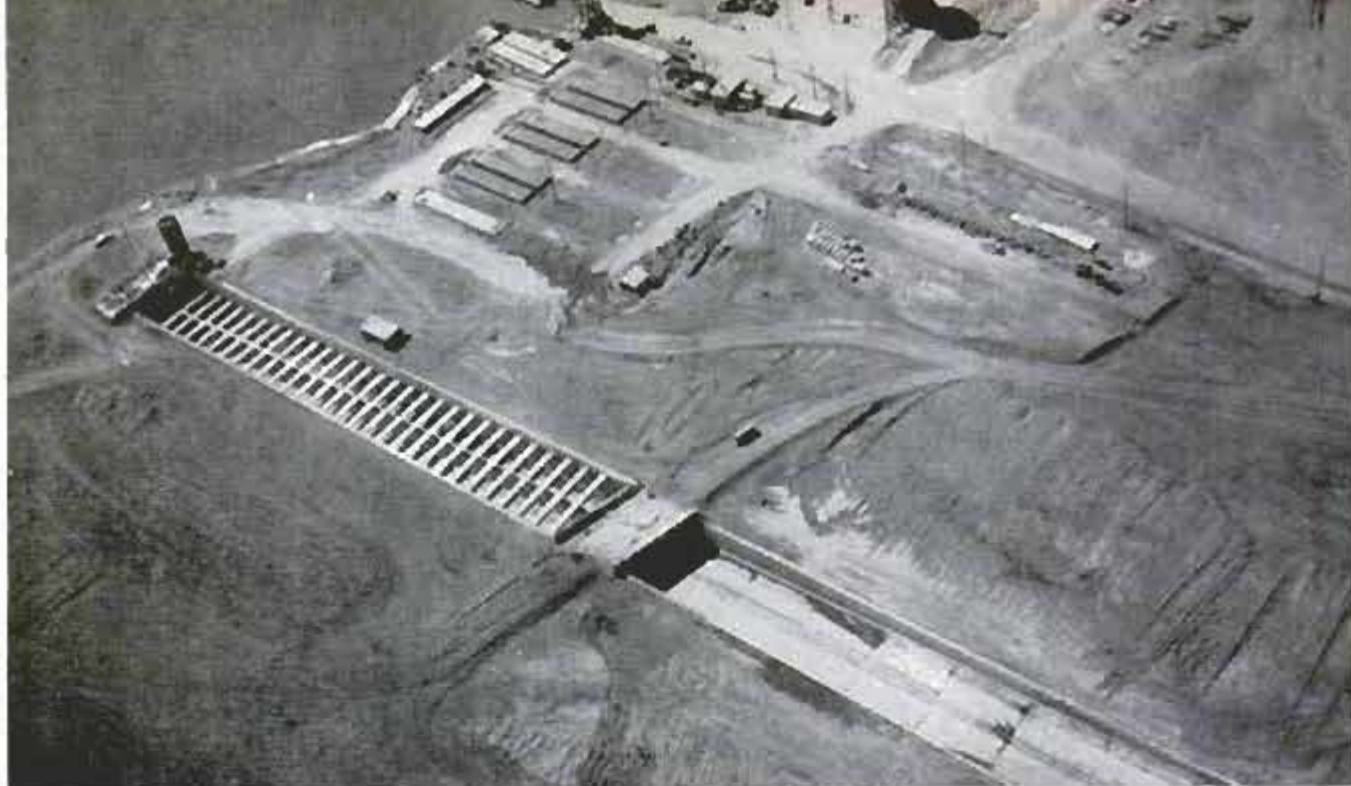

Sun screens over approach prepare drivers' eyes for dimmer interior; dark stack is from ventilation building

Tunnel, the Deas Island Tunnel is of vastly improved design and has many modern features usually associated only with freeways of the future. The maximum flow of 7000 cars per hour is controlled by attendants aided by a maze of safety systems, including magnetic traffic detectors in the roadbed, loudspeakers every 50 feet, and 14 TV cameras placed at strategic points. Emergency telephones are located at 177-foot intervals; there's a sprinkler for every 120 square feet of interior surface, and a number of emergency traffic-signal and fire-alarm push buttons.

Long, troughlike approaches, rather than a continuation of the tunnel, were originally designed mainly to simplify ventilation, but they also make possible one of the more important traffic safeguards. Each has a system of huge sun screens that cause a gradual transition in light intensity from exterior to interior. These serve a double purpose in that they prevent re-entry of vitiated air.

Ventilation buildings at each end are independently founded on slabs and almost completely below ground level; soil pressure around them is the same as that under the approaches. Power for ventilation is provided in both buildings, but each can handle the full load. There is also an emergency storage-battery unit. Variable-speed fans are controlled by time clocks set to suit the traffic pattern, but can be overridden automatically by

carbon-monoxide meters, visibility meters or the fire-alarm system. The fans can also be operated manually.

Throughout the tunnel there are STOP ENGINE signs, which will flash on when the amount of oxygen in the air begins to drop toward the danger point. Abnormal conditions with any degree of frequency are not anticipated, because tests have shown that the ventilation system will normally renew tunnel air every two minutes.

The prefabricated underpass was
(Continued to page 226)

Workman inspects rubber pneumatic seal at the end of section





Goliath Goes Anywhere

It can cover 7 miles per hour on water and 13 on land. It can climb over barriers, cross beaches and travel over lakes, swamps, tundras and muskegs. Goliath is its name, inspired by the 46-foot length, 14½-foot height and 100-ton weight of this Navy amphibious craft. With a 63-ton cargo limit, the vehicle can carry any tank now in use. Two 500-horsepower engines provide the drive for its versatility.



Radio Telescope in Ravine

One of the world's largest radio telescopes will be constructed by the University of Illinois in a ravine 65 feet deep. The sides and bottom of the ravine will be covered with metal, making a giant reflector. The reflector will concentrate radio signals from objects in space on a north-south line of receiving elements supported by towers. The site, near Danville, Ill., was selected because of its freedom from radio interference.

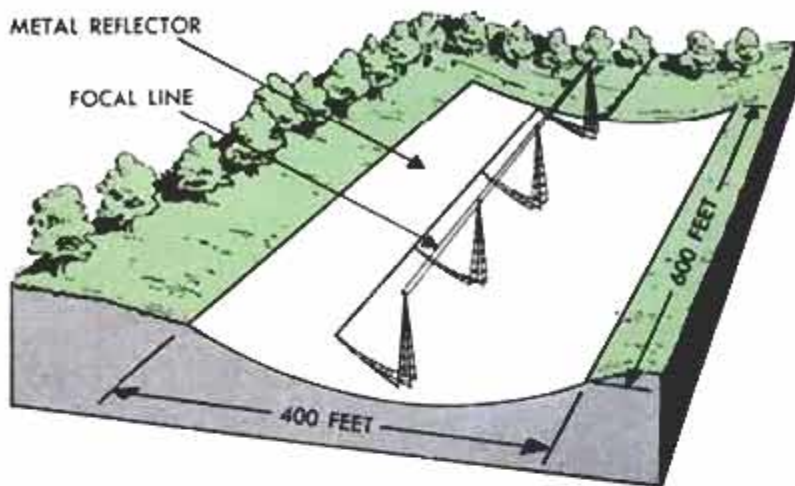

Superhot Jet Tests Missile Materials

Carbon arcs, through a new technique, are developing temperatures so high that no existing thermometers can measure them. The arcs produce a jet of intense flame about six inches long, creating temperatures up to 20,000 degrees Fahrenheit. Such jets are used by Avco Manufacturing Corporation to test small models of missile shapes and materials. Missiles are subjected to intense blasts of heat during their re-entry into the earth's atmosphere.

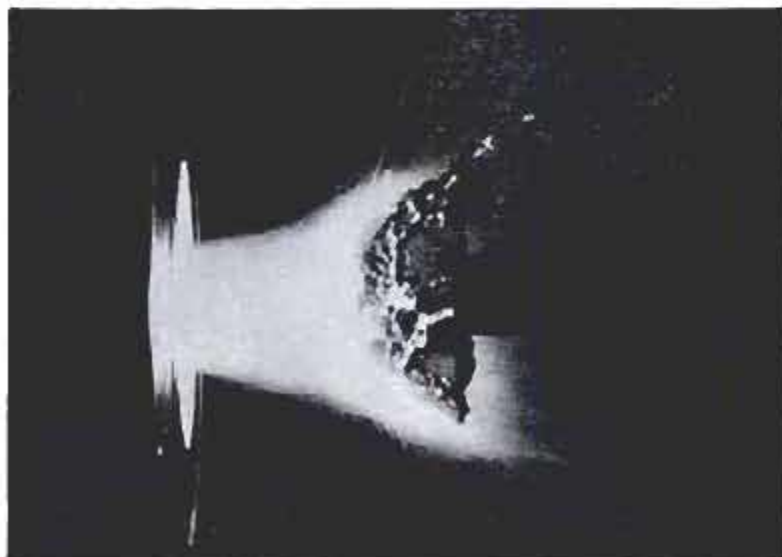



Greeting to American Librarian Association delegates was written in red begonias and featured open book



This close-up shows the method of laying out the letters within an outline formed by pegs and string

Flower layouts are first prepared on the drawing board. About five hours are required to work out details

San Francisco Says "Welcome" With Billboard of Flowers

GOLDEN GATE PARK in San Francisco welcomes convention delegates with a billboard of flowers. On a plot 30 by 15 feet, special greetings are spelled out in colorful blooms. The technique, known in Europe as "carpet bedding," requires about 10 days' preparation. Landscape-gardening foreman Otto Miller first works out a design on paper. The letters and patterns are carefully measured, then outlined on the ground with pegs and string. Small, round, gray-green succulents and grass form the background. Begonias, of the small red variety, frequently are used to make the words of the message. A crew of gardeners may spend a full week at moving plants and transplanting them for a greeting.



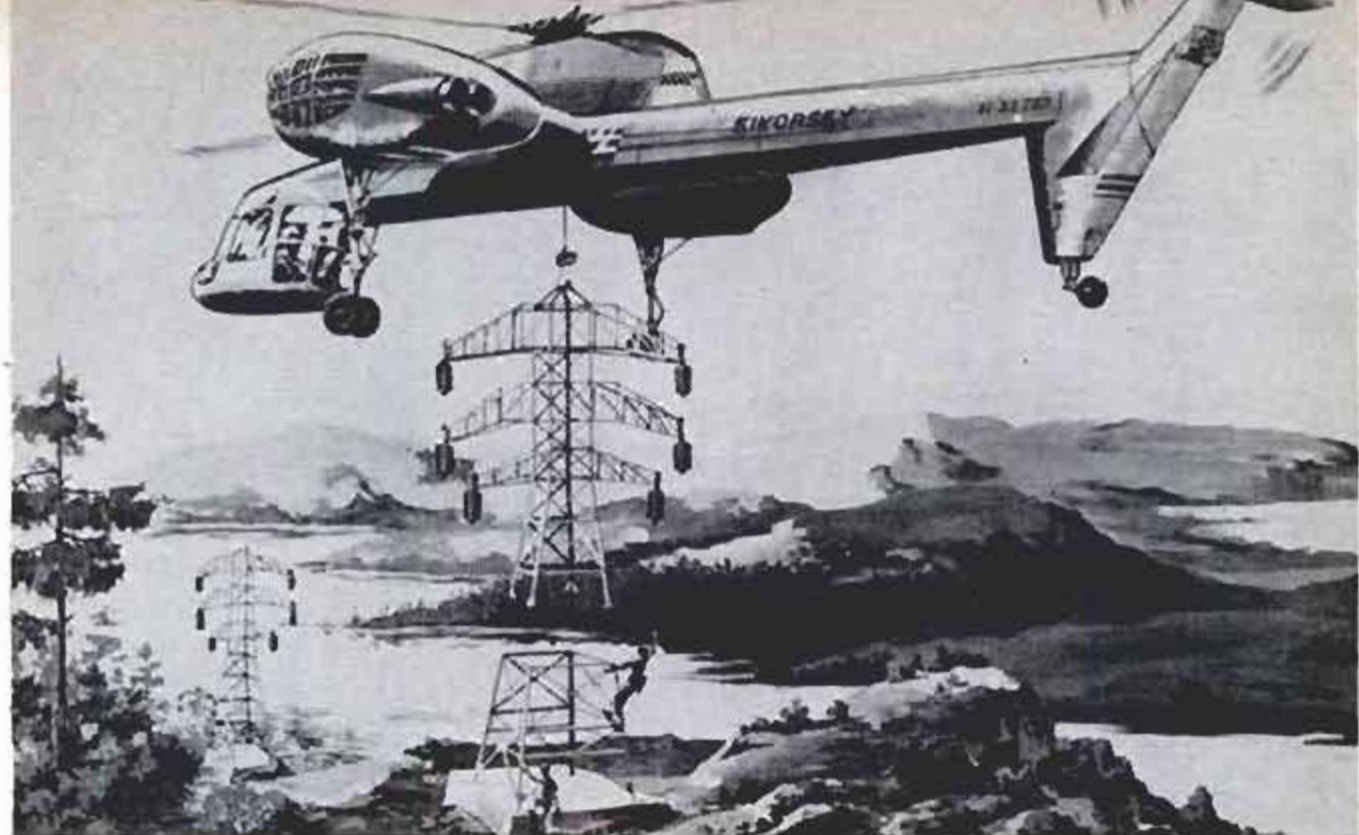

Huge Flying Crane Can Haul Power-Line Towers — or Houses

Sikorsky's new flying crane can carry six tons of cargo. This equips it for hauling prefabricated houses or sections of power-transmission towers. The crane helicopter may be a boon to construction work in remote areas.

Double-Furnace System Gives Better Zone Control

Rambling ranch houses and multilevel dwellings sometimes can be heated more economically with two small furnaces than with one big unit, according to heating engineers. Cost of a twin-furnace system may run up to \$150 more to install than a single furnace, but the work load of each is lessened and they require less servicing. Air conditioning can be added to either furnace.



American-Standard, Air-Conditioning Division

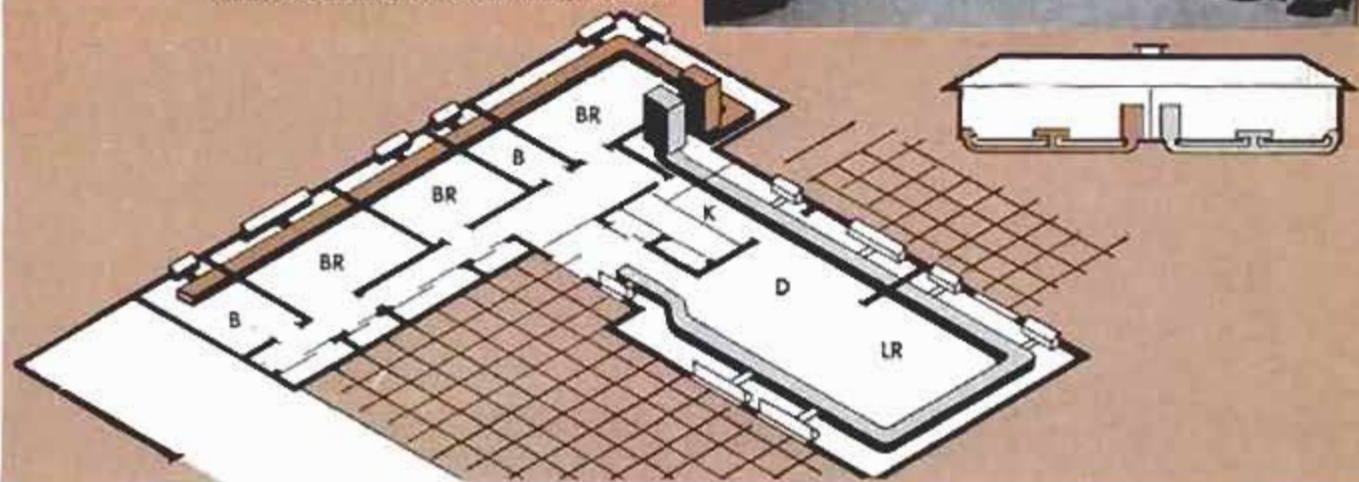



Beehives should be located in the shade of trees and near crops that produce an abundance of nectar



By
A. B. Kennerly

BEEKEEPING is one of the few remaining agricultural pursuits that can be started on a small scale at little expense with a good possibility of its growing large enough to bring in a substantial income. In fact, a \$20 bill and a little spare time can start you in beekeeping. Any of the manufacturers of beekeeping supplies have beginners' outfits that sell for around this figure. The possibilities are as big as you want to make them—a few colonies as a sideline or a full-time business.

Unless you're one of the rare individuals who is allergic to bee stings, you can become accustomed to having the little creatures nip you once in a while. If it's any consolation, remember that while you may be uncomfortable for a short while, the bee pays with its life.

What are the possibilities in beekeeping for the amateur? Claud Burgin, state en-

If you have only a few colonies of bees, the cell caps can be removed from the comb with a kitchen knife

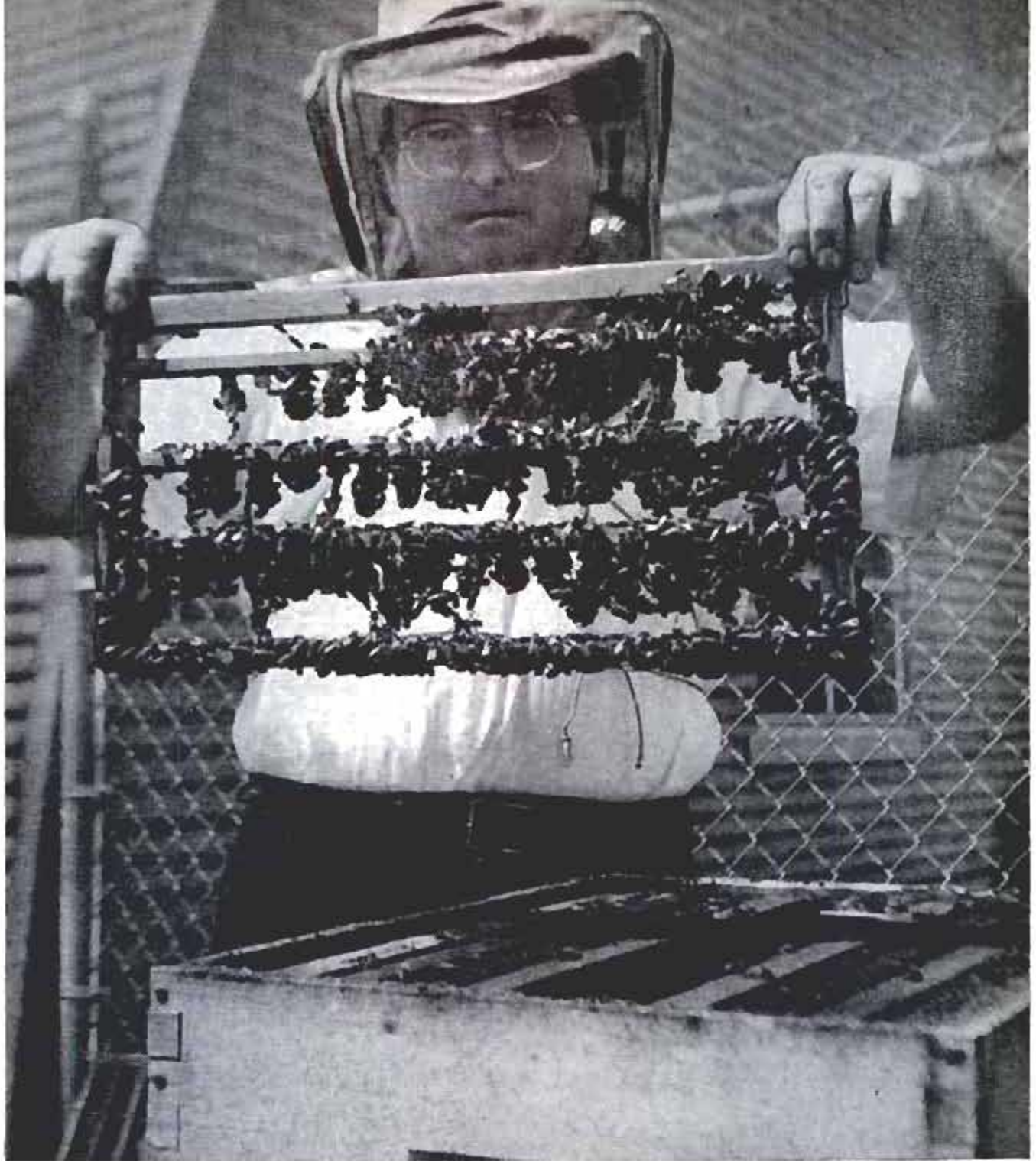

Worker bees will raise queens when given start of queen-size cells with eggs inside and some royal jelly

tomologist at Texas A. & M., says, "The number of beginner beekeepers has increased rapidly in the last year or two. It's a good time to grow into the business."

With good beekeeping management, which can be learned from books and bulletins on the subject, the number of colonies can be rapidly increased. Anyone starting with three to five colonies will have from a dozen to 30 colonies in a few years' time if he wishes. In fact, it's easier to increase colonies than to hold them at a certain number. The bees will help you increase when they swarm in the spring.

The best market for your honey is your own table. One colony that produces a nice surplus of honey, say around 60 or more

pounds, can save you from 35 to 40 cents on each pound of honey the family will eat. And the family will be eating one of the most nearly perfect foods.

As your colonies increase, friends will be wanting to buy honey from you, so your next step will be to purchase a few bottles from the beekeeping supply house and bottle the delicious sweet for sale. By this time you probably will have become a true, beekeeping enthusiast. You will be interested in reading more about what other beginners are doing and how they are handling their little sideline businesses.

If you grow beyond four or five colonies, you will looking toward production of 100 pounds or more surplus a year from each

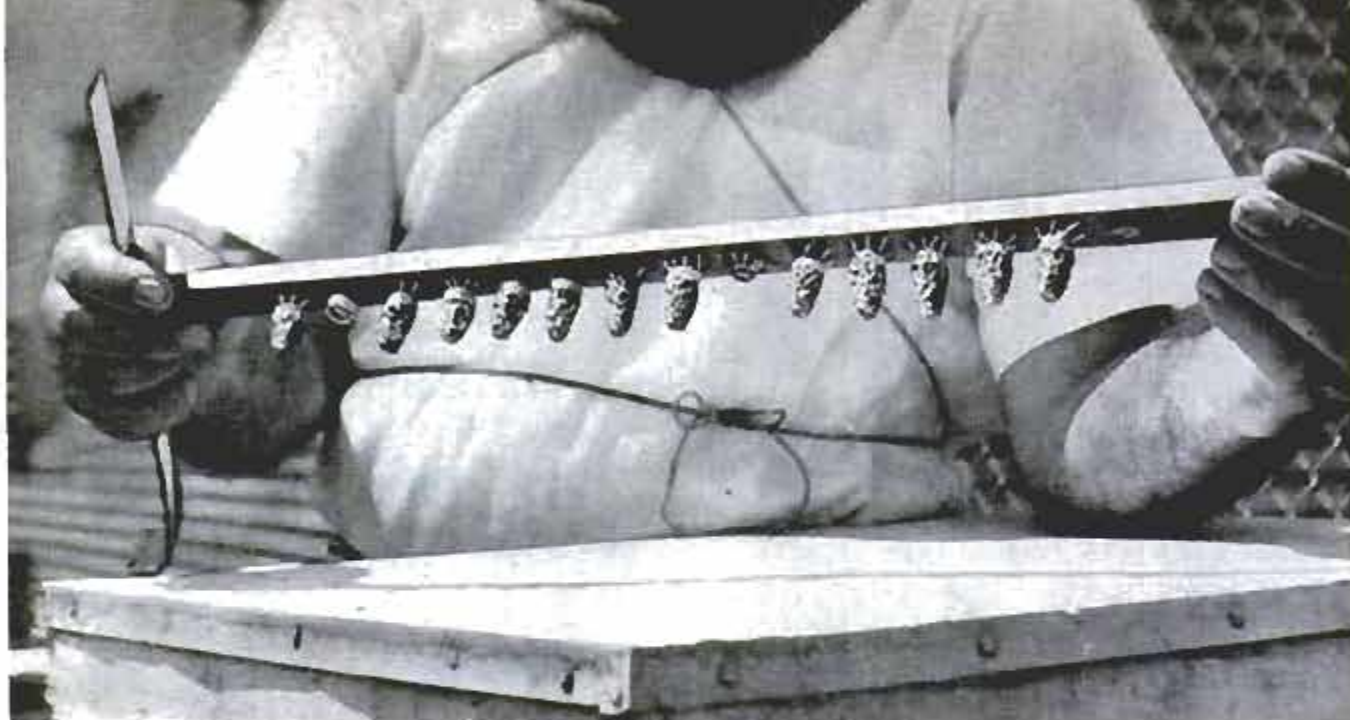

Queens can be successfully grown by the beekeeper. The queens will emerge in a few days from these cells

of your colonies. This will depend upon the location of the yard and the surrounding bee range. But more about that later. Let's look at the marketing situation a little more.

As beekeepers increase their number of colonies, they eventually face the decision as to which route they follow in marketing.

There are two that offer the most promising possibilities: Bottle and sell under your label or sell in bulk to honey processors. Either route makes a good sideline business for small producers and can help the hobby to pay for itself.

Least troublesome is to sell extracted honey in bulk in 60-pound cans. This can be

Worker bees busily store their honey in the comb cells. When the honey is ripened the bees cap the cells

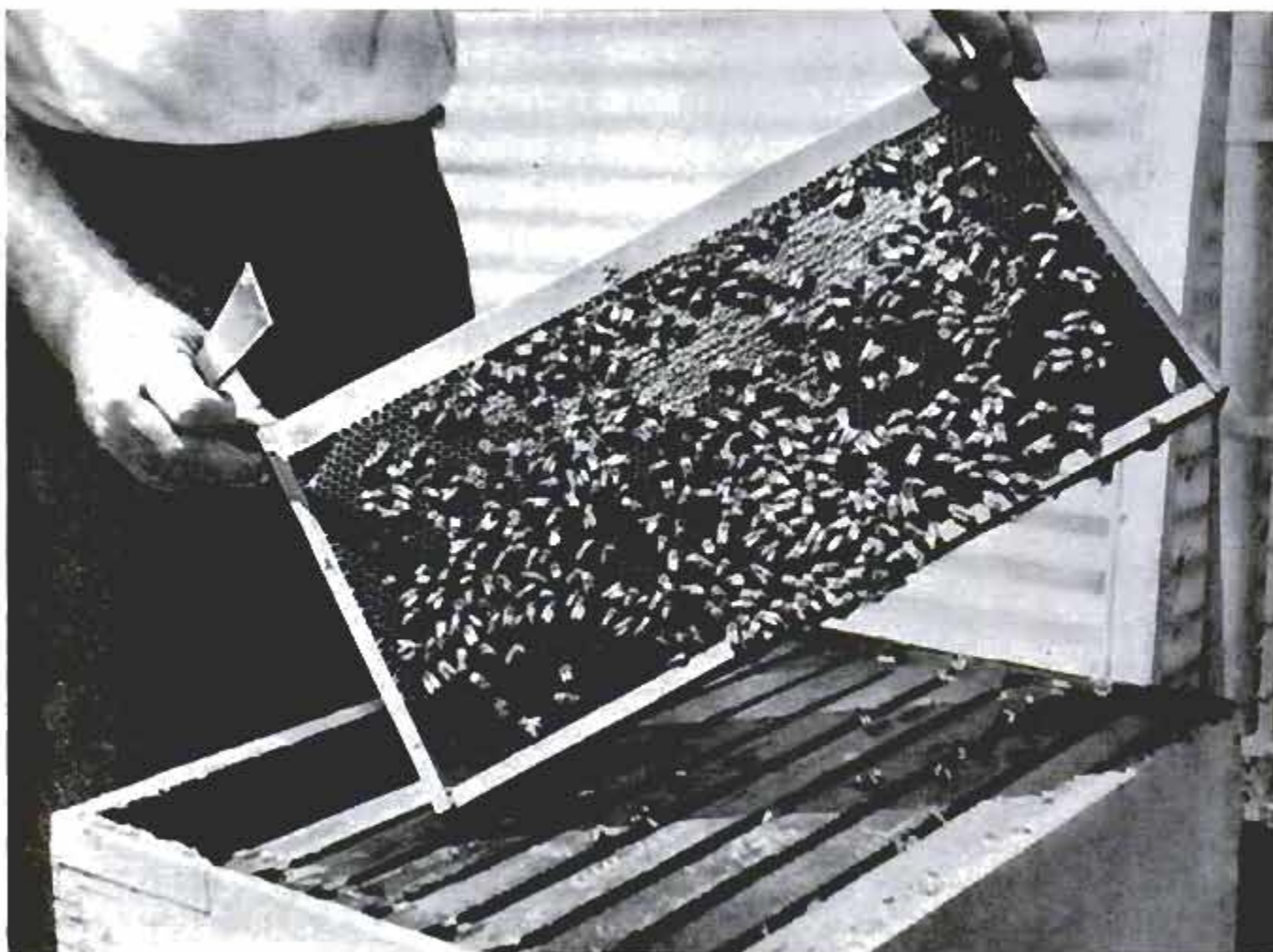

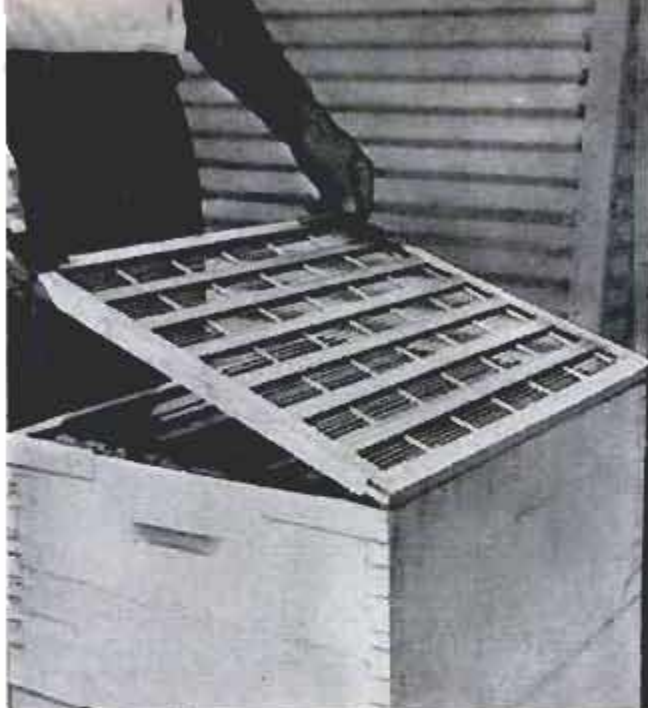

To keep the queen from laying eggs where honey is stored, an excluder is placed over brood chamber

done through an association of beekeepers or individually to a processor. Processors pay lower prices for honey in bulk since they must grade the honey, blend it for bottling and take on the job of bottling and selling it under their own labels. If the beekeeper prefers to spend most of his time working with the bees, leaving the job of bottling and selling to someone else, this is the ideal course.

Your Own Labels

On the other hand, there's a great deal of satisfaction in pasting labels on bottles of crystal-pure honey with your own name printed on the pretty labels that can be obtained from beekeeping supply houses. It's satisfying, too, to watch the business grow from a few customers to as many as you can handle in your spare time.

One of your early decisions will involve the location of your bees. If you live in the suburbs or in the country, you will have little trouble finding a good place to keep the bees. If your home is located where bees may become a nuisance to neighbors you will want to arrange for a location in the country. Bees can go along for two or three weeks at a time without attention so your location is not a major problem. Some beekeepers with a large number of colonies drive 25 to 30 miles to their bees.

The ideal location is on a farm close to clover fields where the bees can bring in pounds and pounds of richly flavored honey. Sometimes the growers are glad to have bees near for pollinating their crops. Otherwise, a gallon or so of honey is considered ample pay for a location.

Bees will fly as far as five miles to gather

(Continued to page 222)



Electric machinery that uncaps combs and extracts honey is available for large beekeeping operations

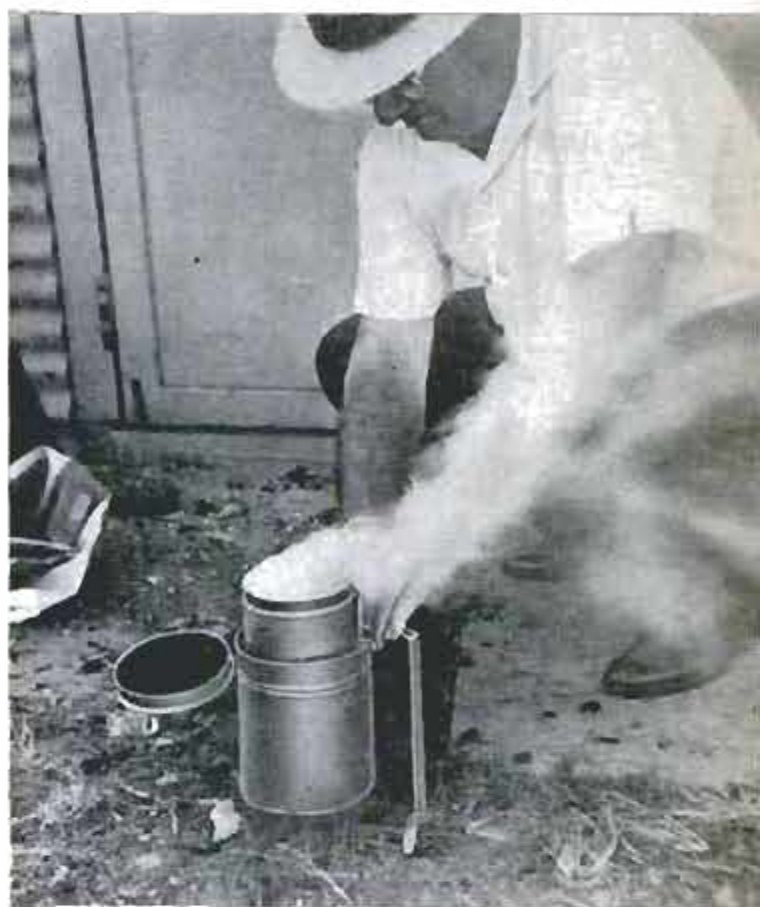

Smoke protects beekeeper from stings. A can filled with sugar water, below, feeds bees in dry seasons

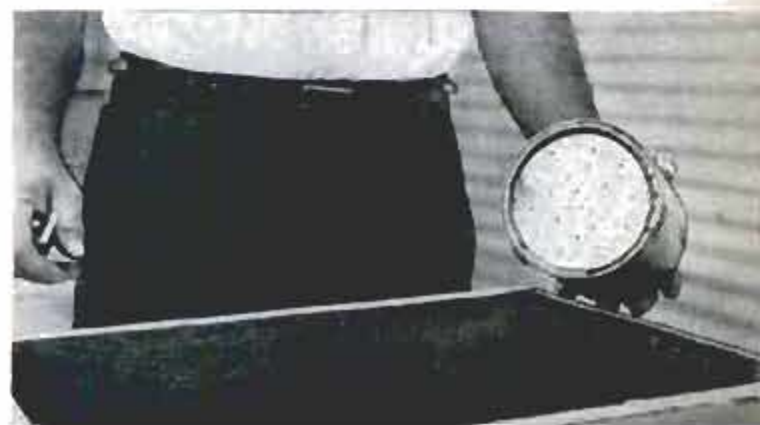

MAN WITH A HIGH HE'S A TV



CHARLIE SOWDERS of Dayton, Ohio, is a "doctor" on 24-hour call—and one of his patients is 1104 feet tall.

As service-maintenance man to a string of television, radio and long-distance-telephone towers, Charlie is the "high man" called by engineers to replace burned-out airplane-warning lights, to repair transmission lines and mount reflectors. Jobs like the latter require that the high man stay aloft, following radioed directions from the engineer below who is watching a monitor, until the reflector has been maneuvered into its exact position for best reception. In a recent installation, this meant 17 hours on the tower without coming down.

Good weather or bad, when there's trouble the TV steplejack goes up. Sudden wind and rainstorms are two of the biggest hazards.

TV transmission lines, whose inner and

Steeplejack Charlie Sowders takes a coffee break 1000 feet up. Since the advent of TV, steplejacks have been rigging towers five times higher than the smokestacks and water towers of former days

Left, Sowders gets his meals from a supply line. Right, a 75-year-old church steeple is dismantled



CALLING— STEEPLEJACK

By
Kirk Polking

outer cables are separated by nitrogen gas to help keep them absolutely dry, present a problem when the lines are opened for repair. Should a rainstorm come up suddenly and dampen the inner cable, the TV equipment could be irreparably damaged.

Such rainstorms can be even more dangerous for the man on the tower, as one serviceman discovered recently. Lightning accompanied the rain, and a streak of electricity that normally strikes the tower and is deflected harmlessly to the ground, followed the lines of least resistance and shot out from the open end of the transmission line.

But this freakish accident is the exception. Most TV high men are sensible, able men who watch weather reports carefully and have a well-founded knowledge of construction, weights and balances, ropes and rigging. This is vital. Their lives depend on it. ★ ★ ★

Below, stack gets painting. Right, Sowders tuckpoints. Far right, he replaces light on 1104-ft. TV tower

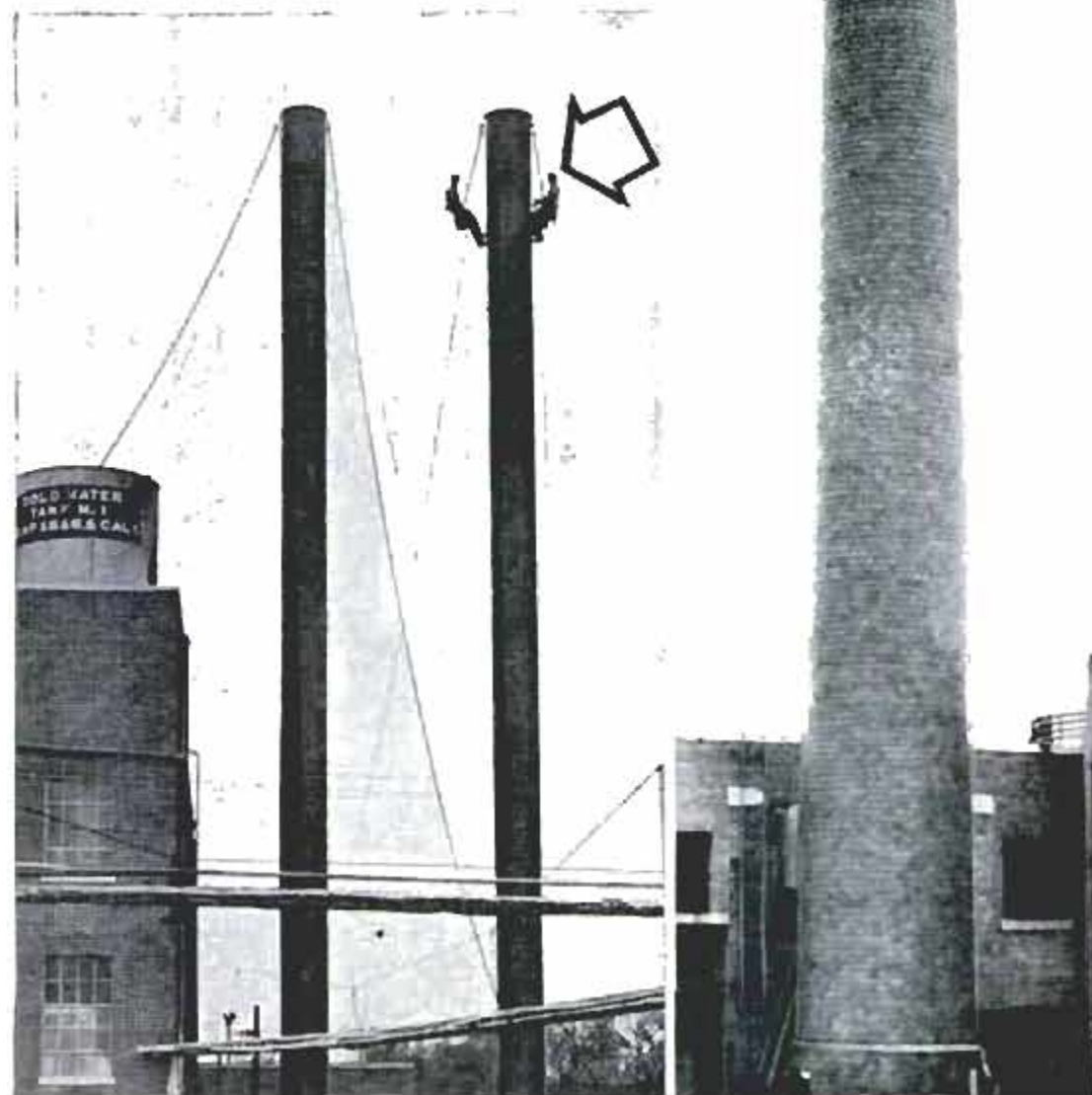



AP/WIDE WORLD

Tilting Operating Table Aids Veterinary Surgeons

Because of new techniques in veterinary medicine, many injured farm animals now can be saved. At Cornell University, an in-

jured horse is given a tranquilizer and placed upright against a table which is then tilted to a horizontal position.

Paper Sailboat

They proved their point! To demonstrate the moisture-resistant properties of a corrugated board (ordinarily used for shipping cartons), one manufacturer recently built a little sailboat of the material. With a paper sail on the mast, the boat carried a young lady for several hours.



Torpedo Resists Jamming

Submarines now have a wire-guided torpedo that can destroy a target despite countermeasures. It is connected to the sub by wire reeled from the torpedo as it shoots through the water. Operators aboard the sub guide the torpedo to a kill by sending electrical signals over the wire.

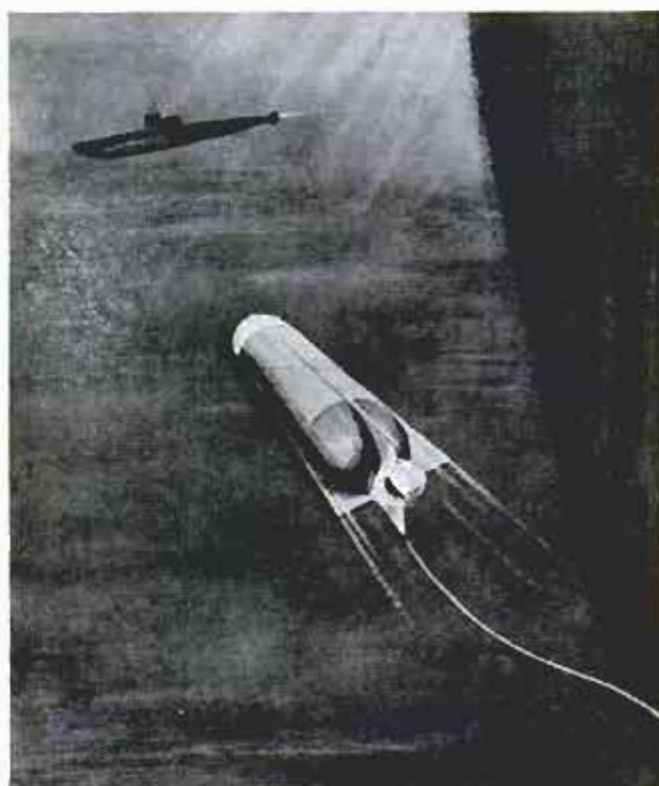



Prefab Panels Make "Dome" Cabin

Geodesic-dome shelters suitable for vacation cabins can be assembled by two men from factory-assembled panels. No special equipment is required to build with the plywood-surface panels. The finished weatherproof structure is 13 feet high, has 458 square feet of floor space.



Radar Antenna In Plastic Bubble

Housed in a plastic sphere, a new radar antenna pinpoints targets in three dimensions — distance, bearing and altitude. It is a single antenna, rather than the two or more antennas required to obtain the same data with conventional radar. Information from the 3-D antenna is transmitted to missile batteries. The radar system, called Frescanar, was developed by Hughes Aircraft Company for the U. S. Army Signal Corps.

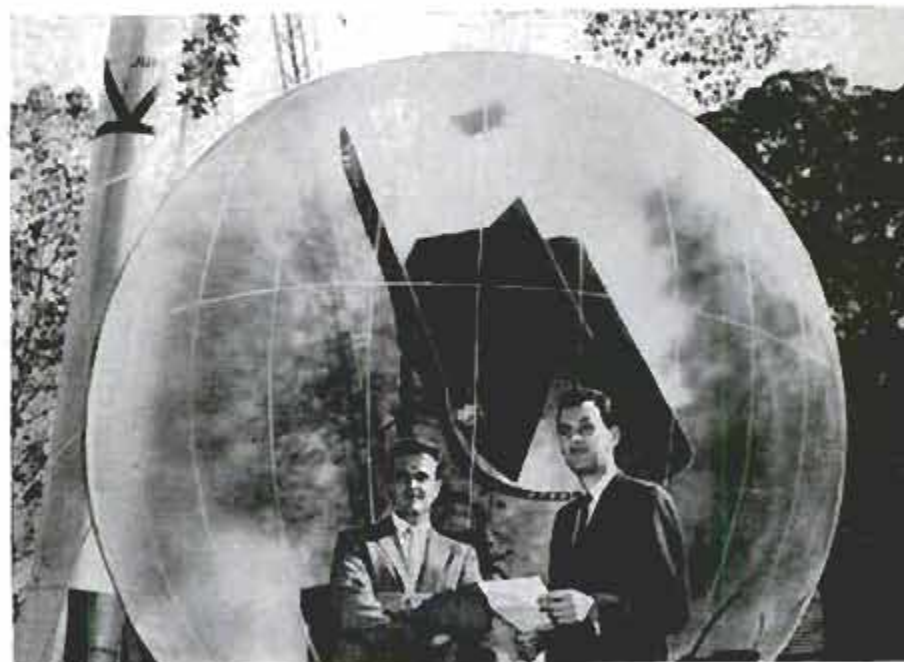



Hidden Ice Crevasses Revealed by Infrared

Because the temperature above a snow bridge over a hidden crevasse is either warmer or colder than the surrounding area, Army Engineers in the Arctic and Antarctic regions can locate the treacherous ice cracks with infrared devices. One of the infrared "boxes" is mounted on the roof of a weasel in the photograph above.



Bread From Miniature Bakery Tests New Varieties of Wheat

Probably the smallest bakery in the world is located at Kansas State College where tiny loaves of bread are made to test new strains of wheat. The reason for baking such small loaves is that there isn't enough wheat of a particular experimental strain to bake standard loaves. In fact, it takes four years to produce enough wheat of a new strain to make the miniature loaves.

Miniature equipment used to produce tiny loaves of bread includes an electric mixer, dough molder made in college machine shop and inch-size pans

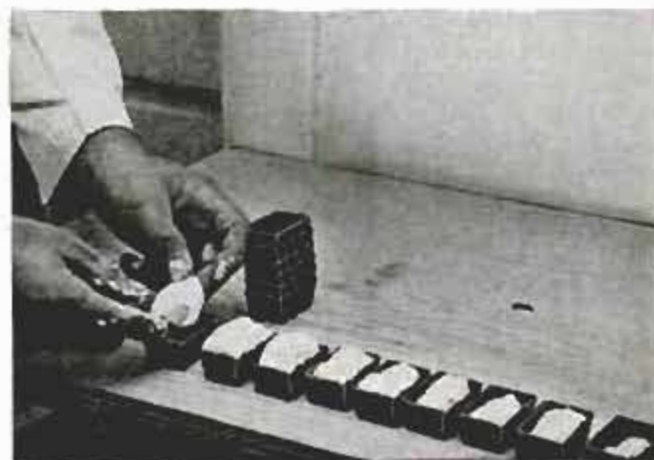
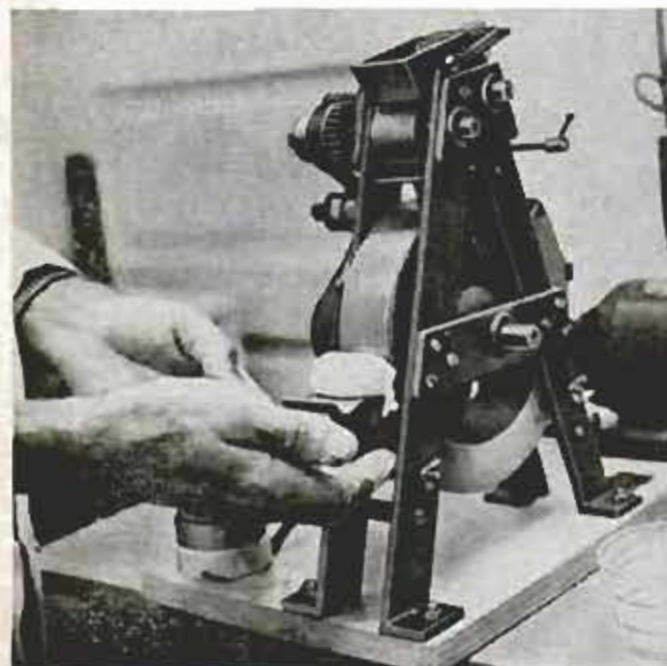



Hydrophone in aquarium detects fish chatter, which Dr. James Moulton, above, amplifies and records on tape

Scientists Lure Fish by Feeding Them a Line—of Chatter

BENEATH THE SURFACE of the sea is a noisy world where fish apparently talk to each other with grunts, groans, rasps, barks and other distinctive sounds. During World War II, it was discovered that the "voice" of a toadfish could explode an acoustical mine. And electronic gear designed to pick up the sounds of submarines frequently detected "enemy craft" that didn't exist. It had been tricked by the sounds of undersea life. Scientists, like Dr. James M. Moulton of Bowdoin College, now are making an intensive study of the conversations of marine animals. At the Bermuda Biological Station, Dr. Moulton makes tape recordings of fish sounds by lowering a hydrophone into the water from a small boat. He also eavesdrops on fish in tanks to learn what effect captivity has on their sound production. And he dissects the fish to learn more about their sound-producing mechanisms and ears. The object of the research is to improve methods of commercial fishing. Eventually, fishing crews may introduce sounds into the oceans to lure certain kinds of fish to their nets. Valuable fish populations might be conserved by introducing sounds that would drive them away from danger areas. Scientists have found several species that respond to imitations of their voices.

The spiny lobster not only talks but it has a voice which gets deeper as it grows older





Eugene Braddock and daughter, Pat, adjust artificial bunny for a race on their training oval near Miami

FOOLMASTER TO THE HOUNDS

By Max Hunn and Edward Dickson

Young greyhounds bound out of the starting box; most of them need 10 or 12 training races before "debut"

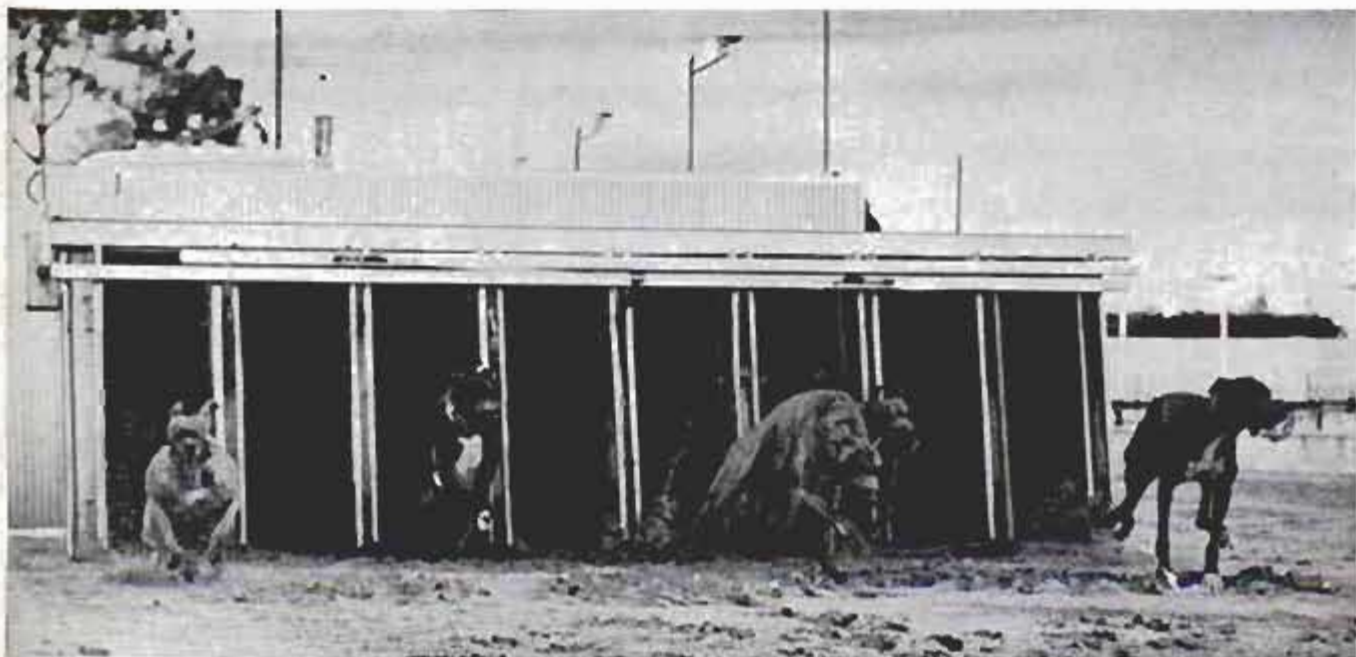



On Braddock's training track, greyhounds chase the mechanical rabbit propelled by motor between rails

EUGENE "SKIPPY" BRADDOCK'S business is foolin' — not people, but greyhounds.

He's engaged in one of the world's most unusual occupations which concerns fooling the speedy greyhounds—both in training and on the race tracks.

During six months of the year he operates a private schooling track, a full-size, quarter-mile oval on his 10-acre estate in the outskirts of Miami. He often trains as many as 400 dogs in one day.

The rest of the year he works as an electrical maintenance man for a greyhound track near Boston. His duties include acting as lure operator (the man who makes sure the bunny always wins) as well as general maintenance chief for the electrically operated track. In his spare time, he builds and installs the gimmicks that fool and train the greyhounds. These include automatic starting boxes, special tracks on which the electrically powered bunny runs, and the ingenious machines that haul the stuffed versions of Br'er Rabbit. Br'er Fox, indeed, would have a tough time catching this Br'er Rabbit no matter how hard he tried.

Braddock, who has been operating his private training track for eight years, begins training shortly before sunrise during the winter months. Dog owners, who are either schooling new dogs or conditioning veteran dogs that need exercise, prefer to train in the cool

early morning hours to avoid overheating their dogs. So Skippy goes to work early, and calls it a day by 10 a. m. Occasionally, if there are too many dogs, he holds another training session late in the afternoon. Most young dogs require 10 to 12 training races before they are ready to compete on regular tracks.

Braddock's training oval is a duplicate of the public tracks, minus, of course, the grandstands and the crowds. He makes all of his mechanical hares, a special type with a two-wheeled motor which runs along the inside of the track; the artificial bunny projects onto the track on a steel pole. His hare will travel 65 miles per hour, the speed governed from a control tower. His

Small four-horsepower electric motor with projecting steel rod speeds the mechanical bunny around the track at 65 m.p.h.





These greyhounds are in hot pursuit of the hare they'll never catch; training track duplicates public oval



two-wheeled hare rolls on a low rail, but gets electricity for its four-horsepower motor from a "hot" upper rail much as an electric trolley car.

He believes he was the first designer of this type of equipment to devise an electrical brake to stop the lure, and the first to add an electrical device for opening the starting boxes with a remote switch in the control tower.

Stop Hounds With Trick

Stopping the greyhounds is as much of a trick as getting them started. Once they've passed the halfway post on the oval, an assistant draws a canvas curtain across the track. When the mechanical rabbit zips around the second time, he ducks behind the canvas. The befuddled greyhounds, who run strictly by sight, lose visual contact with their quarry and come to an abrupt stop to be quickly leashed by their handlers.

Foolin' the hounds is a family project with the Braddocks. Mrs. Braddock helps by making the white, stuffed bunnies which serve as lures. Now she makes a very lifelike bunny, but she recalls "the first rabbit I made looked more like a pig." Another member of the family, 17-year-old Pat Braddock, likes to lend a hand by helping her dad or the dog handlers.

The Braddock family is in the foolin' business all the way, with Skippy the acclaimed "Foolmaster of the Hounds." ★ ★ ★

Pat holds a pair of muzzled young greyhounds ready to race. Below, greyhounds keep running as long as they see bunny



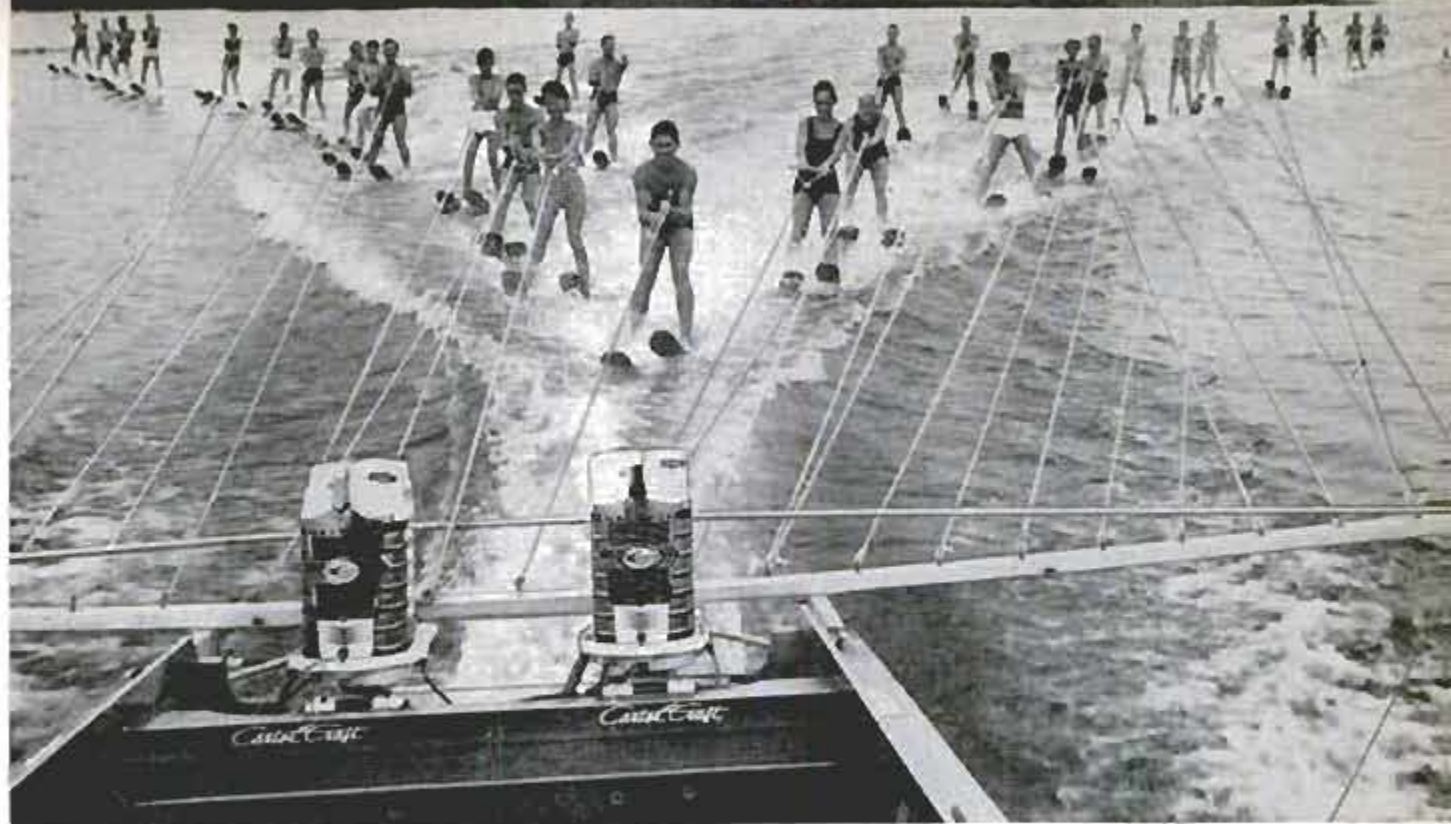

One Small Boat Tows 5146 Pounds of Skiers

Thirty-one water skiers recently skimmed along behind one boat in an impressive demonstration of the power of a small boat equipped with outboard motors.

The 31 skiers, who averaged 166 pounds each, were brought to a simultaneous start from a pier by the unassisted boat. Two 70-horsepower motors pulled the skiers.

Slide Rule for Doctors Helps Diagnose Diseases

Invented by a British physician, a two-foot slide rule is expected to help doctors make diagnoses. "Symptom strips" are inserted under a window on the front, where 340 disease categories are listed. It's called a Nash Grouped Symbol Associator.

Air-Conditioned Cab Cools Combine Operator

Farmers today can work in comfort regardless of weather. An enclosed cab for self-propelled harvesters can be air-conditioned on hot days and heated on raw, cold days. There's even an automatic washer and wiper to clean the tinted windshield.



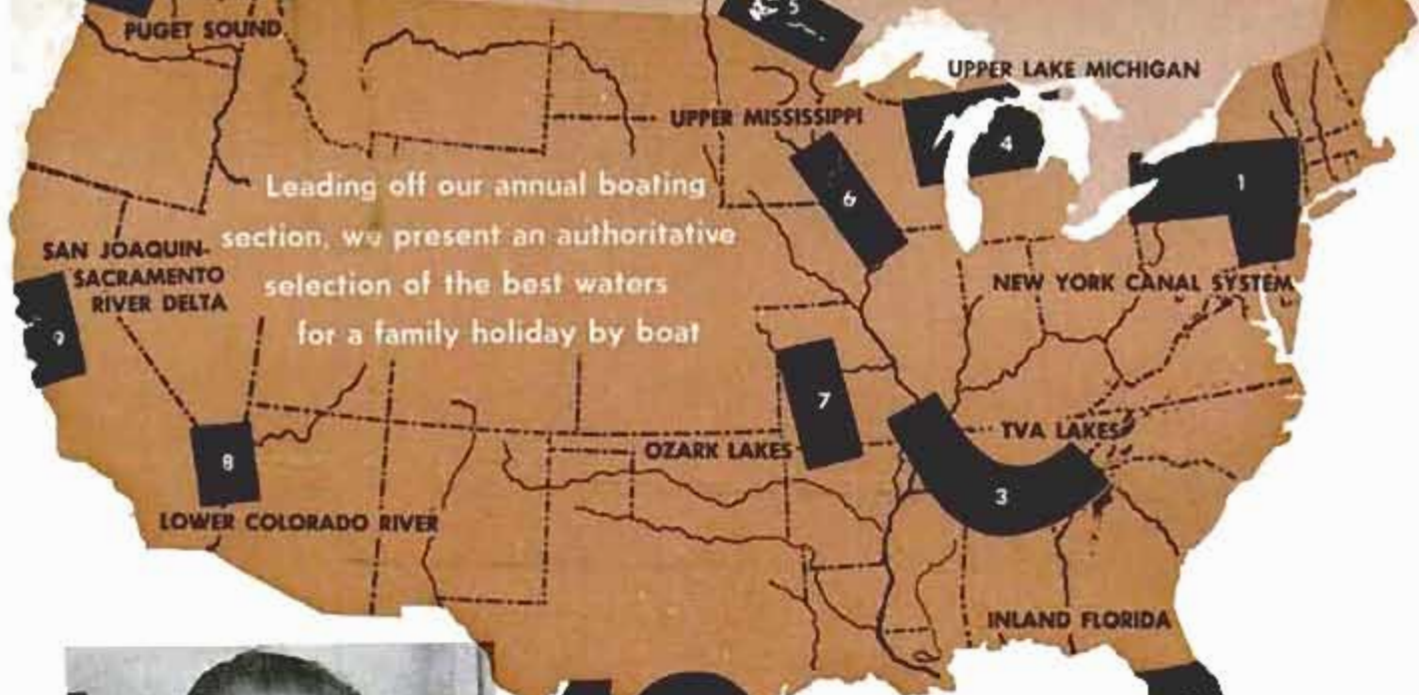

Leading off our annual boating section, we present an authoritative selection of the best waters for a family holiday by boat



By Edward S. Spanke

10 BEST BOATING VACATIONS

The author, a Staff Director of the Outboard Boating Club of America, coordinates OBC's waterways information service and its local boating club program

Reprinted "Fun with Boats"

ADVISING BOATERS on where to take their vacations is as thankless a job as suggesting whom they should marry or how much money to invest in a new business.

But I must admit it's a fascinating subject. At the Outboard Boating Club of America we receive more queries on this subject than on any other.

To select the 10 best boating vacations I consulted the top authorities on our recreational waterways—the organized boatmen, members of local boating clubs. They spend week ends as well as vacations on the water. For more than a year I carefully checked the cruising and vacationing activities of some 1000 clubs. Then I surveyed the 300 most active clubs by mail.

The results of this study appear on the map above, and on the following pages. In these 10 areas, stretching from Florida to Puget Sound, I'm confident you'll find perfect waters for your own vacation.

I have a personal acquaintance with most of the 10 areas. Though boating clubs made the selections, I fully agree with their choices for several reasons:

- The areas are well charted and mapped.
- All the areas offer a variety of interest.

- They are readily accessible to major population centers.
- Most (though not all) of these waters can be easily navigated by novice skippers.
- All the areas lend themselves to boating by boats of nearly every category.
- They are well spread from north to south. Thus you can find a good vacation area any time of year.
- Most of the areas lend themselves to short or long cruises. You can set up a headquarters, or camp as you go.

The areas, as noted above, are well charted and mapped. From two free catalogues you can choose government charts of the areas. One of these free lists is the *Catalogue of the Great Lakes and Connecting Waters*. You can obtain it from the U.S. Army Engineer District, Lake Survey, 630 Federal Building, Detroit 26, Mich. On the following pages, this will be referred to as "Catalogue A." For coastal water charts, write the Coast and Geodetic Survey, U. S. Department of Commerce, Washington 25, D. C. Ask for the *Catalogue of Nautical Charts—Serial 66S*. In this article, it will be referred to as "Catalogue B." You can obtain other maps and charts from oil companies.

Happy cruising!

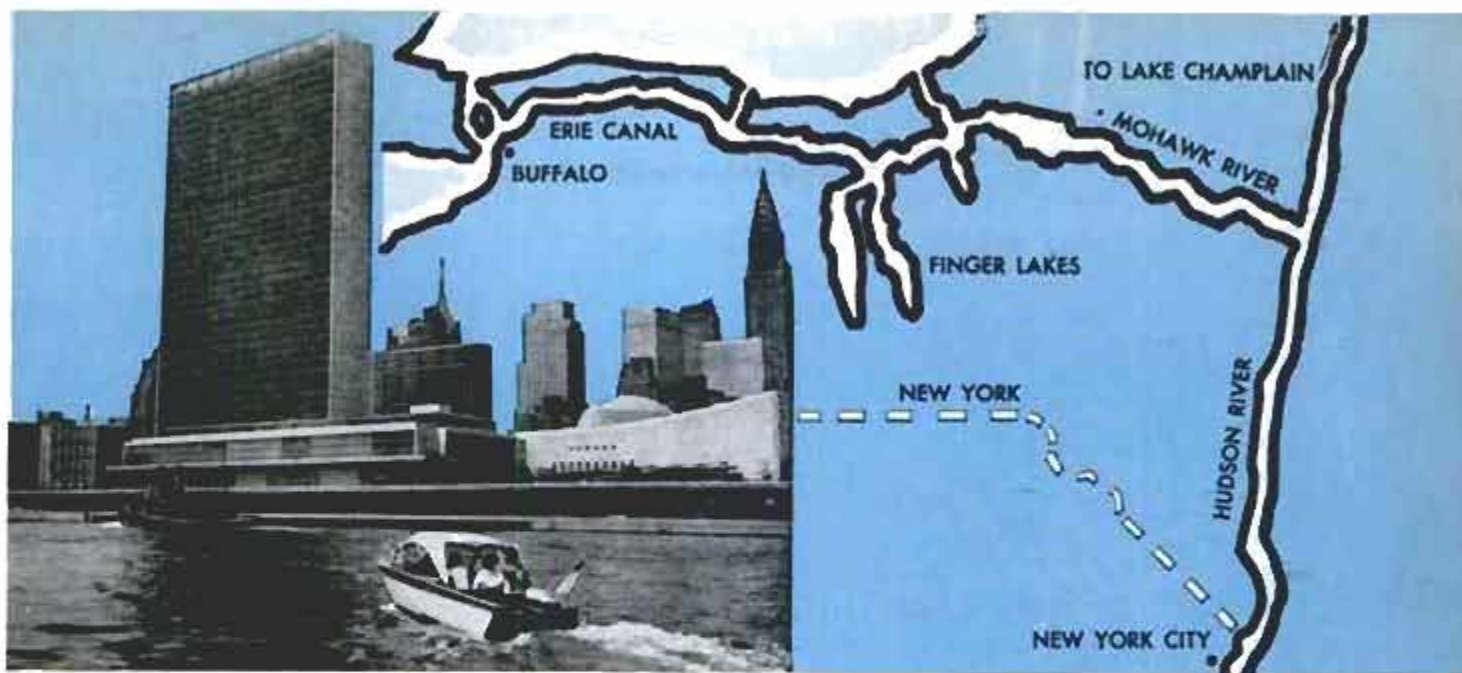

1. NEW YORK CANAL SYSTEM

The canal system links the Atlantic with the Great Lakes. From any point on the system you can embark on a fascinating cruise of days or weeks. You can cover the Erie Canal, the historic Mohawk River, some of the Finger Lakes, Lake Champlain, the St. Lawrence and—via the Hudson River—New York City itself. Good cruises: Tonawanda to New York City, Rome to Watkins Glen, Oneida Lake to Rochester. Pleasure boaters need a permit (free) in these waters. Basic charts: **Catalogue A** and oil-company maps.

2. INLAND FLORIDA

Here's a fine bet for early spring or late fall. Inland Florida is dotted with lakes, interconnected by streams and canals. Or you can cruise along the Intracoastal Waterway. According to the survey, this was the favorite of all vacation areas. Top appeals: Bass fishing, quiet waters, solitude. Best boating routes: The Oklawaha River between Eureka and Leesburg; the Kissimmee River and connecting lakes between Kissimmee and Stuart; Stuart to Fort Myers via canal, lake and river. Basic charts: **Catalogue B**.



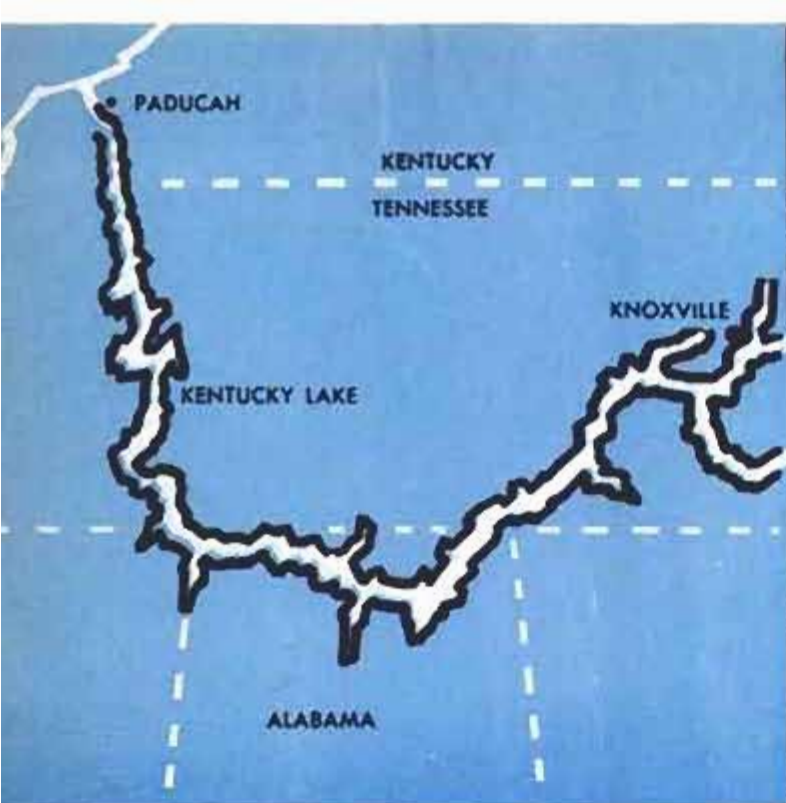

3. TVA LAKES The Tennessee River and its lakes extend some 650 miles between Knoxville, Tenn., and Paducah, Ky., winding through four states. Top appeals: A year-round boating area; magnificent scenery, from mountains to meadows; easy access from other waterways; easy navigation; fine lodging and launching facilities. The fish are big, and include bass, walleye, crappie, bluegill and rainbow trout. Here's everything for a one-day or a two-week cruise. Write Tennessee Valley Authority, Knoxville, Tenn., for charts and maps.

4. UPPER LAKE MICHIGAN AREA Lake Michigan is one of the most treacherous waterways in the country. Yet two offshoots (circled) offer sheltered boating: A complex of lakes and rivers at the southern end of Green Bay; and an inland waterway that cuts across Michigan, from Lake Michigan to Lake Huron. Fish: Northern, walleye, sturgeon, white bass, largemouth black bass and panfish. Both offshoots have fine accommodations and public camp sites. They are top areas for family boating. Basic charts: Catalogue A and oil-company charts.

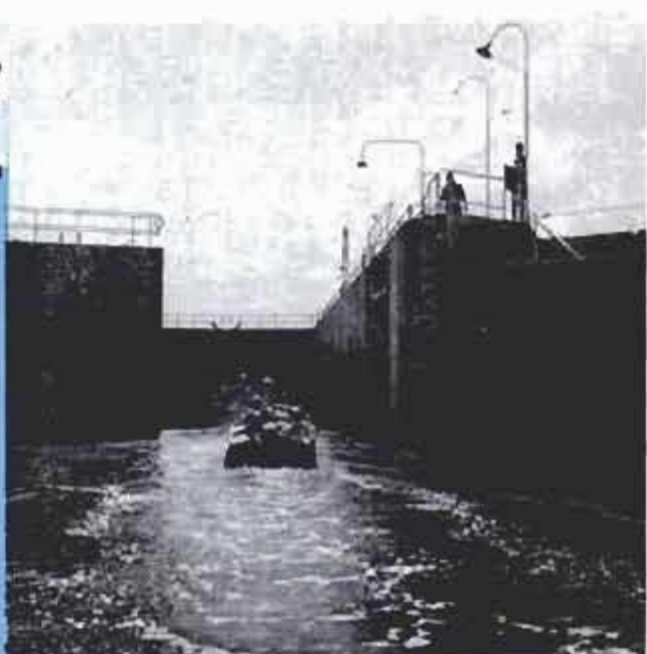



5. LAKE OF THE WOODS This lake on the Minnesota-Canada border is said to have more islands than any other lake in the world —14,000 of them. The islands and channels provide a series of sheltered waterways. The north-woods scenery is spectacular, and there are thousands of miles of shoreline to explore. Top attraction: Fishing for walleye, northern, pickerel, sauger, bass, lake trout, lake perch and that king of the fresh water, the musky. *Caution:* Gas pumps are widely spaced. Plan your fuel stops in advance. Basic chart source: **Catalogue A**.

6. THE UPPER MISSISSIPPI This stretch of the Mississippi, above Lock and Dam No. 13 near Clinton, Iowa, is by far the best section of the river for boating. Scenery ranges from rolling hills to magnificent bluffs. Features: Riverside state parks, friendly lock tenders, generally calm waters, and clean, mosquito-free sandbars. On week ends you'll meet one or more boating clubs cruising these waters. Try the trip from St. Paul downstream, then up the St. Croix River to Taylors Falls. Basic chart sources: **Catalogue A** and oil-company maps.





LAKE OF THE OZARKS

MISSOURI

• SPRINGFIELD



LAKE TANEYCOMO

BULL SHOALS LAKE

NORFORK LAKE

TABLE ROCK LAKE

ARKANSAS



7. LAKES OF THE OZARKS

Five manmade lakes within a 60-mile radius of Springfield, Mo., rated high in the survey. They are: Lake of the Ozarks, Table Rock Lake, Lake Taneycomo, Bull Shoals Lake and Norfolk Lake. Most boaters prefer to spend their nights ashore rather than roughing it, and accommodations are excellent. Fine fishing. Watch your navigation or you'll become lost in the numerous arms of these lakes. Basic chart sources: Write District Corps of Engineers, Little Rock, Ark., and state tourist agencies.

8. LOWER COLORADO RIVER

The 375-mile stretch from the northern end of Lake Mead to the Gulf of California offers top opportunities for trailer sailors. There are four great lakes formed by huge dams. The area abounds in desert canyons of monumental depths and lush mountain-rimmed valleys. Fishing is good, with no closed season, and hunting is excellent. Game includes ducks, geese, doves, quail and deer. With spectacular scenery, what more could a boating family want? *Caution:* Launching ramps are scarce. **Catalogue B.**



• LAS VEGAS

LAKE MEAD

COLORADO RIVER

LAKE MOHAVE

LAKE HAVASU

CALIFORNIA

ARIZONA

IMPERIAL RESERVOIR

• YUMA

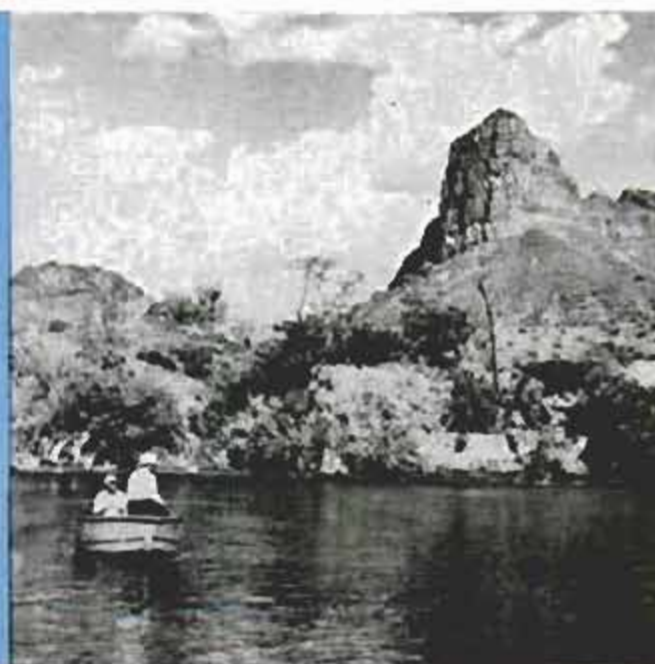

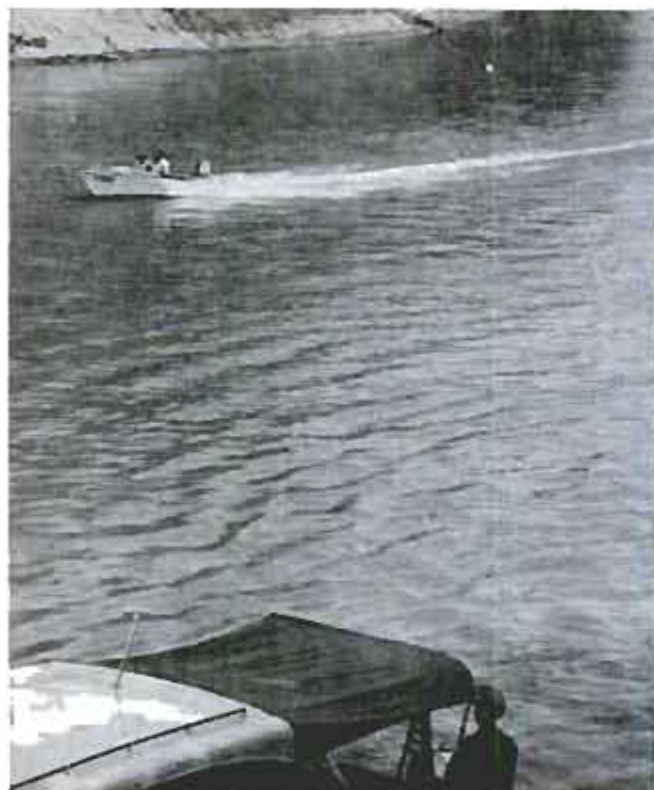

9. SAN JOAQUIN-SACRAMENTO RIVER DELTA On a map, this area extends 65 miles from San Francisco to Stockton, yet if you followed every turn of the rivers, sloughs, cuts and canals you'd log more than 1000 miles. Despite the proximity of big cities, there are few habitations and a minimum of roads. Fish and game are abundant. It's a fine area for a family to study wildlife, and one of the top boating areas of the West. Chart sources: **Catalogue B**, oil-company maps and a map available from Stockton Chamber of Commerce.

10. PUGET SOUND This is a magnificent network of waterways that would take several lifetimes to explore fully. For vacation purposes, consider Puget Sound to extend 110 miles from Orcas Island on the north to Olympia on the south. With snow-capped peaks in the background and wooded shores up close, you are hardly aware of civilization. Salmon are king, but there are many other species. You can boat for years without dropping anchor in the same cove twice. Basic charts: **Catalogue B** and oil-company maps.



The Boating Season Begins . . .

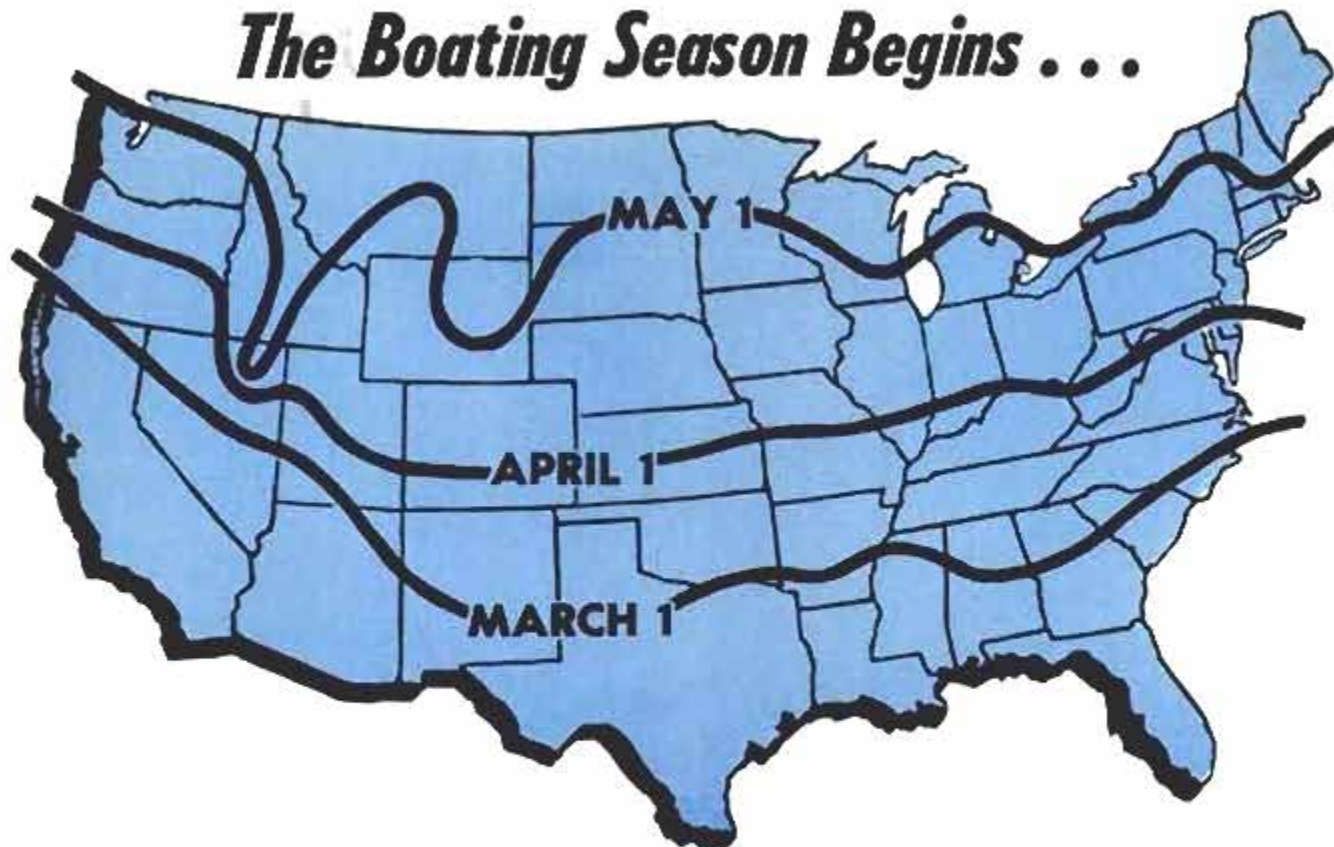

INFORMATION ON the top 10 vacation areas for boaters may help you decide *where* to go. The maps on this page may help you decide *when* to go.

No one can guarantee the vacationer perfect weather, but here's a "guesstimate." These maps, based on U. S. Weather Bureau records going as far back as 100 years, indicate the boating season—the span of time when the weather should be warm enough for fine days on the water.

It is the lines that show the Weather

Bureau records. Each line above shows the date in the spring when the average mean temperature, all along the line, reaches 50 degrees or better, and when afternoon temperatures are likely to reach at least 60 degrees. The lines on the map below show the last dates these temperatures are reached in the fall, indicating the end of the boating season. With a little guesswork you can estimate the beginning and end of the season for any point between the lines. ★★★

. . . and Ends

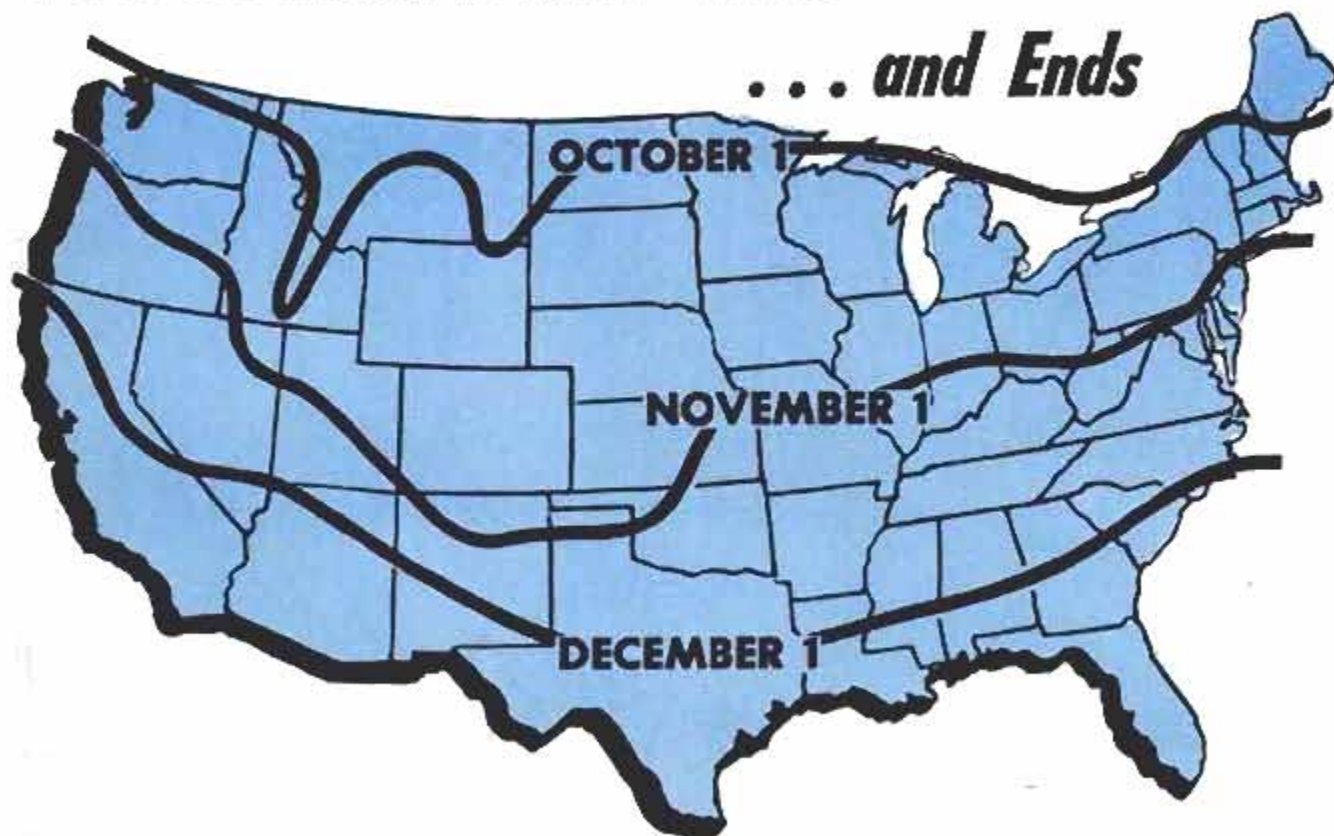

WHAT'S NEW IN **BOATS**

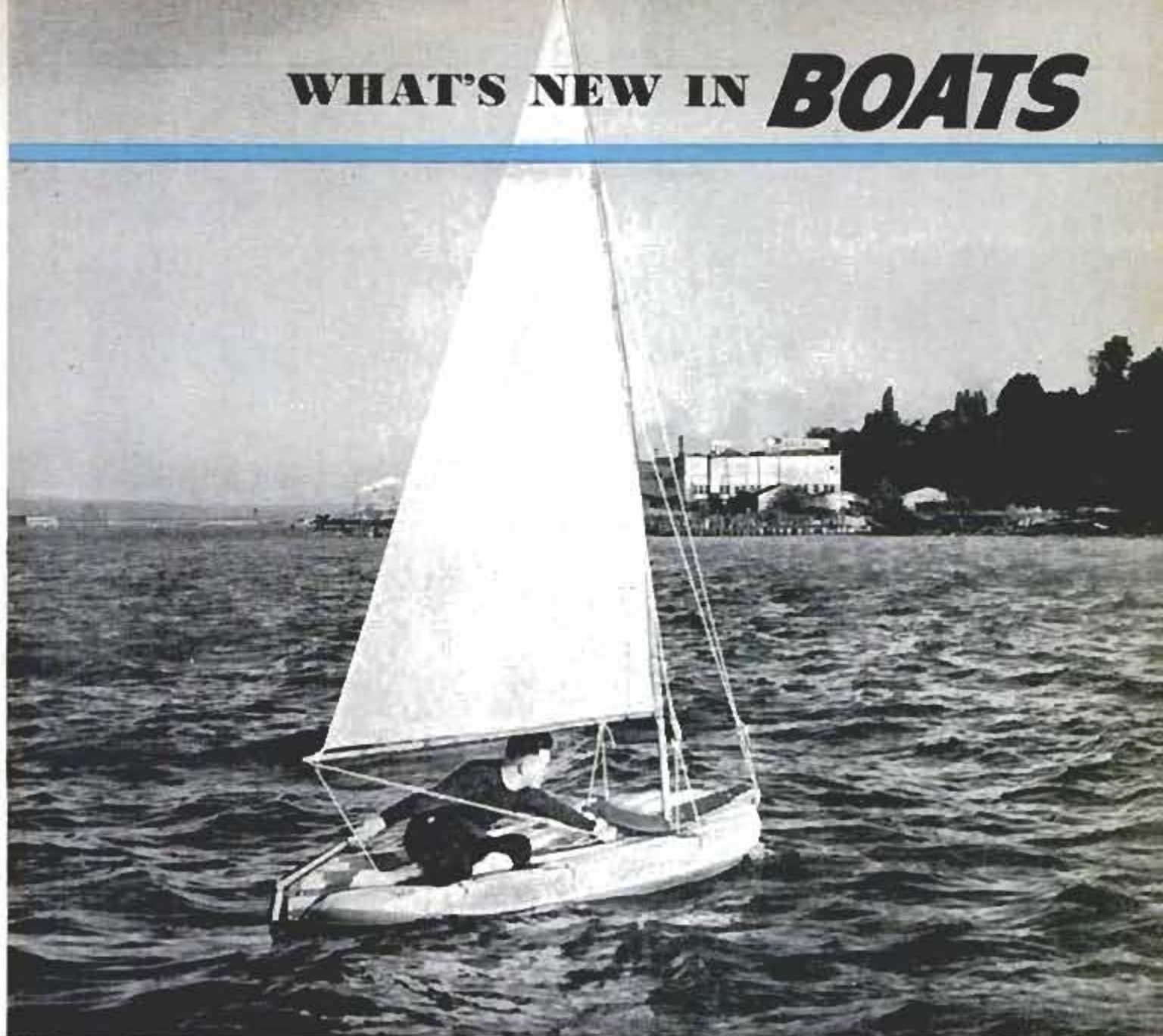

SAILING SAUCER, above and left, is basically an inflatable play raft that can be rigged as a sailboat. Hull consists of two fabric sections in a mahogany frame. Bamboo mast is stepped into the framework.
Yogi Yachts, Midway, Wash.

POWER SKIS, right, combine the fun of skiing and boating. The skis, 10 feet long, will support 300 pounds. Powered by a 25-horsepower motor, they give the skier a fast run in calm waters.
Martin-E-Products, 3030 Bridgeway, Sausalito, Calif.





MICROBOAT provides thrills for small-fry boaters. Only seven feet long, it is made of glass-reinforced plastic and weighs 60 pounds. Thus it can be man-handled by young boaters themselves. Motors up to five horsepower are recommended for the little craft

F. K. Howe Co., Muskegon, Mich.



MORE FUN FOR KIDS is a tiny craft shaped like a bathtub. Made of expanded plastic, it weighs only 15 pounds. Completely filled with water, it still will support a 250-pound man. Ashore, it becomes a wading pool, a windbreaker or even a sunshade

Jay V. Zimmerman Co., 7933 Clayton Rd., St. Louis 17, Mo.



INFLATED RUBBER BOAT is only 83 inches long, has a transom framework to hold a small outboard motor. It seats two, has a total capacity of 400 pounds, is readily collapsed and easy to carry

Little Normie Mfg. Co., 5 E. 1st St., Atlantic, Iowa

STEAM-PROPELLED DORY will carry old-timers back to the quiet days of hissing steam and the odor of hot oil. Boat glides along under the power of the single-cylinder, double-acting, reversible steam engine, shown in the inset, which burns butane

Frostline, 1272 Wellwood Ave., Beaumont, Calif.

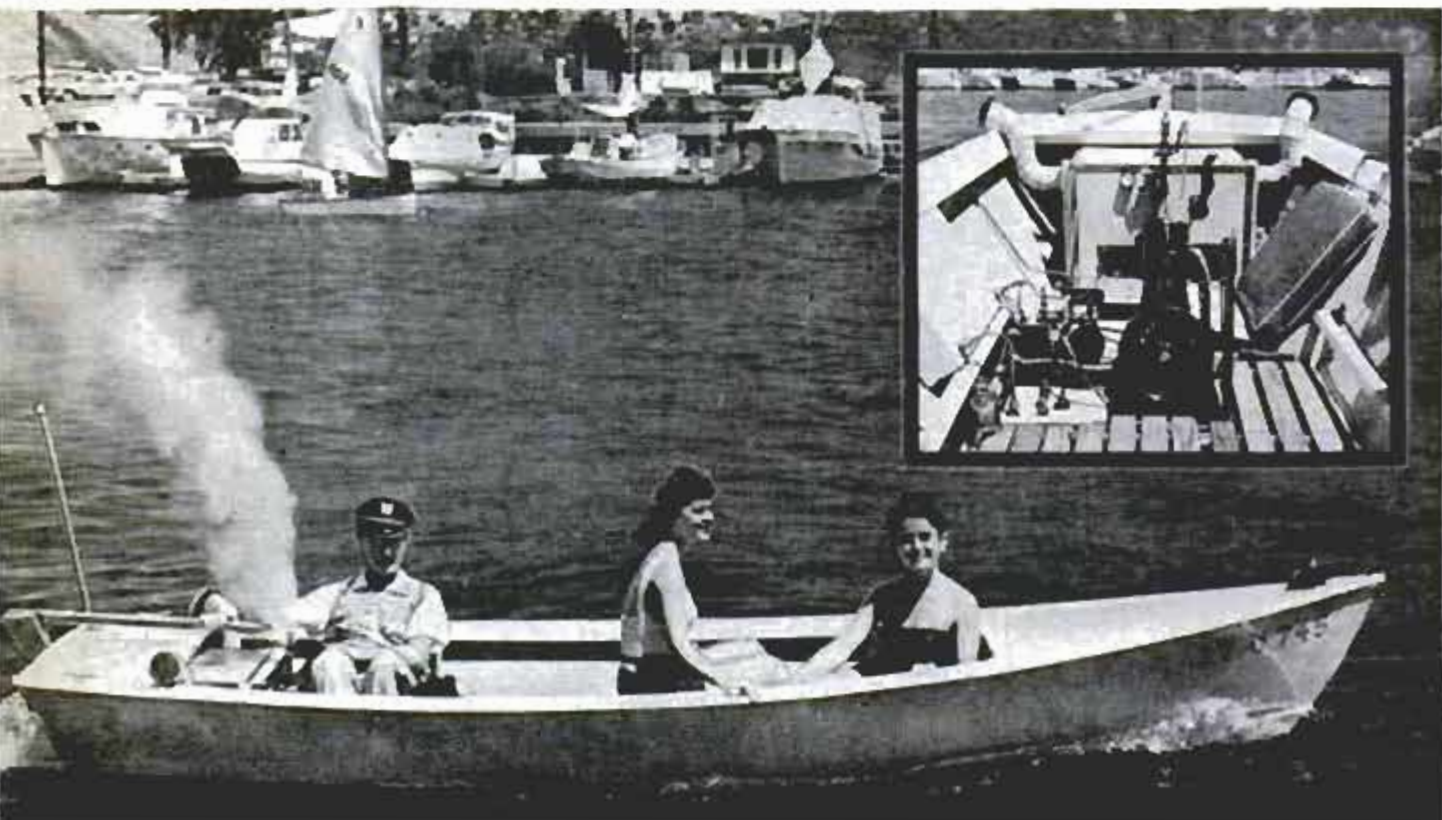



AMPHIBIAN provides a mobile home afloat or on the highway. Built-in wheels are lowered when the craft is converted into a house trailer. The 25-footer sleeps four, has a refrigerator and stove. Steel hull is divided into five compartments
 Har-Mac, Inc., Stratford, Wis.

FUN FOR LOAFERS is this high-platform craft designed for slow cruising, swimming or just plain relaxing. The "hull" and superstructure are both made of aluminum tubing. The unique craft is 21½ feet long, can handle motors up to 30 hp.
 Rain Chief Irrigation Co., Inc.,
 P.O. Box 587, Grand Island, Neb.

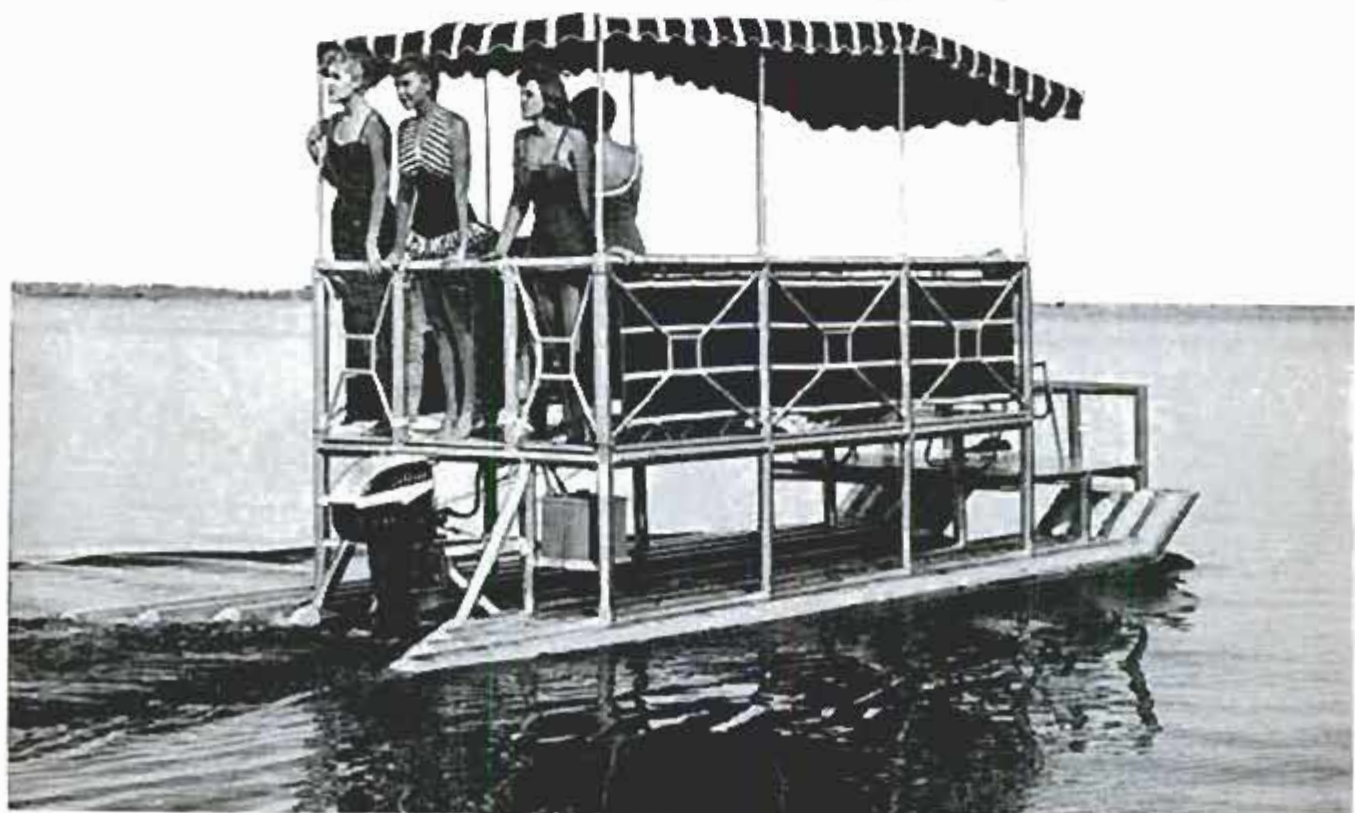



BOARDING STAGES—platforms hinged to the transom—long have been a common sight on Australian boats. Now they are becoming popular in this country. You can swim and dive from the stage (above), use it for gaffing and cleaning fish, or as a boarding platform for swimmers and skiers. A small-size stage, left, permits outboarders to work on propellers

Carpeo Marine, Inc., P. O. Box 3272, Jacksonville 6, Fla.



GASOLINE CADDIE, below, makes it possible for you to wheel fuel to the boat, then pump it into the tank. It rolls easily on large rubber tires, has a hand pump for filling the aboard-boat tanks

Handling Equipment Mfg. Co., Wixom, Mich.

VARIABLE-PITCH PROP permits you to "dial" best propeller pitch for trolling, skiing, cruising or racing. The prop, 10½ inches in diameter, can be varied in pitch from 9 to 15 inches. It can be installed on 25, 30 and 35-horsepower motors of various makes

Lesnor Maehr Marine Co., 118 Cherry Lane, Floral Park, N. Y.

TRANSOM WHEEL gives you a big lift in moving your boat. Clamped to the transom, it permits one man to wheel a small boat along the shore or pier on an easy-rolling semi-pneumatic tire. There are several sizes available to fit transoms of various heights

L. and R. Products, 52 Lake Rd., Framingham, Mass.



OUTFITTING YOUR BOAT?

ROLL-OUT CARRIER takes much of the work out of loading or unloading a boat. Steel rails are held above car top by four brackets. Rails slide out to support the boat well beyond the side of the car during the loading or unloading operation

Plantico Co., 1405 Spring St., Manitowoc, Wis.



BOARDING LADDER folds to the size of a shoe box for easy storage. To install the ladder you simply drop the bottom end over the side, slide steel knobs on the top end into sockets secured to the hull. Rubber tips prevent scratches on hull

Marine Products Div., Detroit Stamping Co., Detroit, Mich.



CAR RACK permits one person to load or unload boat. Axle with two wheels clamps to transom for easy handling ashore. To load the boat, bow simply is placed on rollers and boat is rolled onto top of automobile

Mayville Boat Carriers, Inc., Mayville 10, Mich.

WATER-SKI BOAT has special built-ins to aid the skier. Ski mast, right, fits into a socket near transom, holds line high to eliminate fouling. The 15-foot craft also sports a hinged ladder for boarding, a reversible front seat for watching skier's signals, compartments for storing gear

Switzer-Craft, Inc., Crystal Lake, Ill.

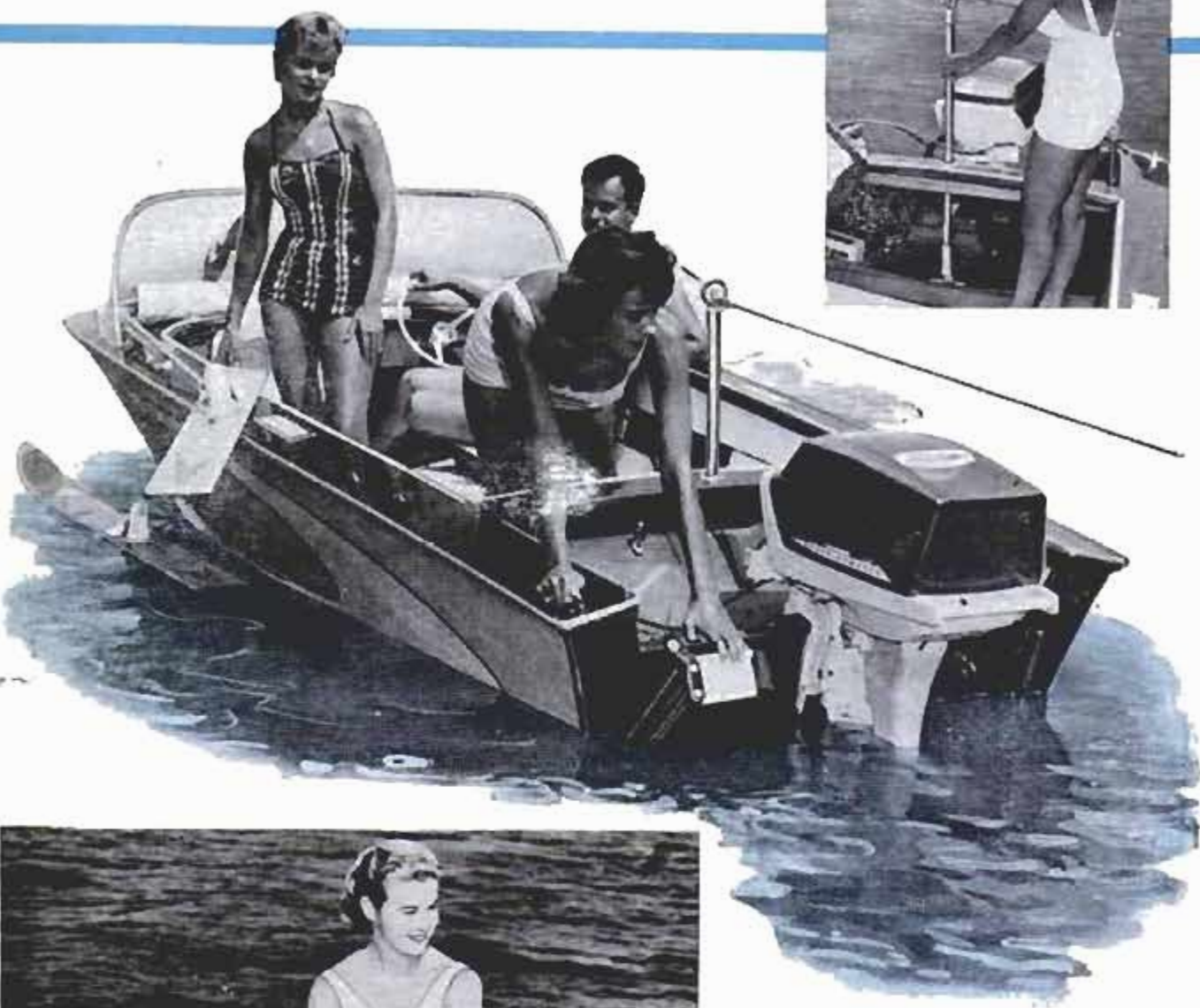

←**LAUNCHER** (also shown on the cover) eases skier into the water after boat has attained skiing speed, eliminating beach or dock starts. Skis are parallel with surface until skier trips a hydraulic mechanism which lowers skis into the water in the proper position. Launcher mounts on any boat over 16 feet and is easily removed for storage by releasing lockpin. Launchercraft Co., Inc., Box 1584, Yakima, Wash.

TOW BAR around motor, right, has an electronic "eye" that "watches" skiers for safety. Tow ropes are attached to the eyebolt, and a switch is flipped on. As long as there is drag on the rope, the signal is inactive, but as soon as the skier lets go or falls, a buzzer sounds an alarm. Thomas Die and Stamping Co., 2170 Walton Blvd., Pontiac, Mich.

WHAT'S NEW IN

WATER SKIING

BUOYANT SKIS, right, enable most skiers to start on top of the water. Made of glass-fiber plastic, the skis are hollow. Because of their buoyancy, they permit skiing with low horsepower. An added safety feature is that they will support a dunked skier in the water indefinitely.

E-Z Plastics, Inc., Blue Earth, Minn.

TOW TRIANGLE floating behind the boat below eliminates the slack that a regular V-rope creates just as the skier starts to come out of the water. The triangle, made of aluminum, floats and has a connecting swivel to prevent rope twists.

Thompson Skis, Inc., Crivitz, Wis.

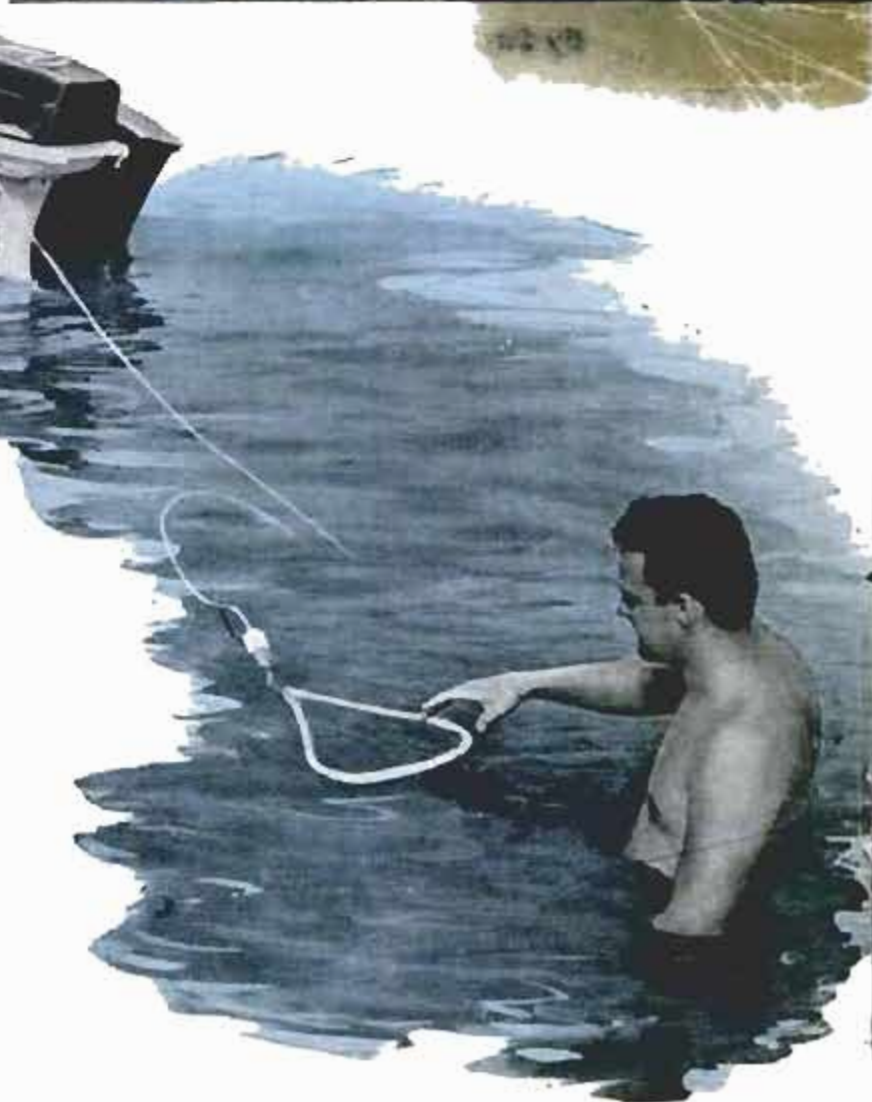



Photo courtesy Mercury Outboard Motors

Small pontoon boat powered by 60-hp. outboard motor demonstrates its versatility by towing water skiers

VERSATILE PONTOON BOATS

*can be fitted with a variety of superstructures
for comfortable camping, hunting or fishing
and even for summer living on lake or river*

X77

By Earl Wobeck

PART I

ONE OF THE LATEST trends in outboard boating is the pontoon boat. Due to its large amount of deck space, it can be a seagoing patio, camping tent, summer cottage or whatever the owner chooses to add to the basic unit. The latter generally consists of two pontoons and a deck and railing, which can be purchased in a number of sizes from several companies at about the cost of a good 15-ft. runabout. For those who wish to build their own boat, construction plans for a 23½-ft. model are included in this article. The completed boat is shown in Figs. 3 and 5.

To the basic unit of any pontoon boat

you can add an awning for protection from the rain and sun as in Fig. 1. There is enough room on board for a chaise longue or cot, or for a card game around a table large enough to accommodate at least six people. For a family that desires cruising accommodations, a cabin complete with head and galley can be built on the deck as in Figs. 2 and 11. In some cases, an extra pontoon may be required to provide proper flotation for the added weight of cabin and furnishings.

For the hunter or fisherman who wishes to trail the boat frequently, such as on week ends, a cabin-type tent may be set

Photo courtesy Gennett & Sons, Inc.



up on deck at the launching place. Manufactured boats are launched from a trailer in the same manner as runabouts and outboard cruisers are handled. The PM boat is built in units that can be loaded easily in a box trailer, Fig. 4, for transporting to a lake, where it can be unloaded and quickly assembled on the water.

These craft can be outfitted to provide safe boating for the entire family. Because of their sturdy construction and extremely shallow draft they can be run up on a beach or tied to a tree on a riverbank. The motor will pull the boat off the beach when shoving off. Speeds range from 10 to 20 m.p.h., depending upon the size of boat and motor.

The PM boat can be made for about the price of a good boat trailer. Construction is simple but strong, using inexpensive, readily obtainable materials. Except for an arc welder, no special tools are needed, although a saber saw will save a great deal of time and effort. A 110-v. a.c. welder in a 40 to 100-amp. size is adequate for this project since none of the welds requires electrodes that are



Above, typical of pontoon boats, PM boat appeals to all ages and is easily handled by means of remote controls mounted on steering station



Above, PM boat disassembles into easily handled sections for hauling in rented box trailer. Fig. 5, 35-hp. motor pushes boat at 12 m.p.h.

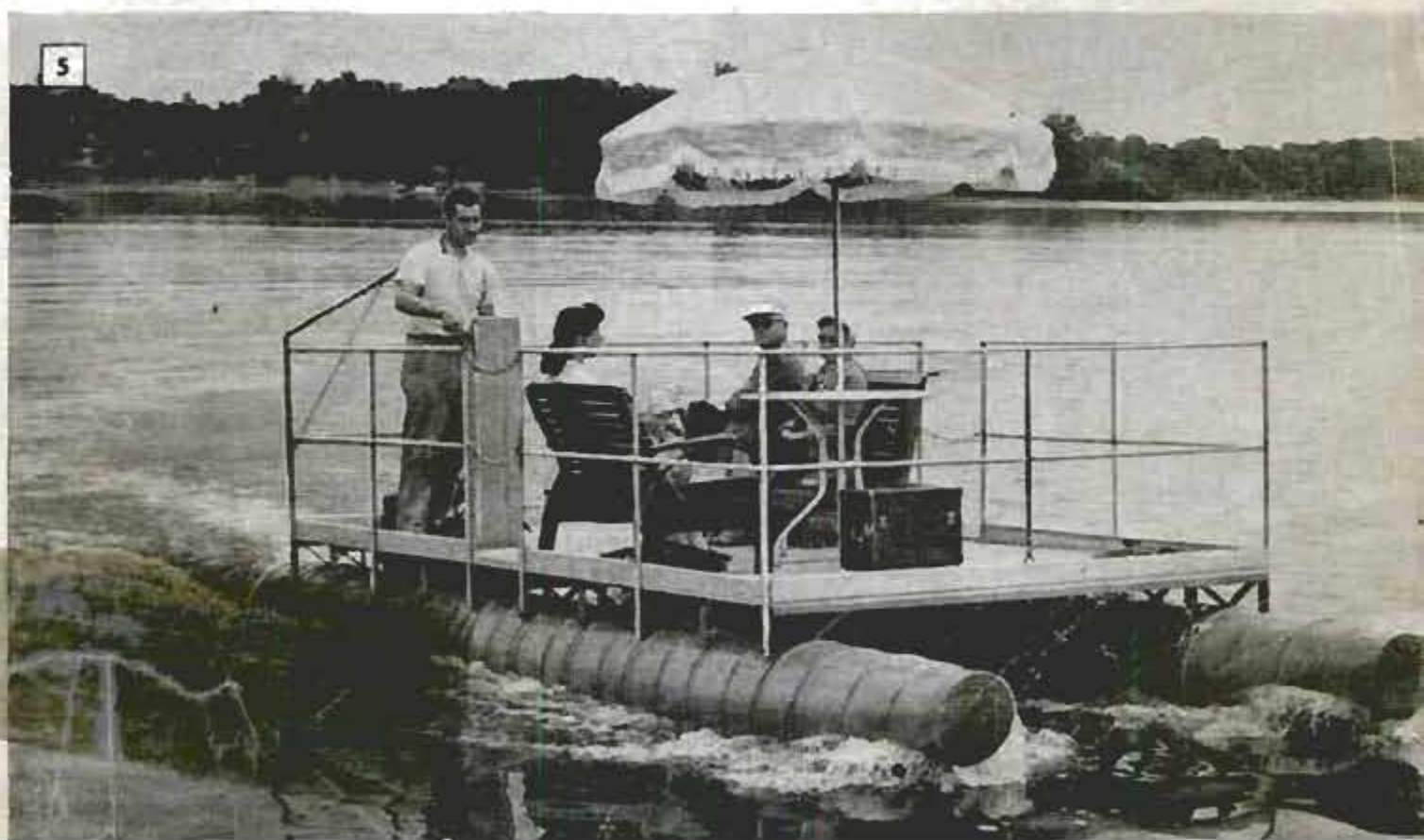



6

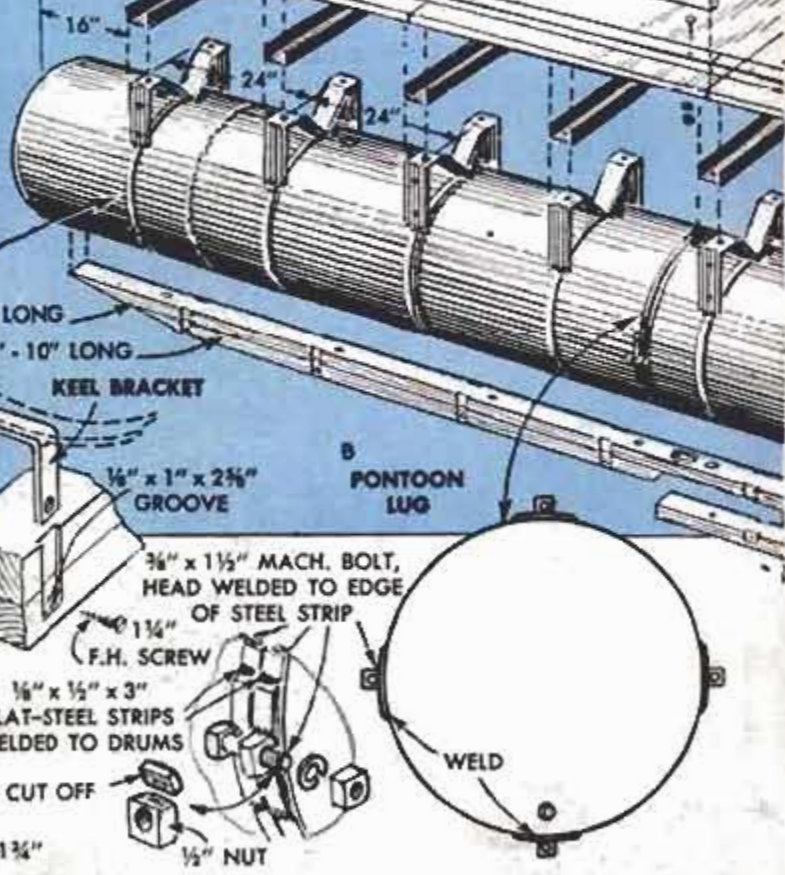
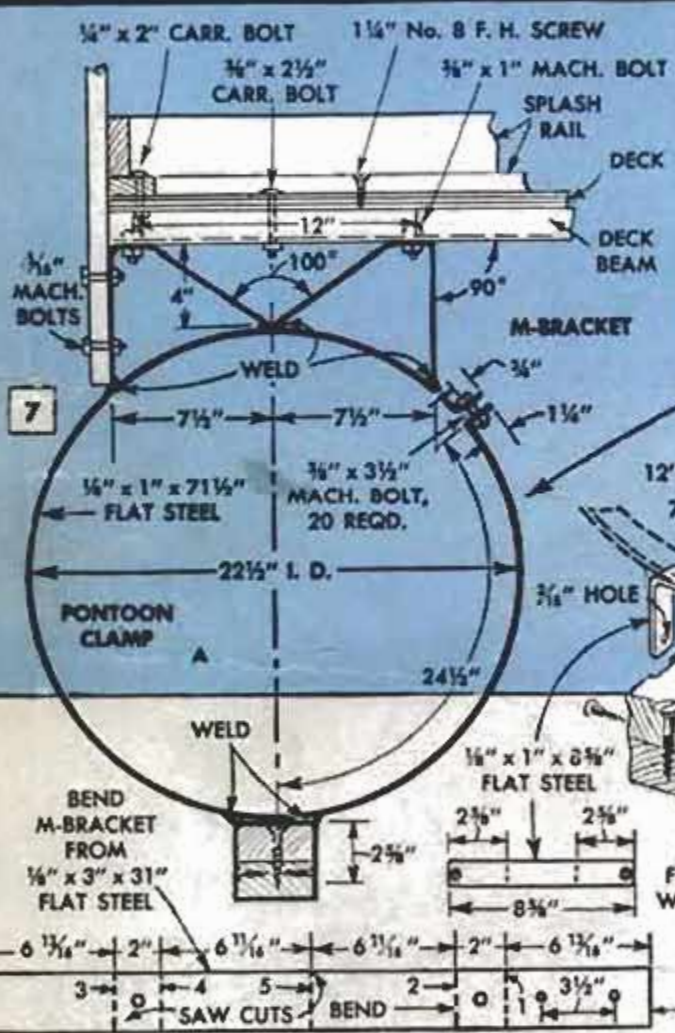
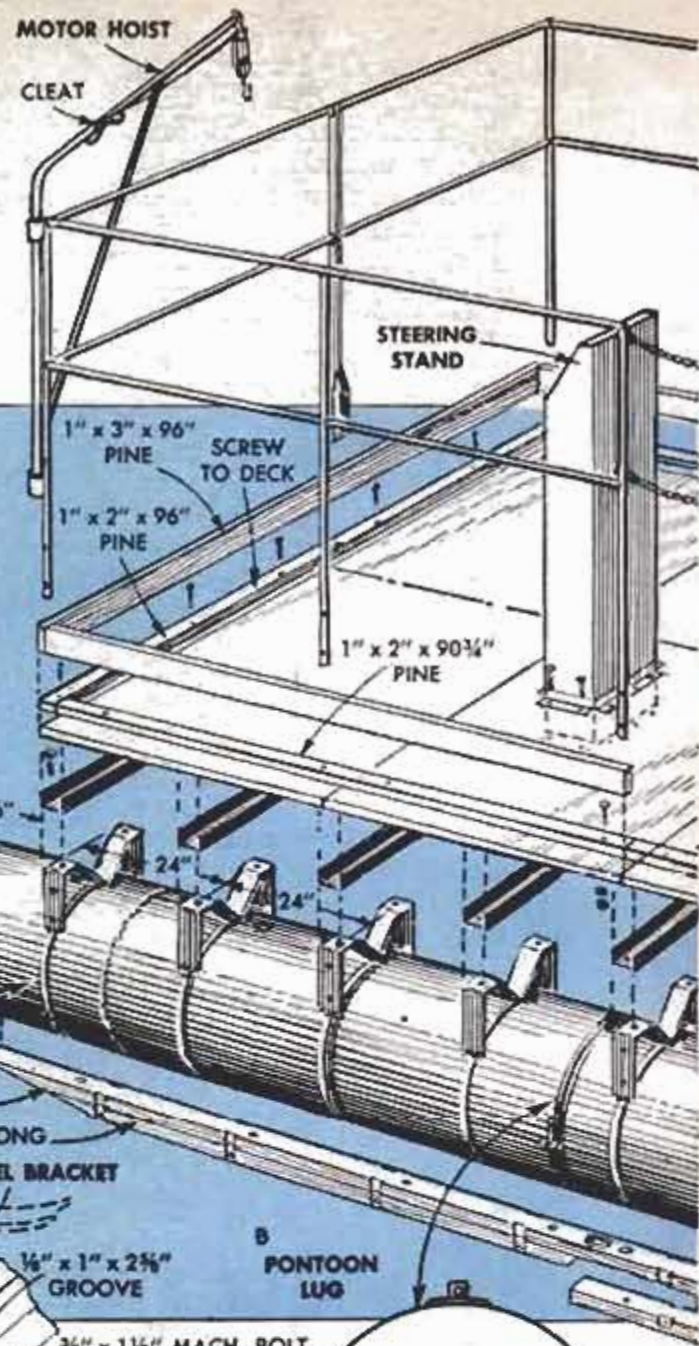

larger than $\frac{3}{16}$ -in. dia. Mild-steel-coated electrodes (Hobart "13") produce strong welds and are easiest to work with for this purpose. If you have never operated an arc welder, make practice welds on metal of the same thickness as that which is used in construction of the boat. An hour's practice is about all you need to make passable welds.

Making the pontoons

Each pontoon is made from 55-gal. steel drums welded together end to end to form three sections. Three drums are used for the stern section, three for the bow section

and two for the center section. All are closed-head drums, except for the one that is used to form the bow which is open at one end. The sections are bolted together by means of lugs welded to section ends that butt together to form a rigid pontoon as shown in Fig. 9, and detail B of Fig. 7. Most used 18-ga. steel drums are suitable for this purpose. They do not require cleaning or reconditioning, but should not have been used as containers of flammable liquids. However, it is important that all drums be of the same diameter and length so that the flanges at the side match when bolted together, also to ensure that the over-all

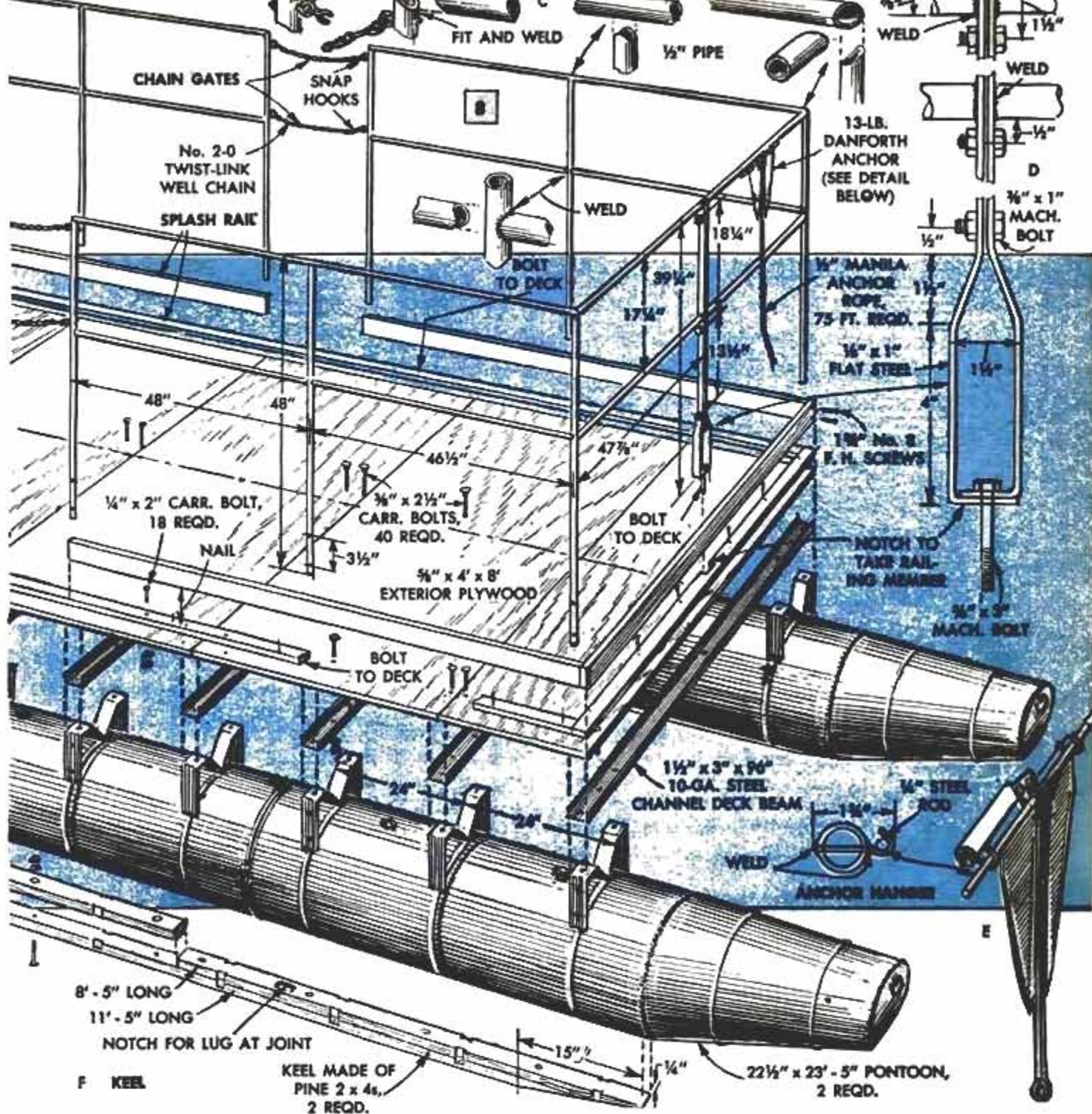

lengths of both pontoons will be the same. Drums of slightly different lengths may be used as long as they are paired off opposite each other in the pontoons according to length. Drums having bungs on the side should be used so that air pressure built up inside when welding can be released. Position the drums so that the filler caps are located on top of the pontoon on the centerline as shown. Before welding the drums together, be sure end caps are turned tight to prevent them from leaking. It is only necessary to make butt welds about 4 in. long where drums are joined together, spaced to match the lug locations.

The angled portion of each bow section is

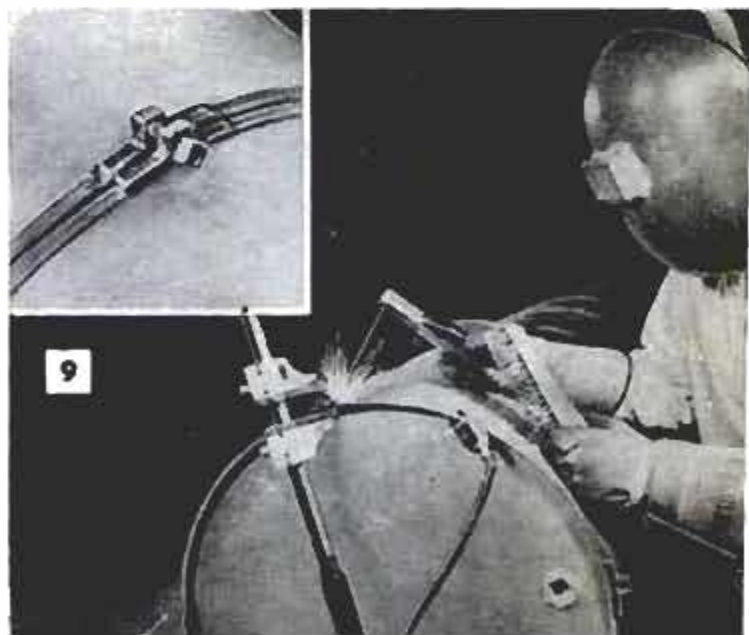

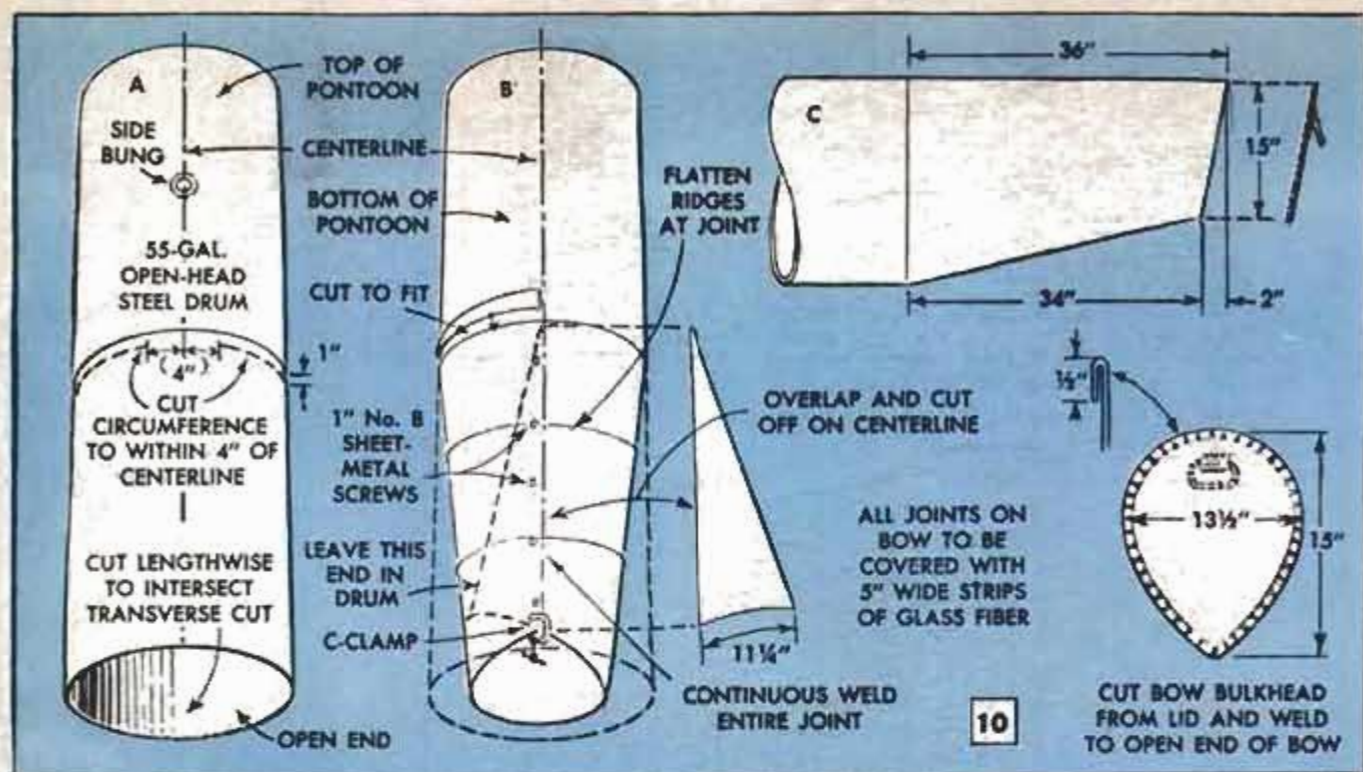

formed from an open-head drum, one having a removable lid as shown in Fig. 10. Before cutting the drum for shaping, weld the closed end to the drum that is next in line on the pontoon to avoid distorting the bottom flange, detail A. Note that the uncut portion of the drum's circumference is located so that the pontoon centerline bisects it and the side bung on the drum is aft of it. The finished dimensions of the bow are given in detail C. Shaping is done simply by compressing the open end and holding it in position with a C-clamp as in detail B. The metal that overlaps the centerline and circumference cut is cut away and the metal at the centerline joint

is drawn together with sheet-metal screws for welding as in Fig. 6. It is not necessary to make these joints watertight by welding since they are to be covered with glass fiber.

The bulkhead that covers the open end of the bow is cut from the drum lid. Before doing this, make a template by holding a piece of cardboard against the bow opening and tracing around it. Add 1/2 in. on all sides of the template to permit bending over the edges of the bulkhead to provide two layers of metal as detailed in Fig. 10. The doubled metal dissipates more heat from the welding arc than when a single thickness is used, thus lessening the

Lightweight cabin built on pontoon deck provides inexpensive summer living afloat for entire family

Photo courtesy Holland Pontoon Boats



chances of melting holes in the metal. When outlining the bulkhead on the lid, position the template to locate the lid handle at the top as indicated. After cutting and fitting the bulkhead, tack-weld it in place and then run a continuous bead around the joint. The latter is covered with glass fiber to make it watertight.

Next make the pontoon clamps and M-brackets as shown in Fig. 7, detail A. The M-brackets are welded to clamps, rather than directly to the pontoons. This results in a stronger boat and also makes it easier when it comes to assembling the deck beams and deck. After the M-brackets and clamps are completed, they are welded together and placed roughly in position on the pontoons in readiness to be drawn up tightly after the deck is assembled on them and properly aligned. Once the latter is done, the clamps need never be moved. Note that pontoon clamps are spaced 24 in. on centers, except for the end ones which are 22½ in. on centers. All holes should be drilled in these parts before bending, using a jig for accuracy and to save work.

The M-brackets are easy to form. Carefully mark the points at which bends are to occur and make ¾-in.-deep saw cuts in each edge of the material at these points for accurate, small-radius bends. Saw cuts are welded shut after the brackets are formed.

Wooden keels protect the bottom of the pontoons and cover the lugs at the bottom. They are made from pine 2 x 4s screwed together and assembled in two parts as shown in detail F, so that no member is too long for hauling when disassembled.

Deck and Railing

The 8 x 18-ft. deck consists of four 4 x 8-ft. and one 2 x 8-ft. panels of 5/8-in. exterior plywood that are bolted to steel-channel deck beams as shown in Fig. 8. The splash rail consists of 1 x 2 and 1 x 3-in. furring strips nailed together to form six sections. Bow and stern sections are screwed to the deck, while side sections are bolted to the deck. The four-piece railing is made of galvanized pipe and lengths of 1/8 x 1-in. flat steel. The latter is welded to facing ends of the railing at the bow and stern for clamping the sections together, detail D. All uprights are 3/4-in. pipe, horizontals are 1/2-in. pipe. Joints must be properly cut and fitted for strong welds, detail C. A 13-lb. Danforth anchor will provide ample holding for most bottoms. The anchor can be hung on the railing by providing two hangers for it as in detail E. Construction of the motor hoist, outboard mounting board, steering stand and installation of controls will be explained in part II next month.



Outboard Can't Slip off Boat When Chained to Transom

To prevent your outboard from accidentally slipping off the transom when under way, Johnson Motors recommends chaining it to the boat. The best way of doing this is to bolt one end of a length of chain to the transom and secure the other end to the motor clamp screw by means of a snap-hook linked to it as shown. For motors that do not have a hole in the clamp screw, drill one in the latter to take the snap.

Grease Fittings on Wheel Hubs Ease Boat-Trailer Servicing

Keeping the wheels greased on a frequently used boat trailer no longer presents a servicing problem for one outboarder who installed a grease fitting on each of the hubs as shown in the photo and inset. Since the fitting must be located as far inboard as possible for proper lubrication, the wheel must be removed before tapping the hub to take it.—Lee H. Schrimpf, Tulsa, Okla.

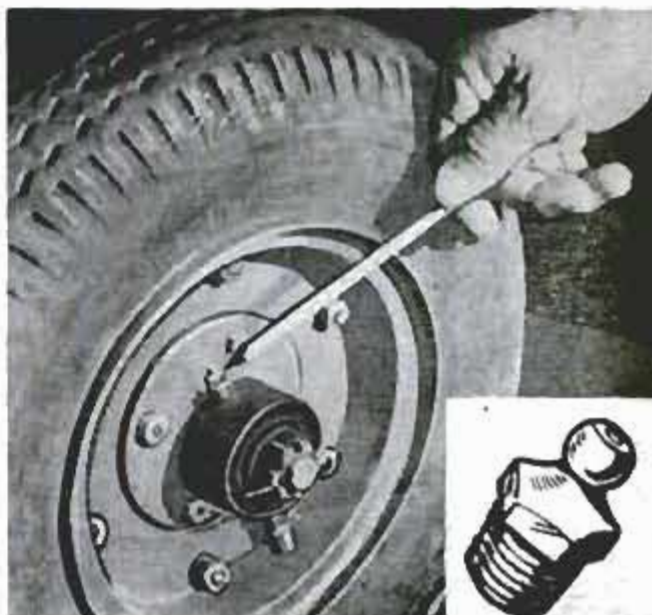



Photos courtesy Michigan Wheel Co.

In race between two identical boats and motors, one equipped with stock propeller and other having propeller recommended for boat and motor. Latter has big lead at end of the measured half-mile course

THE RIGHT PROPELLER WINS

Boating Annual, 1961

By Earl Wobeck

WHETHER YOU WANT to win races, or travel to a favorite fishing spot and back in the quickest possible time, your outboard should be equipped with a type and size of propeller that will permit the rig (boat and motor) to develop its maximum speed. A propeller that is too large for the rig prevents the motor from running within close range of the maximum rated r.p.m. recommended by the manufacturer, so that full power is not developed. A propeller that is too small permits the motor to exceed its maximum r.p.m. to waste power and damage the motor. Underdeveloped or wasted power means less speed, which is graphically illustrated by the finish of a comparative test between two identical boats and motors as shown in Fig. 1. The winning boat differs from the loser in only one respect—the propeller that came with it was replaced with one better suited to the rig.

To make available a good selection of propellers for many specific boat and motor combinations, propeller manufacturers design and test new ones each year as soon as motor manufacturers place their new models on the market. Shown in Fig. 2 are seven propellers, each having slightly different design characteristics, that were tested by Michigan Wheel Company's field

staff to determine the one that would afford maximum effectiveness for a given rig. When satisfied with test results on a propeller, it is placed in production and kept in stock, as are similarly tested propellers for most popular motors. To obtain a propeller that best suits your needs, consult one of the propeller-selector lists that are available from the manufacturers. Then, to further improve the performance of your rig, some testing will have to be done on your own, since the replacement propeller you order undoubtedly was tested on a rig that differed to some degree from your own.

Testing the efficiency of a propeller is easy when you have an understanding of the way in which it moves the boat through the water. It does this very much like a propeller on an airplane, except that the medium in which it is operated is water instead of air. The blades of a propeller are set at an angle on the hub so that when rotated they bear against the water, which forces the propeller forward to the extent forward thrust is developed by the speed of rotation. Since the propeller is connected to the motor and the latter to the boat, the entire unit is driven through the water.

The size of a propeller is always referred to by pitch and diameter. To find the diameter of a propeller, double the distance



Several propellers, each having slightly different pitch, diameter or blade characteristics, are test-driven to determine the one that will give best over-all performance for given motor, hull, type of service and load

in inches from the tip of one blade to the hub center. Pitch is determined by the number of inches the propeller would move forward through a solid in one revolution, Fig. 7. Since it never travels this far in water, the speed the boat would attain if it did is the rig's theoretical speed. The difference between the latter and the actual boat speed is referred to as propeller slip. Slip should be from 15 to 30 percent, depending upon the type of hull being driven.

Here is the way you check propeller slip: An accurate speedometer and a tachometer are needed, the former to check boat speed and the latter to determine propeller shaft r.p.m. First note the r.p.m. and boat speed when moving at a constant speed as indicated by the tachometer and speedometer. Divide the r.p.m. figure by the first number of the motor's gear ratio (for a ratio of 2:1, divide by 2) and multiply the result by the propeller pitch number

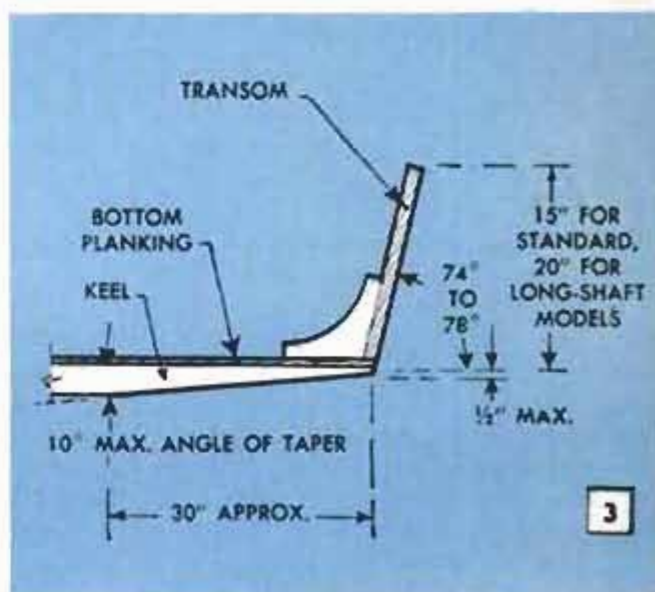

Above, sufficient submergence of lower unit of motor is necessary to prevent cavitation and power loss. Below, tilting motor to correct angle in relation to water surface is important for optimum performance

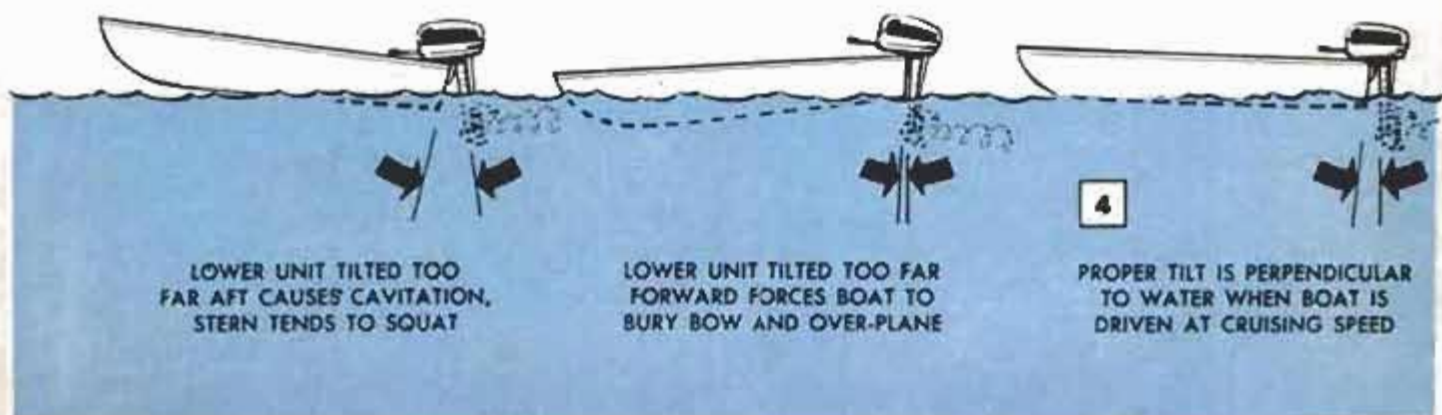

LOWER UNIT TILTED TOO FAR AFT CAUSES CAVITATION, STERN TENDS TO SQUAT

LOWER UNIT TILTED TOO FAR FORWARD FORCES BOAT TO BURY BOW AND OVER-PLANE

PROPER TILT IS PERPENDICULAR TO WATER WHEN BOAT IS DRIVEN AT CRUISING SPEED

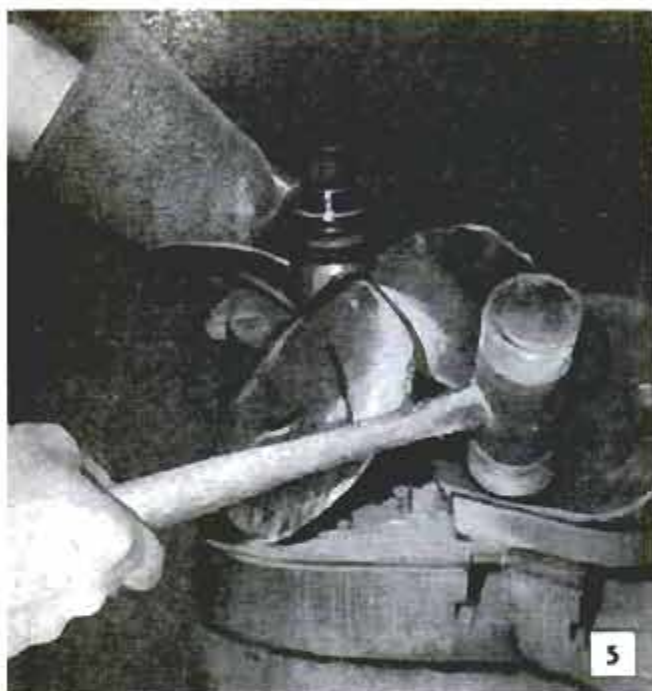

Damaged propeller blades are straightened and trued on pitch block, a job for the professional repairman

for the theoretical forward speed rated in i.p.m. After converting this to m.p.h., subtract the boat speed for the slip in m.p.h. Divide the slip figure by the theoretical speed for the percentage of slip. If slip is excessive, try a propeller having proportionately less pitch than diameter, keeping in mind that a propeller having two blades has less blade area than one having three blades when the given diameter is the same for both. If slip is less than normal, less blade area and more pitch usually are required. To get the right combination of pitch and blade area, it may be necessary to change from a two-blade to a three-blade propeller, Fig. 9, details A and B. Normally, four-blade propellers should be used only for heavy-duty applications, detail C.

When selecting a propeller consider the advantages of having one that is equipped with a cushion hub, Fig. 8. The rubber in-

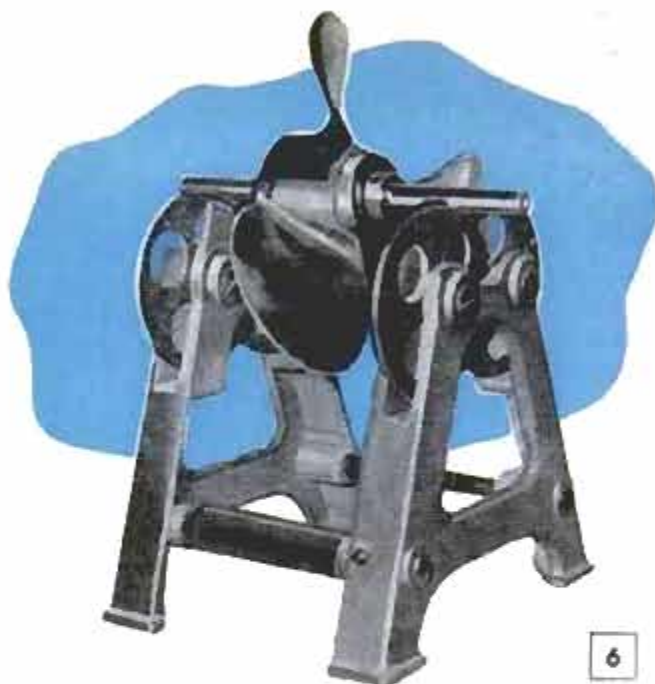

Repaired propeller is statically checked for balance to be sure it will not vibrate at high speed

sert rotates in the propeller hub only at the instant rotation is reversed, relieving strain on the gear assembly in gear-shift models, and reducing strain on the shear pin when an obstruction is encountered.

Propellers with damaged blades should be repaired by a competent workman using proper tools. To assure that a repaired propeller has its original pitch and blade contours, it must be straightened on a pitch block having the same surface design as the propeller blades, Fig. 5. A propeller that has lost metal from nicks must have the metal replaced by welding and then be checked for proper balance, Fig. 6. The balancing procedure is much the same as balancing a car wheel, except that metal is ground from the hub instead of being added to achieve balance.

Most important for obtaining full power from your motor is mounting it on the

Propeller pitch indicates distance in inches propeller would move forward through solid in one revolution

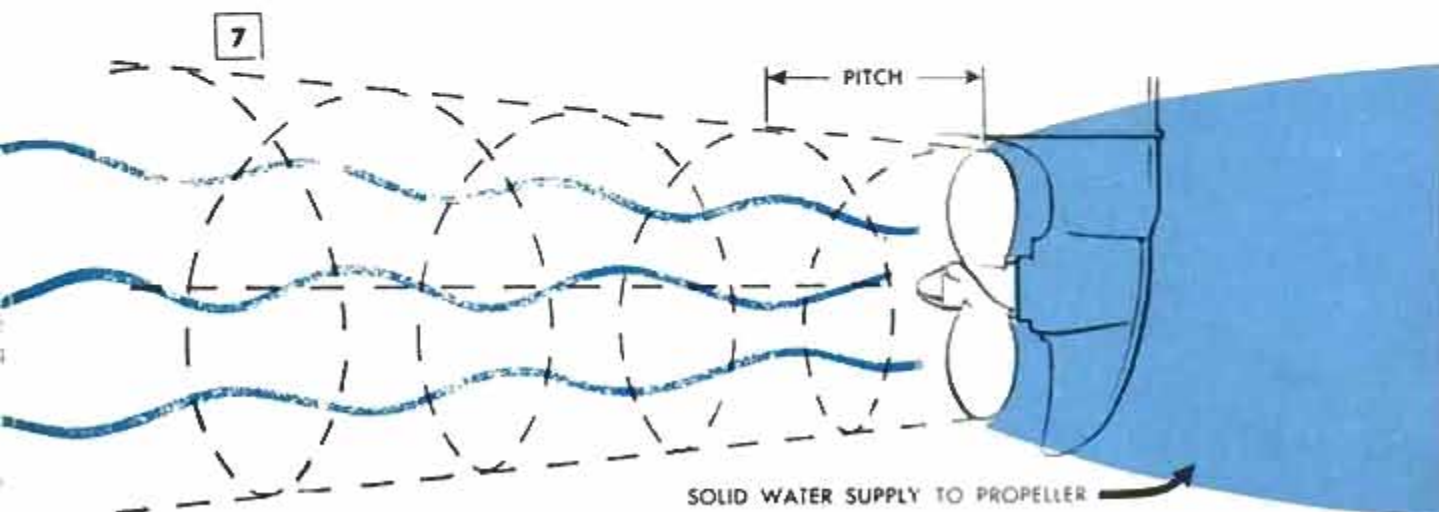

transom so that the lower unit is submerged sufficiently as indicated in Fig. 3. For most runabouts a good rule is to run the anticavitation plate slightly below the boat bottom. But avoid mounting the motor so that the lower unit is overly submerged which would cause drag to reduce boat speed. Also keep in mind that the deeper the motor exhaust outlet is submerged the greater is the build-up of back pressure.

Motor tilt is another important factor. When the lower unit is tilted too far forward, the bow will tend to bury itself and cut speed. Proper tilt for most rigs is with the drive shaft perpendicular to the water surface when the boat is at full speed. For maximum racing speeds the best motor angle is with the lower unit tilted back as far as possible without causing cavitation, a condition wherein the propeller draws air or motor exhaust gases and runs free. Most cavitation is caused by the motor being tilted too far aft or located too high on the transom. Other causes are a bent propeller, wrong propeller size and weeds on the lower unit.

If full speed is to be attained, the bottom of the hull should be straight from the transom to the point at which the bow begins its curve. When there is a substantial keel extending from the hull, the after end should be tapered from full size at a point about 30 in. forward to $\frac{1}{4}$ in. at the transom to reduce turbulence at the propeller, Fig. 3. Some rigs are so sensitive to weight distribution that inside ballast (unattached equipment) must be moved well forward to permit planing when medium to large motors are used. Design, power and type of rig vary so much that weight distribution is an individual problem. ★ ★ ★

Rubber cushion in propeller hub absorbs shock to protect shift gears and reduce shearing of pins

CUSHION HUB

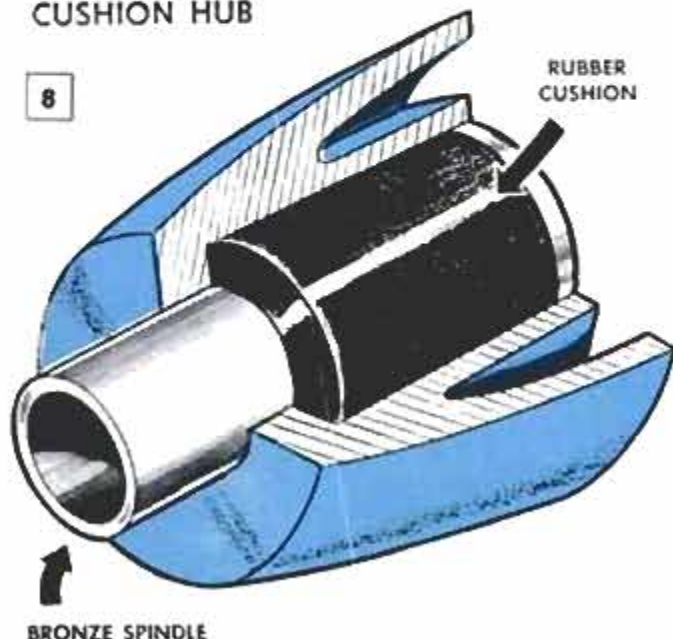

MARCH 1959

9



Above, most two-blade propellers are designed for service on motors used in racing craft and small runabouts where light loads are involved and high speed is of major importance

B

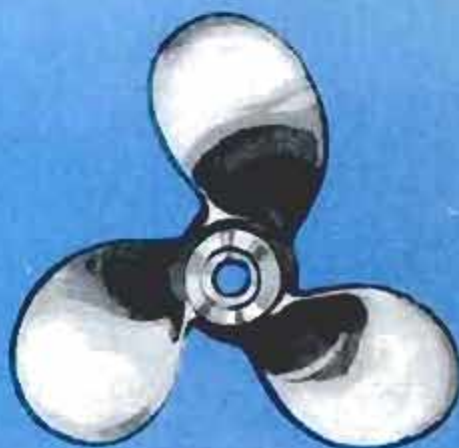

Above, three-blade propellers afford quicker acceleration and have better load-carrying ability than two-blade ones, which makes them ideal for family cruisers and water-skiing

C



Four-blade propellers provide more blade area in limited diameter to improve thrust, maneuverability, starting and stopping. Designed for use on motors of 15 hp. and larger, they are ideal for large cruisers and houseboats

167

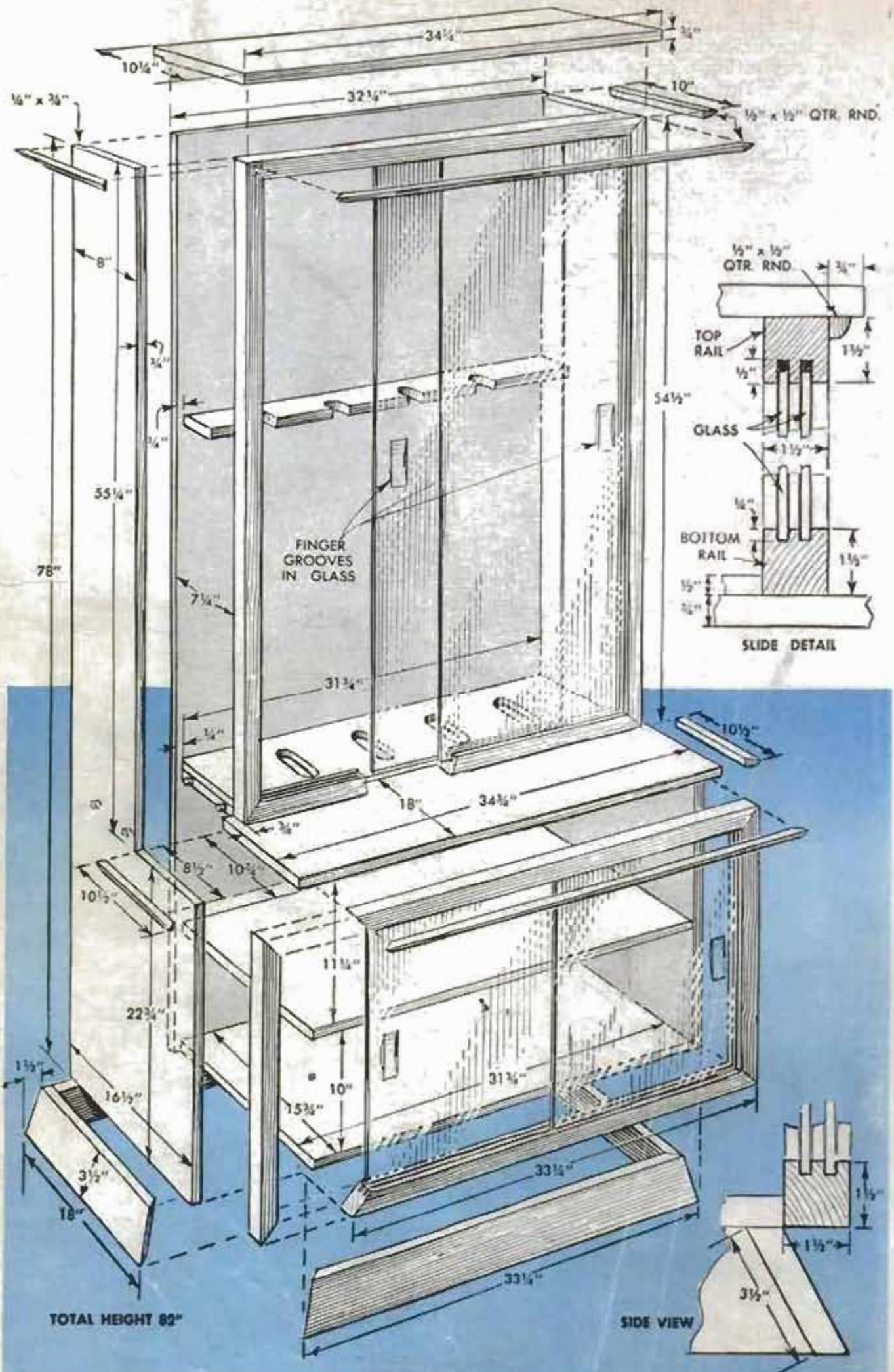

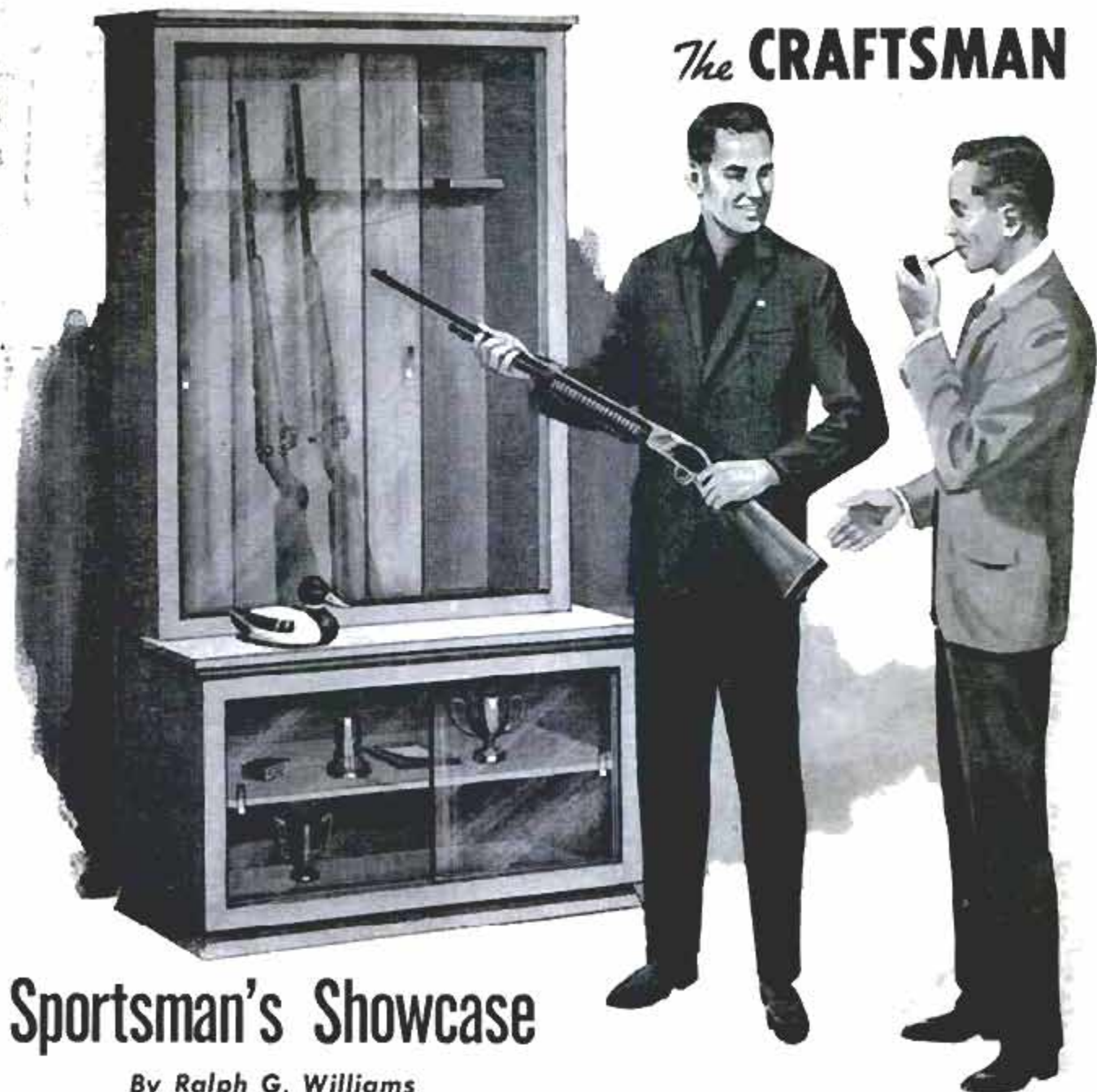

Sportsman's Showcase

By Ralph G. Williams

EVERY SPORTSMAN needs a place to display his equipment and trophies, and this cabinet fills that function in an attractive and practical manner. The upper portion of the cabinet, with slight modifications, can be used for shotguns, rifles and bows and arrows. The lower shelf of the cabinet is ideal for cups and trophies. Sliding glass doors protect the equipment and trophies, yet permit them to be seen easily. If there are toddlers in the household, it is suggested that a metal-mesh cover be fitted over the doors of the lower shelf, to prevent children from being injured should they fall against the cabinet. The original cabinet was made of solid mahogany, separate planks being edge-finished and glued together to form sheets wide enough for the required panels. However, $\frac{3}{4}$ -in. hardwood-faced plywood would do as well, especially as the design of the cabinet results in all exposed edges at the front

of the cabinet being covered with trim. After all the parts of the cabinet have been cut to the dimensions given, the two sides and the top are rabbeted to receive the back panel. This panel must be cut square and true, as the assembled cabinet is clamped and glued around it. Blind holes are drilled in the cabinet sides and the ends of the shelves to receive short lengths of dowels. When the cabinet is assembled, the dowels and shelves are glued in place with the other pieces. Each of the glass doors is $\frac{1}{2}$ in. wider than one-half the width of the opening into which it fits, and $\frac{7}{16}$ in. longer than the height of the opening (after the slides are in place). When the glass doors are ordered, have finger grooves ground in them as indicated. Each groove is located 4 in. below the center of each door, and 2 in. from the edge. The edges of the glass doors should be polished, so they slide easily in the grooves. ★ ★ ★

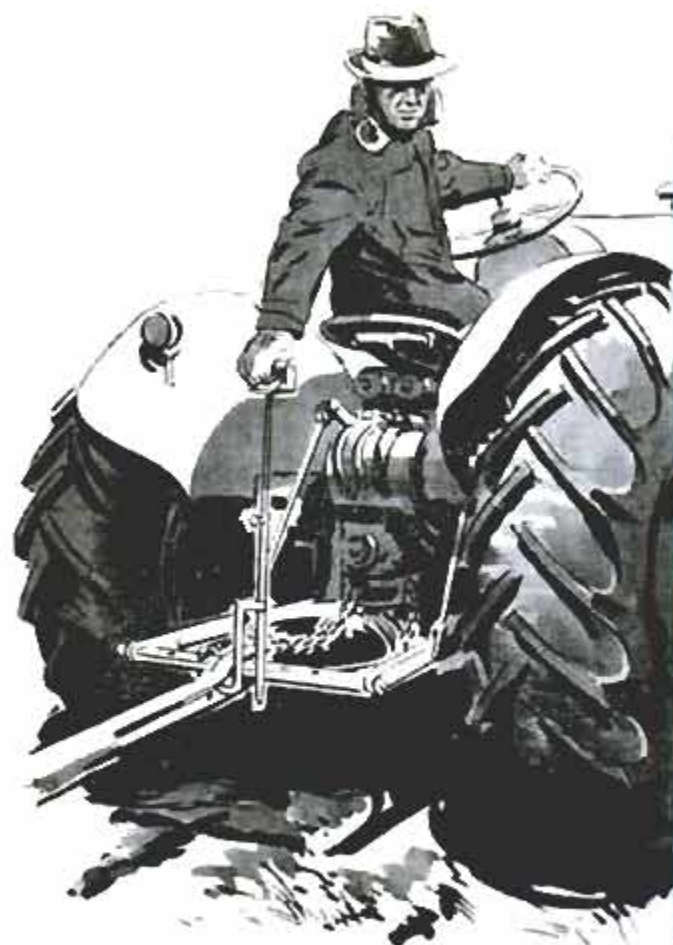

Tractor Hitch Pin Has Hook To Lift Towing Tongue



This hitch pin permits a tractor operator to couple and uncouple machinery without getting off the tractor seat. The tongue of the wagon or machine to be towed is lifted with the hook on the hitch pin, and the tractor backed into it, after which the tongue is locked to the tractor drawbar with a pin. As indicated in the detail, a telescoping handle allows the pin to be adjusted for tractors of various heights. A set-screw in the handle holds the adjustment. When the hitch pin is in continuous use, the handle may be removed. — A. M. Wettach, Mt. Pleasant, Iowa.

☐ Before painting over a knot in a wooden surface be sure to fill any cavities with wood putty, then apply sealer to prevent the resin in the knot from "bleeding" through the new coat of paint.

☐ Before nailing down boards on a porch floor, the underside of which is exposed to changing temperature and humidity, paint the boards so moisture will not enter and loosen paint on the upper surfaces.

Deburring Tool From Can-Opener

To quickly remove the burrs from the edges of sheet metal and plastic, use this simple tool. It is made by cutting or grinding a V-notch in the end of an opener of the type used on metal beverage containers. After the notch is formed, sharpen the edges with a file. To use the tool, simply draw it along the edges of the material as shown, pressing down firmly.

Frank A. Javor, Newark, N. J.



Vacuum Tests Wiper Motor

After repairing windshield-wiper motors of the vacuum-operated type, one mechanic tests them by using a household vacuum cleaner as a power source. Regular wiper-motor hose connects each motor to a length of tubing fitted in a wooden disk. During testing the disk is held against the end of the vacuum-cleaner hose by suction and requires no method of fastening.

R. Hanscom, Elmhurst, Ill.

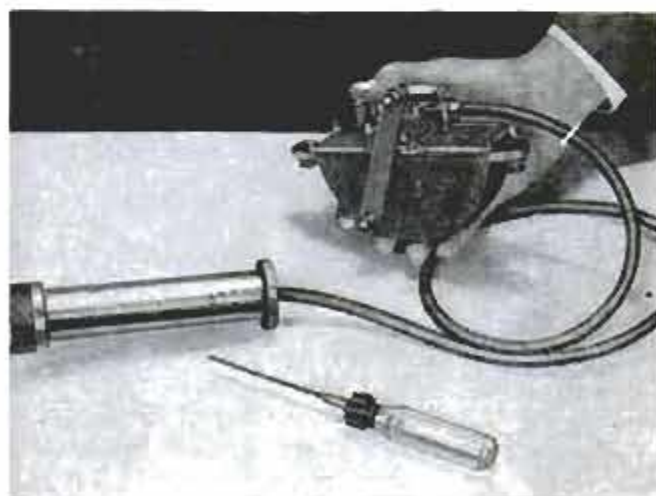

Two-Height Table

By Paul Corey

ESPECIALLY ideal for a small apartment where space is at a premium, this ingeniously designed two-height table is equally useful in a family room, on a patio, or any area utilized for both living and dining. Most of the time, as in Fig. 4, the unit is a coffee table, then at mealtimes it "steps up" to become a standard-height dining table, as in Fig. 1.

The "dual personality" is a result of two sets of pivoting legs. Each of the sets contains two L-shaped legs; one side of each set measures 11 in., the other 25 in. When the table is dining height, the short legs of the L-shapes are locked in broom clamps on the underside of the table as in Fig. 3 and Fig. 5. When the unit is coffee-table height, the longer legs are forced together, each set being slightly offset, as in Fig. 2. The latter arrangement will work for a table of the dimensions given in the details. Should a larger table be built, the longer legs also would require clamps to hold them in the "up" position.

Start by making the top of $\frac{3}{4}$ -in. material. Particle board or plywood is suggested, although strips of 1-in. stock could be glued together to form the surface. If the table is to be covered with a plastic veneer, the table apron can be butt-joined at the corners and the top butt-joined to it, as in Fig. 6, detail B. If the top is to be left natural, it is recommended that the corners be mitered and the top fitted in a rabbet as in detail A.

Legs for the table can be $\frac{3}{4}$ or 1-in. aluminum tubing, with fittings to match. Fittings for both sizes, called "Nu-Rail," are

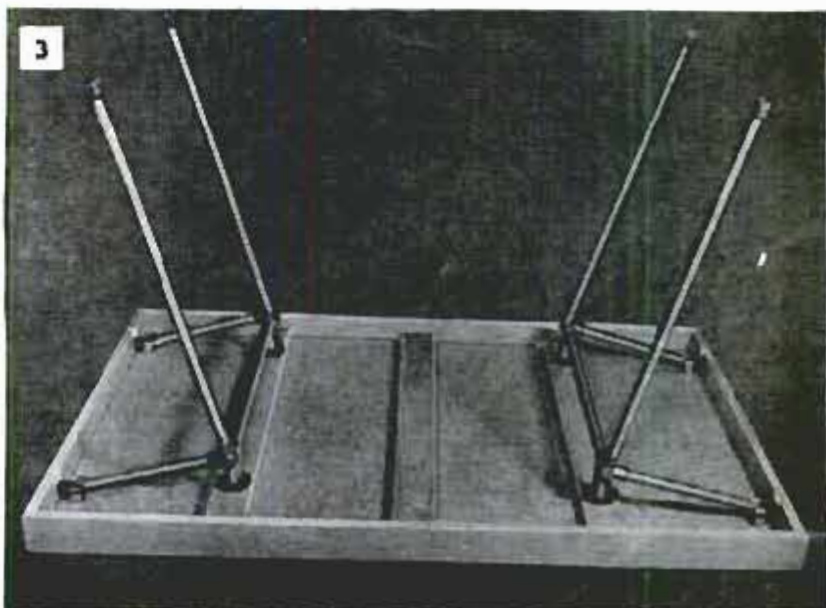
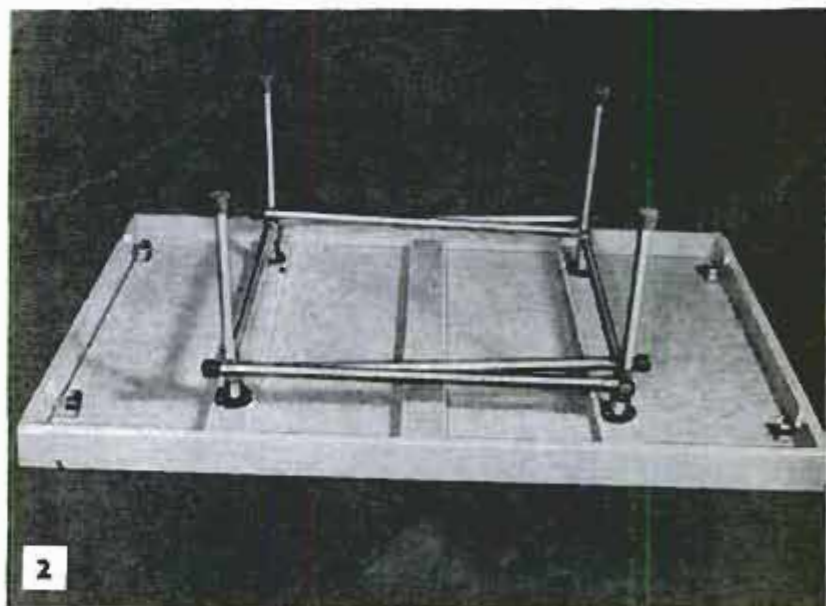

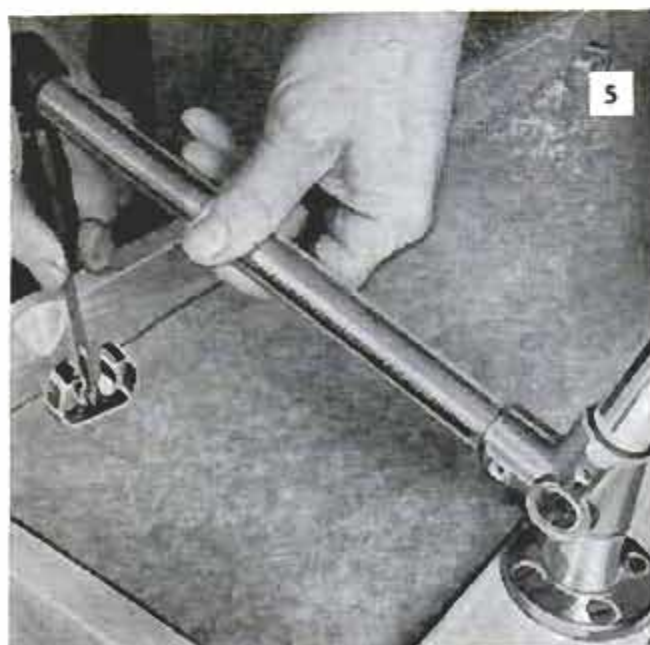

available, while another type, called "Slip-On," fits only 1-in. tubing. Pipe and fittings also could be used, but some fittings would have to be reamed for a slip fit. Regular slip-type fittings are held on the tubing by means of setscrews. Eliminating these screws in the four T-fittings required permits the leg assemblies to pivot in the T-fittings. After the four flanges have been screwed to the cross pieces on the underside of the table top, a 2 $\frac{3}{8}$ -in. length of tubing is fitted in each one. A T-fitting then is slipped on the end of each length of tube. Into the tees are slipped two 24-in. lengths of tubing, one for each set of legs. A side-outlet tee then is clamped on each end of the two cross pieces. Into one side of each side-outlet tee is fitted an 11-in. length of tubing, while a 25-in. length is fitted in the other side of the tee, providing the two lengths of legs. On the end of each of the legs, fit a rubber crutch tip. Check the clearance of the legs in the folded position. It may be necessary, as in Fig. 5, to notch the apron, when the short legs are folded against the underside of the table. Four plugs, or caps, now are snapped into the open ends of the two tubing cross pieces to provide a finished appearance.

For extremely heavy-duty service, such as a 2-height workbench, $\frac{3}{4}$ or 1-in. pipe and fittings could be used. In this case it would be necessary to ream out two pipe tees for a slip fit for the cross pieces. Pipe caps could be used instead of crutch tips for the leg ends. ★ ★ ★

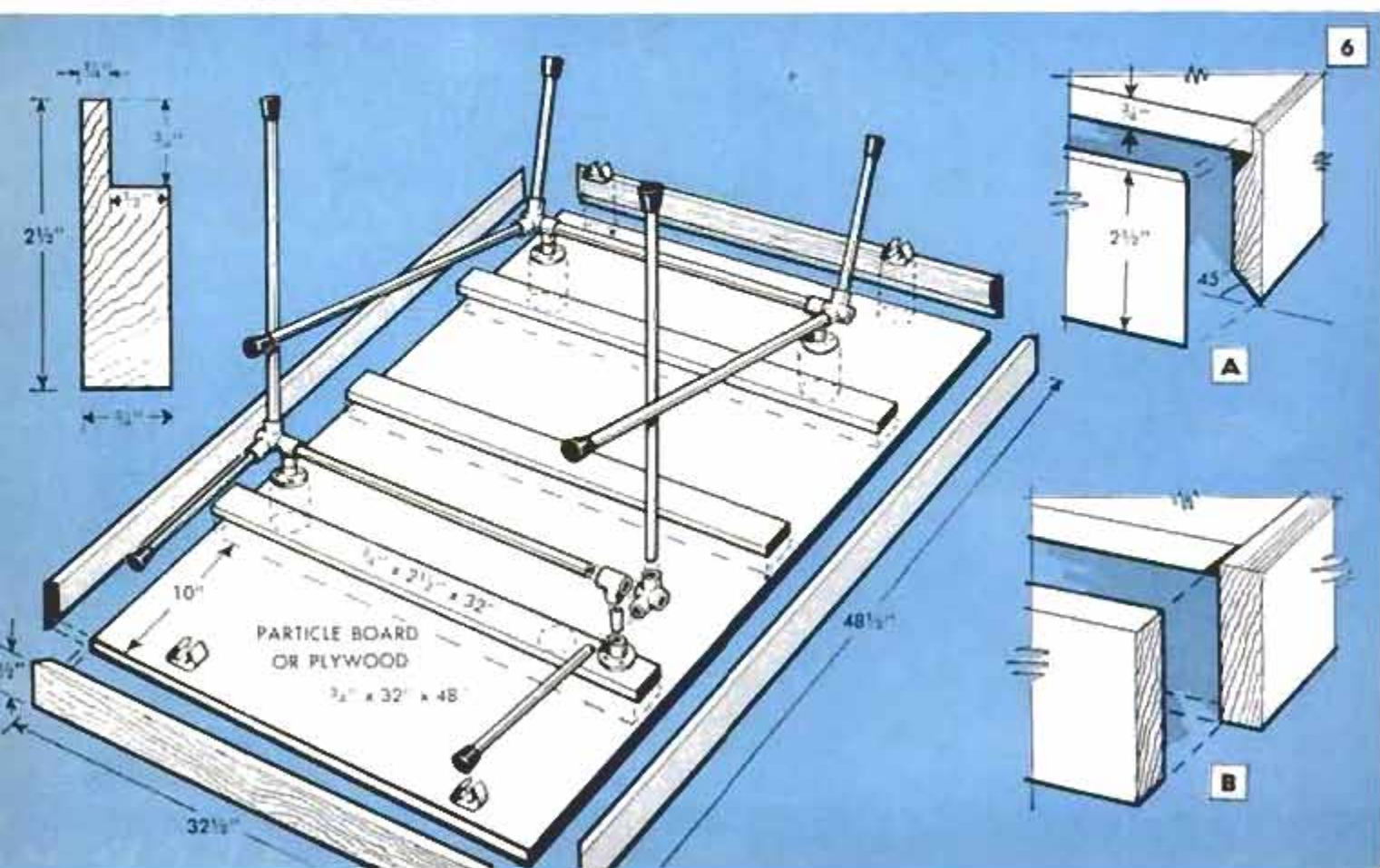

High-Lift Jack Handles Farm Jobs

Greater utility from a mechanical jack is obtained by one farmer who mounted it on an A-frame welded together from lengths of 1½-in. steel pipe and pieces of 1½-in. steel angle. To prevent the pipe legs of the frame from sinking into soft ground, squares of steel plate are welded to the lower ends. The base of the jack is bolted to the lower angle-member of the frame, the upper end is bolted between two steel flats welded to the frame top crosspiece. On the frame, the jack is ideal for lifting bodies of dump wagons. — C. F. Marley, Nokomis, Ill.



Dowels Bandsawed Accurately With Rubber-Faced Guide

When cutting dowels on a bandsaw, you can prevent them from rolling, which binds the blade and results in an inaccurate cut, by using a "guide block." The latter is a block of wood of convenient size to which a strip of sponge rubber is cemented. In use, the dowel to be cut is gripped against the sponge-rubber strip and both block and dowel are pushed past the blade. The rubber acts as a nonslip facing, and the block itself serves as a guide for dowels up to 1 in. in diameter.

G. E. Hendrickson, Argyle, Wis.

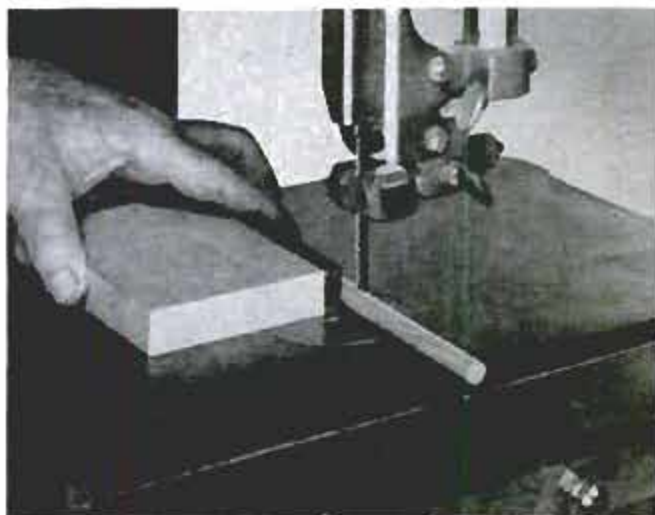

Coating Inside of Metal Planters Prevents Corrosion

Metal containers that are used as planters will last much longer if they are protected on the inside with automobile undercoating or asphaltum paint. Even copper and brass containers should be protected in this way, as corrosion may be caused by chemicals in the soil.

Smoke stains on brick fireplace can be removed by rubbing with a paste consisting of baking soda, 2 oz.; pumice stone, 1 oz.; and salt, 1 oz., mixed with just enough water to form a paste. After rubbing it on the bricks, allow it to stand a few minutes, then brush off.—Charles V. Mathis, Wildwood-by-the-Sea, N. J.





WHAT TO DO with those pan lids, pie tins? Just buy an extra wire draining rack, drop it in a drawer or make space for it on a shelf and there you are, a filing system that keeps the lids and tins in order, always at hand

Solving

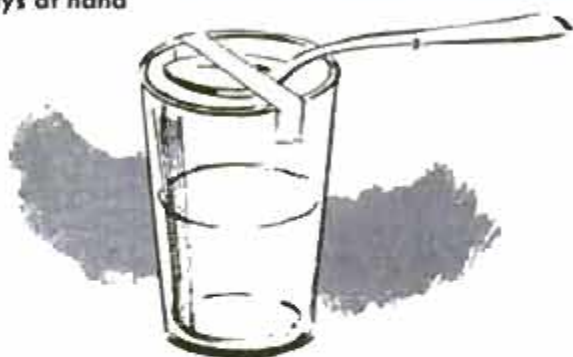

A STRIP OF TAPE across top of tumbler keeps medicine spoon off night stand or dresser. Adhesive on tape keeps spoon in place; it can't fall to floor



CAKE CANDLES won't tip at that critical moment if you insert each one in a chocolate cream before placing on cake. Later the creams serve as an extra treat

INVERTED ASHTRAY of colored glass makes an appropriate base for a figurine. Select tray of shape pictured. A drop of cement holds figure in place



THREADING A CURTAIN ROD through the hem can try your temper, unless, of course, you cut a finger from an old leather glove and slip it over end of rod



HOME PROBLEMS

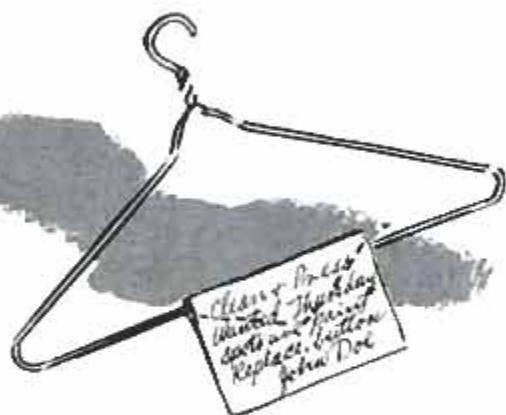

YOUR LOCAL CLEANER will be glad to follow instructions to the letter if you write them on a plain envelope and seal envelope over crossbar of hanger



SCORE A WOODEN RULER with an awl, place ruler under magazine page you wish to clip and then utilize the groove to guide razor blade when making cut

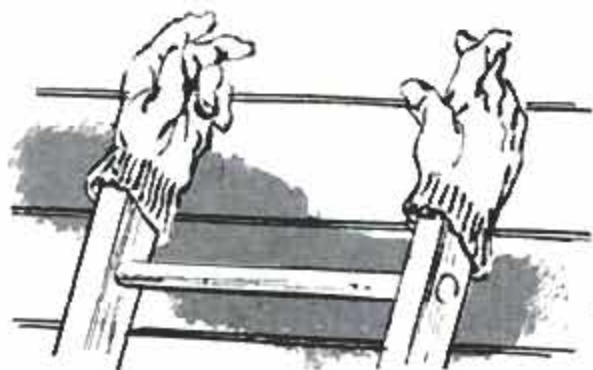

COTTON GLOVES make good pads for the top ends of the ladder rails. They prevent scratches on paint or masonry when ladder is put up, moved, taken down

PAPER DOILIES in metallic gold or silver make attractive ornaments. As an example, clip to the shape pictured, cement at corners of kitchen-cabinet doors

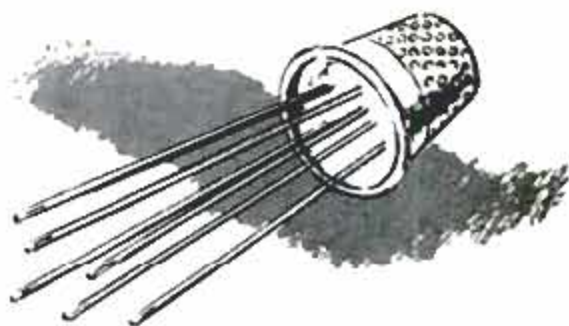
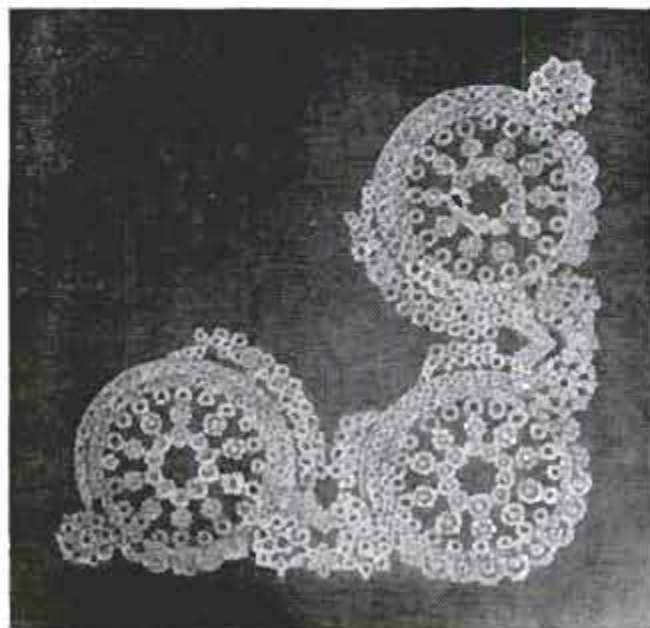

THIMBLE FILLED WITH BEESWAX keeps those straying needles together. Otherwise you may find them on floor, in drapes or sofa cushions, no telling where

GLYCERIN will stickproof a glass stopper if you take time to rub a drop or two of it on the ground portion of the stopper before inserting in bottle



Rubber-Band Tension on Handle Keeps Boat Winch From Slipping



If there is a worksaving hand winch on your boat trailer, you may have noticed that the locking ratchet sometimes bounces loose when the trailer is pulled over rough back roads. If you want to keep the line from the winch drum to the boat tight, no matter what the condition of the roads, fit a couple of heavy rubber bands cut from an inner tube over the winch handle and down to some solid projection on the trailer frame. Tension on the handle from the rubber bands will keep the winch gear firmly against the ratchet, preventing it from jarring loose.

Lee H. Schrimpf, Tulsa, Okla.

Removing reflective tape and decalcomania from auto bodies will cause the least amount of damage to the finish if one corner of the decalcomania first is loosened with a razor blade. Cellulose tape then is pressed over the entire area. Finally, the tape is peeled back, pulling the decalcomania with it. Some spots may require a touch of the razor blade.

James M. Callan, Nipomo, Calif.



Storage Wall for Small Parts

Discarded elevator buckets, 104 of them, nailed to the workshop wall between the studs give this Michigan farmer plenty of storage space for nuts, bolts and small parts. Because the front edge of each bucket is lower than the back, the contents can be checked at a glance and, as most of the depth of each bucket is recessed in the wall, very little floor space is used.

Donald K. O'Brien, Gahanna, Ohio.

Preheating a vacuum bottle by pouring it full of hot water and allowing it to stand for several minutes will assure that the contents to be carried in the bottle will stay hot much longer.

Finishing Quarter-Round Molding

Sanding, staining and varnishing quarter-round molding before it is installed eliminates much of the time and trouble involved in doing these operations after the molding is in place. To further simplify the job, place a few spots of glue on four lengths of the molding and assemble them into a round with masking tape at 1-ft. intervals. After glue has set, remove tape, and sand. This trick prevents rounding the corners, as often happens. After staining and varnishing, pull the strips apart.

W. M. Judy, International Falls, Minn.

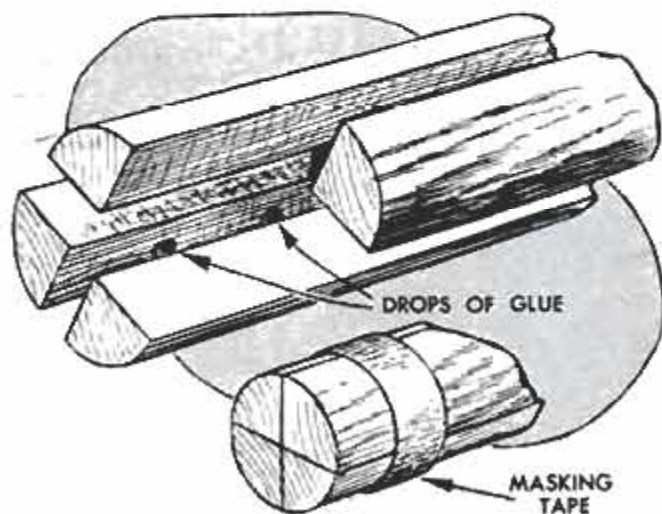

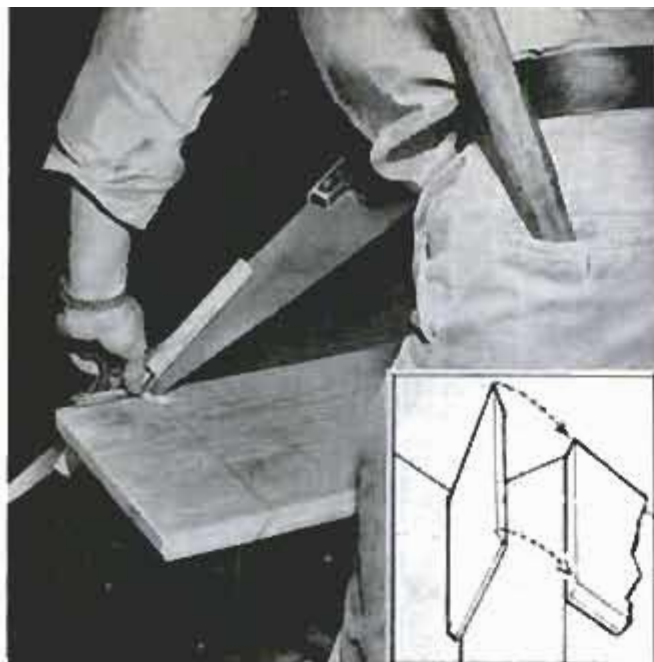

Square Aids in Cutting Accurate Miters With Handsaw

When you have to cut a miter on trim stock, such as ceiling cove around a soffit, and a power circular saw or a miter box is not available, try this handsaw stunt. First, hold a length of the trim stock in position and with a sharp pencil mark it, as in the right-hand photo. This line is the inside edge of the angle to be cut. Mark a 45-deg. angle on each edge of the stock, then join these marks with a line on the opposite side of the stock from the first line. Place the stock flat on two horses,

hold the square on the 45-deg. angle as shown in the left-hand photo and start the cut. Keep the square against the saw blade as long as possible to assure the accuracy of the angle. When the cut is about half through the stock, the square can be shifted to the opposite side of the work and used in the same manner. One big help for this job, and it is not a secret, is that the saw should be sharp. Even an expert craftsman cannot do an accurate job with a dull blade.

Western Pine Association.

Auxiliary Drill-Press Table Fitted With Stop Pins

This plywood auxiliary table for a drill press not only increases the working area, but is fitted with stop pins that prevent the work from rotating. The table is a piece of $\frac{1}{2}$ or $\frac{3}{4}$ -in. plywood cut to a convenient size. The one shown is 14 x 16 in. and has six $\frac{1}{2}$ -in. holes drilled in it over the area of the slots in the original table. Two $\frac{3}{4}$ -in. wooden or metal dowels are shouldered to $\frac{1}{2}$ -in. at one end so they fit into the holes in the wooden table. They project about $\frac{1}{2}$ in. below the table and into the slots in the original table, to hold the plywood in place.

Floor joists were kept straight during construction by one man with the aid of a length of flooring marked off for the proper spacing. After one end of each joist was nailed, the strip was moved to the center of the span for easy installation of the bridging, then to the opposite ends.

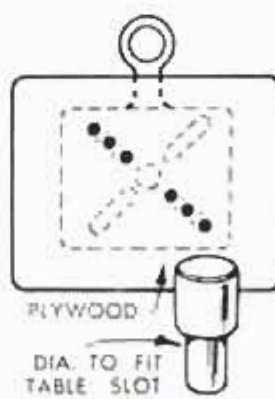



Reprinted SERVICE FILE Postlet 7-20
"Jack-in-the-Box" Trailer Becomes

YOUR VACATION HOME

in a matter of minutes. "Umbrella" top tucked inside unfolds quickly to provide shelter and sleeping for four. Tows safely at high speeds and sets up in 20 min.

PART I

ROUGHING IT in the backwoods is almost like being at home when you hitch this box on wheels to your car. For, aside from lacking the conveniences of modern plumbing, it contains all the other comforts of home to make vacation camping a real family treat.

The Clifford De Leeuw family of Grand Rapids, Mich., builder of this unique camping trailer, found it so in exploring the primitive regions of northern Michigan. Free of the worry of finding a motel for the night, they found they could park in

undeveloped areas at no charge and be snug and as comfortable as bugs in a rug. Two full-size beds (5 x 7 ft.) supported on lids that open like the covers on a box, provide comfortable sleeping for four outside the actual living area. If necessary, two more persons can be bedded down on air mattresses placed on the floor. Dining inside is done on a folding table, with the built-in cabinets along the sides being used as seats. Headroom at the center measures 8 ft. 4 in. and the door, 6 ft., to make crouching and ducking unnecessary

V 770

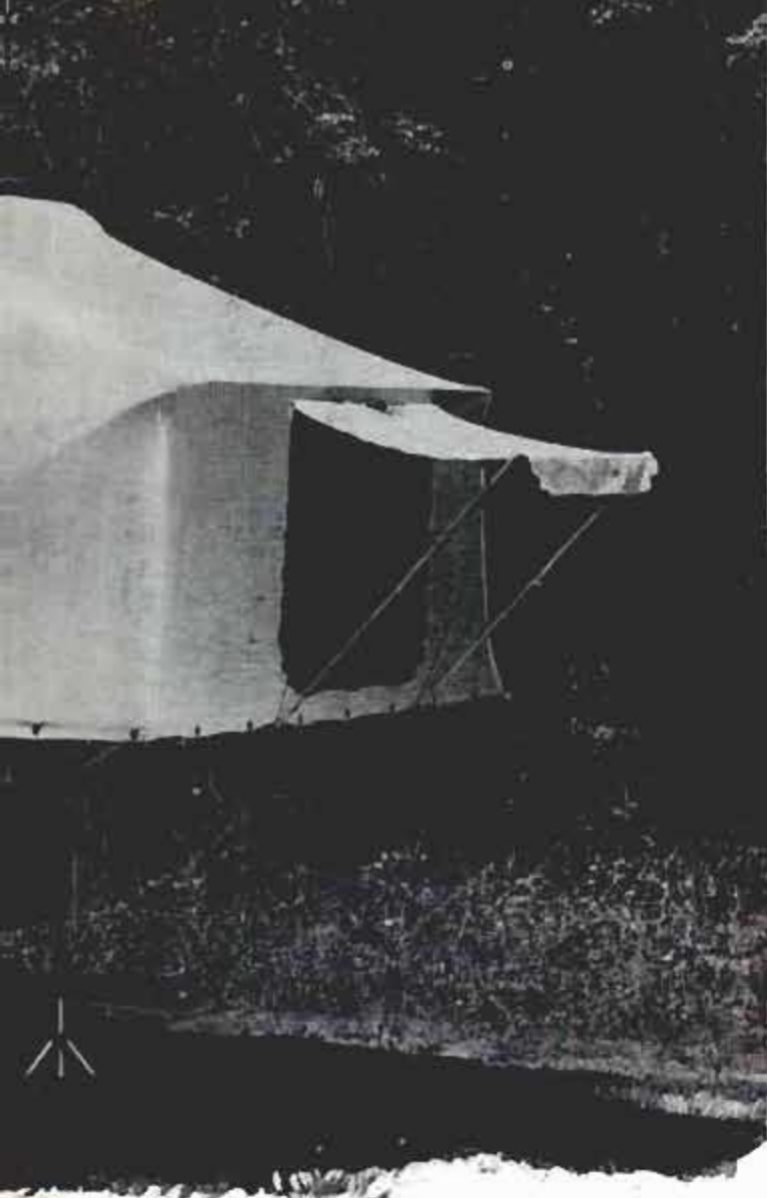

Compact as a nut in a shell, all the paraphernalia you need to camp in style and comfort is tucked away in a plywood box on wheels measuring only 7 x 10 ft.



Photos by Joe Fletcher

Below, roominess and brightness of trailer interior stems from out-of-way bunks and windows on all four sides. Cabinet tops provide work surfaces, seats

Above, lids of box, when flung open and supported on removable pipe brackets, provide outboard bunks for two full-size mattresses which stow on trailer floor

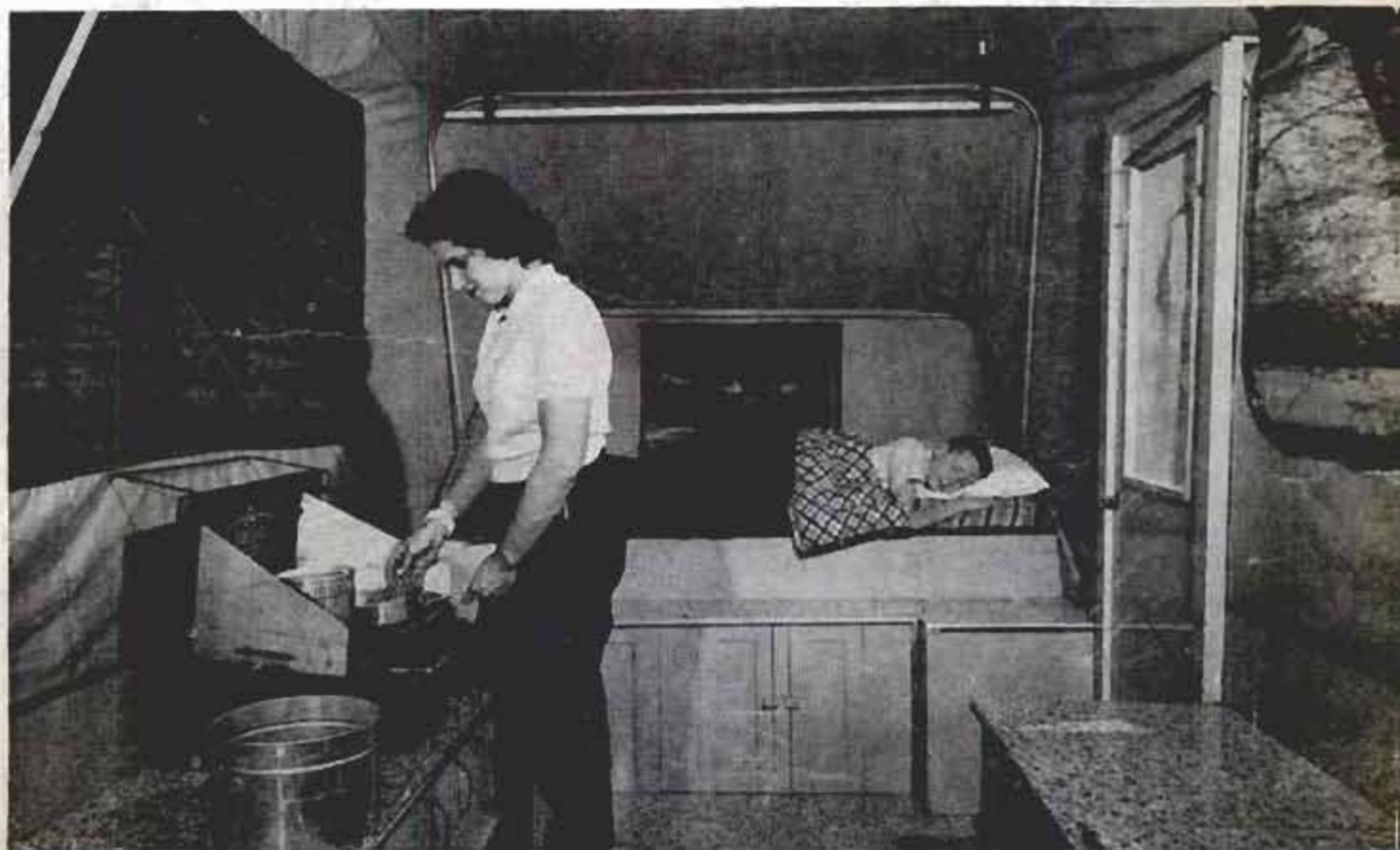

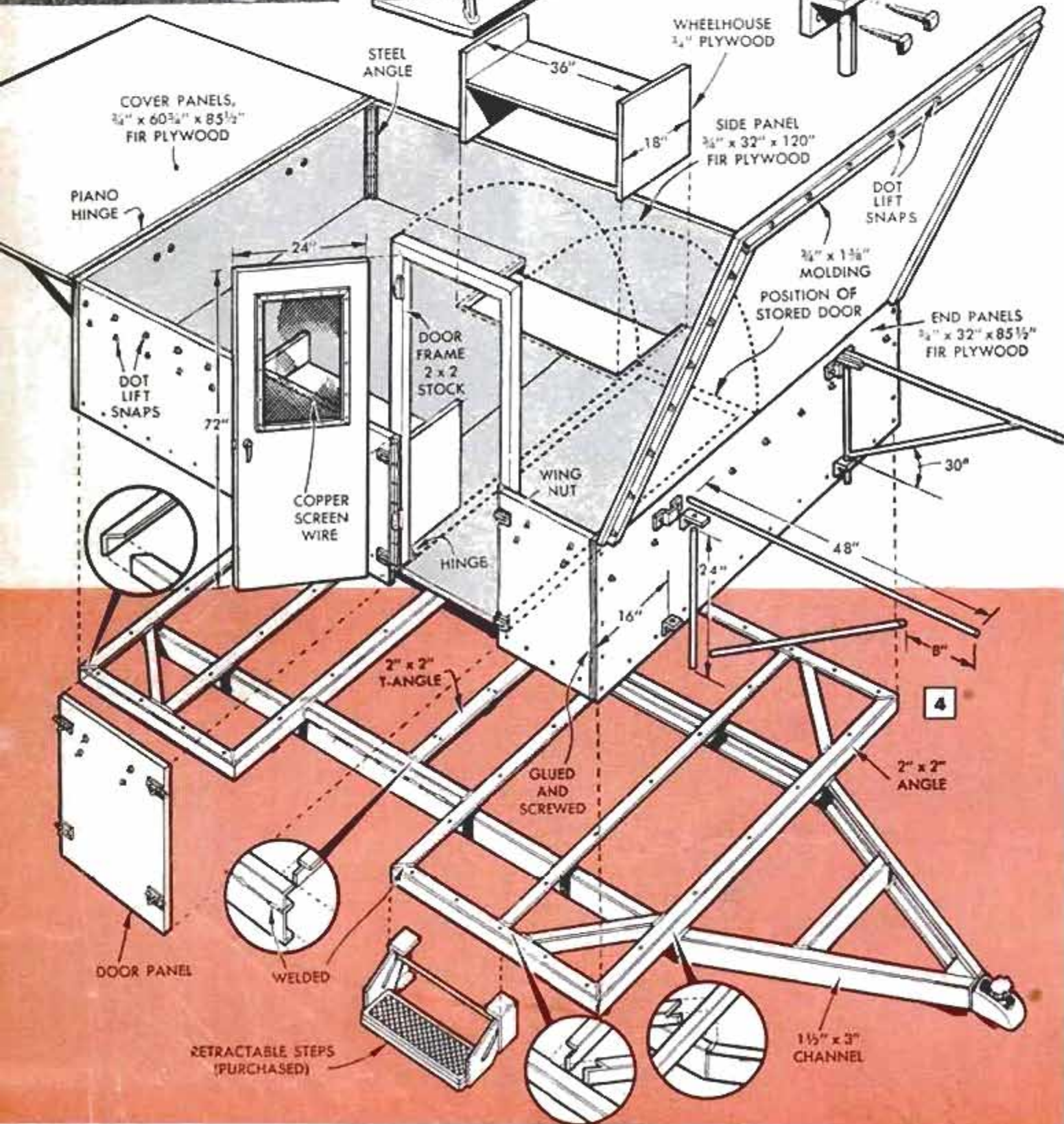
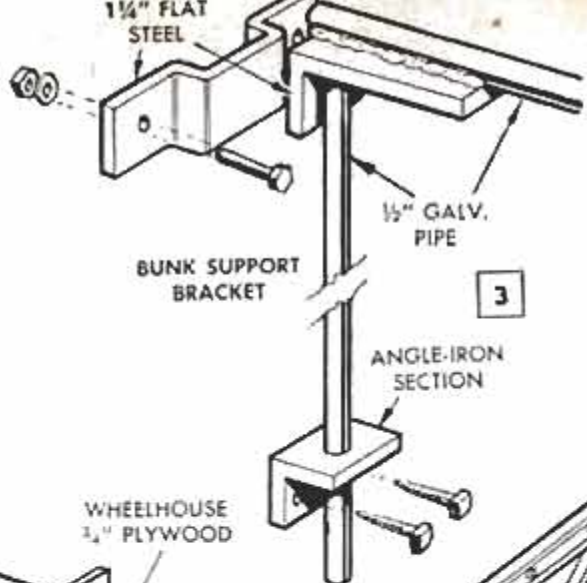
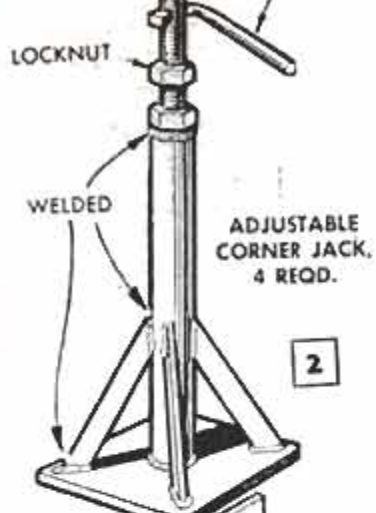

in entering and standing inside.

First study Figs. 4 and 5. The trailer is built on a commercial drop-type, front-axle assembly which you buy. Pick one that has wheels that match the size of those on your car so the spare tire can be used in an emergency. The bed on which the trailer body is built is welded together from lengths of steel angle and channel. This part, plus the tent top, you may have to have made for you. Outdoor fir plywood (marine grade) is used for the floor and body. The welded bed is floored first, cutting out the plywood over the wheel wells and fastening it to the bed with $\frac{1}{4}$ -in. machine bolts spaced 12 in. apart. The joint of the floor panels should center on the T-angle member of the bed. The sides and end panels of the body lap the floor and the bed, and the end panels lap the edges of the sides at the corners. Brass screws and waterproof glue are used to join the plywood, driving the ones around the bottom into the edges of the floor panels and spacing them 4 in. apart. Don't bother cutting the door opening until after the panels are in place. The four corners of the body are reinforced with steel angles placed on the inside. The swinging door is hinged to a frame which in turn is hinged to the floor so that both store flat as a unit on the trailer floor. Bolts passing through the frame and steel angles screwed to the edges of the door opening in the trailer body hold the frame upright. En route, the



Separate removable panel closes regular door opening in side of trailer body when en route. Notice retractable commercial trailer step below opening. Step can be box and stowed inside

door opening in the body is fitted with a separate panel which is held in place with four slide bolts. The bunk lids are hinged with piano hinges and are supported by removable pipe brackets, Fig. 3, that slip into fixtures permanently attached to the ends of the trailer body. The brackets store on top of the lids in wells created by strips of molding applied around three edges, $1\frac{1}{2}$ in. in. Dot lift-type snaps are later screwed to this molding for buttoning the canvas top. Adjustable leveling jacks, Figs. 1 and 2, are placed at the four corners of the trailer box to prevent rocking. The jacks are carried in the car to be available first hand.

(Continued next month)

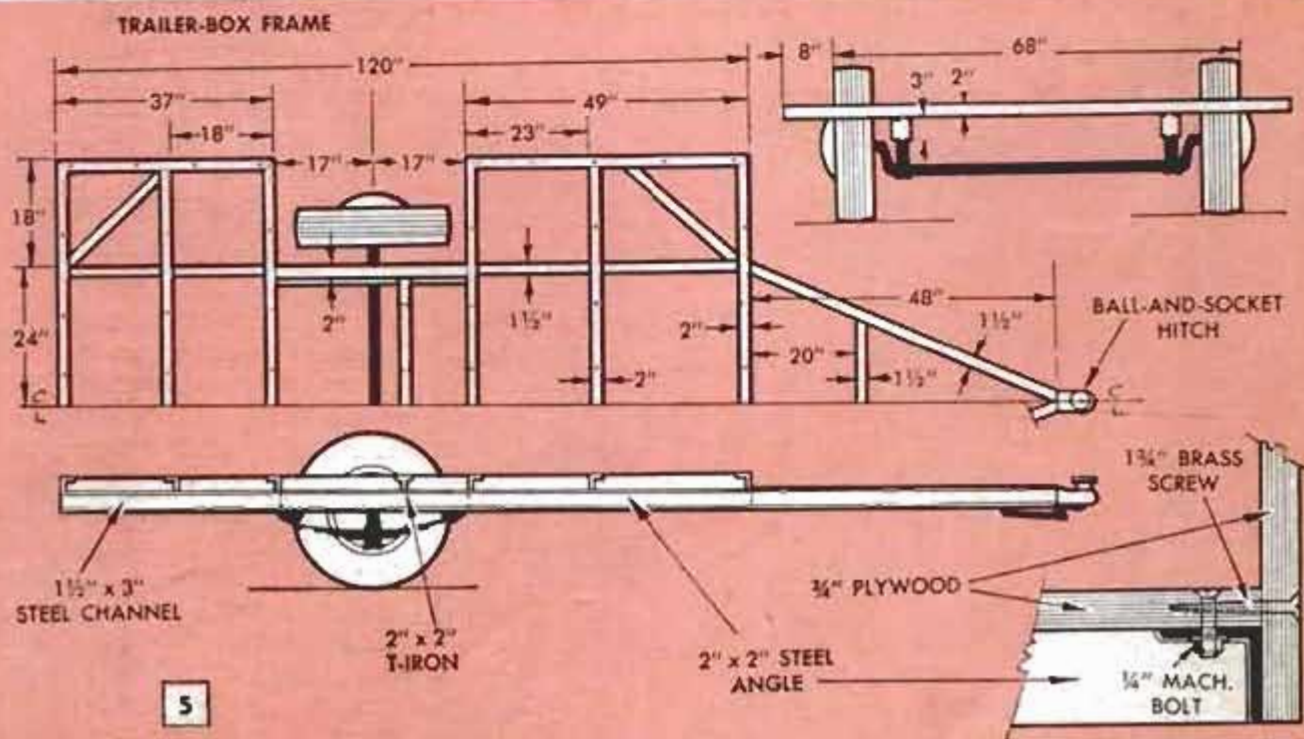

Sawhorse From Windmill Ladder

Handy as a stand for supporting long pieces of lumber that are to be sawed is this steel sawhorse formed by one farmer from a ladder section removed from a dismantled windmill. The legs are 26 in. long and have 2-in. feet bent on the ends to prevent them from sinking when placed on a soft dirt surface as shown in the drawing. If the stand is to accommodate heavy pieces, braces should be welded or bolted to the horizontal member and legs on each side.



Cork "Handle" for Drill Bit

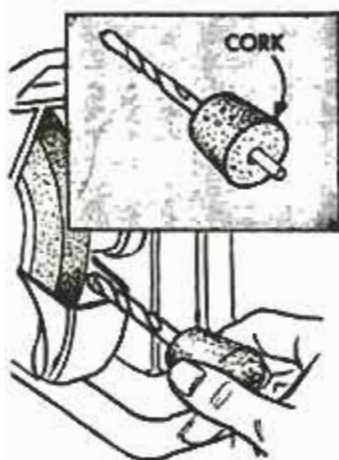

For a safe means of holding a small drill bit when sharpening it on an emery wheel, slip a bottle cork on the shank as in the detail. The cork serves as an insulated handle for a positive grip on the bit and saves the fingers from being burned.

Three-in-One T-Wrench

Two socket-head wrenches can be made into a combination T-wrench. First remove the short leg from two wrenches of the same size. Grind one end to a screwdriver point and

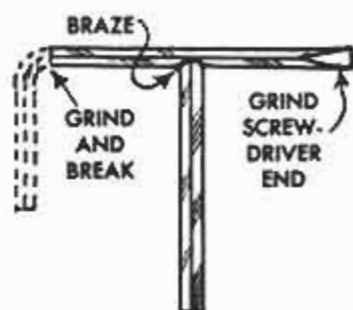

braze the two together as shown. You'll have a wrench that can be used as a socket-head wrench, tee-handle wrench and a screwdriver.—R. Thompson, Clinton, Iowa.



Sky Reproduced On Bedroom Wall

Now you can have imitation starlight in your bedroom nightly according to the Masonite Corp. Part of the evening sky is reproduced by perforated hardboard attached to one wall and painted black. Planets and stars are represented by phosphorescent-painted croquet balls, fishing sinkers and other objects that are pegged to the wall. BLB fluorescent lights flood the sky with black light to make the heavenly bodies appear startlingly realistic.

CUPOLA

With Bandstand Motif

By Hi Sibley

THIS PICTURESQUE CUPOLA, reminiscent of an old-time bandstand, will add interest to a dull roof line. The roof and decorative parts are built on four 2 x 2-in. supporting posts that are attached to the roof with angle brackets as detailed in the drawing. When screwing the brackets to a cedar-shingled roof, be sure to drill holes in the shingles to prevent splitting them, and bed the brackets in tar.

The entire project is made of stock lumber and painted to harmonize with the structure on which it is mounted. The cupola shown in the photo is all white, having shake shingles to match those on the building. The platform on the base has mitered corners that are secured on the upper side with corrugated fasteners and is supported on each side by three wooden knees. Note that the end members of the base are cut to the same angle as the roof.

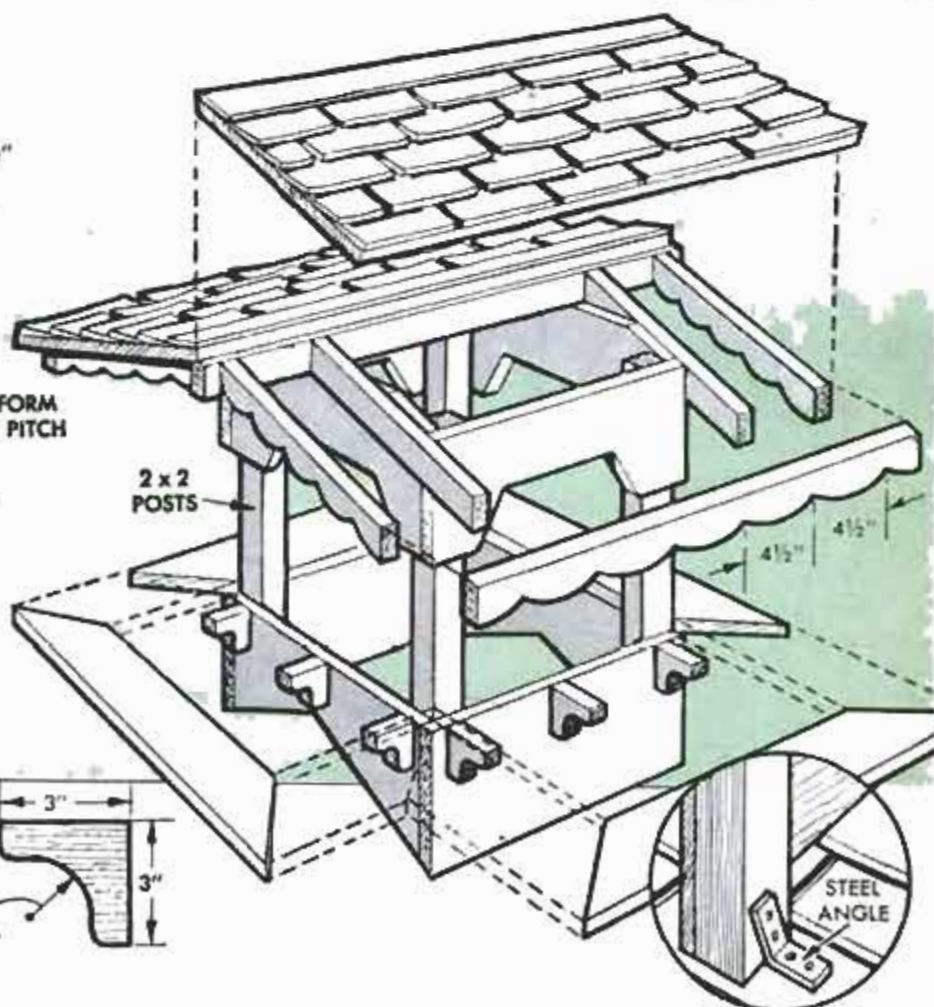
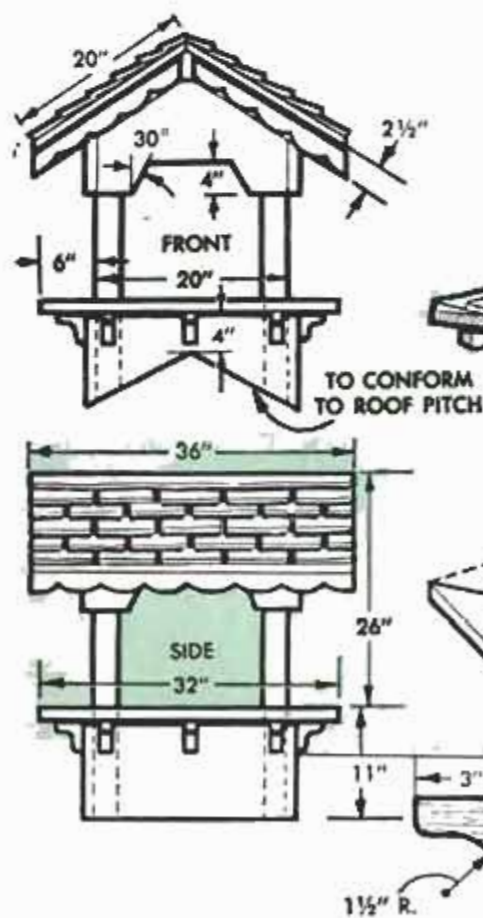



Jig for Spacing Fence Pickets

When erecting a picket fence having pickets arranged in a pattern of varying heights, you can do a better and faster job with a spacing jig like the one shown. It consists of a length of 1 x 3-in. pine in which holes are drilled to take $\frac{3}{8}$ -in. dowels spaced to coincide with the centers of the pickets in the pattern. After cutting the dowels to their required lengths, they are glued in the holes according to the pattern. In use, the jig is slid along the rail as each section is completed.—G. E. Hendrickson, Argyle, Wis.

To tighten a screw in an oversize hole, coat a short length of pipe cleaner with glue, insert it in the hole and clip it flush before driving the screw. The cleaner provides a good bite for the screw and the glue holds it fast when hardened. For a hole that is extremely enlarged, use several lengths of glue-coated pipe cleaners. M. Robert Beasley, Jackson, Mich.

Kerosene lanterns make rustic-appearing flower planters when the wick assembly is removed from each, and artificial or potted flowers or vines are placed in the oil well. Leave the globe in place. Enamel the lantern in a solid color and trim parts of it with silver or gold-colored paint as desired.—Charles V. Mathis, Wildwood-by-the-Sea, N. J.

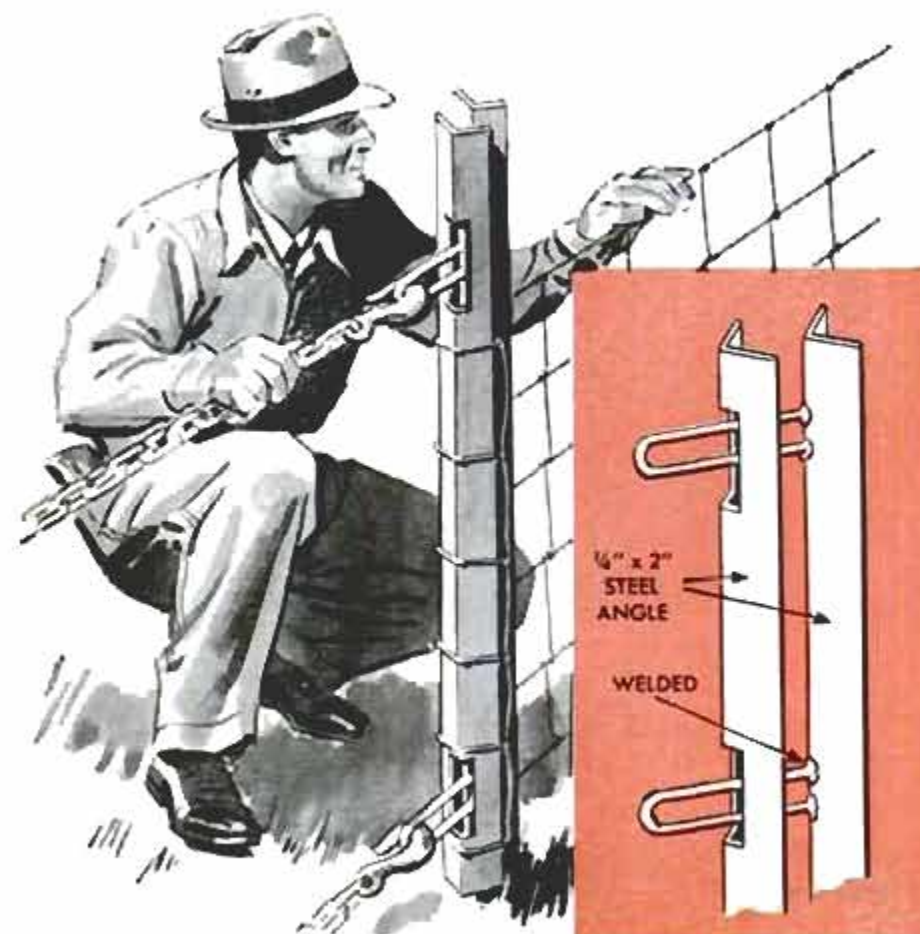

Clamp for Stretching Woven-Wire Fencing

Easy to apply or remove, this clamp for use in stretching woven-wire fencing will pay for its cost in time saved. Just place the end of the fencing wire in the clamp, give it a half twist to bring the wire over the front member and then apply the stretcher. The pulling force of the stretcher and the pull resistance of the wire are applied in opposite directions, which causes the clamp to grip the wire. The clamp consists of two equal lengths of angle steel, one of which is slotted to slip over two U-shaped rods welded to the other length.—A. M. Wettach, Mt. Pleasant, Iowa.

Plastic Squeeze Bottles "Pump" Air and Liquid Soap



Here are two uses for plastic squeeze bottles designed as catchup dispensers: Left-hand photo shows squeeze bottle being used as a miniature bellows for cleaning dust from inside a camera. Photo at right shows bottle clamped to wall with sheet-metal strip and used as hand dispenser for liquid hand soap

Cover on Flash Reflector Reduces Light Intensity for Close-Up

This cover for a flash reflector is used in cases where photos must be taken at close range and it is necessary to reduce the intensity of light to prevent overexposure. The cover is cut from a paperlike translucent cloth (Miracloth) familiar to many housewives as a kitchen aid. One or more disks of the cloth are cut to a size about 2 in. larger in diameter than the flash reflector. Approximately $\frac{1}{4}$ in. in from the edge of each disk a series of holes is punched. Through the holes is threaded a length of light elastic or a rubber band that is pulled and tightened so it will fit snugly around the reflector. Although it was considered that the light intensity should be reduced by about one half, test exposures determine the correct light reduction for a particular situation. The number of thicknesses of the cloth, of course, determines the amount of light reduction. Cutting a T-shaped slit in the cover will permit changing flashbulbs without removing it.

R. Hanscom, Elmhurst, Ill.

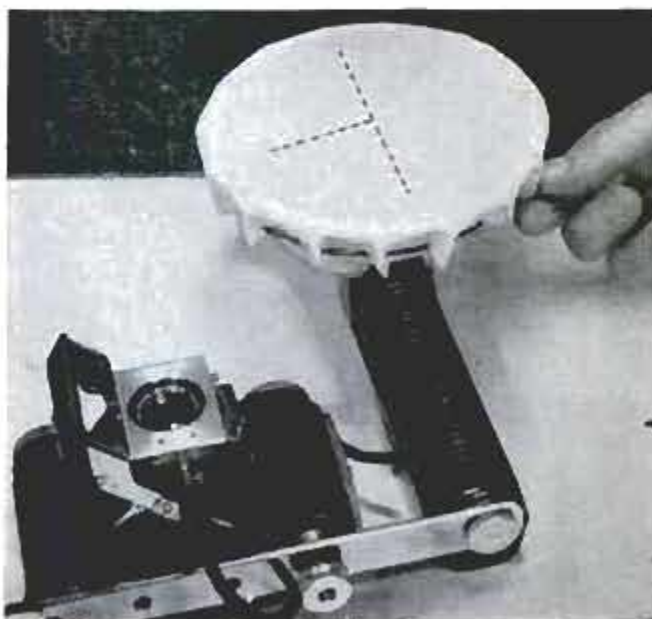

To make an emergency repair in a leaking water pipe, slit a 2-in. section of garden hose lengthwise and fit it around the pipe. A hose clamp then is positioned directly over the leak and tightened as firmly as possible. Although this type of patch may hold for some time, it is recommended that the damaged section of pipe be replaced as soon as practicable.

MODELING THE FRENCH

CONCLUSION

Running rigging and sail installation

THE SAILS are put aside temporarily until some of the running rigging has been installed. This is very similar at both the foremast and the mainmast, consisting of the following: (1) Tackle gear and runner ties to hold the yard. (2) One fore and one aft hoist to adjust the yard. (3) A truss line to the lower tip of the yard. (4) Two foresheets fastened to the lower tip of the yard. (5) Two aftsheets fastened to the lower clew of the leech edge of the sail. (6) Two brail lines on each side of the sail. (7) A flag-halyard line. (8) A yard stay on each side. (9) A parrel where the yard crosses the mast. The runner ties and the fore and aft hoists are installed first, then the rest of the rigging to the yard and sail. Finally the sail is hung and the remainder of the rigging completed. As mentioned in Part IV, all rigging lines are about .018 in. in diameter except where other sizes are specified.

Foremast Yard Tackle

Because of the limited work space between the masts and the shrouds, as is obvious from Fig. 70, you will find it simpler to assemble the tackle of the yard-runner ties and that of the yard hoists on an improvised jig, and then transfer the assembled tackle to the ship. The jig consists of a base block and a dummy mast. The runner-tie tackle of the foremast yard, shown in Fig. 71, consists of two multiple-sheave blocks that lie against the aftside of the mast. You will have to make these blocks. The lower one has six sheave holes in line, and a tiny cleat glued to its starboard side. The block is secured by a standing line that goes through the cross hole at its lower end. The line fastens to eyelets or staples at the base of the mast by means of tiny rings formed from 26 or 28-ga. wire.

The upper block of the tackle has two sheave holes near the top and four at its mid-point. There also is a cross hole at the top and another at the bottom. Fig. 72 shows the sizes of the blocks and also the method of threading the tackle line (.009-in.-dia.) through them. It starts at the lower end of the upper block where one end of the line is threaded through the lower cross hole, and is then glued or knotted to hold it in place. The line should be uniformly taut and the free end tied to a cleat glued to the starboard side of the lower block.

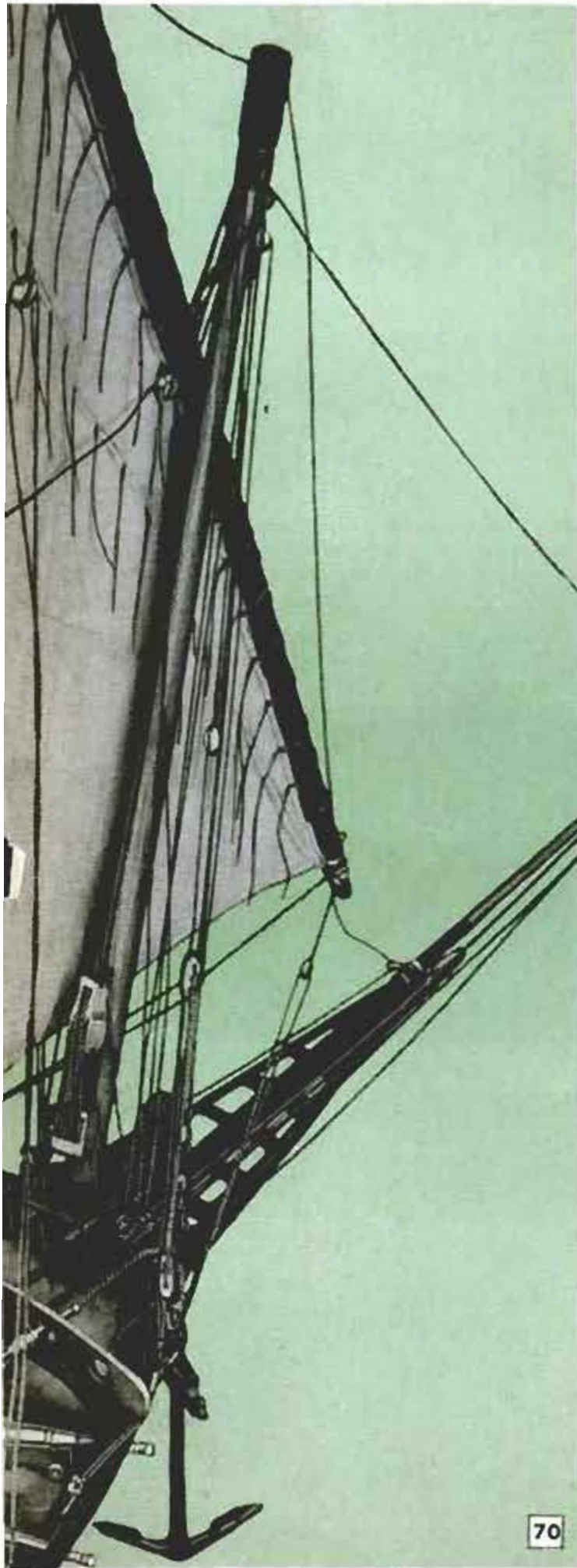

CHEBEC

The runner ties consist of a single line brought through the upper cross hole in the double block. The ends go up to the aft side of the masthead and are threaded through the lower sheave holes after which they are seized to the toggle.

Fore and Aft Yard Hoists

As also shown in Fig. 71, the tackle of the fore hoist of the yard consists of a double block (detailed in Fig. 65, Part IV), and a single block. One end of the tackle attaches to the strop of the single block, goes to the lower sheave of the double block, down to the sheave of the single block and up again to the upper sheave of the double block. Then the free end, or "fall" line, is tied under the lower block. The strop line of the block attaches to the crossrail at hole B, passing through the hole and being knotted under the crossrail. The line from the double block to the lower tip of the yard is threaded through the upper portside sheave hole from the aft side. The free end is left extending beyond this point for about 9 in., to be attached to an eyelet at the lower tip of the yard.

The aft hoist for the fore yard consists of two single blocks. The strop line of the lower one attaches to the crossrail at point C. The single line above the tackle goes up to the fore side of the masthead, then aft through the upper starboard sheave hole. It is left extending about 5 in. so it can be tied just above the lashing that holds the upper brail block. The runner ties and the two hoist lines can be held taut temporarily by means of a narrow strip of removable tape wrapped around the masthead.

Rigging the Foresail

Now you prepare the foresail for mounting. Practically all the rest of the running rigging is attached to the sail and yard as in Fig. 74 before the yard is hung on the mast. This procedure is much easier than attaching the rigging after the sail has been hung. Start with the loop that slips over the toggle at the end of the runner ties, lashing this to the yard about $\frac{1}{4}$ in. below the double brail block.

Next, string the flag halyard. This is a continuous line (.009 in.) passing through the block at the yard tip and another at the lower clew of the sail. Then ends of the line are spliced together by fraying the strands and gluing. The line should be a bit slack.

Brail Lines and Yard Stays

The brail lines (.009 in.), which in the actual ship were used to gather the sail,

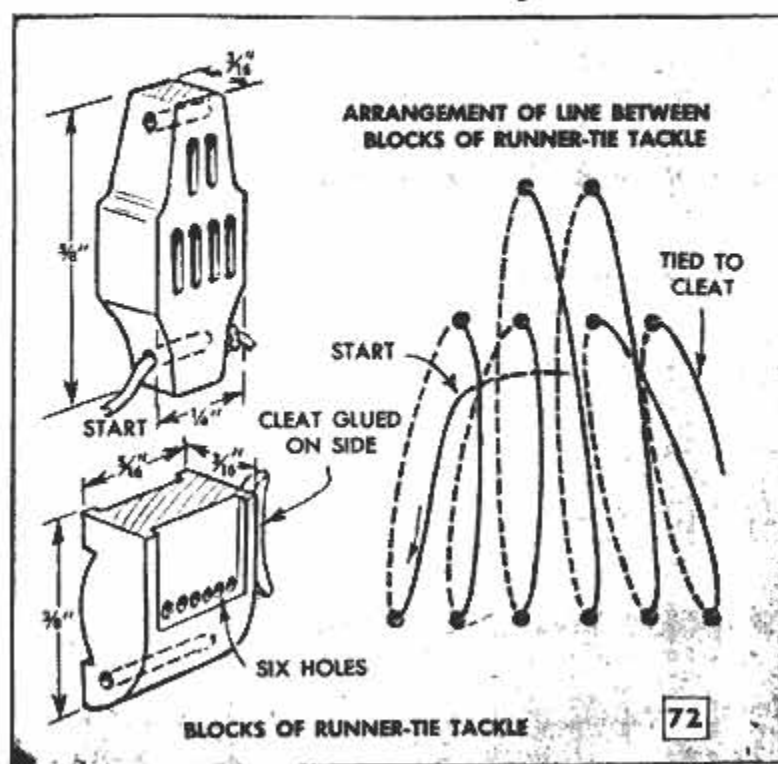
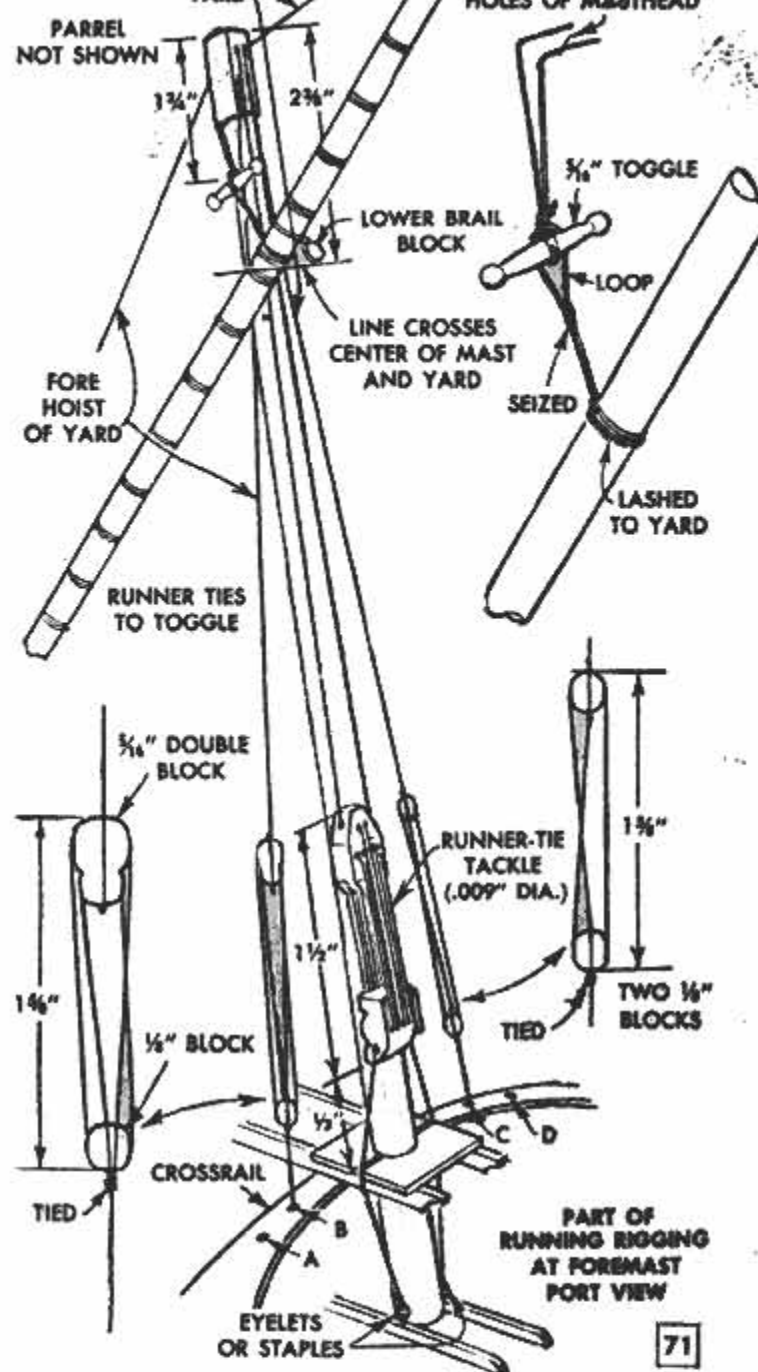

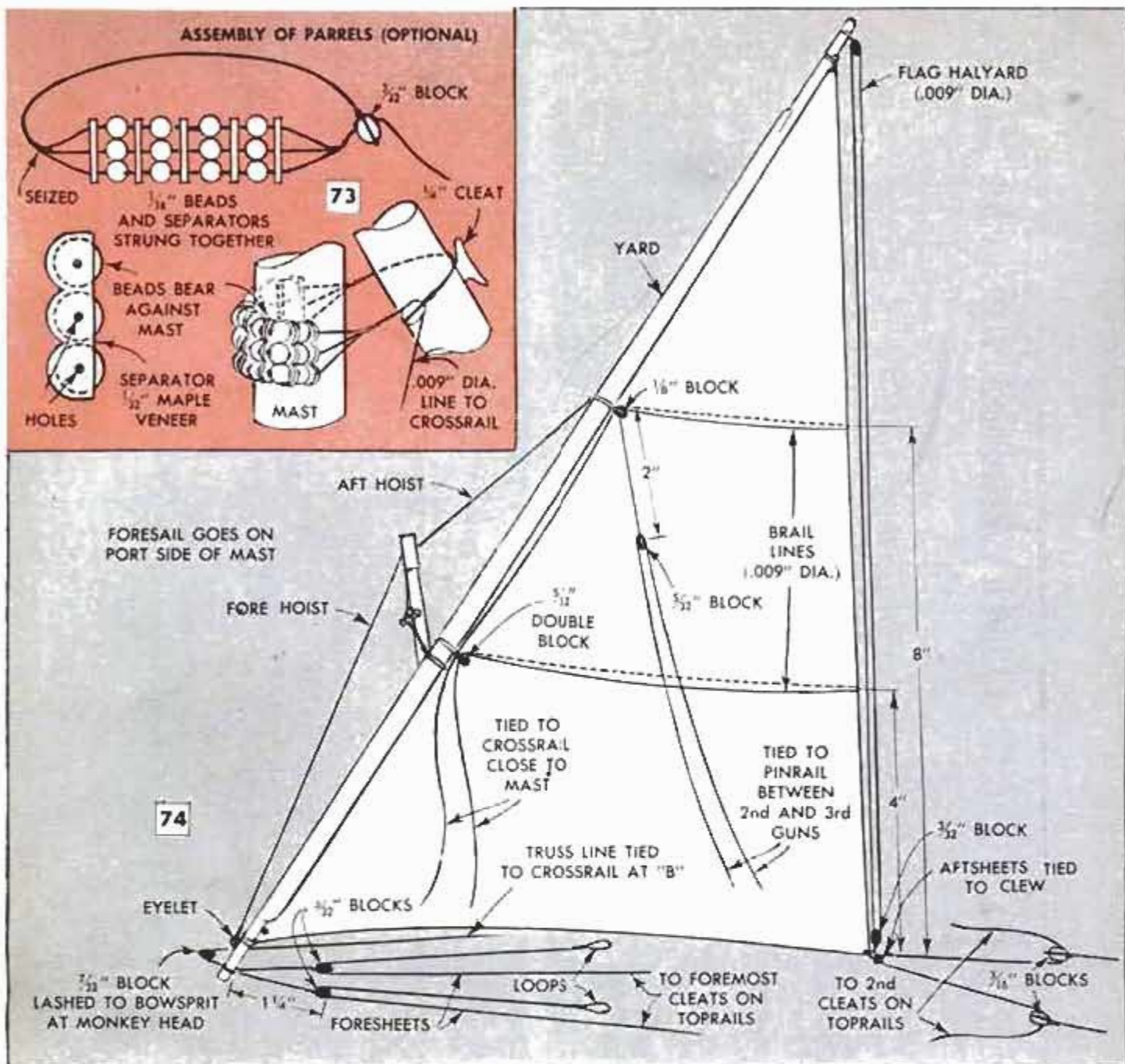

are attached next. A single line is used to form a pair of brails. The upper brail line is run around the leech edge of the sail and the ends brought through the upper brail blocks, then through the lower brail blocks which are double. Let the ends extend beyond the lower blocks far enough to be tied to the crossrail later, allowing for necessary slack. The doubled portion of the line is spot-glued at the leech, or aft, edge of the sail about 8 in. above the clew. Follow the same procedure for the lower brail lines, spot-gluing them to the leech edge of the sail about 4 in. above the clew.

The yard stays, one on each side, are attached at the lashing of the upper brail blocks. The line from the blocks of the yard stays must be long enough to attach to the pinrails at points about 3/8 in. apart at a location between the second and third guns. Some of the yard stays may be loosely

twisted together a few turns instead of letting the lines be separated.

Truss Line and Sheets

The truss line and the foresheets all attach to one lashing of three turns at the lower tip of the yard as shown in Fig. 74. The foresheets have loops at one end to hook over the first set of cleats on the top rail. The sheets are left extending long enough so that the free ends can be fastened to the same cleats. The aft sheets consist of a single line tied at its center to the sail clew. It must be long enough to pass through the blocks tied to the pinrails at points almost abreast of the mainmast, then forward to the second set of cleats.

Hanging Foresail

The foresail goes on the port side of the foremast. After removing the temporary

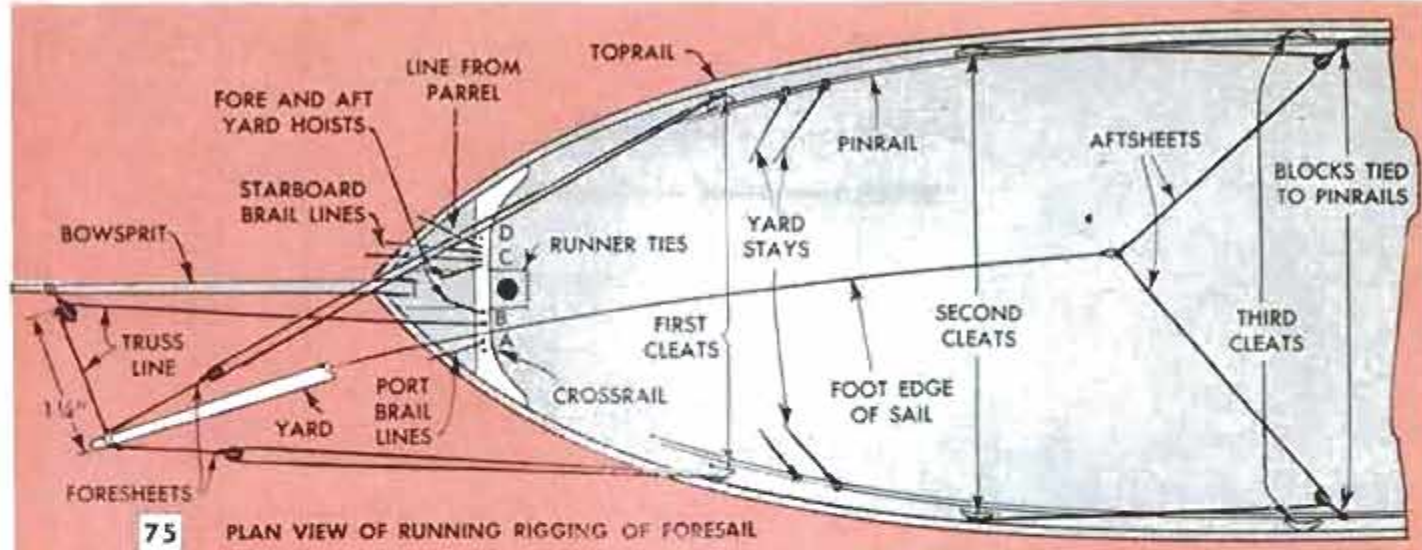

strip of tape from the masthead, place the sail between the shrouds and the running rigging already installed on the foremast. Bring the loop over the toggle and hold the yard in its approximate location. The center of the crossing point of the yard and mast comes $2\frac{3}{8}$ in. below the tip of the masthead as shown in Fig. 71. The lower tip of the yard should come just above the bowsprit. It also extends $1\frac{1}{4}$ in. on the port side of the truss block which is lashed to the bowsprit as shown in Fig. 75. The foresheet loops are hooked over the first set of cleats of the toprail, and the loose ends of the sheets are tied to these also.

Now is the time to install the foremast parrel if you want to add this authentic equipment. It consists of nine vertical rows of $\frac{1}{16}$ -in. beads, three per row, spaced with separators as shown in Fig. 73. The parrel goes directly on the mast so that no rigging lines come between it and the mast. The parrel is held up by a $\frac{1}{4}$ -in. cleat glued to the yard.

Next, the truss line is brought through the block lashed to the bowsprit, and the line is tied to the crossrail at point B, as shown in Fig. 75. Readjust all three lines (the two sheets and the truss line) to be moderately taut. The ends of the line are wrapped on the cleats in the form of a figure eight. Two turns are sufficient and a daub of glue will prevent the lines from loosening. Then fasten the ends of the fore and aft-yard hoists. The fore hoist goes to the eyelet at the lower tip of the mast and the aft hoist is looped around the yard just above the upper brail blocks. Both lines should be moderately taut. Pass the aft-sheets through the blocks attached to the pinrails and fasten the ends to the second set of cleats as shown in Fig. 75. All that now remains is tying the yard stays to the pinrails, moderately taut, and then tying the ends of the brail lines to the crossrail in pairs on corresponding sides of the mast.

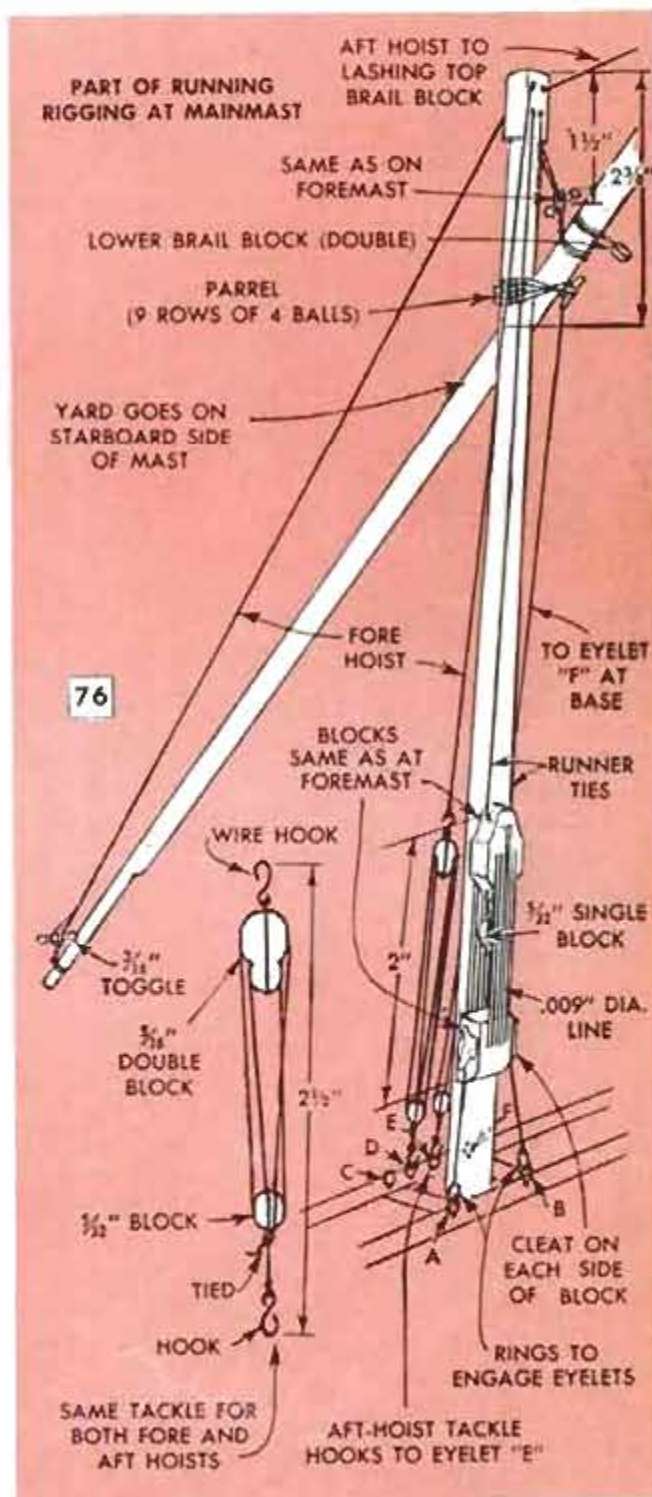

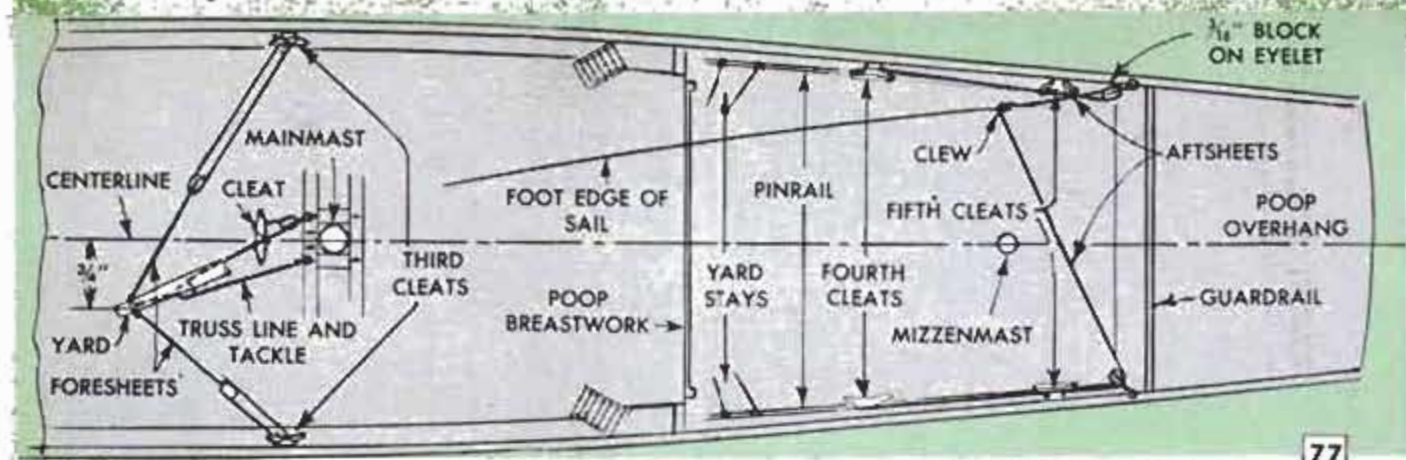

PLAN VIEW: PART OF RUNNING RIGGING OF MAINSAIL

77

PORTFOLIO OF PLANS

Popular Mechanics offers the serious modelmaker plans for building four other famous French ship models, namely *La Sablaise*, a sailboat, *Jeanne D'Arc*, a training cruiser, *Marie Jeanne*, a fishing boat and *Le Terrible*, a light cruiser. For a free descriptive brochure on these plans and their prices, write to Popular Mechanics Co., Dept. 80, 200 E. Ontario, Chicago 11.

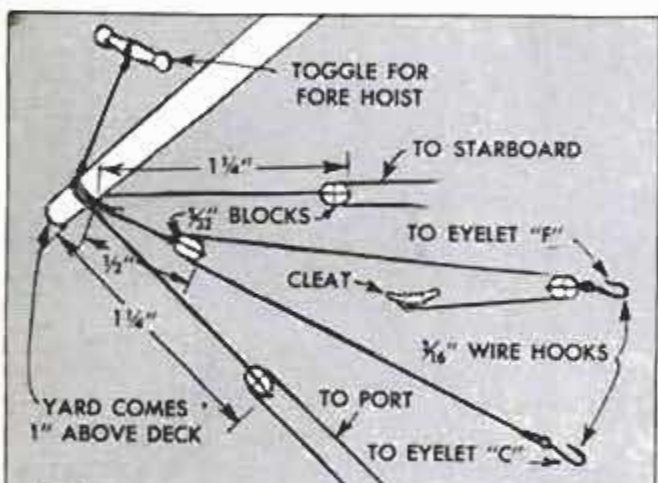

78 DETAILS OF MAINMAST FORESHEETS AND TRUSS-LINE TACKLE

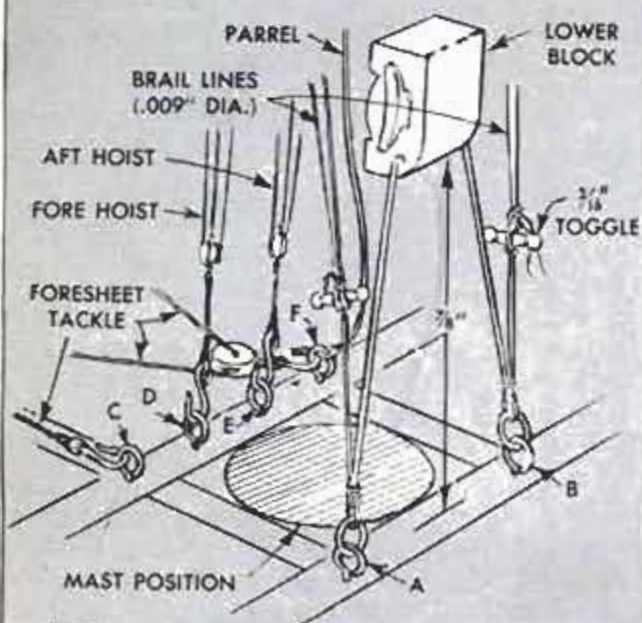

79 DETAILS AT BASE OF MAINMAST

Running Rigging of the Mainsail

To install the running rigging of the mainsail you follow the same general procedure as at the foresail. The runner ties and tackle come first and are detailed in Fig. 76. The tackle differs slightly from that of the foresail. The lower six-sheave block has a cleat on both sides. A single block hangs from the lower end of the upper block. Start the tackle (.009-in. line) on one of the cleats of the lower block, pass it through three sheaves of the blocks, through the single block, and then through the remaining three sheaves of the blocks, fastening the end to the second cleat. Follow the same procedure of assembling this tackle on a jig as before. The runner ties end at a toggle like those of the foremast. The ends of the standing line of the lower block are seized to tiny rings or hooks as at the foremast, which makes it easier to transfer the assembly to its permanent position on the ship. The rings or hooks are attached to eyelets A and B at the base of the mast. Fig. 79 shows a closeup view of the arrangement at the base of the mainmast. The tackle blocks of the fore and aft hoists of the yard are fitted with $\frac{3}{16}$ -in. hooks. The fore hoist attaches to a small toggle at the lower tip of the yard.

Again, you rig the sail before hanging it in position. Begin with the loop that engages the toggle of the runner ties and then put on the flag halyards. Fig. 78 shows how far the blocks of the foresheets and truss line are spaced from the lashing at the tip of the yard. The points of attachment of these lines are shown in Figs. 77, 78 and 79. The mainsail goes on the starboard side of the mast. The lower tip of the yard comes a trifle ahead of the leech edge of the foresail. The two pairs of brail lines (.009 in.) are spot-glued to the leech edge of the sail at points about $4\frac{1}{2}$ and 8 in. above the clew. The fall ends tie to toggles.

The yard stays are attached at the same points on the yard as they are at the fore-

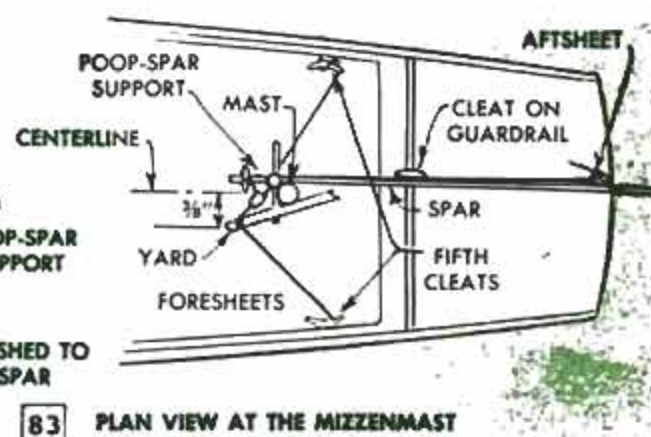
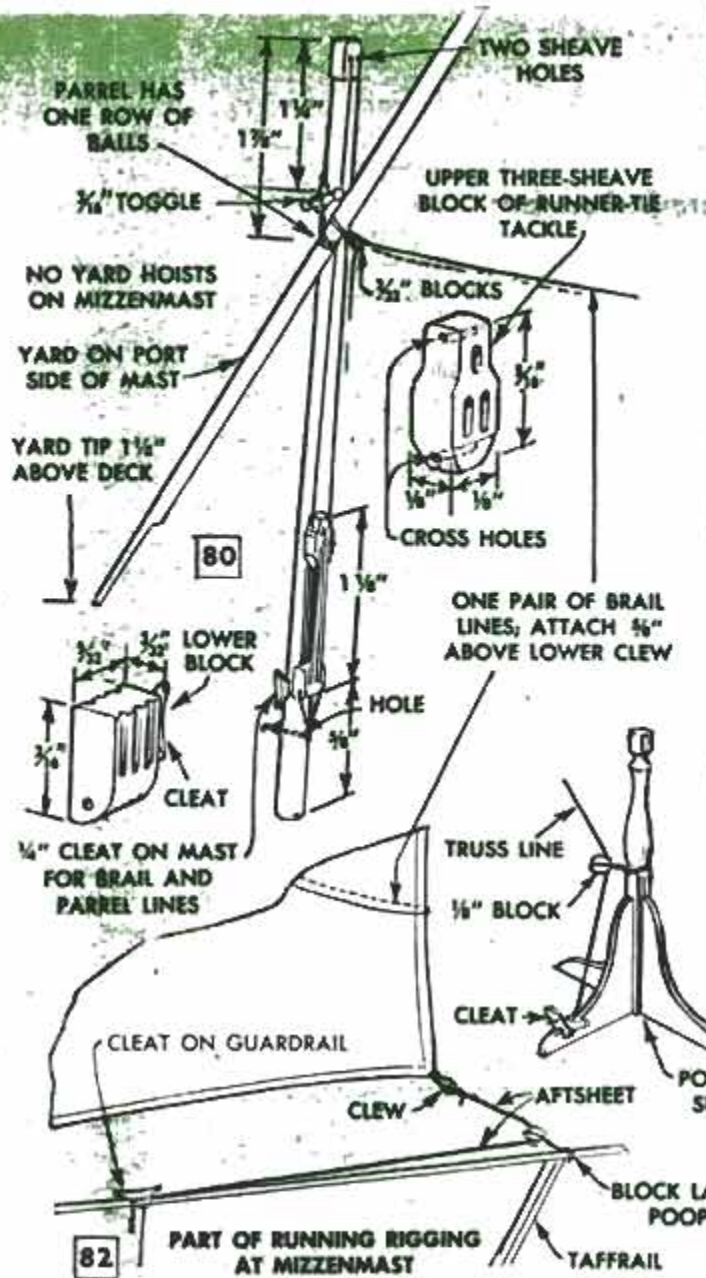

sail, and the distances from the yard to the blocks of the stays are the same. Fig. 77 shows where the stays attach to the pinrails of the poop deck. The lines straddle the foremost guns on this deck and are tied about $\frac{1}{2}$ in. apart. Fig. 77 also shows the fastening points of the aftsheets. They pass through blocks held by eyelets that are driven into the toprails just ahead of the poop overhang and the guardrail, then are brought forward and are tied to the fourth set of cleats. On the poop deck the cleats are glued to pairs of adjacent timberheads just below the toprails. The cleats are larger than those along the rail of the main deck. The parrel for the mainmast has nine rows of beads, four in each row.

As you can see from Figs. 80 and 81, the mizzenmast has no yard hoists or yard stays. The runner-tie tackle is simpler also, consisting of two 3-sheave blocks. The standing line from the lower block goes through a hole drilled through the mast, and is knotted on the fore side. One end of

the tackle is glued or knotted at the lower cross hole of the upper block. Then it passes through the three holes of both blocks and the end of the line attaches to a cleat on the side of the lower block.

Spot-Glue the Brail Lines

The mizzen sail goes on the port side of the mast. It has only one pair of brail lines which are spot-glued to the leech edge of the sail about $\frac{3}{4}$ in. above the lower clew. The fall ends tie to a cleat glued to the port side of the mast near the lower block. As shown in the plan view in Fig. 83, the foresheets are tied to the fifth set of cleats. The truss line passes through a block lashed to the poop-spar support, and then ties to the cleat on its forward foot as detailed. The single aftsheet passes through a block lashed to the poop spar just behind the taffrail and then ties to a cleat on the guardrail. If a parrel is added, it should consist of a single row of balls, and the parrel line is tied to the brail-line cleat. ★ ★ ★

Unique Cattleproof Gate Latch Locks With Barrel Bolt

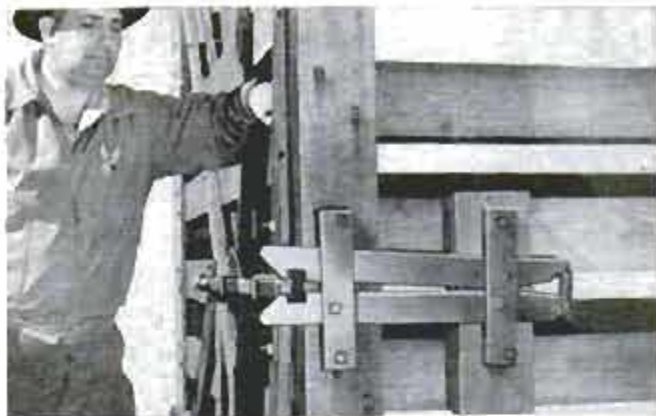

Combining the strength of a barrel-bolt lock with the operating ease of a spring-loaded latch, this cattleproof latch is installed on the gate of a stock pen. The bolt consists of a 4-ft. length of 1 x 1-in. steel bar, one end being turned to a slip fit for a compression coil spring. The bolt slides in three brackets welded from steel flat, and slips between the spring-loaded jaws of a latch mechanism fitted on the corner post and side fence. A square opening is cut in the jaws so they clamp firmly around the bolt. The jaws are pivoted at the rear bracket, so that a compression spring between the ends of the clamps keeps them together. In use, the bolt is pulled back against spring tension, to permit the gate to be opened. When the gate is to be closed, it simply is swung shut and the bolt end slips between the spring-loaded latch jaws and is held securely.

F. Leland Elam, Sacramento, Calif.

Improved Ball-Bearing Center Fits Drill Chuck or Tailstock

On some types of metal-lathe jobs a tail center that turns with the work is advantageous, especially if the operation is carried out at fairly high speeds. Such a center is made quickly by turning and blind-drilling a bronze sleeve to seat a steel ball and a rotating center, as in the detail. The sleeve can be turned to the same diameter throughout its

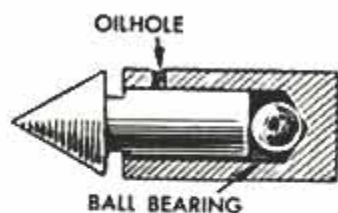

length for use in a drill chuck, as indicated, or machined to a taper to fit a tailstock quill.

Steel-Ball Locator Removed From Machine Casting

Steel balls inserted in holes drilled in machine parts to serve as latches or locators usually are spring-loaded and are held in place by upsetting metal at the edge of the hole. When removal is necessary, one machinist drills a small hole in the casting, the drill bit centered about $\frac{1}{32}$ in. below the center line of the ball. After drilling through to the surface of the ball the latter usually can be removed with a pin punch.—Frank L. Rush, Columbus, Ohio.



Flattened Shanks Hold Bolts

When the nuts on carriage bolts, used to assemble wooden parts, become rusted, they are difficult to remove, as the bolts simply rotate in the wood. To prevent this, one man flattened the shanks of the bolts, then drove them into the holes. When the nuts are turned the distorted shanks bind in the holes and do not turn.

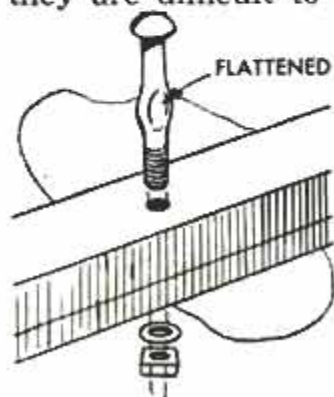

Wrench for Worn-Shanked Taps

If you have some taps, the square shanks of which have become worn and rounded so they cannot be gripped by a regular tap wrench, modify an adjustable wrench for the job. Grind right-angle notches in the two jaws so a square is formed when the jaws are clamped together.—Arthur B. Farwell, Detroit, Mich.

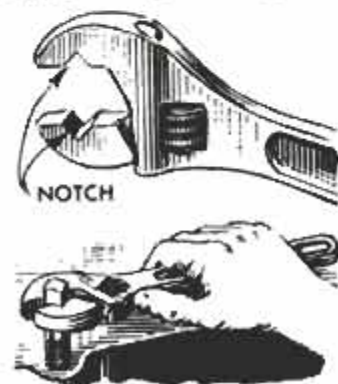

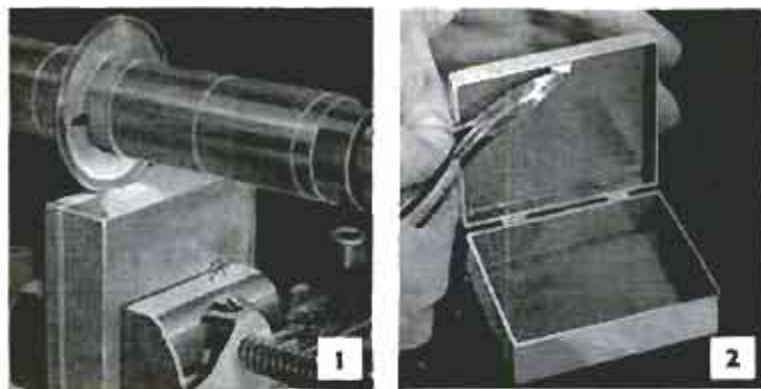

Ornamental Brass Box For Small Parts

An ornamental metal box for paper clips, jewelry, stamps, etc., is easy to make when a wooden block of the size and shape of the box desired is used for a form as shown. The bottom, sides and ends of the box are cut in one piece from sheet brass and partly bent into position, after placing the block on the inside of the bottom as in Fig. 3. The ends and sides are then pressed together by clamping the block and cutout in a vise, after which the block is removed and the joints are soldered. The block is placed in the box again and the top, also cut from sheet brass, is soldered in place. Next the lid is cut from the upper part of the box and the block is removed. This can be done with a hacksaw, or with a slitting saw on a milling machine as in Fig. 1. In either case, the wooden block within the

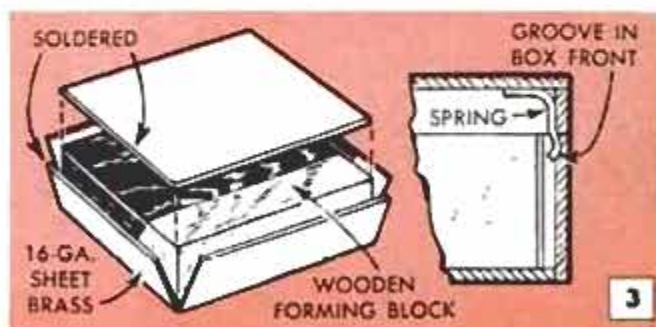

box prevents distortion of the metal when it is held in a vise for cutting. Small brass hinges are soldered to the back of the box and a friction catch is soldered to the front as in Fig. 2 and the detail in Fig. 3. The completed box is polished and lacquered and a sample of its contents is cemented to the top as shown.

Walter E. Burton, Akron, Ohio.

Using Antifreeze Second Season Can Damage Cooling System

Experts agree that a permanent-type antifreeze does not lose its nonfreezing quality after one season of use. They also agree that it is poor economy to reuse it, because the rust and corrosion inhibitor may be ineffective. Minerals in the water, air seeping into the system and corrosive exhaust gases leaking through gaskets can destroy the effectiveness of inhibitor in even premium-quality antifreeze. Also, salts, formed when the inhibitor neutralizes acid in the coolant, remain in solution to cause damage. If you were able to make a chemical analysis of the solution now in your cooling system, then compare it with a sample of unused antifreeze, noting the antifreeze quality, present alkalinity plus the reserve alkalinity available for future protection, you could challenge the experts. The best bet, however, is to drain and flush the cooling system and use new antifreeze.

Handle on Extension Cord Converts It to Trouble Light

An extension cord becomes more convenient to use as a trouble light when it is fitted with a handle. An ideal handle is a bicycle handle-bar grip, since it is rubber and has a hole in the end for the cord. The end of the grip is coated with bicycle-rim cement and forced against the base of the socket, after which electrician's tape is used to bind the two together. Naturally, it is first necessary to remove the wire from the socket to slip the handle over the cord.

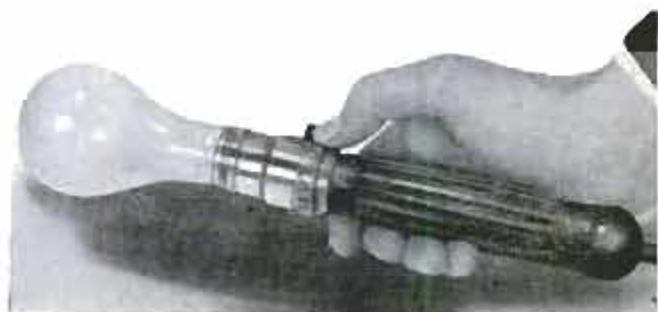

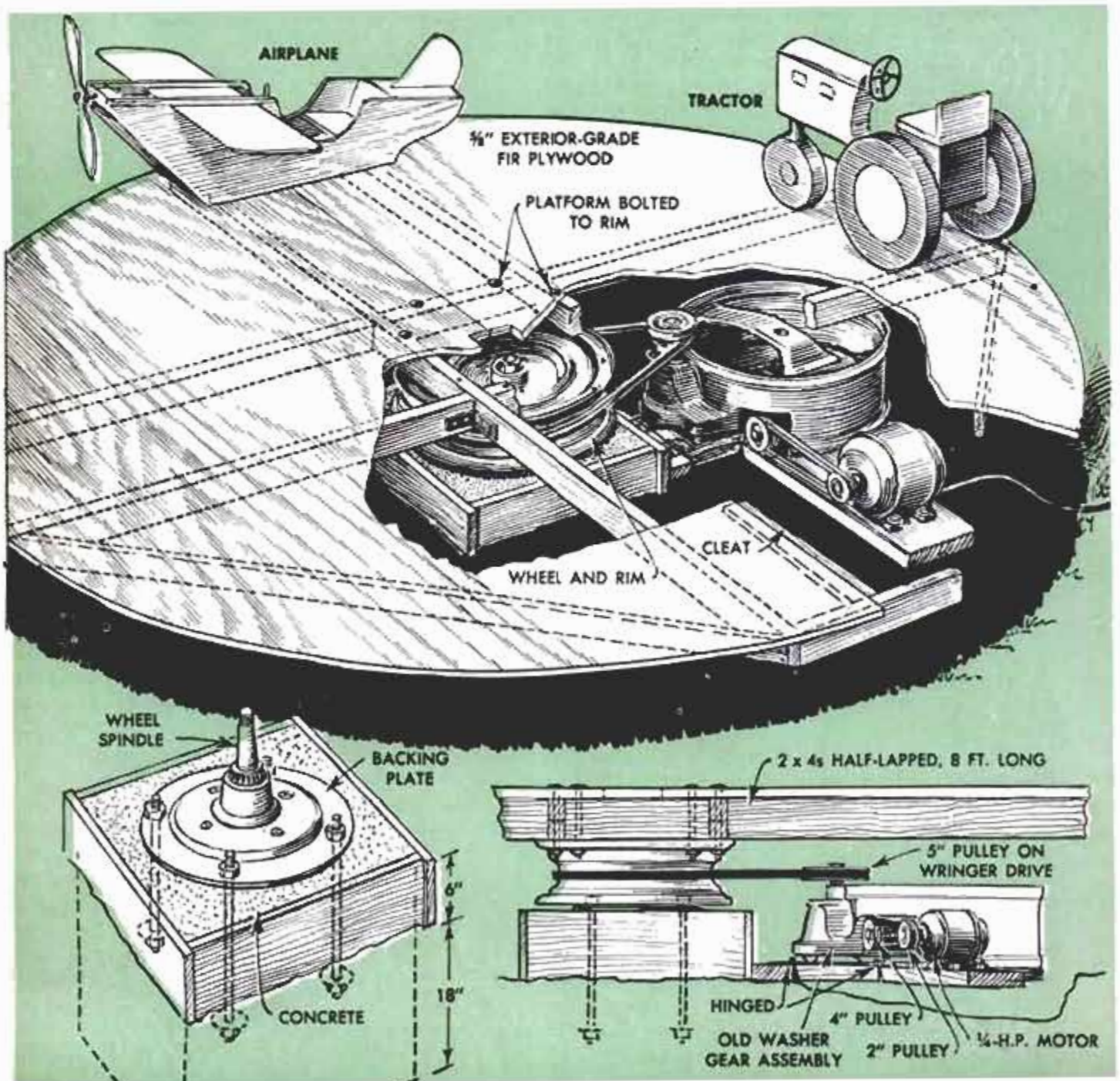
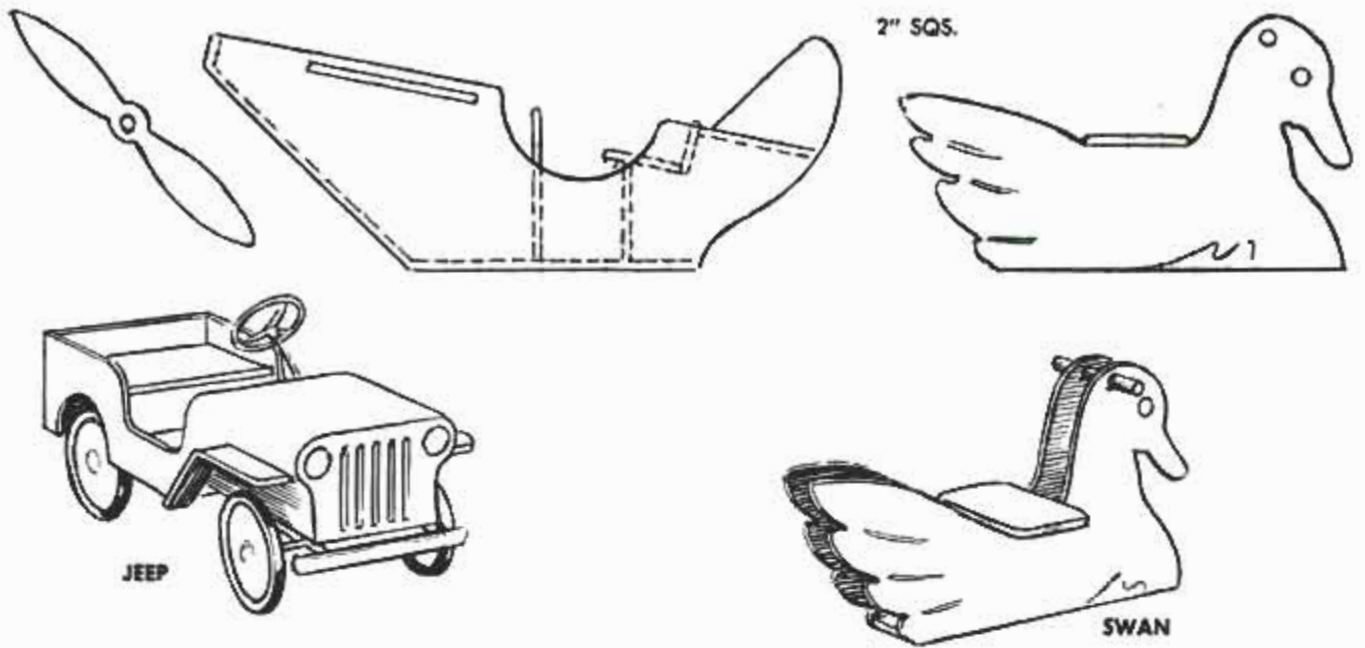



BACKYARD MERRY-GO-ROUND

By Robert E. Wilson

PRESENTING your youngsters with their very own merry-go-round will make you a very popular father, and your children will be the envy of every child in the neighborhood.

Construction starts with digging a hole 20 in. square and 18 in. deep. In areas of severe cold, make the hole 30 in. deep. A form of 2 x 6s around the top of the excavation produces a concrete "pillar" that projects above ground level. Next obtain the front-wheel assembly from an auto-wrecking yard, including the spindle, bearings, backing plate and wheel. Be sure the bearings are in good condition. Drill four holes in the backing plate to accommodate four 1/2-in. bolts, 12 in. long. Suspend the spindle and backing plate, with the long bolts in place and nuts turned just hand-tight, over the excavation and fill it with concrete. After the concrete has seasoned several days, remove the nuts, install lock washers and tighten the nuts thoroughly so the backing plate is solid. Fit the inner bearing on the spindle, slip the brake drum in place and tighten the

large retaining nut. The wheel now is bolted to the drum.

The next step is to build the 2 x 4 framework that supports the merry-go-round platform. Two pairs of 2 x 4s, 8 ft. long, are half-lapped as shown in the detail, and all joints strengthened with steel angles. Two 4 x 8-ft. sheets of 5/8-in. exterior-grade plywood are nailed to the frame and bolted to the wheel. The intersection of diagonal lines from the corners of the platform locate the center from which is scribed an 8-ft.-dia. circle. Cut an opening at the center of the platform over the wheel nut.

Power for the ride is supplied by a 1/4-hp. electric motor. A 2-in. pulley on the motor is V-belted to a 4-in. pulley on the gearbox of an old washing-machine base. A 5-in. pulley is fitted on the vertical shaft of this gearbox that originally rotated the wringer rollers. From this pulley a 56-in. V-belt is fitted around the car wheel. The platform on which the gearbox is bolted is hinged so the weight of the box keeps tension on the belt. Speed of the ride is about 14 to 16 r.p.m. ★ ★ ★

Rustic Wagon-Wheel Garden Seat Has Removable Cushion



Here is a shady garden seat designed to combine rustic beauty with a practical method of storage. The seat consists of a wooden wagon wheel over which is dropped a disk of plywood. The center is cut out to accommodate the projecting hub of the wheel. The plywood is upholstered with rubberized horsehair covered with canvas-backed plastic. A wagon axle can be cut off and set in concrete to support the wheel, or if an axle is not available, a length of pipe can be used. A bolt fitted through the pipe supports the wheel. If the axle is not hollow, the column of the umbrella is fitted in a hole cut in the plywood, located between spokes. Both the plywood disk and the wheel lift off for storing.

Louise P. Bell, Tucson, Ariz.

Be certain that all the polish is absorbed when polishing wood. Otherwise, a cloudy appearance may result. A clean dry finger rubbed over the surface will not leave a trace if the wood is polished properly.

Threading Short Pipe Nipples

Threading the second end of a short pipe nipple usually is done by screwing the threaded end into a pipe coupling held in a vise. The action of the thread die forces the nipple tightly into the coupling, making it difficult to remove without damaging the threads. A bolt, inserted through the coupling as indicated, will prevent the nipple from becoming jammed.

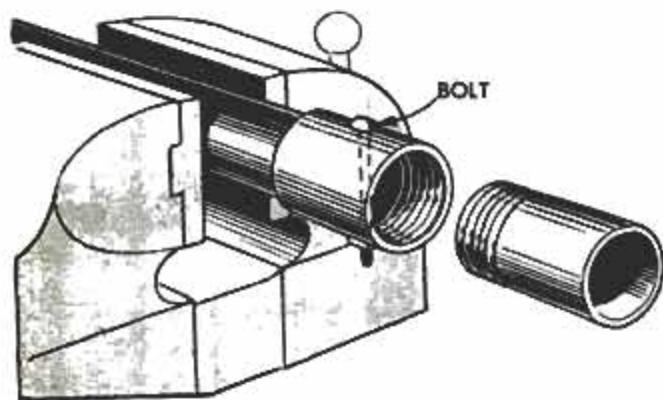

Flat-Steel Hook on Bow Saw Increases Its Usefulness



Bolted near one end of a bow saw, as shown in the photo, a hook bent from $\frac{1}{8}$ x $\frac{1}{2}$ -in. flat steel makes a handy "accessory" when the saw is used for pruning trees. With an approximate diameter of $2\frac{1}{2}$ in., the hook can be used to pull within easy reach branches that ordinarily would require a stepladder for handling. Small, dead branches also can be broken off with the hook, eliminating the need for sawing. When not being used, the saw can be hung in the workshop by means of the hook.

R. Hanscom, Elmhurst, Ill.

If you have chairs with cane seats that have become loose and are sagging, you can clean and repair them with just one operation. Wash the chair seats with hot water and detergent, then place them outside in the sunlight to dry. In the process of drying, the cane will shrink, restoring the seats to their original tension.



“Sound Diagnosing” Engine Troubles

By M. C. Anderson

WHEN THE COMPONENTS of an automobile engine are not functioning properly, they usually sound a warning in the form of noises not common to normal operation. Every rotating or reciprocating part is a potential source of noise, and locating the actual source of engine noises and knocks can be the most puzzling of all engine trouble-shooting jobs. Fortunately, most noises possess characteristics of their own which help identify the source. Given a method of amplifying these sounds and locating their sources, coupled with some knowledge of their meaning, any car owner is equipped to make a “sound diagnosis.”

It is important to know the source of unusual noises as early and accurately as possible, because if some troubles are permitted to continue, extensive damage can occur. In other cases, a knocking engine might run safely for hundreds of miles before an overhaul becomes necessary.

Simplest of the listening devices is a sounding rod, left-hand photo, page 198. Simply rest one end of a length of broomstick or dowel against the engine, hook a thumb over the other end and rest the thumb against the lobe of the ear. Today, a professional mechanic is more likely to use an engine stethoscope, right-hand pho-

to, page 198, which is accurate and flexible in use. The photos and diagram on page 199 show the construction and use of an “electric stethoscope” which a home mechanic can build for himself. It may be used even while driving the car, an advantage when seeking hard-to-find body and running-gear noises. Parts for the stethoscope can be purchased at a radio-supply house. Needed are a set of earphones, a switch, a doorbell transformer, a .25 megohm potentiometer, 3 flashlight dry cells in a holder and a small carbon microphone. A war-surplus throat “mike” will do. These parts are assembled in a metal box, such as a child’s lunch box, and wired as shown in the diagram at the bottom of page 199. A permanent magnet taped to the microphone permits it to be placed almost anywhere on the car. The potentiometer adjusts the volume at the headset.

Always make sound tests with an engine warmed to operating temperature, so that clearances are normal. Test for minor trouble first. Most clicking noises in an engine are caused by loose or worn tappets. Some engines that use hydraulic valve lifters have adjustable tappets requiring occasional adjustment to keep them running quietly. A split muffler can cause a howl identical to that produced by a bad rear-axle assembly, but is much less costly

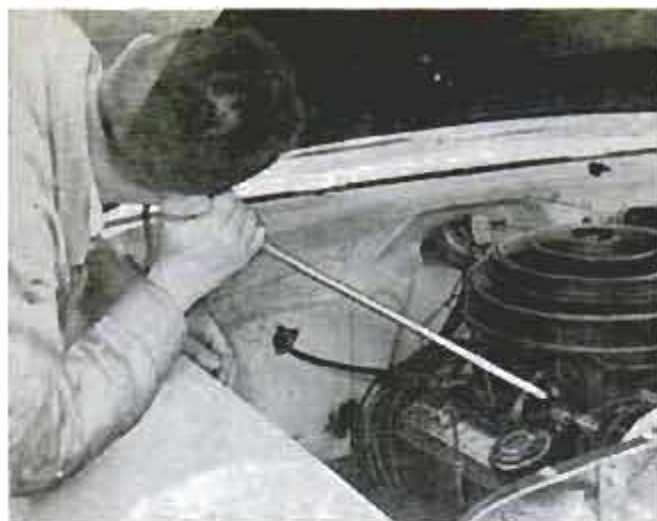

Simplest sound-detector is dowel. One end is held on engine, other end is held against head near the ear

Engine stethoscope, similar to one used by doctors, is in toolkit of many modern automobile mechanics

NOISE	PROBABLE SOURCE	MIKE POSITION	HOW TO CHECK
Dull knock or heavy thud	Loose main bearings	Lower block near bearings	Louder on sudden acceleration or when climbing hill
Sharp, irregular rap	Excessive end play on main bearings	Flywheel housing near main bearings	Depressing clutch will stop noise. Difficult to diagnose with automatic transmission
Sharp, metallic double-knock. (If all are loose, a rattling metallic sound.)	Loose piston pins	Top of block just below head gasket	Usually loudest when idling. Shorting out plug may change tone of knock, make it more severe. Noise is sharp when engine is laboring
Light tapping, click or sharp rattle	Broken ring	Top or bottom of block near head or pan gaskets	Heard at idle and under acceleration. Cannot be eliminated by shorting spark plug
Light pounding, sometimes a clatter or series of raps	Loose connecting-rod bearings	Lower block at pan gasket or on oil pan	Bad case heard at all speeds. Slightly loose rods sound like piston slap or loose piston pins. Loose rod usually knocks loudest at 35 or 40 m.p.h.
Light knock	Bent connecting rod	Lower block at pan gasket	Light knock at idle, increases on acceleration. Reduces, is not eliminated when plug is shorted
Hollow, distinct click or rattle	Piston slap	About 3 in. below head gasket, adjacent to cylinders	Occurs at idle, shows up under load, loudest when engine is cold. Can be eliminated by shorting spark plug
Sharp clatter or knock at idle, growl at 25 to 30 m.p.h.	Loose or worn timing gears	Timing-gear cover at front of engine	Loudest at idle, particularly if idle is rough. May disappear at low speeds, come in again as growl at 25 to 30 m.p.h.
Rumble or scraping noise	Loose timing chain	Timing cover, front of engine	Rumbling noise at idle or on acceleration. A dull scraping sound if chain is striking cover
Clicking sound similar to tappet noise	Worn piston-ring grooves	Side of block, adjacent to cylinder walls	Click twice per crankshaft revolution, instead of every other revolution as for valves
Snapping sound (Engine overhauled)	Rings fitted too tightly	Top of block just below head gasket	Noise cannot be eliminated by shorting out spark plugs
Heavy click or light tapping noise	New rings striking ridge in worn cylinder, or head gasket in rebored cylinder	Side of block adjacent to top and bottom center of piston stroke	Noise is regular and changes with speed. Louder as speed increases. Cannot be shorted out with plugs
Irregular knock at idle	Worn or loose harmonic balancer	Front of block, near balancer	Noise disappears above idle. Grasp balancer at edge and rock back and forth sharply. Looseness can be detected.
Rattling sound	Bad generator bearings	Generator housing near bearings	Check with engine idling. Move mike to determine which bearing, front or rear, is bad
Irregular, heavy knock	Loose flywheel	Flywheel housing	Noise comes and goes. Cannot be eliminated by shorting plugs. Idle engine, cut switch and allow engine to slow. Turn on ignition again. A distinct knock will be heard each time switch is turned on



Electric stethoscope fits neatly inside child's metal lunch box that has handle for easy carrying



Box is placed on seat, earphones on head, microphone is held in place on car body or engine with magnet

to replace. In a similar way, other components may "telegraph" sounds to parts of the car that are not at fault. A thorough diagnosis before any work is done will prevent costly and unnecessary repair bills.

The chart on page 198 lists some of the sounds that can be heard with the electric stethoscope, where to find them and what they mean. As an example of how to use the stethoscope and chart, suppose the engine has a knock that shows up at idle speed as a hollow, distinct click or rattle. The noise is more pronounced when the engine is cold or when it is under a load. Referring to the chart, piston slap is indicated. To verify this diagnosis, place the mike on the block about 3 in. below the head gasket adjacent to the cylinders, as described in the chart. With the engine running, move the mike from one cylinder to the next un-

til the source of the noise is localized. Shorting out the spark plug will eliminate the noise, proving the correctness of the diagnosis.

If you are the type of car owner who is bothered by unusual sounds when a car is driven, the electric stethoscope will be especially valuable. For example, a rattle might sound only when the car is driven on a moderately rough road. It seems to be in the front suspension, but when the car is on a hoist none of the components of the suspension can be pulled or twisted to reveal the sound. With the stethoscope, place the microphone on various parts; the A-frames, shock-absorber links and so on, until you hear the sound loudest in the earphones as the car is driven. This procedure will reveal which component is to be repaired or replaced. ★ ★ ★

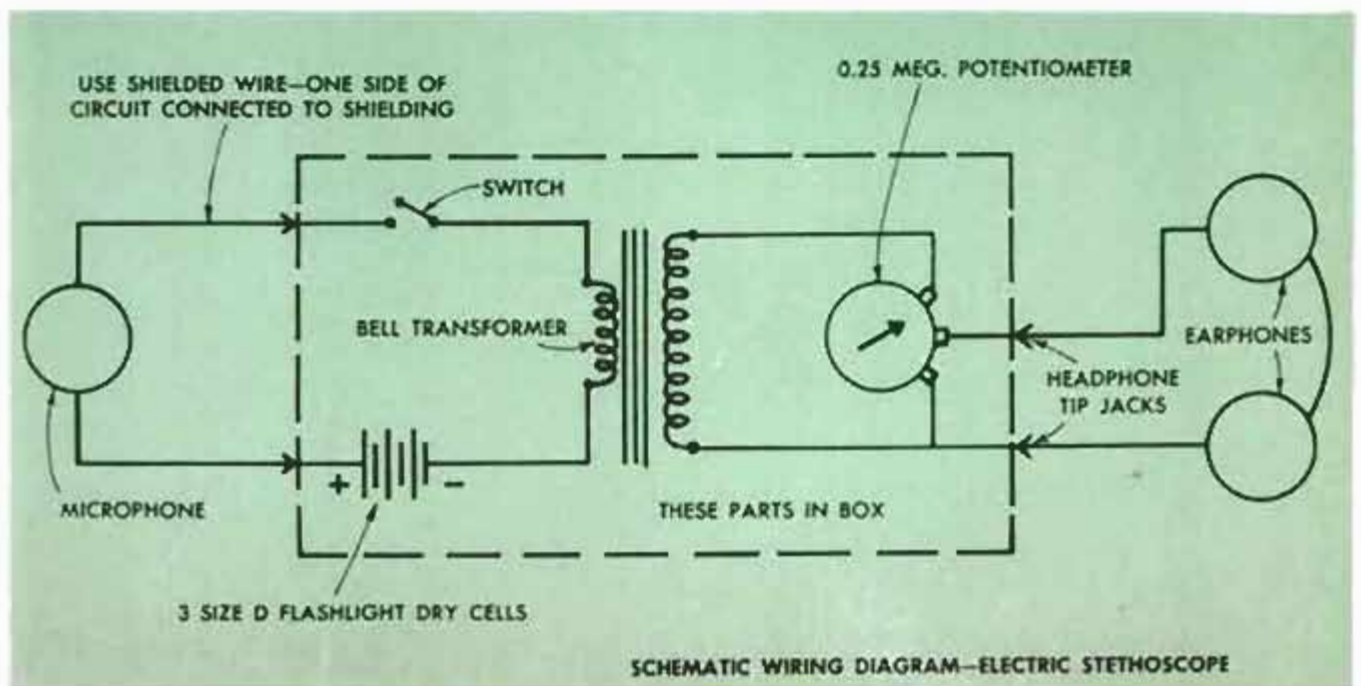

Auxiliary Stop Aids Cutting Paper in Darkroom

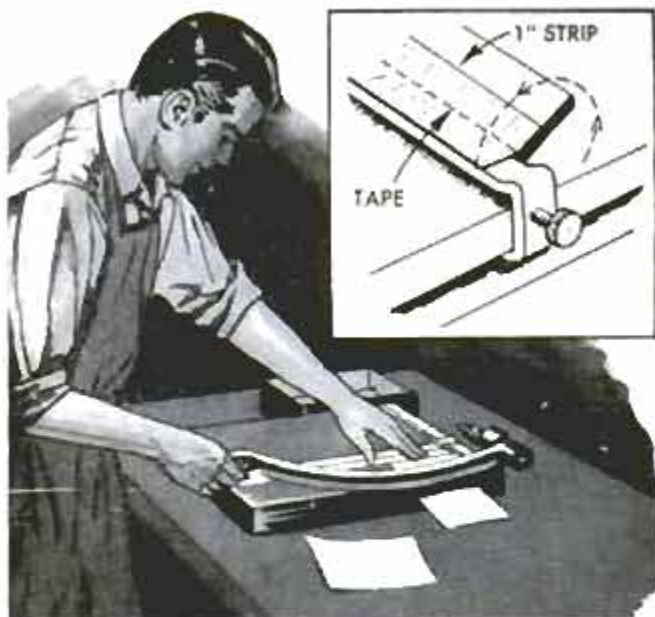

Hinged to the stop on a paper cutter, a 1-in.-wide strip of cardboard simplifies the job of cutting 8 x 10-in. undeveloped print paper to smaller size in the dark. The stop is set at 5 in. to permit cutting 8 x 10-in. paper to 5 x 8-in. size, which is suitable for a 5 x 7-in. print. When the cardboard strip is flipped down and held, the 5 x 8-in. paper can be cut to standard 4 x 5-in. size.

Peter G. Gordon, North Miami, Fla.

Pulls for small drawers, such as are used in small-parts cabinets in a workshop, can be obtained ready-made by cutting off the heads of conventional wooden clothespins. Holes are drilled through the drawer fronts to permit driving a screw into each pull from inside the drawer.

M. Robert Beasley, Jackson, Mich.

Gasket in Pouring Spout Eliminates Need for Extra Cap



On gasoline containers that have a removable spout, the spout must be replaced with a regular cap when the container is transported in a car or boat. You can eliminate this need for carrying two items, with the chance of mislaying one, by fitting a heavy cork or leather gasket inside the cap of the pouring spout as shown. The gasket should be slightly smaller in diameter than the inside of the spout fitting, so that when the spout is removed the gasket can be lifted out easily. The spout then is replaced on the container and gasoline is poured into the tank to be filled. Keep the gasket in a pocket to prevent its loss.

ⓘ Before attempting to remove road-tar stains from clothing with cleaning fluid, rub the stains with petroleum jelly. When the jelly is dissolved with cleaning fluid it will carry the stain with it.

Positions on Opposite Sides of Wall Located With Magnet

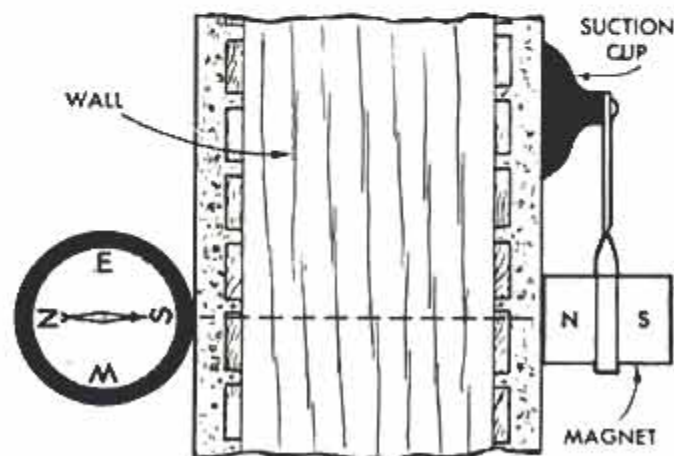

When it is necessary to locate identical positions on opposite sides of a wall, the job can be done accurately with a small bar magnet and a pocket compass. Attach the bar magnet to one side of the wall by means of a suction cup or other hanger, at the exact location. Then, on the opposite side of the wall, move the compass around until the needle points directly at right angles to the wall. If the height from the floor has been measured ahead of time with a rule, it can be double-checked by watching the compass needle as it tilts up and down, pointing to the magnet.

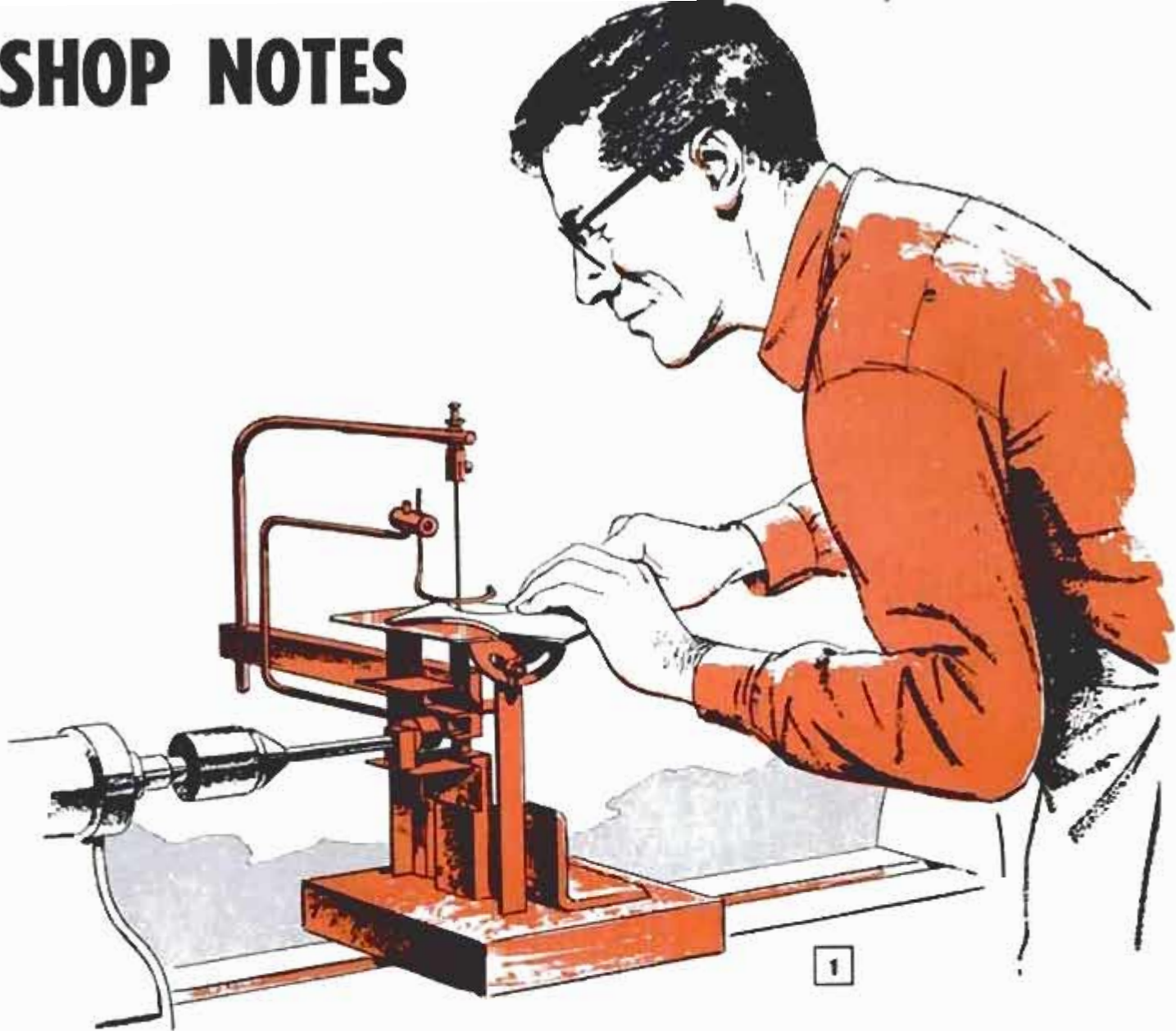

Your Lathe Drives This Jigsaw

By Walter E. Burton

ALTHOUGH designed especially for mounting on the bed of a lathe, this useful jigsaw can be altered easily for V-belt drive from a small motor, rather than from the lathe spindle. The swing, which is the capacity, can range from 8 to 12 in. This is the distance from the blade to the frame, measured at the table. The guard, which is adjustable to clear stock up to about 1 in. in thickness, is optional. The dimensions given on the principal parts adapt the unit to use on a 9-in. lathe. If the unit is used on lathes of greater or lesser capacity, dimensions of certain vertical parts must be altered accordingly. As

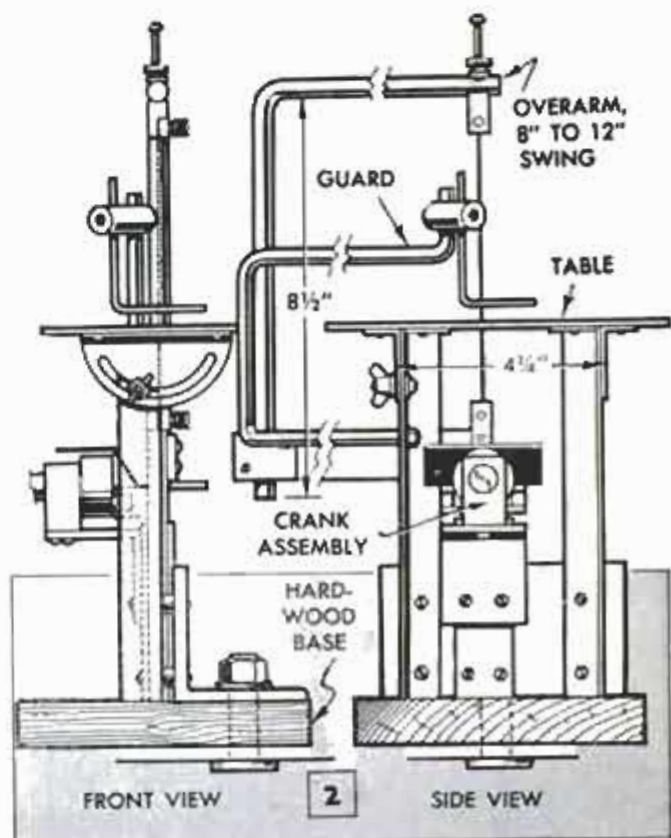

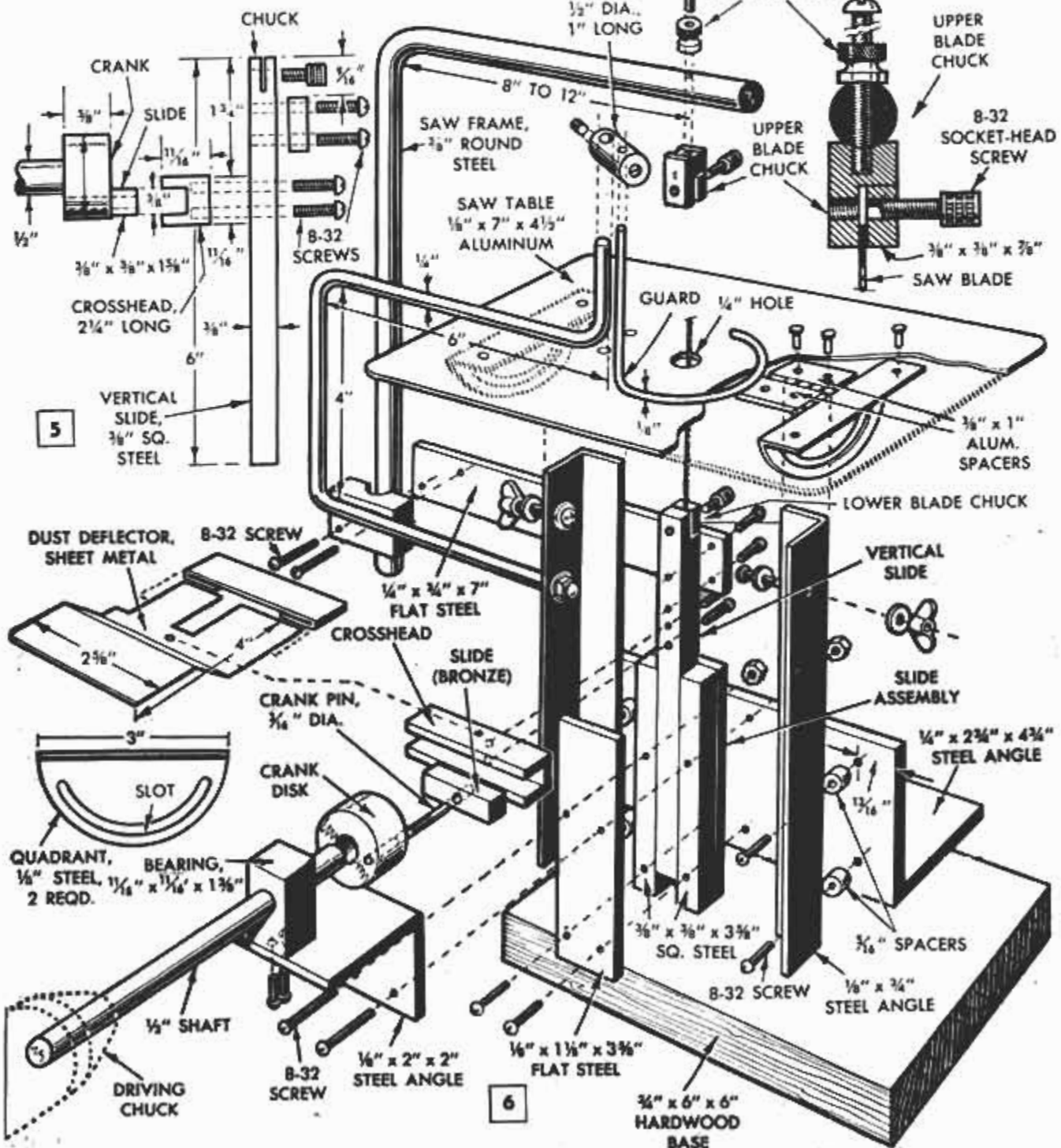
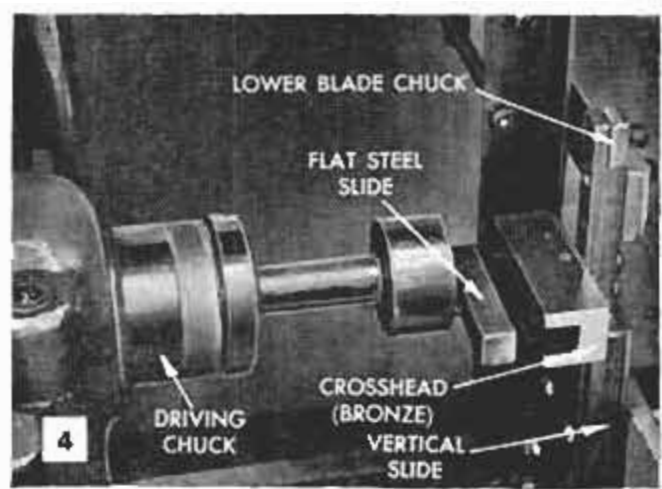
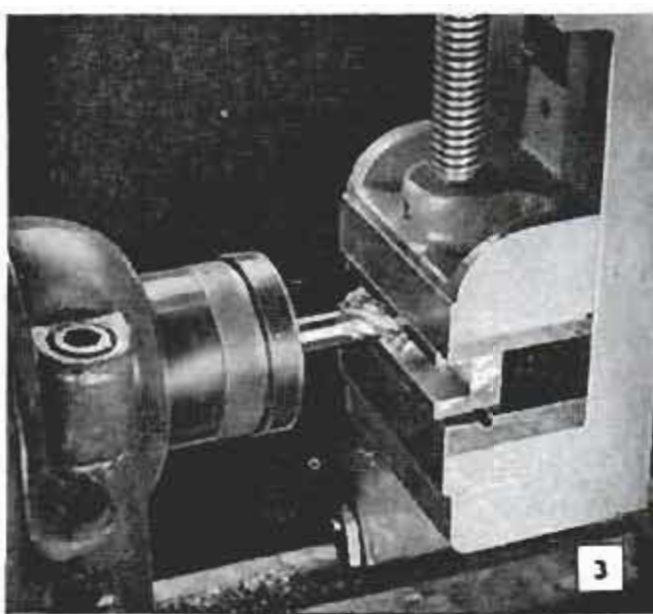

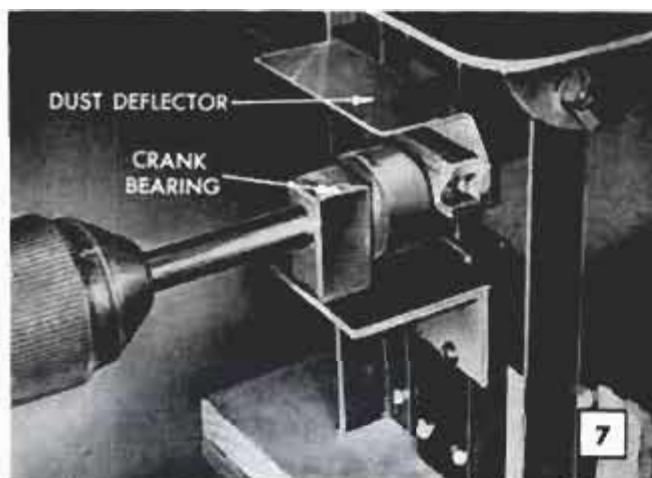

a typical example, it should be noted that the length of the $\frac{1}{8} \times \frac{3}{4}$ -in. steel angles which support the table, Figs. 2 and 6, is not given. For a 9-in. lathe these supports should be $7\frac{1}{2}$ in. long. For a 10-in. lathe they should, of course, be made 1 in. longer and a compensating increase also must be made in the length of the slide carrying the lower blade chuck. If, for example, the unit is made for use with a 12-in. wood lathe, the jigsaw can be blocked or shimmed up to align the crankshaft with the lathe spindle. For these reasons do not cut any stock to length until you have measured the swing of the lathe. Speed of the lathe spindle should not exceed 400 r.p.m.

The crank disk, Fig. 5, is turned to $\frac{5}{8}$ in. in thickness and $1\frac{1}{4}$ in. diameter, and the crank pin, which is $\frac{3}{16}$ in. in diameter, is offset $\frac{7}{16}$ in. to give the blade a stroke of $\frac{7}{8}$ in. The center hole in the crank disk is reamed to a drive fit on the shaft. The slide can be of bronze as in Fig. 6, or, if you have the material at hand, make the cross-head of bronze or brass and the slide of steel, Fig. 6. Do not use steel for both parts. Although you can groove the slide by hand methods, it is better to mill the groove as in Fig. 3, or have it milled at a local machine shop.

If you have a lathe equipped with a collet chuck, you can, in most instances, omit the crank-bearing support and drive the unit direct as in Fig. 4. But if the overhang of the shaft must be more than 2 in., then it is best to provide the bearing as detailed in Figs. 2 and 6 and pictured in Figs. 1 and 7. As detailed, the table is fitted with quadrants that permit it to tilt to the right. The guard is removed when the table is tilted. Note that the quadrant-locking screw is slightly off-center, Fig. 2, and for this reason the slot must be made wider than the diameter of the screw. If your scrollwork includes heavy cuts, then it is best to provide a blade support, or guide. This can be attached to the underside of the table so that it bears against the back of the blade.

Steel Balls Extend Pin Punch

A long pin and a short punch can mean trouble, especially if the punch should wedge tightly in the hole with the pin only part way out. It does happen, so it's well to keep this trick in mind. Lacking a punch of sufficient length you can always extend the reach of the longest one at hand simply by dropping two or more steel balls into the hole after driving the pin part way out. Of course, the steel balls must be of a size to drop into the hole loosely.

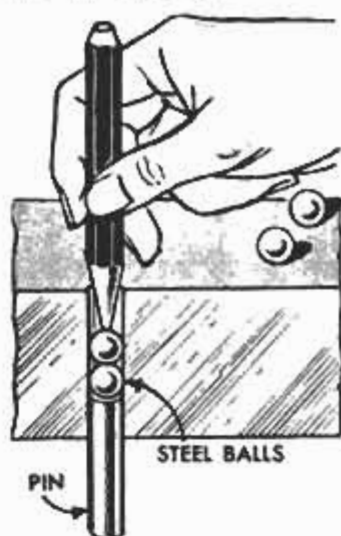

E. R. Haan, Evanston, Ill.

Guard for Glass-Cutter Wheel

Extend the useful life of a glass cutter by protecting the cutting wheel from being nicked or dulled by other tools in a drawer or tool chest. The rubber bulb of a medicine dropper slipped over the end of the cutter is ideal as a guard.

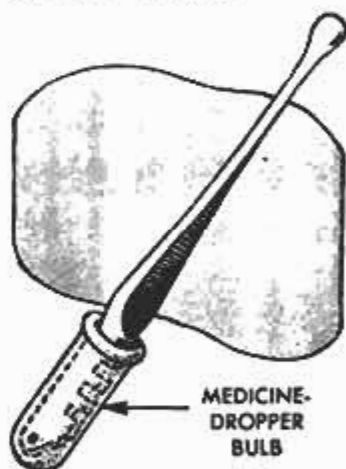

Shop-Made Expanding Mandrel

When you need a short, expanding mandrel in a hurry here's a way to make one quickly for use in a lathe chuck or collet. Machine a length of tubing to the diameter required, leaving a shoulder to serve as a workstop. Tap one end for a pipe plug. Slot the tapped end two ways, preferably running the slots individually on a milling machine. If the slots are cut with a hacksaw, be careful to space them equally and run to a uniform depth. In use, the work is placed over the slotted end of the mandrel and the pipe plug tightened to hold it in place.

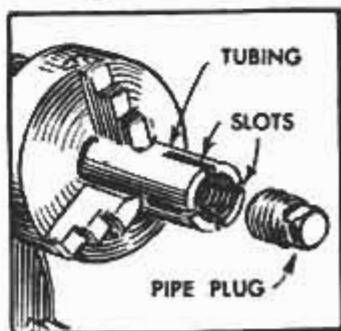

R. B. Courtney, Whittier, Calif.

Reflective Tape on Flashlight Alerts Approaching Motorists

Strips of reflective tape wrapped around the circumference of a flashlight at both ends give it a "built in" safety factor when used on the highway as illustrated at left. Not only is it easier for approaching motorists to see such a flashlight but the reflective tape serves to warn them of the user's presence even when the light fails.

Robert V. Thompson, Clinton, Iowa.

☐ Ideal for brushing dust from silk and rayon lamp shades is the hairbrush your baby no longer needs. The soft bristles will not damage these delicate fabrics.

Thermostat Shuts off Gas Supply When It Burns at Mixing Valve

When there is abnormally reduced line pressure, or a "blow back" in a gas-fired furnace, gas may begin to burn at the air-mixing valve, a situation that not only is a serious fire hazard but one that may also damage the controls. To provide for automatic shutoff of gas when this occurs, mount a room-type thermostat on the furnace directly over the mixing port as shown. The thermostat is then connected to the main room thermostat circuit and adjusted to open at 90 to 100 deg. F. so that the furnace will continue to operate as before. However, presence of abnormal heat near the port will cause the circuit to break and the main gas valve to close, thereby shutting off the gas supply.

Sanding Drums Improvised With Glue and Abrasives

For fast and accurate sanding or shaping of a contoured surface, or a surface that is difficult to reach, make a sanding drum to match the contour of the work surface and fit it with a shaft for chucking in a power drill as shown in the drawing. When making the drum, turn it to the desired shape from a length of hardwood dowel and drill a hole through its axis to take a length of 1/4-in. steel rod to be used as a shaft. Then coat the surface of the drum with glue and sprinkle emery dust or other abrasive particles of the required grit on it. After the glue has set, apply another coat to prevent the abrasive from working loose too easily.

Robert L. Sargisson, Berwyn, Ill.

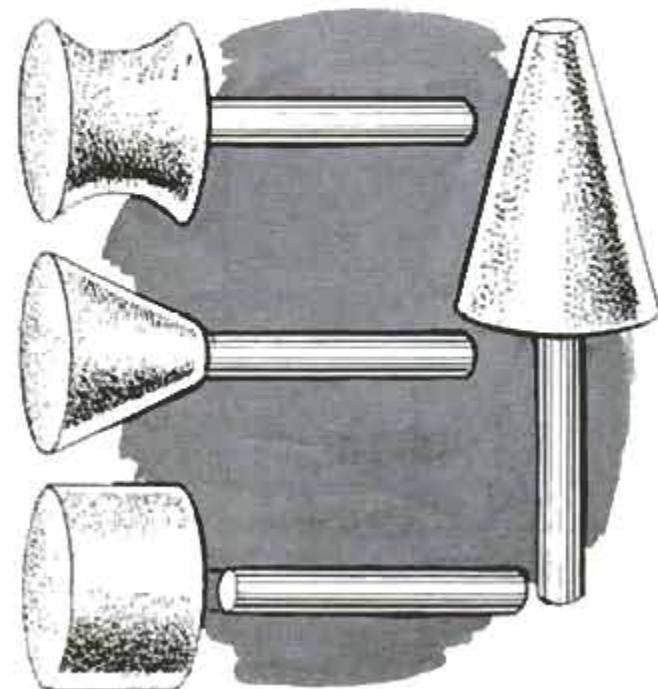
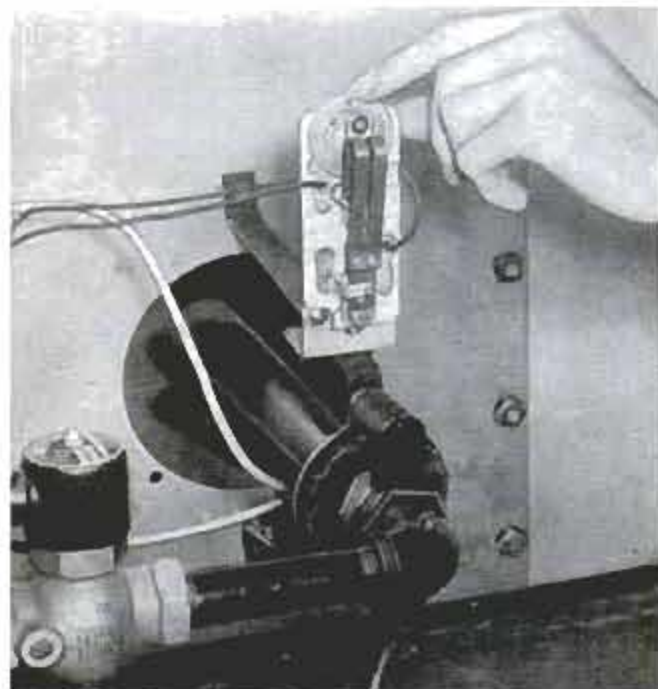



USE A WOOD RASP

for finishing scroll cuts, squaring tenons, half laps, rounding and beveling corners, squaring holes and shaping work to contour

By Edwin M. Love

RASPS AND CURVED RIFFLERS are cutting tools having a number of teeth arranged in a staggered pattern on the flat and curved faces. Rasps and rifflers differ somewhat from files in that the teeth are cut individually while those of the common file are continuous, usually arranged at an angle with the blade to give a shear cut. In Fig. 1, sections A, B and E are common rasp shapes. The others are common file shapes which are useful in smoothing and shaping wood when the larger and coarser sizes are used. The combination file, or rasp-file as it is sometimes called, pictured second from the right in Fig. 1, comes in half-round cross section. The teeth on one half of the blade are rasp-cut, that is, they are individual and are formed in a staggered pattern. Those on the other half of the blade are file-cut, each forming a continuous cutting edge across the width of the blade.

In addition to common rasps and rifflers there are several variations which are coming into wide use by craftsmen who must

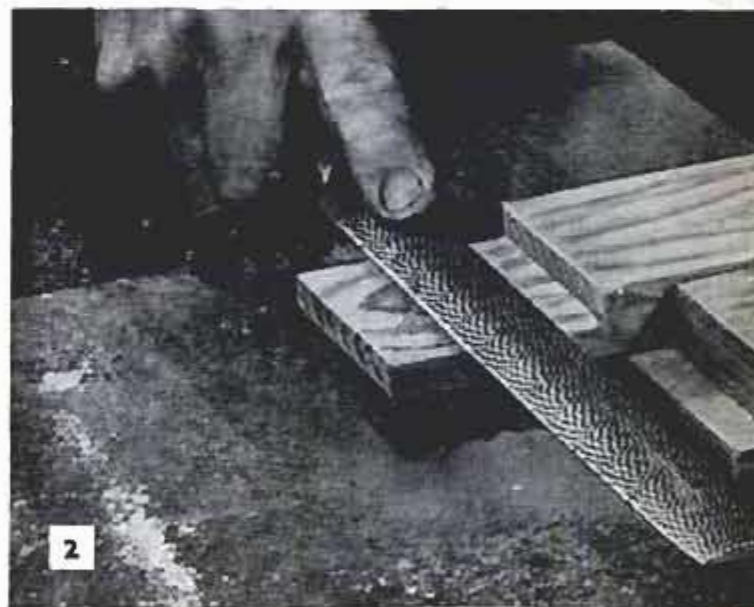

Above, tenons and half laps cut slightly oversize are easily reduced to required dimensions with a cabinetmaker's rasp. Below, a rasp makes short work of removing the saw marks from the edges of scrolls

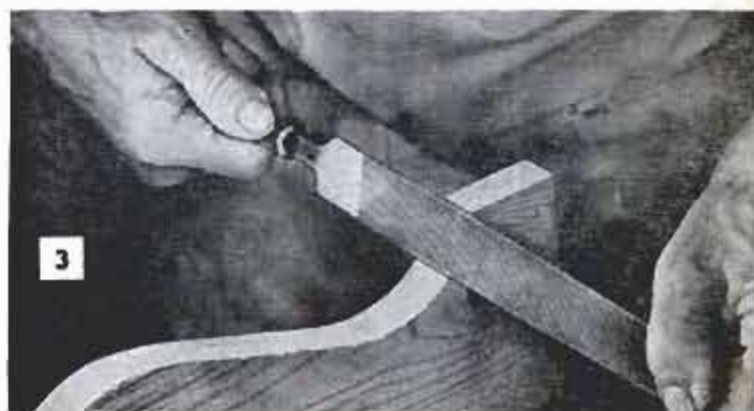



No other hand tool quite equals a rasp for finishing contoured shapes of models in wood and plastic



This new tool is handled like a rasp, cuts very fast and smooth in woods, plastic, nonferrous metals



Above, tungsten-carbide grains are cutting edges of this new tool. Below, perforations in metal form cutting edges of this tool. Cuts in any direction



shape and smooth wood by hand methods. Figs. 5 and 11 picture two of these in use. Each unit consists of a handled frame and a perforated steel strip, or blade, which is replaceable. The perforations form multiple cutters, each of which is an individual beveled blade. The tool in Fig. 5 is used as a rasp. A companion unit utilizes the same blade, but is fitted with handles so that it can be used as a plane. The tool pictured in Fig. 11 can be used either as a rasp or plane by changing the position of the handle. Another variation which can be used either as a rasp or file is pictured in Fig. 6. It is simply a file-shaped piece of flat steel having tungsten-carbide grits fused to both flat faces, fine on one side, coarse on the other. Fig. 7 pictures another hand tool for smoothing wood which has the novel feature of being able to cut in all directions with equal facility. It consists of a perforated steel sheet mounted on a special holder which permits its use in much the same manner as a sandpaper block. Still another rasplike tool is shown in Fig. 13. The body of the unit is a toothed steel helix having a drill point. It will cut in any direction and can substitute for a round rasp, a drill, and a compass saw. Although the variations described are not conventional rasps, they can serve similar uses.

Figs. 2 to 13 inclusive, picture typical work with rasps, rifflers and the newly developed units that can fill in as rasps. The rifflers, Fig. 9, are toothed in a manner similar to rasps. Common sectional shapes are shown in Fig. 9, details A to E inclusive. Note that rifflers are curved, which permits them to be used on both convex and concave surfaces, Figs. 10 and 12.

Rasps are handled, or stroked, like files as they are designed to cut on the forward stroke. When smoothing a flat surface, relax pressure slightly near the end of the cutting stroke. This is especially important when using a rasp with both hands, as otherwise the surface may be rounded slightly. A shearing stroke will prevent chatter marks when it is necessary to work end grain in hardwoods. ★ ★ ★

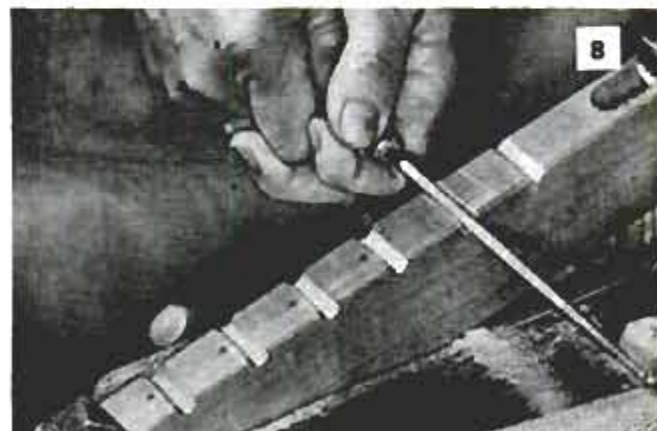



9



10

Above, rifflers are curved, can be used on convex or concave surfaces when shaping contours. Below, small rifflers are useful for finishing handmade moldings and for smoothing deeply relieved carvings

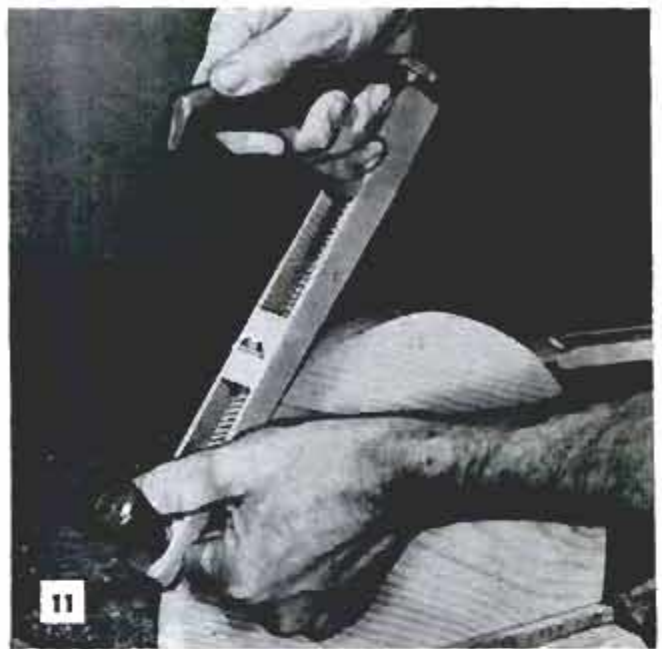

11

Above, this tool can be used either as a plane or as a rasp by changing the position of one handle. Below, this tool can serve as a round rasp, a compass saw and also as a drill. It cuts very fast

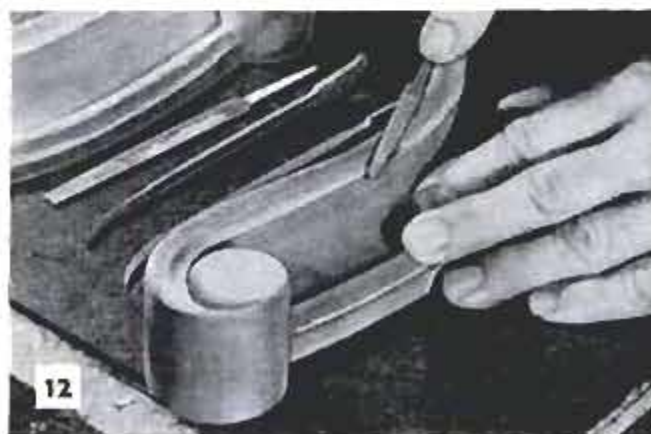

12

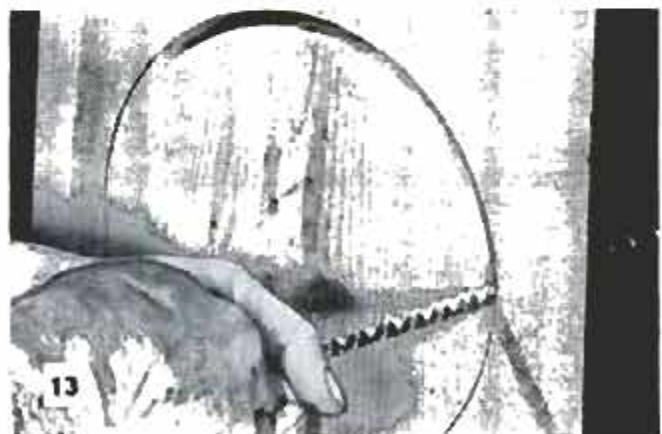

13

Magnets Hold Scale on Machine

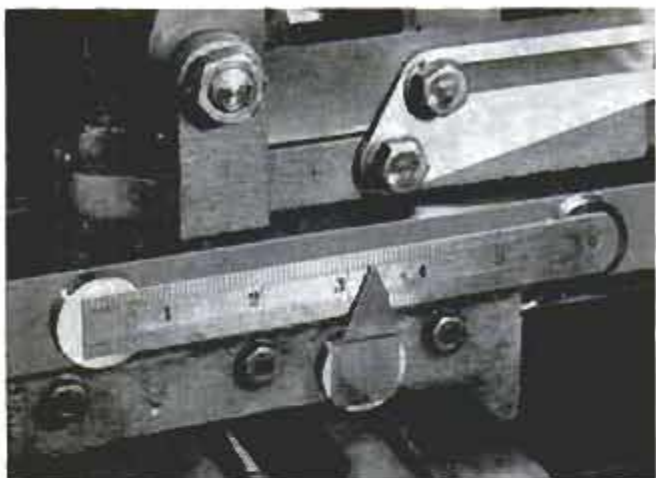

Where tolerances were not critical enough to require the use of a micrometer stop, three magnets were used to attach a steel rule to the edge of a milling-machine table and a pointer to the machine saddle, for measuring table movement. One magnet held a pointer cut from light sheet metal, while the other two magnets were placed under the ends of a 6-in. rule. The magnets permit the rule and pointer to be placed in the initial position easily. This magnet-and-rule setup also could be used on other machines in the shop.

Walter E. Burton, Akron, Ohio.

Rod Gauges Planer Knives



When knives on thickness planers of the type shown are removed for sharpening, it is necessary to realign the table so it is parallel with the knives after they are replaced. This aligning can be done accurately by using a length of brass rod—which will not damage the newly sharpened knives—as a gauge. The bar is rolled across the table from side to side as the table is adjusted, so the knives barely contact the bar. Knowing the diameter of the gauge bar also permits adjusting the thickness gauge accurately after the table is aligned.

H. Hanscom, Elmhurst, Ill.

Build This House Yourself!

Save 65% Easily!

Two bedrooms, a spacious living room, bath, carport, compact dining room and kitchen all in a space 24 x 46 feet. You can build the Precut House in three stages, using any of numerous floor plans—all of which are designed to provide maximum comfort with minimum cost. Think of it! You can build that house you've always wanted. You can make a livable shell for only \$1800. The second stage will give you a summer home with all conveniences for only \$2800. When you add the third stage, you have a luxury home for year 'round living, in any climate, for only \$3800!



Livable Shell—\$1800; Summer Home—\$2800; Luxury Home—\$3800; Simplified How-To-Do-It Instructions—Hundreds of Pictures—Working Blueprint Plans!

You can build the house with the book alone. The plans make it easier. The book gives lists of materials required, all measurements and dimensions, suggestions for financing and tells in words and shows in pictures every detail of construction. Richard Dempewolf, author of the "Precut House" book, built the house in 1650 man hours for \$3731.23—complete!

Features of Expensive Homes are included: built-in furniture, unusual amount of closet space, adaptability to various interior arrangements, and materials designed especially for amateur builders. The book is \$2.95 and a complete set of 10 blueprints \$12.50 (a duplicate set is \$5.00). You can place a C.O.D. order or mail your remittance in full.

Order book and plans from Dept. 359

POPULAR MECHANICS BOOKSHOP

208 E. Ontario St.

Chicago 11, Ill.

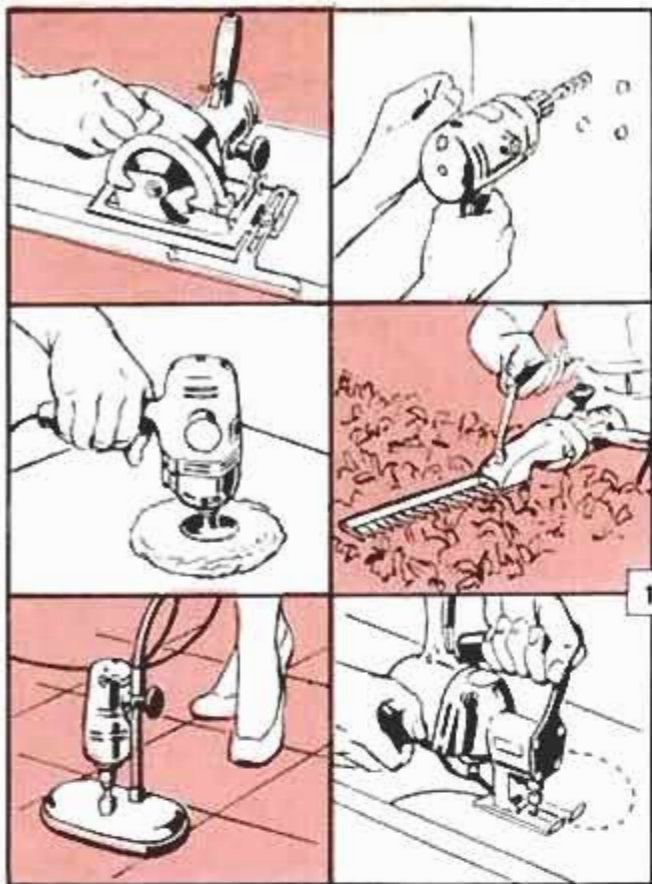

SHOPPING FOR TOOLS

1. PORTABLE POWER UNIT does 24 different jobs in the shop and around the home. Unit alone weighs about 3¼ lb., the average weight of a ¼-in. portable drill. Special attachments, only a few of which are shown above, are designed for direct drive from power unit. This utilizes full power of motor, eliminates any loss of control due to overhang or misalignment between driving and driven units. When the geared chuck pictured is added, the unit becomes a portable drill with a side handle, or knob, for two-handed operation. Motor is controlled by trigger-type switch which can be locked in "on" position

Black & Decker Mfg. Co., Towson 4, Md.

2. TAPPING ATTACHMENT is designed to fit drill press having a Morse-taper spindle. Floating spindle, which is special feature of attachment, produces a consistently perfect thread in both through holes and blind holes and reduces tap breakage and wear to the minimum. Unit is available in common sizes

Homstrand, Inc., Larchmont, N. Y.

3. LOW-VOLTAGE LIGHTER for gas-welding torch gives an instantaneous light. Eliminates less reliable flints and the hazard of open-flame lighters. Just pass the tip of the torch a few inches above the electrically heated element and you get a light, every time. Unit is 3 in. high and 3 in. in diameter

Breese Industries, Inc., Box 1704, Santa Fe, N. Mex.

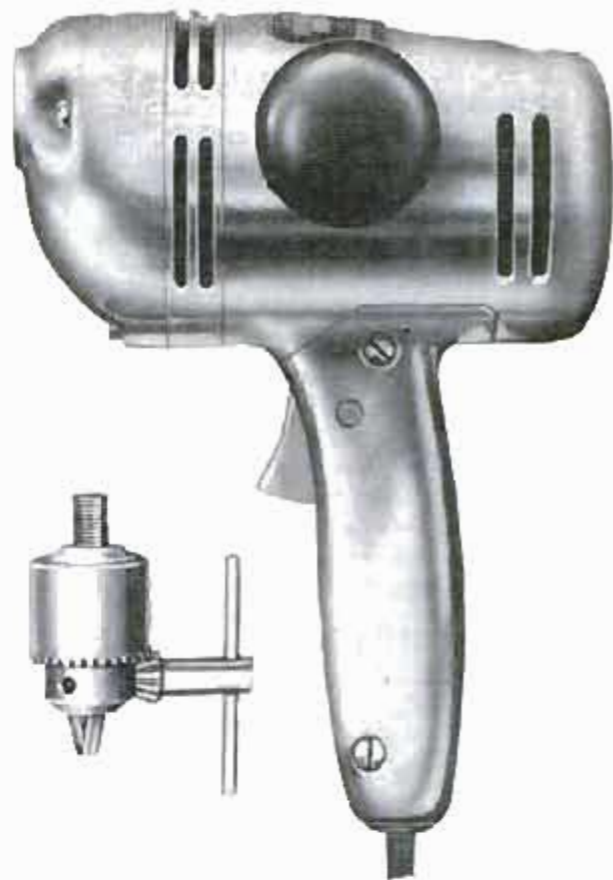

4. MANDREL takes saw blades and other circular-saw accessories, such as dado and molding heads, with $\frac{1}{2}$, $\frac{3}{8}$ and $\frac{3}{4}$ -in. center holes. Ground and polished shaft turns on sealed ball bearings. Pulley takes an A-section V-belt and is 2 in. in diameter
Chicago Die Casting Mfg. Co., 2510 Monroe St., Chicago 12

5. HANDLED PAD for wide range of abrasives combines advantages of several hand tools. Makes an efficient sanding block for wood, a useful auto-body file with a metal abrasive and can serve as a finishing pad for flat surfaces of steel, softer metals, plastic
Jiffy Products Co., 31 S. Michigan Ave., Pasadena, Calif.

6. MITER GUIDE for handsaw is carried to the work, guides the handsaw blade to make accurate cuts at any angle from 90 to 45 deg. Pivoted blade guide has a graduated quadrant and is locked at any desired point by a wing nut. The base has a fixed edge guide
Chesney, Inc., 527 W. Windsor Rd., Glendale 4, Calif.

7. SPADE, OR WING, TYPE BITS for wood have non-slip hexagon shanks for use in portable electric drills. Bits are designed to bore smooth, clean holes in hard or soft wood at any angle and at average electric-drill speeds. Available in sets as shown
Greenlee Tool Co., Rockford, Ill.

8. LOCK WASHER is square, not round, and is designed to prevent loosening of nuts holding parts subjected to unusual vibration and shock. Teeth on washer not only grip surface of workpiece as nut or screw is tightened, they also engage threads of screw
American Stamped Fastener Co., P.O. Box 116, Roselawn Station, Rochester 18, N. Y.

9. SIPHON-FEED SPRAY GUN, or air brush, is designed for small-parts finishing and touchup work. Available in two models, one for light to medium materials such as dyes, other for lacquers, enamels. Spray pattern can be reduced to pencil-line width
Binks Mfg. Co., 3122 Carroll Ave., Chicago 12

10. TOOLHOLDER has swiveling head, permits universal tool settings on lathes, planers, shapers and slotters. Rotating clamping cap, or jaw, has annular serrations that mesh with serrations on shank to provide a positive grip that prevents shifting of tool bit
Maxwell Industries, Inc., 403 E. Fifth Ave., Ashtabula, Ohio

11. STORAGE RACK for screws is made from clear plastic, can be attached to wall, or several units may be purchased and stacked to form a cabinet. Drawers that fit racks can be purchased individually, each containing a given number of screws of a single size
Elro Tool & Screw Corp., Rockford, Ill.

12. LIFTER for cinder and concrete blocks saves hands, enables mason to carry and place block on wall before releasing lifter. A U-shaped jaw grips center rib of block, holds securely. Lowering handle of lifter releases jaw from the center rib
Anchor Mfg. Co., McClure, Ohio

13. BENCH-TYPE HOT STAMPING PRESS will mark almost any shape made from plastic, fiber, wood, leather, any material that can be hot-stamped. Machine is hand-operated, uses roll-leaf in various colors. Has automatic roll feed and temperature control
Aeromark Co., 633 Morrell St., Elizabeth 4, N. J.



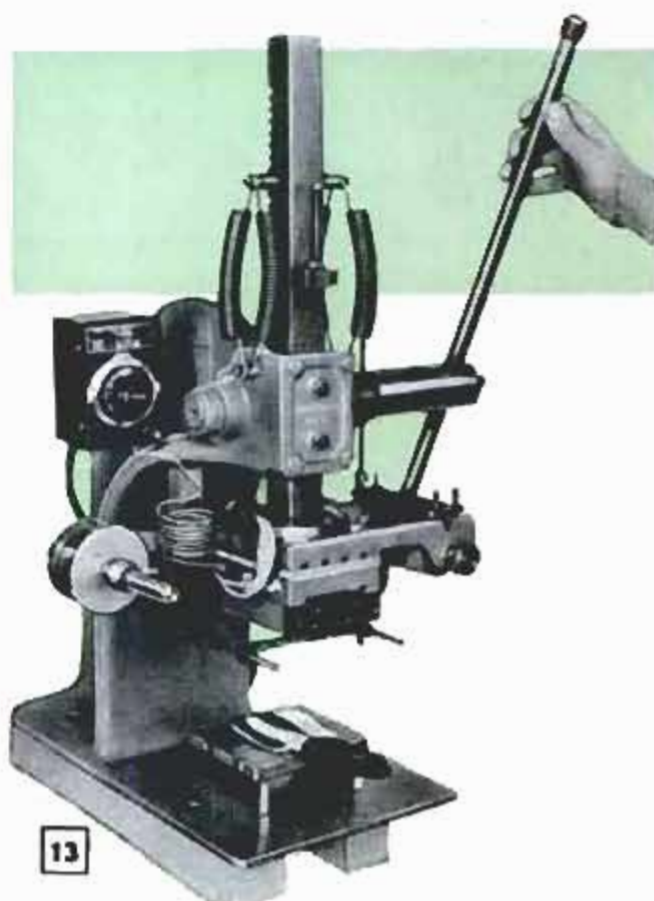
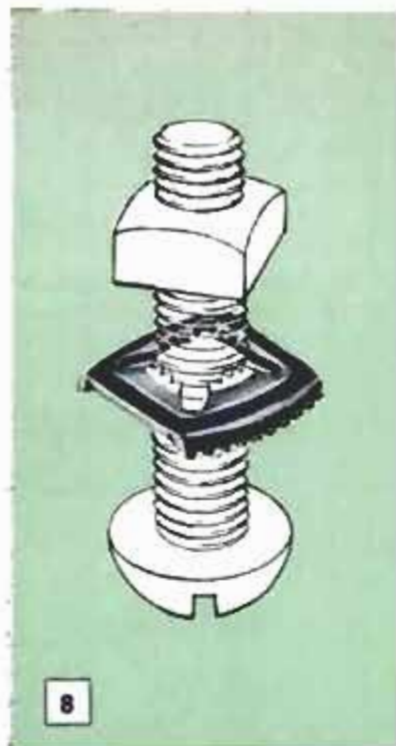

Corrugated-Steel Boat Shed



Lacking space for storing a boat and trailer in the garage, one boatowner erected this corrugated-steel shelter. Since boat and trailer can be parked easily in the shelter, the rig is stored in it when not in use during the boating season as well as in winter. The structure consists of several lengths of corrugated roofing overlapped and bolted to U-shaped frames formed from lengths of thin-wall conduit as shown. A tie rod welded to each frame near the top helps to retain the shape and to provide rigidity for the structure.

L. A. Wilke, Austin, Tex.

Diagnosing Ignition "Flutter"

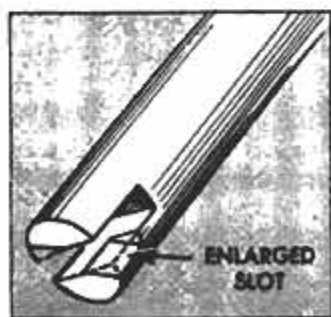

If the timing mark of an engine fluctuates from several degrees advance to several degrees retard when a timing light is used, it generally indicates a worn distributor plate or worn distributor-shaft bushings. There can be another cause, say engineers of the Champion Spark Plug Co. Check for a worn slot in the lower end of the distributor shaft. Worn as indicated, the slot will prevent accurate ignition timing.

When repairing a break in a garden hose, first rub soap on the coupler unit or inside the hose opening. This lubrication makes the coupler slip into the hose easily, and will not damage it.

When repairing a break in a garden hose, first rub soap on the coupler unit or inside the hose opening. This lubrication makes the coupler slip into the hose easily, and will not damage it.

Alter Duplicate Key to Fit Lock

When a newly made duplicate key fails to open the lock for which it is made, try removing the rough edges with emery cloth. If it still fails to work, insert the key in the lock and then withdraw it slightly before attempting to open the lock. If the latter works, remove the key, apply small beads of solder at points A and B as indicated in the detail and then file down the beads until the key operates the lock. A third remedy is to file down the key at points A and B, keeping in mind that only a very small amount of metal may need to be removed. Be sure the key is free of metal filings before inserting it in the lock.

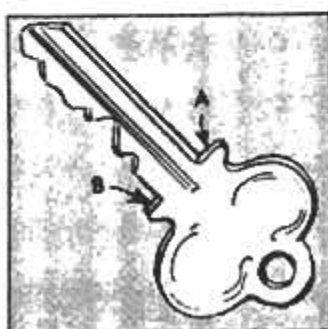

When a newly made duplicate key fails to open the lock for which it is made, try removing the rough edges with emery cloth. If it still fails to work, insert the key in the lock and then withdraw it slightly before attempting to open the lock. If the latter works, remove the key, apply small beads of solder at points A and B as indicated in the detail and then file down the beads until the key operates the lock. A third remedy is to file down the key at points A and B, keeping in mind that only a very small amount of metal may need to be removed. Be sure the key is free of metal filings before inserting it in the lock.

Frank Shore, New York City

Check Rulings Before Converting Your Gun

It has been brought to our attention by the Alcohol and Tobacco Tax Div. of the Internal Revenue Service that the rifle conversion described on page 225 of the January 1959 issue of *Popular Mechanics* is illegal. This conversion, and any similar conversion, has been ruled (1956) to be a firearm as defined by the National Firearms Act, and the manufacture (conversion) of the same without receipt of prior authority from the Alcohol and Tobacco Tax Div. of the Internal Revenue Service would constitute a felony and also would make the manufacturer liable to a \$200 manufacturer's tax on each firearm so manufactured or altered.

In Revenue Ruling No. 56-195 this conversion is ruled upon as follows:

"The Internal Revenue Service has had occasion to examine a Remington Rolling-Block Carbine of 7-mm. caliber converted into a 4¼-lb. handgun-type weapon chambered for the .257 Roberts Rifle cartridge, with a 9⅞-inch barrel. Held, this weapon is a firearm as defined in section No. 5848(1) of the Internal Revenue Code of 1954 and, accordingly, it is subject to the regulatory provisions of the National Firearms Act (Chapter 53 of the Code)."

Questions on this conversion, or any similar conversion, should be referred to your local office of the Alcohol and Tobacco Tax Div. of the Internal Revenue Service, or to the Director, Alcohol and Tobacco Tax Div., Internal Revenue Service, Washington 25, D.C.



Radio Television Electronics

Go Behind the Scenes to Look Ahead in Electronics

By Lothar Stern

WALK THROUGH the doors of a spacious research laboratory at Princeton, N. J., and you approach the world of tomorrow.

You may not live to see some of its wonders, but another generation will.

Some of the electronic marvels here in various stages of research may never be developed for practical uses.

But tomorrow is not far away for other ideas you see taking form in the famous David Sarnoff Research Center of RCA at Princeton.

- Electronic highways that will guide your car warn you by automatic signals of impending danger.

- Stereophonic transmission of programs by your regular AM radio stations.

- Reproduction of a picture or printed page on any surface — glass, cloth, paper, wood, metal—electronically.

- A typewriter that listens to your voice and automatically types out what you say.

This article explains how some of these "miracles" perform their work. Others will be described in a second report next month.

TOMORROW'S HIGHWAY

At the approaches of the research center a warning sign flashes: "Slower Please." It lights up, that is, if your

car is approaching the laboratory faster than the posted rate of 20 miles per hour. Here is the first step of an automatic traffic-control-and-guidance system — a practical test of an idea envisioned as far back as 1953.

Riding on tomorrow's controlled super-highway will be as safe and carefree as today's rail transportation. In fact, predicts Dr. V. K. Zworykin who originated this particular plan, the day will come when a cross-country motorist can enter a limited-access highway on one end and reach his destination without ever touching a steering wheel or brake pedal. En route, his car is completely controlled by the road itself. Its speed is automatically regulated according to traffic and weather conditions. It will swerve around obstacles, decelerate to avoid collisions with other vehicles or objects and, in general, transform a driver

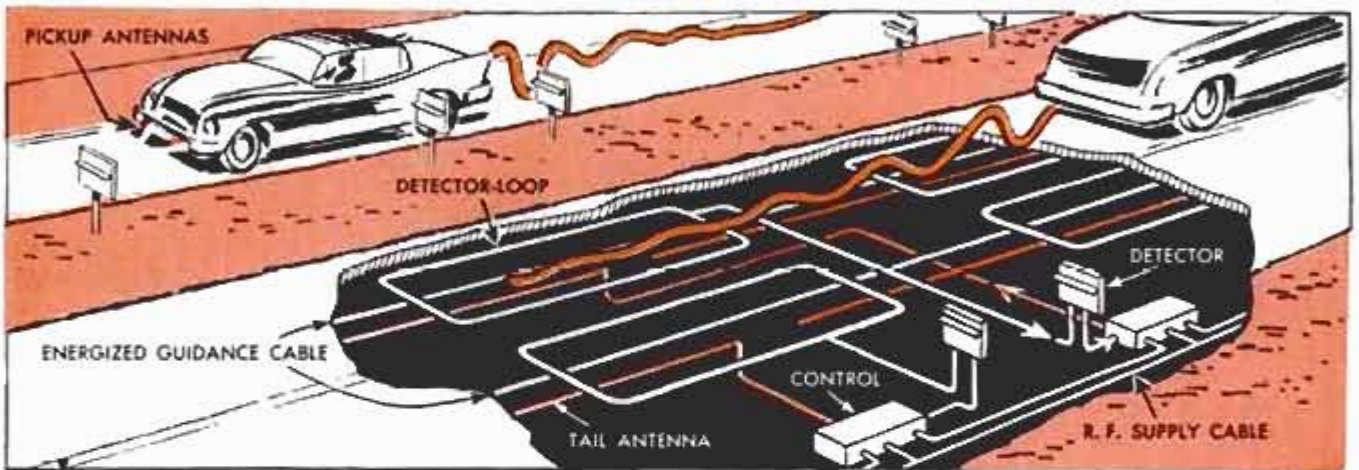
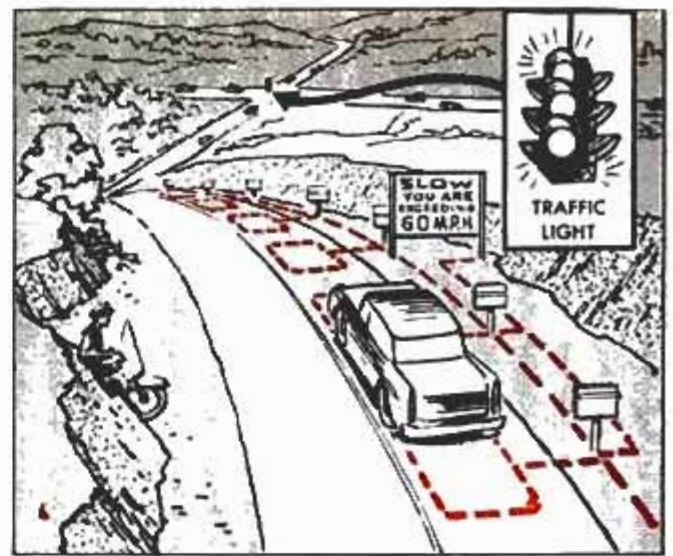
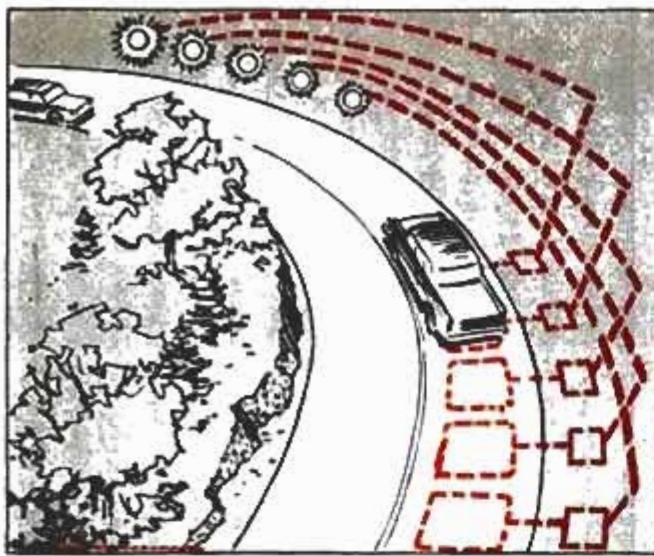

Electronic installations in tomorrow's highway can light roadside lamps (upper left) to warn approaching motorists, control traffic lights and speed-warning signs (upper right) or provide for automatic guidance and speed control. Roadside detectors and control units may be buried underground in final installation

into a passenger, free to watch television, read or just relax and enjoy the scenery.

Incredible as this may sound, research and development along these lines are far more advanced than is generally realized. In November 1957, the Nebraska Department of Roads unveiled a 320-ft. section of highway in which the RCA-proposed control system had been installed. The subsequent demonstration proved that various phases of the system could be of immediate benefit to all cars, and that complete highway control of specially equipped vehicles would present no serious obstacles.

By February 1958, General Motors had incorporated control devices in an experimental automobile which demonstrated the automatic-guidance feature of the system along a one-mile check road at the GM Technical Center.

Currently, RCA is planning the construction of a complete test track where the over-all system, including fully equipped vehicles, can be studied exhaustively.

How It Works

Basically, the automatic-control system is divided into three integral parts:

1) A sensing system which senses the location of every vehicle on the road.

2) A detection and control system which provides a variety of warning and control signals in accordance with the information obtained from the sensors.

3) A guidance method which automatically keeps a specially equipped car in the center of a traffic lane more reliably than a steady and experienced hand at the wheel.

Here's how the system works:

Embedded under the pavement of each traffic lane is a continuous series of wire loops, each one energized by a high-frequency voltage from a roadside power line. A vehicle passing over a specific loop changes its electrical characteristics and causes a variation in the current flowing through that particular loop. Here then, is the means of sensing the location of all vehicles—regardless of their speed or direction of travel.

An electronic detector—transistorized for maximum reliability and power economy—is associated with each sensing loop. It detects instantly any change in loop current and converts this information into an appropriate signal for triggering a control

unit which, in turn, can provide a variety of functions. It can, for example, energize a roadside sign if a passing car exceeds the speed limit. It can regulate a traffic light at a distant intersection in accordance with the flow of traffic. It could light a roadside lamp some distance ahead of a particular car to warn a driver on the other side of a hill or around a curve of an approaching vehicle. And, because all of the equipment is installed in the road, a vehicle need not be specially equipped to benefit from these functions.

Going a step further, each control unit could, in response to a passing car, transmit a radio signal to an antenna buried alongside the sensing loop. Every vehicle would then leave a "flying tail" radio signal trailing in its wake. If a following car were equipped with a special receiver, this radio tail would provide a visual or audible warning of a vehicle directly ahead.

As a final step, the output of such a receiver could be coupled to the car's acceleration and braking system so that the flying radio tail of a preceding vehicle would automatically govern the car's speed.

For automatic guidance, a buried cable runs along the center of each traffic lane. The cable radiates a continuous high-frequency signal which is picked up by two small antennas mounted on either side of a completely equipped car. With the car centered over the cable, each antenna picks up exactly the same amount of signal. If the car deviates from the center line, however, one or the other of the antennas will receive a stronger signal.

Inside the car, the antennas are connected to a differential receiver whose output controls the power-steering mechanism. When one antenna receives a stronger signal than the other, the receiver pro-



AM radio goes stereo. RCA demonstrates tested method for stereo transmission by single AM radio station

duces an output which causes the steering mechanism to bring the car back in line.

The above description only begins to tell the story of the elaborate system developed for automatic traffic control. Actually, the complete plan calls for much greater versatility and, obviously, there are numerous safety devices and safeguards which take over in case of an emergency. But the real beauty of the system lies in its compatibility which permits coexistence of conventional vehicles and specially equipped ones on the same highway—each one benefitting in direct proportion to the amount of special gear it contains. Thus automotive changes can come slowly and gradually while highway safety and motoring pleasure are increased for all.

How long before tomorrow's dream highway becomes a reality? Even Dr. Zworykin won't make a prediction. Much depends on cooperation between the electronics

Block diagrams of stereophonic AM transmitter (left) and receiver (right) illustrate underlying principles for transmitting and receiving two-channel sound via a single amplitude-modulated radio signal

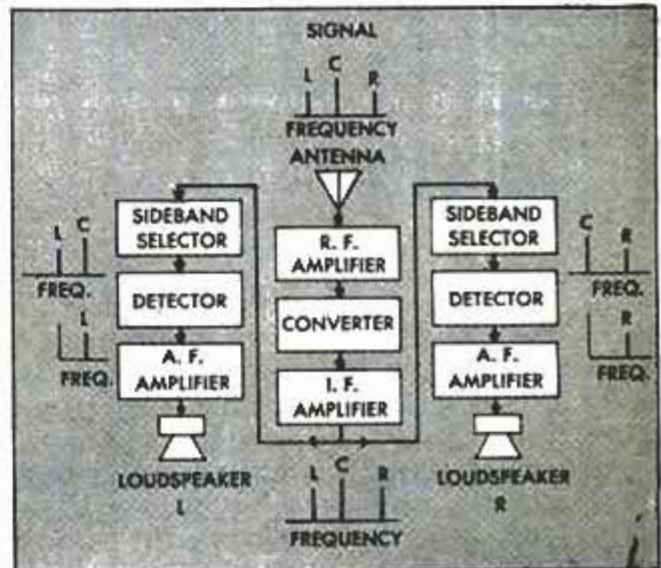
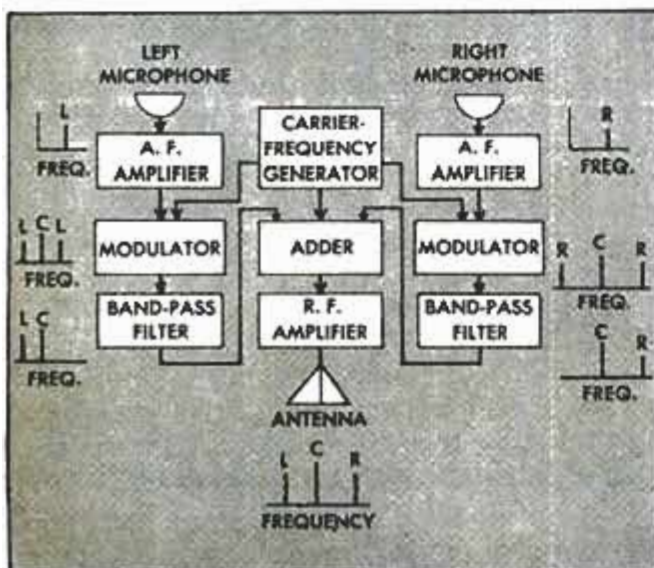



Printing, engraving or reproducing visual material electronically is simple and inexpensive. Charging unit (left) deposits layer of electrons on coated sur-

face. Exposure (center) creates an electron image made visible by brushing the exposed surface with a magnetic brush dipped in a special powder (right)

industry, automobile manufacturers and highway engineers. But adoption of at least a portion of the system in some roads may not be very far away.

ADVANCES IN AM BROADCASTING

Events are moving swiftly in the home entertainment field and stereo is leading the parade of recent developments. Hi-fi fans, just recovering from the impact of the stereo record, are already anticipating stereo broadcasts via FM multiplexing. Multiplexing is a means whereby two separate audio signals are transmitted on a single channel. The advantages are that stereophonic broadcasts could be transmitted by a single station and reception would require only one receiver. This is in contrast with present stereo broadcasts which require the concerted efforts of two stations and make use of two separate receivers.

But even before FM multiplexing has had a chance to prove itself, RCA rocked the audio world by demonstrating a method for broadcasting stereo on the regular AM band—a method which, if adopted by AM stations, could bring the magic of three-dimensional sound into every home and automobile at a relatively small cost.

The principles underlying RCA's stereo-AM broadcasting system are familiar to everyone acquainted with the process of amplitude modulation. In ordinary AM, the amplitude, or strength, of a radio-frequency carrier is changed in accordance with the audio signal from a microphone. During this process, new frequencies—known as the upper and lower sidebands — are added to the original carrier.

Actually all of the audio is stored in these sidebands, and both sidebands carry identical information. To recover the original audio signal, therefore, only one sideband is needed at the detector of a radio receiver.

The block diagram of a stereo-AM transmitter shows how this principle is utilized for the simultaneous transmission of two different audio signals on a single carrier. Here, the signal from a carrier-frequency generator is applied to two separate modulators, each of which also receives the audio signal from a different microphone. The output of each modulator, therefore, contains the carrier frequency plus the upper and lower-sideband frequencies of the respective audio signals.

Since only one sideband is needed for faithful reproduction of the original audio signal, the modulators are followed by bandpass filters which remove the upper sideband from the left channel and the lower sideband from the right channel. The two individual AM waves are then combined in an "adder" and the resultant signal again contains an upper and lower sideband. This time, however, the upper sideband carries the information from the right microphone while the lower sideband contains the information from the left one. This combined signal is then amplified and radiated into space.

Sidebands Are Separated

In the receiver the stereo signal is picked up and amplified in the conventional manner. Before being detected, however, it is applied to two sideband selectors which separate the individual sidebands. Each selector is followed by its own detector, audio amplifier and loudspeaker so that each audio channel receives and reproduces the sounds originally picked up by a different microphone — the requirement for true stereophonic sound.

In the design of the stereo-AM system, great care was taken to preserve complete compatibility. An ordinary AM receiver, by adding the two sidebands of the stereo signal in its conventional detector circuit, provides monophonic reproduction of a stereo transmission without deterioration

(Continued to page 240)

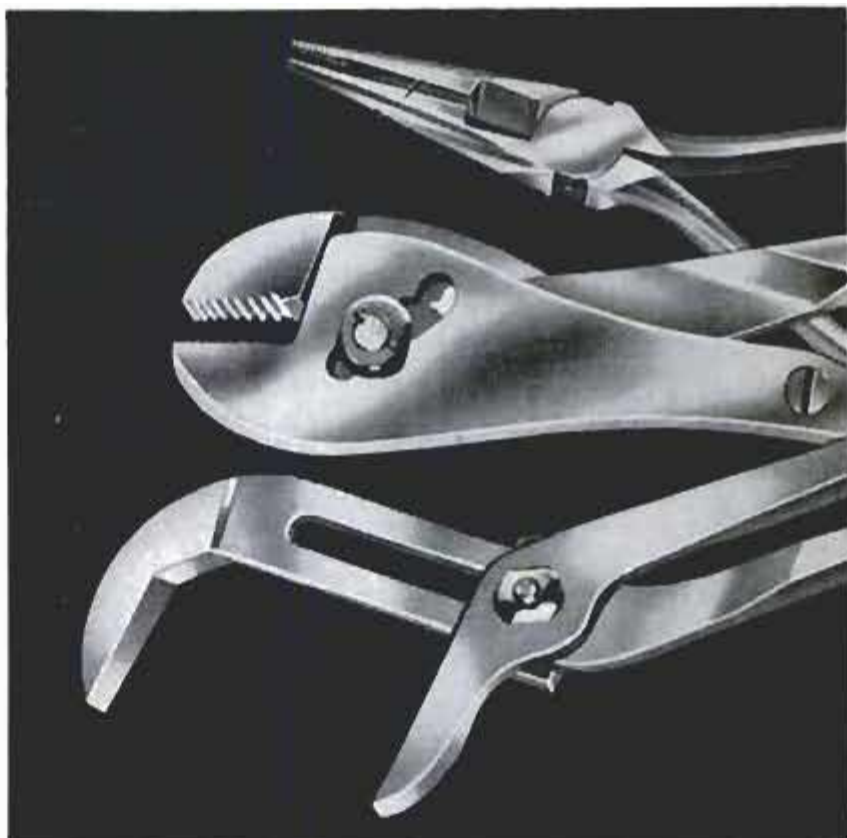

You buy
GUARANTEED QUALITY
 at your
Proto dealers

More than 2,172 professional tools... including more than 70 different types and sizes of pliers... are guaranteed by Proto. Clean, functional design and the highest standards of forging and finishing are Proto features. See them at your Proto dealers, which include Auto Parts, Builders Supply and Hardware stores all over the country.



Pliers in the top photo are, from top to bottom: #226, #234, #248-S.

Proto Tools, Boxes, and Chests are preferred by professionals all over the world. Proto is a division of Pendleton Tool Industries, Inc. World's largest manufacturer of hand service tools.



2202 Santa Fe Avenue, Los Angeles, California
 Jamestown, New York
 Canadian plant: London, Ontario

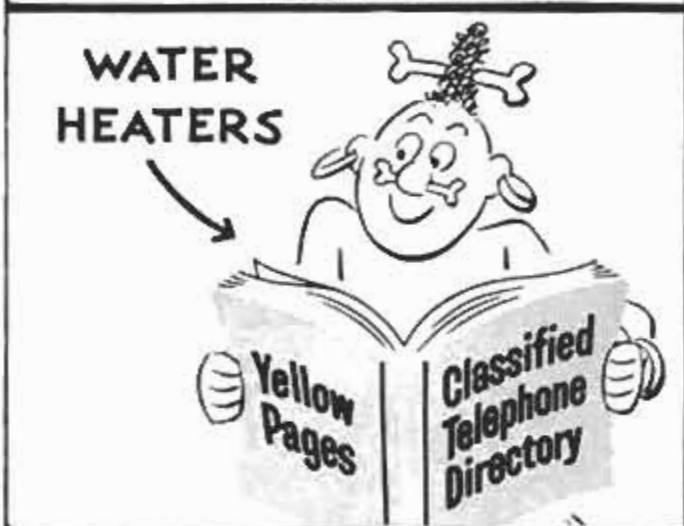

water heaters, laundries,
movers, jewelers, batteries
whatever you need —

Find It Fast
In The
Yellow Pages



Advertisers displaying this emblem make your shopping easy.

Clinic for Homemakers



As a service to our readers in solving the hundreds of problems pertaining to a home—inside or out—the editors of *Popular Mechanics* invite you to present your problems to The Clinic Editor for help and advice. Address your questions to The Clinic Editor, *Popular Mechanics Magazine*, 200 East Ontario Street, Chicago 11, Ill.



Window Condensation

Q—Last fall I had my carpenter install a dual-pane window in my living room. I was told these panes do not sweat, but this one does. It clouds up along the lower edge to a height of about 18 in. or so. The moisture is on the inside. Is there any cure for this?—L. O., Miss.

A—You did not say so we will have to assume that the window you refer to is a commercial product and that it was installed in a frame built at the job site. We also will assume that the condensate forms on the room side of the inner pane and not between the panes. If these assumptions are correct, then the cause of the condensation, or sweating as it is often called, is due to a leakage of cold air through the frame at the corners and along the bottom of the pane where the condensate forms. Undoubtedly your carpenter made sure at the time of installation that the pane was correctly installed, but it should be remembered that in a new installation shrinkage of the new frame or structural members can result in openings that will admit cold air during severe winter weather. It should be a comparatively simple matter for your carpenter to locate these leaks and make repairs that prevent a recurrence of the trouble.



Leaf Curl

Q—I have two peach trees in my yard which are just coming into bearing age. Last season I noticed that many of the leaves quite suddenly curled, turned yellow and fell off. One tree lost nearly half of the original leaves. Is this a disease? What can I do to prevent it?

A. W., Mich.

A—Judging from your description we would say that the trees have been attacked by what is known to orchardists as peach-leaf curl, a fairly common fungus disease which is most serious in the northern states. The fungus spores live through the winter on the buds and become active in the spring after growth starts. Unless checked the disease will interfere with the setting of fruit and will eventually kill the tree. Perhaps the best preventive measure you can take at the present time is to spray the trees, before the buds swell, with a lime-sulphur solution in the proportion of 1 gal. of the

(Continued to page 220)



For the safe, dependable power they *must* have, most aircraft use Champions. Above, Cessna float plane.

Q. Why do *more aircraft the world over* use Champions than any other spark plug?

A. In the air, *dependable* power is vital!
To get that same dependable power in your car, put in new Champions every 10,000 miles. You'll save gasoline, too!



World's favorite spark plug—engineered for every car built by Ford, General Motors, Chrysler, American Motors, Studebaker-Packard and every major foreign maker.

CHAMPION



NEW DELTA HOMECRAFT[®] CATALOG

Send for your **FREE** copy now!

You'll appreciate this valuable addition to your home workshop library. Pictures and describes every tool in the world's most complete line of home workshop power tools—including individual, combination, and all-purpose tools. Gives you many valuable workshop hints plus details on hundreds of money-saving accessories.

HURRY—SEND COUPON TODAY

Rockwell Manufacturing Co., Delta Power Tool Division,
5026 N. Lexington Ave., Pittsburgh 8, Pa.

Yes, send me a **FREE** Homecraft Catalog plus the catalog of famous Deltacraft publications.

(PLEASE PRINT)

Name _____

Address _____

DELTA POWER TOOLS

another fine product by

ROCKWELL



(Continued from page 218)

concentrated lime-sulphur to 10 gal. of spray solution. Or, purchase a prepared lime-sulphur mixture and mix your own spray, following the instructions on the container. Spraying of only two trees can be done with a knapsack sprayer or a garden-hose attachment, but take pains to do a thorough job of covering the entire tree. Follow with the same spray in the fall.



Door Rattles

Q—My home faces west and when the wind blows briskly from that direction the front door rattles. I weather-stripped both the regular door and the storm door, but still the inner door rattles. I even moved the lock plate, but that did not correct the trouble. What to do now?

S. D., Kan.

A—What you have already done ordinarily cures quite persistent door rattles—unless the hinge pins are loose. Did you check them? Rust and lack of lubrication can cause rapid wear of hinge pins and in older doors this can result in appreciable play between the door and jamb, and movement between the hinge leaves when the door is closed. It also is possible that one or both hinges are loose on the jamb due to worn or otherwise enlarged screw holes. This would be a rare cause of rattling under wind pressure, but it is a possibility that should not be overlooked. Sometimes merely turning the hinge pins a quarter or half turn and tightening the screws in the jamb will cure the trouble, but the method is not entirely reliable. If, on removal and examination, the pins show undue wear, the best remedy is to replace the hinges.

Frost Injury

Q—I have been told that potted plants that have been frozen can be saved. Can this be true? And if it is, what must be done to save the plants? Also, I understand that sprinkling with a hose will prevent frost damage to tender plants. Right?

E. T., Pa.

A—Right. But sprinkling is not a common practice and neither is it considered entirely reliable or practical, although the method has been used by commercial growers as an emergency measure. Of course, sprinkling cannot be fully effective unless continued throughout the danger period, which usually means through the night or until such time as the plants can be moved or otherwise protected. As a rule a covering of newspapers or fabric will protect potted plants and annuals against damage by light frost. It is important that the paper or cloth cover the entire plant and reach the ground all around to prevent drafts of cold air under the covering. The covering should be weighted with bricks, small stones or soil. "Un-freezing" plants that have been frosted calls for quick action. They must be moved immediately, before the sun strikes the foliage and before they have a chance to thaw, to a cold room where the temperature is only slightly above freezing. This permits the foliage and the stems to thaw as slowly as possible. If freezing has not been too severe it usually is possible to save the plants.

Mold on House-Plant Soil

Q—I've noticed that the top of the soil in my house-plant pots gradually becomes covered with a mold-like coating that looks something like moss. Is there any way to prevent this?—W. G., Ind.

A—If we can judge correctly from your description this is not actually a mold, but what appears to be a coating over the top of the soil is known as algae, the term referring to tiny plants which grow as a mass. To prevent their growth, keep the soil stirred lightly and water regularly with a solution of potassium permanganate in the proportions of about 6 or 7 drops to 1 gal. of water.



EXTRA BLOWOUT PROTECTION: Nylon has lasting strength to guard against blowout. Nylon protects against the four kinds of unseen tire damage that can lead to sudden tire failure: (1) heat, (2) bruising from bumps, (3) moisture, (4) flexing. All tire makers use nylon cord in their better tires. Why risk a dangerous blowout? Have your tires checked regularly. And whenever you need new tires, be sure they're made with nylon cord!

THE SAFEST, STRONGEST TIRES ARE MADE WITH

NYLON

LOOK FOR THE NYLON IDENTIFICATION ON TIRE SIDEWALL.
Enjoy the "DU PONT SHOW OF THE MONTH" on CBS-TV



BETTER THINGS FOR BETTER LIVING... THROUGH CHEMISTRY

You'll agree—
it's the
HANDIEST
PLIER
OF THEM
ALL

CHAN NEL LOCK
No. 420

You'll like the all 'round usefulness of the Channellock No. 420 . . . its terrific gripping power . . . its quick, non-slip adjustability up to 1-3/4" size. And you'll find it easy to use in hard-to-get-at places because of its compact design. Mechanics everywhere say no other plier does so many jobs so well. You'll say so, too!

**CHAMPION DEARMENT
TOOL COMPANY**
MEADVILLE, PENNSYLVANIA



**ASK YOUR
TOOL SUPPLIER
FOR
CHANNELLOCK
PLIERS**

**Be sure its a genuine CHANNELLOCK
Look for the trademark on the handle**

You Ought to Keep a Bee

(Continued from page 133)

nectar for making honey. But flights this long will not produce much surplus to sell. A few hundred yards' distance from the colonies to the flowers is better.

Three Acres per Hive

For good honey production, experienced beekeepers figure about three acres of heavy flowering plants are necessary for one colony of bees. This information should help the beginner in deciding upon a location and should steer him from any ideas of planting seed to grow his own nectar for the bees. He simply won't be able to plant a sufficient supply at a cost in keeping with his returns. Let others do the planting and raising of plants for the bees, or depend on nature.

The kind of flowers from which bees gather nectar will make considerable difference in the flavor and color of the honey. Some flowers, like horsemint, produce a strong-flavored, dark honey that does not sell well. It makes only a fair table honey, most of the commercial production going into the bakery trade. Clovers and alfalfa make the best honey.

Bee Dance Has Message

It is amazing how bees can locate new sources of nectar and communicate the location to others. They send out scouts to find new fields of blossoms. After discovering such fields, the scout bees hurry back to the hives and by a series of bodily "dance" movements they tell other bees the location of the field. These bees, in turn, fly to the newly discovered nectar source where they load up for the return trip to the hive.

How do the bees communicate? That's one of the many interesting things about beekeeping. Along your road of experience, you'll find out how bees communicate and many other interesting facts. Meanwhile, it takes only one colony of bees to get started in this fascinating hobby-business. Likely, you'll be glad you did. ★ ★ ★

Preserved Pollen Grains Record Prehistoric Life

Geologists are able to reconstruct the vegetation, climate and living conditions of millions of years ago by examining thin layers of pollen preserved in sediment. The pollen grains rain invisibly from the atmosphere after they are carried from plants by the wind. They are able to resist destruction because of their wax-like walls.



NOW

A Porter-Cable

1/4" Drill Only \$19⁹⁵

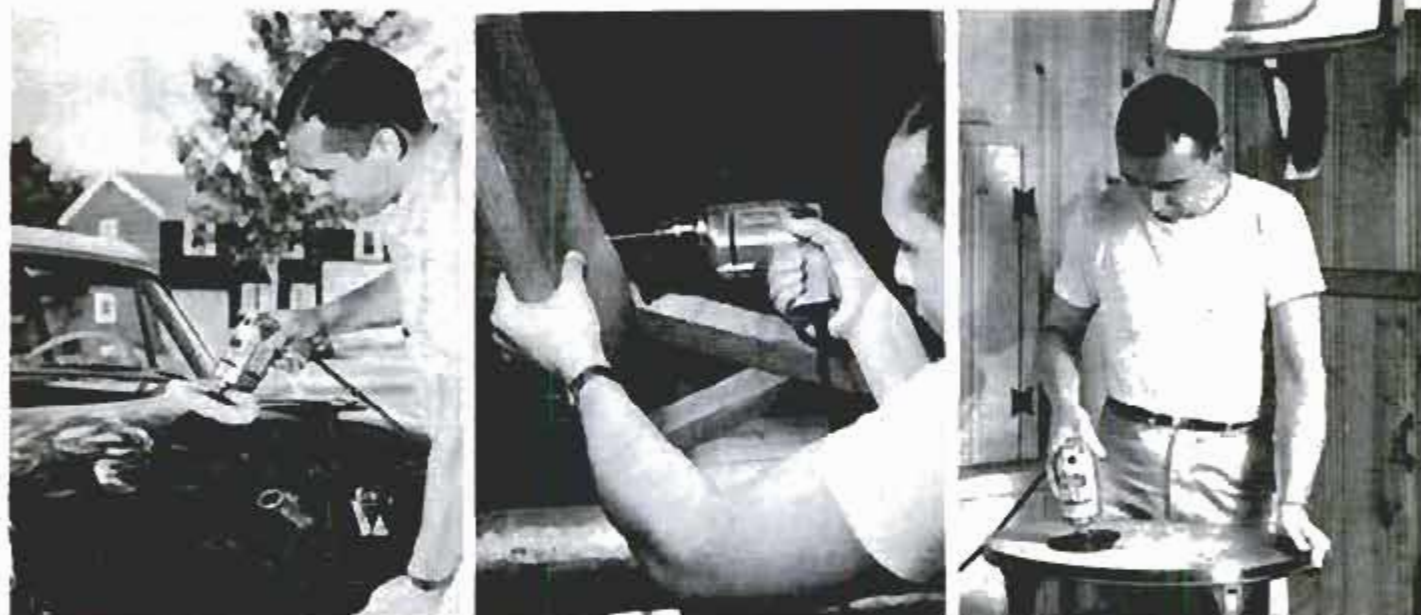

One of the most important and useful tools in any shop is the 1/4" drill. It not only drills through wood, metal, plastics, and other materials—but its accessories make it perform a multitude of tasks . . . from sanding to grinding, from wire-brushing to buffing. This Porter-Cable Model 161 Drill is powered for professional performance and its accessory equipment is designed and built to do a man-sized job. Pick one up, heft it, try it . . . and you'll see why it's tops.

SPECIFICATIONS

- Powerful 2 amp motor.
- Precision Geared chuck.
- Precision reduction gears.
- Trigger switch with lock button.
- Cooling vents—
motor won't overheat.
- Spindle ball bearings.
- 3 prong safety connectors.



For free tool folder and name of your nearest dealer, write

PORTER-CABLE MACHINE COMPANY

9143 Marcellus St., Syracuse 4, New York



AC and GENERAL MOTORS COMBINE TO BRING YOU

**TOPFLIGHT ENGINEERING • ULTRAMODERN LABORATORIES
THOROUGHGOING RESEARCH • CONTINUOUS TESTING
INTENSIVE QUALITY CONTROL**

Knowing that spark plugs play an important role in the performance of your car . . . you'll be interested in this information about AC Hot Tip Spark Plugs and why they give you more!

For more than a half century AC has been the spark plug others followed. The leadership established by AC when cars and trucks became a horse-replacing reality has never been seriously challenged by even the closest of imitators.

AC, sharing some of its basic patents with others, pioneered and developed the kind of

spark plugs high-compression engines demand. AC Spark Plug engineering, research, testing and manufacturing development has kept ahead of ever-growing engine demands!

There's still more. You also get the tremendous advantages of General Motors' unsurpassed research and testing facilities. You can depend on AC to stay ahead in spark plug technology. AC HOT TIP Spark Plugs are used on more new cars than any other brand, and are engineered for *all* makes of cars, trucks and tractors.

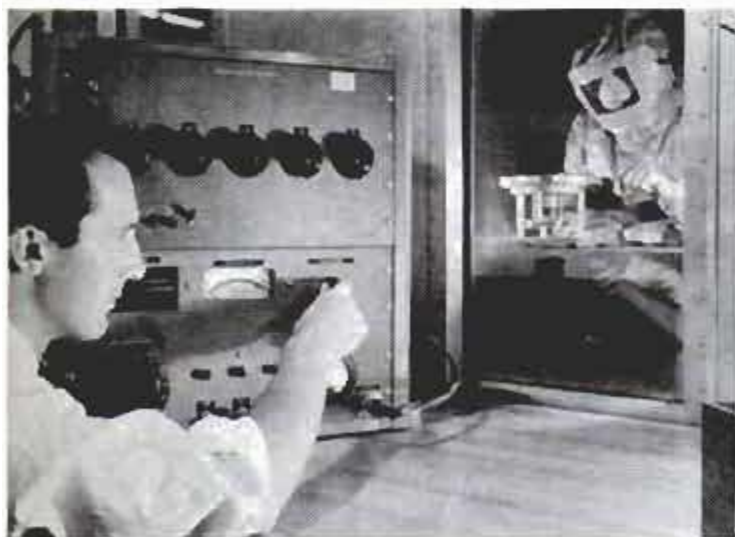

LABORATORIES—AC maintains completely staffed metallurgical, ceramic and mechanical engineering laboratories to constantly assay and improve spark plug materials. This comprehensive research program has produced the many AC "FIRSTS" in technology.

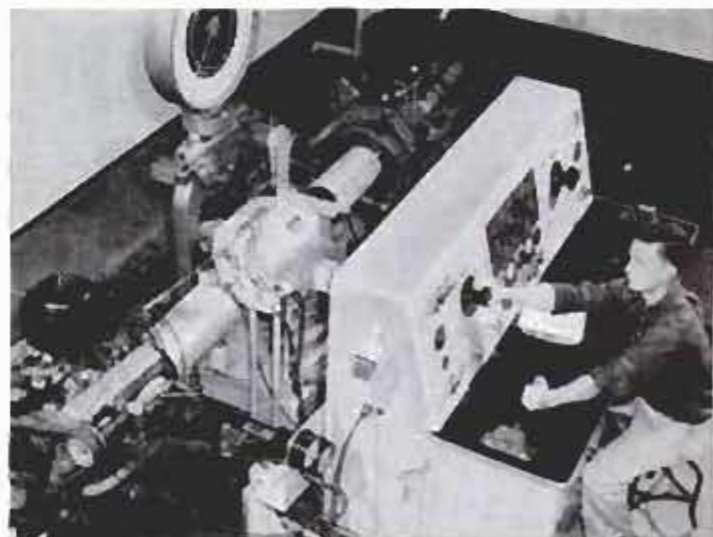

DYNAMOMETER ROOM—AC uses the finest equipment to simulate road tests under laboratory conditions. AC Hot Tips are constantly checked under conditions far more severe than the average driver will ever meet.

AC SPARK PLUG  THE ELECTRONICS DIVISION OF GENERAL MOTORS

ACTION

starts with AC

...the Spark Plug
others follow!

FIRST with the stronger one-piece heat-sealed shell construction.

FIRST in welded side electrode construction for better heat and electrical current conductivity.

FIRST to incorporate a resistor element for elimination of radio interference from the ignition system.

FIRST with fused metal-ceramic seal to stop center-wire compression leakage.

FIRST in the use of unglazed insulator tip to resist lead attack.

FIRST with the aluminum oxide insulator in the United States—a patented AC ceramic composition!

FIRST to use greater "scavenging" area between insulator and shell.

FIRST with the long, thin, recessed, quick-heating insulator tip—the AC Hot Tip—another AC exclusive!

FIRST with the copper-core electrode to improve performance under special high temperature operating conditions in commercial applications.

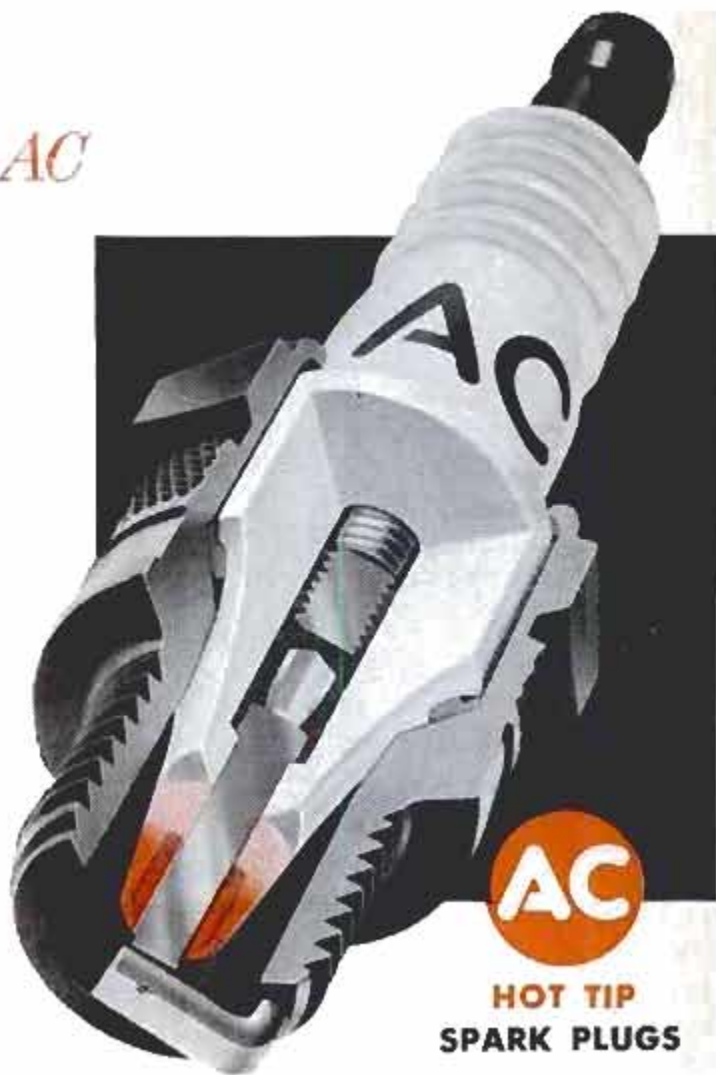

TESTED BY **AC**

TESTED AGAIN BY **GM** *and proved daily...
in millions of vehicles**



PROVING GROUNDS—AC maintains staffs of experts at each of the famous G.M. Proving Grounds. Around-the-clock, around-the-calendar driving under all climate and road conditions demands the best from ACs.



TECHNICAL CENTER—AC employs all of the facilities of the great General Motors Technical Center . . . recognized as one of the finest facilities in the world . . . as a complement to AC's own engineering creativity to insure its continuing leadership.

* *Millions of motorists drive millions of miles daily with AC Hot Tip Spark Plugs. Get better performance and greater economy by installing new AC Spark Plugs in your car. Your nearby AC Dealer has them.*

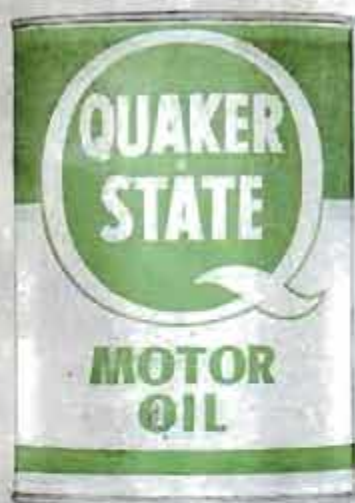

VICTORY PARK AND CAPITOL BUILDING, NASHVILLE, TENN.

On tour or around town, drive with Quaker State, the oil that cuts engine wear, prevents engine breakdown. Fortified with anti-wear detergent additives, this pure Pennsylvania oil stops rusting and corrosion, eliminates sludge, carbon deposits and damaging acid action. Result: moving parts work smoothly and friction-free under all driving conditions! Next oil change, insist on Quaker State.

QUAKER STATE OIL REFINING CORPORATION, OIL CITY, PA.
Member Penn. Grade Crude Oil Assn.

1859— 100th Anniversary of Drake Oil Well —1959
and Founding of the Petroleum Industry

A Prefab Tunnel Conquers A Tough River

(Continued from page 126)

constructed ashore in sections. Instead of tunneling under the river bed, a 40-foot-deep trench was sucked out and the sections were then floated into position, sunk, and sealed together on top of a padding of gravel. The first step in connecting them was the linking of a huge hook-and-eye arrangement. In the past, tunnels have been circular, because of the erroneous belief that they were easier and cheaper to build that way, but the Deas Island Tunnel was built on the square.

"The height of a circular cross section is governed by the width required to accommodate the necessary roadway," Ole Bentzen explains. "Whereas, that of a rectangular cross section depends solely on the vertical clearance required for the traffic lanes. Also, for the same navigable depth, a circular tunnel must be carried deeper, which means longer and deeper approaches and, therefore, greater cost."

Construction, which was started in March of 1957 and was completed late last year, cost \$16,600,000. It involved the use of \$2,000,000 worth of equipment, 100,000 cubic yards of concrete and 12,000 tons of steel. Excavation and backfill totaled 2,500,000 cubic yards. As many as 800 men were employed at one time, but the crew averaged between four and five hundred. Not the least significant record established was that of safety, which resulted from the wearing of lifejackets as well as hard hats by all workmen on or near the water, plus weekly safety meetings throughout the term of the project. Although 90 percent of the work was dangerous, there was never any serious time loss and no loss of life.

This fact is brought into sharp focus when contrasted with the record of another B.C. construction job of similar magnitude, the \$16,000,000 Second Narrows Bridge, an intercity link connecting Vancouver with its main suburb, North Vancouver, across Burrard Inlet. This structure and approaches, with a total length of almost two miles, was originally scheduled to be completed about the same time as the tunnel, but was tragically delayed last June. Two 70-foot sections of the mile-long bridge gave way, workers fell 200 feet to the water and 22 men were killed.

The Deas Island Tunnel probably set a new record for attracting sight-seers, since as many as 10,000 local citizens and tourists served as sidewalk superintendents on week ends. The first act of the big show

(Continued to page 228)

**THE
ROUTER
WITH
THE
LIGHT**

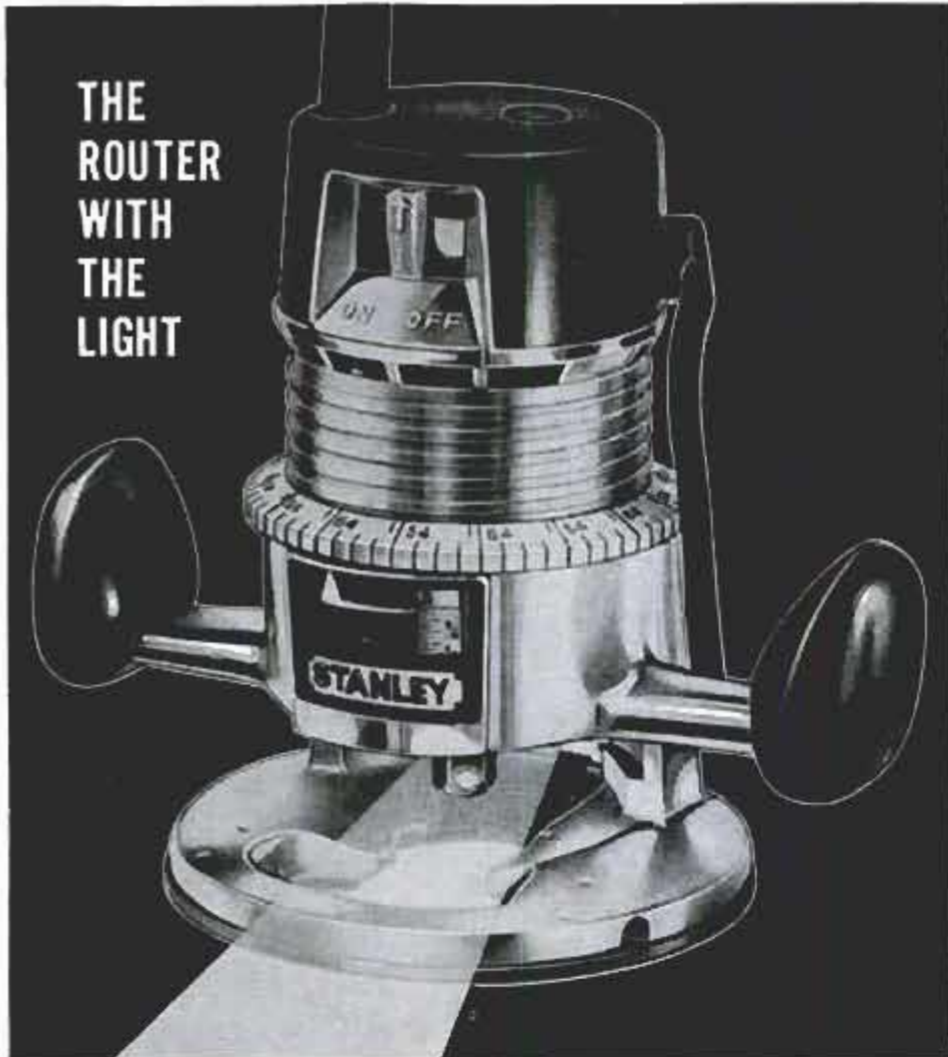

NEW SAFETY SWITCH
Locks shaft automatically. Lets you change bits fast with just one wrench.



FAST DEPTH ADJUSTMENT
Unique depth gauge sets bit for cuts as fine as .004 inches — in seconds!



PERFECT VISIBILITY
Spotlight and open base let you see where you are and where you're going.

Full 7/8 hp...only \$62.50...with these exclusive new features!

Stanley's heavy-duty H264 router. For the price, nothing in its power class can match it. For handling and operating ease, nothing will match it for years to come.

Comfortable 3-position handles give you perfect balance and control on all cuts.

One lever releases or clamps motor in base.

"Window" brush holders. Inspect through "window" without removing brush.

Easy handling! With it goes the power and speed (23,000 rpm) to make accurate cuts, quickly. See the H264 and the 1 1/4 hp H267 today! Stanley Electric Tools, Div. of The Stanley Works, 623 Myrtle St., New Britain, Conn.

STANLEY

Electric tools built for the professional, priced for everyone



Stanley's H15 1/4 hp router. Ideal for light, delicate work. A professional tool yet only \$42

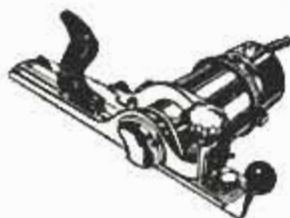

New heavy-duty H283 power plane. Perfect for fitting doors, windows. Cuts to 1/16" wide. \$89.50



H45 1/2 hp router. Another in Stanley's complete line. Powerful, rugged. Only \$49.50

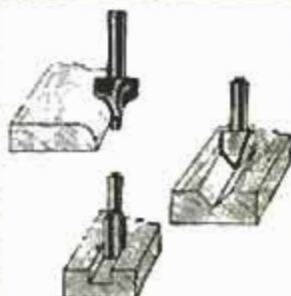

Stanley offers hundreds of router bits plus the most complete line of router accessories.

was the construction of the elements by Narod, Dawson & Hall. Scene 1 was a huge excavation, 684 by 933 feet, 20 feet below the surface of the Fraser and separated from it by an earthen dike. This open cut was used as a drydock during the building of reinforced-concrete sections, each 344 feet long and 24 feet high, weighing 18,500 tons. When they were completed, it was converted to a graving dock by simply breaking through the dike. The flooded sections were then pumped out so they could be floated to the outfitting jetty where their waterproofing, a combination of built-up bituminous and light-steel mantles, was checked by an automatic leak-testing system. Each section was then fitted with a 70-foot stack supporting a shaft with a 6-foot manhole, to allow access after sinking.

Foolproof System Necessary

One of the problems was to keep the sections watertight while workmen went inside to break away temporary bulkheads and finish off the joints with concrete. The sealing system used in constructing the Maas Tunnel had been far from satisfactory, and there was no intention of undertaking the Deas Island job unless a foolproof system could be devised. Company after company turned it down, but Gutta Percha & Rubber Ltd. of Canada tackled it.

Months of exhaustive experimenting led to the development of huge rubber pneumatic seals, resembling colossal inner tubes, each 80 feet long, 26 feet high and 30 inches thick. Designed to withstand pressures up to 4000 tons, these were installed at the ends of five of the tunnel sections. The air space was filled with water and the section was sunk and moved into position near the previously positioned one. Water was then pumped out, the sections were pushed together and the seals kept workmen perfectly safe while permanent joints were secured. While the rubber will deteriorate in about 18 months, this will have no adverse effect, because all joints will have hardened.

Besides, the tunnel is well-encased by concrete "mattresses," timber lagging, sand jetting and backfilling, so that neither ocean nor river action will disturb it. Also, it should easily withstand the most severe earthquake shocks to be expected in the area. Each section is anchored in place by four 37-ton concrete blocks, interconnected in pairs with 12-inch steel pipe, and secured by cable suspension. The whole tunnel is tied to several 3100-pound Dutch anchors (looking like inverted umbrellas, with 7-foot flukes that open when a pin is pulled after they have been placed 30 feet beneath

the bed of the river) and three 7000-pound Navy anchors.

The "sinking fleet" was made up of 14 equipment carriers. Key vessel was a "floating rig" formed from four steel scows, which was used to ease the sections to location and maneuver them into position above a predetermined center line. The rig was hooked up to a complicated system of winches and land and river anchors, and movement was controlled inch by inch as engineers eyed instruments that measured river velocity, tide elevation and the stress on every cable. Typical of the extreme caution with which the sinking operations were carried out is the fact that the top recommended speed of movement was six inches per second, but the first element was moved only 12 inches per hour.

"Anything to do with the Fraser presents problems," Fred Knez, one of the project managers points out. "It's a most difficult body of water. More than anything else, the project required patience. It took three hours just to move one of the sections into the floating rig, seven more to arrange the winches and anchors preparatory to sinking. From outfitting jetty to final position, the first section kept us busy for almost 14 hours."

The actual placing operations were commanded by K.P. Kitchen, a Kiewit riverman of 50 years' experience. While four divers described underwater progress every foot of the way, Kitchen issued instructions by radio from a control room aboard the floating rig—calling for a cable to be clinched here, a pump to be started or stopped there, a jack to be operated somewhere else.

Serving over 3,000,000 residents of the Lower Fraser Valley and 650,000 in Vancouver, the tunnel was built for the Department of Highways and will be operated by the Toll Authority. Maintenance and operation are estimated at \$50,000 annually, and the toll will be 25 cents. Its effect has already been felt on Vancouver Island, where tourist trade is of great importance.

It's more than possible that the success of the tunnel will eventually lead to a similar but much more ambitious project—an underwater passage linking Vancouver Island to the mainland. In any case, the amazingly accurate engineering and almost faultless design of the Deas Island Tunnel have added to the wonders of the modern world. ★ ★ ★

☞ Floating on water that is more than 2000 feet deep, Ross Ice Shelf in the Antarctic is about 1000 feet thick and about as large as France.

Johnson announces nationwide motor warranty service!

Every Johnson Sea-Horse is sold with a factory warranty—now more valuable to you than ever before. The new Johnson warranty not only covers all parts of the motor, but it also assures expert installation of warranty-covered parts by any Johnson dealer, anywhere—at no charge to you.

Wherever you go with your Sea-Horse, Johnson service stands behind it. A far-flung network of 4000 certified dealers and 1300 Master Service Stations ready to serve you. Even thousands of miles from home, you are never far from reliable Sea-Horse service—the same kind of conscientious service you'd expect from the dealer who sold you the motor. Johnson pays any Johnson dealer

who gives your motor warranty service.

Remember—when you buy a Sea-Horse, you get an outboard that is built to be dependable. Every Sea-Horse is test-run and adjusted under running conditions before it leaves the factory. *And*—you get a motor that is serviced to stay dependable. Proof of dependability is the fact that this year Johnson will build its *two-millionth motor!*

For '59 Johnson leads with the newest and best in outboards: Dynautical Design to go better with your boat—make your boat go better. Sizes range from 3 to 50 hp. Visit your nearby Johnson dealer's All-Family Boat Show—March 6 to 15. Get the inside story from the man who knows outboards best!

Johnson

FIRST IN SALES
FIRST IN DEPENDABILITY

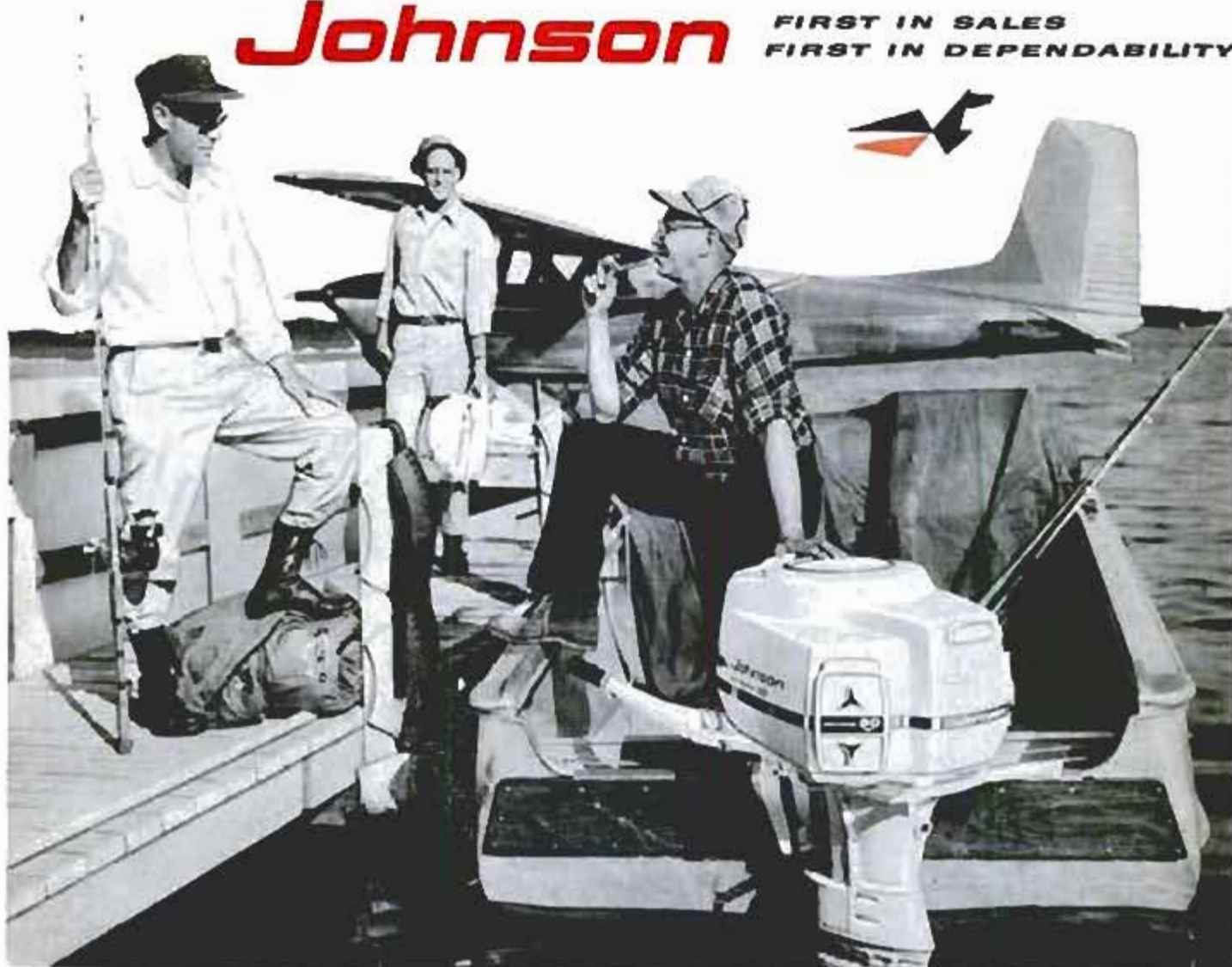

North Woods or Florida Keys—dependable Sea-Horse service is everywhere!



"Take it from me — you need SURFORM®!"

"Anyone who trims, smoothes or forms wood, or other materials like aluminum, plastics, asphalt tiles and even mild steel, can use Stanley SURFORM. In fact, you need SURFORM."

So says an expert who has been using tools and teaching with them for 50 years. Mr. Maximillian Komow knows tools. He also knows the amazing performance of Stanley SURFORM. He recommends it enthusiastically.



Pocket SURFORM
\$1.49 complete

SURFORM Plane
\$3.69 complete

SURFORM File
with regular blade—\$2.69 complete

EXTRA! New Blades Now Available!

- Full size flat blades—98¢ each
- Full size half-round blades—\$1.19 each
- Pocket SURFORM blades—75¢ each

See Stanley SURFORM. Try Stanley SURFORM. You'll want Stanley SURFORM in your shop. On sale wherever good tools are sold.

STANLEY

STANLEY TOOLS • THE TOOL BOX OF THE WORLD
Division of The Stanley Works, New Britain, Conn.

Canada's Fabulous Submarine Killer . . . HMCS Restigouche

(Continued from page 117)

surface or resting on the bottom in shallow water. Then we can blast it with our torpedoes, mortars or the anti-aircraft guns if necessary."

After a tour of the *Restigouche* and an inspection of its searching, tracking and killing devices—most of them electronically guided and remotely controlled—it seems the only place a submarine would be safe from this ship would be under the Arctic ice. The *Restigouche* has three different types of radar and five types of hull-fitted sonar underwater-detection gear, the latter designed to overcome limitations of unfavorable water temperatures, salinity and other conditions.

Under a hatch on the after deck is an innovation in antisubmarine warfare—six deadly 12-inch mortars in two triple mountings. These take the place of the old "ash can" depth charges and can be fired in any direction and with variable range. Lt. Allan F. Morris, torpedo antisubmarine officer, explained that the mortars can be fired individually or all together. When the ship is tracking a submarine with her sonars the information as to speed and depth is fed into a computer that automatically relays the information into the firing station and into the fuses of the mortar bombs. As the submarine goes into evasive action the computer supplies a constant up-to-the-second reading as to its position. When the shooting is over, the hatch above the mortars is closed and serves as landing space for a helicopter.

In the torpedo room, also under remote sonar guidance, homing torpedoes are aimed in the vicinity of a submarine where the "bloodhound" apparatus takes over and relentlessly tracks down the enemy. Lt. Morris explained that there is no danger of a homing torpedo turning back on the

(Continued to page 232)



Insignia of the *Restigouche* bears a fish spear indicative of underwater hunting—fish or submarines



Beautiful wood-paneled walls that last a lifetime—go up in a weekend!

Charter Birch paneling, preserved by exclusive Weldwood lacquer finish, has the look and feel of luxury—only \$52 for a 12' x 8' wall.

Wood paneling does wonders for walls. These new Charter Birch panels, rich in swirls, burls and color variations, are cut to bring out the natural beauty of the wood. Change the style and color scheme of your rooms as often as you like—Weldwood wood paneling, guaranteed for the life of your home, flatters any color

scheme you choose and any furniture style you own.

Install in a weekend. The 4' by 8' random-plank styled panels go up fast with no on-the-job fuss with finishing. Weldwood prefinished panels come ready-made to brighten your home. If you prefer, you can buy Weldwood Paneling *unfinished* at lower cost. See more than 70 types and finishes of Weldwood paneling at your Weldwood lumber dealer's or any of our 115 branch showrooms in U. S. and Canada.



No nail holes mar your handsome wood paneling when you put it up with Weldwood Contact Cement. Gives a permanent bond to furring strips. No clamping necessary.

WELDWOOD® PANELING 
AND OTHER WELDWOOD PRODUCTS FOR HOME AND INDUSTRY.

SEND THIS COUPON TO GET DETAILS! -----

NEW PREFINISHED PANELING BOOK PM 3-59
United States Plywood Corporation
Box 61, New York 46, N. Y.

Please send me a copy of the new full-color folder, "Presenting Weldwood Prefinished Paneling for Fine Interiors," which beautifully illustrates in color the 14 Weldwood prefinished woods and gives complete installation details. I enclose 10¢.

Name.....

Address.....

City.....State.....

AUTO-LITE[®]

RESISTOR SPARK PLUGS WITH

POWER TIP



AT LOW SPEEDS
Power Tip is hot to burn
fouling deposits away clean.

AT HIGH SPEEDS
Power Tip is cool to check
costly pre-ignition.



**"FIRE UP" AT
ALL SPEEDS
WITH
AUTO-LITE.
POWER TIP!**

**Power Tip cleans itself
while you drive!**

ship because of preset depth control.

A twin 3-inch .50-caliber antiaircraft gun is mounted aft and a new twin 3-inch .70-caliber gun is mounted forward. The latter has a faster rate of fire than the .50-caliber gun and is said to be one of the most effective weapons ever mounted on a vessel of this size. Earlier destroyer escorts of the St. Laurent class carried only the .50-caliber guns. Both guns can be aimed and fired remotely from below decks, remotely from a visual-control station, or locally.

The Combat Information Center (C.I.C.) of the *Restigouche* is located convenient to the bridge and is the nerve center of the ship. Here are two big plotting tables, an array of radarscopes, a big aircraft plotting board, and an adjoining sonar room fitted with a battery of gear and computers. One of the plotting tables is used to plot the small-scale over-all scene of action and the other the large-scale immediate vicinity of the ship. All radar and sonar information is fed automatically into each table. In addition to the scopes activated by the ship's three radars are two screens that can pick up pictures from airplane radars.

The *Restigouche* can fight blind without a single man on deck. In C.I.C., lighted only by the eerie reflections from screens and plotting tables, the combat officers know the position of friend or foe in the air or on the sea—with special attention to the enemy below. With the miracle of electronics at their finger tips, mortars can be fired and torpedoes launched. A hit is recorded by the simple disappearance of a hitherto bothersome blip or streak on a radarscope. If he chose, the captain could shout: "Sub electronically sighted! Mortars electronically aimed and remotely fired! Hit electronically recorded!"

Just in case the insulated and air-conditioned *Restigouche* should be traveling sealed through an area of radioactive fallout during this action, the captain could turn to his intercom and order that all decks and superstructure be washed down. This, too, is done remotely with a spray installation that gives the ship a giant shower bath. They call this operation "pre-wetting." The rounded edges of the deck permit the fallout to be washed into the sea. There are no scuttles or vents opening onto the decks and every protrusion that might catch fallout has been eliminated. Lt. Comdr. G. H. Somers, engineer officer, pointed out that even the boiler room, not being pressurized, can be sealed off from contamination. The anchors are housed in recesses and the capstan and cable chain, usually located on the fo'c'sle, are below

(Continued to page 234)

FROM THE MAKERS OF
SKILSAW PRODUCTS

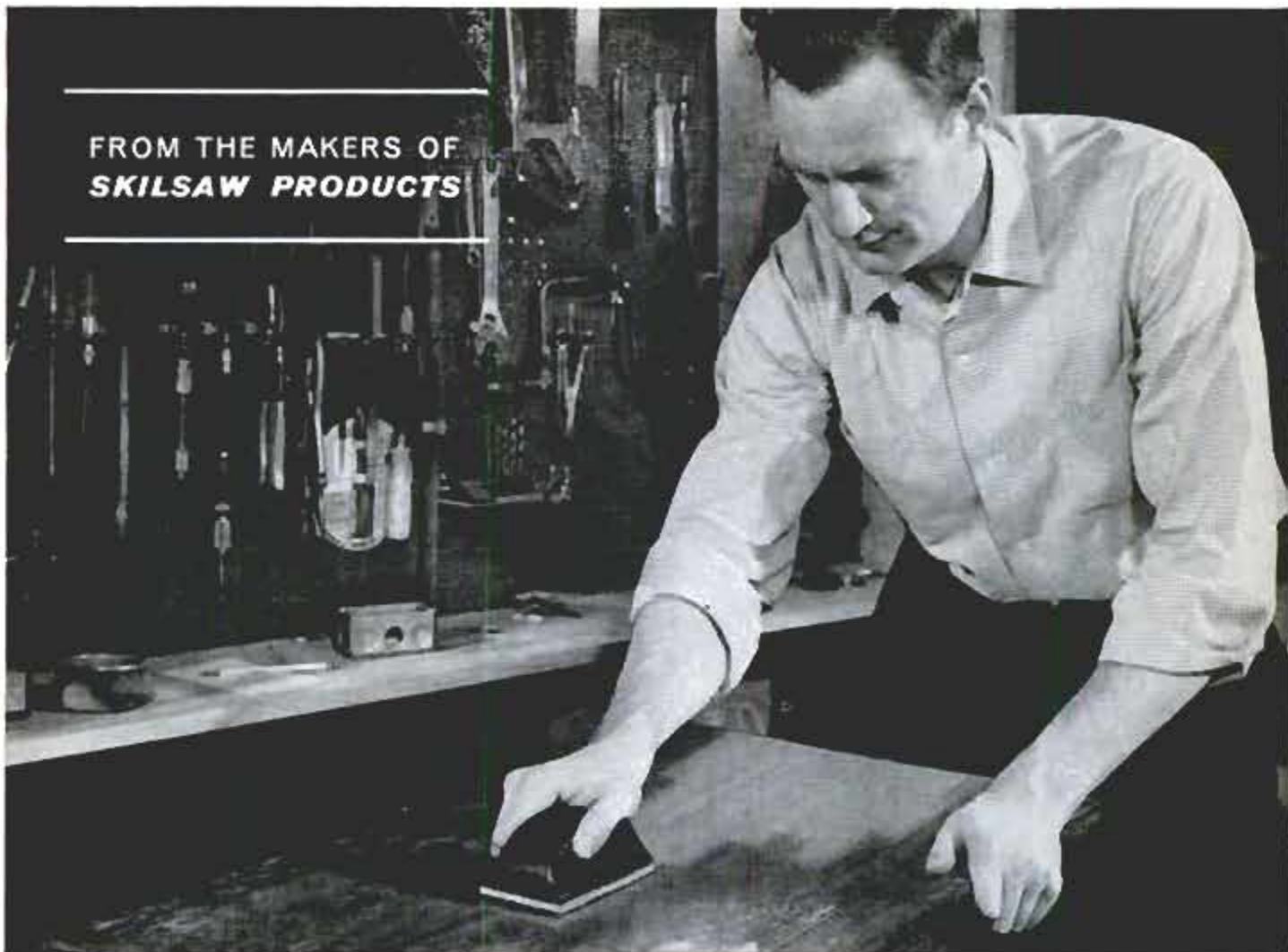

new PERMA-GRIT* hand sander cuts sanding time in half...

A wonderful, new workshop abrasive. Sands twice as fast as old-fashioned sandpaper. Can't be beat for removing old paint or enamel or for sanding wood, plastics, dry-wall, compositions.

Outlasts hundreds of sandpaper sheets—Made with tungsten carbide particles permanently bonded to steel. Always stays sharp and ready to use any time.

Deluxe Hand Sander Kit—Hand sander comes with two sanding sheets, one fine and one medium-coarse, at \$2.95. Sander with choice of either sheet, only \$1.95. Try a free demonstration at your local hardware, paint or lumber store.



PERMA-GRIT
HAND SANDER

*A Trade Mark of SKIL Corporation

PERMA-GRIT FILES PLANE WHEEL



Flat or curved file,
twice as fast



Files, sands, planes,
shapes or notches



Safe wheels for table
or portable saws



Made only by SKIL Corporation,
manufacturer of famous SKIL
and SKILSAW products, 5033
Elston Avenue, Chicago 30, Ill.

10 years

from now you too,
will be glad
you bought an

ALUMA
Craft



"Our family has enjoyed ten years of glorious fun with our Aluma Craft. Dad does most of the fishing. The youngsters do the water skiing and the whole family goes along for week-end cruising. Our boat hasn't cost us one penny for upkeep and is still just as good as the day we bought it."

That's the kind of letters we get because every Aluma Craft is built, and guaranteed in writing, to give years and years of fun-filled, trouble-free pleasure.

The smooth, clean Aluma Craft lines instantly reveal to the experienced eye the built-in stability and the fine performance qualities of these pre-formed aluminum boats that let your motor operate at peak efficiency. Both the live-weight positive flotation and maximum horsepower are OBC certified for every model.

See new Aluma Craft now on display at your dealers or write for free, full color catalog.

ALUMA CRAFT BOAT CO.

1519 Central Avenue N. E.
Minneapolis 13, Minnesota

● Please send catalog
showing Aluma Craft's top-flite line for '59.

NAME _____

ADDRESS _____

CITY _____ ZONE _____ STATE _____



decks. In case any members of the crew are exposed to radioactivity, there are two decontamination rooms on the ship.

In time of combat or peaceful cruising, the *Restigouche* can always keep in touch with its fighting "team" of ships and planes or the outside world. She has three radio rooms for transmitting and receiving on low, medium, high, very high and ultra-high frequencies. It's possible to broadcast or receive from 28 places on the ship. There's a message center with teletypewriter, and a cryptographic room with the latest equipment in coding and decoding devices. For internal communication, the *Restigouche* has 12 separate telephone systems including lines for fueling at sea, docking the ship, radar maintenance, and a dozen loudspeaker systems.

If the ship is crippled in action, the supply officer and engineers have a storeroom filled with 12,000 repair parts and a small but well-equipped workshop. Another storage item of interest to the crew is frozen provisions for 90 days. Back in World War II, destroyer escorts carried only enough fresh food for two weeks.

If the worst comes—an enemy torpedo ripping through the hull of the ship—the *Restigouche* is designed to give its crew a fighting chance for survival. This ship is designed to stay afloat and erect when 70 percent of it is flooded. Formerly, when the engine and boiler room of a destroyer-type ship was flooded, the vessel would capsize almost at once.

The stability of the *Restigouche* is dramatically demonstrated with a \$50,000 transparent model of the ship in the Canadian Navy's ABCD (Atomic, Biological, Chemical Warfare and Damage Control) School at Halifax. The model faithfully duplicates the volume of each compartment in the ship and the weight distribution. It is set in a large tank of water and is flooded by an intricate arrangement of valves.

"The ship has a low center of gravity," explained Lt. Comdr. Ian C. Martin of ABCD, as he proceeded to sink the model. "Even when flooding it will not list more than 18 degrees either way. As the ship fills with water it rights itself and her decks are almost horizontal to the sea until the last. There are many reasons for this ship's amazing stability and buoyancy. The designers used a lot of aluminum in its construction, particularly in the upper parts. Also, the shape of the hull is very important as is the fact that there are no longitudinal bulkheads. All bulkheads are crosswise of the ship. We all think Commodore Rowland Baker did a fine job on the design."

Although Comdr. McDowall insisted that

(Continued to page 236)



ALADDIN READI-CUT HOMES

from
\$3,000 to \$10,000
WE PAY THE FREIGHT

Build your own home
ALADDIN
homeowners have saved up to
\$5,000
using our Read-Cut Materials

Highest quality — Choice of 115 Modern Floor Plans

 During the past 53 years Aladdin has sold more Read-Cut Homes than any other pre-cut house manufacturer. Aladdin Read-Cut Homes have been built in all 49 states and 38 foreign countries. Today, thousands of these homes are as sound and livable as they were 50 years ago. The reason: — High Quality Material plus Sturdy Construction. You enjoy Economy, too, through Aladdin's tremendous Buying Power and Advanced Manufacturing Methods. And you can save up to 30% on labor by doing all or part of the work yourself. More than half of our customers build their own Aladdin Homes. All material is precision cut in our mill — ready to use. Easy-to-read blueprints and special instruction book simplify every step. Aladdin offers the latest designs—5 to 8 rooms—Colonial, Ranch, Cape Cod, Split Level, and 2-Story. Mail coupon today for our beautiful 72-page, full color, 1959 "Book of Homes".



Highest Quality — Best Construction



Mail to THE ALADDIN COMPANY, Bay City, Michigan

I enclose 25c for your 72-page **L-27**

BOOK OF HOMES

NAME _____

STREET _____

CITY _____

ZONE _____ STATE _____

PLEASE PRINT NAME AND ADDRESS

NEW...different

Dual Action
MOTOR OIL
...for both

HOT *and* COLD

RUNNING ENGINES



Short trip city driving causes "cold engine" sludge that promotes excessive wear. Long trip "hot engine" highway driving produces power-robbing piston and valve varnish. New Kendall Dual Action Motor Oil solves *both* problems... sells at the *regular* price.

Ask your favorite dealer for it

KENDALL REFINING COMPANY
BRADFORD, PENNA.

I view the sinking of the model in order to appreciate the stability of the *Restigouche*, he begged off attending Lt. Comdr. Martin's demonstration.

"I don't care to see even a model of the *Restigouche* go down," he said.

The commander's feeling for the ship is reflected by all 15 of his officers and the 210 men of the crew. They like the life on board, the good bunks, the same good food served to both officers and crew, and the reasonably late movies in the big dining hall in the evenings. The men even are tolerant of Lt. Comdr. Somers' avocado pear tree that grows in a wooden tub in the officers' ward room.

They are proud of the little as well as the big things on the ship, like the windshield wipers on the electrically heated windows of the bridge, the scores of luminous disks on gun protrusions and ladders that save cracked heads and shins in time of blackout. They like the idea of the intercom and lighting systems that have battery-operated auxiliaries in case the big generators are knocked out.

HMCS *Restigouche* is a combat ship of which any great navy could be proud. Men of the Royal Canadian Navy are especially proud when they recall that the entire fighting strength of the RCN at the beginning of World War II was just 13 ships—six destroyers, five minesweepers and two training vessels. ★ ★ ★

This Month's "Great Pioneer in Science"

(Page 16)



Charles Goodyear (1800-1860)

BUY **GRAVELY** FOR

MORE PERFORMANCE

MORE POWER

MORE FOR YOUR MONEY

Why tolerate equipment you have to push, pull and pamper? The Gravelly and its Rotary Mower attachment solves your toughest mowing problems!

Whether you cut and mulch heavy, tough weeds over the roughest ground, or mow the finest lawn, Gravelly does the job *better!* Because Gravelly, with its extra power (now 6.6 HP) and versatility, does more tough jobs other tractors can't!

30 Tools



SINCE 1922

UNMATCHED PERFORMANCE!

Choose the tools that fit your jobs from 30 year-round attachments. All powered by one Gravelly tractor!

Do the job *better* because power attachments are driven direct from the engine by splined steel shafts and gears. No belts or chains to slip, wear or break. *More power at the working tool!*

A **FREE** demonstration by your local sales and service representative will show you, beyond doubt, that the Gravelly and its attachments will do your jobs *better, faster, easier.* Compare. You will see that you get *more power, more performance, more for your money!* . . . Available on installment plan.

WRITE FOR FREE 24-PAGE BOOKLET!

Big, 24-page illustrated booklet, "Power vs Drudgery", shows how the Gravelly solves your lawn and garden problems . . . Write for it today!



FREE! MAIL NOW

• ALL-GEAR DRIVE

• POWER REVERSE

• OPTIONAL STARTER

Power attachments *securely* mounted by only four bolts. Balance, easy handling, simple controls. Cutaway view shows Gravelly's clean, compact, power-engineered design — the reason for its remarkable performance. Make the wise choice — choose Gravelly!

GRAVELY TRACTORS, INC.

P.O. BOX 601-C

DUNBAR, W. VA.

Please send "Power vs Drudgery" Booklet and dealer's name to:

Name _____

Address _____

Town _____ State _____

Master LAMINATED Padlocks

protect
your

property
and

valuables!

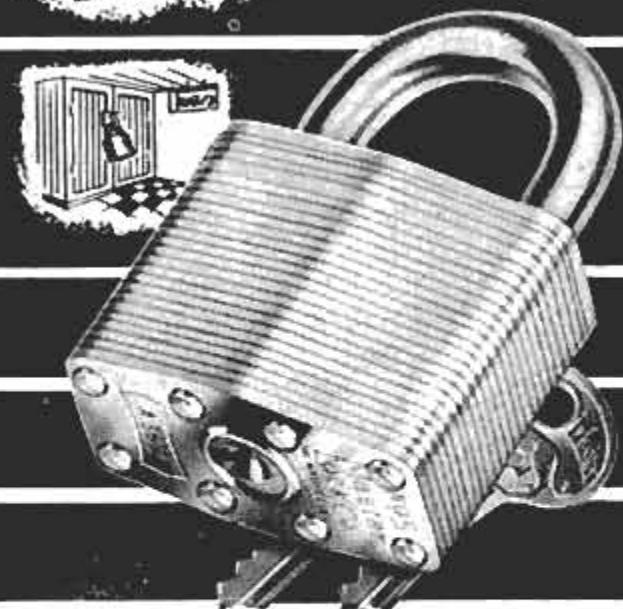

\$1.25 to \$4.00, in a variety of sizes, at
locksmiths and hardware stores everywhere

Master Lock Company

MILWAUKEE 45, WISCONSIN

World's Largest Padlock Manufacturers

Teach the Kids to Swim In One Lesson

(Continued from page 99)

She panicked when she put her face underwater. Experience with her seemed to indicate that this simplified system of teaching a child to swim would not work. The fact was, she could not learn to swim by any method until she overcame the reluctance to put her face into the water. This didn't come about until she was in her teens.

Coleman was a baby while the older ones were learning to swim. While playing in a shallow, swift part of a creek, he fell down and drifted underwater about 10 feet before I could run and pick him up. He came up laughing and then made a game of it. He would fall down, drift along a few feet with his face underwater, then stand up.

Yet when it came to learning to swim—and trying the dead-man's float—he wouldn't do it. It frightened him to put his face down in the water. The simplified method seemed unworkable in such a case.

But later, when he was 10, he decided he wanted to learn to swim. Some other boys his age had been bragging about swimming, so Coleman got serious and practiced the dead-man's float in the bathtub. Then he came to me and said he could float with his face underwater. Would I please try again to teach him to swim? We went to the nearest creek, selected a place where the water was deep enough for him to swim, shallow enough that he always knew he could find bottom with his feet.

Under my tutelage he did the dead-man's float, next, the float with swimming motions, finally, the float with swimming motions and his face raised out of the water just enough to breathe. He was swimming. After something like half an hour, we were swimming along together, a bit splashily and with over-exertion, but swimming.

Now Coleman could learn and practice the various strokes and master the breathing rhythms. Meanwhile, if he had fallen into deep water accidentally, he would have been able to swim to safety. ★ ★ ★

Earth Gives Boost To Three Alaskan Cities

Alaska's capital, Juneau, is moving up in the world. The U.S. Coast and Geodetic Survey reports the elevation of Juneau has risen two feet in the past 50 years. Benchmarks set by the Survey a half century ago also indicate that Skagway, Alaska, has risen three feet and the neighboring city of Haines is up five feet.

15 POWER TOOLS IN ONE!

Minute Magic

DeWALT[®] POWER SHOP[®]

changes operations in one minute



RADIAL SWING SAW
Saws at any angle



TILT ARBOR SAW
Outmodes every table saw



DADO SAW
Layout marks visible



SHAPER
50% more shapes



DISC SANDER
100% more angle work



HORIZONTAL DRILL
Bores at any angle



ROUTER
Ideal for variety work



SURFACER
Smooths out rough stock



GRINDER
Sharpens tools, axes, etc.



METAL CUTTER
Cuts D-I-Y aluminum



DRUM SANDER
Makes unusual jobs easy



BUFFER-POLISHER
Cleans and polishes

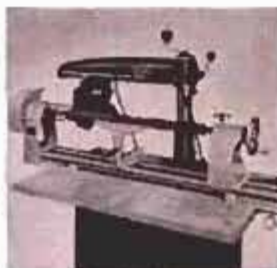

12" LATHE
36" between work centers



JOINTER
Puts straight edge on wood



SABER SAW
Does your curve work

Anybody who enjoys woodworking falls in love with a DeWalt POWER SHOP* the moment he sees it in action and feels the precision work it does!

DeWalt brings you ultra-modern home-safety features. Compact, it fits into a work bench (free plans show how). DeWalt saves you hundreds of dollars in separate power tools. You can own a DeWalt for \$2.50 per week, two years to pay, after a small down payment.

Get the facts—mail this coupon now!

DeWALT, Dept. PM-93, Lancaster, Pa.



Please send Free Catalog and Home Workbench Plans.

I enclose \$4.75 for 186-page textbook—“Easy Ways to Expert Woodworking.” (Check or M.O.—No C.O.D.)

Name _____

Address _____

City _____ State _____

*T.M. DeWalt Division

©1958 American Machine & Foundry Company

ASK YOUR DEALER FOR FREE DeWALT DEMONSTRATION TODAY!

Behind the Scenes in Electronics

(Continued from page 216)

of quality. At the same time, a stereo receiver can faithfully reproduce any monophonic-AM broadcast.

Although technical development of RCA's stereo-AM system is completed, it is not yet ready for market. FCC approval must be obtained before production lines can be set up. Field tests remain to be run and station owners must be convinced that AM stereo is ready. But, with interest in stereo at an all-time high, it is quite likely that AM stereo may yet beat FM multiplexing into the average home.

ELECTRONIC PRINTING

If present developments can be used as a guide, the graphic arts fields may soon experience some drastic revisions.

The word "Electrofax," now principally a laboratory term, will become familiar to everyone engaged in the printing trades.

Electrofax is a revolutionary electronic printing process for reproducing any type of visual information on any solid surface quickly and inexpensively. In this application its uses are limited only by the imagination.

The process is as simple as it is unique.

The surface on which the material is to be reproduced is first coated with an inexpensive chemical solution which can be brushed or sprayed on like ordinary paint. This coating is made light-sensitive by passing over its surface a charging unit, consisting of an array of fine, current-carrying wires. When this is done, a dense layer of invisible electrons covers the entire surface, giving it a uniform, negative charge.

When the charged surface is subjected to light, the electrons quickly leak off in direct proportion to the amount of light striking any part of the surface. Thus, any image projected upon the surface leaves an invisible pattern of electrons whose density corresponds exactly to the light and dark portions of the projected material.

To make the electron image visible, the surface is dusted with a mixture of powdered iron and colored plastic particles by means of a magnetic brush. Tribo-electric action between the iron and the plastic causes the plastic particles to take on a strong positive charge. Therefore, when the "exposed" surface is dusted with the powder, the positive plastic particles adhere to the latent electron image, clinging most heavily to those areas which receive the

(Continued to page 242)

When you do-it-yourself...

CONOLITE®

makes it easy to do!



When your home needs re-doing, do-it-yourself with CONOLITE—the beautiful, hard-surface plastic laminate for sink tops, tables, bars, and walls!

Your reliable Lumber and Paint Dealers have many rich patterns and wood grains now. So cover your home with exciting Conolite color today!

CONTINENTAL © CAN COMPANY

CONOLITE DIVISION

WILMINGTON, DELAWARE



economical • flexible,
easy to handle • adheres
to wood or metal • comes
in rolls • less trimming,
no seams • chip, heat &
stain resistant

*In tilling it's **BALANCED ACTION...***

SPRINGFIELD'S GOT IT!



Springfield engineers have combined four great performance features to give you *balanced tiller action* . . . and it's yours at no added cost.

One, you can adjust for tilling width by adding or removing tines in seconds. Two, you can adjust for tilling depth with the Springfield depth bar. Three, you can adjust for correct tilling pressure on the tines by shifting wheel position. Four, you can adjust for comfort by setting correct handlebar height.

Yes, Springfield's got it! To balanced action add the famous Quick-Lok Handlebar Clutch, your choice of fork or disc type tines (replaced free if they *ever* break), a full year warranty, and a big 3 hp engine.

*See the Springfield, try it!
Here is today's best tiller value!*



Springfield Riding Mower

Springfield Walking Mower



Quality built by
Quick Mfg., Inc., Springfield, Ohio
The House of Power

STEWART-WARNER GIVES YOU



big

MOTORING EXTRAS!



Extra Protection

With Twin Gauge Panel. Tells more than ordinary "warning lights." Gives rate of current flow . . . helps prevent overcharging or discharging of battery. Tells exact oil pressure . . . helps assure safe engine performance. Only \$9.90.

Extra Performance

With Electric Fuel Pump. Gives instant starts...delivers steady flow of gasoline. Ends vapor lock due to abrupt temperature changes. Eliminates stalling due to surging or over-pressure. Ideal for high compression motors. Only \$39.95.



Extra Economy



With dependable Motor Minder. A must for every driver who wants top mileage per gallon of gas. Helps avoid costly repair bills by giving constant check on condition of spark plugs, carburetor, rings, valves, timing, etc. Pays for itself in savings. Easy to install. Only \$12.05.

Get these motoring extras at your car dealer, service station, garage or automotive parts store.

Symbol of SW Excellence INSTRUMENT DIVISION STEWART-WARNER CORPORATION

Dept. AM-39, 1840 Diversey Parkway, Chicago 14, Ill.

least amount of light during the exposure. The result is a high-quality reproduction of the original image.

When heat is applied for a few seconds, the plastic particles will fuse with the coated surface, resulting in a permanent print.

The entire Electrofax process takes less than a minute, even with hand-operated techniques. With mechanized equipment this can be materially reduced. Small wonder that, in the fields of copying and photoengraving, the Electrofax process promises to render obsolete many of the techniques in use today. ***



Morning Coffee, Inc., San Diego, Calif.

Push-Button Coffee Servers For Hotel and Motel Units

Next time you check into a hotel or motel, you may find your room equipped with a hot-water dispenser for making coffee. A San Diego firm is installing push-button units in hotel and motel units throughout the country. To brew a cup of coffee at any time of the day or night, the guest presses a "heat" button that activates an electric heating element within the server. In about four minutes, the water is steaming hot and the guest pushes a second button which releases the water into a cup. A supply of packets of instant coffee, cream and sugar is provided with the room.



SO DUSTLESS, YOU CAN
SAND AND PAINT SIDE BY SIDE!

NEW BLACK & DECKER DUST-LESS FINISHING SANDER

Get set for the cleanest sanding you've ever done! Fine, satin-smooth surface in 1/10 the time of hand sanding! Easier sanding *with, against* or *across* the grain! And truly efficient, healthier dustless operation! The new B&D Dust-Less Finishing Sander connects to

your vacuum cleaner to whisk away dust as it forms, leaves a clean working surface. You can even sand and paint in the same area! Ask your B&D dealer now to demonstrate the new B&D Dust-Less Finishing Sander or send coupon below for full details.



NEW
1/2" B&D
DELUXE
UTILITY
DRILL

With 84% more power per pound!
New B&D motor gives more power per pound for metal drilling, wood boring, and drill press work. Smaller and lighter. All at same low price!

Black & Decker®



World's Largest Maker of Electric Tools

THE BLACK & DECKER MFG. CO.
Dept. MO-39, Towson 4, Md.

Please send complete descriptive literature on your new tools:

- Dust-Less Finishing Sander U-43
 1/2" Deluxe Utility Drill U-21

Name.....

Address.....

City..... Zone..... State.....

NEW GREENLEE ZIP BIT

with non-slip HEX SHANK



**BORES IN ANY WOOD,
ANY ANGLE, ANY SPEED**

- ZIP BIT with exclusive hex shank chucks quickly, accurately in any 1/4" or larger electric drill.
- ZIP . . . it's chucked, ZIP . . . the hole's bored!
- Cutting edges easily resharpener by filing or grinding.

Buy singly or in handy sets



6-piece
set in
metal rack
ONLY \$3.90

6-piece
set in
plastic roll
ONLY \$3.90



60c to 70c
each in sizes
from 1/4" to 1"



GREENLEE TOOL CO.
2110 Columbia Avenue
Rockford, Illinois

From Outer Space— Voices Today, TV Tomorrow

(Continued from page 89)

Spotted across the country from California to Georgia were four mobile ground stations. Inside their trucks, operators manned compact teletypewriters, multiplex panels and transmitters. As the orbiting satellite circled up over the horizon into line-of-sight range of each station in turn, the continuous "beep" of a beacon aboard the rocket was picked up by the groundlings. To obtain any stored messages on the satellite's memory tape, the ground operator simply pushed a button on his transmitter console. Instantly, a radio signal shot skyward to trigger the satellite's relay transmitter, and whatever was on the tape up there was broadcast earthward.

By pushing a series of buttons, a sequence of "command" signals to the satellite could wipe the tape, and the ground operator could then broadcast a message of his own that the satellite would record for command playback at the next station that came into range.

The tiny tape loop was capable of handling seven separate teletypewriter messages plus one voice message simultaneously, at a rate of 420 words per minute. Its four-minute storage capacity could remember and rebroadcast some 1680 telegraphic words.

"If the satellite happened to be within range of two stations simultaneously," Spaulding reveals, "the operator could, by sending up a different electronic command, bypass the tape recorder, and the satellite would rebroadcast his message instantaneously."

After the successful broadcast of President Eisenhower's voice (which was secretly radioed to the Atlas' tape recorders while the missile was still on the pad, during the last seconds of countdown), Signal Corps experts gave their experimental laboratory a real workout to take full advantage of the limited time and power at their disposal. Atlas' eight-watt transmitters were powered by tiny zinc-silver oxide batteries with an estimated life of only four to six weeks; solar batteries were not installed because of the anticipated short life of the Atlas in orbit. Before the power failed, the miniature system had handled relayed messages from station to station and tapes were wiped by radio command. Direct relay through the flying transmitter was successfully tried, using the seven simultaneous voice channels and voice messages. Like the "moon signals" of several years ago, messages were even bounced off

(Continued to page 246)

NOW

*Multi-Color
Painting
is easy
for anyone!*



• Low-cost PRESSURE MAID Paint Sprayer with special spray cap for MULTI-COLOR paints is ideal for *do-it-yourself* projects. Rugged, portable, trouble-free. Complete — ready to spray. Piston-type, direct-drive, single cylinder compressor. 1/3 h.p. 110 Volt AC motor.

Write for new Bulletin PM 500 today!

The Campbell-Hausfeld Co.
1046-C Railroad Ave., Harrison, Ohio



CAMPBELL-HAUSFELD



GENUINE ALNICO MAGNETS

AMAZING, PERMANENT, NON-ELECTRIC, HIGHLY PRACTICAL. Conduct interesting experiments. Hundreds of uses. Retrieve valuable steel items such as guns, tackle from fresh or salt water; tools from tanks & drains. **GUARANTEED.** Try any magnet one week. Money back if you are not well-pleased.

- No. M-710 (Wt. 53 oz.) Has pull of 225 lbs. on steel block... \$18.00
- No. M-025 (Wt. 70 oz.) Has pull of 125 lbs. on steel block... \$10.00
- No. M-075 (Wt. 18 oz.) Has pull of 75 lbs. on steel block... \$7.00
- No. M-500 (Wt. 13 oz.) Has pull of 50 lbs. on steel block... \$5.00
- No. M-300 Kit of Flat Bars 5 Pairs (10 Magnets)... \$2.50
- No. M-250 Kit of Round Rods 5 Pairs (10 Magnets)... \$2.50
- No. M-17 Flat Pad Magnets, 10 for \$1.00... \$1.00
- No. M-15 Hobbyist assortment of 8 small magnets... \$1.50

Send U.S. or check, in your postage. Sorry no C.O.D.'s.
MIAMI MAGNET COMPANY, 3240 N.W. 27th Ave., Miami 42, Fla.

DOES TOUGH JOBS WHILE YOU RIDE! PLOW • DISC • MOW • TILL



A new steel tractor made especially for farms and suburban acreage. Cultivate, Disk, Mow, Plow, Backhoe, PLOW DISC MOW TILL. Motor beautiful lawn (pulls 7 mowers). Over 20 quick change implements. Safe to operate (even for 10 year olds). P.H.S. All gear drive. 8 W x speed work mission clutch differential 770 lbs. Uses regular automotive parts. Easy attachment to tractor. Low cost. Reply to give 100% Satisfaction guaranteed. Thousands in use.

Write for FREE CATALOG TODAY!
COUNTRY SQUIRE TRACTOR CO.
P.O. Box 107-K3, Muskego, Wis.



Have fun removing
paint and varnish

KWIK

So quick and easy! Just brush on to remove all types of paint, enamel, varnish, lacquer... even synthetics. Off comes paint in 5 to 15 minutes. Safe, too. Non-flammable. No acid or alkali. At better hardware, paint and marine dealers.



CHEMICAL PRODUCTS COMPANY, INC.
Aberdeen, Maryland

Now, every family
can afford
fiberglass luxury!



Lone Star
14' SUPER DELUXE

Big-boat performance, quality, styling, and versatility at unmatched price! Completely equipped with automotive-style upholstered front and rear seats (fully adjustable); steering and rigging; windshield; deluxe hardware; five dramatic two-tone color options.

ALSO AVAILABLE: 146 aluminum and fiberglass boats — boat trailers

SPORT *Monterey* FOR \$537*
With upholstered, automotive-style front seat, steering wheel, rigging!



UTILITY *Monterey* FOR \$513*
With two vinyl-covered adjustable utility seats, each 48" x 12"!

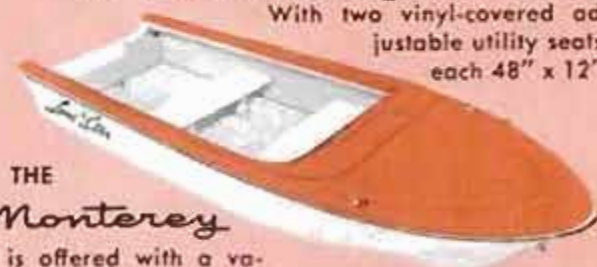

THE
Monterey
is offered with a variety of other options... from \$489* to \$595*... with short (15") or long (20") transom at no extra cost.

LIFETIME FIBERGLASS CONSTRUCTION

Length	Beam	Disc Hp.	Weight
14'	41"	12 to 40	300 to 400 lbs.

Lone Star Boats

MOST WANTED NEW ON TRACER 100

Send for your FREE FACT-FILLED LONE STAR CATALOG now!

SEE
YOUR
AUTHOR-
IZED
LONE
STAR
DEALER

THE *Confederation* LINE FOR '59
LONE STAR BOATS

1948-3 E. Main Street Grand Prairie, Texas

NAME _____

STREET _____

CITY _____ STATE _____

*FOB prices shown do not include freight, packing, dealer make ready charges

the satellite from station to station. In nearly every case the microwave signals came through loud and clear.

Already Pentagon officials are talking about a permanent system of satellites that would relay military messages through the heavens, and relieve congested radio channels in our atmospheric envelope.

Simplest would be a few big fellows that would relay data—just as Atlas did it—picking up messages from one station and delivering them on command to another as it went its orbital rounds.

More complex would be a system of three satellites, moving in equatorial orbits at the same speed at which the earth turns. If equally spaced around the earth at about 22,000 miles' altitude, the three satellites would always be within line of sight of each other. Between them, they would be within microwave range of every inch of the world's surface. Messages could then be instantaneously relayed between any two ground stations anywhere.

"The idea of achieving precise earth speed and having the three satellites maintain their position in space isn't as tough as you'd think," Spaulding points out. "At that altitude, they could drift a thousand miles or so without spoiling the arrangement. And with radio guidance, they could be returned to position."

A third proposal envisions two dozen huge balloons with reflective surfaces, which would be shot into orbit in series, circling the globe like a string of pearls. Carrying no radio equipment at all, they would be used by ground stations to bounce signals around the world.

Since microwave signals are the same type utilized in TV broadcasts, television proponents envision the day when TV-around-the-world may well become a reality—merely by shooting the signals on a 44,000-mile journey through space over the back of a satellite. ★ ★ ★

Basketball Players Evaluated By Electronic Computer

As soon as Case Institute of Technology's basketball team leaves the floor after a game, punched cards containing notes on each player's performance are fed into an electronic computer. The computer rapidly evaluates each man and thus provides important information for the next game, including an "ideal" starting lineup. During each game, mathematicians note such items as the number of minutes a man plays, the number of his short, medium and long shots, the number of baskets for each type of shot, the number of fouls, rebounds, fumbles, bad passes, and similar items.



Electricity anywhere with Cub-mounted electric generator!

MAKE LAWN CARE CAREFREE! WITH AN INTERNATIONAL® CUB® LO-BOY®

Mow, mulch leaves, clear snow... ride your ground cares away on the comfortable seat of an International Cub Lo-Boy! It's a man-sized, full-fledged tractor, yet small enough to work along walks, trees, flower beds with reel, rotary, Hammer Knife, or cutter bar mower. Does so much more—easier—than walking-type equipment. Send for FREE catalog today.

Your son can earn college funds during vacations with a Cub Lo-Boy. He can mow lawns, plow gardens, do landscaping... find dozens of other jobs to keep busy... profitably.

Send for free idea kit. Dept. PM-3, Box 7333, Chicago 80, Illinois.



**INTERNATIONAL
HARVESTER**

If your spirit is
WHEELING



there's a
HARLEY-DAVIDSON
motorcycle for you

You name it! Whether you're looking for luxurious riding comfort, thrilling sport or lightweight economy — Harley-Davidson has the right wheels for you. **DUO-GLIDES** offer cruising comfort for one or two. **SPORTSTERS** give you jet-propulsion on or "off the road." **HUMMERS** and **MODEL 165s** give more smiles and miles to every gallon. In all, there are 7 sensational models to choose from. See them at your Harley-Davidson dealer or fill out the coupon for free, colorful folders.

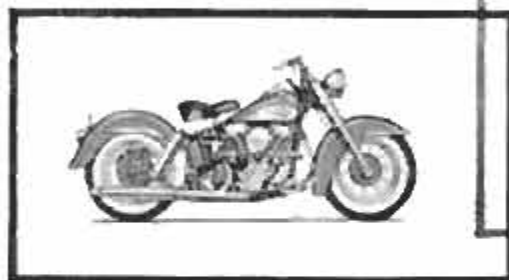

DE-LUXE DUO-GLIDE — The luxury cruiser of motorcycles. Available in the FL series or super-power FLH's.

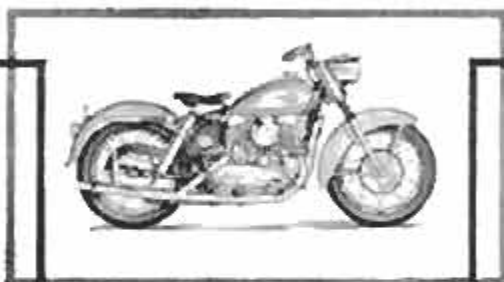

JET-STREAM SPORTSTERS — H model (pictured) for jetaway acceleration on highways and byways. Also Sportster CH for "off-the-road" competition.



LUXURY LIGHTWEIGHT 165 — Smart styling combined with thrifty operation. Not shown is the economical Hummer — up to 100 miles to the gallon.



Harley-Davidson

MOTOR CO.
DEPT. P, MILWAUKEE 1, WISCONSIN
Dealerships Available. Write For Information.

HARLEY-DAVIDSON MOTOR CO.
Dept. P, Milwaukee 1, Wisconsin

Please send me information on
 Duo-Glides Sportsters Lightweights

Name.....Age.....

Address.....

SAVE

\$2.00

SPECIAL 'TIL MARCH 31



INTRODUCTORY OFFER!

CRAFTSMAN

VENEER AND CABINET BLADE TWIN PACK

After April 1, the price will be \$3.98 each, but during March Sears is offering 2 Kromedge thin-rim blades in a special twin pack for only \$5.95. You save \$2! Each is designed for a specific fine-cutting job. One blade assures smooth cutting of plywood and veneers; the other is for precise cabinet work. Each blade has a built-in stabilizer and has been impregnated with hard chrome, will cut up to 5 times longer than an ordinary steel blade! Tempered under pressure, evenly tensioned to run true.

SATISFACTION GUARANTEED OR YOUR MONEY BACK

Make Sears your saw blade headquarters. Buy Kromedge Blades at your nearest Sears Retail Store... or order with confidence from Sears Catalog in your own home by mail, phone or at your nearest Sears Catalog Sales Office.

© 1969 SEARS, ROEBUCK AND CO.

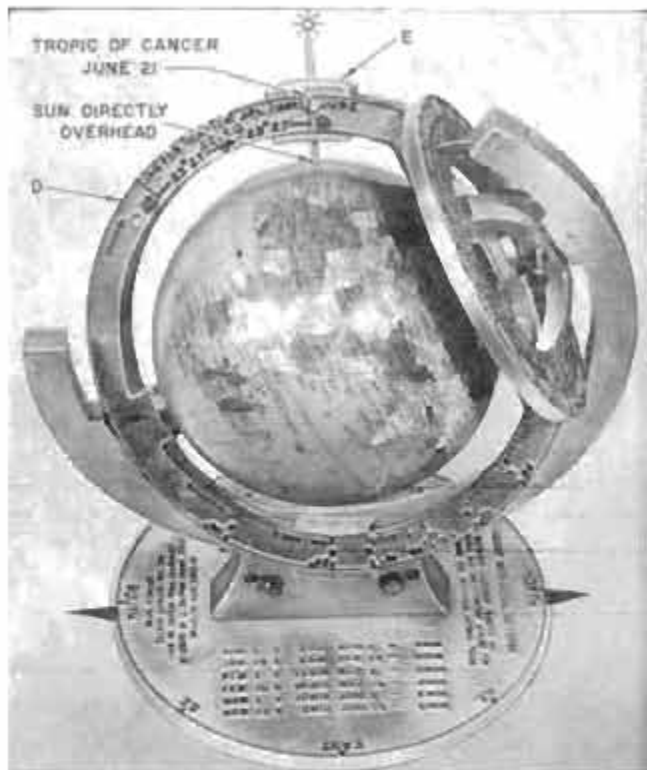

Mechanical Globe "Stops" Sun On Any Day of Year

As a classroom aid, teachers can use a "mechanical universe" to illustrate the earth's relationship to the heavenly bodies. A dial can be set for any latitude or longitude, and a moving slide represents the sun. The slide's position can be set for any day of the year. An indicator in the slide shows where the sun will be directly overhead. Another slide represents the path of the moon during any given month. A scale gives the relative time in the various longitudes and demonstrates at what latitudes prominent stars may be seen directly overhead.

Synchronize Yardsticks!

Beginning July 1, slight changes will be made in international length and weight units used by scientists of English-speaking nations. The new international inch will be equal to 25.4 millimeters and the international yard will be equal to 0.9144 meters. The change amounts to about two parts per million but the difference still is large enough to be significant in the precise measurements of scientists. At the same time, the international pound will become equal to 0.45359237 kilograms, or about six ten-millionths of a kilogram lighter.

By adding a bit of sodium amytal, a sedative, to the water tanks of the trucks transporting salmon from a river to a Washington state hatchery, losses of fish due to human handling have been reduced.



Power-Steering on Jet Plane Aids Pilot on Ground

Conventional steering systems were too slow to cope with the 200-mile-per-hour takeoffs and landings of the F-105 Thunderchief, so engineers designed an electronic power-steering assembly and built it into the nose wheel of the fighter-bomber. When the pilot nudges the rudder pedal, the signal is picked up by a potentiometer, amplified and fed to a servomechanism that turns the wheel. Another potentiometer measures the change and relays the information back to the servo. All this is accomplished within thousandths of a second. The new system is said to make steering the jet as "easy as steering the family car."

Automatic Nose for Alcohol Would Warn "Lit Up" Driver

If you've had too much alcohol to be a safe driver, a Danish inventor's idea would give you a sight-and-sound warning. He has developed what might be called an "automatic nose" to detect drunken drivers. Mounted on the steering wheel, it samples the driver's breath and if the reaction shows a dangerous level of alcohol in his system, a fluorescent light is activated and various relays sound the car horn and prevent turning on the ignition for a quarter hour or more. The device is not yet available.

☐ Black light, so called because its rays are barely visible to the human eye, attracts flying insects for some unknown reason.

SAVE

\$2.00

SPECIAL 'TIL MARCH 31



On all **CRAFTSMAN** TUNGSTEN-CARBIDE-TIPPED SAW BLADES

Make Sears your saw blades headquarters. For the best long-term buy you can make, tungsten-carbide-tipped blades provide more than 20 times longer blade life than untipped steel blades! Regularly priced below comparable-quality blades sold elsewhere, all Carbide-tipped Blades for every type and size of electric hand or bench saw have been further reduced an additional \$2 during March! Buy Carbide-tipped Blades at the Craftsman Home Workshop display at your nearest Sears Retail Store or order from Sears Catalog, by mail, phone or at your nearest Sears Catalog Sales Office.

SATISFACTION GUARANTEED OR YOUR MONEY BACK

Here Are Typical Savings!

- 6½" - ½x¾" arbor
reg. \$8.95, sale price....\$6.95
- 8" - ½x¾" arbor
reg. \$9.95, sale price....\$7.95
- 10" - 1x¾x¾" arbor
reg. \$11.95, sale price....\$9.95

© 1959 SEARS, ROEBUCK AND CO.



HELP US KEEP THE THINGS WORTH KEEPING

Nothing's so precious to a child as her mother's love. It surrounds her and helps her find her way in a big strange world.

And though she doesn't know it yet, peace is precious, too. It makes the lives of both mother and daughter more secure.

But like most precious things, peace is not free. Peace costs money. Money for strength to keep the peace. Money for science and education to help make peace lasting. And money saved by individuals to help keep our economy strong.

Your Savings Bonds, as a direct investment in your country, make you a Partner in strengthening America's Peace Power.

Think it over. Are you buying as many Bonds as you *might*?



HELP STRENGTHEN AMERICA'S PEACE POWER BUY U. S. SAVINGS BONDS

The U.S. Government does not pay for this advertising. The Treasury Department thanks The Advertising Council and this magazine for their patriotic donation.



POPULAR MECHANICS

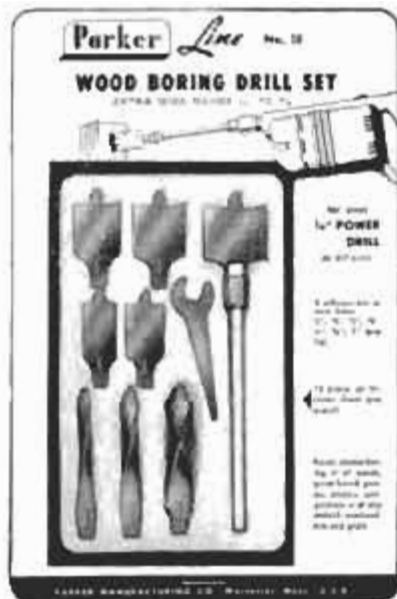

Now!
**A Wood Boring
 Drill Set**
 with an
 extra wide range
 from 1/4" to 1 1/4"
**Yours for
 only \$2.75**

New 10 piece set fits all 1/4" electric drills and drill presses. Bore faster, cleaner, truer holes in wood, plastics, panelboard, plaster, compositions. New plastic case gives you permanent, moisture resistant container for your bits. Hardened tool steel — rugged construction. Sold at leading hardware stores.

Set includes universal shank and wrench.

Buy the **Parker Line**

PARKER MANUFACTURING CO.
 WORCESTER 1, MASS., U. S. A.



FIND BURIED TREASURE
 GOLD, silver, coins, jewelry, strong-boxes, battle relics! M-SCOPE transistorized electronic Treasure-Metal Locators detect them all. Used world-wide. Exciting! Rewarding! Guaranteed. Lightweight, super-sensitive. Indestructible fiberglass cases. From \$59.50. Easy Terms. FREE catalog.
FISHER RESEARCH LAB., INC.
 Dept. PM-3, Palo Alto, Calif.

CURE THAT GAS EATER...
 with triple-action
MILESMASTER®

Mail Coupon for free pamphlet: "THE TRUTH about FUEL PRESSURE REGULATORS"
 Authoritative engineering answers explain why over a MILLION installed in cars and fleets to save 15 ways including:
 Save up to 20% on Gas • Stop Stalling, Vapor Lock, Flooding
 Stop Rough Idling • Stop Hard Starts, Jerky Acceleration
 Improve Filtration, Stop Fuel Clog • Reduce Carburetor Wear

Insist on Milesmaster—get up to 36 to 40 EXTRA miles in a tankful of gas! It's the "3-in-1" quality Leadership Fuel Pressure Regulator.

MONEY BACK
\$6.95
 GUARANTEE



For free "TRUTH" Pamphlet, mail this coupon with your name and address in margin. No obligation. Sold only at retail through 40,000 auto service outlets on Money Back Guarantee.
 Milesmaster, Inc., Dept. 105, 1550 E. 74th Pl., Chicago 1st Ill.

**NEW OAK FLOORING
 LAYS LIKE TILE**
 over concrete, wood or old tile floor



No
 sanding!
 No
 finishing!

Bruce Laminated Oak Block

Modernize your home by installing this beautiful hardwood floor over your old floors. Or use low-cost Bruce Laminated Blocks to create new living space in attic, basement or addition.

Easy to lay — Just apply adhesive (Bruce Everbond Coldstik) and lay blocks. Tongues and grooves assure tight fit. No nailing . . . and no sanding or finishing either, because Bruce Laminated Blocks are completely prefinished at the factory. Your new floor is ready to be used and admired as soon as you lay it.

Moisture-resistant — Blocks are 9" square and only 3/4" thick. The three oak plies are laminated under heat and pressure with waterproof glue to prevent expansion and contraction. Ask your lumber dealer for a cost estimate. Mail coupon for color literature on Bruce Laminated Blocks.

SEND FOR COLOR FOLDER

E. L. Bruce Co.
 Box 397-T, Memphis 1, Tenn.

Send complete information on Bruce Laminated Oak Block Floors.

Name _____
 Address _____

Bruce LAMINATED Oak Block Floors
 By the world's largest hardwood flooring maker

There is
nothing finer
than a...

DIAMOND



For lifetime service satisfaction,
be sure of the DIAMOND trade-mark
on your next wrench or plier purchase,
at your favorite hardware
or auto supply store.

DIAMOND TOOL
and Horseshoe Co.

DULUTH, MINNESOTA  TORONTO, ONTARIO

Manufacturers of the finest forgings for fifty years.

High-Voltage Rainmakers

(Continued from page 85)

electrical charge in the air on the mountain beneath the cloud.

To learn even more about the things that were happening inside those clouds, Moore and two other scientists, M. D. Ross and Dr. Paul MacCready, set out to explore the thunderhead innards personally. Their perch was a four-by-five-foot plywood platform with nylon cloth sides, slung beneath a polyethylene free balloon 44 feet in diameter. With them went half a ton of scientific instruments, cameras and gear. They wore insulated arctic clothing and oxygen masks, and, as Moore puts it, "We were wired for sound." Instruments were rigged to measure their heartbeat, blood pressure, respiration and skin temperature as they soared skyward. Cloud explorer Moore made two hair-raising flights in this rig, both of which he will never forget.

Soar to "Cloud Nine"

On the first, June 24, 1957, Moore and Ross, a Navy expert, took off from Withington's summit into the base of a building cumulus, and were soaring nicely when suddenly their instruments told them they were dropping at the staggering rate of 2000 feet a minute. "We were in a terrific downdraft," Moore recalls. "Many people think that a free balloon, caught up in the shearing vertical winds of a thunderstorm, would be tossed and torn to ribbons. Oddly, there's no sensation of violent movement at all. The whole assembly rides with the winds, smoothly and evenly. Our first sensation of how fast we were falling came when we plummeted through the bottom of the cloud and saw bushes and trees rushing up at us at a phenomenal rate. Ross and I threw 40 percent of our ballast over the side as fast as we could. When we finally checked the plunge, we were hovering 300 feet above a valley floor, and Withington's peak towered more than 2000 feet above us."

Again they soared up, this time through the edge of the cloud, finally breaking out the side and rising through its mushrooming cap at about 22,000 feet. "An interesting thing," says Moore, "is that we were not drawn into the cloud again, which appears to negate the theory that clouds always entrain air from the sides all the way up. Another curious thing that fitted our theory nicely was the fact that a tremendous current of air pouring over the top of the cloud and down its sides was pulling the edges of the mushroom top downward like a gigantic waterfall. Something else no one

(Continued to page 254)

QUICKEE® Waterless Cream HAND CLEANER

Proved in industry for over 20 years. QUICKEE removes paint, grease, tar, putty, carbon, mastic, grime, stubborn stains from hands in seconds. Rich in lanolin . . . safe and soothing as cleansing cream. Indispensable in workshop, car, garage. Handy tube only 59¢ . . . economy can only 79¢.



QUICKEE Waterless WALL TILE CLEANER
No water, no mess. Keeps your wall tile sanitary-clean with Dichlorophene. Only \$1.25

QUICKEE Floor Tile STAIN REMOVER
Greatest cleaner for asphalt tile, vinyl, linoleum. Will not soften asphalt tile! Only \$1.25



Your "Q" to Easier Cleaning
AT HARDWARE, PAINT AND CHAIN STORES.
QUICKEE PRODUCTS, Inc., Yonkers, N. Y.

KING MIDGET

More power, beautiful styling. New Features. Still World's Lowest Priced Car. Drive it for 75¢ a week. Rider agents wanted. Earn your own car.



2 GREAT AUTO BARGAINS

King Midget Junior chassis, finely engineered, ready to run. Agents wanted. Send 25¢ for 32 page picture book, full details, dealers price on both cars. Or send \$1 (refunded first order) for this and Service Manual, plus Repair Manual and 15 5x7 photos of car and factory.

MIDGET MOTORS CORPORATION, ATHENS 1, OHIO

CLOSE-OUT Sale! Biggest Bargains Ever!

NEW CHRIS-CRAFT BOAT KITS

12, 14, 15, 16, 19-ft. kits as low as \$99

WAS ~~\$268~~ NOW \$161



14-ft. Barracuda kit \$161. Only 10% down, balance on delivery.

Sleek, sporty; long forward deck, walk-thru center deck, self-draining motor well, wide 63" beam. Takes outboards to 35 hp; flashing speeds to 35 mph. Kits include pre-cut, machined, or pre-assembled parts, brass fastenings, seam compound, Chris-Craft decals, directions. Assembly is quick, easy, fun. Many models: utilities, runabouts, cruisers for outboard or inboard power. Only \$99 for big 12-ft. Vagabond kit. Supply limited. MAIL ORDER TODAY. Or write for illustrated price list.

Chris-Craft Corporation, Dept. C, Pompano Beach, Florida

Ship freight collect _____ (quan.) 14-ft. Barracuda kits @ \$161 each to:

Name _____

Address _____

City _____ State _____

-----10% deposit must accompany this order-----

WHY

DO 10% OF THE FISHERMEN

...CATCH 60% OF THE

FISH?

FREE HANDBOOK REVEALS THE SECRETS!

Because they're smarter fishermen . . . that's why! And now you can be just as smart and successful. Secrets of the experts are revealed in Heddon's FREE "Patterns For Fishing"® handbook . . . secrets to make you one of the "top 10." Crammed with time-tested nuggets of fish-getting facts, "Patterns For Fishing" tells you, step by step, how to catch more fish! Read about the "4-A's," how to find the "hot spots," and other sure-fire ways to a loaded stringer. And it's all yours for FREE! Send for your copy today.

©JHS 1958



JAMES HEDDON'S SONS

226 West Street • Dowagiac, Mich.
Please send me "Patterns For Fishing" Handbook—FREE!

Name _____

Address _____ (Please Print)

City _____ State _____



Heddon

Simplifies Complicated Measuring:

A New Precision Instrument for Leveling and Incline Measurement

HOPPY

SPLIT IMAGE TRANSIT



Only
\$6⁹⁵

Optional—
also
available
for the
thousands
of Hoppy
Transits
now in use—
sturdy carry-
ing case \$3.25

**Accurate,
Inexpensive,
Simple to Operate**

*Easy as a camera to operate! One man—ALONE—
can do leveling and incline measuring. Accurate to
a fraction of an inch. Many uses on the job and
around the house.*

Carpentry Leveling	Contour Plowing	Guttering
Patio & Terracing	Brick Laying	Drainage
Duct Installation	Yard Grading	Masonry
Foundation Work	Irrigation	ETC.

Guaranteed Product Satisfaction



If not available at your Building Supply or
Hardware Dealer, write directly to:

HOPKINS MANUFACTURING CORP.

Dept. PM-3

Emporia, Kansas

Another Quality Product by HOPPY

had reported to our knowledge was a canopy of ice crystals that covered the entire top of the cloud and surrounded it, like icing on a cake. Inside the cloud, super-cooled water drops had formed ice on us and coated our equipment."

Heat, Overexertion Bring on Sickness

The pair soared to 29,000 feet, then devalved and coasted earthward while Moore became violently sick due to overexertion and to the suffocating heat of his clothing. And the fun wasn't over. Probably coming through the crystals, ice had lodged in the balloon's valve, and it jammed in the open position. For 10,000 feet the men plunged earthward at a rate of 1000 feet a minute before the balloon could be brought under control again. By the time they neared the desert floor, the cloud had grown into a full-fledged thunderstorm and was drifting down on them. After the first touchdown, the men cut all but two shroud lines; on the second bump the others were severed. But the gondola didn't drop off. It tipped over, strewn men and equipment across the dusty ground. They sat there dazed, while the balloon—gondola and all—soared back up into the black sky. "We'd forgotten to cut loose a couple of straps that had been rigged to prevent the gondola from rotating under the big bag," Moore recalls ruefully. "So we picked up our battered equipment and started hiking across the 110-degree desert in our underwear, carrying our arctic clothes over our arms." The balloon and gear were recovered next day, torn and smashed beyond repair.

Takeoff Clips Tree Tops

Two months later, on flight number two, Moore once more headed up into a growing thunderhead above Withington's peak—this time with Dr. Paul MacCready, weather scientist and glider champion. "First flight had made too fast a take-off," says Moore, "so this time we took it easier and nearly creamed ourselves in the woods. Rising at only 50 feet a minute, the gondola knocked the top branches off several trees before we broke away. As we did, the balloon's parachute tore loose and fell off."

This time the cloud explorers went right up through the thunderhead for 25 minutes, rode through the icy cap to 27,000 feet, released gas from the bag and drifted down toward some high-tension lines and a big barn on somebody's ranch. "We threw everything overboard that we could lay our hands on in order to gain a little altitude," says Moore. "And we did. We cleared both obstructions by a cool 3000 feet."

What came out of the New Mexico

(Continued to page 256)



AMPHORA OUTSELLS ALL OTHER IMPORTED TOBACCOS COMBINED

Your first pipeful tells you why

Smooth-smoking, even-burning, long-lasting, mild AMPHORA is blended in Holland. Popular priced. In handy pouches and tins, at tobacco counters everywhere.

Make your next pipeful

AMPHORA



jack-pack

All You Need to Repair Your HYDRAULIC JACKS!

HYDRAULIC JACK REPAIR KITS & JACK OIL

All Makes All Models

Kits contain easy-to-follow instructions and all pack-ings necessary to make your jack work like new.

Save Money...Try a Jack-Pack Today!

- NO MORE BIG JACK REPAIR BILLS
- NO MORE HIGH FREIGHT CHARGES
- NO MORE LONG EQUIPMENT TIE-UPS

JACK-PACK MFG. CO.
2115 NO. MARIANNA AVE., LOS ANGELES 32, CALIF.

Write for Folder

FEATURED AT AUTO PARTS STORES EVERYWHERE!

PEEL OFF PAINT

Remove old finishes easier, faster

- Non-inflammable and needs no afterwash
- For wash-off or scrape-off use

Heavy-Bodied KLEAN-STRIP
PAINT REMOVER

THE KLEAN-STRIP CO., INC.
2340 S. Lauderdale, Memphis 6, Tenn.

For real TRANSPORTATION ECONOMY...ride the smart *Pacemaker* or the all-new 1959 *SuperEagle* by



CUSHMAN

Ruggedly-built Cushman Scooters take you anywhere, everywhere (they're easy to handle in traffic, easy to park). Figuring operating costs, maintenance and depreciation, you really save with a Cushman. Famous Cushman Husky 4-cycle engine delivers up to 100 miles per gallon at speeds of up to 50 miles per hour. Cushman Scooters are so smartly styled, the entire family will enjoy riding.

Ask your dealer for a FREE demonstration ride or write for new colorful booklet today.

Sold and serviced nationally... Replacement parts immediately available. Dealer inquiries invited.

CUSHMAN MOTORS
A subsidiary of Outboard Marine Corporation
920 No. 21st, Lincoln, Nebraska
Please send FREE Scooter booklet

NAME _____
ADDRESS _____
CITY _____ STATE _____



LOW SHOE

???



- Town Brown oxford, soft as a glove
- Heavy Vulcork Neoprene oil resistant sole
- Permacounter
- Leather laces
- Tri-pad arch cushion

HIGH SHOE

??



- Town Brown soft, mellow leather upper
- Heavy Neocork sole and heel
- Permacounter heel support—won't break down
- Leather laces
- Tri-pad arch cushion

THE SHOE

-- for solid comfort -- long wear

RANGER

HEAVY DUTY SHOES

"THE GREATEST NAME IN WORK SHOES"

For name of your dealer write:

ENDICOTT  JOHNSON

Endicott 1, N. Y.

experiments was highly gratifying to both Vonnegut and Moore. "We experienced violent downdrafts in nonraining clouds," says Moore. "Previously they were not thought to exist. They indicate a possible vehicle for development of electrical fields well before rain develops in a cloud."

Rain Shows as Hollow Cup

When all the data was in, the two meteorologists could show a reversal of electrical field in their clouds and, in some cases, a build-up to 10 volts before any rain was spotted by the radarmen. "Another fascinating thing we observed, when the radar sets were moved to the top of Withington where they could get a close look at the growing storm," says Vonnegut, "was that when the first rain finally did show on the screen, it came up in the form of a hollow cup. These hollow precipitation echoes had not been observed before and pose some fascinating scientific questions. Do they conform to the shape of electrical fields in the cloud? We still don't know enough to say. Perhaps they may be the result of other phenomena as yet not understood.

"So far we've measured only the vertical components of the field," says Vonnegut. "We hope to fill in with more research this year."

They're going to string up another one of those wires again, too. This time it will be in a genuine desert area somewhere in the Western badlands. And if there's a lot of big rain where rain has never been known to fall in such quantity and such a time of year, these men may be hot on the trail of one of the most spectacular weather-control developments yet attempted by man. Being scientists, and good ones, this is not their professional goal, however.

"I prefer to think," Vonnegut points out, "that we are 'hot on the trail' not of 'spectacular weather-control developments,' but rather an understanding of some of the basic mechanisms at work in our atmosphere. Only when we have a much greater and more detailed picture of how the atmosphere works will we be able to venture into weather control with any real hope of success." ★ ★ ★

Hydraulic Door Closer Resists Push of Wind

Development of a new hydraulic fluid, which maintains its viscosity in both hot and cold weather, has led to production of a hydraulic closer for residential screen and storm doors. The device has an action that resists wind pressure.

America's "BEST BUY" Riding Mower! ROTO-HOE'S "Islander"



—Combines others' best features with many new exclusive advantages of its own. Big 4½ h.p. engine at rear — you get far less fumes and heat.

Spring seat, extra wide natural rubber double drive wheels, 26" cutting width with close trimming, outrigger wheels to prevent side hill tipping. All for only \$229.50 (subject to slight changes in some areas). Built and guaranteed by America's Leader in Power Lawn & Garden Equipment. Write today for FREE FOLDER and nearby dealer's name for demonstration.

**INTERESTED
DEALERS,
WRITE**

ROTO-HOE, Dept. P-19, NEWBURY, OHIO

WELD

BRAZE

SOLDER

CUT



**4WAY
ONLY
\$14.75
f.o.b. factory**

WELDER

Complete with
Twin Carbon Arc
Torch and ac-
cessories... to
handle all metal-
craft work.

Acclaimed by thousands of Homeowners, Mechanics and Hobbyists as the welder of 1001 uses. Easily operated from properly wired 110 volt AC or DC line. The ideal gift with a life-long use... Order today on 10 day money back guarantee.

**FOUR-WAY WELDER CO., Dept. F2-C
1810 S. Federal St. • Chicago 16, Ill.**

NEW SPEED PROPELLERS



for JOHNSON AND EVINRUDE 18, 35, 50 HP Outboards, SCOTT-ATWATER 25, 40, 60 HP. If you own one of these great motors by all means investigate MICHIGAN'S new, style SMC, 3-blade propellers engineered specifically for them, to provide more speed, better skiing, more fun. Send postcard for FREE 1959 catalog. Also contains outstanding bargains in skis, speedometers, boat accessories. MICHIGAN WHEEL CO., Grand Rapids 2, Mich., Dept. PM-3.

"VISE-GRIP SAVED MY FAMILY IN A BLIZZARD!"

The True Story of Stephen Lootz, Lindenhurst, N. Y.



"I was pulling a trailer during a snowstorm near Richmond, Va., when a trailer tire blew out! I couldn't find my lug wrench. A state trooper drove up... told me my family was in danger. Then I remembered my *Vise-Grip!* Quickly I loosened the lug nuts—changed the tire—and got moving before disaster struck. Thanks to *Vise-Grip!*"

VISE-GRIP Does More Jobs Easier Than Any Other Tool

You'll find *hundreds* of uses for powerful, all-purpose Vise-Grip. It's a pliers, wrench, clamp, hand vise, wire cutter—all in one tool! Ask for the new Vise-Grip with Easy Release at your hardware store. Only \$2.15 to \$2.95.



PETERSEN MFG. COMPANY

Dept. PM-3, DeWitt, Nebraska

EARN GOOD MONEY—Spare or Full Time IN A BUSINESS OF YOUR OWN...

SMALL INVESTMENT — NO EXPERIENCE NEEDED

Thousands of men are making big money in their own business. You too, can have a fine income with an assured future in spare or full time with the Universal lawn mower grinder. Investigate our success plan now, it includes everything you need plus facts on how others have earned over \$3,600 in one season, working part time. Act now! Mail coupon today!

**SEND COUPON
TODAY**

ROGERS
MANUFACTURING CO.
Lindsey, Ohio

ROGERS MFG. CO., Dept. M-39, Lindsey, Ohio
Gentlemen: Rush me FREE details on easy inexpensive way to get into my own business.

Name _____
Address _____
City _____ State _____

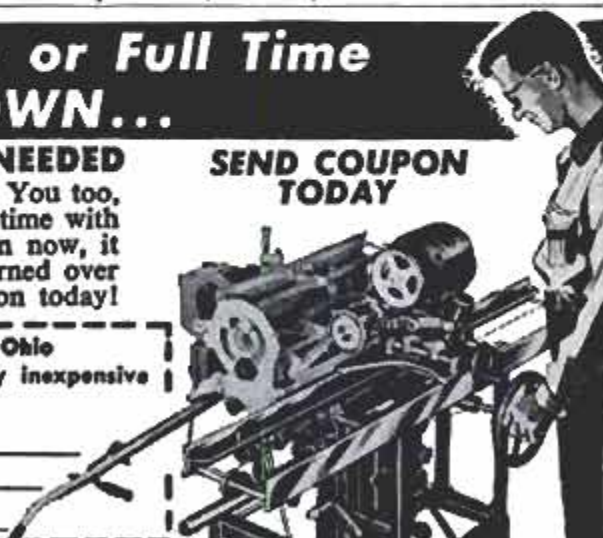

Owners Report on the Buick

(Continued from page 95)

"Make cars look like cars. Leave airplanes and rockets for the air."—Florida display man.

Big cars appeal to many people. They must or they wouldn't sell in the volume they do. Few owners, however, seem anxious to defend bigness. Occasionally, one does:

"I cannot see this trend of going back to small European cars. It is just like going back 30 years to the old powerless, uncomfortable cars we used to have. Gasoline consumption is certainly no factor in this country. The price of gasoline is very low and it is one of the smallest expenses to be considered. The automotive industry is to be congratulated. All American cars are lovely."—Pennsylvania physician.

More Best-Liked Features

The following quotations describe, in order of frequency of mention, additional features on Buick's best-liked list:

"Good response in starting and passing. Absolutely no jerking on acceleration."—Louisiana businessman.

"I like the enlarged air-cooled brakes."—Illinois foreman.

"The best brakes I have ever used in any automobile. A soft pedal, no fade."—California security guard.

"Visibility is excellent. To date, I have noticed no blind spots."—California Air Force officer.

"First car I ever had that tracked right. It doesn't drift right or left—just runs right down the road."—Illinois restaurateur.

"Excellent roadability at high speed. Excellent control. Turns sharp without side roll."—Ohio foreman.

"I like the transmission. Smooth even power. No gear shifting so noticeable in other transmission."—Ohio construction engineer.

"Quiet. Very little wind or road noise."—Illinois Army man.

"Has better economy than the 1957 Buick I owned. Over 1000 miles of careful checking, the average was 13.6 miles per gallon."—New Jersey superintendent.

"Front seat has room to stretch your legs."—Illinois locomotive fireman.

"Luxurious interior with hardware that has a substantial solid feel."—California artist.

"New paints are nice. Beautiful colors that seem to be a little easier to keep clean."—Pennsylvania technician.

"I like the fact that there are needle meters for oil pressure and ammeter."—Illinois police officer.

"Our Buick was struck from behind while parked at the curb last week. The left rear fin acted like a can opener on the other car. Before that I was careful of those fins. Now I see that they will take care of themselves."—California auto body mechanic.

"Happy to get back to 15-inch wheels."—California maintenance man.

"Big ashtray for a change."—Illinois advertising man.

"The trunk deck comes to a narrow point and closes with the touch of your finger. Our 1957 Buick trunk lid formed an air pocket and it took both hands and much force to close it."—Missouri foreman.

The Other Complaints

Here are the other complaints, in order of frequency of mention (see page 95 for actual percentages of owners mentioning them):

(Continued to page 260)

← *The doctor has a point. If gas economy is increased 50 percent, Buick owners will save about \$100 a year. Meanwhile depreciation is about \$1000.*

← *It gets away fast all right, but so do all American cars.*

← *He overlooks the location of the rear-view mirror in the center of the windshield. Rear vision excellent.*

← *Dynaflow is smooth, quiet.*

← *Kelly's tests show otherwise. The 1957 Buick went about 1.5 miles per gallon farther than the new model.*

← *Warning: Stay away from the rear end of Buicks.*

← *Here is a place where styling brought a practical improvement. Flatter trunk lid opens and closes easily because it doesn't entrap air. Of course, there is a sill to lift bags over now.*



ARROW

automatic
GUN TACKER

T-50

ALL-PURPOSE HEAVY DUTY STAPLE GUN

- Shoots a Staple wherever you'd drive a nail!!!
- Does 1001 do-it-yourself nailing jobs!
- Powerful drive with minimum squeeze pressure!
- Jam-Proof Mechanism
- All Steel Construction—All Chrome finish

Takes 6 staple sizes: 1/4", 5/16", 3/8", 1/2", 9/16" and CEILTILE staple for ceiling tile.

Price: \$12.50

Uses 6 different staple sizes up to 9/16", including

ARROW'S CEILTILE® STAPLES! ESPECIALLY DESIGNED FOR CEILING TILE STAPLING

- Unique leg design drives flush, holds tight!
- Flange is never fractured . . . CEILTILE penetrates perfectly!
- Special cement coating provides tremendous holding power!

Tested and Approved by Major Ceiling Tile Manufacturers:



Armstrong
CELOTEX



U. S. GYPSUM
NU-WOOD

ONE-HAND OPERATED — FASTER! CHEAPER! BETTER!

NEW!

T-50MP MULTI-PURPOSE GUN TACKER KIT

Here's the amazing automatic Tool Kit do-it-yourselfers have been asking for! Complete with brand new Tacker attachments. Now you can have an all-purpose Tacking unit to perform almost any fastening job.

If each item bought separately \$19.50

SPECIAL KIT PRICE \$17.50

THIS KIT CONTAINS



Automatic
STAPLE GUN



Multi-Staple
Pak



Staple
Lifter

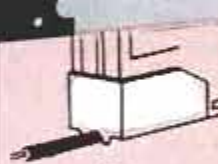

Wire
Attachment

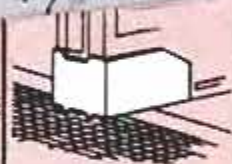

Screen
Attachment

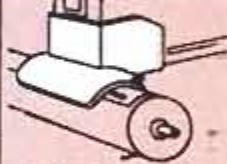

Window Shade
Attachment

Over 30 special purpose Gun Tackers available from \$4.95 up.

Sold at leading Hardware, Building Material, Lumber Yards and Stationery dealers everywhere.

WRITE FOR CATALOG

ARROW FASTENER COMPANY, INC., ONE JUNIUS STREET, BROOKLYN 12, N. Y.

Pioneers and Pacesetters for over a quarter of a century.



"You can't have heat unless blower is on. At road speeds, the blower is not necessary but there is no way of getting heat without turning blower on. And the fan is noisy. I am having blower put on an independent switch."—Ohio cost accountant.

"Levers that operate heater and vents are inconvenient. Front-seat passenger has to annoy the driver to have his vent opened."—Pennsylvania mechanic.

"Lack of headroom in rear seat. My 5-foot-4-inch daughter hit her head twice in one ride. Also question potential danger to tall people of metal piece over rear window."—New Jersey owner.

"Inside space and comfort has been reduced too much."—Virginia soldier.

"Quality control of this early model was not good. Weatherstripping on all doors not attached well."—Ohio salesman.

"No plugs placed in the many holes in the trunk floor. In wet weather the water comes up over the gas tank into the trunk. It has been corrected by undercoating."—Georgia salesman.

"Rattles in right rear section of body, also in dashboard or steering column."—New Jersey dispatcher.

"Front-end stability is very bad. No stabilizer bar at all."—New York service representative.

"On uneven roads car sways at 60 miles per hour."—Wisconsin salesman.

"My wife rode in the back seat through the mountains and complained of constant swaying. Noticeable in front also."—California court reporter.

"This is the smallest Buick and should give better gas mileage, especially on trips."—Utah farmer.

"Must use highest octane gas available or motor pings loudly. This adds greatly to cost of operating car. Mechanic at dealer's says some ping is natural. I disagree."—New York therapist.

"Front end poorest of any car I have ever owned. Hit a sudden bump or hole in road and the shock is terrible. I would also like to see something to stop the rear-end hop on a washboard road."—Ohio foreman.

"Passengers complain it's too hot in sun due to large rear window on two-door hardtop."—Colorado printer.

"Rear-seat riders get a free sunburn."—Georgia police sergeant.

"New type of paint is either improperly applied or worked. Primer is showing through black paint in several places."—South Carolina engineer.

Here are some miscellaneous complaints that only a few of the Buick owners made, but they are of general interest:

"Radiator cap can't be removed without spitting plumes of antifreeze all over yourself and the engine. Too much pressure."—Maryland owner.

"I have had trouble turning the engine off. Dealer said it was due to use of regular gas. The manual says you can use regular gas on the LeSabre, but don't try it."—Pennsylvania university executive.

"Trunk space is ruined by low dip of lid. It necessitates use of selected luggage in order to be able to close trunk."—Kansas soldier.

"Minor improvements could be made in glove compartment, wipers could be just a little longer and the trip-mileage set knob is almost impossible to work."—Illinois millwright.

That is the story of the 1959 Buick as told by the people who know the car best—the owners who use it under all types of conditions. For an engineer's analysis of the car turn to Dale Kelly's report on page 92. ★ ★ ★

← Buick has changed this in current production. Now the blower is on a separate switch.

← The industry has no excuse for putting metal ribs across the car's ceiling—no excuse except styling. Those ribs are dangerous.

Buick has added a stabilizer bar to its front end in recent weeks. Owners can get one installed free if their car has none, Buick tells us. That goes for the new heater switch also.

← Kelly says all pinging is harmful, it's just a matter of degree.

Miscellaneous:
Altogether a satisfactory car. Its faults are mostly those of the industry: Lowness, bigness, too much expensive glass, no padding in center of seats, and so on. Owners report virtually no engine trouble. Only 1.7 percent rate the car poor over-all (in 1957, 7.7 percent rated it poor). Interior environment: quiet, warm and provides a secure feeling. Engine of test car guilty of embarrassing after-running. Dials (except for speedo) are arranged at difficult-to-read-at-a-glance angles and surrounded by confusing chrome. Front-seat back reclines too much for this driver, but you may like it. Brakes good, but have to be as Dynaflo is almost like freewheeling. Interior hardware feels rich and well made (except for horn ring). Glove compartment too distant and too small.

CONCRETE REPAIRS that won't break loose!

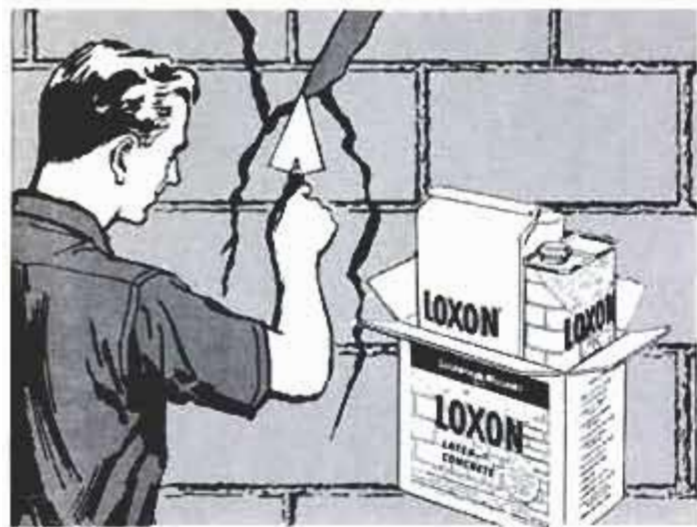

LOXON LATEX CONCRETE patches holes and cracks in any kind of masonry . . . and does it easily, smoothly, permanently. Made of superfine cement and finely ground glassmaker-quality sand mixed with pure liquid latex to provide amazing adhesion. Ideal for repairing foundations, floors, broken steps, brickwork and mortar. Superior to any other type of concrete repair material. At leading paint, hardware, lumber and department stores.

Power at your fingertips!

EVANS

POWER FIFTY

No more tedious hand winding! Press the button and Power Fifty's patented® rewind unit takes over. Release . . . and blade stops instantly where you want it! Measurements always exact; no blade creep. Handsome leather-like vinyl cover. At hardware stores.

50 FT. WHITE STEEL TAPE WITH POWER BLADE RETURN

Only \$6.98

Evans RULE CO.

Factories at Elizabeth, N.J. & Montreal, Que.
®"Power-Fifty" steel tapes, U. S. Patent No. 2,586,386.



MARCH 1959

STOP

...if you have anything to do with —

TAPPING • REAMING • DRILLING
BORING • THREADING
PROFILE MILLING • LATHE CUT-OFF

you should **TRY**

Rapid Tap

TAPPING FLUID
(NOT A CUTTING OIL)

• AN AMAZING NEW TAPPING FLUID THAT...

- MAKES TAPPING EASIER AND FASTER
- STOPS TAP BREAKAGE
- RELEASES STUCK TAPS
- INCREASES THREAD ACCURACY
- IMPROVES SURFACE FINISH
- LEAVES A CLEAN SURFACE

Used extensively in industry, government and home work shops

SAVES TIME • SAVES TOOLS • SAVES MONEY

RAPID TAP immediately breaks down surface tension and adhesions and frees the tool. Effective on most metals and alloys such as: titanium, stainless steel, beryllium copper, bronze, brass, stellite, iron and magnesium. (Not recommended for aluminum.)

A Drop or Two Does the Trick

DO NOT USE ON PLASTICS
NON-INFLAMMABLE NON-EXPLOSIVE

4-Oz. Can . . . \$1.00 1 Pt. Can . . . \$3.00
(Price includes Postage)

TRY IT! SEND CHECK, M. O. OR CURRENCY
NO C. O. D.

MAIL COUPON — ORDER TODAY

RELTON CORPORATION

P. O. Box 5546 PASADENA, CALIFORNIA

I want to try RAPID-TAP. I enclose \$1 for 4-oz. can (\$3.00 for pint can). No C.O.D.'s please. U.S. only.

NAME _____

ADDRESS _____

CITY _____ STATE _____

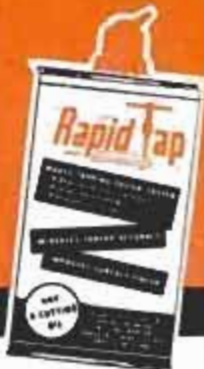

PROOF

ON YOUR DIPSTICK

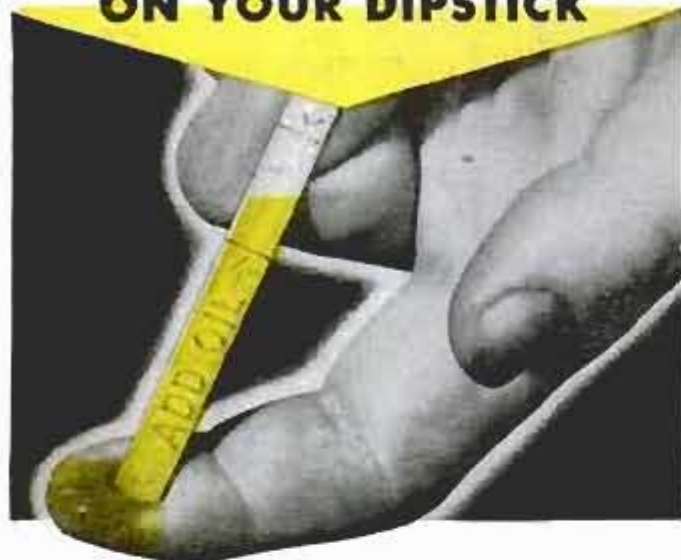

HASTINGS KEEPS OIL CLEAN

Hastings Oil Filter Cartridges keep oil clean from filter change to filter change, when replaced as normally recommended*

That's because only Hastings has Densite filtering material, which traps and holds even the most microscopic dirt particles. The dipstick test proves it!

Just ask for Hastings—next filter change. Be sure of clean oil *all* the time.

* Proved by tests conducted in accordance with U. S. Bureau of Standards.

U. S. Patent Numbers 2,797,811 2,584,771



HASTINGS MANUFACTURING COMPANY
HASTINGS, MICHIGAN

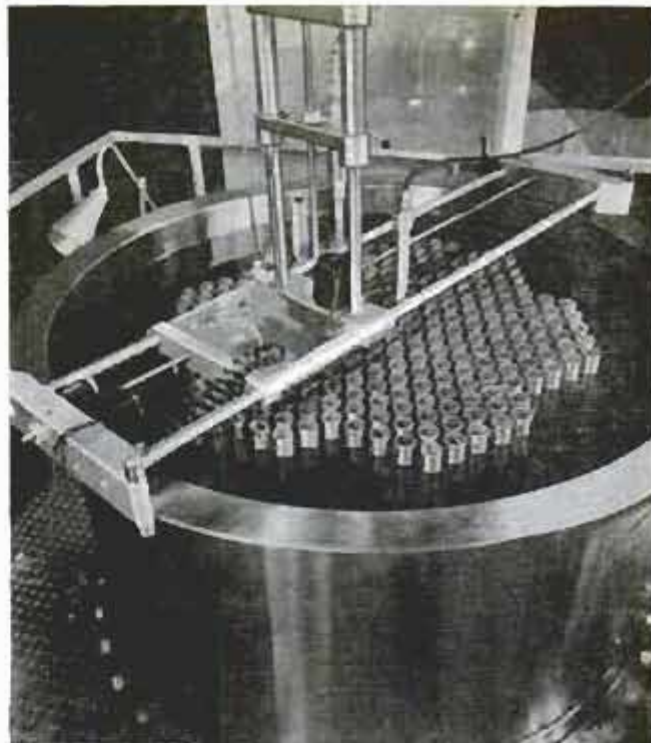

Classroom-Size Reactors For Atomic Energy Students

College students will get a firsthand understanding of the design and operation of nuclear reactors by performing experiments with subcritical training units recently installed at several schools. The reactors, described as "perfectly safe" for classroom work, are five feet high, four feet in diameter and hold 435 gallons of tap water. The natural uranium fuel and a neutron source to "drive" the unit are loaned to the schools by the Atomic Energy Commission.

"Oxygen" Added to Gasoline Doubles Automobile's Power

For years, hot-rod drivers have been increasing their cars' power by adding nitro-paraffins to gasoline. But a University of California engineering professor named Ernest S. Starkman is the first man to conduct a scientific investigation into the possibilities of these chemical compounds as fuels. He has found that up to twice the power now developed by automobiles and diesel engines with conventional fuels can be provided by nitroparaffins. His experiments show that the nitroparaffins can carry oxygen from their own structure into the process of combustion. This increases the energy of the fuel-air mixture, since it allows more fuel per unit of air to reach the engine.

☐ Polyethylene-plastic tubing systems operated by one man are used to gather maple sap in New York and New England, thus eliminating the old-fashioned bucket.



Table-Model Chord Organ Can Be Played in Seconds

You don't have to be a musician to play an electric chord organ. Built on somewhat the same principle as church organs, this simplified instrument can be mastered in 90 seconds. While the left hand produces a full chord by touching a lettered button, the right hand fingers the melody on numbered keys. Music books supplied with the organ contain lettered and numbered notes. Additional books can be bought. The table-model organ weighs 18 pounds. It covers three octaves and has 37 keys and 12 chord-control buttons.

Brain Likened to Computer With 15 Billion Tubes

Your brain is comparable to a computer with about 15 billion electronic tubes. The comparison was made by Dr. Johannes P. Schädé, a research fellow in biology at the California Institute of Technology. He reports there are about 15 billion nerve cells in the brain cortex. Each cell operates at one thousandth of a millionth of a watt. The brain operates at about 10 watts. Functioning electrically and generating both direct and alternating currents, the brain operates at from 1/2000 to 1/200,000 of a volt. Dr. Schädé said that about the same prevailing electrical rhythm — approximately 8 to 14 cycles per second — is found in the brain of all vertebrates, from man through fishes.

Bacteria Warfare on Pests May Help Farmers

Bacteriological warfare against crop-eating worms will be tested in the United States, Puerto Rico, Hawaii and Australia. A species of bacillus that is fatal to insects will be applied to crops of selected growers. The bacteria do not harm warm-blooded animals.

USING TOO MUCH OIL AND GAS?



IT'S TIME FOR HASTINGS

When your oil and gas bills start growing bigger — look out! Using too much oil is your first sign of worn-out piston rings. And worn-out rings mean power drop-off — costly waste of oil and gas — and expensive repairs later on!

The sooner you act, the less it will cost. See your motor specialist the minute oil-pumping warns you there's trouble ahead. When he recommends new piston rings, ask him for Hastings. They're engineered exclusively for replacement service . . . to provide the additional lubrication worn engines need . . . to stop oil-pumping, save gasoline, restore lost performance.

Get new car power and performance from your present car — with Hastings. Truly your best investment for many thousands of extra miles of trouble-free driving pleasure. Hastings Manufacturing Company, Hastings, Michigan. Piston Rings, Oil Filters, Casite, Spark Plugs.

HASTINGS
PISTON RINGS

TOUGH on oil pumping **GENTLE** on cylinder walls

HASTINGS MANUFACTURING COMPANY
HASTINGS, MICHIGAN
Piston Rings, Casite, Oil Filters, Spark Plugs

UNUSUAL BARGAINS



CLOSE OUT! MECHANICAL DRAWING SET

Regular Price \$18.00
Our Price Only \$6.00 Postpd.

American mfr. couldn't compete with foreign imports — thus you get a terrific bargain, even far below import prices. 10 handsome pieces in velvet-lined case. Nickel plated brass — precision American-made. We guarantee you'll be satisfied or money refunded.

Stock No. 50,200-H \$6.00 Postpaid

Quantity Price: 5 Sets for \$5.50 each Postpaid
10 Sets for \$5.00 each Postpaid



BUILD A SOLAR ENERGY FURNACE

A fascinating new field. Build your own Solar Furnace for experimentation—many practical uses. Easy! Inexpensive! Use scrapwood! We furnish instructions. This sun powered furnace will generate terrific heat—2000° to 3000°. Fuses enamel to metal. Sets paper aflame in seconds. Use our Fresnel Lens—14 1/2" diameter . . . f.l. 14".

Stock No. 70,130-H . . . Fresnel Lens . . . \$ 6.00 Postpd.

WAR SURPLUS AMERICAN-MADE 7 x 50 BINOCULARS



Big savings! Brand new! Crystal clear viewing —7 power. Every optical element is coated. An excellent night glass—the size recommended for satellite viewing. Individual eye focus. Exit pupil 7mm. Approx. field at 1,000 yds. is 376 ft. Carrying case included. American 7 x 50's normally cost \$195. Our war surplus price saves you real money.

Stock No. 1533-H only \$55.00 postpd.
(Tax included)

ANASTIGMAT 35MM CAMERA LENS & SHUTTER

— F/3.2 . . . f.l. 44mm. A \$24 value — American-made.
Stock No. 30,311-H . . . Synchronized for flash . . . \$9.50 postpd.
Stock No. 30,312-H . . . not synchronized \$8.50 postpd.

WRITE FOR FREE CATALOG "H"!

Complete Line of Astronomical Telescope Parts and Assembled Telescopes. Also huge selection of lenses, prisms, war surplus optical instruments, parts and accessories. Telescopes, microscopes, Hand Spectroscopes, Sniperscopes, binoculars, etc. Request Catalog "H"!

ORDER BY STOCK NUMBER SEND CHECK OR MONEY ORDER SATISFACTION GUARANTEED

EDMUND SCIENTIFIC CO., BARRINGTON, N. J.

U-MAK-IT FIRST AND OLDEST KIT BOAT MANUFACTURER

BOAT

Most complete line of PRAMS, ROWBOATS, OUTBOARDS, CABIN CRUISERS and new Lapstrake kits.

KITS AND FRAME KITS

Send for BIG New ILLUS. CATALOG Showing all models 8' to 23' BOAT KITS, FRAME KITS, LAPSTRAKE KITS, FIBERGLAS, Accessories, Points, all you need to build your own.

MAIL 50c (coin) for Postage & Hdg.

U-MAK-IT PRODUCTS
DELAND, FLA.—DEPT. 12



REDUCED PRICES • SAVE UP TO 25%

NEW MAGIC RADIO WALKIE TALKIE!

YOUR OWN POCKET SIZE RADIO STATION!

BROADCASTS TO ANY HOME OR CAR RADIO WITHOUT WIRES OR HOOKUPS! Wt. only 5 oz. Telescoping antenna. Powerful Transistor—microphone, break-in switch! Runs for weeks on self-contained flashlight batteries. Durable plastic case. With this Radio Talkie you CAN TALK TO YOUR FRIENDS UP TO A BLOCK OR MORE AWAY!—Or talk between cars! INSTANT OPERATION! Just push button total! NO LICENSE NEEDED. Uses inductive field magnetic radiation. Useful and real fun in a million ways! GUARANTEED TO WORK. 1 YEAR SERVICE GUARANTEE.



SEND ONLY \$3.00 (cash, ck, mo) and pay postman \$9.98 COD postage or send \$12.98 for prepaid delivery. COMPLETE READY TO OPERATE with Instructions and hundreds of ways and tricks for broadcasts thru any radio you desire. Price may go up soon, so get your NEW POWERFUL RADIO WALKIE NOW. Available only from: WESTERN RADIO, Dept. RPW-3, KEARNEY, NEBR.

Shop PM Ads for Exciting Direct-Mail Offers

BUY DIRECT
• SAVE ON •
TILLERS • TRACTORS

5-6-7-9 HP
2 wheel 8

Full line of attachments for mowing, gardening, farming
2-3-4 HP TILLERS 12" 16" CUT.

FREE CATALOG
& PRICE LIST



4 wheel tractor

RED-E TRACTOR CO.

3 - 4th STREET
RICHFIELD, WISCONSIN

REPLACE YOUR
WORN-OUT
WOODEN
HATCHWAY...

with an
all-steel
BILCO
basement
door



. . . and your basement entrance will be weathertight, good-looking — for a lifetime. A spring-balanced Bilco door floats open at a touch . . . locks securely . . . costs so little. And you can install it yourself — in just a few hours!

Bilco

The Bilco Co., Dept. R-93
New Haven 5, Conn.

Please send me your free illustrated folder and name of local dealer.

NAME _____
ADDRESS _____
CITY _____ ZONE _____ STATE _____

AMERICA'S FINEST
BASEMENT DOOR



2500 WATT A. C. ELECTRIC GENERATOR

115-Volt. 60-Cycle
A.C. Single Phase

Government Cost \$250.00

Brand New SURPLUS
Fully GUARANTEED

Only \$125.00
fob

Ideal as a permanent or stand-by unit for electricity IDENTICAL to your house current. Perfect for farms, camps, aboard ship, oil fields, mines, etc. Easily handles lights, refrigerator, deep freeze, oil burner, radio; power for saws, floodlights, drills, pumps, etc. ALL BALL BEARING! Operates at 3600 RPM. Drive with 3 HP or larger engine—or use power take-off. Voltage self regulating. Standard base mfr. Two outlets. Size: 13" long, 8" dia. Wgt. 65 lbs. Delivers 2500 Watts CONTINUOUSLY! Self-Excited!

SUPPLY LIMITED! ORDER DIRECT FROM AD
Free Catalog of other Surplus, Hydraulics

ROBERTS ELECTRIC CO., Dept. PM-908, 849 W. Grand, Chicago 22

EVERY BOAT OWNER

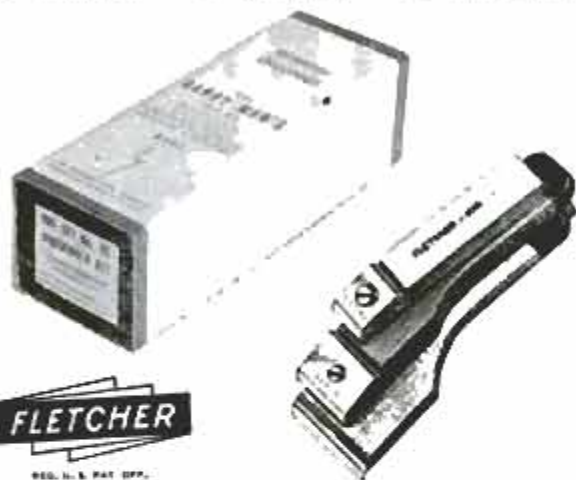

NEEDS WOOD SCRAPERS

Take advantage of this timely opportunity to own a set of three excellent wood scrapers. One each 2½", 1½" and 1" with double-edge steel blades, plus 9 extra blades. Included is the FLETCHER No. 250 scraper with the instantaneous blade changing device.

Ask your dealer for the FLETCHER 3 S Wood Scraper Kit. If he cannot supply you, order direct at \$2.25 per set, prepaid, if check or P.O. Money Order accompanies your order.

**THE FLETCHER-TERRY CO., DEPT. P
FORESTVILLE, CONNECTICUT**

START A BUSINESS

this quick way



FOR ROTARY POWER MOWER BLADES

The Foley 314 Grinder puts a perfect cutting edge on all rotary power mower blades.



with these 2 machines you can sharpen ALL HAND AND POWER LAWN MOWERS

Here's a business you can start in spare time, and begin to make a CASH PROFIT right away. The Foley Lawn Mower Sharpener handles up to 3 or 4 reel type mowers per hour. Prices run \$2.00 to \$3.00 for hand mowers, \$5.00 to \$8.00 for power mowers. You get 99¢ profit out of each dollar.

With the Foley Grinder you can sharpen rotary power mower blades, rip, cross-cut and combination circular saws, dado heads, ice skates, knives, scissors, shears, all sharp-edged tools.



FREE PLAN tells how to put yourself right into a home business that will pay you \$3 to \$6 an hour. Send coupon today for **FREE BOOK** on how to sharpen power mowers and Special Combination Money Saving Offer. No obligation—no salesman will call.

FOLEY MFG. CO., 387-9 Foley Bldg., Minneapolis 18, Minn.
Send Free Plan on lawn mower business and Special Combination Offer.

NAME _____
ADDRESS _____

FEATURE FOR FEATURE

... dollar for dollar

Atlas LATHES LEAD THE LOW-PRICED FIELD



For experimental, development, production and hobby work, Atlas precision lathes give you many more important features that increase accuracy, speed production and cut costs than any other lathes in the low-priced field.

NEW Atlas 12" LATHE

A big capacity lathe with these important features standard equipment: Timken tapered roller bearings, 16 speeds, reversible power cross and longitudinal feeds, wide thread cutting range, V-belt drive. Available in bench models, and in underneath drive models with pedestal base. Investigate before you buy any lathe.

PRICES START AT \$325 F.O.B. FACTORY

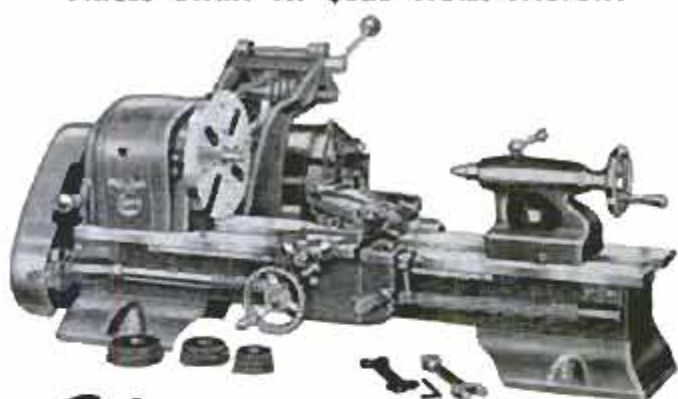

Atlas 6" (screw-cutting) LATHE

For a small investment you can own a back-gear, screw-cutting lathe that, within its capacity, will do everything a high-priced lathe will do . . . and do it fast, efficiently and accurately. It is Timken bearing equipped for precision jobs. Has precision ground bed, 16 spindle speeds, complete V-belt drive, power longitudinal feeds. A most exceptional value.

**PRICES START AT \$167.50
F.O.B. FACTORY**

Write for **NEW CATALOG**

Atlas Press Company



3-24 NORTH PITCHER ST., KALAMAZOO, MICH.

LOT OWNERS

WE MEET ALL BUILDING AND ZONING REQUIREMENTS
Purchase your Home the Pre-Cut Way and
Save 30-40%. Follow our proven sub-con-
tract system and save thousands of dollars.

Complete customer plans and
building guide furnished Free!

Send for FREE Paragon
Pre-cut Leaflet or for Cat-
alogs of 100 models;
summer cottages, 2-story,
split levels, ranches and
contemporaries. \$1.00 in
stamps or coin. Write for
address of your nearest
representative to: —

Prices from \$1633

PRE-CUT
HOMES
PARAGON

499 JERICHO TURNPIKE
MINEOLA, NEW YORK
FIELDSTONE 3-5050 - 4565



The Glen Cove — Popular 6 room 3 bedroom split level 20' living room, Recreation room — Duo type exterior, large overhang.

\$4545 Delivered FREE to
your property via
our own trucks.

All materials to complete, including utilities, even carpentry labor
can be obtained and financed through Paragon Homes. We will
deliver this home and 50 other models with only \$100 Binder.
9 amazing finance plans available. No down payment to lot owners.

**BETTER
BUILT**



Gerstner Chests last
longer and serve bet-
ter. Free Catalog.

GERSTNER TOOL CHESTS
459 Columbia St., Dayton 7, Ohio

Works in seconds!



Loosens Rusted Bolts
nuts, screws, "frozen" parts!

**LIQUID
WRENCH®**
SUPER-PENETRANT

The super-penetrating rust
solvent that quickly loosens
rust and corrosion.

AT ALL HARDWARE AND AUTO STORES
RADIATOR SPECIALTY COMPANY
CHARLOTTE, NORTH CAROLINA

FOR **EASY** LAWN AND
YARD CARE . . . THE NEW 4½ H.P.

Ariens MULTI-
PURPOSE
Imperial



IT'S A RIDING MOWER!
IT'S A YARD TRACTOR!
IT'S A RIDING SNOWPLOW!

Climbs grades
up to 50%

Save time . . . work with Ariens 4½ h.p.
IMPERIAL! With interchangeable attach-
ments it's a 26" rotary mower, 30" reel
mower, snowplow or yard tractor. Finger-
tip controls, optional electric starting. For
full information, write:

Ariens

ARIENS COMPANY
161 Calumet St., Brillion, Wisconsin

Exclusive Double-Bearing HEAVY-DUTY PUMPS
IRRIGATE • DRAIN • CIRCULATE • SPRAY
Use ¼ HP motor or larger . . . 1 HP for up to 7,500
GPH; 1,000 GPH 60' high; or 3,000 GPH from 25' well.
1½" inlet; 1" outlet. Stainless shaft.
TYPE X—2 oil-less bronze
bearings. Won't rust. . . . \$10.95
TYPE X8—Ball bearing model. . . . \$12.95
Postpaid if cash with order. Rush your order today
MONEY BACK GUARANTEE
Centrifugal and Gear Pumps in All Sizes
LABAWCO PUMPS, Belle Mead 2, N. J.



G E A R S

In Stock — Immediate Delivery
Gears, speed reducers, sprockets, thrust
bearings, flexible couplings, pulleys, etc. A
complete line is carried in our Chicago stock.
Can also quote on special gears of any kind.
Send in your blueprints and inquiries.

Send for Complete Catalog No. 10
CHICAGO GEAR WORKS
440-50 N. Oakley Blvd., CHICAGO 12, ILL.

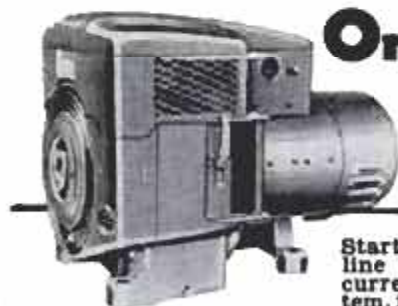

**Onan Emergency
Electric
Plants**

Start automatically when high-
line power is cut off, supply
current for lights, heating sys-
tem, freezer, water pump, stove,
all appliances and machines.
Prevents losses and hardships.
Plant stops automatically when
power is restored. Compact,
easy to install. 500 to 200,000
watts A.C. Priced from \$319.00.



**PORTABLE
MODELS**
500 to 10,000
watts. Supply
plug-in power
anywhere!

Write for Free Folder

D. W. ONAN & SONS INC.
3301 UNIVERSITY AVE. S.E. • MINNEAPOLIS 14, MINN.



great glue for every job you do

For Free Gluing Booklet send stamped, self-addressed envelope to Elmer, The Borden Company, Dept. 3G, 350 Madison Avenue, New York 17, N. Y.

BORDEN'S PRODUCTS FOR THE HOME HANDYMAN

WOODWORKERS!

- Brand new 147th Anniversary Edition of Constantine's Catalog for Craftsmen — 126 pages, many in full color.
- Complete selection of rare and fancy imported and domestic woods, veneers, inlays, carvings, mouldings, hard-to-get items, hardware, upholstery supplies, plans, patterns and Do-It-Yourself Information. Send 25¢ (refunded on first order) for this big catalog and reference guide.

ALBERT CONSTANTINE & SON, INC.
2056-1 Eastchester Rd. New York 61, N. Y.

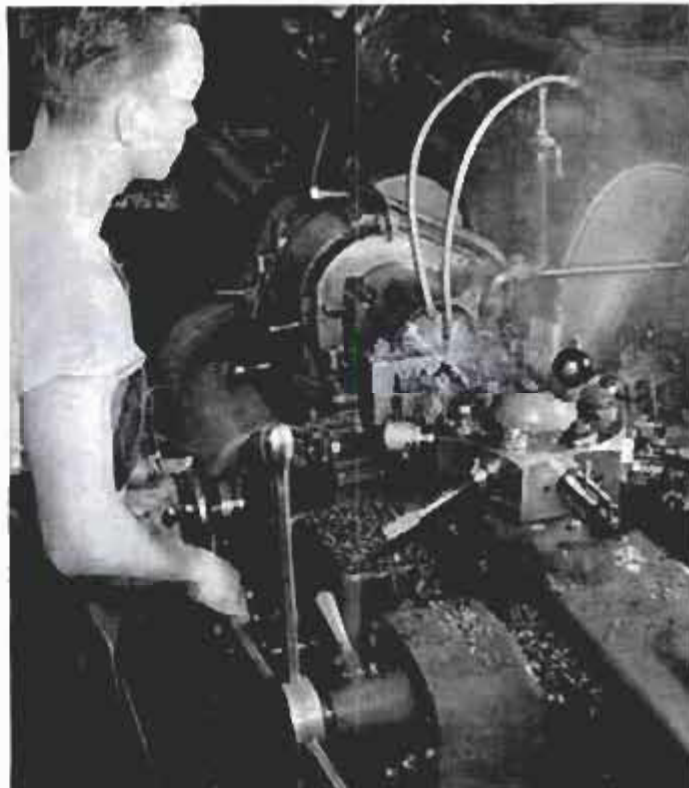

Production + Precision SOUTH BEND Turret Lathes

- Ideal for small precision parts and critical second operations.
- Ruggedly built to hold their accuracy through years of service.
- Responsive and easy to handle.
- Rigid for vibration-free operation.
- More usable power.
- Exceptionally wide ranges of spindle speeds, power turret feeds (handlever feed only on 10" lathes), threading feeds, longitudinal and cross feeds.

ONE BIT FOR ALL

Handiest drill bit made. Use on any electric drill, lathe, drill press, etc. Made of finest American hi-speed steel. 3½" long, ¼" diameter. Has 2" side-cutting section. Cuts steel, wood, plastic, aluminum, etc. 3 types — specify types wanted. (1) All purpose, (2) Wood, (3) Heavy metal, \$2.45 each—3 for \$7.00—Postpaid. Money back guaranteed. Buy from your dealer or send check or Money Order and name of favorite tool dealer TODAY. (Makes ideal gift.)

BEAVER DRILL & TOOL CO., 3008-J McGee Trafficway, Kansas City, Mo.

.... DRILL
SAW • REAM
CUT



BEAVER
Hi-Speed-Saw
DRILL BITS

Jobber & Dealer
Inquiries Invited

BOAT KITS

8'-18': 50 Models

\$41.75 up;

Frt. Pd.

EASY MONTHLY
PAYMENTS



FREE COLOR
CATALOG

Cruisers, convertibles, runabouts, fishing. Easily assembled by anyone. FREE Catalog has natural color photos, complete details, Fiberglas, accessories hardware, paint. Write Today.

LUGER INDUSTRIES, INC., Dept. B-3
9200 Access Road, Minneapolis 20, Minnesota

SPECIFICATIONS and PRICES

Turret Lathe Model	10"	13"	2-H
Swing over bed	10¼"	13¼"	16¼"
Collet capacity	1½"	1½"	1½"
Spindle bore	1¾"	1¾"	1¾"
Turret feeds	hand	144	144
BASE PRICE	\$1748	\$2560	\$3658

Write for catalog on all 3 sizes.

SOUTH BEND LATHE
SOUTH BEND 22, INDIANA

Building Better Tools Since 1906



Up to 24
months to pay.

SAWS

PLANES

MOLDS



NEW BELSAW MULTI-DUTY POWER TOOL



Now you can use this ONE power-feed shop to turn rough lumber into high-value moldings, trim, flooring, furniture ... ALL popular patterns.

RIP... PLANE... MOLD...

separately or all at once by power-feed ... with a one horsepower motor. Use 3 to 5 HP for high speed commercial output.

FULLY SAFE-GUARDED,

Low Cost... You can own this money-making power tool for only \$30.00 down payment.

Write TODAY for free Catalog

BELSAW POWER TOOLS • 909 Field Bldg., Kansas City 11, Mo.

Now You Can Upholster Any Piece of Furniture!

Upholster—Restyle Any Piece of Furniture Yourself

John Bergen, custom furniture designer, tells and shows you how to transform old out-of-date furniture into brand new smart-looking comfortable furniture in his new book **ALL ABOUT UPHOLSTERING**.

No Experience Needed

Bergen tells you every step to follow in amazingly clear easy-to-understand step-by-step instructions and then shows you how in hundreds of big, clear drawings and photos. You read and see how to strip the old frame, install new webbing and springs, apply burlap, install stuffing and padding, fit the muslin cover and the final fabric and install trim.

Use New Materials—Methods

Now you can have furniture upholstered with foam rubber, sagless springs and other new materials that add so much to comfort and durability and are so costly when included in new furniture.

Save 50% of Usual Cost

Don't pay a small fortune for new furniture when you can make your old furniture better than new! Why pay high prices to have someone else upholster and restyle your old furniture when you can do it yourself for cost of materials alone? It's easy and it's fun.

Special Chapter on Slipcovers

Learn how to make custom-made slipcovers with professional look and fit. Find out how you can realize tremendous savings by investing a few spare-time hours and the cost of a few yards of fabrics.

7-Day Money Back Guarantee

Send for your copy of **ALL ABOUT UPHOLSTERING** today. Read and use it for 7 days. If it isn't entirely satisfactory return it for a full refund.

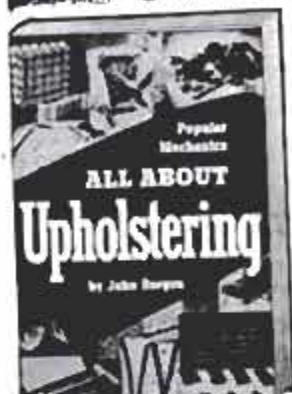
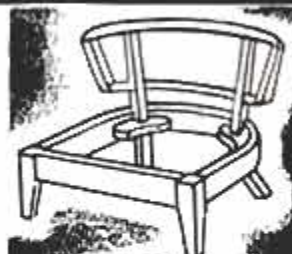

USE THIS HANDY ORDER COUPON

POPULAR MECHANICS PRESS, Dept. 359
200 E. Ontario St., Chicago 11, Illinois

Gentlemen:

Please send my copy of **ALL ABOUT UPHOLSTERING**. Enclosed is my remittance of \$3.95. If I am not completely satisfied with the book I will return it for a full refund after 7 days.

Name _____

Address _____

City _____ Zone _____ State _____

FREE! LAFAYETTE'S 1959 CATALOG



260 GIANT-SIZED PAGES

CONTAINS

HUNDREDS OF EXCLUSIVE LAFAYETTE ITEMS NOT IN ANY OTHER CATALOG OR AVAILABLE FROM ANY OTHER SOURCE—SEND FOR YOUR COPY NOW!

See the newest and finest in Stereo Tuners, Amplifiers, Cartridges and Music Systems

• TAPE RECORDERS • PUBLIC ADDRESS SYSTEMS • AMATEUR EQUIPMENT • INDUSTRIAL SUPPLIES • RADIO & TV TUBES AND PARTS • INSTRUMENTS • TELESCOPES, BINOCULARS, MICROSCOPES & CAMERAS

Everything in Electronics

The Complete Catalog Featuring The Best Values Obtainable

LEADERS IN HI-FI

OUR

38th

YEAR

The most complete electronic supply catalog crammed full of everything electronic at our customary down-to-earth money-saving prices.

The largest selection of hi-fi components and systems; greatest savings on Lafayette endorsed "best-buy" complete systems.

EASY PAY TERMS AVAILABLE — 10% DOWN — UP TO 18 MONTHS TO PAY

Lafayette Radio

P. O. Box 511
JAMAICA 31, N. Y.
DEPT. LC-9

Send FREE LAFAYETTE Catalog 590

Name _____

Address _____

City _____ Zone _____ State _____

CUT OUT AND PASTE ON POST CARD

**Sizzling
with
speed
and
style!**

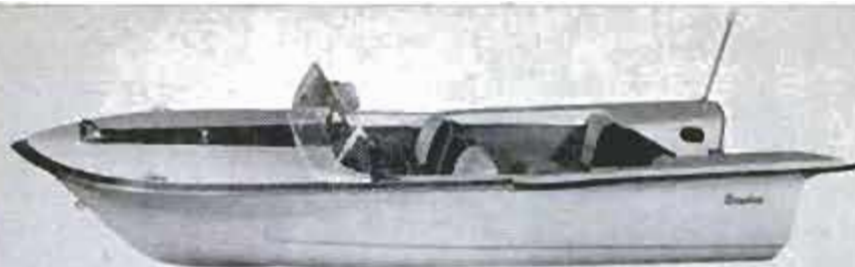

... the Empire line by *Wagemaker*

Here's the fiberglass line for '59 that's alive with speed and style. Ten new care-free models created for years and years of pure pleasure. A model for every purpose, every purse. See your

Empire dealer or write for our free brochure on Empire fiberglass, Wolverine plywood and Cadillac aluminum models. Wagemaker Company, 576 Market St., S.W., Grand Rapids 2, Michigan.

A BETTER DOCK without working in water

with
**PERMA-DOCK
METAL
BRACKETS**

Here's a quick, low cost way to erect and take down a stronger dock. You build wooden dock in sections, attach "Perma-Dock" Brackets, float into place on boat, drive steel pipes thru brackets, lock with set screws. "Perma-Dock" Mooring Bars safely hold boats near dock.



Write for circular on all "Perma-Dock" Marine Specialties
CENTRAL MACHINE WORKS CO. 1235 Central Avenue
Minneapolis 13, Minn.

ELECTRIC WELD - BRAZE & CUT

REPAIR MOST EVERYTHING MADE OF METAL

Home Appliances, Auto parts, Farm-garden equipment, toys, Make equipment, lawn chairs, tables, ornamental iron work gates, wagons, etc. Solder, heat, bend, and straighten, with terrific heat from arc torch. Cut and weld up to 1/2" steel plate. A million uses for Home, auto, farm, inventors, factories, etc. Works from any home plug-in. Complete with welders mask, arc torch, supply of carbon welding and brazing rods. Solder, flux, and complete Welding Instruction Book. Attractive - portable - efficient - durable - 1 year guarantee. Wt. only 2 lbs.

SEND ONLY \$3.00 (cash, ch. mo) and pay postman \$9.95 plus COD postage on arrival or send \$12.95 and we will send postpaid. Ideal gift for mechanically minded home owners, relatives, friends. Order now for early delivery. Available only from: **MIDWAY WELDER, Dept. DPM-3, Kearney, Nebraska**

PROTECT YOURSELF with the only pipe that must be smoked with a filter



\$2.50 including box of 10 filters

MEDICO Ventilator Filter Pipe

For Catalog Z1, write MEDICO, 18 E 54th St. N.Y. 22

CASH FILING SAWS

Make from \$3 to \$6 an hour spare time or start a full time business with the **FOLEY SAW FILER**



Here is a steady repeat CASH business you can start at home. No experience is necessary to turn out perfect cutting saws. With a Foley Saw Filer you can file hand, band and cross-cut circular saws. Easy to operate—no eyestrain. You will find you can make from \$3 to \$6 an hour—\$20 to \$30 a week in spare time as a starter.

FREE BOOK
"MONEY MAKING FACTS" shows you how to get plenty of saws to file. Time payments if desired. Send coupon today—no salesman will call.

FOLEY MFG. CO., 343-9 Foley Bldg.
Minneapolis 18, Minn.

Send me free book "MONEY MAKING FACTS" and Time Payment plan.

Name _____
Address _____
City _____ State _____



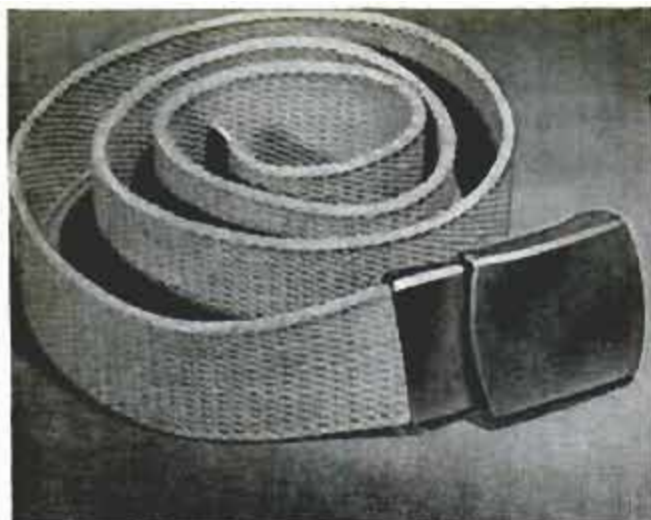

Canon Company, P. O. Box 1173, Beverly Hills, Calif.

Belt Buckle Doubles as Opener

No more do hunters need to search around camp for that elusive can and bottle opener. They wear a belt buckle that is

slipped off easily and opens any kind of can or bottle. The buckle-opener is made of steel and brass.

Computers "Think" Faster With Tiny Electronic Switch

Small enough to be concealed within a human hair, a recently developed electronic switch can be turned on or off in less than 100 trillionths of a second. That is less than the time required for light to travel one inch. The microscopic switch, which

still is in the experimental stage, consists of an alloy junction formed by fusing a speck of aluminum to a particle of silicon. It performs electronically as a semiconductor and will enable computers to "think" 100 times faster.

DREMEL MOTO-TOOL THE "POCKET SIZE MACHINE SHOP"

Handiest tool you'll ever own. Its high speed is ideal for precision grinding, polishing, carving, drilling, engraving, de-burring, sharpening, and hundreds of other household and workshop uses. Eliminates time-consuming hand work — gives the finished job a professional look. Weighs only 13 oz.—handles easily as a pencil. Does fine detail work with pin point accuracy. Fastest, most powerful tool of its kind — develops 27,000 RPM. Widely used by tool and die makers, model builders, craftsmen, lab technicians, repair men, gun smiths, schools, etc.

SEE YOUR DEALER
or write for FREE
catalog on the
complete Dremel
line of power
tools.



MODEL No. 1.....\$14.85
MOTO-TOOL MODEL No. 2.....\$19.95
MOTO-TOOL KIT No. 1.....\$23.50

MOTO-TOOL KIT No. 2
(as shown) Incl. Model
No. 2 Moto-Tool, 23 ac-
cessories (high-speed
steel cutters, grinding
wheels, etc.) in a sturdy
storage case.....\$27.50

QUALITY POWER TOOLS SINCE 1934

DREMEL MFG. CO. Dept. 119C, RACINE, WIS.

LINZER HERE

means
QUALITY HERE

and
PERFECTION
HERE

It's false economy
to use anything but
a LINZER quality brush
... for LINZER Flo-Con-
trolled Brushes retain their
"active bristle" life for years.
No matter how often you use a
LINZER, you will never be troubled
with brush marks or bristle fall-out.

Send 10¢ for latest
"Painting Hints" Book

AS ADVERTISED IN
LIFE

LINZER
Brushes
GUARANTEED QUALITY SINCE 1899

DAVID LINZER & SONS, INC.
10-20 Astor Place, New York 3, N.Y.

HOME appliances



run so **SWEET**
last longer too

WHEN OILED REGULARLY WITH
3-IN-ONE OIL

Always use REGULAR or OIL SPRAY for general jobs:
ELECTRIC MOTOR OIL for heavy duty. BUY ALL THREE!



TRANSEAL
PREVENTS AND STOPS LEAKS IN
AUTOMATIC TRANSMISSIONS

Prevents and stops leaks due to drying, hardening or shrinking of transmission seals. Reduces gear and bearing noise... makes shifting quieter faster... smoother.

AT SERVICE STATIONS, GARAGES,
AND AUTO ACCESSORY STORES

RADIATOR SPECIALTY CO.
CHARLOTTE, NORTH CAROLINA



Sharpen All Circular Saws with QUICK-WAY

Model PG12
\$19.95
Postage Paid



IDEAL for home-workshops; carpenters, contractors, QUICK-WAY unit precision sharpens, joints, gums and retools all circular saws to 12" diameter. Fits all bench, table and radial saws. Thousands of satisfied users. Send for Circular Make money sharpening saws. Order today \$19.95 postage-paid. Complete Unit with Grinder Wheel. No Extras to Buy. Patented.

FREE Saw Set with Initial Order

QUICK WAY SAW CO., T36 Tompkins Street, Cortland, N.Y.

MODEL CHANGEOVER SALE! 1958 MODEL—BELOW COST!

8" TILT ARBOR SAW

BLADE TILTS—TABLE
REMAINS LEVEL

Heavy duty all cast iron and steel construction. Precision ground cast iron table. Price includes massive cast iron mitre gauge and patented motor drive that fits any motor. Cross cuts, rips, bevels,



Shipped Complete as shown Less Blade

NOW
\$9.95
Was \$24.95

mitres, dados, cuts compound angles — everything expected of saws costing four times as much. Depth of cut adjustable; 0" to 2 1/4" — table always level. Send check or M.O. \$2.00 deposits on C.O.D.'s.

SPECIAL BARGAIN — This saw is our 1958 model. Each saw is brand new — sent to you in factory sealed cartons. Sold and guaranteed direct from the factory to you at a fantastic bargain.

FREE 10 DAY TRIAL — MONEY BACK GUARANTEE

Try this famous saw 10 days. If you are not satisfied that it does the work of any tilt arbor saw, regardless of price, return for immediate money back refund.

Sent Express Collect.

We reserve right to refund money if stock is exhausted
AMERICAN MACHINE & TOOL CO.
ROYERSFORD 35, PA.

Everything for the Craftsman!



WRITE FOR NEW 132 PAGE

WOOD
AND HOME
WORKSHOP
CATALOG

Finest Domestic and Imported Woods
... Mouldings, Hardware, Tools ...
ALL AT LOW MONEY-SAVING PRICES!

Your complete wood buying guide and project book. Craftsman is your best, most complete source of finest kiln-dried domestic and rare imported woods, beautiful wood inlays, colorful bandings, matched plywoods, embossed mouldings, carved ornaments, newest woodworking tools, "hard to find" cabinet hardware and fittings... more than 1500 items! Packed with newest scroll saw patterns, project ideas and money making plans. Enclose 5c (refunded with first order) to help pay mailing, handling cost. Write:

CRAFTSMAN WOOD SERVICE COMPANY, Dept. A3
2729 SOUTH MARY STREET - CHICAGO 8, ILLINOIS

Upholstery Materials;
New Tools; Lamp Parts;
Metal and Wood Legs;
Cabinet Hardware;
Music Boxes; Archery
and Water Ski Kits.
Over 1500 Items



NOW! HOME CRAFTSMEN CAN OWN THIS PROFESSIONAL ARC WELDER

EASY TERMS
ONLY \$98.50
F. O. B.

Now you can own a Trindl full 125 amp Industrial Welder at a price far less than smaller machines. With a Trindl 125A you can weld metals up to 1/2 inch thick. Operates off either 110 or 230 volt line, properly wired. 16 heat stages from 20 to 125 amps. Make and repair anything of metal around the home, garage, farm or shop, like a professional. No previous experience or training needed. Full "do-it-yourself" instructions with each machine. Complete only \$98.50 f.o.b. factory, or write for details. Trindl manufactures a complete line of heavy duty welding machines. Dealer inquiries invited.

TRINDL PRODUCTS Ltd., Dept. T2-C
1807 So. Clark St., Chicago 16, Ill.



Guaranteed
12 MONTHS
IN
CONTINUOUS
OPERATION

FREE
WRITE FOR
COMPLETE
DETAILS AND
EASY PAY PLAN

**EARN UP TO
\$5000 PER DAY
-and more!**



**Start your own profitable
excavating business with a**

CASE *Utility* **DIGGER**

Hundreds of local jobs can now be converted into a profitable one-man business or sideline with a fast, mobile 34 hp Case 210B power digger. Work for contractors, builders, home owners, municipalities. Dig septic systems, footings, foundations, sewer and water lines, tile drains... load dirt, gravel, snow.

Case Utility Backhoe digs 10' deep, cuts 14' of trench from one position, loads trucks to 10 1/3'... digs and dumps fast with hydraulic, foot-operated 180° swing.



as little as
\$468*
down

Case Utility Loader lifts 1000 lbs., clears 8'5" after dump. Wide variety of extra tools for landscaping, mowing, and specialized jobs. Converts quickly to handle 100% farm duty.

Pay as you earn
Liberal lease, lease-purchase or monthly installment plans.

**Plus freight, installation, taxes. Slightly higher outside U.S.*

SEND FOR FREE DETAILS...TODAY!

J. I. CASE CO., Dept. C1629, Racine, Wisconsin, U.S.A.

Send free literature on Model 210B diggers

Name

Address

City State

CU-81-59

Beautify Your Furniture and protect Floors with...



Glides, in lacquered brass finish, are styled to beautify your furniture. Swivel base tilts to stand flat; no tipsy furniture. Smooth Styrene base glides over floor; will not mar or scuff. Two sizes.



BOX OF 4 No. 500

ONLY \$100

AT LEADING HARDWARE STORES
ANOTHER DOT LINE PRODUCT FROM:

Columbia Fastener Company

Chicago 8,
Illinois

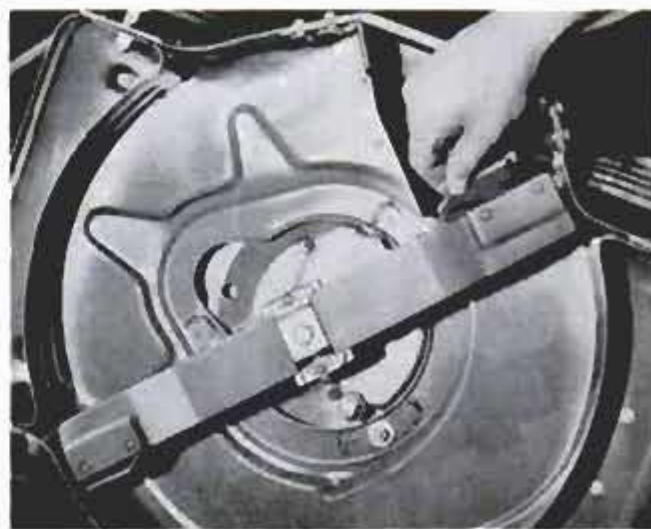

Frontier Development, Inc.,
Box 1582,
Des Moines, Iowa

Replaceable Cutter Blades For Rotary Power Mowers

Less than a minute is required to replace the blade inserts on a new type of cutter bar for rotary mowers. When the blades become dull or nicked, they can be removed and thrown away. The cutter bar for replaceable blades can be attached to most rotary mowers.

☐ In 1957, some 12,156 aircraft were built in the United States, compared with the all-time high of 95,272 planes in 1944.

G-1 160-250 amp, 30V, New \$17.50 used \$9.95
 G.E. 200 Amp, 30 Volt, Good Cond. \$15.50
 R-1 J&H, G.E. 300A. \$16.95 New G.E. \$24.50
 Welding Cable "00" 50' \$12.95 100' \$24.50

AC-DC WELDER KIT #511 G.E. Generator
 Makes 1250 Watts A.C. light plant and 200 amp. D.C. welder and battery charger. Including, 1 helmet, 1 pr. welding gloves, electrode holder, rheostat, switch, voltmeter, R.C. relay, voltage reg. & instr. \$38.50

"Preferred" 300 Amp. Kit includes kit as above plus R-1 300 Amp G.E. & 1 reactor coil, \$48.50 "Economy Buy" Kit consists of 160-250 amp. generator, all accessories listed in Kit #511 plus reactor coil and 30' cable. All pretested, all perfect \$33.50

New Reactor Coil Arc Stabilizer with #4 S. Copper wire, for R-1, P-1, G-1 & AC-DC gen., 7"x5"x4" wt. 11 lbs. \$10.95

V-BELT PULLEY KIT Fits R-1, P-1, G-1 & AC-DC generators; has 2 ball bearing blocks with high speed bearings, three groove V-pulley, Dr. shaft 8" long & flex coupling. \$17.50

New Throttle Solenoid & Idling Device for all welder engine control 1" travel, 6" L = SC-11. Wt. 4 lbs. \$6.95

NEW HYDRAULIC POWER KIT Consists of Hyd. Gear pump, 380 G.P.H. 1000 P.S.I. relief valve, 2 gal. reservoir, unloading valve, 5" accumulator, gauge, hose & fittings for belt or direct drive. Value \$83.05, save \$50.00. Price \$33.05 with 3/4" H.P. 2500 RPM, 200 Amp D.C. motor. \$42.05

Rotary Vane Vacuum Pump Positive displacement, 15 cu. ft. air, 1500-4500 I.P.M. 10" Hg suction, 24" Hg pressure, reversible, 3/4" ports. Wt. 9 lbs. New \$22.50. Good cond. \$14.50

HYDRAULIC LIFT KIT New Weaver hand pump 2000 P.S.I. with relief incl. 1 D.A. cyl. 1 1/2"x6", valve, filter, tank, gauge, hose & fittings. Value \$64.45; kit price \$29.45

New 4 way open center control valve with built in adj. relief for 1 to 4 D.A. cyl. 3/4" ports. = 10000 \$14.50. = 4811 4 way for 1 cyl. \$3.95 (+ postage)

SAVE ON SURPLUS MOTORS
 H.P. 24-12V. D.C. Shaft (+15%)
 1/8 8.4 amp 5/16"x1" 2500 RPM \$5.95
 1/5 6.5 amp 7/32"x2" 2000 RPM \$5.50
 1/4 8 amp 5/16"x1" 4000 RPM \$6.50
 3/8 200 amp 9/16"x1" 2300 RPM \$8.95
 Speed reducer 5:1 or 10:1 ratio 2 HP \$6.45

NEW HYDRAULIC CYLINDERS
 Air or Oil Bore Stroke Shaft D.A. Wt.
 #607 1 1/2" 4 1/2" 1 1/2" 5 lbs \$2.95
 #512 2 1/2" 4" 1 1/2" 6 lbs \$3.95
 #300 2 3/8" 4 1/2" 1 1/2" 7 lbs \$10.95
 #511 3 1/2" 2 1/2" 1 1/2" 15 lbs \$22.50
 #127 4 1/2" 10 3/4" 1 3/4" 16 lbs \$27.50

NEW HYDRAULIC SYSTEM KIT
 #400 K. Heavy duty Power Driven. Rated 14,000 lbs. lift. Consists of 2 D.A. hyd. cylinders, 3" bore x 24" stroke, each rated 7000 lbs. with 1000 P.S.I., 1 four way hyd. control valve with built in relief = \$31. 1 Vickers hyd. pump, 400 G.P.H., 1500 P.S.I., 3750 RPM, 1 hyd. 2 gal. reservoir, 1 Purator hyd. filter, 1 gauge 0-2000 P.S.I. all hose, & fittings. Value \$184.10, save \$90.00. Kit price \$94.10. Kit with two #511 cyl. \$79.95

HYDRAULIC PUMP BARGAINS 1500 P.S.I.
 MFG. TYPE R.P.M. G.P.H. Price
 Pexco Gear 1500 198 \$ 8.95
 7 Pexco Gear 4500 270 \$12.95
 Vickers .410 cu. in. 3750 375 \$15.50
 Weaver hand P.&Pr. relief 20" handle \$8.95
 Romeo D00 G.P.H. & Motor 1/4 HP. 10. \$8.95
GENERAL SALVAGE CO. CHECK ON M.O.
 2022 E. 27 St., Dept. 39, Kansas City 27, Mo.

10" TILT/ARBOR SAW BUILD-IT-YOURSELF from GIL-BILT KITS-PLANS



Sturdy wood, steel, and aluminum construction. NEW DEPARTURE ball bearings. Capacity and performance of floor saws selling for \$150.00 and up. Plans, all metal parts in kit with 10" comb. blade \$27.40, less blade \$23.95. F.O.B. St. Louis. Detail PLANS-PATTERNS only \$1.00 postpaid.

Build-it-yourself 12" and 18" Bandsaws, 6" Belt Sander, Shaper, Simplified plans, build easily with hand tools only. Advertised and sold for 12 years, over 35,000 units in use. Money back guarantee. FREE CATALOG.

GILLIOM POWER TOOLS, Dept. 80-C, Lambert Field, St. Louis 21, Mo.

HUOT ROLLING TOOL CHEST
 PROTECTS YOUR VALUABLE TOOLS



Goes where your work is! It's a handsome professional piece of equipment!

This complete rolling cabinet is ruggedly built of heavy formed and welded steel for permanent service on the job or in your home workshop. Three top drawers are cork-lined for precision tools—two heavy duty bottom drawers are extra deep for power tools. Complete with built-in lock.

MODEL 250 HUOT Rhymes With Do-It

Write for free bulletin showing this and 12 other models!
HUOT MFG. CO., 555 N. Wheeler St., St. Paul 4, Minn.

Print Your Own



Cards, Stationery, Advertising, Circulars, labels, photo and movie titles, church work, tags, etc. Save money. Sold direct from factory only. Raised printing like engraving, too.

Own a Printing Business
 Print for Others, Good Profit. Have home shop. Junior press \$15; Senior \$25 up. We supply everything. Easy rules. Pays for self in short time. Write for free catalog of outfits and all details.
KELSEY PRESSES, C-37 Meriden, Conn.

OUTWORKS THEM ALL

Prepares the toughest soils in one operation. All-purpose tiller-tractor tills to 12" deep—12" to 40" wide. 3 models; 7 rotor styles including mulchers. 40 attachments include all tractor tools, mowers, snow plow. Tough chain-gear drive. Send for details.



MERRY TILLER
 Northern Life Building, Box 1835, Seattle 4, Wash.

PALMGREN ANGLE VISES

GET THIS FREE CATALOG showing the only complete line of work holding tools (for production, tooling and maintenance) available anywhere: Drill press vises, angle vises, swivel machine vises, rotary tables, lathe milling attachments, production vises, heavy duty angle vises and adjustable angle plates, fully described and illustrated, with prices. 68 different models to choose from.



No. X1 ANGLE VISE
 1 1/2" jaw width... \$8.95, other sizes up to 8" jaw widths.

SEND FOR YOUR FREE COPY TODAY

PALMGREN PRODUCTS CO
 8365 SOUTH CHICAGO AVENUE, CHICAGO 17, ILLINOIS

DRAFT-PROOF YOUR HOME



md MACKLANBURG DUNCAN CO.

NEW-GARD AUTOMATIC DOOR BOTTOM

RAISES AUTOMATICALLY WHEN DOOR OPENS!

INSTALL IT YOURSELF!
 Ideal for all doors, inside or out. This silent, automatic door bottom makes your home more comfortable. Designed especially to clear carpet.

Puts an end to under-door drafts. Shuts out winter's cold (and summer's heat). Keeps out dust, noise, odors, bugs and insects. Simple to install. Do it yourself.

At Hardware and Lumber Dealers

MACKLANBURG-DUNCAN CO. OKLAHOMA CITY, OKLA.



DOOR OPEN
 RUB FLOOR

WHEN DOOR OPENS... thick felt bottom raises automatically!



DOOR CLOSED
 RUB FLOOR

WHEN DOOR CLOSES... thick felt bottom lowers automatically!

"Floating Roof" in Tank Reduces Vapor Losses



Hammond Iron Works, 744 Broad St., Newark 2, N. J.

Plastic Masks for Surgeons

Rubber-plastic masks are expected to replace the traditional gauze face masks worn by surgeons in operating rooms. The new mask is 120 times as effective as the gauze type in reducing the spread of bacteria.

Evaporation losses in storage tanks can be reduced by floating a foam-plastic cover near the top. Light and easy to handle, the cover comes in pie-shaped sections that are equipped with slip-fit joints. Flexible foam loops around the edge of the cover seal it to the tank. The cover is highly buoyant and can hold a man's weight.



← **From Head to Head** →
FINEST IN FIT, FEEL
AND FINISH

WILLIAMS
NEW DESIGN SUPERRENCHES®

Fit Square, precision broached openings and sloppy fits and rounded nuts. Strong but thin heads permit plenty of clearance in tight quarters.

Feel Drop-forged alloy steel allows trim heads and slim handles designed to give the same "balanced feel" in all sizes... all styles.

Finish Smooth contours and satin finished handles provide a safe and sure grip. Opening sizes legibly stamped. Chrome plated over nickel.

At Leading Industrial, Auto and Hardware Dealers
WRITE FOR CATALOG 503

BETTER
TOOLS

WILLIAMS

FOR BETTER
WORK

J. H. WILLIAMS & CO.,
DIVISION OF UNITED-GREENFIELD CORPORATION
419 VULCAN STREET, BUFFALO 7, N. Y.

ONLY A SCREW HOLDS LIKE A SCREW

Nails and glues may be good enough in their place but when you need plenty of solid, permanent holding power, you need a Southern quality screw.

Southern Screws provide extra holding power and permanent grip because sharp gimlet points and smooth cutting threads help Southern fasteners to start right, drive right and hold tight!

Buy 'em by Name . . .
Buy 'em by Box and Save!

Sold Through Leading Wholesale Distributors, also Leading Hardware and Building Supply Dealers.



Wood Screws • Tapping Screws • Machine Screws

& Nuts • Stove Bolts • Hanger Bolts • Carriage Bolts • Dowel Screws • Wood Drive Screws



POPULAR MECHANICS



DIAL ANY DADO WIDTH... IN SECONDS

FOR PROFESSIONAL PRECISION...only with a COMET QUICK-SET DADO! Cut to a maximum depth of $\frac{3}{4}$ ". Dial the exact width (from $\frac{1}{4}$ " to $1\frac{3}{16}$ "), without removing the tool from the arbor. Watch the balanced, tool-steel COMET blades cut perfect dados, rabbets and ploughs...on any table or radial arm saw. Use COMET for quick, professional precision... stays sharp 5 times longer! If not at your local dealer, order direct by check or money order. **19.95 PREPAID**

COMET MANUFACTURING CO., Dept. PM3

2033 Santa Fe Avenue, Los Angeles 21, California
a division of The Siegler Corporation



Every \$1 sends a 22 lb. Food Crusade package to the world's hungry thru CARE, New York 16

Cut it with WISS



New Wiss Hy-Power Pruners with vinyl "comfort grips" cut the toughest limbs with ease - protect your hands! No. 907-G (illustrated) 7" long, \$3.25. Others from \$2.75 at hardware, department, and garden supply stores.

OTHER FINE WISS CUTTING TOOLS

GRASS SHEARS

No. 701
\$2.75



Easiest cutting, fastest cutting grass shears you've ever used, with molded vinyl handle grips and special closing latch. Others from \$1.39 to \$4.95.

TIN SNIPS

No. V-13
\$2.25



Only seven inches long, these "mighty midget" snips cut metal, vinyl, rubber, leather. Others 10" to 17" in aviation, combination and solid steel styles.

J. WISS & SONS CO., NEWARK 7, N. J.
World's Largest Manufacturer of Shears, Scissors, Pinking Shears, Skalloping Shears, Metal Cutting Snips and Garden Shears

SUPREME VERSAMATE

Versamate . . . a wonderful tool that fits any power drill —reduces speed to give seven times more power. Drives screws of all sizes. Inexpensive extras make it a nut and bolt driver, heavy-duty drilling unit. See your tool dealer today!



\$995

For Portable Drill Users...

**CHOOSE THE
ATTACHMENTS
THAT DO THE
BIG JOBS!**



\$1495

Versamatic triples portable drill usefulness. *Reverses!* Drives and removes screws, nuts, bolts. Boosts power 7 times. Set includes regular and Phillips-type bits, and 1/4" square drive adapter. For heaviest drilling jobs in steel and concrete, add a 1/2" Supreme Brand Chuck.

SUPREME VERSAMATIC



**SUPREME PRODUCTS
CORPORATION**
2222 S. Calumet, Chicago 16
Div. of A-S-R Products Corp.

Converting to STEREO?

Change for the Better
Change to **V-M**



The Stereo Record Changer With Transcription Turntable Performance Quality stereo reproduction starts with the record changer. Depend on V-M for precision performance — as so many leading manufacturers do. *V-M Stere-O-Matic® Automatic four-speed record changer, Model 1201*, with stereo cartridge and stylus, dual outputs and stereo/monaural switch. *Model 1202*, with four-pole motor and plug-in head for GE and other magnetic stereo or monaural cartridges. Both available on matching base pan as Models 1226 and 1228.

See your dealer now.

World Famous for the Finest in Phonographs,
Tape Recorders and Record Changers.

V-M CORPORATION • BENTON HARBOR, MICHIGAN

the **VOICE of MUSIC**

CHANGE SPARK PLUGS REGULARLY

ARDEN BILGE PUMPS

*Every
Sportsman
Needs One!*



Attractive Gold and Maroon finish. Foolproof. Tamper proof. Rustproof. Precision made. No leather parts. All Metal Diaphragm action. Neoprene check valves. Self lubricating. Nothing to rust, adjust, replace or get out of order. With normal care and use will give years of trouble-free service. Requires very little pumping effort to remove gallons of water.

TACKLE BOX—Size: 1 1/4" Dia. x 10" Long. Rated: 3 Gals. per minute . . . \$3.75

SPORTSMAN—Size: 1 1/4" Dia. x 20" Long. Rated: 4 Gals. per minute . . . \$4.50

JUMBO—Size: 1 1/4" Dia. x 24" Long. Rated: 5 Gals. per minute . . . \$5.00

ARDEN Double Action PUMPS

HEAVY BRASS CYLINDER. 2 CONVENIENT SIZES. 1 1/2" Diameter Brass x 24 1/2" Long. Square stirrup handle. Garden hose fitting. Continuous stream on up and down stroke. "D" Ring Piston. Neoprene check valve. Bronze strainer intake screen. Head, handle and base are red and black enamel finish. Rated 9 1/2 gallons per minute. Easy stroking speed. Double Action 24". No. DA18 . . . \$8.50

1 1/2" Diameter Brass x 29 1/2" Long. Same as No. DA18 but 6" longer. Greater capacity—13 1/2 gallons per minute. Easy stroking speed. Wide grip. Roomy stirrup handle. Large positive take up packing nut. Double Action 24". No. DA24 . . . \$10.25

2" HIGH GALLONAGE BILGE PUMPS

Attractive Red, Black and Gold finish. Precision made. No leather parts. O Ring and Metal Diaphragm action. Neoprene check valves. With normal care and use will give years of trouble-free service. Spigot is threaded for 1 1/2" Pipe Fitting or will take Neoprene Hose.

2 1/2" x 24". Rated 20 Gals. per minute . . . \$14.25

2 1/2" x 30". Rated 25 Gals. per minute . . . \$15.50

2 1/2" x 36". Rated 30 Gals. per minute . . . \$16.75

Patented Product No. C.O.S. **ARDEN PUMP COMPANY** 426 E. 142nd STREET BENTON HARBOR, MICHIGAN

GIGANTIC SURPLUS SALE

TRUCK-BOAT WINCH



• Powerful ball-bearing winch. Reversing switch mounted on winch. For cars, trucks, docks. Use on 6 or 12-v battery. 1000-2000 lb. pulling capacity. Will hold up to 40' cable. Wt. 54 lbs. Govt. cost \$280. **SALE..... \$46.75 FOB**

DIAL PHONE



• Modern hi-efficiency attractive dial phone. Use for extension to main line or private system. Use several for complete private system, etc. Complete with ringer, dial, etc. Work on any dial system. **Cost \$24. SALE..... \$9.95 Ppd.**
We have phones for farms, contractors, mines, factories.

WELDING GENERATOR



• Famous new-condition P-1 200-250 amp aircraft generator. Thousands of these giving excellent service as welders. Other uses are DC power for fast battery charging. Easy to adapt into portable welder, using 10-12 HP engine or drive off tractor pulley. 200-250 amp 24-30-v, 2500-4500 rpm. Size 15"x6". Wt. 48 lbs. Govt. cost \$300. **SALE..... \$18.95 FOB**

ELECTRIC CAR MOTOR



• Powerful gear reduction battery motor. Excellent for golf cart, winch. Fully reversible. Runs on 6 or 12 volts. Speed 25-80. Wt. 35 lbs. **SALE..... \$19.46 FOB**
Other sizes and types.

ORDER DIRECT FROM AD OR SEND FOR FREE CATALOG

BIG, NEW 1959 EDITION

- SURVEYING
- ELECTRONICS
- POWER TOOLS
- TARPULINS
- CHAIN SAWS
- BINOCULARS
- SPORTING
- SEARCHLIGHTS
- METERS
- TRANSFORMERS

AIR SUPPLY UNIT



• Brand new compressor outfit ready to use. Ideal for farm, small factory, home workshop. Complete for 1/2 h.p. cap'r. motor. Almost 3 cfm air. Pressure to 150 psi. 10"x23" high pressure tank, relief valve, 15' air hose, gauge, blow gun, tire chuck. Size 28"x11"x22". Wt. 80 lbs. **List price \$111. SALE..... \$69.95 FOB**
Complete line compressors, guns, gauges, switches, fittings, etc.

POWER PLANTS

• Marvelous buy in new condition government surplus plants and brand new plants and generators direct from factory. All FOB Lincoln.

- 1000-w plant \$169.75
- 2500-w plant 279.50
- 3500-w plant 319.95
- 5000-w plant 497.50
- 3000-w 115-v DC Generator..... 49.50
- 1000-w 115-v AC Generator..... 98.70
- 5000-w 115-230-v AC Generator..... 279.50

Other sizes from 500 to 10,000-w



FARMER-CONTRACTOR PUMP



• 2 1/2" size, 16,500 gph. Brand new bronze ball-bearing centrifugal pump. Fine for irrigation-contractor pump, industrial use. 250 rpm. 65 ft. head. Complete with 6" pulley, 2 1/2" intake, 2" discharge. Wt. 37 lbs. Govt. cost \$98. **SALE..... \$49.50 FOB**
• Same pump in 1 1/2" size, 140 gpm, 70 ft. head. Govt. cost \$62. **SALE..... \$23.95 FOB**
All sizes and types in stock

HYDRAULIC EQUIPMENT BARGAINS



Savings to 80%. Build loaders, diggers, presses, etc. All brand new.

- Hydraulic Wagon Unloader..... \$29.87 FOB
- Control Valve, 1 or 2 way..... 18.00 Ppd.
- Tractor Pump 1000 psi..... 45.50 Ppd.
- 12-v Motor & Pump 1000 psi..... 16.95 FOB
- 2-Way Cyl, 1 1/2" bore 6" str..... 8.79 Ppd.

Many other types, sizes, items.

SEND CHECK OR M.O.
25% DEPOSIT ON CODs

SURPLUS CENTER
DIVISION OF BURDEN SALES COMPANY
DEPT. 805
LINCOLN, NEBR.

SATISFACTION
GUARANTEED
OR MONEY BACK

CUT ANY SIZE - ANY SHAPE WITH Spearhead Cutter



Handy pocket size - cuts leather, asbestos, rubber, cork, etc. - round 1/4" to 6" - any size straight and odd shapes. **Send Check or Money Order!** **935 POSTPAID**

ZIMMERMAN PACKING - NORWOOD 12, OHIO

OPTICAL BARGAINS

ERECT IMAGE LOW POWER MICROSCOPE

5X, 10X, 20X
\$80.00 Value - Only \$19.95



Extremely sturdy with rack and pinion focusing, color corrected optics, turnable microscope body for inclined viewing, three different powers, long working distance under objectives, sufficient eye relief for easy viewing. Made from war surplus optical instrument so that you actually get \$80.00 of value. Weighs 4 lbs., 13" high. 10-DAY FREE TRIAL! Accessory objectives available for powers of 15X, 30X, 40X.
Stock No. 70.172-H..... \$19.95 Postpaid

New! 2 in 1 Combination Pocket-Size 50 Power MICROSCOPE and 10 Power TELESCOPE



Useful Telescope and Microscope combined in one amazing, precision instrument. Imported! No larger than a fountain pen. Telescope is 10 Power. Microscope magnifies 50 Times Sharp focus at any range. Handy for sports, looking at small objects, just plain snooping. **Send Check or M.O. Satisfaction Guaranteed. Order Stock No. 30.059-H..... \$4.50 Postd.**

8 POWER ELBOW TELESCOPE



WAR SURPLUS
\$200 Value - Only \$13.50
Big 2" objective, focusing eyepiece 28mm focal length—Amici erecting system—turret mounted filters, clear, red, amber and neutral—reticle illumination. Sparkling, clear, bright image—6" field (325 ft. at 1,000 yds.). Focus adjusts 15 ft. to infinity. 28mm f.l. eyepiece alone is worth more than \$12.50.
Stock No. 70.173-H..... \$13.50 postpaid

STEREO MICROSCOPE - 23X and 40X
Stock No. 85.056-H..... only \$99.50 F.O.B. Barrington, N. J.

WRITE FOR FREE CATALOG "H"!
Complete Line of Astronomical Telescope Parts and Assembled Telescopes. Also huge selection of lenses, prisms, war surplus optical instruments, parts and accessories. Telescopes, microscopes, Hand Spectroscopes, Sniperscopes, binoculars, etc. Request Catalog "H"!
ORDER BY STOCK NUMBER. SEND CHECK OR MONEY ORDER. SATISFACTION GUARANTEED.
EDMUND SCIENTIFIC CO., BARRINGTON, N. J.

2 TO 4 H.P. 12900 up



WHEEL OPTIONS
Write for free color circular...
DEPT. 93, P.O. BOX 9405, RICHMOND 28, VA.



The Modern PLASTIC for lasting Home Repairs

PERMANENTLY mends cracks or holes in wood, tile, stone or plaster. Sticks and stays put—Does not chip, shrink or fall out. Easy to use. Economical. Mold it, chisel it, polish or paint it. The big 4-lb. can is obtainable from your lumber, paint or hardware dealer at \$1.40; or will be shipped direct postpaid (in U. S.) for \$1.75. Complete satisfaction guaranteed or your money refunded.

DONALD DURHAM CO.
Box 804-T Des Moines, Iowa



YOU'RE LOOKING AT A PIECE OF

Dragon-Skin

Not one of St. George's souvenirs, but an amazing new cutting tool. A "steel sandpaper" that sands, rasps, smooths.



Use Less "Elbow Grease" when shaping, smoothing, rounding, or cutting slots, because Dragon-Skin cuts *fast*. New principle: steel sheet is punched to form special cutters—thousands of 'em—to carve away at the work. Cut is smooth and even. No rough sand "grits," no gouging.

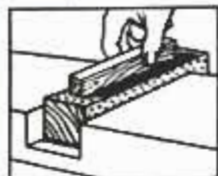

Dragon-Skin Can't Clog like sandpaper, even when you're smoothing softest wood. Chips and dust fall right through the holes. Slap the sheet once and it's clear!



Makes Hundreds of Jobs Easier, and outlasts sandpaper by far. Shapes hard or soft woods, plastics, soft metals... removes paint... at home or at work... on hand or electric sanders. Cut with scissors and wrap around sticks or dowels to make special tools.

1390

LOOK FOR THIS
**Dragon
Skin**
DISPLAY
AT YOUR
Red Devil Dealer



75¢
complete
with holder
25¢ for
single sheets
Also
available in
full sheets
and 1/3-sheets



Red Devil Tools.

Union, N. J., U.S.A.

World's Largest Manufacturer of Painters' and Glaziers' Tools



PLANS • Full-Size PATTERNS and FRAME KITS for ALL STYLES of BOATS

Inboards or outboards, cabins or runabouts, in many sizes, are available in PLANS, PATTERNS or FRAME KITS. They are prepared especially for the amateur builder. Send 50¢ NOW for the large, illustrative '59 catalog showing the many new designs.

GLEN L 9152T ROSECRANS
BELLFLOWER, CALIFORNIA

NOW! Adjustable CORNER CLAMP



AND MITERING VISE

Securely holds mitered or butt joints at 90° angle, or any angle, for nailing, stapling, gluing and splicing. ADJUSTS TO ANY ANGLE. Used for Picture frames, Screens, Storm windows, Shadow boxes, or any place where wood is joined. **\$1.75 PPD.**

SAW SHARPENING IS EASY

Super Filer No. 11 joints and sharpens hand and circular saws 6" to 10" with all teeth correct in height, depth, pitch, bevel. When file hits steel roller, teeth are finished. Saw runs true with no side pull. Includes 8" file. **\$9.95 PPD.**



FREE LITERATURE



"TRU-CIRCLE"
saw set automatically sets teeth at 10° or more. **\$2.95 PPD.**

MONEY BACK GUARANTEE

A. D. McBURNEY, 5908 Hollywood Blvd., Hollywood 28, Cal., Dept. A-39

ALIVE TODAY!



Arch Lightbody is one of 800,000 Americans cured of cancer because they went to their doctors in time. They learned that many cancers are curable if detected early and treated promptly. That's why an annual health checkup is your best cancer insurance.

American Cancer Society



R1 GENERATOR - 300 AMP. Make your own arc welding and battery charging unit. Terrific source of power for all 24-32 V. equipment. Simple installation with our wiring diagram. All generators pre-tested in our own shop. Approx. GOVT. COST \$400. Like NEW. **\$16.50.**

GENUINE P1 GENERATOR - 200-250 AMP. Use for same purposes as above. Approx. GOVT. COST \$250. Like NEW. **\$14.50.**

GE GENERATOR - 400 to 500 AMP. Use for same purposes above. Approx. GOVT. COST \$550. Like NEW. **\$39.50**

ACCESSORIES FOR BUILDING ARC WELDER for above generators consisting of VOLTAGE Regulator, 300 AMP. ammeter, 300 AMP. shunt, heavy-duty welder's gloves, 50' welding cable, electrode holder, rheostat, welder's helmet (hood type), Giant Toggle Switch. All 9 items - Approx. GOVT. COST \$150. Like NEW - Complete **\$21.50.**



COMPLETE PACKAGE ACCESSORIES for arc welding and battery charging kit. Consists of 50' welding cable, 30 V. Voltmeter, welder's adjustable helmet (hood type), electrode holder, 300 AMP. ammeter, 300 AMP. Shunt, Rheostat, Giant Toggle Switch, 300 AMP. Reactor Coil Arc Stabilizer, Voltage Reg., reverse current relay, 1 pr. heavy-duty welder's gloves. All 12 items - Approx. GOVT. COST \$225. Like NEW. Complete with wiring diagram **\$31.50.**



WELDING CABLE DOUBLE-O, heavy duty, neoprene jacket, fiberglass insulation, NEW. Approx. GOVT. COST \$40. Will handle 400 amps, or better, 50' lengths **\$14.50.** 100' lengths **\$26.00.**

WELDING REACTOR for all listed generators. 200 AMP. capacity or better, NEW. **\$7.95.** 300-400 AMP, NEW. **\$10.95.**

HEAVY-DUTY RHEOSTAT Ideal for regulating voltage on electric welders. Rated 5.75 Ohms, 100 Watts with double windings & dual female 25 amp., 125 V. receptacles. 7" hi x 5 1/4" D. Shpg. wt. 2 1/2 lbs. Approx. GOVT. COST \$25. Brand New. **\$2.25** ppd.



FAMOUS NAVY MK14 AIR COMPRESSOR Great for tree, termite, airbrush & paint spraying; filling tires, aquariums, etc. Dual & remote control electric receptacles, 115v 60 cycle AC, heavy duty HP. Westinghouse Motor, Direct drive. Water & explosion-proof. Built-in air filter, adjustable pressure setting up to 47 lbs. 3 cu. ft. per min. Self-contained switch, mounting brackets. These units made under license of Sperry Gyroscope Co. Wt. 66 lbs. gross. Approx. GOVT. COST \$585. Like NEW. **\$21.95.**

With portable steel hand cart (shown), rubber wheels, specially constructed for mounting this unit. Incl. 25' rubber air hose, 6' extension cord with plug & fittings. Wt. 76 lbs. Complete with cart - **\$26.95.**
With new internal pressure spray gun with 3 adjustable spray tips. 1 qt. cap. **\$32.05** complete.



Heavy Duty Type ALLEN PUNCH PRESSES

Model BT-B
5 ton
\$199.50
Job less motor

Hundreds of Different Model combinations 1 to 12 ton capacities Moderate in price Fully guaranteed See your supply dealer or write for Free catalog giving complete information and prices on our Heavy Duty Punch Presses.

ALVA ALLEN INDUSTRIES, Dept. PM, Clinton, Mo.

REVERSIBLE REDUCTION GEAR (250-1) tremendous inertia power 6-12-24 volt winch with 2 power takeoffs! Use on boats, trucks, wreckers, etc. Fantastic power for pennies of original cost. Weight 55 lbs. Approx. GOVT. COST \$475.00 NEW - **\$14.95.**

BENDIX GEROTOR PUMP & MOTOR - NEW! Use wherever fluid pumping required. Excellent for hydraulic installations. Has 3/4" pipe connections, built-in relief valve adjustable up to 1500 lbs. Max. cap. 6 GPM. 1 1/2 H.P., 24 V. motor. Use on 12 to 36 V. Approx. GOVT. COST \$350. NEW LOW PRICE - **\$8.75.**



11 PIECE CROWFOOT WRENCH SETS Wrenches snap onto T-bar in 3 different positions. The only wrenches for hard-to-get-to places. Mfd. by Plomb Tool Co. for U.S. Armed Forces. Finest case hardened tool steel. No shop mechanic should be without this set. Approx. GOVT. COST \$47. NEW. **\$5.95** ppd.

MICROMETER Black frame, smooth finish, clutch ratchet-type. Easy-to-read graduations in .001. NEW. **\$3.95** ppd.

WOOD PROPELLER Genuine rock maple radio drone "prop." perfect for den, trophy room, boy's room. Smooth, highly varnished. 30" tip to tip. Clock, barometer or photo can be inserted easily into center (mounting holes provided). Can use to operate ice sleds, etc. Approx. GOVT. COST \$57. NEW. **\$4.05** ppd.

\$2940 NAVY AIR-COOLED POWER UNIT Most compact engine ever assembled. Portable, net wt. 150 lbs. 200 Amp. Gen. self-starter capable of delivery of double overload or continuous service at 200 Amps. Mfd. by Ranger Aircraft. 2 cylinder, 4 cycle, 10 HP. 3200 RPM. Fully governed for varying loads. This unit makes one of the finest arc welders obtainable. Also makes excellent boat engine. Shipped complete with rheostat & voltage reg. All units checked & pre-tested in our shop. Complete **\$185.**

Engine same as above with deluxe welding accessories as follows: rheostat, voltage reg., dry charged 24 V. battery, 50' heavy duty welding cable, 1 electrode holder, 1 hood, pr. of gloves, voltmeter. All this only **\$225.**



VICKERS HYDRAULIC ANGLE PUMP. 1000 PSI. Piston-type, positive displacement (will displace .410 cu. inches per revolution). Removable hydraulic fittings. Cap. 5 GPM at 3750 RPM. Made to AF spec. Approx. GOVT. COST \$300. Like NEW. Only **\$18.95.**

COMMANDO BOLT & WIRE CUTTER Folding extendable handles for extra leverage. Center cut type hole cutter for hard and medium rods, bolts, tough alloy wires and other metals. Cutting edge has equal bevel on each side for extra strength. Folded it fits in pocket or tool box. Safety latch locks closed. Approximate length 10 3/4" extended 15 3/4". A must for the mechanic or farm hand. Rugged construction. Made of Sheffield tool steel. NEW. **\$3.95.** 2 for \$7.

NEW! 1959 CATALOG! BIGGER & BETTER THAN EVER... 971 price cuts, 1000's of bargains in war surplus & other items! 100's of pictures! Send 25c in coin for your copy today!
Ppd. prices USA only. Other prices FOB Culver City, Calif. Send cash, check or money order. 50% deposit on COD.

AIRBORNE SALES CO., INC. DEPT. PM 359
8501 Stellar Drive, Culver City, Calif.



GOT A STORAGE PROBLEM?

Then you need **TURNBUCKLES** Perforated Board fixtures to end space-wasting clutter and to keep everything neatly in place until needed. **TURNBUCKLES** do-it-yourself fixtures come in a wide variety of shapes and sizes... fit easily into any wall-hung perforated board... and hold everything from clothing and kitchen utensils to hand tools and garden equipment.
Send for your free copy of space-saving suggestions for home, farm and workshop.

TURNBUCKLES, Inc.
60X 333, MICHIGAN CITY, INDIANA

NAME _____
ADDRESS _____
CITY _____ STATE _____

NEW REMINGTON 6½" ELECTRIC SAW

with 14 power-plus features...

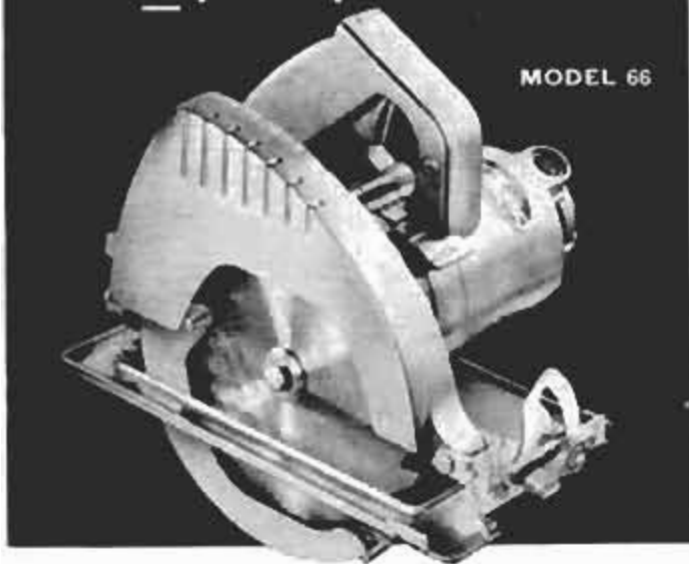

Try and beat this saw for value. Remington's new Model 66, 6½" electric saw combines optimum cutting power with today's most advanced design for safety and ease of use.

Check these features: 1) Powerful 7-amp motor. 2) Depth-adjustment thumb-lever lock nut. 3) Bevel-adjustment thumb-lever lock nut. 4) Sturdy die-cast, aluminum-alloy housing. 5) Heavy-duty, momentary-contact trigger switch. 6) Easy-access brush holders with uniform-tension springs. 7) Sawdust blower. 8) Sturdy aluminum shoe. 9) Telescoping blade guard with retracting lever. 10) Special motor ventilation for cool running. 11) Weight: only 7 lbs. 12) 6½" super-sharp combination blade. 13) Cuts full 2½" depth. 14) Cuts 2" dressed lumber at 45°.

SPRING SPECIAL. Your dealer will be featuring a special springtime price on Remington's tough, new Model 66 saw during March and April. Special for a limited time only—see him today.

Specifications subject to change without notice.

Remington

Remington Arms Company, Inc.
Bridgeport 2, Connecticut

In CANADA: Remington Arms of Canada, Limited,
36 Queen Elizabeth Blvd., Toronto 18, Ont.



FREE 16-PAGE CATALOG shows every type of Remington electric tool. Tells what each will do—gives complete specifications. No cost, no obligation. Just send this coupon.

Remington Arms Company, Inc.
Bridgeport 2, Connecticut

Name _____
Address _____
City _____ Zone _____ State _____



Known brands are known values



WHEN you see a Brand Name that you know, it's like the face of a friend. It inspires confidence.

In fact, Brand Names are built on confidence. You and your neighbors dictate the standards a Brand Name product must meet to consistently deliver the value and service you want.

A respected Brand Name is a manufacturer's most valuable asset and he protects it by constantly testing and bettering his product.

A Brand Name is the maker's guarantee of satisfaction which is *doubly endorsed* by the dealer who sells it.

For dependable quality and consistent satisfaction you will do better with the brands you know best; get to know those you see advertised in this magazine.

To get the most for your money buy by *Brand Name and be sure!*

**A Brand Name is a
maker's reputation**



BRAND NAMES FOUNDATION, INC.
437 FIFTH AVENUE, NEW YORK 16, N.Y.

CRACK IN BOWL?

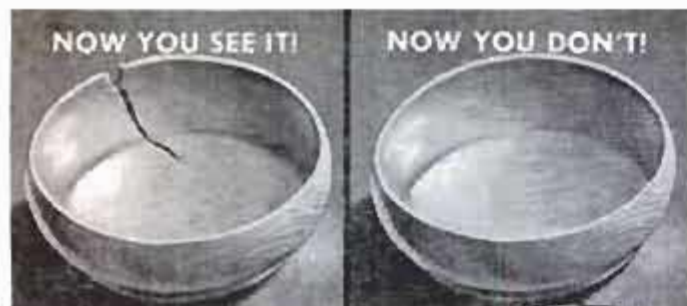

No muss — no fuss with easy-to-use Plastic Wood. Resists grease and water.



For surest results always use GENUINE

PLASTIC WOOD

Handles like putty—hardens into wood!

FEATHER CRAFT



The exciting 1959 Feather Craft line offers fifteen aluminum models with sparkling anodized colors, plus five brand-new fiberglass models for fishing, sports and family fun. Write for brochure.

FEATHER CRAFT, INC.

445 Bishop St., N.W., Atlanta, Georgia
Feather Craft of Canada, Welland, Ont.

Introducing the New

HAHN MODEL 66 . . . 16" ROTARY TILLER

Today's Highest-Quality, Low-Priced Tiller!

Even a child can till or cultivate tough soil with a light, ideally balanced HAHN Tiller! Easy-to-reach controls. Self-sharpening, double-end tines work 6" deep. Extension tines to 24" and furrow attachment, optional. Belt-drive — spring-tension idler. **ONE YEAR GUARANTEE!**

Big-capacity Model 77 HAHN Tiller also a top value!

WRITE TODAY FOR NEW FREE FOLDER ON HAHN TILLERS AND MULTI-JOB TRACTORS

HAHN, INC. DEPT. PM-39
EVANSVILLE 12, IND.



AS LOW AS
\$11995

MARCH 1959

SUDS! SCRUBS! RINSES!



Is yours one of the 20 million homes with kitchen sink rinsing sprays of the "automatic" type—those with a thumb control that turns the spray on and off? You can now replace any thumb-control spray with Dish-Quik—the newest automatic spray! Attaches to existing hose in seconds! Dish-Quik not only rinses but suds and scrubs. For fast dishwashing and dozens of daily kitchen chores! **Only \$9.95 at plumbing and hardware stores.** Write for free booklet on how to replace and repair any automatic spray or hose:

AUTOMATIC SPRAY SERVICE CENTER
1700 E. 58th Place, Los Angeles 1, Calif.



MODERNIZE WITH MARLITE

For years of wear, minutes of care

Marlite is quickly installed over old or new walls with ordinary tools. Baked melamine plastic finish resists heat, moisture, grease, acids, stains; cleans with a damp cloth. Planks, Blocks, large Sheets available from building materials dealers in decorator colors, wood finishes, marble patterns. Look for the Marlite name on the back of every panel—your guarantee of satisfaction. For free decorating book, write Marlite Division of Masonite Corp., Dept. 342, Dover, Ohio.

5901

Marlite plastic-finished paneling

ANOTHER QUALITY PRODUCT OF MASONITE® RESEARCH

281

NOW! a hi-compression
staple gun
for only
\$4.95

With Exclusive
Push-button Loading
and Built-In
Staple Extractor.



Indispensable for home use...and never before priced so low! This compact, all steel, powerful SWINGLINE 101 staple gun is ideal for insulation, carpentry, upholstery, screening, wire fencing, plus thousands of other uses. Handle locks to fit pocket. Lightweight, maneuverable, jam-proof! Staple sizes $\frac{1}{4}$ " , $\frac{3}{16}$ ". Send for FREE book—"Tips for Tacking".

Swingline® INC.

Dept. M39 Long Island City 1, New York

POCKET SIZE BLOW TORCH

only
\$1.95
with charger

Butane gas blow torch gives intense 3500° flame. Solders, brazes, fixes leaks. Perfect for wiring, plumbing, loosening frozen nuts and bolts, 1001 odd jobs. Carry in your pocket. Each charger lasts $\frac{1}{2}$ hour, turns on or off.

Extra chargers, 49¢ per box of 2. Get Jet King Butane Blow Torch at hardware stores. Or, send check or money order, we pay postage. For \$1 more (total \$2.95), get Soldering Kit; torch, tip, 3 feet cored solder, extra charger. Good for TV, radio, jewelry. * Add \$1.00 in Canada



KIDDE MANUFACTURING CO., INC., Dept. PM-34
42 FARRAND ST., BLOOMFIELD, N. J.

Send me _____ JET KING BLOW TORCHES @ 1.95 ea. *

Send me _____ JET KING SOLDER KITS @ 2.95 ea. *

Send me _____ Boxes of Extra Chargers @ .49 per box.

My check, _____ money order _____ for \$ _____ is enclosed

NAME _____

STREET _____

CITY _____ STATE _____

When you want
the finest
in Handsaws
INSIST ON
SANDVIK

Extra high
crown,
taper ground
blade of
Sandvik's own
Swedish
Steel.

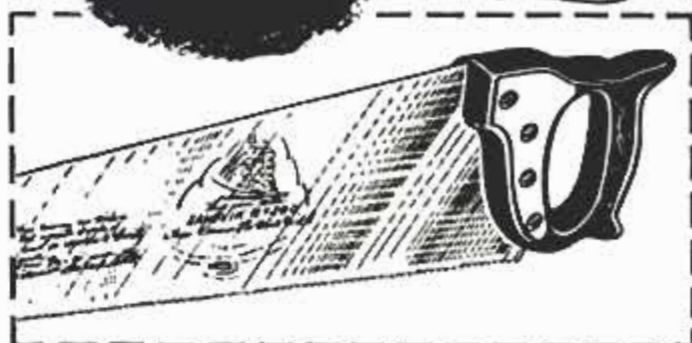

See Sandvik at your
hardware dealer. Write today
for this booklet on the
care and use of hand saws.



Sandvik STEEL INC.

Saw & Tool Division

1704 Nevins Road, Fair Lawn, N. J.

Sandvik Canadian Ltd., P.O. Drawer 1335, Station "O," Montreal 9, Canada

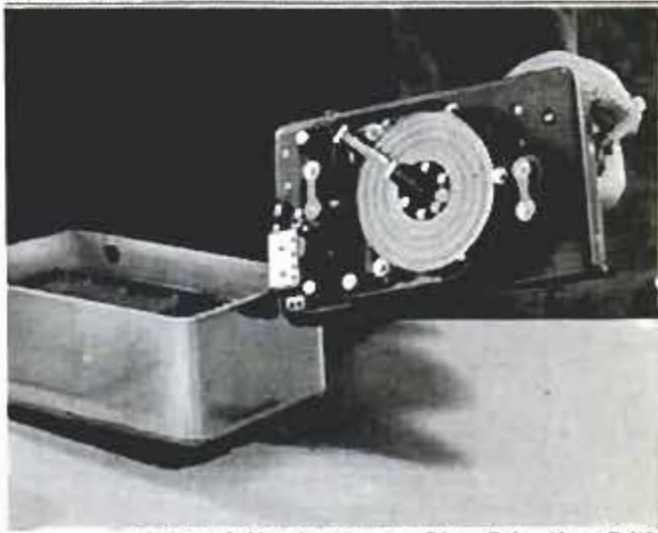

Lockheed Missile Systems Div., Palo Alto, Calif.

Electronic "Space Memory"

Three million pieces of scientific data can be stored on a tape recorder that's small enough to be held in one hand but rugged enough for space flights. The electronic "space memory" can record and store data of the universe during intervals when a spacecraft is out of direct radio contact with the earth. It can then transmit the data on a command signal when the vehicle returns to within range of the listening posts. The recorder, developed by Lockheed, can unload its information in one sixth the time it takes to record it.

POPULAR MECHANICS

BRAND NEW BOLT & WIRE CUTTER

Exclusive: *Extendable Handles for Extra Leverage*
ITEM 478 — CADMIUM PLATED. Center cut type bolt cutter for soft or medium hard rods and bolts, alloy wire, and other metals. Cutting edge has equal level on each side for extra strength. **FOLDED**—It fits into your pocket or tool box—safety latch locks closed when not in use. Capacities: medium hard bolts in thread 3/4"; medium hard metals 5/16". Length closed: 10 3/4"; extended 15 3/4".



A \$9.95 VALUE NOW ONLY 3.95 PPD. 2 FOR \$7.00

NEW BLACKHAWK HYDRAULIC PUMP

ITEM 82—Model P-151 Hydraulic Hand Pump with built-in oil tank (2 qt. capacity) and release valve. Rated from 1200 P.S.I. to 8400 P.S.I. 20" Handle. 9" x 7" x 6". F.O.B. Chi. 23.50



ITEM #55

MULTI-PURPOSE HYDRAULIC PUMP OR MOTOR



Silent high efficiency. Helical Gear Type Ball Bearing. Hydraulic Pump or Motor. Rated 8 Gal. Per Min. At 1500 R.P.M.—

Delivers 1000 P.S.I. Using 6 H.P.—Reversible Rotation—3/4" Pipe Thread Inlet and Outlet Ports—1/4" Drain Port—3/4" shaft with keyway and flat for either direct or pulley drive. Dimensions—5 3/4" high, 7 1/4" long, 5 1/2" wide. Shipping weight 18 lbs. F.O.B. Chicago..... **52.50**

1 1/2 H.P. HYDRAULIC SPEED REDUCER WITH FINGERTIP CONTROL



Variable output speeds from 0 to input speed available by moving control handle. Locking handle maintains setting. Use input power of 1/4 to 1 1/2 H.P. Shaft 3/8" diam. Input rotation counter-clockwise facing shaft. Input speed 750 R.P.M. 7 1/2" x 7 1/2" x 11 1/2". Output rotation reversible. Complete with 2 qt. oil. Weight 31 lbs. F.O.B. Chicago..... **72.50**

DOUBLE ACTION HYDRAULIC CYLINDERS

ITEM 1000—2" bore, 10 3/4" stroke, 1 1/2" chrome plated steel shaft, 3/8" standard size thread ports. Maximum lift capacity, 8400 lbs. with 1200 P.S.I. line pressure. Clevis mounting at both ends. Overall length closed 20 1/4". Shipping weight 18 lbs. F.O.B. Chicago..... **27.50**

ITEM 1024—Same cylinder as above with 24" stroke. Shipping wt. 45 lbs. F.O.B. Chicago.... **39.60**

ITEM 1036—Same as above with 36" stroke. Shipping weight 57 1/2 lbs. F.O.B. Chicago..... **55.00**

For other sizes of hydraulic cylinders, Write for Free Catalog.

Brand New! Compact! Lightweight!

BRIGGS & STRATTON Gas Engine Driven 1000 WATT A.C. POWER PLANT
 115 Volt, 60 Cycle, A.C., Single Phase
ONLY 61 POUNDS! WITH CARRYING HANDLE!

ITEM 1008-B—PORTABLE, weighs only 61 lbs. net! Fits into smallest car trunk. Saves time, labor, money. Provides on-the-spot power for construction, etc. Duplicates standard house current. Generator and engine mounted on strong steel base with sturdy belt guard. Operates at 3600 R.P.M. With standard double outlet receptacle with overload fuse protection. Runs 3 hours on 1/2 gal. gas. Complete, ready to operate. 20 1/2" x 12" x 16".

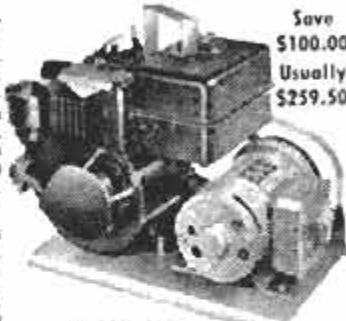

Save \$100.00 Usually \$259.50

GENERATOR 1000 WATT continuous duty. 115 volt, 60 cycle, single phase, A.C. automatic voltage regulation. Ball Bearing.

ENGINE, Famous easy starting 2 3/4 H.P. Briggs & Stratton, 4-cycle air-cooled, with automatic recoil rope starting. Adjustable automatic governor. Adjustable jet carburetor.

159.50 F.O.B. Chicago

OBERDORFER BRONZE CENTRIFUGAL PUMP

For: Fluid Transfer, Sprinkler Boost, Circulating, Marine Coolant

Designed for continuous, heavy service. Carbon bearings require no lubrication. For direct or belt-drive with speeds up to 3450 RPM. All bronze housing and impeller with 1/2" stainless steel shaft. Has 3/4" inlet and outlet, CCW rotation.

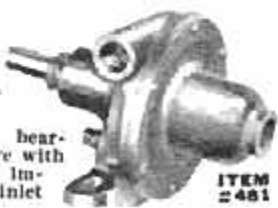

ITEM #481

Using 1/4 H.P. Motor delivers —

Head in Feet	0	4	6	8	12	16	20
GPM							
1750 R.P.M.	3.00	2.00	1.25				
3450 R.P.M.	7.25	6.75	6.50	6.25	6.00	5.25	4.25

Regularly \$26.50 **OUR SPECIAL OFFER 8.95 Ea. Ppd. 2 for \$17.50**

GROBAN FOUR-WAY OPEN CENTER HYDRAULIC CONTROL VALVE

Item #126—Four-way open center control valve, with built-in adjustable relief valve factory set at 1000 P.S.I. Spring loaded neutral position. For use with one double acting cylinder. In neutral position cylinder is locked and pump unloaded. Can be used as single unit or mounted in series. Has 3/4" pipe thread inlet and outlet. 1/2" pipe thread cylinder ports. Finger grip handle. Ship. wt. 10 1/2 lbs.



AN OUTSTANDING BUY!
 F.O.B. Chicago..... **23.50**

SPECIAL BARGAIN SECTION—SENSATIONAL BUYS

WESTINGHOUSE BLOWERS



ITEM 490—Aircraft quality. For marine use—operate on 12, 24, or 32 volts—trucks & trailers. Dim. 12" L. x 9" W. x 8" D. U. S. Air Force paid \$197.00. 12 lbs. F.O.B. Chicago..... **\$17.50**

110 Volt 60 Cycle Selsyn

For Remote Indicators, Weather Vanes, Steering Systems, Antennas, Trans., & Recs., connects by 5 wires, uses house current.

Transmitter... **\$519A \$7.50**
 Receiver... **\$519B \$7.50**
 Differential... **\$519C \$5.00**

POWER CABLE

Good up to 600 volts. Insulated heavy duty Neoprene jacketed. 2 conductor. #9. Lugs on both ends. Now... per 100 ft. coll... **\$14.95**



24 VOLT DC ELECTRIC MOTOR

ITEM 544—1/30 H.P. Right angle output shafts. 1 shaft direct drive, other shaft has 100:1 reduction. Reversible 8 lb. F.O.B. Chicago..... **\$7.95**



FREE!

NEW CATALOG. 60 pages of unsurpassed war surplus & new equipment bargains. Write today or call WEBster 9-3793.

GROBAN SUPPLY CO. Dept. PM-3
 1139 S. WABASH AVE., CHICAGO 5, ILL.

pull the trigger...
spray paint

7 times faster than brushing!



Speedy Sprayer ONLY \$32.00 less motor

Paints anything from a house to a toy. Saves its cost on the first major job! Speedy Sprayer does in minutes what brushing takes hours. Finish is smooth, flawless. Uses any 1/4 h.p. motor with 1/2" shaft. No. 780 Outfit—10 ft. air hose, tire chuck, quart gun, less motor, only \$32.00. Every workshop should have it. At leading stores.

Free! Write for "How To Spray" Booklet and folder.

W. R. BROWN CORPORATION

Specialists in Portable Paint Sprayers for Over 37 Years
2635 N. NORMANDY AVENUE, CHICAGO 35, ILL.

FREE PLAN
tells how to start your own business
FILING SAWS

Here is a steady repeat CASH business you can start in your own basement or garage in your spare time and make from \$3 to \$8 an hour. You can file hand, band and cross-cut circular saws on the Foley Saw Filer. No eyestrain—no experience needed.

"The first saw I sharpened with my Foley Filer came out 100%"—writes Clarence E. Parsons.
Every saw you sharpen with the Foley Saw Filer brings you more customers. "I rented a two-car garage and have all the work I can do."
—Charles H. Smith.

FREE BOOK
Shows How to Start
Send coupon today for "Money Making Facts" and time payment plan. No salesman will call.



SEND COUPON FOR FREE BOOKS

FOLEY MFG. CO., 316-9 Foley Bldg.
Minneapolis 18, Minn.

Send me free book "Money Making Facts," and Time Payment Plan.

Name _____

Address _____

284

UNIVERSAL JOINT



1 1/4" OD trouble free service even in corrosive or abrasive atmosphere and liquids or in extremes of temperatures. Exclusive flexible cover hermetically sealed to insure clean sustained lubrication.

7.50 Value
Our Price
\$1.39 ea.
postpaid
or \$5.00
box of 5

METALS, INC.
FAIRBURN, GA.



PAGE FOR TILLING PLOWING MOWING

FULL LINE 2 to 9 HP with complete gear drive and reverse.
Free Catalog LOW PRICES EASY TERMS Over 40 Years Experience
FULLY GUARANTEED! Over 60 attachment available!

PAGE 1904 S. 81st STREET MILWAUKEE, WIS.

"ARCO SCREW-DRILL"



FOR EVERY WOODSCREW

DRILLS HOLE, COUNTERSINKS, COUNTERBORES in 1 Operation Adjusts for ANY Screw Length!
Set of 4 drills for all 6-8-10-12 wood screws—flat, round, oval heads. Use with hand or elect. drills on woods, plastics, aluminum. Send check, M.O.—ppd. No COD... **\$3.69**
Order today on our 20-day Money Back Guarantee.
ARROW METAL PRODUCTS, Dept. PM-3, 421 W. 203 St., N.Y. 34, N.Y.

MAKE YOUR OWN FURNITURE



200 Pages
Full-color section
\$3.50



Cocktail Table



Dining Chair



Combination Wall Bookcase and Desk

New POPULAR MECHANICS book helps you Beautify your home and save hundreds of dollars on such items as these!

Yours for the asking!... a handsome cocktail table, a new dinette set, a desk. You'll find easy to follow plans and instructions for these and many other modern furnishings that will add to the beauty and comfort of your home. Each piece of furniture is designed by leading craftsmen, for years of use. Translated by POPULAR MECHANICS into words you can understand, "MODERN FURNITURE YOU CAN BUILD" is an asset to any home-maker. You'll save as much as 2/3rds the cost of ready-made furniture. In this 200-page treasure chest, you'll find a big full-color section plus a full chapter on modernizing old furniture. Even if you build only one article from its designs, you'll save many times the price of this book.

Mail coupon below today.

POPULAR MECHANICS PRESS, Dept. 359
200 E. Ontario St., Chicago 11, Ill.
RUSH my copy of Modern Furniture You Can Build. I enclose \$3.50 check or money order in full payment. Send COD (U.S. only). I am protected by full money-back guarantee if not pleased.

Name _____

Address _____

City _____ Zone _____ State _____

POPULAR MECHANICS

NOW the perfect garden sprinklers

MODEL No. 555B-D50



B-Line

"Guaranteed for a Lifetime"

A B-LINE SPRINKLER FOR EVERY NEED. 14 MODELS AND SIZES.

A tremendous new value . . . B-Line Garden Sprinklers give such exceptional service that we can guarantee them against wear for a lifetime.

at leading hardware and garden supply stores

Ask to see . . . the B-Line Guarantee

BUCKNER SALES CO.
P. O. Box 232, Fresno, California

FREE AMAZING NEW BOOK "HOW TO ANSWER ADS"



Never before have you seen anything like this. Tells you in simple language the correct way to answer ads. Gets you quicker replies—better results, and greater satisfaction. Will save you time and money and it's **ABSOLUTELY FREE**. No obligation whatever. Every reader of advertising should have this booklet. Send a postcard for your copy NOW. F. W. JOHNSON, Popular Mechanics Magazine, Room 600-A, 204 East Ontario Street, Chicago 11, Ill.

MILWAUKEE NEW "QUICK-SHIFT" is 3 vises in 1

used for WOOD WORKING



PIPE WORK



BENCH WORK



"Shift" to new speed! Rugged new vise operates in 2 ways . . . conventionally . . . or by using "shift lever" which permits moving the movable jaw in or out . . . instantly. You touch screw handle only when "tightening up". Write today for complete data.

Distributor and dealer inquiries invited!

MILWAUKEE TOOL & EQUIPMENT CO.
2778 South 29th Street, Milwaukee 46, Wisconsin



SAVE UP TO 85% ON SURPLUS ELECTRIC VARIABLE SPEED HYDRAULIC TRANSMISSION

COST GOV'T APPROX. \$500.00

An electric, reversible variable speed transmission. Use where remote or automatically controlled variable speed drive is needed. . . on Lathes, Band Saws, Conveyors, etc. As a Torque Amplifier it will operate a Boat Rudder, Robot Manipulators, etc. As a Servo Motor it will operate large Valves, Ventilators, etc.

Each unit is complete with variable displacement hydraulic pump and motor, both integrally mounted inside oil reservoir. Electric motor is 5/8 HP, 220 volt, 60 cycle, 3-phase - 3425 RPM. - Remote unit has electrical Selenium motor. Lowest gear reduction is 24 to 1 giving tremendous torque thru 1" output shaft. Delivers 435 in. lbs. of torque at 50RPM. Also available with 3/4 HP, 3425RPM, single phase electric motor of same price.

MANUAL CONTROL **138.00** REMOTE CONTROL **148.00**

180°-85 TO 1 GEAR BOX

Has 6-gear train. Self-lubricating, high speed roller bearings. Take-off shafts are 1-1/4" & 3/8" diameter. Overall size is 6" x 4" x 2-1/2". Has a 180° offset drive. High torque at low RPM. A real BUY!

USED **5.95** NEW **8.95**



BENDIX GEAR PUMP & MOTOR

Delivers 3-1/2 gal. per minute. Up to 600 PSI pressure. Motor is 1-1/2 HP, 24 V., DC - use on 12 or 32 volts. Has built-in relief valve. Parts are 3/4" inlet, 1/2" outlet with standard pipe threading. Ideal for use on Hydraulic Lifts, Portable Loaders, etc. Catalog No. HPU-605U

NOW 8.88

SAVE **PEG BOARD** SAVE 50% PER SHEET **79¢ SHEET** GIANT 2 ft. x 4 ft. 6 SHEETS for Only \$3.95

Peg Board has become a MUST for the well ordered home. Convenient for closet walls, in the kitchen or above workbench.

WINCH HOIST 2-TON ONLY 29.95

Has a 4 to 1 gear ratio. Positive action dog type brake plus a drum-shoe type brake. Drum is 6-1/2" wide with 2-1/2" cable depth. Overall size: 14" x 12" x 13" high. Complete with mount frame & crank.



18 TO 1 RATIO MIDGET HOIST

For use in opening Garage, Factory, Shop door, small boat winch, etc. Will operate from 100-115 volt AC current when using transformer (shown below) to step-down the voltage to 24 volt. Reversible motor turns at 9000 RPM. Gear box has 18 to 1 ratio. Power take-off shaft turns at 500 RPM. Limit switches set length of travel or can be inactivated for continuous use. Has magnetic clutch. SAVE! Now ONLY **5.75**

115 VOLT TRANSFORMER for above -

Will step-down voltage on motor of hoist above for 110 V current **3.95**



1500 PSI HYDRAULIC CYLINDER Dbl. action. Has bore of 1", shaft 5/8" stroke 4", length 9". Parts 1/4" AN. Cost gov't approx. \$35 **4.88** Catalog No. H-SASU

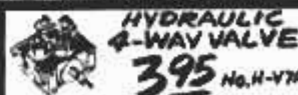

HYDRAULIC 4-WAY VALVE **3.95** No. H-VTA-1 Spring loaded, poppet type. Pressure balanced. Off in neutral. Has 1/4" tube ports. Cost gov't approx. \$30.



20,000 lb. THRUST CYLINDER - Dbl. action. Bore 4", stroke 18", shaft 1-1/2", length 31". May be used on low pres. air systems. Cost gov't approx \$390. Cat. No. H-295U Overhauled **49.95**

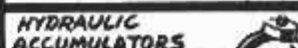

HYDRAULIC ACCUMULATORS Bendix ball type. For 3000 PSI pressure. HA-5 5/8" - 5/8" diam. \$27.50 HA-7 - Has 7" diameter . . . \$32.50 HA-3 AN - New. 2000 PSI. 5/8" . . . \$15.75 HA-3AU - Used. 2000 PSI. 5/8" . . . \$10.75

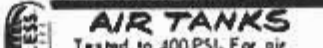

AIR TANKS Tested to 400 PSI. For air chemicals, etc. 1/4" ports. Capacity 2100 cu. in. 12 1/2" x 24", No. G-1U **12.95** No. G-1N - NEW condition . . . \$16.95

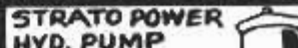

STRATO POWER HYD. PUMP Delivers 10 gal. per. min. at 1500 RPM at 3000 PSI. Pressure adjustable from 2800 to 3800 PSI. A variable displacement piston type pump. **99.50** Displaces 1.694 cu. inches per rev



J-1 AIR or CHEMICAL TANKS - 18,000 cu. in. capacity (77 gallons). Stainless steel. 24" x 45". Worth \$150 - Cat. No. J-1 **99.50**

NOTE: We stock the Largest on-the-shelf supply of Hydraulic Equip. in the country. Send for Catalog H-59 for other Hydraulic Pump, Tubing, Fitting or Motor Bargains.

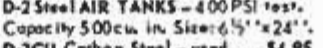

D-2 Steel AIR TANKS - 400 PSI test. Capacity 500 cu. in. Size: 6 1/2" x 24".

D-2CU Carbon Steel - used. . . \$4.95

D-2C Carbon Steel - NEW \$5.95

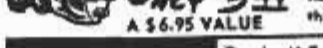

MULTI-STREAM SELF-CLEAN Shower Head ONLY **3.44** A \$6.95 VALUE

NEW SHOWER HEAD

Of heavy duty chromed brass. Gives a needle shower or heavy spray or flip of the lever. 2" head. Easy to install. SAVE!

Pay by M.O. or Check. P.O.'s accept. from D&B firms 1/2 dep. with C.O.D.'s Prices F.O.B. Los Angeles.

3263 E. VERNON AVE. DEPT. PM-59 LOS ANGELES 58, CALIF.

CUT-TO-FIT HOMES CUT BUILDING COSTS

CHOICE OF 57 DESIGNS

ORDER NOW

SAVE UP TO 1/3



Build your own home and save the builders' profit—plus savings in lumber and labor with Sterling Ready-Cut-Homes. Anyone can assemble with simple, easy to follow plans furnished. Every house complete with all lumber, roofing, nails, glass, hardware, paint, doors and windows marked ready to erect. Freight paid. Complete building plans ready for filing at low cost. Sold separately if desired. Write today!

PRICED FROM \$2150 up

Five Easy Payment Plans

Send 25c for NEW COLOR CATALOG

INTERNATIONAL MILL AND TIMBER CO.
DEPT. PM39 BAY CITY, MICHIGAN

ROTARY MOWERS



22" riding type only \$165 at factory

ALL steel construction — reverse gear. Save miles of walking. Many attachments available, cultivator, snow blade, etc.

DEALERS WANTED

WRITE TODAY—for additional information.

HALGOLMAR CO. 905-S E. MAIN CHERRYVALE, KANSAS
Warehouse stock in Ohio & State of Washington

WORK BENCH - TOOL CASE

A Home Worker's Dream!

In two evenings of fun assemble your own Handsome, Deluxe 29" x 6' heavy duty Work Bench with upright Tool Case for only \$25.00. A saving of app. \$30. Write now and get: (1) Complete easy to follow plans and directions for assembling; (2) Material list for purchasing by your lumber dealer; (3) Hardware list. Your money back if you are not entirely satisfied.



WILSCRAFT

Complete Plans and Specifications \$1.00
P. O. BOX 422, EAST POINT, GA.

Find HIDDEN TREASURES

GOLD, SILVER, PRECIOUS METALS with the Famous Model 27 Metal Detector. Lightweight, ultra-sensitive, low cost. None finer. Also GEIGER COUNTERS for uranium and the VIOLITE for tungsten. INFORMATION FREE

THE *Detectron* CORP. Dept. 5
5528 Vineland Ave., No. Hollywood, Calif.



BRONZE FOUNDRY School and Home Workshops

Make your own castings of aluminum, copper, bronze, silver. Foundry sets are available in 3 sizes including 2400 Degree F. Blast Furnaces. \$26.50; \$33.50; and \$46.00. Free Circular.

KANSAS CITY SPECIALTIES CO. DEPT. P-3, P.O. BOX 6022
MARYSVILLE, KANSAS

HAVE FUN!

SAVE MONEY



TRY SUPERSHOP FREE

Factory To You — \$79.95

Think of the fun you'll have and the money you'll save with your own big capacity workshop. Picture yourself sawing with the 8" ball bearing saw. Or drilling in steel with the vertical drill press. You bore with the horizontal drill—exclusive with SUPERSHOP. You sand with the 8" disc sander. You turn with the 30" lathe. You sharpen tools on the 5" grinder.



VERTICAL DRILL PRESS

You are invited to TRY SUPERSHOP FREE. We will pay all shipping expense. Write for full details of this amazing FREE TRIAL PLAN. Mail postcard now.

Power Tools Division UNITED INDUSTRIES, Inc.

117 Yates Ave. Beloit, Wis.

BUILD FINE GRANDFATHER CLOCK NOW

The simple sensible SPEEDE Red-i-Kut way as thousands have—FOR YOURSELF OR SELL AT A GOOD PROFIT. SAVE HUNDREDS OF DOLLARS. SHOP TESTED PLANS "SPIRIT OF THE CENTURY" Narrow waist 63" tall or stately straight side "SPIRIT OF AMERICA." EASY-to-FOLLOW photopack! PLANS & LIFE SIZE PATTERNS toll all—plus MOVEMENT BROCHURE \$4.00 up, of heavy brass weight (Kuempe! original) Westminster tube BELL, chime, movements, gorgeous bronze-silver MOVING MOON dial, 3/4" solid-mahogany Jiffy Joint-Kwik-Bit case kits. Send \$1.00 today—both plans RUSH \$1.50 as folks have for over forty years.

Kuempe! Chime Clock Works, 214 Kuempe! Bldg., Minneapolis 16, Minn.

HUNTER TOOLS

HOLDS... DRIVES... REMOVES SCREWS

YOUR DEALER HAS ALL SIZES

DON'T DROP SCREWS!

USE AN AUTOMATIC

Magic-Tip

SCREW HOLDING SCREWDRIVER

FREE ILLUSTRATED CATALOG
HUNTER TOOLS • 6851 ALBERTS
SANTA FE SPRING, CALIF.

AMERICA'S BEST JET STEAM MASTER

Now, a super efficient portable steam generator that produces live steam at 100 lbs. pressure in 60 seconds from a cold start! Produces large volume of high pressure steam on 2 pints of fuel oil. Instantly cleans sticky grease, dirt, rust, old paint, etc. off implements and road machinery. Pays for itself in a few weeks. Sterilizes soil. Sterilizes as it cleans—milk equipment, etc. Fully automatic—oil fired with new, built-in lifetime bronze water circulating pump. Draws water from faucet or bucket. Simple and safe—anyone can use it; built-in safety valve. Complete with 12 ft. of hi-pressure steam hose and new triple efficiency steam gun that automatically mixes in soap solution if desired. Wt. 250 lbs. Item 463. **\$349.50** Special factory price.



ELECTRIC HOIST

2000 lb. CAPACITY. A fortunate purchase from the Air Force enables us to offer these powerful 2000 lb. electric cable hoists at a fraction of their value. Perfect for material handling, boat hoists, elevators, lifts on assembly lines, etc. Two separate 22 ft. lift cables with independent controls permit leveling the load and controlling it perfectly. Rugged ball bearing motors of geared down design 110 volts. Available for A.C. or D.C. Please specify. Makes a terrific portable hoist with our #273 D.C. light plant at \$99.75. Offered at less than 33% of regular cost (Hook not included). Wt. 145 lbs. A.C. Model, Item 847A. **\$149.50** D.C. Model, Item 847. **\$129.50**

MASTER AIR COMPRESSOR

COMPARE! This is the only compressor built with a NO RUST stainless steel tank. Safe up to 500 lbs. (Item 209) High pressure type (4 c.f.m.) Large volume of air for heavy duty service. For paint spraying, inflating truck & auto tires, greasing, sand blasting, etc. Piston type 2" bore compressor with built-in air filter. Master built with high strength alloys and precision bearings. Tank 12"x24", 2100 cu. in. cap. Equipped with automatic switch that starts and stops motor to maintain desired pressure (up to 150 lbs.) and check valve. Blow-off, shut-off valve, 20 ft. air hose and tire chuck. Beautifully balanced on ball bearing wheels and rubber tires. Don't take chances with used or surplus equipment. Our compressors are factory new and are guaranteed **SAFE.** Low factory prices. **1 1/2 HP Model (cap. 85 lbs.) \$109.50** Reg. \$175. (Item 209) **1/2 HP heavy duty model, Reg. Ind. motor & unloader switch (Item 209a) \$129.50**



Tank Tested up to 500 lbs. per sq. in.

SPECIAL DEALS

MINE DETECTOR for detecting buried pipes, wires, sewers, etc. Carrying case **\$49.50**
AIR HAMMER for hammering dents out of auto bodies. Complete with 2 different shaped arms and 5 bumping dollies. Hammer can also be used without arm for chiseling and drilling, etc. Uses 4 cfm at 60 psi. **\$39.50**
SCREW JACK—16 ton Simpex Jack, 1 1/4" screw, 16" lift. Reg. price \$29.50. **\$9.50** Special Price
HYDRAULIC PRESS. 9 ton press for pushing, bending, straightening, etc. \$365 List. Special Price **\$69.50**
SCREW PRESS. 9 ton capacity with 21" throat. Complete with adjustable table. **\$49.50**
EXTENSION CORD. 2 cond. #14. Neoprene—100 ft. **\$6.95**
2 cond. #12 Neoprene covered—100 ft. **\$7.95**
3 cond. #10 Neoprene covered—100 ft. **\$13.95**
INTERCOM SET. Powerful loud talking intercom set powered by 4 flash light batteries which last for 6 months. Good up to 1,000 ft. Complete with 2 stations—250 ft. of wire and batteries. **\$11.95**
PORTABLE BLOWER powered by 2.2 Briggs Gas engine. Used for ventilating man holes, tanks, or any ventilating purpose. Complete with 20 ft. of 4 in. flexible pipe **\$99.50**
EXHAUST FANS—Heavy duty, powered by sealed explosion proof motors, mounted in steel frames. Ideal for ventilating spray booths, barns, taverns, etc. **\$29.75** 20" fan, only.

MASTER MECHANIC'S BEDROCK FACTORY PRICES



700 WATT LIGHT PLANT
PUSH BUTTON START
115 v. 60 cyc. AC Powered by a rugged 2.2 HP. easy starting Briggs engine. No wiring necessary; just plug in and operate. Plenty of current for any oil burner, freezer, brooder, emergency lights, etc. which require up to 700 watts. Ideal for television and radios. Complete with voltmeter and built-in winding to charge 6 v. auto batteries. (Item 24) Wt. 75 lbs. Easily fits in car trunk. Be prepared if storm knocks out power lines. **\$143.50**
Regular \$275.00 value.
1200 Watt Plant (Item 45) same as Item 24 but larger generator and engine **\$199.50** with 50% greater output.
We make every type and size of light plants. — Write giving us your requirements!

MASTER D.C. ARC WELDER

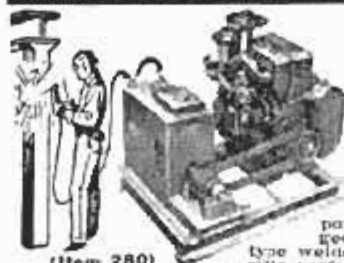

Easy To Use
Now a portable rugged, industrial type welder with terrific performance, yet at a price hundreds of dollars less than you'd expect. Senior model made for years of trouble-free, continuous service. High capacity DC welding unit enables you to tackle any job with confidence—easily welds anything up to 2" plate using from 1/16" to 1/4" rods. Built-in stabilizer and cooling system makes arc easy to strike and hold. Dual control rheostat provides low heat soldering, brazing and welding from 30 to 300 amps. Complete with instructions, guarantee and triple V-belt or flat pulley. Easy to hook up and easy to operate.
WELDER ONLY—DUAL CONTROL MODEL. Same as above, but drive with your tractor, jeep or gas engine of 1 1/2 HP or more. (Item 3Ba.) Wt. 110 lbs. \$450 value **\$119.50**
WELDER ONLY—INDUSTRIAL MODEL same as above but with ceramic rotary type rheostat providing 74 different heat settings for all types of welding (Item 3Bb) **\$139.50** \$500.00 value.
COMPLETE POWER MASTER (illustrated above) powered by a 16 hp., air cooled Wisconsin engine. Wt. 480 lbs. (Item 280) Compares with welder costing \$1200. **\$449.50** Factory Special.

SPEED SELECTOR. Heavy duty made by B. F. Goodrich for industrial use. Provides instant speed selection. Employs reliable planetary system—no power losses. 1-2 HP size. **\$89.50**
HAND WINCH—3 ton, ball bearing. 2 speed. Lightweight but strong. Takes up to 500 ft. of cable. Special. **\$59.50**
BATTERY CHARGING GENERATOR SET. 750 watt, charges 12 or 24 volt batteries, made by DELCO. Engine runs at 1800 RPM. Makes a potent cold weather motor start-up unit as well as a fast charger. **\$119.50**
MOTOR-GENERATOR SET—115 v. 3KW D.C., output with 5 HP-3ph. direct connected motor. Ideal for magnetic chucks, variable speed motors, or electro-plating complete with controls. **\$349.50**
ALUMINUM CONVEYOR—ball bearing skate wheel type, 12" wide, 8 ft. sections & 4 ft. sections. Hook together to form any length desired. Very light and strong. **\$34.50** 8 ft. section (Wt. 40±)
4 ft. Section (Wt. 20±) **\$17.50**
ELECTRIC WATER PUMP—Centrifugal pump—1" pipe thrd.—direct connected to heavy duty sealed 15v. A.C. motor. Ideal for draining tanks, transferring fluids, etc. Capacity 800 g.p.h. Reg. \$79.50. **\$29.50** Special
FOOT VALVE—for above pump. **\$1.95**
WATER PUMP, self-priming pump coupled to a 2.2 HP Briggs engine. Delivers 600 GPH. Pump has both garden hose thread & 1" pipe thread. **\$79.50**

LESS THAN WHOLESALE

1500 WATT PLANT
115v. 60 cyc. AC Push Button Start. Powered by a 4 HP. Clinton engine. Combines big output with easy portability. Provides emergency power for operating any oil burner, sump pump, freezer, television, lights, communications systems, etc. which require up to 1500 watts. (Item 22) Wt. 110 lbs. Reg. \$475 value. **Factory price... \$239.50**
1750 Watt Plant Powered by 4.5 Briggs engine. Electric starting & battery charging built-in. **Factory price... \$279.50**
2500 WATT PLANT—Push Button Start (Item 21) 110/120 v. 60 cyc. A.C. A rugged powerful plant. Reg. \$645. Spec. **\$329.50**
3500 Watt Plant Push Button Start (Item 23) 115 v. 60 cyc. AC. Similar to above but larger and 33% more capacity. Wt. 270 lbs. Reg. \$760. **Factory Price... \$379.50**
DUAL VOLTAGE 110/220 for Item 21 or 23—\$30 additional.



EXCLUSIVE! NEW!

LIGHTWEIGHT WATER COOLED DIESEL GENERATOR PLANT

Never before available! Now offered exclusively by Master Mechanic. A low priced, lightweight, continuous duty Diesel generator set. Powered by a super rugged, exceptionally smooth running, one cylinder Diesel engine. Operates at conservative 1750 r.p.m., and delivers full 1750-2000 watts of power. Operates on low cost fuel oil. Wt. only 240 lbs. representing a triumph of Diesel Engineering. Complete with fuel filter, oil pressure gauge, control box with duplex receptacle and voltmeter. (Item 830) **\$429.50** Special factory price.



115V. AC
2000 W.

SPEED REDUCER

Ideal for lathes, grinders, conveyors, displays, etc. Rugged gear type speed reducer, ball bearings, either increase or reduce speed up to 100 to 1. Takes up to 1 1/2 h.p. Compact. (7x8x5). Wt. 10 lb. **Item 854... \$19.95**

ELECTRIC PUMP

FILL TANKS—DRAIN CELLARS—IRRIGATE **\$29.50**
Powerful completely enclosed G.E. motor direct connected to a 1" pump, portable, pumps anything, std. thrd., use any hose, foot valve incl. free. 10 day money back guar. Wt. 26 lbs. Item C-853 **\$29.50**



Double Acting Hydraulic Cylinder



A powerful cylinder mfr'd. by Massey Harris which develops both a pushing and a pulling action. Will push 8,100 lbs., with a 1000 PSI pump pressure. Cylinder is 3 3/4" O.D. with 6 1/2" stroke—standard heavy duty cylinders on both ends. Has standard 1 1/2" pipe thread on ends. Can be used for lifting buckets or blades, raising or lowering implements, hydraulic presses, etc. Can also be used as an air cylinder. (Item 802) Wt. 17 lbs. Reg. \$68 value. Special **\$14.95**

OTHER DOUBLE ACTING CYLINDERS
6" stroke—1 1/4" bore **\$ 8.95**
8" stroke—3" bore **34.00**
10" stroke—3" bore **34.80**
16" stroke—3" bore **43.00**
24" stroke—3" bore **47.50**
42" stroke—5" bore **75.00**
60" stroke—5" bore **125.00**
We have all sizes of cylinders available.

HYDRAULIC CONTROL VALVE—4 way open center valve with built-in adjustable relief. Controls 1 double, or 2 single acting cylinders. Equalizing feature permits easy control even under heavy loads. 3/4" pipe thread on inlet & outlet. 1 1/2" on cylinder outlets. Easily mounted, finger tip control. Wt. 16 lbs. (Item 822) **\$21.95**
HYDRAULIC PUMP drive from tractor power take off or with separate engine or motor. Capacity is 8 GPM at 800 RPM—has 3/4" shaft with keyway. **\$39.50**
HYDRAULIC HOSE COUPLERS Connect or disconnect hydraulic lines without loss of oil. 1/2" pipe threads. (Item 819) per set **\$3.95**

WELDING KIT Two 10 ft. leads, welding helmet, electrode holder, ground clamp. Sold only with welder at... **\$10.50**

Send check or M.O. Prices f.o.b. Factory. 10 day Money back guarantee. SEND 10c for **BIG NEW Catalog**
MASTER MECHANIC MFG. CO., DEPT. A39 Burlington, Wis.

ALL NEW!

LUXURIOUS "HAND-RUBBED"
NATURAL WOOD FINISH
WITHOUT THE RUBBING!

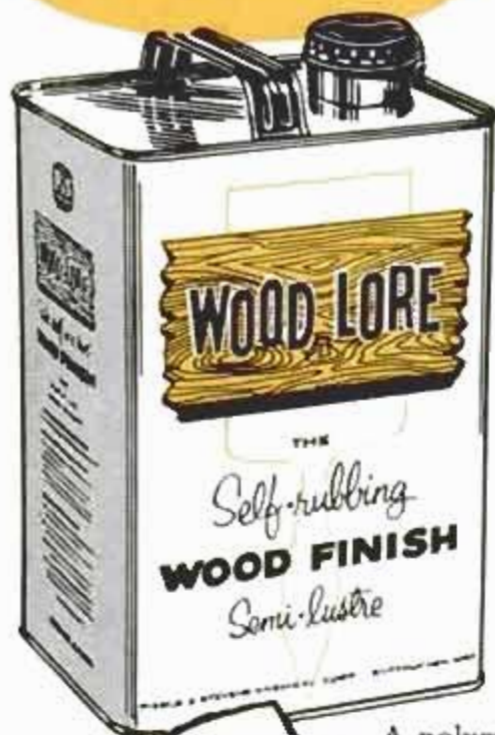

"Rubs itself as it dries"^{DD}

A triumph of space-age chemistry, WOOD LORE is the first semi-lustre clear coating that really produces a "hand-rubbed" finish . . .

- * without primers or sealers
- * without special tools or talents
- * without laborious rubbing

A polymeric resin formulation with a natural affinity for wood, all-new WOOD LORE accentuates grain patterns, tones and shadings . . . actually mellows the natural glow of the wood. Though expressly designed for large wood-panelled areas and similar vertical wood surfaces, WOOD LORE is also ideal for other wood interiors . . . kitchen cupboards, doors, cabinets, book shelves, unfinished furniture, etc. Use WOOD LORE over new work and old finishes alike . . . gives the same luxurious "hand-rubbed" effect . . . truly a decorator's delight!



Other miracles of modern chemistry for homemaker and hobbyist



FABULON the fabulous WOOD FLOOR FINISH. Never needs waxing or scrubbing!



FABULOY clear finish with Resin "X". Preferred to varnish for a brilliant, high-gloss wood finish.



PRYME the fabulous first-coater . . . seals thirsty wood. Best start for a better wood finish.



FAME the WAXLESS wondercoat for linoleum, asphalt tile, rubber and vinyl floors. Twice the wear with half the care.

At paint, hardware and lumber dealers coast-to-coast

Send 25c in coin for comprehensive illustrated step-by-step manuals on natural wood finishing; complete data on finishing and care of all types of wood floors; modern maintenance methods for all resilient floorings.



To:
PIERCE & STEVENS CHEMICAL CORP.
Dept. PM-3
710 Ohio St., Buffalo 3, N. Y.

Enclosed is 25c in coin; please send complete data on wood finishing and floor care to -

Name _____

Street & No. _____

City _____

Zone _____

State _____

Remember Any Name or Face...

A KNACK THAT'S WORTH A MILLION!

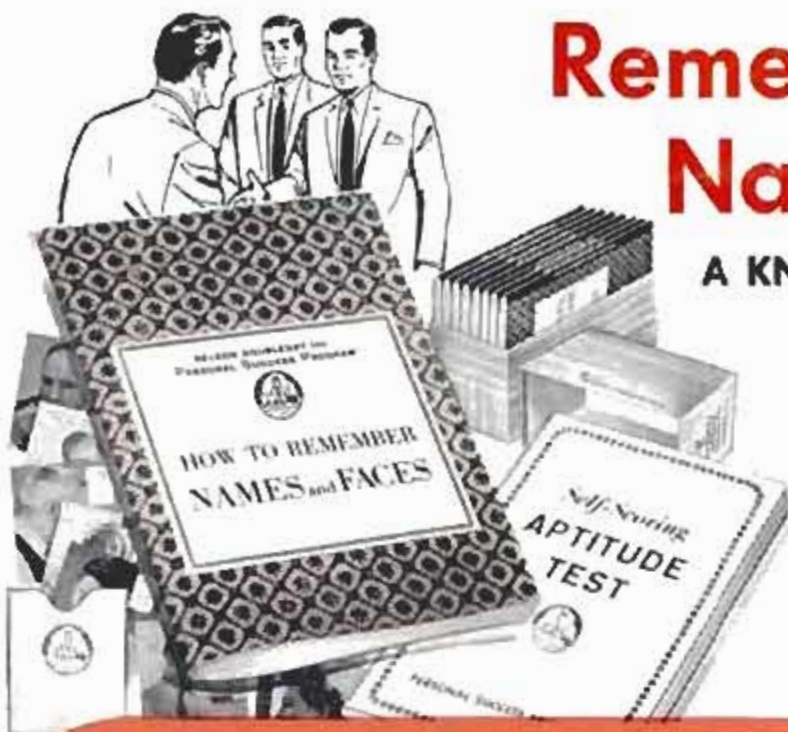

THE man with the "photo" memory possesses the most valuable advantage in the world. When you can instantly recall names, faces, facts, you always appear at your best in any business or social situation. You make valuable friends, and your name is the first to come up when favors and "breaks" are passed around.

An expert memory is easy when you know the secrets of professional memory experts! With this revolutionary new Self-Training Kit, you can actually increase your "memory power" up to 500% in a few weeks! Kit consists of streamlined instructor manual, plus unique pocket set of practice and application cards which you can use inconspicuously at odd moments anywhere. Simple, yet scientific — you'll be amazed at the results! And it's yours virtually as a gift!

This Complete Rapid Memory Trainer Kit yours for only

10¢

including FREE Self-Scoring Aptitude Test and Handsome Desk File

to introduce you to the new NELSON DOUBLEDAY

PERSONAL SUCCESS PROGRAM

The Most Practical, Far Reaching Plan Ever Devised to Help Men Increase Their Earning Power and Enjoy the Good Things of Life!

MONTH by month . . . step by step . . . this brand new Nelson Doubleday Personal Success Program shows you how to develop the personal skills and techniques that pave the way to advancement . . . in any field!

Your introductory Rapid Memory Kit for 10¢ is a sample of the practical Progress Kits you receive each month — each a shortcut to mastery of an essential "success" subject. Each Kit, with instruction manual and "live" do-it-yourself material, is selected and prepared by business and psychological experts especially for this Program. There is nothing like it for completeness, authority and practical usefulness.

What Are These Success Skills?

Look at some of the highest paid men in business. They have developed the basic abilities that always pay off . . . the ability to handle people . . . to speak and write effectively . . . to create ideas and "sell" them to others . . . to organize their time efficiently and achieve more. They have learned to understand business procedures . . . what to read to keep well informed . . . how to win important new friends wherever they go. And they are just naturally sought out by others whenever a responsible job is to be done.

Few of these skills are "born knacks". They can be mastered with surprising ease by any ambitious man. Now, for the first time, the Personal Success Program offers you a tested, rapid, fascinating plan for making these "success" skills your own

— using only a few minutes a day — even the minutes you spend traveling or waiting. The cost is amazingly low — less than you spend for newspapers each month!

Unique "Live" Practice and Application Material

The Program covers every subject of value to the man who, regardless of his present position or training, wants to get ahead faster in business, social and civic life. Each subject is brought to you in a monthly package consisting of self-instruction manual, "live" practice material, and actual application material, carefully prepared and co-ordinated to bring results that you can see from day to day. These unique cards are a new dimension in self-teaching that set this Program apart from anything known before — and that will not be found even in courses costing hundreds of dollars!

Reach the Highest Goals

If you are tired of being in a rut, fed up with "two-bit" raises; if you want to move to a position of responsibility and earn enough to afford the better things of life for yourself and your family, then this Personal Success Program is for you. And make no mistake, there's plenty of room for you "at the top". The business world is actually short of men in the \$20,000-and-up class. It is up to you to take the qualifying steps.

Mail Coupon With Only 10 Cents

To acquaint yourself with the advantages offered by the Personal Success Program, accept this unusual "sample" offer. There is no obligation. If you are delighted with your first self-training kit and wish to continue with the Program, you will receive a new Progress Kit each month, for which you will pay, not the many dollars that most courses on these subjects would cost, but only \$1, plus small shipping cost. There is no minimum purchase requirement, and you may stop whenever you like. Mail the coupon today. No salesman will call. The Nelson Doubleday Personal Success Program, Garden City, N. Y.

MAIL THIS COUPON TODAY!

SEND ONLY 10¢
Stop When You Like

1.
"How to Remember
Names and Faces"
Manual and Cards

2.
Self-Scoring
Aptitude Test

3.
Handsome
Desk File

Nelson Doubleday Personal Success Program
Dept. 9-PM-3, Garden City, N. Y.

I enclose 10 cents. Send me at once my introductory package consisting of handbook "How to Remember Names and Faces," set of practice and application cards and pocket card holder. Also include my free Self-Scoring Aptitude Test and the handsome Desk File for convenient storing of future Progress Kits.

After examining this package, I will decide whether or not I wish to continue. If not, I will simply let you know. If I do continue you will send me a new Progress Kit each month for only \$1 plus shipping. I am not obligated to take any minimum number of kits, and I am free to stop at any time.

Print Name.....

Address.....

City & Zone.....State.....

Offer good only in continental U.S.A.

PS-1

Bring on your most luxurious outboard cruisers . . . put a weekend load aboard! The Mark 78A planes 'em! Hitch on half-a-dozen skiers. The Mark 78A lifts 'em from deep-water starts!



MERCURY THE MOST POWERFUL NAME IN OUTBOARD PLEASURE!



Photographed at Florida's Silver Springs

MARK 78A 70 hp, 6-in-line

World's Most Powerful Family Outboard. Exclusive HYDRAULIC DYNASHOCK ABSORBERS plus Safety-Tilt Switch protect boat, motor and passengers—restrain motor kick-up from underwater obstacles . . . return motor to water to avoid loss of steering. Exclusive FIXED-JET CARBURETORS eliminate all adjustments except for idle, as on your car. Truly the outboard of the year and of all time!



Unequaled thrust power for more fun per dollar, more work per dollar — yet so slim, trim and light that it's a perfect partner for speedy runabouts! Mercury's exclusive 6-in-line design gives you the *most* horsepower per pound, per cubic inch, per dollar; the most miles per gallon — the most propeller thrust per horsepower. *Certified* 50,000-mile dependability. 100+ mph durability! Exclusive single-lever one-hand control combines electric starting, choke, forward, reverse and throttle . . . shifts far faster, far more safely than old-fashioned gear shifts — without jolt or clashing gear noise — and bronze or aluminum propellers may be used! The engine that stays young for years is yours with Mercury. See your dealer for the rest of the story and a *free* demonstration ride!



THE WORLD RECORD LINE FOR '59 — 6 to 70 hp!

Write for *FREE* Catalog. Address Dept. PM-3
©1959 Kiekhaefer Corporation, Fond du Lac, Wisconsin