

POPULAR MECHANICS

MAGAZINE

WHAT YOU CAN UNDERSTAND IT

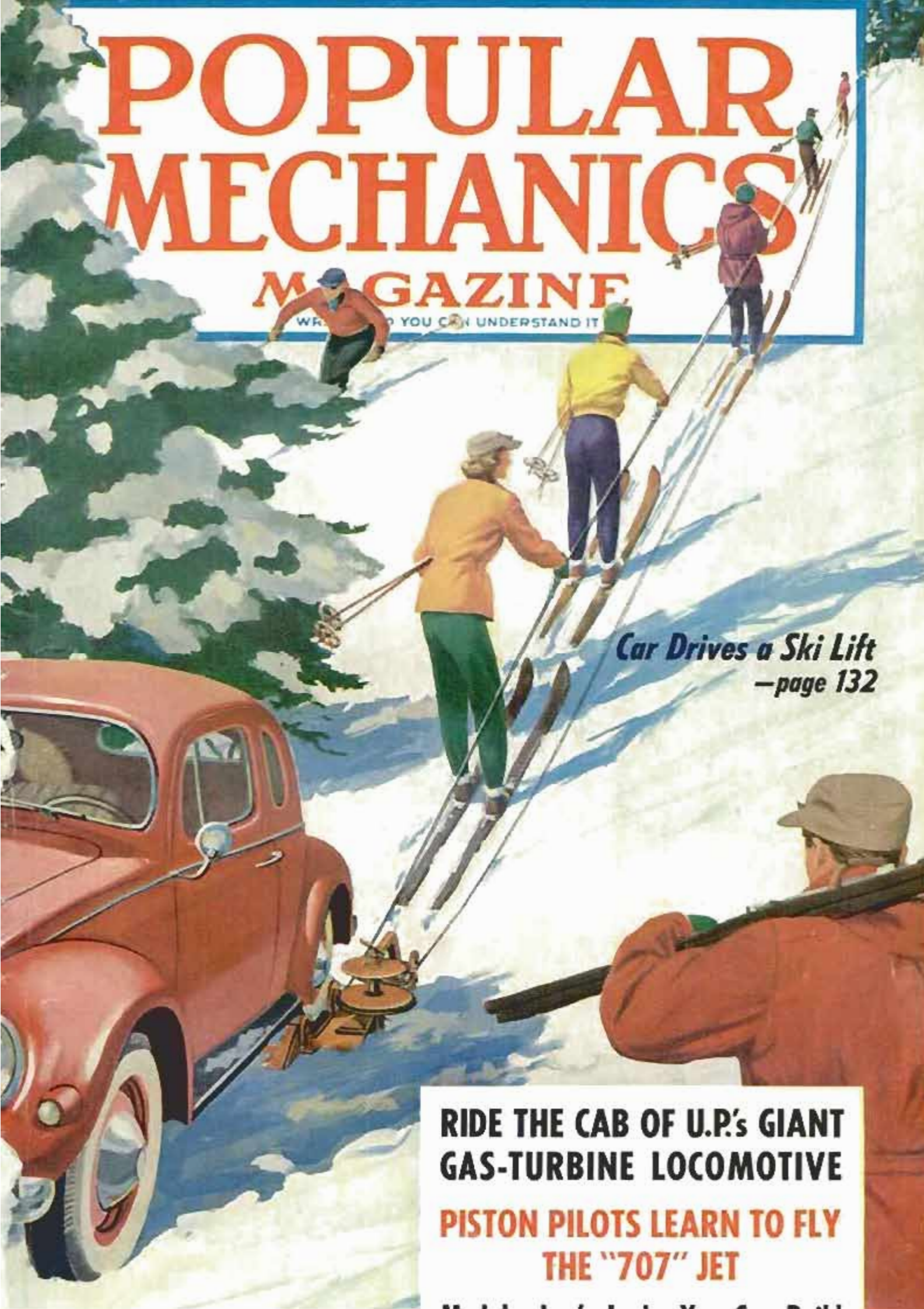

Car Drives a Ski Lift
—page 132

**RIDE THE CAB OF U.P.'s GIANT
GAS-TURBINE LOCOMOTIVE**
**PISTON PILOTS LEARN TO FLY
THE "707" JET**



MORE PLEASURE! MORE FEATURES! MORE VALUE!

more to be proud of in your new '59 Evinrude

Compare features against any and all comers... measure performance under normal boating conditions where it counts... and you'll know these Golden Jubilee Evinrudes set the pace for '59!

Start with Starflite's *V-Block engine*... smoothest, most advanced outboard motor yet produced! Delivers effortless high-torque power at moderate RPMs for better performance under all load conditions... and longer engine life.

Not 2, not 3, but one *single twin-barrel carburetor* feeds the V-4s with fool-proof efficiency. Lark and Big Twin have full-range automotive type carburetion.

Biggest "break-through" in years... thermostat-controlled engines! Now thermostatic control is built into every Evinrude from 5½ to 50 hp! Field tested by commercial fishermen from coast to coast... control tested by engineers... these "hot-blooded" engines proved their superiority in fuel economy, smoother operation, longer spark plug life, longer engine life!

Sound-sealed cushioned power... top to prop... now on all Evinrudes from 5½ to 50 hp! We bottled the sound and sealed it to give you a "magic carpet" of quiet, smooth power.

Full gearshift on all models from 5½ to 50 hp! New *high torque starter*, which draws less current, starts with battery low. Trouble-free *sea-going magnetos* permit manual starting of electric models without battery... a safety feature other motors lack. Rugged new dent-proof, high gloss *fiberglass hoods*.

These and many other features and refinements you'll find in the '59 Golden Jubilee Evinrudes. See the finest motors in 50 years at your Evinrude dealer. Look for his name in your phone book under "Outboard Motors." Ask for free '59 catalog, or write: **EVINRUDE MOTORS, 4394 N. 27th St., Milwaukee 16, Wisconsin.**

A Division of Outboard Marine Corporation
In Canada: Mfd. by Evinrude Motors, Peterborough



EVINRUDE

QUIET OUTBOARD MOTORS

NOW PLYMOUTH OFFERS THE BIGGEST V-8 IN ITS CLASS—AT A REDUCED PRICE!

Meet the New Golden Commando 395—bigger and quicker than its 1958 counterpart—yet lower in price! You can get this giant 361-cubic-inch engine with stick shift or new water-cooled TorqueFlite Drive.

Best news about the New Golden Commando 395 is, of course, that lower price. But there's plenty more to gladden your heart, too. For one thing, this special V-8 is now available even in the lowest priced Savoy Sedans and in popular Plymouth wagons, too. For another, there's the astonishing new smoothness and cat-quickness of this engine. For still another thing, it's got the highest torque per cubic inch of any engine built by Chrysler—395 ft. lbs. at 3000 RPM!

Bore of the New Golden

Commando 395 is 4.12 inches; stroke 3.38 inches; compression ratio 10 to 1. Maximum horsepower is 305 at 4600 RPM. There's a special high-performance camshaft, 4-barrel carburetor, low-restriction dual exhaust system, positive pressure lubrication system and all the other features you expect in a specially-engineered power plant from Chrysler Corporation. See your Plymouth dealer and test-drive the New Golden Commando 395 in one of his sleek, sure-footed new Plymouth models soon!

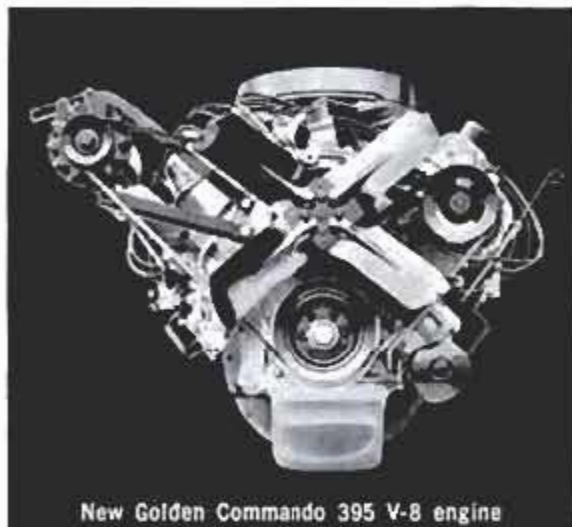

New Golden Commando 395 V-8 engine

TODAY'S BEST BUY . . . TOMORROW'S BEST TRADE

Plymouth



FEBRUARY 1959

This One



Popular Mechanics Magazine

Registered in U. S. Patent Office and Canada

Address all communications to: 200 E. Ontario St., Chicago 11, Ill.

Editor
RODERICK M. GRANT

Executive Vice-President
RICHARD E. DEEMS

Publisher
G. HARRY CHAMBERLAINE

Managing Editor
WAYNE WHITTAKER

Assistant Managing Editor
CLIFFORD B. HICKS

Shop Notes and Crafts Editor
JAMES R. WARD

Associate Editors, General Features
ARTHUR R. RAILTON, Automotive
KENNETH N. ANDERSON

Associate Editors, Shop Notes and Crafts
WAYNE C. LECKEY W. CLYDE LAMMEY

Radio-Television, Electronics Editor
LOTHAR STERN

Assistant Editors
SHELDON A. MIX, General Features
JAY W. HEDDEN, EARL WOBCEK, Crafts
JOHN DALEN, ARLENE HIRSCH, Makeup

Art Staff
FRANK BEATTY, Director
HENRY NEHRBASS, Assistant Director
RICHARD A. POTTS, Art Editor

Eastern Editor
RICHARD F. DEMPEWOLFF
Room 4102, Empire State Bldg., New York City 1

Western Editor
THOMAS E. STIMSON, JR.
Suite 603, 3460 Wilshire Blvd.,
Los Angeles 5, Calif.

London Manager
DOUGLAS W. WEDDERSPOON
Eagle House, Jermyn St.,
London S.W. 1, England

Director, Bureau of Information
ALLAN CARPENTER

Advertising Offices

Chicago: 200 E. Ontario St., Whitehall 4-0100;
New York: Empire State Bldg., 350 Fifth Ave.,
LOngacre 5-7580; Detroit: General Motors
Bldg., TRinity 5-8711; Cleveland: Hanna
Bldg., 1422 Euclid Ave., PROspect 1-0436; Los
Angeles: 3460 Wilshire, DUmkirk 2-8458; San
Francisco: Russ Bldg., 235 Montgomery St.,
Yukon 2-0823.

Published monthly by Popular Mechanics Company,
200 E. Ontario St., Chicago 11, Ill. Richard E.
Berlin, President; Richard E. Deems, Executive
Vice-President; Fred Lewis, Vice-President and
General Manager; John R. Miller, Vice-President;
G. Harry Chamberlaine, Vice-President; G. O. Mar-
kuson, Treasurer; R. F. McCauley, Secretary;
Joseph R. Buell, Jr., Advertising Manager. Single
copy in the United States and Canada, 35 cents;
subscription rates in the United States and pos-
sessions, Canada and countries of the Pan-Ameri-
can Postal Union, 1 year \$3.50; 2 years, \$6.00;
3 years, \$8.00. To all other countries add \$1.00
a year over United States prices for overseas
postage. If you plan to move, notify us at least
30 days in advance so you will not miss an
issue. Give both your old and new addresses.
Entered as Second Class Matter, September 15,
1903, at the Post Office at Chicago, Illinois, under
Act of March 3, 1879. Entered as Second Class
Matter at Post Office Dept., Canada, Registered
as Second Class Matter at the Post Office at
Mexico, D.F., Mexico, June 20, 1950.
Copyright 1959 by Popular Mechanics Company.
Copyright under International Copyright Union.
Copyright in France. All rights reserved under
Pan-American Copyright Union. Printed in the
United States of America.

FOREIGN EDITIONS:	MECANIQUE POPULAIRE (French)	MECANICA POPULAR (Spanish)	POPULÆR MÆKANIK (Danish)	POPULAR MEKANIK (Swedish)	POPULARE MECHANIK (German)
Volume 111			FEBRUARY 1959		Number 2

In This Issue...

Over the Pass With 8500 Horses	81
"Slingshots" Pace the Drag Strips	89
Scraps From the Junk Yard	98
Backyard Roller Coaster	102
Here's Where Pilots' Lives Are Saved	107
Supersonic Baseball With a Live Artillery Shell	114
Homemade Rivers Irrigate the West	121
Precision Parts for Working Models	128
Auto Drives a Ski Lift	132
Piston Pilots Go to Jet School	134
Here's a Blowgun — Get in There and Fight!	140
Big Change in Venezuela — Part II	150
Radio, TV and Electronics	157

For the Craftsman...

Captain's Chair in Modern Design	162
Flashing Lamps Catch the Eye	170
New Beauty for Dated Walls	177
Picture-Frame "Doctor"	180
Modeling the French Chebec—Part IV	184
Trouble-Shooting for Jet Pumps	192
Showcase of Tools	196
Metal-Turning Lathe Built From Stock Parts	205

Regular Departments...

WHERE-TO-FIND-IT LIST	74
Across the Editor's Desk	6
Do You Know This Old-Timer!	14
Detroit Listening Post	86
What's New for Your Home	118
Solving Home Problems	174
On the Market	203
Shopping for Tools	215
Clinic for Homemakers	222

Turn to detailed index on page 74. Sources of additional information on items in this issue are shown on the Where-to-Find-It List, available without charge by writing the Bureau of Information, Popular Mechanics, 200 E. Ontario St., Chicago 11, Ill.

Next Month...

... brings the ANNUAL BOATING SECTION—24 pages of special material for the week-end skipper and his family. A boating authority made a nationwide survey to help him select the "10 Best Boating Vacations," with details on fishing, sight-seeing and side trips. An editor presents his how-to-do-it plans for a versatile pontoon boat, the ideal craft for the entire family... Also in the March issue, the "Owners Report on the '59 Buick."

"MIRACLE MILD" PHILLIES

Now-The Best Selling Blunts in the U.S.A.

The advertisement features a central image of a pack of Phillie Blunts. The pack is white with a black spine that says "PHILLIES" vertically. The top of the pack says "BLUNT" in large, bold letters. A circular window shows four blunts with "PHILLIES BLUNT" labels. Below this is a large orange oval with "PHILLIES" in white. At the bottom of the pack, it says "MIRACLE MILD" and "Blended with Havana" in a cursive font. A large, detailed image of a single blunt is positioned horizontally across the bottom of the pack. To the right of the pack is a black and white photograph of a man in a suit holding a large trophy. A black price tag with white text is overlaid on the pack, stating "NOW 39¢".

"MIRACLE MILD" Phillies Blunts — the first cigar mild enough for *all* smokers. Never before has smoking offered so much pleasure for so little cost. Pick up a pack today!

NEW LOW PRICE!

5 for 39¢

Other Phillies sizes . . .

IMPERIALS—DOUBLE PERFECTOS—KING SIZE—2 for 25c • PERFECTOS—10c • PANATELLAS—5 for 39c • JUNIOR PHILLIES 5c

**MEN OF MECHANICAL ABILITY:
YOU
CAN BE
A
VALUABLE
MAN
IN THE
NEW
AGE OF SPACE**



**TRAIN
IN
THE
U. S. AIR
FORCE**

As a man of mechanical ability, you face a future of unlimited opportunity. This is the Age of Space, and *the valuable man is the man who combines mechanical ability with sound training.* Where can you best get this training? In the U. S. Air Force—where the Age of Space is *reality.* Here, Airmen work, day to day, in actual Space Age specialties: rocketry, supersonic aircraft, advanced electronics—and soon: manned flight in outer space. In short, the Air Force offers you the broadest, most complete range of Space Age specialty training available today. For details, see your local Air Force Recruiter, or mail the coupon.

PASTE COUPON ON POSTAL CARD AND MAIL TO:

Airman Information, Dept. PM-10321
Box 7608, Washington 4, D. C.

Please send me information on my opportunities in the U. S. Air Force. I am between the ages of 17-34 and reside in U. S. A. or possessions.

Name _____

Address _____

City _____ Zone _____ State _____



**THE FUTURE BELONGS
TO THE AIRMAN**



With Champion spark plugs, fire engines roll instantly!
Above: Garden City Park (L. I.) fire department.

Q. *ALL* major fire engine makers use Champion spark plugs. *Why?*

A. With fire engines, every call is an *emergency*. And Champions deliver the instant starts and completely dependable power fire engines must have. To get this performance in your *car*, put in Champions every 10,000 miles!



World's favorite spark plug—engineered for every car built by Ford, General Motors, Chrysler, American Motors, Studebaker-Packard and every major foreign maker.

CHAMPION

ACROSS THE DESK



PM Jewelry Set

You might call Karl Keeler, Jr., a "sandwich man" but he probably wouldn't like it. He does his advertising in a more dignified, subtle way. Karl is one of *Popular Mechanics*' advertising salesmen at Los Angeles. He carries his enthusiasm for the magazine with him in the form of cufflinks and tie clasp (right) bearing the familiar logotype of *Popular Mechanics*. Made for him by a California jeweler, they are of silver or gold, plated over copper. They're \$19.19 a set including that federal luxury tax. If you like 'em, or maybe a set with your own company's name, drop a line to Gray Products, 2073 Maycrest St., South Pasadena 2, Calif.



To the Editor:

There are some things that have not yet been invented. For example, the U. S. Patent Office has yet to issue patent papers on these:

The Farmer's Friend Poultry Calculator.
For counting chickens before they're
(Continued to page 10)



**WILDROOT
CREAM-OIL
HAIR TONIC**

FOR
HANDSOME
WELL-GROOMED
HAIR



Hair problem got you in the doghouse?



Get Wildroot Cream-Oil Charlie!



Just a little bit of Wildroot and... WOW!



To those who want to enjoy
an ACCOUNTING CAREER



FREE SAMPLE LESSON

IF you're that person, here's something that will interest you.

Not a magic formula—not a get-rich-quick scheme—but something more substantial, more practical.

Of course, you need something more than just the desire to be an accountant. You've got to pay the price—be willing to study earnestly, thoroughly.

Still, wouldn't it be worth your while to sacrifice some of your leisure in favor of interesting home study—over a comparatively brief period? Always provided that the rewards were good—a salary of \$5,000 to \$10,000 and up?

An accountant's duties are interesting, varied and of real worth to his employers. He has *standing!*

Do you feel that such things aren't for you? Well, don't be too sure. Very possibly they *can* be!

Why not, like so many before you, investigate LaSalle's modern Problem Method of training for an Accounting position?

Just suppose you were permitted to work in an accounting firm under the personal supervision of an expert accountant. Suppose, with his aid, you studied accounting principles and solved problems day by day—easy ones at first—then more difficult ones. If you could do this—and could turn to him for advice as the problems became complex—soon you'd master them all.

That's the training you follow in principle under the LaSalle Problem Method.

Over 4,500 Certified
Public Accountants among
LaSalle alumni

You cover accounting from Basic Accounting right through Principles and Cost Accounting. As you go along, you absorb the principles of Accounting Systems, Federal Income Tax, Certified Public Accountant Training, and prepare for the CPA examinations.

Your progress is as speedy as you care to make it—depending on your own eagerness to learn and the time you spend in study.

Will recognition come? The only answer, as you know, is that success *does* come to the man who is really *trained*. It's possible your employers will notice your improvement in a very few weeks or months. Indeed, many LaSalle graduates have paid for their training—with increased earnings—before they have completed it! For accountants, who are trained in organization and management, are the executives of the future.

Get Free Sample Lesson—Also "Opportunities in Accounting"

For your own good get all the facts about this completely new and modern accounting training. Write for Free Sample Lesson—also latest book "Opportunities in Accounting." They will prove that Accounting offers brilliant futures to those who aren't afraid of serious home study, and will show the wide range of opportunities that exist today. No cost or obligation. If you want a position of higher income, greater prestige and professional standing... MAIL THE COUPON NOW!

Accredited Member, National Home Study Council

LASALLE EXTENSION UNIVERSITY

A CORRESPONDENCE INSTITUTION

417 S. Dearborn St. Dept. 264H Chicago 5, Ill.

I want to be an accountant. Send me without obligation, Free Sample Lesson—also "Opportunities in Accounting."

Name.....Age.....

Address.....

City, Zone & State.....



BURIED ALIVE!



SIX YEARS ON THE SAME JOB WITH NEVER AN ACCIDENT... AND THEN ONE MORNING...

2 A CAVE-IN PUT ME SIX FEET UNDER FOR SIX LONG MINUTES



3 IN THE HOSPITAL, I HAD PLENTY OF TIME TO THINK



4 I'D PASSED OVER DOZENS OF I.C.S. ADS IN POPULAR MECHANICS. BUT I SAW THIS ONE IN A NEW LIGHT



FREE!

I.C.S. CAREER KIT
Send coupon now...
get all three books

INTERNATIONAL CORRESPONDENCE SCHOOLS
BOX 21626B
SCRANTON 15, PA.

HOW'S IT GOING, DARLING?

FAST! I'M INTO HYDRAULICS ALREADY. AND I THOUGHT I WAS TOO OLD TO LEARN

5 SIGNING UP FOR THAT I.C.S. COURSE WAS THE SMARTEST THING I EVER DID

6 ONE MONTH LATER...

GOOD TO SEE YOU BACK ON YOUR FEET, JIM. IT'LL BE AWHILE BEFORE YOU'RE BACK IN THE FIELD. SO WE'LL FIX A TEMPORARY DESK FOR YOU IN THE OFFICE WHEN YOU'RE READY

I'M READY NOW, MR. WALSH

7 THEY GAVE ME SOME SIMPLE ASSIGNMENTS... AND I SURE SURPRISED THEM!

SAY, WHERE DID YOU LEARN ABOUT PUMPS?

SAME PLACE YOU DID, JOE... I. C. S.

8 THEN A FEW DAYS LATER, MR. WALSH CALLED ME IN...

JIM, I'M KEEPING YOU HERE AND PUTTING YOU ON SALARY. YOU'LL BE GETTING ABOUT \$20 MORE A WEEK. AND AT THE RATE YOU'RE GOING, I EXPECT I'LL HAVE TO RAISE THAT IN SIX MONTHS

9 THAT EVENING, JANE AND I WENT HOUSE HUNTING

OH, JIM! IT'S A DREAM HOUSE!

AND THANKS TO I. C. S. IT'S A "DREAM" THAT CAN COME TRUE!

MODEL HOUSE

1 "HOW TO SUCCEED"
A 32-page gold mine of ideas

2 CAREER CATALOG
Opportunities in the field that interests you most

3 SAMPLE LESSON (MATH)
Shows the famous step-by-step I. C. S. teaching method



HERE'S WHERE YOU COME IN! LET I.C.S. SHOW YOU THE WAY TO MORE PAY, RAPID ADVANCEMENT, REAL JOB SECURITY!
MAIL THIS COUPON TODAY!

For Real Job Security - Get an I. C. S. Diploma! I. C. S., Scranton 15, Penna. Accredited Member. National Home Study Council

INTERNATIONAL CORRESPONDENCE SCHOOLS

BOX 21626B, SCRANTON 15, PENNA. (Partial list of 259 courses)

Without cost or obligation, send me "HOW TO SUCCEED" and the opportunity booklet about the field BEFORE which I have marked X (plus sample lesson):

<p>ARCHITECTURE and BUILDING CONSTRUCTION</p> <ul style="list-style-type: none"> <input type="checkbox"/> Air Conditioning <input type="checkbox"/> Architecture <input type="checkbox"/> Arch. Drawing and Designing <input type="checkbox"/> Building Contractor <input type="checkbox"/> Building Estimator <input type="checkbox"/> Carpenter Builder <input type="checkbox"/> Carpentry and Millwork <input type="checkbox"/> Carpenter Foreman <input type="checkbox"/> Heating <input type="checkbox"/> Painting Contractor <input type="checkbox"/> Plumbing <input type="checkbox"/> Reading Arch. Blueprints <p>ART</p> <ul style="list-style-type: none"> <input type="checkbox"/> Commercial Art <input type="checkbox"/> Magazine Illus. <input type="checkbox"/> Show Card and Sign Lettering <input type="checkbox"/> Sketching and Painting <p>AUTOMOTIVE</p> <ul style="list-style-type: none"> <input type="checkbox"/> Automobile <input type="checkbox"/> Auto Body Rebuilding and Refinishing <input type="checkbox"/> Auto Engine Tuneup <input type="checkbox"/> Auto Technician 	<p>AVIATION</p> <ul style="list-style-type: none"> <input type="checkbox"/> Aero-Engineering Technology <input type="checkbox"/> Aircraft & Engine Mechanic <p>BUSINESS</p> <ul style="list-style-type: none"> <input type="checkbox"/> Accounting <input type="checkbox"/> Advertising <input type="checkbox"/> Business Administration <input type="checkbox"/> Business Management <input type="checkbox"/> Cost Accounting <input type="checkbox"/> Creative Salesmanship <input type="checkbox"/> Managing a Small Business <input type="checkbox"/> Professional Secretary <input type="checkbox"/> Public Accounting <input type="checkbox"/> Purchasing Agent <input type="checkbox"/> Salesmanship <input type="checkbox"/> Salesmanship and Management <input type="checkbox"/> Traffic Management <p>CHEMICAL</p> <ul style="list-style-type: none"> <input type="checkbox"/> Analytical Chemistry <input type="checkbox"/> Chemical Engineering <input type="checkbox"/> Chem. Lab. Technician <input type="checkbox"/> Elements of Nuclear Energy <input type="checkbox"/> General Chemistry <input type="checkbox"/> Natural Gas Prod. and Trans. <input type="checkbox"/> Petroleum Prod. and Engr. <input type="checkbox"/> Professional Engineer (Chem) <input type="checkbox"/> Pulp and Paper Making 	<p>CIVIL ENGINEERING</p> <ul style="list-style-type: none"> <input type="checkbox"/> Civil Engineering <input type="checkbox"/> Construction Engineering <input type="checkbox"/> Highway Engineering <input type="checkbox"/> Professional Engineer (Civil) <input type="checkbox"/> Reading Struc. Blueprints <input type="checkbox"/> Sanitary Engineer <input type="checkbox"/> Structural Engineering <input type="checkbox"/> Surveying and Mapping <p>DRAFTING</p> <ul style="list-style-type: none"> <input type="checkbox"/> Aircraft Drafting <input type="checkbox"/> Architectural Drafting <input type="checkbox"/> Drafting & Machine Design <input type="checkbox"/> Electrical Drafting <input type="checkbox"/> Mechanical Drafting <input type="checkbox"/> Sheet Metal Drafting <input type="checkbox"/> Structural Drafting <p>ELECTRICAL</p> <ul style="list-style-type: none"> <input type="checkbox"/> Electrical Engineering <input type="checkbox"/> Elec. Engr. Technician <input type="checkbox"/> Elec. Light and Power <input type="checkbox"/> Practical Electrician <input type="checkbox"/> Practical Lineman <input type="checkbox"/> Professional Engineer (Elec) <p>HIGH SCHOOL</p> <ul style="list-style-type: none"> <input type="checkbox"/> High School Diploma 	<ul style="list-style-type: none"> <input type="checkbox"/> Good English <input type="checkbox"/> High School Mathematics <input type="checkbox"/> High School Science <input type="checkbox"/> Short Story Writing <p>LEADERSHIP</p> <ul style="list-style-type: none"> <input type="checkbox"/> Industrial Foremanship <input type="checkbox"/> Industrial Supervision <input type="checkbox"/> Personnel-Labor Relations <input type="checkbox"/> Supervision <p>MECHANICAL and SHOP</p> <ul style="list-style-type: none"> <input type="checkbox"/> Diesel Engines <input type="checkbox"/> Gas-Elec. Welding <input type="checkbox"/> Industrial Engineering <input type="checkbox"/> Industrial Instrumentation <input type="checkbox"/> Industrial Metallurgy <input type="checkbox"/> Industrial Safety <input type="checkbox"/> Machine Shop Practice <input type="checkbox"/> Mechanical Engineering <input type="checkbox"/> Professional Engineer (Mech) <input type="checkbox"/> Quality Control <input type="checkbox"/> Reading Shop Blueprints <input type="checkbox"/> Refrigeration and Air Conditioning <input type="checkbox"/> Tool Design <input type="checkbox"/> Tool Making <p>RADIO, TELEVISION</p> <ul style="list-style-type: none"> <input type="checkbox"/> General Electronics Tech. 	<ul style="list-style-type: none"> <input type="checkbox"/> Industrial Electronics <input type="checkbox"/> Practical Radio-TV Eng'g <input type="checkbox"/> Practical Telephony <input type="checkbox"/> Radio-TV Servicing <p>RAILROAD</p> <ul style="list-style-type: none"> <input type="checkbox"/> Car Inspector and Air Brake <input type="checkbox"/> Diesel Electrician <input type="checkbox"/> Diesel Engr. and Fireman <input type="checkbox"/> Diesel Locomotive <p>STEAM and DIESEL POWER</p> <ul style="list-style-type: none"> <input type="checkbox"/> Combustion Engineering <input type="checkbox"/> Power Plant Engineer <input type="checkbox"/> Stationary Diesel Engr. <input type="checkbox"/> Stationary Fireman <p>TEXTILE</p> <ul style="list-style-type: none"> <input type="checkbox"/> Carding and Spinning <input type="checkbox"/> Cotton Manufacture <input type="checkbox"/> Cotton Warping and Weaving <input type="checkbox"/> Loom Fixing Technician <input type="checkbox"/> Textile Designing <input type="checkbox"/> Textile Finishing & Dyeing <input type="checkbox"/> Throwing <input type="checkbox"/> Warping and Weaving <input type="checkbox"/> Worsted Manufacturing
--	--	--	---	---

Name _____ Age _____ Home Address _____
 City _____ Zone _____ State _____ Working Hours _____ A.M. to P.M. _____
 Occupation _____

Canadian residents send coupon to International Correspondence Schools, Canadian, Ltd., Montreal, Canada. . . . Special tuition rates to members of the U. S. Armed Forces.

This Amazing New Home Training Plan in Auto Repairing

starts you earning spare-time money in weeks—makes you an expert mechanic in months!

No longer need you stand by as experienced mechanics take their choice of the 100,000 job openings in the auto repairing field. Now you can get ready for the big money—the bright future—in just a few months. Now you can have new CTI training.



This wonderful new home study course is better written, more clearly illustrated, more understandable. It offers more up-to-date, fresh, usable knowledge. It includes finer tools, more costly testing instruments. And it's so practical that you can put your training to work soon after you enroll—you can actually fix cars spare time and earn good money. Many students earn \$20 to \$50 a week.

Auto mechanics in the large cities average \$3.00 an hour. If you prefer, you can open a shop. An expert says that America is short 25,000 repair shops. Discover how easily you can qualify for a top-pay job in America's No. 1 industry. Mail coupon below for the new CTI catalog and sample lesson.

Get Experience Using Tune-Up Kit & Tools

(included with training)



CTI sends you a Tune-Up Kit, the kind that skilled mechanics use to locate engine troubles. You receive a Compression Tester; Vacuum Gauge & Fuel Pump Tester; Ignition Timing Light; portable steel case. You also get mechanic's tools, including socket set. You acquire experience using kits.

DIESEL MECHANICS OR BODY-FENDER REBUILDING

instruction is also yours—at no additional cost. But get all the facts on CTI training. Discover how we train you in Tune-Up; Overhaul; Electric, Cooling & Lubricating Systems; Power Brakes; Power Steering; Automatic Transmissions; Clutches. Mail coupon for 2 free booklets.—Commercial Trades Institute, Chicago 26, Ill.

MAIL TODAY • TWO FREE BOOKS

COMMERCIAL TRADES INSTITUTE

1400 GREENLEAF AVENUE DEPT. A-1009
CHICAGO 26, ILLINOIS

Mail me your two opportunity booklets: *Big Money in Auto Mechanics*; and *Sample Lesson*. Both FREE.

Name _____ Age _____

Address _____

City _____ Zone _____ State _____



(Continued from page 6)
hatched. Fast, accurate. Estimates total of expected chickens prior to hatching. Maximum annual tolerance, seven chickens.

The Robinson Split-Second-Timer. Measures the exact time required for saying "Jack Robinson." Also the time immediately before.

Everybody's Adjustable Touching Rod. Indispensable for contacting persons normally untouchable with a 10-foot pole.

The Universal Shaking Stick. Unlimited capacity. Stick can be shaken at any number of articles of any nature by anybody.

Electronic Bridge Anticipator. This enables the operator, following simple instructions, to cross any bridge before he comes to it.

Russell McLaughlin,
Detroit, Mich.

☆ ☆ ☆

To the Editor:

Enclosed are pictures of the runabout *Swish*, plans of which appeared in March, April, May issues of *PM*. Steve Denker, 17, and Paul Schuster, 16, shown in photos, are the proud builders.

The boys named the runabout *Zeus* and boast of speeds up to 30 m.p.h. with the aid of a 35-hp. Johnson. The runabout cost approximately \$225 and is built entirely of



raw stock lumber (not a kit). This includes a '54 Olds steering wheel, homemade triangular anchor and Plexiglas windshield; motor and controls extra.

The maneuverability is excellent, properly due to design, and handles well even in choppy waters. The boys' playground is all points between Atlantic beach bridge (Reynolds channel) to the Jones beach inlet (including quite a bit of the ocean).

As the father of one of the boys, I'd like to mention that your magazine with all its variety of things to build, has been solely responsible for an interest which the boys eagerly pursued. And I feel grateful that their energies were not wasted throughout the summer months.

W. Denker,
Elmont, N. Y.

(Continued to page 16)



**A HIGHLY
RESPECTED TRADE—
START SOON TO
EARN EXTRA MONEY
IN SPARE TIME**

Learn at Home IN YOUR SPARE TIME to Fix Electrical Appliances

To build a better future, get into a field where there's much important work and the security that comes from knowing a good trade. Servicing electrical appliances offers that OPPORTUNITY. Every wired home has many electrical appliances and millions and millions of new appliances are sold every year. Owners pay well to keep them in repair. That's making a fast-growing need for trained men.

Add To Your Income Starting Soon Need For Service Technicians Increasing

Make extra money in your spare time. Start soon to fix electric toasters, fans, clocks, vacuum cleaners, and other electric appliances for your neighbors and friends. Work in your basement, garage or spare room. It's easy to increase your earning power—to pay for your training many times over—to have extra money to buy things you need.

Learn and Earn with Multi-Use Tester Built with Parts We Send

This course includes the parts to build a portable, sturdy Appliance Tester that helps you locate electrical defects quickly and easily. You use it to learn and do actual electrical appliance repair jobs. If you want better pay learn this good trade. No need to give up your present

job. You can train at home in your spare time for only \$3.00 down and \$6.00 a month. A small price to pay for increased earnings, a more secure future. Paste coupon below on a postal or mail in envelope for free book and sample lesson. Address **National Radio Institute, Dept. AB9, Washington 16, D. C.**

**MAILING THIS
COUPON MAY START
YOU TO SUCCESS**

**LESSON AND BOOK
FREE**



NATIONAL RADIO INSTITUTE, Dept. AB9, Washington 16, D. C.

Please send me Electric Appliance Training lesson and book free. (No salesman will call.)

Name.....Age.....

Address.....

City.....Zone.....State.....

ACCREDITED MEMBER NATIONAL HOME STUDY COUNCIL

INVENTORS

Learn how to protect your invention. The U. S. Patent Laws provide that any new and useful art, machine, article of manufacture, or composition of matter, or any new and useful improvement thereof, may be patented if the act of invention is involved. Therefore, every inventor with a valuable invention should take advantage of the Patent Laws and proceed for patent protection in order to safeguard his rights.

A patent gives the inventor the exclusive right to prevent others from making, using, or selling the invention claimed in the patent for a period of seventeen years.

The Patent Laws were enacted for the benefit of the inventor to give him protection for the features of his invention which are patentable. These features must be properly and concisely set forth and claimed in a formal application for patent, in order to comply with the requirements of the Patent Laws. For that reason, unless the inventor is familiar with patent matters, he should engage a competent registered patent attorney or agent to represent him. We are registered to practice before the U. S. Patent Office and are prepared to serve you in the handling of your patent matters.

A specially prepared booklet entitled "Patent Guide for the Inventor", containing detailed information with respect to patent protection and procedure, together with a "Record of Invention" form will be promptly forwarded to you without obligation upon request.

CLARENCE A. O'BRIEN & HARVEY JACOBSON

Registered Patent Attorneys

91-B DISTRICT NATIONAL BUILDING

WASHINGTON 5, D. C.



U. S. Forest Service photo

Do You Know These Old-Timers?

Two guesses here. One ancient truck stuck in the mud one July day in 1920, and a familiar old shape at the right that didn't get stuck. Why the truck left that perfectly good highway—the Grand Canyon Trail in

Kaibab National Forest—for the questionable mire is a question we can't answer. Try your luck at identifying the two vehicles and then turn to page 230 for the answers.

Draw Lincoln

YOU MAY WIN A \$430.00 SCHOLARSHIP IN COMMERCIAL ART

Winner gets a complete art course—free training for a money-making career in commercial art, illustrating or cartooning.

You are coached, individually, by professional artists on the staff of world's largest home study art school. Many successful artists have studied with this school, founded over 40 years ago. It's an accredited member of the National Home Study Council. Contest winner also gets a drawing outfit and valuable art textbooks. Try for this free art course!



ART INSTRUCTION, INC., STUDIO 2139
500 South 4th Street, Minneapolis 15, Minn.

Please enter my attached drawing in your contest. (PLEASE PRINT)

Name _____ AGE _____

Address _____ Apt. _____

City _____ Zone _____ County _____

State _____ Occupation _____

DRAW LINCOLN'S HEAD

5 inches high. Use pencil. Drawings for March 1959 contest must be received by March 31. None returned. Winner notified. Amateurs only. Our students not eligible.

A Practical New Way to End Your Job Worries!

TRAIN AT HOME FOR A SUCCESSFUL FUTURE IN
AIR CONDITIONING
AND REFRIGERATION



R. C. ANDERSON
President

If you want an interesting job that pays real well and offers year-round work—get into Air Conditioning and Refrigeration! It's a big, uncrowded field that is well-established—yet growing fast! Each year over 20,000 newly-trained mechanics are needed. No wonder! Today there are 150 million units in use—and each year over 6 million new air conditioners, refrigerators and freezers are manufactured. All units need periodic service and repair. The pay? It ranks with the best!

Refrigeration mechanics is an easy trade to learn... Especially when you get your training through CTI. You can learn at home in spare time by practicing with commercial equipment. Get all the facts about this wonderful new way to acquire a highly-profitable technical education. Mail coupon today for fact-filled free booklets. No obligation whatever.

25
BIG KITS



Easy Way to Start a Business

Own a business—and enjoy independence. Thrill to the satisfaction of being the boss. Give orders—not take them! The refrigeration field is ideal for getting started on your own. You can make friends as you make service calls. In time, you'll have a list of potential customers. You can also sign service contracts with food stores, taverns, restaurants, etc. Thousands of CTI graduates have their own successful small shops.

Get Into Auto Air Conditioning

Experts say that over 400,000 air conditioners are to be installed in autos this year. The field is growing very fast. Already auto shops are advertising for skilled air conditioning mechanics. Opportunities are excellent for starting repair shops. Some day, air conditioners will be standard equipment on cars. So get in on the ground floor now. Our catalog has information on this specialized, profitable field. It's worth looking into.



You Get Experience as You Train Because You Practice with Commercial Equipment

Another CTI first! You learn by practicing—you get experience as you train—because CTI sends you 25 kits. You get all parts and tools to build a heavy-duty, commercial-type, 1/4 h.p. condensing unit (illustrated above.) You build an air conditioner, freezer, refrigerator, or milk cooler. You complete 23 field-type projects—do 10 service and trouble-shooting jobs! You "boil down" years of apprentice-like training into months. Kit training perfects your skill, provides practical knowledge, assures useful experience, and helps you learn faster! CTI makes your home a training center.

Earn Extra Cash in Spare Time as You Train

Because CTI training is so practical, you'll soon be making profitable service calls. Perhaps you'll work "on your own." Or, you may prefer to get a part-time job with a local appliance dealer or air conditioning contractor. You can add to your income this way. With extra cash, you can buy additional shop equipment, pay your tuition, even bank money. Be sure to mail coupon for complete details. Act today!—Commercial Trades Institute, Chicago 26, Illinois.

TYPICAL LETTERS FROM SUCCESSFUL STUDENTS

"I have been very busy. Had an offer to work for an appliance dealer but it looks like I'll be in business for myself before long."
—Frank Fuller, Wells, N. Y. . . "Am now working in the field. Earn \$40 more per month than before."
—Frank Krotzer, Houston, Texas. . . "I not only got a job, but today am foreman, earning \$60 a week more than before I enrolled."
—E. E. Hughes, Chicago . . . "Have my own business. Only problem is: Too much business!"
—Conrad King, Cynthia, Ky. You can do as well as these men!

COMMERCIAL TRADES INSTITUTE

1400 GREENLEAF AVENUE
CHICAGO 26, ILLINOIS

DEPT. R-553

Tell me how I can qualify for a better job or a business of my own. Send booklet, *Success in Air Conditioning & Refrigeration*, and Lesson Sample. Both FREE.

Name _____ Age _____

Address _____

City _____ Zone _____ State _____



FIRST GET THE FACTS—THEN DECIDE

Mail Coupon Today for 2 Free Booklets



Easy as A-B-C



Be Your Own MUSIC Teacher

PLAY ANY INSTRUMENT

**LEARN AT HOME THIS QUICK,
SIMPLE, MONEY-SAVING WAY**

SIMPLE as A-B-C. Your lessons consist of real selections, instead of tiresome exercises. You read real notes—no "numbers" or trick music. Some of our 1,000,000 students, such as Lawrence Welk, are band LEADERS. Everything is in print and pictures. First you are told what to do. Then a picture shows you how. Then you play it yourself and hear how it sounds. Soon you are playing popular tunes, hymns, classical and any other music.



No special talent or previous training needed. Even if you don't know a single note of music now, you can soon play piano, guitar, accordion, organ, any instrument. Your friends will be amazed!

STOP CHEATING YOURSELF OF THESE JOYS!

Popularity! New friends. Gay parties. Good times. Career. Extra Money. Understand, appreciate and converse about music. Learn lives and compositions of modern and great masters . . . Relax! Banish worries and frustrations. Satisfy self-expression, creative urge. Gain self-confidence.

MAIL COUPON FOR FREE BOOK

See for yourself why our method has been successful for 61 years! Read the whole fascinating

story of this wonderful method in 36-page illustrated book. For **FREE** copy, mail coupon. No obligation. No salesman will call. **U. S. School of Music, Studio A302, Port Washington, N.Y.**



U. S. SCHOOL OF MUSIC
Studio A302, Port Washington, N.Y.

Please send me your 36-page illustrated Free Book. I'm interested in playing (name instrument) _____

I do I do NOT — have instrument now.

Name _____
(please print)

Address _____

City _____ Zone _____ State _____

Flying Carpet

You've read about them in the papers and the cartoons, but Eddie Ogurchak, Jr., of Lebanon, Pa., says his is the first flying carpet that really flies. The carpet is red, and, says Ogurchak, "it's powered by a K



and B 'Torp 35' engine using Supersonic 100 fuel. . . . It actually flies, proven in public at an A.M.A. sanctioned model meet at Pittston, Pa." Eddie is 17 years old, and he and his father spend a good deal of time teaching "anyone who is interested, how to fly combat, rat-racing, etc."

☆ ☆ ☆

To the Editor:

For many a long year I have been a newsstand fan of *PM*. At home in Shawneetown, Ill., there are a couple of boxes of them waiting to be scanned for the hundredth time. At present, I take a monthly excursion to the *Stars and Stripes* newsstand for your product. You probably get many good words from readers but I have a bug for science and I know from experience good material and bad. Your material is all good but among the good are jewels.

My brainstorm is the product of a soldier's eternal pastime of counting the days to "go." Counting over a whole calendar or picking months and multiplying runs into quite a job. It occurred to me that a decimal fraction of a year ought to do in rough calculations involving time.

(Continued to page 24)

Learn TELEVISION-RADIO

Servicing or Communications
by Practicing at Home in Spare Time

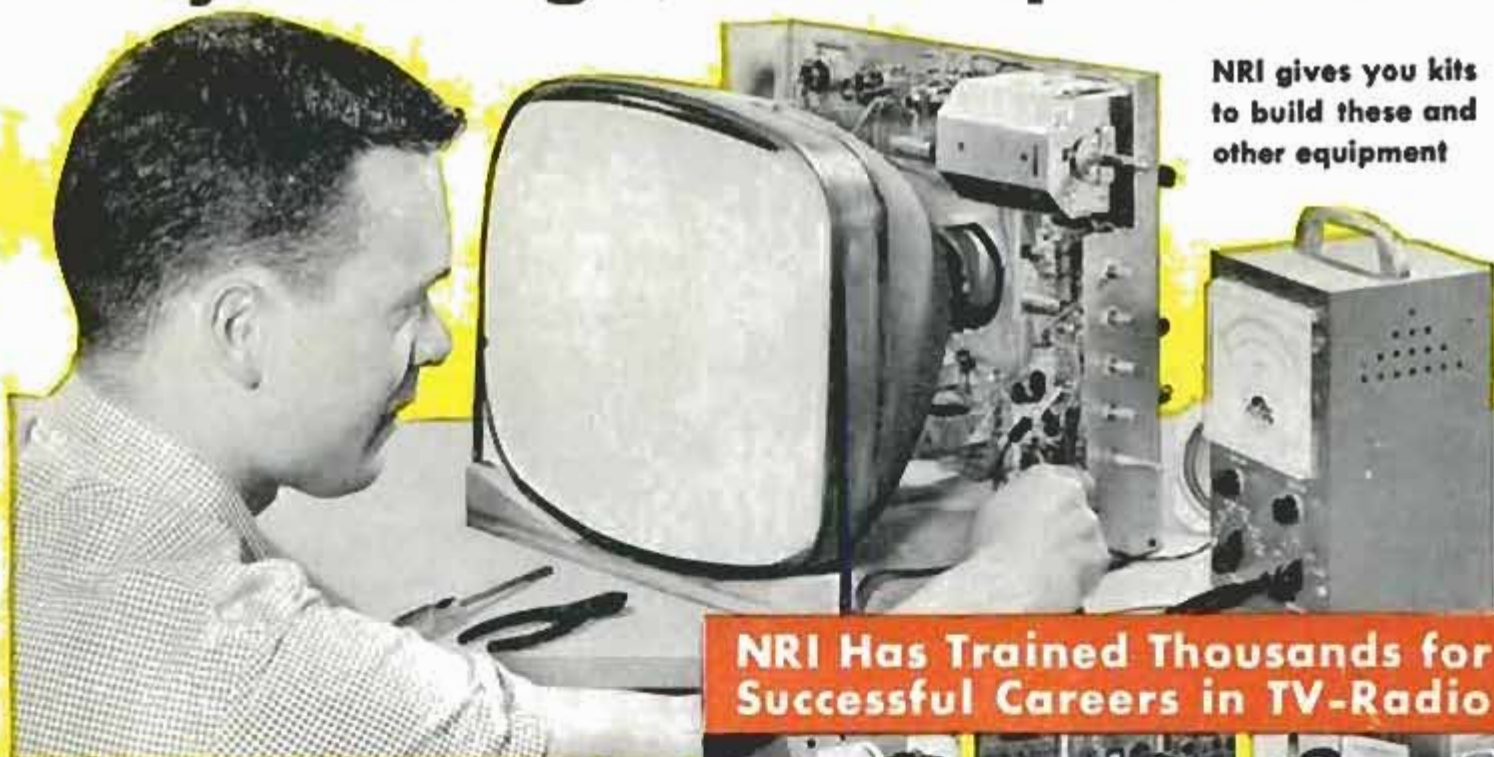

NRI gives you kits to build these and other equipment

NRI Has Trained Thousands for Successful Careers in TV-Radio

Electronic Technicians Have High Pay, Prestige Jobs

People look up to and depend on the Technician, more than ever before. His opportunities are great and are increasing. Become a TV-Radio-Electronic Technician. At home, and in your spare time, you can learn to do this interesting, satisfying work—qualify for important pay.

A steady stream of new Electronic products is increasing the job and promotion opportunities for Television-Radio-Electronic Technicians. Right now, a proven field of opportunity for good pay is servicing the millions of Television and Radio sets now in use. The hundreds of TV and Radio stations on the air offer interesting jobs for Operators and Technicians.

**Make Extra Money Soon,
\$10 to \$15 a Week
in Your Spare Time**

NRI students find it easy to start fixing sets for friends a few months after enrolling, pick up \$10, \$15 and more a week extra spending money. Many who start in spare time soon build full time TV-Radio service businesses. NRI has devoted over 40 years to developing simplified, practical training methods. Learn-by-doing. You get many kits to build equipment for actual practice.

**ACT NOW
FIND OUT WHAT
NRI OFFERS YOU**



Studio Engineer KATV
"Now Studio Engineer at KATV. Before enrolling, I was held back by sixth grade education." **BILLY SANCHEZ**, Pine Bluff, Arkansas.



All the Work He Can Do
"Since finishing NRI Course I have repaired 2,000 TV and Radio sets a year. NRI proved a good foundation." **H. R. GORDON**, Milledgeville, Georgia.



Has Good Part Time Business
"Quite early in my training I started servicing sets. Now have completely equipped shop. All equipment is paid for." **E. A. BREDDA**, Tacoma, Wash.

Cut Out and Mail Postage-Free Card NOW

Sample Lesson and Catalog Both FREE

SEE OTHER SIDE

OLDEST & LARGEST HOME STUDY RADIO-TV SCHOOL
National Radio Institute
Dept. 9BA, Washington 16, D.C.

Please send me sample lesson of your Radio-Television Training and Catalog FREE. (No salesman will call.)

Name.....Age.....

Address.....

City.....Zone.....State.....

ACCREDITED MEMBER NATIONAL HOME STUDY COUNCIL



NRI SUPPLIES LEARN-BY-DOING KITS WITHOUT EXTRA CHARGE
Technical Know-How Pays Off in Interesting, Important Work

YOU BUILD AC-DC Superhet Receiver

NRI Servicing Course includes all needed parts. By introducing defects you get actual servicing experience practicing with this modern receiver. Learn-by-doing.



YOU BUILD This 17 Inch Television Receiver

As part of your NRI course you can get all components, tubes, including 17" picture tube, to build this latest style Television receiver; get actual practice on TV circuits.



YOU BUILD Broadcasting Transmitter

As part of NRI Communications Course you build this low power Transmitter, learn commercial broadcasting operators' methods, procedures. Train for your FCC Commercial Operator's License.



YOU BUILD Vacuum Tube Voltmeter

Use it to earn extra cash fixing neighbors' sets; bring to life theory you learn from NRI's easy-to-understand texts.



For Higher Pay, Better Jobs Be a TV-Radio-Electronic Technician



Servicing Needs More Trained Men

Portable TV, Hi-Fi, Transistors, Color TV are making new demands for trained Technicians. Good opportunities for spare time earnings or a business of your own. Enjoy prestige.



J. E. Smith, Founder

Train at Home the NRI Way Famous for Over 40 Years

NRI is America's oldest and largest home study Television-Radio school. The more than 40 years' experience training men, the outstanding reputation and record of this school—benefits you many ways. Successful graduates are everywhere, in small towns, big cities. You train in your own home, keep your present job while learning. Let us send you an actual lesson, judge for yourself how easy it is to learn.

Broadcasting Offers Satisfying Careers

4000 TV and Radio stations offer interesting positions. Govt. Radio, Police, Two-Way Communications are growing fields. Trained TV-Radio Operators have a bright future.



No Experience Necessary - NRI Sends Many Kits for Practical Experience

You don't have to know anything about electricity or Radio to understand and succeed with NRI Course. Clearly written, illustrated NRI lessons teach Radio-TV-Electronic principles. You get NRI kits for practical experience. All equipment is yours to keep. Mailing the postage-free card may be one of the most important acts of your life. Do it now. Reasonable tuition, low monthly payments available. National Radio Institute, Dept. 98A, Wash. 16, D.C.

NRI Graduates Do Important Work



NRI Course Easy to Understand
 "Opened my own shop before receiving diploma. I am independent in my own business." D. P. CRESSEY, Stockton, California.



Works on Color TV
 "NRI changed my whole life. If I had not taken the course, probably would still be a fireman, struggling along." J. F. MELINE, New York.

FIRST CLASS
 Permit No. 20-R
 (Sec. 34.9, P. L. & R.)
 Washington, D.C.

BUSINESS REPLY CARD

No Postage Stamp Necessary if Mailed in the United States

POSTAGE WILL BE PAID BY
NATIONAL RADIO INSTITUTE
3939 Wisconsin Avenue
Washington 16, D.C.

See Other Side

SAMPLE LESSON
64-page CATALOG
both FREE

INVENTORS

If you believe that you have an invention, you should find out how to protect it. The first step is to have a search made of the prior pertinent U. S. patents. If a report on this search indicates that the invention appears patentable you can apply for a patent, and the specifications and claims should be prepared.

The firm of McMorrow, Berman & Davidson, with offices in Washington, D. C., is qualified to take the necessary steps for you. We can make a preliminary search on your invention, advise you whether we think it can be patented, and prepare your application for patent.

Unless you are fully familiar with the U. S. Patent Laws, we recommend that you engage the services of a Registered Patent Attorney to protect your interests. The patent laws are *your* laws. A patent gives you the right to prevent others from making, using or selling the invention claimed in your patent for a period of 17 years.

Use these patent laws for your protection. Investigate whether your invention can be patented. If you have what you believe to be an invention, we suggest that you have this firm make a search for you:

Send for a copy of our Patent Booklet entitled "How To Protect Your Invention," containing information about patent protection and patent procedure. Along with this we will also send you an "Invention Record" form, for your use in writing down and sketching details of your invention. We will mail them promptly. No obligation. They are yours for the asking.

McMORROW, BERMAN & DAVIDSON

Registered Patent Attorneys

PATENTS • COPYRIGHTS • PATENTS

1356 VICTOR BUILDING, WASHINGTON 1, D. C.

**You can start a
\$40⁰⁰ A DAY BUSINESS
in Your Spare Time!**



MAKE BIG CASH PROFITS IN YOUR OWN HOME SHARPENING HOUSEHOLD, GARDEN AND SHOP TOOLS
Now you can turn your spare time into Big Cash Profits with new BELSAW SHARP-ALL. Sharpen knives, scissors, shears, snips, ice skates, mower blades, hedge trimmers, grass whips, axes, chisels, screw drivers, scrapers and saws . . . just about any household, garden and shop tool. Your own CASH business in 15 square feet of your basement or garage . . . all your prospects in your own neighborhood. No calls to make. No experience needed. No inventory. SHARP-ALL quickly pays for itself.

FREE BOOK

FREE BOOK tells how to start your own cash business.

Learn how easily you can start your own spare time business. Amazing low cost, easy-payment plan. Send coupon today for FREE BOOK.

BELSAW SHARP-ALL CO
719 Field Building • Kansas City 11, Mo.
Send me your FREE BOOK.

Name _____
Address _____
City and _____
State _____

PRESTO MASTER GLAZE
--FOR ALL CARS--



Car Owners! Meet Master Glaze—the sensationally different luster for new and used cars! Not a wax—not an oil polish—not a paint!—nothing that “smears” over the surface.

AGENTS
A unique opportunity! Quick, flashy demonstrator. Big profits. Good territory. Write today!

MASTER GLAZE is a unique discovery—quick and easy to apply! Gives a hard, glass-like surface. Even gasoline cannot dull it! Lasts six months to a year! Amazing luster—beautiful, sparkling clean and brilliant! Doesn't finger-mark—doesn't smear! A match box full glazes an entire car. Seals the pores, protects! **NOTHING LIKE IT!**

FREE SAMPLE

Send name, address on postcard for details and free sample
MASTER GLAZE, 7720-896 Hardwood Ave., Milwaukee 13, Wis.

Better Than
Your Own

**SHOE STORE
AT HOME**



No investment, no experience needed. Just show magic cushion comfort to friends, neighbors, co-workers. Advance commissions to \$4.00 a pair, plus Cash Bonus, Paid Vacation, \$25.00 Reward Offer. Outstanding values for men, women, children. Money back guarantee. Shoe samples supplied without cost. Write TODAY for FREE new 84 page catalog and full details.
TANNERS SHOE CO., 128 BROCKTON, MASS.

MEN WANTED

Earn \$100 Per
Week and up
**AUTO DIESEL
MECHANICS**

Master a trade with a future—learn Auto-Diesel mechanics in our shops. You learn with tools on real equipment. Earn while you learn. Many of our graduates earn \$100 per week and up. No previous experience necessary. Day and night courses. Approved for veterans. Write for free bulletin.

NASHVILLE AUTO-DIESEL COLLEGE

226 7th Ave., N., Dept. 75

Nashville 3, Tenn.

MEN PAST 40

**Afflicted With Bladder Trouble,
Pains in Back, Hips, Legs,
Nervousness, Tiredness.**

If you have these troubles, particularly bladder trouble, then your condition may be traced to Glandular Inflammation . . . a constitutional disease. Neglect of this condition often leads to premature old age and sometimes incurable malignancy.

The Excelsior Medical Clinic has a New Free Book that tells how thousands of men have been successfully treated here at Excelsior Springs for Glandular Inflammation by NON-SURGICAL Methods. They found soothing relief and a new outlook in the future of life.

This Free Book may prove of utmost importance in your life. Write Today. There is no obligation.

Excelsior Medical Clinic, Dept. B6129, Excelsior Spgs., Mo.

**NOW...GET
EVERYTHING
YOU NEED TO
PREPARE TO EARN
REAL MONEY IN**

ELECTRONICS

RADIO • TELEVISION • RADAR, etc.

**One of
Today's
BRIGHTEST
Opportunity Fields!**



Today's great Electronics field offers you a chance of a lifetime to prepare for highly interesting work and a wonderfully promising future! With so many new developments coming up in Electronics, opportunities for trained men were never brighter. Send coupon for details.

Right in your own home you may now get one of today's most interesting . . . PRACTICAL WAYS to prepare for a good job or your own business in Electronics. No previous technical experience or advanced education are needed! DeVry Tech brings you a unique 3-WAY COMBINATION of texts, home movies and real equipment—the same type of basic equipment as found in our well-equipped Chicago and Toronto Laboratories.

EMPLOYMENT SERVICE

. . . helps you get started toward a good job, or toward advancement in the company you now work for. FREE to all graduates.

EARN WHILE YOU LEARN

DeVry Tech's practical program helps you to earn EXTRA MONEY in your spare time, servicing Radio and TV sets.

Your Guide

to PROFITABLE JOB OPPORTUNITIES

See how YOU may get ready for such opportunities as:

- TV-Radio Broadcast Technician
- Color Television Specialist
- Radar Operator • Laboratory Technician
- Airline Radio Man • Computer Specialist
- Quality Control Manager
- Your Own Sales & Service Shop
- . . . PLUS MANY OTHERS

"One of North America's
Foremost Electronics
Training Centers"

Accredited Member of
National Home
Study Council



DeVRY TECH INSTITUTE

Formerly DeForest's Training, Inc.
CHICAGO 41, ILLINOIS

300 EXPERIMENTS

Build over 300 practical projects from many shipments of Radio-Electronic parts. You build and operate TV-Radio circuits . . . wireless microphone . . . and many other major projects—all designed to provide outstanding practical experience at home.



HOME MOVIES

Thanks to this exclusive home training aid, many important fundamentals quickly become "movie clear." Now you can actually see electrons on the march and other "hidden actions"—a wonderful advantage that is almost like having a teacher at your side.



BUILD YOUR OWN TEST EQUIPMENT

As part of your home laboratory projects, you BUILD and KEEP a fine quality 5-inch COLOR OSCILLOSCOPE and a Jewel Bearing VACUUM TUBE VOLT-METER. You will find this equipment ideal for helping you earn in your spare time while a student—and later when working full time in the field.



BUILD AND KEEP A BIG 21-INCH TV SET

For added practical experience, you can also build and keep this quality 21-inch TV SET that provides TV reception at its finest (DeVry Tech also offers another home training without the TV set).



SEND FOR FACTS TODAY!

DeVRY TECHNICAL INSTITUTE
4141 Belmont Avenue, Chicago 41, Ill., Dept. PM-2-P

Please give me your FREE booklet, "Electronics and YOU," and tell me how I may prepare to enter one or more branches of Electronics.

Name _____ Age _____
PLEASE PRINT
Street _____ Apt. _____
City _____ Zone _____ State _____

208

Canadian residents address DeVry Tech of Canada, Ltd.
626 Roselawn Ave., Toronto 12, Ont.

Inventors

The following are the usual preliminary steps to take toward patent protection.

You are advised first, to make a disclosure of your invention. Date, sign and have this document witnessed by two or more persons who are capable of understanding your invention. The "Evidence of Invention" form mentioned below, we offer as a convenience in making your disclosure and in starting action leading toward patent protection.

Mail your disclosure to the registered patent attorney or agent whom you select to assist you, together with a letter authorizing him to conduct a

preliminary search among previously granted U. S. patents for similar types of invention. He then prepares for you a report on the probable patentability of your invention and, if the report is favorable, recommends the further course you should take.

This firm is registered to practice before the U. S. Patent Office and is available to assist you in the preparation and prosecution of patent applications. We shall be glad to send you without obligation, the "Evidence of Invention" disclosure form mentioned above and our instructive booklet, "Patent Protection for Inventors".

VICTOR J. EVANS & Co. *Merlin M. Evans*
REGISTERED PATENT ATTORNEY
530-B MERLIN BUILDING, WASHINGTON 6, D. C.

Curious Coins!

ODD PAPER MONEY!

Worth \$1 - But Yours

FREE!

to get names for our mailing list

SEND TODAY for this valuable packet of odd and curious coins, paper money - an exciting introduction to fastest growing hobby in the world! You'll find an African coin with a hole in the middle, a 50-pfennig coin from Germany, unusual money from Switzerland, Mexico, Austria, etc., Actual value at least \$1-but yours FREE on this special offer!

JOIN THE FUN RIGHT AWAY

This is our way of showing how much fun others have collecting strange money - Money over 1500 years old - Gambling coins from old Siam - Tokens used for barter before Christ - and other exciting curios. All listed with other valuable offers for inspection. Get FREE packet of coins and money-plus \$100,000 Confederate Money bonus -by sending coupon (with 10¢ for shipping) to: LITTLETON COIN CO., Dept. 9-PM-2, Littleton, N. H.

ALSO FREE!



\$100,000 in CONFEDERATE "MONEY"!

These lots-of-fun facsimiles are yours for promptness while the supply lasts.

LITTLETON COIN CO., Dept. 9-PM-2, Littleton, N. H.

Rush FREE packet of "Curious Coins and Currency" plus \$100,000 in Confederate "money." I enclose 10¢ to help cover shipping. Also send lists of rare coins available and other offers for inspection. No obligation to buy.

Name.....

Address.....

City.....Zone...State.....

Learn ACCOUNTING

Business Administration
Bookkeeping, secretarial and allied subjects at home in your spare time or attend nationally approved resident school. Write for FREE Success Book giving complete details on courses, plans, rates and employment opportunities. G.I. approved. Write Dept. A.

Hills BUSINESS UNIVERSITY AND EXTENSION SCHOOL
619 W. MAIN ST. OKLAHOMA CITY 2, OKLAHOMA

FOR **TALL MEN ONLY!**
SHIRTS
WITH YOUR EXACT
LONG SLEEVE LENGTH



BIG FREE CATALOG!

Shoes, size 10AAA to 16EEE! Fine quality in smartest new dress styles. Also sport and work shoes, boots, socks, slippers. All FOR BIG MEN ONLY! A postcard brings you big color Catalog, FREE! Write today!

PERFECT FIT IN your big size! Sleeve lengths to 38, neck sizes to 18½! Ivy League stripes, plaids, solid-tones, whites in Sport and Dress styles. New wash-and-wear fabrics! Bodies cut 4" longer than ordinary shirts! Not sold in stores - by mail only! We are America's best-known specialists for BIG MEN ONLY! Finest quality at amazingly low prices! Satisfaction Guaranteed! Write for FREE Catalog!

KING-SIZE
INC.

186 Brockton,

Massachusetts

NOW!
at a price
you can afford!

MAKE MORE MONEY in TELEVISION RADIO-ELECTRONICS

**BETTER...MORE COMPLETE...LOWER COST...
WITH NATIONAL SCHOOLS SHOP-METHOD
HOME TRAINING!**

BETTER... Training that is proved and tested in Resident School shops and laboratories, by a School that is the **OLDEST** and **LARGEST** of its kind in the world.

MORE COMPLETE... You learn **ALL PHASES** of *Television-Radio-Electronics*.

LOWER COST... Other schools make several courses out of the material in our **ONE MASTER COURSE**... and you pay more for less training than you get in *our course* at **ONE LOW TUITION!**



These two **FREE** books will show you how!

You get all information by mail... You make your own decision... at home! **NO SALESMAN WILL CALL**

TOP PAY... UNLIMITED OPPORTUNITIES LIFETIME SECURITY CAN BE YOURS!

You are needed in the Television, Radio, and Electronics industry! Trained technicians are in growing demand at excellent pay—in **ALL PHASES**, including Servicing, Manufacturing, Broadcasting and Communications, Automation, Radar, Government Missile Projects.

NATIONAL SCHOOLS SHOP-METHOD HOME TRAINING, with newly added lessons and equipment, trains you in your spare time at home, for these unlimited opportunities, including many technical jobs leading to supervisory positions.

YOU LEARN BY BUILDING EQUIPMENT WITH KITS AND PARTS WE SEND YOU. Your National Schools course includes thorough *Practical* training—**YOU LEARN BY DOING!** We send you complete standard equipment of professional quality for building various experimental and test units. You advance step by step, perform more than 100 experiments, and you build a complete TV set from the ground up, that is yours to keep! A big, new TV picture tube is included at no extra charge.

EARN AS YOU LEARN. We'll show you how to earn extra money right from the start. Many of our students pay for their course—and more—while studying. So can you!

LESSONS AND INSTRUCTION MATERIAL ARE UP-TO-DATE, PRACTICAL, INTERESTING. Every National Schools Shop-Method lesson is made easy to understand by numerous illustrations and diagrams. All instruction material has been developed and tested in our own Resident School Shops, Laboratories and Studios.

SEND FOR INFORMATION TODAY... it can mean the difference between **SUCCESS** and failure for you! Send for your **FREE BOOK** "Your Future in Television-Radio-Electronics" and **FREE Sample Lesson.** Do it **TODAY**, while you are thinking about your future. It doesn't cost you anything to investigate!

GET THE BENEFITS OF OUR OVER 50 YEARS EXPERIENCE

Approved for GI Training



NATIONAL SCHOOLS
Los Angeles 37, Calif.

YOU GET...

- 19 Big Kits—**YOURS TO KEEP!**
- Friendly Instruction and Guidance
- Job Placement Service
- Unlimited Consultation
- Diploma—Recognized by Industry
- **EVERYTHING YOU NEED FOR SUCCESS!**

SHOP-METHOD HOME TRAINING COVERS ALL PHASES OF INDUSTRY

1. Television, including Color TV
2. Radio AM & FM
3. Electronics for Guided Missiles
4. Sound Recording and Hi-Fidelity
5. FCC License
6. Automation and Computers
7. Radar & Micro-Waves
8. Broadcasting and Communications

NATIONAL TECHNICAL SCHOOLS

WORLD-WIDE TRAINING SINCE 1905

MAIL NOW TO
NATIONAL SCHOOLS, Dept. RB-29
4000 S. FIGUEROA ST., LOS ANGELES 37, CALIF.
Rush free TV-Radio "Opportunity" Book and sample lesson. No salesman will call.

NAME _____ AGE _____
ADDRESS _____
CITY _____ ZONE _____ STATE _____

Check if interested **ONLY** in Resident School training at Los Angeles.
VETERANS: Give date of Discharge _____

RESIDENT TRAINING AT LOS ANGELES

If you wish to take your training in our Resident School at Los Angeles, the world's TV capital, start **NOW** in our big, modern Shops, Labs and Radio-TV Studios. Here you work with latest Electronic equipment - - professionally installed - - finest, most complete facilities offered by any school. Expert, friendly instructors. Personal Attention. Graduate Employment Service. Help in finding home near school - - and part time job while you learn. Check box in coupon for full information.

Even Men with No Experience
are Making as High as

\$1,000⁰⁰ IN A MONTH!



A message to all men who are looking for a way to make more money faster, with one of America's greatest inventions wanted by millions.

Here's Your Opportunity to get into the **BIG MONEY CLASS FAST** with sensational **PRESTO FIRE EXTINGUISHER**

Over 3,000,000 Sold for Homes, Offices, Autos, Service Stations, Stores, Farms, Boats

Not everybody makes \$1,000 in a month to start out, but read this: Florida salesman reports \$600 in 1 month. Ohio man earned \$2,100 in 2 months! Men everywhere, even in off hours, are rolling up amazing profits. Here's why. PRESTO's amazing new chemical, developed as secret defense during war, is 1½ to 6 times as effective as ordinary chemicals on equal weight basis. So PRESTO can be light, so handy a child can use. How about you cashing in on this great invention?

Folks are Amazed when you Tell Them This New Kind of Protection Costs Only

\$4.95

ONLY PRESTO HAS ALL THESE FEATURES

- Ends fire as fast as 2 seconds.
- Needs no inspection or recharging.
- Outperforms bulky extinguishers costing much more.
- Guaranteed for 20 years.

Why Large Profits Are Easy

Everyone is terrified by FIRE! Millions have been waiting for this pure, simple, inexpensive safeguard. Most people who see the dramatic 5-second demonstration want one or more. You make as much as \$2.70 on every one. Get started in this rich new field now!

Complete Sales Outfit FREE!

Mail coupon for big Illustrated Sales Kit with everything you need to make fine money first day — NOW. Every day you hesitate can cost you \$10, \$15, even \$50 you could be making! Everything FREE — no obligation — so MAIL COUPON TODAY!

BIG MONEY LIKE THIS EVEN IN SPARE TIME

Reports \$80 a Week
Averaging less than a day or two a week. I have made as much as \$75 to \$80 a week. Walter Gable, Md.

Averages \$15.20 an Hour
For every hour I devoted to PRESTO, I earned an average of \$15.20. W. F. Wydalitis, Ohio.



MERLITE INDUSTRIES INC. 114 E. 32nd St., Dept. P-15U New York, New York

MERLITE INDUSTRIES INC. (Presto Div.)
114 E. 32nd St., Dept. P-15U, New York 16, N. Y.

Rush me complete Sales Outfit with full details how I can make big money very first day with Presto Fire Extinguisher. All FREE, no obligation.

Name _____

Address _____

City _____ Zone _____ State _____

In Canada: Mopa Co., Ltd., 371 Dowd St., Montreal 1, P.Q.

SAVE 75%

ON



WORK CLOTHES!

SURPLUS STOCK FROM MIDWEST SUPPLY FIRM!

Terrific values you've got to see to believe!

SHIRTS 79c

Made to sell for 2.99! Now only 4 for \$2.99

What a buy! 4 for the price of one! These shirts, though used, are washed, sterilized and ready for long, tough wear. In blue, tan or green. Send neck size, 1st and 2nd color choice.

PANTS to match Unbelievable 99c

Bargains! Sold for 3.95. Now only 4 for \$3.75

Send waist measure and inside leg length.

COVERALLS... wear 'em used and save plenty! Originally 6.95. Now only \$2.29

Send chest measurement. 3 for \$6.75

SHOP COATS... fully reconditioned. \$1.79

Take advantage of this rock-bottom price. Send chest measurement. Now only 3 for \$5.00

SATISFACTION GUARANTEED! Your money back if you can beat these bargains anywhere! You can't lose so order TODAY for immediate delivery! Send \$1.00 deposit on C.O.D. orders. Add 25¢ postage and handling on prepaid orders.

GALCO SALES CO. Dept. 132

7120 Harvard Ave. • Cleveland 5, Ohio

Double Shot, Silver-Tipped, All Brass
REFILLS 20 for \$1

Retractable **PENS 12 for \$1**

100 for \$8.00
Choice of Red, Blue, Black or Green Ink! Add 10¢ shipping charge. Money back guarantee. Quantity and imprint prices on request.

REFILLS, VISUAL INK SUPPLY—26 FOR \$1
BARCLAY DISTRIBUTORS

DEPT. 59-B 86-24 PARSONS BLVD. JAMAICA, N.Y.

MECHANICAL DENTISTRY

A profession offering unlimited opportunities. Most modern and complete course embracing every branch from Plate to Porcelain Work, which prepares you to work for Dentists or start your own business. Individual instruction—practical training in day or night school. No books—no classes. Catalog upon request.
MCCARRIK SCHOOL OF MECHANICAL DENTISTRY
207 N. Broad Street Dept. 85 Philadelphia 7, Penna.

SEND FREE!
FOR THIS

Make money. Know how to break and train horses or ponies. Write today for this book FREE, together with special offer of a course in Animal Breeding. If you are interested in Gaiting and Riding the saddle horse, check here (). Do it today—now.
BEERY SCHOOL OF HORSEMANSHIP
Dept. 1102 Pleasant Hill, Ohio

WAR SURPLUS BARGAINS

\$500,000.00 INVENTORY for QUICK LIQUIDATION

Surplus items—hundreds of them for home, shop, factory, farm and outdoor use. New items, used items, reconditioned items—all at tremendous savings—all priced for quick sale.

Page After Page of Values

This big catalog shows page after page of amazing money saving values. Write for your copy today. Send 10¢ to cover postage, mailing, etc. Write today! **SEND TODAY FOR YOUR COPY**

10c

STARK'S

212 W. Madison St. Dept. PM-592 CHICAGO 6, ILL.

Fix ANY Part of ANY of These Cars —ALL MODELS, 1952 thru 1959:

Buick
Cadillac
Chevrolet
Chrysler
Clipper
Continental
De Soto

Dodge
Edsel
Ford
Hudson
Imperial

Jeep
Lincoln
Mercury
Nash

Oldsmobile
Packard
Plymouth
Pontiac

Rambler
Studebaker
Thunderbird
Willys

How to Keep ANY Car in TIP-TOP Shape —from bumper to bumper

Here's How Even A Beginner Can "Lick" ANY Car Repair
—and How Expert Mechanics Can SAVE Time, Work,
and Money on ALL Repairs, Maintenance Jobs, Tune Ups!

YOU name it — ANY car repair, maintenance, tune-up — and this brand-new Edition of famous MOTOR'S AUTO REPAIR MANUAL will make it easy for you to breeze right through the job. Right off the bat, you know exactly WHERE to look for the trouble . . . HOW to start . . . WHAT tools to use . . . HOW to do the job quickly, easily, right!

Automatic transmission trouble? A carburetor adjustment? A brake or valve job? Or a complete overhaul? No matter what the trouble, MOTOR'S MANUAL starts you from "scratch", leads you every step of the way through the entire job. You CAN'T GO WRONG because your hands are guided by the men who actually build the cars—the "blue prints" developed by factory experts to save time, work, and money on every job.

The "Meat" of 176 Official Shop Manuals

The editors of MOTOR'S Manual have gathered the "meat" from 176

Official Shop Manuals—the work and time-saving methods used by the manufacturers themselves. And to make things as easy as possible for you, this goldmine of fix-it "know how" has been "boiled down" into clear A-B-C directions, pictures, and diagrams—all crammed into ONE handy indexed book!

BIG, NEW, REVISED edition! 1,120 giant pages, 2,900 "This-Is-How" pictures — clear drawings, diagrams, cut-away photos — make every step EASY. 291 "Quick Check" charts — 23,436 essential repair specifications. 225,000 service and repair facts. Instructions and pictures so complete, so clear even a green beginner can do a good job. And top mechanics will be amazed at the time-saving procedures.

Everything You Need to Know —Right At Your Fingertips

Includes ALL Automatic Transmissions, Air Suspension, Carburetors, Engines, Fuel Pumps, 12-Volt Ignition Systems, Starting Motors, Generators, Distributors, Voltage Regulators, Brakes, Power Steering, etc. PLUS Trouble-Shooter section that enables you to spot any car trouble in a jiffy—and much more!

Used by hundreds of thousands of auto service men! 3,000,000 copies sold!

SEND NO MONEY

Try Book for a Week FREE

Just mail coupon. (Attach it to postcard for fast action.) Test book in your own garage or shop. GUARANTEED to pay for itself in 7 days. If it doesn't, return book and owe nothing. MOTOR Book Dept., Desk 912, 250 West 55th St., New York 19, N.Y. (Schools, Bookstores: Write for Discounts).

Same FREE 7-Day Offer on MOTOR'S Brand-New TRUCK REPAIR MANUAL

Covers EVERY job on EVERY popular — make gasoline — powered truck made since 1952. Includes GM, Mack and Cummins Diesels. Over 2,000 illustrations. Over 300,000 facts. Check proper box in coupon for free 7-day trial.

3,000,000
COPIES SOLD!

MOTOR'S
AUTO
REPAIR
MANUAL

SEND NO MONEY!
TRY BOOK
FOR A WEEK FREE!

Newest Up-to-the-Minute Edition Used by U. S. Armed Forces

- 1,120 Giant Pages
- 2,900 "This-Is-How" Pictures, Diagrams, Cut-Away Photos
- 291 Valuable "Quick Check" Charts
- 23,436 Essential Repair Specifications
- 225,000 Service and Repair Facts
- Complete Trouble Shooter
- Almost a Foot High. Shipping Weight Almost 5 pounds

Just 2 of the Many Letters of Praise

Does Every Job. "My MOTOR Manual is a wonderful help. It has put me in a position to do every job."
—S. L. Sharplest, Los Angeles, Calif.

Amazed Self and Friends. "I amazed myself and my friends, too. Now do jobs that stumped me before."
—Michael Baliczky, Newark, New Jersey.

MAIL COUPON NOW FOR 7-DAY FREE TRIAL (Attach to Postcard if More Convenient)

MOTOR Book Dept., Desk 912,
250 West 55th Street, New York 19, N. Y.
Rush to me at once: (Check box opposite book you want).
 MOTOR'S New AUTO REPAIR MANUAL. If okay, I'll remit just \$2.00 in seven days, then \$2.00 monthly for two months and a final payment of \$1.00 (plus 35c delivery charge) one month after that. Otherwise, I'll return the book postpaid in seven days. (Foreign price: Remit \$16 cash with order.)
 MOTOR'S New TRUCK REPAIR MANUAL. (Described at left.) If okay I will remit \$3.00 in seven days, and \$2.00 monthly for three months, plus 35c delivery charge with final payment. Otherwise I will return book promptly. (Foreign price: Remit \$11.00 cash with order.)

Print Name.....Age.....
Print Address.....
City & Zone No.....State.....

SAVE 35c delivery charge by enclosing WITH COUPON in envelope full payment of \$1.00 for Auto Repair Manual (or \$9.00 for Truck Manual). Same 7-day return-for-refund privilege applies.

course I

Electronic Fundamentals



course II

Television Servicing



course III

Color Television



RCA Institutes offers you the finest of Home Study training. The equipment illustrated and text material you get with each course is yours to keep. Practical work with very first lesson. Courses for the beginner and the advanced student. Pay-as-you-learn. You need pay for only one study group at a time.

Send for **FREE** RCA Institutes Catalog

See coupon on opposite page

RESIDENT SCHOOL offers Technical Institute and Vocational School Courses in Electronics. Day and Evening classes. Resident School Catalog sent free on request.

(Continued from page 16)

The system ought to be useful in everyday life, too. I found that a system could be set up. I use the scientifically correct year of 365.4 days. Divided into twelve equal parts, this year is exactly twelve months of 30.45 days each. There are 4.35 weeks in a month, 52.2 weeks in a year, 8769.6 hours in a year, 730.8 hours in a month and 168 hours in a week. So far I have always been able to come within hours of a correct answer. With meticulous care, one could come within minutes of an exact answer. It is probably obvious that it is easier to extract units of time from the calendar than it is to apply the units to the calendar and come up with the proper day or time of day. When working from units of time or decimal days, I simply extract so many hours per day or minutes per day and days per month. After the decimal units are broken up into months, days and hours, it is simple to count off to the day of the month. Excluding leap year makes the system applicable to long periods of time and doesn't seem to detract from short-time accuracy.

I have used this system for a year and in less than one more it will have served its purpose. However, I intend to use the system in another mode of life for a long time.

Robert Gibson, Pfc.,
U.S. Army Signal Service Co.
APO 757, N.Y.

☆ ☆ ☆

Home Product

Wilbur Smith of Bloomington, Ind., built this experimental plane of his own design at a cost of \$300, using salvage parts wherever he could adapt them. It is 15 feet 3 inches long with a wing spread of 23 feet



6 inches, weighing 394 pounds empty. Powered by a 1937 model 2-cylinder, 36-horsepower Aeronca engine, the plane cruises at 80 miles per hour and can land at 32 miles per hour, using 2½ gallons of fuel per hour. The fuselage is of wood.

(Continued to page 260)



RCA INSTITUTES proudly announces a new home study course... **ELECTRONICS for AUTOMATION**

Nucleonics, Photoelectronics, Digital Techniques, Synchros and Servomechanisms, Data Recorders, Automatic Process Controllers, Telemetry and Remote Control, Ultrasonics, and Automatic Control Systems . . . these are just a few of the many Industrial Electronics subjects covered in the new Electronics for Automation course.

RCA Institutes — now celebrating 50 years of electronic training — adds this new home study course to prepare you for a career as an electronic technician. Pay-as-you-learn. You need pay for only one study group at a time.

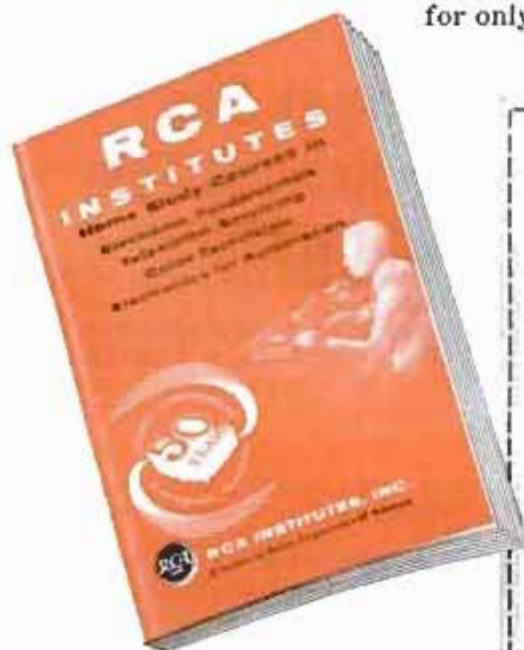

RCA INSTITUTES, INC., Home Study School, PM-29

A Service of Radio Corporation of America • 350 West Fourth Street, New York 14, N. Y.

Without obligation, send me the FREE catalog of Home Study Courses. No salesman will call.

NAME

PLEASE PRINT

ADDRESS

CITY ZONE STATE

Korean Vets! Enter discharge date

CANADIANS Take advantage of these same RCA Courses at no additional cost. No postage, no customs, no delay. Send coupon to:

RCA VICTOR COMPANY, LTD. • 5001 Cote de Liesse Rd., Montreal 9, Que.

TO SAVE TIME, PASTE COUPON ON POSTCARD

94.6% OF BAILEY GRADUATES ARE EMPLOYED AT TOP PAY IN THE FIELDS WHICH THEY WERE TRAINED!



DIESEL-AUTO MECHANICS DESPERATELY NEEDED!

We have a far greater demand for our students than we can fill!

We can show you an actual waiting list of leading companies throughout the world who have tried Bailey graduates — found them outstanding, and are coming back for more!

Bailey Graduates are Successful . . . RECEIVE BIG PAY — HAVE SECURE FUTURE!

The Famous Bailey Course prepares you for BOTH Diesel and Gasoline Mechanics.

This is a must—due to the advent of using Diesel principles, such as 'Fuel Injection' on passenger cars . . . use of gasoline engines for starting Diesel engines, etc. You learn all this at Bailey in the amount of time ordinarily required to learn just one of these subjects, ALL FOR THE PRICE OF ONE.

Don't be satisfied with a 'futureless', one-type job — learn how you can make big money now! Write today for Free Booklet that takes you on a step-by-step camera tour through our spacious, modern shops — See Bailey students in action as they Learn-by-doing with the Famous Bailey Method of training!

We provide you with housing and part time jobs while in school, plus nation-wide placement service for graduates.

BAILEY Technical SCHOOLS

1634 S. GRAND ST. LOUIS 4, MO.

MAIL TODAY!

Please mail immediately this free booklet without obligation.

FREE BOOKLET



Name.....

Address.....

City..... State.....

APPROVED FOR VETERAN... NON-VETERAN

Earn \$217 a Month EXTRA With My FREE SHOE OUTFIT!

Just 2 Sales a Day Does It!

Rush a postcard today for my powerful FREE Shoe Selling Outfit. It contains everything you need to start a steady profit, repeat-order shoe business! Just 2 sales a day earns you up to \$217 a month EXTRA! It's amazingly easy! Just show friends, relatives Mason's famous shoes with comfortable Air-Cushion innersoles. People like buying the Mason way because they choose from over 160 dress, sport, work styles for men and women—including Nylon mesh, Cush-N-Crepe and Safety Toe work shoe styles. Because you draw from stock of 200,000 pairs, in an amazing range of sizes and widths, customers get the exact size, width and style they order! Our shoes are not sold in stores . . . people must buy from YOU! Start making BIG MONEY now . . . send for your FREE Special Outfit TODAY!



Write TODAY!

MASON SHOE MFG. CO. DEPT. F-421 CHIPPEWA FALLS, WIS.

WORLD'S LOWEST PRICED CALCULATOR! NOT \$3.95 NEW! NEW! NEW! But Only \$1.97

TOM THUMB ADDING MACHINE

With beautiful Leatherette carrying case. MADE IN AMERICA BY AMERICANS. Beware of cheap imported imitations. ADDS UP TO ONE BILLION — 1,000,000,000 SUBTRACTS — MULTIPLIES — DIVIDES Mistake Proof • Positively 100% Accurate • Lightning Fast • Shock Proof Solid Steel Mechanism • GUARANTEED FOR YOUR LIFETIME. Ideal for Housewives, Shoppers, Students, Engineers and Tax work. Take it to the Super Market—Save \$ \$ 5 every week. We pay postage if you send check, cash or money order—or just send your name & address and pay postman \$1.97 plus postage. Immediate Delivery—10 Day Free Trial—Satisfaction Guaranteed or money refunded by return mail. SPECIAL GIFT OFFER—3 Machines for only \$4.99 AGENTS WANTED—Make easy money selling a Top Quality Calculator at our unbelievably low price.



TOM THUMB ADDING MACHINE P.O. BOX 5066 Dept. F-19 Philadelphia 11, Penna.

MAKE BIG MONEY—ALL PROFIT—AT HOME

INVISIBLE MENDING

Pays up to \$10 in an Hour!

Make moth holes, cigarette burns, tears, rips, disappear from all fabrics. Little-known craft pays extra spare-time profits at home. Write today for exciting details FREE!

FABRICON, 6238 Broadway DEPT. 322, - CHICAGO 40, ILLINOIS



Shrinks Hemorrhoids New Way Without Surgery Stops Itch—Relieves Pain

For the first time science has found a new healing substance with the astonishing ability to shrink hemorrhoids and to relieve pain — without surgery.

In case after case, while gently relieving pain, actual reduction (shrinkage) took place.

Most amazing of all — results were so thorough that sufferers made astonishing statements like "Piles have ceased to be a problem!"

The secret is a new healing substance (Bio-Dyne*) — discovery of a world-famous research institute.

This substance is now available in suppository or ointment form under the name Preparation H.* Ask for it at all drug counters—money back guarantee. *Reg. U.S. Pat. Off

make \$25 before noon

(This chair alone brought \$4.50 with twenty-five minutes work and 32¢ in cleaning materials.)

"Just a few months ago I made the big move. I gave up my job and started spending all my time in the little business I had been running on the side. It wasn't an easy decision, but, now I'm tickled to death I made it. Not just because I'm my own boss or because I have an excellent chance of making over \$10,000 this year. It goes deeper than that.

"You see, this idea has caught on like wildfire in my town. Not a day goes by without my phone ringing with women calling for appointments. The beauty of it is that once a woman becomes my customer, she calls back year after year. Not only that, she tells her friends, too, and they call me. Before I know it I'm swamped with work. (And at \$7.50 an hour net profit it doesn't take long before my bank account is really mushrooming.)

"Funny thing, but back last year, before I started, I never realized the money there was in this business waiting for someone to come along and collect it. Just think: every house in town has furniture and most have rugs or carpeting. I concentrate on just the better homes and have more work than I can handle. You know why? Because women are fussy about their furnishings. Can't stand to see them dirty. That's why they call me over every year.

"The average job is worth \$25.00 to me and takes a little over 2 hours. Out of this, after paying for materials, advertising and other expenses I net about \$15.00 clear profit. This means I need just 3 jobs a day to clear \$11,250.00 in a year. Frankly, since this will be my first full-time year I'll be glad to hit the \$10,000 mark. But after that this business should grow larger each year until I have to hire men to help me handle the business.

Personally Trained

"Believe me there's nothing magic about it. I didn't know a thing about cleaning home furnishings before I became a Duraclean dealer. But after my application was accepted, I was trained in their factory-training school and by a dealer in a nearby town. I was astonished by the short time it took me to become an expert. Actually, much of the credit must go to the Duraclean process, which is so safe it has earned the Parents' Magazine Seal.

"The portable machine you see is just one of the electrical machines I use. It manufactures a light aerated foam with a peculiar action chemists call 'peptizing'. It means that instead of being scrubbed deep into the fabric, dirt is gently ABSORBED by the foam, leaving the fabric clean all the way down. Women can't believe their eyes when they see how it works. Colors appear bright again, and rug pile unmat and rises like new. I don't have to soak rugs or upholstery to get them clean, which ends the problem of shrinkage, and means the furnishings can be used again the very same day. This alone has brought me a lot of customers.

"As a Duraclean dealer I make money with four other services, too: **Duraproof** . . . which makes furnishings immune to moth and carpet beetle damage (it's backed by a six year warranty). **Durashield**, a brand new dirt-delaying treatment. It coats fabrics with an invisible film that keeps dirt out. **Duraguard**, another new service, flameproofs draperies, upholstery and carpets to reduce charring

by
**Harold
Holmes**



and the tendency of fires to flame up. And **Spotcraft**, which consists of special chemical products for removing stubborn spots and stains. On jobs where I perform all five services, I multiply profits!

"One of the nicest things about being a Duraclean dealer is that I get continuous help from Duraclean Headquarters. My services are nationally-advertised in famous magazines like McCall's, House Beautiful and many others. I also get a complete advertising kit prepared by experts. (There's even a musical commercial!) I get a monthly magazine full of methods to build business and I can meet with other dealers at Duraclean conventions. I'm also backed by insurance. In fact there are over 25 regular services I get under their unique System.

No Shop Needed

"Maybe you too would like to break away from your job and make a fresh start in a business of your own. Do you need a shop? Certainly not. I operate from home. Need a lot of money to start? Not at all. Duraclean finances reliable men, after a moderate down payment, and furnishes enough supplies to return your TOTAL investment.

"You get everything you need: equipment, supplies, advertising matter, personal training, and regular help from Headquarters. To get all the details, fill out the coupon. There's no obligation and you can *decide for yourself*. I'll say one thing: if you DO become a Duraclean dealer, you'll be glad the rest of your life that you took time today to write."

Irl H. Marshall, Jr., International Headquarters
Desk 9-162, 839 Waukegan Avenue, Deerfield, Ill.

IRL H. MARSHALL, Jr., International Headquarters
Desk 9-162, 839 Waukegan Avenue, Deerfield, Ill.

I'm interested in owning my own business. Please send illustrated booklets and full details FREE outlining the Duraclean Dealership Program and territory arrangement.

Name _____ Please print

Address _____

City _____ State _____

Check the Kind of Body YOU Want:



- Slimmer Waist, Hips
- Broader Chest, Shoulders
- More Weight, Solid
- More Powerful Arms
- More Powerful Legs
- More Energy, More Restful Sleep

... and I'll Show You How EASILY You Can HAVE It!

JUST tell me, in coupon below, the kind of body you want—and I'll give it to you SO FAST your friends will be amazed! I'll show you how you can become a NEW MAN in just 15 minutes a day—in your own home—or it won't cost you a penny!

You wouldn't believe it, but I myself used to be a 97-lb. weakling. Fellows called me "Skinny." Girls made fun of me. THEN I discovered my marvelous new muscle-building system—"Dynamic Tension." It turned me into such a specimen of MANHOOD that today I hold the title "THE WORLD'S MOST PERFECTLY DEVELOPED MAN."

"DYNAMIC TENSION"—that's my secret! When you look in the mirror and see a healthy, husky fellow smiling back at you—then you'll realize how fast "Dynamic Tension" GETS RESULTS. That's because it's the natural method you can practice in your own room—JUST 15 MINUTES A DAY—while your chest and shoulder muscles begin to swell... those arms and legs of yours bulge... and your whole body starts to feel "alive"—full of zip and go—INSIDE and OUT!



FREE Illustrated 32-Page Book Just Mail the Coupon

Send NOW for my famous book showing how "Dynamic Tension" can make you a new man. 32 pages, packed with photos, valuable advice, answers to vital questions. I'll send you a copy absolutely FREE if you rush coupon to me personally.

Charles Atlas, Dept. 88,
115 E. 23rd St., New York 10, N.Y.

**CHARLES ATLAS, Dept. 88,
115 East 23rd St., New York 10, N. Y.**

Dear Charles Atlas—Here's the Kind of Body I Want:

- (Check as many as you like)
- Slimmer Waist, Hips
 - Broader Chest, Shoulders
 - More Weight, Solid
 - More Powerful Arms
 - More Powerful Legs
 - Better Energy

Send me, absolutely FREE, a copy of your famous book showing how "Dynamic Tension" can make me a new man. 32 pages, crammed with photographs, answers to vital questions, and valuable advice. No obligation.

Name _____ Age _____
(Please Print or write plainly)

Address _____

City _____ Zone _____ State _____



TIRE SALE



**FREE
PASS.
TUBE**

25 YEARS IN BUSINESS AT THE SAME ADDRESS

Seeing is believing—IF YOU GO SHOPPING YOU'LL END HERE. Be Wise, try one! You'll buy more, GUARANTEE given with each used tire sold. SEND AD.

400x16	\$4.72	670x15	\$4.72	650x16(6)	\$8.43	800x15	\$6.22
600x16(6)	7.62	710x15	4.72	750x16(6)	8.72	820x15	6.42
850x14	7.52	760x15	4.72	640x15	5.32	700x16(6)	8.72
750x14	7.52	800x14	8.72	1100x29	19.52	1100x22	20.32
700x15(6)	\$9.92	700x20	\$10.92	750x17	\$13.72	825x20	\$18.52
750x16(8)	11.62	750x20(10)	15.22	600x20	9.92	900x20	19.72
700x17	10.92	750x20(8)	13.32	650x20	11.32	1000x20	19.92

12 MOS. WRITTEN GUARANTEE. WHITE WALLS \$1.00 EXTRA
"EXTRA SPECIAL" TOP QUALITY all size 4-ply pass. FREE TIRE with 2 or more of these. W.W. \$8.82
\$1.00 Extra — GIANT TIRE SALE. EA.

Thousands of tires shipped all over the U.S.A. All tires shipped F.O.B. Phila. Send Check or M.O. with this ad. Dept. 2. No C.O.D.
STANDARD 834 N. Broad St., Philadelphia 30, Pa.

SHORTHAND in 6 WEEKS

Famous SPEEDWRITING shorthand. 120 words per minute. No symbols; no machines; uses ABC's. Learn at home. Lowest cost. For business and Civil Service. Over 500,000 graduates. Typing available. 36th year. Write for FREE booklet to: SCHOOL OF

© 1959

Speedwriting
Dept. 1502-9, 55 W. 42 St., New York 36 (R)

"How to Make Money with Simple Cartoons"



A book everyone who likes to draw should have. It is free; no obligation. Simply address

FREE BOOK

CARTOONISTS' EXCHANGE
Dept. 92-D Pleasant Hill, Ohio

REAL ESTATE BE A BROKER

PAYS BIG! SEND FOR FREE, BIG, ILLUSTRATED CATALOG NOW! Graduates report making substantial incomes. Start and run your own business quickly. Men, women of all ages, learn easily. Course covers Sales, Property Management, Appraising, Loans, Mortgages, and related subjects. STUDY AT HOME or in classrooms in leading cities. Diploma awarded. Write TODAY for free book! No obligation.

FREE BOOK TELLS HOW

Approved for World War II and Korean Veterans
WEAVER SCHOOL OF REAL ESTATE (Est. 1936)
2020R Grand Avenue Kansas City, Mo.

JEEP OWNERS

RE-POWER NOW WITH A V-8 ENGINE — Use **FORD • CHEVROLET • MERCURY** in 2 or 4 Whl-Dr. Jeeps, Jeepsters, Sta-Wgn, Trucks, W. J. and Kaiser cars. Conversion Kits \$43.25 to \$59.85. If you want fast action tell us which engine you wish to use, give us year, Model (2 or 4 Whl-Dr) of your vehicle. Send Min. \$15.00 Dep. and we will ship correct kit, Sat. COD. Send full amt. for Prepaid shipment. Wire, phone or write for free details. Also Kits for FORD 6 engine.
HOOSIER MACHINE PRODUCTS CO.
312 S.E. 6th St. Phone CR 6-3442 Pendleton, Oregon, U.S.A.

STOP FRONT DRIVE DRAG ON YOUR Jeep



PROVEN IN OVER A BILLION MILES OF SERVICE!
Warn Hubs on your 4 w.d. give double-duty value — economical, free-wheeling 2 w.d. (with added pep!), normal 4 w.d. — automatically with Lock-O-Matics, manually with Warn Locking Hubs. See your 4 w.d. dealer!

WARN HUBS WARN MFG. CO., Inc.
Riverton Box 6064-A2
Seattle 88, Wash.

DON'T BE HALF-TRAINED! Be A Master Technician

NOW... ONE
modern master
home training course
IN ALL 3 PHASES



AIR CONDITIONING - REFRIGERATION ELECTRICAL APPLIANCES

ALL AT ONE
LOW TUITION
only National Schools gives
you this complete training
at no extra cost

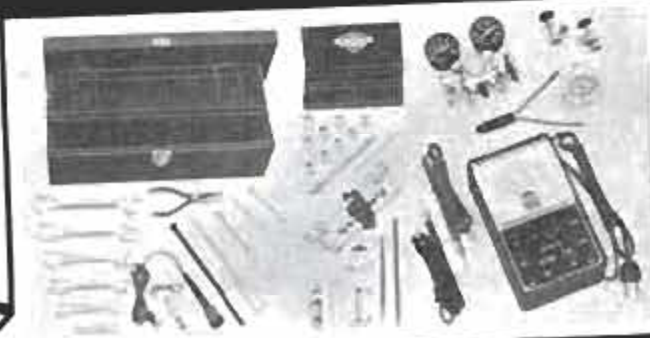

**YOU GET
AND KEEP
ALL THESE
TOOLS
AND
INSTRUMENTS**

Incomplete training limits your earning power, even disqualifies you for top-pay jobs. The big service companies require complete, all-phase training. If you open your own shop, you'll be called upon to service and repair all types of refrigerators, air conditioners and appliances. With complete training—as only National Technical Schools can give you—you can accept every job, make big profits all year round.

FUTURE BRIGHT FOR TRAINED MASTER TECHNICIANS

Over 30,000 new technicians must be trained annually. You are needed to help service and repair the 50 million air conditioners, refrigerators and electrical appliances that will need fixing this year alone. No wonder the Master Technician has steady work, at high pay, year after year. He can go places in his own business or with a manufacturer, dealer, distributor or department store. Armed with all-phase training, his earning power is unlimited.

THE MOST FOR LESS

We give you illustrated Shop-Tested Lessons and Manuals...many other training aids...privilege of CONSULTATION with our instructors and engineers. Every lesson, every manual has been SHOP tested and approved.

JOB TRAINING AT HOME

You get Professional Tools, Precision Instruments, PLUS a Factory-Made APPLIANCE TESTER! A shop-full of PRACTICAL, professional equipment. Use them to conduct over 100 experiments...also in Spare Time Work and ON THE JOB. It is all yours to keep...no EXTRA MONEY DEPOSITS...no EXTRA COST on your equipment kits.

EARN AS YOU LEARN

We show you how. Many of our students pay for their entire course—and more—in Spare Time while learning. So can you. Graduate Advisory Service, too.

GET THE BENEFIT OF OUR OVER 50 YEARS EXPERIENCE

**N.T.S. also offers training in
TV - RADIO - ELECTRONICS
and AUTO MECHANICS - DIESEL**



MEMBER



NATIONAL TECHNICAL SCHOOLS

WORLD-WIDE TRAINING SINCE 1905

4000 SO. FIGUEROA ST., LOS ANGELES 37, CALIF., U. S. A.

RESIDENT TRAINING AT LOS ANGELES

If you wish to take your training in our Resident School at Los Angeles, start NOW in our big modern Shops and Labs. Here you work with latest equipment, professionally installed... finest, most complete facilities offered by any school. Expert, friendly instructors. Personal attention. Graduate Advisory Service. Help in finding home near school...and part time job while you learn. Check box in coupon for full information.



**SEND FOR
FREE
BOOK AND
ACTUAL
LESSON NOW!**

We'll rush you our big, illustrated OPPORTUNITY BOOK and ACTUAL LESSON, show you how easily you can learn. NO OBLIGATION; no salesman will call. Do it NOW! It costs nothing to find out.

NATIONAL TECHNICAL SCHOOLS

WORLD-WIDE TRAINING SINCE 1905

MAIL NOW TO
National Technical Schools, Dept. CB-29
4000 S. Figueroa St., Los Angeles 37, Calif.
Rush FREE "Opportunity" Book and Actual
Lesson. No Salesman will call.

NAME _____

ADDRESS _____

CITY _____ ZONE _____ STATE _____

Check here if interested ONLY in Resident Training at Los Angeles.



WHY DOESN'T MY PAY CHECK GROW?

"Some day I'll really get a break and go right on to the top." That's wishful thinking.

You know that the "breaks" go to the man or woman who is prepared to take advantage of them—to the person who can fill the better job and is worth more money. He makes the "breaks" instead of waiting for them.

You can influence your own future by preparing now for the step forward—so that openings come because you are equipped for them—not as the result of luck.

DON'T LIMIT YOURSELF

During our more than 50 years, over 1,400,000 ambitious men and women have turned to LaSalle training for more money—larger success in life—and greater job security.

Prepare now. Send the coupon below—check the business field of your choice and we'll send you without obligation our FREE book describing the opportunities and complete information on that field.

Send the coupon Now. It may be the turning point in your life to that better job and more money.

Accredited Member, National Home Study Council

MAIL THIS COUPON TODAY

LASALLE Extension University

A Correspondence Institution

417 S. Dearborn St., Dept. 264R, Chicago 5, Ill.

Please send free book on the subject I have checked.

- | | |
|---|---|
| <input type="checkbox"/> Accounting | <input type="checkbox"/> Foremanship |
| <input type="checkbox"/> Law: LL.B. Degree | <input type="checkbox"/> Stenographic-Secretarial |
| <input type="checkbox"/> Business Management | <input type="checkbox"/> Stenotype-Machine |
| <input type="checkbox"/> Traffic & Transportation | <input type="checkbox"/> Shorthand |
| <input type="checkbox"/> Industrial Management | <input type="checkbox"/> Sales Training |

Name.....Age.....

Address.....

City.....Zone.....State.....

NEW WONDER AUTO GLAZE



FREE SAMPLE

with Miracle DOW
CORNING 200 Fluids
Gives You \$55.00 a Day Clear Profit
... on Your Own Exclusive Route!

GUARANTEED to outshine, outlast and outperform ANY wax polish on the market today—or money back!
FAST, REPEAT SELLER! Needed by 45,000,000 car owners. Demonstrates like magic. Just apply, wipe off. No hard rubbing. Keeps car and chrome like new for months!

OVER 175% PROFIT! Retail is \$2.00 pint (year's supply). Your profit can be over \$1.35 each pint.

FREE SAMPLE sent to try on your car. Rush name for FREE sample and money-making details. No Obligation!

ROYALTONE PRODUCTS CORP., Dept. PM-2
1035 E. 10th St., Brooklyn 30, N. Y.

If Your Child Is a Poor Reader

See how The Sound Way To Easy Reading can help him to read and spell better in a few weeks. New home-tutoring course *drills* your child in phonics with records and cards. Easy to use. University tests and parents' reports show children gain up to *full year's grade* in reading skill in 6 weeks. Write for free illustrated folder and low price. Bremner-Davis Phonics, Dept. E-57, Wilmette, Ill.

BRONZE FOUNDRY



Schools • Home Workshops • Inventors

Make your own castings of aluminum, copper, bronze, silver. Foundry sets are available in three sizes including 2400 Deg. F. blast Furnaces. \$26.50; \$33.50; and \$46.00 f.o.b. Marysville. Free Circular.

KANSAS CITY SPECIALTIES CO. DEPT. P-2, P.O. BOX 6022, MARYSVILLE, KANSAS

Now Many Wear FALSE TEETH With More Comfort

FASTEETH, a pleasant alkaline (non-acid) powder, holds false teeth more firmly. To eat and talk in more comfort, just sprinkle a little FASTEETH on your plates. No gummy, goeey, pasty taste or feeling. Checks "plate odor" (denture breath). Get FASTEETH at drug counters everywhere.

SELL MASTER Advertising Uniforms To Business Men

• FULL OR PART TIME • SAMPLE FURNISHED

- Not House-To-Home
- You Invest Nothing
- Full or Part Time

Sell 10, 20, 100 uniforms at a time. Big reorders. No experience needed. Free powerful sample outfit. Tested selling methods. A few calls can bring you \$50 and more per day. We show you how. Write today. No obligation.



GEORGE MASTER GARMENT CO. Dept. J-40 Ligonier, Ind.

TRAIN FOR OPPORTUNITY FIELD OF

ELECTRONICS

ON REAL EQUIPMENT

IN THE NEW SHOP-LABS

OF COYNE



**LARGEST, OLDEST AND
BEST EQUIPPED
SCHOOL OF ITS
KIND IN U.S.**



This fireproof building is occupied entirely by Coyne and houses the NEW COYNE SHOP-LABS with over a quarter of a million dollars worth of Equipment. Thousands of successful men have trained at Coyne. There is no substitute for Coyne's wealth of experience.

OPPORTUNITIES IN ELECTRICITY-ELECTRONICS

Train the Coyne way for a better job in Electricity-Electronics—a field that offers a world of opportunities now and in the years ahead. In industry—in the home—Electricity and Electronics are playing a vastly greater role than ever before. New developments and rapid growth are creating increasing job opportunities. Automation Electronics—one of the more recent applications of Industrial Electronics to manufacturing processes—promises to create additional demands for trained Electrical-Electronics men such as we have never seen. Electrical-Electronics Training can be taken separately or combined with Television-Radio training. Send coupon for more information.

Training in Refrigeration and Electric Appliances can be included.

YOU TRAIN IN CHICAGO—Learn the easier practical way in the NEW SHOP-LABS of Coyne in Chicago. Shop work plus technical training. No advanced education or previous experience needed. Lifetime Employment Service to Coyne Graduates.

START NOW—PAY LATER

New liberalized credit terms and Finance Plans. Pay most of tuition after graduation. Part-time employment service to students.

VETERANS OR NON-VETERANS

Coyne training is offered to Veterans and Non-Vets alike. We'll send Bulletin giving full information. Send coupon for details.



1. You are told the how and why of each job.



2. You're shown how to do it by trained instructors.



3. You do the jobs yourself on actual equipment.

B. W. COOKE JR., President

COYNE

ELECTRICAL SCHOOL

FOUNDED 1899

Chartered As An Educational Institution Not For Profit

1501 W. Congress Parkway, Chicago, Dept. 29-3A

ELECTRICITY • RADIO • TELEVISION • REFRIGERATION • ELECTRONICS



TELEVISION—RADIO ELECTRONICS

Great opportunity for a good job or your own business in one of America's fastest growing branches of Electronics! New stations by the hundreds . . . new sets by the millions . . . and now Color TV . . . all means greater opportunities in Sales and Service. Separate courses in Radio-Television or in combination with Electricity-Electronics available.

SEND FOR FREE BOOK!

Mail coupon in envelope—Paste on Postal Card or write to address below for 48 Page Illustrated Book, "Guide to Careers" and all the facts. Whether you prefer Electricity-Television-Radio or Combined Electronics Training this book describes all training offered.

Information comes by mail. No obligation and no salesman will call.



Coyne Electrical School,
Dept. 29-3A, New Coyne Building
1501 W. Congress Pkwy., Chicago 7, Ill.

Send FREE BOOK, "Guide to Careers," and details of all training you offer.

Name _____

Address _____

City _____ State _____

(I understand no Salesman will call.)

DRAFTSMEN



CASH BIG PAY CHECKS!

Train Now for more success, greater security

LEARN AT HOME IN SPARE TIME (or at college in Chicago)

Check the want ads in any newspaper—SEE the big-pay opportunities open to you as a draftsman. What's more, you can learn this well-paid, prestige profession at home—quickly, easily! No special talent needed. Get complete, step-by-step Chicago Tech lessons in the mail, spend a few pleasant hours studying each week. In a short time you'll be a well-trained draftsman, ready to take your pick of many good jobs. Act now!



Free Information—Mail Coupon Today!

Get FREE TRIAL LESSON plus information about C.T.C. practical training. Learn what successful Chicago Tech graduates say about high pay and opportunities in drafting. No charge, or obligation.

CHICAGO TECHNICAL COLLEGE

B-217 Tech Bldg., 2000 So. Michigan Ave. Chicago 16, Illinois

Mail me FREE lesson with facts about big opportunities in DRAFTING.

Name _____ Age _____

Address _____

City _____ Zone _____ State _____



HIGH WAGES!

High Wages can be yours as an Operating Engineer of heavy construction equipment! Learn NOW to operate our diesel engined bulldozers, draglines, cranes, back hoes, scrapers and motorgraders! Machines of major manufacturers are used in our training program. Contractors need trained operators and pay high wages to our graduates. We invite comparison and inspection at the nation's original construction equipment operator's training schools.

Veterans: Ask about GI benefits!

Write today for free school catalogue
No obligation, to either address

**THE NATIONAL SCHOOLS
of HEAVY EQUIPMENT OPERATION**
Dept. D-26

P.O. Box 8243, Charlotte, N. C. • P.O. Box 527, Weiser, Idaho

New Isotronic Training Method

LEARN TV REPAIR IN ONE SHORT WEEK!

Now, after 5 year's research—a streamlined training system that *obsoletes all others!* In just 7 days you may earn \$150 weekly, without paying up to \$250 for training, studying long months! Developed by electronic scientists in cooperation with major TV mfr's., the new Isotronic method is the most practical ever devised! For conclusive proof, write for details and FREE SAMPLE LESSON. Use it on your own set or a friend's—repair it—convince yourself you can make big money immediately in your own TV business! Hurry—Free Lesson supply limited. Write:

TV SERVICING SYSTEMS, Dept. C-172
1038 So. La Brea, Los Angeles 19, Calif.



EXACT REPLICA U. S. MARINE GRENADE

As Used in Hand Combat

Get a real bang when you toss this replica of a Marine grenade. Startle ex-G.I.'s. Explodes automatically 4 seconds after pulling pin as it strikes ground. Can't break. Heavy gauge steel firing mechanism. Uses standard caps. Can be exploded over and over. Real collector's item. Comes complete with instructions. Send \$1.98 plus 25c shipping charge—cash, check or money order to: Standard American Suppliers, Inc. Grenade Dept. PM-2, One Park Ave., New York 16, N. Y.

Secrets of VENTRILOQUISM Now Revealed!



Easy to learn in 60 to 90 days with our Home Study Course. RESULTS GUARANTEED. Make Money! Be Popular! Have Fun! Big Opportunity! Radio, Television, Stage Appearance! For FREE information regarding price and terms WRITE. You must state your age. Dummy Catalog 25c. MAHER HOME COURSE OF VENTRILOQUISM Box 36, Studio PM-2, Kensington Station Detroit 24, Michigan

MONEY in DONUTS

Make new greaseless donuts. Start in kitchen. No smoke. Sell stores. HALF PROFIT. Cash daily. Free recipes. No obligation. Write! MARTIN RAY CO., 3605 SO. 15th AVENUE, MINNEAPOLIS 7, MINN.

Print Your Own

Cards, Stationery, Advertising, Circulars, labels, photo and movie titles, church work, tags, etc. Save money. Sold direct from factory only. Raised printing like engraving, too.

Own a Printing Business
Print for Others. Good Profit. Have home shop. Junior press \$15; Senior \$29 up. We supply everything. Easy rules. Pays for self in short time. Write for free catalog of outfits and all details. KELSEY PRESSES, C-37 Meriden, Conn.

RUPTURED

BE FREE FROM TRUSS SLAVERY

Surely you want to THROW AWAY TRUSSES FOREVER, be rid of Rupture Worries. Then Why Do you put up with wearing a griping, chafing and unsanitary truss the balance of your life? If you do, it will NOT be through necessity but through choice on your part.

Now there is a new modern Non-Surgical treatment that is designed to permanently correct rupture. These Non-Surgical treatments are so certain, that a Lifetime Certificate of Assurance is given. Write today for our New FREE Book that gives facts that may save you painful, expensive surgery. Tells how non-surgically you may again work, live, play, love and enjoy life in the manner you desire. There is no obligation. Excelsior Medical Clinic, Dept. H6124, Excelsior Springs, Mo.

WHAT ALL AUTO MECHANICS WANT TO KNOW



This Big Practical Book gives full information, with working diagrams, covering the principles, construction, ignition, service and repair of modern cars, trucks and buses.

Diesel Engines, Hydraulic and Fluid Drives Fully Explained.

A complete guide of 1696 Pages, with over 1500 Illustrations showing inside views of working parts, with instructions for service jobs. Completely up-to-the-minute! Priced at only \$6.

CIRCLE No. 1 IN COUPON



CARPENTERS AND BUILDERS GUIDES



PRACTICAL STOREHOUSE OF MODERN CONSTRUCTION INFORMATION (4 vol. set) for carpenters and all woodworkers. Explains in easy language and by profuse illustration principles, advances, short cuts, trade secrets, all based on the **NEWEST** information.

Vol. 1—Tools, steel square, saw filing, joinery, furniture, etc.; Vol. 2—Builders' mathematics, drawing plans, specifications, estimates, etc.; Vol. 3—House and roof framing, laying out, foundations, etc.; Vol. 4—Doors, windows, stair building, millwork, painting, etc. 4 vols. 1904 Pages. 3760 Illustrations. Whole set only \$8.

CIRCLE No. 8 IN COUPON

THE NEW ELECTRIC LIBRARY

A COMPLETE ENCYCLOPEDIA explaining in the simplest terms the fundamental principles, rules and applications of applied electricity.

A COMPLETE COLLEGE EDUCATION!

Fully illustrated with diagrams and sketches, calculations and tables for ready reference. Questions and answers. Trial tests for practice study and review. All based on the most modern theory.

Vol. 1—Principles and rules of electricity, magnetism, armatures, repairs. No. 15
Vol. 2—Dynamios, DC Motors, construction, installation, maintenance, etc. No. 16
Vol. 3—Testing instruments and tests, storage battery constn. and repairs. No. 17
Vol. 4—Alternating current, power factor, alternators, transformers. No. 18
Vol. 5—A.C. Motors, windings, maintenance, converters, switches, fuses, etc. No. 19
Vol. 6—Relays, condensers, regulators, rectifiers, meters, switchboards, etc. No. 20
Vol. 7—Wiring, house light and power, circuits, high tension, plans, code, etc. No. 21
Vol. 8—Railways, signals, elevators, ignition, etc. No. 22
Vol. 9—Radio, telephone, telegraph, television, motion pictures. No. 23
Vol. 10—Refrigeration, illumination, welding, x-ray, electrical appliances, Index. No. 24

7,000 fully illustrated pages. Priced at only \$20 for the **ENTIRE SET**. Also sold individually for \$3 each.



HOW TO FIX HOME APPLIANCES

REFRIGERATORS WASHERS TOASTERS DRYERS IRONERS RANGES VACUUMS FREEZERS

Many other **GAS AND ELECTRIC APPLIANCES**

Handy Reference for Electric & Gas Servicemen, Mechanics, Dealers and Homeowners. Explains clearly and simply how to locate trouble, how to test, reassemble and connect. Wiring diagrams. 1000 Facts. Easy to read. Answers ALL your questions. 864 Pages. Illustrated. Only \$6.

CIRCLE No. 2 IN COUPON



PRACTICAL ELECTRICITY

A COMPLETE HANDBOOK—Quick, simplified, ready reference. Complete instruction and practical information on the rules and laws of electricity—Maintenance of Machinery—A.C. and D.C. Motors—Armatures—Wiring Diagrams—House Lighting—Power Wiring—Meters—Batteries—Transformers—etc. Simple to understand. 1520 Pages. 2600 Illustrations. Priced at \$5.

CIRCLE No. 4 IN COUPON

DIESEL

ALL THERE IS TO KNOW ABOUT MODERN DIESEL ENGINES—Basic principles, starting valves, timing, fuel pumps, fuel injection compressor, air compressors, pistons, cylinders, lubrication, cooling systems, etc. Answers on operation, calculations. 640 Pages. Fully Illustrated. Priced \$3.

CIRCLE No. 9 IN COUPON

WELDERS GUIDE

Covers Electric, Oxy-acetylene, Thermit, Unionmelt welding for sheet metal, spot and pipe welds, pressure vessels and aluminum, copper, brass, bronze and other metals. Airplane work, surface hardening, hard facing, cutting, brazing, etc. 608 Pages. Fully Illustrated. Only \$5.

CIRCLE No. 10 IN COUPON

MATHEMATICS MADE EASY

A COMPLETE HOME STUDY COURSE—Starting with the first principles of arithmetic, advancing step by step through the various stages of mathematics, including the rules and calculations for mechanical and electrical problems. New **EASY** correct methods. Includes plane and solid geometry, trigonometry, algebra, calculus, etc. Practical tests, reference tables and data. How to use slide rule. 752 Pages. 550 Illustrations. Priced at only \$3.

CIRCLE No. 11 IN COUPON

NEW MACHINISTS AND TOOLMAKERS HANDBOOK

MODERN MACHINE SHOP PRACTICE—5 PRACTICAL BOOKS IN ONE. New from cover to cover. Tells how to set up and operate lathes, screw and milling machines, shapers, drill presses and all other machine tools. A COMPLETE INSTRUCTOR AND REFERENCE BOOK. 1728 Pages. Fully Illustrated. Priced at only \$6.

CIRCLE No. 12 IN COUPON

WIRING DIAGRAMS

This book gives the practical facts on wiring of electrical apparatus. It explains clearly and SIMPLY how to wire apparatus for all fields of electricity. Each diagram is complete and self-explaining. Know your **HOOK-UPS!** 304 Pages. Illustrated. Only \$2.

CIRCLE No. 13 IN COUPON

REFRIGERATION & AIR CONDITIONING

FOUR BOOKS IN ONE—basic principles, servicing, operation, repair of: 1. Household Refrigeration. 2. Special Refrigeration Units. 3. Commercial & Industrial Refrigeration. 4. Air Conditioning Systems. A GOLD MINE of essential information. Completely up-to-date. 1360 Pages. Fully Illustrated and Indexed. Priced at only \$6.

CIRCLE No. 14 IN COUPON

ALL TYPES OF BLUEPRINT READING

How to read scales, the standard symbols, detail and assembly prints, working drawings, short cuts, helps, hints and suggestions. **THE MAN WHO CAN READ BLUEPRINTS IS IN LINE FOR A BETTER JOB.** This book gives you the secret language, step by step in easy stages. 448 Pages, Very Fully Illustrated. Priced at \$3.

CIRCLE No. 25 IN COUPON

MASONS & BUILDERS GUIDES

A PRACTICAL ILLUSTRATED 4 VOL. SET—Explaining in clear, simple language and profuse illustrations, principles, advances, short cuts, trade secrets, based on modern practice—including how to figure and calculate various jobs.

Vol. 1—Brick work, bricklaying, bonding, designs. Vol. 2—Brick foundations, arches, tile setting, estimating. Vol. 3—Concrete mixing, placing forms, reinforced stucco. Vol. 4—Plastering, stone masonry, steel construction, blueprints. 4 Vols. 1440 Pages. 2067 Illustrations. Complete Set only \$8.

CIRCLE No. 26 IN COUPON



ELECTRIC MOTORS

THIS GUIDE covers the construction, hook-ups, control, maintenance and trouble shooting of all types of motors. Includes armature winding. Explains entire subject in great detail in simple language. Over 1050 Pages of information. 517 Diagrams. All types of motors fully illustrated and indexed for ready reference. Priced at only \$5.

CIRCLE No. 27 IN COUPON

OIL BURNERS

New, complete, explaining in detail both domestic and industrial oil burners. Includes electrical hook-ups and wiring diagrams. Fully covering the theory, construction, installation, operation, testing, servicing and repair of all equipment. Indexed for ready reference. Over 416 Pages. 320 Illustrations and Diagrams. Only \$3.

CIRCLE No. 28 IN COUPON



ADDITIONAL IMPORTANT TITLES

- The following Audel Guides are all the best in their fields, written in clear simple fashion, all lavishly illustrated. Circle the numbers wanted in the MAIL ORDER COUPON below. All books are sent for **FREE EXAMINATION**.
- No. 29 SHEET METAL PATTERN LAYOUTS. 1152 Pages. \$7.50
 - No. 30 SHEET METAL WORKER'S HANDBOOK. 448 Pages. 2.00
 - No. 31 MECHANICAL DRAWING GUIDE. 192 Pages. 2.00
 - No. 32 MECHANICAL DRAWING AND DESIGN. 480 Pages. 3.00
 - No. 33 ELECTRICIAN'S EXAMINATIONS. 272 Pages. 2.00
 - No. 34 ELECTRIC POWER CALCULATIONS. Page 480. 2.00
 - No. 35 ELECTRIC DICTIONARY. 9000 Terms. 3.00
 - No. 37 POWER PLANT ENGINEERS GUIDE. 1568 Pages. 5.00
 - No. 38 ENGINEERS AND FIREMANS EXAMS. 544 Pages. 2.00
 - No. 39 OPERATING ENGINEERS LIBRARY. 3 Book Set. 12.00
 - No. 40 PUMPS, HYDRAULICS AND AIR COMPRESSORS. 1760 Pages. 6.00
 - No. 41 HOUSE HEATING GUIDE. 1008 Pages. 5.00

KNOW YOUR TRUCK

THE TRUCK & TRACTOR GUIDE for Mechanics & Drivers, Foremen, Garagemen, Helpers, Owners, Trouble Shooters, Farmers, etc. Covering Gas & Diesel Motor Principles—Construction—Operation—Maintenance—Repair—Brakes—Service of all Parts. 1576 Pages. FULLY ILLUSTRATED. Index. Only \$5.

CIRCLE No. 5 IN COUPON



PLUMBERS AND STEAMFITTERS GUIDES

Practical Trade Assistant & Reference Set. Explains in plain language and by clear illustrations, diagrams, charts, graphs and pictures the principles of modern plumbing practice including Pipe Fitting and Air Conditioning. 4 Vols.—3624 Pages—3642 Diagrams & Illustrations. Only \$8 for the complete set of 4 vols.

CIRCLE No. 6 IN COUPON

PAINTING & DECORATING MANUAL

Inside Trade information on outside and inside work; how to mix paints, preparation of surfaces, paper hanging, wood finishes, tools, synthetic paints, color (with color chart), spray equipment, coats, estimating, etc. A COMPLETE guide to easier, better painting and decorating. 464 Pages. Fully Illustrated. Only \$2.

CIRCLE No. 7 IN COUPON

7-DAY FREE EXAMINATION

SEND NO MONEY—Pay the postman nothing! We are glad to send you any of the Audel Guides for absolutely **FREE** examination in your own home. We take all the risks and leave all the decisions up to YOU. There is no obligation! If you decide to keep the books of your choice you may pay for them under our astounding easy-pay plan of only \$2 a month.

HERE IS ALL YOU DO

IT'S EASY TO ORDER: In the No-Risk Mail Order Coupon at the right just draw a circle around the number of Audel Guides you want us to send you for **FREE EXAMINATION**. We will send them to you at once to help you build a brighter future by increasing your **SKILL**. If for any reason at all you are not **COMPLETELY** satisfied, return the books to us, and that will end the matter! **NO STRINGS OR CATCHES TO THIS OFFER.**

THEO. AUDEL & CO.
49 West 23rd Street, New York 10, N.Y.
FEBRUARY 1959

MAIL THIS NO-RISK COUPON TODAY!

THEO. AUDEL & CO.—Self Improvement Publishers Since 1879— P-2
49 W. 23rd Street, New York 10, N.Y.

Please mail me for 7 days' **FREE EXAMINATION** the books I have circled at right. I agree to mail \$2 in 7 days on each book or set ordered, and to further mail \$2 a month on each book or set ordered until I have paid the purchase price, plus shipping costs. If I am not completely satisfied with my Audel Guides I may return them.

NAME _____

ADDRESS _____

OCCUPATION _____

SAVE SHIPPING COSTS! Check here if you enclose complete payment with order. We pay postage charges. You have same return privilege.

1	2	3	4	5	6
7	8	9	10	11	
12	13	14	15	16	
17	18	19	20	21	
22	23	24	25	26	
27	28	29	30	31	
32	33	34	35	36	
37	38	39	40	41	

UNUSUAL TELESCOPE BUYS.

See the Stars, Moon, Planets Close Up!
3" ASTRONOMICAL REFLECTING TELESCOPE
 60 to 160 Power — Famous Mt. Palomar Type! An Unusual Buy!



Assembled—ready to use! You'll see the Rings of Saturn, the fascinating planet Mars, huge craters on the Moon, Star Clusters, Moons of Jupiter in detail, Galaxies! Equatorial mount with lock on both axes. Aluminized and overcoated 3" diameter high-speed f/10 mirror. Telescope comes equipped with a 60X eyepiece and a mounted Barlow Lens, giving you 60 to 160 power. Low-cost accessory eyepiece available for higher powers. An Optical Finder Telescope, always so essential, is also included. Sturdy, hardwood, portable tripod. Valuable STAR CHART and 272-page "Handbook of Heavens."

Stock No. 85.050-M. \$29.95 postpaid

KNOW THE TRUTH about power. Telescope experts will confirm that an Astronomical Telescope will only give you practical powers to about 60 or 65 times per inch of objective diameter—powers above this only produce empty magnification—make viewing dim, difficult and unsatisfactory.

4 1/4" ASTRONOMICAL TELESCOPE!



UP TO 270 POWER! With this scope you can see everything as above but with greater power plus will split finer stars. Mirror has twice the light gathering power. Mirror guaranteed to give theoretical limit of resolution. Rack and pinion focusing, hardwood tripod, real equatorial mounting—only one adjustment follows stars! Aluminum tube, 6 power finder telescope, 2 standard size eyepieces and mounted Barlow lens give you powers of 40X, 90X, 120X, and 270X. Low-cost accessory eyepiece available for higher powers. Free handbook and Chart. Shipping weight 25 lbs. Stock No. 85.006-H \$74.50 f.o.b.

WRITE FOR FREE CATALOG "H"!

Complete Line of Astronomical Telescope Parts and Assembled Telescopes. Also huge selection of lenses, prisms, war surplus optical instruments, parts and accessories. Telescopes, microscopes, Hand Spectroscopes, Sniperscopes, binoculars, etc. Request Catalog "H"!

ORDER BY STOCK NUMBER (SEND CHECK OR MONEY ORDER. SATISFACTION GUARANTEED)
EDMUND SCIENTIFIC CO., BARRINGTON, N. J.

Millions have done it! You can too!
 Also FREE Photo Book of Strong Men

Stop being **SKINNY** like I was
 Quickly **GAIN 25 LBS.** of
HANDSOME, POWER-PACKED MUSCLES like I did
 Send for these 5 AMAZING PICTURE COURSES

All 5 FREE before \$1 price goes back

1. How to GAIN MIGHTY ARMS
2. How to GAIN A BIG CHEST
3. How to GAIN A MIGHTY BACK
4. How to GAIN POWERFUL LEGS
5. How to GAIN A GRIP OF STEEL

Send 10c for postage for all 5 items

Jowell Institute, Dept. PM-92, 220 Fifth Avenue, N.Y. 11, N.Y.

I'll Send You This Handsome SAMPLE CASE—FREE



and Show You How to Make Up to \$30.00 in a Day

Mail coupon for this Free Tailoring Sample Case packed with 100 beautiful, big-value suit and overcoat fabrics. Take orders from friends, fellow-workers, others, for fine quality, made-to-measure clothes. Pocket big cash profits in advance. Because wearing our suits and overcoats brings more orders, we make it easy for you to get your own clothes without the cost. No experience is needed. **SATISFACTION GUARANTEED. SKIND NO MONEY.** Just fill out and mail coupon—today!

W. Z. GIBSON, INC., 500 South Throop Street
 DEPT. K-516 CHICAGO 7, ILLINOIS

W. Z. GIBSON, INC., Dept. K-516
 500 S. Throop St., Chicago 7, Ill.

Dear Sir: I WANT A MADE-TO-MEASURE SUIT TO WEAR AND SHOW, without paying for it. Rush details and Sample Kit of actual fabrics, ABSOLUTELY FREE.

NAME _____ AGE _____
 ADDRESS _____
 CITY _____ STATE _____

OPERATE EARTH MOVING EQUIPMENT



Learn to operate bulldozers, cranes, motor scrapers, crawler tractors, draglines, off-highway dump trucks, etc., on 1,700 acre Greer Training Area 60 miles S.W. of Chicago, Ill. on Route 60. Courses include operation, equipment care, preventive maint., stake reading, etc. Minimum classroom instruction. You learn by actually operating the equipment. 200 hour 15 week complete course in the operation of bulldozers, loaders, scrapers, dump and off-highway trucks as low as \$375. Classes start every Monday. Reserve your space today. Approved for vets and civilians

MECHANIC TRAINING

Complete Mechanics Course covering Diesel engine transmissions; torque converters; fuel injection systems; track assemblies; final drive assemblies; steering systems; idlers; rollers; power transfer systems; cable control systems; hydraulic control cylinders & welding pertaining to heavy equipment such as bulldozers, scrapers, loaders, off-highway trucks, etc. Course time 540 hours—10 weeks to 13 1/2 weeks. Convenient payment plan. Write for details. Approved for vets and civilians



Greer TECHNICAL INSTITUTE
 ATT: M. B. Hutch, Box 276, Braidwood, Ill.



Make your own Gems 36⁵⁰

The Gem Maker comes complete with all necessary equipment, including a super-charged diamond blade for sawing, and all the wheels for grinding, shaping and polishing; also complete instructions. The complete equipment as shown, less motor and belt for only \$136.50, f.o.b., Burlington, Wisconsin. Write today for information and literature.

B&I MANUFACTURING CO.
 Dept. P. Burlington, Wis.



WANT MORE MONEY? GET INTO PHOTOGRAPHY

Coast to coast, high-paying jobs in photography are waiting for people with the "know-how" to fill them. You can quickly, easily qualify at home with the world-famous NYI Learn-by-Doing Method. Write today for free catalog. Also resident training in N. Y. 49th Year. Approved for Veterans.

NEW YORK INSTITUTE OF PHOTOGRAPHY
 Dept. 49 10 West 33 St. New York 1, N. Y.

"YOU ARE UNDER ARREST!"



Help Bring Crooks to Justice Through Scientific CRIME DETECTION!

We have taught thousands this exciting, profitable, pleasant profession. Let us teach you in your own home. Learn Fingerprinting, Firearms Identification, Police Photography, Secret Service Methods thoroughly, quickly, at small cost. Over 800 of all American Bureaus of Identification employ I.A.S. students or graduates. Write for FREE "Blue Book of Crime."

(A Correspondence School Since 1916)
INSTITUTE OF APPLIED SCIENCE, 1920 Sunnyside Ave., Dept. 1352, Chicago 40, Ill.

GET INTO ELECTRONICS

V.T.I. training leads to success as technicians, field engineers, specialists in communications, guided missiles, computers, radar, automation. Basic & advanced courses in theory & laboratory. Assoc. degree in 20 mos. U.S. obtainable. ECPD accredited, G.I. approved. Graduates with major companies. Start Feb., Sept. Dorms, campus. H. S. graduate or equivalent. Catalog.

VALPARAISO TECHNICAL INSTITUTE
 DEPT. D VALPARAISO, INDIANA

TOOLS and HARDWARE WHOLESALE!

Start Your Own Business

Sell nationally advertised tools to your friends and neighbors. Also for your own industrial and institutional use. New giant wholesale catalog has room for only your name on it. You get all the orders and reorders. A MILLION DOLLAR INVENTORY AT YOUR FINGERTIPS. NO STOCK TO CARRY. ORDER AS YOU NEED IT! Electric drills, saws, sanders, micrometers, snips, tool boxes, vises, motors, trowels, wrenches, socket sets, chisels, mitre boxes, squares and many others too numerous to mention. **WHOLESALE DISCOUNTS UP TO 50% OFF** . . . Send \$1 deposit and get the new giant wholesale catalog. Your \$1 is credited to your first purchase or refunded if not 100% satisfied. Write NOW!

U. S. SUPPLY CORP., Dept. 220 149 Church St. N. Y. 7, N. Y.

**NEW WAY TO
TRAIN AT HOME
FOR A
BIG PAY CAREER
AS A TOP NOTCH
AUTO MECHANIC
PROVE IT ABSOLUTELY FREE!**

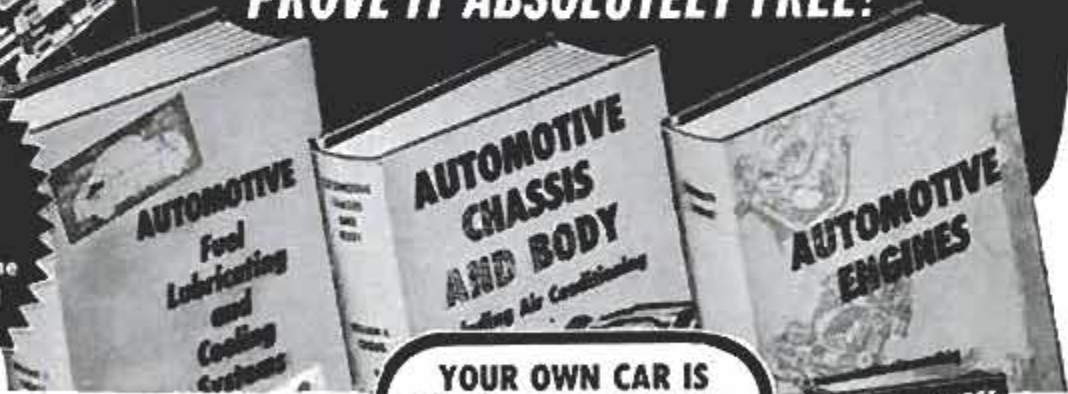

SEND NO MONEY!

Mail coupon below to examine these Complete Library and Home Course volumes on Auto Mechanics 10 days FREE!

**2,745 PAGES — Nearly 2,000 Illustrations —
Dozens of Charts. The Complete Information
You Need To Be A Qualified Auto Mechanic!**

Start at once training this HOME SHOP way for the highest mechanics' wages in history! No matter what you are doing now, you can learn at home quickly, surely—qualify for steady work, security and rapid advancement. You can make CASH money while training—and plan to open your own shop, be your own boss! Right now 30,000 mechanics are desperately needed. Get in on this booming field and prepare for a CAREER as a specialist!

PROVE This Amazing Training ON THE JOB!

That's right! TEST the giant 6-volume McGraw-Hill Complete Auto Repair and Servicing Library which includes the Home Course Outline. We want to send you this made-to-auto-industry-specifications training so that you can see this Set in front of you—sample it—use it on a job—understand why ONLY a

**STEP-BY-STEP INSTRUCTIONS
TELL AND SHOW YOU HOW TO**

- OVERHAUL any engine
 - SERVICE, MAINTAIN any unit
 - CHECK and DIAGNOSE any engine trouble
 - TRACE troubles in lines
 - CORRECT excess engine wear conditions
 - INSTALL any new part or unit
 - ADJUST all moving parts, etc.
- THOUSANDS OF FACTS!**

master Set of many volumes can give you the complete facts for repairing and servicing any part in any car!

No Longer Any GUESSWORK!

We want you to prove how the step-by-step instructions and "every-angle" photographs, drawings and diagrams make the most complex repair easy—quick—right the first time! See how you can tune engines, overhaul carburetors, service transmissions in all cars from 1926 right up to the present day with full confidence. See how each volume is like a specialist—ready to train and guide you to meet each car need—including servicing all of the modern innovations. Make the secrets of experts your own; see how you will be in control of every situation, as if you had an engineer standing by your side to guide your entire training!

**The MASTER LIBRARY of
Automobile Mechanics**

The McGraw-Hill Library is the work of William H. Crouse, noted author of practical auto repair books and at one time a Director of Field Service Education for a division of General Motors. He takes nothing for granted, leaves no point uncovered. He has planned the Library for the man who wants to master auto mechanics—not just "tinker" at it... who wants to know the why as well as how. BASIC reasons for all work are explained in clear

**YOUR OWN CAR IS
YOUR TRAINING LAB!**

The most natural place to learn auto mechanics is in your own garage! With this 6-volume Library by your side, you work on neighbors' cars, too... make cash money in spare time!



**ADDITIONAL
FREE - HOME
COURSE OUTLINE**

A proven plan for making auto mechanics a lifetime CAREER! Tells how to get started and how to get ahead. An absolute must for the ambitious man who wants more than just a "job." Prepared by Wm. H. Crouse. OUTLINE is yours FREE!

terms. Your knowledge is checked every few pages with exciting Self-Quizzes. You learn when to repair, how to service and the why of every job you'll ever do. Everything has been tested with thousands of beginners and engineers.

MAIL THE COUPON — WITHOUT MONEY — TODAY

Yes, we want you to use this giant 6-volume Library for 10 days and then make up your mind! Mail the coupon: when books arrive use them to guide you to the most complex repair you can think of. Make them prove what we say. Then — in 10

days either return them and that will end the matter, or remit \$4.75 and \$5.00 each month thereafter until \$29.75 is paid... an actual saving of \$14.25 on the regular list price of \$44.00. Don't miss out on this opportunity. Mail the coupon now!

FREE EXAMINATION COUPON SAVES YOU \$14.25

McGraw-Hill Book Co., Dept. PM-2
327 West 41st St., New York 36, N. Y.

Send me for 10-day FREE trial the McGraw-Hill 6-vol. Complete Auto Repair and Servicing Library including Home Course Outline "How To Get Ahead in the Automotive Business." In 10 days I will remit \$4.75 and \$5.00 a month until \$29.75 is paid — a \$14.25 saving on list price of \$44.00. Otherwise, I will return books postpaid.

Check below to examine free for 10 days individual Crouse books from the Library

<input type="checkbox"/> Engines—\$8.50	<input type="checkbox"/> Fuel, Lub. & Cooling Systems—\$8.50
<input type="checkbox"/> Transmissions—\$9.50	<input type="checkbox"/> Chassis & Body—\$9.00
<input type="checkbox"/> Automotive Electrical Equipment—\$8.50	

For any single book I keep I will send \$3.00 plus delivery cost in 10 days. Balance of regular price one month later.

Name..... (Please Print)

Address.....

City..... Zone..... State.....

For price and terms outside the U.S., write McGraw-Hill Int'l., New York, N. Y. PM-2

TESTED AND PROVED BY THOUSANDS OF TRAINEES

"MADE \$1200 ON ONE JOB"

Some make more, some less...

We help you start Your Own All-Year Business

Make BIG Money! With our easily operated, highly efficient wall washer, G. H. Jones made \$1200 on one school job. E. L. Goss took in more than \$10,000 in one year.

E. C. Taber wrote, "I made \$400 gross in two weeks." And no wonder...this machine washes walls 6 times faster and better than by hand—with no mess...no drop cloths.

Your Money-Making Opportunity • We want more men to go into this profitable business for themselves and enjoy independence—freedom from layoffs and bosses. Customers everywhere—homes, offices, schools, churches, hotels, etc. How much you earn depends largely on you. What you take in is mostly profit. No need to rent shop or office; operate from home. Start spare time until full time is justified.

Lose No Time — Send Coupon Today for All the Facts

FREE BOOK! MAIL COUPON TODAY!

VON SCHRADER MFG. CO.

210 "W" Pl., Racine, Wisconsin

Send at once (no obligation) your **FREE** booklet containing information about your **WALL WASHING MACHINE** and how I can start my own permanent, profitable business.

Name _____

Address _____

City _____ Zone _____ State _____



INVENTORS

PROTECT YOUR INVENTION BY A U. S. PATENT. SEND FOR FREE "INVENTION RECORD" FORM AND "PATENT INFORMATION EVERY INVENTOR SHOULD HAVE."

CARL MILLER

REGISTERED PATENT ATTORNEY

WOOLWORTH BLDG., 36th FLOOR, 29A
NEW YORK CITY

INVENTORS

U. S. Patents protect your inventions. Our free book of "Instructions on Patent Procedure for Inventors," also "Certificate of Invention" form sent without obligation.

C. A. SNOW & CO.

REGISTERED PATENT ATTORNEYS

428 SNOW BUILDING WASHINGTON 1, D. C.

INVENTORS

Whether an invention is patentable can be substantially determined by a search of the U. S. Patent records. Without obligation, write for information explaining the steps you should take to secure a patent.

JOHN N. RANDOLPH

Registered Patent Attorney

801 Victor Building, Washington 1, D. C.

GET THE HABIT OF READING

OUR CLASSIFIED ADS.

Wonderful Opportunities Amazing Bargains

INVENTORS NEEDED AT ONCE

If you have an invention you wish to sell outright or license on royalty, write us at once. We are seeking inventions of household items, games, toys, sports items, tools, and mechanical and technical devices. Patented or unpatented. For further information and free brochure outlining manufacturers' requirements, royalty rates, send name (no drawings, please) on letter or postcard at once.
KESSLER CORPORATION, Dept. D-52, Fremont, Ohio

INVENTORS

Send for **PATENT INFORMATION** Book and **INVENTOR'S RECORD** without obligation

GUSTAVE MILLER

29-PM WARNER BUILDING
WASHINGTON 4, D. C.

REGISTERED PATENT ATTORNEY

ASSOCIATE EXAMINER
U. S. PAT. OFF. 1922-1929

Patent Attorney & Advisor
U. S. NAVY DEPT. 1930-1947

PATENT LAWYER

INVENTORS

I shall be pleased to furnish you, upon request, with full information relative to patent procedure—without any obligation on your part.

PATRICK D. BEAVERS

Registered Patent Attorney

934 Victor Building Washington 1, D. C.

SAVE YOUR HAIR

HAIR CAN BE SAVED

"GIVE YOUR HAIR A CHANCE" is the reliable book (8th printing) by J. W. King, Sc.B. which tells how he saved himself from dandruff, baldness, thinning, and premature grey hair, simply and easily.

Much usable information.—Ohio State Medical Journal. Best investment.—Science Education. Debunks hair fads.—Scientific American. Scientific fact.—Sunset Magazine. Practical.—Science News Letter.

Send only \$3.00 today for postpaid copy of this reliable instruction on how to save your hair.

5 DAY MONEY BACK GUARANTEE
KING PUBLICATIONS (Established 1933)
Dept. 101, Dixon, Illinois, U.S.A.

8th PRINTING



**PAY
SECURITY
OPPORTUNITY**

FOR YOU!

IN AUTO MECHANICS AND DIESEL

Your spare time pays off **BIG** with our world-famous **SHOP TESTED** Home Training

Why wait around for a small raise or promotion that may never come? National Technical Schools ALL-AROUND MECHANICS are always in demand...for high pay jobs in car dealer shops, garages, truck and bus lines, construction projects, government labs, factories, and many others. That **BIG** opportunity, that **BIG** salary, or a **BUSINESS OF YOUR OWN** can soon be yours by preparing **NOW!**

You master the entire field of Auto Mechanics and Diesel, at home in your spare time. You also earn while you learn. And it's easy...our illustrated lessons and diagrams make every step crystal clear...you'll learn fast regardless of your age or education.

Latest equipment and newest techniques. Tools and kits are yours to keep. Many students pay for their course with Spare Time Earnings. We show you how.

Why N.T.S. Training is Better... More Complete... Lower Cost. **BETTER**... Because training is Shop Tested in Resident School Shops and Labs, by oldest and largest School of its kind in the World. **MORE COMPLETE**... you learn all phases of Auto Mechanics and

GOOD JOBS ARE YOURS IF YOU'RE WELL TRAINED



You'll be on top as an all-around Mechanic... thousands of shops will pay you big money for your all around know-how.



N.T.S. Training leads you into top supervisory jobs in industry — service manager, foreman, where the Extra Big paychecks will be yours.



You can operate your own Auto Repair and Motor Tune-up Shop — big profits, real independence. **BE YOUR OWN BOSS!**

YOU GET AND KEEP ALL THIS EQUIPMENT



Diesel. **LOWER COST**... one low tuition covers entire cost of course and all equipment. Friendly instructors, unlimited consultation privileges. Free graduate advisory service.

DON'T DELAY: WASTED TIME IS WASTED MONEY! You don't have to leave your job... you learn at home. Before you know it, you'll be ready for a far better job, more money, lifetime security. **Act TODAY: Mail coupon.**



RESIDENT TRAINING at Los Angeles

If you wish to take your training in our Resident School at Los Angeles, start **NOW** in our big, modern Shops and Labs. Work with the latest Auto and Diesel engines — all types — fuel injection, automatic transmissions, all power equipment. Most complete facilities offered by any school. Expert, friendly instructors. Graduate Advisory Service. Help in finding home near school — and part time job while you learn. Check coupon for information.



FREE Send for **FREE ILLUSTRATED BOOK and Actual Lesson**

Send coupon now! No obligation... no salesman will call. Complete training programs in TV-Radio-Electronics also available.

NATIONAL TECHNICAL SCHOOLS
WORLD-WIDE TRAINING SINCE 1905

MAIL NOW TO
NATIONAL TECHNICAL SCHOOLS, Dept. DB-29
4000 S. FIGUEROA ST., LOS ANGELES 37, CALIF.
Send for **FREE** Auto-Diesel Opportunity Book and actual Lesson.

NAME _____ AGE _____

ADDRESS _____

CITY _____ ZONE _____ STATE _____

Check if interested **ONLY** in Resident School training at Los Angeles.

VETERANS: Give date of Discharge _____

NATIONAL TECHNICAL SCHOOLS
WORLD-WIDE TRAINING SINCE 1905

4000 SO. FIGUEROA ST., LOS ANGELES 37, CALIF., U. S. A.



MEMBER

CUT OUT COUPON — FILL IN INFORMATION — MAIL TODAY

SAVE 1/2 ON ACCORDIONS • SAVE 1/2 ON ACCORDIONS • SAVE 1/2 ON ACCORDIONS

ACCORDION PRICES SMASHED



**SAVE 1/2
AND EVEN MORE ON
NEW '59 MODELS**

**5 DAYS
FREE
TRIAL!**

Hurry! Get in on these sensational values in world's finest Italian-made accordions! Play the most popular instrument of all... for fun, leadership and profit! Over 40 newest models of glorious tone and breathtaking beauty offered at amazing low prices—save 50% and more! Buy direct from world's leading dealer. Small down payment; easiest terms on balance. Extra bonus gifts FREE if you buy during sale. Trade-ins accepted. Try before you buy on FREE 5-Day NO-RISK PLAN. Satisfaction guaranteed or money back. Lifetime guarantee!

RUSH COUPON TODAY! See how easily you can own and play a fine accordion. Rush coupon for big new COLOR Catalogs and lowest wholesale prices. **ALL FREE!** No obligation. Write now! **Accordion Manufacturers and Wholesalers Outlet, Dept. R-29, 2003 W. Chicago Av. Chicago 22, Ill.**

FREE BONUS GIFTS

for promptness
• E-Z Lessons
• Music Stand
• DeLuxe Case
• other gifts, too!

MONEY BACK GUARANTEE

FREE COLOR CATALOGS
and wholesale prices

Accordion Manufacturers and Wholesalers Outlet
2003 W. Chicago Ave., Dept. R-29, Chicago 22, Ill.
Send FREE Color Catalogs and wholesale prices.

NAME _____

ADDRESS _____

CITY _____

Zone _____ STATE _____

EARN \$100 A WEEK AND UP

BE AN AUTO-DIESEL MECHANIC — EARN WHILE YOU LEARN

Many of our graduates earn \$100 a week and up. You learn fast in our school and shops because you learn with tools on real equipment. Experienced instructors explain WHY and show you HOW, then you DO IT YOURSELF. One of the best equipped technical schools in the United States. Thirty-nine years' experience training men. Successful graduates in 48 states and many foreign countries. Approved for veterans. Day and evening classes. Free bulletin—write today.

NASHVILLE AUTO-DIESEL COLLEGE
226 7th Ave. N., Dept. 86, Nashville, Tenn.

only 27 months for engineering degree

Realize your dream of becoming a graduate engineer. Then promotion will not pass you by. Share rewards awaiting college men . . . higher income . . . rapid advancement. Important firms visit Tri-State campus to interview seniors. Approved for veterans. *Bachelor of Science Degree in 27 months* in Electrical Engineering with either Electronics or Power major . . . also in Mechanical, Civil, Chemical, Aeronautical Engineering. *In 36 months* a B. S. in Business Administration (General Business, Accounting, Motor Transport Management majors). For earnest, capable students. Small classes. More professional class hours. Well-equipped, new and modernized buildings and labs. Modest costs. Year-round operation. Enter Mar., June, Sept., Jan.

Write J. E. McCarthy, Director of Admissions, for Catalog and Career Book.



TRI-STATE COLLEGE

429 College Avenue

Angola, Indiana



Let me ask you

IS YOUR ENGLISH HOLDING YOU BACK?

I have helped thousands of men and women to overcome the handicap of poor English and to become effective speakers, writers, and conversationalists. With my new C.I. METHOD, you can stop making mistakes, build up your vocabulary, speed up your reading, develop writing skill, learn the "secrets" of conversation. You don't have to go back to school. Takes only 15 minutes a day at home. Costs little. 32-page booklet mailed FREE upon request. Send me a card or letter TODAY!

Don Bolander, Career Institute
Dept. E-1052, 30 E. Adams St., Chicago 3, Illinois



DRAINS cellars, cisterns, wash tubs; **\$7.95**
IRRIGATES - CIRCULATES - SPRAYS

1,001 uses. Stainless shaft. Won't rust or clog! Use 1/2 HP motor or larger . . . 3/4 HP for up to 1000' lift. 450 GPH 3/4" inlet or 1800 GPH from 25" well. 1" inlet. 3/4" outlet. Coupling included free. **\$7.95.** **HEAVY DUTY BALL-BEARING PUMP.** Up to 7,500 GPH; or 3,000 GPH from 25" well. 1 1/2" inlet. 1" outlet. **\$12.95.** Postpaid if cash with order. **MONEY BACK GUARANTEE.** Centrifugal and Gear Pumps in All Sizes. **LABAWCO PUMPS, Belle Mead 7, New Jersey**

TASOPE PHOTO-ENGRAVING PLANTS



Material Cost
Of This Cut 3.2c
Selling Price
\$1.00 And Up

Establish your own profitable PHOTO-ENGRAVING business. Make cuts for newspapers, printers, and advertisers. Make etched name plates, plaques, etc. Instructions furnished, no experience necessary. Sold direct from factory since 1931. First five hundred cuts sold locally or by mail will pay for plant and pay you well for your time. Write for FREE catalog.

TASOPE, DEPT. PM2, AURORA, MO.

PAINT STRAIGHT or CURVED LINES with Sensational PAINT PEN

DECORATE Furniture, Interiors, Autos, Bikes, Model Planes, Boats, Toys, Linoleums, Wall Board, etc.

PAINTS on wood, glass, plastic, ceramics, metals, fabrics and paper. Use any color paint, glue, tempera, textile paint or underglaze; secure clean, professional decorative lines. No clog or smear.

ORDER NOW Direct or (MASTER) Single 1/16" Stripe Model. From Your Dealer Only **\$125**

Other single stripe models:
1/64" 1/32" 3/64" 5/64"
3/32" 1/8" only \$1.75 ea. Extra tips
90c each. Extra 1/4" tip \$1.20.

SPECIAL: Complete Set \$500
(Pen and all 7 tips) Only
Single Line.

Double Stripe Model-w/5 combination \$3.25 C.O.D. Postage Collect.
**WENDELL MFG. CO., 4234 LINCOLN AVE., DEPT. 347
CHICAGO 18, ILL.**



MFRS. ask about heavy duty, precision industrial and production stripping tools.
FOR DEALERS: Fast profitable seller; attractive display, write for money-making details.
PAINTERS, CRAFTSMEN: "Professional" results every time with this time-saver.

Get into...

PLASTIC LAMINATING AT HOME!

Sensational New
**"ONE MAN
BUSINESS"**

...pays 110 to 120 profit
for each dollar of cost.

Make Up to \$5 an Hour by
our **MAGIC MAIL PLAN**... get
orders and cash from your mailman!

Here's the newest and most fascinating of all home-operated businesses. For the first time, a simplified machine brings the fabulous profits of Plastic Sealing and Plastic Laminating within the reach of the small operator. Can be

operated in a corner of the kitchen, basement, or garage. And any man or woman, regardless of age, education, or experience—can learn this interesting work in a few minutes of reading—can turn out professional jobs after one hour's practice.



TWO EXCITING FIELDS FOR BIG PROFITS!

No house-to-house canvassing. No face-to-face selling. We not only supply the equipment you need for the work, but also show you exactly how to cash in big daily profits from two big demand fields.

A FORTUNE IN PLASTIC SEALING

Millions of people want to protect valuable cards, photographs, documents and papers against wear, soil, and damage. By our **MAGIC MAIL Plan** you get this business through the mails. Open envelopes and take out money and orders. Details of this plan will amaze you. It will be sent free. Just mail coupon.

ENORMOUS PROFITS IN LAMINATING

A creative, artistic business. Gift shops sell your entire output. Just a few of thousands of giftwares illustrated on this page. Beautiful colors. Endless designs. Exclusive "one of a kind" appeal brings sales at ten to twenty times the cost of materials. Beautiful illustrations and instructions for making these artistic novelties sent free.

**NO MONEY—
Just Send Name!**



RUSH COUPON

Never before has such an opportunity been offered the small, home-operator—an opportunity to gain complete personal independence in a big money business of your own. Don't lose a minute. Get the facts at once. All information, fully illustrated with pictures, is free. Send the coupon—or send your name and address on a postcard. There is no charge now, or at any other time. Send for the information on this exciting opportunity today

Cash Money Comes to You in the Mail

By our **MAGIC MAIL Plan** you sit at home, send out mail, and get back money and orders. Additional profits in supplying lifetime protection for **SNAPSHOTS—IDENTIFICATION CARDS—DISCHARGE PAPERS—DRIVERS' LICENSES—SOCIAL SECURITY CARDS—VOTERS REG. CARDS—MENUS—BIRTH CERTIFICATES—CREDIT CARDS—BIRTH AND WEDDING ANNOUNCEMENTS—PASSES—DOCUMENTS.**

Lifetime protection. See how laminating prevents soiling, wear, and moisture damage with flexible, plastic covers.



WARNER ELECTRIC CO.
1512 Jarvis, Dept. L-2-B, Chicago 26, Illinois

Thousands of Beautiful ART CREATIONS

Made by Laminating as explained in our Free information. Send coupon for list and pictures of **COSTUME JEWELRY—JEWELS—CIGARETTE BOXES—CUFFLINKS—NOVELTY BUTTONS—TRAYS—CANDLESTICKS—COASTERS—CLOCK CASES—LAMP BASES—PICTURE FRAMES—BOOK ENDS—CHARMS—ADVERTISING SIGNS—NAME PLATES—BELT BUCKLES—CHECKERS—PAPER KNIVES—CHESSMEN—BOOKMARKS—TIE RACKS—KEEPSAKES OF ALL KINDS.**

WARNER ELECTRIC CO., Dept. L-2-B
1512 Jarvis Avenue, Chicago 26, Illinois

Please mail, postage prepaid, complete information with illustrations showing the things I can make and the money possibilities in Plastic Laminating. All this is free. No Salesman is to call. Also, tell me how I get orders and money from my Postman by the **MAGIC MAIL Plan.**

NAME _____
ADDRESS _____
CITY _____ ZONE _____ STATE _____

EARN MORE in TRAFFIC and TRANSPORTATION THE FAST GROWING PROFESSION!



Outstanding opportunities exist today for excellent paying positions in the Traffic & Transportation field due to the great shortage of qualified men and women.

LaSalle traffic specialists can train you in your spare time through a proven step by step success plan—which has helped thousands to rise rapidly to top level traffic positions. More than 1,400,000 ambitious men and women have trained for greater success through our famous problem method.

Industry, Truck Lines, Steamship

Lines, Railroads, Air Lines and Government are constantly seeking skilled help who can qualify for the better jobs and more money.

Get all the facts. Our book, describing the opportunities in Traffic and Transportation, is Free. Send for it today. Learn how you can prepare at home for the many fine positions open in this highly profitable and constantly expanding field.

Accredited Member, National Home Study Council
LA SALLE EXTENSION UNIVERSITY
A Correspondence Institution
Dept. 264T, 417 S. Dearborn, Chicago 5, Ill.

High School at Home

MANY FINISH IN 2 YEARS

No classes. No time wasted going to and from school. Progress as fast as your time and abilities permit. Standard H.S. texts supplied. Thousands enroll each year in this 62-year-old school. Send for FREE descriptive booklet.

AMERICAN SCHOOL, Dept. H-245
Drexel at 58th St., Chicago 37, Ill.

Without obligation, please send FREE descriptive booklet.

Name _____

Address _____
Accredited Member National Home Study Council

FREE! U.S. AIRMAIL STAMPS



Rush coupon for one of the most exciting offers ever made. Imagine! . . . this colorful collection of beautiful, hard-to-get United States Airmail stamps. They're all *genuine*, all *different*, all *FREE!* Think how they will grow in value. What a grand addition for your collection. PLUS, a FREE copy of our helpful, illustrated "Stamp Collector's Guide." All this is *FREE!* Other valuable offers for your free inspection. Don't delay . . . supply limited so offer may be withdrawn soon . . .

GARCELON STAMP CO., Dept. PM2A
Colais, Maine. Rush FREE Airmail Stamps, other offers.
Enclosed 10c for postage, handling. (PLEASE PRINT)

Stamp Collector's Guide



DAN LURIE BARBELL CO., 52M-2 Bristol St., Dept. 050B, Bklyn. 12, N.Y.

ADD UP TO 25 POUNDS of SOLID MUSCLES or you pay NOTHING

\$10 BODY MOLD course included FREE with DAN LURIE BARBELLS. Only DAN LURIE BARBELLS and "Body Mold" courses produce such amazing results. 15 minutes a day can make you a bigger man. Send today for details. Order now at lowest factory price.

50 lb. set \$8.98 • 100 lb. set \$14.98
150 lb. set \$21.98 • 200 lb. set \$27.98
Semisteel sets approx. 10% higher. Extra wts. 14c per lb. Send 50% cash, balance C.O.D. F.O.B. Plant.

STUDY TO BE A DOCTOR of Psychology or Metaphysics

Obtain a Ps.D., Ms.D., or Ph.D. Be a Teacher, Lecturer or Accredited Practitioner. Teach others how to achieve Health, Happiness and Contentment. Chartered by State. Correspondence Courses only. Write for FREE book telling how.

THE NEOTARIAN FELLOWSHIP
Desk 8, Pickwick Building Kansas City 8, Missouri

YES! SEND



directly
to my door
every month

I am enclosing

- \$3.50 for 1 year
 \$8.00 for 3 years

name _____

address _____

city _____

zone _____

state _____

Hand this order to your newsdealer or send it to
POPULAR MECHANICS
200 East Ontario St. Chicago 11, Ill.

Earn BIG MONEY



Learn
**ELECTRIC
APPLIANCE
REPAIRING**
At Home
In Your
Spare Time!

**WE FURNISH YOU
THIS AMAZING
ELECTRONIC KIT**

**WE
GIVE YOU
ALSO THE
CERAMIC
HEATER
KIT**



"All CTS grad-
uates are en-
titled to CTS
lifetime ad-
visory service."



R. L. Frazer, President

START YOUR OWN BUSINESS

There are millions of electrical equipment units in daily use in factories, homes, office buildings and on farms. Skilled electrical technicians are needed to keep this equip- ment in good running condition. Learn at home in your spare time.

\$5.00-\$6.00 PER HOUR

is often charged for making ordinary repairs. We show you how to repair refrigera- tors, vacuum cleaners, washing machines, motors, factory equipment, electrical farm equipment, do house wiring, etc.

BEGIN IN YOUR OWN KITCHEN, BASEMENT OR GARAGE. You don't need elaborate fixtures or expensive equipment to be a successful repairman. Work as many hours as you wish. The Electrical Appliance Technician is his own boss!

IF YOU ARE MECHANICALLY INCLINED, can hold and use tools, we will give you the training and time saving kits—a multi-purpose **CHRISTY ELECTRONIC KIT** whose dials show you exactly where the trouble lies with electrical equipment that does not work properly—a **CERAMIC HEATER KIT** that enables you to wire your own heating elements and pocket all of the profits for yourself—**LESSON MANUALS** writ- ten in simple, easy-to-understand language profusely illustrated showing step-by-step repair shortcuts—all of which give you the Know-how for making more money and how to get financial security.

YOU ALSO LEARN how to build power tools from spare parts, how to solicit business and keep business coming in, what to charge your customers, etc. Thousands of **CHRISTY** graduates in all parts of the world prove the value of **CTS Training**. **WRITE FOR SPECIAL PAY LATER FORM.**

CHRISTY TRADES SCHOOL, 3214-16 W. Lawrence, Dept. A-7003, Chicago 25

**SEND FOR OUR
NEW 32 PAGE
CATALOGUE!**



MAIL THIS COUPON TODAY!

**CHRISTY TRADES SCHOOL, Dept. A-7003,
3214-16 W. Lawrence, Chicago 25, Ill.**

Gentlemen:

Please rush me your **FREE ILLUSTRATED BOOK** about Electrical Appliance Servicing, facts on your Electronic Kit and Special form for paying later from earnings while learning.

Name _____ Age _____

Address _____

City _____ Zone _____ State _____

NOW The Short Cut to Learning You've Been Waiting for



Learn
While You Sleep
with the **DORMIPHONE**
The Scientific Discovery
That Works FOR You . . .
Awake and Asleep

Now, at last, science gives you an easy shortcut to learning. With university-tested Dormiphone, you "start" to learn while awake—then this amazing new tool takes over, continues the learning process for you while you sleep.

Do you want to learn a language—memorize a speech or an array of important facts, figures, formulas—Correct your speech—Break bad habits? The Dormiphone is so simple to use, children benefit—so remarkable it is used by scientists, educators, psychologists, people of all ages, occupations all over the world.

Break Down Barriers to Learning

Find out HOW the Dormiphone works FOR YOU—how it can help you learn in less time, without intensive self-application. Eliminate drudgery—**SAVE YOUR TIME—EFFORT.** Write for FREE Book, "A New Dimension in Learning," or call for FREE DEMONSTRATION—Get the Scientific Evidence Today.

MODERNOPHONE, INC.
236-029 Radio City, New York 20, N. Y.

Gentlemen: Please send me your FREE Booklet. I am interested in learning more about the DORMIPHONE and what it can do for me. No obligation—no salesman will call.

If under 18, check here for Special Booklet A.

NAME _____

ADDRESS _____

CITY _____ ZONE _____ STATE _____

My main interest in the Dormiphone is for:

- | | |
|--|---|
| <input type="checkbox"/> Language Learning | <input type="checkbox"/> Speech Improvement |
| <input type="checkbox"/> Memorization | <input type="checkbox"/> Sleep Inducement |
| <input type="checkbox"/> Habit Correction | <input type="checkbox"/> School or College Work |

make it with 60c worth of sand & cement!

SELL IT FOR \$2000

every home a prospect for these "LIFETIME"

CONCRETE INCINERATORS

Make big profits manufacturing rust proof, fire proof, almost indestructible concrete incinerators in your own backyard or garage . . . full or part time. Sell to home-owners, hardware, department and garden supply stores. Phila. manufacturer doing big volume with Sears, Roebuck; large department stores. Easy to follow instructions and all needed equipment supplied. Exclusive protected franchise—No competition! Territories going fast. Write immediately for full details.



Dept. PM-29, T. C. TOR
318 Rancocas Ave., Delanco, N.J.

Gentlemen:
Rush full information about your concrete incinerator protected franchise offer.

Name _____

Street No. or R.D. _____

City _____ Zone _____ State _____

For sportsmen 6 to 60!
Broad line of models—complete kits from **\$39.95**
Send 25¢ for catalog.

Dealer inquiries invited.

MIDGET CAR HEADQUARTERS

ARNOLD-DAIN CORP.
Box 78, Mahopac, N. Y.

FREE

MUSCLE BUILDING INFORMATION

Sensational New Methods
Less Time—Less Effort—Better results
BODY-TONE, Box 638, North Miami 61, Fla.

GUARANTEED UP TO 300% PROFIT

AUTOMOTIVE ACCESSORIES

Be your own boss. Sell high profit line newest Car polisher, Corrosion Neutralizer, Auto theft Alarm, Windshield anti fog cloth, others. Earn FREE sales bonus 59 Ford or Chevy, TV set, Camera, Radio in addition to 300% profit as full or part time distributor your exclusive area. Send for no risk no obligation information now. Receive free 160 bonus point certificate.

Clyde Company, 120 AJ East 82 St., N.Y. 28, N.Y.

WHOLESALE Electric Guitars - Parts - Factory to You

Professional electric solid body Spanish guitars, amplifiers, electric bass, double-necks, triple-necks, tone changers, double-neck Spanish, electric mandolin, pickups. Parts to outfit your own. 1959 Models wholesale — Free catalog.

CARVIN CO., Box 287, PM-2, Covina, Calif.

HYDRAULIC JACK REPAIRS

Earn While You Learn at Home
Millions of jacks in gas & auto-service stations, truckers, body-shops, riggers, factories, farms need servicing. We show you HOW—easy step by step directions—what tools to use. **EARN UP TO \$5 an hour**, in spare time, in your own basement or garage. Start your own business NOW.
Write for folder No. PM-2 & free bonus offer

Institute of Hydraulic Jack Repair
P.O. Box 50, Bloomfield, N. J.

Finish HIGH SCHOOL

AT HOME

Complete 4 Years in 12 Months
diploma

Learn More! Earn More!
Enter College, professional or technical schools.
Advance Socially. Live a Happier, Fuller Life. Individual Courses or complete schedule.

WRITE FOR SCHOOL BULLETIN, Dept. PM-29

ACADEMY FOR ADULTS 30 W. Washington Chicago 2, Illinois

Superior's New Model 70 UTILITY TESTER®

**FOR REPAIRING ALL ELECTRICAL APPLIANCES
and AUTOMOBILE CIRCUITS**



As an electrical trouble shooter the Model 70:

- Will test Toasters, Irons, Broilers, Heating Pads, Clocks, Fans, Vacuum Cleaners, Refrigerators, Lamps, Fluorescents, Switches, Thermostats, etc.
- Measures A.C. and D.C. Voltages, A.C. and D.C. Current, Resistances, Leakages, etc.
- Will measure current consumption while the appliance under test is in operation.
- Incorporates a sensitive direct-reading resistance range which will measure all resistances commonly used in electrical appliances, motors, etc.
- Leakage detecting circuit will indicate continuity from zero ohms to 5 megohms (5,000,000 ohms).

As an Automotive Tester the Model 70 will test:

- Both 6 Volt and 12 Volt Storage Batteries • Generators • Starters • Distributors
- Ignition Coils • Regulators • Relays • Circuit Breakers • Cigarette Lighters • Stop Lights
- Condensers • Directional Signal Systems • All Lamps and Bulbs • Fuses
- Heating Systems • Horns • Also will locate poor grounds, breaks in wiring, poor connections, etc.

INCLUDED FREE This 64-page book—practically a condensed course in electricity. Learn by doing.

Just read the following partial list of contents: What is electricity? • Simplified version of Ohms Law • What is wattage? • Simplified wattage charts • How to measure voltage, current, resistance and leakage • How to test all electrical

appliances and motors using a simplified trouble-shooting technique.

- How to trace trouble in the electrical circuits and parts in automobiles and trucks.

Model 70 comes complete with 64 page book and test leads. **Only \$15⁸⁵**

Superior's New Model 82A A truly do-it-yourself type

TUBE TESTER

TEST ANY TUBE IN 10 SECONDS FLAT!



- ① Turn the filament selector switch to position specified.
- ② Insert it into a numbered socket as designated on our chart (over 600 types included).
- ③ Press down the quality button—

THAT'S ALL! Read emission quality direct on bad-good meter scale.

FEATURES:

- Tests over 600 tube types.
- Tests OZ4 and other gas-filled tubes.
- Employs new 4" meter with sealed air-damping chamber resulting in accurate vibrationless readings.
- Use of 22 sockets permits testing all popular tube types and prevents possible obsolescence.
- Dual Scale meter permits testing of low current tubes.
- 7 and 9 pin straighteners mounted on panel.
- All sections of multi-element tubes tested simultaneously.
- Ultra-sensitive leakage test circuit will indicate leakage up to 5 megohms.

Production of this Model was delayed a full year pending careful study by Superior's engineering staff of this new method of testing tubes. Don't let the low price mislead you! We claim Model 82A will outperform similar looking units which sell for much more—and as proof, we offer to ship it on our examine before you buy policy.

Model 82A comes housed in handsome, portable Saddle-Stitched Texon case. **Only \$36⁵⁰**
(Picture Tube Adapter available for \$5.50 additional)

**SHIPPED ON APPROVAL
NO MONEY WITH ORDER — NO C.O.D.**

Try any of the above instruments for 10 days before you buy. If completely satisfied then send down payment and pay balance as indicated on coupon. No Interest or Finance Charges Added! If not completely satisfied return unit to us, no explanation necessary.

MOSS ELECTRONIC, INC.

Dept. D-573, 3849 Tenth Ave., New York 34, N. Y.

Please send me the units checked on approval. If completely satisfied I will pay on the terms specified with no interest or finance charges added. Otherwise, I will return after a 10 day trial positively cancelling all further obligation.

- Model 70 Total Price \$15.85 \$3.85 within 10 days. Balance \$4.00 monthly for 3 months.

Name

Address

City Zone State.....

All prices net. F.O.B. N.Y.C.

- Model 82A Total Price \$36.50 \$6.50 within 10 days. Balance \$6.00 monthly for 5 months.
- Include Picture Tube Adapter at \$5.50

BE A COMMERCIAL

Artist

Learn Illustrating, Cartooning, Figure Drawing, Fashion Drawing, TV Art, etc. At Home, in Spare Time

**All for 20c
a Day!**

PREPARE for a fascinating, profitable Art career this easy, proven way. We supply TWO ARTIST OUTFITS at no extra cost. Our low-cost "teach-yourself" course includes all branches of art listed here. Cash in on demand for trained artists in advertising agencies, newspapers, magazines, TV stations, etc. Make good money part time or full time; free lance or be your own boss.

FREE BOOK describes our easy method. Send for it. No obligation. No salesman will call. Clip ad, fill in name, address and mail to: **Washington School of Art, Studio 142, Port Washington, N. Y. (Est. 1914)**



ONE LOW-COST COURSE INCLUDES:

- Commercial Art
- Illustrating
- Cartooning
- Lettering
- Fashion Drawing
- Landscape
- Oil and Water-color Painting

Name _____ Age _____

Address _____

City _____ Zone _____ State _____

Free! Fabulous Collection from **SOUTH of the BORDER**



Get this big, valuable collection of genuine, all-different postage stamps from the exciting land of the mysterious Amazon . . . scarce airmails, gorgeous commemoratives, giant-sized stamps picturing wild horses, covered wagons, action-packed fights, native war heroes; **PLUS** sensational train stamp, beautiful "Christ of the Andes"; many others. **EXTRA!** Bargain Catalog, "Collectors' Manual" plus other exciting offers for your inspection. Enclose 10¢ for mailing expenses . . . **ACT NOW!**

JAMESTOWN STAMPS, Dept. N29PM, Jamestown, N.Y.

RUSH my Free "South of the Border" Collection and other offers. I enclose 10c for mailing costs.

Name _____

Address _____
City & State _____

Take the **ache** out of **GUMS RUBBED SORE BY FALSE TEETH**

Get quick-soothing relief of sore, throbbing gums by applying medically-formulated **NUM-ZIT Adult Strength**. Thousands of false teeth wearers have already had this blessed relief. Pleasant-tasting NUM-ZIT eases discomfort while you break in new false teeth. Works wonders, too, for relief of toothache, neuralgic pains. Keep it handy for quick first aid. *At all drug counters.*

Adult **NUM-ZIT**

Another fine Purepac product

TOOLS WHOLESALE

**\$100
PUTS YOU IN
BUSINESS**

Start your own business, sell tools to your friends and neighbors, or buy tools for your own use and **SAVE MONEY \$\$\$**

A MILLION DOLLAR INVENTORY AT YOUR FINGERTIPS. NO STOCK TO CARRY. ORDER AS YOU NEED IT.

Send \$1. for Tool Catalog today. **BUY AT WHOLESALE PRICES.** Extra \$25.00 profit on your accumulated purchases. \$1.00 is refunded if you are not 100% satisfied with our offer.

THOUSANDS! of Nationally Advertised items of Hand Tools, Power Tools, Machinist Tools, Tool Chests, Paint Sprayers, Light Fixtures, Appliances, Guns, Gifts, Toys and other items too numerous to mention. **WE SHIP COAST TO COAST Wholesale Discounts up to 50% OFF**

SILVO HARDWARE CO., Dept. PM-2 107 Walnut St., Phila. 6, Pa.

5 x 7 COLOR ENLARGEMENT

Send ANY SIZE Kodacolor Negative and this adv't. Fast service: **only 29c** (Add 10c for Postage & Handling) **\$1.50 Value** satisfaction guaranteed. **VIRGINIA PHOTO, Dept. B-2, P.O. Box 7, Richmond, Va.**

TERMITES?

GET RID OF THEM YOURSELF!

Don't pay up to \$300 and more to get rid of termites or prevent infestation. Do-it-yourself—Easily! Quickly! Inexpensively with "TERM-OUT" solution. Send 10¢ for fact-filled handbook.



COMPASS RESEARCH
701-A INVESTMENT BLDG., PITTSBURGH 22, PA.



MASTER MIND!



LEARN SHORT-CUT MATHEMATICS

Juggle figures, do baffling number tricks. Make people gasp at your marvelous lightning-quick mind. Multiply 4 figures by 4 figures without using old-fashioned multiplication! Big cloth-bound volume; fully illustrated course for self-instruction.

SHARPEN UP YOUR BRAIN POWER

Includes worked-out problems, answers, etc. Sensational bargain, only \$3.95, postpaid or COD plus postage. Satisfaction guaranteed or refund. Order this amazing "Short-Cut Mathematics" today!

NELSON-HALL CO., 210 S. Clinton St., Dept. 38R-2 Chicago 6, Ill.

\$3.95 Complete

RUPTURED?

Write for New Relief FACTS FREE!

ENJOY NEW FREEDOM

of action, peace of mind and comfort at work or play. Proven, patented MILLER holds your rupture back Day and Night — will bring you lasting relief! Has helped thousands of others!

For **FREE** facts in plain wrapper—Send Name and Address to **FRED B. MILLER, DEPT. 1-B** Manufacturer, HAGERSTOWN, MARYLAND



POPULAR MECHANICS

THESE ARE THE AMAZING SHOES

that have helped more than a million men

"GROW" ALMOST 2 INCHES TALLER!



It's true! You just step into a pair of these amazing "ELEVATORS" Shoes and instantly they add almost 2 inches to your height! No one will know how it's done because "ELEVATORS" look just like any other smart shoes. So, don't envy TALL men . . . be one. Over 30 styles for street, dress and sport. Most styles, \$25.95.

Write for FREE Booklet today!

STONE-TARLOW SALES CORP., Dept. 6-29, Brockton 68, Mass.



75 POWER TELESCOPE \$3.98

NEW 3 in one telescopes, 3 variable 25X, 45X-75X magnification. Brass bound. 25 power for ultra bright images. 45 & 75 power for long range. Guaranteed to bring distant stars, moons, objects, sports 75 times closer. Most powerful scope sold anywhere near this amazing low price. American made, 5 sections. Opens 36", closes 1 ft.; contains 4 ground & polished lenses. Can also be used as powerful compound microscope. Mass production enables us to offer telescope complete at \$3.98 postpaid. Money back guarantee. CRITERION CO., Dept. PMB 66, 331 Church St., Hartford, Conn.



A TRADE THAT PAYS IN MANY WAYS CLOCK AND WATCH REPAIR

Wide Choice of Opportunities in Precision Instrument Fields for the Trained, Skilled Watchmaker. Aviation, Electronics, Defense, and other Technical Fields. Watchmakers are Rated High by Industrial Personnel. Write today for your copy of "THE VITAL ROLE OF THE WATCHMAKER IN DEFENSE."

KANSAS CITY SCHOOL OF WATCHMAKING
1226 Admiral Blvd. Kansas City 6, Missouri

"MINIATURE MACHINE SHOP"

No Bigger Than A Typewriter, Outperforms Machines Many Times Its Size! That's what a popular publication says about UNIMAT in their 3 page feature story in the May issue. If you want a reprint of this story plus complete information about this amazing 10 in 1 combination precision tool write to:



AMERICAN EDELSTAAL Inc.

UNIMAT DIV., DEPT. 329, 350 BROADWAY, NEW YORK 13

8 FT. SPECIALS—\$1.25



FOR PARTIES AND FUN

YOUR MESSAGE HERE

A special purchase makes it possible to offer these GIANT 8 FOOTERS at a fraction of their value. New, genuine neoprene govt. surplus. Great for advertising, you paint your message on 'em, inflate & fly. Attracts crowds to sales, displays, openings, stores, gas stations. Fun at home for young & old and just the thing for any party or school prom. Perfect for beach or picnic. They're BIG and they do a BIG job! Order yours today!
8"—\$1.25 ea. 5 for \$6.00
13"—\$1.95, 15"—\$2.95, 18"—\$3.95
Postage pd. on ppd. orders.
Cal. res. add sales tax.

FRANK SALES • Dept. PM259
3930 Sunset Blvd., Los Angeles 29, Cal.

FOR ADVERTISING

TRAIN AT HOME

in Your Spare Time or in the Great Allied School

1338-42 South Michigan Ave. Chicago 5, Ill.

DRAFTING—All Branches
• Mech. • Structural • Aeronautical

ENGINEERING
• Industrial Engineering
• Tool Engin. & Designing

ELECTRONICS

AUTO MECHANICS

AIR CONDITIONING
Refrigeration — Heating & Cooling

TOOL & DIE MAKING
Machinist Trade

SEND FOR FREE BOOKS

Choose the Allied Way for Best Pay

Prepare for the best jobs in your spare time at home. With ALLIED'S practical home study program you can progress so rapidly that big new opportunities will soon be open to you. Students planning a career in engineering can begin their training in short courses at Home or at Allied Institute and continue progressively toward an Engineering Degree in 31 months. Allied is approved by Industry, National Home Study Council, Department of Education, Office of Public Instruction, State of Illinois, U. S. Department of Justice.

ALLIED INSTITUTE OF TECHNOLOGY,

1338-42 South Michigan Ave., Dept. PM-29, Chicago 5, Ill.

- Send me without obligation information on your courses:
- MECHANICAL DRAFTING
 - STRUCTURAL DRAFTING
 - AERONAUTICAL DRAFTING
 - INDUSTRIAL ENGINEERING
 - TOOL & DIE DESIGNING
 - HOME STUDY
 - AUTO MECHANICS
 - ELECTRONICS
 - AIR CONDITIONING
 - REFRIGERATION
 - TOOL & DIE MAKING
 - RESIDENT
 - VETERAN
 - NON-VETERAN

NAME _____ AGE _____
ADDRESS _____
CITY _____ COUNTY _____ STATE _____



**YOU
can
acquire**

**LAW AT HOME!
EARN LL. B. DEGREE**

LaSalle's famous Law Library—used as reference in many Law libraries and Law offices—has enabled thousands to master Law surprisingly fast, in spare hours at home, for business and professional advancement.

These 14 remarkable volumes, compiled by leading professors and lawyers, cover the whole basic field of Law in condensed, orderly, simplified manner.

You advance rapidly with this great library, plus special lectures furnished. We guide you step-by-step with personalized Problem Method of instruction...you 'earn by doing'—handling legal problems—not by memorizing rules.

Send for two FREE booklets, "Law Training for Leadership," and "Evidence," answering questions about Law and its value to you. Mail coupon below. No obligation.

Accredited member, National Home Study Council

**LA SALLE EXTENSION UNIVERSITY
A Correspondence Institution**

417 S. Dearborn St. Dept. 264L Chicago 5, Ill.

Send me your two FREE booklets described above, without obligation

Name.....Age.....

Street.....

City, Zone & State.....

BE AN INDIVIDUALIST!

Free COLORFUL BROCHURE tells how you, too, can add your own personality to prized possessions with a smartly crafted custom made-to-order inexpensive "Prestige Plate".

Write today to
PRESTIGE PLATES, INC., 805 Colorado Ave., Avon Ohio



LOT OWNERS! LAND OWNERS!

SAVE 30% on a new beautiful GOLDEN KEY HOME

Whether you hope to build for your family, or to start your land producing high income, a Golden Key Home is the answer! Choose from 70 different models of expertly pre-manufactured homes, Ranch—Split Level—Cape Cod—2 Story—2, 3 or 4 bedrooms—designed by registered Architects—floor plans can be varied under Golden Key's exclusive "Flex-A-Plan" to suit your own wishes at no additional cost. Golden Key Homes save you both time and money through new controlled assembly line methods of construction. All difficult heavy construction is completed in our plant. Your Golden Key Home comes to you sectionalized with all instructions! Easily erected by the "do-it-yourselfer." Golden Key Homes meet all building codes—FHA or VA requirements. Easy financing through your own bank or Building and Loan! Get the facts. Write today for free book of plans, prices and address of nearest model home. Send us your name, address and state size and location of lot. No obligation! Write today!

Send For
**FREE
BOOK**

GOLDEN KEY HOMES INC. ANNAPOLIS JUNCTION, HOWARD COUNTY, MD.

Nutria... NEWEST OPPORTUNITY

New fur-bearing animal now being bred in U. S. Offers huge profits to breeders. This fur is next to Mink NOW in price and will soon surpass it. 15 to 20 young per year. Most easily and economically raised animal known. 1 1/2¢ per day to feed. ANY CLIMATE. disease resistant. The Cabana Marrone strain is obtainable ONLY through Cabana Nutria, Inc., and its authorized dealers and distributors. For free booklet and address of Cabana ranch nearest you write:

CABANA NUTRIA, INC.
Dept. 46, 636 W. Lemon Ave., Arcadia, Calif.

NO JOB WORRIES

PLASTEX INDUSTRY needs manufacturers on small scale for big production of Lamps, Clock Stands, Art Glands, Novelties in Plastic Marble imitation. No Experience necessary. Use material makes regular 10¢ store sellers. Moulds furnished for fast production. Small investment brings good profit. **BIG WHOLESALE ORDERS NOW BEING PLACED.** Ambitious men have chance for real prosperity and job security. Our NEW FREE booklet will interest and benefit you.

PLASTEX INDUSTRIES, Dept. A
3400 Third Ave. New York 56, N.Y.

Locksmithing AND KEY MAKING

Now Made Easy! Practical up-to-date course teaches you how to pick locks, de-code, make master keys, repair, install, service, etc. New self-instruction lessons for every handyman, homeowner, carpenter, mechanic, service station operator, fix-it shop, hardware dealer, gunsmith. 33 easy illustrated lessons. Full price only \$5.95 postpaid or C.O.D. plus postage. Satisfaction or refund guaranteed!

Complete course \$5.95 now only \$3.95

Nelson-Mall Co., Dept. BR-2
210 S. Clinton Chicago 6, Ill.

MONEY in WORMS

sell 20,000 fish-worms per week @ \$4 per 1000 from a bed 2 feet wide and 8 feet long. We teach you how to raise and where to sell fish-worms and crickets. Write for free literature.

CARTER WORM RANCH, PLAINS, GEORGIA

ENGINEERING DEGREE IN 27 MONTHS

B. S. degree (27 mo.): Aero., Chem., Civil, Elec., Mech. & Electronics, S.E. (36 mo.): Aero., Chem., Civil, Elec., Mech., Metal, B.S. (36 mo.): Math., Chem., Physics. Prep courses. Demand for grads. Campus. 20 bldgs.; dorms, gym. Low rate. Earn board. G.I. appr. Enter March, June, Sept., Dec. Catalog.

1629 E. Washington Blvd., Fort Wayne 2, Ind.
Keeping pace with progress

INDIANA TECHNICAL COLLEGE

INVEST IN

SAFE AS AMERICA

\$10 EACH FOR BLOOMS

"This Orchid bloomed on Mother's Day with beautiful 8 1/2" flowers. A local florist made up corsage for my mother without charge, and offered me \$10 a flower for the rest."

Minnie E. Skillman
New Jersey



ORCHIDS AT HOME!!

GOOD PROFITS - LOTS OF FUN!

LEARN HOW
ORCHIDS GROW - All about special light, temperature and humidity required to **RAISE 30 DIFFERENT VARIETIES at HOME!**

We Raised Orchid Plants Worth a Fortune - Starting at Home in Spare Time!

Louis & Gladys Schirmer - Successful Home Growers

We began raising Orchids as a hobby, but soon started getting orders from friends and nearby florists. Within a few years we were able to retire from other work, to live on the profit from our Orchids. Would you like to learn how we did this, and how it may be possible for you to do the same? We'll help you every step of the way, if you'd like to start.



Exciting Profit Opportunity!

Wholesale, Retail, Mail Order. There's a year-round demand for Orchids - for party wear, travel, weddings, anniversaries, Christmas, Mother's Day, etc. Take big-profit orders from friends, neighbors, florists - at home and nearby cities. Flowers last for weeks. Millions shipped by mail order into big-city wholesalers from all over U.S. The Schirmer's own gardens are in the country - miles from the nearest town. Their Course shows how to do it!



There are many kinds of Orchids in every rainbow color. Some need different care than others. We show you how to raise 30 different types, including all the popular corsage Orchids you see in the florist shops.

NO LONG DELAY - START WITH PLANTS READY TO BLOOM SOON!!!

Have you heard that it takes 7 years to get an Orchid flower? It's absolutely false! You can start with full grown plants, that should flower in a few months - even a few weeks if you get them with this season's buds already forming.



VISITORS DROVE 100 MILES
"This plant had 10 flowers, 8 1/2 inches across. People drove over 100 miles to see it. Your Course is wonderful."
Thomas Hurst
Utah



WAS OFFERED \$100 FOR PLANT
"This Cattleya bloomed on Mother's Day. We were offered \$100 for it, but refused. Orchids give me pleasure I cannot express in words."
Mrs. L. Kunkel
California



LOCAL FLORIST WANTED BLOOMS
"A local florist said I couldn't grow Orchids, but later apologized and wanted to buy the flowers. I am grateful for your guidance."
Frederick Anderson
New York

HOW ORCHIDS MULTIPLY

Most exciting thing about Orchids is the way they multiply themselves. As the plants enlarge they may be divided, to create two from one. And these same divisions may often be divided again and again in the future. A "Magic Key" to Orchid profits which has helped bring security and independence to many Orchid growers - just as it has to Mr. and Mrs. Schirmer!



These Illustrated Instructions Have Helped Hundreds of Families Throughout U. S. & Canada to Grow Beautiful Orchids at Home

FINE HOME BUSINESS FOR MEN, WOMEN, FAMILIES

"Never raised Orchids till I read your Course. This plant had 10 blooms. My husband says they require less care than any flower he knows."

MRS. A. K. END
Pennsylvania



FREE!

(Nothing to Buy)

3-MO. SUBSCRIPTION to "THE ORCHIDIAN"

"Show-how" publication for home Orchid Growers. Valuable, instructive, fascinating. Absolutely FREE.

FREE - SEND NO MONEY - MAIL COUPON NOW

TROPICAL FLOWERLAND, Dept. 33
100 S. Vermont Ave., Los Angeles 4, Calif.

Please rush - FREE and POSTPAID - full details on offer of Louis & Gladys Schirmer's instructions which show how to grow and market Orchids at home. I understand the complete instructions include a real blooming-size Orchid plant and valuable "Quick-Profit Plan" - all sent for me to examine at home before I decide. Also please send the 3-month FREE Subscription to "The Orchidian." Thank you.

Name _____ Age _____
Street _____
Town _____ Zone _____ State _____

★ QUICK-PROFIT PLAN... LETS YOU START AT ONCE Instructions include exciting "Quick-Profit Plan." Helps you make money immediately. Coupon brings details.

Tropical Flowerland, Dept. 33, 100 S. Vermont Ave., Los Angeles 4, Calif.

ENGINEERING



Photo of Heald Students in Electrical Laboratory

Enroll Now for New Term
Heald College Ranks **FIRST**
West of the Mississippi
in "Who's Who in America"

Send for **FREE** Information
Heald Engineering College
Est. 1862
Van Ness at Post, Dept. P.M.
San Francisco, California

American Industry
Steps Up Its Demand
for Trained Engineers.
Train Now at Healds

BACHELOR OF SCIENCE DEGREE, 27 MONTHS

Degree Courses:

- Radio-Electronic Eng.
- Electrical Engineering
- Highway Engineering
- Mechanical Engineering
- Structural Engineering
- Civil Engineering
- Architecture

Diploma Courses:

- TELEVISION Color TV
- Radio-Electronic Tech.
- Industrial Electronic Tech.
- Tool & Die Design
- Architectural Drafting
- Mechanical Drafting
- Structural Drafting

Approved for Veterans

NAME _____
STREET _____
CITY _____
STATE _____

LEARN UPHOLSTERY

in your spare time
run your own
business
AT HOME



FREE TOOLS WITH COURSE!

FREE BOOK
with
sample
lessons

with course
**YOU MAKE
SLIPPER
CHAIR**



**CLUB
CHAIR**



OTTOMAN

**PLUS
SLIP COVERS
Yours to Keep
or Sell**

BE YOUR OWN BOSS

Earn more from the start! Set up your own profitable business, in your own home, enjoy steady income, independence for life. You're in demand—in good times and bad—in the booming field of Custom Furniture Upholstery. Right off you start learning and earning with tools, complete frames, fabrics and materials, included **FREE** with N. Y. State-approved UTS course. You learn skilled professional custom upholstery, reupholstery, furniture finishing, repairs, how to make beautiful slip covers, cushions and draperies. **EARN WHILE YOU LEARN**, in your spare time **AT HOME**. . . the UTS easy way.

FREE ILLUSTRATED BOOK—FREE SAMPLE LESSON
Get ready for well-paid job and big profits, from steady work, as your own boss, running your own business. Mail coupon. Training in N. Y. School also available.

APPROVED FOR VETERAN TRAINING

UPHOLSTERY TRADES SCHOOL
Dept. H8-310, 721 B'way, N. Y. 3, N. Y.

Please send me **FREE** book, "Your New Way to a Successful Career." **FREE** sample lesson. No obligation—no salesman will call.

Home Study Training in N. Y. School

Name _____ (Please Print)
Address _____
City _____ Zone _____ State _____
 Check if Korean Veteran

**FIX
YOUR OWN
MUFFLER**

**SAFE-EASY-PERMANENT
REPAIRS with
MUFFLER CEMENT**

If your muffler sounds like a fire truck, you need help. Forget about costly replacements. **MUFFLER CEMENT** spreads like putty, hardens like steel. Heat-proof, leak-proof, makes a perfect seal every time!

RESISTS WATER & RUST
NO SPECIAL TOOLS NEEDED
STOPS LEAKS AT PIPE CONNECTIONS
REPAIRS HOLE ANY SIZE

\$1.00
POSTPAID
(sorry, no COD's)



PONY EXPRESS 1017 So. Charlotte
Lombard, Illinois



BARBELLS

100
POUND
SET
\$12.80

Extra Plates Only
12c Pound

140-Pound, **CHROME DELUXE** Barbell-Dumbbell set only **\$19.80**. This is our feature set and is the finest ever manufactured.

Training with adjustable weight is the **BEST** way to keep fit; the **ONLY** way to develop great strength and a perfect body. As the oldest and best equipped barbell company, **BULL** gives value and prices no one can equal.

SEND FOR **FREE CATALOG**
BUR BARBELL CO.
Lyndhurst 9, New Jersey

LAW FREE BOOK

THE LAW
TRAINED
MAN

Write today for a **FREE** copy of illustrated law book, "THE LAW-TRAINED MAN," which shows how to earn the professional Bachelor of Laws (LL.B.) degree through home study of the famous Blackstone Law Course. All necessary books and lessons provided. Moderate cost; convenient monthly terms. Write for **FREE** law training book today.

Blackstone School of Law, 307 N. Michigan Ave.
Founded 1890 Dept. 52, Chicago 1, Illinois

BINOCULARS TELESCOPES MICROSCOPES

All kinds, sizes and prices. Also Geiger and scintillation counters, electronic and chemical items, etc. **FREE CATALOG.**

J. D. CLINTON SCIENTIFIC, MT. CLEMENS 20, MICH.

Now! TEST YOUR OWN TV & RADIO TUBES



All of Them—Even Picture Tube
Nearly half of TV service calls are due to defective filaments. Tester shows if filaments are good. Insert tube in tester. Light shows if tube is burned out. Easy, safe to use. One service call saved pays for tester. Metal case. AC or DC. Checks fuses, appliances, etc. Only **\$3.98** ppd. or C.O.D. plus charges. Deluxe Model **\$4.98**. Instructions. Guaranteed.

GEIGER ENGINEERING CORP., Dept. AB-111
6349 N. Western Ave., Chicago 45, Ill.

Get Yourself FIXED FOR LIFE in the Big Pay Shoe Business!

It's no trick at all to make big money—**FULL OR SPARE TIME**—with the only shoe line featuring baby shoes in addition to shoes for all the family with new Family Discount plan. Lifetime security. Amazing new "Spring-Step" cushion invention proves it by actual demonstration. Only **ORTHO-VENT** has it! There is no other shoe in the world like it. Repeat orders are sure, steady. One try and a customer is sold for life. Profits are **BIG**. Orders are sure and easy with the most amazing 2-minute demonstration in the history of the shoe business. No experience needed. No investment to make. Everything, including actual cut-a-ways, furnished free! Be the big-pay **ORTHO-VENT** man in your territory. Write **TODAY!**

ORTHO-VENT SHOE COMPANY
1192 BRAND RD. SALEM, VIRGINIA



I GIVE
PRODUCERS
THEIR OWN
SHOES AS A
Bonus!

MAKE GARDENCRETE G-4

A Spare-Time Activity Can Lead to a Full-Time Business

On one compact, low price, easy-to-operate machine you can make 24 different kinds or sizes of Gardencrete for patios, walks, planters, barbecues, terraces, etc. Easily set up in shed or garage. With small investment, you can turn idle hours into profit and build into a full-time operation. Gardencrete enables you to cash in on large, growing demand for garden masonry in color.



\$1.00 worth of materials can be turned into \$5.00 to \$8.00 worth of Gardencrete. A cash-and-carry business. We supply full instructions. Complete information in full-color brochure. Write today.

COLORCRETE INDUSTRIES, INC.
704 Ottawa Ave., Holland, Mich.

Patio Stones
Flag Stones
Solid Brick
Hollow Brick
Roman Brick
Stump Brick
Cap Stones
Curb Stone
etc., etc.

"\$7,108.50 First Year SERVICING RADIATORS!" NEW!

— Hank Koster, Newcastle, Wyo.
Make good money servicing auto-truck-tractor radiators with new Inland 1-Piece Radiator Shop. Easy to test, clean and repair radiators. Inland, world's largest radiator equipment mfrg., trains you free. Small down payment starts you. Proved merchandising assures volume. Profitable dept. for garage or service station. Write
INLAND MFG. CO., Dept. PM-2, 1108 Jackson St., Omaha 2, Nebr.



Renew roofs in your neighborhood! Average \$189 PROFIT a week

Right in your neighborhood there are dozens of homes that need to be re-roofed. With new Quikspray Unit, you can spray up to 3 roofs a day with colored aluminum roof coating. Excellent money . . . either full or part time. Write for free booklet "How to Quikspray Roofs."

QUIKSpray, INC., Box 327A, Port Clinton, Ohio

DO MAGIC FOR FUN AND PROFIT



Selected magic you can do. Send for new amazing GIANT SURPRISE CATALOG today! Low prices on professional and amateur magic, pocket tricks, illusions, secrets, joke novelties, puzzles, etc. Two catalogs combined into one terrific edition! \$1.00 Value. Now only 50¢. Rush today!

\$1.00 VALUE
NOW ONLY
50¢

House of 1000 Mysteries • 202C Pinewood, Trumbull, Conn

\$1 BRINGS YOU \$18

Discover Flok-Kraft and Earn \$\$\$\$\$ AT HOME

Earn up to \$15.00 per hour spare time. Amazing new Velvet-fiber spray instantly makes any object (Lamps, Radio & TV Cabinets, Figurines, Signs, Auto dash boards, toys, furniture, draperies—anything) worth expensive \$\$\$\$ Prices . . . like magic, you can spray anything with this beautiful new suede-like finish that feels like rich Velvet.

EARN UP TO \$300.00 PER WEEK SPARE TIME

Imagine, materials cost only 3¢ per square foot. (Average TV or radio cabinet can be beautifully sprayed with this startling new 3-dimensional Velvet finish in 15 minutes at a cost of only 3¢ in materials. Your charge for this job is at least \$10.00.)

REPRESENTATIVES IN YOUR AREA URGENTLY NEEDED

Own your own business. Work at home in your spare time. Help fill the huge growing demand for this amazing new beautiful Velvet-fiber finish. Orders come from stores, offices, homes, architects, auto dealers—everywhere. Possible \$20,000,000.00 worth of jobs to be done. Investigate today—be first in your area! Actual samples in 16 Radiant Colors. Booklet of 50 Home Business Opportunities and Confidential Details all sent free! Send No Money. Write: Coast Industries, Los Angeles 61, Calif., Dept. B-2.

Learn Woodworking and Cabinetmaking at Home



Complete Home Training Course Now Available

Today—it's easy to acquire the skills and craftsmanship of fine woodworking and cabinetmaking with Interstate's complete "shop method" course. Prepared by expert instructors, the course consists of 22 profusely illustrated training manuals containing more than 1100 pages of instruction. Covers all phases of woodworking, including selection of woods, planning and laying out projects, correct use and care of all hand and power tools, joint making, cutting, assembling, finishing, simple upholstery, etc. Over 75 learn-by-doing instruction projects give work bench training and experience in actual construction. Course is approved for beginners and professionals alike.

Interstate Training Service

PORTLAND 13, OREGON



Accredited Member, National Home Study Council



SEND FOR FREE BOOKLET TODAY

INTERSTATE TRAINING SERVICE
Dept. F-3, Portland 12, Oregon

Please send free booklet and information on your complete course in Woodworking and Cabinetmaking.

Name _____
Address _____
City _____ Zone _____ State _____



DRAFTING *pays* BIG MONEY!

Draftsmen earn more, enjoy pleasanter working conditions. Get into DRAFTING and Blue-Printing, the starting point of all production. Trained Draftsmen are needed everywhere. Machines can never replace the draftsman.

LEARN AT HOME IN SPARE TIME

Revolutionary new method teaches you quickly the hows and whys of Mechanical, Structural, Machine, Architectural, etc. Drafting. You are sent professional drafting instruments, drafting equipment, portable drafting table, etc., at no extra cost. You learn by making actual drawings.

BIG MONEY...ADVANCEMENT OPPORTUNITIES offered trained draftsmen. Drafting is light, pleasant work, paying big salaries. It is a stepping stone to top managerial jobs. The draftsman plans the World of Tomorrow. That is why drafting is such interesting work.

OWN YOUR OWN DRAFTING FIRM

The investment requirement is small, the earning possibilities great. Many draftsmen eventually branch out into manufacturing the products they created. Learn of the opportunities in Drafting.

MAIL THIS COUPON TODAY!

CHRISTY TRADES SCHOOL, Dept. DB-4403
3214-16 W. Lawrence Ave., Chicago 25

Mail at once your big FREE book on Drafting and Blue-Printing. Tell me how your Home Training and Professional Drafting Instruments, Portable Drafting Table, Drafting Equipment, etc. can be had on a PAY AS YOU LEARN plan.

NAME _____ Age _____

ADDRESS _____ CITY _____ STATE _____

BIG BOOM CARBIDE CANNON



\$4.40
Sounds like dynamite blast! BRILLIANT FLASH! Mighty roar echoes for blocks. Fine July 4th noisemaker, starting gun, celebrations, etc. Safe. No recoil. Hundreds of shots for few cents. Uses carbide. Fast firing. Attractively made of heavy cast iron. Money back guarantee. 9-in. Cannon
\$3.95 plus 45c post, SEND \$4.40. 17-in. \$8.95 plus 55c post, send \$9.50. Ammunition 30c tube (500 shots); 3 tubes \$1.00 postpaid.
JOHNSON SMITH CO. DEPT. 765 Detroit 7, Michigan

150 SHOT BB REPEATER PISTOL



New BULLS-EYE 150 SHOT REPEATER. Hard hitting, accurate firing. Centers shots in 1-inch circle at 10 feet. Shoots 30 shots a minute. Sights, feels, looks like expensive match pistol. Thumb-palm moulded checkered plastic grips. Blued steel. Shoots standard BBs. 25 shots for 1¢. 10 1/2-in. long; weighs 1-lb. Adjustable peep-or-open sight. Includes 2 tubes BBs. Price \$4.95, plus 50c ship. charges. SEND... \$5.45
Copper-Coated Steel BBs, 3 Pkgt. 25c
JOHNSON SMITH & CO. Dept. 765 Detroit 7, Michigan

New Jet Engine Burns Gasoline



Powerful continual thrust for models: boats, cars, planes. No moving parts. Easy to start. Runs on regular gas. 6-in. long. Complete. Only \$1.49
JOHNSON SMITH & CO. Dept. 765 Detroit 7, Michigan

Catalog of 3100 Novelties 10c

Send 10c for amazing catalog of novelties, live animals, scientific supplies, hobbies, funmakers, planes & boats, looms, magic tricks, joke articles, unusual seeds, gadget timepieces, cameras, optical goods, projectors, movies, lucky jewelry, religious novelties, disguises, musical instruments, stamps, coins, puzzles, fortune tellers, radios, auto & bike accessories, telescopes, magnifiers, compasses, banks, smokers' gadgets, artists' sunn'ics, printing sets, engines, motors, shockers, knives, rifles, sports, books, games, plants, etc. Send 10c.
JOHNSON SMITH & CO. Dept. 765 Detroit 7, Michigan



SHEET METAL MACHINES

Brakes form angles, locks, pans, etc. Quick eccentric clamp. All steel construction.

15"-16 gauge steel.....	\$28.00
36"-22 gauge steel.....	\$37.00
18"-21 gauge steel.....	\$52.00
Floor stand.....	\$ 8.00
15"-24 gauge Folder.....	\$17.50
36" Pan and Box brake.....	\$60.00
1/4 x 3 Adjustable Bender.....	\$14.00
16 gauge 7" Bench Shear 3 adj. gauge.....	\$16.50
30"-20 gauge Curve Former.....	\$12.00

ORDER DIRECT OR SEND FOR FREE CATALOG
VYKE MFG. CO., P-4158 Jason St., Denver 11, Colo.

RUPTURED?

TEST THIS TRUSS FREE FOR 30 DAYS



Wear a Web—for comfortable support. Rupture relief guaranteed. If not satisfied after trial, full purchase price refunded. Write today for your free book on rupture care.

WEB TRUSS Co. Dept. PM-2, Hagerstown, Md.

After the city,
Before the state
The ZONE keeps your mail
From being late



The Post Office has divided 106 cities into postal delivery zones to speed mail delivery. Be sure to include zone number when writing to these cities; be sure to include your zone number in your return address — after the city, before the state.



GENUINE DIAMONDS

AT ROCK BOTTOM PRICES

Buy diamonds and diamond jewelry direct from Kaskel's, America's Oldest Diamond Discount House. Every diamond is set in a luxurious new mounting . . . graded according to nationally accepted standard . . . and bonded to this effect. For over 70 years, we've served over 1,000,000 satisfied customers. CASH OR CREDIT

10 DAY UNCONDITIONAL MONEY-BACK GUARANTEE
References: Your bank, or any Rating Agency

KASKEL'S 41 West 57 St.
N.Y. 19, N.Y. Dept. 907-B
Send FREE CATALOG and Advice about DIAMONDS without obligation. No Salesman Will Call.

NAME _____
ADDRESS _____
CITY _____ STATE _____

SEND FOR BIG
FREE
ILLUSTRATED
CATALOG

Pocket Size - Loose Leaf

LEFAX

TECHNICAL DATA BOOKS

Printed on loose leaf, 6 hole, 6 1/4"x3 1/4" bond paper, each book contains about 140 pages of technical data, condensed, accurate, essential, for engineer, technical worker, teacher, student, business man

\$1.25

Architecture	Surveying	Machinist's Data	Radio
Home Heating	Tables	Mech. of	Television & FM
Illumination	Highway Eng'g.	Materials	Electricity, AC
Electrician's	General Math	Pwr. Trans.	Electricity, DC
Data	Math Tables	Mach.	AC Motors and
Builder's Data	Physics	Thermo. Tbls.	Generators
Lumber Data	Trig-Log Tables	& Charts	Conversion Tabl.
Air Conditioning	Gen'l Chemistry	Phys. & Thermo-	Steel Forms
Building Constr.	Chemical Tables	dynamic Data	Welding Data
Roof. Concrete	Analytic Chem.	Metallurgy	Transformers,
Piping Data	Mech'l Drawing	Hydraulics	Relays & Meters
Surveying	Machine Design	Metals	

Write for FREE catalogs (2000 listings). See how helpful LEFAX can be to you. Send \$1.25 book, or \$6 for any five books to

LEFAX PUBLISHERS, Dept. PM-29, PHILADELPHIA 7, PA.

Learn to MOUNT BIRDS

Tan SKINS, Make Up FURS

Be a Taxidermist. We teach you at Home. Mount Birds, Animals, Pets, Game Heads, Fish. Save your hunting trophies; decorate your home and den. **MAKE MONEY.** Mount and Krometan for others. Big spare-time profits. 100 game pictures.

FREE BOOK 48 pages - Hunters. Get this wonderful book. It's Now Free. Send postcard TODAY. State AGE. **NORTHWEST TAXIDERMIST SCHOOL** Dept. 4004 Omaha, Nebraska

MAIL ORDER BUSINESS

How to Start a Profitable Business of Your Own at Home or in a Small office. Amazing new instruction course shows you how to run a good mail order business, spare time or full time. Up-to-date, practical training—a treasure-house of the best plans and practices being used TODAY by successful operators. Only \$5.95. Complete—Satisfaction Guaranteed! This is BIG. You get 34 money-making lessons in 5 separate volumes, all in one shipment. You must be satisfied or your money back immediately. Full price only \$5.95, postpaid or C.O.D. plus postage. Nothing more to pay! Order "Mail Order Course" today. **Nelson-Hall Co., 2105 Clinton St., Dept. 98R-2, Chicago 6, Ill.**

Learn BAKING At Home

Baking is one of America's high industries in wages. Nearly depression-proof. Thorough basic home course lays sound foundation. If you have aptitude, write for **FREE BOOKLET**, "Opportunities in Commercial Baking." **National Baking School, 835 Diversay Pkwy., Dept. 1352, Chicago 14, Illinois**

HANDWRITING ANALYZE

You can analyze handwriting—at home, in your spare time. No interference with job or social life. Win more pay, social recognition, prestige! Men and women both needed now. Complete lesson and answer service. Personalized instruction. Handsome, suitable-for-framing! Diploma to graduates!

I.G.A.S. is the oldest and only grapho analysis school in the world! Write now for three free services: (1) Sample 16-page Lesson (2) Free Entrance Examination (3) Full Color 48-page Success Book. Absolutely No Obligation. Adults only.

INTERNATIONAL GRAPHO ANALYSIS SOCIETY, INC.
DESK 36 SPRINGFIELD, MISSOURI

FORTUNES IN DIVING

Train at Home in Spare Time

Write Today for Amazing Free Booklet

Here is one of the greatest opportunities of our time. Make big money fast in Skin and Lung Diving. Trained divers needed in hundreds of industries and by government. Build a successful business of your own. Hourly rates among highest paid in any field. Training program by E. R. Cross, world famous master diver. Get the facts now. Mail coupon for **FREE BOOKLET TODAY!**

DIVEMASTER, Dept. PM-29
5637 W. 63rd Place, Chicago 38, Ill.

Send me free information about Diving.

Name _____ Age _____
Address _____
City _____ State _____

Only \$6⁰⁰ starts you in TELEVISION and RADIO

Learn in spare time at home to fill the best paying jobs - my new, faster way!



Mason R. Warner
President

We're making it easier than ever to become a well paid Radio-TV Service Technician the proved 'Learn-by-Doing' Sprayberry way!



Get valuable shop bench practical experience fast with expertly engineered kits you'll assemble.



EARN WHILE YOU LEARN! Trained Radio-Television Service Technicians are needed at once by the thousands! If you are looking for better pay, a bright future and interesting work . . . there's a place for you in Radio and Television. Be ready to step into a good paying job in 10 months or less . . . or your own profitable business! Train at home in spare time. I'll help you earn extra money while you train . . . doing instructive radio service jobs. Our new tuition terms are more liberal than ever . . . only \$6 starts you towards success in this booming field!

25 KITS OF RADIO-TV PARTS In addition to modern lessons, you train with actual parts and equipment. Build the famous Sprayberry Training Television Set, Multi-Range Tester, 2-Band Radio, Test Equipment—all yours to keep. Get latest training on Color TV, Transistors, Hi-Fi and UHF Conversions!

SEE HOW EASILY YOU CAN LEARN See for yourself . . . in actual pictures and descriptions . . . what Sprayberry Radio-Television Training offers you. Backed by almost 30 years of training experience. Three training plans to suit your exact needs. Rush coupon today for big new catalog and sample lesson. No obligation; no salesman will call. **SPRAYBERRY ACADEMY OF RADIO-TV** 1512 Jarvis Ave., Dept. 10-R, Chicago 26, Ill.



FREE 60 Page Catalog and Sample Lesson

Sprayberry Academy of Radio-Television
1512 Jarvis Ave., Dept. 10-R, Chicago 26, Ill.

Please rush catalog on your **ALL-NEW** Radio-Television Training Plans. I understand this does not obligate me. No salesman will call. Include Sample Lesson **FREE**.

Name _____ Age _____
Address _____
City _____ Zone _____ State _____

YOUR NEIGHBORHOOD NEEDS AN ELECTRICAL APPLIANCE

TROUBLE SHOOTER

MEN WANTED NOW! BIG PROFITS

ONE-MAN HOME BUSINESS SPARE OR FULL TIME



Biggest home-business opportunity in U.S. today! Huge increase in use of "electric servants" creating boom in demand for service. Turn corner of garage, basement, attic, or porch into gold mine. We show you how to make business come to you. No selling. No previous experience needed. Our new "Home Practice" method prepares you quickly with hundreds of step-by-step photos and drawings. Professional tools make practice fun.

BIG DEMAND YEAR 'ROUND

from HOMES - Hundreds of repair jobs in every neighborhood pay somebody up to \$5 and more. Many jobs up to \$25 and more. *It might as well be you!* Fix electric irons, toasters, mixers, coffee makers, sweepers, washers, refrigerators, freezers, etc. Also repair and alter house wiring. Skyrocketing demand in room air conditioning.

from BUSINESS & INDUSTRY - Offices and stores are big users of electrical appliances - fans, heaters, refrigerators and many kinds of motor driven equipment. Single factory may have hundreds of electric motors operating saws, drills, sanders, lathes, etc. Many pay service man flat monthly fee to keep everything in order. *Steady income!* Pick up and do the work at home.

EVERYTHING FURNISHED including BIG TOOL KIT - We supply complete illustrated instruction for all kinds of electrical appliance repair - with a big Tool Kit and professional Appliance Tester. Everything you need to start - plus an amazing Business Plan that shows you how to start the orders rolling in almost without effort! Mail Coupon now. Start banking the profits in 30 days or less!

OTHERS MAKE BIG MONEY YOU CAN DO IT, TOO!

"I have made better than \$300 in spare time since I started the Course." P. A. ARKANSAS

"Less than 6 months after starting your Course, I obtained a full time job as a refrigeration and appliance service man." P. H. S. DAKOTA

"I have my own shop and getting more work than I can handle. I made enough in one week to more than pay for the Course." J. W. VIRGINIA

NEW 30-DAY INCOME PLAN!

Shows you how to start your own Big Profit Business without investment - no big overhead

Send for this FREE BOOK! AIR MAIL COUPON NOW!



← **FREE BOOK** Exciting, valuable, helpful Begin Making Money in 30 days or less Mail Coupon for FREE Plan. PACIFIC TRAINING SCHOOL, Dept. PM592 11029 So. Vermont Ave., Los Angeles 44, Calif.

PACIFIC TRAINING SCHOOL, Dept. PM592 11029 So. Vermont Ave., Los Angeles 44, Calif.

Gentlemen: Rush me postpaid your FREE plan for success in the Appliance Repair Business and the Free Book Entitled "The Appliance Repair Business and You" and remember I am under no obligation.

Name _____ Age _____
Address _____
City _____ Zone _____ State _____

RETIRE IN MEXICO ON \$150 A MONTH

or less in a resort area. 365 days of sun a year, dry temp. 65-80°. Or maintain lux. villa, servants, ALL expenses \$200-250 a mo. Am.-Eng. colony on Lake Chapala 30 min. to city of 1/2 million, medical center. Schools, arts, sports. Few hours by Air. Train, bus, paved roads all the way. Full time servants, maids, cooks, \$8 to \$15 per mo. Filet mignon 50c lb., coffee 45c, gas 17c gal. Bacardi rum 90c fth; gin, brandy 70c to \$1.15; whiskey \$2.50 qt. Houses \$10 mo. up. No fog, smog, confusion, jitters. Just serene living among considerate people. For EXACTLY how Americans are living in world's most perfect climate on \$90-\$150-\$250 a mo., mail \$2.00 for complete current information, photos, prices, roads, hotels, hunting, fishing, vacationing and retirement conditions from Am. viewpoint (Pers. Chk. OK) to Thayer of Mexico, File PM. Ajijic, Jalisco, Mexico. (Money-back guarantee-If you prefer airmail delivery, add 40c to U.S.-\$1.25 to other countries).

CONCRETE BLOCK HOME PLANS

\$1000 COTTAGE



Build your own 22'x26' cottage complete for \$1,000. Slab floor, beamed ceiling. Contains Liv. Rm., kitchen, two bedrooms, bath and fireplace. Blueprints, instructions and material list \$3.00 ppd. Money back guarantee. Other plans-\$1150 Garage Apt., \$1800 Duplex, \$2500 Ranch Home, \$3800 Cape Cod, \$3800 three bedroom, two bath, family room Ranch Home. FREE FOLDER.

MEMBER ARKANSAS HOME BUILDERS ASSOC.

BAILEY BUILDERS, 308 Hiawatha Drive, Little Rock, Ark.

DRAW The First Day! NO LESSONS! NO TALENT!



New Amazing Invention-"Magic Art Reproducer." You can draw Your Family, Friends, Anything From REAL LIFE-Like An Artist Even If You CAN'T DRAW A Straight Line! Anything you want to draw is automatically seen on any sheet of paper thru the "Magic Art Reproducer." Then easily follow the lines of the "picture image" with a pencil for an original "professional looking" drawing. Also reduces or enlarges. SEND NO MONEY! Free Trial! Pay Postman on delivery \$1.08 plus postage. Or send only \$1.08 with order and we pay postage. Money Back Guarantee.

NORTON PRODUCTS, Dept. 267, 296 Broadway, N. Y.



Every Boy Should Have This Build-It-Yourself Book for Boys!

It's natural for boys to want to make things-to fuss with tools-to fashion the kind of things "kids" want. So give boys the Build-It-Yourself Book for Boys. Encourage a youngster to express himself through the sensational new Popular Mechanics book that shows how to make 56 different things every boy dreams about. It covers science, mechanics, electricity, modeling and other fields. 192 pages of easy-to-follow instruction and 469 how-to-do-it pictures.

56 Toys, Games, Gadgets, Models, Boats, Electrical Devices, Cars and Other Things Boys Can Make at Home

How to make-Airplane Models, Aquaplane, Archery Kit, Bird Houses and Shelter, Boats, Bobsleds, Boomerangs, Cannon Toy, Electric game, Electric Motors, Garage Toy, Helicopter Toy, Hunting Knife, Hydroplane Model, Kites, Log Cabins, Marble Game, Microscope, Printing Press, Radio Sets, Rafts, Railroad Modeling, Shooter, Scooter, Sidewalk Cars, Sprinkler Truck, Squirt Gun, SS United States Model, Surfboard, Tank Toy, Taxidermy, Telegraph Set, Telephone, Tree House, Water Skis, Weather Instruments, Toboggan, Worktable. Build-It-Yourself for Boys sent postpaid for \$2.95 or COD, charges additional. Money refunded if you are not pleased after 5 days' use. Mail order to address below.

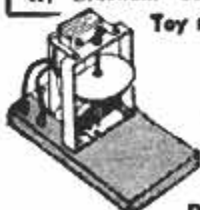

Toy motors



Boomerangs



"Ju-be"-the punt.

POPULAR MECHANICS PRESS Dept. 259, 200 E. Ontario St., Chicago 11



The steady dependable trade of Meat Cutting taught easily in 8 short weeks. YOU LEARN BY DOING under actual meat market conditions in big modern school at Toledo.

For beginners or men with experience. Get a profitable store of your own. Remember, PEOPLE MUST EAT! Big pay jobs. Free employment help. Thousands of successful graduates.

Buying, cutting, percentage, pricing, advertising, selling, etc. A complete retail meat education. National School established 36 years. Get National training NOW. Pay your tuition in easy weekly

payments after you graduate. Send coupon for FREE school catalog — TODAY. G.I. approved.

National School of Meat Cutting, Inc., Dept. 50-N, Toledo 4, Ohio
 Send me your FREE school catalog on National Training at Toledo in Meat Cutting, Meat Merchandising and Self Service Meats. No obligation. No salesman will call.

Name _____ Age _____
 Address _____
 City _____ State _____
 Approved for Veterans

ARTHRITIS—RHEUMATISM VITAL FACTS EXPLAINED

FREE DESCRIPTIVE BOOK

How crippling deformities may be avoided. This amazing FREE BOOK explains why ordinary methods give only temporary relief —if that. Describes a drugless method of treatment successfully applied in thousands of cases. Write for this 36-page FREE BOOK today. No obligation.

BALL CLINIC, DEPT. 756, EXCELSIOR SPRINGS, MO.

\$2.95 OR 2 FOR \$5.00!
TESTED AND GUARANTEED
 Write for free list on all types of telephones. Shipments F.O.B. Simpson, Pa.
 TELEPHONE ENGINEERING CO., Dept. 2B9, Simpson, Pa.



PROTECT MONEY and valuables while traveling. Ideal for salesmen, doctors, construction workers and trailer owners. Send for FREE Folder TODAY!

BANKAR CO., 1220 Broadway, Oakland 12, Calif.
 Name _____
 Address _____
 City _____ State _____

INVESTIGATE ACCIDENTS

Train quickly in your own home for repeat income in the exciting, secure Claim Investigation and Claim Adjusting field. Our students and graduates are already earning \$4, \$5, \$6 an hour extra SPARE TIME — and up to \$10,000 a year Full Time. You need NO prior experience or higher education. Your age does NOT matter.

HERE IS YOUR CHANCE FOR ACTION AND REAL JOB SECURITY

As a trained Claim Investigator you will (1) INVESTIGATE FACTS and (2) DISTRIBUTE MONEY as the representative of wealthy organizations.

No other business offers you greater opportunities for success and security. Here's why: The huge, rapidly expanding Claim Investigation and Adjusting Profession right now distributes more money than any other service industry. And it's growing fast. Over 200 MILLION ACCIDENTS must be investigated this year for Insurance Companies, Airlines, Railroads, Steamship Lines, and Government Offices.

MAIL NOW for FREE BOOK ➔

SEND TODAY for Big, FREE, Illustrated Catalog. Learn the exciting facts about Universal Schools' low cost training. No obligation. No salesman will call. GI APPROVED.



UNIVERSAL SCHOOLS
 6801 Hillcrest Ave.
 Dept. PM-2, Dallas 5, Texas
 Please rush me your FREE book on Claim Investigation. This does not obligate me and no salesman will call.

Name _____ Age _____
 Address _____
 City _____ Zone _____ State _____
 Approved by Government for Korean Veterans



One of our BEST Values!
2.9 AMP HEAVY DUTY
1/4" RAM DRILL

with Jacobs Geared Chuck & Key

Reg. \$39.95—Our Price **\$14.95**
 plus 50c pp. & hdg.

Ask any expert and he'll always say "RAM for Heavy Duty Work." Not just an ordinary 2, 2 1/4 or 2 1/2 amp unit, but a powerful full 2.9 AMP, drill to do every heavy duty job in home, shop or industry. Built to take years of rough-tough use. Newer, more rugged motor gives 1 1/2" capacity in hard wood and 1/4" capacity in steel with a full load speed of 1200 R.P.M. Durable, mirror finished, lightweight aluminum housing. Features Universal, series wound AC-DC motor; heavy duty multiple thrust ball bearings; automatic release trigger switch with locking pin; 6 ft. 2 conductor, UL approved cord and plug. Standard 115 V. AC-DC. This powerhouse measures 9" in length yet weighs only 3 1/2 lbs. If you've ever needed a drill or find that your present 1/4" job just won't do the things you expect of it, ORDER THIS 2.9 AMP 1/4" RAM DRILL TODAY! Limited quantities.

75c ea. for Finest Imported PRECISION PLIERS!

• Flat Nose • Combination • Diagonal Cutter • End Cutting Nippers • Round Nose • One Side Flat — One Side Round • Snipe

FOR JEWELERS, OPTICAL WORKERS, HOBBYISTS, CRAFTSMEN OF ALL KINDS! These superb European instruments are of deep-forged, heat-treated high quality tool steel, fabricated to most exacting specifications. All-over ground and polished to smooth hard surfaces. Smooth working joints with just the right tension. Jaws meet perfectly to safely and securely hold even the most delicate objects in the hard-to-reach corners and angles. Each plier is 4" long and a veritable gem of precision and strength.

75c each . . . ALL 7 for \$5.00 ppd.

CHROME VANADIUM
29 Pc. DRILL SET

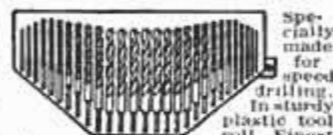

Specially made for speed drilling. In-sturdy plastic tool roll. Finest alloy steel drills hardened and precision ground to the sharpest, longest lasting cutting edge obtainable; will easily and cleanly bite through hardwoods, plastics, aluminum, iron and the toughest steels. Unconditionally guaranteed for thousands of drillings. Full jobber lengths. Sizes by 64ths from 1/16" to 1/2". NOW **\$6.49** ppd. Also available with Turned Down Shanks to fit all 1/4" drills. In individual pocket roll. **\$8.95** ppd.

60 Pc. Set Wire Gauge
CHROME VANADIUM DRILLS



Top quality German import high test Chrome Vanadium Drills designed for speed drilling through toughest steels, woods, plastics, iron and aluminum. Precision ground, long-lasting cutting edges. Guaranteed to give years of satisfaction. A full 60 pc. set. Nos. 1 through 80. A **\$14.95 value—NOW ONLY \$5.40** PLUS 50c PP. & HDG. Same set above available with Hunt Metal Index container. PLUS 50c PP. & HDG. **\$6.65** Also Available 20 Pc. Set — Nos. 61-80 **WIRE GAUGE DRILLS** In plastic kit with marked pocket for **\$2.50** ppd.

World Famous "Threadit" Specially Hardened Steel
36 pc TAP & DIE SET



Here's a kit that will make a discerning craftsman say "That's for me." Every tap, die and component precision crafted of the finest steels to give lifelong performance. Kit contains Tap and Reamer Wrench. Die Stock plus one tap and die in each of the following sizes: 4x30 NS, 6x32 NC, 8x32 NC, 10x32 NF, 10x24 NC, 12x24 NC, 14x20 NC, 1/4x28 NF, 5/16x18 NA, 3/8x24 NF, 3/8x18 NC, 7/16x20 NF, 7/16x14 NC, 1 1/8x13 NC, 1 1/2x20 NF and 1 1/2" pipe. All units come packed in a sturdy, unbreakable two removable shelf plastic case with each piece fitted into a compartment for protection and quick selection. **A \$29.95 value — NOW \$19.95** plus 50c pp. & hdg.

12" and 24" Long — All Purpose
CARBIDE DRILL BITS

Now, drill thru deep concrete, wood, glass, brick, aluminum, fiberglass, plastics and steel with this amazing new all-purpose carbide drill bit. Fits any 1/4" power drill. Drill can be sharpened 10 to 15 times. Special thin shaft permits drilled particles to flow freely from the hole without packing—drill runs "cool" eliminating breaking failures. Requires so little power that large diameter holes can now be drilled with smallest electric drills.

	12" SHANK	24" SHANK
5/16" Bit	\$1.40	\$1.75
3/8" Bit	1.60	1.90
7/16" Bit	1.90	2.25
1/2" Bit	2.45	2.75
9/16" Bit	2.75	3.25
5/8" Bit	3.25	3.60

(All 6—\$12.25 ppd.) (All 6—\$14.50 ppd.)

COMPLETE POWER TOOL ACCESSORY SET
100 PIECES Designed for use in all 1/4" capacity Electric Drills and Motor Chuck

A complete power tool accessory set that can handle almost any job of grinding, sawing, cutting-off, polishing, buffing, reaming, sanding, drilling, cleaning, etching, etc. KIT CONTAINS:—Wire Wheel, Mounted Grinding Wheels, Rotary File, Abrasive Cartridge Rolls, Circular Saw Blade, Felt Bob and Wheels, Honing Stones, Jewelers Rouge, Buffing Wheels, Midget Steel Cutters, Bristle Brushes, Abrasive Sheets and sufficient Arbors to accommodate all the unmounted items. **Over \$15 value. only \$4.98 ppd.**

SANDING PROBLEMS SOLVED FOREVER WITH
Dura-Grit Tungsten Carbide Sanding Accessories!

The Miracle Abrasive That is Harder THAN ANY KNOWN STEEL! The amazing discovery of brazing tough tungsten carbide grits to steel creates a diamond-like cutting hardness—makes possible the finest sanding equipment ever known. Each grit becomes a sanding edge that performs perfectly—stays keen and sharp indefinitely—never needs replacing—makes sandpaper obsolete! Excellent for use on all WOODS, PLASTICS, PLASTER, WALLBOARD and all COMPOSITION MATERIALS! Sands twice as fast as sandpaper—never tears! Saves time and torn hands because you never need to change Discs, Sheets and Wheels are all LIFETIME GUARANTEED!

LIFETIME HANDY SANDER

With 2 sanding sheets (1 for Coarse and 1 for Fine Sanding) The hand-sanding block that does away with the nuisance of sandpaper forever. A guaranteed smooth, satin-like finish every time! PRICE **\$2.00** plus 20c post. & hdg.



5-in-1 WHEEL

It Saws • It Shapes • It Ploughs • It Sands • It Dadoes Performs five separate operations: saws, shapes, ploughs, sands and dadoes. It can cut and sand in the same operation . . . there's no teeth to drag, bind or snag and eliminates dangerous "kick-back." The perfect accessory for both table and radial saw use. 80 grit on one side; 36 grit on edge and other side. Never needs sharpening . . . lasts for years. **6 1/2" Wheel 1 1/2" 8" Wheels 50" Arbor With Arbor With Bushing to reduce Bushing to reduce to 3/8" Arbor. \$6.95 + 25c pp. \$7.95 + 25c pp. & hdg.**



SANDING DISCS

For Use With All Standard Power Drills Convert portable electric power drills to efficient sanding machines. Does away with sandpaper forever—no longer will the nuisance of tearing sandpaper delay the work. Ideal for use by the handyman as well as the professional carpenter. Save effort . . . time . . . and dollars! **4" DISC \$1.00 5" DISC \$1.29 6" DISC \$1.49** Available in 3 Sizes of Grit Fine Grit (150) Medium Grit (80) Coarse Grit (60)



SANDING SHEETS

3 1/2 x 9 in. For Use With All Standard Oscillating And Orbital Type Sanders. Complete the most difficult sanding job in a fraction of the time it takes with sandpaper — eliminates forever the nuisance of stopping to change torn and worn-out sandpaper. Even the amateur handyman achieves a beautifully sanded job every time . . . and it's an indispensable need for the professional carpenter. Available **\$1.49** in 3 Sizes of Grit Fine Grit (150) Medium Grit (80) Coarse Grit (60)



3.1 AMP 3/8" DRILL

Mfd. by Speedway Div. of THOR with Heavy Duty Sealed Radial Thrust Ball Bearing on Spindle!

For the really TOUGH jobs that call for sure, steady power, nothing in its class can beat this new, sensational 3 1/8" Speedway Drill—built to professional standards for the same price you would pay for an ordinary 1/4" drill. This highly polished drill has perfect speed and power for driving screwdriver attachments; drills through the hardest woods, steel, masonry (with attachments); saws (with attachments) thru wood and steel with the greatest ease. It's great for driving hole saws up to 2 1/2"; perfectly sands, polishes, mixes paints! Here's the right tool for the man who wants the best; 3-jaw geared chuck, die-cast housings, steel gears, re-reinforced construction throughout. Ideal for "demanding" hobbyists, homeowners, electricians, appliance installers and all other craftsmen. SPECIFICATIONS: Capacity in steel 3/4"; Capacity in wood 1 1/2"; Ampere rating 3.1; No load speed 925 RPM; Full load speed 610 RPM; Bearings, Sealed ball and oilite; Lgth. 8 1/2"; Wgt. 4 1/2 lbs.



AMAZING BLOCK & TACKLE

• PORTABLE—weighs 13 oss. fits in pocket!
 • One Hand Operation
 • POWERFUL—lifts up to 1000 pounds!
 For HUNTERS • HANDYMEN • FARMERS • TRUCK DRIVERS • YACHTSMEN • MOTORISTS The great strength, small size, complete portability of the Midget Babe Block & Tackle gives it many uses. In car, home, factory, farm. For sportsmen; loading deer, boats, etc. For lifting heavy articles anywhere! Best grade aluminum. Steel axles. Lubricated for life! Two lifting slings, top and bottom. Heavy welded steel rings. Slings can be doubled for extra strength. With 80 ft. nylon cord, 5-1 ratio, 1000 lb. test. **\$9.95** Carrying bag, instructions. 1 yr. guarantee. ppd. Also Available—Tiny Babe; Lifts up to 2000 lbs! With 100 ft. nylon cord, 7-1 ratio, 2000 lb. test, 15 oz. wgt. **\$12.95** Twice as powerful as \$9.95 model, only . . . ppd.



"Hoppy" SPLIT-IMAGE TRANSIT



One Of The Most Revolutionary LEVELS & INCLINE MEASURES ever made! This simple yet amazingly accurate instrument indicates level and measures incline down to a fraction of an inch. Makes bubble type or string levels obsolete. It not only indicates level, but shows exactly how much correction is needed. Just one person, using the split-image transit and target supplied with it, can perform any leveling, incline-measuring quickly, easily, accurately—measure incline down to the thinness of a dime at 25 feet. So accurate, it can be used instead of expensive surveying equipment for most grading and construction work. **\$6.95** ppd. IDEAL FOR—Leveling & Grading Model Train Tables, Contour Plowing, Carpentry, Brick Laying, Cement Work, Surveying, Gutting, Foundation Work, etc.

Precision Micrometers
AT BARGAIN PRICES!



Chrome plated, adjustable equipped with ratchet stop and lock nut. Adjustable for zero. Decimal equivalents of fractional sizes die sunk on frame. Recessed frame to allow readings in tight spots. Precision made for accurate readings, fully polished. In velvet lined case. 0-1", 1/1000" Readings **\$5.95** 1-2", 1/10,000 Readings with 1" test gauge **\$7.95** 0-1", 1/10,000 Readings **\$7.50** 1-2", 1/10,000 Readings with 1" test gauge **\$9.50**

Send Check or Money Order. If COD, fees extra. **MONEY BACK GUARANTEE**

SCOTT MITCHELL HOUSE, INC.
 Dept. F-2 415 So. Broadway, Yonkers, N.Y.

**WORLD'S
BEST
WANT-AD
MEDIUM**

CLASSIFIED ADVERTISEMENTS



Advertisements in this section \$1.25 per word, each insertion, minimum 10 words, payable in advance.

To be inserted under proper classification, copy must be in our office the

20th of the second month preceding date of issue

F. W. Johnson, Manager, Classified Advertising

Popular Mechanics Magazine, 200 East Ontario Street, Chicago 11, Illinois

YOU'LL PROFIT

By reading and answering the classified ads in this section. Hundreds of opportunities for you to make and save money

AUTOMOBILES, MIDGET CARS

$\frac{1}{4}$ MIDGET Racer plans \$1.00. Also $\frac{1}{4}$ and $\frac{1}{2}$ fiberglass bodies available. Hayman Fiberglass Prod., 13502 Alburts Ave., Norwalk, Calif. (M)

MIDGET Car. Two seater. Build at home. Complete plans \$1.00. Clark's, 33 Arbor Lane, Hicksville, L. I., N. Y.

1959 CATALOG On parts kits for golf buggy or Jr. sports car 25¢. Indus Corporation, 1815 Madison, Indianapolis.

HOT Cart racer—\$129.00 up. 2 to 4 hp. Wheel options. Free folder. Dept. 22, Box 9405, Richmond 28, Virginia.

HUNDREDS Of automobile catalogs—American, antique, foreign; dealer books, glossy photographs, shop manuals; free motor magazines listed by non-profit organization. Write immediately; get on free mailing list. Auto Maniacs, Stockbridge, Mich.

TEN Complete illustrated automobile driving lessons prepared by Automobile Driving Aids, Inc., Box 6A, Turtle Creek, Penna. \$1.00, no c.o.d.'s.

MIDGET Car. Plans and pricelist of parts 35¢. B. Sypher Co., Sta. F., Toledo, Ohio.

NEW 1959 Automobiles—To 25% off retail. Meder, 550-PM Fifth Avenue, New York City 36.

AUTOMOTIVE Books. Send for 1958 general book catalog. 10¢. Popular Mechanics Press, 631 N. St. Clair St., Chicago 11, Ill.

AUTO SUPPLIES AND EQUIPMENT

FREE List. Colorful, souvenir decals. Box 504, Nyack, N. Y.

FIBERGLASS Automobile fans. 1/5 weight \$10.30. Sun-Glas, Mt. Sterling, Ill.

SUPREME Racing camshafts. Cleveland Hone & Mfg. Co., 8816 Harkness, Cleveland 6, Ohio.

RING-Valve job while driving, \$6.00. Free details. Motaloy, Grantham, Penna.

REVOLUTIONARY Gasoline saver device! Particulars, send 10¢, refundable. Grable Enterprises, 26314 Normandy, Roseville, Michigan.

BARGAIN. Exciting Little Library booklets. 25¢ each. How to use tools, painting, welding, home improvement, games, models, plastics, lamp making, glass blowing, boats, photographs. Free Little Library catalog. Popular Mechanics Press, 200-LB East Ontario St., Chicago 11.

SAVE Money on Jeep and army truck parts. Large inventory. Catalogs for Jeep or G.M.C. owners. American Auto Parts Co., 1830 Locust, Kansas City, Mo.

JEOP Owners attention: Free wheeling selective drive hubs for your front drive axles only \$39.95, postpaid. Tractor Supply Company, 2700 North Halsted Street, Chicago, Illinois. Also available at any of our 40 branch stores.

NEW And used parts at savings. Complete guaranteed parts service for all models cars and trucks, 1924 and later. Largest in the West. Jeep and army parts specialists. Newest type shifting hubs for all Jeep and all military and latest production front end drive vehicles, \$27.00 and up. Write, Pioneer Auto and Truck Parts Co., 734 W. 13th Avenue, Denver 17, Colo.

FREE! New catalog. Speed, power, mileage increasing equipment. Discounts! Almqvist Engineering, Milford PM5, Penna.

AMAZING Discovery. Master Glaze, puts brilliant glass like surface on cars. Free sample. Information. Big commissions. Master Glaze, Dept. 901, 7720 Harwood, Milwaukee, Wis.

DIAT. Auxiliary accelerator left foot gas pedal \$6.95. Lehner Company, Ness City, Kansas.

1958 HOTTSPARK: Starting, pep, mileage \$4.50. Vartypers, IBM's, mimeographs, multiliths, Barbel's wholesale. EG, Elmsford, N. Y.

PARTS Model A, older V-8s. Express needs. Matco, Box 135, San Pedro, Calif.

PROFIT! Battery repair manual \$3.00. Bayer, 938P Betty, Neenah, Wis.

GASRATOR Converts water to gas! Powerful! Economical! Plans and kit, \$2.00. National, P.O. Box 606-B, Redwood City, Calif.

JEOP Owners — V-8 conversions. Read Jeep Owners ad, page 28.

1959 GIANT Auto parts catalog. Thousands accessories stores don't handle. Gadgets, custom equipment. Send 25¢ (refundable). Newhouse Automotive Industries, 5805 PM-2 Beverly, Los Angeles 22, Calif.

AUTO Shop welding repair training in world's largest nonprofit welding school. Catalog free. Hobart Welders, Box M-291, Troy, Ohio.

1959 EDITION. It's new! It's different! Get world's largest auto accessories and parts catalog, save up to 50%. 308 pages, over 85,000 items for 1920 to 1959 models including Hollywood accessories, custom styling and hi-speed equipment. All parts and accessories for all cars and trucks. We have that hard to get part. Jam packed with bargains. Completely illustrated. Send 25¢ (refundable). J. C. Whitney, 1919PM-2, Archer, Chicago 16, Ill.

AUTO TRAILERS

BUILD Expanding eight foot trailer. Accommodates five. Literature 10¢. Frammar Company, Wilmington, Mass.

BUILD "Flexi-Trailer"—Anyone can do it easy! Use as box, flat, boat, or camping trailer. Converts in one minute! Complete plans \$3.00. Write for free details. Outdoor Industries, Dept. PM-2, R. 4, Excelsior, Minn.

TRAILER Building guide supply catalog \$1.20. Blueprint booklet floor plan 60¢. Komcraft, Box 1153, Milwaukee 1, Wis.

MOTORCYCLES, BICYCLES, MOTORSCOOTERS AND SUPPLIES

MIDGET Auto \$25.00; 1954 Whizzer \$20.00; Cushman motorscooter \$25.00; motorcycle \$10.00. Rush 25¢ (35¢ first class mail) for new catalog #963 listing amazing bargains in motors, midget cars, motorcycles, motorbikes, construction plans. Associated, Box 534, Toledo, Ohio.

1000 MOTORCYCLE Bargains. Motors, parts, equipment. Catalog 25¢. Bunico, 146-XX, Covington, Virginia.

HARLEY - Davidsons — Used bargains. New, used parts, accessories for all models. Bulletin, catalog 25¢. Knuth's (Factory Dealer), 1753 Muskego, Milwaukee, Wis.

RECONDITIONED Motorcycles and motors. Chromium accessories. Complete stock Indian parts. Expert rebuilding. Fast service. Indian Motorcycle Sales, Kansas City 27, Missouri.

RACING Power cams for Cushman, Whizzer, Mustang, Hiawatha, Continental. Send your cam and \$10. Weber Cams, Box 33175, Los Angeles 33, Calif.

WHIZZER Engine \$7. Motorbike conversion \$4. Cushman motorscooter \$15. Boy's auto \$35. Highway midget \$40. Crosley station wagon \$75. (Mailorder only). Send 25¢ (35¢ for first class mailing) for new 32 page directory-catalogue Number 87. Listing these and hundreds of other bargains in motorscooters, midget cars, engines, homebuilder's parts, plans, etc. Midget Motors Directory, Athens, Ohio.

AVIATION

HELICOPTER, Kits, plans. Free brochure. Adams, Box 6042-A, Lakewood, Calif.

FLYING Platform. Three drawings, \$2.00. Rotron, Box 573-A, Bellflower, Calif.

HELICOPTER Mechanics urgently needed. Train at home. Southern Cross Helicopter Institute, 345 SIP, Jersey City 6, N. J.

PROPELLERS, Plans, supplies for airboats and snowplanes. Latest designs. Prompt delivery. Catalog 25¢. Banks-Maxwell, Box 3301E, Ft. Worth 5, Texas.

BOOKS; Hundreds of subjects. Big 1958 book catalog — 10¢. Popular Mechanics Press, 200-BC East Ontario St., Chicago 11.

AIRCRAFT Data book for the homebuilder \$1.50. Read Sport Aviation. Subscription \$5.00. Write for free brochure. Experimental Aircraft Association, Hales Corners, Wisconsin.

AVIATION Surplus bargain catalogue. One dime. Box 22PM9, Thomasville, Penna.

BOOKS, Aviation. Free catalog. Aero Publishers, 2162-PM2 Sunset, Los Angeles 26, California.

ELECTRICAL SUPPLIES

WHOLESALE Appliance parts catalogue 25¢. Sico, 26 South 20 Street, Birmingham 3, Alabama.

FREE Instrument screwdriver! Just send postcard. Hurry, while supply lasts. Laircraft, Box 5008-BA, Detroit 35, Michigan.

ELECTRIC Pencil: Engraves all metals \$2.00. Beyer Mfg., 10511-H Springfield, Chicago 43.

LAMP, Electrical parts, wholesale. Thousands of items for repairing, converting. Catalog 25¢. Brown Lamp, Box 305, Clayton 5, Mo.

LAMPS—Parts catalog containing wiring instructions, 25¢. Gyro Lamps, 3438P N.W. 54 Street, Miami, Fla.

HOUSE Wiring—Electrical repairs. Booklet. Send for 1958 general book catalog, 10¢. Popular Mechanics Press, 633 N. St. Clair St., Chicago 11.

FREE Bargain catalog—Fluorescent fixture kits, fixtures, parts. Shoplite, 650M Franklin, Nutley 10, New Jersey.

WELDING, SOLDERING, PLATING

WELDERS, 110/220, \$39.50. Morris, 1070 Inner Drive, Schenectady 3, New York.

PLATING Equipment, supplies. Complete line of anodes, solutions. Home workshops, industrial sizes. Hollywood Bronze Supply, Dept. C, 1624 East First, Los Angeles 33, California.

FREE Catalog, welders, welder kits. Build 300-ampere welder using aircraft generator, plans 25¢. Agents wanted. Dunbar Manufacturing, Minneapolis 8, Minn.

FREE Factory catalog. Welders, assemble yourself kits. Build 350 ampere welder at low cost. Guaranteed plans 25¢. LeJay Manufacturing, Asheville, N. C.

MACHINERY, TOOLS, SUPPLIES

CLAUSING Mill riser blocks 3 1/2", \$29.95. Bridgeport Mills vertical rapid traverse \$249.88. Magnetic sine chucks \$139.50. Table of sines 50¢. Horton Machine & Tool Co., 868 N. Prior Ave., St. Paul 4, Minn.

FREE Instrument screwdriver! Just send postcard. Hurry, while supply lasts. Laircraft, Box 5008-BB, Detroit 35, Michigan.

1/4" TUBE Benders, all steel, wt. 14 oz. Bends in a jiffy. \$3.80 post paid. Meyer, 1909 W. 7th St., Los Angeles 57, California.

ENGINES, MOTORS, DYNAMOS

WINDING Data. 275 motors, single and three phase, \$1.10. Data Company, Box 7631, Kansas City 28, Mo.

REWIND Motors yourself. Complete instructions \$1.00. Lewis Mfg., Howell, Michigan.

DIESEL Injector parts wanted. GM51-71-110. Bares, 7120 Carnegie, Cleveland 3, Ohio.

REWIND Your own motors. It's easy. Simplified method. Only \$1.00. Bee Enterprises, Box 102, Boulder, Colorado.

BOATS, OUTBOARD MOTORS

BOAT Plans—Full size patterns, frame kits. Modern inboards and outboards for amateur builders. Complete new catalog 50¢ or specify requirements. Glen Designs, 9152 Rosecrans, Bellflower, California.

BOAT Leaking? Make it dry. Fiberglass covering kits, molding supplies. Aqua Glas, Box 99, Altadena, Calif.

FIBERGLAS Permanent boat waterproofing. Special 25% discount. Complete kits, \$9.45 up. Guaranteed materials. Easy application. Full instructions. Free literature. Ajax Plastics, Dept. PM, P.O. Box 1323, Fort Worth, Texas.

PROPELLERS, Plans, supplies for airboats, snowplanes. Catalog 25¢. Banks-Maxwell, Box 3301F, Ft. Worth 5, Texas.

SAVE Money. New, used outboard motor parts. Send wants. Stamp appreciated. Outboard Motor Mart, 229-M State, Boston 9, Mass.

NEW, Used, rebuilt marine motors. Marine conversions, fittings. Free catalog. Stokes Marine Supply, Dept. 24, Coldwater, Michigan.

FULL Size, shape-cut boat patterns, blueprints, 7 1/2-38 feet. Send 50¢ for 88-page illustrated "Build a Boat" catalog of all types, naval-architect-designed, boats. "How to Build a Boat" booklet, \$2.50. "Hardware and equipment," \$2.00. Cleveland Boat Blueprints, Dept. A-66, Box 1651, Cleveland Ohio.

NYLON Rope, lines, cords, nets, seines. Every description for commercial, sportsmen and household use. Finest quality. Free catalog. Beebe Cordage Co., Cranford 8, New Jersey.

BUY Direct from the factory. Core-glass boats and molded fiberglass boats. Fishing and runabout models 14 to 18 feet. Tremendous savings on complete package of boat, motor and trailer. Boat trailers 400# to 2000# capacity. Free wholesale catalog. Osage Mfg. Company, 117M, Osage, Minn.

MARINE Conversions. Ford, Chevrolet, Jeep engines. Catalog 25¢. Lehman Manufacturing Company, 800 Elizabeth Avenue, Linden 4, N. J.

FREE Catalog! Boat kits, trailers, fiberglass, marine hardware. Luger Industries, Dept. M-2, 9200 Access Rd., Minneapolis 20, Minnesota.

300 POWERBOAT Plans, kits. Catalog, 50¢ Fiberglass dinghies. Marinecraft, Box 161-M, Brighton 35, Mass.

HYDRAULIC Steering. New, guaranteed. Easy installation, outboard and inboard boats. Also waterproof trailer lights. Hulse Industries, P.O. Box 1163, Palos Verdes Estates, California.

BOAT Kits, easiest to assemble, ocean tested, many models. Write for descriptive folder. Beachcraft Boat Company, 212 North Quarantina Street, Santa Barbara, California.

\$57.50 ALUMAKIT Boats. Sails, canvas work. Noble Products, Southbridge 2, Massachusetts.

ROPE, Nylon or polyethylene wholesale prices. Wolfe Specialties Inc., 350 Stanford, Akron 14, Ohio.

I Want to send you proof of the wonderful pulling power of Popular Mechanics classified pages. What's your proposition? Write me today. Include literature if possible. F. W. Johnson, Manager Classified Advertising, Popular Mechanics Magazine, 200 E. Ontario St., Chicago 11, Ill.

ATHLETIC EQUIPMENT, BODY BUILDING COURSES

JUDO—20 Best tricks. Offense-defense. Easy to learn. Fully explained. Brief Japanese-English judo dictionary added. Rush \$1.00 to: National, P.O. Box 63-R, Brooklyn 14, N. Y.

BREAK Planks, masonry bare-handed with Karate Kung-Fu. Deadliest oriental defense. Illustrated training manual \$3.98. J. Yim Lee, 771 Sacramento St., San Francisco, Calif.

4 MUSCLE Courses 25¢. Fully guaranteed. 12 courses \$2.00. Personal supervision. Sid's System, Southgate, Calif.

SLOWING Down? Legs or feet muscles cramp and ache? Active men and women know you are only as young as your feet and legs. Amazing Perrin Method activates, stimulates and intensifies circulation and nervous force. No expensive equipment. One small cost covers lifetime benefits. Why lose out on these advantages? Write today for free information. Orin Company, 1017-PM 13th St., Des Moines, Iowa.

FREE Muscle building information. Body-Tone, Box 638B, North Miami, Florida.

BARBELLS, Dumbbells, Courses. Booklet 10¢. Good Barbell Co., Siloam Springs, Arkansas.

SPORTING GOODS, GUNS, FISHING TACKLE, ARCHERY, TRAPPING

FISHERMEN! Our new sputnik, buck-tail, spinning popper. All for \$2. Bentley, Christoval, Texas.

154 PAGE Catalog—A real "dream book" for fishermen! It's free! Netcraft Company, Dept. B-2, Toledo 13, Ohio.

CROSSBOWS! Hunting—Bows! Factory prices! Jayco, Box 1355, Wichita, Kansas.

BIG Money raising crickets and 12 inch African fishworms. Free literature. Carter Ranch, Plains, Georgia.

GUNS, Swords, knives, daggers, flasks. Large list 25¢ coin. Ed Howe, Coopers Mills 52, Maine.

HOW To catch fish with smell, 25¢. Johnson's, 312 Lake Avenue, Ithaca, New York.

10,000 GUNS! Swords, Kentuckies, Colts, Lugers, hunting guns! Bargain catalog 50¢. Agramonte's, Yonkers 2-G, N. Y.

FISHING Rod kits, custom quality. Illustrated catalogue 25¢. Makit Rod Company, 113 Adolph, Ft. Worth 7, Texas.

FREE—Wholesale catalog. Beads. Spinners. Lure parts. Sinkers molds. Jigs. Reels. Finny sports (ME), Toledo 6, Ohio.

COLUMBUS Game for pond or pool. Mac's Hobby Ranch, P.O. Box 14, Dallas-town, Penna.

KILL Submersed water weeds which foul up motor propellers, tangle fishing gear and choke irrigation ditches with R-H Granular Weed Rhap-20. Inexpensive, easy to use, sure results. For details write Reaser-Hill Corporation, Box 36PM, Jacksonville, Arkansas.

MOLDS For fisherman's sinkers, jigs, squids, casting and spinning lures. Free catalog. Sweet's Molds, Tonawanda 1, New York.

5000 BARGAINS, Firearms, binoculars, war relics. Catalog 50¢. Smith Firearms, Runnemeade, N. J.

AMAZING Wholesale sporting catalog. Save 70%. Tremendous selections. Econ-O-Mart, Whippany 2, New Jersey.

JAP Rifle altering to 30-06, \$6.00. Jap-shells, \$3.95. Catalog 10¢. T. P. Shop, West Branch 11, Mich.

MACHINE Guns, cannons, rifles. Surplus military arms, ammunition, accessories. Profusely illustrated catalog 50¢. Service Armament Co., Fort Lee Road, Bogota 8, N. J.

MIRACLE Fish lure attracts fish beyond belief full season's supply only \$1.00. Keating Manufacturing Corporation, 5050 Logan Street, Denver 16, Colorado.

CAMOUFLAGE For archers, hunters. 3—\$1.00 postpaid. Underhill Co., Philomath, Oregon.

NORWEGIAN "Stonefly" free, wholesale tackle catalog. Haakonsen, 479 Senator, Brooklyn 20, N. Y.

EARTHWORMS, CRICKETS, FROGS

\$1,000 MONTHLY Possible raising earthworms. African plants. Backyard, garage, basement. Complete illustrated booklet explains raising, feeding, packing, marketing. Only 25¢. Ozark Worm Farm-J, Willow Springs, Missouri.

FREE Folder. "How to Make Big Money Raising Worms." Maxwell, Rt. 2, 422, Irving, Texas.

EARN Money at home raising fishworms for us! Backyard, garage, basement. We buy your crop! Inquire: Oakhaven-56, Cedar Hill, Texas.

BIG Money raising fishworms and crickets. We teach you how to raise and where to sell. Free literature. Bedrun redworms, 3000, \$6.50; 10,000, \$19.95. Carter Redworms, Plains, Georgia.

FREE Details, literature. Raise red hybrid earthworms. Campbell's Fishbait, Fort Payne, Alabama.

DO-It-Yourself booklets. 32 different home and hobby projects. Send for 1958 book catalog 10¢. Popular Mechanics Press, 631 N. St. Clair St., Chicago 11.

BINOCULARS, TELESCOPES, MICROSCOPES, MAGNIFIERS

BUILD Your own reflector telescopes. Complete kits; mirrors, eyepieces, tripods, all other accessories. Request free illustrated literature. Criterion Manufacturing, Dept. DPM 49, Hartford, Conn.

TELESCOPES—Refractor, reflector, kits and accessories. Free illustrated booklet. Dell Optics Co., Limited, Dept. PM, 329—55th Street, West New York, New Jersey.

BINOCULARS, Telescopes, microscopes. Terrific values, \$3.98 up. Request free money-saving catalog. Criterion, Dept. P75, Hartford, Conn.

TELESCOPES, Binoculars — all sizes. Complete optics, parts, accessories for telescopes. Free catalog. Suffolk Science, Mattituck, New York.

DYNASCOPES—Sensational new reflector telescopes. Send for details. Criterion Co., Dept. DP52, Hartford, Conn.

REFLECTING Telescope, 60X, completely assembled. Guaranteed observatory clearness. Free information. Skyscope, P.O. Box 55, Brooklyn 28, N. Y.

WAR Surplus bargains: Millions of lenses, instruments, telescopes, binoculars, components and complete line of astronomical telescope items. World's greatest optical market-place! Send only \$1.00 for beginner's 10-lens kit and big instruction booklet stock 2-CH. Write for catalog CH free! Edmund Scientific Co., Barrington, New Jersey.

FREE 48 Page science catalog. Optical, biological. Research Scientific, 126M West 23rd St., New York City 11.

SPECIAL Winter sale, precision binoculars. Amazing prices. Folder "Binocular Selecting," catalog free. Prentiss Importers, Mercury Bldg., West Los Angeles 25, Calif.

PLANTS, SEEDS, BULBS, NURSERY AND GARDEN SUPPLIES

GROW Dwarf trees! Pot, sell. Instructions and seeds 35¢. Mail Order Specialties, 1439-8, Sabraton Ave., Morgantown, W. Va.

RAISE Your shrubs, trees from seed. Free planting guide, price list. Woodlot Seed Co., Norway 9, Michigan.

WORLD'S Greatest cash crop. Free information. Write Ginseng Gardens, Asheville, N. C.

PETS—DOGS, BIRDS, RABBITS, HAMSTERS, ETC.

GOLDEN Hamsters—Pedigreed breeders \$3.85 pair. Literature. Moore's Hamster Ranch, Shepherdstown 25, West Virginia.

EARN \$10,000 Yearly raising Angora rabbit wool for us. Information 25¢ coin. American Angora Company, Malta 12, Montana.

RAISE Rabbits successfully by knowing facts. 48 page illustrated book describing 25 breeds. Housing, feeding, breeding, marketing, etc. Plus bulletin, 25 cents. American Rabbit Association, 36 Arba Building, Pittsburgh, Penna.

SKUNKS, Reptiles, hawks, raccoons. Illustrated catalogue, 25¢. Trails End Co., St. Stephen, S. C.

CHINESE Pug puppies (like toy Boxers). free pictures. Herb Miller, 513 Kent, Lubbock, Texas.

ALIVE! Scentless skunks \$15.00. Raccoon cubs \$10.00. Armadillos, opossums, flying squirrels \$5.00. Birds, turtles, snakes. Catalog 10¢. Ray Singleton, Interbay Station, Tampa, Fla.

HAMSTERS—Golden: Young, \$3.00 pair, breeders, \$4.00 pair. New mutation, \$5.00 pair. Adirondack Hamstery, Prospect 20-B, New York.

TRAINING Gun dogs the easy way. Enlarged second edition. Complete training, care of bird dogs and retrievers, \$2.50 postpaid. Win-Key Specialties, 54 Moulton St., Eight Mile, Alabama.

MOST Profitable rabbits—Angoras, Chinchillas. Particulars free. Grinsteads, Edwardsville, Illinois.

RAISE Rabbits. Send 35¢. Free breeding stock offer, marketing, housing information. A. Johnson, 683, Kansas City 41, Mo.

MAKE Money raising chinchillas, mink, nutria, rabbits, cavies for us. Free catalog. Keeney Brothers, New Freedom 2, Penna.

HAMSTERS — Ideal pets, \$2.95 pair. Free booklet. Jer-Fre's Hamstery, 2216 East Broadway, Muskegon 13, Mich.

RAISE Rabbits on \$500 month plan. Plenty markets. Free details. White's Rabbitry, Delaware, Ohio.

FUR BEARING ANIMALS

RACCOONS, Minks, skunks — Catalog, 25¢. Shady Fur Farm, Springfield, Minn.

MINK Raising information free. Complete. Lake Superior Mink Farm, Superior, E.E. Wisconsin.

RAISE Mink: Free booklet, pen plans, inside secrets, feed, care. Mink are money makers. Investigate today. Lawrence Moggard, Brigham City 12, Utah.

FARMS, FARM LANDS, REAL ESTATE

CANADIAN Tax sale lands, average price four dollars an acre. Small monthly payments. Farms, timber, hunting and fishing camps, minerals. Limited number of properties. Write at once for free catalogue. Tax Sale Service, Room 105, 120 Bloor Street, West, Toronto 5, Canada.

FLORIDA \$580 Homesite only \$290 now during half-price predevelopment sale, \$10 monthly. Beautifully wooded 80 foot lots. Money-back guarantee. Write Wendell Wood, Fountain, Florida.

CANADIAN Tax lands. Mining, hunting, fishing and lakefront sites. Invest in Canada's minerals and forests. Most properties less than \$1 per acre. Monthly lists only \$1. Mineral Club of Canada, S.W. Box 187, Windsor, Ontario.

\$10 DOWN, \$10 Monthly buys your home-site in central Florida's finest retirement and vacation community in the high ridge section near Sebring. On 84 square mile Highlands Lake. Free community parks and beaches. Get free color brochures, house plans; learn how we help you plan, finance, build your low cost, tax-exempt home. Write Florida Realty Bureau, Inc., Dept. EZ, Lake Placid, Fla.

CENTRAL Florida lakefront home sites, \$795 at \$15 monthly. Literature. Grace Parker, Paisley, Florida.

FLORIDA 2 1/4 Acres, near Gulf; 50 foot elevation. \$795.00; \$15.00 down and month. Russell Hancock, Realtor, Brooksville, Florida.

FREE Strout catalog! Farms, homes, businesses, resorts, retirement properties. Over 3000 values in 36 states. 58 years' service. World's largest! Write Strout Realty, 7-MP S. Dearborn, Chicago 3, Ill.

LAKEFRONT, Highway, acreage and trailer lots, from \$295.00. Fifteen central Florida developments. Monthly terms. Box 2005, DeLand, Florida.

OPPORTUNITIES! Government land. U. S., Alaska, Canada Sledge Surveys. Macon, Mississippi.

FLORIDA, 75x100', Access to Lake Josephine near Sebring \$10 mo. Free brochure. Eastern Enterprises, 325 E. 15th St., Hialeah, Florida.

SIXTEEN Acres, Harford, N. Y. \$500 cash. Maxwell Bielawski, Dunkirk, N. Y.

FLORIDA, Free! Business lot 50 x 250-ft., fronting U. S. highway 301 in booming Tampa Bay area, given free with purchase of 5-acre garden tract at Willow Shores, Florida. Within 20-mile radius of Tampa, Bradenton, St. Petersburg, Sarasota. Gift-estate investment for planned retirement and profits from rising land values. Lush, rich soil for vegetable farming and orange groves. Tomato growers in vicinity make \$1,000 an acre. Fronts on river and major highway from the north to Florida west coast. Pre-development price only \$499 per acre; total \$2495 for 5 acres. Convenient terms: 4 years to pay. Write today for brochure and plat map, and attach \$10 to reserve your 5-acre tract and free highway-front business lot for your approval. Deposit refunded on request within 30 days. Gulf Coast Land and Title Company, Dept. PM11, 632 South Tamiami Trail, Sarasota, Florida.

FLORIDA'S Biggest lot value! No money down! \$5 monthly. Pull price only \$133. Between Orlando and Ocala. High, dry, adjoining city, streets, electricity, phones, churches, schools, shopping. In heart of 3000 lakes. World's best fishing! Write for free photos. Abner Huysman, Box 467, Belleview, Florida.

UNITED'S Famous catalog! Big 128-page picture-book of happy retirement homes, recreational properties, money-making farms, ranches, rural businesses, coast to coast! All-new spring issue, sent free! Our 34th year! United Farm Agency, 2825-PM Main St., Kansas City 41, Mo.

\$9 ACRE Timbered retirement investment lands. Listings free. Address: Armstrong's, Shook, Missouri.

HOMESITES \$15 Monthly—California's finest garden section. Morro Bay's scenic shores. Wonderful fishing, boating. Fertile soil, softest water, temperate climate, congenial community. Free literature. Richard Otto, Department M, San Luis Obispo, California.

FLORIDA, Nice homesites, \$345 at \$10 monthly. Folder free. Howard Vernor, DeLand, Florida.

FARM MACHINERY AND SUPPLIES

SENSATIONAL Garden tractor. Hoes between plants and rows, including strawberries. Eliminates hand hoeing. Standard in size, yet entirely different. Patent 2742840. Also tills. Fantastic offer to first few inquiries. Auto Hor. DePere 68, Wis.

PROFITABLE OCCUPATIONS

BIG Money raising fishworms and crickets. Free literature. Carter Wormery, Plains, Georgia.

EARN \$240.00 A month at home, spare time doing only two \$5.00 invisible mending jobs a day. Big money paid for service that makes cuts, tears disappear from fabrics. Steady demand. Details free. Fabricon, 6236 Broadway, Chicago 40, Ill.

FREE. Facts on your own profitable mailorder business. Robert Barckert, Dewey Rd., Amherst, Ohio.

WHY Worry about work? Escape jobs forever! Retire securely now. Lead leisurely life. Unusual new book shows how. Postcard brings details free. Belmont, Wyckoff 156, New Jersey.

BUY Wholesale: 100,000 nationally advertised products. Appliances, cameras, sporting goods, housewares, watches, typewriters, tools, clothing, etc. Discounts to 80%. Buy-Rite, Box 258, Hawthorne 103, New Jersey.

MUSHROOMS Quicker, easier, cheaper. "Magic" preplanted trays. Newest facts free. Spawn \$1.00. Luxur, 641 South 19th, Newark 3, N. J.

MAKE Flexible molds. Cast plaques, figurines. Free sample. Tooker, 1045-M Fairview, Hamilton, Ohio.

AUCTIONEERING—Home study course. Diploma granted. Auction School, Ft. Smith, Ark.

MONEY Plans! "Secret Journal," Grandpa, two daughters made \$2500 first month! Work home. Publiccos, Oceanside, Calif.

BAKE New greaseless doughnuts in kitchen. Sell stores. Free recipes. Michael Ray, 3605 South 15th, Minneapolis 7, Minn.

FREE Book "505 Odd, Successful Businesses." Work home. Pacific, Oceanside, Calif.

SAVE Money! Buy wholesale! Free catalog general merchandise. Norris, 487-M Broadway, New York City.

BECOME Independent with your own franchise business. Thousands earning handsome incomes. Request interesting facts today. National Franchise Reports, PM-528, 333 North Michigan, Chicago 1.

FREE Book "990 Successful, Little-Known Businesses." Work home. Plymouth, 1610-43 Street, Brooklyn 4, N. Y.

RAISE Pheasants on \$100 week plan. Little capital and space can make you independent. Free details. Great Central System, Columbus 1, Kansas.

SHARPEN Scissors, pinkers. Inexpensive machine. Sharpening supplies. Black-hawks, Sheldahl, Iowa.

SPARETIME Repeat profits taking magazine subscriptions. Special offers. Cassell Agency, Boynton Beach, Florida.

HOME Mailorder beginner's manual. Opportunities catalog, 25¢. Carnahan Bros., 9610 Acacia, Fontana, Calif.

\$400.00 MONTHLY Raising worms. Soil-less method. Three Oaks Ranch, Dresden, Tenn.

WE Pay \$3.50 lb. dried. Grow mushrooms. Cellar, shed and outdoors. Spare, full time, year round. We pay \$3.50 lb. Free book. Mushrooms, Dept. 99, 2954 Admiral Way, Seattle, Wash.

YOUR Own income tax business tax service. Licensed training. Union Institute, Hoboken (2V), N. J.

MAGAZINE Subscriptions—Largest commissions. Bonus. Qualified Agency, 451TA Kingston, Brooklyn 25, N. Y.

INVESTIGATE Accidents—Earn \$750 to \$1,000 month. Thousands of airlines, insurance companies, steamship lines urgently need claim investigators. We train you home spare time. Placement counsel and help. Free book! No obligation. Write: Universal Schools, T-2, Box 8202, Dallas 5, Texas.

MANUFACTURE Highly saleable specialty wire products easily. Start own company at record low cost. Let us prove it to you. Get free brochure from Jon-Cee Products Co., 1203 Ford Rd., Cleveland 24, Ohio.

STAY Home—Get orders by mail. Big profits. We supply literature, lists. Fill your orders. Write: Knowles, 139 Greene, Wollaston 70, Mass.

BIG Money in imported paintings. Buy direct at low low prices. Free details. Hrebenyar Company, 4436-C Hamilton Scipio Road, Hamilton, Ohio.

LEARN Real estate, world's richest business. Course on records. Pass exams. Work from home. Ten sales yearly averages \$200 weekly! Lee Institute, Brookline, Mass.

788 HOMEWORKER'S Markets. Details, 25¢. Bryant, R. 2-PM, Lawrenceburg, Ky.

UNLIMITED Mailorder income. Everything furnished. Sundal, 1603 Sun Valley, Austin, Minnesota.

BOOKS, PERIODICALS, PICTURES, POSTCARDS

BOOKS. New, 1800 titles, 10¢ each postpaid. World famous authors. Catalog 60 pages, 25¢. Bargain Books (M), 722 East Silver Spring, Milwaukee 17, Wisconsin.

USED Books bought, sold, swapped. Free lists. Book Exchange, 110 Manzanita, Redwood City, California.

BRITISH Book bargains — Any subject. Catalog free. Transbooks, Box 1-PLP, Wantagh, N. Y.

BOOKKEEPING Made easy. Simplified course. Record keeping for your business. Includes "Bookkeeping — Budgeting for Housewife." \$1.98 postpaid. Edgemont Sales, Whitesboro 1, New York.

BACK Issues magazines reasonable. Books, 950 Columbus Ave., New York, N. Y.

RARE Magazines, catalog 15¢. Nationwide Exchange, Box 4373-P, San Antonio 7, Texas.

USED Book exchange. Send \$1.00 and 4 books for 4 different. Mostly fiction. John Palmer, 676 39th St., Sacramento 16, Calif.

UNIQUE Book rebinding and restoring service. Bibles, antique books, etc., rebound back to like new condition. Satisfaction guaranteed. Deleen and Lillie, Dept. D-9, Bookbinding Service, 621 W. 12th Street, Bonham, Texas.

TECHNICAL Books—Drafting, welding, plastics, woodworking, mechanics, etc. Free catalog. Madison Technical School, 118 Merlham Drive, Madison, Wisconsin.

FLYING Saucers are real! 50¢. 40 pages. Stendik, Box 657, Waterloo, Iowa.

READ 'N write "Winnie Wright" — Reading fun for all sexes, you participate. 25¢. Editor, 1369 Solano, Albany 6, Calif.

BUILD Small boats. Send for 1958 general book catalog. 10¢. Popular Mechanics Press, 633 N. St. Clair St., Chicago 11.

FREE Catalog. Self-help books. Write: Wilshire, 8721 Sunset, Los Angeles 46P.

"SCIENCE Milestones." Records march of science starting 400 years before Christ, right up to date. Amazing facts revealed. 312 pages packed with startling information that will thrill you. A real history of science. \$5.00. Literature free. Popular Mechanics Press, 200-SM East Ontario St., Chicago 11, Ill.

BOOKFINDERS! All subjects. Send wants! Jaher Book Service, 183 Hazelwood Drive, Westbury, N. Y.

OUT-Of-print books at lowest prices! You name it, we find it! Fast service. No obligation. International Bookfinders, Box 3003-PM, Beverly Hills, Calif.

MAGAZINES, Comics, novels. Wholesale-retail catalogue 10¢. Backdates, 1181 East Lombard, Baltimore 2, Maryland.

EXCITING Catalog packed with books covering most everything. Think of it—From cover to cover you will find described and illustrated hundreds of books telling how to fix and how to build almost anything. How to remodel your home! do your own decorating, plumbing, electrical work, carpentry, painting, furniture making and refinishing. How to build your own boat, home workshop tools. Best books on photography, welding, hobbies, homecraft. How to make a home freezer. Send now for 1958 book catalog—only 10¢. Popular Mechanics Press, 200-BC E. Ontario St., Chicago 11, Ill.

MAGIC TRICKS, PUZZLES, JOKER NOVELTIES

STINKBOMBS. Super-potent! 50/\$1.00, 300/\$5.00. "Amerotrix," Philadelphia 44.

PROFESSIONAL Catalog, 175 pages, 25¢. Williams, 900 Plymouth, Ellwood City, Penna.

NOVELTIES, Tricks, magic. Free price list. Behnke Sales, Box 373, Temple City, Calif.

MAGIC Locostick. Neat trick if you know how. Appears to obey spoken commands. No skill required. Satisfaction guaranteed. \$1.00 postpaid. Arrowhead Novelty Co., P.O. Box 227-P, Redlands, Calif.

3000 TRICKS. Pocket, parlor, stage. World's finest magic catalog (408 pages), \$2.50. Kanter's, M-1311 Walnut, Philadelphia 7.

PASTEST Service to magicians for over 30 years. Send 10¢ for Douglas famous catalog, 500 tricks, containing magic for pocket, parlor, stage with balls, coins, cards, cigarettes, ropes, silks, apparatus. Douglas Magicland, Dept. 10, Dallas, Tex.

"VENTRILLO." Voice-thrower 25¢. Ventriloquist puppet 75¢. Box 971-PM, Philadelphia 5.

VENTRILLOQUISM, easiest method. Details free. Smith, 2125 N. Bigelow, Peoria, Ill.

3100 NOVELTIES, Jokes, tricks, gadgets, funmakers, hobbies. Big catalog 10¢. Johnson-Smith, D-491, Detroit 7.

WORLD'S Finest professional magic. Joker novelties. Giant illustrated catalog 10¢. Top Hat, Evanston 12, Illinois.

BE A magician! Large professional catalog of latest tricks. 35¢. Ireland, C-109 North Dearborn, Chicago 2, Illinois.

SMOKEBOMBS, Gigantic! 25¢. 7—\$1.00. (Nonpoisonous.) 4463-PM Greene, Philadelphia 44.

SAWING Lady, Hindu rope. 100 world's greatest illusions, described, illustrated catalogue 25¢. Thayer Studios, Traverse City, Michigan.

FREE Magic catalog novelties. Houdini sensations. Write Great Heaney, Oshkosh, Wisconsin.

GAMES, TOYS, NOVELTIES

NINE Word games—"Blocks of Fun." \$1.00. Fulop, 69 Northwest Sixth St., Miami, Florida.

COINS, TOKENS, CURRENCY

TWELVE Different Barber dimes \$2.00. Bargain lists free. Sayers, 1000 Unaka, Johnson City, Tennessee.

GOLD U. S. and foreign gold coins, wholesale list, 10¢ deductible. Samuel Kisin, 720 Flushing Ave., Brooklyn 6, N. Y.

5 DIFFERENT V-nickels \$1.00 (G-VG). Sadler Stamp Post, Cumberland Gap, Tenn.

DELUXE 32 Page U. S. catalog 10¢. Contains over 100 illustrations; 5,000 delightful bargains. Stone, 260 Washington, Boston 8, Mass.

TWENTY Different Indian cents \$2.50; ten different \$1.00. Collector's Bargains, New Hope, Penna.

U. S. rare coin value guide, 48 pages, 50¢. Griffin, 322 W. State, Ithaca, N. Y.

"EAGLET" Numismatic Magazine, 35¢ subscription \$2 year 229 South 11th, Newark 7, N. J.

GET Profit and pleasure in collecting old coins. Send 20¢ for 68-page illustrated coin catalog. You'll be delighted with it. Send for it now. B. Max Mehl, Box 750-B, Costa Mesa, Calif. Oldest rare coin establishment in U. S. Established 59 years.

44 DIFFERENT Coins, \$1.00. 44 different bills, \$1.00. Oddehon, Box 482, St. Louis, Mo.

1959 GIANT U. S. coin catalogue 25¢. Ace, 107 N. Dearborn, Chicago 2.

LARGEST Coin magazine, 200 pages, 40¢. Scrapbook, 7320-J Milwaukee, Chicago 31.

RAREST CC mint dollar 1885 uncirculated \$5.00. Illustrated catalogue 25¢. Schultz, Salt Lake City 10, Utah.

BARGAINS. U. S. coins: 1893 Columbian world's fair half dollar, \$1.00. Ten different Indian pennies, 75¢. Two-cent piece, and 3-cent piece, \$1.00. Gold 1/4 eagle, \$9.00. Gold 1/2 eagle, \$12.50. Beautiful coin bracelet. \$1.00. Many coins available. What do you need? Rare Coin Company, 31 North Clark, Chicago 2.

COIN Cleaners — Mix your own with cheap chemicals obtained from your druggist. Laboratory tested formulas, \$1.00. Guaranteed. Colonial Laboratories, Pittsburgh 18, Penna.

COMPLETE United States coin bargain lists, Indianhead cent, 10¢. Economy Sales, 156-A Dean, Mansfield, Mass.

INDIAN Cent plus Bargain Lists 10¢. Hutchinson's, Box 4747, Philadelphia 34, Penna.

SIXTEEN Page price list of U.S.A. and Canadian coins free. Selling prices on thousands of coins and supply items. Bryson Inc., 612A White, Toledo 5, Ohio.

\$12.50 FOR One silver dollar. Amazing new 1959 U.S. coin book by Jacques DelMonte. Everything on every single coin minted; worth, value, how to sell, speculating, investment; other valuable facts. Clothbound, 150 illustrations. Send no money. Pay postman \$2.00 (plus postage) or \$2.00 postpaid. (Refundable.) Arden Book Co., 386-CP Fourth Ave., New York City 18.

\$4,000.00 FOR 1913 Liberty head nickel. Uncirculated dollars 1804-1839, 1893-S, 1895-P, 1903-O pay \$100.00-\$5,000.00. Certain dates Lincoln cents before 1932, \$125.00; flying eagle cents, \$500.00; Indian cents, \$175.00; dimes before 1943, \$2,000.00; quarters before 1924, \$1,500.00; half dollars before 1929, \$3,000.00; 2¢ pieces, \$125.00; 3¢ pieces, \$150.00; half-dimes, \$1,500.00. Hundreds of others worth \$10.00, \$1,000.00. Canadian coins, 1921, 5¢ silver, \$100.00. 1875 quarters, \$100.00. 1921, 50¢, \$750.00. Wanted: 20¢ pieces, gold coins, paper money, etc. Our large illustrated guarantee buying-selling catalogue, giving complete allcoin information, send \$1.00. Purchase catalogue before sending coins. Worthycoin Corporation (K-220-C), Boston 8, Massachusetts.

COLLECTORS Items: United Nations medallion, solid goldene bronze 1 1/4" diam. Front shows U.N. buildings, back U.N. pledge. America's famous dollar that George Washington threw across Rappahannock! Piece of eight of pirate fame! Solid German silver. Buried treasures map shows where now being recovered, also other locations. Only \$1.00 each, 3 for \$2.75, 6 for \$5.00 ppd. Hano, 1598 Third Ave., New York City 28. (Dealers wanted.)

OLD Money wanted. Do you know that coin collectors pay up to \$500 for certain U. S. cents? And high premiums for all rare coins? We buy all kinds. Send 5¢ for large coin folder. May mean much profit to you. Numismatic Co., Box 750-A, Costa Mesa, Calif.

LIBERTY Nickels — 15 different \$3.00. Rhode, 105 Windsor, Reading, Penna.

UNCIRCULATED Rolls! What do you need? 1909S VDB XF \$48.00. Lund, 200 S. Sycamore, North Platte, Nebraska.

NEW! Valu-packed 1959 bargain American coin catalog. Revised prices! Now only 25¢. Write! Sullivan's, 128-TT East Fourth, St. Paul 1, Minn.

FREE List! U. S. coins! Best prices! Hugh's, Box 361-FG, Hickory, N. C.

10 DIFFERENT Desirable Indian cents, \$1.00; 7 different liberty nickels, \$1.00; large lists, curious coin, 10¢. Elliott, 235 Juniper, Coraopolis, Penna.

ILLUSTRATED Price list 3000 different foreign coins 50¢. James Randall, Box 2205B, Fort Lauderdale, Fla.

COINS From Formosa, Vatican, etc., plus foreign banknote, 10¢ with coin approvals. Littleton Coin Company, Littleton 51, New Hampshire.

I'M Buying coins! New higher prices! My confidential buying guide only \$1.00! Hubers, National Building, Minneapolis, Minnesota.

WORLD'S Greatest 92-page bargain catalogue \$1.00. (Deductible first \$10.00 order). Guidebook \$1.75. Premium Handbook \$1.00. Paying highest cash prices \$1.00-\$50.00 gold coins. Send list for free offer. Bebee's, 4514 North 30th, Omaha 11, Nebraska.

LINCOLN Cents: 1910-S, \$1.25; 1911-S, \$2.75; 1912-S, \$2.25; 1913-S, \$1.50; 1915-S, \$1.50; 1926-S, \$1.00; 1923-S, \$1.00. Condition fine. Berry, Box 306, Westminster, California.

15 MIXED Foreign coins, bills 25¢. Interesting lists. Manor Coins, Box 505-B, Dunbar, West Virginia.

WANTED—Coins. Send 10¢ for buying list. Holcomb, 4127 1/2 Centinela Ave., Los Angeles 66, California.

"BRILLIANTIZE" Coins safely. \$1.00 prepaid. Amazing, guaranteed. Stephenson's, Ames, Iowa.

LIBERTY Nickels, 6 different \$1.00. Price list 10¢. R&M Coin Co., Box 5, DeLanco, New Jersey.

LINCOLN'S 1916S, 1921S, 1925S, 1926S, 1927S. \$1.25 complete. United, 101 Cranston, Providence 7, R. I.

OBSOLETE U. S. coins. 10 different Indian cents (1899-1908) 69¢; 10 different Liberty head nickels (1900-1911) \$1.79; large cent before 1857, \$1.00; flying eagle cent 1857, \$1.75; copper nickel Indian cent, 3¢; nickel and half-dime, all before 1873, \$2.00; 1859, 1860 and 1862 copper nickel Indian cents, \$3.00; bust type half dollar before 1838, \$3.00. Satisfaction guaranteed. Empire State Coin & Stamp Co., Empire State Building, New York City.

STAMP COLLECTING

"ELEPHANTS OF LAOS"—Three brilliant mint pictorials, portraying elephants in life-like multicolor, 10¢. Approvals. Gustave Gebhard, 26 Westwood Drive South, West Orange, New Jersey.

100 DIFFERENT Belgium free. UPU, Brussels fair, railroad stamps free. Approval applicants only. Trylon, Box 179-P, Forest Hills 75, N. Y.

FREE! Wonderful, new 84 page U. S. catalog. Handling 10¢. Norrisco, Milwaukee 7, Wis.

307 WORLDWIDE Different stamps only 25¢. Approvals. Niagastamp, St. Catharines 671, Ontario.

MINT U.S. at face! Older commemoratives only. Send 25¢ for all different packet with first selection mint U.S. approvals. Western, Box 1689P, Salinas, California.

FREE! Colorful Somaliland animals, others. Approvals accompany. Advise preference. Rogers, Box 485M, Albany 1, N. Y.

50 DIFFERENT Latin America, 10¢ with approvals. Quynn's, Scotland 2, Penna.

1000 DIFFERENT Worldwide stamps \$1.00. Valued over \$20.00. Universal, Box 6, Kenosha 5, Wisconsin.

12,000 PENNY Approvals waiting for you. Many from exotic countries, pictorials, airmails, new issues. Tilbury, Box 862, Newark 1, N. J.

100 DIFFERENT Austria 10¢. Approvals. Aronson, Box F, Newton Centre 59, Mass.

FREE! Newfoundland, Israel, animals, birds, sports, Pipeex; with approvals. Tropicana, Box 449M, Hollywood, Florida.

BEAUTIES! Pictorials from Andorra, Iceland, Monaco, New Caledonia, Togo, San Marino, Singapore, etc. Only 10¢. Approvals. Champplain, Isle La Motte, Vermont.

FREE! 25 Egypt, 5¢ handling, approvals. Bellet, Mapledale, Hazel Park, Mich.

SWITZERLAND, France, beautiful pictorials cataloging \$1.34 only 15¢. Approvals. Evan Davis, Riverside, Connecticut.

FREE 60 Different stamps to collectors requesting approvals. Stanley Zajac, 159 Emerson Ave., Toronto, Canada.

U. S. commemoratives: 141 different \$1; 201 different \$2. Moseley, 6 Hanley Downs, St. Louis 17, Missouri.

PRE-1888 U.S.—Two free copies, with approvals. Collier, Chamblee, Ga.

1959 U. S. catalog free. Contains almost 1000 illustrations, over 10,000 delightful bargains. Stone, 260 Washington, Boston 8, Mass.

TERRIFIC Value. Eight complete mint sets 10¢ with approvals. Beatties, 58 Glenagar, Islington, Ontario, Canada.

FREE! 50 British Empire. 5¢ handling. Approvals. Kensington Stamps, Buffalo 15, N. Y.

1000 DIFFERENT worldwide with approvals. Alfred Jacobsen, Crompond, New York.

FREE—Your choice any volume Scott's international albums. 1959 Scott's complete catalogues, even Master Global albums free when you buy our sensational foreign approvals. Bargain Stamps, Redlands, Calif.

50 CHINA 10¢. Approvals, gifts. Coast, P.O. 2187A, Santa Ana, California.

HAWAII—2 exciting classics or 25 Czarist Russia 10¢ with approvals. Belmont Stamps, Washington 15, D. C.

FREE! Eight sided stamp, triangle, diamond, midget, mammoth, to approval buyers. Plymouth, Dept. A-9, Bell, Calif.

FREE U.S. list for advanced collectors. National, Box 60, Boston 1, Mass.

GIANT Approvals, thousands different, 1¢ and 2¢ each. Wahl's Stamp Exchange, 7008P Farragut, Chicago 31, Ill.

FREE 40 Exotic giant pictorials! Free 144-stamp worldwide mix! Free stamp newspaper! Free illustrated bargain lists! With approvals. Rush 10¢ for postage. Philatelica, Dept. R, New Paltz, N. Y.

SUPERIOR Worldwide mission mixture. Amazing variety! Six ounces \$1.50. Pound \$3.75. Bay Nielsen, 4545B Harvard, Montreal 28, Canada.

MEXICO, 25 Beautiful 10¢. Approvals. Salsman, Box 702, Berkeley, Calif.

50 DIFFERENT Berke stamps free! Approvals. Marford, Box 48, Queens Village 29, New York.

FREE 1958 Illustrated U. S. price list. H & S, 45-PM Bromfield, Boston, Mass.

TRADE Your duplicates toward our approvals! (Foreign only.) Complete detailed information, 10¢. (Refundable.) Variety Stamp Service, Box 98-P, Newton Highlands 61, Mass.

60 DIFFERENT U. S. (30 commemoratives) 25¢. No approvals. Seidenberg, Appleton, Wisconsin.

HONG KONG, 25 different, 25¢. Foreign approvals. Spicka, 518 No. 85th, Omaha 14, Nebraska.

1000 DIFFERENT, \$1.00 With approvals. Louis Golden, 6721 Eastwood, Philadelphia 49, Pennsylvania.

WORLDWIDE, 50 All different, absolutely free, just to introduce our incomparable approvals. Kent Stamp Company, GPO Box 87, Brooklyn, N. Y.

ALBUM Only 10¢! Hundreds of spaces! Stampart Company, Hartford 1, Conn.

ECONOMICAL 1/4¢-3/4¢ Approvals, 33,000 varieties. Dresel, Box 128-N, West Englewood, New Jersey.

UNITED States commemorative collection containing 33 different—10¢. Approvals. White, 516-A Avenue L, Brooklyn 30, New York.

SELL Your surplus good grade stamps. Write, describing fully what you have. Vanroy Shirk, Lebanon Pennsylvania.

AMAZING Offer! 200 United States stamps—including commemoratives, airmails, high denominations to \$1.00. Only 10¢ to approval applicants! Illustrated bargain lists free. Mystic Stamp Co., Dept. 80, Camden, New York.

100 STAMPS, 10¢ With approvals. Smith, 508A Brooks, College Station, Texas.

OLD Scarce U.S. seconds on approvals. Slight imperfections, lowest prices. Hernefeld, Clintonhill Sta., Newark 8, N. J.

100 OLD United States between 1861 and 1935, \$1.00. Roush Stamps, 51 Chestnut, Mansfield, Ohio.

10 CANAL Zone 25¢. Approvals. Merkel Stamps, 30 Grandview, South Hadley Falls, Mass.

FREE Sample! Interesting, informative, illustrated. National Stamp News, Anderson, South Carolina.

FREE Packet! Angola, Azores, Mongolia, Nepal, Palestine Fascinating approvals. Coral, Box 7095 (Ludlam), Miami 55, Florida.

TWO \$5.00 U. S. postage stamps free to approval buyers. Send dime for postage, details. Irwin Stamp Co., Box 11-55, Brooklyn 30, N. Y.

135 DIFFERENT U. S. commemoratives \$1.00; 50, 25¢. Approvals. Harold Holub, 18 East 198th St., New York 68, N. Y.

TERRIFIC U. S. list free! Bailey, 45 Bromfield, Boston 8-G, Mass.

225 STAMPS For only 10¢! This mammoth value includes airmails, pictorials; stamps from strange countries cataloging up to 25¢ each! Also approvals. Mystic Stamp Company, Camden 80, New York.

WEIRD Diamond shape coffee stamps. Lovely flower triangle! First American big commemorative. Greenland, idol dancer, etc. Free with approvals. Capital Stamp Co., Ferrysburg 2, Mich.

25 DIFFERENT Commemoratives 1893 up 10¢. U. S. approvals. K&B, Box 70, Brooklyn 23, N. Y.

SELL Stamps to our readers. Your ad in this space will be read by thousands of stamp buyers. I'll prove that to you. Write now for Folder "S." P. W. Johnson, Classified Advertising Manager, Popular Mechanics, 200 E. Ontario St., Chicago 11, Ill.

UNITED States price list, 116 pages, price 25¢. Mark Hanna, 335 Fifth Ave., Pittsburgh 22, Penna.

INTRODUCING Our better United States approvals, we offer 15 United States stamps including Columbian, Pan-Pacific, famous American, airmails, others; only 10¢. Ocean Stamps, Box 64-PM, Brooklyn 29, New York.

14,000 DIFFERENT! Amazing new plan builds your collection systematically, country by country. Only 50¢ weekly. Free details. L. G. Ware, Stepney 75, Conn.

U. S. Mint flag set, complete, \$1.00. Free list. Brooks, 2323 Avenue X, Brooklyn 35, New York.

FREE 50 Worldwide introducing inexpensive approvals. University Stamps, P.O. Box 95, Tamiami Station, Miami 44, Florida.

40,000 VARIETIES Available on approvals. 1/4¢ upwards. Keigwin, Box 933B, Daytona, Florida.

STAMP Zoo including kookaburra, zebu, kangaroo, koalabear, rhinoceros 10¢. Approvals. Linstamp, St. Catharines 618-A, Ontario.

FREE! Over 100 different, \$2.50 value, including space satellite, Israel, British, U. S., first U. N., Siberia. Approvals, catalogue. Send 25¢ for mailing. Gatewood, Box 346, Winston-Salem, N. C.

103 DIVERSIFIED British colony stamps only 10¢. Approvals. Niagastamp, St. Catharines 671-A, Ontario.

FREE—Your choice of 100 different Canada, 100 different Philippines, or 100 different from 100 different countries, each collection over \$5.00 catalogue value, when you buy our sensational foreign approvals. Topval, Box 488, Redlands, California.

80 DIFFERENT U. S. stamps, includes 19th century, commemorative, high values. Plus 1943 flag stamp of occupied nations. All for only 25¢. Approvals included. Willett Co., Box 338-C, Yorktown Heights, N. Y.

DAZZLING Original stamp! Features a white cross with red border! Blue and orange background. Limited one per person! Only \$1.00 while offer lasts! NuStamp, Box 1463, Dallas, Tex.

GOOD Worldwide stamps for serious collectors. Sears Stamps, Bay City, Texas.

102 DIVERSIFIED Worldwide stamps 10¢. Approvals. Linstamp, St. Catharines 618, Ontario.

FIRST U.N. set. Among world's prettiest. Only 10¢. Approvals. Welles, Box 1246-R, New York City 8.

GERMANY: 500 Different only 50¢. Approvals. Norge Company, Ho-Ho-Kus, N. J.

STAMPS For collectors. Robert A. Arthur, 920 Third, Seattle 4, Washington.

STAMP Collection for beginners. Write me for information. Trumbo, Box 5, Jordan, Mont.

UNPICKED U. S. mission mixture. Pound \$1.00. Mission, 220 W. Allerton, Milwaukee 7, Wis.

FREE! 50 Different Portuguese; Colorful, inexpensive approvals. Elkhart, Box 33, Elkhart, Indiana.

77 DIFFERENT U. S.—25¢. Approvals. Utechts, 1143D North Keeler, Chicago 51.

BET You haven't stamps from North West Pacific Islands! Absolutely free with approvals, elusive North West Pacific Islands stamp. Viking, Great Neck 113, N. Y.

FREE! 19 Different Bavaria plus world's only octagonal stamp, plus Abyssinia Red Cross set; to those requesting approvals. C. B. Cleaveland, 806 North Humphrey, Oak Park, Illinois.

RUSSIA Brussels fair free with approvals. Herget, 2884 Balle, Buffalo 15, N. Y.

BRITISH Honduras mint approvals. William Williamson, Belize, Br. Honduras; Central America.

WOW! 110 All different Germany 10¢. Zeppelins, semi-postals, airmails, high values, etc. Giant catalog, bargain lists included with beautiful approvals. Jamestown Stamp, Dept. A29PM, Jamestown, N. Y.

LAOS Unesco set complete mint 10¢. Approvals. 49th State Stamps, Box 4-1106, Spenard, Alaska.

FIRST Approval selection free! Bargains. Tude, Box 78, Crystal Beach, Florida.

333 DIFFERENT Stamps only 25¢ with approvals. Finney, Box 89, El Monte, Calif.

DISCOUNT Approvals, tremendous savings. Stanley's, 33 Dublin Street, Brantford, Ontario, Canada.

INTERESTING Packet free. Approvals. Farley Stamps, 204 Tanguy, Logansport, Indiana.

TEN Foreign to treasure. \$2.00 catalog. Handling 10¢. Approvals. Reid Stamps, 441 N. 6th, Allentown, Penna.

508 DIFFERENT Worldwide from Madagascar, Macao, Guinea, etc., cataloguing over \$15 only 35¢. Approvals. Littleton Stamp Company, Littleton Q1, New Hampshire.

19TH Century U. S. commemoratives, flags, presidents with approvals. Free gift, 10¢ handling. Metropolitan Stamps, Box 312YC, Jackson Heights, N. Y.

RUSSIA Sputnik; U. S. air; Egyptian jets, first U. N. set; packets; surprises free with purchases. Approvals. Stamp Farm, M2-10, Oxford, Wis.

105 DIFFERENT Worldwide from Liberia, Macao, etc., cataloguing over \$2.75 only 10¢. Approvals. Goliath, Bethlehem J1, New Hampshire.

UNITED Nations scarce 2¢ postcard free. Approvals. Teddie, Box 78C, Crystal Beach, Florida.

FREE! Giant bargain catalog—New edition listing thousands of bargains including U. S. and B. N. A. stamps, packets, mixtures, albums, accessories and supplies; sent with beautiful approvals. Jamestown Stamp, Dept. E29PM, Jamestown, N. Y.

U. S. 100 Different 20¢ with approvals. White Mountain Stamps, U1, Bethlehem, N. H.

ANDORRA. Ifni, Lundy, Oceania, Reunion, etc., assortment 25¢. With approvals. Jebramek, Box 566, Terminal A, Toronto, Canada.

EXCITING Strange countries packet. Free with approvals! Saxon, Orange, California.

LOOK! Six different Queen Elizabeth mint sets! Basutoland, Malta, Virgins, etc. 21 bicolors 25¢! Attractive approvals! Gannon Stamps, Box 931, Canton 1, Ohio.

GIGANTIC Collection free. Includes triangles, early United States, animals, commemoratives, British Colonies, high value pictorials, etc. Complete collection plus big illustrated magazine all free. Send 5¢ for postage. Gray Stamp Company, Dept. PM, Toronto, Canada.

8 DIFFERENT U. S. airmails free! Approvals accompany. Dee, Box 926, Ormond Beach, Florida.

427 STAMPS 10¢. Catalogue value \$10.00. Mystery mixture including U. S., Ireland, Asia, Africa, pictorials, commemoratives, air-mails. Worldstamps, 8203PM Grubb, Silver Spring, Maryland.

WANTED—Stamp collections, accumulations. Murray Gold, 62-95P Saunders, Rego Park 74, N. Y.

SOUVENIR Sheets Czechoslovakia 1937 plus Japan 1947, 10¢ with approvals. Kingman, 30 Empire, Yonkers 4, N. Y.

U. S. Bargain. 101 different 25¢, with U. S. approvals. Stamps, Box 37, Kennebunk, Maine.

FREE! Pictorial packet, with approvals. Conklin, Box 388-PM, Osage, Iowa.

800 MIXED U. S. Various issues 25¢. Monjar, Fairmount, Cincinnati 14, Ohio.

NATIVES, Boats, trains, plus beautiful bi-color collection. 25¢. Half price approvals. Fromm, 90 Glen Road, Toronto, Canada.

PIERCE Jungle animals, snakes, 10¢. Approvals. Marshall, Box 451-PD, Long Beach, Calif.

FREE—100 Different foreign, with approvals. Dunning, 1634 Chippendale, Houston 18, Texas.

FREE! 33 Somaliland! Philippines! Caledonia! Others. Approvals. Keating, 2520-P Boulevard, Jersey City 4, New Jersey.

50 DIFFERENT Large U. S. commemoratives 10¢ with approvals. Jack Clancy, Box 2187, Portland 10, Ore.

110 INCLUDING Airmails, triangles, U. S., 10¢. Approvals. Stamparee, Box 68, Sierra Madre, Calif.

17 DIFFERENT Mint United Nations \$1.00. Weiss Stamps, 253-05 61st Ave., Little Neck 62, N. Y.

SIBERIA—First issues, free, with approvals. W-B Stamps, Wilkes-Barre, Penna.

WORLDWIDE Stamps 1100 — \$1.00, includes pictorials, commemoratives. No approvals follow. Harrison's Stamps, 1435 First Avenue, Oakland 6, Calif.

500 FINE Mixed U. S. 15¢. Wright, 201M Mealey, Hagerstown, Maryland.

CIGARETTES—Make 20 filtertips for 9¢. Facts free. Moberly, 954, Owensboro, Kentucky.

SAN Marino, latest bicolored fruits, free! Approvals. William Deems, 226H Race, Ravenswood, West Virginia.

BELGIUM—6 Painters. Just out. Unused. Send \$1.00. Hendrickx, Doggenhout, Ranst, Belgium.

U. S. commemoratives, 100 mixed, 25¢. Rayworth, 321 So. Cicero, Chicago 44.

FAMOUS—Famous American set. Flag set, national parks set, and presidential set to \$5. Send 10¢ for 15 of the above stamps plus full particulars and approvals. Park Row Stamp Co., Inc., 145 Nassau St., New York City 38, Dept. 804.

COMPLETE Kit for 25¢! Get large illustrated album, hinges, 107 fine stamps, midget identifier-dictionary, and approvals. Rush 25¢. Ask for lot FO-31, Zenith, 81 Willoughby St., Brooklyn 1, N. Y.

PANTASTIC Introductory offer—Fifteen complete sets, 10¢. Approvals. Valley's, Box 414PM, Spring Valley, California.

INDONESIA—15 Different 10¢. Approvals. United. Box 6, Baldwin, New York.

WORLD'S Only twice weekly stamp newspaper. Three years \$3.00. Western Stamp Collector, Albany 1, Oregon.

U. S. Approvals. Low prices. Eagle Stamps, Romine Ave., Pittsburgh 26, Penna.

ANTIQUES, RELICS, INDIAN GOODS, CURIOS

ANCIENT Grooved stone tomahawk \$3.00. Indian relic list free. Lear's, Glenwood, Arkansas.

THE Antique Trader, national newspaper on all kinds of antiques, \$2.00 year, 25¢ sample. The Antique Trader, Box 302-P, Kewanee, Ill.

4 ASSORTED Arrowheads \$1.00. Smith, 841 N. Tacoma, Indianapolis 1, Indiana.

ILLINOIS—Stayschunneydenteeekayshun. Selling: Hundreds of Confederate items. Historical, Civil War, Revolutionary, Indian War muskets, rifles, insignias, pistols, pepperboxes, swords, bayonets, flasks, bullet molds, duelling pistols, 50,000 Indian relics, 10,000 coins, Confederate money. Thousands agates, fossils, mineral specimens, deerheads, steerhorns, tomahawks, bo-wood, gold dollars. Kentucky rifles, frontiers. Circular 35¢. Heikeson, Wenona, Illinois.

PRECIOUS STONES, MINERALS

LOWEST Prices on quality tools, uncut gems, fittings, tumbled stones, equipment. From largest suppliers in the jewelry trade. Write for free booklet; Grieger's, Dept. A-91, Pasadena 4, California.

TWELVE New Mexico minerals \$2.00, six fluorescent \$1.00, five crystallized minerals \$1.00. Fool's gold 35¢. Minerals, Winston, New Mexico.

CUT Gems, make jewelry—For profit or fun. 100 page magazine tells how; where to get supplies. Sample 25¢ or request free literature. Lapidary Journal, Del Mar 2, Calif.

"GEMS & Minerals Magazine," largest rock hobby monthly. Field trips, "how" articles, pictures, ads. \$3.00 year. Sample 25¢. Box 687A, Mentone, California.

SAPPHIRE And four more uncut gems, \$1.00. Ten polished gems, baroque-shaped, \$1.00. Free gem list. Lapidary catalogue, 25¢. O'Brien's, 1116M Wilcox, Hollywood 38, Calif.

SEMI-Precious uncut gems. Ten different for \$1.00. Request list 26. Prospectors Shop, 201 San Francisco, Santa Fe, New Mexico.

EARTH Science, the rockhounds national magazine. Subscription \$2.00. Sample 35¢. Box 1357-PM, Chicago 90, Ill.

GEMSTONES, Thirty, uncut, \$4.00. Minerals. Lists. Reed's, 4930B Palo Alto, S.E., Albuquerque, New Mexico.

ROCKHOUNDS—Visit rockhound paradise. Circular. Heike's Agate Shop, Wenona, Illinois.

18 COLORFUL And basic U.S. minerals specimens attractively boxed. Descriptive folder \$1.00 prepaid. Included free dinosaur bone pocket piece. Rock Haven Mineral Co., Dept. B-2, Whitefield, N. H.

HOBBIES AND COLLECTIONS

INCOME And gifts from two hobbies, \$2.00 each. Martha Dawson, 620 Santa Rosa Ave., Berkeley, California.

INVENTING Can be an interesting and profitable hobby. Write for complete particulars. Institute of American Inventors, Dept. 40-E 635-F St., N.W., Washington 4, D. C.

COLLECTORS Matchbook covers, 100 different unused, \$1.00. Catalog 25¢. Album \$3.00. Charles Edelman, 1311-C East 84, Cleveland 3, Ohio.

DO-It-Yourself booklets, 32 different home and hobby projects. Send for 1959 book catalog 10¢. Popular Mechanics Press, 631 N. St. Clair St., Chicago 11.

NAZI Swastika armband and catalog, \$1.00. Hobbies, Box 71B, Rockaway Park 94, N. Y.

NAZI Insignia book. 600 illustrations, \$1.50, 12 Nazi insignia, \$1.00. Hobbyland, Calgary, Canada.

ARMY-Navy-Marines-A.F. New assortment of one military tie clip, military belt with brass buckle plus 25 assorted medals, badges, campaign ribbons, battle stars, patches, ratings, etc. All for \$1.00 (limited to U.S. and Canada only). Supreme Military, Dept. PM, 48 West 27 St., New York City.

EIGHT Rare foreign seashells with names \$2.00. Edward Dunav, 229 S. 9th, Philadelphia 7, Penna.

CAMERAS, PHOTO SUPPLIES

PHOTOGRAPHY For pleasure or profit. Learn at home. Practical basic training. Long established school. Free booklet. American School of Photography, 835 Diversey Parkway, Dept. 3431, Chicago 14, Illinois.

FREE Photographic bargain book. Thousands of bargains in photographic equipment and supplies. Write: Dept. 1-F3, Central Camera Company, 230 S. Wabash Ave., Chicago 4, Illinois.

WONDERSLIDES—Send \$1.00 for 3 stereos or 4 2x2 and catalog. The Stereo Lab., P.O. Box 37, Boulder, Colorado.

ETCH Nameplates with car battery. Free samples. Acme, Box 9647, Jackson, Mississippi.

PHOTO FINISHING

8-HOUR Service on deluxe jumbo prints. 8-exposure roll developed and 8 jumbo prints 40¢, 12 exposure 55¢, 16 exposure 70¢; 35mm. 20 exposure 75¢, 36 exposure \$1.25. Jumbo deckle reprints 5¢ each. Contact prints made if specified. Bay Photo Service, P.O. Box 210, Oakland, California.

KODACHROME Processing by Kodak. 8mm. roll or 35mm., 20 exp., \$1.35. Prompt service. Write for mailers and prices. Color Pix, Dept. P, CPO Box 30, Kingston, N. Y.

ENLARGEMENTS Doubleweight matte paper 4-5x7's \$1.00. Bovenzi Photo Service, 47 Locust St., Rochester 13, N. Y.

TWELVE Exposure rolls 49¢. Wallets 20 for \$1.00. Lincoln Studios, Dept. K, Box 13, Lincoln, Nebr.

ENLARGEMENTS, Heavyweight, six 5x7's or three 8x10's \$1.00. Jack Koons, Huntington Mills, Penna.

ENLARGEMENTS—Professional double weight. Cropped. Dodged studio quality, 8x10, 35¢; 5x7, 28¢; minimum \$1.00. Tony Laboratories, 132 Glenville Street, Schenectady 6, N. Y.

MOTION PICTURES AND SOUND EQUIPMENT

PROFESSIONAL Color movies Europe, Russia, America, Box 664, Meriden, Conn.

16MM African animal movie. Color. 410 feet, \$85. Finest closeups on all the dangerous animals. John McGowan, 831 Maple Downers Grove, Illinois.

ROSE Parade 1959 in color, 8mm. 50' special \$4.95. Complete Parade, 200', \$17.50. Finest photography. Rose Parade Movies, Box 10M, Van Nuys, Calif.

8MM-16MM sound shorts. Also tremendous assortment full length features as low as \$15.00. Used 16mm. sound projectors our specialty, \$79.50 up. Send for 1959 catalog. Abbe Films & Equipment Co., Dept. PM259, 417 West 44th Street, New York 36. Plaza 7-2219.

5,000 8-16MM. Movie films. Free catalogues. International, Greenvale, N. Y.

SAVE 50%! Guaranteed-fresh color, b&w. movie film! 8mm., 16mm. Free catalog! Eeo-R, 47th Holly, Kansas City 12, Missouri.

FREE Catalog. Save dollars. Fresh 8mm., 16mm. b&w and color film. Home processing equipment. Superior Bulk Film Company, 448 No. Wells, Chicago 10.

16MM. Sound, projectors, films. Sale, rental, exchange. Visit store or write for catalog. National Cinema, 71 Dey St., New York City.

SOUTHSEAS — 2x2 Colorslides. Catalogue, sample, 30¢. Avery Colorslides, 4818A Placidia, North Hollywood, Calif.

SENSATIONAL Offer. 8mm. 50 ft. movies. Reg. \$1.95, only \$1.00. Comedies, cartoons, travel, animals, airplanes. Send \$1.00 each. Home Movies, Box 10M, Van Nuys, Calif.

16MM. Sound films. Bargain bulletin. Duquette, 97-T Snow, Fitchburg, Mass.

FREE! Blackhawk's big sale catalog 8mm., 16mm. movies, 2"x2" color slides. Biggest selection anywhere! Projectors, cameras, supplies. Big discounts! Get free, every three weeks, 12-page newspaper size bargain list! Blackhawk Films, Davenport 14, Iowa.

MOVIE Camera film: 8mm. roll \$1.50, 16mm. 100' \$3.00. Free processing. Better Films, 742 New Lots, Brooklyn, N. Y.

BOOKS; Hundreds of subjects. Big 1958 book catalog — 10¢. Popular Mechanics Press, 200-BC East Ontario St., Chicago 11.

MUSIC AND MUSICAL INSTRUMENTS

1959 ACCORDIONS Wholesale — 10 day trial. Free catalog. American Accordion Center, 5329 PM-20 Belmont, Chicago.

TUNE Put to your poem. Recorded by radio artist. Send poems for inspection. Mac Odell, WLAC, Nashville, Tenn.

NEW Pianos \$395.00. Photo 25¢. James, 5758 Magnolia, Riverside, Calif.

JAZZ Records. Big discounts. Catalog 10¢. Record Shop, 2068 Front, Cuyahoga Falls, Ohio.

SONGWRITERS With New York publisher contacts want new song ideas. Share royalties. Not a service, no fees. Send poems, ideas. Songwriters' Associates, 507 5th Avenue, New York City 17.

SONGS Printed. 20 lead sheets \$1.25. Skoumal Music, 319 E. State, Rockford, Ill.

GUITAR Making books, plans, imported woods, tools. List 10¢. Store, 510 East 11th Street, New York 9, N. Y.

SONGPOEMS And lyrics wanted. Mail to: TinPan Alley, Inc., 1650 Broadway, New York 19, N. Y.

POEMS Wanted for new songs and recording. Immediate consideration. Send poems. Songcrafters, Box 6145, Acklen Station, Nashville, Tenn.

POEMS Wanted for musical setting and recording by America's largest song studio. Send poems. Free examination. Five Star Music Masters, 630 Beacon Building, Boston.

112 PA WISDOMS, Santa Monica, Calif.
ACCORDIONS — 1959 Models. Lowest wholesale prices. Save up to 75%. Free home trial. Trades accepted. Big color catalog free. Accordion Manufacturers, Box R, 2003 Chicago, Chicago 22.

ELECTRIFY Player pianos and reed organs. Lee Mfg., 10630 Hillhaven, Tujunga, Calif.

ELECTRIC Guitars, amplifiers, wholesale. Free catalog. Carvin PMM, Covina, California.

WANTED! Poems, lyrics, songs, ideas. Bengal, 93 Jefferson, Chelsea 50, Mass.

ACCORDIONS, Wholesale to everyone. Save up to 60%. All national known brands. Free catalogue. Del Principe, 29 South Cicero, Chicago 44.

SONGS Into dollars. Share \$33 million dollars yearly for new songwriters, song poets. Any subject, songs composed, published, promoted by largest firm, Information, appraisal free. Send Nurdyke Music Publishers, 6000 Sunset, Hollywood 28 PM, California.

RADIO, TELEVISION AND ELECTRONICS

ELECTRIC Guitars, amplifiers, wholesale. Free catalog. Carvin, PMR, Covina, California.

HI-FI components, recorders, tape, records. Wholesale catalog free. Audio Fair, 1799M 1st Avenue, New York 28, N. Y.

GOVERNMENT Surplus radios, parabolic reflectors, sniperscopes, mine detectors, parts. Catalog 10¢. Meshna, Malden 48, Mass.

RECORDERS, HI-FI. Free wholesale catalogue. Carston, 215-PM East 88, New York City 28.

QUALITY One tube radio wired, complete with batteries, tube, \$6.95 ppd. Electro-Mechanical Company, Springboro, Ohio.

TWO-Way radio for everyone. No tests. Inexpensive equipment, even home-made. Is usable on new "Class D Band." Send dollar for complete "Class D Report" or write for circular. Human, 6 Berkshire, Worcester 9, Mass.

TAPE Recorders, HI-FI components, sleep learning equipment, tapes. Unusual values. Free catalog. Dressner, 69-02M, 174 St., Flushing 65, N. Y.

RADIO Course only \$22.95. Includes all tubes, parts, tools, instructions. Write for full information. Progressive "Edu-Kits" Inc., Dept. 563-B, 1186 Broadway, Hewlett, New York.

FIX your own TV the easy way, and save 80%! Send 10¢ for new, illustrated TV trouble shooter chart showing which tubes to replace, for all common TV picture troubles. We'll include latest wholesale tube price list free. Zalytron Tube Corp., Dept. PM, 220 West 42nd Street, New York City.

CRYSTAL Radio kit \$1.00; preassembled \$1.25; phone \$1.75; catalogue. Clearco Crystal Company, 2966 No. 4th, Milwaukee 12, Wisconsin.

15 TESTED One-tube circuits, 25¢. Laboratories, 1131-C Valca, Redwood City, California.

SAVE Money on all types radio and TV tubes! 100% guaranteed! Brand new! Write United Radio, Box 1000, Newark, N. J.

RECHARGE Flashlight penlight batteries. Instructions \$1.00. E-Z-Way, 112 Bond St., Toronto, Canada.

LEARN While asleep with your recorder, phonograph or amazing new "Electronic Educator." Details free. Research Association, Box 24-N, Olympia, Washington.

FREE Instrument screwdriver! Just send postcard. Hurry, while supply lasts. Laircraft, Box 5008-BC, Detroit 35, Michigan.

AMPEX Tape recorders, components. Boynton Studio, 10-PM Pennsylvania, Tuckahoe, N. Y.

SIMPLE Television repairs. Marvelous booklet or book. Send for 1958 general book catalog, 10¢. Popular Mechanics Press, 633 N. St. Clair St., Chicago 11.

order opportunity! Everything supplied.

EARN Money raising fishworms for us! Inquire: Oakhaven-38, Cedar Hill, Texas.

CANDIED Popcorn and potato chip equipment. Eakins, Box 933-A9, Springfield, Ohio.

BUSINESSES, Resorts, motels, investment property, ranches. Our special service dept. at your disposal. No obligation. World's largest. 58 years' service. Strout Realty, 7-MB S. Dearborn, Chicago 3, Ill.

GUARANTEED Market! Earn ready cash raising fishworms for us! Backyard, garage, basement! We buy your crop! Exciting details free! Oakhaven-38, Cedar Hill, Texas.

MAKE Durable building plastic easily. Beautiful. 101 uses. 800% profit. Bays Laboratory, Keams Canyon, Arizona.

BIG Money raising fishworms and crickets. Free literature. Carter Farms, Plains, Georgia.

SELL Books by mail. 400% profit. Royal, Box 368-X, Cleveland 27, Ohio.

SELLING By mail fascinating. Profitable. Free information. Alfano, 19 Pine, Closter, New Jersey.

NEW! Robinson's Sewing Machine Service Manual. 579 illustrations. 144 pages. Earn to \$5.00 hour. Price \$6.25. Where to buy wholesale. Details free. Lee Robinson, Book Nook Bldg., Walla Walla, Wash.

YOUR Own home-operated business! Take over your area as our service distributor keeping stores supplied. Nationally advertised 28-year-old line pays you 66 2/3% mark-up. Less than \$100 for merchandise starts you. For samples, highly successful plan, write Novo, Inc., 1168-F Milwaukee, Chicago 22, Ill.

CAMERA Profits! Make \$50.00 weekly spare time. Instructions \$1.00. Details free. Wilson, Box 965, Evanston, Ill.

POR Sharpening handsaw, circular saws or lawn mowers there is nothing to compare with Acme sharpeners. Free literature. Max Mfg. Co., 138 Stockton Ave., San Jose 26, Calif.

EVERYBODY Likes candy. Make professionally home. Instruction, tools, supplies. Details free. (Our 49th year.) Ragsdale Candies, B107, East Orange, New Jersey.

QUICK Profits, with no capital! Take orders for magazines your neighbors like, want. Make cash on the spot! We show how with free kit. Get yours now. Write McGregor Magazine Agency, Dept. 311, Mount Morris, Ill.

OPERATE Mailorder folio business. Free details. Ballard's, 1834 Edgeland, Louisville 4, Ky.

\$20.00 PROFIT Per hour! Homes, offices, insurance companies pay big money for invisible carpet reweaving. Makes cuts, holes, tears, disappear from expensive rugs and carpets. Brand new industry. Huge, unfulfilled demand. All trade secrets revealed. Details free. Carpeton, 1201D Rosemont, Chicago 40, Illinois.

FREE Copy, "Five Steps to Mail Order Success." Fireside, 9430 St. Cyril, Detroit 13, Michigan.

GROW Mushrooms. For pleasure. In boxes, lawns, pastures, grasslands, farmlands, gardens. Send \$1.00 for spawn, instructions. Thomas Company, D, 3604-30th S.W. Seattle, Wash. Copyright © 1958.

BRUSH Plating outfits for plating articles in the home and shop. No tanks necessary, silvering mirrors, spare or full time. Free particulars. Gunmetal Co., Ave. H, Decatur, Ill.

QUICK Money! "Repairing Car Batteries." At home! Easy too! Free details! Batteryman, Penrose, Colorado.

FREE Sharpening manual. Good money servicing cutters, saws, cutlery. Thousands doing it. Treyco, North Tonawanda, N. Y.

MUSHROOMS Quicker, easier, cheaper. "Magic" preplanted trays. Newest facts free. Spawn \$1.00. Luxur, 641 South 19th, Newark 3, N. J.

LEARN Sewing machine repairing. To \$125 weekly. Sparetime. Supplies. Add to present business. Shipping from Chicago. New York, Los Angeles. Write today! Taylor Service, Box 2126, San Bernardino, Calif.

MAIL Trade magazine has moneymaking opportunities galore. Sample 25¢. Donovan, 79-PM Greenbelt, Levittown, New York.

FREE "Franchise profit letter" describes nationwide opportunities. Exclusive distributorships, dealerships, agency operations. Write today. National Franchise Reports, W-528, 333 North Michigan, Chicago 1.

BOOMING Business. Ground floor opportunity. Free booklet. Stone-Craft, Box 856-A, St. Louis, Mo.

MAKE Signs. Just nail on. Hoag's Sign Letters, 507 E. Chicago Blvd., Tecumseh, Michigan.

\$34.70 TWO Hours. Manufacturing concrete products. No selling. Carlayne Castings, 1803 Fremont, Rapid City, South Dakota.

TO \$100.00 Weekly. Sparetime, home operated mailorder business. Successful beginner's plan. Everything supplied. Lynn, 10420-M National, Los Angeles 34.

CAMERA Owners! Earn \$50.00 week-ends! Instructions \$1.00, information free! Kline, 935-PM North Austin, Chicago 51, Illinois.

COLORGLAZED Concrete pottery made without molds. Patented method. Cemetery products, novelties, tiles. Basement leak-sealing. Money-making projects. Booklet, details free. Men only. National Pottery Company, Grand Rapids, Minnesota.

PIANO Tuning learned quickly at home. Tremendous field! Musical knowledge unnecessary. Information free. Empire School of Piano Tuning, Champaign, Ill. (Founded 1935).

WANT To make big money at home? \$10,000 profit in an hour possible with invisible mending. Make tears, holes, disappear from clothing, fabrics. Steady year-round demand from cleaners, laundries, homes. Details free. Fabricon, 6234 Broadway, Chicago 40, Illinois.

\$70 WEEKLY—Home, spare time. Simplified mail bookkeeping. Immediate income—easy! Auditax, 34757A, Los Angeles 34.

MINK Raising information free. Complete. Lake Superior Mink Farm, Superior, EE1, Wisconsin.

MAKE Flexible molds. Cast plaques, figurines. Free sample. Tooker, 1045-R Fairview, Hamilton, Ohio.

NATURAL Molding rubber, extra thick. Free sample. W. Wooley, 1016-A Donald, Peoria, Illinois.

I want to send you proof of the wonderful pulling power of Popular Mechanics classified pages. What's your proposition? Write me today. Include literature if possible. F. W. Johnson, Manager Classified Advertising, Popular Mechanics Magazine, 200 E. Ontario St., Chicago 11, Ill.

INCOME With garden golf. Motivated archery ranges. Brockway, Box 3924, Portland 8, Oregon.

YOUR Own high profit business. Sell name brands, full or part time. No inventory, no investment. More than 2,000 name brand items; lowest wholesale prices. Watches, jewelry, cameras, hi-fi radios-phonos, appliances, housewares, hardware, power tools, luggage, musical instruments, garden equipment, sporting goods, toys, many others, 8 floors of name brands. Million dollar inventory. Orders shipped complete within 24 hours! Send for free, beautifully illustrated catalog now! Separate dealer price list. H. B. Davis Corp., Dept. 11, 145 W. 15 St., New York 11, N. Y.

OPERATE Profitable mailorder business! Write: Bond, 1637-H West Vernon, Phoenix, Arizona.

RAISE Rabbits on \$500 month plan. Plenty markets. Free details. White's Rabbitry, Delaware, Ohio.

MONEY Plans! "Secret Journal." Grandpa, two daughters made \$2500 first month! Work home. Publicco, Oceanside, Calif.

11,000 NEW Prospects daily. Baby record books, shoes, albums. Sell mailorder. Use our literature. Write: No-Co-Ro, Capitola, California.

BAKE New greaseless doughnuts in kitchen. Sell stores. Free recipes. M. Ray, 3605 South 15th, Minneapolis 7, Minnesota.

PLATE Baby shoes, jewelry, gifts, bronze and colored pearl. Free booklet. Platex, 11029 South Vermont, Los Angeles 44.

COPUBLISH Mail Sale Advertiser. Leading mail order paper. Details, latest copy, dime. Vanroy Shirk, Lebanon, Penna.

FREE Catalog. Contains hundreds of businesses, farms and income properties throughout U.S., Canada. Specify type and location desired. Deal direct with owners. U. 1 Buyers Digest, 1608 Hillhurst, Dept. PM-3, Los Angeles 27, Calif.

BRONZE Baby shoes: Instructions, equipment and mountings for genuine electroplating process. Largest supplier of all plating equipment, supplies. Free catalog. Hollywood Bronze Supply, Dept. B-3, 1624 East First, Los Angeles 33, Calif.

FREE Book "505 Odd, Successful Businesses." Work home. Pacific, Oceanside, Calif.

FREE Folio "\$5,000-\$45,000. Unlimited Vacations." No merchandise. Unknown! Work home, sparetime! Haylings, Carlsbad, Calif.

MAKE \$46 From square foot plywood; jigsaw necessary. Free details. Woodart, Bridgewater, Mass.

GROW Orchids at home. Profitable, fascinating. Successful home grower explains special light, temperature and humidity conditions orchids need. Free! Full details. Orchids, 100 S. Vermont, Los Angeles 4.

FREE Book "994 Successful, Little-Known Businesses." Work home. Plymouth, 1610-43 Street, Brooklyn 4, N. Y.

REBUILD Batteries; repair dolls; make rubber stamps. "75 Ideas" free. Universal, Box 1076-A, Peoria, Ill.

BUY Direct from factories—Appliances, cameras, watches! Free details! Cam Company, 6810PM—20th Ave., Brooklyn 4, N. Y.

PLASTERCRAFT Molds, liquid rubber, plasters, flocks, candle supplies. Catalog and manual free. Blue Rapids Supply, Blue Rapids, Kansas.

LIQUID Molding rubber, free sample. Shellcraft supplies, Chaney's, 1907-A East Road, Jacksonville 11, Fla.

\$5,000 YEARLY. Spare time at home. Nothing to buy. No local selling. Dignified. Guaranteed. Home Harvest, 1933 Lakeview Road S.W., Albuquerque, N. Mex.

LEARN Professional TV servicing in one week! Fabulous new simplified system. No big expense. No studying. No tools or equipment. Spare, full time. Own your own big profit business! Save! Amazing but true! Free! Write, TV Systems, Dept. CC-172, 1028 So. LaBrea, Los Angeles 19, Calif.

INVISIBLE Reweaving: \$5 in one hour possible reweaving burns, tears, moth-holes. Spare-full time. Free details. Skillweave, Dept. SC-162, 335 W. Madison, Chicago 6.

MARKETS Everywhere. Make artistic concrete birdbaths, pottery. Best coloring. Home workshop. Hundred varieties. Hollywood Cementcraft, 8527-S Wonderland, Hollywood 46, California.

WHOLESALE Catalog—Shoes, shirts, pants, underwear, hosiery, etc. Bostonian, 14-CA Dock Square, Boston 8, Mass.

START A profitable business sharpening scissors, pinking shears, on precision electric machine. No experience necessary. Easisharp, 4221-B Rocky River Drive, Cleveland 35, Ohio.

MAKE Extra money—Big cash commissions plus premiums for you and your customers. Sell advertising book matches. Sensational new tenorana, glamour girls, hillbillies; dozens others. All sizes. Quick daily sales; big repeat business. Free master kit makes selling easy. No experience necessary. Superior Match, Dept. MX-259, 7530 Greenwood, Chicago 19.

FREE, 50 Proven moneymaking plans! Planrite, 1817A Illinois, Wheaton, Ill.

RAISE Earthworms for profit. Write for free folder. Angler's, P.O. Box 265, Malibu, Calif.

SHINE Cars without polish. New invention. Lightning seller. Cars gleam like mirror. Samples sent on trial. Kristee 106, Akron, Ohio.

FIX Typewriters. Free repair course. Home operated. Remit 25¢ for book explaining free course and agency appointment. Athey, Tarentum, Penna.

OPPORTUNITY Unlimited! Harley-Davidson Motor Co. now has available choice dealer franchises for selling and servicing its famous line of motorcycles and a new scooter line. Here is an opportunity for cashing in on the rapidly expanding youth market. Write and tell us all about yourself, your background and experience. We will give your inquiry prompt attention. Harley-Davidson Motor Co., Dept. F, Milwaukee 1, Wisconsin.

MAILORDER To motels, restaurants, churches, institutions. Complete individual setup, not just instructions. Hermes Advertising, 152-C West 42, New York City 36.

BE A home manufacturer. Make the highest profits. Our sales organization gets the orders, helps sell your products. Build luggage and cases for 1001 needs. We supply instructions, supplies, everything. Work full, sparetime. Details free. Abarst, 807-S2 Sunset Blvd., Los Angeles 12, Calif.

BECOME Finance specialist. Handsome profits. Tucker Associates, 3633 Warder N.W., Washington 10, D. C.

IMPORT-Export business made easy. Complete setup service, not just instructions. Hermes, 152 West 42, New York City 36.

"50 NEW Home-Business Ideas" booklet, sample free. Spray exotic Velvet-Suede on anything. Flokcraft-FY, Los Angeles 61.

MAKE Money by mail! Free details! Hunholz, 902 Eighth, Wamego, Kansas.

CASH From sawdust, tin-cans, newspapers. Over 200 uses. Instructions \$1.00. Charles Company, 42-GPD, Norwood, Ohio.

IMPORT-Export opportunity, profitable, world-wide, mail-order business from home, without capital; or travel abroad. Established world trader ships instructions for no-risk examination. Experience unnecessary. Free details. Mellinger, X702, Los Angeles 24.

FULL Or part time effort for steady monthly income. Each sale gives you \$30.00 per month income for six years. Product sells itself. You erect and maintain. Send \$1.00 for photograph and literature. Ames Inc., Grafton, Wisconsin.

FORTUNE—Directing fascinating collection agency business! Extraordinary. Collections, Box 1346-PB, Denver 1.

\$250.00 WEEK Profit possible. Earn at home spare time with fascinating printing method. \$5 starts you. Send no money now. Free confidential facts and valuable samples. Screen-Print FY, Los Angeles 61.

DISTRIBUTORS Wanted for needed tool. Barnes Tool Service, Pulaski, Tenn.

START Profitable mail order business. Home operated. Everything furnished. Wayne's Service, 3016 Channing N.E., Washington 18, D. C.

GROW Expensive herbs for us! Big profits home-business of your own. Year around profitability! We supply everything necessary! Send for free rare seeds and revealing plan. (State your age.) National Herb Exchange, Dept. FY, Gardena, Calif.

WE Pay \$3.50 lb. dried. Grow mushrooms. Cellar, shed and outdoors. Spare, full time, year round. We pay \$3.50 lb. Free book. Mushroom, Dept. 172, 2954 Admiral Way, Seattle, Wash.

"HOW To Make a Fortune by Mail." Revelations of successful mailorder operator. Moneymaking handbook. Inside secrets, rackets, 223 pages, illustrated. Airmail \$1.00 (refundable). Peter Borsch, Hillerod, Denmark.

HAVE A profitable business of your own selling the "World's Most Usable Pictorial Bible." Let us tell you about this opportunity. International Book Company, Dept. M., P.O. Box 118, Wichita 1, Kansas.

GROW A living miniature forest or orchard (only inches high) that bears tasty tiny fruit at home. Learn amazing dwarfing secrets! Fascinating hobby. Profitable home-business opportunity. Free seeds and plan. (State your age.) Miniature Nurseries, Dept. FY, Gardena, California.

REPAIR Hydraulic jacks, earn high wages. Complete illustrated course \$3.98. Hydraulic Parts Supply, Box 8695B, Brightwood 11, D. C.

START Your own business on credit (U.S. and Canada). Your own boss. 1425 dealers sold \$5,000 to \$32,000 in 1957. We supply stocks, equipment on credit. 200 home necessities. Sales experience unnecessary. Pleasant profitable business backed by world-wide industry. Write Rawleigh's, Dept. B-U-PPM, Freeport, Ill.

LEARN Fascinating hobby-business, engraving plastics! New engraving-carving-pantograph attachment. "DupliScaler," Uncovers exciting profitivities! Details, sample 15¢. Desco Distr's., 5262-F Van Nuys, Van Nuys, Calif.

GIGANTIC Profits with free advertising. Confidential method of free advertising is a must for mail-order dealers. Details \$2.00. Satisfaction guaranteed, but hurry, offer very limited. Gordon Gomes, 367 Lunallilo Home Road, Honolulu 16, Hawaii.

\$100.00 WEEKLY Raising earthworms! Free information. Alamo Earthworms, 425 Oaknoll, San Antonio 1, Texas.

PUNCHBOARDS, Catalog 10¢. DeLuxe Sales, Blue Earth, Minn.

WANTED: Home producers, to be subcontractors. Cast plastic products for manufacturers in our clearing house service. Thousands of easily made items required. Cash in at home, without previous experience. Plastic Service Associates, Dept. 2-PM, East Boston 28, Massachusetts.

INTERNATIONAL Home import mail-order business! Experience unnecessary. Earnings unlimited. Free import bulletin. Foreign Traders, 7814-BF Forsyth, St. Louis 5.

\$100 WEEKLY! Men, women! Work home! Sparetime! Free "confidential plan." Scott Sales, Box 388, Great Neck, New York.

DO You have saleable product? Let us advertise it. Radio, magazines. No money. Ronald Morris Co., Box 95, Port Washington, N. Y.

1000% PROFIT New easy home mail-order setup dealing in names. We help. Write: Factory Agents Bureau, 135-AB Liberty, New York 6, N. Y.

CAMERA Earnings unlimited! Complete instructions shows how, gives markets. \$5.00 postpaid. Southwest Research, Jasper, Mo.

OPERATE Profitable mail order business. Write Walter Service, 4159A East 112th, Cleveland 5, Ohio.

START Stamp machine route, \$50.00 capital. Details free. Box 31, Medford 56, Mass.

LIQUID Marble—Colorful, glossy! Molded, brushed, sprayed! Cast novelties, statuary. Composition floors, tile. Flexible molds. Particulars free. Marbleizing Service, Edwardsville, Illinois.

CIGARETTES — Make 20 filtertips for 9¢. Facts free. Moberly, 950, Owensboro, Kentucky.

COSTS 8¢—Retail \$1.00. Needed automotive product. You manufacture, distribute, easily. Everything furnished. Wilson, 505-E, Princeton, W. Va.

EXCEPTIONAL Profits! "Bronzing" baby shoes. Mountings. Poster, 1520 Ardmore, Chicago 26.

FREE Information. A new product that is needed by every car and truck owner. A \$2 product. Agents make \$1.50 on each retail sale. Webster's Products, P.O. Box 508, Centralia, Wash.

FLEXIBLE Rubber molds for plaster and Marbleite figurines. Sample and large illustrated catalog 25¢, refunded on first order. K-C Novelties, Dept. 86, Southampton, Mass.

\$600.00 POSSIBLE Mailing 100 catalogs. \$1.00 brings sample and details, plus free manual. Tuco Products, 216 W. Jackson Blvd., Chicago 6, Illinois.

FREE Information about new "World Trade Guide and Import Directory." Tells how to get into importing without investment. Or order your copy prepaid \$2.00 money back guarantee. Direct Mail Service Co., P.O. Box 581, Bakersfield, Calif.

\$50.00 WEEKLY Making Formica knock-down furniture. Details and plans. Write Woodcrafters Supply, Box 844, Evergreen Park, Ill.

NEW Home-import mail order profit-unity! Your mailbox stuffed with money! No selling. No experience. No investment. We supply everything. Free details. Mail Order Distributors (Import Division), 15201 South Broadway, Los Angeles 61A1, Calif.

and earn at home. Write for free facts. Candy And Cake, Dept. 241, Fallbrook, California.

EASY To start rubber stamp business at home in spare time. Make up to \$9.80 an hour without experience. Facts free. Write to Roberts, 1512 Jarvis, Room CR-2-A, Chicago 26.

INVISIBLE Reweaving: \$5 in one hour possible reweaving burns, tears, moth-holes. Spare-full time. Free details. Skill-Weave, Dept. SC-162-A, 335 W. Madison, Chicago 6.

RICHES! From ideas never patented! Authentic guide, \$1.00. Traphogen, 624 N. Ashland, Chicago 22, Ill.

SELL The new \$19.95 Regina adding machine. Everyone a prospect. Write for free information. Holes-Webway Co., St. Cloud, Minnesota.

SELL Awnings in spare time. Oldest manufacturer in business. Box 6271, Jacksonville, Florida.

FREE Plan and help. Start home mail order business. In 1952 I was almost broke. Today I own \$18,000 home, drive Cadillac, have bank account. Anyone can do this. Norris Cole, 217 West 49th, Bradenton, Florida.

WANT A Good job? All occupations needed. Free information. Employment Headquarters, 79 Wall Street, Personnel Department, New York City 5.

SNAKES Are worth up to \$25.00 each, lizards \$8.00, turtles \$25.00, toads and frogs \$1.75. We buy all kinds, sizes. Full details and collectors brochure 25¢. Biological Exchange, 1311L Wagner Lane, El Paso, Texas.

MAKE Money at home. Excellent opportunity! Men or women. Write: P. Merrill Hixson, Hatfield, Penna.

UNUSUAL Hand-made jewelry. Painted scenic stones. Birthstones. Generous (saleable) samples, \$1.00. Poster, 3315 Beech, Baltimore 11, Md.

FREE Manual "16 Ways to Make Money." Miller, Box 588-P, Oshkosh, Wis.

MAKE Money writing short paragraphs! No tedious study. I tell you what to write, where and how to sell; and supply list of editors buying from beginners. Many small checks add up quickly. Write to sell, right away. Send for free facts. Benson Barrett, Dept. C-27-A, 7464 Clark, Chicago 26.

CATHOLIC Religious articles. 50% discount. Start your own business. Catholic Guild, 11 Harding Ave., White Plains, N. Y. Samples and kit \$1.00.

BIG Money raising fishworms and crickets. Free literature. Carter Hatchery, Plains, Georgia.

START Big-pay business at home in spare time. No experience needed to operate little table-top machine for bronzing baby shoes. Make \$5.46 profit on every pair. Full particulars free. Send postcard to Mason, 1512 Jarvis, Room CM-2-A, Chicago 26, Ill.

MAKE \$200.00 Monthly spare time with jigsaw. Free details. Elkman, 346F North Summit, Sioux Falls, South Dakota.

MEN — Women! Start money-making plastic laminating business at home in spare time. Material that costs 11¢ brings back \$2.50. No canvassing or selling but mail orders bring in \$20 a day. Write for full particulars free. Rush name on postcard to Warner, Room CL-2-A, 1512 Jarvis, Chicago 26, Ill.

EARN Cash at once, sending us easy orders for magazines your friends, neighbors want. Instant profits! We show how. For free kit, everything you need, write McGregor Magazine Agency, Dept. 321, Mount Morris, Ill.

AMAZING Successes through franchises! Become exclusive franchise holder your territory. Information rushed. National Franchise Reports, MP-528, 333 North Michigan, Chicago 1.

HOW To make money—Over 150 plans \$1. Catlin, 68 North Ellsworth, San Mateo 8, California.

WIN Contests. Complete information, 10¢. Spence, Box 11569, St. Petersburg, Fla.

tions, 3974-P Milwaukee, Chicago 41, Ill. SELL Titania gems. Far more brilliant than diamonds. Catalog 10¢. Diamonite, 2420-M 77th, Oakland 5, California.

SELL Information by mail. 10-to-1 profit ratio. Valuable suggestions free. Rawson F. Wood, 3974 Milwaukee, Chicago 41.

EARN Money evenings copying and duplicating comic cartoons for advertisers. Adservice, Argyle 1, Wisconsin.

BOOKS; Hundreds of subjects. Big 1958 book catalog — 10¢. Popular Mechanics Press, 200-BC East Ontario St., Chicago 11.

WIN Contest money. General Contest Bulletin gives hundreds of tips. Lists current contests, rules. Sample magazine 25¢. General Contests, 1609 1/2 East 5th, Duluth 12, Minnesota.

FREE Folio "\$5,000-\$45,000. Unlimited Vacations." No merchandise. Unknown! Work home, sparetime! Haylings, Carlsbad, Calif.

MAKE Money, operating mail order business, selling business cards. Vosacek Printing, 4444A Ute, San Diego 17, Calif.

CIGARETTES — Improved roller makes 20 for 9¢. Facts free. Moberly, Box 821, Owensboro, Kentucky.

READ Progressive Mailtrade, the magazine that tells how to make money by mail. Dime brings sample and special offer. Progressive Mailtrade, Box 357, Sheboygan, Wisconsin.

"COLLECTIONS Unlimited" offers extraordinary agency proposition! Amazing opportunity. Box 1346-PM, Denver 1.

FREE Copy: "How People Make Money" at home, with hobbies, foods, animals and unusual ways. Scores of ideas that make ordinary people \$80.00 to \$1500.00 monthly. Mirro, 715 E. Colorado, Glendale, Calif.

MAKE Big easy profits making costume jewelry at home in spare time! Quick, easy to make; easier to sell! Details free! Don-Bar, 3511 W. Armitage, Dept. B-192, Chicago 47, Ill.

WE Pay \$3.50 lb. dried. Grow mushrooms. Cellar, shed and outdoors. Spare, full time, year round. We pay \$3.50 lb. Free book. Mushrooms, Dept. 173, 2954 Admiral Way, Seattle, Wash.

MAKE \$5,000 Yearly sparetime raising mink, chinchillas, nutria, etc. Free booklet reveals proved plans. Write: Furs, 588 Mt. Pleasant Road, Toronto 1, Canada.

RAISE Gladiolus. \$10,000 yearly possible. Free details. Daffoglad Farm, Rockbridge, Ohio.

OPPORTUNITIES, Unlimited, 100 selected, small manufacturing opportunities. Exciting details, free. Alpha-Midwest, La-Porte, Indiana.

HAMMER? Saw? Drill? \$100 weekly. Jet, Box 422, Escondido, California.

EARN \$5,000-\$15,000 Yearly at home, in spare time. Respectable field. No experience or public contact necessary. Proof? Send 10¢. Columbia, 8203PM Grubb, Silver Spring, Maryland.

MAKE Big money teaching others by mail. Teach them how to get ahead. Big money being made. Learn how, write C. Welch Co., 735 Bank of America Bldg., San Diego 1, Calif.

MONEY Making opportunities for every one. Write. Bunton Industries, P.O. Box 354-C, Philadelphia 5, Penna.

WANT Daily cash in your mailbox or pocket? Easy, pleasant homework pays big profits with Plasti-Clear. Details free. \$1 brings demonstrator kit. Milford House, Box 227, Salem, W. Va.

NEW Magazine shows you how to operate profitable mailorder business. Free details. Mailorder Income, 2639-22 Howard, Chicago, Illinois.

MAKE Money with typewriter. Instructions \$1.00. Haverty, 745 15th St., Douglas, Arizona.

CASH From mail box. 100 ways. Details free. Adan, 210 E. South, Orlando, Fla.

START Building that fortune you dream about now! You can. Exciting new booklet "Founding a Fortune on a \$10 Bill" shows how fortunes are made and how you can plan your program for financial independence. Mailed free on request. Stephen Matuszak, 79 Wall Street, Dept. 1202, New York 5, N. Y.

CROSSWORD-Value puzzle contest. \$2100 cash prizes. Word list supplied. Fun, fascinating. Highest score must win. Send for free entry blank. Town and Country Association, P.O. Box 1562-P, Tacoma, Wash.

\$3.00 HOURLY. Sparetime. Typewriter required. Confidential home-setup 35¢. Interstate, 37 Besch, Albany 9, N. Y.

MONEY Maker. A travel service in your own home, \$5 complete plans, and you are in business. No experience required. Replies air mailed. Anderson, Box 5815, Chicago 80, Ill.

FORMULAS, PLANS, ETC.

4 PROFITABLE And useful formulas \$1.00. John Palmer, 676 39th St., Sacramento 16, Calif.

FORMULAS For latest money-making discoveries. New! Good! Valuable literature free! Miller, Chemist, 1517-D, Tampa, Florida.

FORMULAS; All kinds, latest, best. Literature free. Kemikal, Park Ridge, Ill.

LATE, Modern manufacturing formulas. List free. Moon Chemical, Martville, New York.

PLASTICS

LAMINATING Supplies. Free price list. Solomson, 46 Cornhill, Boston 8, Mass.

BOXES, Plastic. Free list. Althor, 170 Bay 23 Street, Brooklyn, N. Y.

LEARN Plastics fabrication for spare time income. Low cost home training now available. Write for free booklet. Interstate Training Service, Dept. D-3, Portland 13, Ore.

PLEXIGLAS, Square foot cost, 1/16", \$1.20; 1/8", \$1.52; 3/16", \$1.86; 1/4", \$2.21; 5/16", \$3.23; 3/8", \$4.36; Colors add 15%. Send 15¢ for postage. Aristocrat Plastics, 23 Sussex Avenue, Newark, N. J.

NEW Liquid casting plastic, clear, colors. Embed real flowers, butterflies, photos, coins. Send 25¢ for two handbooks "How to Cast Liquid Plastics" and "How to Make Extra Money at Home." Castolite, Dept. B-101, Woodstock, Illinois.

NEW Do-it-yourself casting and molding plastics! No experience or machinery necessary. Send 25¢ for big 64 page catalog listing hundreds of materials, molds, complete outfits and accessories. Castacraft Corp., Dept. B-22, P.O. Box 555, Palo Alto, California.

NEW Plasti-Clear is best for laminating cards, papers, photos. Free details. \$1 brings demonstrator kit. Milford House, Salem, W. Va.

CASTING, Embedding, laminating. Catalog 25¢. Gel, Box 261, Union, N. J.

ELECTRIC Laminating kit. Presses. Laminating. Burr, 330 East Center, Kalamazoo, Mich.

LAMINATING Plastics. All types plastic sheets, vinylite, acetate, plexiglas. Free catalogue. Arthur Blank & Co., 44 Cumington, Boston 15, Mass.

CHEMISTRY

AMAZING New Book of Science experiments, formulas, and catalogue of laboratory supplies. Only 25¢. National Scientific Co., Dept. PM-2, 11 E. St. Charles Road, Lombard, Illinois.

LARGE Supply catalog. 25¢. Experiment book. 25¢. Used materials. Laboratory Sales, Box 161-A, Brighton, Mass.

FREE Laboratory equipment! Details \$1.00. Box 9038, Chicago 90, Ill.

VISUALIZED Chemistry-science books! Lists free. Franks, 3121 Racine, Chicago 8.

DIRECTORY Of free chemicals and valuable chemical literature, only \$3.00. National, P.O. Box 606-B, Redwood City, Calif.

MICROSCOPE Slides, anatomical. Free list. Bay, 409 Roosevelt, San Francisco 14, California.

EXPERIMENTERS: Bargains galore catalog. 25¢ (refundable). Hagenow Laboratories, Manitowoc, Wisconsin.

CHEMICALS And apparatus for industrial, analytical, and private laboratories. Catalog 25¢. Dept. M-50, Biological Supply Co., 1176 Mt. Hope Ave., Rochester 20, N. Y.

ILLUSTRATED Catalog: Chemistry, mineralogy, biology 25¢. Tracey Laboratories, Evanston, Illinois.

AGENTS WANTED

AMAZING Greeting card money-maker. Make \$75.00 on 100 deluxe \$1.25 assortments. Newest 21 for \$1 tall cards, gift novelties, 125 fast sellers. Gift bonuses besides biggest profits. Experience unnecessary. Stationery samples free, others on approval. \$1.00 gift for prompt action. Creative Cards, 4401 Cermak, Dept. 525-K, Chicago 23.

MAKE \$50-\$300 Quickly, easily, showing outstanding all occasion, Easter, Valentine cards, costume jewelry, gifts, imprinted stationery, household items. Costs nothing to try. Bonus to 7%. Special plan for churches, organizations. Write for best-sellers on approval. Free surprise gift offer. Money-making details. Hedenkamp, 361 Broadway, Dept. PM-54, New York City.

FREE Sample! Beautiful feather pictures. Send 14¢ stamps mailing. Sylviak, Apartado 9636, Mexico 1, D. F.

60% PROFIT On cosmetics—Famous nationally advertised Hollywood cosmetics pay 60%. Make \$35 day up. Hire others. For free samples, details, write Studio Girl, Glendale, Calif. Dept. 1292G.

CLEANS Windows without mess. Strange dry cleaning-cloth. Replaces liquids. Windows gleam. Samples sent on trial. Kristee 59, Akron, Ohio.

"BEST-Gro" plant food will make you friends and money! Opportunities unlimited. Write Best's Nursery, Kissimmee, Florida.

BUY Wholesale—Shoes, shirts, pants, underwear, etc. Complete catalog. Bostonian, 14-C Dock Square, Boston 8, Mass.

NEW Car thief signal. Lightning seller. Samples sent on trial. Northwest Electric, 107, Mitchell, S. Dak.

\$1,000.00 A Month for making dramatic 3-second demonstration of amazing lightweight Presto fire extinguisher. New chemical used by Airforce snuffs out fires instantly. Only \$4.95. Terrific commissions. Millions want it. Free kit. Merlite, 114 E. 32nd, Dept. P66U, New York City 16.

WANTED Fire extinguisher salesman. Send \$3.95 for quart automatic fire extinguisher with complete sales kit. Huge profits. Out-O-Matic, 1737-A E. 31st, Denver 5, Colo.

WILL You test new items in your home? Surprisingly big pay. Latest conveniences for home, car. Send no money. Just your name. Kristee 58, Akron, Ohio.

ATTENTION! Here is a tremendous potential for men seeking exceptional profits from an accepted, nationally advertised product. No experience necessary, no obligation. Send for powerful, proven sales plan and samples on approval. Special fund raising plan for churches, clubs, etc. Sunshine, 24 Warwick, Springfield 1, Mass. (West of Rockies, write Pasadena 1, Calif.)

WHOLESALE Jewelry closeouts! Catalogue! A&S Distributors, 677 Washington, Norwood, Mass.

MAKE \$1,000 "Without selling! All you need is a pencil to take orders for over 700 fascinating new gifts, gadgets, toys, and novelties that sell themselves on sight. Just show your friends our exciting catalog and make profits up to 92%. Write today for full details and big, free, colorful catalog. Greetings Unlimited, 9-304 Park Square, St. Paul 1, Minnesota.

DAMASCENE Earrings! Exotic orientalism. Huge profit. OHGA, PM132, Sigakenkusatu, Japan.

SKYROCKET To success: Sell fast moving, new improved auto specialties. Millions wanted. Modernday, Dept. 5944-C, Los Angeles 65.

SELLS On sight to anyone who uses a hammer. Atlas nail driver and screw starter. Sample \$1.00. K-J Company, Dept. P-1, 1423 S. 2nd St., Milwaukee 4, Wis.

MAKE Money selling bumper signs, decals. Box 2223, Paterson, New Jersey.

TWO Hot items. Needed in every home. Good profit. Literature free. La-Sal Products Company, 3315-61st, Des Moines, Iowa.

TERRIFIC Winter seller; door closers. \$3.00 dozen. Guthrie, 559 Haverhill, West Palm Beach, Florida.

SALON Reducing tables, rollers, belts, cushions, slant boards. Coin timers factory, Mary-Mac, 1012 Powhattan St., Dallas 2, Tex.

WORLD'S Greatest seller. The Holy Bible. Protestant or Catholic. Illustrated. Profitable. Watson, Box 4775, Kansas City 9, Missouri.

BIG Profits. Stamp social security plates, key protectors. Sample 50¢. Catalog free. General Products, 188-PM State, Albany 10, N. Y.

EARN \$12,000 Yearly—Only two sales daily. World's best seller. The Holy Bible. Illustrated. Protestant or Catholic. Margareta's, P.O. Box 92, Hazleton 7, Penna.

EASY Handwork makes fast-selling useful articles. Sample free. Sunmade Company, Brockton 64, Massachusetts.

BE The Popular Mechanics representative in your neighborhood and earn big profits in your spare time. Write Popular Mechanics Magazine, Room 305M, 200 E. Ontario St., Chicago 11.

GOLDMINE Of 600 money makers. Free copy. Specialty Salesman Magazine, Desk 5B, 307 North Michigan, Chicago 1, Ill.

PRINTING, Advertising salesmen—Excellent moneymaking sideline selling decalomania name plates, small quantities. Automobile initials, sign letters. Free samples. Ralco, XL, Boston 19, Mass.

GOLD Or silver letters, numbers. Windows, doors, trucks. 1" to 6". 500% profits. Free samples. Atlas-T, 544 West 79th, Chicago 20.

AGENTS—300% Profit selling genuine gold window letters; stores and offices. Free samples. Metallic Sign Letter Co., 1217-D West Newport, Chicago.

YOUR Ad in this space will get some good agents for you. Yes, I'll prove it. Write for Folder "A" right now. F. W. Johnson, Classified Advertising Manager, Popular Mechanics Magazine, 200 E. Ontario St., Chicago 11, Ill.

YOUR Own business—Used suits \$1.50, overcoats 65¢, mackinaws 35¢, shoes 12.5¢, ladies coats 30¢, dresses 15¢. Enormous profits. Catalog free. Nathan Portnoy Associates, 2109-AA Roosevelt Road, Chicago 8.

SELL Champion, AC, Autolite spark plugs. Reconditioned, electroplated, guaranteed 10,000 miles. 100% profit. Free sample. City Motors, 2913-E Fannin, Houston 2, Texas.

CASH Commissions at once, taking orders for magazines every family wants! No experience needed. For free money-making kit, with everything you need, write McGregor Magazine Agency, Dept. 301, Mount Morris, Ill.

RUN A spare-time greeting card and gift shop at home. Show friends samples of our wonderful new 1959 all-occasion greeting cards and gifts. Take their orders and earn up to 100% profit. No experience necessary. Costs nothing to try. Write today for samples on approval. Regal Greetings, Dept. 31, Ferndale, Michigan.

SELL Desk calendars. Make \$25 a day. Every business firm a prospect. Details free. Steel Advertising, 13 East Franklin, Richmond, Va.

BUY IT WHOLESALE

TREMENDOUS Savings. Large wholesale catalog. \$1.00 (refundable). Robert Barckert, Dewey Rd., Amherst, Ohio.

BUY Wholesale: 100,000 nationally advertised products. Appliances, cameras, sporting goods, housewares, watches, typewriters, tools, clothing, etc. Discounts to 80%. Buy-Rite, Box 258, Hawthorne 104, New Jersey.

USED And new watches \$2 up. Free list. Southern Watches, 5-PM So. Wabash, Chicago 3.

LARGEST Wholesale supply source in U.S.! Furniture, clothing, appliances, housewares, automobiles and accessories, tools, sporting goods, hobby supplies, farm equipment, imports, new products, bargain merchandise. Free details. Associated Wholesalers, Box 52-DD, Burlington, Iowa.

IMPRINTS—152 wholesale sources for products of 41 countries. \$2. Mandeville, 405 Olympia, Pittsburgh 11, Penna.

DIAMOND Rings! Below wholesale, catalog. Distributors, Box 106M, Hudson, New York.

ACCORDIONS Wholesale! Save 1/2. Home trial. Free catalog. Accordion Warehouse, Dept. 29-RW, 2003 Chicago. Chicago 22.

TREMENDOUS Profits buying merchandise wholesale! Free details! Heritage, 210-PM29 Fifth Ave., New York 10, N. Y.

BUY Wholesale! Tremendous discounts! United Wholesalers, 1265-M Broadway, New York 1, N. Y.

SALESMEN—DISTRIBUTORS

SALESMEN—Big money every day showing nationally known drain cleaner. No chemicals. Nothing like it. Minute demonstration. Commissions paid daily. Sample furnished. Campbell Co., (Est. 1928), Rochelle 604, Illinois.

IT Ain't sellin'—Just servicing! Take over your area as our service distributor keeping retail stores supplied. Nationally advertised 28-year old line pays you 66 2/3% mark-up. For samples and highly successful plan, write Novo, Inc., 1166-T Milwaukee, Chicago 22, Illinois.

IF You're interested in making money in selling, see the hundreds of exceptional opportunities in Salesmen's Opportunity Magazine. Send name for your copy, absolutely free. Tell us what you're selling now. Opportunity, 848 N. Dearborn, Dept. 17, Chicago 10, Illinois.

TAKE Over your area—Agents, dealers, farmers, make \$125 up weekly selling nationally advertised Campbell's Go-Green liquid fertilizer concentrates. No investment. Everything free. Campbell Co., (Est. 1928), Rochelle 5, Illinois.

BIG Money making opportunity. Exclusive line uniforms, jackets, pants, shirts, coveralls, sportswear. Advertising embroidered. Every business prospect. Get selling outfit free! Master Co., Dept. K-20, Ligonier, Indiana.

AD Match sales! Your own business, without investment! Sell for world's largest direct selling manufacturer of advertising matchbooks. Big spot cash commission. Start without experience. Our tested sales kit tells you where and how to get orders. Men, women, part or fulltime. Match Corporation of America, Dept. PM-29, Chicago 32.

DISTRIBUTE Awnings. Good profit. Oldest manufacturer in business. Box 6271, Jacksonville 5, Florida.

BUSINESS Kit free! Postcard puts you in business! Complete line 230 shoe styles, also jackets! New discoveries pay big commissions. No investment. Send for free kit. Mason, Chippewa Falls K-135, Wis.

AMAZING Opportunity. New low priced fire alarm protects homes, farms, offices, factories, etc. No wiring, hangs like picture. Pays up to \$1.100 a month. Free kit. Merlite (Alarm Div.), 114 E. 32nd St., Dept. F-66U, New York 16, N. Y.

INCREASE Your earnings by applying time proven sales methods. The selling plan in "The Magic Key to Selling" has greatly increased the earnings of thousands of salesmen. Send \$4.98 today for this effective selling plan. Satisfaction guaranteed. Specialty Sales Consultants, P.O. Box 222, Muncie, Indiana.

WILL You wear new suits and topcoats without one penny cost and agree to show them to friends? You can make up to \$30.00 in a day even in spare time, without canvassing. Stone-Field, 532 South Throop Street, Dept. K-926, Chicago 7, Illinois.

\$1,000.00 A Month for making dramatic 3-second demonstration of amazing lightweight Presto fire extinguisher. New chemical used by Airforce snuffs out fires instantly. Only \$4.95. Terrific commissions. Millions want it. Free kit. Merlite, 114 E. 32nd, Dept. P-66U, New York City 16.

EARN \$50.00 Daily. Listing past due accounts for national company. Instructions free. 304Z Pickwick Bldg., Kansas City 6, Mo.

100% PROFIT. Fast easy money! Take orders for Sweet Georgia Brown cosmetics. Colored people buy quick. Free sample. Valmor, Dept. RK, 2451 Michigan, Chicago 16.

MAKE Extra money—Big cash commissions plus premiums for you and your customers. Sell advertising book matches. Sensational new tenor, glamour girls, hillbillies; dozens others. All sizes. Quick daily sales; big repeat business. Free master kit makes selling easy. No experience necessary. Superior Match, Dept. M-259, 7530 Greenwood, Chicago 19.

I'LL Send you free stocking sample newest advancement in hosiery since nylon. Patented, full-length. Stays up over-the-knee without supporters, without girdle! Nationally advertised price \$1.95. Make money introducing to friends at \$1.00 pair. American Mills, Dept. 672, Indianapolis, Ind.

BIG Multicolor wholesale catalog! Housewares, appliances, clothing, silverware, cookware, luggage, binoculars, shavers, radios, phonographs, cameras, projectors, recorders, typewriters, sewing machines, furniture, power tools, toys, sporting goods, watches, diamonds, jewelry, automobiles, etc. Name brands. Huge discounts. Postcard: Selbyco, Decatur 153, Illinois.

MAKE Money! Take big profit orders, famous fruit trees. Including sensational discovery, Starkrimson Delicious apple! Also dwarf, shrubs, roses, vines. Sales outfit free. Stark Bro's, Desk 30129, Louisiana, Missouri.

ANYONE Can sell famous Hoover uniforms for beauty shops, waitresses, nurses, doctors, others. All popular miracle fabrics: Nylon, dacron. Exclusive styles, top quality. Big cash income now, real future. Equipment free. Hoover, Dept. B-100, New York 11, N. Y.

CAPITALIZE On bowling's popularity. Sell "My Bowling Scores"; new, different score book. Over 100% profit. Sample 25¢, deductible when you order 12 or more copies. Pope Enterprises, 1907 Cuyler Ave., Chicago 13 Illinois.

SENSATIONAL Salesmaker. New do-it-yourself plastic laminating kits. \$1 brings demonstrator. Details. Milford House, Box 32, Salem, W. Va.

"TELE-Tabs" needed by millions of telephone books. Free details. Bernay Products, 412 So. Wells St., Chicago 7, Illinois.

BIG Profits. Amazing new foolproof home safety lock. All data free. Loxem, 483 Main, New Rochelle, N. Y.

START Your own business for 7¢. Net \$25 first day. Kahm Co., 413 So. Osceola, Orlando, Florida.

"SPIRITUAL Birth certificates." It's new, marvelous, unique, exclusive, fascinating, beautiful, copyrighted. Market goal 125,000,000 certificates. Possibly \$70,000,000 retail sales. Franchise available to qualified jobbers, distributors, salesmen, etc. Write Spiritual Birth Certificates, Red Springs, North Carolina.

GARAGES Buy, oil filter wrench. Sample \$2. Free details. Sha-Khan-Eck Sales, Atlanta 6, Georgia.

EMPLOYMENT INFORMATION

JOBS To \$15,000. Travel, adventure, world wide, Alaska, Japan, South America, Far East, Europe. Ages 18 to 65, skilled and unskilled, thousands of positions open. Write for free information. Personnel Director, International Employment Information Center, P.O. Box 115, Boston 27, Mass.

CARPENTERS, Laborers, drivers. Foreign project. Bonus pay. Free information. Employment Headquarters, 79 Wall Street, Dept. 160, New York City 5.

LAND Your dream job. Personnel manager reveals job-winning secrets. Economical. Satisfaction guaranteed. Details free. Practical, Box 53, Little Falls, New Jersey.

AMERICAN Overseas jobs. High pay, men, women. Transportation paid. Free information. Write Transworld, Dept. 11D, 200 West 34th St., New York City.

(mailed). Satisfaction guaranteed. International Reports, Dept. B, P.O. Box 621, San Jose, California.

JOB Hunters—Procedure booklet, secrets; \$1.00. Counselors, 514 Forest, Collinsville, Illinois.

ALASKA Hourly scale: Laborers \$4.16; truck drivers \$4.45; carpenters \$4.38; plumbers \$5.00; electricians \$5.00. Construction projects awarded over \$335,000,000. Names and addresses of companies hiring; total contract awarded; location; wage scale; also information regarding homesteading. Send \$1.00 to Alaska Employment Opportunities, Box 1032, Anchorage, Alaska.

JOBS On ships, \$100 weekly beginners. plan your future now. Seamens Service, Box 17-P, Brooklyn 8, N. Y.

CALIFORNIA Jobs and pay rates. New 48-page book lists firms, jobs, wage and salary information. Valuable sample employment tests, essential job-getting information. Send \$1. Periday Co., Box 331, Inglewood, California.

MERCHANT Marine jobs. Top wages. Ship's captain reveals how to join. Beginners book \$2.00. Details free. Captain, Box 501-P, Reading, Massachusetts.

OPPORTUNITIES Afloat. Procedure for obtaining jobs on ships. Free information. Dept. A, Box 1593, New York 1, N. Y.

AMAZING New job service. We'll recommend you to companies seeking workers in all categories on our official business stationery. Send \$3.00 for job list and complete application service. Write Jobs Dept. A-5, Box 125, Rugby Station, Brooklyn 3, N. Y.

JOBS Overseas! Write Janecek Development Co., 109 Hub Station, New York 55, N. Y.

NATION'S Capital! Latest classified \$1.00. Jensen, 1935 N. Upland St., Arlington 7, Va.

BOOMING Latin America! Fabulous Brazil, Venezuela, only hours from the States. New data regarding jobs, opportunities, conditions, American companies employing, etc. All skills required. Salaries to \$1,650.00 monthly. U. S. tax exempt. Bonuses, living allowances, travel expenses, exciting vacations, and more. First hand information direct, \$2.00. (\$2.35 airmail) checks, money orders Ok! Paul B. Smith, Avenida 16, No. 68-49 Maracaibo, Zulia, Venezuela.

INFORMATION — U.S.A. overseas jobs. High pay, transportation. Futures, Dept. M, 215 West 34th Street, New York City 1.

FOREIGN Jobs—Latin America, Alaska, Canada, up to \$1500 monthly. Up-to-date 1959 foreign service directory gives complete information; hot list of firms hiring for military and civilian construction, aircraft, oil, exporters-importers, mining. How-when-where to apply. 11th successful year. \$1.00. Global Reports, Box 8873-S, Los Angeles 8, Calif.

JOIN The merchant marine. For information write Box 4092, Jacksonville 1, Fla.

STEAMSHIP And yachting jobs, traveling foreign countries. Box 1354, GPO, New York 1, N. Y.

WHY Worry about work? Escape jobs forever! Retire securely now. Lead leisurely life. Unusual new book shows how Postcard brings details free. Belmont Wyckoff 157, New Jersey.

JAPAN! Many hi-paying jobs available. Full details (complete coverage) airmailed \$2.00. K. Wats, C.P.O. Box 903, Tokyo.

ALASKA Information. Unlimited opportunities. Homesteading, employment 254. Haase, De Forest, Wisconsin.

JOBS \$400 Month. Merchant marine. Write: Box 1804-T, Paterson, N. J. Beginners only.

FOREIGN Employment information. Make big money in Europe, Africa, South America, Canada, Alaska, Far East, Transportation paid. Construction workers, clerks, truck drivers, etc. Travel, adventure. Complete information application blanks, sent by return mail. Send \$2.00 to Foreign Bureau, P.O. Box 512, New Orleans, Louisiana.

COMING To Florida? Send for complete report, jobs, salaries, cost of living. Information you need. \$2.00. Survey, 904 Chamber of Commerce Bld., Miami 32, Fla.

BIGGER, Uninterrupted income. Earnings-proven method shows, brings best jobs, rapid advancement, security. Free details. Valon, Box 9235, Chicago 90, Ill.

COPYRIGHTED Reports. Best paying jobs with travel, adventure, promotions. Construction, aviation, shipping, oilfields, laborers, clerical, trades, supervisory, factory, unusual opportunities. Skilled, unskilled. Foreign, stateside. Men, women. Only \$2.00 (\$2.25 airmail) (c.o.d.'s accepted), including registration-advisory service. Satisfaction guaranteed. Included free: Special reports on Alaska, Venezuela, South American opportunities, husband and wife foreign jobs, Research Services, Suite 514-PM Meramec Building, St. Louis 5, Missouri.

JOBS—High pay; U.S.A., So. America, the Islands. All trades. Many companies pay fare. Write Dept. 71J, National Employment Information, 1020 Broad, Newark, N. J.

SPECIAL SERVICES

BELIEVE It! Or not! Your handwriting gives you away! Signature, 25¢ coin. Full page, \$1.00. Oriscom, Certified Analyst, Box 23pm, Sandy Hook, Conn.

TRANSLATION Service, correspondence school. All languages. Box 1995, Dallas 21, Texas.

DEEDS Plotted. Write to Burt D. Horn, Mt. Pocono, Penna.

INFORMATION On anything. Ferguson Research Specialists, 116-14 141 St., South Ozone Park 36, N. Y.

EDUCATIONAL AND INSTRUCTION

USED Correspondence courses and books sold and rented. Money back guarantee. Catalog free. Courses bought. Lee Mountain, Pisgah, Alabama.

PROFESSIONAL Investigators correspondence school. Badge, diploma, future. Box 41197, Los Angeles 41, Calif.

EARN Degrees by correspondence courses: Associate of Arts, Bachelor of Arts also Bachelor of Science in Business Administration. Pacific International College of Arts and Sciences, primarily a correspondence school. Resident classes also carried. 5719-D Santa Monica Blvd., Hollywood 38, California.

OPERATE Collection agency. Gold mine opportunity. Lifetime business. Be respected. Franklin Credit, Roanoke, Va.

ENGINEERING Degrees earned through home study. Electronics, electrical, mechanical, civil, physics. When writing, specify course desired. Pacific International College of Arts & Sciences primarily a correspondence school. Resident classes also carried. 5719-B Santa Monica Blvd., Hollywood 38, California.

SWEDISH Massage. Home study. Diploma. Swanson's Illinois Licensed School, 3809 Alta Vista, Chicago, Ill.

1959 INDUSTRY Training. Home-study. Drafting, design, electronics. Aero Tech, 2166-PM Sunset Blvd., Los Angeles 26, Calif.

HIGH School diploma at home. Licensed teachers. Approved materials. Southern States Academy, Station E-16, Atlanta, Ga.

SECRET Investigations. Experience unnecessary. Investigators particulars free. George Wagner, M125 West 86th, New York City 24.

SING. Speak with power. Self-training records. Amazing! Canfield, 2018-A Fifth Avenue South, Minneapolis 4, Minnesota.

BE An investigator. Write for free details. State age. National Detective Academy, Dept. P, P.O. Box 1082, Scottsdale, Arizona.

EARN Degree. Free bulletin. Home-study only. Midwestern Bible School, 1080 Broadripple, Indianapolis.

STUDY To be a doctor of psychology, metaphysics, divinity or philosophy. Correspondence courses only. The Neotarian Fellowship, Desk 9, Kansas City 6, Mo.

STUDY For Doctor's degree of psychology, metaphysics and divinity. Correspondence courses only. College of Divine Metaphysics, Dept. P-M, 2811 North Illinois, Indianapolis 8, Indiana.

WANT A diesel job? New opportunities to increase income. Higher pay. More money. We can help you qualify. Tools. Shop method home training. Write today! Diesel, Tractor, Heavy Equipment Division, Interstate Training Service, Dept. B-2, Portland 13, Oregon.

BOOKKEEPERS! Increase your earnings! Operate your own simplified "Dollar-A-Week" bookkeeping and tax service. Full or spare time. Details free. No obligation. Ellis, Box 200, Cedar Grove, North Carolina.

LEARN Appliance service and repair. Motors, washers, refrigeration, cleaners, everything. Free booklet. Armstrong, 11027-A South Vermont, Los Angeles 44.

BE A real estate broker. Study at home. Write for free book today. GI approved. Weaver School of Real Estate, 2018P Grand, Kansas City, Missouri.

EARN While you learn. Auto and diesel mechanics master this top paying trade. Many graduates earn \$100 a week and up. Approved for Korean veterans. For free information write Dept. No. 256, Nashville Auto-Diesel College, Nashville 3, Tenn.

PHYSICAL Therapy and massage. Home training. Practice privately or work with doctors and hospitals. Free catalogue. National Institute, Desk 4, 159 E. Ontario, Chicago, Ill.

INVESTIGATOR Training. Phillips Secret Service System, 1917-B North Kenneth, Chicago 39.

PIANO Tuning pays. Learned easily at home. GI approved. 58th year. Free booklet. Niles Bryant School, Dept. P, 3731 Stockton, Sacramento 20, Calif.

LEARN Blueprint reading at home. Insure your job. Higher income and advancement. Madison Technical School, 118 Meriham Drive, Dept. PM, Madison 5, Wisconsin.

YOU May qualify for a job in the fast moving, highly specialized Diesel and heavy equipment industry with proper training. We have been doing a successful job of training men for the past 18 years. For free information, write Tractor Training Service, Room 11E29, 1525 E. 53rd St., Chicago.

LEARN By ear with Dormiphone. While you sleep, amazing new scientific invention works for you. Revolutionary Dormiphonic tools give you a shortcut to learning languages, correct speech; memorizing facts, figures; ideal for self-improvement, relaxation, habit training. Saves time, effort. So simple to use, children benefit. Used by educators, psychologists. Write for fascinating free book. No obligation. Modernophone, Inc., 320-029 Mezz., Radio City, New York City 20.

FINISH High School at home, spare time. No classes. Diploma awarded. Write for free catalog. Wayne School, Catalog HF-91, 2527 Sheffield, Chicago 14.

DRAFTING. Design, blueprint reading. Good paying. Easy to learn at home. Minimum age 17. Write Utilities Engineering Institute, Dept. TC-15, 2525 Sheffield, Chicago 14.

MASTER Watchmaking at home. Free sample lesson. Chicago School, 2328-YO, Milwaukee, Chicago 47.

HARIAN'S New Garden Guide. Less work, less cost! 144 pages of information. \$2.00. Grote, P.O. Box 266, Bronx 51, N. Y.

LEARN Civil and criminal investigation at home. Earn steady good pay. Institute Applied Science, 1920 Sunnyside, Dept. 162, Chicago 40, Ill.

ELECTRONICS — Television. Expert technician salaries \$150.00-\$200.00 weekly. Earn while you learn. Free job placement. Ages 18-55. Information free. Universal Electronics, 324 East Tenth, Kansas City, Missouri.

STUDY Dianetics and scientology. Start your course at home. Teaches you how to control and handle your fellow man and your own thinkingness, reactive mind, and body. Be clear. Write today for information and enrollment. Academy of Scientology, 1812 19th St., N.W., Washington 9, D. C.

GAIN Self mental mastery. New health, new beauty. Specify need. The Leavitt Science, Clinton, Illinois.

"HOW To Train Horses"—A book everyone who likes horses or ponies should have. Free. No obligation. Simply address Beery School of Horsemanship, Dept. 1102-C, Pleasant Hill, Ohio.

IT'S Fun learning a language by Lingua-phone, world's standard conversational method. At home, quickly, easily learn to speak French, Spanish, German, Japanese, Russian, Modern Greek—Your choice of 34 languages. It's like living in another country. Complete recorded courses on free trial. Send for free book and details. No obligation. Try, don't buy! Lingua-phone Institute, T-83-029 Radio City, New York City 20.

OIL Coloring photographs—A fascinating hobby or profitable sideline for those with artistic talent. Learn at home. Easy simplified method. Free booklet. National Photo Coloring School, 835 Diversey Parkway, Dept. 3432, Chicago 14.

COMPLETE Your high school at home in spare time with 62-year-old school. Texts furnished. No classes. Diploma. Information booklet free. American School, Dept. X245, Drexel at 58th, Chicago 37, Illinois.

CRIMINOLOGY—Certificate courses that qualify in criminal identification and investigation. Boston School of Criminology, Box 2121, Boston 6, Massachusetts.

WELDERS Earn big money. Easy to learn arc, gas, automatic welding. New equipment, low cost training in non-profit school. GI approved, free booklet. Hobart Welding School, Box M-292, Troy, Ohio.

LEARN Piano tuning at home! Only \$29.95 including tools, recording. Write Musical Enterprises, Box 5074-M, St. Paul, Minnesota.

BOOKS, Free general catalog, 100 pages. Text, vocational, educational, instructional subjects. Millions of volumes, new and used. Bargain prices. Books bought, Est. 1902. Long's College Book Co., Dept. PM, Columbus 1, Ohio.

BUILDING Trades pay big money. Home training offered by not-for-profit organization. Free information for interested men. Write ATS-C22, 850 E. 58th, Chicago.

NEW! Study at home. Courses in business, industry, science, liberal arts. Free bulletin. Automent, Inc., 2166 Market, San Francisco 14, Calif.

VOICE Secrets! Information! Free! Studio. 14356-M South Jersey, Norwalk, California.

LEARN While asleep with your recorder, phonograph or amazing new "Electronic Educator" endless tape recorder. Details free. Research Association, Box 24-N, Olympia, Washington.

ANALYZE Handwriting for profit, pleasure, self-understanding. TV, radio, newspaper columns, teaching, lecturing, court work, counseling. Men, women, spare time up to \$50 an hour. Amazing opportunities. Sample lesson free. Must be 21. IGAS, Inc., 48, Springfield 4, Missouri.

PLAYS, STORIES, MANUSCRIPTS

WANTED: Book manuscripts, all subjects considered. Greenwich Book Pub., Atten. Mr. Zealand, 489 Fifth Ave., New York City.

WANT Your book published? Learn how we publish, advertise, promote, distribute. Many successes. Free booklet PM. Vantage, 120 West 31, New York City, Midwest office: 220 S. Michigan Ave., Chicago, Ill.

ADVERTISING AGENCIES, LETTER WRITERS, FOR ADVERTISERS

BEFORE Advertising—Get instructive Ad-Guide and newspaper-magazine rate-book, free. Chicago Advertising Agency, Chicago 4.

FREE! 1959 Advertisers Rate and Data Directory. 52 pages! E. H. Brown Advertising Agency, 20 N. Wacker, Chicago 5.

ADVERTISING. Result-getting ads prepared, placed newspapers, magazines, radio, anywhere! Lowest rates. Catalogue free. Baker Advertising Agency, 189 W. Madison, Chicago 2.

"AMAZING New Book"—"Profits From Classified Advertising." Tells how and what to advertise. Be sure to read this book before you invest one cent in advertising. Write for your copy now. Just send 10¢ for postage and handling. W. Johnson, Classified Advertising Manager, 202 East Ontario Street, Chicago 11, Illinois.

MAILING Lists most any classification \$5.00 1000. Your circulars mailed with ours \$4.00 1000. Write for our literature. Dixie Mailers, King, N. C.

Now Ready: New, Amazing Classified Advertising Record Book—prepared especially for classified advertisers. Here is a book that tells you instantly whether or not your advertising in any publication is paying you real results. You can tell immediately how many inquiries each publication produced—how much cash received from every ad. Spaces are provided for the name and address of the publication, date of issue, space used, rate, cost of ad, key number, etc. You have a complete record of each publication right before your eyes. Plenty of space to keep accurate record of 28 separate publications. You can have a copy by sending only 10¢ to cover postage and handling. Send for your copy now. W. F. Johnson, Classified Adv. Mgr., Popular Mechanics Magazine, 304 E. Ontario Street, Chicago 11, Illinois.

CARTOONING. COMMERCIAL ART. SHOWCARD & SIGN PAINTING. TATTOOING

CARTOON Your way to success! Internationally known instructor, Raye Burns, will personally teach you to create original, salable cartoons at home. Cost of course is very low. Write for free details. Raye Burns School, Box 3583-P, Cleveland 18, Ohio.

YOU Can entertain with chalk talks. Catalog 10¢. Baida The Cartoonist, Oshkosh, Wis.

LEARN Sign painting at home. Free talent test. Ben Kerns, Box 812-PM, Greenville, S.C.

LEARN Sign painting with fascinating system. Straley, 410 S. Western, Springfield, Ohio.

LEARN Profitable, fascinating tattooing. Illustrated information \$1. Zeis, 728-C Leslie, Rockford, Illinois.

"HOW To Make Money With Simple Cartoons." A book everyone who likes to draw should have. It is free; no obligation. Simply address Cartoonists' Exchange, Dept. 92-C, Pleasant Hill, Ohio.

HOW To draw. 46 lesson course, \$2.00 postpaid. Simmons, Box 4462, Philadelphia 40.

RUBBER STAMPS AND OFFICE SUPPLIES

4 LINE Rubber stamp. Sailors, 537 Conn. St., Gary, Indiana.

FREE! Rubber stamp catalog. Many items. Campfeld, Box 798, Springfield 1, Mass.

YOUR Name. One line. 30¢. Owens, 4503 Firnat, Houston 16, Texas.

POCKET, 3 Lines \$1.00. Guaranteed. W. J. Specialty, 8464 Manhattan, Detroit 11, Michigan.

TYPEWRITERS. DUPLICATORS. OFFICE DEVICES

RECONDITIONED Typewriters, duplicating, printing devices. \$25.00 up. Supplies. Appliances. DixieGraph, King, N. C.

PRINTING. MULTIGRAPHING. MIMEOGRAPHING. GUMMED LABELS

BUSINESS Printing. Quality work. Free catalog. Color Press, Sacred Heart, Minn.

BUSINESS Cards with glamour. Reasonable. Samples free. Heavener's, Colmar, Penna.

FREE Catalog postpaid printing, rubber stamps. DM Press, Sebastopol, Calif.

MULTILITHED Quality letters for less than mimeographing. Get facts, samples, prices. Perkins Printing Service, Fremont, Nebraska.

BUSINESS Printing. Samples. Prices free. Howprint, 723-G Eunice, Webster Groves 19, Missouri.

MIMEOGRAPHING—Letters, pricelists, formulas, instructions. Lowest prices. Lem's Letter Shop, 5710 Stanton, Detroit 8.

100 6 3/4 ENVELOPES, 100 5 1/2 x 8 1/2 Letterheads quality printed, \$2.00. Millard Fortney, R3, Dillsburg, Penna.

dianapolis 2, Indiana.

QUALITY Printing. Postpaid low prices. Free illustrated catalog. Samples. Alexander, 1324 Alcot, Dayton 6, Ohio.

1000 GUMMED Labels, 3 lines \$1.00. Free pocket knife. General Supply, Box 128, Depew, N. Y.

PRINTING For particular people. Free samples. B. Vincent, Skippers, Virginia.

LOW Cost business printing. Samples, prices free. Chicago Mail Service, 192-A North Clark, Chicago 1.

YOUR Name and address printed on gummed labels 500-3 lines \$1.00. 15¢ each extra line. 1/2 x 1 1/2. Print clearly. No c.o.d.'s. Addison Mail Order, PMB-2, 1840 Addison, Chicago 13.

ECONOMICAL Business—Personal printing. Free literature. Vail, 334, Hicksville, N. Y.

1,000 NAME And address labels in plastic box \$1.00. Heights Industries, Capitol Heights 27, Md.

THERMOGRAPHED Letterheads 8 1/2 x 11, 100, \$2.95. Samples. Printshop, 17030 Miles, Cleveland 28, Ohio.

MIMEOGRAPHING, 100 8 1/2 x 11 \$2.00. Postpaid. California Mimeo Service, Simi, California.

100 LETTERHEADS (8 1/2 x 11 Watermarked) and 100 6 3/4 envelopes, printed carefully, \$2.00. Postpaid. Race Printers, Hudson, New York.

OFFSET—Free samples, price lists. Litho, 53 Laurie Drive, Ft. Walton Beach, Florida.

1,000 BUSINESS Cards. Raised letters, \$3.50. Samples. Pioneer, PM-2, Island Park, N. Y.

LETTERHEADS, Circulars, postcards. Samples. Valatts, 1705 South 2nd, Philadelphia 11, Penna.

CATALOGUES Printed 1 1/4¢ apiece, free price list. Copen Press, 105 Court Street, Brooklyn, N. Y.

5,000 COLORED Circulars—\$39. Complete: Art, copy, layout, printing. Promotion-M2, 385 Broadway, New York City 13.

OFFSET Printing: 24 hour service. Only 67 1/2¢ per 100 8 1/2 x 11. (Minimum order 1,000.) National Letter, 306 West 43 St., New York City 36.

BUSINESS Cards 1000—\$2.95. Fast service. Other quality printing low prices. Tribune, Green Forest, Arkansas.

ENVELOPES, Statements, business forms continuous, snaps, books. Eddi Rose Printing, Bronx 72, N. Y.

250 BUSINESS Cards \$1.00 postpaid. Randolph Press, Box 3406-A, Detroit 3.

COMPLETE Business printing, rubber stamps. Inexpensive. Speedy service. Free; Samples. Hildreth, 1047 Inner, Schenectady 3, New York.

1000 RAISED Business cards \$2.95. Craftex Cards, Box 243, Waltham 54, Mass.

EMBOSSED Business cards, post cards. Inexpensive. Samples. Grasso, 611 Lovers, San Antonio 12, Texas.

BUSINESS, Personal printing. Reasonable. Catalog. Press, Box 1, Weaubleau, Missouri.

1,000 PERSONALIZED Labels plus attractive rubber stamp (three lines) \$1.89. George Nemitz, Cedarburg, Wisconsin.

1000 GENUINE Engraved 8 1/2 x 11 letterheads \$16.00 postpaid. Hamilton, 4341 Meade, Chicago 34, Illinois.

1000 3x5 GUMMED Labels \$4.75 postpaid. Taylor, Box 72, Brentwood, Maryland.

FREE Folder personalized stationery items, envelopes, labels, cards, name plates. Myers Company, 1228 Adams, Owosso, Michigan.

ADS Running under this heading sell printing. Ask me for proof. I'll gladly send you amazing facts. Ask for Folder "P." F. W. Johnson, 200 E. Ontario St., Chicago 11, Ill.

Argyle 1, Wisconsin.

DO Your own printing. Save money. Simple rules. We supply everything. Print for others; good profit. Raised printing like engraving too. Have home shop. Details free. Kelsey Presses, V-11, Meriden, Connecticut.

MIMEOGRAPHS, \$9.95 Up. New. Guaranteed. Price list free. Independent Distributor, 1055 48th St., Oakland, Calif.

RUBBER Stamp making presses, hydraulic operated, electrically heated. Sizes 5"x8", 8"x12", 10"x15", starting outfits. All kinds supplies. Custom Manufacturing, 507-P N. Jefferson, Springfield, Mo.

PATENT ATTORNEYS

C. A. Snow & Co.—M427, Snow Building, Washington 1, D. C. Registered Patent Attorneys. Write for information.

INVENTORS: Without obligation, write for information explaining the steps you should take to secure a patent. John Randolph, Registered Patent Attorney, 803 Victor Bldg., Washington 1, D. C.

"INVENTOR'S Guide" and **"Record of Invention"** free on request. Frank P. Ledermann, Registered Patent Attorney, 154 Nassau Street, New York City.

INVENTION Record form free and **"Patent Information Every Inventor Should Have."** Carl Miller, Registered Patent Attorney, Woolworth Building, New York.

CANADA—Ramsay Company Registered, 273 Bank Street, Ottawa, Canada.

INVENTORS: Learn how to protect your invention. Unless the inventor is familiar with patent matters, he should engage a competent registered patent attorney or agent to represent him. We are registered to practice before the U. S. patent office and prepared to serve you in handling your patent matters. **"Patent Guide for the Inventor"** containing detailed information concerning patent protection and procedure with **"Record of Invention"** form will be forwarded to you upon request, without obligation. Clarence A. O'Brien & Harvey Jacobson, Registered Patent Attorneys, 91B-A District National Building, Washington, D. C.

INVENTORS—Take these preliminary steps toward patent protection. Sketch and describe your invention. Sign, date and have this disclosure witnessed by two people who understand your invention. Have us make a preliminary search among U.S. patents already granted for similar types of invention. We report on the probable patentability of your invention and recommend your further course of action. Write for our instructive booklet, **"Patent Protection for Inventors"** and convenient **"Evidence of Invention"** disclosure form. Victor J. Evans & Co., 531-B Merlin Building, Washington 6, D. C.

INVENTORS—If you believe you have an invention, you should find out how to protect it. The firm of McMorro, Berman & Davidson with offices in Washington, D. C., is qualified to take the necessary steps for you. Send for copy of our patent booklet **"How to Protect Your Invention."** We will also send you an **"Invention Record"** form. No obligation. They are yours for the asking. McMorro, Berman & Davidson, Registered Patent Attorneys, 1349 Victor Building, Washington 1, D. C.

FOR INVENTORS

MODELS Will sell your invention. Henry Herman, 350 Hewes, Brooklyn 11, N. Y.

INVENTIONS Wanted now by my manufacturer-clients. Patented, unpatented. Write Gilbert Adams, Patent Broker, 80-A Wall Street, Financial District, New York City.

FREE—Vital information every inventor needs before selling invention. Brown, 141-A Broadway, New York City.

"INVENTOR'S Guide" sent free. Frank P. Ledermann, 154 Nassau Street, New York 38, N. Y.

PATENT Searches, including copies of nearest patents, \$8.00. Reports airmailed within 48 hours. More than 100 registered patent attorneys use my service. For free invention protection forms, write Miss Ann Hastings, P.O. Box 178, Washington 4, D. C.

WE Have the markets if you have the ideas. Harvey Engineers, Cambridge 1, Maryland.

INVENTION Record form free and "Patent Information Every Inventor Should Have." Carl Miller, Registered Patent Attorney, Woolworth Building, New York.

INVENTORS, Don't sell your invention patented or unpatented until you receive our offer. Write Cowgill, Box 298, Marion, Ohio.

PATENT Searches \$6.00. 48-hour service. Free invention protection forms. Write Raymond L. Smith, Patent Searcher, 620 Sheraton Building, Washington 5, D. C.

INVENTORS: Information on patent procedure furnished on request, without obligation. John Randolph, Registered Patent Attorney, 802 Victor Bldg., Washington 1, D. C.

INVENTORS: Test the commercial value of your patented or unpatented inventions, quickly and inexpensively. Write for free information. Institute of American Inventors, Dept. 40-B, 635-F St., N.W., Washington 4, D. C.

PATENT Searches \$6.00. 48-hour airmail service. Invention protection forms free. Write Patent Engineering Service, 711 14th Street N.W., Washington 5, D. C.

INVENTORS—This firm is registered to practice before the United States Patent Office and available to assist you in the preparation and prosecution of your patent application. "Patent Protection for Inventors" booklet containing detailed information and steps to take toward patent protection sent promptly upon request. No obligation. Victor J. Evans & Co., 532-B Merline Building, Washington 6, D. C.

INVENTORS! Have your good patentable ideas? Write Mr. Metzler, 11 West 42nd, New York City.

INVENTORS—If you believe you have an invention, you should find out how to protect it. The firm of McMorror, Berman & Davidson with offices in Washington, D. C., is qualified to take the necessary steps for you. Send for copy of our patent booklet "How to Protect Your Invention." We will also send you an "Invention Record" form. No obligation. They are yours for the asking. McMorror, Berman & Davidson, Registered Patent Attorneys, 1348 Victor Building, Washington 1, D. C.

SAVE High fees! Apply for a patent yourself. New do-it-yourself kit now makes it easy. Free "registration form." Miss Claire Arden, 806 Wm. Penn Annex, Philadelphia 5, Penna.

"**FORTUNES** In Unpatented Ideas!" An authentic guide for turning your big ideas into big money. Only \$1.00. Traphagen, 624 N. Ashland, Chicago 22, Ill.

INVENTORS—Would be patentee. Don't spend a red cent on invention business until you have my bulletin No. One. My forty years of experience will save you hundreds of dollars and much wasted time. Price \$2.00. R. G. Evans, P.O. Box 1654, Detroit 31, Mich.

INVENTORS—Where to offer your invention. Particulars from Location Service Bureau, Box A37, Almond, Wis.

INVENTORS: Learn how to protect your invention. Unless the inventor is familiar with patent matters, he should engage a competent registered patent attorney or agent to represent him. We are registered to practice before the U. S. patent office and prepared to serve you in handling your patent matters. "Patent Guide for the Inventor" containing detailed information concerning patent protection and procedure with "Record of Invention" form will be forwarded to you upon request—without obligation. Clarence A. O'Brien & Harvey Jacobson, Registered Patent Attorneys, 91A-A District National Building, Washington, D. C.

FREE Invention protection form, sales assistance. Inventors Engineering Bureau, Box 4973, Washington 8, D. C.

INVENTORS—Send for free Patent Information book and Inventor's Record. Registered Patent Attorney, Associate Examiner, Patent Office 1922-29, Patent Attorney & Advisor, Navy Department 1930-47, Gustave Miller, 29A Warner Building, Washington 4, D. C.

INVENTIONS Pay inventors when profitable sales are certain from constructions soundly patented, and wise steps taken to reach the best markets. I help inventors to make the most profit with low definite fees for all services. Searches \$15. 30 years experience as patent-development engineer, U. S. and foreign patents secured. Joseph O'Brien, 132 Nassau Street, New York 38, N. Y.

INVENTIONS WANTED

INVENTORS: If you have an invention for sale, patented or unpatented, write for free brochure outlining manufacturers' requirements, royalty rates. Kessler Corporation, 52-IW, Fremont, Ohio.

RICHES! From ideas never patented! Authentic guide, \$1.00. Traphagen, 624 N. Ashland, Chicago 22, Ill.

SEEKING Inventions and ideas. We finance, patent, market, manufacture. Any and all inventions and ideas welcomed. Patented and patent pending items may be sent for approval. All others write for appointment giving brief resume of items and ideas. All information treated confidentially. Addison Mfg. Co., 3550 N. Spaulding, Chicago, Illinois.

\$20,000 FOR Inventions, ideas, any kind. Send \$3.00 for document. 150 needed. Legal form \$2.00. Our brokerage fee \$10.00. Researchers, 210 5th Ave., New York 10, N. Y.

INVENTORS—Turn your talents into immediate cash! Join Inventors of America. Write National Headquarters, 3136-A Sylvia Avenue, Toledo 13, Ohio.

INVENTORS. Don't sell your invention patented or unpatented until you receive our offer. Write Cowgill, Box 298, Marion, Ohio.

INVENTORS: Hundreds of manufacturers have requested our assistance in locating marketable new products. Complete information free. Institute of American Inventors, Dept. 40-D, 635-F St. N.W., Washington 4, D. C.

INVENTIONS Wanted. Patented; unpatented. Tremendous manufacturers lists. Global Marketing Service, 2420 77th, Oakland 5, California.

INVENTIONS Wanted: Patented, patent pending. 28 years experience promoting inventions. National Service Bureau, 3120 Meramec, St. Louis 18, Mo.

INVENTORS: Have you tried to sell your invention without success? Contact us, we succeed where others fail. Chapman, 5250 W. Montrose Ave., Chicago 41, Ill.

INVENTIONS Wanted for manufacturers. Free details. Write: Allen, 712 Davis Bldg., Dallas 2, Tex., Dept. B.

FREE Vital information every inventor needs before selling invention. Brown, 141-A Broadway, New York City.

INVENTIONS Bought and sold. Write: Your I.D.E.A., Incorporated, Box 8627, Oklahoma City, Oklahoma. Bonded and licensed.

ARE You interested in offers from reliable manufacturers for your invention? Patented, unpatented. Harvey Engineers, Cambridge, Maryland.

INVENTIONS Wanted now by my manufacturer-clients. Patented, unpatented. Write Gilbert Adams, Patent Broker, 80-S Wall Street, Financial District, New York City.

PATENTS FOR SALE

PLASTIC Novelty. Sell millions, simple to manufacture. P.O. Box 147, Apache Jct., Arizona.

MANUFACTURING

MODELS—Small lot manufacturing. Metals, plastics, etc. Milburn, Burlington, Kentucky.

DESIGNING, Tools, dies, models, manufacturing. Bald Knob Products, 1640 Lionel, Cincinnati 14, Ohio.

CUSTOM Models, parts, tools, instruments. Henry Herman, 350 Hewes, Brooklyn 11, N. Y.

MODELS, MODEL SUPPLIES

MINIATURE Screws instrument and model maker's small precision tools. Brockton Jewelers' Supply, Box 695, Brockton, Massachusetts. Literature available.

ROCKETS: Six different complete plans. Hold altitude records. Instrumented. \$1.00. Rocketry, Spencer, Iowa.

POWER Models. Unusual steam, gasoline and traction engines, fittings, metals. Model engineer taps and dies. Comprehensive catalog \$1.00. Chas. Cole, Ventura, Calif.

ROCKETS! Five new plans including fuel formulae. 1. Two stage, 4.5 mile altitude. 2. Parachute return, 21" length. 3. Electrical ignition, 1.5 mile altitude. 4. 1,600' altitude. Less than \$1.00 builds it. 5. Fiber tube construction, experimental design. Any two, \$1.00. All five \$2.40. J. Krohn, Carleton College, Northfield, Minn.

SHIP Models and yacht supplies complete. Large 68 page catalogue 50¢. Bill Wild's, 510 East 11 St., New York City 9.

SCALE Model materials for building model homes and architectural buildings of any type, 1/4" and 1/8" scale. Send 25¢ for catalog. A & B Model Builders, 454-P Donovan Road, Kansas City, Kansas.

MINIATURE Engines, gas and steam. Build them on your metal lathe using our castings, blueprints. Also available, machined steam engine kits ready to assemble. Illustrated catalogue 15¢. Octura Models, Box 536-PM, Park Ridge, Illinois.

SHIP And yacht model fittings; blueprints. Send 35¢ for illustrated catalog listing hundreds of items. A. J. Fisher, 1002-1 Etowah Ave., Royal Oak, Mich.

BALSA Wood and model aircraft. 40-page catalog 25¢. Sig Co., Montezuma, Iowa.

ROCKET Supplies. Nozzles, nose cone, tubes, fuse. Send 10¢ for catalog to Alana Manufacturing Company, Mineral Point, Penna.

SHIP Model kits and fittings: Fishermen, clippers, frigates, schooners, brigs, tugboats. Also half-hull models for interior decoration. Send 25¢ for 1959 catalog and booklist. Model Shipways, Box 85, Bogota, N. J.

SHIP Models. Most complete line in New England, kits, fittings, plans, books, tools, engines, motors. Illustrated catalog 35¢. James Bliss & Co., Inc., Dept. SM, 342 Atlantic Ave., Boston 10, Mass.

ROCKET Plans, photographically illustrated directions sent with new supply catalog 25¢ (refundable). Central Rocket Company, Waupaca, Wisconsin.

HOME CRAFTSMEN

KNOCKDOWN Cedar chests, also over fifty kits. Catalog 25¢. Gilles Kendall Co., Huntsville 2, Alabama.

BUY Picture frame moldings at wholesale, actually less than cost of raw lumber. All styles and widths. Free delivery. Write for price list. Chesapeake Picture Frame Co., Box 533, Baltimore 3, Maryland.

FREE! Leathercraft catalog. Hundreds of new items. Write MacPherson Bros. Leather Company, Dept. E, 730 Mission St., San Francisco 3, Calif.

FREE "Do-it-yourself" leathercraft catalog. Tandy Leather Company, Box 791-Y28, Fort Worth, Texas.

FREE Seashells catalog. Instruction book 35¢. Secor's, Bradenton, Florida W.

WOODWORKING And cabinetmaking course for beginning and advanced home craftsmen. Only complete low-cost home training program available. Write for free booklet. Interstate Training Service, Dept. G-3, Portland 13, Ore.

2430 ARTIST-Drawn patterns, new catalog 10¢. Craftplans, 1322-A Wabash, Chicago 5.

REMODEL Your own home. Save hundreds of dollars. New, amazing book shows you how. Written so you can understand it. Step by step instructions make it easy. Fully illustrated, 400 photographs, hundreds of diagrams, 160 pages. \$3.50. Literature 10¢. Popular Mechanics Press, 200-RH East Ontario St., Chicago 11, Ill.

LEARN Art metalcraft and jewelry making. Complete, inexpensive, home training course now available. Special tools and materials furnished. Write for free booklet. Interstate Training Service, Dept. L-3, Portland 13, Oregon.

FREE Leathercraft catalog. Quality kits, leathers, tools. Handcrafters, Box 427, Montrose, California.

STYLECRAFT "Pretraced" leather kits. Handbags, billfolds, filigree belts. Patterns on leather. Just carve, assemble and lace. "Pre-carved" kits also available. Send 25¢ for catalog, free folder. Refunded first order. Apache Leather Company, 2804 E. Washington St., Phoenix, Arizona.

OREGON Myrtlewood. A rare beautiful wood for the lathe. Ken Dorman, Oakland, Oregon.

BUILD Your own 6x48 belt sander, bench-type, with end and side fence. Unfinished stock available. Plans \$1.00. O. Gipple, 121 School St., Buffalo 13, N. Y.

NEW Big illustrated catalog. Supplies for leathercraft, metalcraft and numerous small inexpensive crafts. Prompt shipments. Top values. Latest ideas. Send 10¢ today to J. C. Larson Co., Dept. 8427, 820 S. Tripp, Chicago 24.

GET Acquainted offer. Limited time. One square free when you order two. Free list hardwoods. Midland Lumber Co., P.O. Box 262, Savannah, Missouri.

LEATHERCRAFT. Send 10¢ for new 102-page catalog of tools, supplies, kits, including metalcrafts, enameling, ceramics, all other crafts. Complete stock. Reasonable. Since 1910. Sax Bros., Dept. PM-2, 1111 N. 3rd, Milwaukee, Wis.

101 PATTERNS Of smart gifts, novelties, shelves, action windmills plus "Make Money Jig Sawing." \$1.00. Mastercraft, 25M, 7041 Olcott, Chicago 31.

TABLE-Top tiles. Catalogue original designs, 10¢. Mary Conger, R. 2, Iola, Kans.

FREE Details. Make "natural wood bricks" with table saw. Holiday House, 7225G, 4th Plain, Vancouver, Washington.

FREE Leathercraft catalog. Quality kits. Warne Leather Company, Montrose, Calif.

DO IT YOURSELF

ELECTRIC Blankets. Make your own. Full kit, instructions. \$3. Wirral Electric, Irby, Wirral, England.

GRANDFATHER Clock movements, barometers, blueprints, kits. Wholesale catalogue 25¢. Mason-Sullivan, Noroton, Conn.

DISCOVER Your kinsfolk in history. Fascinating hobby. Complete directions \$1.25. Alice Worden, Rockport, Mass.

AMAZING Carburetor. 200 miles per gallon. Illustrated patent story how it's done. For fun or profit. Send \$2.00. Scientific Electric, Box 12PM, Wickliffe, Ohio.

FIRE Brings disaster in the night. Build your own home fire alarm systems. Easy, inexpensive. Plans free! A. Levorsen, 5118 So. Asotin St., Tacoma 8, Washington.

WATCHES, OLD GOLD, JEWELRY

DIAMOND Jewelry. Free merchandise. Literature. Aristocrat, 349 Salem, Billerica, Mass.

COSTUME Jewelry supplies, settings, rhinestones, etc. 88 page illustrated catalog. 25¢. Milady, Box 1328, G.P.O., New York City.

FREE Catalog. Costume jewelry parts. Supplies. Reasonable prices. Fast service. Guaranteed quality. Unique merchandise. Folsom's, Box 52, Medford 55, Mass.

HIGHEST Cash for old gold, broken jewelry, gold teeth, watches, diamonds, silverware, spectacles, platinum, mercury. Free information. Rose Refiners, Heyworth Building, Chicago 2.

FACETED Birthstone rings; unbelievably inexpensive! Lapidex, 514 Forest, Collinsville, Illinois.

WATCHBANDS Repaired, lengthened or shortened, \$2.00 per band. Federal Band Co., Box 3244, So. El Monte, California.

WE Pay tremendous prices for cast off, broken jewelry, dental gold, watches, bracelets, etc. Mail yours today. Check mailed out same day received. Satisfaction guaranteed or money back. Roberge Co., 500 Walnut, San Carlos, Calif.

WATCH And clock repairing books. Free catalogue. North American, 2320-AB Milwaukee, Chicago 47, Illinois.

GUARANTEED Watch repair. \$3.95. Automatics \$4.95. Lan's Watch Service, 17 South Center, American Fork, Utah.

HIGHEST Cash paid for old gold, jewelry, gold teeth, diamonds, watches, silver. Mail articles today. Information free. Chicago Gold Refining Co., 6 E. Monroe, Dept. 1158, Chicago 3.

WATCHES Expertly overhauled; guaranteed. Regular watches, including new unbreakable mainspring, \$5.95; automatics \$7.95. Send watch, remittance, insured. Unreparables returned. Edward Ash, 13227 Oxnard, Van Nuys, Calif.

DIAMONDS — Lowest wholesale prices, direct from Belgium's world-leading market. Save up to 43%. Tax free. Lloyds insured. Write airmail for free, illustrated catalog. Royal Diamond Exporters, 103-B Rue Royal, Brussels, Belgium.

TOBACCO, SMOKERS' SUPPLIES

CIGARS 5³/₄" Hand made clear Havana. Box 50, \$6.75 or 5 samples 75¢. Prepaid. Money back guarantee. Jack Catani, 2306 North Habana, Tampa 7, Florida.

FOR THE HOME

FOAM Rubber furniture cushions. Factory seconds. 50% discount. Free catalog. Perma-Foam, 390-C Nye Avenue, Irvington, N. J.

PLAN Family income, expenditures. Best, simplest budget book. \$1.25. Marion, Box 397, Freeport, Illinois.

OF INTEREST TO WOMEN

DRESSES 24¢; Shoes 39¢; men's suits \$4.95; trousers \$1.20. Better used clothing. Free catalog. Transworld, 164-S Christopher, Brooklyn 12, N. Y.

SELL Fine fabrics. Get yours wholesale. Box 863, Norwalk, Conn.

STAMPED Linens for embroidery or painting. Buy direct from manufacturer and save. Send for free catalog. Merribee, 16 West 19th St., Dept. 456, New York 11, N. Y.

60% PROFIT On cosmetics — Famous nationally advertised Hollywood cosmetics pay 60%. Make \$25 day up. Hire others. For free samples, details, write Studio Girl, Glendale, Calif. Dept. 1292G.

COLGATE'S Lustre-Creme shampoo 4 lbs. \$4.85 postpaid. Geller, 2089P Matthews, 62, New York City.

"8 MISTAKES Parents Make." Every parent should have this new book about child training. It is free; no obligation. Simply address Parents Association, Dept. 672, Pleasant Hill, Ohio.

MAKE Money mailing. Details free. PM. 8007 S.E. 65th, Portland 6, Oregon.

PERSONAL

SAVE 50% On vitamins. New, free catalogue lists all brands, formulas, prices. Compare and save. State vitamins now using. Vitamin Specialties, Box 4435-A, Philadelphia 40, Penna.

BIBLE Questions answered. Stamped envelope. Bylon, 17167 Bentler, Detroit 19, Michigan.

BORROW By mail. \$100-\$600. Anywhere. Air mail service. Postal Finance. 200 Keeline Building, Dept. 917B, Omaha 2, Nebraska.

"YOU Can find out!" Confidential information developed, any matter, person, anywhere. Officially licensed. Established 1922. Equitable Service Bureau, 15 Malden Lane, New York City.

LOANS By mail. Borrow \$50 to \$500 for any purpose. Employed men and women over 25, eligible. Confidential, no co-signers. Up to 2 years to repay, low monthly payments. Supervised by State of Nebraska. Loan application sent free in plain envelope. Give occupation. American Loan Plan, City National Bldg., Dept. PM-2, Omaha 2, Nebraska.

CHESS Instruction \$1.00. Grbovic, 245 East 77 Street, New York 21, N. Y.

BORROW \$50 To \$600 by mail. Quick, easy, private. No co-signers. Repay in 24 small monthly payments. For the amount you want write today to Dial Finance Co., 410 Kilpatrick Bldg., Dept. B-1, Omaha 2, Nebr.

100 FOTOSTAMPS \$1.50. Any photo. Personalized stationery, labels. Free samples, information. Variety, Box 864, Brooklyn 1, N. Y.

ARRANGE. Supply anything. Also address for rent. Remails 25¢. Box 395, Times Square, New York City 36.

MEXICO — Vacation, retire, work, invest. Informative publication, send two dollars. Mexico Unlimited. Apartado 19536, Mexico City.

MEXICAN Information. Any subject. Suarez, Box 2104, Mexico City, Mexico.

FLYING Saucers, E.S.P., Psychic conventions. Brotherhood of Faithists, Toronto 17, Canada.

REMAILING SERVICE

LETTERS Retailed 25¢. Monthly \$3.00. Weintraub's, Box 1481, New Orleans 5, Louisiana.

SECRET Mail address, \$3 month. Hedg-peth, Box 830, Alhambra 23, Calif.

HOUSTON Remails 25¢. Monthly \$3.00. Remailing Services, Box 12112, Houston, Texas.

REMAILS 25¢. Monthly \$3. Rex Co., Box 5831, Baltimore 8, Maryland.

RENT A confidential mailing receiving-forwarding address. Agents since 1950. Details free. William McLaughlin, 800 Stewart, Columbus 6, Ohio.

"QUEEN Of the West." San Francisco remails. 25¢. Box 1003, Richmond, Calif.

MAIL Received, forwarded, 25¢ letter, \$3.00 month. Prompt, confidential. Lloyd V. Moffitt, 319 1st Street, West Palm Beach, Florida.

ALASKA Remails 25¢. M. Miller, Box 758, Anchorage, Alaska.

REMAILING 25¢. Receiving, forwarding \$3.00 monthly. Willis, 4729 Ave. N, Birmingham 8, Alabama.

FLORIDA Remails. 25¢. Monthly \$3.00. Art Service, Box 1861, Clearwater, Fla.

MONTERREY, Mexico. \$1.00. Seattle 25¢ Marina, 1740 So. 91st, Seattle 8, Washington.

REMAILING, Receiving, forwarding \$3.00 monthly. Details free. Beasley, 1829-A Claiborne, Richmond 20, Va.

REMAILS 25¢. 5 scenic California cards remailed \$1.00. Mail forwarding \$3.00 mo. John Palmer, 676 39th St., Sacramento 16, Calif.

REMAILS 25¢. Forwarding, \$3.00 month. Sund, 3602 Ferdinand, Tacoma 7, Wash.

118 CITIES. Foreign postcards. Worldwide Remailing, 58 East 11th, Columbus 1, Ohio.

FLORIDA, Miami Beach, Coral Gables confidential. Information, fruit, souvenirs, hotel stationery, etc. 25¢ plus. Driftwood Apts. 74, 820 N.W. 18 Place, Miami, Fla.

LETTERS Retailed 25¢. Miami, Miami Beach, Box 33-632, Miami, Fla.

HAWAII! Confidential receiving-forwarding \$3.00 month. Details free! Fobel, 617-G Kuaaina, Kailua, Hawaii.

MEXICO Address \$1.00. Re-airmails 35¢ postpaid. Apartado 2042, Guadalajara 25, Mexico.

CUBA Reairmails 50¢. Information \$1.00. Frank Pozo, Neptune 632, Havana.

REMAILS. 25¢. Harold Bullis, 7237 N. Canyon Way West, Phoenix, Arizona.

REMAILS 25¢. Receiving, forwarding. Kusz, Box 206, Station B, Hamilton, Ont., Canada.

LETTERS Retailed from Colorado Springs, Colorado. 25¢. Monthly \$3.00. J.A.G., Box 2353.

TREASURE FINDERS

TREASURE! Exciting handbook 25¢. Locators. Howe, 811 Kansas, Atchison, Kansas.

NEW—Extremely light weight economical transistorized metal detectors. Waterproof search head. Kit or assembled models. Geiger counters and mineralights. Free literature. Electronic Applications, Dept. M, P.O. Box 8, Arlington, Virginia.

FIND Buried treasure, gold and silver, with Goldak's sensational 3 1/2 lb. "find-it" locator, only \$64.50. Write for free literature on complete line of mineral, metal locators; Geiger and scintillation counters. Goldak, 1541 W. Glenoaks Blvd., Glendale, Calif.

MAP 445 Treasures, \$1.00. Free catalogue treasure books. Foul Anchor, Rye 2, N. Y.

GOLD-Silver detectors. Geiger counters. Violates for tungsten, etc. Best available. Guaranteed. Information free. Detectron, 5528 Vineland Ave., Dept. 4, North Hollywood, Calif.

TREASURE! Buried coins, gold, silverware, relics. Transistorized M-scope locates them! From \$59.50. Easy terms. Free catalog. Fisher Research, Dept. C-1, Palo Alto, Calif.

FOR SALE—MISCELLANEOUS

HEARING Aid batteries, wholesale. Free list. Habs, Box 51, York, Penna.

GENUINE Leather link belts. Particulars free. Leather, Box 43, Easton, Penna.

LEFT Hand chucks for Kirby vacuum, \$1.95. L. H. drills available, 1023 Broadway, Boise, Idaho.

WANTED—MISCELLANEOUS

SCRAP Mercury (quicksilver) containers supplied—Tantalum, tungsten, silver, platinum. Metallurgical Products Company, Established 1909, 35th & Moore Sts., Philadelphia 45, Penna.

GOLD, Silver, platinum, old jewelry, diamonds, watches, spectacles, wanted. Highest prices paid immediately. Information free. Wilmot's, 1067 W. Bridge, Grand Rapids 4, Michigan.

QUICKSILVER, Platinum, silver, gold. Ores analyzed. Wholesale Terminal, Norwood, Mass.

MISCELLANEOUS

CLOGGED Sewers, drains, cesspools, septic tanks. Free catalog on equipment used by sanitary contractors. Box 224, Allston, Mass.

FREE Vitamin catalogue—Feel more vigorous, younger, better. Potent formulas, quality capsules for better, healthier living. Buy direct, save! Vitacenter, Drawer 2318-P, Detroit 31.

COLLECT Past due accounts. Guaranteed system. Free details. Box 11, Flat River, Mo.

BOOKS On antiques and their prices. Free circular! P. Warman Publishers, Uniontown, Penna.

GOLD Leafing—Decorate the easy modern way. Instructions \$1.00. Superior Products, Silver Creek, N. Y.

WREN House. Long lasting wood and metal, \$1.00, postage paid. Thornton, RR3, Terre Haute, Indiana.

PERFUMES—24 Samples \$1.00. Tax 10¢. Evelyn Martin, Lawson St., Martinsville, Virginia.

SPONSOR Nationally advertised name brands. Your merchandise free. Catalog and trade stamps only 25¢. Miracle Plan Company, 410 S. Williams, Amarillo, Tex.

NAMES, Numbers on reflective sheeting. 3½ cents square inch. Reductions on large signs. Pictorial prices quoted. Gillespie Studios, 515 R.R. Ave., Steubenville, Ohio.

CASH Paid! For unwanted items. Weik's Co., 925 W. Sycamore, Willows, Calif.

"WHO Manufactures It?" We supply lists covering anything. Box 171, Midland, Penna.

RETIRE Now, regardless of age or money. Be secure and content. Enjoy every day. Write for facts. Future Plans, Box 76, Tarzana, Calif.

YOUR Name on giant mailing list. Receive big mail for two years. Send 25 cents to Direct Mail Service Co., P.O. Box 581, Bakersfield, Calif.

FREE Folder gives helpful hints about what to do before, after and during an atomic attack. Write Atomic Aid, 215 West 34th Street, New York City 1.

JAPAN: Buy direct, mail-order, kimono, dolls, etc., 24 page catalogue, manufacturers' addresses, business informations. Send \$1.00. Clarence Yamagata, 202 Naka 7 Bldg., Marunouchi, Tokyo.

70 BIBLE Lessons, 25¢. Bulletin, Box 87, Cathedral Station, New York City 25.

MINERAL Map of Canada. Showing complete mining areas of gold, uranium, silver, copper, etc. Over 1,000,000 sq. miles. Excellent for exploration and reference. Only \$1 to Mineral Club of Canada, S.W. Box 187, Windsor, Ontario.

EXPOSED! "How to Win Prize Contests" \$1. Guaranteed. Erickson, 250-E McLaughlin, Muskegon, Mich.

EXTRAORDINARY Opportunity! Retire now! Lead leisurely life. Remarkable book shows how. Free details. Belmont, Wyckoff 158, New Jersey.

BUY Wholesale: 100,000 nationally advertised products. Appliances, cameras, sporting goods, housewares, watches, typewriters, tools, clothing, etc. Discounts to 80%. Buy-Rite, Box 258, Hawthorne 102, New Jersey.

CIGARETTES—Improved roller makes 20 for 9¢. All types pipe tobaccos. Facts free. Moberly, Box 910, Owensboro, Ky.

RECEIVE Magazine samples, mails, catalogues. Bargains from everywhere. Get listed 25¢. Rorick, Cincinnati 26, Ohio.

100,000 PRODUCTS Wholesale—Free catalog! Send postcard: Econ-O-Mart, Whippany 15, New Jersey.

CESSPOOLS, Septic tanks, clogged drains. How they function and how to keep them working. Free literature. Chemical Cesspool & Drain Cleaning Co., Boston 34, Mass.

YOUR Name wanted. We'll send 1000 publishers, mailers, wholesalers your name, on our list one year 25¢. Dixie Mailers, King, N. C.

HUMOROUS Cards, plenty of laughs, 25¢. Stoddard's, 4164 Byron, Chicago 41.

SUPER Memory overnight! Success guaranteed! Bijou, Box 1727-M, Hollywood 28, California.

HOW To remodel, basement, attic. Booklet or book. Send for 1958 book catalog—10¢. Popular Mechanics Press, 633 N. St. Clair St., Chicago 11.

BRAZILIAN Orchid catalog \$1.00 airmailed. Philodendrum speciosum \$100.00; bipinnatifidum \$50.00; Adamantium \$100, per 10,000 seeds airmailed. Orquideario Catarinense, Corupá, S.C., Brazil.

FREE GIANT NEW CATALOG 1959 B-A



180 KING-SIZED PAGES

EVERYTHING IN RADIO TV AND ELECTRONICS

100'S OF NEW ITEMS LISTED HERE FOR 1st TIME

21 PAGES OF BARGAINS NOT IN ANY OTHER CATALOG

BURSTEIN-APPLEBEE CO.

Dept. PM, 1012 McGee St., Kansas City 6, Mo.

Send Free 1959 B-A Catalog No. 591.

Name.....

Address.....

City..... State.....

SEND FOR IT TODAY

FREE GERMAN HUNTING KNIFE



4-INCH BLADE

We give you handiest hunting and fishing knife you've ever had! Has 4-INCH LONG highly tempered steel blade—VERY SHARP! Attractive handle. We send knife FREE to acquaint you with our below-wholesale bargains. Please send 25c for handling. NO LIMIT—but send 25c handling for each knife. Order TODAY! HUNTING KNIFE, Dept. K-378, Box 881, St. Louis, Mo.

SIGN PAINTING

Home-Study Course — Only \$5.95

Teaches you commercial sign painting and sign building as it is being done TODAY in leading shops all over the country. Complete practical course for self-instruction. Shows latest methods of truck lettering, office doors, wood letters, reflecting signs, plastics, sprayed signs, gold leaf, silk screen process, up-to-date alphabets, money-making business information, etc.

SATISFACTION GUARANTEED OR REFUND! Contains all the instruction of a high-priced correspondence course. Full price, only \$5.95, postpaid. Or C.O.D. plus postage. No risk—order today. Satisfaction or money back! Order "Sign Painting Course," NELSON-HALL CO., 210 S. Clinton St., Dept. 28R-2, Chicago 6, Ill.

Electronic Engineering in Florida

DEGREE IN 24 MONTHS

Electronic engineers are urgently needed in Florida—the nation's electronic and missile center. Train for these top-pay jobs at Massey Tech while you enjoy pleasant living in Florida. Accredited electronic engineering degree in only 24 months. Also, short residence and homestudy courses for electronic, radio and TV technician job training. VA Approved.



Send for fact-packed booklet. Learn how you can qualify for top-pay electronic jobs in Florida.

MASSEY TECHNICAL INSTITUTE Inc
Box 1338, Jacksonville, Florida

A New Pill That Helps You Quit Smoking

Science at Last Tells You What to Do if You Want to Stop Smoking

By George Clark

THE INABILITY to give up smoking is one of the more curious idiosyncrasies of 20th century man. Ever since Sir Francis Drake in 1586 brought tobacco back to England from Virginia and the habit of smoking was reimported to America by the Pilgrim fathers, the "noxious weed," as an eminent Victorian referred to it, has had half the world in its grip.

There are signs that this grip is at last being loosened. It is being loosened by a harmless little white pill. The story of how this little white pill was discovered is a curious one.

In 1947, doctors composing a research team at Chicago's Loyola University, set out to study gingivitis, a rather unpleasant inflammation of the gums that bedevils mankind. It had long been theorized that smoking contributed to this inflammation. But would stopping smoking help? In true scientific fashion our researchers decided that half of their patients should stop smoking to see if they showed any improvement over the other half.

But what could they give a patient that would help him to stop smoking quickly and easily? Up to that time medical experience showed that there was no easy, pleasant way to stop smoking. Years before, some experimental work had been reported with a drug called Lobeline Sulphate. This curbed the desire to smoke; but in doses large enough to be effective, it produced various unpleasant side effects. Here at least was a starting point.

Soon the tail was wagging the dog and the project of finding a way to help people conquer the tobacco habit had become the all-important problem. After months of research and experimentation, our scientists hit upon the solution. The addition of two common antacid ingredients to Lobeline Sulphate accomplished two things. First, any unpleasant side effects were eliminated; secondly, the amount of Lobeline Sulphate necessary to do an effective job was greatly reduced. The



result was a harmless little white pill which, when given to test patients, enabled them to stop smoking in 5 days!

What made it work? Lobeline Sulphate is extracted from the Lobelia plant which is sometimes called "Indian Tobacco." It is a first cousin to nicotine, mimicking its action but without its harmful effects. It works by removing the craving for nicotine in the system and not by making smoking unpleasant or intolerable.

The footnote to this story is an interesting one. It turned out that smoking did irritate the gum tissues. Those gingivitis patients who, with the help of the little pill, stopped smoking, showed a marked improvement over the smoking half.

And of course there was a sequel. The university realized that in this little pill they had something that thousands longed for. Here was something that would really help anybody who wanted to free him or herself from the smoking habit. More research was carried on, more tests were made on hundreds and hundreds of patients. It was proved that 83%, more than 4 out of 5, of all people who wanted to stop smoking, could do so easily and pleasantly in five to seven days with the help of the little pills. Significantly, it was found that those who didn't stop completely had cut down their smoking drastically.

This new discovery was soon reported in medical journals; demand for it came overnight from every corner of the globe. The Campana Company of Batavia, Illinois, was chosen to market these amazing pills. Today you can buy them at any drug store in the United States, under the name of *Bantron*, for only \$1.25 a box. They are also available in Canada. *Bantron* has been proven so safe, it can actually be bought without a doctor's prescription.

Of course, *Bantron* can't do *all* the work for you alone. It will not tie your hands behind your back. But if you really want to stop or cut down smoking, it can be a powerful helper.

As Capt. Roger Don Rae, a senior pilot for TWA, said: "I used to smoke all the time. I just couldn't stop. Then one day I heard about *Bantron*. With the help of *Bantron*, I stopped smoking in a few days. Today I am free of the habit."

Advertisement

Not everyone does as well, but T. N. CODY, who started a business of his own, reports...

For 12 months I've averaged

\$800

per month income

— most of it clear profit for me!

Many men have discovered how to be independent, to be free of layoffs and bosses. C. G. Naples grossed more than \$200 his first week. A father-son combination grossed \$44,000 their second year. H. Lemon says, "I netted \$133 in one 8-hour day."

How much you make depends largely on you. You need no special skill, no large investment. Start part time if you wish.

NO SHOP NECESSARY • Our Electric Deterger shampoos rugs, carpets right on floor—removes dirt and grime and helps to show their natural color and beauty. So efficient and safe it is used by largest railroads and hotels.

This is not a lease proposition. You own the machine, you work when and where you please and all the money you take in is your own. No risk. Machines fully guaranteed.

VON SCHRADER MFG. CO.,

Without obligation send me **FREE** booklet about your RUG DETERGER and tell me how I can start my own permanent, profitable business.

Mail Coupon Today for **FREE** Book

Name _____
Address _____
City _____ Zone _____ State _____



You can make money in

WATCH REPAIR

Learn at home the low cost Sweazey Way

Watch repairing pays up to \$6 an hour, part time watch makers report on survey. Unique and modern Sweazey home study System starts you making repairs right away on Swiss and American watches. Professionally prepared training. No previous experience needed. Special tools provided for practice. Tuition only \$5 a month. Free sample lesson and opportunity book give all facts. Write today. No obligation.

CHICAGO SCHOOL OF WATCHMAKING
2330 N. Milwaukee Ave., Dept. 129, Chicago 47, Illinois

FREE BOOK and SAMPLE LESSON

CHICAGO SCHOOL OF WATCHMAKING
2330 N. Milwaukee Ave., Dept. 129, Chicago 47, Illinois
Please rush **FREE** BOOK and Sample Home Study Lesson.

Name _____ Age _____
Address _____
City _____ Zone _____ State _____

FORD OWNERS

save money!



Make Your Ford Run Better . . . Last Longer . . . and Save Hundreds of Dollars with PM's Completely New **MANUAL FOR FORD OWNERS!**

Get this book, written especially for you, without one penny of risk and get more out of your car. Mail coupon for **MANUAL FOR FORD OWNERS** today. When the book comes, skip through the pages and see how your investment in one of America's most popular automobiles can be even a better investment than you thought. If you don't agree, send the book back and you'll get your money back.

A Popular Mechanics Book Written Just for You

Not a re-hash of service manuals. A complete new Popular Mechanics book written for the Ford owner by an outstanding automotive authority with the full cooperation of Ford engineers and service directors. It will save you money on repairs and service; make your Ford last longer; give you safe, economical and trouble-free motoring. And this is true whether you take your Ford to a regular service station or service it at home.

Prevents Trouble. Cuts Down on Repair Bills

Nothing like this manual anywhere. It covers all phases of operation, service and maintenance. It has entire chapters on the individual parts of your Ford—battery, ignition, starter, generator, regulator, lighting, fuel system, engine, lubrication, gasoline qualities, cooling systems, transmission, differential, rear axle, brakes, wheel alignment, tire care, body maintenance, trouble shooting on the road, etc. It covers your Ford, new and older models, step by step — bumper to bumper — showing you how parts operate; what can go wrong; how repairs and adjustments should be made and how to avoid all types of trouble.

Money Back If Not Satisfied

Mail the coupon today. Send only \$3.95 or you can pay postman. Money back guarantee protects you.

Official, Authoritative, Practical Information

Written by C. E. Packer, formerly service school instructor and auto show lecturer for automobile manufacturers, Member Society of Automotive Engineers, Special Services Editor of Automobile Digest, contributor to leading magazines, author of some of the biggest selling books on Automotive subjects.

All New!

Covers All Models
1950 to 1958

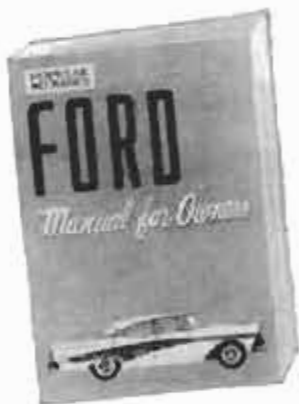

368 Pages. Hundreds of How-To-Do-It Illustrations and Diagrams

The entire book follows Popular Mechanics famous easy-to-read and easy-to-understand style. While primarily intended for the Ford owner, to help him get more out of his car at lower cost, it can be worth its weight in gold to the auto mechanic and service station operator who works, not only on Fords, but on all other makes as well, to which the information in the book can be easily applied.

Order on this Coupon

POPULAR MECHANICS PRESS, Dept. 259
200 E. Ontario St., Chicago 11, Ill.

Send Manual for Ford Owners at once. If not satisfactory I will return it within 7 days and you will refund full purchase price.

Remittance for \$3.95 enclosed. Send C.O.D.

Name _____
Address _____
City _____ State _____



YOUR GIFT TO EASTER SEALS

assures continued
skilled service
to all the crippled

National Society
for Crippled Children
and Adults
2023 W. Ogden Ave.
Chicago 12, Ill.

**SPILL MONEY
out of YOUR
MAIL-BOX!**

NEW! IMPORT-MAIL ORDER
PROFITABILITY—START AT HOME—SELL RARE
EXOTIC IMPORTS by MAIL ORDER Exclu-
sively! No experience required, no face to
face selling. We want a limited number of
ambitious men and women to participate at home in a new, exclusive
IMPORT MAIL ORDER Business proposition. We do all IMPORTING, furnish
expensive literature, names, addresses, and fill orders for you. All you do
is mail for us and receive money coming direct to your own mail box. Hurry
for Big Profits. MAIL ORDER DISTRIBUTORS (Import-Franchise Division)

15201 South Broadway, Dept. 2-2, Los Angeles 61, Calif.

LOW COST *RUPTURE HELP

"Cushion of Air" Appliance has helped mil-
lions of *reducible ruptured forget their rup-
ture worries! Guaranteed to bring you heav-
enly comfort, security or it costs you nothing!
Low-cost; light. Fascinating "Cushion" facts
free. Write now!



BROOKS CO., 143-B STATE ST., MARSHALL, MICH.

CONCRETE BIRD BATHS AND OVER 250 OTHER MONEY MAKING ITEMS



You've seen them all over the country... concrete bird baths,
garden seats, flower boxes, appealing statuary, and many other
items that add charm around the house and lawn. They're made
by enterprising people, just like you, from our
COPYRIGHTED ALUMINUM MOLDS.
It's easy. It's fun. It's profitable.

Send \$2.00 today for this 82-page
"How to" book. 20 pages of clear
instructions. Valuable trade secrets.
Over 250 items beautifully pictured
(with description, dimensions, and
prices of molds). Rushed to you by first
class mail.

CONCRETE MACHINERY CO. INC.
HICKORY 1, NORTH CAROLINA

Name _____

Address _____

**HOW TO
TURN
CONCRETE
INTO
GOLD**

EARN MORE - LEARN AUTO DIESEL MECHANICS

OR TRAIN WITH OTHER GREER DIPLOMA COURSES

- | | |
|--|---|
| <input type="checkbox"/> AUTO MECHANICS | <input type="checkbox"/> REFRIGERATION |
| <input type="checkbox"/> DIESEL MECHANICS | <input type="checkbox"/> AIR CONDITIONING |
| <input type="checkbox"/> BODY & FENDER REPAIR | <input type="checkbox"/> MACHINIST TRADE |
| <input type="checkbox"/> GAS-ARC WELDING | <input type="checkbox"/> ADVANCED MACHINIST |
| <input type="checkbox"/> PIANO TUNING & REPAIR | |

Skilled men are needed in every part of the country. Earn
top pay in established shops or start your own business.
Greer's expert instruction and actual shop training teaches
you how. You learn by doing—quick, easy courses using
the latest tools and equipment. Day, evening and part
time instructions available.

Job placement and convenient living accommodations are
yours while training. Contact GREER'S FREE JOB PLACE-
MENT SERVICE when you enroll if you wish part time
or full time employment.

ENGINEERING DEGREE COURSES

- | |
|--|
| <input type="checkbox"/> DIESEL AUTOMOTIVE ENGINEERING 27 MOS. |
| <input type="checkbox"/> REFRIGERATION & AIR COND. ENGINEERING 18 MOS. |
| <input type="checkbox"/> WELDING ENGINEERING 18 MOS. |

All Courses Approved Civ. or G.I.

Please rush me free literature on the trade indicated
at no obligation.

NAME _____ AGE _____

STREET _____

TOWN _____ ZONE _____ STATE _____

Established 1902

**GREER SHOP
TRAINING**
2236 S. Michigan Ave.
Chicago 16, Illinois



can open the door
to a **BETTER JOB** at
BIGGER PAY for YOU

TODAY, CHOOSE YOUR CAREER! Then take the first
easy step toward preparing for the goal you can reach
in spare time at home. Or, if you are in work you like,
learn how you can earn quicker promotions and bigger pay.
For 62 years AMERICAN SCHOOL has helped many thou-
sands of ambitious people succeed. Think seriously
about the subjects listed. Fill in and mail coupon today.

AMERICAN SCHOOL, Dept. G245, Drexel at 58th, Chicago 37, Ill.

Without obligation, send FREE information on the subjects I have checked.

- | | | |
|--|---|---|
| <input type="checkbox"/> Accounting | <input type="checkbox"/> Contracting | <input type="checkbox"/> Mechanical Engineering |
| <input type="checkbox"/> Apprenticeship Courses | <input type="checkbox"/> Diesel Technician | <input type="checkbox"/> Mechanical Technology |
| <input type="checkbox"/> Architecture & Building | <input type="checkbox"/> Drafting—Building Trades | <input type="checkbox"/> Metalworking Courses |
| <input type="checkbox"/> Automotive Technician | <input type="checkbox"/> Drafting—Machine Trades | <input type="checkbox"/> Plumbing—Practical |
| <input type="checkbox"/> Better Foremanship | <input type="checkbox"/> Electrical Engineering | <input type="checkbox"/> Private Secretary |
| <input type="checkbox"/> Blueprint Reading | <input type="checkbox"/> Electricity—Practical | <input type="checkbox"/> Retail Merchandising |
| <input type="checkbox"/> Bookkeeping | <input type="checkbox"/> Electronics—Industrial | <input type="checkbox"/> Salesmanship—Outside |
| <input type="checkbox"/> Business Management | <input type="checkbox"/> HIGH SCHOOL COURSES | <input type="checkbox"/> Sheet Metal Work |
| <input type="checkbox"/> Civil Engineering | <input type="checkbox"/> Machinists | <input type="checkbox"/> Tool Making |

NAME _____ OCCUPATION _____
HOME ADDRESS _____ AGE _____
CITY _____ STATE _____

Accredited Member NATIONAL HOME STUDY COUNCIL



**MEN! Make up to
\$1,000⁰⁰
IN A MONTH!**

without "SELLING"

Sensational Demand for Low-Priced Fire Alarm PLUS Sure-Fire "No-Selling" Plan Offers Ambitious Men Huge Profit Opportunities

AMAZING NEW INVENTION



Even beginners who never sold anything in their lives are cleaning up unbelievable profits with the first practical effective, low priced Fire Alarm ever invented . . . needed, wanted in homes, factories, offices, stores, on farms, for boats, everywhere. Professional salesmen are making biggest profits in years! Later in this ad I'll tell you about the plan that's producing orders for 1 to 12 Fire Alarms per sale from 8 out of 10 prospects . . . without selling. Here are the facts about the Fire Alarm. It hangs on the wall like a picture—no wiring, no installation. It's always on guard . . . It "smells" a fire before danger point. When temperature rises, Fire Alarm goes off automatically, howls loud warning that can be heard 1/5 mile, wakes up soundest sleeper, give precious time to put out fire, call fire department, or escape. And it sells for only \$4.95 with profit up to \$2.70 on each one.

Nearest Thing to AUTOMATION SELLING

With our field-tested plan customers sell themselves. No cold canvassing. No hard selling. It's the nearest thing to "Automation Selling." Imagine a sales plan even a child can use successfully because the sales tools we give you (and which you leave with your prospects) do all your selling even while you sleep! No room here to give you all the details but if you want big money fast rush the coupon now.



Make This Lighted-Match Demonstration

Sensitive! Lighted match triggers Alarms in 3 seconds.

Free Sales Kit

Send no money. Just rush coupon below for all the exciting moneymaking facts, complete Illustrated Sales Kit, everything you need to make money your first day. Learn how selling only 20 Fire Alarms a day pays you \$1,080.00 profit in a month. No competition anywhere. Get in on the ground floor now. Rush this coupon.

Made \$26.52 in 3 Hours! "Received first shipment about noon. Worked 3 hours and made \$26.52 profit. It's a terrific seller!" —Stanley



MERLITE INDUSTRIES, Inc.

(ALARM DIVISION)

114 E. 32nd St., Dept. F-15U New York 16, N. Y.

ALVIN WESLEY, Sales Manager
Merlite Industries, Inc. (Alarm Division)
114 E. 32nd St., Dept. F-15U, New York 16, N. Y.

Rush FREE SALES KIT and full details about your "No-Selling" plan which gives me opportunity to make up to \$1,000.00 in a month without cold canvassing and hard selling—automatically. I am not obligated.

Name _____
Address _____
City _____ Zone _____ State _____
In Canada: Mopa Co., Ltd., 371 Dowd St., Montreal 1, P.Q.

WHERE-TO-BUY-IT INDEX

AUTOMOTIVE

TV protects drivers at rail crossing 96
Station wagon seats fold into the floor112
Flashing signal light guides car in garage (Ease-In, P.O. Box 32, Northville, Mich.) 131
Rubber stop on floor prevents garage damage (Vi-Jo Sales Co., P.O. Box 387, Geneva, Ill.)148
Build-it-yourself auto travels nearly 100 miles to the gallon (York Nobel Industries Ltd., 33 Park Lane, London W.1, England)149
Miniature electric motors develop high speed155
What? Ride a bicycle when he can drive an automobile? (Master Enterprises, Inc., Eau Claire, Mich.)258
Electronic alarm buzzer warns driver that level of gasoline is low (Selectronic Sales, Inc., 2421 Westchester Ave., New York City 61)258

AVIATION

Army's VTOL craft changes flight direction by rotating ducts. 97
Cargo plane opens wide to swallow destroyer's propeller shaft.101
VTOL jet soars 30 feet in first free flight101
Army's aerial "Jeep" leaves ground vertically and flies forward (Piasecki Aircraft Corp., Island Rd., International Airport, Philadelphia 42, Pa.)104
Two story muffler "tunes" jet noise from loud roar to low moan113
Pilotless drone may carry TV to spy on enemy troops117
Radar for British jet fighter fits inside air intake138
"Helicopter plane" has wing louvers139
Hiller's light helicopter is highest-powered in its class (Hiller Aircraft Corp., Palo Alto, Calif.)149
Copter can carry heavy pylon156
Pine trees mark runways and aid maintenance men250

CONSTRUCTION

Ventilator for concrete-block walls (Vent-A-Wall, Inc., 429 N.W. 1st Ave., Fort Lauderdale, Fla.) 96
Huge swamp buggy carries drilling rig through Everglades ..105
"Blind" divers bore holes in bedrock with conventional drill.106
Improvised "train" hauls pipe sections on trestle above marshes120
Fitted roof sections in prefab panel package (Pulfab, Inc., 1525 Whipple Rd, S.W., Canton, Ohio)126
Foamed aluminum handles like wood (Foamalum Corp., P.O. Box 445, La Salle, Ill.)148

MISCELLANEOUS

Rubberized-fabric tanks are Marines' portable filling stations. 97
Backyard roller coaster102
Platform on motor scooter converts it for first-aid service (Lofstrand Co., Rockville, Md.)105
Camera-shaped microscope magnifies 1000 times (Nippon Kogaku, c/o N. Sakata, 12 Fujimicho 2-Chrome Chiyodaku, Tokyo, Japan)112
Eyeglass frames molded to fit area behind the ears112
Versatile stapler clips to pocket (Bostitch, 815 Briggs Dr., East Greenwich, R.I.)116
Projector has built-in movie screen (Triangle Projectors, Inc., 3706 Oakton St., Skokie, Ill.)117
Revolving brush on tractor sweeps away snow (Gravelly Tractors, Inc., Dunbar, Va.)127
Embosses labels plastic or metal tags (Roovers-Latch Corp., 3611 14th Ave., Brooklyn, N.Y.)131
Locomotive tipped over to instruct crew138
German microprojector permits group viewing and accurate tracing (Siegfried Unutzka, Hamburg 1, Postfach 873)145
Closed-circuit TV patrols stream155
Fish prefer blue or green lights250
Dome-shaped telephone booth256
Plastic tube on tray makes photoprint washer (Spiratone, Inc., 135-06 Northern Blvd., Flushing 54, N. Y.)256

ROCKETS AND MISSILES

Jupiter missile shelter opens like flower petals 87
Torch heats to 30,000 F. for melting hardest materials 88
Missile carries supplies to front-line troops120
Simulator determines whether missile can survive atmosphere re-entry125
Rocket gliders could circle globe148
Portable missile uses solid fuel155

(Continued to page 76)

The skilled hand of the German gunsmith is responsible for this .22 caliber, 6-shot repeater automatic with self-ejecting clip. Just 4" long, fits easily into pocket or purse. Ideal for sporting events, stage use.



(Not available to California residents)
Comes for \$6.95 ppd. from
BEST VALUES
Dept. G-75, 403 Market, Newark, New Jersey

I'll show YOU... how to
Draw CARTOONS

Learn in one day even if you have no previous training or art ability!



YOURS FREE!

SEND FOR FREE BOOK
"CARTOONING FOR PROFIT"

CONTINENTAL SCHOOLS, INC. Dept. A-2, 4201 South Broadway Los Angeles 37, California

WAR SURPLUS GADGETEERS — ENGINEERS — R&D LABS.

30 Pages of U. S. Govt. surplus Radio, Radar, Aerial Photo, Electronic Test eqpt., Microphones, Head sets, Armament, Instruments. PAGE AFTER PAGE OF FANTASTIC SAVINGS.

SEMLER INDUSTRIES, INC. 25¢
6019 LANKERSHIM BLVD. NORTH HOLLYWOOD, CALIF. Send Today



GET THE HABIT OF READING

OUR CLASSIFIED ADS.

Wonderful Opportunities Amazing Bargains



SUPER JU JITSU

Now get tough double quick!

A course of instruction in the art of practicing and using this method of applying LIGHTNING-QUICK Super Ju Jitsu. Be Dangerous! These amazing lessons show you how it's done... in a big illustrated home-study course. The weapons are just your BARE HANDS—they can be used effectively if you know how and practice the art. Easy to learn; quick. Full 76-lesson course only \$5.95 postpaid—or COD, plus postage. Satisfaction or your money back guaranteed! Order "super Ju Jitsu Course."

NELSON-HALL CO., 210 S. Clinton, Dept. 88R-2, Chicago 6, Ill.

Be a **LOCKSMITH** Your Own Business?



You can quickly step into a well-paid job or start a big-profit business of your own. Shortage of locksmiths means opportunities everywhere, spare-time or full-time.

EARN EXTRA MONEY FROM THE START!
All Special Tools, Supplies Furnished Free. Age, education, minor physical handicaps don't matter in this growing, steady-income trade. You learn fast at home—gain practical experience through well-illustrated lessons. You do real jobs under the personal guidance of experts. Only school of its kind. Licensed State of N. J.; Accredited Nat'l. Home Study Council.
For a future as your own boss, or in a big pay job, send for FREE illustrated book. Mail coupon at once. No salesman will call. Approved for Veterans Locksmithing Institute Dept. 102-9, 150 Park Ave., E. Rutherford, N. J.

Locksmith Inst., Dept. 102-9, 150 Park Ave., E. Rutherford, N. J.
Please send FREE and without obligation illustrated book.
Name _____
Address _____
City _____ Zone _____ State _____

IMPORT PAYS BIG!



B. L. MELLINGER
Exporter-Importer

NEW WORLD TRADE BOOM OFFERS BIG PROFIT OPPORTUNITY to ambitious Men and Women everywhere. I'll show you how you may Import Thousands of desirable products at low foreign prices for buyers in your locality at high U.S. Prices—how you can operate a world-wide mail-order Import-Export business from home whether you live in a big city, or small town.

B. L. Mellinger



HERE'S PROOF!

As startling first-hand proof I will send you an actual import from overseas, AT MY COST—something to see and use. Just mail me 25¢ in coin and I will rush you this Imported Melson Automatic cigarette lighter—made to retail in the U.S. at \$2. This magnificent Import will convince you of the tremendous profits being made in World Trade.

START AT ONCE WITHOUT CAPITAL or previous experience. Fantastic profits are possible. My training also includes shipment to you of many sample imports from 'round the world.

GRASP THIS OPPORTUNITY TODAY! Send for your Melson Automatic cigarette lighter now and I will include full details that show you how to learn my Big Profit secrets of Import-Export—complete instructions that will put you on the road to a Profitable business of your own. Opportunity to travel abroad for profit and pleasure. I'll also show you how you can save many dollars on your own purchases of Clothes, Tools, Gems, Antiques, Watches, Cameras, China, Silks, Toys, etc. You can have the complete details FREE without ordering the lighter if you wish, but I would like to send you the Melson lighter as an actual demonstration of Import Values. Either way, mail coupon Now. Airmail reaches me overnight.
The Mellinger Co., Dept. X252, 1717 Westwood, Los Angeles, 24, Calif.

HERE'S MORE PROOF!

"We operate a profitable World Trade Business from our home... Thanks to MELLINGER."



Don and Muriel Bowman, Calif.

MAIL COUPON NOW!

The Mellinger Co., Dept. X252
1717 Westwood, Los Angeles 24, Calif.

Mr. Mellinger: Show me the big profits to be made through World Trade. I enclose 25¢ in coin. Send me one Melson Cigarette Lighter and your plan that shows me how to learn the secrets of World Trade. [No lighter without a coupon. Only one to a person.]
 Just send your FREE World Trade Plan.
Name _____ Age _____
Street _____
Town _____ Zone _____ State _____

DON'T PAY FOR THESE GREAT SHOES

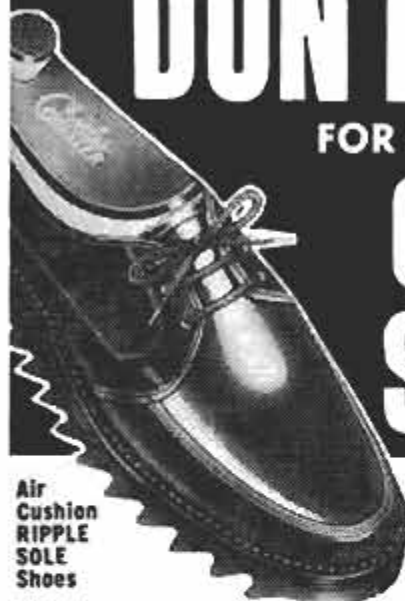

Air
Cushion
RIPPLE
SOLE
Shoes

GET THEM
WITHOUT COST
AS A REWARD
— PLUS —

THE CHANCE TO "BE BOSS" OF YOUR OWN \$10,000 A YEAR SHOE BUSINESS! Sell friends Work, Dress, Casual Shoes and Boots in spare time. No investment, no overhead, no stock to carry. Simple 2-finger demonstration of patented AIR CUSHION comfort makes shoe selling a snap! Actual shoe samples supplied.



Soft,
Light,
Double
Air Cush-
ioned
Storm
Seal'd
Boot

WE BACK YOU WITH OVER
A QUARTER MILLION
PAIRS IN STOCK!

Show America's greatest values in Guaranteed Comfort footwear for men, women and children. Over 180 styles. Sizes 4 to 18, widths AAAA to EEEE. Sell full time if you wish, or spare time if now employed. Develop an extra income for life! Advance Commissions to \$5.00 a pair, plus big Bonus and "Vacation Checks." Get your own shoes as "extras" at no cost!

"TRADE-IN SALE OF OLD SHOES" SELLS NEW SHOES FOR YOU! Only Charles Chester offers your customers cash for old worn-out shoes! Helps you get profitable orders faster! No pick-up or delivery on your part. We donate serviceable old shoes to worthy charities.

SEND FOR NEW SELLING OUTFIT! Write NOW if you want the security and big steady income of a business of your own. You can't lose—so act today! CHARLES CHESTER SHOE CO. Dept. B-593, Brockton 64, Mass.

Exclusive! Leather Soles GUARANTEED to give twice the wear!

MAIL COUPON RIGHT THIS MINUTE!

CHARLES CHESTER SHOE CO.
Dept. B-593, Brockton 64, Mass.

I want to make spare time money. Send all equipment I need—without obligation—and tell me how I can get my own shoes without cost.

Name _____

Address _____

City _____ Zone _____ State _____

(Continued from page 74)

SCIENCE

Portable radar unit tested by Signal Corps	101
This kitchen sink cleans dishes with high-frequency sound waves (Westinghouse Electric Corp., Pittsburgh, Pa.)	104
Chemical reaction makes electricity	127
Furnace of 180 mirrors simulates nuclear heat	127
Lunar power station	131
Lineup of 32 dish antennas will study sun and stars	156

SPORTS

Electronic starting system thwarts jumping of gun	113
Sonar for small boats helps locate fish (Lowrance Sales Co., 114½ E. 13th St., Joplin, Mo.)	116
Bowling bag has shoe shelf (Advance Golf Bag Co., 627 W. Lake St., Chicago 6)	116
Sled delivers ice troll line (E. N. Skillman Co., 316 E. Kansas City, Rapid City, S. D.)	125
"Repeating" bow (Wyly Sports Products, 6405 Livernois, Troy, Mich.)	145

WHAT'S NEW FOR YOUR HOME

Cabinet drawers that deliver the goods	118
Buffing machine weighs only 40 ounces	118
Ribbed plastic sheeting	118
Game table on wheels	118
Shoe polisher	119
Pull-out oven	119
Canned food rack	119
Disposer cleaner	119
Vanishing clothesline	119

Radio-Television, Electronics

Transistorized car radio doubles as portable	157
--	-----

Craftsman and Shop Notes Index

AUTOMOTIVE

Strip map easier to handle	165
Installing battery correctly	168
Handy generator touch-up tool	182
Isolated burning of spark plugs	190
Boost wiper-motor efficiency by cleaning felt air filter	210
"Break in" fouling causes plug misfiring in new engine	218

FARMING

Increase uses for hay barrack	164
Wagon converted to stock feeder	165
Fowl prevented from flying by taping one wing	168
Windmill ladder used as portable still	173
Wheels on cattle chute "retract" when axle is rotated by lever	173
Poultry apply own mite dust	179
Usefulness of barn extended with dual-purpose doors	194
"Cornerless" hay-bale stack improvement over square one	202

HOUSE AND HOME

Mexican candle lantern	169
Drain plugs in oil sumps made easier to remove	179
Hand-shaped metal planter is assembled with cement	183
Wheeled frame simplifies moving refuse containers	191
Pipe straps used for pulls on small-parts drawer	191
Rubber ladder "bumpers" prevent scarring paint	218

MISCELLANEOUS

List of tab stops saves time	165
Improvised soft hammers for xylophone give muted tones	176
Clip-on tote handle carries dozen or more berry boxes	176
Level speeds layout of letters to be painted on signboard	195

ON THE MARKET

Plastic "solder" repairs holes, dents on car body	203
Glue in stick form can't stain or spill	203
Fluorescent fixture is only 1 in. in thickness	203
Nonflammable contact cement can be brushed	203
Special penetrant and lubricating oil	203

(Continued to page 78)

The Big Opportunity - Auto Mechanics

Your ATS Training includes all this—

AUTO Mechanics
BODY & Fender
DIESEL TRACTOR & Crawler

Give a Man His Chance to Go Places—He'll Do All Right!

Today jobs are open, really good paying jobs, for men trained in the many branches of **AUTO MECHANICS**. For the man who likes to handle tools, the automotive industry is the big opportunity for success. Trained men in the automotive field are among the highest paid skilled workers in industry. They step into good starting jobs where promotion can be rapid, and often they build a successful business of their own in a surprisingly short time. The American Technical Society's remarkable training program is a result of an intensive research program which has been maintained in the world's automotive center, Detroit, Michigan, for over ten years. A man can progress rapidly with the help of ATS training and services. Mail coupon today for free information.



ATS Home Training Shows the Way FREE ILLUSTRATED BOOKLET—MAIL COUPON TODAY

American Technical Society, Dept. BH-29
850 East 58th St., Chicago 37, Ill.

Please send me FREE Automotive Maintenance and Repair Booklet and facts about the ATS home training plan and services.

Name _____ Age _____

Address _____

City _____ State _____

For More than Half a Century ATS Has Helped Train Men for Success

Behind ATS training is a great 60 year record of success in training men for good paying jobs. ATS offers you a "Work-Plan" method, and many earn as they learn. This not-for-profit organization offers its amazing plan to you now. Get the facts today.

American Technical Society, Dept. BH-29
850 East 58th Street, Chicago 37, Ill.



American citizens are better informed—thanks to Advertising!

AVIATION CAREER

SPECIALIZED EDUCATION / PROFESSIONAL TRAINING...only 16 months to 2 years

Top-pay prestige positions, bright future in aviation. Job opportunities waiting for you as soon as you're ready. Airframe and Powerplant Technician, Aeronautical Engineering Technologist, Business or Executive Pilot. Classes in Miami.

SEND FOR FREE 48-PAGE BOOK

Embry-Riddle Aeronautical Institute
Dept. B Miami, Florida (Founded 1926)

Name.....

Address.....

City.....Zone.....State.....

OPTICAL BARGAINS

REPLICA GRATING — LOW, LOW COST

It's here—after decades of effort! Replica Grating—on film—at very low price. Breaks up white light into full spectrum colors. An exciting display, 13,400 lines per inch, running long way on film 8" wide—grating area 7 1/2". Thickness about .005". Dispersion about 24°. Use it for making spectroscopes, for experiments, as a fascinating novelty. First time available such large size—so cheaply. Comes in clear-plastic protector.

Stock No. 50,202-H... includes 2 pieces 8" x 5 1/2"—1 transmission type, 1 reflecting type \$2.00 Postpd.
Stock No. 50,180-M... 1 piece transmission type 8 in. x 6 ft. \$5.95 Postpd.
Stock No. 50,203-M... 1 piece reflecting type 8 in. x 6 ft. \$10.95 Postpd.

SALE! TERRIFIC WAR SURPLUS BARGAIN! AERIAL CAMERA LENSES



Gov't. Cost \$1218—Now Low as \$39.50 Used Made by B & L and E.K.—24" F.L. f/6, in 23" long Lens Cone. Use as long range, Big Bertha Telephoto lens—for Richest field (wide field, low power) telescope, etc. Lenses are 4" dia.—precision 4-element type, Aero Tessar and Aero Ektar. Easily removed. Diaphragm (f/6 to f/22) is included. Opens approx. 1" to 3 1/2". Lens and cone—wt. 25 lbs. Sturdy carrying trunk—wt. 26 lbs.

Stock No. 85,059-H 24", used. Price \$39.50 f.o.b. Utah
Stock No. 85,060-H 24", new. Price \$59.50 f.o.b. Utah



SPECIAL! SPECIAL!

Complete Optical Kit! Build a 6" Reflecting Telescope! (Described in Mech. Illus. Feb. & March 1958 issues)

Consists of plate glass mirror blank; tool; 2 finely ground and polished lenses to make 1/2" F.L. eyepiece; first surface diagonal mirror; magnifying lens; 8 abrasives; pitch.

Stock No. 70,154-M... \$9.00 Postpaid
Stock No. 70,004-M... Deluxe Kit with Pyrex mirror blank—1" eyepiece lenses... \$11.95 Postpaid

WRITE FOR FREE CATALOG "H"!

Complete line of Astronomical Telescope Parts and Assembled Telescopes. Also huge selection of lenses, prisms, war surplus optical instruments, parts and accessories. Telescopes, microscopes, Hand Spectroscopes, Sniperscopes, binoculars, etc. Request Catalog "H"!

ORDER BY STOCK NUMBER SEND CHECK OR MONEY ORDER SATISFACTION GUARANTEED
EDMUND SCIENTIFIC CO., BARRINGTON, N. J.

Free!

ALLIED'S

MONEY-SAVING 1959

ELECTRONIC SUPPLY CATALOG

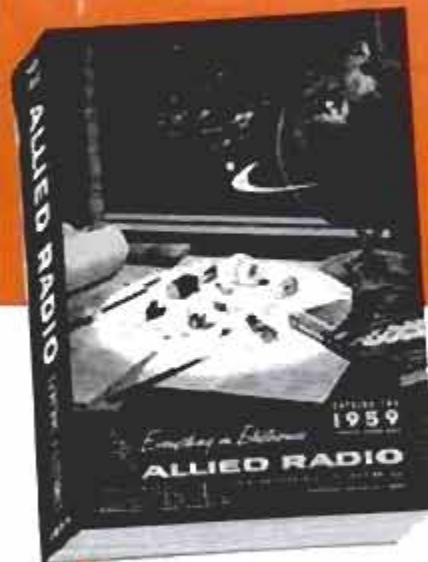

452

value-packed pages

send for it!

SAVE

ON EVERYTHING IN ELECTRONICS

EASY TERMS AVAILABLE

WORLD'S LARGEST STOCKS

Here is the complete guide to everything in Electronics for Experimenters, Builders, Amateurs, Servicemen, Engineers and Hi-Fi enthusiasts:

- Amazing Build-Your-Own KNIGHT-KITS
• Everything in STEREO Hi-Fi
• Hi-Fi Music Systems & Components
• Recorders & Phono Equipment
• Public Address & Paging Systems
• TV Tubes, Antennas, Accessories
• Amateur Station Equipment
• Latest Test & Lab Instruments
• Industrial Electronic Supplies
• Parts, Tubes, Transistors, Tools & Books

SAVE on everything in Electronics at ALLIED—get fast, dependable service, expert personal help, guaranteed satisfaction. Send today for your FREE 1959 ALLIED Catalog.

Everything in Electronics From One Reliable Source

Send for FREE Catalog

OUR 38th YEAR

ALLIED RADIO

ALLIED RADIO, CORP., Dept. 5-B9 100 N. Western Ave., Chicago 80, Ill.

Rush FREE 1959 ALLIED 452-Page Catalog

Name

Address

City Zone State

(Continued from page 76)

PHOTOGRAPHY

- Removing curl from photoprints 165
Aspirin box keeps lens brush free of dust while in storage 169
Tape stop centers wet negative on enlarger carrier 195

SHOPPING FOR TOOLS

- Abrasive drums 215
Flexible-shaft unit 215
Plier-wrench 215
Bearing packer 215
Engine-driven concrete saw 216
5X magnifier 216
Drill rack 216
Saber saw 216
Wire holder for thread measuring 216
Folding leg bracket 217
Lawn and garden tools 217
Drying oven 217
Two-speed drill 217
Expanding wheel 217

SOLVING HOME PROBLEMS

- Double boiler made from two saucepans 174
Bobby pin holds broken drain stopper to chain 174
Eliminate chance of tearing clothes hung on nail 174
Colored tapers dimpled with drill 174
Door rattle silenced with piece of rubber 174
Cloth measuring tape stays folded 175
Daybed or couch secured to wall 175
Prevents misplaced croquet arches 175
Peg replaces missing setscrew in doorknob 175
Hinge pins notched for future removal 175
Garment hangers slide easily on waxed pole 175
Pail containers can be reused for paint, etc. 175

TOOLS

- Calking tips stored in water 164
Saw blade filed while in table 164
Cardboard used as sanding block 168
Handy marking gauge improvised from ordinary folding rule 168
Spring supports motor mount to relieve V-belt tension 173
Accurate point found on center punch when chucked in drill 176
Combination-grit sanding disks have fine and coarse paper 182
Lapping-in a follower rest 190
Sheet metal cemented to wooden block for jigsawing 194
Sanding disk warmed with torch before applying stick adhesive 195
Portable tool box is stored as "drawer" in workbench 202
Lathe dog holding square stock saves time on duplicate jobs 202
Jig speeds cutting multiple lengths of rod or tubing 204
Overarm fixture takes micrometer head 209
Numbering chuck-jaw screws aids in centering work 209
Extension jaw for parallel clamp permits "over reaching" 210
Efficient paint scraper utilizes adjustable-wrench leverage 214

WORKSHOP HINTS

- Angle-cutting duplicate pieces 164
Brush "seals" corrugated joint 168
Transferring molding contour 179
Threaded pipe held for sawing on steel rod clamped in vise 182
Paint labels kept spatter-free 182
Dowels grooved lengthwise 182
Steel plate braces light stock while machining it 190
"Measuring tape" labels on bins indicate lengths of contents 194
Slot in sawhorse aids ripping short boards with handsaw 204
Shield protects radio parts from heat of soldering iron 204
Tape protects legibility of measurement marks on saw table 210
Grooved nut used to clean rusted bolt threads 214
Handy angle-steel pruning shears 218
Lathe tools centered quickly with aluminum-angle gauge 218

NOTICE—It is the intention of this magazine to provide its readers with information regarding the latest developments in the mechanical arts. Except where otherwise indicated, this magazine has no information as to any unexpired patents in respect of the developments reported herein. In the event that commercial use is to be made of any of the developments reported herein, it is suggested that legal counsel be consulted to avoid liability for patent infringement. It is not the purpose of this magazine to encourage patent infringement but, as indicated, it is the intention of this magazine to report on the latest developments in the mechanical arts.

FOCUS YOUR  **BENJAMIN**
 AMAZING NEW
Line of REPEATERS
 WITH THE LATEST IMPROVEMENT
 IN FAST, SURE, GRAVITY
 LOADING ACTION AND
PIGGY-BACK SHOT MAGAZINE

\$18.95

A Shot is placed in Firing Position each time Bolt is Pulled Back and Closed. Flash Ammo Count on Full View Magazine.



No. 2600 BENJAMIN Super 35-Shot BB Gas Pistol. Safe—No Pumping—Uniform Hi-Power. For Target & Small Game. \$17.95
 No. 2620 BENJAMIN 20-Shot Cal. 22 Gas Pistol. Economical. \$19.95
 No. 1300 50-Shot BB Air Pistol \$22.50
 No. 1320 BENJAMIN 35-Shot Cal. 22 Air Pistol \$24.50

No. 3600 BENJAMIN Super 100 Shot BB Gas Rifle. Non-Toxic—Safe—Convenient—Uniform Hi-Velocity Power. →
 No. 3620 BENJAMIN Super 85 Shot Cal. 22 Gas Rifle . . . \$20.95
 No. 3100 Super 100 Shot BB Air Rifle. Adj. Shooting Force \$23.95
 No. 3120 BENJAMIN Super 85 Shot Cal. 22 Air Rifle . . . \$25.95

FREE Catalog All Models Benjamin Single Shot & Repeaters—Cal. BB or 177 or 22. Also, Special Hunting & Fishing Knife Offer.

BENJAMIN AIR RIFLE CO. 896 MARION ST., ST. LOUIS 4, MO.



WOOD

PLIOBOND

CANVAS



SYNTHETIC RUBBER

"BONDS

PLASTIC



GLASS

ANYTHING

LEATHER



COMPOSITION BOARD

TO



ANYTHING!

STAINLESS STEEL

EASY TO APPLY. PLIOBOND requires no mixing, brushes on, dries rapidly.

EXCELLENT ADHESION. PLIOBOND exhibits exceptional strength — up to 1600 lbs./sq. in. in shear tests.

EXTREMELY DURABLE. PLIOBOND resists age, heat, cold, water, chemicals, oils.



Pliobond
 BY
GOOD YEAR

Pliobond—T. M. The Goodyear Tire & Rubber Company, Akron, Ohio

"FASCINATING" says NEWSWEEK

AUTOBIOGRAPHY OF A YOGI

By Paramahansa Yogananda



"I am grateful to you for granting me some insight into this fascinating world."
 —Thomas Mann, Nobel prize man

Self-Realization Fellowship
 Dept. PMA2, Los Angeles 65, Calif.
 At Your Local Bookstore... \$4.00

ENGINEERING DEGREE IN 27 MONTHS

Students given option of studying engineering under accelerated program leading to Bachelor of Science Degree in 27 months; or the standard four-year program leading to Bachelor of Engineering Degree in 36 months. The B.S. degree in Mathematics, Chemistry, or Physics (including Nuclear Physics) may be earned in 36 months. By attending classes year-round, students can graduate in 3 years and have one year of experience and income in the time usually needed to complete a four-year college course. Preparatory courses. Thorough, practical program. Individualized instruction.

Keeping pace with progress in science and engineering
 Campus. Dorms, gym, playing fields. Superior faculty. 2,000 students. New Dana Science Building. Low tuition. Earn board. G.I. approved. Enter March, June, Sept., Dec. Students from 48 states, 40 foreign countries. Send coupon for free catalog, full information. Enroll now!

INDIANA TECHNICAL COLLEGE

529 E. Washington Boulevard, Fort Wayne 2, Indiana

Please send me free information on 27 mo. B.S. DEGREES in:

Aeronautical Chemical Civil Electrical
 Mechanical Electronics

on 36 mo. B. E. DEGREES in:

Aeronautical Chemical Civil
 Electrical (Power or Electronics) Mechanical Metallurgical

on 36 mo. B.S. DEGREES in:

Mathematics Chemistry Physics

Name _____
 Address _____

prepare for your career in

ELECTRONICS RADIO-TV COMPUTERS

and other fields of ELECTRICAL ENGINEERING

At MSOE, you can equip yourself for a career in many exciting, growing fields: MISSILES • RADAR AUTOMATION • RESEARCH DEVELOPMENT • ELECTRICAL POWER • AVIONICS • ROCKETRY

When you graduate from the Milwaukee School of Engineering, you are prepared for a dynamic career as an Electrical Engineer or Engineering Technician. Under a faculty of specialists, you gain a sound technical education in modern, completely equipped laboratories and classrooms. As a result, MSOE graduates are in great demand and highly accepted by industries nationally.

At MSOE you will meet men from all walks of life and all parts of the country — some fresh out of high school or prep school, others in their twenties — veterans and non-veterans.

You can start school in any one of four quarters and begin specializing immediately. Engineering technicians graduate in 2 years with an Associate in Applied Science degree. For a Bachelor of Science degree in Engineering, you attend 4 years. A 3-month preparatory course also is available.

If you're interested in any phase of electronics, radio or television, be sure to look into the programs of study offered by the Milwaukee School of Engineering. Just mail the coupon.

FREE CAREER BOOKLET!



MILWAUKEE SCHOOL OF ENGINEERING

Dept. PM 259, 1025 N. Milwaukee St., Milwaukee, Wis.

Please send FREE Career Booklet. I'm interested in

- Electronics Radio Television Computers
 Electrical Power Industrial Electronics
 Mechanical Engineering Electrical Engineering

(PLEASE PRINT)

Name _____ Age _____

Address _____

City _____ Zone _____ State _____

I'm eligible for veterans education benefits

MS-111

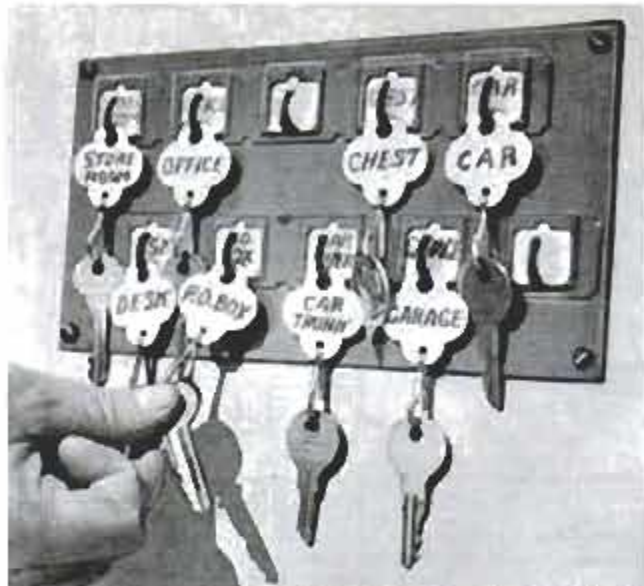

P.O. Moore, Inc., Glen Riddle, Pa.

Key Keeper Mounts on Wall

Lost keys can be a thing of the past if you have a rack where they can be filed when not in use. A metal rack on the market, in three sizes, has looped hooks to hold the keys and slots to hold tags that identify them. Screw holes at each corner permit the rack to be mounted on a wall or some other vertical surface, preferably in some part of the house to which only members of the family have access.

Computer for Jet Planes Does Pilot's Arithmetic

All calculations necessary to control a jet aircraft from take-off to landing are handled by a transistorized computer that can perform 64,000 additions per second. The airborne electronic "brain" solves problems concerning speed, altitude, navigation, fuel efficiency and engine performance. In a military plane, the computer can handle interception and weapon-delivery calculations. The device weighs about 150 pounds, contains 3500 transistors and uses 60 watts of direct current.

Philco Corp., Philadelphia, Pa.

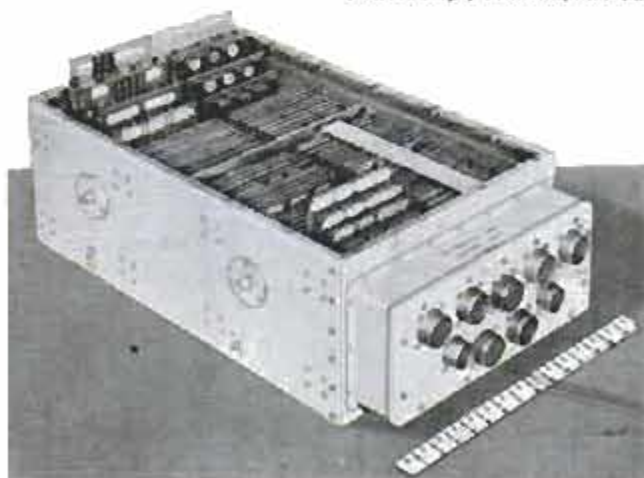

POPULAR MECHANICS

100% FRESH NEW DELCO DC-7



\$15⁹⁵
6 VOLT EXCHANGE

Ask for the DC-7! It's the new low cost addition to Delco's fine line of dry charge batteries. Like all Delco Dry Charge batteries, the DC-7 can't get old before it's sold. It's kept factory-fresh, dry as a bone. When you buy it, you see the dealer add the activator fluid, so you know you're getting all the power you pay for! Ask your dealer for the new Delco DC-7... *extra starts at no extra cost.*

6- AND 12-VOLT MODELS FOR ALL CARS—A GENERAL MOTORS WARRANTY GOOD ALL OVER THE UNITED STATES AND CANADA

Quality built by Delco-Remy, available everywhere through



General Motors starts with Delco Batteries

Get satisfying flavor...So friendly to your taste!

NO FLAT "FILTERED-OUT" FLAVOR!

NO DRY "SMOKED-OUT" TASTE!



See how Pall Mall's famous length of fine tobacco travels and gentles the smoke—makes it mild—but does not filter out that satisfying flavor!

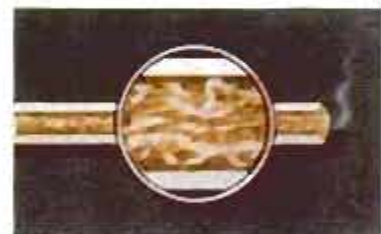

HERE'S WHY SMOKE "TRAVELED" THROUGH FINE TOBACCO TASTES BEST

1 You get Pall Mall's famous length of the finest tobaccos money can buy.

2 Pall Mall's famous length travels and gentles the smoke naturally . . .

3 Travels it over, under, around and through Pall Mall's fine tobaccos!

Outstanding . . . and they are Mild!

Product of The American Tobacco Company — "Tobacco is our middle name"

Union Pacific's new gas-turbine locomotive pulls long freight through the mountains



Over the Pass with 8500 Horses

The newest railroad locomotive, nearly twice as powerful as the Union Pacific's first gas turbine, climbs mountain grades at a sprint

By *Thomas E. Stimson, Jr.*

Author Tom Stimson drives the new gas turbine during part of the mountainous run from Ogden to Echo

IT WAS NO ORDINARY freight rolling up Weber Canyon, eastbound out of Ogden, Utah.

This was Union Pacific's "Extra 3 East" hauling 68 gondola cars loaded with iron ore, plus nine empties, a total weight of 6611 tons.

With a load like this, railroaders would expect to see the train laboring behind six powerful diesel engines with a helper boosting from behind. But there was only one locomotive at the head end: the most powerful self-contained railroad engine in the world, the brand-new 8500-horsepower



Cutaway shows the three sections of gas-turbine power plant. The 850-horsepower auxiliary diesel is in front and the fuel tender is coupled at rear

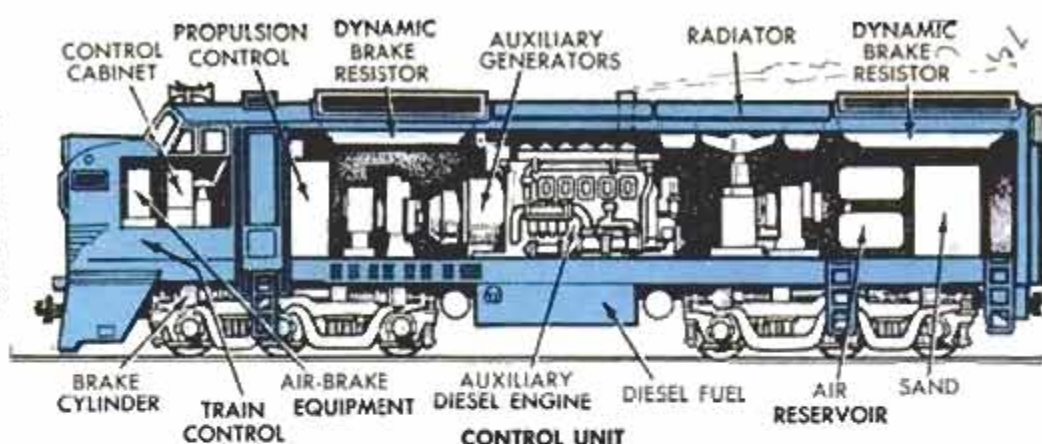

turboelectric locomotive that Union Pacific is just putting into service.

"Clear block!" called Fireman S. J. Kennedy.

"Clear block!" echoed Engineer E. R. G. Pope, moving the throttle a couple of notches as we began rolling.

I rode the cab of this sleek streamlined monster for part of a day, from Ogden to Echo with grades as steep as 1.14 percent, then on up Castle Rock hill to Wahsatch, the summit, and east to Evanston in the Wyoming mountains.

This engine is so big that it hauls an 850-horsepower diesel around simply as an auxiliary, to serve as a starting engine and to run the compressors for the air brakes. The diesel is also used as a hostler engine for moving the locomotive at slow speeds in the yards. Including its immense tender, the turbine locomotive takes up 178 feet of track.

There was plenty of room for me. On my left sat the fireman and Brakeman A. E. Barnes; on my right was the engineer. Beside me stood Bill Alberts, road foreman of engines, who was along to coach the engineer on this newest form of motive power.

This was railroading deluxe, with foam-rubber seats for the crew, a tinted safety-glass "picture window" windshield, indirect overhead heating, and a ride that approached that of a railroad lounge car. The whole locomotive rests on bonded-rubber sandwiches and the only metal-to-metal connection with the running gear is an electrical ground strap. Coil springs and airplane-type hydraulic shock absorbers, mounted in vertical and horizontal attitudes, also help make the ride a soft one. And it's quiet. You can barely hear the rumble of the diesel auxiliary through the insulated walls of the cab.

On the steepest part of the grade

Pope kept the throttle in the last notch, the 20th position, and the speedometer was reading 18 miles per hour. We were using a steam helper, a big 3700-class locomotive at the rear of the train, three quarters of a mile behind.

"Do we really need the helper?" I asked. Bill Alberts said it helped, that with it we would never drop below 18 miles per hour and we would often creep up toward the 25 miles per hour speed restriction that was in our train orders. At Wahsatch we would drop the helper and continue east under turbine power alone.

I had a chance to drive this locomotive. Maybe there's a regulation against it somewhere but I could do no wrong, not with Pope standing right beside me and with Alberts at my back. "Just keep your foot on the deadman's pedal," Pope cautioned. "If you lift your foot the brakes will automatically stop the train." I put both feet on the pedal to be doubly sure.

The engineer's controls resemble those

Enormous exhaust opening of the 8500-horsepower gas-turbine engine is almost as wide as the powerful locomotive itself

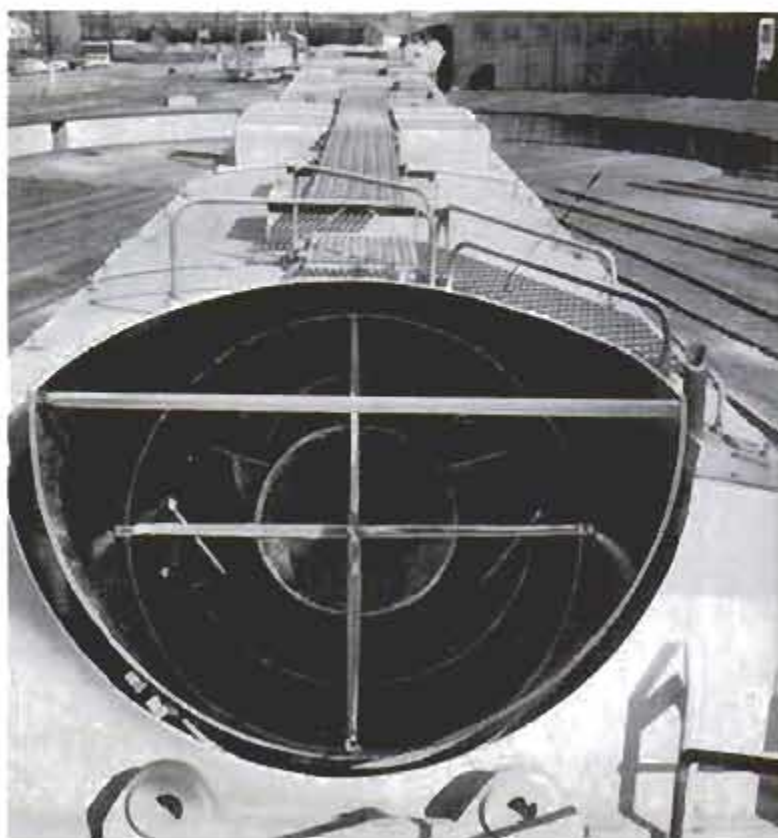

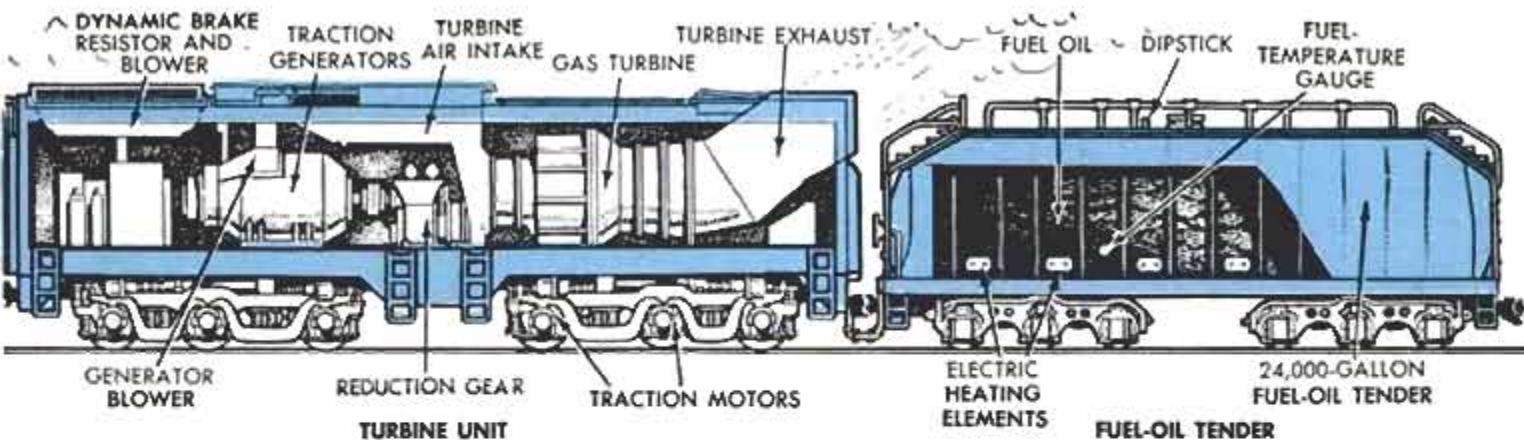

of a diesel engine. At my left was the master controller pedestal with the throttle, the reverse handle, and the selector handle that is used for dynamic braking.

In front of me were the two air-brake stands, one for the locomotive brakes, one for operating all the brakes of the train. There were dials on a front panel, too, some showing pressures in the air-brake system, some the condition of the turbine.

Looking at the speedometer above the controller pedestal, I saw that the train had worked itself up to 19 miles per hour. Then suddenly the needle shot past 22 miles per hour and a buzzer sounded. "You've got wheel slip," Alberts directed me. "Give it some sand." He pointed to the sanding valve. I shoved it forward. The speedometer went back to 19 miles per hour and the buzzing stopped. "Have to use sand on every one of these curves," Bill commented.

There was no way of telling, sitting there at the controls, that you were pulling a record tonnage up the grade and doing it easier and faster than trainmen had

thought possible a few years ago. There was nothing in the cab to indicate the tremendous strength of the turbine.

Only when you looked in the outside rear-vision mirror on a long curve and saw the steam helper at the end of the train did you get an impression of the power being exerted in shoving the tonnage up the hill. The helper was swathed in a cloud of steam and its stack was ejecting a tall column of smoke. You couldn't hear its bellowing but you could see how hard it was working.

Until a few years ago the pride and joy of Union Pacific was a group of giant steam locomotives known affectionately as Big Boys. These 4000-class engines are the largest and heaviest of their type ever built. They are so long that they are hinged, or articulated, in order to bend around some of the curves. They are an awe-inspiring sight on the rails. Their starting tractive effort is 135,375 pounds, a third greater than the big 3700-class locomotives.

Then the diesels came along. The diesels

William Alberts, road foreman of engines, inspects electric cables between the turbine unit and the diesel auxiliary

Alberts checks level of oil in diesel auxiliary; engine keeps up pressure for the brakes





Big Boy — one of the class of most powerful steam engines ever built; it has a rating of 6000 horsepower

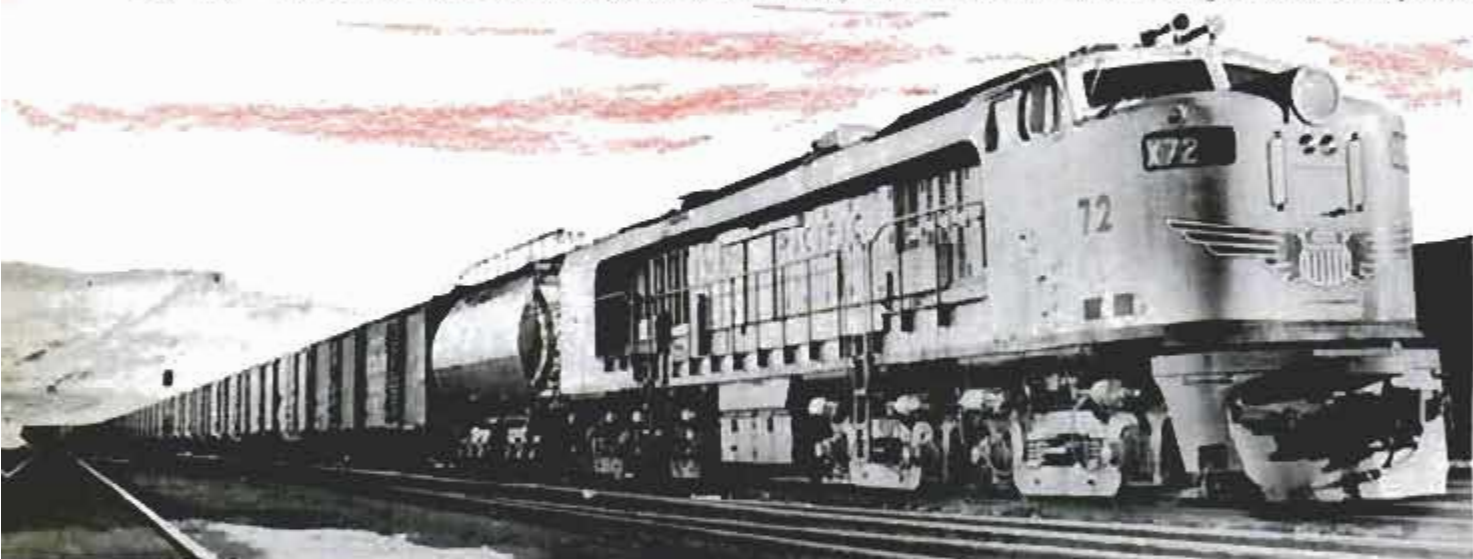

Union Pacific's first successful gas-turbine locomotive (above) has been in service several years; it has 4500 horsepower. Below, new 8500-horsepower turbine makes a stop at Evanston, Wyo., for change of crew





Engineer E.R.G. Pope is about to start train by moving throttle handle back. Three gauges show air pressure in reservoir and part of brake system. Dial at upper left alongside whistle cord is the speedometer

were smaller power packages, to be sure, but a number of them could be hooked together and controlled as one unit.

After that, Union Pacific sponsored the first gas turbines, 4500-horsepower locomotives that could almost outpull a Big Boy. The system has 25 of these turbines in service now; as well as 1182 diesels. The first turbines were so successful and trouble-free that Union Pacific asked General Electric to design a really big turbine, an engine that would develop 7000 horsepower at the rail. These are the ones now

being broken in on freight service. Each of the big turbines has close to 100,000 pounds more starting tractive effort than a Big Boy. To put it another way, the new turbine can haul 5000 tons at 18 miles per hour up the same grade that a Big Boy can haul 4000 tons at 15 miles per hour, both pulling without helpers.

The big turbine engine actually consists of three separate units. The "A" unit in front contains the operating cab with all controls, the diesel auxiliary and the air

(Continued to page 262)

Steam helper behind long freight was used for grade out of Ogden. The new turbine could have done job alone, but the helper gave train greater speed





DETROIT LISTENING POST

By Art Railton

IF YOU WANT to get rich, buy yourself an aluminum company. In the years ahead, the auto industry is going to gobble up a lot of lightweight metal.

Not only for engines, but for other parts as well. The forthcoming aluminum General Motors engines, designed particularly for the revolutionary small car, will require plenty of metal, but so will the big cars.

You'll see cast-aluminum wheels on some 1960 models. These will reduce weight while providing stylists with a way to combine function with flash. Wheels will become as important to stylists as taillights. The heat-transfer properties of aluminum will help solve the brake-cooling problem.

Aluminum bumpers (now on Greyhound buses) may be here by 1960. They solve the rust problem and also reduce weight on the front end. Stylists will have fun working the tractable metal into exciting shapes.

The lightweight metal may cost more to buy, but it is expected to reduce production costs. Doors can be made in one piece, saving costs. The outer surface of the die casting will be smooth, ready for paint, while the inner surface will have the ribs and brackets for strength and hardware mounts. Complete doors will pop out of the production dies like bottle caps once the machinery is set up. Use of die-cast aluminum in trunk lids and hoods is expected to follow with revolutionary effects.

Secret of the cost saving is hot-metal delivery. The auto maker builds his plant next door to the aluminum company (or vice versa). Molten metal is delivered to him by insulated pipe, like water.

The auto maker doesn't have to heat ingots to get the metal ready for casting. When he shuts down the plant at night, he turns off the faucet and the meter stops running. Thus the foundry (with all its mess) is gone and the plant becomes as neat and orderly as a candy factory. More important, of course, is the absence of a fuel bill for metal melting.

The lightness of the cars of the future (and not too distant future) will make today's 4000-pound monsters as anachronistic

as the old flatiron that women thought smoothed clothes by weight when it actually did it by heat. Today women use feather-weight irons. Tomorrow we'll have feather-weight cars, confounding all those who still believe that heavy cars last longer, ride better or are safer.

The lightness will make the horsepower race even more ludicrous—so much so that the industry will be forced to give it up. Six-cylinder aluminum engines will be powerful enough to give the light cars the getaway of today's peppiest. Gas mileage will soar by today's standards.

Industry observers eagerly await the new GM small car to see if the giant corporation has solved the problem of stability in a rear-engine car. If it has eliminated the cross-wind wander, it will have done something European designers have never been able to do in any "big" rear-engine car.

Europeans have never gone for rear-engine cars of more than 100-inch wheelbase (except the Czech Tatra). The supposition is that at about 100 inches, the rear-engine design develops impossible problems of stability. GM is coming into the field above this limiting 100 inches.

General Motors probably has the solution. Its Firebird III must have been a big help in solving suspension problems, it being a fabulous laboratory on wheels. GM certainly didn't spend all that money just to prove that a turbine works.

Ford and Chrysler prefer a conventional approach to the "small" car with front engine, rear drive. There is talk, however, that Ford hopes to have a front-wheel-drive car within a few years. This would solve many problems, including that of passenger space—the real bugaboo of today's big cars as well as future smaller cars.

Front drive gives a no-tunnel flat floor. It does away with the space-taking rear axle and makes the trunk virtually bottomless. It has so many advantages, there is no doubt that it's coming. Its disadvantage: Cost. But that will be licked.

Chrysler's all-new big cars for 1960 are said to have a modified unit body. There is to be (rumor) no continuous frame from stem to stern, and the body shell will be unitized as far forward as the windshield. Separate front ends will be designed to be welded on to suit the wheelbases of various divisions.

American Motors does the same thing with its Ambassador. For 1960, AM, too, will have an all-new car. It won't be as off-beat as its 1956 models (its most recent all-new body). AM learned then that for the small guy to succeed he must be unobtrusive. Fins will be retained for 1960, but not with flamboyance. They will fold over and lie quietly horizontal.

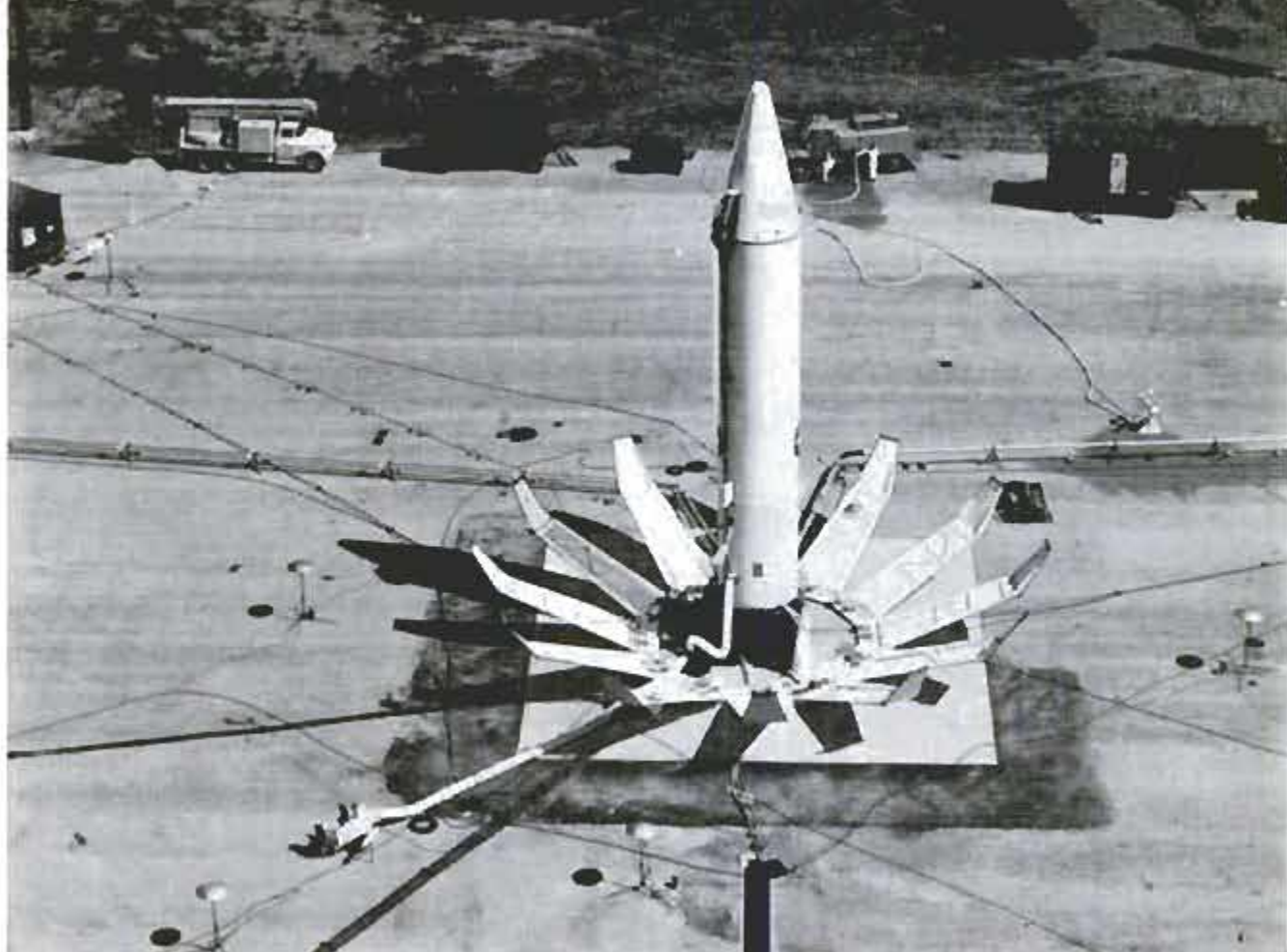

Jupiter Missile Shelter Opens Like Flower Petals

VERTICAL MISSILE SHELTERS that open like the petals of a flower will be blossoming soon at Jupiter launching sites. Purpose of the portable, stand-by shelters is to protect the Jupiter missiles from inclement weather during the "waiting" stages. When a missile is ready to be fired,

the "rose petal" shelter's 12 sections unfold from the base of the weapon. Eight of the petals are made of paper-honeycombed aluminum sheet. The others are of weatherproof and fireproof plywood and can be replaced after several firings. There's enough room inside the shelter for missile workers.

Designed by Barnes & Reinecke, Inc., for the Army Ballistic Missile Division





Nose cone for a missile, above, is given a heat-resistant tungsten coating with Plasma Arc Torch which harnesses highest temperatures used in industry, up to 30,000 degrees Fahrenheit. Diagram below shows how torch applies surfacing material

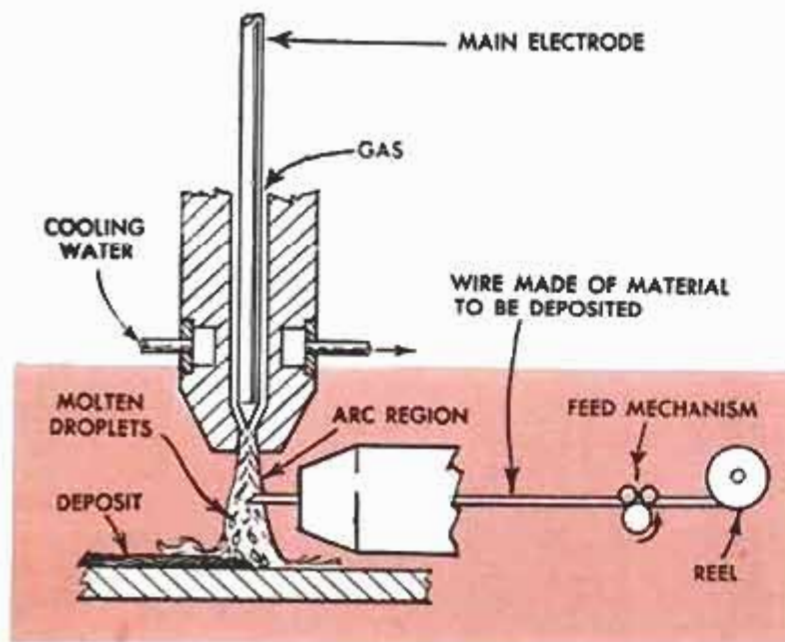

Rocket nozzles, nozzle liners, crucibles and vacuum-tube-grid cages, below left, are among products fabricated or coated with torch. Photo to the right shows stainless-steel coat being applied to aluminum plate

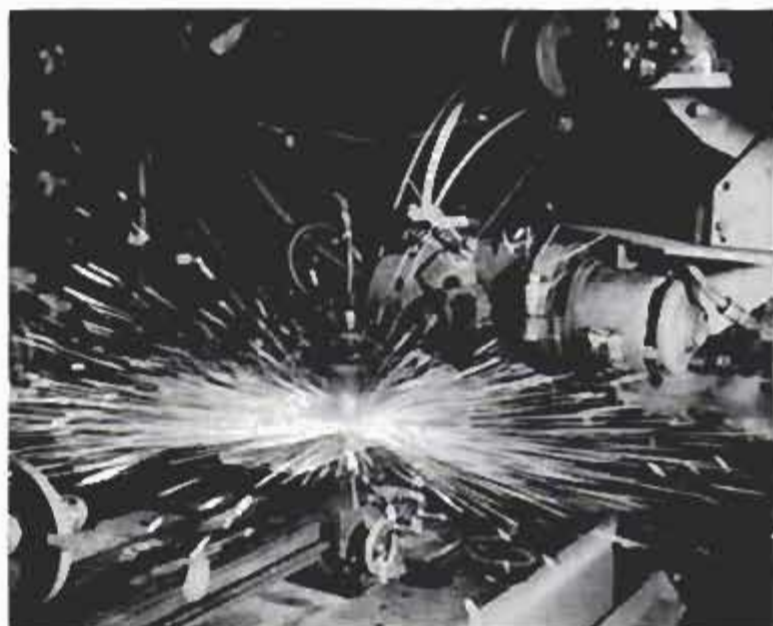

Torch Creates Superheat To Melt Hardest Metal

NOSE CONES, jet vanes and other rocket and missile parts subjected to extremely high temperatures are being fabricated with a Plasma Arc Torch. The torch, developed by the Linde Company, makes it possible to work with the toughest materials known in controlled temperatures up to 30,000 degrees Fahrenheit. The material to be worked is prepared in either wire or powder form and fed into the intense arc of the torch. Because of the high heat of the arc, the material is changed into a fluid state. Inert gas flowing at high velocity through the torch forces the molten material against the surface of the object being fabricated or plated. The force with which the material is deposited assures a firm bond. Separate torches are needed for wire-fed and powder-fed materials. Stainless steel usually is handled in wire form while tungsten and the carbide materials are powder-fed. When tungsten is fabricated into a nozzle liner for a rocket engine, the Plasma Arc Torch is held over a spinning mandrel. Molten tungsten particles are deposited at near-sonic speeds in successive layers on the mandrel, until the desired thickness is reached. The mandrel is then dissolved in acid, leaving the nozzle liner. Besides rocket parts, the torch is used to make electronic components.

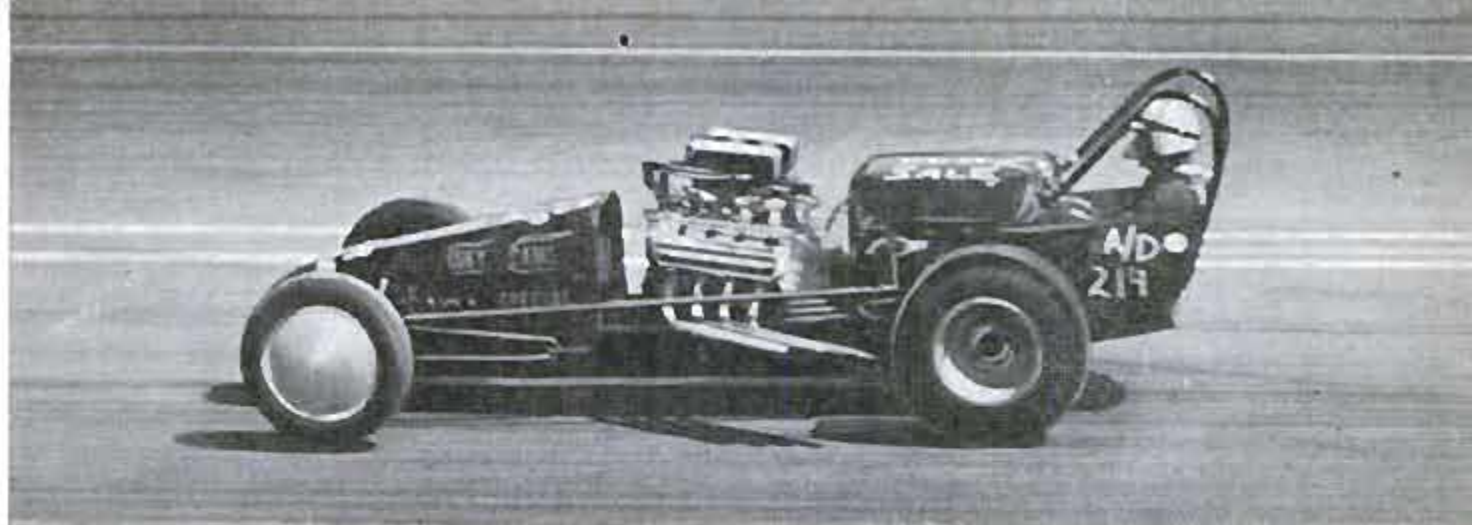

Winner of 1958 national championship drag races was this slingshot with nonsupercharged Chrysler engine

"Slingshots" Pace the Drag Strips

By Ewart Thomas

HOT-ROD ENTHUSIASTS have come up with a brand new breed of competition car that they call the "slingshot" because of its odd appearance. The driver sits behind the rear wheels, sometimes just a few inches off the ground.

These weird vehicles must be pushed by another car to start the engine. Clutch action is so stiff that it takes much of a driver's strength to depress the clutch pedal. The engine won't idle below 1500

r.p.m. and a driver must continually pump the throttle to avoid stalling while waiting for the green flag. The engine would freeze up solid if driven much more than a mile, for it does not have a conventional cooling system.

Sometimes the clutch and flywheel explode into shrapnel. As a safety precaution the flywheel assembly must be enclosed by an armored scatter shield to protect the driver. Most of the car's weight is on the

Slingshot dragster below burns rubber from spinning eight-inch-wide rear tires at the start of time trials

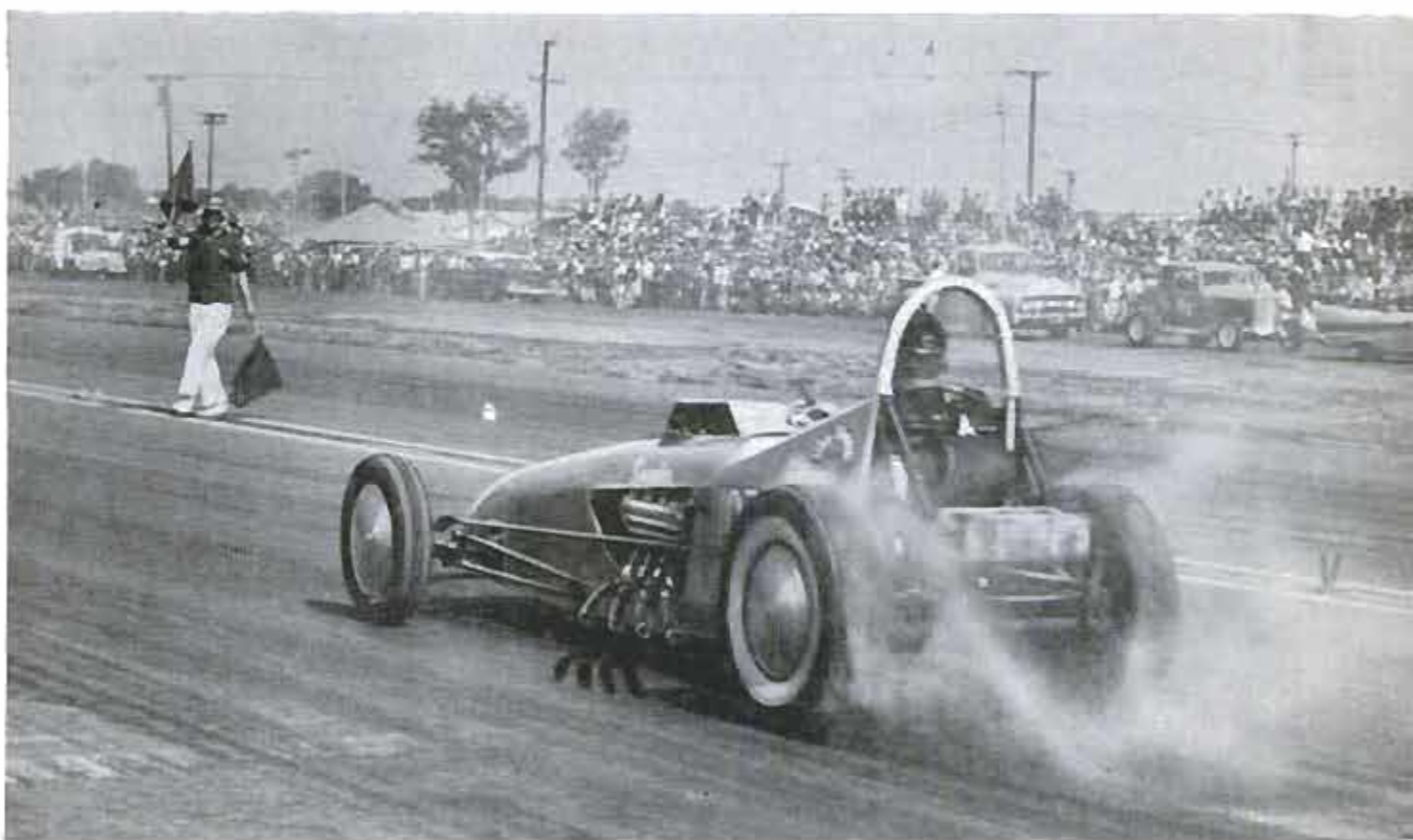



Driver sits in engine compartment of coupe, above. Rear view of slingshot racer below has parts labeled

SMALL MOTORCYCLE-TYPE FRONT WHEELS

CHEVROLET ENGINE WITH SIX CARBURETORS

TACHOMETER
WATER TEMPERATURE

OIL PRESSURE
FUEL PRESSURE

TUNED EXHAUSTS

CLUTCH PEDAL

HAND BRAKE

ACCELERATOR PEDAL

AIRCRAFT-TYPE
STEERING WHEEL

CAGE-TYPE ROLL BAR

WIDE, FLAT-TREAD TIRES
REAR TREAD NARROW
TO REDUCE SKIDDING

SHOULDER-HARNESS SAFETY BELT

FIRE EXTINGUISHER

PUSHBAR FOR STARTING

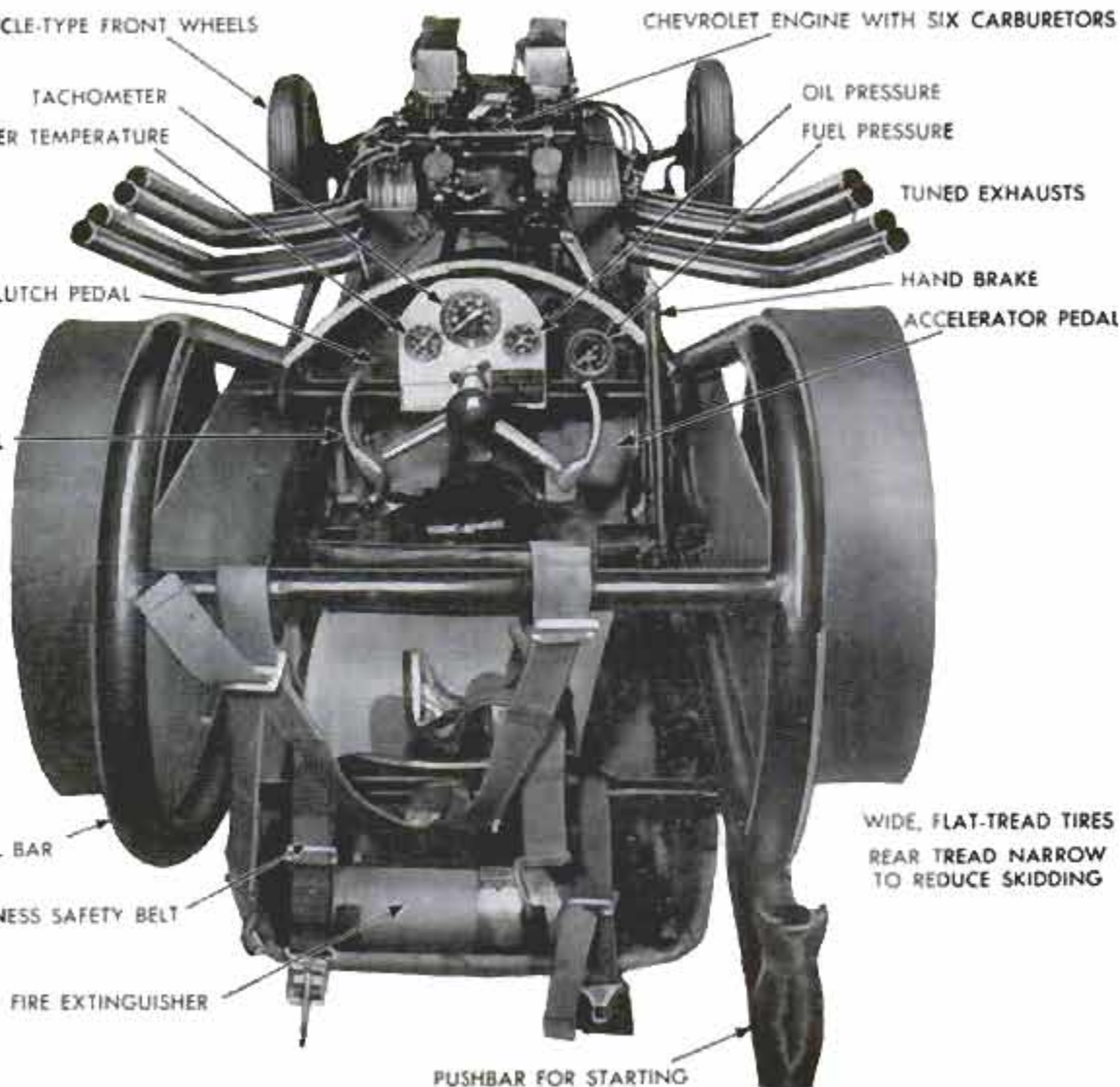

ing is quick and very tricky.

In spite of these handicaps the slingshots are the champions of the drag strips. From a standing start they can cover a quarter of a mile in 10 or 11 seconds. At the end of the quarter they may be traveling at the rate of 130 to 150 miles per hour.

They are the fastest sprint cars in the world.

Some were built for as little as \$1500, some have cost more than \$5000. Possibly 2000 of them have been built in the last few years, each representing an owner's idea of how to travel a quarter of a mile in the shortest possible elapsed time. His goal is to combine maximum power, maximum traction and minimum weight in the same vehicle.

Maximum power often means a Chrysler or Chevrolet engine that has been bored and stroked for greater displacement, balanced, equipped with "wild" full-race camshafts and with fuel injectors or as many as six carburetors, and possibly supplied with a supercharger. Special manifolds are used. Individual exhaust stacks are tuned, each having exactly the same length and shape as the others. This detail can add five or more horsepower to an engine's output at certain r.p.m.s. Fully reworked, an engine may develop 500 to 600 horsepower, as much as twice its original factory rating.

The desire for maximum traction accounts for much of a slingshot's peculiar appearance. With the engine placed amidships and the driver in the tail, as much as 80 percent of the car's weight rests on the rear wheels. This weight distribution increases the traction between the rear tires and the track surface. Ordinary tires would spin, scream and burn up when power is applied. To avoid this, special dragster slicks are used. These are recaps of soft,

Dragster lineup, starting at top, shows: Six-carburetor job with magnesium wheels; streamlined tail behind Ford engine; engine and supercharger exposed for maximum cooling; rear wheels inside body, fuel-injection Chrysler engine, and light-weight model with Crosley front wheels

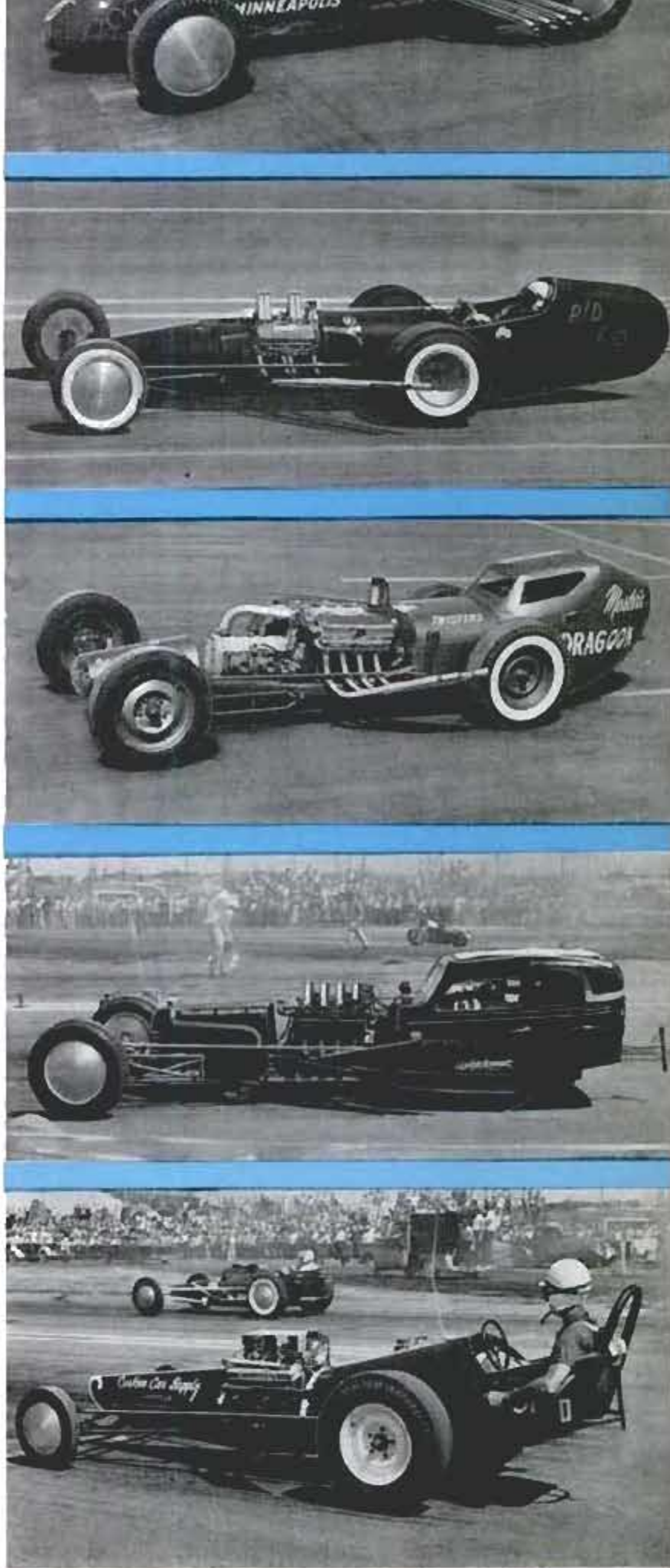



spongy cold rubber, eight inches wide and with a slightly dished surface. They flatten out under the car's weight and present maximum gripping surface to the track. In many slingshots, the rear wheels are placed as close together as is practical to reduce the chances of going sideways while spinning the wheels.

Minimum weight is the reason why a slingshot often uses small motorcycle wheels and tires in front, with lightweight magnesium racing wheels in the rear. It's the reason no starter or battery is carried and why the cooling radiator and fan are left off. This is the reason, too, why a flywheel may fly apart at any time. Most of the flywheel's weight (and much of its strength) have been machined away, leaving little more than a face for the clutch to seat against. Most slingshots weigh from 1300 to 1600 pounds and a shrewd driver figures that for every 100 pounds of weight that he can eliminate, he chops several thousandths of a second from his time.

You don't climb into a fast slingshot without plenty of previous drag-strip experience. One of these cars can get away from an

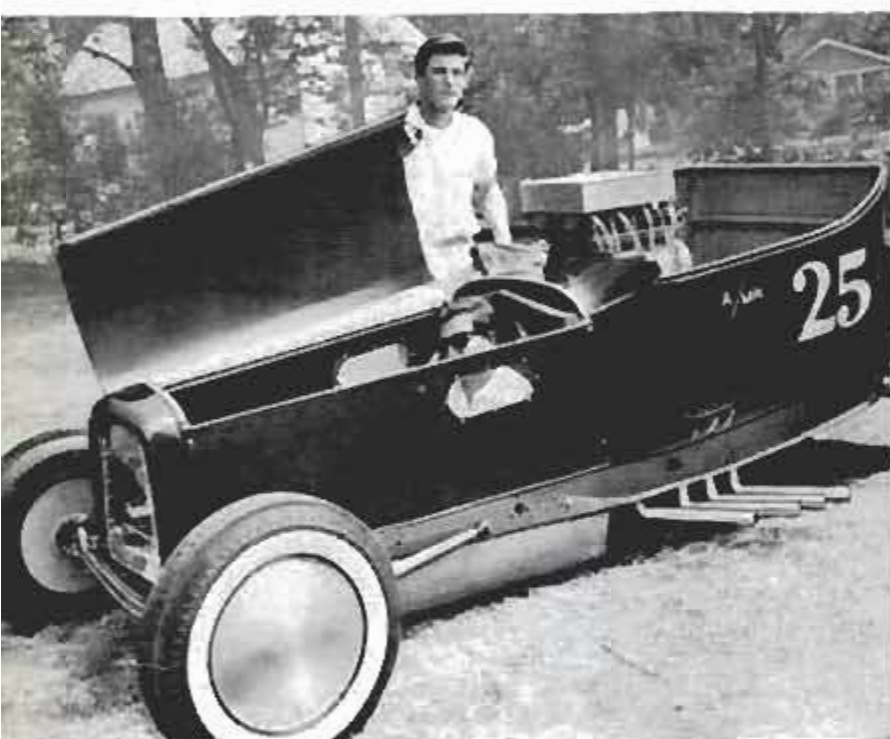

Hot rod at top right looks like a "runaway" but driver Don Mitchell actually is at controls beneath hood. Plastic insert in 1932 Ford grille shell is windshield. Openings in side panels permit driver to look out either side. This unique model has been clocked at 123 miles per hour over a quarter-mile course. A Chrysler V8 engine produces 410 horsepower at the flywheel



Photos on this page by Robert Hegge

Mitchell demonstrates tight squeeze for driver between modified frame rails from 1932 Ford. Engine has eight carburetors and a GMC 6-71 blower, plus a Chrysler 300-B camshaft and a Plymouth flywheel

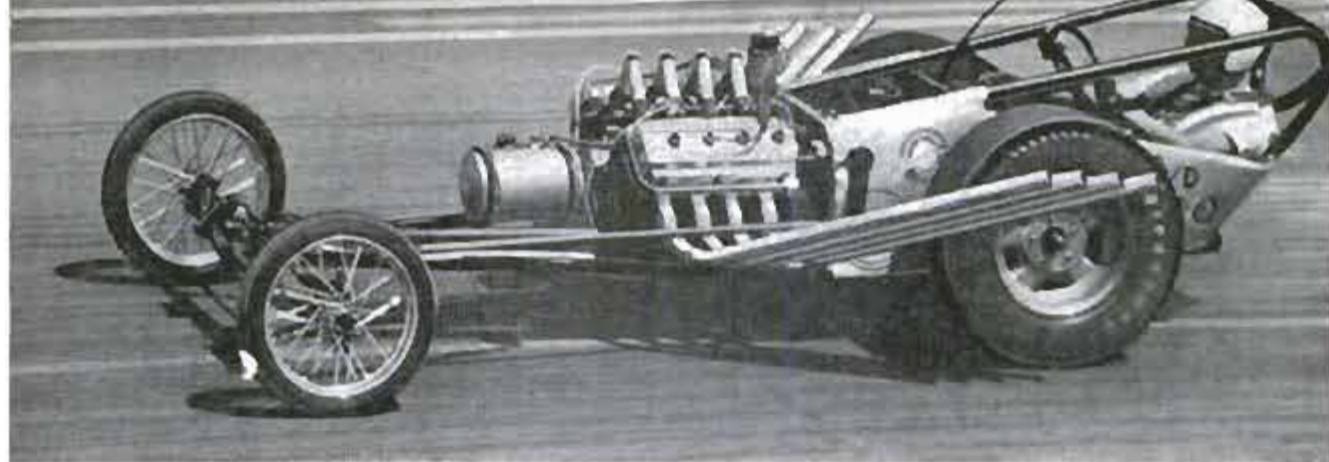

Fuel-injection Chrysler engine develops 550 horsepower for this 1200-pound slingshot with tuned exhausts unskilled driver. Even an experienced driver flinches as he lets out the clutch, for he is literally hammered into the back of his seat by the tremendous acceleration. He pulls a G load all the way to the finish, then surges forward against the harness when he lets up on the throttle.

Most dragsters have been using a two-speed shift and when a driver is racing against elapsed time he stays in the lower gear until his engine revolutions reach peak power, then he shifts into high. But if he is trying for record speed at the finish instead of the shortest elapsed time he shifts into high only 50 feet or so from the start. The engine lugs for a bit, then accelerates to top speed.

It isn't always the car with the most power that gets to the finish line first. An unblown engine usually accelerates at a fairly constant rate all the way to the finish, while a supercharged engine is apt to

accelerate slowly until it builds up engine speed. Then it begins to fly. The supercharged car can be going the fastest when it hits the finish, though the nonsupercharged car may get there first.

The most recent trend is to a direct drive with no shift. This eliminates the weight of the gearbox and saves the slight pause that occurs when shifting gears. With direct drive, a car is always equipped with a quick-change rear end so that one set of rear-end gears can be used for fastest elapsed time, another set of gears for top speed.

The word "drag" is a descriptive term for an acceleration contest and a drag race is simply a match race between two vehicles to see which can cover the quarter mile in the shortest time. Drag racing is continuing to grow in popularity because it has all the thrills of big-time competition,

(Continued from page 242)

Driver sits above engine, his head sticking through hole in roof of coupe body on the dragster below

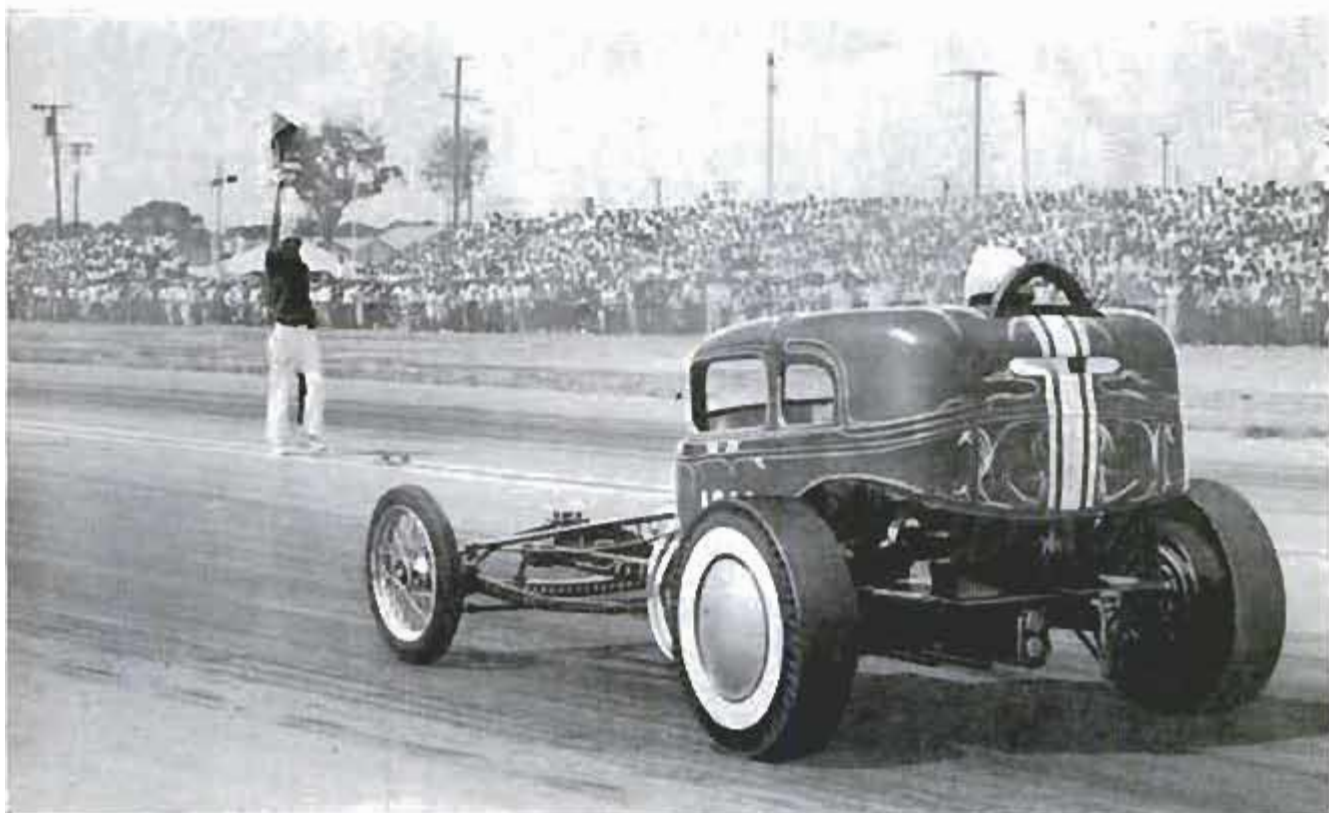

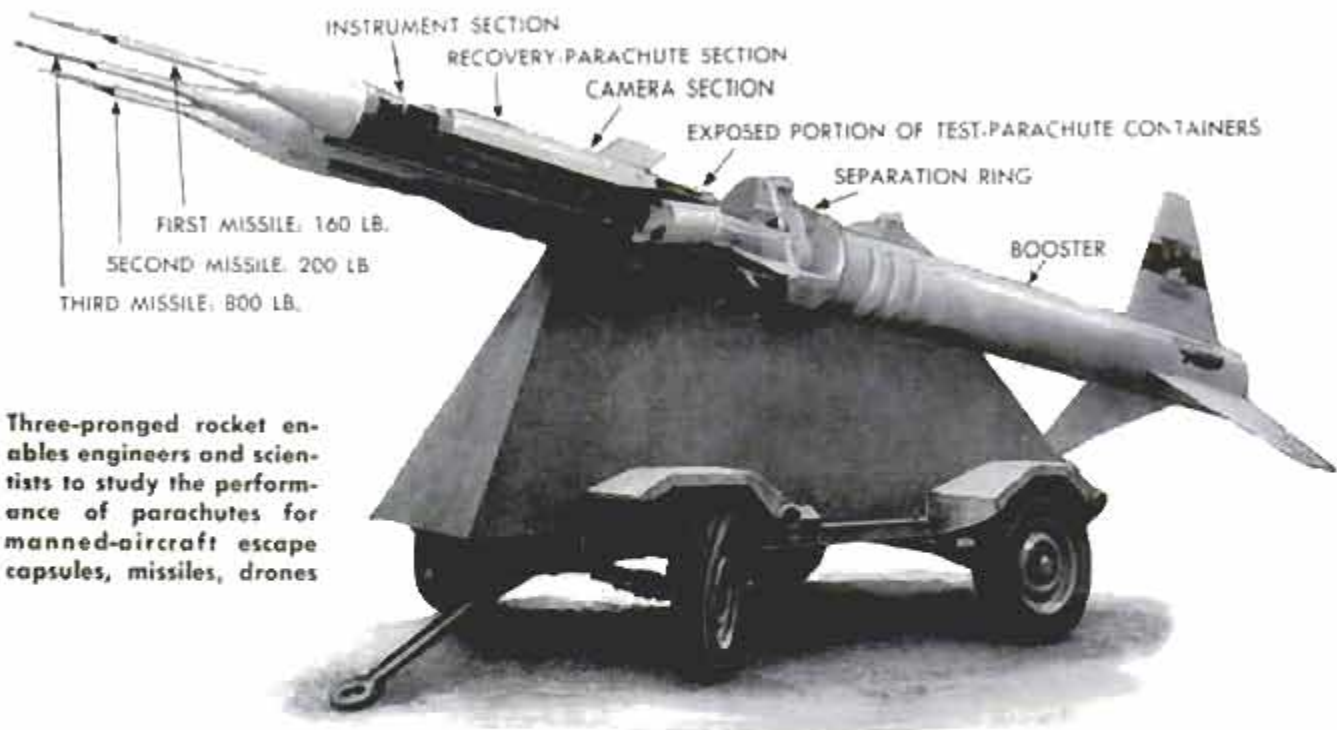

Three-pronged rocket enables engineers and scientists to study the performance of parachutes for manned-aircraft escape capsules, missiles, drones

ROCKET TESTS PARACHUTES

THREE PARACHUTES at once are tested by a rocket missile nicknamed the "Cree." It is composed of three missiles mounted parallel and propelled by a ground-to-air booster unit. The center missile mounts on the booster. In the air, the two outside missiles separate from the center one and timers on each then release test parachutes. The actions of the chutes are recorded by cameras focusing through

the tails of the missiles. Thirty seconds after the chutes open, the nose cones drop off, exposing the blunt surfaces of the missiles and slowing them down. Timing mechanisms in the missiles then release 12-foot recovery parachutes that lower the units gently to the ground. The Air Force is conducting the tests at altitudes between 30,000 and 150,000 feet and at speeds from 1520 to 3040 miles per hour. ★ ★ ★

Each missile goes through three stages in the test. The parachute container pops out, a camera films performance of the chute and, finally, a recovery chute lowers missile to the ground



NOSE CONE DROPS OFF, PROVIDING DRAG AND SLOWING DOWN MISSILE



CAMERA INSIDE MISSILE RECORDS PARACHUTE'S REACTION



RECOVERY-PARACHUTE COMPARTMENT DOORS

Clothes Clips Can be Hung On Housewives' Fingers

Housewives who can't carry as many clothespins in their hands as they would like to when hanging wash on the line will be interested in new plastic clips that can be strung conveniently on their fingers. The clips, made by combining two molded pieces of plastic with a one-loop wire spring, are said to be unbreakable, non-splintering and nonstaining. They are equally good for holding heavy and light clothes. The clips can also be used to hold several sheets of paper together, close partly emptied plastic food bags and suspend envelopes, photo negatives and other objects from nails and hooks. The clips are available in several different colors.



Dial Reminds Motorist He Forgot to Douse Lights

If you frequently forget to turn out your car lights after parking, a new electronic accessory may help solve the problem. As soon as the engine is shut off, this device automatically illuminates the word "Lights" on its dial if the bright lamps, dimmers or parking lights are on. Called the "Light-Minder," the accessory contains no moving parts and is installed easily on the steering column or instrument panel without changes to original wiring. The Light-Minder can be installed on any automobile or truck that has either a 6 or a 12-volt electrical system.

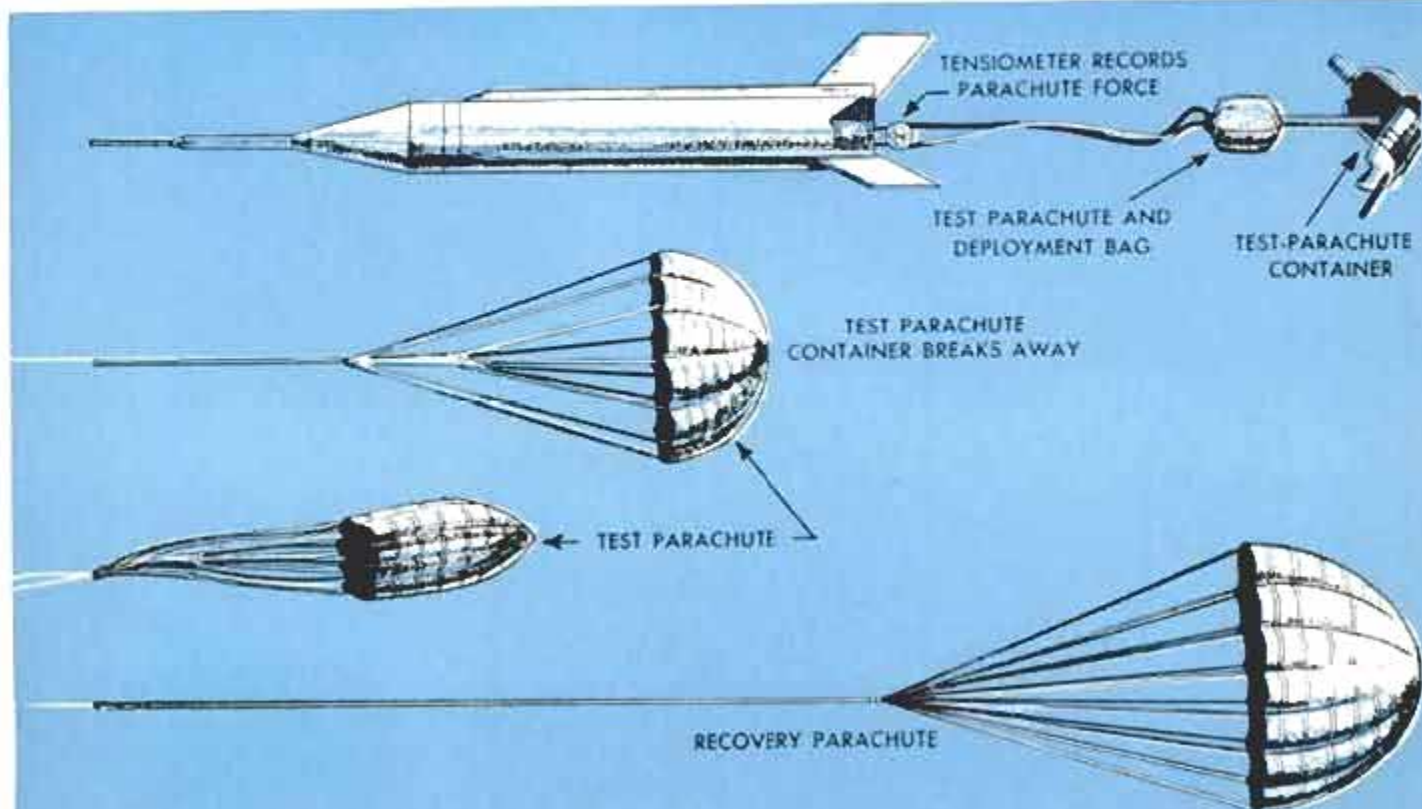
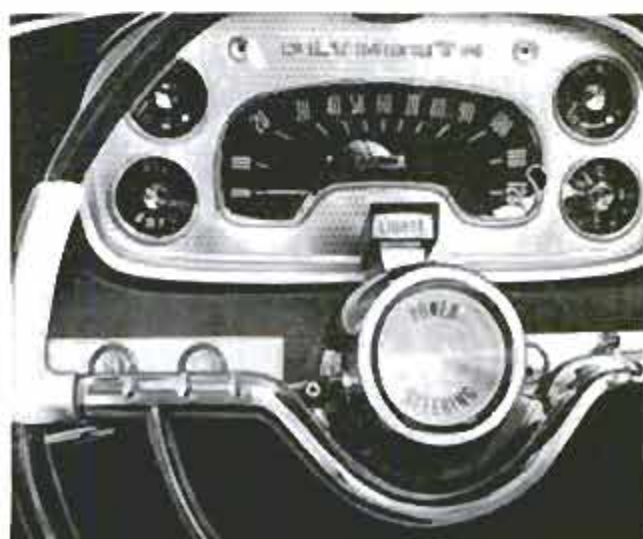



TV Protects Drivers At Rail Crossing.

German Federal Railway is experimenting with television as a means of protecting motorists at a busy train crossing. A TV camera atop a tower scans the highway on both sides of the track. The camera is connected by cables to two screens in the gateman's house. The gateman, who operates the crossing gates electrically on signal from approaching trains, is aided by observing auto traffic on the screens. The gates can be seen on the screens, and their position is also indicated by lights.

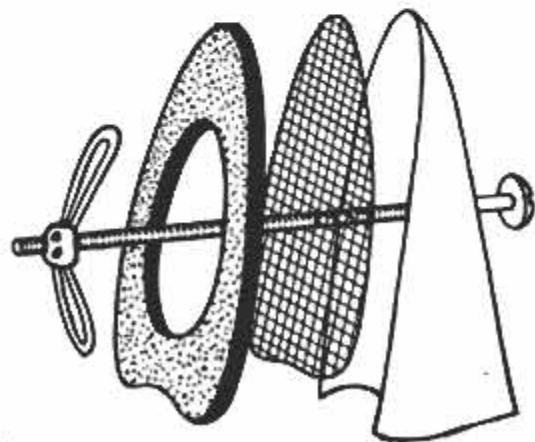

Ventilator for Concrete-Block Walls

Dead-air spaces in concrete-block walls can be eliminated by installing a pair of patented ventilators at 48-inch intervals along the wall. One of the ventilators consists of a curved piece of aluminum, a wire screen and a gasket, all held in place by a toggle bolt. They are installed in a plumb line, one inch below window-top level and one inch above floor level. Air circulates inside the wall, from bottom to top, preventing dampness and other dead-air faults.



Army's VTOL Craft Changes Flight Direction by Rotating Ducts

It can hover like a helicopter, but it can also do some things a copter can't do. The Army's Doak 16 can take off horizontally as well as vertically, and it can fly forward like a conventional plane—with much high-

er speed and longer range than a helicopter. The pilot of the unusual craft merely points the ducted propellers straight up for vertical takeoff, then rotates them forward for horizontal flight.

Rubberized-Fabric Tanks Are Marines' Portable Filling Stations

When the Marines have landed, the fuel situation should be well in hand. For the Leathernecks now carry their own filling stations—collapsible 10,000-gallon rubberized fabric tanks. Each tank weighs about

600 pounds, less than a tenth the weight of a standard steel tank. The tanks can be folded into compact packages for transport. When filled, the tanks are 40 feet long, 11 feet wide and four feet high.





It's metal content, not the design of scrap, that interests sculptor who finds raw material in junk yard

Scraps From the Junk Yard Are Welded Into Works of Art

By Rafe Gibbs

TOOLS OF A MECHANIC and the soul of an artist, plus coat hangers and junk-yard metal scraps, are all that are needed today to produce objects of art that will pass Michelangelo's famed test: "If it can roll down a hill without breaking, it is good sculpture."

Working with an oxyacetylene torch—generally at 6000 degrees Fahrenheit—George Roberts, art instructor at the University of Idaho, is turning out sculpture that is exhibited in New York, Chicago, Detroit and other major art centers. Main substance of his sculpture is steel, but Roberts may also add a dash of aluminum, concrete, ceramics, wood or brass.

"I guess I use about everything except the kitchen sink, and the reason I don't use that is because it is made of cast iron,

which is not easy to weld," said Roberts. "My wife is a lapidarist, and every now and then I manage to talk her out of one of her prize stones to work into a sculpture."

One of Roberts' sculptures, recently exhibited in New York's Audubon Show, is his impression of an Oriental city gate. He felt it needed a certain something—particularly one of his wife's agates. He got it.

Haunting a local junk yard, Roberts finds odd pieces of metal, worn beyond original purpose but still of sound substance. Often picked up by Roberts, for instance, is an old disk plow.

"Good steel goes into a disk, and it is easy to work with," said the sculptor.

He stresses that pieces should be selected for their materials and for their application to a particular creation. If unlimited funds



The sculpture of a bull about to charge was fashioned by the artist from a bunch of clothes hangers

were available, Roberts said it would probably be better to purchase new stock. On the other hand, he feels that there is a bit of a challenge in seeking out just what is wanted amidst the maze of a junk yard.

A sculpture of modernistic design—"ebbing moons pyramiding into more ebbing moons"—was formed almost entirely from an old piece of steel pipe.

"With an oxyacetylene torch, you can peel a section of pipe as you would an orange," Roberts explains.

Perhaps his main material comes from clothes closets—his own and friends'. He uses metal coat hangers by the dozens.

"Drops of metal fall from them nicely," says Roberts, "but perhaps most significant is the fact that your material costs you nothing—if you can train your friends to take their clothes to the dry cleaners in bundles and then bring them back with wire hangers."

A bull sculptured by Roberts' torch has about 90 percent coat-hanger content. It was no trick at all to form the ribs of the

Roberts uses oxyacetylene torch to add finishing touches to his conception of ancient Oriental gate





Old water pipe becomes a piece of abstract art, above, while a piece of rusted steel, below, takes on new beauty as a sail of an old Chinese dragon ship



bull from bits of wire clothes hangers. Producing works of art from steel or iron is far from new. Oxidized remains of ornamental iron beads, dating back to 4000 B.C., were found in an Egyptian cemetery at Gezirah. Decorative art with iron was known to the Celts in Britain long before the Roman invasion. In the Middle Ages, the ingenuity of the swordsmith was woven into various forms of ornamentation. An early English swordsmith had on the point of his anvil as his trademark, a beautifully sculptured head of an ox.

Pablo Picasso also works in the medium. He once took a piece off a stove and entered it in an exhibit as sculpture. Critics accused him of poking fun at art. But Picasso proved his point that art is where you find it—and it can be of materials other than the conventional ones.

Generally, the great works of sculpture have been of stone, marble, wood or cast bronze.

"But you must remember that the oxyacetylene torch is a relatively new development of the 'Mechanical Age,' and sculpturing in steel or iron was difficult before its development," Roberts points out. "There is the arc welder, too, but I prefer the oxyacetylene torch. It's more versatile. With the torch you can puddle your metal—work it around. Too, you can see better what you are doing."

When Roberts studied art at the University of Wisconsin he was looking for a medium he could consider exciting. He found it in steel and iron.

"With this medium there is the excitement of drawing in space," he says.

Roberts, who also paints in oils, feels that drawing in space "is much more fascinating than painting on canvas." He adds:

"Working with a torch on metal, you can do things that you never could do with a chisel on stone. Art today is dramatic—sometimes even melodramatic. When sculpturing with a torch, you can achieve some effects that would not be possible in any other art medium."

Roberts points out that hot steel is almost as plastic as clay. You can alter it, add or subtract. He warns that some metals such as brass should be given only a "touch of heat." Brass melts at lower temperatures than steel.

Mistakes can be "erased." If there is too much metal in one spot, it can be burned off.

The sculptor's final admonition:

"Good art is good whether it is realistic or abstract. Create as you choose—just don't get too sentimental, for sentimentality can destroy art. And, working in metal, remember that art is creating—not just doing tricks with pieces of junk." ★ ★ ★

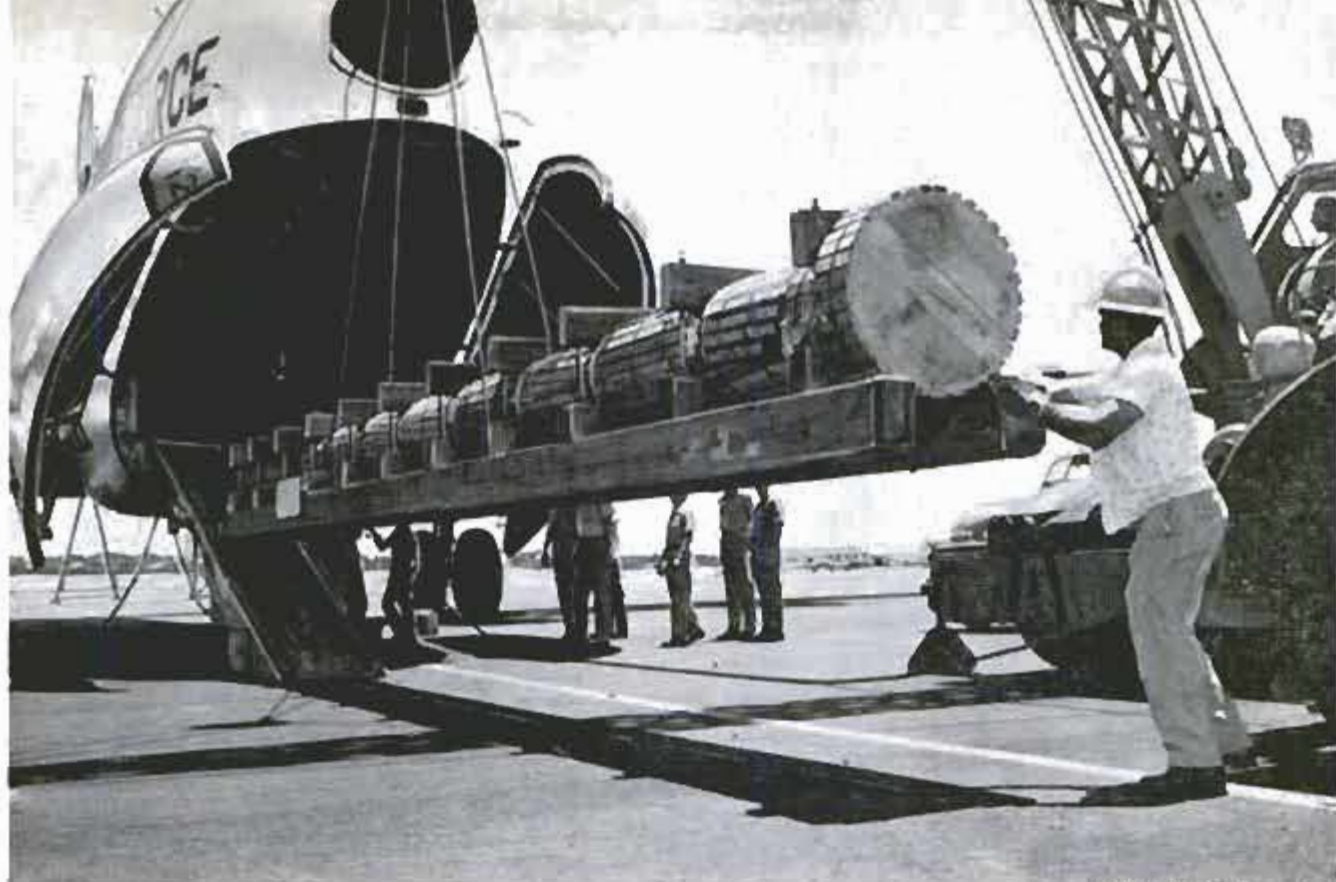

Official U. S. Navy photo

Cargo Plane Opens Wide to Swallow Destroyer's Propeller Shaft

What's the hauling capacity of a C-124 Douglas Globemaster? In Pearl Harbor, one of these giant cargo planes was used to transport a destroyer's propeller shaft. The

shaft, 40 feet in length and 30 inches in diameter, weighed 23,000 pounds. A crane was used to hoist the load, and two fork-lift trucks eased it into the plane.

Portable Radar Unit Tested by Signal Corps

Soldiers at Fort Huachuca, Ariz., have been experimenting with a lightweight radar unit that is carried on the back. The experimental equipment was developed by the Army Signal Corps. The goal is a compact detection unit that is highly mobile.



VTOL Jet Soars 30 Feet In First Free Flight

In Belfast, Ireland, the SC-1 vertical-take-off jet did something akin to a child taking its first steps alone. It made its first free flight, soaring 30 feet vertically. Previously the plane had flown vertically only while "tethered" in a gantry.





With a good grip on the hand bar, a neighbor child enjoys thrill on Hunsicker's homemade roller coaster. Below left, builder oils wheels, Son Karl, below right, pulls safety pin before takeoff as Gaylen looks on

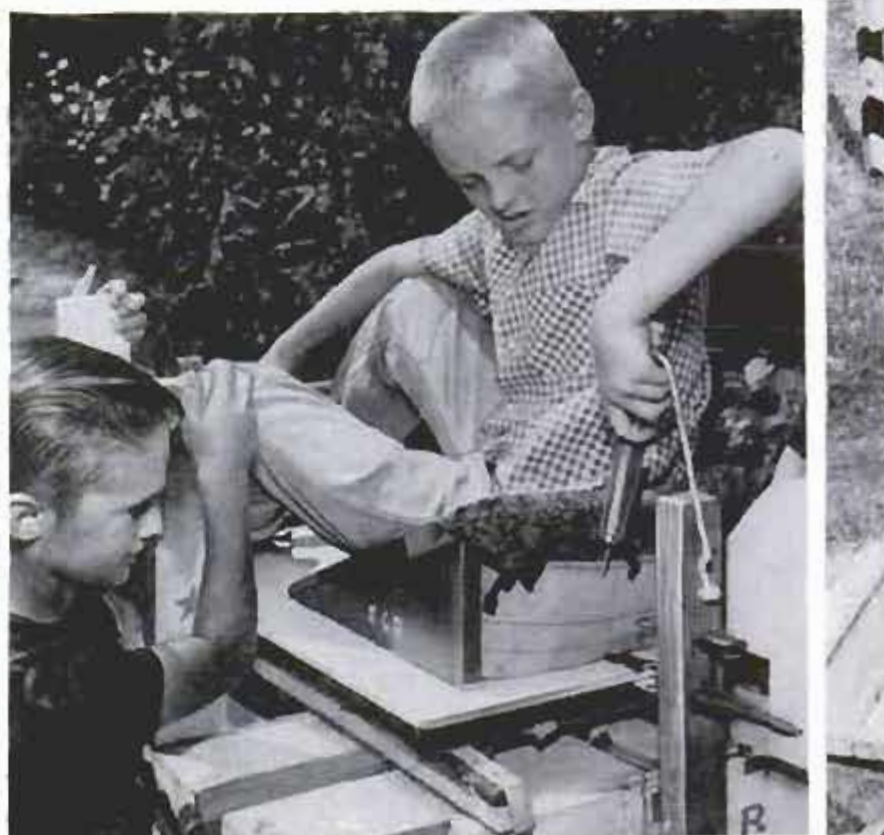

ROLLER COASTER

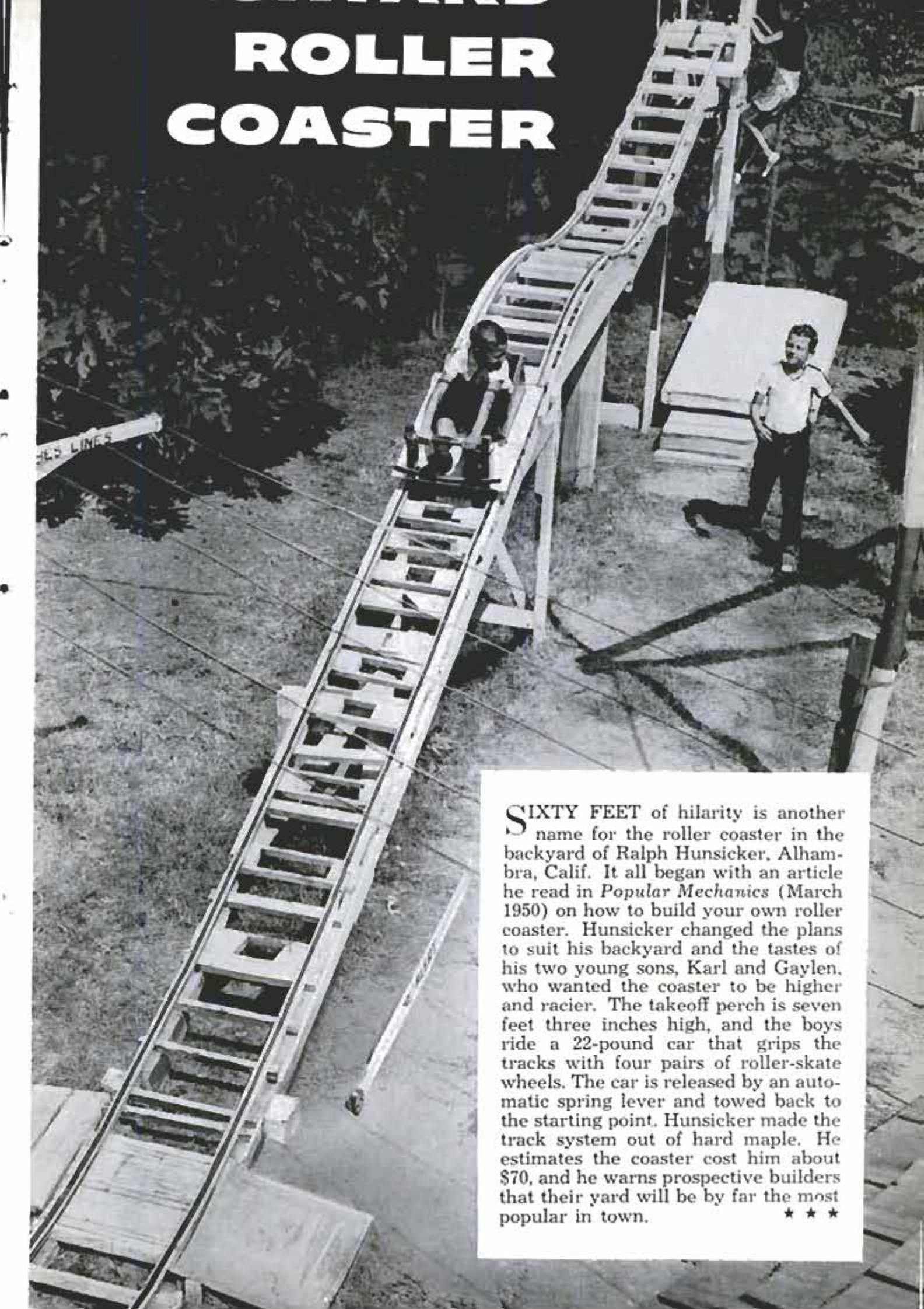

SIXTY FEET of hilarity is another name for the roller coaster in the backyard of Ralph Hunsicker, Alhambra, Calif. It all began with an article he read in *Popular Mechanics* (March 1950) on how to build your own roller coaster. Hunsicker changed the plans to suit his backyard and the tastes of his two young sons, Karl and Gaylen, who wanted the coaster to be higher and racier. The takeoff perch is seven feet three inches high, and the boys ride a 22-pound car that grips the tracks with four pairs of roller-skate wheels. The car is released by an automatic spring lever and towed back to the starting point. Hunsicker made the track system out of hard maple. He estimates the coaster cost him about \$70, and he warns prospective builders that their yard will be by far the most popular in town. ★ ★ ★



Army's Aerial "Jeep" Leaves Ground Vertically and Flies Forward

Army airmen now have an aerial "Jeep." Able to rise vertically from the ground on two columns of air and hover under its own power, the craft can hug the ground, fly under bridges and wires, and operate in heavily congested areas that are inaccessible to other vehicles or aircraft. The

aerial Jeep, designed and built by Piasecki Aircraft Corporation, has two horizontal-ducted propellers located within the body to provide both vertical lift and forward flight. The props are shielded on all sides. Piasecki is developing a similar craft for civilian use. It will be called the "Sky-Car."

This Kitchen Sink Cleans Dishes With High-Frequency Sound Waves

Your kitchen sink of the future may contain a device that will clean the dishes by ultrasonic vibrations. Westinghouse scientists have built an experimental sink in which an ultrasonic transducer has been installed. The transducer converts electrical pulsations into sound waves above the

range of human hearing. The high-frequency sound waves cause the rapid formation and collapse of tiny bubbles in a liquid. This "cold boiling" action has the effect of microscopic scrubbing that reaches every crevice of a surface. The tumbler in the photo is being cleaned by ultrasonics.





Huge Swamp Buggy Carries Drilling Rig Through Everglades

Seven hollow steel wheels, each seven feet in diameter, move a massive drilling rig through the Florida Everglades where a new canal is being built. The canal is in a remote section of the swamp where the

only surface travel is by air boat or out-board skiff. The "drill buggy" is maneuvered by two Ingersoll-Rand air motors geared to two of the wheels. The strange vehicle carries five 24-foot rock drills.

Platform on Motor Scooter Converts It for First-Aid Service



Platform area can convert a standard three-wheel motor scooter into a handy emergency vehicle that can speed immediate assistance for nearby first-aid calls. It carries such things as fire extinguishers, fire-fighting tools, grappling poles, first-aid kits, a resuscitator, gas mask, stretcher and a ladder extendable to 14 feet. A walkie-talkie, shown at left, is extra equipment.



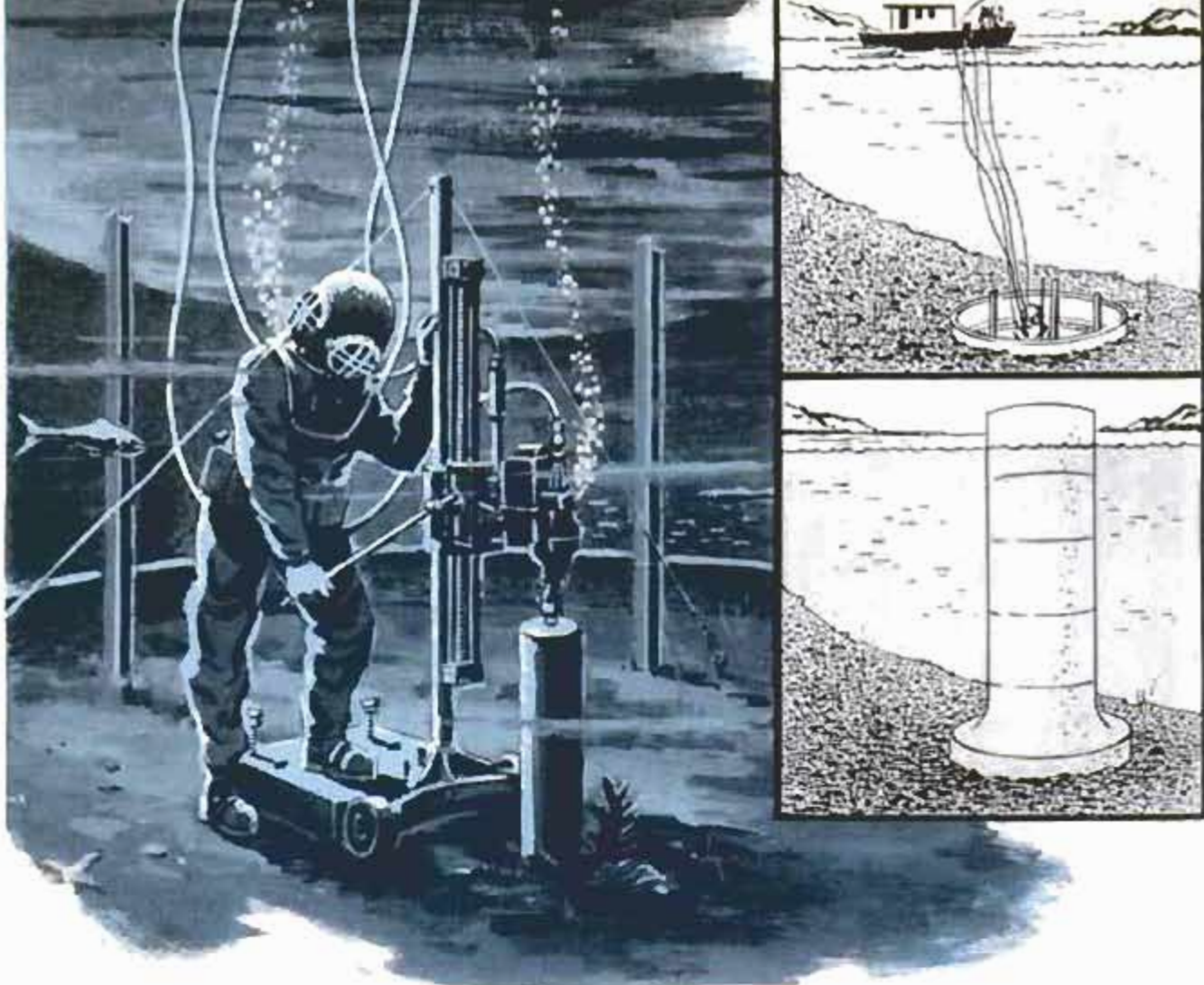

"Blind" Divers Bore Holes in Bedrock With Conventional Drill

Divers working blindly in 65 feet of turbulent water recently bored accurate holes in bedrock with a conventional diamond drilling machine. The holes were made for steel H-beams. Concrete pedestals then were lowered around the beams to support

two new piers off Texada Island, 85 miles north of Vancouver. The 10 holes, eight inches in diameter, were drilled to a depth of five feet. The divers, blinded by the turbulent waters, located the drill-hole centers by a template positioned by instruments.

Next month . . .

ANNUAL BOATING SECTION

PM's big bonus for boaters—

—24 pages packed with feature articles, shorts, how-to-do-its of special appeal to the amateur skipper and his family

- An authoritative survey of the "10 Best Boating Vacations" . . . where to go, what you'll see, the fish you'll catch, side trips of special interest
- Take-apart pontoon boat: Complete how-to-do-it plans for building an inexpensive but versatile craft that's ideal for family fun afloat
- What's new in boats and accessories
- What's new in water skiing
- How to choose the right propeller

. . . Don't miss this big bonus in March!





Here's Where Pilots' Lives Are Saved

By David Kenyon Webster

MORE PILOTS owe their lives to tiny airplane models than to all the parachutes and life jackets in the world today. The importance of these models, which are flight-tested in wind tunnels long before the actual plane is built, was recently highlighted by the opening of North American Aviation's \$5,000,000 trisonic wind tunnel in El Segundo, Calif.

One of the largest precision instruments in the world, this facility, like all of its predecessors, was designed solely to test

advanced aircraft and missile models in "flight" and thus improve them so that the actual planes and rockets will fly safely and with accuracy. Such testing provides a mass of information that cannot be obtained in any other way. Today, research with models is done in greater volume than with regular aircraft, and without risk to human life. The savings in the development of missiles are tremendous. With proper correction, interpretation and application, the data so obtained are accurate.

In North American Aviation's subsonic tunnel, a flutter model of F-100 Super Sabre is rigged for tests

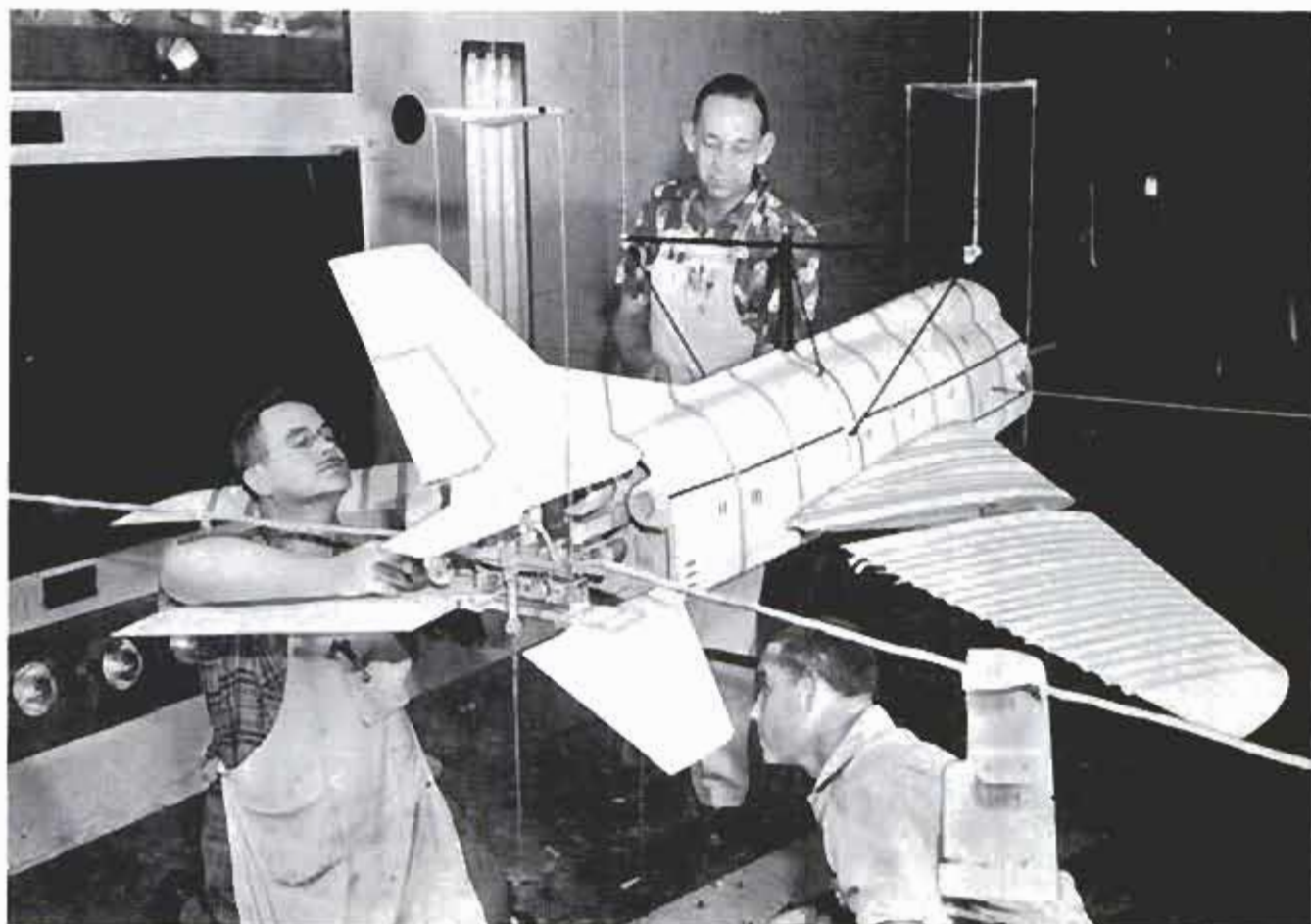



This is the control console during a test blow. The model airplane is viewed on the screen in the center

Wind-tunnel models are one of the most interesting and least-publicized aspects of our defense industry. Fantastically accurate miniatures of the actual plane, missile or component, they are built by skilled craftsmen working with jewel-like precision to tolerances of $\frac{1}{1000}$ inch in wood, metal or plastic—at costs above those of earlier airplanes. The average supersonic airplane model with a four-foot wingspan,

for example, costs about \$50,000, while some run higher than \$250,000 each, or twice the cost of a full-size World War II fighter plane, without engine. When a new series of aircraft is begun, the total investment in models can sometimes run into millions of dollars.

There are two basic types of wind-tunnel models: Static and dynamic. To the layman's eye, both frequently look much alike, for the difference is in their purpose more than their design. Each is built to explore a particular type of information that might pertain to the design of life-size airplanes.

Static models are the most common. Of relatively rigid construction and mounting, they have little "give" or flexibility under test conditions and are used to measure such things as the aerodynamic forces on the model and local pressures on its surfaces. Static models can be complete or partial, large or small, and low subsonic, high subsonic or supersonic. Power plants, external stores, duct inlets, ejection seats and internal-flow models are examples of a few partial-static models.

Duct-inlet models of the air openings for jet engines are so important that about half the country's current wind-tunnel work is with them. Getting an efficient air inlet for a jet engine at high speed presents a staggering problem because of the inter-



A half model of the F-100 is used for testing aerodynamic characteristics at supersonic speeds



In test section of trisonic wind tunnel, a technician rigs a supersonic model on the sting, or support
 ference of shock waves at speeds of Mach 3 (thrice the speed of sound) and above. Duct-inlet models range in length from about 20 inches to 20 feet.

Cameras Record Tests

Dynamic models are rarer. They are also more flexible and often require special tunnels for testing. All have a certain freedom of movement; some rotate, while others actually fly on the proper air stream. Dynamic models may be restrained by springs, as in the case of dynamic stability and flutter models, or they may be free-flight devices, as in the case of spin models, which are dropped into vertical wind tun-

nels to see whether the proposed plane can work itself out of a spin. This category also includes models of stores like rockets and bombs or crew members, all of which are jettisoned into the roaring air stream from a complete model. Twenty or thirty models of external stores were built and tested not too long ago for one aircraft, the F-100 Super Sabre. Motion-picture cameras are used in most cases to record data from tests in which these dynamic models are involved.

Testing the model of a new aircraft is an extremely lengthy and involved process. Here's how it's done at North American, as good an example as any, since they have

TRISONIC WIND TUNNEL

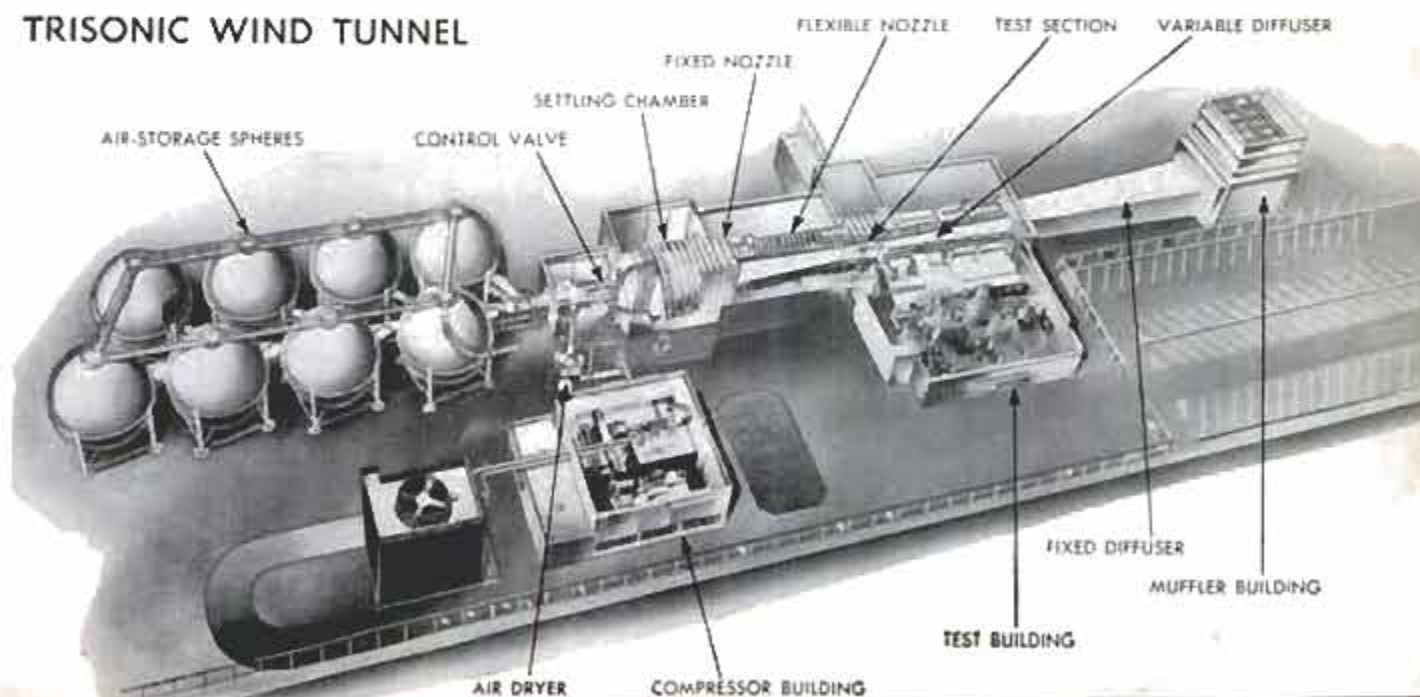



Low-speed models like this one of the T2J jet trainer are built of wood and plastic on a metal frame

built more planes than any other company in the world. The procedure they follow is typical.

First, a simple, small, preliminary full model is built of metal and wood, or all metal, and tested through its entire speed range in the company's 16-inch supersonic tunnel. This takes about two months and shows what modifications are needed.

While this is going on, a larger preliminary model is made of metal and tested over a period of about four months for aerodynamic characteristics that determine stability, control and performance. These models are tested and modified until the best possible airplane design has been evolved. A more detailed metal model is

This tiny model of a duct inlet has internal flow and dozens of pressure tubes, .064 inch in diameter

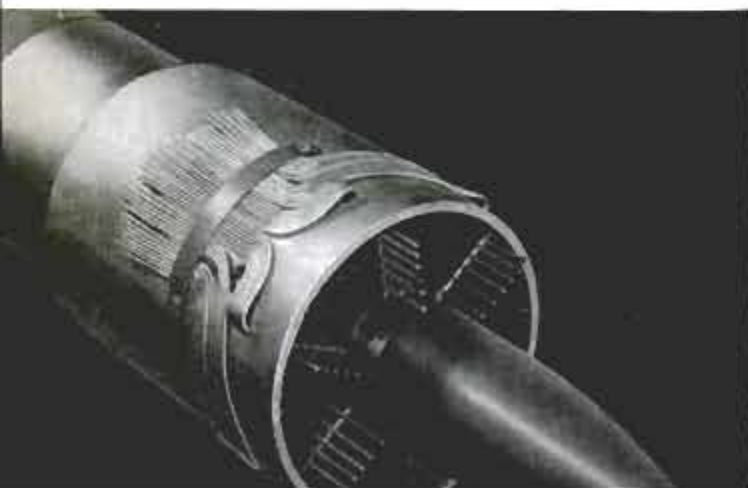

then constructed with high-lift devices, instrumented and adjustable control surfaces, instrumented speed brakes, landing gear, an internal duct with flow-instrumentation and other devices.

One Engineer to Three Craftsmen

To build a model takes a proportion of about one engineer in the design group for every three craftsmen in the shop. It has been found over the years that architects and mechanical engineers are better suited for model work than experienced aircraft designers. It has also been found that for the actual construction, experimental machinists are superior to tool and die makers in the metal division, while experienced patternmakers are best for woodworking. In most companies, all work together in a "model group." A small, independent factory within the main plant, this organization usually has its own shop, administration, scheduling and design, structures and time-accounting units. It works to the order of such units as the aerodynamics, thermodynamics, wind tunnel, and flutter and vibration groups. At North American, the model group has designed items ranging in size from models with wing panels no larger than a thumbnail to the million-pound variable nozzle now in action in the trisonic wind tunnel.

Once the model has been completed, it is taken to the trisonic tunnel (if designed for that purpose) and set up for a test. This takes four or five men several hours. About as long a time is consumed in dismantling the model afterward, for the wiring attached to it is amazingly fine and complex and must be handled very carefully. Up to 200 or more wires from various recording devices within the model run down through a hollow support and out to the control room. An equal number of tiny metal tubes .064 inch in diameter follow the same route from the model's surfaces to pressure transducers within the tunnel, which convert pressure to an electrical voltage. Wires then carry these voltages to the control room, where they are automatically recorded. Though pictures are also taken during a test, they are secondary in importance to the automatic recordings provided by the wires and tubes, the total number of which can run as high as 300 on a single model.

In the average model, most of the fuselage is taken up by an extremely sensitive balance that records forces and movements, while space in the wings and tail is occupied by various strain gauges. The model's attitude is changed during a blow, and the position of certain movable components is often varied.

Flutter models, being suspended from springs, are the only kind that move as a whole, responding to the force of air with considerable motion. To watch one, an observer gets the impression that the plane, though restrained, is in actual flight in air.

Models of jettisonable stores like drop tanks and rockets, as well as models of crew members for seat-ejection tests, have the most action of all. They are used to determine the flight path of a body from an airplane to see whether it will

(Continued to page 246)



Looking downstream inside the \$5,000,000 wind tunnel, a model is shown being rigged for a test in the subsonic-transsonic section. The average supersonic model costs about \$50,000, but findings based on tunnel tests have saved countless lives



Halfway through construction, a flutter model of a fuel drop-tank has the fragile delicacy of a cocoon. On the workbench, behind a model drying in the mold, is a finished one. It is made of glass fabric stretched over thin plastic bulkheads

Improved ejection seats have resulted from tests made with pilots that are barely three inches tall





Eyeglass Frames Molded to Fit Area Behind the Ears

Now you can get custom-fitted eyeglass frames that will hold your glasses in place even while you're diving into a swimming pool. S/Sgt. Cecil T. Butler of Walter Reed

Army Medical Center developed the method for making molds of the areas behind the wearer's ears. The frames are then produced from the molds.

Camera-Shaped Microscope Magnifies 1000 Times

Designed for fieldwork or expeditions is a Japanese microscope that has the shape and size of a small camera. It will magnify objects up to 1000 times. A built-in lamp operates on flashlight batteries. A wheel on the front changes the focus.

Station Wagon Seats Fold Into the Floor

Rear seats fold into the floor of a station wagon recently introduced by Citroen, the French auto manufacturer. It is one of four new utility-type Citroen vehicles. The others include a family car, a light pickup truck and an ambulance.





John S. Kelley photos

Electronic Starting System Thwarts Jumping of Gun

Runners can't jump the gun when a new electronic starting system is used. Each runner rests his thumb on a pad connected to a control panel. When all pads are pressed, the gun is fired from a button on the panel. If one or more of the runners gets away too soon, a horn sounds and the gun won't fire. Buttons indicate which runners are the offenders.



Two-Story Muffler "Tunes" Jet Noise From Loud Roar to Low Moan

In a specially built muffler, roars of the F-105's 20,000-pound-thrust jet engine are reduced to a low-pitched moan. The two-story front section has a metal liner backed

by glass fiber. The liner absorbs most of the sound. What's left is funneled through the pipelike structure to a muffler tank. Gases are blown out the smokestack.

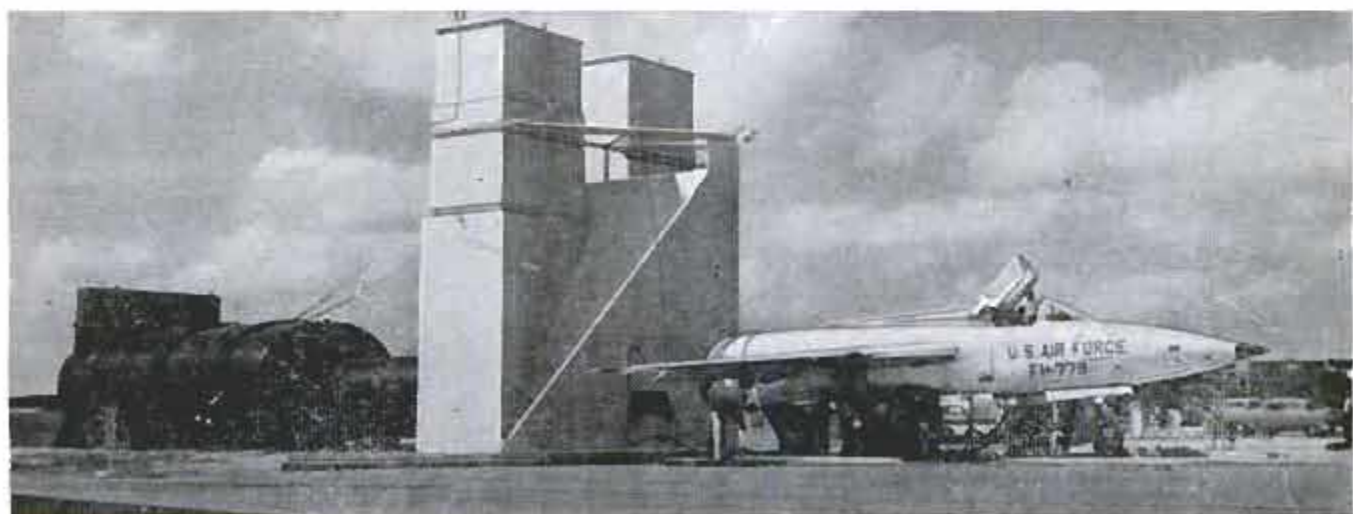

Supersonic Baseball With a Live Artillery Shell

THEY PLAYED a strange kind of supersonic baseball at Holloman Air Force Base recently. The code name of the project was "Catcher's Mitt," and the aim of the game was to snag live artillery shells without damage.

Ordnance experts long have been trying to determine firing effects (entirely separate from impact effects) on a live shell. The 35,000-foot captive-missile test track at Holloman seemed to offer possibilities. A 155-mm. howitzer was brought to the

track, and a sled designed to catch the shell.

The sled's rockets developed 200,000 pounds of thrust for each run. The sled itself, dubbed the "Monster," was 19 feet long and weighed more than 10,000 pounds. The catcher's mitt on the sled was a compartment packed with foam rubber and foam plastic.

The gun mount was sunk 39 inches into the desert floor to keep the shell's peak trajectory within the limits of the moving

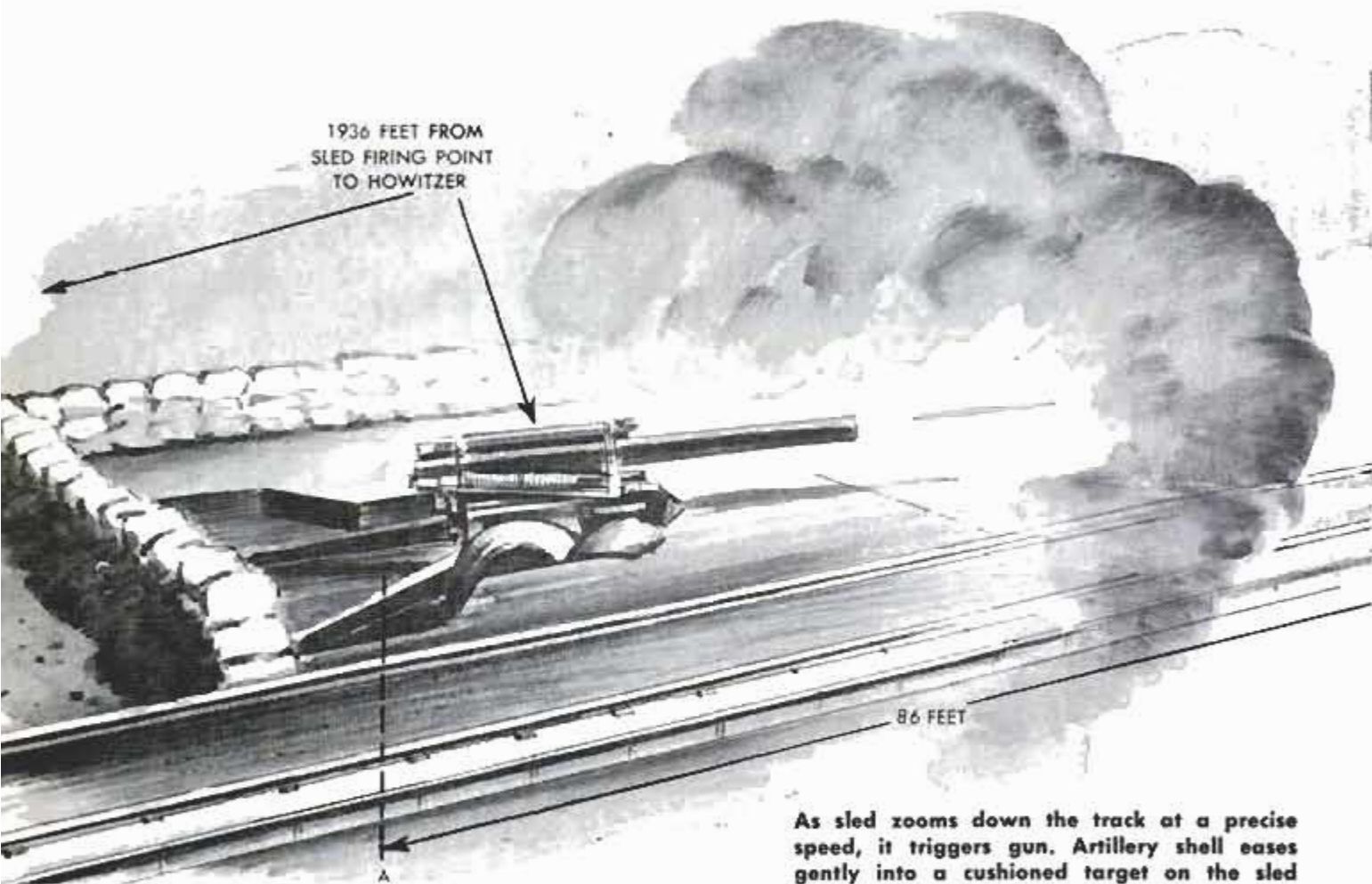

As sled zooms down the track at a precise speed, it triggers gun. Artillery shell eases gently into a cushioned target on the sled

Special target sled was built for the experiment. Its rocket motors develop 200,000 pounds of thrust

At its maximum speed the 10,000-pound sled rushes down the long track at more than 1000 miles per hour

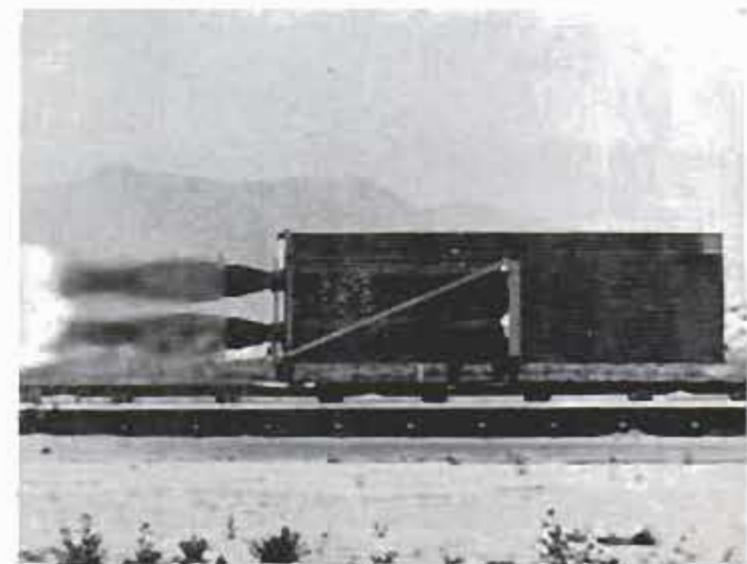

aimed at a slight diagonal. This meant that the shell and sled had to come together at a precise instant or they never would meet.

The shell traveled 1650 feet per second (1100 miles per hour). A timing mechanism was rigged so that if the sled passed between two points 86 feet apart in 59 milliseconds, the gun would be triggered.

Everything ready, the researchers sent the sled zooming down the track. It attained its speed precisely, triggered the gun, the shell met the sled and eased unharmed into the cushioning material!

Some ball game!

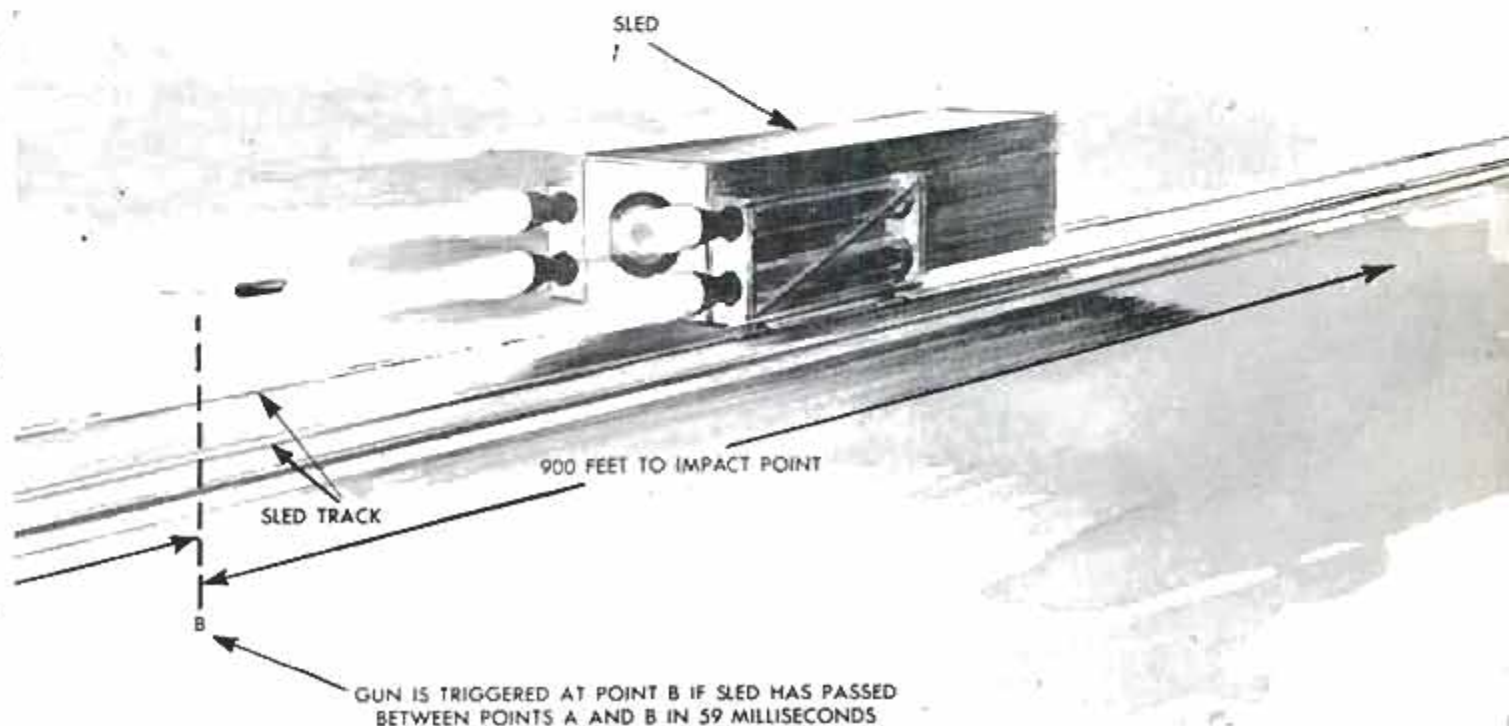

Miraculous catch is made in "catcher's mitt"—and close to center of the target. Timing had to be accurate to 1/1000 second to enable the streaking sled to snare the artillery shell in mid-air

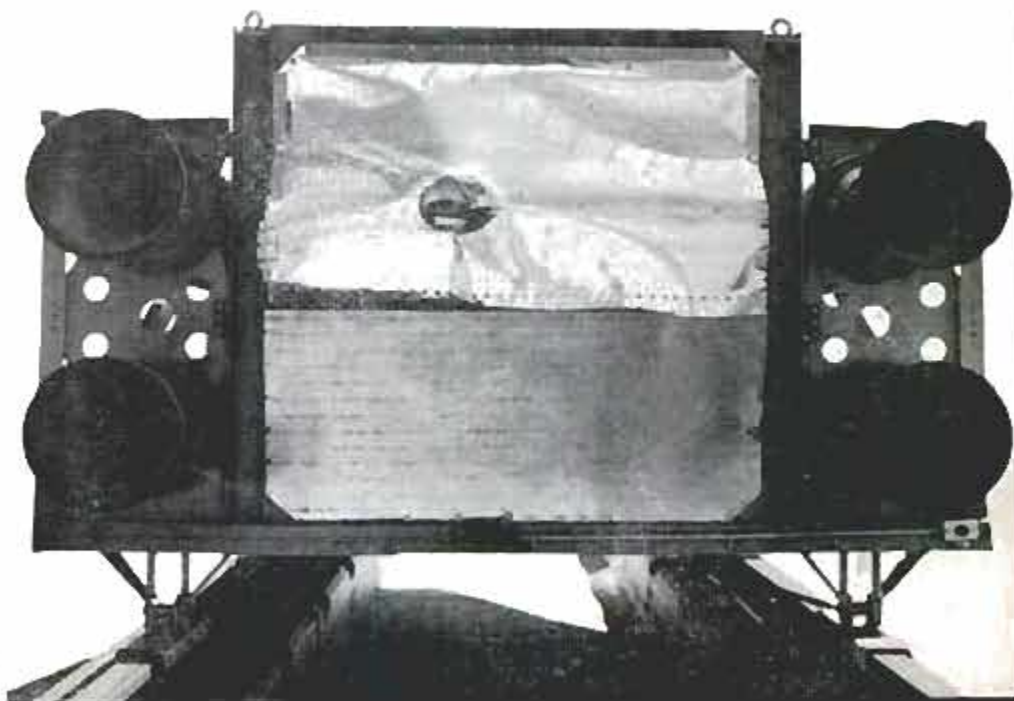



Sonar for Small Boats Helps Locate Fish

Even the small-boat fisherman now can use sonar to spot individual fish and determine their depth. The transducer of the instrument is held by suction cups on the

side of any boat. It sends a high-frequency sound wave down through the water. The echo of the wave bounces off fish and the bottom, and shows up as lines on the dial.

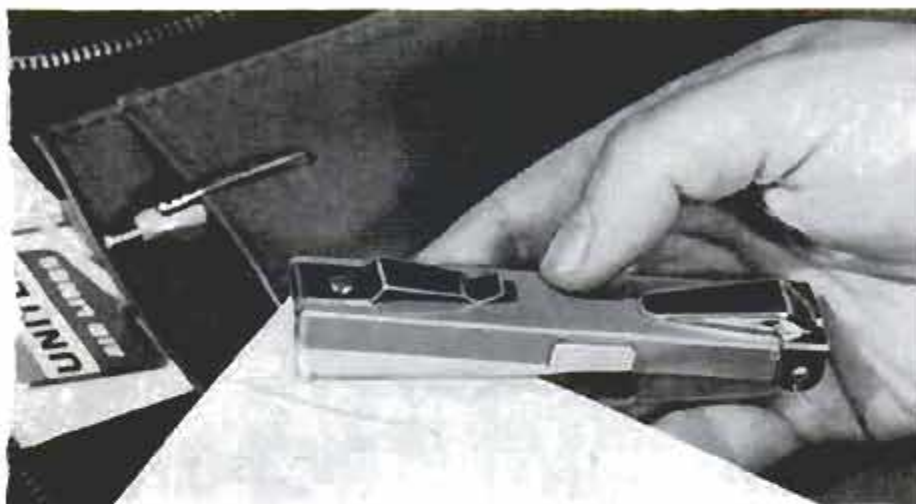

Versatile Stapler Clips to Pocket

Designed for use by businessmen and students, a new pocket-size stapler can be opened up for tacking jobs—such as fastening papers to a bulletin board. It also has an attachment which can be used to remove staples. A clip at one end permits the owner to carry it in his pocket.



Bowling Bag Has Shoe Shelf

Separate compartments for ball and shoes are provided in a bowling bag with zipper openings on both the top and front. This permits the bowler to place either his shoes or the ball in the bag first. The shoes rest on an offset bridge frame of aluminum which can be removed to make an overnight bag.

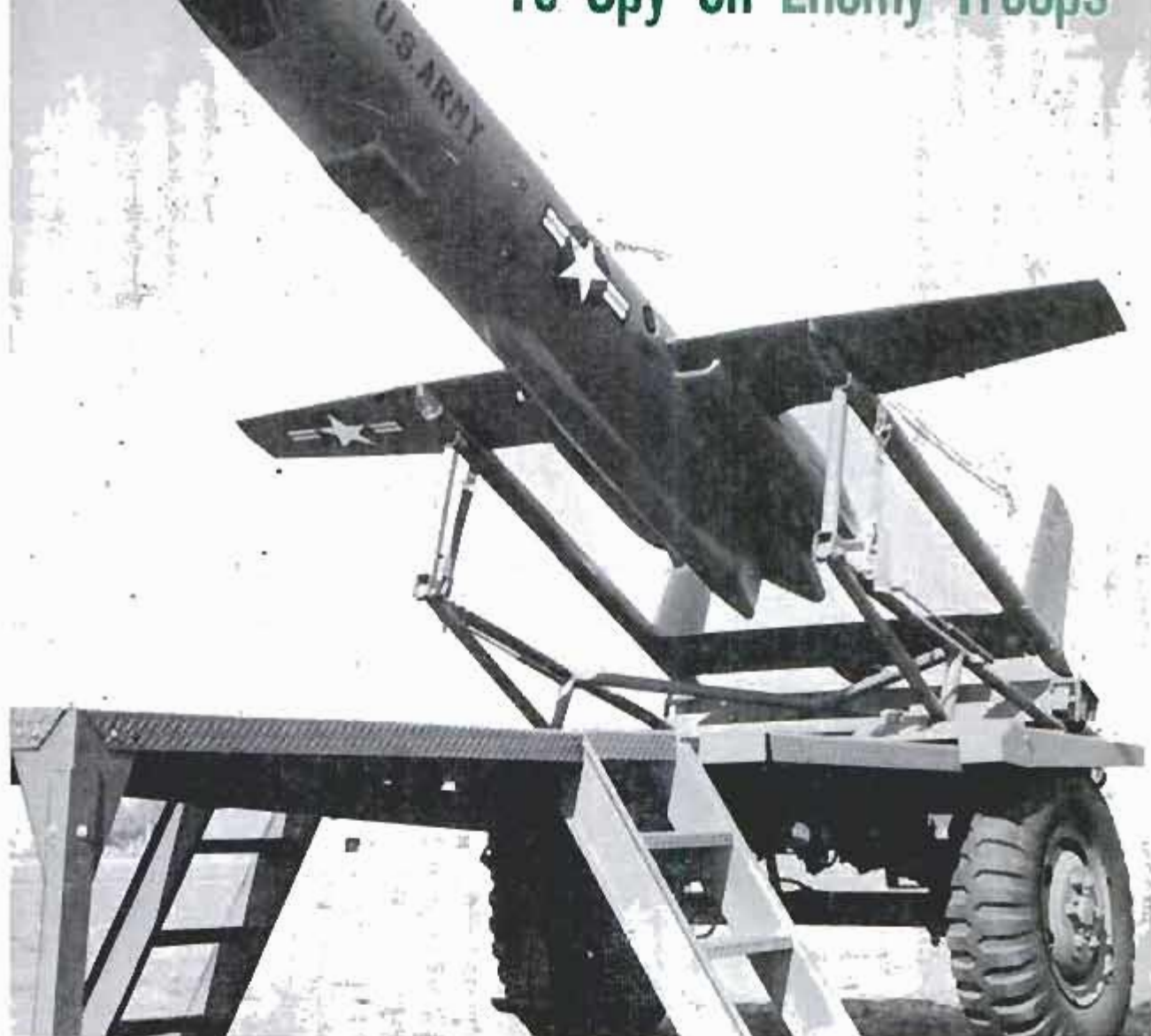

Army signalmen will use a pilotless, recoverable drone to perform aerial reconnaissance in any future war. Employing advanced sensory devices such as infrared, radar and an air-to-ground television sys-

tem, the propeller-driven drone is recovered by parachute. There are two models of the drone: SD-3, above, manufactured by Republic Aviation Corp., and the SD-2, made by Rheem Mfg. Co.

Projector Has Built-in Movie Screen

Capable of both front and rear projection, a 16-millimeter projector can show movies either on a wall or portable screen, or on a built-in screen that measures 18 by 13 inches, equivalent to a 21-inch TV screen. To convert from rear to forward projection, the operator swings a mirror out of the light beam and replaces the lens with a normal two-inch-focal-length lens. An eight-inch speaker is positioned so that the sound comes from behind the screen. Packed for carrying, the unit measures 2 feet long, 1½ feet high and 10 inches wide.

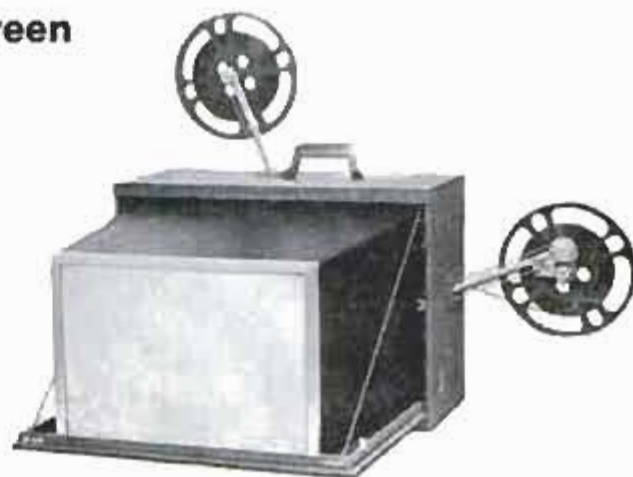

WHAT'S NEW FOR Your Home



CABINET DRAWERS that deliver the goods to your fingertips are produced in nearly a dozen different shelf arrangements. One drawer unit stores two cases of canned foods, another stores cans on one side and packages on the other. Each of the gliding drawer units is 20 inches deep and 26 inches high

EZ Reach Mfg. Co., 1773 N. Second St., El Cajon, Calif.



BUFFING MACHINE that weighs only 40 ounces can be used for all sorts of household polishing jobs, from furniture and wood paneling to shoes and cars. The buffing bannet can be slipped off and washed. A hand strap helps the user get a firm grip. A speed regulator prevents overheating of the electric motor

Howard Houseware Div., LaPointe Industries, Inc., Rockville, Conn.

RIBBED PLASTIC SHEETING is available in lightweight, narrow widths for shelf lining and heavier, 30-inch widths for floor protection. Each kind is made in a variety of decorator colors. The heavy sheeting can be used as door mats or under flower pots. It can be cut with scissors, cleaned with a damp cloth

Gering Products, Inc., Kenilworth, N. J.

GAME TABLE ON WHEELS provides regulation 5 by 9-foot playing surface when opened for table tennis, but it can be folded in the middle and rolled away for storage. It can be stored in an area only 18 inches deep. The surface is finished in flat green, with white court lines. Table won't move during play

Stee Mfg. Co., Inc., Dept. KP, 5215 Eden Ave. S., Minneapolis 24, Minn.





SHOE POLISHER, with a bristle brush on one side and a polishing bonnet on the other, is powered by an electric motor. You don't even have to bend over to turn it on—just touch the switch with your foot. Large rubber suction cups hold it in place

Dremel Mfg. Co., Racine, Wis.

PULL-OUT OVEN, featured in one of the new 40-inch electric ranges, is intended to reduce the time spent in kitchen cleaning chores. The entire oven can be removed from the cabinet. When the top is removed, the oven interior is completely exposed

Frigidaire Div., General Motors Corp., Dayton 1, Ohio



CANNED FOOD RACK, designed to fit a standard-depth kitchen cupboard shelf, allows you to store up to 15 cans in a space where only eight could be stacked by conventional methods. As one can is removed from the rack, another rolls forward to take its place. The device is particularly handy for storing baby food, pet food or fruit juices. Rack is made of heavy-plated steel wire and has rubber-tipped legs

Kelly Co., 1021 Emporia, Muskogee, Okla.

DISPOSER CLEANER was developed by a plumber for the specific purpose of clearing jammed garbage disposer units. The tool is about two feet long with a short crossbar attached at the bottom with a rivet. The crossbar rests firmly on the bottom of the disposer and is turned to the right or left to break up the garbage jam. The tool is plated to prevent rust

D. A. Bell Enterprises, Inc., 1016 E. Maryland Ave., Phoenix, Ariz.

VANISHING CLOTHESLINE can be installed in almost any wall with simple hand tools. A spring-loaded reel holds the line out of sight in a receptacle box inside the wall when it's not being used. Only a chrome-plated, tile-size plate and pull ring on one wall and a matching hook plate on the opposite wall are visible. The kit includes a heavy-duty line

Lotta Manufacturing Company, 714 Race St., Rockford, Ill.

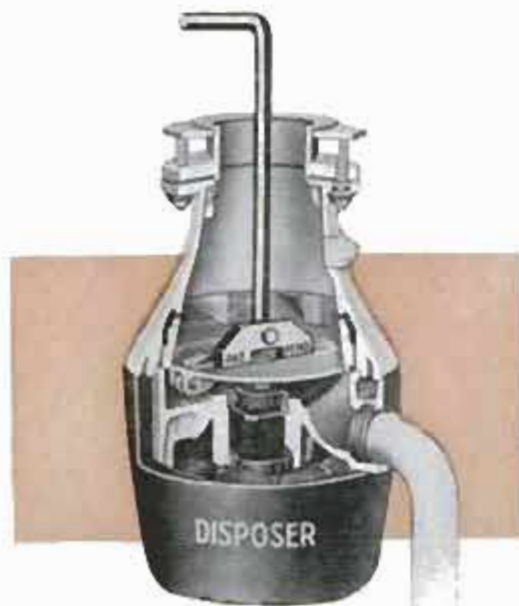

MISSILE CARRIES SUPPLIES TO FRONT-LINE TROOPS

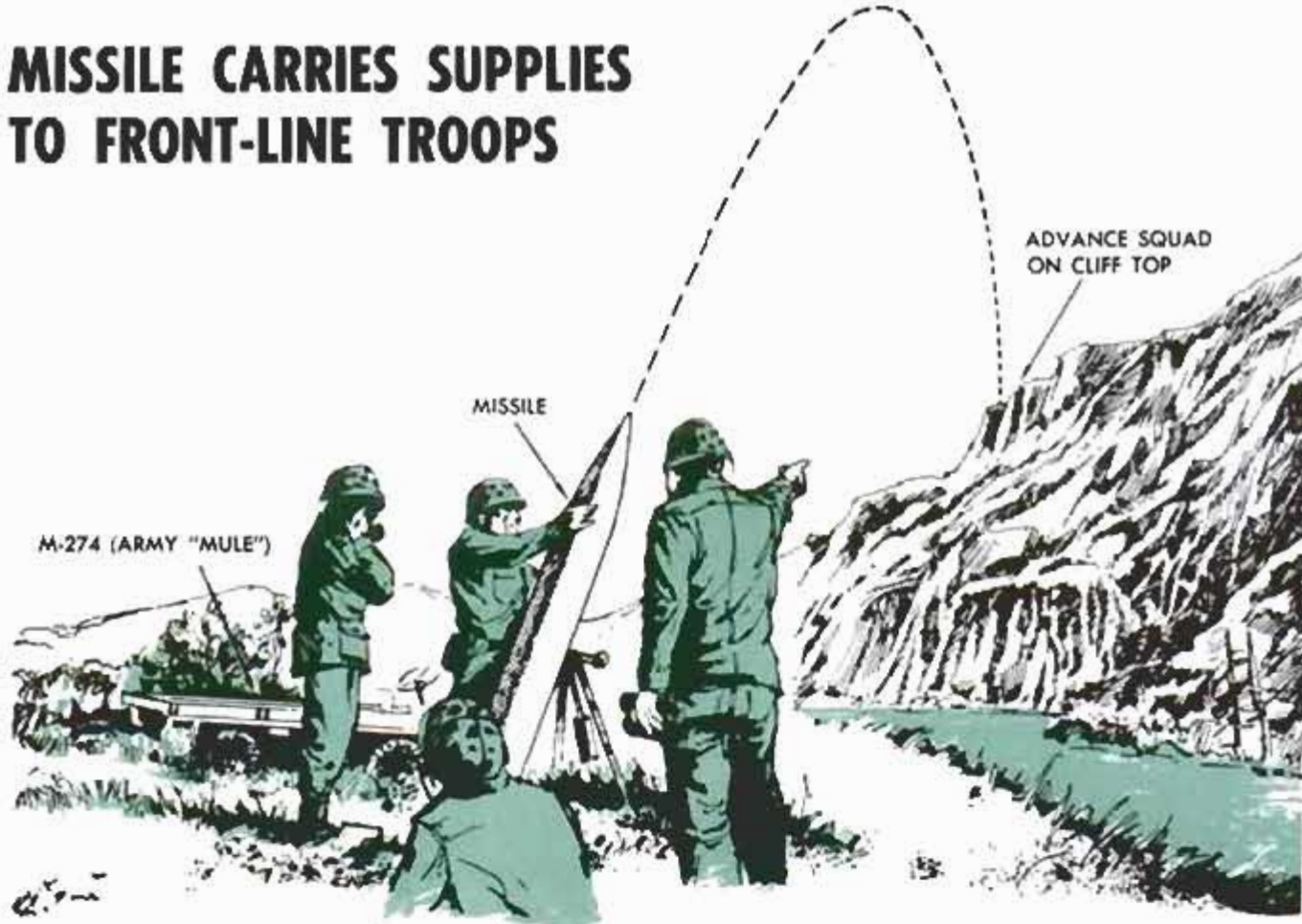

Front-line troops in any future war will be supplied by missile. Called the "Lobber," the missile is about nine feet long and ten inches in diameter. It has an effective range of six to eight miles and carries up to 30 individual meals or an equivalent amount of ammunition or medical supplies.

The missile is lowered by parachute. It can be carried by three men in the field. Besides having the advantage of speed, the Lobber can be employed when bad weather prevents or restricts air drops, or when airspace over a combat area is under enemy control.

Improved "Train" Hauls Pipe Sections on Trestle Above Marshes

Laying water pipe across the marshy Snohomish River flats just southeast of Everett, Wash., presented a problem. How could the heavy sections of piping be moved from the unloading point to the place where they were to be installed? The problem was

solved by improvising a "train"—two carriages and a cut-down jalopy. Using the trestle framework as a road bed, the carrier moved the 8800 feet of steel piping above the marshes into exactly the right position for installation.

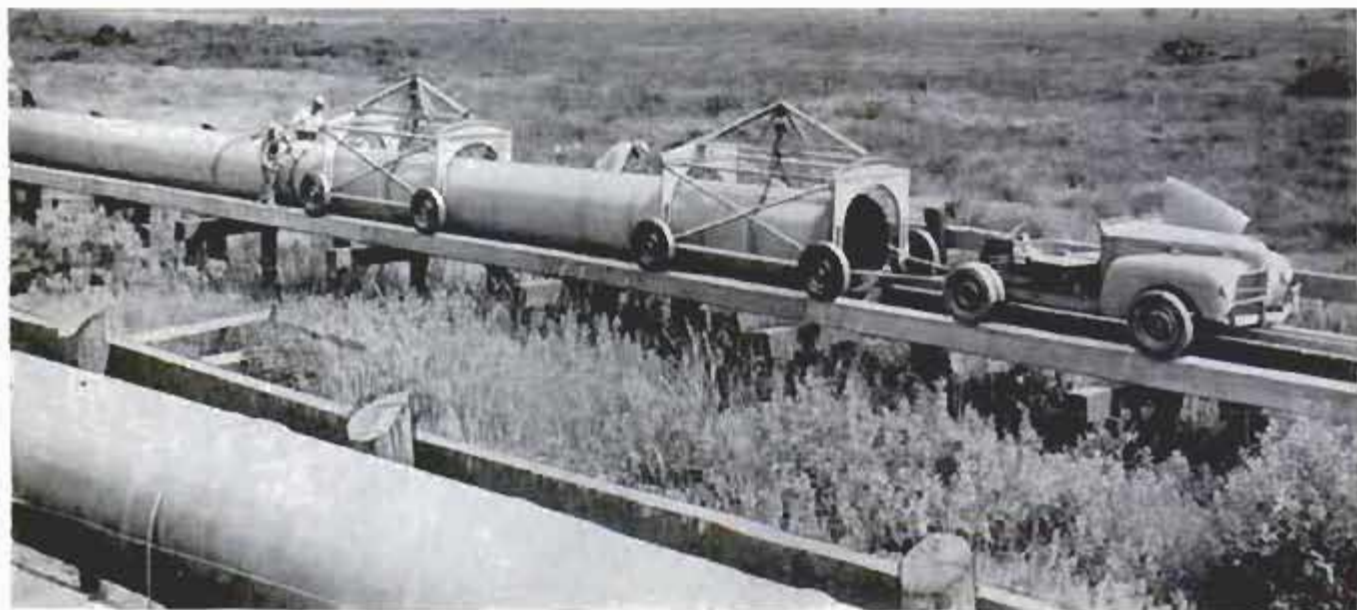



HOMEMADE RIVERS IRRIGATE THE WEST

By F. Leland Elam

THE UNPLEASANT REALITY that one fourth to two thirds of our water is wasted through leakage and seepage has at last been realized by technologists who are trying to stop such waste by developing machines and materials that will bring about satisfactory control.

Today, in many areas, water for agriculture and industry is a scarce commodity. Farmers must dig deep for it and water thus obtained is expensive. Cities and states spend billions of dollars to trap water and transport it to users. The federal government is financing multimillion-dollar reservoirs to supply water to parched farmlands. If much of this water is lost during transportation the value of these projects is diminished.

One important development to conserve water during its transportation is the continuous jointless concrete pipe. Realizing the need for a leakproof concrete pipe for water, Elmer Tunsen of Yuba City, Calif., worked for 10 years on the idea of a cast-on-the-spot jointless pipe.

"This continuous concrete pipe has many advantages," Tunsen explains. "Connections and curves are simply made. Expansion and contraction troubles that often cause leakage are minimized by the bond between the pipe and trench which restrains movement. A five-man crew is all that's needed to lay continuous concrete pipe as compared to 19 men for conventional pipe-laying techniques."

A ditch-digging machine excavates a

This multiple-use machine rejuvenates an irrigation canal by scraping the weeds and moss from the sides and bottom of the ditch





Steel sloper blade, above, is used to clean and re-shape the side walls of a canal. Dirt is carried to top of bank where lister spreads it behind tractor

trench with a semicircular shape and a self-powered steel sled carries the forming devices needed to make the pipe.

The sled fits closely into the trench. It carries electrically operated shovels and vibrators that put the concrete in its circular form after it has been poured. The shovels in the traveling form move the concrete down and around the circumference of the pipe. The vibrators compact the concrete.

A cable drum moves the sled. As the form is filled with concrete the drum winds up the cable, pulling the sled forward. Collapsible metal forms are fed into the front of the sled assembly and are hooked together as it moves forward. The forms support the top and sides of the pipe. After the concrete has set, a truck hooks onto the outermost form and pulls the entire line out so they can be used again.

Another method of conserving water in transit is by use of jointless concrete canal lining. The ditch is first shaped, then steel reinforcing mesh is laid in it. The concrete



Boom on the machine at left pushes huge shovel which is held in line by steel sled. Boom then pulls in shovel which bites into ground at the right depth. It leaves behind smooth ditch walls



When shovel is filled, the boom is lifted and swung to one side. Shovel then is tilted and dirt is dumped beside the new ditch. When machine moves ahead, shovel is positioned for next bite



Ditch left by huge shovel can be surfaced with concrete by machine that travels behind the ditch digger

is mixed and sent by compressed air through a hose. The concrete comes out at a rapid rate and is forced into a mesh mat.

To give proper placement, the mesh is raised to the desired position with a hooked bar. The concrete is "shot" first at strategic points on the reinforcing mat to hold the mesh in place. Then the areas between the "chairs," or strategic points, are filled to the required thickness.

"Airblown concrete gives a good clean job," according to California's State Water Development Committee. "There are no joints from which leaks can begin. The surface is smooth and water flows swiftly and without any impediments."

Asphalt panels are being used to put leakproof linings in both old and new irrigation ditches. The reinforced molded panels are laid directly on old cracked surfaces or on earthen excavations. As a liner for water-storage or water-carrying facilities, the panels are flexible and crackproof. They hold their form in any climate and are not bothered by frost.

This paneling is made of five protective waterproofing materials. Its center is a thick core of ductile airblown asphalt, fortified with certain minerals and reinforcing fibers. The mixture is compounded and molded under pressure and heat into panels of the desired thickness and length. On both sides of this core is a layer of asphalt-impregnated felt. And added to both sides as the outside surface is a protective coat of waterproofing asphalt.

Bentonite, a mineral clay, sometimes is used to seal dirt surfaces. The material swells up to many times its original size when it contacts water. It is mixed with the surface soil by raking and rolling it to

a depth of three to four inches. Thus it fills the natural voids between granules of soil and stops water seepage. Once applied it carries on its sealing function indefinitely. It is not affected by repeated dryings and wettings.

Since costs quite often control the methods of constructing ditches, especially on ranches, some do not have waterproof linings. As a result, weeds grow inside and

Reinforced asphalt panels, made of five layers of materials, also are used as leakproof ditch lining





Continuous concrete pipe is produced in ditch which has curved floor. Fresh concrete runs from truck into hopper at rear of form-packing sled

it of bulrushes and other weeds while re-shaping it.

This ditcher constructs a flat-bottom ditch of uniform width and slope. It has three blades on each side, all of which are easily controlled by hydraulic rams from a control board in front of the operator.

The rams can work the blades in many positions, making it possible

to slope the sides to meet any standard shaping specifications. The blade units can be adjusted to different positions to control the width of the ditch.

Still another recent development in ditch diggers is a giant machine built by A. Teichert and Son, Inc., of Sacramento, Calif. It has on its front a shovel that works back and forth on a heavy boom which pushes, pulls and swings.

Machines, materials and methods are helping overcome the multitude of water problems associated with the rapid utilization of both urban and rural land. These water problems reach deep into the taxpayers' pocketbooks.

In California alone, over \$6,000,000,000 has been spent on water projects in the past 75 years. "Yet, in spite of the efforts of the agencies planning and building water projects," says Harvey O. Banks, Director of California's Department of Water Resources, "we are losing the race to keep pace with the booming growth in population, agriculture and industry. We must take every means available to keep from wasting water." ★ ★ ★

outside the ditches. Any obstruction or depression in the surface impedes the flow of water, causing a drop in capacity and setting the stage for erosion.

"These conditions bring a major maintenance problem," reports an official of the U. S. Conservation Service. "But today the problems are being simplified by new ditch building and cleaning tools."

One such tool fits on the side of a tractor. It was developed by Briscoe Manufacturers of Kerman, Calif. It is a 21-foot-long steel sloper blade hinged to the back of a tractor. The blade is lowered, to rest on the slope of the ditch bank. As the tractor moves forward, it cleans the wall of weeds and moss and smooths the surface. When the blade is filled with plant material cables pull the blade to the top of the bank where the material is deposited. A wing behind the tractor spreads the dirt to prevent its falling into the ditch.

The same firm has developed a multiple-use machine that makes, shapes and cleans ditches. It will work its way through a field, digging a ditch of nearly any size. Or it will pass along an old ditch, cleaning

Butane flame thrower with five nozzles is employed to burn weeds which retard the flow of water in irrigation ditches



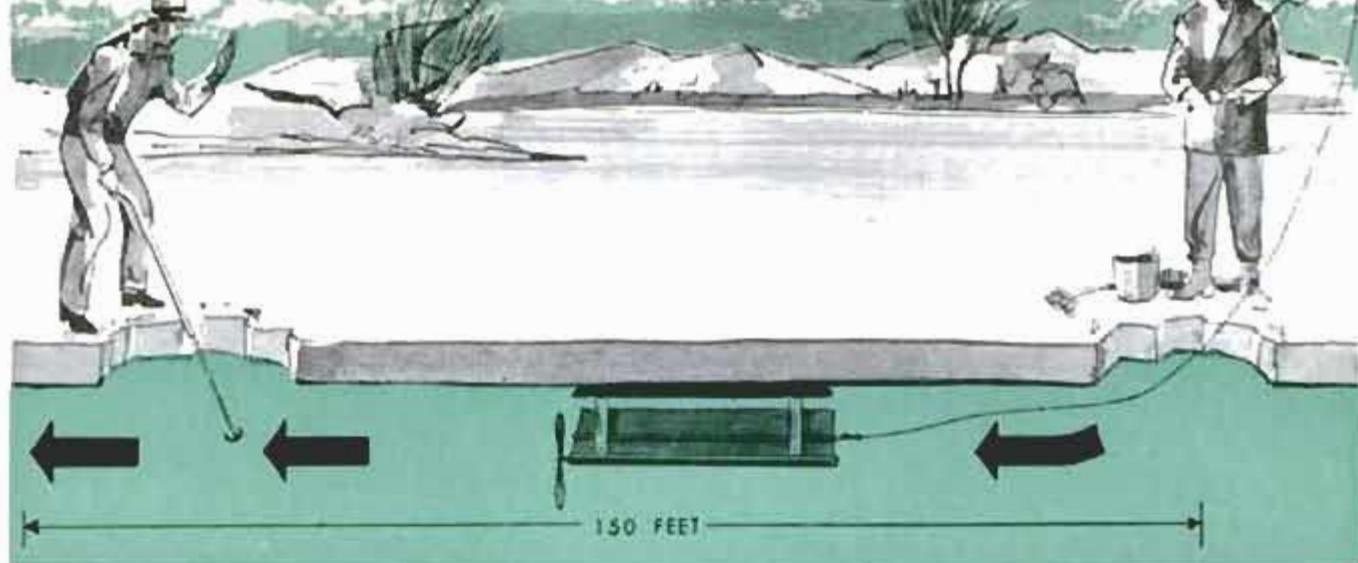

Sled Delivers Ice Troll Line

Fishermen can now set up trolling lines in ice-covered lakes and streams with the help of a rubber-band-powered sled. The sled doesn't do the actual trolling; it merely pulls a line from one ice-fishing hole to another. The fishermen then attach the bait or lure and troll the line back and forth. The sled travels 150 feet.



Simulator Determines Whether Missile Can Survive Atmosphere Re-Entry

Flight of a missile as it re-enters atmosphere can be duplicated by a simulator with a trumpet-shaped nozzle and a high-speed gun. The gun fires a model missile through the nozzle while high-pressure air

flows into the nozzle from a tank. Shadow-graph pictures record the flight. In a few thousandths of a second, the model experiences decelerations, stresses, pressures and temperatures of actual re-entry.

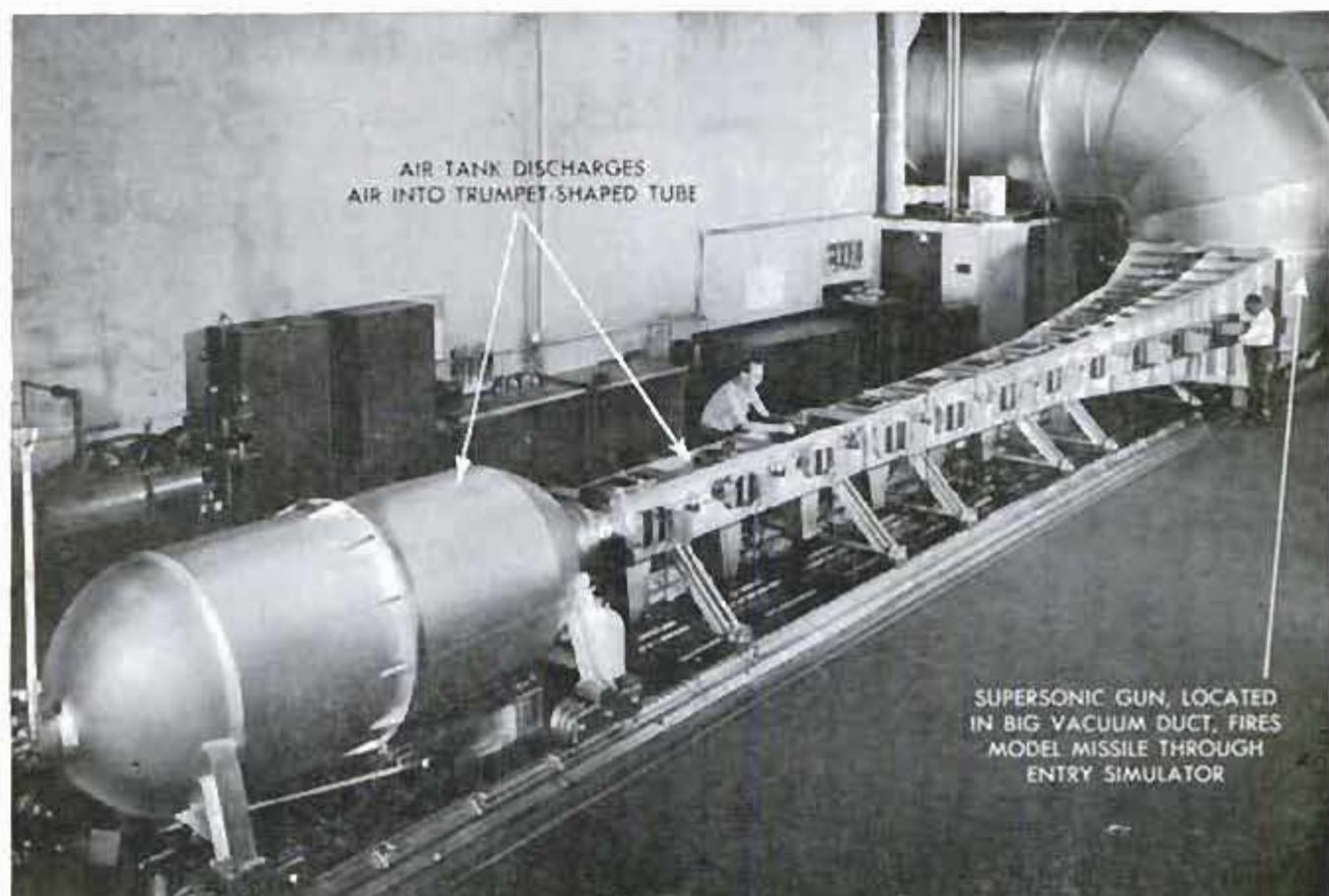



Resin Holds Creases in Cotton

Both of the cotton cord coats in the upper left photo have been washed and tumble dried. The coat on the left has been treated with a newly developed resin solution which makes the garment wrinkle-resistant. Photos at the left and upper right show garment being soaked in the solution and then spun dry. Cleaners with standard equipment can use the new process.



Pitched Roof Sections In Prefab Panel Package

Two men can erect a garage, tool shed or similar building in a matter of hours with 10-foot panels of 24-gauge galvanized steel. The panels are reinforced by an angle-iron frame. The pitched roof is assembled from V-shaped steel strips. The roof sections and panels are fastened together with bolts. The structure can be dismantled quickly and moved to another site. Wall panels are 6 feet 8 inches high, with windows or doors already installed.





Revolving Brush on Tractor Sweeps Away Snow

Snow can be removed quickly from sidewalks, driveways and skating ponds by using a power tractor equipped with a revolving brush. Two different types of brushes

are available: One fits straight across the front of the tractor and sweeps an area 42 inches wide; the other, an angle brush, covers an area 38 inches wide.

Chemical Reaction Makes Electricity

Hydrogen and oxygen, the gases that form water, can react with a catalyst to make electricity. Allis-Chalmers Manufacturing Company has developed a "fuel cell" that yields 24 volts when oxygen and hydrogen react with its electrodes.

Furnace of 180 Mirrors Simulates Nuclear Heat

Composed of 180 spherical mirrors, the nation's largest solar furnace will test materials designed to protect soldiers against thermal effects of nuclear weapons. The furnace can produce temperatures near 5000 degrees F.

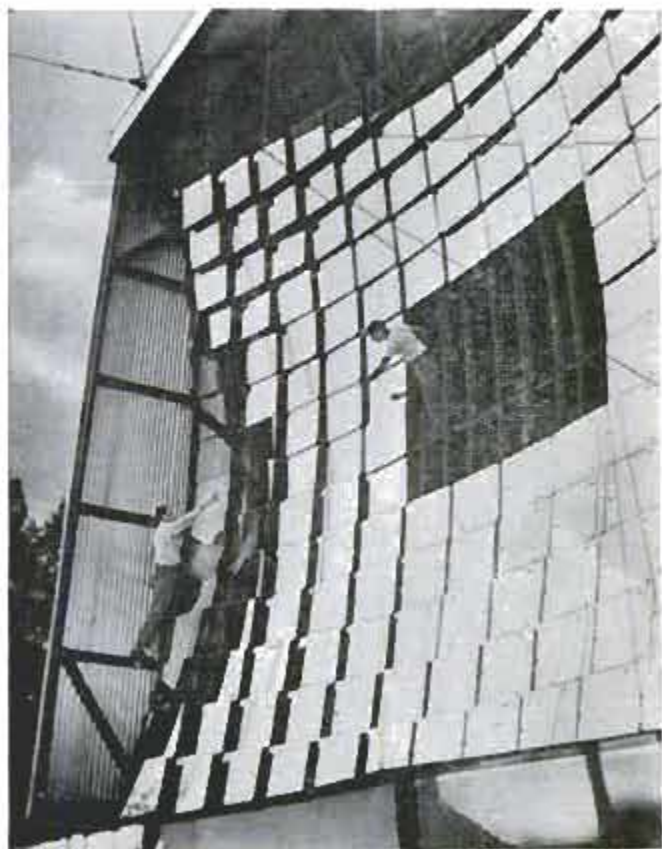

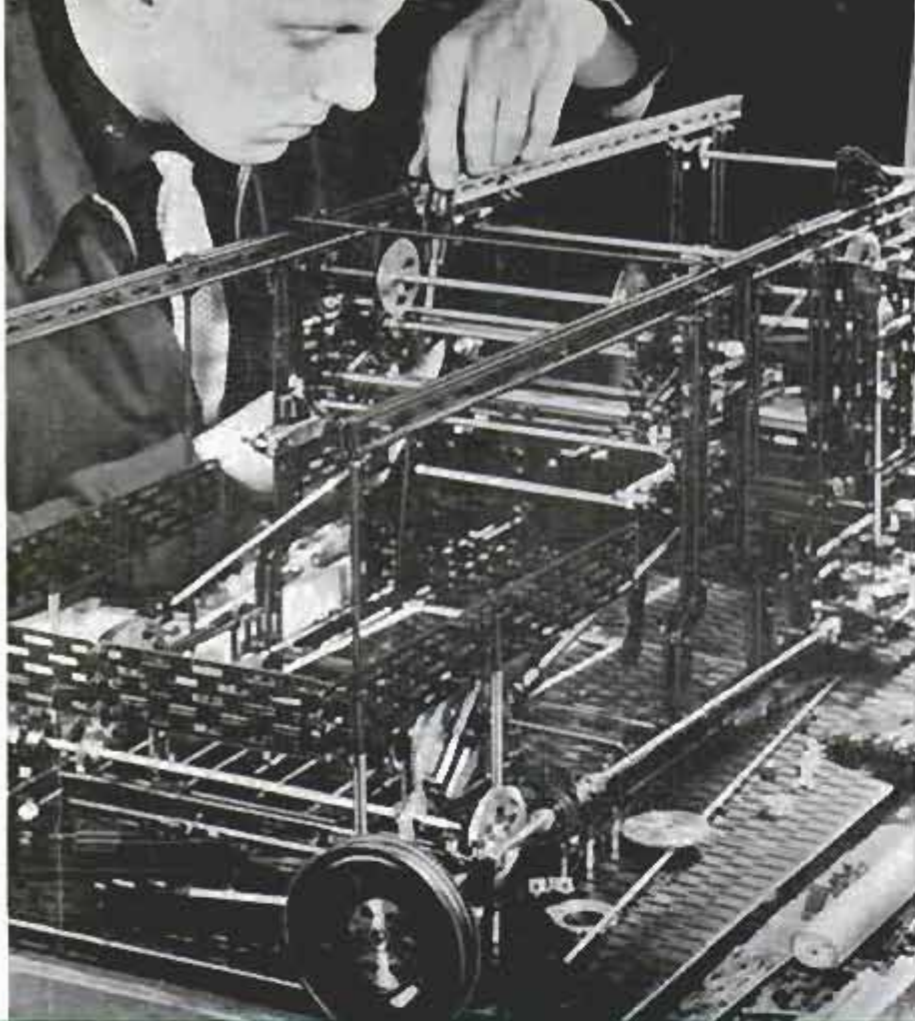

Parts include several kinds of connectors for making almost any type of strong framework



←Working model of a rotary printing press takes shape from standard precision parts of kit

PRECISION PARTS FOR WORKING MODELS

By Chris Edwards

AT FIRST GLANCE the photos on these pages appear to show a glorified construction toy. Actually the set was developed for professional engineers, designers and inventors. It consists of thousands of precision parts which can be assembled into smoothly working mechanical models. Thus the user can test and alter his plans as he works, before building an expensive scale model.

Two sets are available, one containing 2700 parts, the other, 4700. Included are gears, sprockets, pulleys, sheaves, couplings, wheels, disks, bearings, universal joints and structural parts.

The construction set was developed in Sweden. All the parts are designed according to metric dimensions. However, those dimensions are multiples of two basic modules, permitting almost un-

Operating model of gang log saw permits design problems to be ironed out during blueprint stage

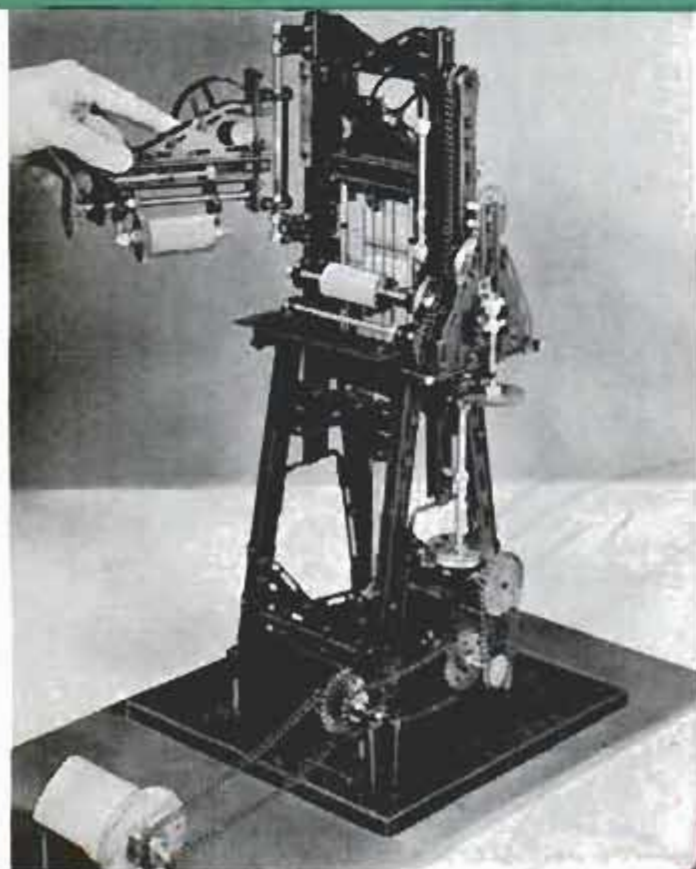



Here a vehicle's undercarriage and chassis-drive system, complete with differential, is ready for testing before elaborate scale model is made

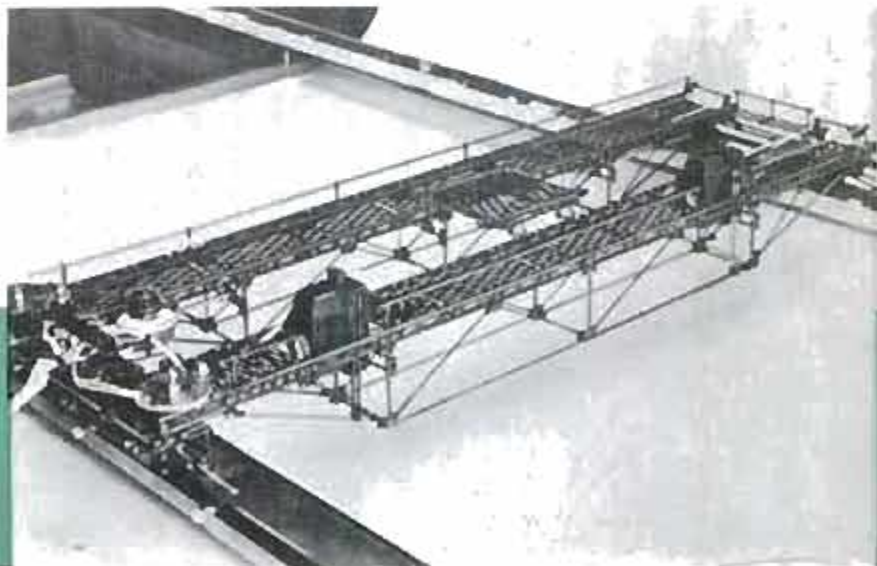

Motorized traveling crane has moving carriage and rolls along side rails. Machine actually performs life tests on two to four ballpoint pens

limited flexibility in the construction of models.

Precision shafts and the parts that fit those shafts, such as wheels, gear-wheel hubs, bushings and ball bearings, are manufactured to such close tolerances that they can actually be assembled into small machines to perform useful work.

Mechanical movements that can be constructed with the kit include reciprocating motions, slide motions, geared transmissions, differentials and rolling stock.

In each kit, the parts are selected on the basis of use-frequency calculations. Individual parts can be purchased to enlarge the kits. ★ ★ ★

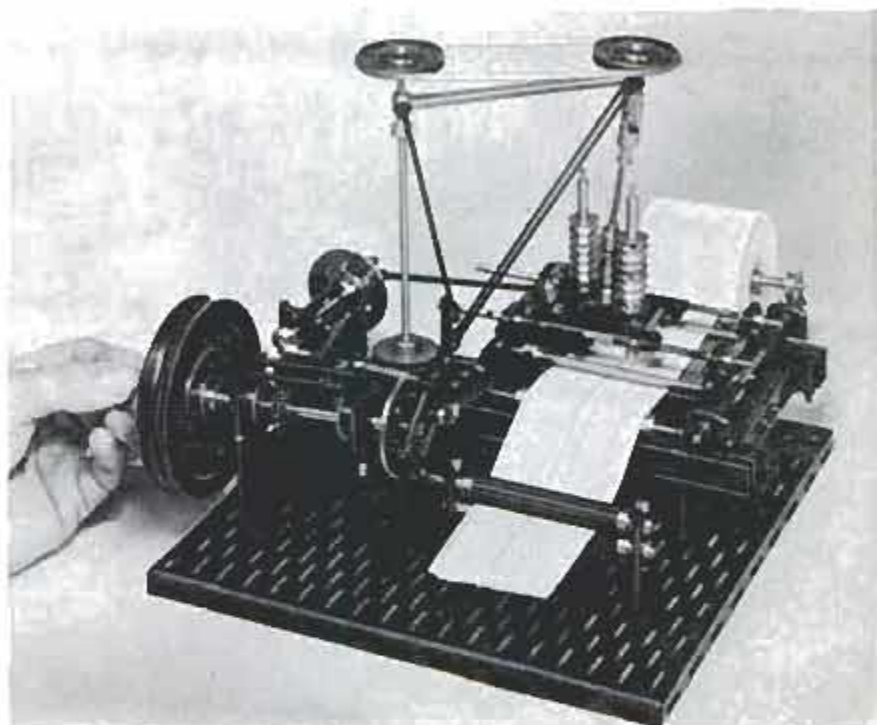



Wing-tip tank for North American's T2J jet trainer is formed by exploding charge inside of special die



Above, cone is placed in die. Below, finished curved section of tank is shown alongside straight-walled original cone blank



Explosion Forms Jet Fuel Tanks

NORTH AMERICAN Aviation is using high explosives to form aircraft fuel tanks. The technique employed is familiar to anyone who has ever lighted a firecracker under a tin can and observed how the can's ends bulged out after the explosion. Industrially, the technique is simply a way of controlling explosive force. North American is using "explosive forming" to make 12-foot wing-tip fuel tanks for the T2J jet trainer now being built for the Navy. In forming the two-piece fuel tank, a cone-shaped sheet of metal about $\frac{1}{16}$ inch thick is placed inside a die of the desired shape. The cone is cut off at one end. The die is filled with water, and the air is pumped out, creating a vacuum between the cone and the sides of the die. A high explosive is then fired inside the cone, the water acting as both a force-conductor and shock-dampener. The finished tank section is removed from the containing die in the shape of the prescribed, curved mold line.

Forming with explosives instead of with conventional heavy machines simplifies production of aircraft components. North American has established a production line for the new technique: Parts and dies are wheeled down inclined rails into a water-filled pit. The forming charge is automatically fired as soon as the tool and part are in position.



Lunar Power Station

Now scientists have made complete plans to "farm" electrons on the moon. The scheme was devised by Westinghouse scientists to provide electricity for a possible lunar station. The moon, they point out, has a vacuum such as that in an electronic tube. A wire mesh similar to window screening could cover a plastic sheet coated with a light-sensitive chemical. As sun rays struck the sheet, the chemical would emit electrons which would be collected by the mesh.



Flashing Signal Light Guides Car in Garage

If you have trouble aiming a car into your garage, you can get an assist from a device that flashes a light when you drift too close to the door opening or garage wall. The light signal is actuated by a length of flexible rubber hose placed on the garage floor. The unit can be installed in 30 minutes.



Vandalproof Street Lights

Unbreakable globes for street lights are being manufactured from polyethylene, a flexible plastic material.

Embosser Labels Plastic or Metal Tags

Metal or plastic tags can be embossed on the spot with a portable labeler that's just 10½ inches long. It is operated by dialing letters and numbers, then squeezing the handle. The strips are ½ in. wide and are housed in the handle. Self-feeding through the unit, the labels are backed with adhesive.





The rear wheels of the ski-lift-driving automobile rest on cylinders placed at each end of the rotating shaft

Four skiers hitchhike by cable to a hill-top. The automobile is on the road below



AUTO DRIVES

EVER HAVE a skiing holiday spoiled because you wore yourself out trudging uphill? A young Austrian engineer has invented a solution to this problem: A "pocket" ski lift that fits into the trunk of an automobile. The device weighs only 145 pounds and is capable of lifting 150 persons an hour on any grade up to 30 percent. The inventor uses his car as a motor to drive a drum, around which a steel cable is wound. The car is jacked up on wedges, lifting the rear wheels off the ground

The front wheels are underpinned and stabilized while the rear ones drive the axle that transfers motion to the cable drum





After the cable is unwound, it is carried to the top of the hill and anchored either to a tree or pole

A SKI LIFT

and transferring their rotation to an axle, which in turn transfers it to the cable drum. The inventor then takes one end of the

The car wheel drives the drum, while the unwound cable moves freely between the car and the hilltop

cable to the top of the hill and anchors it to a pole. The cable is moved upward and downward by the motor's rotation. ★ ★ ★

Each skier holds onto this handle while being drawn uphill. The lift accommodates 150 skiers an hour



PISTON PILOTS GO TO JET SCHOOL



Author (right) and Captain Bittner, one of first pilots to take jet training, study four wheels on one unit of landing gear

THE LARGEST AIRPLANE ever used in passenger service—the Boeing 707 jet—may be moving high over your head at this moment. American Airlines now is flying this new turbine transport coast to coast on a regular schedule.

The huge plane will bring tremendous changes in air travel, changes not only to passengers, but to crew members as well. It carries up to twice as many passengers at almost twice the speed of our present airliners. Even the size is something new to a pilot. The 707 is 35 feet longer than a DC-7 and weighs twice as much. Its fuel capacity—15,500 gallons—is three times greater than that of the DC-7, and its engines deliver twice as much power.

During the training, Captain Bittner, left, is checked out in the cockpit of the 707 by author Ted Melden



Sure you can teach an old dog new tricks. Pilots with thousands of hours of flight time now are learning how to make "wet" takeoffs and what to do if a flame-out occurs

By Capt. Ted Melden

WESTERN REGIONAL MANAGER OF FLYING OPERATIONS, AMERICAN AIRLINES

There were a lot of behind-the-scenes preparations for the jet service; among other things, our veteran American Airlines piston-engine pilots had to go back to school.

The pilots had to learn the special techniques of flying the big sweptwing transports. They studied the procedures for handling them with maximum efficiency and safety. Each pilot had to pass a stiff flight examination by a Civil Aeronautics Administration official, who checked his competence under every operating and emergency condition before he was certified for jet operations.

To learn some of the new techniques, let's sit at the elbow of Capt. Si Bittner, one of

Comparative chart shows typical coast-to-coast altitudes flown by jet transport and piston-engine plane

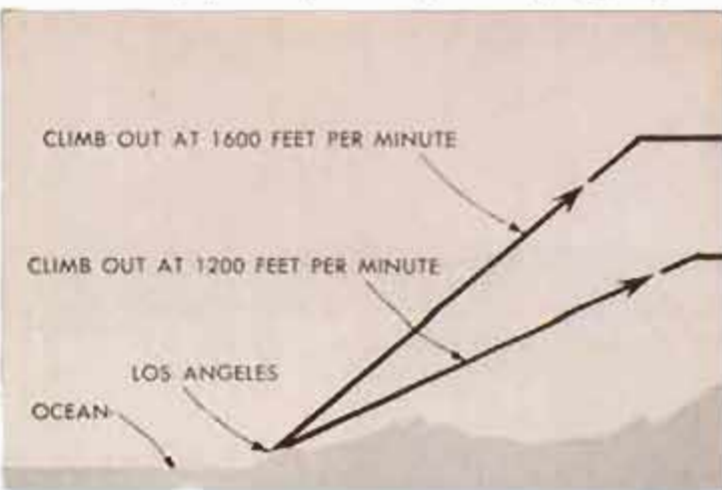



Black smoke is caused by water pumped into the four jet engines during a "wet" takeoff on a warm day

the line pilots, while he plans today's east-bound jet flight, nonstop from Los Angeles to New York. He'll be carrying 112 passengers and 12,000 pounds of mail and baggage. Counting the 50 tons of fuel, his airplane will weigh 247,000 pounds at the head of the runway.

"That gross weight and a ground temperature of 76 degrees call for a wet takeoff," Bittner decides. "We'll reach V-2 at 7000 feet of runway and climb out at 1600 feet per minute. Cruising altitude: 28,000 feet."

Marking all this on his flight plan, Bittner looks over the latest report on upper-air winds and temperatures. "Too cold today at 28,000 feet to use maximum cruise thrust. We'll save fuel by cruising at constant Mach instead, reducing our thrust as our weight goes down while maintaining the same speed.

"An hour and a half after takeoff we'll climb to 32,000. We'll burn less fuel at that altitude and will average 484 knots.

"We'll start our high-speed descent 99 miles out of New York and will be down close to the field in 12 minutes, right on schedule, 4½ hours out of Los Angeles."

Captain Bittner has been flying DC-7s and other transports for American Airlines and its predecessors for 30 years. He has rolled up 31,000 hours of flight time. For the last three years he has been on our nonstop transcontinental Mercury run. He is typical of the line pilots who are now flying the jet equipment.

His transition training began about eight months ago with a home-study program. His reading included a review of the behavior of high-speed aircraft, the fundamentals of jet propulsion, upper-air meteorology, and the operating procedures for

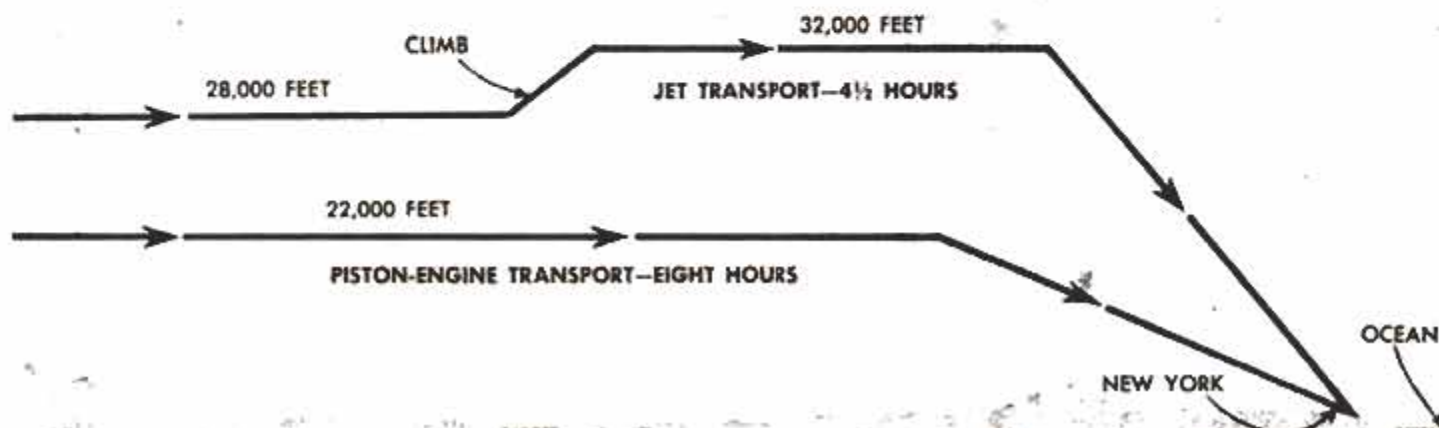



If decompression should occur, individual oxygen masks automatically drop down in front of passenger seats

the 707. That gave him the fundamentals.

More recently Si started intensive training. Six flight crews in Los Angeles and six in New York spent three weeks in ground school, with the flight engineers receiving an extra week of special instruction. Supervisory pilots, including myself, were the instructors. We had been thoroughly drilled on all aspects of the 707 at Boeing's Seattle and Renton plants this past summer. In brief, ground school consisted of detailed studies of the aircraft's structure, power-plants, and its various systems. Emergency procedures were outlined and the various standby systems were explained.

Simulator Practically Flies

Then Bittner and the others put in 13 hours in a 707 flight simulator, a mock-up of the 707 cockpit that is so complete it practically flies. If you move the controls to put one wing down, the imitation terrain that you see through the cockpit windows actually rises just as it would during a turn in the air.

In this simulator the crews rehearsed the procedures for lighting up the engines, taxiing, taking off and maneuvering. They practiced various cruise procedures just

as would be necessary in actual flight.

Later, each flight crew spent 12 hours in the air in a 707, half the time doing the actual flying and half the time observing while another crew was at the controls. Finally, each flight-crew member underwent the two-hour CAA certification examination and the final AAL equipment check-out.

Basically, the crews learned that flying a turbine-powered transport is about the same as flying a piston-engine plane. In detail, however, there are quite a few differences.

Warm Weather, "Wet" Takeoff

One example is the way that power is built up to takeoff rating. In warm weather a pilot will take off "wet," pumping 4000 pounds of demineralized water into the engines during the first two minutes of flight. The reason for using water injection is that on a warm day the air is less dense than on a cold day, and the engines don't develop as much power. By using water, a denser air flow is created in each engine, allowing it to develop its full 13,000 pounds of thrust.

Any time you see black smoke pouring from the engines of a jet airliner during takeoff, the takeoff is wet. After climb-out

the pilot jettisons any water remaining in the tanks to prevent its freezing at high altitude and clogging the lines.

Low temperature on the ground provides good thrust for takeoff but low temperature at high altitude causes high fuel consumption. Our line pilots study the forecast of temperatures they will encounter at high altitude to help decide the cruise procedure they will select for a flight.

If the temperature is relatively warm, say 35 degrees below zero, they will fly at maximum cruise thrust. This gives reasonable fuel consumption and allows the plane to fly continuously faster as the weight of its fuel is burned.

But if the temperature is below minus 48 degrees the pilot probably will select a different cruise procedure. He may use the constant Mach method that Si Bittner chose above, or he may go for a constant altitude, long-range cruise. This is a fuel-saving method that is favored for long overwater flights or against strong headwinds. The best cruise procedure can save as much as two tons of fuel per hour. Pilots aren't worried about the cost of the fuel, of course; they merely want to retain a surplus beyond the CAA reserve that is required in case the plane must be diverted to an alternate field or must delay its landing on account of traffic.

An important part of pilot training is a study of the medical aspects of high-altitude flight. At 30,000 feet the air pressure is less than a third the pressure at sea level and there isn't enough oxygen to keep you conscious for long.

The airplane is pressurized to equal an altitude of 3500 feet, so passengers and crew are perfectly comfortable. The fuselage is built like a spaceship, a pressure vessel, to withstand this difference in pressure. There's virtually no chance of leakage; nevertheless precautions are taken against what is called rapid decompression.

Oxygen Mask Drops Into Place

First of all, if cabin pressure ever drops below 14,000 feet, an oxygen mask automatically drops from overhead in front of every passenger seat. All a passenger needs to do is pick up the mask and hold it

(Continued to page 232)



Noise suppressors on each engine materially reduce amount of noise reaching the ground during the takeoff run and climb

Flight engineers, along with Boeing and American Airlines officials, study mockup of the jet's surface-control system



Family enjoys the flight in one of the luxurious lounges of the huge new jetliner. Windows are triple-paned for safety





Radar for British Jet Fighter Fits Inside Air Intake

Housed in a bullet-shaped container, Britain's newest airborne radar fits inside the air intake of jet fighters. The equipment gives navigational instructions to the

pilot, enabling him to intercept the target and lock the beam onto it. Then the radar tracks the target, feeding information to the equipment's sighting system.



Locomotive Tipped Over To Instruct Crew

When officials of the German Federal Railways wanted young train crews to get practice in putting an overturned locomotive back on the rails, they didn't wait for an accident to happen. Instead, they steamed an old iron horse out of retirement and tipped it over. The crews, training for future rescue work, placed hydraulic presses under the 70-ton locomotive and had it back in position within 60 minutes — standard time for such an operation. As was expected, the most ticklish part of the job was getting the wheels exactly in place.

How Deep Is the Ocean?

Deepest ocean depth plumbed by the U. S. Coast and Geodetic Survey is 25,093 feet below sea level, south of the Aleutian Islands. It was measured by a sonic depth recorder.



Courtesy Goodyear Aircraft Corp.

"Helicopter Plane" Has Wing Louvers

BY SIMPLY CHANGING the direction of air flow, a plan for a new type of Army aircraft combines helicopter and airplane characteristics. The Convoplane, as the craft is called, would be powered by two large rotors housed in the combined wing-fuselage area. To fly vertically, the pilot would open louvers or slats on the wings, allowing air to flow vertically as in a heli-

copter. In forward flight with louvers closed, air would enter at the leading edge of the wing, be directed through the rotor blades, and exit at the trailing edge. Small vanes would aid in changing the direction of flow. The Convoplane can be designed as a small, light plane for reconnaissance, or it can be built larger and used to transport materiel.

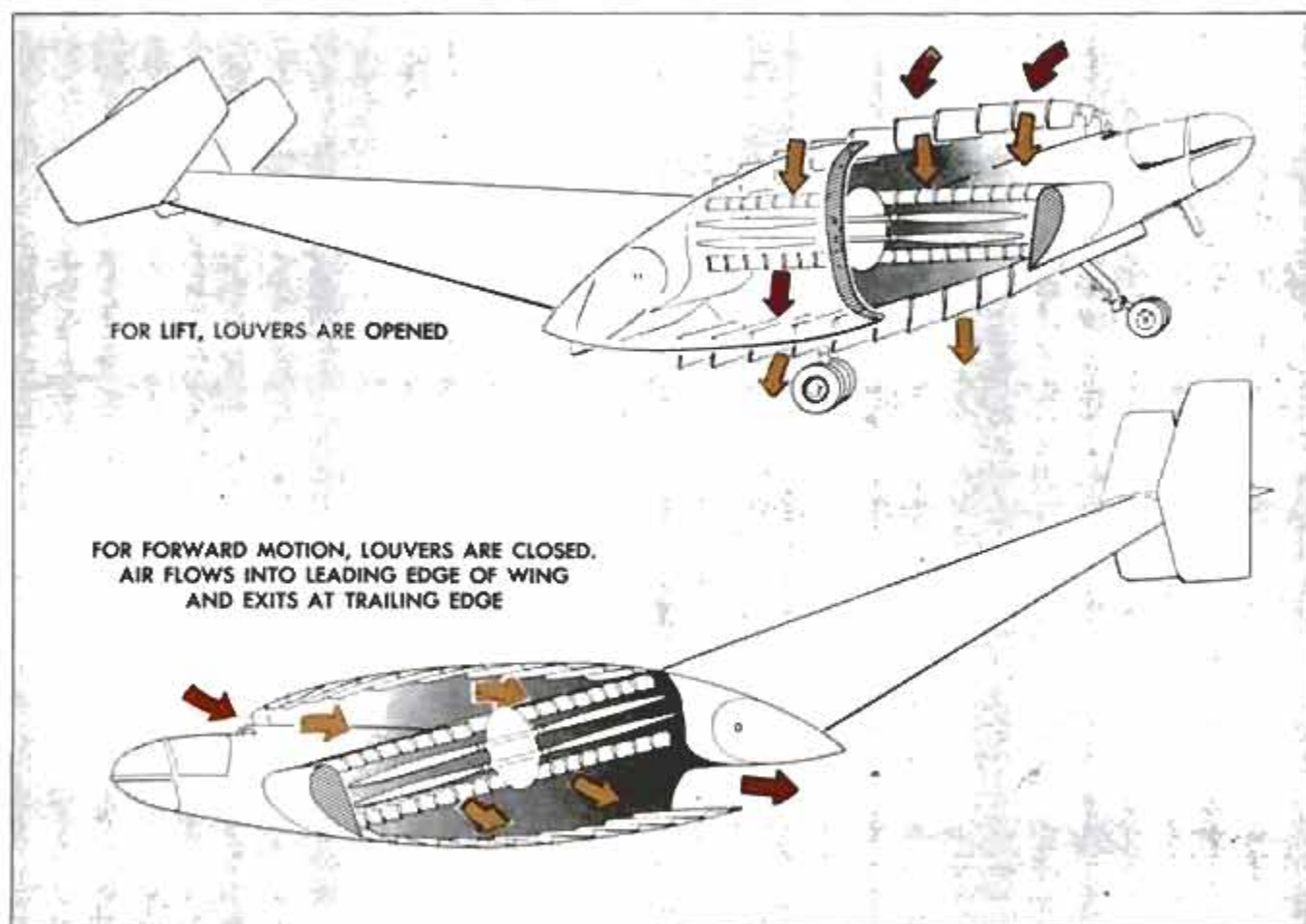

Here's a Get In There

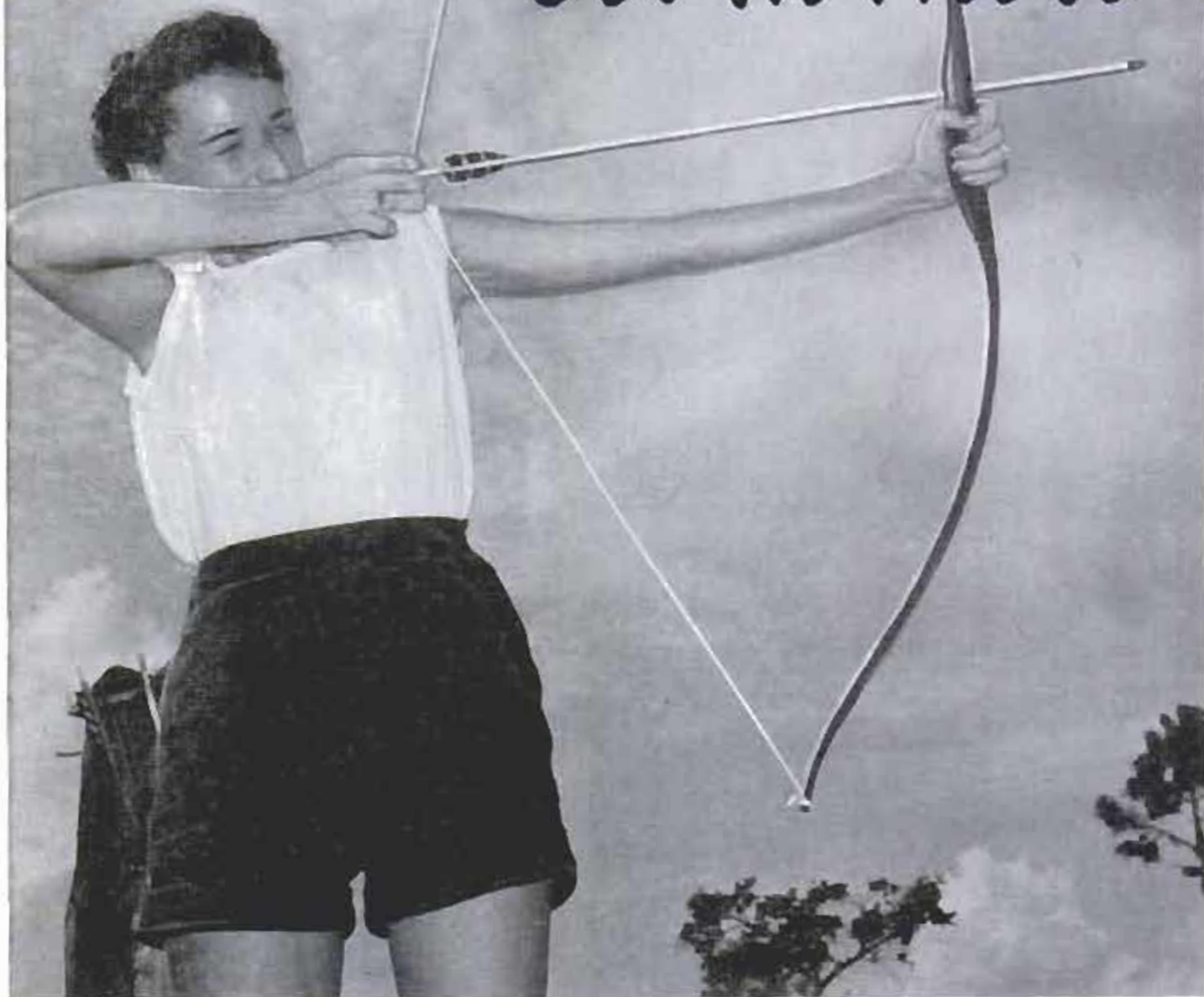

At Weapons of the World near Winter Haven, Fla., a guest tries a bow reminiscent of Robin Hood's day

By Max Hunn

HAVE YOU ever wanted to swing a Civil War cavalry saber? Fire a cross-bow? Or perhaps crack a bullwhip?

Those who have such desires will be interested in a new attraction near Winter Haven, Fla., where visitors can wield these strange weapons or use blowguns, slingshots, a battering-ram, a catapult, knives, bows and spears.

This unique establishment is not a museum, although many of the weapons are ancient enough to warrant museum interest. Instead, it's a place where the visi-

tor is urged to participate, whether it be shooting a longbow, tossing a spear or javelin or using blowguns or boomerangs.

Known as Weapons of the World, it's the brain child of two Ph. D.s, neither of whom previously had any experience or interest in weapons of any type. Martin Muma, Ph. D. in entomology from the University of Maryland, and Joseph McBride, Ph. D. in chemistry from the University of Delaware, are the originators.

Weapons of the World is a part-time project with Muma and McBride, who

Blowgun-

and Fight!

— and people love to, as a couple of Florida agricultural scientists found when they opened an exhibit where you can try your skill with ancient weapons from crossbows to Civil War sabers.

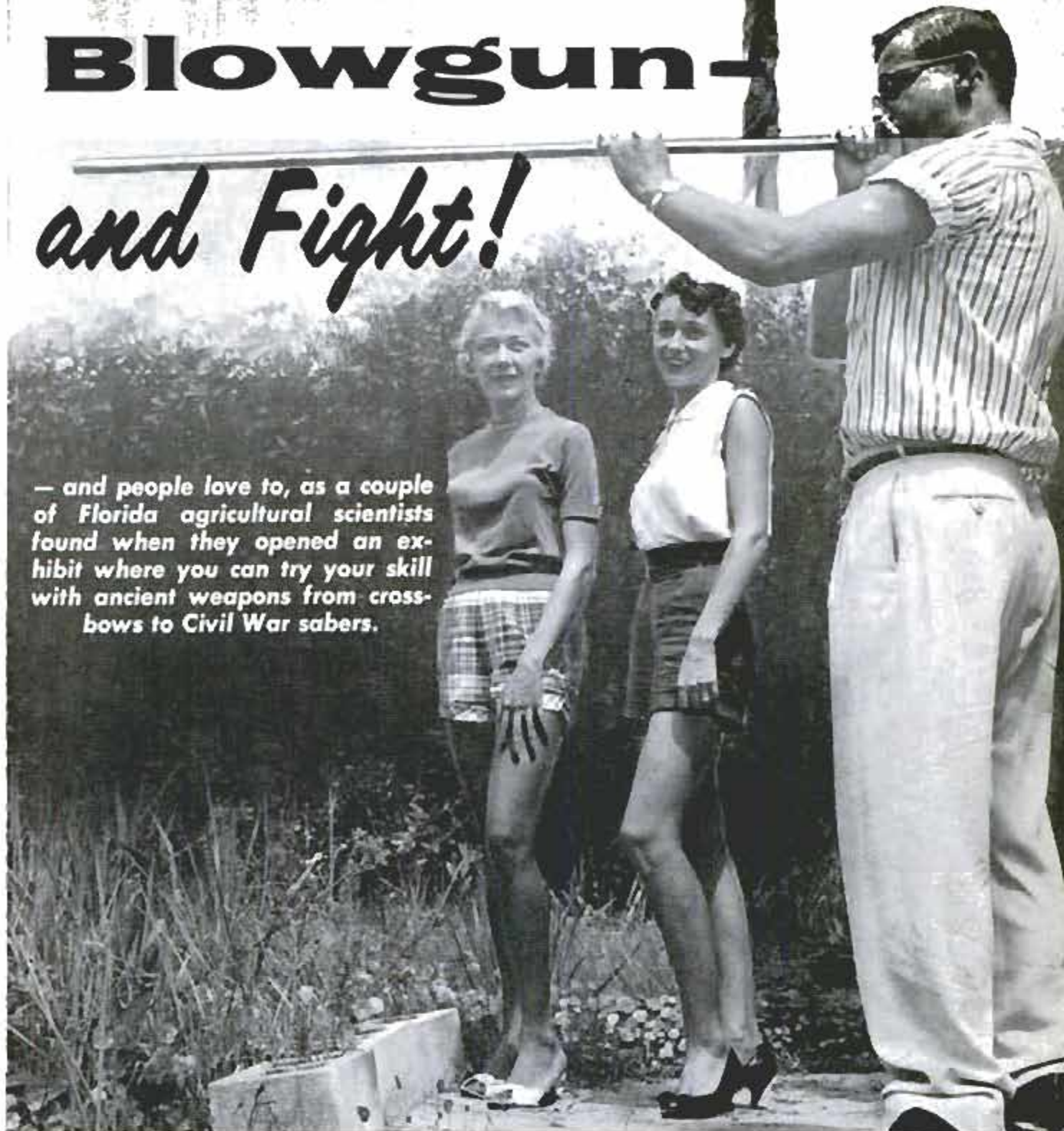

Puffing a blowgun is one of the rare experiences a tourist can have at the unique Florida weapons exhibit

earn their living as scientists with the University of Florida citrus experiment station at Lake Alfred, Fla. But when not engaged in studying scientific problems connected with Florida's citrus crop, they're busy supervising their new business, repairing broken equipment, replenishing their supply of darts and arrows, and now and then taking a turn at guiding visitors around the establishment.

They've collected their unusual assortment of weapons from all over the world. The insect expert, Muma, has just finished collecting specimens

Martin Muma repairs a 17th century crossbow. Muma and a fellow scientist, Joseph McBride, originated the exhibit





Those who like to swing the Civil War cavalry saber have a post to slash. The post has to be replaced about twice a month. At the right, a guest demonstrates the proper crouch in firing the Pygmy bow



The Romans didn't have such attractive warriors, but they did have assault towers like the one shown here

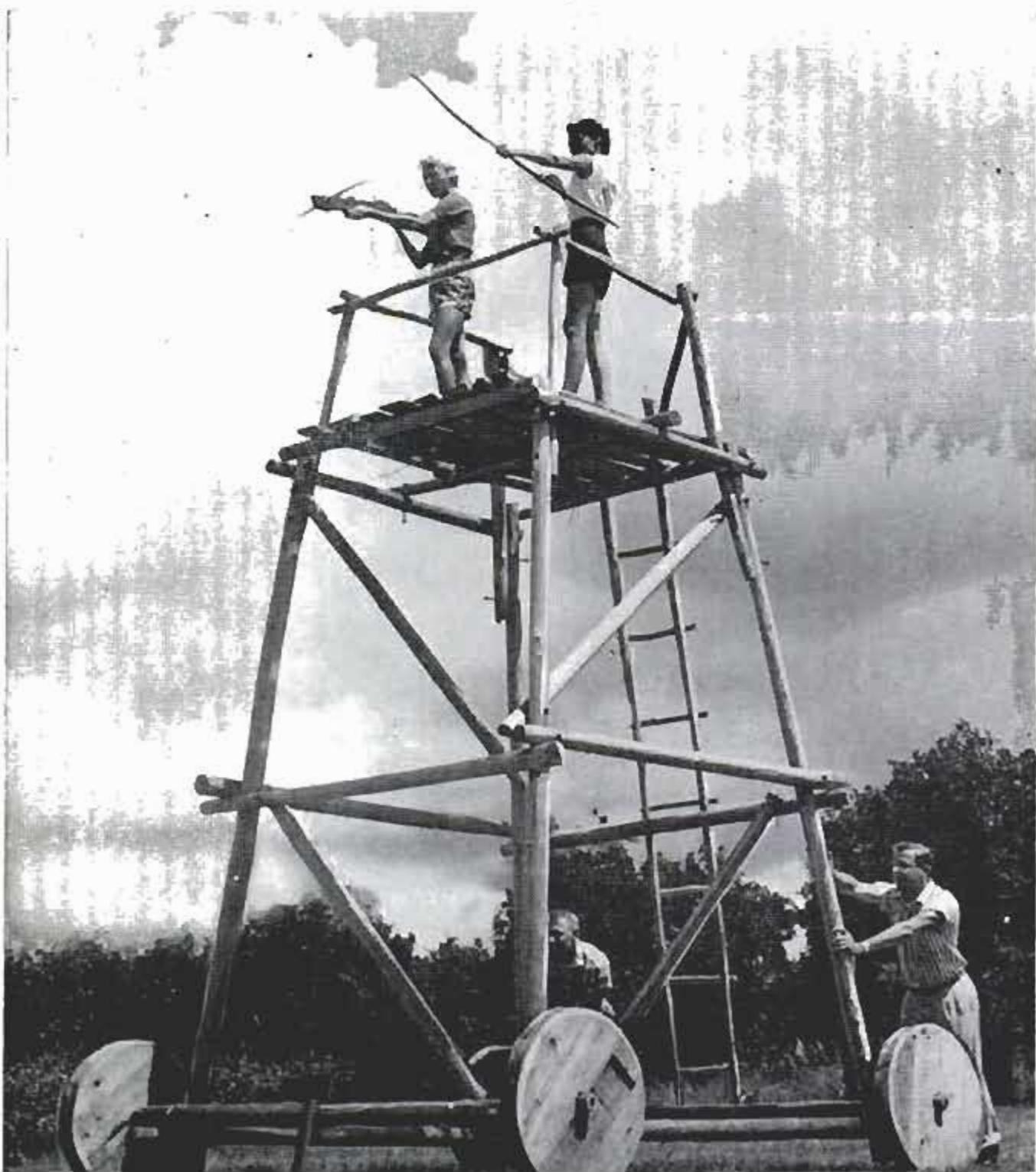

While they've bought some weapons — including the 17th century crossbow—most of their prizes have been obtained from friends in such distant places as Rhodesia, Thailand and Japan. John Hamlet, of Ocala, Fla., the famous falcon trainer, has provided them with a complete assortment of Philippine blowguns, krises (daggers) and similar weapons.

What they haven't been able to buy or borrow, they've reproduced themselves. An assault tower of the type used by the Romans to storm walled cities has been reproduced, with solid wooden wheels. They've also built a crude battering-ram, used to knock down a specially made wooden door. People like to engage in this unorthodox type of door knocking. A homemade catapult lobs coconuts instead of rocks or dead animals, as was customary during the days when this was a mighty weapon of warfare.

Operating the unusual establishment has resulted in a quota of unusual incidents, and has led Muma and McBride to revise their estimates of what the public will do.

They've found they always encounter a psychological block when the visitors first arrive. Conditioned by years of "don't touch" signs, the average visitor is at first reluctant to handle a weapon, let alone operate it. This is especially true of adults. But once the ice is broken, young and old waste no time in accepting invitations to use the various weapons.

Muma and McBride have found

Shooting a crossbow is an exciting experience. In fact, it's the favorite weapon of both men and women who visit the exhibit



Using coconuts instead of rocks, Martin Muma shows how war-makers of old used to catapult objects inside a walled fortress

The proprietors of Weapons of the World set up this battering ram and door so guests could take part in "storming a fort"





McBride, shown here, and Muma manufacture their own arrows and darts. Patrons use 1000 a month

that their guests use an average of a thousand darts and arrows a month.

In studying their visitors, Muma and McBride have discovered that the popularity of the various weapons varies with the sexes. Men generally prefer the crossbow, throwing knives, longbow, blowgun, bullwhip and saber in that order. The women, on the other hand, prefer the crossbow, blowgun, longbow, throwing knives and modern pistol crossbow. ★ ★ ★

Weapons have been collected from all over the world. Right, a visitor hurls an African broad-leaf spear

Bullwhips have all but disappeared from our society. At Weapons of the World you can still crack one





"REPEATING" BOW

Archers can get off two arrows in short order with an "automatic loader" attached to the bow. The loader is clamped to the handgrip and the spare arrow is slipped into a holder, which pivots to a vertical position. The archer then holds another arrow in the normal hunting position. Upon spotting the game, he shoots the first shaft. The "kick" of the first arrow trips the loader, which instantly swings the second arrow into the bowstring. As this arrow is drawn, the holder is released and drops from view. The automatic loader is installed with aluminum mounting straps.

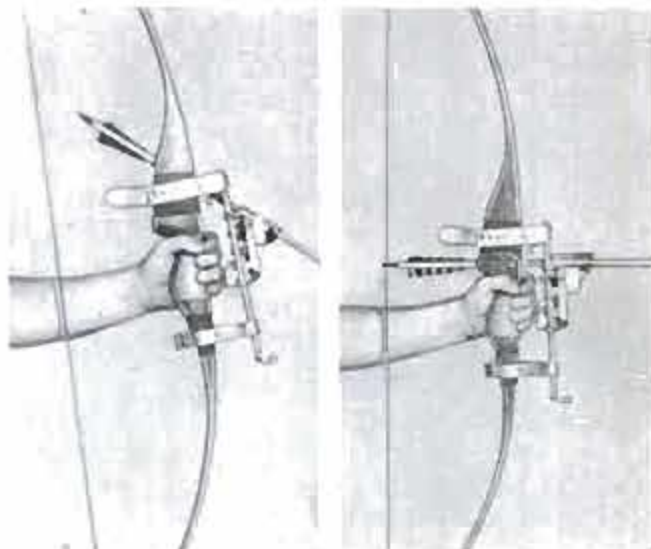

German Microprojector Permits Group Viewing and Accurate Tracing



Several persons can study microscopic subjects at the same time with a new microprojector designed in Hamburg, Germany. The picture is projected on a screen. A mirror attachment can deflect the picture downward onto a sheet of drawing paper so that accurate tracings can be made. The subjects can be photocopied in a darkroom by using the projector and a plate film. In the daylight, photocopying can be done with the projector and a special camera attachment. The mirror of the microprojector absorbs the infrared rays generated by the lighting unit. The result is a practically heat-free light for projection, thus, delicate living microorganisms can be studied.

CRASH SEAT

ERNIE CLEMMONS has had more than 200 head-on collisions, and he hasn't a scratch or bruise to show for them.

Ernie works for the Protect-O-Matic Corporation of Tonawanda, N. Y., an automotive safety-research organization that uses human drivers instead of electronic dummies in test crashes.

What saves Ernie Clemmons as he rams his automobile head-on into another at a speed of 50 miles per hour? A simple device that upon impact tilts the car's front seat backward instantly to a 30-degree angle, preventing the driver and passengers from being thrown forward into the steering wheel, dashboard or windshield.

Here's how it works: A trigger bar, resembling a chrome bumper guard, is mounted on the front of a car in the same manner as a bumper guard. When the bar is struck at speeds exceeding seven miles per hour, hydraulic fluid flows through steel tubing and moves two scissorslike linkages into action under the front seat. These mechanisms pull the seat forward on

slides and tilt it back 30 degrees. On impact, then, the driver and his passengers "sit out" the crash as if they were sitting back in an adjustable lounging chair. The force of the impact is absorbed by hips and thighs.

The system can be installed so that it automatically turns off the ignition and applies the brakes when activated. In a 50-mile-per-hour crash, says Protect-O-Matic Corporation, the driver and his passengers are placed in protective position within .0031 of a second.

Neither safety belts nor helmets are needed. Except for the trigger bar, a car equipped with the new safety device appears no different from any other. The steel tubing and a reservoir the size of an oil filter are placed under the car's hood. The two steel slides and steel linkages cannot be seen under the front seat.

The unit weighs 85 pounds. It can be installed in about two hours. The hydraulic system is self-bleeding to insure that it's in working order when needed. ★ ★ ★

Passengers in crash position. Seat tilts within .0031 of a second following 50-mile-per-hour head-on



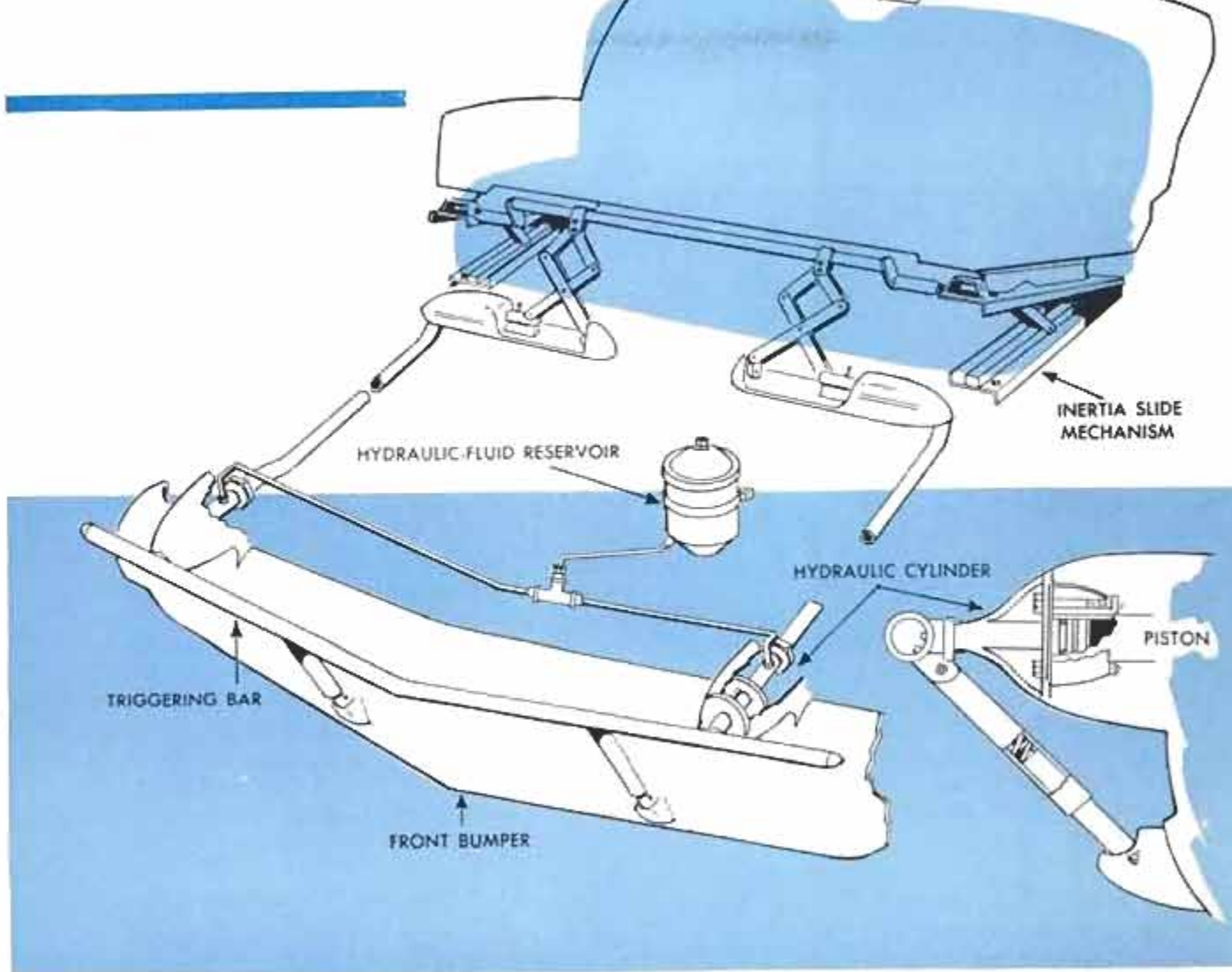

Using the crash seat shown above, test driver Ernie Clemmons has survived 200 crashes like the one below

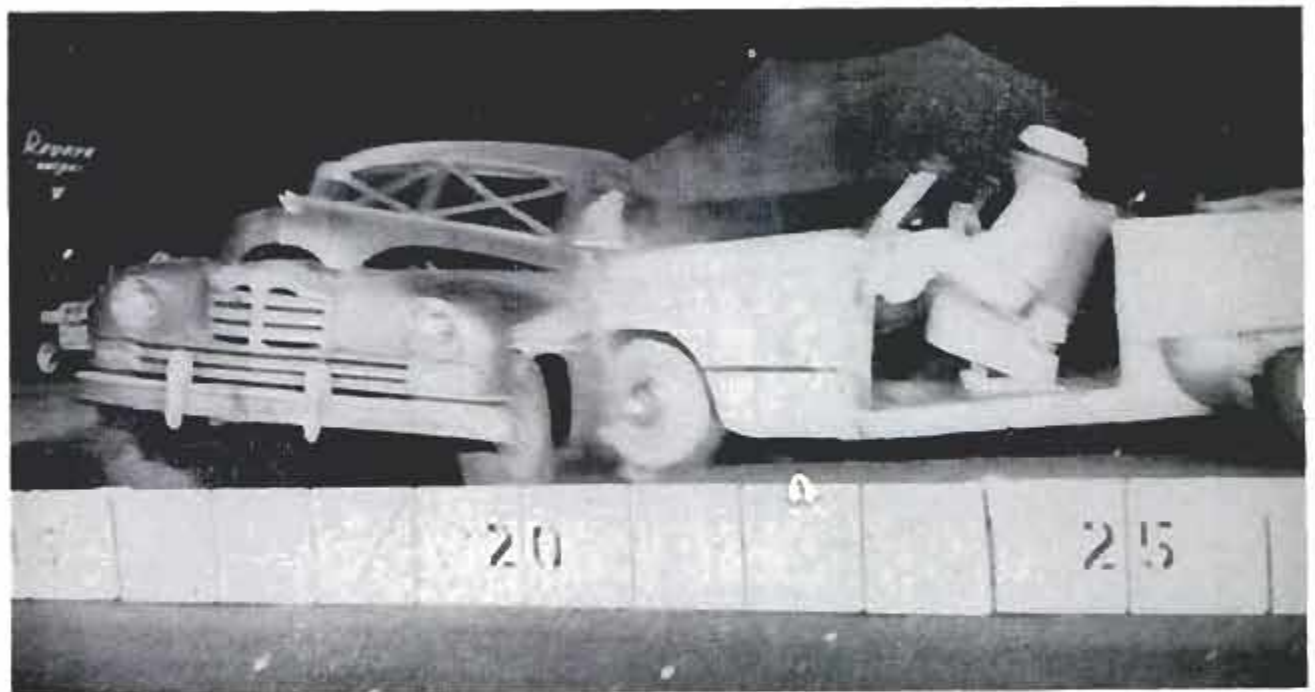



Foamed Aluminum Handles Like Wood

So light that it will float like wood, a new metal called foamed aluminum may be used as a basic construction material. After the molten aluminum is poured, hydrogen bubbles form. On cooling, the metal is honeycombed with gas cells, resulting in a light, strong material that can be sawed, nailed, cemented, screwed or bolted.



Rocket Gliders Could Circle Globe

Piloted, long-range rocket gliders that can circle the globe at near-satellite speeds are within technical reach. Ryan Aeronautical Company's design studies indicate that present-day structural designs, metals and rocket power plants are capable of hurling gliders around the world in little more than two hours, at altitudes of 40 miles or more. Such a rocket glider would hit its high point of flight three minutes after take-off. The gliders would put men into space for extended periods so that effects of space travel could be studied.

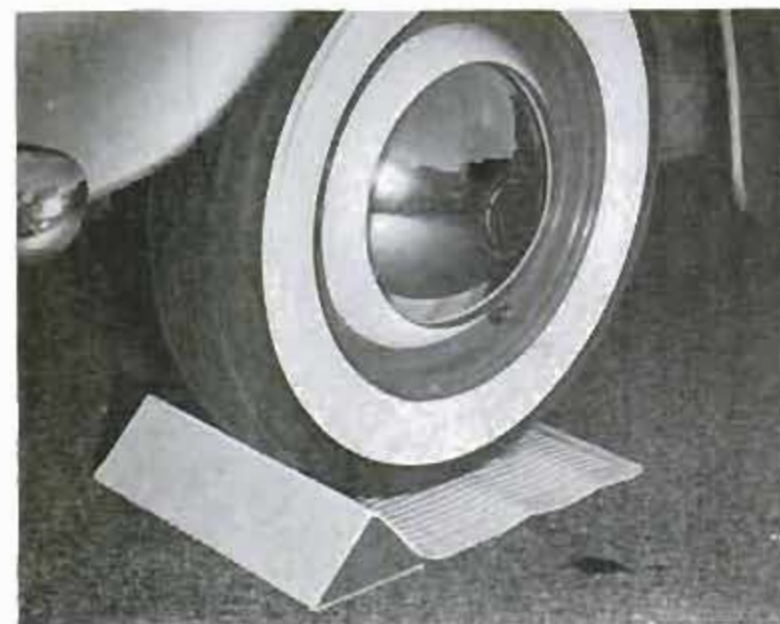

Rubber Stop on Floor Prevents Garage Damage

When you drive into the garage, do you sometimes edge the car too far forward? A rubber stop helps prevent damage to lumber, garden tools, bushel baskets and other things that are directly in front of the car. You align the stop with a front tire, leaving enough room between the bumper, fenders and garage walls for walking space. The car rolls to the marker and then stops. The marker will not slip. It is colored a high-visibility yellow and has red reflectors for after-dark guidance. Ribbed design enables marker to be cleaned easily.

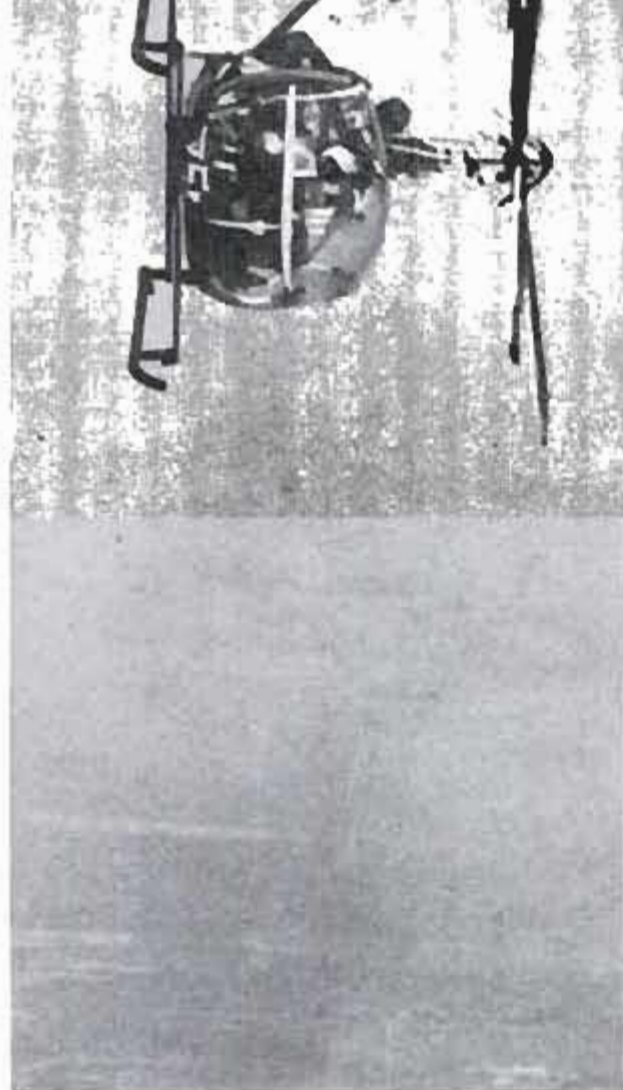

The 12E has demonstrated great maneuverability and 24 percent more power than any other light copter

Hiller's Light Helicopter Is Highest-Powered in Its Class

With a 305-horsepower engine, Hiller Aircraft's new 12E helicopter becomes the highest-powered copter in the light class. The three-place utility craft is expected to be a popular seller in the civilian market.

It is a higher-powered version of the H-23D Raven, which the Army is using for observation, light utility and as a trainer for helicopter pilots. The 12E has 24 percent more power than any other in its class.

Build-it-Yourself Auto Travels Nearly 100 Miles to the Gallon

Now you can buy a car in a kit and build it yourself. Packaged in Britain, with a German engine, the car comes in sedan and truck-convertible models. Its top speed is 50 miles per hour and it goes nearly 100 miles on a gallon of gas. The engine has a British rating of 10 horsepower.

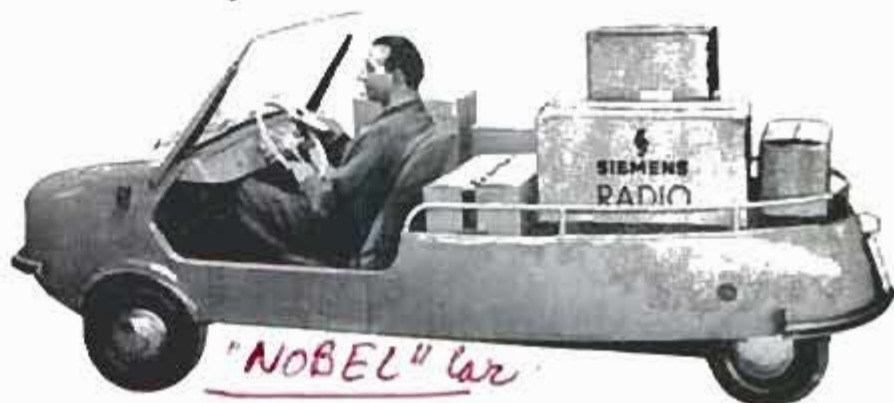

FEBRUARY 1959

149
 mld by: YORK NOBLE INDUSTRIES LTD.
 1, GT. CUMBERLAND PL.
 MARBLE ARCH, LONDON W. 1

'Round the clock, huge construction crews are tearing down slums, building skyscraper homes and blasting superhighways through the mountains to herald a

Big Change

By Clifford B. Hicks

PART II

IN A BREAKNECK RACE to lift themselves into the jet age, impatient Venezuelans are altering the face of their country overnight. Particularly is this true in Caracas, the nation's capital, and other large cities. As you ride through Caracas, bizarre and richly colored skyscrapers on every side give you the feeling that you are riding through the city of tomorrow.

The skyline represents oil—oil transformed into lofty buildings. Venezuela is determined to raise its standard of living pronto, and is financing its incredible effort with income from vast oil deposits.

Consider the matter of housing. For decades, workers in Caracas have lived in tiny shacks of mud or scraps of wood, carved into the mountainsides. Sanitary facilities have been nonexistent, and water has been toted up steep slopes in tin cans.

Then came the world's biggest slum-clearance project, completed in three leap-frog phases.

In the 1955 phase, bulldozers rumbled into action, scraping away the entire side of a mountain. By the first of July the site was cleared and ready. From then on, the speed of construction was unbelievable. By

←Some natives still live in vilages built above the water, walking to and from shore on high stilts



Reprinted
'PM HIGHLIGHTS'

in Venezuela

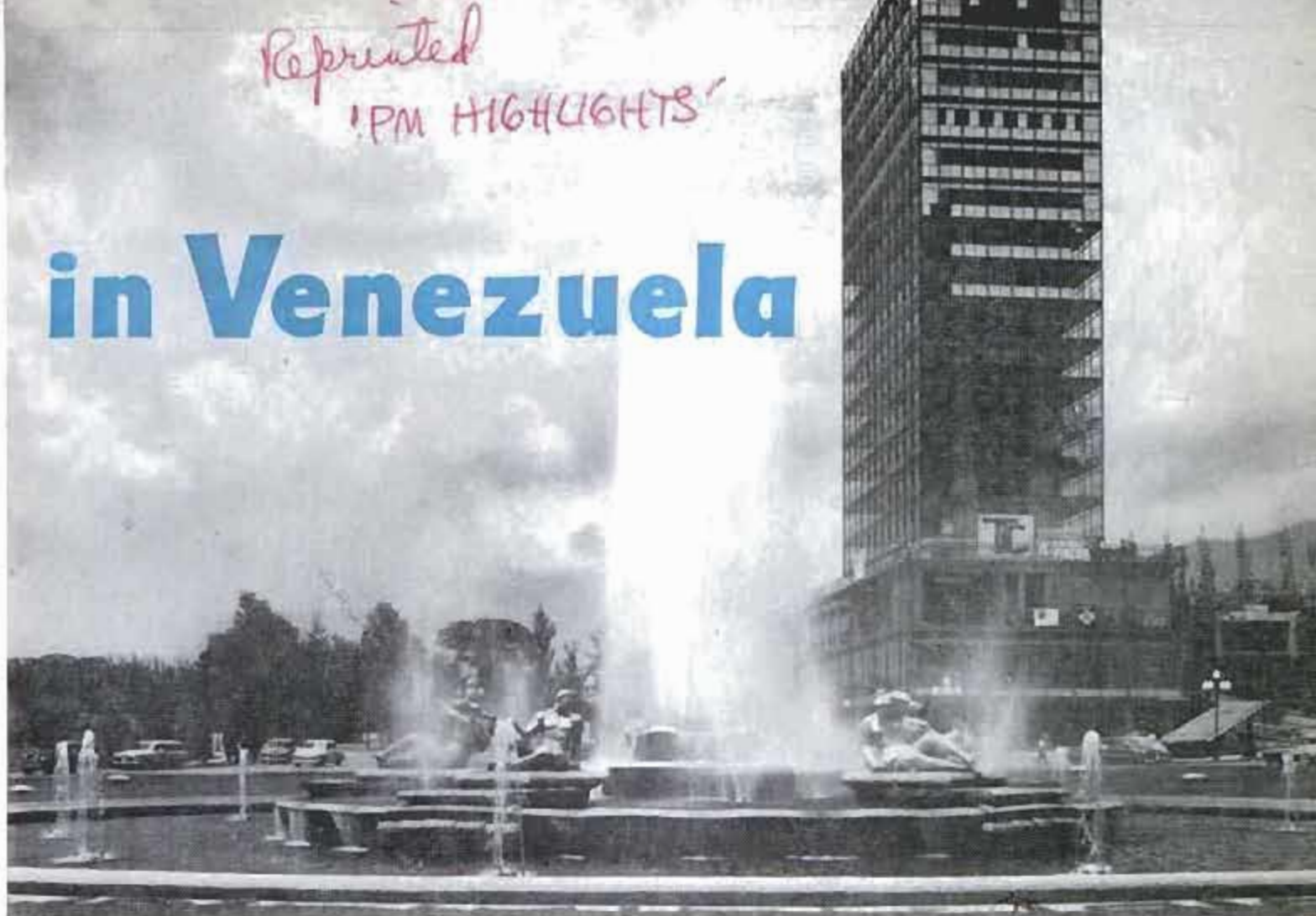

Towering skeleton of steel was erected in Caracas, then big office building grew floor by floor overnight

the second of December, 13 magnificent apartment buildings, each 15 stories high and 10 apartments long, complete with elevators, were ready for occupancy. Many four-story apartment buildings also were built. Workers from an area of concentrated slums quickly were moved into the 2366 attractive and spacious four and five-room apartments.

Immediately, bulldozers moved in to smash over their former homes. Again in

1956, by the first of July, this area of slums had been cleared and was ready for construction. By December, 16 new apartment-skyscrapers were ready for occupancy. As soon as these were occupied, more vacant shacks were razed to make room for the third project. It was completed in 1957 and consists of 20 super-apartment buildings. The speed of construction is phenomenal on such projects. There are three shifts of workers, thousands of men to each shift,

Old and new ways of life are contrasted as a train of burros moves along roadbed of eight-lane highway under construction

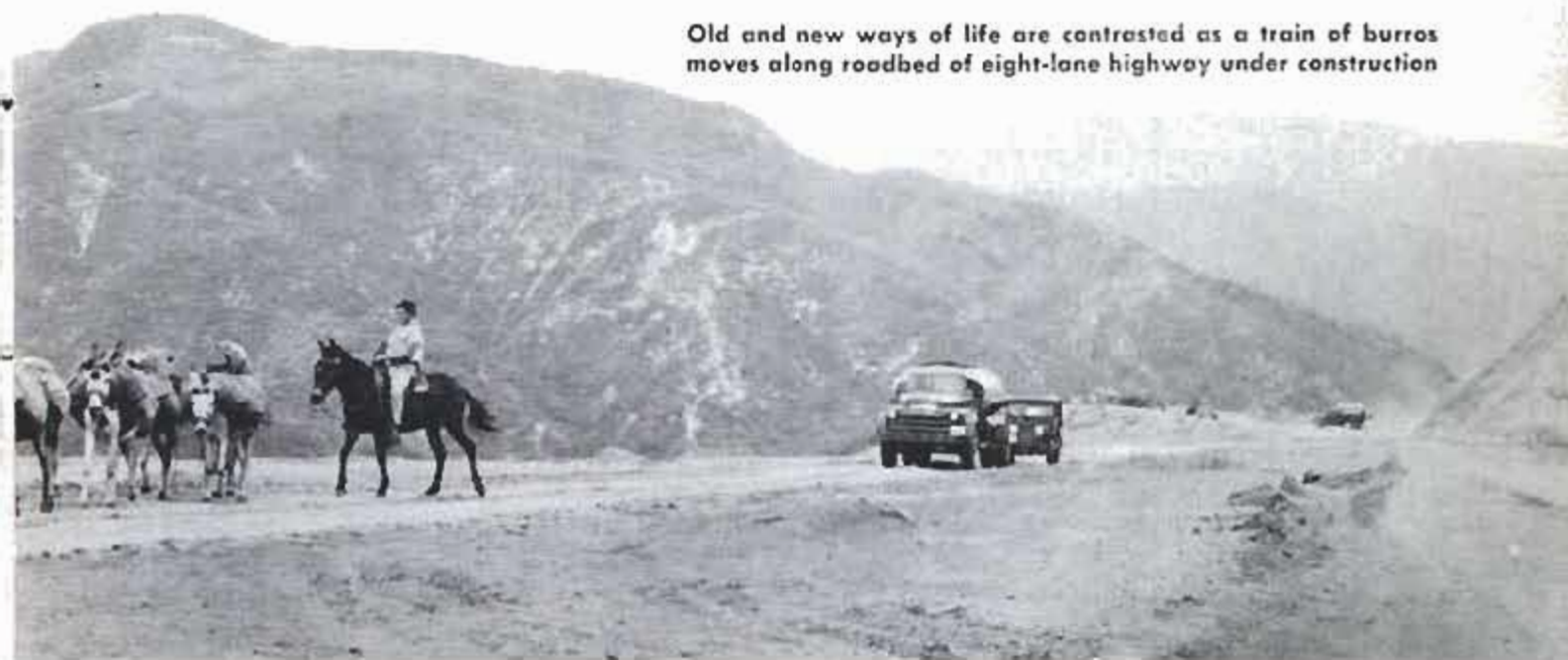



Amazing rate of construction is illustrated in two photographs, taken just five months apart in Caracas





Oil—oil by the millions of barrels—is pumped up from beneath Lake Maracaibo to pay for the big change

and the buildings actually appear to grow, floor by floor, overnight.

Six more 15-story blocks are under construction. Other housing projects are under way both in Caracas and in other cities, but Venezuela admittedly has a long way to go to clear its vast slum areas.

The buildings are daring, both in design and appearance. For the most part they are sparkling white, but huge panels, painted at random in bold hues, produce a stark and colorful effect. Sections of construction tile, set on their sides, make a lacy mosaic up the sides of the buildings. These open tiles form the open walls of the apartment kitchens, providing air conditioning in a climate that approaches the ideal anyway.

Nestled around the tall buildings are schools, theaters and shopping areas, all built simultaneously with the apartments. And there's a whole series of "beisbol" diamonds, for baseball is the national sport of Venezuela, too. (In fact, baseball is almost a cult. The banner headline on the front page of one of the Caracas newspapers during my visit concerned the record of Saturnino Orestes Minoso, better known as Minnie throughout the beisbol-playing world.) The huge new baseball stadium in Caracas seats 35,000 spectators,

Complicated but efficient cloverleaf serves traffic entering Caracas from section of Pan-American Highway





Daring in design is the Helicoid, being built in spiral around a small mountain. Shoppers will drive up "through" the building

and there isn't a post to obstruct your view in the entire structure.

By 1960 the existing skyscrapers of Caracas will be overshadowed by a new building still more daring in design and unique in concept. This 25-story structure will be built in a spiral around a mountain. The "Helicoid" or "spiral in space," built with private funds, will cost \$25,000,000. Already the miniature mountain has been bulldozed into the shape of a cone with a spiral up the side. When the Helicoid is finished, shoppers will be able to drive up a spiral road right "through" the building, and shop on both sides of the ramp.

Venezuelan architecture, bizarre in appearance, features sheer walls, elaborate

mosaics and panels painted in brilliant colors. For the most part, the new buildings have skeletons of reinforced concrete. Curtain walls of concrete block or glass are built up around the skeletons. This type of construction, along with the highway-building program, has produced a soaring demand for cement. The ideal occupation in Venezuela would appear to be that of cement salesman. The largest cement company in Venezuela is raising its capacity from 2780 to 4600 tons per day!

Auto traffic, that bane of the high-speed world, is causing growing pains in Venezuela, too. Caracas, like a jewel in an exquisite setting, lies in a beautiful mountain valley only nine miles from the seacoast, but the elevation of the city is 3000 feet. A mountain

range intervenes between the city and the coast. Five years ago the only access to the city was via a perilous two-lane road that wound for 21 miles and 365 curves through a spectacular but dangerous spur of the Andes. Accidents were common, and an accident could well send you tumbling down 1000 feet of mountainside. Today you can travel the six-lane Autopista from the coast 11 miles into the center of the city, where you pick up another superhighway that slices through central Caracas, dipping right under the two 30-story towers of Bolivar Center.

Southeast of Caracas 300 miles, in an area that was virtually uninhabited a few

(Continued to page 226)

Administration building of petrochemical industry is typical of ultramodern architecture of the new Venezuela





Miniature Electric Motors Develop High Speeds

Tiny electric motors built by Joseph d'Haens of Belgium run on either a.c. or d.c. They draw one to four volts with speeds up to 6000 r.p.m. The coin in the photo is three fourths of an inch wide.

Closed-Circuit TV Patrols Stream

TV has been demonstrated as a safety measure against drownings in treacherous Onondaga Creek, near Syracuse, N. Y. Four cameras brought a winding, 800-foot stretch of the patrolled stream—otherwise out of sight—into view on a 21-inch monitor. The TV "lifeline" would be used with a loudspeaker to warn children.



Portable Missile Uses Solid Fuel

Designed for use against tanks and similar targets, a portable missile made in England is powered by solid fuel and sustainer rocket motors. It's guided to its short-range target by signals passed through thin wires from a control the soldier holds in his left hand and works with his thumb. The operator views the flight of the five-foot long missile through periscopic monoculars with high and low power vision.



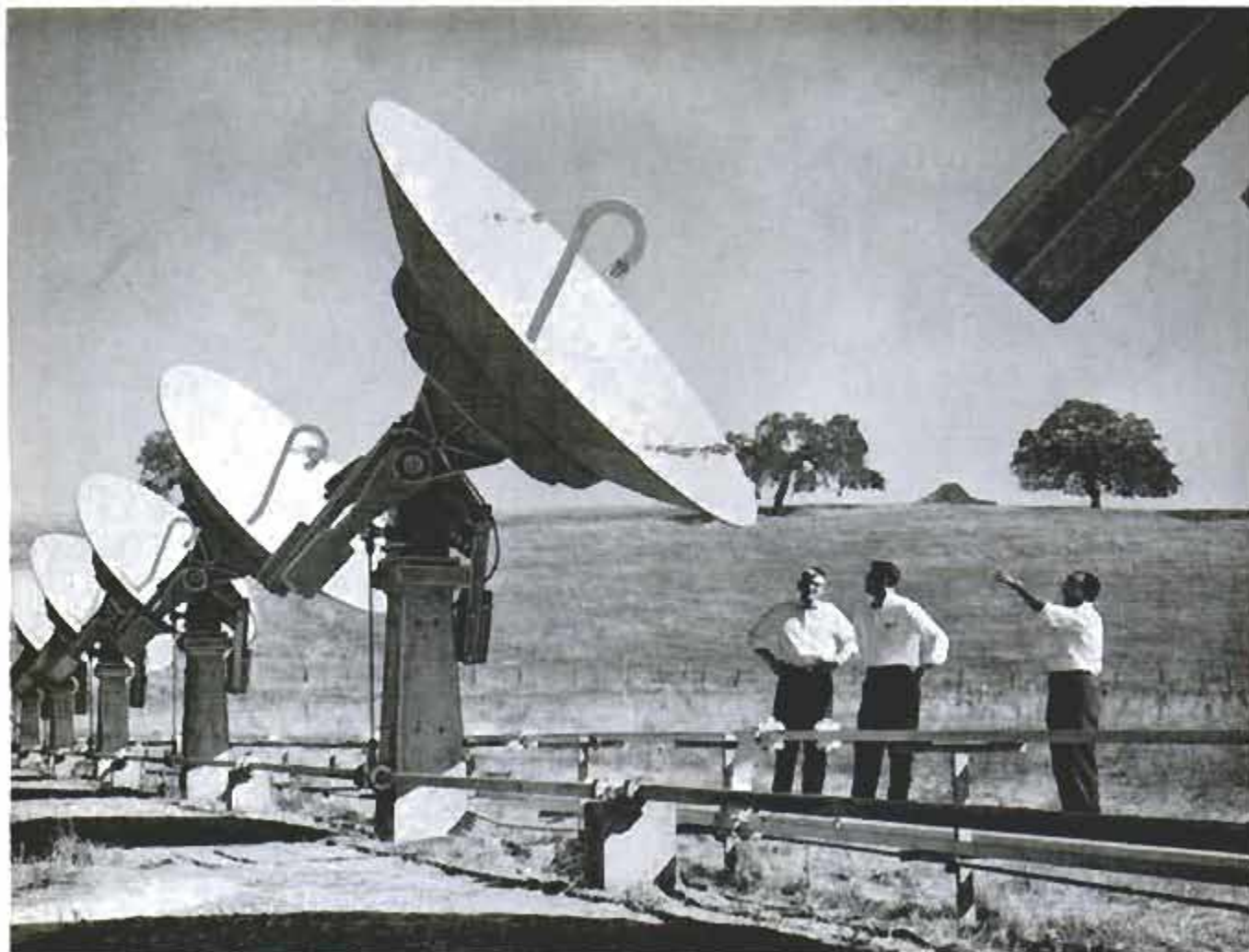

Lineup of 32 Dish Antennas Will Study Sun and Stars

When Stanford University's radio telescope is completed, it will have the highest resolving power (focal clarity) of any radio telescope in the United States. The device will be used to study the sun and stars by "seeing" their invisible electromagnetic waves just as optical telescopes see their visible light waves. The "eye" of a radio telescope becomes sharper as the antenna

increases in size. The Stanford antenna will be equal to a single "dish" 375 feet in diameter. However, since a saucer-shaped antenna of such magnitude would be impractical to build, the device will be constructed in the shape of a cross. Each arm of the cross will have 16 aluminum "dish" antennas, each 10 feet in diameter. The 32 dishes will scan the sky in unison.



Copter Can Carry Heavy Pylon

It may look like a skeleton craft, but England's Westland Westminster flying crane is powerful. It has a six-ton lift that's equal to the chore of transporting a steel pylon to its construction site. The Westland Westminster's five-bladed rotor is powered by two shaft-driven turbine engines mounted on top of the craft's tubular frame. The rotor of the "prehistoric flying monster" measures 72 feet in diameter.

Radio Television Electronics

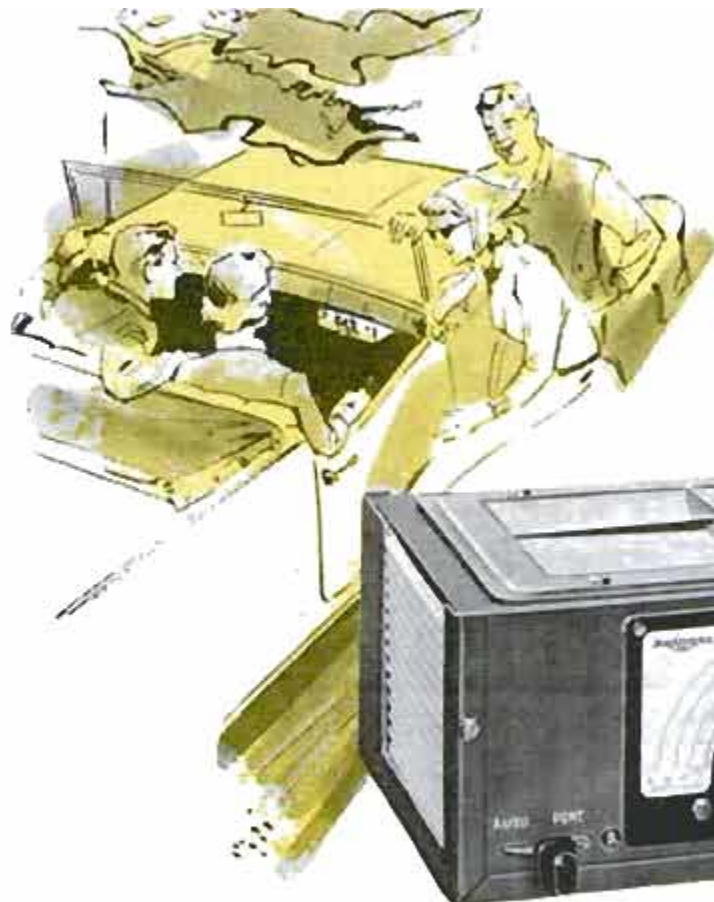

TRANSISTORIZED CAR RADIO DOUBLES AS PORTABLE

(A CONSTRUCTION PROJECT FOR ADVANCED EXPERIMENTERS)

By Peter Otto

IF YOU'VE BEEN thinking of building a radio for your automobile, why not build one which will do double duty? Triple duty, in fact, because there is no reason why a single receiver cannot be equally at home in your car, your house and on the beach.

Transistors provide the bridge for spanning the design differences between various types of radios. The appearance of reasonably priced power transistors permits the design of a single receiver which has the power output required to overcome the high noise level in a moving car, the low battery drain essential for portable use, and the sound quality expected of home radios. The unit described here combines all three of these essential features.

Design Principles

At first glance, the design of this receiver (see schematic diagram on page 158) does not appear to be extraordinary. Its r.f. and i.f. sections are, in fact, entirely conventional. There is the usual converter stage, TR1, followed by two stages of i.f. ampli-

fication, TR2 and TR3, and a detector diode, CR1. The two i.f.s (three i.f. transformers in all) impart excellent selectivity and sensitivity to the receiver.

The audio section of the radio, however, differs considerably from that of other transistor radios. While not apparent from the schematic, the push-pull-connected output transistors, TR5 and TR6, are high-power units as compared with the low-power transistors normally employed. As a result, the audio amplifier provides in excess of 4 undistorted audio watts—which is considerably more than many car radios, whether transistor or vacuum-tube operated.

But the mere use of power transistors does not mean that these must actually be employed as such. After all, even transistors draw considerable battery current at high audio-power levels. When operated with less than optimum bias current and an increased load impedance however, they act much like ordinary low-power transistors and provide similar performance.

To provide for two power-output levels

LIST OF MATERIALS

RESISTORS: (All $\frac{1}{2}$ -watt, $\pm 10\%$ carbon unless otherwise stated. K=1000 ohms.)

R1=33K; R2=8.2K; R3, R4=5.6K; R5, R10, R14, R19=22K; R6, R9=100K; R7, R11=820; R8, R12=1K; R13=5K pot. audio-taper w. switch; S1; R15=2.7K; R16=470; R17=220; R18=750; R20=6.8 ohms wirewound; R21, R22=0.47 ohms, 1 w., wirewound; R23=100; R24, R25=10K.

CAPACITORS: C1=100-mmfd. mica; C2, C3=tuning cap. w. trimmers; C4=6.8-mmfd. ceramic (see text); C5=.001-mfd. ceramic; C6, C18=.01-mfd. ceramic; C7, C10, C13, C17=.05-mfd. ceramic; C8, C11, C16=50-mfd./25-v. electrolytic; C9, C12=.1-mfd. tubular; C14=6-mfd./3-v. electrolytic; C15=90-mfd./3-v. electrolytic.

TRANSISTORS and DIODE: TR1=RCA 2N140; TR2, TR3=RCA 2N139; TR4=RCA 2N109; TR5, TR6=RCA 2N301 (power); CR1=Type 1N34A diode.

TRANSFORMERS: T1=25000:600-ohm i.f., Miller 2041; T2, T3=25000:1000-ohm i.f., Miller 2042; T4=500CT:5000CT-ohm interstage, Stancor TA-4; T5=400CT:4/8-ohm output, Thordar-

son TR-22; T6=48CT:8/16-ohm output (5-w.) Stancor TA-11.

MISCELLANEOUS: L1*=loopstick; L2*=osc. coil; S1=s.p.s.t. switch on R13; S2=4-pole, 2-position lever switch (only 2 poles used); J1=shorting jack for external 8-ohm speaker; J2=12-contact socket, Cinch-Jones S-312-AB; P2=matching plug, Cinch-Jones P-312-CCT; J3=antenna jack, (use ordinary phono jack); SP1, SP2=3.2-ohm PM speaker, $3\frac{1}{2}$ -in. square, Quam 3A07; batteries=Burgess Z4, (2).

HARDWARE: Aluminum "Minibox," 8 x 6 x $3\frac{1}{2}$ -in., Bud type CU-2109; leather handle; vernier dial; knob for vol. cont.; transistor sockets, (4); material for power-transistor mounting (see text); decorative speaker grille Allied Radio No. 82D252; aluminum for r.f. and audio chassis and brackets (see text); assorted terminal strips, solder lugs, screws, nuts and lock washers; hookup wire; rosin core solder.

* Select component designed to track in the broadcast band.

(one for portable and home use and the other for automobile use) two different output transformers, T5 and T6, are employed. The primary windings of both are connected to the output transistors, although the high-power transformer is isolated from the transistors by resistors R24 and R25. Both secondary transformer windings are connected to section "b" of switch S2 which, depending on its setting, connects either the low-power transformer, T5, or the high-power unit, T6, to the speakers. Simultaneously, section "a" of S2 applies power to the radio from either the built-in batteries or from the automobile battery.

When the receiver is used as a car radio, operating power is applied from the car battery through plug P2 which must be

plugged into socket J2 mounted on the rear panel of the case. This multiprong socket has certain of its pins connected to biasing and stabilizing resistors R19 and R17, and to the two transformer-isolating resistors R24 and R25. Plug P2 has jumper wires connected across correspondingly numbered prongs so that, when the two are mated, the above-mentioned resistors are shorted out. This changes the operating characteristics of the output circuit to provide the necessary audio power output for car installations.

When used as a portable or home radio, plug P2 is removed from the socket and S2 is set to the PORT. position (marked INT. on the schematic). Changing the switch setting connects the low-power transformer to the speakers and connects the internal

Schematic diagram of radio for car or portable use. Dotted box shows wiring of car-battery connector

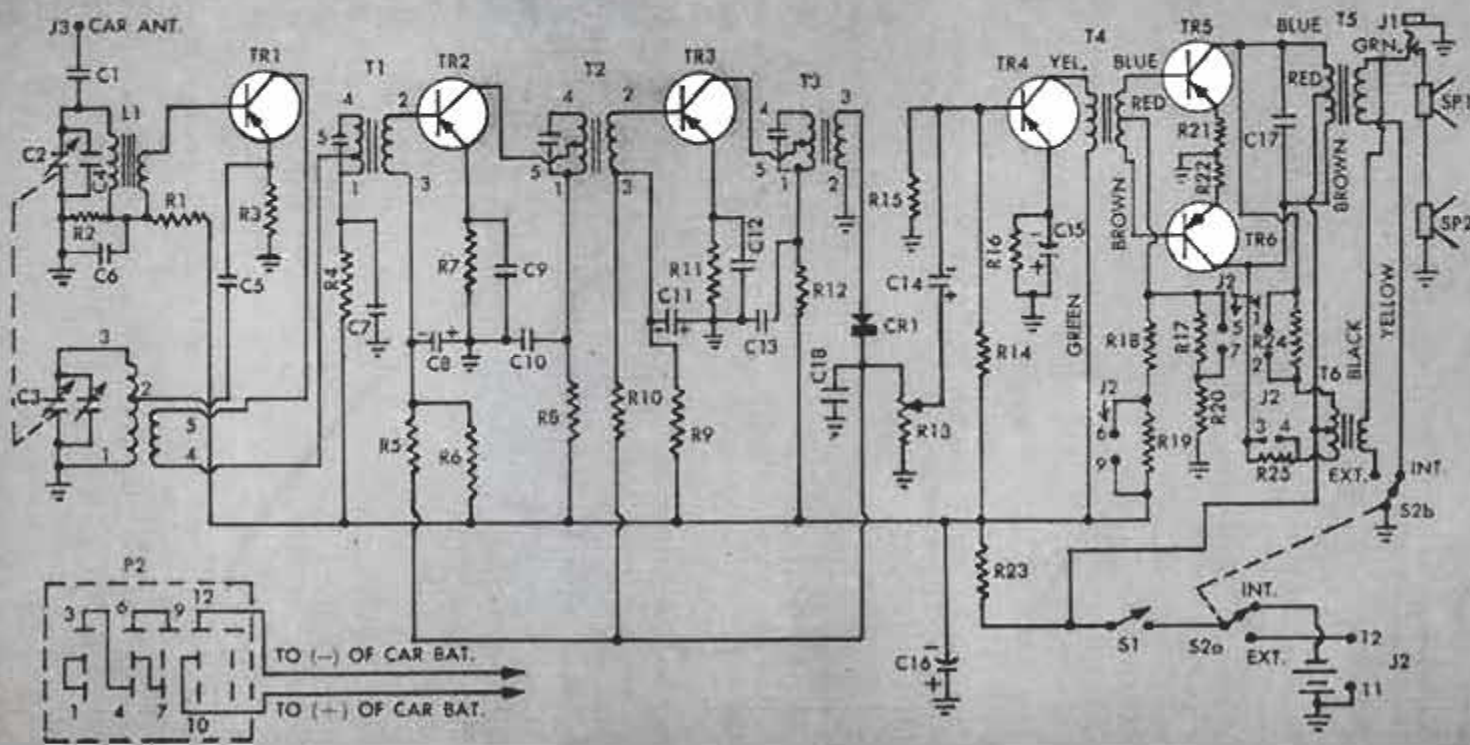

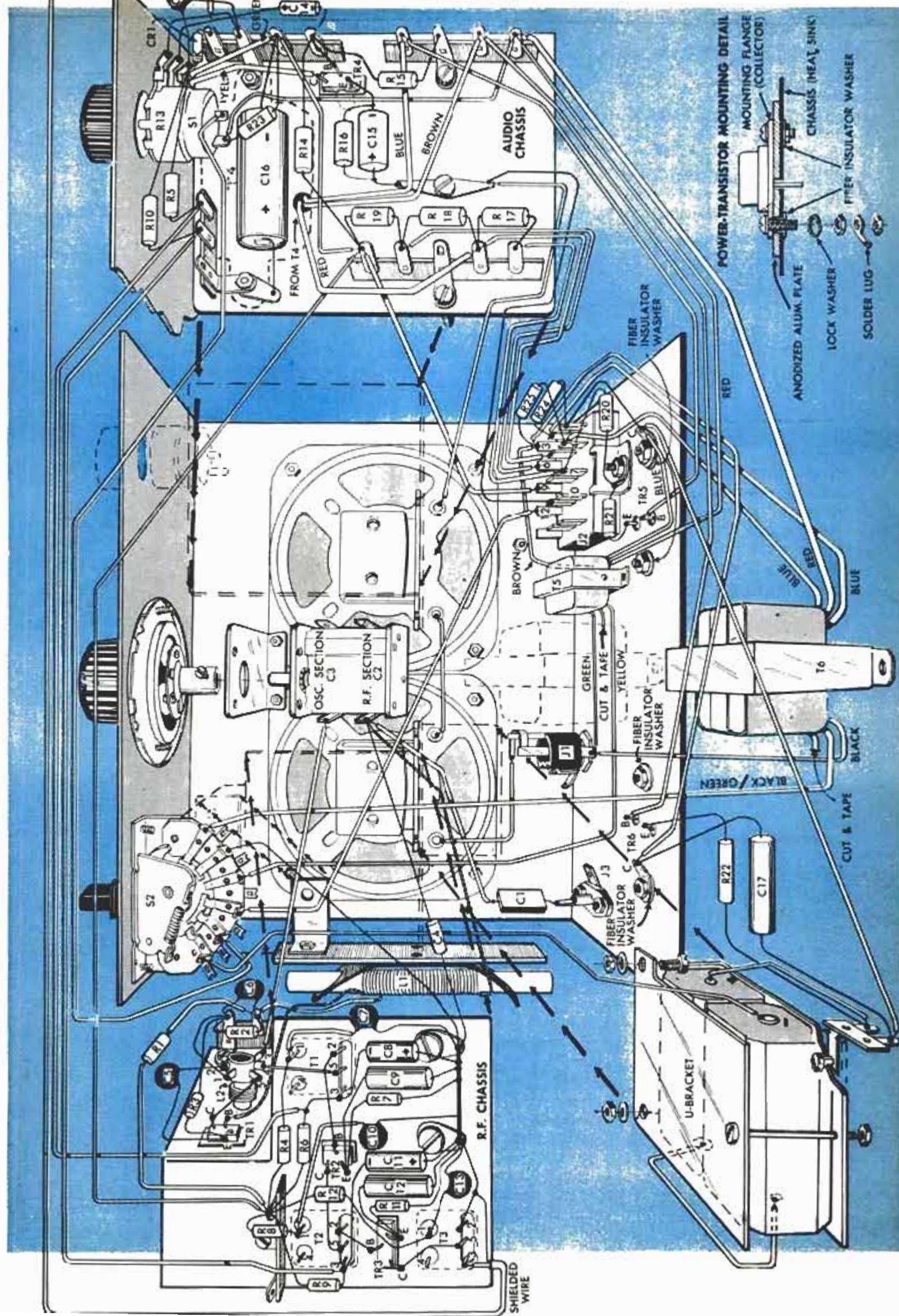

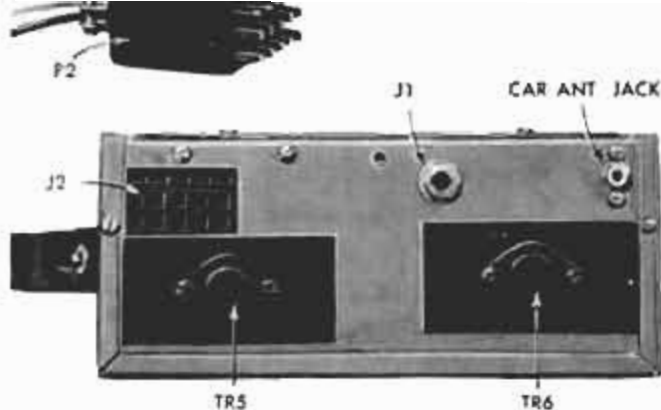
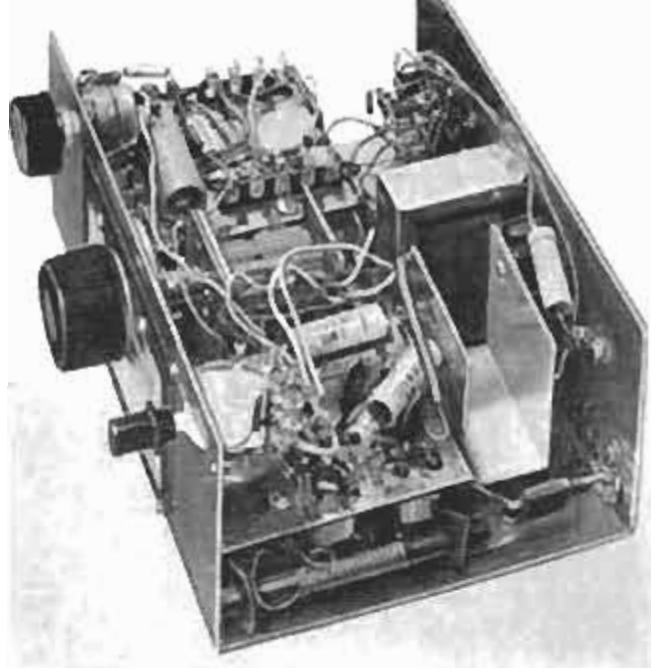

Rear view of receiver illustrates power-transistor mounting. Two wires from plug P2 lead to car battery. Internal wiring of plug is shown in schematic

Left: Inside the case, all parts fit neatly, though compactly, in place. U-shaped bracket, lower right, will hold two built-in batteries, for portable use. Batteries are wired into circuit to insure good contact

batteries to the radio. Removal of the plug increases the total bias and stabilizing resistance values in order to conform with the altered load impedance and to reduce battery current drain.

Although little more than $\frac{1}{4}$ watt of power is available for portable applications, this is more than enough for ordinary needs. The two 4-in. speakers and the relatively large enclosure give much greater volume and far better sound quality than normally is attributed to transistorized portables.

Construction

Building this radio requires careful attention to layout details if all of the parts are to fit neatly into the recommended 8 x 6 x 3 $\frac{1}{2}$ -in. aluminum case. Before beginning the actual construction, assemble all of the required components and place the case-mounted parts in the approximate positions shown in the pictorial diagram (page 159). Components mounted on the rear panel (T5, T6, J2, etc.) must be placed close together to provide room for the battery holder. Transformer T5 and socket J2 are placed near the bottom of the case so that they do not interfere with the mounting of transistor TR5 on the outside of the case. (A 15-lug socket is shown for J2. Actually, a 12-lug socket will suffice.)

Mounting details for the power transistors are shown in the diagram. The mounting of these units can be greatly simplified through the use of a Motorola No. MK-10 mounting kit currently available from a number of radio parts distributors. The kit includes a power-transistor socket and the necessary washers to give electrical insulation while providing for sufficient heat transfer to the chassis. All electrical connections are then made to the socket lugs rather than to the transistor leads.

Parts mounted on the front panel should be mounted as close to the top edge as possible without interfering with the lip on the case cover.

The two speakers are fastened to the bottom of the case after the necessary speaker cutouts have been made. Speakers are centered in the case, approximately $\frac{3}{8}$ in. from each open edge. A decorative grille (see title photo and parts list) protects the speaker cones against damage from the outside.

A homemade bracket, fastened to the bottom of the case underneath two of the speaker mounting nuts, holds the tuning capacitor (C2-C3) in place. Particular care must be used in the placement of the panel-mounted vernier dial, or in the placement of the capacitor bracket, to make sure that the hole in the bracket is perfectly aligned with that in the dial bushing. If a vernier dial is not desired, the capacitor may be fastened directly to the front panel of the case.

Another homemade L-bracket is used to fasten the antenna loopstick, L1, to the bottom of the case. The loopstick comes mounted on a fiber back for easy chassis installation. Make the short end of the L-bracket just long enough to permit the bottom edge of the fiber back to rest against the bottom of the case.

Two tapped holes in the back of each of the suggested speakers are used for the eventual mounting of the fully wired r.f. and audio chassis. Each of these chassis is a flat 3 $\frac{3}{8}$ x 2 $\frac{3}{4}$ -in. aluminum plate. The right-front portion of the r.f. chassis, to which transistor TR1 and oscillator coil L2 are fastened, is bent downward at a 60° angle, as shown. The front edge of this chassis rests flush against the front panel to allow sufficient space for the U-shaped

(Continued to page 236)



Two TVs and only one antenna? Even 20 or more TV and FM receivers can be serviced by one antenna in a normal-signal area. New Wizard electromagnetic TV-FM coupler simply attaches to existing antenna lead-in and couples signal to an additional set without materially reducing signal strength or creating a mismatch. Ideal for apartments and motels, too



How much recording or playback time is left on your tape reel? Even recorders with footage indicators don't give an immediate answer. But this simple, graduated plastic rule does. Accurately calibrated for all types of tapes, it shows at a glance how much time is left on a 7-in. reel. Available separately or permanently mounted on 7-in. plastic reel

New Products Solve Old Problems

Tired of fussing with your car aerial? Here's a high performance remote-controlled antenna which rises automatically when the radio is turned on and retracts smoothly when radio is turned off. Can be installed by any car mechanic without tampering with the radio

How to receive special broadcasts is no longer a problem with inexpensive, self-powered converter. This one covers the 2738 and 2638 kc. marine bands and simply connects between antenna and any ordinary radio. Similar units for police, fire, aircraft and other special frequencies are available. Does not prevent broadcast-band reception

No telephone facilities? Try radio for short range point-to-point communications. Transmitter-receiver combination operating in new exam-free citizen's band has range up to 10 miles. For either fixed or mobile operation, units are available with 115-v. a.c., 6-v. d.c. or 12-v. d.c. power supplies





CAPTAIN'S CHAIR IN MODERN

Modern version of popular Captain's chair makes it a companion piece for the smart drop-leaf dining table presented last month



BROUGHT UP TO DATE, minus turned legs and bow back, the captain's chair becomes a chair that can take its place among modern furnishings. In its modified version, this Early American favorite can be reproduced with hand tools alone and its padded arms and seat provide accents of color in keeping with modern decor.

The front and back legs are made in pairs and differ only in their length and the angle at which they are cut off at the tops. You will notice that only the inner adjacent faces of the legs are tapered, be-

MATERIAL LIST

CABINET WOOD

- 2 pcs. $1\frac{3}{4}$ " x $1\frac{3}{4}$ " x $27\frac{3}{4}$ "—Front legs
- 2 pcs. $1\frac{3}{4}$ " x $1\frac{3}{4}$ " x $28\frac{1}{4}$ "—Back legs
- 2 pcs. $\frac{3}{4}$ " x $2\frac{3}{4}$ " x $16\frac{3}{4}$ "—Side seat rails
- 2 pcs. $\frac{3}{4}$ " x $2\frac{3}{4}$ " x 19"—Front and back seat rails
- 2 pcs. $\frac{3}{4}$ " x $1\frac{3}{4}$ " x $19\frac{3}{8}$ "—Arms
- 1 pc. $\frac{3}{4}$ " x $3\frac{1}{8}$ " x $22\frac{1}{2}$ "—Top back rail

HARDWOOD

- 1 pc. $\frac{3}{4}$ " x $1\frac{1}{2}$ " x $17\frac{1}{2}$ "—Seat cleat

PLYWOOD (FIR)

- 1 pc. $\frac{1}{2}$ " x $20\frac{1}{2}$ " x $22\frac{1}{2}$ "—Seat and arm upholstery boards

MISCELLANEOUS

- 3 pcs. $\frac{5}{8}$ " Dia. x $11\frac{1}{2}$ " wooden dowels or brass tubing
- 4— $\frac{5}{8}$ " Dia. furniture glides for legs

By John Bergen



DESIGN

ginning from the lower edge of the seat downward. The padded seat board is supported by a simple boxlike frame, which is strengthened at the corners with glue blocks, counterbored for screws and fastened to the legs with screws driven from the inside. A cleat across the back of the seat frame permits holes to be bored at a 15-deg. angle for the dowel or brass tubing members. In studying the side view you will see that the holes actually straddle the joint. The U-shape frame that is screwed to the tops of the legs consists of three pieces half-lapped at the corners and rounded. Holes for the dowels are bored completely through it. One piece of plywood provides the padded seat and arm boards, the latter being formed by sawing around three sides of the plywood piece. Upholsterer's cotton or foam rubber is used to pad the seat and arm boards, after which they are wrapped with fabric and tacked neatly to the underside. ★ ★ ★

The CRAFTSMAN

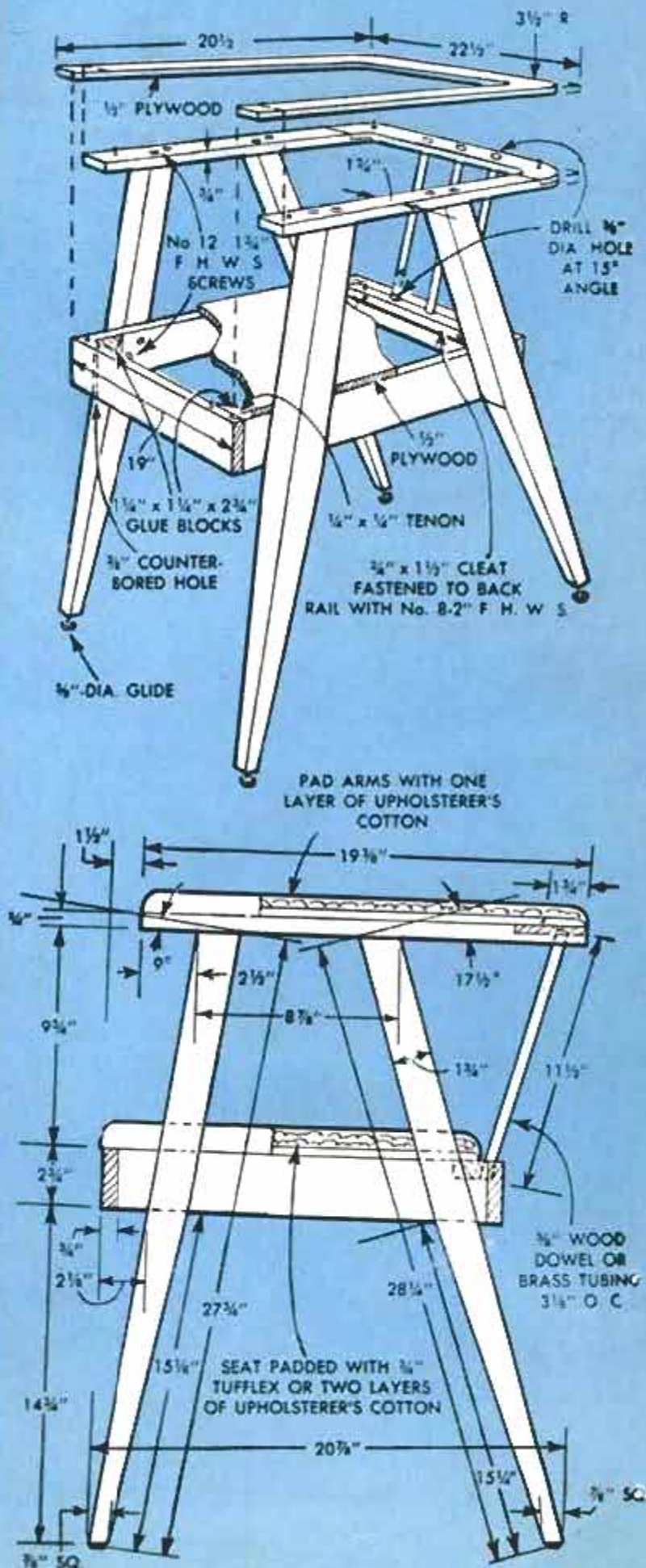



Calking Tips Stored in Water

It is not necessary to clean the removable tips of a calking gun each time during interrupted use if the tips are dropped into a jar of clean water. Stored in water this way the calking compound does not harden, but remains in its original consistency. This stunt is ideal for the home craftsman who must take several days to do the job of calking his home. After the job is done, of course, both the gun and tips should be cleaned. This idea also applies to the cartridge type of calking gun.

R. Hanscom, Elmhurst, Ill.

Saw Blade Filed While in Table

When you want to just touch up the teeth of a circular saw with a file, it is not necessary to remove it from the arbor. Clamp a length of 1-in. stock alongside the blade as shown and file the teeth that project above the strip. The clamp is loosened each time and the blade rotated to bring another portion of the blade into position. When clamping the blade, keep the clamp pads inside the teeth to avoid altering the set in the teeth.

G. E. Hendrickson, Argyle, Wis.



Increase Uses for Hay Barrack

Covering two sides of a hay barrack with sheets of corrugated roofing nailed to 2 x 6 cross members extends the usefulness of this structure to year-round use. It now is used at times for machinery storage and for storing baled hay. Feeder cattle also are penned in the building, plank rails being nailed across the corner posts to prevent the stock from pushing out the sides of the building. Used roofing is ideal for this purpose if available.

A. M. Wettach, Mt. Pleasant, Iowa.

Angle-Cutting Duplicate Pieces

Angle-cutting the ends of a number of pieces of lumber that are to be identical in length can be done quickly on a table saw with the aid of a simple jig. The jig, clamped to the saw table as indicated, is a block of wood in which an accurate right-angle cut is made. The block is positioned to hold the lengths of stock at the correct angle and length, so they can be held firmly—or clamped, if the miter gauge is so fitted—against the miter gauge and run through the saw. Make sure the blade is sharp.—J. C. Roby, San Diego, Calif.



5 ft. high from wagon bed to the top. The sides of the feedbox are supported by steel angles salvaged from a windmill tower. Lengths of angles tie the uprights to other angles bolted across the bed of the wagon. The feeder can be filled in the field with a forage chopper or hauled to a silo chute, then moved to a feedlot.

A. M. Wettach, Mt. Pleasant, Iowa.



List of Tab Stops Saves Time

If you frequently type out forms that require a number of tabulator-stop settings, time can be saved by taping a list of the stops to the typewriter in an easily seen location. If several different forms are often needed, make a list of the forms by number or description, along with the required stops, and fasten it to the wall above the typewriter desk, or on the dictation slide of a regular desk.

Frank A. Javor, Newark, N. J.

Strip Map Easier to Handle

There will be no awkward folding and unfolding of a road map on your next auto trip if you carry, instead of an entire map, a strip about 6 in. wide cut from the map, showing your route. Folded accordion fashion, the narrow strip is easy to handle. A full map should be carried in the glove compartment, should a detour or change of plans, such as a side trip, require it. Marking the route with a colored pencil is an additional aid. If your trip is a long one and the route extends over two maps, cut both maps and glue the strips back to back.

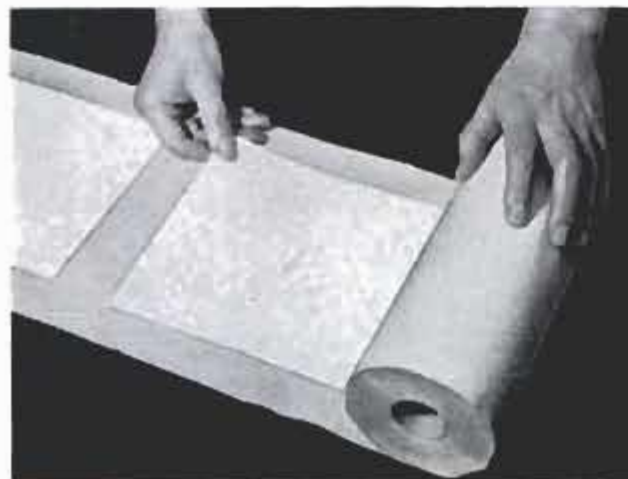
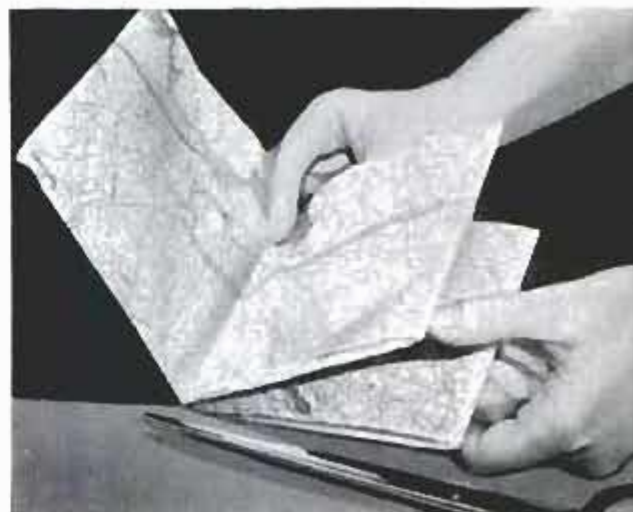

Removing Curl From Photoprints

Do your prints curl up in a roll when you take them off the ferrotype plate? Here is a way you can take the curl out of them: First dampen the backs of the prints with a sponge dipped in water. Then place the prints face down on paper toweling and roll them up in the roll. The curve of the roll will counteract the reverse curl of the prints. Let the prints remain rolled up for eight hours. When removed, they will lie flat. You should use a full or nearly full, roll of paper toweling.

Russ Whitaker, Altadena, Calif.

MAKE ONE OF THESE EACH EVENING—

A serving tray to save steps, magazine rack, telephone stand and an end table with shelves for newspapers

By Ted Fenn

HERE ARE THREE pieces of occasional furniture and a serving tray, any one of which can be made in a few hours using inexpensive materials and tools that most home craftsmen own.

To make the serving tray, first cut out the $\frac{1}{2}$ x 12-in. plywood disk to be used for the bottom. Then cut a disk of the same diameter from sheet copper and cement it on top of the plywood one. Next a 1-in.-wide strip of sheet copper is nailed to the edge of the bottom with copper nails, after crimping the upper edge to produce a rolled edge as shown. The handle consists of two wooden arms shaped as shown in the detail and screwed to the edge of the bottom at opposite sides, after which a length of hardwood dowel is glued in holes drilled in the upper ends of the arms.

Construction of the end table is so simple that a pair of them can be made in little more time than it takes to make one. The top and shelves are cut from the same pattern so that only one full-size pattern need be made for all three pieces. To assure proper alignment of the holes that take the legs, clamp the top and shelves together when drilling them. Note that the holes in the underside of the top are drilled only to a depth of $\frac{3}{8}$ in. The legs are cut to length from hardwood dowels and assembled with glue and screws as shown. Brass ferrules glued on the ends of the legs add a touch of quality.

The magazine rack is easy to construct and can be made longer if desired to accommodate more magazines than the one shown. The bottom and back pieces of the rack are cut from $\frac{3}{8}$ -in. plywood and the ends are cut from $\frac{3}{4}$ -in. plywood according to the dimensions given in the drawing. Glue and screws are used for assembling it. Make certain the blind holes for the dowel ends of the handle are drilled before assembling the ends.

The combination telephone stand and cabinet not only is a handsome piece of occasional furniture but it provides ample enclosed storage space for directories and other references. It can be made of plywood, knotty pine or other woods as shown in the drawing and details.



SERVING TRAY

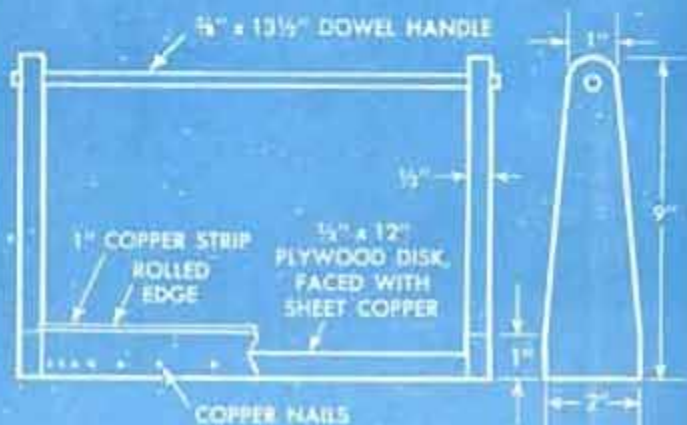

END TABLE

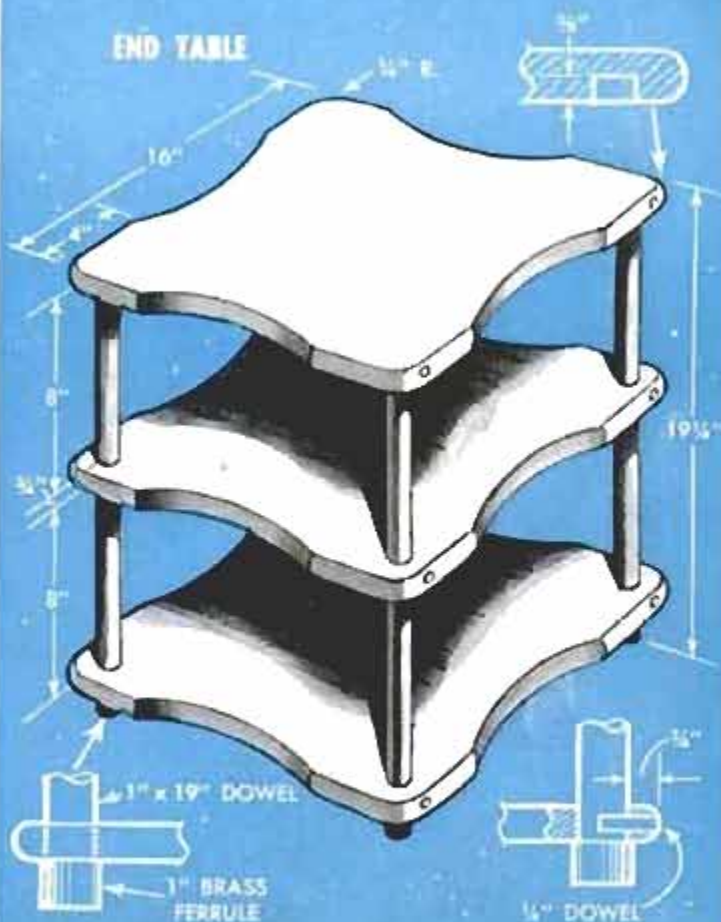

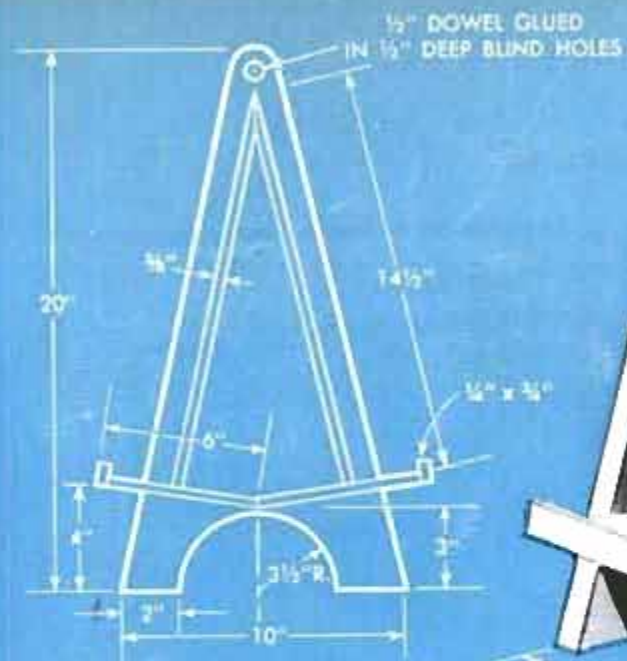

MAGAZINE RACK

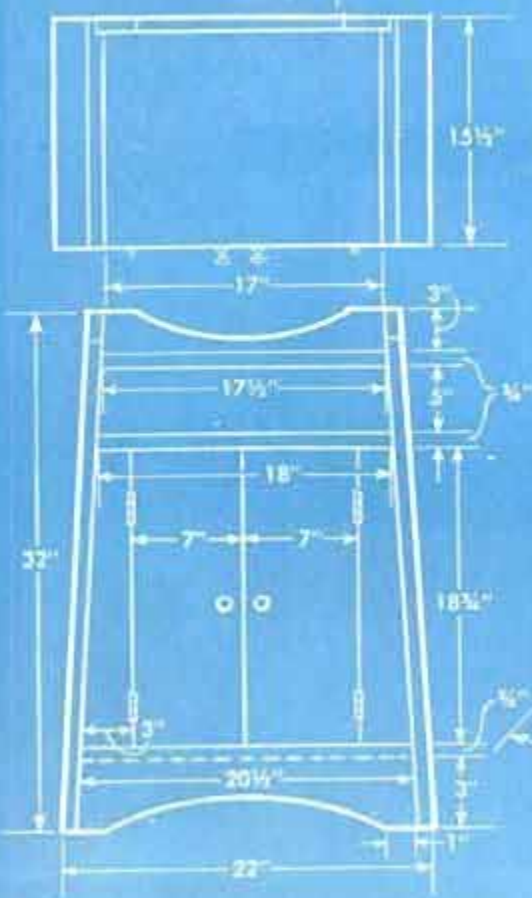
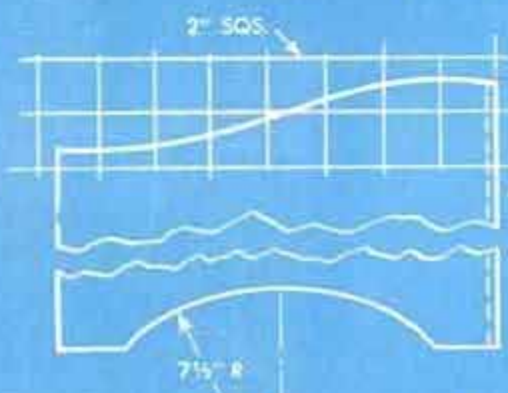

TELEPHONE STAND

Fowl Prevented From Flying By Taping One Wing

If one or more chickens or other fowl have acquired the habit of flying over the fence of the yard in which they are kept, a strip of adhesive tape will keep them grounded. Wrap the tape around one wing of the bird so the flight feathers are bound. When the bird attempts to fly it will circle and never reach its objective. The tape does not injure the bird or damage the plumage.

Brush "Seals" Corrugated Joint

When lap-soldering two pieces of corrugated metal, an ordinary stiff scrub brush can be an invaluable tool. The bristles of the brush will bend to conform to the shape of the corrugations when pressure is applied to its back, and thus will hold the irregular surfaces firmly together to assure a tight, easily soldered joint.

Robert M. Beasley, Jackson, Mich.

Cardboard Used as Sanding Block

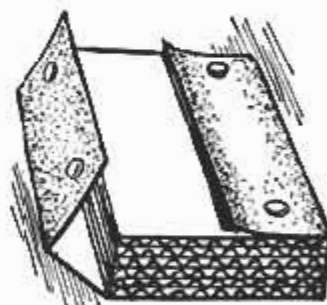

Hand-sanding a crowned surface is much less of a problem if the sanding block consists of several layers of corrugated cardboard stapled together. The block is firm enough to hold the paper in full contact with the surface, yet is resilient enough to conform to the contour of a curved surface.—Ray Wencil, Chicago.

Handy Marking Gauge Improvised From Ordinary Folding Rule

Adjusting a folding rule as shown in the photograph permits it to be used as a marking gauge, or for checking one measurement against another with reasonable accuracy. The body of the rule is placed on the edge of the work and the vertical section of the rule is held firmly to the body with one hand. Although only one section of the rule is used in the illustration, two or more could be extended to increase the usable length of the gauge. Of course, this may affect accuracy somewhat, especially if there is a loose joint in the sections.



Installing Battery Correctly

It is important when replacing a battery to install it correctly. Note which of the two battery terminals has a cable that is bolted to some part of the engine or transmission. This will be the ground terminal. If a car is fitted with an ammeter, an incorrectly installed battery will show full discharge when the engine is running. If there is only a warning light, ground the positive lead of a voltmeter and momentarily touch the negative lead to a spark plug. The meter should read up-scale, as negative voltage is delivered to the plugs, no matter which side of the battery is grounded. If the scale reads down, reverse terminals.

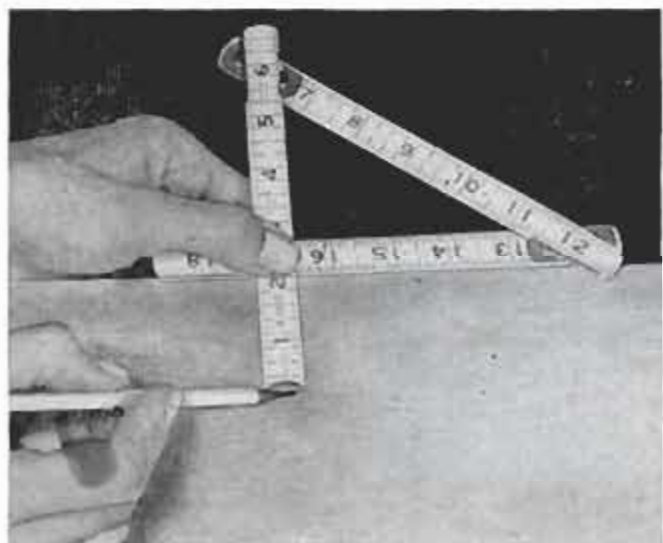

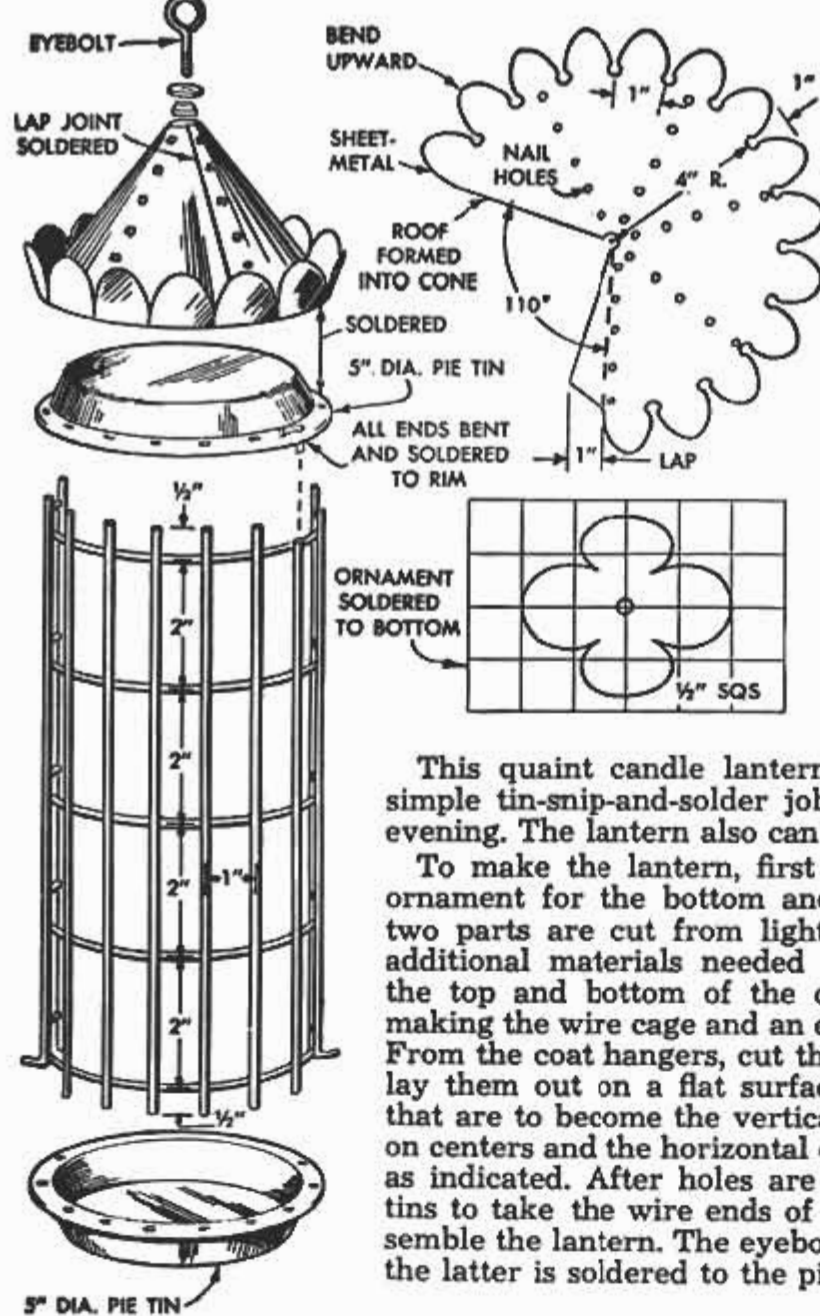

This quaint candle lantern from below the border is a simple tin-snip-and-solder job that can be completed in an evening. The lantern also can be used as a planter if desired.

To make the lantern, first draw full-size patterns of the ornament for the bottom and the cone-shaped roof. These two parts are cut from lightweight sheet metal. The only additional materials needed are two 5-in.-dia. pie tins for the top and bottom of the cage, several coat hangers for making the wire cage and an eyebolt for hanging the lantern. From the coat hangers, cut the required lengths of wire and lay them out on a flat surface to form squares. The wires that are to become the verticals of the cage are spaced 1 in. on centers and the horizontal ones are spaced 2 in. on centers as indicated. After holes are drilled in the rims of the pie tins to take the wire ends of the cage, you are ready to assemble the lantern. The eyebolt is attached to the roof before the latter is soldered to the pie tin at the cage top.

Hi Sibley, Nuevo, Calif.

Aspirin Box Keeps Lens Brush Free of Dust While in Storage



For dustfree storage of a lens-cleaning brush, cut out one end of the lid and bottom of an aspirin box and cement strips of heavy felt to the lid and bottom as shown. The brush is placed in the box so that when it is closed the felt strips clamp the flat part of the ferrule to prevent dust from reaching the bristles. A small-size box is best for this purpose.

Ken Murray, Colon, Mich.

☞ To remove stains on the cement between ceramic tiles, use fine steel wool. Be careful not to leave steel-wool particles behind as they will form rust spots.

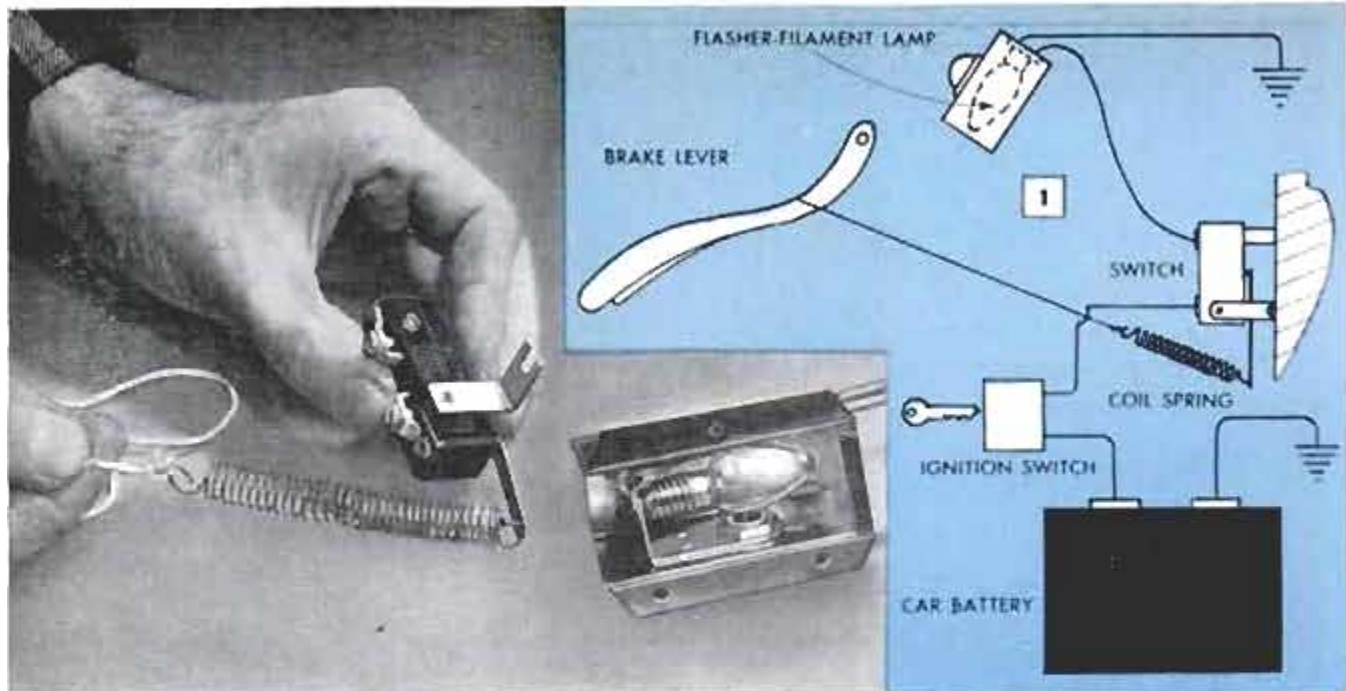

Flashing Lamps Catch the Eye

By *Walter E. Burton*

THERE IS NO DOUBT that a flashing light is more effective as an "attention getter" than one that burns steadily. This factor is utilized every day in store signs, theater marquees and in turn indicators on automobiles. Although automatic, momentary-contact switches are used in these applications, a craftsman or hobbyist who has need for a flashing light can assemble one with only an off-on switch in the circuit. Incandescent electric lamps are available that have an automatic "switch" in the filament to make and break a circuit. Because the lamps require only from about 4 to 6 volts (12-volt lamps are to be available soon) they can be used in portable setups powered by dry cells or an automobile bat-

tery. For permanent installations, house current can be reduced with a stepdown transformer for the low-voltage lamps.

If you have ever driven with the parking brake of your car pulled on, you will appreciate the warning lamp shown in Fig. 1. When the brake handle is pulled, a spring-loaded, momentary-contact switch is closed and a light flashes on and off until the brake handle is moved to the "release" position, or the ignition switch is turned off. Switches of the type shown can be purchased at radio-supply houses, or regular parking-brake warning-light switches can be obtained at some auto-supply houses. A piece of sheet aluminum is shaped into a box that contains a socket to receive a G-E

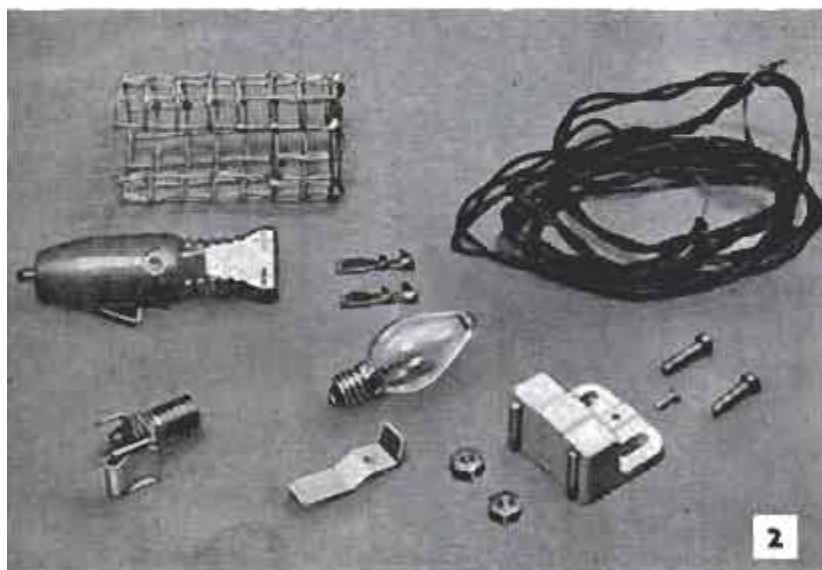



No. 405 flasher-filament lamp. If a 12-volt lamp is not available, a 30-ohm, 2-watt resistor can be wired in series with a 6-volt lamp when used in a car with a 12-volt ignition system. The box is attached to the lower edge of the instrument panel where it can be seen by the driver. The switch is mounted on the fire wall and is actuated by means of a length of fishline. A spring between the cord and switch prevents damage to the switch.

Figs. 2 and 3 show another application for flasher-filament lamps. In this auto-emergency light, a G-E No. D-25 lamp is used, it being available in colors. A No. 405 lamp also could be used if covered with a colored glass or plastic housing. The light itself consists of an L-shaped bracket to which is fastened a socket of the type used for radio pilot lights. The bracket is screwed to a magnetic cabinet latch which positions the light vertically when the unit is placed on a horizontal metal surface, such as a car roof. A piece of hardware cloth is shaped as a shield to protect the lamp. An 8-ft. length of 2-wire cord and an auto-accessory plug that fits the cigarette-lighter receptacle provide battery current to the lamp.

Youngsters with sidewalk cars want their vehicles to be as much like real cars as possible, and flasher-filament lamps can aid this wish for realism. Fig. 4 shows how two

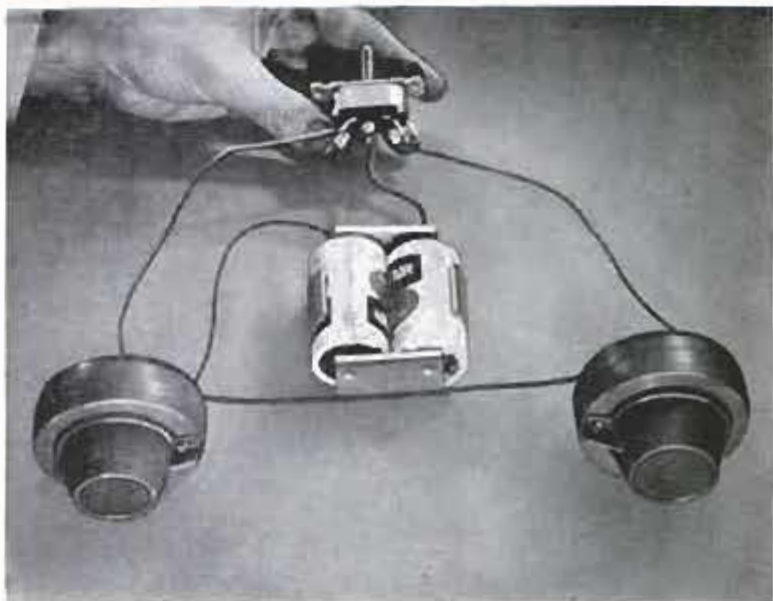
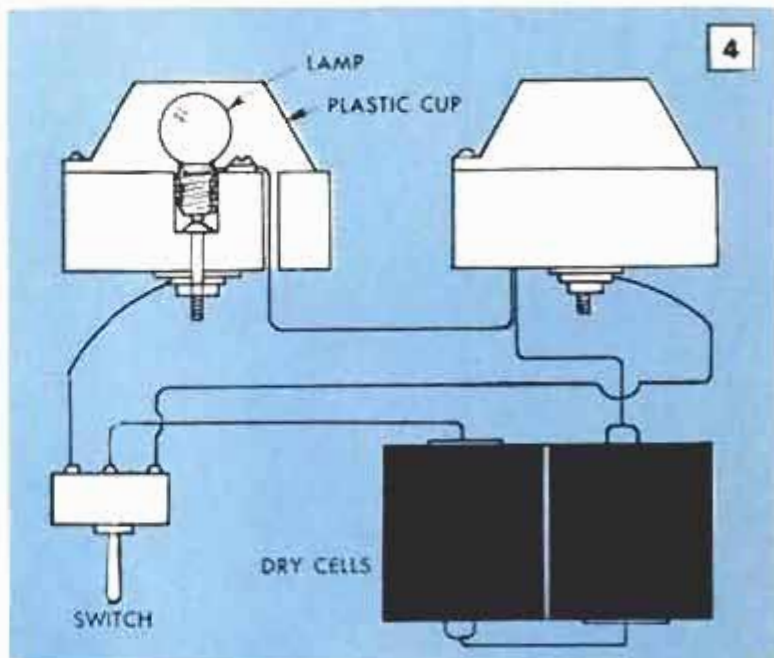

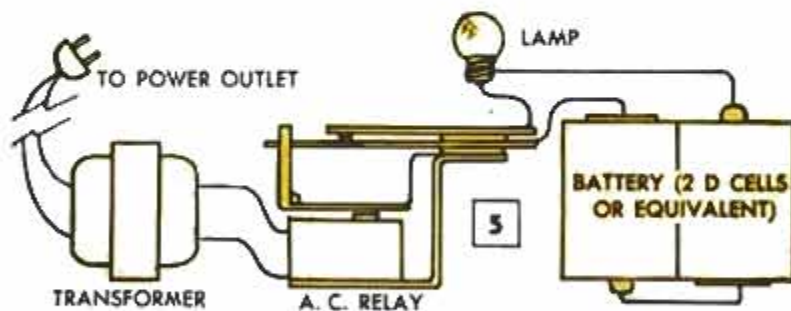
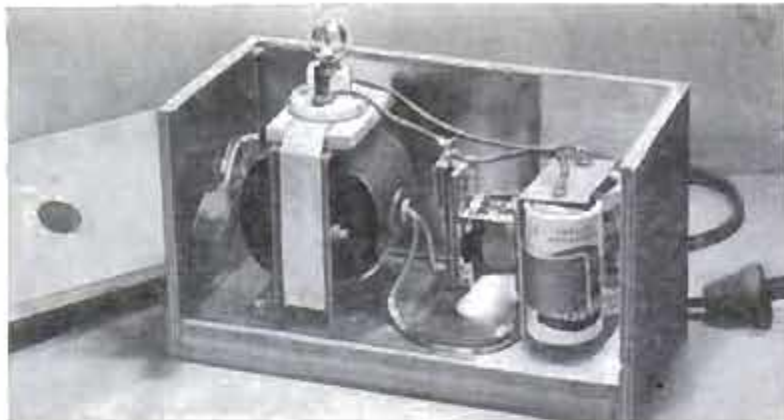

G-E No. 406 lamps are employed as turn-indicator lights for a miniature car. Translucent red or amber plastic cups are screwed to wooden disks as "lenses" for the lights. The wiring diagram shows how the lamps are wired through a single-pole, double-throw switch that automatically returns to the center "off" position when released.

The diagram and photos in Fig. 5 illustrate a use for a flashing lamp to indicate when there is a power failure. Plugged into the same receptacle as, for example, a food freezer or water pump, it will warn when current stops flowing to the unit so steps can be taken to correct the situation. Inside a wooden cabinet—used for sake of appearance—is a transformer that is wired to a relay. A G-E No. 406 or 407 lamp is wired to the opposite side of the relay as

indicated. The relay is of the type that keeps the contact points open as long as current flows through it. When the current stops, the contacts close and the flasher-filament lamp then is energized by the dry cells. For the No. 406 lamp, two size-D dry cells are required. A 6-volt lantern battery is used with a No. 407, and this latter setup will last approximately twice as long.

Where a warning light is needed, for example, to indicate that someone is using the bathroom for a darkroom, the pin-up light in Figs. 6 and 7 does the job. A transformer reduces household current to 6 volts to power a No. 405 or D-25 lamp. An L-shaped bracket supports a socket of the type used for illuminating radio dials, and is fastened to an aluminum disk for a "pin up lamp" appearance. A small shade would make the lamp even more attractive. ★★★



Farmers who sometimes find it necessary to make frequent trips over a barbed-wire fence for temporary periods of time not long enough to warrant installing a gate, will find this stile ideal. It is made from a section of an old windmill ladder, which is heated and bent to the shape indicated. The stile is light in weight so that it can be moved about as needed. If the ladder ends have a tendency to sink into soft ground, metal pads may be welded to the ends of the rails. If pads 8 to 10 in. long and 4 to 5 in. wide are used, the stile will be stable enough to be used as a stepladder when picking fruit, etc.

Dusty spider-web cross hairs in surveying instruments can be cleaned by using an ordinary soda straw. After the eyepiece is removed to expose the cross hairs, blow gently through the straw to remove the dust. Be sure not to touch the hairs with the straw, as they can be broken easily, and are difficult to replace.

Henry S. Jansen, Baltimore, Md.



Spring Supports Motor Mount to Relieve V-Belt Tension

Maintaining tension on the V-belt between the pulleys of a motor and circular saw, or other power tool, usually is accomplished by mounting the motor on a hinged platform. The V-belt then supports most of the weight of the motor. In some cases this method produces excessive wear on the belt and on the motor bearings. One method of reducing this problem is to fit a spring between the motor and a convenient spot on the frame of the power tool. The spring should be of sufficient strength to support most of the weight of the motor, yet still allow sufficient tension on the belt. If a spring is slightly stronger than required, stretch it, then cut off enough of the coils to permit it to be used.

R. Hanscom, Elmhurst, Ill.

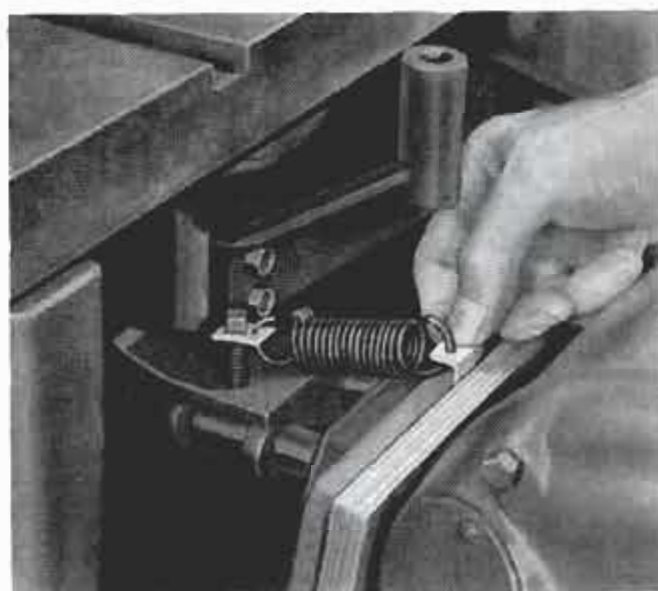

Wheels on Cattle Chute "Retract" When Axle Is Rotated by Lever

Rotating the axle under this cattle chute 90 deg. by means of a hand lever raises the chute up onto the wheels for towing. The retracting-wheel effect is obtained by using a curved front axle from a truck. It is fitted into notches cut in the upper edges of the skid timbers, and held in place by steel flats bolted to the skids. Rotating the axle to offset its curve raises and lowers the wheels just a few inches, which keeps the center of gravity low for ease of towing.

A. M. Wettach, Mt. Pleasant, Iowa.





Solving HOME PROBLEMS

DOUBLE BOILER can be made from two saucepans of different size by resting the smaller pan on three fruit-jar lids placed in bottom of large pan

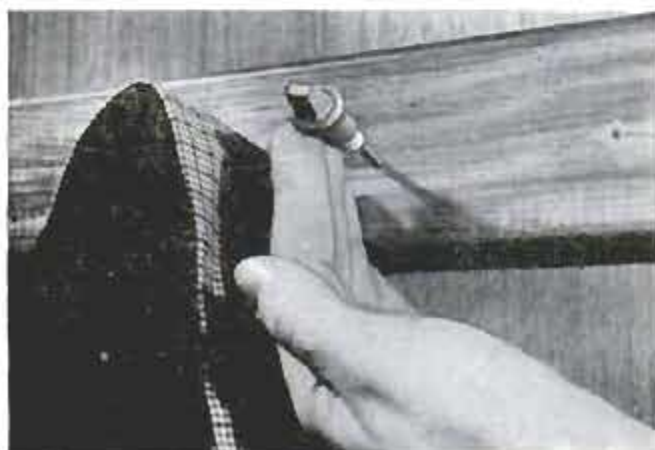

BOBBY PIN comes to rescue in reattaching chain and ring to broken drain stopper. Fit pin over ring, push through hole in stopper and bend ends up

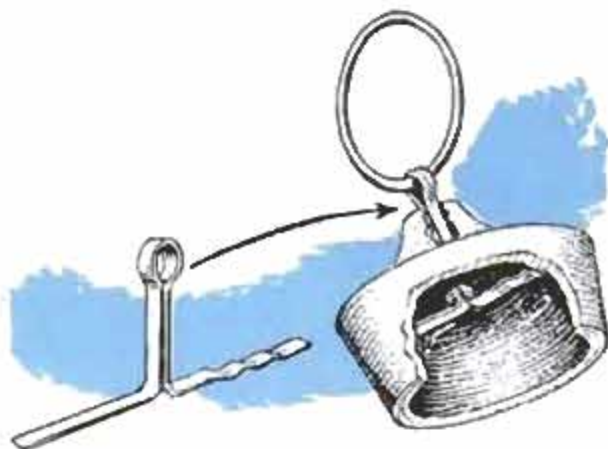

SLIP-ON PENCIL ERASERS placed over nails on which garments are hung will eliminate chance of tearing clothing. Nail diameter is first built up with tape

COLORED TAPERS take on novel decorative touch when dimpled with $\frac{1}{2}$ -in. drill. Series of shallow depressions expose white wax under surface color

ANNOYING DOOR RATTLE against steel frame is silenced by cementing piece of rubber to doorstep. A slice from center of a slip-on eraser was used here

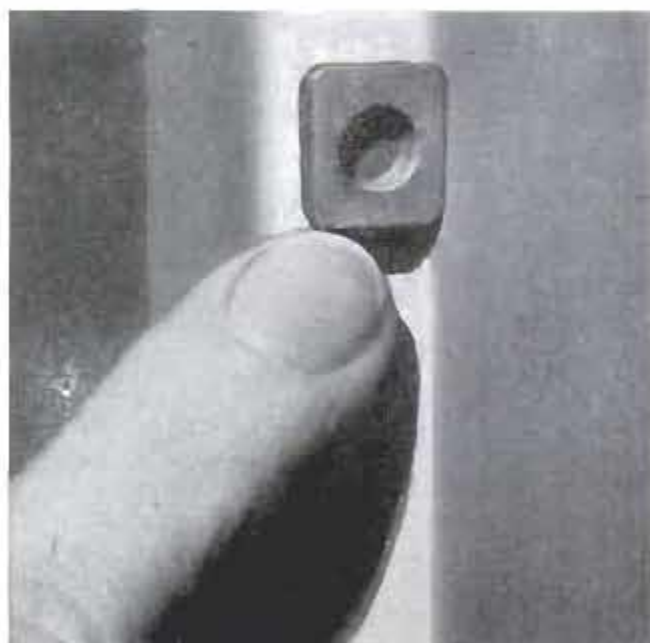

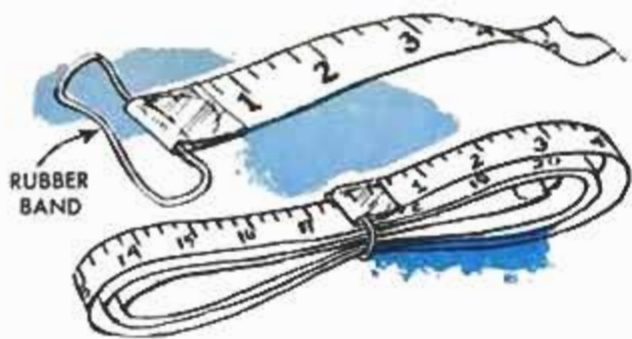

CLOTH MEASURING TAPE stays folded in sewing box when small rubber band is taped to end. Folded tape is inserted through rubber band to hold it

MISPLACED CROQUET ARCHES are a thing of the past when a length of soft iron wire is soldered to one of them. Store arches by twisting wire around others

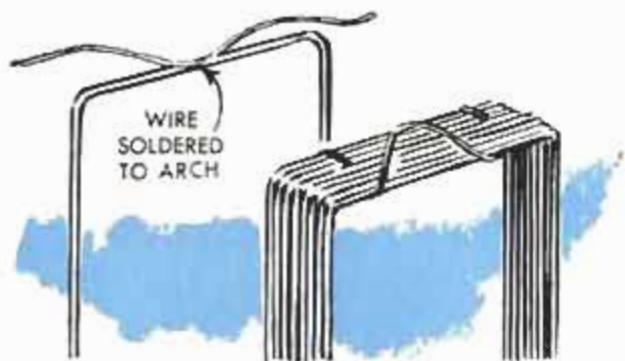

HINGE PINS ARE REMOVED at future times with less effort if V-notches are filed in the ends so that the blade of a screwdriver will fit under the pins

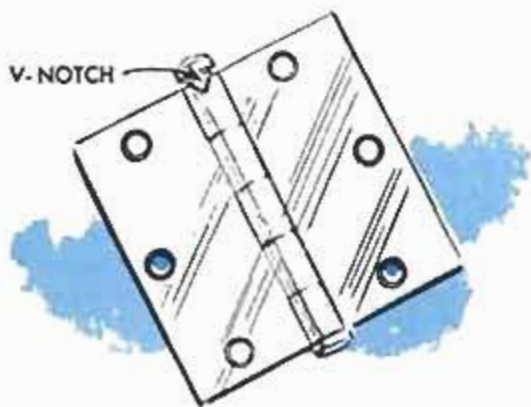

SLIDING HEAVY GARMENTS back and forth on a closet pole to make additional room requires little effort when pole is waxed. Makes hangers slide freely



FEBRUARY 1959



A DAY BED OR COUCH won't creep away from a wall, yet can be moved, when hooked to the baseboard. Put the screw eye into the back of the couch leg

IF SETSCREW FALLS OUT of doorknob and becomes lost, you can hold knob in place temporarily with a wooden peg, reinforced through center with nail

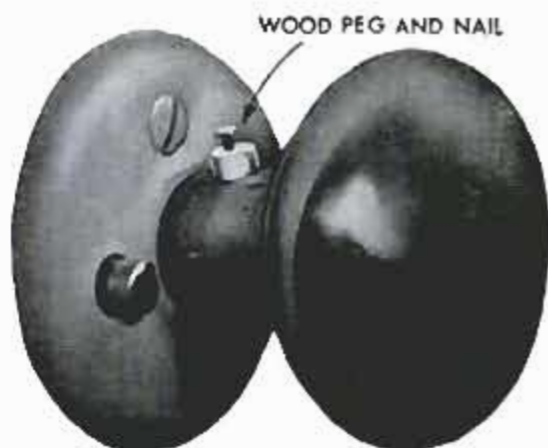

DON'T THROW AWAY the foil containers in which frozen foods are packaged. They make dandy disposable pans for paints, brush cleaners and other uses



175

Improved Soft Hammers for Xylophone Give Muted Tones



Both regular and toy xylophones, chimes and some other percussion musical instruments respond with pleasing, muted tones when played with these soft hammers. To make each hammer, cut off the head and point of a No. 8 plastic knitting needle and then cut the remainder in half to make two handles, each $6\frac{3}{4}$ in. long. Press a $\frac{5}{8}$ -in. Fuller ball on the end of each handle. If longer handles suit you best, use two needles, cutting each to the length desired.

Art Trauffer, Council Bluffs, Iowa.

Auto hose clamps of the adjustable type will prove helpful when gluing round, hexagonal, or octagonal shapes for lamp bases, clockcase columns or similar projects. Hose clamps of the type which are adjustable within a wide range have a maximum capacity of about $3\frac{1}{2}$ in. To be most effective, the clamps should be spaced 2 to 4 in. apart and should be drawn to a uniform tension to assure sound glue joints.

Accurate Point Ground on Center Punch When Chucked in Drill



Holding a center punch by hand when grinding a point on the end can result in only a fairly accurate job. A much better way is to use your electric drill to hold the punch. With the center punch chucked in the drill and both the drill and the grinding wheel rotating, a perfectly centered point will result every time. Let the punch rest on the grinder steadyrest in the manner shown, and hold it at an angle which will produce the desired degree of point. Rod stock can be pointed in the same manner and in duplicate lengths by providing a stop to limit the grinding.

Rex Bush, Columbus, Ohio.

Clip-on Tote Handle Carries Dozen or More Berry Boxes

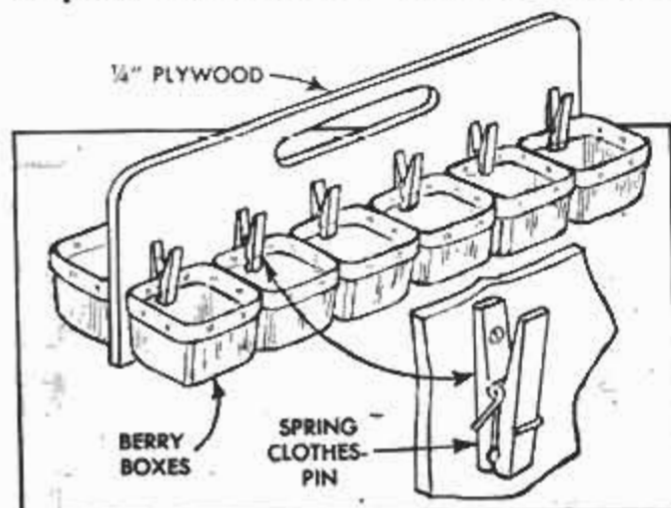

The difficulty of holding and carrying a number of berry boxes when picking strawberries and other small fruits is solved when you use this novel carrying handle. It is nothing more than a piece of plywood cut out to fit the hand and fitted with a row of spring-type clothespins on each side. The boxes are clipped to the clothespins.

Minor floor squeaks often can be silenced by squirting powdered graphite in the joints between the boards. If this doesn't work, try pouring hot liquid soap in the joints to lubricate the rubbing parts.

New Beauty for **DATED WALLS**

Plain walls become walls of distinction when decorated with a new wall covering called Decorator Motifs. Comes prefinished, ready to be glued to any wall surface with cement

YOUR DRAB interior walls are in line for a decorating "pick me up." A new concept in 3-D wall coverings offers the discriminating homeowner the choice of unusual wood textures, the art of ancient cultures and the exciting forms of contemporary design. Available in the form of interlocking and lapping plastic panels, this new dimensional wall covering can be applied to almost any surface by anyone. Not only is it easy for the do-it-yourselfer to apply, but the completed wall is washable and grease and stain-resistant.

Among the unusual patterns from which to choose are: Bamboo, Aztec Stone, Driftwood, Rafted Bamboo and Contemporary Grid, any one of which will transform an uninteresting wall into a stunning and elegant focal point. Departing from the traditional stone and brick effects, the covering is enhanced by color highlights which include gold on black, gold on white and variations of grays and natural tones. The Aztec Stone sculpture pattern is an authentic reproduction of ancient archeological findings.

The panels range in sizes from 23 x 38 in. to 24 x 48 in.,



Photos courtesy The Decor-Wall Corp
Gold-on-black Aztec Stone forms a most distinctive background

RAFTED BAMBOO



AZTEC STONE



DRIFTWOOD





CONTEMPORARY GRID—Unusual pattern inspired by the timeless Taj Mahal for the contemporary mood. **BAMBOO**—A touch of exotic Orient for smart living



which makes them easy to handle and fit when applying. Some are die-cut to interlock; all lap in a continuous matching pattern. Although it is of paper-thinness, the vinyl material produces an exceptionally tough and durable surface covering. The Contemporary Grid pattern is made eight grid squares per panel and comes in two colors, white and sand. The Aztec Stone pattern has four plaques per panel and is available in gold on white, gray or black, and plain sand color. The Driftwood pattern comes in gold on gray or on white, as well as plain white, tan and gray. You have a choice of white and natural in selecting the Bamboo patterns.

The adhesive that is used to cement the panels to the wall comes in tubes and is gently squeezed in long beads directly onto the back of all mortar lines or the ridges that are pressed into the material. Panels are applied one at a time and pressed in place immediately with the fingers. Where a panel is to interlock, the die-cut sections are broken out. In all cases, succeeding panels lap those already mounted. ★ ★ ★

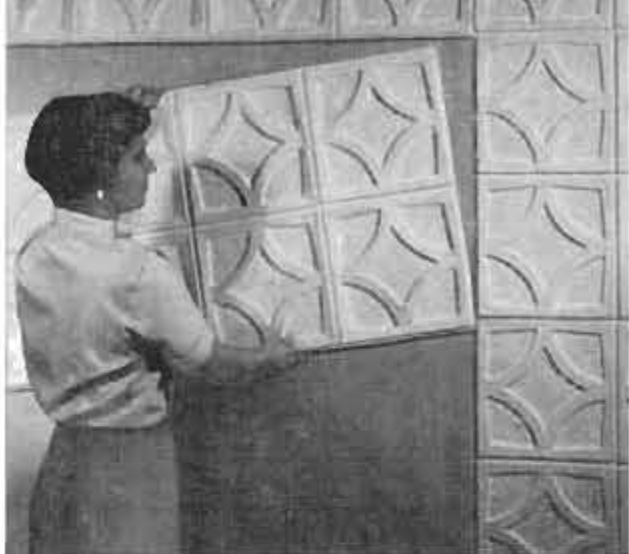

Start at center of a wall so you will have uniformity at the corners. The panels lap the edges of one another rather than butt, and in the case of the Driftwood pattern, the panels interlock at ends



Above, the paper-thin, yet tough, material is easily cut when necessary with common household scissors. Below, cement is squeezed from tube onto the ridges on the backs of the panels in long beads. Apply immediately to wall and press ridge lines with fingers

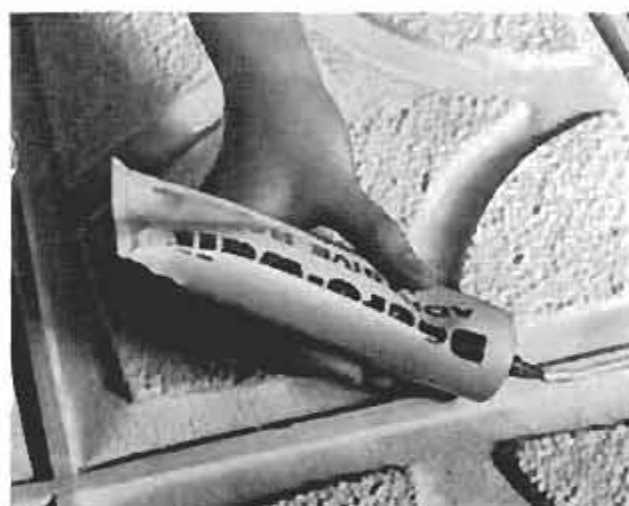

FEBRUARY 1959

sumps of gear housings, reduction drives and other equipment having enclosed power-transmission units, are difficult to reach and remove with a wrench. Removal and replacement can be made easier by simply slotting the square head of the plug with a hacksaw and welding a washer in the slot as shown. If desired, cut the washer in half to form wings like those on a wing nut.

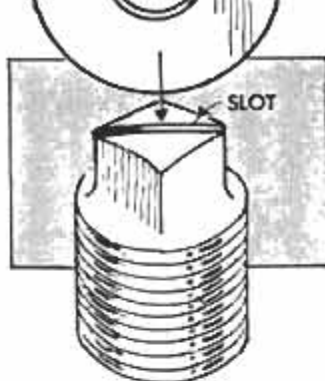

Hugh Lineback, Stillwater, Okla.

Poultry Apply Own Mite Dust

In tests conducted at a large poultry ranch near Anaheim, Calif., it was found that the hens would dust themselves when boxes filled with 4 percent of malathion dust were provided. Described as being 20 percent less expensive than conventional spraying in the ridding of mites, the self-dusting method also was found to avoid the costly emotional disturbance caused among hens when they were sprayed. White leghorns, for example, accepted the dust-bath boxes quite readily, dusting themselves enthusiastically and applying the insecticide as they did so.

John Bunker, San Diego, Calif.

Transferring Molding Contour

Have you ever tried to reproduce a piece of irregularly shaped molding that could not be traced, and it was not desired to remove it for this purpose? One of the simplest ways to transfer such a shape to drawing paper is to first form a pattern of the molding by bending a length of stovepipe wire carefully and then tracing it on paper. A straight portion of the wire should be left extending above and below the molding. Handy when fitting a bookcase over a baseboard so it will stand against wall.

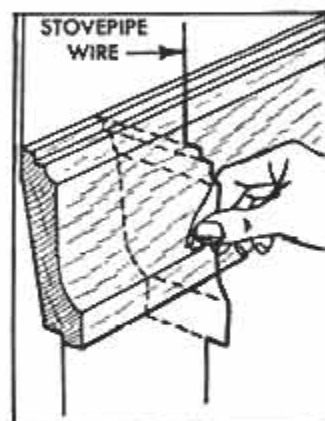

179

PICTURE-FRAME "DOCTOR"

HOW DOES AN EXPERT repair an ornately carved, gilded frame of the type in which are displayed priceless paintings in museums and art galleries? Would the same skills enable anyone to repair an equally ornate, though perhaps not so valuable, frame they own? Shown on these pages in step-by-step photos is the method used by Mr. Edward Santrucek, picture-frame "doctor" for the New York Historical Society.

His method is to obtain a mold from an undamaged section of the frame, taking advantage of the fact that most such frames are symmetrical. Casting a replacement piece from the resulting mold assures a duplicate of the carving done by the original artisan. By carefully duplicating this method, and with persistence and patience, any home craftsman can make a similar repair. Applying gold leaf is not a well-known skill, although some commercial artists occasionally practice this age-old craft. If you do not have a friend who is a gilder, it is suggested that you purchase a copy of a book on applying gold foil. It also is possible that some hobby shops might have the foil and tools for application, as well as an instructor in this skill. If not, they may have the name and address of such an instructor you could contact. Where foil has been used on a frame, its replacement assures a perfect match.

★ ★ ★

First step is to press modeling wax onto undamaged section of frame that is duplicate of part needed to make repairs on the damaged corner of the frame



Above, picture-frame "doctor" in his workshop. Below, damaged corner of ornate, hand-carved picture frame illustrates type of repairs that are required

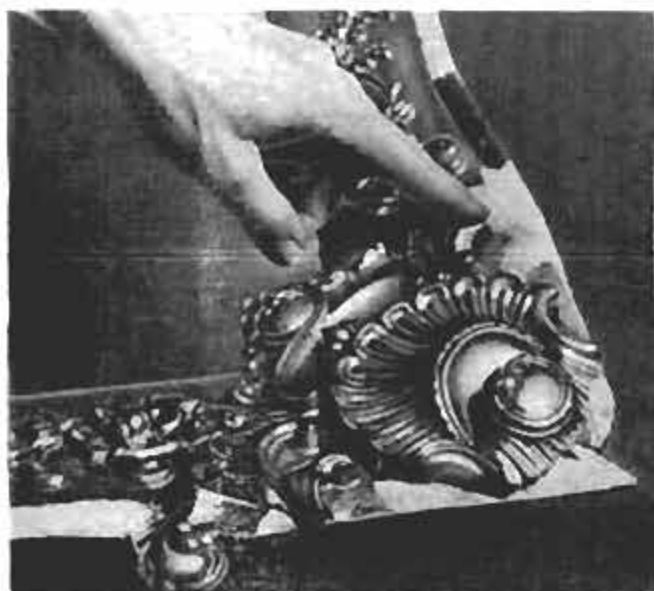

Below, after skillful replacement of damaged sections, frame is restored to original appearance so it matches diagonally opposite corner of frame





Above, wax mold now is removed from frame, coated with parting agent and filled with plaster of paris



When plaster has dried, above, finished casting is removed from mold, trimmed to fit missing section



Above, cast pieces are trimmed and fitted in place. Below, tissue-thin gold foil is slipped off heavy paper with brush made magnetic by static electricity



Above, completed frame is shellacked or varnished to waterproof it. Below, after gold foil is in place it is brushed to contact fully all frame irregularities





Threaded Pipe Held for Sawing On Steel Rod Clamped in Vise

When cutting short lengths of small, threaded pipe, such as frequently are used in the assembly of electric fixtures, slip the pipe over a piece of steel rod clamped in a vise. The rod will support the pipe without damage to the threads. Small-diameter tubing that would be crushed or damaged if clamped in a vise for cutting can be supported by using the same method.

Paint Labels Kept Spatter-Free

Do you have cans of paint on the workshop shelf with labels so paint-smearred that you cannot determine kind and color without removing the lids? Avoid this problem by removing the labels the first time the paint is used. Fold the labels, printed side in, and tape them to the lids. The lids, of course, are always removed and are away from any spattered paint.

Handy Generator Touch-up Tool

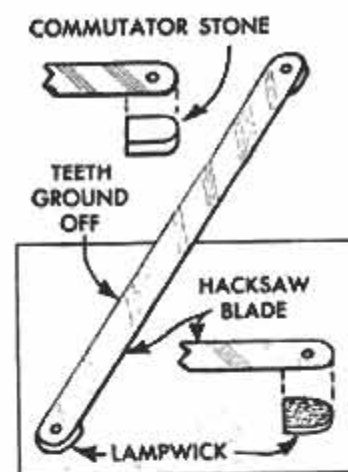

For quick generator touch-ups, one mechanic uses a hacksaw blade, to which is cemented a piece of commutator stone and a piece of lampwick. The wick is soaked in carbon "tet" to clean commutators polished with the stone.

Dowels Grooved Lengthwise

Instead of planing a flat on a dowel to provide a vent for excess glue to escape when driving it into a hole, saw a lengthwise groove in it. Groove a block to hold the dowel snugly while it is passed over a circular saw to cut the groove.

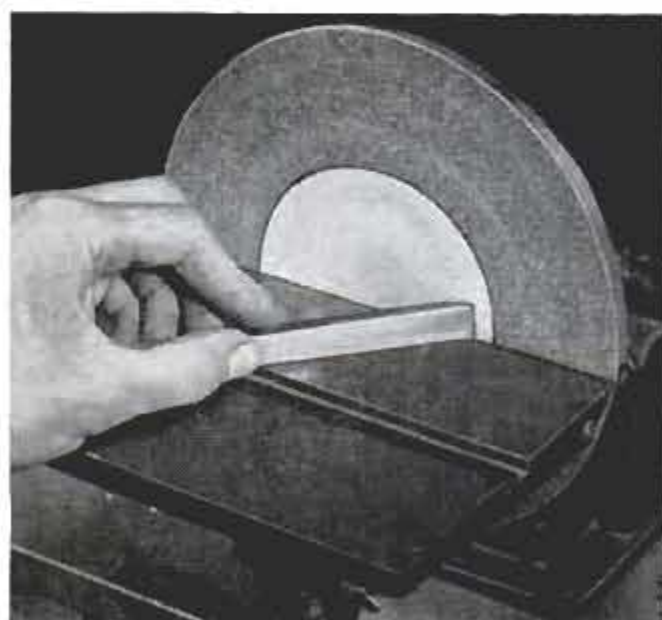
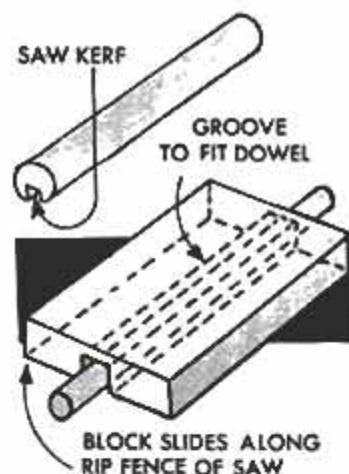

Combination-Grit Sanding Disks Have Fine and Coarse Paper

Often it would be an advantage to be able to fine-sand a number of small parts on a disk sander without the need for changing disks. One way to do this is to cut out the center of a large disk of coarse paper to accommodate a smaller-diameter disk of fine paper. Reverse the large disk on the sander, rotate it by hand and cut out the proper-size area with a razor blade. Now, cement the small disk in place, then fit the large disk around it to provide, in effect, two grades of paper on the same disk. Save the disk cut from the coarse paper and use it for an alternate coarse-fine combination on some other job.

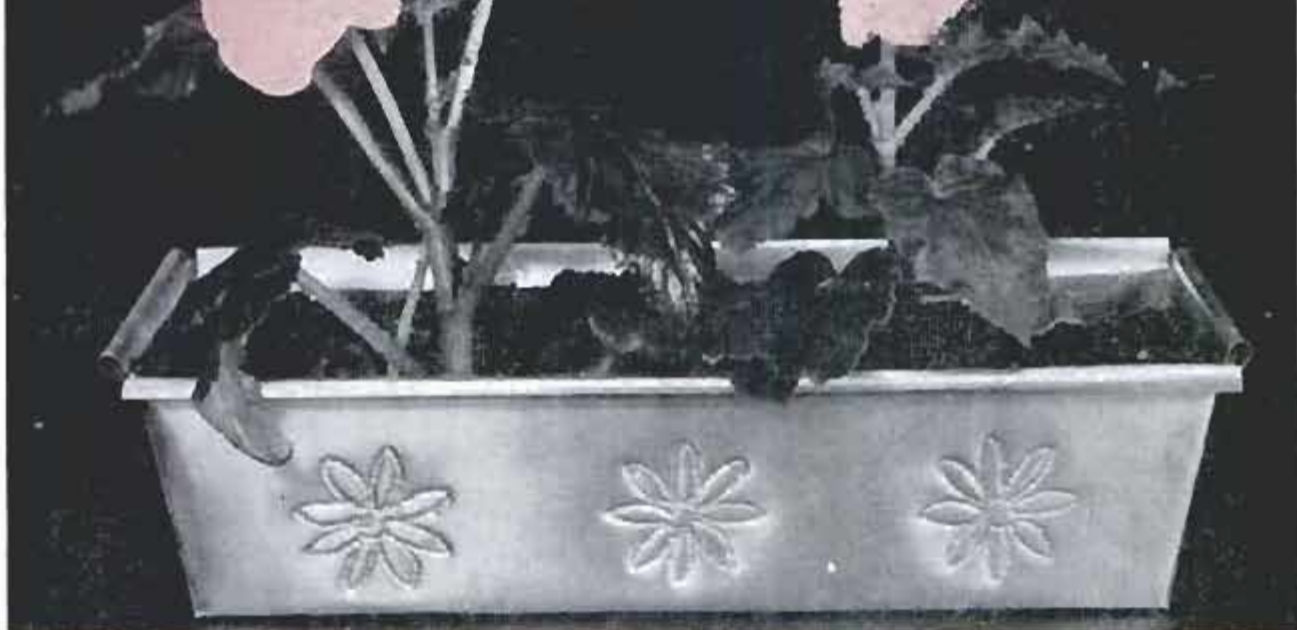

Hand-Shaped Metal Planter Is Assembled With Cement

By Jerry Parker

NO RIVETS, screws or bolts are used to assemble this attractive aluminum planting box. The aluminum is the type manufactured especially for do-it-yourselfers, so it is formed easily with hand tools. Use the pattern on this page for cutting out the box, then stamp designs on one or more sides by using a hammer and blunted nail, as in lower left-hand photo. The next step, center photo below, is to roll the edges with the aid of a slotted dowel. To make the bends, clamp the metal between two strips of wood and use a third strip and hammer to form the metal evenly. The ends and flanges of the box now are coated with con-

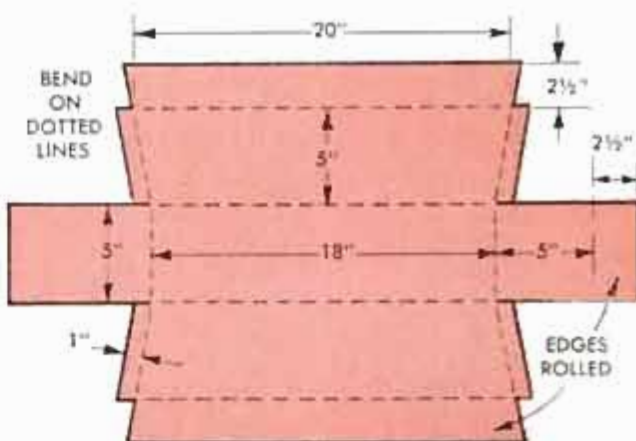

tact adhesive, right-hand photo below, and joined. Because some soils have an acid or alkali condition that would corrode the aluminum, coat the inside of the box with asphalt paint up to the soil line. Place gravel in the bottom of the box before adding the soil, to assure proper drainage.

Photos show step-by-step how single piece of aluminum is embossed, shaped and cemented to form planter



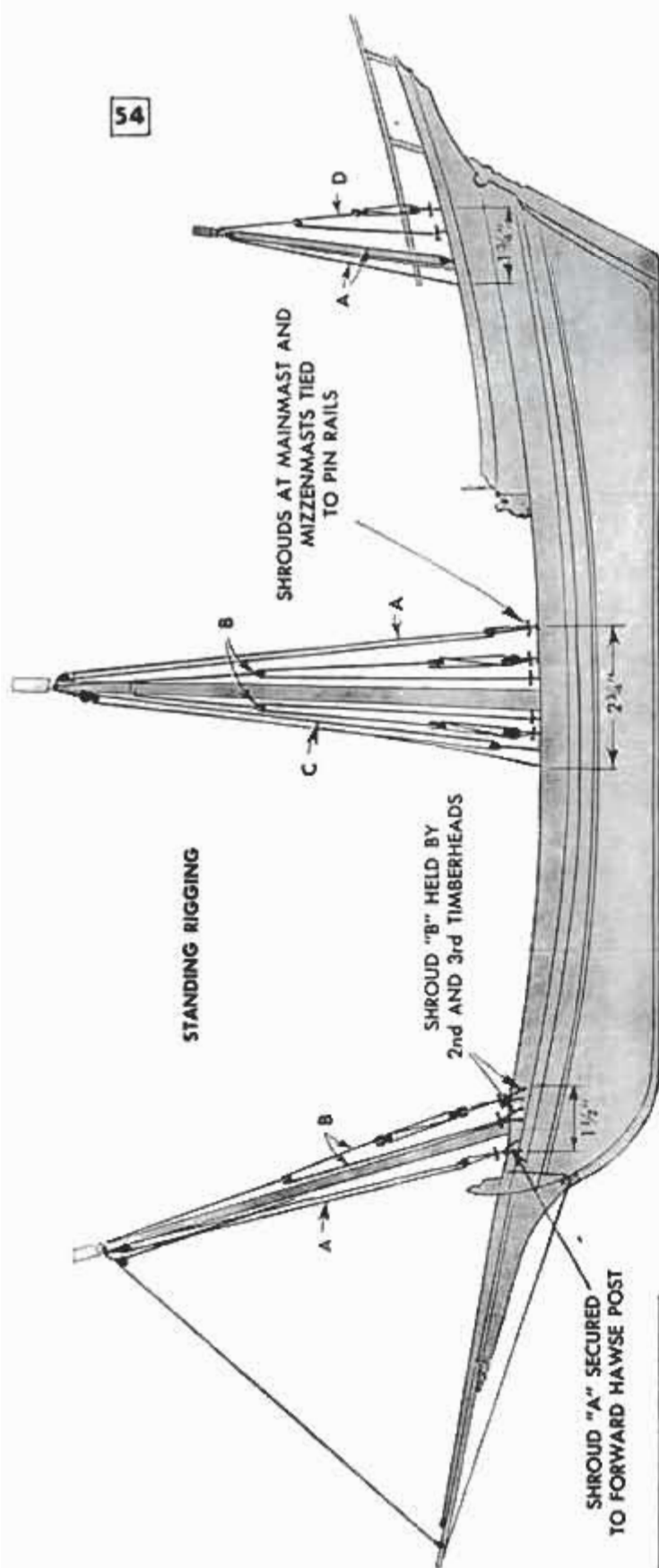

STANDING RIGGING

PORTFOLIO OF PLANS

Popular Mechanics offers the serious modelmaker plans for building four other famous French ship models, namely *La Sablaise*, a sailboat, *Jeanne D'Arc*, a training cruiser, *Marie Jeanne*, a fishing boat and *Le Terrible*, a light cruiser. For a free descriptive brochure on these plans and their prices, write to Popular Mechanics Co., Dept. 80, 200 E. Ontario, Chicago 11.

MODELING THE FRENCH CHEBEC

PART IV

Standing rigging and sails

ALTHOUGH THE RIGGING of this model may appear somewhat complicated, it is actually quite simple when undertaken step by step. First comes the standing rigging, shown in the port view, Fig. 54. This braces the masts, as distinguished from the running rigging which serves for handling the yards and sails. Start with the standing rigging at the bowsprit and work aft.

Materials for Rigging

With the exception of the black-thread woodings that hold the two members of each yard together as shown in Fig. 53 of Part III, all the rigging lines and cordage of this model should be a light coffee shade. Hard-twisted-linen line, which resembles rope in miniature, is best as it does not change appreciably in length because of temperature and humidity variations. Impregnating it with beeswax increases the dimensional stability. After rubbing wax on the line, wrap it

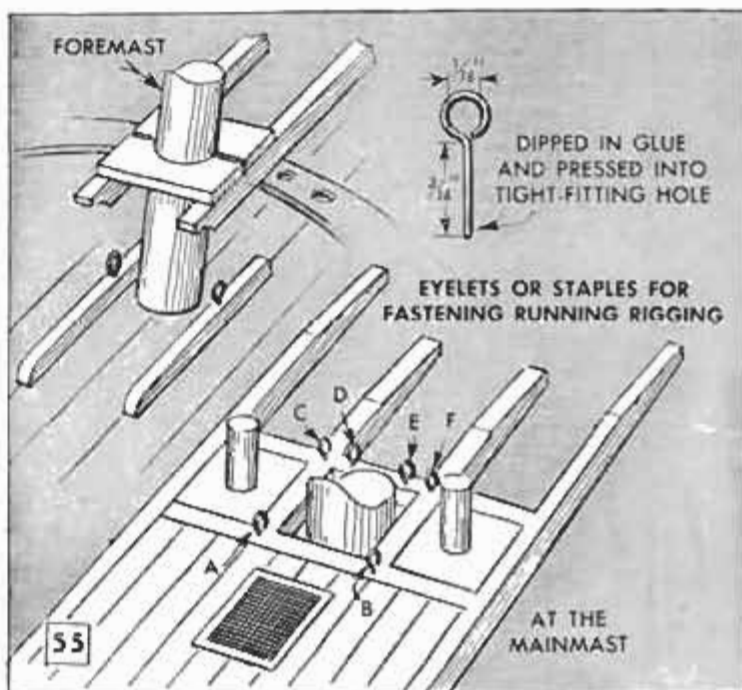

53

AT THE MAINMAST

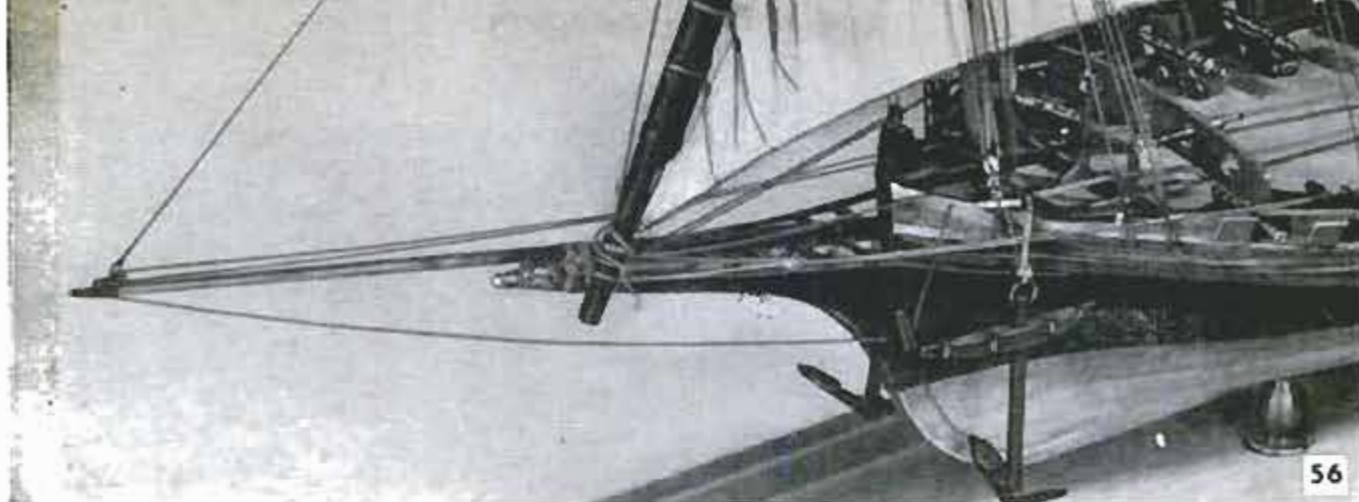

around a tubular electric bulb, the heat of which will cause the wax to be absorbed. However, cotton line is claimed to have satisfactory dimensional stability when it is thoroughly impregnated with beeswax, which also eliminates the surface fuzziness. Nylon line and thread expand and contract much more but still can be used for very short lengths like reef points, for lines that must be kept slack and for lashing and seizing.

Size of Rigging Lines

All of the standing and running rigging lines of this model are approximately .018 in. (a trifle more than $\frac{1}{64}$ in.) in diameter, except where other sizes are specified. The

sizes will be given in decimals of an inch since suppliers of rigging line refer to size only in terms such as heavy, medium, fine and very fine. That called fine by one may be the same size as that called medium by another. Line of .018-in. thickness corresponds to No. 18 upholsterer's linen thread, which you may be able to obtain and can be used for rigging. However, it is relatively smooth and therefore has less resemblance to rope than the hard-twisted-linen rigging line.

For bolt ropes on the sails use line from .018 to .025 in. in diameter. For lashings to the masts and yards, for reef points, flag halyards, brails, parrel lines, tackle of the yard runner ties, and also for the double

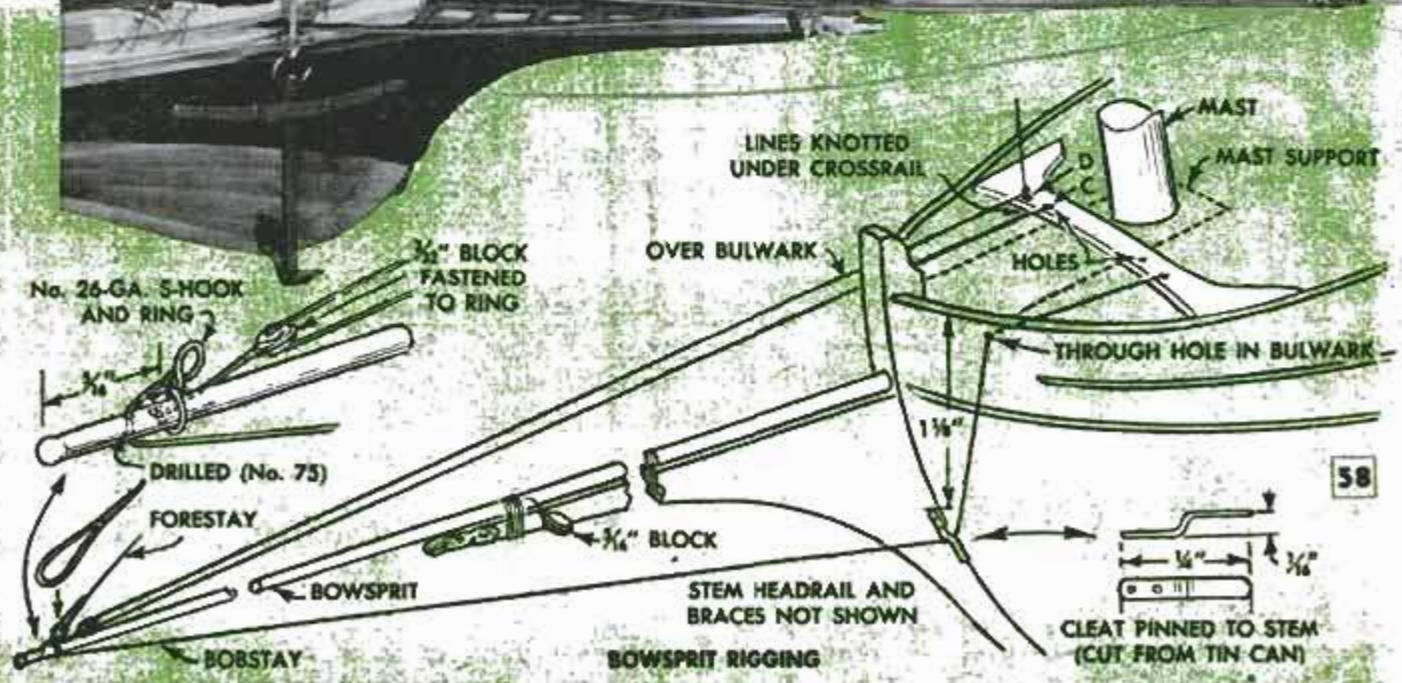

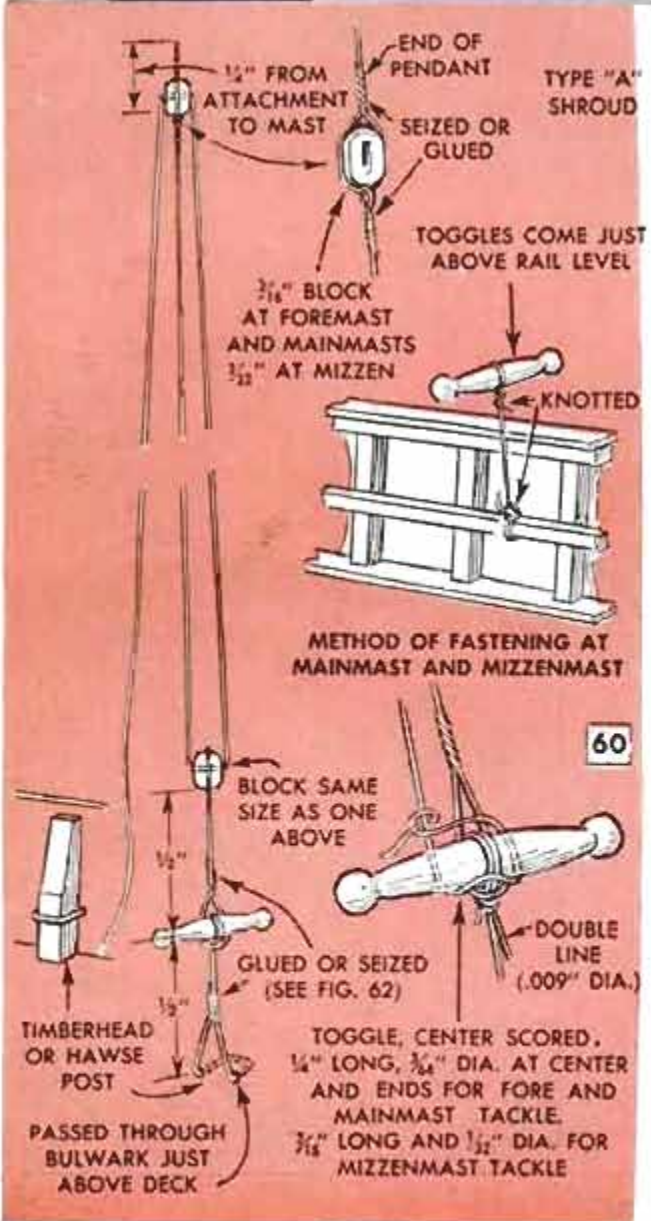
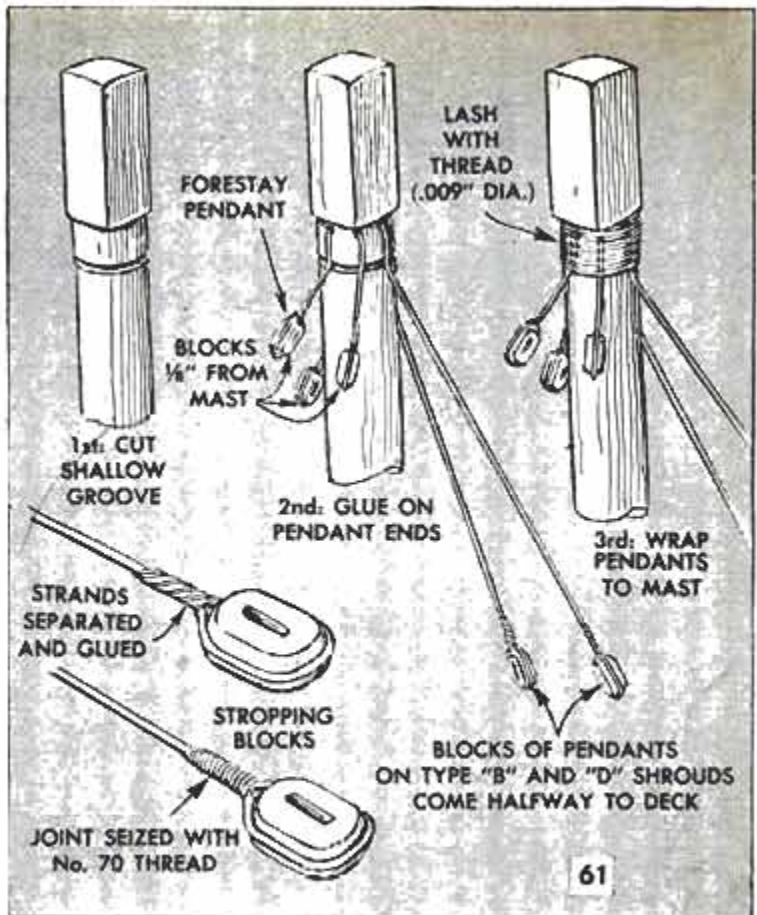

lines that hold toggles to which shrouds are attached, use line .009 in. in diameter. For seizing lines, as at blocks and sail clews, use No. 70 to No. 50 thread which runs from .004 to .006 in. in diameter.

Bowsprit Rigging

Before you start on the rigging, install the tiny eyelets or staples at the base of the mainmast and foremast as detailed in Fig. 55. The bowsprit rigging is shown in Figs. 56, 57 and 58. Note the tiny ring with attached hook, and also the cleat that is pinned to the stem almost straight below the stemson. These parts are made first.

Instead of using belaying pins on the crossrail at the foremast to fasten a number of lines, the latter are attached in two ways to avoid a bulky appearance. Some go through holes in the crossrail and are knotted under it while others are simply tied on. The bowsprit lines go through tiny holes C and D, Fig. 59, and are knotted underneath. The line passing under the cleat serves as a bobstay. After knotting one end, thread the line up through hole A, forward through the bulwark, then under the cleat and up through a No. 75 hole drilled in the bowsprit. Draw the line up moderately taut and glue it in the hole. Keep the line taut until the glue dries, then seize it to the lower end of the hook and apply a spot of glue.

The line from hole D in the crossrail passes through a block attached to the ring on the bowsprit and returns to hole C in

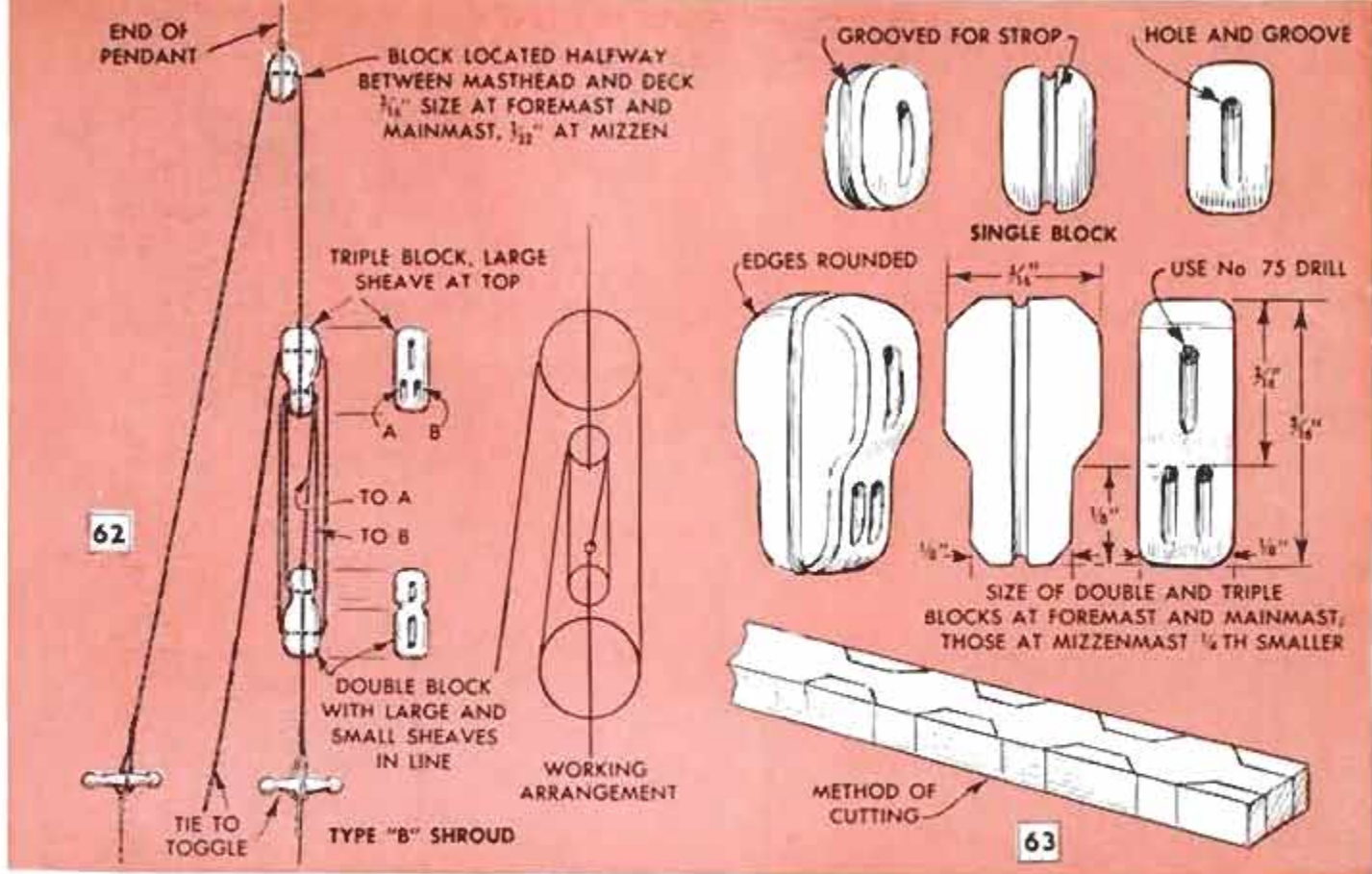

the crossrail. The forestay, which runs from the bowsprit hook to a block on the masthead, and then down to the crossrail at D, is added after the foremast shrouds are in place. Note that the lower end of the forestay forms an eye which engages the hook on the bowsprit. The block attached to the lashing midway on the bowsprit is to be used for the truss line of the foreyard, which is running rigging, but can be fastened in place at this time.

Shroud Pendants

Mast-bracing lines that extend from the bulwarks to the mastheads are called shrouds and consist of pendants (shroud hangers) and tackle. The pendants are the upper portions from which the tackles hang, and are lashed to the masts as shown in Fig. 61. A shallow groove cut around the mast serves to prevent the lashing from slipping down in case it should become slightly loose. Before attaching the pendants, fit them with blocks of proper size as given in the details of the shrouds. Then glue the ends of the pendants to the mast vertically just above the groove, after which the lashing is applied. The ends of the lashing are self-held as already detailed in Fig. 53 of Part III. Apply a coat of glue over the lashing for added strength and as a protection against moisture. The foremast has five pendants, four for shrouds and one for the forestay tackle.

After pendants have been attached, rig

the shroud tackle. There are four variations referred to as types A to D inclusive. All these types are shown in Fig. 54, and they are detailed separately in Figs. 60, 62 and 66. Those on one side of a mast are identical to those on the other side. Start with the forward starboard shroud of the foremast. Starboard is the side of a ship on your right as you face forward; port then is on your left. Next, do the forward port shroud and continue aft alternating from side to side to equalize the slight pull on opposite sides.

Note from Figs. 54, 59 and 60 that the shrouds of the foremast fasten to toggles held by double lines, three on each side. These pass through the bulwarks after





which one goes around the forward hawse post, and the other two around the second and third timberheads. The approximate spread of the shrouds at their fastening points along the bulwarks is given in Fig. 54. The free or "fall" ends of type-A shrouds at the foremast and the mainmast are secured to the toggles, but at the mizzenmast this ties to the pinrail. Those at the mainmast and mizzenmast fasten to the pinrails.

A closeup view of the mainmast shrouds (with background blocked out) is shown in Fig. 64. These include two type-A shrouds, four type-B shrouds, Fig. 62, and two type-C shrouds, Fig. 66. The shroud assembly at the mizzenmast also is shown in Fig. 66. This includes two type-A shrouds and two type-D shrouds, the latter being detailed in Fig. 66. On type-B and type-D shrouds the blocks of the pendants come about halfway between the masthead and deck.

About the Blocks

For both standing and running rigging purchase the following blocks: 20 single $\frac{3}{32}$ in., 10 single $\frac{1}{8}$ in., 23 single $\frac{5}{32}$ in., 15 single $\frac{3}{16}$ in., and 4 double $\frac{5}{32}$ in. All blocks referred to are single-sheave blocks of wood except where other types are specified. Most multiple-sheave blocks used on this model will have to be made. Double and triple blocks for the shrouds are detailed in Fig. 63. There is a difference in the size of these blocks also. Those at the mizzenmast are about one fourth smaller than those at the foremast and mainmast. Boxwood is the best wood for making blocks and other small fittings. A broken carpenter's rule provides a good source. Drill the holes and form the grooves before severing the blocks from the strip.

A strop is the end of a line wrapped in the peripheral groove around a block to hold it. To strop a block as shown in Fig. 61, wrap the line around it once tightly, and glue the loose end to the line. Separating the strands of the line before gluing will produce a less bulky joint. For added strength and durability, you can wrap, or seize, the joint with fine thread, which also is coated with glue.

Finely woven white linen cloth such as can be obtained from a discarded shirt, a pillow casing or from some handkerchiefs, is used for sails. All three sails of this model can be cut from a 16 x 20-in. piece. After ironing the cloth to eliminate all wrinkles, mount it on a smooth backing such as a piece of hardboard or plywood. Stick the edges down with draftsman's removable tape, taking special pains to get the material moderately taut with the weave running perfectly straight in both directions. Next make patterns of heavy paper or light

65

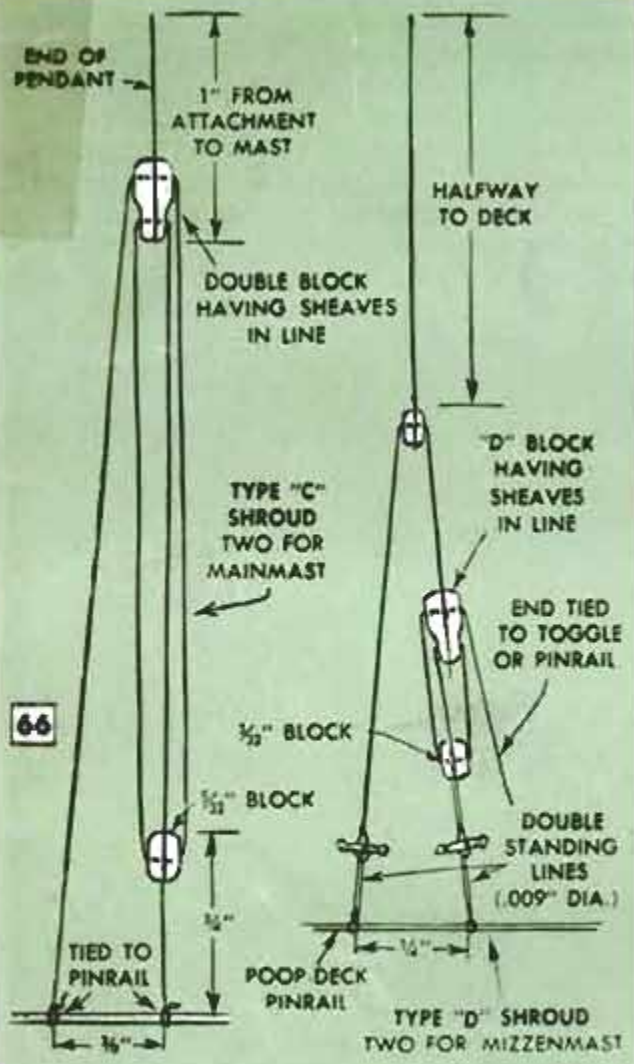

66

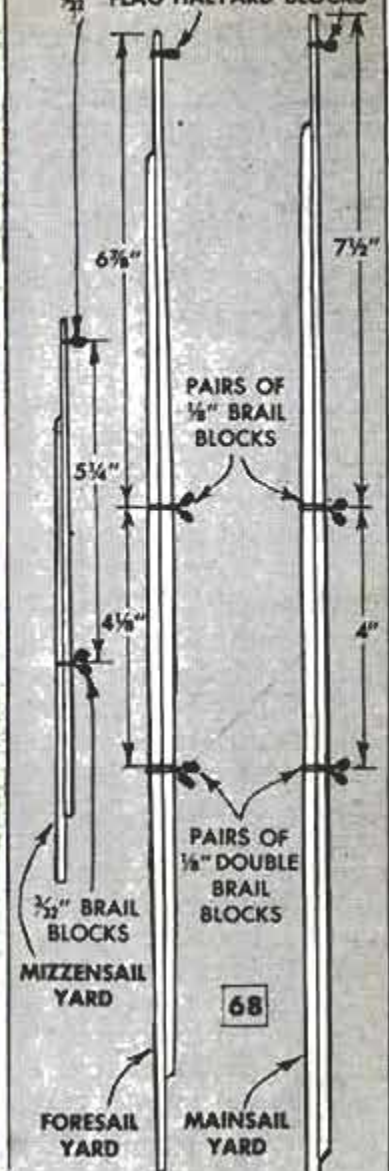
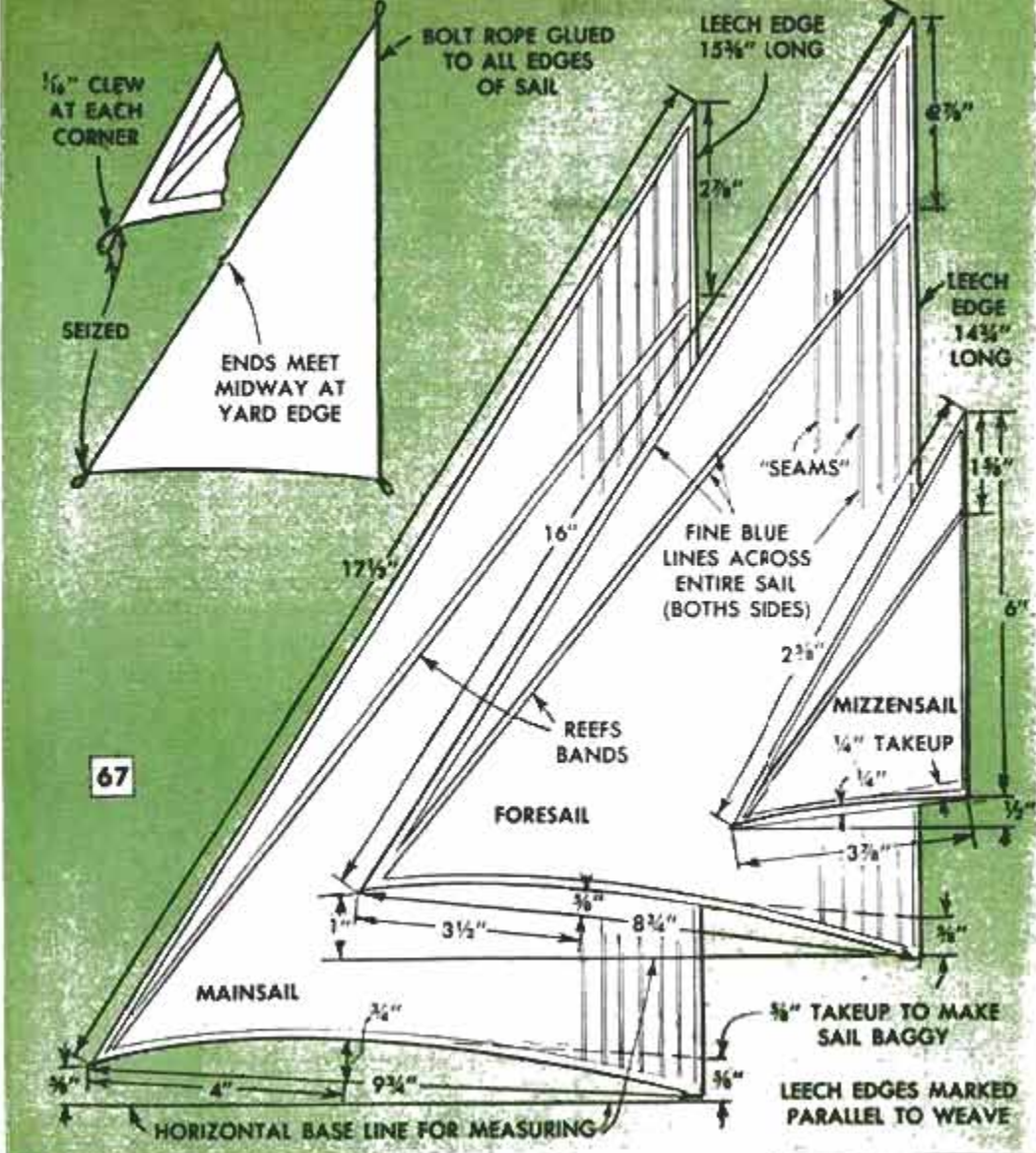

cardboard to dimensions as given in Fig. 67. Lay the patterns on the cloth so that the leech or aft edge of the sails will be parallel to the weave.

Ruling "Seams" With Ink

To represent reef bands and seams of the sails rule fine lines with blue ink, using a fine-pointed fountain pen, which is drawn along the edge of a straight ruler or draftsman's curve as required. Experiment on some waste cloth to ascertain the right speed at which the pen must be drawn along without letting ink spread in the cloth. It can be done quite slowly. Avoid going over a line a second time or it will become too heavy.

Start with ruling lines $\frac{1}{8}$ in. inside the sail edges and parallel to them. Use the draftsman's curve along the foot edges. Then rule the reef band, following this with the vertical "seams." Two lines spaced $\frac{1}{16}$ in. apart represent a seam, and the seams are spaced $\frac{1}{4}$ in. The ruling is duplicated on the other side of the cloth, making it necessary to remove it from the backing, turn it over and refasten it. Don't

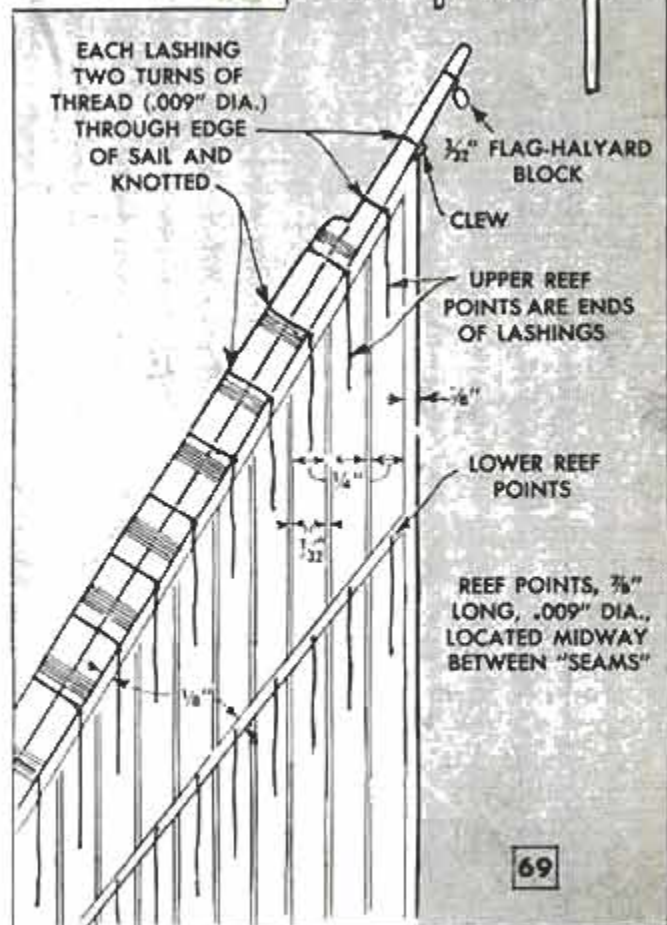

pull the tape off the cloth but use extra strips for fastening it down again. If you tape the cloth this time to a large window pane, the lines already made will be visible through the cloth making it easy to rule directly over them.

Bolt Ropes Glued to Sail Edges

Next, with the cloth still mounted on the backing, glue the bolt ropes (.018 to .025-in. dia.) along the edges of the sails. These go on one side only. Use a single length for each sail, starting and stopping about midway along the head or yard edge of the sails. At each corner loop the bolt rope to form a "clew" or eye which is seized. See Fig. 67. Apply glue to the sail edges and also to the rope, and press the two together firmly when the glue becomes tacky.

To produce the desired bagginess in sails, which in real ones allows them to belly in the wind, the leech edges are gathered up uniformly while the bolt rope is being attached. First loosen the tape holding the cloth at points in line with the leech edges to relieve tautness. With tweezers, pull the leech edge up the required takeup distance as given in the drawings, and then spot-glue the rope, while holding it taut, to the lower corner. Spot-glue the center of the rope to the center of the sail edge to produce equal slack on either side. Continue dividing the remaining distances and spot-gluing the cord to distribute the takeup evenly. The bolt rope should be glued to the sail along its full length for greater strength.

Reef Points and Lashing to Yards

Cut out the sails alongside the bolt ropes with a sharp razor blade after the glue has dried. Spot-glue the reef points, which are $\frac{7}{8}$ in. long and .009 in. in diameter, to the reef-band markings on each side of the sails as shown in Fig. 69. The reef points are located midway between seams. A second row of reef points is located along the yard edge. These are the ends of lashing that hold the sails to the yards as shown in Fig. 67. For each lashing, bring the thread through the sail with a needle and wrap it around the yard twice, after which you tie a knot. The thread goes through the same hole three times, which leaves the thread ends on opposite sides of the sail. Also lash the clews to the yard. Next, fit on the flag-halyard blocks and pairs of brail blocks as shown in Figs. 66 and 67. The lower brail blocks of the foremast and mainmast are double to accommodate both upper and lower brail lines. The mizzen yard has only one pair of single brail blocks.

(Continued next month)

Steel Plate Braces Light Stock While Machining It

When shaping, planing or milling comparatively light metal, it is difficult to prevent the material from being flexed or distorted by the cutting tools. This trouble can be avoided if the work is clamped in a vise along with a piece of heavy metal plate, the plate being placed behind the work as indicated to provide solid support. — Federico Strasser, Santiago, Chile.

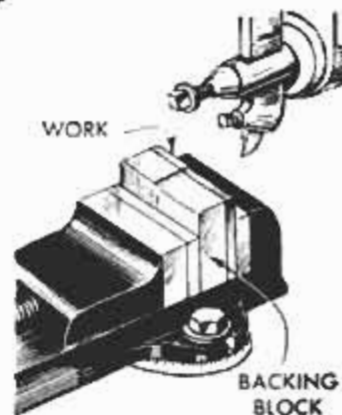

Isolated Burning of Spark Plugs

Occasionally, when removing and examining spark plugs, you will notice that certain isolated plugs will be burned, while others are firing normally. This may be due to variations in the distributor-cam lobes which cause certain cylinders to fire sooner than others. According to engineers of Champion Spark Plug Co., valves and intake-manifold leaks are usually blamed for this condition when cam-lobe variations may be the cause. To check for this, observe the firing pattern on an oscilloscope or use a regular distributor tester. If variations of more than two or three degrees are found between the cylinders it is best to service or replace the distributor.

Lapping-in a Follower Rest

To assure satisfactory service from the follower rest on his lathe, one machinist reconditions the jaws occasionally by lapping to a predetermined radius. A brass rod is mounted between centers and turned to a diameter slightly greater than the average diameter of the work on which the rest is to be used. This is then coated with a fine abrasive compound and used as a lap. With the lathe running at its highest speed, the rest is brought into contact with the lap and the carriage is hand-fed left and right with a uniformly slow motion. Jaws of a rest lapped in this manner will not score the work and will give full support throughout their width.—H. Gerber, Stillwater, Okla.

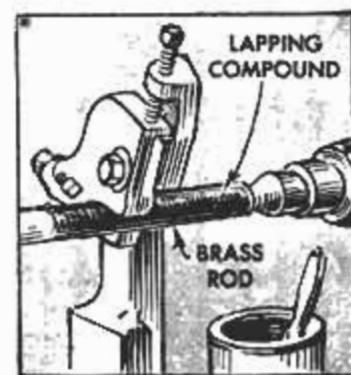

Wheeled Frame Simplifies Moving Refuse Containers

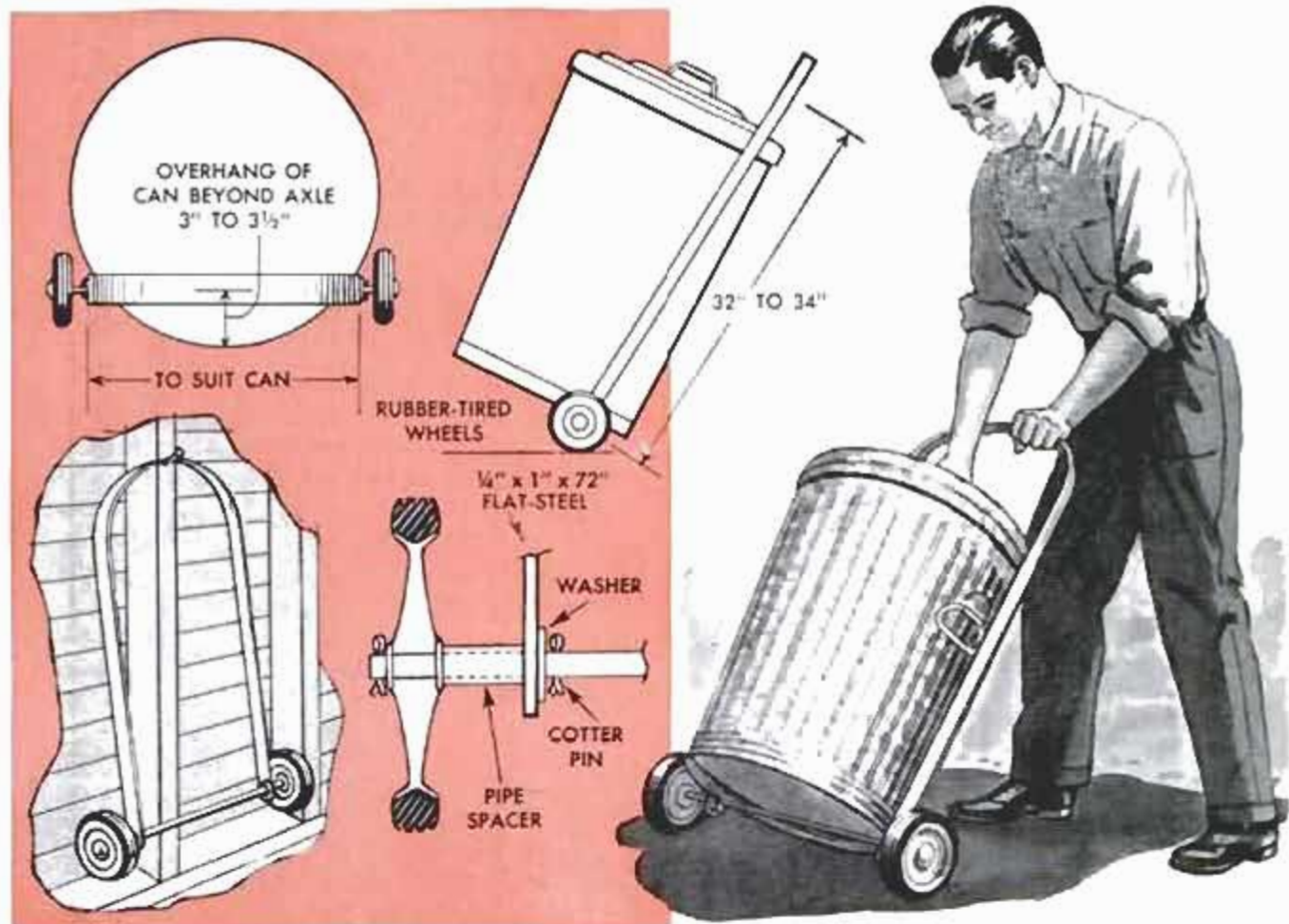

Carrying trash or refuse cans to the street curb, a job done weekly by many homeowners in neighborhoods that have no alleys, need not be awkward and difficult. All you need is a simple wheeled frame like the one shown, that can be hung up on a fence or garage wall, or merely placed behind a trash can, when not in use. The frame consists of a U-shaped length of $\frac{1}{4}$ x 1-in. flat steel having the ends drilled to receive a $\frac{1}{2}$ or $\frac{5}{8}$ -in. axle.

The axle is held in place in the frame by means of washers and cotter pins, and is fitted with small rubber-tired wheels such as those from a discarded coaster wagon or other toy. A trash can to be moved is tipped slightly to permit the axle to be pushed under it. Then both the frame and can are pulled back so that the can is raised above the ground and becomes wedged slightly between the sides of the frame, which provides the required rigidity.

Pipe Straps Used for Pulls On Small-Parts Drawer

Small-size pipe straps are ideal for pulls on small-parts drawers that are made from cigar boxes or other suitable containers. The straps are attached to the front of the drawers by means of $\frac{1}{8}$ -in. roundheaded stove bolts as indicated in the photo at right. Use flat washers under the nuts.

Frank A. Javor, Newark, N. J.

☞ To provide a convenient means of hanging lingerie in a bathroom, place several extra shower-curtain hangers on the rod. Then drill a hole in one handle of each of the same number of spring-type clothespins and slip them on the hangers.

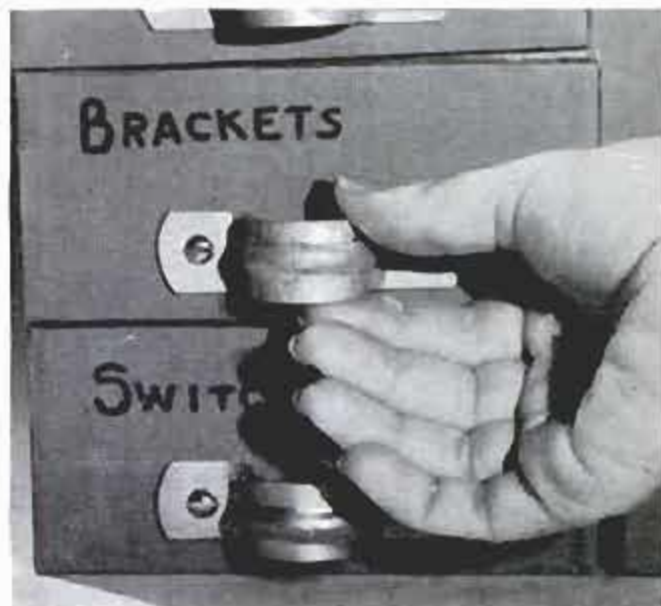

TROUBLE-SHOOTING HINTS

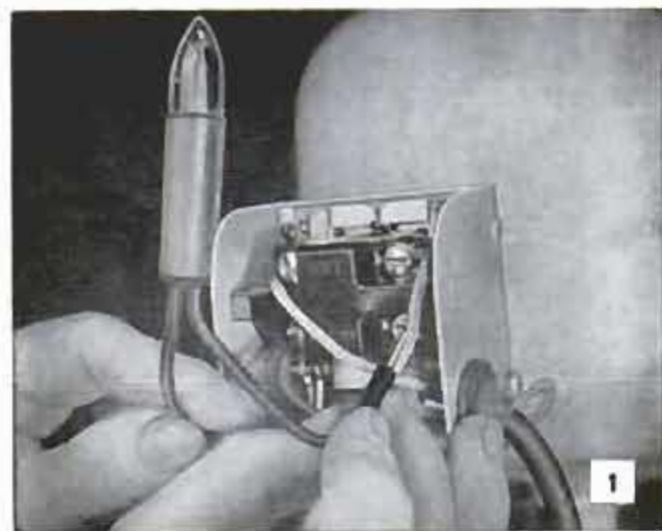

Above, testing continuity of circuit through pressure switch determines if that component is working. Shown below are two types of air-volume controls

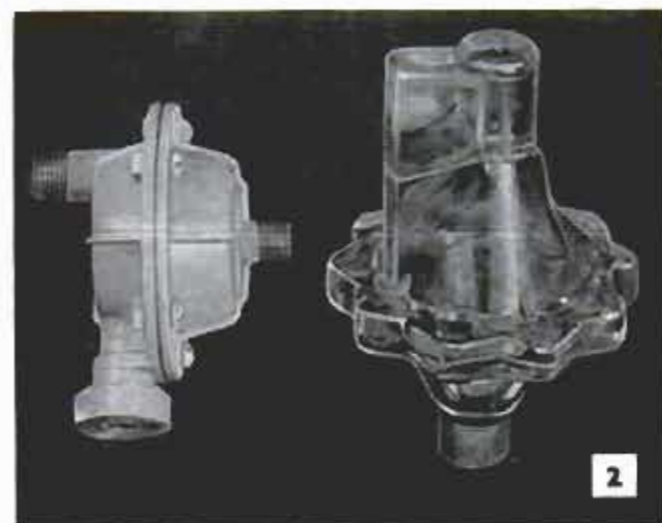

Below, centrifugal governor is spring-loaded device at center, internal switch is V-shaped object above it. Cylinder is capacitor, overload switch is below



ALTHOUGH THE JET PUMP used in most home water systems is a reliable unit that will run for years with very little attention, it will pay the homeowner to know something about its operation. Then, when the pump stops running—inevitably this will be on a week end or at night when no service man can be reached—he can do something about restoring this service.

Basically, a jet pump, Fig. 4, is a centrifugal pump in which is included an orifice that discharges part of the water pumped by the impeller through a venturi. This action creates a vacuum, increasing the capacity of the pump. A shallow-well pump has the jet cast into the pump body, while a deep-well pump has the jet located outside the pump itself. If your pump will not shut off and produces only low pressure, check the jet. If it is clogged with scale or dirt it will not work properly. A centrifugal pump without a jet will produce only about 25 lb. of pressure. As the pressure shutoff switch on a jet pump is adjusted to start the pump at 20 lb. and shut it off at 40 lb., the low pressure simply will not actuate the switch.

If the pump motor does not run, first check the fuses and power supply. Next, remove the cover on the pressure switch, Fig. 1, and check for continuity of circuit. A neon-type test light, such as shown, is ideal for this. Now check the internal motor switch, which is located at the end of the motor housing, Fig. 3. This switch, one arm of which carries the numeral 5, works in conjunction with a centrifugal governor, its purpose being to change the motor from the start winding to the run winding at the proper speed. If the switch points are dirty, or if one of the springs is missing or broken, or if the switch is not adjusted properly against the governor, no current will flow. A capacitor and an overload switch also are located on this end of the motor. Check these by bypassing them with a jumper wire. Do not run the motor very long with no water in the pump. Most shaft seals are water-lubricated.

If a pump loses prime, or cannot be primed, check the foot valve, located at the lower end of the suction line. Whether gravity type or spring-loaded, this valve must close tightly when the pump is not running. If a pump loses prime while it is running, make sure the foot valve is submerged. A small-diameter drilled well may have too slow a recovery rate during dry spells to keep the valve submerged. If a

FOR JET PUMPS

By Lynn Brueback



pump runs even when no water is being drawn, it is due to a leak in the pressure side of the system. Check all connections and the pump seal, Fig. 5. Water-logging of a pump can be traced to a faulty air-volume control, Fig. 2, or to continuous running for long periods. Most air-volume controls draw in air only when the pump is not running. The water-volume control is also adjustable, being located between the pump and tank on the pressure side. For adjusting this, use a vacuum gauge, connected to the pump at the air-volume control. Start the pump and adjust the water-volume control until the gauge reads about 22 in. of vacuum at sea level. ★★ ★

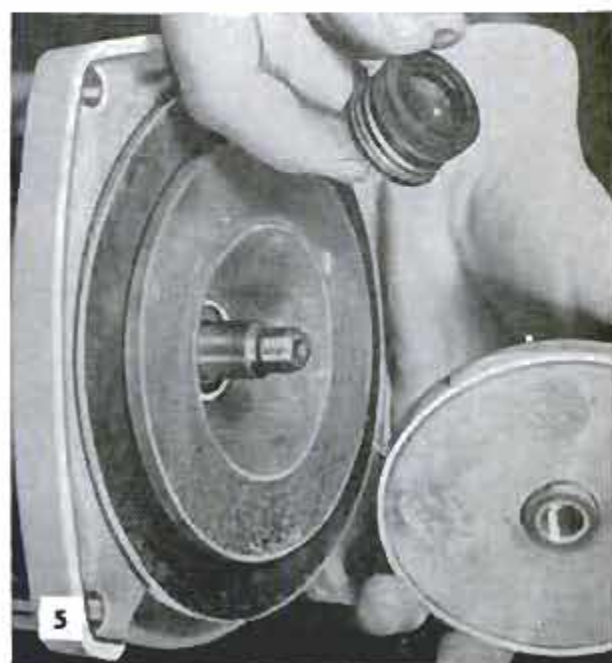
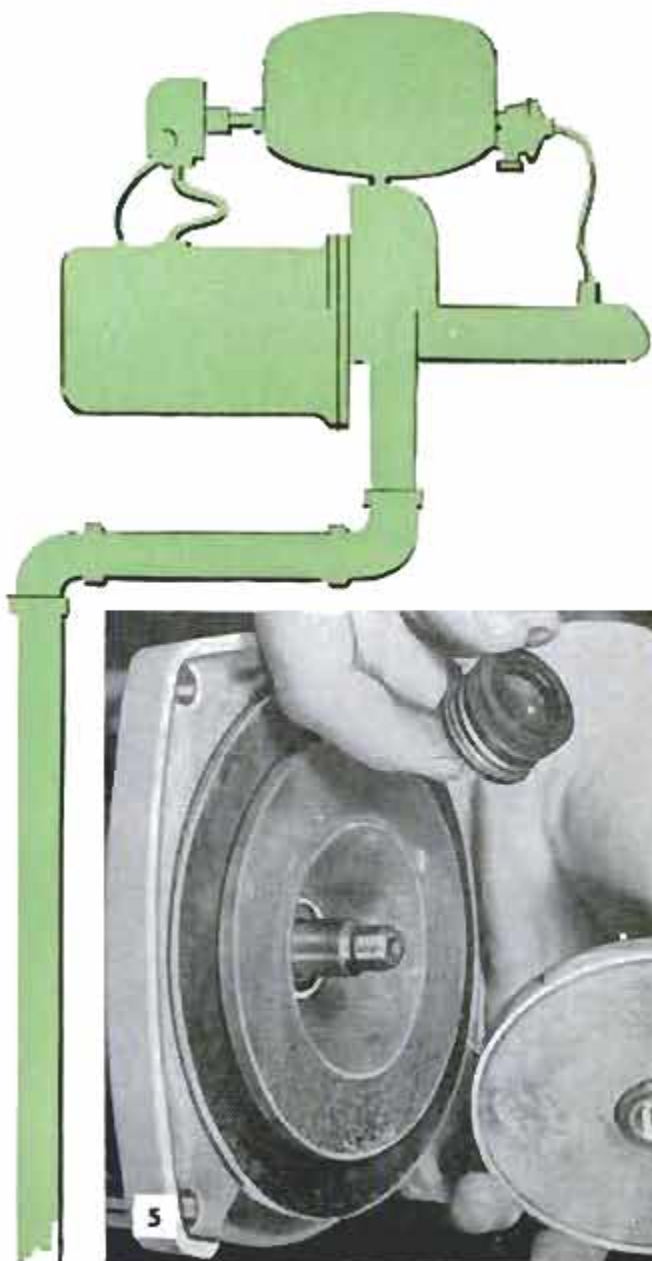



"Measuring Tape" Labels on Bins Indicate Lengths of Contents

Matching a bolt, pipe nipple or other fitting from a supply in stockroom bins can be done quickly and without the need for measuring if each bin is marked with a strip of masking tape that is the same length as the items in the bin. When a part is to be matched, it is compared to the lengths of tape until one is found that is the identical length. The part in the bin also will be the correct length.

To increase the idling speed of his car engine to aid in charging the battery is done by one motorist with a brick placed on the accelerator pedal. As with most late-model cars, there is no hand throttle, and adjusting the idle speed at the carburetor takes time and could mean getting dirty. The brick also is useful to block a wheel when changing a tire.

Robert V. Thompson, Clinton, Iowa.

Sheet Metal Cemented to Wooden Block for Jigsawing

When light sheet aluminum, copper or brass is cut on a jigsaw, the metal has a tendency to move up and down with the saw blade, resulting in a ragged-edged cut. The flexing metal also binds on the saw blade, snapping off teeth, if not breaking the blade. To avoid this trouble, attach the metal to a piece of wood with rubber cement. Intricate cuts can be made without the metal flexing. After the cutting has been done, pry up the metal at one point, and "peel" it off the wood. Fine sections of the metal may have to be loosened with a putty knife. Rubber-cement solvent can be used to remove cement from the metal.

H. J. Gerber, Stillwater, Okla.

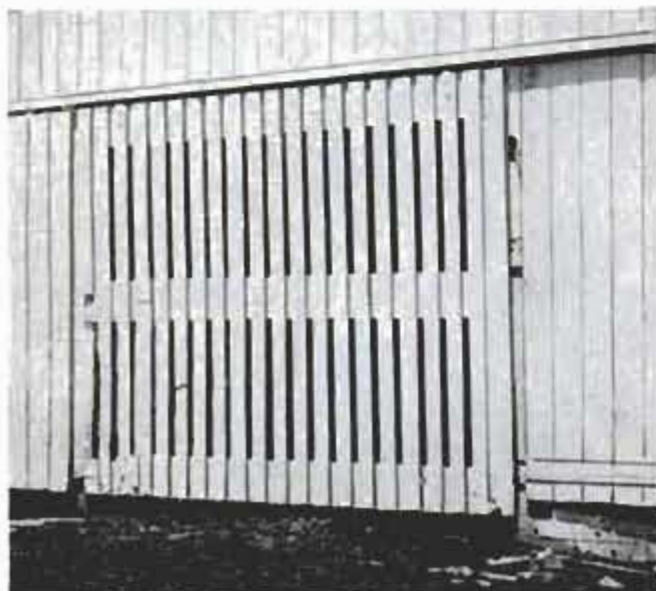
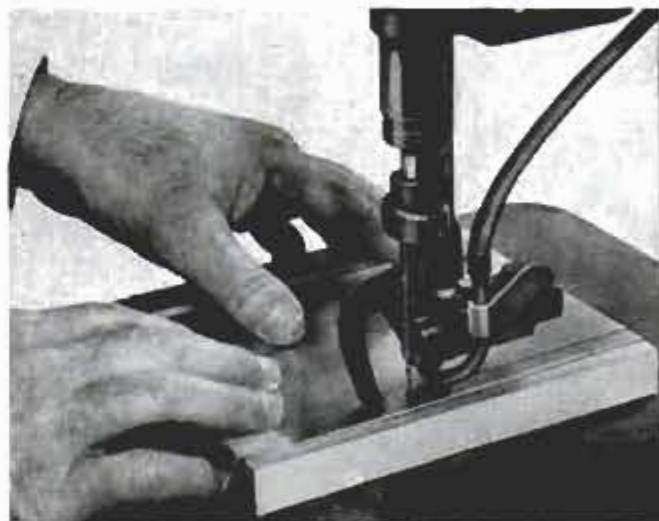

Usefulness of Barn Extended With Dual-Purpose Doors

Two sets of doors are used at each end of this barn, the inner sets being made of heavy slats, while the outer doors are solid. The slat doors provide ventilation when sheep that have been sheared early are kept in overnight. These doors also provide ventilation and keep out stock when men are working inside the barn. The solid doors are used, of course, to close the barn.

☞ A mascara brush is ideal for cleaning rings and other jewelry as it is small enough to reach in around prongs and settings for thorough scrubbing.

to be painted on a signboard, use a small level for a straightedge as shown in the drawing at right. The bubble in the transverse glass is centered when drawing vertical lines and the bubble in the level glass is centered when drawing the horizontal ones.—G. E. Hendrickson, Argyle, Wis.

Paint overspray on ignition wiring and spark-plug insulators of an auto engine that has been reconditioned and painted may cause misfiring under load when voltage requirements are highest. To avoid such trouble, the service department of Champion Spark Plug Co. recommends removing the paint from these parts as soon as possible, using a solvent that will not damage the rubber insulation on the wires.



Tape Stop Centers Wet Negative on Enlarger Carrier

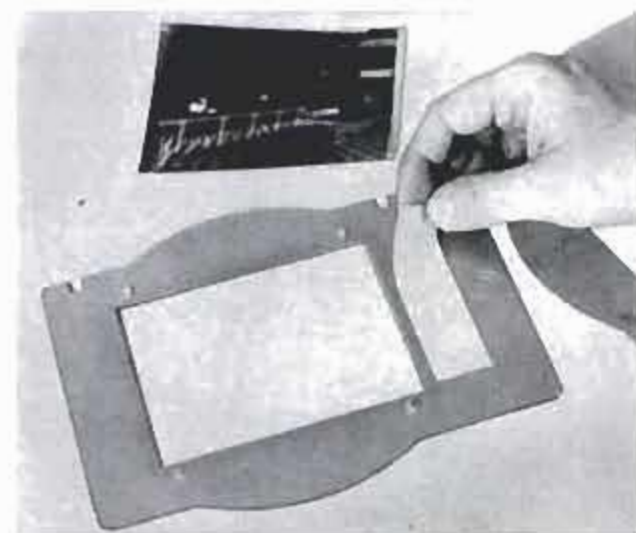

When prints are needed immediately after developing sheet film, here is a quick and positive way of centering the wet negatives on the enlarger carrier even though the darkroom is dimly lighted by just a safelight. Simply apply a small strip of masking tape to the lower member of the carrier so that it is located $\frac{1}{4}$ in. from the side of the opening shown in the photo at left. The tape acts as a stop against which the right-hand edge of the negative is butted when sliding it into position between the guides of the carrier. Also, the tape prevents the negative from sliding to the right when the carrier is inserted in the enlarger. Replace the tape when the edge that contacts the film becomes worn.

P. G. Gordon, North Miami, Fla.

Sanding Disk Warmed With Torch Before Applying Stick Adhesive

To permit faster and more uniform spreading of stick adhesive on a sanding disk, warm the disk while it is rotating, using a propane torch as indicated in the photo at right. By prewarming the disk in this manner, the adhesive is softened so that it spreads in a uniform coating to which the abrasive disk will adhere readily. The disk may also be warmed by friction, although it is a slower method. To do this, hold a wooden block against the rotating disk for a few minutes and then apply the adhesive immediately.

Lucien R. Greif, Thornwood, N. Y.

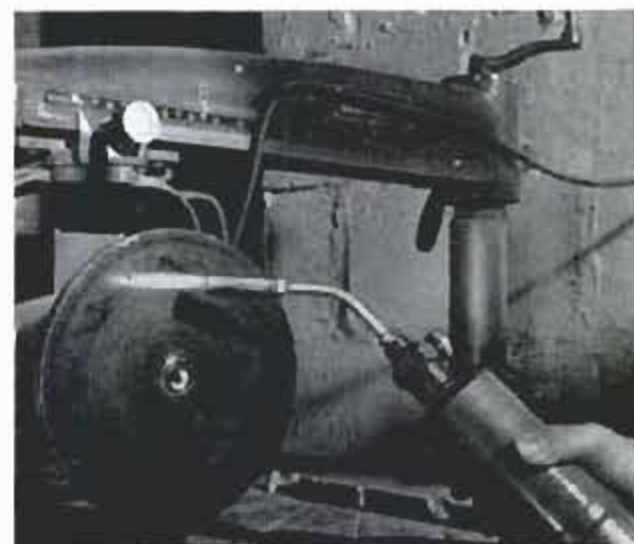

POPULAR MECHANICS SHOWCASE OF TOOLS

In this, the fourth installment of our Showcase of Tools, we present a number of portable electric drills with their general specifications. These tools are shown only as a shopping service to give you an idea of the many sizes and types available



Photo Courtesy Millers Falls Co.

METAL-DRILLING LUBRICANTS

Metal	Lubricant, First Choice	Lubricant, Alternate	Speed
Hard steel	Turpentine	Kerosene	800 r.p.m. or less
Malleable iron, Wrought iron	Soluble oil, Lard oil	Soluble oil	1500 r.p.m.
Brass, Aluminum	Paraffin, Kerosene	Dry, Soluble oil	2000 r.p.m. or more

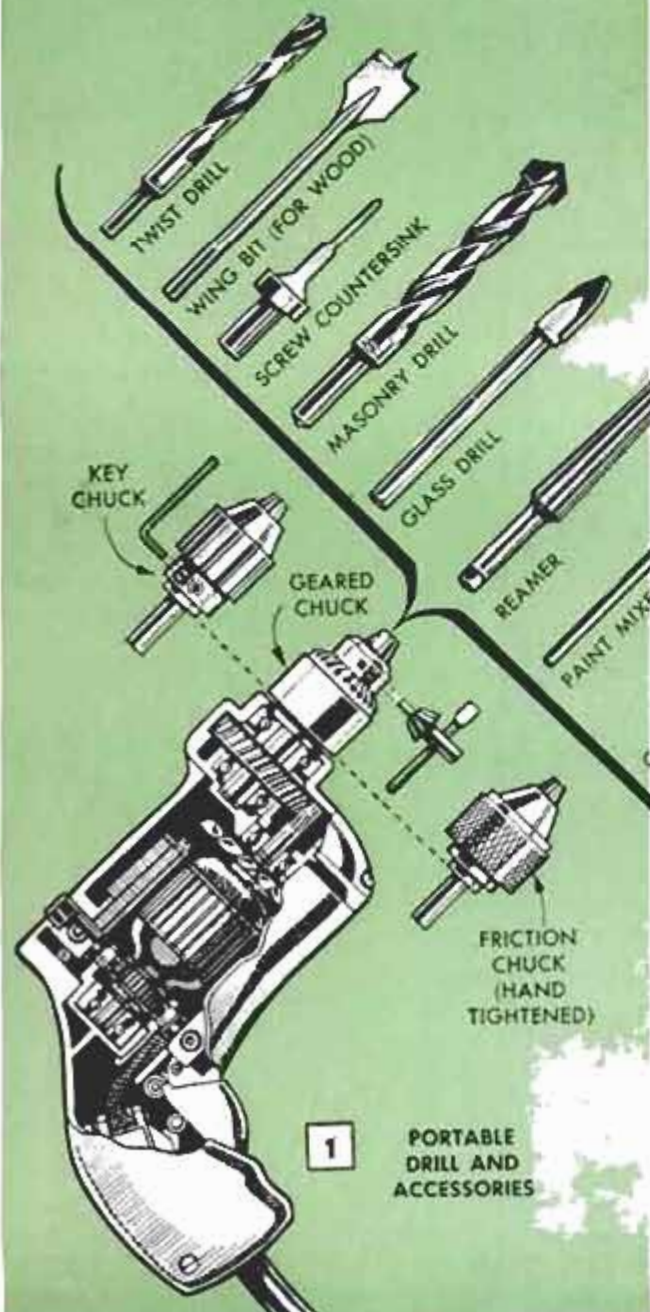

1 PORTABLE DRILL AND ACCESSORIES

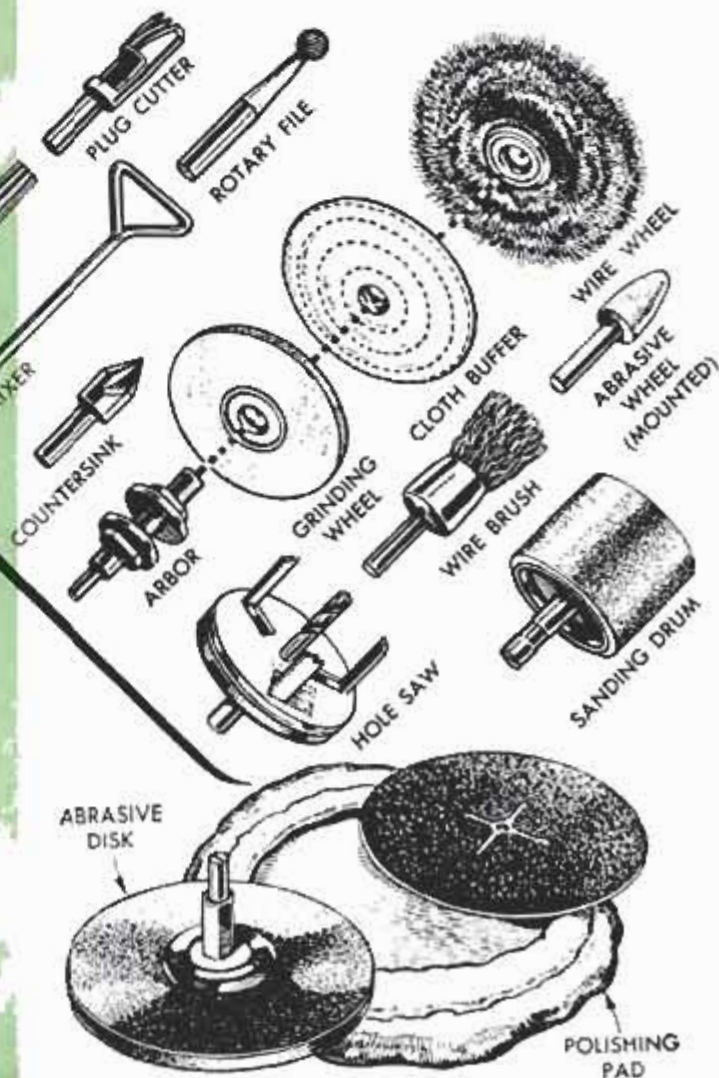



2

Photo Courtesy Pioneer Gen-E-Motor Corp.

PORTABLE ELECTRIC DRILLS

By E. R. Haan

THE WORKHORSE of all the portable power tools, the electric drill is second to none in versatility. Besides its regular use for drilling holes in almost any material, when fitted with a suitable bit, it will operate countersinks, plug cutters, hole saws, wire brushes, grinding wheels, sanding and polishing disks, and sanding drums as indicated in Fig. 1.

Stands, Fig. 3, convert portable drills into bench power tools. Other attachments and accessories, Figs. 5 to 10 inclusive, transform a portable drill into a portable circular saw, saber saw, power plane, belt or pad sander, and hedge trimmer. A drill also can run a small bandsaw, Fig. 4. Some special accessories in addition to those illustrated also are available.

Sizes, chucks and speeds: Light and medium-duty, $\frac{1}{4}$ and $\frac{3}{8}$ -in. portable drills are most popular for home and workshop use. A number of these made by various manufacturers are shown on succeeding pages. All drills have a trigger switch conveniently located in the handles. Some switches are the spring-loaded type that keep the drill going only while depressed. Nearly all small drills are available with acces-

sories in kit form, Fig. 2, which costs less than buying the items separately. The size of a drill is designated by its maximum chuck capacity. The sizes range from small $\frac{1}{4}$ -in. light and medium-duty drills, weighing as little as 3 lb., to the heavy-duty drills having a 1-in. capacity and weighing as much as 16 $\frac{1}{2}$ lb.

There are three types of chucks which hold tools, Fig. 1. These are the friction or hand-tightening chuck, the geared chuck which is tightened with a key, and the hex-key chuck. Many manufacturers give the maximum capacity of a drill for holes in metal and holes in wood. The no-load speed of most $\frac{1}{4}$ -in. general-purpose drills varies from 1600 to 2500 r.p.m. and that for most $\frac{1}{2}$ -in. general-purpose drills ranges from 400 to 600 r.p.m. However, special-purpose drills may have speeds ranging from 275 to 5000 r.p.m. Small drill bits require high speeds to work efficiently.

Electrical data: Three-wire cord, with which most drills are equipped, has a ground wire, usually green, which should be used at all times. The three-prong plug of the cord is plugged into an adapter, which in turn is plugged into an ordinary



BLACK & DECKER MFG. CO.



SEARS, ROEBUCK & CO.



MILLERS FALLS CO.



PORTABLE ELEC. TOOLS, INC.



MONTGOMERY WARD & CO.



PIONEER GEN-E-MOTOR CORP.

SPECIFICATIONS

TRADE NAME, MANUFACTURER AND DRILL NUMBER	SIZE AND CAPACITY IN STEEL (in.)	CAPACITY IN WOOD (in.)	NO-LOAD SPEED (r.p.m.)	FULL-LOAD SPEED (r.p.m.)	WEIGHT (lbs.)	LENGTH (in.)	BEARINGS
Black & Decker Mfg. Co. U-3	1/4	1/2	2700		3 1/8	8 1/4	
"Craftsman," Sears, Roebuck & Co. 9A770 pistol grip and 9A771 saw grip	1/4		1900	1200		7 1/4 and 10 1/2	B
"Cummins," John Oster Mfg. Co. 305	1/4	1	1800		3 1/2	8 3/8	B
Dormeyer Corp. 5-2400	1/4	1/2	2200			8 3/4	B
"Dyno-Mite," Millers Falls Co. 814 pistol grip and 1614 spade grip	1/4	3/4	2500			8 3/32 and 10 7/32	B
Portable Elec. Tools, Inc. "Shopmate", (2-Speed)	3/8	1	2000	1200	6	10 1/4	B
"Mall," Remington Arms Co	1/4	1/2	2500	1500	3	8	B
"Manning Bowman," McGraw-Edison Co. 1153	1/4	1/2	2100	1200			
Milwaukee Electric Tool Corp. 250	1/4	1/2	2000		3 1/4	8 1/2	A
"Pincor" Pioneer Gen-E-Motor Corp. 120G	1/4	1/2	1600	900	3 1/4	8	B
"Powr-Kraft," Montgomery Ward & Co. 9305 (2-speed)	3/8		1000 2000	600 1200			A
Ram Tool Corp. R250	1/4	1/2	2000	1200	3 1/2	9	A
"Sioux," Albertson & Co., Inc. RC 1885	1/4	3/4	2250	1350	3 1/4	7 1/4	
Skil Corp. 549	1/4	1/2	2500		3 1/2	8 3/4	
Stanley Electric Tools H 132	1/4		2500		3 1/4		A
Sunbeam Corp. 70	1/4	1	2200	900		7 3/4	B
Thor Power Tool Co. 23	1/4	1/2	2400	1600	4	9	B
Wen Products, Inc. 808 (2 speed)	3/8	3/4	1000 and 3000				B

NOTE: Most manufacturers make many other models and sizes than those shown on these pages and listed below.
A—All ball bearings. B—Ball-thrust bearing on spindle and other self-lubricating bronze bearings



CUMMINS-JOHN OSTER MFG. CO.



MALL TOOL CO., DIV. OF
REMINGTON ARMS CO.



RAM TOOL CORP.



SKIL CORP.



SUNBEAM CORP



DORMEYER CORP.



MILWAUKEE ELEC. TOOL CORP



ALBERTSON & CO.



STANLEY ELEC. TOOLS
DIV OF STANLEY WORKS

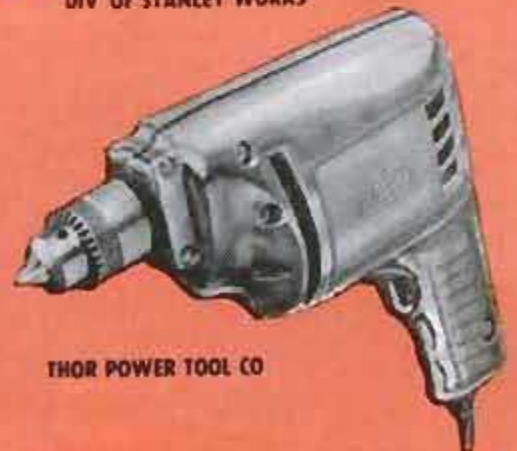

THOR POWER TOOL CO

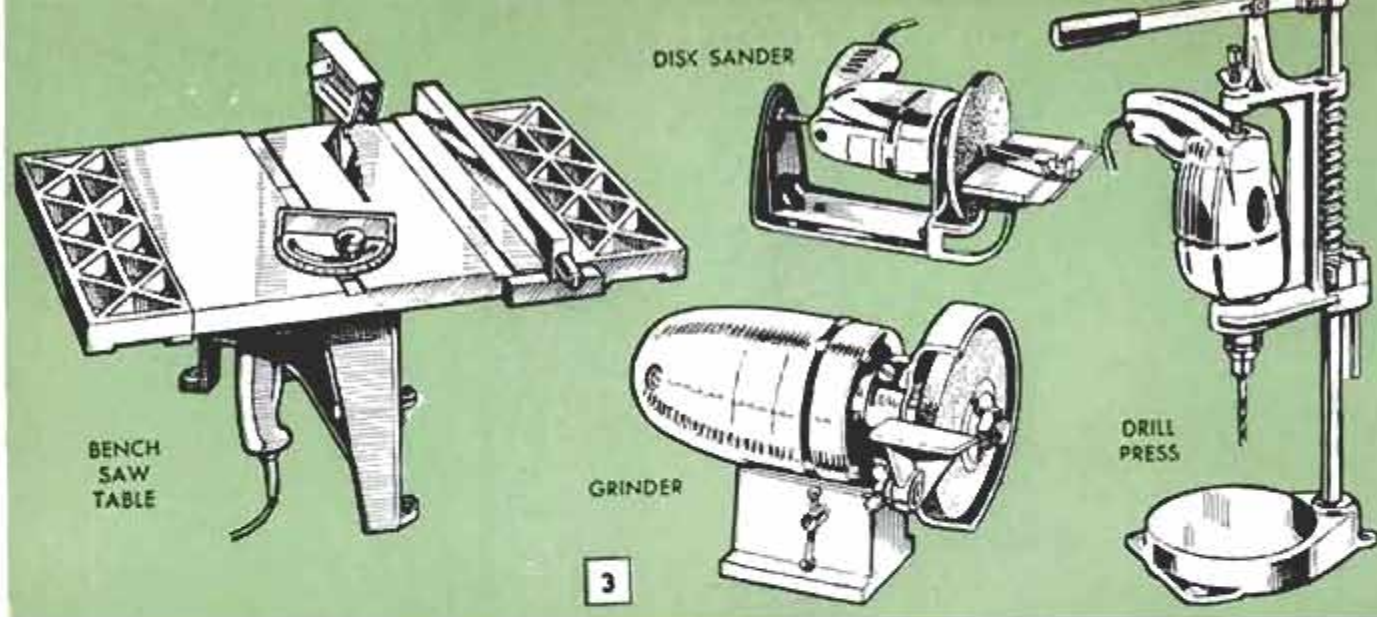

BENCH
SAW
TABLE

DISK SANDER

DRILL
PRESS

GRINDER

3

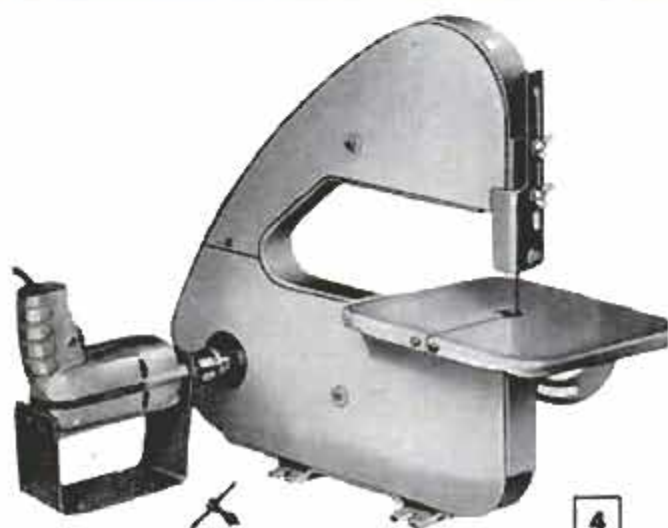

4

Photo Courtesy Pioneer Gen-E-Motor Corp.



WEN PRODUCTS, INC.

McGRAW-EDISON CO.



wall outlet. The green wire of the adapter then is connected to the outlet-cover screw. When a drill is connected to a long extension cord, this also should be of the three-wire type. An extension cord 50 ft. long, supplying a 1/4-in. drill, should have No. 14 wire conductors. If the cord is more than 50 ft. in length the wire should be at least No. 12, or better, No. 10.

Drilling procedure: Before drilling in any material, you center-punch the exact spot to be drilled. This prevents the drill from drifting. The center-punch "dimple" should be slightly larger than the drill point. While drilling any kind of ferrous metal except cast iron, keep the drill well lubricated, using the lubricant listed in Fig. 1 for the type of metal being drilled.

When drilling sheet metal, place it on a wood backing piece to prevent the metal from buckling under pressure of the drill. Be sure to clamp down small pieces of sheet metal. This prevents the work from turning with the drill and possibly causing injury. Be sure to tighten the chuck. Hold the drill at right angles to the work, in the center-punched dimple, before you start the motor.

Apply pressure on a drill in a straight line with its axis. Any side movement or sway that occurs while drilling may bend or break a small bit. Ease up the pressure just before the drill bit breaks through. This avoids binding in metal and excessive splintering of wood. For wood, you can use twist drills or round-shank auger bits that have a brad point. Always back up wood being drilled with a piece of waste stock to prevent any possibility of splintering caused by the drill breaking through.

Avoid overloading a drill: Don't use twist drills or wood-boring bits that are beyond the capacity of the drill even if they have

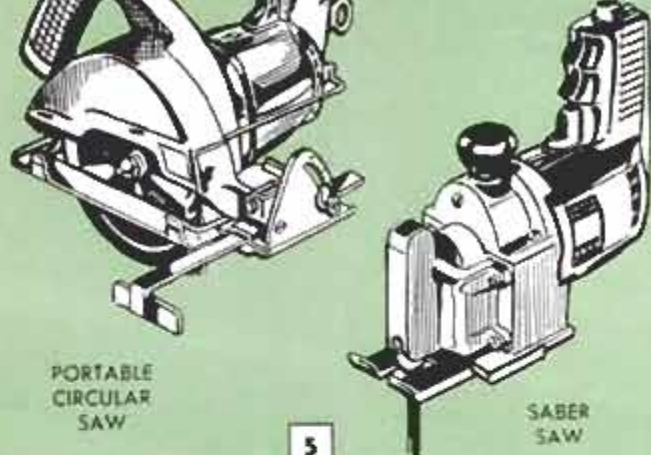

PORTABLE
CIRCULAR
SAW

5

SABER
SAW



6

Photo Courtesy Sunbeam Corp.

shouldered shanks which fit the chuck. This is likely to overload the motor. When drilling a large hole through tough or thick metal, first drill a small pilot hole. This not only serves to guide the large drill, but also reduces the amount of work it must do.

Twist drills should be kept sharp, for which many homeowners find a drill-grinding jig an aid to accuracy. High-speed twist drills retain their keen cutting edges much longer than carbon-steel drills, but they also cost more. Twist drills come in numbered, fractional and letter sizes. When a twist drill heats excessively, does not "bite," or seems to require excessive pressure, it is likely to be dull or possibly damaged. Repeated overloading will damage your portable-drill motor. Overloading is evidenced by slowing below the normal load speed or excessive heating.

Sanding, polishing and grinding: When using a flexible sanding or polishing disk, Figs. 1 and 10, best results generally are obtained by holding the disk at a slight angle to the work surface. A grinding wheel or a wire wheel is held by means of an arbor mounted in the drill chuck. For grinding and wire-brushing, it is generally preferable to mount the drill on a stand, Fig. 3, and feed the work against the edge. This is much easier than attempting to guide the drill freehand. When grinding or using a wire brush, always wear goggles to protect the eyes.

When a grinding wheel is to be mounted on an arbor, inspect it for possible fracture. A cracked wheel can break and cause serious injury. If possible, it is best to provide a guard over a grinding wheel mounted on a stand, Fig. 3. Light, steady pressure on work held against a grinding wheel gives the best results. Dip the work in water frequently to keep it cool. ★★★

FEBRUARY 1959

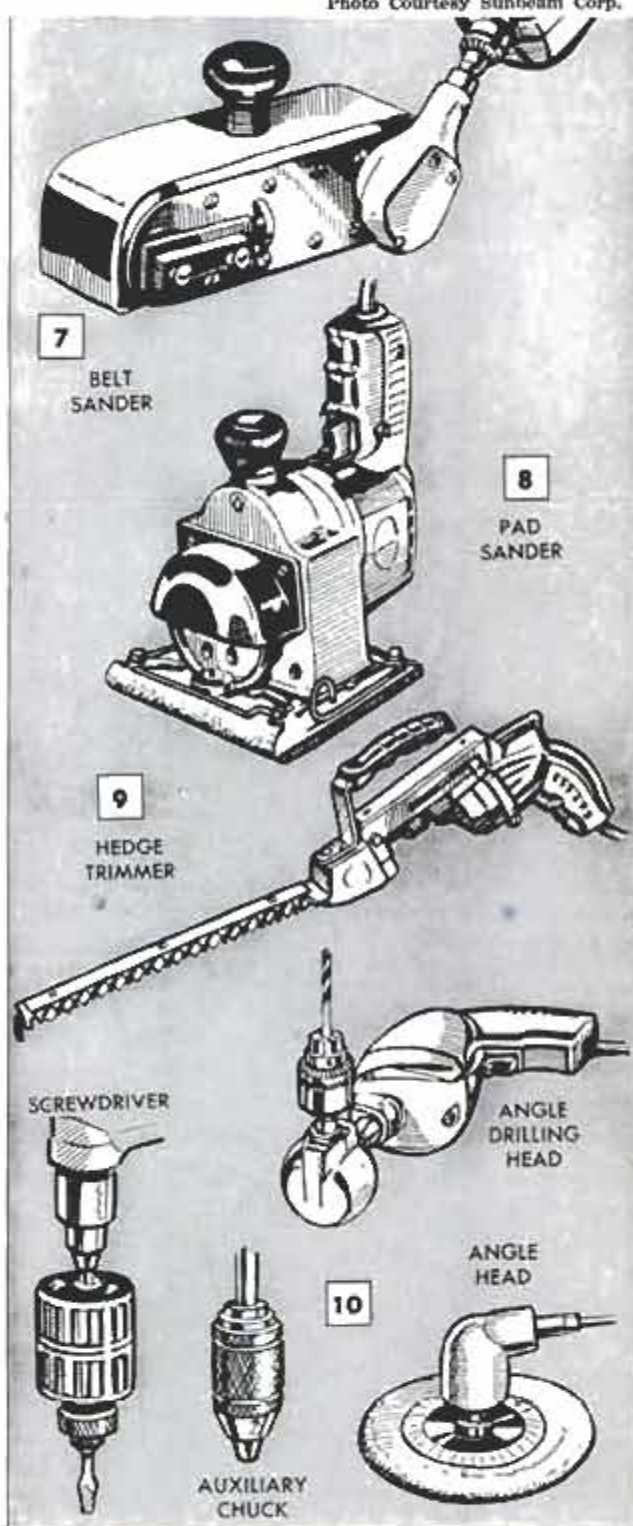

7

BELT
SANDER

8

PAD
SANDER

9

HEDGE
TRIMMER

SCREWDRIVER

ANGLE
DRILLING
HEAD

10

ANGLE
HEAD

AUXILIARY
CHUCK



Portable Tool Box Is Stored As "Drawer" in Workbench

Rounding up your tools to make a repair somewhere in the house will be less of a problem if they are kept in this tool box that stores neatly under a workbench, like a drawer. The handle of the box is a piece of flat stock that extends beyond the vertical members to form "runners" that fit into rabbeted blocks screwed to the underside of the bench top. The center section of the handle is narrowed and smoothed to provide a comfortable handgrip when the box is carried.

When taking up baseboard quarter round for reuse or repositioning, it is almost impossible to pry it loose without breaking it. Avoid this by driving the nails through the wood with a slender drift pin. The quarter round then can be lifted easily. Projecting nails in the floor can be removed with nippers or diagonal-cutting pliers, or driven out of the way with a nail set.

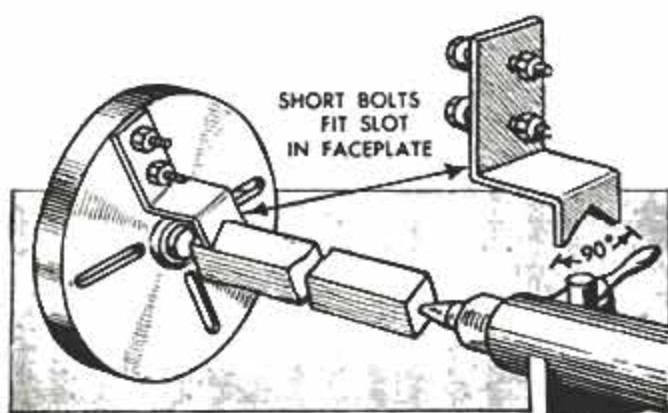

Lathe Dog Holding Square Stock Saves Time on Duplicate Jobs

This lathe dog saves time when turning a number of duplicate pieces from the same size square stock, as it need not be removed from one workpiece and attached to the next like a regular lathe dog. The work is slipped into place under the V-notch of the dog which remains attached to the lathe faceplate. Two short bolts are used to keep the dog in position.

"Cornerless" Hay-Bale Stack Improvement Over Square One



Resembling a giant beehive, this round stack of hay bales is used by one farmer to eliminate the problem of having the corner bales in square and rectangular stacks give way and collapse part of the stack. Each level of the round stack is started by making a circle of bales, then filling in the circle with other bales. After two years of using the round stack, it has been found perfectly satisfactory.

C. F. Marley, Nokomis, Ill.

As a substitute for Prussian blue when scribing fine lines on metal, black or brown liquid shoe polish can be used. It dries quickly, providing an ideal surface on which to mark with a scribe, or even a lead pencil. After the work has been completed, if necessary the polish can be removed with turpentine or other common solvents used with paint.

On the MARKET

for Do-It-Yourselfers

1. PLASTIC "SOLDER" repairs holes, dents and rusted areas on a car body. To prepare material for use, equal portions from each container are mixed. Complete instructions are included for preparation

Co-Polymer Chemicals, Inc.
12350 Merriam Rd., Livonia, Mich.

2. GLUE IN STICK FORM can't stain or spill. Just rub on surface as you would mark with crayon. Used for mounting foil, paper, etc., on almost any surface. Mounted work can be peeled off without tearing

Gem Color Co., Inc., Paterson, N. J.

3. FLUORESCENT FIXTURE is only 1 in. in thickness, is designed for mounting inside cabinet or under shelf where space is limited. Takes 8-watt tube. Reflector, 5 x 12½ in., is ideal for small cabinets

Mutschler Brothers Co., Nappanee, Ind.

4. NONFLAMMABLE CONTACT CEMENT can be brushed, rolled or sprayed. Application equipment can be washed clean in warm, soapy water. No-smoking rules do not apply during application of cement

Formica Corp., 4614 Spring Grove Ave.,
Cincinnati 32, Ohio

5. SPECIAL PENETRANT and lubricating oil combined in a pressurized container make this a product of wide application. Loosens metal parts that stick; cleans and oils tools, guns, fishing tackle, golf clubs

Kano Laboratories, 1000 S. Thompson Lane,
Nashville 11, Tenn.





Slot in Sawhorse Aids Ripping Short Boards With Handsaw

Holding a board while ripping it with a handsaw is easy when it is placed on a sawhorse having a slot cut in the top member as illustrated. If the sawhorse is made of 2 x 4s, cut the slot in a 1 x 6-in. board instead and nail it to the sawhorse to provide a wider base for supporting the stock to be ripped. Position the board so the slot is adjacent to the sawhorse top.

G. E. Hendrickson, Argyle, Wis.

Fragments of metal that are not removed from newly cut pipe threads may prevent tight connections when the pipe is installed. To avoid this, clean the threads with a discarded toothbrush and use another one to apply the joint compound. The short bristles are ideal for cleaning such threads and permit even distribution of the compound.—M. R. Beasley, Jackson, Mich.

Jig Speeds Cutting Multiple Lengths of Rod or Tubing

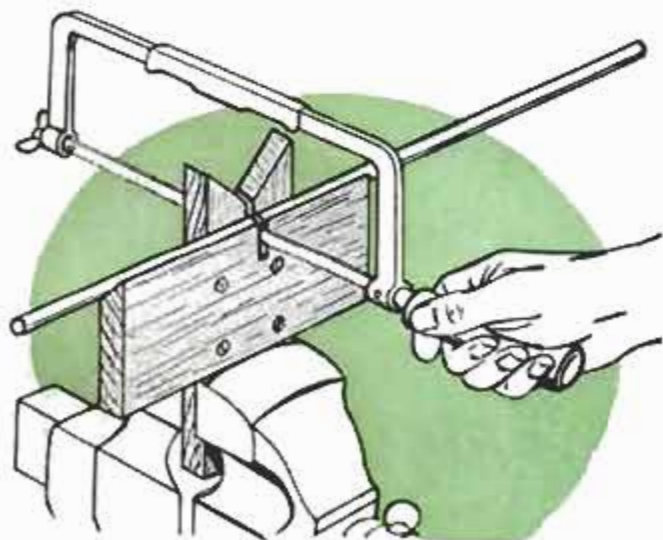

Here is a jig that makes an easy job of cutting small-diameter rod or tubing when several lengths must be cut. It consists of two wooden blocks screwed together and clamped in a vise as shown. The beveled upper edge on the horizontal block holds the rod in position to be cut and the slots cut in both pieces serve as a guide for the saw blade.

To keep dust off the collar and the shoulders of a suit kept in a closet, use a dry-cleaning bag that has been cut to a length of 7 in. Place the cut-down bag over the garment as you would a plastic or cloth protector sold for this purpose.—C. V. Mathis, Wildwood-by-the-Sea, N. J.



Shield Protects Radio Parts From Heat of Soldering Iron

When soldering resistors and other small parts into a radio circuit, the parts can be protected from heat that may travel along wire leads or terminals by shielding the latter with a slotted piece of sheet aluminum as shown. The slot permits contact with the terminal on three sides so that most of the conducted as well as radiated heat is dissipated by the shield before it can reach the part. The size and shape of the shield used will depend upon the working space available. Therefore it is a good idea to make a set consisting of several sizes and shapes for future use.

R. Hanscom, Elmhurst, Ill.

SHOP NOTES

X38

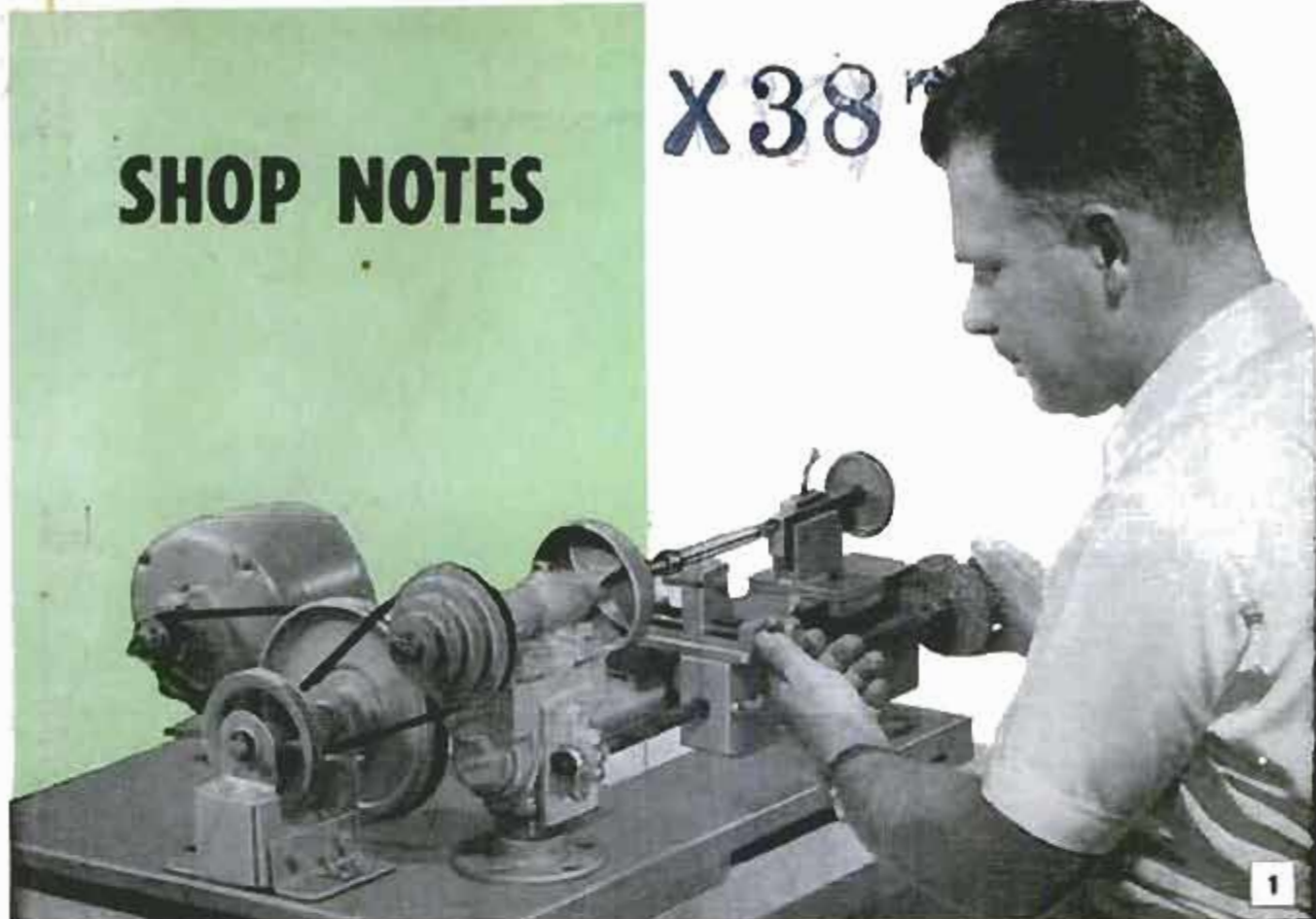

METAL-TURNING LATHE

Built From Stock Parts

By Frank Beatty

USING STANDARD PARTS and stock materials that are available almost anywhere, you can build this metal-working lathe with only a few tools. Because of simplification of the assembly in order to make the unit easy for anyone to build, the lathe as pictured and detailed cannot be rated as a precision tool. It is simply designed to do practical work within reasonable limits. As detailed, the lathe swings $4\frac{1}{4}$ in. over the bed and takes 10 in. between centers. Standard pipe and fittings are used to form a frame on which the headstock, tailstock and bed are fitted.

The first step is to assemble the pipe and fittings. Do this before any other parts are made or stock cut to dimension. The reason for this first step is that in the manufacture of standard pipe there are allowable variations and some changes in dimensions of lathe parts may be necessary because of these variations. The pipe assembly consists of one 14-in. length of $1\frac{1}{2}$ -in. pipe, two close nipples, two

tees, two floor flanges and one pipe plug (optional) for closing the tee at the headstock end of the assembly. Screw the parts tightly together and then mount on a hardwood base as in Fig. 5. Later when the countershaft, motor and motor mount are added to the assembly, a second piece is attached to the first, making an L-shaped base as pictured in Figs. 1 and 2.

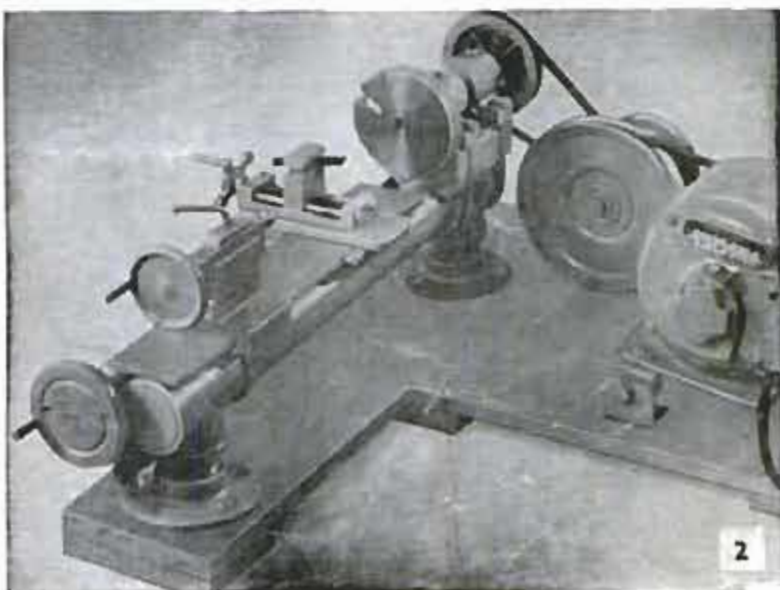

Also at the outset it should be noted that the spindle-thread characteristics are not given. The reason for this is that chucks are available to fit spindles threaded $\frac{1}{2}$ -24, $\frac{1}{2}$ -20 and $\frac{3}{4}$ -16. You can use a $\frac{1}{2}$ or $\frac{3}{4}$ -in. spindle and have it threaded to take any one of these chucks. The original lathe spindle was threaded $\frac{1}{2}$ -20 and is suitable only for light work. A solid spindle is, of course, much simpler and less expensive to make or have made than is a hollow spindle with a No. 0 or No. 1 Morse taper. For turning work between centers the solid spindle requires a special 60-deg. center with a driving pin, Fig. 5. This center and the spindle can be made in a machine shop at a very nominal cost.

The headstock-spindle bearings, Fig. 5, are held on the pipe tee by means of U-bolts and a saddle block of hardwood. One face of the saddle is shaped to the contour of

the tee; the other is faced with a $\frac{1}{8}$ -in. steel plate on which the pads of the pillow blocks rest. The purpose of the steel plate is to make it easier to align the bearing sleeves when the assembly is bolted in place. Cut the saddle about $\frac{1}{8}$ in. thicker (about $2\frac{1}{4}$ in.) than indicated. Then assemble the parts temporarily.

Next, build up the tailstock, assembling from parts as indicated in Fig. 5. Then assemble the bed on the pipe frame. Slide the tailstock onto the bed and check the alignment of the centers, both vertically and horizontally. Any misalignment can be corrected by reducing the height of the saddle and by tapping the bed lightly to shift it on the frame. Once the centers are aligned, tighten the parts permanently in place.

The tool post, tool-post slide and the actuating screw are shown in an exploded

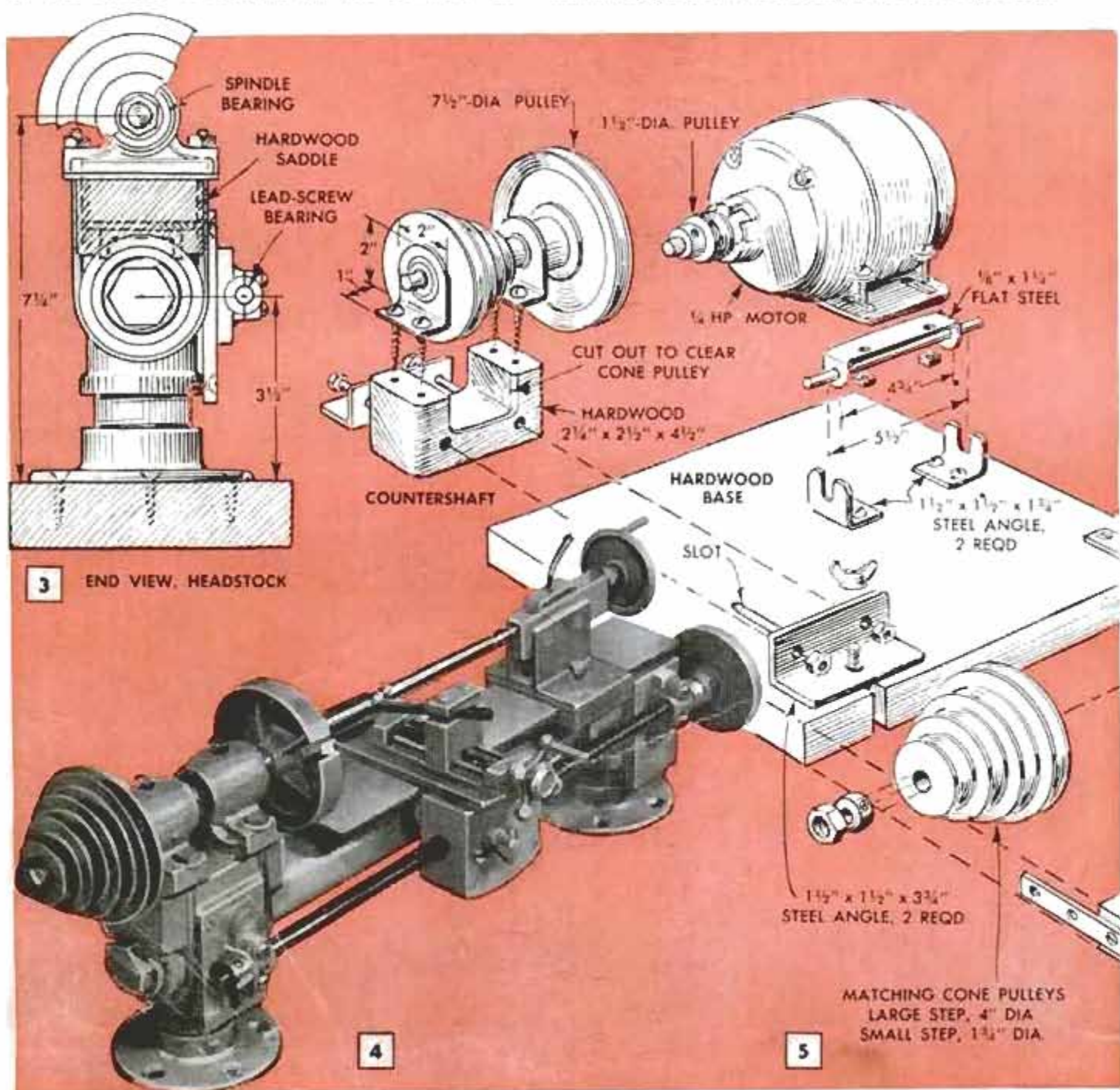

view at the lower right in Fig. 5 and are shown in more complete detail in Figs. 7, 8 and 9. In this assembly the tool is moved in either direction by turning the hand-wheel at the end of the lathe bed. The actuating screw consists

of the lead screw A, the split nut B and the split-nut cam C, Fig. 5. These parts were purchased ready-made from the manufacturer of a 6-in. metal-turning lathe. An alternate assembly for running the carriage right and left would be to attach a rack to the underside of the flat bed and fit a handwheel and pinion gear in the carriage apron, the pinion engaging the rack. This assembly would shift the carriage somewhat faster and for ordinary work would be quite as effective as the use of the lead screw.

Likewise the tool post detailed in Fig. 7 can be supplanted by a standard tool post from a small lathe. It can

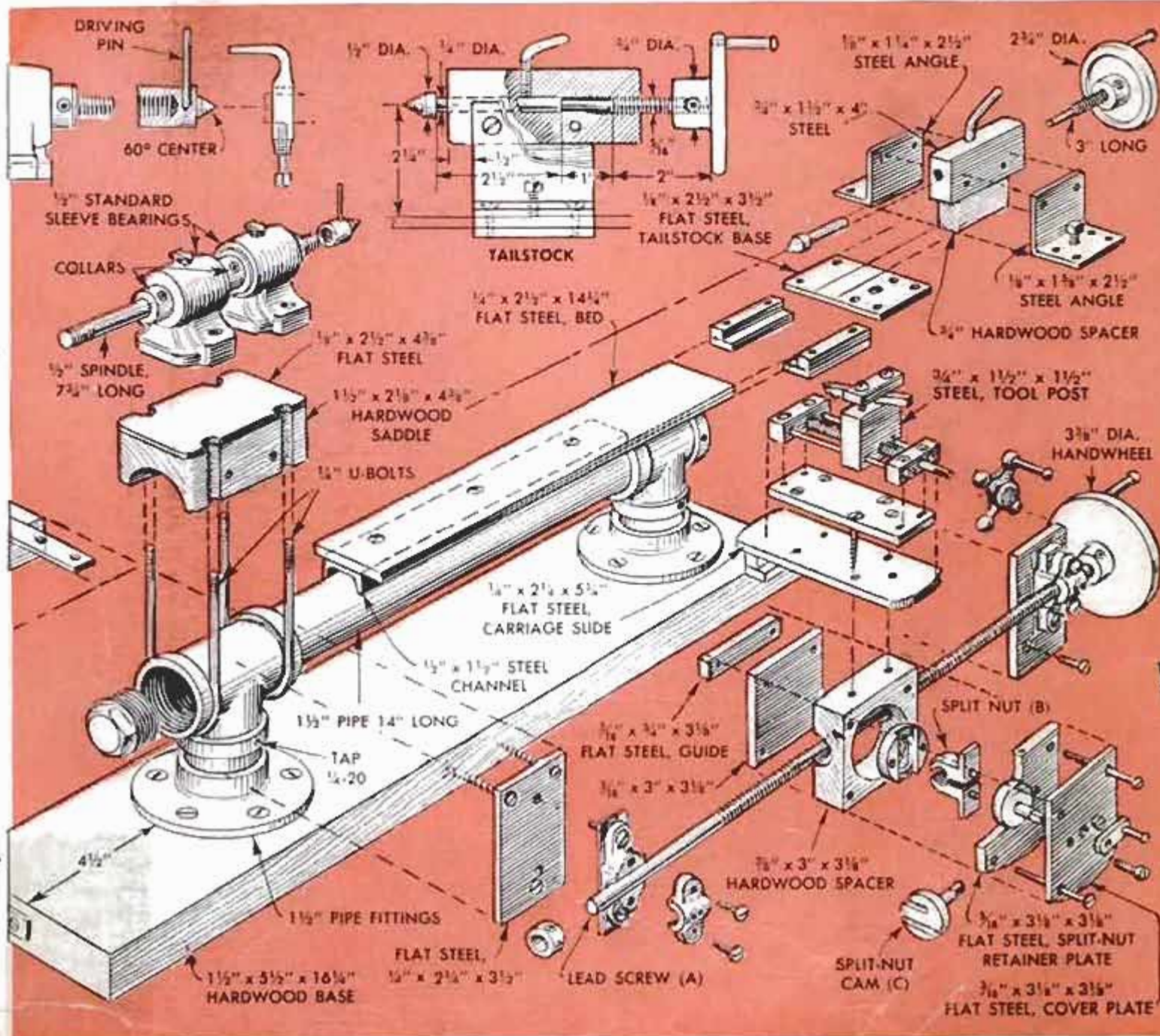
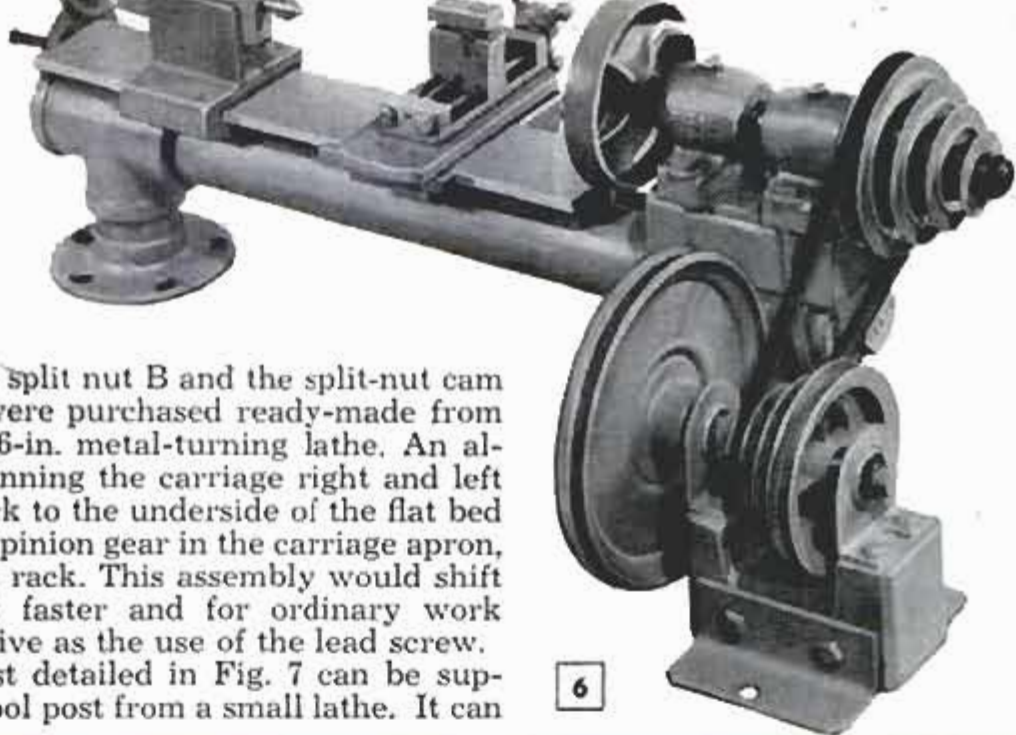

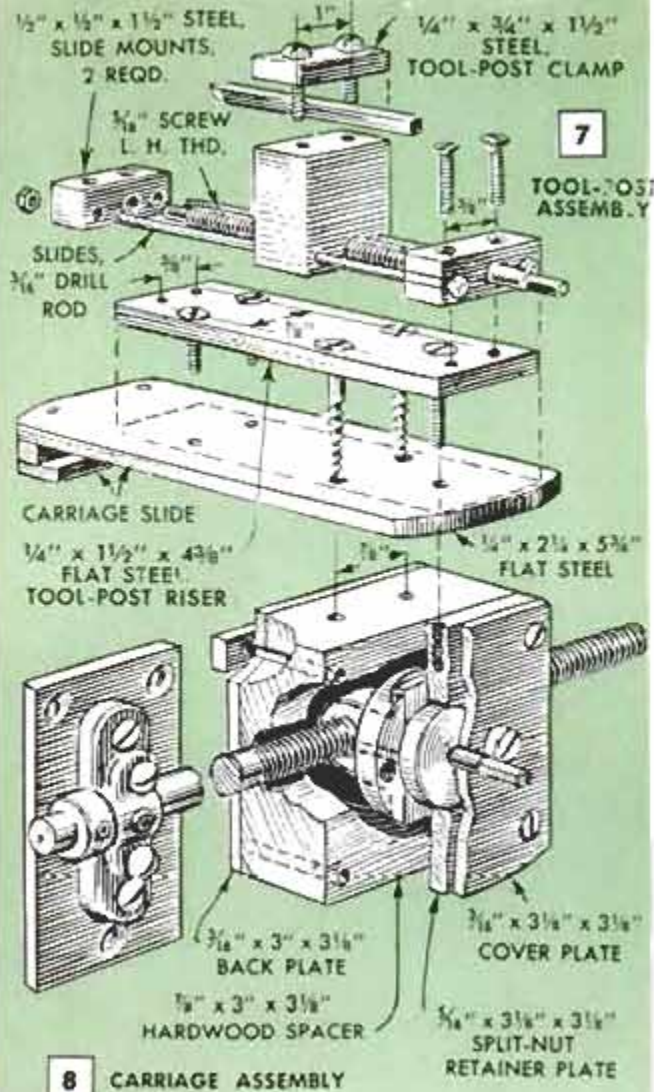

8 CARRIAGE ASSEMBLY

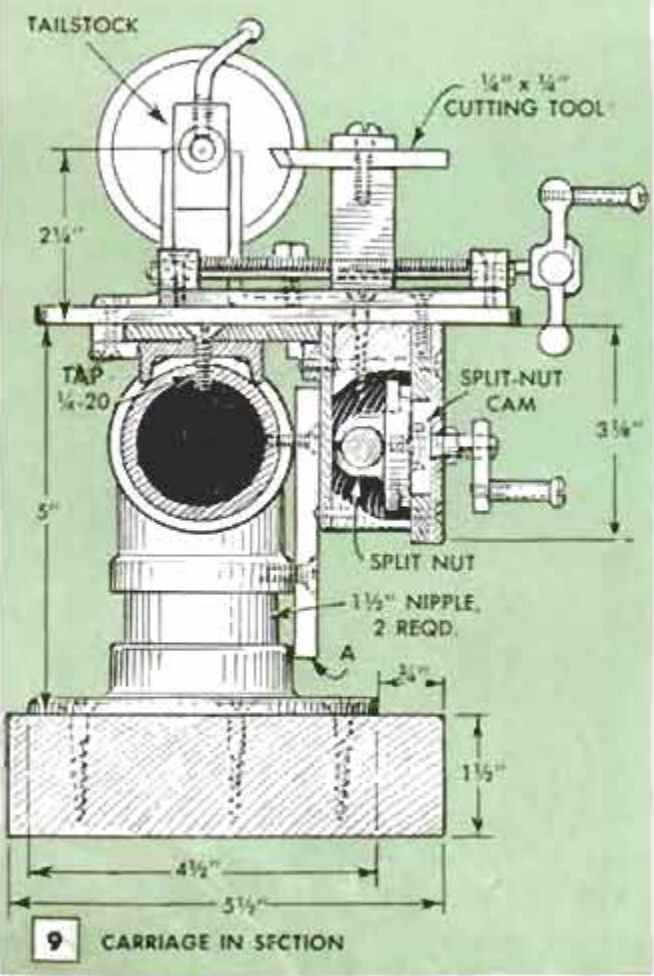

9 CARRIAGE IN SECTION

be mounted by having a small block-steel T-slotted at a local machine shop drilled and tapped for the guide rods and the screw. This assembly would, of course, allow more latitude in adjustment of the cutting tool.

In the original lathe the carriage consists of two steel plates stacked, and an apron built up from three steel plates and a hardwood spacer, the latter also serving as a housing for the split-nut assembly. Figs. 5, 7, 8 and 9 show quite clearly how the parts are assembled. Fig. 9, the sectional view, shows the relationship of the parts when the carriage is fully assembled. Note in Fig. 5 that the lead-screw-bearing plates are attached to the pipe tees with screws, the latter being turned into holes drilled and tapped into the pipe-tee flanges. These holes should not be drilled and tapped until the carriage is fully assembled with the lead screw in position. Only then can the bearing plates be accurately located.

Care must be taken to fit the carriage to the flat bed so that it moves along the full length of the bed without side play at any point. It is best temporarily to fit the parts tightly, then free them by polishing the edges and top of the bed with fine abrasive or with an oilstone. The same procedure should be carried out when fitting the parts of the tool-post assembly, Fig. 7, and the tailstock, Fig. 5. Hand fitting and hand stoning of the sliding parts give a smooth slow motion essential to the performance of the lathe and to accurate work. It is especially important that the tool post move throughout its entire travel without any tendency to rock on the supporting plate. It should move on the slides (rods) with a slight amount of friction and should seat firmly on the supporting plate.

The countershaft, Figs. 1, 2 and 6, is detailed in Fig. 5. It can be built from any parts at hand, or available, that will serve the purpose. Although the original countershaft was mounted in ball-bearing hangers, sleeve-bearing hangers will do quite as well. Standard shaft hangers having a range of adjustment sufficient to give clearance for the countershaft and drive pulley will eliminate the necessity of blocking up the hangers as detailed. Adjustable hangers can be bolted directly to the base. Construction time also can be saved by purchasing the cradle motor mount rather than making it up as detailed. Or, if desired, you can simply bolt the motor directly to the hardwood base and rely on the slotted motor base to provide adjustment for tensioning the belt. Pulleys of the diameters given will give ample speed range for turning nearly all metals. Use a motor of 1750 r.p.m. ★★★

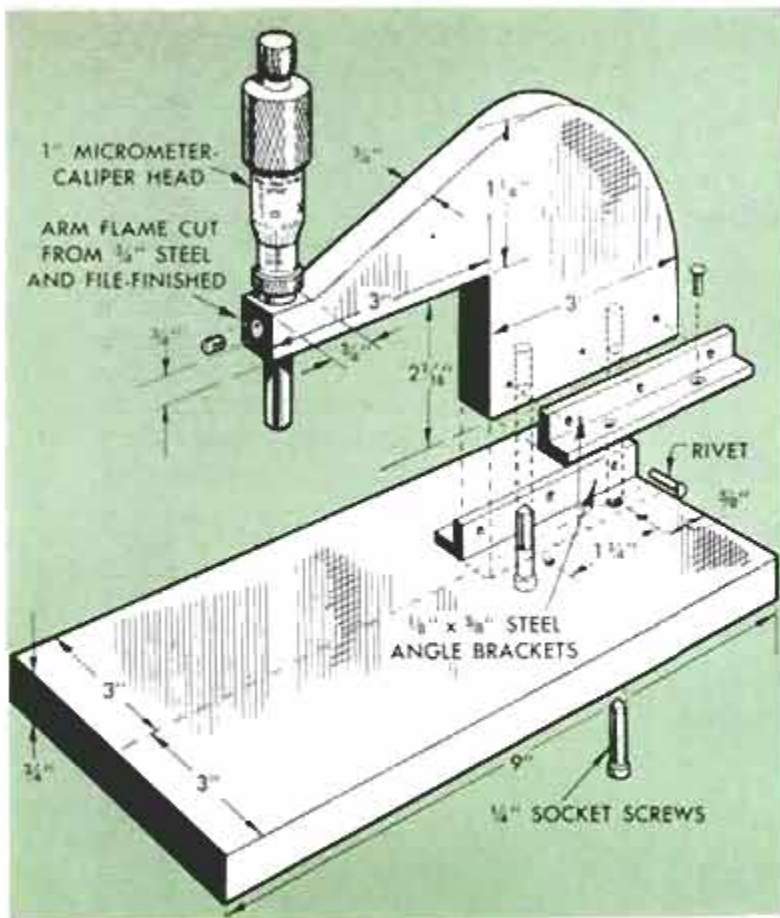

Overarm Fixture Takes Micrometer Head

Precise measurements of finished or semifinished parts can be made at the bench with this fixture, or table, fitted with a standard micrometer head. As detailed, the base, or table, and overarm are flame-cut from mild steel and then squared and finished either by filing, or milling, if a milling machine is available. Of course, the parts

can be made from tool steel if greater accuracy is required. The dimensions given are optional and can be changed to suit the work requirement. If ground stock is used for the table and arm and if the bottom of the arm can be finished by milling, then the brackets, or braces, detailed will not be necessary.—C. W. Woodson, Chicago.

Numbering Chuck-Jaw Screws Aids in Centering Work

Centering work in a four-jaw chuck can be speeded up if you number the jaws as pictured. The numbers are especially helpful when partially finished work must be moved by adjusting the jaws in pairs. As a rule only two of the jaws will need to be numbered, but in some instances it may be helpful to have all four jaws numbered consecutively.—R. Hanscom, Elmhurst, Ill.

When hanging double doors in a closet and they must pass, keep in mind that they must overlap slightly when closed and that there is a visible space between the two doors. The trick is to hang the inside door on that side of the opening farthest from the entrance to the room. Then when the doors are closed you will not see the space between.

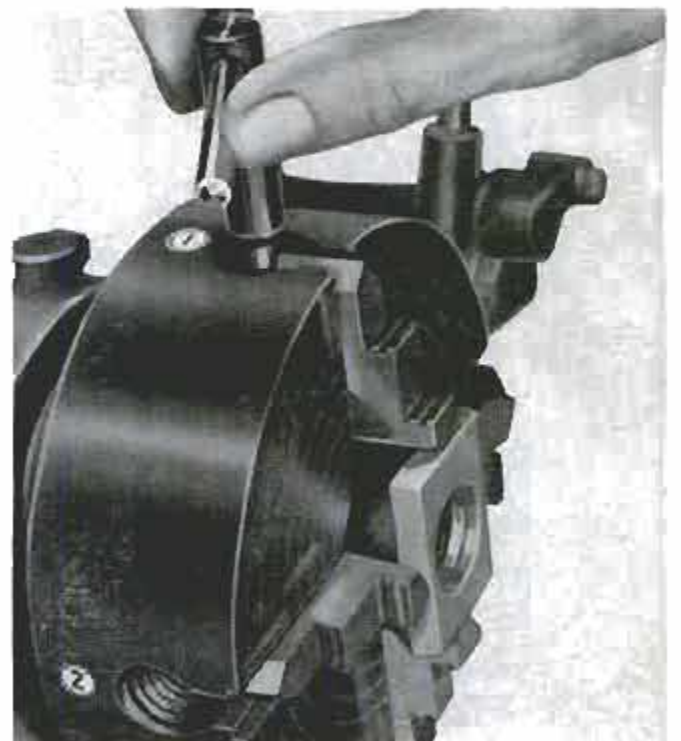

Tape Protects Legibility of Measurement Marks on Saw Table



Penciled measurement marks on the table of a jigsaw, required to assure accurate cutting of small lengths of material, will not be erased or smudged accidentally if covered with a strip of cellulose tape. The tape is thin enough to allow work to pass over it without interference, and can be removed in a moment when a particular job is done. Also, as shown in the detail, a strip of the tape could be used for inked measurement marks which, in some cases, might be more legible.

When you must cut caramels, marshmallows or other sticky confections with scissors for a dessert or cake trim, save time and temper by using powdered sugar. Dip the blades of the scissors into a box of the sugar frequently so the metal of the blades is "insulated" from the adhesive stickiness of the food being cut.

Boost Wiper-Motor Efficiency By Cleaning Felt Air Filter



Most vacuum-operated windshield-wiper motors have a felt pad that acts as a filter for incoming air. To assure maximum efficiency and power from the motor, occasionally remove the pad and clean it in gasoline or cleaning fluid to remove any accumulation of dust and dirt that tend to clog it. After the filter has been cleaned, remove excess fluid by draining and allow the filter to dry before it is replaced in the wiper motor.

Old wagon wheels used as garden decorations may be embellished with potted plants attached to the spokes with brackets.

Extension Jaw for Parallel Clamp Permits "Over Reaching"

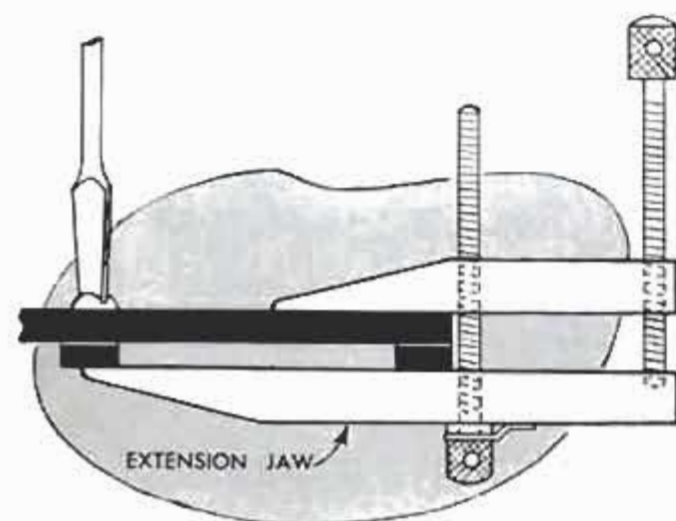

Lengthening one jaw of a toolmaker's parallel clamp will increase its capacity and usefulness for holding together work that is to be drilled, tapped, machined in some manner or accurately assembled. The longer jaw is made from tool steel and is shaped to match the original jaw with an inch or two added to its length. The new jaw is drilled for the clamp screws as indicated, one hole being drilled all the way through the jaw to provide clearance for one screw. The other hole in the jaw is bored only $\frac{1}{8}$ in. deep, so that it merely engages the end of the other screw. Use the old jaw to locate the holes.

C. W. Woodson, Chicago.

CUT PERFECT DISKS ON YOUR BANDSAW

THIS JIG can be made to fit small bandsaws and enables you to cut one or more disks in the time normally required to set up the work on a lathe. The work is supported on a flat surface throughout the length of the cut, a feature which prevents binding of the saw blade due to tilting of the stock. It is not necessary to drill a center hole in the stock when cutting any disk up to 14 in. in diameter.

As will be noted in the detail below and in the upper photo at the right, the jig consists of the parts A, B, C and D, the inner edges of the parts B and C being cut at a 45-deg. angle. Corresponding cuts are made on the edges of the slide, D. This forms a single dovetail when the parts A, B and C are assembled. The part D slides in the dovetail. The pivot pin is made by cutting off the head of a screw and grinding the body to a sharp point. This is turned into a hole centered in the slide $\frac{1}{2}$ in. from the end. The point should project about $\frac{1}{16}$ in. above the surface. Lay off the graduations as indicated to give a capacity of 14 in., rising by eighths. On bandsaws having a grooved table, the jig is held in place by a cleat clamped in the table groove. On machines having no groove in the table, the jig usually can be clamped at the rear edge of the table, clearance being allowed for rotating the stock.

Wm. J. Kadi, Long Beach, Calif.

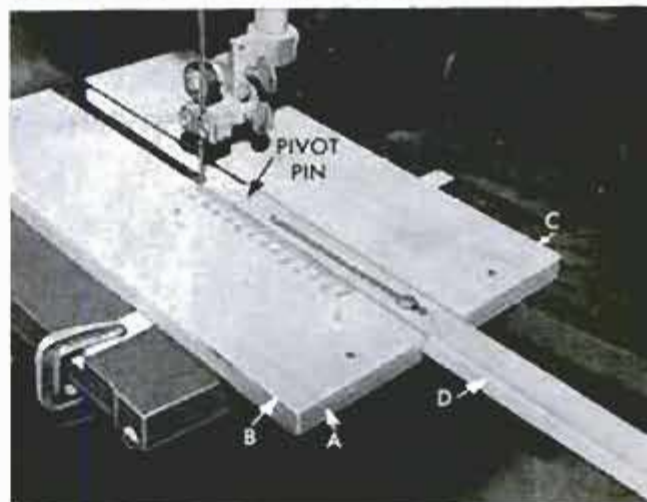

Above, circle jig gives full support to work, preventing tilting of work which causes saw to bind

Below, you merely turn stock on pivot pin to cut a perfect disk. Light sanding finishes edge smooth

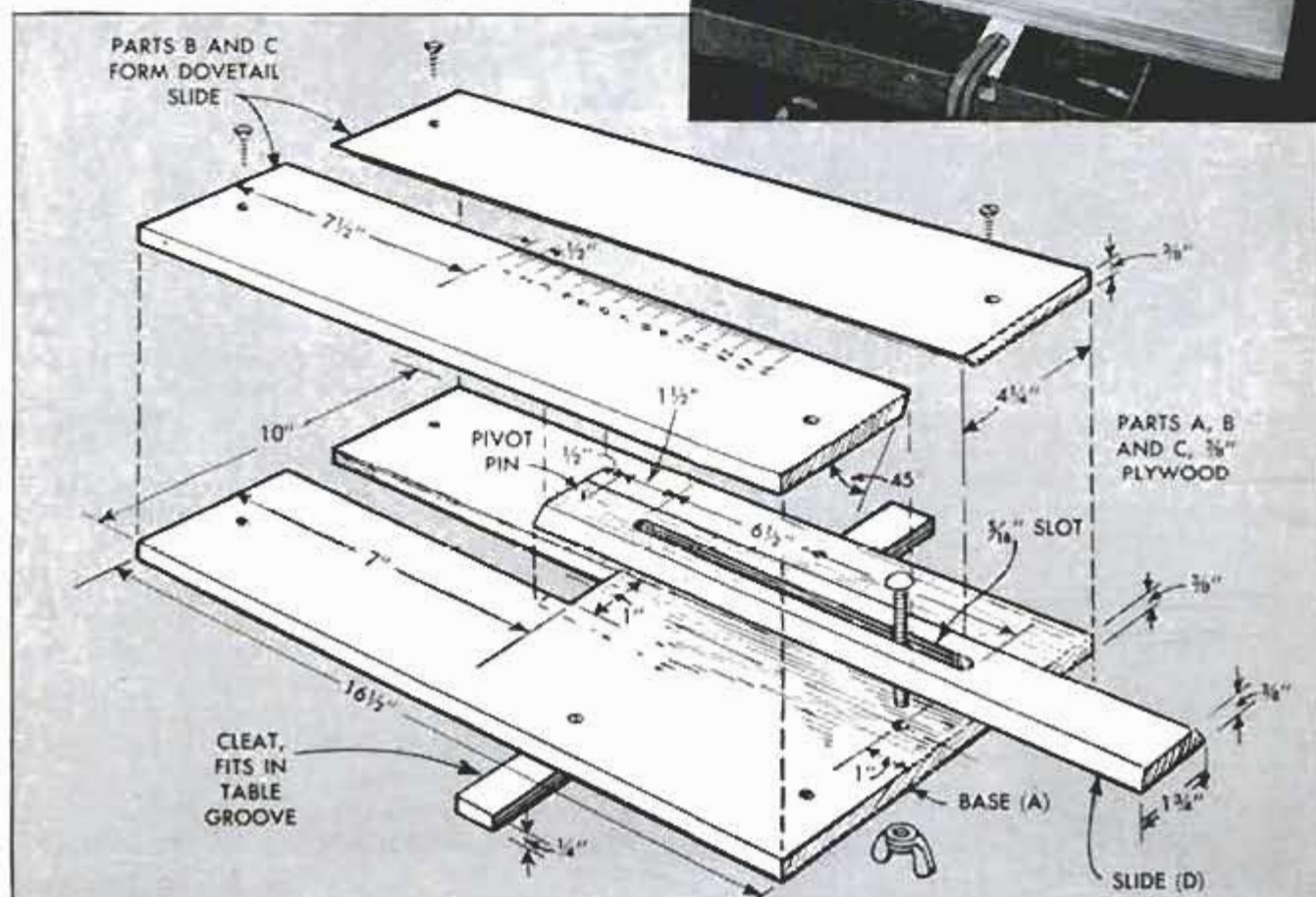
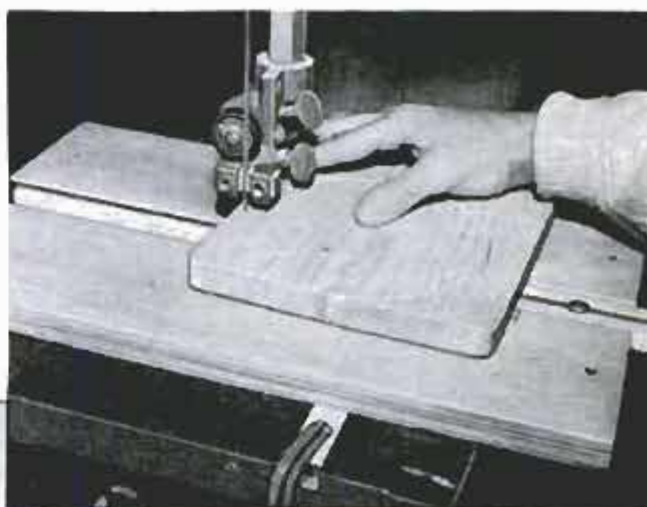

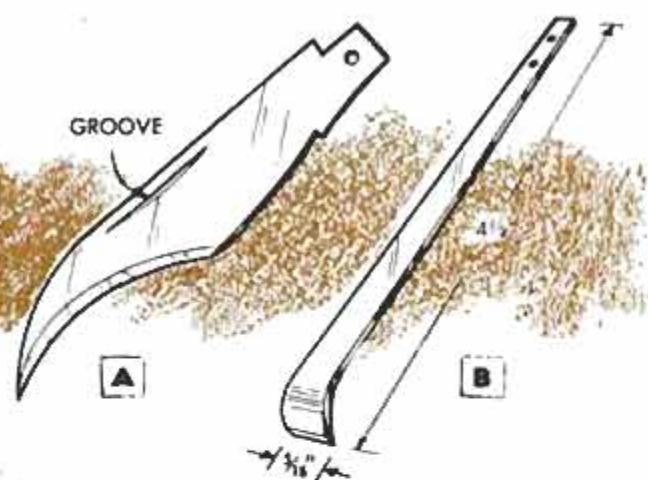

IF YOU LIKE

here are several unusual types good craftsmen find useful for hand work on wood, leather and plastic

By Walter E. Burton

YOU WILL BE PROUD of hand tools you make yourself, either for regular uses or for a special purpose. That's because there is something individual about a fine handmade tool that delights the eye of a craftsman. Let's say, for example, you are a whittler and good at it. Usually such work is done with a pocketknife, but perhaps the standard shapes of pocketknife blades just won't do for your particular purpose. So you consider making a blade to suit and fitting it to the knife handle, Fig. 1, just like the original. It's easier to do than you might think.

The tool steel from which many types and sizes of hand tools can be made is known to the trade as ground flat stock. It is available in a wide range of sizes, generally comes coated and annealed for easy layout and workability. It can be sawed, filed, also bent to a comparatively short radius by heating. After oil-hardening and tempering, it will hold a razor-keen cutting edge. Instructions for oil-hardening and tempering usually come with the material or are available from the manufacturer. If you do not have facilities for this work it may be possible to have it done locally.

Details A through F, above, show typical tools that can be made from flat stock. Of course, there are many other applications, such as flat carving chisels, gauges, small machine parts and templates. The replacement knife blade, detail A and Fig. 1, can be made almost any shape to suit requirements. Modelmakers and others who work on small parts will find the tiny scraper, detail B and Fig. 2, a handy addition to the toolkit. It gets into places that

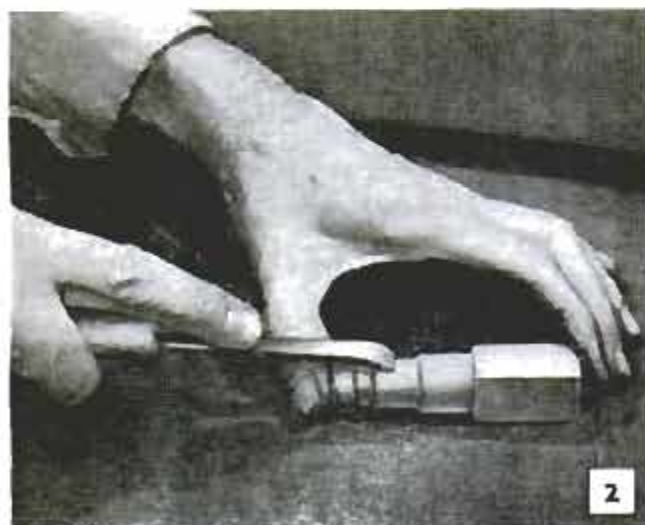
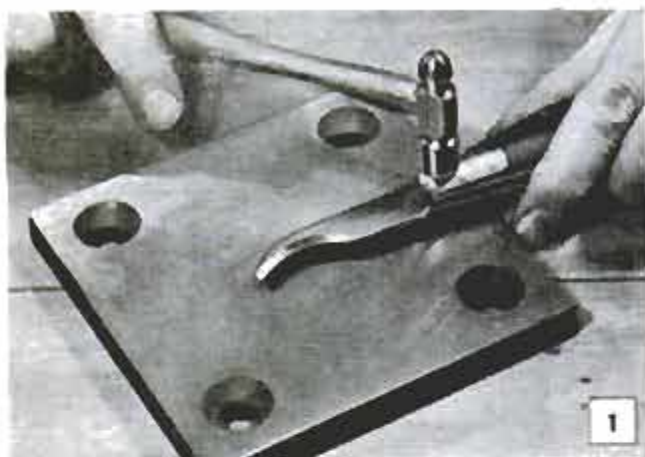

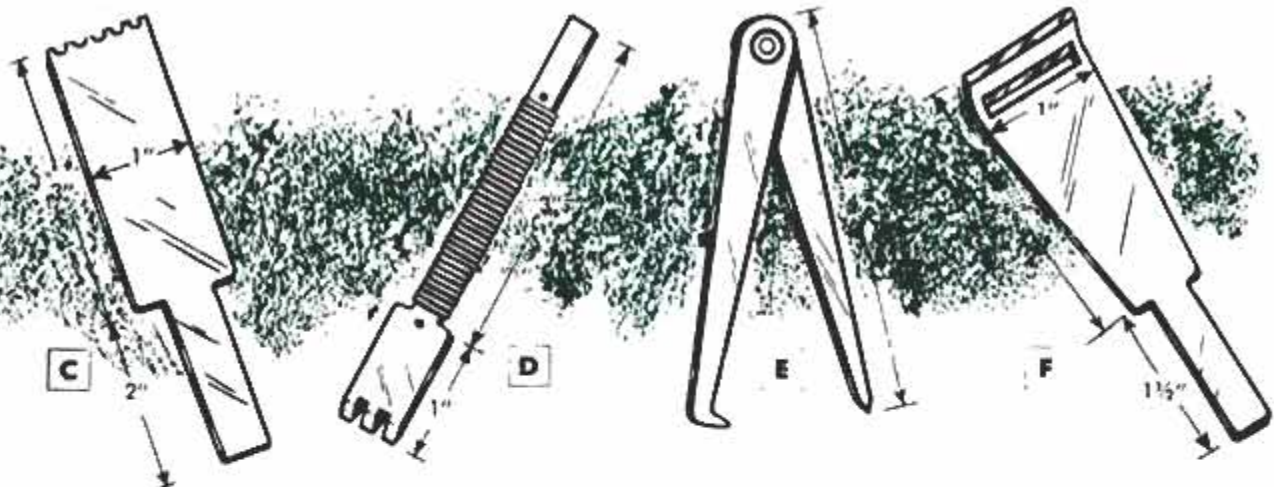

TO MAKE HAND TOOLS—

cannot be reached with conventional scrapers, even with a knife blade. A multiple-beading tool that wood turners find useful for running duplicate beads on older style turnings is shown in detail C and pictured in use in Fig. 3. The round-bottomed grooves that form the beads are made with a round file and the edge is beveled before hardening. Thonging chisels for leatherwork come in various sizes but nearly all experienced leatherworkers prefer a three-prong chisel, especially for following curved edges. The three-prong chisel is easily made from flat stock as in detail D. The handle, or handhold, is simply a wrapping of light-gauge wire. The chisel is shown in use in Fig. 4. The caliper, detail E, known in shops as a hermaphrodite caliper, is handy for setting from the end of a scale, for working from an edge as in Fig. 5, and for transferring certain measurements. They can be made any length, the caliper dimensioned in detail E being of small size. The special tool in detail F can be used for scraping wood and scarfing leather and also as a spokeshave or draw knife as in Fig. 6. All tools should be fitted with turned wooden handles, preferably hardwood. ★★★

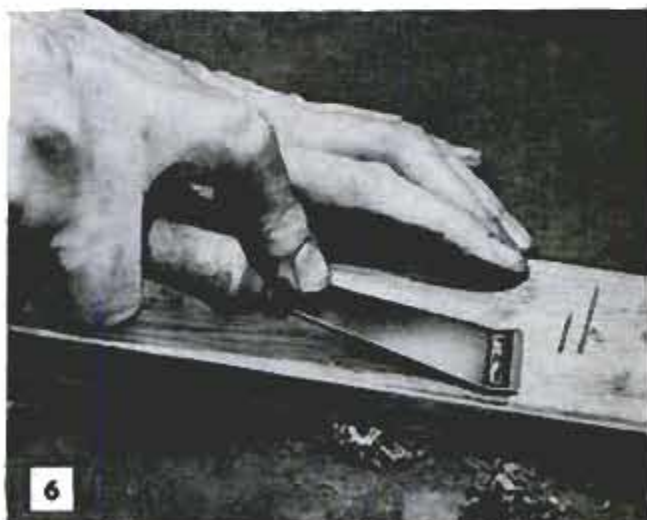
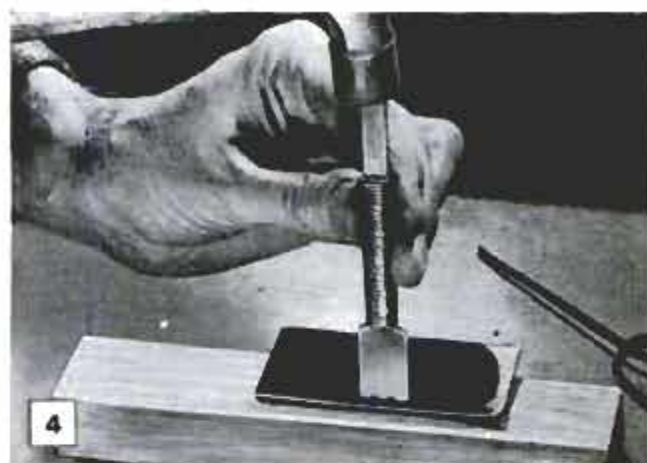
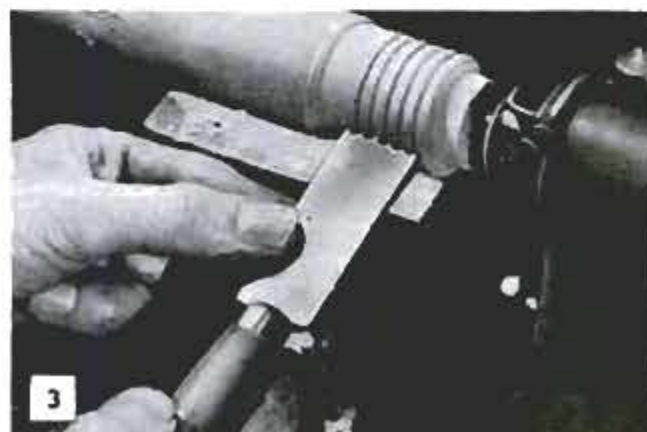

Efficient Paint Scraper Utilizes Adjustable-Wrench Leverage



A scraper that will remove several coats of paint, even without the application of remover, consists of a broken flat file and an adjustable wrench. The end of the file is ground off square and at a slight bevel. When in use, the file is guided with one hand while downward pressure is applied

with the other hand on the wrench, which is clamped to the file as shown. For better control of the file, replace the regular round handle with a rectangular one made from wood or plastic.

Robert L. Sargisson, Berwyn, Ill.

Grooved Nut Used to Clean Rusted Bolt Threads

When the threads of a number of bolts must be cleaned of rust and dirt which cannot be wire-brushed out, and a die of proper diameter and thread size is not at hand, try using a nut having a slot and grooves as shown.

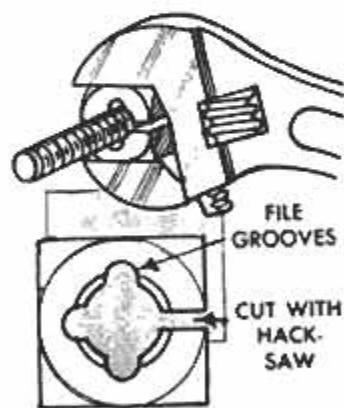

A cut is made through the nut from one side, and three grooves are made across the threads with a file. The cut and the grooves will permit the nut to turn on the bolt and to collect the dirt and rust.

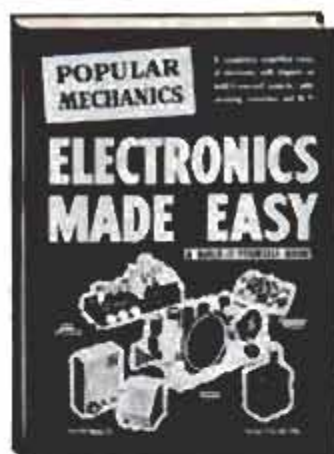

Enrich Your Life With the Marvels of Hi-Fi! Thrill to a Pocket-Size Transistor Radio . . .

Have you been wanting a Hi-Fi set for your home . . . a portable transistor radio no bigger than your hand . . . and any of the other pieces of electronic equipment that are adding so much enjoyment to modern living? Then here's how you can have them, at merely a fraction of the usual purchase price. Using Popular Mechanics' new book—*Electronics Made Easy*—

You Can Make These Electronic Devices Yourself!

This unusually practical book enables you, without any previous experience, to enter the amazing field of electronics for fun or profit. In 192 pages of simple step-by-step instructions and hundreds of illustrations, you learn all about Hi-Fi—exactly what it is and how to build your own Hi-Fi system. You discover how to make the "miracle" transistor radio, how electronic tubes work, how to do radio

servicing, how to use test instruments and make your own, and how to convert old radios into inter-com systems and other devices. It's fun and easy to build your own electronic equipment with the help of this book which contains numerous do-it-yourself projects. Send for your copy of *Electronics Made Easy*. It's your key to the most fascinating hobby of these times **\$3.50** for just.....

Send your order to Dept. 259

POPULAR MECHANICS PRESS, 208 East Ontario Street, Chicago 11, Illinois



SHOPPING FOR TOOLS

1. ABRASIVE DRUMS faced with tungsten-carbide particles are available in diameters from 3/16 to 1 1/2 in. They are designed to be chucked in a portable drill or drill press and used for smoothing and shaping operations on wood, plastics and hardboard. An outboard bearing seated in a palm pad comes with set, is used to give two-handed control as in left-hand photo. Drums to 3 in. dia. are available

H. A. Ness & Co., 5083 Elston Ave., Chicago 30

2. FLEXIBLE-SHAFT UNIT consists of high-torque motor and 30-in. flexible shaft designed for a speed of 3450 r.p.m. Nylon handpiece is fitted with a steel finger grip which enables operator to maintain precise control on close-tolerance operations. Handpiece takes 1/16, 3/32 and 3/8-in. collets. A number of attachments are available for converting unit to a bench grinder, buffer, shoe polisher and disk sander

Dremel Mfg. Co., Racine, Wis.

3. PLIER-WRENCH serves both as a wrench and pliers, and when supplied as a kit it comes with a universal jaw, pipe jaw, wire bender and tube cutter. Jaws are always parallel, from wide-open position to the tightly closed position, the movable jaw being actuated by a "gear" and rack with a shift, ratchet and lock. By means of the latter, jaws can be locked in any position and unit used as wrench

Plierwrench Co. of America, 4615 N. Ravenswood, Chicago 40

4. BEARING PACKER designed for use with either a hand or air grease gun, eliminates hand packing of bearings in autos, trucks, farm and industrial equipment. Cleans bearings automatically as the old grease is forced out as new grease enters the bearing under pressure. At the same time new grease is protected from contamination by dirt or grit that may possibly be contained in the old lubricant

Gordag Industries, Inc., 3945 Wooddale Ave., Minneapolis, Minn.



SHOPPING FOR TOOLS

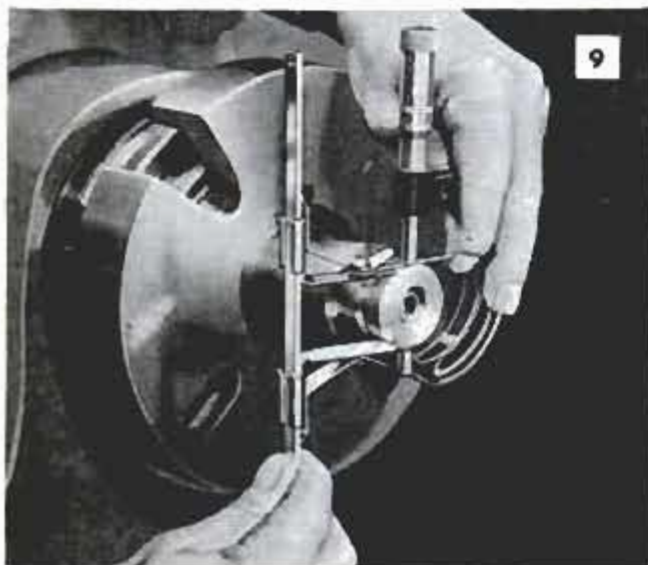
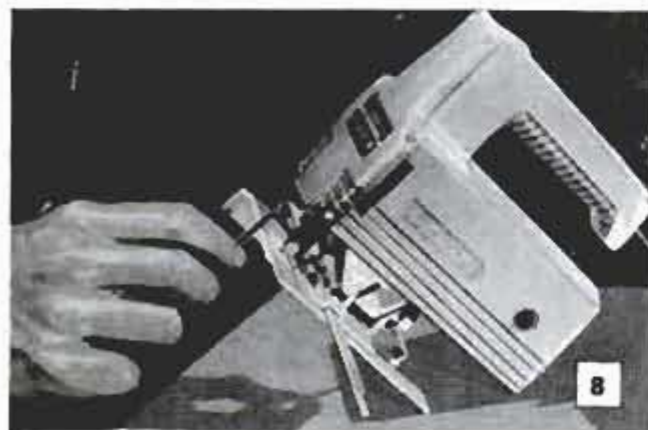
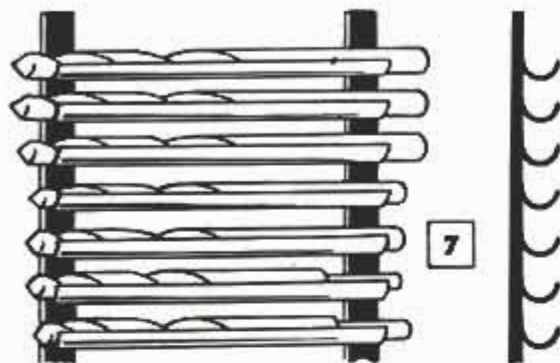

5. ENGINE-DRIVEN CONCRETE SAW features a precision adjustment to compensate for variations in the hardness of the aggregate, cutting differences in the blades and for sawing on curves or slopes. Self-propelling drive is slipfree. Speed-control mechanism provides operator with fingertip control of the cutting speeds which range from 1 to 25 ft. per min.

The Robert G. Evans Co., 6024 Troost, Kansas City, Mo.

6. 5X MAGNIFIER comes with a swiveling clamp and stand which allows adjustment of magnifier to the most convenient viewing position. Clamp is made with a sleeve which takes 5/16-in. rod for attachment to laboratory apparatus. Lens is highly corrected for spherical aberration and to eliminate distortion. Lens mounting is vapor and dust-tight metal construction.

S. B. Logan & Co., Genoa City, Wis.

7. DRILL RACK saves tools and time in the toolroom and in the school shop. Large drill bits, taps, straight reamers in varying sizes, and small and medium-size end mills can be safely stored in the minimum of space with each item always visible for quick selection of the desired size and type. Fabricated entirely of metal, unit is light, exceptionally rigid.

Lenox Tool Co., 3074 Caniff, Detroit 12, Mich.

8. SABER SAW has a comfortable handle for positive control when making straight or curved cuts. Shoe tilts right or left for angle cuts and can be locked securely at any angle. Built-in blower clears cutting line and reduces blade drag due to resinous sawdust. Cuts through 2-in. wood and also cuts plywood, plastic, leather and metal with special blades.

Cummins Portable Power Tool Co.,
Div. of John Oster Mfg. Co., Milwaukee, Wis.

9. WIRE HOLDER for thread measuring improves on the older, less certain 3-wire system where the wires must be hand-held while miking. This holder grips the 3 wires, holds them parallel in two sliding elements, or jaws, which are adjustable to fit work of varying diameters. The unit can be held in the hand, as pictured, or can be mounted stationary on bench.

Flynn Boring Tool Co., Ferndale, Mich.

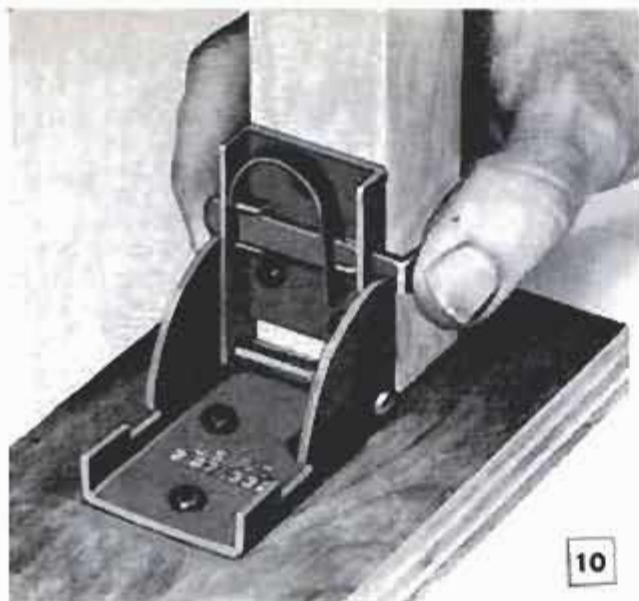

10. FOLDING-LEG BRACKET locks the leg rigidly in both the folded and extended positions. Just drive 6 screws to attach each bracket to leg and underside of table top. Makes any type of folding table a one-evening project for do-it-yourselfers, provides a quick, economical way of constructing duplicate banquet tables or light benches for industrial use
Royal Oak Tile & Paint Co., 611 S. Washington, Royal Oak, Mich.

11. LAWN AND GARDEN TOOLS in a new matched design feature a number of advancements in ease of operation and performance. Included are three types of hand pruners, two grass shears, lopping and shrub shears, grass whips and lawn and shrubbery rakes. Quality materials and the very best workmanship add to the list of outstanding features of these tools
The Stanley Works, 111 Elm St., New Britain, Conn.

12. DRYING OVEN for low-temperature operations is completely self-contained, operates at temperatures up to 300 deg. and is heated by elements of the fin-strip type. Chamber size is 38 x 36 x 48 in. and over-all cabinet size is 42 x 65 x 66 in. Unit is equipped with a 7-day timer and a circular-chart, recorder-type controller. Connected load is 9 kw.
Percy Equipment Co., 8101 Chambers Rd., Columbus 12, Ohio

13. TWO-SPEED DRILL features motor of full 3.5-amp. rating, has power to handle 3/8-in. twist drill in steel, 1-in. bit in hardwood. Two-position selector switch gives high no-load speed of 2000 r.p.m. and load speed of 1200 r.p.m. In low-speed position switch gives no-load speed of 1000 r.p.m., full load speed of 600 r.p.m. Length is 10 1/4 in. Net weight is 6 lb.
Portable Electric Tools, Inc., 320 W. 81st St., Chicago 20

14. EXPANDING WHEEL for grinding and polishing takes an abrasive sleeve 1 1/4 in. wide and 21 in. in circumference. Wheel consists of Neoprene disk, or core, faced with two steel flanges which are slotted tangentially. Pins passing through the Neoprene disk engage the slots. This construction gives the wheel a free-floating action, eliminating edge distortion
Miller Products Co., 1438 12th St., Box 325, North Chicago, Ill.

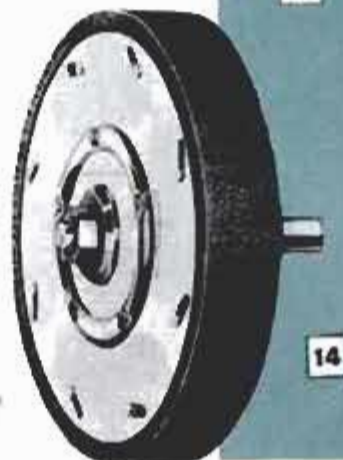
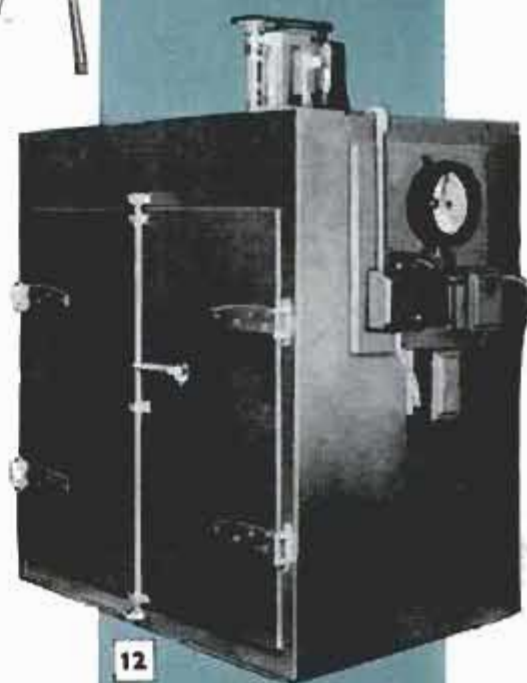



Heavy-Duty Shears From Steel Angles

Rather than discard two short lengths of 1 x 1-in. steel angle, one homeowner utilized them in making a pruning shears. The two pieces were each cut to 48 in. in length and pivoted web-to-web at a point 5½ in. from the ends, using a ¾-in. rivet (a machine bolt also can be used). Meeting edges of the webs were then ground to form cutting edges, and a round-bottom notch was ground in each as detailed. Hardwood handles were then turned and the square sections riveted to the opposite ends of the angles. — George H. Holden, Chesterfield, Derbyshire, England.

Lathe Tools Centered Quickly With Aluminum-Angle Gauge

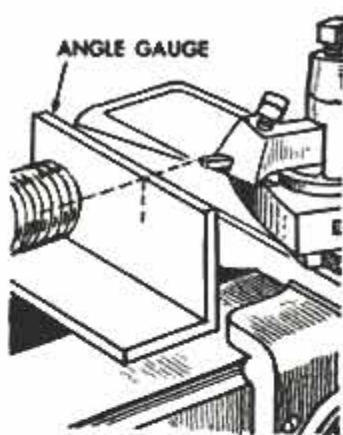

When cutting threads, turning tapers and for facing operations, a lathe tool bit must be positioned exactly at lathe-center height. To make this adjustment quickly, a gauge made from a length of aluminum angle can be used. One leg of the angle is cut to be exactly at lathe-center height when the angle is resting on the lathe-bed ways, as indicated. The top edge of the tool bit then is aligned with the top edge of the gauge. C. W. Woodson, Chicago.

Rubber "Bumpers" for Ladder Prevent Scarring Paint

To prevent the ends of a ladder from marking or scarring paint on the outside of the house when putting windows or touching-up the trim, fit the ends with rubber bands cut from an inner tube. Cut the bands 3 or 4 in. wide, and twist and double them over as shown in the detail. The doubled bands provide two layers of rubber cushion and will be held on the ladder by their own tension. They also may be tacked in place.

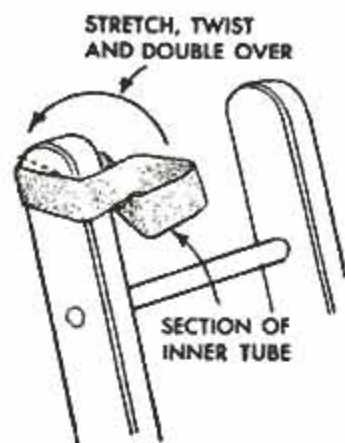

E. R. Haan, Evanston, Ill.

"Break in" Fouling Causes Plug Misfiring in New Engine

Although alarming, spark-plug misfiring in the engine of a new car that has been driven relatively few miles is not serious. Called "break in" fouling, the condition can be caused by one of several factors. Usually it is the result of oil blowing past the piston rings before they are seated. Piston rings on late-model cars last much longer in service, but also require a longer

break-in period. Piston travel is reduced, due to the short-stroke design of modern engines, so more miles are required for break-in wear. Oil sometimes is introduced through the carburetor to coat the insides of new engines to prevent rust during storage. If your engine runs roughly, speed it up occasionally on the open road to burn off the oily deposits and clear the plugs.



Full power for cutting laminates, plastics, 2" wood—even 1/2" steel bar!



Exclusive feature that lets you cut flush—right up to a vertical surface.



Starts own hole in surface of stock. Cuts fast, blows chips clear of cut.

The ONE heavy-duty sabre saw you can buy for as little as \$54⁵⁰

Compare the prices of other heavy-duty sabre saws: \$135, \$138, \$99.50! The lowest priced, heavy-duty, industrial-rated sabre saw you can buy is Stanley's H75 saw, shown above.

Like the top-priced saws, the H75 cuts 2" wood; has completely balanced anti-vibration construction; produces over 3000 long strokes

per minute; is rated at 2.5 amps.

But *unlike* these costly sabre saws, only Stanley's H75 permits flush cutting; is lightweight and costs as little as \$54.50. See it before you buy *any* sabre saw. For free catalog write: Stanley Electric Tools, Div. of The Stanley Works, 622 Myrtle St., New Britain, Conn.

STANLEY

Electric tools built for the pro, priced for the amateur



Heavy-duty 3/4 HP router with spotlight. A professional tool at \$62.50.



Stanley's rugged orbital sander for super-fine finishes costs only \$54.95.



Powerful belt sander rough sands and finishes wood, metal: \$89.95.



Full 3-amp 1/4" drill. The most powerful drill you can buy for \$24.95.

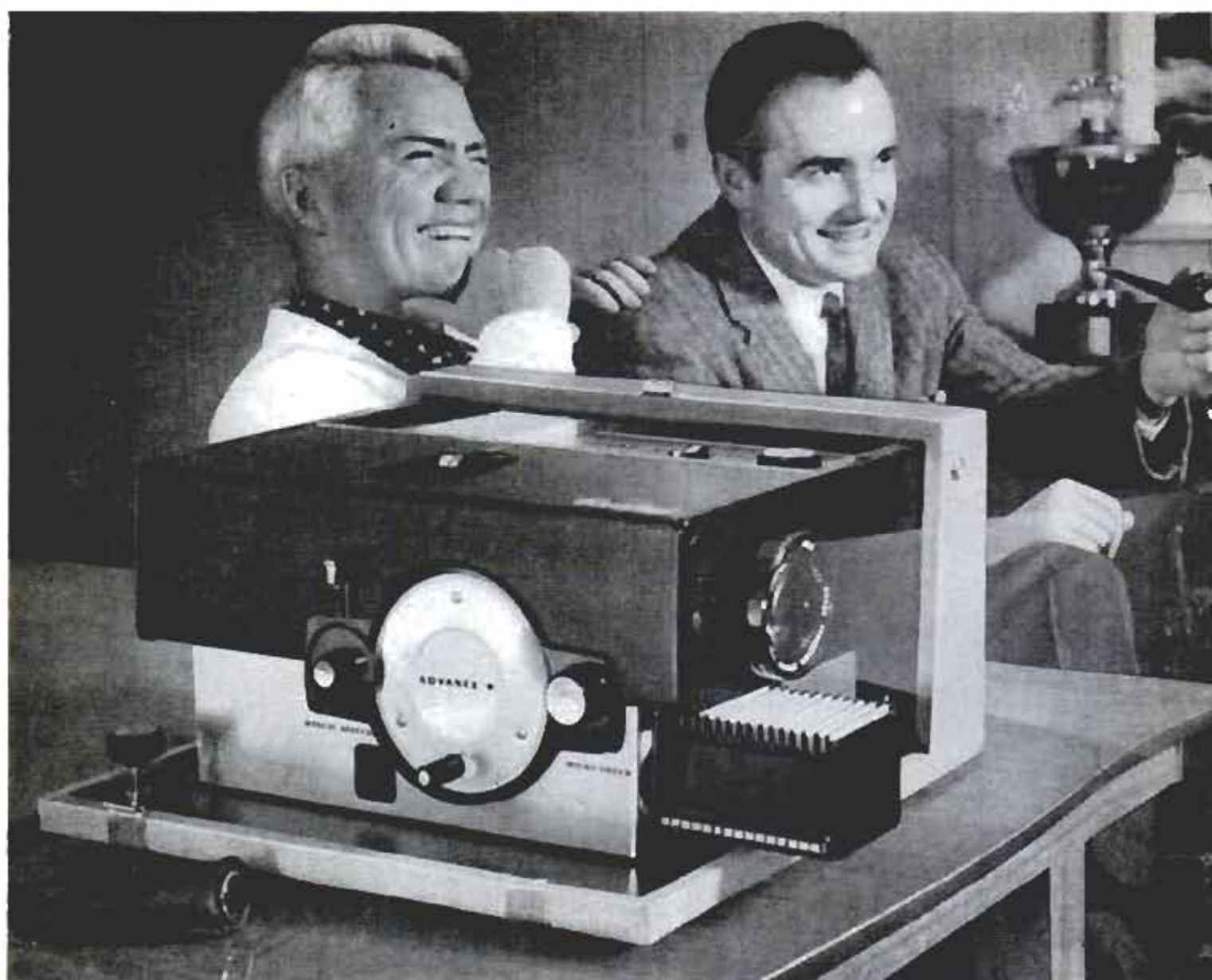

You turn it on . . . it does the rest!

New Kodak Cavalcade Projector Projects your slides

Now you can relax—be both master showman *and* guest at your own slide shows!

For the new Kodak Cavalcade Projector changes your color slides *automatically*. You can come and go—the show goes on without interruption.

And you can do new things—such as home-taped music and commentary, paced to each show.

Guests like this kind of complete showmanship. It's dramatic and *automatic*—easy with the versatile Cavalcade.

Ask your photo dealer to demonstrate the great new Kodak Cavalcade Projector. With sharp $f/2.8$ lens, remote control cord, \$149.50 or as little as \$15 down. (Price is list, includes Federal Tax, is subject to change without notice.)

Kodak
TRADEMARK

EASTMAN KODAK COMPANY, Rochester 4, N. Y.

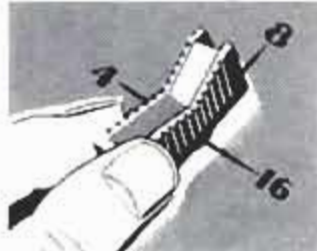

You choose from 3 automatic slide change intervals: 4-, 8-, or 16 seconds.



You can change slides by remote control up to 12 feet from projector.

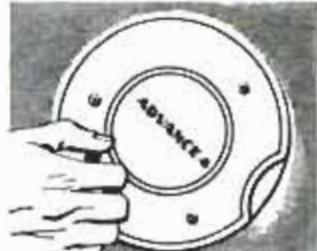

Forward or backward change by control wheel; pushbutton change, too.



You can choose 300- or 500-watt illumination. Just flick the switch.



You can show any popular slide size. New steel guards protect your slides.

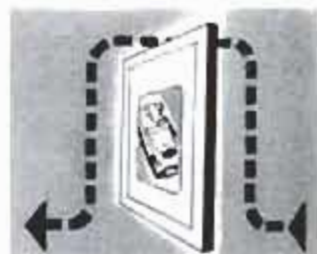

Your slides are treated with temperature-controlled air to stay in focus.



You can edit slides while tray is in projector—remove one slide, replace it.

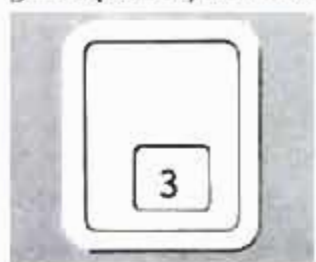

You arrange and change slide order by checking index window number.



You can point out slide details on screen with the built-in arrow pointer.

changes color slides for you! big-as-life... protects them, too!



You get sharp, brilliant screen images with the 5-inch, *f*/2.8 Ektanar Lens.



You focus your slides smoothly, accurately with the micro-focus knob.



You can preview your slides on the built-in screen of projector's self-cover.



You can remove optical system quickly for cleaning—lamp is easy to change.

See Kodak's "The Ed Sullivan Show" and "The Adventures of Ozzie and Harriet"

Here it is...

and it's
Adjustable

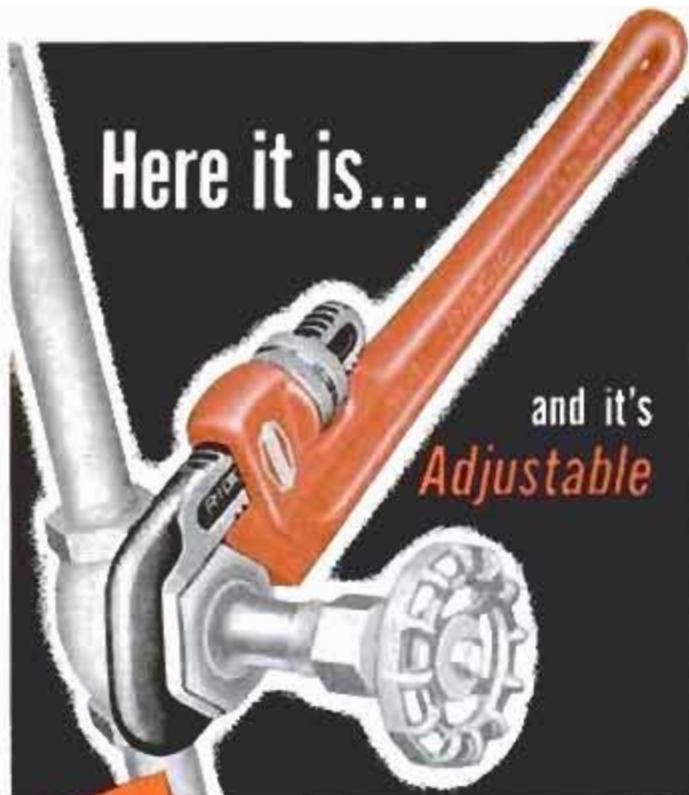

New

Pat. Applied For

RIDGID Hex Wrench

gives you Time-Saving, Positive, 4-Sided Grip on Hex Nuts, Square Nuts, Valve Packing Nuts, Unions, Gas Cocks

Here's the adjustable wrench you've always needed for hexes, squares and flatheads. Ideal for toy, mower, tractor and implement, car and home repairs. No more barked knuckles or rounded nut shoulders. New wide-open jaw goes on easy... won't slip off. 4-sided grip gives extra leverage.

Famous **RIDGID** heavy-duty construction with guaranteed housing. Narrow jaw design makes work easy in tight places. Comfort grip I-beam handle has handy hang-up-hole.

Most Wrench For Your Money!

The new **RIDGID** Hex Wrench gives you more for your money than wrenches costing twice as much. See, try and buy it at your Hardware Dealer's.



Available in 3 Sizes

$\frac{3}{8}$ " to $\frac{1}{2}$ ", $\frac{5}{8}$ " to $1\frac{1}{4}$ " and 1 " to 2 ".

The Ridge Tool Company • Elyria, Ohio, U. S. A.

Clinic for Homemakers



As a service to our readers in solving the hundreds of problems pertaining to a home—inside or out—the editors of *Popular Mechanics* invite you to present your problems to The Clinic Editor for help and advice. Address your questions to The Clinic Editor, *Popular Mechanics Magazine*, 200 East Ontario Street, Chicago 11, Ill.



Pruning Grapevine

Q—I have a grapevine on a large arbor which has deteriorated to the point where it is about to collapse. I'd like to trim the vine back and train it to grow on a new arbor. I don't know how or when to trim, or prune, the vine. Can you outline a procedure? — Y. L., Ohio

A—The vine should be pruned, or cut back, only while it is dormant and in your locality this usually means that the work should be done not later than February 15, earlier if practical, the date of pruning depending somewhat on the season. First step is to cut out all the dead wood and small shoots. Save the main trunk and arms but remove the long and extremely slender branches which have only a few short canes, or tendrils at, or near, their ends. These instructions are more or less commonly adhered to when reclaiming an old vine, but if the vine is very old, has several main trunks, and the live growth is exceptionally profuse, then it generally is best to plan to reduce the live growth not more than 25 percent the first pruning season. This usually can be accomplished by removing a few of the smaller live canes and cutting back the larger of those remaining about one fifth to one fourth the total length. When removing the vine from the trellis, and when dismantling the latter, be careful not to damage any of the live wood. It should be understood, of course, that this brief outline of a procedure is only a general first-season schedule for reclaiming an old and neglected vine and is not a method used when training a vine for maximum fruit production.



Length of Pendulum

Q—I've just acquired what appears to me to be a very old clock. It has a wooden movement but no pendulum. Case is pretty much of a wreck but the movement appears to be in fairly good condition. I'd like to try rebuilding this clock, get it running again. No one I've consulted can tell

me how long the pendulum should be. Is there a way to determine this?—H. S., N. Y.

A—Are you referring to a shelf clock or to a tall clock, commonly known in later years as a grandfather's clock? Both types of clock were made with

(Continued to page 224)

FREE PLAN shows you how to build this "Gay Paree" fun room



You'll find Masonite panels economical, easy to work with

Imagine! A touch of the *Rue de la Paix* in your own home. A gay and inviting "sidewalk cafe" where you and your friends will enjoy many a restful hour.

It's fun to build when you use Masonite® hardboard panels. On the walls you'll place Shadowvent® siding, the panel that hides all nails. You'll use the combed surface texture of Ridgeline® for contrast. And you'll rely on famous Tempered Presdwood® for making shutter slats, canopy and beam covering.

You'll enjoy working with these dense, grainless Masonite panels. They're easy to work with, easy to paint, economical to buy. You can get them at your local lumber dealer's. Send for a free plan folder. Just mail the coupon—now!



MASONITE CORPORATION
Dept. PM2, Box 777, Chicago 90, Ill.
In Canada: Masonite Corporation, Gatineau, Quebec

Please send me, free, your plan folder No. AE-319 and more information about Masonite panels.

Name.....

Address.....

City..... State.....

Zone..... County.....

MASONITE 
CORPORATION

©Masonite Corporation—manufacturer of quality panel products.

*the drill attachment that
doubles usefulness
of any portable drill*



Supreme Products' New

VERSAMATE®

POWER DRILL SPEED REDUCER

10 reasons why Versamate is the new 'must' tool for your shop:

- | | |
|---------------------------------------|---|
| 1. Gives drill seven times more power | 2. Fits all makes of power drills |
| 3. Reduces drill speed seven-to-one | 4. Drives screws of all sizes... easily |
| 5. Fast, safe, easy to operate | 6. Enough power for 1/2" masonry drilling |
| 7. Precision cut gear transmission | 8. Yankee-style quick-change bits |
| 9. Industrial tool quality throughout | 10. Low price... just \$9.95 |



ASK YOUR TOOL DEALER FOR
VERSAMATE
BY THE MAKERS OF VERSAMATIC
AND SUPREME BRAND CHUCKS

SUPREME PRODUCTS CORP. CHICAGO 16

(Continued from page 222)

wooden movements. You did not say which type you are referring to, so we'll assume you have what was known as a shelf clock. If the wooden movement is original (wooden movements are made and sold as kits at the present time) then it must be more than 100 years old and undoubtedly was fitted with a short, fast pendulum. Such movements usually were weight-driven, the weights rising and falling in channels built into the sides of the shelf-type case. Most shelf clocks having wooden movements of the period to which yours appears to belong were made with a 1/2-second pendulum which measured roughly 9 3/4 in. (9.78 in.) from the pivot point to the center of the bob, or weight, at the lower end. This weight was adjustable by means of a thumbscrew.



Finishing Door

Q—My outside doors, one front and one side door, are protected by canopies. One is of pine, the other birch. Both were sanded and finished with spar varnish less than two years ago. The pine door has darkened, one cross member having a very dark reddish-brown streak through the

center. The birch door shows dark spots in several places and the wood is rough. What happened and is there a way to remedy it?—G. H., Kans.

A—Pine tends to darken as you describe when finished in the natural color with a clear varnish, especially when exposed to light and to the effects of temperature and humidity variations. However, in most cases this tendency to intensification of colors inherent in the wood is not at all objectionable. If you use a clear finish, then there is little you can do to entirely prevent a slow change of color, other than staining the door a uniform shade at the time of finishing the new wood. You can remove the present finish, bleach the wood to some extent, stain to the desired shade and then re-finish with spar varnish or an outside clear finish made especially for outside application. Even then there is likely to be some change in the color over a period of time. Referring to the birch door, we assume you are describing the condition of the finish on a veneered door or a hollow-core door rather than one of solid-wood construction. In this case the darker spots probably are due to a vertical or near-vertical grain in the areas which seem to be affected. The fibers tend to swell when exposed to extremes of temperature and humidity and in time tend to break the finish film, permitting moisture to enter. In your case it probably will be best to remove the present finish, sand smooth and apply a mild oxalic-acid bleach to the dark areas. Finish with a sealer and an outside clear finish.

Cutting Glass

Q—I've always had trouble cutting glass. Just what is the correct procedure? In my experience the glass breaks, or it chips along the line of the cut, never breaking smooth and clean like I want it. I'm told it's very simple but I don't find it so.
—B. E., Ky.

A—The procedure is simple, that is, there is nothing involved about it, but it does require careful attention to details. First, wash the glass and wipe dry. Place the pane on a rigid, flat surface with two or more thicknesses of newspaper underneath. It's important that the surface on which the cutting is done be flat so that no undue stresses occur while the glass is being scored with the cutter. Although a yardstick can be used as a straightedge, a length of 1 x 2 in. stock is better as it is more easily held in position. Dampen the lower face of the straightedge so that it will "grip" the surface of the glass. Place a drop of light oil on the glass-cutter wheel. Hold the glass cutter in a vertical position against the straightedge. Hold the latter firmly in place and score the glass in one swift stroke from edge to edge of the panel. Lift one edge of the glass, grip it with a thumb and forefinger on each side of the score and exert pressure until it breaks along the scored line.



Now you can train in a field you pick yourself! Under the Army's new "Choose-it-Yourself" Vocational Training System, *you* choose your voca-

tional training . . . and it's guaranteed *before* you enlist. Here's your chance to get valuable training and practical experience in work you *enjoy!*

Here's how you "CHOOSE-IT-YOURSELF":



1. CHOOSE

... before enlistment!

Choose the vocational training *you* like from the categories currently available. Your Army recruiter will give you all information and advice you need.



2. QUALIFY

... before enlistment!

Take aptitude and physical examinations. To be eligible, you must have a qualifying aptitude score and meet minimum physical requirements for your choice.



3. KNOW

... before enlistment!

If you qualify, you *know* you'll get the vocational training you like! Your choice is written into your future Army record—guaranteed *before* you enlist.

CHOOSE, QUALIFY and KNOW...WITHOUT OBLIGATION!

Choose from Radar & TV Repair, Electronics, Surveying, Automotive Maintenance, Atomic Weapons, Construction, Military Police, Machine Accounting and many more. Take your choice—without the slightest obligation to enlist. You *get* the Army vocational training *you* like—guaranteed in writing—or you *don't enlist!* This week, get details from your local Army recruiter.

NEW "CHOOSE-IT-YOURSELF" VOCATIONAL TRAINING SYSTEM

U.S. ARMY



skilled hands reach for...

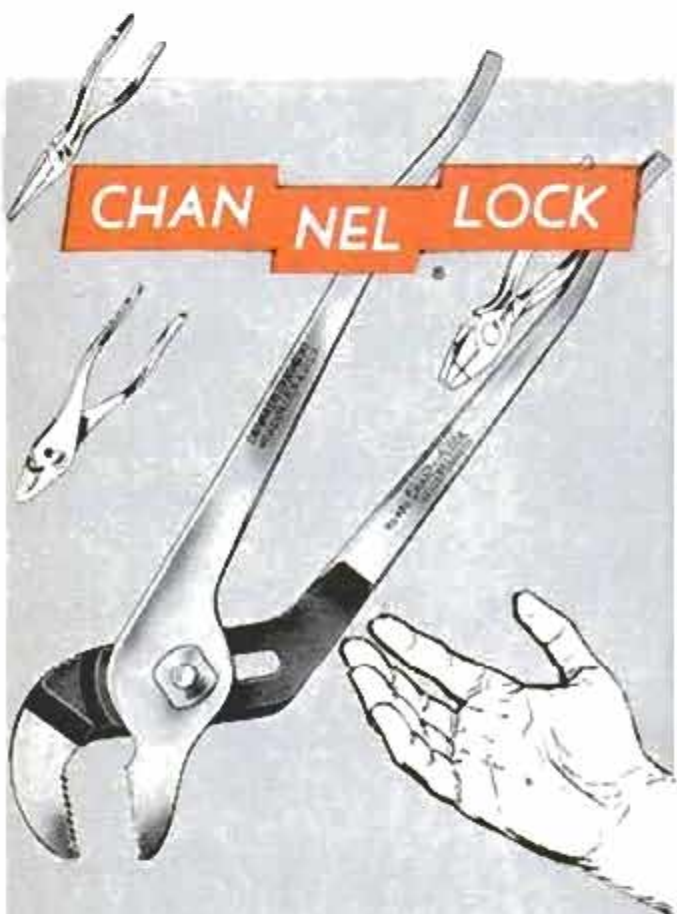

Skilled mechanics . . . thousands of them every year . . . reach for and buy Channellock pliers. Why? Ask them. They'll tell you they like the positive gripping power . . . the rugged strength . . . the precision balance . . . the all 'round handy "feel" of these quality pliers. And you will too!

CHAMPION DeARMENT TOOL COMPANY
MEADVILLE, PENNSYLVANIA

ASK YOUR TOOL SUPPLIER FOR
Genuine **CHANNELLOCK PLIERS**

Big Change in Venezuela

(Continued from page 154)

years ago, a huge new steel mill is rising that eventually will provide 1.2 million tons of steel annually. Nearby, on the turbulent Caroni River, electricians are putting the finishing touches on the powerhouse of a new dam, 165 feet high and 1165 feet long, which will power the steel mill. At present it is turning out 50,000 kilowatts, but this will eventually be expanded to 300,000.

Oil Derricks Cover a Lake

Over in the northwest corner of the country is Lake Maracaibo, one of the richest spots in the world because of its oil. The black gold, for the most part, lies in pools under the lake. Oil derricks punctuate the surface of the water like so many stakes marking off the plot of a real-estate development. Thousands of men are at work building a \$100,000,000 bridge across the lake, a bridge that will be carefully studied by engineers throughout the world, for it will be one of the longest prestressed-concrete structures ever built.

Throughout modern times, Venezuela has been forced to import a significant part of its food requirements. Now, thanks to a coordinated effort to solve the problem, Venezuela is raising 85 percent of its food. Farm lands rapidly are being upgraded through fertilizers and irrigation. Agricultural research and education are providing better crops and larger harvests. Twenty-one agricultural colonies have been established. In some respects the colonists remind you of our own settlers during the homesteading days, for colonists are given an opportunity to "prove up" or pay for their land. Homes, tools, seeds and schools are provided. As the settler brings in his crops, he uses the income to buy his land and home. At Turen, biggest of the colonies, 600 farm families are harvesting corn, beans and sesame in an area that produced nothing a few years ago.

Big Boom in Education

Improving the country is almost a bootstrap operation because of the former level of education. Even today, about half the population is illiterate. But the current administration has ordered construction of 223 new schools, and school registrations today are double what they were 10 years ago. Thousands of illiterate adults are awkwardly learning to hold pen and pencil as they squirm through classroom sessions at night in an effort to educate themselves comparatively late in life. You can't build

(Continued to page 228)

IT'S HERE!



WITH
6½"
BLADE

NEW PORTER- CABLE SAW with all the professional features

Only
\$39⁹⁵



KICKPROOF CLUTCH—Automatically puts saw into "neutral" if it jams or pinches in the cut. Prevents kickback for all around safety.



TELESCOPING SAFETY GUARD—New design of telescoping guard eliminates jamming and "drag" at the start and during any type cut.



POWERFUL—Model 66 has full 8 amp power for all types of work. Accessory rip guide is used for fast, accurate ripping.

Now you can have professional performance at a new low price! This powerful Model 66 Saw is loaded with all the famous and exclusive features found on Porter-Cable professional models.

Now you can make every possible cut, including compound miters—zip thru 2 x 4's! This safest-to-operate saw has all kinds of instant depth and bevel adjustments for supreme accuracy... weighs only 8½ lbs. perfectly balanced—built for long wear and trouble-free service.

See it at your dealers, heft it, try it—and you'll agree that you need one.

PORTER-CABLE MACHINE COMPANY
9152 Marcellus Street, Syracuse, N. Y.

Porter-Cable
Quality Power Tools

FREE FISHING CATALOG

"How to choose and use your Tackle"

BY
WORLD CHAMPION
CASTER AND
VETERAN FISHERMAN
BEN HARDESTY



"Use the right tackle,
Catch More Fish!"
says the champ

Complete fishing catalog on tackle selection and assembly with helpful tips by world champion caster Ben Hardesty. Shows you all the latest tackle for fly fishing, bait casting, spinning, salt water and exciting new push-button fishing. 32 value packed pages, plus 1959 pocket fishing calendar by Joe Godfrey showing best fishing days. Best of all, it's all free. Your gift from Shakespeare to help you catch more fish, have more fun fishing. Send coupon today.



EASY CASTS—QUICK AS A FLASH
WITH PUSH-BUTTON MAGIC!



Just a push of the
button—s-w-i-s-h
of the rod . . .
PRESTO—
PUSH-BUTTON
FISHING!
Make long, easy
casts every time
without backlash.

No. 1797 NEW heavy
duty level-wind model
with approx. 90 yds.
12-lb. line . . . \$24.95

Shakespeare
PUSH-BUTTON
WONDERCAST

SHAKESPEARE CO., Dept. PM-2, Kalamazoo, Mich.
Please send me absolutely free your brand new 1959 fishing tackle
catalog by world champion Ben Hardesty with pocket fishing
calendar.

Name _____

Street _____

City _____ State _____

a new country without learning how. Down in the tropical lowlands along the seacoast, a swarm of workers is putting the finishing touches on a huge dry dock, one of the few in Latin America. First step was simply the digging of a tremendous hole, 759 feet long, 111 feet wide and 40 feet deep, some 1½ miles from the sea. The reinforced-concrete dry dock was poured inside the hole. Then a channel for ships was dredged from the sea to the dry dock. An artificial lagoon gives vessels elbow room to turn around. In planning the dry dock, designers cocked an eye to the future. In a new building nearby is a "radioactivity room" for the decontamination of persons or objects exposed to the radioactivity of atomic-powered ships.

"Monument to the Dead Mosquito"

Drive just a few miles down the road from the dry dock and you'll come across a unique monument—a tall shaft of concrete with a steel sculpture at its base. The sculpture depicts a huge mosquito lying on its side, its legs curled up. A plaque on the shaft labels this the "monument to the dead mosquito." Venezuela has become a showplace of the world in the control of malaria. The program started in 1944. Every home in the country has been sprayed for insects, and men and equipment have sprayed vast swamps to kill off the malaria-bearing mosquito. The battle has been so successful that last year only nine deaths from malaria were reported. Prior to 1945 there were more than a million cases of malaria each year.

One thing you can't escape in Venezuela is the smell of fresh paint. If a stop watch could serve as an appropriate national symbol, a paintbrush could well be the great seal of the land. Everywhere you go you see Venezuelans wielding paintbrushes. Many of the jerry-built slum shacks are painted in clean, bright colors. Down along the seacoast I spotted a man giving the trunks of a whole grove of palm trees a coat of gleaming white paint. When I asked him why he was painting the trees, he thought a moment and replied, "Because they told me to." Then, gazing down the rows of white pillars, he added, "Looks most beautiful, doesn't it?" It did, too.

Thanks to Venezuela's booming economy, a large number of American companies have established branches there. In your wanderings through the countryside you spot countless well-known names atop industrial plants—Firestone, Chrysler, U. S. Rubber, American Can, Procter and Gamble, Pittsburgh Paints, Pure Oil.

Venezuelans, perhaps, are proudest of

(Continued to page 230)

BUY **GRAVELY** FOR MORE PERFORMANCE MORE POWER MORE FOR YOUR MONEY

Why plow with equipment you have to push, pull and help? Gravelly and its Rotary Plow attachment tills a perfect seedbed in *one operation*—all you do is guide it!

Gravelly does the tough jobs other tractors can't . . . because Gravelly has *reserve power*—now 6.6 Horsepower! Improvements in design and quality make the new Gravelly an even better buy than ever!

INVEST in the
BEST!



30 TOOLS

UNMATCHED PERFORMANCE

Choose the tools that fit your jobs from 30 year-round attachments. All powered by one Gravelly tractor!

Do the job *better* because power attachments are driven direct from the engine by splined steel shafts and gears. No belts or chains to slip, wear or break. More power *at the working tool!*

A FREE demonstration by your local sales and service representative will show you, beyond doubt, that the Gravelly and its attachments will do your jobs *better, faster, easier*. Compare. You will see that you get *more power, more performance, more for your money!*

FREE 24-PAGE BOOKLET!

Big, 24-page illustrated booklet, "Power vs Drudgery", shows how the Gravelly solves your lawn and garden problems . . . Write for it today!



FREE! MAIL NOW



- ALL-GEAR DRIVE
- POWER REVERSE

SINCE 1922

- OPTIONAL STARTER

Power attachments *securely* mounted by only four bolts. Balance, easy handling, simple controls. Cutaway view shows Gravelly's clean, compact, power-engineered design—the reason for its remarkable performance. Make the wise choice—choose Gravelly!

EASY PAY PLAN

GRAVELLY TRACTORS, INC.

P.O. BOX 601-B

DUNBAR, W. VA.

Please send "Power vs Drudgery" Booklet and dealer's name to:

Name _____

Address _____

Town _____ State _____

NEW midget pliers added to KLEIN line



Hardly larger than a package of your favorite cigarettes, these new Klein Midget Pliers will simplify many of those small jobs where space is confined.

Midgets in size but giants in performance, they solve major problems when wiring up electronic assemblies; making model trains, airplanes, automobiles, or in any extremely small or confined work.

These new midgets are additions to the famous Klein line of high-quality pliers that are backed by over a century of manufacturing experience. See your hardware dealer.

No. 257-4 Oblique Cutting Plier	Size 4 in.
321-4½ Long Nose Plier	4½ in.
322-4½ (Without Knurl)	4½ in.
224-4½ End Cutting Plier	4½ in.



Free Bulletin on Klein Pliers
Bulletin 758 lists the many various pliers in the Klein line. A copy is yours for the asking. Write for it today.

Mathias **KLEIN** & Sons
Established 1857 Chicago, Ill., U.S.A.
7200 McCORMICK ROAD • CHICAGO 45, ILLINOIS



their petrochemical plant. Three years ago the 750-acre site was nothing but untouched jungle and swamp. Overnight more than 3500 workers moved in with their families, built themselves a community and started erecting buildings. Today more than 20 huge factories dot the landscape and 10,000 people are living in a city that didn't exist three years ago. Already the plant is turning out fertilizer by the hundreds of thousands of tons, and soon it will produce plastics, artificial textiles, explosives, insecticides, synthetic rubber and vital industrial chemicals, all made from petroleum.

The health and wealth of this land of violent contrasts are of considerable importance to the United States. In the market for American goods, Venezuela ranks second only to Canada. In one recent year, Venezuela paid a thumping \$1,000,000,000 for U. S. products and another half-billion for intangibles such as ocean shipping and insurance. That's enough dollars to produce a profound effect on the economy of this country.

At this moment a middle-aged Venezuelan, newly introduced to the sight of jet planes and Jaguars, is tying steel rods into the forms for a new section of the Pan American Highway. Another middle-aged man is rolling out steel rods in a mill at Joliet, Ill. There's a direct connection between the two; the better one lives, the better the other is likely to live, too. ★ ★ ★

Rivers Are Higher on One Shore

According to the Coast and Geodetic Survey, a river is higher on one shore than the other because the deflecting force of the earth's rotation swerves any moving body—to the right in the Northern Hemisphere and to the left in the Southern Hemisphere.

Do You Know These Old Timers?

(Answers to quiz, page 14)



Left, Kelly-Springfield 1913 truck.
Right, 1917 Model-T Ford touring car.

NEW!

THE DRILL THAT DRIVES A WORKSHOP

Patterned after Millers Falls famous "888" Power Unit, this versatile new 1/4" electric drill direct-drives a wide line of rugged, quick-change attachments — many of them the same as are used with the "888". It's truly a mighty mite with full 2.7 amp. motor and 2250 RPM gearing for high torque. Ask your dealer to let you see it soon. It's the dollar-saving way to start a 14-tool power workshop with maximum performance and *real economy*.

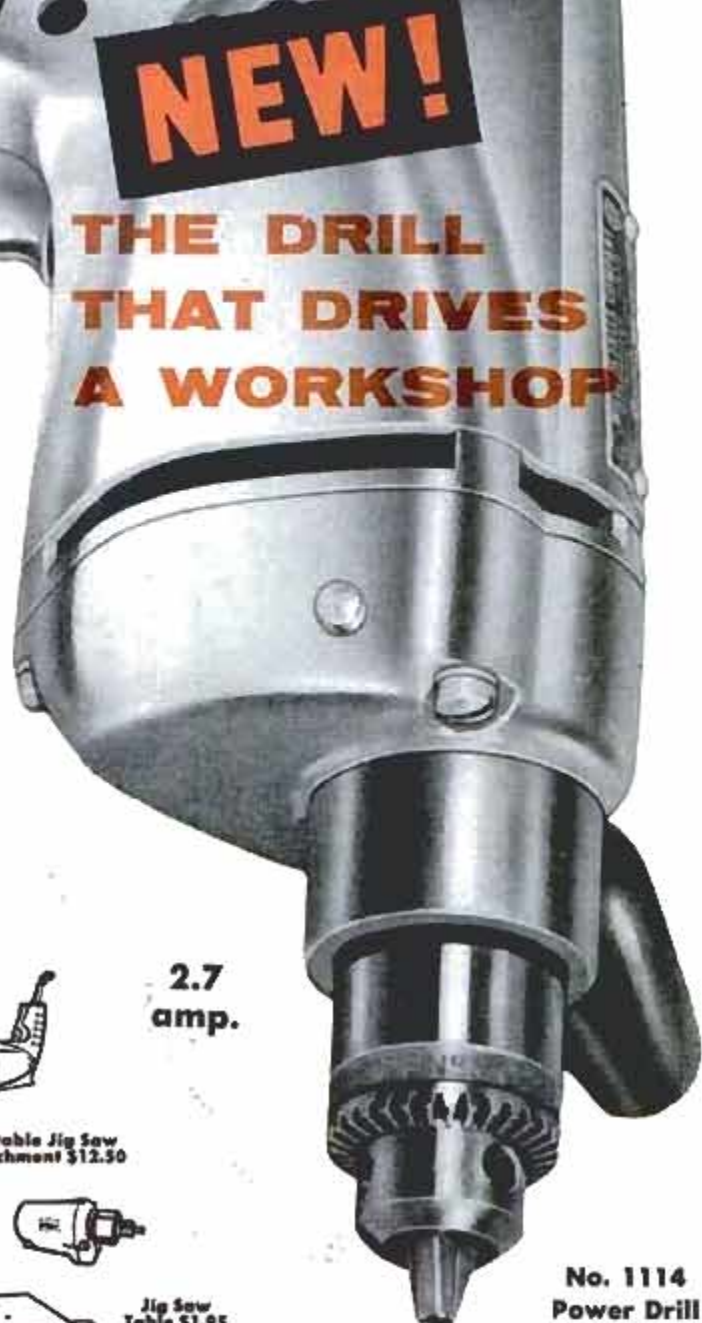

2.7 amp.

No. 1114 Power Drill \$22.95



Orbital Sander Attachment \$13.50

Portable Saw Attachment \$13.50



Bench Sander Attachment \$9.95



Drill Press Stand \$15.95
Drill Press Vise \$5.95



Portable Jig Saw Attachment \$12.50

7-to-1 Speed Reducer \$13.50



Jig Saw Table \$1.95

Bench Grinder Attachment \$7.95



Floor Polisher Attachment \$29.95



Hedge Trimmer Attachment \$12.95



Bench Stand \$1.95



Write for free literature
MILLERS FALLS COMPANY
Dept. PM-27, Greenfield, Mass.

**Skilled
Machinists
Prefer
South
Bend**



Photo from Learcal Division, Lear, Inc., Los Angeles

The day of the precise craftsman is not past. You should see how some of the nation's finest workmen go about doing their jobs with painstaking accuracy.

Such accuracy is absolutely vital in the manufacture of many of the precision components that make this "Space Age" possible.

To get the accuracy and fine finish so necessary on precision parts, skilled machinists choose South Bend 16" Lathes.

- Dependable—Trouble-Free
- Spindle bearings designed specifically for precision work.
- Quiet running—No Vibration—No Gear Marks—Delivers parts with extremely fine finish.

Prices of South Bend 16" Lathes start at \$2468 f.o.b. factory

Write for catalog of South Bend Lathes, Milling Machines, Shapers, Drill Presses and Pedestal Grinders

SOUTH BEND



LATHE

SOUTH BEND 22, INDIANA
BUILDING BETTER TOOLS
SINCE 1906

Piston Pilots Go to Jet School

(Continued from page 137)

against his mouth and nose. He is immediately on 100 percent oxygen. Meanwhile, cockpit crew members are strapping on their demand-type masks. As a matter of fact, either the pilot or copilot wears a mask at all times at high altitude, or keeps it laid out in front of him ready for instant use.

The first thing a pilot would do if rapid decompression occurred would be to make an immediate rapid emergency descent to below 14,000 feet. He would get down there as fast as the Mach limit of the airplane would permit. All crews are trained in this emergency procedure.

The engines on the 707 are Pratt & Whitney JT3C-6 gas turbines, known to the military as the J-57. The commercial version is without afterburner, of course. They are so dependable that they go 1000 hours between overhauls in military use. On the 707 they are equipped with thrust reversers that do the same job as reversible-pitch propellers in reducing the length of the landing run. They also are equipped with noise suppressors that minimize exhaust noise on the ground while climbing out from an airport.

Pilots Study Jet Engines

Part of pilot training is to become completely familiar with these power plants. Pilots learn it's never safe to stand closer than 25 feet ahead of an engine intake, or closer than 75 feet from the jet exhaust at takeoff power. They learn how to handle a hot start or a hung start when lighting up. They rehearse fire-fighting procedures, including engine shut-down, and the technique of getting an air start in case of flame-out. They learn to measure the amount of thrust developed by an engine by reading the engine-pressure ratio gauge on the instrument panel, and how to monitor the exhaust-gas temperature gauges.

Two other new, and important, instruments are the true-air-speed indicator and the Machmeter. The true-air-speed indicator makes its own corrections for temperature and altitude and always shows the actual speed of the airplane. It has become a basic flight instrument for takeoffs and landings.

When Captain Bittner was planning his takeoff he first used a chart to find the speed at which the plane would lift off the ground, based on its gross weight, pressure, altitude, headwind and a temperature correction. This takeoff speed is designated as V-2 and is 1.3 times the stalling speed of the airplane under the existing weight and

(Continued to page 234)

Did '59 Bring You The Car You Asked For?

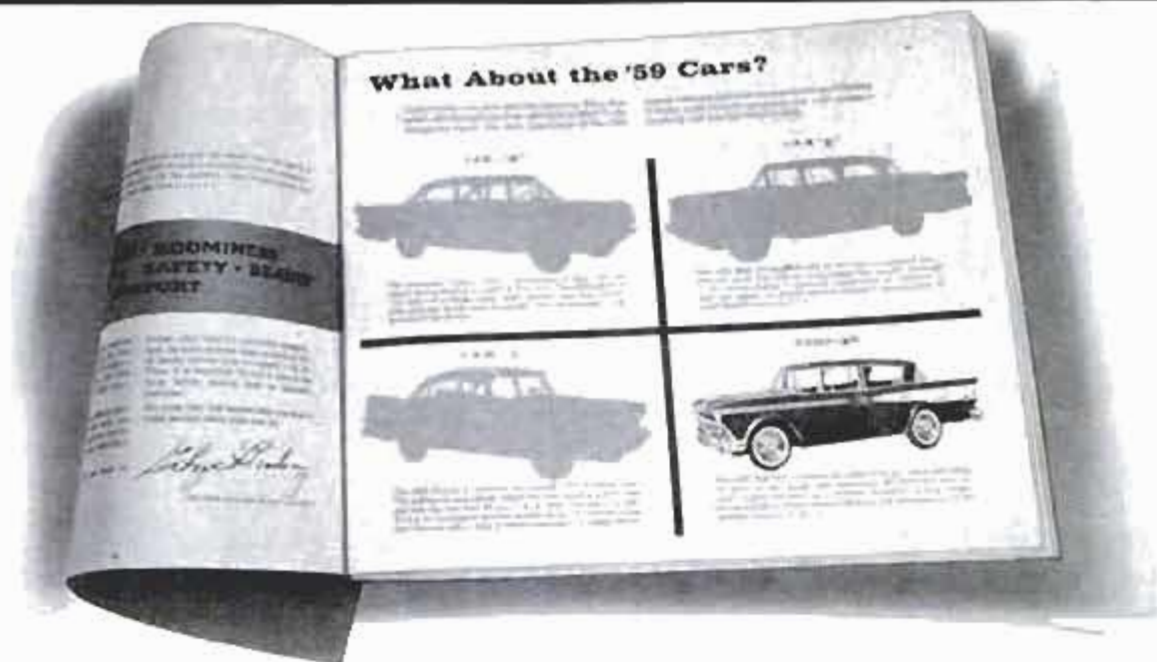

New Automotive X-Ray Compares All Leading 1959 Low-Priced Cars!

Before you buy any new car, you'll want the straight facts on quality, features, economy, performance, room and comfort.

Within the pages of the 1959 edition of the popular AUTOMOTIVE X-RAY you'll find the answers. The X-Ray gets beneath the skin of each car . . . analyzes them side-by-side to show you what you get for your motor car dollar. Here is a revealing comparison of the

new cars that presents the facts in clear, easy-to-read, easy-to-understand fashion.

All information is derived from automotive engineering publications and from the official literature of car makers.

Save time . . . save money when buying a new car. Go first to your nearby Rambler dealer for your FREE copy of the authoritative 1959 AUTOMOTIVE X-RAY.



1959 RAMBLER 4-DOOR SEDAN

Has 1959 brought you the car you want? Contrary to the expressed wishes of most car buyers, most American cars have grown bigger, bulkier, more expensive to operate. Rambler has held the line on size in '59 . . . further improved economy and comfort. Get all the facts in the 1959 AUTOMOTIVE X-RAY.

See Your Nearby **RAMBLER** Dealer
For Your Free Copy of The 1959 Automotive X-Ray
Get It Today . . . No Obligation!



*"I'm sure of
top precision
with this"*

Starrett® LEVEL

(No. 132 Series)

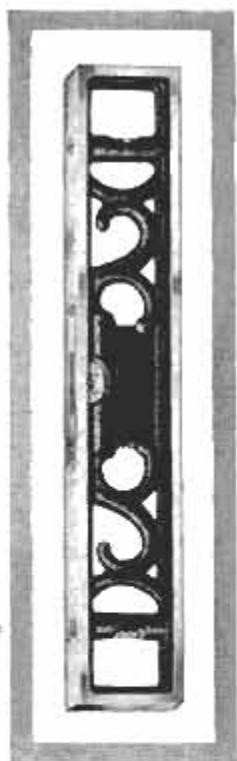

"After you've put a lot of work into a job, it's a poor time to discover you can't trust your level . . .

"That's why I use the Starrett No. 132 Precision Level. It's made from the finest seasoned cast iron — built to take hard use and give a lifetime of accurate service. The big main vial and double plumbs are graduated for easy reading. Base has new involute groove for use on flat or cylindrical work and the frame has a tough black wrinkle finish that stays clean, always looks good."

Starrett No. 132 Series Levels are made in 4, 6, 9, 12, 18 and 24-inch sizes. Recommended for mechanics, machinists, carpenters, plumbers, masons, home workshops. Starrett also makes Master Precision Levels, Bench Levels, Engineer's and Plumber's Levels, Cross Test Levels, Line Levels, Pocket Levels and more than 3,000 fine tools for mechanics in every craft and trade.

BIG NEW CATALOG — FREE

Describes and illustrates over 3000 Starrett Tools. Send the coupon.

STARRETT TOOLS are carried by leading Industrial Supply Distributors and Hardware Tool Stores

THE L. S. STARRETT COMPANY

Dept. AP, Athol, Mass., U. S. A.

Please send my free copy of the big, new Starrett No. 27 Catalog.

Name.....

Occupation.....

Address.....

City.....Zone.....State.....



other conditions. For this particular trip of Captain Bittner, it worked out to be 143 knots.

During his takeoff run, Bittner would first pass V-1, the speed at which he decides whether performance is up to standard. Then, five knots short of V-2, at 138 knots, he rotates the nose upward to take-off attitude, and the plane breaks ground exactly at V-2. His noise abatement climb will be V-2 plus 10 knots, and within a couple of minutes he will be accelerating to 355 knots while still climbing.

At high cruising speeds Captain Bittner refers mostly to the Machmeter instead of to the true-air-speed indicator. The Machmeter shows the airplane's speed in relation to the speed of sound and is red-lined at Mach .88, which the pilot won't exceed. Under the right conditions passengers can actually see sound waves forming on the wings and can feel the slight buffeting that occurs at high but safe Mach numbers.

Other additions to the cockpit include an air-date system that uses a computer to show true outside-air temperature (for jet-stream identification) and true corrected altitude. There is also a flight-director system that consists of a horizon-director indicator and a course-deviation indicator. Between them, the two instruments show which way to go to reach a desired radio marker, and provide information to the autopilot for flying a preselected heading.

The standard autopilot has been improved for jet use and now contains an automatic-flight monitor that safeguards against erratic maneuvers that might be caused by an autopilot malfunction.

Today American Airlines is continuing to train more of its crews for flying the jets, in groups of six flight crews at a time. We are changing over to jet transportation just as fast as we can get deliveries. By 1962 we expect to have a fleet of 110 turbine transports, of which 75 will be pure jets and 35 will be turboprops. ★ ★ ★

Number, Please!

Whenever you write us to

- Renew your subscription
- Change your address
- Order your own or a gift subscription

. . . In fact, whenever you write us,

PLEASE INCLUDE YOUR CITY POSTAL ZONE NUMBER IN YOUR ADDRESS

*This insures better delivery.
It helps you and it helps the postman.*



10" Band Saw

DELTA SHOP



Saw, Jointer, Drill Press, Sander



9" Tilting Arbor Circular Saw



Deluxe 4" Jointer



"Super 900" Radial Saw



14/11 Lathe



Heavy Duty Shaper



11" Drill Press

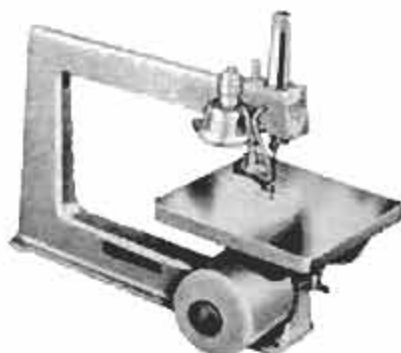

16" Scroll Saw

DELTA[®] HOMECRAFT[®] TOOLS

put more of your skill to work

You're well equipped for *any* job—from a bird house to a boat—when you own the finest power tools money can buy! That's why more home craftsmen insist on the quality, capacity, and performance only Delta tools can give. And because Delta makes the world's most *complete* line, you can choose tools exactly right for your jobs.

No need to dream and wait, either—just add the tools you need NOW and pay on terms to fit your budget. See your Delta Dealer (he's listed under "TOOLS" in the Yellow Pages) or at leading Department, Hardware, and Building Supply stores.

Get this handy Homecraft Catalog FREE



Shows every tool complete; describes hundreds of money-saving accessories; gives valuable workshop hints. Also shows Saw-Jointer combination, Dust Collector, 6" Bench Grinder. Write: Rockwell Manufacturing Co., Delta Power Tool Division, 502B N. Lexington Ave., Pittsburgh 8, Pa.

DELTA POWER TOOLS

another fine product by

ROCKWELL



80¢ makes a hard job easy

 A few quick strokes with this 80-cent Red Devil Scraper File makes dull scrapers razor-sharp. You'll be astonished at the difference. If you really hate work, buy our replacement scraper blades instead — 20¢ to 50¢.

 You sand the wood instead of your hand with this comfortable Red Devil Sandpaper Holder that lets you bear down hard. 55¢, or a dime more with sponge rubber backing pad.

 Poor patching of plaster often results from inadequate scrape-out of cracks. So the expert uses a special Red Devil Crack Scraper. For 55¢, you can afford to do likewise.

 Glass cutting is easier than you think with a Red Devil Glass Cutter and a few tips in the booklet offered below. We make 15 kinds for professionals but the 55-cent No. 024 serves most amateurs nicely. Look for the red, white, and blue package.

It's always best to buy where Red Devil Tools are sold, for wider choice, top quality, correct "how-to" advice.

Free booklet,
"How To Cut Glass."
Address Dep't B-2

4870



Red Devil Tools.

Union, N. J., U. S. A.

World's largest manufacturer of painters' and glaziers' tools.

Refinishing's EASIER WITH Heavy-Bodied KLEAN-STRIP

LOWEST PRICED
WATER-WASHABLE
PAINT REMOVER

Peels off paint and all other finishes quickly, easily. Non-inflammable and needs no neutralizing. Use for either wash-off or scrape-off removal. Write for free folder describing a professional's way to remove old finishes. The Klean-Strip Co., Inc., P. O. Box 10083A, Memphis 6, Tenn.

Transistorized Car Radio

(Continued from page 160)

battery holder between the speaker and the parts on the back panel of the case.

Leave approximately 1/4-in. clearance between the front panel and the edge of the audio chassis to permit passage for the green and yellow leads of T4 which is fastened to the chassis from underneath.

The battery holder should be made just wide enough to provide a snug fit for the two batteries. A 1 1/2-in. machine screw and nut serve as a clamp to hold these firmly in place. Two holes near the bottom of the battery holder are used to fasten it to the bracket which is a part of the loudspeaker.

When used in a car, the radio will be subjected to considerable vibration. All parts mounted with screws and nuts, therefore, should be fastened securely and lock-washers should be inserted under each nut.

Wiring and Soldering

Wiring of the receiver is entirely conventional. Connecting points for all small parts and wires are clearly shown in the pictorial diagram.

Begin the wiring with the audio chassis and the parts mounted on the case. All wiring and soldering should be done before the transistors are inserted in their sockets. If the aforementioned power-transistor mounting kit is not employed, the wires to the emitter and base leads should be soldered as quickly as possible to prevent damage to the transistors.

Two 8-32 screws, the same screws which fasten the 5-lug terminal strip and the two ground lugs to the audio chassis, are used to fasten the chassis to the speaker frame. The chassis holes for these screws must be carefully spaced to coincide with the spacing of the tapped holes in the back of the speaker frame.

Like the audio chassis, the r.f. chassis should be completely prewired before being mounted to the second speaker. In fact, the entire receiver can be aligned before this chassis is finally mounted. To do this, the leads interconnecting the r.f. chassis with other components of the receiver are made somewhat longer than actually necessary, but these can be shortened after the final installation. Furthermore, the chassis will have to be grounded to the case before any adjustments can be made and, of course, the batteries must be wired into the circuit. Carefully observe battery polarity, as shown in the pictorial wiring diagram.

Alignment of a transistor radio is similar

(Continued to page 238)

SAVE MONEY on LUMBER

with the LOW-COST
BELSAW PLANER

Convert Rough and Random Size Lumber Into Cabinet Finished Stock

Now anyone can make perfect cabinet finished stock from low-cost rough lumber... any size up to 12 1/4 inches wide and 6 inches thick. Turn out high grade finished material at a fraction of the cost you pay lumber yards. Big 42-inch-long bed makes it easy to plane heavy, wide and long pieces... BELSAW self-feeds at 14 to 34 feet per minute.

USE THIS ONE LOW-COST MACHINE for Planing, Jointing, Sawing, Milling, Tongue and Groove. You can easily make flooring, siding and many other popular patterns with your Belsaw. Your Belsaw quickly pays for itself with savings on raw materials and profits on finished stock... a highly profitable machine for custom work. Compare Belsaw with any 12-inch planer on the market... Belsaw gives you more essential features—yet costs you \$50 to \$125 less than others.

Send Today for Free Literature on the Belsaw Multi-Duty Planer.

BELSAW MACHINERY CO 2059 Field Bldg. Kansas City 11, Mo.



HULL AUTO COMPASS

installs in ALL newer cars ... EASILY

ONLY Hull's universal bracket permits easy mounting on upper or lower windshield moulding. Vacuum cup also included for windshield mounting. Fits any car of today or tomorrow. Compensates easier, reads easier. \$5.50 and \$6.95. At your dealer's, write for literature.

MOST-USED COMPASS OF MOTORISTS, BOATERS

HULL MFG. CO. P.O. Box 246-D-2, Warren, Ohio



TRANSEAL

PREVENTS AND STOPS LEAKS IN AUTOMATIC TRANSMISSIONS

Prevents and stops leaks due to drying, hardening or shrinking of transmission seals. Reduces gear and bearing noise... makes shifting quieter faster... smoother.

AT SERVICE STATIONS, GARAGES, AND AUTO ACCESSORY STORES

RADIATOR SPECIALTY CO.
CHARLOTTE, NORTH CAROLINA



CONCRETE REPAIRS that won't break loose!



LOXON LATEX CONCRETE patches holes and cracks in any kind of masonry... and does it easily, smoothly, permanently. Made of super-fine cement and finely ground glassmaker-quality sand mixed with pure liquid latex to provide amazing adhesion. Ideal for repairing foundations, floors, broken steps, brickwork and mortar. Superior to any other type of concrete repair material. At leading paint, hardware, lumber and department stores.

KING MIDGET

More power, beautiful styling. New Features. Still World's Lowest Priced Car. Drive it for 75c a week. Riders agents wanted. Earn your own car.



2 GREAT AUTO BARGAINS

King Midget Junior chassis, fully engineered, ready to run. Agents wanted. Send 25c for 32 page picture book, full details, dealers price on both cars. Or send \$1 (refunded first order) for this and Service Manual, plus Repair Manual and 15 5x7 photos of car and factory.

MIDGET MOTORS CORPORATION, ATHENS 1, OHIO



EARN GOOD MONEY-Spare or Full Time IN A BUSINESS OF YOUR OWN...

SMALL INVESTMENT — NO EXPERIENCE NEEDED

Thousands of men are making big money in their own business. You too, can have a fine income with an assured future in spare or full time with the Universal lawn mower grinder. Investigate our success plan now, it includes everything you need plus facts on how others have earned over \$3,600 in one season, working part time. Act now! Mail coupon today!

SEND COUPON TODAY

ROGERS
MANUFACTURING CO.
Lindsey, Ohio

ROGERS MFG. CO., Dept. M-29, Lindsey, Ohio
Gentlemen: Rush me FREE details on easy inexpensive way to get into my own business.

Name _____
Address _____
City _____ State _____

to that of a vacuum-tube receiver. If a signal generator is available, follow the alignment procedure outlined in the manual accompanying the instrument. But even without test instruments, the receiver can be aligned if there are stations in your area which operate near the top and bottom end of the broadcast band, 1600 kc. and 550 kc., respectively.

Alignment can be simple or difficult, depending upon the degree of matching between the components of the tuning circuits. Those used in the original model were not precisely matched, requiring the removal of a few turns of wire from the loopstick, L1, and the addition of capacitor C4 in order to obtain proper tracking. With matched components, including the loopstick, the oscillator coil, L2, and the tuning capacitor, C2-C3, this would not be necessary. Since matched components now appear in a number of radio catalogues, the following instructions assume that such parts are being used.

With the receiver fully wired and all parts interconnected, set switch S2 to the PORT. position and advance the volume-control setting to about three fourths of maximum. If there is a tendency towards audio oscillations, it can be eliminated by temporarily soldering a wire between a ground lug of the audio chassis and one on the r.f. chassis.

Now rotate the tuning dial across the band. You should be able to tune in some stations immediately although the volume may be low. If the receiver whistles when you tune past a station, oscillations in the r.f. chassis are indicated. You may be able to eliminate these by a slight adjustment of the i.f. transformers T1, T2 and T3. If not, replace R3 with the next lower resistance value.

Tune in a station near the low-frequency end of the band and compare the dial setting of the receiver with that of any other radio tuned to the same station. If the dial setting is incorrect, rotate the dial to the correct position and adjust the screw or "slug" of the oscillator coil until the station is again audible.

Tune in a station near the high-frequency end of the dial and adjust the trimmer screw on the frame of capacitor C2 until the station comes in with maximum volume. Again compare the setting of the dial pointer with that of another radio tuned to the same station. If they do not coincide, rotate the dial to the proper position and adjust the trimmer on the frame of capacitor C3 until the same station is heard. Then retune the r.f. trimmer (on C2) for maximum station volume.

Finally, tune in a station near the center of the band and adjust the i.f. transformer cores for maximum volume. Repeat the previous checks and readjust the tuning capacitor trimmers if necessary.

Final Assembly

After the adjustment is completed, mount the r.f. chassis on the speaker frame. You may need a couple of 1/4-in. metal spacers between the chassis and the speaker to permit the i.f. transformers to clear the loopstick mounting board.

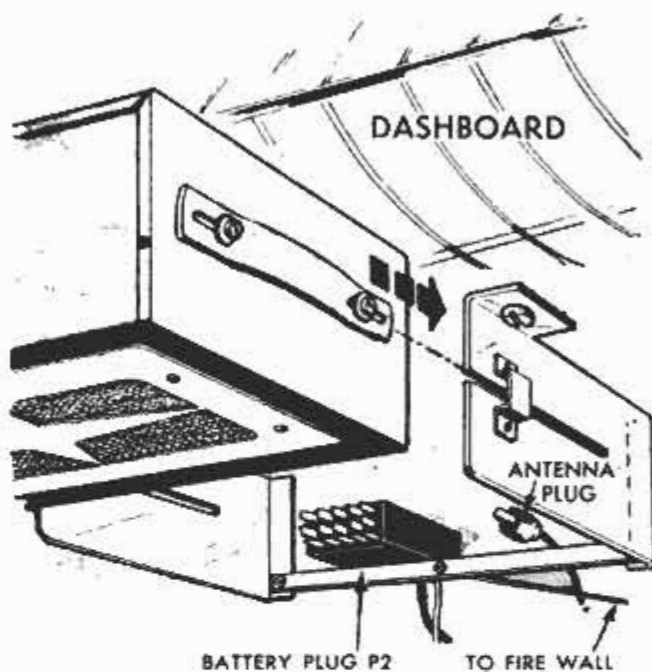

One possible method for mounting radio inside car. For cars with negative ground, mounting brackets must be insulated from dash with fiber washers

Though not shown in the pictorial, a heavy wire, or wire braid, should be soldered between the r.f. chassis, the tuning capacitor frame and audio-chassis ground.

To permit radio signals to reach the loopstick, an opening must be made in the case cover to coincide with the position of the loopstick (see title photograph). The opening can be covered from the inside with a thin piece of stiff plastic or similar insulating material.

A leather strap fastened to one end of the case cover serves as a carrying handle when the receiver is used as a portable.

Car Installation

Schemes for mounting the receiver in a car may be as varied as the automobiles themselves. One possible method is illustrated on this page. Here, two slotted brackets, spaced the width of the receiver, are fastened underneath the dash. The brackets are mounted so that they slope downward to the rear and they are fastened

(Continued to page 240)



New Sea-Horse V-50—so quiet at full throttle you can enjoy your radio or conversation!

Secrets of the soft-spoken Sea-Horse!

In recent years, the biggest news in outboard boating has been strictly "hush-hush"! Johnson has been keeping things quiet—its motors, that is. Though more powerful, these beautiful outboards are now made quieter than ever before. Every Sea-Horse for '59 includes four special features to eliminate annoying noise.

THE PERFECT MUFFLER

No gasoline engine could operate without exhaust. Johnson motors use the ideal exhaust muffler—water! By discharging exhaust under the water, noise is reduced to a gentle, bubbling sound.

SPECIALLY DESIGNED GEARS

Johnson engineers did away with the whine of fast-turning gears by designing unique Spiral Bevel gears. Velvet-quiet when new, they stay quiet even after years of use.

VIBRATION CUSHIONING

Soft rubber mounts "float" the larger Sea-Horse motors within their housings. On smaller engines, a unique Johnson Suspens-

sion Drive separates the motor from the boat, dampening noise radiation.

SOUND-SEALING HOUSINGS

Any remaining sound from a Sea-Horse motor is tightly sealed inside the motor housing—right down to the water line. The new '59 fiberglass-reinforced plastic hoods with Johnson's exclusive Dynautical Design are particularly effective in this respect.

Also, sound frequency is controlled. This can make the difference between an annoying whine and a hearty engine purr. Johnson engineers use the most modern electronic instruments to track down sources of high-frequency sound and reduce them to comfortable levels.

No wonder Sea-Horse owners are pleased with the quietness of their outboards, whether they own a 3 or 50 hp model. Johnson is the only outboard motor ever to win an award for quietness from the National Noise Abatement Council. See for yourself how quiet a Sea-Horse can be. Your Johnson dealer is listed under "Outboard Motors" in the Yellow Pages.



Johnson

FIRST IN SALES
FIRST IN DEPENDABILITY

FREE PLAN

Tells How to Start
Your Own Business

FILING SAWS



Sharpens 1000
Saws a Year

"I sharpen around 1000 saws a year in my part-time shop. Work comes from as far as 55 miles away." — Joe H. Walker.

Foley Filer
Buys Our Groceries

"I have filed about 500 saws in spare time. My wife agrees the Foley Filer is a good investment because it earns enough extra cash to buy our groceries." — R. J. Kreuser.

FOLEY FILED SAWS BRING NEW CUSTOMERS

Here is a steady repeat CASH business that pays up to \$3 or \$6 an hour, and you can start in your own basement or garage in your spare time. Every saw you sharpen with the machine accuracy of the Foley Saw Filer is an ad that brings more customers. J. C. Deibert wrote us: "Since I got my Foley Filer five years ago, I have averaged 4 1/2 saws each day over all this time." Howard Kuhns says "We operate 2 Foley Filers, and our business averages about 500 saws per month. The count last year was 5,798 saws."

You can file all hand saws, also band and crosscut circular saws on the Foley Saw Filer. The adjustments are simple—there is no eyestrain and you can start right away to turn out perfect cutting saws. "The first saw I sharpened with my Foley Saw Filer came out 100%. I think it is a marvel of perfection."—writes Clarence E. Parsons.

"**MONEY MAKING FACTS**" explains how you can get business from hardware stores, home owners, farmers, carpenters, schools, mills, factories, etc. Just think with a modest investment, no overhead, no stock of goods to carry, you can start right in on a cash business that will help pay the rent, buy groceries, or a new car. Time payments if desired. Get the facts—send coupon today for this practical, money-making plan. No salesman will call.



Send for **FREE BOOK**

FOLEY MFG. CO., 216-9 Foley Bldg.,
Minneapolis 18, Minn.

Send me free book "MONEY MAKING FACTS"

Name _____

Address _____

together at the back with a connecting bar. The bar is securely connected to the fire-wall of the car to support the assembly.

To use this arrangement, two binder-head screws are fastened to the end of the case cover, directly opposite those holding the leather strap. The screws are mounted with nuts and lockwashers both on the outside and inside of the case so that there is about 1/8 in. separation between the screwhead and the outside nut. The two sets of screws on opposite ends of the radio case fit into the slotted dash-mounted brackets for easy installation and removal of the radio.

External Connections

Two external connections, one to the automobile antenna and the other to the car battery, are required to operate the receiver in your car. Since complete antenna-installation instructions are supplied with each antenna purchased from a dealer, these need not be repeated here. Battery connections, however, are extremely important and the following directions must be explicitly observed to eliminate the danger of damaging the transistors or short-circuiting the car battery.

Battery connections are made through two flexible wire leads soldered to pins 11 and 12 of plug P2. Insulated 18-ga. wire is suitable for this purpose. The wire connected from pin 11 must go to the positive side of the battery while the wire from pin 12 goes to the negative side. Color-coded wires should be used to prevent a possible mixup.

But here's the important point. This receiver was designed specifically for a foreign sports model having a 12-volt ignition system with a *positive (+) ground*. Most American 12-volt ignition systems operate with a *negative (-) ground*. When the radio is used with a negative ground system it is essential that the receiver case be electrically insulated from the car frame or dash. If the radio is to be installed as shown, use insulating fiber washers (one flat and one shouldered) at each mounting screw for fastening the brackets to the dash. But whatever mounting method you decide to use, the receiver case should not be permitted to contact any metal part of the car under any circumstances. Moreover, if the antenna lead-in is a shielded wire, the shield braid should not be connected to the antenna plug.

With these instructions carefully followed, the receiver should provide excellent service both in and out of the car—a rewarding finish to an interesting project.

★ ★ ★



Smooth-smoking, even-burning, long-lasting, mild AMPHORA is blended in Holland. Popular priced. In handy pouches and tins, at tobacco counters everywhere.

Make your next pipeful
AMPHORA



For Many Uses!
Metal Turning Lathe
Only **\$49.95**
F.O.B. Lansing, Ill.
15 1/2" bed with 4 1/2" swing,
7" between centers.
Satisfaction Guaranteed.
FREE FOLDER
Write for it today!

Rosemoor Manufacturing Co.
Box 147J, Lansing, Ill.

BE YOUR OWN BOSS . . . in the fast growing, profitable excavating business. The tractor mounted Sherman Power Digger will enable you to dig for septic tanks, drainfields, sewer lines, swimming pools and many other jobs. For full information, write **Sherman Products, Inc.**, Dept. 1789, Royal Oak, Michigan.

OUTWORKS THEM ALL

Prepares the toughest soils in one operation. All-purpose tiller-tractor tills to 12" deep - 12" to 40" wide. 3 models; 7 rotor styles including mulchers. 40 attachments include all tractor tools, mowers, snow plow. Tough chain-gear drive. Send for details.



MERRY TILLER

Northern Life Building, Box 1835, Seattle 4, Wash.



Onan Emergency Electric Plants

Start automatically when high-line power is cut off, supply current for lights, heating system, freezer, water pump, stove, all appliances and machines. Prevents losses and hardships. Plant stops automatically when power is restored. Compact, easy to install. 500 to 200,000 watts A.C. Priced from \$117.00.

PORTABLE MODELS

500 to 10,000 watts. Supply plug-in power anywhere!

Write for Free Folder

D. W. ONAN & SONS INC.
3299 UNIVERSITY AVE. S.E. • MINNEAPOLIS 14, MINN.

FEBRUARY 1959

241

The NEWEST and FINEST: Buck's 400 Series



CHROME EDGE CHISELS

You get: • The Finest Cutting Edges
• Tough Tenite II Handles with Inserted Steel Caps
• Rust Proof Tools



Plastic pocket Kit - 4 Sizes \$10.30

Most complete line of Chisels, Gauges and Carving Tools

CATALOG AVAILABLE!

1" - \$2.90
3/4" - \$2.70
1/2" - \$2.40
1/4" - \$2.30

BUCK BROS. INC.
RIVERLIN WORKS • MILLBURY, MASS.

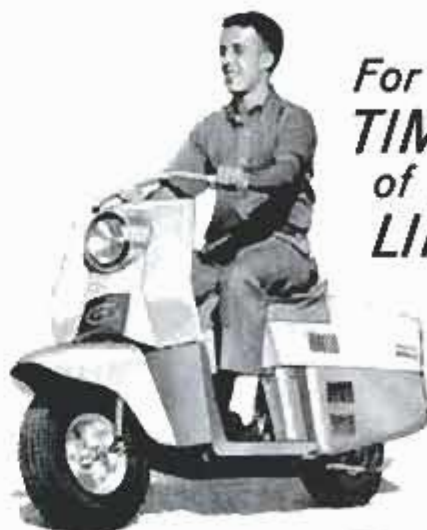

For the
TIME
of your
LIFE...

CUSHMAN. Pacemaker

Get aboard—discover a whole new world of fun and excitement. New styling, new mechanical advances make this sleek scooter more distinctive than ever. Powered by the famous Cushman Husky 4-cycle engine. Up to 50 miles per hour, up to 100 miles per gallon.

Ask your dealer for a FREE demonstration ride or write for new colorful booklet today. Sold and serviced nationally . . . Replacement parts immediately available. Dealer inquiries invited



CUSHMAN MOTORS

A subsidiary of Outboard Marine Corporation
919 No. 21st, Lincoln, Nebraska

"Slingshots" Pace the Drag Strips

(Continued from page 93)

doesn't need to cost very much, and when properly supervised is an extremely safe automotive sport. The National Hot Rod Association, with 33,000 members, enforces stringent safety rules at the approximately 100 affiliated drag strips. Safety helmets, goggles, belts and roll bars are required for all open cars and for all modified closed cars. Each car must pass a rigorous safety inspection by a technical committee before it can compete. There are numerous other safety requirements.

Class Distinctions

For competition, the NHRA divides cars into the following categories: Stock cars, to which very slight modifications are permitted; coupes, sedans and roadsters with reworked engines but that are still suitable for street use (fenders, headlights and mufflers are required); sports cars with street equipment; altered coupes, sedans and roadsters for which street equipment is not required; all-out competition coupes and sedans, and the unlimited dragsters themselves.

Each group of cars is further broken down into classes that depend on a car's weight divided by the cubic-inch displacement of its engine. All vehicles must run on service-station pump gasoline.

Ingenious builders find lots of leeway in the class rules and some of them come up with surprising innovations. Thus one competition coupe actually consists of a slingshot dragster having the driver's seat enclosed in an almost-stock coupe body. In some other competition coupes the usual locations of engine and driver are reversed, with the engine inside the body and the driver sitting in the conventional engine compartment. Sometimes, too, an engine is mounted sideways in a chassis, with a chain drive connecting to the rear axle.

Multiple-Engine Models

Two engines on two differentials, or two engines end-to-end and geared together for maximum power also have been tried. One driver mounted his single engine on tracks on the chassis so that he could move it back or forth between trial runs to find the location that gave the best distribution of weight.

One outstanding slingshot dragster, built by Mickey Thompson of Los Angeles, is powered by two reworked Chrysler engines that develop a total of more than 1000 horsepower. One engine drives the rear wheels, the other engine drives the front wheels. Last fall, Thompson set a new one-way speed record on the Bonneville Salt

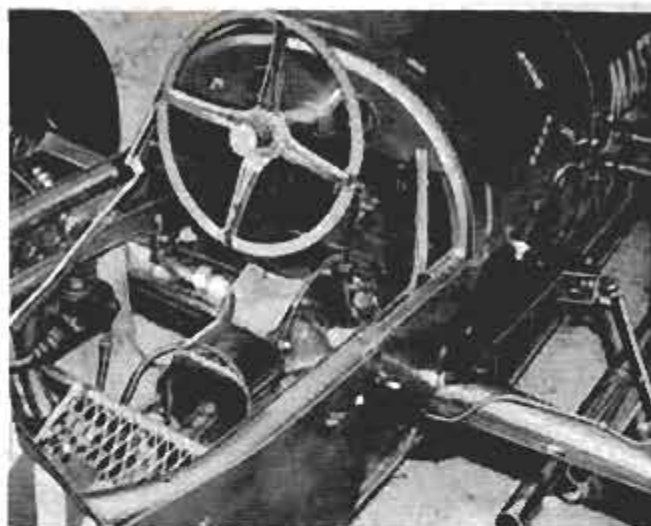

Cockpit closeup of a slingshot shows fuel-pressure-pump handle in the center of the steering wheel

Flats with this car, going through the traps at 294 miles per hour. His two-way average might have been almost as fast except for the fact that one engine blew up and he coasted much of the way on his return trip. Even so, his two-way average speed of 266.8 miles per hour beat the previous record by a fraction of one mile per hour.

NHRA officials estimate that some 300,000 cars are driven on the drag strips every year, of which 60 percent are stock cars that average around 70 miles per hour at terminal speed. At most strips, races are held every week end except during inclement weather. High point of each year's activity is the annual national championship drag races, always scheduled over the Labor Day week end and for the last several years held at the Oklahoma State Fair Grounds at Oklahoma City.

Old Dragster Is Winner

Five hundred of the fastest cars in the country competed in the 1958 drag championships, and the event was watched by 70,000 spectators. Surprisingly, the car that whipped all others in a series of elimination matches was by no means the newest car or the one with the most power. The winner was an old slingshot powered with an unblown Chrysler that was entered almost as an afterthought by Ted Cyr and Bill Hopper of California. The two men were pinning their real hopes on a slingshot they had just finished, powered by a 1958 Chrysler engine equipped with a GMC supercharger. Cyr drove each of the two cars in the eliminations and actually got the most acceleration out of the old car, eventually winning the final runoff with it. ★★★

☐ In emergencies, the Army may replace standard jute bags with knitted-paper sandbags treated with urea-formaldehyde resin for excellent wet strength.

There's An Elmer's Glue for
Every Job You Do!

ELMER'S® GLUE CHART FOR THE HOME HANDYMAN

Gluing Jobs

Special Requirements

The Glue To Use

For general interior gluing: wood, paper, pottery, cloth or other porous materials. Light wood assembly (joining, laminating, veneering, dowelling), novelties, toys, models, school projects and all types of repairs.

Good, transparent bond with speed and convenience. No mess, non-staining. Ready to use—no mixing.

ELMER'S GLUE-ALL
The modern plastic glue in the handy squeeze bottle!

For gluing plastic laminates to wood without clamps . . . Formica, Micarta, Textolite, Parkwood, Consoweld, etc. to counter tops, tables, desks, kitchen cabinets, etc. For thin gauge metal or foil to wood. Also, leather, linoleum, synthetic rubber to other porous or non-porous surfaces.

Good bond not requiring heat or excessive pressure. Highly resistant to heat or moisture. Fireproof, non-toxic, easy to use.

ELMER'S CONTACT CEMENT
Water based—non-flammable. Washes off hands and equipment with warm, soapy water.

For wood gluing where a waterproof bond is required . . . boats, outdoor furniture, sports equipment, window boxes and all types of outdoor gluing.

Maximum strength bond, completely waterproof with resistance to mold, fungus, acids, alkalis, solvents, boiling water, moist and dry heat. Lasting durability, excellent gap-filling qualities.

ELMER'S WATERPROOF GLUE
Forms bond stronger than the wood itself!

For stainfree gluing of acid woods like oak, mahogany, etc. For furniture panels, cabinet-work, veneering . . . any job where a clean glue line is important.

Good, long-lasting, heat and water resistant bond. Easy to work with. Good gap-filling qualities. For use with clamps in a working temperature above 75°F.

ELMER'S PLASTIC RESIN GLUE
Powdered Urea Resin Glue. Mixes easily in cold water.

For wood gluing where a reliable, economical glue is required. For outdoor gluing in low temperature. For heavy-duty wood work like laminating beams, gluing sashes and doors, counter tops, tables, etc.

Good water resistant bond. Easy to work with, regardless of temperature. Good gap-filling qualities. Inexpensive by comparison with many other glues. Should be used with clamps.

ELMER'S CASEIN GLUE
Powdered casein. Easy to mix with cold water.



Borden's Products FOR THE HOME HANDYMAN



For technical information on special adhesives or free Gluing Guide write The Borden Company, Dept. G2, 350 Madison Avenue, New York 17, New York. There is no one glue that will do all jobs well, but with these five great Elmer glues, most home, farm, shop and school jobs can be done correctly. Tear out and keep this chart as a handy reference.

Look what you can do with
Western Pine Region woods*



Family Room wall of Ponderosa Pine finished in Fuego Flame



Finish them any color...but let the natural beauty and grain show through

Here's *decorating news*... the warmth and beauty of natural wood paneling comes alive in modern color... for any room in your home. A specially prepared book (described below) gives full details.

You can create colors and effects similar to those on the opposite page... and many more. Here's how: select your paneling of Western Pine Region woods. Choose from a variety of patterns, in ten distinctive soft-wood species, in clear or knotty grades.

- Careful *sanding* is important. Sand first with medium-coarse paper to remove any rough imperfections. Progress to 3/0 sandpaper for fine surfacing.
- In kitchens, bathrooms or basements guard against moisture. Apply *commercial sealer* to all sides, edges and ends of paneling.
- *Color* can be applied two ways. Brand name, ready-made stains in bright or pastel shades are easily applied, and available everywhere. To create your *own* shades, mix oil-base paint and mineral thinner, or "colors-in-oil" and mineral thinner. Brush onto the paneling liberally. Then rub off with a soft cloth. Before proceeding, always test your color on samples of the exact wood being treated.
- To *highlight knots and grain*, rub over the stain with fine steel wool until the desired effect is achieved.

- An ideal *finish coat* is lacquer-sealer over the stain, rubbed with 6/0 sandpaper. Follow with a minimum of two coats of clear varnish or shellac rubbed with 3/0 steel wool when completely dry. Or... a simple paste wax may be substituted for the above.

For traditional or contemporary decorating, a wide range of textures can be attained through different surface treatments of Western Pine Region woods. They may be purchased ready-planed to a smooth working surface, or "rough sawn." They can be dimpled with a ball peen hammer, striated with a stiff wire brush, or sandblasted for a driftwood texture.

Western Pine Region woods make any woodworking job a pleasure. Due to their even texture and soft grain, they take any paint, stain or surface treatment with ease, and are easily worked with hand or power tools. Western Pine Region woods have a reputation for precise manufacture, quality seasoning and careful grading.

For your next remodeling job, workshop project or building program... choose versatile Western Pine Region woods. Your retail lumberman is the man to see. He will be pleased to talk to you about them. And remember... for more details, clip the coupon below.

Look for this



mark on well-manufactured and carefully graded lumber

*IDAHO WHITE PINE
PONDEROSA PINE
SUGAR PINE
WHITE FIR
INCENSE CEDAR
DOUGLAS FIR
LARCH
RED CEDAR
LOGEPOLE PINE
ENGELMANN SPRUCE

Western Pine Association

Dept. 403-N, Yeon Bldg., Portland 4, Oregon

Please send me a free copy of "Nature Makes News" which tells more about color-finishing Western Pine Region woods.

Include "101 Home Ideas" featuring many decorating and remodeling tips using Western Pine Region woods.

Name _____

Address _____

City _____ State _____



Let's face it, mister,
**YOU'VE
GOT**

TROUBLE!

Spots under your car on your garage floor can mean the seals in your automatic transmission are drying up and the transmission fluid is leaking out. Real trouble. A repair bill up to \$150.

The guaranteed way to stop leaks and rough shifting in automatic transmissions is with Wynn's Friction Proofing for Automatic Transmission and Wynn's Motor Cleaner.

Your local service station, garage or new car dealer will give your car this guaranteed Wynn's Friction Proofing treatment in a *matter of minutes*. If the leak doesn't stop within a hundred miles *it costs you nothing!*



THE *Proof* IS IN THE *Performance!*

Also available in Canada and everywhere in the free world.

WYNN OIL CO • 1151 W. FIFTH ST. • AZUSA, CALIF

Here's Where Pilots' Lives Are Saved

(Continued from page 111)

strike part of the aircraft. Findings based on these tests have saved countless lives. They have also prompted modifications that prevented planes from being damaged by released stores.

A common test for jettisonable models is performed with external fuel tanks. Made of a glass-laminate plastic like glass fiber, these are built to scale and mounted below the wing on pylons in either the full, partially full or empty condition. During a blow, the tank is released by a spring-powered or gas-powered device, and its flight is recorded by high-speed cameras. Generally shattered in the process, its pieces are collected in a screen downwind. Partially filled tanks are used to determine the sloshing effects of fuel on the dynamic characteristics of tanks during tests.

From Simple to Complex

Models have kept pace with the increasing complexity of aircraft. Pressure on their surfaces in a test blow has risen in the last 50 years from about 10 pounds per square foot to more than 1000. Wings and other airfoils have become thinner and thinner, adding to the problems of the stress group and increasing the need for flutter research. As a result, models have progressed from simple ones of solid wood to highly complex ones of stainless steel. At the same time, the use of plastics has increased, both as a coating for wooden parts and as a replacement for aluminum alloy and magnesium castings. The plastics' strength is comparable to those metals; the finished part is as accurate, and construction time and cost are far less.

In the construction of a model, designers reduce airplane lines photographically to model scale and make drawings from these

(Continued to page 248)



These Super Sabres—F-100C, top; F-100D, bottom; and F-100F, middle—had their genesis in a wind tunnel



PAINT NEWS



New Du Pont Oil Stains in Vibrant Colors!

Here's the big decorating news of the year. Oil stains in *color* ... to give a modern brightness, yet let the natural beauty and grain of the wood show through. The latest thing for wood furniture, wood panel walls, wood trim and floors. Du Pont Satin-Sheen Oil Stains come ready mixed in all natural wood effects ... or you can create almost any color you choose by mixing Du Pont Custom Tinting Colors with Du Pont Satin-Sheen Platinum Oil Stain. Never before have you had such a wealth of unusual color effects to enhance the beauty of any wood surface. Full instructions for mixing and applying are right on the can!

A Satin-Sheen Varnish That Resists Marring!

"Dulux" Satin-Sheen Varnish gives furniture and interior woodwork a satin-smooth hand-rubbed effect ... brings out the beauty of the grain. Odorless; minimizes surface defects; wears and wears. Unexcelled for mar and water resistance.

Buy the paint that's worth the work! Your time is too valuable to risk on "bargain" paints. When you buy Du Pont Paint, you know that the beauty is going to last. Du Pont Paint Chemistry assures you of that. See your Du Pont Paint Dealer ... you'll find him listed in the Yellow Pages.



Better Things for Better Living
... through Chemistry

Simplifies Complicated Measuring:

**A New Precision Instrument
for Leveling and Incline
Measurement**

HOPPY

**SPLIT
IMAGE
TRANSIT**



Only
\$6.95

**Accurate,
Inexpensive,
Simple to Operate**

Optional—
also
available
for the
thousands
of Hoppy
Transits
now in use—
sturdy carry-
ing case \$3.25

*Easy as a camera to operate! One man—ALONE—
can do leveling and incline measuring. Accurate to
a fraction of an inch. Many uses on the job and
around the house.*

Carpentry Leveling	Contour Plowing	Guttering
Patio & Terracing	Brick Laying	Drainage
Duct Installation	Yard Grading	Masonry
Foundation Work	Irrigation	ETC.

Guaranteed Product Satisfaction

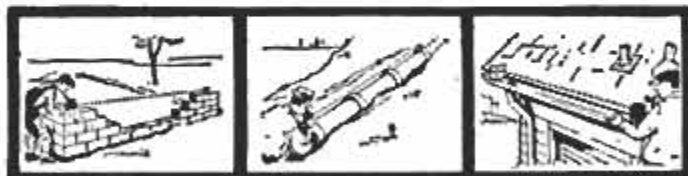

If not available at your Building Supply or
Hardware Dealer, write directly to:

HOPKINS MANUFACTURING CORP.
Dept. PM-2 Emporia, Kansas

Another Quality Product by HOPPY

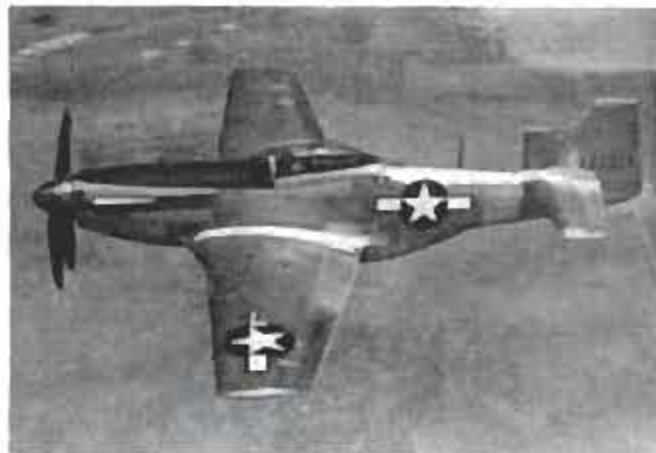

Cost of wartime P-51's airframe was half that of
some models now being tested in U.S. wind tunnels

for the guidance of craftsmen in the shop. It takes three to nine months to design and build a model. By comparison, the famous P-51 Mustang fighter plane of World War II was designed and built in four months. Its model was designed and built in about two months.

Work With Great Care

Once they get the plan, the builders set to work with great care, making the model's various components. Each man makes one part. He uses various machine tools as needed, instead of passing the part from one machine operator to another, as is done with a regular aircraft part.

Wood is still used for many of the smaller models and some of the larger ones as well. Blocks of white holly or laminated Honduras mahogany are screwed to a central spar of stainless steel that provides an anchor for the wing, empennage, and perhaps for the model-support connection. After it has been shaped to the proper configuration, the model is sanded and polished. Then a sanding sealer is applied. If

(Continued to page 250)

A photograph taken through a porthole in a wind tunnel shows a supersonic model plane in a test run

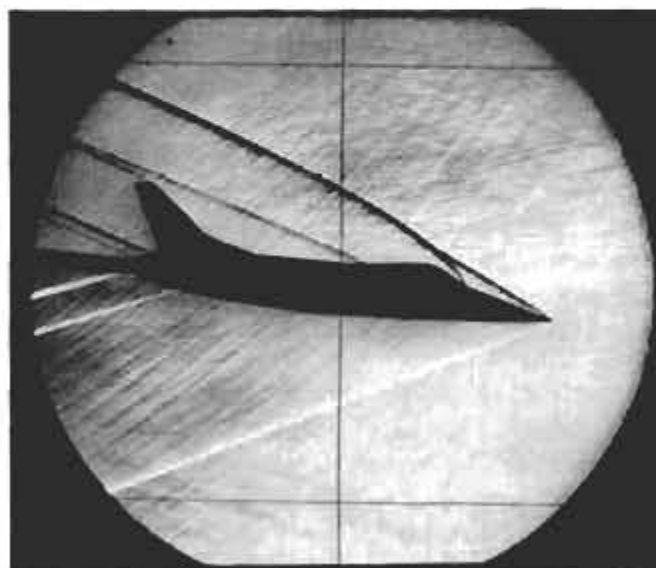

LUBRIPLATE
KEEPS TOOLS LIKE NEW
PREVENTS RUST
AND LUBRICATES TOO!



TRY LUBRIPLATE! Not an old-fashioned oil that runs off or gets gummy. LUBRIPLATE is a new, white and clean, semi-fluid lubricant that stays put.

• In handy 25¢, 50¢ and \$1.00 tubes at Sporting Goods, Hardware, Marine and Auto Supply Stores.

• Dealers write to LUBRIPLATE DIVISION, Fiske Bros. Refining Co., Newark 5, N.J.

LUBRIPLATE
THE MODERN LUBRICANT



**DOES TOUGH JOBS
WHILE YOU RIDE!**
PLOW • DISC • MOW • TILL

A man steel tractor made especially for farms and suburban acreage. Cultivate, Bake, Mow, Plant, Roll, Disc, PLOW, MOW, Spray, Saw. Maximum beautiful lawn (pulls 2 mowers). Over 70 quick change implements. Safe to operate even for 10 year olds. 9 hp. All gear drive. 8 W X 4 speed main mission, clutch differential, 770 lbs. Uses regular automotive parts. Easy economy to maintain. Low cost. Ready to drive 100%. Satisfaction guaranteed. Thousands in use.

Write for FREE CATALOG TODAY!
COUNTRY SQUIRE TRACTOR CO.
P.O. Box 107-K2, Muskego, Wis.



**GENUINE ALNICO
MAGNETS**

AMAZING, PERMANENT, NON-ELECTRIC, HIGHLY PRACTICAL. Conduct interesting experiments. Hundreds of uses. Retrieve valuable steel items such as guns, tackle from fresh or salt water; tools from tanks & drains. **GUARANTEED.** Try any magnet one week. Money back if you are not well-pleased.

No. M-710 (Wt. 53 oz.) Has pull of 225 lbs. on steel block	\$18.00
No. M-625 (Wt. 70 oz.) Has pull of 125 lbs. on steel block	\$10.00
No. M-575 (Wt. 18 oz.) Has pull of 75 lbs. on steel block	\$7.00
No. M-500 (Wt. 13 oz.) Has pull of 50 lbs. on steel block	\$5.00
No. M-300 Kit of Flat Bars 5 Pairs (10 Magnets)	\$3.00
No. M-250 Kit of Round Rods 5 Pairs (10 Magnets)	\$2.50
No. M-47 Hot Pad Magnets. 10 for \$1.00	\$1.00
No. M-35 Hobbyist assortment of 8 small magnets	\$1.50

Send M.O. or check. We pay postage. Sorry no C.O.D.'s.
MIAMI MAGNET COMPANY, 3240 N.W. 27th Ave., Miami 42, Fla.

**KEEP YOUR
WORKSHOP TOOLS
SAFE AND ORDERLY**



This 7-drawer machinist's chest has a place for every tool. Extra durable heavy gauge steel. Felt lined drawers protect delicate edges... operate easily. Size: 8½" x 13½" x 20¼". \$27.95 at leading hardware stores. Slightly higher west. Other home workshop models from \$1.25 up.

WATERLOO VALVE SPRING COMPRESSOR CO.
Waterloo, Iowa

**NO OTHER WRENCH LIKE
CRESTOLOCK**

No. ACL110
10" Size. 1½" cap.

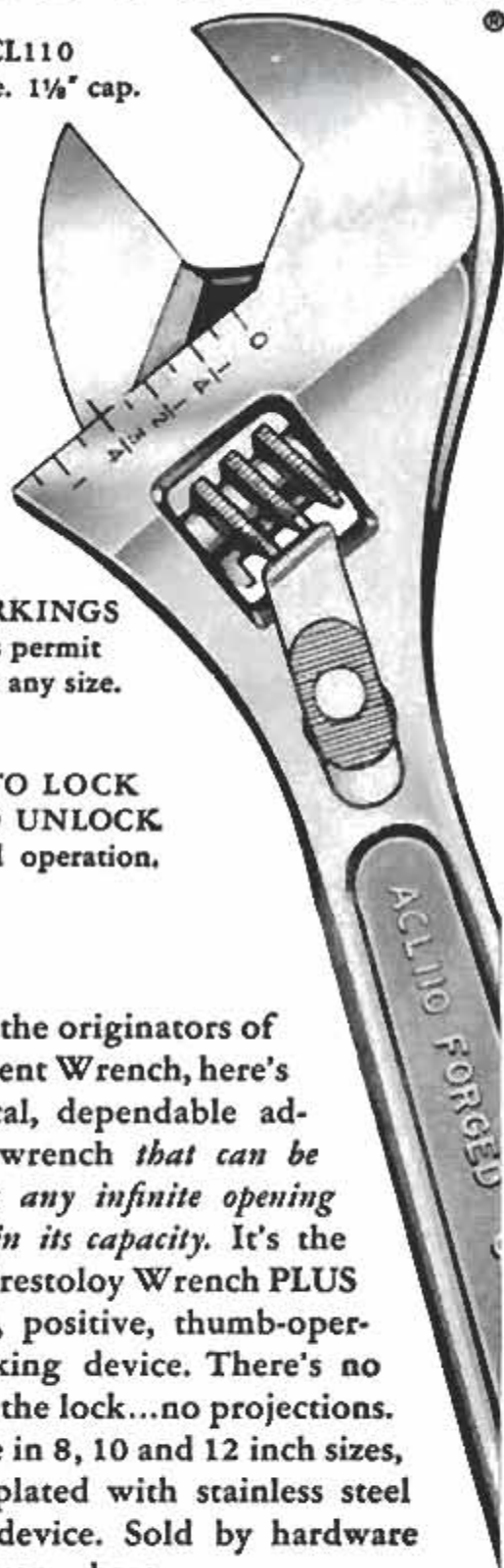

SCALE MARKINGS
on the jaws permit
presetting to any size.

**PUSH TO LOCK
PULL TO UNLOCK**
one hand operation.

Made by the originators of the Crescent Wrench, here's a practical, dependable adjustable wrench that can be locked at any infinite opening size within its capacity. It's the famous Crestoloy Wrench PLUS a simple, positive, thumb-operated locking device. There's no strain on the lock...no projections. Available in 8, 10 and 12 inch sizes, chrome plated with stainless steel locking device. Sold by hardware dealers everywhere.

CRESCENT TOOLS
Give Wings to Work

Crescent is our trade-mark, registered in the United States and abroad, for wrenches and other tools. Sold by leading distributors and retailers everywhere and made only by
CRESCENT TOOL COMPANY, JAMESTOWN, N. Y.

**Rush
Coupon for
FREE**

**J. C. Whitney's 1959 Catalog
Auto Accessories and Parts**



**324
PAGES
85,000
ITEMS**

Saves You UP TO 50%

On everything you need for your car, station wagon, custom car, hot rod or truck . . . Including the latest customizing accessories, parts, hi-speed and power equipment.

Get this all-new edition of the World's Largest & Most Complete Automotive buying guide—324 pages! See pages & pages of brand new 1959 items not yet offered in stores. Over 85,000 items in stock ready for shipment. Our tremendous buying power & huge volume will save you up to 50%. This catalog will show you the greatest money-saving values & the greatest selections we've ever offered.

Just Off the Press! It's the Latest & Largest—324 Pages! See what's new for 1959 in the automotive field. Buy with utmost confidence—Whitney Guarantees 100% Satisfaction or Your Money Back.

J. C. Whitney & Co., 1917 (P-2) Archer, Chicago 16

J. C. Whitney & Co., 1917 (P-2) Archer Ave., Chicago 16, Ill.

Rush giant 1959 Catalog of Auto Accessories & Parts. I enclose 25c to cover part of mailing & handling cost, refunded on my first \$5.00 or more order. This Offer Good in U.S.A. only.

Name _____
Address _____
City _____ Zone _____ State _____

intended for supersonic testing, protection from heat and abrasive action of dust in the air is often provided by a coat of glass-laminate plastic $\frac{1}{16}$ inch thick.

The same great care is given to missile models, for they have no pilot to correct any slight design errors that might creep into the finished version despite all the advance research and testing. If a missile ever gets to the moon, its successful flight through the immensity of space will have begun, as every manmade flight has in the past, in a wind tunnel with a model that most people would regard as nothing more than a shiny toy. ★ ★ ★

Fish Prefer Blue or Green Lights

Japanese fishermen have doubled their catches of lobsters and crabs by mounting bright lights, preferably blue or green, on their nets. Scientists along the Scottish coast have found, meanwhile, that whiting, young herring and sprats are susceptible to lights. However, the lights indirectly attract predatory fish which may destroy the catches.

**Pine Trees Mark Runways
And Aid Maintenance Men**

Small pine trees planted alongside runways at Youngstown, Ohio, Municipal Airport enhance safety two ways when the field is covered with snow. In daylight landings, pilots use the trees to guide them onto the concrete strips. The trees aid night landings too. Each tree is planted near a runway light, so maintenance men seeking to brush snow off the lights have no trouble finding them under the drifts.



When you do-it-yourself...

CONOLITE®

makes it easy to do!



When your home needs re-doing, do-it-yourself with CONOLITE—the beautiful, hard-surface plastic laminate for sink tops, tables, bars, and walls!

Your reliable Lumber and Paint Dealers have many rich patterns and wood grains now. So cover your home with exciting Conolite color today!

economical • flexible,
easy to handle • adheres
to wood or metal • comes
in rolls • less trimming,
no seams • chip, heat &
stain resistant

CONTINENTAL CAN COMPANY

CONOLITE DIVISION

WILMINGTON, DELAWARE



Find HIDDEN TREASURES

GOLD, SILVER, PRECIOUS METALS with the Famous Model 27 Metal Detector, Lightweight, ultra-sensitive, low cost. None finer. Also GEIGER COUNTERS for uranium and the VIOLITE for tungsten. INFORMATION FREE

THE *Detectron* CORP. Dept. 3
5528 Vineland Ave., No. Hollywood, Calif.



LEARN SCIENCE FACTS EASILY WITH WILSON'S MOTORS & KITS

Combine pleasure with learning. Absorb basic scientific facts easily while applying Wilson's battery-operated motors and power kits to models, many hobby items and research projects.

- No. 8-100 Hi-Drive Motor, 3-6V. \$2.50
- No. 9-100 Same for 12V. \$3.00
- No. 3-100 Tiny Atom Motor, 1 1/2-3V. \$2.00
- For 0 V. \$2.50 For 12 V. \$3.00
- No. 12 Solid shaft supports kit \$2.50
- No. 14 Adjustable shaft supports kit \$3.00
- No. 26 Couplings kit. \$1.50
- No. 77 Set of 7 large pulleys. \$3.00
- No. 88 Kit of 8 pulleys—2 belts \$2.00
- No. 1300N Small accessories kit \$1.00
- No. 4000 DeLuxe accessories kit with motor. \$5.00
- No. 3000 Vari-speed gear unit. \$4.00
- No. 1049 Gear train with Hi-Drive motor No. 8-100. \$5.95
- Same with No. 9-100 Motor. \$6.45

* Item illustrated. Ask for FREE Cat. All motors have ALNICO magnets. Remit with order and we pay postage in U.S.A., No C.O.D. Add 3% Sales Tax for delivery in Ohio. Write Dept. PM.

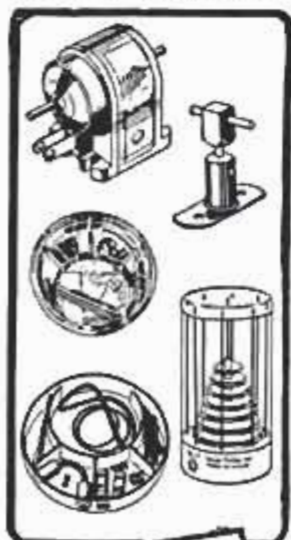

For quick delivery see your local dealer — or order direct



WILSON'S OF CLEVELAND

425 Lakeside Ave., N.W. • Cleveland 13, Ohio

NOW! a hi-compression
staple gun
for only
\$4.95

With Exclusive Push-button Loading and Built-In Staple Extractor.



Indispensable for home use... and never before priced so low! This compact, all steel, powerful SWINGLINE 101 staple gun is ideal for insulation, carpentry, upholstery, screening, wire fencing, plus thousands of other uses. Handle locks to fit pocket. Lightweight, maneuverable, jam-proof! Staple sizes 1/4", 3/16". Send for FREE book—"Tips for Tacking".

Swingline® INC.

Dept. M29 Long Island City 1, New York

HOME-STUDY COURSES

By Lawrence W. Tice, President
National Home Study Council



POPULAR MECHANICS takes pride in presenting for the information and guidance of its readers, this thorough evaluation and description of the home-study or correspondence system of education. The author is one of our nation's leading educators. Lawrence W. Tice, possibly more than any other educator, is in a position to know the advantages of taking home-study courses. His educational experience spans nearly 30 years and includes teaching positions in a resident vocational school, the University of Wisconsin Engineering Faculty and Extension Division, as well as more than 20 years as an executive and president of one of the largest home-study schools in the country. Mr. Tice is also President of the National Home Study Council. In this position, the highest elective position in home-study education, Lawrence Tice represents 53 of the finest private correspondence schools in our nation. Mr. Tice's article tells you exactly how home-study education works, and how it has trained and helped hundreds of thousands of people advance and succeed materially in their chosen occupations.

The alumni of home-study schools include names familiar to all of us—successful men who have distinguished themselves in every profession. At this moment 1,500,000 Americans are taking correspondence courses. Over six thousand business and industrial firms are using home-study courses to train their employees. The students of home-study schools today will be among the leaders of business and the professions tomorrow. They have planned their futures well, putting education foremost.

For years, the correspondence school has been a favorite subject for the gag writer . . . the correspondence school teacher receiving an apple by mail . . . the home-study student receiving a dunce cap from the postman. . .

But, to millions of Americans who have received the benefits of home study, correspondence education is no joke. That home-study administrators can laugh at the humorous aspects of home study is a sign that correspondence education has reached a well deserved and accepted place in the field of general education.

The reason correspondence education has been the butt of so many jokes is a misunderstanding of the exact nature of education by correspondence.

How the Home-Study System Works

Home study is amazingly simple. Every home-study institution follows the same basic operating procedures. This is true not only of those private home-study schools accredited by the National Home Study Council, but by the various Armed Forces correspondence schools and the college and university extension divisions.

In the home-study procedure, the student enrolls by mail or through local sales representatives. The application is then submitted for approval by the Registrar and the Director of Education of the school.

If approved, the first instruction texts are sent, usually with a booklet on how to study by the correspondence method. This

booklet discusses a study pattern which, although advantageous to the student, requires a greater degree of concentration than is necessary in resident classwork.

After the student completes his first assignment, he mails it to the school for correction. Highly specialized, well trained instruction staffs grade the examination and return it with personal study advice. Although the type of examination offered varies from school to school, personalized instruction is a foundation of all home-study schools.

The student's grade is recorded on his educational record and the examination is returned by mail.

The student reviews the instructor's analysis and applies the principles learned to future assignments. In the meantime, his next examination is on its way to the school, completing the procedure for study by the correspondence method.

Personal Instruction Stressed

Like resident schools, correspondence education consists of a teacher, a textbook and a student. But, in home study, the teacher is built into the text, and instruction is by written communication rather than oral. Correspondence schools do not "teach by mail." Teaching is by the written word and personalized instruction, part of the traditional system of education. The mail is simply the carrier bringing written evidence of the student's understanding to the teacher.

CAN HELP YOU SUCCEED

Job-Related Training for Advancement

Not everyone can attend college or even high school. Many people would like more education so they could enter more profitable or interesting fields of work. But they can't afford to give up their present jobs. Many others have already started in their chosen vocations but need job-related technical training for advancement or pay increases. For these persons, correspondence education is often the best and possibly the only educational route to self-improvement.

Advantages of Home Study

Correspondence education has an edge on classroom-type training in many ways:

1) **The correspondence student always comes to class prepared.** The correspondence student must prepare and write out the answers to all important points in each assignment.

2) **Each correspondence assignment is carefully organized.** Each text is carefully checked by technical experts, educators and editors to make certain that it is technically and educationally sound.

3) **Progress is made at the correspondence student's own pace.** Every correspondence student is in a class by himself. He sets his own pace, "rings" his own school bell. If he is a fast learner he moves along as rapidly as he can master each assignment. If he must put more time on his studies than others, he doesn't have to worry about being left behind.

4) **Instruction is personal and individual.** Each student is in a class of his own and each student has a teacher for himself. The time of that teacher is devoted wholly to his problems, not the problems of 20 or 30 other students.

5) **The correspondence student is vocationally prepared for his studies.** The average home-study school offers job-related training. Students are adults (average age 25-27) with work experience, home responsibilities and definite training goals. Most of them study courses directly related to their jobs.

6) **The correspondence method prepares for life in the business and industrial world.** Each student puts into writing his own solutions to the questions and problems. Questions and problems used by the better schools force him to carefully reason, analyze, and evaluate to answer the question or solve the problem. Then he must shape his answer into presentable form.

These same good habits can later be put to use in the work world. Walter D. Fuller, Chairman of the Board of the Curtis Publishing Company, who as a young man studied and completed a home-study engineering course, had this to say:

"One of the great advantages of correspondence training is that it forces the individual to work his own way out of his problems. He must take the fundamental communication, the written or printed word, and from it translate into his own mind just what information is in the instructions. This is not always easy. Home study helped through the clarity and brevity of its instruction, but even then at times it was difficult for me to get the idea. But that very fact is one of the benefits of correspondence instruction, because once the problem is solved then it is never, never forgotten.

"Another great advantage is that the correspondence-school student must so organize his efforts that he can find time for his studying. The correspondence school habit, together with the necessity of the individual putting his nose to the grindstone, also develops a power of self-analysis which is of value all through life."

High School Diplomas By Home Study

Education in this country is currently being checked more carefully than at any time since Thomas Jefferson first proposed our public school system in 1779, for the "... education of the common people."

Approximately 40 million adult Americans have not completed high school, many through no fault of their own. This presents a serious challenge to American education. For these 40 million Americans, accredited home-study schools offer possibly the only chance to become high-school graduates.

Recent studies show that the typical high-school dropout is 16 years old and should be starting his junior year. About five out of every ten freshmen leave high school before graduation. This is a conservative estimate.

The person without a high-school diploma faces life severely handicapped. He is limited vocationally, economically and socially. He can apply only for jobs which do not require a high school diploma. And, in this age, these jobs are rapidly becoming nonexistent. The National Manpower Commission reported that there soon may be almost no place left for the unskilled industrial worker.

Education—Your Partner in Earnings

Possibly the most frightening point is that your lifetime earning power is controlled to a great degree by the amount of education you have.

In preparing the "Skills for America" series on education, *Popular Mechanics Magazine* came up with Department of Commerce figures showing that the average high-school graduate can expect to make almost \$50,000 more during his lifetime than the man who dropped out of school after the eighth grade. The college graduate can expect to earn \$100,000 more than the high-school graduate.

Thanks largely to correspondence schools which start a new "semester" every hour of every day, the doors to educational opportunity are always open.

New Skills—Knowledge for Millions

Today, more than 2,000,000 persons all over the world study by correspondence.

More than 750,000 new students—more than the total freshmen in all colleges and universities—enrolled in home-study schools in 1957, a four percent increase over the year before.

In the United States between 1,000,000 and 1,500,000 students study home-study courses each year. Significantly, 25 percent of all Certified Public Accountants and more than 10 percent of all engineers get their training through correspondence education.

Since it began almost 100 years ago, correspondence study has won an important and unique place in American education.

Home study is not too concerned with the 32 percent of the high-school graduates who will go to college. Home study is concerned with the needs of the vast majority who will not go on to college, and the millions who have not completed high school. It has and will continue to serve also the college person who wishes to supplement or continue his education.

As the Russians successfully launched their satellites, Americans suddenly became aware of some of our educational weaknesses. Educators began tallying some of the contributions of correspondence institutions, which have:

1) *Supplied education and training to millions who could not attend resident schools.*

2) *Taken the initiative in cooperating with business and industry in establishing employee-training programs.*

3) *Supplemented public-school programs through supervised study in small schools which could offer only a limited program.*

4) *Achieved an outstanding record in the nation's apprenticeship program.*

5) *Provided vocational, technical and business training for the millions who constitute the bulwark of the American labor force.*

Home-study administrators agree that there is no substitute for a good resident-school education. Home-study schools are not in competition with resident schools. Rather, they supplement the training offered by these schools.

For example, a trained engineer, after a few years in the field, finds himself in an administrative job. While his technical training is fine, he lacks training in supervision and management techniques. Unable or unwilling to return to school, his only solution is home study.

The typical home-study student is about 27 years old, married, has a home and family, is employed, and is a high-school graduate. He is seriously interested in getting ahead but can't quit work to return to school. Frequently, his financial status prohibits enrollment in a resident school. Or, perhaps there are no local classes in the subjects he needs at the hours he can attend.

For the ambitious student, these circumstances pose no great obstacle. For a single four-cent postage stamp he can get all the information he wants about the thousands of courses from home-study schools which are ready and willing to help him.

Choosing the Right School and Course

What subjects can you take by correspondence? It would be hard to list a subject that is not taught by correspondence. The subjects run the gamut from Absorption Apparatus to Xerography. By mail you can study almost anything in the technical and business fields.

Let's assume that you have decided that the correspondence method is the best for your particular situation. How do you choose the right school and course? If you can't go to a trained vocational-guidance counselor, here's a set of rules to help you. (Courtesy National Home Study Council, 1420 New York Ave., N. W., Washington 5, D. C.) Make sure the school of your choice:

- 1) **Has a competent faculty.**
- 2) **Has educationally sound and up-to-date courses.**
- 3) **Admits only qualified students.**

- 4) Provides satisfactory educational service.
- 5) Can demonstrate reliable student success and satisfaction.
- 6) Advertises truthfully.
- 7) Has reasonable tuition charges.
- 8) Is financially responsible and able to deliver a high quality of educational service.

Personal Rewards from Home Study

What are the rewards of persons studying through correspondence? You've seen ads promising: "Make more money soon"; "Train now for more success"; "Greater Security"; "Hold a good job"; "More Money"; "Bright Future." By asking correspondence school graduates themselves, a national magazine recently separated fact from fiction about these promises. The magazine's editors found that the majority of correspondence graduates reported that:

- 1) They got from the courses what they had expected to get.
- 2) Their earnings increased an average of \$22.50 per week.
- 3) They won promotions or found new and better jobs.
- 4) They were well pleased and even enthusiastic about the content of the courses and the home-study method.

The magazine survey revealed that 77 percent of the home-study graduates testified to making more money; 43 percent reported that they were much better off.

These are the tangible results. The by-products of correspondence education are perhaps even more important:

- 1) 64 percent reported more opportunities for advancement.
- 2) 36 percent revealed that they were given more and greater responsibilities in their work.
- 3) 30 percent told of a higher standing in the community.
- 4) 61 percent said that their work is more satisfying.

The final question asked was: "If you had it to do over again, would you take a correspondence course?" A resounding 85 percent answered: "Yes!"

More Education Required for Jobs

The President's Committee on Education Beyond High School points out that the educational level of our population is rising slowly. But, while the demand for trained manpower is growing rapidly, the demand for unskilled labor is slipping away.

The National Manpower Commission reported that skilled workers who used to measure with calipers and micrometers will soon have to learn to work with tolerances measured with light waves. *There may be almost no place left for the unskilled industrial worker.*

Home-study educators have analyzed the current needs of business and industry. They build their study content on this basis rather than from materials already published. Thus, some of the finest up-to-date instruction material related to technical and business knowledge has been produced for correspondence study.

In a series of articles in the Pittsburgh Press, columnist Gilbert Love posed two questions which readers of *Popular Mechanics* might ask themselves: 1) *What are you going to do if you can't get into a college or university because they are overcrowded?* 2) *What can you do if you are already out in the work-a-day world and find that your advancement is stalled because you don't have enough or the proper kind of education?* Mr. Love supplies the answer: "**You might take a correspondence course.**"

By 1970 U. S. population may be more than 200 million. The tremendous growth and change in our economic wants, standards of living, materials used in production methods, etc., demand a new breed of trained workers. While education will get more attention, the number of school buildings and teachers cannot keep up with the demand.

By 1975 we will need 75 percent more professional and technical personnel. Clerical and sales people must increase by 49 percent; craftsmen by 45 percent; operators of all types by 38 percent; service workers, 27 percent; proprietors and managers, 14 percent. On the other hand, the need for laborers, including farm workers, will decrease by 25 percent. In the next few years, 15 million more jobs will be available. At our current rate of progress, our public and regular resident schools can never train enough people to fill these jobs. With 15 years of manpower shortages behind us, it sounds odd to expect 10 million educationally unemployed in less than 10 years. But it may happen—and strangely enough while jobs are waiting for trained workers.

The scientist Huxley once said, "There ought to be an agency that would go up and down the world seeking out capable men wherever they may be found and turning them to account." Correspondence schools do exactly that!

NOW—Movable electrical outlets
wherever you want them

Electrostrip

"4-FOOTER" KIT PATENTED



ONLY \$2.95! Takes just minutes to install electric outlets you can move. No more "octopus" outlets, dangerous extension cords. Electrostrip installs easily with just a screwdriver in your kitchen, bedroom, den, workshop, anywhere. Comes complete with 3 twist-in receptacle plugs and polarized connector. Underwriters' Laboratories listed. "Good Housekeeping" Seal. Purchase the 4-footer kit, or the larger 15-footer, at your local retail store. Or get the 4-footer by sending \$2.95 plus 50 cents for postage to BullDog Electric Products Co., Dept. EM, Box 177, Detroit 32, Michigan. Your kit will be mailed promptly by an Electrostrip Distributor. Money back guarantee. © BEPCO



Dome-Shaped Phone Booth

Public telephone booths may acquire a "new look." Bell Telephone Laboratories are testing a number of new ideas in booth design. One, shown here, has an aluminum frame and flooring plus transparent plastic walls. A standard desk-model telephone is connected to the traditional coin box. This type of booth might be installed in an area protected from the weather, such as a railway concourse.

Plastic Tube in Tray Makes Photoprint Washer

Any tray with one side 10 inches or larger can be converted to a photoprint washer with a specially designed plastic washer. One end of the perforated tube is connected to a hose which can be attached to a faucet. Tap pressure forces water through the holes in a slightly downward direction, producing a constant wash-water change.

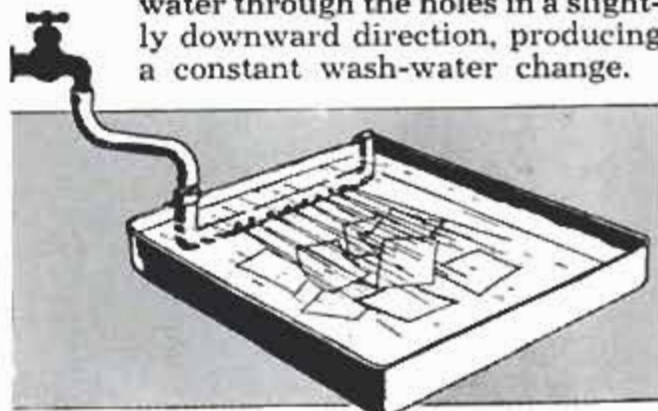

Rare, Fancy & Imported Woods... Veneers... Plywoods
Mouldings... Patterns... Hardware... Mosaic Tile
Ornaments... Tools... Archery and Skiing Supplies

Everything You Need in Craftsman's New WOOD and Home Workshop CATALOG

Get Yours! Rush Coupon Today!



OVER
1,500
ITEMS

NEW—MOSAIC TILE PROJECTS!

World's Largest Selection of Finest Domestic and Imported Woods... Mouldings, Hardware, Tools—ALL AT LOW MONEY-SAVING PRICES! Your complete wood buying guide and project book. Craftsman is your best, most complete source of finest kiln-dried domestic and imported woods, beautiful wood inlays, colorful bandings, matched plywoods, embossed mouldings, carved ornaments, newest wood-working tools, "hard-to-find" cabinet hardware; more than 1,500 items! Packed with newest scroll saw patterns, project ideas and money making plans. Enclose 25c (refunded with first order) to help pay mailing and handling cost. Write TODAY to

CRAFTSMAN WOOD SERVICE CO.,
Dept. A-2, 2729 S. Mary St., Chicago 8

CRAFTSMAN WOOD SERVICE CO., Dept. A-2
2729 S. Mary Street, Chicago 8, Ill.
Enclosed find 25c. Rush new CRAFTSMAN WOOD CATALOG.

NAME _____
ADDRESS _____
CITY _____ ZONE _____ STATE _____

Make
Painting
is easy
for anyone!



• Low-cost PRESSURE MAID Paint Sprayer with special spray cap for MULTI-COLOR paints is ideal for do-it-yourself projects. Rugged, portable, trouble-free. Complete — ready to spray. Piston-type, direct-drive, single cylinder compressor. 1/3 h.p. 110 Volt AC motor.

Write for new Bulletin PM 500 today!

The Campbell-Hausfeld Co.
1046-B Railroad Ave., Harrison, Ohio



CAMPBELL-HAUSFELD



Home Plan Books

By Garlinghouse! Show hundreds of Plans For Custom Building

A custom built home is better—meets your needs better. See the wide selection of popular sizes and styles in these beautiful books — exteriors, floor plans, descriptions.

- Ranch & Suburban. 125 popular plans for town or country. 50¢
- Income & Retirement Homes. 125 plans. Duplex, multiple units, small homes. 50¢
- New American Homes. 110 larger size homes. Popular styles \$1.00

All 3 books \$1.50. All books postpaid

LOW COST Builders blueprints, specifications, mill and lumber lists ready to mail for every plan. Your best investment when building. Plans guaranteed. ORDER TODAY.

L. F. GARLINGHOUSE CO., INC., Box PM-29 TOPIKA, KANSAS



BUY GREAT NECK HAND TOOLS

. . . for long-lasting performance



GREAT NECK SAW MFRS., Inc.

MINEOLA, N. Y. — SEE YOUR LOCAL STORE

HOW TO PROTECT YOUR INCOME!

Earn Extra Money With A Rapid

SHEAR SHARPENER AND KNIFE SERRATOR



Easy to operate — professional-type sharpener does a perfect job in just 2 minutes on all types scissors and shears, including pinkie shears. Knife guide puts proper edge on any blade. Knife serrating attachment puts saw-tooth edge on hard or soft steel blades. Quick profits from homes, dressmakers, barbers, restaurants, hotels, butchers, etc. No experience needed. Big opportunities with this precision ball bearing machine. Has 1/2 h.p. motor. A money-making investment—write for FREE FOLDER PM-2.

BEAVER MFG. CO P.O. BOX 434, 800 So. 1st Ave. Inglewood, Calif.

FEBRUARY 1959

Build quality money-saving

knight-kits

A PRODUCT OF ALLIED RADIO



see them all in

ALLIED'S 1959 ELECTRONIC SUPPLY CATALOG



free

BUILD YOUR OWN!
IT'S EASY—IT'S FUN—
SAVE UP TO 50%



HI-FI
KITS

452
value-packed
pages



HAM KITS



HOBBY
KITS

INSTRUMENT
KITS



SAVE on Everything in Electronics



WORLD'S LARGEST STOCKS: Everything for Experimenters, Builders, Amateurs, Servicemen, Engineers, Hi-Fi enthusiasts. Get more for your money in Hi-Fi systems and components, including latest Stereo; save on build-your-own KNIGHT-KITS; recorders and tape; Amateur station equipment; TV tubes, antennas, accessories; test instruments; industrial electronic equipment—plus the world's largest stocks of parts, tubes, transistors, tools and books. Send today for your FREE 1959 ALLIED Catalog!

EASY TERMS AVAILABLE

our 38th year

ALLIED RADIO

Everything in Electronics at Lowest Prices

send for
FREE
Catalog

ALLIED RADIO CORP., Dept. 24-89
100 N. Western Ave., Chicago 80, Ill.

Rush FREE 1959 ALLIED 452-Page Catalog.

Name _____

Address _____

City _____ Zone _____ State _____



What? Ride a Bicycle When He Can Drive an Automobile?

Even your three-year-old can imitate you as a driver these days. He can operate an automobile powered by a two-horsepower engine and equipped with semi-pneumatic tires, brakes and a 12-volt elec-

tric starter. The auto, which weighs 140 pounds, has a steel frame and a glass-fiber body. It is also available with a plywood body. The speed of the vehicle is approximately 10 miles per hour.

Electronic Alarm Buzzer Warns Driver That Level of Gasoline Is Low

For less than the cost of a towing charge you can buy an audio fuel-alarm unit for your car to warn you that the gas tank is nearly empty. The buzzer that sounds the alarm can be mounted behind the dash and

its wires attached to terminals on the fuel gauge. When a gas tank's contents drop to about two thirds of a gallon, the buzzer sounds. It continues until the gas is replenished or the ignition is turned off.

**Compact!
Battery-
Powered!**



- **For Boating**

Bilge pumping, water systems, bait tanks, washdowns

- **Trailer**

Water systems

- **Camping**

Gear, auto and child washing

The Jabasco "Water Puppy" Pump fills a practical need for outdoorsmen and Do-It-Yourselfers everywhere. Designed for years of hard service, the "Water Puppy" features bronze housing and flexible neoprene impeller. Trouble and maintenance free! Ports threaded externally for 3/4" garden hose, internally for 3/8" pipe thread.

See the "Water Puppy" Pump today! At your dealer or write direct. 6-volt - \$26.50 12-volt - \$27.50 24-volt - \$28.00 32-volt - \$28.50

JABSCO PUMP COMPANY

Dept. PM • 1485 Dale Way • Costa Mesa, California

FREE POWER TOOL CATALOG

Get the right tool for the job! Write:
World's largest maker of **Black & Decker®**
electric tools Dept. MO29, Towson 4, Maryland



FIND BURIED TREASURE

GOLD, silver, coins, jewelry, strong-boxes, battle relics! M-SCOPE transistorized electronic Treasure-Metal Locators detect them all. Used world-wide. Exciting! Rewarding! Guaranteed. Lightweight, super-sensitive. Indestructible fiberglass cases. From \$59.50. Easy Terms. FREE catalog. **FISHER RESEARCH LAB., INC.** Dept. PM-3, Palo Alto, Calif.

NEW! 16 FT. MOLDED FIBERGLASS BOAT KITS



EASY TERMS!

EASILY ASSEMBLED IN ONE EVENING!

SAVE UP TO 60%

FREIGHT PAID! FULLY GUARANTEED!

No need to pay extra for a fiberglass boat just because of additional expense of factory assembly. With Luger's simplified, patented assembly procedure, anyone can easily assemble the 3 basic 1-piece molded units (deck, hull, upper bow) into a super-strong, professionally finished, 1-piece fiberglass boat. No need to pay dealer profit either. Buy Luger Fiberglass Boats factory-direct. Luger pays the freight! No hand finishing. Lustrous colors molded in. 3 exciting models. WRITE FOR FREE FULL-COLOR CATALOG.

LUGER INDUSTRIES INC., Dept. GE-2
9200 Access Road, Minneapolis 20, Minn.

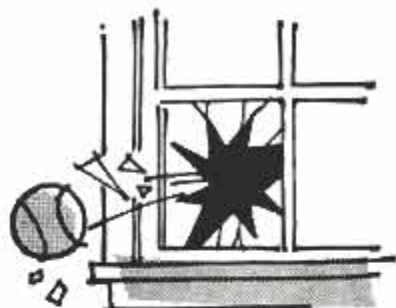

now's the time for
DAP

GLAZING COMPOUND

Set new window glass in wood or metal sash with DAP 33 GLAZING Compound—or replace old, dried-out putty around glass that leaks water and air. Fast, easy, longest lasting. Get DAP 33 at hardware, paint and building supply dealers. Ask about other famous DAP products for home sealing jobs, too.



DICKS-ARMSTRONG-PONTIUS, inc.
Dayton 3, Ohio

**SUDS! SCRUBS!
RINSES!**



Is yours one of the 20 million homes with kitchen sink rinsing sprays of the "automatic" type—those with a thumb control that turns the spray on and off? You can now replace any thumb-control spray with Dish-Quik—the newest automatic spray!

Attaches to existing hose in seconds! Dish-Quik not only rinses but suds and scrubs. For fast dishwashing and dozens of daily kitchen chores! Only \$9.95 at plumbing and hardware stores. Write for free booklet on how to replace and repair any automatic spray or hose:

AUTOMATIC SPRAY SERVICE CENTER
1700 E. 58th Place, Los Angeles 1, Calif.

PIONEERS IN DRY-WALL CONSTRUCTION

The new "4-in-1"
Weatherproof HOMASOTE

One-Man Panel

- For sheathing • For ceilings
- For exterior and interior wall finish

For striking new decorative effects—indoors and out—and for an easy-to-handle sheathing material—here is a many-purpose building material in a wholly new form. These 2' x 8' panels are 3/8" thick, V-grooved on both edges and end-matched.

For walls—apply them horizontally or vertically. For ceilings—over or under the beams. End-matched means the ends need not all be supported by joists, beams or rafters—therefore there is almost no waste. The "linen-surface" panels take any paint or stain. Along with fine appearance, the building gains in structural strength, insulation value and moisture-resistance. This weatherproof material also has sound-deadening qualities beyond those of any but true acoustical boards.

Mail the coupon for full details on this and other Homasote building materials. All are money-savers.



HOMASOTE

COMPANY

Trenton 3, New Jersey
Homasote of Canada, Ltd.
224 Merton St., Toronto 12, Ontario

Send me the literature checked below:

- One-Man Panels
- Striated Homasote
- Exterior Finishes
- Underlayments
- Homasote (72-pg.) Handbook—10¢

Name.....

Address.....

City.....Zone....State.....B-1

(Continued from page 24)

Engineer's Holiday

Like the mail carrier going for a hike on his day off, a locomotive engineer drives his live steamer when he's off duty. In this case the Southern Pacific Railway engineer, Jack M. Fesco of Los Angeles, not only operates his miniature "iron horse," he also built it over a period of years. Actually, the cart came before the horse: He built the caboose first, then in 1944 began building the locomotive directly from blueprints of the original which he obtained

from his railroad. He scaled it $\frac{3}{4}$ inch to the foot.

"All the parts were fabricated or built up from the solid," says Fesco, "except the cylinders and driving wheels. The boiler is copper, superheated. It has roller-bearing driving boxes, rods and ball-bearing trucks, fully sprung and equalized. The locomotive will pull about 14 men. Fesco, who has both fired and run steam locomotives such as the big Mallets as well as the diesel-electrics, spent 6000 hours on the engine and 4000 on the caboose.



Till close to hedges,
under shrubs!

Simplicity

Rotical

TILLER-CULTIVATOR

Plenty of capacity for tilling or cultivating heavy soils. Non-winding, self-sharpening tines, guaranteed against breakage! "Fastatch" tine assemblies ($8\frac{3}{8}$ " to 29") change in seconds. Full working visibility.

SIMPLICITY MANUFACTURING
COMPANY

5927 Spring St.
Port Washington, Wis.

Write
for
FREE
catalog



NOW
3 hp.

First WITH FINGER-TIP
CONTROL **POWER REVERSE**

GOT A LOCK PROBLEM?



Get **LOCK-EASE**
Graphited Lock Fluid—

Flushes out dirt, seals out moisture. Ideal for car locks and all others that can rust, freeze or stick. "Make your lock problems disappear—Lock-Ease your locks at least twice a year!"

4-oz. "drop or stream" can **49¢**

L-204

Also ask for American Dripless Oil in same handy "drop or stream" can. The finest oil for appliances, tools, guns, etc. Runs in—stays put. 4 oz., 35¢ everywhere. American Grease Stick Co., Muskegon, Mich.

**They
All Came to
Admire!**

The crowds are gathering around the new Arkansas Traveler Fiber Glass lapstreak boats. Join them at your Dealer's — or write for free catalog on the 25 aluminum and fiber glass models for '59.

ARKANSAS TRAVELER BOATS
2006 E. 14th St. Little Rock, Ark.



arkansas traveler
THE QUALITY NAME IN BOATS—ALUMINUM—FIBER GLASS



10" TILT/ARBOR SAW
BUILD-IT-YOURSELF
from GIL-BILT KITS-PLANS

Sturdy wood, steel, and aluminum construction. NEW DEPARTURE ball bearings. Capacity and performance of floor saws selling for \$150.00 and up. Plans, all metal parts in kit with 10" comb. blade, \$27.40, less blade \$23.95, F.O.B. St. Louis. Detail PLANS-PATTERNS only \$1.00 postpaid.

Build-it-yourself 12" and 18" Bandsaws, 6" Belt Sander, Shaper. Simplified plans, build easily with hand tools only. Advertised and sold for 12 years, over 35,000 units in use. Money back guarantee. FREE CATALOG.

GILLIOM POWER TOOLS, Dept. 80-B, Lambert Field, St. Louis 21, Mo.

<p>Gov't Surplus BRAND NEW Regular \$15.00 (10) GUARANTEED</p>	<p>FOLDING, 8 1/2" Capacity BOLT & CABLE CUTTER The ingenious folding handle features gives the leverage of a full 18" Bolt Cutter — with the compactness of a pair of pliers. \$3.75 Our Low Price FOR</p>	<p>EXTRA HEAVY DUTY ALIGNED Y Magnetics MAGNET Lifting capacity 1000 LBS. (Steel) Price \$12.50 — 100% more power than any other magnet of this size. High 4 1/2" wide. Overall size 4 1/2" x 3 1/2" x 1 1/2". Net weight 7 1/2 lbs. \$12.50 WILL LIFT THE LBS. SEND FOR OUR FREE CATALOG</p>
---	---	---

ASH & CO. 3102 GRAND RIVER, DETROIT 9, MICH.

**WELD BRAZE
SOLDER CUT**

4WAY
ONLY **\$14.75**
f.o.b. factory

WELDER
Complete with Twin Carbon Arc Torch and accessories... to handle all metal-craft work.

Acclaimed by thousands of Homeowners, Mechanics and Hobbyists as the welder of 1001 uses. Easily operated from properly wired 110 volt AC or DC line. The ideal gift with a life-long use.... Order today on 10 day money back guarantee.

FOUR-WAY WELDER CO., Dept. F2-B
1810 S. Federal St. • Chicago 16, Ill.

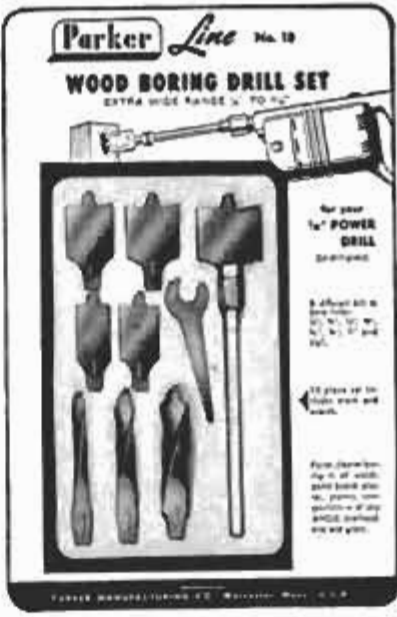

Now!
A Wood Boring Drill Set
with an extra wide range from 1/4" to 1 1/4"
Yours for only \$2.75

New 10 piece set fits all 1/4" electric drills and drill presses. Bore faster, cleaner, truer holes in wood, plastics, panelboard, plaster, compositions. New plastic case gives you permanent, moisture resistant container for your bits. Hardened tool steel — rugged construction. Sold at leading hardware stores.

Set includes universal shank and wrench.

Buy the **Parker Line**

PARKER MANUFACTURING CO.
WORCESTER 1, MASS., U. S. A.

Power at your fingertips!

EVANS
POWER
FIFTY

No more tedious hand winding! Press the button and Power Fifty's patented* rewind unit takes over. Release... and blade stops instantly where you want it! Measurements always exact; no blade creep. Handsome leather-like vinyl cover. At hardware stores.

Only **\$6.98**
Evans RULE CO.
Factories at Elizabeth, N.J. & Montreal, Que.
*Power-Fifty" steel tapes, U. S. Patent No. 2,586,386.

WHY DEPEND ON SOCIAL SECURITY!

ADD TO YOUR INCOME • UP TO \$5.00/HR. SHARPENING ALL TYPES OF LAWN MOWERS

Modern Manufacturing's precision Lawn Mower Sharpener and Bed Knife Grinder makes it easy for you to earn extra cash on a full or part time basis. Many mowers need sharpening. Do it in your basement or garage. Anyone can learn to operate this sharpener. Write today for free brochure. Dept. 10

MODERN MFG. CO.
160 N. Fair Oak Ave.
Pasadena, Calif.

\$27500
F.O.B. Pasadena

NOW

A SATISFACTION GUARANTEED POWER TOOL BY *Remington*



Unmatched Power—Remington's new Model 149DL de luxe $\frac{1}{4}$ " drill delivers up to $\frac{1}{2}$ horsepower. Elegant triple-tone styling—copper-plated gear case, black trim and trigger, polished aluminum housing—permanently good-looking. Has 3-conductor cord with adapter. See it at your dealer's . . . only \$29.95.*

REMINGTON GUARANTEES that unless you are satisfied in every way with the 149DL de luxe $\frac{1}{4}$ " drill you may return the tool within 60 days from date of purchase and get your money back. Remington Arms Company, Inc., Bridgeport 2, Conn.—famous for quality since 1816.



*Suggested retail price subject to change without notice. Price valid only in the U.S. and Canada.

Over the Pass With 8500 Horses

(Continued from page 85)

compressors and air-storage reservoirs. "B" unit is taken up entirely by the mammoth turbine and the electric generators that it drives. The generators produce the 800-volt current that powers the traction motors on the 12 axles of the two units.

Behind the power plant is the insulated tender that has a capacity of 24,000 gallons of black sticky bunker C. This residue of petroleum refining is cheap and, when heated, is an ideal fuel for a turbine.

However, the turbine's 10 combustion chambers won't light up on bunker C. The turbine is started on diesel fuel, then automatically transfers to bunker C after the combustion process is going well. And the turbine never shuts down on bunker C. The stuff would clog all the lines and orifices when it cooled off. Part of the shut-down process includes a transfer back to diesel fuel.

All this happens automatically. To start the turbine the engineer presses a button labeled "turbine start-stop"; he holds the button down until a green light comes on, indicating that the robot turbine controller has taken charge. The controller starts cranking the turbine up to speed, switches on the ignition at the right time, opens the diesel-fuel valves to the combustion chambers, transfers to bunker C at the proper

(Continued to page 264)

Turbine technician adjusts pipe leading to combustion chamber; engine work cannot be done en route



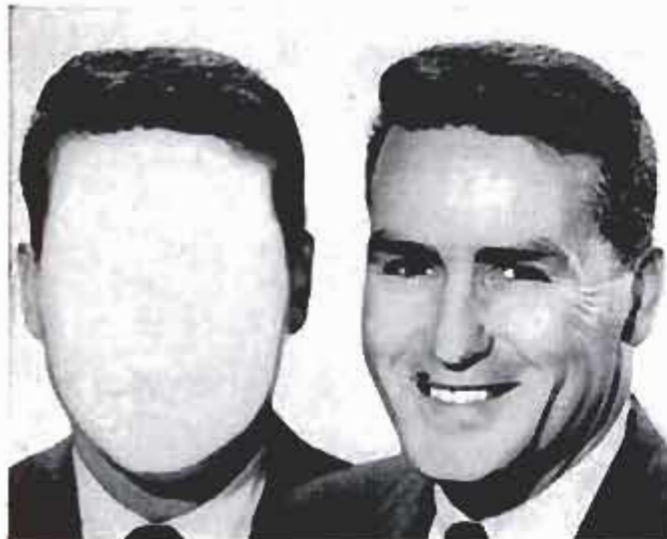

WHEN you see a Brand Name that you know, it's like the face of a friend. It inspires confidence.

In fact, Brand Names are built on confidence. You and your neighbors dictate the standards a Brand Name product must meet to consistently deliver the value and service you want.

A respected Brand Name is a manufacturer's most valuable asset and he protects it by constantly testing and bettering his product.

A Brand Name is the maker's guarantee of satisfaction which is *doubly endorsed* by the dealer who sells it.

For dependable quality and consistent satisfaction you will do better with the brands you know best; get to know those you see advertised in this magazine.

To get the most for your money buy by *Brand Name and be sure!*

A Brand Name is a maker's reputation



BRAND NAMES FOUNDATION, INC.
437 FIFTH AVENUE, NEW YORK 16, N.Y.

FEBRUARY 1959

little money...



Lone Star's 14'
Malibu
ONLY

Only the nation's largest aluminum and fiberglass outboard manufacturer can offer such value! Highly-maneuverable, plush, maintenance-free, the MALIBU is your greatest boating bonus buy in '59!

\$525*

Standard equipment that's "extra" on other makes ... (A) automotive-style seating with plush two-tone upholstery; (B) steering and rigging; (C) windshield; (D) Sur-foam flotation; (E) four tri-tone color options. Also available: **Deluxe CORONADO, \$499***

... same high-performance hull with steering, rigging, upholstered front seat, windshield.

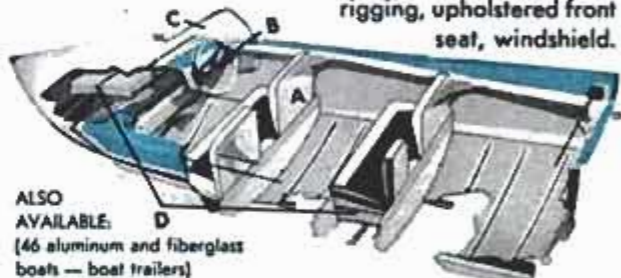

ALSO AVAILABLE: D
(46 aluminum and fiberglass boats — boat trailers)

AIRCRAFT-TYPE ALUMINUM CONSTRUCTION

Length	Beam	OBC Hp.	Weight
14'	61"	18 to 40	270 lbs.

Lone Star Boats

Send for your FREE FACT-FILLED LONE STAR CATALOG now!

SEE YOUR AUTHORIZED LONE STAR DEALER

THE LONE STAR BOATS LINE FOR '59
1948-2 E. Main Street • Grand Prairie, Texas

NAME _____
STREET _____
CITY _____ STATE _____

*FOB prices shown do not include freight, packing, dealer make-ready charges.



This point lets you bore holes up to 1½" with small electric drill

It's hollow ground to bore cleaner, faster at any angle

NOW YOU CAN increase the boring range of your small electric drill or drill press. New Irwin Speedbor "88" bits bore faster, cleaner holes up to 1½" in any wood. ¼" shank chucks perfectly. No wobble, no run-out. Sharp cutting edges on Irwin exclusive hollow ground point start holes faster, permit spade-type cutters to bore up to 5 times faster. All Irwin Speedbor "88" wood bits are forged from single bar of special bit steel, tempered full length and machine-sharpened for extra accuracy, longest life. 17 sizes, ¼" to 1½". Buy individually or in sets from your Irwin hardware or building supply dealer.

Only 75¢ each, sizes ¼" to 1"

Only \$1.25 each, sizes 1½" to 1½"

IRWIN SPEEDBOR "88" WOOD BITS

at Wilmington, Ohio, since 1885

Build this smart vacation cabin for \$1,000 with easy-to-use FIR PLYWOOD



PLANS ONLY
25¢

... include six 14" x 20" sheets. Fully detailed with materials list, illustrated step-by-step instructions

Here's a good looking, low-cost "second home" for beach or mountains that combines real livability with strong, money-saving fir plywood construction. Cabin is 400 sq. ft.: includes big living area, bedroom, kitchen and bath—plus roomy 8' x 20' "second floor" sleeping deck. Big plywood panels simplify construction—even for amateurs. Parts can be pre-built in your garage or basement to speed work on site. Materials cost about \$1,000, not including fireplace.

ORDER CABIN PLAN NO. 2. 25c per set postpaid. Or send 10c for idea-packed 12-page color illustrated Cabin Plans Catalog. (Offer good USA only)

DOUGLAS FIR PLYWOOD ASSOCIATION, Dept. 9, Tacoma, Wash.

point, and finally reports back to the engineer that the turbine is operating. The starting sequence takes seven minutes. When shutting down, the robot controller similarly performs the whole sequence of operations, even cranking the turbine over during the cool-down period.

Basically the locomotive turbine is the same as a jet-aircraft engine. It doesn't produce thrust through an exhaust nozzle, of course; its shaft is geared to the generators that create power for the traction motors. The turbine spins at a constant speed of 4860 revolutions per minute no matter what the load. When the engineer moves his throttle for more power he puts a greater load on the generators and this automatically increases the amount of fuel being delivered to the combustion chambers, thus maintaining the turbine's speed.

The locomotive doesn't sound like a jet. It produces about the same amount of noise as a diesel engine, a steady soft swoosh of sound. There's no loud compressor whine, no sharp exhaust roar.

The turbine is so sensitive to temperature changes that in hot weather it may temporarily gain considerable horsepower while passing under a dark, cooling cloud. Its power depends on the density of the air it uses, hence power drops off at high altitude or on a hot day. Knowing this, Union Pacific officials specified that the big turbine should develop its rated 8500 horsepower input to the generators at 6000-foot altitude on a day when the temperature soared to 90 degrees.

These big packages of power weren't built and tested without a few faults developing. No one before had designed so large a turbine, with so much power, and with such complete automatic controls. Naturally, there were a few bugs. General Electric made its own tests, ran into problems and corrected them, then turned over three locomotives to Union Pacific for final trials. G-E technical crews went along to make adjustments that might be needed in actual service.

At first the locomotives occasionally experienced a partial flame-out, a condition in which a few combustion chambers lost their fire and ejected raw fuel during the lighting-up process. This created a spectacular but harmless "fire in the stack" with flames rising out of the huge exhaust for a few seconds. That trouble was whipped and now the first group of locomotives is in steady service.

Union Pacific likes them so much that it has ordered 30 and is putting them to work just as fast as it gets deliveries. ★★★

SPEED REDUCER CLUTCH COMBINATION TRANSMISSION

GOVT. COST
\$262.00

SPECIAL
SALE!

\$49.50
FOB



FULLY
GUARANTEED

BRAND NEW
SURPLUS

Speed Reducer
alone worth
triple this
low price!

- Reduces speed at a 3-to-1 Ratio—These units hard to get at any price!
 - 2 Independent Output shafts, each separately controlled by its own adjustable clutch
 - Rated up to 3.6 HP (electric), or 7.5 HP (gas engine)
 - Ball and Taper Roller Bearings throughout (smooth, quiet)
 - Input shaft 1-3/16" diameter, Output shaft 1 1/8" diameter
 - Weight 108 lbs.—Dimensions approx. 17 1/2" long x 8" wide x 8" high
- This SPEED REDUCER-CLUTCH COMBINATION can be utilized when low speeds are required . . . for starting heavy loads . . . or, for engaging and disengaging machine operation without stopping input drive. *Supply limited!*
- ORDER DIRECT FROM THIS AD! SUPPLY LIMITED!**
FREE Catalog of Hydraulics, Generators, Surplus
Phone TAYLOR 9-1385
ROBERTS ELECTRIC CO., Dept. PM-893, 849 W. Grand, Chicago 22, Ill.

LOOKS COOLER-
IS COOLER!



\$2.50

AIR COOLED
VIKING

DR. GRABOW PIPES • GREENSBORO N. C.

HOME REPAIR TIP NO. 41



Mend cracked radiator hoses with a tight wrap of tough, waterproof "SCOTCH" Brand Plastic Tape. Stretchy, all-plastic tape resists heat, oil, corrosion, sticks tight as skin. Will not crack. Comes in seven permanent colors and clear. Ideal for mending, decorating, identifying. Get "SCOTCH" Brand Plastic Tape, 3/4" width, 25¢; 1 1/2" width 50¢ at stores everywhere.

Don't run short . . .
NEXT TIME BUY TWO!

Made by
Minnesota Mining & Mfg. Co.
St. Paul 6, Minn. ©3M Co., 1959



Big Volume and Big Profits are yours . . . with versatile "Two-Way" Grinding Option on the New IDEAL 900 Lawnmower Sharpener

New heavy-duty IDEAL MODEL 900 sharpener precision grinds either by "hook" or "straight-line" method for EXTRA VOLUME and EXTRA PROFIT. Unit sharpens all kinds of reel-type mowers from the smallest edger to the largest fairway or power machine.

Outstanding Features Include:

- Gravity Feed
- Screw-type Adjustments
- 1/2 h.p. Motor
- 6-inch Grinding Wheel
- Includes Bed-knife Grinding Bar, Reconditioner and Tool Tray

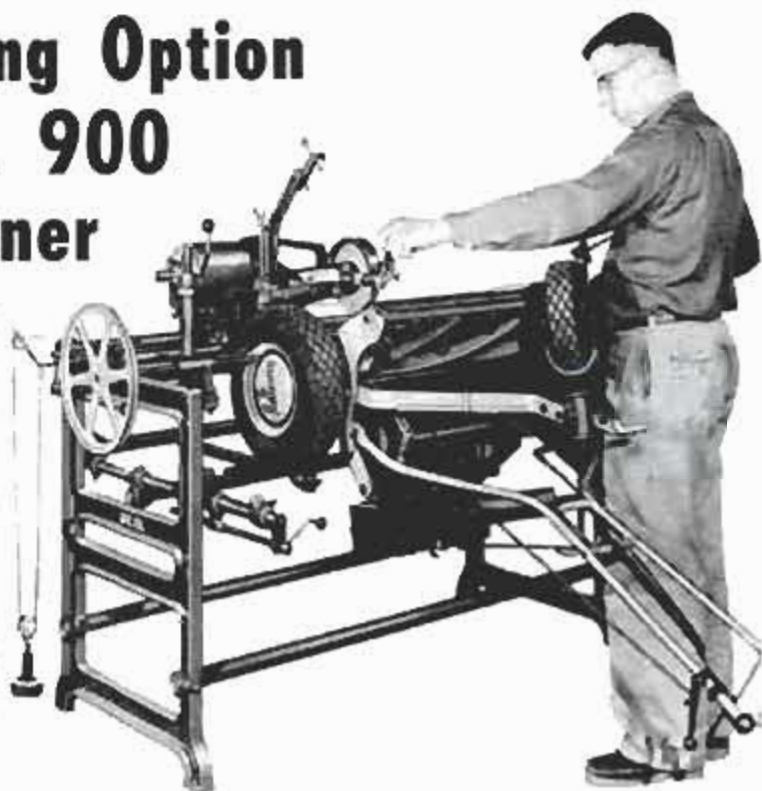

THE FATE-ROOT-HEATH COMPANY

Dept. PM-2 • Plymouth, Ohio

Write today for full details on the
NEW IDEAL MODEL 900

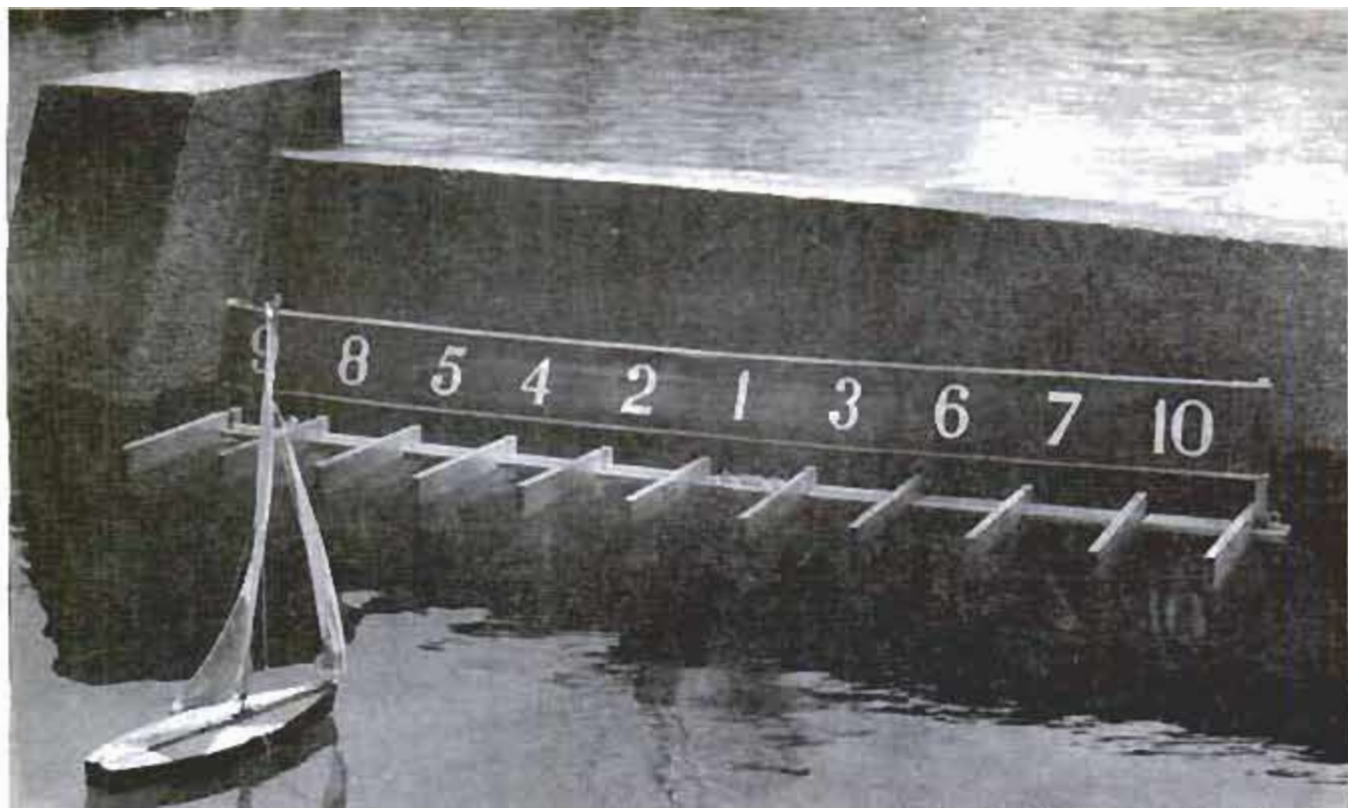

Mae's Hobby Ranch, Box 14, Dallastown, Pa.

Game for Model Boats Requires Good Guidance

Object of a new game for model boats is to guide your entry into the highest scoring dock of a floating target. The "finish line" is made of white pine coated with

marine varnish and joined with waterproof glue. It can be taken apart and carried in the trunk of the car. Set up on dry land, the game can be played with model cars.

SHOPMATE®

ALL-NEW TWO-SPEED 3.0 AMP. 3/8" DRILL

FEATURES: powerful 3.0 amp. universal AC/DC fan-cooled motor • electro-mechanical transmission changes speed instantly, electrically • interlocking speed range selector switch • precision geared chuck and key • spindle lock for easy chuck removal • multiple ball thrust bearing • weighs under 6 lbs., perfectly balanced • silver luster finish



**2-SPEEDS...
THE RIGHT SPEED
FOR EVERY DRILLING JOB
AND YOUR SANDING, POLISHING, SAWING ATTACHMENTS
AT THE FLICK OF A SWITCH!**

Here's the world's most revolutionary new drill... the drill that will handle every drilling job! Two separate speed ranges! 2000 rpm for drilling wood, plaster, plastic, and other "light" materials, and 1000 rpm for heavy-duty drilling applications. To change speeds instantly, you merely touch the interlocking electro-mechanical speed range selector switch. And, both speed ranges develop full power for fast, efficient drilling under any conditions!

\$32⁹⁵
Complete
Model SD-382

at hardware and building supply dealers or write to . . .

PORTABLE ELECTRIC TOOLS, INC. • 320 WEST 83RD STREET • CHICAGO 20, ILLINOIS

CUT-TO-FIT HOMES CUT COSTS UP TO 40%

Save labor cost up to 100%, reducing completed home cost up to 40%. You can assemble any of 57 designs from easy-to-follow plans. No measuring or cutting . . . every piece precision machine pre-cut and marked. **BUY DIRECT FROM MILL.** Eliminate all between overhead, profit and labor

costs. Nothing to plan or figure. Complete with all lumber, hardware, paint, nails, glass, roofing, etc. Sterling Home quality material throughout. Freight paid most areas. Write today. Send 25c for illustrated, color catalog, floor plans and details.



PRICED FROM
\$2150 UP

CHOICE
OF
57
DESIGNS

FIVE EASY-PAYMENT PLANS

INTERNATIONAL MILL & TIMBER CO. Bay City, Michigan, DEPT. PM29



America's Biggest Garden Tractor Value

Simplicity

**MORE POWER
FOR BIG JOBS**

*Better Traction
on All Surfaces*

**3 Great
Models:**

7 hp.
5½ hp.
3 hp.



**SIMPLICITY
MANUFACTURING CO.**

5927 Spring Street
Port Washington, Wis.

Makers of Simplicity Wonder-Boy
Riding Lawn Mower and Rotical
Tiller-Cultivator

Year 'round labor saving for mowing — plowing — tilling — hauling — snow removal. Auxiliary power for a host of jobs. New Controlled Traction differential improves traction for all different soil conditions, for ice and snow. And all control is at your finger tips! Write for **FREE** catalog.

CHANGED YOUR OIL LATELY?

FREE Vacation Guide to Tennessee



40 Pages
116 Pictures
41 in Color

Tells all about
**GREAT SMOKY
MOUNTAINS NATIONAL PARK**
most visited National Park in U. S.

22 GREAT LAKES—TVA DAMS
wonderful fishing and water sports

HISTORIC SHRINES — including
homes of three presidents

**MAIL
COUPON
TODAY**

TENNESSEE DIVISION OF INFORMATION
1952 Cordell Hull Bldg., Nashville, Tennessee

Please send Free Vacation Guide

NAME _____

ADDRESS _____

CITY _____ STATE _____

BIG LOAD!

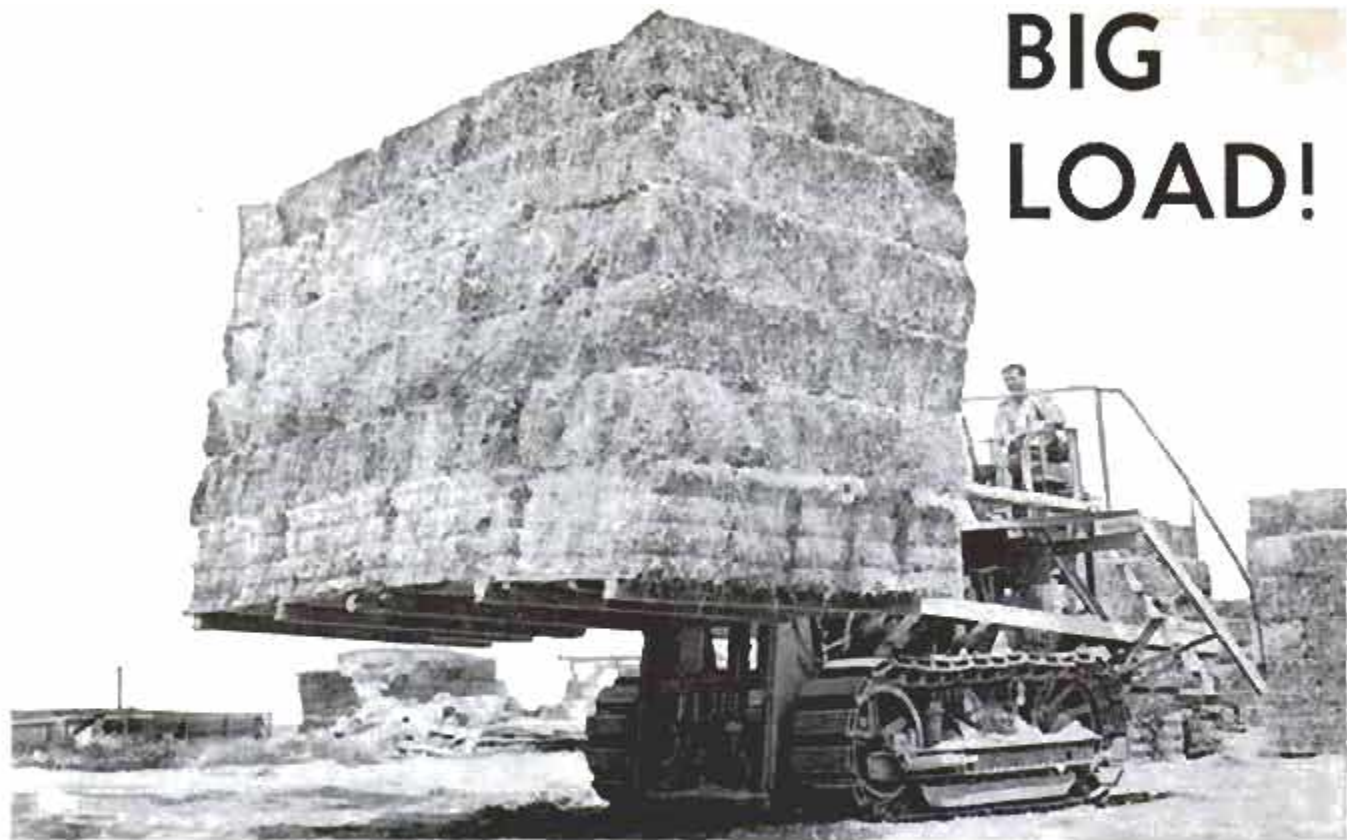

In one big flex of its muscles, a home-made lift truck can lift 120 bales of hay to load or unload a truck. The baled hay is stacked on pallets as it is picked up in the field. At the transfer point, where the hay

is distributed, the big lift truck handles the hay in huge stacks. The truck was designed and built by Howard Beeman of Woodland, Calif. It cuts the loading time of a transport truck from four hours to ten minutes.



**MAKE YOUR OWN GLASS SCREENS
with REAL Flowers and Butterflies**

permanently embedded in Castoglas. Also make unusual place-mats, bowls, dishes, trays, table tops and other distinctive items with embeddings of colorful leaves, shells, coins, photos, unusual fabrics and other interesting objects.

**MAKE GOOD MONEY AT HOME
No Experience, No Equipment Needed**

The laminating process is so simple anybody can do it. No heat, pressure or special equipment are needed. In a short time you can produce articles of professional quality. Sell them direct or have department stores and specialty shops handle your sales for you. Also do custom work for interior decorators, architects and builders.

NEW HANDBOOK SHOWS YOU HOW

Illustrated step-by-step directions show you how to make these beautiful screens and room dividers. Apply the same process to your own ideas to make articles that people really want and are willing to pay good money for.

The complete set of manuals contains 25 projects, illustrated with over 150 photographs and many sketches. Nothing like it has ever been published before. The price of only ONE DOLLAR also includes a copy of "How to Earn Extra Money at Home." Send your order now to Commercial Crafts Division, Dept. B-1.

THE CASTOLITE COMPANY, Woodstock, Illinois



MONEY FOR YOU... in hidden treasures

Locate buried treasure... coins, gold and silver. New transistorized instruments for greater locating depth, less weight, operates on flashlight batteries. Complete line priced from \$79.50. FREE literature... authentic books of known treasures available. WRITE today.

GOLDAK COMPANY

1542-2 W. Glenoaks Blvd., Glendale, Calif.



Break
the
grip
of the
crippler

ARTHRITIS



Hoffman Electronics Corp., 3761 S. Hill St., Los Angeles 7, Calif.

Electricity Made From Light With Solar-Energy Kit

Direct conversion of light into electricity can be demonstrated with a small solar-energy kit for schools and industrial laboratories. The device has four silicon-junction solar converters, wired in series, which activate a small electric motor when exposed to sunlight. A 150-watt incandescent light bulb also will activate the motor.

Parking Meter Reminder Also Holds Eight Coins

For less than the cost of an overtime-parking fine in many cities, you can buy a pocket piece designed to solve a couple of common parking-meter problems. One side of the device has a watch face and hands to remind you of the time your parking privilege expires. On the back are coin sockets for eight nickels, pennies or dimes.

Central States Specialties, Inc., 222 West Huron St., Chicago 10

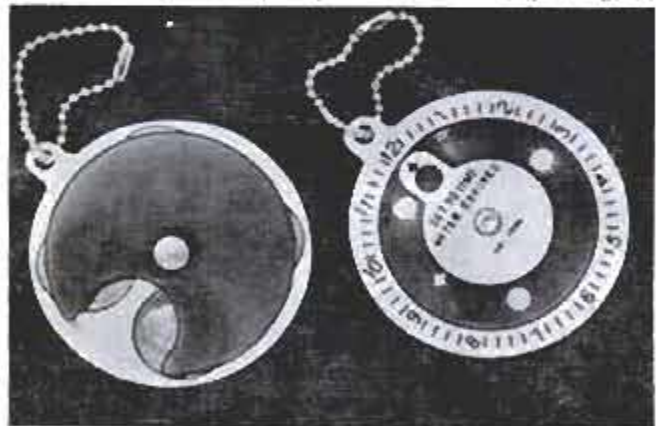

India is converting its measuring system from British and Indian units to the metric system.



HINGES?



QUICK! Hush 'em up with handy 3-IN-ONE OIL. Just a drop or two and away go squeaks. Dozens of other uses.

3-IN-ONE OIL
REGULAR · OIL SPRAY · ELECTRIC MOTOR

Improve Your Home



do-2



DIAL ANY DADO WIDTH... IN SECONDS

FOR PROFESSIONAL PRECISION... only with a COMET QUICK-SET DADO! Cut to a maximum depth of $\frac{3}{4}$ ". Dial the exact width (from $\frac{1}{4}$ " to $1\frac{3}{8}$ "), without removing the tool from the arbor. Watch the balanced, tool-steel COMET blades cut perfect dados, rabbets and ploughs... on any table or radial arm saw. Use COMET for quick, professional precision... stays sharp 5 times longer! If not at your local dealer, order direct by check or money order. **19.95 PREPAID**

COMET MANUFACTURING CO., Dept. PM2

2033 Santa Fe Avenue, Los Angeles 21, California
a division of The Siegler Corporation

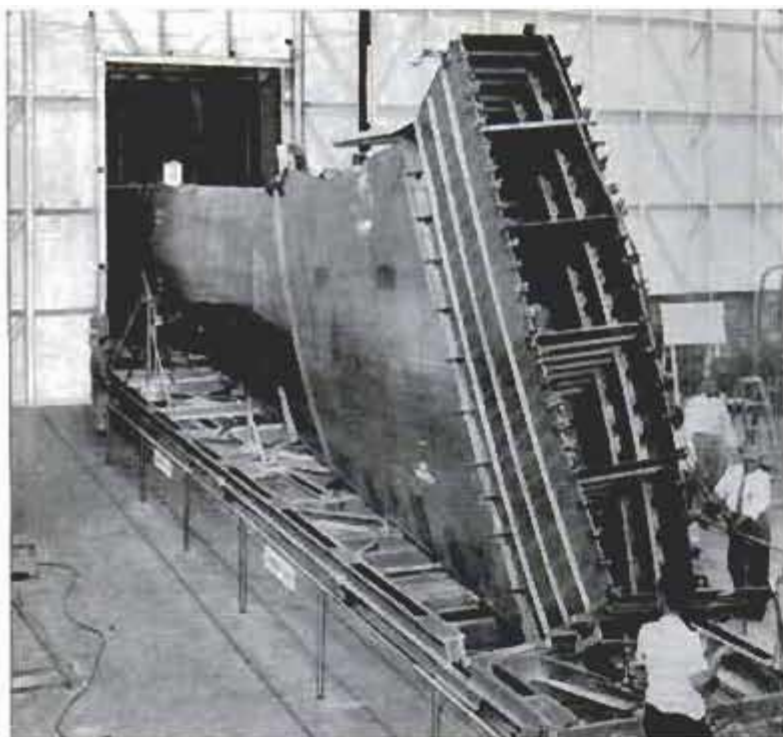

Giant Electric Oven Cures Airplane Wings

Part of the process of making the fuel tanks of the Convair 880 leakproof requires an adhesive-bonding treatment in a 16,000-cubic-foot electric oven. The jet airliner's wings are cured in the oven for one hour at 320 degrees Fahrenheit. They are moved in and out of the oven on a flatcar which runs on a 170-foot "railroad."

Pills Defeat Poison Ivy

Experiments indicate that a new pill taken orally will give season-long immunity from poison ivy.

Mice Gain Cancer Immunity From X-Ray Treated Cells

Some mice can be immunized against cancer with a vaccine of cancer cells which have been altered by X-rays, according to a team of medical researchers at the University of California at Los Angeles. More than 90 percent of the mice given five in-

jections of X-rayed cancer cells were immunized against later transplants of untreated cancer. The X-rays changed the manner in which the cancer cells used oxygen and sugars. The vaccine affected only a certain strain of mouse cancer.

POCKET SIZE BLOW TORCH

only
\$1.95
with charger



Butane gas blow torch gives intense 3500° flame. Solders, brazes, fixes leaks. Perfect for wiring, plumbing, loosening frozen nuts and bolts, 1001 odd jobs. Carry in your pocket. Each charger lasts 1/2 hour, turns on or off. Extra chargers, 49¢ per box of 2.

Get Jet King Butane Blow Torch at hardware stores. Or, send check or money order, we pay postage. For \$1 more (total \$2.95), get Soldering Kit; torch, tip, 3 feet cored solder, extra charger. Good for TV, radio, jewelry.

* Add \$1.00 in Canada

**KIDDE MANUFACTURING CO., INC., Dept. PM-24
42 FARRAND ST., BLOOMFIELD, N. J.**

Send me JET KING BLOW TORCHES @ 1.95 ea.*

Send me JET KING SOLDER KITS @ 2.95 ea.*

Send me Boxes of Extra Chargers @ .49 per box.

My check, money order, for \$ is enclosed

NAME

STREET

CITY STATE

PREFERRED

by Leading
Appliance Manufacturers
NOW AVAILABLE TO YOU!

EMERSON  ELECTRIC

multi  duti 

MOTORS

First choice of manufacturers for 68 years! Now you can choose from 21 different designs from 1/4 to 1 H.P. Write for free catalog No. M-197. The Emerson Electric Mfg. Co., St. Louis 21, Mo.

EMERSON-ELECTRIC 
of St. Louis . . . Since 1890

ONLY \$5.75
LESS 6-V BATTERY



FOR THIS DELTA SEALED BEAM

Real value! Delta quality plus famous G.E. Sealed Beam unit. Handle folds. Head swivels 180 degrees. Get one soon!

Delta Electric Co., Marion, Ind.

Delta **POWERTOP**
Sealed Beam Electric Lantern

Other "BUYS" Check Here

- 1/4 Ton Utility Auto
- GOLF CARS Electric or Gas
- CAR SHOW PLOW. Bolts on.
- Children's Autos

ESHELMAN TRACTORS LOW AS \$99 **WRITTEN FULL YEAR GUARANTEE**



Eshelman Tractors, Tillers, Riding Rotary Mowers for Better Lawns and Gardens. Advertised in GOOD HOUSEKEEPING. Thousands of satisfied users. Write for Free Literature. **DEPT. 7, ESHELMAN, Balto. 2, Md.** *illus. Model #119*

Exclusive Double-Bearing HEAVY-DUTY PUMPS

IRRIGATE • DRAIN • CIRCULATE • SPRAY

Use 1/4 HP motor or larger . . . 1 HP for up to 7,500 GPH; 1,000 GPH 60' high; or 3,000 GPH from 25' well. 1 1/2" inlet; 1" outlet. Stainless shaft.

TYPE X—2 oil-less bronze bearings. Won't rust. . . . \$10.95

TYPE XB—Ball bearing model. . . . \$12.95

Postpaid if cash with order. Rush your order today

MONEY BACK GUARANTEE
Centrifugal and Gear Pumps in All Sizes

LABAWCO PUMPS, Belle Mead 2, N. J.



America is a Better
America —
thanks to Advertising!

FOR PANELING... BUILT-INS... CABINETS... FURNITURE

The Complete Interior

WOOD FINISH

in One Can

READY TO USE

A finer clear, semi-gloss for natural wood beauty. Non-darkening. ANYONE can use Deft... it's so easy.

Wherever paints are sold, or write Dept. PM
Deft, 1826 W. 54th St., Los Angeles 62, Calif.



NEW MODEL CHANGEOVER SALE

NOW \$9.95
WAS \$24.95



8" TILT ARBOR POWER SAW

Shipped Complete As Shown Less Blade

1958 MODEL NOW SOLD BELOW COST
BLADE TILTS • TABLE REMAINS LEVEL

Heavy duty all cast iron and steel construction. Precision ground cast iron table. Price includes massive cast iron mitre gauge and patented motor drive that fits any motor. Does everything same as saws costing four times as much — cross cuts, rips, bevels, mitres, dados, cuts compound angles. Adjustable depth of cut; 0" to 2 1/4". Send check or M.O. \$2.00 deposits on C.O.D.'s.

SAVE \$15 ON THIS SPECIAL BARGAIN DURING OUR MODEL CHANGEOVER

This saw is our 1958 model. Brand new — sent to you in factory sealed cartons. Sold and guaranteed direct from factory to you at a fantastic bargain.

LOOK AT ALL THESE SPECIAL FEATURES

Blade adjusts to any angle up to 50° • Single Hand Wheel Control. Tilts and locks blade with a twist of the wrist • Blade raises and lowers; cuts from 0 to 2 1/4 • Precision-ground cast iron table. Lasts a lifetime. Resists nicking and wear • Patented Motor Mount takes any standard 1/4 or 1/2 h.p. motor • Always keeps belt tight; transmits full power • Massive accurate iron mitre gauge • Saw insert removable for dado heads and other accessories • Heavy long-lasting, all-metal construction • Built for a lifetime • Shipping weight 25 lbs.

FAMOUS AMERICAN IRON CLAD GUARANTEE

Try this famous saw 10 days. If not completely delighted — **FOR ANY REASON** — return for immediate money back refund. All power tools sent express collect. We reserve the right to refund money if stock is exhausted. Use this handy coupon.

AMERICAN MACHINE & TOOL CO.
ROYERSFORD 1, PA. 1

MAIL COUPON TODAY

American Machine & Tool Co.
Royersford 1, Pa.

Gentlemen: Please send me 8" Tilt Arbor Saw(s) at \$9.95 each. Enclosed is check , M.O. , or send C.O.D. . . . \$2.00 deposit, please. Add \$1. for delivery west of Mississippi.

Name

Address

City Zone State



PAY 1¢ on the DOLLAR

for 1000's of Useful Items

U.S. GOV'T SURPLUS

LOOK AT THESE LOW PRICES

Jeeps... \$223 Tractors... \$68
 Trucks... \$212 Motors... 99c
 Boats... \$5.90 Airplanes... \$366
 Fork-lifts, \$197 Typewriters, \$6.80
 Hydraulic cylinders \$1.01 • Gear
 Reducers 97c • Transmissions \$7.80
Paid at Govt. Surplus Sales

Eliminate the middleman—Save big money! Buy direct from U. S. Government at TREMENDOUS savings. Pay as low as 1¢ on the dollar or less. Our Directory Govt. Surplus Sales lists 100's of Army, Navy, Air Force, and other government surplus depots. Many of them right in your own back yard. Buy sports equipment, hunting, fishing and photographic equipment and supplies, radio, electronic and electrical equipment, trucks, boats, jeeps, airplanes. Plumbing, hardware, office equipment supplies. Power tools, machinery, furniture. Directory is indexed for quick information. Answers your questions. Tells you how to buy. Get on the gravy train while you can. Send \$1 for "Govt. Surplus Directory" to— Aviation Surplus, Dept. PM-2, Box 789, York, Pa.

NEW LAPSTRAKE KITS

U-MAK-IT BOAT KITS

FIRST AND OLDEST
KIT BOAT
MANUFACTURER

Most complete line of PRAMS,
ROWBOATS, OUTBOARDS, CABIN
CRUISERS and new Lapstrake kits.
MAIL 35c (coin) for post. & hdg.
for ILLUSTRATED CATALOG
Showing all models 8' to 23'
including accessories, paints, etc.

and FRAME
KITS



All you need to build
your own.
U-MAK-IT PRODUCTS
DELAND, FLA.— DEPT. 12



BRAND NAMES FOUNDATION, INC.
437 FIFTH AVENUE, NEW YORK 16, N.Y.



**REPLACE YOUR
WORN-OUT
WOODEN
HATCHWAY...**

with an
all-steel
BILCO
basement
door



... and your basement entrance will be weathertight, good-looking — for a lifetime. A spring-balanced Bilco door floats open at a touch... locks securely... costs so little. And you can install it yourself — in just a few hours!

Bilco

The Bilco Co., Dept. R-92
New Haven 5, Conn.
Please send me your free illustrated folder
and name of local dealer.

NAME _____
 ADDRESS _____
 CITY _____ ZONE _____ STATE _____

AMERICA'S FINEST
BASEMENT DOOR

**PLEASE
SEND ME**



for the
time checked.
I am enclosing . . .

- 1 year \$3.50
 2 years \$6.00

name _____
 address _____
 city _____ zone _____ state _____

Hand this order to your newsdealer or send it to
POPULAR MECHANICS
 200 East Ontario St. Chicago 11, Ill.



Kleinschmidt Laboratories, Inc., Lane-Cook Road, Deerfield, Ill.

Automatic Switchboard "Remembers" Messages

Inside the administrative headquarters of the Virginia State Police is a new automatic switchboard for microwave radio and teletypewriter circuits. Besides automatically routing all messages to the proper destination, the electronic unit clears all circuits for "general alarm" or emergency messages. It "remembers" the messages received while the circuits are cleared and resumes transmission of them after the urgent messages have been sent.

Chemical Extinguishers For Aircraft Fires

Potassium-bicarbonate powders may be adopted by the Navy for extinguishing fires caused by aircraft accidents and spilled fuel. Tests indicate the agent has twice the efficiency of sodium bicarbonate in extinguishing hydrocarbon fires.

Portable Nuclear Reactor Could Fight Farm Pests

Nematodes, fungi, insects and weeds could be removed from farm soil at a cost of about \$70 an acre, according to scientists at the University of California at Los Angeles. Drs. Samuel G. Wildman and Amos Norman suggest that a portable nuclear reactor, moving at about six miles per hour, could sterilize 100 square feet of soil per second with gamma rays and neutrons. The radioactivity would be shortlived and would not constitute a hazard in the soil or in crops grown in it.

OPTICAL BARGAINS

ERECT IMAGE LOW POWER MICROSCOPE

5X, 10X, 20X

\$80.00 Value - Only \$19.95



Extremely sturdy with rack and pinion focusing, color corrected optics, turnable microscope body for inclined viewing, three different powers, long working distance under objectives, sufficient eye relief for easy viewing. Made from war surplus optical instrument so that you actually get \$80.00 of value. Weighs 4 lbs., 13" high. 10-DAY FREE TRIAL! Accessory objectives available for powers of 15X, 30X, 40X.

Stock No. 70.172-H.....\$19.95 Postpaid



New! 2 in 1 Combination! Pocket-Size 50 Power MICROSCOPE and 10 Power TELESCOPE

Useful Telescope and Microscope combined in one amazing, precision instrument. Imported! No larger than a fountain pen. Telescope is 10 Power. Microscope magnifies 50 Times. Sharp focus at any range. Handy for sports, looking at small objects, just plain snooping. Send Check or M.O. Satisfaction Guaranteed. Order Stock No. 30.059-H.....\$4.50 Pstpd.

8 POWER ELBOW TELESCOPE

WAR SURPLUS

\$200 Value - Only \$13.50

Big 2" objective, focusing eyepiece 28mm focal length—Amiel erecting system—turret mounted filters, clear, red, amber and neutral—reticle illumination. Sparkling, clear, bright image—6" field (325 ft. at 1,000 yds.). Focus adjusts 15 ft. to infinity. 28mm f.l. eyepiece alone is worth more than \$12.50.

Stock No. 70.173-H...\$13.50 postpaid



STEREO MICROSCOPE - 23X and 40X

Stock No. 85.056-H.....only \$99.50 F.O.B. Barrington, N. J.

WRITE FOR FREE CATALOG "H"!

Complete Line of Astronomical Telescope Parts and Assembled Telescopes. Also huge selection of lenses, prisms, war surplus optical instruments, parts and accessories. Telescopes, microscopes, Hand Spectroscopes, Sniperscopes, binoculars, etc. Request Catalog "H"!

ORDER BY STOCK NUMBER SEND CHECK OR MONEY ORDER SATISFACTION GUARANTEED
EDMUND SCIENTIFIC CO., BARRINGTON, N. J.

FREE! LAFAYETTE'S

1959

CATALOG

260 GIANT-SIZED PAGES

CONTAINS

HUNDREDS OF EXCLUSIVE LAFAYETTE ITEMS NOT IN ANY OTHER CATALOG OR AVAILABLE FROM ANY OTHER SOURCE—SEND FOR YOUR COPY NOW!

See the newest and finest in Stereo Tuners, Amplifiers, Cartridges and Music Systems

Everything in Electronics

The Complete Catalog
Featuring The Best Values
Obtainable

• TAPE RECORDERS • PUBLIC ADDRESS SYSTEMS • AMATEUR EQUIPMENT
• INDUSTRIAL SUPPLIES • RADIO & TV TUBES AND PARTS • INSTRUMENTS
• TELESCOPES, BINOCULARS, MICROSCOPES & CAMERAS

LEADERS IN HI-FI

The most complete electronic supply catalog crammed full of everything electronic at our customary down-to-earth money-saving prices.

OUR
38th

The largest selection of hi-fi components and systems; greatest savings on Lafayette endorsed "best-buy" complete systems.

YEAR

EASY PAY TERMS AVAILABLE —
10% DOWN - UP TO 18 MONTHS TO PAY

CUT OUT AND PASTE ON POST CARD

P.O. Box 511
JAMAICA 31, N. Y.
DEPT. LB-9

Send FREE LAFAYETTE Catalog 590

Name

Address.....

City..... Zone..... State.....

POPULAR MECHANICS PRESS, Dept. 259

200 E. Ontario Street, Chicago 11, Illinois

Gentlemen: Please send copies of book nos.:

1 2 3 4 5 6 7 8 9 10 11 12 13 14
15 16 17 18 19 20 21 22 23 24 25 26
27 28 (circle numbers desired)

Remittance enclosed

Send C.O.D. (\$2.00 or more) I enclose \$_____

Name _____

Address _____

City _____ Zone _____ State _____

**FILL-IN and
MAIL THIS
← COUPON!**

SAVE MONEY *with these* NEW DO-IT-YOURSELF BOOKS



- 1. HOW TO PAINT INSIDE AND OUT:** Step-by-step instructions. Easy to follow illus.
- 2. HOW TO LAY LINOLEUM AND TILE:** How to get the best from your labors. Diagrams.
- 3. HOW TO REMODEL YOUR BASEMENT AND ATTIC:** Planning ideas, hints, instructions. Illus.
- 4. HOW TO TAKE CARE OF YOUR LAWN:** Detailed guide to a perfect lawn and healthy shrubs.
- 5. HOUSE WIRING AND ELECTRICAL REPAIRS:** Ideas and instructions for the homemaker. Diagrams.
- 6. SMALL BOATS YOU CAN BUILD:** Plywood dinghy, 15-ft. sailing knockabout, 8-ft. duckboat, etc.
- 7. PLUMBING REPAIRS MADE SIMPLE:** Fix faucet noises, water hammer, clogged pipes yourself.
- 8. FENCES, GATES, TRELLISES AND WALKS:** Variety of fences, etc., with instructions, diagrams.
- 9. BUILT-IN FURNITURE FOR YOUR HOME:** Wall cabinet, wardrobe, linen closet, crib, etc.
- 10. BUILD YOUR OWN BARBECUE:** Stone and brick fireplaces, grills, barbecue pits, etc.
- 11. LAWN AND GARDEN PROJECTS:** Picnic furniture, folding chairs, garden pool, etc.
- 12. THREE LOW-COST HOMES YOU CAN BUILD YOURSELF:** Build your own home—save half the cost.
- 13. 125 SIMPLE HOME REPAIRS:** Stop faucet leaks, replace sash cords, cut glass, etc.
- 14. SIMPLE TELEVISION REPAIRS:** Only a screwdriver, pliers and soldering iron necessary.

- 15. MODERNIZE YOUR KITCHEN:** Planning for convenience and economy. Ideas, diagrams.
- 16. 30 ONE-EVENING PROJECTS:** Decorative, easy-to-make chairs, lamps, tables, shelves, etc., for the home.
- 17. HOW TO WINTERIZE YOUR HOME:** Prepare for bad weather. Make storm windows, repair roofs, etc.
- 18. HOW TO SET UP YOUR HOME WORKSHOP:** Detailed layout plans for basement conversion. Diagrams.
- 19. LANDSCAPING YOUR HOME AT LOW COST:** How to plan and plant beautiful home surroundings.
- 20. CONCRETE CONSTRUCTION AROUND THE HOME:** How to make steps, walks, driveways, fireplaces, etc.
- 21. REFINISHING FURNITURE, FLOORS AND WOODWORK:** What you need and how to do the job properly.
- 22. HOW TO USE POWER TOOLS IN YOUR HOME WORKSHOP:** Basic and advanced operations, ideas, tips.
- 23. HOW TO CURE YOUR LEAKY BASEMENT:** Causes of, and how to stop, dampness and water seepage.
- 24. MONEY-SAVING HOUSEHOLD FORMULAS:** Safe, efficient polishes, cosmetics, etc., you can make.
- 25. UPHOLSTERING AT HOME:** Using foam rubber, upholster chairs, benches, etc., at a big saving.
- 26. HOW TO GET THE MOST OUT OF YOUR CIRCULAR SAW:** How to build and use this tool for best results.
- 27. HOW TO MODERNIZE HARDWOOD FLOORS:** Step-by-step instructions and diagrams for renovation.
- 28. HOW TO MODERNIZE WALLS AND CEILINGS:** Ideas for wall and ceiling treatments and how to carry them out.

**ONLY
25¢ EACH**

PLEASE NOTE
Minimum Order Five (5) Books

**5 for
\$1.00**

AMAZING NEW PERSONAL POCKET RADIO



GUARANTEED—FOR YOUR LIFE!
 FOR AS LONG AS YOU OWN IT!
 NO TUBES, BATTERIES, TRANSISTORS OR ELECTRICAL PLUG-INS NEEDED! Will never run down or burn out! SMALLER THAN A PACK OF CIGARETTES! RECEIVES LOCAL RADIO STATIONS ANYTIME—ANYWHERE YOU GO! Easy thumb turn NO DANGLING EARPHONE! HAS BUILT-IN SPEAKER PHONE! Black gold plastic cabinet, semi-conductor wave detector. NOT IMPORTED. MADE AND GUARANTEED BY AMERICANS—You can always get service.

SEND ONLY \$2.00 (full, ok, mo) and pay postpaid \$4.00 (100 postage included) package in arrival or send \$6.00 for postpaid delivery. SENT COMPLETE READY TO LISTEN WITH LIFE GUARANTEED—NIGHTS! EXTRA TO BUY EVER! (111) 1350 DISTANCE ANTENNA if you order now. Available only from MIDWAY COMPANY Dept. WPM-2 KEARNEY, NEBRASKA



Every \$1 sends a 22 lb. Food Crusade package to the world's hungry thru CARE, New York 16

No Wonder We Sell So Many!

Taft

BOAT KITS

FREE COLOR CATALOG

World's finest line of top quality kits... cruisers, runabouts, fishing boats... at mass production prices!

RUNABOUTS

New! 16-ft. "Big Motor" Runabout

One of 12 Taft runabouts that deliver more speed, safety and comfort! Taft runabouts start at \$99.00



CRUISERS

Taft has 9 cruisers—day, express, overnight! Advanced design, quality materials assure utmost family comfort and luxury!

YOU CAN PAY MORE, BUT YOU CAN'T BUY BETTER!

Taft MARINE WOODCRAFT

Dept. PM-259, 636 39th Ave. N.E., Minneapolis, 21 Minn.

CHECK YOUR TIRES . . . YOUR LIFE DEPENDS ON THEM!



National Society for Crippled Children and Adults
 2023 W. Ogden Ave.
 Chicago 12, Ill.



earn
BIG PROFITS

Sharpening Hand Saws

The Foley Saw Retooler cuts perfect new teeth right over old ones in less than 1 minute, without removing saw handle. Makes filing easy. Takes all hand saws 4 to 16 points per inch. Relieves eye-strain. No experience needed.

FREE Foley Price Guide of saw sharpening charges. A valuable chart of actual prices. Send coupon today. No salesman will call.

FOLEY MFG. CO. 270-9 FOLEY BLDG. MINNEAPOLIS 10, MINN.

Send FREE Price Guide and Foley Retooler circular.

Name _____

Address _____

Save 1/3 on SELF-LOCKING HOOKS and FIXTURES



STARTER SET (30 pieces, \$1.50 value) YOURS, SPECIAL ONLY \$1.00!

The original SELF-LOCKING HOOKS made for perforated wall-board. Lock themselves securely in place. Order this special starter set today; SELF-LOCKING HOOKS are invaluable in your workshop, garage, kitchen, tool shed or barn.

THE KERR WIRE PRODUCTS CO.
 933 N. Cicero Avenue, Chicago 51, Illinois
 Send Starter Set. I enclose \$1. (No C.O.D.'s please)
 Name _____
 Address _____
 City & State _____
 Hardware Dealer _____

Continental U.S.A. only

TOYS BROKEN?

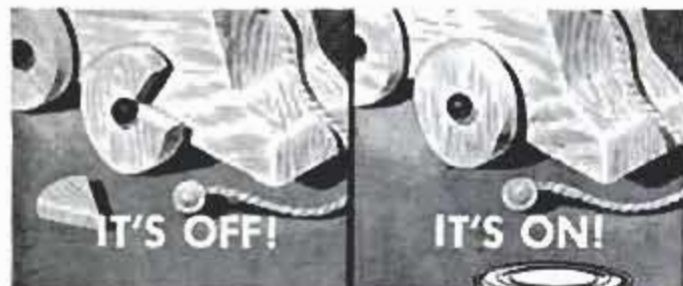

Fix 'em quick with the one and only Plastic Wood. It can be sanded, planed, painted!



For surest results always use GENUINE

PLASTIC WOOD

Handles like putty—hardens into wood!



Purple-Tailed Squirrels Aid Wildlife Study

University of Florida wildlife-management researchers are tracing the migratory habits of game animals by dyeing their tails purple and tagging them. Among things they've learned so far: Squirrels have a particular territory in which they live, and don't wander more than 200 yards from that spot during their entire lifetime. Since squirrels are color blind, they don't object to the colored dye on their tails.

Hinges With Spiral Design Keep Door From Scraping Rug

Spiral-action hinges lift a door automatically when it is opened. This prevents bumping rugs. One half of the hinge rises spirally—in much the same way that a person ascends a spiral staircase. When the door is closed, the action is reversed. In "high," or open, position the hinge raises the door $\frac{3}{4}$ inch.

Beckhart Hinge Co., 11433 E. Garvey Ave., El Monte, Calif.

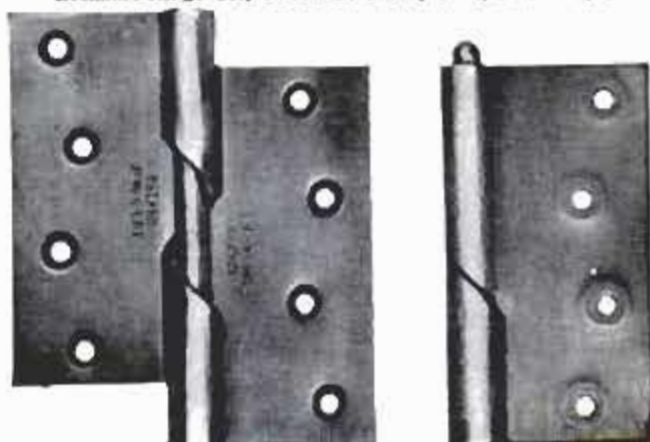

for just easy tilling

ARIENS JET

ROTARY TILLER



Home gardening is fun with an Ariens JET! This low-cost tiller has recoil-starting 3 h.p. Briggs & Stratton or Clinton engine . . . fingertip controls . . . all-steel tines for S-L-O-W, steady tilling 8" to 20" wide . . . free-swinging depth bar . . . Timken and needle bearings. Other tillers may look like an Ariens JET but not one can equal it for engineering . . . performance . . . and dependability! See your dealer or write for free literature!

Ariens

ARIENS COMPANY
161 Calumet Street, Brillion, Wisconsin

SURPLUS SALE

GOVT SURPLUS
EXCESS INVENTORY
BANKRUPT STOCK

ARMY POWER PLANTS

- Marvelous buys in new condition Govt. surplus plants and generators. All FOB Lincoln.
- 1000-w, 115-v, 60-c. \$169.75
- 2500-w, 115-v, 60-c. 279.50
- 3500-w, 115/230-v. 319.95
- 3000-w, 115-v, DC Gen. 49.50
- 2000-w, 115-v, AC Gen. 109.70
- 5000-w, 115-v, AC Gen. 279.50

SURVEYING-LEVELING INSTRUMENTS

- Outstanding buys in leading make leveling, grading, surveying levels and transits. Lowest prices, latest 1959 fully guaranteed models. Satisfaction or money back.
- Farm Level with tripod and case, \$41.64 Ppd.
- Contractor's Level-Transit with tripod and case \$69.95 Ppd.
- Engineers-Surveyors Dumpy Deluxe Level. Finest lens and mechanism. Complete with tripod, case, etc. \$155.00 Ppd. Full instructions, plumb bob, etc., plus prepaid express to you in USA on all of the above.
- 2-Section 9 1/2' Rod and Target \$11.95 Ppd.
- 2-Section 14' Rod and Target \$19.50 Ppd.

DIAL PHONE

- Modern hi-efficiency attractive dial phone. Use for extension to main line on private system. Use several for complete private system, etc. Complete with ringer, dial, etc. Work on any system. Govt. cost \$25.00. SALE.....\$9.95 Ppd.

G.E. TELECHRON CLOCK SWITCH

- Marvelous clock-timer switch will turn appliances, heaters, radios, TVs, air conditioners, pumps and electric signs on and off at any pre-set time.
- Finest telechron motor. Furnished for 110-v unless otherwise requested. Switch contacts will handle up to 15 amperes on either 110 or 220-volts. Original cost \$13.50. SALE \$5.97 Ppd.

STORAGE BATTERY WINCH

- Powerful fully reversible, ball-bearing gear reduction winch. 1000-2000 lb. pull. Use on 6 or 12-v battery. Holds 40' of 1/4" cable. For trucks, docks, boats, etc. Wt. 54 lbs. Govt. cost \$280. SALE.....\$46.75 FOB

GOLF CAR MOTOR

- Runs on 6 or 12-v batt. Build golf or car motor. Powerful gear reduction speed 25-80 rpm. Fully reversible, 100s applications. Also makes fine electric winch. Wt 35 lbs. Govt. cost over \$250. SALE.....\$19.46 FOB

AIR COMPRESSOR BARGAINS

- For painting, cleaning, tires, control terminals. Assemble your own outfit. Lowest prices in U.S.
- Deluxe Kit, Compressor, Tank, gauge, regulator, paint gun, relief valve, fittings, hose, instructions. Wt. 34 lbs. List \$52. SALE.....\$43.91 FOB
- Air Components, Compressor 1-cyl. \$20.50; Air tank, \$12.95; Regulator \$3.95; Pop-off \$1.95; Press. Gauge \$1.89; Finest Paint Gun, \$8.75; Auto Switch \$4.75. All Ppd. in U. S.

HYDRAULIC EQUIPMENT BARGAINS

- Savings to 80%. Build loaders, diggers, presses, etc. All brand new.
- Hydraulic Wagon Unloader...\$29.87 FOB
- Control Valve, 1 or 2 way... 18.00 Ppd.
- Tractor Pump 1000 psi; 12 gpm 45.50 Ppd.
- 12-v Motor & Pump 1000 psi. 16.95 FOB
- 2-Way Cyl. 1 1/2" bore 6" stroke 5.79 Ppd.
- Other types, sizes and items. Free catalog

GEAR SPEED REDUCER

- 80-to-1 gear reduction unit. 8 roller bearings, multiple gears. Reduces standard motor to 21 rpm - increases torque. Shafts 3/8" input, 1 1/4" output. Power winches, revolving signs, door openings, etc. Govt. cost \$66. SALE.....\$8.98 Ppd.

SPECIAL OF THE MONTH!

AC-120 Volt 60-C GENERATOR

- Outstanding brand new surplus unit. Heavy duty Deluxe generator. Nominal rating 500-w but will deliver up to 1000-w of 60-c, 120-v power. Speed 3,600 r.p.m.
- Complete ready to use. Size 9" diameter, 10" wide, 10" high - 14" overall. Shaft 2" long, 3/4" diameter. Finest ball bearings. Wt. 52 lbs. Brand new in original crate.
- Ideal for cabins, tractor drive, operation of electric saws, drills, etc. Govt. cost \$92.50. SPECIAL.....\$69.50 FOB

IRRIGATION PUMPS

- 2 1/2", 16,500 gph. Centrifugal. All bronze ball bearing. New. 30 lbs. Govt. cost \$103. SALE.....\$49.50 FOB
- Also 1 1/2" 6000 g.p.m. pump. Govt. cost \$62.50. SALE.....\$23.95 FOB.

115-V AC and 30-V DC GENERATOR

- Air Corps ball bearing unit. Puts out 115-v, 1500-w, 800 cycle, AC and 30-v, 75 amp DC.
- Makes good small welder, battery charger or will furnish 115-v for lights, stove, iron, etc. Size 6"x9"x15". Wt. 50 lbs. Full instructions. Govt. cost over \$200. SALE...\$19.91 FOB

MISCELLANEOUS SPECIALS

- Some of the many buys in our new 1959 catalog are listed below:
- Leading make 1 1/2" Electric Drill...\$27.95
- 20-Piece Drill Bit Set..... 7.95
- Leading make Oscillating Sander 110-volt..... 18.97
- Electric Meters—wonderful bargains
- Finest Treated Heavy Tarps, per sq. ft. 8 1/2c
- World's Largest Searchlight.....395.00
- Umbrella Tent, 9'x9'..... 28.69
- Hundreds of other values

Order from ad or get new 1959 catalog.

BURDEN SALES COMPANY
804 West "O" St., LINCOLN, NEBR.

SAVE WITH DIRECT MAIL

Shop PM's pages for money-saving direct mail offers

THE ORIGINAL PACKAGED

BOAT KITS

• World's Largest Line—New Fiberglass Hulls. Over 200 styles Boats-Kits, Formed-Hulls, Semi & Custom finished. All types: Prams, Cruisers, Racers, Inboards, Outboards. Easy to build. Professional results. Dealers - Agents Inquire.

Send 25¢ for 3-Color Catalogs 52 pg. Kit Catalog plus 20 pg. Hardware and 8 pg. Armor Glass books. (SPECIAL OFFER)

All 3-colored CATALOGS plus "Boating Handbook"...all for \$1.

CUSTOM • CRAFT

MADE ONLY BY *Catalina Corp.*



★ **BOAT PLANS, PATTERNS FRAME PACS**

• Over 400 Plans-Patterns, Frame Pak Kits, Prams, Kayaks, Racers, Runabouts, Catamarans, Cruisers-In-Outboards (6' to 40') Wood, Plywood and Steel. **Send 35¢ for 120 pg. Plan Catalog.** Catalog plus "Boat Building Handbook"... Send \$1.00.

Buffalo 7L, N. Y.

NEW! DREMEL MOTO-SHOP

Complete All-Family Power Work Shop

The Dremel Moto-Shop is an ideal power tool for the man with a family. It's safe, versatile, inexpensive and amazingly easy to operate—yet it's a professional-quality tool that outperforms bigger, more expensive models.

The basic unit is a 15" jig saw with a ball-bearing rotary motor and power take-off. To this you simply connect the other attachments—disc sander, bench grinder, buffing wheel, and flexible shaft machine. Takes only seconds to switch from one to the other. Actually it's 5 power tools in 1 compact unit with hundreds of uses.

Whether you're a craftsman, hobbyist, or handyman the Moto-Shop will be the most useful power tool you ever owned. For Mom and the kids it will provide creative, constructive recreation the year around. It's portable—sets up anywhere. Cuts 1 3/4" wood, metals, plastic; drills, routs, sharpens, etc. See your power tool or hobby dealer today.

- MODEL 571 (jig saw with disc sander)..... **\$33.95**
- MODEL 572 (with all attachments shown)..... **\$49.95**

FREE Moto-Shop Catalog. Write today!
DREMEL MFG. CO., Dept. 119B, Racine, Wis.

**5
POWER TOOLS
IN ONE**



Model 572



ABSOLUTELY FREE!



**IN JUST
15 MINUTES
I'LL PROVE
I CAN GIVE
YOU A VIRILE,
RUGGED,**

HE-MAN BODY!

In just 15 minutes, right in the privacy of your own room, through my TRIPLE-PROGRESSIVE COURSE, I'll slap pounds of steel-like muscles all over your body. I'll add 4 inches of power-packed muscles to your chest — another 3 inches of steel-packed muscles to your arms — I'll give you lifeguard shoulders and speedy, athletic legs. I'll also build inner strength and give you that virile look that men envy and women admire. LET ME PROVE AT MY OWN EXPENSE THAT EVERYTHING I SAY CAN BE DONE!

Send me this coupon and I will rush you my GIANT 48-PAGE COURSE that teaches you privately how you can become a real HE-MAN. DON'T MISS THIS ONCE-IN-A-LIFETIME OPPORTUNITY.

JOE WEIDER Dept. 38-29W
"Trainer of the Champions"
803 Palisade Avenue
Union City, New Jersey

Dear Joe:
Rush me my FREE POWER-PACKED MUSCLE COURSE. I am under no obligation, and I enclose 10¢ to cover handling and postage charges.

Name

Address

City..... State..... Age.....

**AMAZING
FREE TRIAL
OFFER**



Chicago Apparatus Co., 1735 N. Ashland Ave., Chicago 22.

Automatic Uranium Analyzer Does Everything But Speak

Fully automatic, a uranium analyzer can go through as many as 20 steps in analyzing complex chemicals and recording findings. The instrument is used at a uranium-processing plant to monitor 16 different points along the production stream. Besides eliminating the possibility of analytical errors due to human fatigue or mistakes, the instrument can operate 24 hours a day, at from 50 to 200 percent faster than the normal human pace.

Machine Counts Atomic Tracks Made by Flying Particles

Physicists at the University of Michigan have combined a microscope, a television camera and an electronic computer to form a machine that can detect and count tracks left by flying atomic particles. Called a nuclear emulsion scanner, the machine is used to count the thousands of faint tracks left by particles that pass through thick sheets of photographic film in the university's atom-smasher experiments. The machine can do the job 15 times faster than humans and promises to ease the tedious task of examining hundreds of film strips with microscopes.

☐ Average annual precipitation of the United States is about 29 inches, but the wettest state, Louisiana, averages 57 inches and the driest, Nevada, about 8 inches.

QUICKEE® Waterless Cream HAND CLEANER

Proved in industry for over 20 years. QUICKEE removes paint, grease, tar, putty, carbon, mastic, grime, stubborn stains from hands in seconds. Rich in tannin . . . safe and soothing as cleansing cream. Indispensable in workshop, car, garage. Handy tube only 59¢ . . . economy can only 79¢.



**QUICKEE Waterless
WALL TILE CLEANER**
No water, no mess.
Keeps your wall tile
sanitary-clean with
Dichlorophene.
Only \$1.25

**QUICKEE Floor Tile
STAIN REMOVER**
Greatest cleaner for
asphalt tile, vinyl,
linoleum. Will not
soften asphalt tile!
Only \$1.25



Your "Q" to Easier Cleaning
AT HARDWARE, PAINT AND CHAIN STORES.
QUICKEE PRODUCTS, Inc., Yonkers, N. Y.

Utility, quality, design*... 28 times, too!

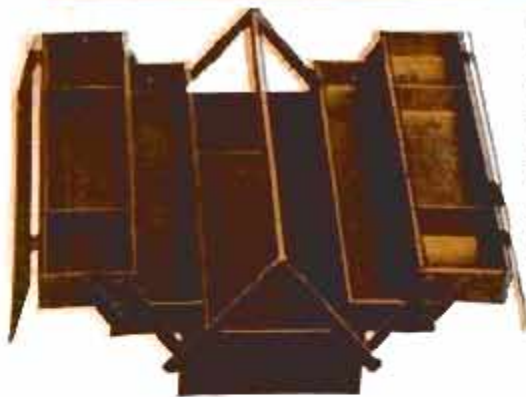

Protect, organize your good tools. The new Duplex line has the right box or chest. 28 types & sizes... variety of drawer sizes, compartments, protective fittings. Heavy gauge steel, beautifully finished. Write for illustrated catalog.



subsidiary of **PENDELTON TOOL INDUSTRIES, INC.**
P. O. BOX 856
FORT SMITH, ARKANSAS

* Shown: No. 114, Mechanics Box, available in 8 sizes and arrangements. Quick, convenient. Press handle down, box opens. Lift handle, box closes.

SANDVIK HAND SAWS

Swedish Steel



SEE THEM AT YOUR DEALER

Send for Free "How to Use" Booklet

Sandvik STEEL INC.
SAW & TOOL DIVISION
1704 NEVINS RD., FAIR LAWN, N. J.

BUY DIRECT
• SAVE ON •
TILLERS • TRACTORS

5-6-7-9 H.P.
2 wheel &



4 wheel tractors

Full line of attachments for mowing, gardening, farming
2-3-4 H.P. TILLERS 12"-16" CUT.

FREE CATALOG & PRICE LIST

RED-E TRACTOR CO.

2-4th STREET
RICHFIELD, WISCONSIN

FREE AMAZING NEW BOOK "HOW TO ANSWER ADS"



Never before have you seen anything like this. Tells you in simple language the correct way to answer ads. Gets you quicker replies—better results, and greater satisfaction. Will save you time and money and it's ABSOLUTELY FREE. No obligation whatever. Every reader of advertising should have this booklet. Send a postcard for your copy NOW. F. W. JOHNSON, Popular Mechanics Magazine, Room 800-A, 204 East Ontario Street, Chicago 11, Ill.

ONE-MAN SAWMILL LOW \$50.00 DOWN AS...



Take BELSAW Portable Sawmill right to the trees—turn out valuable lumber for home and farm—sell to local yards—make up to \$50 a day custom sawing for neighbors. BELSAW lasts a lifetime. No crew needed. Power with tractor or auto engine. Beginners get excellent results. Send today for FREE BOOK.

BELSAW MACHINERY CO.
3459 Field Bldg. Kansas City 11, Missouri

ELECTRIC WELD - BRAZE & CUT

REPAIR MOST EVERYTHING MADE OF METAL



Home Appliances, Auto parts, Farm-garden equipment, toys. Make and repair playground equipment, lawn chairs, tables, ornamental iron work gates, wagons, etc. Solder, heat, bend, and straighten, with terrific heat from arc torch. Cut and weld up to 1/4" steel plate. A million uses for home, auto, farm, inventors, factories, etc. Works from any home plug-in. Complete with Welders mask, arc torch, supply of carbon welding and brazing rods. Solder, flux, and complete Welding Instruction Book. Attractive—portable—efficient—durable—1 year guarantee. Wt. only 4 lbs. **SEND ONLY \$3.00** (cash, ck, mo) and pay postman \$9.95 plus C.O.D. postage on arrival or send \$12.95 and we will send postpaid. Ideal gift for mechanically minded home owners, relatives, friends. Order now for early delivery. Available only from: **MIDWAY WELDER, Dept. DPM-2, Kearney, Nebraska**

BOAT KITS

8'-18': 50 Models
\$41.75 up;
Frt. Pd.
EASY MONTHLY PAYMENTS



FREE COLOR CATALOG

Cruisers, convertibles, runabouts, fishing. Easily assembled by anyone. FREE Catalog has natural color photos, complete details, Fiberglass, accessories hardware, paint. Write Today.

LUGER INDUSTRIES, INC., Dept. B-2
9200 Access Road, Minneapolis 20, Minnesota

START A BUSINESS

this quick way



FOR ROTARY POWER MOWER BLADES
The Foley 314 Grinder puts a perfect cutting edge on all rotary power mower blades.



with these 2 machines you can sharpen ALL HAND AND POWER LAWN MOWERS

Here's a business you can start in spare time, and begin to make a CASH PROFIT right away. The Foley Lawn Mower Sharpener handles up to 3 or 4 reel type mowers per hour. Prices run \$2.00 to \$3.00 for hand mowers. \$5.00 to \$8.00 for power mowers. You get 99c profit out of each dollar.

With the Foley Grinder you can sharpen rotary power mower blades, rip, cross-cut and combination circular saws, dado heads, ice skates, knives, scissors, shears, all sharp-edged tools.



FREE PLAN tells how to put yourself right into a home business that will pay you \$3 to \$6 an hour. Send coupon today for FREE BOOK on how to sharpen power mowers and Special Combination Money Saving Offer. No obligation—no salesman will call.

FOLEY MFG. CO., 207-9 Foley Bldg., Minneapolis 18, Minn.
Send Free Plan on lawn mower business and Special Combination Offer.

NAME _____
ADDRESS _____

EVERYTHING in TOOLS WOODS materials for the workshop! & SUPPLIES



FINE rare imported and domestic woods, veneers, cabinet lumber, turning blocks, squares and hard-to-get hardware items. Constantine's over 147 years of service to the fine wood trade gives everything you need and want. Craftsmen's manual is a complete source for cabinet woods, lumber, plywood, veneers, inlays, bandings, carving and trim mouldings, upholstery supplies, "hard-to-get" and unusual hardware, wood finishing materials, plans, projects, patterns and "how-to-do-it" articles. CONTAINS identification chart of over 60 rare woods classified and reproduced in natural color suitable for framing. Everything available on our famous SHIP THE SAME DAY service at no extra cost. No need to hold up a project or suffer delays for material. SEND 25¢ (refunded on 1st order) today for copy of our fine manual and we'll include "Chips & Chats" publication FREE.

Act Now—Get "CHIPS & CHATS" FREE

FREE!

Constantine's "Chips & Chats," a new publication with copy of New Catalog for Craftsmen. Write today!

MAIL COUPON TODAY!

Albert Constantine and Son, Inc.
2056-H Eastchester Rd., New York 61, N. Y.
Enclosed 25¢ (refunded on 1st order) for the new Constantine Catalog. Also send Constantine's "Chips & Chats" FREE.

Name _____
Address _____
City _____ State _____

Only a Ready-Cut Liberty Home offers you so much

Space. Quality. Beauty

Get more home for less money with a Liberty Ready-Cut Home. 57 exciting designs from \$2465 to \$7926. **Build it yourself or be your own contractor.** World's original manufacturer of Ready-Cut Homes guarantees you highest quality kiln-dried lumber machine-cut to exact size, all siding, shingles, hardware, paints, windows, doors, flooring, etc. . . . plus complete building plans. Save on labor, save on material and contracting costs. You pay no salesman or architects fees. **Write us today!**

Financing is Easy With Our Exclusive Plan
Materials Shipped Freight Prepaid.

Send 25c for
EXCITING 56-PAGE
COLOR CATALOG

Mail to: LIBERTY HOMES
1292 LAFAYETTE AVE.
BAY CITY, MICH.

NAME _____
ADDRESS _____



R. E. Dietz Co., 225 Wilkinson St., Syracuse 1, N. Y.

Plastic Battery Cover Prevents Corrosion Damage

One way to avoid battery deterioration caused by corrosive deposits is to cover the top surface of the battery with a plastic "bib." Inexpensive sheets of polyethylene, with holes for filler plugs and contact posts already cut, are available in most car-battery sizes.

Tapered Tank Ball

Conical sides and a tapered point on a new style of toilet-tank ball assure proper reclosing of the drain opening after each flushing. The tapered point never leaves the opening. A soft foam-rubber gasket on the ball forms a tight seal over any rough edges caused by corrosion or mineral deposits around the drain opening.

Kinnard Sales, Little Falls, N. J.

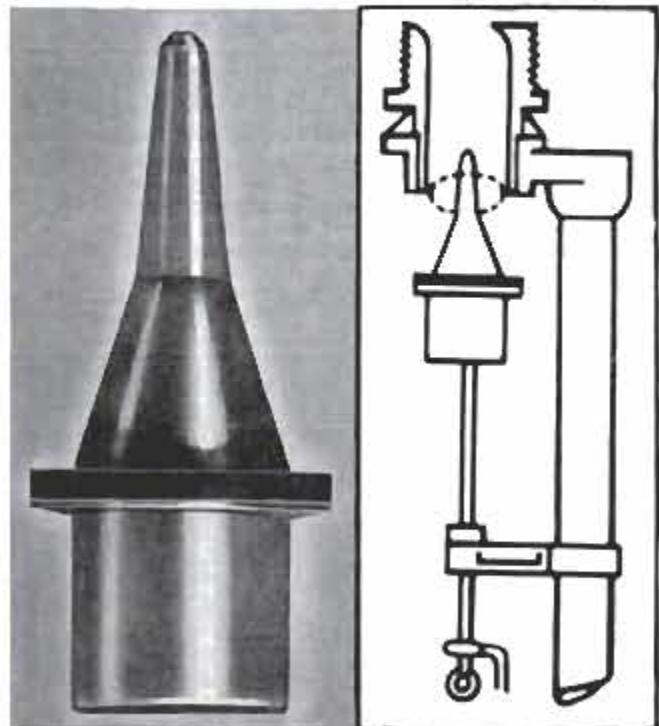

ABOVE PICTURE IS POPULAR MECHANICS
CROSS DRAW—
Nov. APRIL 1959 /

AMERICA'S
LARGEST STOCKS
of JEEP PARTS

LOWEST PRICES!
SATISFACTION
GUARANTEED!



COMPLETE JEEP PARTS CATALOG
FREE

WRITE FOR IT TODAY!

Shop by mail from "BERG." Immediate Delivery
on all Army and Civilian Jeep Parts

BRAND NEW CAPSTAN WINCHES

6000 lb. capacity. Accurately machined gears provide for smooth efficient operation. Suitable for both front or rear mounting. May be used on jeeps or trucks. All units are brand new and fully guaranteed. C.O.D. shipments, 25% deposit with order.



SPECIAL
\$25.00 EACH

Scoop! Complete line of 24 volt
late Army Type Jeeps and Parts

SPECIAL SERVICE TO GARAGES AND SERVICE STATIONS

IMMEDIATE processing of all mail orders. Wire and phone service available. All phones MA 7-6930. Cable Address "Jeeping"

BERG TRUCK & PARTS CO., INC.

1608 S. WABASH AVE., DEPT. 22, CHICAGO 16, ILLINOIS

See newest home improvement products advertised on these pages . . .



"ARCO SCREW-MATIC"

CONVERTS EVERY ELECTRIC DRILL into a
POWER SCREW DRIVER!
EXCLUSIVE!

• Drives biggest screws perfectly everytime because of powerful Industrial-type Clutch. Cannot slip, as often happens with friction-type clutches. Clutch disengages automatically when screw is driven home.

• Bit cannot slip off screw head to damage work or hurt operator's hand because of Special Bit Holder.

NO ATTACHMENT UNDER \$10.00 HAS THESE 2 FEATURES!

Includes Phillips Head Bit, 1/4" Bit for slotted screws & instructions... **\$5.95**

At Your Dealer or order direct - we pay post. No C.O.D. 20-day Money Back Guarantee.

ARROW METAL PRODUCTS CO.

Dept. PM-2, 421 W. 203 St., N.Y. 34, N.Y.

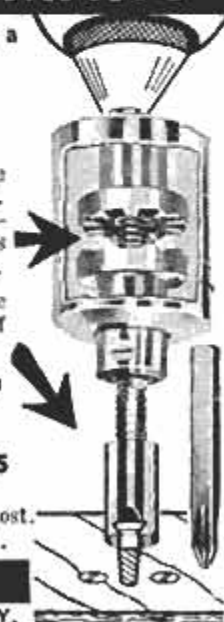

**DIESEL
TRACTOR &
HEAVY
EQUIPMENT**

**TRAINING FOR AMBITIOUS MEN
WHO LOOK AHEAD!**

This is your opportunity to get a start in the rapidly expanding Diesel, Tractor and Heavy Equipment fields. Diesel power is the key to the Construction, Transportation, Mining and other fast-moving industries. Qualified Diesel and Heavy Equipment men are needed in every city, county, and state today.

T.T.S. has specialized successfully in putting men on the road to beginning a career in the Tractor, Heavy Equipment and Diesel Industry for over 18 years. We can help you prepare for this profitable, fast-moving industry just as we have helped thousands of other men. Send for free information today.

MAIL COUPON
TODAY
FOR FREE
INFORMATION

TRACTOR TRAINING SERVICE, DEPT. 11B29

1525 E. 53rd St., Chicago, Illinois

NAME _____ AGE _____

ADDRESS _____

CITY & STATE _____

**MANUFACTURE THIS BEAUTIFUL
CONCRETE OUTDOOR FIREPLACE**

Right In Your
Own Backyard

**\$4.00 Worth of
Sand & Cement
produces this
Attractive
Fireplace.**

Sells on Sight
from \$60. to \$80.
Easy to start your
own Profitable
Business.

The General Fireplace
Molds and Process are the most
amazing and foolproof ever invented.
Simple to operate. Two men can produce five fireplaces a day.



BIG DEMAND!!

Sell all you produce to Department Stores, Homeowners, Parks, Nurseries and Picnic Groves. Fireplaces sell on sight. No experience necessary. We supply full operating instructions and equipment plus the know-how that spells **BIG PROFITS**. This is an outstanding opportunity for men of vision and small capital to get into a busy rich paying field. Don't delay, be the only exclusive manufacturer in your own home town. Mail coupon at once for full details as to how you can reserve your territory. **Molds sold only on exclusive franchise.**

GENERAL ENGINES CO., Inc., Dept. MF-29
ROUTE 130, THOROFARE, N. J.

Mr. Tor of Philadelphia writes:
Sold 250 in first 4 months. Selling to Sears Roebuck, John Wanamaker, and Gimbel Bros. in Philadelphia area.

Name
Address
City Zone
State

HELP US KEEP THE THINGS WORTH KEEPING

Nothing's so precious to a child as her mother's love. It surrounds her and helps her find her way in a big strange world.

And though she doesn't know it yet, peace is precious, too. It makes the lives of both mother and daughter more secure.

But like most precious things, peace is not free. Peace costs money. Money for strength to keep the peace. Money for science and education to help make peace lasting. And money saved by individuals to help keep our economy strong.

Your Savings Bonds, as a direct investment in your country, make you a Partner in strengthening America's Peace Power.

Think it over. Are you buying as many Bonds as you *might*?



HELP STRENGTHEN AMERICA'S PEACE POWER BUY U. S. SAVINGS BONDS

The U.S. Government does not pay for this advertising. The Treasury Department thanks The Advertising Council and this magazine for their patriotic donation.





AC POWER PACK Use your car, truck, boat for mobile AC power supply. 110 V. 60 cycle AC Gen. 3600 RPM. This versatile generator can be adapted to any engine. Carry your own AC power wherever you go on land or sea. Great for contractors, farmers, fire dept., Civil Defense, wherever emergency AC power is desired. Rugged construction. Tremendous overload capacity. Dual plug-in receptacles, mounts quickly and easily on engine and is driven from fan belt. Both units supplied with dash mount type control panel—with light and voltmeter. Also included is remote control cable and all mounting brackets. NEW. 100% guaranteed.

Model A-2. 1350 watt, \$99.50. Model A-3. 2500 watt, \$129.50



FAMOUS NAVY MK14 AIR COMPRESSOR Great for tree, termite, airbrush & paint spraying; filling tires, aquariums, etc. Dual & remote control electric receptacles, 115v 60 cycle AC, heavy duty HP. Westinghouse Motor, Direct drive. Water & explosion-proof. Built-in air filter, adjustable pressure setting up to 47 lbs. 3. cu. ft. per min. Self-contained switch. Mounting brackets. These units made under license of Sperry Gyroscope Co. Wt. 66 lbs. gross. Approx. GOVT. COST \$583. Like NEW, \$21.95.

With portable steel hand cart (shown), rubber wheels, specially constructed for mounting this unit. Incl. 25' rubber air hose, 6' extension cord with plug & fittings. Wt. 76 lbs. Complete with cart—\$28.95.

With new internal pressure spray gun with 3 adjustable spray tips. 1 qt. cap. \$33.95 complete.

"DELUXE 11" ARC WELDING KIT

Consists of 160-250 AMP Gen., voltage reg., ammeter, shunt, adjustable helmet, electrode holder, pr. welder's gloves, 30' welding cable, reactor coil, giant toggle switch, rheostat. Approx. GOVT. COST \$650. All units guaranteed pre-tested. \$24.95 complete.



"SUPER 9" 200 AMP WELDING KIT With Deluxe accessories consisting of one 200 AMP Gen., adjustable helmet, electrode holder, 30' welding cable, rheostat, giant toggle switch, voltmeter, voltage reg., 1 pr. heavy-duty welder's gloves. All units guaranteed pre-tested. Approx. GOVT. COST \$500. Most items new—all perfect. \$28.00.

WELDING CABLE DOUBLE-O, heavy duty, neoprene jacket, fiberglass insulation. NEW. Approx. GOVT. COST \$40. Will handle 400 amps. or better. 30' lengths \$14.50. 100' lengths \$28.00.

NEW! Welding Reactor for above kits. 200 Amp. csp. or better. NEW. \$7.95.

"BIG 12" ARC WELDING & BATTERY CHARGING KIT With Deluxe Accessories consisting of one R1 300 Amp Gen., 30' welding cable, welder's adjustable helmet, electrode holder, 300 AMP ammeter, 300 AMP shunt, Rheostat, Giant Toggle Switch, 300 AMP reactor coil arc Stabilizer, Voltage Reg., Reverse Current relay, 1 pr. heavy duty welder's gloves. All units guaranteed pre-tested. Approx. GOVT. COST \$750. Most items new—all perfect. \$49.50. *400 AMP Gen. with above accessories—\$64.50.

LORD RIAM BATTERY-POWERED ELECTRIC SHAVER Take it anywhere... on trips, camping, office, etc. Swiss-made, precision shaver that gives smooth, close shave. No plug, no cord, no separate battery case. Uses 2 ordinary batteries (3 months average shaving). 2-tone unbreakable case. Real motor, no vibrator. Only \$12.95 ppd. with batteries.



BATTERIES!—START

—a battery factory at home and Re-cast junk batteries into new; Latest achievement. We supply complete instructions and everything needed. Large daily profits!

BATTERY LABORATORIES, So. Div., Dept. PM, Bayou La Batre, Ala.



The Modern PLASTIC for lasting Home Repairs

PERMANENTLY mends cracks or holes in wood, tile, stone or plaster. Sticks and stays put—Does not chip, shrink or fall out. Easy to use. Economical. Mold it, chisel it, polish or paint it. The big 4-lb. can is obtainable from your lumber, paint or hardware dealer at \$1.40; or will be shipped direct postpaid (in U. S.) for \$1.75. Complete satisfaction guaranteed or your money refunded.

DONALD DURHAM CO.
Box 804-T Des Moines, Iowa

13 PC. PROTO SNAP-ON MIDGET SOCKET KIT. Consists of 8 Proto sockets from 3/16 in. to 1/2 in. 1 Proto Universal Joint, 1 swivel handle, 1 Tee Bar, 1 pr. chain lock dropped forged adjustable pliers, 1 pr. insulated wire cutters—wire strippers with adjustable gauge marker. Approx. GOVT. COST \$21. While they last—\$7.95 ppd.

140-1 REDUCTION GEAR For beaching boats, winches, hoists. Ideal for motor in golf or boy's electric car. DC motor & clutch. Easily reversible wiring diagram furnished. Hi torque, 1* speed. Runs on 6-12 or 24 V. Wt. 65 lbs. gross. Approx. GOVT. COST \$300. Like NEW, \$12.00. Matched spined gear for above—\$3.00 ea. *225-1 Reduction Gear—\$13.50

11 PIECE CROWFOOT WRENCH SETS Wrenches snap onto T-bar in 3 different positions. The only wrenches for hard-to-get-to places. Mfd. by Plomb Tool Co. for U.S. Armed Forces. Finest case hardened tool steel. No shop mechanic should be without this set. Approx. GOVT. COST \$47. NEW, \$9.95 ppd.

WOOD PROPELLER Genuine rock maple radio drone "prop." perfect for den, trophy room, boy's room. Smooth, highly varnished, 30" tip to tip. Clock, barometer or photo can be inserted easily into center (mounting holes provided). Can use to operate ice sleds, etc. Approx. GOVT. COST \$37. NEW, \$4.95 ppd.

BENDIX GEROTOR PUMP & MOTOR Use wherever fluid pumping required. Excellent for hydraulic installations. Max 3/4" pipe connections. built-in relief valve adjustably up to 1500 lbs. Max. cap. 6 GPM. 1 1/2 H.P., 24 V. motor. Use on 12 to 36 V. Approx. GOVT. COST \$350. NEW \$10.95.

HANSEN AIRHOSE COUPLING quick-disconnect type. 3/8 in. pipe thread. Approx. GOVT. COST \$5. NEW. Only \$1.50 ea. ppd. Three for \$4 ppd.

DRAFTING MACHINE For engineers, draftsmen, designers, architects. Portable. Complete with 11 in. x 17 in. hard surface drawing board with scale divided in 50ths to inch and 180 deg. protractor. This unit is not a toy, it's the real McCoy! NEW. While they last—\$10.50 ppd. *Same as above with 10 in. x 13 in. drawing board—\$9.95 ppd.

SPECIAL ON \$4770 NAVY AIR-COOLED POWER UNITS Tremendous power package. Can be used as a portable or stationary unit. Makes terrific welder. 30D-1A Lawrence. 24V. 2 Cylinder opposed 4 cycle 10 1/2 H.P. Complete with various generators. Net wt. 180 lbs. Gross wt. 250 lbs. Like NEW. With 140 Amp, 24 V. Gen. — \$125. With 200 Amp. Gen. — \$137.50. With AC-DC NEA5, DC side 24 V., 200 Amps.; AC side 10.5 Amps. 800 cycle — \$142.50. 300 Amp. Gen. — \$142.50. Engine only \$127.50.

MICROMETERS Black crackle finish frame. Easy-to-read graduations in .001. NEW. 0-1" cap. \$2.89 ppd. 1-2" cap. \$3.79 ppd.

VISCOUNT 6-TRANSISTOR RADIO Powerful reception, hi-fi quality sound, beautiful case. Weighs only 11 oz., fits in your pocket. No tubes to burn out, uses 1 standard 9V battery. Written 90 day guarantee. Gift box includes radio, battery, earphone, leather case & strap. A terrific value at \$29.95 ppd.

NEW! 1959 CATALOG! BIGGER & BETTER THAN EVER... 971 price cuts. 1000's of bargains in war surplus & other items! 100's of pictures! Send 25c in coin for your copy today! Ppd. prices USA only. Other prices FOB Culver City, Calif. Send cash, check or money order. 50% deposit on COD.

AIRBORNE SALES CO., INC. DEPT. PM 259
8501 Stellar Drive, Culver City, Calif.

NOW! Adjustable CORNER CLAMP

AND MITERING VISE Securely holds mitered or butt joints at 90° angle, or any angle, for nailing, stapling, gluing and splicing. ADJUSTS TO ANY ANGLE. Used for Picture frames, Screens, Storm windows, Shadow boxes, or any \$1.75 place where wood is joined. PPD.

SAW SHARPENING IS EASY Super Filer No. 11 joints and sharpens hand and circular saws 6" to 10" with all teeth correct in height, depth, pitch, bevel. When file hits steel roller, teeth are finished. Saw runs true with no side pull. Includes 8" file. **\$9.95 PPD.**

"TRU-CIRCLE" saw set automatically sets teeth at 10° or more. **\$2.95 PPD.**

MONEY BACK GUARANTEE
A. D. McBURNEY, 5908 Hollywood Blvd., Hollywood 28, Cal., Dept. A-29



with a *kwikset*
MODERNIZATION KIT

This low-cost, easily installed kit fits any door and is complete in one package. You'll be delighted at the difference when you replace old mortise locks with new Kwikset locksets and the Kwikset Modernization Kit. For illustrated folder, write:

America's largest selling residential locksets



A subsidiary of The American Hardware Corporation
 Dept. PM, Anaheim, California

**CUT PERFECT GROOVES
 WITH *Warren* WASHERS
 ON YOUR SAW BLADE!**

*You Just DIAL
 the Cut Wanted*

**over 250,000
 sets in use!**

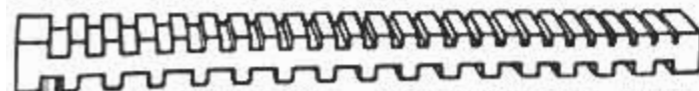

**NOT ONE—NOT TWELVE—BUT
 40 DIFFERENT CUTS!**

Warren Washers—engineered to cut clean, accurate, parallel grooves with your present power saw. 40 micrometric adjustments—just dial the desired width. Actually strengthens blade, eliminates vibration—leave on saw for straight cuts. No burning or chewing. Over 250,000 satisfied users in 48 States and many foreign lands. Be sure to get genuine Warren Washers . . . they're guaranteed!

FREE! Send for free descriptive booklet. Arbor sizes 1/2", 3/8", 3/4", 1". See your dealer or write direct.

WARREN WASHERS CO.

Dept. 22, Box 98, North End Station, Detroit, Mich.

**ONLY
 \$4⁹⁵
 SET**



Oscar Fisher Co., Inc., P.O. Box 426, Newburgh, N. Y.

**Permanent Water Filter
 Reverses for Cleaning**

Processing 10 gallons a minute, an all-metal water filter has a filtering element that doesn't need to be replaced. The element is sintered metal, which is a compressed, powdered substance that permits water to flow through it. When this permanent filtering element needs cleaning, the unit is reversed, a valve is turned and a petcock opened. Accumulated filtered elements are flushed out.

**Adjustable Flow Control
 For Tank Refill Tube**

Hundreds of gallons of water per year can be saved by controlling the amount of water emptying into the overflow tube of a toilet tank. A replacement tube now on the market is made of transparent plastic with an adjustable brass valve at one end to increase or decrease the flow to the correct amount.

Halbro Products, P.O. Box 541, Blasdell Br., Buffalo 10, N. Y.

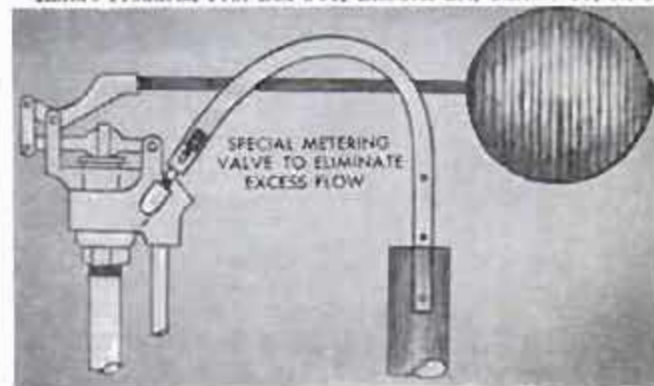

POPULAR MECHANICS

ORDER DIRECT FROM AD

SURPLUS AT FRACTION OF GOV'T COST

TOP VALUE SPECIALS

SHOP BY MAIL AND SAVE AT GROBAN'S

SATISFACTION GUARANTEED

BRAND NEW 5-TON BLACKHAWK HYDRAULIC LIFT KIT

For: Snow Plows • Presses
• Dump Wagons • Lifts
KIT CONSISTS OF

1—New Blackhawk Model P-151—Hydraulic Hand Pump with built-in oil tank and release valve. Rated from 1200 P.S.I. to 8400 P.S.I. 20" Handle Dim: 8"x6"x6". Item #82.....\$23.50

1—6 Foot Length Double Wire Braid Hydraulic Hose—Tested to 20,000 Lbs. Item #27B4...\$3.95

1—Heavy Duty Hydraulic Cylinder. 2" Bore, 6" Stroke, 1" Solid Steel Shaft, Will lift 10,000 lbs. using Pump Pressure. 1/2" Clevis Mounting & 1/2" Port. Overall length 18 3/4". May also be used separately for double action service. Item #229.....\$11.50

2 Quarts Non-Foaming Hydraulic Fluid.....\$1.00
Plus all necessary hydraulic fittings.

Ready to Install — Immediate Service

COMPLETE KIT PRICE... Item #K-116M.....**38.95**
Shp. Wght. 52 lbs. F.O.B. Chicago

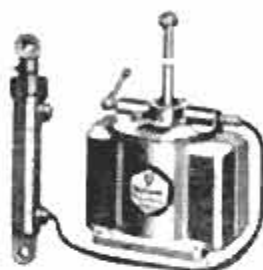

ITEM #K-116M

BOLT & WIRE CUTTER

Exclusive: Extendable Handles for Extra Leverage

CADMIUM PLATED. Center cut type bolt cutter for soft or medium hard rods and bolts, alloy wire, and other metals. Cutting edge has equal bevel on each side for extra strength. FOLDED—It fits into your pocket or tool box—safety latch locks closed when not in use. Capacities: medium hard bolts in thread 3/8"; medium hard metals 5/16". Length closed: 10 3/4"; extended 15 3/4".

A \$9.95 NOW **3.95** 2 FOR
VALUE ONLY PPD. \$7.00



SURPLUS

BRAND NEW!

ITEM #478

EXTRA RUGGED

MULTI-PURPOSE

HYDRAULIC PUMP OR MOTOR

Silent high efficiency. Helical Gear Type Ball Bearing. Hydraulic Pump or Motor. Rated 8 Gal. Per Min. At 1500 R.P.M.—Delivers 1000 P.S.I. Using 6 H.P.—Reversible Rotation—3/4" Pipe Thread Inlet and Outlet Ports—1/4" Drain Port—3/4" shaft with key-way and flat for either direct or pulley drive. Dimensions—5 3/8" high, 7 1/4" long, 5 1/2" wide. Shipping weight 18 lbs. F.O.B. Chicago.....**52.50**



ITEM #55

1/2 H.P. ELECTRIC MOTOR

Item #469—Ideal to power fans, blowers, pumps, gear boxes, etc. on trucks, cars, marine equipment, golf buggies—operating on 12 or 24 volts. Built at great expense for the Signal Corps. by Air Associates, this ball bearing motor is rated—1/2 H.P.—3300 R.P.M.—20 Amp.—27.5 Volts. Will deliver 1/4 H.P.—1900 R.P.M.—with 12 volt input. Standard 3/8" shaft—4 bolt mounting flange. Dimensions: 6 1/2"x4"x4". Shipping Weight 10 lbs. COST U. S. A SPECIAL **8.95** F.O.B. GOV'T. \$78.00 AT ONLY Chicago



12-24 VOLTS D.C.

2 H.P. Electric Motor

Item #315—24 Volts, 90 Amps., 1000 RPM. Splined shaft both ends. Style similar to above. Mfgd. by Hobart or Diehl. F.O.B. Chicago.....**13.00**

HIGGINS BRONZE CENTRIFUGAL PUMP

PUMPS ALMOST ANYTHING

Fine for: — • Irrigation • Sump Pumping • Sewer Drainage • 75 gallons per minute @ 2400 R.P.M. Higgin's Type PNB Model R, marine Bilge pump. Open Impeller design for handling muddy water. Delivers 75 gallons per minute, 30 foot head with 3/4 H.P. motor. Pump body and impeller are made of solid bronze, with alloy steel 1/2" diameter shaft, 1 3/4" long. Rotation of the pump is clockwise. Inlet has 1 1/2" pipe thread. Plain 1 1/2" outlet for hose connection. Dimensions: 12"x7"x8". Shipping weight 23 lbs. F.O.B. Chicago.....**23.50**

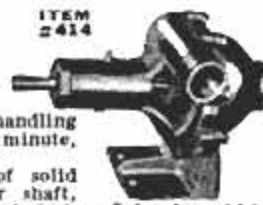

ITEM #414

GROBAN FOUR-WAY OPEN CENTER HYDRAULIC CONTROL VALVE

Item #126—Four-way open center control valve, with built-in adjustable relief valve factory set at 1000 P.S.I. Spring loaded neutral position. For use with one double acting cylinder. In neutral position cylinder is locked and pump unloaded. Can be used as single unit or mounted in series. Has 3/4" pipe thread inlet and outlet. 1/2" pipe thread cylinder ports. Finger grip handle. Ship. wt. 10 1/2 lbs. AN OUTSTANDING BUY! F.O.B. Chicago.....**23.50**



DOUBLE ACTION HYDRAULIC CYLINDERS

Item #C419—Hydraulic cylinder. 3" bore, 6" stroke. Husky 3/4" solid steel shaft. Will lift 10,000 lbs. using 1500 lbs. of pump pressure. Clevis mountings that take 3/4" dia. pins. May be used for single or double action service. Shipping wt. 17 lbs. F.O.B. Chicago.....**12.50**
Item #1000—3" bore, 10 3/4" stroke, 1 1/2" chrome plated steel shaft, 3/8" standard pipe thread ports. Maximum lift capacity, 8400 lbs. with 1200 P.S.I. line pressure. Clevis mounting at both ends. Overall length closed 20 1/4". Shipping.....**27.50**
Item #16-C—1 1/2" bore, 26" stroke. Will lift 1760 lbs. with 1000 lbs. pump pressure. Great for hay loaders, etc. 1" stainless steel piston rod. Postpaid.....**16.95**



FREE! NEW, BIG CATALOG VALUE PACKED PAGES GALORE! Unsurpassed War Surplus, newly manufactured equipment. Bargains for farm, home, factory, workshop. Write today. For phone orders call Webster 9-3793.

GROBAN SUPPLY CO. Dept. PM-2
1139 S. WABASH AVE., CHICAGO 5, ILL.

INCREASE HOME VALUE—MAKE NEEDED IMPROVEMENTS NOW

WELD IN A JIFFY! IT'S DYNAMIC \$38.50 F.O.B.



Now any one can weld, cut, braze or solder almost any metal quick, safe and easy with this professional type welder. Make repairs in home or shop and farm: repair auto bodies and fenders, build wrought iron furniture, railings, fences, etc.—1001 metal items. No previous experience necessary. Designed to operate on any properly wired 110 V. A.C. line. Order today! Literature on larger industrial equipment on request.

EASY PAY PLAN
Low down payment. Pay as you USE. Money back guarantee. Act now!

SEND ONLY \$6.00
CHECK CASH or M.O. PAY POSTMAN BALANCE PLUS CHARGES 1 YEAR GUARANTEE 10 DAY MONEY BACK TRIAL

DYNAMIC WELDER COMPANY, 1808 S. Federal St., Dept. D2-B, Chicago 16, Ill.



BOOKS for CHILDREN



**Ideal for summer fun and pleasure . . .
Packed with fascinating facts for boys and girls!**



Mr. Wizard's Science Secrets

The star of the famous TV program penned this educational, entertaining book that will help in school and through a lifetime. The book is just like Don Herbert's unusual program and just as intriguing. It contains more than 150 of his experiments in word and picture. Answers thousands of "how" and "why" questions children ask on the human body, gravity, flight, heat and radiation, electricity, etc. It's facts with fun—so interesting children never tire of learning. They turn wine into water, make mothballs dance, cause water from a faucet to bend mysteriously, other breath-taking tricks. . . .

\$3.50



Golf for Boys and Girls

"Start right" . . . says Chick Evans, golfdom's greatest amateur stylist, and with this handsomely illustrated book he teaches young readers the fun, fundamentals and rules of golf. Gives Chick's own "golden rules," selected from more than 30,000 notes he has made during a half-century of play as boy, youth and man, and first double crown winner in history capturing the national amateur and open championships in the same year. It will quickly introduce your boy or girl to this exciting game, or help improve their skill. . . .

\$3.95



Build-It-Yourself Book for Boys

Every active boy enjoys creating things with his hands. Give your or a friend's "Tom Sawyer" this book and watch his face light up! It contains 56 toys, games, gadgets, electrical and mechanical devices that any boy can make: a tree house, slide-airplane and boat models, water skis, surf-board, hobbits, boomerangs, hunting knife, rafts, scooters, kites, log cabins, radios, weather instruments, taxidermy projects, telegraph set, telephone and many others. Easy-to-follow instructions and 400 how-to-do-it pictures will encourage and inspire him. . . .

\$2.95



"There's Adventure In" Career Books for Boys 11-17

Introducing a unique new series of career books for the boy of today who needs and wants to know more about the technical, scientific world we live in . . . and his future in the world of tomorrow. Each story is told as exciting fiction through the eyes of teen-age boys, but skillfully woven throughout the stories are the even bigger, even more startling facts about the career opportunities in the title sciences. The books suggest the kind of educational preparation needed, the types of occupations that are now open and will be opening in the future. Well researched and authentic, but full of fun, facts and practical inspiration. . . . Each

\$2.95



Popular Mechanics JUNIOR Do-It-Yourself ENCYCLOPEDIA

A 12-volume set, complete with beautiful rack, which contains 3,072 informative pages, over 5,000 pictures, photos, and diagrams and literally thousands of subjects and projects children want to know about and do. Highly recommended by leading educators, child experts and counselors. It guides your boy and girl into worthwhile interests, fully develops their natural talents. It's easy to read, with large type, and overflowing with myriad delightful projects for the 8-to-16-year-old. Worth many times its cost in lifetime dividends for them and you. . . .

\$19.95



Science Milestones

This record of the march of science will fire the imagination, and inspire youngsters in their pursuit of scientific knowledge. Contains dramatic revelations of 60 important individuals whose contributions, from 400 B.C. to the present, are landmarks in the history of science. . . . Hippocrates, Archimedes, Galileo, Newton, Franklin, Watt, Fulton, Faraday, Pasteur, Lister, Koch, Edison, Bell, the Curies, Einstein, Fleming and others. They will thrill to its triumphs and tragedies, the idealism and the persecution, the brilliant flashes of insight and patient plodding of research. . . . Adults will too! . . .

\$5.00



The Boy Mechanic

For over forty years the standard handbook for the young home craftsman. The completely new sixth edition has 500-plus projects for the boy who wants to make things that work and go. It describes how to improve the performance of a bicycle or a power lawn mower, or how to get more fun out of an electric train. It tells how to build a soap box racer, an ice boat, a dinghy—something for every place, time and season. 1100 photos and diagrams make it one of the most elaborately illustrated "What To Make" books ever printed. PM's step-by-step instructions make it one of the best. . . .

\$3.95



The Boy Scientist

This book won for Popular Mechanics the 1955 award of the Thomas Alva Edison Foundation as publisher of "The Best Children's Science Book." It's an outstanding introduction to the exact sciences, bursting with facts every modern boy wants to know. Written and illustrated with such clarity that even complex principles are quickly grasped by the young mind. . . . astronomy, physics, chemistry, sound, electricity, atomic theory, relativity, hydraulics, space flight. A gift of this book may well start some boy on the way to becoming one of the nation's top scientists. . . .

\$3.95

POPULAR MECHANICS PRESS, Dept. 259, 200 E. Ontario St., Chicago 11
RUSH books I have checked below for FREE TRIAL. If O.K., I'll remit purchase price for books ordered, plus shipping charges. Otherwise I agree to return books postpaid within 7 days.

- I want to save shipping charges, so I enclose payment in full. Rush postpaid. Same 7-day return privilege, with money refunded.
- Mr. Wizard Golf for Boys & Girls Book for Boys Junior Encyclopedia
 Adventure in Chemistry Adventure in Electronics Adventure in Atomic Energy Science Milestones Boy Mechanic Boy Scientist

Name _____
Address _____
City _____ Zone _____ State _____

SEND NO MONEY!

**Just Mail Coupon NOW
for**

7-DAY FREE TRIAL

U. S. GOV. SURPLUS

HEAVY DUTY COMPRESSOR for continuous operation, with G.E. or equal B.B. Motor, 110 V., A.C., rated 1/2 H.P., develops up to 1/4 H.P. 1-Quart Pressure type gun with round, fan and ceiling spray nozzles. Line filter, air gauge, 20 ft. cord & plug, 20 ft. air hose. Sprays paint, lacquer, enamel, insecticides, etc. Paints house, auto, ANYTHING. Operates gun continuously. Instructions furnished, NOTHING ELSE TO BUY, Wt. 80 lbs.

ORDER FROM THIS AD.
Money Back Guarantee. Send check or money order.

ILLINOIS MFG. & SUPPLY CO.
1829 S. State Street, Dept. PM2, Chicago 16, Ill.

ORIGINAL COST \$425
OUR LOW PRICE... \$3450
F.O.B. Chicago



ANNOUNCING NI-BRAL UNBREAKABLE PROPELLERS

MICHIGAN'S new NI-BRAL props, for large motors only, may be nicked but virtually never bent or broken... carry 5 year guarantee against breakage... eliminate repair lay-ups. Send card for FREE 1959 catalog giving propeller recommendations for motors of 5 HP and larger which by actual test provide far MORE SPEED, BETTER SKIING or LOAD CARRYING than original prop... other helpful data. MICHIGAN WHEEL CO., Grand Rapids 2, Mich., Dept. PM-2.



CUT ANY SIZE - ANY SHAPE WITH Spearhead Cutter

Handy pocket size - cuts leather, asbestos, rubber, cork, etc. - round 1/4" to 6" - any size straight and odd shapes.

Send Check or Money Order!

935
POSTPAID



ZIMMERMAN PACKING - NORWOOD 12, OHIO

G E A R S

In Stock - Immediate Delivery
Gears, speed reducers, sprockets, thrust bearings, flexible couplings, pulleys, etc. A complete line is carried in our Chicago stock. Can also quote on special gears of any kind. Send in your blueprints and inquiries.

Send for Complete Catalog No. 10 CHICAGO GEAR WORKS
440-50 N. Oakley Blvd., CHICAGO 12, ILL.



ROTARY MOWERS



22" riding type only \$165 at factory

ALL steel construction - reverse gear. Save miles of walking. Many attachments available. cultivator, snow blade, etc.

DEALERS WANTED
WRITE TODAY-for additional information.
HALGOLMAR CO. 905-S E. MAIN CHERRYVALE, KANSAS
Warehouse stock in Ohio & State of Washington

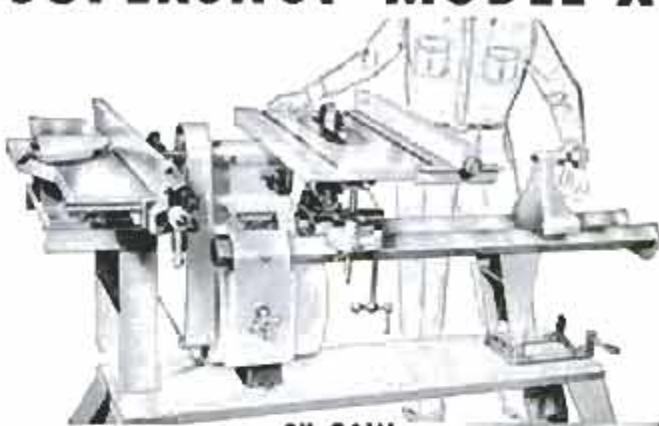

8" SAW

WE PAY ALL FREIGHT FOR YOUR FREE HOME TRIAL

ONLY \$139.50 EASY PAY PLAN

Never before have you seen so much deluxe, precision-built power tool workshop at any price! Designed for the man who wants the best. Massive cast and precision-machined headstock, self-centering inverted "V" bedways (like precision metal lathes), exclusive non-friction speed changer, extra-large cast and precision-ground saw table. 100% ball bearing, lifetime-lubricated. You save by ordering direct from factory. You are invited to test Supershop Model X in your home FREE. Mail coupon or postcard for FREE brochures, photos, details, specifications, accessory list - and amazing freight prepaid FREE HOME TRIAL PLAN. All free.



Vert. Drill Press



Hor. Drill Press



8" Sander



30" Lathe



5" Grinder

MAIL COUPON OR POSTCARD TODAY

Power Tools Division UNITED INDUSTRIES, Inc.
116 Yates Avenue
Beloit, Wisconsin

NAME _____
ADDRESS _____
CITY _____ STATE _____

UNUSUAL BARGAINS

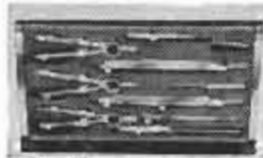

CLOSE OUT! MECHANICAL DRAWING SET

Regular Price \$18.00
Our Price Only \$6.00 Postpaid.

American mfr. couldn't compete with foreign imports — thus you get a terrific bargain, even far below import prices. 10 handsome pieces in velvet-lined case. Nickel plated brass — precision American-made. We guarantee you'll be satisfied or money refunded.

Stock No. 50,200-H \$6.00 Postpaid
Quantity Price: 5 Sets for \$5.50 each Postpaid
10 Sets for \$5.00 each Postpaid



BUILD A SOLAR ENERGY FURNACE

A fascinating new field. Build your own Solar Furnace for experimentation—many practical uses. Easy! Inexpensive! Use scrapwood! We furnish instructions. This sun powered furnace will generate terrific heat—2000° to 3000°. Fuses enamel to metal. Sets paper aflame in seconds. Use our Fresnel Lens—14 3/4" diameter f.l. 14".

Stock No. 70,130-H Fresnel Lens \$ 6.00 Postpaid.

WAR SURPLUS AMERICAN-MADE 7 x 50 BINOCULARS



Big savings! Brand new! Crystal clear viewing —7 power. Every optical element is coated. An excellent night glass—the size recommended for satellite viewing. Individual eye focus. Exit pupil 7mm. Approx. field at 1,000 yds. is 376 ft. Carrying case included. American 7 x 50's normally cost \$195. Our war surplus price saves you real money.

Stock No. 1533-H only \$55.00 postpaid.
(Tax included)

ANASTIGMAT 35MM CAMERA LENS & SHUTTER

— F/3.2 . . . f.l. 44mm. A \$24 value — American-made.
Stock No. 30,311-H . . . Synchronized for flash . . . \$9.50 postpaid.
Stock No. 30,312-H . . . not synchronized . . . \$8.50 postpaid.

WRITE FOR FREE CATALOG "H"!

Complete Line of Astronomical Telescope Paris and Assembled Telescopes. Also huge selection of lenses, prisms, war surplus optical instruments, parts and accessories. Telescopes, microscopes, Hand Spectroscopes, Sniperscopes, binoculars, etc. Request Catalog "H"!

ORDER BY STOCK NUMBER SEND CHECK OR MONEY ORDER SATISFACTION GUARANTEED
EDMUND SCIENTIFIC CO., BARRINGTON, N. J.



PAGE FOR TILLING PLOWING MOWING

FULL LINE 2 to 9 HP with complete gear drive and reverse.
Free Catalog LOW PRICES EASY TERMS Over 40 Years Experience
FULLY GUARANTEED! Over 60 attachments available!

PAGE 1904 S. 81st STREET MILWAUKEE, WIS.

NEW MAGIC RADIO WALKIE TALKIE!



YOUR OWN POCKET SIZE RADIO STATION! BROADCASTS TO ANY HOME OR CAR RADIO WITHOUT WIRES OR HOOKUPS! Wt. only 5 oz. Telescoping antenna. Powerful Transistor—microphone, break-in switch! Runs for weeks on self-contained flashlight batteries. Durable plastic case. With this Radio Talkie you CAN TALK TO YOUR FRIENDS UP TO A BLOCK OR MORE AWAY!—Or talk between cars! INSTANT OPERATION! Just push button to talk! **NO LICENSE NEEDED.** Uses inductive field magnetic radiation. Useful and real fun in a million ways! **GUARANTEED TO WORK. 1 YEAR SERVICE GUARANTEED.**
SEND ONLY \$3.00 (cash, ck, mo) and pay postman 10, 98¢ COD postage or send \$12.50 for prepaid delivery. COMPLETE READY TO OPERATE with instructions and hundreds of ways and tricks for broadcasts thru any radio you desire. Price may go up soon, so get your NEW POWERFUL RADIOVON RADIO TALKIE NOW. Available only from:
WESTERN RADIO, Dept. RPM-2, KEARNEY, NEBR.

LAWNMOWER SHARPENERS



The ONLY complete shop-in-one, with built-in work bench, hoist for heavy mowers, and LIGHTNING-fast bed grinder for sharpening bed knives in mower. Lapping attachment and narrow grinding head to hollow grind reel blades. The famous BALTRAK for rotary blades. Write and experienced shopmen will answer.

TURNER-CLINE MFG. CO.
New address: 906 Virginia Ave., Alamogordo, N.M.



— TIPS & TECHNIQUES —
MACHINE TOOL RECONDITIONING & THE ART OF HAND SCRAPING (3rd printing)
SEND FOR FREE FOLDER DESCRIBING ILLUSTRATED MANUAL FOR MACHINISTS
MACHINE TOOL PUBLICATIONS, 382 Holly Ave., Saint Paul 2, Minn.

You can make BIG MONEY with these LOW COST WELDERS



180 amp. "HUSTLER"
For a surprisingly low investment you can start a well paying business, doing repairs, construction, metal fabrication, etc. These versatile, low cost Hobart welders are easy to use. Built-in features usually found on larger, more expensive models assure professional results, long life.

The 180 amp. "HUSTLER" is a complete welding package—including accessories. It welds, cuts, burns holes, hard surfaces, and heats metal for bending and forming. Meets REA requirements.
The 200 amp. POWER/WELD furnishes DC current for welding—and simultane-

"POWER-WELD" ac power plus dc weld
ously supplies 110/220 v. power for running lights, tools, motors, pumps, sprays, etc. Can also be used as an emergency power source to run brooders, milking machines, etc. Write today for complete details.....

HOBART BROTHERS CO., BOX M-29, TROY, OHIO, Phone FE.2-1223



ALIVE TODAY!

Arch Lightbody is one of 800,000 Americans cured of cancer because they went to their doctors in time. They learned that many cancers are curable if detected early and treated promptly. That's why an annual health checkup is your best cancer insurance.

American Cancer Society

U.S. ARMY MUKLUKS

Keeps your feet warm in the coldest weather. Made of waterproof canvas with felt inner soles. Has drawstrings at top, instep and ankles for snug fit. Sizes: Sm., Med., Lg.



FOLDING BAYONET

Has 7" blade of fine tool steel. Blade folds into handle. Comes with all-metal belt scabbard.



MOTOR DRIVEN GEAR PUMP

Only 1288
No. H-HPU-155U
An electric motor driven gear pump. Has a capacity of 4.5 GPM at 2300 RPM at 1000 PSI. Displaces .447 cu. in. per revolution. Integral by-pass valve returns oil to input side of pump at 1200 PSI. Motor rated at 3.75 HP (intermittent duty) operates on 24 V, DC, 2.50 Amps at 2300 RPM.

WELDING REACTOR - Has iron core wound with No. 4 wire. Stands load of 400 Amps. Use with generator shown at left 1095

THROTTLE CONTROL SOLENOID
Use as welder or motor control. Has 5" shaft, 1" travel, 795

DBL-ACTION HYDRAULIC CYLINDER

No. H-24D
2000 PSI CYLINDER
A heavy duty steel barreled cylinder. Ideal for hydraulic press work. Has 2 1/2" bore, 7" stroke, 1-5/8" shaft and 19" length. Cost Gov't approx. \$270.00 Reg. Palley price \$12.75 **NOW 995**

No. H-14
A 1500 PSI Cylinder. Has bore of 1-3/8", Shaft of 1" diam., Stroke 15-5/8", Length 22". Cost Gov't Approx. \$90.00 Palley Cat. Price \$11.75 **ONLY 795**

SAVE
1500 PSI. Has bore of 1 1/2", Shaft of 9/16", Adjustable stroke - 1-3/16" to 4-3/8", Length 14-1/2". Cost Gov't approx. \$35. Cat. No. H-84ASU. **ONLY 395**

1500 PSI. Bore is 2-3/8", adjustable stroke is 7-3/8" to 9-5/8". Shaft 7/8". Length 20". No. H-17USU - Used Reg. Cat. price \$10.75 **NOW 788**
No. H-17NSU - NEW Reg. Cat. price - \$19.75 **1488**

NEW SURPLUS BARGAIN
No. H-60
1500 PSI heavy duty, double action cylinder. Will make excellent clutch or throttle control when used as a master and slave. Bore 5/8", Stroke 4-1/8", Shaft 7/16", Eye-to-eye lgh. 9-5/8" closed. Ports 1/4" tube (7/16 - 20 thread). Cost Gov't approx. 35.00 **375**

688 **HYD. HAND PUMP**
Operates at 1500 PSI. Displaces 0.19 GPM at 30 cycles per min. Capacity 1.5 cu. in. per cycle. Has a built-in return flow check valve. Cost Gov't Approx. \$80.00 **SAVE!**

2263 E. VERNON AVE., DEPT. PM-29
LOS ANGELES 58, CALIF.

SKI PARKA SPECIAL 395

Off-white, water resistant twill. Slip-over style. Has drawstring at the neck and on the hood for a snug fit at face. 2 slash openings allow access to clothing worn under. Specify size: Small, medium or large.



U.S. NAVY FLEECE LINED WINTER COAT

Heavy cotton drill coated with a special plastic to make it all waterproof. The lining is soft, warm, durable sheepskin. The double breasted front with four button closure gives additional warmth. Has two slash and two flap pockets. Specify size from 42 thru 46. A BUY!



SPECIAL AUTOMATIC PILOT SERVO UNIT

ADAPTS TO
AUTOMATIC BOAT STEERING
TV or BEAM ANTENNA ROTORS
AUTOMATIC DOOR OPENER
REMOTE MACHINERY CONTROL
Ideal for reverse motion applications. Has 1/20 HP, 24 V, DC, 2270 RPM continuous duty motor. A 133 to 1 gear reduction train gives a 15 RPM take-off speed. Twin, plate type clutches are solenoid operated. When used with a special galvanometer it will indicate percent of rotation. Comes with FREE wiring diagram.

NEW SURPLUS GYRO NOW 995

Turns to 50,000 RPM. Electric motor drive is integral with balance wheel. Has ball bearing mounts on either side for precision mounting. Balance wheel is ball bearing mounted. Will operate on 24V, DC-AC current. Ideal for science lab, experimental work, hobbyist, etc.

SAVE! R-1 GENERATOR BUY

Gov't aircraft type. Easily converted for Arc Welder. Rated 300 Amps, 24-32 V, DC. Has 3750 to 4000 RPM with counter-clockwise rotation. 3/4" spline shaft, instructions for Arc Welder conversion FREE. **1695**

"V" BELT PULLEY ADAPTER
adapt V-Belts to use on generators as at left. **2750**
24 Volt RHEOSTAT for use as a welder output control. Has five variable outputs. **295**

2 HP SPECIAL GEAR HEAD MOTOR

A Gov't Surplus Bargain. Powered by a 2 HP, 24 Volt DC motor. Has take-off shaft turning at 110 RPM with clutch set at 100 foot/pounds. Gear ratio is 40 to 1. Has an electro-magnetic clutch that disengages gears when current is off. Overall size: 10-1/2" x 8-1/2" x 5-1/2". Cost Gov't approx \$250.00 **1388**

NEW HEAVY DUTY HYD. CYLINDERS

Designed to meet the most rigid requirements of industry. Here is a newly developed line of hvy. duty, press type cylinders with bores of 3", 5", 6" and 8" - thrusts range up to 75 TONS at 3000 PSI. **5675**
AS LOW AS
For complete list of our tremendous on-the-shelf stocks and prices send for our special HYDRAULIC CATALOG supplement.

NEW UNIVERSAL JOINT

Takes 1-3/8" shaft on one side, 1-1/4" dia. shaft other side. Hvy. duty type. Designed for drive take-off to winch Width 4", length 5-1/2". One yoke is key slotted. Zerklubricated. **494**

VICKERS 1000PSI ANGLE PUMP

H-P4-USU
Another Palley Hydraulic Bargain. A piston type, positive displacement Hydraulic Angle Pump. Will displace .507 cubic inches per revolution. Capacity: 6 GPM at 3000 RPM at 1000 PSI or 3 GPM at 1500 RPM.

BALL & SOCKET UNIVERSAL JOINT

A heavy duty, solid bronze universal sol. Rotates with full flexibility from 90° to 180°. Shafts are 29/32" dia. Ball & socket joint. **595**

ANGLE PUMP MOUNTING UNIT

Designed to adapt the above pump to a 1/2" key slotted drive shaft. Has ball bearings and foot mount NEW **1195**

4-SPEED HOBBY MOTOR NOW \$888

A rugged, precision built electric motor for home workshop, barbecue, etc. Uses 110 V, 60 cycle current. Has four take-off shafts turning at speeds of 5, 25, 150 and 4000 RPM. Worth \$14.95.

VICKERS 1500 PSI PUMP

No. H-PSAUSU
A positive displacement, piston type pump. Displaces .208 cubic inches per rev. Has a pressure limit of 1500 PSI at 3750 RPM.

SAVE! PORTABLE SHOVEL

Has 20" wood handle. Blade folds to form pick or shovel. Carry for emergency uses.

SPECIAL ARMY PICKMATTOK
Has 12" steel head with pick and a mattok. Ideal for garden or comp. **2 FOR 229 OR 129 EA**

PUMP MOUNTING UNIT

For above pump - To adapt pump to a 5/8" key slotted drive shaft. Has foot mount. NEW **1695**

4-WAY HYD. VALVE

No. H-V13USU
Sliding piston type. Has built-in relief valves to limit the cylinder stroke. Pressure balanced in neutral position with fluid return when not in use. Has 5/8" AC tube parts. **788**
Reg. Cat. Price \$12.75, NOW

TO ORDER - Send Check or Money Order. 50% deposit with C.O.D.s. All prices F.O.B. Los Angeles Warehouse. Shipments are Freight or Postage Collect.

palley's

ELECTRIC HAND GRINDER
Fits in the palm of the hand and has an air-cooled motor that runs at 20,000 rpm AC or DC at 110 volts. Comes complete with both 3/32 and 1/4 inch Collets, cord and plug. **\$11.50 P.P.**

75 Mounted Wheels & Miniature Cutters. Regular \$11.00 value **\$4.50**
For cutting and grinding on paid wood, metal or plastic. Includes 26 mtd. wheels and points on 3/32" shanks; 24 miniature cutters on 5/32" shanks; 25 short shank min. cutters. Will fit all electric drills and hand grinders.

FLEXIBLE SHAFT—ONLY \$6.50
Postpaid
Fits all electric drills & hand power tools. 35-3/4" long. Oilite bearings. Core of specially wound, high carbon steel wire in flexible steel casing. Will accommodate tool shafts up to 1/4" dia. For lathes, electric drills, etc.

2 DRUM SANDERS
With 12 Bands in Assorted Grits. 1 1/2" dia. x 1" long on 1/4" arbor with 12 bands. **\$1.50 P.P.**
One drum, 1" dia. x 1" long on 1/4" arbor with 6 extra sleeves **\$1.00 P.P.**

2 Circular saws. On 2 Mandrels—all at one low price. 1" diameter saws on 1/4" Mandrels. For cutting wood, plastic or soft metal. **\$1.50 P.P.**

12 MOUNTED WHEELS and points on 1/4" Shank. **\$2.95**
36 for \$7.50 p.p.
For grinding on plastic, wood, soft & hard metals. Regular Value \$8.40. 18 Mounted points on 3/32" shank \$2.50; 12 mtd. wheels on 1/4" shank \$3.60.
7 U.S. and carbon drills from 6" to 12" in length. Assorted sizes up to 1/2" diam. for drilling in hard to reach places. A **\$1.95 P.P.** reg. \$10 val. for only **\$1.95 P.P.**

12 India Silicon Carbide and Arkansas Stones—Squares, Rounds, Triangles. An assortment from 3 1/2" long to 6" long. Fine, medium and coarse. A real **\$9.00 value.** 12 for **\$4.25 P.P.**

52 U.S. steel drills. Threaded shanks from 3/32" to 1/4". Reg. \$9.50 value. **\$2.00 P.P. only.**

18 Rotary Cutters \$5.85 P.P.
\$13.50 value. Assorted size cutters on 1/4" or 3/32" shank. Will fit all hand grinders. Ideal for cutting wood, metal or plastic.

10 HIGH SPEED STEEL REAMERS—Straight and Taper Shanks— all brand new and in excellent condition. Reg. \$25 value. 10 for **\$4.50 P.P.**

No. C.O.D.'s. Catalog 10 cents

SCHUPACK SUPPLY CO. 1331 COTTAGE GROVE AVE DEPT PM-20 CHICAGO 15, ILL

EXTRA VALUE Value "plus" is built into every Gerstner Chest to guarantee long life and superior service. Free Catalog. **GERSTNER TOOL CHESTS** 459 Columbia St., Dayton 7, Ohio

you can always **BE SURE OF A JOB**



WITH A FOLEY SAW FILER

Have you been laid off—or afraid you may be? If you want security, plus a bigger income too—don't look for a job—start your own spare time business. In his first 2 months J. P. Robitaille earned \$300 with his Foley Saw Filer. From his starting day R. T. Hart made \$600 in 4 months. Frank P. Layne wrote—"In our town of 2,800 instead of 200 to 300 saws I did over 1,500 the first year, averaging about \$1.50 each."

FREE booklet "MONEY MAKING FACTS" shows you how to get business. The Foley sharpens hand, band and circular saws. Use our Time Payment Plan—pay for the machine out of your CASH profits. Send coupon today—no obligation, and no salesman will call.

FOLEY MFG. CO., 243-9 Foley Bldg., Minneapolis 18, Minn.
Send Free Booklet and Time Payment Plan on Foley Saw Filer.
Name _____
Address _____
City _____ State _____



BUILD YOUR OWN HOME

SAVE MANY HUNDREDS OF DOLLARS



One of every five U. S. homes now being built is at least partially owner built. You can do it, too, and save big money! These PM books make it easy—with plans, ideas you can adapt anywhere and beautiful, tested designs . . .

POPULAR MECHANICS PRECUT HOUSE
The small picture can only hint at the beauty of this exciting home. Best of all, you can build it yourself and save up to 65% of its market value. You can do the job in three stages; a shell using a kit of pre-cut materials for cut your own from stock sizes; that you can live in while finishing the house—only \$1,800; then a summer house with gas heat, all kitchen and plumbing facilities—only \$2,800; finally, a fine year-round home featuring luxurious redwood paneling and dry-wall construction for \$3,800, complete. Basic floor plan is 24' by 46' for a 5 or 6-room house with two or three bedrooms, porch, carport, utility room and bath. Build it from the book alone . . . or buy the full size plans to make the job **\$2.95** even easier—see coupon.

RANCH-TYPE HOUSE
The most popular of all homes today—the ranch style. You can build this beautiful home and save \$7,000 to \$10,000! It's a year-round home, a full 81' long, 29' wide. Fully insulated. Finished inside and outside with durable plywood; requires no costly plastering. Has brick "island wall" and big fireplace in living room. Heating, ventilating and wiring system included. Build the basic home first—living room, dining area, two bedrooms, bath, utility room and carport—all for about \$5,000. Later on, add garage, breezeway (carport becomes a third bedroom)—all for about \$2,500 more. Actual pictures and carefully explained instructions cover every step in proper order. Includes notes on construction, framing, lumber list, specifications. Ten working size blueprints available to aid in construction—see coupon. **\$3.95**

CONCRETE BLOCK HOUSE
A project well within the reach of any handy man who can use simple tools! This unique book covers every step of building a modern five-room concrete block house that has been completed in many communities for less than \$4,500, with all plumbing, heating and electrical equipment. If you can mix a batch of concrete and saw a board straight, you'll have no trouble building this attractive Popular Mechanics home. Concrete construction throughout—poured concrete floors and concrete block walls, with vapor-sealed insulation. Walls are plastered inside and stuccoed outside. Very little carpentry required—which makes the home easy to clean and maintain at a minimum cost. Complete list of needed materials with prices and source of supply, including mill work and equipment. Blueprints also available if desired—see coupon. **\$3.50**

YOUR HOME and HOW TO BUILD IT YOURSELF
Here's the real answer—build it yourself! Yes, you can construct a modern, truly beautiful 1 1/2 story home with a basement, living room, kitchen, dining nook, two bedrooms, bath, plenty of closet space—plus an extra two bedrooms on the second floor, a breezeway and an attractive garage. Think the cost is beyond your pocketbook? Not if you follow the leadership and plans given here! The house is a whopping 35'-9" x 28'-11" breezeway 20'-10" x 8'; garage 20'-10" x 12'. Easy to build in most any style of architecture, traditional or modern. Book gives floor plans, elevations, construction notes, lumber list and specifications. Includes hundreds of drawings and photos to make every step of construction crystal-clear even for the amateur-builder. Set of ten blueprints is available—see coupon. **\$2.50**

Springtime is building time! Order the book of your choice now and be ready to go when the weather's right. Satisfaction guaranteed or your money back.

POPULAR MECHANICS PRESS, Dept. 259
200 E. Ontario St., Chicago 11, Illinois

RUSH book and/or blueprints I have checked below. If not pleased, I can return in good order within seven days for full refund.

Remittance enclosed Send C.O.D.; U.S.A. only

PM Precut House book \$2.95 Precut House plans only \$12.50
 Precut House book and plans \$14.00 Ranch House book \$3.95
 Ranch House plans only \$13.50 Ranch House book, plans \$15.00
 Concrete House book \$2.50 Concrete House plans only \$12.00
 Concrete House book, plans \$13.00 Your Home book \$3.50
 Your Home plans only \$12.50 Your Home book, plans \$14.00

Name _____
Address _____
City _____ Zone _____ State _____



100 lbs. pressure in a cold start! Produces large volume of high pressure steam on 2 pints of fuel oil. Instantly cleans sticky grease, dirt, rust, old paint, etc. off implements and road machinery. Pays for itself in a few weeks. Sterilizes soil. Sterilizes as it cleans. milk equipment, etc. Fully automatic—oil fired with new, built-in lifetime bronze water circulating pump. Draws water from faucet or bucket. Simple and safe. Anyone can use it: built-in safety valve. Complete with 12 ft. of hi-pressure steam hose and new triple efficiency steam gun that automatically mixes in soap solution if desired. Wt. 250 lbs. Item 403. Special factory price..... **\$349.50**

ELECTRIC HOIST

2000 lb. CAPACITY. A fortunate purchase from the Air Force enables us to offer these powerful 2000 lb. electric cable hoists at a fraction of their value. Perfect for material handling, boat hoists, elevators, lifts on assembly lines, etc. Two separate 22 ft. lift cables with independent controls permit leveling the load and controlling it perfectly. Rugged ball bearing motors of geared down design 110 volts. Available for A.C. or D.C. Please specify. Makes a terrific portable hoist with our 273 D.C. light plant at \$99.75. Offered at less than 33% of regular cost (hook not included). Wt. 145 lbs. A.C. Model, Item 847A..... **\$149.50** D.C. Model, Item 847..... **\$129.50**

MASTER AIR COMPRESSOR
COMPARE! This is the only compressor built with a **NO RUST** stainless steel tank. Safe up to 500 lbs. pressure type 7/4 c.f.m.) Large volume of air for heavy duty service. For paint spraying, inflating truck & auto tires, greasing, sand blasting, etc. Piston type 2" bore compressor with built-in air filter. Master built with high strength alloys and precision bearings. Tank, 12"x24", 2100 cu. in. cap. Equipped with automatic switch that starts and stops motor to maintain desired pressure (up to 150 lbs.) and check valve, safety valve, gauge, shut-off valve, 20 ft. air hose and tire chuck. Beautifully balanced on ball bearing wheels and rubber tires. Don't take chances with used or surplus equipment. Our compressors are factory new and are guaranteed **SAFE**. Low factory prices. 1/2 HP Model (cap. 85 lbs.)..... **\$109.50** 1/2 HP heavy duty model, Reg. Ind. motor & unloader switch (Item 209A)..... **\$129.50**

SPECIAL DEALS

MINE DETECTOR for detecting buried pipes, wires, sewers, etc. Carrying case and fresh batteries included..... **\$49.50**
AIR HAMMER for hammering dents out of auto bodies. Complete with 2 different shaped arms and 5 bumping dollies. Hammer can also be used without arm for chiseling and drilling, etc. Uses 4 cfm at 60 psi..... **\$39.50**
SCREW JACK—16 ton Simplex Jack, 1 1/4" screw, 16" lift. Reg. price \$29.50. Special Price..... **\$9.50**
HYDRAULIC PRESS, 9 ton press for pushing, bending, straightening, etc. 3305 List. Special Price..... **\$69.50**
SCREW PRESS, 9 ton capacity with 21" throat. Complete with adjustable table..... **\$49.50**
EXTENSION CORD, 2 cond. #14, Neoprene—100 ft..... **\$6.95**
 2 cond. #12, Neoprene covered—100 ft. **\$7.95**
 3 cond. #10, Neoprene covered—100 ft. **\$13.95**
INTERCOM SET. Powerful loud talking intercom set powered by 4 flash light batteries which last for 6 months. Good up to 1,000 ft. Complete with 2 stations—250 ft. of wire and batteries..... **\$11.95**
PORTABLE BLOWER powered by 2.2 Briggs Gas engine. Used for ventilating man holes, tanks, or any ventilating purpose. Complete with 20 ft. of 4 in. flexible pipe..... **\$99.50**
EXHAUST FANS—Heavy duty, powered by sealed explosion proof motors, mounted in steel frames. Ideal for ventilating spray booths, barns, taverns, etc. 20" fan, only..... **\$29.75**

Send check or M.O. Prices f.o.b. Factory. 10 day Money back guarantee. SEND 10c for **MASTER MECHANIC MFG. CO.,** DEPT. 437 Burlington, Wis.

(Item 24)
700 WATT LIGHT PLANT
PUSH BUTTON START

115 v. 60 cyc. AC Powered by a rugged 2.2 HP. easy starting Briggs engine. No wiring necessary: just plug in and operate. Plenty of current for any oil burner, freezer, brooder, emergency lights, etc. which require up to 700 watts. Ideal for television and radios. Complete with voltmeter and built-in winding to charge 6 v. auto batteries. (Item 24) Wt. 75 lbs. Easily fits in car trunk. Be prepared if storm knocks out power lines..... **\$143.50**
 1200 Watt Plant (Item 45) same as Item 24 but larger generator and engine with 50% greater output..... **\$199.50**
 We make every type and size of light plants. — Write giving us your requirements!

MASTER D.C. ARC WELDER

Easy To Use
 Now! a portable rugged industrial type welder with terrific performance, yet at a price hundreds of dollars less than you'd expect. Senior model made for years of trouble-free, continuous service. High capacity DC welding unit enables you to tackle any job with confidence—easily welds anything up to 2" plate using from 1/16" to 3/4" rods. Built-in stabilizer and cooling system makes arc easy to strike and hold. Dual control rheostat provides low heat soldering, brazing and welding from 30 to 300 amps. Complete with instructions, guarantee and triple V-belt or flat pulley. Easy to hook up and easy to operate.
WELDER ONLY — DUAL CONTROL MODEL. Same as above, but drive with your tractor, jeep or gas engine of 14 HP or more. (Item 38A) Wt. 140 lbs. \$450 value..... **\$119.50**
WELDER ONLY—INDUSTRIAL MODEL same as above but with ceramic rotary type rheostat providing 74 different heat settings for all types of welding (Item 38B) \$500.00 value..... **\$139.50**
COMPLETE POWER MASTER illustrated above) powered by a 16 hp., air cooled Wisconsin engine. Wt. 480 lbs. (Item 280) Compared with welder costing \$1200. Factory Special..... **\$449.50**

SPEED SELECTOR. Heavy duty made by B. F. Goodrich for industrial use. Provides instant speed selection. Employs reliable planetary system—no power losses..... **\$89.50**
HAND WINCH—3 ton, ball bearing, 2 speed. Lightweight but strong. Takes up to 500 ft. of cable. Special..... **\$59.50**
BATTERY CHARGING GENERATOR SET. 750 watt, charges 12 or 24 volt batteries, made by DELCO. Engine runs at 1800 RPM. Makes a potent cold weather motor starting unit as well as a fast charger..... **\$119.50**
MOTOR-GENERATOR SET—115 v. 3KW D.C. output with 5 HP-3ph. direct connected motor. Ideal for magnetic chucks, variable speed motors, or electro-plating; complete with controls..... **\$349.50**
ALUMINUM CONVEYOR—ball bearing skate wheel type, 12" wide, 8 ft. sections & 4 ft. sections. Hook together to form any length desired. Very light and strong. 8 ft. section (Wt. 40#)..... **\$34.50**
 4 ft. section (Wt. 20#)..... **\$17.50**
ELECTRIC WATER PUMP—Centrifugal pump—1" pipe thrd.—direct connected to heavy duty sealed 115v. A.C. motor. Ideal for draining tanks, transferring fluids, etc. Capacity 800 g.p.h. Reg. \$79.50. Special..... **\$29.50**
FOOT VALVE—for above pump..... **\$1.95**
WATER PUMP, self-priming pump coupled to a 2.2 HP Briggs engine. Delivers 600 GPH. Pump has both garden hose thread & 1" pipe thread..... **\$79.50**

ating any oil burner, pump, freezer, television, lights, communications systems, etc. which require up to 1500 watts. (Item 22) Wt. 110 lbs. Reg. \$475 value. Factory price..... **\$239.50**
1750 Watt Plant Powered by 4.5 Briggs engine. Electric starting & battery charging built-in! Factory price..... **\$279.50**
2500 WATT PLANT—Push Button Start (Item 21) 110/120 v. 60 cyc. A.C. A rugged powerful plant. Reg. \$645. Spec..... **\$329.50**
3500 Watt Plant Push Button Start (Item 23) 115 v. 60 cyc. AC. Similar to above, but larger and 33% more capacity. Wt. 270 lbs. Reg. \$780. Factory Price..... **\$379.50**
DUAL VOLTAGE 110/220 for Item 21 or 23—\$30 additional.

EXCLUSIVE! NEW!

LIGHTWEIGHT WATER COOLED DIESEL GENERATOR PLANT
 Never before available! Now offered exclusively by Master Mechanic. A low priced, lightweight, continuous duty, Diesel generator set. Powered by a super rugged, exceptionally smooth running, one cylinder Diesel engine. Operates at conservative 1750 r.p.m. and delivers full 1750-2000 watts of power. Operates on low cost fuel oil. Wt. only 240 lbs. representing a triumph of Diesel Engineering. Complete with fuel filter, oil pressure gauge, control box with duplex receptacle and voltmeter. (Item 830) Special factory price..... **\$429.50**

SPEED REDUCER
 Ideal for lathes, grinders, conveyors, displays, etc. Rugged gear type speed reducer, ball bearings, either increase or reduce speed up to 100 to 1. Takes up to 1/2 h.p. Compact. (7x8x5). Wt. 10 lbs. Item 854..... **\$19.95**

ELECTRIC PUMP
FILL TANKS — DRAIN CELLARS — IRRIGATE
 \$29.50
 Powerful completely enclosed G.E. motor direct connected to a 1" pump, portable, pumps anything, std. thrd., use any hose, foot valve incl. free, 10 day money back guar. Wt. 26 lbs. Item C853..... **\$29.50**

Double Acting Hydraulic Cylinder

A powerful cylinder mfr'd. by Massey Harris which develops both a pushing and a pulling action. Will push 8,100 lbs., with a 1000 PSI pump pressure. Cylinder is 3 3/4" O.D. with 6 1/2" stroke—standard heavy duty clevises on both ends. Has standard 1/2" pipe thread openings. Can be used for tilting buckets or blades, raising or lowering implements, hydraulic presses, etc. Can also be used as an air cylinder. (Item 802) Wt. 17 lbs. Reg. \$68 value. Special..... **\$14.95**

OTHER DOUBLE ACTING CYLINDERS
 6" stroke — 1 1/2" bore..... **\$ 8.95**
 8" stroke — 3" bore..... **34.00**
 10" stroke — 3" bore..... **34.80**
 16" stroke — 3" bore..... **43.00**
 24" stroke — 3" bore..... **47.50**
 42" stroke — 5" bore..... **75.00**
 60" stroke — 5" bore..... **125.00**
 We have all sizes of cylinders available.
HYDRAULIC CONTROL VALVE—4 way open center valve with built-in adjustable relief. Controls 1 double, or 2 single acting cylinders. Equalizing feature permits easy control even under heavy loads. 3/4" pipe thread on inlet & outlet, 1/2" on cylinder outlets. Easily mounted, finger tip control. Wt. 16 lbs. (Item 822)..... **\$21.95**
HYDRAULIC PUMP drive from tractor power take off or with separate engine or motor. Capacity is 8 GPM at 800 RPM—has 3/4" shaft with keyway..... **\$39.50**
HYDRAULIC HOSE COUPLERS Connect or disconnect hydraulic lines without loss of oil—1/2" pipe threads. (Item 819) per set **\$3.95**
WELDING KIT Two 20 ft. leads, welding helmet, electrode holder, ground clamp. Sold only with welder at..... **\$10.50**

HOW GOOD A FAMILY MAN ARE YOU?

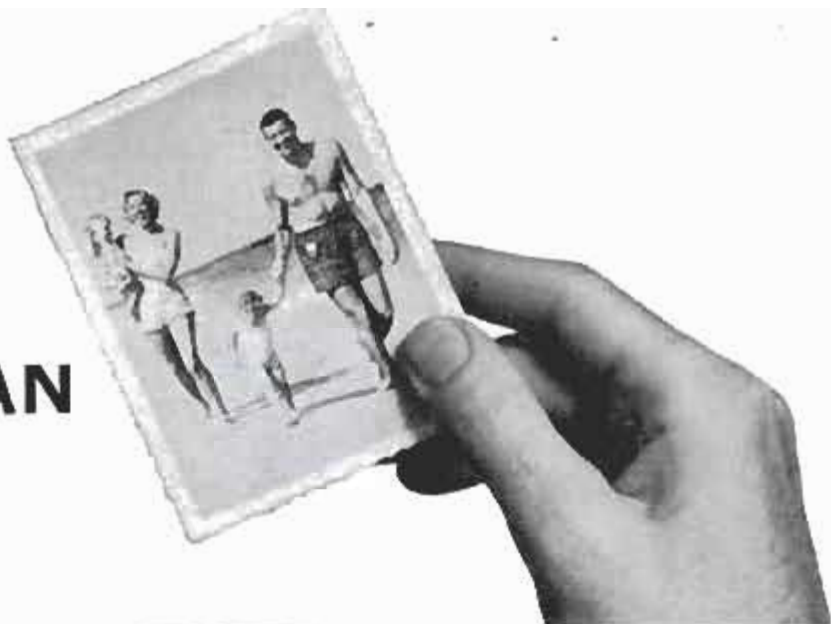

Easy enough to find out . . .

Take a close look at your family. Do they have everything they need? Will they be hurt by hard times? Are they enjoying the comforts and security you want them to have?

Now your job. How long has it been since you've had a raise? What about your prospects for a promotion? Can you see yourself making any headway?

Add up your answers. Now ask yourself frankly, honestly: "Am I a good family man?"

Others have discovered they are not. But—they decided to do something about it. They decided to enroll with I.C.S. for the job training they needed to move ahead; to provide for their families—good times or bad.

I.C.S. is the world's largest and oldest home study school. More I.C.S. trained men are in supervisory and management positions now than from any other school. It's

the success-proven method of getting ahead—in your present job or any one of more than 200 "blue chip" job fields.

You study at home—in your spare time—at your own pace. Everything you learn is practical, usable. More than likely, by the time you get your I.C.S. diploma, you'll already be on your way to a successful, rewarding career.

Right now your future—and that of your family—may depend on whether you mail the coupon or simply turn the page. It's up to you . . .

FREE! I.C.S. CAREER KIT

Coupon brings all three books

- 1 "How to Succeed," 36-page gold mine
- 2 Career Catalog with opportunities in your field
- 3 Sample lesson (Math) shows the I. C. S. method



For Real Job Security—Get an I. C. S. Diploma! I. C. S., Scranton 15, Penna.

Accredited Member,
National Home Study Council

INTERNATIONAL CORRESPONDENCE SCHOOLS



BOX 26626B, SCRANTON 15, PENNA.

(Partial list of 259 courses)

Without cost or obligation, send me "HOW TO SUCCEED" and the opportunity booklet about the field BEFORE which I have marked X (plus sample lesson):

- | | | | | |
|--|--|--|--|---|
| <p>ARCHITECTURE and BUILDING CONSTRUCTION</p> <ul style="list-style-type: none"> <input type="checkbox"/> Air Conditioning <input type="checkbox"/> Architecture <input type="checkbox"/> Arch. Drawing and Designing <input type="checkbox"/> Building Contractor <input type="checkbox"/> Building Estimator <input type="checkbox"/> Carpenter Builder <input type="checkbox"/> Carpentry and Millwork <input type="checkbox"/> Carpenter Foreman <input type="checkbox"/> Heating <input type="checkbox"/> Painting Contractor <input type="checkbox"/> Plumbing <input type="checkbox"/> Reading Arch. Blueprints <p>ART</p> <ul style="list-style-type: none"> <input type="checkbox"/> Commercial Art <input type="checkbox"/> Magazine Illus. <input type="checkbox"/> Show Card and Sign Lettering <input type="checkbox"/> Sketching and Painting <p>AUTOMOTIVE</p> <ul style="list-style-type: none"> <input type="checkbox"/> Automobile <input type="checkbox"/> Auto Body Rebuilding and Refinishing <input type="checkbox"/> Auto Engine Tuneup <input type="checkbox"/> Auto Technician | <p>AVIATION</p> <ul style="list-style-type: none"> <input type="checkbox"/> Aero-Engineering Technology <input type="checkbox"/> Aircraft & Engine Mechanic <p>BUSINESS</p> <ul style="list-style-type: none"> <input type="checkbox"/> Accounting <input type="checkbox"/> Advertising <input type="checkbox"/> Business Administration <input type="checkbox"/> Business Management <input type="checkbox"/> Cost Accounting <input type="checkbox"/> Creative Salesmanship <input type="checkbox"/> Managing a Small Business <input type="checkbox"/> Professional Secretary <input type="checkbox"/> Public Accounting <input type="checkbox"/> Purchasing Agent <input type="checkbox"/> Salesmanship <input type="checkbox"/> Salesmanship and Management <input type="checkbox"/> Traffic Management <p>CHEMICAL</p> <ul style="list-style-type: none"> <input type="checkbox"/> Analytical Chemistry <input type="checkbox"/> Chemical Engineering <input type="checkbox"/> Chem. Lab. Technician <input type="checkbox"/> Elements of Nuclear Energy <input type="checkbox"/> General Chemistry <input type="checkbox"/> Natural Gas Prod. and Trans. <input type="checkbox"/> Petroleum Prod. and Engr. <input type="checkbox"/> Professional Engineer (Chem) <input type="checkbox"/> Pulp and Paper Making | <p>CIVIL ENGINEERING</p> <ul style="list-style-type: none"> <input type="checkbox"/> Civil Engineering <input type="checkbox"/> Construction Engineering <input type="checkbox"/> Highway Engineering <input type="checkbox"/> Professional Engineer (Civil) <input type="checkbox"/> Reading Struc. Blueprints <input type="checkbox"/> Sanitary Engineer <input type="checkbox"/> Structural Engineering <input type="checkbox"/> Surveying and Mapping <p>DRAFTING</p> <ul style="list-style-type: none"> <input type="checkbox"/> Aircraft Drafting <input type="checkbox"/> Architectural Drafting <input type="checkbox"/> Drafting & Machine Design <input type="checkbox"/> Electrical Drafting <input type="checkbox"/> Mechanical Drafting <input type="checkbox"/> Sheet Metal Drafting <input type="checkbox"/> Structural Drafting <p>ELECTRICAL</p> <ul style="list-style-type: none"> <input type="checkbox"/> Electrical Engineering <input type="checkbox"/> Elec. Engr. Technician <input type="checkbox"/> Elec. Light and Power <input type="checkbox"/> Practical Electrician <input type="checkbox"/> Practical Lineman <input type="checkbox"/> Professional Engineer (Elec) <p>HIGH SCHOOL</p> <ul style="list-style-type: none"> <input type="checkbox"/> High School Diploma | <ul style="list-style-type: none"> <input type="checkbox"/> Good English <input type="checkbox"/> High School Mathematics <input type="checkbox"/> High School Science <input type="checkbox"/> Short Story Writing <p>LEADERSHIP</p> <ul style="list-style-type: none"> <input type="checkbox"/> Industrial Foremanship <input type="checkbox"/> Industrial Supervision <input type="checkbox"/> Personnel-Labor Relations <input type="checkbox"/> Supervision <p>MECHANICAL and SHOP</p> <ul style="list-style-type: none"> <input type="checkbox"/> Diesel Engines <input type="checkbox"/> Gas-Elec. Welding <input type="checkbox"/> Industrial Engineering <input type="checkbox"/> Industrial Instrumentation <input type="checkbox"/> Industrial Metallurgy <input type="checkbox"/> Industrial Safety <input type="checkbox"/> Machine Shop Practice <input type="checkbox"/> Mechanical Engineering <input type="checkbox"/> Professional Engineer (Mech) <input type="checkbox"/> Quality Control <input type="checkbox"/> Reading Shop Blueprints <input type="checkbox"/> Refrigeration and Air Conditioning <input type="checkbox"/> Tool Design <input type="checkbox"/> Tool Making <p>RADIO, TELEVISION</p> <ul style="list-style-type: none"> <input type="checkbox"/> General Electronics Tech. | <ul style="list-style-type: none"> <input type="checkbox"/> Industrial Electronics <input type="checkbox"/> Practical Radio-TV Eng'r'g <input type="checkbox"/> Practical Telephony <input type="checkbox"/> Radio-TV Servicing <p>RAILROAD</p> <ul style="list-style-type: none"> <input type="checkbox"/> Car Inspector and Air Brake <input type="checkbox"/> Diesel Electrician <input type="checkbox"/> Diesel Engr. and Fireman <input type="checkbox"/> Diesel Locomotive <p>STEAM and DIESEL POWER</p> <ul style="list-style-type: none"> <input type="checkbox"/> Combustion Engineering <input type="checkbox"/> Power Plant Engineer <input type="checkbox"/> Stationary Diesel Engr. <input type="checkbox"/> Stationary Fireman <p>TEXTILE</p> <ul style="list-style-type: none"> <input type="checkbox"/> Carding and Spinning <input type="checkbox"/> Cotton Manufacture <input type="checkbox"/> Cotton Warping and Weaving <input type="checkbox"/> Loom Fixing Technician <input type="checkbox"/> Textile Designing <input type="checkbox"/> Textile Finishing & Dyeing <input type="checkbox"/> Throwing <input type="checkbox"/> Warping and Weaving <input type="checkbox"/> Worsted Manufacturing |
|--|--|--|--|---|

Name _____ Age _____ Home Address _____

City _____ Zone _____ State _____ Working Hours _____ A.M. to P.M. _____

Occupation _____

Canadian residents send coupon to International Correspondence Schools, Canadian, Ltd., Montreal, Canada. . . . Special tuition rates to members of the U. S. Armed Forces.

ENCYCLOPAEDIA BRITANNICA

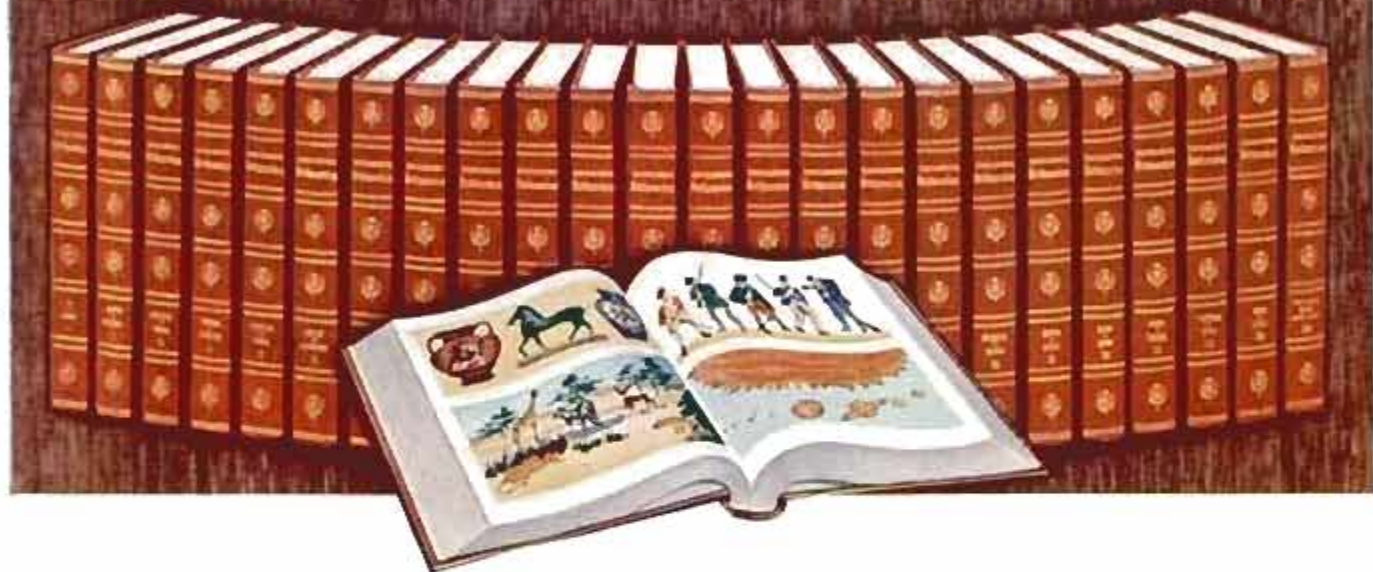

You Get All 24 Volumes Now... Pay Later

On Easy... Book a Month Payment Plan

■ Yes, the latest edition of Britannica—the greatest treasure of knowledge ever published—is now being offered on a remarkable direct-from-the-publisher plan that puts this world-renowned reference library within reach of every family. All 24 volumes will be placed in your home NOW... you pay for it later on convenient budget terms. It's as easy as buying a book a month.

Savings Passed on to You

You may wonder how we're able to make this truly amazing offer. First, because of the great demand for this magnificent set, we have ordered a tremendous printing. This enormous printing materially reduces our costs and, under a remarkable *direct-from-the-publisher plan*, we pass these savings on to you.

New Edition is Profusely Illustrated

The new Britannica almost "televises" information with 23,494 magnificent illustrations. But it does not merely show "attractive" pictures—it is the work of 5,565 of the world's greatest authorities.

Britannica in your home can give you the broad knowledge that makes people listen when you talk, enabling you

to speak factually and intelligently on the widest range of subjects.

Essential for Homework

For students, Britannica is indispensable. It is the largest and most complete reference set published in America. Its use develops the active, alert minds that bring success in school and later life.

Britannica has always been the symbol of a good home. It is a treasure house of knowledge that can open a richer, fuller, more successful life to every member of your family.

Preview Booklet Offered FREE

Simply fill in and mail the coupon today, and we will send you... *without cost or obligation*... a copy of our beautiful new booklet which contains an exciting preview

of the latest edition of Encyclopaedia Britannica. Send no money—not even for postage. It's yours *absolutely free!*

In color so beautifully etched it gives the illusion of a third dimension, you will see art treasures of famous museums, world landmarks, scientific wonders. Also pictured is the most magnificent scenery on the North American continent, a cruise through France, the mysterious Orient, a Pacific island, and a rocket trip to the moon.

Offer Limited

Just as soon as we receive your coupon, we will send your illustrated, free booklet. There is no obligation, of course. However, this offer is necessarily limited, so mail the coupon *today*.



ENCYCLOPAEDIA BRITANNICA, DEPT. 66-H

425 N. Michigan Avenue, Chicago 11, Illinois

Please send me, *free and without obligation*, your colorful Preview Booklet. Also include complete information on how I may obtain ENCYCLOPAEDIA BRITANNICA *direct from the publisher*, on the Book a Month Payment Plan.

Name _____
(Please print)

Address _____

City _____ Zone _____ State _____

In Can., write E. B. Ltd., Terminal Bldg., Toronto, Ont.

Have a real cigarette —

have a **CAMEL**

Nobody beats Camel to the draw for rich tobacco flavor and easygoing mildness. "My kind of cigarette—no fads or fancy stuff," says "Lawman" star John Russell. Co-star Peter Brown goes along: "Tastes good, smokes mild." Today more people smoke Camels than any other brand. The best tobacco makes the best smoke.



R. J. Reynolds Tobacco Co., Winston-Salem, N. C.

Tune in Camel's exciting new "LAWMAN" on ABC-TV