

50 PAGES ABOUT CARS - PLUS ALL REGULAR FEATURES

POPULAR MECHANICS

MAGAZINE

WRITTEN SO YOU CAN UNDERSTAND IT

JANUARY 1959
35 CENTS

REG. U.S. PAT. OFF.



**HEROIC YEARS
OF THE AUTOMOBILE**
—A Color Album

HOW TO CHECK YOUR IGNITION

CAR STYLISTS TALK BACK

HOW GOOD ARE THE GADGETS?
an Engineer Discusses the Accessories



GALE

BUCCANEER

Smart, tough, and terrific

The dramatic new 35 hp. Sovereign by GALE is an exciting outboard motor, equally at home at a swank club anchorage or on the racing waters of a North Woods river!

This handsome husky, in spray-white and black, comes with trim, functional lines and smart styling—and underneath, *pure* power!

Yet it takes no time at all to master mighty Sovereign! Start it with a quick, easy turn of a key. The hot-

test spark of any outboard motor comes from GALE's Magic Magneto.

In fact, starting improves with age. The points wear evenly. And the Magic Magneto never wears out. With gentle fingertip control, send Sovereign racing at over 30 m.p.h., or tame it down to a slow idle.

GALE offers a model for your every need, in 3, 5, 12, 25 and 35 hp. . . . Write to us today for the name of your nearby GALE Buccaneer dealer, and a free catalog.



35 H.P. BUCCANEER BY

Gale

Gale Products, Dept. 319, Galesburg, Ill., Div. Outboard Marine Corp.



"MIRACLE MILD" PHILLIES

Now-The Best Selling Panatellas in the U.S.A.

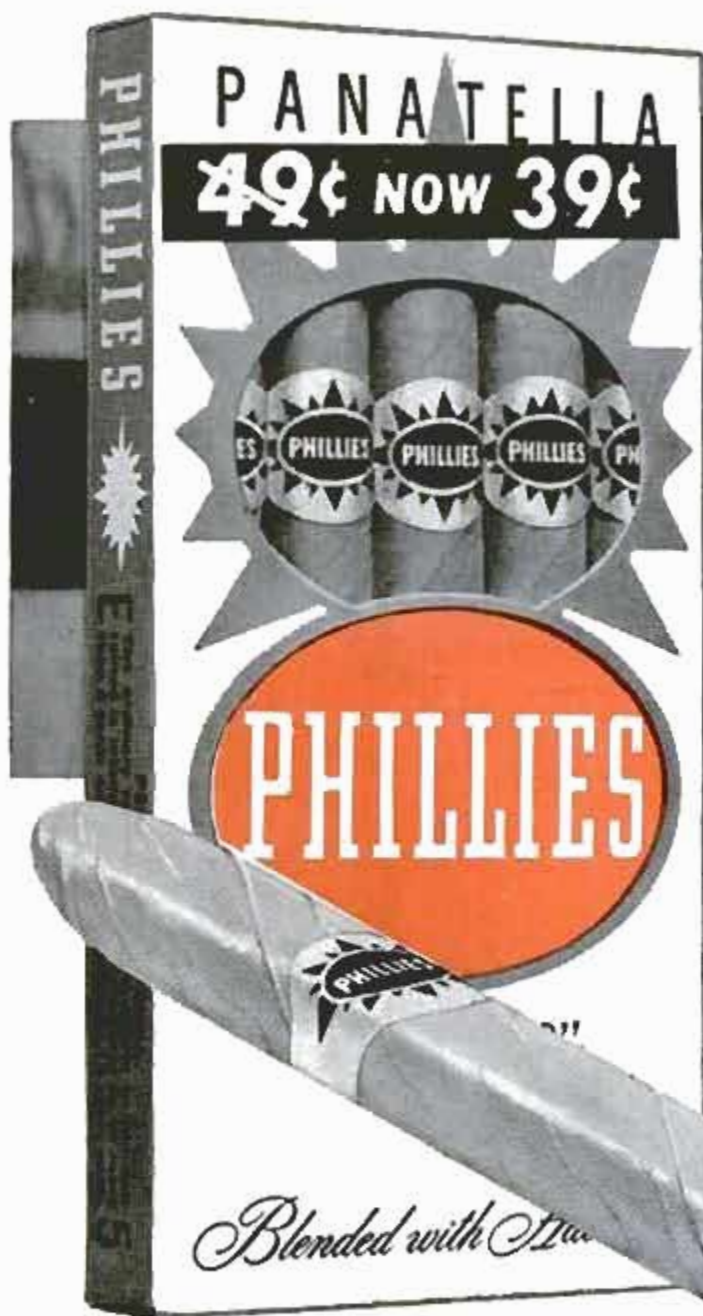

Cigar and cigarette smokers alike
are now enjoying
"MIRACLE MILD" Phillies
Panatellas — the first cigar
mild enough for all smokers.
Never before has smoking offered
so much pleasure for so little cost.
Pick up a pack today!

NEW LOW PRICE!

5 for 39¢

Other Phillies sizes . . .

IMPERIALS—DOUBLE PERFECTOS—KING SIZE—2 for 25c • PERFECTOS—10c • BLUNTS—5 for 39c • JUNIOR PHILLIES—5c

JANUARY 1959

This One



1

Popular Mechanics Magazine

Registered in U. S. Patent Office and Canada

Address all communications to: 200 E. Ontario St., Chicago 11, Ill.

Editor
RODERICK M. GRANT

Executive Vice-President
RICHARD E. DEEMS

Publisher
G. HARRY CHAMBERLAINE

Assistant Managing Editor
WAYNE WHITTAKER

Shop Notes and Crafts Editor
JAMES R. WARD

Associate Editors, General Features
CLIFFORD B. HICKS
ARTHUR R. RAILTON, *Automotive*
KENNETH N. ANDERSON

Associate Editors, Shop Notes and Crafts
WAYNE C. LECKEY W. CLYDE LAMMEY

Radio-Television, Electronics Editor
LOTHAR STERN

Assistant Editors
SHELDON A. MIX, *General Features*
JAY W. HEDDEN, EARL WOBECK, *Crafts*
JOHN DALEN, ARLENE HIRSCH, *Makeup*

Art Staff
FRANK BEATTY, *Director*
HENRY NEHRBASS, *Assistant Director*
RICHARD A. POTTS, *Art Editor*

Eastern Editor
RICHARD F. DEMPWOLFF
Room 4102, Empire State Bldg., New York City 1

Western Editor
THOMAS E. STIMSON, JR.
Suite 1010, 3460 Wilshire Blvd.
Los Angeles 5, Calif.

London Manager
DOUGLAS W. WEDDERSPOON
Eagle House, Jermyn St.,
London S.W. 1, England

Director, Bureau of Information
ALLAN CARPENTER

Advertising Offices

200 E. Ontario St., Whitehall 4-0100;
Empire State Bldg., 350 Fifth Ave.,
New York 17-7580; Detroit: General Motors
City 5-8711; Cleveland: Hanna
Euclid Ave., Prospect 1-0456; Los
Angeles: 10 Wilshire, DUnkirk 2-8458; San
Francisco: Russ Bldg., 235 Montgomery St.,
City 4-3131.

Published monthly by Popular Mechanics Company,
200 E. Ontario St., Chicago 11, Ill. Richard E.
Deems, President; Richard E. Deems, Executive
Vice-President; Fred Lewis, Vice-President and
General Manager; John H. Miller, Vice-President;
G. Harry Chamberlaine, Vice-President; G. O. Mar-
kison, Treasurer; R. F. McCaskey, Secretary;
Joseph H. Bush, Jr., Advertising Manager. Single
copy in the United States and Canada, 35 cents;
subscription rates in the United States and pos-
sessions, Canada and countries of the Pan-Ameri-
can Postal Union, 1 year \$3.50; 2 years, \$6.00;
3 years, \$8.00. To all other countries add \$1.00
a year over United States prices for overseas
postage. If you plan to move, notify us at least
30 days in advance so you will not miss an
issue. Give both your old and new addresses.
Entered as Second Class Matter, September 15,
1903, at the Post Office at Chicago, Illinois, under
Act of March 3, 1879. Entered as Second Class
Matter at Post Office Dept., Canada. Registered
as Second Class Matter at the Post Office at
Mexico, D. F., Mexico, June 20, 1950.
Copyright 1958 by Popular Mechanics Company.
Copyright under International Copyright Union.
Copyright in France. All rights reserved under
Pan-American Copyright Union. Printed in the
United States of America.

FOREIGN EDITIONS: MECANIQUE POPULAIRE (French) MECANICA POPULAR (Spanish) POPULAER MEKANIK (Danish) POPULAR MEKANIK (Swedish) POPULARE MECHANIK (German)

Volume 111

JANUARY 1959

Number 1

In This Issue...

Stairway to the Sea	-	-	-	-	97
Greatest Magic Illusions of All Time—Part II	-	-	-	-	105
Big Change in Venezuela—Part I	-	-	-	-	117
Fusion Power for the World of Tomorrow	-	-	-	-	125
Rocket Shoot at M.I.T.	-	-	-	-	133
The Cruiser With the Supersonic Sting	-	-	-	-	140

Annual Automotive Section

Heroic Years of the Automobile	-	-	-	-	144
Parade of New Cars	-	-	-	-	153
Parade of Foreign Cars	-	-	-	-	165
Where Did the Inches Come From?	-	-	-	-	172
Why Do Our Cars Look the Way They Do?	-	-	-	-	176
The Suburban Runabout	-	-	-	-	180
How Good Are the Gadgets?	-	-	-	-	182
Reringing Those Pistons	-	-	-	-	186
Do You Know Ignition?	-	-	-	-	189

For the Craftsman...

Drop-Leaf Table	-	-	-	-	193
Modeling the French Chebec—Part III	-	-	-	-	206
Molding Makes the Difference	-	-	-	-	218
It's the Cutting Edge That Counts	-	-	-	-	231
Clutch Controls Power Tools	-	-	-	-	237

Regular Departments...

Know This Old-Timer?—Quiz	-	-	-	-	44
What's New for Your Home	130	Shopping for Tools	-	-	240
Solving Home Problems	198	Radio, TV and Electronics	-	-	245
On the Market	228	Clinic for Homemakers	-	-	250

Turn to detailed index on page 88. Sources of additional information on items in this issue are shown on the Where-to-Find-It List, available without charge by writing the Bureau of Information, Popular Mechanics, 200 E. Ontario St., Chicago 11, Ill.

Next Month...

ARE YOU a railroad fan? A PM editor reports next month on his ride in the cab of the newest railroad giant, an 8500-horsepower gas-turbine locomotive on the Union Pacific. DRAG STRIP BUG? A February article tells how the new "sling-shots" are burning up the strips. YEARNING TO BE a jet pilot? An American Airlines captain writes in the next issue of his job—training the veteran piston pilots to fly the Boeing 707 airliners over the transcontinental routes

How I retired in 15 years with \$300 a month

"Some things you remember always. And one was an afternoon Doc Mason and I spent fishing in May 1943. It's solely because of him that I'm retired today—only 15 years later, with \$300 a month that no recession can take away.

"Doc and I got to talking. I'd just been turned down by the Army. I admitted it had kind of shocked me. Although I felt young, I was *too old*.

"Doc looked at me sideways and said, '*Everybody's surprised when he's forty*. People really don't feel different then—but they *are* different. And the ones who are happiest are the ones who do something about it.'

"I said, 'I always figured I had plenty of time ahead. But now I see that I'm actually at my peak. I may not earn more and more. And I may not *save it*.'

"Doc said, 'Some people don't figure *that* out till they're sixty. And that's too late.' He looked thoughtful and said, 'Where would you like to be 15 years from now?'

"Well, I hedged, 'You can't plan—with the war on.'

"That's just it,' said Doc, 'there's always a war or something. Never a time when things are certain. Never a *best* time to plan. But I've seen lots of people who *thought* they wanted to work forever change their minds at sixty. *Then* they want to take it easy, stop worrying.'

"But, I said to Doc, 'What can I do?' Salaries were frozen in '43. Raises weren't much.

And I'd never been able to save much more than I put in my insurance and the house.

"It was then that he told me that, in his experience, the people who had the fewest ulcers were those who *included* something in their insurance to provide for their retirement, as well as for their families. 'There are ways,' he said, 'of making your salary now provide you a retirement income later.'

"I kept turning that over in my mind. And later that week, in Life magazine, I saw an ad for the Phoenix Mutual Life Insurance Company. It told how a man with a good job, but no big savings, had retired in 15 years with \$300 a month. Well, I thought, *it can't cost anything to look into it*.

"I did. And now, 15 years later, I'm mighty glad. I retired *before sixty*. I'm getting a check for \$300 a month, each month, every month—with no worry about the next one. It's something anybody can do, if he stops and thinks about it in time."

Send for free booklet

This story is typical. Assuming you begin at a young enough age, you can plan to have an income of \$100 to \$300 a month or more—starting at age 55, 60, 65 or older. Send the coupon and receive, by mail and without charge, a booklet which tells about Phoenix Mutual Plans. Similar plans are available for women. Don't delay. Send for your copy now.



ESTABLISHED 1851

PHOENIX MUTUAL

Retirement Income Plan

GUARANTEES YOUR FUTURE

OVER 100 YEARS OF LIFE INSURANCE PROTECTION
FOR BUSINESS AND FAMILIES

COPYRIGHT 1958, BY PHOENIX MUTUAL LIFE INSURANCE COMPANY

PHOENIX MUTUAL LIFE INSURANCE CO.
282 Elm Street, Hartford 15, Conn.

Please send me, without obligation, your free 28-page book showing new retirement income plans.

Plan for Men

Plan for Women

Name _____

Date of Birth _____

Business Address _____

Home Address _____

Now... See in spite of



BRACE YOURSELF! Here comes another driver who hasn't dimmed his lights. He's 175 feet away. Your vision of your side of the road is "washed out" by his glare. Then after you pass,

it takes precious seconds for your eyes to re-adjust to the reduced light, and you still can't see the road ahead clearly. It's like entering a dark theatre on a sunny day!

New G-E SUBURBAN Headlamps have

No other 2-headlamp system ever gave you as much light *in the low beam* as new General Electric SUBURBAN Headlamps. And you *need* more light in the low beam when meeting oncoming cars—even if the other driver dims his lights and has them aimed properly.

This new General Electric low beam fila-

ment is *optically centered* in the reflector—gives a "built-in spotlight" effect, puts more light where you need it to make passing easier and safer. Helps you recover your vision more quickly when the other car has passed.

Have a pair of new G-E SUBURBAN Headlamps installed and aimed by your

the other car's lights!

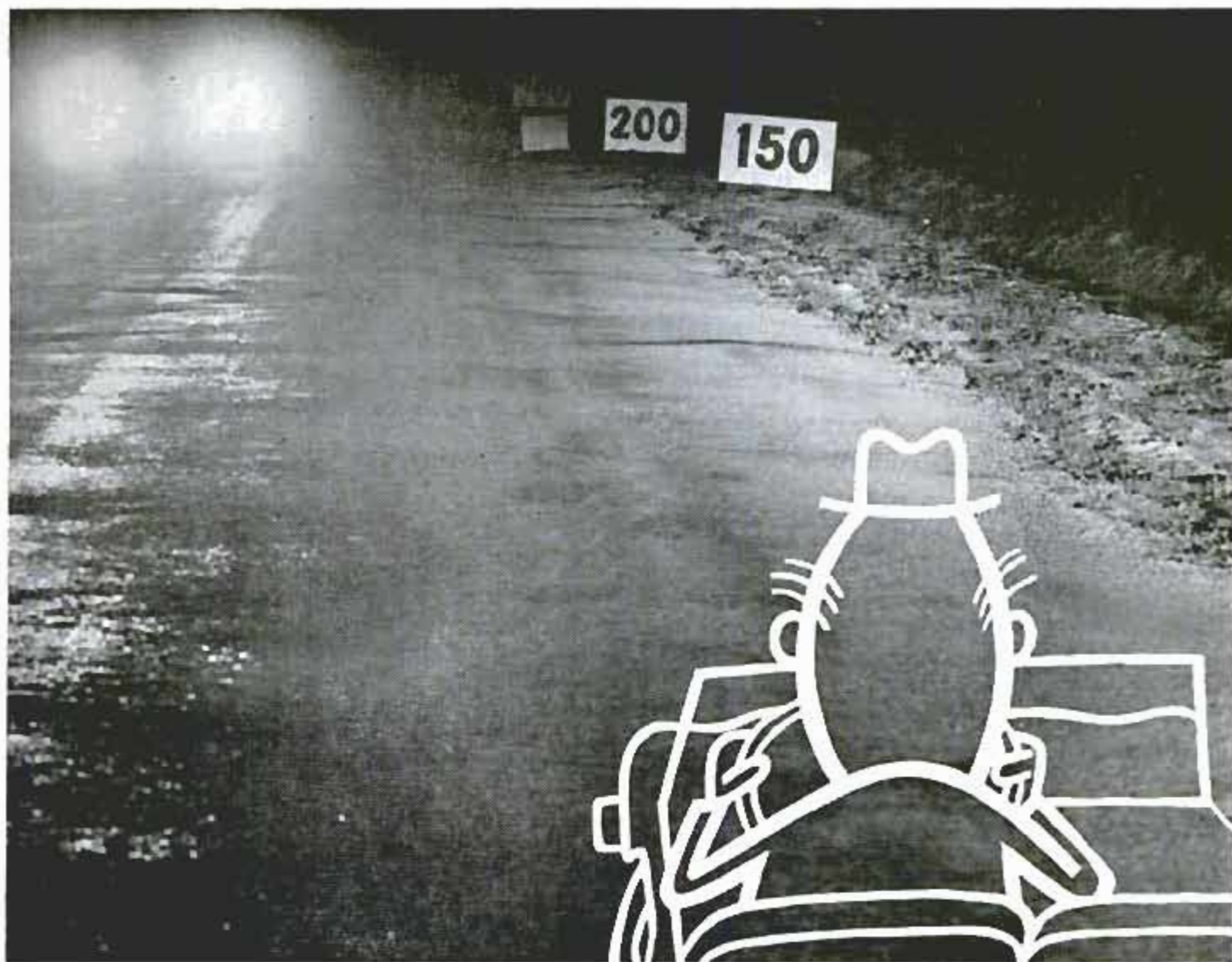

NOW YOU CAN SEE in spite of the other car's lights—better than ever before, because you have new G-E SUBURBAN Headlamps. Their "built-in spotlight" effect in the low beam pro-

jects more light along the right shoulder, helps keep your eyes on your side of the road. Now you can spot that fallen box at the 200-foot mark—which you *couldn't* see with old headlamps.

a "built-in spotlight"..in the low beam!

dealer, garage or service station! General Electric Co., Miniature Lamp Dept., Nela Park, Cleveland 12, Ohio.

Progress Is Our Most Important Product

GENERAL  ELECTRIC



Special low-beam filament shield lets you see better in fog, rain or snow.

Upper beam reaches far and wide for safer driving on open road.

SAVE UP TO \$11 ON B&D ATTACHMENTS WITH CERTIFICATE BELOW!



A wonderful opportunity for the proud owner of a Black & Decker 1/4" Drill or Power Driver! But you'll have to hurry! Good only until Jan. 31, the special certificate below will be redeemed at your Black & Decker dealer's toward any or all of B&D's six most popular attachments! Save over 20% on such work-and-time-savers as the B&D Jig Saw Attachment (above left), the B&D Finish Sanding Attachment (above right) and other attachments for sawing, hedge trimming, floor polishing, screw driving. See them at your B&D dealer's now!



Black & Decker®

Towson 4, Md. World's Largest Maker of Electric Tools

BLACK & DECKER

This CERTIFICATE is worth up to ELEVEN DOLLARS on Black & Decker Magic Switch ATTACHMENTS

Certificate Value	On Purchase of—
\$2.00	U-1022 Floor Polishing Attachment*
\$2.00	U-1013 Saw Attachment
\$2.00	U-1016 Finish Sanding Attachment
\$2.00	U-1014 Hedge Trimming Attachment
\$2.00	U-1017 Jig Saw Attachment
\$1.00	U-1011 Screw Driving Attachment*

*Fit any 1/4" Drill; others fit B&D Utility Drills only.
Cash redemption value 1/20 mil.

Mr. Dealer: Please redeem for amounts specified toward purchase of Black & Decker Attachments at your store. Customer must pay any sales tax. Our wholesalers will redeem from you at normal discount when you reorder attachments in like quantity to replenish stock.

This offer good only in U.S.A., Hawaii and Alaska; void where prohibited, taxed, license required or otherwise restricted.

Customer Validation:
Name _____
Address _____
City-State _____

Dealer Endorsement:
Name _____
Address _____
City-State _____

The BLACK & DECKER Manufacturing Company
Towson 4, Maryland, U.S.A. MO19

HURRY! GOOD ONLY UNTIL JAN. 31, 1953

ACROSS THE DESK



No subject brings us more comments from readers than the "Detroit Listening Post," the once-a-month "Owners Reports" that tell you what car owners themselves find good and bad in their automobiles, and the year-end issues in which we report the new models.

This being our annual automobile issue, we present a few of these comments from mail of recent months. We'd like to print them all, but obviously that is impossible. It's human nature that the vast majority of motorists are completely sold on their own make; it's also human nature that those who voluntarily write letters about cars are often the severest critics. Here, then, are some excerpts from the interesting letters you and others have written us:

Your article "What Engineers Say About Today's Cars" [August] leads one to make this statement: If automotive management were suddenly finding their best-qualified engineering personnel leaving to take positions where "down to earth" objective engineering rates, and where the efforts of research show up as useful improvements in the product (instead of being used to find ways to motivate consumers to buy what they want to sell them), I'm sure there would be some return to a sense of basic values on the part of such management.

Edward Kramer,
Cincinnati, Ohio.



This is the first time I have ever read a PM magazine, mostly because I am not much of a mechanic (popular, or otherwise) and I think it is astounding. I am celebrating the occasion by writing my first letter to any editor. The comment that really spurred this was in your report on the "Olds" [June]: "The public is buying foreign-made scooters for one reason only: gasoline economy; etc."—by an Alabama accountant. Now, I don't know exactly why the "public" is buying these "scooters" (you can tell the implication really ices me) but I'm real happy to say that our part of it (my husband, our four sons, and me) didn't buy our little jewel for that reason. We have been driving GM cars since our marriage eight years ago and the latest was a hardtop beauty of a Buick; and we have no complaints. Fortunately we are stationed in Germany where there are narrow

(Continued to page 10)

LEARN ACCOUNTING

for a
**BETTER
JOB**

...MORE MONEY



**A SHORT STREAMLINED COURSE TO PREPARE YOU QUICKLY
FOR YOUR START IN A SUCCESSFUL ACCOUNTING CAREER!**

Free Sample Lesson Will PROVE You Can Master The Training

You need no special talents to be a success in Accounting. You do not even need a preliminary knowledge of bookkeeping. All you need is the will to win—the will to work—and if you apply yourself you, too, can get into the permanent bigger-money class.

Demand for Trained Bookkeepers and Accountants far exceeds the supply—and this demand is increasing every day. A capable accountant should never have any trouble getting a job—and at better than average earnings.

We Guide You Step By Step

Through more than 50 years' experience in training hundreds of thousands of successful accountants, including nearly 5,000 CPA's, we have developed through the LaSalle problem method a practical training in sound accounting principles and practices designed to prepare you rapidly for countless numbers of high paying bookkeeping and accounting positions.

The success of LaSalle accounting graduates has resulted from their knowledge and application of the principles acquired thru Basic and Practical Accounting, Principles of Accounting and Cost Accounting training, offered in our step-by-step accounting program.

Federal Income Tax is included to give you the necessary training to qualify for the many opportunities available to bookkeepers

**ACCREDITED MEMBER
NATIONAL HOME STUDY COUNCIL**

and accountants with this valuable knowledge. Success in mastering the training is assured through the guidance of expert accountants and CPA instructors. You complete the lessons right in your own home, in your spare time, advancing as rapidly as your time and ability permit.

Send For Sample Lesson And Free Book, "Opportunities In Accounting"

Send the coupon today—our FREE booklet "Opportunities in Accounting" will be sent promptly along with a sample lesson. It explains fully how we train you from the ground up—or from where you are now—according to your individual needs.

Get all the facts. The cost is low—terms easy. Don't pass this page without tearing out the coupon and mailing it promptly. It can be the means of your success—more money—a better job. Get our FREE booklets and judge for yourself.

LEU

SEND FOR FREE BOOK



LaSalle Extension University

—A Correspondence Institution—

Dept. 164H, 417 S. Dearborn St., Chicago 5, Ill.

Please send me, free of all cost or obligation, a sample lesson in Accounting... also, your latest illustrated book, "Opportunities in Accounting."

Name..... Age.....

Address.....

City, Zone, State.....

THE MAILMAN

REMEMBER THE MORNING I FOUND ANDY SHOLL TRYING TO TAKE ON THE WHOLE NEIGHBORHOOD...



IT WASN'T LONG BEFORE I BEGAN TO NOTICE CHANGES IN THE SHOLL'S HOME. LITTLE THINGS. NEW CURTAINS. FLOWER BOXES. FRESH PAINT. AND THEN, ONE MORNING...

LOOK, MR. McCURDY. HOW DO YOU LIKE OUR NEW CAR? WOW! THAT'S A BEAUTY!



GOSH, ANDY, WILL YOUR POP TAKE US FOR A RIDE IN IT?

A FEW WEEKS LATER, MRS. SHOLL MET ME AS I CAME UP THE STEPS...

HAS ANDY TOLD YOU THE NEWS? WE'RE MOVING. MR. SHOLL IS BEING TRANSFERRED. HE'S TO BE A SECTION LEADER IN THE NEW MILDALE PLANT. HERE'S OUR NEW ADDRESS



WELL, I'M REAL HAPPY FOR YOU. BUT I'M GOING TO MISS ANDY—AND THAT I.C.S. MAIL



IT WAS YOU AND I.C.S. THAT MADE IT ALL POSSIBLE. WE THANK YOU BOTH!

I'VE SEEN IT HAPPEN OFTEN. I.C.S. NOT ONLY CAN CHANGE PEOPLE'S ADDRESSES, IT CAN CHANGE THEIR WHOLE WAY OF LIVING.



IF YOUR LETTER CARRIER IS LIKE ME, HE'LL BE GLAD TO TAKE A LETTER THAT HAS THE I.C.S. COUPON INSIDE. IT REALLY STARTS THINGS!

FREE!

I.C.S. CAREER KIT

Send coupon now... get all three books

- 1 "HOW TO SUCCEED" 32-PAGE GOLD MINE
- 2 CAREER CATALOG... OPPORTUNITIES IN YOUR FIELD.
- 3 SAMPLE LESSON (MATH) SHOWS I. C. S. METHOD.



For Real Job Security—Get an I. C. S. Diploma! I. C. S., Scranton 15, Penna. Accredited Member, National Home Study Council

INTERNATIONAL CORRESPONDENCE SCHOOLS



BOX 01626A, SCRANTON 15, PENNA.

(Partial list of 259 courses)

Without cost or obligation, send me "HOW TO SUCCEED" and the opportunity booklet about the field BEFORE which I have marked X (plus sample lesson):

- | | | | | |
|--|--|--|--|---|
| <p>ARCHITECTURE and BUILDING CONSTRUCTION</p> <ul style="list-style-type: none"> <input type="checkbox"/> Air Conditioning <input type="checkbox"/> Architecture <input type="checkbox"/> Arch. Drawing and Designing <input type="checkbox"/> Building Contractor <input type="checkbox"/> Building Estimator <input type="checkbox"/> Carpentry and Millwork <input type="checkbox"/> Carpenter Foreman <input type="checkbox"/> Heating <input type="checkbox"/> Interior Decoration <input type="checkbox"/> Painting Contractor <input type="checkbox"/> Plumbing <input type="checkbox"/> Reading Arch. Blueprints <p>ART</p> <ul style="list-style-type: none"> <input type="checkbox"/> Commercial Art <input type="checkbox"/> Magazine & Book Illus. <input type="checkbox"/> Show Card and Sign Lettering <input type="checkbox"/> Sketching and Painting <p>AUTOMOTIVE</p> <ul style="list-style-type: none"> <input type="checkbox"/> Automobiles <input type="checkbox"/> Auto Body Rebuilding and Refinishing <input type="checkbox"/> Auto Engine Tuneup <input type="checkbox"/> Auto Technician | <p>AVIATION</p> <ul style="list-style-type: none"> <input type="checkbox"/> Aero-Engineering Technology <input type="checkbox"/> Aircraft & Engine Mechanic <p>BUSINESS</p> <ul style="list-style-type: none"> <input type="checkbox"/> Accounting <input type="checkbox"/> Advertising <input type="checkbox"/> Business Administration <input type="checkbox"/> Business Management <input type="checkbox"/> Cost Accounting <input type="checkbox"/> Creative Salesmanship <input type="checkbox"/> Managing a Small Business <input type="checkbox"/> Professional Secretary <input type="checkbox"/> Public Accounting <input type="checkbox"/> Purchasing Agent <input type="checkbox"/> Salesmanship <input type="checkbox"/> Salesmanship and Management <input type="checkbox"/> Traffic Management <p>CHEMICAL</p> <ul style="list-style-type: none"> <input type="checkbox"/> Analytical Chemistry <input type="checkbox"/> Chemical Engineering <input type="checkbox"/> Chem. Lab. Technician <input type="checkbox"/> Elements of Nuclear Energy <input type="checkbox"/> General Chemistry <input type="checkbox"/> Natural Gas Prod. and Trans. <input type="checkbox"/> Petroleum Prod. and Engr. <input type="checkbox"/> Professional Engineer (Chem) <input type="checkbox"/> Pulp and Paper Making | <p>CIVIL ENGINEERING</p> <ul style="list-style-type: none"> <input type="checkbox"/> Civil Engineering <input type="checkbox"/> Construction Engineering <input type="checkbox"/> Highway Engineering <input type="checkbox"/> Professional Engineer (Civil) <input type="checkbox"/> Reading Struc. Blueprints <input type="checkbox"/> Structural Engineering <input type="checkbox"/> Surveying and Mapping <p>DRAFTING</p> <ul style="list-style-type: none"> <input type="checkbox"/> Aircraft Drafting <input type="checkbox"/> Architectural Drafting <input type="checkbox"/> Drafting Machine Design <input type="checkbox"/> Electrical Drafting <input type="checkbox"/> Mechanical Drafting <input type="checkbox"/> Sheet Metal Drafting <input type="checkbox"/> Structural Drafting <p>ELECTRICAL</p> <ul style="list-style-type: none"> <input type="checkbox"/> Electrical Engineering <input type="checkbox"/> Elec. Engr. Technician <input type="checkbox"/> Elec. Light and Power <input type="checkbox"/> Practical Electrician <input type="checkbox"/> Practical Lineman <input type="checkbox"/> Professional Engineer (Elec) <p>HIGH SCHOOL</p> <ul style="list-style-type: none"> <input type="checkbox"/> High School Diploma | <ul style="list-style-type: none"> <input type="checkbox"/> Good English <input type="checkbox"/> High School Mathematics <input type="checkbox"/> Short Story Writing <p>LEADERSHIP</p> <ul style="list-style-type: none"> <input type="checkbox"/> Industrial Foremanship <input type="checkbox"/> Industrial Supervision <input type="checkbox"/> Personnel-Labor Relations <input type="checkbox"/> Supervision <p>MECHANICAL and SHOP</p> <ul style="list-style-type: none"> <input type="checkbox"/> Diesel Engines <input type="checkbox"/> Gas-Elec. Welding <input type="checkbox"/> Industrial Engineering <input type="checkbox"/> Industrial Instrumentation <input type="checkbox"/> Industrial Metallurgy <input type="checkbox"/> Industrial Safety <input type="checkbox"/> Machine Design <input type="checkbox"/> Machine Shop Practice <input type="checkbox"/> Mechanical Engineering <input type="checkbox"/> Professional Engineer (Mech) <input type="checkbox"/> Quality Control <input type="checkbox"/> Reading Shop Blueprints <input type="checkbox"/> Refrigeration and Air Conditioning <input type="checkbox"/> Tool Design <input type="checkbox"/> Tool Making <p>RADIO, TELEVISION</p> <ul style="list-style-type: none"> <input type="checkbox"/> General Electronics Tech. | <ul style="list-style-type: none"> <input type="checkbox"/> Industrial Electronics <input type="checkbox"/> Practical Radio-TV Eng'g <input type="checkbox"/> Practical Telephony <input type="checkbox"/> Radio-TV Servicing <p>RAILROAD</p> <ul style="list-style-type: none"> <input type="checkbox"/> Car Inspector and Air Brake <input type="checkbox"/> Diesel Electrician <input type="checkbox"/> Diesel Engr. and Fireman <input type="checkbox"/> Diesel Locomotive <p>STEAM and DIESEL POWER</p> <ul style="list-style-type: none"> <input type="checkbox"/> Combustion Engineering <input type="checkbox"/> Power Plant Engineer <input type="checkbox"/> Stationary Diesel Engr. <input type="checkbox"/> Stationary Fireman <p>TEXTILE</p> <ul style="list-style-type: none"> <input type="checkbox"/> Carding and Spinning <input type="checkbox"/> Cotton Manufacture <input type="checkbox"/> Cotton Warping and Weaving <input type="checkbox"/> Loom Fixing Technician <input type="checkbox"/> Textile Designing <input type="checkbox"/> Textile Finishing & Dyeing <input type="checkbox"/> Throwing <input type="checkbox"/> Warping and Weaving <input type="checkbox"/> Worsted Manufacturing |
|--|--|--|--|---|

Name _____ Age _____ Home Address _____
 City _____ Zone _____ State _____ Working Hours _____ A.M. to P.M. _____
 Occupation _____

Canadian residents send coupon to International Correspondence Schools, Canadian, Ltd., Montreal, Canada. . . . Special tuition rates to members of the U. S. Armed Forces.



Train AT HOME for a GOOD JOB in

AUTO MECHANICS

A better job with more pay will mean *better living* for you. It can mean a fine home, a new car, nice vacations, and good educations for the kids. If you would like to earn up to \$125 a week and more—and be able to afford better living, *train yourself* in Auto Mechanics. You can do it with CTI showing you how—and you can learn at home in spare time!

GOOD JOBS ARE WAITING EVERYWHERE because there are over 60 million cars and trucks on the road—7 million new ones each year. One-third are in the heavy-repair classification. Skilled mechanics are needed to keep these cars operating. You can be one of them—make big money, enjoy lifetime security—even open a shop!

EARN AS YOU LEARN just as many CTI students do. They make up to \$15 a week and more in spare time. Some start their own shops by graduation time. CTI Shop-Method Home training, based on resident school practice, makes every step easy.

DIESEL MECHANICS OR BODY-FENDER TRAINING is also yours at no extra cost. A wonderful chance to give yourself a well-rounded education. Only CTI gives you this extra choice! Get the facts: Mail coupon.



YOU PRACTICE WITH THIS TUNE-UP KIT

Kit includes a Compression Tester, a Vacuum Gauge and Fuel Pump Tester, an Ignition Timing Light, and a portable steel case. These professional instruments help you locate engine troubles, let you get useful practice. You keep this kit!

MECHANIC'S TOOLS TOO

You'll use these tools to get real experience. They'll increase your interest, stamp you as a "pro." You'll earn spare time cash with them. No extra cost for tools—you keep them.

MAIL COUPON TODAY!

MAIL TODAY FOR 2 FREE BOOKS

COMMERCIAL TRADES INSTITUTE
1400 Greenleaf Ave., Chicago 26
Dept. A-990

Send your new Auto Mechanics book and Sample Lesson, BOTH FREE.

Name _____ Age _____

Address _____

City _____ Zone _____ State _____



(Continued from page 6)

cobblestone roads or we never would have bought our '58 Opel Caravan. We had a problem: the four active youngsters just couldn't be accommodated in our great big Buick (ironically: no room) and fighting the many narrow travel routes in a "big" car was becoming a hazard . . . hence the Opel and how neatly she solved our dilemma! Now that we are in our Opel I'm almost positive we'll never put out \$4000, or its equivalent, for an automobile again. Unlike your Alabama accountant, we think the Opel (other models included) is one of the sharpest shapes on the road and those great, hulking American cars are beginning to look a little ridiculous, like somebody wearing diamond-studded underwear. But beyond the looks that are a matter of taste anyhow, the car is a masterpiece. We get a smoother ride on these terrible roads and not a rattle yet. With the chrome luggage rack on top we have more than enough room and, with another couple plus camping equipment and luggage, went to the world's fair, getting 33 miles to the gallon. They ordered an Opel as soon as we arrived home. The engine doesn't ping and is everything the size and weight of the car needs and it handles best at a *safe speed!* The interior is lovely, durable and wipe-off-able. In fairness, I will state some of the drawbacks, if you think of them as such: If you are overweight and under-spry you may have a little difficulty getting into the back seat as she is a two-door, so the kids can't exit at 50 m.p.h. You have to shift the gears, but she handles as though she were in the palm of your hand. When we want another car we'll get one, but the Opel stays.

P.S. I hope our Cadillac drivin' "uncles" read this! We live in Wiesbaden, Germany.

Mrs. Wm. N. Walker,
c/o 1/Lt. W. N. Walker,
A Btry., 443rd. AAA Bn.,
APO 633, New York City

☆

I read with interest your "Owners Report on the Rambler American." Under the complaints a Missouri owner said "Windows in rear should roll down." Recently I wrote to Mr. Romney, president of American Motors, that the American "Deluxe" [lower-priced series] didn't have roll-down rear windows.

In a short time I received a kind letter from Mr. Romney in which he stated that only a few Rambler Americans were made that didn't have roll-down rear windows. Crank-type windows were installed shortly after production started.

(Continued to page 14)

Make More Money Soon Fixing Electric Appliances



**Actual Lesson
FREE**

Fast Growing
Field Offers
Good Pay, Security
Interesting Work

Learn at Home in Spare Time

Earn more money. Enjoy doing important, interesting work. Learn Electrical Appliance Servicing. This is a field of increasing opportunity. Today every wired home has many electrical appliances and millions and millions of new appliances are made and sold each year. Find out more about this great, growing field. Find out how NRI can train you, at home and in spare time to be an Appliance Service Technician. See how you can start soon to make extra money servicing appliances.

Add to Your Income Soon After Enrollment Opportunities Increasing for Service Technicians

NRI Training is practical, thorough. You get easy-to-understand lessons, and NRI supplies parts to build professional type Multi-Use Tester. Use it to get practical experience. Soon, you can add to your income by servicing appliances. Build a profitable *sideline* for your spare time—qualify for a good job—develop a business and be your own boss. As an Appliance Service Technician, your opportunities are broad—your services wanted, gladly paid for, highly regarded in your community.

Appliances are necessary to comfortable, convenient living. Owners pay well to keep them in repair. The field is amazingly big. In addition to major appliances such as electric ranges, air conditioners, refrigerators, there are over 40,000,000 electric irons, 5,000,000 electric blankets, 15,000,000 coffee makers, plus more millions of vacuum cleaners, fans, toasters, mixers, etc.



Learn and Earn With Tester Diploma When You Finish

Locate appliance troubles easily with Portable Appliance Tester you build. You use it to learn and do actual electric appliance repair jobs. For only \$3.66 with enrollment and \$6 per month, get training including Tester—a small price to pay for increased earnings. Mail coupon for Sample Lesson and Book—your first step toward more interesting work, bigger earnings. **NATIONAL RADIO INSTITUTE, Dept. AA9, Washington 16, D. C.**



Over 40 Years
Experience
Backs Up
NRI Training



Find Out What
Appliance Repair
Offers You

Mail Coupon FOR LESSON AND BOOK FREE

**National Radio Institute
Dept. AA9, Washington 16, D. C.**

Please send me Electric Appliance Servicing Lesson and Book FREE. (I understand no salesman will call.)

Name _____ Age _____

Address _____

City _____ Zone _____ State _____

ACCREDITED MEMBER NATIONAL HOME STUDY COUNCIL

This Tiny German Adding Machine Adds & Subtracts to ONE BILLION!

1,000 Times Higher than Other Pocket Machines

OVER 4,000,000 POCKET ADDERS USED IN FACTORIES, OFFICES, HOMES, ARMY, NAVY & AIR FORCE PERSONNEL!

- Checks Personal & Business Expenses
- Keeps Golf, Bridge & Canasta Scores
- Helps Homeowners, Professionals, Businessmen, Students, Housewives
- Checks Children's Schoolwork
- Adds Sales Slips & Grocery Tapes

- Fitted Vinyl Wallet Case ➔
- Lightning Clearing Lever ➔
- Fast, Smooth Operation ➔
- Enduring Steel Mechanism ➔

IT'S HERE at last from Germany — the new 1959 high-speed **WIZARD** Calculator. Barely larger than a pack of cigarettes. Yet it's precision made with enduring Korium Steel working parts. This new, high-speed model now subtracts and adds up to **ONE BILLION**—never makes a mistake! And now—for the first time ever—it has a fitted **MAGIC RECKONER** for multiplying and dividing **INSTANTLY**—without paper or pencil. Yet this complete, high-speed calculating system can now be yours for **HALF PRICE**—only **1.98**—direct from importer to you!

Just Feed it Your Number Problems and the answer pops up — automatically

This new 1959 high-speed calculator is so easy, so simple to use. All you do is "feed" it your list of figures, small or big, and instantly the correct answer pops up in the 9 tiny windows — **AUTOMATICALLY!** For multiplication or division use the **MULTI-RECKONER** and get lightning fast answers. For instance, you divide 39 into 1872 — you get the answer in less than 2 seconds! Or multiply 43 by 47 and get your answer (2,021) in just about **ONE** second. No other pocket adding machine gives you this wonderful plus feature! Other machines costing \$3.98 just add up to one million. The **WIZARD** costs only 1.98 and adds up to 1000 times more — up to **ONE BILLION**.

SAVES Time, Work, Money For Entire Family

This new 1959 high-speed **WIZARD** saves the entire family time,

work, money. Avoids frazzled nerves. Prevents costly human mistakes — because this mathematical marvel can't make a mistake! Adds mountains of numbers in **MINUTES**—instead of hours. Now it's so fast, so easy to check all purchases, statements, even restaurant bills. Keeps a running tab of market purchases as you take food off shelves. Records car mileage. Helps you maintain a budget, figure out your income tax, check children's homework, keep bridge and canasta scores, figure discounts, insurance and stock dividends, salesmen's expenses. The 1959 **WIZARD** gives you freedom from figuring slavery. Lets you perform scores of everyday adding, subtracting, multiplication and division jobs, easily without any mental fatigue—without silly mistakes . . . in just seconds!

Developed in Germany! Used Thruout the World For Home & Business Use!

The **WIZARD** is a mechanical marvel developed by German Mathematicians. Human beings can make mistakes, but this machine **NEVER DOES!** Precision made with genuine Korium Steel mechanism—no gears, no wheels to wear out . . . virtually lasts a lifetime! That's why over 4,000,000 men, women, even children use this very same type calculator today in business . . . in the home . . . even in government work thruout the world! Four million people can't be wrong! Mail coupon below for 10 days **FREE** trial. You must be 100% satisfied or **YOUR MONEY BACK!**



NEW LOW PRICE
1.98
Sold Only by Mail,
Only by Thoresen's
MAIL COUPON!

This Type Adding Machine Used by Personnel of Leading Railroads, Oil Companies, Schools, Colleges, Government Bureaus in 48 Countries

Over 4 million men, women and school children use pocket adding machines in 48 countries. 4,000,000 people can't be wrong! Needed in every home, store, office, factory, engineering firm, school and college. Save time! Save mental fatigue! Save yourself from costly figuring mistakes! Get the new 1959 **WIZARD** with the Magic Reckoner today!

Now . . . Multiply and Divide Faster with The Magic Reckoner

The **NEW 1959 WIZARD** is the world's only adding machine with the Magic Reckoner. This plus feature lets you multiply and divide too with amazing speed. You pay not 3.98 or 4.98 but only 1.98 for this deluxe **WIZARD** with fitted **VINYL** case. Wonderful value, indeed! That's why more **WIZARDS** are sold than any other pocket adder made.

SAVE MONEY — AVOID ERRORS AT CHECK-OUT COUNTER!

Now add your purchases as you take them off the shelves. You know how much you're spending as you go along. Check-out counters are crowded. And you know how fast the clerks tally your purchases. Everybody's human — everybody makes mistakes. Know your bill **BEFORE** the clerk has punched a single figure on the register!



THORESEN, Inc.,
Dept. 6-A-1182
585 Water Street
New York 2, N. Y.

Mail This Coupon For FREE Trial!

THORESEN, Inc., Dept. 6-A-1182
585 WATER STREET, NEW YORK 2, N. Y.

RUSH new 1959, Wizard Calculators, 1.98 each, with carrying wallet and Magic Reckoner on 10 day home trial—satisfaction guaranteed or money back.

Check, cash or M.O. enclosed. Rush postage-paid.

Send C.O.D. plus 49¢ C.O.D. fee and postage.

PRINT NAME & ADDRESS

Canadians: Address 439 King Street West, Toronto 2B, Ont.

INVENTORS

Learn how to protect your invention. The U. S. Patent Laws provide that any new and useful art, machine, article of manufacture, or composition of matter, or any new and useful improvement thereof, may be patented if the act of invention is involved. Therefore, every inventor with a valuable invention should take advantage of the Patent Laws and proceed for patent protection in order to safeguard his rights.

A patent gives the inventor the exclusive right to prevent others from making, using, or selling the invention claimed in the patent for a period of seventeen years.

The Patent Laws were enacted for the benefit of the inventor to give him protection for the features of his invention which are patentable. These features must be properly and concisely set forth and claimed in a formal application for patent, in order to comply with the requirements of the Patent Laws. For that reason, unless the inventor is familiar with patent matters, he should engage a competent registered patent attorney or agent to represent him. We are registered to practice before the U. S. Patent Office and are prepared to serve you in the handling of your patent matters.

A specially prepared booklet entitled "Patent Guide for the Inventor", containing detailed information with respect to patent protection and procedure, together with a "Record of Invention" form will be promptly forwarded to you without obligation upon request.

CLARENCE A. O'BRIEN & HARVEY JACOBSON

Registered Patent Attorneys

91-A DISTRICT NATIONAL BUILDING

WASHINGTON 5, D. C.



BE A CLERK all my life? NOT ME!!

Of course you say you won't.

But you may be unless you do something about it.

Hoping and wishing won't get you a better job and more money.

You must prepare for that step ahead—be ready to make promotion come.

DON'T LIMIT YOURSELF TAKE OFF THE BRAKES

For over 50 years more than 1,400,000 ambitious men and women have turned to LaSalle training for greater job security, more money, and larger success in life.

At least you should investigate. It may be the turning point in your life to a better job and more money. So send the coupon without delay. Check the field of your choice and we'll send you without obligation the requirements and opportunities in that field.

Accredited Member, National Home Study Council

MAIL THIS COUPON TODAY

LASALLE Extension University

A Correspondence Institution

417 S. Dearborn St., Dept. 164R, Chicago 5, Ill.

Please send free book and full information about your home-study training and the opportunities in the field I have checked.

- | | |
|---|--|
| <input type="checkbox"/> Accounting | <input type="checkbox"/> Foremanship |
| <input type="checkbox"/> Law: LL.B. Degree | <input type="checkbox"/> Stenographic-Secretarial |
| <input type="checkbox"/> Business Management | <input type="checkbox"/> Stenotype-Machine Shorthand |
| <input type="checkbox"/> Traffic & Transportation | <input type="checkbox"/> Sales Training |
| <input type="checkbox"/> Industrial Management | |

Name.....Age.....

Address.....

City.....Zone.....State.....

(Continued from page 10)

Also, those who said gas mileage wasn't sufficient will want the free booklet put out by American Motors which tells how to get better gas mileage in all cars.

Bruce Lowry,
Dayton, Ohio.

☆

Long after most car owners have forgotten the good features of their cars, they have *total recall* of the poor workmanship and sloppy assembly, the aggravation of repeated expense and loss of valuable time in having numerous factory-built defects repaired. . . . The main reason . . . they do not complain to top management long enough and strong enough to get results.

R. Blagden,
East Hampton, Conn.

☆

I am very glad to see that you are going to make your annual report on the '59 automobiles. I hope this will be as good as your past reports.

Tom Cygan,
East St. Louis, Ill.

☆

Any improvement we've made in engines has been to make them faster, rather than capable of doing their job; it takes an expert to find out what's wrong with these high-compression engines and nothing is made simple and compact. . . . The simpler it is, the better the product and the more people will buy it. . . . About 75 horsepower is sufficient. . . . People want smaller cars and less horsepower, and they want designing, yes, but not necessarily these little sports models that won't even hold an extra pair of shoes. There's no room in the parking lots and no room on the roads for so many of us.

M. S. Benjamin,
Richmond, Va.

☆

I enjoyed your story on camping [May] because we were planning our first camping trip, in Europe. Europe is a camper's paradise. Each country has many camping sites, usually near scenic rivers and lakes. All one has to do to find a place to camp is watch for signs along the highway, then look for the tents. We traveled over 2500 miles in eight countries and the three-week trip cost under \$300. [The campers: Sergeant Carrie, Mrs. Carrie and four sons aged 19, 9, 6 and 3.]

Owning and operating camping sites in America could be a profitable business. All

(Continued on page 16)



Now! Work Over 300 PRACTICAL PROJECTS with these PARTS AT HOME!



to help You learn

ELECTRONICS

RADIO-TELEVISION-RADAR

NOW . . . at home in your spare time you can get the very kind of training and subsequent Employment Service you need to get started toward real earnings in one of today's brightest opportunity fields—TELEVISION-RADIO-ELECTRONICS. Now that Electronics is entering so many new fields, here is a chance of a lifetime to prepare to cash in on its remarkable growth.

DeVry Tech's amazingly practical home method enables you to set up your own HOME LABORATORY. You spend minimum time to get maximum knowledge from over 302 practical projects, using the same type of basic equipment used in our modern Chicago and Toronto Training Centers!

DeVry Tech Provides EVERYTHING YOU NEED . . .

—to help you master TV-ELECTRONICS. In addition to the home laboratory and easy-to-read lessons, you even use HOME MOVIES—an exclusive DeVry Tech advantage. You watch hidden actions . . . see electrons on the march. Movies help you to learn faster . . . easier . . . better.

LABORATORY TRAINING

Full time day and evening training programs in our modern Chicago and Toronto Laboratories are also available. MAIL COUPON TODAY for facts.

EARN WHILE YOU LEARN

DeVry Tech's practical training helps you toward spare time income servicing Radio and Television sets.

BUILD and KEEP Valuable TEST EQUIPMENT

As part of your training, you build and keep a fine Jewel-Bearing Vacuum Tube VOLTMETER and a 5-inch COLOR OSCILLOSCOPE—both high quality, needed test instruments.

EFFECTIVE EMPLOYMENT SERVICE

Get the same Employment Service that has helped so many DeVry Tech graduates get started in this fast-growing field.

"One of North America's Foremost Electronics Training Centers"

Accredited Member
of National Home
Study Council



DeVRY TECH INSTITUTE

Formerly DeForest's Training, Inc.
CHICAGO 41, ILLINOIS



VACUUM
TUBE
VOLTMETER

5 INCH
COLOR
"SCOPE"

5-INCH
COLOR
OSCILLOSCOPE



21 INCH

Build and keep this BIG DeVry Engineered TV set—easily converted to U.H.F. (DeVry offers another home training, but without the TV set.)

✉ CHECK
These Exciting
Job
Opportunities:

- TV-Radio Broadcast Technician
- Color Television Specialist
- Radar Operator
- Laboratory Technician
- Airline Radio Man
- Computer Specialist
- Quality Control Manager
- Your Own Sales & Service Shop
- . . . PLUS MANY OTHERS

MAIL COUPON TODAY!

DeVRY TECHNICAL INSTITUTE
4141 Belmont Ave., Chicago 41, Ill., Dept. PM-1-P

Please give me your FREE booklet, "Electronics and YOU," and tell me how I may prepare to enter one or more branches of Electronics.

Name _____ Age _____
PLEASE PRINT
Street _____ Apt. _____
City _____ Zone _____ State _____
2045 Canadian residents address DeVry Tech of Canada, Ltd.
626 Roselawn Ave., Toronto 12, Ontario

Check the Kind of Body YOU Want!

RIGHT IN THE COUPON BELOW

... and I'll Show How EASILY You Can Have It!

Charles Atlas

Twice winner and holder of the title "The World's Most Perfectly Developed Man."



JUST tell me where you want it—and I'll add SOLID INCHES of powerful muscle SO FAST your friends will grow bug-eyed with wonder. I'LL SHOW HOW you can be a new man in just 15 minutes a day—in your own home—or it won't cost you a penny!

I myself used to be a 97-lb. weakling. Men called me "Skinny." Girls made fun of me. THEN I discovered my great new muscle-building system—"Dynamic Tension." It turned me into such a specimen of MANHOOD that today I hold the title "THE WORLD'S MOST PERFECTLY DEVELOPED MAN."

"Dynamic Tension" is the easy, NATURAL method you can practice in your own room—JUST 15 MINUTES A DAY—while your chest and shoulder muscles begin to swell . . . those arms and legs of yours bulge . . . and your whole body starts to feel "alive," full of zip and go!

FREE My 32-Page Illustrated Book Just Mail the Coupon

Send NOW for my famous book showing how "Dynamic Tension" can make you a new man. 32 pages, packed with photographs, valuable advice, answers many vital questions. This book is a real prize for any fellow. Yet I'll send you a copy absolutely FREE. Just glancing through it may change your life. Rush coupon to me personally: CHARLES ATLAS, Dept. 8-A, 115 East 23rd St., New York 10, N. Y.



CHARLES ATLAS, Dept. 8-A,
115 East 23rd St., New York 10, N. Y.

Dear Charles Atlas: Here's the Kind of Body I want:

(Check as many as you like)

- | | |
|--|--|
| <input type="checkbox"/> More Weight—Solid—in The Right Places | <input type="checkbox"/> Powerful Arms and Grip |
| <input type="checkbox"/> Broader Chest and Shoulders | <input type="checkbox"/> Slimmer Waist and Hips |
| | <input type="checkbox"/> Powerful Leg Muscles |
| | <input type="checkbox"/> Better Sleep, More Energy |

Send me absolutely FREE a copy of your famous book showing how "Dynamic Tension" can make me a new man. 32 pages, crammed with photographs, answers to vital health questions, and valuable advice. I understand this book is mine to keep and sending for it does not obligate me in any way.

NAME _____
(please print or write plainly)

ADDRESS _____

CITY _____ ZONE _____ STATE _____

(Continued from page 14)

that is required is a piece of ground, grassy field, shade trees, drinking water, sanitation facilities and trash containers. Most of the camping sites here also have a small grocery store—another way to make money.

M/Sgt. Clyde E. Carrie,
36th Fld. Maint. Sq.,
APO 132, New York City

☆☆☆

PM House Sprouts in Michigan

The summer home-basic house that PM's New York editor, Richard F. Dempewolf, built in Pennsylvania's Pocono Mountains is the home Frank A. Dawson has built for himself at Republic, Mich. Mr. Dempewolf's cabin was the basis of articles beginning in the March issue of 1955 and later



appeared in the book, *Popular Mechanics Pre-Cut House*, which gave home builders complete instructions for building it.

Mr. Dawson, who started building his home (pictured above) in 1957, writes: "I changed the windows and doors to suit myself, but otherwise used your plans exclusively and it has been a very easy home to build. So far [with inside walls unfinished at time of writing] I have 1,004 hours on it, all in my spare time, with no hired help." He installed a gas furnace and water pump in a crawl space.

☆☆☆

To the Editor:

I read your article "Festival of the Iron Men" and have just one criticism. The threshing steam engine came in about 1860, drawn by horses. And as early as 1867 the Russell Threshing Machine Company had a steam engine with a man steering it. However, in the state of Ohio, even if you had a self-steering steamer the law required you to put a team of horses ahead of the engine when traveling a public road, for "safety" reasons.

Our association had the first revival of the "threshing bee" on Oct. 12, 1941. Our biggest crowd was in 1953, when about 14,000 people attended.

(Continued to page 20)

INVENTORS

If you believe that you have an invention, you should find out how to protect it. The first step is to have a search made of the prior pertinent U. S. patents. If a report on this search indicates that the invention appears patentable you can apply for a patent, and the specifications and claims should be prepared.

The firm of McMorrow, Berman & Davidson, with offices in Washington, D. C., is qualified to take the necessary steps for you. We can make a preliminary search on your invention, advise you whether we think it can be patented, and prepare your application for patent.

Unless you are fully familiar with the U. S. Patent Laws, we recommend that you engage the services of a Registered Patent Attorney to protect your interests. The patent laws are *your* laws. A patent gives you the right to prevent others from making, using or selling the invention claimed in your patent for a period of 17 years.

Use these patent laws for your protection. Investigate whether your invention can be patented. If you have what you believe to be an invention, we suggest that you have this firm make a search for you.

Send for a copy of our Patent Booklet entitled "How To Protect Your Invention," containing information about patent protection and patent procedure. Along with this we will also send you an "Invention Record" form, for your use in writing down and sketching details of your invention. We will mail them promptly. No obligation. They are yours for the asking.

McMORROW, BERMAN & DAVIDSON

Registered Patent Attorneys

PATENTS • COPYRIGHTS • PATENTS

1355 VICTOR BUILDING, WASHINGTON 1, D. C.

Even Men with No Experience
are Making as High as

\$1,000⁰⁰ IN A MONTH!



Folks are Amazed when you Tell Them This New Kind of Protection Costs Only **\$4.95**

ONLY PRESTO HAS ALL THESE FEATURES

- Ends fire as fast as 2 seconds.
- Needs no inspection or recharging.
- Outperforms bulky extinguishers costing much more.
- Guaranteed for 20 years.

Why Large Profits Are Easy

Everyone is terrified by FIRE! Millions have been waiting for this pure, simple, inexpensive safeguard. Most people who see the dramatic 5-second demonstration want one or more. You make as much as \$2.70 on every one. Get started in this rich new field now!

Complete Sales Outfit FREE!

Mail coupon for big Illustrated Sales Kit with everything you need to make fine money first day — NOW. Every day you hesitate can cost you \$10, \$15, even \$50 you could be making! Everything FREE — no obligation — so MAIL COUPON TODAY!

MERLITE INDUSTRIES INC. 114 E. 32nd St., Dept. P-15T New York, New York

MERLITE INDUSTRIES INC. (Presto Div.)
114 E. 32nd St., Dept. P-15T, New York 16, N. Y.

Rush me complete Sales Outfit with full details how I can make big money very first day with Presto Fire Extinguisher. All FREE, no obligation.

Name _____

Address _____

City _____ Zone _____ State _____

In Canada: Mopa Co., Ltd., 371 Dowd St., Montreal 1, P.Q.

A message to all men who are looking for a way to make more money faster, with one of America's greatest inventions wanted by millions.

Here's Your Opportunity to get into the BIG MONEY CLASS FAST with sensational PRESTO FIRE EXTINGUISHER

Over 3,000,000 Sold for Homes, Offices, Autos, Service Stations, Stores, Farms, Boats

Not everybody makes \$1,000 in a month to start out, but read this: Florida salesman reports \$600 in 1 month. Ohio man earned \$2,100 in 2 months! Men everywhere, even in off hours, are rolling up amazing profits. Here's why. PRESTO's amazing new chemical, developed as secret defense during war, is 1½ to 6 times as effective as ordinary chemicals on equal weight basis. So PRESTO can be light, so handy a child can use. How about you cashing in on this great invention?

BIG MONEY LIKE THIS EVEN IN SPARE TIME

Reports \$80 a Week

Averaging less than a day or two a week. I have made as much as \$75 to \$80 a week. Walter Gable, Md.

Averages \$15.20 an Hour

For every hour I devoted to PRESTO, I earned an average of \$15.20. W. P. Wydaluk, Ohio.



C-10
Beauty by Colorcrete Can Earn High Incomes



Beautifying buildings by Colorcrete is a business opportunity awaiting men of modest capital everywhere. Owners of homes, stores, motels, schools — almost any type of construction — are looking for means to give lifetime eye-appeal to drab or dirty concrete, stucco and similar masonry surfaces. Colorcretors can do such jobs, in little time and at little cost, and pocket generous profits. Colorcrete is a cementitious material, applied by air pressure. Tough, tenacious, enduring; 30 colors. Investigate this low-investment enterprise by writing for the Opportunity Book.

COLORCRETE INDUSTRIES, INC.
570 Ottawa Ave., Holland, Mich.

COLORCRETE

"MINIATURE MACHINE SHOP

No Bigger Than A Typewriter, Outperforms Machines Many Times Its Size!"

That's what a popular publication says about UNIMAT in their 3 page feature story in the May issue. If you want a reprint of this story plus complete information about this amazing 10 in 1 combination precision tool write to:

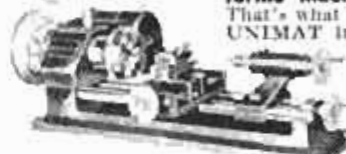

AMERICAN EDELSTAAL, Inc.

UNIMAT DIV., DEPT. 319, 350 BROADWAY, NEW YORK 13



MECHANICAL DENTISTRY

To make Crowns, Plates, Bridgework, etc., for Dentists. Easy practical way to learn mechanical dentistry at home in spare time. FULL EQUIPMENT OF TOOLS AND MATERIALS INCLUDED WITH COURSE. Low tuition. Easy terms. Write for FREE BOOK about this money making profession that is not affected by operating age.

McCARRIE SCHOOL OF MECHANICAL DENTISTRY
207 N. Broad St., Dept. 84, Philadelphia 7, Pa.

HYDRAULIC JACK REPAIRS



Earn While You Learn at Home

Millions of jacks in gas & auto-service stations, truckers, body-shops, riggers, factories, farms need servicing. We show you HOW — easy step by step directions — what tools to use. EARN UP TO \$5 an hour, in spare time, in your own basement or garage. Start your own business NOW.

Write for folder No. PM-1 & free bonus offer

Institute of Hydraulic Jack Repair
P.O. Box 50, Bloomfield, N. J.

FISHERMEN

SEND FOR

FREE

CATALOGUE TODAY!

FULLY ILLUSTRATED
FULLY DESCRIPTIVE
ALL PRICES LISTED

Make Your Own SINKERS! JIGS! SOUIDS! CASTING AND SPINNING LURES!

It's fun, It's easy with Sweet's **ALUMINUM MOLDS**

Molds for fresh and salt water fishermen. Handled and hinged for easy, fast operation. Over 100 types, 500 sizes. Write for free catalogue.

AS LOW AS

\$2.95

PER MOLD



SWEET'S MOLDS
Tonawanda 16, N. Y.

A Practical New Way to End Your Job Worries!

TRAIN AT HOME FOR A SUCCESSFUL FUTURE IN
**AIR CONDITIONING
AND REFRIGERATION**



R. C. ANDERSON
President

If you want an interesting job that pays real well and offers year-round work—get into Air Conditioning and Refrigeration! It's a big, uncrowded field that is well-established—yet growing fast! Each year over 20,000 newly-trained mechanics are needed. No wonder! Today there are 150 million units in use—and each year over 6 million new air conditioners, refrigerators and freezers are manufactured. All units need periodic service and repair. The pay? It ranks with the best!

Refrigeration mechanics is an easy trade to learn... Especially when you get your training through CTI. You can learn at home in spare time by practicing with commercial equipment. Get all the facts about this wonderful new way to acquire a highly-profitable technical education. Mail coupon today for fact-filled free booklets. No obligation whatever.

25
BIG KITS



Easy Way to Start a Business

Own a business—and enjoy independence. Thrill to the satisfaction of being the boss. Give orders—not take them! The refrigeration field is ideal for getting started on your own. You can make friends as you make service calls. In time, you'll have a list of potential customers. You can also sign service contracts with food stores, taverns, restaurants, etc. Thousands of CTI graduates have their own successful small shops.

Get into Auto Air Conditioning

Experts say that over 400,000 air conditioners are to be installed in autos this year. The field is growing very fast. Already auto shops are advertising for skilled air conditioning mechanics. Opportunities are excellent for starting repair shops. Some day, air conditioners will be standard equipment on cars. So get in on the ground floor now. Our catalog has information on this specialized, profitable field. It's worth looking into.



You Get Experience as You Train Because You Practice with Commercial Equipment

Another CTI first! You learn by practicing—you get experience as you train—because CTI sends you 25 kits. You get all parts and tools to build a heavy-duty, commercial-type, 1/4 h.p. condensing unit (illustrated above.) You build an air conditioner, freezer, refrigerator, or milk cooler. You complete 23 field-type projects—do 10 service and trouble-shooting jobs! You "boil down" years of apprentice-like training into months. Kit training perfects your skill, provides practical knowledge, assures useful experience, and helps you learn faster! CTI makes your home a training center.

Earn Extra Cash in Spare Time as You Train

Because CTI training is so practical, you'll soon be making profitable service calls. Perhaps you'll work "on your own." Or, you may prefer to get a part-time job with a local appliance dealer or air conditioning contractor. You can add to your income this way. With extra cash, you can buy additional shop equipment, pay your tuition, even bank money. Be sure to mail coupon for complete details. Act today!—Commercial Trades Institute, Chicago 26, Illinois.

TYPICAL LETTERS FROM SUCCESSFUL STUDENTS

"I have been very busy. Had an offer to work for an appliance dealer but it looks like I'll be in business for myself before long."
—Frank Fuller, Wells, N. Y. ... "Am now working in the field. Earn \$40 more per month than before."
—Frank Krotzer, Houston, Texas ... "I not only got a job, but today am foreman, earning \$60 a week more than before I enrolled."
—E. E. Hughes, Chicago ... "Have my own business. Only problem is: Too much business!"
—Conrad King, Cynthia, Ky. You can do as well as these men!

FIRST GET THE FACTS—THEN DECIDE
Mail Coupon Today for 2 Free Booklets

COMMERCIAL TRADES INSTITUTE

1400 GREENLEAF AVENUE
CHICAGO 26, ILLINOIS

DEPT. R-545

Tell me how I can qualify for a better job or a business of my own. Send booklet, *Success in Air Conditioning & Refrigeration*, and Lesson Sample. Both FREE.

Name _____ Age _____

Address _____

City _____ Zone _____ State _____



course I

Electronic Fundamentals



course II

Television Servicing



course III

Color Television



RCA Institutes offers you the finest of Home Study training. The equipment illustrated and text material you get with each course is yours to keep. Practical work with very first lesson. Courses for the beginner and the advanced student. Pay-as-you-learn. You need pay for only one study group at a time.

Send for **FREE** RCA Institutes Catalog

See coupon on opposite page

RESIDENT SCHOOL offers Technical Institute and Vocational School Courses in Electronics. Day and Evening classes. Resident School Catalog sent free on request.

(Continued from page 16)

I have 43 steam engines and my son has nine. This is the largest collection in the United States, and second only to Saskatoon, Sask., in the world.

Joseph T. Rynda, Jr.,
President, Pioneer Historical
Association of Montgomery, Minn.

☆☆☆

To the Editor:

I got quite a charge out of your article in the September issue, "Festival of the Iron Men." I saw two of those old engines sitting under a tree in Logan County, Okla., when I was back there in 1957 . . . my wife and I both remarked about them at the time. . . . Thought I would drop you a line about them as I was quite overwhelmed by your article.

Dale F. Thomas,
Ukiah, Calif.

☆☆☆

To the Editor:

In your October [1957] ^{P. 110} issue I noticed a picture of a snow sled. I also built one; the state issued me a license for it so I can drive it on the highway. It's equipped with horn, lights, hydraulic brakes; skis can be detached in seconds. Equipped with trailer



hitch, it can be pulled behind the car for long trips. It is powered with a 75 Continental engine, and has been clocked at 85 miles per hour on the highway. It seats three people.

Peter J. Fuchs,
Avon, Minn.

☆☆☆

To the Editor:

Just thought I'd drop a line to tell you that your article on bass fishing [July 1958] was very good. This was the best fishing article I ever read.

Thomas King,
Brooklyn, N. Y.



RCA INSTITUTES proudly announces a new home study course ... ELECTRONICS for AUTOMATION

Nucleonics, Photoelectronics, Digital Techniques, Synchros and Servomechanisms, Data Recorders, Automatic Process Controllers, Telemetry and Remote Control, Ultrasonics, and Automatic Control Systems . . . these are just a few of the many Industrial Electronics subjects covered in the new Electronics for Automation course.

RCA Institutes — now celebrating 50 years of electronic training — adds this new home study course to prepare you for a career as an electronic technician. Pay-as-you-learn. You need pay for only one study group at a time.

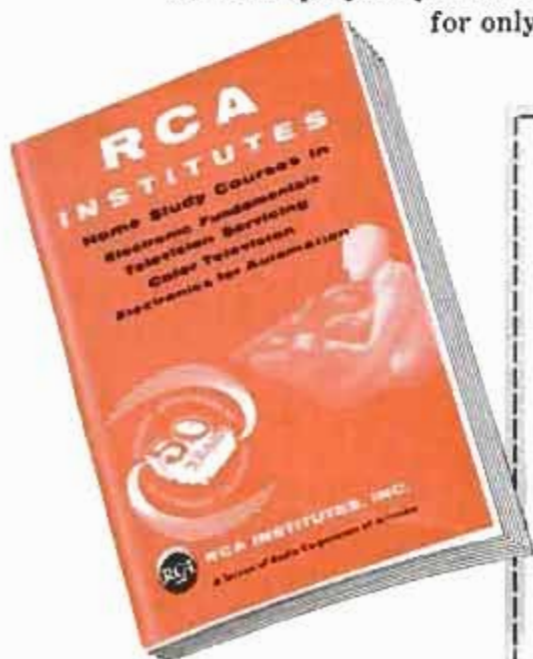

RCA INSTITUTES, INC., Home Study School, PM-19

A Service of Radio Corporation of America • 350 West Fourth Street, New York 14, N. Y.

Without obligation, send me the FREE catalog of Home Study Courses. No salesman will call.

NAME PLEASE PRINT

ADDRESS

CITY ZONE STATE

Korean Vets! Enter discharge date

CANADIANS Take advantage of these same RCA Courses at no additional cost. No postage, no customs, no delay. Send coupon to:

RCA VICTOR COMPANY, LTD. • 5001 Cote de Liesse Rd., Montreal 9, Que.

TO SAVE TIME, PASTE COUPON ON POSTCARD.

WHAT SECRET POWER DID THIS MAN POSSESS?



BENJAMIN FRANKLIN
(A Rosicrucian)

WHY was this man great? How does anyone—man or woman—achieve greatness? Is it not by mastery of the powers within ourselves? Know the mysterious world within you! Attune yourself to the wisdom of the ages! Grasp the inner power of your mind! Learn the secrets of a full and peaceful life!

Benjamin Franklin—like many other learned and great men and women—was a Rosicrucian. The Rosicrucians (NOT a religious organization) first came to America in 1694. Today, headquarters of the Rosicrucians send over seven million pieces of mail annually to all parts of the world. Write for YOUR FREE COPY of "The Mastery of Life"—TODAY. No obligation. No salesmen. A non-profit organization. Address: Scribe B.Q.W.

THIS BOOK FREE!



The ROSICRUCIANS

SAN JOSE • (AMORC) • CALIFORNIA

—SEND THIS COUPON—

Scribe B.Q.W.
The ROSICRUCIANS (AMORC)
San Jose, California
Please send me the free book, *The Mastery of Life*, which explains how I may learn to use my faculties and powers of mind.

Name _____
Address _____
City _____

FREE CATALOG



MAKE YOUR OWN RODS AND LURES

SEND FOR FREE WHOLESALE CATALOG
Beads, Spinners, Tools, Jigs, Lure Parts, Sinkers, Molds, Hooks, Feathers, Rod Blanks, Reels, Swivels, Wire.



Learn the secret tricks of bait manufacturers, design and assemble all kinds of lures and spinners. Our Baitmaker's "bible" will teach you the secrets and tricks of making lures. Hundreds of tips you can't find anywhere else.
Sampler Kit = \$3.59 contains a generous sample of many kinds of special lure making beads and spinners, with catalog included only. \$1.00
Quick Kit = \$4.59 you can get the catalog and Baitmaker's "bible" by return mail, 7 to 15 days quicker only. .50c
Order by mail. No C.O.D.'s accepted.

FINNYSPORTS
2667K Monroe St., Toledo 6, Ohio

NEW 16 FT. "BIG MOTOR" \$229 **FREE New Color Catalog**
RUNABOUT KIT

Fast—Safe—Roomy
Many custom accessories.
Full line of cruisers, runabouts, fishing boats.

TAFT MARINE WOODCRAFT
Dept. PM-159 636 - 39th Ave. N.E., Minneapolis, Minn.



119 JIG SAW PATTERNS

FULL-SIZE . . . trace on wood and saw out. Clever, ORIGINAL designs, things you can make to SELL. Wall shelves, lawn signs, planters, book ends, others. **\$1** postpaid

BURGESS VIBROCRRAFTERS, INC.

Rush \$1 today. DEPT. C-84, Grayslake, Illinois

MONEY in WORMS

Sell 20,000 fishworms per week @ \$4 per 1000 from a bed 3 feet wide and 8 feet long. We teach you how to raise and where to sell fishworms and crickets. Write for free literature.
CARTER WORM RANCH, PLAINS, GEORGIA

MAKE BIG MONEY—ALL PROFIT—AT HOME

INVISIBLE MENDING
Pays up to \$10 in an Hour!
Make moth holes, cigarette burns, tears, rips, disappear from all fabrics. Little-known craft pays extra spare-time profits at home. Write today for exciting details FREE!
FABRICON, 6238 Broadway
DEPT. 321, - CHICAGO 40, ILLINOIS

MEN PAST 40

Afflicted With Bladder Trouble, Pains in Back, Hips, Legs, Nervousness, Tiredness.

If you have these troubles, particularly bladder trouble, then your condition may be traced to Glandular Inflammation . . . a constitutional disease. Neglect of this condition often leads to premature old age and sometimes incurable malignancy.

The Excelsior Medical Clinic has a New Free Book that tells how thousands of men have been successfully treated here at Excelsior Springs for Glandular Inflammation by NON-SURGICAL Methods. They found soothing relief and a new outlook in the future of life.

This Free Book may prove of utmost importance in your life. Write Today. There is no obligation.

Excelsior Medical Clinic, Dept. B6129, Excelsior Spgs., Mo.

NOW!
at a price
you can afford!

MAKE MORE MONEY in TELEVISION RADIO-ELECTRONICS

**BETTER...MORE COMPLETE...LOWER COST...
WITH NATIONAL SCHOOLS SHOP-METHOD
HOME TRAINING!**

BETTER... Training that is proved and tested in Resident School shops and laboratories, by a School that is the **OLDEST** and **LARGEST** of its kind in the world.

MORE COMPLETE... You learn **ALL PHASES** of *Television-Radio-Electronics*.

LOWER COST... Other schools make several courses out of the material in our **ONE MASTER COURSE**... and you pay more for less training than you get in our course at **ONE LOW TUITION!**

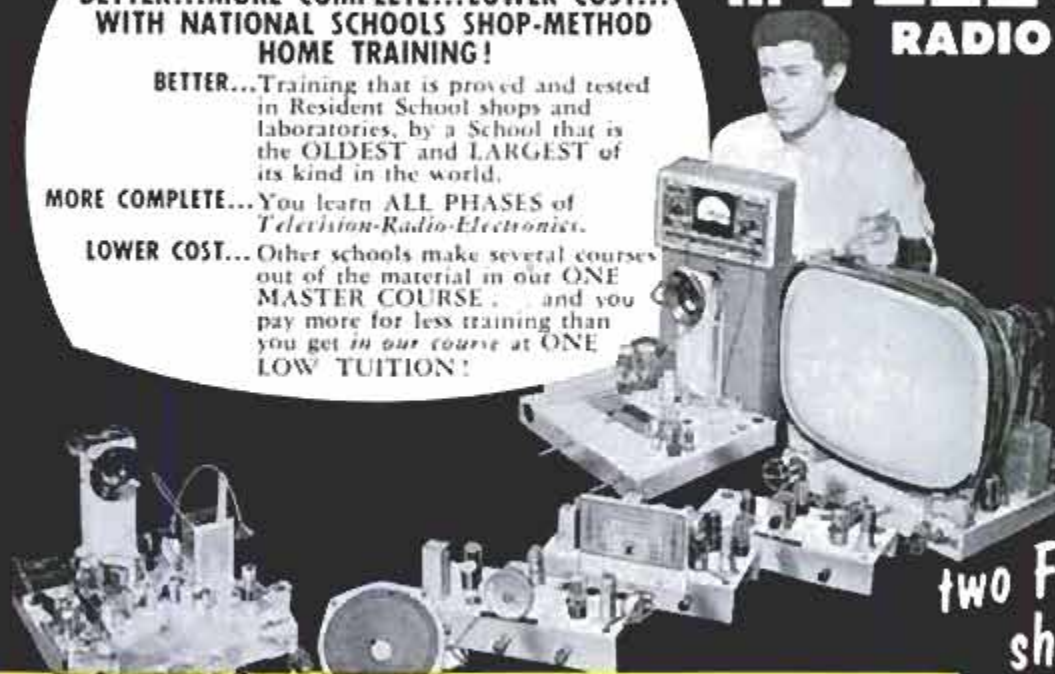

These two **FREE** books will show you how!

You get all information by mail... You make your own decision... at home! **NO SALESMAN WILL CALL**

TOP PAY... UNLIMITED OPPORTUNITIES LIFETIME SECURITY CAN BE YOURS!

You are needed in the Television, Radio, and Electronics industry! Trained technicians are in growing demand at excellent pay—in **ALL PHASES**, including Servicing, Manufacturing, Broadcasting and Communications, Automation, Radar, Government Missile Projects.

NATIONAL SCHOOLS SHOP-METHOD HOME TRAINING, with newly added lessons and equipment, trains you in your spare time at home, for these unlimited opportunities, including many technical jobs leading to supervisory positions.

YOU LEARN BY BUILDING EQUIPMENT WITH KITS AND PARTS WE SEND YOU. Your National Schools course includes thorough *Practical* training—**YOU LEARN BY DOING!** We send you complete standard equipment of professional quality for building various experimental and test units. You advance step by step, perform more than 100 experiments, and you build a complete TV set from the ground up, that is yours to keep! A big, new TV picture tube is included at no extra charge.

EARN AS YOU LEARN. We'll show you how to earn extra money right from the start. Many of our students pay for their course—and more—while studying. So can you!

LESSONS AND INSTRUCTION MATERIAL ARE UP-TO-DATE, PRACTICAL, INTERESTING. Every National Schools Shop-Method lesson is made easy to understand by numerous illustrations and diagrams. All instruction material has been developed and tested in our own Resident School Shops, Laboratories and Studios.

SEND FOR INFORMATION TODAY... it can mean the difference between **SUCCESS** and failure for you! Send for your **FREE BOOK** "Your Future in Television-Radio-Electronics" and **FREE Sample Lesson**. Do it **TODAY**, while you are thinking about your future. It doesn't cost you anything to investigate!

GET THE BENEFITS OF OUR OVER 50 YEARS EXPERIENCE

Approved for
GI Training



NATIONAL SCHOOLS
Los Angeles 37, Calif.

YOU GET...

- 19 Big Kits—**YOURS TO KEEP!**
- Friendly, Instruction and Guidance
- Job Placement Service
- Unlimited Consultation
- Diploma—Recognized by Industry
- **EVERYTHING YOU NEED FOR SUCCESS!**

SHOP-METHOD HOME TRAINING COVERS ALL PHASES OF INDUSTRY

1. Television, including Color TV
2. Radio AM & FM
3. Electronics for Guided Missiles
4. Sound Recording and Hi-Fidelity
5. FCC License
6. Automation and Computers
7. Radar & Micro-Waves
8. Broadcasting and Communications

RESIDENT TRAINING AT LOS ANGELES

If you wish to take your training in our Resident School at Los Angeles, the world's TV capital, start **NOW** in our big, modern Shops, Labs and Radio-TV Studios. Here you work with latest Electronic equipment—professionally installed—finest, most complete facilities offered by any school. Expert, friendly instructors. Personal attention. Graduate Employment Service. Help in finding home near school—and part time job while you learn. Check box in coupon for full information.

NATIONAL TECHNICAL SCHOOLS

WORLD-WIDE TRAINING SINCE 1905

MAIL NOW TO
NATIONAL SCHOOLS, Dept. RB-19
4000 S. FIGUEROA ST., LOS ANGELES 37, CALIF.
Rush free TV-Radio "Opportunity" Book and sample lesson. No salesman will call.

NAME _____ AGE _____
ADDRESS _____
CITY _____ ZONE _____ STATE _____

Check if interested **ONLY** in Resident School training at Los Angeles.
VETERANS: Give date of Discharge _____

YOU CAN PLAY



ANY INSTRUMENT

... even if you don't know a single note of music now!

IMAGINE! Even if you never dreamed you could play... you can soon surprise your friends with your musical ability.

No special talent or previous training needed. Clear, simple directions tell you exactly what to do, so you can't go wrong! Spend a few minutes a day—and only a few cents per lesson. Teach yourself piano, guitar, accordion, organ, any instrument. Play popular music, hymns, classical, any other music—by note, quickly. Over ONE MILLION students have taken up music this famous way, including TV Star Lawrence Welk.

Stop Cheating Yourself of These Joys!

Popularity! New friends. Gay parties. Good times. Career. Extra Money... understand, appreciate, converse about music. Learn lives and compositions of modern and great masters... Relax! Banish worries and frustrations. Satisfy self-expression, creative urge. Gain self-confidence.

MAIL COUPON FOR FREE BOOK

See for yourself why our method has been successful for 61 years! Read the whole fascinating story of this wonderful method in 36-page illustrated book. For FREE copy, mail coupon. U. S. School of Music, Studio A301, Port Washington, N.Y.



Now You Can Learn Music in Your Own Home



U. S. SCHOOL OF MUSIC
Studio A301, Port Washington, N.Y.

Please send me your 36-page illustrated Free Book. I'm interested in playing (name instrument) _____

I do I do NOT—have instrument now.

Name _____ (please print)

Address _____

City _____ Zone _____ State _____

215 STAMPS 25¢
plus 88 FLAGS OF THE WORLD
plus BOY SCOUT SOUVENIR SHEET

Master O.D.
Product No.
738



What a bargain! You get the stamps shown here — plus Germany "Sputnik" Stamp, St. Thomas Explorer, Chile "Christ of the Andes." Grand total 215 stamps — all different! You also receive 88 Flags of the World in full color — plus Boy Scout Souvenir Sheet, an unusual tribute to the 1957 Jamboree. All this for 25¢ to introduce our Bargain Approvals. Midget Encyclopedia of Stamps included FREE.

Send 25¢ Today. ASK FOR LOT FO-30
ZENITH CO., 81 Willoughby St., Brooklyn 1, N. Y.

WORLD'S LOWEST PRICED CALCULATOR! NOT \$3.95
NEW! NEW! NEW! But Only \$1.97

TOM THUMB ADDING MACHINE

With beautiful Leatherette carrying case. MADE IN AMERICA BY AMERICANS. Beware of cheap imported imitations. ADDS UP TO ONE BILLION — 1,000,000,000. SUBTRACTS — MULTIPLIES — DIVIDES. Mistake Proof • Positively 100% Accurate • Lightning Fast • Shock Proof Solid Steel Mechanism • GUARANTEED FOR YOUR LIFETIME. Ideal for Housewives, Shoppers, Students, Engineers and Tax work. Take it to the Super Market—Save \$ \$ every week. We pay postage if you send check, cash or money order—or just send your name & address and pay postman \$1.97 plus postage. Immediate Delivery—10 Day Free Trial—Satisfaction Guaranteed or money refunded by return mail. SPECIAL GIFT OFFER—3 Machines for only \$4.99. AGENTS WANTED—Make easy money selling a Top Quality Calculator at our unbelievably low price.



TOM THUMB ADDING MACHINE
P.O. BOX 5066 Dept. J-19 Philadelphia 11, Penna.

GET LATEST OFFICIAL AIRCRAFT PHOTOS

SPECIAL INTRODUCTORY OFFER!

- 4 3 1/2 x 5 photos, world's fastest jets.
 - 4 3 1/2 x 5 World War II planes.
 - 4 3 1/2 x 5 of Rockets, Missiles.
 - 1 8x10 Boeing B-52 Jet Bomber.
 - 1 8x10 Lockheed F-104A Starfighter.
- Only 25¢ a set. Send \$1 for all 5.
(\$2 value)



Illustr. CAT. with order. Money back guar.

AVIATION PHOTO EXCHANGE

DEPT. PE BOX 75084
LOS ANGELES 5, CALIFORNIA

'How to Make Money with Simple Cartoons'

A book everyone who likes to draw should have. It is free; no obligation. Simply address

FREE BOOK

CARTOONISTS' EXCHANGE
Dept. 91-D Pleasant Hill, Ohio

WAR SURPLUS BARGAINS

\$500,000.00 INVENTORY for QUICK LIQUIDATION

Surplus items — hundreds of them for home, shop, factory, farm and outdoor use. New items, used items, second-hand items—all at tremendous savings—all priced for quick sale.

Page After Page of Values

This big catalog shows page after page of amazing money saving values. Write for your copy today. Send 10¢ to cover postage, mailing, etc. Write today! SEND TODAY FOR YOUR COPY

10c

STARK'S

212 W. Madison St.
Dept. PM-591
CHICAGO 6, ILL.

COVERS ALL THESE MAKES
— ALL MODELS, 1949 THRU 1958

Buick	De Soto	Jeep	Plymouth
Cadillac	Dodge	Lincoln	Pontiac
Chevrolet	Edsel	Mercury	Rambler
Chrysler	Ford	Nash	Studebaker
Clippor	Hudson	Oldsmobile	Thunderbird
Continental	Imperial	Packard	Willie

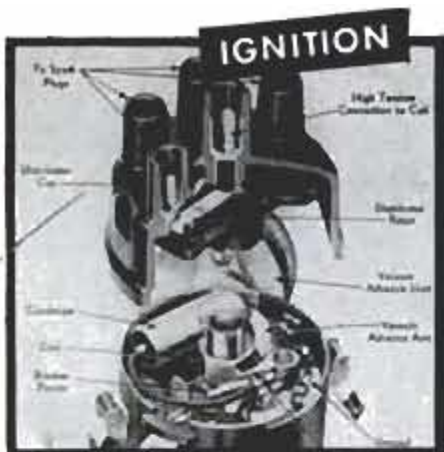

Clear photos, cutaway drawings and diagrams, plus know-how directions make every part of any ignition system crystal-clear.

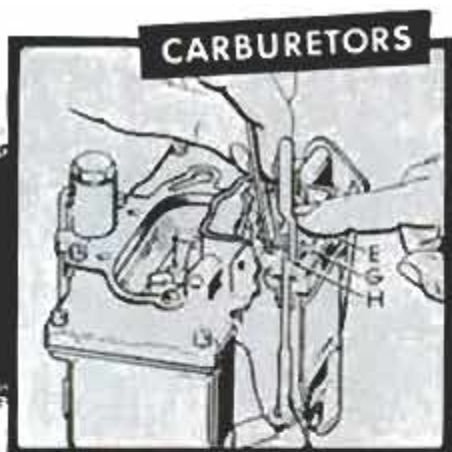

No more guesswork. You get illustrated, step-by-step procedures for all types of carburetors.

Let Factory Experts Show You HOW TO FIX ANY PART OF ANY CAR

OVER
2½ MILLION
COPIES SOLD!
USED BY
U. S. ARMED
FORCES

This Famous "Auto Repair Bible" Turns Beginner Mechanics Into Experts—Saves Experts Time, Trouble, Money

SUPPOSE crews of trained factory experts were ready to guide your hands as you start to fix any part of any car. If they told you **EXACTLY WHAT TO DO**, couldn't you "wrap up" any repair job—quickly, easily, right? That's exactly the kind of expert guidance you get in **MOTOR'S** new **AUTO REPAIR MANUAL!**

YOU CAN'T GO WRONG!

With clear illustrations and step-by-step instructions, these experts show you how to "breeze through" any job on any car listed—1949 thru 1958. Even if you're a beginner, this famous Manual can show you how to fix cars the way the **EXPERTS** do. Tells you **WHERE** to start, what **TOOLS** to use, guides you every **STEP** of the way!

You get practical how-to-do-it procedures—worked out by **AUTOMOTIVE ENGINEERS**—from 176 official Shop Manuals, hundreds of factory bulletins, boiled down in simple, easy-to-follow language. Over **ONE THOUSAND** giant pages, 2,900 "This-is-How" pictures, 291 Quick-Check Charts—23,436 essential repair specifications. Over 225,000 service and repair facts. Instructions and pictures are so clear you can't go wrong!

3 BOOKS IN 1

You actually get three complete "show-how" books in one giant handy, indexed volume:

1. Complete TROUBLE-SHOOTER SECTION spots more than 2,300 car troubles, helps you find the "bugs" fast.

2. HOW TO SERVICE, REPAIR ALL CAR PARTS—Transmissions, Air Suspension Systems, Rear Ends, Generators and Regulators, Fuel Pumps, Ignition Systems, Overdrives, Automatic Transmissions, Brakes, Rings, Water Pumps, Distributors, Dash Gauges, Power Steering, Power Brakes, etc., etc.

3. STEP-BY-STEP INSTRUCTIONS AND PICTURES on each specific car make and model—covers over 600 car models—1949 thru 1958.

PLUS Factory Specifications and Adjustment Tables, Tune-up Charts, Overhauling and Replacement facts—and **MUCH MORE!** Used by Armed Forces, hundreds of thousands of auto service men.

TRY BOOK FREE 7 DAYS

Send no money! Just mail coupon (paste it to a postal card if you prefer). Use Manual for a week, *free*. Unless you agree that it is the greatest time and money-saver you've ever seen, return it in 7 days—and you won't owe a cent! Mail coupon today! Address: **MOTOR BOOK DEPT., Desk 911, 250 West 55th St., New York 19, N. Y.** (SCHOOLS, BOOKSTORES: Write for discounts.)



FREE 7-DAY TRIAL
Return and Pay Nothing
If Not Delighted

Same FREE 7-Day Offer on MOTOR'S Brand-New TRUCK REPAIR MANUAL

Covers **EVERY** job on **EVERY** gasoline-powered truck made since 1949—**PLUS** GM and Cummins Diesels. Over 3,000 illustrations; over 300,000 facts. Check proper box in coupon for **FREE 7-DAY TRIAL**.

Amazed Self and Friends—"I amazed myself and my friends, too. Now do jobs that stumped me before."—Michael Ballesky, Newark, N. J.



So Complete and Easy to Understand—"So complete, easy to understand—have done jobs with Manual I would not have attempted without it."—C. L. Vanerstrom, Mich.



MAIL COUPON NOW FOR 7-DAY FREE TRIAL (Attach to postcard if more convenient)

MOTOR BOOK DEPT.,
Desk 911, 250 W. 55th St., New York 19, N. Y.

Rush to me at once (check box opposite book you want):

MOTOR'S New **AUTO REPAIR MANUAL**. If O.K., I will remit \$3 in 7 days, \$2 monthly for 3 months and a final payment of \$1.95 (plus 35c delivery charges) one month after that. Otherwise I will return the book postpaid in 7 days. (Foreign price, remit \$18 cash with order.)

MOTOR'S New **TRUCK REPAIR MANUAL**. If O.K., I will remit \$3 in 7 days, and \$2 monthly for 3 months, plus 35c delivery charges with final payment. Otherwise I will return book postpaid in 7 days. (Foreign price, remit \$11 cash with order.)

Print Name _____ Age _____

Address _____

City _____ Zone _____ State _____

Check box and save 35c shipping charge by enclosing **WITH** coupon in envelope entire payment of \$7.95 for Auto Repair Manual (or \$9 for Truck Repair Manual). Same 7-day return-refund privilege applies.

MEMORY UNLIMITED

I JUMPED into the first railway compartment which seemed empty: my eyes fell on a book left on the seat opposite by a previous passenger.

I took it up absent-mindedly and ran through the first lines. Five minutes later I was reading it as eagerly as a clue to a hidden treasure. I learned that everyone's memory is capable of fantastic feats; that an ordinary person if he has taught himself to control the way in which his brain stores impressions can memorize accurately long and complicated lists of facts after reading them over only once or twice. I thought I would test the truth of the statement.

I took a timetable out of my suitcase and began reading quietly in the manner prescribed, the names of about one hundred railway stations. I observed that, after reading them over a few times, I could recite the whole list off with hardly a mistake. With a little more practice I found I had committed them so completely to memory that I could remember them in the reverse order and even pick out one station from the list and say which number it was, and what were the names of the towns before and after it.

I was astonished at the memory I had acquired and spent the rest of my journey on more and more difficult experiments in memory, and reflecting how this new control I was achieving over my mind would materially help me to a greater success in life. After this, I worked hard at this wonderful memory system, and within a week I found I could recall passages from books and quote them with ease; names, addresses and business appointments were remembered immediately; and in four months I had succeeded in learning Spanish.

If I have obtained from life a measure of wealth and happiness, it is to that book I owe it, for it revealed to me the workings of my brain.

Three years ago, I had the good fortune to meet its author, and I promised him to propagate his method, and today I am glad of this opportunity of expressing my gratitude to him.

I can only suppose that others wish to acquire what is, after all, the most valuable asset towards success in life.

Borg's address: R. C. Borg, c/o Aubanel Publishers, 14 Highfield Road (Rathgar), Dublin, Ireland. Apply to him for his little book, "The Eternal Laws of Success." It is free to all who wish to develop their memory.

F. ROBERTS.

Advertisement

EARN \$100 A WEEK AND UP

BE AN AUTO-DIESEL MECHANIC - EARN WHILE YOU LEARN

Many of our graduates earn \$100 a week and up. You learn fast in our school and shops because you learn with tools on real equipment. Experienced instructors explain WHY and show you HOW, then you DO IT YOURSELF. One of the best equipped technical schools in the United States. Thirty-nine years' experience training men. Successful graduates in 48 states and many foreign countries. Approved for veterans. Day and evening classes. Free bulletin—write today. **NASHVILLE AUTO-DIESEL COLLEGE** 226 7th Ave. N., Dept. 86, Nashville, Tenn.

ENGINEERING DEGREE IN 27 MONTHS

B. S. degree (27 mo.): Aero., Chem., Civil, Elec., Mech. & Electronics, E.E. (36 mo.): Aero., Chem., Civil, Elec., Mech., Metal. B.S. (36 mo.): Math., Chem., Physics. Prep courses. Demand for grads. Campus, 20 bldgs.; dorms.; gym. Low rate. Earn board. G.I. appr. Enter March, June, Sept., Dec. Catalog. 1619 E. Washington Blvd., Fort Wayne 2, Ind. Keeping pace with progress

INDIANA TECHNICAL COLLEGE

MONEY in DONUTS

Make new greaseless donuts. Start in kitchen. No smoke. Sell stores. HALF PROFIT. Cash daily. Free recipes. No obligation. Write! MARTIN RAY CO., 3605 SO. 15th AVENUE, MINNEAPOLIS 7, MINN.

make your own Gems 36.50

The Gem Maker comes complete with all necessary equipment, including a super-charged diamond blade for sawing, and all the wheels for grinding, shaping and polishing; also complete instructions. The complete equipment as shown, less motor and belt for only 36.50, f.o.b., Burlington, Wisconsin. Write today for information and literature.

B&I MANUFACTURING CO.
Dept. P. Burlington, Wis.



MAKE \$50.00 A DAY AND MORE

Taking Orders for MASTER UNIFORMS with Embroidered-to-Order Advertising Emblems

Big and small firms in your area are hot prospects for MASTER Advertising Work Uniforms with firm name and design embroidered to order. Companies order uniforms for all their men. Show prospects what other firms have done and take easy orders which give you as much as \$50.00 profit in a day! Many of our top men average \$12,000 and more yearly. You can, too...even work spare time. No investment now or ever. No inventory to carry. **FREE Big Selling Outfit**, which we send you without obligation, includes actual sample fabrics. Here's the perfect business for you! Write now! **Geo. MASTER Garment Co., Dept. J-39, Ligonier, Ind.**



Make more money in one of today's FASTEST-GROWING industries

We'll train and establish you in YOUR OWN LIFETIME BUSINESS



U. S. Dept. of Commerce says: 45 million homes in U.S. with

\$750 million yearly potential in rug and upholstery cleaning.

In your town, 2 jobs a day earns \$8,750 profit first year.

You gain financial success as an independent businessman.

START PART-TIME . . . IF EMPLOYED



Get in on the ground floor of a potential \$750,000,000 yearly industry . . . the home-furnishings cleaning field. Record population growth and home construction have created a great demand for these services. If you qualify for a dealership in your town, you'll be trained by an established dealer and at a training school to expertly clean furnishings, with emphasis on wall-to-wall carpeting and fine upholstered furniture so popular today. Start part-time if employed. As you expand operations, switch to full-time. Alert dealers gross \$9.00 hourly. All service rendered on location. No shop needed. If needed, we help finance you. If you are willing to work to secure financial independence, send for full details.

dered on location. No shop needed. If needed, we help finance you. If you are willing to work to secure financial independence, send for full details.

We Help You Grow

YOUR personal success is of the utmost importance to Hdqtrs, for as you grow so grows the Duraclean Dealer organization. Thus, your initial training is only the start of a continuous assistance program to help build your business. When you write or phone Hdqtrs, you receive prompt, expert counsel from specialists. Among 25 regular services you receive are conventions, regional conferences, product development, tested ads, monthly magazines, etc. Cooperative program and customer satisfaction built this world-wide organization.



Unique Process

Duraclean cleans by *absorption*, utilizing electric Foam-ovator (shown above) which produces a light aerated foam. When spread onto fibers or fabrics, chemicals in foam safely and gently loosens soil and absorbs it like a blotter absorbs ink; thus, eliminating scrubbing, soaking, shrinkage, color run or dry rot. This unique process revitalizes fibers, restores color and adds years to their life. "On location" cleaning also permits use of furnishings again the same day. Customers are so elated they become your best salesmen. You also provide 4 other services to increase profits: **soil retarding, mothproofing, flameproofing and spot-tinting.** As a specialist you provide a complete service.



What Manufacturers Say

" . . . (Duraclean) standards in keeping with service to which . . . carpets and consumer are entitled." —Avisco (American Viscose Corp)

" . . . superior to any on-location process with which I'm familiar." —President, Modern Tufting Co.

" . . . we approve this process . . . in keeping with better service to Mrs. Housewife." —Aldon Rug Mills

Backed by Famous Awards



These two important honors conferred on Duraclean give proof of your superior services. As a Duraclean Dealer, you will be the only cleaning service in town backed by both these famous seals. No wonder customers buy Duraclean so quickly!



BACKED BY NATIONAL ADVERTISING

You are backed by a national advertising program which is larger than all other similar programs in the industry combined!

Consumer Advertising: Ads dramatizing your unique services reach millions of homeowners through leading magazines as Parents', Canadian Homes & Gardens, House & Garden, McCall's, plus others.

Trade Advertising: More and more retailers are referring customers to Duraclean Dealers for servicing. Key trade journals target local furniture retailers, dept. stores, dry cleaners, decorators, etc., to become agents for you.

To coordinate both trade and consumer campaigns in your town, we provide you with tie-in materials as ad reprints, mailing pieces, display cards plus others.



What Dealers Say

W. Looklebill (St. Louis): My 28th year! Began during depression and built business on good service.



D. Chilcott (N. Platte): Duraclean say gross \$9.00 per hour. I gross up to \$12.00. Many dealers do much better.

M. Lyons (Chgo): 3rd year should hit \$100,000; 2nd was \$60,000; 1st was \$40,000. Hdqtrs help make it possible.



E. Roddey (Hampton, Va.): Did \$600.00 first 12 days in January. My business keeps growing each month.

A. Wilson (Tulsa): Made \$1,299 this month working alone. Duraclean outperforms all competitors.



MAIL COUPON—GET FREE BOOKLETS!

"OWN A BUSINESS" COUPON

DURACLEAN CO., 9-161 Duraclean Bldg., Deerfield, Ill.
WITHOUT OBLIGATION, show me how I may enjoy a steadily increasing life income in my OWN business. Enclose FREE booklets and free details.

Name _____

Address _____ County _____

City _____ State _____

Duraclean Co., 9-161 Duraclean Bldg. Deerfield, Illinois

94.6% OF BAILEY GRADUATES ARE EMPLOYED AT TOP PAY IN THE FIELDS WHICH THEY WERE TRAINED!



DIESEL-AUTO MECHANICS DESPERATELY NEEDED!

We have a far greater demand for our students than we can fill! We can show you an actual waiting list of leading companies throughout the world who have tried Bailey graduates — found them outstanding, and are coming back for more!

Bailey Graduates are Successful . . . RECEIVE BIG PAY — HAVE SECURE FUTURE!

The Famous Bailey Course prepares you for BOTH Diesel and Gasoline Mechanics.

This is a must—due to the advent of using Diesel principles, such as 'Fuel Injection' on passenger cars . . . use of gasoline engines for starting Diesel engines, etc. You learn all this at Bailey in the amount of time ordinarily required to learn just one of these subjects, ALL FOR THE PRICE OF ONE.

Don't be satisfied with a 'futureless', one-type job — learn how you can make big money now! Write today for Free Booklet that takes you on a step-by-step camera tour through our spacious, modern shops — See Bailey students in action as they Learn-by-doing with the Famous Bailey Method of training!

We provide you with housing and part time jobs while in school, plus nation-wide placement service for graduates.

BAILEY Technical SCHOOLS

1634 S. GRAND ST. LOUIS 4, MO.

MAIL TODAY!

Please mail immediately this free booklet without obligation.

FREE BOOKLET



Name _____

Address _____

City _____ State _____

APPROVED FOR VETERAN . . . NON-VETERAN

2 Bushels of Ripe TOMATOES from ONE VINE



One packet of this sensational Tomato grown right in your own garden, will produce enough fruit for the average family.

New BURGESS CLIMBING TRIP-L-CROP

TOMATO grows 10 to 18 ft. high on trellis or side of building. Huge, meaty, delicious fruits, weigh up to 2 lbs. Wonderful flavor. Awarded Agricultural Research Foundation "Seal of Approval".

INTRODUCTORY OFFER: TRIAL PACKET 10¢
3 PACKETS FOR 25¢

FREE Garden Guide Catalog of famous "BLIZZARD BELT" Seeds, Bulbs and Plants.

BURGESS SEED & PLANT CO. 117-D Galesburg, Mich.

FREE OUTFIT STARTS YOU IN BIG MONEY SHOE BUSINESS!



Run your own profitable "shoe store" business from home! Represent fast growing million dollar firm in spare or full time. We give you—FREE—complete Starting Outfit that makes you \$217 EXTRA each month for just 2 easy orders a day. Feature 195 fast-selling dress, sport, work shoe styles for men, women. Air-cushion shoes, many special features! Sizes 2½-15—AAAA to EEEE. Sell to friends and folks where you work. Rush postcard for FREE Outfit!

MASON SHOE, Dept. F-420, Chippewa Falls, Wisconsin

75 POWER TELESCOPE \$3.98

NEW 3 in one telescopes, 3 variable 25X, 45X-75X magnification. Brass bound. 25 power for ultra bright images 45 & 75 power for long range. Guaranteed to bring distant stars, moons, objects, sports 75 times closer. Most powerful scope sold anywhere near this amazing low price. American made. 5 sections. Opens 36" closes 1 ft.; contains 4 ground & polished lenses. Can also be used as powerful compound microscope. Mass production enables us to offer telescope complete at \$3.98 postpaid. Money back guarantee.

CRITERION CO., Dept. PMB 65, 331 Church St., Hartford, Conn.

ARTHRITIS—RHEUMATISM VITAL FACTS EXPLAINED

FREE DESCRIPTIVE BOOK

How crippling deformities may be avoided. This amazing FREE BOOK explains why ordinary methods give only temporary relief —if that. Describes a drugless method of treatment successfully applied in thousands of cases. Write for this 36-page FREE BOOK today. No obligation.

BALL CLINIC, DEPT. 756, EXCELSIOR SPRINGS, MO.

Million Dollar Inventory — All Famous Brands



SAVINGS NEVER LESS THAN 50% UP TO 70% OFF REGULAR PRICES HEADQUARTERS FOR ALL SPORTS CAR TIRE SIZES → SEND FOR YOUR FREE CATALOG! ←

RELIABLE TIRE • 728 MORGAN BLVD. CO. CAMDEN 4, N. J.

"We're looking for people who like to draw"

By **ALBERT DORNE**
Famous Magazine Illustrator

Do you like to draw or paint? If you do — America's 12 Most Famous Artists are looking for you. We'd like to help you find out if you have talent worth developing.

Here's why we make this offer. About ten years ago, my colleagues and I realized that too many people were missing wonderful careers in art . . . either because they hesitated to think they had talent . . . or because they couldn't get top-notch professional art training without leaving home or giving up their jobs.

Plan to Help Others

We decided to do something about this. First, we pooled the rich practical experience, the professional know-how, and the precious trade secrets that helped us reach the top. Then — illustrating this knowledge with over 5,000 special drawings and paintings—we created a complete course of art training that folks all over the country could take right in their own homes and in their own spare time.

Our training has helped thousands of men and women win the creative satisfactions and the cash rewards of part-time or full-time art careers. Here are just a few:

Don Smith lives in New Orleans. Three years ago Don knew nothing about art — even doubted he had talent. Today, he is an illustrator with a leading advertising agency—and has a future as big as he wants to make it.

Helps Design New Cars

Halfway through our training,

railroad worker Don Golemba of Detroit landed a job in the styling department of a major automobile company. Now he helps design new car models.

John Whitaker of Memphis was an airline clerk when he began studying with us. Recently, a huge syndicate signed him to do a daily comic strip.

Earns Seven Times as Much

Eric Ericson of Minneapolis was a clerk when he enrolled with us. Now, he heads an advertising art studio business and earns *seven times* his former salary.

Having taken our training, busy New York mother, Elizabeth Merriss, now adds to her family's income by designing greeting cards and illustrating children's books.

Cowboy Starts Art Business

Donald Kern—a Montana cowboy—studied with us. Now he paints portraits, sells them for \$250 each. And he gets all the business he can handle.

Gertrude Vander Poel had never drawn a thing until she started studying with us. Now a swank New York gallery exhibits her paintings for sale.

Free Art Talent Test

How about you? Wouldn't you like to find out if you have talent worth training for a full-time or part-time art career? Simply send for our revealing 12-page talent test. Thousands paid \$1 for this test, but we'll send it to you *free*. If you show promise, you'll be eligible for at-home training under the program we direct. No obligation. Mail the coupon today.



ALBERT DORNE



NORMAN ROCKWELL



JON WHITCOMB



AL PARKER



HAROLD VON SCHMIDT



STEVAN DOHIANOS



FRED LUDEKENS



PETER HULCK



ROBERT FAWCETT



BEN STAIL



DONG KINGMAN



AUSTIN BRIGGS

FAMOUS ARTISTS SCHOOLS

Studio 890, Westport, Conn.

Send me, without obligation, your Famous Artists Talent Test.

Mr. _____
Mrs. _____ Age _____
Miss (please print) _____
Address _____
City _____ Zone _____
County _____ State _____

DRAFTSMEN



**CASH BIG
PAY CHECKS!**

Train Now for
more success,
greater security

LEARN AT HOME IN SPARE TIME
(or at college in Chicago)

Check the want ads in any newspaper—SEE the big-pay opportunities open to you as a draftsman. What's more, you can learn this well-paid, prestige profession at home—quickly, easily! No special talent needed. Get complete, step-by-step Chicago Tech lessons in the mail, spend a few pleasant hours studying each week. In a short time you'll be a well-trained draftsman, ready to take your pick of many good jobs. Act now!

Free Information—Mail Coupon Today!

Get FREE TRIAL LESSON plus information about C.T.C. practical training. Learn what successful Chicago Tech graduates say about high pay and opportunities in drafting. No charge, or obligation.



CHICAGO TECHNICAL COLLEGE

A-217 Tech Bldg., 2000 So. Michigan Ave.,
Chicago 16, Illinois

Mail me FREE lesson with facts about big opportunities in DRAFTING.

Name _____ Age _____
Address _____
City _____ Zone _____ State _____

MAKE TREMENDOUS PROFITS

Have fun! Earn Big Money! Cast plaster figurines, bookends, plaques, novelties at home in your spare time with N.L. rubber molds! NO EXPERIENCE NEEDED! Models and rubber for 3 molds, only \$1.50 post. Send 25c (refundable with order) for 40 page catalog now!

PLASTIC ARTS STUDIO 3403 S. MADISON, DEPT. PM2
MUNCIE, INDIANA

Tells How You Can Learn to

FREE BOOK MOUNT BIRDS!

Learn At Home
Men, Boys, Hunters, Fishermen, mount and save your lovely wild-game trophies. Be a Taxidermist. Mount Birds, Animals, Heads, Fish, Tan skins. YOU learn easily, quickly in spare time. Have a grand home-museum. The finest and the greatest hobby known, for sportsmen. Fun, real profits.

FREE BOOK
Yes, FREE. Beautiful strange, valuable Book, telling all about Taxidermy. Contains over 100 beautiful game-pictures. And it's yours FREE, if you rush your request. You can mount all kinds of wild-game, and common specimens too. We can positively TEACH YOU. So GRASP this opportunity. RUSH letter or postal for this amazing FREE BOOK. Don't delay. State your AGE.
N. W. SCHOOL OF TAXIDERMY, 2501 Elwood Bldg., Omaha 2, Neb.



My pupils—from 11 to 87—prove
**YOU CAN HAVE A NEW
BODY AT ANY AGE...**

with New Health — New Strength!

Now — at last — you can quickly and easily GAIN pounds of solid muscle — or REDUCE unsightly, dangerous fat. Build a SUPER-PHYSIQUE, with POWERFUL, shapely muscles — OR — just keep fit and healthy . . . in top condition.

Billy Van says: "ALL YOU NEED IS A ROPE!"

My amazing scientific discovery, **ROPERCISE**. Guarantees Results in a few minutes **3 DAYS A WEEK!** Write NOW for FREE booklet.

BILLY VAN—PHYSICAL DIRECTOR © B.V. 1958

4834 Art St. Studio 1 San Diego 15, California

GROW HERBS FOR US!

AT HOME — IN YOUR SPARE TIME

Help fill our huge demand — used in expensive medicines. Easy to grow indoors or out — multiply rapidly. Year around Profitability! You grow 'em — we buy 'em! We supply everything you need. Free rare seeds and revealing plan is yours free for the asking. Be one of the first to profit — rush name and address to: **NATIONAL HERB EXCHANGE**. Dept. A-1 Gardena, Calif.

Design Your Own Transformers

Simple-to-use book (208 pages, 47 charts) details EVERY STEP and HOOK-UP for winding, reconnecting and testing transformers. No engineering or math needed. Tells you how to design standard and auto-transformers, current and potential transformers, starting compensators, DC balance coils for 3-wire generators, Saturable Core Reactors, and many others. For designs from 50 VA to 100 KVA. Used in industry, research. \$25. Send check or m.o. 10-day money back guarantee.

DATARULE PUBLISHING CO.

P.O. Box 69 Scarsdale, N. Y.

EARN
WHILE
YOU
LEARN



Be a LOCKSMITH

Learn fascinating, profitable trade from experts in spare time at home! Age no disadvantage. Year 'round, steady income. Full or part time. Practical, illustrated lessons. Make money even while learning! All materials and special tools supplied.

SEND
FOR FREE
BOOKLET

LOCKSMITHING INSTITUTE, Dept. 101-9
150 Park Ave. East Rutherford, N. J.
Lic. by N. J. State Board of Ed. Apprvd. for Vets

FREE GERMAN HUNTING KNIFE

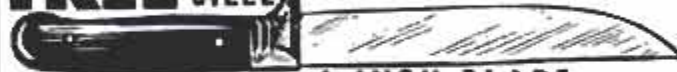

4-INCH BLADE

We give you handiest hunting and fishing knife you've ever had! Has 4-INCH LONG highly tempered steel blade—VERY SHARP! Attractive handle. We send knife FREE to acquaint you with our below-wholesale bargains. Please send 25c for handling. NO LIMIT—but send 25c handling for each knife. Order TODAY!
HUNTING KNIFE, Dept. K-365, Box 881, St. Louis, Mo.

FREE!

DO-IT-YOURSELF AUTO BARGAINS!

New GIANT 1959 CATALOG



Every page is jam packed with the NEAREST in auto parts & equipment. Thousands upon thousands of brand new surprise accessories from our stock of over 150,000 auto items. GUARANTEED SAVINGS TO 50%. You'll be amazed at the new 1959 auto parts included. Every car owner should order now. Send only 25c (refundable first order) to cover handling & mailing.



5805 E. Beverly Blvd., Dept. 270, Los Angeles 22, Calif.

Stepping stones to success!

Give your child the BOOK OF POPULAR SCIENCE

You can start your child on the climb to success with THE BOOK OF POPULAR SCIENCE. It will give him a basic foundation in the sciences. It may even spur him on to a brilliant scientific career.

THE BOOK OF POPULAR SCIENCE is much more than an encyclopedia. Like any good science teacher, it makes "complicated" subjects clear and exciting. It is up-to-date and remarkably complete. It is published by The Grolier Society, who also publish the world-famous BOOK OF KNOWLEDGE.

It takes your children through 15 major areas of science, including The Universe (ASTRONOMY, ASTROPHYSICS); The Earth (GEOLOGY, MINERALOGY, METEOROLOGY); Life (BIOLOGY, BOTANY, ZOOLOGY, etc.); Man (ANTHROPOLOGY, GENETICS, PSYCHOLOGY, PHYSIOLOGY); Matter and Energy (PHYSICS, CHEMISTRY); Industry (METALLURGY, ENGINEERING)... as well as Transportation (AERONAUTICS, AUTOMOTIVE ENGINEERING); Communication (ELECTRONICS, PHOTOGRAPHY, etc.); Health (HYGIENE, MEDICINE). And there are 21 chapters of exciting Projects and Experiments.

THE BOOK OF POPULAR SCIENCE brings your child 132 distinguished scientists and educators as his science teachers: specialists like Willy Ley on *Rockets*, Dr. R. Marlin Perkins on *Animals*, Dr. Lee De Forest on *Radio*. There is no set quite like it. To find out more about THE BOOK OF POPULAR SCIENCE—without obligation—send for the free booklet described below.



The Only Reading and Reference SCIENCE LIBRARY of its kind

... 10 volumes, 4300 pages, more than 4300 photographs, charts, etc.—hundreds in full color. New 1958 copyright edition.

... Over 150 simple experiments and "do-it-yourself" projects children

can perform unassisted with everyday materials.

... 15 departments of science, including The Universe, The Earth, Plant Life, Animal Life, Man, Matter and Energy, Industry, Science Through the Ages, etc.

FREE! BOOKLET OF 12 FASCINATING EXPERIMENTS



A cup and a coin will show your children how to "bend" light rays. A ping pong ball and a funnel will demonstrate a law of flight. Your whole family will enjoy all of the twelve safe, easy experiments included in THE LITTLE BOOK OF POPULAR SCIENCE! For your free copy, mail coupon at once.

LIMITED PRINTING MAIL COUPON NOW!

The Grolier Society, Inc. (Science Division)
2 West 45th Street, New York 36, N. Y.

I would like a free copy of THE LITTLE BOOK OF POPULAR SCIENCE, without obligation.

There are _____ children in my family,
ages _____

My name.....

Address.....

City.....Zone.....State.....

PM-1

Some make more, some less:

F.E. DORAN reports:

\$1050
gross in single
MONTH
in my own business



Start your own business!

Here's YOUR chance to start a money-making, year 'round business of your own and make the success you've dreamed about.

G. R. Adcock took in \$102 in one day. O. W. Hare landed a \$750 hotel job. J. S. Corbit grossed \$279.50 his first month. Homes, hotels, offices, clubs, offer you big profit possibilities. Auto upholstery also.

NO SHOP OR OFFICE NECESSARY • You clean furniture on customers' premises. No hauling, no high rents. Supplies inexpensive; you operate from your own home. What you take in is mostly profit.

If you want to be your own boss—free from lay-offs and strikes, we will help you to start and succeed.

This is not a lease proposition. You own the machine, you work when and where you please and all the money you take in is your own.

Mail
Coupon
Today
for
FREE
Book

VON SCHRADER MFG. CO.
110 "D" Pl., Racine, Wisconsin
Without obligation rush your **FREE** booklet about how I can start my own permanent, profitable electric Upholstery Cleaning business.

Name _____
Address _____
City _____ Zone _____ State _____

G2

**You Can Be a
Manufacturer
of Gardencrete**

Set of 18 Flagstones (below). Sells for \$5.25; Costs to make, \$3.00. Your markup, \$5.25.



Your spare-time manufacture of Gardencrete can lead to a full-time business, with broad sales potentials and generous income possibilities. A small investment buys the Colorglazing machine and a few molds. Add more molds as your business continues to expand.

Gardencrete has wide sales appeal wherever people have pride of lawn and garden. Colors are fused on under air pressure. Stay put for years and years. Choice of 30 colors.

Your mark-up on basic costs is 200%—300%. Products easily made in shed or garage. We supply full instructions. Write for literature and information on costs and selling prices on complete line.

Colorcrete Industries, Inc.
710 Ottawa Ave., Holland, Mich.

Bird Baths
Jars and Vases
Flower Boxes
Flagstones
Lawn Seats



**SHORTHAND
IN 6 WEEKS**

Write 120 words per minute
Age no obstacle—**LOWEST COST**

Famous **SPEEDWRITING** shorthand. No symbols; no machines; uses ABC's. Easiest to learn and use. Past preparation for a better position. Nationally used in leading offices and Civil Service. 120 words per minute—50% **FASTER** than Civil Service requirements. Over 500,000 taught by mail or through classroom instruction. The very low cost will surprise you. Typing available. 36th Year. Schools in over 400 cities in U.S., Canada, Cuba and Hawaii. Write For Free Booklet To: School of

**DID YOU SEE
READER'S DIGEST
ARTICLE ON**

Speedwriting
Dept. 1501-9, 55 W. 42 St., N.Y. 36

**LEARN ENGINEERING DESIGN
DRAFTING**

for **MISSILE, ROCKET & MILITARY AIRCRAFT** research & development. A fine approach to engineering if you missed college. Work with Engineers—advance as you continue to learn.

MANY OPPORTUNITIES

100% more draftsmen needed by 1960 due to expanded scientific effort. Write today.

ENCINO TRAINING CENTRE, P.O. Box 652, Encino, Calif.

MAKE BIG MONEY

MAKING COSTUME JEWELRY AT HOME!

Thrilling spare-time, **MONEY-MAKING** hobby! Make newest, beautiful jeweled earrings, necklaces, bracelets, pins, pendants, cuff links, tie clips! Quick, easy to make—easier to sell to friends, neighbors, stores, at big profit! Details **FREE!**



DON-BAR CO., Dept. A-19
3511 W. Armitage Ave., Chicago 47, Ill.

**STUDY TO BE A DOCTOR
of Psychology or Metaphysics**

Obtain a Ps.D., Ms.D., or Ph.D. Be a Teacher, Lecturer or Accredited Practitioner. Teach others how to achieve Health, Happiness and Contentment. Chartered by State. Correspondence Courses only. Write for **FREE** book telling how.

THE NEOTARIAN FELLOWSHIP
Desk B, Pickwick Building Kansas City 6, Missouri

FIX OUTBOARD MOTORS

**POWERMOWERS, AND ALL SMALL
2 & 4-CYCLE GASOLINE ENGINES**

MAKE EXTRA MONEY—or, repair your own equipment and **SAVE!** Fully illustrated, easy-to-understand, Home Study Course. Write today for **FREE** information.

LINCOLN TECHNICAL INSTITUTE
SUITE 1-E, 472 MARKET STREET, NEWARK 5, N. J.

Better Than
Your Own

**SHOE STORE
AT HOME**



No investment, no experience needed. Just show magic cushion comfort to friends, neighbors, co-workers. Advance commissions to \$4.00 a pair, plus Cash Bonus, Paid Vacation, \$25.00 Reward Offer. Outstanding values for men, women, children. Money back guarantee. Shoe samples supplied without cost. Write **TODAY** for **FREE** new 84 page catalog and full details.
TANNERS SHOE CO., 127 BROCKTON, MASS.

**Two-Eyelet
Hit With
Cushioned
Comfort**

32

INVENTORS

The preparation of an application for patent and the conducting of the proceedings in the Patent Office to obtain the patent is an undertaking requiring knowledge of patent law and Patent Office practice as well as knowledge of the scientific or technical matters involved in the particular invention.

Unless you are familiar with these matters, you are advised to call upon the knowledge, experience and skill available to you from a registered patent attorney or agent in order that the patent, if obtained, will adequately protect your invention.

The firm of Victor J. Evans & Co. is registered to practice before the United States Patent Office and is available to advise and assist you in all steps necessary to the preparation and prosecution of patent applications.

Let us send you a copy of our instructive booklet "Patent Protection for Inventors" which explains pertinent points concerning procedures which must be followed and how this firm acts in your behalf. We also will send "Evidence of Invention" disclosure form (with instructions for proper use) to help you take the first step toward securing a patent—a search among previously granted U. S. patents for similar types of inventions to determine probable patentability. Booklet and form sent without obligation.

VICTOR J.
EVANS & Co. *Merlin M. Evans*
REGISTERED PATENT ATTORNEY

530-A MERLIN BUILDING

WASHINGTON 6, D. C.

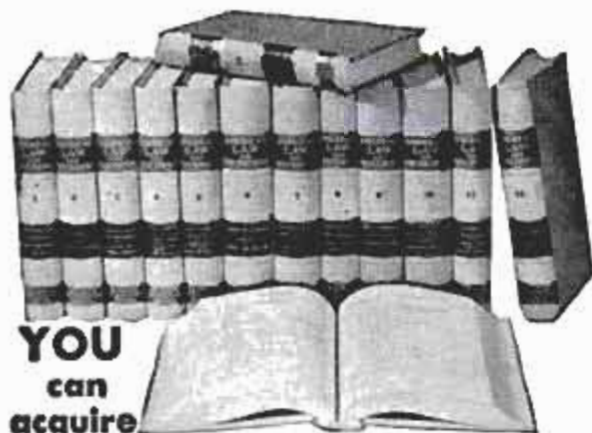

YOU
can
acquire

LAW AT HOME! EARN LL. B. DEGREE

LaSalle's famous Law Library—used as reference in many Law libraries and Law offices—has enabled thousands to master Law surprisingly fast, in spare hours at home, for business and professional advancement.

These 14 remarkable volumes, compiled by leading professors and lawyers, cover the whole basic field of Law in condensed, orderly, simplified manner.

You advance rapidly with this great library, plus special lectures furnished. We guide you step-by-step with personalized Problem Method of instruction...you *learn by doing*—handling legal problems—not by memorizing rules.

Send for two FREE booklets, "Law Training for Leadership," and "Evidence," answering questions about Law and its value to you. Mail coupon below. No obligation.

Accredited member, National Home Study Council

LA SALLE EXTENSION UNIVERSITY A Correspondence Institution

417 S. Dearborn St., Dept. 164L, Chicago 5, Ill.

Send me your two FREE booklets described above, without obligation

Name.....Age.....

Street.....

City, Zone & State.....



You can make money in

WATCH REPAIR

Learn at home the low cost Sweazey Way

Watch repairing pays up to \$6 an hour, part time watch makers report on survey. Unique and modern Sweazey home study System starts you making repairs right away on Swiss and American watches. Professionally prepared training. No previous experience needed. Special tools provided for practice. Tuition only \$5 a month. Free sample lesson and opportunity book give all facts. Write today. No obligation.

CHICAGO SCHOOL OF WATCHMAKING 2330 N. Milwaukee Ave., Dept. 119, Chicago 47, Illinois

FREE BOOK and SAMPLE LESSON

CHICAGO SCHOOL OF WATCHMAKING
2330 N. Milwaukee Ave., Dept. 119, Chicago 47, Illinois

Please rush FREE BOOK and Sample Home Study Lesson.

Name.....Age.....

Address.....

City.....Zone.....State.....

TIRE SALE

FREE PASS. TUBE 25 YEARS IN BUSINESS AT THE SAME ADDRESS
Seeing is believing—IF YOU GO SHOPPING YOU'LL END HERE. Be Wise, try one! You'll buy more. **GUARANTEE** given with each used tire sold. SEND AD.

600x16	\$4.72	670x15	\$4.72	650x16(8)	\$8.42	800x15	\$6.22
600x16(6)	7.62	710x15	4.72	750x16(6)	8.72	820x15	6.42
850x14	7.52	760x15	4.72	640x15	5.32	700x16(6)	8.72
750x14	7.52	800x14	8.72	1100x29	19.52	1100x22	20.32
700x15(6)	\$9.92	700x20	\$10.92	750x17	\$13.72	825x20	\$19.52
750x16(8)	11.62	750x20(10)	15.22	600x20	9.92	900x20	19.72
700x17	10.92	750x20(8)	13.32	650x20	11.32	1000x20	19.92

12 MOS. WRITTEN GUARANTEE. WHITE WALLS \$1.00 EXTRA
"EXTRA SPECIAL" TOP QUALITY all size 4-ply pass. FREE TIRE with 2 or more of these. W.W. \$8.82 EA.
\$1.00 Extra — GIANT TIRE SALE.

SNOW TIRES \$8.62 AND \$6.32 ANY SIZE

BLACK WALL PASS.
SUBURBANITE OR TOWN & COUNTRY TREAD
Thousands of tires shipped all over the U.S.A. All tires shipped F.O.B. Phila. Send Check or M.O. with this ad. Dept. 2, No C.O.D.
STANDARD 834 N. Broad St., Philadelphia 30, Pa.

Let me show you
HOW TO SPEAK AND WRITE LIKE A COLLEGE GRADUATE

I have helped thousands of men and women who have not had college training in English to become effective speakers, writers, and conversationalists. With my new C.I. METHOD, you can stop making mistakes, build up your vocabulary, speed up your reading, develop writing skill, learn the "secrets" of conversation. You don't have to go back to school. Takes only 15 minutes a day at home. Costs little. 32-page booklet mailed FREE upon request. Send me a card or letter TODAY!

Don Bolander, Career Institute
Dept. E-1051 30 E. Adams St. Chicago 3, Illinois

"YOU ARE UNDER ARREST!"

Help Bring Crooks to Justice Through Scientific
CRIME DETECTION!

We have taught thousands this exciting, profitable, pleasant profession. Let us teach you in your own home. Learn Finger Printing, Firearms Identification, Police Photography, Secret Service Methods thoroughly, quickly, at small cost. Over 800 of all American Bureaus of Identification employ I.A.S. students or graduates. Write for FREE "Blue Book of Crime."
(A Correspondence School Since 1916)

INSTITUTE OF APPLIED SCIENCE, 1920 Sunnyside Ave., Dept. 1351, Chicago 40, Ill.

Learn LANDSCAPE GARDENING

A thorough, interesting home study Course for those who wish to become a Landscape, Garden Consultant, Contractor or Designer for profit or pleasure. Write today for FREE Booklet.

NATIONAL LANDSCAPE INSTITUTE
Dept. M-19 11826 San Vicente Blvd. Los Angeles 49, Calif.

BRONZE FOUNDRY

Schools • Home Workshops • Inventors

Make your own castings of aluminum, copper, bronze, silver. Foundry sets are available in three sizes including 2400 Deg. F. blast Furnaces. \$26.50; \$33.50; and \$46.00 f.a.b. Marysville. Free Circular.

KANSAS CITY SPECIALTIES CO. DEPT. P-1, P.O. BOX 6022, MARYSVILLE, KANSAS

Mail Order Pays BIG!

NEW METHOD STARTS YOU NOW!
Men-women, your opportunity for big cash profits in mail order. World renowned mail order master, B. L. Mellinger, now reveals secrets of his lifetime success. Tells you inside facts that have brought him a fortune from modest beginning at home. First real guide of its kind to mail order money making—shows you short-cuts to success. New method endorsed by top mail order authorities shows you how to get best products for full or spare time mail order business, how to pocket profits in advance, how to get free ads, how to start from home with no previous experience or investment in products. Write for full details—ALL FREE! Air mail reaches us overnight.

Yours FREE!
MELLINGER, INC., Dept. X251, 1718 WESTWOOD, LOS ANGELES 24, CALIF.

DON'T BE HALF-TRAINED! Be A Master Technician

NOW... ONE
modern master
home training course
IN ALL 3 PHASES



AIR CONDITIONING - REFRIGERATION ELECTRICAL APPLIANCES

ALL AT ONE
LOW TUITION
only National Schools gives
you this complete training
at no extra cost



**YOU GET
AND KEEP
ALL THESE
TOOLS
AND
INSTRUMENTS**

Incomplete training limits your earning power, even disqualifies you for top-pay jobs. The big service companies require complete, all-phase training. If you open your own shop, you'll be called upon to service and repair all types of refrigerators, air conditioners and appliances. With complete training—as only National Technical Schools can give you—you can accept every job, make big profits all year round.

FUTURE BRIGHT FOR TRAINED MASTER TECHNICIANS

Over 30,000 new technicians must be trained annually. You are needed to help service and repair the 50 million air conditioners, refrigerators and electrical appliances that will need fixing this year alone. No wonder the Master Technician has steady work, at high pay, year after year. He can go places in his own business or with a manufacturer, dealer, distributor or department store. Armed with all-phase training, his earning power is unlimited.

THE MOST FOR LESS

We give you illustrated Shop-Tested Lessons and Manuals...many other training aids...privilege of CONSULTATION with our instructors and engineers. Every lesson, every manual has been SHOP tested and approved.

JOB TRAINING AT HOME

You get Professional Tools, Precision Instruments, PLUS a Factory-Made APPLIANCE TESTER! A shop-full of PRACTICAL, professional equipment. Use them to conduct over 100 experiments...also in Spare Time Work and ON THE JOB. It is all yours to keep...no EXTRA MONEY DEPOSITS...no EXTRA COST on your equipment kits,

EARN AS YOU LEARN

We show you how. Many of our students pay for their entire course—and more—in Spare Time while learning. So can you. Graduate Advisory Service, too.

GET THE BENEFIT OF OUR OVER 50 YEARS EXPERIENCE

**N.T.S. also offers training in
TV - RADIO - ELECTRONICS
and AUTO MECHANICS - DIESEL**



MEMBER



NATIONAL TECHNICAL SCHOOLS

WORLD-WIDE TRAINING SINCE 1905

4000 SO. FIGUEROA ST., LOS ANGELES 37, CALIF., U. S. A.

RESIDENT TRAINING AT LOS ANGELES

If you wish to take your training in our Resident School at Los Angeles, start NOW in our big modern Shops and Labs. Here you work with latest equipment...professionally installed...finest, most complete facilities offered by any school. Expert, friendly instructors. Personal attention. Graduate Advisory Service. Help in finding home near school...and part time job while you learn. Check box in coupon for full information.



**SEND FOR
FREE
BOOK AND
ACTUAL
LESSON NOW!**

We'll rush you our big, illustrated OPPORTUNITY BOOK and ACTUAL LESSON, show you how easily you can learn. NO OBLIGATION; no salesman will call. Do it NOW! It costs nothing to find out.

NATIONAL TECHNICAL SCHOOLS

WORLD-WIDE TRAINING SINCE 1905

MAIL NOW TO

National Technical Schools, Dept. CB-19
4000 S. Figueroa St., Los Angeles 37, Calif.
Rush FREE "Opportunity" Book and Actual Lesson. No Salesman will call.

NAME _____

ADDRESS _____

CITY _____ ZONE _____ STATE _____

Check here if interested ONLY in Resident Training at Los Angeles.

UNUSUAL TELESCOPE BUYS.

See the Stars, Moon, Planets Close Up!
3" ASTRONOMICAL REFLECTING TELESCOPE
 60 to 160 Power — Famous Mt. Palomar Type! An Unusual Buy!



Assembled—Ready to use! You'll see the Rings of Saturn, the fascinating planet Mars, huge craters on the Moon, Star Clusters, Moons of Jupiter in detail. Galaxies! Equatorial mount with lock on both axes. Aluminized and overcoated 3" diameter high-speed f/10 mirror. Telescope comes equipped with a 60X eyepiece and a mounted Barlow Lens, giving you 60 to 160 power. Low-cost accessory eyepiece available for higher powers. An Optical Finder Telescope, always so essential, is also included. Sturdy, hardwood, portable tripod. Valuable STAR CHART and 272-page "Handbook of Heavens."
 Stock No. 85,050-M \$29.95 postpaid

KNOW THE TRUTH about power. Telescope experts will confirm that an Astronomical Telescope will only give you practical powers for to about 50 or 60 times per inch of objective diameter—powers above this only produce empty magnification—make viewing dim, difficult and unsatisfactory.

4 1/4" ASTRONOMICAL TELESCOPE! UP TO 270 POWER!



With this scope you can see everything as above but with greater power plus will split finer stars. Mirror has twice the light gathering power. Mirror guaranteed to give theoretical limit of resolution. Rack and pinion focusing, hardwood tripod, real equatorial mounting—only one adjustment follows stars! Aluminum tube, 6 power finder telescope, 2 standard size eyepieces and mounted Barlow lens give you powers of 40X, 80X, 120X, and 270X. Low-cost accessory eyepiece available for higher powers. Free handbook and Chart. Shipping weight 25 lbs.
 Stock No. 85,006-M \$74.50 f.o.b.

WRITE FOR FREE CATALOG "H"!
 Complete Line of Astronomical Telescope Parts and Assembled Telescopes. Also huge selection of lenses, prisms, War surplus optical instruments, parts and accessories. Telescopes, microscopes, Hand Spectroscopes, Sniperscopes, binoculars, etc. Request Catalog "H"!
 ORDER BY STOCK NUMBER SEND CHECK OR MONEY ORDER. SATISFACTION GUARANTEED.
EDMUND SCIENTIFIC CO., BARRINGTON, N. J.

Free! AIRMAIL COLLECTION



Get this spectacular collection of all-different, genuine Airmails from strange, far-away countries in Asia, Africa, Europe, the exotic Orient! World's largest airmail, scarce \$27 stamp, old Zeppelin, many, many others. A truly remarkable collection containing stamps worth up to 40c each at catalog prices! PLUS Bargain Catalog and other unusual offers. Send 10c for mailing costs. ACT NOW!

JAMESTOWN STAMP CO. Dept. F19PM, Jamestown, N. Y.

RUSH my Free Airmail Collection and other offers. I enclose 10c* for mailing costs.

Name.....
 Address.....
 City & State.....

8' SPECIALS — \$1.25



FOR PARTIES AND FUN



FOR ADVERTISING

A special purchase makes it possible to offer these GIANT 8 FOOTERS at a fraction of their value. New, genuine neoprene gov. surplus. Great for advertising, paint your message on 'em, inflate & fly. Attracts crowds to sales, displays, openings, stores, gas stations. Fun at home for young & old and just the thing for any party or school prom. Perfect for beach or picnic. They're BIG and they do a BIG job! Order yours today!

8'—\$1.25.....5 for \$6.00
 13'—\$1.95, 15'—\$2.95, 18'—\$3.95

Postage pd. on p.p.d. orders.
 Cal. res. add sales tax.
FRANK SALES - Dept. PM159
 3930 Sunset Blvd., Los Angeles 29, Cal.

MEN WANTED

Earn \$100 Per Week and up
AUTO DIESEL MECHANICS

Master a trade with a future—learn Auto-Diesel mechanics in our shops. You learn with tools on real equipment. Earn while you learn. Many of our graduates earn \$100 per week and up. No previous experience necessary. Day and night courses. Approved for veterans. Write for free bulletin.

NASHVILLE AUTO-DIESEL COLLEGE

226 7th Ave., N., Dept. 75

Nashville 3, Tenn.

TASOPE PHOTO-ENGRAVING PLANTS



Material Cost Of This Cut 34c
 Selling Price \$1.00 And Up

Establish your own profitable PHOTO-ENGRAVING business. Make cuts for newspapers, printers, and advertisers. Make etched name plates, plaques, etc. Instructions furnished, no experience necessary. Sold direct from factory since 1931. First five hundred cuts sold locally or by mail will pay for plant and pay you well for your time. Write for FREE catalog.

TASOPE, DEPT. PM1, AURORA, MO.

GROW MINIATURE TREES FREE! SEEDS & PLAN



New Fascinating HOBBY or HOME-BUSINESS OPPORTUNITY! Learn little-known techniques for growing living "Ming" Trees only inches high. Beautiful Elm, Cherry, Orange, Cypress, Peach, etc., that BLOSSOM AND BEAR TINY TASTY FRUIT. Help fill demand for these sensational dwarfed Trees. FREE SEEDS (8 kinds) and Plan. State your age. Write: MINIATURE TREE NURSERIES, Dept. K-1, Home-Growers Division! Gardena, Calif.

FLORIDA JOBS

All kinds, entire state, hundreds guaranteed actual openings listed every week. Telegraph or write at once. Full details of our service will be rushed immediately. WRITE Fastway Service, Daytona Beach 26.



EXACT REPLICA U. S. MARINE GRENADE
 As Used in Hand Combat

Get a real bang when you toss this replica of a Marine grenade. Startle ex-G.I.'s. Explodes automatically 4-seconds after pulling pin as it strikes ground. Can't break. Heavy gauge steel firing mechanism. Uses standard caps. Can be exploded over and over. Real collector's item. Comes complete with instructions. Send \$1.98 plus 25c shipping charge—cash, check or money order to: Standard American Suppliers, Inc. Grenade Dept. PM-1, One Park Ave., New York 16, N. Y.

TRAIN FOR OPPORTUNITY FIELD OF

ELECTRONICS

ON REAL EQUIPMENT

IN THE NEW SHOP-LABS

OF **COYNE**



**LARGEST, OLDEST AND
BEST EQUIPPED
SCHOOL OF ITS
KIND IN U.S.**



This fireproof building is occupied entirely by Coyne and houses the NEW COYNE SHOP-LABS with over a quarter of a million dollars worth of Equipment. Thousands of successful men have trained at Coyne. There is no substitute for Coyne's wealth of experience.



OPPORTUNITIES IN ELECTRICITY-ELECTRONICS

Train the Coyne way for a better job in Electricity-Electronics—a field that offers a world of opportunities now and in the years ahead. In industry—in the home—Electricity and Electronics are playing a vastly greater role than ever before. New developments and rapid growth are creating increasing job opportunities. Automation Electronics—one of the more recent applications of Industrial Electronics to manufacturing processes—promises to create additional demands for trained Electrical-Electronics men such as we have never seen. Electrical-Electronics Training can be taken separately or combined with Television-Radio training. Send coupon for more information.

Training in Refrigeration and Electric Appliances can be included.

YOU TRAIN IN CHICAGO—Learn the easier practical way in the NEW SHOP-LABS of Coyne in Chicago. Shop work plus technical training. No advanced education or previous experience needed. Lifetime Employment Service to Coyne Graduates.

START NOW—PAY LATER

New liberalized credit terms and Finance Plans. Pay most of tuition after graduation. Part-time employment service to students.

VETERANS OR NON-VETERANS

Coyne training is offered to Veterans and Non-Vets alike. We'll send Bulletin giving full information. Send coupon for details.



1. You are told the how and why of each job.



2. You're shown how to do it by trained instructors.



3. You do the jobs yourself on actual equipment.

B. W. COOKE JR., President

COYNE
ELECTRICAL SCHOOL

FOUNDED 1899

Chartered As An Educational Institution Not For Profit

1501 W. Congress Parkway, Chicago, Dept. 19-3A,

ELECTRICITY • RADIO • TELEVISION • REFRIGERATION • ELECTRONICS

TELEVISION—RADIO ELECTRONICS

Great opportunity for a good job or your own business in one of America's fastest growing branches of Electronics! New stations by the hundreds... new sets by the millions... and now Color TV... all means greater opportunities in Sales and Service. Separate courses in Radio-Television or in combination with Electricity-Electronics available.

SEND FOR FREE BOOK!

Mail coupon in envelope—Paste on Postal Card or write to address below for 48 Page Illustrated Book, "Guide to Careers" and all the facts. Whether you prefer Electricity-Television-Radio or Combined Electronics Training this book describes all training offered.

Information comes by mail. No obligation and no salesman will call.



Coyne Electrical School,
Dept. 19-3A, New Coyne Building
1501 W. Congress Pkwy., Chicago 7, Ill.

Send FREE BOOK, "Guide to Careers," and details of all training you offer.

Name _____

Address _____

City _____ State _____

(I understand no Salesman will call.)

ABSOLUTELY FREE!

Amazing 48-page
muscle-building
course, with
photos of
Champs! NOW
TO DEVELOP A

HE-MAN BODY!

TRADE IN that skinny, scrawny, milk
toast body of yours for a jet-charged
WEIDER physique — rippling with
mountains of mighty muscle, oozing
confidence and virility out of every
pore! Now get my SENSATIONAL
INTRODUCTORY MUSCLE-BUILDING
COURSE — not for \$100, not for
\$50 but ABSOLUTELY FREE if
you act now!

Mail this coupon for your FREE COPY.
See how easy it is to have a DYNAMIC
HE-MAN BODY in just 15 minutes a
day in your own home! Hurry,
while offer lasts! Mail today!

JOE WEIDER, Dept. 38-19M
803 Palisade Ave., Union City, N. J.
Rush FREE Power-Packed Muscle
Building Course. I enclose 10¢ for
handling and postage. (offer
limited to men over 16)

Name

Address

City State Age



... TURN CONCRETE INTO GOLD!



MAKE UP TO \$75 A DAY IN YOUR OWN BUSINESS

If you want to have your own business — to start a
business on your own — here's your big opportunity!
New high speed, low cost General block machine
produces up to 1,000 concrete blocks a day. Sell all
you make to builders, supply houses, and others for
homes, factories, buildings, garages. Cash in on the
building boom! You can make profits of 100% to
150% — up to \$75. a day! General block machine
equipped with 1/2 h.p. electric motor — or can be
supplied with gasoline engine — works anywhere, in
little space, indoors or out. Operates from ordinary
house light socket. Simple, foolproof 3 step operation
— so easy a child can do it. Makes superior 3 core
blocks any size from 4" to 12". Also makes chimney,
tosh, corner and other types. Blocks meet any build-
ing code anywhere in the country. Materials — sand,
water, cement, available anywhere. Simple illustrated
operating instructions and mixing formulas for
cement and cinder blocks supplied with each machine.
Write for FREE folder with full information.

**MOTOR
DRIVEN**

R.L.T. of
New York City re-
ports: "MY GENERAL
BLOCK MACHINE
PAID FOR ITSELF
IN FIRST 2 WEEKS!"
Hundreds now in
use the world over!
Write for FREE details today!

EXTRA

book gives floor plans for 6 sensational concrete block bungalows. Tells how to lay blocks, lay out building lines, mix concrete, build steps, porch and concrete floors all at great savings. Written by experts. Can save many times the cost of the machine! Get it now! No strings attached. Send \$1.

BOOK SENT FREE IF YOU BUY MACHINE.
\$1 REFUNDED IF YOU BUY LATER.

GENERAL ENGINES CO.

DEPT. M-19, ROUTE 130, THOROFARE, N. J.



INVENTORS

PROTECT YOUR INVENTION BY A
U. S. PATENT. SEND FOR FREE
"INVENTION RECORD" FORM AND
"PATENT INFORMATION
EVERY INVENTOR SHOULD HAVE."

CARL MILLER

REGISTERED PATENT ATTORNEY

WOOLWORTH BLDG., 36th FLOOR, 19A
NEW YORK CITY

INVENTORS

Whether an invention is patentable can be substan-
tially determined by a search of the U. S. Patent re-
cords. Without obligation, write for information ex-
plaining the steps you should take to secure a patent.

JOHN N. RANDOLPH

Registered Patent Attorney

801 Victor Building, Washington 1, D.C.



INVENTORS

U. S. Patents protect your inventions. Our free
book of "Instructions on Patent Procedure for
Inventors," also "Certificate of Invention" form
sent without obligation.

C. A. SNOW & CO.

REGISTERED PATENT ATTORNEYS

428 SNOW BUILDING WASHINGTON 1, D. C.

GET THE HABIT OF READING

OUR CLASSIFIED ADS.

Wonderful Opportunities Amazing Bargains

INVENTORS

Send for
PATENT INFORMATION

Book and
INVENTOR'S RECORD
without obligation

GUSTAVE MILLER
19-PM WARNER BUILDING
WASHINGTON 4, D.C.

REGISTERED PATENT
ATTORNEY

ASSOCIATE EXAMINER
U.S. PAT. OFF. 1922-1928

Patent Attorney & Advisor
U. S. NAVY DEPT. 1930-1947
PATENT LAWYER

INVENTIONS WANTED

If you want to market, or sell, your invention for cash or royalties,
Write for our Free Booklet. Send no drawings. We also welcome hear-
ing from firms, or private capital, wishing to review inventions in
any field. We will be glad to send notice of our clients' inventions.

GLOBAL MARKETING SERVICE

2420 77th Ave. Dept. PD Oakland 5, Calif.

INVENTORS

I shall be pleased to furnish you,
upon request, with full information
relative to patent procedure—without
any obligation on your part.

PATRICK D. BEAVERS

Registered Patent Attorney

934 Victor Building Washington 1, D.C.

BIG PAY SECURITY OPPORTUNITY FOR YOU! IN AUTO MECHANICS AND DIESEL

Your spare time pays off with our **BIG** world-famous **SHOP TESTED** Home Training

Why wait around, for a small raise or promotion that may never come? National Technical Schools ALL-AROUND MECHANICS are always in demand... for high pay jobs in car dealer shops, garages, truck and bus lines, construction projects, government labs, factories, and many others. That **BIG** opportunity, that **BIG** salary, or a **BUSINESS OF YOUR OWN** can soon be yours by preparing **NOW!**

You master the entire field of Auto Mechanics and Diesel, at home in your spare time. You also earn while you learn. And it's easy... our illustrated lessons and diagrams make every step crystal clear... you'll learn fast regardless of your age or education.

Latest equipment and newest techniques. Tools and kits are yours to keep. Many students pay for their course with Spare Time Earnings. We show you how.

Why N.T.S. Training is Better... More Complete... Lower Cost. **BETTER**... Because training is Shop Tested in Resident School Shops and Labs, by oldest and largest School of its kind in the World. **MORE COMPLETE**... you learn all phases of Auto Mechanics and

GOOD JOBS ARE YOURS IF YOU'RE WELL TRAINED



You'll be on top as an all-around Mechanic... thousands of shops will pay you big money for your all around know-how.



N.T.S. Training leads you into top supervisory jobs in industry — service manager, foreman, where the Extra Big paychecks will be yours.



You can operate your own Auto Repair and Motor Tune-up Shop — big profits, real independence. **BE YOUR OWN BOSS!**

YOU GET AND KEEP ALL THIS EQUIPMENT



Diesel. **LOWER COST**... one low tuition covers entire cost of course and all equipment. Friendly instructors, unlimited consultation privileges. Free graduate advisory service.

DON'T DELAY: WASTED TIME IS WASTED MONEY! You don't have to leave your job... you learn at home. Before you know it, you'll be ready for a far better job, more money, lifetime security. **Act TODAY: Mail coupon.**



RESIDENT TRAINING at Los Angeles

If you wish to take your training in our Resident School at Los Angeles, start **NOW** in our big, modern Shops and Labs. Work with the latest Auto and Diesel engines — all types — fuel injection, automatic transmissions, all power equipment. Most complete facilities offered by any school. Expert, friendly instructors. Graduate Advisory Service. Help in finding home near school — and part time job while you learn. Check coupon for information.

ACTUAL LESSON

FREE Send for **FREE** ILLUSTRATED BOOK and Actual Lesson

Send coupon now! No obligation... no salesman will call. Complete training programs in TV-Radio-Electronics also available.

NATIONAL TECHNICAL SCHOOLS

WORLD-WIDE TRAINING SINCE 1905

MAIL NOW TO
NATIONAL TECHNICAL SCHOOLS, Dept. DB-19
4000 S. FIGUEROA ST., LOS ANGELES 37, CALIF.
Send for **FREE** Auto-Diesel Opportunity Book and actual Lesson.

NAME _____ AID _____

ADDRESS _____

CITY _____ ZONE _____ STATE _____

Check if interested **ONLY** in Resident School training at Los Angeles.

VETERANS: Give date of Discharge _____

NATIONAL TECHNICAL SCHOOLS

WORLD-WIDE TRAINING SINCE 1905

4000 SO. FIGUEROA ST., LOS ANGELES 37, CALIF., U. S. A.



MEMBER

CUT OUT COUPON — FILL IN INFORMATION — MAIL TODAY

ENGINEERING

DEGREE IN 27 MONTHS

Students given option of studying engineering under accelerated program leading to Bachelor of Science Degree in 27 months; or the standard four-year program leading to Bachelor of Engineering Degree in 36 months. The B.S. degree in Mathematics, Chemistry, or Physics (including Nuclear Physics) may be earned in 36 months. By attending classes year-round, students can graduate in 3 years and have one year of experience and income in the time usually needed to complete a four-year college course. Preparatory courses. Thorough, practical program. Individualized instruction.

Keeping pace with progress in science and engineering

Campus. Dorms, gym, playing fields. Superior faculty. 2,000 students. New Dana Science Building. Low tuition. Earn board. G.I. approved. Enter March, June, Sept., Dec. Students from 48 states, 40 foreign countries. Send coupon for free catalog, full information. Enroll now!

INDIANA TECHNICAL COLLEGE

519 E. Washington Boulevard, Fort Wayne 2, Indiana

Please send me free information on 27 mo. B.S. DEGREES in:

Aeronautical Chemical Civil Electrical
 Mechanical Electronics

on 36 mo. B. E. DEGREES in:

Aeronautical Chemical Civil
 Electrical (Power or Electronics) Mechanical Metallurgical

on 36 mo. B.S. DEGREES in:

Mathematics Chemistry Physics

Name _____

Address _____



Exclusive Double-Bearing HEAVY-DUTY PUMPS

IRRIGATE • DRAIN • CIRCULATE • SPRAY
Use 1/4 HP motor or larger . . . 1 HP for up to 7,500
GPH; 1,000 GPH 60' high; or 3,000 GPH from 25' well.
1 1/2" inlet; 1" outlet, Stainless shaft.

TYPE X—2 oil-less bronze bearings. Won't rust. . . . \$10.95

TYPE XB—Ball bearing model. . . . \$12.95

Postpaid if cash with order. Rush your order today

MONEY BACK GUARANTEE

Centrifugal and Gear Pumps in All Sizes

LABAWCO PUMPS, Belle Mead 2, N. J.

THRILLS! EXCITEMENT! ADVENTURE!



JOIN THE NAAA*

*The NAAA is the NATIONAL ASSOCIATION OF ARMCHAIR ADVENTURERS—a grand group of bold, dare-do-wells devoted to effortless, world-wide travel and exploration through the medium of Shortwave Radio Listening. Membership in this exclusive, international organization is limited to those with the courage to risk 50c for a membership certificate and a copy of an exciting new book on Shortwave Listening. Tells when, where, how to listen. Provides log for listing countries you hear. Send 50c to—

NATIONAL COMPANY, INC.
MALDEN 48, MASSACHUSETTS



ROCKET PLANS

BUILD YOUR OWN WORKING MODEL
SINGLE AND TWO STAGE

Detailed 12 pg. illustrated PLANS for:
Rocket construction for 3/4" to 3 1/2" dia. rockets
Launching platform
Numerous solid fuels
Electrical ignition
How to measure firing height
Safety rules — Many other features

Designed for high altitude performance. Our plans may be modified to your own design and size.

Not a Toy — All For Only - \$1.00
SATISFACTION GUARANTEED

ROCKETS, Dept. MJ

4106 Beecliff, Columbia, S. C.



WANT MORE MONEY? GET INTO PHOTOGRAPHY

Coast to coast, high-paying jobs in photography are waiting for people with the "know-how" to fill them. You can quickly, easily qualify at home with the world-famous NYI Learn-by-Doing Method. Write today for free catalog. Also resident training in N. Y. 49th Year. Approved for Vets.

NEW YORK INSTITUTE OF PHOTOGRAPHY

Dept. 49 10 West 33 St. New York 1, N. Y.

HANDWRITING ANALYZE

You can analyze handwriting—at home, in your spare time. No interference with job or social life. Win more pay, social recognition, prestige! Men and women both needed now. Complete lesson and answer service. Personalized instruction. Handsome, suitable-for-framing Diploma to graduates!

I.G.A.S. is the oldest and only grapho analysis school in the world!
Lesson (2) Free Entrance Examination (3) Full Color 48-page Success Book. Absolutely No Obligation. Adults only.

INTERNATIONAL GRAPHO ANALYSIS SOCIETY, INC.
DESK 36 SPRINGFIELD, MISSOURI



SUPER JU JITSU

Now get tough double quick!

A course of instruction in the art of practicing and using this method of applying LIGHTNING-QUICK Super Ju Jitsu. Be Dangerous! These amazing lessons show you how it's done . . . in a big illustrated home-study course. The weapons are just your BARE HANDS—they can be used effectively if you know how and practice the art. Easy to learn; quick. Full 76-lesson course only \$5.95 postpaid—or COD, plus postage. Satisfaction or your money back guaranteed! Order "super Ju Jitsu Course."

NELSON-HALL CO., 210 S. Clinton, Dept. SAR-2, Chicago 6, Ill.

JEEP OWNERS

RE-POWER NOW WITH A V-8 ENGINE — Use
FORD • CHEVROLET • MERCURY

in 2 or 4 Whi-Dr. Jeeps, Jeepsaters, Sta-Won, Trucks, M. J. and Kaiser cars. Conversion Kits \$43.25 to \$59.85. If you want fast action tell us which engine you wish to use, give us year, Model (2 or 4 Whi-Dr) of your vehicle. Send Min. \$15.00 Dep. and we will ship correct kit, Bal. COD. Send full amt. for Prepaid shipment. Wire, phone or write for free details. Also Kits for FORD 6 engine.

HOOSIER MACHINE PRODUCTS CO.

312 S.E. 6th St. Phone CR 6-3442 Pendleton, Oregon, U.S.A.



HOTTEST THING ON Jeep FRONT WHEELS

STOP FRONT DRIVE DRAG IN 2 W. D.

Warn Hubs on your 4 w. d. disengage the front drive in 2 w. d., give it double-duty value with free-wheeling 2 w. d. economy, performance, plus normal 4 w. d.—automatically, with Warn Lock-O-Matics, manually with Warn Locking Hubs. See your dealer soon!

WARN HUBS

WARN MFG. CO., INC.
Riverton Box 6064-A1, Seattle 88, Wn.

WHAT ALL AUTO MECHANICS WANT TO KNOW



This Big Practical Book gives full information, with working diagrams, covering the principles, construction, ignition, service and repair of modern cars, trucks and buses.

Diesel Engines, Hydramatic and Fluid Drives Fully Explained.

A complete guide of 1696 Pages, with over 1500 Illustrations showing inside views of working parts, with instructions for service jobs. Completely up-to-the-minute! Priced at only \$6.

CIRCLE No. 1 IN COUPON

HOW TO FIX HOME APPLIANCES

REFRIGERATORS TOASTERS IRONERS VACUUMS WASHERS DRYERS RANGES FREEZERS

Many other GAS AND ELECTRIC APPLIANCES

Handy Reference for Electric & Gas Servicemen, Mechanics, Dealers and Homeowners. Explains clearly and simply how to locate troubles, how to test, reassemble and connect. Wiring diagrams. 1000 Facts. Easy to read. Answers ALL your questions. 864 Pages. Illustrated. Only \$6.

CIRCLE No. 2 IN COUPON



TV TELLS HOW TO ANSWER RADIO RADIO TV QUESTIONS SERVICE LIBRARY

HERE IS LATE INFORMATION IN A HANDY FORM FOR RADIO AND TELEVISION REPAIRMEN, SERVICEMEN AND STUDENTS

TWO COMPLETE VOLUMES - 1568 Pages - 1085 Illustrations and Diagrams. 1001 Important Facts and Figures on Modern T.V., Radio Electronic Devices. INCLUDES TRANSISTORS & Transistor Circuits, Rectifiers, Record Changers, P.A. Systems, Phonograph Pick-ups, F.M., Auto Radio, Short Wave,

Basic principles, Construction, Installation, Operation, Shooting. How to get Sharp, Clear T.V. Pictures. Install Antennas. How to Test. Explains COLOR SYSTEMS. Methods of Conversion, Terms, etc. Includes Ultra High Frequency. Quick ready reference or use as a home study course. Only \$8 for BOTH volumes.

CIRCLE No. 3 IN COUPON

KNOW YOUR TRUCK

The TRUCK & TRACTOR GUIDE for Mechanics & Drivers, Foremen, Garagemen, Helpers, Owners, Trouble Shooters, Farmers, etc. Covering Gas & Diesel Motor Principles - Construction - Operation - Maintenance - Repair - Brakes - Service of all Parts. 1376 Pages. FULLY ILLUSTRATED. Index. Only \$5.

CIRCLE No. 5 IN COUPON

PLUMBERS AND STEAMFITTERS GUIDES



Practical Trade Assistant & Reference Set. Explains in plain language and by clear illustrations, diagrams, charts, graphs and pictures the principles of modern plumbing practice including Pipe Fitting and Air Conditioning. 4 Vols. - 2624 Pages - 3642 Diagrams & Illustrations. Only \$8 for the complete set of 4 vols.

CIRCLE No. 6 IN COUPON

PAINTING & DECORATING MANUAL

Inside Trade information on outside and inside work, how to mix paints, preparation of surfaces, paper hanging, wood finishes, tools, synthetic paints, color (with color chart), spray equipment, costs, estimating, etc. A COMPLETE guide to easier, better painting and decorating. 464 Pages. Fully Illustrated. Only \$2.

CIRCLE No. 7 IN COUPON

7-DAY FREE EXAMINATION

SEND NO MONEY - Pay the postman nothing! We are glad to send you any of the Audel Guides for absolutely FREE examination in your own home. We take all the risks and leave all the decisions up to YOU. There is no obligation! If you decide to keep the books of your choice you may pay for them under our astounding easy-pay plan of only \$2 a month.

HERE IS ALL YOU DO

IT'S EASY TO ORDER: In the No-Risk Mail Order Coupon at the right just draw a circle around the number of Audel Guides you want us to send you for FREE EXAMINATION. We will send them to you at once to help you build a brighter future by increasing your SKILL. If for any reason at all you are not COMPLETELY satisfied, return the books to us, and that will end the matter! NO STRINGS OR CATCHES TO THIS OFFER.

THEO. AUDEL & CO.

49 West 23rd Street, New York 10, N.Y.

JANUARY 1959

CARPENTERS AND BUILDERS GUIDES



PRACTICAL STOREHOUSE OF MODERN CONSTRUCTION INFORMATION (4 vol. set) for carpenters and all woodworkers. Explains in easy language and by profuse illustration principles, advanced, short cuts, trade secrets, all based on the NEWEST information. Vol. 1-Tools, steel square, saw filing, joinery, furniture, etc.; Vol. 2-Builders' mathematics, drawing plans, specifications, estimates, etc.; Vol. 3-House and roof framing, laying out, foundations, etc.; Vol. 4-Doors, windows, stair building, millwork painting, etc. 4 vols. 1904 Pages. 3700 Illustrations. Whole set only \$8.

CIRCLE No. 8 IN COUPON

PRACTICAL ELECTRICITY

A COMPLETE HANDBOOK-Quick, simplified, ready reference. Complete instruction and practical information on the rules and laws of electricity-Maintenance of Machinery -A.C. and D.C. Motors-Armatures-Wiring Diagrams-House Lighting-Power Wiring-Meters-Batteries-Transformers-etc. Simple to understand. 1520 Pages. 2600 Illustrations. Priced at \$5.

CIRCLE No. 4 IN COUPON

DIESEL

ALL THERE IS TO KNOW ABOUT MODERN DIESEL ENGINES-Basic principles, starting valves, timing, fuel pumps, fuel injection compressor, air compressors, pistons, cylinders, lubrication, cooling systems, etc. Answers on operation, calculations. 640 Pages. Fully Illustrated. Priced \$3.

CIRCLE No. 9 IN COUPON

WELDERS GUIDE

Covers Electric, Oxy-acetylene, Thermit, Unionmelt welding for sheet metal, spot and pipe welds, pressure vessels and aluminum, copper, brass, bronze and other metals. Airplane work, surface hardening, hard facing, cutting, brazing, etc. 608 Pages. Fully Illustrated. Only \$3.

CIRCLE No. 10 IN COUPON

MATHEMATICS MADE EASY

A COMPLETE HOME STUDY COURSE-Starting with the first principles of arithmetic, advancing step by step through the various stages of mathematics, including the rules and calculations for mechanical and electrical problems. New EASY correct methods. Includes plane and solid geometry, trigonometry, algebra, calculus, etc. Practical tests, reference tables and data. How to use slide rule. 752 Pages. 550 Illustrations. Priced at only \$3.

CIRCLE No. 11 IN COUPON

NEW MACHINISTS AND TOOLMAKERS HANDBOOK

MODERN MACHINE SHOP PRACTICE-5 PRACTICAL BOOKS IN ONE. New from cover to cover. Tells how to set up and operate lathes, screw and milling machines, shapers, drill presses and all other machine tools. A COMPLETE INSTRUCTOR AND REFERENCE BOOK. 1728 Pages. Fully Illustrated. Priced at only \$6.

CIRCLE No. 12 IN COUPON

WIRING DIAGRAMS

This book gives the practical facts on wiring of electrical apparatus. It explains clearly and SIMPLY how to wire apparatus for all fields of electricity. Each diagram is complete and self-explaining. Know your HOOK-UPS! 304 Pages. Illustrated. Only \$2.

CIRCLE No. 13 IN COUPON

REFRIGERATION & AIR CONDITIONING

FOUR BOOKS IN ONE - basic principles, servicing, operation, repair of: 1. Household Refrigeration. 2. Special Refrigeration Units. 3. Commercial & Industrial Refrigeration. 4. Air Conditioning Systems. A GOLD MINE of essential information. Completely up-to-date. 1360 Pages. Fully Illustrated and Indexed. Priced at only \$6.

CIRCLE No. 14 IN COUPON

THE NEW ELECTRIC LIBRARY

A COMPLETE ENCYCLOPEDIA explaining in the simplest terms the fundamental principles, rules and applications of applied electricity.

A COMPLETE COLLEGE EDUCATION!

Fully illustrated with diagrams and sketches, calculations and tables for ready reference. Questions and answers. Trial tests for practice study and review. All based on the most modern theory.

Vol. 1-Principles and rules of electricity, magnetism, armatures, repairs. No. 15

Vol. 2-Dynamos, DC Motors, construction, installation, maintenance, etc. No. 16

Vol. 3-Testing instruments and tests, storage battery constr. and repairs. No. 17

Vol. 4-Alternating current, power factor, alternators, transformers. No. 18

Vol. 5-A.C. Motors, windings, maintenance, converters, switches, fuses, etc. No. 19

Vol. 6-Relays, condensers, regulators, rectifiers, meters, switchboards, etc. No. 20

Vol. 7-Wiring, house light and power, circuits, high

tension, plans, code, etc. No. 21

Vol. 8-Railways, signals, elevators, ignition, etc. No. 22

Vol. 9-Radio, telephone, telegraph, television, motion pictures. No. 23

Vol. 10-Refrigeration, illumination, welding, X-ray, electrical appliances, Index. No. 24

7,000 fully illustrated pages. Priced at only \$20 for the ENTIRE SET. Also sold individually for \$2 each.



ALL TYPES OF BLUEPRINT READING

How to read scales, the standard symbols, detail and assembly prints, working drawings, short cuts, helps, hints and suggestions. THE MAN WHO CAN READ BLUEPRINTS IS IN LINE FOR A BETTER JOB. This book gives you the secret language, step by step in easy stages. 448 Pages. Very Fully Illustrated. Priced at \$3.

CIRCLE No. 25 IN COUPON

MASONS & BUILDERS GUIDES

A PRACTICAL ILLUSTRATED 4 VOL. SET-Explaining in clear, simple language and profuse illustration, principles, advances, short cuts, trade secrets, based on modern practice - including how to figure and calculate various jobs.

Vol. 1-Brick work, bricklaying, bonding, designs. Vol. 2-Brick foundations, arches, tile setting, estimating. Vol. 3-Concrete mixing, placing forms, reinforced stucco. Vol. 4-Plastering, stone masonry, steel construction, blueprints. 4 Vols. 1440 Pages. 2067 Illustrations. Complete Set only \$8.

CIRCLE No. 26 IN COUPON

ELECTRIC MOTORS

THIS GUIDE covers the construction, hook-ups, control, maintenance and trouble shooting of all types of motors. Includes armature winding. Explains entire subject in most detail in simple language. Over 1956 Pages of information. 617 Diagrams. All types of motors fully illustrated and indexed for ready reference. Priced at only \$5.

CIRCLE No. 27 IN COUPON

OIL BURNERS

New, complete, explaining in detail both domestic and industrial oil burners. Includes electrical hook-ups and wiring diagrams. Fully covering the theory, construction, installation, operation, testing, servicing and repair of all equipment. Indexed for ready reference. Over 416 Pages. 320 Illustrations and Diagrams. Only \$2.

CIRCLE No. 28 IN COUPON

ADDITIONAL IMPORTANT TITLES

The following Audel Guides are all the best in their fields, written in clear simple fashion, all lavishly illustrated. Circle the numbers wanted in the MAIL ORDER COUPON below. All books are sent for FREE EXAMINATION.

- No. 29 SHEET METAL PATTERN LAYOUTS. 1152 Pages. \$7.50
- No. 30 SHEET METAL WORKERS HANDY BOOK. 448 Pages. 2.00
- No. 31 MECHANICAL DRAWING GUIDE. 192 Pages. 2.00
- No. 32 MECHANICAL DRAWING AND DESIGN. 480 Pages. 3.00
- No. 33 ELECTRICIANS DEVICES. 304 Pages. 2.00
- No. 34 ELECTRICIANS EXAMINATIONS. 272 Pages. 2.00
- No. 35 ELECTRIC POWER CALCULATIONS. Page 480. 3.00
- No. 36 ELECTRIC DICTIONARY. 9000 Terms. 3.00
- No. 37 POWER PLANT ENGINEERS GUIDE. 1568 Pages. 5.00
- No. 38 ENGINEERS AND FIREMANS EXAMS. 344 Pages. 2.00
- No. 39 OPERATING ENGINEERS LIBRARY. 3 Book Set. 12.00
- No. 40 PUMPS, HYDRAULICS AND AIR COMPRESSORS. 1760 Pages. 4.00
- No. 41 HOUSE HEATING GUIDE. 1008 Pages. 5.00

MAIL THIS NO-RISK COUPON TODAY!

THEO. AUDEL & CO. - Self Improvement Publishers Since 1879 - p-1

49 W. 23rd Street, New York 10, N.Y.

Please mail me for 7 days' FREE EXAMINATION the books I have circled at right. I agree to mail \$2 in 7 days on each book or set ordered, and to further mail \$2 a month on each book or set ordered until I have paid the purchase price, plus shipping costs. If I am not completely satisfied with my Audel Guides I may return them.

NAME _____	7	8	9	10	11
ADDRESS _____	12	13	14	15	16
OCCUPATION _____	17	18	19	20	21
	22	23	24	25	26
	27	28	29	30	31
	32	33	34	35	36
<input type="checkbox"/> SAVE SHIPPING COSTS! Check here if you enclose complete payment with order. We pay postage charges. You have some return privilege.	37	38	39	40	41

LEARN PLASTICS FABRICATION AT HOME!

Complete Low-Cost Home Training Course NOW Available

There's exciting opportunities for you in Plastics Fabrication. Fun and relaxation as a hobby! Big money as a spare or full-time business! Course teaches you how to make molded, cast, internally carved colored plastic jewelry, toys, furniture, novelties, signs. Professionally prepared. Used by Manual Training and Industrial Arts Teachers. Earn as you learn. All materials furnished. For men, women.

Accredited Member National Home Study Council



SEND FOR FREE BOOKLET



INTERSTATE TRAINING SERVICE
Dept. C-3, Portland 12, Oregon
Send Free Booklet on Plastics Home Training Course.

Name _____
Address _____
City _____ Zone _____ State _____

AMAZING STAMP OFFER!

Free

TO GET NAMES FOR OUR MAILING LIST

- 1 WORLD MAP—authentic 3 ft. sq. Mercator projection map, used by air and sea navigators—yours FREE!
- 2 STAMP FINDER—identifies stamps around the world—no matter how strange their script letters—yours FREE!
- 3 ENCYCLOPEDIA OF STAMP-ISSUING COUNTRIES—Tells area, location, population, parent country, etc.—yours FREE!

Also FREE: 30 MUCH-WANTED FOREIGN STAMPS

NOW you can identify even the strangest stamps—at a glance—with this GIANT world map and stamp guide. Opens up to 3 SQUARE FEET to make a big handsome wall map you'll be proud to display in your room. THE PHILATELIC WORLD MAP & GUIDE is well-known among stamp fans all over the country. Complete and up-to-date. Locates the tiniest, most remote stamp-issuing countries in the world. While our supply lasts—we'll send it to you FREE. But that's not all! You also get—FREE—30 colorful foreign stamps—from exciting, far-off places like San Marino, Djibouti, etc. Included is Chi-

nese anti-Communist stamp with face value of \$10,000 in Nationalist money! Also interesting stamp offers for your inspection. No obligation. But hurry. Offer may be withdrawn at any time. Send your name and address, with 10c to cover postage and handling, to LITTLETON STAMP CO., Dept. 9-PM-1, Littleton, New Hampshire.



ACCORDION PRICES SMASHED



SAVE 50% AND MORE DURING THIS GREAT SALE

5 Days' FREE TRIAL

Hurry! Get in on these sensational accordion values. America's largest exclusive accordion dealer selling out finest brand new accordion overstock! Fabulous savings. Leading brands in more than 30 new models. Small down payment. Easy terms. Trade-ins accepted. Chance of a lifetime.

- FREE for promptness...
- FREE Lessons
 - Music Stand
 - Deluxe Case
 - Lifetime Guarantee

FREE COLOR CATALOG & Wholesale Prices

Learn how easily you may own and play a fine accordion. Rush name and address for big FREE Color Catalog and new low wholesale price list. No obligation. WRITE TODAY!

ACCORDION MANUFACTURERS AND WHOLESALERS OUTLET
2003 W. CHICAGO AVE., Dept. R-19, CHICAGO 22, ILLINOIS

REAL ESTATE BE A BROKER

PAYS BIG! SEND FOR FREE, BIG, ILLUSTRATED CATALOG NOW! Graduates report making substantial incomes. Start and run your own business quickly. Men, women of all ages. Learn easily. Course covers Sales, Property Management, Appraising, Loans, Mortgages, and related subjects. STUDY AT HOME or in classrooms in leading cities. Diploma awarded. Write TODAY for free book! No obligation. Approved for World War II and Korean Veterans. **WEAVER SCHOOL OF REAL ESTATE (Est. 1936)** 2020R Grand Avenue Kansas City, Mo.



Finish HIGH SCHOOL AT HOME

Complete 4 Yrs. in 12 Months

Learn More! Earn More! Enter professional or technical schools. Advance Socially. Live a Happier, Fuller Life. Individual Courses or complete schedule. WRITE FOR SCHOOL BULLETIN.

ACADEMY FOR ADULTS

30 W. Washington, Dept. PM-19, Chicago, Ill.

Learn ACCOUNTING Business Administration

Bookkeeping, secretarial and allied subjects at home in your spare time or attend nationally approved resident school. Write for FREE Success Book giving complete details on courses, plans, rates and employment opportunities. G.I. approved. Write Dept. A.

Hills BUSINESS UNIVERSITY AND EXTENSION SCHOOL

619 W. MAIN ST. OKLAHOMA CITY 2, OKLAHOMA

Shrinks Hemorrhoids New Way Without Surgery Stops Itch—Relieves Pain

For the first time science has found a new healing substance with the astonishing ability to shrink hemorrhoids and to relieve pain—without surgery.

In case after case, while gently relieving pain, actual reduction (shrinkage) took place.

Most amazing of all—results were so thorough that sufferers made astonishing statements like "Piles have ceased to be a problem!"

The secret is a new healing substance (Bio-Dyne*)—discovery of a world-famous research institute.

This substance is now available in suppository or ointment form under the name Preparation H.* Ask for it at all drug counters—money back guarantee. *Reg. U.S. Pat. Off

NOW READY! McGraw-Hill's New Train-Yourself Course

TELEVISION AND
RADIO REPAIRING

REPAIRING
RECORD CHANGERS

PROFITABLE RADIO
TROUBLESHOOTING

PRACTICAL RADIO
SERVICING

PROFITABLE
TELEVISION
TROUBLESHOOTING

**6 BIG
VOLUMES**
Including
Home Course
Outline!
Shows how
to Get
Ahead Fast.

FIX TV RADIO and RECORD CHANGERS RIGHT AWAY

—even if you've never looked inside a set before!



AT LAST — at Amazing LOW COST — The Most Complete TV-Radio Repair Course Ever Published. TELLS and SHOWS How to Do Every Job Quickly and Easily — Make GOOD MONEY, Full or Spare Time in the BOOMING Repair Business

AFTER 10 YEARS OF PREPARATION — McGraw-Hill's new 6-Volume Course brings you everything you need to know to "cash in" on the TV-RADIO boom. Over 2,350 pages of money-making "know-how" by top factory engineers and electronic experts. **THREE** giant REPAIR MANUALS tell and show how to FIX every trouble the easy way. **TWO** huge TROUBLESHOOTERS tell exactly WHERE to begin, WHAT tools to use, HOW to "polish off" every job. Complete Home Study Volume guides you every step of the way, tells how to get ahead fast as a repairman — build up your own business, full or spare time, for **BIG PROFITS!**

EARN While You Learn

Tested — and now used in top schools, and repair shops — Course volumes are simple enough for green beginners, amazed "pros" with new easy methods. Starts you doing simple repairs — and earning money — from very first chapter. ABC pictures and directions make tougher jobs a "snap." Before you finish you can earn many times its cost.

NO previous training needed. NO complicated formulas. PLAIN ENGLISH

pictures and directions cover ANY job on EVERY set — tubes, circuits, speakers, new a-c/d-c portables, Color TV, even what to charge for every job!

BIG MONEY — Spare or Full Time

Forget lack of experience. Forget your age. Over 40 MILLION TV sets, 130 MILLION radios — and the shortage of repairmen — mean big money for you. Course makes it easy to "cash in," spare time or full, start your own business, enjoy your work and a big bank account!

SEND NO MONEY

Try Course 10 days FREE. (We pay shipping!) If you don't agree it can get you started in a money-making repair business — return it, pay nothing. Otherwise keep it. Earn while you learn; and pay the low cost on easy terms. Mail coupon NOW. McGraw-Hill Book Co., Dept. PM-1, 327 West 41st St., New York 36, N. Y.

Examine
Entire Course
FREE
for 10 Days!

PARTIAL CONTENTS

- 1 Television and Radio Repairing — Testing, repairing, replacing parts, 566 pages. 700 "This-Is-How" pictures, diagrams. By John Markus, Feature Ed., Electronics Magazine.
- 2 Practical Radio Servicing — Easy-to-follow directions, diagrams, drawings — with job sheet for every repair job. 599 pages. 473 illus. By William Marcus, Alex Levy, Electronic Training Experts.
- 3 Profitable Radio Troubleshooting — WHERE to look and WHAT to do for every trouble. How to avoid costly mistakes, handle customers profitably. 330 pages. 153 "how-to" illus. By William Marcus, Alex Levy.
- 4 Profitable TV Troubleshooting — Short-cuts to SPOT and FIX every trouble — fast, for big profits. By Eugene A. Anthony, Service Consultant, General Elec. Co.
- 5 Repairing Record Changers — Step-by-step pictures and directions — how to set up service bench, etc. 278 pages. 202 A-B-C pictures. By Eugene Ecklund, Eng. DuMont Lab., Inc.
- 6 Complete Home Course Outline — Getting started in television and radio servicing. How to get the most out of your Course. How to get ahead FAST. By John Markus.

Free ALL THREE Valuable Repair Aids: TV, RADIO, and CIRCUIT Detect-O-Scopes (Total Retail Value \$3.00)



FREE — whether you keep the Course or not — **THREE** amazing DETECT-O-SCOPE Charts. TV and RADIO Scopes enable you to spot all tube troubles in a jiffy. CIRCUIT Scope spots all circuit troubles. Make fix-it jobs easier, faster. 16 x 21 inches. ALL THREE (worth \$3.00) yours FREE while they last on this introductory offer.

THIS COUPON SAVES YOU \$11.85

McGraw-Hill Book Co., Dept. PM-1
327 West 41st St., New York 36, N. Y.

Send me — postpaid — for 10 DAYS' FREE TRIAL the 6-Vol. McGraw-Hill TV, Radio and Changer Servicing Course. If okay, I'll remit only \$4.95 in 10 days; then \$5.00 monthly for 5 months. (A total savings of \$11.85 on the regular price of the Course and Detect-O-Scopes.) Otherwise, I'll return Course in 10 days; pay nothing.

ALSO send FREE (to keep whether or not I keep the Course) the 3 TV, RADIO, and CIRCUIT DETECT-O-SCOPE CHARTS, — total value \$3.00.

Name

(Please Print Clearly)

Address

City Zone No. State

CHECK HERE if you prefer to enclose first payment of \$4.95 with coupon. Same easy pay plan; same 10-day return privilege for full refund.

PM-1



U. S. Forest Service photo

Do You Know This Old-Timer?

The time is about 40 years ago, if you need a clue. Two forest rangers are ready to attempt a hazardous 89-mile mountain trip from Enches River to Tavern Creek in Snoqualmie National Forest, Wash. (They

made it—in four days!) Don't let that car top fool you—it really didn't belong to that automobile. Can you identify the car and the model year? Turn to page 268 for the answer.



MAKE YOUR OWN GLASS SCREENS with REAL Flowers and Butterflies

permanently embedded in Castolite. Also make unusual place-mats, bowls, dishes, trays, table tops and other distinctive items with embeddings of colorful leaves, shells, coins, photos, unusual fabrics and other interesting objects. Make them for yourself, for gifts or to sell at handsome profits.

MAKE GOOD MONEY AT HOME No Experience, No Equipment Needed

The laminating process is so simple anybody can do it. Neither heat nor pressure are required nor is any equipment needed except a pair of scissors, a knife and a set of measuring spoons. In less than one hour, you can produce articles of professional quality. Sell them direct or have department stores and specialty shops handle your sales for you. Also do high priced custom work for interior decorators, architects and builders of fine homes and offices.

NEW HANDBOOK SHOWS YOU HOW

Top-flight designers and craftsmen like Alexander Bick, Dorothy Thorne, Nancy Hutchings (who designed the screen shown in photo) and others have written illustrated step-by-step directions which show you how to work with liquid Castolite plastics. When you have learned the simple laminating technique, you can apply the same process to your own ideas to make articles that people really want and are willing to pay good money for.

The complete set of manuals contains 25 projects, illustrated with over 150 photographs and many sketches. Nothing like it has ever been published before. The price of only ONE DOLLAR also includes a copy of "How to Earn Extra Money at Home." Send your order now to Commercial Crafts Division, Dept. A-1.

THE CASTOLITE COMPANY, Woodstock, Illinois

FREE THE HISTORY OF THE COMPASS SEND FOR YOUR COPY

New **DINSMORE** *Celebrity* COMPASSES

in Beautiful GOLD or SILVER

A jeweled, precision instrument—designed for modern cars. Full, indirect illumination. Sharp, clear letters. Silver or gold Celebrity models \$6.95, standard models \$5.45, illuminated \$6.45 APPROVED BY AUTO MAKERS Fine Quality Compasses for over 31 Years

DINSMORE INSTRUMENT CO. 1802-21 Kelso St., Flint 1, Michigan



Write for Folder

EXTRA! ANOTHER Scoop!

SENSATIONAL NEW BENJAMIN BB REPEATERS...

The Only Repeating Gun on the Market with... **Piggy-Back SHOT MAGAZINE**

THE REVOLUTIONARY NEW GRAVITY FEED ACTION THAT LOADS BB AMMUNITION automatically!

A shot is placed in firing position each time bolt is pulled back and closed. Finest quality. Powerful—Accurate—Economic. Use indoors or out. New Bar-V sight.

FREE Ask for Catalog All Models Benjamin Single Shot and Repeaters... Cal. BB or 177 or 22. ALSO, SPECIAL OFFER ON HUNTING AND FISHING KNIVES, ETC.

No. 3600 Benjamin Super 100 Shot BB Gas Rifle, No Pumping... Auto Loading. — \$14.95
 No. 3600CS DeLuxe Gas Rifle with Custom Stock — \$17.95
 No. 3100 Benjamin Super 100 Shot BB Air Rifle with Regular Stock. Economical. — \$21.95
 No. 3100CS DeLuxe Air Rifle with Custom Stock — \$24.95

BENJAMIN AIR RIFLE CO.
 606 MARION ST. ST. LOUIS 4 MO. U.S.A.

\$14.95

Superior's New Model 70 UTILITY TESTER® FOR REPAIRING ALL ELECTRICAL APPLIANCES and AUTOMOBILE CIRCUITS



As an electrical trouble shooter the Model 70:

- Will test Toasters, Irons, Broilers, Heating Pads, Clocks, Fans, Vacuum Cleaners, Refrigerators, Lamps, Fluorescents, Switches, Thermostats, etc.
- Measures A.C. and D.C. Voltages, A.C. and D.C. Current, Resistances, Leakages, etc.
- Will measure current consumption while the appliance under test is in operation.
- Incorporates a sensitive direct-reading resistance range which will measure all resistances commonly used in electrical appliances, motors, etc.
- Leakage detecting circuit will indicate continuity from zero ohms to 5 megohms (5,000,000 ohms).

As an Automotive Tester the Model 70 will test:

- Both 6 Volt and 12 Volt Storage Batteries • Generators • Starters • Distributors
- Ignition Coils • Regulators • Relays • Circuit Breakers • Cigarette Lighters • Stop Lights • Condensers • Directional Signal Systems • All Lamps and Bulbs • Fuses
- Heating Systems • Horns • Also will locate poor grounds, breaks in wiring, poor connections, etc.



INCLUDED FREE This 64-page book—practically a condensed course in electricity. Learn by doing.

Just read the following partial list of contents: What is electricity? • Simplified version of Ohms Law • What is wattage? • Simplified wattage charts • How to measure voltage, current, resistance and leakage • How to test all electrical

appliances and motors using a simplified trouble-shooting technique.

- How to trace trouble in the electrical circuits and parts in automobiles and trucks.

Only **\$15⁸⁵**
Model 70 comes complete with 64 page book and test leads.

Superior's New Model 82 A truly do-it-yourself type



TUBE TESTER

TEST ANY TUBE IN 10 SECONDS FLAT!

- 1 Turn the filament selector switch to position specified.
- 2 Insert it into a numbered socket as designated on our chart (over 600 types included).
- 3 Press down the quality button—

THAT'S ALL! Read emission quality direct on bad-good meter scale.

FEATURES:

- Tests over 600 tube types.
- Tests OZ4 and other gas-filled tubes.
- Employs new 4" meter with sealed air-damping chamber resulting in accurate vibrationless readings.
- Use of 22 sockets permits testing all popular tube types and prevents possible obsolescence.
- Dual Scale meter permits testing of low current tubes.
- 7 and 9 pin straighteners mounted on panel.
- All sections of multi-element tubes tested simultaneously.
- Ultra-sensitive leakage test circuit will indicate leakage up to 5 megohms.

Production of this Model was delayed a full year pending careful study by Superior's engineering staff of this new method of testing tubes. Don't let the low price mislead you! We claim Model 82 will outperform similar looking units which sell for much more—and as proof, we offer to ship it on our examine before you buy policy.

Model 82 comes complete, housed in portable, hand-rubbed oak cabinet with removable cover. Only

\$36⁵⁰

SHIPPED ON APPROVAL NO MONEY WITH ORDER — NO C. O. D.

Try any of the above instruments for 10 days before you buy. If completely satisfied then send down payment and pay balance as indicated on coupon. No Interest or Finance Charges Added! If not completely satisfied return unit to us, no explanation necessary.

MOSS ELECTRONIC, INC.

Dept. D-552, 3849 Tenth Ave., New York 34, N. Y.

Please send me the units checked on approval. If completely satisfied I will pay on the terms specified with no interest or finance charges added. Otherwise, I will return after a 10 day trial positively cancelling all further obligation.

Model 70 Total Price \$15.85
\$3.85 within 10 days. Balance \$4.00
monthly for 3 months.

Name

Address

City Zone State

All prices net. F.O.B., N.Y.C.

Model 82 Total Price \$36.50
\$6.50 within 10 days. Balance \$6.00
monthly for 5 months.

FREE! 100 WORLDWIDE STAMPS
... just released!



Send today for 100 scarce, beautiful stamps — FREE! Get newest issues of last 12 months, including United Arab Republic, Belgian Atomium, Morocco, Zanzibar — everywhere. So new, some are not cataloged yet. All different, genuine, mint and used, bi-colors, pictorials, topicals. This FREE Worldwide collection has never been offered before. Supply limited, one packet per collector. Send for this rare offer today, plus helpful "Collector's Guide" and other offers for free inspection. Rush name, 10¢ for handling to GARCELON STAMP CO., Dept. PM1W, Calais, Maine.

GARCELON STAMP CO. Dept. PM1W, Calais, Maine
Rush FREE 100 Different Stamps, Collector's Guide, other offers. Enclosed 10¢ for handling. (PLEASE PRINT)

NOW! Home Wiring Made Easy

... Step-by-step book shows you how to do HUNDREDS of jobs — from simplest repairs to wiring a complete house
THINK OF THE MONEY YOU'LL SAVE—or earn—when you can do residential wiring jobs! No previous experience needed. This 495-page, step-by-step guide **Practical Residential Wiring** gives you crystal-clear diagrams, simple directions on how to do the actual work; how to read and prepare wiring plans; what tools to use; splicing, taping joints; bending conduits; cutting cables; connecting fixtures; switches; testing circuits.

Tells how to wire a bungalow, large house, workshop, garage, house being remodeled; how to install signaling, paging systems, burglar alarms, bell-ringing transformers, incandescent and fluorescent lighting fixtures—and much more! PLUS glossary of electrical terms, big Trouble-Shooting Section, Electrical Code Tables.

SEND NO MONEY NOW
Examine book for 10 days —FREE. If not convinced it can save you money (or help you earn it) return book: owe nothing. Otherwise send only \$1.95, plus small postage charge, and \$2 per month for 2 months. For FREE EXAMINATION copy, write today to: D. Van Nostrand Co., Dept. 471, 120 Alexander St., Princeton, N. J. (Established 1848)

- Simple A-B-C Directions On:**
- Household appliances
 - Floor plans
 - Wiring ceiling, attic
 - Door bells, chimes
 - Door-opener systems
 - Open wiring
 - Armored cable
 - Grounding
 - Surface extensions
 - Proportioning load
 - Cable installation
 - Volt current testing
 - Defective wiring
 - Rigid conduits
 - tools, equipment, plan-reading
- ... and much more!



HIGH WAGES!

High Wages can be yours as an Operating Engineer of heavy construction equipment! Learn NOW to operate our diesel engined bulldozers, draglines, cranes, back hoes, scrapers and motorgraders! Machines of major manufacturers are used in our training program. Contractors need trained operators and pay high wages to our graduates. We invite comparison and inspection at the nation's original construction equipment operator's training schools.

Veterans: Ask about GI benefits!
Write today for free school catalogue
No obligation, to either address
THE NATIONAL SCHOOLS
of HEAVY EQUIPMENT OPERATION
Dept. D-25
P.O. Box 8243, Charlotte, N. C. • P.O. Box 527, Weiser, Idaho

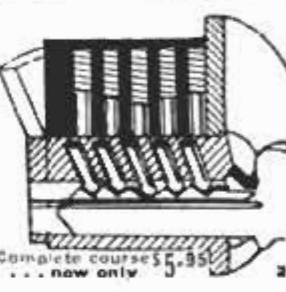

Locksmithing AND KEY MAKING
Now Made Easy! Practical up-to-date course teaches you how to pick locks, de-code, make master keys, repair, install, service, etc. New self-instruction lessons for every handyman, homeowner, carpenter, mechanic, service station operator, fix-it shop, hardware dealer, gunsmith. 53 easy illustrated lessons. Full price only \$5.95 postpaid; or C.O.D. plus postage. Satisfaction or refund guaranteed.
Nelson-Hall Co., Dept. AR-2
210 S. Clinton Chicago 6, Ill.
... now only \$5.95



MEN!
MAKE \$4.00 AN HOUR
After Work—Easy!

Show Wonderful PARAGON Shoes
Work with friendly people. Free Selling Kit—up to \$4.00 cash commission per sale. Full or spare time. Over 153 styles. Big Cash Bonus. Easy selling helps, Magic Cushion. No investment.
WRITE for Free Catalog.
PARAGON SHOE CO.
79 Sudbury St., Dept. 20
Boston 14, Mass.

\$1 BRINGS YOU \$18

Discover Flok-Kraft and Earn \$\$\$\$\$ AT HOME
Earn up to \$15.00 per hour spare time. Amazing new Velvet-fiber spray instantly makes any object (Lamps, Radio & TV Cabinets, Figurines, Signs, Auto dash boards, toys, furniture, draperies—anything) worth expensive \$\$\$\$\$ Prices... like magic, you can spray anything with this beautiful new suede-like finish that feels like rich Velvet.
EARN UP TO \$300.00 PER WEEK SPARE TIME
Imagine, materials cost only 3¢ per square foot. (Average TV or radio cabinet can be beautifully sprayed with this startling new 3-dimensional Velvet finish in 15 minutes at a cost of only 34¢ in materials. Your charge for this job is at least \$10.00.)
REPRESENTATIVES IN YOUR AREA URGENTLY NEEDED
Own your own business. Work at home in your spare time. Help fill the huge growing demand for this amazing new beautiful Velvet-fiber finish. Orders come from stores, offices, homes, architects, auto dealers,—everywhere. Possible \$20,000,000.00 worth of jobs to be done. Investigate today—be first in your area! Actual samples in 16 Radiant Colors. Booklet of 50 Home Business Opportunities and Confidential Details all sent free! Send No Money. Write: Coast Industries, Los Angeles 61, Calif., Dept. B-1.

Can You Move to a **BETTER JOB** at **BIGGER PAY?**

or do you lack training
for the job you want?

**Use Your Spare Time
at Home and Prepare
for YOUR CAREER!**

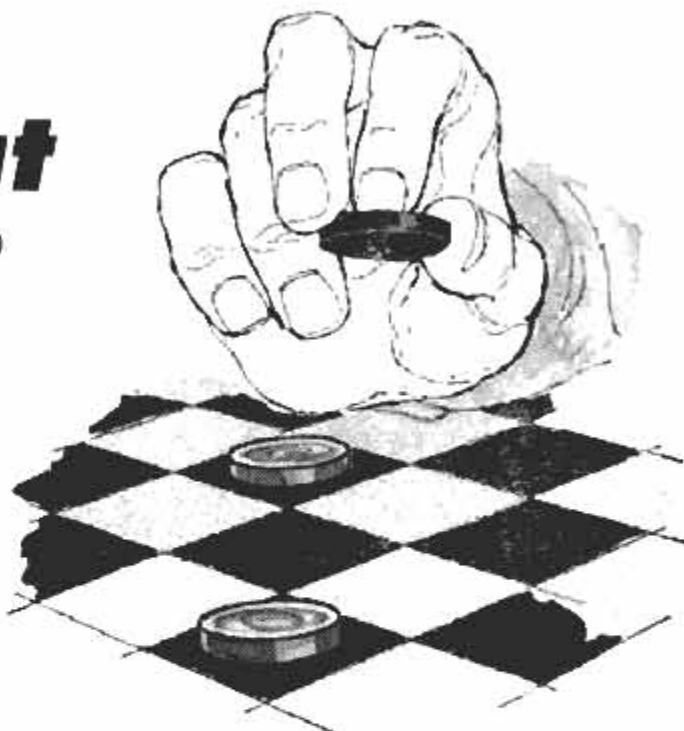

FULL INFORMATION...NO COST...NO OBLIGATION

Yes, what about your future? Do you look into a rather hazy and distant time when all you can do is hope for the promotion or job you want? Or, can you look into the future with confidence...knowing you have the training which makes you capable of progress?

U. S. Government statistics show that high school graduates earn an average of \$38 more per week than people with only a grade school education... this proves the importance of a high school diploma. But even with a high school education, job competition today is extremely tough. And if it's time for your move...and you don't know which way to go...you can't expect to cope with that situation. That is why, last year alone, over half a million people enrolled

in home study job advancement courses.

Are you working toward the security you and your family need and deserve? *You can do this by making spare time self-improvement time.* It isn't too late to train for a successful career because in home study age is no barrier.

If you are in work you like, but want to progress faster, you can apply what you learn while you are studying.

American School, founded in 1897 as an educational institution not for profit, has helped many thousands of other ambitious people earn more while they learned more. TODAY you can make the big decision of your life. Check, fill out and mail coupon today. (Check more than one if you are undecided as to which appeals most.)

AMERICAN SCHOOL, Dept. G 145, Drexel at 58th, Chicago 37, Ill.

Canadian Residents: Write to American School, 6083 Sherbrooke St., W., Montreal

AMERICAN SCHOOL, Dept. G145, Drexel at 58th, Chicago 37, Ill.

Without obligation, send FREE information on the subjects I have checked.

- | | | |
|--|---|---|
| <input type="checkbox"/> Accounting | <input type="checkbox"/> Contracting | <input type="checkbox"/> Mechanical Engineering |
| <input type="checkbox"/> Apprenticeship Courses | <input type="checkbox"/> Diesel Technician | <input type="checkbox"/> Mechanical Technology |
| <input type="checkbox"/> Architecture & Building | <input type="checkbox"/> Drafting—Building Trades | <input type="checkbox"/> Metalworking Courses |
| <input type="checkbox"/> Automotive Technician | <input type="checkbox"/> Drafting—Machine Trades | <input type="checkbox"/> Plumbing—Practical |
| <input type="checkbox"/> Better Foremanship | <input type="checkbox"/> Electrical Engineering | <input type="checkbox"/> Private Secretary |
| <input type="checkbox"/> Blueprint Reading | <input type="checkbox"/> Electricity—Practical | <input type="checkbox"/> Retail Merchandising |
| <input type="checkbox"/> Bookkeeping | <input type="checkbox"/> Electronics—Industrial | <input type="checkbox"/> Salesmanship—Outside |
| <input type="checkbox"/> Business Management | <input type="checkbox"/> HIGH SCHOOL COURSES | <input type="checkbox"/> Sheet Metal Work |
| <input type="checkbox"/> Civil Engineering | <input type="checkbox"/> Machinists | <input type="checkbox"/> Tool Making |

NAME _____ OCCUPATION _____

HOME ADDRESS _____ AGE _____

CITY _____ STATE _____

Accredited Member NATIONAL HOME STUDY COUNCIL

The sooner
you **ACT**,
the sooner
YOUR GOAL
can be
REACHED

SAVE 1/2 OR MORE

Build this six transistor

portable radio

\$29⁹⁵

No other portable gives you so many features at such a low price: 4" x 6" speaker, 500 to 1000 hr. battery life, two-tone molded plastic case, plus high quality, all-transistor circuit.



IT'S EASY, FUN, EDUCATIONAL

No special tools or skills required. Clearly illustrated step-by-step instructions guarantee your success—and you learn about electronics the easy way—BY DOING!

SEND FOR FREE CATALOG

... Describing nearly 100 other "do-it-yourself" HEATHKITS for hobby, hi-fi, ham radio or professional.



HEATH COMPANY

pioneer in "do-it-yourself" electronics

BENTON HARBOR 17, MICH.

a subsidiary of Daystrom, Inc.

name _____
address _____
city & state _____

Make \$500 an Hour CASH PROFIT THE DAY YOU START!



START YOUR OWN BUSINESS AT HOME... SHARPEN HOUSEHOLD, GARDEN AND SHOP TOOLS IN SPARE TIME

Now you can turn spare time into Big Cash Profits with new Belsaw Sharp-All. Sharpen knives, scissors, shears, snips, ice skates, mower blades, hedge trimmers, grass whips, axes, chisels, screw drivers, scrapers and saws... just about any household, garden and shop tool. Your own CASH business with no inventory. No calls to make. No experience needed.

Learn how easily you can start your own spare time business. Amazing low cost easy-payment plan. Send postcard for FREE BOOK.

BELSAW SHARP-ALL CO
719 Field Bldg. • Kansas City 11, Missouri



college graduates get ahead faster!

You see it in your own city. They have higher incomes... advance more rapidly. Grasp your chance for a better life. Industrial growth... automation... technical advances create career opportunities for engineers, accountants, management experts. Share rewards awaiting college men. Important firms visit campus regularly to employ Tri-State College graduates. Start any quarter in this world-famed college. Approved for veterans.

Bachelor of Science degree in 27 months

In Mechanical, Civil, Electrical (Electronics or Power Major), Chemical, Aeronautical Engineering. In 36 months a B.S. in Business Administration (General Business, Accounting, Motor Transport Management majors). Superior students may accelerate. 36-weeks course in Drafting. *Interstate program:* Technical fundamentals stressed; comprehensive courses with more professional class hours. *Small classes:* personalized instruction. Enrollment limited. Preparatory courses. *Beautiful campus.* Well-equipped, new and modernized buildings and laboratories. Enter March, June, Sept., Jan. Earnest, capable students (whose time and budget require accelerated courses and modest costs) are invited to write Jean McCarthy, Director of Admissions, for catalog and book "Your Career in Engineering and Commerce."



TRI-STATE COLLEGE

419 College Avenue • • • Angola, Indiana

CARBURETOR SAVES GAS VACUATING OVERRICH MIXTURES



Car owners who are getting poor gas mileage, and wasting money due to overrich mixtures, will be pleased to learn how to save gas. Easily installed Vaco-matic invention is **Automatic** and operates on the supercharge principle. For cars, trucks, tractors. **SALESMEN WANTED! Big Profits!** FOR FREE PARTICULARS. HOW YOU CAN GET ONE ON YOUR OWN CAR FOR INTRODUCING, just send your name and address on a post card to—

VACU-MATIC CARBURETOR, Dept. 871, Wauwatosa, Wis.

NEW ADVERTISING MACHINE

Prints & Illustrates Postal Cards

Learn how businesses are now boosting sales in spite of conditions—with ad messages—printed on government postals with amazing new patented **CARDMASTER**. Guaranteed five years. Low price—sold direct. SEND NAME for FREE illustrated book of money-making ideas and complete unique advertising plans. Send your name today to **CARDMASTER CO., 1920 Sunnyside Avenue, Dept. 121, Chicago 40, Ill.**



LAW FREE BOOK



Write today for a FREE copy of illustrated law book, "THE LAW-TRAINED MAN," which shows how to earn the professional Bachelor of Laws (LL.B.) degree through home study of the famous Blackstone Law Course. All necessary books and lessons provided. Moderate cost; convenient monthly terms. Write for FREE law training book today. **Blackstone School of Law, 307 N. Michigan Ave. Dept. 51, Chicago 1, Illinois**
Founded 1890

RUPTURED

BE FREE FROM TRUSS SLAVERY

Surely you want to THROW AWAY TRUSSES FOREVER, be rid of Rupture Worries. Then Why Do you put up with wearing a griping, chafing and unsanitary truss the balance of your life? If you do, it will NOT be through necessity but through choice on your part.

Now there is a new modern Non-Surgical treatment that is designed to permanently correct rupture. These Non-Surgical treatments are so certain, that a Lifetime Certificate of Assurance is given. Write today for our New FREE Book that gives facts that may save you painful, expensive surgery. Tells how non-surgically you may again work, live, play, love and enjoy life in the manner you desire. There is no obligation. **Excelsior Medical Clinic, Dept. H6124, Excelsior Springs, Mo.**

HERE'S A READY-MADE FUTURE FOR YOU

Start Your own Business IN

ELECTRICAL APPLIANCE REPAIRING

MILLIONS OF HOMES IN U.S.
HAVE 6-12 SMALL APPLIANCES
& MILLIONS MORE SOLD EVERY
YEAR. -MILLIONS
NEED REPAIR NOW
WITH THE NEED
INCREASING
DAILY!

EARN WHILE YOU LEARN

"Only had your course a few short weeks and have already made \$800.00."

J.D.S., St. Louis, Mo.

"I work day times at the shipyard and after 4:00 P.M. I operate from my cellar and garage. I average \$10.00 to \$15.00 clear every day."

W. H. Brookline, Mass.

"Make \$15.00 Saturdays and more. Am only able to operate in my spare time. It is just what a mechanically minded man needs." G.O.F., Thomasville, Ga.

3 EASY STEPS

We send you the "CHRISTY" Electronic Kit. A multi-purpose trouble tracer. Indicates current consumption, shorts, breaks, etc.

We teach you Electrical Appliance Repairing with cross indexed Illustrated Manuals. The Easy-to-Remember-Way.

We show you How to Get Business and Keep Business Coming to you.

WE GIVE
YOU THIS
ELECTRONIC
KIT TROUBLE
FINDER



IN YOUR OWN KITCHEN, BASEMENT OR GARAGE

Learn at home in your spare time this fascinating, big paying profession.

If you are mechanically inclined, can hold and use tools, we can give you the training and time saving kits that will enable you to . . . Command More Money At Work . . . A Better Paying Job Elsewhere . . . Or A Business Of Your Own! New Shop Method Home Training teaches you both the technical and practical side of Electricity by having you work with your hands Building, Testing, Repairing. All instruction manuals are written in easy-to-understand language, chock full of hundreds of detailed photos and drawings. We show you how to quickly locate the trouble, how to fix it and what to charge. ALSO, how to do House Wiring, Welding, Nickel Plating, Sharpen Lawn Mowers, Skates, etc. and how to build power tools you need from spare parts.

\$5.00 TO \$6.00 AN HOUR

Often charged for making ordinary repairs. We show you how to repair refrigerators, vacuum cleaners, washing machines, motors, irons, etc.

CHRISTY TRADES SCHOOL, Dept. A-6903
3214-16 W. LAWRENCE AVE. CHICAGO 25

SEND FOR FREE BOOK!

CHRISTY TRADES SCHOOL, Dept. A-6903
3214-16 W. Lawrence Ave., Chicago 25, Ill.

Please send me FREE Illustrated Book on Electrical Appliance Repairing and Special form for Paying Later from Earnings.

NAME _____ AGE _____

ADDRESS _____

CITY _____ ZONE _____ STATE _____

EARN MORE - LEARN AUTO DIESEL MECHANICS

OR TRAIN WITH OTHER GREER DIPLOMA COURSES

- | | |
|--|---|
| <input type="checkbox"/> AUTO MECHANICS | <input type="checkbox"/> REFRIGERATION |
| <input type="checkbox"/> DIESEL MECHANICS | <input type="checkbox"/> AIR CONDITIONING |
| <input type="checkbox"/> BODY & FENDER REPAIR | <input type="checkbox"/> MACHINIST TRADE |
| <input type="checkbox"/> GAS-ARC WELDING | <input type="checkbox"/> ADVANCED MACHINIST |
| <input type="checkbox"/> PIANO TUNING & REPAIR | |

Skilled men are needed in every part of the country. Earn top pay in established shops or start your own business. Greer's expert instruction and actual shop training teaches you how. You learn by doing—quick, easy courses using the latest tools and equipment. Day, evening and part time instructions available.

Job placement and convenient living accommodations are yours while training. Contact GREER'S FREE JOB PLACEMENT SERVICE when you enroll if you wish part time or full time employment.

ENGINEERING DEGREE COURSES

- | |
|--|
| <input type="checkbox"/> DIESEL AUTOMOTIVE ENGINEERING 27 MOS. |
| <input type="checkbox"/> REFRIGERATION & AIR COND. ENGINEERING 18 MOS. |
| <input type="checkbox"/> WELDING ENGINEERING 18 MOS. |

All Courses Approved Civ. or G.I.

Please rush me free literature on the trade indicated, at no obligation.

NAME _____ AGE _____

STREET _____

TOWN _____ ZONE _____ STATE _____

Established 1902

GREER SHOP TRAINING

Box M, 2236 S. Michigan Ave.

Chicago 16, Illinois

95% PROFITS YEAR 'ROUND

Be your own boss. Operate a SIMPLEX lawnmower sharpening service in your community. One compact machine grinds all mowers, sharpens cutlery. Low investment, 95% profit. Pays for itself in average month.

SIMPLEX

—4 Machines in One!
Reel Grinder—sharpens any mower reel in or out of mower.
Bed Knife Grinder—grinds with either round or cup wheel.



Rotary Blade Grinder—hollow grinds any rotary mower blade.
Cutlery Knife Grinder—sharpens cutlery, tools, scissors.

Send for free, money-making details!

The FATE-ROOT-HEATH Company • Dept. PM1, Plymouth, Ohio



100
POUND
SET
\$12.80

Extra
Plates Only
12c Pound

BARBELLS

140-Pound, CHROME DELUXE Barbell-Dumbbell set only \$19.80. This is our feature set and is the finest ever manufactured.

Training with adjustable weight is the BEST way to keep fit; the ONLY way to develop great strength and a perfect body. As the oldest and best equipped barbell company, BUI gives value and prices no one can equal.

SEND FOR FREE CATALOG
BUR BARBELL CO.
Lyndhurst 9, New Jersey

WHOLESALE Electric Guitars - Parts - Factory to You

Professional electric solid body Spanish guitars, amplifiers, electric bass, double-necks, triple-necks, tone changers, double-neck Spanish, electric mandolin, pickups. Parts to outfit your own. 1959 Models wholesale — Free catalog.

CARVIN CO., Box 287, PM-1, Covina, Calif.

DRAW ANY PERSON IN ONE MINUTE

Anyone Can Draw With This Amazing New Invention—Instantly! The "Magic Art Reproducer"

NO LESSONS! NO TALENT!

You Can Draw Your Family, Friends, Anything From REAL LIFE—Like An Artist Even if You CAN'T DRAW A Straight Line!

Also Excellent for Every Other Type of Drawing!

- Human Figures • Outdoor Scenes, landscapes, buildings
- Still life, vases, bowls of fruit, lamps, furniture, all objects
- Copy photos, other pictures, portraits, etc.
- Copy blueprints, designs, decorations, etc., for woodwork, machine, for needlework, crocheting, knitting
- Copy all cartoons.

Yes, anyone from 5 to 80 can draw or sketch or paint anything now . . . the very first time you use the "Magic Art Reproducer" like a professional artist — no matter how "hopeless" you think you are! Anything you want to draw is automatically seen on any sheet of paper instantly! Then easily and quickly follow the lines of the "picture image" with your pencil . . . and you have an accurate original drawing that anyone would think an artist had done. Also makes drawing larger or smaller as you wish. Anyone can use it on any desk, table, board, etc.—indoors or outdoors! No other lessons or practice or talent needed!

Have fun! Be popular! Everyone will ask you to draw them. You'll be in demand! After a short time, you may find you can draw well without the "Magic Art Reproducer" because you have developed a "knack" and feeling artists have—which may lead to a good paying art career.



Complete for only \$1.98

FREE with order

A.B.C. Guidance of Figure Drawing
This valuable illustrated guide contains simple guidance on drawing human figures. Includes techniques, shading, proportions, etc., to use with your "Magic Art Reproducer" for added touches to your drawings.



SEND NO MONEY! Free 10-Day Trial!

Just send name and address. Pay postman on delivery \$1.98 plus postage. Or send only \$1.98 with order and we pay postage. 10 Day Trial must satisfy or money will be refunded.

NORTON PRODUCTS, Dept. 263, 286 Broadway, N. Y. C.

PLEASE SEND ME



for the time checked.
I am enclosing . . .

- 1 year \$3.50
 2 years \$6.00

name _____

address _____

city _____

zone _____

state _____

Hand this order to your newsdealer or send it to
POPULAR MECHANICS
200 East Ontario St. Chicago 11, Ill.

Now... Before I Retire...

I Will Share My Million Dollar Secret With You!



After thirty years of success in the export-import business, my friends have convinced me that, before I retire, I should reveal my secret for making money to others. This, I have now decided to do, to help a limited number of sincere men and women who are really open minded to a new opportunity—one which may change your whole idea of the kind of money you can make at home in full or spare time.

If you are interested in a "get rich scheme" that promises quick money with no effort, don't read further. But, if you want to make handsome profits *without investment* in merchandise—if you can follow simple suggestions, this message from my life's work may be worth \$100 for every word you read!

START FROM YOUR OWN HOME!

My proved formula for success in making money is simpler than you might think—just buying good imports at next-to-nothing "below wholesale" foreign prices and selling them in the U.S. by mail order. Also take orders from stores or friends. Others I have shared this plan with have reported big profits. You can make your home your office—your kitchen table your desk. You can use your spare time to help build a fascinating and profitable business!

To most people, importing smacks of mystery, romance and costly things for collectors. Actually, any capable man or woman can use past experience and training to great advantage in the Home-Import Business. To my knowledge, this is the *only* business in which previous experience in almost *any* other field can be used profitably. When you turn to this field of big profit opportunity, you do *not* throw away the valuable experience you've gained through your jobs, hobbies or interests. Rather, *combine* that experience with export-import methods I have proved by taking in millions of dollars. This combination then goes to work *for you* and can easily pay off far more profitably than everyday salary of a "worker."

For example, the mechanic or factory worker has a great knowledge of tools and industrial materials. The salesman or saleswoman whether an "outside salesman" or selling in a retail store has a profound understanding of products sold in the past. Who could be better qualified to deal in office equipment than the office worker? The doctor—medical supplies, equipment. Truck driver—automotive parts, supplies. Beauty shop operator—beauty aids.

I could go on and on — because for almost *every* type of business and hobby, there are *hundreds* of beautifully-made imports at trifling cost abroad for you to offer at a big profit. You will find that you can easily deal with these products because they are "old friends." You'll also find a ready American market for *new* imports — people are always ready to snap up fantastic bargains you can offer. And there are also great opportunities exporting U.S. products.

HOW TO BUY BELOW WHOLESALE

Those who follow my plan will receive free, confidential monthly bulletins which reveal suppliers of new and desirable imports. These bulletins tell you how to contact and deal with traders in foreign lands who urgently need U.S. dollars and offer bargains to get them. They are eager to trade with you or me or anyone who knows the methods I will show you.

A THOUSAND CASH ORDERS A DAY

I have proved this plan with 103 imports — and the opportunities for the sale of thousands more are breathtaking. For example, I have received as many as 1,000 cash orders a day for imported clocks — all by mail order. They cost me only 63¢ and I sell them at a big profit, far below the U.S. market. They are shipped direct to the buyer from abroad, *after I receive the cash.*

POCKET PROFITS IN ADVANCE

So you see, it is even possible to do business of this kind without investing in merchandise. You can take cash orders, pocket your profits in advance, *then* order the merchandise. And you don't have to travel abroad — unless you want to. You don't even have to know a foreign language. You might ask, "Why do you let others in on your plan? Why don't you keep it all for yourself?" The answer is that the demand is virtually impossible to fill. No one person could handle even a small portion of this gigantic market. There's plenty of business in import-export for you and me and many others.

I'LL SEND YOU ALL DETAILS FREE

I have told you a little about the business I have devoted the last 30 wonderfully happy and successful years to, and I'd like to tell you more. But the final decision must be up to you. If you're sincerely interested in learning more about how to start a profitable full or spare time Home-Import Business of your own, write me today. I'll gladly send you a letter with full details. I'll also enclose a list of 157 imports, showing amazing low foreign prices & revealing book, describing some of the profitable businesses operated by followers of my plan. No cost or obligation. Send coupon NOW. Air mail reaches me overnight. **B. L. MELLINGER, Director, Dept. X251, 1717 Westwood, Los Angeles 24, California.**

MAIL COUPON TODAY

B. L. MELLINGER, Director, Dept. X251
1717 Westwood, Los Angeles 24, Calif.
Rush full details on how to start a profitable Home-Import Business of my own. I understand there is no cost or obligation. (Please print)

Name _____

Address _____

City & Zone _____ State _____

Pocket Transistor Radio

"Hit Parade"
Mighty Midget



\$7.95

Low Priced
Smart Design!
Marvelous Reception!

Size of cigaret package, yet thrilling performance. Weighs only 4 ounces. Listen while traveling, at ball games, in home or office or school. Includes Hi-Fi speaker-phonograph for private listening. Modern two-tone moulded plastic case, red with gold metal grille. Complete broadcast band. On-off switch one end. Uses 2 standard penlight cells (included). Guaranteed. Complete, ready for immediate playing. Postpaid Only. . . . **\$7.95**

JOHNSON SMITH & CO. Dept. 759 Detroit 7, Michigan

USED ELECTRIC GENERATOR

Cost Over \$20.00 New; While They Last. \$3.95

Generates Up to 75 Volts. Use to generate electricity, to ring bells, light up lights, as a medical battery, deliver terrific electric shock as joke, many electrical experiments, classroom uses, etc. Cost over \$20 new. Used but excellent operating condition. Hand crank or gear wheel drive. Made by leading electrical companies. Each has 3 or 4 five-inch 1-lb. bar magnets (alone worth more than total cost), generating armature, wire leads, gear crank, ready for use. Originally used in crank phones. Complete unit weighs over 5 lbs. Postpaid **\$3.95**. JOHNSON SMITH COMPANY, Dept. 759, Detroit 7, Mich.



See Your Photos Same Day

Camera & Photo Processing Set. Finished pictures soon after roll is taken. Set includes Midget Watch-Size Camera, takes eight 1 1/4 x 1 1/2" photos; Rapid Processing Set to develop & print pictures at once. Complete Outfit Only. . . **\$1.75**. Film 35c Roll, 3 for **\$1.00**. Rapid Processing Set Only (Use with Any Camera) 50c.

Johnson Smith Co., Dept. 759, Detroit 7, Mich.

12-Foot BULL WHIP

HARD HITTING! LOUD CRACKING! Experts knock ashtrays off cigarettes. Yank people off feet. Used by trainers, ranchmen. Loud cracker like shot-gun blast. 4-ply hand plaited all leather. With loop handle.

6-ft. \$1.98. 8-ft. \$2.69. 10-ft. \$3.29. 12-ft. \$5.45.

Johnson Smith Company, Dept. 759, Detroit 7, Mich.

Catalog of 2900 Novelties 10c

Send 10c for amazing catalog of novelties, live animals, scientific supplies, hobbies, funmakers, planes & boats, looms, magic tricks, joke articles, unusual seeds, gadget time-savers, cameras, optical goods, projectors, movies, lucky jewelry, religious novelties, disguises, musical instruments, stamps, coins, puzzles, for fun, auto & bike accessories, telescopes, magnifiers, combs, smokers' gadgets, artists' supplies, printing sets, engines, motors, shockers, knives, billfolds, guns, rifles, sports, books, games, plants, etc. Send 10c.

JOHNSON SMITH & CO. Dept. 759 Detroit 7, Michigan

KIT BOATS Boat Plans Patterns Frame Kits

KIT CATALOGS—Over 50 Models—Pre-assembled. Runabouts, Cruisers, Fishing (8' to 19'). Anyone can assemble. Complete Marine Accessories, Fiberglass plastics, trailers, paint, etc. Also **CATALOG** on 50 Modern Plans and Patterns. Prefab Frame Kits—All types best for the amateur builder.

SAVE 2/3
FREE FREIGHT
CREDIT TERMS
Tonawanda IL, N.Y.

SEND FOR FREE COLORED CATALOG NOW!
Name _____ City _____
Address _____ State _____
Craig Craft

TELEPHONES

and ALL SUPPLIES

Room to room, house to garage, private telephone service. **HANSET CRADLE TELEPHONES** (2) Complete outfit with 100' wire, battery, staples, diagram, CD-2. . . . **\$17.25**
WORM HARVESTER—Dan Mac Magneto—gathers (fish) worms by electricity. Complete with instructions. **\$7.50**



FREE Illustrated bulletin "AA-118"

TELEPHONE REPAIR & SUPPLY CO.
1760 LUNT AVE. CHICAGO 26, ILL.

HOW YOU CAN RETIRE WITH AN INCOME

Now you can enjoy leisurely living with a welcome income. Start **YOUR OWN BUSINESS AT HOME** with **TREYCO Grinding Equipment**. Sharpen knives, cutters, saws, scissors, clippers, tools, and make up to \$5 per hour. Write for free money-making plan.

TREYCO PRODUCTS 334 NIAGARA AVE. N. TONAWANDA, N.Y.

MASTER MIND!

LEARN SHORT-CUT MATHEMATICS
Juggle figures, do baffling number tricks. Make people gasp at your marvelous lightning-quick mind. Multiply 4 figures by 4 figures without using old-fashioned multiplication! Big cloth-bound volume! Fully illustrated course for self-instruction.

SHARPEN UP YOUR BRAIN POWER
Includes worked-out problems, answers, etc. Sensational bargain, only \$3.95 postpaid or COD plus postage. Satisfaction guaranteed or refund. Order this amazing "Short-Cut Mathematics" today!

NELSON-HALL CO., 210 S. Clinton St. Chicago 6, Ill. **\$3.95 Complete**



the Boy Scientist

You Can Open the Doors of Wonderful Worlds for Young Americans... With

New Popular Mechanics Book Packed With Thrilling Facts and Fascinating Information!

Every boy is a scientist at heart. Every boy can learn about and actually enjoy world-shaking discoveries in astronomy, physics, chemistry, sound, electricity, atomic theory and relativity and other scientific developments. As presented especially for him in the Boy Scientist, he will thrill too as he meets Galileo, Newton, Franklin, Faraday, Einstein and other greats in the worlds of science. He can participate in monumental discoveries by performing the many experiments which this fascinating book describes. The Boy Scientist can easily be one of the most important books your boy can read.

Money Back if Not Pleased!
Get this big (6 1/2" x 10") entertaining and informative book for your boy. 264 thrilling pages. 277 vital pictures he will pore over for weeks and weeks. Written in Popular Mechanics easy-to-read and easy-to-understand style by John Lewellen, noted writer on science and natural history. Sent postpaid for only **\$3.95**. COD if you wish. Write today. Your money back if you are not pleased.

POPULAR MECHANICS PRESS, 200 E. Ontario St., Chicago 11

The Greats of Science and Their Achievements
Galileo, the first modern scientist . . . Newton and the law of gravity . . . Boyle and how gases behave . . . Archimedes, Pascal, Bernoulli, and liquids . . . Mersenne, and the laws of sound . . . Huygens on light . . . Rumford and heat . . . Becquerel's radioactive fog . . . Franklin and electricity . . . Einstein's theory of relativity. And others.



Train NOW as HEAVY EQUIPMENT OPERATORS

PUT YOURSELF IN THE DRIVER'S SEAT!

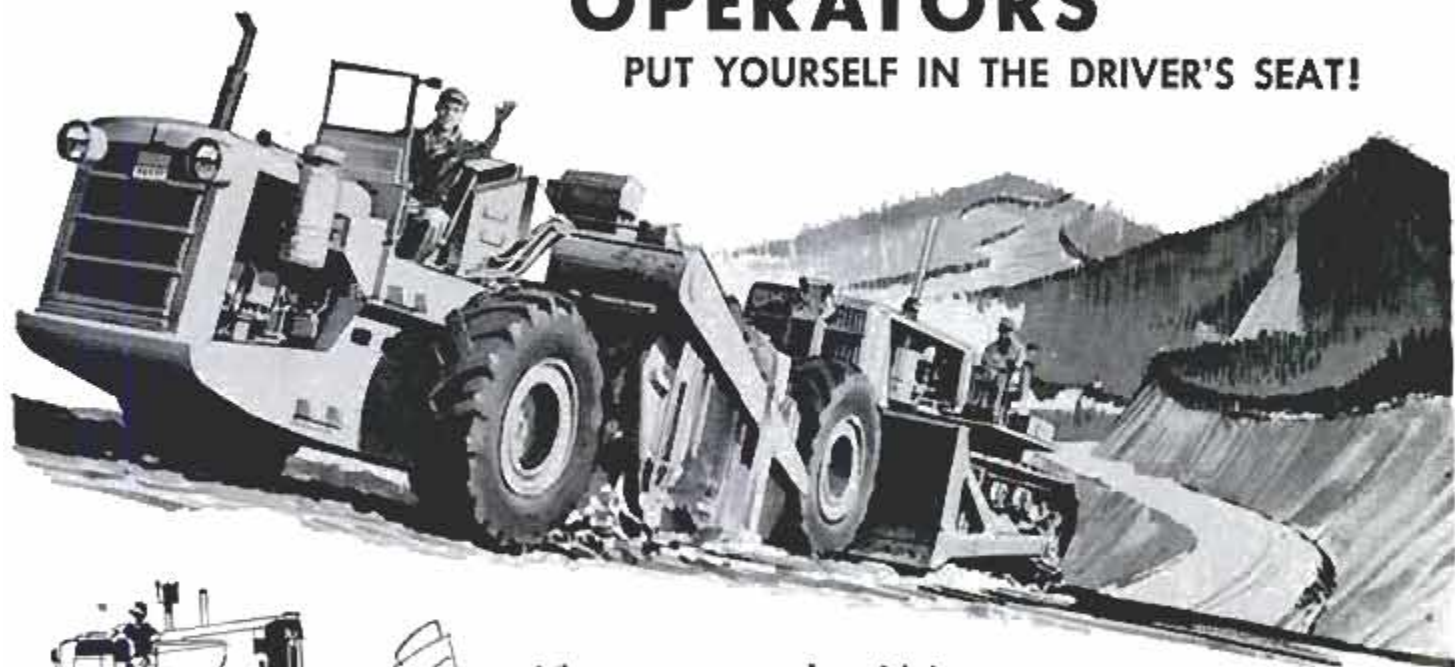

The most tremendous highway building program in history is under way... bridges, dams, houses, factories, are springing up all across the nation... The construction industry is booming as never before. And *You* can have a box seat for this greatest show on earth!

EXPERIENCE UNNECESSARY — APPLY NOW

You will be trained thoroughly for modern heavy equipment operation. Learn to master heavy equipment such as: tractors, scrapers, graders, carry-alls. Engineering fundamentals... blueprint reading... operating controls... diesel engine operation... highway construction, etc.

If you are between 17 and 45, you can get into Heavy Equipment NOW — regardless of your present position, training or income. Nationwide placement service available upon completion. We help you with financing.



SEND FOR FREE INFORMATION

HEAVY EQUIPMENT TRAINING

Northwest Schools, Inc. (Dept. M-1)
1221 N. W. 21st Avenue • Portland 9, Oregon
Rush information without obligation.

Name _____

Address _____

City _____ State _____

Phone _____ Age _____

Education _____ Hours Worked _____





\$100 a Week to BEGIN. Car Furnished.

Compare THIS Job to the One You Have GOT

**Then—if you'd like to switch
—I'll Show You How to DO It**

Yes, I'll show you how to get into one of the best paying professions in America today—Auto Claim Investigating. Here's why employers are glad to pay top salaries to men in this particular field.

This year more than 25 million auto accident claims will have to be settled! No wonder Auto Claim Adjustors are so greatly needed. No wonder insurance companies pay as much as \$450 a month to start; provide a private office, a secretary and a car for personal use—all expenses paid! That's why the money-making opportunities in this exciting field are so great. Even if you have only an average education you can go far in this exciting new profession. Let me teach you at home by mail. In a few weeks you can learn enough to get on the road to a five-figure salary. You can either work for yourself or for a big reliable company. No need to change your location. No tedious office hours! You owe it to yourself to find out all about this interesting profession. Get in touch with me right away. ERIC P. McNAIR, President, LIBERTY SCHOOL OF CLAIM INVESTIGATING, Dept. 91, Libertyville, Illinois.

BANKAR
auto vault



PROTECT MONEY

and valuables while traveling. Ideal for salesmen, doctors, construction workers and trailer owners.

Send for **FREE Folder TODAY!**

BANKAR CO., 1220 Broadway, Oakland 12, Calif.

Name _____

Address _____

City _____

State _____

FORTUNES IN DIVING

Train at Home in Spare Time

Write Today for Amazing Free Booklet

Here is one of the greatest opportunities of our time. Make big money fast in Skin and Lung Diving. Trained divers needed in hundreds of industries and by government. Build a successful business of your own. Hourly rates among highest paid in any field. Training program by E. R. Cross, world famous master diver. Get the facts now. Mail coupon for **FREE BOOKLET TODAY!**

DIVEMASTER, Dept. PM-19

5637 W. 63rd Place, Chicago 38, Ill.

Send me free information about Diving.

Name _____ Age _____

Address _____

City _____ State _____

New Isotronic Training Method

LEARN TV REPAIR IN ONE SHORT WEEK!

Now, after 5 year's research—a streamlined training system that *obsoletes all others!* In just 7 days you may earn \$150 weekly, without paying up to \$250 for training, studying long months! Developed by electronic scientists in cooperation with major TV mfr's., the new Isotronic method is the most practical ever devised! For conclusive proof, write for details and **FREE SAMPLE LESSON.** Use it on your own set or a friend's—repair it—convince yourself you can make big money immediately in your own TV business! Hurry—Free Lesson supply limited. Write:
TV SERVICING SYSTEMS, Dept. C-171
1038 So. La Brea, Los Angeles 19, Calif.

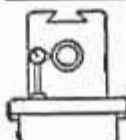

— TIPS & TECHNIQUES —

MACHINE TOOL RECONDITIONING

& THE ART OF HAND SCRAPING (3rd printing)

SEND FOR FREE FOLDER DESCRIBING

ILLUSTRATED MANUAL FOR MACHINISTS

MACHINE TOOL PUBLICATIONS, 382 Holly Ave., Saint Paul 2, Minn.

ALIVE TODAY!



Arch Lightbody is one of 800,000 Americans cured of cancer because they went to their doctors in time. They learned that many cancers are curable if detected early and treated promptly. That's why an annual health checkup is your best cancer insurance.

American Cancer Society



HOW TO GROW ORCHIDS AT HOME!!

GOOD PROFITS - LOTS OF FUN!

LEARN HOW
ORCHIDS GROW - All about special light,
temperature and humidity required to
RAISE 30 DIFFERENT VARIETIES at HOME!

Exciting Profit Opportunity!

FLORIST OFFERS \$10 EACH FOR BLOOMS

"This Orchid bloomed on Mother's Day with beautiful 6 1/2" flowers. A local florist made up corsage for my mother without charge, and offered me \$10 a flower for the rest."

Minnie E. Skillman
New Jersey



We Raised Orchid Plants Worth a Fortune
- Starting at Home in Spare Time!

Louis & Gladys Schirmer - Successful Home Growers

We began raising Orchids as a hobby, but soon started getting orders from friends and nearby florists. Within a few years we were able to retire from other work, to live on the profit from our Orchids. Would you like to learn how we did this, and how it may be possible for you to do the same? We'll help you every step of the way, if you'd like to start.



There are many kinds of Orchids in every rainbow color. Some need different care than others. We show you how to raise 30 different types, including all the popular corsage Orchids you see in the florist shops.

Wholesale, Retail, Mail Order. There's a year-round demand for Orchids - for party wear, travel, weddings, anniversaries, Christmas, Mother's Day, etc. Take big-profit orders from friends, neighbors, florists - at home and nearby cities. Flowers last for weeks. Millions shipped by mail order into big-city wholesalers from all over U.S. The Schirmer's own gardens are in the country - miles from the nearest town. Their Course shows how to do it!

NO LONG DELAY - START WITH PLANTS READY TO BLOOM SOON!!!

Have you heard that it takes 7 years to get an Orchid flower? It's absolutely false! You can start with full grown plants, that should flower in a few months - even a few weeks if you get them with this season's buds already forming.



VISITORS DROVE 100 MILES
"This plant had 10 flowers, 8 1/2 inches across. People drove over 100 miles to see it. Your Course is wonderful."
Thomas Hurst
Utah



WAS OFFERED \$100 FOR PLANT
"This Cattleya bloomed on Mother's Day. We were offered \$100 for it, but refused. Orchids give me pleasure I cannot express in words."
Mrs. L. Kunkel
California



LOCAL FLORIST WANTED BLOOMS
"A local florist said I couldn't grow Orchids, but later apologized and wanted to buy the flowers I am grateful for your guidance."
Frederick Anderson
New York

HOW ORCHIDS MULTIPLY

Most exciting thing about Orchids is the way they multiply themselves. As the plants enlarge they may be divided, to create two from one. And these same divisions may often be divided again and again in the future. A "Magic Key" to Orchid profits which has helped bring security and independence to many Orchid growers - just as it has to Mr. and Mrs. Schirmer!



EXAMINE COURSE & LIVING ORCHID PLANT IN YOUR OWN HOME Before You Decide!

Yes - before you decide, let us send you our complete Course to examine. Nearly 300 pages, filled with "show-how" pictures. Learn how Orchids grow without soil, getting food from the air. Read detailed directions for marketing Orchids for big profits. Then decide. No obligation to buy a thing unless you wish. And remember, a real blooming-size Orchid plant comes with the Course! FREE, full details. Just mail coupon.

FINE HOME BUSINESS FOR MEN, WOMEN, FAMILIES

"Never raised Orchids till I read your Course. This plant had 10 blooms. My husband says they require less care than any flower he knows."

MRS. A. K. END
Pennsylvania



These Illustrated Instructions Have Helped Hundreds of Families Throughout U. S. & Canada to Grow Beautiful Orchids at Home

FREE!

(Nothing to Buy)

3-MO. SUBSCRIPTION to "THE ORCHIDIAN"

"Show-how" publication for home Orchid Growers. Valuable, instructive, fascinating. Absolutely FREE.

FREE - SEND NO MONEY - MAIL COUPON NOW

TROPICAL FLOWERLAND, Dept. 311
100 S. Vermont Ave., Los Angeles 4, Calif.

Please rush - FREE and POSTPAID - full details on offer of Louis & Gladys Schirmer's instructions which show how to grow and market Orchids at home. I understand the complete instructions include a real blooming-size Orchid plant and valuable "Quick-Profit Plan" - all sent for me to examine at home before I decide. Also please send the 3-month FREE Subscription to "The Orchidian." Thank you.

Name _____ Age _____
Street _____
Town _____ Zone _____ State _____

★ QUICK-PROFIT PLAN... LETS YOU START AT ONCE Instructions include exciting "Quick-Profit Plan." Helps you make money immediately. Coupon brings details.

Tropical Flowerland, Dept. 311, 100 S. Vermont Ave., Los Angeles 4, Calif.

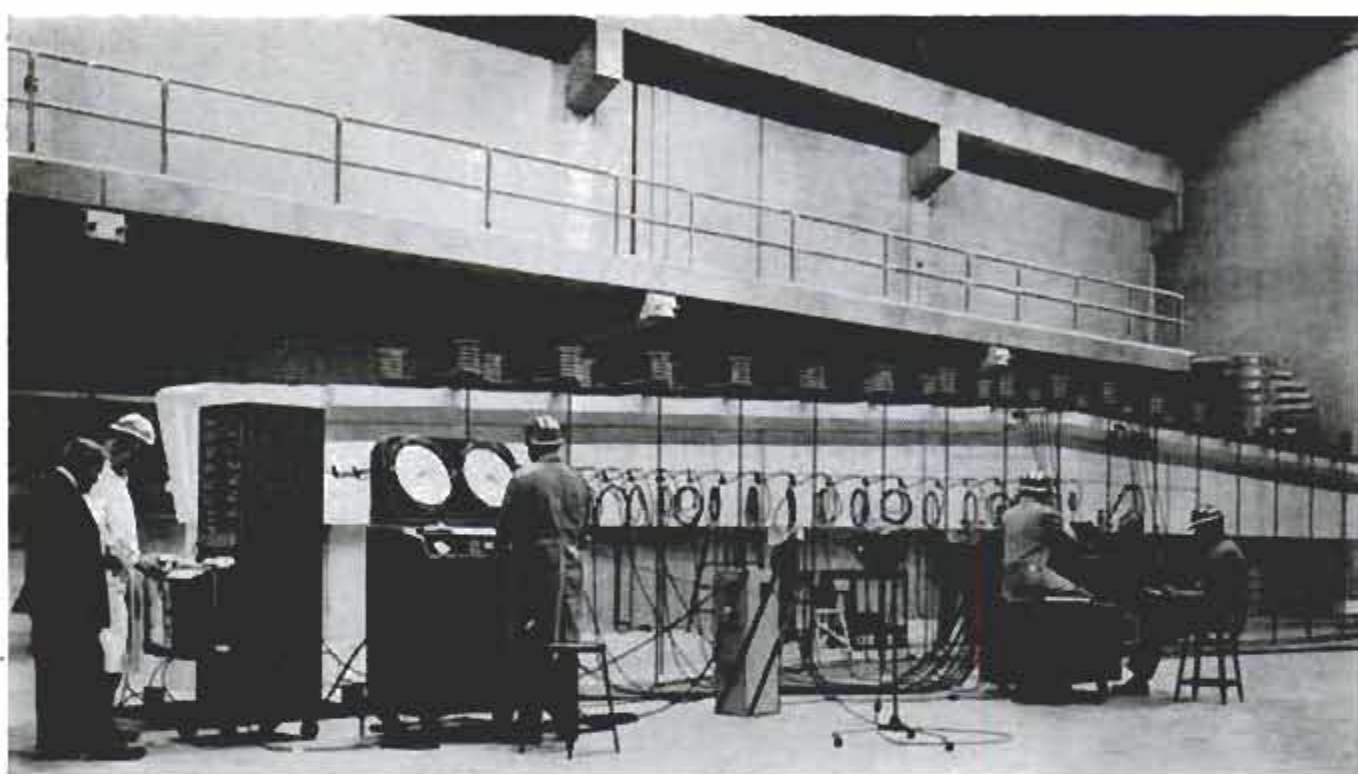

Concrete Girder 60 Feet Long Gets Strength Test in Lab

To test a 60-foot girder in Portland Cement Association's structural laboratory, forces were applied through steel rods extending from cross pieces over the girder

down through holes in the floor. Under the floor were hydraulic jacks that pulled down on the rods. The girder was finally broken under a total load of 360,000 pounds.

Your ATS Training includes all this—

AUTO
Mechanics
BODY
& Fender
DIESEL
TRACTOR
& Crawler

JOBS OPEN
with Opportunities for
GOOD PAY
Free Illustrated Booklet
Tells Way to
LEARN AT HOME
IN SPARE TIME

Trained men in the automotive field are among the highest paid skilled workers in industry. They step into good starting jobs where promotion can be rapid, and often build a successful business of their own in a surprisingly short time.

ATS HOME TRAINING SHOWS THE WAY

The American Technical Society's remarkable training program is a result of an intensive research program which has been maintained in the world's automotive center, Detroit, Michigan, for over ten years. A man can progress rapidly with the help of ATS training and services.

For More than Half a Century ATS Has Helped Train Men for Success

Behind ATS training is a great 60 year record of success in training men for good paying jobs. ATS offers you a "Work-Plan" method, and many earn as they learn. This not-for-profit organization offers its amazing plan to you now. Get the facts today.

FREE ILLUSTRATED BOOKLET — MAIL COUPON TODAY

AMERICAN TECHNICAL SOCIETY, Dept. BH-19
850 East 58th St., Chicago 37, Ill.

Please send me FREE Automotive Maintenance and Repair Booklet and facts about ATS home training plan and services.

Name _____ Age _____

Address _____

City _____ State _____

Learn **BAKING** At Home

Baking is one of America's high industries in wages. Nearly depression-proof. Thorough basic home course lays sound foundation. If you have aptitude, write for **FREE BOOKLET**, "Opportunities in Commercial Baking." National Baking School, 835 Diversey Pkwy., Dept. 1351, Chicago 14, Illinois



YOU'D NEVER KNOW I HAD PSORIASIS

For 26 years psoriasis sufferers have learned that Siroil tends to remove unsightly external crusts and scales. If lesions recur, light applications of Siroil help control them. Siroil won't stain clothing or bed linens. Offered on 2-weeks-satisfaction-or-money-refunded basis.

SIROIL

AT ALL DRUG STORES

Write for new **FREE BOOKLET**, written by Registered Physician.



SIROIL LABORATORIES, INC.

Dept. PM-12 Santa Monica, Calif.

Please send me your new **FREE** booklet on PSORIASIS.

NAME _____ Please Print

ADDRESS _____

CITY _____ STATE _____



**TALL
men
get
the
plums**

People naturally look up to a Tall Man! You've done it yourself. Slip into "ELEVATORS" and you are that Tall Man—almost 2 inches taller instantly...confidentially. Only you know the secret, but everyone notices the difference. Step into "ELEVATORS" today. Step up in the world! Gain the poise and confidence only a Tall Man has.



Over
30
styles

*Write for FREE
"ELEVATORS" BOOKLET today!
STONE-TARLOW Sales Corp., Dept. 6-19, Brockton 68, Mass.



Only \$6⁰⁰ starts you in TELEVISION and RADIO

**Learn in spare time at
home to fill the best paying
jobs—my new, faster way!**



Mason R. Warner
President

We're making it easier than ever to become a well paid Radio-TV Service Technician the proved 'Learn-by-Doing' Sprayberry way!

EARN WHILE YOU LEARN!

Trained Radio-Television Service Technicians are needed at once by the thousands! If you are looking for better pay, a bright future and interesting work... there's a place for you in Radio and Television. Be ready to step into a good paying job in 10 months or less... or your own profitable business! Train at home in spare time. I'll help you earn extra money while you train... doing instructive radio service jobs. Our new tuition terms are more liberal than ever... only \$6 starts you towards success in this booming field!

25 KITS OF RADIO-TV PARTS

In addition to modern lessons, you train with actual parts and equipment. Build the famous Sprayberry Training Television Set, Multi-Range Tester, 2-Band Radio, Test Equipment—all yours to keep. Get latest training on Color TV, Transistors, Hi-Fi and UHF Conversions!

SEE HOW EASILY YOU CAN LEARN

See for yourself... in actual pictures and descriptions... what Sprayberry Radio-Television Training offers you. Backed by almost 30 years of training experience. Three training plans to suit your exact needs. Rush coupon today for big new catalog and sample lesson. No obligation; no salesman will call.

SPRAYBERRY ACADEMY OF RADIO-TV
1512 Jarvis Ave., Dept. 10-Q, Chicago 26, Ill.



Get valuable shop bench practical experience fast with expertly engineered kits you'll assemble.



TOOLS WHOLESALE

\$1.00 PUTS YOU IN BUSINESS

Start your own business, sell tools to your friends and neighbors, or buy tools for your own use and SAVE MONEY \$\$\$

A MILLION DOLLAR INVENTORY AT YOUR FINGERTIPS. NO STOCK TO CARRY. ORDER AS YOU NEED IT.

Send \$1. for Tool Catalog today. BUY AT WHOLESALE PRICES. Extra \$25.00 profit on your accumulated purchases. \$1.00 is refunded if you are not 100% satisfied with our offer.

THOUSANDS!! of Nationally Advertised items of Hand Tools, Power Tools, Machinist Tools, Tool Chests, Paint Sprayers, Light Fixtures, Appliances, Guns, Gifts, Toys and other items too numerous to mention.

WE SHIP COAST TO COAST. Wholesale Discounts up to 50% OFF

SILVO HARDWARE CO., PM-1 107 Walnut St., Phila. 6, Pa.

How to Write Short Stories, Mysteries, Articles

Willing to spend a few hours a week learning to write so you may earn \$500 to \$1500 a year part-time? Or many thousands full time? Earn while learning. H. F. Wenderoth sold first story for \$240. Free sample lesson and book, "Art of Writing Salable Stories," tells how unique home-study method gives you thorough, professional training in writing for magazines, radio-TV, movies. Write today!

PALMER INSTITUTE OF AUTHORSHIP, Since 1917
1680 N. Sycamore Desk T-19 Hollywood, Calif.

SEND FOR Free Record

START SPEAKING
FRENCH
OR
SPANISH ALMOST OVERNIGHT!

HERE'S the easiest way to learn FRENCH, SPANISH, Russian, German, Italian, Japanese or Brazilian. Listen to FREE 2-sided non-breakable record. Let your eyes follow words in FREE sample lesson. Almost at once you'll be chatting in a new language with a perfect accent! That's all you hear! No dull, tedious work. Just listen—imitate! It's that easy! Offer may end soon. Rush 25¢ to help cover cost of special packaging, shipping. State language you want. We'll also send free information on full Cortina course. CORTINA ACADEMY, Dept. 641, 136 W. 52nd St., New York 19

FREE 60 Page Catalog and Sample Lesson

Sprayberry Academy of Radio-Television
1512 Jarvis Ave., Dept. 10-Q, Chicago 26, Ill.

Please rush catalog on your ALL-NEW Radio-Television Training Plans. I understand this does not obligate me. No salesman will call. Include Sample Lesson FREE.

Name _____ Age _____
Address _____
City _____ Zone _____ State _____

"HOW I DOUBLED MY INCOME In Less Than A Year, As A CUSTOM UPHOLSTERER"



**Alvin Lederkramer, Former Low Salaried
Auto Mechanic — Now Earning Big Pay**

"When I enrolled for UTS training I was an auto mechanic earning a meager salary. While learning I earned good spare-time money. After graduation, I got a job in upholstery with better pay than ever before. Now, less than one year later, I've doubled my income. Soon, I'll get into my own business. The future looks bright, thanks to UTS."

WHAT DO YOU WANT? Your Own Profitable Business—A Steady Job — Substantial Sparetime Earnings — A More Secure Future? They're all Waiting for YOU in the Big-Opportunity Field of Custom Furniture Upholstery.

There's always a great demand for your services as a trained upholsterer in good times and bad. Earn RIGHT OFF as you quickly, easily prepare for this well-paid trade. You can earn as you learn to make good money all year 'round at home, in your own shop, or in a well-paid job. With practical N. Y. State-approved UTS Course you learn professional custom furniture upholstery, reupholstery, slip-covers, furniture finishing, window cornice, cushion, and drapery making. Course includes —FREE—ALL tools, complete frames and materials.

FREE ILLUSTRATED BOOK — FREE SAMPLE LESSON! Our FREE book, "YOUR NEW WAY TO A SUCCESSFUL CAREER" with FREE Sample Lesson shows you how. WRITE TODAY! Training in N. Y. School also available. Upholstery Trades School, Dept. HA-305, 721 B'way, N.Y. 3

MAIL COUPON TODAY. NO OBLIGATION

**MATERIALS FREE
WITH COURSE
YOU MAKE**



**Yours to keep
or sell**

**APPROVED
FOR VETERANS**

**UPHOLSTERY TRADES SCHOOL, Dept. HA-305
721 Broadway, New York 3, N. Y.**

Please send the FREE book with FREE Sample Lesson. No obligation—no salesman will call.
 Home Study In N. Y. School Training

Name _____
Please print plainly!

Address _____

City _____ Zone _____ State _____
 Check if Korean Veteran

Doghouse Life Made Easier By Electric Heating System

Life in an electrically heated doghouse can mean steady 65-degree temperatures for Rover even in subzero weather. The heating element is automatically controlled



D. W. Hart Adv., 816 Illinois Bldg., Indianapolis 4, Ind.

by a thermostat and is grounded to protect the dog. The house, insulated with glass fiber to prevent loss of heat, is made of galvanized steel and is 30 inches high, 29½ inches long and 24 inches wide.

Borneo Mold Yields Wonder Drug

From a soil-mold organism found in Borneo, medical scientists have produced an antibiotic that can stop the rapid spread of staphylococcal infections.

Perfect Photo Enlargements Made With Electronic Control

Amateurs can now make better enlargements of their photographs without guesswork and endless test-printing. An electronic control called "Photo-Genie" makes all the decisions. A darkroom reading is made of the projected-negative image as it is received on the device's photosensitive cell. This information is automatically relayed to a lamp, which signals the correct diaphragm aperture to be used.

Ideax Corp., 150 Fifth Ave.,
New York City 11



POPULAR MECHANICS



**This Integrated Mechanism is the Reason Why
V-M Stereo Record Changers Outsell All Others**

Public opinion is the best recommendation for V-M automatic record changers. Listeners by the millions rely on this beautifully simplified mechanism—the heart of every V-M changer—for years of flawless performance. Model 1201—'Stere-O-Matic'® Automatic 4-Speed Changer with patented drive motor,



Stereo Cartridge and Stylus, \$50 (Slightly higher in the West.) V-M Corporation, Benton Harbor, Michigan.

the **Voice**  of **Music**®

Prepare for your career in **METALLURGY** **INDUSTRIAL ENGINEERING** **AIR CONDITIONING** **MECHANICAL ENGINEERING**

Missiles or machinery, rockets or refrigeration, MSOE equips you for a career in many fields:

**PRODUCT DESIGN • RESEARCH
DEVELOPMENT • QUALITY CONTROL
TIME STUDY • PURCHASING
SALES ENGINEER**

When you graduate from the Milwaukee School of Engineering, you are prepared for a dynamic career as a Mechanical Engineer or Engineering Technician. Under a faculty of specialists, you gain a sound technical education in modern, completely equipped laboratories and classrooms. As a result, MSOE graduates are in great demand and highly accepted by industries nationally.

At MSOE you will meet men from all walks of life and all parts of the country — some fresh out of high school or prep school, others in their twenties — veterans and non-veterans.

You can start school in any one of four quarters and begin specializing immediately. Engineering technicians graduate in 2 years with an Associate in Applied Science degree. For a Bachelor of Science degree in Engineering, you attend 4 years. A 3-month preparatory course also is available.



If you're interested in any phase of metallurgy, air-conditioning or mechanical engineering, be sure to look into the programs of study offered by the Milwaukee School of Engineering. Just mail coupon.

FREE CAREER BOOKLET

MILWAUKEE SCHOOL OF ENGINEERING

Dept. PM 159, 1025 N. Milwaukee St., Milwaukee, Wis.

Please send FREE Career Booklet. I'm interested in

- Mechanical Engineering Air Conditioning
 Industrial Engineering Metallurgy
 Electrical Engineering

Name _____ Age _____

Address _____

City _____ Zone _____ State _____

I'm eligible for veterans education benefits.

MS-112

SIGN PAINTING

Home-Study Course — Only \$5.95

Teaches you commercial sign painting and sign building as it is being done TODAY in leading shops all over the country. Complete practical course for self-instruction. Shows latest methods of truck lettering, office doors, wood letters, reflecting signs, plastics, sprayed signs, gold leaf, silk screen process, up-to-date alphabets, money-making business information, etc.

SATISFACTION GUARANTEED OR REFUND!

Contains all the instruction of a high-priced correspondence course. Full price, only \$5.95, postpaid. Or C.O.D. plus postage. No risk—order today. Satisfaction or money back! Order "Sign Painting Course," NELSON-HALL CO., 210 S. Clinton St., Dept. 2AR-2, Chicago 6, Ill.



CONCRETE BLOCK HOME PLANS

\$1000 COTTAGE



Build your own 22'x26' cottage complete for \$1,000. Stab floor, beamed ceiling. Contains Liv. Rm., kitchen, two bedrooms, bath and fireplace. Blueprints, instructions and material list \$3.00 ppd. Money back guarantee. Other plans—\$1150 Garage Apt., \$1900 Duplex, \$2500 Ranch Home, \$3500 Cape Cod, \$3800 three bedroom, two bath, family room Ranch Home. FREE FOLDER.

MEMBER ARKANSAS HOME BUILDERS ASSOC.

BAILEY BUILDERS, 308 Hiawatha Drive, Little Rock, Ark.

INVESTIGATE ACCIDENTS

Train quickly in your own home for repeat income in the exciting, secure Claim Investigation and Claim Adjusting field. Our students and graduates are already earning \$4, \$5, \$6 an hour extra SPARE TIME — and up to \$10,000 a year Full Time. You need NO prior experience or higher education. Your age does NOT matter.

HERE IS YOUR CHANCE FOR ACTION AND REAL JOB SECURITY

As a trained Claim Investigator you will (1) INVESTIGATE FACTS and (2) DISTRIBUTE MONEY as the representative of wealthy organizations.

No other business offers you greater opportunities for success and security. Here's why: The huge, rapidly expanding Claim Investigation and Adjusting Profession right now distributes more money than any other service industry. And it's growing fast. Over 200 MILLION ACCIDENTS must be investigated this year for Insurance Companies, Airlines, Railroads, Steamship Lines, and Government Offices.

MAIL NOW for FREE BOOK ➔

SEND TODAY for Big, FREE, Illustrated Catalog. Learn the exciting facts about Universal Schools' low cost training. No obligation. No salesman will call. GI APPROVED.



UNIVERSAL SCHOOLS

6801 Hillcrest Ave.
Dept. PM-1, Dallas 5, Texas

Please rush me your FREE book on Claim Investigation. This does not obligate me and no salesman will call.

Name _____ Age _____

Address _____

City _____ Zone _____ State _____

Approved by Government for Korean Veterans

I'll Send You This Handsome SAMPLE CASE—FREE!



Make up to
\$30⁰⁰ in a Day!

Your Own
Tailored Suits
Without 1¢ Cost

If you want to make more money, spare time or full time, rush the coupon below today for this big, valuable tailoring Sample Case packed with 100 beautiful, big-value suit and overcoat samples. Just show the samples and last-minute styles to friends, fellow-workers, others. Take their orders for fine made-to-measure clothes—and pocket BIG CASH PROFITS in advance. No experience, no tailoring knowledge needed—and no money needed, ever. WE SUPPLY EVERYTHING FREE... sample case, sample suitings, equipment, complete instructions. Start making money first day!

Use Spare Evenings... Weekends... Make Money... Get Suits!

It's easy to make money taking orders in just spare time—lunch-time, evenings, weekends. When men see the fine fit, quality and value of our suits—THEY ORDER! So we make it easy for you to get your own personal suits and overcoats without paying even one penny. Don't wait! Rush coupon with your name, address, and age for FREE Sample Case.

J. C. FIELD & SON, Dept. J-1716
Harrison & Throop Streets, Chicago 7, Ill.

J. C. FIELD & SON, Dept. J-1716
Harrison & Throop Sts., Chicago 7, Ill.

Please rush ABSOLUTELY FREE the valuable Sample Case with suit fabrics and style display. Include instructions, money-making plans and details for getting my own suits without paying one cent.

Name _____ Age _____
Address _____
City _____ State _____

FREE! LAFAYETTE'S



1959

CATALOG

260 GIANT-SIZED PAGES

CONTAINS

HUNDREDS OF EXCLUSIVE LAFAYETTE ITEMS NOT IN ANY OTHER CATALOG OR AVAILABLE FROM ANY OTHER SOURCE—SEND FOR YOUR COPY NOW!

See the newest and finest in Stereo Tuners, Amplifiers, Cartridges and Music Systems

• TAPE RECORDERS • PUBLIC ADDRESS SYSTEMS • AMATEUR EQUIPMENT • INDUSTRIAL SUPPLIES • RADIO & TV TUBES AND PARTS • INSTRUMENTS • TELESCOPES, BINOCULARS, MICROSCOPES & CAMERAS

Everything in Electronics

The Complete Catalog
Featuring The Best Values
Obtainable

LEADERS IN HI-FI

OUR
38th

YEAR

The most complete electronic supply catalog crammed full of everything electronic at our customary down-to-earth money-saving prices.

The largest selection of hi-fi components and systems; greatest savings on Lafayette endorsed "best-buy" complete systems.

EASY PAY TERMS AVAILABLE —
10% DOWN — UP TO 18 MONTHS TO PAY

Lafayette Radio

P.O. Box 511
JAMAICA 31, N.Y.
DEPT. LA

Send FREE LAFAYETTE Catalog 590

Name _____

Address _____

City _____ Zone _____ State _____

CUT OUT
AND PASTE
ON POST
CARD



POPULAR MECHANICS

Books for the Farmer

- to reduce work
- protect and improve livestock
- increase profits



New Ed. Veterinary Guide for Farmers

Written by farm expert, G. W. Stamm, this amazing book has sold more than a quarter million copies... now completely revised with most modern discoveries and methods fully discussed. Adopted by the U. S. Government for farm training. Used by farmers everywhere to diagnose and treat livestock diseases. Covers virtually every farm animal ailment and tells how to tell one from another; explains treatment or best procedure until the vet arrives. Includes a special, invaluable 12-page diagnostic chart that helps you locate symptoms in short order. A special chapter is devoted to artificial insemination and tells how this breeding method can improve the quality of your herd as well as increase your profits. Noted authorities proclaim this book the finest and most complete guide of its kind available to the farmer and stock raiser.

\$3.95



New Edition Farm Manual

Helps you step up farm efficiency, improve property appearance and values, increase farm production and income. Every member of the farm family will find something in this book he or she can use to great advantage in farm operation, maintenance and improvement... from the building and care of equipment to painting the farm home and fast freezing of fruit and vegetables. Covers every aspect of farm machinery maintenance... includes detailed plans for building essential equipment from scrap and discarded materials. Even suggests how to mix and pour concrete that will last longer! Here is a book brimming with short cuts, labor-saving ideas and methods that will simplify farm chores and save you money as well. Adopted by State Farm Training Programs. Hundreds of pictures and clearly drawn diagrams.

\$3.50



Artificial Breeding and Livestock Improvement

Now—the secrets of the key to better livestock revealed by farm editor, G. W. Stamm! The first book in ten years to cover the up-to-date principles and practices of Artificial Breeding... and written in words every farmer and stockman can understand easily and follow surely. This astonishing book presents the true, approved facts on inbreeding, line-breeding and cross-breeding, plus sections on timing, heat periods, how to pick a good dairy cow, how to choose a herd sire, what to do when a bull fails to perform, what's ahead in the field of frozen semen and many other topics of equal interest. Included is a 13-page directory of semen producers, the areas they serve and the breeds of bulls in their studs. If you are a modern livestock producer interested in the best methods and top profits, you simply cannot afford to be without this book for regular reference.

\$3.50



Developing a Profitable Dairy Herd

Here, in a single, practically written book is everything you want and need to know about profitable dairy herd management. Written by Carnation Farms' Merton L. Moore and E. M. Gildow, D.V.M., there is complete information on feeding values, fertilization of pastures, silo practices, breeding, production, pedigrees, management problems and operating economies, vitamins and many other vitally important subjects. A most interesting chapter covers the showing and selling of cattle. Hundreds of charts, photos, drawings and diagrams leave nothing to the imagination. Whether you raise just a few cows or maintain a huge operation involving hundreds of animals—you'll profit from using this book.

\$3.50



Hog Profits for Farmers

Hog raising can be highly profitable for the farmer... if proper management and feeding methods are employed. Even if you raise only a few hogs you can make a much bigger profit by applying the suggestions and ideas contained in this outstanding Popular Mechanics book. Written by Dr. W. N. McMillen, it offers down-to-earth, practical money-making information on care and management, feeds and feeding, equipment, marketing, breeds and breeding, judging, showing and sales tips. Contributors include many well-known agricultural experts and renowned college instructors. Only a mere 15 minutes of reading time will show you how to apply the six high points of profitable hog raising to improve your profits immediately.

\$3.50

Satisfaction Guaranteed or Your Money Refunded.
Place your order now. Use coupon below.

MAIL TODAY

POPULAR MECHANICS PRESS, Dept. 159
200 East Ontario St., Chicago 11, Illinois

RUSH books I have checked below. If not pleased, I can return in good order within seven days for full refund.

Remittance enclosed. Send prepaid. Send C.O.D.; U.S.A. only
 Veterinary Guide Farm Manual Artificial Breeding
 Profitable Dairy Herd Hog Profits

Name _____

Address _____

P.O. _____ State _____



PAY 1¢ on the DOLLAR for 1000's of Useful Items U.S. GOV'T SURPLUS

LOOK AT THESE LOW PRICES

Jeeps ... \$223
Trucks ... \$212
Boats ... \$5.90
Fork-lifts, \$197
Hydraulic cylinders \$1.01
Reducers 97c
Tractors \$68
Motors 99c
Airplanes .. \$366
Typewriters, \$6.80
Gear
Transmissions \$7.80
Paid at Govt. Surplus Sales

Eliminate the middleman—Save big money! Buy direct from U. S. Government at TREMENDOUS savings. Pay as low as 1c on the dollar or less. Our Directory Govt. Surplus Sales lists 100's of Army, Navy, Air Force, and other government surplus depots. Many of them right in your own back yard. Buy sports equipment, hunting, fishing and photographic equipment and supplies, radio, electronic and electrical equipment, trucks, boats, jeeps, airplanes. Plumbing, hardware, office equipment supplies, Power tools, machinery, furniture. Directory is indexed for quick information. Answers your questions. Tells you how to buy. Get on the gravy train while you can. Send \$1 for "Govt. Surplus Directory" to—Aviation Surplus, Dept. PM-1, Box 789, York, Pa.

NEW! IMPORT-Mail Order
PROFITABILITY—START AT HOME
Sell RARE EXOTIC IMPORTS
by MAIL ORDER Exclusively! No experience required, no face to face selling. We want a limited number of ambitious men and women to participate at home in a new, exclusive IMPORT MAIL ORDER Business proposition. We do all IMPORTING, furnish expensive literature, names, addresses, and fill orders for you. All you do is mail for us and receive money coming direct to your own mail box. Hurry, for Big Profits.
MAIL ORDER DISTRIBUTORS (Import Franchise Division)

15201 South Broadway Dept. P-1 Los Angeles 61, Calif.

\$2.95 OR 2 FOR \$5.00!
TESTED AND GUARANTEED
Write for free list on all types of telephones.
Shipments F.O.B. Simpson, Pa.
TELEPHONE ENGINEERING CO., Dept. 189, Simpson, Pa.

GET INTO ELECTRONICS
V.T.I. training leads to success as technicians, field engineers, specialists in communications, guided missiles, computers, radar, automation. Basic & advanced courses in theory & laboratory. Assoc. degree in 20 mos. B.S. obtainable. ECPD accredited, G.I. approved. Graduates with major companies. Start Feb., Sept. Dorms, campus. H. S. graduate or equivalent. Catalog.
VALPARAISO TECHNICAL INSTITUTE
DEPT. D VALPARAISO, INDIANA

"\$10,784 FIRST YEAR"
SERVICING RADIATORS!
—Sidney Rad. Shop, Sidney, Mont.
Make good money servicing auto-truck-tractor radiators. Easy to learn. Inland, world's largest radiator equip. mfr., offers complete package—equipment, merchandising, "Pays-for-itself" Purchase Plan, free training. Small down payment on equipment starts you. Profitable dept. for garage or service station. Write:
INLAND MFG. CO., Dept. PM-1, 1108 Jackson St., Omaha 2, Nebr.

FLY YOUR OWN Bensen HELICOPTER
Simple to fly — build it yourself, with engine or as inexpensive glider type which can be mounted on floats or boat. Order 3-view drawing, specs and photo of Glider for \$1 or motor powered Gyro-Copter \$2. Ask about detailed plans and construction kits.
BENSEN AIRCRAFT CORP., Dept. PM-19
P. O. Box 2746, Raleigh, N. C.

Send \$1 or \$2

Name _____
Address _____

LEARN MEAT CUTTING AT NATIONAL

Pay After Graduation



The steady dependable trade of Meat Cutting taught easily in 8 short weeks. YOU LEARN BY DOING under actual meat market conditions in big modern school at Toledo.

For beginners or men with experience. Get a profitable store of your own. Remember, PEOPLE MUST EAT! Big pay jobs. Free employment help. Thousands of successful graduates.

Buying, cutting, percentage, pricing, advertising, selling, etc. A complete retail meat education. National School established 36 years. Get National training NOW. Pay your tuition in easy weekly

payments after you graduate. Send coupon for FREE school catalog — TODAY. G.I. approved.

National School of Meat Cutting, Inc., Dept. 50-M, Toledo 4, Ohio
Send me your FREE school catalog on National Training at Toledo in Meat Cutting, Meat Merchandising and Self Service Meats No obligation. No salesman will call.

Name _____ Age _____
Address _____
City _____ State _____
Approved for Veterans

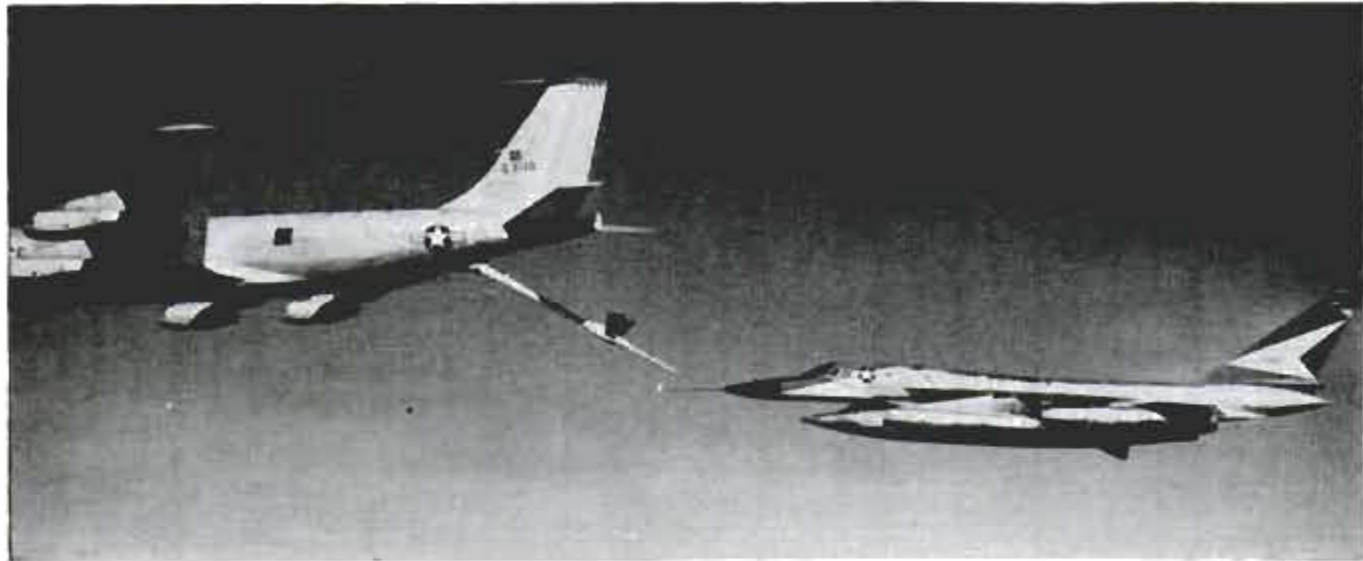

Supersonic B-58 Hustler Bomber Refueled in Flight

Midair refueling of the "world's fastest bomber," the B-58 Hustler, from a KC-135 tanker has been accomplished in tests over Texas. The Boeing-built tanker has a top speed of around 600 miles per hour while

the bomber, produced by Convair, flies at 1300 miles per hour. The fuel transfer was made without difficulty in maneuvering or holding the delta-winged bomber to the speed of the subsonic tanker.

Fast Winds

Wind velocities up to 133 miles per hour during an April storm that blew away anemometers were recorded at the Wilkes Station in the Antarctic.

Synchronize Watches!

Atomic clocks, based on the vibrations of cesium atoms, indicate the length of a day is increasing by half a thousandth of a second per year.

Start your own \$
SCREEN-PRINT BUSINESS
EARN \$\$\$\$\$\$\$\$

Amazing opportunity for Men & Women who want a Spare or Full-Time Home-Business

PRINT without a PRINTING PRESS

No big investment. Now, right in your own home - right in your kitchen, spare room, garage - any place you can go into the amazing Screen-Printing business. Print beautiful SIGNS, POSTERS, BANNERS, FABRICS - Anything in fabulous "Glowing" FLUORESCENT COLORS - can be seen for miles. No art ability. It's easy! We supply everything.

PRINT YOUR OWN MONEY

Things you print literally turn into money. Average \$100.00 job costs you less than \$10 in materials - you pocket the difference. Big profit opportunities almost everywhere. Some make more, some less, but Mr. J. T. Anderson reports he earns over \$400 a week printing Greeting Cards certain times of year.

MEN & WOMEN WANTED NOW to help fill the demand for Screen-Printing where you live. Free Samples and Revealing details write:

Free Samples - MAIL COUPON

Screen-Print Co., 15127 S. Broadway, Los Angeles 61, Calif., Dept. 21
 Please send free BOOKLET, "GLOWING" SAMPLES, "HOME-BUSINESS PLAN." All sent free. I am under no obligation ever.

Name _____
 Address _____
 City _____ Zone _____ State _____

How To Learn
 CONFIDENTIAL
 HOME-BUSINESS Plan
 SAMPLES

RUPTURED?

Be comfortable working, playing night or day! "Cushion of Air" Appliance guarantees security or costs you nothing! Facts free! Write now! **BROOKS CO., 143-A State St., Marshall, Mich.**

MAKE MORE MONEY!
 Be a Manufacturer's Agent!

You, too, can make a fabulous income if you know the money-making "angles" of being a manufacturer's agent. Our easy-to-follow course shows you how. Complete details free. Write today.

MANUFACTURER'S AGENTS SURVEY
 Dept. PM, 508 Forsyth Bldg., Atlanta 3, Ga.

BIG MONEY NEVER SO EASY TO MAKE WITH PRODUCT FOR WHICH THERE'S CRYING NEED!

Make up to \$1,000 a month with **MOTOR OVERHAUL!**

Today millions of motorists are holding on to their old cars, want to economize. You know this. That's why NOW is best time to sell these millions of older-car owners (and new-car owners) **MOTOR OVERHAUL**. It gives autos greater money-saving efficiency, freedom from costly repairs. You can prove that for \$2.98 **MOTOR OVERHAUL**, when added to engine oil, will give increases in compression (up to 58%), gas mileage (up to 54%), oil-saving efficiency (up to 90%)... proved by Independent Laboratory Road Tests. Big re-order business in spare time. Make up to \$1,000 a month, even more. For big Illustrated Sales Kit **FREE** write

POPE CHEMICAL CO.
 224 W. Huron St. Dept. R-3 Chicago 10, Ill.

BE A COMMERCIAL

Artist

— for less than 20c a day

Prepare for a fascinating, profitable Art career this easy, proven way. One "low-cost" teach yourself course covers Illustrating, Cartooning, Lettering, Oil Painting, TV Art, etc. Plus TWO ARTIST OUTFITS at no extra cost. Cash in on demand for trained artists. Be your own boss or high pay staff artist. FREE BOOK describes our easy method, opportunities in art. No obligation. No salesman will call. Just send your name, address to: WASHINGTON SCHOOL OF ART, Studio 141, Port Washington, N. Y. (Estab. 1914). Tear this out.



MAIL ORDER BUSINESS

How to Start a Profitable Business of Your Own at Home or in a Small office. Amazing new instruction course shows you how to run a good mail order business, spare time or full time. Up-to-date, practical training—a treasure-house of the best plans and practices being used TODAY by successful operators. Only \$5.95, Complete—Satisfaction Guaranteed! This is BIG. You get 34 money-making lessons in 5 separate volumes, all in one shipment. You must be satisfied or your money back immediately. Full price only \$5.95, prepaid—or COD plus postage. Nothing more to pay! Order "Mail Order Course" today. Nelson-Hall Co., 2105 Clinton St., Dept. 9AR-2, Chicago 6, Ill.



BINOCULARS TELESCOPES MICROSCOPES

All kinds, sizes and prices. Also Geiger and scintillation counters, electronic and chemical items, etc. FREE CATALOG.

J. D. CLINTON SCIENTIFIC, MT. CLEMENS 20, MICH.

STUDY FOR THE DEGREE

of Doctor of Psychology (Ps.D.) Doctor of Metaphysics (Ms.D.) or Doctor of Divinity (D.D.). Correspondence Courses only. Write for further information.

COLLEGE OF DIVINE METAPHYSICS, INC. DEPT. R-T • 2811 N. ILLINOIS ST. • INDIANAPOLIS 8, INDIANA

YOU CAN DO MAGIC

AMAZE, MYSTIFY AND MAKE MONEY TOO



NEW GIANT SURPRISE CATALOG 50c

Magic is thrilling and profitable too. Greatest hobby in the world. Now you too can astonish others. Start now. Get this amazing catalog today. Check full of Professional and Amateur Magic Tricks! Secret! Illusion! Mysteries! Joker's Novelty! Puzzles! Two catalogs combined into one giant edition. Rush City cents now—today!

HOUSE OF 1000 MYSTERIES • 2027 PINWOOD TR. • TRUMBULL, CONN.

OPERATE EARTH MOVING EQUIPMENT



Learn to operate bulldozers, cranes, motor scrapers, crawler tractors, draglines, off-highway dump trucks, etc., on 1,700 acre Greer Training Area 60 miles S.W. of Chicago, Ill. on Route 66. Courses include operation, equipment care, preventive maint., stake reading, etc. Minimum classroom instruction. You learn by actually operating the equipment. 200 hour (5 weeks) complete course in the operation of bulldozers, loaders, scrapers, dump and off-highway trucks as low as \$375. Classes start every Monday. Reserve your space today. Approved for vets and civilians.

MECHANIC TRAINING

Complete Mechanics Course covering Diesel engine transmissions; torque converters; fuel injection systems; track assemblies; final drive assemblies; steering systems; idlers; rollers; power transfer systems; cable control systems; hydraulic control cylinders & welding pertaining to heavy equipment such as bulldozers, scrapers, loaders, off-highway trucks, etc. Course time—540 hours—10 weeks to 13 1/2 weeks. Convenient payment plan. Write for details. Approved for vets and civilians.



Greer TECHNICAL INSTITUTE
ATT: M. A. Hutch, Box 278, Braidwood, Ill.

YOUR NEIGHBORHOOD NEEDS AN ELECTRICAL APPLIANCE



TROUBLE SHOOTER

MEN WANTED

NOW!

BIG PROFITS

ONE-MAN HOME BUSINESS

SPARE OR FULL TIME

Biggest home-business opportunity in U.S. today! Huge increase in use of "electric servants" creating boom in demand for service. Turn corner of garage, basement, attic, or porch into gold mine. We show you how to make business come to you. No selling. No previous experience needed. Our new "Home Practice" method prepares you quickly with hundreds of step-by-step photos and drawings. Professional tools make practice fun.

BIG DEMAND YEAR 'ROUND

from HOMES — Hundreds of repair jobs in every neighborhood pay somebody up to \$5 and more. Many jobs up to \$25 and more. It might as well be you! Fix electric irons, toasters, mixers, coffee makers, sweepers, washers, refrigerators, freezers, etc. Also repair and alter house wiring. Skyrocketing demand in room air conditioning.

from BUSINESS & INDUSTRY — Offices and stores are big users of electrical appliances — fans, heaters, refrigerators and many kinds of motor driven equipment. Single factory may have hundreds of electric motors operating saws, drills, sanders, lathes, etc. Many pay service man flat monthly fee to keep everything in order. Steady income! Pick up and do the work at home.

EVERYTHING FURNISHED Including

BIG TOOL KIT — We supply complete illustrated instruction for all kinds of electrical appliance repair — with a big Tool Kit and professional Appliance Tester. Everything you need to start — plus an amazing Business Plan that shows you how to start the orders rolling in almost without effort! Mail Coupon now. Start banking the profits in 30 days or less!



OTHERS MAKE BIG MONEY YOU CAN DO IT, TOO!

"I have made better than \$300 in spare time since I started the Course." P. A. ARKANSAS

"Less than 6 months after starting your Course, I obtained a full time job as a refrigeration and appliance service man." P. H. S. DAKOTA

"I have my own shop and getting more work than I can handle. I made more in one week to more than pay for the Course." J. W. VIRGINIA

NEW 30-DAY INCOME PLAN!

Shows you how to start your own Big Profit Business without investment — no big overhead

Send for this FREE BOOK!



AIR MAIL COUPON NOW!

FREE BOOK Exciting, valuable, helpful

Begin Making Money in 30 days or less

Mail Coupon for FREE Plan. PACIFIC TRAINING SCHOOL, Dept. PM591

11029 So. Vermont Ave., Los Angeles 44, Calif.

PACIFIC TRAINING SCHOOL, Dept. PM-591 11029 So. Vermont Ave., Los Angeles 44, Calif.

Gentlemen: Rush me postpaid your FREE plan for success in the Appliance Repair Business and the Free Book Entitled "The Appliance Repair Business and You" and remember I am under no obligation.

Name _____ Age _____
Address _____
City _____ Zone _____ State _____

ARE YOU SEARCHING FOR SUCCESS?



THE NEXT FEW moments may be among the most important of your life.

By sending for this booklet, you have indicated that you are a man looking for an opportunity; a man feeling the stirrings of active ambition; a man with his eyes toward the future.

You are a man *searching for success*.

You want prestige, increased income, job security, an assured future. Everyone wants these things that represent a better life.

And they can be yours. You can *earn* success. All you need to do is *take action*.

Success follows naturally from two steps, which are equally important:

1. *You must make the basic decision to succeed.*

You already are well on your way to making this decision. You are far ahead of some people, who simply aren't willing to earn success. Really, they say, it's much easier to drift along in this old rut. It may not be a comfortable rut, but why change? We're getting by. Besides, we're "too busy" to make any extra effort.

The lives of thousands of successful men—those who have climbed out of the "rut"—show an amazingly similar pattern. They weren't satisfied—*so they made a decision*. In each man's life there was a moment—perhaps the same as this moment in yours—when he *decided to succeed*. From somewhere deep inside himself he drew an overwhelming determination. He *would* succeed. From that moment he focused all his energies in a single direction—to succeed in his chosen career.

In most cases, once he had made this all-important decision, he found that the sacrifices were small compared to the rewards. Indeed, most of these successful men found that there were no real sacrifices, that work toward their goal became

fun, that every new step upward brought a new challenge.

But first they had to make the decision to succeed. Only you can make this basic decision for yourself. No one can make it for you. And it must be made without any reservations.

Sure you want to succeed. You can—if *you decide to!*

2. Once you've made this decision, only one thing remains to be done: *You must take action.*

The key to success is *action*. Only by *doing something* can you succeed. The world is made up of many people who "get by" in their less-than-comfortable rut, and a few people who *perform* to lead the others. You can be one of these leaders.

What sort of action? Obviously the first step is to *train yourself for your career*. No one ever has enough training. It is a recognized phenomenon that the more training and education a person gets, the more eager he is to learn. Whether you dropped out of high school or earned a doctor's degree in college, the best action you can take toward your goal in life is to obtain still more intensive training.

ATTENTION!

For copy of Career Guidance Booklet, "SKILLS FOR AMERICA,"

mail this coupon right now to:

POPULAR MECHANICS MAGAZINE

Department SFA-19

200 East Ontario Street

Chicago 11, Illinois

Please send copy of
"SKILLS FOR AMERICA" to:

Name _____
(PLEASE PRINT)

Street _____

City _____

State _____

POPULAR MECHANICS

DISTRIBUTORS

Now It Can be Sold!

Latest battery development now available for local distribution. The **BOROLYTE** Battery with **BORON-COMPOUNDED ELECTROLYTE** and iron-clad 7 year warranty.



Advanced offer of exclusive territories makes possible your ground-floor participation in newest development for booming automotive replacement market. No charge for territory, but you will be required to purchase reasonable inventory. Good character and business ability necessary. Write, wire or telephone for full details.

International Tire & Rubber Co.

PM-19, 2126 S. La Brea — WEbster 6-2255 — Los Angeles 16, Calif.

EARN UP TO \$100. A DAY

Start at home and have two incomes.

Tired of Being A Slave?

If you have two good hands and one good eye, you can become an expert in a few hours, keep your present job and earn up to \$50.00 in one evening while learning a real sound lifetime business. You can begin in spare room, garage or basement. Nothing like it offered anywhere. Don't miss the opportunity of a lifetime. For full details and illustrated booklet in beautiful color send 25c to cover cost of mailing.

MURALAMA ARTS
P.O. BOX 271 SEDONA, ARIZONA

ENGINEERING



Photo of Heald Students in Electrical Laboratory

American Industry Steps Up Its Demand for Trained Engineers. Train Now at Healds

BACHELOR OF SCIENCE DEGREE, 27 MONTHS

Degree Courses:

- Radio-Electronic Eng.
- Electrical Engineering
- Highway Engineering
- Mechanical Engineering
- Structural Engineering
- Civil Engineering
- Architecture

Diploma Courses:

- TELEVISION Color TV
- Radio-Electronic Tech.
- Industrial Electronic Tech.
- Tool & Die Design
- Architectural Drafting
- Mechanical Drafting
- Structural Drafting

Approved for Veterans

Enroll Now for New Term

Heald College Ranks FIRST West of the Mississippi in "Who's Who in America"

Send for FREE Information

Heald Engineering College

Est. 1862

Van Ness at Post, Dept. P.M. San Francisco, California

NAME _____
STREET _____
CITY _____
STATE _____

I'll show YOU...how to Draw CARTOONS

Learn in one day even if you have no previous training or art ability!
Cartoonists Earn Up To \$10-\$25 and More Per Hour

I have imported a revolutionary new patented system of learning to draw. This new short-cut method, although simple and easy to master has, in a few short weeks, made big pay cartoonists out of thousands of my students around the world who previously couldn't even draw a straight line!

After many requests from advertising agencies, magazines and many other types of firms who need cartooning talent so desperately, I have decided to disclose these long sought-after secrets—the Manual System—to American men and women of any age, in the hope that the sharing of these secrets will help fill the urgent need for cartoonists in the U.S. Since my agreement with my overseas agents limits the number of students I can accept, I have decided to hold this offer open to people who answer this advertisement without delay.

YOU MAY MAKE BIG PROFITS AT ONCE!

The amazing Manual System of cartooning is an entirely new concept in art instruction. There is no tedious home study—you learn by doing. And, you learn well—even though you may have never tried to draw before. Without wasting time, you can start making big, full or spare time profits with your very first lessons—whatever your age or training. You don't have to move, or even quit your job unless you want to. Throughout your training, you receive individualized and unlimited consultation service. As soon as you graduate, you receive employment assistance, if you desire.

CONTINENTAL SCHOOLS, INC.
Dept. A-1, 4201 So. Broadway, Los Angeles 37, Calif.



FREE of Extra Cost! 15 PIECE PROFESSIONAL KIT! Contains all the equipment you need during your instruction. Later on, valuable for your professional use.



Help Fill Huge Demand for BIG-PAY CARTOONISTS!

COMICS "Syndicated comic strips looking for fresh talent. Pay up to \$1000 per week and more."

ANIMATION "Thousands men, women are needed to produce animated cartoons for Hollywood Studios. Live in California! Earn up to \$150 a day!"

TV COMMERCIALS "Hundreds animated commercials, signs made daily in every town that has TV. Associate with top TV personalities. Pay up to \$15 per hour."

MAGAZINES & NEWSPAPERS "5,000 magazines, 24,000 newspapers now published. Almost all use cartoons. Some pay up to \$2500 assignment accepted."

ADVERTISING AGENCIES "Ad agencies demand more cartooning talent. Cartoons used more and more in magazine, newspaper, billboard, TV ads."

SIGN SHOPS "Help fill huge demand for signs everywhere. Start your own shop! Sell \$1 worth of materials for \$25. Help fill Today's demand for Cartoonists!"

But you must hurry! Airmail the coupon and I'll rush you my free book, details on the secrets of the revolutionary new "Manual Short Cut System" to cartooning and how to attain the 15 piece Professional Kit—ALL FREE! No obligation. No salesman will call. Write today!

Continental Schools, Inc.
(Schools in 8 Foreign Countries)

SEND FOR FREE BOOK!



AIRMAIL COUPON TODAY!

CONTINENTAL SCHOOLS, INC.
Dept. A-1, 4201 So. Broadway, Los Angeles 37, Calif.

Mr. Berman: Prove to me that your students can make Big Money cartooning. Rush me your free book, details on secrets of revolutionary new system, and how to receive 15 piece Professional Kit—ALL FREE. I understand there's no obligation, now or ever, and that no salesman will call.

NAME _____
ADDRESS _____
CITY _____ ZONE _____ STATE _____



Service Stations for Air Force Fighters

Supersonic F-102A and F-106 jet interceptors can be completely serviced in 12 minutes at stations installed at the Palm-dale, Calif., facility of Convair. Eight planes can be handled at once from four fueling pits. The fighters are fueled in eight min-

utes from underground tanks that hold 40,000 gallons of jet fuel. While the plane is being serviced the flight engineer confers with the pilot about any performance problems and decides whether the plane shall go to the preflight line or to a work area.

OPTICAL BARGAINS ERECT IMAGE LOW POWER MICROSCOPE

5X, 10X, 20X

\$80.00 Value - Only \$19.95

Extremely sturdy with rack and pinion focusing, color corrected optics, turnable microscope body for inclined viewing, three different powers, long working distance under objectives, sufficient eye relief for easy viewing. Made from war surplus optical instrument so that you actually get \$80.00 of value. Weighs 4 lbs., 13" high. 10-DAY FREE TRIAL! Accessory objectives available for powers of 15X, 30X, 40X.

Stock No. 70.172-H.....\$19.95 Postpaid



New! 2 in 1 Combination! Pocket-Size 50 Power MICROSCOPE and 10 Power TELESCOPE

Useful Telescope and Microscope combined in one amazing, precision instrument. Imported! No larger than a fountain pen. Telescope is 10 Power. Microscope magnifies 50 Times. Sharp focus at any range. Handy for sports, looking at small objects, just plain snooping. Send Check or M.O. Satisfaction Guaranteed. Order Stock No. 30.059-H.....\$4.50 Postpd.



WAR SURPLUS AMERICAN-MADE 7 x 50 BINOCULARS

Big savings! Brand new! Crystal clear viewing —7 power. Every optical element is coated. An excellent night glass—the size recommended for satellite viewing. Individual eye focus. Exit pupil 7mm. Approx. field at 1,000 yds. is 376 ft. Carrying case included. American 7 x 50's normally cost \$195. Our war surplus price saves you real money.

Stock No. 1533-H.....only \$55.00 postpd. (Tax included)



STEREO MICROSCOPE — 23X and 40X

Stock No. 85.056-H.....only \$99.50 F.O.B. Barrington, N. J.

WRITE FOR FREE CATALOG "H"!

Complete Line of Astronomical Telescope Parts and Assembled Telescopes. Also huge selection of lenses, prisms, war surplus optical instruments, parts and accessories. Telescopes, microscopes, Hand Spectroscopes, Sniperscopes, binoculars, etc. Request Catalog "H"!

ORDER BY STOCK NUMBER SEND CHECK OR MONEY ORDER. INSTALLATION GUARANTEED.
EDMUND SCIENTIFIC CO., BARRINGTON, N. J.

MAKE YOUR OWN FURNITURE



200 Pages

Full-color section

\$3.50



New POPULAR MECHANICS book helps you Beautify your home and save hundreds of dollars on such items as these:

Combination Wall Bookcase and Desk

Yours for the asking! . . . a handsome cocktail table, a new dinette set, a desk. You'll find easy to follow plans and instructions for these and many other modern furnishings that will add to the beauty and comfort of your home. Each piece of furniture is designed by leading craftsmen, for years of use. Translated by POPULAR MECHANICS into words you can understand. "MODERN FURNITURE YOU CAN BUILD" is an asset to any home-maker. You'll save as much as 2/3rds the cost of ready-made furniture. In this 200-page treasure chest, you'll find a big full-color section plus a full chapter on modernizing old furniture. Even if you build only one article from its designs, you'll save many times the price of this book.

Mail coupon below today.

POPULAR MECHANICS PRESS, Dept. 159
200 E. Ontario St., Chicago 11, Ill.

RUSH my copy of Modern Furniture You Can Build. I enclose \$3.50 check or money order in full payment. Send COD (U.S. only). I am protected by full money-back guarantee if not pleased.

Name _____

Address _____

City _____ Zone _____ State _____

\$40 for 1 1/2 DAY'S SPARE TIME WORK GRINDING LAWNMOWERS

Yes, J. H. B. writes, "not bad for a 76 year old young fellow earning \$40 for a day and a half's work" . . . and others are making even bigger money with the Universal Model B Lawnmower Grinder. You, too can make good spare or full time profits in your own business in your garage or basement. We furnish everything you need. Write today. No cost or obligation. Dept. M-19



ROGERS
MANUFACTURING CO.
LINDSEY, OHIO

*After the city,
Before the state*

*The ZONE keeps your mail
From being late*



The Post Office has divided 106 cities into postal delivery zones to speed mail delivery. Be sure to include zone number when writing to these cities; be sure to include *your* zone number in *your* return address — after the city, before the state.

High School at Home

MANY FINISH IN 2 YEARS

No classes. No time wasted going to and from school. Progress as fast as your time and abilities permit. Standard H.S. texts supplied. Thousands enroll each year in this 62-year-old school. Send for FREE descriptive booklet.

AMERICAN SCHOOL, Dept. H-145
Drexel at 58th St., Chicago 37, Ill.

Without obligation, please send FREE descriptive booklet.

Name _____

Address _____

Accredited Member National Home Study Council

TRAIN AT HOME

in Your Spare Time or in the Great Allied School

1338-42 South Michigan Ave.
Chicago 5, Ill.

DRAFTING—All Branches
• Mech. • Structural • Aeronautical

ENGINEERING
• Industrial Engineering
• Tool Engin. & Designing

ELECTRONICS

AUTO MECHANICS

AIR CONDITIONING
Refrigeration — Heating & Cooling

TOOL & DIE MAKING
Machinist Trade

Choose the
Allied Way for Best Pay

SEND FOR
FREE
BOOKS

Prepare for the best jobs in your spare time at home. With ALLIED'S practical home study program you can progress so rapidly that big new opportunities will soon be open to you. Students planning a career in engineering can begin their training in short courses at Home or at Allied Institute and continue progressively toward an Engineering Degree in 31 months. Allied is approved by Industry, National Home Study Council, Department of Education, Office of Public Instruction, State of Illinois, U. S. Department of Justice.

ALLIED INSTITUTE OF TECHNOLOGY,
1338-42 South Michigan Ave., Dept. PM-19, Chicago 5, Ill.

Send me without obligation information on your courses:

- | | |
|---|--|
| <input type="checkbox"/> MECHANICAL DRAFTING | <input type="checkbox"/> AUTO MECHANICS |
| <input type="checkbox"/> STRUCTURAL DRAFTING | <input type="checkbox"/> ELECTRONICS |
| <input type="checkbox"/> AERONAUTICAL DRAFTING | <input type="checkbox"/> AIR CONDITIONING |
| <input type="checkbox"/> INDUSTRIAL ENGINEERING | <input type="checkbox"/> REFRIGERATION |
| <input type="checkbox"/> TOOL & DIE DESIGNING | <input type="checkbox"/> TOOL & DIE MAKING |
| <input type="checkbox"/> HOME STUDY | <input type="checkbox"/> RESIDENT |
| <input type="checkbox"/> VETERAN | <input type="checkbox"/> NON-VETERAN |

NAME _____ AGE _____

ADDRESS _____

CITY _____ COUNTY _____ STATE _____



I'd like to give this to my fellow men... while I am still able to help!

I was young once, as you may be—today I am older. Not too old to enjoy the fruits of my work, but older in the sense of being wiser. And once I was poor, desperately poor. Today almost any man can stretch his income to make ends meet. Today, there are few who hunger for bread and shelter. But in my youth I knew the pinch of poverty; the emptiness of hunger; the cold stare of the creditor who would not take excuses for money. Today, all that is past. And behind my city house, my

summer home, my Cadillacs, my Winter-long vacations and my sense of independence—behind all the wealth of cash and deep inner satisfaction that I enjoy—there is one simple secret. It is this secret that I would like to impart to you. If you are satisfied with a humdrum life of service to another master, turn this page now—read no more. If you are interested in a fuller life, free from bosses, free from worries, free from fears, read further. This message may be meant for you.

By Victor B. Mason

I am printing my message in a magazine. It may come to the attention of thousands of eyes. But of all those thousands, only a few will have the vision to understand. Many may read; but of a thousand only you may have the intuition, the sensitivity, to understand that what I am writing may be intended for you—may be the tide that shapes your destiny, which, taken at the crest, carries you to levels of independence beyond the dreams of avarice.

Don't misunderstand me. There is no mysticism in this. I am not speaking of occult things; of innumerable laws of nature that will sweep you to success without effort on your part. That sort of talk is *rubbish!* And anyone who tries to tell you that you can *think* your way to riches without effort is a false friend. I am too much of a realist for that. And I hope you are.

I hope you are the kind of man—if you have read this far—who knows that anything worthwhile has to be *earned!* I hope you have learned that there is no reward without effort. If you have learned this, then you may be ready to take the next step in the development of your karma—you may be ready to learn and use the secret I have to impart.

I Have All The Money I Need

In my own life I have gone beyond the need of money. I have it. I have gone beyond the need of gain. I have two businesses that pay me an income well above any amount I have need for. And, in addition, I have the satisfaction—the deep satisfaction—of knowing that I have put more than three hundred other men in businesses of their own. Since I have no need for money, the greatest satisfaction I get from life, is sharing my secret of personal independence with others—seeing them achieve the same heights of happiness that have come into my own life.

Please don't misunderstand this statement. I am not a philanthropist. I believe that charity is something that no proud man will accept. I have never seen a man who was worth his salt who would accept

something for nothing. I have never met a highly successful man whom the world respected who did not sacrifice something to gain his position. And, unless you are willing to make at least half the effort, I'm not interested in giving you a "leg up" to the achievement of your goal. Frankly, I'm going to charge you something for the secret I give you. Not a lot—but enough to make me believe that you are a little above the fellows who merely "wish" for success and are not willing to sacrifice something to get it.

A Fascinating and Peculiar Business

I have a business that is peculiar—one of my businesses. The unusual thing about it is that it is needed in every little community throughout this country. But it is a business that will never be invaded by the "big fellows". It has to be handled on a local basis. No giant octopus can ever gobble up the whole thing. No big combine is ever going to destroy it. It is essentially a "one man" business that can be operated without outside help. It is a business that is good summer and winter. It is a business that is growing each year. And, it is a business that can be started on an investment so small that it is within the reach of anyone who has a television set. But it has nothing to do with television.

This business has another peculiarity. It can be started at home in spare time. No risk to present job. No risk to present income. And no need to let anyone else know you are "on your own". It can be run as a spare time business for extra money. Or, as it grows to the point where it is paying more than your present salary, it can be expanded into a full time business—overnight. It can give you a sense of personal independence that will free you forever from the fear of lay-off, loss of job, depressions, or economic reverse.

Are You Mechanically Inclined?

While the operation of this business is partly automatic, it won't run itself. If you are to use it as a stepping stone to independence, you must be able to work with your hands, use such tools as hammer and screw driver, and enjoy getting into a pair of blue jeans and rolling up your sleeves. But two hours a day of manual work will keep your "factory" running 24 hours turn-

ing out a product that has a steady and ready sale in every community. A half dollar spent for raw materials can bring you six dollars in cash—six times a day.

In this message I'm not going to try to tell you the entire story. There is not enough space on this page. And, I am not going to ask you to spend a penny now to learn the secret. I'll send you all the information, free. If you are interested in becoming independent, in becoming your own boss, in knowing the sweet fruits of success as I know them, send me your name. That's all. Just your name. I won't ask you for a penny. I'll send you all the information about one of the most fascinating businesses you can imagine. With these facts, you will make your own investigation. You will check up on conditions in your neighborhood. You will weigh and analyze the whole proposition. Then, and then only, if you decide to take the next step, I'll allow you to invest \$15.00. And even then, if you decide that your fifteen dollars has been badly invested I'll return it to you. Don't hesitate to send your name. I have no salesmen. I will merely write you a long letter and send you complete facts about the business I have found to be so successful. After that, you make the decisions.

Does Happiness Hang on Your Decision?

Don't put this off. It may be a coincidence that you are reading these words right now. Or, it may be a matter that is more deeply connected with your destiny than either of us can say. There is only one thing certain: If you have read this far you are interested in the kind of independence I enjoy. And if that is true, then you must take the next step. No coupon on this advertisement. If you don't think enough of your future happiness and prosperity to write your name on a postcard and mail it to me, forget the whole thing. But if you think there is a destiny that shapes men's lives, send your name now. What I send you may convince you of the truth of this proverb. And what I send you will not cost a penny, now or at any other time.

VICTOR B. MASON
1512 Jarvis Ave., Suite M-2-A
CHICAGO 26, ILLINOIS

POPULAR MECHANICS

**WORLD'S
BEST
WANT-AD
MEDIUM**

CLASSIFIED ADVERTISEMENTS



Advertisements in this section \$1.25 per word, each insertion, minimum 10 words, payable in advance.

To be inserted under proper classification, copy must be in our office the 20th of the second month preceding date of issue

F. W. Johnson, Manager, Classified Advertising

Popular Mechanics Magazine, 200 East Ontario Street, Chicago 11, Illinois

YOU'LL PROFIT By reading and answering the classified ads in this section. Hundreds of opportunities for you to make and save money

AUTOMOBILES, MIDGET CARS

TEN Complete illustrated automobile driving lessons prepared by Automobile Driving Aids, Inc., Box 6A, Turtle Creek, Penna. \$1.00, no c.o.d.'s.

FIX Lights, horn. Analyze shorts, charging, starting and battery failure. Troubleshooting dialchart \$1. Auto Generator Service, 8 Ball St., Irvington, N. J.

MIDGET Car. Plans and pricelist of parts 35¢. B. Sypher Co., Sta. F., Toledo, Ohio.

NEW 1959 Automobiles—To 25% off retail. Meder, 550-PM Fifth Avenue, New York City 36.

NON-Profit organization offers automobile catalogs, old, modern and foreign; dealer books, glossy photographs, service manuals; free motor magazines. Write to get on free mailing list. Auto Maniacs, Stockbridge, Mich.

AUTOMOTIVE Books. Send for 1958 general book catalog. 10¢. Popular Mechanics Press, 631 N. St. Clair St., Chicago 11, Ill.

AUTO SUPPLIES AND EQUIPMENT

1959 GIANT Auto parts catalog. Thousands accessories stores don't handle. Gadgets, custom equipment. Send 25¢ (refundable). Newhouse Automotive Industries, 5805 PM-1 Beverly, Los Angeles 22, Calif.

BUMPERS Replated. Kit \$1.50 postpaid. Guaranteed. Box 147, Hamtramck 12, Michigan.

SOMETHING You've been waiting for. Tire chains you simply throw on. Even if stuck there's no rolling or lifting of tires; nor reaching around to far side of tires for fastening. "A motorist dream come true." Send \$2.00 for car chains, \$3.00 for heavy truck, and kit complete with instructions to change your present chains over will be sent postage prepaid. Satisfaction guaranteed or money refunded. Thro-on Tire Chains, 3031-33 Roosevelt St., Kansas City, Kansas.

AMAZING Performance and beauty kit. Details free. Automotico, 1727 Ninth Avenue, San Francisco 22, California.

MOTORISTS Save gasoline vacuumating overrich mixtures. For free particulars, how to get one for your car for introducing write, Vacuumatic, Dept. 873, Wauwatosa, Wis. Salesmen wanted.

ENGINES, OHV V8's. All popular makes. 1956-1958. Ledbetter Enterprises, 1015 West 17th, Texarkana 4, Texas.

DEMINERALIZED Water for batteries, steam irons, laboratory work. Details free. Metro Service, Box 111, Ridgewood, N. J.

FREE List. Colorful, souvenir decals. Box 504, Nyack, N. Y.

AUTO Shop welding repair training in world's largest nonprofit welding school. Catalog free. Hobart Welders, Box M-191, Troy, Ohio.

FIBERGLASS Automobile fans. 1/5 weight \$10.30. Sun-Glas, Mt. Sterling, Ill.

PROFIT! Battery repair manual \$3.00. Bayer, 938 Betty, Neenah, Wis.

1959 EDITION. It's new! It's different! Get world's largest auto accessories and parts catalog, save up to 50%. 308 pages, over 85,000 items for 1920 to 1959 models including Hollywood accessories, custom styling and hi-speed equipment. All parts and accessories for all cars and trucks. We have that hard to get part. Jam packed with bargains. Completely illustrated. Send 25¢ (refundable). J. C. Whitney, 1919PM-1, Archer, Chicago 16, Ill.

LUCIDATOR Pocket computer key-ring. Unique, useful, fascinating touring gadget. Motorists' model calculates m.p.g. and m.p.h. Tourists' model converts ten currencies. Both models convert metric to English measures as well. Fitted real English leather case with key-ring and full instructions. Send \$2.00 stating model required. We supply return post direct to you. Lucidator Limited, 7, Birchlin Lane, London, E.C.3, England.

BATTERY Weld sticks. Battery men send letterhead for sample. Northlaker 607, Peoria 4, Illinois.

NEON Stop sign. 6-12 volt cars. Instructions \$1.00. E. V. Anderson, 356 Lenox Rd., Fairfield, Conn.

JEEP Owners—V-8 conversions. Read Jeep Owners ad, page 40.

CRANKSHAFT Grinder. Hand operated makes bearings fit without taking engine apart. \$3.75. Literature. L. D. McGee, 719 Cascade St., Wenatchee, Wash.

1909-1934 NEW Ford parts. Catalog 25¢. Mark, Layton, New Jersey.

SUPREME Racing camshafts. Cleveland Hone & Mfg. Co., 8816 Harkness, Cleveland 6, Ohio.

RING-Valve job while driving. \$6.00. Free details. Motaloy, Grantham, Penna.

REVOLUTIONARY Gasoline saver device! Particulars, send 10¢, refundable. Grabie Enterprises, 26314 Normandy, Roseville, Michigan.

BARGAIN. Exciting Little Library booklets. 25¢ each. How to use tools, painting, welding, home improvement, games, models, plastics, lamp making, glass blowing, boats, photographs. Free Little Library catalog. Popular Mechanics Press, 200-LB East Ontario St., Chicago 11.

SAVE Money on Jeep and army truck parts. Large inventory. Catalogs for Jeep or G.M.C. owners. American Auto Parts Co., 1830 Locust, Kansas City, Mo.

FREE! New catalog. Speed, power, mileage increasing equipment. Discounts! Almuist Engineering, Milford PMS, Penna.

NEW And used parts at savings. Complete guaranteed parts service for all models cars and trucks, 1924 and later. Largest in the West. Jeep and army parts specialists. Newest type shifting hubs for all jeep and all military and latest production front end drive vehicles. \$27.50 and up. Write. Pioneer Auto and Truck Parts Co., 734 W. 13th Avenue, Denver 17, Colo.

AUTO TRAILERS

BUILD "Flexi-Trailer"—Anyone can do it easy! Use as box, flat, boat, or camping trailer. Converts in one minute! Complete plans \$4.95. Write for details. Outdoor Industries, Dept. PM-1, R. 4, Excelsior, Minn.

PICKUP Coaches. Trailer blueprints. Literature 10¢. Comstock Trailers, Parsons, Kansas.

HOW To build trailers. Step by step procedure. All sizes, specific plans, complete list of suppliers. \$3.00. Fully illustrated. Trail-R-Club of America, Box 1376-14, Beverly Hills, Calif.

TWO Wheel camper and utility trailer. Build your own. Sleeps 4-6. Detail plans \$3.00. Surinak, 13100 West Cleveland, Waukesha, Wis.

TRAILER Building guide, supply catalog \$1.20. Blueprint booklet floor plans, 60¢. Kameract, Box 1153, Milwaukee 1, Wis.

BUILD Expanding eight foot trailer. Accommodates five. Literature 10¢. Fram-Mar Company, Wilmington, Mass.

MOTORCYCLES, BICYCLES, MOTORSCOOTERS AND SUPPLIES

WHIZZER Engine \$7. Motorbike conversion \$4. Cushman motorscooter \$15. Boy's auto \$35. Highway midget \$40. Crosley station wagon \$75. (Mailorder only). Send 25¢ (35¢ for first class mailing) for new 32 page directory-catalogue Number 87, listing these and hundreds of other bargains in motorscooters, midget cars, engines, homebuilder's parts, plans, etc. Midget Motors Directory, Athens, Ohio.

NSU Scooters and motorcycles. BMW motorcycles, 2 to 35 h.p. shaftdrive and chaindrive. Butler & Smith, P.O.B. 45, New York City 24.

1000 MOTORCYCLE Bargains at giveaway prices. World wide parts service. We trade for anything. Catalog 25¢. Bunico, 146-BK, Covington, Virginia.

HARLEY - Davidsons — Used bargains. New, used parts, accessories for all models. Bulletin, catalog 25¢. Knuth's (Factory Dealer), 1753 Muskego, Milwaukee, Wis.

RECONDITIONED Motorcycles and motors. Chromium accessories. Complete stock Indian parts. Expert rebuilding. Past service. Indian Motorcycle Sales, Kansas City 27, Missouri.

RACING Power cams for Cushman, Whizzer, Mustang, Hiawatha, Continental. Send your cam and \$10. Weber Cams, Box 33175, Los Angeles 33, Calif.

AVIATION

BOOKS. Aviation. Free catalog. Aero Publishers, 2162-PM1 Sunset, Los Angeles 26, California.

WANTED—Aviation books, etc., before 1920. Ed Sterne, 2949 Balboa, San Francisco 21, Calif.

AIR Cushion vehicle, travels over any surface. Three views. Specifications \$1.00. Aeromarine, P.O. Box 12, Ferndale, Mich.

HELICOPTER. Kits, plans. Free brochure. Adams, Box 6042-A, Lakewood, Calif.

FLYING Platform. Three drawings, \$2.00. Rotron, Box 573-A, Bellflower, Calif.

HELICOPTER Mechanics urgently needed. Train at home. Southern Cross Helicopter Institute, 345 SIP, Jersey City 6, N. J.

AIRLINE Careers. Starting salary \$3400 up. Short, easy course. G.I. approved. Free catalog B. McConnell Airline School, 1030 Nicollet, Minneapolis, Minnesota.

SMALL Helicopters theory and guide manual. Drawings. Construction data. \$2.00. Sandhill Aircraft, Box 336, Atkinson, Nebraska.

PROPELLERS. Plans, supplies for airboats and snowplanes. Latest designs, prompt delivery. Catalog 25¢. Banks-Maxwell, Box 3301E, Ft. Worth 5, Texas.

BOOKS; Hundreds of subjects. Big 1958 book catalog—10¢. Popular Mechanics Press, 200-BC East Ontario St., Chicago 11.

ELECTRICAL SUPPLIES

FREE Bargain catalog—Fluorescent fixture kits, fixtures, parts. Shoplite, 650M Franklin, Nutley 10, New Jersey.

APPLIANCE Parts wholesale, catalogue 25¢. Sico, 26 South 20 Street, Birmingham 3, Alabama.

FIND Shorts quick! Free details! Dynamic, Electronics Div., Harwich Port, Mass.

ELECTRIC Pencil: Engraves all metals \$2.00. Beyer Mfg., 10511-H Springfield, Chicago 43.

LAMP, Electrical parts, wholesale. Thousands of items for repairing, converting. Catalog 25¢. Brown Lamp, Box 305, Clayton 5, Mo.

LAMPS—Parts catalog containing wiring instructions, 25¢. Gyro Lamps, 3438P N.W. 54 Street, Miami, Fla.

HOUSE Wiring—Electrical repairs. Booklet. Send for 1958 general book catalog. 10¢. Popular Mechanics Press, 633 N. St. Clair St., Chicago 11.

WELDING, SOLDERING, PLATING

ACETYLENE Welding outfits, new \$54.50, arcwelders \$56.50. Eagle Welding, Dept. P.M., 5085 Broadway, Chicago 40, Ill.

WELDERS, 110/220, \$39.50. Morris, 1070 Inner Drive, Schenectady 3, New York.

PLATING Equipment, supplies. Complete line of anodes, solutions. Home workshops, industrial sizes. Hollywood Bronze Supply, Dept. C, 1624 East First, Los Angeles 33, California.

FREE Catalog, welders, welder kits. Build 300-ampere welder using aircraft generator, plans 25¢. Agents wanted. Dunbar Manufacturing, Minneapolis 8, Minn.

MACHINERY, TOOLS, SUPPLIES

MATERIAL, Metals, plastics—Quoted your sketch. Box 35B, Bloomfield, N. J.

1/4" TUBE Benders, all steel, wt. 14 oz. Bends in a jiffy. \$3.80 post paid. Meyer, 1909 W. 7th St., Los Angeles 57, California.

THROW-Away-filter wrench. Free details. Sha-Khan-Eck Sales, Atlanta 6, Ga.

WEASEL Parts. You build your snow tractor. Symington's, Union Bay Place, Seattle 5, Wash.

ENGINES, MOTORS, DYNAMOS

MINIATURE Electric motors—Will run ten hours on one flashlight battery. \$2. Limited supply. Doland, Box 2041, Madison 5, Wis.

WINDING Data. 275 motors, single and three phase. \$1.10. Data Company, Box 7631, Kansas City 28, Mo.

REWIND Motors yourself. Complete instructions \$1.00. Lewis Mfg., Howell, Michigan.

DIESEL Injector parts wanted. OM51-71-110. Bares, 7120 Carnegie, Cleveland 3, Ohio.

SURVEYING INSTRUMENTS

NEW And guaranteed factory rebuilt transits and levels, sale or rent, with purchase option. We will repair, trade or buy old instruments. Write for list M-91, Warren-Knight Co. (Manufacturers of Surveying Instruments), 136 N. 12th St., Philadelphia 7, Penna.

BOATS, OUTBOARD MOTORS

FREE Catalog! Boat kits, trailers, fiberglass, marine hardware. Luger Industries, Dept. M-1, 9200 Access Rd., Minneapolis 20, Minnesota.

FORDS And Jeeps 100% marine engines with famous Convo-Kits. Deluxe catalogue 25¢ coin. Oscomotor, 3627B Lawrence, Philadelphia 40, Penna.

ALUMINUM Boat kits, save 50%. Literature 10¢. Alumakit, Box 42, Beverly 13, Massachusetts.

FIBERGLAS And Epoxy paste repair kit. Repairs anything. Stronger than steel. \$1.49 postpaid. No c.o.d. Literature free. Glass Plastic Corp., 1605 West Elizabeth Ave., Linden, N. J.

300 BOAT Plans, patterns, catalog 50¢. Fiberglass dinghies. Marinecraft, Box 161-M, Brighton, Mass.

NEOPRENE Dock bumper stripping; 1 1/2" round with fastening lip 1 1/8". Navy surplus material in coils of 25 feet at 15¢ per ft. Ideal also as weatherstripping or gasket for garage doors, hatches, etc. Write for sample: Starline Processes, 317 Glasgow Ave., Inglewood, California.

YACHTS Custom designed. Sail or power. Sorensen, Box 602, New Rochelle, N. Y.

BOAT Plans—Full size patterns, frame kits. Modern inboards and outboards for amateur builders. Complete new catalog 50¢ or specify requirements. Glen Designs, 9152 Rosecrans, Bellflower, California.

BOAT, 14 Ft. Fiberglass outboard. Mahogany trim, only \$395 f.o.b. Toledo. Free catalog. Bock Boats, Inc., Toledo 2, Ohio.

BOAT Leaking? Make it dry. Fiberglass covering kits, molding supplies. Aqua Glas, Box 99, Altadena, Calif.

STEAM Boats, cars. Build with our engines, folder 25¢. Tiny Power, Corvallis, Oregon.

FIBERGLAS Permanent boat waterproofing. Special 25% discount. Complete kits, \$9.45 up. Guaranteed materials. Easy application. Full instructions. Free literature. Ajax Plastics, Dept. PM, P.O. Box 1323, Fort Worth, Texas.

MARINE Conversions, Ford, Chevrolet, Jeep engines. Catalog 25¢. Lehman Manufacturing Company, 972D Broad Street, Newark 2, New Jersey.

PROPELLERS, Plans, supplies for airboats, snowplanes. Catalog 25¢. Banks-Maxwell, Box 3301F, Ft. Worth 5, Texas.

SAVE Money. New, used outboard motor parts. Send wants. Stamp appreciated. Outboard Motor Mart, 229-M State, Boston 9, Mass.

NEW, Used, rebuilt marine motors. Marine conversions, fittings. Free catalog. Stokes Marine Supply, Dept. 24, Coldwater, Michigan.

I want to send you proof of the wonderful pulling power of Popular Mechanics classified pages. What's your proposition? Write me today. Include literature if possible. F. W. Johnson, Manager Classified Advertising, Popular Mechanics Magazine, 200 E. Ontario St., Chicago 11, Ill.

MARINE Conversion, Willys to Cadillac, engines, kits and parts. Catalogue and conversion hints free. Barr Marine, 2706 Castor Avenue, Philadelphia 34, Penna.

ATHLETIC EQUIPMENT, BODY BUILDING COURSES

4 MUSCLE Courses 25¢. Fully guaranteed. 12 courses \$2.00. Personal supervision. Sid's System, Southgate, Calif.

SLOWING Down? Legs or feet muscles cramp and ache? Active men and women know you are only as young as your feet and legs. Amazing Perrin Method activates, stimulates and intensifies circulation and nervous force. No expensive equipment. One small cost covers lifetime benefits. Why lose out on these advantages? Write today for free information. Orin Company, 1017-PM 13th St., Des Moines, Iowa.

HOW To overpower bullies, thugs, intoxicated, violent or demoted persons twice your size easily. 10 official police Jiu Jitsu holds. 33 photographic illustrations. Amazing copyrighted home study course by world famous instructor. Full price only 35 cent postpaid. Satisfaction guaranteed. Jorgensen, Box 5082PM159, Seattle 7, Wash.

FREE Muscle building information. Body-Tone, Box 638B, North Miami, Florida.

BARBELLS. Dumbbells. Courses. Booklet 10¢. Good Barbell Co., Siloam Springs, Arkansas.

SPORTING GOODS, GUNS, FISHING TACKLE, ARCHERY, TRAPPING

TENTS—For outdoor living, fun, for kids \$6.95 up; for adult, \$16.95 up. Capri Tent Co., 77-41 160 St., Flushing 66, N. Y.

CROSSBOWS! Hunting—Bows! Factory prices! Jayco, Box 1355, Wichita, Kansas.

LURES—Small shiny discs attract them all. Sample portion 50¢. Lure-em-all Co., Box 335, Montclair, New Jersey.

BIG Money raising crickets and 12 inch African fishworms. Free literature. Carter Ranch, Plains, Georgia.

GUNS, Swords, knives, daggers, flasks. Large list 25¢ coin. Ed Howe, Coopers Mills 52, Maine.

HOW To catch fish with smell, 25¢. Johnson's, 312 Lake Avenue, Ithaca, New York.

SPECIAL Value—Imported hunting knives \$2.95 ppd. Values to \$5.00. Tomart Co., 4322 Mt. Vernon Rd., Cedar Rapids, Iowa.

NATIONAL Fishing and hunting club. Receive 300 catalogs, magazines, fish barometer. Membership \$1.00. Linco, 5117 East 22, Tulsa 14, Okla.

10,000 GUNS! Swords, Kentuckies, Colts, Lugers, hunting guns! Bargain catalog 50¢. Agramonte's, Yonkers 2-G, N. Y.

FISHING Rod kits, custom quality. Illustrated catalogue 25¢. Makit Rod Company, 113 Adolph, Ft. Worth 7, Texas.

CAST Brilliant plastic fish lures. Profit on hobby. Literature 10¢. Fish-Allure, Box 421, Provo, Utah.

FREE—Wholesale catalog. Beads. Spinners. Lure parts. Sinker molds. Jigs. Reels. Finnyports (ME), Toledo 6, Ohio.

COLUMBUS Game for pond or pool. Mac's Hobby Ranch, P.O. Box 14, Dallas-town, Penna.

KILL Submersed water weeds which foul up motor propellers, tangle fishing gear and choke irrigation ditches with R-H Granular Weed Rhap-20. Inexpensive, easy to use, sure results. For details write Reasor-Hill Corporation, Box 36PM, Jacksonville, Arkansas.

MOLDS For fisherman's sinkers, jigs, squids, casting and spinning lures. Free catalog. Sweet's Molds, Tonawanda 1, New York.

5000 BARGAINS, Firearms, binoculars, war relics. Catalog 50¢. Smith Firearms, Runnemed, N. J.

AMAZING Wholesale sporting catalog. Save 70%. Tremendous selections. Econ-O-Mart, Whippany 2, New Jersey.

JAP Rifle altering to 30-06, \$6.00. Japshells, \$3.95. Catalog 10¢. T. P. Shop, West Branch 11, Mich.

EARTHWORMS, CRICKETS, FROGS

EARN Money at home raising fishworms for us! Backyard, garage, basement. We buy your crop! Inquire: Oakhaven-56, Cedar Hill, Texas.

BIG Money raising fishworms and crickets. We teach you how to raise and where to sell. Free literature. Bedrun redworms, 3000, \$6.50; 10,000, \$19.95. Carter Redworms, Plains, Georgia.

\$1000 MONTHLY Possible, raising earthworms. African Giants. Backyard, garage, basement. Complete illustrated booklet, only 25¢! Ozark Worm Farm-J, Willow Springs, Missouri.

RAISE Nightcrawlers, redworms. Easy soilless method. Three Oaks Ranch, Dresden, Tenn.

MOUSEE Grubs—For winter bait. 150—\$1.00; 500—\$3.00; 1000—\$5.00. Shipped prepaid. Herb's Bait Sales, Box 172, North Webster, Indiana.

FREE Details, literature. Raise red hybrid earthworms. Campbell's Fishbait, Fort Payne, Alabama.

DO-It-Yourself booklets, 32 different home and hobby projects. Send for 1958 book catalog 10¢. Popular Mechanics Press, 631 N. St. Clair St., Chicago 11.

BINOCULARS, TELESCOPES, MICROSCOPES, MAGNIFIERS

TELESCOPES—Refractor, reflector, kits and accessories. Free illustrated booklet. Dell Optics Co., Limited, Dept. PM, 329-55th Street, West New York, New Jersey.

REFLECTOR And refractor telescopes ready for immediate use from \$3.98 to \$475, and all necessary parts to construct your own reflector scopes. Mirrors, eyepieces, tripods, all other accessories. Also complete line binoculars, microscopes. Send for free illustrated literature. Criterion "DynaScope" Reflector Telescope, Dept. P74, 331 Church St., Hartford, Conn.

TELESCOPES, Binoculars — all sizes. Complete optics, parts, accessories for telescopes. Free catalog. Suffolk Science, Mattituck, New York.

REFLECTING Telescope, 60X, completely assembled. Guaranteed observatory clearness. Free information. Skyscope, P.O. Box 55, Brooklyn 28, N. Y.

SPECIAL Sale, amazing prices precision binoculars. Folder, "Binocular Selecting," catalog free. Prentiss Importers, Mercury Bldg., West Los Angeles 25, Calif.

WAR Surplus bargains: Millions of lenses, instruments, telescopes, binoculars, components and complete line of astronomical telescope items. World's greatest optical market-place! Send only \$1.00 for beginner's 10-lens kit and big instruction booklet stock 2-CH. Write for catalog CH free! Edmund Scientific Co., Barrington, New Jersey.

FREE 48 Page science catalog. Optical, biological. Research Scientific, 126M West 23rd St., New York City 11.

REFLECTOR Telescopes from Esco. Assembled and "do-it-yourself" telescopes from \$7.50 (3") to \$175 (12"). Complete line of optics and accessories. Send for free illustrated booklet. Esco Products Company, Oak Ridge, New Jersey.

PLANTS, SEEDS, BULBS, NURSERY AND GARDEN SUPPLIES

RAISE Your shrubs, trees from seed. Free planting guide, price list. Woodlot Seed Co., Norway 9, Michigan.

GROW Dwarf trees! Pot, sell. Instructions and seeds, 35¢. Mail Order Specialties, 1439-7 Sabraton Ave., Morgantown, W. Va.

WORLD'S Greatest cash crop. Free information. Write Ginseng Gardens, Asheville, N. C.

PETS—DOGS, BIRDS, RABBITS, HAMSTERS, ETC.

SKUNKS, Reptiles, hawks, raccoons. Illustrated catalogue, 25¢. Trails End Co., St. Stephen, S. C.

HAMSTERS—Golden: Young, \$3.00 pair, breeders, \$4.00 pair. New mutation, \$5.00 pair. Adirondack Hamstery, Prospect 20-A, New York.

CROWS Make comical talking pets, \$4.95 c.o.d. and express. Logston's, Box 3045, Fort Worth, Texas.

RAISE Rabbits. Send 35¢ for names buyers market rabbits everywhere; also prices breeding stock. A. Johnson, 683, Kansas City 41, Mo.

SPECIALS: Descended skunks, pigmy skunks, Baby raccoons, alligators, snakes, Monkeys \$22.50. Free list. Thompson Wild Animal Farm, Clewiston, Fla.

INCREASE Rabbit profits. Read "National Rabbit Raiser Magazine," 422-D South 6th Street, Minneapolis 15, Minnesota. Year, \$2.00.

GOLDEN Hamsters—Pedigreed breeders \$3.85 pair. Literature. Moore's Hamster Ranch, Shepherdstown 25, West Virginia.

EARN \$10,000 Yearly raising Angora rabbit wool for us. Information 25¢ coin. Montana Angora Company, Malta 12, Montana.

RAISE Rabbits successfully by knowing facts. 48 page illustrated book describing 25 breeds. Housing, feeding, breeding, marketing, etc. Plus bulletin. 25 cents. American Rabbit Association, 36 Arba Building, Pittsburgh, Penna.

MAKE Money raising chinchillas, mink, nutria, rabbits, caries for us. Free catalogue. Keeney Brothers, New Freedom 2, Penna.

HAMSTERS — Ideal pets, \$2.95 pair. Free booklet. Jer-Fre's Hamstery, 2216 East Broadway, Muskegon 13, Mich.

STRAIGHT Cooners! World's oldest kennel. Combination hounds, rabbit, fox, beagles, deerhounds, bird dogs. Puppies of all breeds. Prices reasonable. Trial. Free catalogue. Raccoon Mountain Kennels, Box 464, Boaz, Alabama.

RAISE Rabbits on \$500 month plan. Plenty markets. Free details. White's Rabbitry, Delaware, Ohio.

SPORTSMEN: World's largest kennels offers 500 bird dogs, straight cooners, combination hounds, beagle hounds, rabbit hounds, small squirrel dogs, fox and deer hounds. Catalogue free. Smokey Mountain Kennels, Cleveland, Tennessee.

FUR BEARING ANIMALS

RACCOONS, Minks, skunks — Catalog, 25¢. Shady Fur Farm, Springfield, Minn.

MINK Raising information free. Complete. Lake Superior Mink Farm, Superior, E.E.I. Wisconsin.

RAISE Mink: Free booklet, pen plans, inside secrets, feed, care. Mink are money makers. Investigate today. Lawrence Mølgard, Brigham City 12, Utah.

FARMS, FARM LANDS, REAL ESTATE

CANADIAN Tax sale lands, average price four dollars an acre. Small monthly payments. Farms, timber, hunting and fishing camps, minerals. Limited number of properties. Write at once for free catalogue. Tax Sale Service, Room 105, 120 Bloor Street, West, Toronto 5, Canada.

UNITED'S Famous catalog! Big 128-page picture-book of happy retirement homes, recreational properties, money-making farms, ranches, rural businesses, coast to coast! All-new winter issue, sent free! Our 34th year! United Farm Agency, 2825-PM Main St., Kansas City 41, Mo.

FLORIDA \$580 Homesite only \$290 now during half-price predevelopment sale. \$10 monthly. Beautifully wooded 80 foot lots. Money-back guarantee. Write Wendell Wood, Fountain, Florida.

WE Sell on the installment plan. Best varieties peach and apple trees, low as 20¢; grapevines 8¢; shrubs 13¢; evergreens 20¢; berries and plants. Catalog free. Benton County Nursery, Box 561, Rogers, Arkansas.

CANADIAN Tax lands, Mining, hunting, fishing and lakefront sites. Invest in Canada's minerals and forests. Most properties less than \$1 per acre. Monthly lists only \$1. Mineral Club of Canada, S.W. Box 187, Windsor, Ontario.

\$10 DOWN, \$10 Monthly buys your home-site in central Florida's finest retirement and vacation community in the high ridge section near Sebring. On 84 square mile Highlands Lake. Free community parks and beaches. Get free color brochures, house plans; learn how we help you plan, finance, build your low cost, tax-exempt home. Write Florida Realty Bureau, Inc., Dept. EZ, Lake Placid, Fla.

CENTRAL Florida lakefront home sites, \$795 at \$15 monthly. Literature. Grace Parker, Paisley, Florida.

FLORIDA 2½ Acres, near Gulf; 50 foot elevation. \$795.00; \$15.00 down and month. Russell Hancock, Realtor, Brooksville, Florida.

FLORIDA. All types of property. Low taxes. Realtor Cummins, Eustis.

FREE Strout catalog! Farms, homes, businesses, resorts, retirement properties. Over 3000 values in 36 states. 58 years' service. World's largest! Write Strout Realty, 7-MP S. Dearborn, Chicago 3, Ill.

LAKEFRONT, Highway, acreage and trailer lots, from \$295.00. Fifteen central Florida developments. Monthly terms. Box 2005, DeLand, Florida.

FREE Florida Silver Springs Ocala folder. Homesites \$595.00, \$10.00 month. Write Silver Springs Guaranty Land & Title Corporation, 366 WP, Eight Mile, Detroit 20, Michigan.

OZARK Specialty farms. Terms. Description mailed free. 20 years service. Armstrongs, Shook, Missouri.

OPPORTUNITIES! Government land. U. S., Alaska, Canada. Sledge Surveys, Mazon Mississippi.

HOMESITES \$15 Monthly—California's finest garden section. Morro Bay's scenic shores. Wonderful fishing, boating. Fertile soil, softest water, temperate climate, congenial community. Free literature. Richard Otto, Department M, San Luis Obispo, California.

FLORIDA. Nice homesites, \$345 at \$10 monthly. Folder free. Howard Vernor, DeLand, Florida.

FLORIDA — Potterfield Garden Acres Section M, first addition, a new West Coast subdivision. Close to bathing, boating, fishing, parks, on Gulf Mexico and cities. High, dry, finest climate. Live better for less. Full ½ acre tracts only \$795.00 and only \$10.00 month. More information. G. B. Potterfield, Union Bldg., Charleston, West Virginia.

FARM MACHINERY AND SUPPLIES

SENSATIONAL Garden tractor. Hoes between plants and rows, including strawberries. Eliminates hand hoeing. Standard in size, yet entirely different. Patent 2742840. Also tills. Fantastic offer to first few inquiries. Auto Hoe, DePere 68, Wis.

POULTRY, FARM SUPPLIES

DUCK-Goose book 25¢. Poultry book 25¢. Illustrated, history, facts, markets. Free circular popular, rare, ornamental poultry. Stromberg's, Fort Dodge 25, Iowa.

PROFITABLE OCCUPATIONS

MAGAZINE Subscriptions—Largest commissions. Bonus. Qualified Agency, 451SA Kingston, Brooklyn 25, N. Y.

YOUR Own income. List past due accounts for our service. Desk C, National Credit Company, Pickwick Bldg., Kansas City 6, Mo.

INVESTIGATE Accidents—Earn \$750 to \$1,000 month. Thousands of airlines, insurance companies, steamship lines urgently need claim investigators. We train you home spare time. Placement counsel and help. Free book! No obligation. Write: Universal Schools, T-1, Box 8202, Dallas 5, Texas.

BIG Money raising fishworms and crickets. Free literature. Carter Wormery, Plains, Georgia.

EARN \$240.00 A month at home, spare time doing only two \$5.00 invisible mending jobs a day. Big money paid for service that makes cuts, tears disappear from fabrics. Steady demand. Details free. Fabricon, 6236 Broadway, Chicago 40, Ill.

FREE. Facts on your own profitable mailorder business. Robert Barckert, Dewey Rd., Amherst, Ohio.

RAISE Ponies. Farm not necessary. Free details. Daffoglad Farm, Rockbridge, Ohio.

WHY Worry about work? Escape jobs forever! Retire securely now. Lead leisurely life. Unusual new book shows how. Postcard brings details free. Belmont, Wyckoff 156, New Jersey.

BUY Wholesale: 100,000 nationally advertised products. Appliances, cameras, sporting goods, housewares, watches, typewriters, tools, clothing, etc. Discounts to 80%. Buy-Rite, Box 258, Hawthorne 103, New Jersey.

GROW Mushrooms. We buy mushrooms and pay high prices. Use cellar, shed and outdoors. Spare, full time, year round. We sell 100% pure cultured mushroom spawn. Free book. Mushrooms, Dept. 99, 2954 Admiral Way, Seattle, Wash.

HOME Mailorder beginner's opportunities catalog, 10¢. Carnahan Bros., 9610 Acacia, Fontana, Calif.

WANT To make big money. Sparetime or full. Be a checker. Let us inform you. Send one dollar to: Goery's, 53 Fairview Blvd., Toronto, Ont.

MUSHROOMS Quicker, easier, cheaper. "Magic" preplanted trays. Newest facts free. Spawn \$1.00. Luxur, 641 South 19th, Newark 3, N. J.

MAKE Flexible molds. Cast plaques, figurines. Free sample. Tooker, 1045-M Fairview, Hamilton, Ohio.

AUCTIONEERING—Home study course. Diploma granted. Auction School, Ft. Smith, Ark.

MONEY Plans! "Secret Journal." Grandpa, two daughters made \$2500 first month! Work home. Publiccos, Oceanside, Calif.

BAKE New greaseless doughnuts in kitchen. Sell stores. Free recipes. Michael Ray, 3605 South 15th, Minneapolis 7, Minn.

FREE Book "505 Odd, Successful Businesses." Work home. Pacific, Oceanside, Calif.

SAVE Money! Buy wholesale! Free catalog general merchandise. Norris, 487-M Broadway, New York City.

BECOME Independent with your own franchise business. Thousands earning handsome incomes. Request interesting facts today. National Franchise Reports, PM-528, 333 North Michigan, Chicago 1.

FREE Book "990 Successful, Little-Known Businesses." Work home. Plymouth, 1610-43 Street, Brooklyn 4, N. Y.

RAISE Pheasants on \$100 week plan. Little capital and space can make you independent. Free details. Great Central System, Columbus 1, Kansas.

BUY Wholesale! 25,000 nationally advertised products. Get amazing dealer catalogs. Complete details free. American Wholesalers, 1841B Levee, Dallas 7, Texas.

BOOKS, PERIODICALS, PICTURES, POSTCARDS

BRITISH Book bargains — Any subject. Catalog free. Transbooks, Box 1-PL, Wantagh, N. Y.

MERCHANT Ships photographs. Lists 10¢. Sozafava, 1648 59th St., Brooklyn 4, N. Y.

BOOKS. May we find for you the hard-to-get books you want? Free search. Send want list. Carl S. Dress, DeBary, Florida.

TRADE Your read pocket books. Send 8 books plus \$1 bill and we will mail you 8 similar books. Citywide Sales, 844 South Halsted, Chicago 7.

BUILD Small boats. Send for 1958 general book catalog. 10¢. Popular Mechanics Press, 633 N. St. Clair St., Chicago 11.

FREE Catalog. Self-help books. Write: Wilshire, 8721 Sunset, Los Angeles 46P.

"SCIENCE Milestones." Records march of science starting 400 years before Christ, right up to date. Amazing facts revealed. 312 pages packed with startling information that will thrill you. A real history of science. \$5.00. Literature free. Popular Mechanics Press, 200-SM East Ontario St., Chicago 11, Ill.

BOOKFINDERS! All subjects. Send wants! Jaher Book Service, 183 Hazelwood Drive, Westbury, N. Y.

OUT-Of-print books at lowest prices! You name it, we find it! Fast service. No obligation. International Bookfinders, Box 3003-PM, Beverly Hills, Calif.

EXCITING Catalog packed with books covering most everything. Think of it—From cover to cover you will find described and illustrated hundreds of books telling how to fix and how to build almost anything. How to remodel your home: do your own decorating, plumbing, electrical work, carpentry, painting, furniture making and refinishing. How to build your own boat, home workshop tools. Best books on photography, welding, hobbies, homecraft. How to make a home freezer. Send now for 1958 book catalog—only 10¢. Popular Mechanics Press, 200-BC E. Ontario St., Chicago 11, Ill.

GAMES, TOYS, NOVELTIES

"AERO-Record" — Imported projectile game. Free details. Sample game \$2.00. Perkins, 4001-P Robert, Cleveland 9, Ohio.

MAGIC TRICKS, PUZZLES, JOKER NOVELTIES

279 MAGIC Tricks only 15¢. Bookmaster, 2432 Fernwood, San Jose 6, Calif.

STINKBOMBS. Super-potent! 50/\$1.00, 300/\$5.00. "Amerotrix," Philadelphia 44.

WHAT Is instant money? It's an exciting new novelty guaranteed to amaze and amuse your friends. Instant fun with Instant Money. Only 50¢. Nova, Box 446, Sunland, Calif.

PROFESSIONAL Catalog, 175 pages, 25¢. Williams, 900 Plymouth, Ellwood City, Penna.

FREE Catalog—Magic, illusions, sensational escapes. Write: Great Heaney, Oshkosh, Wisconsin.

ANECDOTE, Jokes professionally prepared. Excellent for m.c. Hundreds each series. 65¢ series c; 80¢ series d; 90¢ series e; \$1.75 all three. J. G. A. Goulet, P.O. Box 1628, Boston 5, Mass.

MAGIC Locostick. Neat trick if you know how. Appears to obey spoken commands. No skill required. Satisfaction guaranteed. \$1.00 postpaid. Arrowhead Novelty Co., P.O. Box 227-P, Redlands, Calif.

3000 TRICKS, Pocket, parlor, stage. World's finest magic catalog (408 pages), \$2.50. Kanter's, M-1311 Walnut, Philadelphia 7.

FASTEST Service to magicians for over 30 years. Send 10¢ for Douglas famous catalog. 500 tricks, containing magic for pocket, parlor, stage, with balls, coins, cards, cigarettes, ropes, silks, apparatus. Douglas Magicland, Dept. 10, Dallas, Tex.

"VENTRILLO," Voice-thrower 25¢. Ventriloquist puppet 75¢. Box 971-PM, Philadelphia 5.

VENTRILLOQUISM, easiest method. Details free. Smith, 2125 N. Bigelow, Peoria, Ill.

3100 NOVELTIES, Jokes, tricks, gadgets, funmakers, hobbies. Big catalog 10¢. Johnson-Smith, D-491, Detroit 7.

WORLD'S Finest professional magic. Joker novelties. Giant illustrated catalog 10¢. Top Hat, Evanston 12, Illinois.

BE A magician! Large professional catalog of latest tricks. 35¢. Ireland, C-109 North Dearborn, Chicago 2, Illinois.

SMOKEBOMBS, Gigantic! 25¢. 7—\$1.00. (Nonpoisonous.) 4463-PM Greene, Philadelphia 44.

COINS, TOKENS, CURRENCY

FREE List! U. S. coins. Best prices! Hughs, Box 361-BC, Hickory, N. C.

FLYING Eagle plus large cent \$2.00. Rhode, 105 Windsor, Reading, Penna.

INDIAN Head cents, two different only 10¢. Approvals. Littleton Coin Company, Littleton R1, New Hampshire.

TWELVE Different Barber dimes \$2.00. Bargain lists free. Sayers, 1000 Unaka, Johnson City, Tennessee.

GOLD U. S. and foreign gold coins, wholesale list, 10¢ deductible. Samuel Kisin, 720 Flushing Ave., Brooklyn 6, N. Y.

\$100.00 FOR Certain Indianheads; Lincoln pennies \$75.00. All rare coins wanted. Booklet listing prices, 25¢. Lincoln Coins, D-229, Glendale, Arizona.

REVISED U. S. coin price list. Bargains. Only 25¢. Huber, National Bldg., Minneapolis, Minnesota.

OLD Money wanted. Will pay \$5,000.00 for nickel of 1913 with Liberty head (not buffalo). We pay cash premiums for all rare coins. Send 5¢ for large coin folder. May mean much profit to you. Numismatic Co., Box 750-A, Costa Mesa, Calif.

5 DIFFERENT V-nickels \$1.00 (G-VG). Sadler Stamp Post, Cumberland Gap, Tenn.

GOLD: \$5, \$11.90; \$10, \$22.90; \$20, \$42.95; 10 German inflation notes, \$1.00; Confederate notes wanted. Cook, Box 181, Jackson 5, Mississippi.

CASH For Canadian American coins. Complete catalogue values all coins 1793 to date, prices we pay. 50¢ postpaid. Bourse, Box 274, Ft. Wayne, Ind.

NEWS! Bargains! Canadian bulletin 10¢. Marles, Box 533, Calgary, Canada.

COINS Wanted: We pay \$50.00 for 30 Lincoln pennies. Send \$1.00 for explanatory album. Coin Club, 2302 Price Avenue, Charlottesville, Virginia.

CONFEDERATE, Obsolete currency: Gold coins, stamps wanted. Send for decent offer. Held, 1152 Kensington, Buffalo 15, N. Y.

BEAUTIFUL Uncirculated sets (in holders): Roosevelt dimes \$15.95; Franklin 1/2 \$35.95; Irish animals \$2.50; General MacArthur \$3.75. Paying highest prices nice gold coins: Gold dollars \$10.00; \$2.50, \$8.50; \$3.00, \$40.00; \$4.00, \$1,000.00; \$5.00, \$9.00; \$10.00, \$18.00; \$20.00, \$38.50; \$50.00, \$500.00. Send any quantity for airmail remittance. Bebee's, 4514 North 30th, Omaha 11, Nebraska.

"BRILLIANTIZE" Safe for proof coins. \$1.00. Dealers needed. Stephenson's, Ames, Iowa.

DELUXE 32 Page U. S. catalog 10¢. Contains over 100 illustrations; 5,000 delightful bargains. Stonie, 260 Washington, Boston 8, Mass.

SIX Different liberty nickels \$1.00. Large cents; \$1.00 each. Ten different Indian heads \$1.00. Berry, Box 306, Westminster, Calif.

GENUINE Foreign paper money. Five countries 25¢. Manor Coins, Box 505, Dunbar, W. Va.

PENNIES Wanted. Send 25¢ for list and free foreign coin. Wayne Coin Company, 1205 California Ave., Fort Wayne, Ind.

TWENTY Different Indian cents \$2.50; ten different \$1.00. Collector's Bargains, New Hope, Penna.

U. S. rare coin value guide, 48 pages, 50¢. Griffin, 322 W. State, Ithaca, N. Y.

\$4,000.00 FOR 1913 Liberty head nickel. Uncirculated dollars 1804-1839, 1893-S, 1895-P, 1903-O pay \$100.00-\$5,000.00. Certain dates Lincoln cents before 1932, \$125.00; flying eagle cents, \$500.00; Indian cents, \$175.00; dimes before 1943, \$2,000.00; quarters before 1924, \$1,500.00; half dollars before 1929, \$3,000.00; 2¢ pieces, \$125.00; 3¢ pieces, \$150.00; half dimes, \$1,500.00. Hundreds of others worth \$10.00, \$1,000.00. Canadian coins, 1921, 5¢ silver, \$100.00. 1875 quarters, \$100.00. 1921, 50¢, \$750.00. Wanted: 20¢ pieces, gold coins, paper money, etc. Our large illustrated guarantee buying-selling catalogue, giving complete allcoin information, send \$1.00. Purchase catalogue before sending coins. Worthycoin Corporation (K-288-C), Boston 8, Massachusetts.

"EAGLET" Numismatic Magazine, 35¢. subscription \$2 year. 229 South 11th, Newark 7, N. J.

GET Profit and pleasure in collecting old coins. Send 20¢ for 68-page illustrated coin catalog. You'll be delighted with it. Send for it now. B. Max Mehl, Box 750-B, Costa Mesa, Calif. Oldest rare coin establishment in U. S. Established 59 years.

ADVANCE Orders taken now for 1959 proof sets, only \$2.50! 10 sets \$24.50; 25, \$60.00; 50, \$115.00; 100, \$225.00. Other proof sets in stock: 1958, \$3.00; 1957, \$3.00; 1956, \$4.00; 1955, \$6.00; 1954, \$7.00; 1953, \$12.00; 1952, \$18.00; 1951, \$29.00; 1950, \$47.00. Complete set 1950-1959 inclusive \$125.00. Wow! Silver dollars. Brilliant. Uncirculated. 1878-CC, 82-CC, 83-CC, 84-CC, only \$3.00 each! 80-CC, 81-CC, 85-CC, 90-CC, 91-CC, only \$3.75 each! 1878-S, 79-S, 80-S, 81-S, 82-S, 90-S, 21-S, 82-O, 83-O, 84-O, 85-O, 78-P, 79-P, 83-P, 84-P, 85-P, 86-P, 87-P, 89-P, 90-P, 96-P, 97-P, 98-P, 1921-PM, 1922-P, 1923-P, 1924-P, 1925-P, 1921-D, only \$1.50 each! Free, with your order, our new price list! Everything postpaid. 10-day money-back guarantee of satisfaction. Thousands of other coins in stock. Gold. Silver dollars. Cents. Etc. Postal Products Co., Fast Mail Order, Joe Gordon, 5614-MC California Street, San Francisco 21, California.

44 DIFFERENT Coins, \$1.00. 44 different bills, \$1.00. Oddehon, Box 482, St. Louis, Mo.

MEXICO Gold and silver. Beautiful, interesting, unusual coins. Free list. Joe, Box 1305, Pecos, Texas.

1959 GIANT U. S. coin catalogue 25¢. Ace, 107 N. Dearborn, Chicago 2.

LARGEST Coin magazine, 200 pages, 40¢. Scrapbook, 7320-J Milwaukee, Chicago 31.

RAREST CC mint dollar 1885 uncirculated \$5.00. Illustrated catalogue 25¢. Schultz, Salt Lake City 10, Utah.

BARGAINS, U. S. coins: 1893 Columbian world's fair half dollar, \$1.00. Ten different Indian pennies, 75¢. Two-cent piece, and 3-cent piece, \$1.00. Gold 1/4 eagle, \$9.00. Gold 1/2 eagle, \$12.50. Beautiful coin bracelet, \$1.00. Many coins available. What do you need? Rare Coin Company, 31 North Clark, Chicago 2.

COMPLETE United States coin bargain lists, Indianhead cent, 10¢. Economy Sales, 156-A Dean, Mansfield, Mass.

COIN Cleaners — Mix your own with cheap chemicals obtained from your druggist. Laboratory tested formulas, \$1.00. Guaranteed. Colonial Laboratories, Pittsburgh 18, Penna.

40 DIFFERENT Foreign coins \$1.00. Claud Denney, 3406 S. Harwood, Dallas 15, Texas.

SIXTEEN Page price list of U.S.A. and Canadian coins free. Selling prices on thousands of coins and supply items. Bryson Inc., 612A White, Toledo 5, Ohio.

INDIAN Cent plus Bargain Lists 10¢. Hutchinson's, Box 4747, Philadelphia 34, Penna.

STARTER Collections. 20 different Indian cents, \$2.50, 13 different liberty nickels \$2.50, 20 different Barbour dimes in folders, postpaid \$5.00. Frager, 470 27th Avenue, San Francisco, Calif.

ILLUSTRATED Retail foreign coin catalogs. Gold coins. 800 different. Price 50¢. Silver, copper coins. 3000 different. Price 50¢. James Randall, Box 2205N, Fort Lauderdale, Florida.

STAMP COLLECTING

COLLECTION 100 Different United States stamps. Contains commemoratives, airmails, regular issues, high denominations, including some over 70 years old. Worth over \$1.00 but our price only 20¢ with approvals. Sundman, Littleton T1, New Hampshire.

TEN Foreign to treasure. Catalog \$2. Handling 10¢. Approvals, Reid Stamps, 441 N. 6 St., Allentown, Penna.

"ELEPHANTS Of Laos"—Three brilliant mint pictorials, portraying elephants in life-like multicolor, 10¢. Approvals. Gustave Gebhard, 26 Westwood Drive South, West Orange, New Jersey.

FREE U. S. commemorative, foreign packet lists. Thom, 4808—15th Avenue, Minneapolis 17, Minnesota.

FREE Stamps. 15 cents handling. Stevens, 126 Wing, Newark, Ohio.

FREE! 53 Different stamps. Approvals. J. Schuster, 301 Sandpiper, Playa Del Rey, California.

100 DIFFERENT Belgium free. UPU, Brussels fair, railroad stamps free. Approval applicants only. Trylon, Box 179-P, Forest Hills 75, N. Y.

100 DIFFERENT World—15¢. Approvals. Utechs, 1143D North Keeler, Chicago 51.

STAMP Finder, world map and encyclopedia of stamp issuing countries only 5¢. Approvals. Goliath, Bethlehem K1, New Hampshire.

TERRIFIC Stamp bargain! Israel, Iceland, Vatican assortment—Plus exotic triangle set. Also fabulous British Colonial accumulation. Plus large stamp book. All four offers free. Send 10¢ to cover postage. Empire Stamp Corp., Dept. PM, Toronto, Canada.

FREE! Giant bargain catalog—New edition listing thousands of bargains including U. S. and B. N. A. stamps, packets, mixtures, albums, accessories and supplies; sent with beautiful approvals. Jamestown Stamp, Dept. E19PM, Jamestown, N. Y.

FREE—Mint British colonies from Brunei, Solomon Islands, Negri Sembilan, Sarawak, St. Christopher, Nevis, Trengganu, Gilbert Ellice. Free with approvals. Viking, Great Neck 8, N. Y.

FREE! Wonderful, new 84 page U. S. catalog. Handling 10¢. Norrisco, Milwaukee 7, Wis.

307 WORLDWIDE Different stamps only 25¢. Approvals. Niagastamp, St. Catharines 671, Ontario.

FREE, \$3.00 Value, all different stamps. Finley, Box 6961Z, Washington, D. C.

TOPS! Free book. "How to Collect Stamps." Send for your copy today! Approvals. Littleton Stamp Co., Littleton E1, N. H.

MINT U.S. at face! Older commemoratives only. Send 25¢ for all different packet with first selection mint U.S. approvals. Western, Box 1689P, Salinas, California.

FREE Mint set! Approvals enclosed. Stampco, 5151 Princeton, Memphis 17, Tennessee.

FREE! Colorful Somaliland animals, others. Approvals accompany. Advise preference. Rogers, Box 485M, Albany 1, N. Y.

AIRMAILS. 15 Different countries. free! Modestly priced approvals accompany. Norden Hobbies, Box 106, Batavia, Illinois.

PERSIA: 25 Different only 10¢. Approvals. Norge Company, Ho-Ho-Kus, N. J.

WOW! 110 All different Germany 10¢. Zeppelins, semi-postals, airmails, high values, etc. Giant catalog, bargain lists included with beautiful approvals. Jamestown Stamp, Dept. A19PM, Jamestown, N. Y.

100 BRITISH Empire 10¢. Approvals accompany. Robert Arthur, 920 Third, Seattle 4, Wash.

50 DIFFERENT Latin America, 10¢ with approvals. Quynn's, Scotland 2, Penna.

U. S. Stamps. Giant bargain catalog 15¢. Raymax, 35-VZ Maldenlane, New York City 38.

1000 DIFFERENT Worldwide stamps \$1.00. Valued over \$30.00. Universal, Box 6, Kenosha 5, Wisconsin.

DEALERS—Wholesale list. Postage 4¢. Frank, 5031 Queensberry, Baltimore 15, Maryland.

12,000 PENNY Approvals waiting for you. Many from exotic countries, pictorials, airmails, new issues. Tilbury, Box 862, Newark 1, N. J.

LARGE U. S. commems on paper—\$4.75 per pound, \$9.00 per two pounds. Satisfaction guaranteed. Wm. Rice, 87 Washington Ave., Kingston 16, N. Y.

FREE 45 Different to approval applicants. Bert Collier, Chamblee, Ga.

EXCEPTIONAL Variety old U. S., flags, presidents, commemoratives with approvals, free gift, 10¢ handling. Metropolitan Stamps, Box 312KS, Jackson Heights, N. Y.

100 DIFFERENT Austria 10¢. Approvals. Aronson, Box F, Newton Centre 59, Mass.

90,000 STAMPS Sale: Bargains 40¢. Big lot \$1. Extra special \$2. Giant assortment \$5. Persil, 436 N. Y. Ave., Brooklyn 25, N. Y.

OLD Revenues on paper. \$1.00 quarter pound. Tivoli, 127 Livingston, Brooklyn, N. Y.

100 WORLDWIDE Stamps 5¢ with approvals. Herget, 2884 Bailey, Buffalo 15, N. Y.

FREE! Newfoundland, Israel, animals, birds, sports, Pipex; with approvals. Tropicana, Box 449M, Hollywood, Florida.

FREE! 25 Different New Zealand; colorful inexpensive approvals. Elkhart, Box 33, Elkhart, Indiana.

ISRAEL, 10 Different free. Approvals. Chippewa, Box 65M, Doylestown, Ohio.

FREE! Variety packet! Worldwide approvals. Kaw, Box 355, Topeka, Kansas.

BEAUTIES! Pictorials from Andorra, Iceland, Monaco, New Caledonia, Togo, San Marino, Singapore, etc. Only 10¢. Approvals. Champlain, Isle La Motte, Vermont.

SCANDINAVIA Mixture \$3.00 pound. Sluis, P.O. Box 3874, Thornton 29, Colo.

FIFTY Different United States. Obsolete and current. 10¢. Ed Keller, Library, Pennsylvania.

FREE! 25 Egypt, 5¢ handling, approvals. Bellel, Mapledale, Hazel Park, Mich.

233 DIFFERENT Worldwide plus 66 different U. S. 25¢. Approvals. Casto, Box 357, Dunbar, W. Va.

SWITZERLAND, France, beautiful pictorials cataloguing \$1.34 only 15¢. Approvals. Evan Davis, Riverside, Connecticut.

FREE 60 Different stamps to collectors requesting approvals. Stanley Zajac, 159 Emerson Ave., Toronto, Canada.

COLOMBIA—25 Different 10¢. Approvals. Doppko, 3482 Laura Lane, Riverside, California.

SPECIAL Goyas, nudes only 50¢. Kahs, Box 732, Pontiac, Michigan.

U. S. commemoratives: 141 different \$1; 201 different \$2. Moseley, 6 Hanley Downs, St. Louis 17, Missouri.

RED Russia—28 all different unused, high catalog, 5¢. Approvals. Hamilton, 912 North Mesa, El Paso, Texas.

TERRIFIC! Penny approvals. Thousand varieties! Marshall, Box 451-PA, Long Beach, Calif.

PICTORIALS—\$8.00 Catalogue, only \$1.00. Profit sharing approvals. Warden, 68, Sierra Madre, Calif.

AIRMAILS—Forty-nine different, 10¢. Approvals. Valley's, Box 414P, Spring Valley, California.

FREE! U. S. commemorative first day cover. Approvals. Arrow Stamps, Box 4905, Oklahoma City 9, Oklahoma.

AMERICAN Commemoratives, beautiful colonial sets. World mixtures included 5¢. Approvals. Bristols, Canton Center, Conn.

50 LARGE U. S. commemoratives 10¢ with approvals. Jack Clancy, Box 2187, Portland 14, Ore.

107 WORLDWIDE Plus bonus packet, 10¢. Approvals. Cowtown, Box 16352, Fort Worth 14, Texas.

50 SOUTH Africa, queens, 25 cents. Approvals. Seevee, Center Ossipee, N. H.

CANNIBALS, Animals, diamonds, triangles, 110 different 10¢, with approvals. Imperial, Box 414, Atlantic Beach, Fla.

PRE-1888 U.S.—Two free copies, with approvals. Collier, Chamblee, Ga.

"JESUS Christ" collection. Scarce, valuable religious stamps, retail value \$1.00. Yours only 35¢ with approvals. Chester Garlangier, 1019 Pearl St., St. Joseph, Mich.

BEGINNER'S Special. Desirable premium stamp free with requested approvals, priced right. Dixon, 8716 Alameda, Ysleta, Texas.

BAHAWALPUR UPU complete set free with approvals. Taconic Stamps, Box 1371, Ancram, New York.

CANADA Totem dollar only 25¢ with attractive approvals. Rheume, 6591 11th Ave., Montreal 36, Canada.

FREE! Ghana-Gold Coast "overprints." Approvals. Keating, 2520-P Boulevard, Jersey City 4, New Jersey.

1959 U. S. catalog free. Contains almost 1000 illustrations, over 10,000 delightful bargains. Stone, 260 Washington, Boston 8, Mass.

MINT 1936 Navy complete set 25¢. Free list. Salmon, 51C Fourth Avenue, E. Orange, N. J.

TERRIFIC Value. Eight complete mint sets 10¢ with approvals. Beatties, 58 Glenagar, Islington, Ontario, Canada.

13 U. S. over 50 years old 10¢. Rayworth, 321 South Cicero, Chicago 44.

15 MINT French colonies free! Inexpensive approvals accompany. White Mountain Stamp Service, B2, Bethlehem, New Hampshire.

ITALY—100 Different 10¢ with approvals. DeRespinis, G.P.O. Box 771F, New York 1, N. Y.

UNITED Nations. Five different 10¢. Approvals. Anderson, 1112 Harrison, San Francisco 3, Calif.

EXCITING Strange countries packet. Free with approvals. Saxon, Orange, Calif.

20 SELECTED Sets \$1.00. Approvals. Klondike, 682 Jefferson, Elgin, Illinois.

FREDRICK Chopin; Egyptian jets; U. S. beacon air! Surprises; Roosevelt memorial free purchasing approvals. Stamp Farm, M2-9, Oxford, Wis.

VATICAN City special! Pope Pius XII, saints, churches, Swiss guards, holy shrines, colorful pictorials, 25 different \$1.00; 50 different \$2.50; 100 different \$4.95. No approvals. Worldstamps, #203-ME Grubb, Silver Spring, Maryland.

GIANT Diamond, midget triangle, Timor, 15 beautiful topicals, 26 others 10¢ with approvals. Carpenter, P.O. Box 310, Claremont, Calif.

FREE United States price list. Carlos Elbert, 31450 N. River Road, Mt. Clemens, Michigan.

FREE! 50 British Empire. 5¢ handling. Approvals. Kensington Stamps, Buffalo 15, N. Y.

1000 DIFFERENT worldwide with approvals. Alfred Jacobsen, Crompond, New York.

U. S. approvals. Low price. Eagle Stamps, Romine Ave., Pittsburgh 26, Penna.

FREE—Your choice any volume Scott's international albums. 1959 Scott's complete catalogues, even Master Global albums free when you buy our sensational foreign approvals. Bargain Stamps, Redlands, Calif.

BEAUTIFUL Stamp albums and stamps. Send 20¢ for catalogue. New-Way Stamp, Lawrence, Massachusetts.

50 CHINA 10¢. Approvals, gifts. Coast, P.O. 2187A, Santa Ana, California.

ALL Different—65 U. S. commemoratives 50¢, 100 British Empire 25¢, 90 Canada 50¢, 150 worldwide 25¢; 300—50¢. Better-Bilt, 25625 Koontz, Roseville, Mich.

JAPAN: One hundred different pictorials, animals, birds, flowers, etc. Everything sent for twenty cents with oriental approvals. Boger, Box 152, North Wales, Penna.

HAWAII—2 exciting classics or 2 Czarist Russia 10¢ with approvals. Belmont Stamps, Washington 15, D. C.

FREE. 10 Japan war stamps. Approvals. Schroeder, 1486½ Sherburne, St. Paul 4, Minn.

FREE! Eight sided stamp, triangle, diamond, midget, mammoth, to approval buyers. Plymouth, Dept. A-9, Bell, Calif.

WANT Lists filled. Mint-used. Downey, Box 70, Bell, California.

FREE 400 genuine postage stamps! Worth \$10.00 at catalogue prices. Africa-Europe-Asia-British Emp.—a fascinating, valuable mixture from foreign convents, banks, etc. Who knows what you will find. Also free helpful Collectors Handbook. Adults only. Approvals enclosed. Frasek Co., PM, White Plains, N. Y.

SPUTNIK; Croatian legion; airmails; U. N. sets; U. S. parks. Packets free with approval purchases. Stamp Farm, M2-8, Oxford, Wis.

1000 DIFFERENT Stamps free to regular buyers from our price lists. No approvals. Write for details. Lucas Stamps, 612 White, Toledo 5, Ohio.

UNITED States approvals. Select copies, used—mint. Kingsbury, Groton, Vermont.

427 STAMPS—10¢! Catalogue value \$10.00. Mystery mixture including U. S., Ireland, Asia, Africa, pictorials, commemoratives, air mails. Worldostamps, 8203-MC Grubb, Silver Spring, Maryland.

FREE U.S. list for advanced collectors. National, Box 60, Boston 1, Mass.

MAGNIFICENT Mint collection free, introducing approvals. Philatelic Pageant, Pennington, New Jersey.

1000 STAMPS—25¢ With approvals. Wm. Rice, 87 Washington Ave., Kingston 9, N. Y.

5 TERRIFIC Packets; Malta, Mozambique, etc.! Mulready replica! 10¢. Approvals. Westgate Stamp Co., 5 Centre St., Hempstead, N. Y.

GIANT Approvals, thousands different, 1¢ and 2¢ each. Wahl's Stamp Exchange, 7008P Farragut, Chicago 31, Ill.

FLAGS And Spa mint complete \$1.00 to approval applicants. Smith, 6 Greencroft, Champaign, Illinois.

300 DIFFERENT Given free with approvals. Particulars. Windsor Stamps, 8834 Cornell Avenue, Chicago 17.

FREE 40 Exotic giant pictorials! Free 144-stamp worldwide mix! Free stamp newspaper! Free illustrated bargain lists! With approvals. Rush 10¢ for postage. Philatelics, Dept. R, New Paltz, N. Y.

50 DIFF. Peru to approval applicants 20¢ for mailing. C. I. Yuotz, Mountville, Pennsylvania.

100 DIFFERENT Pictorials 5¢. approvals. Hope, 142 Emeline Street, Providence 6, R. I.

SUPERIOR Worldwide mission mixture. Amazing variety! Six ounces \$1.50. Pound \$3.75. Bay Nielsen, 4545B Harvard, Montreal 28, Canada.

MEXICO, 25 Beautiful 10¢. Approvals. Salsman, Box 702, Berkeley, Calif.

50 DIFFERENT Stamps free! Approvals. Marford, Box 48, Queens Village 29, New York.

PENNY Approvals! Regardless catalogue! Kloster, 4164—52nd St., San Diego 5, Calif.

FREE 1958 Illustrated U. S. price list. H & S, 45-PM Bromfield, Boston, Mass.

TRADE Your duplicates toward our approvals! (Foreign only.) Complete detailed information. 10¢. (Refundable.) Variety Stamp Service, Box 98-P, Newton Highlands 61, Mass.

60 DIFFERENT U. S. (30 commemoratives) 25¢. No approvals. Seidenberg, Appleton, Wisconsin.

MAKE 20 Filter cigarettes for 9¢. Facts free. Moberly, 954, Owensboro, Kentucky.

U. S. bargain. 100 different 25¢. 50 different commemoratives 25¢. Both 40¢. Request approvals. Stamps, Box 37, Kennebunk, Maine.

WORLDWIDE Stamps, 1000-\$1.00, includes pictorials, commemoratives. No approvals follow. Guaranteed. Harrison's Stamps, 1435 First Avenue, Oakland 8, Calif.

HONG KONG, 25 different, 25¢. Foreign approvals. Spicka, 518 No. 85th, Omaha 14, Nebraska.

1000 DIFFERENT, \$1.00 With approvals. Louis Golden, 6721 Eastwood, Philadelphia 49, Pennsylvania.

100 DIFFERENT 10¢ With approvals. Roger Davis, 525 Main St., New York Mills, N. Y.

FREE U. S. stamps, 1943 flag, commemoratives included in collection of 25 different, plus valuable \$5.00 stamp. All for 10¢ mailing charge. Approvals. Willett Co., Box 338-A, Yorktown Heights, N. Y.

WORLDWIDE, 50 All different, absolutely free, just to introduce our incomparable approvals. Kent Stamp Company, GPO Box 87, Brooklyn, N. Y.

ALBUM Only 10¢! Hundreds of spaces! Stampmart Company, Hartford 1, Conn.

ECONOMICAL ½¢-3¢ Approvals, 33,000 varieties. Dresel, Box 128-N, West Englewood, New Jersey.

UNITED States commemorative collection containing 33 different—10¢. Approvals. White, 516-A Avenue L, Brooklyn 30, New York.

SELL Your surplus good grade stamps. Write, describing fully what you have. Vanroy Shirk, Lebanon, Pennsylvania.

AMAZING Offer! 200 United States stamps—including commemoratives, airmails, high denominations to \$1.00. Only 10¢ to approval applicants! Illustrated bargain lists free. Mystic Stamp Co., Dept. 80, Camden, New York.

100 STAMPS, 10¢ With approvals. Smith, 508A Brooks, College Station, Texas.

OLD Scarce U.S. seconds on approvals. Slight imperfections, lowest prices. Hernefield, Clintonhill Sta., Newark 8, N. J.

100 OLD United States between 1861 and 1935, \$1.00. Roush Stamps, 51 Chestnut, Mansfield, Ohio.

LOOK! Six different Queen Elizabeth mint sets! Dominica, Gibraltar, Virgins, etc. 21 bicolors—25¢! Attractive approvals! Gannon Stamps, Box 931, Canton 1, Ohio.

10 CANAL Zone 25¢ Approvals. Merkel Stamps, 30 Grandview, South Hadley Falls, Mass.

168 BICOLORED World flags and monograms, 10¢. Exciting approvals accompany. Dee, Box 926, Ormond Beach, Florida.

FREE Sample! Interesting, informative. Illustrated. National Stamp News, Anderson, South Carolina.

200 DIFFERENT Argentina \$1.00. Doc Shoenfelt, 259 Belmont, Mansfield, Ohio.

FREE Packet! Angola, Azores, Mongolia, Nepal, Palestine. Fascinating approvals. Coral, Box 7095 (Ludlum), Miami 55, Florida.

TWO \$5.00 U. S. postage stamps free to approval buyers. Send dime for postage. details. Irwin Stamp Co., Box 11-55, Brooklyn 30, N. Y.

135 DIFFERENT U. S. commemoratives \$1.00; 50, 25¢. Approvals. Harold Holub, 18 East 198th St., New York 68, N. Y.

TERRIFIC U. S. list free! Bailey, 45 Bromfield, Boston 8-G, Mass.

225 STAMPS For only 10¢! This mammoth value includes airmails, pictorials; stamps from strange countries cataloging up to 25¢ each! Also approvals. Mystic Stamp Company, Camden 80, New York.

WEIRD Diamond shape coffee stamps. Lovely flower triangle! First American big commemorative. Greenland, idol dancer, etc. Free with approvals. Capital Stamp Co., Ferrysburg 2, Mich.

25 DIFFERENT Commemoratives 1893 up 10¢. U. S. approvals. K&B, Box 70, Brooklyn 23, N. Y.

SELL Stamps to our readers. Your ad in this space will be read by thousands of stamp buyers. I'll prove that to you. Write now for Folder "S." P. W. Johnson, Classified Advertising Manager, Popular Mechanics, 200 E. Ontario St., Chicago 11, Ill.

INTRODUCING Our better United States approvals, we offer 15 United States stamps including Columbian, Pan-Pacific, famous American, airmails, others; only 10¢. Ocean Stamps, Box 64-PM, Brooklyn 29, New York.

UNITED States price list, 116 pages, price 25¢. Mark Hanna, 335 Fifth Ave., Pittsburgh 22, Penna.

14,000 DIFFERENT! Amazing new plan builds your collection systematically, country by country. Only 50¢ weekly. Free details. L. G. Ware, Stepney 75, Conn.

U. S. Mint flag set, complete, \$1.00. Free list. Brooks, 2323 Avenue X, Brooklyn 35, New York.

FREE 50 Worldwide introducing inexpensive approvals. University Stamps, P.O. Box 95, Tamiami Station, Miami 44, Florida.

40,000 VARIETIES Available on approvals, ¼¢ upwards. Keigwin, Box 933B, Daytona, Florida.

11 MINT Sets—Soldiers, flowers, heroes, planes, 10¢. Worldostamps, 8203-PM, Grubb, Silver Spring, Maryland.

STAMP Zoo including kookaburra, zebu, kangaroo, koalabear, rhinoceros 10¢. Approvals. Linstamp, St. Catharines 618-A, Ontario.

102 DIVERSIFIED Worldwide stamps 10¢. Approvals. Linstamp, St. Catharines 618, Ontario.

FREE! Over 100 different, \$2.50 value, including space satellite, Israel, British, U. S., first U. N. Siberia. Approvals, catalogue. Send 25¢ for mailing. Gatewood, Box 346, Winston-Salem, N. C.

103 DIVERSIFIED British colony stamps only 10¢. Approvals. Niagastamp, St. Catharines 671-A, Ontario.

ANTIQUES, RELICS, INDIAN GOODS, CURIOS

CHOICE \$1.00—Spearhead, four arrowheads, three warpoons, hatchethead, knife, two birdpoints. Palmer, 435 Washington Road, McKeesport, Penna.

ILLINOIS—Stayschunneyedenteeefekayshun. Selling: Hundreds of Confederate items. Historical, Civil War, Revolutionary, Indian War muskets, rifles, insignias, pistols, pepperboxes, swords, bayonets, flasks, bullet molds, duelling pistols, 50,000 Indian relics, 10,000 coins, Confederate money. Thousands agates, fossils, mineral specimens, deerheads, steerhorns, tomahawks, bo-wood, gold dollars, Kentucky rifles, frontiers. Illustrated catalog 35¢. Heikes, Wenona, Illinois.

4 PERFECT Arrowheads \$1.00. Smith, 841 N. Tacoma, Indianapolis 1, Indiana.

ANCIENT Grooved stone tomahawk \$3.00. Indian relic list free. Lear's, Glenwood, Arkansas.

PRECIOUS STONES, MINERALS

NO Serious treasure hunter or rockhound can be without Greiger's encyclopedia. Tells where to search, how to identify, how to cut and polish gems, how to market them. Write for free booklet today! Greiger's, Dept. A-90, Pasadena 4, California.

CHALCEDONY Desertrose, fluorescent green, \$1.00. Desert Rocks, 2720 W. Roselane, Phoenix, Arizona.

UNCUT Australian opal, wholesale, \$2.00 ounce. Western Rocks, 20385 Stanton, Castro Valley, California.

GEMSTONES, Thirty, uncut, \$4.00. Minerals. Lists. Reed's, 4930B Palo Alto, S.E., Albuquerque, New Mexico.

ROCKHOUNDS—Visit rockhound paradise. Circular. Heike's Agate Shop, Wenona, Illinois.

AGATES, Jade gems, Free list. Northwest Gems, 2819 North Warner, Tacoma 7, Washington.

CUT Gems, make jewelry—For profit or fun. 100 page magazine tells how; where to get supplies. Sample 25¢ or request free literature. Lapidary Journal, Del Mar 2, Calif.

"GEMS & Minerals Magazine," largest rock hobby monthly. Field trips, "how" articles, pictures, ads. \$3.00 year. Sample 25¢. Box 687A, Mentone, California.

SAPPHIRE And four more uncut gems, \$1.00. Ten polished gems, baroque-shaped, \$1.00. Free gem list. Lapidary catalogue, 25¢. O'Brien's, 1116M Wilcox, Hollywood 38, Calif.

SEMI-Precious uncut gems. Ten different for \$1.00. Request list 26. Prospectors Shop, 201 San Francisco, Santa Fe, New Mexico.

EARTH Science, the rockhounds national magazine. Subscription \$2.00. Sample 35¢. Box 1357-PM, Chicago 90, Ill.

HOBBIES AND COLLECTIONS

NAZI Swastika armband and catalog, \$1.00. Hobbies, Box 71B, Rockaway Park 94, N. Y.

WE Sell sea shells, 15 assorted \$1.10. Andex Shells, Box 607, Sarasota, Florida.

NAZI Insignia book, 600 illustrations, \$1.50. 12 Nazi insignia, \$1.00. Hobbyland, Calgary, Canada.

ARMY-Navy-Marines-A.F. New assortment of one military tie clip, military belt with brass buckle plus 25 assorted medals, badges, campaign ribbons, battle stars, patches, ratings, etc. All for \$1.00 (limited to U.S. and Canada only). Supreme Military, Dept. PM, 48 West 27 St., New York City.

20 MATCHBOOKS Plus surprise gift from fabulous Las Vegas. Send \$1.00. P.O. Box 342, Phoenix, Arizona.

INCOME And gifts from two hobbies, \$2.00 each. Martha Dawson, 620 Santa Rosa Ave., Berkeley, California.

INVENTING Can be an interesting and profitable hobby. Write for complete particulars. Institute of American Inventors, Dept. 40-E, 635-F St., N.W., Washington 4, D. C.

COLLECTORS Matchbook covers, 100 different unused, \$1.00. Catalog 25¢. Album \$3.00. Charles Edelman, 1311-C East 84, Cleveland 3, Ohio.

DO-IT-Yourself booklets, 32 different home and hobby projects. Send for 1958 book catalog 10¢. Popular Mechanics Press, 631 N. St. Clair St., Chicago 11.

CAMERAS, PHOTO SUPPLIES

FREE Photographic bargain book. Thousands of bargains in photographic equipment and supplies. Write: Dept. 1-J3, Central Camera Company, 230 S. Wabash Ave., Chicago 4, Illinois.

PHOTOGRAPHY For pleasure or profit. Learn at home. Practical basic training. Long established school. Free booklet. American School of Photography, 835 Diversey Parkway, Dept. 3431, Chicago 14, Illinois.

ETCH Nameplates electrolytically. Free samples. Graphart, Box 9647, Jackson, Miss.

ALASKAN Color slides. Northern Color Film Co., Box 16, Cooper Landing, Alaska.

PHOTO FINISHING

TRIAL 8 Jumbo roll 35¢. 12-50¢. Western Photo, PM 19, Box 298, San Francisco 1.

ENLARGEMENTS Doubleweight matte paper 4-5x7's \$1.00. Bovenzi Photo Service, 47 Locust St., Rochester 13, N. Y.

SAVE Money. Kodacolor developed with 8 prints \$2.70; 12 prints \$3.70. Reprints 25¢ each. Write for free mailers. Money Saver Photo, Box 97, San Lorenzo, Calif.

20% OFF Kodacolor film developed and printed. All prints jumbo size. Send for free mailer. Colonial Photo Service, 142 North Main Street, Whitinsville, Mass.

PROFESSIONAL Quality Ektachrome-Anscochrome processing \$1.00. Kodachrome 8mm-35mm \$1.25. Write for mailers. National Color Corporation, Box 12155C, Atlanta 5, Georgia. Box 8370C, Chicago 90.

TWELVE Exposure rolls 49¢. Wallets 20 for \$1.00. Lincoln Studios, Dept. K, Box 13, Lincoln, Neb.

ENLARGEMENTS, Heavyweight, six 5x7's or three 8x10's \$1.00. Jack Koons, Huntington Mills, Penna.

ENLARGEMENTS, Any size. 8x10, 35¢; 11x14, 75¢; 16x20, \$1.75. Guaranteed. Enlargements Unlimited, 203 Woodward, Buffalo 14, N. Y.

8-HOUR Service on deluxe jumbo prints. 8-exposure roll developed and 8 jumbo prints 40¢, 12 exposure 55¢, 16 exposure 70¢; 35mm. 20 exposure 75¢, 36 exposure \$1.25. Jumbo deckledge reprints 5¢ each. Contact prints made if specified. Bay Photo Service, P.O. Box 210, Oakland, California.

KODACHROME Processing by Kodak. 8mm. roll or 35mm., 20 exp., \$1.35. Prompt service. Write for mailers and prices. Color Fix, Dept. P, CPO Box 30, Kingston, N. Y.

TWO Beautiful prints from each picture on roll. 8 exposure 45¢; 12 exposure 55¢. Thirty-seven years of satisfied customers. Quick service. Lens Photos, Dept. J4, Janesville, Wis.

SUPERIOR Quality. Prompt service. 8 jumbos in album 40¢. 16 contacts 50¢. Jumbo reprints 5¢. Satisfaction guaranteed. Also complete color film finishing service. Write for free circulars and mailers. Fast-X-Foto, Box A, Jersey City, N. J.

MOTION PICTURES AND SOUND EQUIPMENT

SOUTHEAS — 2x2 Colorslides. Catalogue, sample, 30¢. Avery Colorslides, 4818A Placidia, North Hollywood, Calif.

SENSATIONAL Offer. 8mm. 50 ft. movies. Reg. \$1.95, only \$1.00. Comedies, cartoons, travel, animals, airplanes. Send \$1.00 each. Home Movies, Box 10M, Van Nuys, Calif.

PROJECTOR: Movie sound 35mm. portable. 5322 North 51st, Milwaukee 18, Wis.

16MM. Sound films, Bargain bulletin. Duquette, 97-T Snow, Fitchburg, Mass.

FREE! Blackhawk's big sale catalog 8mm., 16mm. movies, 2"x2" color slides. Biggest selection anywhere! Projectors, cameras, supplies. Big discounts! Get free, every three weeks, 12-page newspaper size bargain list! Blackhawk Films, Davenport 14, Iowa.

MOVIE Camera film; 8mm. roll \$1.50, 16mm. 100' \$3.00. Free processing. Better Films, 742 New Lots, Brooklyn, N. Y.

BOOKS: Hundreds of subjects. Big 1958 book catalog — 10¢. Popular Mechanics Press, 200-BC East Ontario St., Chicago 11.

5,000 8-16MM. Movie films. Free catalogues. International, Greenvale, N. Y.

SAVE 50%! Guaranteed-fresh color, b.&w. movie film! 8mm., 16mm. Free catalog! Eso-R, 47th Holly, Kansas City 12, Missouri.

FREE Catalog. Save dollars. Fresh 8mm., 16mm. b&w and color film. Home processing equipment. Superior Bulk Film Company, 448 No. Wells, Chicago 10.

16MM. Sound, projectors, films. Sale, rental, exchange. Visit store or write for catalog. National Cinema, 71 Dey St., New York City.

MUSIC AND MUSICAL INSTRUMENTS

SONGS Printed. 20 lead sheets \$1.25. Skoumal Music, 319 E. State, Rockford, Ill.

GUITAR Making books, plans, imported woods, tools. List 10¢. Store, 510 East 11th Street, New York 9, N. Y.

SUCCESSFUL Songwriting. Free booklet. Complete instruction. Write: Box 227, Van Nuys, Calif.

SONGWRITERS With N. Y. publisher contacts want new song ideas. Share royalties. Not a service, no fees. Send poems, ideas. Songwriters' Associates, 507 5th Avenue, New York City 17.

EASY Guitar method \$2.00. Rudolph Rodenius, 2207 W. 3rd, Duluth 6, Minn.

1958 ACCORDIONS Wholesale — 10 day trial. Free catalog. American Accordion Center, 5329 PM-19 Belmont, Chicago.

SONGWRITERS! Don't mail poems or songs anywhere! Write for safe procedure! Song Service P. 333 West 56th, New York City 19.

VIOLIN Making supplies. Free catalog. Fred Artindale, Box 71992, Los Angeles 1, Calif.

RECORDS Hi-fi. Big discounts. Noelson. Box 211, Wall Street, New York City 5.

GET Started in country and western music. Radio, Records, Television. Your own band. Free booklet. Country Music, Inc., P.O. Box 685c, Gaffney, S. C.

SONGPOEMS And lyrics wanted. Mail to: TinPan Alley, Inc., 1650 Broadway, New York 19, N. Y.

POEMS Wanted for new songs and recording. Immediate consideration. Send poems. Songcrafters, Box 6145, Acklen Station, Nashville, Tenn.

POEMS Wanted for musical setting and recording by America's largest song studio. Send poems. Free examination. Five Star Music Masters, 630 Beacon Building, Boston.

VIOLINMAKERS, Repairers. Fine tone wood, and all violin supplies. Send for free wholesale new price list. International Sales, 414-MPM E. Baltimore St., Baltimore 2, Maryland.

SONGWRITERS — Outstanding, ethical offer. Hibbler, C-5, 6808 Oleander, Chicago 31, Illinois.

POEMS Wanted for musical setting and recording. Send poems. Free examination. Crown Music Company, 49-C West 32 Street, New York 1.

SWISS Musical movements. Mechanical, electrical. Spielman, 131 West 42nd, New York City 36.

SONG Poems wanted. Free examination. Send poems. McNeil, Master of Music, 1112 PM Wilshire, Santa Monica, Calif.

SONGS And poems wanted. U. S. Music, Box 222A, Belmont, Mass.

ACCORDIONS — 1959 Models. Lowest wholesale prices. Save up to 75%. Free home trial. Trades accepted. Big color catalog free. Accordion Manufacturers, Box R, 2003 Chicago, Chicago 22.

SAXOPHONES, Clarinets, trumpets, trombones from factory. Save 50%. Free catalog. Libro Music Center, 591 Chapel St., New Haven, Conn.

ELECTRIFY Player pianos and reed organs. Lee Mfg., 10630 Hillhaven, Tujunga, Calif.

PHONOGRAPH Records cheap, postpaid. Catalogue. Paramount, Box 242-M, Williamsport, Penna.

ELECTRIC Guitars, amplifiers, wholesale. Free catalog. Carvin P.M.M., Covina, California.

WANTED! Poems, lyrics, songs, ideas. Bengal, 93 Jefferson, Chelsea 50, Mass.

ACCORDIONS, Wholesale to everyone. Save up to 60%. All national known brands. Free catalogue. Del Principe, 29 South Cicero, Chicago 44.

SONGS Into dollars. Share \$33 million dollars yearly for new songwriters, song poets. Any subject, songs composed, published, promoted by largest firm. Information, appraisal free. Send Nordyke Music Publishers, 6000 Sunset, Hollywood 28 PM, California.

RADIO, TELEVISION AND ELECTRONICS

RADIO Course only \$22.95. Includes all tubes, parts, tools, instructions. Write for full information. Progressive "Edu-Kits" Inc., Dept. 562-B, 1186 Broadway, Hewlett, New York.

PERSONAL Phone radio assembled, \$3.50; wave-powered transistor kit, April PSM, \$6.50. Telepower, Wheaton, Maryland.

"RADIO Explained." 64-page book 10¢. Bookmaster, 2432 Fernwood, San Jose 18, California.

SIMPLE Television repairs. Marvelous booklet or book. Send for 1958 general book catalog. 10¢. Popular Mechanics Press, 633 N. St. Clair St., Chicago 11.

20 DISTANCE Crystal set plans, 30¢. Laboratories, 1131-C Valota, Redwood City, California.

CRYSTAL Radio kit with phone \$3.00; plans, catalogue free. Clearco Crystal Company, 2966 N. 4th, Milwaukee 12, Wis.

ELECTRIC Guitars, amplifiers, wholesale. Free catalog. Carvin, P.M.R., Covina, California.

HI-FI components, recorders, tape, records. Wholesale catalog free. Audio Fair, 1799M 1st Avenue, New York 28, N. Y.

GOVERNMENT Surplus radios, parabolic reflectors, sniperscopes, mine detectors, parts. Catalog 10¢. Meshna, Malden 48, Mass.

RECORDERS, HI-FI. Free wholesale catalogue. Carston, 215-PM East 88, New York City 28.

TAPE Recorders, hi fi components, tapes. Unusual values. Free catalog. Dressner, 69-02M 174 St., Flushing 65, N. Y.

BUSINESS OPPORTUNITIES

NEW Home business. Repair binoculars. Easily learned. Pays well. Free details. Waldeyer, 404 20th Ave., San Francisco 21, Calif.

INVISIBLE Reweaving: \$5 in one hour possible reweaving burns, tears, moth-holes. Spare-full time. Free details. Skilweave. Dept. SC-161, 335 W. Madison, Chicago 6.

GUARANTEED Market. Raise fish-worms for us. Free details. Golden Farms, Lubbock 12, Texas.

OWN Your own business applying aluminum siding. Solupak Co., 1620 Plymouth, Minneapolis 11, Minnesota.

CLEANS windows without streaks. Strange "dry" cleaning-cloth. Replaces liquids. Windows gleam. Samples sent on trial. Krister 105, Akron, Ohio.

\$400.00 MONTHLY Raising giant tropical worms. Odorless, soilless method. Charlie Morgan, Box 116E, Bushnell, Florida.

PROFITABLE — Tested sparetime mail-order opportunity! Everything supplied. Jackson, Newfoundland, Kentucky.

AMAZING Profits! Sensational home mailorder opportunities. National, 2696 So. 10th, Fresno 25, California.

MAKE Extra money. Cash commissions. Everybody buys easy-to-sell advertising book matches. Union label. All sizes. Cuts for all businesses. Powerhouse selling kit free. Steady repeat business. No experience necessary. Superior Match Co., Dept. MX-159, 7528 S. Greenwood, Chicago 19.

\$250.00 WEEK Profit possible. Earn at home spare time with fascinating printing method. \$5 starts you. Send no money now. Free confidential facts and valuable samples. Screen-Print JY, Los Angeles 61.

BE Appointed state notary public. Write Notary Publics', 3230-M1, Stoner, Los Angeles 66, Calif.

GROW Expensive herbs for us! Big profits home-business of your own. Year around profitability! We supply everything necessary! Send for free rare seeds and revealing plan. (State your age.) National Herb Exchange, Dept. JY, Gardena, Calif.

GROW A living miniature forest or orchard (only inches high) that bears tasty tiny fruit at home. Learn amazing dwarfing secrets! Fascinating hobby. Profitable home-business opportunity. Free seeds and plan. (State your age.) Miniature Nurseries, Dept. JY, Gardena, California.

EARN Money raising fishworms for us! Inquire: Oakhaven-38, Cedar Hill, Texas.

\$250 WEEK Cleaning venetian blinds. Patented machinery. Free literature. Robinson, 7213B, Indianapolis 1, Indiana.

SELL Plastic-coated, pre-trimmed 1960 wallpaper. Free details. Morton's, 3414 Roosevelt, Chicago 24, Illinois.

"50 NEW Home-Business Ideas" booklet, sample free. Spray exotic Velvet-Suede on anything. Flokerat-JY, Los Angeles 61.

LEARN Make moulded terrazzo monuments. Terrific profits. Material available locally. No expensive machinery. One man operation. Granitex Monuments, Box 262, Dyersburg, Tenn.

CANDIED Popcorn and potato chip equipment. Eakins, Box 933-A9, Springfield, Ohio.

BUSINESSES, Resorts, motels, investment property, ranches. Our special service dept. at your disposal. No obligation. World's largest. 58 years' service. Strout Realty, 7-MB S. Dearborn, Chicago 3, Ill.

EARN Quick cash. Sell custom made-to-measure shirts. Free sales kit. Write Henlein, Box PM, Textile Bldg., Cincinnati, Ohio.

BE A home manufacturer. Make the highest profits. Our sales organization gets the orders, helps sell your products. Build luggage and cases for 1001 needs. We supply instructions, supplies, everything. Work full, sparetime. Details free. Abarsl, 807-S1 Sunset Blvd., Los Angeles 12, Calif.

START Your own business on credit (U.S. and Canada). Your own boss. 1425 dealers sold \$5,000 to \$32,000 in 1957. We supply stocks, equipment on credit. 200 home necessities. Sales experience unnecessary. Pleasant profitable business backed by world-wide industry. Write Rawleigh's, Dept. A-U-PPM, Freeport, Ill.

GUARANTEED Market! Earn ready cash raising fishworms for us! Backyard, garage, basement! We buy your crop! Exciting details free! Oakhaven-38, Cedar Hill, Texas.

MAKE Durable building plastic easily. Beautiful. 101 uses. 800% profit. Bays Laboratory, Keams Canyon, Arizona.

BIG Money raising fishworms and crickets. Free literature. Carter Farms, Plains, Georgia.

SELL Books by mail. 400% profit. Royal, Box 368-X, Cleveland 27, Ohio.

MONEY Raising earthworms. Illustrated booklet 40¢. Organic Gardens, Mountainburg, Arkansas.

SELLING By mail fascinating. Profitable. Free information. Alfano, 19 Pine, Closter, New Jersey.

NEW! ROBINSON'S Sewing Machine Service Manual. 579 illustrations. 144 pages. Earn to \$5.00 hour. Price \$6.25. Where to buy wholesale. Details free. Lee Robinson, Book Nook Bldg., Walla Walla, Wash.

YOUR Own home-operated business! Take over your area as our service distributor keeping stores supplied. Nationally advertised 28-year-old line pays you 66% mark-up. Less than \$100 for merchandise starts you. For samples, highly successful plan, write Novo, Inc., 1168-F Milwaukee, Chicago 22, Ill.

A & W franchises available U.S.A. and Canada for popular A & W root beer. Want to own your own business? Make money, have time to enjoy it. Financing available on credit approval. Write A & W Root Beer Co., Box 1039 PMM., Santa Monica, California.

IMPORT-Export opportunity, profitable, world-wide, mail-order business from home, without capital; or travel abroad. Established world trader ships instructions for no-risk examination. Experience unnecessary. Free details. Mellinger, X701, Los Angeles 24.

LEARN Landscaping and growing of plants. Latest information on propagation, soil testing, plant growth regulators, garden design. Start a profitable business or wonderful hobby. Unique and modern home study course. Earn your diploma at home! National Landscape Institute, Dept. MC-19, 11826 San Vicente Blvd., Los Angeles 49, Calif.

MOTEL-Resort management. Qualify for hundreds fascinating, leisurely, well-paid executive openings. Learn at home. Free booklet. Motel Managers Training School, PM-19, 612 S. Serrano, Los Angeles 5.

CAMERA Profits! Make \$50.00 weekly spare time. Instructions \$1.00. Details free. Wilson, Box 965, Evanston, Ill.

\$100.00 WEEKLY, Mailorder business, little or no stock. Ebly, 3026 Waterloo, Chicago 14, Illinois.

CASH in on the booming boom by representing nationally famous Aristo-Craft, America's most wanted sport boats. Take order for 1 each of 5 magnificent models from friends, neighbors, boat fans in spare time and make over \$1500. Only investment required is \$386, for demonstrator at regular dealer cost. Choice areas open. Write on your letterhead to see if you can qualify for this valuable franchise. Atlanta Boat Works, 665 Pylant St., N.E., Atlanta, Ga.

FOR Sale — Aluminum patterns and stamping dies for the manufacture of cement roof tile machines. \$2000.00. L. Billa, 505 Priscilla Way, Anaheim, California.

START Home mail order business. Household products. B.C. Company, Box 1, New London, Ohio.

"HOW To Build Your Own Mailorder Business." Idea book for beginners 50¢ postpaid. Satisfaction guaranteed. Rocky Service, 6740 Waterworks Rd., Norfolk 2, Virginia.

FOR Sharpening handsaw, circular saws or lawn mowers there is nothing to compare with Acme sharpeners. Free literature. Max Mfg. Co., 138 Stockton Ave., San Jose 26, Calif.

WANTED: Home producers, to be subcontractors. Cast plastic products for manufacturers in our clearing house service. Thousands of easily made items required. Cash in at home, without previous experience. Plastic Service Associates, Dept. 1-PM, East Boston 28, Massachusetts.

\$20 DAILY Spare time plating baby shoes, jewelry, novelties. Free details. Jo-Ca Electroplater, 7840-D Northwest Sixth Court, Miami 50, Florida.

UP To \$1000.00 month for life. Free details. Lindsay, 5117 East 22, Tulsa 14, Okla.

PAYROLL Tax changes January. Weekly tax calculator, new rates, \$3.50. Details free. Dealer inquiries welcome. Morton Engineering Service, 5134 Meadowlark Lane, Kalamazoo, Michigan.

OWN An exclusive territorial franchise to sell fantastic profit making hostess apron originals created by leading fashion designers. Good for men, women. Full time, parttime. Send only \$5 for sales kit and sample. Write to Jobs, Dept. M-1, Box 125, Rugby Station, Brooklyn 3, N. Y.

CASH From sawdust, tin-cans, newspapers. Over 200 methods. Instructions \$1.00. Charles Company, 42-GDW, Norwood, Ohio.

MAILORDER business. Weekly bulletin, 260 new products a year, advice of experts, world's foremost mailorder services. Free booklet. U. S. Mailorder Research Bureau, 549-A West Washington, Chicago 6.

FREE! Private labels! Exclusive sales! Let us put you into business! Terrific profits! Repeats! We supply product-plan, advertising. VitaMins, 4801A Cedardale, Wichita 10, Kans.

EVERYBODY Likes candy. Make professionally home. Instruction, tools, supplies. Details free. (Our 49th year.) Ragsdale Candies, B107, East Orange, New Jersey.

INTERNATIONAL Home import mail-order business! Experience unnecessary. Earnings unlimited. Free import bulletin. Foreign Traders, 7814 Forsyth, St. Louis 5-BE, Missouri.

AMAZINGLY Profitable! Bronzing baby shoes. Mountings. Foster, 1520 Ardmore, Chicago 26.

QUICK Profits, with no capital! Take orders for magazines your neighbors like, want. Make cash on the spot! We show how with free kit. Get yours now. Write McGregor Magazine Agency, Dept. 311, Mount Morris, Ill.

LIQUID Marble—Colorful, glossy! Molded, brushed, sprayed! Particulars free. Marbleizing Service, Edwardsville, Illinois.

OPERATE Mailorder folio business. Free details. Ballard's, 1834 Edgeland, Louisville 4, Ky.

AMAZING Profits making concrete drain tile with simple machine. Circular free. Ceeten Products, Cornelia, Ga.

UP To \$20 daily spare time sharpening scissors, pink shears with amazing electrically-driven machine. Experience unnecessary. Eastsharp, 4221-A Rocky River Drive, Cleveland 35, Ohio.

LEARN Professional TV servicing in one week! Fabulous new simplified system. No big expense. No studying. No tools or equipment. Spare, full time. Own your own big profit business! Save! Amazing but true! Free! Write, TV Systems, Dept. CC-171, 1028 So. LaBrea, Los Angeles 19, Calif.

\$1 PAYS \$16.00. Enclose \$1 bill, receive charges prepaid materials for making \$16.00 worth sensational new tire cleaning discovery. Lifetime opportunity. Money-back guarantee. Watts Products, 4809 Poplar Level Rd., Louisville 13, Ky.

HIDDEN Treasures in the auto salvage, new and rebuilt parts business. Where to buy and my experience. \$2.00 postpaid. Auto Parts, Box 111, Scottville, Michigan.

TREMENDOUS Profits buying merchandise wholesale! Free details! Heritage, 210-PMM19 Fifth Ave., New York 10, N. Y.

95% PROFIT Easy! Sell mail order or direct. Name brand watches, rings. No investment. Free color catalog, details. Coleman, 1218-BA West Olive, Burbank, California.

COSTS 8¢—Retail \$1.00. Needed automotive product. You manufacture, distribute, easily. Everything furnished. Wilson, 505-D, Princeton, W. Va.

\$20.00 PROFIT Per hour! Homes, offices, insurance companies pay big money for invisible carpet reweaving. Makes cuts, holes, tears, disappear from expensive rugs and carpets. Brand new industry. Huge, unfilled demand. All trade secrets revealed. Details free. Carpeton, 1201D Rosemont, Chicago 40, Illinois.

MAKE Essential oils. Stay home, no boss, no time clock, no age limit. Good wages easy made. Process method, plants and buyers list, \$2.00. G. A. Keech, Box 611, Greenville, Calif.

LUCRATIVE Home workshop business opportunity. New patented process available for mass-producing mosaic tiles. You make quantity mosaics cheaply, sell at high profit, your customers or our buyer contacts. Send \$1.00 to Box #43, Seaford, L. I., N. Y. for complete prospectus.

BIG Money — Operate own fix-it shop. Service household appliances, motors, mowers, saws, skates, etc. Free book. Christy Trades School, A-7303, 3214 Lawrence, Chicago 25.

FREE Copy, "Five Steps to Mail Order Success." Fireside, 9430 St. Cyril, Detroit 13, Michigan.

IDEA Guide. New money-making information; nothing else like it. Only \$1.00. Ideal Industries, 216 S. Harvard, Addison, Ill.

ATTENTION: Heating, builders, hardware dealers, everywhere that cold, dampness predominate. Add dollars to your income, service to customers. Install Econo-heat, new heating treat. Saves up to 30% on fuel. Much more heat. Not formula or gadget but essential, practical for oil or stoker fired furnaces and boilers. Testimonials, all information, no obligation, 25¢. Less fuel, more heat. Main Industries Inc., 56 South Anderson Street, Pontiac 20, Michigan.

HOME Business! Men, women amazing profits, needed every home. \$1 bill brings formula. Acmay, Box 542, Birmingham 1, Alabama.

MADE \$10,000 Typing at home. Guaranteed proof. Amazing information 15¢. Lenore Felgen, Box 1125-PM, Oak Park, Illinois.

GROW Mushrooms. For pleasure. In boxes, lawns, pastures, grasslands, farmlands, gardens. Send \$1.00 for spawn, instructions. Thomas Company, D. 3604—30th S.W. Seattle, Wash. Copyright © 1958.

BRUSH Plating outfits for plating articles in the home and shop. No tanks necessary, silvering mirrors, spare or full time. Free particulars. Gunmetal Co., Ave. H, Decatur, Ill.

BEFORE Starting any mailorder business read "Mailorder Laws and Regulations" and "Mailorder Rules for Beginners." \$2.00. Licenses, taxes, legal requirements explained. Tasker, Box 3131, Alexandria, Virginia.

QUICK Money! "Repairing Car Batteries." At home! Easy too! Free details! Batteryman, Penrose, Colorado.

GROW Mushrooms. We buy mushrooms and pay high prices. Use cellar, shed and outdoors. Spare, full time, year round. We sell 100% pure cultured mushroom spawn. Free book. Mushrooms, Dept. 172, 2954 Admiral Way, Seattle, Wash.

FREE Sharpening manual. Good money servicing cutters, saws, cutlery. Thousands doing it. Treyco, North Tonawanda, N. Y.

MAKE 20 Filter cigarettes for 9¢. Facts free. Moberly, 950, Owensboro, Kentucky.

EARN Extra money at home in spare time. Exciting income plan. Details free. W. E. Hull, 1923 Berkley, Dallas 24, Texas.

MUSHROOMS Quicker, easier, cheaper. "Magic" preplanted trays. Newest facts free. Spawn \$1.00. Luxur, 641 South 19th, Newark 3, N. J.

LEARN Sewing machine repairing. To \$125 weekly. Sparetime. Supplies. Add to present business. Shipping from Chicago. New York, Los Angeles. Write today! Taylor Service, Box 2126, San Bernardino, Calif.

HOW To operate a printing brokerage. Complete instructions \$2.00. G & A Sales, P.O. Box 3466-K, Mdse. Mart, Chicago 54, Ill.

MAIL Trade magazine has moneymaking opportunities galore. Sample 25¢. Donovan, 79-PM Greenbelt, Levittown, New York.

FREE "Franchise profit letter" describes nationwide opportunities. Exclusive distributorships, dealerships, agency operations. Write today. National Franchise Reports, W-528, 333 North Michigan, Chicago 1.

TREMENDOUS Possibilities in home mail order. I retired after five years. Plan and help given absolutely free. Norris Cole, 217 West 49th, Bradenton, Florida.

OPERATE Your own home mail order business, it's profitable. Write. Webb Imports, Pico Rivera, Calif.

BOOMING Business. Ground floor opportunity. Free booklet. Stone-Craft, Box 856-A, St. Louis, Mo.

MAKE Signs. Just nail on. Hoag's Sign Letters, 507 E. Chicago Blvd., Tecumseh, Michigan.

\$34.70 TWO Hours. Manufacturing concrete products. No selling. Carlayne Castings, 1803 Fremont, Rapid City, South Dakota.

TO \$100.00 Weekly. Sparetime, home operated mailorder business. Successful beginner's plan. Everything supplied. Lynn, 10420-M National, Los Angeles 34.

LEARN Real estate by listening to records. Lee Institute, Brookline 46, Mass.

CAMERA Owners! Earn \$50.00 week-ends! Instructions \$1.00. Information free! Kline, 935-PM North Austin, Chicago 41, Illinois.

COLORGLAZED Concrete pottery made without molds. Patented method. Cemetery products, novelties, tiles. Basement leak-sealing. Money-making projects. Booklet, details free. Men only. National Pottery Company, Grand Rapids, Minnesota.

PIANO Tuning learned quickly at home. Tremendous field! Musical knowledge unnecessary. Information free. Empire School of Piano Tuning, Champaign, Ill. (Founded 1935).

WANT To make big money at home? \$10.00 profit in an hour possible with invisible mending. Make tears, holes, disappear from clothing, fabrics. Steady year-round demand from cleaners, laundries, homes. Details free. Fabricron, 6234 Broadway, Chicago 40, Illinois.

\$70 WEEKLY—Home, spare time. Simplified mail bookkeeping. Immediate income—easy! Auditax, 34757A, Los Angeles 34.

MINK Raising information free. Complete. Lake Superior Mink Farm. Superior, EE1, Wisconsin.

MAKE Flexible molds. Cast plaques, figurines. Free sample. Tooker, 1045-R Fairview, Hamilton, Ohio.

NATURAL Molding rubber, extra thick. Free sample. W. Wooley, 1016-A Donald, Peoria, Illinois.

I want to send you proof of the wonderful pulling power of Popular Mechanics classified pages. What's your proposition? Write me today. Include literature if possible. F. W. Johnson, Manager Classified Advertising, Popular Mechanics Magazine, 200 E. Ontario St., Chicago 11, Ill.

INCOME With garden golf. Motivated archery ranges. Brockway, Box 3924, Portland 8, Oregon.

YOUR Own high profit business. Sell name brands, full or part time. No inventory, no investment. More than 2,000 name brand items; lowest wholesale prices. Watches, jewelry, cameras, hi-fi radios-phonos, appliances, housewares, hardware, power tools, luggage, musical instruments, garden equipment, sporting goods, toys, many others. 8 floors of name brands. Million dollar inventory. Orders shipped complete within 24 hours! Send for free, beautifully illustrated catalog now! Separate dealer price list. H. B. Davis Corp., Dept. 11, 145 W. 15 St., New York 11, N. Y.

OPERATE Profitable mailorder business! Write: Bond, 1637-H West Vernon, Phoenix, Arizona.

THE All profit offer plus my big mail 30¢. Satisfaction guaranteed! Crews, Box 56, Valrico, Florida.

RAISE Rabbits on \$500 month plan. Plenty markets. Free details. White's Rabbitry, Delaware Ohio.

SALES-By-Mail could be your opportunity. Valuable food for thought free. Rawson Wood, 3974 Milwaukee, Chicago 41.

MONEY Plans! "Secret Journal." Grandpa, two daughters made \$2500 first month! Work home. Publicco, Oceanside, Calif.

11,000 NEW Prospects daily. Baby record books, shoes, albums. Sell mailorder. Use our literature. Write: No-Co-Ro, Capitola, California.

BAKE New greaseless doughnuts in kitchen. Sell stores. Free recipes. M. Ray, 3605 South 15th, Minneapolis 7, Minnesota.

FIX Typewriters. Inexpensive home course teaches factory secrets. Free booklet. Athey, Tarentum, Penna.

PLATE Baby shoes, jewelry, gifts, bronze and colored pearl. Free booklet. Platex, 11029 South Vermont, Los Angeles 44.

COPUBLISH Mail Sale Advertiser, leading mail order paper. Details, latest copy, dime. Vanroy Shirk, Lebanon, Penna.

FREE Catalog. Contains hundreds of businesses, farms and income properties throughout U.S., Canada. Specify type and location desired. Deal direct with owners. U. I. Buyers Digest, 1608 Hillhurst, Dept. PM-3, Los Angeles 27, Calif.

BRONZE Baby shoes: Instructions, equipment and mountings for genuine electroplating process. Largest supplier of all plating equipment, supplies. Free catalog. Hollywood Bronze Supply, Dept. B-3, 1624 East First, Los Angeles 33, Calif.

FREE Book "505 Odd, Successful Businesses." Work home. Pacific, Oceanside, Calif.

FREE Folio "\$5,000-\$45,000. Unlimited Vacations." No merchandise. Unknown! Work home, sparetime! Haylings, Carlsbad, Calif.

MAKE \$46 From square foot plywood; jig saw necessary. Free details. Woodart, Bridgewater, Mass.

GROW Orchids at home. Profitable, fascinating. Successful home grower explains special light, temperature and humidity conditions orchids need. Free! Full details. Orchids, 100 S. Vermont, Los Angeles 4.

FREE Book "990 Successful, Little-Known Businesses." Work home. Plymouth, 1610-43 Street, Brooklyn 4, N. Y.

REBUILD Batteries; repair dolls; make rubber stamps. "75 Ideas" free. Universal, Box 1076-A, Peoria, Ill.

BUY Direct from factories—Appliances, cameras, watches! Free details! Cam Company, 6810PM—20th Ave., Brooklyn 4, N. Y.

PLASTERCRAFT Molds, liquid rubber, plasters, flocks, candle supplies. Catalog and manual free. Blue Rapids Supply, Blue Rapids, Kansas.

LIQUID Molding rubber, free sample. Shellcraft supplies. Chaney's, 1907-A East Road, Jacksonville 11, Fla.

\$5,000 YEARLY. Spare time at home. Nothing to buy. No local selling. Dignified. Guaranteed. Home Harvest, 1933 Lakeview Road S.W., Albuquerque, N. Mex.

MONEYMAKING OPPORTUNITIES

OREGON Opportunities Magazine. Moneymaking products, businesses, farms, imports, wildlife, trades. Year \$1. Sample 25¢. 27 2nd, Corvallis, Oregon.

FREE Manual "16 Ways to Make Money." Miller, Box 588-P, Oshkosh, Wis.

MAKE Money writing short paragraphs! No tedious study. I tell you what to write, where and how to sell; and supply list of editors buying from beginners. Many small checks add up quickly. Write to sell, right away. Send for free facts. Benson Barrett, Dept. C-27-A, 7464 Clark, Chicago 26.

MONEY Sparetime weaving. Build simple rug weaving loom. Instructions \$1. Crafts, 10 Central, Hallowell, Maine.

MAKE Money installing home burglar fire alarms. Simple diagrams 35¢. Amora Products, 7648 W. Sunset Dr., Elmwood Park 35, Ill.

CATHOLIC Religious articles. 50% discount. Start your own business. Catholic Guild, 11 Harding Ave., White Plains, N. Y. Samples and kit \$1.00.

MEN And women wanted to start home business in spare time with little table-top rubber stamp machine. Easy to earn up to \$9.80 an hour without previous experience. Full particulars free by mail. Send postcard to Roberts, 1512 Jarvis, Room CR-2-A, Chicago 26, Ill.

\$5,000.00 ANNUALLY Possible for you in mailorder. Free information. Ransie, Box 1719-A, Richmond 14, Virginia.

BIG Money raising fishworms and crickets. Free literature. Carter Hatchery, Plains, Georgia.

START Big-pay business at home in spare time. No experience needed to operate little table-top machine for bronzing baby shoes. Make \$5.46 profit on every pair. Full particulars free. Send postcard to Mason, 1512 Jarvis, Room CM-2-A, Chicago 26, Ill.

MAKE Money gathering herbs, roots, barks, moss, cones, flowers, leaves, etc. Free folder. Kelly, B-10-M, Looneyville, West Va.

MAKE Big easy profits making costume jewelry at home in spare time! Quick, easy to make; easier to sell! Details free! Don-Bar, 3511 W. Armitage, Dept. A-192, Chicago 47, Ill.

DECIDEDLY Different mailorder opportunity. Profitable. Details free. Prehn Chemical Company, Dept. 7, Box 291, Addison, Illinois.

\$10.00 IN An hour possible at home with "Magic Wonder Method" of invisible reweaving. Steady demand. Details free. Invisible Reweaving Industries, 8411 La Mesa Blvd., Dept. "B," La Mesa, Calif.

START Home manufacturing business. Sell agents, stores. Big profits. Raby Products, 733 River, Ypsilanti, Michigan.

MAKE \$200.00 Monthly spare time with jig saw. Free details. Elkman, 346F North Summit, Sioux Falls, South Dakota.

AMAZING Magazine with money-making suggestions. Sample 10¢. Pinkerton, 1738-B North West 12th, Oklahoma City 6.

MEN — Women! Start money-making plastic laminating business at home in spare time. Material that costs 11¢ brings back \$2.50. No canvassing or selling but mail orders bring in \$20 a day. Write for full particulars free. Rush name on postcard to Warner, Room CL-2-A, 1512 Jarvis, Chicago 26, Ill.

EARN \$5,000-\$15,000 Yearly, at home, in respectable field. 3 hours weekly attention. No experience necessary. Proof? Details. Mail 10¢. Columbia Enterprises, 8203-ME Grubb, Silver Spring, Maryland.

RAISE Earthworms for health and profit. Postcard brings free instruction offer. Edith, Terra-Vermis, Allegan, Mich.

TWO Mailorder magazines, instructive articles, tips, sources, new products, 25¢. E. J. Thompson, Box 94-N, Salinas, Calif.

EARN Cash at once, sending us easy orders for magazines your friends, neighbors want. Instant profits! We show how. For free kit, everything you need, write McGregor Magazine Agency, Dept. 321, Mount Morris, Ill.

BECOME Wealthy—Learn buying and selling real estate for profit. Eagle, 17579 Ohio, Detroit 21, Michigan.

BIG Profits making flowers. Beginner's outfit, \$1.10. Hauser House, Box 6524-P, Phoenix, Arizona.

PROFITABLE Homework; typing, mailing. Instructions and supplies \$1.00, refundable. Interstate, 37-A Besch, Albany 9, New York.

AMAZING Successes through franchises! Become exclusive franchise holder your territory. Information rushed. National Franchise Reports, MP-528, 333 North Michigan, Chicago 1.

START Profitable mailorder business! Home. Beginners folio \$1.00. Refund if not satisfied. Details free. James Thompson, 75 Ridge Avenue, Youngstown 2, Ohio.

HOW To make money—Over 150 plans \$1. Catlin, 68 North Ellsworth, San Mateo 8, California.

GROW Mushrooms. We buy mushrooms and pay high prices. Use cellar, shed and outdoors. Spare, full time, year round. We sell 100% pure cultured mushroom spawn. Free book. Mushrooms, Dept. 173, 2954 Admiral Way, Seattle, Wash.

PERFUMES. Literature, quantity prices. Malord Sales, Box 86, Pekin, Ill.

WIN Contests. Complete information, 10¢. Spence, Box 11569, St. Petersburg, Fla.

ALWAYS Broke? Send for our home budget. Free information. Budget Plan, Box 481, St. Louis 66, Mo.

MUSHROOMS Quicker, easier, cheaper. "Magic" preplanted trays. Newest facts free. Spawn \$1.00. Luxur, 641 South 19th, Newark 3, N. J.

JOIN The prosperity parade with a mail order bookshop in your own home. Valuable information free. Practical Publications, 3974-F Milwaukee, Chicago 41, Ill.

FREE Plan and help. Home mail order. A. Cole, 217 West 49th, Bradenton, Florida.

START Successful home mail order business. Plan and personal help absolutely free. Johns, Box 1013, North Little Rock, Arkansas.

SELL Titania gems. Far more brilliant than diamonds. Catalog 10¢. Diamonite, 2420-M 77th, Oakland 5, California.

SELL Information by mail. 10-to-1 profit ratio. Valuable suggestions free. Rawson F. Wood, 3974 Milwaukee, Chicago 41.

EARN Money evenings copying and duplicating comic cartoons for advertisers. Adservice, Argyle 1, Wisconsin.

BOOKS: Hundreds of subjects. Big 1958 book catalog — 10¢. Popular Mechanics Press, 200-BC East Ontario St., Chicago 11.

WIN Contest money. General Contest Bulletin gives hundreds of tips. Lists current contests, rules. Sample magazine 25¢. General Contests, 1609½ East 5th, Duluth 12, Minnesota.

FREE Folio "\$5,000-\$45,000. Unlimited Vacations." No merchandise. Unknown! Work home, sparetime! Haylings, Carlsbad, Calif.

MAKE Money, operating mail order business, selling business cards. Vosacek Printing, 4444A Ute, San Diego 17, Calif.

CIGARETTES — Improved roller makes 20 for 9¢. Packs free. Moberly, Box 821, Owensboro, Kentucky.

READ Progressive Mailtrade, the magazine that tells how to make money by mail. Dime brings sample and special offer. Progressive Mailtrade, Box 357, Sheboygan, Wisconsin.

EXPORT — IMPORT

IMPORT-Export business made easy. Complete setup service, not just instructions. Hermes, 152 West 42, New York City 36.

IMPORTING Is big business. Razor blades \$2.43 per 1000. Our "World Trade Guide and Import Directory" gives hundreds of confidential sources plus how to start importing immediately. Free information or your copy prepaid \$2.00. Money back guarantee. Direct Mail Service Co., P.O. Box 581, Bakersfield, Calif.

FORMULAS, PLANS, ETC.

BOOK 10,000 Formulas. Price \$5.00. A. Hanlon, Malvern, Penna.

FORMULAS For latest money-making discoveries. New! Good! Valuable literature free! Miller, Chemist, 1517-D, Tampa, Florida.

FORMULAS; All kinds, latest, best. Literature free. Kemixal, Park Ridge, Ill.

LATE, Modern manufacturing formulas. List free. Moon Chemical, Martville, New York.

PLASTICS

LAMINATING Plastics. Plastic sheets, vinylite, acetate, plexiglas. Free catalogs. Arthur Blank & Co., 44 Causeway, Boston 14, Mass.

CASTING; Mold supplies. Catalog 25¢. Gel, Box 261, Union, N. J.

PLEXIGLAS. Square foot cost, 1/16", \$1.20; 1/8", \$1.52; 3/16", \$1.86; 1/4", \$2.21; 3/8", \$3.23; 1/2", \$4.36. Colors add 10%. Send 15¢ for postage. Aristocrat Plastics, 23 Sussex Avenue, Newark, N. J.

LAMINATING Supplies. Free price list. Solomon, 46 Cornhill, Boston 8, Mass.

BOXES, Plastic. Free list. Althor, 170 Bay 23 Street, Brooklyn, N. Y.

LEARN Plastics fabrication for spare time income. Low cost home training now available. Write for free booklet. Interstate Training Service, Dept. D-3, Portland 13, Ore.

PLASTICS—Plexiglas, acetate, vinylite, polyester, fiberglass, epoxy, styrofoam, polyethylene, mold materials, cements, supplies. Instructive, informative wholesale-retail catalog, 25¢. Gem-O-Lite, 5527 Cahuenga, North Hollywood, Calif.

NEW Liquid casting plastic, clear, colors. Embed real flowers, butterflies, photos, coins. Send 25¢ for two handbooks "How to Cast Liquid Plastics" and "How to Make Extra Money at Home." Castolite, Dept. A-101, Woodstock, Illinois.

SELL Our latest plastic product. Boyll Plastic Products, Cadillac, Michigan.

NEW Do-it-yourself casting and molding plastics! No experience or machinery necessary. Send 25¢ for big 64 page catalog listing hundreds of materials, molds, complete outfits and accessories. Castacraft Corp., Dept. A-22, P.O. Box 555, Palo Alto, California.

NOW—Electric laminating kit. Hobby. Profitable. Burr, 330 East Center, Kalamazoo, Mich.

CHEMISTRY

EXPERIMENTERS: Bargains galore catalog, 25¢ (refundable). Hagenow Laboratories, Manitowoc, Wisconsin.

CHEMICALS And apparatus for industrial, analytical, and private laboratories. Catalog 25¢. Dept. M-50, Biological Supply Co., 1176 Mt. Hope Ave., Rochester 20, N. Y.

ILLUSTRATED Catalog: Chemistry, mineralogy, biology 25¢. Tracey Laboratories, Evanston, Illinois.

BOOKLETS! Chemistry, Physics, Astronomy, Science, Relativity, Electricity, Radio, Light, Tables, Mathematics. 10¢ each. Franks, 3121 S. Racine, Chicago 8.

SPECTROSCOPE For quick analysis \$3.00. Kuttingson, 26278 Arastradero, Los Altos, Calif.

LARGE Supply catalog 25¢; experiment book 25¢. Laboratory Sales, Box 161-A, Brighton, Mass.

MICROSCOPE Slides, anatomical. Free list. Bay, 409 Roosevelt, San Francisco 14, California.

AMAZING New Book of Science experiments, formulas, and catalogue of laboratory supplies. Only 25¢. National Scientific Co., Dept. PM-1, 500 West Road, Lombard, Illinois.

AGENTS WANTED

EIGHTY Million prospects! Sample and complete details \$1.00. Sell stores or direct. Lee Products Company, Box 32, Winterset, Iowa.

BIG Profits. Stamp social security plates, key protectors. Sample 50¢. Catalog free. General Products, 188-PM State, Albany 10, N. Y.

FREE Sample! Beautiful feather pictures. Send 12¢ stamps mailing. Sylviak, Apartado 9036, Mexico 1, D. F.

EARN \$12,000 Yearly—Only two sales daily. World's best seller, The Holy Bible. Illustrated. Protestant or Catholic. Margareta's, P.O. Box 92, Hazleton 7, Penna.

BUY Wholesale! 25,000 nationally advertised products. Get amazing dealer catalogs. Complete details free. American Wholesalers, 1841DC Levee, Dallas 7, Tex.

EASY Handwork makes fast-selling useful articles. Sample free. Sunmade Company, Brockton 64, Massachusetts.

BE The Popular Mechanics representative in your neighborhood and earn big profits in your spare time. Write Popular Mechanics Magazine, Room 305M, 200 E. Ontario St., Chicago 11.

GOLDMINE Of 600 money makers. Free copy. Specialty Salesman Magazine, Desk 5B, 307 North Michigan, Chicago 1, Ill.

PRINTING, Advertising salesmen—Excellent moneymaking sideline selling decalcomania name plates, small quantities. Automobile initials, sign letters. Free samples. Ralco, XL, Boston 19, Mass.

GOLD Or silver letters, numbers. Windows, doors, trucks. 1" to 6". 500% profits. Free samples. Atlas-T, 544 West 79th, Chicago 20.

AGENTS — 300% Profit selling genuine gold window letters; stores and offices. Free samples. Metallic Sign Letter Co., 1217-D West Newport, Chicago.

YOUR Ad in this space will get some good agents for you. Yes, I'll prove it. Write for Folder "A" right now. P. W. Johnson, Classified Advertising Manager, Popular Mechanics Magazine, 200 E. Ontario St., Chicago 11, Ill.

YOUR Own business — Used suits \$1.50, overcoats 65¢, mackinaws 35¢, shoes 12½¢, ladies coats 30¢, dresses 15¢. Enormous profits. Catalog free. Nathan Portnoy Associates, 2109-AA Roosevelt Road, Chicago 8.

EXCLUSIVE Line of personal initialed buckles, belts, cap badges, 3000 emblems. Hook-Fast, Dept. PM, Roanoke, Va.

SELL Bowling shirts with players' names, team emblems colorfully embroidered. For men, women. Entire teams, leagues buy at low prices. Make \$500 monthly extra. Sales kit free. Master, Dept. K-19, Ligonier, Indiana.

FOG—Stop windshield cloth. Instantly removes blurry mist, frost, sleet, snow. Stops windshield fogging. Samples sent on trial. Kristee, 56, Akron, Ohio.

\$1,000.00 A Month for making dramatic 3-second demonstration of amazing lightweight Presto fire extinguisher. New chemical used by airforce snuffs out fires instantly. Only \$4.95. Terrific commissions. Millions want it. Free kit, Merlite, 114 E. 32nd, Dept. P-66T, New York City 16.

ANYONE Can sell famous Hoover uniforms for beauty shops, waitresses, nurses, doctors, others. All popular miracle fabrics: Nylon, dacron. Exclusive styles, top quality. Big cash income now, real future. Equipment free. Hoover, Dept. A-138, New York City 11.

SEEKING New products? Get my outfit 47 money-making specialties. Latest conveniences for home, car. Send no money. Just your name. Kristee 57, Akron, Ohio.

50 VALENTINES Only 25¢. Make biggest money showing friends best greeting card sellers for every occasion all year. Mother's, Father's Day, Easter, birthday, everyday assortments, gifts, stationery. Samples on approval. Send 25¢ for Valentine special. Midwest, 1113 Washington, Dept. 616C, St. Louis 1, Mo.

ATTENTION! Here is a tremendous potential for men seeking exceptional profits from an accepted, nationally advertised product. No experience necessary, no obligation. Send for powerful, proven sales plan and samples on approval. Special fund raising plan for churches, clubs, etc. Sunshine, 13 Warwick, Springfield 1, Mass. (West of Rockies, write Pasadena 1, Calif.)

MEN-Women agents: Sensational new money-makers — Beautifully hand-painted, plastic personalized photo enlargements, compacts, rings, bracelets, lockets, etc. Simply take orders, pocket 40% commission. We deliver and collect. Sales outfit free. Novelco, 3343 North Ave., Chicago 41.

DAMASCENE Earrings! Exotic orientalism. Huge profit. OHGA, PM131, Sigakensuatu, Japan.

CRAZY Cards. Two sets 25¢. Catalog free. Dohn-GF-Marks, Broadview, Ill.

MAKE \$50-\$300 Quickly, easily, showing outstanding all occasion, Easter, Valentine cards, costume jewelry, gifts, imprinted stationery, household items. Costs nothing to try. Bonus to 7%. Special plan for churches, organizations. Write for best-sellers on approval, free surprise gift offer, money-making details. Hedenkamp, 361 Broadway, Dept. PM-53, New York City.

AMAZING Greeting card money-maker. Make \$75.00 on 100 deluxe \$1.25 assortments. Newest 21 for \$1 tall cards, gift novelties, 125 fast sellers. Gift bonuses besides biggest profits. Experience unnecessary. Stationery samples free, others on approval. \$1.00 gift for prompt action. Creative Cards, 4401 Cermak, Dept. 524-K, Chicago 23.

FOR Easiest extra money, get samples of 1959's fastest-selling greeting card assortments, gifts, exclusive stationery. Lovelier, bigger values, more profitable. Cash bonus, too. Big line. Samples on approval. \$1.25 gift introductory offer free. Cardinal, 1400 State, Dept. A-79, Cincinnati 14.

NO Tricks—No gimmicks. Substantial quality home appliance sells on 9 out of 10 demonstrations. Risk no money. Free big profit details. Write Patented Products Corp., Dept. C-1, Danville, Ohio.

WANTED. Fire extinguisher salesman. Huge profits. Out-O-Matic, 1737 E. 31st, Denver 5, Colo.

HOTTEST! Automotive invention, keeps heater working with engine off. Big profits, free details. Harmon & Co., P.O. Box 8026 Northgate Station, Seattle 55, Wash.

SELL Champion, AC, Autolite spark plugs. Reconditioned, electroplated, guaranteed 10,000 miles. 100% profit. Free sample. City Motors, 2913-E Fannin, Houston 2, Texas.

FABULOUS Money makers. Fast selling dish cloths, 500 other popular articles. Lowest wholesale prices. Smiling Scot, DP3 1266 Goodale, Columbus 8, Ohio.

SELL Profitable imports. Literature free. Dale, 1959 Clays Mill Rd., Lexington, Ky.

SURE Sales every day with our red hot big demand items. Stop betting on dead horses. Write, Arco, 291 East Seventh Street, St. Paul, Minn.

MAKE \$50 To \$500 selling friends, neighbors our beautiful all occasion greeting cards, personalized stationery, wedding invitations, gift items and novelties. Profits to 100% plus bonus. Free box offer included with feature assortments on approval, free selling guide, free catalogue. New England Art Publishers, North Abington 127, Mass.

"GEM-16" Camera \$2.00. Free literature! Gem Corporation, C.P.O. 545, Tokyo.

JEWELRY. Gerlach Mail Sales, 302 N. 112 St., Wauwatosa 13, Wisconsin.

CASH Commissions at once, taking orders for magazines every family wants! No experience needed. For free money-making kit, with everything you need, write McGregor Magazine Agency, Dept. 301, Mount Morris, Ill.

TREMENDOUS Profits, quick bandage. Charlson, 1840 South Racine, Chicago 8.

AUTO Accessories. Distribute, exclusive franchise. 300% profit plus earn bonus 1959 car. Clyde, 120Y East 82, New York 28, N. Y.

RUN A spare-time greeting card and gift shop at home. Show friends samples of our wonderful new 1959 all-occasion greeting cards and gifts. Take their orders and earn up to 100% profit. No experience necessary. Costs nothing to try. Write today for samples on approval. Regal Greetings, Dept. 31, Ferndale, Michigan.

BONUS Plan, plus commission. Sell cast aluminum nameplates for homes and desks. Free information. C. W. Storey, Box 86, Tilton, N. H.

YOU Keep all the dollars, everyday. Seeing is believing. Free details. Lane, 8438 Forrest Ave., Philadelphia 50, Penna.

SELL Desk calendars. Make \$25 a day. Every business firm a prospect. Details free. Steel Advertising, 13 East Franklin, Richmond, Va.

BUY IT WHOLESALE

BIG Multicolor wholesale catalog! Housewares, appliances, clothing, silverware, cookware, luggage, binoculars, shavers, radios, phonographs, cameras, projectors, recorders, typewriters, sewing machines, furniture, power tools, toys, sporting goods, watches, diamonds, jewelry, automobiles, etc. Name brands. Huge discounts. Postcard: Selbyco, Decatur 152, Illinois.

ILLUSTRATED Wholesale merchandise catalog 25¢. (Refundable.) Stafford Company, 806 North Emerson, Indianapolis 19.

ACCORDIONS Wholesale! Save 1/2. Home trial. Free catalog. Accordion Warehouse, Dept. 19-RW, 2003 Chicago, Chicago 22.

PLYWOOD Wholesale, fir, quarter inch, four by eight feet \$2.50; half inch \$4.35; three quarters \$5.60. Above sizes hardwoods available. Mail 20¢ for prices. Lewis, Box 172, Medford, Oregon.

VITAMIN Users write for confidential wholesale price list. Seven potent formulas, made by one of largest manufacturers. Buy for self, family, or groups at lowest discount prices. Send today for free list. Wholesale Vitamins, 1811 Factory Street, Kalamazoo, Michigan.

HOW To obtain over 100 free wholesale catalogs. 200,000 nationally advertised products. Wholesale Buyers, Together Building, Clayton 5-PG, Missouri.

TREMENDOUS Savings. Large wholesale catalog. \$1.00 (refundable). Robert Barkert, Dewey Rd., Amherst, Ohio.

BUY Wholesale! Tops appliances, etc. Free catalog! United Wholesalers, 1265-M Broadway, New York 1, N. Y.

FRENCH Imported cologne and perfume: Chanel #5, Intoxicacion, Arpege, My Sin and Shalimar. Retail for \$12.50 per oz., yours for \$3.50 postpaid. Bettcrst Wholesale, 1130 North Los Robles, Pasadena, California.

BUY Wholesale: 100,000 nationally advertised products. Appliances, cameras, sporting goods, housewares, watches, typewriters, tools, clothing, etc. Discounts to 80%. Buy-Rite, Box 258, Hawthorne 104, New Jersey.

LUBRICATING Oils and petroleum products. Highest quality, send for listings. Moderne Oils, Lyceum Bldg., Tarrytown, N. Y.

NEON Window signs — Custom made. Save 50%. Salesmen invited. Neon Tube Co., 1758 South Cleveland Ave., Canton 6, Ohio.

MOST Unusual catalog—Gift included, 25¢ (refundable). Seegay, Box 10126, San Antonio 21, Texas.

USED And new watches \$2 up. Free list. Southern Watches, 5-PM So. Wabash, Chicago 3.

LARGEST Wholesale supply source in U.S.! Furniture, clothing, appliances, housewares, automobiles and accessories, tools, sporting goods, hobby supplies, farm equipment, imports, new products, bargain merchandise. Free details. Associated Wholesalers, Box 52-DD, Burlington, Iowa.

BUY Wholesale! 25,000 nationally advertised products. Get amazing dealer catalogs. Complete details free. American Wholesalers, 1841C Levee, Dallas 7, Texas.

ELECTRIC Guitars, amplifiers, wholesale. Free catalog. Carvin PMW, Covina, Calif.

SALESMEN—DISTRIBUTORS

BIG Money-making opportunity. Exclusive line uniforms, jackets, pants, shirts, coveralls, sportswear. Advertising embroidered. Every business prospect. Get selling outfit free! Master Co., Dept. K-18, Ligonier, Indiana.

NEW 159% Profit aerosol wax shoe shine. High luster polish to any color shoe. Fast seller. Sample \$1. Write Easy-Wax-Shine, 74-80 Washington Street, New York City.

CALENDARS. Advertising novelties, matches. All styles, including religious, varnished, 12 sheet, girls. Hundreds of advertising novelties, book matches, etc. Fleming Calendar Co., Sales Division, 6539 Cottage Grove, Chicago 37, Ill.

WILL You wear new suits and topcoats without one penny cost and agree to show them to friends? You can make up to \$30.00 in a day even in spare time, without canvassing. Stone-Field, 532 South Throop Street, Dept. J-926, Chicago 7, Illinois.

\$1,000.00 A Month for making dramatic 3-second demonstration of amazing lightweight Presto fire extinguisher. New chemical used by airforce snuffs out fires instantly. Only \$4.95. Terrific commissions. Millions want it. Free kit, Merlite, 114 E. 32nd, Dept. P-66T, New York City 16.

AD Match sales! Your own business, without investment! Sell for world's largest direct selling manufacturer of advertising matchbooks. Big spot cash commission. Start without experience. Our tested sales kit tells you where and how to get orders. Men, women, part or fulltime. Match Corporation of America, Dept. PM-19, Chicago 32.

I'LL Send you free stocking sample newest advancement in hosiery since nylon. Patented, full-length. Stays up over-the-knee without supporters, without girdle! Nationally advertised price \$1.95. Make money introducing to friends at \$1.00 pair. American Mills, Dept. 668, Indianapolis, Ind.

ANYONE Can sell famous Hoover uniforms for beauty shops, waitresses, nurses, doctors, others. All popular miracle fabrics: Nylon, dacron. Exclusive styles, top quality. Big cash income now, real future. Equipment free. Hoover, Dept. F-100, New York 11, N. Y.

AMAZING Opportunity. New low priced fire alarm protects homes, farms, offices, factories, etc. No wiring, hangs like picture. Pays up to \$1,100 a month. Free kit, Merlite (Alarm Div.), 114 E. 32nd St., Dept. F-66T, New York 16, N. Y.

MY Free outfit puts you in a fine business! Just 8 easy orders a day brings you up to \$960 extra a month in big money shoe business! Complete line air cushion shoes for men, women. Rush postcard for powerful free selling outfit! Mason, Chipewa Falls K-134, Wisconsin.

MAKE Extra money. Cash commissions. Everybody buys easy-to-sell advertising book matches. Union label. All sizes. Cuts for all businesses. Powerhouse selling kit free. Steady repeat business. No experience necessary. Superior Match Co., Dept. M-159, 7528 S. Greenwood, Chicago 19.

MAKE Money! Take big profit orders, famous fruit trees. Including sensational discovery, Starkrimson Delicious apple! Also dwarfs, shrubs, roses, vines. Sales outfit free. Stark Bro's, Desk 30119, Louisiana, Missouri.

NO Selling. Big commissions paid daily listing past due accounts. All merchants have them. No experience necessary. Desk 9, General Finance Company, 903 McGee, Kansas City 6, Mo.

FRANCHISE Available, automotive and construction products never before offered. Hudson T. Marsden Mfg. Co., Inc., 645 Beahan Rd., Rochester 11, New York.

JUST Invented, automatic perpetual calendar. Bargain advertising medium. Lawrence, 334 Kings Court, West Palm Beach, Florida.

EXCEPTIONAL Opportunity in \$3,000.-000 industry-distributorship for multiple vitamin food supplement. Profitable repeat business. Hire full, sparetime agents, from home. Experience unnecessary. Profit-making chain plan guarantees good income. Retail \$3.98. Full details and sample package. Send \$2.00 Renhill Products, 951 Bergen Street, Newark 12, N. J.

GET New shirt outfit free! Make \$90.00 weekly on 5 average orders a day. Famous quality made-to-measure dress and sport shirts at \$3.95 up sell fast to all men. No experience needed. Full or part time. Write: Packard Shirt Co., Dept. 839, Terre Haute, Ind.

\$6.73 PROFIT On every sale of Lightning portable adding machines, retail \$14.95. Wide market. Full details, actual size. Color photo free. Lightning Adding Machine Sales Company, 2306A West Slauson Avenue, Los Angeles 43, California.

TAKE Over your area—Agents, dealers, farmers, make \$125 up weekly selling nationally advertised Campbell's Go-Green liquid fertilizer concentrates. No investment. Everything free. Campbell Co., (Est. 1928), Rochelle 5, Illinois.

SALESMEN—Big money every day showing nationally known drain cleaner. No chemicals. Nothing like it. Minute demonstration. Commissions paid daily. Sample furnished. Campbell Co., (Est. 1928), Rochelle 604, Illinois.

IT Ain't sellin'—Just servicing! Take over your area as our service distributor keeping retail stores supplied. Nationally advertised 28-year old line pays you 66 $\frac{2}{3}$ % mark-up. For samples and highly successful plan, write Novo, Inc., 1166-T Milwaukee, Chicago 22, Illinois.

IF You're interested in making money in selling, see the hundreds of exceptional opportunities in Salesmen's Opportunity Magazine. Send name for your copy, absolutely free. Tell us what you're selling now. Opportunity, 848 N. Dearborn, Dept. 17, Chicago 10, Illinois.

EMPLOYMENT INFORMATION

FOREIGN Jobs—Latin America, Alaska, Canada, up to \$1500 monthly. Up-to-date 1959 foreign service directory gives complete information; hot list of firms hiring for military and civilian construction, aircraft, oil, exporters-importers, mining. How-when-where to apply. 11th successful year. \$1.00. Global Reports, Box 8873-S, Los Angeles 8, Calif.

AMAZING New job service. We'll recommend you to companies seeking workers in all categories on our official business stationery. Send \$3.00 for job list and complete application service. Write Jobs, Dept. A-4, Box 125, Rugby Station, Brooklyn 3, N. Y.

LATEST Overseas U.S.A. jobs. Men, women. All trades. Free transportation. New complete lists. \$1.00. Universal Research, Box 4912, Baltimore 20, Maryland.

JOBS All around you. 64 page packet shows how to find and land them. Others fall. You succeed. Guaranteed. Order today. \$2.00 postpaid. Better Jobs, 2044 McPherson, North Bend, Oregon.

JOIN The merchant marine. For information write Box 4092, Jacksonville 1, Fla.

FLORIDA Jobs available. Sunday classifieds, \$1.00. Grimm's, Box 1781, Tampa 1.

ALASKA—Complete job information. Weekly employment reports. \$1.00. Alaska Unlimited, Box 197, Ketchikan, Alaska.

BOOMING Denver ads \$1.00. Barrett, 983 So. Penn. Denver 9, Colo.

OPPORTUNITY Knocks. Chicago classified \$1.00. Box 192, Franklin Pk., Ill.

MEN, Women, U. S. A., foreign jobs. High pay. Construction, clerical, supervisory, shipping, aviation, oilfields, etc. Skilled, unskilled. Free transportation, adventure, promotions. Unusual opportunities. Complete information plus worldwide project listings. Airmailed, \$3.00 (no other fees). Satisfaction guaranteed. International Reports, Dept. A., P.O. Box 621, San Jose, California.

JOBS Overseas. Reply to X-109, Hub Station, New York 55, N. Y.

SUNSHINE Opportunities, Florida jobs, 25¢. Charles Masten, Box 4571, Wauhtown Station, Winston-Salem, N. C.

BOOMING Latin America! Fabulous Brazil, Venezuela, only hours from the States. New data regarding jobs, opportunities, conditions. American companies employing, etc. All skills required. Salaries to \$1,650.00 monthly. U. S. tax exempt. Bonuses, living allowances, travel expenses, exciting vacations, and more! First hand information direct, \$2.00, (\$2.35 airmail) checks, money orders Ok! Paul B. Smith, Apartado 172, Maracaibo, Zulia, Venezuela.

JOBS, Ships, \$100 weekly beginners. Travel, adventure. Details free. Seaman's Service, Box 17-M, Brooklyn 8, N. Y.

STEAMSHIP And yachting jobs, traveling foreign countries. Box 1354, GPO, New York 1, N. Y.

AMERICAN Overseas jobs. High pay, men, women. Transportation paid. Free information. Write Transworld, Dept. 10D, 200 West 34th St., New York City.

WHY Worry about work? Escape jobs forever! Retire securely now. Lead leisurely life. Unusual new book shows how. Postcard brings details free. Belmont, Wyckoff 157, New Jersey.

JAPAN! Many hi-paying jobs available. Full details (complete coverage) airmailed \$2.00. K. Waits, C.P.O. Box 903, Tokyo.

ALASKA Information. Unlimited opportunities. Homesteading, employment, 25¢. Haase, De Forest, Wisconsin.

MEXICO—Work, invest, retire, vacation. Informative book, send two dollars. Mexico Unlimited, Apartado 19536, Mexico City.

JOBS \$400 Month. Merchant marine. Write: Box 1804-T, Paterson, N. J. Beginners only.

FOREIGN Employment information. Make big money in Europe, Africa, South America, Canada, Alaska, Far East. Transportation paid. Construction workers, clerks, truck drivers, etc. Travel, adventure. Complete information application blanks, sent by return mail. Send \$2.00 to Foreign Bureau, P.O. Box 512, New Orleans, Louisiana.

COMING To Florida? Send for complete report, jobs, salaries, cost of living. Information you need. \$2.00. Survey, 904 Chamber of Commerce Bl., Miami 32, Fla.

BIGGER, Uninterrupted income. Earnings-proven method shows, brings best jobs, rapid advancement, security. Free details. Valon, Box 9235, Chicago 90, Ill.

COPYRIGHTED Reports. Best paying jobs with travel, adventure, promotions. Construction, aviation, shipping, oilfields, laborers, clerical, trades, supervisory, factory, unusual opportunities. Skilled, unskilled. Foreign, stateside. Men, women. Only \$2.00 (\$2.25 airmail) (c.o.d.'s accepted), including registration-advisory service. Satisfaction guaranteed. Included free: Special reports on Alaska, Venezuela, South American opportunities, husband and wife foreign jobs. Research Services, Suite 514-PM Meramec Building, St. Louis 5, Missouri.

FREE Information—U.S.A. overseas jobs. High pay, transportation. Futures Unlimited, Dept. M, 215 West 34th Street, New York City 1.

JOBS—High pay; U.S.A., So. America, the Islands. All trades. Many companies pay fare. Write Dept. 71J, National Employment Information, 1020 Broad, Newark, N. J.

SPECIAL SERVICES

TRANSLATION Service, correspondence school. All languages. Box 1995, Dallas 21, Texas.

WHAT Do you want to find? If sold in U.S. we will locate best sources for you. Mandeville Source Finders, 405 Olympia Road, Pittsburgh 11, Pennsylvania.

DEEDS Plotted. Write to Burt D. Horn, Mt. Pocono, Penna.

REDUCE Your income taxes. Free computation. Tax, Box 215, Pembroke, N. C.

INFORMATION On anything. Ferguson Research Specialists, 116-14 141 St., South Ozone Park 36, N. Y.

EDUCATIONAL AND INSTRUCTION

COMPLETE Your high school at home in spare time with 62-year-old school. Texts furnished. No classes. Diploma. Information booklet free. American School, Dept. X145, Drexel at 58th, Chicago 37, Illinois.

USED Correspondence courses and books sold and rented. Money back guarantee. Catalog free. Courses bought. Lee Mountain, Pisgah, Alabama.

PROFESSIONAL Investigators correspondence school. Badge, diploma, future. Box 41197, Los Angeles 41, Calif.

MASTER Watchmaking at home. Free sample lesson. Chicago School, 2328-YN, Milwaukee, Chicago 47.

BUILDING Trades big money. Home training offered by not-for-profit organization. Free information for interested men. Write ATS-C15, 850 E. 58th, Chicago.

OIL Coloring photographs—A fascinating hobby or profitable sideline for those with artistic talent. Learn at home. Easy simplified method. Free booklet. National Photo Coloring School, 835 Diversey Parkway, Dept. 3431 Chicago 14.

'HOW To Train Horses'—A book everyone who likes horses or ponies should have. Free. No obligation. Simply address Beery School of Horsemanship, Dept. 1101, Pleasant Hill, Ohio.

FINISH High School at home, spare time. No classes. Diploma awarded. Write for free catalog. Wayne School, Catalog HP-90, 2527 Sheffield, Chicago 14.

BECOME Tax consultant. Licensed home training. Union Institute, Hoboken 2R, N. J.

LEARN Secret handwriting analysis. Profit, social, counseling. Free sample lesson. Belieff System, 5102 60 Ave., Hyattsville, Maryland.

EARN Degrees by correspondence courses: Associate of Arts, Bachelor of Arts also Bachelor of Science in Business Administration. Pacific International College of Arts and Sciences, primarily a correspondence school. Resident classes also carried. 5719-D Santa Monica Blvd., Hollywood 38, California.

OPERATE Collection agency. Gold mine opportunity. Lifetime business. Be respected. Franklin Credit, Roanoke, Va.

LEARN Arc, gas, heliarc welding spare time at home. Big pay trade. Easy practical training covers metallurgy, latest techniques, short cuts, metal repairs, etc. Free booklet. Write Utilities Engineering Institute, Dept. WC-19, 2523 Sheffield, Chicago 14.

WATCHMAKING Instructions for start. Wholesale tool supply catalog \$1.50. Refund not satisfactory. Stewart's, Holland Building, St. Louis 1, Mo.

LEARN Civil and criminal investigation at home. Earn steady good pay. Institute Applied Science, 1920 Sunnyside, Dept. 161, Chicago 40, Ill.

ENGINEERING Degrees earned through home study. Electronics, electrical, mechanical, civil, physics. When writing, specify course desired. Pacific International College of Arts & Sciences primarily a correspondence school. Resident classes also carried. 5719-B Santa Monica Blvd., Hollywood 38, California.

HELP Yourself to abundant living. Our courses have aided students to richer, fuller lives. Learn secret of contentment, happiness. Earn degrees Ps.D., MsD. Write for free book. College of Universal Truth Correspondence School, 23-C E. Jackson, Chicago.

WRITE With your left hand. Instructions 50¢. Levinsohn, Box 207-A, North Sea Road, Southampton, N. Y.

FREE Details, job-getting and promotions. Educators Placement Service, Gainesville, Florida. \$1.00 postpaid.

25 PERSONALITY Improvement posters \$1. Easy three minute daily plan. 25 greatest ideas on self improvement condensed to few words on each poster. Posters suitable for framing: 2 $\frac{1}{2}$ x6 $\frac{1}{4}$ inches with colored borders. Amazingly successful results reported by 83 big companies after using posters for employee personality development. Money back guarantee. Fairfax Company, Box 6799, Chicago 80.

HOW To Draw. 46 lesson manual, \$2.00 postpaid—Simmons, Box 4462, Philadelphia 40.

VOICE! Natures! Secrets! Free! Studio, 14356K South Jersey, Norwalk, Calif.

SWEDISH Massage. Home study. Diploma. Swanson's Illinois Licensed School, 3809 Alta Vista, Chicago, Ill.

1959 INDUSTRY Training. Home-study. Drafting, design, electronics. Aero Tech, 2166-PM Sunset Blvd., Los Angeles 26, Calif.

COLLEGE Correspondence courses, for Doctor of Psychology, Metaphysics, Divinity. Catalogue. Dr. Dorothy B. Arnhelter, Forest Park, Greenwood Lake, New York.

WELDERS Earn big money. Easy to learn arc, gas, automatic welding. New equipment, low cost training in non-profit school. GI approved, free booklet. Hobart Welding School, Box M-192, Troy, Ohio.

USED Correspondence courses, educational books. Satisfaction guaranteed. Catalog 10¢ refundable. Courses bought. Bayles, 78-B Courtright, Wilkes Barre, Penna.

TEST Preparation for civil service careers. Write, N.T.S., Box 873, Greenwich, Conn.

DEGREE Program by mail. (Courses or tests). Colleges abroad. Auries, Central Valley, New York.

HIGH School diploma at home. Licensed teachers. Approved materials. Southern States Academy, Station E-16, Atlanta, Ga.

LEARN-Teach physical training, physical therapy, massage, body building. Literature. Standard Publications, St. Charles 6, Illinois.

ARITHMETIC Poor? Send \$2 for rapid calculation drills. Progress Productions, Box 754, Clermont, Fla.

MEMORY Unlimited: On page 26 of this magazine you can read how a chance find in a train enabled a man to develop his memory to such an astonishing extent that it brought his fortune and success. We should like to remind readers to write to R. C. Borg c/o Aubanel Publishers, 14, Highfield Road (Rathgar) Dublin, Ireland. By mentioning the name of this magazine they will receive free of charge a little book which will put them on the road to good fortune too.

LEARN Physical therapy, massage. Diplomas. Drugless Therapy Institute, Fruitland 11, Idaho.

ANALYZE Handwriting for profit, pleasure, self-understanding. TV, radio, newspaper columns, teaching, lecturing, court work, counseling. Men, women, spare time up to \$50 an hour. Amazing opportunities. Sample lesson free. Must be 21. IGAS, Inc., 45, Springfield 4, Missouri.

CASH For correspondence courses. (Buyers and sellers.) Gem, Dept. 12-M, Linwood, New Jersey.

SECRET Investigations. Experience unnecessary. Investigators particulars free. George Wagner, M125 West 86th, New York City 24.

HOME Study. 32 commercial, industrial subjects. Modest registration fee. Tuition when satisfied. Free bulletin. Automent, 2166 Market, San Francisco 14, Calif.

FREE Booklet. How to make money with astrology. Profitable career. Study home. Bachelor's, Master's, Doctor's degree. Ford, Box 193, Williamsport, Penna.

SING, Speak with power. Self-training records. Amazing! Canfield, 2018-A Fifth Avenue South, Minneapolis 4, Minnesota.

LEARN Old time fiddle playing, quickly, easily. Play for square dances. Complete course \$3.00. Satisfaction guaranteed. Old Time Fiddle, Mt. Marion 2, N.Y.

LEARN While asleep! Exciting details free. Research Association, Box 24-NN, Olympia, Washington.

BE An investigator. Write for free details. State age. National Detective Academy, Dept. P, P.O. Box 1082, Scottsdale, Arizona.

EARN Degree. Free bulletin. Home-study only. Midwest Bible School, 1060 Broadripple, Indianapolis.

STUDY To be a doctor of psychology, metaphysics, divinity or philosophy. Correspondence courses only. The Neotarian Fellowship, Desk 9, Kansas City 6, Mo.

STUDY For Doctor's degree of psychology, metaphysics and divinity. Correspondence courses only. College of Divine Metaphysics, Dept. P-M, 2811 North Illinois, Indianapolis 8, Indiana.

PIANO Tuning pays. Big money in spare time. Learn at home in 30 days. No musical knowledge necessary. Phonograph, records, tools and instructions furnished. Personal instructions available. Free catalog. Capital Piano Tuning School, 3160 S.W. 16th Court, Fort Lauderdale, Fla.

WANT A diesel job? New opportunities to increase income. Higher pay. More money. We can help you qualify. Tools. Shop method home training. Write today! Diesel, Tractor, Heavy Equipment Division, Interstate Training Service, Dept. B-2, Portland 13, Oregon.

BOOKKEEPERS! Increase your earnings! Operate your own simplified "Dollar-A-Week" bookkeeping and tax service. Full or spare time. Details free. No obligation. Ellis, Box 200, Cedar Grove, North Carolina.

LEARN Appliance service and repair. Motors, washers, refrigeration, cleaners, everything. Free booklet. Armstrong, 11027-A South Vermont, Los Angeles 44.

BE A real estate broker. Study at home. Write for free book today. GI approved. Weaver School of Real Estate, 2018P Grand, Kansas City, Missouri.

EARN While you learn. Auto and diesel mechanics master this top paying trade. Many graduates earn \$100 a week and up. Approved for Korean veterans. For free information write Dept. No. 256, Nashville Auto-Diesel College, Nashville 3, Tenn.

PHYSICAL Therapy and massage. Home training. Practice privately or work with doctors and hospitals. Free catalogue. National Institute, Desk 4, 159 E. Ontario, Chicago, Ill.

INVESTIGATOR Training. Phillips Secret Service System, 1917-B North Kenneth, Chicago 39.

PIANO Tuning pays. Learned easily at home. GI approved. 59th year. Free booklet. Niles Bryant School, Dept. P, 3731 Stockton, Sacramento 20, Calif.

LEARN Blueprint reading at home. Insure your job. Higher income and advancement. Madison Technical School, 118 Merham Drive, Dept. PM, Madison 5, Wisconsin.

ASTROLOGY — Palmistry. Complete courses are offered on these subjects. For information write The Reno School, 1001 Glendale Blvd., Box 356, Los Angeles 26, Calif.

PLAYS, STORIES, MANUSCRIPTS

YOU Can write stories. Get help from simplified instructions. Send \$2. Writecraft, Box 9126, Long Beach 10, California.

MAKE Money writing features. Amazing book tells how. Free literature. Ben Arid, Hermosa Beach, Calif.

WANTED: Book manuscripts, all subjects considered. Greenwich Book Pub., Atten. Mr. Zealand, 489 Fifth Ave., New York City.

WANT Your book published? Learn how we publish, advertise, promote, distribute. Many successes. Free booklet PM. Vantage, 120 West 31, New York City. Mid-west office: 320 S. Michigan Ave., Chicago, Ill.

ADVERTISING AGENCIES, LETTER WRITERS, FOR ADVERTISERS

ADVERTISING Ratebook leading newspapers, magazines, free. Chicago Advertising Agency, Chicago 4.

FREE! 1959 Advertisers Rate and Data Directory. 52 pages! E. H. Brown Advertising Agency, 20 N. Wacker, Chicago 6.

ARIZONA Birth-marriage lists, gummed labels \$7.00-1000. P.O. Box 342, Phoenix.

CLASSIFIED Mailing lists, write for our literature. Gorgo Mailers, Box 151, Toledo 10, Ohio.

ADVERTISING. Result-getting ads prepared, placed newspapers, magazines, radio, anywhere! Lowest rates. Catalogue free. Baker Advertising Agency, 189 W. Madison, Chicago 2.

"AMAZING New Book"—"Profits From Classified Advertising." Tells how and what to advertise. Be sure to read this book before you invest one cent in advertising. Write for your copy now. Just send 10¢ for postage and handling. W. Johnson, Classified Advertising Manager, 202 East Ontario Street, Chicago 11, Illinois.

MAILING Lists most any classification \$5.00 1000. Your circulars mailed with ours \$4.00 1000. Write for our literature. Dixie Mailers, King, N. C.

NOW Ready: New, amazing Classified Advertising Record Book—prepared especially for classified advertisers. Here is a book that tells you instantly whether or not your advertising in any publication is paying you real results. You can tell immediately how many inquiries each publication produced—how much cash received from every ad. Spaces are provided for the name and address of the publication, date of issue, space used, rate, cost of ad, key number, etc. You have a complete record of each publication right before your eyes. Plenty of space to keep accurate record of 28 separate publications. You can have a copy by sending only 10¢ to cover postage and handling. Send for your copy now. W. P. Johnson, Classified Adv. Mgr., Popular Mechanics Magazine, 204 E. Ontario Street, Chicago 11, Illinois.

ADVERTISE: 24 Words, 100 Canadian newspapers \$5.50. Lists free. Advertising Bureau, 10511-C Springfield, Chicago 43.

CARTOONING, COMMERCIAL ART, SHOWCARD & SIGN PAINTING, TATTOOING

"HOW To Make Money With Simple Cartoons." A book everyone who likes to draw should have. It is free; no obligation. Simply address Cartoonists' Exchange, Dept. 91-C, Pleasant Hill, Ohio.

LETTERING Pens, Lino knives. Bamberger Bros., P.O. Box 127, Cathedral Station, New York City 25.

CARTOON Your way to success! Internationally known instructor, Raye Burns, will personally teach you to create original, salable cartoons at home. Cost of course is very low. Write for free details. Raye Burns School, Box 3583-P, Cleveland 18, Ohio.

YOU Can entertain with chalk talks. Catalog 10¢. Balda The Cartoonist, Oshkosh, Wis.

LEARN Sign painting at home. Free talent test. Ben Kerns, Box 812-PM, Greenville, S.C.

LEARN Sign painting with fascinating system. Straley, 410 S. Western, Springfield, Ohio.

LEARN Profitable, fascinating tattooing. Illustrated information \$1. Zeis, 728-C Leslie, Rockford, Illinois.

RUBBER STAMPS AND OFFICE SUPPLIES

3 LINES, \$1.00 Script or print. Free catalog. Fast! Evero Co., Box 5377, Phoenix, Arizona.

4 LINE Rubber stamp. Sailors, 537 Conn. St., Gary, Indiana.

POCKET, 3 line \$1.00. W. J. W. Specialty, 8464 Manhattan, Detroit 11, Mich.

FREE! Rubber stamp catalog. Many items. Campfeld, Box 798, Springfield 1, Mass.

TYPEWRITERS, DUPLICATORS, OFFICE DEVICES

RECONDITIONED Typewriters, duplicating, printing devices. \$25.00 up. Supplies. Appliances, DixieGraph, King, N. C.

PRINTING, MULTIGRAPHING, MIMEOGRAPHING, GUMMED LABELS

YOUR Message on our inexpensive colorful artistic circulars sell. Free samples, prices. Repro, 115 East 13th Street, Indianapolis 2, Indiana.

BUSINESS, Personal printing. Free price list. Hickman Company, Coalgate, Oklahoma.

START Profitable mail order business. Home operated. Everything furnished. Wayne's Service, 3016 Channing N.E., Washington 18, D. C.

BUSINESS Printing. Quality work. Free catalog. Color Press, Sacred Heart, Minn.

QUALITY Offset printing. \$7.00-1000. 8 1/2 x 11. Acme, Box 100, N. Fond du Lac, Wisconsin.

5,000 COLORED Circulars—\$39. Complete: Art, copy, layout, printing. Promotion-MI, 385 Broadway, New York City 13.

TWO-Color 8 1/2 x 11 letterheads 50 \$1.00. Printer, 704 East Morris, Hammond 2, Louisiana.

1000 EMBOSSSED Business cards, \$3.00. Samples. F. Hogan, Box 1653, Boston 5, Mass.

300 BUSINESS Cards \$1.25 prepaid. Randolph Press, 152-A Victor, Detroit 3.

1000 EMBOSSSED Business cards, \$3.95. Low cost printing. Samples. Vincent, Skippers, Virginia.

THOUSAND Embossed business cards \$3.00. Giant printing catalog. Arthur Steinbergen, 1274B Stebbins, New York City 59.

BUSINESS Printing, rubber stamps, reasonable. Free! Literature, samples. Hildreth, 1047 Inner, Schenectady 3, New York.

QUALITY High. Prices low. Printing, offset, photo-engraving, color. Herrion, 119 Lafayette, New York City 13.

SALES Books, order books, envelopes, business forms. Free catalogs. Eddiross Printing, Bronx 72, N. Y.

YOUR Name and address printed on gummed labels 500-3 lines \$1.00. 15¢ each extra line. $\frac{1}{2} \times 1\frac{1}{2}$. Print clearly. No c.o.d.'s. Addison Mail Order, PMB-1, 1840 Addison, Chicago 13.

1,000 BUSINESS Cards. Raised letters, \$3.50. Samples. Pioneer, Island Park PM-1, New York.

BUSINESS Cards with glamour. Reasonable. Samples free. Heavener's, Colmar, Penna.

1000 NAME And address labels in plastic box \$1.00. Heights Industries, Capitol Heights, Maryland.

FREE Catalog postpaid printing, rubber stamps. DM Press, Sebastopol, Calif.

BUSINESS Printing. Top quality. Bottom prices. A. Hanlon, Malvern, Penna.

SIMULATED Engraved business cards, post cards. Sales, 17 South 9th, Wilmington, N. C.

MULTILITHED Quality letters for less than mimeographing. Get facts, samples, prices. Perkins Printing Service, Fremont, Nebraska.

500 ENVELOPES Printed. #6 $\frac{3}{4}$ —\$3.50 postpaid. Statements same. Stanley Press, Lake Katrine, New York.

BUSINESS Printing. Samples. Prices free. Howprint, 723-G Eunice, Webster Groves 19, Missouri.

COLOR Mimeographing—Letters, price list, samples. A. M. Letter Shop, 2190 Harkins, Menlo Park 6, Calif.

MIMEOGRAPHING—Letters, pricelists, formulas, instructions. Lowest prices. Lem's Letter Shop, 5710 Stanton, Detroit 8.

1500 PERSONALIZED $\frac{3}{8} \times 1\frac{3}{4}$ Labels \$1.00. Your 3 line name and address printed with blue ink on fine quality white gummed paper. Money back guarantee. Hamilton-Ward, Dept. 10B, Westfield, Mass.

ADS Running under this heading sell printing. Ask me for proof. I'll gladly send you amazing facts. Ask for Folder "P." F. W. Johnson, 200 E. Ontario St., Chicago 11, Ill.

OFFSET Printing: 24-hour service. \$6.75. 1000, 8 $\frac{1}{2} \times 11$. National Letter, 251 West 42 St., New York City 36.

PRINTING OUTFITS AND SUPPLIES

MIMEOGRAPHS. \$9.95 Up. New. Guaranteed. Price list free. Independent Distributor, 1055 48th St., Oakland, Calif.

RUBBER Stamp making presses, hydraulic operated, electrically heated. Sizes 5"x8", 8"x12", 10"x15", starting outfits. All kinds supplies. Custom Manufacturing, 507-P N. Jefferson, Springfield, Mo.

MAKE Your own self-molding rubber stamps and printing cuts. Flexirubber, Argyle 1, Wisconsin.

DO Your own printing. Save money. Simple rules. We supply everything. Print for others; good profit. Raised printing like engraving too. Have home shop. Details free. Kelsey Presses, V-11, Meriden, Connecticut.

PATENT ATTORNEYS

INVENTORS: Learn how to protect your invention. Unless the inventor is familiar with patent matters, he should engage a competent registered patent attorney or agent to represent him. We are registered to practice before the U. S. patent office and prepared to serve you in handling your patent matters. "Patent Guide for the Inventor" containing detailed information concerning patent protection and procedure with "Record of Invention" form will be forwarded to you upon request, without obligation. Clarence A. O'Brien & Harvey Jacobson, Registered Patent Attorneys, 91B-A District National Building, Washington, D. C.

C. A. Snow & Co.—M427, Snow Building, Washington 1, D. C. Registered Patent Attorneys. Write for information.

INVENTORS: Without obligation, write for information explaining the steps you should take to secure a patent. John Randolph, Registered Patent Attorney, 803 Victor Bldg., Washington 1, D. C.

INVENTORS—Take these preliminary steps toward patent protection. Sketch and describe your invention. Sign, date and have this disclosure witnessed by two people who understand your invention. Have us make a preliminary search among U.S. patents already granted for similar types of invention. We report on the probable patentability of your invention and recommend your further course of action. Write for our instructive booklet, "Patent Protection for Inventors" and convenient "Evidence of Invention" disclosure form. Victor J. Evans & Co., 531-A Merlin Building, Washington 6, D. C.

INVENTORS—If you believe you have an invention, you should find out how to protect it. The firm of McMorow, Berman & Davidson with offices in Washington, D. C., is qualified to take the necessary steps for you. Send for copy of our patent booklet "How to Protect Your Invention." We will also send you an "Invention Record" form. No obligation. They are yours for the asking. McMorow, Berman & Davidson, Registered Patent Attorneys, 1346 Victor Building, Washington 1, D. C.

"**INVENTOR'S** Guide" and "Record of Invention" free on request. Frank P. Ledermann, Registered Patent Attorney, 154 Nassau Street, New York City.

INVENTION Record form free and "Patent Information Every Inventor Should Have." Carl Miller, Registered Patent Attorney, Woolworth Building, New York.

FOR INVENTORS

INVENTORS—This firm is registered to practice before the United States Patent Office and available to assist you in the preparation and prosecution of your patent application. "Patent Protection for Inventors" booklet containing detailed information and steps to take toward patent protection sent promptly upon request. No obligation. Victor J. Evans & Co., 532-A Merlin Building, Washington 6, D. C.

INVENTORS—If you believe you have an invention, you should find out how to protect it. The firm of McMorow, Berman & Davidson with offices in Washington, D. C., is qualified to take the necessary steps for you. Send for copy of our patent booklet "How to Protect Your Invention." We will also send you an "Invention Record" form. No obligation. They are yours for the asking. McMorow, Berman & Davidson, Registered Patent Attorneys, 1347 Victor Building, Washington 1, D. C.

MODELS Will sell your invention. Henry Herman, 350 Hewes, Brooklyn 11, N. Y.

INVENTORS—Send for free Patent Information book and Inventor's Record. Registered Patent Attorney, Associate Examiner, Patent Office 1922-29, Patent Attorney & Advisor, Navy Department 1930-47. Gustave Miller, 19A Warner Building, Washington 4, D. C.

DRAWINGS Made for searches, invention records, patents. Free literature. Norval Riggs, Box 1906, North Las Vegas, Nevada.

PATENT Drawings expertly prepared. Free estimate. Capitol Patent Drafting Company, 4206 Arthur Drive, S.E., Washington 22, D. C.

INVENTIONS Wanted now by my manufacturer-clients. Patented, unpatented. Write Gilbert Adams, Patent Broker, 80-A Wall Street, Financial District, New York City.

PROTOTYPES. Scale models of inventions built, engineered. Labind, 801 N. Wabash, Chicago 11.

FREE—Vital information every inventor needs before selling invention. Brown, 141-A Broadway, New York City.

"**INVENTOR'S** Guide" sent free. Frank P. Ledermann, 154 Nassau Street, New York 38, N. Y.

INVENTORS: Learn how to protect your invention. Unless the inventor is familiar with patent matters, he should engage a competent registered patent attorney or agent to represent him. We are registered to practice before the U. S. patent office and prepared to serve you in handling your patent matters. "Patent Guide for the Inventor" containing detailed information concerning patent protection and procedure with "Record of Invention" form will be forwarded to you upon request, without obligation. Clarence A. O'Brien & Harvey Jacobson, Registered Patent Attorneys, 91A-A District National Building, Washington, D. C.

FREE List needed inventions. Protection form. Invention Bureau, Box 4973, Washington, D. C.

INVENTORS! Have you good patentable ideas? Write Mr. Metzler, 11 West 42nd, New York City.

PATENT Searches, including copies of nearest patents, \$6.00. Reports airmailed within 48 hours. More than 100 registered patent attorneys use my service. For free invention protection forms, write Miss Ann Hastings, P.O. Box 178, Washington 4, D. C.

INVENTORS—Save high fees! Let me show you how to prepare and file your own application for U. S. patent. Everything ready to fill in and file. For free "Registration Form," write Miss Claire Arden, 806 Wm. Penn Annex, Philadelphia 5, Penna.

WE Have the markets if you have the ideas. Harvey Engineers, Cambridge 1, Maryland.

INVENTION Record form free and "Patent Information Every Inventor Should Have." Carl Miller, Registered Patent Attorney, Woolworth Building, New York.

INVENTORS. Don't sell your invention patented or unpatented until you receive our offer. Write Cowgill, Box 298, Marion, Ohio.

PATENT Searches \$6.00. 48-hour service. Free invention protection forms. Write Raymond L. Smith, Patent Searcher, 620 Sheraton Building, Washington 5, D. C.

INVENTORS: Information on patent procedure furnished on request, without obligation. John Randolph, Registered Patent Attorney, 802 Victor Bldg., Washington 1, D. C.

INVENTORS: Test the commercial value of your patented or unpatented inventions, quickly and inexpensively. Write for free information. Institute of American Inventors, Dept. 40-B, 635-F St., N.W., Washington 4, D. C.

PATENT Searches \$6.00. 48-hour airmail service. Invention protection forms free. Write Patent Engineering Service, 711 14th Street N.W., Washington 5, D. C.

INVENTIONS Pay inventors when profitable sales are certain from constructions soundly patented, and wise steps taken to reach the best markets. I help inventors to make the most profit with low definite fees for all services. Searches \$15. 30 years experience as patent-development engineer, U.S. and foreign patents secured. Joseph O'Brien, 132 Nassau Street, New York 38, N. Y.

INVENTIONS WANTED

INVENTIONS Wanted: Patented, patent pending, 28 years experience promoting inventions. National Service Bureau, 3120 Meramec, St. Louis 18, Mo.

IF Your invention is adaptable to promoting we will contract for selling on cash or royalty. Free booklet outlines royalty rates, requirements. Kessler Corporation, 51-IW, Fremont, Ohio.

SUPERIOR Promotions. Patented; unpatented inventions. Information booklet, free. Superior, 338-344 North Rodeo, Beverly Hills, Calif.

INVENTORS: Have you tried to sell your invention without success? Contact us, we succeed where others fail. Chapman, 5250 W. Montrose Ave., Chicago 41, Ill.

INVENTIONS Wanted for manufacturers. Free details. Write: Allen, 712 Davis Bldg., Dallas 2, Tex., Dept. B.

FREE Vital information every inventor needs before selling invention. Brown, 141-A Broadway, New York City.

INVENTORS—Turn your talents into immediate cash! Join Inventors of America. Write National Headquarters, 3136-A Sylvania Avenue, Toledo 13, Ohio.

INVENTIONS Bought and sold. Write: Your I.D.E.A., Incorporated, Box 8627, Oklahoma City, Oklahoma. Bonded and licensed.

ARE You interested in offers from reliable manufacturers for your invention? Patented, unpatented. Harvey Engineers, Cambridge, Maryland.

INVENTIONS Wanted now by my manufacturer-clients. Patented, unpatented. Write Gilbert Adams, Patent Broker, 80-S Wall Street, Financial District, New York City.

INVENTORS: Don't sell your invention patented or unpatented until you receive our offer. Write Cowgill, Box 298, Marion, Ohio.

INVENTORS: Hundreds of manufacturers have requested our assistance in locating marketable new products. Complete information free. Institute of American Inventors, Dept. 40-D, 635-F St. N.W., Washington 4, D. C.

INVENTIONS Wanted. Patented: unpatented. Tremendous manufacturers lists. Global Marketing Service, 2420 77th, Oakland 5, California.

PATENTS FOR SALE

ELECTRIC-Tots tracing desk. Pat. pending. Nothing like it before. Royalties, outright. Adam and Eve, 406 West Wheeler, Rockwood, Tennessee.

MANUFACTURING

DESIGNING. Tools, dies, models, manufacturing. Bald Knob Products, 1640 Lionel, Cincinnati 14, Ohio.

CUSTOM Models, parts, tools, instruments. Henry Herman, 350 Hewes, Brooklyn 11, N. Y.

WIRE Forming stamping tools, dies. Send your print, part or sketch. B. L. Tool & Die. B. Lindberg, Prop., 413-26th St., Union City, N. J.

MODELS—Small lot manufacturing. Metals, plastics, etc. Milburn, Burlington, Kentucky.

MODELS, MODEL SUPPLIES

SCALE Model materials for building model homes and architectural buildings of any type, 1/4" and 1/8" scale. Send 25¢ for catalog. A & B Model Builders, 454-P Donovan Road, Kansas City, Kansas.

24" ROCKET—Solid fuel, high altitude performance, will carry living specimens, parachute return. Educational. Complete scale plans and instructions \$1.00. Advance Engineering, P.O. Box 2274, Dallas 21, Tex.

POWER Models. Unusual steam, gasoline and traction engines, fittings, metals. Case steam traction engine. Comprehensive catalog \$1.00. Chas. Cole, Ventura, Calif.

ROCKET Supplies. Nozzles, nose cone, tubes, fuse. Send 10¢ for catalog to Alana Manufacturing Company, Mineral Point, Penna.

SHIP Model kits and fittings: Fishermen, clippers, frigates, schooners, brigs, tugboats. Also half-hull models for interior decoration. Send 25¢ for 1959 catalog and booklet. Model Shipways, Box 85, Bogota, N. J.

SHIP Models. Most complete line in New England, kits, fittings, plans, books, tools, engines, motors. Illustrated catalog 35¢. James Bliss & Co., Inc., Dept. SM, 342 Atlantic Ave., Boston 10, Mass.

ROCKET Plans, photographically illustrated directions sent with new supply catalog 25¢ (refundable). Central Rocket Company, Waupaca, Wisconsin.

ROCKETS—Complete plans, 1 and 2 stage, 3/4" to 3 1/2" diameter. See ad page 40.

MINIATURE Engines, gas and steam. Build them on your metal lathe using our castings, blueprints. Also available, machined steam engine kits ready to assemble. Illustrated catalogue 15¢. Octura Models, Box 536-PM, Park Ridge, Illinois.

WORKING Steam engines, boilers, tractors, fittings. Catalog \$1.00. Tiny Power, Corvallis, Oregon.

SHIP And yacht model fittings: blueprints. Send 35¢ for illustrated catalog listing hundreds of items. A. J. Fisher, 1002-1 Etowah Ave., Royal Oak, Mich.

LIONEL Trains, Big discounts. Bulletin free. Catalog 25¢. Mack Bros., 3043P Chicago Ave., Chicago 22.

BALSA Wood and model aircraft. 40-page catalog 25¢. Sig Co., Montezuma, Iowa.

HOME CRAFTSMEN

BUY Plastic 3D molded brick and stone veneer panels from us. Make and sell large room dividers and planters to our patterns, given. General Plastics Corporation, Box 747, Marion, Indiana.

KNOCKDOWN Cedar chests, also over fifty kits. Catalog 25¢. Giles Kendall Co., Huntsville 2, Alabama.

NEW Big illustrated catalog. Supplies for leathercraft, metalcraft and numerous small inexpensive crafts. Prompt shipments. Top values. Latest ideas. Send 10¢ today to J. C. Larson Co., Dept. 8327, 820 S. Tripp, Chicago 24.

BUY Picture frame moldings at wholesale, actually less than cost of raw lumber. All styles and widths. Free delivery. Write for price list. Chesapeake Picture Frame Co., Box 533, Baltimore 3, Maryland.

LEATHERCRAFT. Send 10¢ for new 102-page catalog of tools, supplies, kits, including metalcrafts, enameling, ceramics, all other crafts. Complete stock. Reasonable. Since 1910. Sax Bros., Dept. PM-1, 1111 N. 3rd, Milwaukee, Wis.

CONSTRUCT Practical \$40.00 solar barbecue for \$10.00. Cook without flames. No ashes. Complete easy instructions. \$3.00. Shelby Industries, Box 516-B, San Anselmo, California.

FREE! Leathercraft catalog. Hundreds of new items. Write MacPherson Bros. Leather Company, Dept. E, 730 Mission St., San Francisco 3, Calif.

89 JIG Saw patterns. Beautiful shelves, ornaments, novelties. Plus "How, Where to Sell" \$1.00. Mastercraft 19M, 7041 Olcott, Chicago 31.

FREE "Do-it-yourself" leathercraft catalog. Tandy Leather Company, Box 791-Y28, Fort Worth, Texas.

WALNUT And cherry. Special. For a limited time one square free with purchase of two. Free price list. Midland Lumber Company, P.O. Box 262, Savannah, Mo.

FREE Do it yourself woodcraft catalogue. Formica at lowest prices. Woodcraft's Supply Co., Box 844, Evergreen Park, Ill.

101 PATTERNS of smart gifts, novelties, shelves, action windmills plus "Make Money Jig Sawing." \$1.00. Mastercraft, 15M, 7041 Olcott, Chicago 31.

FREE Seashells catalog. Instruction book 35¢. Secor's, Bradenton, Florida W.

WOODWORKING And cabinetmaking course for beginning and advanced home craftsmen. Only complete low-cost home training program available. Write for free booklet. Interstate Training Service, Dept. G-3, Portland 13, Ore.

16 LAWN Chairs, 22 tables, benches, trellises. Plans and necessary patterns, \$1.00. Mastercraft, 13M, 7041 Olcott, Chicago 31.

2430 ARTIST—Drawn patterns, new catalog 10¢. Craftplans, 1322-A Wabash, Chicago 5.

REMODEL Your own home. Save hundreds of dollars. New, amazing book shows you how. Written so you can understand it. Step by step instructions make it easy. Fully illustrated. 400 photographs, hundreds of diagrams. 160 pages. \$3.50. Literature 10¢. Popular Mechanics Press, 200-RH East Ontario St., Chicago 11, Ill.

LEARN Art metalcraft and jewelry making. Complete, inexpensive, home training course now available. Special tools and materials furnished. Write for free booklet. Interstate Training Service, Dept. L-3, Portland 13, Oregon.

KNOCKDOWN Cedar chests and lumber. Free price list. Bedford Lumber Company, Shelbyville, Tennessee.

FREE Leathercraft catalog. Quality kits, leathers, tools. Handcrafters, Box 427, Montrose, California.

STYLECRAFT "Pretmaced" leather kits. Handbags, billfolds, filigree belts. Patterns on leather. Just carve, assemble and lace. "Pre-carved" kits also available. Send 25¢ for catalog, free folder. Refunded first order. Apache Leather Company, 2804 E. Washington St., Phoenix, Arizona.

DO IT YOURSELF

EUROPEAN Wall-clock kit. Fascinating. \$3.25. Details free. LeRoy International Company, 1613-61st Court, Cicero 50, Ill.

TOOLMAKERS: Build your own height gage. Terrific savings: Kits, plans, graduated scales. Write for information. Henn Industries, 1341 Cloverfield Ave., Dayton 29, Ohio.

ELECTRIC Blankets. Make your own. Full kit, instructions. \$3. Wirral Electric, Irby, Wirral, England.

MOUNT Your own deer horns. Complete kit with instructions. Only \$5.95 prepaid in U. S. Conaways, Box 7261PM, San Antonio 10, Texas.

EVERLASTING Welder from junk. Fain Electric, R13, Ft. Worth 5, Texas.

GRANDFATHER Clock movements, barometers, blueprints, kits. Wholesale catalog 25¢. Mason-Sullivan, Noroton, Conn.

WATCHES, OLD GOLD, JEWELRY

WATCH And clock repairing books. Free catalog. North American, 2320-AA Milwaukee, Chicago 47, Illinois.

HIGHEST Cash for old gold, broken jewelry, gold teeth, watches, diamonds, silverware, spectacles, platinum, mercury. Free information. Rose Refiners, Heyworth Building, Chicago 2.

FACETED Birthstone rings; unbelievably inexpensive! Lapidex, 514 Forest, Collinsville, Illinois.

HIGHEST Cash paid for old gold, jewelry, gold teeth, diamonds, watches, silver. Mail articles today. Information free. Chicago Gold Refining Co., 6 E. Monroe, Dept. 1058, Chicago 3.

WATCHBANDS Repaired, lengthened or shortened. \$2.00 per band. Federal Band Co., Box 3244, So. El Monte, California.

WE Pay tremendous prices for cast off, broken jewelry, dental gold, watches, bracelets, etc. Mail yours today. Check mailed out same day received. Satisfaction guaranteed or money back. Roberge Co., 500 Walnut, San Carlos, Calif.

GUARANTEED Watch repair \$3.95; automatics \$4.95. Lans', 17 South Center, American Fork, Utah.

DIAMONDS—Lowest wholesale prices, direct from Belgium's world-leading market. Save up to 50%. Tax free. Lloyds insured. Write airmail for free, illustrated catalog. Royal Diamond Exporters, 103-B Rue Royal, Brussels, Belgium.

CLOCKS, Watches, timers, cigaret lighters repaired. Reliable, Bensen, 408 Mills, Joliet, Illinois.

DIAMOND Jewelry. Free merchandise. Literature. Aristocrat, 349 Salem, Billerica, Mass.

WATCHMAKERS Journal contains instructions in watch repairing. Sample copy 25¢. Dean Co., Box 3218-M, Daytona Beach, Fla.

COSTUME Jewelry supplies, settings, rhinestones, etc. 88 page illustrated catalog. 25¢. Milady, Box 1328, G.P.O., New York City.

FREE Catalog. Costume jewelry parts. Supplies. Reasonable prices. Fast service. Guaranteed quality. Unique merchandise. Palsom's, Box 52, Medford 55, Mass.

FOR THE HOME

CATALOG 10¢. Household items, toys. Otto, 2450 Shetland, Toledo 7, Ohio.

NEW Ironing safety, folding rack. Locks on board, holds iron, \$1.00. With extension cord, \$2.00. Fleming Mfg. Co., 3240 N.W. 27 Ave., #47, Miami 42, Fla.

FOAM Rubber furniture cushions. Factory seconds. 50% discount. Free catalog. Perma-Foam, 390-C Nye Avenue, Irvington, N. J.

OF INTEREST TO WOMEN

\$25 A Day easy with 60% profit. Friends and neighbors will thank you for demonstrating new beauty tips and most glamorous ways to use famous Studio Girl Hollywood Cosmetics. Information I send you quickly qualifies you as a beauty adviser so you can make up to \$25 or more a day to start—or \$5.00 an hour for spare time. If you write me today I will include actual samples for which you pay nothing, now or ever. Send name, letter or postcard, to me personally. Harry Taylor, President, Studio Girl Cosmetics, Dept. 1291K, Glendale, Calif.

SEND Stamp for free brochure "Earn at Home." Barnes, 1400 Kearny N.E., Washington 17, D. C.

DRESSES 24¢; Shoes 39¢; men's suits \$4.95; trousers \$1.20. Better used clothing. Free catalog. Transworld, 164-S Christopher, Brooklyn 12, N. Y.

SELL Fine fabrics. Get yours wholesale. Box 863, Norwalk, Conn.

PERSONAL

LOANS By mail. Borrow \$50 to \$500 for any purpose. Employed men and women over 25, eligible. Confidential, no co-signers. Up to 2 years to repay, low monthly payments. Supervised by State of Nebraska. Loan application sent free in plain envelope. Give occupation: American Loan Plan, City National Bldg., Dept. PM-1, Omaha 2, Nebraska.

BORROW By mail. \$100-\$500. Anywhere. Air mail service. Postal Finance, 200 Keeline Building, Dept. 917A, Omaha 2, Nebraska.

ENJOY Health Free booklet, Nutrition, 152-PM Kearny, San Francisco, Calif.

BORROW \$50 To \$600 by mail. Quick, easy, private. No co-signers. Repay in 24 small monthly payments. For the amount you want write today to Dial Finance Co., 410 Kilpatrick Bldg., Dept. A-1, Omaha 2, Nebr.

NEW Zealand view cards \$1. Reairmails \$1. Classified #1, P.O. Box 25, Kaikoura, New Zealand.

"A Guide to Alaska" with photographs \$2. Covers: Free land! Job opportunities! Business opportunities! Wages to \$12 hour. C.O.D. \$2.50. Alaska Press, Box 12008, Houston 17, Texas.

DO-Duct-It. Save tax money. 64 page book. CPA edited. Helpful hints on deductions most overlooked. Send \$2.00. Do-Duct-It, Box 36072, Los Angeles 36.

HEARING-Aid users, guaranteed better telephone hearing \$1.00. Phonaid, 1504 Brooklyn, Ann Arbor 5, Mich.

BIBLE Vs. Evolution—Free. Bible Standard, 2109 South 11th, Philadelphia 48, Penna.

SAVE 50% On vitamins. New, free catalogue lists all brands, formulas, prices. Compare and save. State vitamins now using. Vitamin Specialties, Box 4435-A, Philadelphia 40, Penna.

BIBLE Questions answered. Stamped envelope. Bylon, 17167 Bentler, Detroit 19, Michigan.

"YOU Can find out!" Confidential information developed, any matter, person, anywhere. Officially licensed. Established 1922. Equitable Service Bureau, 15 Maiden Lane, New York City.

GAIN Self confidence, memory power, magnetic personality by recordings. Invisible Psychologist, Box 24-NN, Olympia, Washington.

REMAILING SERVICE

RENT A confidential mailing receiving-forwarding address. Agents since 1950. Details free. William McLaughlin, 800 Stewart, Columbus 6, Ohio.

N.Y.C. remails 25¢, Times Square receiving, forwarding address for rent, Merlestein, Box 395, Times Square, New York City 36.

MEXICO Re-airmails 35¢, 3—\$1.00; we pay postage. Guadalajara address \$1.00 monthly; details free. Mexico Memo, Apartado 2042, Guadalajara 25, Mexico.

REMAILING 25¢, Monthly \$3.00. Carter, 8721 E. Garvey, So. San Gabriel, Calif.

MIAMI Remails 25¢, monthly \$3.00. Elco, Box 811, Riverside, Miami 35, Fla.

"QUEEN Of the West." San Francisco remails. 25¢. Box 1003, Richmond, Calif.

SAN Francisco confidential address! Remails 25¢. Kent Remailing Service, Box 4606-1.

FLORIDA Remails 25¢. Receiving-forwarding \$3.00 month. Grimm's, Box 1781, Tampa 1.

KETCHIKAN. Alaska, remails 25¢, \$3.00 monthly. Alaska Unlimited, Box 197, Ketchikan, Alaska.

FLORIDA Miami Beach, Coral Gables. Confidential. Souvenirs, hotel stationery, information, etc. 25¢ plus. Driftwood Apts., 820 N.W. 18 Pl., Miami, Florida.

DETROIT Address, receiving, forwarding 25¢. Ed. 16115 Pierson, Detroit 19, Mich.

HAWAII! Confidential receiving-forwarding \$3.00 month. Write: Fobel, 617-C Kuaaina, Kailua, Hawaii.

MAIL Received, forwarded, 25¢ letter, \$3.00 month. Prompt, confidential. Lloyd V. Moffitt, 319 1st Street, West Palm Beach, Florida.

105 U. S., foreign-remail points: 25¢, 60¢. Worldwide postcards: 10¢, 25¢. 58 East Eleventh, Columbus 1, Ohio.

SOUTHWESTERN Postmark, 25¢. Frost, 1200 North Stanford, Albuquerque, New Mexico.

LETTERS, Greeting cards remailed from New York, world's greatest city, 25¢, 5 for \$1.00. Reairmails 40¢, 3 for \$1.00. Frank, P.O. Box 523, New York City 8.

PUERTO Rico remails 50¢, reairmails \$1.00. L & M Specialties, Box 10818, Caparra Heights, P. R.

TACOMA Remailing 25¢, \$3.00 month. Sund, 3602 Ferdinand, Tacoma 7, Wash.

REMAILS 25¢, Monthly \$2.00. Classifieds \$1.00. Zer, Box 4282, Washington 12, D. C.

LETTERS Remailing 25¢, Monthly \$3.00. Weintraub's, Box 1481, New Orleans 5, Louisiana.

LETTERS Remailing 25¢, Jerry Love, 1419 E. 83rd, Los Angeles 1, Calif.

REMAILS 20 Cts. Colorful cards, something different, and amazing booklet 50 cts. Perail, 436 New York Ave., Brooklyn 25, N. Y.

SECRET Mail address, \$3 month. Hedg-peth, Box 830, Alhambra 23, Calif.

HOUSTON Remails 25¢, Monthly \$3.00. Remailing Services, Box 12112, Houston, Texas.

REMAILS 25¢, Monthly \$3, Rex Co., Box 5831, Baltimore 8, Maryland.

TREASURE FINDERS

GEIGER Counters! New and used. We buy and sell them. Richards, 809 St. Paul St., Baltimore 2, Md.

MAP 445 Treasures. \$1.00. Free catalogue treasure books. Foul Anchor, Rye 2, N. Y.

ULTRAVIOLET Lamps, accessories. Mineralogists, prospectors, etc. Write. Radiant, Cambria Heights 11, New York.

TREASURE! Exciting handbook 25¢. Locators. Howe, 811 Kansas, Atchison, Kansas.

NEW—Extremely light weight economical transistorized metal detectors. Waterproof search head. Kit or assembled models. Geiger counters and mineralights. Free literature. Electronic Applications, Dept. M, P.O. Box 8, Arlington, Virginia.

FIND Buried treasure, gold and silver, with Goldak's sensational 3 1/2 lb. "find-it" locator, only \$64.50. Write for free literature on complete line of mineral, metal locators; Geiger and scintillation counters. Goldak, 1541 W. Glenoaks Blvd., Glendale, Calif.

FOR SALE—MISCELLANEOUS

GOVERNMENT Service ribbons. Assorted 10 yards, \$1.50 postpaid. Rex's, Box 5831, Baltimore 8, Maryland.

EQUIPPED Print shop, and some photo developing, \$2750. Furnished apartments with \$50 weekly income. Complete \$9950. TVPC: Titusville, Penna., only job printer except newspaper in our area.

BUY Knapp shoes. Brochure 25¢. James, 5758 Magnolia, Riverside, Calif.

HEARING Aid batteries, wholesale. Free list. Habs, Box 51, York, Penna.

WANTED—MISCELLANEOUS

GOLD, Silver, platinum, old jewelry, diamonds, watches, spectacles, wanted. Highest prices paid immediately. Information free. Wilmot's, 1067 W. Bridge, Grand Rapids 4, Michigan.

QUICKSILVER. Platinum, silver, gold. Ores analyzed. Wholesale Terminal, Norwood, Mass.

SCRAP Mercury (quicksilver) containers supplied — Tantalum, tungsten, silver, platinum. Metallurgical Products Company, Established 1909, 35th & Moore Sts., Philadelphia 45, Penna.

MISCELLANEOUS

FREE Folder gives helpful hints about what to do before, after and during an atomic attack. Write Atomic Aid, 215 West 34th Street, New York City 1.

JAPAN: Buy direct, mail-order, kimono, dolls, etc., 24 page catalogue, manufacturers' addresses, business informations. Send \$1.00. Clarence Yamagata, 202 Naka 7 Bldg., Marunouchi, Tokyo.

70 BIBLE Lessons, 25¢. Bulletin, Box 87, Cathedral Station, New York City 25.

NEW Adhesive "Sobo" makes the needle needless. Hobbyists, handicrafts. Strong bond, 2 oz. squeeze bottle \$1 postpaid. Guaranteed. Edgemont Sales, Whitesboro, New York.

DON'T Die without a will. Two forms and do-it-yourself instructions \$1.00. AtoZ Printing Service, 800 Wanda, Ferndale 20, Mich.

FREE Vitamin catalogue — Potent formulas, quality capsules for better, healthier living. Feel more vigorous, younger. Buy direct, save! Vitacenter, Drawer 2318-P, Detroit 31.

"WHO Manufactures it?" We can supply lists covering any item. Box 171, Midland, Penna.

MINERAL Map of Canada. Showing complete mining areas of gold, uranium, silver, copper, etc. Over 1,000,000 sq. miles. Excellent for exploration and reference. Only \$1 to Mineral Club of Canada, S.W. Box 187, Windsor, Ontario.

GIFT Catalog free. Frank Deisz, 7407 N. Leonard, Portland 3, Oregon.

HAIRCUT As you like it. Booklet 25¢. Mastrolia, 32-22HM 89th, Jackson Heights 69, New York.

GOLD Country cancellations. Hand stamped, old California mining towns. Historical insert included. 30¢ each. Don. Sierra Magazine Exchange, 727 E. Church St., Stockton 3, Calif.

EXPOSED! "How to Win Prize Contests" \$1. Guaranteed. Erickson, 250-E McLaughlin, Muskegon, Mich.

"ROCKET Science for Amateurs". Just published. Featuring: Zinc-sulfur rocket plans, formulas, performance, theory, \$2.00. Sooner Science, Box 145, Norman, Oklahoma.

LUCKY Charms. Four leaf clover sealed in sparkling plastic. 35¢. Willard's, 12663 Ralston, San Fernando, Calif.

EXTRAORDINARY Opportunity! Retire now! Lead leisurely life. Remarkable book shows how. Free details. Belmont, Wyckoff 158, New Jersey.

MODERNIZE Your clotheslines. Make them automatic. Kit of parts to service one line \$3.50 postpaid. Reelway Products Company, Box 5610, Nokomis Station, Minneapolis 17, Minn.

BUY Wholesale: 100,000 nationally advertised products. Appliances, cameras, sporting goods, housewares, watches, typewriters, tools, clothing, etc. Discounts to 80%. Buy-Rite, Box 258, Hawthorne 102, New Jersey.

HAIRCUTTING: Do-it-yourself at home. Butch, regular, flattops. Complete simple illustrated instructions. Written by registered barber. \$1.00. Modern Barber Shop, Marengo, Ill.

BARGAIN Necessities. Catalog free. Miller, P.O. Box 104, Findlay, Ohio.

TV Photo lamp. Cattle scenes 12x5 inches. Only \$4.95 prepaid in U.S. Conaways, Box 7261PM, San Antonio 10, Tex.

CIGARETTES — Improved roller makes 20 for 9¢. All types pipe tobaccos. Facts free. Moberly, Box 910, Owensboro, Ky.

BUY Wholesale. Send 25¢ for information. Lee Products Company, Box 32, Winterset, Iowa.

RECEIVE Magazine samples, mails, catalogues. Bargains from everywhere. Get listed 25¢. Rorick, Cincinnati 26, Ohio.

100,000 **PRODUCTS** Wholesale — Free catalog! Send postcard: Econ-O-Mart, Whippany 15, New Jersey.

CESSPOOLS. Septic tanks, clogged drains. How they function and how to keep them working. Free literature. Chemical Cesspool & Drain Cleaning Co., Boston 34, Mass.

BUY Wholesale! 25,000 nationally advertised products. Get amazing dealer catalogs. Complete details free. American Wholesalers, 1841D Levee, Dallas 7, Texas.

YOUR Name wanted. We'll send 1000 publishers, mailers, wholesalers your name, on our list one year 25¢. Dixie Mailers, King, N. C.

HUMOROUS Cards, plenty of laughs, 25¢. Stoddard's, 4164 Byron, Chicago 41.

SUPER Memory overnight! Success guaranteed! Bijou, Box 1727-M, Hollywood 28, California.

HOW To remodel, basement, attic. Booklet or book. Send for 1958 book catalog—10¢. Popular Mechanics Press, 633 N. St. Clair St., Chicago 11.

NOW! Shut Out Cold, Wind, Water, Snow . . . Keep Garage Warm & Dry ALL WINTER with FLEXIBLE RUBBER GARAGE DOOR BOTTOM

Don't waste precious heating dollars! Keep winter cold, snow, rain, dust and drafts out—keep heat in with this amazing heavy-duty live rubber weatherstripping. Ingenious front and back lip contour design makes it an automatically perfect closure regardless of shape of floor. Guaranteed never to harden, rot or deteriorate in any fashion. Eliminates forever ear-shattering noises no matter how hard you slam down your overhead garage door. Ideal also for sides of double hung garage doors, barn doors, etc. Can be permanently applied in only 10 minutes—requiring just a hammer—we supply the nails. Complete, simple instructions in plastic pack.

9 foot strip \$2.89 ppd.
16 foot strip \$4.98 ppd.

Send check or money order. If COD, fees extra. **MONEY BACK GUARANTEE**

SCOTT MITCHELL HOUSE, INC.

Famous Frost King PLASTIC STORM WINDOWS

- Shatterproof
- Waterproof
- Winterproof

720"x36" — 180 sq. ft. — More than enough to winterproof an average house **\$2.69** only plus 21¢ pp. & hdg.

Only pennies per window give you sure-fire protection the year 'round. Installs in minutes—no skill needed. All you need is a shears and hammer—we supply all else. Unlike ordinary plastic sheeting, Frost King is expressly designed for storm window use. It seals in heat as it seals out cold, "breathes" with your house. Frost King is unconditionally guaranteed to give you years of satisfactory use under the severest of conditions . . . guaranteed never to shatter . . . unaffected by wind, rain, snow, sleet or dampness.

Dept. F-1, 415 South Broadway
Yonkers, New York

NO JOB WORRIES

PLASTEX INDUSTRY needs manufacturers on small scale for big production of Lamps, Clock stands, Art Goods, Novelties in Plastic Marble imitation. No Experience necessary. Use material makes regular 10¢ store sellers. Moulds furnished for fast production. Small investment brings good profit. **BIG WHOLESALE ORDERS NOW BEING PLACED.** Ambitious men have chance for real prosperity and job security. Our NEW FREE booklet will interest and benefit you.

PLASTEX INDUSTRIES, Dept. A
3400 Third Ave. New York 56, N.Y.

Learn FRENCH or SPANISH OR ITALIAN, GERMAN, RUSSIAN or HEBREW

through the miracle of **LIVING LANGUAGE LONG PLAY RECORDS**

Here's all you need to learn to speak a foreign language fluently and fast! Entire **LIVING LANGUAGE COURSES** (over 500,000 sold in 3 years) are contained on four Long Play Hi-Fidelity records of unbreakable vinylite. The 40 lessons teach you to speak by listening to thousands of words and phrases; records can be played over and over again. *Comprehensive Conversation Manual* repeats in print so that you see what you hear. Also, you get the *Common Usage Dictionary* with over 16,000 entries. Now save **TWO-THIRDS** on original price . . . keep for 7 days at no risk. Mail coupon now!



PRICE SLASHED
Original Course \$29⁹⁵
NOW \$9⁹⁵

LIVING LANGUAGE COURSES, Dept. PM-1
419 Fourth Avenue, New York 16, N. Y.

Rush me the **LIVING LANGUAGE COURSE** checked below on 7-day no risk basis. Enclosed find check, money order for \$9.95. I will return course for full refund if not satisfied.

Fr. Span. Ital. Germ. Russ. Heb.

Name _____

Address _____

City _____ Zone _____ State _____

CAN WE MAKE MONEY TOGETHER?



Charles E. Bowes, President
Bowes "Seal Fast" Corp.

Do you have what it takes to start your own automotive wholesale business?

I want a practical, hard-headed man with the guts to succeed in his own business. Someone who doesn't kid himself about how easy it would be if he were the boss. This opportunity is only for a man who will work hard, devote his full time and be able to make an investment of about \$7,500 in a truck and stock.

Still with me? Then here's the story: If you are the man I'm looking for, you will have a chance to become a franchised distributor, for the Bowes "Seal Fast" Corporation. In this business of your own, you'll meet the needs of service station operators for automotive parts and accessories—products they must have to stay open. You'll make money. Good money. And there's no ceiling on your earnings. We'll make money too. So we're careful to pick the right man and give him all the training and help he needs toward building a solid, depression-proof business.

Is this what you're looking for? Then mail in the coupon below. You'll have the full story back in a matter of days. Of course, there's no obligation.

Bowes Distributors throughout the country are part of a multi-million dollar operation. They represent a firm which in 40 years has grown to be one of the largest of its kind, with plants in London, England, Hamilton, Ontario, Riverside, California, and Indianapolis. Its credit rating through Dun & Bradstreet is the highest (AAA-1) available.

CLIP THIS

Mr. **CHARLES E. BOWES**, President
The Bowes "Seal Fast" Corporation,
Dept. 2923, 5902 E. 34th Street, Indianapolis 18, Indiana

Please send a copy of "So You Want To Be Your Own Boss!" Also tell me without obligation how I can go into business for myself as a Bowes Distributor.

Name _____ Age _____

Address _____ Phone _____

City and State _____

BOWES
the famous "500" line of car care products



**MEN! Make up to
\$1,000⁰⁰
IN A MONTH!**

without "SELLING"

Sensational Demand for Low-Priced Fire Alarm PLUS Sure-Fire "No-Selling" Plan Offers Ambitious Men Huge Profit Opportunities

AMAZING NEW INVENTION



Even beginners who never sold anything in their lives are cleaning up unbelievable profits with the first practical effective, low priced Fire Alarm ever invented . . . needed, wanted in homes, factories, offices, stores, on farms, for boats, everywhere. Professional salesmen are making biggest profits in years! Later in this ad I'll tell you about the plan that's producing orders for 1 to 12 Fire Alarms per sale from 8 out of 10 prospects . . . without selling. Here are the facts about the Fire Alarm. It hangs on the wall like a picture—no wiring, no installation. It's always on guard . . . It 'smells' a fire before danger point. When temperature rises, Fire Alarm goes off automatically, howls loud warning that can be heard 1/5 mile, wakes up soundest sleeper, give precious time to put out fire, call fire department, or escape. And it sells for only \$4.95 with profit up to \$2.70 on each one.

**Nearest Thing to
AUTOMATION SELLING**

With our field-tested plan customers sell themselves. No cold canvassing. No hard selling. It's the nearest thing to 'Automation Selling.' Imagine a sales plan even a child can use successfully because the sales tools we give you (and which you leave with your prospects) do all your selling even while you sleep! No room here to give you all the details but if you want big money fast rush the coupon now.

**Make This
Lighted-Match
Demonstration**

Sensitive! Lighted match triggers Alarms in 3 seconds.

Free Sales Kit

Send no money. Just rush coupon below for all the exciting moneymaking facts, complete Illustrated Sales Kit, everything you need to make money your first day. Learn how selling only 20 Fire Alarms a day pays

**Made \$28.52
in 3 Hours!**

"Received first shipment about noon. Worked 3 hours and made \$28.52 profit. It's a terrific seller!"
—Stanley



you \$1,080.00 profit in a month. No competition anywhere. Get in on the ground floor now. Rush this coupon.

MERLITE INDUSTRIES, Inc.

(ALARM DIVISION)

114 E. 32nd St., Dept. F-15T New York 16, N. Y.

ALVIN WESLEY, Sales Manager
Merlite Industries, Inc. (Alarm Division)
114 E. 32nd St., Dept. F-15T, New York 16, N. Y.

Rush **FREE SALES KIT** and full details about your "No-Selling" plan which gives me opportunity to make up to \$1,000.00 in a month without cold canvassing and hard selling—automatically. I am not obligated.

Name _____

Address _____

City _____ Zone _____ State _____

In Canada: Mopa Co., Ltd., 371 Dowd St., Montreal 1, P.Q.



Nibs, Inc., 1760 W. Wrightwood, Chicago 14

**Trap Tosses Targets
From Spare-Tire Mount**

Hunters who want to sharpen their aim by trapshooting can buy a lightweight trap which mounts in a minute on a spare wheel and tire. A mounting bolt supplied with the welded-steel trap holds it firmly. The trap is released by pressure of the shooter's leg against a lever. It throws standard clay targets, double or single, the regulation distance or farther.

**Box Holds Rodent Poison
To Prevent Accidents**

Domestic animals and youngsters are safe from rodent poisons that are dispensed inside a plastic box which, the manufacturer claims, only mice and rats can enter. The dispenser handles either dry or liquid bait and it can be adjusted to supply only enough liquid poison at one time to kill a single rodent.

3 Way Co., P. O. Box 242, Vacaville, Calif.

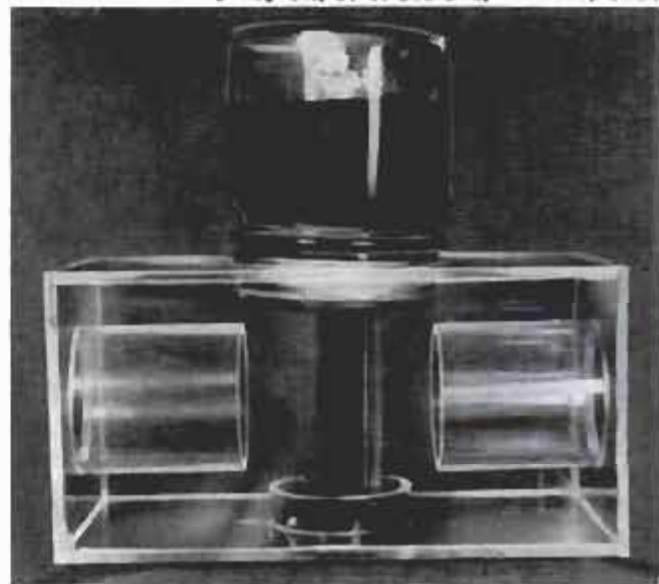

Get info..

PLASTIC LAMINATING AT HOME!



THIS MAN ..
... is taking out of the machine a Plastic Sealing Job—ordered by mail—only 11¢ in material cost brings back \$2.58 in cash by mail. Capacity of machine: **\$25.00 profit per hour of operation.**

Get **ORDERS** and **CASH** from your mailman—do work in **SPARE TIME** at home—or expand into **FULL TIME** business. Send coupon for Free facts about the newest and most fascinating of all home operated businesses. For the first time a simplified machine brings the fabulous profits of **Plastic Sealing** and **Plastic Laminating** within the reach of the small operator. Anyone can learn to operate the machine with a few minutes practice—then with our **Magic Mail Plan** can get mail orders pouring in daily with cash in every envelope. **No canvassing—no selling.** We even

Make up to \$5 an Hour..
MAGIC MAIL PLAN!

supply the circulars you mail to bring back cash and orders. Don't waste a minute. Rush your name. We'll send you **FREE** and postpaid, pictures, prices, details, and all the facts you need to start. Mail coupon or send name on postcard. No charge. Warner Electric Co., 1512 Jarvis Av., Dept. L-2-A, Chicago 26, Ill.

Make Thousands of Beautiful Art Creations

COSTUME JEWELRY • CIGARETTE BOXES TRAYS • CANDLESTICKS • COASTERS LAMP BASES • BOOK ENDS...ALL IN SPARKLING COLORED PLASTIC



WARNER ELECTRIC CO., 1512 Jarvis Av. Dept. L-2-A, Chicago 22, Ill.

At no cost to me, please rush complete details postage prepaid. I am under no obligation.

Name _____

Address _____

City _____ Zone _____ State _____



FREE CATALOG

ADD UP TO 25 POUNDS of SOLID MUSCLES

of you pay NOTHING

\$10 BODY MOLD course included **FREE** with **DAN LURIE BARBELLS**. Only **DAN LURIE BARBELLS** and "Body Mold" courses produce such amazing results. 15 minutes a day can make you a bigger man. Send today for details. Order now at lowest factory price.

50 lb. set \$8.98 • 100 lb. set \$14.98
150 lb. set \$21.98 • 200 lb. set \$27.98
Semiannual sets approx. 10% higher. Extra wts. 14¢ per lb. Send 50% cash, balance C.O.D. F.O.B. Plant.

DAN LURIE BARBELL CO., 52M-1 Bristol St., Dept. 950A, Bklyn. 12, N.Y.

LEARN NOW! How to Become a GAME WARDEN • GOVT. HUNTER

• Join Forestry, Wildlife Services!

Let your love of field and forest guide you to real success! Be a career conservationist! - Protect resources. Arrest violators. Work with wildlife amid scenic surroundings, away from city pressures. Enjoy a "way of life" others can't even buy! Good pay, security, prestige. Full time and seasonal opportunities, men 17 to 45! Hunting, farming, military experience valuable. Prepare now, spare time. **HELP FILL NEED IN YOUR AREA!** All states. If over 17 write NOW! **FORESTRY & WILDLIFE COURSE, Dept. C-171, 1038 S. La Brea, Los Angeles 19, Calif.**



INVEST IN



OPTICAL BARGAINS

TAKE PHOTOS of the MOON Through Your Telescope with EDMUND CAMERA HOLDER for TELESCOPES



Bracket attaches permanently to reflecting or refracting telescopes. Removable rod holds camera over eyepiece to take pictures of Moon... or terrestrial telephoto shots of distant objects.

White metal projection screen permits you to see the sun spots! Includes brackets, 28 3/4" rod, projection screen, screws, directions. Order Stock No. 70.162-H... \$9.95 Postpaid (Send Check or M.O. — Money-Back Guarantee)

SALE! TERRIFIC WAR SURPLUS BARGAIN! AERIAL CAMERA LENSES



Gov't. Cost \$1218—Now Low as \$39.50 Used Made by B & I. and E.K.—24" F.L. f/6, in 23" long Lens Cone. Use as long range, Big Bertha Telephoto lens—for Richest field (wide field, low power) telescope, etc. Lenses are 4" dia.—precision 4-element type, Aero Tessar and Aero Ektar. Easily removed. Diaphragm (f/6 to f/22) is included. Opens approx. 1" to 3 1/2". Lens and cone—wt. 25 lbs. Sturdy carrying trunk—wt. 26 lbs.

Stock No. 85.059-H 24", used. Price \$39.50 f.o.b. Utah
Stock No. 85.060-H 24", new. Price \$59.50 f.o.b. Utah

NEW HAND SPECTROSCOPE

Never before such low price! Only possible because it employs newly developed replica grating film—with 13,400 lines per inch. This grating is mounted in aluminum tube 4 1/2" long, 1/2" dia., with a fixed slit. Stock No. 30.280-H... \$2.50 Postpaid

SPITZ MOONSCOPE A precision-made 45 power reflecting telescope. Clearly reveals the craters on the moon. Shows Saturn, Jupiter, other wonders of the heavens. Based on same principles as world's giant telescopes. Fascinating 18-page instruction book is included. Stock No. 70.068-H... \$14.95 Postpd.

WRITE FOR FREE CATALOG "H"!

Complete Line of Astronomical Telescope Parts and Assembled Telescopes. Also huge selection of lenses, prisms, War surplus optical instruments, parts and accessories. Telescopes, microscopes, Hand Spectroscopes, Sniperscopes, binoculars, etc. Request Catalog "H"!

ORDER BY STOCK NUMBER SEND CHECK OR MONEY ORDER. SATISFACTION GUARANTEED.
EDMUND SCIENTIFIC CO., BARRINGTON, N. J.

FREE EARN '59 NEW CAR SELLING AUTOMOTIVE ACCESSORIES

Make 300% profit full or part time, & earn BONUS new car. Sell high profit line newest auto accessories. Your lifetime business, own exclusive area. **CLYDE & CO., 120-X East 82, New York 28, N. Y.**

CONCRETE BIRD BATHS AND OVER 250 OTHER MONEY MAKING ITEMS



You've seen them all over the country... concrete bird baths, garden seats, flower boxes, appealing statuary, and many other items that add charm around the house and lawn. They're made by enterprising people, just like you, from our **COPYRIGHTED ALUMINUM MOLDS**. It's easy. It's fun. It's profitable.

Send \$2.00 today for this 82-page "How to" book, 20 pages of clear instructions. Valuable trade secrets. Over 230 items beautifully pictured (with descriptions, dimensions, and prices of molds). Rushed to you by first class mail.

CONCRETE MACHINERY CO., INC. HICKORY 2, NORTH CAROLINA

Name _____

Address _____

HOW TO TURN CONCRETE INTO GOLD



WHERE-TO-BUY-IT INDEX

AUTOMOTIVE

Foot pressure lifts garage door (Marman Co., Inc., P. O. Box 6-T, Waltham, Mass.)	90
One man "road tests" eight cars at a time on treadmill	95
Eso Research Eng. Co., 15 W. 51st St., New York City	103
Telescoping dash light handy for map reading	111
Carbon-monoxide detective	114
Cook and eat "dogs" while you drive (Don E. Bailey and Assoc., 5950 S. Normandie Ave., Los Angeles, Calif.)	260
Plastic brush and scraper cleans snow off car (Mark Mfg. Co., P.O. Box 191, Owosso, Mich.)	286
Auto performance meter makes everyone a test driver (Peduzzi International, P.O. Box 68, Huntington, Long Island, N. Y.)	

AVIATION

"Venetian blind" reduces jet noise with high-pressure water	116
Navigation system traces flight path of helicopter	129
Jet helicopter uses same principle as rotary lawn sprinkler	

CONSTRUCTION

Piggyback bridge eliminates trestle supports on highway	111
Retractable dome will cover arena	115
Japanese police station designed with "peaceful" motif	116
"Hurricaneproof" house on stilts	124
Face-lifting operation for the Old Man of the Mountain	139
Air holds up steel roof	143
Tower for newlyweds	

HOUSE AND HOME

Clothes-drying rack hangs over bathtub	111
Snow-plow blade can be attached to rotary mower (Cooper Mfg. Co., 409-411 S. First Ave., Marshalltown, Iowa)	138
Fastener of nylon strips (Velcro Sales Corp., 681 Fifth Ave., New York City)	138

MISCELLANEOUS

Automatic lens unit can be added to movie camera (Elgeet Optical Co., Rochester, N. Y.)	115
TV watches tots for motel guests	123
Blind operators man Braille switchboard	129
Diffused light saves sight (Westinghouse Electric Corp., Bloomfield, N. J.)	132
Slide rule for soils figures erosion on farms	136
Radar through trunk lid	136
Barge becomes stage	137
Plastic-protected motor works underwater	138
In your future: rolling refrigerator, portable bottle warmer (Westinghouse Electric Corp., 3 Gateway Center, Pittsburgh 30, Pa.)	143
Powder suspends particles in tube of water (B. F. Goodrich Chemical Co., New York City 17)	277
Neon sign without wires (Radelite National Corp., 41-18 38th St., Long Island City 1, N. Y.)	280
Wheeled aluminum frame helps move light loads (Clark Metals Co., Fort Morgan, Colo.)	

SCIENCE

"Balloon" houses 3-D radar	104
Inspector checks X-rayed products on TV receiver	110
Robot fire fighters (Akron Brass Mfg. Co. Inc., Weoster, Ohio)	111
Electronic "cat eye" photographs stars in daylight	123
Will it show the butterflies?	129
Electricity from heat	132
Chemically treated rubber resists oil and high temperatures	137
Unmanned space vehicle designed for trip to Mars	137
Eyes generate electricity in normal light	138
Blind learn to read by hearing sound patterns of letters	139

WHAT'S NEW FOR YOUR HOME

Rotating rug brush	130
Jalousie seal	130
Steam cooker	130
Bottle-cap remover	131
Egg beater	131
Measuring cup	131
Versatile furniture	131
Bread-slicing appliance	131
Range hood has radio	131

Radio-Television, Electronics

Simple accessories provide more work for the VTVM	245
---	-----

Craftsman and Shop Notes Index

AUTOMOTIVE

Several factors can be responsible for rough idling of engine	185
Efficient engine operation requires clean fuel filter	204
Infant's bed-playpen fits between front and rear seats of car	212
Unburned gas pollutes air	216
Ignition trouble from oil vapor	

HOUSE AND HOME

Stainless lubricant in stick form has variety of uses	195
Brush "holster" on paint pail	195
Rubber cement seals glass jars	197
Old-style buffet cut apart to make modern furniture	200
Molding strips nailed to ladder top to retain work materials	201
Shoe cabinets hinged to closet doors	

(Continued to page 90)

free! ALLIED'S MONEY- SAVING 1959 ELECTRONIC SUPPLY CATALOG

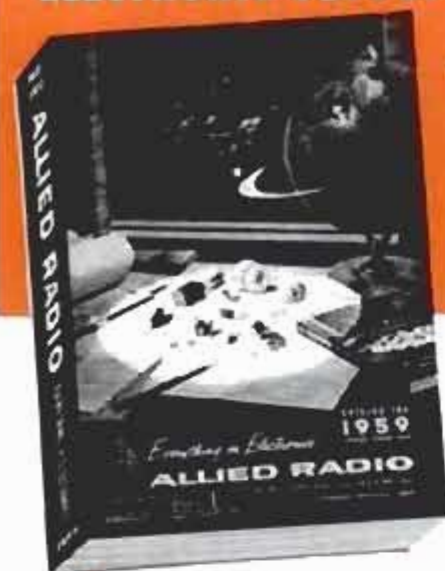

452

value-packed
pages

send for it!

SAVE

ON EVERYTHING
IN ELECTRONICS

EASY TERMS
AVAILABLE

WORLD'S LARGEST STOCKS

Here is the complete guide to everything in Electronics for Experimenters, Builders, Amateurs, Servicemen, Engineers and Hi-Fi enthusiasts:

- Amazing Build-Your-Own KNIGHT-KITS
- Everything in STEREO HI-FI
- Hi-Fi Music Systems & Components
- Recorders & Phono Equipment
- Public Address & Paging Systems
- TV Tubes, Antennas, Accessories
- Amateur Station Equipment
- Latest Test & Lab Instruments
- Industrial Electronic Supplies
- Parts, Tubes, Transistors, Tools & Books

SAVE on everything in Electronics at ALLIED—get fast, dependable service, expert personal help, guaranteed satisfaction. Send today for your FREE 1959 ALLIED Catalog.

Everything in Electronics
From One Reliable Source

Send for
FREE
Catalog

OUR 38th YEAR

ALLIED RADIO

- ALLIED RADIO, CORP., Dept. 5-A9
- 100 N. Western Ave., Chicago 80, Ill.
- Rush FREE 1959 ALLIED 452-Page Catalog

Name _____

Address _____

City _____ Zone _____ State _____



Westinghouse, Lamp Div., Bloomfield, N. J., and Danco Telephone Co., Inc., New York City

Built-in Germ Killer For Telephone Mouthpiece

Designed for telephones that are used by more than one person is an attachment that kills germs on the mouthpiece. Each time the mouthpiece is replaced in its normal position, a lamp is activated for approximately one minute. The ultraviolet rays emitted by the lamp destroy any germs that have been deposited on the mouthpiece.

Reflective Coat on Sheathing Helps Light Garage Interior

Water and fire-resistant gypsum sheathing with a coating of aluminum paper is now available for garages and other structures to improve the interior lighting. Used on the interior of a garage, the surface reflects and diffuses light from the headlights of a car, providing safer entry. The reflective surface also helps insulate.

National Gypsum Co., Buffalo 2, N. Y.



GET HIGH PAY FASTER AS AN ENGINEER OR TECHNICIAN

In every branch of engineering—electronics, electrical, mechanical, civil, aeronautical—the demand for engineers and technicians is acute. Men with engineering qualifications command top positions in industry. They draw large salaries, have security and prestige. You can enter this high income field yourself by training at home in your spare time through

our proven home study courses.

HIGH PAY CAREER CAN BE YOURS

No previous experience is required. Start from the ABC's if necessary or at whatever point to suit your present knowledge. Each course is written by an eminent authority in his field and includes a library of standard textbooks. Step-by-step instruction methods proved successful by thousands of our graduates, lets you understand the toughest problem with ease. If you are ambitious and willing to study, send the coupon below and we will forward two booklets describing the course and the Institute's advanced teaching methods. C.I.S.T. courses are endorsed by some of North America's leading companies.

OVER 90 HOME TRAINING COURSES

- | | | |
|------------------------------|-----------------|-------------------|
| Civil Eng. | Mechanical Eng. | Electronics |
| Surveying | Refrigeration | Television |
| Architecture | Heating | Aeronautical Eng. |
| Forestry | Journalism | Aircraft Engineer |
| Mining | Drafting | General Education |
| Structural | Plastics | Chemical |
| Industrial Eng. & Management | Electrical Eng. | Mathematics |
| | Radio | Accounting |

Make this the turning point in your life, fill in and send the coupon below to:

Canadian Institute of Science and Technology Ltd., 714 Century Bldg., 412, 5th St. N.W., Wash., D.C.

No salesmen will call.

MAIL NOW FOR 2 FREE BOOKS

Canadian Institute of Science and Technology Ltd.
714 Century Bldg.,
412, 5th St. N.W., Wash., D.C.

Gentlemen: Please forward to me your two free booklets.

Name

Address

City State

Course of Interest Age

Occupation

Canadians: Send to Canadian Institute of Science & Technology Ltd., 714 Garden Bldg., 263 Adelaide St. W., Toronto, Ontario.



Foot Pressure Lifts Garage Door

Your overhead garage door can be started upward with a minimum of effort when a lifting device is attached to the bottom of the door. You simply step on the pedal and your foot pressure provides the initial lifting action. The lifter is made of aluminum and can be attached to the door in a few minutes.

Automatic Lens Unit Can Be Added to Movie Camera



Owners of eight-millimeter motion-picture cameras with "D mount" lenses can now get automatic interchangeable lens units which are activated entirely by changes in light and shade. The iris is controlled by electric energy from a selenium cell which, in turn, responds to the amount of sunlight or artificial light on the area being photographed. The lens unit can be set for use with color films in the range from ASA 10 to 16. It also can be switched to manual settings for stop-motion or slow-motion effects.

(Continued from page 88)

"Linoleumize" your kitchen and bathroom.....	202
Keep your knives in a wall cabinet.....	217
Sectional insert on window gives multipane effect.....	224
Photo lamp on rafter illuminates attic.....	227

MISCELLANEOUS

Trouble lamp from sealed-beam light housed in carrying case.....	185
Electric starter for model plane.....	196
Improvised float arrangement controls electric pump at farm well.....	196
Wire "tongs" speed application of paint stripes on golf balls.....	200
35-mm. bulk-film loader.....	205
Balanced suspension keeps scale handy for weighing milk.....	216
Dropping-pear-on-knife trick is interesting party game.....	230

OFFICE, SHOP AND STORE

Handy pen wiper on ink bottle.....	204
Nonlip surface on erasing shield.....	204
Aluminum letter caddy.....	213
Metal handle converts injector-razor blade into stencil knife.....	224

ON THE MARKET

Instant upholstery cleaner.....	228
Wood stain and lacquer combined.....	228
Parquet patterns in linoleum tile.....	228
Aluminum reflector.....	228
Dry lubricant comes in small plastic tube.....	228
All-purpose primer.....	228
All-steel door.....	228
Semiconcealed cabinet hinge.....	228
Shutter panels.....	228
An attractive and novel fence.....	228

SOLVING HOME PROBLEMS

Card tables used to dry sweaters.....	198
Sheet-metal screws to fasten fixtures.....	198
Envelope made "tamperproof".....	198
Keep umbrella from skidding in corner.....	199
Tall tapers can be straightened.....	199
Shelf-paper edging.....	199
Doorknob guard protects tots.....	199
Flashlight handy in clothes closet.....	199
Stops for clothes hangers.....	199
Novel "mosaic" treatment.....	199

SHOPPING FOR TOOLS

Spray gun designed for application of new roof coating.....	240
Dye penetrant.....	240
Hole saw cuts clean, round holes.....	240
Radial-saw unit.....	240
Roof-framing calculator.....	240
Drill-press vise.....	240
Snubber, or lock, holds rope.....	240
Power screwdriver attachment.....	240
Miter trimmer.....	240
Sheet-metal fastening machine.....	242
Pancake motor.....	242
Cleaners for cutting-torch tips.....	242
Sanding block.....	242
Metal bender.....	242
Pail holder.....	242
Paint mixer for portable electric drills.....	242
Individual radius gauges.....	242
Rotary planer head.....	242

TOOLS

Data taped to grinder housing shows correct operating speed.....	196
Tool roughens joint surfaces for better glue bond.....	197
Drill-bit rack is nonclogging.....	204
Holder for steel square.....	212
Reversed tip on soldering iron produces better joint on flat work.....	216
Jig aids cutting rock-wool batt.....	226
Renew wire brush by grinding.....	226
Kerf anchors collar on shaft.....	227
Tighten shaft with taper pins.....	227
Jig for accurate setting of most circular saws.....	227
Simple "stone" for honing edges of cutting tools.....	230
Bracket permits clamping sketch board in vise at desired angle.....	236
Handled socket wrenches assembled into four-way wrench.....	236
Level drill press with bolts.....	236
Cutting edges of bit are modified to produce broken brass chips.....	244
Broken hacksaw blade repaired temporarily to finish job.....	244
Jig mounted in vise facilitates welding work at desired angle.....	244

WORKSHOP HINTS

Block clamped to jointer fence permits uniform chamfered cuts.....	200
Notch locates cotter-pin hole.....	204
Three-stage cut prevents binding when bandsawing bushing.....	212
Protecting hole finish.....	212
Household cleanser on tape ideal for small polishing jobs.....	224
Paper helps remove small parts picked up with permanent magnet.....	230

NOTICE—It is the intention of this magazine to provide its readers with information regarding the latest developments in the mechanical arts. Except where otherwise indicated, this magazine has no information as to any unexpired patents in respect of the developments reported herein. In the event that commercial use is to be made of any of the developments reported herein, it is suggested that legal counsel be consulted to avoid liability for patent infringement. It is not the purpose of this magazine to encourage patent infringement but, as indicated, it is the intention of this magazine to report on the latest developments in the mechanical arts.

OPPORTUNITIES

A number of one-man mail order enterprises are paying their owners an income of \$40,000 to \$50,000.

special feature



Mail order is big business. Annual catalog sales volume of Sears, Roebuck and Co. is over 700 million dollars!

HOW TO START

Your Own Mail Order Business

By John Winkler

You can make a fortune by mail. New firms will set you up in a fabulous mail order business of your own! They'll make up your catalogs, prepare your advertising, supply mailing lists and even ship your products for you!

WHEN Arthur Johnson decided to earn some extra cash during his spare time he chose the mail order business because it could be run right from his own home. He reasoned that it was one of the few fields still open in which you could start your own business with a minimum of capital. In fact, his total investment was less than \$100.00.



Witness the success of Arthur Johnson. He obtained a franchise from Mail Order Associates and within three months the profits started pouring in.

What began as a spare time job mushroomed into a profitable full-time business.

How successful was Johnson? Well, he drives a Cadillac convertible, owns a home in Nevada and a summer place in Florida, with a Cris-Craft cruiser to boot!

No, Johnson didn't find Uranium or answer the \$64,000 question. He simply cashed in on the fabulous mail order business — with the help of one of the new mail order organizations which back enterprising new comers to the mail order business.

Like so many other beginners in this field, Johnson was plagued with the problem of finding the 'ideal' mail order product. One that would have a large market, offer a good profit margin, bring repeat sales, and one which could be easily shipped by mail. After reading several books and courses on the subject, it seemed impossible. In order to obtain wholesale prices from manufacturers he had to purchase large quantities, which meant all his capital would be spent in inventory. The additional cost of sales letters and advertising and the risk of picking a poor mail order product and being stuck with all that merchandise made it even more obvious he'd have little chance of success.

Then he heard about Mail Order Associates of Maywood, New Jersey — an organization set up to aid the small mail order operator.

He wrote to M.O.A. for full information, sent in his application for a franchise and within three months the profits started pouring in.

Johnson attributes his success to the large selection of novel and unusual mail order products carried by M.O.A.

Mail Order Associates is one of the few new pioneers in the fabulous mail order business. One of the first organizations formed to put the small mail order operator in business—big business, they fill a definite need for the beginner with little capital. Here's what they offer you:

(1) Complete, ready-to-mail catalogs printed with your name and address . . . in any quantity you wish. Catalogs, sales letters or self mailers may be based on any of the following typical categories:

BABY GIFTS AND NOVELTIES

VITAMINS

**INSTRUCTION BOOKLETS AND COURSES
COSMETICS**

You select your own market.

(2) Profits range from 50% to 150% on most items. For example, you may sell a \$20.00 mail order course and make \$10.00 on each sale. Or you sell two appliances at a discount, give one away free and still make a 50% overall profit!

(3) Everything is drop-shipped for you. You have no merchandise to carry—no capital tied up in inventory. All merchandise is stocked and shipped for you by Mail Order Associates or the manufacturer. You forward orders and your own shipping labels to M.O.A. and all merchandise is sent direct to your customer — using **YOUR OWN LABEL**.

(4) Up to date mailing lists are made available to you. Lists of proven mail order buyers are compiled for the market you select. Records are kept so that no two distributors use the same names. All names are supplied on gummed labels — all you do is apply them to your catalogs.

(5) A consultation service is provided to answer any questions you may have. In addition, you're supplied with a list of leading national magazines that provide free editorial write-ups. You're even given form letters to use to obtain free advertising of your products from these magazines.

(6) Your choice of at least four new mail order programs during the year. One may be a catalog of baby items, another on household gadgets, etc. You may select one or as many as you can handle.

Here's how they operate: Unlike the individual mail order dealer who looks for the ideal product, M.O.A. searches the market first! After making surveys and tests to determine a profitable mail order market, they select the products to suit the market. For example, the market of selling baby items to new mothers is a big one. Over four million babies are born in the U. S. each year. This is the first step in selecting a mass market for their franchised dealers. Then comes the selection of products to suit this market. They contact every manufacturer of products sold to new mothers. From thousands of items offered by various companies, only those suit-

able for mail order are selected for preliminary tests. The final survey is made for new novelties and products not yet manufactured! If they feel certain ideas for new products have merit, they'll manufacture the items on a royalty basis and produce them for their dealers exclusively!

From this preliminary selection of new mail order products suited to this particular market, they make actual tests to see which items will sell and produce the greatest profit for their



The thrill of receiving money in your morning mail is one you'll never tire of.

franchised dealers. Having finally selected the best products they begin layout and artwork on a new mail order catalog for their dealers. The final catalog may consist of a small 6 x 9 brochure, a large 8½ x 11 illustrated booklet or even a small one page self-mailer, depending upon the market and selection of products. Sales letters are prepared by experienced copy writers, and the complete job—layout, copy and printing is done by experts to produce professional results.

By purchasing merchandise in large quantities and running catalogs on large presses, they are able to offer their dealers complete backing at a fraction of the cost the individual would have to pay for the same job.

The final step is to supply the franchised dealers with names of prospective customers! In this particular example, they would make available the names and addresses of over 7000 new mothers every day!

Although many mail order firms use magazines and newspapers to advertise single items, the larger established firms have proven that direct mailings to prospective customers and previous mail order buyers is far more profitable.

A notice is then sent to all franchise holders explaining in detail the complete sales program for the particular market covered. The dealers then have the option to accept the offer or wait for a complete new sales program set up for a new market. At least four complete new sales programs are prepared by Mail Order Associates each year.

If the dealer decides to go ahead he may begin ordering catalogs (his personal name or business name is printed on all sales literature), and mailing them to his lists of prospective customers. As he receives orders for merchandise he simply forwards the orders together with addressed shipping labels to M.O.A. and they fill the orders and mail direct to his customers with the dealer's shipping label attached to each parcel. In some cases M.O.A. prepares a catalog of merchandise which manufacturers have agreed to drop-ship for the dealer. Mail Order Associates simply turns over this list of firms to the dealer and he works directly with the manufacturer. The customer pays the dealer the retail price of each item in the catalog. The dealer in turn pays M.O.A. or the manufacturer only the wholesale price of each item and pockets the difference—which really adds up when you mail a few hundred catalogs a week.

The operation of Mail Order Associates is based on a small margin or profit, but tremendous volume, which spells BIG PROFITS FOR ITS FRANCHISED DEALERS.

Mail Order, however, just as any other business, does involve a certain amount of risk. But the initial investment required is relatively small (\$80-\$100) compared to other businesses. By eliminating the initial cost of stocking merchandise and preparing expensive catalogs, M.O.A. dealers can keep their initial investment to a bare minimum. On the other hand, few other occupations offer such exceptional income potential as a small specialized Mail Order business. The important thing to remember is that in Mail Order like everything else, the person who works hard and is not easily discouraged has a good chance of succeeding.



Big firms will carry all stock for you. They ship orders direct to your customers using your own shipping labels.

Your OWN Catalogs of Top Mail Order Items!



Mail Order Associates will prepare your catalogs, write your sales letters, supply mailing lists and even ship merchandise for you, using your own shipping labels!

We don't say you'll be a mail order millionaire or another Sears & Roebuck, but if you're looking for a business of your own with a potential income of \$50,000 per year the answer is mail order.

MAIL ORDER ASSOCIATES

Gilbert Turk, founder of Mail Order Associates, is certainly well qualified to head such an organization. Formerly president of two large mail order companies, his articles on selling by mail have appeared in national magazines throughout the country. He has sold everything from build-it-yourself plans to name brand appliances. When the paint-by-numbers fad was

sweeping the country, he invented a three dimensional paint set which sold like wildfire. With Turk, Mail Order is almost an obsession. He thinks, talks and lives it.

Firmly convinced that no other business offers the tremendous opportunities of mail order he is an outspoken advocate of the man or woman who wants to start in business for himself. As Turk puts it, "By all means, start your own business and start TODAY! If you want security, independence and a chance to hit the jackpot, make your choice Mail Order. There's nothing like it. Absolutely nothing!"

FOR FREE DETAILS

Mail coupon below today

Mr. Gilbert Turk, Pres.
MAIL ORDER ASSOCIATES
Dept. PM-84, 130 W. Pleasant Ave., Maywood 84, N. J.

Dear Mr. Turk:

The co-operative dealer franchise plan with Mail Order Associates sounds exactly like the kind of lifetime business of my own I want to establish. Please send me complete FREE details on how I can get my own franchised dealership.

NAME _____

ADDRESS _____

CITY _____ ZONE _____ STATE _____

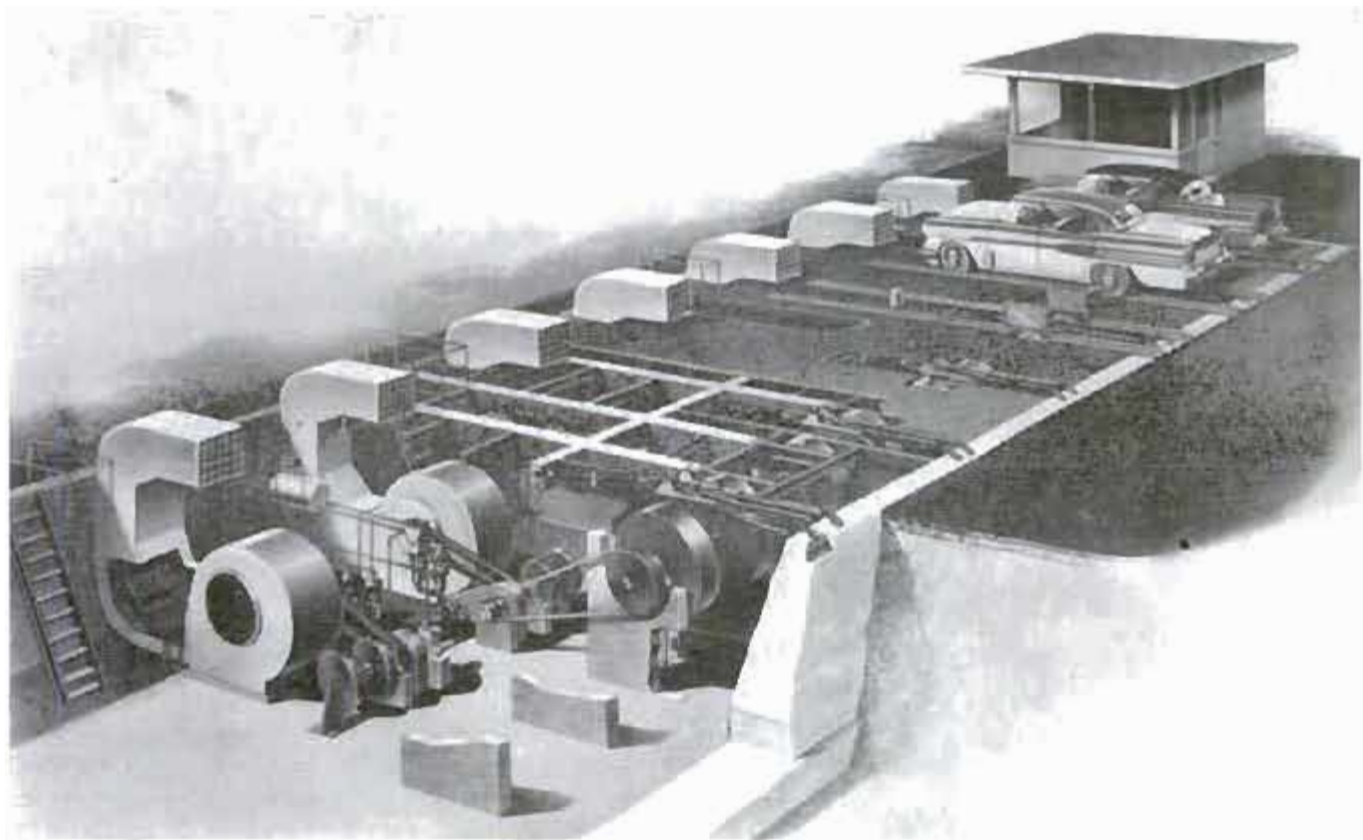

One Man "Road Tests" Eight Cars at a Time on Treadmill

IT TAKES ONLY ONE MAN sitting in a control room to run realistic "road tests" of as many as eight cars at a time at the Esso Research Center in Linden, N. Y. Magnetic tape recordings control the operation of cars and can be recorded for any type of driving desired. The recordings are made on actual road tests and then played back to control the cars on the treadmill.

The rear wheels of the cars rotate rollers which, in turn, spin huge blowers that provide the load for the tests and also provide cooling air across the radiators. Incidentally, the road tests reveal that rock-and-roll music on a car radio can reduce gasoline mileage as the driver unconsciously jiggles his foot to the music's rhythm.

...





NEW PERFECT CIRCLE ROAD TEST SIMULATOR... another first in power protection for your car!

Remarkable Perfect Circle development tape-records actual road test, electronically duplicates exact engine operation on the test stand!

Perfect Circle's new Road Test Simulator records hours of test driving over all kinds of roads in all kinds of weather and reproduces the test right in the engine test lab...electronically.

Weeks of testing are accomplished in days to speed engine improvements and give you the very best piston rings obtainable—Perfect Circles!

Other Perfect Circle firsts include famous PC 2-in-1 Chrome piston

ring sets. Top rings and oil rings are plated with thick, solid chrome. Entire area of ring travel gets complete wear protection, *more than doubling* life of cylinders, rings, and pistons. No tedious break-in is necessary—rings are pre-seated at factory.



New Perfect Circle Valve Seals stop oil loss through valve guides of overhead valve engines. For best performance, valve or ring jobs should include installation of Perfect Circle Valve Seals. The cost is surprisingly low.



**For full power protection
insist on Perfect Circles!**

PERFECT

Hagerstown, Indiana



CIRCLE

Don Mills, Ontario, Canada

2

WRITTEN SO YOU CAN UNDERSTAND IT
VOL. 111 NO. 1

1

3

4

5

6

Key points in Seaway include: 1. Wiley-Dondero Canal, with Eisenhower Lock above it and Snell Lock below; 2. Long Sault Dam; 3. Barnhart Island; 4. Robert H. Saunders-St. Lawrence Generating Station (the Canadian half) and the Robert Moses Power Dam (the United States half); 5. Cornwall, Ont., 6. old Cornwall Canal

Photo courtesy Power Authority of State of New York

STAIRWAY to the SEA

*Reprinted
"PM Highlights"*

This is the year that the St. Lawrence Seaway opens its gates to let ocean liners and freighters sail the lakes—an epochal feat of engineering and of international cooperation

By Richard F. Dempewolff

FOR THE PAST FOUR YEARS, a Canadian-American army of mud-begrimed men in hard hats, numbering at times up to 22,000, has been digging a king-size ditch. To the clatter of jackhammers, the rumble of more than 150 giant shovels and draglines, and the roar of an endless stream of earthmovers, they have ground deep into

the ancient bedrock beneath a brawling 180-mile section of the St. Lawrence River. Behind miles of protective dikes and cofferdams, their clanking steel monsters have gouged out footings for a string of big dams, massive concrete locks and many super powerplants.

In early spring, when the last of the mud



Lake steamer leaves Eisenhower Lock and moves on its way to Snell Lock, about three miles downstream

has settled in the miles of canyonlike channels they have carved, and the last raw earth embankment has healed under a new hide of turf, the St. Lawrence Seaway will have become a Gargantuan \$1,090,000,000 reality.

Unlike the 50-mile Panama Canal and the 100-mile Suez, the world's third great

inland seaway (built jointly by the United States and Canada) is a two-fisted giant. The mighty dams that back up its rapids into usable waterways also harness the once-wild river, steering it through batteries of sluice gates in two big power dams. One of these is second only to Grand Coulee. From its rumbling generators,

Cross-section of the Seaway from Lake Superior to the Atlantic Ocean shows relative location of the locks.

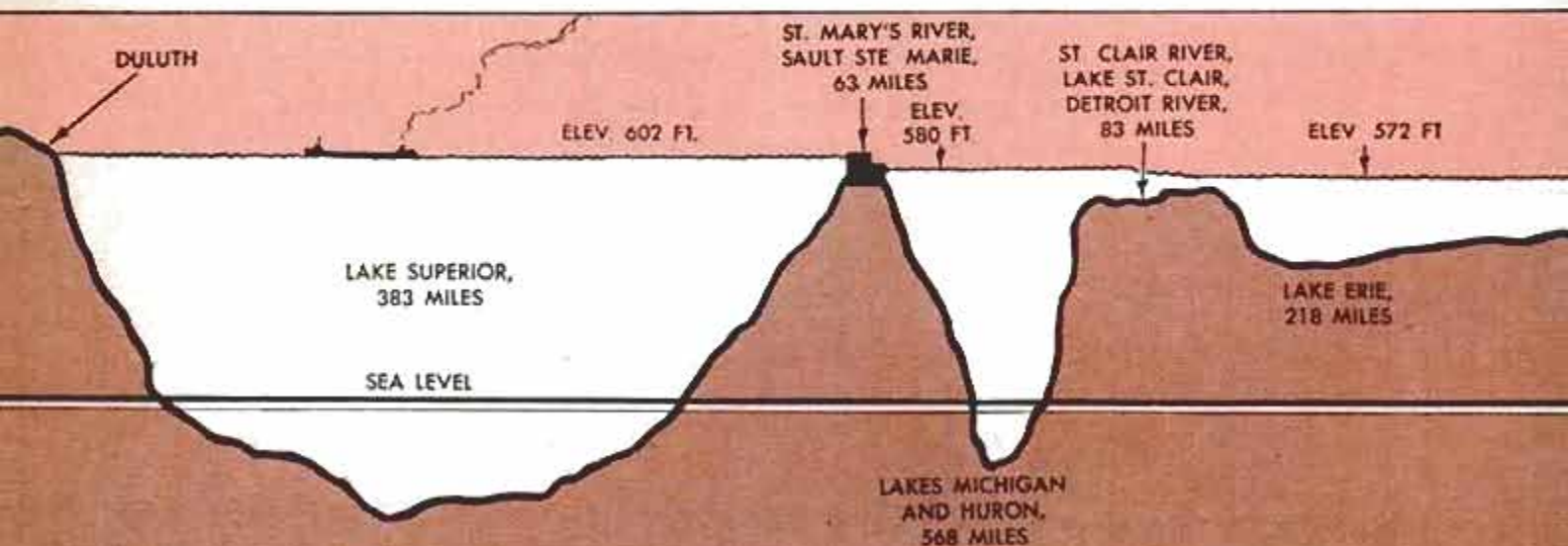



Controls for lock valves and gates are on console. Warning lights prevent operator from making mistakes

1,800,000 kilowatts of electricity will be fed into the power grids of Canada and the United States.

No less dramatic in its implications is the waterway created by the great dams. For the first time, deep-draft ocean ships will be able to sail 2370 miles from the Atlantic to the heart of North America. Midwest-

ern cities fringing the Great Lakes' 8300 miles of shoreline will become true sea-ports. Cities like Chicago, Duluth, Milwaukee, Detroit, Cleveland and Toronto are destined to become world ports. You may climb aboard a passenger liner at Chicago, and sail to Liverpool, Bremerhaven, Cherbourg, Singapore — or where

Water level drops more than 600 feet, most of it within the 360 miles between Lake Erie and Montreal

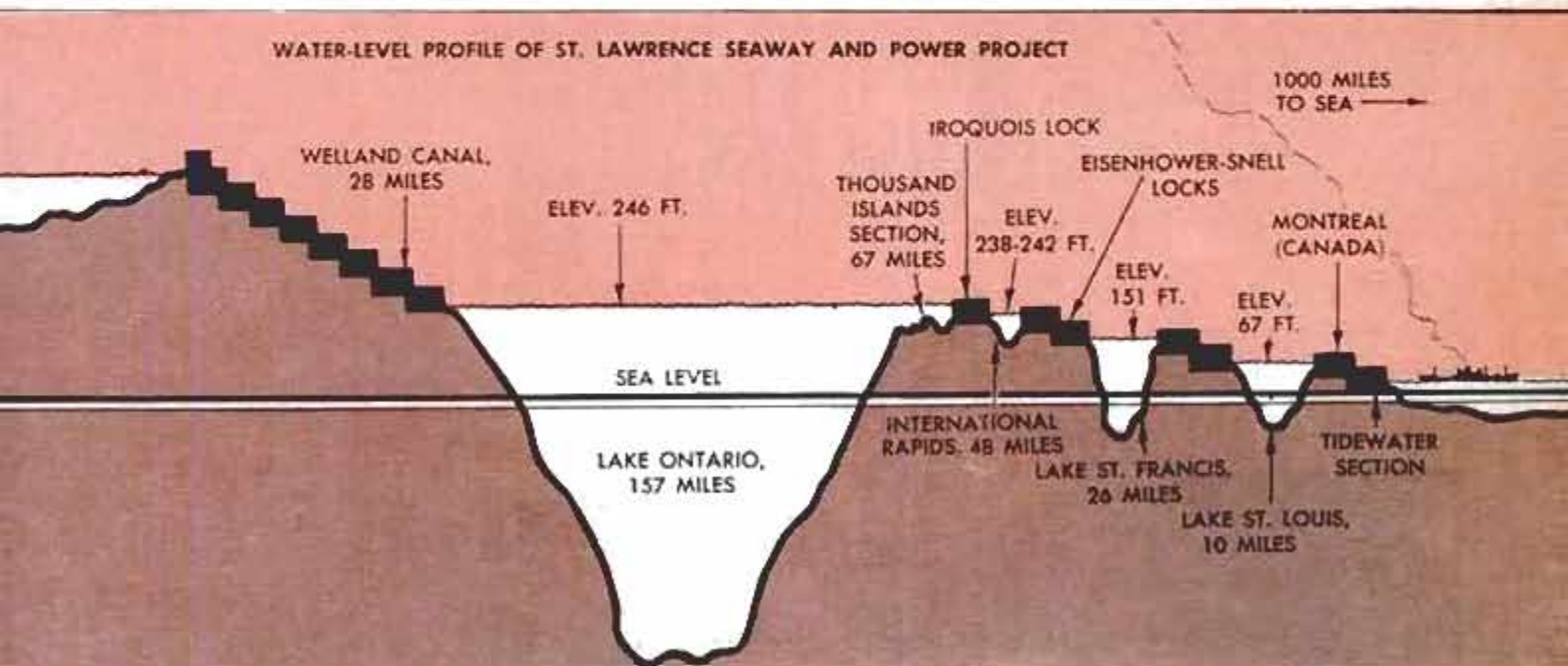

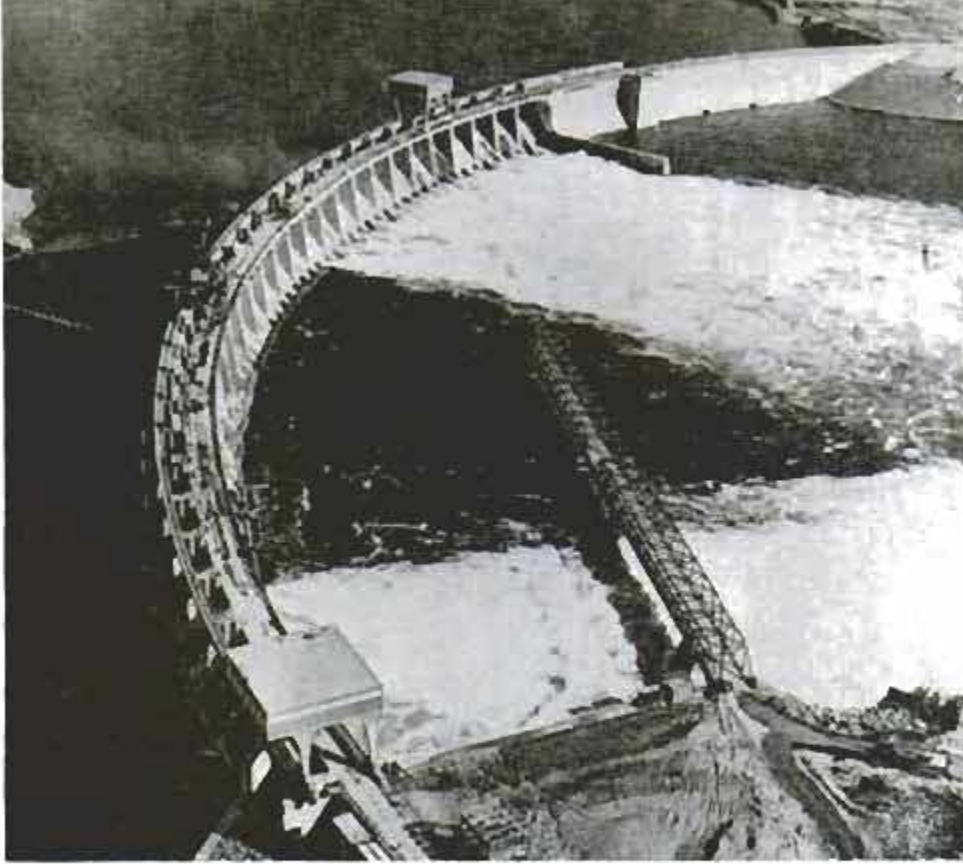

Water roars from both sides of nearly completed Long Sault Dam. Bridge downstream was used by earth-movers to reach a cofferdam during construction. The bridge will be removed later

you will. The Dutch-owned Fjell-Orange Line already has launched one passenger-cargo liner, with accommodations for 110, for the Great Lakes trade. Another is on the ways. Fare? About \$180 to Europe one way, they say.

You get some inkling of the staggering size of this project when you realize that the engineers had to devise a way to lift an ocean liner the height of a 60-story skyscraper, for Lake Superior sits 602 feet above the Atlantic. The St. Lawrence River and its Great Lakes headwaters, draining a land mass greater than Britain and

France, make this drop in a series of steps like the cascading water in a tiered fountain. What the Seaway does is climb over those tiers on a series of great locks—huge “stairs” with water for treads.

Coming in from the Atlantic, a ship will steam up the broad Gulf of St. Lawrence and into the narrowing river as far as Montreal. Two miles below the Jacques Cartier bridge, the skipper will nudge his bow into a broad channel on the north side of the river. Massive 35-ton miter gates will yawn to admit his vessel into St. Lambert and Cote St. Catherine Locks—first

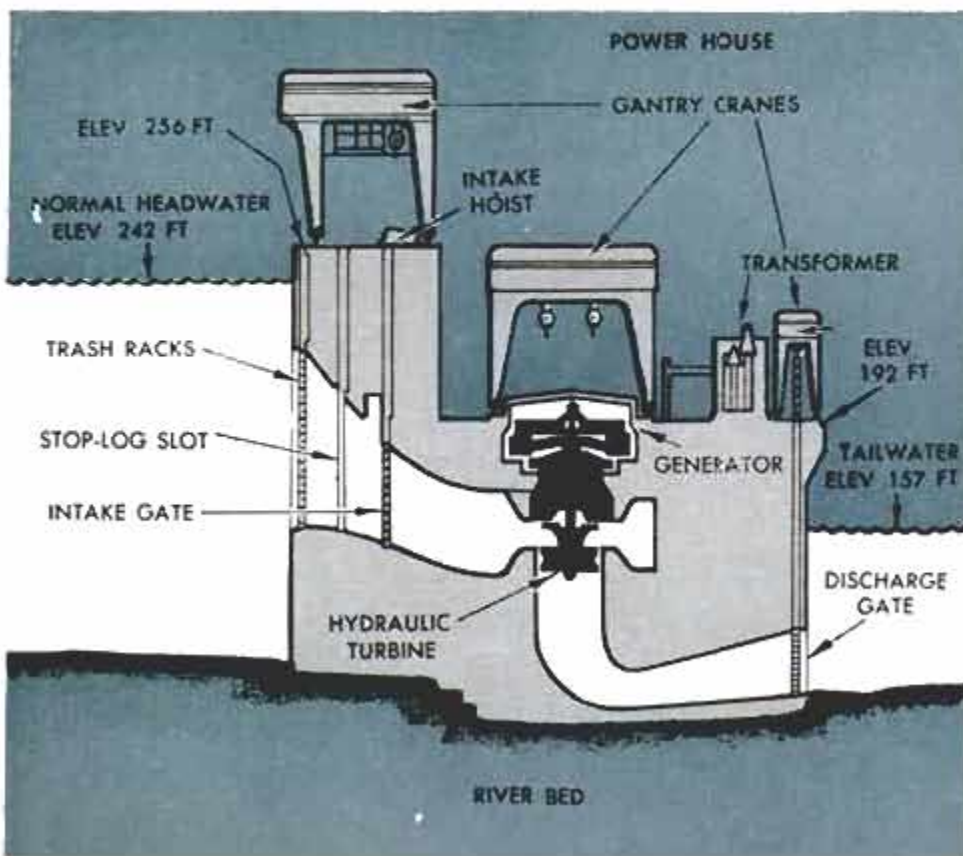

Cross-section of a Seaway generating station shows how water rushing from intake gate spins hydraulic turbine connected to generator. The gantry cranes are used to raise or lower gates

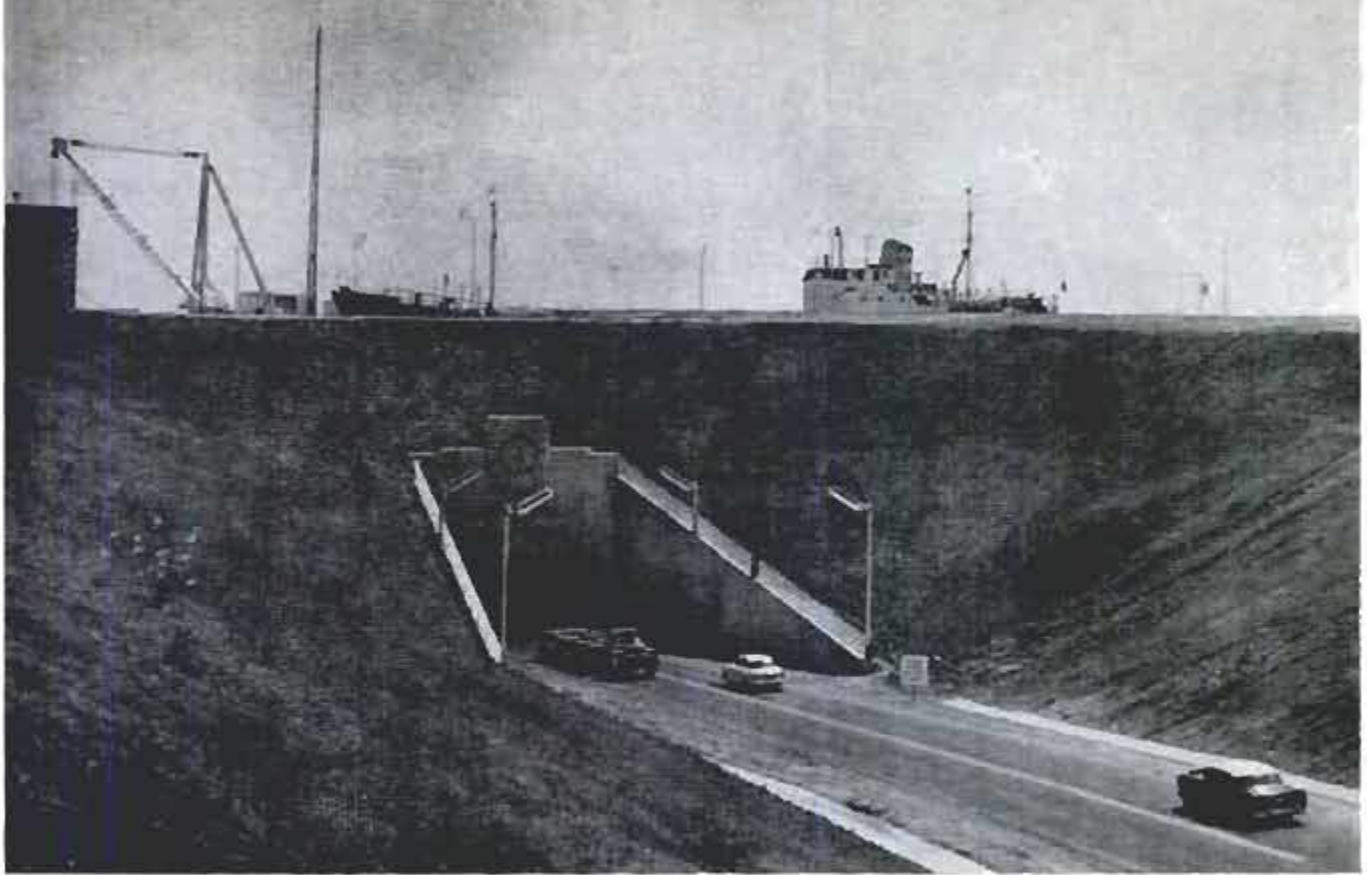

Vehicular tunnel permits trucks and cars to drive beneath ships at Eisenhower Lock on Wiley-Dondero Canal

two steps in the giant staircase. Like all the steps in the new waterway, these locks measure 800 feet long, 80 feet wide, with 30 feet of water over the sills. Allowing minimum clearance, a ship 768 feet long, 75 feet abeam and drawing 27 feet of water can squeeze in.

In two 25-foot leaps the ship will clear Lachine Rapids. Sailing up a broad pool in the river called Lake St. Louis, the ship moves westward toward Beauharnois

Locks, which hoist the vessel 84 feet to the level of a broad canal, carved in solid rock, that feeds Beauharnois Power Dam. On this pond, the ship glides into another broad stretch of river—Lake St. Francis. Up to this point, the new system is entirely Canadian-built.

Fifty miles upstream the ship signals for clearance at the Bertrand H. Snell and Dwight D. Eisenhower Locks, on the American side. These two hydraulic elevators

Huge turbine runner assembly for one of the dam's generators is moved into lowering position by gantry
Photo courtesy Power Authority of State of New York



Riding the top of power dam like giant four-legged stool is gantry crane that lifts and lowers gates





Innovation in the locks are mooring posts that slide up and down in slots in wall as water level changes

perform a 90-foot lift previously accomplished by 11 separate locks between the foot of International Rapids and the town of Iroquois, on the old Cornwall Canal that once accommodated small lake steamers. The old canals, locks and even the rapids themselves, lie deep under the placid water of a new lake, formed by water backed up behind mountainous piles of concrete—Long Sault Control Dam and Robert H. Saunders-St. Lawrence Generating Station

and Robert Moses Power Dam. These bulwarks, built through the combined efforts of New York State and Ontario Province, form the heart of the international seaway power giant. Between them they pile up a placid navigation pool for nearly 40 miles upstream, and use the 81 to 90-foot head thus created to spin the giant generators.

At the western end of this pool, another Canadian lock lifts the ship five more feet to Ontario-level waters behind Iroquois Dam, which controls the flow of water into the great power pool.

Ready crane at each portal would drop steel stop-logs on each side of the channel to stop water flow if gates were damaged

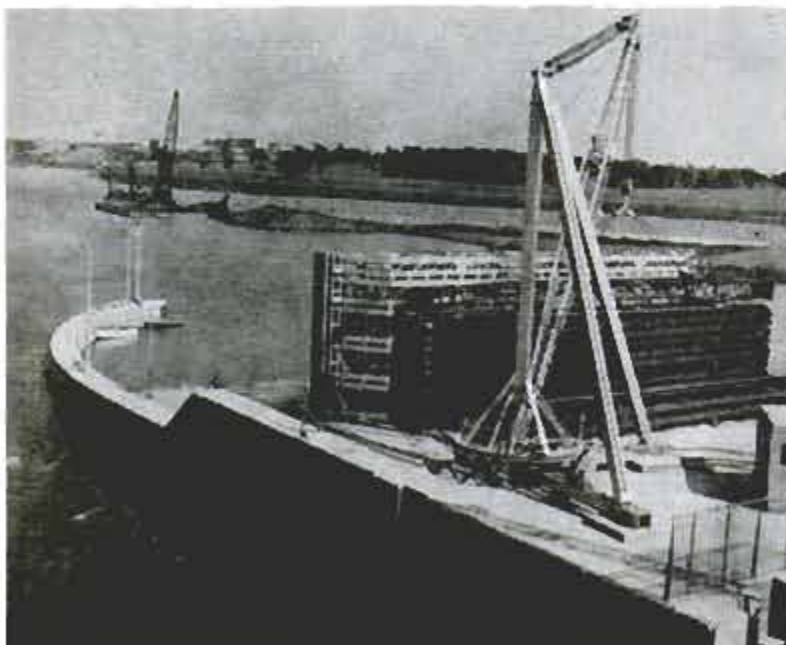

Across Lake Ontario comes the spectacular 327-foot heave. This is accomplished in Canada's 28-mile Welland Canal, bypassing the Niagara River with its falls and gorge. Four single locks, a flight of three double locks and one guard lock do the job. Opened in 1932 to replace a century-old 14-foot-deep canal, the present locks and channels have been deepened to conform with the new Seaway specifications.

Once atop the Welland, a ship has navigated all of the official Seaway. The Soo Locks, providing the final lift into Lake Superior at Sault Ste. Marie, form the top step in the long stairway. But all through the Great Lakes big

(Continued to page 270)



"Venetian Blind" Reduces Jet Noise With High-Pressure Water

Jet-engine noise can be suppressed by a "Venetian blind" unit that turns the plane's heat blast into steam. Placed 12 feet behind the jet's exhaust, the apparatus absorbs

the blast by ejecting high-pressure water through the first set of blinds. A second set deflects the reduced blast upward to final dissipation on a ramp.

Telescoping Dash Light Handy for Map Reading

Designed to blend with other dashboard devices is a telescoping light that can be pulled out for map reading. The lamp can be turned all the way around if it's needed to locate the ignition or to light the step. It fits in a one-inch dashboard opening.

Clothes-Drying Rack Hangs Over Bathtub

By hanging a wire rack directly over the tub, clothes can be dried in the bathroom without dripping water on the floor. When not in use, the rack can be unhooked from the uppermost fastener and lowered against the wall.

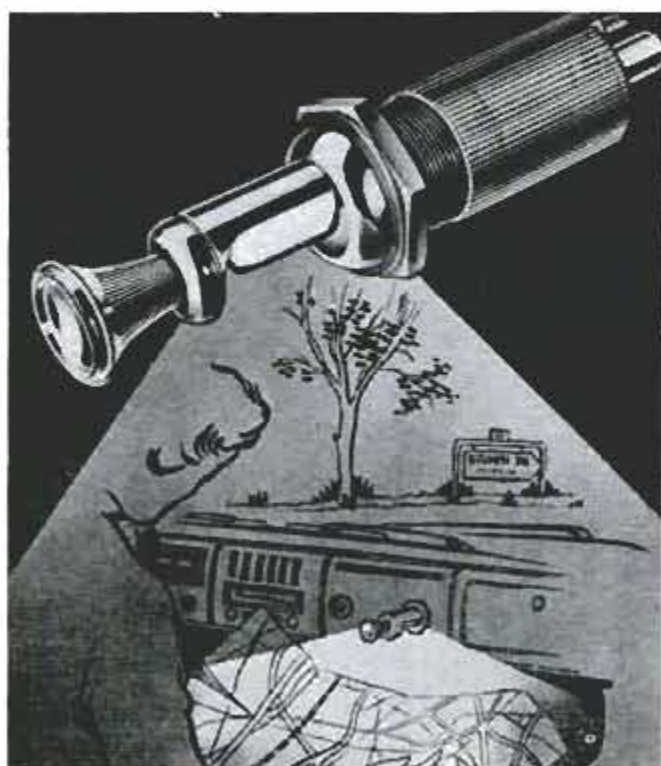

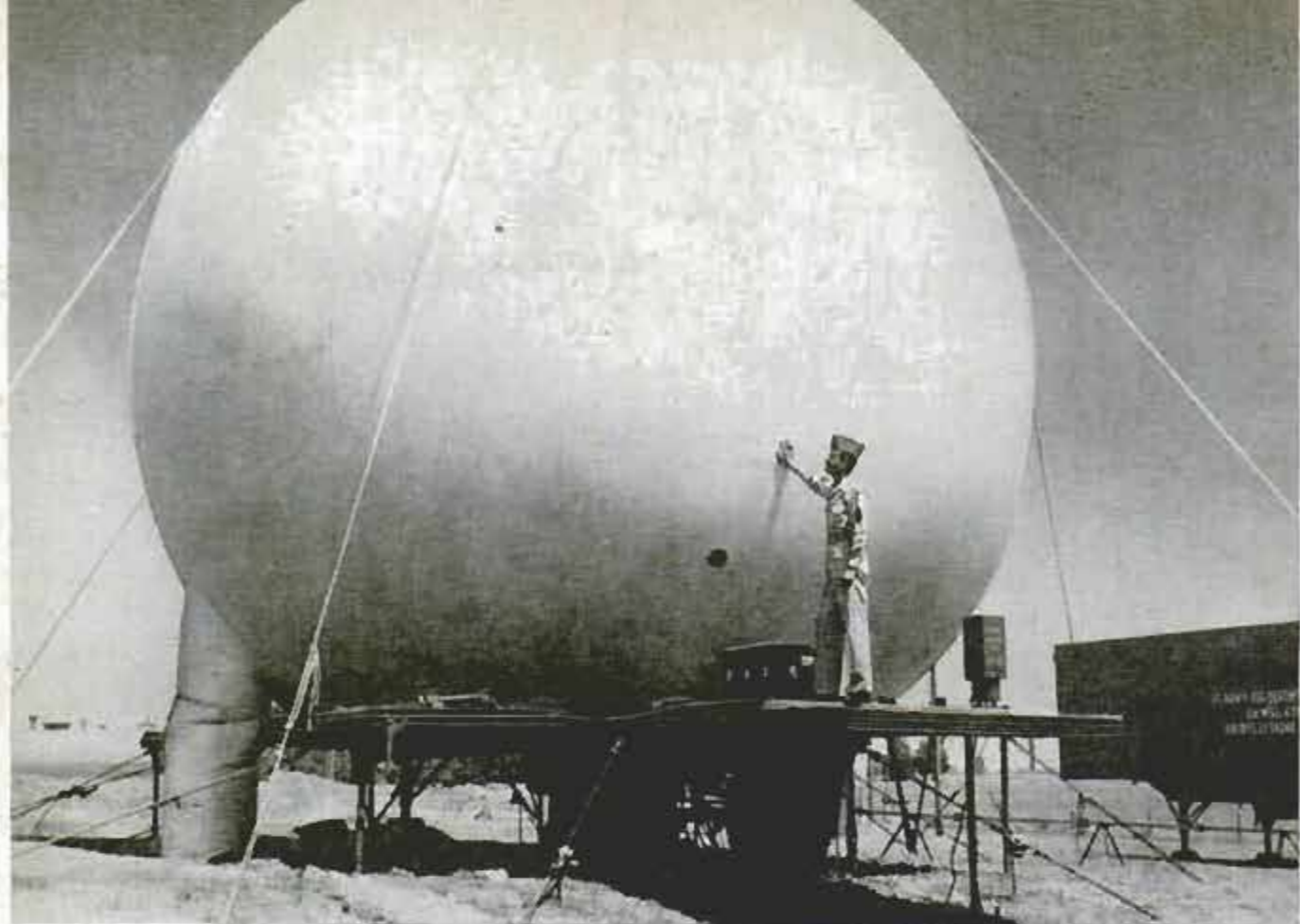

'Balloon' Houses 3-D Radar

AIRBORNE TARGETS are pinpointed as to distance, bearing and altitude by a new 3-D radar. Conventional radar systems yield no information on altitude. The new system, developed by Hughes Aircraft Company, can be moved in one equipment van, one power truck and an antenna trailer. At the radar site, air blowers are used to inflate a radome of rubberized nylon around the antenna. The dome, under slight air pressure, protects the antenna from wind, snow and ice. The information from the radar is displayed on two scopes; one gives target range and bearing, the other altitude. The information, in digital form, is fed to missiles for interception of targets.



PART II

IN ALL THE history of hocus pocus, no magician created greater turmoil than Houdini, master showman, when he made an elephant vanish at a pistol shot.

Houdini debuted with this illusion on the stage of the New York Hippodrome in 1918. A huge elephant was led up an incline and into a large cabinet. The open front of the box then was closed. The box was swung around on heavy wheels. Houdini fired a pistol. Presto—the box was empty!

At first, many thought a trap



Author Christopher places open box over Gary Moore's head

I Call These ...
**THE
GREATEST
MAGIC
ILLUSIONS
OF ALL
TIME**



Closing box, Christopher stabs knives into it from several angles, then opens box to show that Moore's head has vanished

door was used. That is, they thought so until they were reminded that directly under the stage was the huge water-filled tank which the theater used for bathing-ballet numbers. Besides, the box was raised off the floor.

The vanishing elephant was a masterpiece of stage magic, and will live in the annals of hocus pocus as long as magic survives.

The scientific secrets of illusions are zealously protected. The basic appeal of magic is mystery. Once the mystery is gone, there is no magic. By keeping their secrets hidden, wizards not only protect





Charles Morritt would display an empty cabinet, then produce an entire fox hunt in full view of the audience

their huge investments, but more important, keep magic alive as a diverting entertainment.

A prime example of such entertainment was offered more than 100 years ago when Robert-Houdin, the French innovator, baffled continental theatergoers with his "Suspension Ethereneene." Ether was then a mysterious new liquid. Robert-Houdin

uncorked a bottle under his son's nose. Fumes seeped through the audience. The wizard announced ether would make a body lighter than air. The boy fell asleep. Rods supported him under his armpits, and a stool kept his feet above the stage. The stool was removed. Then one of the rods was taken away. The boy remained suspended by a single slender rod under his

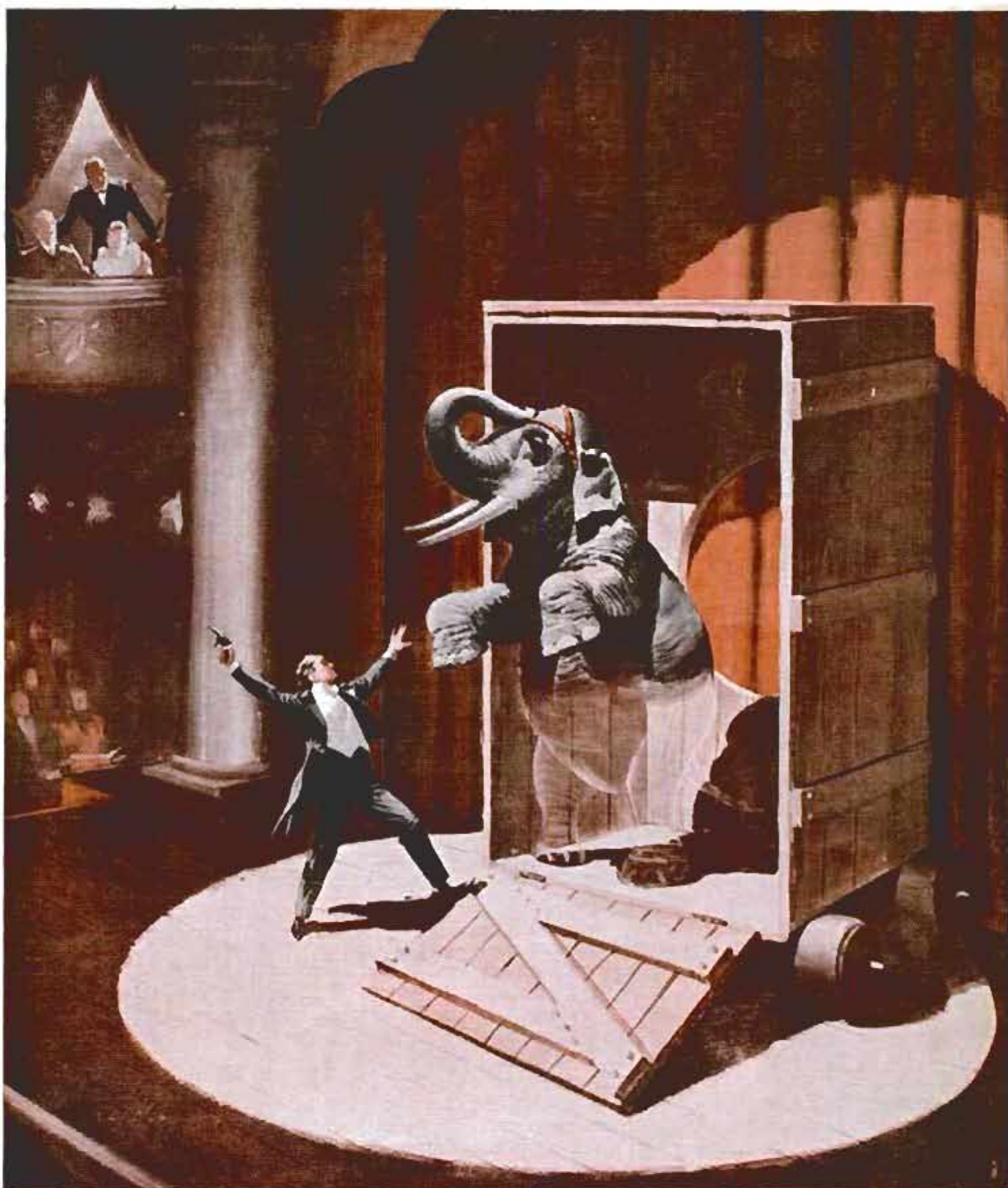

Houdini originated the most famous of all illusions, making a huge elephant disappear at a pistol shot

arm. He was lifted until his body was horizontal. Only his elbow touched the rod. Still he remained suspended. The illusion was a sensation.

When the properties of ether became better known, performers omitted it from their presentations. And after suspensions lost their novelty, it was inevitable that illusionists would cause their assistants to

float up, down and around the stage. John Nevil Maskelyne created a master method. Harry Kellar, the American, improved it. In his version of levitation, a hypnotized subject rose slowly from her couch at the wizard's command.

"Ah," thought many spectators, "wires or glass panels." But Kellar calmly passed a solid hoop over the floating body, then

tossed it down to the audience for examination.

Thurston, Kellar's successor, heard people say, "If only I could get closer to the floating girl, I'd discover the secret." He invited 20 or 30 spectators to come to the stage and watch her ascend from a few feet away. They were the most baffled people in the theater!

Large-scale sorcery is expensive to produce. Thurston told me that he spent \$50,000 to perfect the levitation. To the audience, there was no evidence of lifting power other than his words and the gestures of his expressive hands.

One of the greatest of the now-you-see-it, now-you-don't illusions was created by William Robinson, better known to the public as the Chinese magician, Chung Ling Soo.

A chair was suspended by two ropes from the top of a framework. A securely tied assistant sat in the chair. At a signal from the wizard the chair dropped to the stage—empty!

Charles Morritt, an Englishman, offered one of the most fantastic and colorful creations of all time. It was called "Tally Ho!" First he displayed a giant empty cabinet. It remained in full view on the stage. Then he fired a shot. Tally ho! To the stirring music, the production began. A fox darted from the box, followed by a pack of barking dogs, several huntsmen and a girl in riding habit on horseback. This incredible production of a complete fox hunt drew thunderous applause.

The Great LaFayette, a versatile quick-change artist, had one of the most elaborate productions ever staged, with magnificent scenery, his own musicians, a corps of assistants, dogs, horses and a lion. His greatest illusion was a playlet entitled "The Lion's Bride." A captured princess was thrown into a cage with a live lion as the action reached its peak. The lion crouched to spring. Timid onlookers shut their eyes. Suddenly, what was once a lion was now LaFayette, the conquering hero of the drama!

Horace Goldin made an illusion from the time-honored trick of rings in a nest of boxes. In the old trick, the wizard borrowed finger rings, loaded them into a pistol, and fired them at a box hanging at the side of the stage. When the boxes were opened, the rings turned up in the innermost container. Goldin used large, suspended boxes and added eye appeal with a girl instead of finger rings. He fired her



from a huge cannon. The climax came of course, when the girl was found deep inside the nest of boxes.

Perhaps the most frequently performed illusion in the world today is what is generally called the "Substitution Trunk." Houdini called his effect "Metamorphosis." The magician's assistant is handcuffed, then tied in a sack. The sack is locked in an examined trunk and tied with ropes. A cabinet is put around the trunk for a moment. The magician dashes inside the cabinet. In a split second the assistant dashes out. The cabinet is taken away. The ropes are untied, the trunk unlocked, the sack opened—and inside, securely handcuffed, is the magician. Top that one!

Boy Becomes Bathing Beauty

Steve Shepard, a California conjurer, has topped it with his latest illusion for water shows. A boy in a bathing suit is tied securely and locked in a trunk. The trunk is lowered into the water. After a brief, suspenseful wait, the trunk is hauled out. Has something gone wrong? The trunk is opened. The boy has vanished. Out pops a bathing beauty!

But what about that most discussed illusion of all time, "The Indian Rope Trick"? Here are the facts. An Arabian sheik, Abu Abdullah Mohammed, is the first known writer to describe it. He said he saw it performed about 1355 in Hangchau, China—not India. He said it was performed

1. One of the most famous of illusionists was Thurston, who presented an elaborate stage show. One of his illusions was a variation on the old mystery of slicing a girl in half. At left, blindfolded assistant is shackled to the sides of the cabinet

2. Thurston closes cabinet doors over center section of the girl's body. He then produces very thin metal plates, which he shows are made in one piece with no possibility of sliding sections. He inserts the plates to slice girl at her neck and knees

3. When Thurston opens the cabinet doors to prove that girl's body has been sliced, the audience discovers that her torso has completely vanished. Two assistants reach out through cabinet to demonstrate that the girl's body just isn't there any more

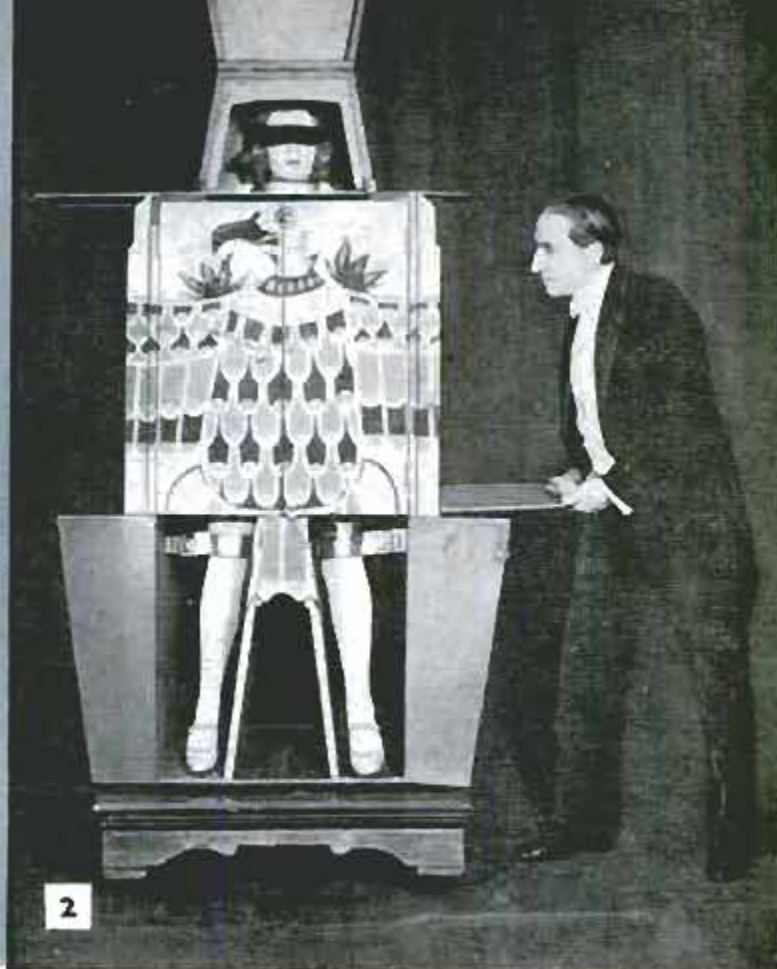

with a leather thong—not a rope. In his story, the boy climbed the thong to disappear from sight, and the wizard went up after him with a sword. Soon pieces of the boy's body fell from above. The wizard slid back into view. He gathered up the scattered anatomy and gave it a kick. Lo, the boy was whole again!

So, contrary to public opinion, the Indian Rope Trick isn't Indian. It isn't done with a rope. It isn't a trick, but an illusion. And the boy doesn't disappear.

Many wizards worked out stage versions, but to date, no magician has done it in the open air, away from trees or buildings.

Though the Indian Rope Trick may intrigue most people, the illusion that hopelessly fascinates me was advertised by a Mr. Ingleby in Birmingham, England, in 1806. I have the original handbill in front of me as I write:

"He will take two new-laid Eggs, the Whole of the Company may examine them, and any Person in the Room may break them, and a Child shall come out of one, and a Set of Bed Linen out of the other."

Matter of fact, Mr. Ingleby could skip the bed linen and I'd still give him the crown! ★ ★ ★





Operator, seated at a remote television monitor, watches X-ray images of parts passing down assembly line

Inspector Checks X-Rayed Products on TV Receiver

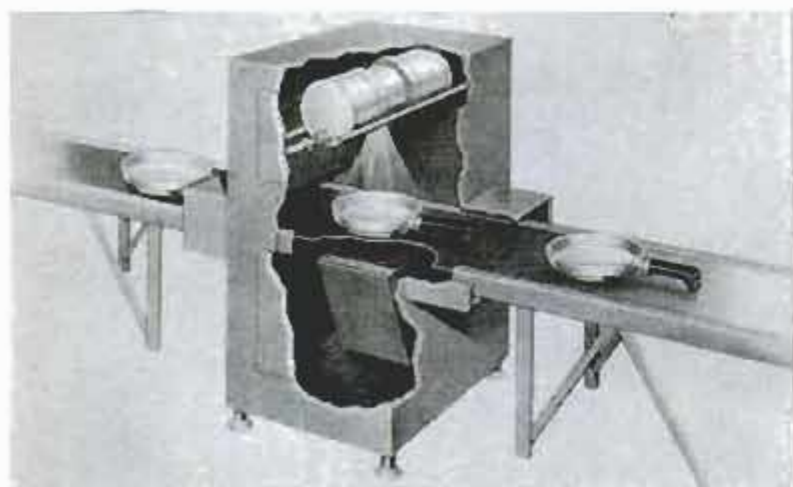

X-ray unit plus the special TV camera can be installed almost anywhere on the line to inspect hidden parts of the product. Faulty circuit can be spotted in X-ray of electronic unit

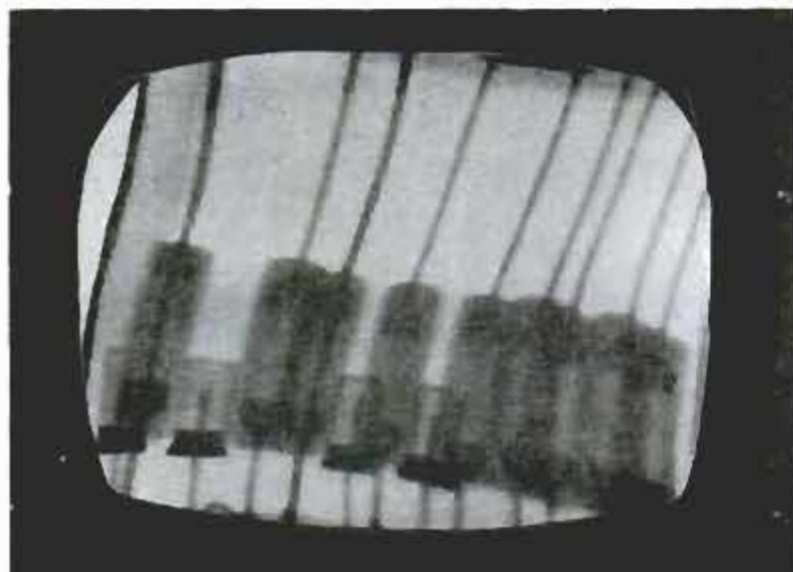

MANUFACTURERS now can "peer inside" their products with "X-ray eyes" to make routine inspections. Every product moving down an assembly line can be X-rayed on a continuous basis. The new technique is made possible by coupling a closed-circuit television system with the X-ray equipment. The system, developed by General Electric, makes it possible for an inspector to sit in front of a television screen in another part of the building and check each product even though it may be sealed inside a metal container. Fluoroscopes have been used for some time to inspect products, but the inspector could work only in a darkened room for short periods of time. The new equipment consists of an X-ray-sensitive TV camera, a control unit and a viewing monitor. It can be used with any standard X-ray generating apparatus. The camera picks up the X-ray image and passes it to the control unit, which feeds it to the 12-inch picture tube. Ordinary TV receivers may be added to the system, making possible simultaneous observations from separate locations. The system is expected to be particularly useful in checking aircraft parts and sealed electronic units.



Piggyback Bridge Eliminates Trestle Supports on Highway

When U.S. Highway 40 was widened at Auburn, Calif., engineers found the steel supporting towers of a railway trestle blocking the road. To clear the roadway,

they built a 240-foot-long "piggyback" bridge on concrete pillars beneath the trestle. The trestle is now supported by the bridge.

Carbon-Monoxide Detective

Meters that can detect one part of carbon monoxide in 50,000 parts of air protect motorists who park in Hamburg, Germany, underground garages. The device automatically turns on electric air circulators which remove the poisonous fumes.

Robot Fire Fighters

Automatic fire-fighting equipment has been installed at the Cape Canaveral rocket-launching site. Remote controls in a bunker a quarter mile away can raise or lower the streams of foam, rotate the nozzles or change the width of the stream.

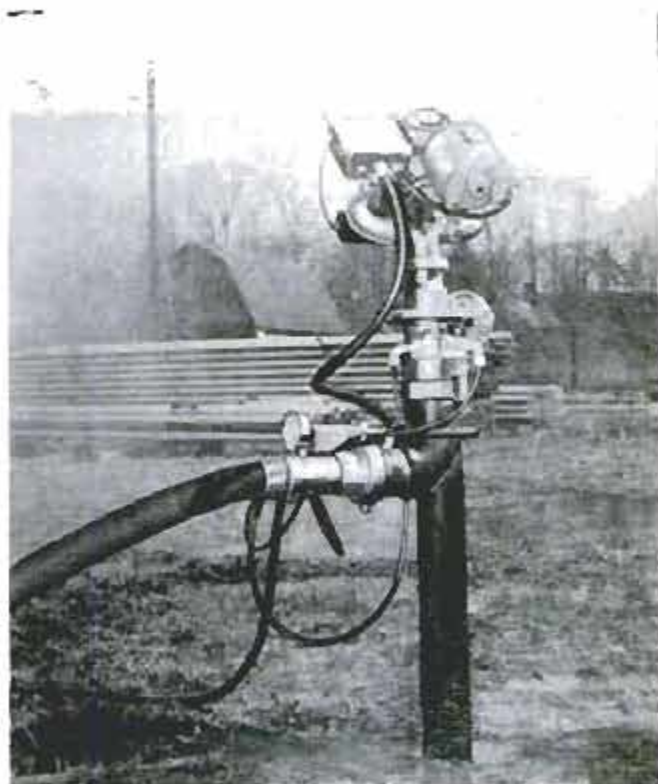
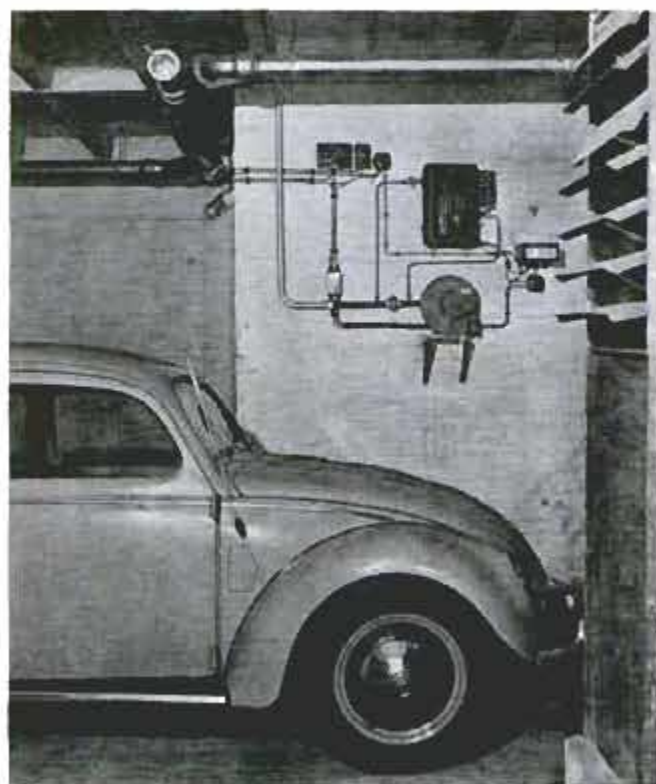

Whirlybirds Reseed Forests



Families are earning extra money picking up pine and fir cones and selling them for their seed values

By Homer Hathaway

A NEW METHOD of reforestation used by Weyerhaeuser Timber Company, Tacoma, Wash., is giving hundreds of families in Oregon and Washington the opportunity to earn "pin money."

The method employs helicopters, affectionately known as "whirlybird cowboys," to spread the seed, while the families get into the act by hunting fir and pine cones to sell to the company. The cones are valued for their seeds. A filled, two-bushel sack brings anywhere from \$4.50 to \$20, depending on the type of cones inside. Last year, families and youth groups in the area earned about \$90,000 cone-hunting.

The cones must come from specific areas, because company research has shown that seeds will thrive best when planted at the same elevation as the parent tree, and under similar conditions.

Reforestation gets under way just as soon after logging operations as possible. Often the area to be reforested has to be plowed, or scarified. Large bulldozers push down the brush left after logging, since brush can choke out the seedlings. The dozer blades leave an exposed mineral soil in which the seeds find a good place to grow.

Chemical sprays, applied by helicopter, are another means used to kill off the com-

peting brush. The helicopter, saving many man-hours in brush eradication, has also proved to be the ideal method for the re-seeding part of the project.

Flying at a speed between 45 and 60 miles per hour, the helicopter never flies higher than 200 feet above the ground on seeding operations. The helicopter's maneuverability is advantageous in areas where it has to dip down between high canyons and mountain ridges.

On each side of the helicopter's bulbous "eye" is a seed tank or hopper that has a 200-pound capacity. Just below each hopper is a power-driven meter for controlling the rate of seed flow. Air tubes from the outlet of the meter lead to a center-mounted, hollow disk, called a slinger, which is driven from the engine shaft. The slinger rotates in flight, distributing seeds in a 90-foot swath.

The seed tanks are loaded evenly to maintain balance when the copter is aloft. While in flight the pilot listens to an instrument that transmits the vibrations of the seeds leaving the slinger. It tells him when all the seed has been distributed from the tanks.

Since the seeds are scattered at the same elevation as the parent tree, the helicopters are loaded with seed for only one 500-



In reseedling, helicopters never fly higher than 200 feet. Their speed is between 45 and 60 miles per hour

foot elevation level. Before they reseed another level, they must return to the ground for a new supply of seed.

Seed is generally scattered at the rate of one pound to an acre. It takes more than 40,000 seeds to make a pound, so an area one-mile square would receive about 25,000,000 seeds. They are sown in a cross-flight pattern that requires two flights over the area, with the second run at approximately right angles to the first. This is the best way yet devised to provide an even distribution of seed. An acre of ground can be covered in about 15 seconds.

An effective method of rodent control has been developed to discourage this traditional enemy of seeds. With chemical repellents on the seeds, rodents gradually develop a distaste for the seed that normally is their favorite fare.

The helicopter method of seeding has proved itself in two ways: It is much easier than hand planting of seedlings, and it is more practical. Hand planting takes many hours of labor, while the helicopter cuts labor down to minutes.

The operation is part of a long-range forestry program called "Operation Rehab," which has two objectives: To return to production those lands that do not adequately restock after being logged, and to reclaim old timberlands that have been lost to active production because of fires and brush encroachment. ★ ★ ★



Seed tanks are behind helicopter's "eye." Below, slinger throws seed in 90-foot swath at the rate of one acre in 15 seconds

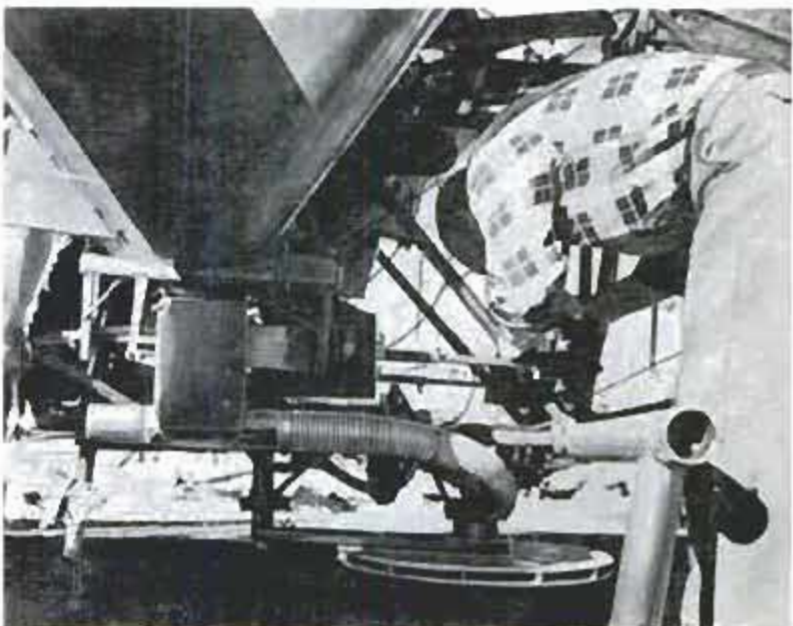



Retractable Dome Will Cover Arena

Both indoor and outdoor events can be staged in a new Civic Arena planned for downtown Pittsburgh. The auditorium, which will seat up to 14,000 persons, will have a retractable roof of stainless steel. The roof will be composed of eight sections, two stationary and six movable. The pictures show the auditorium with roof open and closed. The dome will require about 200 tons of steel.



Cook and Eat "Dogs" While You Drive

Now there's no need to interrupt long motor trips with food stops—if you can exist on a diet of hot dogs, that is. A compact two-barrelled heater plugs into the cigarette-lighter socket and heats two frankfurters at a time. Buns are toasted by placing them atop the heater while the dogs are cooking. It takes about seven minutes to get the first pair of dogs to sizzle, but after that the heating time is reduced to about four minutes, according to the manufacturer.





TV Watches Tots For Motel Guests

Television is the "baby sitter" at a Florida motel. A camera suspended from the wall is trained on the sleeping child. Through closed-circuit TV, a nurse sitting in a central room can tend five children at once. She can speak and listen through an intercom system. If a child cries or doesn't heed instructions, she dispatches an employee to give personal supervision.



Japanese Police Station Designed With "Peaceful" Motif

Something new in the way of police stations is a circular, glass and brick-wall structure in downtown Tokyo. The designer, Professor Kichiro Taniguchi, insisted

that the building be surrounded by flowers, that birds be kept in a cage to create a peaceful atmosphere and that all policemen assigned to the station be "handsome."



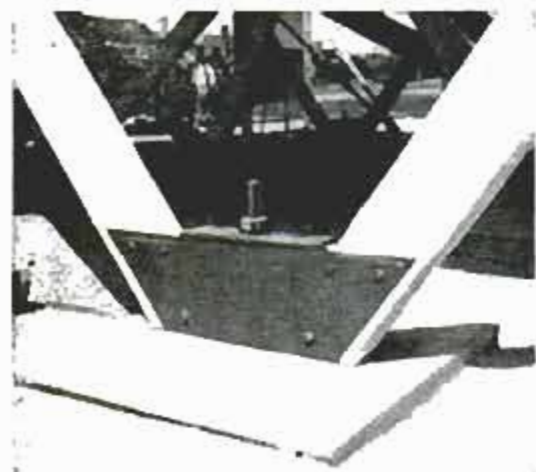

“Hurricaneproof” House on Stilts

Designed to withstand hurricanes and tidal waves is a house on nine-foot-high stilts at North Dartmouth, Mass. The stilts actually are part of a V-strut foundation intended to hold the house in place against the impact of rushing water. The V-struts are anchored to concrete piers buried deep in the ground. Two-inch bolts embedded in the concrete have a shearing strength of 40,000 pounds per square inch. The struts are made of 4 by 10-inch lumber. Screw-threaded nails fasten sidewalls to the studs and framing of the five-room house.

Navigation System Traces Flight Path of Helicopter



Helicopters have their own navigation system, now under evaluation by the Airways Modernization Board. In front of the copter pilot is a pictorial map of his regular route. During his flight, a stylus moves across the map, constantly showing his present position and the path he has flown. The system automatically measures radio transmissions from a chain of stations along the route. It is designed primarily to expedite helicopter operations in busy terminal areas, and is under test at New York City airports.

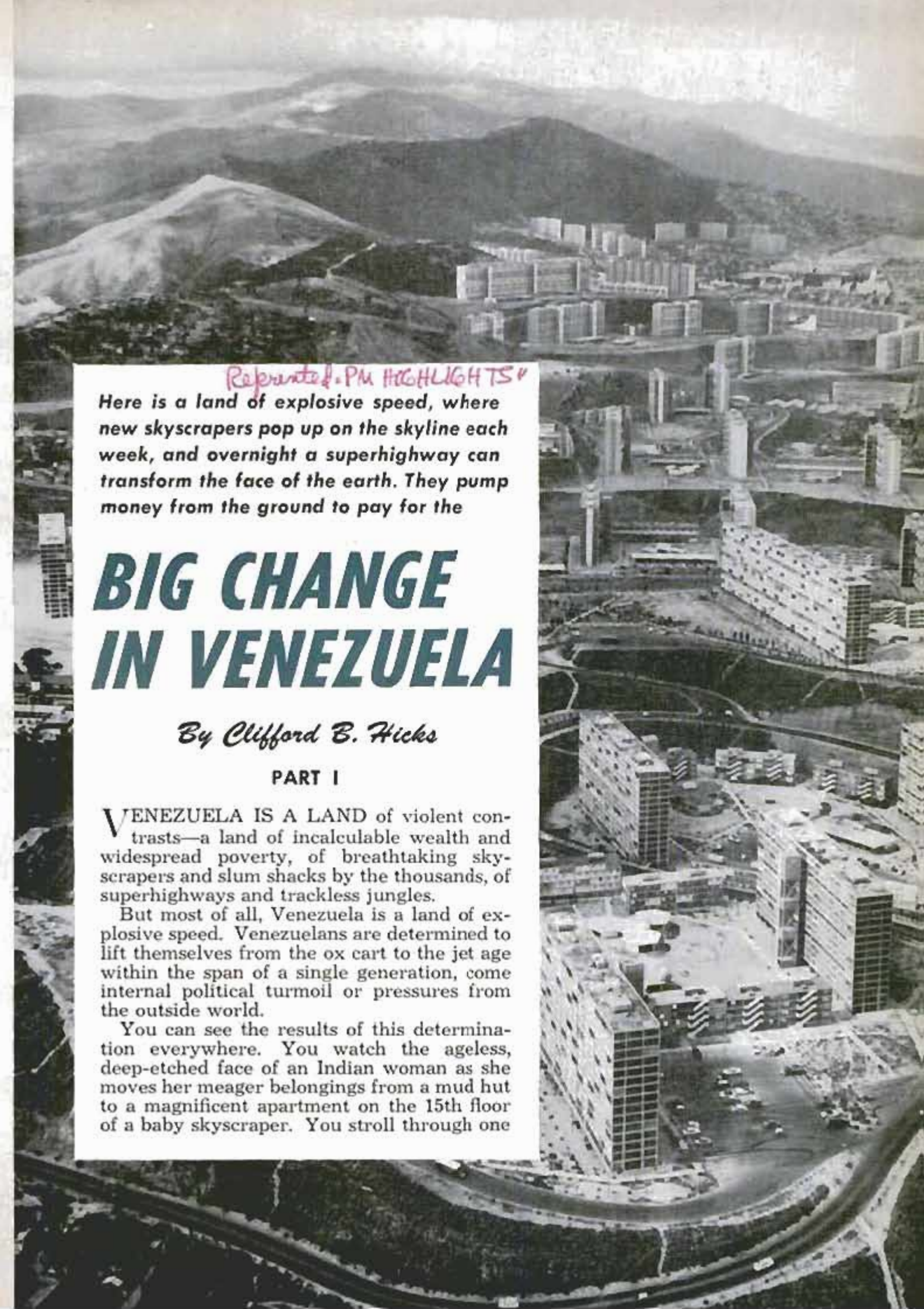

Reprinted from PM HIGHLIGHTS

Here is a land of explosive speed, where new skyscrapers pop up on the skyline each week, and overnight a superhighway can transform the face of the earth. They pump money from the ground to pay for the

BIG CHANGE IN VENEZUELA

By Clifford B. Hicks

PART I

VENEZUELA IS A LAND of violent contrasts—a land of incalculable wealth and widespread poverty, of breathtaking skyscrapers and slum shacks by the thousands, of superhighways and trackless jungles.

But most of all, Venezuela is a land of explosive speed. Venezuelans are determined to lift themselves from the ox cart to the jet age within the span of a single generation, come internal political turmoil or pressures from the outside world.

You can see the results of this determination everywhere. You watch the ageless, deep-etched face of an Indian woman as she moves her meager belongings from a mud hut to a magnificent apartment on the 15th floor of a baby skyscraper. You stroll through one

AUTOMOBILES



of the world's most modern and beautiful universities with a student whose cousin, deep in the interior, lives a hundred miles from the closest elementary school. You watch Jaguars by the dozens wheeling along the Autopista, and at the same moment, deep in the jungle, a naked Indian is stalking his kind of jaguar with a blowgun.

Venezuela also is the land of the incredible statistic, for only statistics can show the magnitude of the people's efforts to raise themselves to the jet age overnight. Venezuelans love to quote statistics to prove the

magnitude of their effort. Here are a few:

- In the short span of 10 years, 200,000 people will have been moved from shacks into magnificent apartment buildings.

- A huge complex of chemical factories, built in less than three years, soon will be turning out 180,000 tons of fertilizer per year (more than three times Venezuela's own requirements) along with plastics, synthetic rubber and industrial chemicals.

- In just 18 months, thousands of workers and machines toiling day and night moved more than 15 million cubic yards of



SISAL

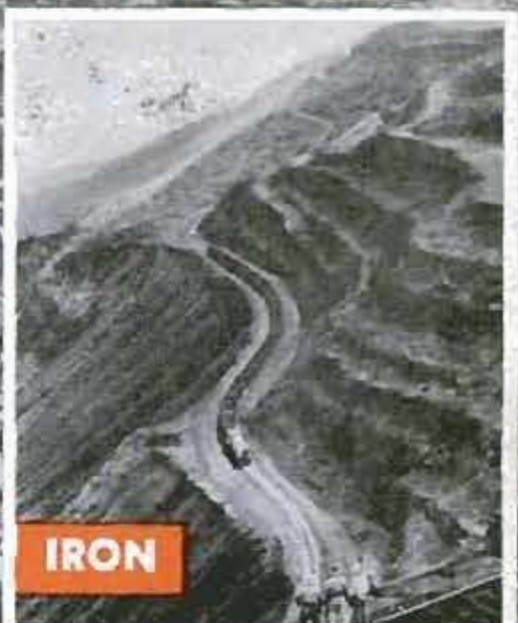

dirt to build what Venezuelans say is the world's longest earthen dam, a dam that stretches for nine miles and will irrigate 300,000 acres of now-arid land, boosting livestock production by five times in central Venezuela.

- In central Caracas, the 400-year-old capital city, more than 400 buildings were razed to build a magnificent commercial center. Already \$90,000,000 has been poured into the center, and the total cost eventually will reach \$300,000,000 if the original plans are carried out — compared

with \$100,000,000 for our own Rockefeller Center. In 15 years Caracas has been transformed from a sleepy overgrown village of 300,000 persons to an exciting metropolis of more than a million.

- In just 12 months Venezuela completed more than 1000 public-works projects costing some \$500,000,000. In five years more than \$2,000,000,000 have been spent on public improvements.

And Venezuelans seem determined to maintain such staggering statistics, come what may. Following the revolution last





Slum areas (shown in foreground) are cleared as modernization progresses. New apartment buildings now dominate the skyline



Big day for a peasant family! A truck moves the family's meager possessions from miserable slum to one of the new apartments

January, a junta of military officers and civilians took over the administration of the national cash register. One of the first acts of this group was to announce:

"We intend to maintain a high level of public construction, placing emphasis on projects that are essential, such as railroad, harbor and highway improvements and development of new petrochemical and steel industries. Showplace projects such as fancy hotels and monuments, which often were pushed by the last administration, will have low priority."

Venezuelans are well on their way to their goal of lifting themselves by their oil derricks overnight. Gone are the ox carts around Caracas. Today the new Autopista, a six-lane superhighway, is jammed with Thunderbirds, Cadillacs, Jaguars and Imperials. For centuries the University of Caracas struggled along in the same ancient buildings. Today, with facilities for 7500 students, it is one of the most beautiful and modern universities in the world, boasting all spanking-new buildings within a period of four years. In the mountains above Caracas a 3000-kilowatt atomic reactor soon will yield nuclear energy for scientific research.

The annoyances of high-speed civilization, of course, go hand-in-hand with the benefits. Radios in Venezuela spout endless adver-

Gang of workers terraces mountainside above Caracas to prevent erosion. Grass will be planted on terraces



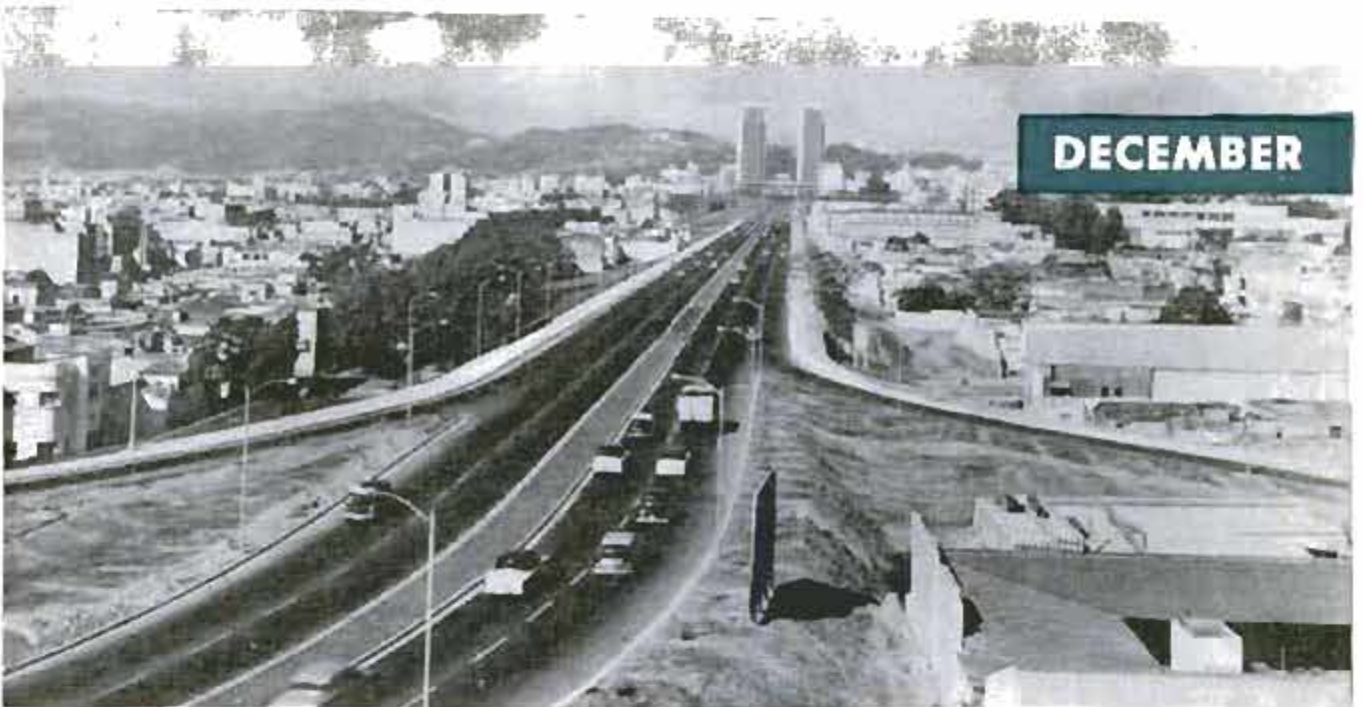

Incredible speed of highway construction is shown in photos taken from same spot about four months apart

tisements, and Latin-type ducks squawk singing commercials from television screens. In downtown Caracas, prior to the revolution, you had to drop the equivalent of 30 cents into a parking meter for just one hour's parking. (It may be significant that as soon as the revolt was touched off, parking meters were ripped out by the dozens!)

Throughout the populated sections of Venezuela there is a throbbing urgency to tear down the old and build up the new overnight. A stop watch could well be the national symbol. You see construction gangs working 'round the clock everywhere. Nightfall is the signal only to turn on the huge floodlights. Standing on any of the hills of Caracas, you are surrounded by small armies of men working on projects

of breathtaking scope. And, except for the remaining slum shacks, a majority of the multistory buildings within your view have been built within the past 10 years. The sight is electrifying and in a way terrifying, for you wonder how the patient peasants of Venezuela can adapt themselves to this resounding environment of clanging bulldozers and thundering concrete mixers.

Fortunately Venezuela can afford the pace of its progress. It is, indeed, a land of fantastic wealth. Again, only statistics can tell the story. Oil production has doubled since 1950, and now can run as much as 2,245,000 barrels per day. Venezuela is the world's largest oil exporter, and second only to the United States in the production of crude. And the ground will continue to



Showplace hotel of unbelievable opulence is perched on a 7000-foot mountain, accessible only by cable car

gush this black wealth for years to come, for Venezuela has 16-billion barrels of proven oil reserves, six percent of the world's total.

Down in the wild interior of the country are several vast deposits of iron ore estimated at well over two billion tons. In 1957, iron-ore production increased by a third to 15 million tons. Pockets of gold, precious stones and valuable minerals pockmark the trackless jungles. Many areas have not even been prospected.

In Venezuela, despite changes in government, it's not a question of whether to spend for vast public works, but how best to spend the money that's pumped up by the oil derricks. In one recent year, 57 percent of the budget was set aside for public works. So far as is known, no other government in history has spent more than 30 percent on such projects. (Another sizeable whack of the budget has gone to equip the armed forces with the latest weapons including jet planes.) Part of the 57 percent for public works went into highways, industries and other projects essential to the economy. Another part went into the tremendous housing projects for lower-income workers.

But a substantial share also went to "showplace" projects, designed for the most

part to impress the rest of the world. A dozen tourist hotels of unbelievable opulence, built and operated by the government, are strewn across the country—but relatively few tourists check in, and many of the magnificent suites stand empty. At the time I visited the Hotel Humboldt, perched atop a 7000-foot mountain and accessible only by cable car, I spotted only half a dozen guests in a building which would put most other hotels throughout the world to shame. The Armed Forces Club, for sheer splendor, would outrank the pleasure palaces of ancient Rome. And at the very moment of the revolution a year ago, workers were putting the finishing touches on a spectacular \$50,000,000 racetrack.

It's a safe bet that the current administration in Venezuela will not emphasize such showplaces. However, projects necessary to a sound and diversified economy, as well as those of value to lower-income families, will be continued. Venezuela is a land of the poor and the rich, with very little in between. Its people now seem determined to use the gushing oil and mountains of ore to improve the living standard throughout the country—and do it at an incredible pace.

(Continued next month)

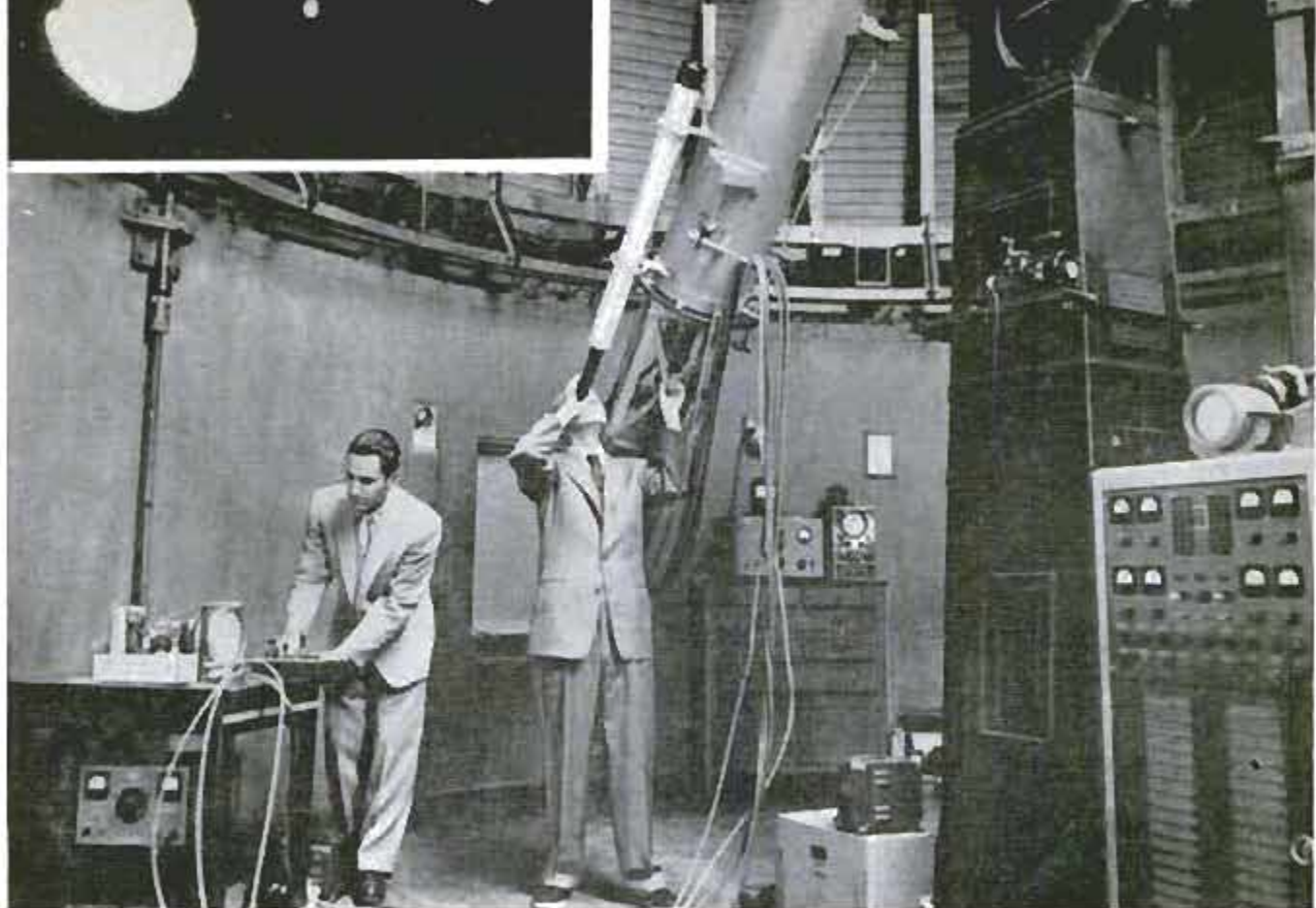

Electronic "Cat Eye" Photographs Stars in Daylight

Now it's possible to take daylight pictures of planets and stars. It's done with an electronic system called "Cat Eye," which is similar to television and has an optical amplifier 1000 times more sensitive than

that of an ordinary camera. Hooked to a telescope, Cat Eye, left, permits very short exposures in daylight or darkness. The inset shows Jupiter's moons photographed by Cat Eye.

Blind Operators Man Braille Switchboard

Using a Braille switchboard, the blind can now be telephone operators. Attached to the board is a box with rows of plungers. When a call comes, a plunger pops up with

a buzz and the operator locates the plunger and "reads" the station number indicated in Braille below it. She completes the call after locating the number on the board.





Face-Lifting Operation for the Old Man of the Mountain

FOR NEARLY 150 YEARS tourists have traveled to Franconia Notch, in New Hampshire, to view a natural rock formation that resembles a human face. The formation, called the "Old Man of the Mountain," has shown signs of "aging" in recent years. Freezing weather caused

cracks and seams that threatened to dislodge the boulders that make up the profile. To save the landmark, workmen went to the top of the 1200-foot cliff where supplies were delivered by helicopter. The boulders were tied to the cliff with turnbuckles and the cracks were patched.

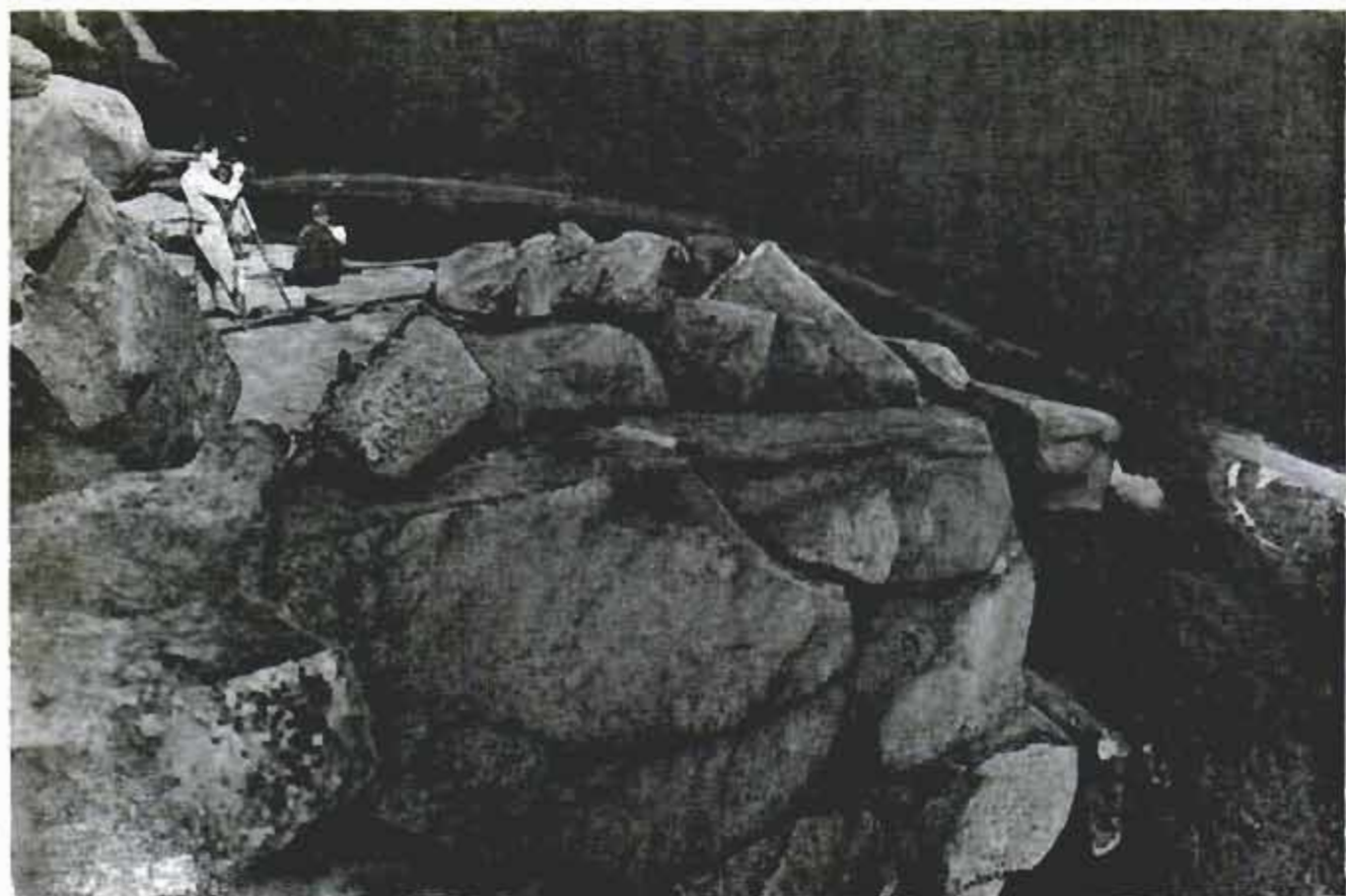

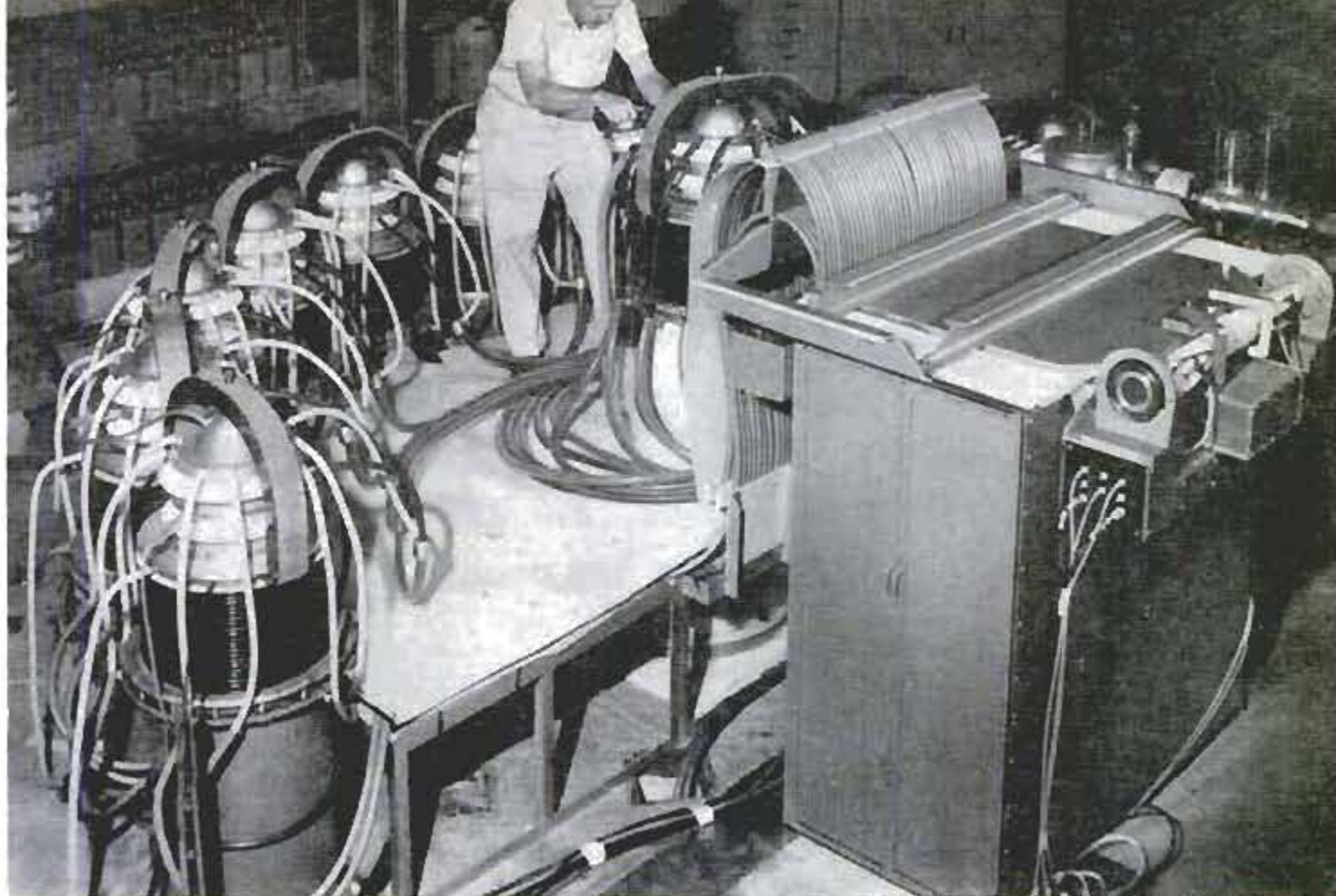

Los Alamos Scientific Laboratory photo

Scylla is one of the newest thermonuclear instruments. Bank of capacitors sends tremendous discharge to tube

Reprinted "P.M. Highlights"

Fusion Power for the World of Tomorrow

Here, simply stated, is where we stand in harnessing the H-bomb for peaceful uses. It may come sooner than you think!

By Clifford B. Hicks

THE SCENE WAS straight from a grade-B horror movie. Scientists at control panels pushed buttons and threw switches to create blinding bolts of lightning in a weird array of glowing vacuum tubes.

This was no horror movie, though. It was the Atoms for Peace exhibit of the 1958 Geneva Conference. The visitor could pause to inspect machines with such out-of-this-world names as Stellerator, Scylla, Astron, Alpha, Ogra, Zeta and the mildly optimistic Perhapsatron. The significance of this equipment—and the guarded opti-

mism at the conference—was inescapable.

All over the world, scientists are making big strides in their efforts to harness for peaceful ends the fury of the H-bomb.

Indeed, as the visitor paused before the machines in the exhibit hall, he may well have been witnessing nuclear fusion. Some of the scientists have a sneaking suspicion that at least one of the instruments actually was producing fusion energy while it was on display.

The best evidence of progress in this field is not success, but lack of failure. As former



Los Alamos Scientific Laboratory photo

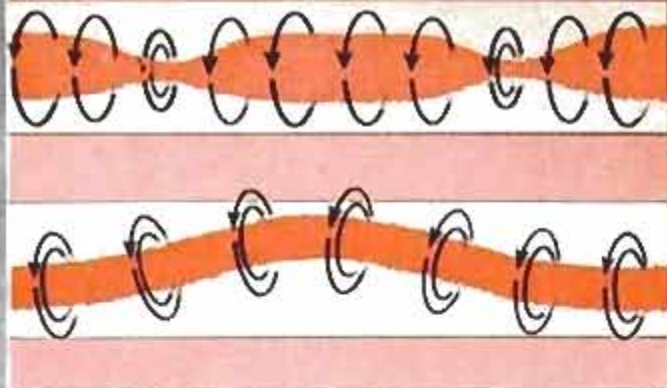

Left, circular tube is used in studies of the pinch effect. Electrical field squeezes high-temperature gas into thin "rope" inside the tube. However, big problem is that "rope" tends to break into "sausage links" or kinks, above, that touch sides of tube. Diagrams at right show the four major approaches in attempts to control fusion

Atomic Energy Commission Chairman Lewis L. Strauss has pointed out: "We think the fact that we have worked with it now for a number of years and have not been able to prove it impossible is a very considerable gauge of its eventual success."

Dr. Arthur E. Ruark, chief of controlled nuclear research for the AEC, confirms the optimism: "There is general belief in the American laboratories that the ignition temperature [the temperature at which the fusion reaction is self-sustaining] will be achieved within a few years."

Proof of success will be the discovery of invisible particles which the scientists wryly call "thermonukes" (thermonuclear neutrons). All over the world, right now, scientists are seeking thermonukes. It's a baffling search because a thermonuke is exactly like any other neutron, so how do you prove the origin of the little beast?

Whether thermonukes attended the Geneva Conference or not, scientists in attendance estimated that sometime within the next 10 to 20 years a switch will be thrown and the first full-scale, power-producing fusion reactor will go into operation. Even this first crude reactor probably will have a power output comparable to the huge hydroelectric plant at Hoover Dam.

That moment, if it comes, will be a pivot point of history. Nations need never fear that their power sources will run dry. For

a time, obviously, petroleum will remain as a source of mobile power, and coal will continue to provide industry with heat. You can't change a way of life overnight. But eventually, according to the experts, oil will give way to some form of stored electrical power which has been derived from the fusion reaction, and coal will be simply another source of industrial chemicals.

At that supreme moment, man can look ahead through the halls of time for literally billions of years and still see a plentiful supply of fuel. *Billions of years!* When new kilowatts are needed, they simply will be plucked from sea water.

Advantages of Fusion

Why will fusion reactors be so much better than today's fission reactors?

1. The fuel supply, as noted above, will be inexhaustible and inexpensive.
2. The problem of disposing of radioactive wastes will be negligible. This is a major problem of fission reactors. The critters are just plain dirty. For example, if all our current energy requirements were provided by fission reactors, we'd have to dispose of radioactive waste material equivalent to that from the explosion of 200,000 atomic bombs *each year*. Fusion reactors will produce very little radioactive waste.
3. The fusion reaction, by its nature, is

Birth and death of possible fusion power: Series of photos of glass tube shows the plasma being squeezed into a thin "rope." Then kinks begin to form, and within microseconds they cause the "rope" to disintegrate

Los Alamos Scientific Laboratory photos



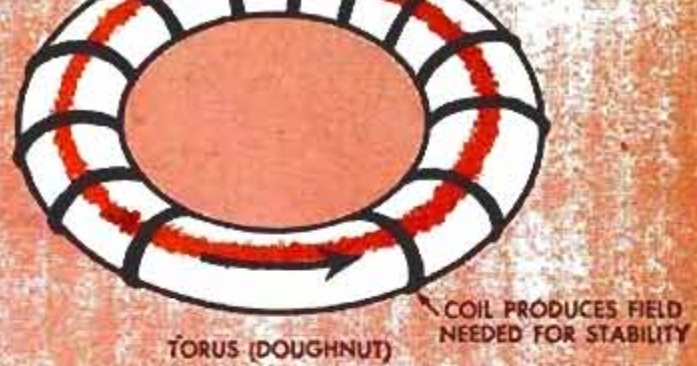
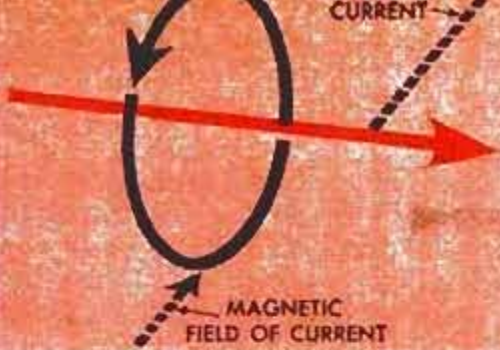

safer than fission. A fusion reactor could never explode. It would simply collapse and fail to function.

4. There's a fascinating possibility that electricity can be drawn directly out of a fusion reactor. In fission, the reactor produces heat, which then is pumped through conventional turbines and generators to produce electricity. This is a highly inefficient way of producing electricity from nuclear energy.

For these reasons, controlled fusion would be an infinitely greater achievement than wresting power from fission, shooting satellites into orbit or sending rockets to the moon. Indeed, inexhaustible and inexpensive power on earth may well give man the means of navigating to the stars.

Basic Power of the Universe

To achieve fusion, the scientist must crack the secrets of those stars, for nuclear fusion has been generating sunshine and starlight since the beginning of time. It is really the basic source of power of the

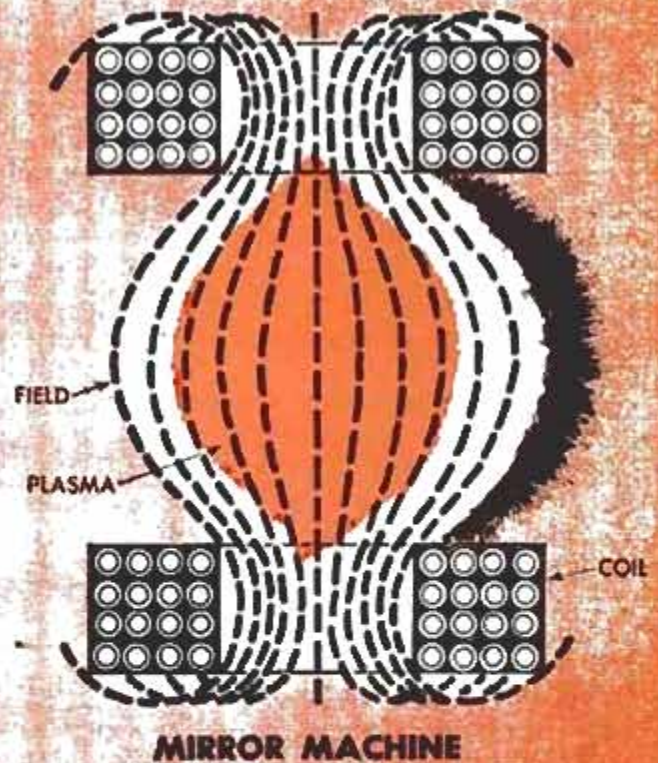
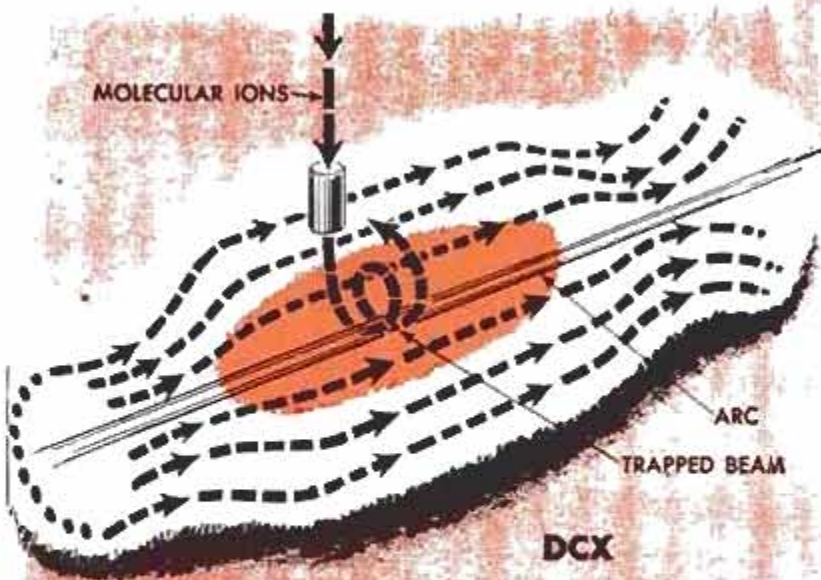
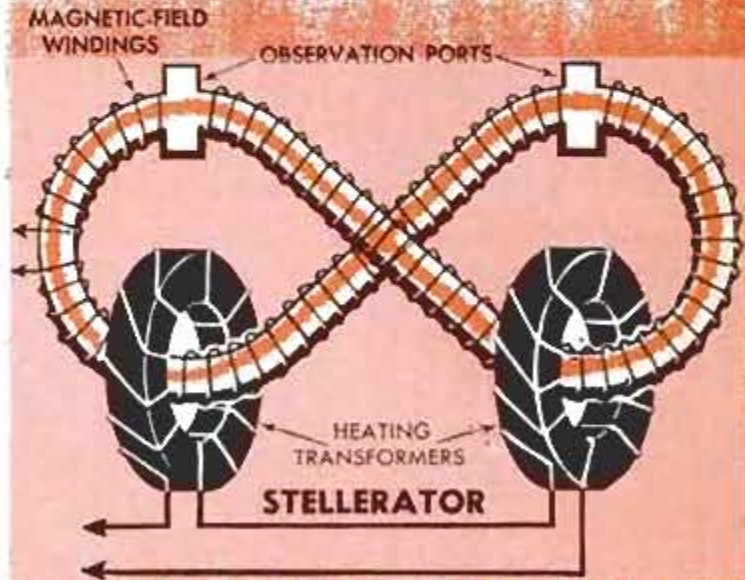

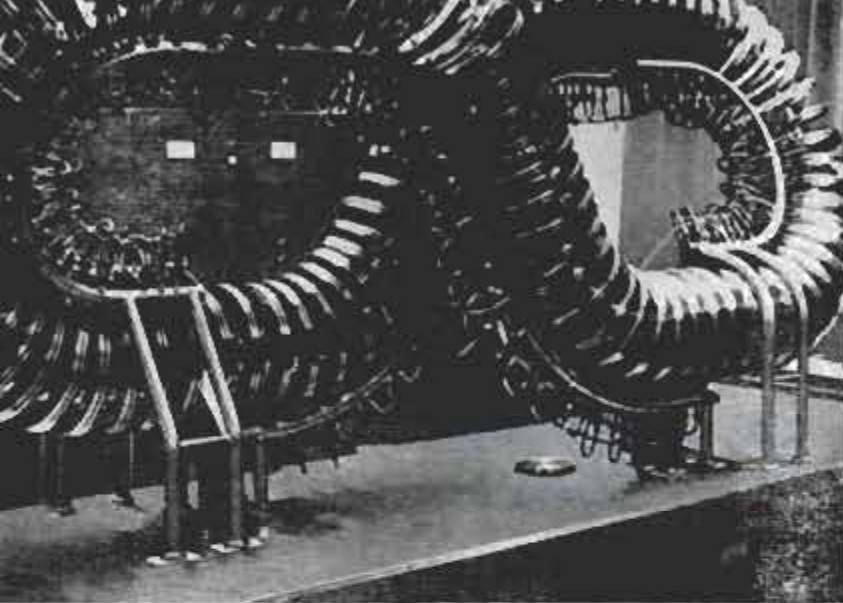

Princeton University photo

Novel shape of pretzel-type Stellerator helps prevent kinks from forming, concentrates plasma in the "magnetic bottle"

universe. In effect, the scientist must create a star on earth, bottle it up and clamp on a lid. If he succeeds, he can draw from the bottle any amount of power he wishes.

But each step in this field is a tremendous effort. Dr. Amasa S. Bishop, in a recent AEC report on fusion research, stated that progress may be "slow and halting" because of the many problems involved, but that as yet "no basic obstacle" has been uncovered.

Just what are the obstacles, basic or otherwise? Only a top physicist can understand the mathematics of the fusion process, but the basic idea isn't difficult to comprehend. Suppose you want to bottle up your own star. Here's how you'd go about it:

First, you might be wise to review the differences between fission (A-bomb energy) and fusion (H-bomb energy). In a fission reactor, the nuclei or "cores" of atoms are broken apart. The process has been compared to the explosion of ordinary TNT. Touch off TNT with a blasting cap, and the shock explodes one molecule, which explodes the next, etc., in a chain reaction. Similarly in a fusion reactor, atoms are blasted into particles, which blast other atoms into particles, etc. Poof! You either have an A-bomb explosion or controlled fission, depending upon the speed of the process. In either case you get a scad of atomic particles and considerable energy.

Superhotfoot for Nuclei

In a fusion reaction, however, these atomic "cores" are forced, against their wishes, to unite. This process is somewhat similar to the burning of logs in your fireplace. You give the molecules of the logs a hotfoot by burning kindling under them.

They become so agitated they collide violently, forcing them to unite, and the logs burst into flame. Once the logs are ablaze, the fire itself continues to heat the molecules, so the reaction is self-sustaining. Similarly, in a fusion reactor you raise the temperature to force nuclei to unite. Only in the case of nuclear fusion, you must give the nuclei a superhot-foot, raising the temperature to hundreds of millions of degrees. You must create the temperature of the stars.

For a moment, forget about the problem of kindling such a fire, and concentrate upon the fuel itself. Where do you get atomic "cores" suitable for the fusion process? The most promising source is deuterium, which is simply one form of hydrogen. Turn on the faucet at the kitchen sink, and you'll let an untold quantity of deuterium flow down the drain. Deuterium is found in ordinary water everywhere.

You might suspect that there is a hitch here, that it would be expensive to extract deuterium from water. The United States already is producing deuterium on a significant scale, and published figures indicate that it can be extracted so cheaply that deuterium as a fuel would cost about one percent as much as coal!

Furthermore the quantity of deuterium just asking to be extracted is staggering. Take the current power demand of the entire world and multiply that figure by 1000. There is enough deuterium in the oceans to supply this much power, year in and year out, for quite literally billions of years. No kidding.

Now assume that you have extracted just two of these deuterium nuclei, which are called deuterons. If you can hurl these two deuterons at each other with enough force to make them fuse, you will create three things: helium atoms, neutrons—and from 3.25 to 4 million electron volts, an incredible amount of energy. Here is an example of just how much energy: If you "burn" or fuse just *one pound* of these deuterons, you'll end up with *43 million kilowatt-hours* of electricity, the equivalent in energy of more than a million gallons of gasoline!

If all the deuterium in the world were extracted from the sea and burned completely, it would produce one thousand million, million, million kilowatt-years of electricity, a figure beyond comprehension. To put it in a much more credible way, just

(Continued to page 264)



Jet Helicopter Uses Same Principle as Rotary Lawn Sprinkler

Operating on the same principle as a rotary lawn sprinkler, the Djinn jet helicopter uses air instead of water for its driving force. Air is piped to the rotor hub,

where it is distributed to the two blades through a revolving airtight seal. The air rushes out the blade tips like water from a sprinkler, propelling the rotor.

Will It Show the Butterflies?

Eight photographs can be taken of the inside of a human stomach, in black and white or color, by a tiny camera. The camera fits inside a cigar-shaped stainless-steel shell which the patient swallows.

Diffused Light Saves Sight

Soft, glareless light for reading and other close tasks is produced by a new household bulb, below left. The inside of the bulb is coated with silica diffusing material which gives better light distribution.

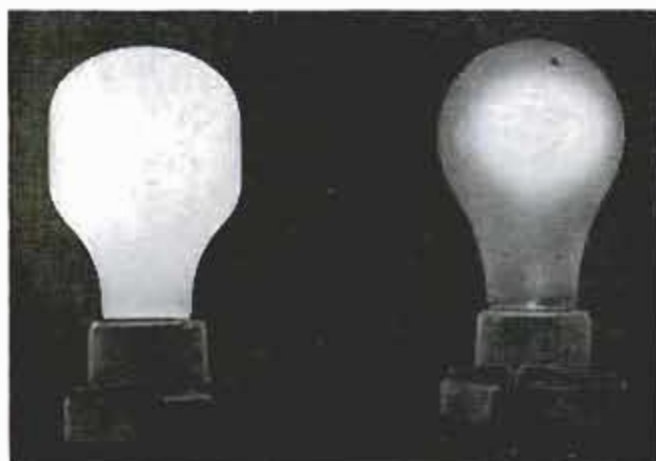

WHAT'S NEW FOR

Your Home

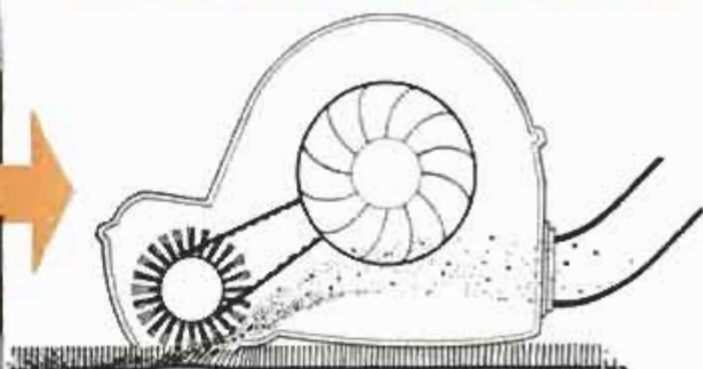

STEAM COOKER prepares vegetables on top of frying pan filled with boiling water. Enough servings for eight persons can be steam-cooked at one time. Vegetables retain much flavor, color, nutritional value

Kitchen-Mac, 6200 N. Broadway, St. Louis 15, Mo.

BOTTLE-CAP REMOVER loosens and tightens every size of twist-off cover. Versatile wrench-type device also removes vacuum-jar and paint-can lids. It is compact for storage and made of nickel-plated steel

Foley Mfg. Co., Minneapolis, Minn.



ROTATING RUG BRUSH can be attached to tank and canister-type vacuum cleaners. Attachment's motor is powered by air and turns brush, which levels itself to height of nap. Dirt is carried up pipe to tank

Preco Inc., 6300 E. Slauson Ave., Los Angeles 22, Calif.

JALOUSIE SEAL prevents mildew, cuts drafts and holds temperatures in air-conditioned rooms. Made of silicone rubber, it is placed over edges and can be cut with scissors. Color matches that of aluminum

Alto Products, Dept. PM, 482 Riverside Ave., Jacksonville 2, Fla.





EGG BEATER is operated with one hand by pushing down on handle. Tiny beater whips egg in cup or glass in moments. Besides eliminating need for big mixing bowls for small jobs, beater frees one hand to steady container. It's ideal for mixing drinks, milk shakes and paints

Ekeo Products Co.,
1949 N. Cicero Ave., Chicago



VERSATILE FURNITURE is attractive enough to be used indoors as well as outdoors. Folding chairs and table are made of highly polished tubular aluminum. Wood braces and arms are finished like fine furniture

Telescope Folding Furniture Co., Inc., Granville, N. Y.

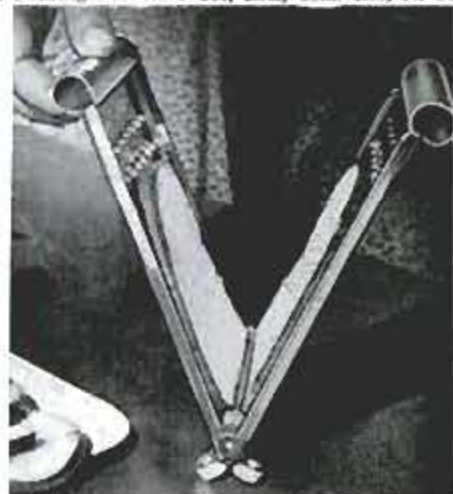
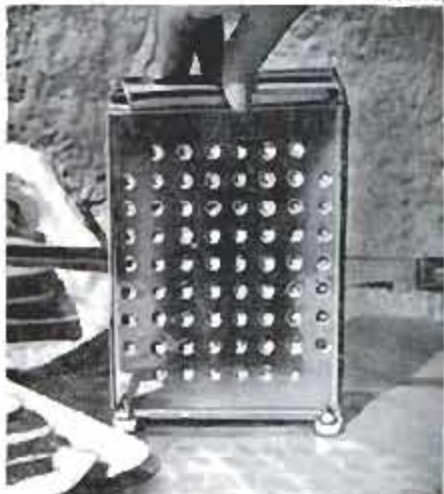

MEASURING CUP is two receptacles in one. It measures dry ingredients in one part, liquids in the other. Made of unbreakable, translucent polyethylene plastic, the double cup is 5½ inches high and is colored frosty white. Graduations show on inside as well as outside

Southwest Products, P.O. Box 9421,
Fort Worth 7, Tex.

BREAD-SLICING APPLIANCE holds piece of bread firmly and guides knife in cutting it in half for melba toast, canapes, party snacks, patty shells, etc. Metal device has hinged bottom and opens and closes like a book

Ace Products Co., Chalfont, Bucks County, Pa.

RANGE HOOD HAS RADIO concealed under it. Only control knobs are visible. Music from five-tube radio comes through grille. Hood front contains light switch and control button for three-speed ventilating fan

Borns Air King Corp., 3050 N. Rockwell St., Chicago 18.



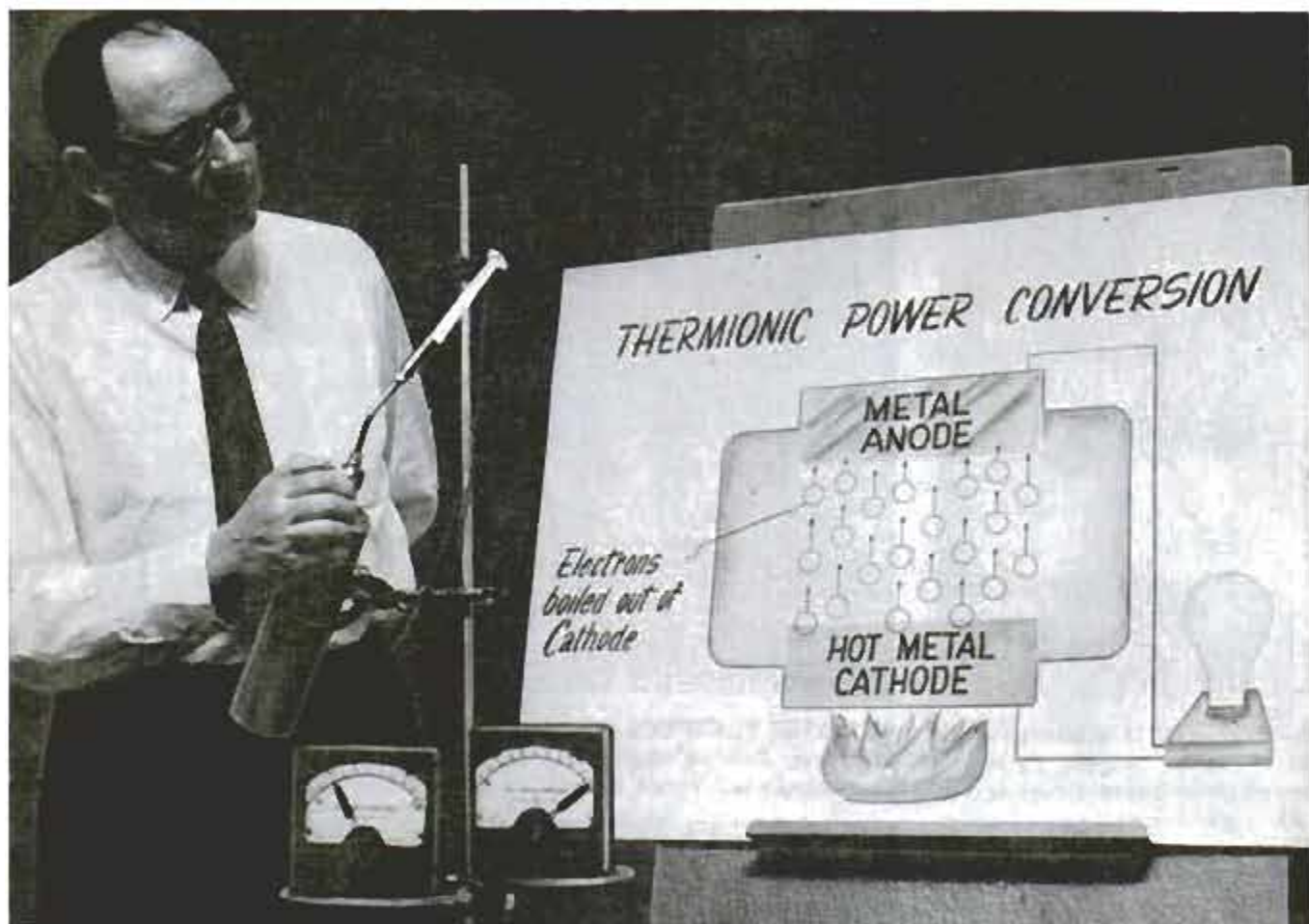

Electricity From Heat

When the flame of a blowtorch is played upon it, a disk the size of a quarter produces electricity. The new "thermionic converter" is a combination of metal and ceramic disks surrounding a high vacuum. There are possible applications wherever a source of high-temperature heat is available and a supply of electricity is needed—such as in missiles.



Slide Rule for Soils Figures Erosion on Farms

How much soil will be lost from a farmer's fields because of erosion? A Soil Conservation Service expert has developed a slide rule that will calculate the rate of erosion when several factors such as the kind of soil, the type of crops and the steepness and length of slope of the field are known. The device figures the annual loss in tons of soil per acre. The slide rules are not available to the general public; they are issued only to soil-conservation technicians. They are designed for use primarily in Midwestern states.



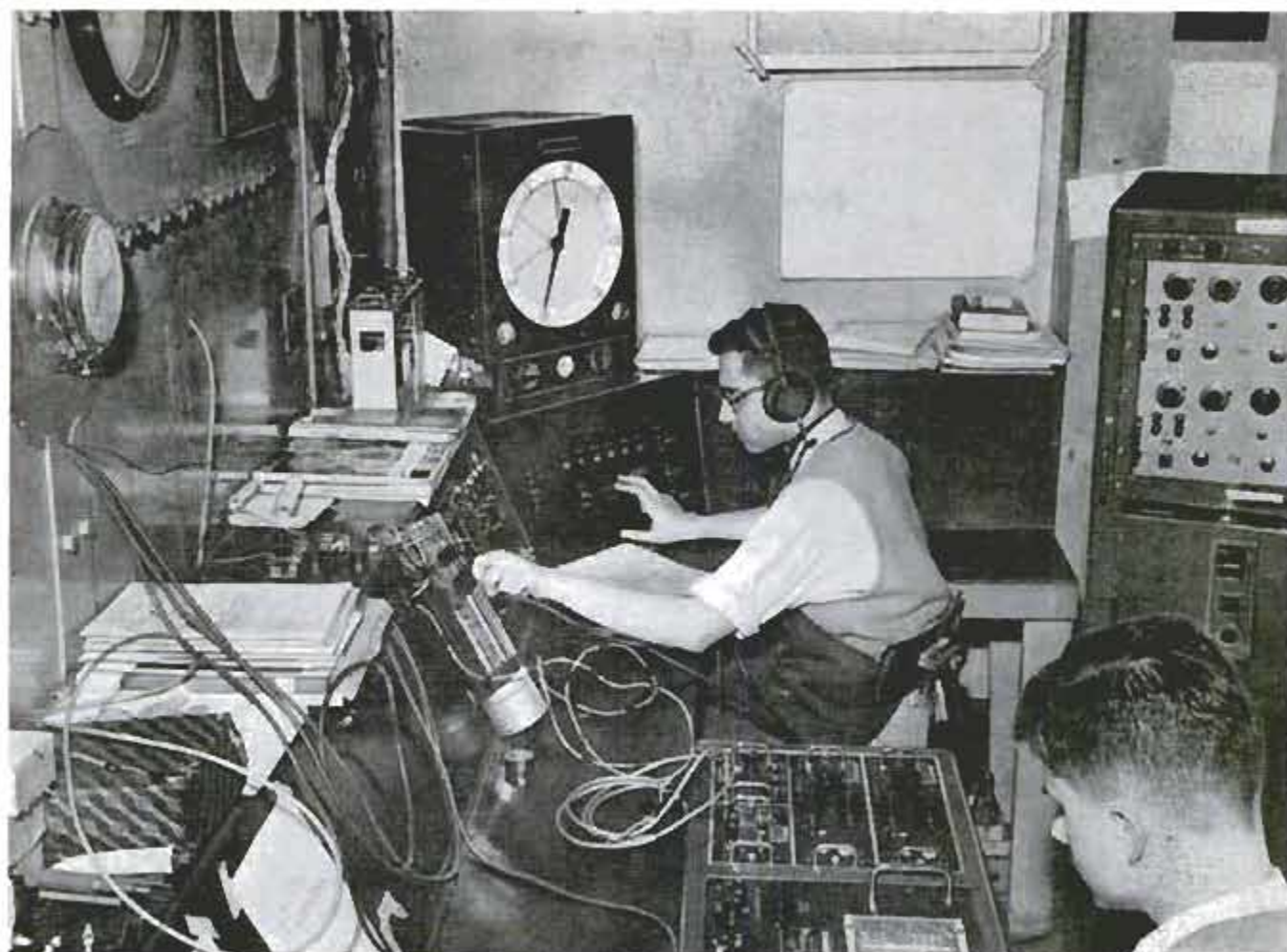

Massachusetts Institute of Technology students test homemade rocket motors from this control console

ROCKET SHOOT at M.I.T.

By Michael Day

MUFFLED ROARS, beginning like claps of distant thunder, rumble through the basement corridors of the main building at Massachusetts Institute of Technology these days. But no one looks out, puzzled, at the clear blue sky anymore. Everybody knows what's up—the student Rocket Research Society has just “blasted off” another rocket engine on a static-test run in its armor-plated cell downstairs.

The thunder started five years ago when a group of determined amateur student rocket enthusiasts at M. I. T. wanted to make live studies of rocket-propulsion systems. Scouting military-surplus depots, they stumbled across a ponderous test cell about 10 feet square, made of one-inch steel armor plate. It had been used in a World War II research program to test fuels for high-altitude-burning properties. The multiton affair rode to the campus on a flatbed

truck, was jockeyed into its donated location in the cellar, and became what the amateur rocketeers believe is the finest, safest, amateur rocket-testing facility in the country.

Today, if you wander into their shop during a firing, you'll find most of the 37 members busy at a complex of home-assembled instruments and switching consoles reminiscent of a Canaveral test-pad blockhouse. All are engrossed in measuring and tabulating things like thrust, burning time and combustion-chamber temperatures, as white-hot flame scorches from the exhaust nozzle of an experimental homemade rocket engine bolted to a floating steel rack inside the vault. One man watches through a six-inch porthole of layered glass, alert for signs of malfunction. If there's an interesting motor on the stand, several members can watch at once

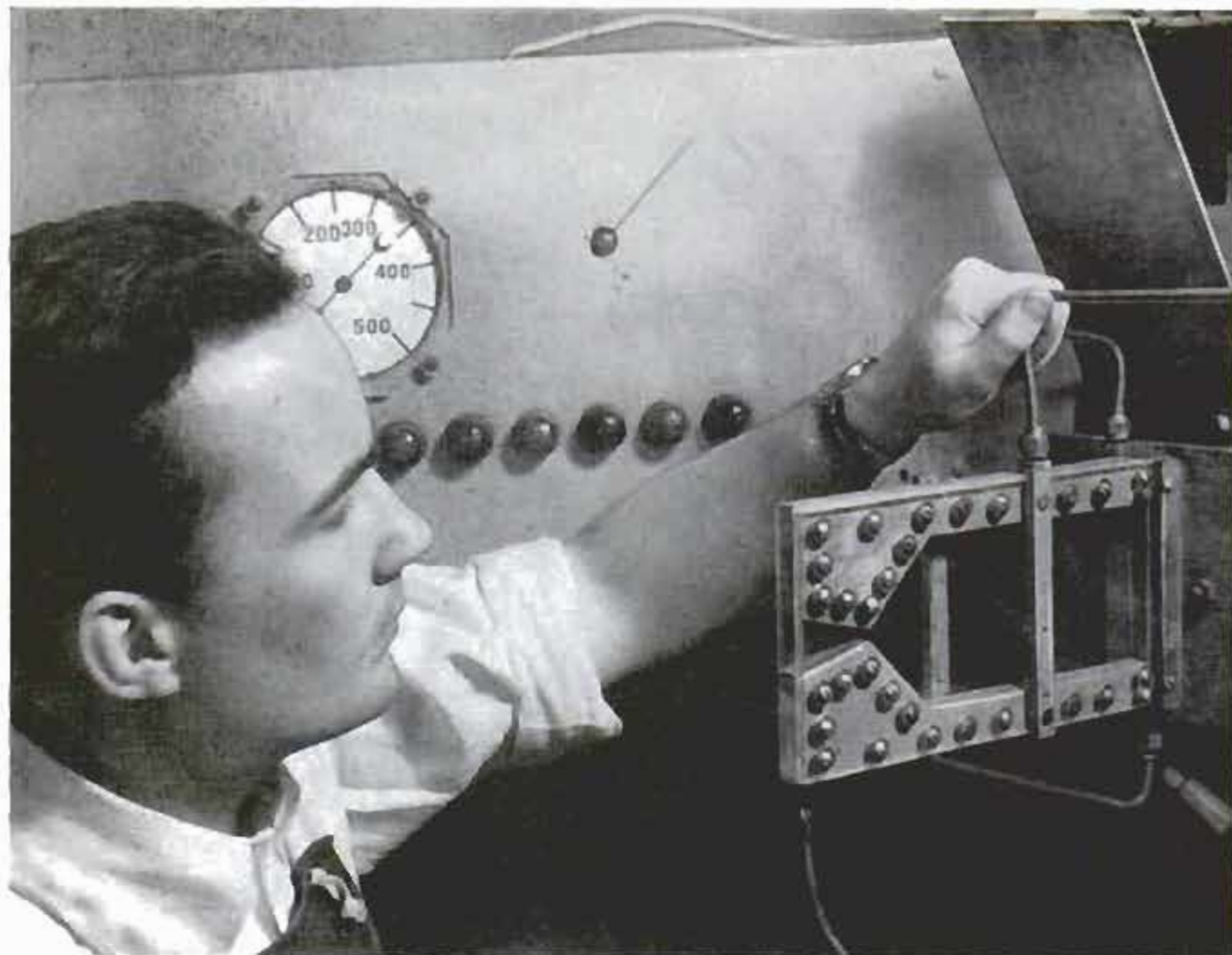

Experimental rocket motor with transparent plastic sides is mounted for static test in M.I.T. test facility

in a mirror rigged for peering through the port to reflect what's happening inside the vault.

Last year, under Reece Roth, their president (who won a \$1000 American Rocket Society award for his paper on a new way to measure rocket-exhaust velocities), the group ran 31 live firings with seven rocket

Remains of homemade rocket motor that exploded during static firing emphasize the need for safety



motors turned out in their own shop. Nearly all were made on a donated old metal lathe they rebuilt. Most test motors are steel cylinders six to ten inches long and capable of about five pounds' thrust. One, a unique affair for studying ignition and combustion patterns, has flat Lucite sides. Students can see the flame burning inside the combustion chamber. "The Lucite stands up about five seconds," says Roth, who designed and built it. "That's long enough to collect interesting data."

Though strictly an amateur group, there's nothing amateurish about the way these rocketeers work. Most are mechanical engineering and physics students.

"We keep a complete log of each firing," says Roth. "And the accent is on safety. Many amateur groups like to fire flight rockets. Besides being dangerous, such ventures yield little data." This year, the M. I. T. rocketeers debated sending up a sounding rocket they'd designed. The idea was dropped when all agreed the only thing they could learn would be the peak altitude reached (30 miles on paper). "Our membership hasn't flown a rocket since 1953 when the static-test chamber was installed," Roth reveals.

Fuels, one of the most hazardous ele-

ments in amateur rocketry, are handled with some tricky safety gadgets devised by the M. I. T. amateurs. Mix for solid fuels, such as asphalt and potassium perchlorate, is stirred up in a steel box inside the vault, by a man standing outside. He works a paddle handle that extends through a tiny hole in the wall.

Liquid and gaseous fuels feed to test motors via fuel lines from outside tanks. Automatic cutoff valves are shut electronically at the first hint of malfunction. Backstopping this is a manual cutoff switch to shut everything down and a carbon-dioxide bottle that turns on automatically if things get hot.

Amateurs in Trouble

"Many amateur groups got in trouble using fuels like zinc and sulphur," says Roth, "probably because they're easy to obtain. But they're tough to handle, detonate easily and give only 40 percent of the performance of liquid fuels. Amateurs using solid fuels should be sure they're really solid—not granular powders. Even in a long, pencil-thin rocket, granular fuel of this type can burn down an entire five or six-foot column in about $\frac{1}{1000}$ second, and chances are good that the rocket will explode."

With all the precautions built into the M. I. T. rocketeers' lab, Roth has an impressive collection of twisted and distorted chunks of solid cylindrical steel two inches in diameter. Once they were rocket motors. One of them blew a steel plug against the vault wall with such force that it folded open like a flower.

To other amateur groups who query him for advice, Roth usually points out that there are two safe ways to static-test rocket motors: "You can enclose the motor in an explosionproof case," he says, "or you can enclose the people in a blockhouse. A supervised group can achieve the first solution by working out a well-planned pit with good walls and bunkers." ★ ★ ★

☐ Banked turn-offs will permit pilots landing the new jet airliners at Indianapolis airport to turn from the main runway to feeder runways at speeds up to 63 miles per hour.

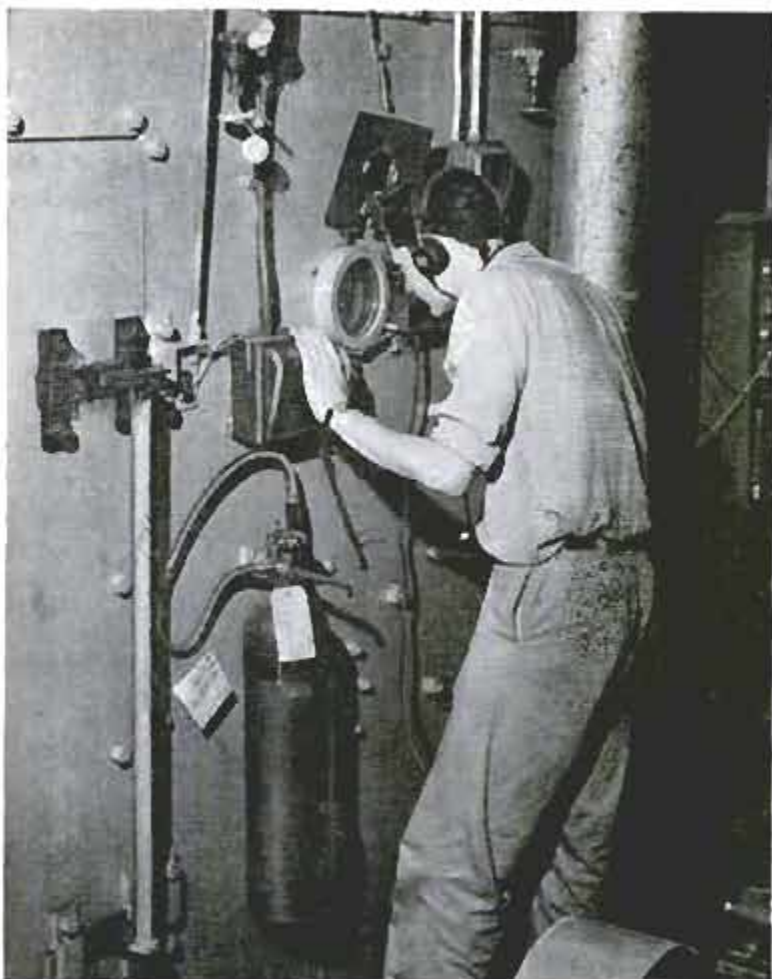

Observer watches rocket-motor test through safety-glass port-hole. Test cell has walls of inch-thick steel armor plate

Even rocket fuels are handled with caution. Student outside test cell works paddle that mixes fuels in small steel box

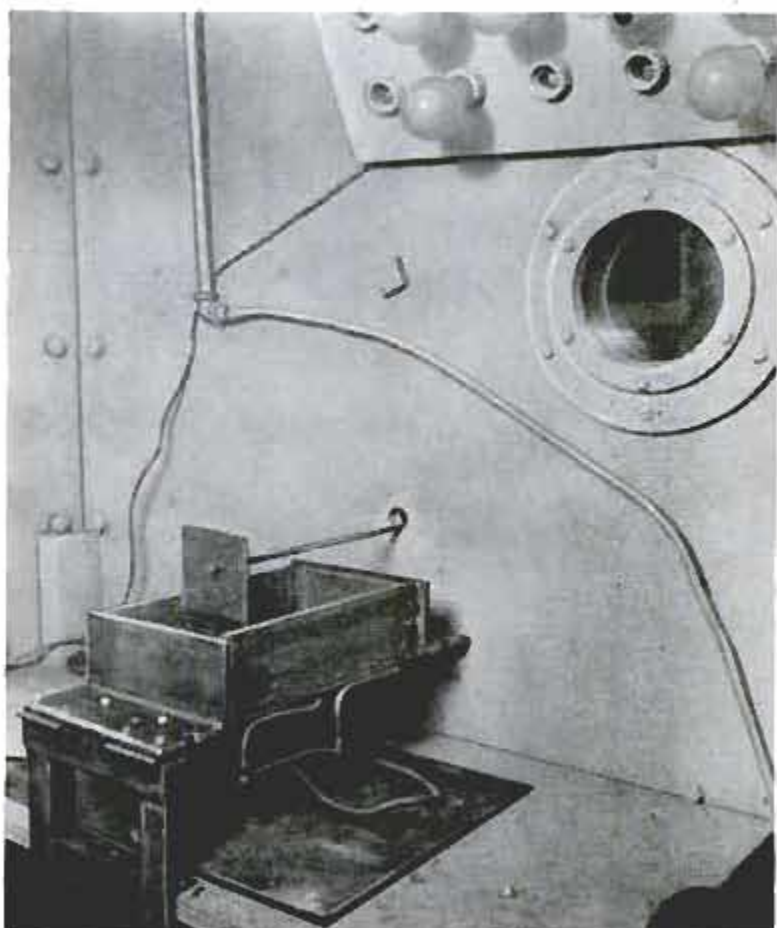



Barge Becomes Stage

In little more than a month, a barge formerly used for carrying construction materials around Pittsburgh was converted into a floating stage. After the barge's cargo box was removed, a concrete deck was built on top of the steel deck. Then the stage was erected and two rehearsal rooms added.

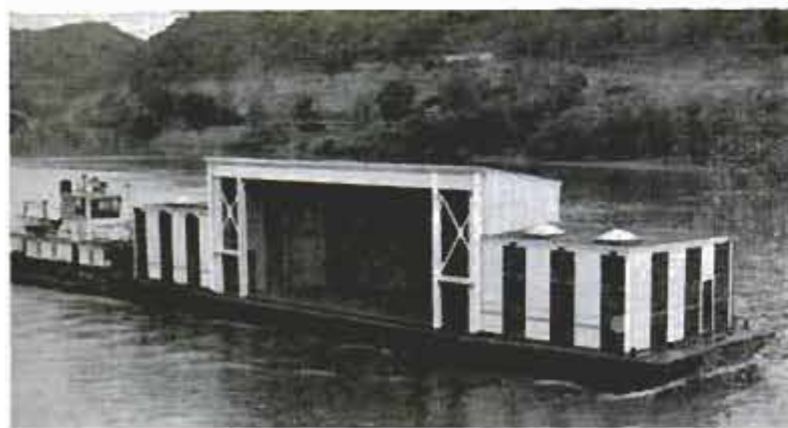

Radar Through Trunk Lid

Chicago police are spotting speeders with a radar set mounted inside a squad-car trunk. Since a radar beam would be deflected by the trunk lid, alterations were made. The inner taillights were removed and panels, painted to match the car, were bolted over the openings. The panel in front of the set is Plexiglas, which doesn't interfere with the radar beam. The other panel is made of hardboard. Cars moving in either direction are tracked by the set, which reports speeds on a meter.



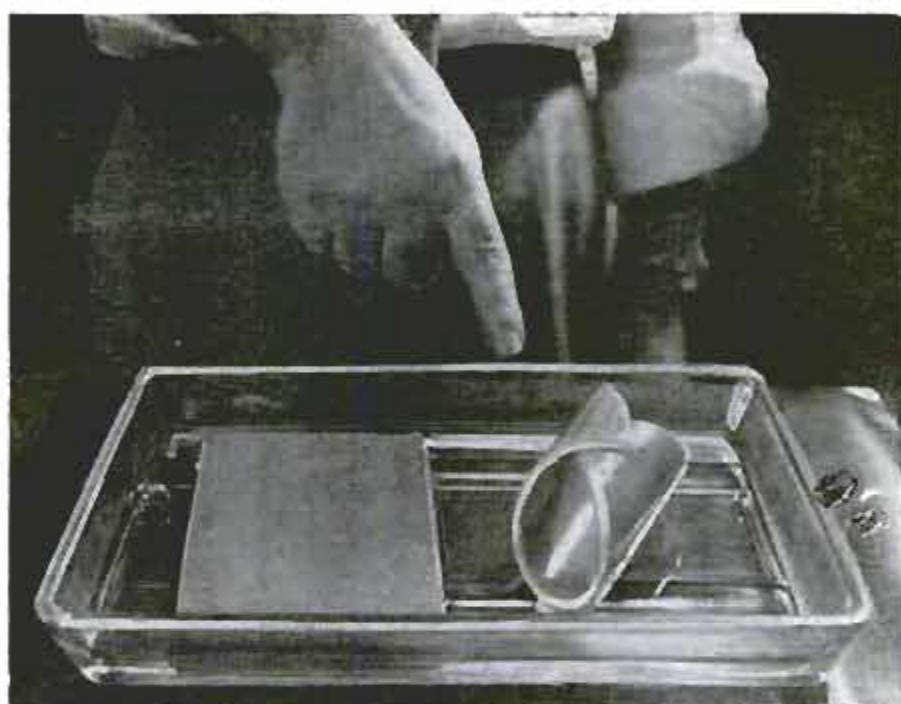

Chemically Treated Rubber Resists Oil and High Temperatures

Better seals and gaskets for cars and planes are expected from a nitrile-silicone rubber developed by General Electric. In the photographs: An O-ring of ordinary

silicone rubber swells in boiling jet-engine fuel while a ring of the new material maintains its size and shape; a sheet of ordinary silicone rubber swells and curls in jet fuel.

Plastic-Protected Motor Works Underwater

Special insulation systems using irradiated polyethylene permit electric motors to work while immersed in water. The motors can be used for boiler-circulating pumps, in mines and sewage plants. Water circulates through the windings, bearings and magnetic parts without damage.

Unmanned Space Vehicle Designed for Trip to Mars

Boeing scientists have designed an unmanned space vehicle that could make close-up studies of Mars. They've built a $\frac{1}{20}$ -scale model of the vehicle, which at full size would be about 40 feet across and weigh 600 pounds. Images received by its telescope would be transmitted to Earth.

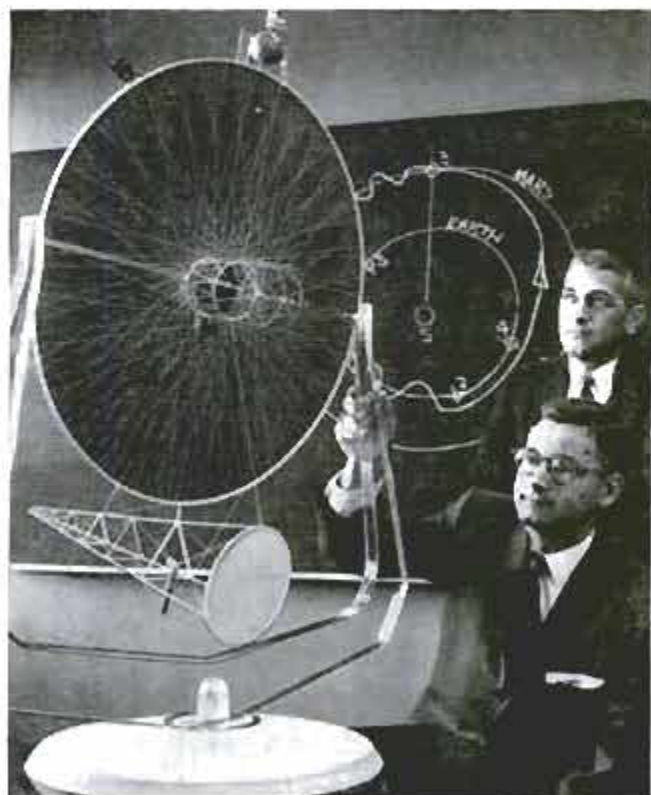
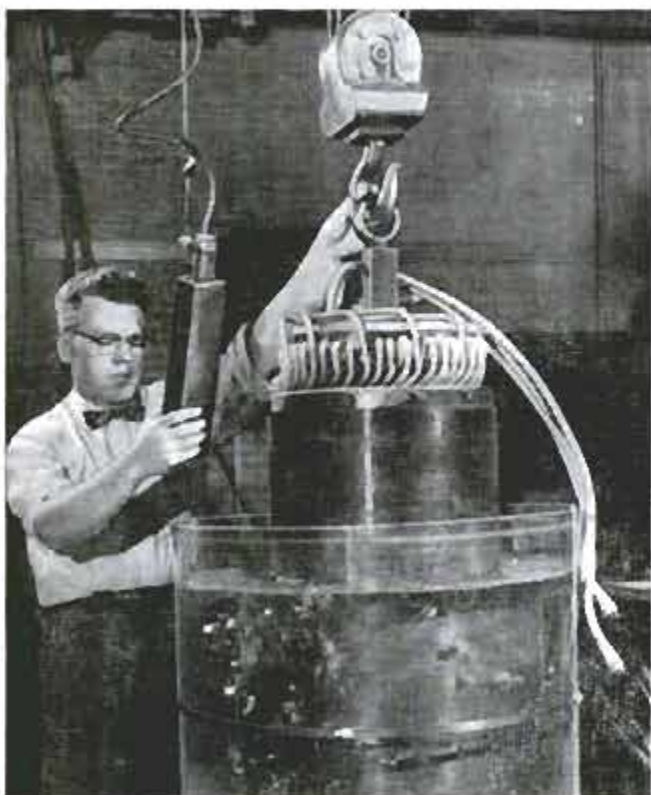



Westinghouse Electric Co. photos

In Your Future: Rolling Refrigerator, Portable Bottle Warmer

Hostess carts that warm and cool foods in separate sections, and bottle warmers for traveling parents, are among electrical appliances now in the experimental stage. They use a new principle of refrigeration

and heating by devices that occupy little space and have no moving parts. The cart can be operated on batteries. The bottle warmer, which plugs into the car's cigarette lighter, also can be set to cool the bottle.



Fastener of Nylon Strips

Clothing, upholstery and other items can be held securely by a fastener that consists of two strips of nylon. One strip has a velvet-type surface with thousands of tiny loops. The other has thousands of tiny hooks. When the strips are pressed together, the hooks engage the loops. To open, you simply peel the strips apart.

Snow-Plow Blade Can Be Attached to Rotary Mower

If you have a push-type (not self-propelled) rotary mower, you can attach a snow-plow blade to the machine and clear a 24-inch swath through a heavy snowfall. The snow blade bolts to the engine-base adapter plate of most four-cycle engine mowers with cutting widths up to 22 inches. The blade is made of extra heavy-gauge steel which is ribbed for added strength. It will move up to eight inches of dry or five inches of wet snow.



Eyes Generate Electricity In Normal Light

Your eyes generate about $\frac{1}{10,000}$ of a volt of electricity while reading under normal room light. This is the estimate of Dr. Leo E. Lipetz of Ohio State University, a biophysicist. The scientist has been studying the electric current produced by nerve cells in the eyes of animals. The current is amplified about one million times and its patterns studied on an oscilloscope screen.

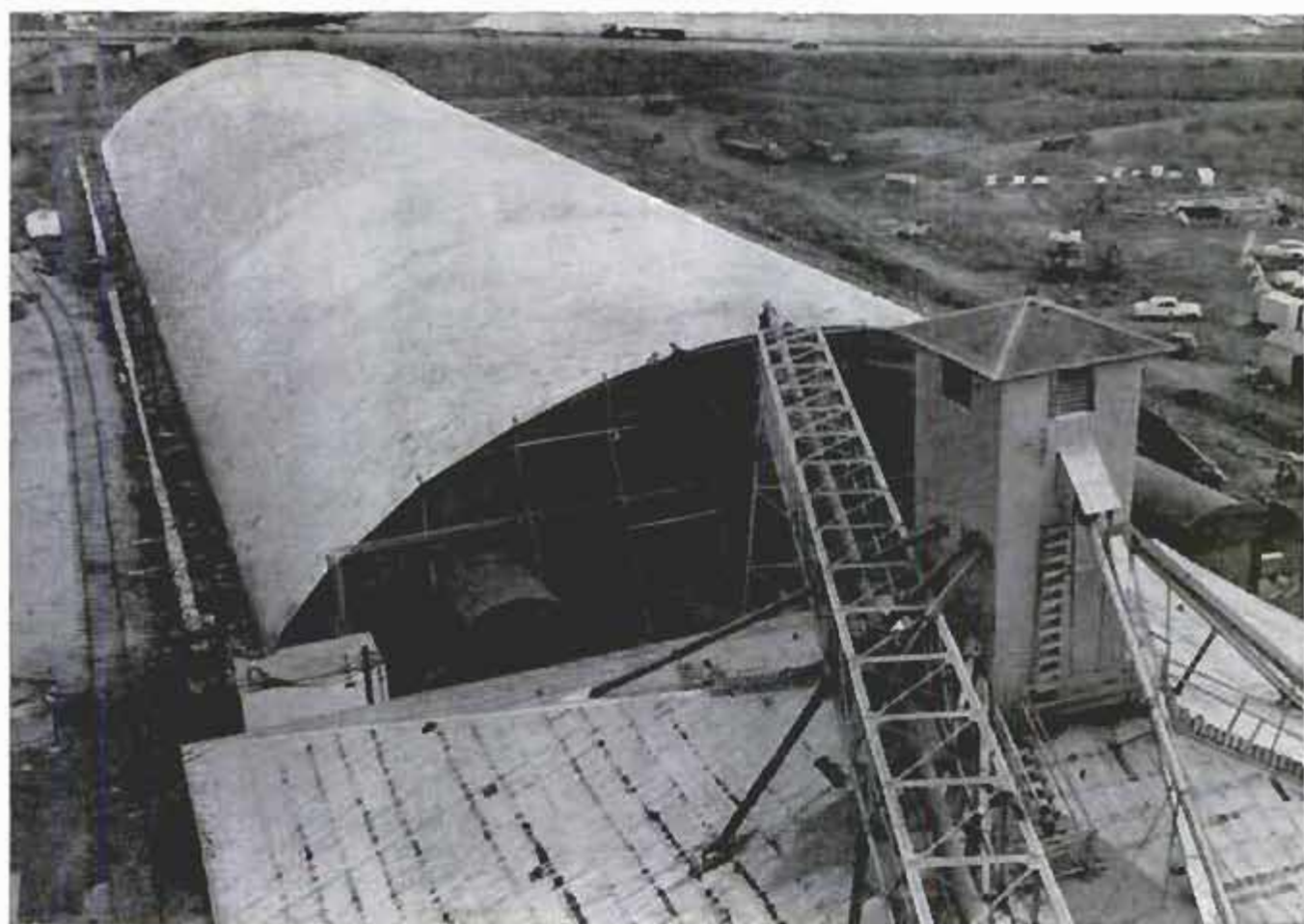

Air Holds up Steel Roof

Weighing more than 50 tons, the steel roof of a new grain storage building is held up by air pressure. The roof, made of aluminized-steel sheeting, covers 2.3 acres. End walls made of steel were erected first. The strips of roof sheeting were welded on the site. Then giant fans built up air pressure to lift and hold the roof in place. Entrance is through air locks.



Blind Learn to Read by Hearing Sound Patterns of Letters

Persons who are totally blind can learn to read printed material, including typewritten letters, with an electronic device called an aural-reading machine. When its probe is moved over a printed page, photocells translate each letter into a sound pattern with a specific pitch. The sounds do not resemble spoken words but are more like musical tones, or organ chords. By interpreting the tones, the blind person ultimately can attain a reading speed of 30 words per minute. The device was designed by Battelle Memorial Institute of Columbus, Ohio.



The CRUISER With the SUPERSONIC STING

By J. A. Lynch, Ensign, USN, and M. D. Buoncuore, JO 1, USN

THE RECENT commissioning of the USS *Galveston*, guided-missile light cruiser, was a unique event in the annals of modern naval history. The long and once-independent histories of the ship herself and the Talos missile that forms her most formidable armament are both of considerable interest. But it's the successful termination of these two formerly divergent projects that presents an example of the modernization of the new Navy.

Had the *Galveston* been completed, as scheduled, in the period just following World War II, she would have been armed exclusively with six-inch guns able to fire about 10 miles with accuracy. Today the *Galveston* is fitted in part with traditional armament, but it's also equipped with the Talos, which can be effective at distances up to 65 miles. The Talos affords not only greater range, but also more accurate firepower. With only six-inch guns, the *Galveston* would have been just slightly more effective than her namesake in the Great White Fleet.

The Talos ramjet missiles can destroy enemy aircraft within 65 miles. They are equally effective against surface targets



The construction of the *Galveston* was authorized by Congress on July 19, 1940. Her keel was laid February 24, 1944, and on April 22, 1945, the ship was launched. Final construction was halted after the war, and the nearly completed ship was turned over to the mothball fleet.

On February 4, 1956, the Navy Department decided that the *Galveston* should be completed and partly redesigned to be the first ship to house and launch the deadly Talos missile. This remodeling involved the complete recasting of the afterpart of the ship's structure. On May 28, 1958, she was finally commissioned—nearly 18 years after being first authorized.

About the time the *Galveston* was being launched in 1945, the Navy's Bureau of Ordnance began the highly secret "Operation Bumblebee." The Bureau asked the applied physics laboratory at Johns Hopkins University to suggest a means to combat the Japanese kamikaze menace. Why the name was chosen for the project is uncertain, but it is believed that it may have been prompted by a slogan displayed throughout the Johns Hopkins laboratory: "According to recognized aerotechnical tests, the bumblebee cannot fly because of the shape and weight of his body in relation to total wing area. But the bumblebee doesn't know this, so he goes ahead and flies anyway."

Not Impossible After All

At the time, the task of developing a ramjet engine to power the flight of a military weapon seemed almost as impossible as making a bumblebee fly. The ramjet had been a theory in physics since before World War I, and was thought to hold great promise as a supersonic engine. But it would not work efficiently unless boosted to nearly sonic velocity. Solid-propellant rockets, such as the German V-2, were thought to be a possible answer.

On June 15, 1945, the long-awaited practical demonstration of a ramjet engine took place. A ramjet fashioned from the exhaust pipe of a Thunderbolt warplane made a successful flight over the sand dunes of Island Beach, N. J.,

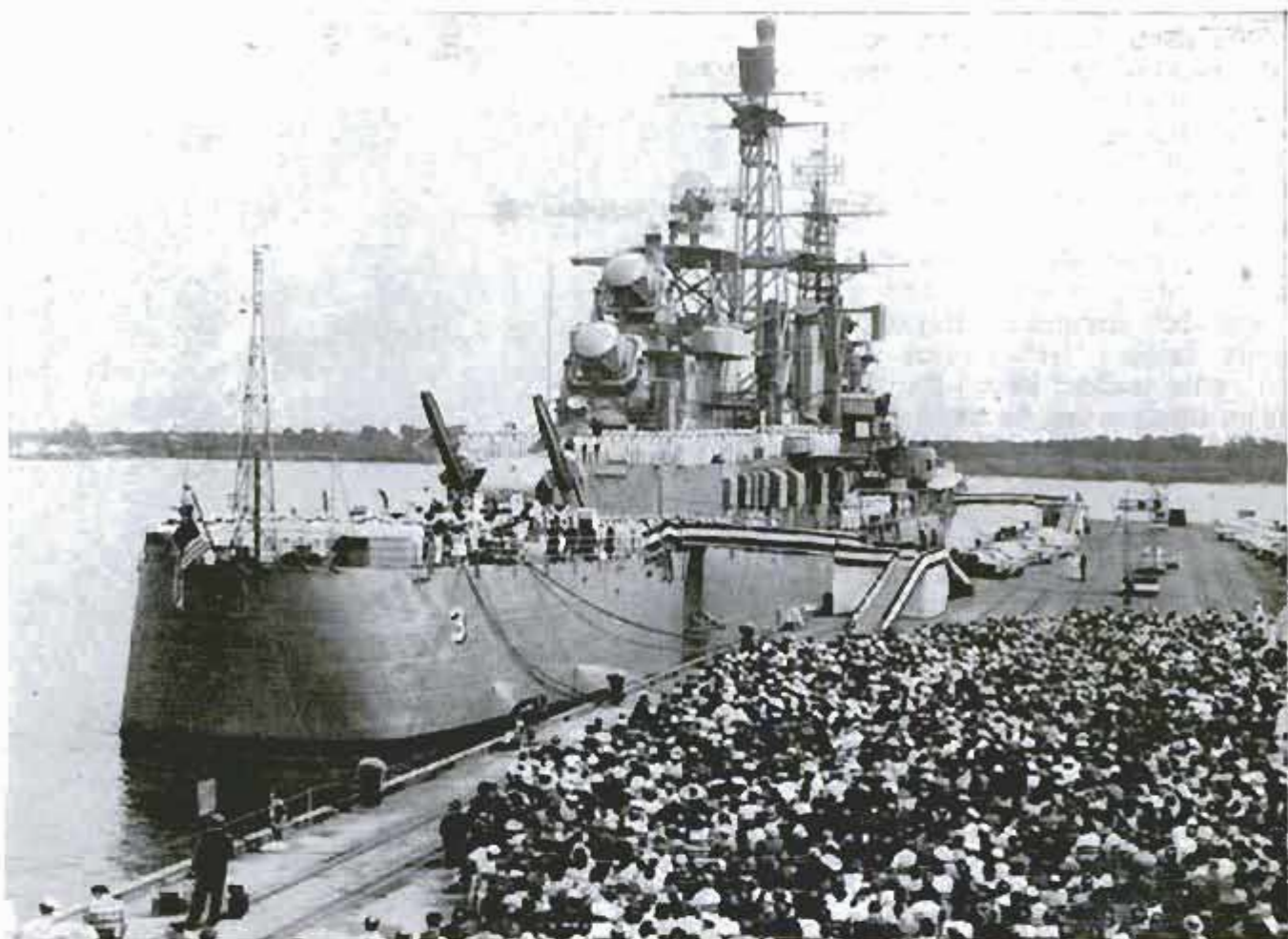

At commissioning ceremonies, the USS Galveston was heralded as the first new ship of a new naval era

attaining a velocity of 1200 miles per hour. In October of the same year, a similar model was demonstrated in free flight with a thrust greater than its aerodynamic drag. A replica of this vehicle is on exhibit in the Smithsonian Institution.

The original test vehicle embodying the ramjet engine went through various phases of development. Diameters increased from six to thirty inches. Research also concentrated on such items as aerodynamics, propulsion, radar, guidance, control systems, launching, warheads, structure, simulation and ground and flight-testing. A new means of fuel and airflow controls was designed, thereby enabling the first simple model to be developed into present types, which

have a much higher degree of thrust control and provide the propulsion plant of the Talos missile. While Bumblebee also developed other guided missiles, such as the Terrier and the Tartar, the ramjet engine itself was placed in a special division and called the Talos program.

Guiding the supersonic missiles is a pair of super radars that can pick up targets many miles beyond the horizon



The name Talos, taken from a mythological character, is appropriate for a weapon whose mission is to defend the nation. King Midas of Crete asked Zeus, the father of the gods, for someone to defend his island domain. Zeus in turn asked Hephaestus, god of metalsmiths, to supply him with a suitable defender. Hephaestus made Talos, a living brass demigod, who walked about the island three times a day to ward off any would-be attackers from the sea. Nearly indestructible, Talos had his "Achilles' heel" that proved his undoing. He had one vein that was plugged with a rivet in his foot. The resourceful enchantress Medea magically drew out the rivet and poor Talos bled to death.

Talos Is Versatile, Awesome

Propelled at supersonic speeds and guided by remote-controlled aiming, the Talos missile almost infallibly destroys an oncoming attack at distances up to 65 miles. While primarily a surface-to-air missile, it is sufficiently versatile to be used as a surface-to-surface missile in shore bombardment as well. While it is conceivable that some defensive measures against Talos will be developed, the missile is presently an awesome weapon in our national-defense arsenal.

The weapon has already set a new level in the size and performance of solid-fuel booster rockets. It was the first missile to employ a dual-guidance system, accurate at both short and long ranges. The Talos program has also pioneered the introduction of atomic warheads to anti-aircraft missiles. Adm. Arleigh Burke, chief of naval operations, has called it "the best missile in any arsenal in the world."

The Talos missile now in production weighs 3000 pounds and is approximately 20 feet long and 30 inches in diameter. Its 40,000-horsepower ramjet engine enables it to maintain a level-flight altitude higher than that reached by any bomber. It is accelerated to supersonic speed by a solid-fuel rocket propellant about 10 feet long. This booster is jettisoned when the missile reaches cruising speed. Here the ramjet engine takes over.

Like an Automobile Carburetor

Unlike a turbojet, the Talos propulsion unit does not require a complex and expensive compressing unit to inject large quantities of air for the combustion of the



At a battle station below decks on the *Galveston*, a gunner's mate inspects the end of one of the supersonic ramjet "birds"

Talos fuel (kerosene). In the ramjet the motion of the missile itself serves to compress the air that enters from the front. The Talos needs only 10 to 15 percent of the fuel load a rocket would need to develop the same thrust for the same length of time. Further, variations in the rate of fuel injection determine the speed and thrust of the missile, somewhat as a carburetor does in an automobile.

There are two phases to the direction of the weapon toward its target. Initially there is a beam-type guidance from the launching point to the target area. Guidance here is supplied from the launching area, where information on the presence of hostile targets is available by radar. In the second phase, control shifts from beam guidance to homing guidance. The control systems contain the latest applications of etched-circuit wiring and modular packaging to missile design. A safety and economy measure is the Talos Tactical Test Equipment (Tatte), which electronically records and reveals through flashing red and green lights whether each component is functioning properly prior to firing the weapon. Whether the Talos is equipped with atomic or conventional warheads, a proximity fuse sets off the warhead when it is within range of the target. ★ ★ ★

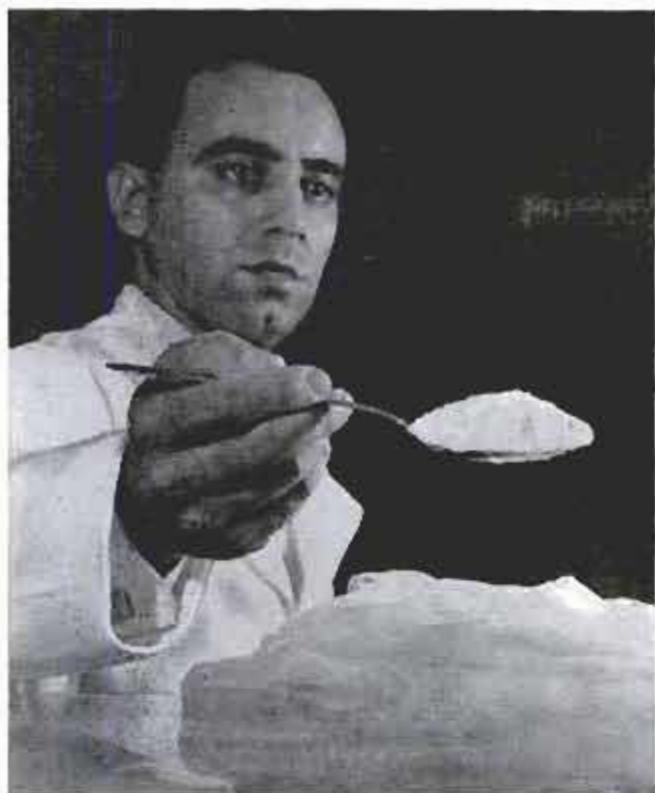

Powder Suspends Particles in Tube of Water

One tablespoon of a new white powder added to a tube of water suspends golf balls at various levels in the tube. The powder

is expected to have wide uses in industry and may eliminate the "shake well before using" label from many bottles.

Tower for Newlyweds

Honeymooners will have a new view of Niagara Falls. A 270-foot observation tower is being built at the foot of the falls. The tower, with green-tinted glass walls, will have an elevator reaching six observation decks.

Tank Car Is Tornado Shelter

What can you do with old railway tank cars? Gerald Federgreen of Topeka, Kans., bought a tank car section and had it buried in his front yard as a tornado shelter. It will accommodate about 25 adults. Cost of the shelter was about \$250.



POPULAR MECHANICS presents its Seventh Annual Automotive Section, your yearbook of the industry. It features a full-color tribute to four motoring epics—four events that dramatize the almost insane determination of pioneers to prove the automobile's reliability. Other articles range from a conversation with the industry's top stylists to a proposal by an industrial designer for a small, economical car for the shopper-commuter. Also, as usual, there is a complete listing of all 1959 cars plus the most popular imported models.

1895 to 1908:

HEROIC YEARS OF THE AUTOMOBILE

Text by Arthur R. Railton, Automotive Editor

Paintings by PM Artist Robert C. Korta

THIS IS THE STORY of heroes—human and mechanical. The story of brave, indomitable men who trusted beyond reason, the mechanical wonder of their time, the automobile.

The motorcar had scarcely been built before these visionaries realized that it was destined to break down geographical barriers. With it, men could go anywhere and they were determined to prove it. Beginning in 1895 with an unbelievable 732-mile race in France, and ending in 1908 with the greatest motoring adventure of all, the race from New York to Paris around the world, these years were the automobile's most heroic.

To those pioneers who believed in the automobile and its future, *Popular Mechanics* dedicates these paintings.

PM acknowledges with thanks the help of the Automobile Manufacturers Association and the Automotive History Collection of the Detroit Public Library in the preparation of this feature.

READY-TO-FRAME REPRINTS AVAILABLE

Full-color reprints of these four paintings of the automobile's heroic years are available (unfolded and printed on one side only). Send 25 cents in coin to the Bureau of Information, *Popular Mechanics Magazine*, 200 East Ontario, Chicago 11



1903 . . .

First Coast-to-Coast Drivers: Jackson and Crocker

WHEN THE vacationing Dr. H. Nelson Jackson heard some men in San Francisco's University Club agree that it would be impossible to drive a car across the continent, he decided to try it—he had to be getting back to his home in Vermont anyway.

He bought a 1903 Winton, added an extra gas tank, piled on some camping equipment and four days later, on May 23, 1903, he and a mechanic, Sewall K. Crocker, left for New York.

They drove north to Oregon, east across the alkaline wastes of the Great Desert. So irritating was the alkali dust that they had to equip their dog with goggles. (Painting shows Jackson driving across canvas spread over a soft spot in the sand to provide traction.)

Once through the desert, heavy rains made frequent use of block and tackle necessary. Except for this (and an occasional horse tow), the Winton made the trip unaided.

Fuel was a problem as only enough for 300 miles could be carried. Once Crocker walked 30 miles for gasoline. Breakdowns were minor and the ingenious mechanic improvised repairs when necessary.

The pair arrived in New York without fanfare 64 days after starting out, beating by almost a month a much publicized, factory-organized trip by the Packard, Old Pacific.



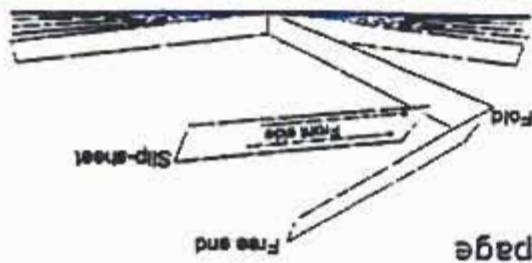

1. Open the foldout page
2. Insert this sheet with
 1. Front side touching the free page
 2. Arrow pointing to the fold
3. Slice the folded edge
4. Close the page and slip-sheet

Inverted Foldout slip-sheet

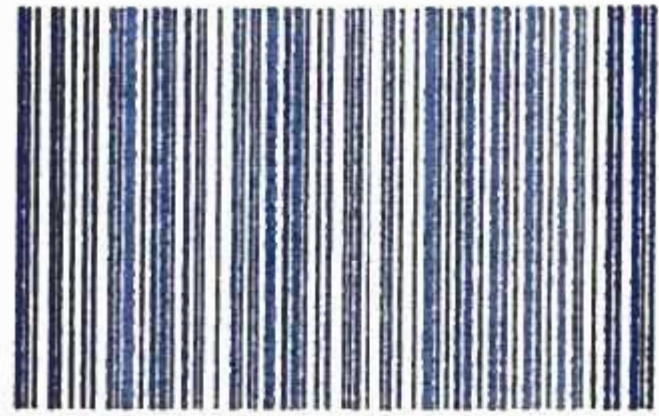

GbsSlipSheet-001



Folded edge of the page

Foldout slip-sheet

1. Open the foldout page
2. Insert this sheet with
 1. Front side touching the free page
 2. Arrow pointing to the fold
3. Slice the folded edge
4. Close the page and slip-sheet

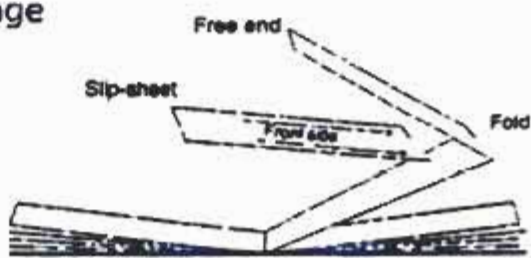

1. Follow instructions on the other side

Inverted Back

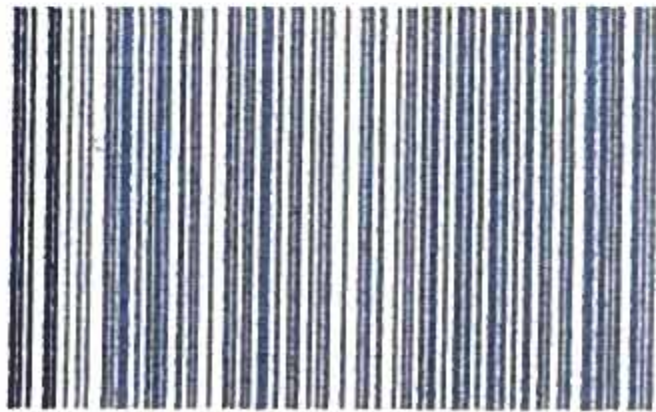

GbaSlipBack-001B

Back

1. Follow instructions on the other side

1907 . . .

Pekin to Paris: Four Cars Cross Two Continents

ON JUNE 10, 1907, five cars left Peking, China, to drive to Paris. No one had done it before, nobody was certain what lay ahead.

Four of the cars were manned by professional, factory-paid crews. The fifth was owned and driven by an Italian nobleman and motoring enthusiast, Prince Scipione Borghese.

The first 150 miles of the 9000-mile trip were over China's rugged mountains. Scores of coolies manhandled the incongruous machines along mountain trails and rock-strewn river beds. (This painting shows Borghese in his Itala car being pulled over one of many mountain passes.)

Sixty-one days after leaving Peking, the Itala arrived in Paris, marking the end of an unbelievable story of human and mechanical endurance. Three other cars arrived 20 days later. The fifth car never reached Paris, having been abandoned in the vastness of Asia.

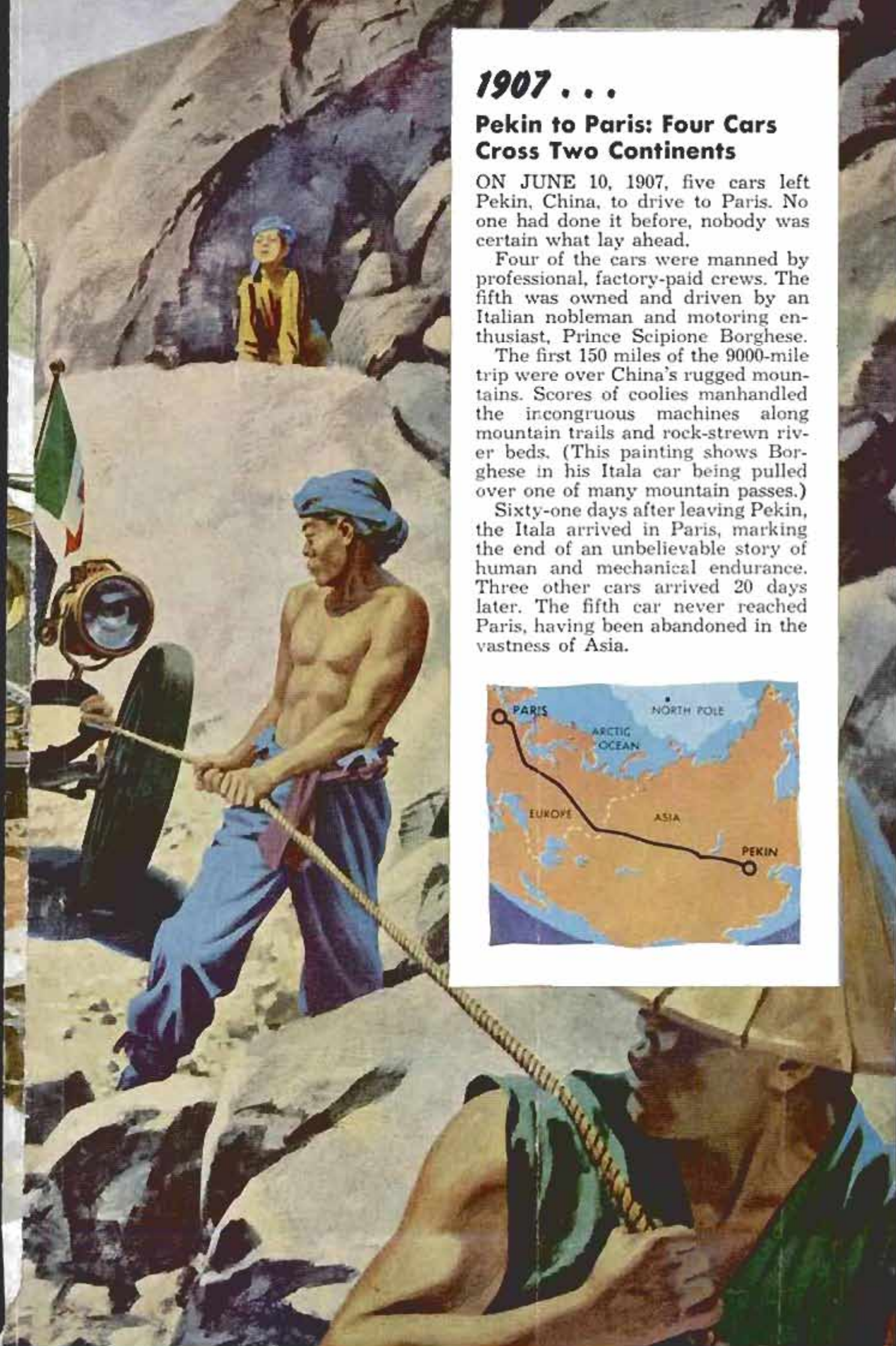

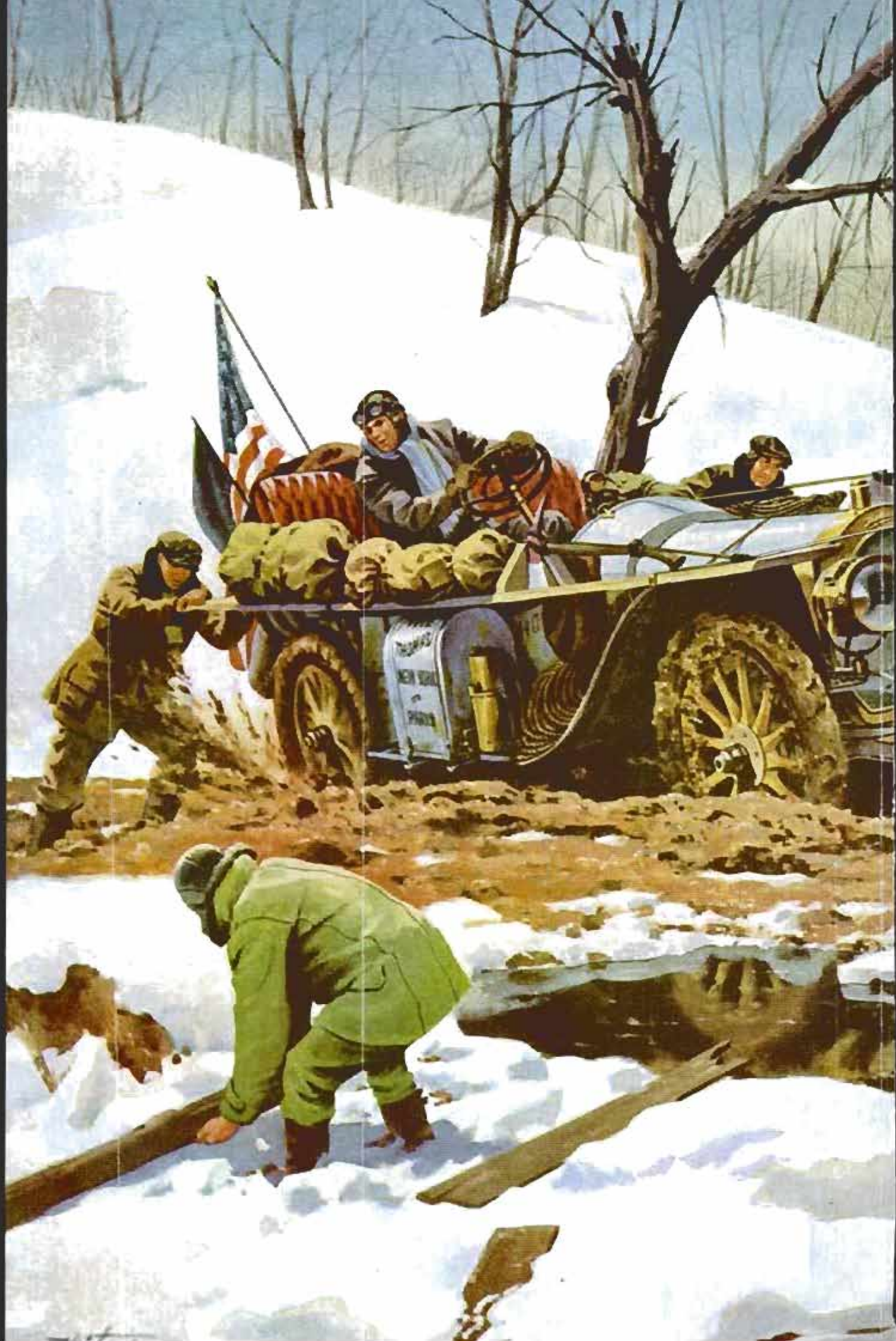

1. Open the foldout page

2. Insert this sheet with

1. Front side touching the free page

2. Arrow pointing to the fold

3. Slice the folded edge

4. Close the page and slip-sheet

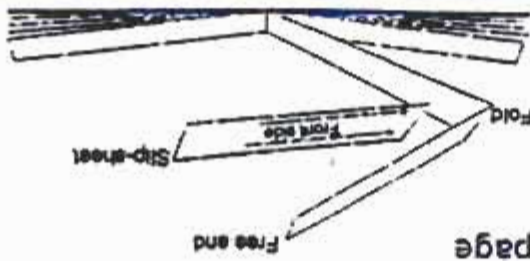

Inverted Foldout slip-sheet

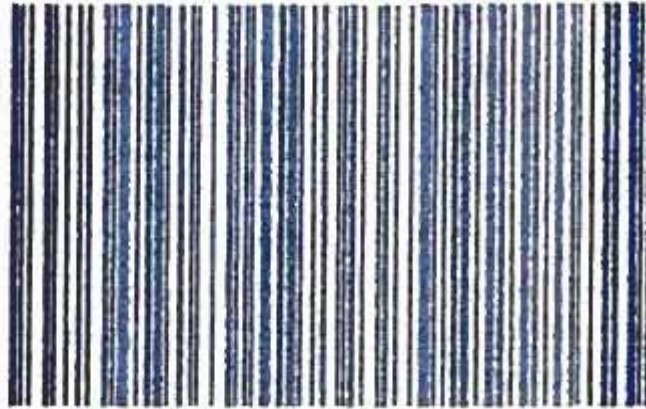

GbeSlipSheet-001



Foldout slip-sheet

Folded edge of the page

1. Open the foldout page
2. Insert this sheet with
 1. Front side touching the free page
 2. Arrow pointing to the fold
3. Slice the folded edge
4. Close the page and slip-sheet



1. Follow instructions on the other side

Inverted Back



GbaSlipBack-0018

Back

1. Follow instructions on the other side

1895 . . .

Paris - Bordeaux - Paris: Levassor's Triumph

NO MAN did more for the automobile than the Frenchman, Emile Levassor. He, more than any other person, "invented" the motor car.

But his most heroic achievement took place in 1895 when he drove a car of his own design from Paris to Bordeaux and back, a distance of 732 miles, in 48 hours and 48 minutes.

This first speed event of all time proved the superiority of the gasoline engine. Twenty-one vehicles started—14 gasoline-powered, 6 steam and 1 electric. Only nine finished within the 100-hour limit. Of these, eight were gasoline cars. The one steamer finished ninth, 41 hours behind the winner.

Levassor drove all the way without relief. He had planned to turn over the tiller to a relief driver at Ruffec on the way to Bordeaux, but he went so fast that he reached Ruffec several hours ahead of time. The relief driver was not ready. Not wanting to lose time, he drove on, arriving at Bordeaux in the middle of the night and immediately started back. On his return through Ruffec, he picked up the relief driver (who was ready this time) but, refreshed by the prospect of victory, Levassor insisted on driving all the way.

The scene shown here is his triumphant arrival at the finish line on the Boulevard Maillot in Paris.





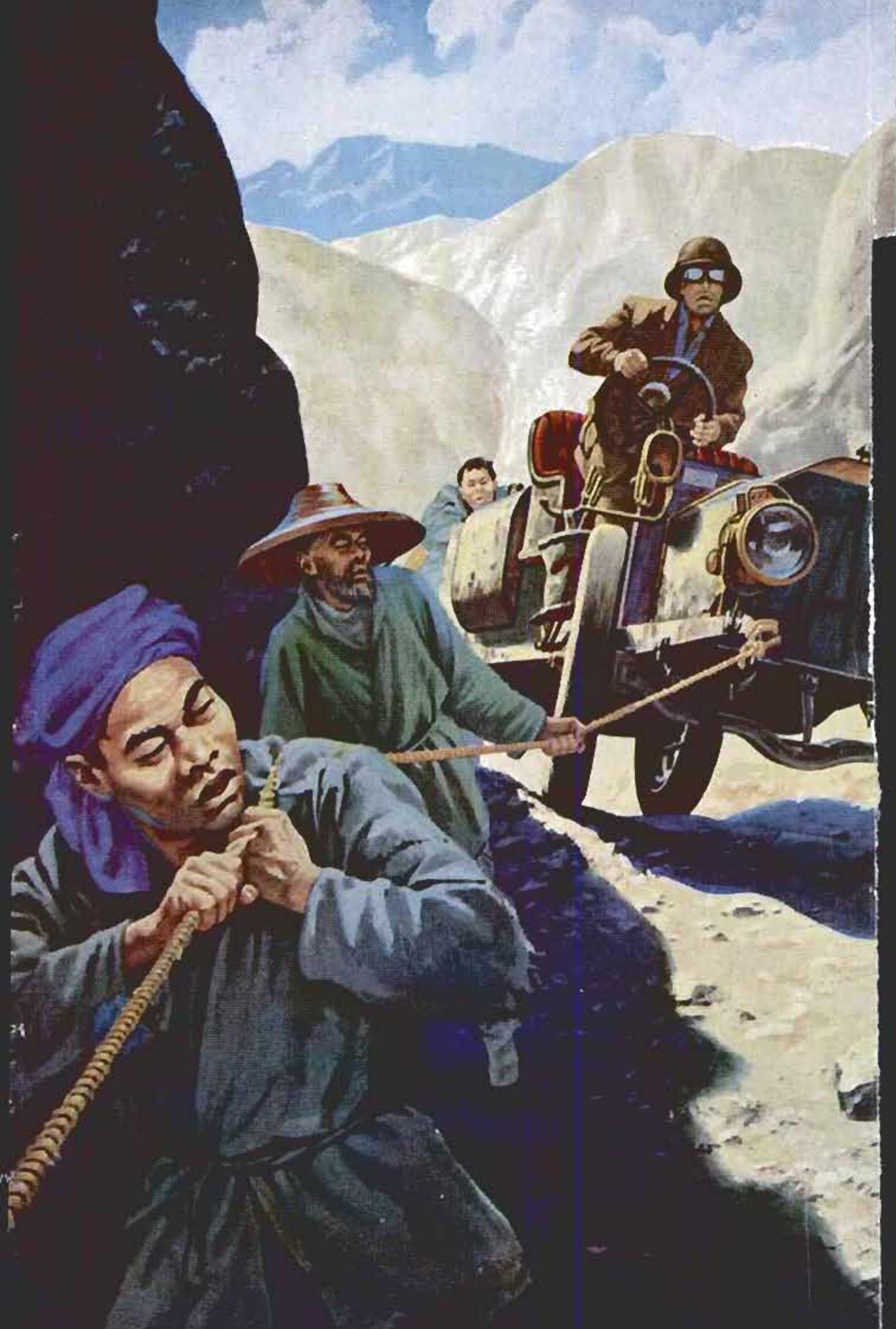

1908 . . .

Race Around the World: New York West to Paris

IT WAS INEVITABLE after Pekin-Paris and the next year it happened. The automobile was to roll around the world. Never has anything so big, so potentially dangerous, been so poorly planned. It was a debacle from start to finish. But the courage of determined men and the indestructibility of the machines they drove made the misadventure important in automotive history.

February 12, 1908, six cars left New York to drive west to Paris, all the way by land, hoping to cross the Bering Straits on frozen ice. Maniacal as it sounds, the men believed the trip possible although no reconnaissance had been made. They discovered, of course, the grand plan was a tragic blunder. Months later, three of the cars arrived in Paris by the substitute route shown on the map. Winner was the American Thomas, shown here mired in the sticky mud of Indiana early in the race.





**DETROIT
LISTENING POST**

By
Art
Railton

1959

PARADE OF CARS

IT WAS a year of decision—a year in which major decisions had to be made, decisions that will set the course of the industry for years ahead.

Some were made, others postponed until the industry is more certain what you, the public, think. That makes 1959, *your* year of decision.

It was a year for drawing the line—the little foreign cars went as far as they could be permitted to go. At one period in the year, they were selling 11 percent of the total market. That did it. The big boys decided to get into the game.

Before the 1959 World Series is over, you will be admiring the all-new domestic small cars as they scoot around the streets of your town.

What will this new breed of American cars be like? Nobody is saying for sure, but it certainly will be handsome, it certainly will be economical, and it certainly will sell.

But there was more to 1958 than the small-car decision.

Most important (and most frightening) item in 1958 was the sharp drop in sales of new cars. Total industry sales were down about 30 percent. Some makes were down twice that much. Obviously, this must be stopped if the industry is to maintain its present stature.

Detroit experts blame the sales lag on the recession. Some critics outside the industry put the blame in a different order: They argue that the excessive opulence of the 1958 cars so out-priced the average

American that he couldn't buy a new model or, if he could buy it, he was so sickened by the excesses of the machines that he wouldn't buy. This, these critics claim, created the recession.

So the argument deteriorated into "which came first" and as with the hen and the egg, nobody knew.

Meanwhile in South Bend, Indiana, where gloom had been hip-deep for years, the fast-weakening, almost desperate Studebaker-Packard Company came up with the biggest news story of 1959: A small American car that could make critics eat their words.

This new car, the Lark, is a mere foot longer than the tiny foreign cars and yet seats six (snugly, to be sure). It has a good, old-fashioned American water-cooled engine. It comes as a six or a V8, and the V8 is a scat-wagon in the best American tradition. It has a trunk in the back where the bellhop has learned to expect it.

How the public is taking to this car is uncertain at this writing (late November), but expectations are great. Not only South Bend, but Detroit also, is watching, because its reception will provide valuable information about other small cars' prospective sales.

Only two cars set sales records in 1958: The Rambler (with the help of its new and smaller brother, the American); and the expensive Thunderbird.

Two more different cars would be hard to find. The only quality they share is dimensional. Both are smaller than other cars in their price classes. Yet the men who designed the Thunderbird do not credit the car's smallness with its success (see page 176). "Small" continues to be a verboten word in the industry. American Motors still isn't bold enough to use it in describing its Ramblers. (Even the current Studebaker Lark makes no mention of the car's smallness, describing it instead as a "new dimension in motoring.")

There just weren't enough Thunderbirds to satisfy the orders, so meteoric was its success. In its first year as a full-size car (with four seats, that is), the Thunderbird

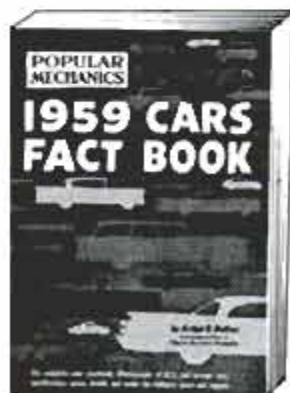

PM's 1959 Cars Fact Book is off the press with 160 pages about domestic and foreign cars. Written by Arthur R. Railton, *PM's* Auto Editor, it discusses the new cars in an adult, informative manner. Get a copy at your newsstand for 75 cents or send 85 cents to *Popular Mechanics*, 200 E. Ontario, Chicago 11

What's under the sheet metal?

On the next 17 pages are photographs of all 1959 American cars and many European makes. In addition, there are drawings which show what the sleek, shiny metal hides: The frame; the suspension and running gear. These are the parts that make a car behave the way it does; these are the parts that most people never see.

Among the American cars there is considerable variation in frame design, less in running gear, and little or none in engines. European cars are more varied. They range from front engine, front-wheel drive to rear-engine, rear-wheel drive; from water to air-cooled; from two to three to four cylinders; from torsion bars to transverse leaf springs to horizontal coil springs.

The sketches are self-explanatory. The white arrow on each foreign chassis points to the front of the car. The small "X" inside the square on the American cars locates the universal joints in the drive shafts. Beneath each sketch is pertinent descriptive material.

took 22 percent of the prestige-car market. It sold more than twice as many cars as Imperial and about 25 percent more than Lincoln. Yet, says Ford, the smallness of the car has nothing to do with its success.

The Rambler American, a revival of a 1955 design, outsold even the most optimistic hopes of its sponsors. Not spectacular in either looks or performance, it is small, neat and practical—and it sells.

Among most of the new cars for 1959,

stylists were king. The engineer was in a hiatus between last year's achievements and the big promises for 1960.

The exciting advances of the 1958 models somehow seem less exciting one year later. Air suspension, introduced as the greatest thing since independent front suspension, failed to attract a market. It was too expensive, too temperamental, too marginal. The public didn't get excited about it.

(Continued to page 294)

PRODUCTION OF PASSENGER CARS DURING 1958

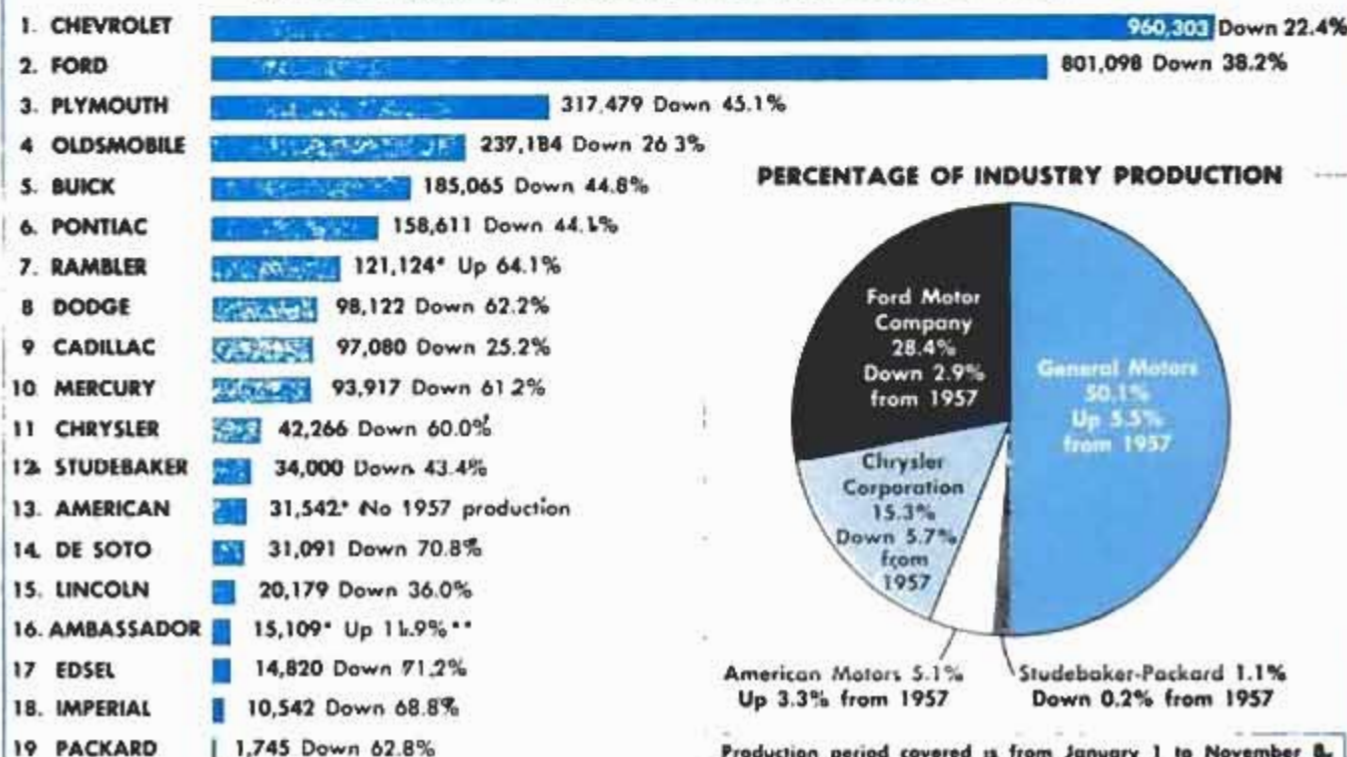

PERCENTAGE OF INDUSTRY PRODUCTION

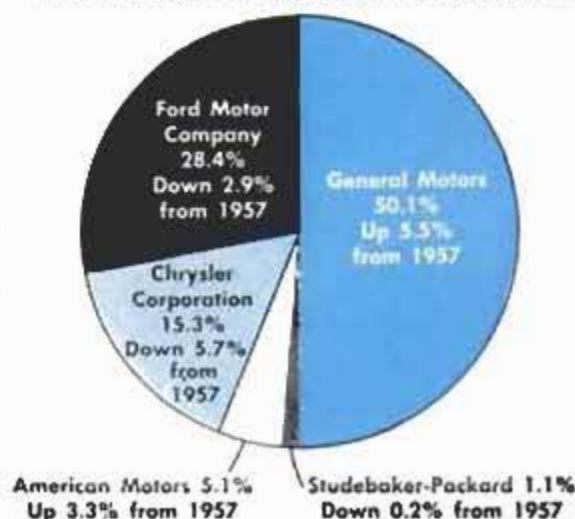

* Approximate ** Compared to 1957 Hudson-Nash total
TOTAL FOR INDUSTRY: 3,270,877 passenger cars—Down 36.8% from 1957

Production period covered is from January 1 to November 8, 1958, and comparisons are with same period of 1957. Total production for 1958 is expected to be about 4,520,000 cars. Data by courtesy of Automotive News



AMERICAN

Wheelbase: 100.0 inches
 Leaf springs, rear
 Solid rear axle
 Drive through rear springs
 Unit body-frame
 One-piece exposed drive shaft
 Coil springs, independent front suspension
 Six-cylinder engine only

American, unlike other members of the American Motors family, has an exposed drive shaft and leaf springs at the rear in the normal Hotchkiss arrangement. Drive is through the rear springs, no torque tube being used. Front suspension is by coils as with the other American Motors products. It is entirely conventional except that the coil springs extend higher than in the usual design. The unitized body and frame eliminates the necessity for side rails.



Six-Cylinder Two-Door	Lowest Priced	Displacement	Shipping Weight	Over-All Length	Over-All Width	Trunk Space	
AMERICAN	\$1835	195.6	2476	178.3	73.0	8.2	
STUDEBAKER	\$1925	169.6*	2597	175.0	69.0	12.6	
	Turn Circle	Legroom		Headroom		Hiproom	
		Front	Rear	Front	Rear	Front	Rear
AMERICAN	36.0	44.0	37.5	35.3	34.0	58.0	45.3
STUDEBAKER	37.5	44.0	41.0	36.0	35.0	59.5	59.0

*259.2-cu.-in. V8 also available.



Leaf springs, rear
 Solid rear axle
 Drive through rear springs
 Ladder frame
 One-piece exposed drive shaft
 Coil springs, independent front suspension
 V8 or Six-cylinder engine
Wheelbase: 108.5 inches

Studebaker Lark's box-section frame is of heavier gauge than its previous models and being shorter, also, is about 30 percent more rigid. Actual frame design is unchanged except for the shortening to allow the smaller wheelbase. Rear suspension is conventional with semielliptical leaf springs that take the thrust of the exposed drive shaft in the normal Hotchkiss manner. Front suspension is by coils. These springs are designed to have a variable rate so stiffness varies with the amount of load. The ladder-type frame has a slight belly for increased rear-seat legroom.

STUDEBAKER





4-Door Sedan Data	Lowest Priced	Standard V8 Displacement	Shipping Weight	Over-All Length	Over-All Width	Trunk Space	Turn Circle
PLYMOUTH	\$2402*	318.0	3430	208.2	78.0	35.6	42.2
CHEVROLET	\$2419*	283.0	3614	210.9	79.9	19.2	40.2
FORD	\$2391*	292.0	3485	208.0	76.6	33.9	40.6
RAMBLER	\$2398*	250.0	3287	191.2	72.2	13.5	37.6

*V8s only, for Sixes subtract about \$120



PLYMOUTH



Wheelbase: 118.0 inches

Leaf springs, rear
Solid rear axle
Exposed drive

Ladder frame
One-piece drive shaft
Drive through rear springs

Torsion bars, front
Independent front suspension
V8 or Six engines

Plymouth's straight-railed ladder frame is typical of the Chrysler line. Front-end springing is by torsion bars which, for 1959, have been thinned and shortened thanks to improved metallurgy. Rear suspension is Hotchkiss with conventional leaf springs. A change in the roof of hardtop sedans has given added rear-seat headroom and better seat padding over the drive-shaft tunnel.



Wheelbase: 119.0 inches

Coil springs, rear
Solid rear axle
Exposed drive

X-frame
Two-piece drive shaft
Drive through control arms

Coil springs, front
Independent front suspension
V8 or Six engines

Chevrolet keeps its bodies low by using a two-piece drive shaft with its center joint inside the tubular midsection of the X-frame. Coil springs at the rear make necessary a set of control arms to transmit thrust from the rear wheels to the frame. The narrow-waisted frame permits wide stepdowns in the rear floor. Coil springs are mounted conventionally at the front end.

Legroom		Headroom		Hiproom	
Front	Rear	Front	Rear	Front	Rear
45.5	41.5	35.7	34.2	63.0	62.7
45.0	42.8	36.1	34.3	66.1	65.5
42.7	40.3	33.5	33.3	60.4	60.8
43.0	40.0	36.0	35.0	59.8	60.1

LOW PRICE

FORD



Wheelbase: 118.0 inches

Leaf springs, rear
Solid rear axle
Exposed drive

Ladder frame with cow belly
One-piece drive shaft
Drive through rear springs

Coil springs, front
Independent front suspension
V8 or Six engines

Ford makes room for rear foot wells by giving its ladder frame a broad belly. The added width makes room for lowering the floor inside the side rails. Drive shaft is of one piece. Front and rear suspensions are conventional with coils in front and semielliptical leaf springs in the rear. The rear end is a standard Hotchkiss setup with wheel thrust being transmitted through the leaf springs.

RAMBLER

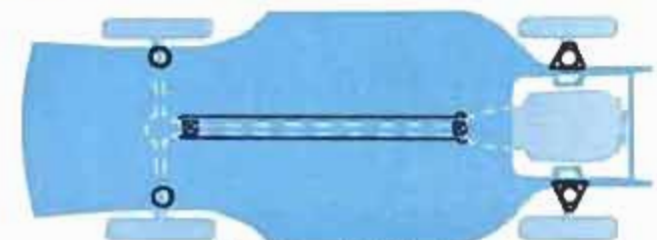

Wheelbase: 108.0 inches

Coil springs, rear
Solid rear axle
Torque-tube drive

Unit body-frame
One-piece drive shaft
Drive through torque tube

Coil springs, front
Independent front suspension
V8 or Six engines

Rambler's unit body eliminates the conventional side rails. Thrust from the rear wheels is taken through the torque tube that connects the transmission and rear axle. Within it, the drive shaft rotates. Coil springs are used on all wheels and no control arms are necessary because of the torque tube. Front-end suspension is conventional. The unit body permits the floor to be lowered without rail problems.



4-Door Sedan Data	Lowest Priced	Standard V8 Displacement	Shipping Weight	Over-All Length	Over-All Width	Trunk Space	Turn Circle
PONTIAC	\$2704	389.0	3940	213.7	80.7	19.0**	42.7
AMBASSADOR	\$2587	327.0	3428	200.2	72.2	13.5	39.8
DODGE	\$2707*	326.0*	3615	217.4	80.0	38.6	43.6
EDSEL	\$2684*	292.0**	3675	210.9	79.8	32.0	41.8

* V8s. Dodge Six \$2587, Edsel Six \$2600

** Catalina, Star Chief and Bonneville 220.7 length, 24.3 trunk space

* Coronet, Royal and Custom Royal 361.0

** Ranger, Corsair 332.0



PONTIAC



Wheelbases: 122.0 and 124.0 inches

- | | | |
|---------------------|----------------------------|---------------------|
| Coil springs, rear | Tubular center | Coil springs, front |
| Solid rear axle | X-type frame | Independent front |
| Exposed drive shaft | Two-piece drive shaft | suspension |
| | Drive through control arms | V8 engine only |

Pontiac's tubular-center X-frame requires no side rails and allows the rear foot wells to be wider than usual. Coil springs suspend all four corners of the body. The two-piece drive shaft has a center universal inside the junction of the frame. At the rear, the coils are mounted ahead of the axle on pivoted control arms that take the thrust of the wheels.

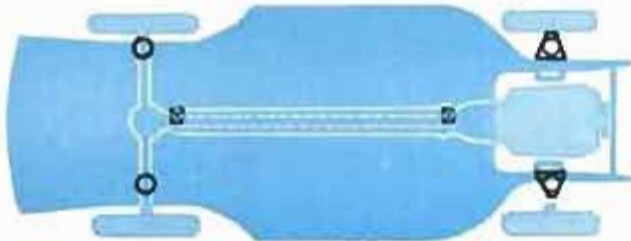

Wheelbase: 117.0 inches

- | | | |
|----------------------|---------------------------|---------------------|
| Coil springs, rear | Unit body and frame | Coil springs, front |
| Solid rear axle | One-piece drive shaft | Independent front |
| Enclosed drive shaft | Drive through torque tube | suspension |
| | | V8 engine only |

AMBASSADOR

Ambassador shares the same chassis layout as the smaller Rambler (but differs from the American). It has coil springs all around and a torque tube takes up the drive and torque. The drive shaft, rotating inside the tube, is one piece. At the front, conventional coil springs are used, but mounted higher than is customary due to the unit design that eliminates side rails.

Legroom		Headroom		Hiproom	
Front	Rear	Front	Rear	Front	Rear
44.8	42.5	34.8	33.9	65.4	65.4
43.0	40.0	36.0	35.0	59.8	60.1
45.5	42.5	35.7	34.5	63.0	62.7
42.8	40.4	33.8	33.5	60.4	60.8

LOWER



Wheelbase: 122.0 inches

- | | | |
|---------------------|----------------------------|---------------------|
| Leaf springs, rear | Ladder frame | Torsion bars, front |
| Solid rear axle | One-piece drive shaft | Independent front |
| Exposed drive shaft | Drive through rear springs | suspension |
| | | Six and V8 engines |

Dodge has a straight-through ladder frame that is typical of Chrysler products and that makes impossible the use of rear-seat foot wells. Front suspension is by torsion bars that run longitudinally. At the rear, the suspension uses semielliptical leaf springs. The one-piece exposed drive shaft is conventional Hotchkiss design and thrust is taken through the rear springs.

DODGE



Wheelbase: 120.0 inches

- | | | |
|---------------------|----------------------------|---------------------|
| Leaf springs, rear | Ladder frame | Coil springs, front |
| Solid rear axle | One-piece drive shaft | Independent front |
| Exposed drive shaft | Drive through rear springs | suspension |
| | | Six and V8 engines |

Edsel has a ladder frame but, like Ford, it incorporates a billowing cow belly that allows clearance for rear-seat foot wells. Its front suspension is conventional with coil springs and wishbones. Rear suspension, too, is conventional with semielliptical leaf springs that take the drive and torque from the one-piece exposed drive shaft in a standard Hotchkiss-drive manner.

EDSEL



4-Door Sedan Data	Lowest Priced	Standard V8 Displacement	Shipping Weight	Over-All Length	Over-All Width	Trunk Space	Turn Circle
BUICK	\$2804	364.0*	4229	217.4**	80.7	15.0	44.0
DE SOTO	\$2904	361.0*	3670	215.5**	78.7	37.5	43.6
OLDSMOBILE	\$2902	371.0*	4162	218.4**	80.8	17.6	45.0
MERCURY	\$2832	312.0*	4001	217.8**	80.7	31.5	44.0

* LeSobre Invicta and Electro 401.0
 ** Electro 220.6, Electro 225, 225.4

† Firesweep Fireflite and Firedome 383.0
 †† Firesweep Fireflite 219.5, Firedome 221.1

* "88" Super 88 and "98" 394.0
 ** "98" 223.0



BUICK



Wheelbases: 123.0 and 126.3 inches

Coil springs, rear Ladder frame with Coil springs, front
Solid rear axle K-member Independent front
Enclosed drive Two-piece drive suspension
shaft shaft V8 engine only
Drive through torque tube



Wheelbases: 122.0 and 126.0 inches

Leaf springs, rear Ladder frame Torsion bars, front
Solid rear axle One-piece drive Independent front
Exposed drive shaft suspension
shaft Drive through V8 engine only
rear springs

DE SOTO

De Soto has a straight-through ladder frame like all Chrysler Corporation cars. Its independent front suspension is with longitudinal torsion bars that are shorter and thinner this year as a result of the improved metals. Rear suspension is with standard semielliptical leaf springs that take the wheel thrust in Hotchkiss fashion. The exposed drive shaft is in one piece.

Legroom		Headroom		Hiproom	
Front	Rear	Front	Rear	Front	Rear
44.6	42.6	35.7	34.2	66.1	65.5
45.5	43.0	35.7	34.5	63.0	62.7
44.8	42.5	34.9	34.2	66.1	65.5
44.3	43.6	33.2	32.9	62.5	62.8

*Monterey Montclair 383.0 Park Lane 430.0

**Park Lane 222.8



Wheelbases: 123.0 and 126.3 inches

Leaf springs, rear Ladder frame with Coil springs, front
Solid rear axle X-member Independent front
Exposed drive Two-piece drive suspension
shaft shaft V8 engine only
Drive through rear springs

UPPER MEDIUM OLDSMOBILE

Oldsmobile combines an X-frame and a ladder frame (most cars with ladder frames use X-bracing on convertible bodies only). It also has a cow belly to allow for the step-down floor in the rear. Front coil springs are conventional as are the semielliptical leaf springs at the rear end. Its two-piece drive shaft has the center universal joint mounted within the tunnel.



Wheelbases: 126.0 and 128.0 inches

Leaf springs, rear Ladder frame Coil springs, front
Solid rear axle One-piece drive Independent front
Exposed drive shaft suspension
shaft Drive through V8 engine only
rear springs

MERCURY

Mercury's ladder frame with a bowed center portion to give foot-well space in the rear has an unusual cross member at the rear axle. It is a wide, arched bracing and gives great lateral strength without taking up much vertical space. Front suspension by coils and rear by long leaf springs are both conventional. Drive shaft is one piece and its setup is Hotchkiss.



4-Door Sedan Data	Lowest Priced	Standard V8 Displacement	Shipping Weight	Over-All Length	Over-All Width	Trunk Space	Turn Circle
LINCOLN	\$5090	430.0	4986	227.1	80.1	17.2	45.0
CADILLAC	\$5080	390.0	4835	225.0	80.2	19.3	47.0
CHRYSLER*	\$4424	413.0	4120	220.9	79.5	37.5	47.1
IMPERIAL	\$5016	413.0	4735	226.3	81.0	36.7	48.2

* New Yorker series

All have automatic transmission, power brakes and steering standard.



LINCOLN

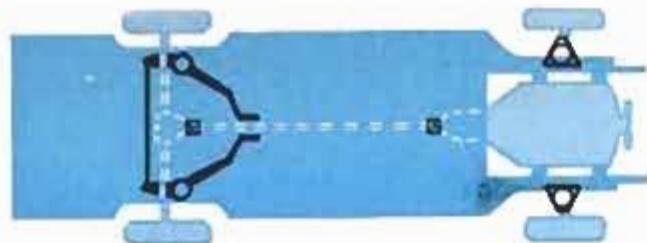

Wheelbase: 131.0 inches

Coil springs, rear
Solid rear axle
Exposed drive

Unit body-frame
One-piece drive shaft
Drive through trailing arms

Coil springs, front
Independent front suspension
V8 engine only

Lincoln's unitized body (probably the largest in the world) eliminates the conventional frame and its restrictive side rails. Front suspension is conventional with coil springs and wishbones. The drive is through an exposed propeller shaft with no center universal. Trailing arms that carry the rear coil springs are attached to a body cross member at their forward ends. A track bar is mounted behind the rear axle.

CADILLAC



Wheelbase: 130.0 inches

Coil springs, rear
Solid rear axle
Exposed drive

Tubular center X-frame
Two-piece drive shaft
Drive through four links

Coil springs, front
Independent front suspension
V8 engine only

Cadillac's tubular-center X-frame eliminates the problem of the restrictive side rails and allows rear floor wells to be wider. The exposed drive shaft is in two sections with its center universal joint inside the frame's narrow waist. The rear section of the shaft is rubber cushioned. Coil springs support the rear of the body and mount ahead of the axle on trailing arms. Front suspension is conventional with coil springs.

Legroom		Headroom		Hiproom	
Front	Rear	Front	Rear	Front	Rear
44.1	46.1	34.9	33.7	61.0	65.5
45.6	45.3	34.8	33.2	64.6	64.4
45.5	43.0	35.7	34.5	63.0	62.7
45.5	46.5	36.2	34.2	61.0	60.2

HITCH RICE

CHRYSLER



Wheelbase: 126.0 inches

Leaf springs, rear
Solid rear axle
Exposed drive

Ladder frame
One-piece drive shaft
Drive through rear springs

Torsion bars, front
Independent front suspension
V8 engine only

Chrysler's front wheels are sprung by two longitudinal torsion bars anchored to a frame cross member that supports the transmission. Although the drive shaft remains one piece, tunnel height has been reduced by changing to a stepped-diameter shaft that is narrower at the end, fatter in the middle, requiring less bounce clearance. Leaf springs are used in the Hotchkiss-drive rear end.

IMPERIAL



Wheelbase: 129.0 inches

Leaf springs, rear
Solid rear axle
Exposed drive

Ladder frame
Two-piece drive shaft
Drive through rear springs and struts

Torsion bars, front
Independent front suspension
V8 engine only

Imperial, like other Chrysler products, has torsion bars for its front suspension. This year its frame is slightly different from that used by Chrysler. Also different is the two-section drive shaft with its center universal being mounted on a frame cross member. The rear suspension is conventional Hotchkiss with the thrust being taken through longitudinal leaf springs.

For the Young in Heart:



CORVETTE

Here's the only true sports car stamped "Made in U.S.A." Refined steadily since 1953, it is now among the best in the world. It has coils in front, leaf springs in back. New are radius rods that take the torque reactions of the rear axle, relieving the rear springs of the job. Four-speed gearbox has a reverse lockout.



CHRYSLER 300E

Not a sports car in the nimble sense of a Corvette, the 300E is a high-performance machine that covers long distances at high speed with a maximum of comfort. Interiors are elegant in perforated leather that is cool on the hottest day. Dignified but debonair, it is a car to please those who love to go places in a hurry but feel out of character in a sports car.



SILVER HAWK

THUNDERBIRD

If you want a car that looks like a sports car, and are not particularly anxious for it to be a bomb, the Studebaker Silver Hawk belongs in your garage. Low, long and finned, its small V8 or even smaller Six puts it among the featherweights. But who cares? It is a handsome, pleasant machine.



No sports car, no bombshell, yet this is a car for the young of all ages. And it seems to be proving that as wallets get fatter, cars needn't get bigger. Handsome, luxurious and overwhelmingly youthful, it still is dignified enough to be driven to a Board of Directors' meeting at the First National Bank.

PARADE OF FOREIGN CARS

THE CHART at the bottom of the page tells the story. It describes more graphically than words the spectacular sales rise of foreign cars in this country.

But it doesn't answer the question that still bothers Detroit: *Why* are they selling? It's this that bewilders the industry.

Is it simply size? Economy? Handling ease? If these are all, then Detroit has no worries. It can and will build cars that satisfy these demands.

But there may be something more—something that Detroit can't possibly provide. It may be the glamor of the imported product. It may be the wide variety of styling that enables the buyer to own an economy car that is not a carbon copy of his neighbor's. It may be the variety of engineering (the chassis diagrams on the following pages show how much variety there really is among the imported cars). This variety gives the owner reason to brag about air-cooled engine, swing axles, rack-and-pinion steering, front-wheel drive, trailing-arm suspension, unit body and all the vast cabala of automobile design that seems completely foreign to the American-car buyer.

Whatever the reason, Detroit now realizes that the foreign-car success cannot be ignored any longer. What started out as

a fad for funny fellows with berets has turned into an epidemic. Small foreign cars that were originally bought as second cars apparently are becoming first cars in more and more families.

The total foreign-car sales in this country for 1958 were about 275,000 cars, which is equal to the combined 1958-model sales of Chrysler, Edsel, Studebaker, De Soto, Lincoln, Imperial and Packard. And estimates are that 1959 sales will be higher.

Next year, the big American companies will have their small cars in the battle. Actually, these forthcoming small cars will not compete directly with the best-selling foreign cars in either price or size.

The new American small cars will be more like the Borgward and Peugeot in size and price. Cars like Volkswagen, Renault and Fiat (which currently combine to make most of the foreign-car total) will still have the below-\$2000 market to themselves despite the counterattack of the Americans.

Whether the difference between \$1700 and \$2000 (the expected domestic small-car price) will be enough advantage to keep these foreign cars in volume business remains to be seen. In any case, on the following pages are 18 of the best-known foreign cars, the cars that made Detroit admit that it may have been wrong.

Sales of imported cars skyrocketed to 11.5 percent of all cars sold in this country by September 1958

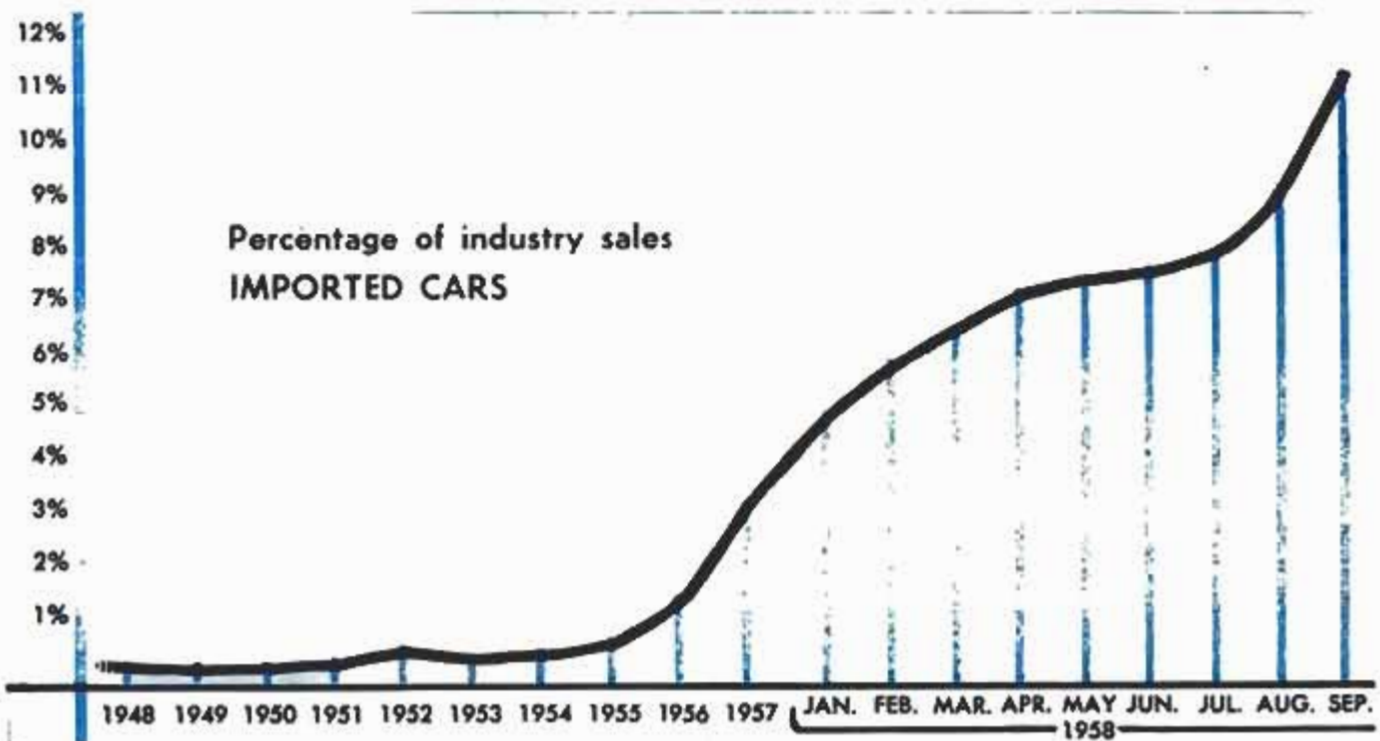



Styling changes on the 1959 Hillman are minor. Its engine has been enlarged for better performance and quieter high-speed operation. Like most British cars, the Hillman is conventional in its chassis design



Wheelbase: 96.0 inches
 Front engine, inline OHV four-cylinder, water-cooled, 57.5 horsepower

Front suspension: Independent	Unitized body and frame	Rear suspension: Nonindependent
Coil springs	Four-speed transmission	Leaf springs
Wishbones	automatic clutch, optional	Solid rear axle
Ball joints	Top speed: About 80 m.p.h.	Rear-wheel drive by exposed drive shaft
Gas mileage: About 25 m.p.g.		

HILLMAN

	Price*	Displacement	Curb Weight	Over-All Length	Over-All Width	Turn Circle	Front Headroom	Front Legroom
HILLMAN MINX	\$1849	91.1	2221	163.0	60.8	34.3	37.8	34.5
FIAT Multipla 600	\$1598	38.6	1610	139.2	57.1	29.0	36.2**	35.4**
FORD ANGLIA	\$1539	71.6	1716	149.8	60.8	34.5	36.0	44.0

* Port-of-entry price at New York City

** Two-door sedan, other data for Multipla model (illustrated)



Wheelbase: 78.8 inches
 Rear engine, inline OHV four-cylinder, water-cooled, 22 horsepower

Front suspension: Independent	Unitized body and frame	Rear suspension: Independent
Coil springs (Transverse leaf spring on sedans)	Four-speed transmission	Semitrailing wishbones with coil springs
Wishbones	Top speed: About 60 m.p.h.	Rear-wheel drive through swing axle
Gas mileage: About 35 m.p.g.		

Fiat makes so many models it covers the whole market. This four-door Multipla wagon is about as roomy as a small car can be. Chassis layout is shown at right. The larger Fiats have their engines in the front, the smaller ones in the rear. All but the very smallest are watercooled

FIAT



Wheelbase: 87.0 inches
 Front engine, inline flathead four-cylinder, water-cooled, 36 horsepower

Front suspension: Independent	Unitized body and frame	Rear suspension: Nonindependent
Coil springs	Three-speed transmission	Leaf springs
Wishbones	Top speed: About 68 m.p.h.	Solid rear axle
Gas mileage: About 30 m.p.g.		Rear-wheel drive by exposed drive shaft

As you can see at the right, the English Ford has a chassis layout very similar to most American cars (except for the unit body). Shown here is the smallest, the two-door Anglia. Others include the four-door Prefect sedan on the same chassis and several larger and more expensive models

ENGLISH FORD

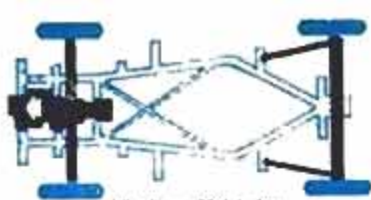

Wheelbase: 92.6 inches

Front engine, valveless two-stroke, three-cylinder water-cooled, 40 horsepower

Front suspension: Independent Transverse leaf spring	Box-section ladder frame with X-member Four-speed transmission (automatic clutch optional)	Rear suspension: Nonindependent Transverse leaf spring Solid, floating rear axle
Front-wheel drive Rack-and-pinion steering	Top speed: About 80 m.p.h.	
Gas mileage: About 30 m.p.g.		

DKW



If you like unusual designs, look at the DKW. It has a three-cylinder two-stroke engine with front-wheel drive. Its chassis is so simple and trouble-free that you wonder who decided that cars had to be complicated

	Price*	Displacement	Curb Weight	Over-All Length	Over-All Width	Turn Circle	Front Headroom	Front Legroom
DKW	\$1995	54.7	2075	166.0	66.0	36.0	37.0	N.A.
SAAB 93 B	\$1895	45.6	1806	158.0	62.0	36.0	38.5	36.0
PRINZ NSU	\$1398**	35.6	1137	142.8	57.0	28.0	37.0**	40.0**

* Port-of-entry price at New York City

** Two-door sedan model all other data for Sport Prinz, (illustrated)

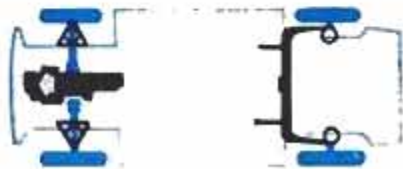

Wheelbase: 98.0 inches

Front engine, valveless two-stroke, three-cylinder, water-cooled, 38 horsepower

Front suspension: Independent Coil springs Wishbones	Unitized body and frame Three speed transmission	Rear suspension: Nonindependent Coil springs Solid U-shaped rear axle pivots in center
Front-wheel drive Swing axles Rack-and-pinion steering	Top speed: About 75 m.p.h. Gas mileage: About 30 m.p.g.	

SAAB



Saab uses the same engine design as the DKW. Built by a Swedish airplane company, it is sleek and agile. Having a front-wheel drive, it requires no longitudinal drive shaft. Its rear-axle design is most unconventional. For sure-footedness in deep snow and on ice, this car is hard to beat



Wheelbase: 78.8 inches

Rear engine, inline overhead-camshaft, two-cylinder, air-cooled, 20 horsepower

Front suspension: Independent Coil springs Wishbones	Unitized body and frame Four-speed transmission, all synchromesh	Rear suspension: Independent Coil springs Front and rear radius rods Rear-wheel drive through swing axles
Gas mileage: About 50 m.p.g.	Top speed: About 65 m.p.h.	

NSU



One of the world's best-known motorcycle companies, NSU now has a small car, the Prinz. Newest model is the sports coupe shown here. No price is available for this sleek beauty (the sedan price is listed above). Both are powered by a two-cylinder air-cooled engine mounted in the rear



Freshest design of the year is this Austin A40 sedan-wagon. Its roof extends all the way to the rear of the body. Back seat folds to make a huge luggage area, combining the advantages of sedan and station wagon



Wheelbase: 83.5 inches
 Front engine, inline OHV four-cylinder, water-cooled
 38.5 horsepower
 Front suspension: Unitized body and frame
 Independent coil springs
 Rear suspension: Nonindependent leaf springs
 Solid rear axle
 Rear-wheel drive by exposed drive shaft
 Four-speed transmission
 Gas mileage: About 32 m.p.g.
 Top speed: About 70 m.p.h.

AUSTIN

	Price*	Displacement	Curb Weight	Over-All Length	Over-All Width	Turn Circle	Front Headroom	Front Legroom
AUSTIN A40	\$1795	57.82	1620	144.3	59.4	35.0	36.0	37.5
SKODA 440	\$1686	66.43	1984	160.1	63.0	33.0	36.8	38.0**
VOLKSWAGEN	\$1545	72.74	1609	160.2	60.6	36.0	38.6	40.0**

* Port-of-entry price at New York City

** Approximate



Skoda has an unusual forked frame and uses transverse leaf springs both front and rear. Built in Czechoslovakia, it is one of the few vehicles now being imported into the United States from behind the Iron Curtain



Wheelbase: 94.5 inches
 Front engine, inline OHV four-cylinder, water-cooled,
 40 horsepower
 Front suspension: Forked tubular frame with transverse leaf spring
 Rear suspension: Independent transverse leaf spring
 Four-speed transmission
 Gas mileage: About 30 m.p.g.
 Top speed: About 70 m.p.h.
 Swing axles
 Rear-wheel drive through torque tube

SKODA



Completely unconventional, the Volkswagen continues the same chassis and over-all styling it has had since it began. There are no changes for 1959. Torsion bars suspend all four wheels (all independently) and the flat four-cylinder air-cooled rear engine is as dependable as always



Wheelbase: 94.5 inches
 Rear engine, flat OHV four-cylinder, air-cooled,
 36 horsepower
 Front suspension: Forked tubular frame with welded-on platform
 Rear suspension: Independent by trailing arms, solid transverse torsion bars
 Four-speed transmission
 Gas mileage: About 32 m.p.g.
 Top speed: About 68 m.p.h.
 Swing axles
 Rear-wheel drive

VOLKSWAGEN



Wheelbase: 105 inches
 Front engine, inline OHV four-cylinder,
 water-cooled, 66 horsepower

Front suspension: Independent
 One transverse leaf spring
 Rack-and-pinion steering
 Gas mileage: About 26 m.p.g.

Unitized body and frame
 Four-speed transmission, all synchromesh
 Top speed: About 80 m.p.h.

Rear suspension: Nonindependent
 Coil springs
 Solid rear axle
 Rear-wheel drive through torque tube

PEUGEOT



Substantial and not at all austere in looks, the French Peugeot is a full-size car (about as big as the Lark). But it's amazingly economical. And the price is very low, considering the extras that you get with it

	Price*	Displacement	Curb Weight	Over-All Length	Over-All Width	Turn Circle	Front Headroom	Front Legroom
PEUGEOT 403	\$2175	89.6	2352	176.0	66.0	30.0	36.0	40.0**
LLOYD TS	\$1395	36.4	1260**	132.1	55.8	34.5	33.8	39.8
CITROEN 2CV	\$1298	25.9	1120	148.8	58.3	32.5	36.0	42.0

* Part-of-entry price at New York City

** Approximate



Wheelbase: 78.8 inches

Front engine, inline OHV two-cylinder, air-cooled,
 25 horsepower

Front suspension: Independent
 Two transverse leaf springs (superimposed)
 Rack-and-pinion steering
 Gas mileage: About 42 m.p.g.
 Front-wheel drive

Tubular backbone with welded-on platform
 Four-speed transmission, all synchromesh
 Top speed: About 62 m.p.h.

Rear suspension: Independent trailing wishbones and coil springs
 No rear axle as driving wheels are in front

LLOYD



Lloyd has a new and larger engine that drives through the front wheels. Its rear suspension is unusual with the trailing wishbones and coil springs. Its tubular backbone is the main structural member of the car



Wheelbase: 94.4 inches
 Front engine, flat OHV two-cylinder,
 air-cooled, 12 horsepower

Front suspension: Independent on leading arms interacting with rear through central coil springs
 Front-wheel drive
 Gas mileage: About 46 m.p.g.

Ladder-type box-section frame
 Four-speed transmission, all synchromesh
 Centrifugal clutch
 Top speed: About 52 m.p.h.

Rear suspension: Independent on trailing arms sharing common coil springs with front wheels
 No rear axle as driving wheels are in front

CITROEN



If you tried to make a car uglier than the 2 CV, you couldn't. Nor could you make one more beloved by its owners. It will go anywhere, under any conditions. Suspension is as unique as its styling and is soft enough to cushion eggs, rugged enough to haul pianos—no wonder the French love it



Wheelbase: 102.5 inches

Front engine, inline OHV four-cylinder, water-cooled, 85 horsepower

Front suspension: Independent	Unitized body and frame	Rear suspension: Nonindependent
Coil springs	Three-speed transmission	Coil springs
Wishbones	(four-speed all-synchromesh optional)	Solid rear axle
Gas mileage: About 25 m.p.g.	Top speed: About 90 m.p.h.	Rear-wheel drive through torque arms
		Two-piece exposed drive shaft

Volvo is built by Swedes to last forever—or at least so it seems. It is a solid car, unadorned but peppy. And it travels a surprising distance on a gallon. It may look stodgy, but don't be fooled. It goes!

VOLVO

	Price*	Displacement	Curb Weight	Over-All Length	Over-All Width	Turn Circle	Front Headroom	Front Legroom
VOLVO PV 444	\$2239	96.5	2140	177.0	62.5	32.5	39.0	47.0
RENAULT Dauphine	\$1645	51.5	1397	155.0	60.0	30.0	37.5	42.0
OPEL REKORD	\$1958	90.8	1995	174.0	63.6	34.8	36.0	43.5

* Part-of-entry prices at New York City



Wheelbase: 89.4 inches

Rear engine, inline OHV four-cylinder, water-cooled, 32 horsepower

Front suspension: Independent	Unitized body and frame	Rear suspension: Independent
Coil springs	Three-speed transmission	Coil springs
Wishbones for lower arms	(automatic clutch optional)	Swing axles
Rack-and-pinion steering	Top speed: About 70 m.p.h.	Rear-wheel drive
Gas mileage: About 36 m.p.g.		

Renault's little princess, the Dauphine, is currently the best selling four-door foreign car in the United States. And with reason. It has European styling, but is not so peculiar as to be embarrassing. Its rear engine, a water-cooled four-cylinder, purrs around town and is almost inaudible at idle. Typically French, it has wet cylinder liners

RENAULT

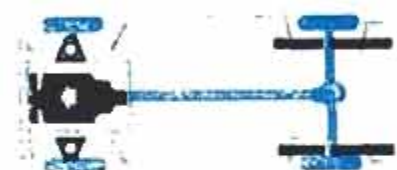

Wheelbase: 100 inches

Front engine, inline OHV four-cylinder, water-cooled, 56 horsepower

Front suspension: Independent	Unitized body and frame	Rear suspension: Nonindependent
Coil springs	Three-speed transmission	Leaf springs
Wishbones	all-synchromesh	Solid axle
Gas mileage: About 26 m.p.g.	Top speed: About 78 m.p.h.	Rear-wheel drive by exposed drive shaft

Certainly the most American looking of the imports is the Opel Rekord. Built by General Motors in Germany, it is sold by Buick over here. The chassis is conventional and except for its unit body, it could be a domestic GM car. Also available is a very handsome station-wagon model

OPEL



Wheelbase: 84.0 inches

Front engine, inline OHV four-cylinder, water-cooled, 40 horsepower

Front suspension: Independent	Unitized body and frame	Rear suspension: Nonindependent
Coil springs	Four-speed transmission	Leaf springs
Wishbones	automatic clutch optional	Solid rear axle
Gas mileage: About 35 m.p.g.	Top speed: About 65 m.p.h.	Rear-wheel drive by exposed drive shaft

TRIUMPH



If you want a truly compact car, this is it. Inside its 145-inch overall length are four doors, a front engine and a rear trunk. Narrow doors make exit and entry tricky, but once inside there's amazing room

	Price*	Displacement	Curb Weight	Over-All Length	Over-All Width	Turn Circle	Front Headroom	Front Legroom
TRIUMPH	\$1699	57.8	1680	145.0	58.0	32.0	38.0	45.5
VAUXHALL Victor	\$1958	91.9	2180	166.2	62.5	34.0	35.5	43.0
SIMCA Aronde	\$1645	77.5	2100	162.0	61.3	31.0	35.4	37.0

* Port-of-entry price of New York City



Wheelbase: 98.0 inches

Front engine, inline OHV four-cylinder, water-cooled, 54.8 horsepower

Front suspension: Independent	Unitized body and frame	Rear suspension: Nonindependent
Coil springs	Three-speed transmission, all synchromesh	Leaf springs
Wishbones	Top speed: About 74 m.p.h.	Solid rear axle
Gas mileage: About 30 m.p.g.		Rear-wheel drive by exposed drive shaft

VAUXHALL



First of the British cars with a wrapped windshield, the Vauxhall, like Opel, is a "naturalized" American citizen. It is built in England by GM and, some British claim, is more American than English. Whatever its origin, it is a trim, sensible design. Suspension is conventional and the shift lever is on the steering post where Americans expect it to be



Wheelbase: 96.3 inches

Front engine, inline OHV four-cylinder, water-cooled, 48 horsepower

Front suspension: Independent	Unitized body and frame	Rear suspension: Nonindependent
Coil springs	Four-speed transmission	Leaf springs
Wishbones	automatic clutch optional	Solid rear axle
Gas mileage: About 30 m.p.g.	Top speed: About 80 m.p.h.	Rear-wheel drive by exposed drive shaft

SIMCA



Chrysler now sells Simca in this country. It is a conventional design, well thought of in France. A new model of the Aronde was introduced recently (not shown here) which has a lower, more modern look. The car in this photo, however, is the one now being sold over here

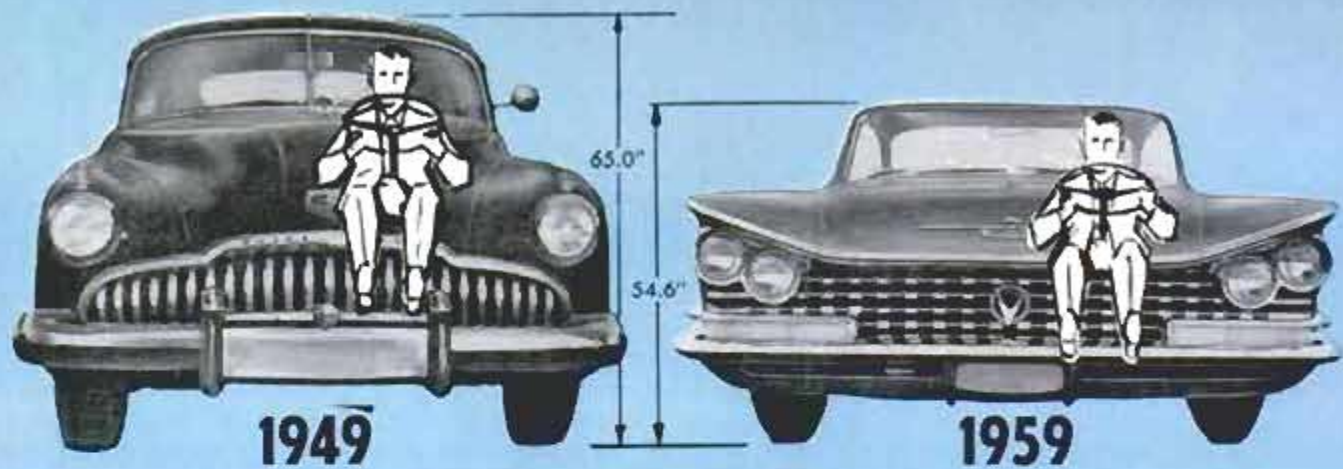

Drivers don't change, but look what has happened to the automobile in just 10 years—10 inches lower!

WHERE DID THE INCHES COME FROM?

By Roger Huntington, SAE

THIRTY YEARS AGO, a prominent Packard engineer, surveying the company's new low-slung hypoid rear axle, confidently predicted that American passenger sedans might some day be as low as 66 inches.

The 1959 model crop out of Detroit runs in height from 54 to 59 inches. Some models

are as much as two inches lower than corresponding 1958 bodies.

Yet the crystal-ball gazers tell us we're heading even lower—down to 52 inches. They say sales indicate that the low look is what John Q. wants and Detroit is going to give it to him.

Where did the inches come from? How

Here are the body's vital statistics. After 10 years, the problem is the same, but the solution is different

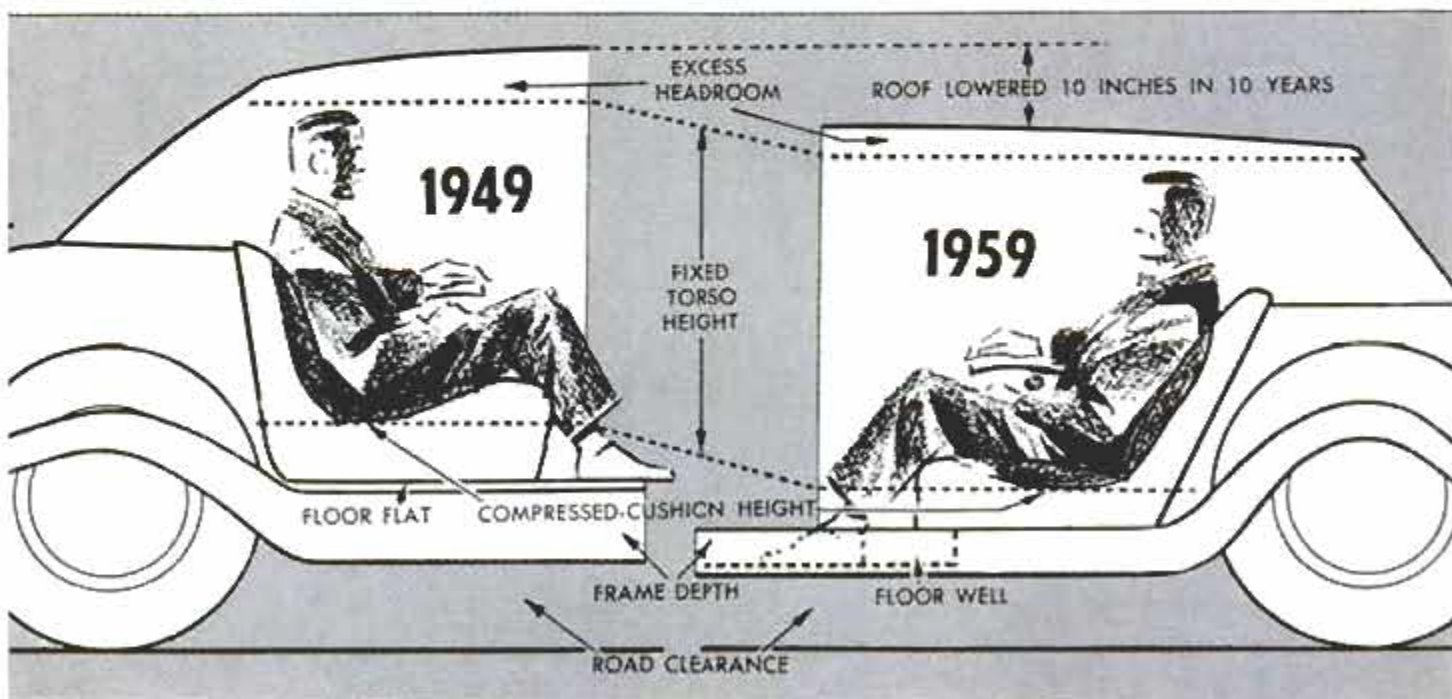

did we get so much lower than the best engineers were predicting 30 years ago? How can we possibly get any lower?

Good questions, all of them. To get the answer you must analyze what determines car height. Several vital dimensions add up to set the over-all height of a body. Starting at the pavement, we move up through the "ground clearance" area, the distance between the ground line and the lowest part of the car's undercarriage.

There has to be space here to clear obstructions on back-country roads and to provide ramp clearance at the center of the chassis for leaving steep driveways. Current models have minimum ground-clearance figures ranging from a little over five inches to about seven inches. Engineers don't see how they dare reduce this even as much as a half inch on future models.

The vertical distance between the ground-clearance line and the floor of the passenger compartment is "open to negotiation," so to speak. It will depend on the layout of the chassis. If the car uses a frame, the floor can be dropped below the top of the frame side rails by putting footwells in the floor pan. This is the by-now-familiar step-down construction, used by all except Chrysler Corporation. It requires a special frame design to make room between the rails for wells while maintaining adequate stiffness.

Things are simplified with the unit body construction in which there is no separate chassis frame and the body is welded up as a sturdy box structure. In this design, you can place the floor anywhere you want. Of course, there still must be room under the floor for the exhaust pipes and mufflers. Running the exhaust along the frame rails (as on the Continental Mark II) is expensive. Finding room for the exhaust system is one of Detroit's biggest headaches today and you'll see radical changes by 1961.

The next dimension is seat height. Seats have been getting lower and lower for 10 years. The passenger is sitting more and more with his feet straight out in front of him. There's nothing particularly wrong with this, but it requires very careful seat design to get acceptable comfort in this position. Thigh and kidney support is vital. Some seats in low foreign sports cars do the job very well. Detroit is definitely behind in this problem. It looks now as though a minimum practical distance between the floor line and the lowest point of the compressed seat cushion (with an average-weight person in the seat) might be four inches. Many 1959 models are close to that right now.

Frame shape determines size of the floor wells for rear-seat riders. These drawings explain the reason

FRAMES DESIGNED TO PERMIT FLOOR WELLS

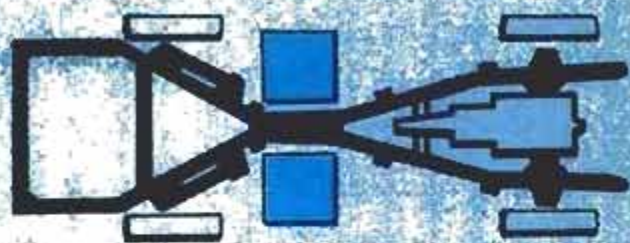

CADILLAC CHEVROLET PONTIAC

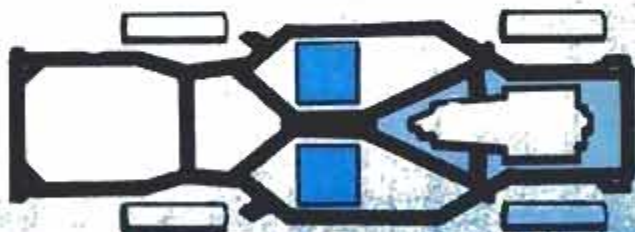

OLDSMOBILE



BUICK

STEP-DOWN FOOTWELL

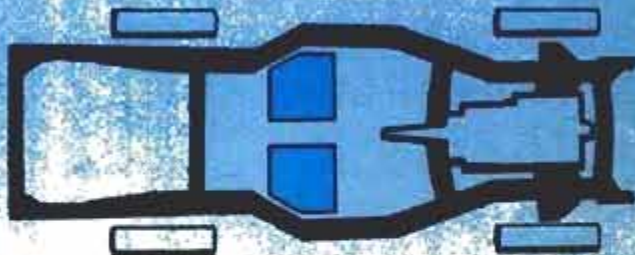

FORD MERCURY

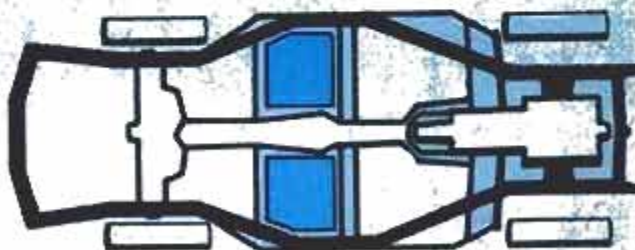

UNITIZED BODY

LINCOLN, THUNDERBIRD, RAMBLER, AMBASSADOR

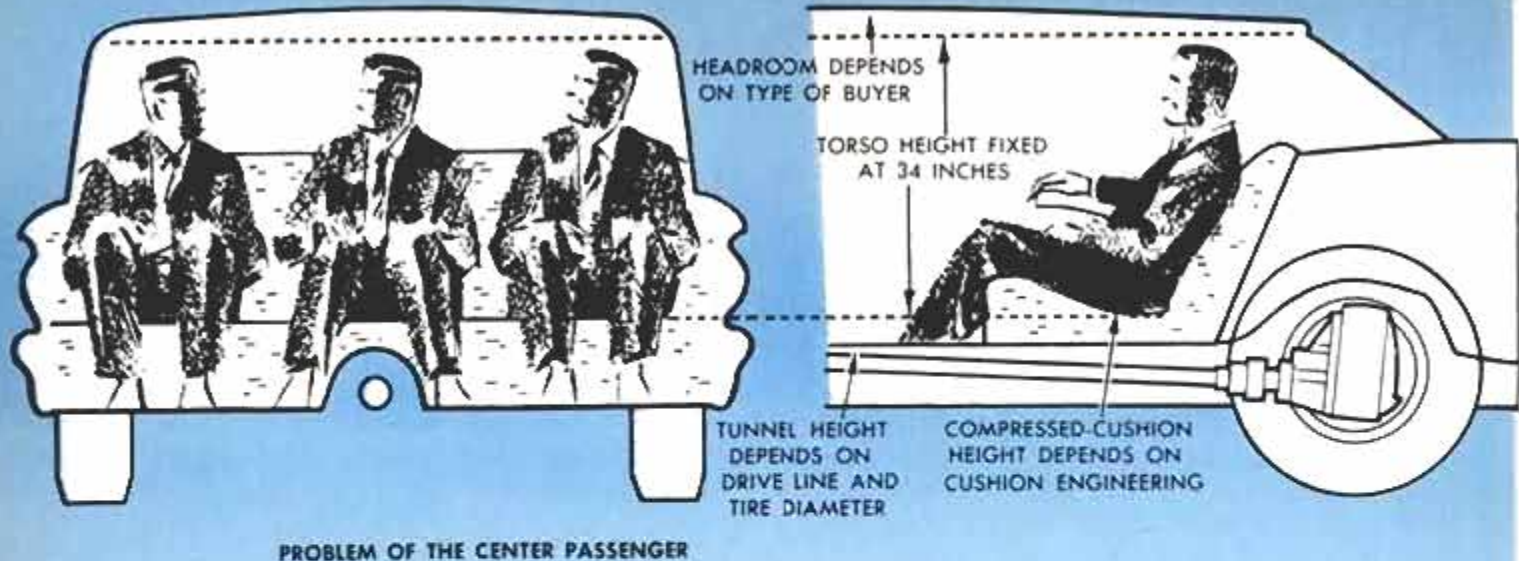

PROBLEM OF THE CENTER PASSENGER

Major problem is the center passenger. Unless we get major chassis changes, he will limit the lowering trend

Next is one of the fixed dimensions in body design—the height of the human torso in a seated position. In a reasonably upright position, the average height is 34 inches from seat to the top of the head. There is little we can do to reduce this dimension on future cars. Of course, we could tilt the passenger back a little, putting him in a semireclining position. There is just a hint of this on some 1959 models. How much of this the public will put up with for style, only time will tell.

Above the head we must allow a little excess room for the taller riders and, in some cases, for hats. This dimension is not so fixed as some others. For instance, you would allow more headroom in a Cadillac limousine than in a sporty Plymouth Fury. The man who buys the Fury will put up with less headroom (perhaps even would be willing to take his hat off) to get the flashy body lines.

Probably an average allowance on all cars for excess headroom should be four inches between head and ceiling.

The thickness of the roof structure (upholstery and metal) doesn't need to be much over a half inch. If the roof panel is curved, obviously we're going to have waste headroom in the center. We must allow a certain minimum headroom at the sides and clearance at the center where the roof bulge is more than needed. This makes the body one or two inches higher than necessary.

Flat roofs are the answer, of course. And the 1959 flattops will be common to the industry in the future.

Add up all these individual heights and what do you get? It looks as though the practical minimum over-all car height, using all the tricks, might fall somewhere between 48 and 53 inches. But only if we don't plan to seat more than four persons in the car.

We could reduce height to 52 inches tomorrow if it weren't for that center passenger in the back seat of our so-called six-passenger sedans. Between him and the drive-shaft tunnel is about 90 percent of

Flat roofs are practical as well as stylish. They eliminate the wasted headroom in the center of the seat

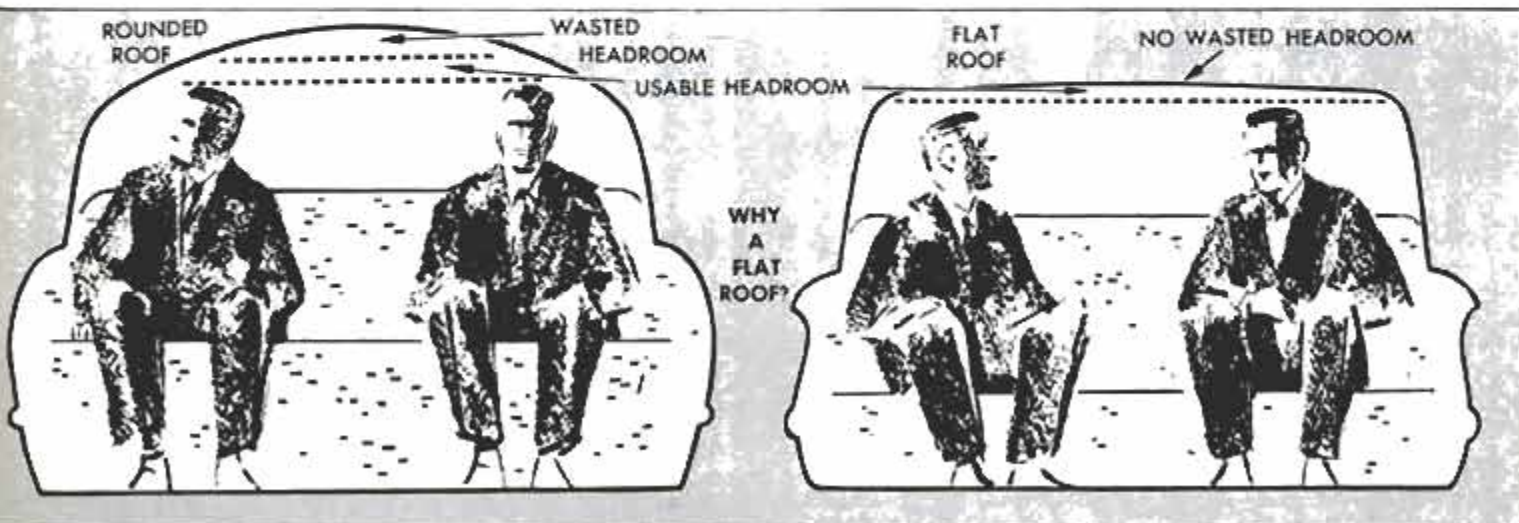

Detroit's problem. There just isn't any room left there to play with.

Three significant dimensions are involved: First, there is the height of the top of the drive-shaft tunnel above the road. This is largely determined by tire radius and the design of the differential and drive shaft. The 14-inch wheels have helped some (although the latest low-profile 15-inch tires are just as low).

Ford reduced the drive-shaft height at the rear axle by designing the hypoid rear-end gears to lower the pinion gear $\frac{3}{4}$ inch on the ring gear (which, incidentally, was a very ticklish engineering and production problem). The GM divisions have gone to two-section drive shafts so there won't be so much up-and-down swing as wheels go over bumps. Oldsmobile even shortened its rear shaft section for 1959, to reduce further the amount of upswing. Ford and Chrysler have necked down the outside diameter of their one-piece drive shafts at the rear. On its bulky torque-tube drive, Buick designed a clever two-section tube with a kink near the rear axle under the seat.

The second dimension is the seat-cushion thickness above the tunnel. This is a killer. Every inch of cushion that the occasional center-passenger gets (and how often do you ride three in back?) is one inch added to the car's over-all height.

Detroit is trying to compromise here. On some cars compressed-cushion thickness over the tunnel is less than one inch and the passenger "bottoms" on many bumps on reasonably smooth roads. A heavy passenger may contact the tunnel all the time (which might be less annoying and uncomfortable than bumping up and down on it). On the other hand, some companies, by clever design all through the chassis and body, manage to get compressed-cushion thickness of two to four inches over the tunnel and still retain low body lines.

The third dimension is the passenger.

(Continued to page 278)

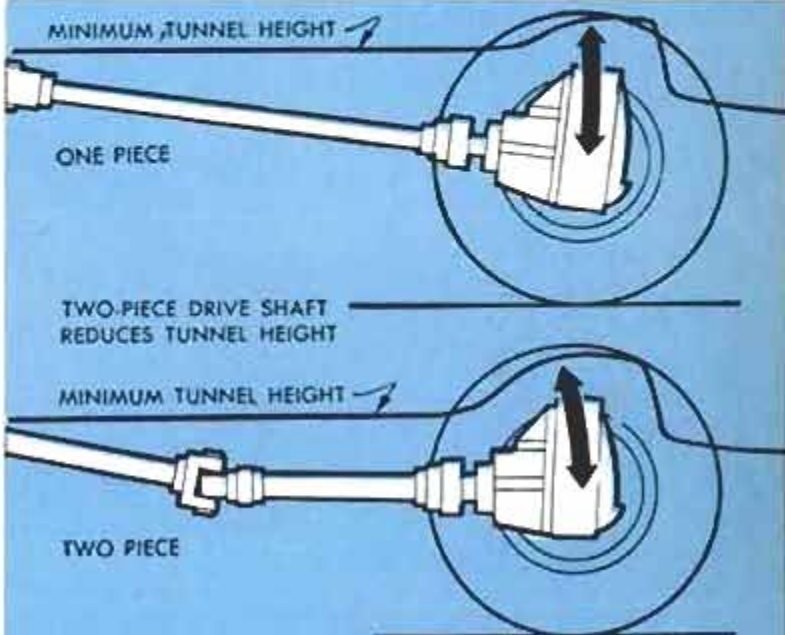
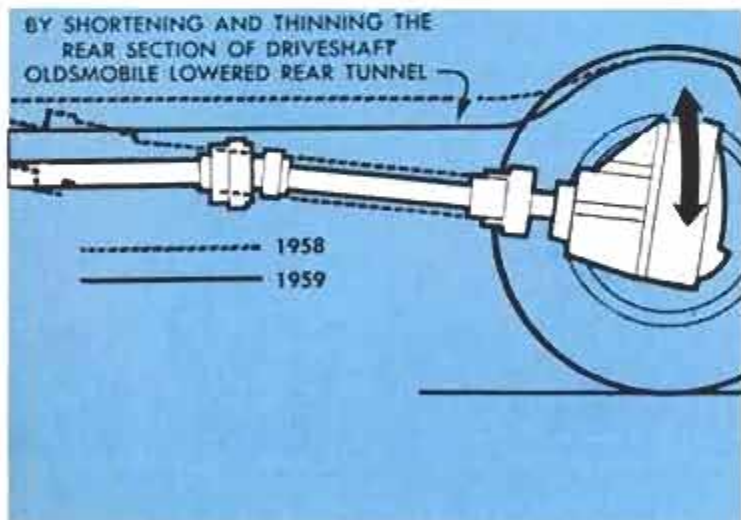
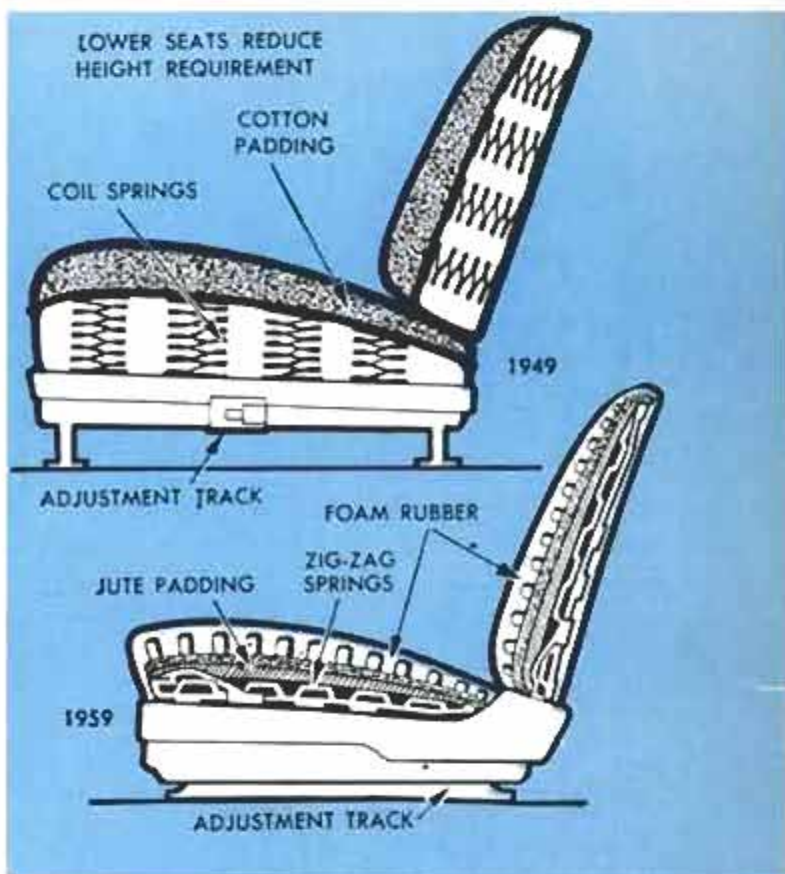
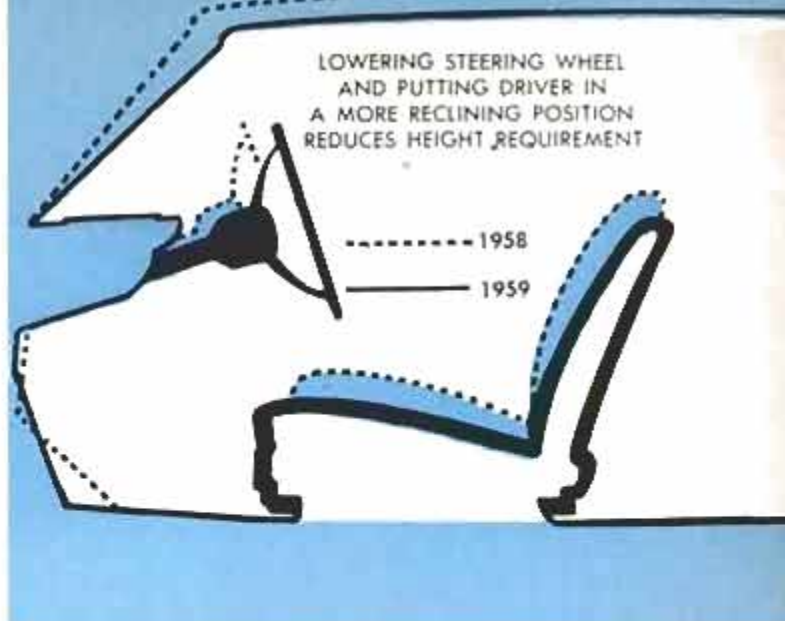



In this exclusive *PM* interview, Ford Motor Company's top stylists talk frankly about automobile styling

WHY DO OUR CARS

Here's what stylists say at Ford:

QUESTION: Many writers are saying that you stylists are doing the best you can to destroy the automobile industry by your designs. It seems that this is a good time to ask you "What does a stylist do? How does he think?"

WALKER: Let me start off by saying that there are people who are asking "Why are cars so long? They won't go in my garage." This is not always true. The average garage is 20 feet long and there isn't a car that is 20 feet long. If they would take the baby buggy and the wheelbarrow out of the garage they could get the car in. Of course, we don't want to dictate to the public how to run their garages.

QUESTION: How do you define an automobile? What is this thing you design?

MAGUIRE: It is many things to many people. Today's Thunderbird is two or

three cars. It could be a tailored, refined car for the man who wants it to be that. It could be a spooky, sporty little car to the man who wants that. A car isn't like a radio or a refrigerator or a house. It has to have more character.

WALKER: When you think of an automobile, you think of movement and that means aerodynamics.

ENGEL: You can easily define a refrigerator. It's a box to hold food that must be neat and clean. But a car is more than just a bus or taxi.

WALKER: It's the most expensive expendable product a family buys so there is pride of ownership involved.

QUESTION: You say cars are many things to many people. Does this complicate your design problems?

(Continued to page 178)

Interviewed by Arthur R. Railton, PM's Automotive Editor, were George W. Walker, Vice-President and Director of Styling; Elwood P. Engel, staff stylist, and Robert H. Maguire, chief interior stylist, all of the Ford Motor Company.



George W. Walker, Ford Vice-President and Director of Styling:

"How many times a day does a person get in and out of a car? We say . . . about four times a day. Why would he forsake good silhouette just because he knocks his hat off a few times a day. If we were designing a milk wagon we would make it high enough so a man could jump in and out without knocking his hat off."



Chrysler stylist Exner, center, set the pattern for the industry with the Dart look of his 1957 products

Here's what stylists say at Chrysler:

QUESTION: Why is there so much criticism of auto styling today?

EXNER: Everyone is looking for some place to lay the blame for the poor business conditions of the past year. If cars had sold the way they did in 1955 you wouldn't have heard any of this.

QUESTION: How do you define an automobile? How do you think of it while designing one?

EXNER: First, it's a means of transportation, but it must be as exciting as possible. It should create a desire for ownership and a pride of ownership. A person is looking for something with a feeling of motion that inspires him with its grace and excitement.

SCHMIDT: If we can bring out a new car that is a fine means of transportation, but makes you enthusiastic about going in-

to the showroom to buy it, then we've done an excellent job.

QUESTION: Then the stylist must create demand?

SCHMIDT: I'd say so. We are really merchandisers.

EXNER: Your product must look more exciting than the other fellow's. First of all, though, it must look like an automobile. That's why we have this Dart theme, this look of motion.

QUESTION: You must be flattered to be imitated in this concept by General Motors.

EXNER: Yes, we are somewhat flattered.

QUESTION: What is a good automobile design?

EXNER: I think we've already answered that. Excitement is the word for it. It must excite your desire to own it.

(Continued to page 179)

Taking part in the PM interview were Virgil M. Exner, Chrysler Vice-President and Director of Styling, and William M. Schmidt, Executive Stylist. Arthur R. Railton, PM's Automotive Editor, asked the questions.

Virgil M. Exner, Chrysler Vice-President and Director of Styling:

"We could put excitement in a smaller package. But the public has indicated its preference for larger packages. . . . Stylists don't want a lot of chrome, either. But people have demanded it through the years. Every attempt I know of that has ever been made to strip a car, to take off its chrome, has met with failure."



MAGUIRE: Right. You buy a car more because you want it than because you need it. The old car probably didn't wear out. You have a desire to acquire a new car. You don't have this feeling about a refrigerator. You get excited about a car. You don't get excited about any other product to the same extent.

WALKER: You should have been with us all afternoon. We've been looking at the '61 models and trying to answer these questions for ourselves.

MAGUIRE: It's a frightening thing to look at future models. Over here, there will be a new concept of a car. Across the room, there will be another concept. Both are aimed at the same objective. Both will carry passengers. Which do you pick? Which fits the character we have created for our automobiles? The design must fit that character. If we were designing a radio or a desk, there would be more "form follows function" and we wouldn't have that problem. But a car is more than a machine. It has to be a lot more than just a machine.

ENGEL: And it has to be right because it involves millions and millions of dollars.

MAGUIRE: Don't get me wrong. It also has to be a good machine. It has to be clean and nice, but it has to be more than just clean and nice. Many industrial designers don't understand that.

ENGEL: Industrial design has a little of the architectural quality about it, a little stiffness that you can't have in a car.

QUESTION: How should an automobile look?

MAGUIRE: It is easy to say how it should not look. It is something else to be constructive. It's easy to say cars are too big, too low or have too many fins. But take all the fins off and you end up with a piece of soap with wheels on it. Those fins finish off the metal, they give the full length to the car. The question is how much fin?

QUESTION: In other products, the simple designs seem to be taking over. Like furniture, for example. Is this true of automobiles, too?

ENGEL: Yes, there has been a change since 1955 or so when people wanted lots of chrome and two and three-toning. They want it played down a little now, want it a little quieter.

MAGUIRE: We have just looked at four brand-new concepts of cars for future use here. That's a hard job—to willfully get off, to drop, something that's doing well. You have to decide whether to stay with a good thing and just evolve or to cut off and start something real new. Today's Buick, for example, is utterly different from last year's. They must have decided to wipe the slate and start over. Fine. That takes nerve.

WALKER: We did a big thing with the Thunderbird. The public is saying it doesn't want luxurious, expensive cars. So we come along with the Thunderbird. It's not a cheap car, it sells for nearly \$5000 and we can't make them fast enough to keep up with orders.

QUESTION: But doesn't the success of the Thunderbird, which is small, indicate that there may be some justification for the criticism that cars are too big?

MAGUIRE: No. I don't think so. I think it just happens to be small, but the reason people buy it is because it's lush.

QUESTION: Then you don't think its appeal has anything to do with its size?



WALKER: "The American public is moving upward all the time. When the workingman gets a little more money, he wants a bigger car. You can't change that."



ENGEL: "I would say cars are not going to get much longer. But I'd never say they weren't going to get any lower. I don't know how low they'll go."



MAGUIRE: "It's easy to say cars are too big, too low, or have too many fins. But take all the fins off and you end up with a piece of soap with wheels on it."

Continued to page 282)

QUESTION: But aren't there people who don't like to be excited into buying something?

EXNER: There are, I suppose, people who might be content with just transportation, without this excitement. But I think if they were put to the test, they would feel just a bit cheated if you gave them just transportation.

SCHMIDT: They can go out and buy many automobiles that have nothing but transportation right now. Automobiles with no excitement, no flair, no modern feeling, but with just a way to get from one place to another. But sales don't indicate that there is a majority in this group.

QUESTION: Do we need bigness to get this excitement you talk about?

EXNER: It could be done in a smaller package. But the public has indicated its preference for larger packages through the years, through sales experience. Stylists don't want a lot of chrome either. But people have demanded it through the years. Every attempt I know of that has ever been made to strip a car, to take off its chrome, has met with failure.

QUESTION: Are you concerned with more than looks, with the practical nature of the car?

EXNER: Contrary to what a lot of people think, we work very closely with engineering and manufacturing groups. Many things we might want to do strictly for looks are not practical and have to be turned down.

QUESTION: It seems to me that there have been great changes in styling in recent years, but few in engineering. Are engineers failing to keep up?

EXNER: They are always working on changes, but many are too costly. That is one reason why they haven't appeared. But I would say that engineers have kept up. In fact, we couldn't have done many things we've done in styling if they hadn't.

SCHMIDT: No matter what car he buys today, the customer assumes it will be dependable. So the next question is, which car does he want to be seen driving? And then you're talking about the appearance factor. We make you want to buy our car because you'd rather be seen in it than in somebody else's.

QUESTION: Who initiated the demand for a lower car? Stylists or engineers?

EXNER: The stylists. It is to get better proportions. But in most cases engineering agrees with us because it gives the car more stability and that reflects well on them. The styling reflects well on us, so we both stand to gain from it.

QUESTION: Aren't there undesirable complications that go along with lowness?

EXNER: That's true. But we feel that the plusses outweigh the minuses. It took a lot of engineering, a lot of head scratching and hard work by a lot of people to get cars down as low as we have while retaining the same major chassis components. There's plenty of engineering in that low package. Perhaps it isn't as sensational as the styling changes, but it's still a lot of achievement.

QUESTION: Are we ever going to have comfortable six-passenger cars as long as we have low cars with high center tunnels?

EXNER: I believe so. Continuous effort is being made, although it may seem slow to the public. Seats are being made more comfortable. We need some major changes

(Continued to page 288)



SCHMIDT: "If we can bring out a new car that is a fine means of transportation, but makes you enthusiastic about going into a showroom to buy it, then we've done an excellent job."



EXNER: "We call it horse-trading. If we can save \$5 on a rear bumper we might take that money and put it into a more expensive grille. We don't have to spend a certain amount on each part, but the total cost must not exceed a certain amount."



SCHMIDT: "They can go out and buy many automobiles that have nothing but transportation right now. Automobiles with no excitement, no flair, no modern feeling . . . But sales don't indicate that there is a majority in this group."



Two industrial designers offer an imaginative design for the most useful vehicle of all . . .

THE SUBURBAN RUNABOUT

IT HAS NO TAILFINS. It has almost no overhang (what little there is can be unbolted and replaced if damaged). It doesn't look like anything you've ever seen.

At the front it has the sleekness of a fast sports car. At the rear, the roominess of a Greyhound bus.

It is an imaginative shopper-commuter vehicle sketched by two industrial designers as a possible solution to the transportation mess in urban and suburban America.

Jay Doblin, Director of the Institute of Design, Illinois Institute of Technology and former president of the American Society of Industrial Designers, and W. W. Fitzgerald, head of the Product Design Department at the same school, put this practical "dream car" on paper.

Popular Mechanics asked these men, typical of the industrial designers who criticize Detroit styling, to suggest a ve-

hicle which, in their judgment, would be a practical, serviceable machine for housewife, commuter or small-city dweller—a new form of transportation appliance.

They were asked to design a car that might become the "first" car among America's fast-increasing two-car families—a car that would be used most of the time while the bigger, more powerful family car was saved for long trips and vacations.

Designed for urban use exclusively, the car they suggest would seat two adults in comfort, with ample headroom and legroom. There is space for three children in the rear-facing back seat.

It is very small. Wheelbase is only 80 inches, over-all length only 140.5 inches (making it almost six feet shorter than a Ford, Chevy or Plymouth). But it will do almost everything the average suburbanite requires of a car and do it, the designers say, cheaper and more efficiently than the big car.

The rear-facing back seat folds down to form an easy-to-load package shelf for hauling groceries or even such bulky items as chairs and tables for the PTA or the bridge club. Front seats fold individually so the handyman owner can haul long boards home from the lumberyard for his week-end projects.

Doors slide back (they don't swing) and the car parks in tight spaces without entrapping its occupants. Stoplights and turn indicators are mounted





high on the roof so big-car drivers can't fail to see the smaller vehicle. In traffic, the lights can be seen several cars back.

Rubber-tipped impact nose and tailpiece absorb minor bumps in parking jostling. More serious collisions would crumple the impact pieces, providing absorption of forces and reducing the chance of injury to occupants. Damaged pieces are unfastened and replaced (as are all body panels) by removing easily accessible bolts hidden under pop-out plugs.

There's plenty of visibility for relaxed handling in traffic and for effortless parking. An integral roll bar wraps entirely around the passenger compartment and also supports the roof, permitting the use of the narrowest window posts. Brakes are big, open and well cooled.

A small air-cooled engine is proposed, probably a flat four. The designers suggest a two-speed automatic transmission.

Obviously, this car is not going to replace the great American automobile, but it does indicate what could result if tradition is ignored and designers take a fresh look at the old problem of sitting down while going from one place to another. ★ ★ ★

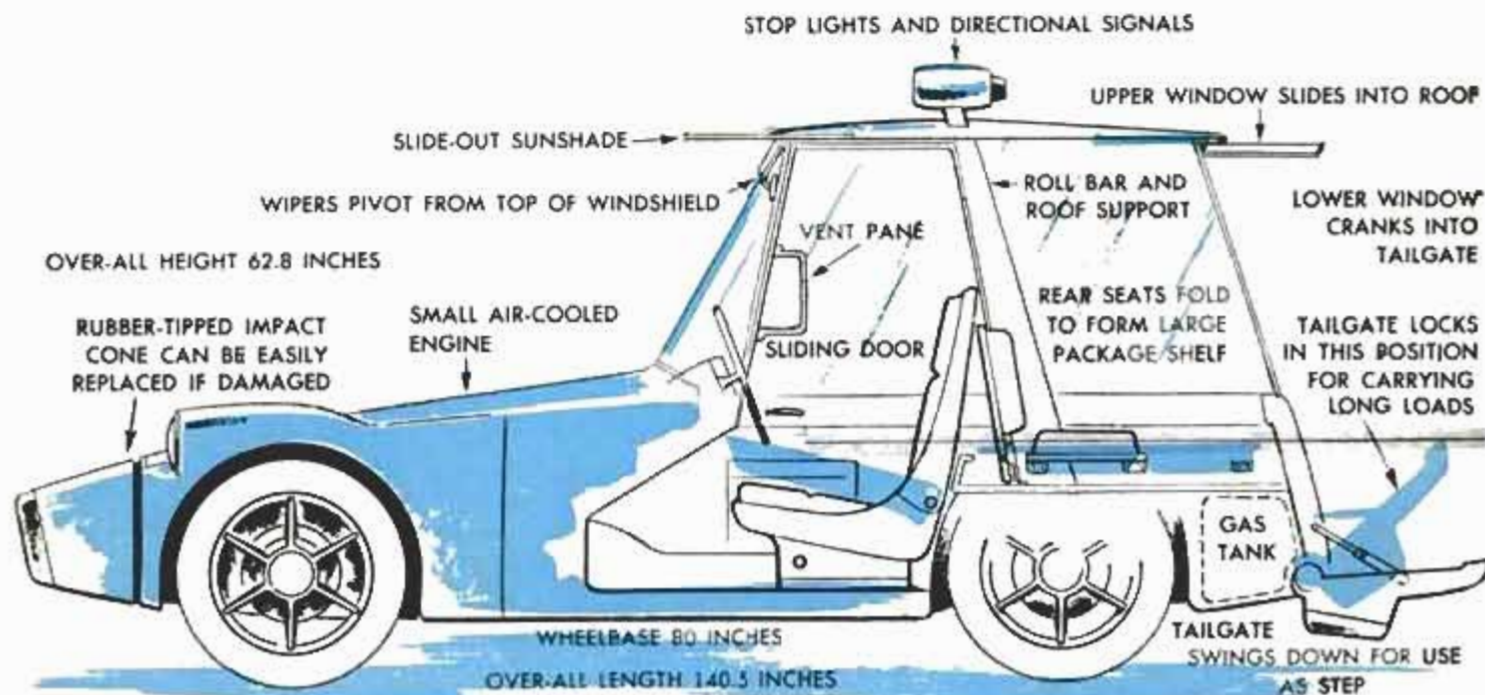



By Dale Kelly, SAE

TO SOME OF US, a new car is to drive, to enjoy and, less pleasantly, to pay for. But to others, it's a challenge to invest in gadgets that claim to banish wear, eliminate friction, reduce gas consumption and boost performance.

Unfortunately, many "miraculous" gadgets are not all they are claimed to be. Some are out-and-out frauds. A few do have real value, others may even damage your car.

The most flagrantly worthless devices are usually the ones with the longest list of testimonials from satisfied owners. No real test data is given, only generalities. No real explanation is given of how the device works.

Testimonials are not necessarily proof of a product's value. If an utterly useless device is tried out by enough motorists, some will imagine that their cars run better and a few will even claim, as a result of slipshod tests, amazing increases in performance and economy.

If a device actually does have measurable value, the manufacturer will probably substantiate it by a test report from an independent test laboratory. Many laboratories are available that will run such tests at a

cost equal to a tiny fraction of the profits frequently made by a successful car gadget.

Anybody who makes a device that operates on a new principle will usually patent it to protect his rights. If a product is not patented, it is probably not a new principle. If the advertisement does give a patent number you can get a copy of the patent and find out exactly what is new about it simply by sending 25 cents to the Patent Office in Washington, D. C.

Promises of "satisfaction or your money back" are not always proof of merit. Promoters know that only a small fraction of dissatisfied buyers will bother to remove, wrap and mail back a device that costs only a few dollars.

In the following pages we list several types of products, ranging from the worthless to the acceptable. Our judgments are based on available scientific and engineering knowledge.

Of course, the gasoline engine, the self-starter and even the automobile were at one time considered impractical by experts. So there is always a chance that some genius will come up with one of the following that really works. But it is unlikely.

These Probably Won't Do What You Expect Them to

Ignition intensifiers, complex spark plugs or coils that claim to give more sparks or "hotter" sparks.

A normal ignition system in good condition consistently delivers a spark hot enough to initiate the flame wave, which in turn ignites the bulk of the fuel-air mixture.

If the ignition system is not in good condition, it may occasionally miss. But there is no such thing as a "partial" miss, nor can you get better combustion from a hotter-than-normal spark.

No matter how many electrodes a spark plug has, the spark will, at any given moment, occur only at the one that requires the least voltage.

Furthermore, some special coils draw excessive current which may rapidly burn distributor points. Some special spark plugs, because of their complex gap configurations, are difficult or impossible to clean and have gaps that cannot be adjusted for wear or to suit the requirements of a specific engine.

So-called igniters or other devices intended to be used in place of spark plugs probably are nothing more than spark plugs with a fancy name. They usually have the disadvantages of the complex configuration mentioned above.

Idle adjustments with additional air bleed.

These affect the proportions of air and gasoline at idle, but not at normal driving speeds. Standard carburetor adjustments permit complete control of idling mixtures and any result that can be obtained by the special adjustment screws can be obtained by adjusting the original carburetor.

Rebuilding engines by pills, pastes or liquids.

Tests in which gas-tank pills were weighed before and after use have shown no significant loss in weight of pills. Even if metal could be gotten into the cylinder (as by direct injection of liquids or pastes) it is hard to see how any metal could be expected to stick to the oil-covered cylinder walls. Not included in this classification are those cleansing agents and solvents which are designed to dissolve and remove deposits from carburetors and other parts of the engine. These solvents do have value for cleaning and freeing vital parts. They do not "rebuild" parts nor does any legitimate brand claim to.

Gas-tank additives or pills that reduce carbon formation in engine.

It is true that gasoline is 85 percent carbon, but the carbon is not "free." It is combined with hydrogen in various hydrocarbon molecules. Consequently nothing that can be done to it in the gasoline tank can, by any process now known, affect the way it burns in the engine.

Additives to make batteries last longer.

The National Bureau of Standards has tested scores of these and hasn't found a good one yet. A few years ago a promoter whose battery additive had been tested and found wanting by the Bureau persuaded a committee of the Congress that this was persecution of a struggling inventor by

ignorant bureaucrats, but a committee appointed by the National Academy of Science (the nation's highest scientific authority) found, after thorough investigation, that the Bureau's findings were correct.

Nonacid electrolyte for batteries.

These liquids are intended to be put into conventional storage batteries after the original dilute acid has been poured out. Plain water works about as well. Enough of the original acid adheres to the plates and the interior of the case to operate the battery, but at greatly reduced power and ampere-hour capacity.

Storage batteries guaranteed for unreasonable lengths of time.

The very best lead-acid batteries, at present, can't be counted on for longer than five years of automobile service. Guarantees of batteries that last forever are often limited (in fine print) to the time the battery is kept in the original car for which purchased and in the possession of the original buyer.

Waterless batteries which are claimed not to need periodic addition of water.

Any battery will operate for a while without additional water and these so-called waterless batteries usually last longer if water is occasionally added.

Generator-charge controllers for boosting generator output.

These are intended to increase charging rate for a short period each time the engine is started, then, by a time-delay circuit, cut out after a short overcharge. The standard regulator that comes with the car allows the generator to charge at the maximum rate it can deliver without overheating. Any higher rate involves risk of damage. If you want to take a chance on forcing a 30-ampere generator to deliver 35 or 40 amperes you can easily have it adjusted for that current. At least you know how much you are overloading the generator which is more than you can say when the "miracle" gadget is installed.

Theoretically, These Could Be Helpful. They Are Based On Reasonably Sound Principles, But . . .

Sintered-bronze oil filters.

It would seem that if properly serviced at frequent intervals these should be effective, but there is no test information to show that they would be more effective than the normally used disposable variety.

Magnetic crankcase drain plugs.

These have a magnet to remove iron and steel chips from the oil and, usually, have a small piece of magnesium to control acidity. A few iron and steel particles are found in most crankcases, but they seldom do any

harm. Acids do attack magnesium more readily than iron, steel or copper and every molecule of acid that reacts with the magnesium is, of course, one less to corrode vital engine parts. However, in the type of driving that keeps oil fairly warm, moisture does not collect, hence acid is not a serious problem. But a magnesium "sacrificial anode" could, if large enough, be useful in winter stop-and-go driving.

Radiator "neutralizers."

These serve the same function as the magnesium in the crankcase, but are not likely to do anything that won't be done as well, or better, by a liquid corrosion inhibitor which you should use regularly in your cooling system. If you live where antifreeze is necessary you won't need a neutralizer because most of the good antifreezes contain corrosion inhibitors.

Carburetor gadgets to admit extra air.

In some cars (those designed for economy of operation, rather than hot performance), carburetors are built to deliver the most economical proportions of air and gasoline. Admitting extra air, as the "miracle" gadgets do, can do no good and often can do considerable harm by oxidizing (burning) such hot parts as exhaust valves. In other cars, because the intake manifold does not distribute the mixture evenly to all cylinders, smooth operation and good power are obtained only by a mixture that is a little richer in gasoline than would be most economical.

In such engines, extra air in the right amount can improve economy a few percent, but too much air will burn the valves in the cylinders that inevitably get less than their correct proportion of gasoline because of the manifold shape.

In any case, the best way to obtain a mixture leaner in gasoline than afforded by the manufacturer's standard carburetor specifications, is to use the lean metering rods or jets with which most carburetor servicemen are familiar.

Some of these carburetor attachments also incorporate pinwheels below each carburetor throat. These add little or nothing to the performance of the device.

Extra air could substantially improve economy if (perhaps because of a partly closed choke) the mixture was much too rich to start with, but it would be simpler and cheaper to fix the carburetor than to buy and install a "miracle" gadget.

Fuel-pressure regulators, filters, neutralizers.

There are two general types: One reduces fuel-pump pressure (normally three to eight pounds) to about two or three pounds; the other type merely smooths out or damps the pressure pulsations. Most of them also have magnets to trap iron or steel particles, filters to remove other foreign particles, and active metals (such as magnesium) to control acidity.

Every fuel pump is designed to deliver a certain pressure and the carburetor that goes with it in the car is designed to handle the amount of pressure the fuel pump delivers. A pressure regulator, of course, can be helpful when a defective fuel pump delivers too much pressure or when the carburetor is not working correctly and cannot control the gasoline flow. But in either case, the more logical remedy, it would seem, would be to repair the fuel pump or the carburetor.

Most cars already have fuel filters and also have fuel-pump air chambers to damp out pulsations. If Detroit wanted lower pressures at the carburetor, a lighter spring in the fuel pump would provide them without need for additional plumbing.

If the regulator substantially reduces pressure at the carburetor, it could, at high speeds and under heavy loads, starve the carburetor and produce the injurious lean mixture described previously.

As for the magnets, filters and active metals, the first two duplicate in function the filters that come on most cars and we know of no evidence that the active metal is necessary or effective.

These Will Work But May Be More Trouble And Expense Than They Are Worth . . .

Alcohol-water injector.

You may have noticed that engines are less likely to knock in rainy weather. It is well established that high humidity in the air entering the engine has an effect similar to a high octane number. Consequently, when water or, better yet, an alco-

hol-water mixture, is injected into the intake manifold, an engine will run without knocking on gasoline of a lower octane than usually required. In some cars, an injector might permit the use of regular gasoline instead of premium, but it would take

(Continued to page 254)

Trouble Lamp From Sealed-Beam Light Housed In Carrying Case

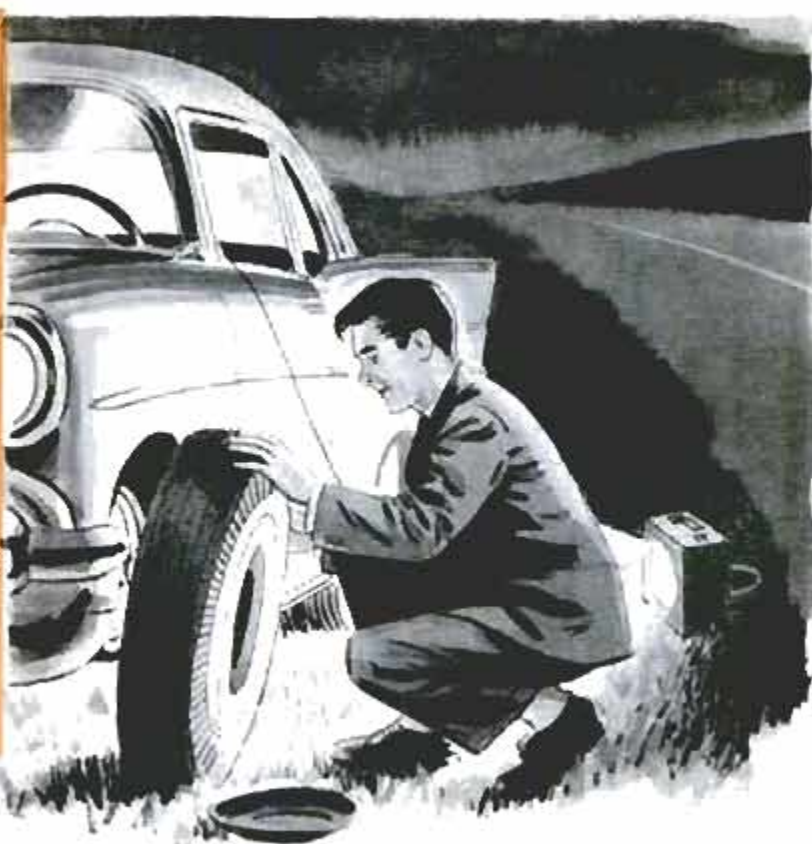
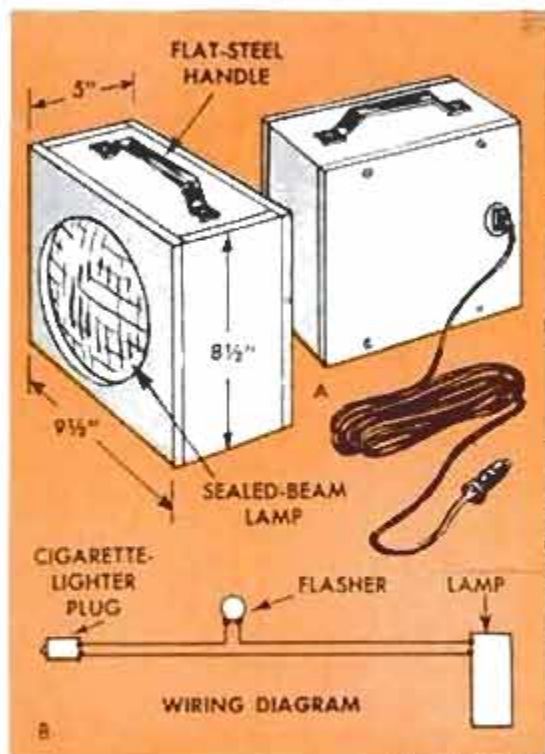

Housed in a carrying case fitted with a carrying handle, a discarded sealed-beam headlight provides a good trouble lamp. Use a light with one element still working. The case may be made of $\frac{3}{8}$ -in. plywood. One side is cut out slightly smaller than the lamp, which then is mounted over the opening with metal straps across the upper

and lower sides. Wire the lamp to a female plug mounted on the back and fit an extension cord with a male plug at one end and a cigarette-lighter plug at the other end. A piece of red plastic over the lamp and a flasher in the line will convert the lamp to a warning light.

J. Russell Krupps, Mill Hall, Pa.

Several Factors Can be Responsible for Rough Idling of Engine

When an automobile engine idles roughly, first check to make sure the spark-plug wires are separated far enough to prevent cross fire. Then adjust the carburetor and inspect it for air leaks. Old rubber boots

on spark plugs may be conductive and cause shorting outside the plugs. Finally, check the heat-riser valve. If it is frozen shut, it will cause a back pressure that will prevent proper running of the engine.

Efficient Engine Operation Requires Clean Fuel Filter

If the engine of your car seems to lose power and "surges"—intermittently speeds up, then slows down—check the fuel filter and sediment bowl of the fuel pump before having the carburetor overhauled. Extreme temperature changes during winter weather tend to cause formation of water in the gasoline tank. This water, plus sediment, will partially block the screens in the fuel pump and the element in the filter. Clean the sediment bowls and filter elements then add a quality fuel-system demoisurizer to the gasoline tank to prevent further trouble.





RERINGING THOSE PISTONS

is only part of the job. You'll also have to check the pistons, cylinders, bearings, wrist pins and cooling system

TO ASSURE maximum effectiveness, new piston rings should be installed in an automobile engine only as part of a complete overhaul. Rings alone seldom will eliminate excessive oil consumption in a worn engine. For example, loose connecting-rod bearings will throw too much oil up onto the cylinder walls. Even new rings cannot control this excess, Fig. 9, and the oil will be burned along with the fuel-air charge in the combustion chamber. Worn,

wrist-pin bushings also allow an oversupply of oil to be forced onto the cylinder walls where it is wasted.

If an engine has a tendency to overheat, the cooling system must be flushed, timing set correctly or the carburetor overhauled to provide the correct fuel-air mixture, to eliminate the heating problem before the overhaul is started. Even when an engine is in good condition it will tend to operate at somewhat higher-than-normal tempera-

Photos and information courtesy Perfect Circle Corp.

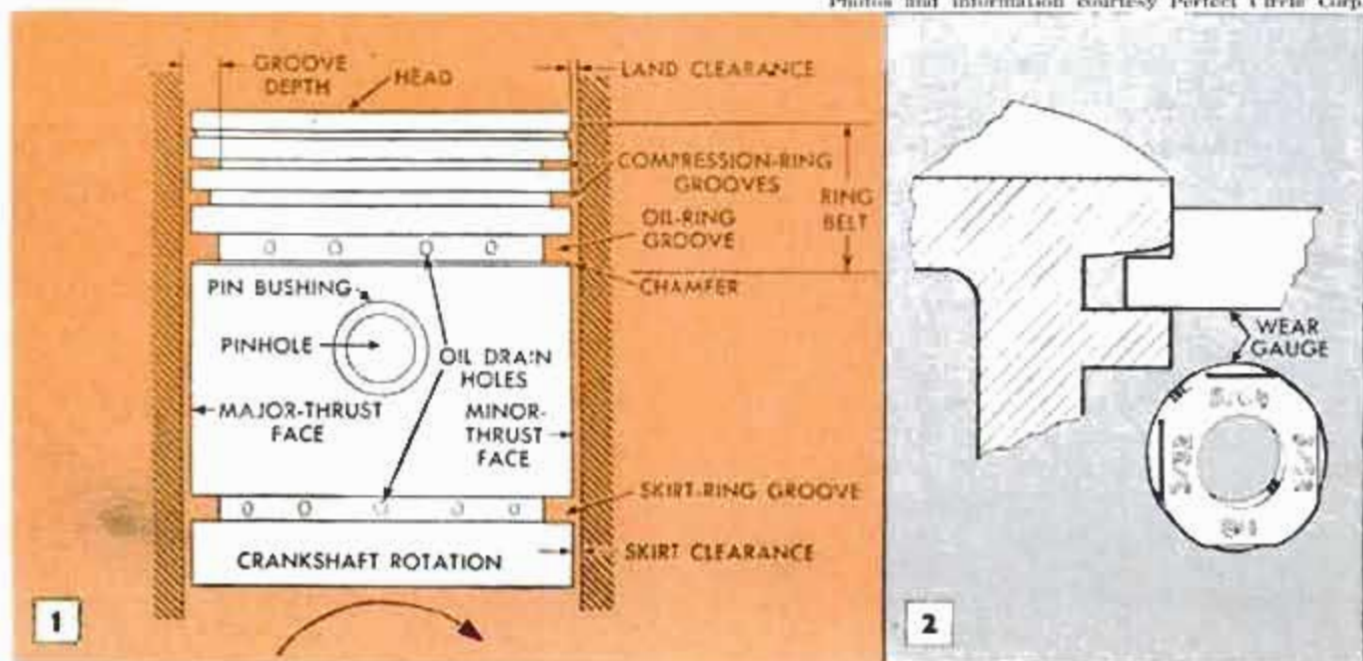

tures after tight-fitting new parts have been installed. Because of this, an engine that has been overheating will almost certainly run much too hot after an overhaul. The heat will destroy the oil film between the new rings and the cylinder walls, and scored or scuffed cylinders and pistons will result. The cylinders then will have to be rebored and new, oversize pistons installed.

A good reringing job begins after the head, or heads, and oil pan have been removed, but before the pistons are pulled. Due to ring wear on the cylinder walls there will be a shoulder at the upper end of each cylinder, Fig. 5. This shoulder must be removed before the pistons are taken out. It is true that a piston with its old rings probably can be pulled past the shoulder; there also is the chance that a ring land, Fig. 1, will be broken and the piston ruined. If new rings are installed without removal of the shoulder, the top ring will be broken during the first few revolutions of the engine when the square edge of the new ring slams against the radius of the shoulder. Use a proper reamer, and extend the reaming no more than $\frac{1}{32}$ in. onto the ring-worn area, keeping it flush with that surface.

After the pistons have been pulled from the block and the old rings removed, the ring grooves are cleaned and the top groove of each piston is gauged. If a regular wear gauge is available, Fig. 2, it is used as indicated. If none is available, install the new top ring and insert a .006-in. feeler gauge between the ring and the groove. If the gauge will enter more than $\frac{1}{16}$ in. in from the edge of the ring land, the groove should be machined to accept an insert, a ring and spacer, or the piston should be replaced with a new one. If the piston is aluminum, of the type that has a steel insert in the top-ring groove, also gauge the second groove, as it will wear

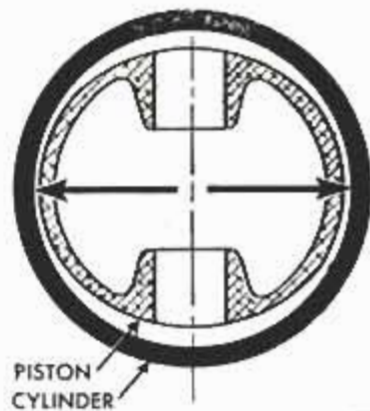

3

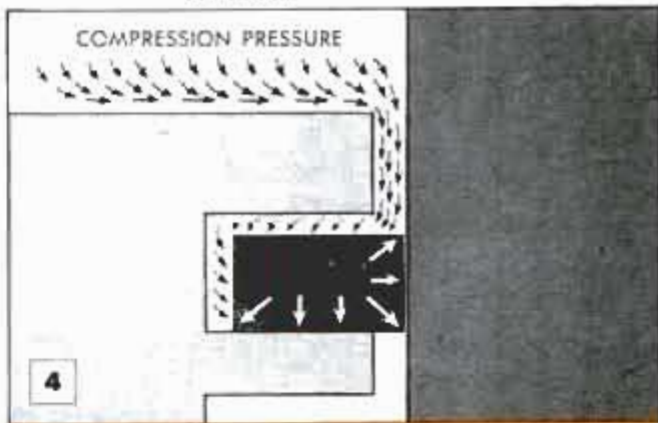

4

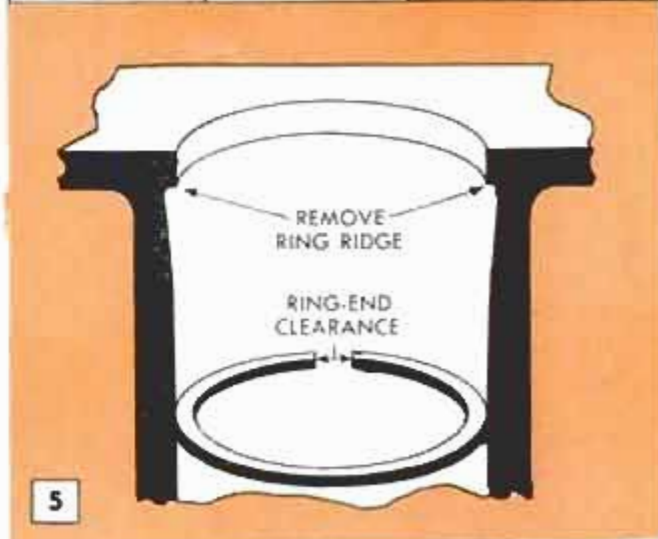

5

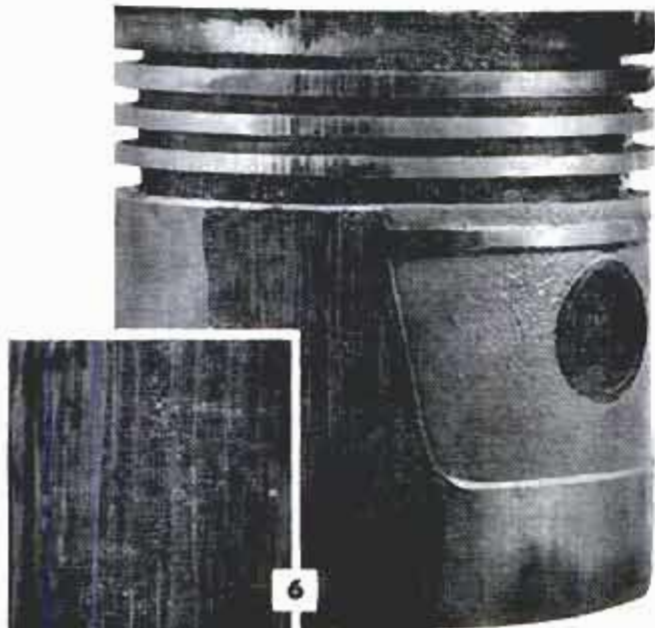

6



7



8 Above, twisting ring as shown, when installing it on the piston, will completely destroy its effectiveness

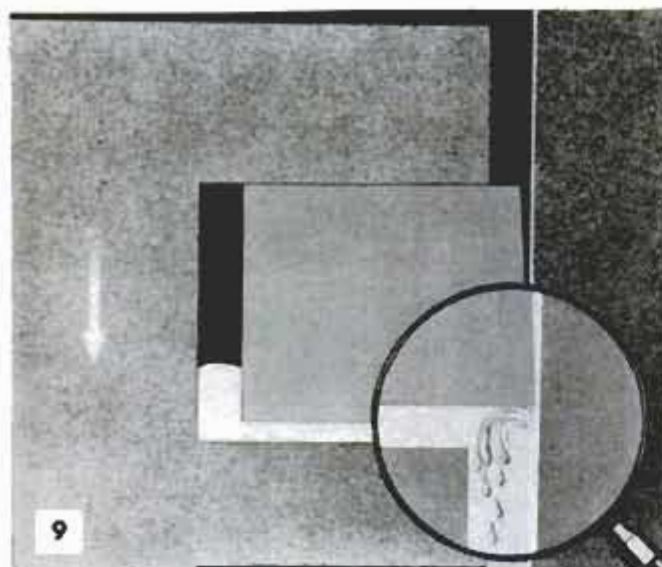

9 Above, on downstroke of piston, lower edges of rings scrape off excess oil, leave thin film for lubrication. Below, new ring checks depth of ring groove

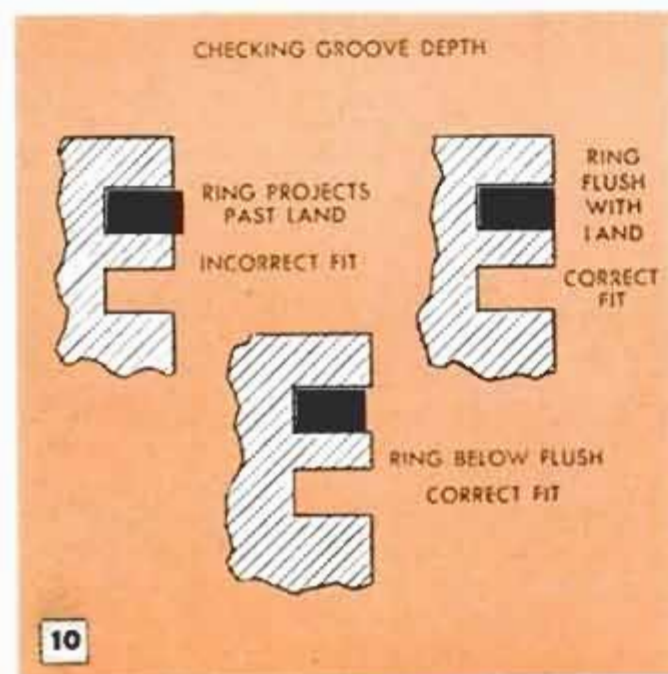

10

more rapidly than the first ring groove does. The new rings now are checked against the pistons and the cylinders. The top, or compression ring, is fitted into the top-ring groove on the piston and the groove depth is checked, Fig. 10. If the rubbing surface of the ring is flush or below the surface of the ring land, the ring is the correct one. If the ring projects, it is the incorrect size. A compression ring now is fitted into each cylinder, being pushed down to the lower end of the cylinder at the point of least wear by using an inverted piston. The piston also aligns the ring squarely in the cylinder. If the clearance at the ends of the ring is less than specified in the manufacturer's instructions that are packaged with the rings, the ring set is wrong for that particular cylinder. Insufficient ring-end clearance will allow the ends to contact when the ring expands with heat. The ring will either break or jam out against the cylinder wall and cause scoring.

Although thin steel piston rings can be spiraled onto a piston, cast-iron compression rings and oil-control rings must not be twisted as is being done in Fig. 8. A cast-iron ring distorted in this manner will not lie flat in the ring groove to seal compression pressures. Fig. 4 shows how compression acts to seal itself above a piston by forcing the piston rings down in their grooves and out against the cylinder wall.

If any piston has to be replaced, the new piston must be fitted into the cylinder and checked for proper size and clearance. Because aluminum pistons, used in most automobile engines today, expand at a greater rate than the cast-iron engine block, sufficient clearance must be present between the pistons and cylinders to allow for the difference. One method of providing this expansion differential is to make the pistons "cam ground" in shape. This means that the diameter of such pistons is greater at right angles to the wrist pin than parallel to the pin, as in Fig. 3. The greater amount of piston expansion then moves along the wrist pin. When checking the fit of a piston in a cylinder, the piston is moved down to the lower end of the cylinder and a feeler gauge slipped between cylinder and piston. Clearance should conform to the specifications of the engine manufacturer. If a piston that is too large is installed, it will expand and "seize" when heated. The result will be a piston that looks like the one in Fig. 7.

Proper piston clearance also is affected by the fit of the wrist pin. If the pin is fitted too tightly, when it expands from heat it will distort the piston and cause it to expand at right angles to the length of the pin. Fig. 6 demonstrates what happens to a piston under such a situation. ★ ★ ★

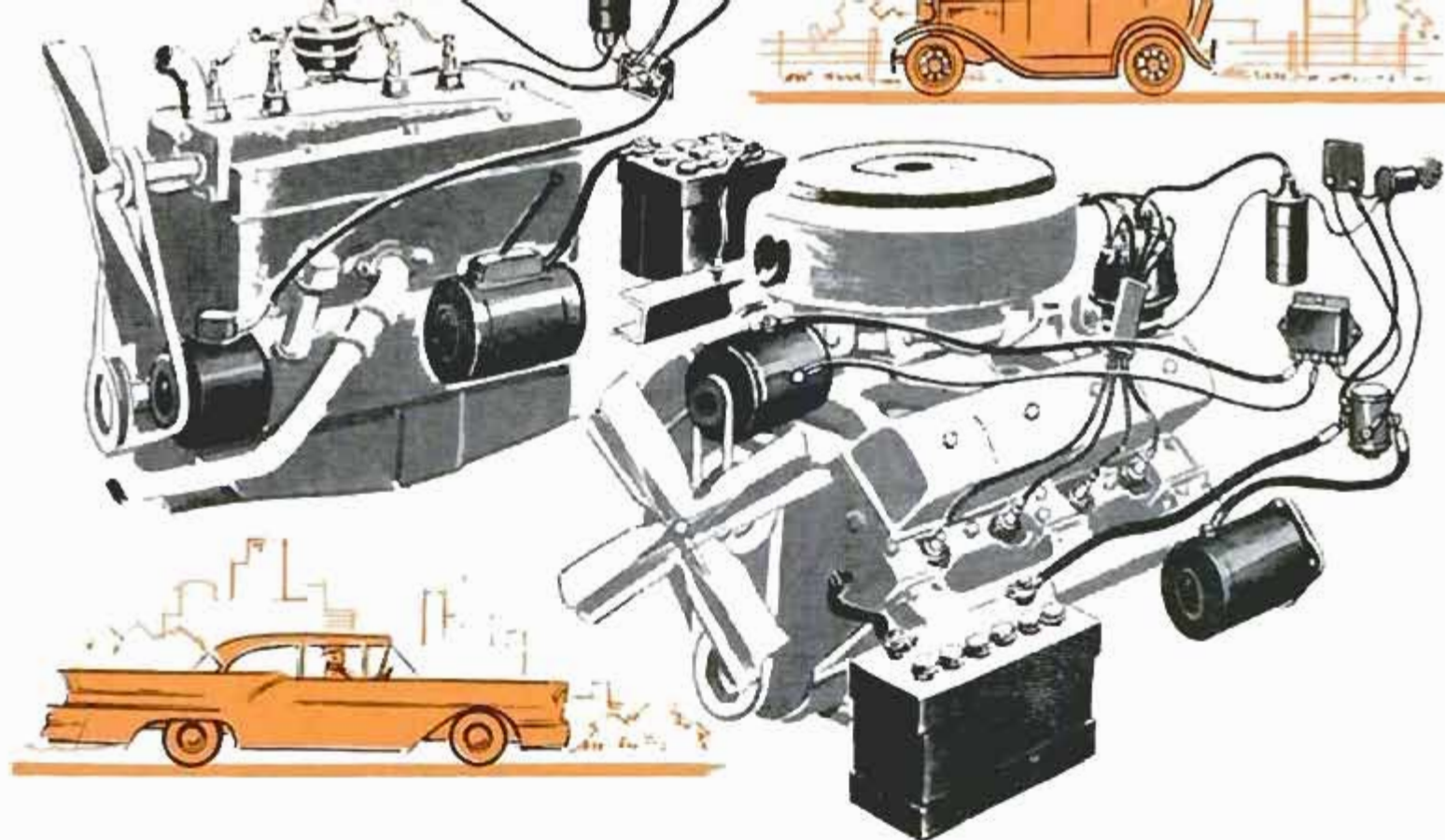

DO YOU KNOW IGNITION?

By Jay W. Hedden

IF YOU BELIEVE your new Super Duper V8 300-hp.-engine car has nothing in common with its brother of the '20s, look at the ignition systems above. Both the 4-cylinder engine that produced about 25 hp. in the '20s and the 300-plus-hp. engine of today have ignition systems with identical components. Refinements have increased the reliability of the units, but essentially the battery ignition system used in the '20s is the one used today.

Test equipment has made diagnosing of ignition problems much simpler for the modern-day mechanic, but correcting the problems requires the same know-how used by old-time mechanics. As an example: In the old days a mechanic shorted out each spark plug to determine which were not firing. Today, an oscilloscope might be used to show which plug is misfiring. However, after the plugs are removed from the engine, the mechanic must determine *why* the plug is not firing.

To refresh our memories, let's go through the ignition system, diagram top of page 190, to see how it works. When the ignition switch is turned on, current from a battery—6 or 12-volt—flows into a coil that transforms low battery voltage to high voltage. To finish this circuit another switch also

must be closed—the distributor contact points. With the points closed, current flows through the primary side of the coil, which consists of a few hundred turns of relatively heavy wire. A magnetic field is built up around the wire, but not instantaneously. A fraction of a second is required. The value of the magnetic field is determined by the resistance in the wire, the inductance of the winding and the length of time the points are closed. In actual operation, the magnetic field seldom reaches maximum because the points are closed only a short time. When the points open, the current in the primary circuit from the battery tends to become less. Due to an electrical phenomenon—varying voltage in a circuit causes an induced voltage—induced voltage tends to keep the current flowing in an arc across the gap formed as the points open. Ordinarily, current flow would reduce gradually as the gap widened. This slow reduction of current would not collapse the magnetic field in the coil quickly enough to produce the required high voltage, and arcing would quickly burn out the points. The condenser now does its job, as in the diagram at the left. When the points open, current that keeps flowing goes into the condenser. By

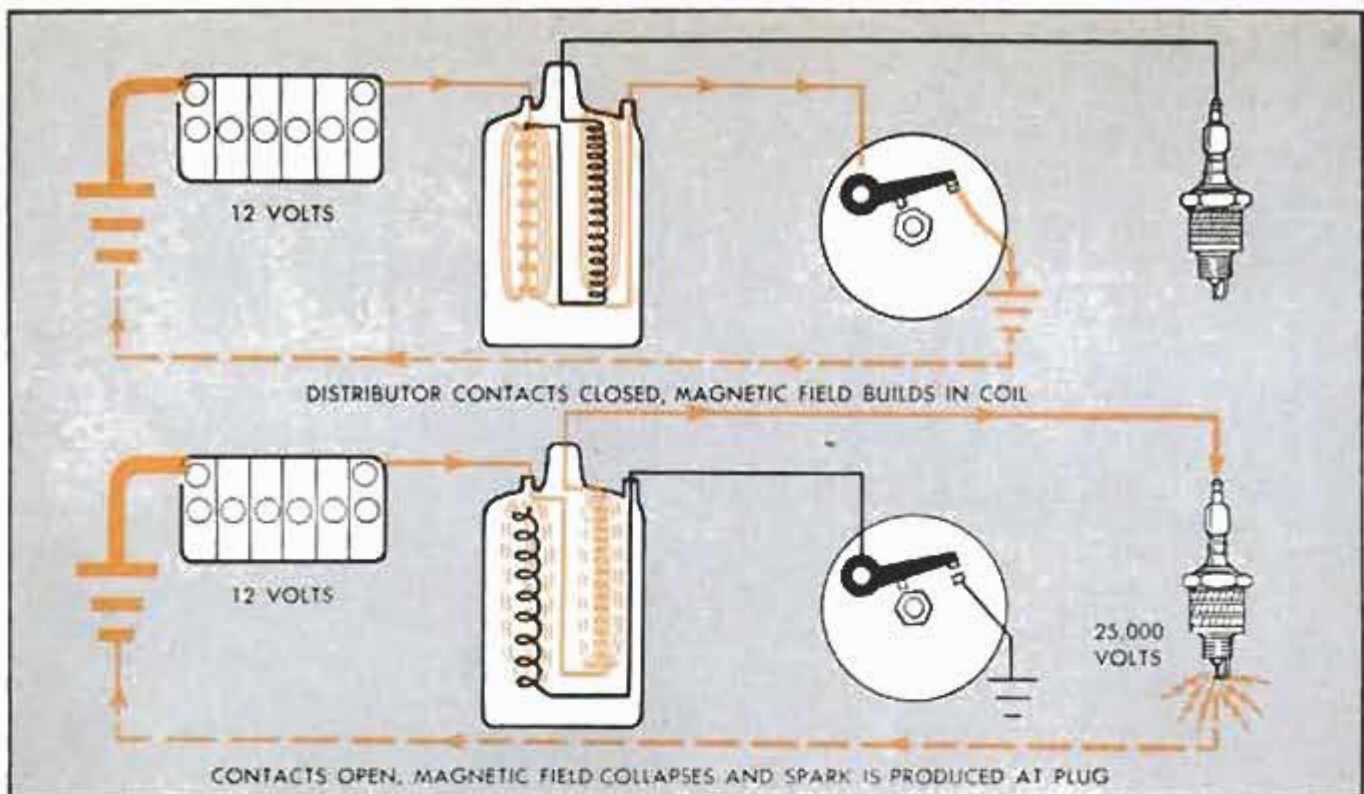

Information courtesy Electric Auto-Lite Co.,
Champion Spark Plug Co., Delco-Remy Corp.

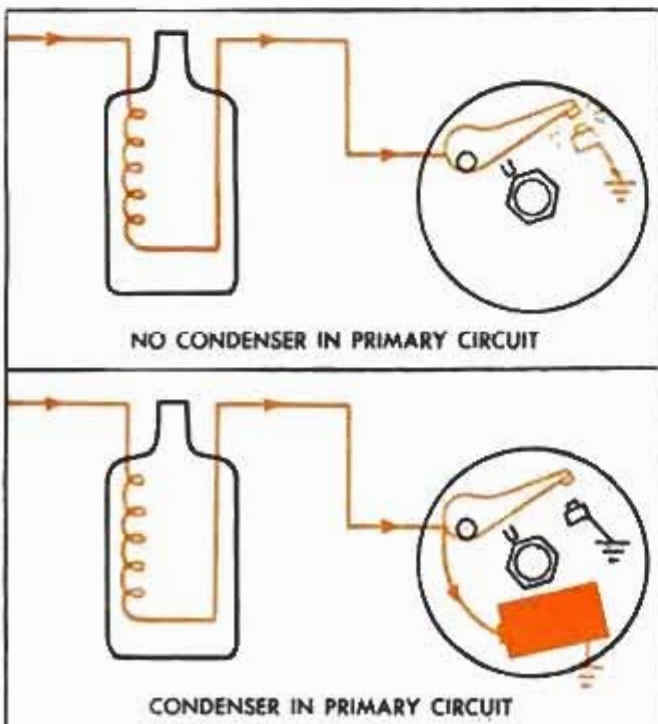
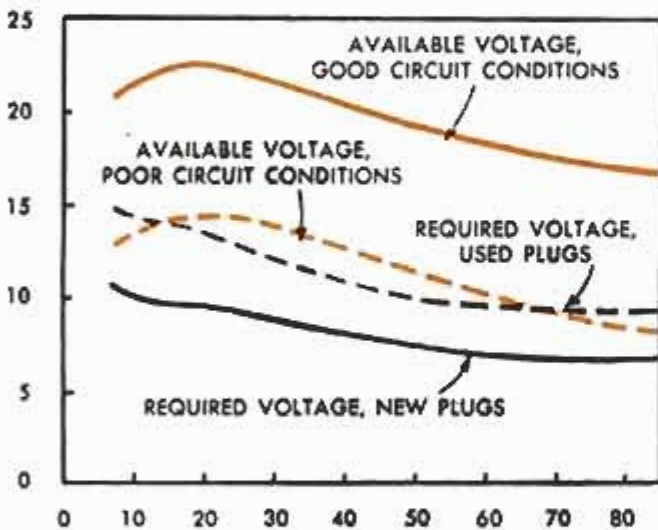

the time it is fully charged, and ready to discharge, the points have opened far enough to prevent an arc. The primary current stops quickly, the lines of magnetic force collapse quickly across the several thousand turns of fine wire in the secondary winding in the coil and high voltage is induced in the secondary circuit. Under ideal conditions when the points open, voltage in the secondary circuit may reach 25,000 volts. In actual operation, when sufficient voltage is reached to jump the spark-plug gap—usually between 4000 and 10,000 volts—voltage drops off. An oscilloscope will show that this voltage drop is relatively slow. Called the inductive component, this latter part of the spark does not aid in firing the fuel-air mixture, but does cause electrical interference and severe erosion on the spark-plug electrodes. For this reason, resistor spark plugs, with a built-in resistance that chokes off most of the unwanted inductive spark, have longer electrode life and reduce electrical interference. Because the inductive portion of the spark makes the brightest flash, eliminating that part will produce a spark with much less light. It can be understood, then, that brightness of spark does not necessarily indicate that one plug is better than another in its operation in an engine.

Spark plugs too often are blamed for trouble that actually can be traced to other components of the ignition system. If the coil is connected incorrectly so polarity is reversed, from 20 to 40 percent more current will be required to produce the required voltage at the spark plugs. No matter which way the battery in a car is grounded, current to the plugs is negative,

as this causes the spark to jump from the center electrode to ground. Lower voltage is required because electrons will flow more readily from the hotter center electrode. Badly burned distributor contact points will cause plugs to misfire. The burning of the points, in turn, may be caused by a voltage regulator that is set for excessive voltage.

Because today's powerful V8 engines are frequently driven at slow speeds in traffic where only part of their power is required, lead deposits from gasoline tend to condense on the surfaces in the combustion chamber, including the spark-plug insulator. When the car then is driven at high speeds on the highway, or suddenly accelerated, the resulting increase in heat melts the deposits and they become conductive, shorting out the plugs. Sometimes the plugs can be sandblasted clean and regapped. To help overcome this problem, additives now are used in gasoline, and spark-plug makers have produced plugs with extended insulators that project into the combustion chamber. At low speeds exhaust gases keep the insulator hot and burn away deposits. At high speeds the insulators are kept cool by the intruding fresh fuel-air mixture to prevent preignition. These plugs are available in various heat ranges that must be selected for a particular engine. These plugs are used in overhead-valve engines only. In valve-in-block engines the extended insulators might be struck by valves or pistons. The extended insulators on these plugs also provide a longer fouling path, as in the diagram above. This longer path presents greater resistance to passage of current, preventing misfiring.

Four reaches, or thread lengths, are available in spark plugs, as in the photo

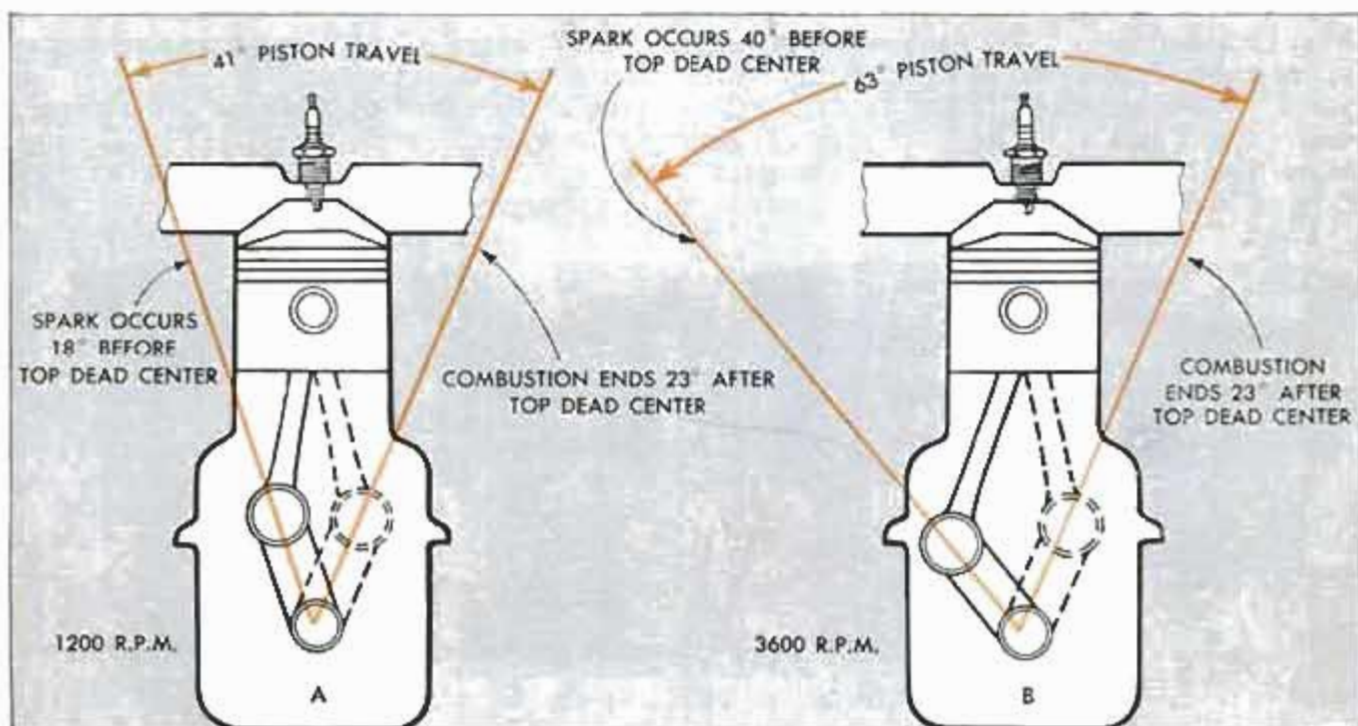
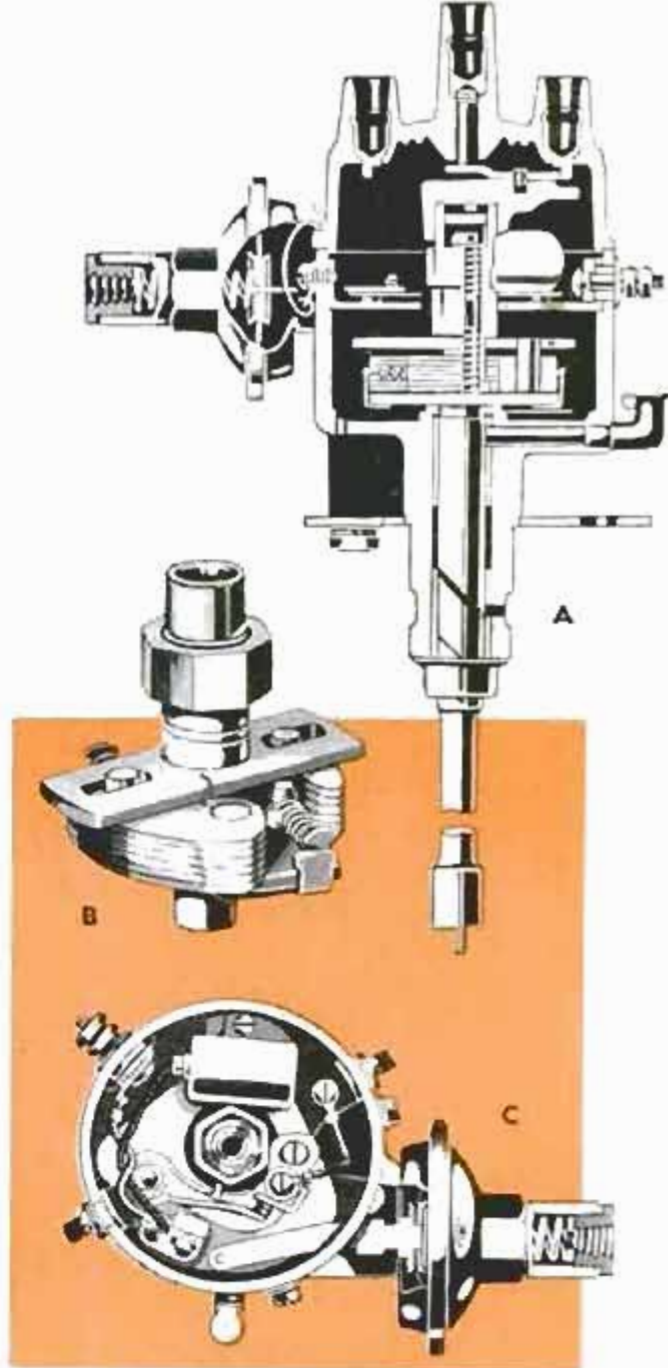

CONVENTIONAL-TIP SPARK PLUG

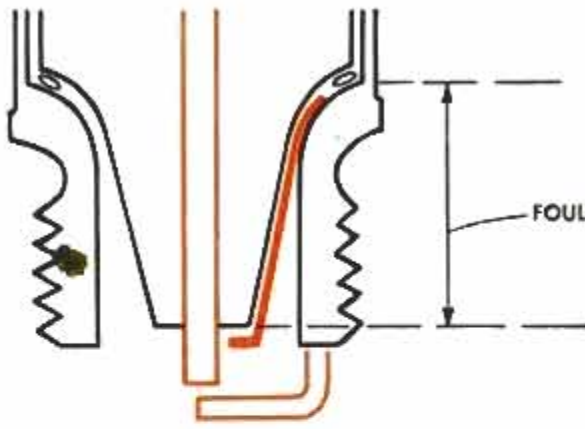

EXTENDED-TIP SPARK PLUG

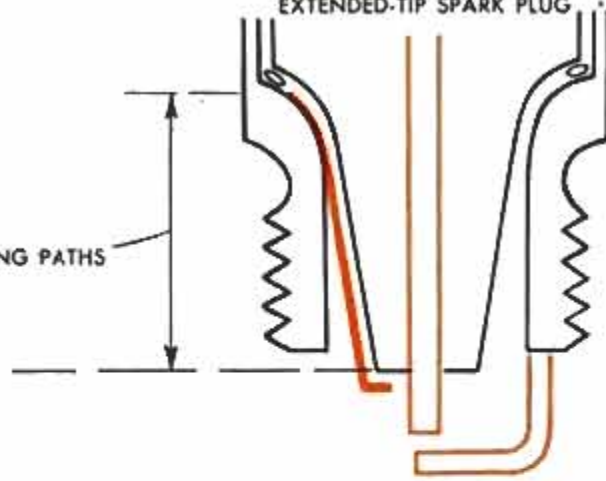

below. Should a long-reach plug be used in an engine requiring a short-reach type, a valve or piston could hit the plug end. Also, the exposed threads would glow and cause preignition. Removing the plug would be difficult when the threads filled with deposits. In the opposite instance, a short-reach plug in a long-reach cylinder head would be so shrouded it could not properly ignite the fuel-air mixture. Exposed threads in this case would be in the head. Installing the proper plugs would be difficult if the threads in the head were filled with deposits.

The distributor, top of page 191, is the device used to distribute the high-voltage current to the plugs by means of a rotor. The points, and usually the condenser also, are located in the distributor. The high-voltage current must be delivered to each spark plug at the proper moment. The correct time of firing will vary with engine speed, engine load and other factors. So there must be a means of changing spark timing. For maximum power, combustion must be completed by the time the piston reaches about 20 deg. after top dead center. Details at the bottom of page 191 show an engine that is assumed to be designed so that combustion ends at 23 deg. after T.D.C. for most efficient combustion. Detail A shows that at 1200 r.p.m. the ignition must occur at 18 deg. before T.D.C. if combustion

is to be completed at 23 deg. after T.D.C. When the engine is speeded up to 3600 r.p.m. as in detail B, it is necessary to advance the spark to 40 deg. before T.D.C. (gasoline burns at a fairly constant rate). To obtain spark advance, distributors have a centrifugal-advance mechanism, detail B, page 191, consisting of spring-loaded weights that are thrown out to advance the breaker-plate cam as engine speed increases. Under part-throttle operation there is a high vacuum created in the intake manifold. The fuel-air charge is not so highly compressed and burns more slowly. An additional spark advance will increase fuel economy, so a vacuum-advance device, detail C, provides this. A diaphragm is connected to the breaker-point plate by a lever. The opposite side of the diaphragm is connected to a passage in the carburetor by a copper tube. The passage in the carburetor is on the atmospheric side of the throttle plate, and when the throttle opens, the passage is under manifold vacuum. The diaphragm then moves the breaker plate to advance the spark according to the amount of vacuum. A spring returns the diaphragm to a neutral position when vacuum reduces. Available voltage from the battery, as shown in the chart on page 190, determines ignition efficiency. Loose connections lower available voltage, worn plugs and burned points increase required voltage. ★ ★ ★





DROP-LEAF TABLE

By John Bergen

DESIGNED for that dining alcove that must serve as a dining room when entertaining, this king-size, drop-leaf dining table folds and rolls and takes its place against the wall when not in use. It opens into a table 40 x 60 in., seating six persons nicely. Brass posts give it just the accent needed to enhance the elegant sweep of its teakwood or African-mahogany top.

Construction is simple. The swinging legs are made alike and in pairs from 1 $\frac{3}{4}$ -in. stock, 2 $\frac{1}{4}$ -in.-wide pieces being used at the tops, 2 $\frac{1}{2}$ -in. pieces at the sides and 4-in. pieces as the bottom. These U-shaped assemblies are half-lapped at the corners and glued. Holes for the brass posts are bored 1 in. deep and holes for caster sockets are drilled 1 $\frac{5}{8}$ in. deep. Rounding the ends of the members is a simple job if you have a disk sander. A rasp and sandpaper attached to a flat board will do the trick,

however, when working with hand tools. In each case, the radius should be marked on top and bottom edges beforehand. Even with a disk sander, final sanding should be done with a sanding block to blend the rounded ends into the face grain. When

MATERIAL LIST

CABINET PLYWOOD

- 1 pc.— $\frac{3}{4}$ " x 24" x 40"—Top
- 2 pcs.— $\frac{3}{4}$ " x 28" x 40"—Drop leaves

LUMBER

- 2 pcs.—1 $\frac{3}{4}$ " x 2 $\frac{1}{2}$ " x 28 $\frac{1}{2}$ "—Center pedestal ends
- 1 pc.—1 $\frac{3}{4}$ " x 4" x 23"—Center pedestal base
- 1 pc.—1 $\frac{3}{4}$ " x 2 $\frac{1}{2}$ " x 23"—Center pedestal top
- 1 pc.— $\frac{3}{4}$ " x 6" x 24"—Top cleat
- 1 pc.—1 $\frac{3}{4}$ " x 2 $\frac{1}{2}$ " x 28 $\frac{1}{4}$ "—Pedestal hinge posts
- 4 pcs.—1 $\frac{3}{4}$ " x 4" x 18 $\frac{5}{8}$ "—Side pedestal bases
- 4 pcs.—1 $\frac{3}{4}$ " x 2 $\frac{1}{4}$ " x 18 $\frac{5}{8}$ "—Side pedestal tops
- 4 pcs.—1" O. D. brass tubing 24 $\frac{1}{4}$ " long—Pedestal pillars
- 4—Continuous piano hinges 28 $\frac{1}{2}$ " long
- 4—Open butt hinges (3" x 2") with spun pins
- 6—1 $\frac{1}{4}$ " dia. castors

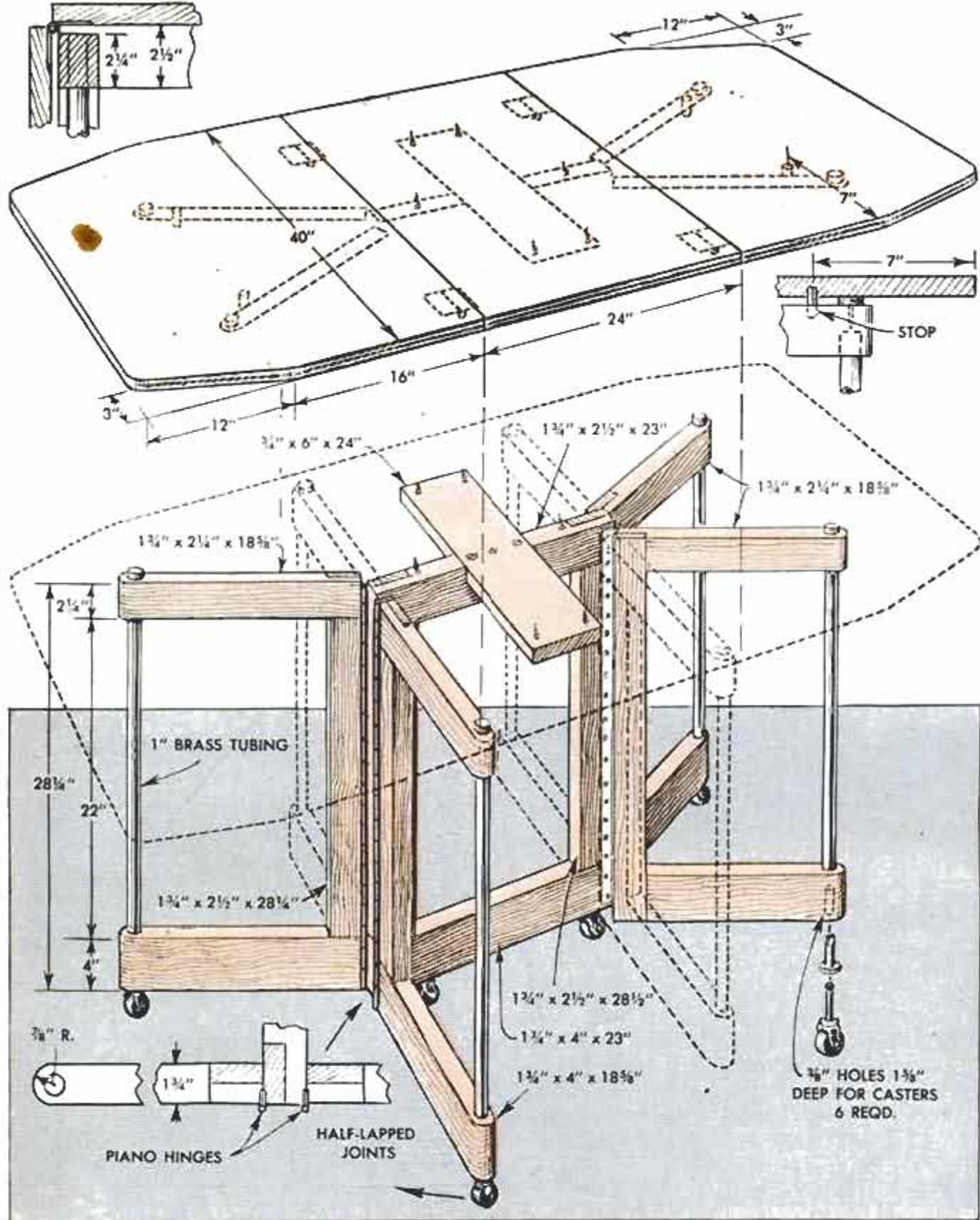

assembling the members, remember the brass posts must be in place before the corners are lapped, glued and clamped.

If you have difficulty finding brass tubing, you can use 1-in. hardwood dowels instead. In picking them out, select four that are as straight as you can find. The best way to do this is to roll each dowel over a flat surface. Any bow or twist in the dowel can be detected right away.

The center framework to which the

swinging legs are hinged with piano hinges, is made $\frac{1}{4}$ -in. higher, or $28\frac{1}{2}$ in. This is done to allow for the thickness of the felt-covered furniture glides which are driven into the upper corners of the swinging legs. You'll notice that the top member of the center frame is dadoed for a $\frac{3}{4}$ -in. flat board, and that counterbored holes are drilled from the underside for two of the six screws which are used to fasten the table top. Like the legs, the members are

half-lapped at the corners. Holes for two caster sockets are made in the bottom.

The three-section top is made of $\frac{3}{4}$ -in. veneer-faced plywood, the edges of which are later covered with veneer tape to hide the plies. Holes for dowel-pin stops are made on the underside of the table leaves 7 in. in from the edges. Bore these not more than $\frac{1}{2}$ in. deep and use a twist drill so the point won't poke through the top surface. The stops limit the swing of the leg supports and automatically align them. The butt hinges which are used to hinge the leaves should be mortised flush into the underside and the hinge pins should be positioned a bit off-center to allow for finish. Use short enough screws in attaching the top to the understructure so there is no chance of the points breaking through the surface or even forming telltale bumps to mar it. Screws that are too long can be shortened by snipping off the ends.

A finish resulting very close in tone to that of the virgin wood can be obtained by using one of the new synthetic finishes, such as Satinlac. After a thorough sanding

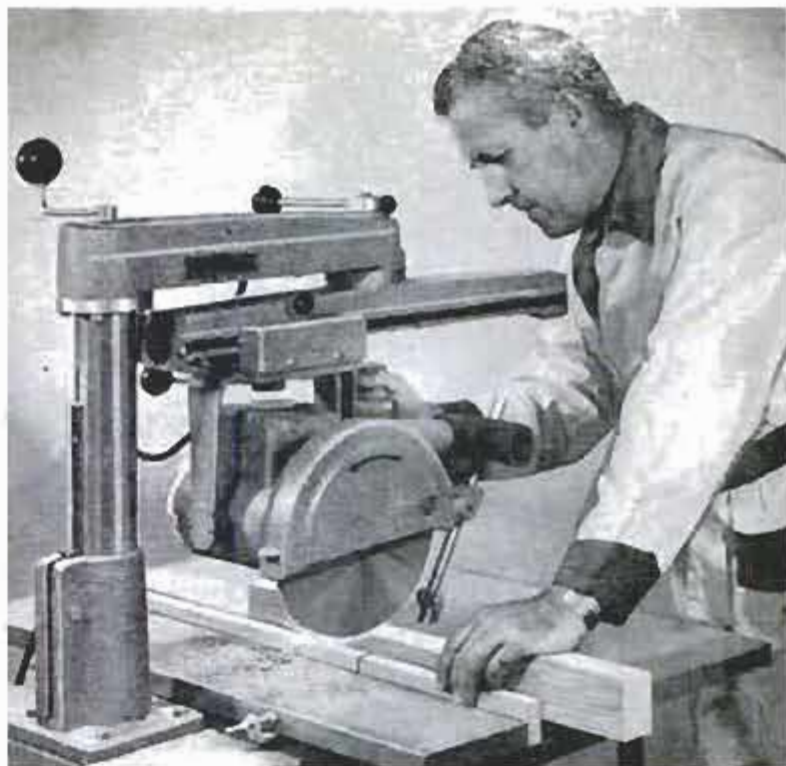

and a close inspection of the work, particularly the top and leaves, to spot any flaws, apply a coat of lightener to the bare wood. After it dries, sand lightly and apply two coats of Satinlac. The resulting "natural" finish does not darken or yellow with age.

★ ★ ★

Stainless Lubricant in Stick Form Has Variety of Uses

Used much in the manner of a child's crayon, stainless lubricant in stick form is available for many uses around the home, shop and office. For zippers that are slightly difficult to work when a garment is returned from the cleaners, simply apply a light coat of the lubricant from the stick. Friction catches on cabinets, ranges and refrigerators work smoothly and easily when touched with a bit of the lubricant. Another use for the long-lasting, non-

staining material is to make double-hung sash slide easily. Doors that stick against the jamb also can be freed with the stick. If the bar of soap you keep in the toolbox for lubricating wood screws does not stay soft and usable, substitute a stick of lubricant that will never dry up and always is ready to help with the driving of wood screws. A touch of the stick to the cutting edges of saws, planes and other tools aids in smoother cutting.

Brush "Holster" on Paint Pail

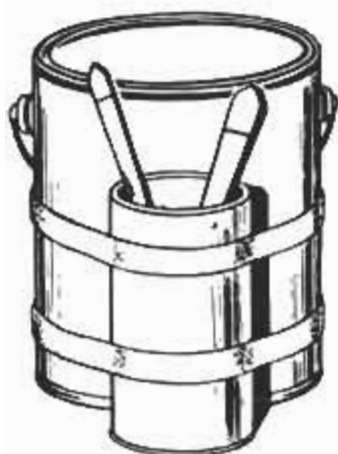

Tape a small-diameter, rather tall food tin to the side of your paint pail. This tin is an ideal holder for smaller brushes used for trimming and edging. It will be especially handy when working at the top of a ladder. —P. E. Fitzpatrick, Gary, Ind.

Rubber Cement Seals Glass Jars

If you save small quantities of paint or other liquids in screw-top glass jars, make more certain that the liquids will be kept in good condition by sealing the jar. Apply rubber cement to the jar threads before turning on the top, as indicated.



Electric Starter for Model Plane

Rotating the propeller of a model airplane two or three hundred times to wind up its rubber-band "motor" can be a time consuming, wrist-tiring job. One father who was faced with this task for his young son cut a Y-shape from the hook portion of a wire coat hanger to make a "power winder" for the rubber-band motor. The wire device is chucked in a $\frac{1}{4}$ -in. electric drill and the winding operation then takes only seconds. — J. J. Mason, Lawton, Okla.



Data Taped to Grinder Housing Shows Correct Operating Speed

To avoid damage to the wheel and bearings, and to assure a good finish, lathe grinders must be driven at the correct speeds. High speed is used for external grinding, low speed for internal grinding. To minimize the chance of operating a grinder at the wrong speed, press a strip of tape to the grinder housing on which is indicated which speed is to be used.

Improved Float Arrangement Controls Electric Pump at Farm Well

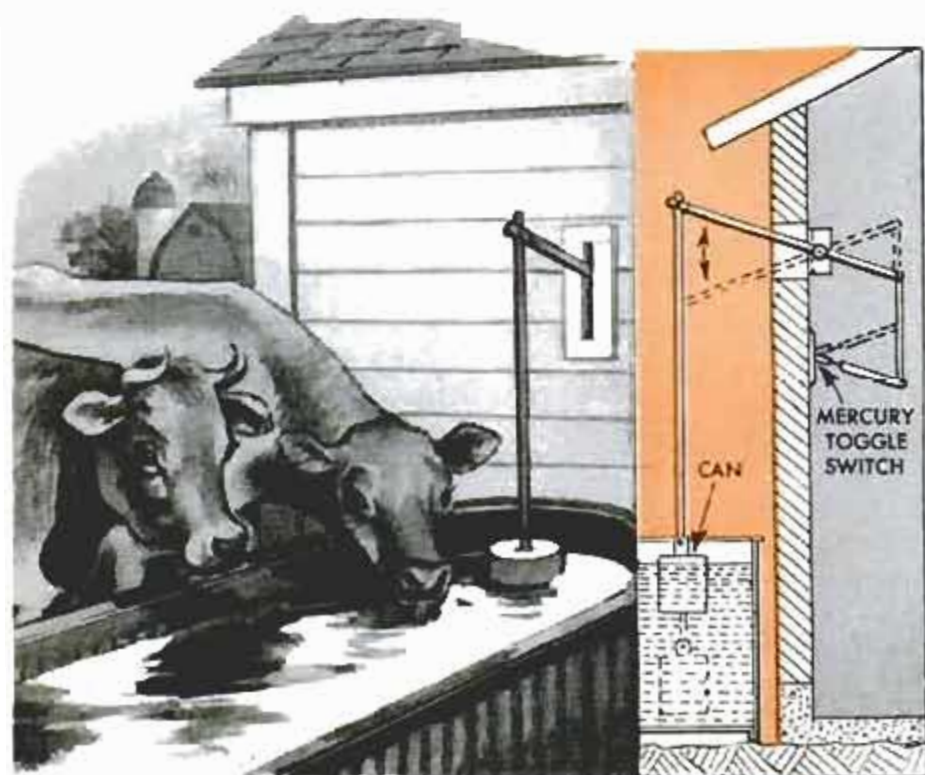

Requiring only occasional testing of the electrical circuits to make sure it is all right, this device was assembled by one farmer to make the filling of a stock-watering tank automatic. An empty 5-gal. oil can, soldered shut to be watertight, acts as a float to actuate a system of levers pivoted in a slot in the barn wall. Inside the barn the levers act on an extension screwed to the toggle of a mercury-type switch that controls the water pump. The switch is not spring-loaded, and the mercury mechanism is long-wearing. — Henry Josephs, Gardenville, Pa.

Old-Style Buffet Cut Apart to Make Modern Furniture

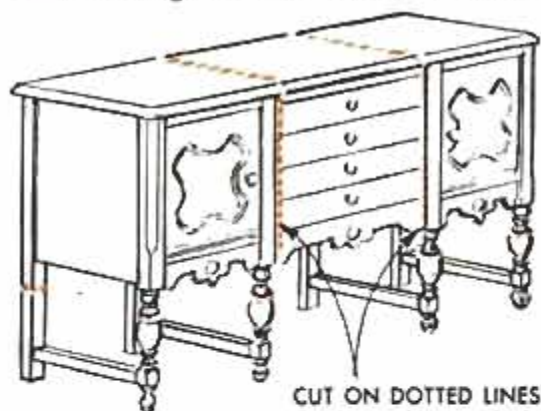

Long, oversize buffets that once were popular in dining rooms are too large to fit in modern dining areas that usually are fairly small. However, these pieces of furniture can be cut down and used for other purposes. In the example shown, the buffet was cut as indicated along the dotted lines to produce two end or lamp tables. The legs also were shortened to match the trend to lower furniture surfaces. The center section of the buffet contained drawers. These ready-made drawers are ideal for use in built-ins, or in any furniture built in the home workshop. Their size and shape might, for example, suggest a small piece of furniture that could be used in some particular location. When the buffet shown was modified, the center section of the top was refinished and fastened to the wall in a hallway. With a mirror mounted above it, it is the ideal spot to display fresh cut flowers. Save the portions of the turned legs that are removed. They might be just the thing for a low coffee table, or, with some slight modifications, could be used simply as decorative knobs or columns. If the newly ex-

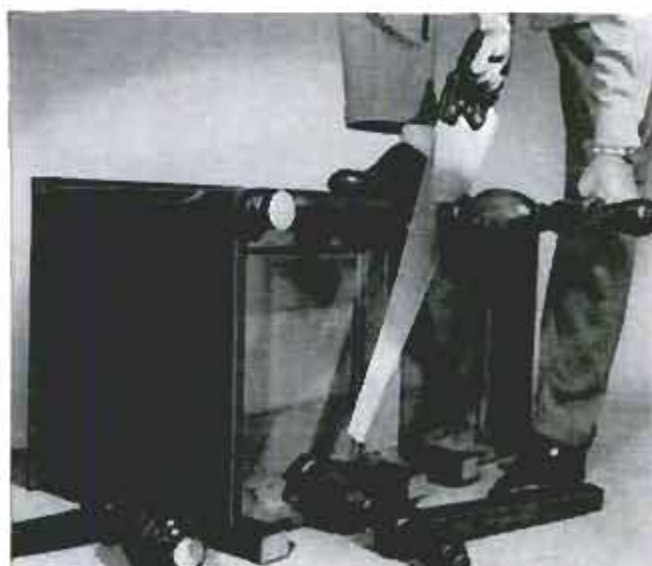

posed sides of the sectioned buffet are of plywood or hardboard, cover them with a piece of hardwood-faced plywood to match the finish of the rest of the resulting end table, or with plastic veneer.

Fred Haitz, Sioux City, Iowa.

Tool Roughens Joint Surfaces For Better Glue Bond

Glue will form a better bond when the surfaces of wooden workpieces to be glued are roughened by a tool such as the one shown at right. To make the tool, drill two holes in a corrugated fastener and screw it to one end of a short length of wooden scrap as in the detail.

Norm Jacky, Fond du Lac, Wis.

To save steps when it is necessary to take medicines and miscellaneous articles to the bedside of a sick person, pin a shoe bag to the side of the bed so that most of the things desired by the patient are within easy reach. When used for children, do not place in the bag medicines that are to be administered under supervision.

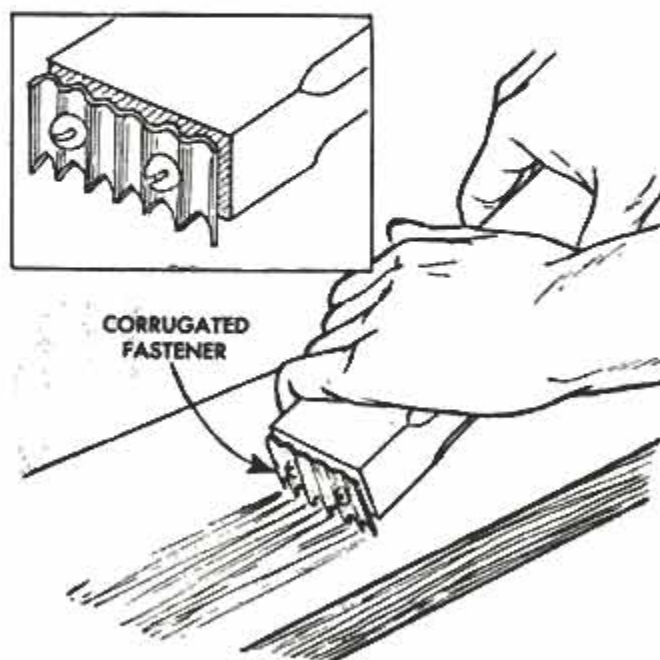

Solving HOME PROBLEMS



1. YOU WOULDN'T USE your best card table for this but an old one fitted with a plastic-screen top makes it quite simple to dry a sweater. The outline of the sweater is marked on the screen with chalk then washed and later spread out on the plastic screen to coincide with the chalked line



2. SHEET-METAL SCREWS are better than regular ones when it comes to fastening fixtures to thin material, such as hardboard and plywood facing on doors. The reason is that the threads on sheet-metal screws run right up to the heads of the screws which makes them hold their full length

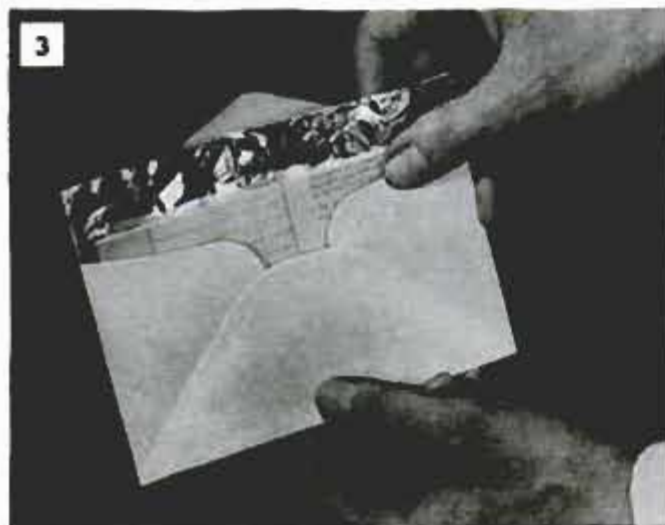

3. WHEN MAILING CHECKS or cash or other material of a personal nature and you want to make the envelope lightproof to conceal the contents, cut a piece of aluminum foil to fit the envelope and slip it inside. It will make it "tamperproof" and add very little to the weight of the letter

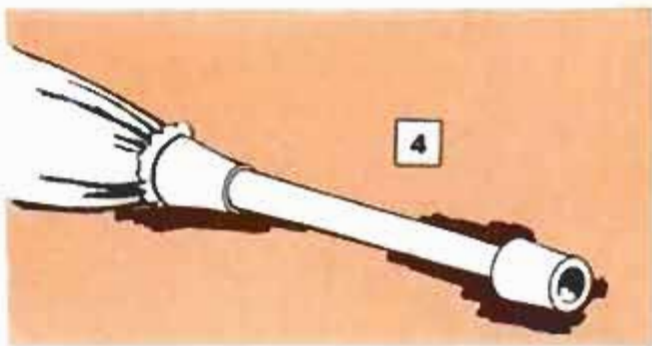

4. MOST TIMES you can hang an umbrella by its handle when putting it away, but there is the occasion when it must stand in a corner. At such times it is worthwhile to have the umbrella spike tipped with a piece of hose to keep it from skidding

5. TALL TAPERS often become bent from the summer's heat. A quick way to straighten them is to wrap in cellophane and hold under hot water. This softens the candles, after which they are unwrapped and straightened by rolling with palm on flat surface

6. THE SHELF-PAPER EDGING on your cupboard or pantry shelves can be made to look like it is buttoned in place by cementing small buttons to the heads of thumbtacks. Spaced evenly along the edging, the buttons add a novel decorative touch

7. A DOORKNOB GUARD that keeps a small tot from opening an outside door and yet allows unrestricted use by other members of the family can be improvised from half a tin can attached to the inside. Tabs at one end permit attaching with screws

8. AN EXTRA FLASHLIGHT left in a clothes closet will prove itself handy when rummaging in the dark. A simple way to store it is to cut a notch in one of the shelves. A window turn button will keep it from being dislodged by shelf items

9. THE LAST SUIT OR GARMENT on the rod generally takes a beating in a crowded closet. A simple way to prevent this is to wrap rubber bands around the rod a few inches from each end to provide stops for the wire hangers. Use enough bands to form a ridge

10. NOVEL "MOSAIC" TREATMENT for the front of a small drawer or other object is to peel the color chips from outdated paint-color charts and glue them side by side in a brickwork pattern. A sealer coat of clear shellac is applied when the glue dries

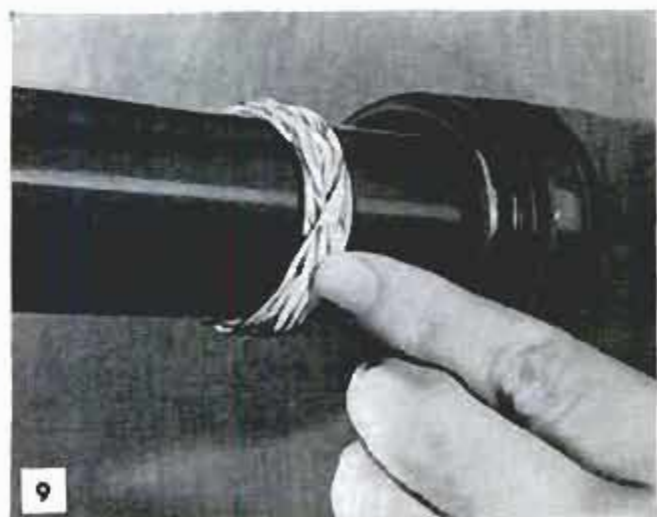
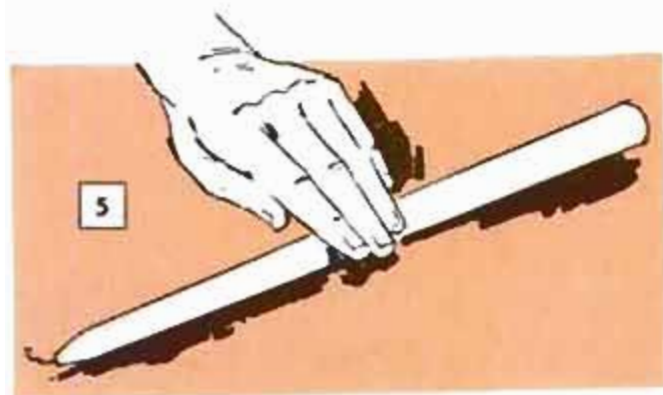

Wire "Tongs" Speed Application Of Paint Stripes on Golf Balls

An easy way of marking golf balls for positive identification is to roll a stripe of brightly colored enamel on each of them from a freshly painted scrap of glass or metal as shown in the drawing at left. The small handle used for gripping and rolling the balls, is made from a length of steel wire that is pointed on both ends. The wire is then bent in half and twisted together, leaving enough of it straight at each end to form "tongs" with which to grasp a ball.

Before starting a project requiring the use of dowels, heat the dowel stock in a low to medium-warm oven to remove the moisture from the wood. This slightly reduces the diameter of the dowels so that they are easier to position in the work. Then, after being glued into position, the dowels absorb moisture again resulting in a tight fit. — M. Beasley, Jackson, Mich.



Block Clamped to Jointer Fence Permits Uniform Chamfered Cuts

To permit chamfering the edges of several pieces of wood so that all chamfered cuts are uniform, clamp a stop block to the jointer fence in the position shown. The stock to be chamfered must be fed into the jointer knives so the latter cuts with the grain and not against it which would result in splintering and chipping. The chamfered cuts produced, of course, are slightly concave. For purposes of illustration only, the jointer is pictured incomplete and without a guard. Notice that a wide follow-up block is used to support the work vertically and rigidly.

E. R. Haan, Evanston, Ill.

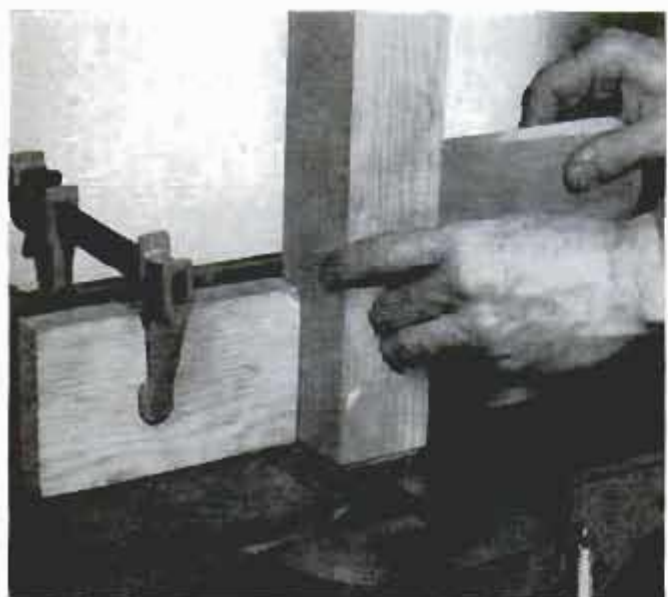

Molding Strips Nailed to Ladder Top Retain Work Materials

Strips of quarter-round molding nailed to the edges of the top of a stepladder as shown at left, convert that surface into a handy tray for holding screws, nails, tools and small parts when working from the ladder. Wooden strips of other than quarter-round stock may be used for this purpose but the joints should be mitered for a good job. Use small finishing nails for attaching the strips to avoid splitting them or the ladder top, and to prevent catching clothing on the heads as might happen if common nails are used and the flat heads work out. Use stove bolts for attaching such strips to the top of an aluminum ladder.—Ted Fenn, Skokie, Ill.

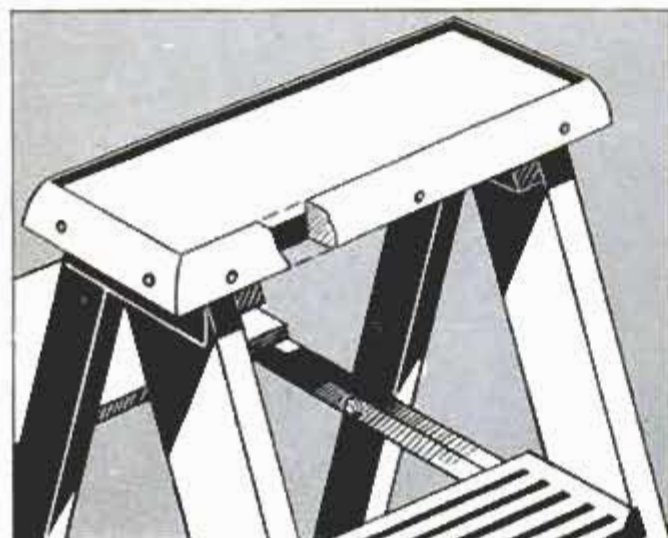

SHOE CABINETS

Hinged to Closet Doors

By Hi Sibley

IF YOUR WIFE or daughters have been complaining of lack of closet space for shoes, here is a way of giving them the desired convenience without enlarging present closets or building new ones. Simply build shoe cabinets like the ones illustrated and attach them to existing closet doors by means of the hinge arrangement shown in the details. Friction catches keep the cabinets closed tightly when not in use to exclude dust and prevent interference with access to the closet. A single shoe cabinet may be added to a closet with one door by altering the height and width of the cabinet to suit. The spacing of the carriage bolts, that are used as pegs on which to hang the shoes, is adequate for most adult sizes, requiring two pegs for each pair of shoes. Men's shoes may be stored in the cabinets as well, except that there is space for only one shoe on each pair of pegs. The bolts that are used for pegs should be painted black, or left natural if cadmium-plated or galvanized. When tightening the bolts in place, turn outside nuts flush with the ends to guard against cuts from exposed threads.

A cubicle is provided in the bottom of each cabinet for footwear that cannot be hung on the pegs. The dimensions of this compartment may also be changed to best suit individual needs. Note that a closet that is to be provided with a shoe cabinet or cabinets must be of sufficient depth to permit clearance between the clothes and the cabinets when the doors are closed.

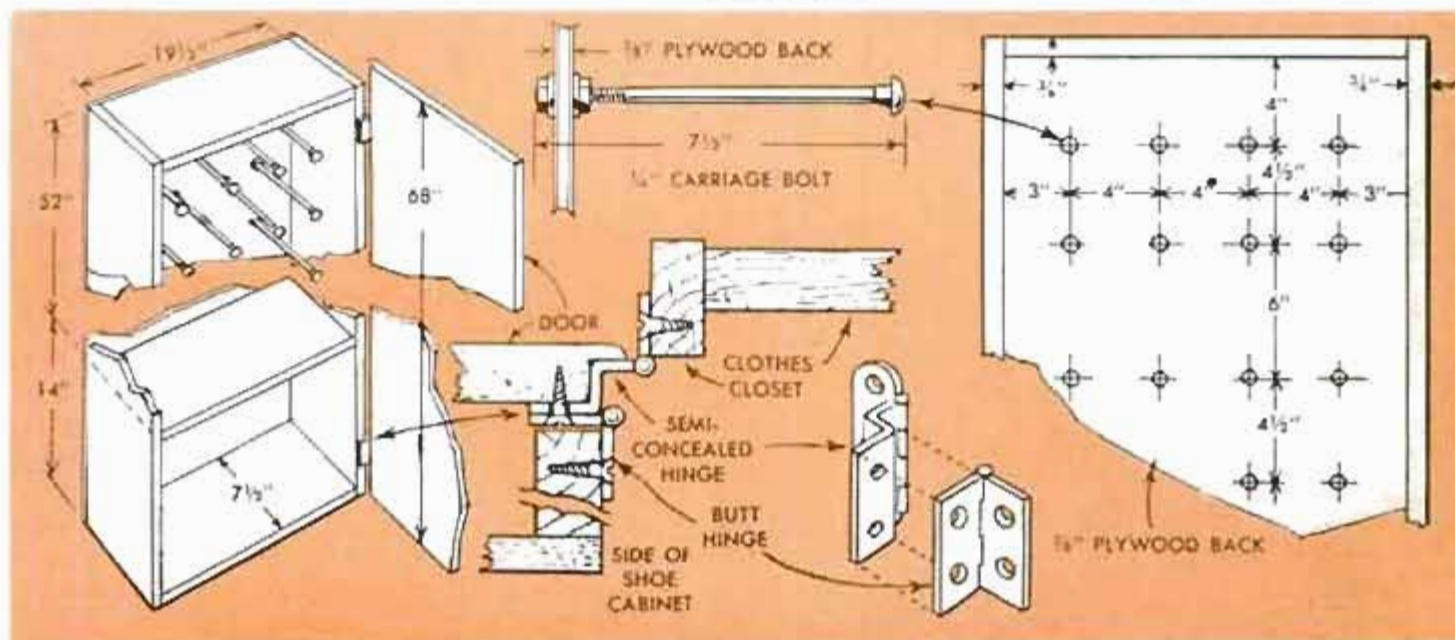

"LINOLEUMIZE"

Your Kitchen and Bathroom

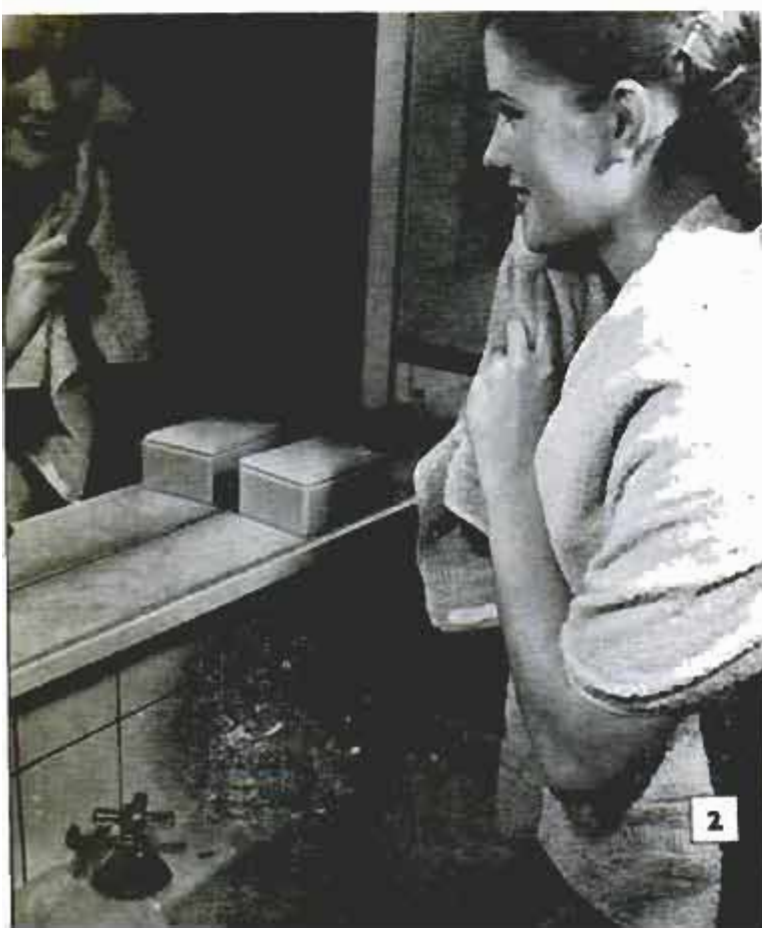

A VAILABLE in a variety of colors, patterns and weights, linoleum is being used by many homemakers as a covering material for almost every surface in the home that receives hard use or is exposed to frequent soiling. Remnants that usually are obtainable at low cost from linoleum stores, are large enough for steps on hall and basement stairways, window cornices, doors and other small surfaces. The photos on this page and the next illustrate only a few of many such uses for linoleum. The next time you redecorate the bathroom or kitchen, consider using linoleum to cover all or part of the walls and other minor surfaces. Easy to work with adhesives and ready-made metal moldings that come in a wide selection of styles permit anyone to turn out professional-appearing work. ★★★

Fig. 1: For long service and easy cleaning, wax your linoleum only with preparation made especially for it. **Fig. 2:** Tile-patterned linoleum dado provides attractive, easily cleaned wall covering for lavatory

Fig. 3: Scarred and badly worn kitchen cabinets are given "face lifting" by covering of linoleum in solid color that contrasts with countertop and floor. Linoleum is cut to fit each door and drawer front and cemented in place



Fig. 4: Odd piece of linoleum is used for covering top of sewing table to provide smooth, easy-to-keep-clean surface that does not snag lightweight synthetic materials. Such pieces can be purchased as remnants at very low cost

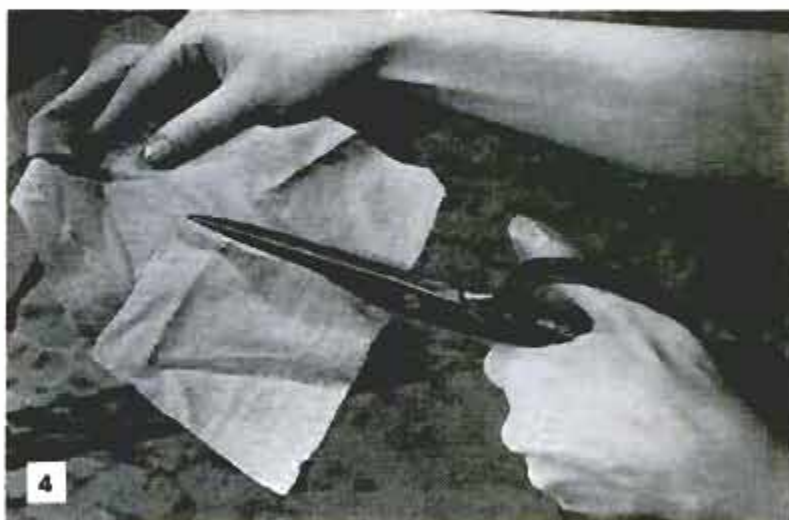

Fig. 5: Inlaid linoleum leftover strips are excellent for covering hall or basement steps to save them from the hard wear resulting from sand and other highly abrasive particles frequently tracked in from outdoors and workshop

Fig. 6: Attractive patterns and colors available in linoleum make it an excellent covering material for cornice to give interesting treatment to kitchen window. The smooth surface can be kept clean with very little effort

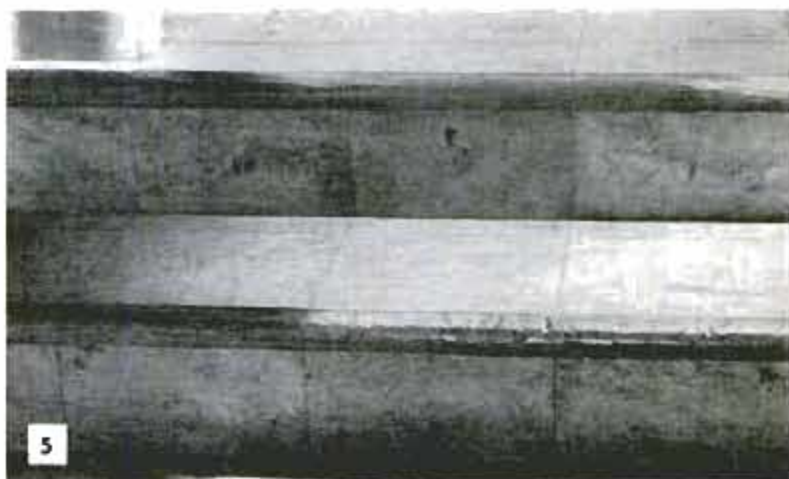

Fig. 7: Painted kitchen door was hard to keep clean until it was covered with linoleum in color that blends with doorway and upper half of walls. Edges of linoleum at side and bottom of door are beveled to prevent tearing it

Fig. 8: Desk top is covered with remnant piece of linoleum in solid, dark color. Edges of linoleum are beveled on all sides for attractive and serviceable writing surface. Ink stains and soil are easily removed with a damp cloth



Infant's Bed-Playpen Fits Between Front and Rear Seats of Car



Auto travel with an infant is no problem when a car bed of the type shown is used. There is room for an older child at each side of the rear seat. Ends and bottom of the bed are cut from $\frac{1}{2}$ -in. plywood and the

side rails are $\frac{3}{4}$ x $1\frac{1}{2}$ -in. hardwood. The front end rests on the car floor and is cut to fit. The rear end is supported by flat-steel hooks over the rear seat.

M. C. Anderson, Arlington, Va.

Drill-Bit Rack Is Nonclogging

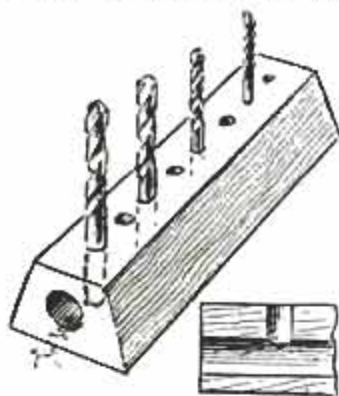

One craftsman who prefers to make his own drill racks from pieces of hardwood prevents the holes from becoming clogged simply by drilling a hole lengthwise through each block as detailed. This prevents sawdust

and other foreign matter from collecting in the holes that were drilled to hold the bits of various sizes. Blowing through the horizontal holes, or running a bottle brush through them prevents an accumulation of shop dust and dirt.

Handy Pen Wiper on Ink Bottle



Artists will find that one or two pipe cleaners wrapped around the neck of an ink bottle provide a pen wiper that is always at hand. Since the cleaners are very inexpensive, they may be discarded when saturated with the dried ink.

Notch Locates Cotter-Pin Hole

Locating the hole for a cotter pin when using a castellated nut is easy if a guide is provided across the end of the bolt. The guide can be a notch filed parallel with the hole. Then it is just a matter of lining up the nut with the filed indicator notch to insert the cotter pin. This idea is especially handy when working with bolts coated with grease and dirt, or when the bolts are located in places which are difficult to reach.

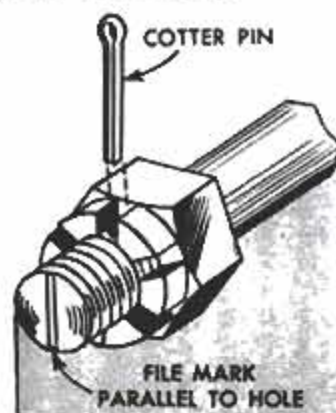

Nonslip Surface on Erasing Shield

The difficulty of holding an erasing shield in place may be overcome by using drafting tape as indicated. Use two strips on each side of the shield. The tape provides a nonslip surface when pressed against the work.—T. V. Walters, Chicago.



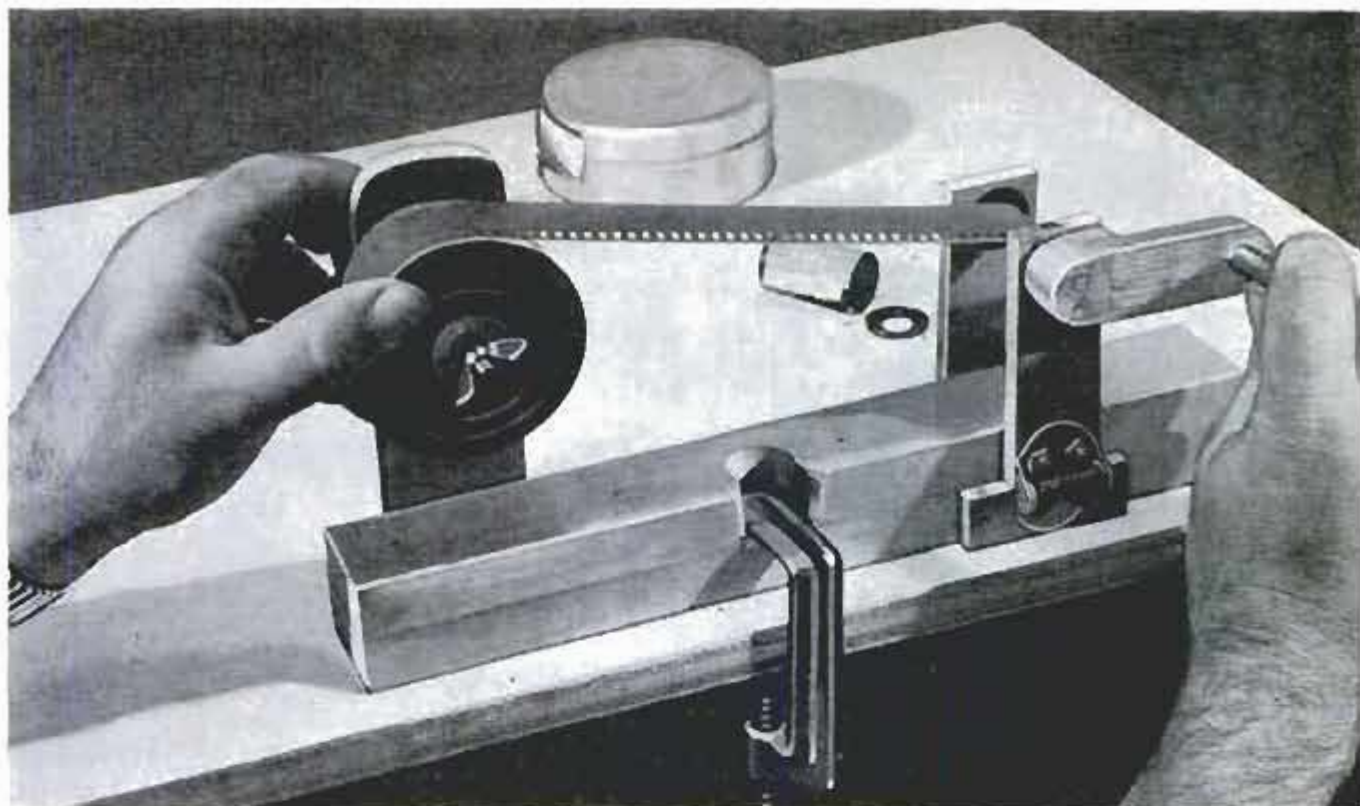

35-MM. BULK-FILM LOADER

By Louis Hochman

DESIGNED for the photographer who shoots 35-mm. film extensively, and buys in bulk to save up to 75 percent of film cost, this jig makes quick work of rewinding the film on 20 or 36-exposure spools. As indicated, the empty spool is fitted between the spring-loaded uprights and the crank is fitted on the end of the spool to permit rotating it. Tension is kept on the roll of bulk film by means of a spring and thumb-screw. The correct tension may require

some experimentation to determine at what setting the film unrolls to provide a properly wound spool for insertion in its cassette. Thirty rotations of the crank on the spool will produce a film length of 5 ft., which is the equivalent of a 36-exposure spool. All rewinding of bulk film is, of course, done in total darkness. This rewinding jig is designed for simplicity of operation in the dark, but it still is necessary to use care to avoid scratching the film or finger marking it. Cellulose tape fastens the end of the film to the empty spool.

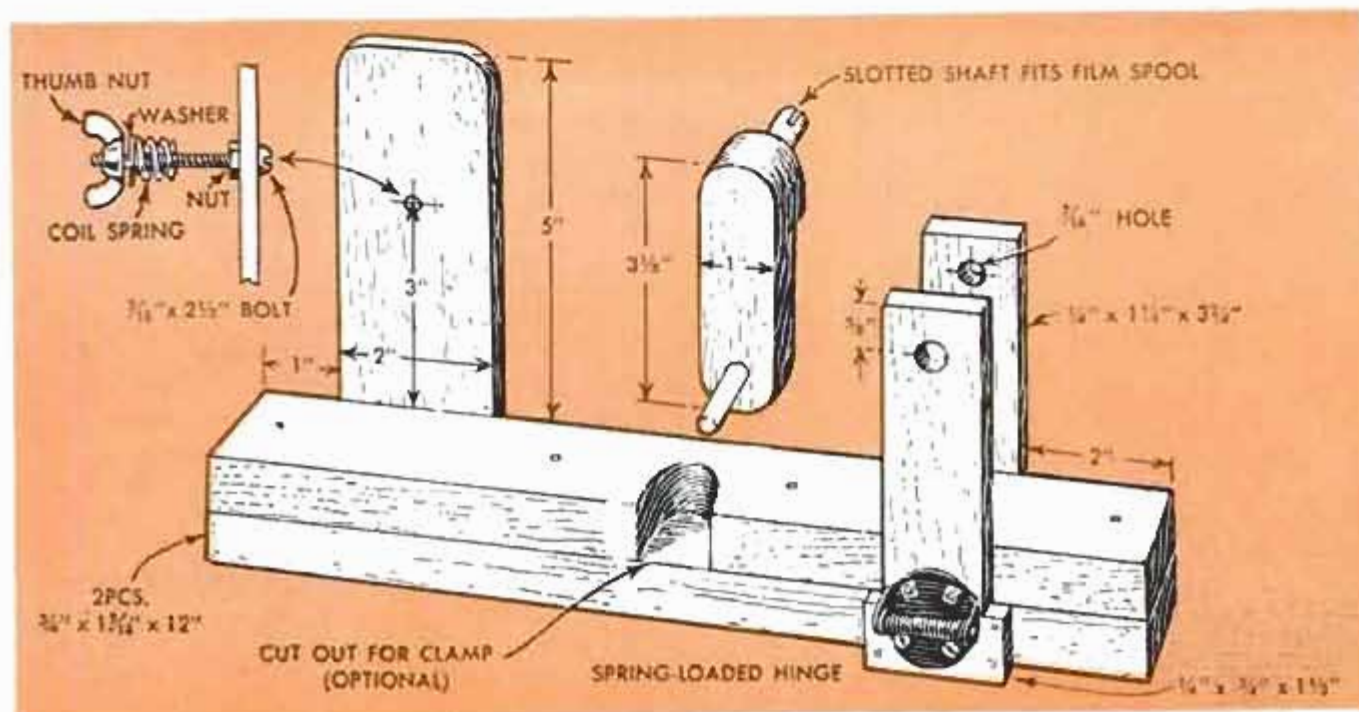

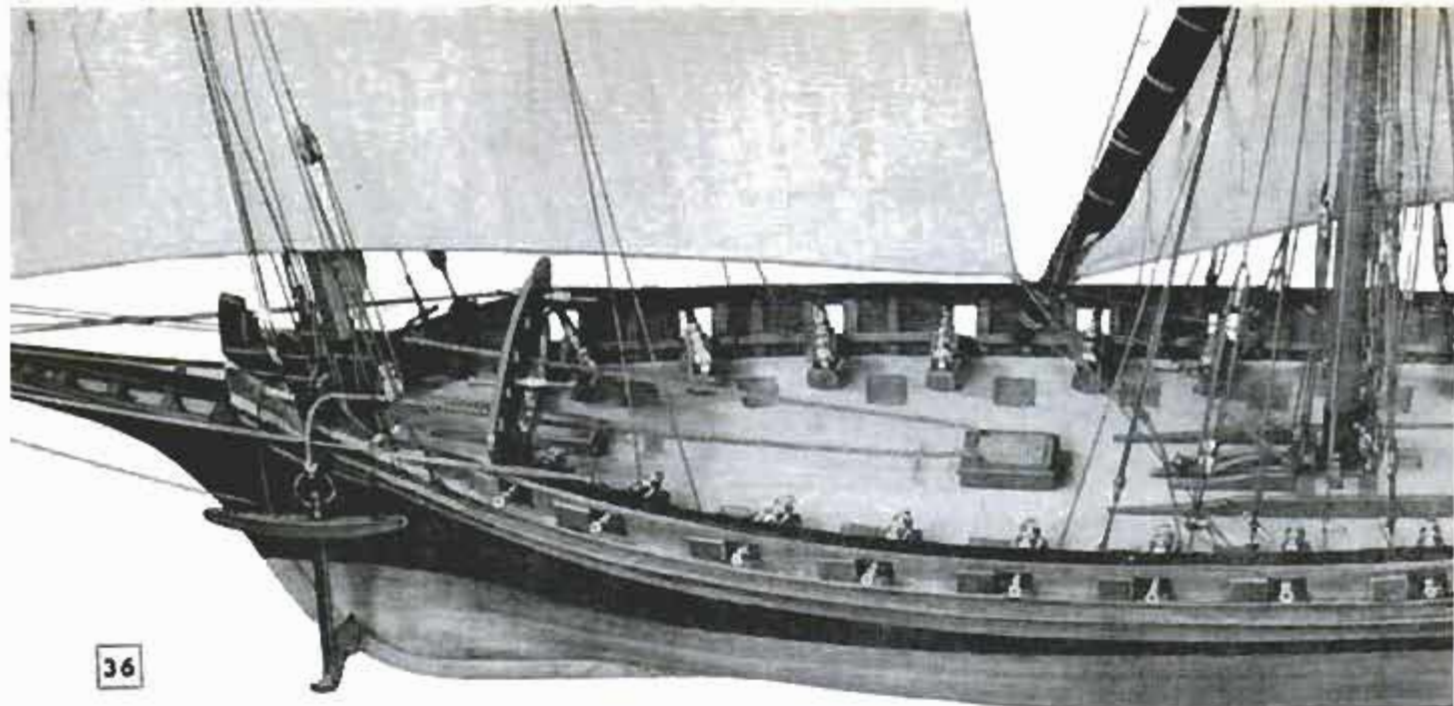

MODELING THE FRENCH

Guns, deck fittings, longboat and masting

AT THIS STAGE of building your model *Chebec*, which began in the Nov. 1958 issue, you are ready to proceed with the deck fittings and other small equipment as well as the masts and yards. Fig. 36 shows the appearance of the deck with all fittings except the longboat after the model has been completed, including the rigging.

Making the Guns

There are 24 six-pounder cannon positioned on the main deck at locations indicated in Figs. 14 and 42. Details on making them are given in Fig. 37. You may be able to purchase somewhat similar guns already mounted on carriages and thus eliminate considerable work. But if you intend to make them, turn them from either brass or maple, using a cutting tool that you have ground to the gun shape. Drill the guns crosswise for pins that serve as mounting pivots. The gun carriages are grooved to take the pivots and the barrels, and the guns are glued in place. The carriages are pinned to the deck to fit snugly against the bulwarks. It is possible to cut 12 carriages from a single small block of maple by following the procedure outlined in Fig. 37. The carriage wheels are punched from $\frac{1}{16}$ -in. fiber and are pinned in position.

There also are 34 two-pounder blunderbusses; eleven at each side of the poop deck, and six on each breastwork, if you wish to include all of them. Originally the

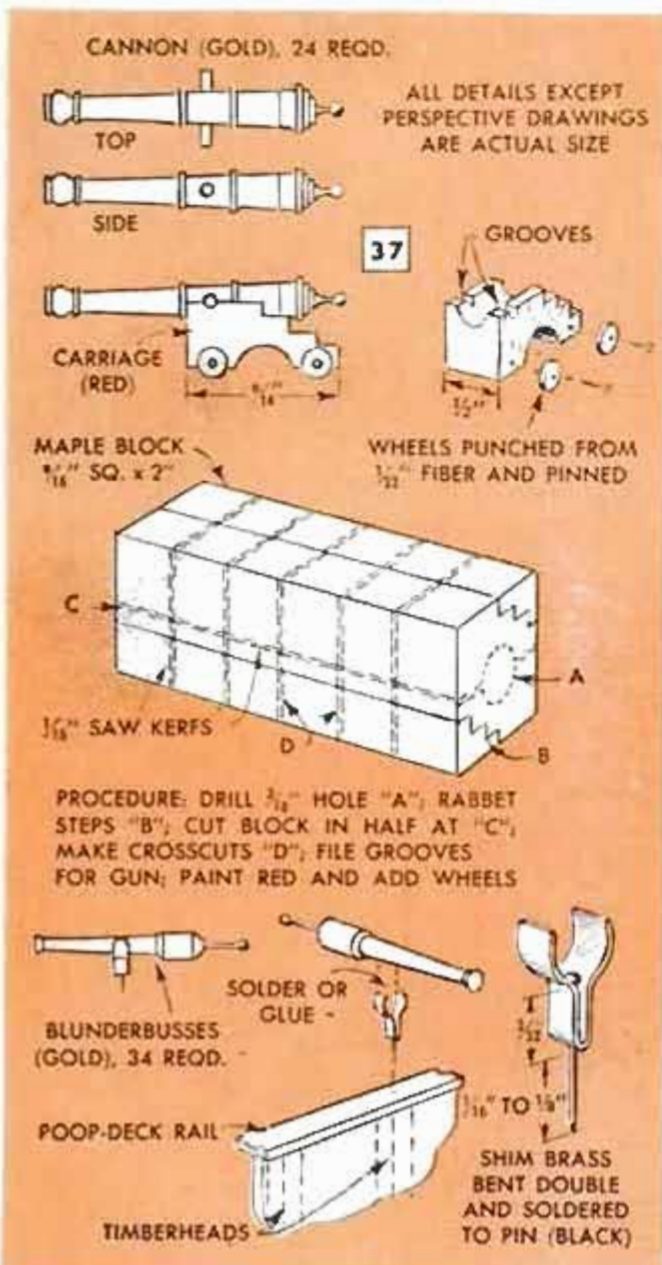

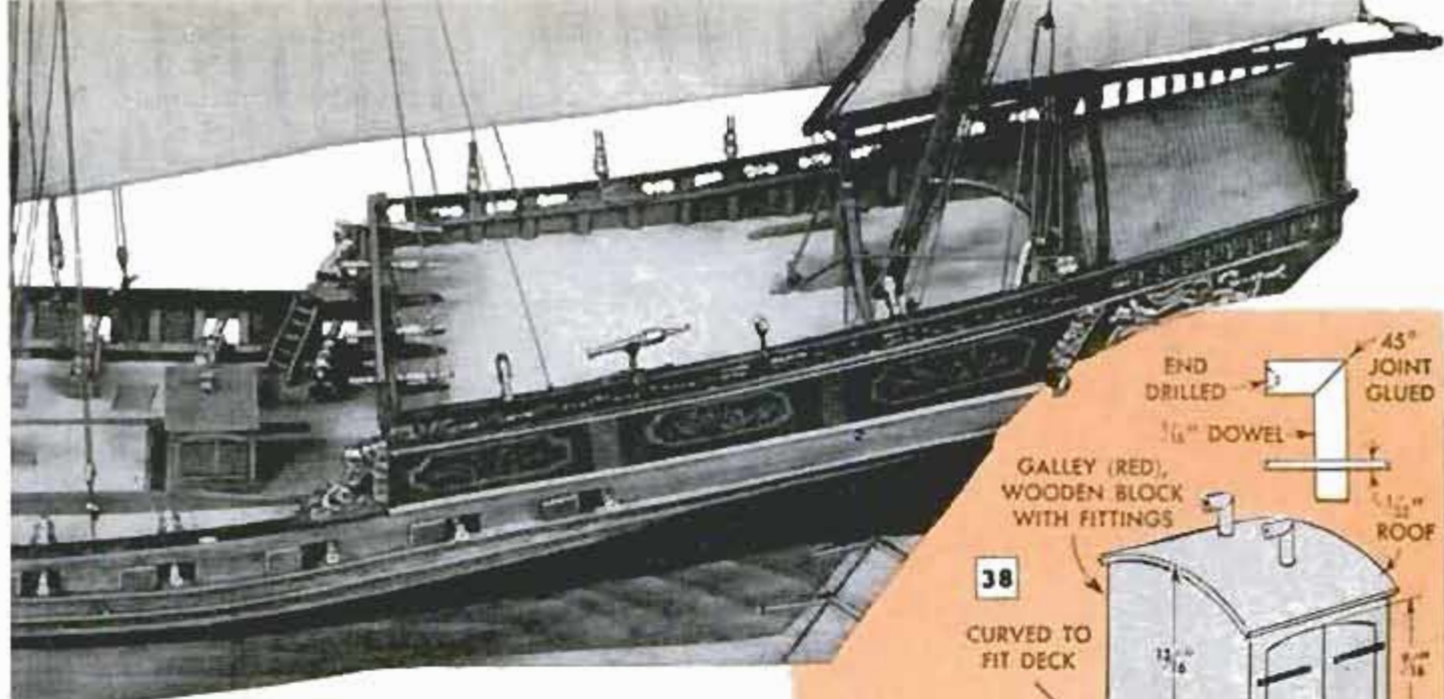

CHEBEC

PART III

blunderbusses had universal movement, but those made for the model only swing horizontally since they are soldered or glued to holders also detailed in Fig. 37. You make the holders by doubling tiny strips of shim brass on pins, spreading the ends to the gun diameter, and then soldering the brass and pin together. The pins are cut down to the required lengths later. Those at the sides of the poop deck extend into the ends of the timberheads about $\frac{1}{8}$ in., but those on the breastworks are necessarily shorter. The guns are painted gold to represent brass. The cannon carriages are red and the blunderbus holders are black. It's best to wait with installing the guns on the model until after the rigging has been completed as they are easily broken.

Galley and Ladders

For location of all the deck fittings refer to Fig. 42. You can start on these by making the galley, Fig. 38. This is simply a wood block, the bottom of which is sanded down concave so that it fits the deck properly for gluing. However, if you want to eliminate such shaping, just glue little blocks to the four bottom corners. The roof, which projects equally on all sides, is a piece of $\frac{1}{32}$ -in. veneer glued on. The two doors also are overlays of either cardboard or veneer. The hinges are painted in black over the red galley surface. The smoke pipes of the galley face forward, not aft.

Construction of the two ladders and

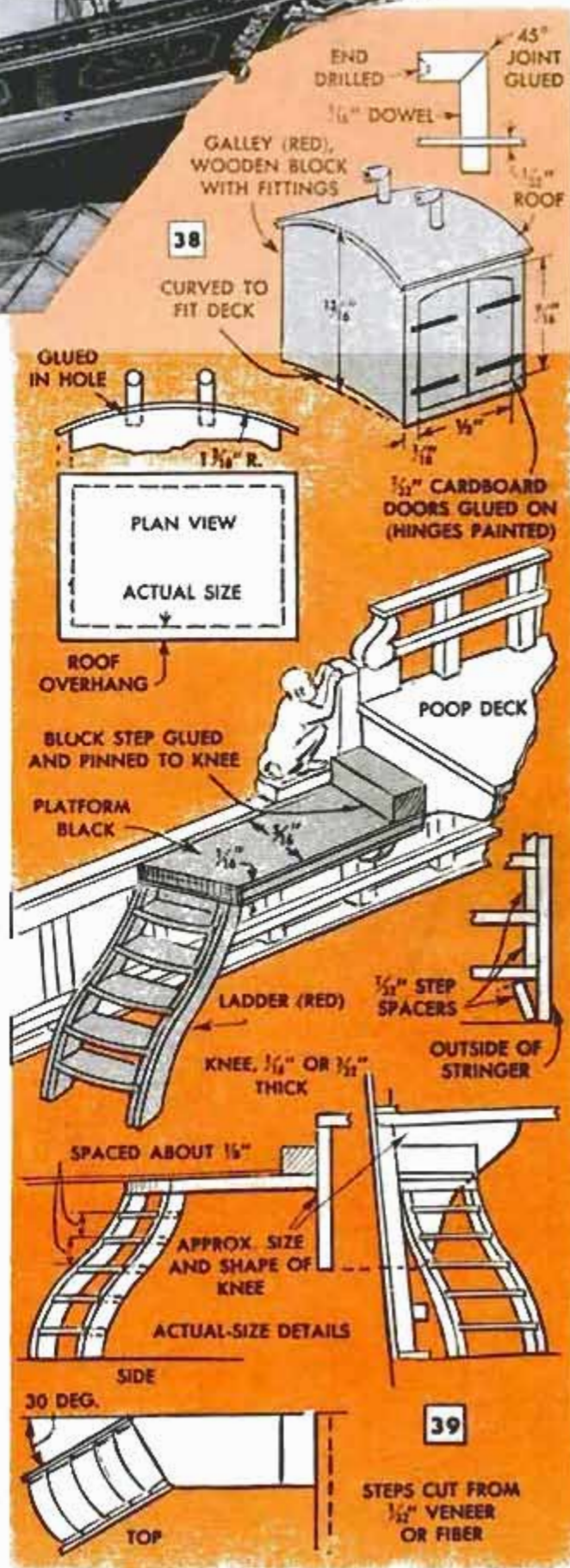

platforms that give access to the poop deck is shown in Fig. 39. First install the knees between the poop deck and the two timberheads at station No. 4. Pin the poop deck to the knees besides gluing the contacting edges. Note how the steps are held by means of filler blocks for uniform spacing and strength of assembly when glued together. The ladders are set at an angle to the bulwarks, and come about midway between two guns, near one corner of the grating between them.

Poop-Deck Fittings

The front view of the poop breastwork is shown actual size but half width in Fig. 40. The end posts may be pinned or have tenons glued in holes in the deck. Note that the horizontal lines of the breastwork are parallel to the crown curvature lines of the poop deck. The center opening is the belfry where the ship's bell was

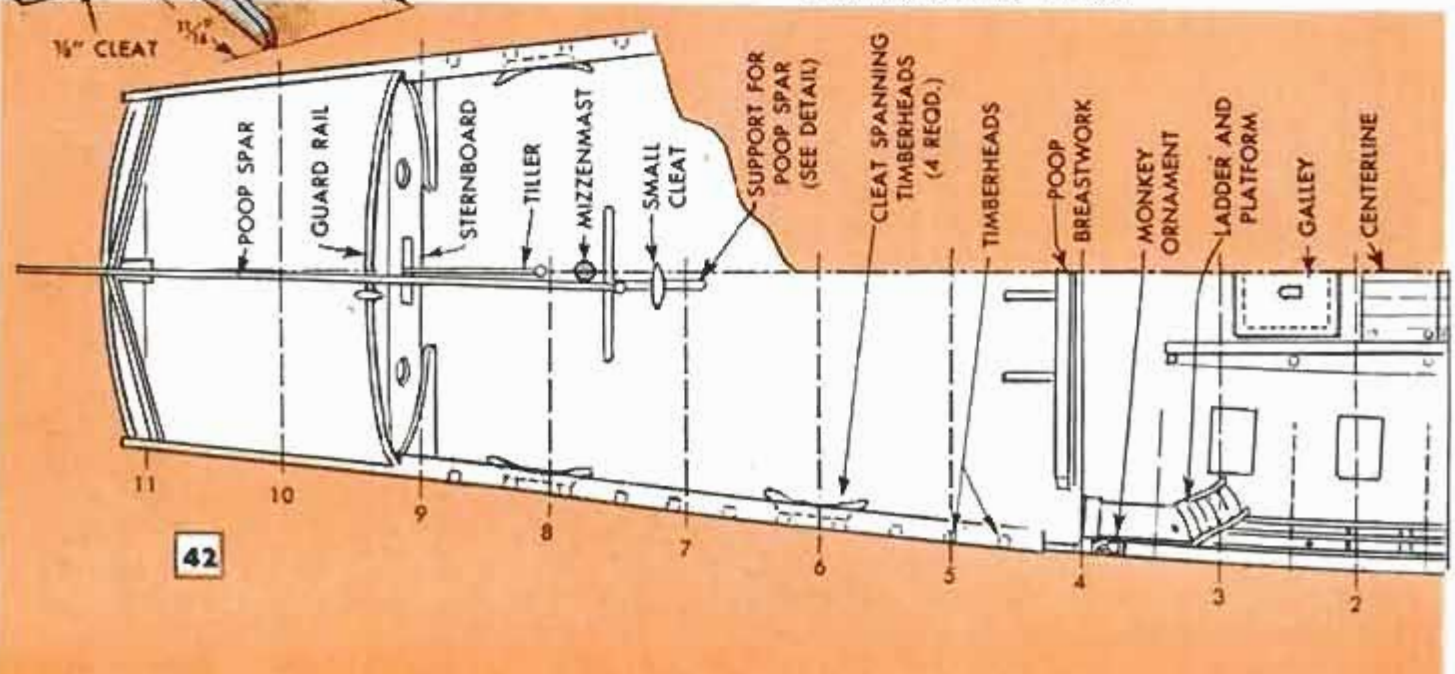
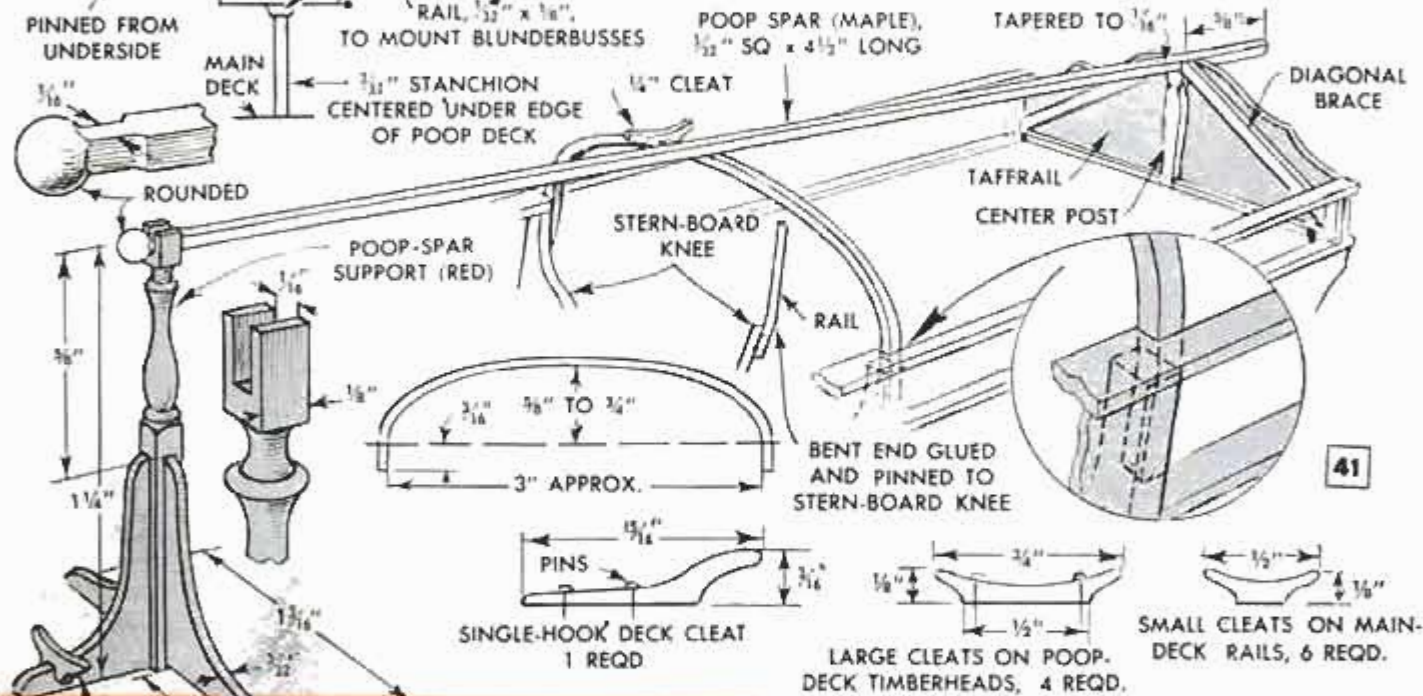
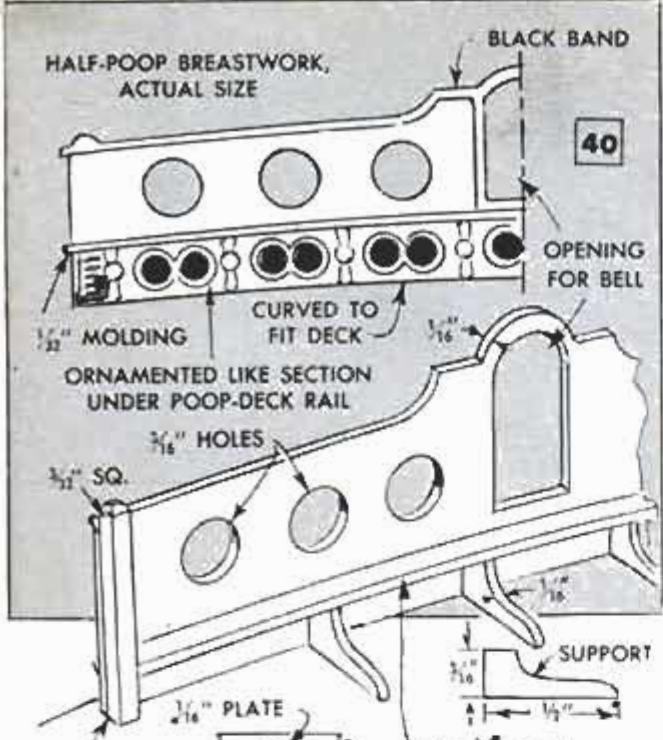

hung. The poop breastwork is more ornamental than the forward breastwork. The molding along its upper edge can be glued on, produced with gesso, or merely simulated with a band of black paint on the red surface. After the breastwork has been installed, you can fit the single stanchion that supports the edge of the poop deck at its center, also detailed in Fig. 40.

As shown in Figs. 41 and 43, the aft end of the poop spar fits between the two diagonal braces on the taffrail, and rests on the center post. The forward end of the spar is held by a decorative support of which the upper part is turned. The lower part, which is left square, is glued to three knees. These, in turn, are glued to the deck so that the center of the support comes about $\frac{3}{16}$ in. on the starboard side of the

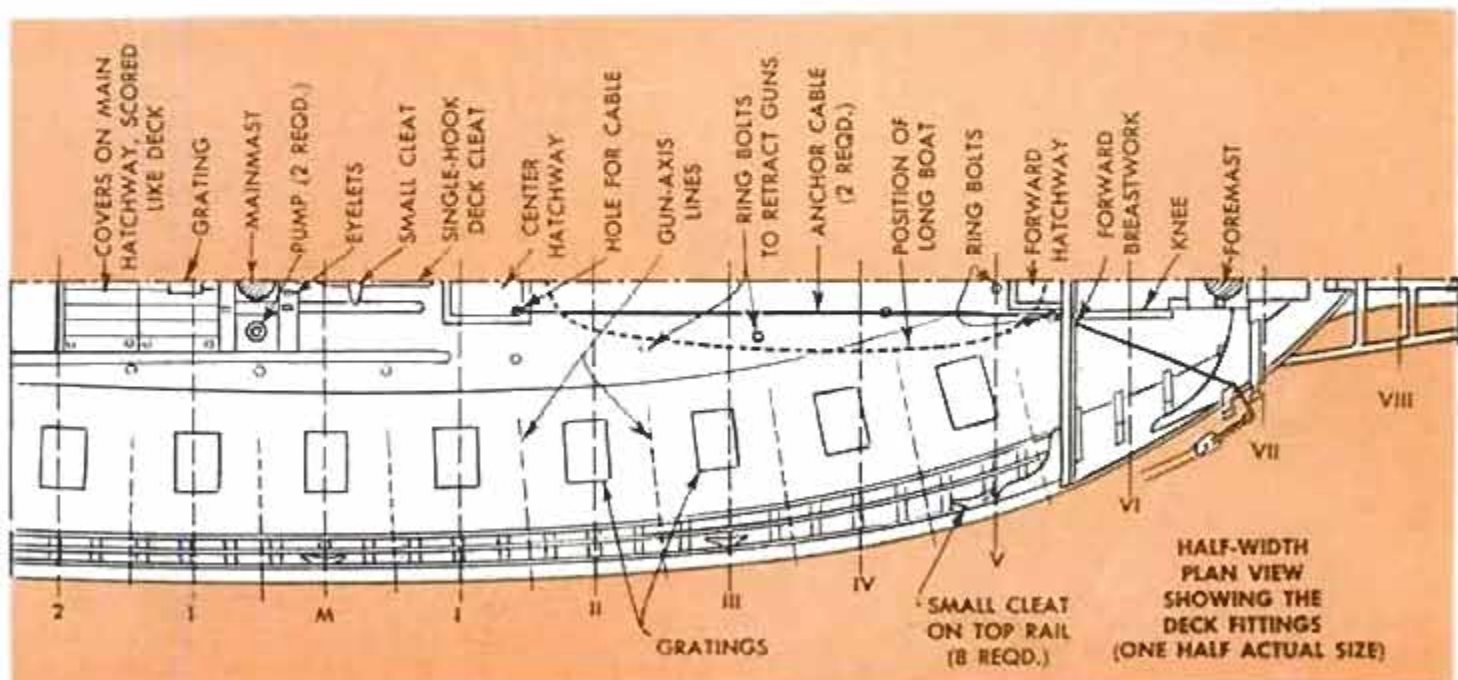
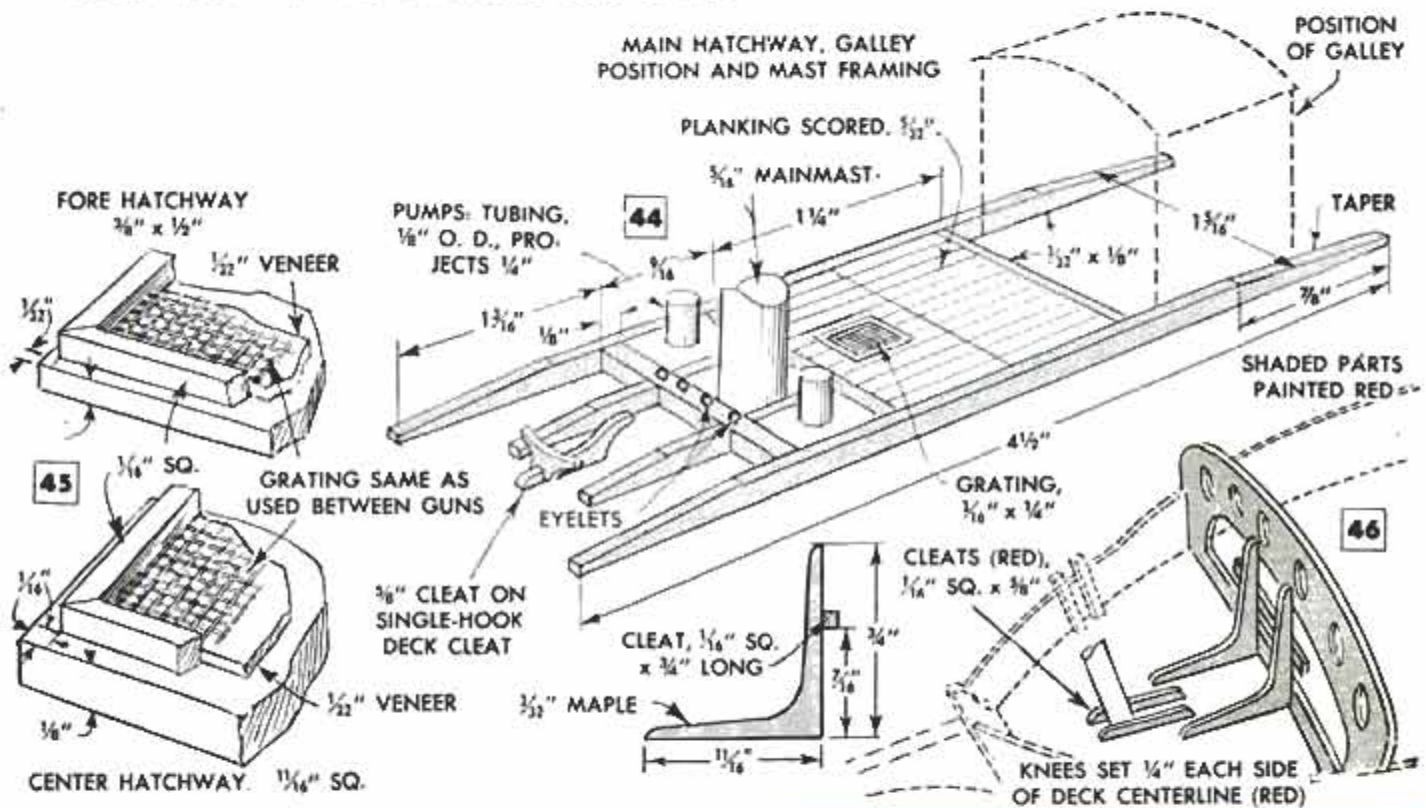

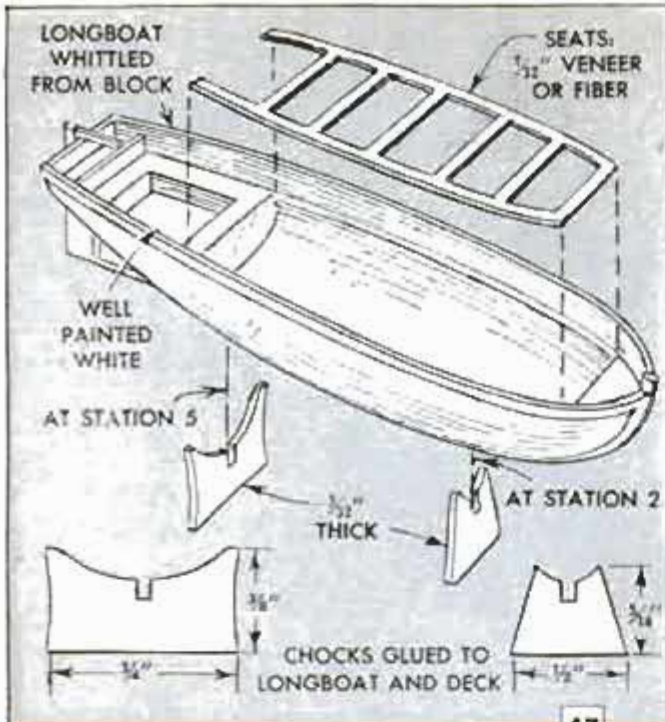

42. One single-hook cleat is located on the main deck just ahead of the mainmast. To it is glued a smaller cleat which is notched to fit. Six 1/2-in. cleats are glued to the main-deck rails for the attachment of rigging lines. Their positions are also indicated in Fig. 42.

Hatchways and Grating

Fig. 44 shows the two-piece main hatchway, which is scored and stained like the deck. The detail includes the two pumps on either side of the mainmast. Tiny wire eyelets at the base of the mainmast, to be used for rigging, are to be installed later. Their size, position and purpose will be detailed in Parts IV and V.

The forward breastwork is provided with two supporting knees connected with a cross cleat as detailed in Fig. 46 which also shows cleats on the deck at either side

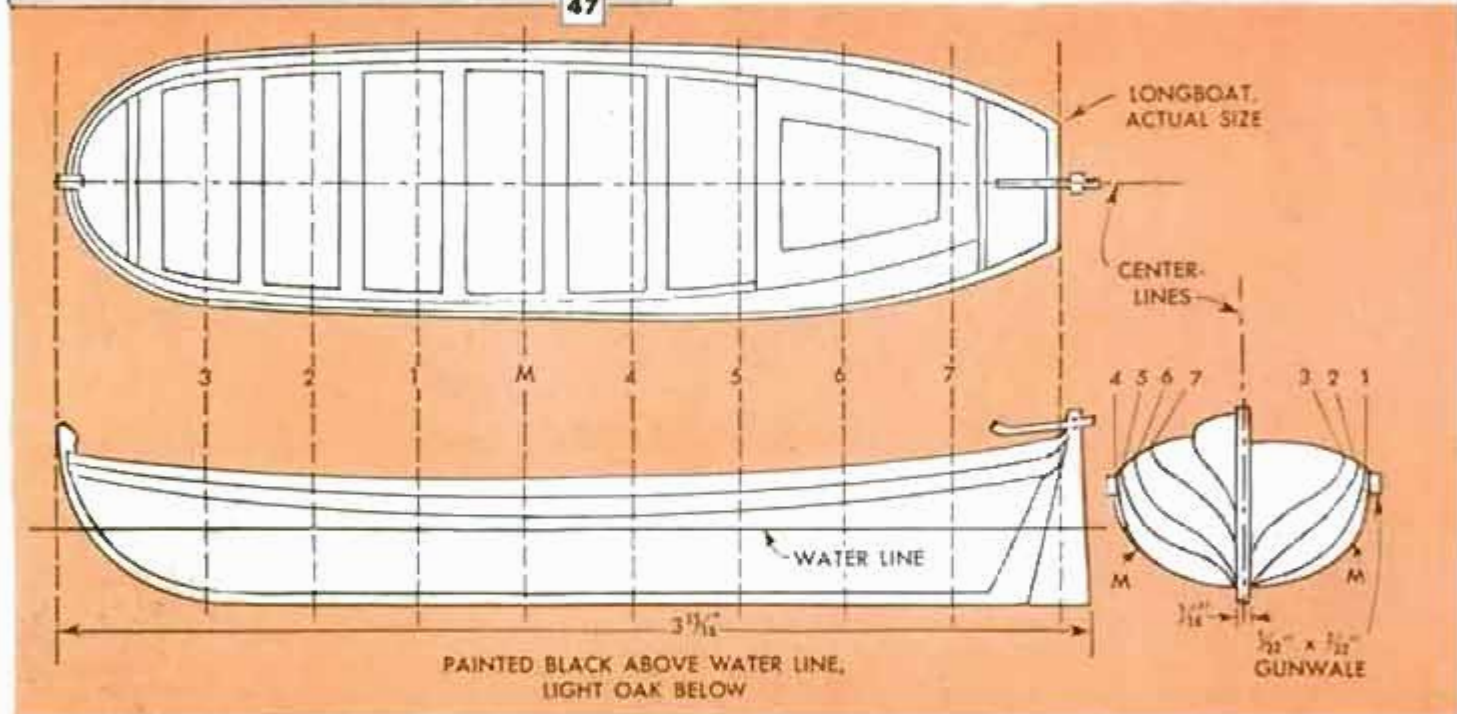

hull centerline so it will clear the mizzenmast. A small cleat is notched and fitted to the center knee of the support.

The spar also is supported near its midpoint by a guardrail. Both are pinned and glued together, which gives additional reinforcement to the taffrail. The guardrail may be square copper bus-bar wire, or aluminum rod filed square, both being easy to bend. Or, you can make it from a strip of maple, steam-bending the ends. Note how the ends are pinned and glued to the knees that brace the sternboard, which arrangement also helps to support the poop rail.

Fig. 41 shows the shape and size of the three kinds of cleats that are used. Four large ones are fastened with glue and pins to the poop-deck timberheads just below the top rails at locations indicated in Fig.

of the foremast. These are easy to glue in place even though the bolster plate and crossrail unit are already installed. The center and fore hatchways are located ahead of the main hatchway. They vary slightly in size and height above the deck as shown in Fig. 45. The grating used on hatchways is the same as that used between the guns as detailed in Part I.

The longboat shown in Fig. 47 can be made accurately with the aid of templates for which station lines and contour lines

PORTFOLIO OF PLANS

Popular Mechanics offers the serious modelmaker plans for building four other famous French ship models, namely *La Sablaise*, a sailboat, *Jeanne D'Arc*, a training cruiser, *Marie Jeanne*, a fishing boat and *Le Terrible*, a light cruiser. For a free descriptive brochure on these plans and their prices, write to Popular Mechanics Co., Dept. 80, 200 E. Ontario, Chicago 11.

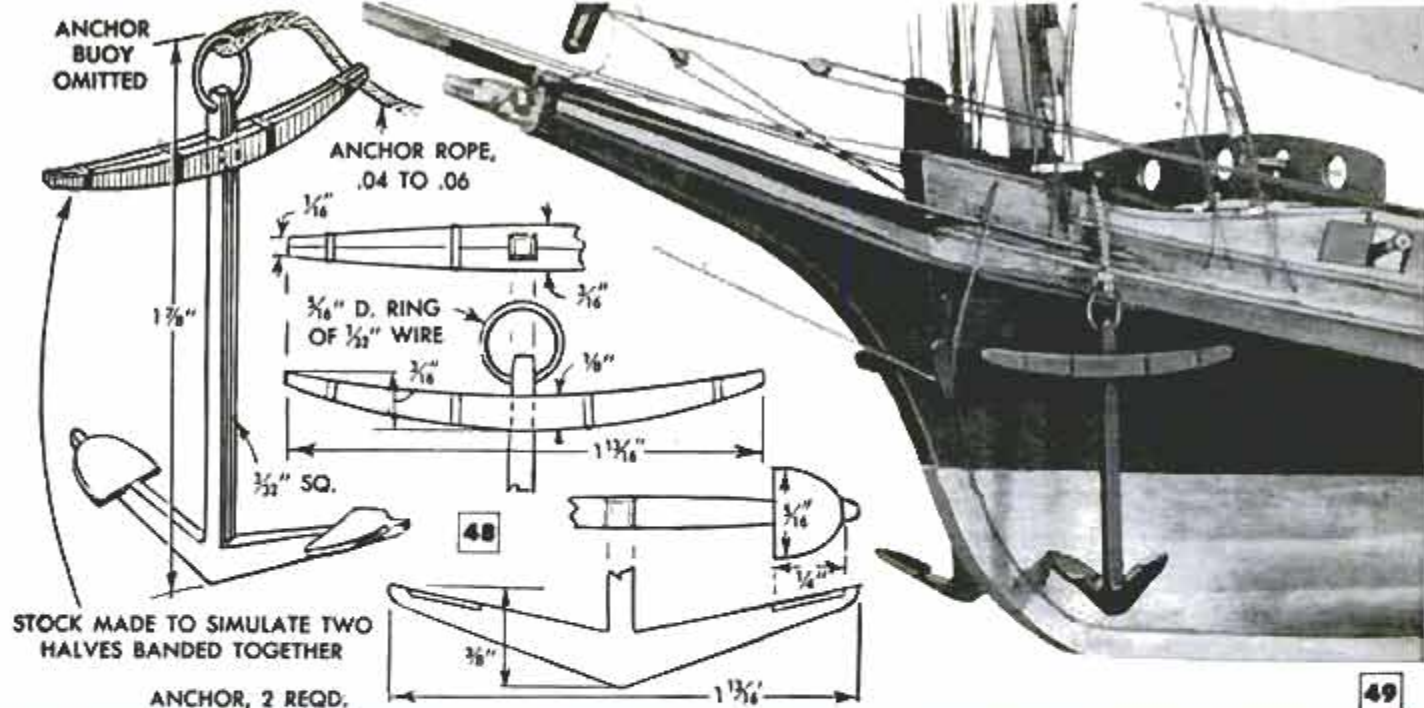

	LENGTH ABOVE DECK	ANGLE FROM VERTICAL	D.A. AT DECK	DIA. AT TIP	SIZE OF MASTHEAD BLOCKS
FOREMAST	8-3/8	15 DEG. FORE	1/4	5/32	5/32 SQ. 5/8 LONG
MAINMAST	9-1/2	2 DEG. AFT	5/16	3/16	3/16 SQ. 3/4 LONG
MIZZENMAST	5	7 DEG. AFT	5/32	3/32	3/32 SQ. 3/8 LONG

	LENGTH	A	B	C	D	E	F	G	H	I	J	K
FORESAIL YARD	16-7/8	1/4	3/16	5/32	5/32	1	1-1/2	5/64	1/16	1/8	1/2	4
MAINSAIL YARD	18-1/2	5/16	1/4	3/16	3/16	1	1-7/8	3/32	3/32	3/16	1/2	4
MIZZEN YARD	8-3/16	5/32	1/8	3/32	3/32	7/8	1-1/2	1/16	1/16	1/8	3/8	3

are given. The boat can be whittled to shape, hollowing out the inside so a piece of veneer or fiber cut to represent seats can be glued in place. The two chocks that support the boat are notched to take the keel and are shaped to fit the hull contour near stations 2 and 5. They are glued to the longboat hull and also to the main deck of the ship at the location indicated in Fig. 42. Except for the well of the longboat,

which is painted white, the rest of the interior is red. The outside is black above the water line and light oak below. It is possible that you can purchase a longboat of approximately correct size from a model-supply house and thus eliminate the work of making one, even though the details vary a little.

Figs. 48 and 49 show the shape and size of the two anchors. These can be purchased

ready-made. If you do make them of wood, use maple. Drill a hole through the stock to take the tapered end of a $\frac{1}{8}$ -in. dowel, which you sand or file square after gluing it in place. The lower end of the shank is whittled down to form a tenon that is glued in the piece that forms the flukes. Fig. 42 shows the location of the anchor cable, one end being glued in a hole drilled in the corner of the center hatch.

Bowsprit, Masts and Yards

Being slender and fragile, the bowsprit detailed in Fig. 52 is installed after all the deck fittings have been placed. Besides glue, pins are used to secure the bowsprit to the headrail and stem. It also is lashed to the stem just behind the figurehead. Use the same kind and size of thread as for the yard woodings given in Fig. 52. A detail shows how the free ends of the thread are self-held. An added spot of glue helps to prevent loosening. One end of the bowsprit lashing is left extending for attachment of a rigging block.

The lateen sails are the distinguishing features of the xebecs, and are held by yards arranged diagonally as seen in Fig. 3. Details of the masts are given in Fig. 51. Their length includes square masthead blocks which are formed when tapering. The blocks are drilled and grooved as indicated in Fig. 50 to represent sheaves for some of the running rigging. As shown in Fig. 52, the yards are made by sanding two flats on dowels of proper size, then cutting the ends and scoring grooves so that each yard looks like two pieces lashed together with woodings. Note how the ends are cut so that the rounded end of one member seems to fit into a groove in the adjacent member, which keeps them in alignment and provides both strength and flexibility. The letters in Fig. 52 indicate the size of the parts, spacing of woodings, number of turns, as given for the three masts in Fig. 53. It's best to paint the yards black before applying the woodings.

(Continued next month)

Unburned Gas Pollutes Air

According to Champion Spark Plug Co., about half the cars on the road have one or more spark plugs misfiring. This means a tremendous waste of fuel and power. But it also means a lethal dose of air-polluting gas is being pumped into the air we breathe. Automobile mechanics can do much to correct this condition by servicing the spark plugs and air cleaner regularly and by keeping carburetors properly adjusted.

Three-Stage Cut Prevents Binding When Bandsawing Bushings

To prevent binding of the blade when bandsawing bushings or collars, one machinist runs a first and second cut, the first cut running only halfway through the wall thickness of the bushing. Then he turns the bushing 180 deg.

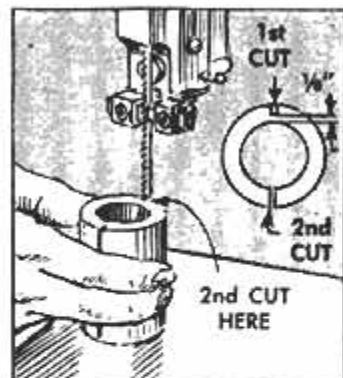

and runs the second cut all the way through, finishing the first cut from the inside. This prevents any tendency of the cut to close up.

Frank LaSaracino, New York City.

Holder for Steel Square

Although a nail or hook usually is driven into the shop wall to store a steel square, a short strip of flooring nailed in place horizontally will make a much neater and even more secure support. The square drops easily into the groove of the flooring strip.

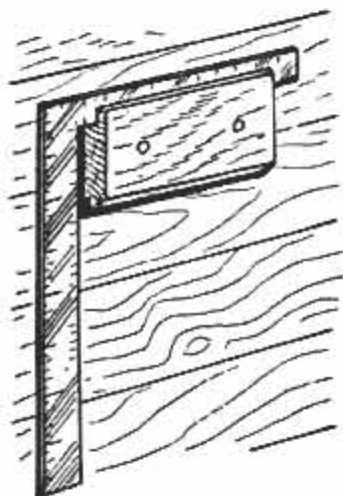

Protecting Hole Finish

You can prevent possible scoring of the hole finish when counterboring by using a fixed pilot made to suit the job at hand. Remove the regular pilot from the counterbore and fit the big end of the pilot into a reamed hole in a piece of flat steel which is placed under the work in the set-up. Then place the work over the pilot spindle and center it. Finally, bring the counterbore down to the required depth. The pilot should be a light press fit in the hole.

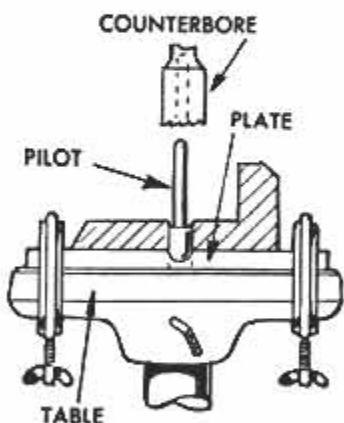

The pilot should be a light press fit in the hole.

ALUMINUM LETTER CADDY

By Bertram Brownold

LETTERS AND BILLS that are to receive your attention or be placed in a file, will not be neglected or misplaced if they are kept in a correspondence holder like the one illustrated. This is a one-evening project requiring a minimum of experience with hand tools. All parts of the holder, except the letter opener and beads used for the feet, are made of aluminum bar and sheet stock that is available at large hardware and department stores.

To make a holder, cut the perforated aluminum to size as indicated in the squared pattern. Then from a sheet of embossed aluminum, make the cutout for the frame, position the perforated piece on it as indicated by the dotted line and bend it over on the edges of the perforated piece, after which the frame is hammered flat. The corners of the frame must be cut as shown to permit the metal to be properly crimped in those areas. The handle is cut and formed from $\frac{1}{8}$ -in. stock as shown and should be fastened to the bottom of the holder before bending the sides into position. The feet are riveted to the corners with small cut-down nails as in the drawing. Ornamental medallions are riveted to the handle of a plain letter opener to complete the job.

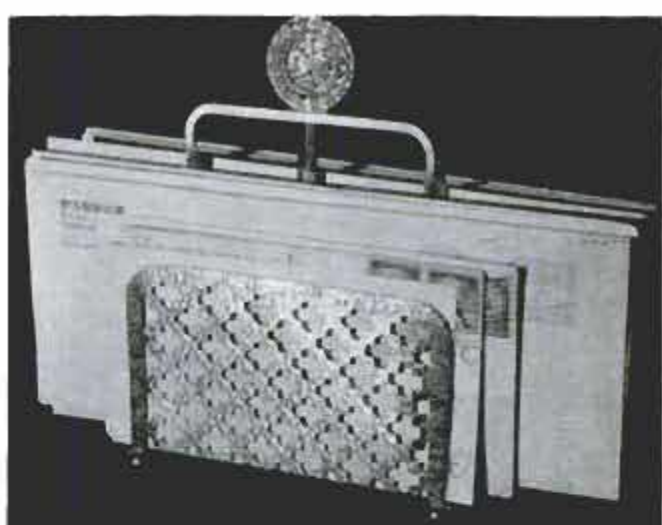

Above, handle is located in center of correspondence holder so that unread mail can be placed on one side, unanswered letters and unpaid bills on other side

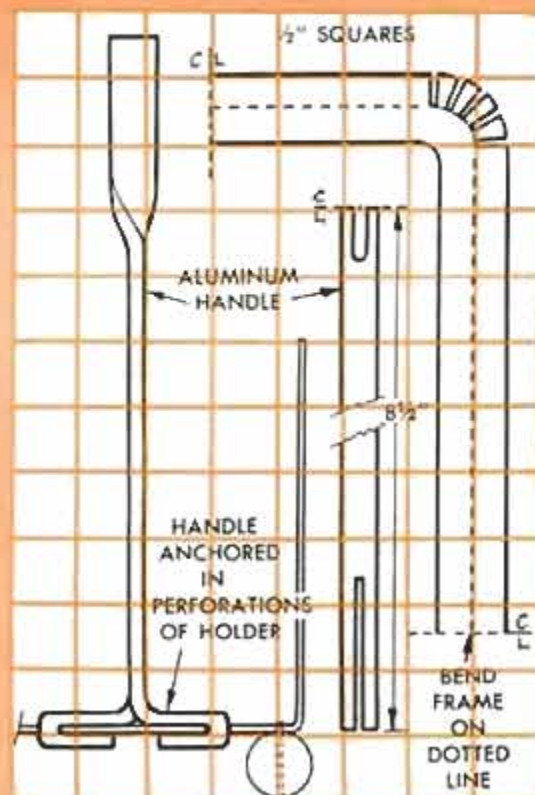
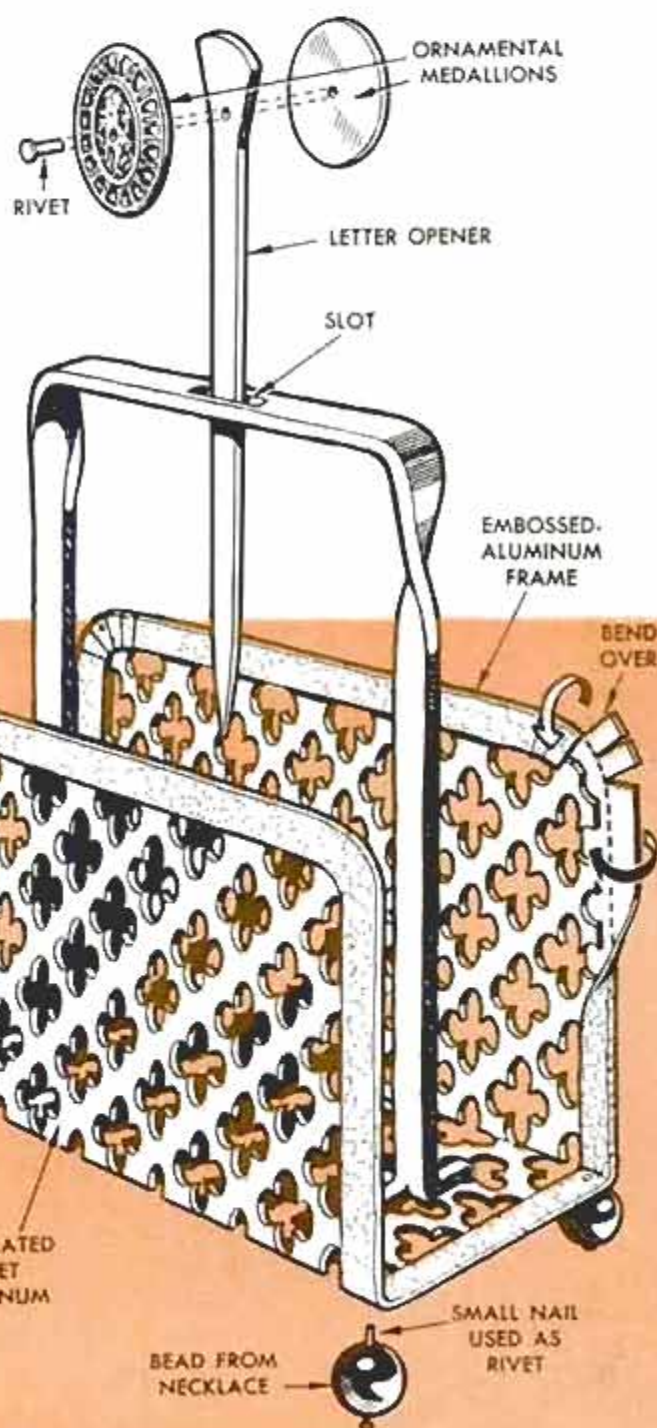

Multipurpose ORTHOPEDIC WALKER

Designed by F. H. Overman



HERE is an easily constructed orthopedic walker that is designed to help restore the use of muscles of the lower body of a child who is recovering from polio, or is a cerebral palsy or muscular dystrophy victim, by helping him exercise with little or no assistance. Used at the University of Illinois Division of Services for Crippled Children, the walker consists of a base unit of welded-steel tubing and four accessories, the shoulder support, bar support, foot separator and handle bar. The former three are adjustable vertically so that they can be raised as the child grows, providing proper support at all times.

The shoulder support is designed to completely enclose the trunk of the body to provide maximum support and stability in the beginning stages of rehabilitation. The dimensions given in the drawing and details A and B are suitable for a child of four or five of average size and can be changed as required. Padded edges protect the child from bruises and provide comfortable underarm support. The bar support is used in place of the shoulder support after the child has partially re-

gained the use of leg muscles and requires more freedom for further development. When first making the change-over, a strap should be secured between the two verticals of the support as shown in the illustration on this page, to give the child a feeling of security and to provide some means of support in case of accidental loss of balance. Thumbscrews on the T-members that take the verticals of the shoulder and bar supports permit horizontal as well as vertical positioning of these members for maximum comfort as shown in the drawing and details.

The foot separator is used for a child whose legs tend to cross. It is made of 1 x 8-in. pine,

with steel brackets screwed to both ends of it for bolting the device to the walker as shown in the drawing and detail C. A strip of foam rubber folded over the upper edge of the separator protects the child's legs from bruises. The rubber is held in place by a strip of leatherette fitted over it and tacked to the sides of the separator.

To permit the patient to move the walker across a smooth floor with ease yet require some exertion to develop muscles, the front legs are mounted on 3-in. casters and the rear ones are fitted with swivel glides. These are installed in the open ends of the tubing by first gluing a short length of dowel in each of the legs. Then the dowels are drilled to take the glide and caster assemblies as indicated in the details.

Use a $\frac{3}{4}$ -in. thin-wall-conduit bender for making the right-angle bends in the tubing as required in each of the assemblies. If a welder is not available, take the assemblies to a welding shop to have this work done. Added wall thickness to the conduit is provided for the thumbscrews by welding nuts over holes in the pipe. Nuts are not needed for the 1-in. pipe. ★ ★ ★

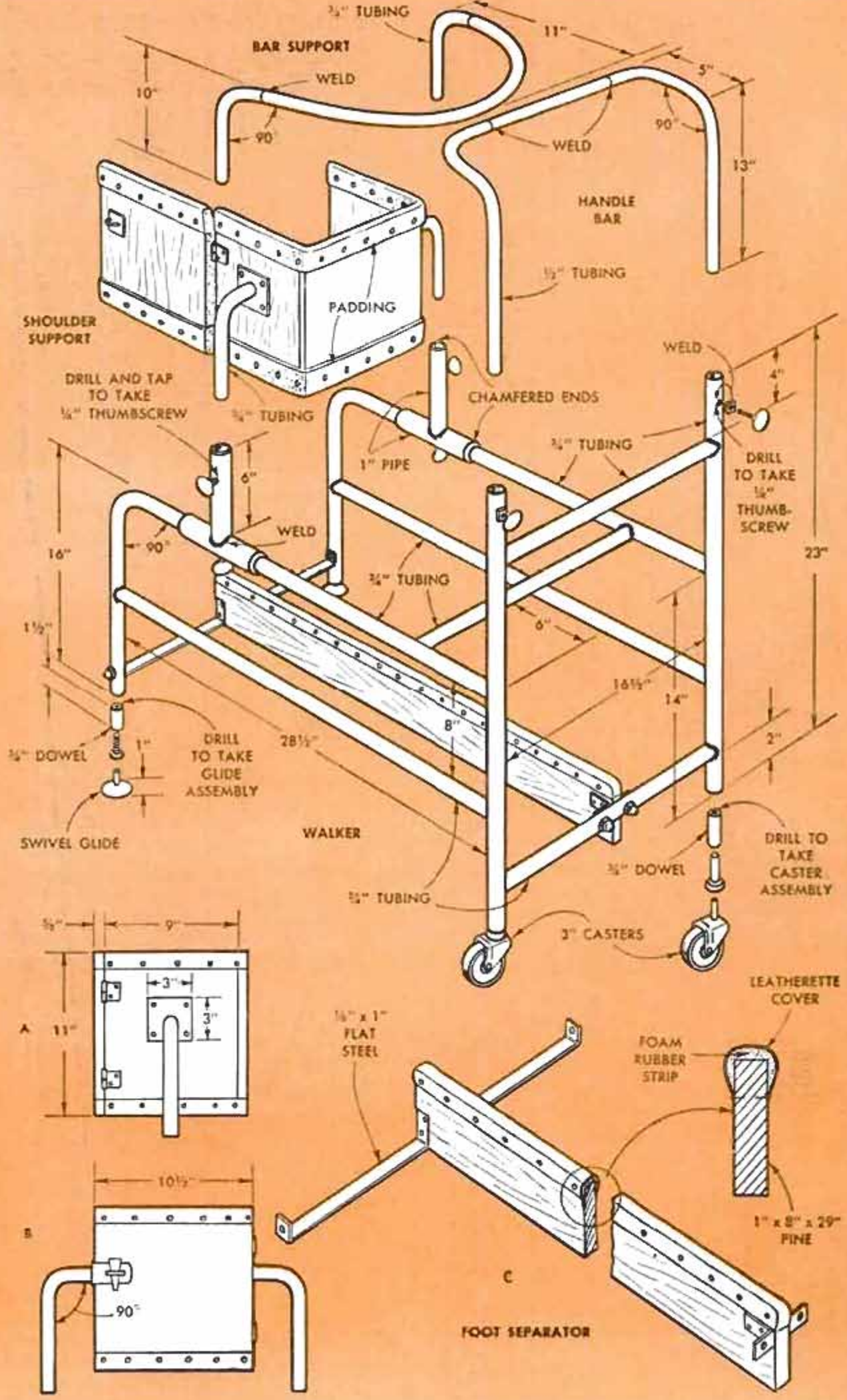

Balanced Suspension Keeps Scale Handy for Weighing Milk



When keeping a record of the milk produced by each cow in your herd, the scale used for weighing the milk can be kept conveniently at hand by suspending it from the ceiling of the dairy barn by means of a counterbalanced rope-and-pulley arrangement similar to the one shown at left. When not in use, the counterweight automatically pulls the scale up to the ceiling where it remains out of the way until needed again. The counterweight used should be only slightly heavier than the scale, so that the latter gently rises to the ceiling without impact of a force that may affect the accuracy of the scale.

New engine pistons that are to be installed as a set should be carefully weighed on an accurate scale to check on excessive weight variation. If there is more than $\frac{1}{2}$ -oz. difference between the heaviest and lightest pistons, objectionable engine roughness will result. Such pistons should be returned and exchanged for a set that is within acceptable weight tolerances.

Harvey Muller, Danboro, Pa.

Ignition Trouble From Oil Vapor

Not infrequently, auto-ignition trouble is the result of vaporized crankcase oil condensing on the breaker plate of the distributor which induces arcing and rapid burning of the points. This may occur when the distributor shaft is worn, allowing vaporized oil to travel from the crankcase to the distributor, or it may occur when the cap on the oil-filler pipe is clogged, restricting passage of air. A clogged cap is easily cleaned with gasoline but a defective distributor shaft requires replacement of the shaft or bushings to correct this trouble. The latter should be done by an experienced mechanic.

M. Robert Beasley, Jackson, Mich.

Number, Please!

Whenever you write us to

- Renew your subscription
- Change your address
- Order your own or a gift subscription

... In fact, whenever you write us,

PLEASE INCLUDE YOUR CITY POSTAL ZONE NUMBER IN YOUR ADDRESS

*This insures better delivery
It helps you and it helps the postman.*

Reversed Tip on Soldering Iron Produces Better Joint on Flat Work



If your electric soldering iron has a removable copper tip that is of the same diameter throughout its length, try reversing it the next time you have a soldering job that requires joining one or more flat surfaces, such as enclosing the end of a tube as shown in the photo at left. The flat end and cylindrical sides of the reversed tip permit better contact with the surfaces of the joint to make the melted solder flow evenly. It is difficult to avoid forming irregular and poorly bonded metal when soldering such a joint with the pointed end.

Ken Murray, Colon, Mich.

Keep Your Knives In a Wall Cabinet

By Stanley Roberts

THERE'S NO BETTER PLACE for household carving knives than a dustfree wall cabinet conveniently located, but out of reach of small fry as shown in the illustration. The cabinet may be flush mounted in a wall, or screwed to an existing cabinet or wall as desired. For a flush mounting, the front of the cabinet should overlap the sides, top and bottom by at least $\frac{1}{4}$ in. to conceal the edges of the cutout that is to receive it. Fir or hardwood plywood may be used for all parts of the cabinet, except the slotted knife rack which is made of solid stock and screwed to the inside of the door as shown in the two details at the bottom of the drawing. The dimensions given are intended to serve only as a guide and may be enlarged to accommodate more pieces of cutlery, or they can be reduced to fit a smaller space.

The door pivots on pins made from screws. To install these, tightly wedge the door into position in the frame and drill holes through the top and bottom of the inside frame to take the shanks of $2\frac{1}{2}$ -in. No. 8 screws. Then drill pilot holes in the upper and lower edges of the door, drive the screws into position and cut off the heads. A washer placed on the lower pivot when the screw is driven, serves as a spacer and bearing as indicated in the detail.

Below left, completed fir-plywood cabinet is ready to be painted and screwed to kitchen wall. Below right, birch plywood is used for door and front of cabinet that is to be varnished and mounted flush

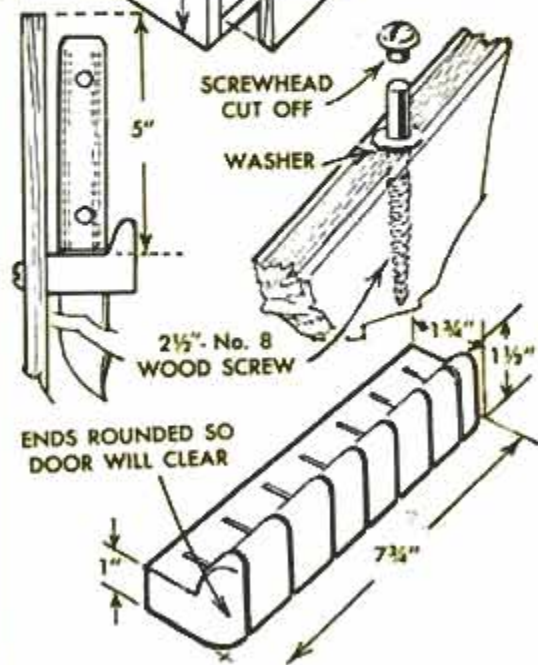
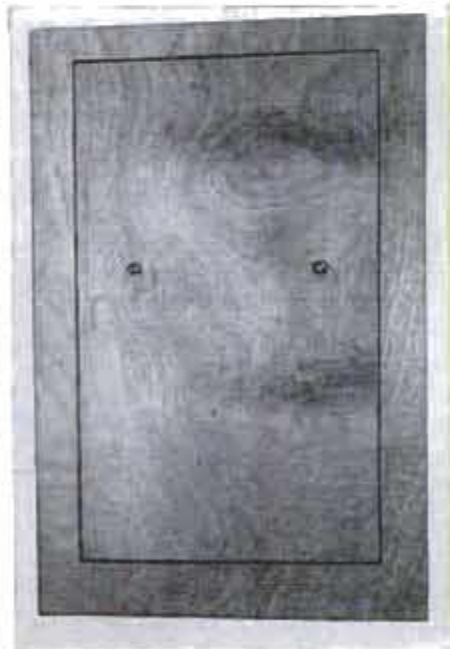
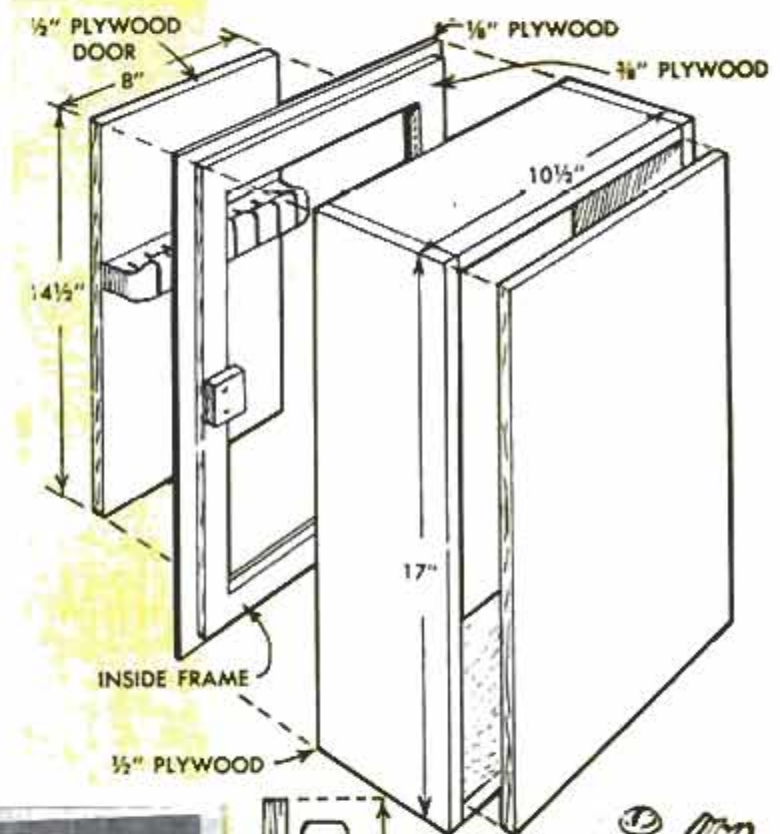

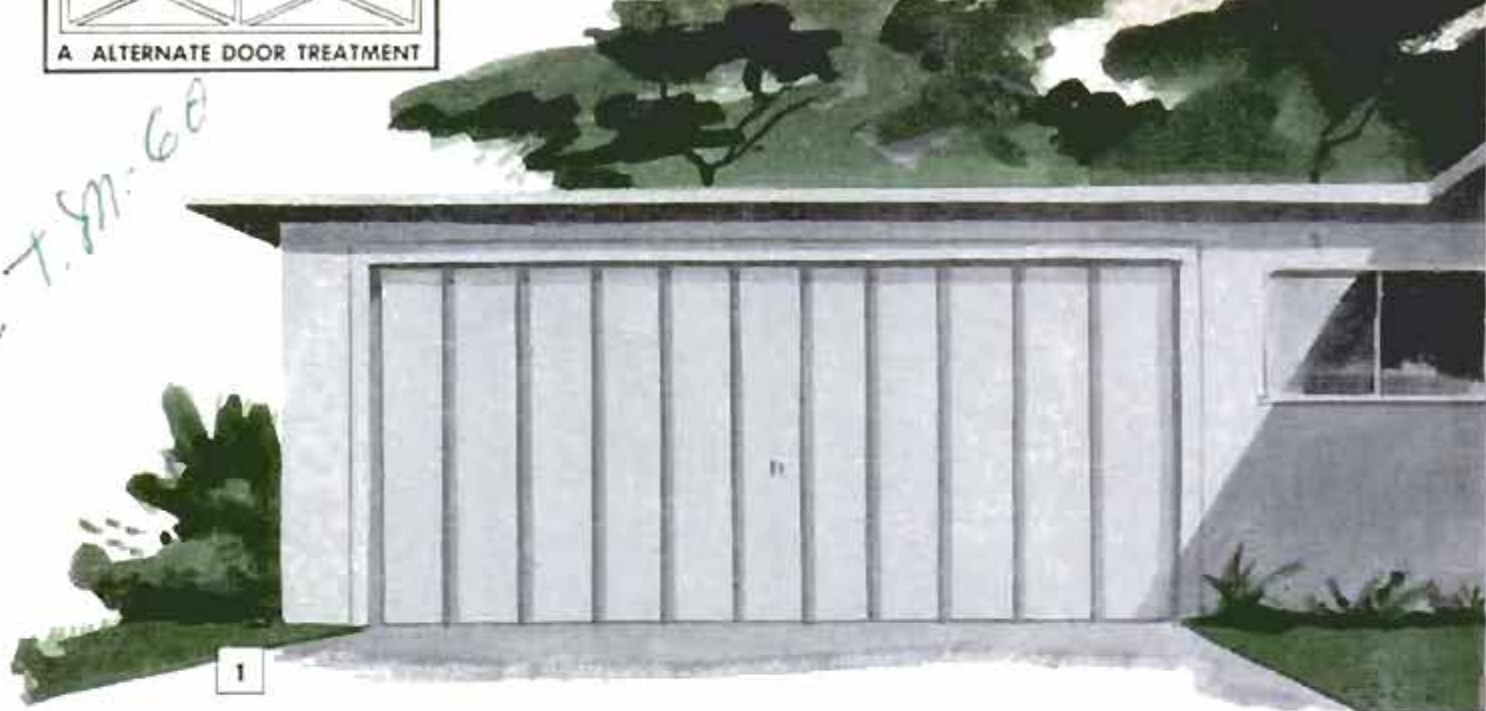

Whether you use it to hide a joint, to create a high or low-room effect or to take away that homemade look from your shop-built furniture projects, you'll find that

MOLDING MAKES THE

AS MOST EVERYONE knows, a piece of molding is just the thing for covering up an ill-fitting joint. But that's far from all it can do. Each of the hundreds of different moldings that you will find in a well-stocked lumberyard was made to do a certain job. Add a touch of ingenuity and they will do more in the way of smart cabinet-door handles, facings for plywood edges, unique picture frames and so on. In addition, moldings can be used to add

height, or lowness, to separate surface planes and to create textural effects. The effect—the decor—can be either traditional or contemporary.

Shapes Standardized

Most moldings are of softwood, with the lion's share coming from pines, firs, redwoods, spruces and cedars of the Western states. In the past, many mills made fairly similar "standard" patterns, but pieces



High-level look to modern rooms with low ceilings is created by applying nested rectangles of half-round molding to the ceiling. This stunt also affords chance to put more color into a ceiling without losing the unity that the plane provides a room

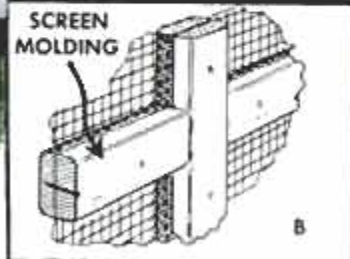
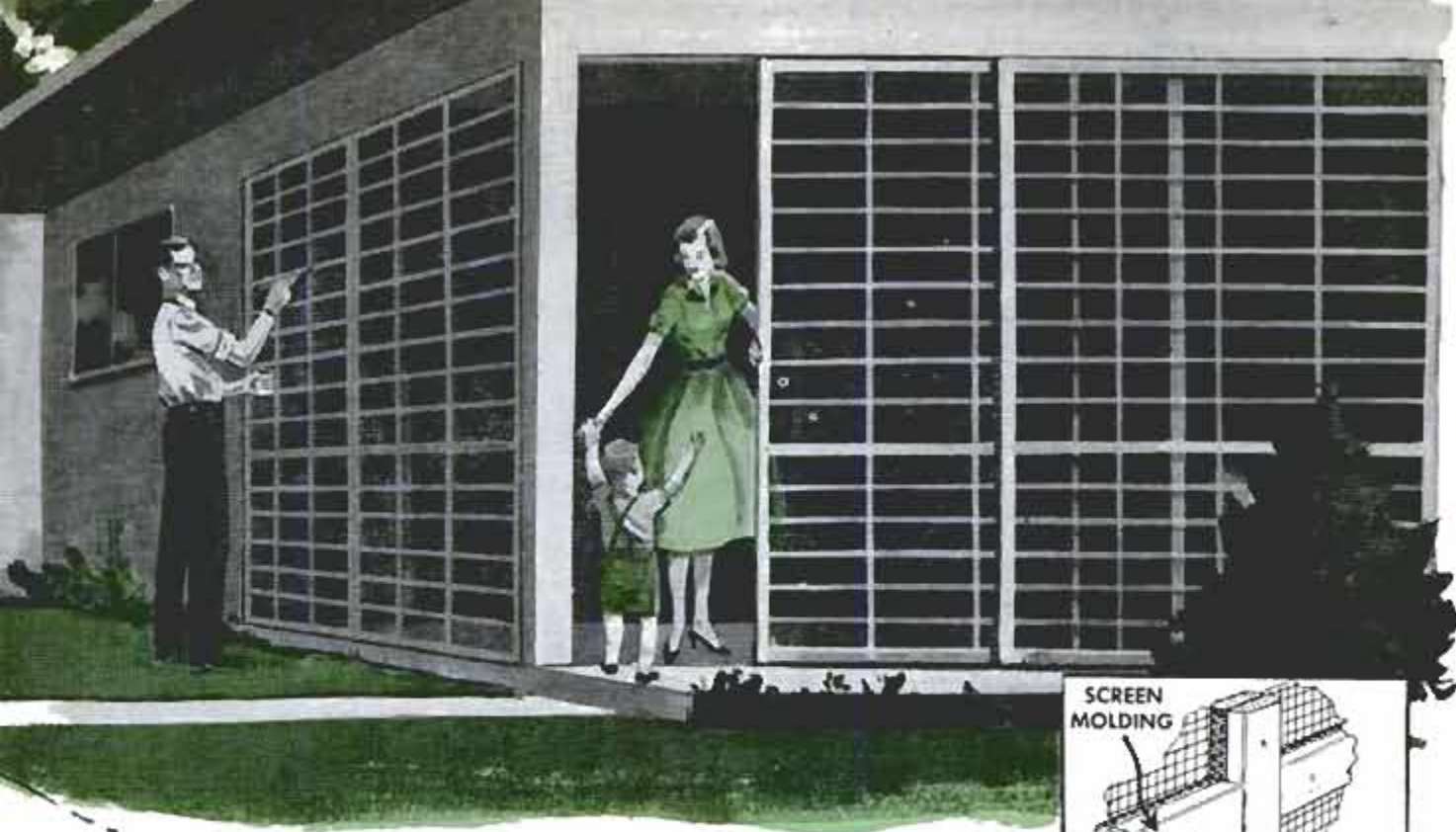

DIFFERENCE

By Tom Riley

seldom matched exactly unless they all came from the same stack. However, in 1957 the Western Pine and West Coast Lumberman's associations joined in establishing exact sizes and shapes for more than 500 standard patterns of molding, and the mills in the West and many others have replaced their molding knives to conform with those standards. Today, you'll find that most of the moldings obtained at different times or places will match.

The names given to some standard moldings are confusing. Crown, bed and cove moldings, Fig. 8, are similar, mechanically, and in the larger sizes, are used primarily for wall-to-ceiling joints. Bases are baseboards. Base shoes are designed to cover the joint between the baseboard and the floor. They come in varied patterns and can replace ordinary quarter-round for many other usages. Picture moldings are not for picture frames (though many will

Long, low lines are stressed in this interesting use of molding which emphasizes length and lowness to a built-in sofa. Note, too, how molding ties planes and surfaces together. Permits areas between molding to be decorated in harmonizing colors

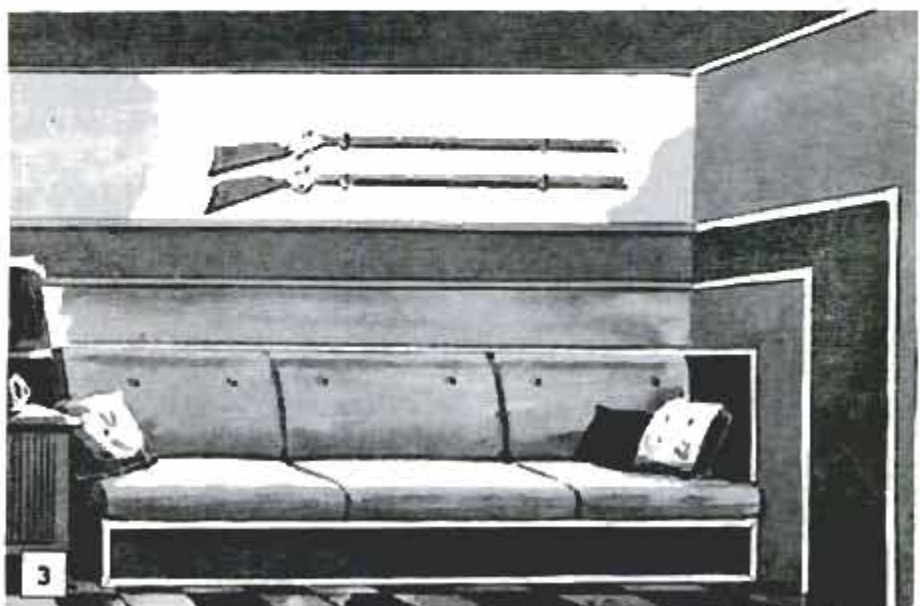



4 CABINET AND DRAWER HANDLES

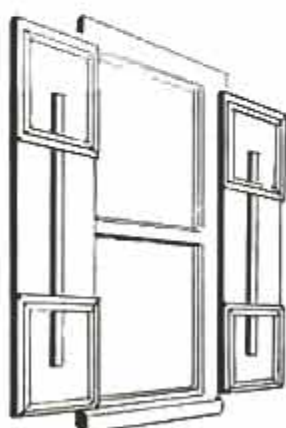
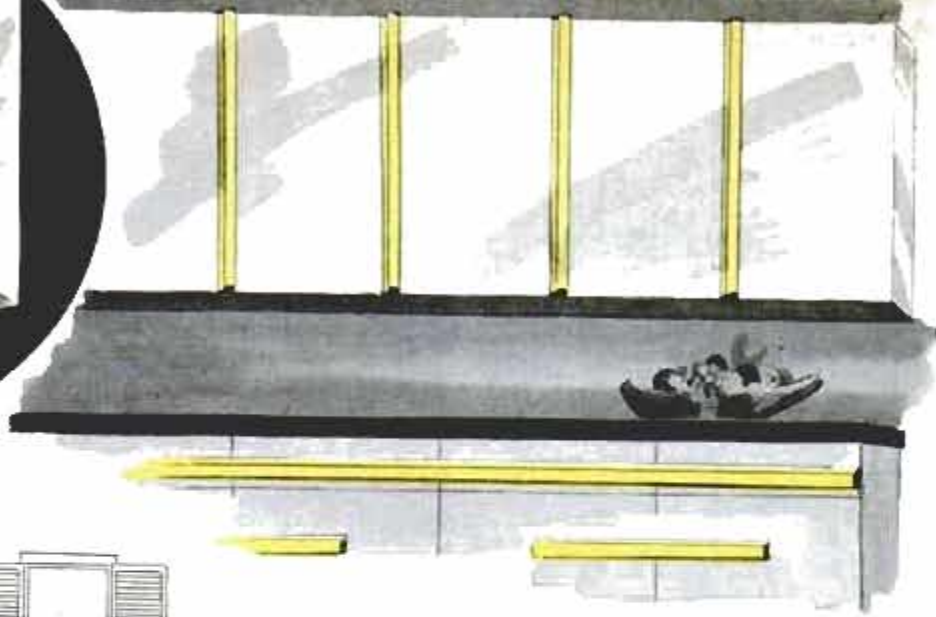

5

DOOR AND SHUTTER TREATMENT

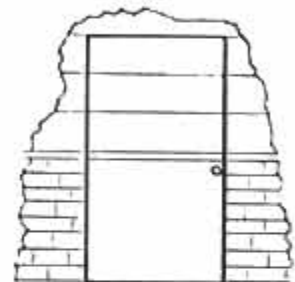
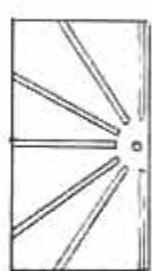
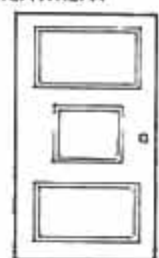
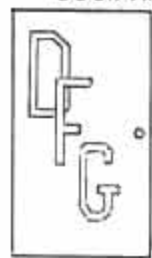

serve nicely) but are the horizontal strips near the ceiling for hanging pictures. Casings are the trims for doors and windows. Sometimes base molding is used for a casing and vice versa. Mullion casing was originally made to cover the narrow space between two side-by-side windows but today is used for battens, wainscoting trim and the like. Screen stock, Fig. 12, balusters and others are quite similar to ordinary-dimension lumber, the difference being a better grade of wood and more careful sizing. Stops are the strips in doors and windows for stopping or guiding same, drip caps go over doors and windows; stools are the flat part of a window sill on the inside, Fig. 13. All of these and many more standard moldings are available today in a great variety of patterns and sizes. You'll find that most flat moldings are hollow-backed, Fig. 7. The hollow lets them fit snugly against a plaster wall instead of riding on top of any small surface irregularities. Two special groups of moldings also have many uses around the home. One is picture-frame stock, more expensive than standard molding but available in unique shapes and often prefinished. The other is machine-carved hardwood trim, designed for trimming the edges of furniture.

Moldings are highly versatile. Fig 1

6



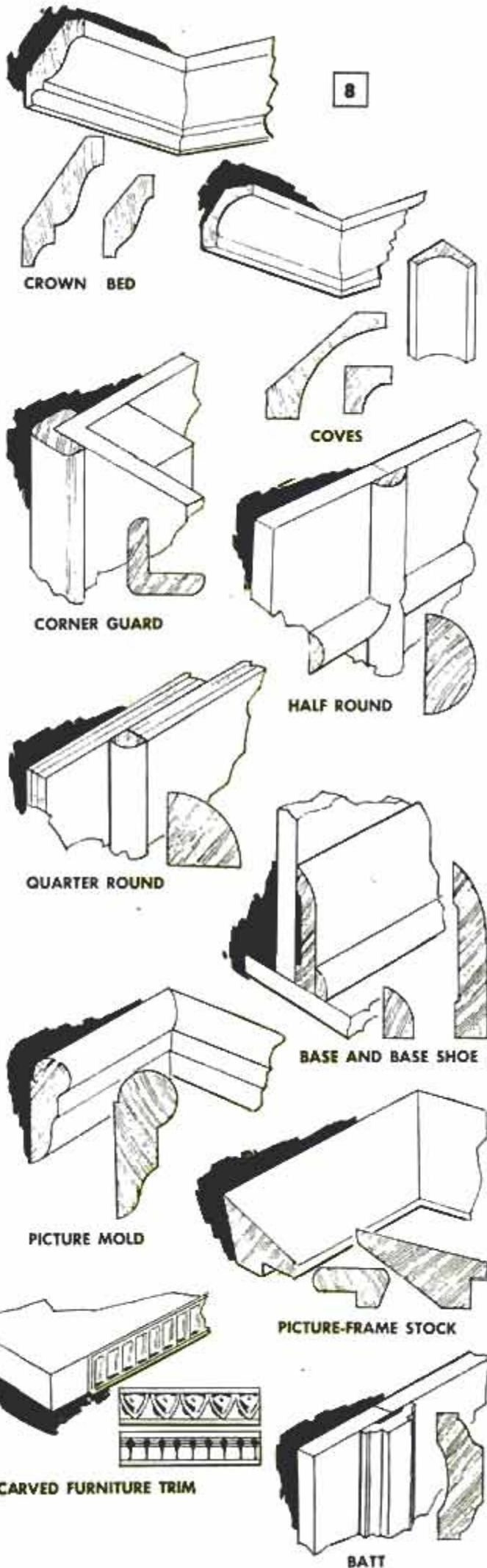
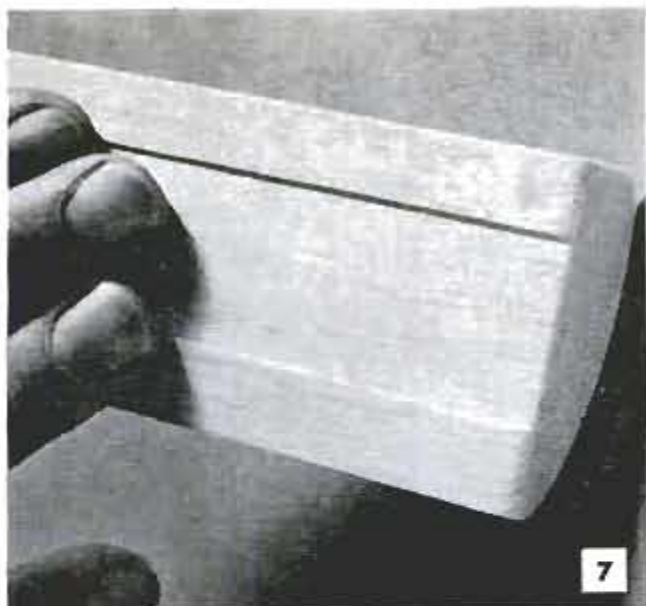

shows how a board-and-batten treatment of common screen-stock will relieve the plain, uninteresting look of a one-piece overhead garage door. When the same treatment is carried out on a board-and-batten exterior, the door becomes less conspicuous by blending in with the rest of the house. An overlay of molding in the design of a gate as shown in detail A, Fig. 1, adds the feeling of lowness and width to a garage door. Fig. 2 shows how molding can be used on a ceiling to give the illusion of height. Applied in the form of nesting frames, the molding permits the ceiling to be painted several colors without losing the unity the plane gives to a room. Detail B, Fig. 1, shows how regular screen molding can be used to transform dated porch screens to modern Shoji screens. The screen areas are divided into a grid pattern by nailing the molding back to back with the wire between. An example of how half-round molding will serve to emphasize length and lowness of a built-in sofa is shown in Fig. 3. Here the molding is run horizontally on the walls and the areas between are painted different colors. Novel bed headboards consisting of molding attached directly to a bedroom wall and framing inserts of cloth, cane mat or wallpaper, is another way you can use molding to good advantage. Clever cabinet and

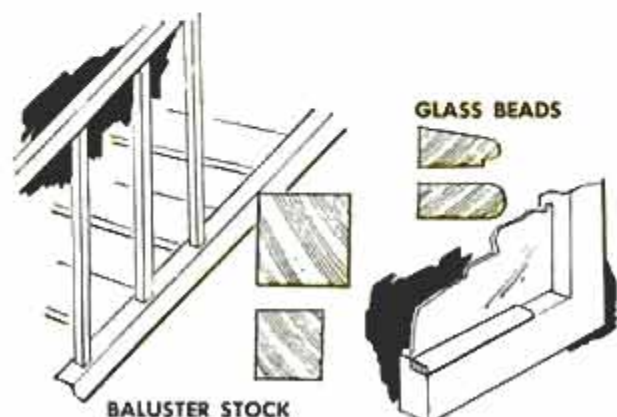

BALUSTER STOCK
JANUARY 1959

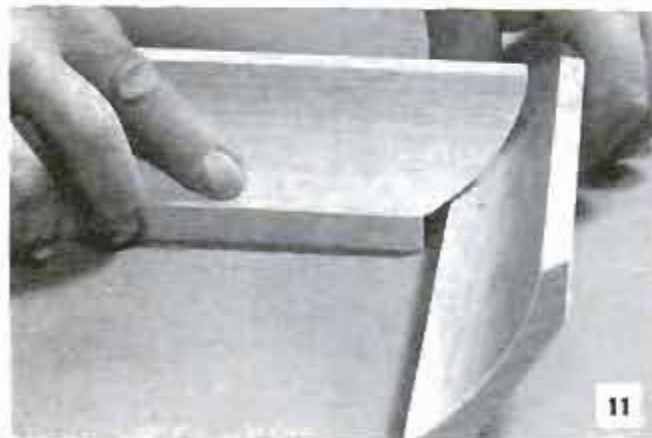
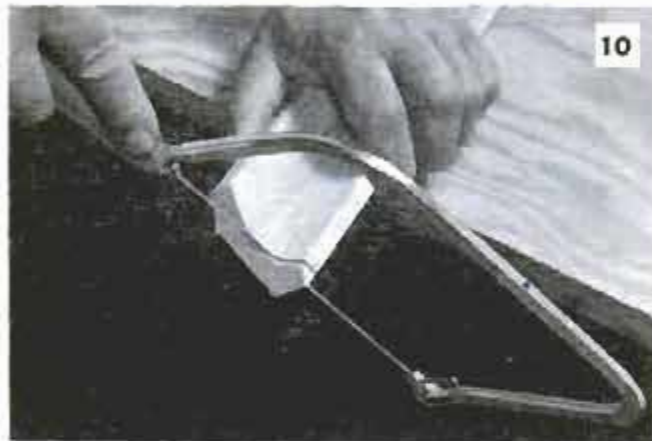

Western Pine Association photos

drawer handles that are both decorative and practical are nothing more than strips of picture molding applied in the manner shown in Fig. 4. What you can do with molding to decorate your window shutters and entrance doors is suggested in Fig. 5. Note particularly how quarter-round molding applied to the face of a plywood panel closely simulates louvered shutters. Interiors can be given added interest and the feeling of warmth by facing the doors with squares of cloth or paper which match the room drapes or wallpaper. In the example shown in Fig. 6, squares of cloth matching the pattern of the bedspread are framed by applying strips of molding over the edges of the cloth. Gives the effect of paneled doors and makes them belong to the rest of the room.

Coping Molding

The trick of good joinery with moldings is to miter all outside corners and to cope all inside corners. Figs. 9, 10 and 11 show how to cope molding when fitting it around the ceiling of a room. First, the piece of molding is held against the back-guide of a miter box in the same position it will be when installed, and it is cut off at a 45-deg. angle with the saw. In the photo the piece to be coped is at the right, behind the saw. If you were making a mitered outside corner with this same type molding, you would cut it the same. The piece to be coped is trimmed off with a hand coping saw, using the inside edge of the miter sawcut as a guide line. Saw perpendicularly, trimming away the wedge of wood left by the 45-deg. cut. The piece also can be coped on the jigsaw by laying the back side of the molding flat on the table. When coped, the end will have an exact reverse profile of the molding against which it is to be butted,

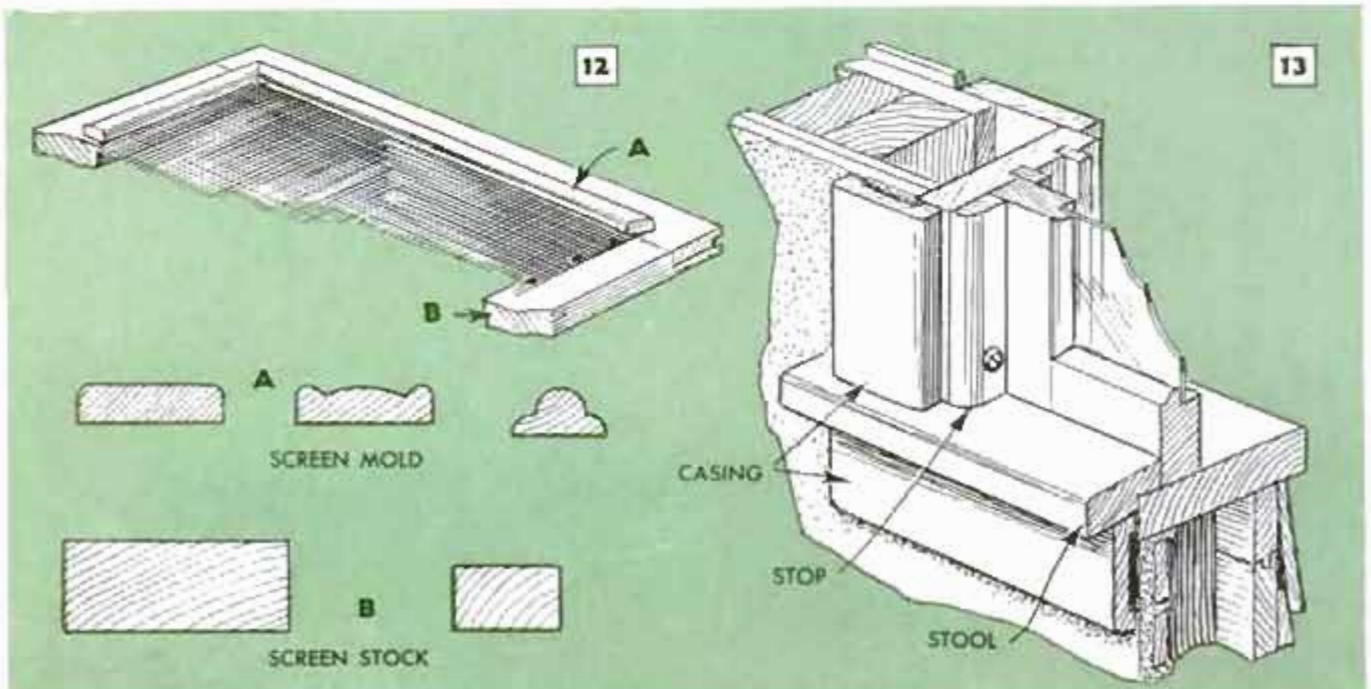
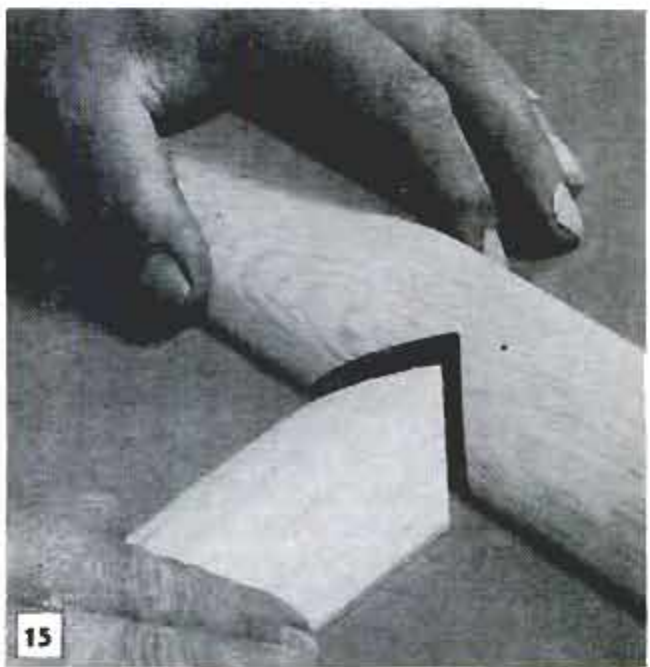

Fig. 11. In placing molding completely around a ceiling, two methods can be used. You can cope only one end of the four lengths, cutting the others square, or cope both ends of two lengths, leaving the ends of the other two lengths square. In the later case, the uncoped lengths are applied first. In all cases, the coped ends butt against the face of the adjacent molding. The reason for coping instead of mitering an inside corner is that corners of rooms are seldom square and you can compensate for this more easily with a coped end since you can trim away front or back edges to make the joint fit perfectly. Even if the joint is a little ill-fitting, or if some shrinkage in the wood should occur, the joint will still look neat because the cut itself cannot be seen except when sighting along the line of the molding.

Joining Molding

When two or more pieces of molding intersect as in Figs. 14 and 15, it is best to use a symmetrical molding, such as a round casing, or a half-round. Then the pieces can be smoothly joined together. The piece to be let-in is trimmed to a point by two 45-deg. cuts and it is used as a pattern to mark the notch in the other piece. When different or asymmetrical moldings are being joined, a plinth block is used as in Fig. 16. Likewise, a plinth block can be used in a corner to avoid coping. Standard moldings come up to 16 ft. or more in length but sometimes it is necessary to splice, or join, two pieces. Fig. 17 shows how both pieces are mitered 45 deg. and lapped. When glued, a stronger joint results and is less noticeable. A partial V-cut gives the most attractive joinery where pieces of mullion casing or the like, which are shaped only along the edges, are to intersect. ★ ★ ★



Western Pine Association photos

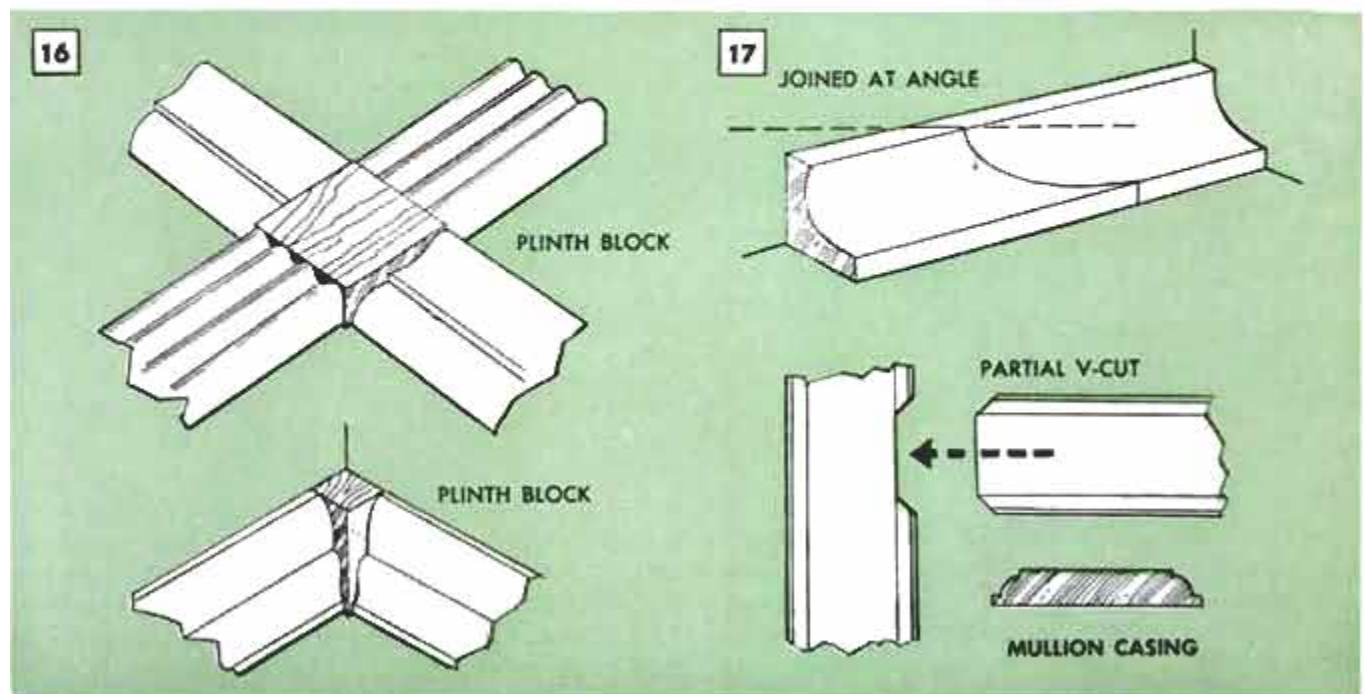



Sectioned Insert on Window Gives Multipane Effect

To change double-hung sash with single panes into windows that appear to have multiple panes for a colonial effect, one homeowner made inserts to fit flush against the inside of the windows as illustrated. All members of the inserts are $\frac{5}{8}$ x $\frac{5}{8}$ -in. pine. Joints are half-lapped and glued. Friction catches fitted on the sides permit easy removal and replacement of the inserts when desired. Such inserts also can be made for use on a picture window to provide the appearance of multipane windows at each side, or the entire window can be covered as desired.

Don Brooks, Lombard, Ill.

ⓘ Before glazing new wooden windows, paint the wood that will be in contact with the putty. If this is not done, the wood will quickly draw the oil from the putty, causing it to crumble.

Metal Handle Converts Injector-Razor Blade Into Stencil Knife

When fitted with a handle, injector-razor blades are handy for stencil cutting, silk-screen work and other cutting jobs requiring a sharp knife. A blade can be ground to almost any shape desired. To do this, first sketch the shape on the blade. Then insert one end in the handle and shape the other end on a fine-grit wheel. The handle is formed from a $\frac{9}{16}$ x 5-in. strip of sheet metal, as indicated in the drawing. To form the channels along the sides of the strip, clamp it between two $\frac{1}{2}$ x $\frac{5}{16}$ x 5-in. lengths of flat steel and then fold over the edges. The channels are then closed with a center punch a distance of 1 in. from one end of the handle to prevent the blade from sliding into it beyond the desired point as shown. After the blade is inserted in the handle, punch marks are made on the chan-

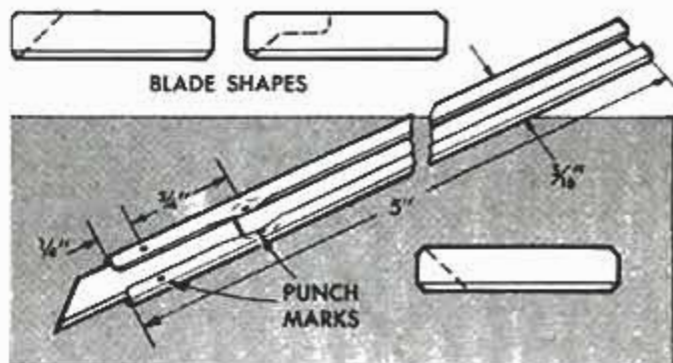

nels at a point $\frac{1}{4}$ in. from the blade end to further secure the injector blade in the handle. When not in use, remove the blade from its cutting position and tape it to one side of the handle to prevent injury.

Leon Reissman, Brooklyn, N. Y.



Household Cleanser on Tape Ideal for Small Polishing Jobs

When very fine grit abrasive cloth is needed for polishing small metal parts with round surfaces, one home craftsman uses a strip of friction tape coated on both sides with a powdered cleanser, such as is used for scouring pots and pans. The cleanser is applied by sprinkling a light coating of it on a flat surface and then firmly pressing the tape on the cleanser several times until completely coated.

Walter E. Burton, Akron, Ohio



FROM RIFLE TO **HANDGUN**

By Alfred J. Goerg—
*3009 S Laurel St
Pasadena, Wash.*

A HARD-HITTING HANDGUN for use as a side arm when hunting large game or working a trapline where dangerous animals may be encountered, is quite easily converted from a single-shot rifle chambered for high-velocity cartridges. The conversion pictured above was made from a Remington rifle with a rolling-block action and chambered for the 7-mm. Mauser cartridge. Before converting this rifle make sure the action is tight, that all parts are in reliable working order and that the chamber is in good condition. If there is any doubt, have the arm checked by a com-

petent gunsmith. Unless you have facilities for altering the tang as in Fig. 3, it may be a good idea to have this done by your gunsmith. It's a rather tricky job as it involves altering the original flat lock spring. The rest of the work you can do yourself with a few simple tools.

After acquiring the rifle of your choice for conversion, remove the stock and forend wood and then cut off the barrel to the desired length and crown it. Care in selecting a rifle with a good barrel may save work and the expense of rebarreling the action. Next, a standard rifle ramp with a wide

Fig. 1, completed single-action handgun converted from Remington rolling-block single-shot rifle has shortened barrel, Micro and partridge-type sights, custom-made stock, streamlined hammer spur and shortened forend wood. Fig. 2, first step of conversion is to remove stock



Right, tang is modified to take sharp curve of pistol stock. Lower member of tang and hammer spring are annealed and bent to curve downward. Upper member of tang is cut off close to receiver and a length of rod is welded to it to provide better base for mounting pistol stock





Above, left and right halves of stock are carefully grooved to provide tight fit when bolted together on tang of gun. Right, heavy gun requires custom-made holster of stiff leather bound with heavy thongs



partridge-type front sight attached is silver-soldered to the barrel. The rear sight used is a Micro adjustable sight installed by drilling and tapping two shallow holes in the receiver directly above the chamber to take the mounting screws. To accommodate the curve of the revolver-style grips, the tang members must be bent into a downward curve as in Fig. 3. Since the upper member of the tang would be too short after bending, it is cut off near the receiver and a rod of the proper diameter and length is welded in the position shown. After this is done, it is necessary to reshape the hammer spring to make it work properly. Note that the hammer spur has been bent downward to streamline the gun, Fig. 3. Care must be taken to anneal all steel parts that are to be bent to avoid breaking them.

Grips for the gun may be hand-carved from walnut to any style desired, or the gun can be sent to a custom-grip maker for this phase of the work, Fig. 4. For a more professional appearing and easier job of carving the grips, first make wax models of them. To do this, wind masking tape over the parts of the tang having open spaces and then dip the entire tang in melted wax a sufficient number of times to build up a mass from which the grips of the desired style can be carved. When sat-

isfied with the appearance and feel of the wax prototype, cut it in half with a hacksaw blade to form the left and right halves of the grips. Then, carefully remove them from the gun. Use the wax models for patterns and as a reference when cutting and carving the walnut grips. Carefully cut the grooves in the grips so that they tightly clamp the tang when bolted in place. Next cut down the forend wood (the wooden piece fitted against the underside of the barrel) to a pleasing proportion, Fig. 1. The lug on the forward end of the receiver is then drilled and tapped to take a rod threaded on both ends and slightly longer than the forend. A knurled ejector-rod head of the type used on some revolvers is turned on one end of the rod and the other end is inserted in a hole drilled in the forend wood and then turned in the tapped lug to securely fasten the forend in place.

Since a pistol of this size and shape will not fit in a stock holster, it is necessary to custom-make one as shown in Fig. 5. Use heavy, stiff leather for the body of the holster and close the seam at the back with a leather thong as shown, or have it sewn at a shoe-repair shop. Parts of the holster may be tooled. A thong lacing and a loop for one spare cartridge give the holster a Western appearance. ★ ★ ★

Jig Aids Cutting Rock-Wool Batt

Cutting a rock-wool insulation batt with a handsaw is easy when this jig is used. It consists of cleats nailed across the ends of two boards to space the latter 1 in. apart. It is used to support the insulation and provide passage for the saw. The jig may be used on saw horses or other supports.

Renew Wire Brush by Grinding

To give an old steel-wire brush a better "bite," hold it against the side of a rotating grinding wheel to remove the rounded ends on the bristles. When doing this, hold the brush lightly against the grinding wheel and wear safety goggles.

M. Robert Beasley, Jackson, Mich.

Photo Lamp on Rafter Illuminates Attic

Instead of searching in half-darkness when looking through trunks and boxes stored in an unlighted attic, use a photoflood reflector, with 100-w. lamp, that can be clipped on a rafter as shown. The lamp also may be clamped to the back of a chair or other object. If there is no electrical outlet in the attic, run an extension cord from an outlet downstairs, but be sure to disconnect the cord when the lamp is not in use. You will find this means of illumination much handier than a flashlight, which has to be hand-held.

Mrs. M. Fey, New York City.



Kerf Anchors Collar on Shaft

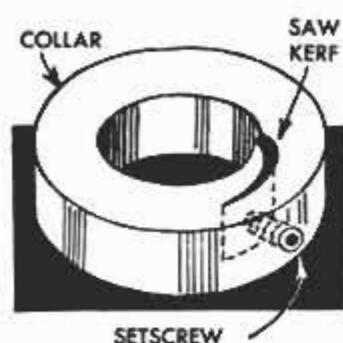

When securing a collar on a threaded shaft by means of a setscrew, the latter can be prevented from damaging the threads if a saw kerf is cut in the collar as shown. Make the cut well beneath the depth of the

threads, after which you drill the hole up to the kerf and tap it with a bottoming tap for the socket setscrew.

Enno R. Haan, Evanston, Ill.

Tighten Shaft With Taper Pins

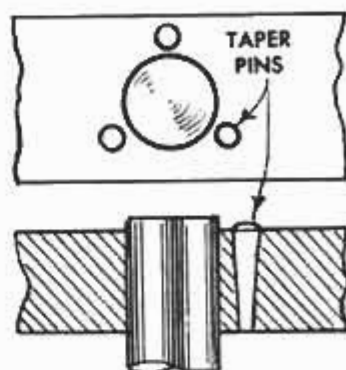

When a shaft that rotates in a hole bored in the casting of a machine becomes loose, it can be tightened by driving taper pins into holes drilled in the casting. Holes for the pins should be spaced equally

around the shaft hole about $\frac{1}{4}$ in. from it so the taper pins expand the metal when driven into the casting.

Frank L. Rush, Columbus, Ohio.

Jig for Accurate Setting Of Most Circular Saws

Here is a saw-setting jig that is adjustable to take most common sizes of circular saws. Because of the accuracy of work that can be performed with it, you will find it easy to keep your saws always in perfect shape. The base is made of two $\frac{1}{4}$ x $1\frac{1}{2}$ x $1\frac{1}{2}$ steel angles 10 in. long. Steel spacer blocks, each 1 x 1 x $3\frac{1}{2}$ in., are bolted in the ends to provide a slot for positioning the bolts that clamp the saw support and tooth-setting anvil to the base as shown in the details. Each angle of set required is filed on the face of the anvil as indicated. — W. Judy, International Falls, Minn.

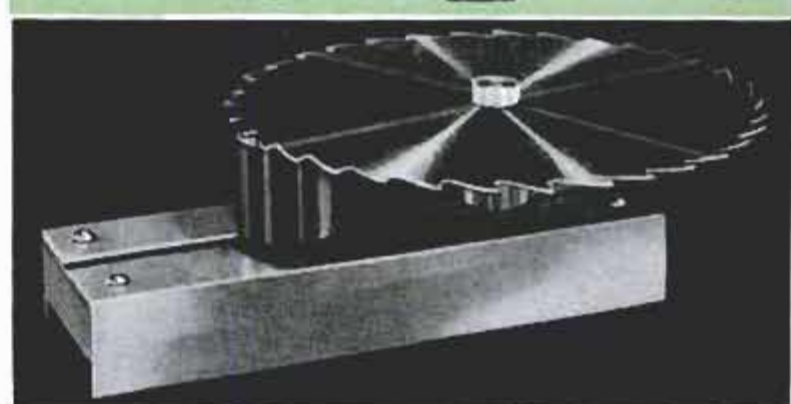
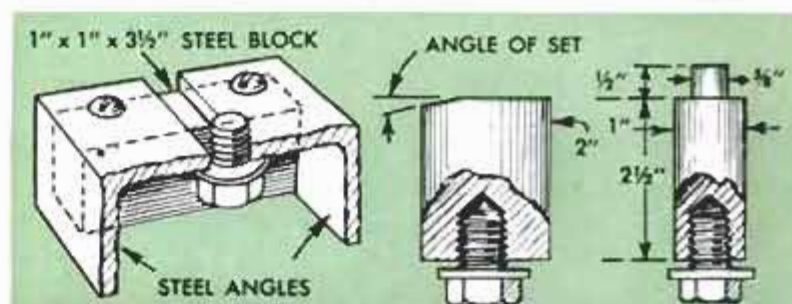

On the **MARKET** for Do-It-Yourselfers



1. INSTANT UPHOLSTERY CLEANER removes all the common stains from upholstery materials such as woven fabrics, leather, vinyl and nylon. Penetrating action lifts dirt and discoloration from the surface

Glamur Products, Inc.,
1024 Montgomery St., Syracuse, N. Y.

2. WOOD STAIN AND LACQUER are combined in a 16-oz. pressurized container for finishing, refinishing and touching up old finishes. Comes in brown and red mahogany, brown and red maple, blond and walnut

Kay Chemical Co., North Hollywood, Calif.

3. PARQUET PATTERNS IN LINOLEUM TILE are available in four distinctive colors, or wood tones, can be arranged to form a variety of decorative effects. Patterns are made in service gauge, in 9 x 9-in. size

Armstrong Cork Co., Lancaster, Pa.

4. ALUMINUM REFLECTOR is 8 in. in diameter and is designed for drop lights and other installations having no reflectors or shades. To install, simply unscrew bulb, slip reflector over it and replace

Hocar Mfg. Co., 2569 N. Clark St., Chicago 14

5. DRY LUBRICANT comes in a small plastic tube with an elongated nozzle for reaching those hard-to-get-at places where lubricant is so often needed. Just the thing for hinges, locks, certain workshop tools

Bradley Container Corp., Maynard, Mass.

6. ALL-PURPOSE PRIMER speeds up job of refinishing, provides ideal surface over which to spray enamels or lacquers. Comes in pressurized container, takes only a few minutes to dry. Use on metal, wood

Krylon, Inc., 18 W. Atry St., Norristown, Pa.

7. ALL-STEEL DOOR for outside basement entryway comes complete with steel frame and fittings ready to install. Just remove the old door and frame, repair masonry if necessary. Complete instructions included

The Bilco Co., New Haven 5, Conn.

8. SEMICONCEALED CABINET HINGE is available in a variety of finishes to match modern decor. Offset leaf is convex, providing deeper countersink and a firmer grip for screws. Made from heavy-gauge steel

Ajax Hardware Sales Co.,
4355 Valley Blvd., Los Angeles 32, Calif.

9. SHUTTER PANELS come unfinished in 12 sizes to fit nearly all conventional openings such as windows, bars, pass throughs and kitchen cabinets. Panels have light stops at top and bottom and plain louvers

Paul Heinley Indoor Movable Shutters.,
P. O. Box 100, Santa Monica, Calif.

10. AN ATTRACTIVE AND NOVEL FENCE is made from a new corrugated steel which is zinc-coated to protect it against rust. Just set the posts, install nailing strips, unroll the sheet and nail in place

Ceco Steel Products Co., 5601 W. 26th St., Chicago 50

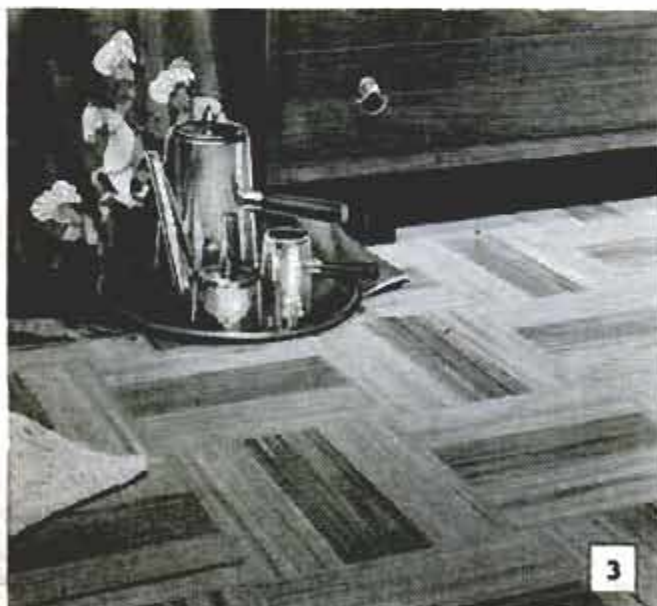
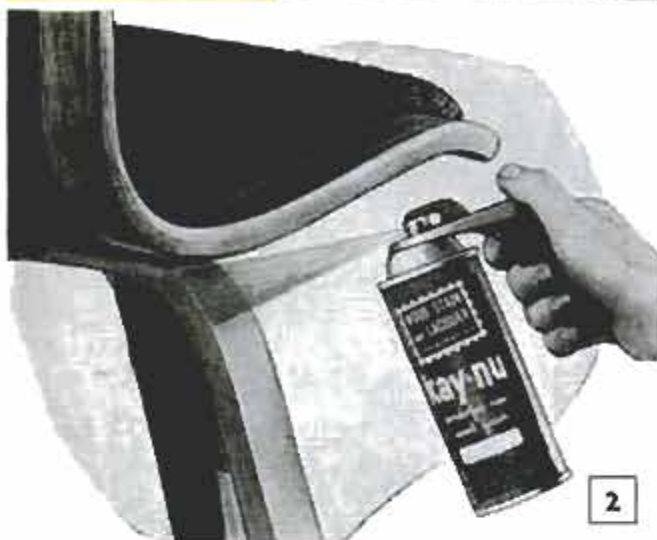

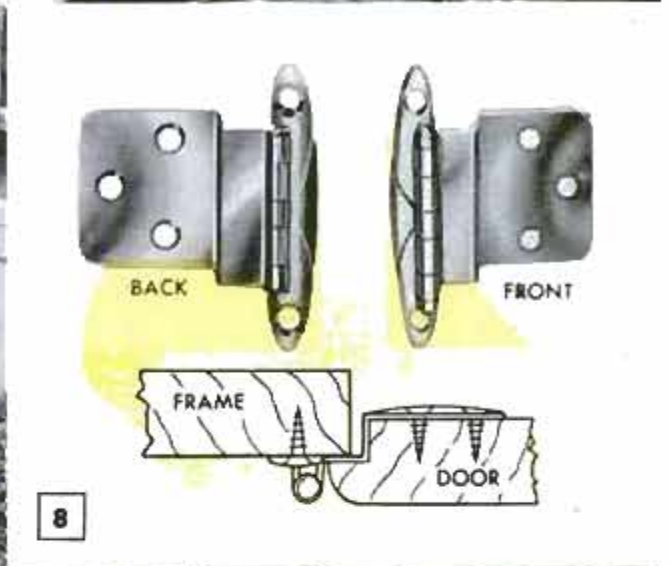
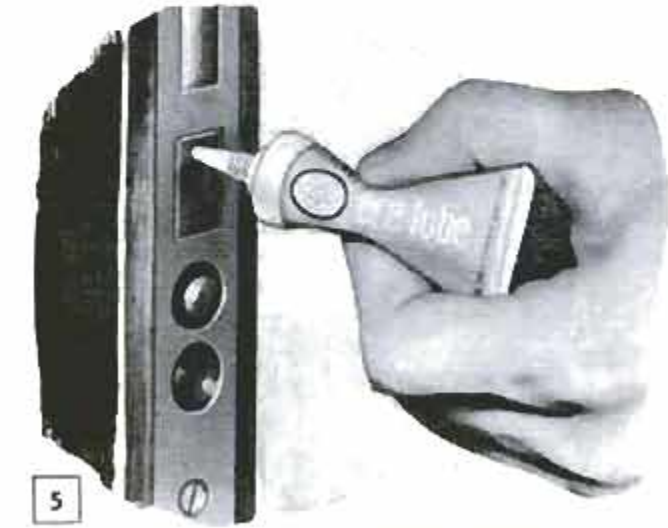
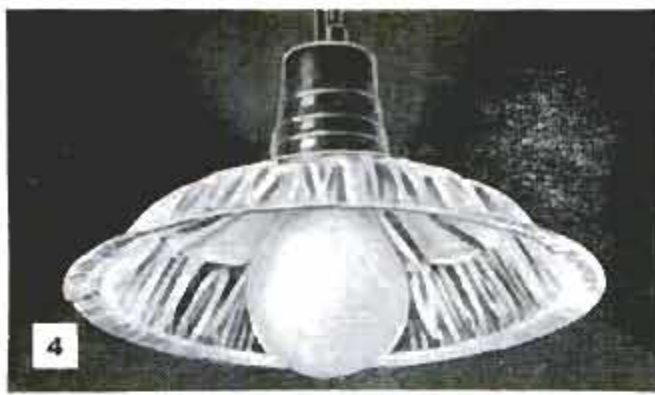



Dropping-Pear-on-Knife Trick Is Interesting Party Game

Here is a trick that can be used as a game at your next party. Have the guests try to cut a pear in half by dropping it at arm's length on a carving knife as shown. After your guests fail to accomplish the trick, simply wet the pear and "sight" on the target by holding it so that water drops fall directly on the blade at which time the pear is released to be cut neatly in half as indicated.—Perry Deming, Bristol, Conn.

When the trunk light of one motorist's car stopped providing full illumination, he soldered one end of an electrical wire to the frame and the other end to the trunk lid to establish a better circuit. Such lights utilize the car frame and body for one side of the circuit and when rust and grime accumulate on hinge pins of the trunk lid, the flow of current to the light is reduced.

James P. Arnold, Fort Wayne, Ind.

Paper Helps Remove Small Parts Picked up With Permanent Magnet



If you use a permanent magnet for picking up tacks and similar small parts, here is an easy way of removing them. Fold a piece of paper over the ends of the magnet and pick up the parts as shown in the photo. Then hold the magnet over a container and pull off the paper. This method is ideal for picking up sharp tacks.

Frank A. Javor, Newark, N. J.

Carburetors on many late-model cars are equipped with dry-type air filters that require periodical cleaning or replacement for smooth idling and efficient operation. When dirty, the air cleaner restricts the air supply to the carburetor, resulting in an over-rich fuel mixture that will cause increased gasoline consumption.



Simple "Stone" for Honing Edges of Cutting Tools

Dull chisels, knives, plane irons and similar cutting tools can be given an extra-keen edge by honing on a strip of crocus cloth and then on a strip of leather. If the cloth and leather strips are tacked side by side to a heavy wooden block, they may be used in a manner similar to an oilstone. It is a good idea to provide some kind of cover to keep dust and dirt off the abrasive surfaces when not in use.

John A. Comstock, Wellsboro, Pa.

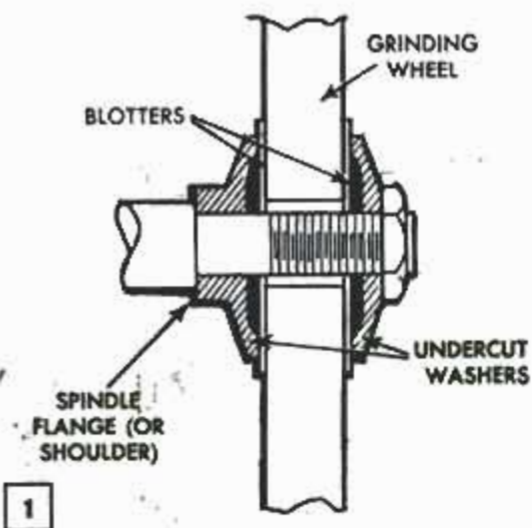

It's the CUTTING EDGE THAT COUNTS

Tricks in Sharpening Edge Tools That Every User Needs to Know

By C. W. Woodson

TAKING THE TIME to sharpen a cutting tool to a keen edge pays off in greatly improved performance, better workmanship and, in the end, an actual saving in job time. In general the procedure is divided into three simple steps: Grinding the beveled cutting edge to the correct angle, whetting on an oilstone to remove the wire edge formed by the grinding operation and finishing on a hone or leather strop to produce a smooth, razor-keen edge. These three steps apply to nearly all types of cutting tools, either hand or power-operated. In some instances, such as sharpening auger bits, filing is substituted for grinding as the first sharpening operation, but the end result is the same.

For the initial step in sharpening tools, your grinder must be in good condition. A direct motor-driven unit with fine and coarse wheels turning at 1750 r.p.m. is preferred by many skilled craftsmen for sharpening edge tools. Others prefer the higher speed grinders with wheels turning at 3450 r.p.m. Abrasive wheels driven at the higher speeds cut a trifle faster and

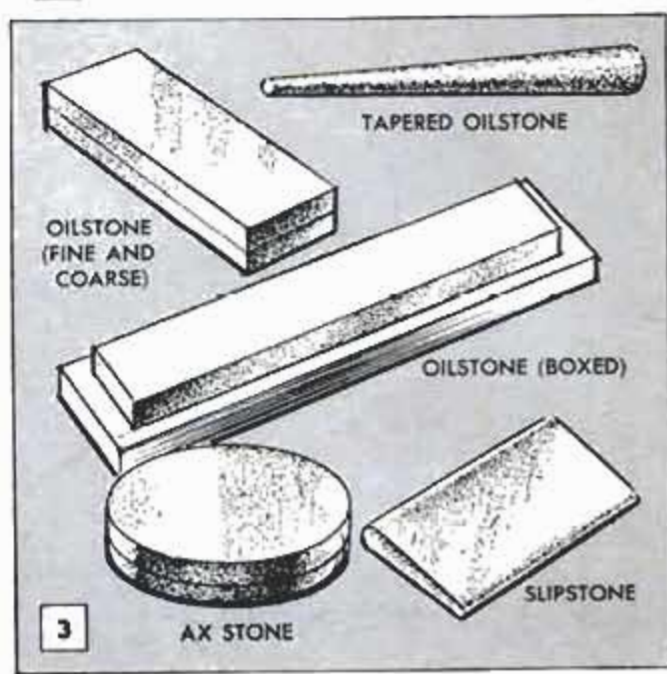
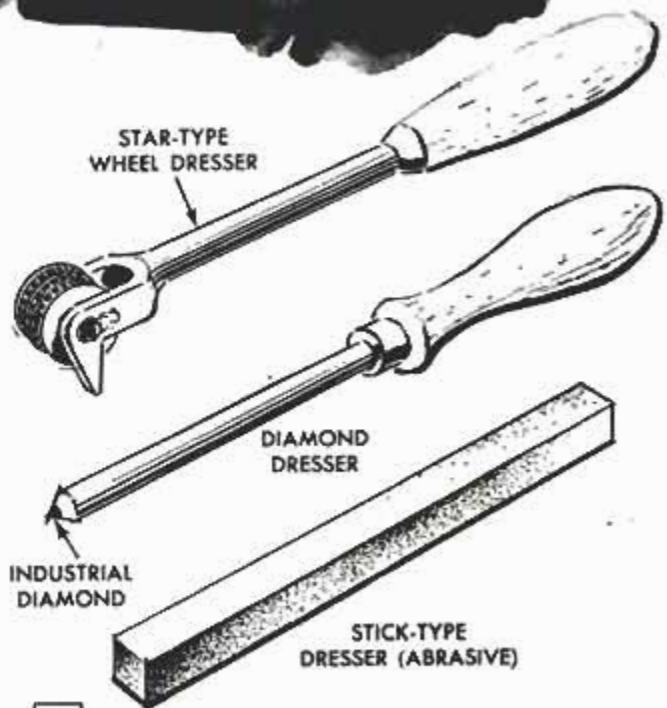

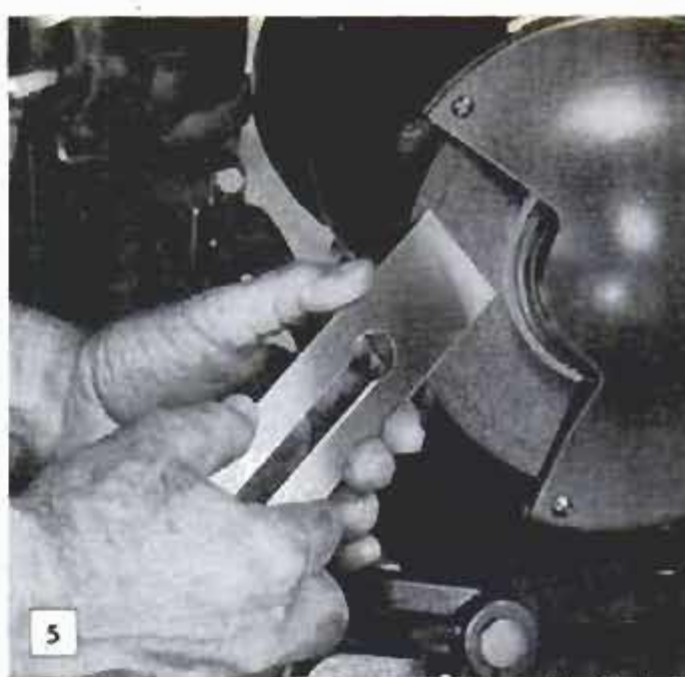
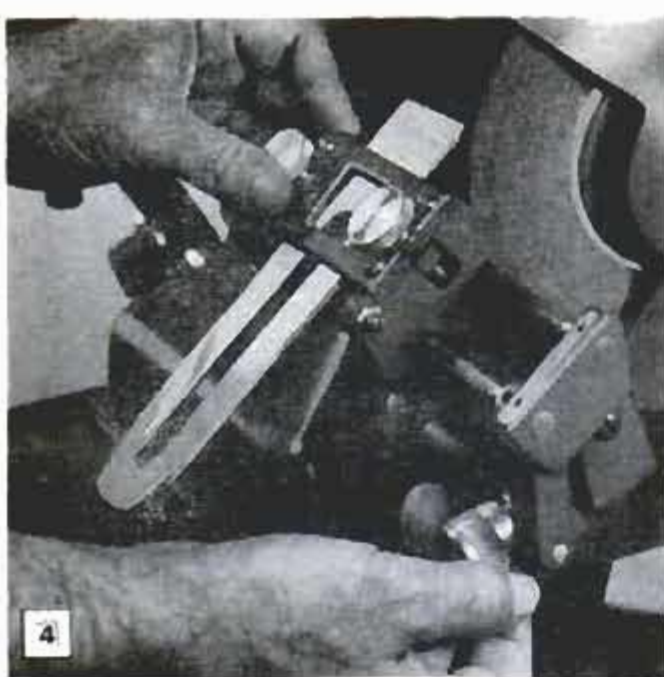

Photos courtesy Stanley Electric Tools

An attachment for grinding plane irons and chisels enables you to do an accurate job of squaring bevel and truing edge. Next best thing is to grind and square bevel on side of wheel. Use very light pressure

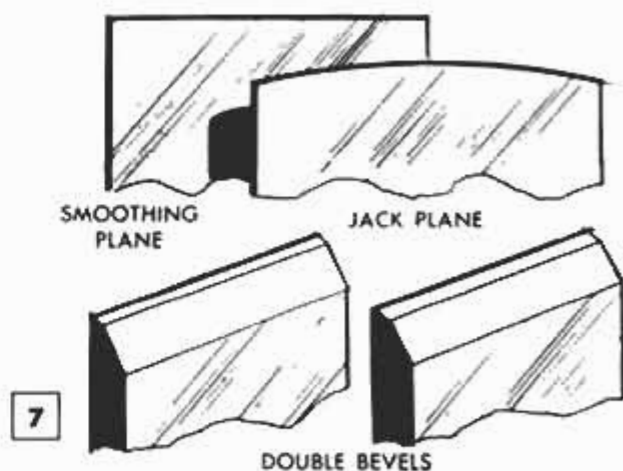
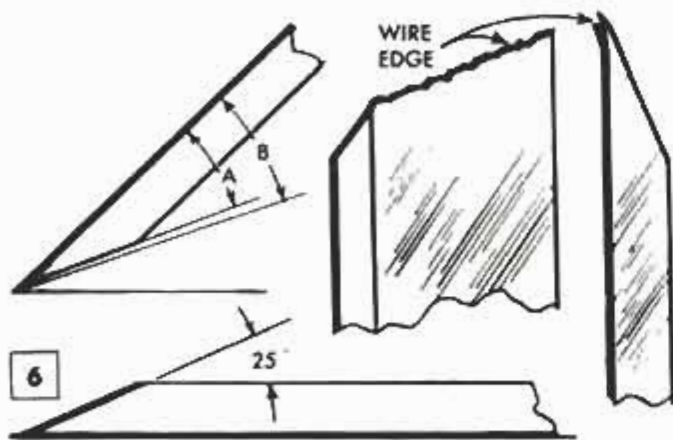

When grinding and finishing the edge of a plane iron check the squareness. Squaring the edge will make it unnecessary to tilt the iron sidewise in the plane

Second step after grinding plane irons and chisels is finishing edge on oilstone. If edge is used for rough work, form double bevel as detailed above

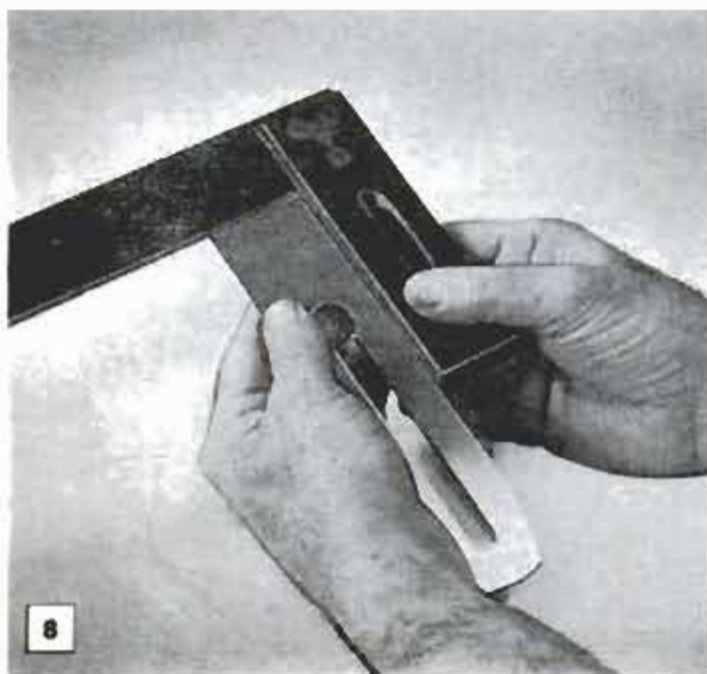

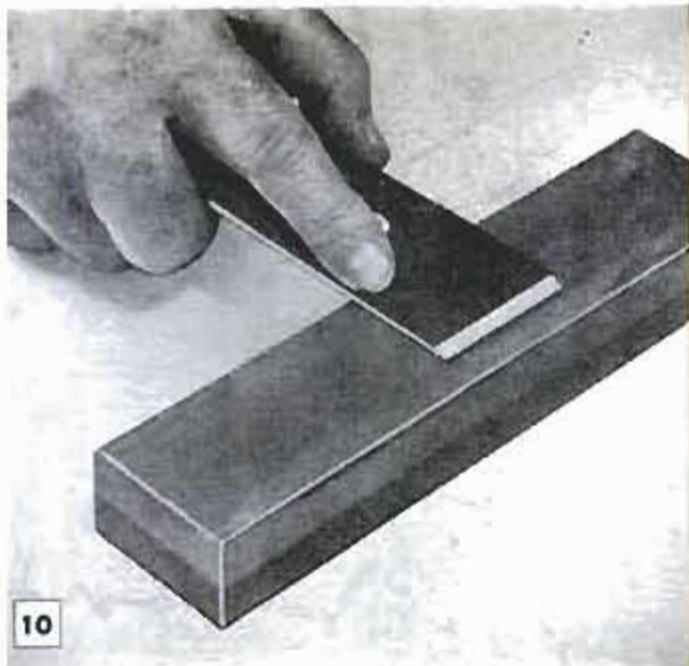

10 As final step turn blade over, lay flat on oilstone and stroke lightly. Be sure not to form a bevel

smoother, but additional care must be taken to avoid overheating the tool and drawing the temper.

It's important that the wheels run true on the spindle and this should be checked occasionally. On all small grinders the wheels are held in place on the spindle with two undercut washers and a nut, Fig. 1. The wheels are cushioned by blotters (disks cut from blotting paper and cemented to the wheel) and a lead bushing. Be sure not to damage the bushing or the washers when removing or replacing the wheel on the spindle. When the wheel becomes glazed (loaded with fine particles of metal) and the corners rounded due to prolonged use, the wheel should be trued up, or dressed, with a wheel dresser. Several types of wheel dressers are detailed in Fig. 2. Handle these tools carefully as they cut very fast, especially the diamond dresser, Fig. 20, which is perhaps the best of the three types.

For the second operation in sharpening tools you will need an oilstone and a hone, or slipstone, Fig. 3. The type needed depends on what tool is being sharpened. Ordinarily, you will need the fine oilstone (boxed if desired) for such tools as plane irons and straight chisels, a tapered oilstone for gouges and a straight and tapered slipstone, the latter used for the final operation of honing, or slipstoning.

Grinding plane irons and straight chisels can be done very accurately on a grinder fitted with a blade-grinding attachment, Fig. 4. With this unit you get a square edge and a true bevel. If you do not have the attachment, then it is permissible (although not a recommended procedure) to

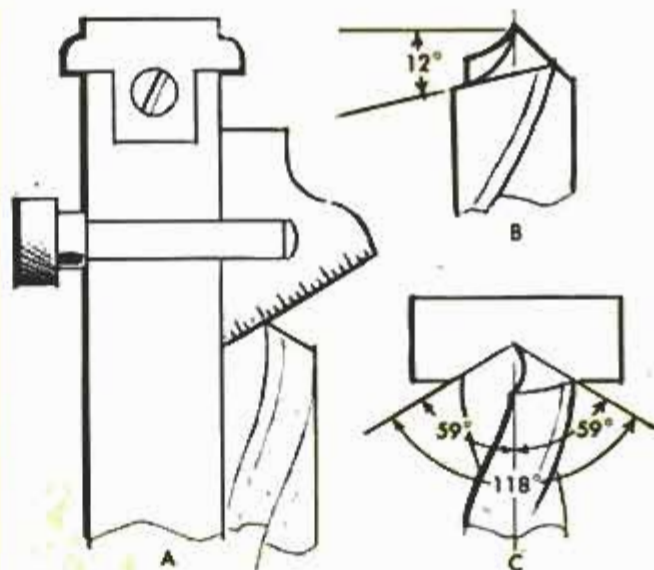

11

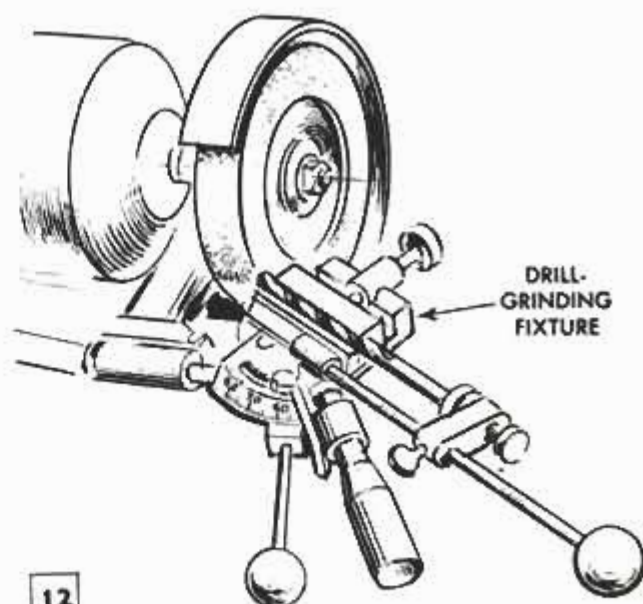

12

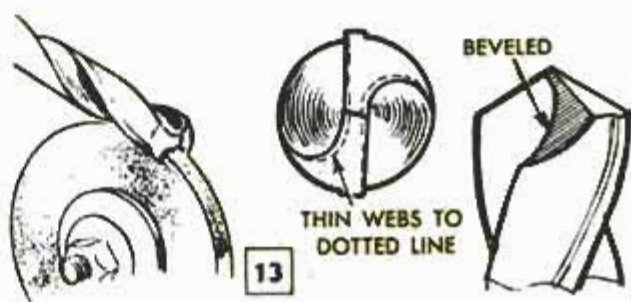

13

grind plane irons and chisels on the side of the wheel as in Fig. 5. Use care and light pressure. Check for squareness as in Fig. 8. Grinding leaves a wire edge shown exaggerated in the right-hand details, Fig. 6. This is removed on the oilstone as in Fig. 9.

Edge tools, such as chisels, gouges and plane irons, that are to be used for heavy cuts in hardwood, usually are finished with a double bevel, Fig. 6, A and B, and also Fig. 7. Grinding and finishing the edge with a double bevel gives the cutting edge greater support due to the added thickness



It's permissible to sharpen outside gouge on side of wheel as in Fig. 14. Figs. 15, 16 picture two methods of finishing inside gouge. In the first, Fig. 15, gouge is moved, stone is stationary. In Fig. 16, stone is moved

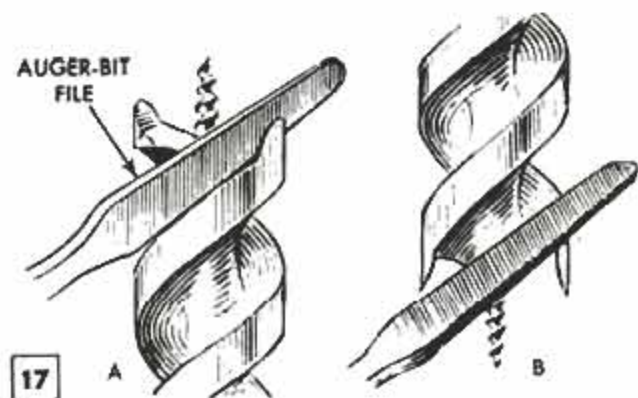

Above, auger bits are sharpened with special file and finished with abrasive stick. Below are methods of sharpening and finishing inside, outside gouges

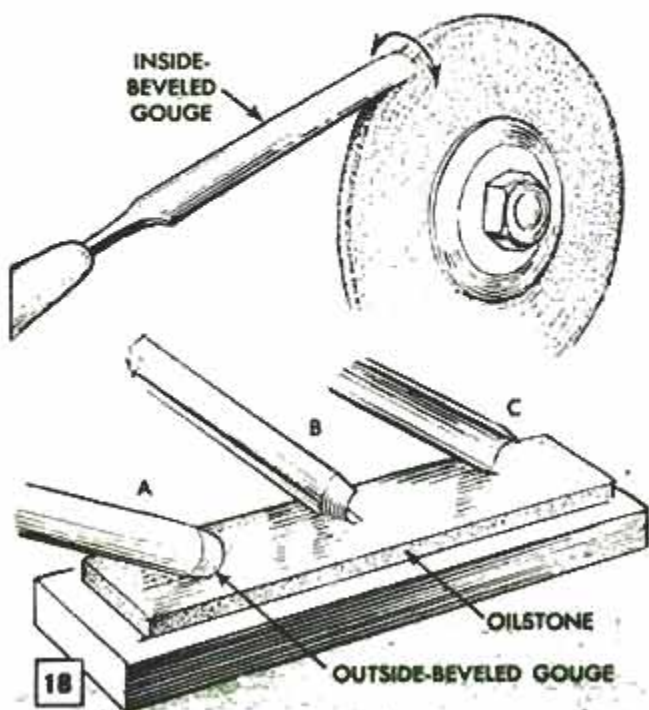

of metal. In the two views in Fig. 7 the bevels are, of course, exaggerated. Normally the second bevel is formed in the second sharpening operation, Fig. 9, and should not be more than $\frac{1}{2}$ in. wide. Normally the bevel on plane irons and chisels is ground to 25 deg., Fig. 6, but craftsmen often vary this to suit special conditions. As a final touch in whetting a plane iron or chisel, turn it over, lay flat on the oilstone as in Fig. 10 and smooth up the edge with a few light strokes. For average work craftsmen often finish the cutting edges of plane irons, chisels and gouges with a slipstone and dispense with stropping on leather as a final sharpening operation. With care this third step produces a cutting edge very nearly equal in smoothness to that obtained by stropping.

Carbon-steel and high-speed-steel twist drills can be used in either wood or metal but will not perform satisfactorily in either material unless they are correctly sharpened. A drill-grinding fixture, or jig, Fig. 12, provides the best method, but you can do very well freehand if you use a gauge, detail A, Fig. 11, to bring the cutting edges to the correct rake angle and included angle, details B and C, Fig. 11. Thinning the webs of twist drills shortened by repeated sharpening can be done on a round-faced wheel. Grind a bevel back of the cutting edges as in the right-hand detail.

Sharpening an outside gouge (bevel on convex side of blade) can be done on the side of the grinding wheel as in Fig. 14. This is permissible if only light pressure is used. The inside gouge is ground on a round-faced wheel as in the upper detail, Fig. 18. Unless it is badly dulled or nicked,

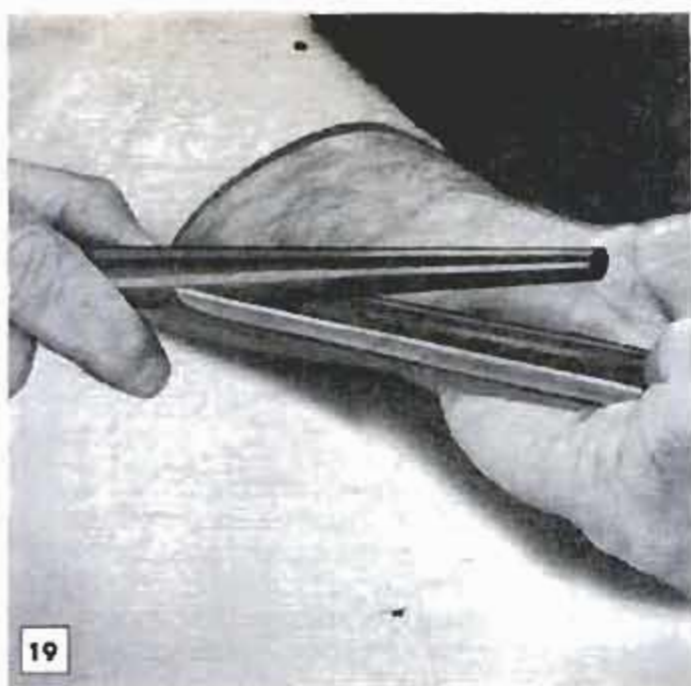

19 Unless dulled or badly nicked, small inside gouges can be sharpened several times with tapered stone

grinding is not always necessary as the edge can be sharpened with a tapered stone as in Fig. 19. The outside gouge is finished on the oilstone (fine side) by either of two methods. In the first, Fig. 18, detail A, the bevel is simply rolled right to left with only a slight sidewise movement across the stone. In the second method, details B and C, the bevel is rolled from B to C in a sweeping stroke right to left and back. Users generally choose between the two methods, using the one that produces the best results for them individually. There also are two ways of finishing an inside gouge, Figs. 15 and 16. Some craftsmen prefer to hold the tool stationary and move the slipstone, Fig. 16. Others hold the stone stationary and move the tool, Fig. 15.

Lips and cutters of auger bits should be sharpened with an auger-bit file, Fig. 17, details A and B, and finished with a fine abrasive stick, or slip. If you have a hollow-chisel mortising attachment for your drill press and have no way of sharpening the chisel, Fig. 21 shows a simple and practical way of doing the job. The short length of dowel also can be held in the drill chuck.

Owners of choice pocketknives use various methods of sharpening the blades. One method quite generally favored is shown in Fig. 22, that of sharpening against the edge rather than with it. Likewise, some users of axes prefer to sharpen away from the edge, lower detail, Fig. 22, but others prefer to reverse the direction of the sharpening stroke, that is, make the strokes against the edge rather than with it. Some use a circular stroke, gradually decreasing the pressure, in sharpening a pocketknife or ax when a very keen edge is desired. ★★

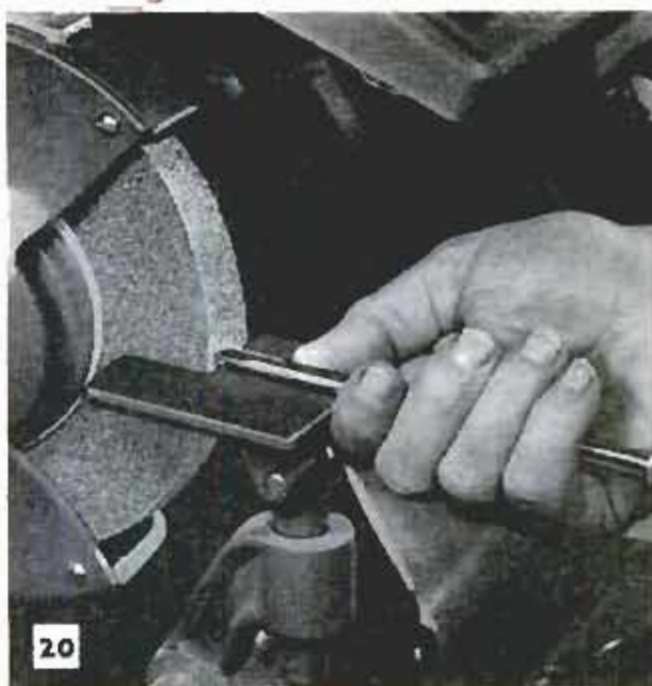

20 Always use a wheel dresser to true up a grinding wheel before sharpening any type of edge tool

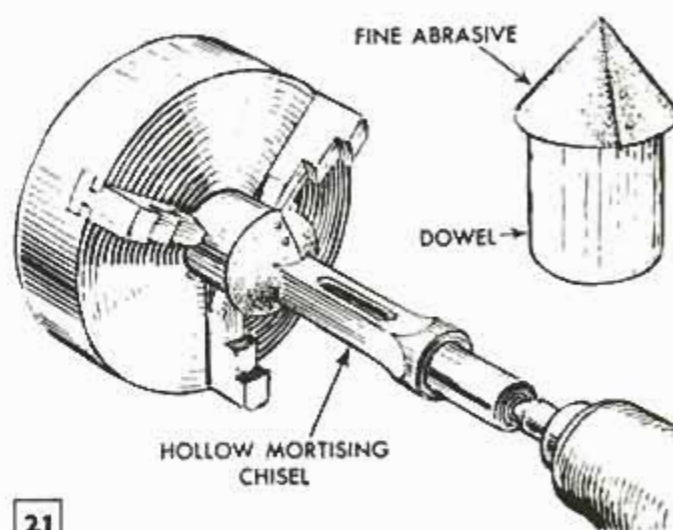

21

Above, one practical way to sharpen a hollow chisel is to use pointed dowel faced with abrasive. Below, owners of knives and axes use various methods of sharpening. Detail show methods generally favored

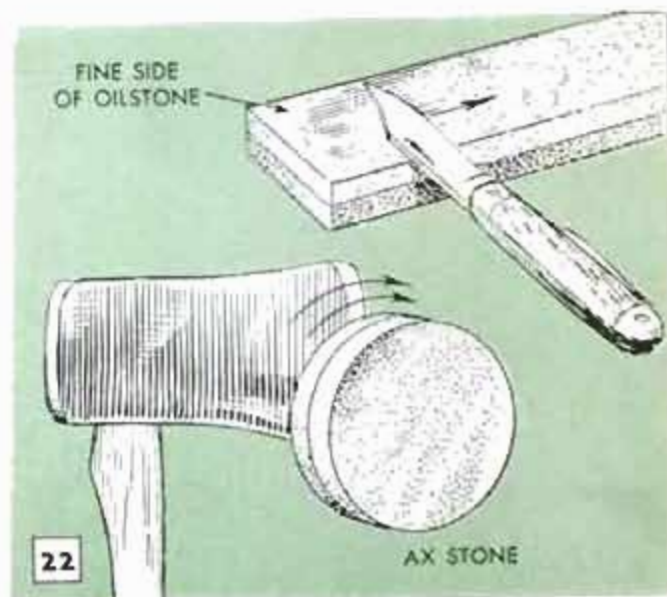

22

Bracket Permits Clamping Sketch Board in Vise at Desired Angle

If you have occasional need for a small sketch board in the workshop, here is an excellent way of supporting the board at a convenient angle for drawing. Simply bend a length of $\frac{1}{8}$ x 1-in. flat steel to give the angle desired and drill two holes near one end for attaching to the back of the sketch board as shown. The other end is clamped in a bench vise.

When cleaning paintbrushes that have been suspended in turpentine, one home craftsman uses a square of insulating wall board to remove old paint and solvents. The porous material absorbs the solvent and the rough texture of the surface permits rubbing off the pigments without damaging the bristles. Lay the brush on a flat surface and stroke the board over the bristles in one direction only.

J. H. Capron, Winona, Minn.



Handled Socket Wrenches Assembled Into Four-Way Wrench

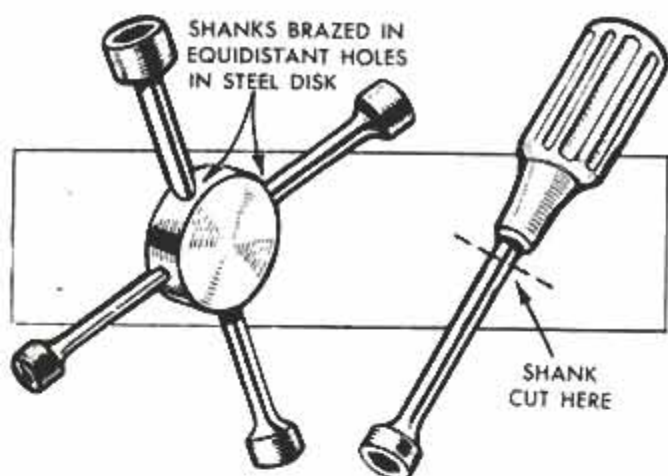

For more convenient use of screwdriver-type hexagon wrenches, braze the four most-used sizes to a steel disk as shown at left. Besides saving time, this arrangement affords greater leverage and causes less wrist fatigue than does the use of such wrenches in the conventional manner. The wrenches are arranged on the disk so that the sizes are in consecutive order. Size numbers may be stamped next to the shanks on both sides of the disk for easy selection. If the wrench is to be used on work requiring less leverage, simply reduce the length of each shank.

Level Drill Press With Bolts

About the best way of leveling a drill press or other shop machine is to place a bolt in each of the mounting holes and turn a nut on each as indicated in the detail at left. When the machine is in an upright position, the weight of it bearing against the nuts holds the latter in place, permitting the bolts to be turned as required to obtain level and solid position as shown in the photo. For heavy machines, the leveling bolts should be threaded for their entire length so that they can be positively secured in the mounting holes with locknuts to prevent vibration and lateral movement when a machine is in operation and pressure is exerted against work. Grind ends of bolts to a point to overcome any tendency of the machine to creep.



CLUTCH CONTROLS POWER TOOLS

A clutch permits smooth, gradual starts and stops, achieves a degree of spindle control not otherwise possible on small machines

By Walter E. Burton

THIS CLUTCH is especially useful for controlling a small lathe or milling machine when you're doing close work and it is necessary to start and stop the machine frequently. As detailed, it is assembled with pulleys of the same diameter for use with a small bench lathe without changing the original motor-to-jack-shaft pulley ratio. Pulleys of varying diameters can be used to adapt the unit to other uses.

The braking mechanism consists of a drum controlled by internal-expanding shoes actuated by a hand lever. Parts of the clutch are pictured in Figs. 3, 4 and 5 and an assembly view and sectional view are shown in Fig. 6. The clutch is pictured being assembled in Fig. 1, the hub being machined in Fig. 2 and the clutch completely assembled and mounted to drive a small lathe is pictured in Fig. 7. The parts are assembled on a 10½-in. length of ½-in. steel shafting, the shaft being mounted on ½-in. ball-bearing pillow blocks. The pulley A, Fig. 6, on which the clutch mechanism is mounted, is bronze-bushed as it must turn freely on the shaft when the clutch is disengaged.

The clutch mechanism is attached to pulley A, Fig. 6, and consists of the back plate B, the hub flange C, the split ring D, the halves of which carry the shoes, the clutch hub, arms and sliding cone. These parts in their relative positions are shown in the sectional view, Fig. 6. The drum can be made from extra-heavy pipe or from steel tubing having a ⅞-in. wall. The backplate B, Fig. 6, is cut from ⅜-in. steel plate and is drilled near the edge for 6-32 screws, the holes being equally spaced. Using the plate as a template, drill and tap holes for 6-32 screws in one edge of the drum. On approximately the same spacing, holes are drilled for the

⅛-in. rivets which hold the plate to the web of the pulley, A. A center hole is drilled and reamed to ½ in. to fit the shaft. The brake shoes, or clutch shoes, are semi-circular segments cut from steel tubing having a ⅜-in. wall and an outside diameter of 3½ in. The shoes are faced with regular brake lining riveted in place. One edge of each shoe is drilled and tapped for three 6-32 screws so that the split rings, or segments, can be attached to the shoes in the same manner as the drum is attached to the backplate. Note that the assembly

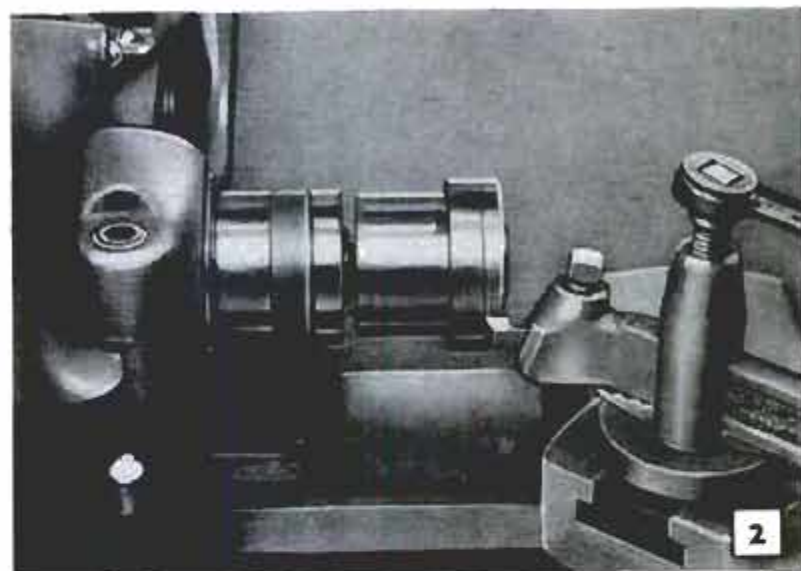

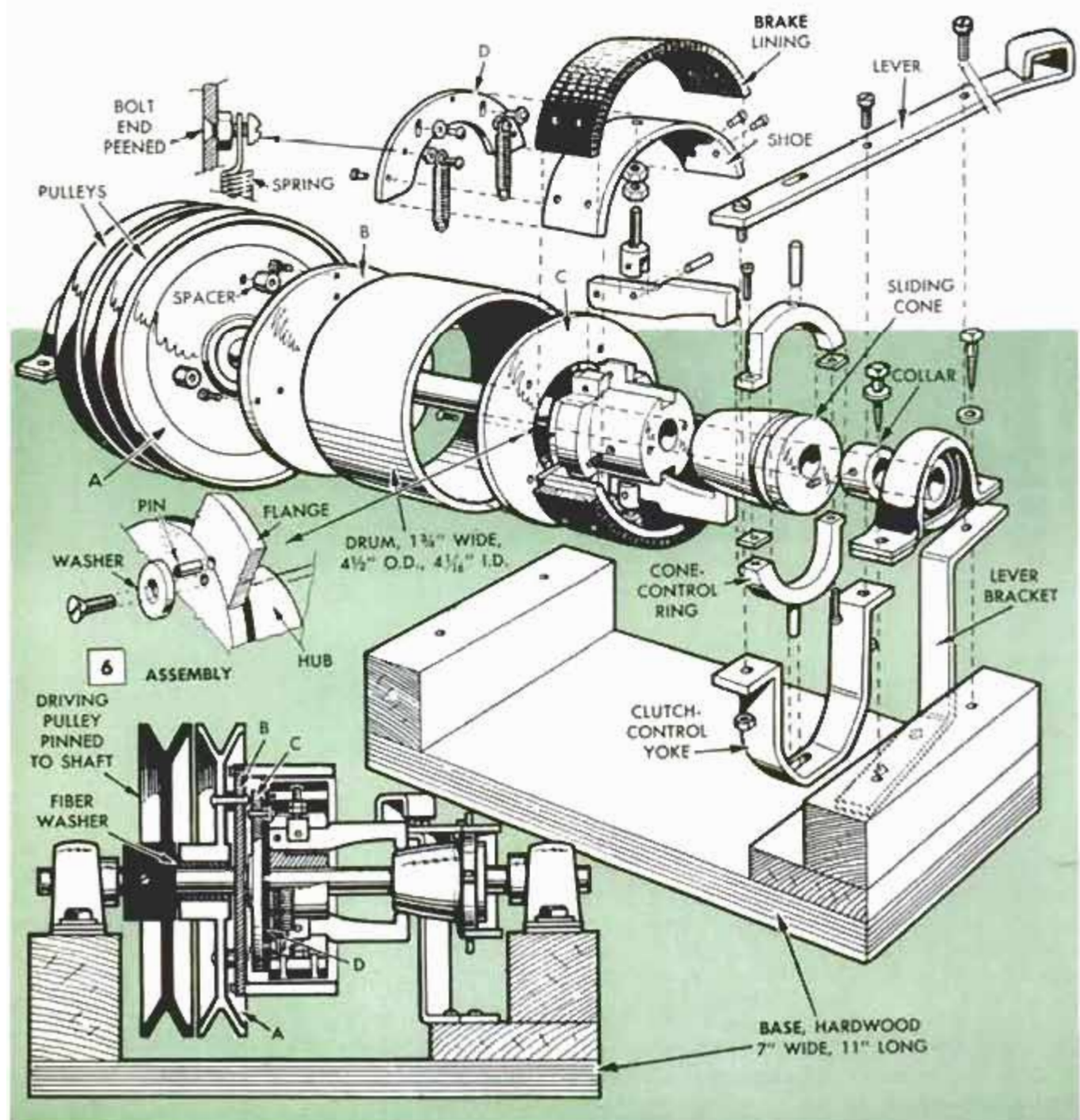
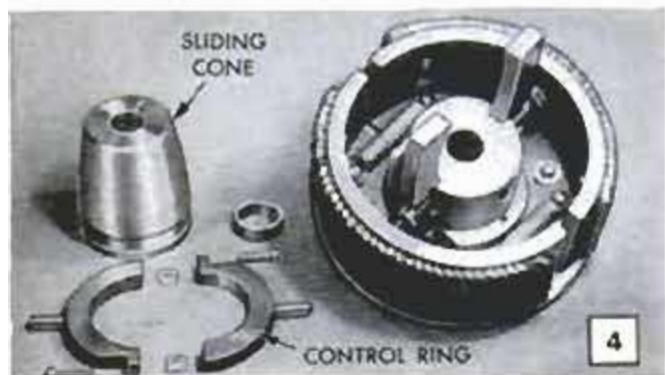
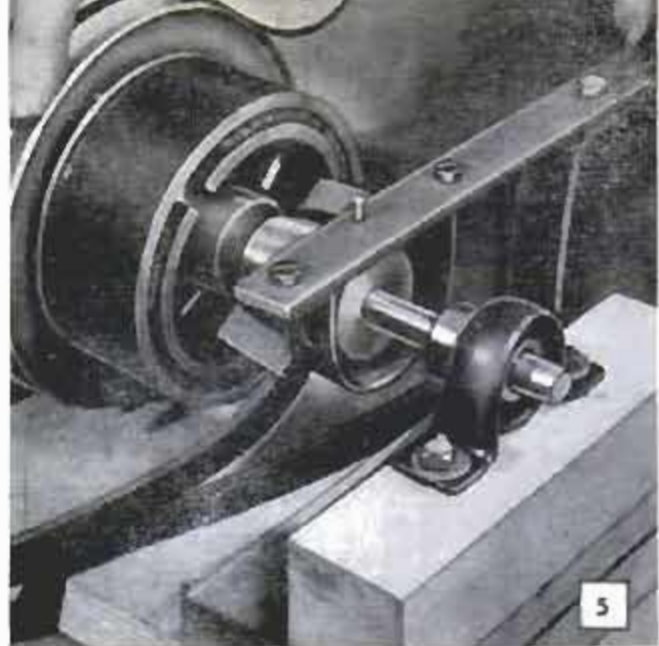



(shoe and split ring, D) is riveted to the hub flange, the rivet ends being peened over on washers to permit each shoe free movement in and out as the clutch is engaged and released.

The hub, Figs. 6 and 8, can be made by turning to outside dimensions and then filing in the grooves, but it is best to have it milled to final shape. Note that the hub is shouldered at the big end to take the flange. The latter is pinned (with two round pins) to the hub. The pins are held in place with screws and retaining washers as in the detail, Fig. 6. Main parts of the clutch mechanism are detailed in Figs. 8 to 12 inclusive. The base, Fig. 6, is dimensioned as 7 x 11 in., but its general construction and the height of the riser blocks will depend to some extent on the application.

In an assembly of this type some hand fitting will be necessary. As an example, note in Figs. 6 and 9 that the arm pivots are fitted with locknuts for adjustment. This adjustment usually can be determined with fair accuracy when the brake-shoe unit has been assembled to the stage pictured in Fig. 4. The control ring, Figs. 6 and 11, should be hand-fitted as it is necessary that it be shimmed to just the right amount of clearance. If the ring is fitted loosely, it may tend to bind. Although not detailed, it's a good idea to provide small oilholes in the hub of the pulley A, the clutch hub and also in the control ring. A drop or two of oil placed in the oilholes occasionally will cause the clutch to operate somewhat more smoothly and, equally important, will help to reduce wear on the parts when the work requires frequent starting and stopping with comparatively long idling periods. As pictured, the clutch operated smoothly at speeds up to 500 r.p.m. Higher speeds are not advisable.

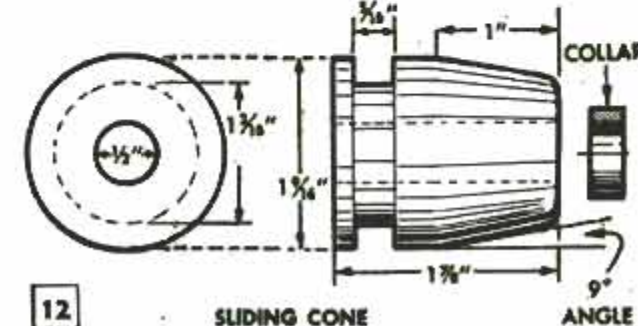
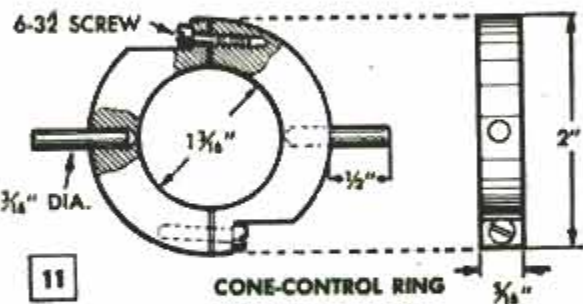
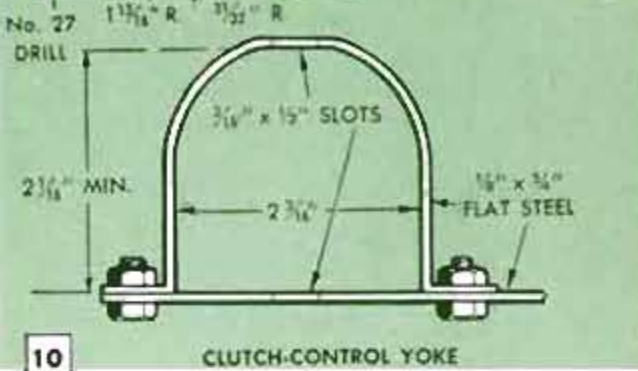
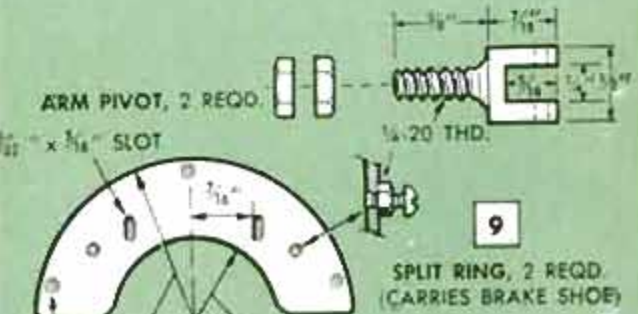
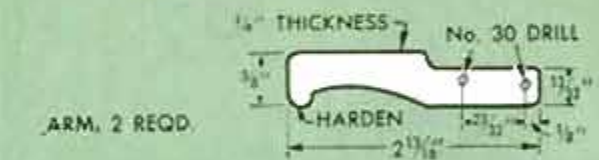
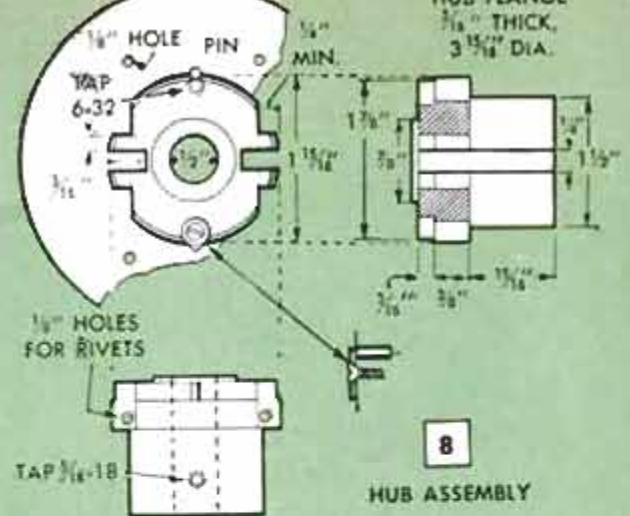

SHOPPING FOR TOOLS

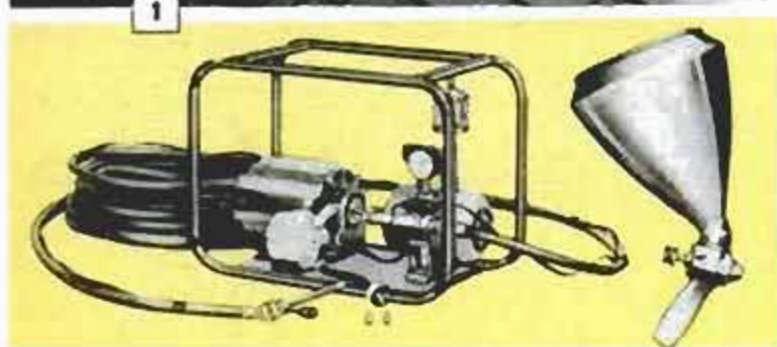

1. SPRAY GUN is especially designed for application of new roof coatings. Tank, or hopper, holds 2 gal. of material which gives a coverage of 150 to 200 sq. ft. of roof area. Hopper is attached to gun at an angle so that unit can be held in comfortable operating position. Interchangeable orifices are available
QUIKspray, Inc., P. O. Box 327, Port Clinton, Ohio

2. DYE PENETRANT is now available in nonflammable and high flash-point formulas in pressurized containers for convenient application. Reveals cracks, seams and degree of porosity in almost any solid material. Used to test machine parts assembled or disassembled. Penetrant is also available in bulk
Magnaflex Corp., 7300 Lawrence Ave., Chicago 31

3. HOLE SAW cuts clean, round holes 2 $\frac{3}{4}$ in. deep through wooden floors and partitions for installing pipe. Saws a hole 3 $\frac{1}{2}$ in. in diameter, has $\frac{1}{2}$ -in. dia. shank for use with $\frac{1}{2}$ -in. portable electric drills. Large knockout slots permit removal of waste after sawing through. Teeth have wide set for clearance
H. M. Starbuck & Sons, Inc.,
P. O. Box 1318, Hartford 1, Conn.

4. RADIAL SAW UNIT utilizes two radial saw heads and a specially designed power feed to do multiple ripping, tongue and groove and molding operations and various combinations of these operations in one pass through the machine. Opens new fields in production for small commercial woodworking shops
Inckwell Mfg. Co., Delta Power Tool Div.,
400 N. Lexington Ave., Pittsburgh 8, Pa.

5. ROOF-FRAMING CALCULATOR does all the calculations necessary in laying out the average pitched roof. Determines lengths and plumb and level or side cuts for common rafters, hip and valley rafters, gable cripples and jack rafters, collar beams, sheathing
Gordon L. Joseph & Associates, Q & C Bldg.,
New Orleans 12, La.

6. DRILL-PRESS VISE is made for heavy work. Width of jaws is 4 in. and depth 2 in. Base size over-all is 6 $\frac{1}{4}$ x 11 $\frac{1}{8}$ in. Weighs 18 lb. Four bolt lugs, two on each side of base, permit the vise to be bolted to drill-press table or to the milling machine table
Alva Allen Industries, 1001-15 N. 3rd St. Clinton, Mo.

7. SNUBBER, or lock, holds rope up to $\frac{3}{8}$ in. in diameter at any point after the load is hoisted to desired height. Just swing the taut rope slightly outward to lock. Release with a straight downward pull. Holds weight up to 750 lb. Weighs only 9 oz.
McManus Mfg. Co., 7543 Santa Monica Blvd.,
Los Angeles 40, Calif.

8. POWER SCREWDRIVER ATTACHMENT for portable drills has an industrial-type clutch that will not slip when driving large screws in hardwood. Clutch disengages automatically when screw is driven home. Special holder prevents bit slipping out of screw slot
Arrow Metal Products Co., 421 W. 203 St., New York City 34

9. MITER TRIMMER cuts with a shearing action that produces a glass-smooth surface on miters and square cuts across the grain of both hard and soft woods. Hand lever operates a rack-and-pinion gear which actuates the cutters and gives a positive control
Dosh Mfg. Co., Thornton, Delaware Co., Pa.

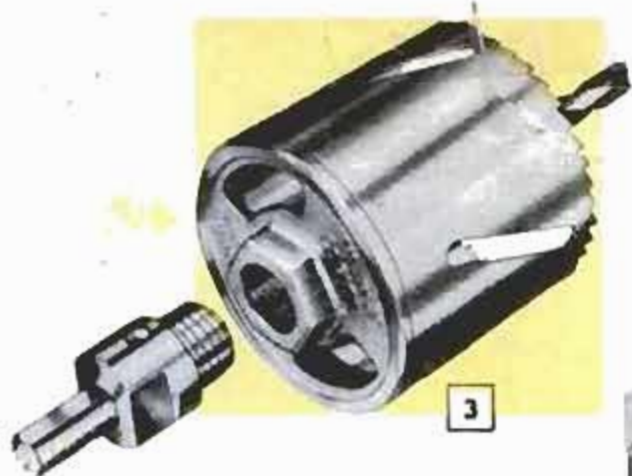

3

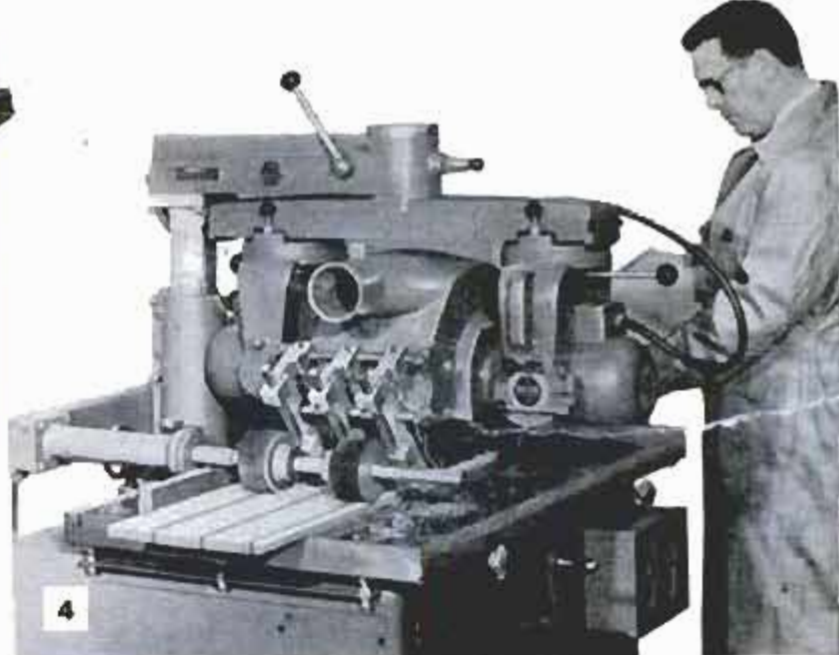

4



5

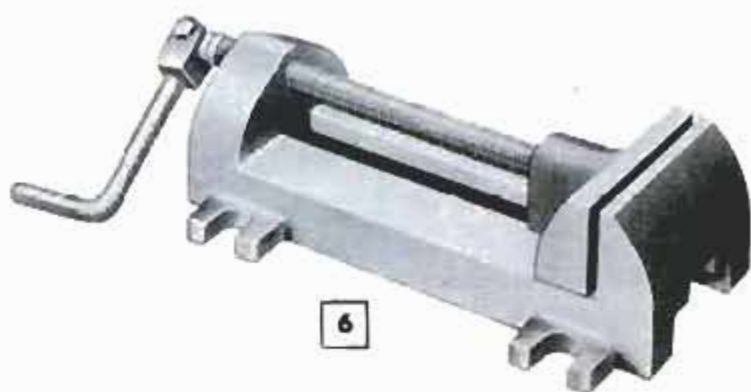

6



7

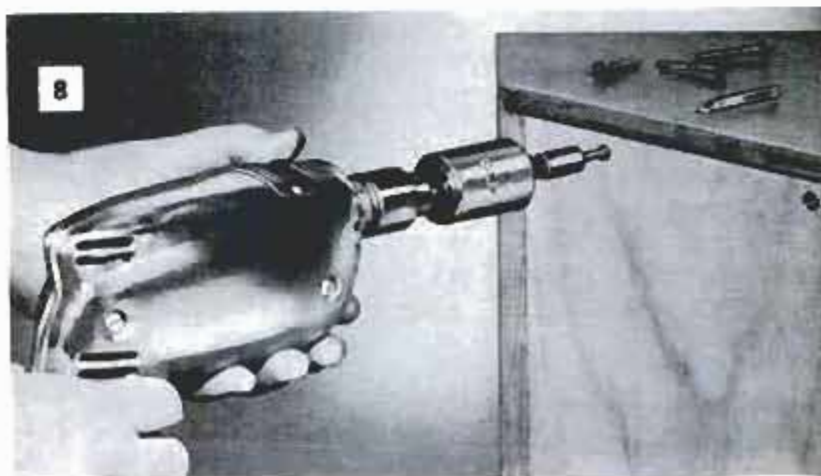

8

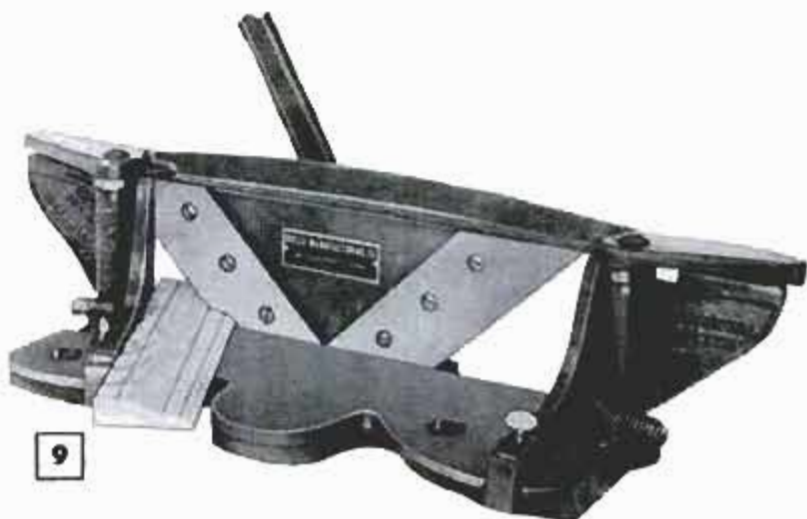

9



10. SHEET-METAL FASTENING MACHINE forms a rigid button-and-slot lock joint in sheet metal up to 18-ga. Each fastening is made with a single stroke of the control lever. Machine operates like an arbor press. Can be bolted in any position for feeding work and adjusting for spacing, edge alignment
Bar-Brook Mfg. Co., Inc., 6135 Linwood Ave., Shreveport, La.

11. PANCAKE MOTOR for space-cramped applications on machines, fans and similar equipment, takes about 60 percent less space than standard motors of equal power output. Motor is designed for flange mounting and for normal operating conditions is built in open dripproof type. Enclosed types available
The Louis Allis Co., 427 E. Stewart Ave., Milwaukee 1, Wis.

12. CLEANERS for cutting-torch tips are made 2 3/4 in. long to go all the way through the tip for a quick, thorough cleaning job. A complete set of 12 covers sizes 48 to 75 inclusive. Set comes in a plastic container of sufficient rigidity to prevent its being crushed when carried in toolkit or stored in a drawer
Easy Tip, Box 689, Columbia, Mo.

13. SANDING BLOCK is available with tungsten-carbide inserts that cut fast with light pressure, won't wear down when used on any surface on which ordinary sandpaper is normally used. Abrasive surface of the fine and coarse inserts is easily cleaned with a paint solvent or a wire brush. Block is of birch
Major Products Co., 17342 Kvergreen Rd., Detroit 19

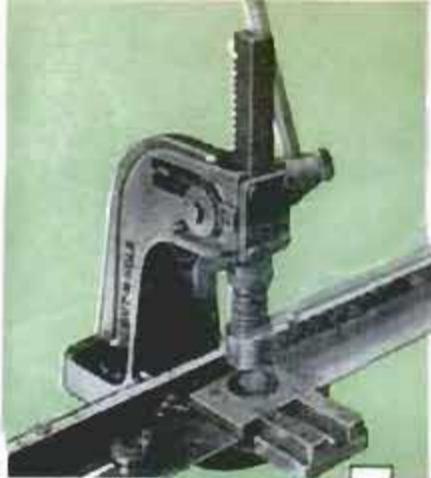

10



11



12

14. METAL BENDER takes flat steel and wrought iron from 1/16 to 3/32 in. thickness and from 1/4 to 1/2 in. wide. Consists of a flat-steel base, which is locked in the bench vise, on which are mounted four fixed mandrels of varying radii for controlled bending
Chas. W. Barnes Co., 31630 Lake Rd., Bay Village, Ohio

15. PAIL HOLDER will be appreciated by painters and window washers when working from a ladder. Locks solidly onto right or left ladder rail. Holds the pail firmly within easy reach. Adjusts to ladder angle to keep pail level and prevent spilling contents
Lockhart Mfg. Corp., 6350 E. Davidson St., Detroit, Mich.

16. PAINT MIXER for portable electric drills and hand drills operates on a new principle to bring paint to brushing consistency quickly without spattering. Secret of thorough, fast mixing of paint is in the manner in which mixer circulates liquid and pigments
Gunver Mfg. Co. Manchester, Conn.

17. INDIVIDUAL RADIUS GAUGES are made from stainless steel, each one having five gauging edges for testing both convex and concave radii. Available in three sets, one 1/32 to 17/64 in. by 64ths; one 9/32 to 1/2 in. by 32nds and a set combining both ranges
Brown & Sharpe Mfg. Co., Providence, R. I.

18. ROTARY PLANER HEAD does speedy, accurate surfacing of hard and soft woods when mounted in drill press and driven at speeds up to 5000 r.p.m. Specially designed cutters eliminate danger of kick-back. Widely used in woodworking and pattern shops
Kint-Collins Co., 12653 Elmwood Ave., Cleveland 11, Ohio

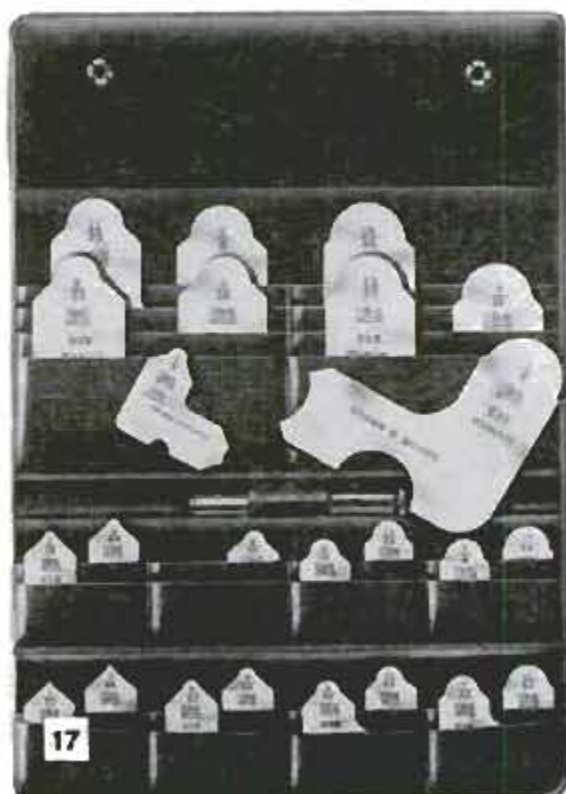
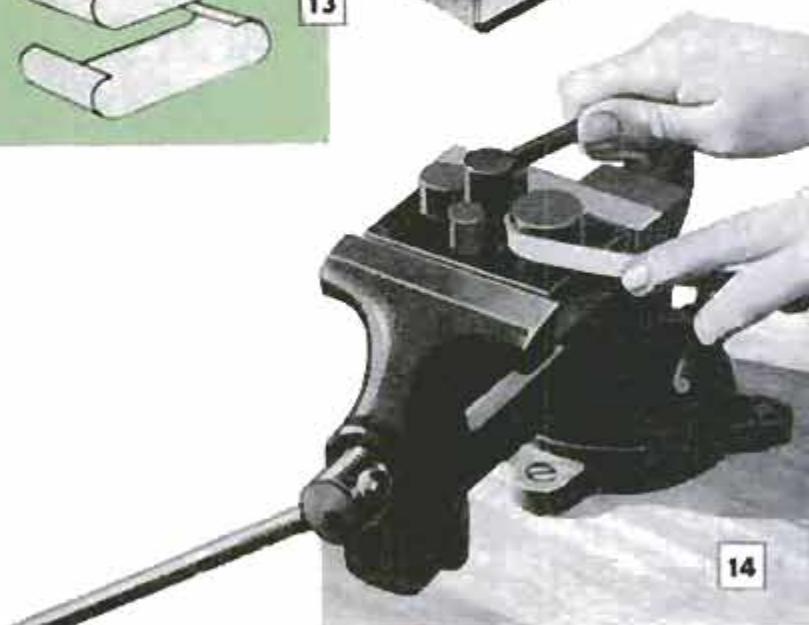
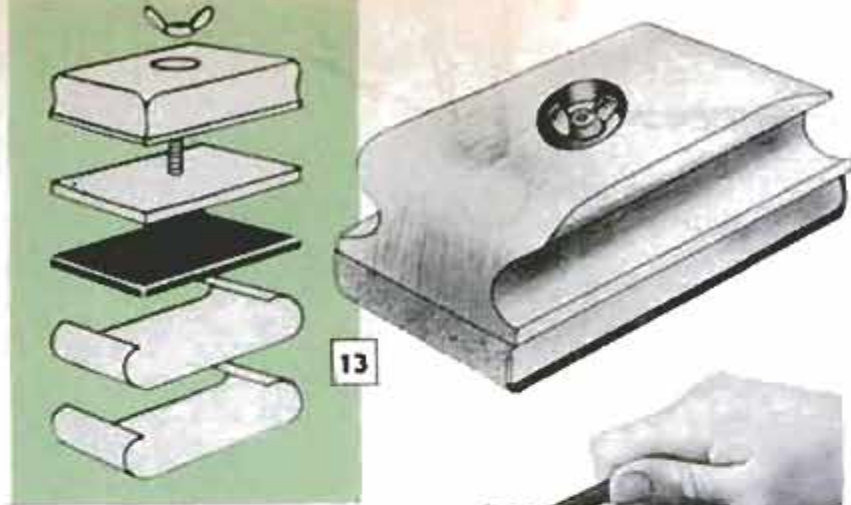

Cutting Edges of Bit Modified to Produce Broken Brass Chips



To avoid producing brass-drilling chips in sharp, brittle ribbon form that frequently cause painful cuts when handled, one home craftsman modified the cutting edges on the bits used for drilling such material as shown in the details. All such work should be done on a fine-grit grinding wheel, as when sharpening a drill bit. To do this, first grind the cutting surface on the bit point to the desired angle for brass drilling (usually a wider angle than when it is used for drilling steel) and then carefully grind a new cutting edge on each side to a zero or slightly less than zero rake. This means that the angle formed by the new cutting edge and the surface of the bit point will approximate 90 deg. Be sure not to grind away more than half of the land width to assure accurate hole size.

Broken Hacksaw Blade Repaired Temporarily to Finish Job



If you break a hacksaw blade half-way through a job, and another one is not available, the broken blade can be "patched together" to permit completing the work. Shorten the hacksaw frame enough to allow the broken pieces of the blade to overlap about $\frac{1}{2}$ in. and clamp them together with a C-clamp. In case a clamp is not available, use a couple of $\frac{1}{4}$ -in. nuts and bolts. The edges of the bolt heads and the nuts are clamped over the edges of the blade sections by drawing them up tight. One nut and bolt is used on the lower edge, and one on the upper edge of the blade. When cutting with the clamped blade, take short strokes to avoid striking the doubled portion of the blade against the work.

Fred Haitz, Sioux City, Iowa.

Jig Mounted in Vise Facilitates Welding Work at Desired Angle

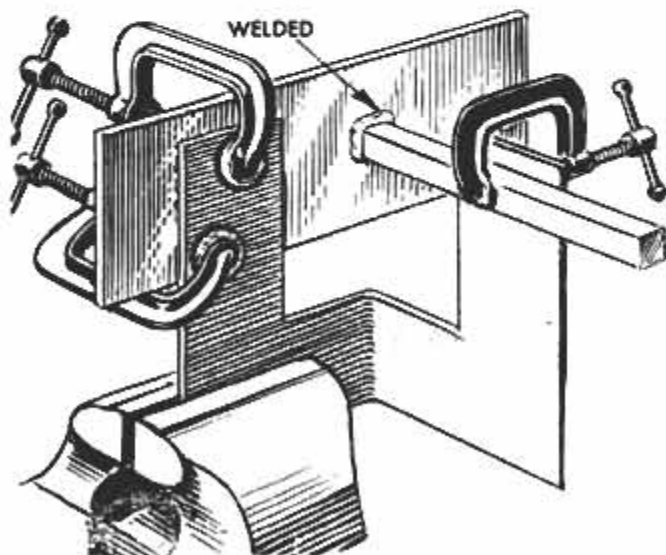

This welding jig provides an easy way of holding pieces of work that are to be welded at right angles to one another. To make the jig, cut out a square from one side of a piece of heavy-gauge sheet metal and bend the two legs formed by the cutout so that they are at right angles to each other. The jig then is placed in a vise and the workpieces are positioned and held on the legs with C-clamps as shown in the drawing at left. Also, the legs of the jig can be bent to form many other angles and positions to facilitate welding pieces of a job at the exact angle or location required by the design.

Albert Ujcic, Mexico City, Mexico.

Radio Television Electronics



Simple Accessories Provide

MORE WORK FOR THE VTVM

By Otto Fried

MODERN ELECTRONICS is a complicated business. The electronics technician working in a well-equipped shop may have access to a dozen different test instruments to help him in his everyday

Schematic wiring diagram of VTVM preamplifier. Unit increases VTVM sensitivity by a factor of 10

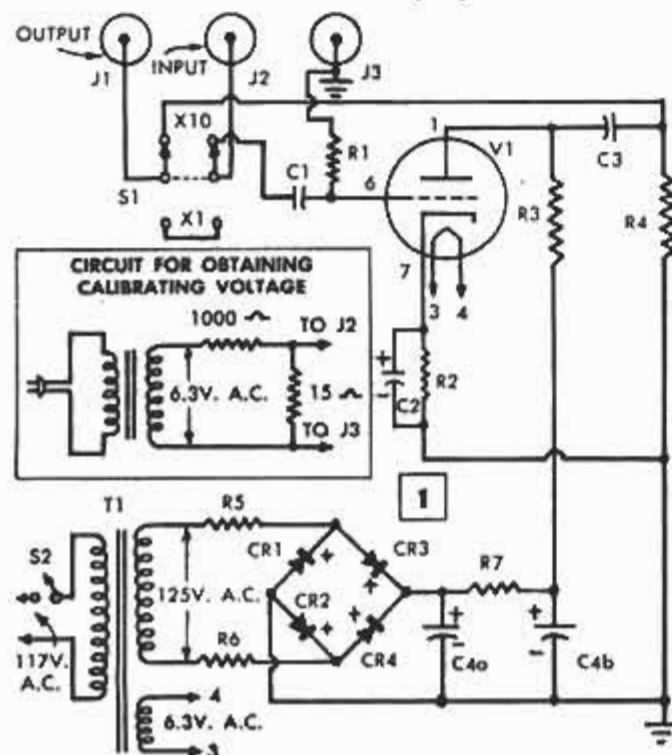

work. The home experimenter or hobbyist, however, is often limited only to a vacuum-tube volt-ohmmeter, VTVM for short, with which to check or repair electronic circuits. Yet, with a few easy-to-build accessories and simple modifications, the VTVM can handle a variety of jobs normally calling for the use of separate test instruments.

One of these jobs is the measurement of extremely small a.c. voltages. While most modern VTVMs provide accurate indications for signals as low as 100 millivolts (.1 volt), below this value the needle-swing is too small for any degree of accuracy. In high-fidelity work, where voltages on the order of a few millivolts are often encountered, the VTVM needs a little help.

LIST OF MATERIALS FOR PREAMPLIFIER

RESISTORS (all $\frac{1}{2}$ -watt $\pm 10\%$): R1=2.2 meg-ohms; R2=4700; R3=27,000; R4=270,000; R5, R6=47; R7=47,000.

CAPACITORS: C1=.05 mfd./400-v.; C2=10 mfd./10-v. electrolytic; C3=.1 mfd./200-v.; C4a, C4b=80-40 mfd./150-v electrolytic.

MISCELLANEOUS: V1=6C4 tube; CR1, CR2, CR3, CR4=sel. rectifier, 150-v./20ma.; S1=d.p.d.t. switch; S2=s.p.s.t. switch; J1, J2, J3=binding post; T1=power transformer, sec. windings—125v./15ma. and 6.3v./6a.; chassis or case, $6\frac{1}{4} \times 3\frac{3}{4} \times 2$ in.; assorted screws, nuts, terminal strips; line cord.



2

Preamplifier is connected between signal source and VTVOM. Signal is measured with separate test leads

Fig. 1 shows the schematic diagram of a simple preamplifier which increases VTVOM sensitivity by a factor of 10. Its use permits voltage measurements from magnetic phono cartridges, tape heads or low-level generators whose signals are too small to activate the normal VTVOM meter movement.

The circuit is that of a conventional r-c coupled amplifier having a high input resistance and a flat frequency response over the entire audio range. A bridge-type rectifier employed in the power supply permits the use of an inexpensive power transformer and reduces power-supply ripple to a minimum. Switch S1 is a feed-through switch which permits the preamplifier to remain connected between the VTVOM and the signal under test even for normal voltage measurements. With this switch in the X1 position, any signal applied to input jack J1 is transferred directly to output jack J3 without being amplified. With the switch in the X10 position, the preamplifier

fier employed in the power supply permits the use of an inexpensive power transformer and reduces power-supply ripple to a minimum. Switch S1 is a feed-through switch which permits the preamplifier to remain connected between the VTVOM and the signal under test even for normal voltage measurements. With this switch in the X1 position, any signal applied to input jack J1 is transferred directly to output jack J3 without being amplified. With the switch in the X10 position, the preamplifier

Schematic diagram and photographs of simple capacitor checker. Bottom photo shows wiring simplicity

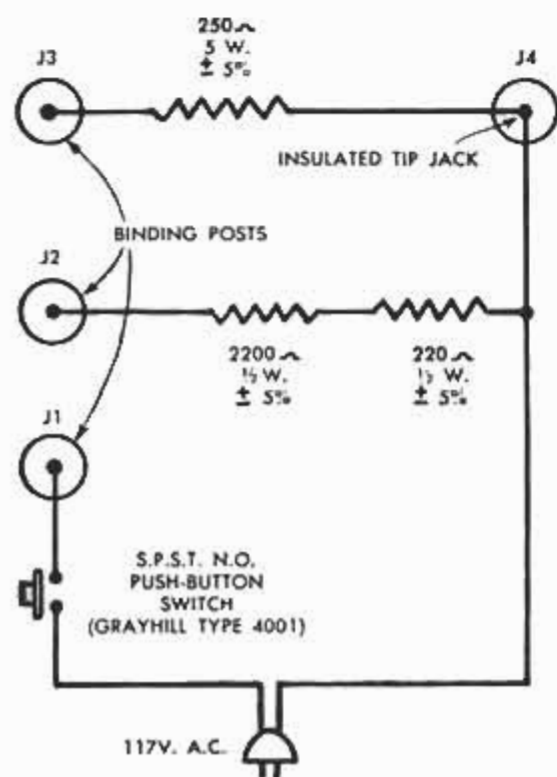

3

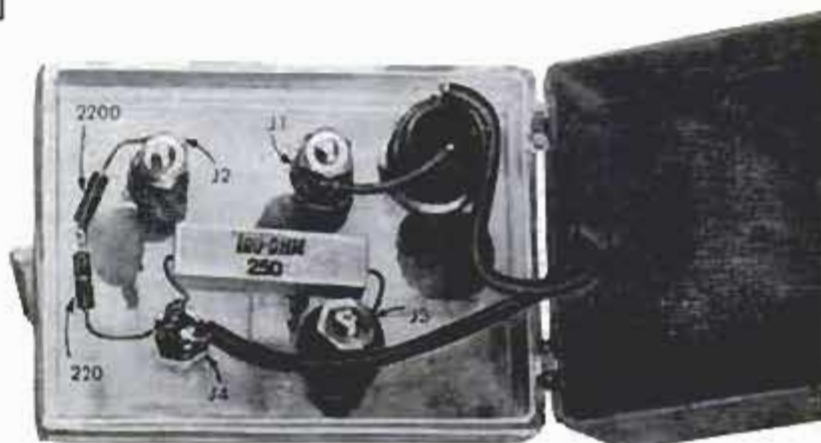
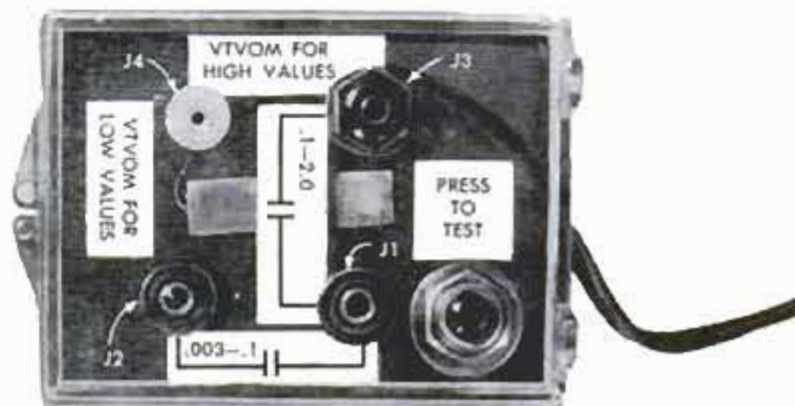

NOTE: UNIT SHOULD BE HOUSED IN A PLASTIC BOX

TABLE I

CAPACITY	VTVOM PROBE CONNECTIONS	VOLTAGE READING
1.5 mfd.	J3—J4	15 VAC
1.0 mfd.	J3—J4	10 VAC
.5 mfd.	J3—J4	5 VAC
.25 mfd.	J3—J4	2.5 VAC
.1 mfd.	J3—J4	1.0 VAC
.05 mfd.	J2—J4	5.0 VAC
.01 mfd.	J2—J4	1.0 VAC
.005 mfd.	J2—J4	.5 VAC
.003 mfd.	J2—J4	.3 VAC
.0003 mfd.	J2—J4	.03 VAC

provides an amplification factor of 10.

The small amount of power required for the preamplifier may be obtained directly from the power supply of the VTVOM, if the latter contains a well-filtered source of B+ between 70 and 120 volts. The preamplifier could then be installed as a permanent part of the VTVOM and its construction cost would be cut by more than 50% due to the elimination of a separate power supply. If the VTVOM power supply is not well filtered, a portion of the preamplifier's filter section, R7 and C4b, should be retained. R7 should be connected to the cathode of the VTVOM rectifier and its value should be reduced to approximately 10,000 ohms.

With the parts values indicated, an accuracy of better than 10% can be expected. For greater accuracy, resistor R2 should be replaced with a 10,000 ohm, linear-taper potentiometer, connected as a rheostat, so that the circuit can be accurately calibrated.

A low-voltage calibrating signal can be obtained from a voltage divider connected across the 6.3-v. filament winding of the power transformer, as shown in Fig. 1. With the VTVOM and preamplifier set up as in Fig. 2, measure the voltage across the 15-ohm resistor with the preamplifier switch, S1, in X1 position. Then, with S1 in the X10 position, adjust the calibrating potentiometer until the same test voltage provides a meter reading of 10 times the original value.

The setup in Fig. 2 is used for all a.c.-voltage measurements. The preamplifier switch, S1, should be set to the X10 position only when the voltage under test is too small to be measured accurately on the lowest VTVOM scale without preamplification.

About two dollars' worth of parts, most of which are probably available from your "junk box," is all that is needed to convert your VTVOM into a direct-reading capacity meter. With this simple accessory, see Fig. 3, you can measure the values of all nonelectrolytic capacitors between .003 and 2 mfd. When the VTVOM is used in conjunction with the previously described preamplifier, values as low as .0003 mfd. can be accurately measured.

The operation of the capacitor checker is simple. The unknown capacitor and a series resistor form a voltage divider across the 117-volt a.c. line. Compared to the capacitive reactance, the resistance value is so low that it contributes almost nothing to the total circuit impedance. The current in the circuit, therefore, depends entirely on the value of capacitive reactance.

Current-flow through the resistor, however, does produce an a.c. voltage drop across this unit which can easily be calculated and measured with the VTVOM.

In actual use, small capacitors ranging from .0003 (if the preamplifier is employed) to .1 mfd. are connected between jack J1 and J2, and the a.c. voltage is measured between J2 and J4. Larger capacitors, from .1 to 2 mfd., are connected between J1 and J3 and voltages are measured between J3 and J4. The relationship between typical capacitor values and VTVOM readings are shown in table 1.

To eliminate any possibility of shock, a normally open, push-button switch, S1, is inserted between the a.c. line and J1.

A few additional parts will permit any VTVOM to measure d.c. Parts can usually be mounted inside VTVOM case as shown below

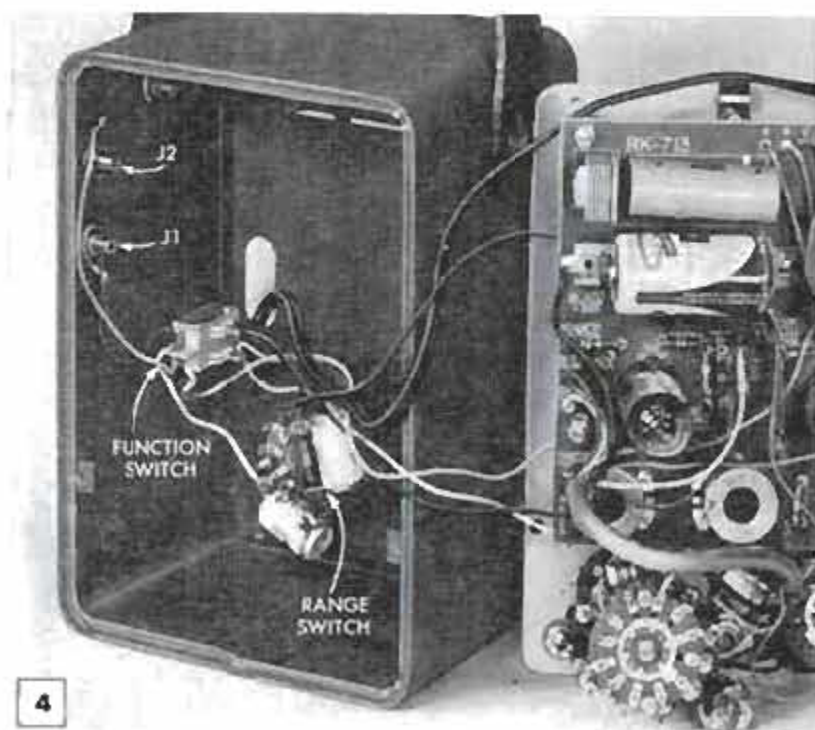

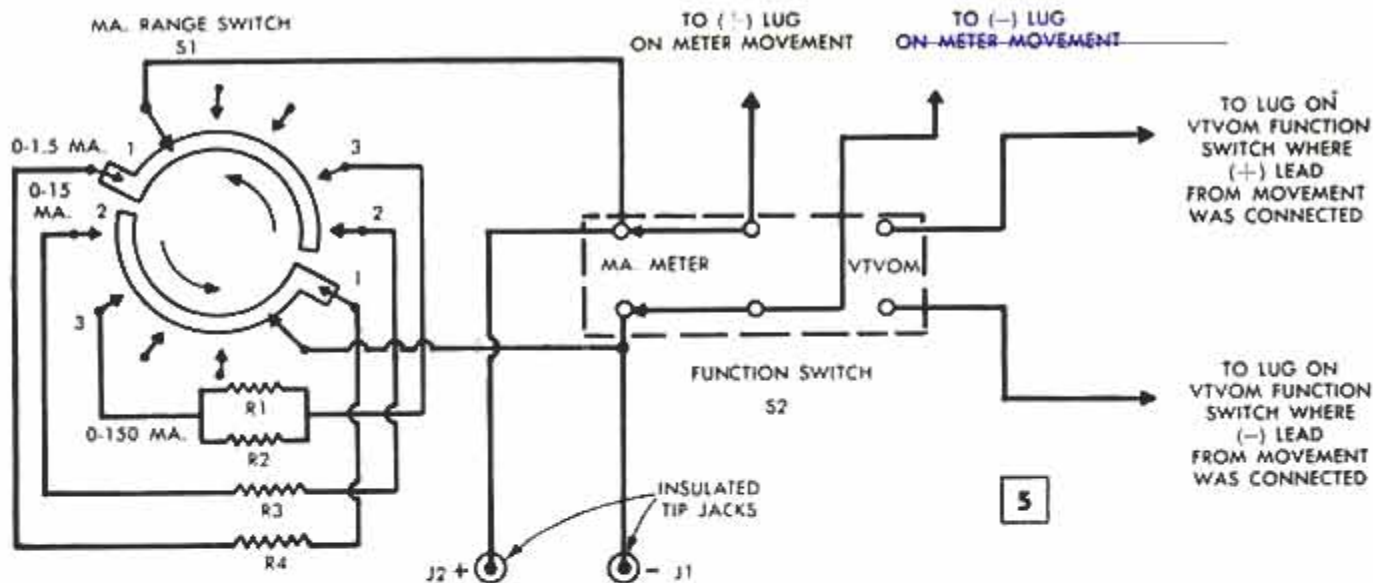

Schematic diagram shows simple wiring, parts requirements for adding current-measuring function to VTVOM

LIST OF MATERIALS FOR MA. FUNCTION

S1=2 pole-5 position rotary switch, (shorting type); S2=d.p.d.t. toggle switch; R1=2.2 ohms, $\frac{1}{2}$ -watt; R2=5.1 ohms, $\frac{1}{2}$ -watt; R3=15 ohms, $\frac{1}{2}$ -watt; R4=150 ohms, $\frac{1}{2}$ -watt; J1, J2=insulated-tip jacks

time-consuming for ordinary servicing or design work. Now, however, current measurements are routine procedures in many instances involving transistor circuits. With a few simple wiring changes and additions, and some easy calculations, you can modify your VTVOM to add this useful function to its range of operation.

For current measurements, a couple of

(Continued to page 256)

Unless this switch is pressed and held down, no voltage is applied to the binding posts. As a second precaution, all parts should be mounted in a plastic or wooden box, as illustrated in Fig. 3.

WARNING: Capacitors above .1 mfd. often retain a charge for a considerable length of time. It is a good idea to discharge them, by shorting their pigtail leads, after each test.

Adding a D.C. Milliampere Function

Until the invention of the transistor, d.c. measurements were considered much too

LIST OF MATERIALS FOR SEMICONDUCTOR CHECKER

R1=10,000 ohm potentiometer; R2, R3=220K, $\frac{1}{2}$ -w.; R4=1500 ohms, $\frac{1}{2}$ -w.; J1=insulated binding post; J2=insulated pin jack; J3=double phone jack; S1=d.p.d.t. spring-return slide switch; Stackpole SS-6; B=22 $\frac{1}{2}$ -v. battery, Burgess U-15; transistor sockets (2); knob for pot.; plastic case, 3 x 4 x 1 $\frac{1}{2}$ -in.; aluminum panel, 3 x 4-in.; battery holder; assorted nuts, screws and hookup wire

Schematic diagram and photo of semiconductor checker. Parts can be housed in 3 x 4 x 1 $\frac{1}{2}$ -in. plastic case

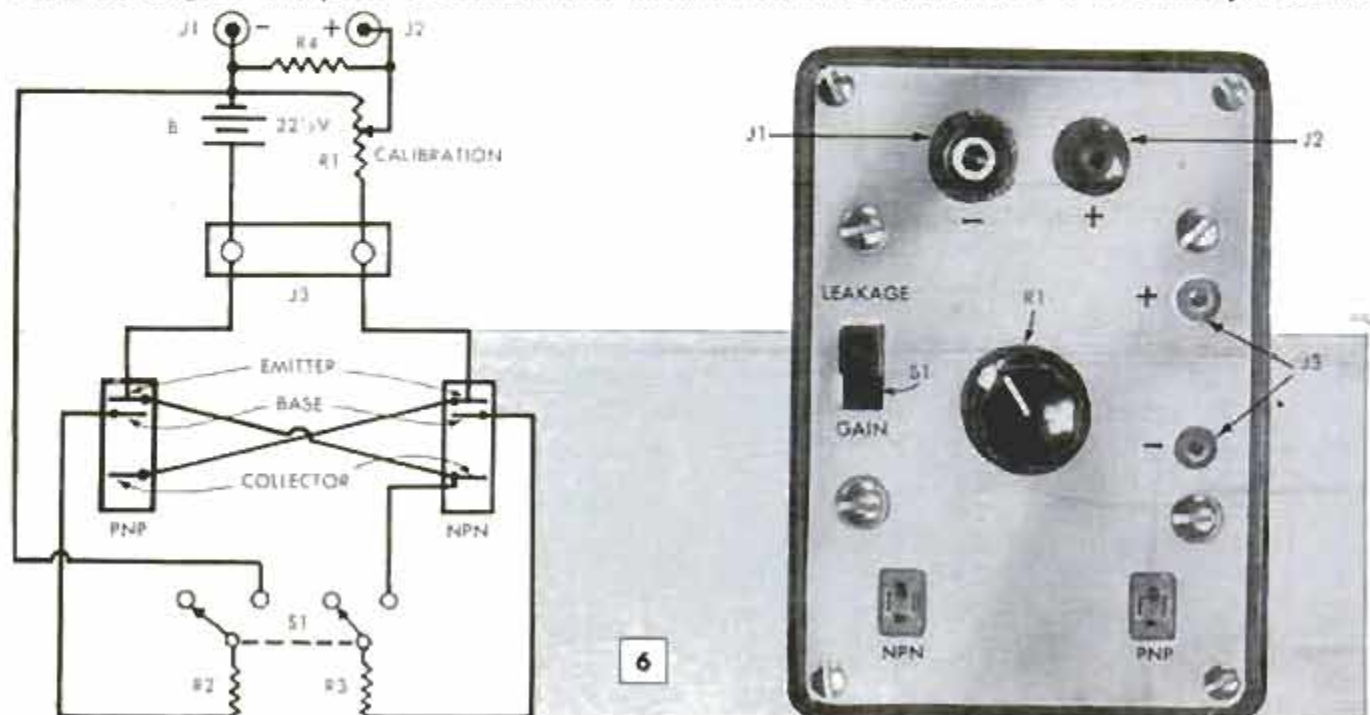



Hydroplane racing proves that engines do their *best* with Champion spark plugs. The last 13 Gold Cup winners have been powered by Champions.

Q. Why do 9 out of 10 powerboat winners use Champion spark plugs?

A. These experts know spark plugs can win or lose a race. And Champions deliver the full-firing spark they need to win. For performance like this in your car, insist on Champions.



CHAMPION

World's favorite spark plug—engineered for every car built by Ford, General Motors, Chrysler, American Motors, Studebaker-Packard and every major foreign maker

DIAMALLOY TOOLS . . .

fine as jewels



*"There is nothing finer
than a DIAMOND"*

DIAMOND

In the kit of the skilled mechanic or the enthusiastic home craftsman, tools bearing the famous Diamond trademarks indicate the discerning workman . . . one who appreciates and enjoys using the finest. Diamond Tools are made by makers of fine forgings for fifty years. Sold at your favorite hardware store.

DIAMOND TOOL

and Horseshoe Co.

DULUTH, MINNESOTA



TORONTO, ONTARIO

EST. 1908

Clinic for Homemakers



As a service to our readers in solving the hundreds of problems pertaining to a home—inside or out—the editors of *Popular Mechanics* invite you to present your problems to The Clinic Editor for help and advice. Address your questions to The Clinic Editor, *Popular Mechanics Magazine*, 200 East Ontario Street, Chicago 11, Ill.



Cleaning White Tile

Q—The ceramic-tile floor in my bathroom is discolored after many years of use. Dirt seems to be embedded in the surface of both tile and joints and scrubbing with a strong cleaning solution appears to have little, if any, effect on it. I tried rubbing with the fine side of an oilstone and the results were mildly en-

couraging but the method too slow. Is there any other way? — T. L., Fla.

A—There are several methods of cleaning tile, but where the tile are old and have seen a lot of service some of these methods do not always prove satisfactory. One method that is quite generally reliable is to make a paste, about the consistency of thick cream, by mixing white portland cement and water. Spread this mixture on the tile with a brush or cloth, allow to stand for a few minutes and then rub with a coarse cloth or a piece of burlap. When the cement film thickens, dip the cloth in water and continue rubbing until all loose material has been picked up by the cloth. Immediately dampen a clean cloth and wipe the surface, then go over it with a dry cloth. Used in this way the cement acts both as a cleaner and as a filler which works into the worn tiles and joints and brightens the floor quite effectively.



Installing Sump Pump

Q—My plumber is to install a sump pump in my basement. He says that the sump, a large bell-end tile, should be installed with the top flush with the floor and that a tile should lead from the floor drain to the sump, a distance of about 18 in. He says this will prevent flooding of

the floor should water back from the downspouts. I do not see how. Also, he plans to install the tile with a gravel bottom rather than sealing with concrete. Why? — E. N., N. J.

A—When your plumber says he plans to install tile from the floor drain to the sump "to prevent flooding of the floor should water back from the downspouts" he probably is thinking of the possibility of the drains from the downspouts becoming clogged. If the floor drains are connected to the downspout drains (a common arrangement in older homes) then water from the downspouts

(Continued to page 252)



Paneling in random-plank style is 4' x 8' Weldwood Prefinished Walnut V-Plank®.

You can panel a room like this in a weekend . . .

Weldwood prefinished wood panels give you ready-made beauty—save time and fuss—as little as \$75 for a 12' x 8' wall.

You can panel a lovely room like this in a weekend even with no previous experience. Weldwood *prefinished* wood panels come in a wide range of choice woods, prefinished and ready to brighten your home. Weldwood's exclusive 14-step lacquer process produces a true fine furniture finish so luxurious you can actually feel the difference. Saves you time and fuss in installing, too. What's

more, it's a stain- and smear-resistant finish that's easy to keep clean through the years.

If you prefer, you can buy Weldwood Paneling *unfinished* at lower cost. Use Weldwood Satinlac® Lightener as a first coat to prevent the darkening or "wet" look usual when new wood is finished. And for a lustrous, *hand-rubbed* look with half the effort use Weldwood Satinlac®. Protects wood and brings out its beauty. See the more than 70 types of finishes of Weldwood paneling at your Weldwood lumber dealer's or at any of our 115 offices in U. S. and Canada.



No nail holes mar your handsome wood panels when you use Weldwood Contact Cement. Gives a permanent bond to furring strips. No clamping is necessary.

WELDWOOD® PANELING

AND OTHER WELDWOOD PRODUCTS FOR HOME AND INDUSTRY.

SEND THIS COUPON TO GET DETAILS!

NEW PREFINISHED PANELING BOOK PM 1-59
United States Plywood Corporation
Box 61, New York 46, N. Y.

Please send me a copy of the new full-color folder, "Presenting Weldwood Prefinished Paneling for Fine Interiors," which beautifully illustrates in color the 14 Weldwood prefinished woods and gives complete installation details. I enclose 10¢.

Name.....
 Street.....
 City..... State.....

would likely back into the basement should the downspout drains become clogged at some point below grade. By laying a tile from the floor drain to the sump under the floor, water that backs from the drains will be taken out by the pump before it reaches the floor level. It's a fairly common practice, especially when installing a submersible pump, to partially fill the sump with coarse gravel rather than concrete. This permits water under the floor to seep into the sump. Your plumber undoubtedly has this in mind when he recommends installing the sump in this way.



Applying Gold Leaf

Q—How does one apply gold leaf, such as is so often seen on old picture frames and other ornamental objects? I'd like to learn the procedure and I have several old picture frames to practice on. These are small and quite plain, and two have liners which have apparently been coated with gold paint. Can you

outline a proper procedure for me? — E. C., Vt.

A—We hesitate to recommend that you attempt to apply gold leaf, not that it is a difficult process, but rather that it requires such close attention to detail that results of one's first efforts are likely to be disappointing. Space will not permit a complete outline of the methods of gilding with gold leaf, but if you are determined to learn the general procedure then perhaps the following suggestions will be of help to you. Preparation of the surface has everything to do with the success of the job. Clean off paint (with remover) and grime to the bare wood. Sand smooth. Then coat the surfaces to be gilded with a mixture of glue and whiting. When this is dry, sand smooth and finish with very fine steel wool to a glass-smooth surface. Coat the surface with a prepared gold size and allow to stand until the size becomes rather stiffly tacky. Gold leaf comes in a "book" containing a number of gold leaves placed between specially prepared sheets of paper to which it will not adhere readily. Don't attempt to pick up the leaf with your fingers. Cut it into small pieces with a razor blade by placing the edge on the leaf and pressing down lightly. Gilders use a special brush, usually referred to as a tip, to pick up gold leaf, but a clean camel's-hair brush is a fairly good substitute. Stroke the brush briskly on a piece of fabric, place the bristles over the piece of leaf, lift it and then tip it onto the area which has been sized. If the size has been allowed to reach the correct degree of tackiness the leaf will adhere readily. Immediately place a piece of waxed paper over the applied leaf and press it very lightly into contact. Repeat the process, tipping the second leaf onto the sized surface so that one edge slightly overlaps that previously applied. Portions of the leaf that overlap the sized area can be removed by brushing lightly.

Finishing Log Siding

Q—I plan to build a summer home to be finished on the outside with precut log siding. I want to preserve the natural color of the siding; don't want it to turn dark on exposure to weathering like some other log-siding jobs I've seen. Also, want to treat the wood to prevent damage by insects. What do I use?—O. W., Minn.

A—If you have visualized the wood of the log siding remaining in the natural color indefinitely, you are likely to be disappointed. Even though you use a specially prepared log-siding finish, the wood itself will darken somewhat in time, due mainly to the effects of light and the variations in temperature and humidity. The wood will age slowly under any nonpigmented finish. However, the color variations intensified in this process are not at all objectionable, in fact, are quite attractive. When using a prepared finishing material be sure to follow the manufacturer's instructions in all details.

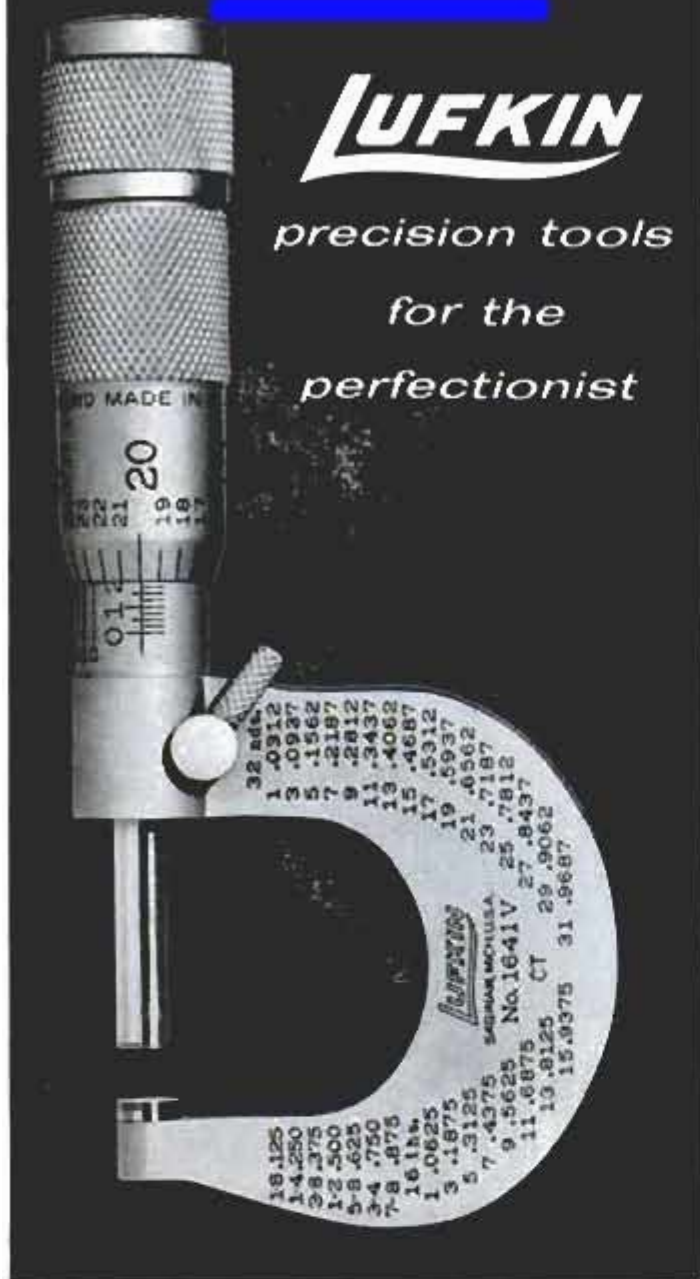

LUFKIN
precision tools
for the
perfectionist

EASIER TO READ

Bigger Barrel. Graduations are farther apart and numbers are larger for fast, accurate reading.

Exclusive Cam Lock. A flick of your thumb and you lock the setting. Prevents costly errors in reading.

Simple Adjustment. Reading line stays in original position. Makes it easier to keep your mike accurate.

Always buy from your distributor



THE **LUFKIN** RULE COMPANY

TAPES • RULES • PRECISION TOOLS
SAGINAW, MICH. • MIDDLETOWN, N. Y. • BARRIE, ONT.

What kind of a car do you want, exactly? Chevrolet has a choice of nine engines, five transmissions, two suspension systems, regular or Positraction rear axles, special cams, two air-conditioning systems, even Fuel Injection—the list of extra-cost options is tremendous. But what it means is that you can virtually design your own car, tailored precisely to your needs. Here's just one example:

“I ‘built’ my Chevy for top economy . . .
and extra easy running at 300 miles a day.”



“As a traveling salesman with a big Midwest territory I rack off about 300 miles a day—and, boy, how I love gas economy. But I like all the comfort I can get, too.

“I used to wish I could design my own car, until this year. That’s when my on-the-ball dealer friend showed me how I could ‘build’ just the right car out of Chevy’s terrific list of options. Look what I got:

“I picked a Biscayne two-door, ‘cause I pay for my own auto and that’s right at the base of the price list. A Hi-Thrift 6 engine—that’s the world’s best workhorse. And Overdrive; with that high ratio you can just whisper down the road at good fast cruising speeds. No strain, hour after hour . . .

and that gas needle *never* seems to go down!

“Then I pampered myself a little bit. Foam rubber padding in the seats (I’m a big guy and I spend *hours* at the wheel); Chevy’s new throttle-holder where you just set your cruising speed for those long straights and the car holds it while you rest your right foot; the big ‘fresh-air’ heater. Man, you should drive my car. It fits me like a glove!”

There’s something to figure on, friends. Whatever kind of car you want—sports car, salesman’s car, town car—you can “design” it for yourself. But check your Chevrolet dealer and see how you can suit yourself to a T. . . . Chevrolet Division of General Motors, Detroit 2, Michigan.



BUILD THE BEST!

build quality money-saving

knight-kits

A PRODUCT OF ALLIED RADIO



see them all in

ALLIED'S 1959 ELECTRONIC SUPPLY CATALOG

free

**BUILD YOUR OWN!
IT'S EASY—IT'S FUN—
SAVE UP TO 50%**



HI-FI
KITS



HAM KITS



HOBBY
KITS

INSTRUMENT
KITS



452

value-packed
pages

SAVE on Everything in Electronics



WORLD'S LARGEST STOCKS: Everything for Experimenters, Builders, Amateurs, Servicemen, Engineers, Hi-Fi enthusiasts. Get more for your money in Hi-Fi systems and components, including latest Stereo; save on build-your-own KNIGHT-KITS; recorders and tape; Amateur station equipment; TV tubes, antennas, accessories; test instruments; industrial electronic equipment—plus the world's largest stocks of parts, tubes, transistors, tools and books. Send today for your **FREE** 1959 ALLIED Catalog!

EASY TERMS AVAILABLE

ALLIED RADIO

Everything in Electronics at Lowest Prices

our 38th year

send for
FREE
Catalog

ALLIED RADIO CORP., Dept. 24-A9
100 N. Western Ave., Chicago 80, Ill.

Rush **FREE** 1959 ALLIED 452-Page Catalog.

Name _____

Address _____

City _____ Zone _____ State _____

How Good Are the Gadgets?

(Continued from page 184)

about two years to pay back the purchase price (about \$35) and there will be the annoyance of keeping the auxiliary fuel tank filled.

Automatic fan release.

The fan is needed less than five percent of the time. It uses up about ½ horsepower at 2000 revolutions per minute (engine speed) and 4 horsepower at 4000. In one test, removal of the fan boosted gas mileage by two percent at 60 miles per hour. At this rate you would have to drive 100,000 miles to get back the \$40 the fan release costs. And the improvement is even less at the more usual, slower driving speeds (greater at higher speeds). An extra benefit of the device is the tiny increase in horsepower and the reduction of fan noise, objectionable in some cars.

Oil-firing spark plugs.

The National Bureau of Standards (along with most experienced mechanics) has found that in an engine with oil-fouled spark plugs, ignition is better if there is an extra air gap in the wiring connection at the top of the spark plug. The gap may be built into the plug or just added to the top of the plug.

This is easily explained. The coil delivers energy to the plug, not instantaneously, but over a short period of time. When the plug is oil fouled, the charge may leak through the oil film as fast as it arrives and never build up a charge strong enough to jump across the electrodes and ignite the fuel mixture. With the extra air gap at the top of the plug, the charge is held up there until its voltage is enough to jump this extra gap. Then the full charge arrives instantaneously at the regular spark-plug gap inside the cylinder and fires the mixture.

The auxiliary gap should not be used all the time. In some cases the coil does not develop enough voltage to jump both gaps while the battery is cranking the engine. This would obviously prevent the engine from starting, especially under extreme conditions as in subzero temperatures.

Dashboard spark control.

Cars using high-octane gasoline accelerate a little better than normal if the spark is slightly advanced. The same cars will perform fairly well on low-octane gasoline if the spark is slightly retarded. To permit the driver to make these adjustments, a spark control on the dash is convenient. It permits the driver temporarily to retard

(Continued to page 262)

Now...choose your vocational training!

new "choose-it-yourself" training system guarantees CHOICE, not chance

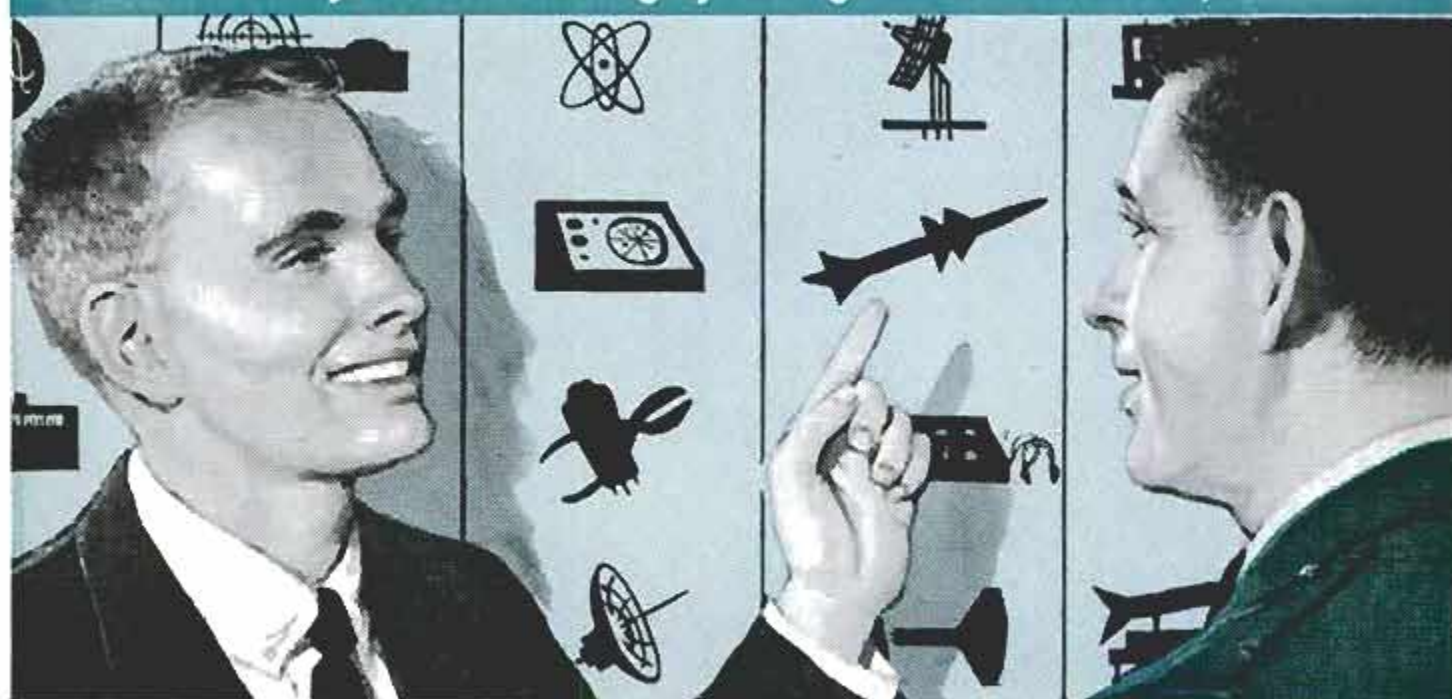

Now you can pick the vocational training *you* like! Under the Army's new "CHOOSE-IT-YOURSELF" Vocational Training System, *you* choose your vocational training

... and it's guaranteed *before* you enlist. Here's your opportunity to get valuable training and practical experience in the kind of work you *enjoy!*

Choose your vocational training from many interesting categories like these...

Radar & TV Repair
Atomic Weapons
Surveying
Military Intelligence

Military Police
Printing
Physical Medicine
Electronics

Finance
Construction
Ballistic Missile Repair
Combat Engineering

Drafting & Cartography
Metal Working
Automotive Maintenance
Machine Accounting

Here's how you "CHOOSE-IT-YOURSELF":

1. CHOOSE

... before enlistment!

Choose the vocational training *you* like from the categories currently available. Your Army recruiter will give you all information and advice you need.

2. QUALIFY

... before enlistment!

Take aptitude and physical examinations... to be eligible, you must have a qualifying aptitude score and meet minimum physical requirements for your choice.

3. KNOW

... before enlistment!

If you qualify, you *know* you'll get the vocational training you like! Your choice is written into your future Army record—guaranteed *before* you enlist.

CHOOSE, QUALIFY and KNOW... without the slightest obligation to enlist! You *get* the Army vocational training you like—guaranteed in writing—or you *don't enlist!* This week, ask your local Army recruiter for complete details about the new Army system which lets *you* do the choosing.

**NEW "CHOOSE-IT-YOURSELF"
VOCATIONAL TRAINING SYSTEM
U.S. ARMY**

More Work for the VTVOM

(Continued from page 248)

switches and a separate pair of test-lead jacks must be added. Fig. 4 shows these additions on a Knight VTVOM kit which has been converted for this purpose. The location of the added parts is not at all critical. They can be installed any place on the panel or case where they will not interfere with the other wiring.

In order to convert your instrument, sensitivity and internal resistance of the meter movement must be known, and the calibration of the d.c. voltage scale must be taken into consideration. Meter specifications are usually printed in an instruction manual which was supplied with the VTVOM, but they can be obtained from the manufacturer if the manual is no longer on hand.

Fig. 5 shows the parts and wiring which add a ma. function and 3 ranges to any VTVOM. The original VTVOM wiring need not be disturbed, except for the two wires which connect the meter movement to the VTVOM function switch. These must be unsoldered from the switch terminals and connected to the center terminals of the added function switch, S2. Two wires connected to the terminals at one end of the new function switch are then soldered to

the VTVOM switch terminals from which the meter leads were removed. With the new function switch in the VTVOM position, the original VTVOM circuitry is restored. With S2 in the ma. position, the meter movement is connected to the ma. range switch, S1, in a typical ma-meter circuit. Shunt-resistance values given in the material list are correct for meter movements having an internal resistance of 1000 ohms and a sensitivity of 200 microamps. The current ranges are 0-1.5 ma., 0-15 ma. and 0-150 ma. for range-switch positions 1, 2 and 3, respectively. Exact values can be read on the 0-15 voltmeter scale.

Shunt resistance values for meters with other specifications and ranges can be calculated as described in the following example.

GIVEN:

Meter sensitivity=400 microamps for full-scale deflection.

Meter resistance=2000 ohms.

Lowest voltmeter scale=0-3 volts.

PROCEDURE:

Because the lowest voltmeter scale is graduated from 0-3 volts, we will settle for milliammeter ranges of 0-3, 0-30 and 0-300 ma. The correct current value can then be read directly on the 0-3 volt scale. For the 0-3 ma. range-switch position, a maximum

(Continued to page 258)

KEEPING PACE WITH THE DYNAMIC AUTOMOTIVE INDUSTRY



CARTER

...world's largest independent manufacturer of automotive fuel systems marks its first fifty years of engineering the future

CARBURETORS • FUEL PUMPS • FUEL FILTERS

Keep swift, sure power for years
... have your car serviced regularly at the Sign of the Carter-Trained Expert. Look for the Carter sign or check the yellow pages of the phone book.



CARTER CARBURETOR

DIVISION OF QCF INDUSTRIES, INCORPORATED
ST. LOUIS 7, MISSOURI



10" Band Saw



Delta Shop—combines Saw, Jointer, Drill Press, Sander.



9" Tilting Arbor Circular Saw



Deluxe 4" Jointer



"Super 900" Radial Saw



14/11 Lathe



Heavy Duty Shaper



11" Drill Press



16" Scroll Saw

DELTA [®] HOMECRAFT TOOLS

put more of your skill to work

You're well equipped for *any* job—from a bird house to a boat—when you own the finest power tools money can buy! That's why more home craftsmen insist on the quality, capacity, and performance only Delta tools can give. And because Delta makes the world's most *complete* line, you can choose tools exactly right for your jobs.

No need to dream and wait, either—just add the tools you need NOW and pay on terms to fit your budget. See your Delta Dealer (he's listed under "TOOLS" in the Yellow Pages) or at leading Department, Hardware, and Building Supply stores.

Get this handy Homecraft Catalog FREE

Shows every tool complete; describes the hundreds of money-saving accessories; gives you valuable workshop hints. Also shows Saw-Jointer combination, Dust Collector, 6" Bench Grinder. Write: Rockwell Manufacturing Co., Delta Power Tool Division, 502A N. Lexington Ave., Pittsburgh 8, Pa.



**THIS NUGGET OF
INFORMATION ON HOW TO GET**
Double Pleasure
**FROM YOUR OUTBOARD
MOTOR AND BOAT**



THE 1959 MICHIGAN WHEEL OUTBOARD CATALOG contains carefully engineered propeller recommendations for virtually every engine-boat-and-purpose combination, including the new large motors . . . each one proved by exhaustive running tests to provide far superior performance to that obtained by the original all-purpose propeller.

BETTER SKIING . . . MORE SPEED . . . BETTER CRUISING . . . whichever you want, can be obtained with the proper MICHIGAN WHEEL. And it is easy to spot in the new MICHIGAN catalog. See your Michigan Dealer — Send for catalog. The catalog also contains

8 CHECK POINTS TO BETTER OUTBOARD PERFORMANCE . . . highly valuable information gained from years of experience on what you can do to your boat and motor to enhance performance . . . plus literally hundreds of

BARGAINS IN BOATING ACCESSORIES

MICHIGAN WHEEL COMPANY
Dept. PM-1, Grand Rapids 2, Mich.

Gentlemen: Please send me FREE of charge a copy of your new 1959 Outboard Catalog.

NAME _____

ADDRESS _____

CITY _____ STATE _____

of 3 ma. will flow through the meter and shunt. Only 400 microamps may be permitted to flow through the meter itself, with the rest of the current going through the shunt. The shunt, therefore, must carry .003-.0004=.0026 amperes of current. The shunt resistance value can be calculated by means of the formula:

$$R \text{ shunt} = \frac{R \text{ meter} \times I \text{ meter}}{I \text{ shunt}}$$

Substituting values in this formula gives
 $R \text{ shunt} = \frac{2000 \times .0004}{.0026} = 308 \text{ ohms (approximately)}$

For the 0-30 ma. range, $I \text{ shunt} = .03-.0004 = .0296 \text{ amperes.}$

Substitution in the formula gives—
 $R \text{ shunt} = \frac{2000 \times .0004}{.0296} = 27 \text{ ohms (approximately)}$

For the 0-300 ma. range, $I \text{ shunt} = .3-.0004 = .2996 \text{ amperes.}$

$R \text{ shunt} = \frac{2000 \times .0004}{.2996} = 2.7 \text{ ohms (approximately)}$

The closest commercially available, 1/2-watt resistors provide sufficient accuracy for all ordinary applications.

The newly installed test-lead jacks are employed for all current measurements. Both of these jacks must be insulated from the meter case (if the latter is made of metal) in order to eliminate any shock hazard.

When measuring current in a circuit, the VTVOM need not be turned on. Remember, however, the test leads must always be connected in series with the circuit under test. Carelessness in observing this precaution will almost certainly result in a burned-out meter movement and shunt resistor—a mistake which is likely to entail considerable expense.

Semiconductor Checker

With transistors becoming increasingly popular, there is a definite need for a simple, inexpensive device capable of indicating transistor quality. The semiconductor checker in Fig. 6, used with your VTVOM, not only checks all types of germanium transistors (not including power transistors), but can also be used to check the performance of selenium rectifiers and crystal diodes.

As shown in the schematic diagram, the unit is self-powered by a 22½-volt battery which, because of the low current requirements of the circuit, will have almost "shelf life" in actual operation.

Two transistor sockets are mounted on the front panel. These are so wired that the correct battery voltage is applied to either PNP or NPN transistors when these units are plugged into their corresponding

(Continued to page 260)

BUY **GRAVELY** FOR

MORE PERFORMANCE

MORE POWER

MORE FOR YOUR MONEY

Why plow with equipment you have to push, pull and help? Gravelly and its Rotary Plow attachment tills a perfect seedbed in *one operation*—all you do is guide it!

Gravelly does the tough jobs other tractors can't . . . because Gravelly has *reserve power*—now 6.6 Horsepower! Improvements in design and quality make the new Gravelly an even better buy than ever!

INVEST in the BEST!



POWER CULTIVATE GARDENS

30 TOOLS



MOW FINE LAWNS

UNMATCHED PERFORMANCE

Choose the tools that fit your jobs from 30 year-round attachments. All powered by one Gravelly tractor!

Do the job *better* because power attachments are driven direct from the engine by splined steel shafts and gears. No belts or chains to slip, wear or break. More power *at the working tool!*

A FREE demonstration by your local sales and service representative will show you, beyond doubt, that the Gravelly and its attachments will do your jobs *better, faster, easier*. Compare. You will see that you get *more power, more performance, more for your money!*



MOW GRASS MULCH LEAVES

FREE 24-PAGE BOOKLET!

Big, 24-page illustrated booklet, "Power vs Drudgery", shows how the Gravelly solves your lawn and garden problems . . . Write for it today!



HAUL HALF-TON LOADS

FREE! MAIL NOW

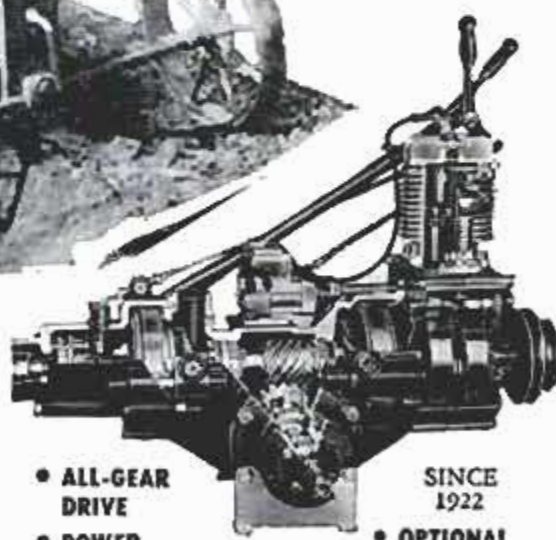

- ALL-GEAR DRIVE
- POWER REVERSE

- SINCE 1922
- OPTIONAL STARTER

Power attachments *securely* mounted by only four bolts. Balance, easy handling, simple controls. Cutaway view shows Gravelly's clean, compact, power-engineered design—the reason for its remarkable performance. Make the wise choice—choose Gravelly!

EASY PAY PLAN

GRAVELLY TRACTORS, INC.
 P.O. BOX 601-A DUNBAR, W. VA.

Please send "Power vs Drudgery" Booklet and dealer's name to:

Name _____
 Address _____
 Town _____ State _____

sockets. The leakage-gain switch, S1, is a d.p.d.t., spring-return slide switch wired so that it is normally in the leakage position, as shown in the schematic. In this position, the base of a transistor plugged in the socket is open-circuited and only a relatively small leakage current will flow through the transistor. When the switch is moved to the gain position, a small bias current is applied to the base through resistor R2 or R3. Consequently, the transistor collector current increases appreciably. The ratio of gain-to-leakage current is a good indication of transistor quality.

To check transistor quality connect the d.c. probe of the VTVOM to J2 and the "common" lead to J1. Set the VTVOM range switch to the lowest voltage range (usually 1.5 volts) and plug the transistor in the correct socket. (Check catalogue description or manufacturer's literature to determine whether the transistor is an NPN or PNP unit.)

Move the gain-leakage switch, S1, to the gain position and adjust the calibration potentiometer, R1, to obtain a meter reading of 1.5 volts. Release the switch so that it returns to the leakage position and note the meter reading.

For a good quality transistor, the gain-to-leakage ratio indicated by the meter will be high. The greater this ratio, the greater is the potential current gain of the transistor.

If no meter reading is obtained with the switch in either the gain or leakage position, the transistor is open-circuited. If the leakage current equals or exceeds the gain current, the transistor is short-circuited. If the leakage current approaches the gain current, the transistor is capable of very little or no amplification.

SELECTING MATCHED PAIRS. For push-pull or complementary symmetry circuits, the transistors used should have very nearly the same characteristics. A pair of transistors is "matched" if the gain and leakage currents of both transistors are the same, or nearly the same. By checking a number of transistors, those with the closest corresponding characteristics can be selected for critical circuit applications.

CHECKING TRANSISTOR NOISE. Low-level amplifiers, such as preamplifiers, require the use of low-noise transistors. The relative noise level of a number of transistors can be compared by connecting a pair of crystal headphones to the double phone jack, J3, and adjusting the gain current of each transistor for a 1.5-volt meter reading. (A pair of magnetic headphones may be used for this purpose by connecting a .05 mfd. capacitor in series with one of its

leads.) Transistor noise will be audible in the headphones.

CHECKING RECTIFIERS AND DIODES. Rectifiers and diodes can be checked with a pair of test leads plugged into the double phone jack. This jack must be wired so that the terminal marked (+) in the photograph is connected to the positive side of the battery and the negative terminal is connected to one end of potentiometer R1. To check forward-to-reverse conduction ratio of rectifiers and diodes, connect the lead from the negative jack of the tester to the positive terminal of the rectifier or diode, and the positive test lead to the negative rectifier or diode terminal. (The positive terminal of crystal diodes is often marked with a band, a dot or a "K.")

When so connected, the rectifier or diode is forward biased and R1 can be adjusted for a 1.5-volt indication on the VTVOM. Now reverse the test-lead connections to the rectifier or diode and note the meter deflection. With good components, the reverse-current is very low so that a ratio of at least 20 to 1 is obtained. (Some high-conduction diodes, such as video detectors, are good if the forward-to-reverse current ratio is 10 to 1, or greater.)

Selenium rectifiers, in addition to having a high forward-to-reverse current ratio, must have low internal resistance when biased in the forward direction. Otherwise, they might break down under full load. To check for this possible defect, short out the test leads and adjust R1 for a meter deflection of 1.5 volts. Then, without disturbing the setting of R1, connect the negative test lead to the positive rectifier terminal, and the positive lead to the negative terminal. If the rectifier is good, the meter should read at least 1.35 volts. ★ ★ ★

Plastic Brush and Scraper Cleans Snow off Car

You can clean snow off the roof, hood and windshield of your car with a combination brush and scraper. The brush has polyethylene bristles that retain their shape indefinitely. On the back of the brush is a seven-inch blade that doubles as a scoop for heavy snow. It is also a squeegee. The scraper end has a five-inch curved row of teeth. The device can be separated in the center for storage.



INSIDE STORY of the mighty Sea-Horse V-50!

Inherently balanced "V" design

A firing impulse every 90° gives smooth flow of power with minimum vibration. Note how the compact "V" design allows the crankshaft to be rigid, short and strong.

Synchro-setting carburetor

Twin barrels are simple to set with a single synchronized lever for high speed — another for slow speed.

Automatic fuel-saver

A cruising range throttle linkage that gives up to 20% in fuel savings. One gallon saved out of every five!

New propeller design

For greater speed plus plenty of power under load, the V-50 for '59 carries a 12" x 14" prop. It's made of a new, stronger and more ductile aluminum alloy.

ADVANCED ENGINEERING AND DYNAMICAL DESIGN SHOW WHY JOHNSON LEADS IN BIG MOTORS

New electric starting motor

This is a more powerful unit, yet it actually uses less battery current than previous motors.

High output magneto

This distributor-type magneto (Johnson's own design) is easily accessible for service. It's mounted on special anti-friction bearings.

Thermostat-controlled cooling

For smoother running and less engine wear, cooling system water is recirculated and kept between 130° and 150° F. — regardless of outside water temperature.

ONLY A V-50 SEA-HORSE GIVES YOU SO MUCH— ALL THESE FEATURES COMBINED IN DYNAMICAL DESIGN. SEE IT NOW AT YOUR DEALER LISTED UNDER "OUTBOARD MOTORS" IN THE YELLOW PAGES.



Johnson

First in dependability

New

EASY-TO-LAY

Bruce Crestwood Floor



It's PREFINISHED Oak!

All you do is nail it down

Now you can have beautiful new oak floors in less than a day. Crestwood is a modern prefinished flooring in a special size (2" wide by only 3/8" thick) designed to be laid over your old wood floor or subfloor.

Completely finished—even waxed—at the factory, Crestwood requires no sanding or finishing. It's ready for use as soon as it's laid, and will give your home rich style and beauty.

Crestwood is packaged in an easy-to-handle carton containing enough flooring (with proper nails) to cover 25 sq. ft. of floor area. Flooring strips have tongues and grooves for blind nailing, with nail positions marked on tongues for your convenience and to assure adequate nailing.

A new Bruce Crestwood Floor will cost you less than a good rug or carpet . . . and will last the life of your home. Sold by leading lumber dealers. Mail coupon below for colorful literature.

MAIL FOR LITERATURE

E. L. Bruce Co.,
Box 397-S, Memphis 1, Tenn.
Send literature on Bruce Crestwood
Floors to:

Name _____

Address _____



BRUCE CRESTWOOD FLOOR

Product of world's largest hardwood flooring maker

the spark to prevent knocking on the occasional tankful of gasoline that may have a below-average octane rating. The engine can, of course, be damaged if the driver is so foolish as to run with the spark far enough advanced to make the engine knock.

It is also possible on many cars to get a few percent more gas mileage at some spark setting other than standard, but few motorists will have the ability or inclination to make the lengthy tests required to find the correct setting.

A simple, inexpensive cable, such as used on a hand choke, will work about as well as the special controls sold for the purpose. The micrometer (so-called) adjustment on the latter has little real value.

Relay for using 12 volts on six-volt system.

At temperatures lower than 10 below zero, the starter may not be able to crank the engine fast enough to start it running (a properly winterized car with electrical equipment in good condition should start without trouble at temperatures above that). A relay, which when used with two six-volt batteries delivers 12 volts to the starter, will give a substantial increase in cranking speed on extra-cold days. However, there is some risk to the starting motor because it is not designed to operate on 12 volts. Most of the advantages can be obtained without any risk of damage by using an oversize six-volt battery or two standard six-volt batteries permanently connected in parallel (positive to positive, negative to negative). ★ ★ ★

Mushrooms Grow in Three Days

Morel mushrooms, a favorite of gourmets, are grown to full commercial size in three days by a new pure vat-culture method. Common shed-grown mushrooms require about 60 days to grow to commercial size. Yorktown Products Corporation and Battelle Memorial Institute devoted 10 years of research to development of the new process of growing the mushrooms in vats of pure, aerated nutrient fluid.

Tiny Tubing Made From Quartz

Microtubing about the diameter of human hair is being produced from quartz by the Monsanto Chemical Company. The tubing is so fine that one drop of water would fill 50 feet of it. The microtubing will be used in the recovery of billions of cubic feet of helium now lost in natural gas.

Cuts Without CHIPPING*

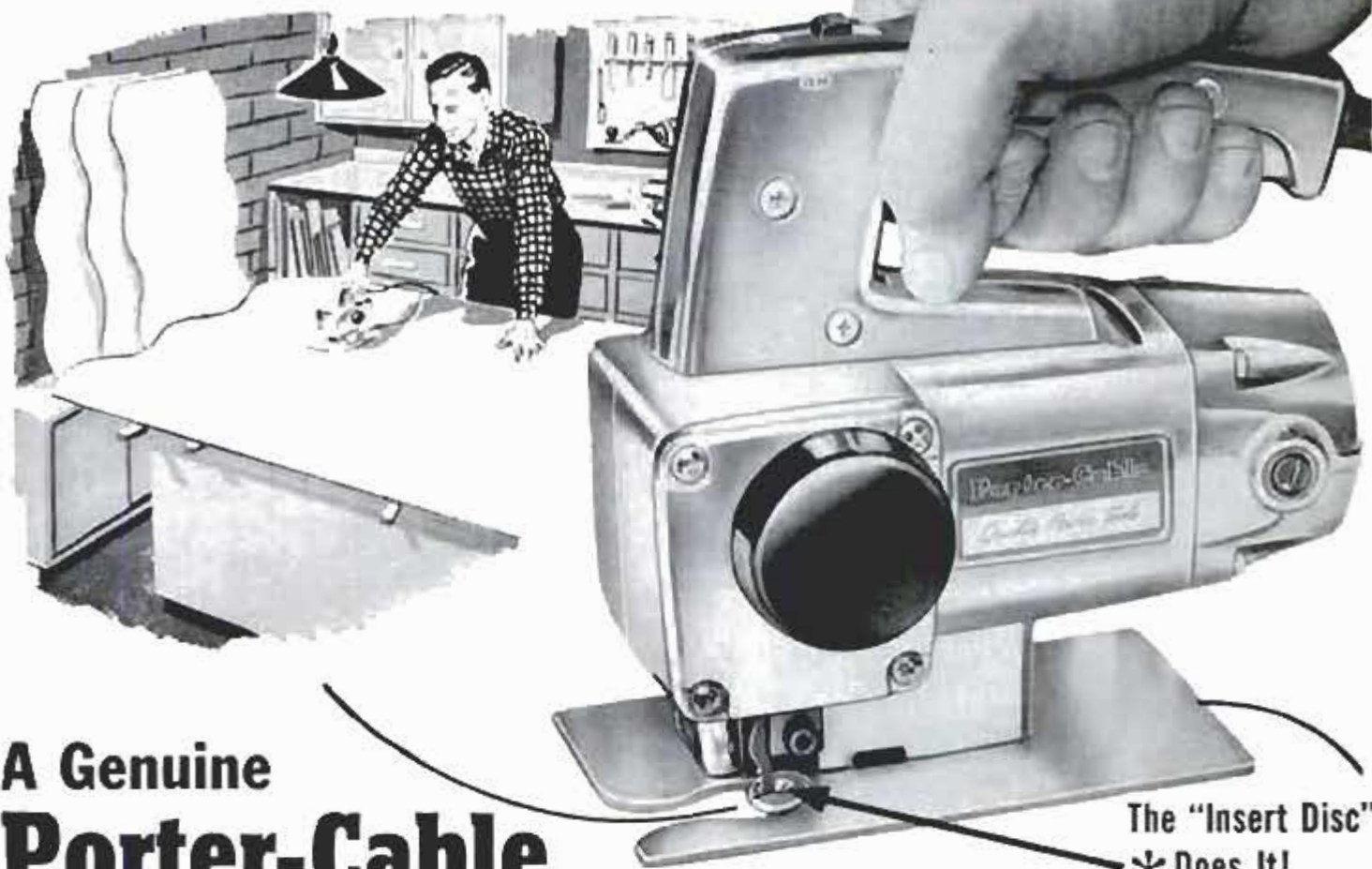

A Genuine Porter-Cable

Electric Hand Saw Loaded with Exclusive Features!

The "Insert Disc"
*Does It!

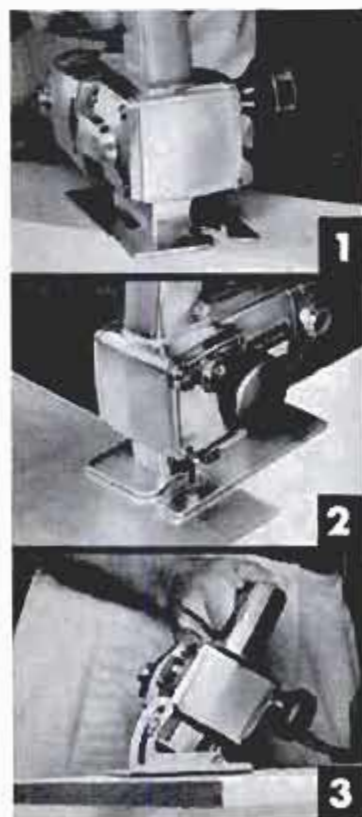

The Porter-Cable 152 Hand Saw is the only saw with the patented insert disc which virtually eliminates chipping and insures a smooth, even cut on plywood, plastic laminates and other materials. It's the all-purpose saw for home or workshop - hack saw, scroll-saw, cross-cut saw, jig saw, keyhole saw, coping saw and rip saw.

1 SLICES 2x4's in 8 SECONDS. Use it as cross-cut or rip saw. Handles full 2" dressed lumber, plywood, other materials.

2 CUTS METALS, TOO - 1/4" aluminum, 1/8" steel! Sheet metal, fittings, bar stock, and pipe are cut quickly and cleanly.

3 CUTS ANGLES...accurately! Accessory base allows precise angle cuts up to 45°. Easily and quickly adjusted.



EXCLUSIVE ORBITAL ACTION Blade moves ahead on upward stroke—backs away from work on down stroke. Eliminates drag and excess heat. Cuts 3 times faster. Blade life up to 30 times longer.

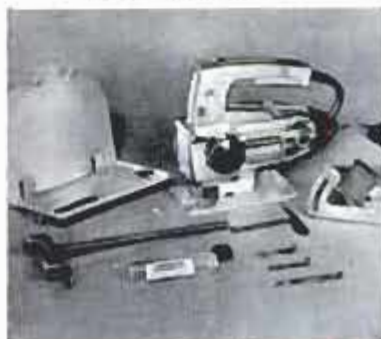

Complete with package of 3 assorted blades, patented "Insert Disc," allen wrench and tube of grease.

ONLY \$54⁹⁵

SPECIAL KIT
Saw plus handy wall bracket, angle base, rip guide, and extra blade assortment.

ONLY \$59⁹⁵

PORTER-CABLE MACHINE COMPANY
9141 Marcellus St., Syracuse 4, New York

JANUARY 1959

Porter-Cable
Quality Power Tools

10 years

from now you'll be
glad you bought

ALUMA

Craft



THE MARK OF QUALITY

Wherever boating enthusiasts see the Aluma Craft name it is instantly accepted as the mark of quality . . . the guarantee of fine design, precision construction and quality materials. Aluma Craft also means excellent performance. It stands for the speed, stability, safety, and strength that assures years and years of boating pleasure.

MORE FUN AND LESS WORK

Owning an Aluma Craft is practically all fun with no work. Your Aluma Craft is always ready to give you a day, a week or a season of pleasure. They are strong and sturdy, yet light and easily handled. They require little or no upkeep and are easily trailered or car-topped. Winter storage problems are mostly eliminated.

WARRANTED

Every Aluma Craft comes to you with a nine year warranty . . . a complete guarantee of quality materials and construction. Send for new catalog showing the new models in our top-flite line for '59. All in full color.

ALUMA CRAFT BOAT CO.

1519 Central Avenue N. E.
Minneapolis 13, Minnesota

● Please send catalog
showing Aluma Craft's top-flite line for '59.

NAME _____

ADDRESS _____

CITY _____ ZONE _____ STATE _____

Fusion Power for the World of Tomorrow

(Continued from page 128)

10 gallons of ordinary tap water contains enough deuterium to supply all the electrical requirements of your family for one full year. And this much fuel, even now, can be separated from the water for less than 30 cents!

Such are the stakes in this scientific game.

How do you go about fusing deuterons? Each deuteron has a positive electrical charge, so they repel each other with incredible violence. Whenever two deuterons approach, they instantly fly apart. The only way to force them together is to heat them. Then, like ants on a hot stove, they'll move so fast they'll collide blindly before they have a chance to recognize each other.

The temperature of the "stove" must be a hundred million degrees or more. At that temperature, atoms break down into free electrons and nuclei. This gaseous mixture is called a *plasma*. The electrons in the plasma will be traveling 90,000 miles per second, and the deuterons at 1500 miles per second. This is precisely what is happening in the stars of the sky.

Bottle to Hold a Star

Obviously, finding a bottle to hold a star is the toughest obstacle science has ever tackled. The melting point of the most heat-resistant of known solids is around 3000 degrees. Strange as it sounds, however, heat is not much of a problem, as there is very little actual heat in the bottle. The plasma is such a thin gas that, although individual particles are superhot, the total heat content is not very high. In fact, even when a liter of the gas reaches 350 million degrees it will hold just about enough heat to make a cup of coffee palatable!

The big problem, from the standpoint of the physicist, is *keeping* the gas hot. If the deuterons, in their wild dance, should touch the sides of the bottle, the gas would instantly be cooled to a point where fusion couldn't take place.

Since the ants on this hot griddle all have an electrical charge, they should be subject to control in a magnetic field. This is the approach that is being tried on a worldwide basis in the search for the elusive thermonukes. Anyone investigating this field is somewhat surprised to discover that there are virtually no security wraps on the research in magnetic bottles. Research papers show that scientists apparently are approaching the last difficult steps to success.

(Continued to page 266)

Perfect mating

of man and machine



CRUISING COMFORT ON A HARLEY-DAVIDSON DUO-GLIDE

Highways . . . expressways . . . country lanes . . . city streets — there's always a *smooth* road ahead when you ride a Duo-Glide. Solo or with a buddy, you travel as smooth as silk—hydraulically smooth from front fork to rear suspension.

And this glide-ride is a go-ride too. 74 cubic inches of OHV power are nestled compactly in this chrome and steel beauty. Also available in an "H" super-powered model with extra speed . . . extra stamina. Make a date to test ride the Duo-Glide at your Harley-Davidson dealer. Or use the coupon for free color folders.



1 **FRONT** — Hydraulically damped, Hydra-Glide front fork goes into action on all surfaces — takes the bumps out of rough roads, makes smooth roads even smoother.

2 **MIDDLE** — Spring-loaded seat post offers an extra measure of riding pleasure. Alone or riding double, springs give you a level ride at all times.

3 **REAR** — Husky, hydraulic shock absorbers control the amazing swinging arm. Bounce and bumps are ironed out . . . wheel actually hugs the road around curves.



Harley-Davidson
MOTOR CO.
Milwaukee 1, Wisconsin

HARLEY-DAVIDSON MOTOR CO.
Dept. P, Milwaukee 1, Wisconsin

Name.....Age.....

Address.....

.....

.....

SPEEDRY
PRODUCTS

Speedry magic marker®

PATENTED

Your **HANDIEST**, and most **EFFICIENT** tool for work or hobby. Just **LIFT THE CAP** and Magic Marker is ready to Mark, Sketch, Write on paper, wood, metal, glass, leather... anything!



77¢ 11 Brilliant colors plus black and white

Refills 39¢

**INSTANT DRY
WATERPROOF
WRITES ON
ANYTHING**

FREE: "77 magic ways to use magic marker."

WRITE:

SPEEDRY PRODUCTS, INC.

DEPT. PM-5 RICHMOND HILL 18, N. Y.



Model Detail & Coloring



Silhouette Tool Board



Color-coding



Metal working



Nail jar identification

**EARN EXTRA MONEY
IN YOUR SPARE TIME!**
Send for **FREE**
"Agents Sales Plan"
portfolio. Tells how
you can earn
\$15-30-\$50 and more
right in your own area.
Write Dept. MC-5.
Address below.

Significant numbers of neutrons have been captured in some of the equipment. Whether they are true thermonukes, or neutrons from side reactions, has not yet been proved.

Four Approaches

So far, four different approaches to the magnetic bottle have been tried:

1. The first method takes advantage of the so-called "pinch effect." In this method, a strong magnetic field is created around the plasma, forcing it away from the sides of the bottle and into a sort of a rope. As the current is increased, the rope tends to shrink, constricting or pinching the deuterons into a narrow field where the temperature builds up and they are more likely to collide. This is the technique used in the famous Zeta machine of the British. The principal difficulty is that the plasma rope begins to writhe, creating such kinks and "sausage links" that it destroys itself. As Dr. Ruark says, "Asking the pinched current to stay quietly in the middle of the tube is something like asking a boa constrictor not to constrict." Still, ways are being found to tame the boa. One is to place a strong magnetic field down the middle of the plasma, giving it a sort of a spine or stiffener.

2. A more recent approach, under investigation at the University of California Radiation Laboratory, is a "magnetic mirror." This instrument consists of a long straight tube surrounded by coils of wire to create a field around the plasma, preventing it from reaching the sides of the tube. At each end of the tube, extra strong magnetic fields or "mirrors" reflect stray particles back, holding the plasma in an unbelievably hot ball. This creates a more stable plasma, but there is one disadvantage: Before this reaction will be self-sustaining, it may be necessary to raise the temperature of the plasma to a billion degrees or more.

Most Promising

3. One of the most promising approaches is the Stellerator at Princeton. In this technique, the tube is either doughnut-shaped or formed into a figure 8. After the plasma has been heated to about a million degrees, the deuterons are further speeded by alternating the field rapidly (called magnetic pumping).

4. An apparatus called DCX at Oak Ridge National Laboratory is basically a new means of injecting deuterium into the magnetic bottle. The deuterium atoms are shot into a static magnetic field, where a carbon arc blasts them into electrons and

(Continued to page 268)

HOW AMERICA'S NUMBER ONE CARBURETOR PUTS A TOUCH OF TOMORROW IN YOUR CAR!



• Dynamometer tests determine the effect of carburation on maximum power output of a GM car engine. Carburetor design is matched to the specific requirements of each GM engine.

Every Rochester-GM Carburetor is a result of engineering dreams that are originated, researched and developed right here at Rochester. Backed by GM's Technical Center, engineers are now busy with tomorrow's fueling systems. And they are constantly developing new advances for today's Rochester-GM Carburetor. America's number one carburetor is serviced everywhere by Rochester-GM Carburetor specialists with the skill and knowledge passed along by these engineering masters. Let them adjust and maintain your Rochester-GM Carburetor for the best possible performance and economy. *Rochester Products Division of General Motors, Rochester, New York.*



• In the Research Fuel House at GM's Tech Center, seventeen different fuels are tested for operational effects. Result: carburetors designed to get better performance, stricter economy.



• At the Proving Grounds, these carburetors are given thousands of tortuous miles to test their ability to withstand extreme driving situations. Longer, trouble-free service is passed on to you.



• Millions of miles of stop-and-go traffic are put on these carburetors to assure you of the best possible mileage and performance from your GM car.

ROCHESTER  **CARBURETORS**

GENERAL MOTORS

America's
number one
original equipment
carburetors

You'll

DO THE JOB EASIER WITH THE RIGHT PLIER

CHAN NEL LOCK



*Full Polish Finish
Quality Pliers*

Any job is a hard job without the right tools. These special purpose Channellock quality pliers will help you do hundreds of jobs easier, faster. They're precision-built of high grade drop forged steel to last longer, work better. And you'll like the gleaming, full-polished finish at no extra cost.

Ask for Genuine Channellock pliers by name.
Look for the trademark on the handle.

CHAMPION DeARMENT TOOL COMPANY
MEADVILLE, PENNSYLVANIA

nuclei. This creates a very high temperature plasma from the outset, and the system, if successful, should be useful in the Stellerator and some of the other instruments.

Scientists Are Optimistic

Scientists, who normally are cautious men, tend to be surprisingly optimistic about one or more of these approaches. An AEC brochure at the Geneva exhibit, for example, states that when Stellerator C is completed in 1960, "it is expected to be capable of producing abundant thermonuclear fusion reactions."

Even if reactions are achieved, there is no guarantee that a true power-producing reactor is possible. But the stakes are so high in this game that most countries are boosting their ante each year. Since 1953 the AEC funds for fusion research have increased 1000 percent.

The best part of this game is that if one player wins, all win. It seems quite likely that within the next year, scientists at a laboratory somewhere on the face of the earth, will capture significant quantities of genuine thermonukes. And in 10 to 20 years, the first successful fusion reactor will go into operation.

Such a tremendous stride will herald the day when bottled stars will glow everywhere, and every man will have an incredible amount of power at his fingertips.

Ⓜ Don't be too sure that caviar you ate last night was from Russian sturgeon. They're processing caviar now from fish eggs of Ohio River channel catfish, freshwater drum, paddlefish and gizzard shad.

Do You Know This Old-Timer?

(answer to quiz, page 44)



1919 FORD

(but not a Ford top)

**FORMER SERVICEMEN:
MAKE
YOUR
SKILLS
PAY OFF
WHERE THE
AGE OF SPACE
IS REAL**

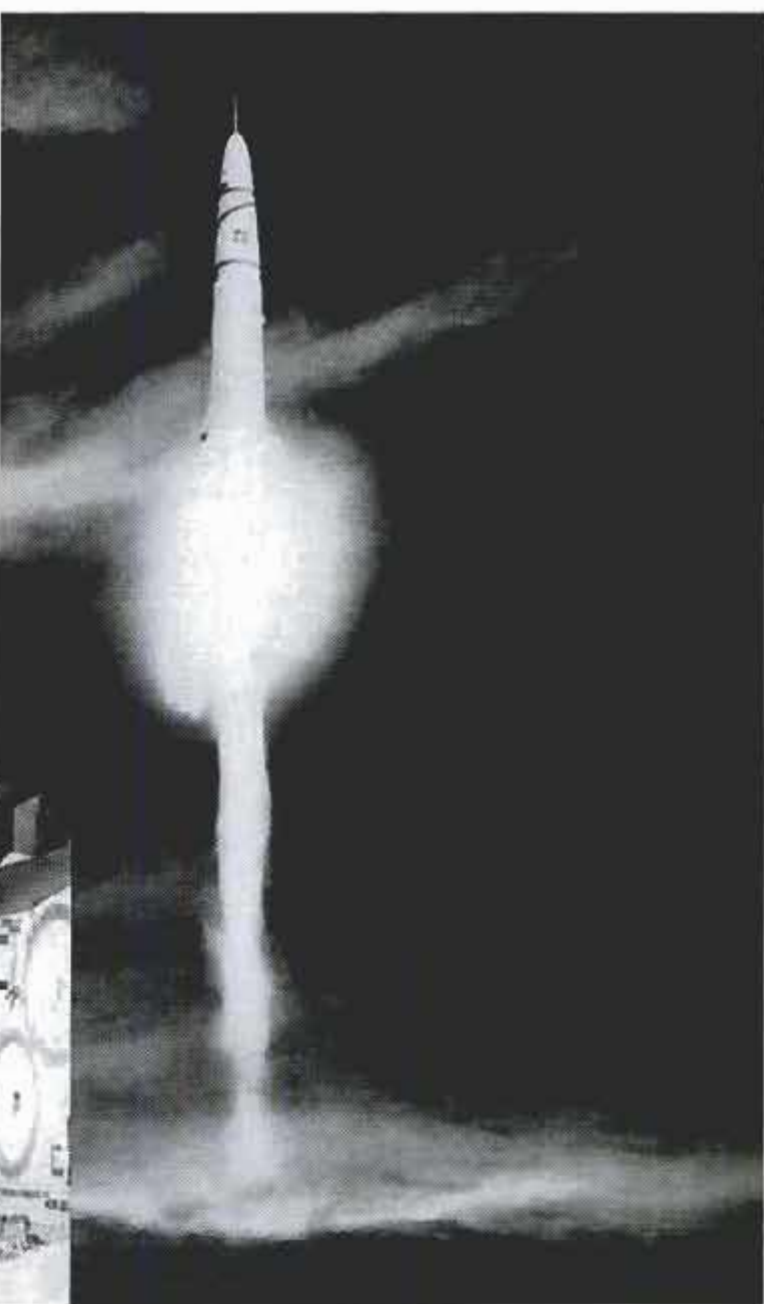

**AS
A SPECIALIST
IN THE
U.S. AIR FORCE**

With the new Age of Space, more and more men are finding that their previous military training can really pay off in the U. S. Air Force. If *you* have a skill the Air Force needs, you, too, can step into an important job. You'll work with the latest equipment, learn the newest techniques of your specialty – and look to a future that's guaranteed. Find out if there is a place for you, where the Age of Space is *real*. See your local Air Force Recruiter, or mail the coupon.

PASTE ON POSTAL CARD AND MAIL TO:

Prior Service Information, Dept. PM-9321
Box 7608, Washington 4, D. C.

Please send me more information on the Air Force Prior Service Program.

Name _____

Address _____ Age _____

City _____ Zone _____ State _____

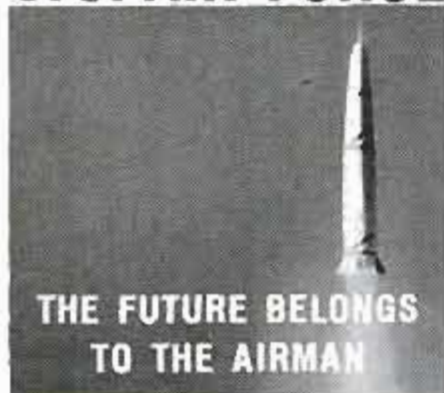

**THE FUTURE BELONGS
TO THE AIRMAN**

If it takes more
ACCURACY
 it's a job for a
**SOUTH
 BEND**
 10" lathe

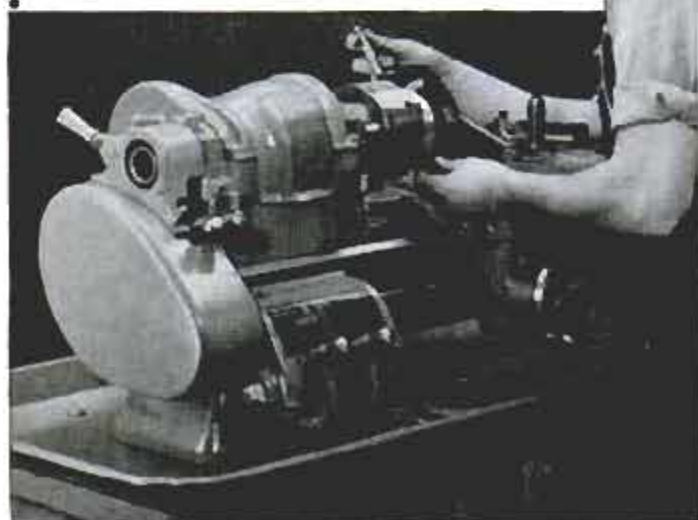

- Accuracy that's a match for any job.
- Superfinished spindles with sleeve type bearings that hold tolerances for years.
- Hardened and ground bed ways optional for extreme conditions.
- Smooth, vibration-free operation for fine finishes.
- More usable power.
- 1-1/16" collet capacity—70 threading, longitudinal and cross-feeds.
- 14 engine and toolroom models.

PRICES START AT \$1282 F.O.B. FACTORY

WRITE for complete catalog of South Bend 9" to 16-24" lathes, turret lathes, milling machines, shapers, drill presses, pedestal grinders and attachments.

SOUTH BEND LATHE
 SOUTH BEND 22, INDIANA
Building Better Tools Since 1906



Stairway to the Sea

(Continued from page 102)

dredges, working under U. S. Army Engineers, are busy deepening harbors and interlake channels to the seaway's official 442-foot bottom width and 27-foot depth. Target date for the last of this work is 1962.

Locking through the seaway will be swift and efficient. At Eisenhower and Snell Locks, which began lifting lake steamers through their concrete walls last July, you get a preview of what a trip up the finished waterway will be like.

"We cleared a backlog of 109 ships in the first 48 hours of operation," Norman Ashley will tell you. Ashley is one of the lock control operators on the 3½-mile Wiley-Dondero Canal linking Eisenhower and Snell. "The Canadians up at Iroquois figured we'd be a bottleneck because of our inexperience with this type lock, but it turned out we kept them hustling. We've lifted ships the entire 45 feet in six minutes at this lock. On the old canal half that lift took 15 to 20 minutes."

Errorproof Control Console

In a glass-enclosed blockhouse, jutting from the lock's broad apron like an airport control tower, Ashley operates the great miter gates and flood valves at a console of lights and switches. "Everything works in sequence," he points out. "If the big boom isn't down, I won't get a circuit okay to close the gates. If the gates aren't closed properly, I won't get a clear circuit to open the valves."

At his big board, Ashley watches as a lake-bound freighter enters the downstream gate and sails into the cavernous lock chamber in which water has been dropped to downstream level. Actually, the new locks can take two lake steamers with room to spare. "A cabin cruiser wants to come through—let him in," Ashley suddenly shouts over an intercom to the downstream control operator.

"Those small-boat skippers," he explains, "are sometimes scared to come in with a big ship for fear they'll get banged all over the lock by water rushing in as the lock fills. Even in the Panama locks that happens. Here you'll hardly see a ripple as she comes up. Watch that little boat slip a bight over the floating bollard—that's all the mooring he needs."

Gates Protected by Fenders

The bollard, one of the new lock's innovations, is a floating mooring post that slides up a vertical track in the wall as water rises in the lock.

(Continued to page 272)

COAST TO COAST ONLY 1½ CENTS PER MILE FOR GAS!

Pontiac's new Tempest 420E V-8 sets the year's most important economy mark—Here's the story and what it means to you!

PONTIAC COAST-TO-COAST ECONOMY RUN

San Diego, California to Savannah, Georgia

COMPLETED OCTOBER 17, 1958

DISTANCE	2,442.7 MILES
DRIVING TIME	60.72 HOURS
FUEL CONSUMED	112.5 GALLONS
FUEL COST	\$35.79
MILES PER GALLON	21.7 Average for entire trip
AVERAGE SPEED	40.2 MILES PER HOUR
COST PER MILE	1.465 CENTS



We asked one of America's most respected car testers—"Uncle Tom" McCahill—to put a standard Pontiac Catalina Sedan with our new economy V-8 to the test.

And with only one specification—that the run would be exactly like *you* would drive coast to coast yourself—in mountains, in city traffic, across deserts, buying gas wherever the tank ran low.

And here's the phenomenal story in every complete detail—all officially certified by NASCAR, America's top automobile competition authority.

What does it mean to you?
Simply—and very importantly—this: For the first time, you can get deep-chested V-8 pep with better mileage than from many smaller so-called "economy cars" . . . and get it on regular fuel!

If you owned a Pontiac with this new Tempest 420E V-8 you'd be saving up to 5 cents a gallon on regular fuel. This new economy V-8 is optional at no extra cost on any Hydramatic Pontiac!

See your Pontiac dealer soon—and discover the newest in V-8 performance and economy!

PONTIAC!

America's Number ① Road Car

3 Totally New Series • Catalina • Star Chief • Bonneville

PONTIAC MOTOR DIVISION • GENERAL MOTORS CORPORATION



THE ONLY CAR WITH
WIDE-TRACK WHEELS

**Rush
Coupon for
FREE**

**J. C. Whitney's 1959 Catalog
Auto Accessories and Parts**



**324
PAGES
85,000
ITEMS**

Saves You UP TO 50%

On everything you need for your car, station wagon, custom car, hot rod or truck . . . Including the latest customizing accessories, parts, hi-speed and power equipment.

Get this all-new edition of the World's Largest & Most Complete Automotive buying guide—324 pages! See pages & pages of brand new 1959 items not yet offered in stores. Over 85,000 items in stock ready for shipment. Our tremendous buying power & huge volume will save you up to 50%. This catalog will show you the greatest money-saving values & the greatest selections we've ever offered.

Just Off the Press! It's the Latest & Largest—324 Pages! See what's new for 1959 in the automotive field. Buy with utmost confidence—Whitney Guarantees 100% Satisfaction or Your Money Back.

J. C. Whitney & Co., 1917 (P-1) Archer, Chicago 16

J. C. Whitney & Co., 1917 (P-1) Archer Ave., Chicago 16, Ill.

Rush giant 1959 Catalog of Auto Accessories & Parts. I enclose 25c to cover part of mailing & handling cost, refunded on my first \$5.00 or more order. This Offer Good in U.S.A. only.

Name _____
Address _____
City _____ Zone _____ State _____

With both vessels tied up, Ashley and the downstream operator begin to throw switches in orderly sequence. The massive gates swing shut. Outside in the downstream canal, a huge girder lowers across the channel like a railroad crossing gate. "Each gate is protected by a fender like that," said Ashley. "It will stop an ocean freighter traveling at four knots."

Down below the control house, two giant whirlpools form outside the upstream gate as a pair of intake valves opens and gravity sucks a roaring torrent down through 15 by 16-foot culverts running through the sidewalls of the lock.

Deep in the lock chamber, the mirror-like surface of the water creeps up the foot-age markers, faster and faster.

Secret of the smooth lift, according to L. W. Angell, chief engineer for the seaway project, is a tricky system of intake ports. Instead of shooting straight up from the bottom, as it does in older locks, the rising water is fed through culverts in the sidewalls and shoots out into the 85-foot-deep lock bottom. Side ports from these transverse mains face each other, so that the water's tremendous energy is expended against itself. "We ran model tests that told us we had a good system," says Angell.

Plugs That Hold the Water

Going downstream, ships enter a full lock, and the water is dumped through outlet ports at the lower end.

Looking at the towering level of water outside the sheet of steel upstream of an empty lock, you can't help wondering what would happen if a ship should rupture that gate and let the whole upper St. Lawrence roar down the valley.

Not likely, according to Angell. The outside fenders protect that side of the big gate from ships. "Inside," he reveals, "two more fenders lying across the lock bottom lift up fore and aft of the ship to protect the gates from sharp prows and stern projections. This accounts for the fact that a 768-foot ship is the longest you can put into the 800-foot lock chamber. The difference is safety clearance."

That's not all. On the upriver side of Eisenhower Lock, facing the huge power pool, there's a superbackstop—a 350-ton vertical lift gate sunk in a deep slot in the massive concrete sill. "It will raise itself hydraulically," says Angell, "right through a full head of water roaring into the lock."

On top of that, beside each gate stands a crane and a pile of "stoplogs"—28-ton steel panels that can be dropped into slots just outside the gates.

(Continued to page 274)

Be Your Own Boss in the Profitable Excavating Business!

EARN UP TO \$1,000 AND MORE PER MONTH

Wherever you live, you'll find plenty of profitable work the whole year 'round for this versatile outfit . . . not just a "trencher" but an all-purpose excavating machine! Custom operators everywhere are making big money with Sherman Power Diggers. ONE BOUGHT A FARM WITH JUST THREE YEARS' PROFITS! Work for builders, contractors, utilities, and municipalities on such jobs as septic tanks and drainfields, sewer lines, fuel tank installations, foundations and footings, gas and water lines, field tilling and many others. The Sherman Power Digger mounted on a Ford Tractor travels quickly from job to job, digs at a fraction of the cost of manual labor. It's simple to operate, easy to maintain, built to last.

Send now for information about the easy-to-get jobs for your Sherman Power Digger. Let us tell you—without obligation—how you can go into business for yourself with an investment of less than \$5000. Or make a small down payment and pay the balance from earnings.

SHERMAN PRODUCTS, Inc.
Dept. 1736 Royal Oak, Michigan



Send Now for FREE LITERATURE!

Sherman Products, Inc.
Dept. 1736 — Royal Oak, Michigan

Send me information on how I can get into the excavation business on my own.

NAME _____

ADDRESS _____

CITY _____ STATE _____

GENUINE ALNICO MAGNETS

AMAZING, PERMANENT, NON-ELECTRIC, HIGHLY PRACTICAL. Conduct interesting experiments. Hundreds of uses. Retrieve valuable steel items such as guns, tackle from fresh or salt water; tools from tanks & drains. **GUARANTEED.** Try any magnet one week. Money back if you are not well-pleased.

No. M-710 (Wt. 53 oz.) Has pull of 225 lbs. on steel block . . .	\$18.00
No. M-625 (Wt. 70 oz.) Has pull of 125 lbs. on steel block . . .	\$10.00
No. M-575 (Wt. 18 oz.) Has pull of 75 lbs. on steel block . . .	\$7.00
No. M-500 (Wt. 13 oz.) Has pull of 50 lbs. on steel block . . .	\$5.00
No. M-300 Kit of Flat Bars 5 Pairs (10 Magnets)	\$3.00
No. M-250 Kit of Round Rods 5 Pairs (10 Magnets)	\$2.50
No. M-47 Hot Pad Magnets. 10 for \$1.00	50 for \$4.87
No. M-35 Hobbyist assortment of 8 small magnets	\$1.50

Send M.O. or check. We pay postage. Sorry no C.O.D.'s.
MIAMI MAGNET COMPANY, 3240 N.W. 27th Ave., Miami 42, Fla.

UNMATCHED  Gerstner Chests are unequalled in quality and performance. Free Catalog. **GERSTNER TOOL CHESTS**
459 Columbia St., Dayton 7, Ohio

Wood Carvers!

"HERE'S THE NEWEST IN THE CARVING FIELD! \$10.95 PER SET! OVERALL LENGTH OF EACH TOOL 6 1/2". PLASTIC HANDLES



6 PIECE CARVING SET

Most Complete Line of Chisels and Gouges
CATALOG AVAILABLE!!

BUCK & BROS. INC.
RIVERLIN WORKS MILLBURY MASS.

EXTERIOR FIR PLYWOOD BOAT PLANS

Only 25¢ ea.

Big, fully-illustrated, step-by-step plans make it easier than ever to build your own boat. Designed by top marine architects. Every model has been thoroughly tested for ease of construction and seaworthiness.

OUTBOARDS

- 11' (Plan 35) Fast, roomy car-top utility model.
- 13' (Plan 40) Great for skiing. High freeboard for open water.
- 16' (Plan 55) Deluxe runabout. Double cockpits seat 6.

CABIN CRUISERS

- 18' (Plan 60) Trim lines. Easy to build for size.
- 20' (Plan 65) Sleeps 2, has galley, head.

SAILBOATS

- 8' (Plan 75) Build as dinghy or sailing pram.
- 15' (Plan 80) Fast, seaworthy knockabout.

Plans Only 25c Each. Order by number. (Offer good USA only)
DOUGLAS FIR PLYWOOD ASSOCIATION, Dept. 9, Tacoma, Wn.

Use only Exterior plywood (EXT-DFPA®) for boats. Comes in several sizes, grades—including premium quality solid-core "Marine Exterior" for hull construction.



Only a Ready-Cut Liberty Home offers you so much



Space. Quality. Beauty

57 EXCITING DESIGNS FROM \$2465 TO \$7926

For less money, there's more of everything in a spacious Ready-Cut Liberty Home. And so many designs to choose from including split levels, rambling ranch homes with 2, 3 or 4 bedrooms . . . 1 or 1½ baths . . . for wide or narrow lots.

BE YOUR OWN CONTRACTOR SAVE THOUSANDS OF DOLLARS

It's so easy to direct the construction of your own Liberty Home, saving as much as \$5000 and more. You save on labor, material and contracting costs . . . and there are no salesman or architect fees.

FINEST QUALITY MATERIALS

Liberty Home materials are selected top quality, kiln-dried and machine cut to exact size for perfect fit. You receive ready-to-assemble materials including all framing and finish lumber, siding, nails, paints, hardware, windows, doors, flooring . . . plus complete building plans.

IRON-CLAD GUARANTEE PROTECTS YOU ABSOLUTELY

You are guaranteed, in writing, to receive the highest quality materials in sufficient quantity to complete your new home . . . assuring your full satisfaction.

Financing Is Easy With Our Exclusive Plan



Materials Shipped
Freight Prepaid

Send 25c for
EXCITING 56-PAGE
FULL COLOR CATALOG

MAIL TO:
LIBERTY READY-CUT HOMES
1291 Lafayette Ave., Bay City, Mich.

NAME _____

ADDRESS _____

When it is finished, the new Seaway between Montreal and Ontario will climb through a total of seven locks, instead of 21, as on the old canal.

Far from being a recent brainstorm, the idea of slipping vessels around the cascades flowing down from the Great Lakes dates 'way back. Pioneering trappers and traders scooped out a tiny ditch around Lachine back in 1700 in order to float fur-laden freight canoes safely past white water. By 1908, Canada had built the chain of locks and canals that, until now, has carried small lake ships from Montreal to Lake Ontario. Slowly the 14-foot-draft canal was extended and improved.

Then came Canada's big dream—the joint U. S.-Canadian effort to broaden and deepen the channel and locks to accommodate ocean shipping. For nearly half a century the plan was kicked around by U. S. politicians and pressure groups. Then, in 1953, Canada threatened to build it alone. That did it! Within a year the St. Lawrence River valley became a bedlam of roaring machinery, shouting men and flying earth. Ontario's Hydro-Electric Power Commission and the New York State Power Authority combined forces on the power part of the project while the United States' St. Lawrence Seaway Development Corporation and Canada's St. Lawrence Seaway Authority tore into navigational problems.

Exactly 210,515,000 yards of earth had to be moved to make way for the giant seaway. If you piled it all on a football field, that much dirt would reach 25 miles in the air. Or, as M. W. Oettershagen, Deputy Administrator for the Seaway, puts it: "you could haul it away in 60,000 trainloads of 100 cars each."

Tough Rock Wrecks Drills

None of it was easy. Paul Bunyan's fabled deeds pale beside some of the tales that are bandied about Massena, N. Y., where the heart of activity is centered. Canadian contractors on the Beauharnois Canal had to gouge their two-mile channel—to standard seaway depth of 30 feet—through solid rock so tough it wrecked the best steel drills in eight hours. Kerosene torches burning at 4000 degrees were used to soften it so blast holes could be sunk.

To make room for the new power lake that would flood 38,000 acres in the International Rapids section, seven complete Canadian towns were moved, lock, stock and tavern on the backs of gigantic, multi-tired house-moving flatbed trucks; 42 miles of highway and 35 miles of railway had to be relocated; 21 miles of dikes had to be built to contain the new waterway.

(Continued to page 276)

Utility, quality, design*... 28 times, too!

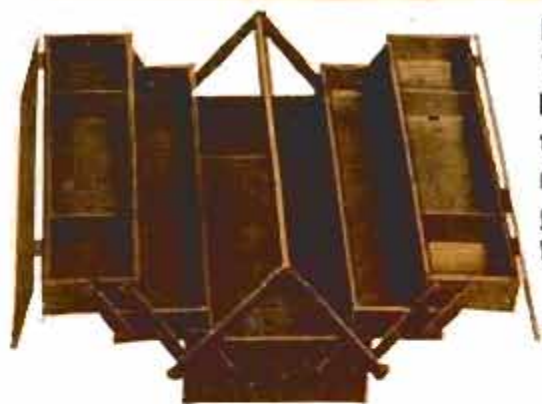

Protect, organize your good tools. The new Duplex line has the right box or chest. 28 types & sizes... variety of drawer sizes, compartments, protective fittings. Heavy gauge steel, beautifully finished. Write for illustrated catalog.



PENDLETON
SUBSIDIARY OF TOOL INDUSTRIES
INC.

P. O. BOX 856
FORT SMITH, ARKANSAS

* Shown: No. 114, Mechanics Box, available in 8 sizes and arrangements. Quick, convenient. Press handle down, box opens. Lift handle, box closes.



America is a Better
America -
thanks to Advertising!

PEEL OFF PAINT *Easier
Faster • Safer*
Heavy-Bodied KLEAN-STRIP
PAINT REMOVER

For wash-off or scrape-off use. Strips many coats of any finish with one application, leaving surface clean, dry, ready for new finish. Non-inflammable and needs no neutralizing. Takes the work out of refinishing. The Klean-Strip Co., Inc., P. O. Box 10083, Memphis 6, Tenn.

Presenting... the excitingly new
CUSHMAN[®] SCOOTERS
for 1959!

*The Distinctive
Super Eagle and Pacemaker*



For fun and excitement—as well as low-cost utility—go Cushman. Distinctive new styling for 1959 plus sturdy new construction features and new mechanical advances all mark the Cushman Super Eagle and Pacemaker as well as their companion machines, the Eagle and Road King. Famous Cushman Husky 4-cycle engine delivers up to 50 miles per hour, up to 100 miles per gallon.

Ask your dealer for a FREE demonstration ride or write for colorful booklet today. Sold and serviced nationally. Replacement parts immediately available. Dealer inquiries invited



CUSHMAN MOTORS

A subsidiary of Outboard Marine Corporation
918 No. 21st, Lincoln, Nebraska
Please send FREE Scooter booklet

NAME _____
ADDRESS _____
CITY _____ STATE _____

USING TOO MUCH OIL AND GAS?



IT'S TIME FOR HASTINGS

● If your engine has started to use too much oil—look out! It's your first sign of worn-out piston rings. And worn-out piston rings mean power drop-off—costly wastage of gas and oil—expensive repairs later on.

The sooner you act, the less it will cost. See your motor specialist the minute oil-pumping warns you there's trouble ahead. When he recommends new piston rings, ask him for Hastings. They're engineered exclusively for replacement service . . . to provide the additional lubrication worn engines need . . . to stop oil-pumping, save gasoline, restore lost performance.

Get new car power and performance from your present car—with Hastings. Truly your best investment for many thousands of extra miles of trouble-free driving pleasure. Hastings Manufacturing Company, Hastings, Michigan. Piston Rings, Oil Filters, Casite, Spark Plugs.

HASTINGS
PISTON RINGS

TOUGH on oil pumping • **GENTLE** on cylinder walls

HASTINGS MANUFACTURING COMPANY
HASTINGS, MICHIGAN

Many contractors faced problems they'll never forget. Canadians, working through the crackling northern winters, had to blast great ice floes that threatened cofferdams; their fresh-poured concrete had to be kept under a barrage of steam jets to keep it from freezing. In summer, dredge operators, who had to work in white-water rapids, cabled their barges to bedrock ashore, or tied on to great blocks of concrete on the bottom to keep from being swept away.

Oettershagen likes to recount the adventures of an ingenious contractor named Badgett, who brought in a gigantic 650-ton walking dragline from Madisonville, Ky. "It had feet," he recalls. "Great snowshoe-like platforms, about 15 by 30 feet, with a camlike device that would pick 'em up and lay 'em down. Badgett inched that thing overland 18 miles to the Green River in 68 days, put it on a barge and sailed it up here. When a two-lane highway bridge got in his way he got permission to unhook it from its piers, lifted it on the dragline's boom, sailed down river about 50 yards with the bridge dangling, then swung around, put the thing back in place and continued on his way.

"In Chicago they told him he'd never run the Galop Rapids with that monster—but he did. Welded the whole works to the barge deck, dragged his big boom and bucket behind him in the river bed, like an anchor to windward, and shot the rapids in fine style."

Rhythm Breaks the Ice

Contractors didn't have all the ingenuity. When three-foot-thick river ice held up the start of spring construction on the power and control dams, Frank Matejka broke it up by opening and closing the control dam's new gates rhythmically and putting the whole ice table into harmonic motion. "We gained six weeks' construction time," he points out.

On June 30, 1957, everything nearly went galley-west when a hurricane's low-pressure eye literally tipped Lake Ontario backward, so that its water was several feet higher downstream than upstream! Bob Connors, one of Matejka's engineers, had the headache of facing all that water as it roared down from Iroquois on a wild night that knocked out all communications. Using radio cars to report water levels upstream, his gantries were still inching up gates in the unfinished Long Sault Control Dam when the wall of water hit Massena. "We barely got enough gates open," he says. "The level at Massena went to 204.4 feet—just 1½ inches from flooding the Cornwall canals on the Canadian side."

Job Finished on Schedule

In spite of it all, the St. Lawrence was harnessed on schedule. "Last April first was deadline day for removal of the cofferdams at the powerhouse," says Matejka. "And on April first the last pile was pulled. May first was scheduled for commencing closure of rail and road access gaps in the dikes, and on that day we began pulling spikes. July one was set for the pool raising, and that was the day we blasted the cofferdam plug."

Today visitors can stand on any one of a dozen parks and sites, carved out of the river's lush banks and scenic islands, and look out on the inspiring sight of some 250,000 gallons per second of tumbling white spray as it roars from the two dams' batteries of sluices, marching across nearly two miles of river. Along the top of the 167-foot-high power dam, mammoth gantries, resembling four-legged stools for some giant to sit on, rumble along tracks atop the dam crest, raising and lowering gates to adjust the flow through the 32 big turbines (half for Canada, half for the U. S.) buried deep in concrete. Already, many of them are turning generators.

Everything you see is living proof of what the administrators cheer as an historic example of international cooperation.

Neon Sign Without Wires

Interchangeable letters and numbers are part of a new kind of neon sign that uses no wired connections. The sign characters, available in five colors, are set on a three-foot plastic rack. They are illuminated by electrical energy broadcast from a high-frequency transmitter. The various fluorescent colors can be mixed for unusual effects and the signs can be moved to different locations when desired.

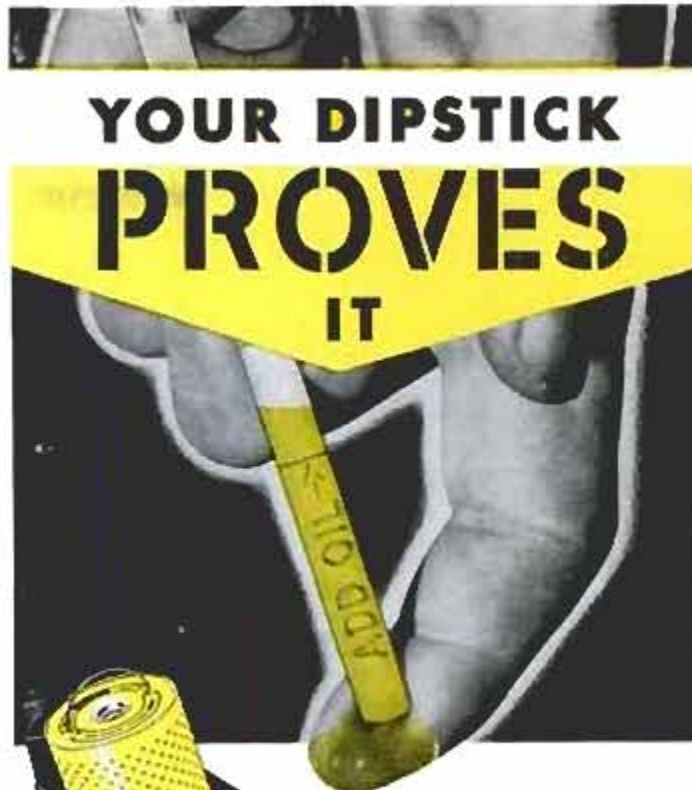

YOUR DIPSTICK PROVES IT



HASTINGS keeps oil clean all the time

See for yourself! If your oil shows dirt before it should—you'd better change to Hastings. Hastings Oil Filter Cartridges keep oil clean from filter change to filter change, when replaced as normally recommended. Proved by tests conducted in accordance with U. S. Bureau of Standards.

Here's the reason: Only Hastings has Densite filtering material. Millions of selected, pressure-packed cotton fibres trap and hold even the most microscopic dirt particles. Your dipstick will prove it!

Next filter change, call for Hastings—for clean oil all the time.

U. S. Patent Nos. 2,797,811 2,584,771

HASTINGS

OIL FILTER
CARTRIDGES

HASTINGS MANUFACTURING COMPANY
HASTINGS, MICHIGAN

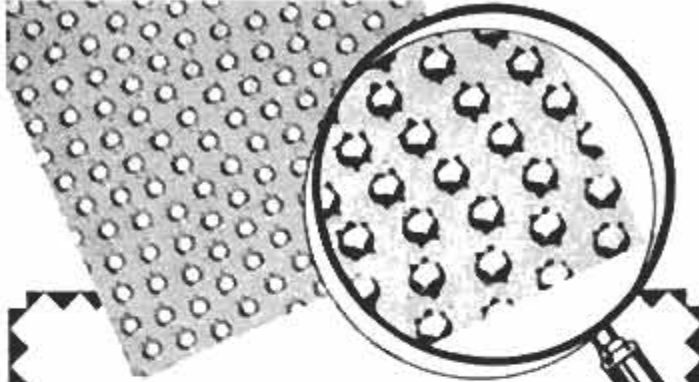

YOU'RE LOOKING AT A PIECE OF

Dragon-Skin

Not one of St. George's souvenirs, but an amazing new cutting tool. A "steel sandpaper" that sands, rasps, smooths.



Use Less "Elbow Grease" when shaping, smoothing, rounding, or cutting slots, because Dragon-Skin cuts fast. New principle: steel sheet is punched to form special cutters—thousands of 'em—to carve away at the work. Cut is smooth and even. No rough sand "grits," no gouging.

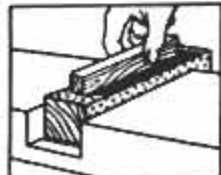

Dragon-Skin Can't Clog like sandpaper, even when you're smoothing softest wood. Chips and dust fall right through the holes. Slap the sheet once and it's clear!



Makes Hundreds of Jobs Easier, and outlasts sandpaper by far. Shapes hard or soft woods, plastics, soft metals...removes paint...at home or at work... on hand or electric sanders. Cut with scissors and wrap around sticks or dowels to make special tools.

1390

LOOK FOR THIS
**Dragon
Skin**
DISPLAY
AT YOUR
Red Devil Dealer



75¢
complete
with holder
25¢ for
single sheets
Also
available in
full sheets
and 1/2-sheets



Red Devil Tools.

Union, N. J., U.S.A.

World's Largest Manufacturer of Painters' and Glaziers' Tools

BOAT KITS

8'-18': 50 Models
\$41.75 up;
Frt. Pd.
EASY MONTHLY
PAYMENTS



FREE COLOR
CATALOG

Cruisers, convertibles, runabouts, fishing. Easily assembled by anyone. FREE Catalog has natural color photos, complete details, Fiberglass, accessories hardware, paint. Write Today.

LUGER INDUSTRIES, INC., Dept. B-1

9200 Access Road, Minneapolis 20, Minnesota

Where Did the Inches Come From?

(Continued from page 175)

We add the usual 34 inches of torso height and three to five inches of excess headroom. Add these up and if you accommodate the center passenger you get about 54 inches minimum instead of 50 or 52—and therein is the big problem today of the Detroit body engineer.

You might be surprised at the difference in corporation policies regarding the relative values of comfort and convenience and styling lines. Ford Motor Company is probably the most conservative at the moment. Its low-pinion rear axles, step-down "Coke-bottle" frames and flat roofs have given reasonably low body lines while maintaining headroom and respectable cushion thickness over the tunnel. But its 1959 bodies are not quite so low as GM's and who knows which way Ford might jump in 1960?

The GM divisions have put a tremendous amount of time and money into engineering for low body lines while maintaining acceptable headroom and seat height. GM Styling set an arbitrary limit of 40 inches metal-to-metal distance between the top of the drive-line tunnel and the roof, measured near the center of the rear seat. Such a limit gives at least two inches of compressed-cushion thickness and four inches excess headroom. It forced engineers to concentrate on step-down frames (all GM uses them), roof and drive-line design. And it paid off with the lowest-looking line of cars among the 1959 model crop.

Chrysler Corporation, which was once the most conservative on things like seat height and headroom, pulled out all stops two years ago to get under competition. It lowered its bodies with a minimum of tooling changes. It uses no step-down frame and its floor line is above the frame rails. Seats and seat mountings had to be lowered to compensate. A single-piece drive shaft with the modest 1½-inch pinion drop meant a relatively high tunnel. This has been compensated somewhat by limiting the upward rear-axle travel by rubber stops and accounts, in part, for the superior stability in high-speed cornering of Chrysler products.

It is obvious from the above that major changes in chassis and body layouts will be necessary in order to take many more inches out of car height. There are several possibilities.

It would be simple if we could get rid of the center passenger in our sedans. The four-place Thunderbird is an example. It is 52½ inches high with excellent seat

(Continued to page 280)

CUT-TO-FIT HOMES CUT BUILDING COSTS

CHOICE OF 57 DESIGNS

ORDER NOW

SAVE UP TO 1/3



Build your own home and save the builders' profit—plus savings in lumber and labor with Sterling Ready-Cut-Homes. Anyone can assemble with simple, easy to follow plans furnished. Every house complete with all lumber, roofing, nails, glass, hardware, paint, doors and windows marked ready to erect. Freight paid. Complete building plans ready for filing at low cost. Sold separately if desired. Write today!

PRICED FROM \$2150 up

Five Easy Payment Plans

Send 25c for NEW COLOR CATALOG

INTERNATIONAL MILL AND TIMBER CO.
DEPT. PM19 BAY CITY, MICHIGAN

... THE HIGH VISCOSITY OIL FOR DELICATE MECHANISMS



Hoppe's Lubricating Oil... Companion to Hoppe's Famous Number 9 Solvent

Test its viscosity by rubbing between thumb and finger. Feel the penetrating thinness and long-lasting film that make it best for clocks, guns, delicate mechanisms. At all Hardware and Sporting Goods Stores. Send 25c for 1-oz. size to cover postage and handling. "Gun Cleaning Guide" sent free on request.

1 OZ. 20¢
3 OZ. 35¢

- Won't gum
- Flows freely
- Sticks out fast

FRANK A. HOPPE, INC. 2310-20 N. EIGHTH STREET PHILADELPHIA 33, PENNA.

KING MIDGET

More power, beautiful styling, New Features. Still World's Lowest Priced Car. Drive it for 75c a week. Rider agents wanted. Earn your own car.



2 GREAT AUTO BARGAINS



King Midget Junior chassis, finely engineered, ready to run. Agents wanted. Send 25c for 32 page picture book, full details, dealers price on both cars. Or send \$1 (refunded first order) for this and Service Manual, plus Repair Manual and 15 5x7 photos of car and factory.

MIDGET MOTORS CORPORATION, ATHENS 1, OHIO

SURE CURE FOR EXHAUST LEAKS



New magic

MUFFLER SEALER

- SEALS NEW — REPAIRS OLD — MUFFLERS AND PIPES
- HEAT-PROOF — PERMANENT
- EASY TO USE — JUST SQUEEZE THE PLASTIC TUBE
- MAKES FASTER, EASIER INSTALLATIONS
- MAKES EVERY CONNECTION A PERFECT FIT!
- PREVENTS RUSTED CONNECTIONS
- MENDS HOLES AND BURST SEAMS LIKE NEW!
- WORKS LIKE PUTTY — DRIES HARD AS METAL

SEALS NEW — REPAIRS OLD MUFFLERS AND PIPES

\$1.00 for large 6 oz. tube at leading Auto Supply Stores or send \$1.00 direct to:

MAGIC IRON CEMENT CO., INC. 5400 Bower Avenue Cleveland 27, Ohio

HULL AUTO COMPASS



installs in ALL newer cars ... EASILY

ONLY Hull's universal bracket permits easy mounting on upper or lower windshield moulding. Vacuum cup also included for windshield mounting. Fits any car of today or tomorrow. Compensates easier, reads easier. \$5.50 and \$6.95. At your dealer's, write for literature.

MOST-USED COMPASS OF MOTORISTS, BOATERS

HULL MFG. CO. P.O. Box 246-E-1. Warren, Ohio

NOW! Adjustable CORNER CLAMP



AND MITERING VISE

Securely holds mitered or butt joints at 90° angle, or any angle, for nailing, stapling, gluing and splicing. ADJUSTS TO ANY ANGLE. Used for Picture frames, Screens, Storm windows, Shadow boxes, or any place where wood is joined.

\$1.75 PPD.

SAW SHARPENING IS EASY

Super Filer No. 11 joints and sharpens hand and circular saws 6" to 10" with all teeth correct in height, depth, pitch, bevel. When file hits steel roller, teeth are finished. Saw runs true with no side pull. Includes 8" file.

\$9.95 PPD.



"TRU-CIRCLE" saw set automatically sets teeth at 10° or more.

\$2.95 PPD.

MONEY BACK GUARANTEE

A. D. McBURNEY, 5908 Hollywood Blvd., Hollywood 28, Cal., Dept. A-19

REPAIR FOR YOUR B&D TOOLS



For genuine B&D repairs check Yellow Pages under "Tools-Electric" for address of nearby Black & Decker

FACTORY SERVICE BRANCH

Free tool inspection when requested • Genuine B&D parts used • Factory-trained technicians • Standard B&D Guarantee at completion of recommended repairs • Fast service, reasonable cost, always.

Or write for address of nearest of 48 branches to: *The Black & Decker Mfg. Co., Dept. S5001, Towson 4, Md.*



QUALITY ELECTRIC TOOLS

Rare, Fancy & Imported Woods... Veneers... Plywoods
Mouldings... Patterns... Hardware... Mosaic Tile
Ornaments... Tools... Archery and Skiing Supplies

Everything You Need in Craftsman's New WOOD and Home Workshop CATALOG

Get Yours! Rush Coupon Today!

132 pages



OVER
1,500
ITEMS

NEW—MOSAIC TILE PROJECTS!

World's Largest Selection of Finest Domestic and Imported Woods... Mouldings, Hardware, Tools—ALL AT LOW MONEY-SAVING PRICES! Your complete wood buying guide and project book. Craftsman is your best, most complete source of finest kiln-dried domestic and imported woods, beautiful wood inlays, colorful bandings, matched plywoods, embossed mouldings, carved ornaments, newest wood-working tools, "hard-to-find" cabinet hardware; more than 1,500 items! Packed with newest scroll saw patterns, project ideas and money making plans. Enclose 25c (refunded with first order) to help pay mailing and handling cost. Write TODAY to

CRAFTSMAN WOOD SERVICE CO.,
Dept. A-1, 2729 S. Mary St., Chicago 8

CRAFTSMAN WOOD SERVICE CO., Dept. A-1
2729 S. Mary Street, Chicago 8, Ill.

Enclosed find 25c. Rush new CRAFTSMAN WOOD CATALOG.

NAME _____

ADDRESS _____

CITY _____ ZONE _____ STATE _____

height and headroom. This type of body will most certainly grow in popularity in the years ahead.

We'll get a substantial reduction in drive-shaft tunnel height by switching to independent rear suspension, in which the differential is mounted rigidly on the frame and the shaft doesn't move up and down at all—only the wheels. Look for this by 1961.

Ford is working hard on front-wheel drive which gets rid of the shaft altogether. Other things like lower-profile tires, smaller wheels, more compact rear axles, drive shafts in the form of a thin torsion bar instead of a big tube will help also.

No, sir, you haven't seen anything in lowness yet. Your car will be lower tomorrow! ★ ★ ★

Wheeled Aluminum Frame Helps Move Light Loads

Old cardboard boxes can be attached to a two-wheel aluminum frame which serves as a caddy for hauling grass clippings, leaves or weeds. Long springs with clip ends hold the container in place. The frame is designed to carry loads up to 100 pounds. The caddy also can be used to carry golf clubs, laundry, luggage or groceries.

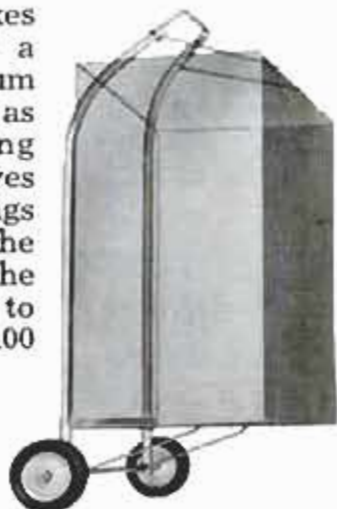

Photos Snapped at 10,000 Feet Detect Disease in Cereal Crop

Aerial photographs of cereal crops, taken from 10,000 feet, can detect infected areas missed by trained ground observers standing only 10 feet away. Infrared, color and panchromatic films are used. The same photographic methods can be used to distinguish soil and mineral types, plant species and water depths, as well as to single out timber stands vulnerable to epidemic-size disease or insect attacks.

Extract Takes Bite Out of Sting

Injecting an extract of bee venom under the skin makes some people less sensitive to bee stings, according to a South African medical scientist. The extract is made by grinding up whole bodies of bees, since this is easier than preparing an extract from stingers alone. The extract was reported successful in 19 of 24 cases treated.

VENCO ELECTRIC TRUCK WINCH



New All Purpose —
farmers,
sportsmen, contractors

Easily installed. no power take-off, no drive lines. Front or rear cab mount. Complete with dash panel switch, cable, wire rope and hook. Reversible motor with automatic brake. 3000 lbs. cap. Low price—no costly installation.

Send for catalog and nearest dealer.

VEN CORP., 2828 NEWELL
LOS ANGELES 39, CALIF.

WIRE STRIPPER



Handy, pocket size tool, strips solid and stranded wires from 10 to 18 gauge. Individual stripping holes for each size wire assure a precision job. Also cuts wires and makes terminal loops. A real mechanics tool built for rugged service. Only \$2.65. Order by catalog number 45-120.

POWER PARTS COMPANY
1860 Wilmont Avenue
Chicago, Illinois



Print Your Own

Cards, Stationery, Advertising, Circulars, labels, photo and movie titles, church work, tags, etc. Save money. Sold direct from factory only. Raised printing like engraving, too.

Own a Printing Business

Print for Others, Good Profit. Have home shop. Junior press \$15; Senior \$29 up. We supply everything. Easy rules. Pays for self in short time. Write for free catalog of outfits and all details.
KELSEY PRESSES, C-37 Meriden, Conn.

Find HIDDEN TREASURES

GOLD, SILVER, PRECIOUS METALS with the Famous Model 27 Metal Detector. Lightweight, ultra-sensitive, low cost. None finer. Also GEIGER COUNTERS for uranium and the VIOLITE for tungsten. INFORMATION FREE

THE *Detectron* CORP. Dept. 1
5528 Vineland Ave., No. Hollywood, Calif.



The Modern PLASTIC
for lasting Home Repairs

PERMANENTLY mends cracks or holes in wood, tile, stone or plaster. Sticks and stays put—Does not chip, shrink or fall out. Easy to use. Economical. Mold it, chisel it, polish or paint it. The big 4-lb. can is obtainable from your lumber, paint or hardware dealer at \$1.40; or will be shipped direct postpaid (in U. S.) for \$1.75. Complete satisfaction guaranteed or your money refunded.

DONALD DURHAM CO.
Box 804-T Des Moines, Iowa

"My new Atlas
12" LATHE
handles every job
faster...and better!"



TIMKEN TAPERED
ROLLER BEARINGS



QUICK-CHANGE
GEARS



HEAVY-DUTY
PRECISION GROUND BED

For experimental, development, production and hobby work, Atlas precision lathes give you many more important features that increase accuracy, speed production and cut costs than any other lathe in the low priced field.

They have big capacity — 12 1/4" swing over bed, 12" swing over saddle wings, 8" over cross slide, up to 36" between centers. And they're ruggedly built throughout to handle bigger jobs, and a wider variety of work with dependable precision. These important features are standard equipment: Timken tapered roller bearings, 16 spindle speeds, reversible power cross feed and longitudinal feed, wide thread cutting range, V-belt drive.

Available in bench models with standard change gears or quick-change gears, and in two under-neath drive models with pedestal base as illustrated. See your nearest Atlas Dealer . . . use coupon below for latest catalog.



ATLAS 12" LATHE PRICES **\$325.00** F.O.B. FACTORY
START AT

DEPENDABLE QUALITY TOOLS SINCE 1911

SEND FOR FREE CATALOG

ATLAS PRESS CO., 1-24 N. Pitcher St., Kalamazoo, Mich.
Please send latest information on ATLAS Tools.

12" Lathe Drill Press
 Miller Shaper Grinder-Hone

NAME _____

ADDRESS _____

CITY _____ ZONE _____ STATE _____

Here's What Ford Stylists Say

(Continued from page 178)

MAGUIRE: Well, my wife likes the size of it, yes.

WALKER: And my wife likes the size of it.

MAGUIRE: I'm not denying the size thing altogether. The fact that the Thunderbird is smaller than the Lincoln appeals to her. But she has told me that she would just as soon drive the Lincoln. It's as easy to maneuver as the Thunderbird except in parking. I think the Thunderbird sells because of the spooky, lush quality of it. It's a distinguished car.

WALKER: They keep talking about cars being too big to park. How many times does a person park a car or get in and out of it in a day? We say somebody gets in and out of a car about four times a day. That's not very often. Why would he forsake good silhouette and design just because it knocks his hat off a few times a day? If we were designing a milk wagon we would make it high enough so a man could jump in and out without knocking his hat off.

MAGUIRE: The Thunderbird is very low and I don't hear any owner complaining about it. I don't think size has as much to do with its success as you seem to think. People are buying it because it's a spooky style leader. I am distinguished when I am in it.

WALKER: But I am sure that if it sold for \$3000 you'd still see a lot on the road. It wouldn't be as exclusive, but it would sell just the same. The balance of the car is so nice, the silhouette is so nice, it could be the concept of a whole new line.

QUESTION: When are you going to have a four-door version?

WALKER: I couldn't answer that. I don't know.

QUESTION: Would a four-door model hurt Lincoln's business?

MAGUIRE: I think you could say that it is hurting Lincoln's business right now. That is one thing that makes it so difficult to make decisions in this business. Lincoln is trying to sell a quality car. What is a quality car? A big one? Here we have a quality car that's a little one.

QUESTION: Isn't it true that by the time you can afford a fine car you probably don't need a big one?

WALKER: Well, there's a yes and no to that. The American public is aggressive, it's moving upward all the time. The average man still likes that up, up, up, and that means bigness. When the American workman gets a little more money he wants

(Continued to page 284)



ZUIDER CHURCH (1814), AMSTERDAM, HOLLAND

On tour or around town, keep your car engine whistle-clean and smooth-running with Quaker State. This pure Pennsylvania motor oil prevents harmful deposits. Quaker State lubricates better and lasts longer, giving you three-way economy: freedom from repairs, improved gasoline mileage and low oil consumption. In all the world, it's the best motor oil money can buy. Ask for **Quaker State!**

QUAKER STATE OIL REFINING CORPORATION, OIL CITY, PA.

Member Pennsylvania Grade Crude Oil Association



NOW! HOME CRAFTSMEN CAN OWN THIS PROFESSIONAL ARC WELDER

EASY TERMS
ONLY \$98.50
F. O. B.



FREE

WRITE FOR
COMPLETE
DETAILS AND
EASY PAY PLAN

Now you can own a Trindl full 125 amp Industrial Welder at a price far less than smaller machines. With a Trindl 125A you can weld metals up to 1/2 inch thick. Operates off either 110 or 220 volt line, properly wired. 16 heat stages from 20 to 125 amps. Make and repair anything of metal around the home, garage, farm or shop, like a professional. No previous experience or training needed. Full "do-it-yourself" instructions with each machine. Complete only \$98.50 f.o.b. factory, or write for details. Trindl manufactures a complete line of heavy duty welding machines. Dealer inquiries invited.

TRINDL PRODUCTS Ltd., Dept. T2-A
1807 So. Clark St., Chicago 16, Ill.



Guaranteed

12 MONTHS
IN
CONTINUOUS
OPERATION



G E A R S

In Stock - Immediate Delivery

Gears, speed reducers, sprockets, thrust bearings, flexible couplings, pulleys, etc. A complete line is carried in our Chicago stock. Can also quote on special gears of any kind. Send in your blueprints and inquiries.

Send for Complete Catalog No. 10
CHICAGO GEAR WORKS
440-50 N. Oakley Blvd., CHICAGO 12, ILL.



For Many Uses!

Metal Turning Lathe

Only **\$49.95**

F.O.B. Lansing, Ill.
15 1/4" bed with 4 1/2" swing.
7" between centers.
Satisfaction Guaranteed.

FREE FOLDER
Write for it today!

Rosemoor Manufacturing Co.
Box 147J, Lansing, Ill.

OUTWORKS THEM ALL

Prepares the toughest soils in one operation. All-purpose tiller-tractor tills to 12" deep - 12" to 40" wide. 3 models; 7 rotor styles including mulchers. 40 attachments include all tractor tools, mowers, snow plow. Tough chain-gear drive. Send for details.



Pat'd.
Also Pat's. Pend.

MERRY TILLER

Northern Life Building, Box 1835, Seattle 4, Wash.

D. C. WELDING GENERATOR



\$16.50

Westinghouse high quality 200 amp. 28 1/2 volt D.C. Ball Bearing 2500 r.p.m. direct or belt drive Generator in used tested cond., \$16.50. Same in rebuilt condition, \$23.50. Brand new \$33.50. Double V belt pulley, installed \$15.00 extra. Forced blower cooling assy. installed \$8.50 extra.

All prices FOB our Plant. Cash, check or M.O. No COD's.

HENRY HUNT, OLDSMAR, FLORIDA

ALSO NEW LAPSTRAKE KITS

U-MAK-IT BOAT KITS

FIRST AND OLDEST
KIT BOAT
MANUFACTURER

Most complete line of PRAMS, ROWBOATS, OUTBOARDS, CABIN CRUISERS and new Lapstroke kits.

MAIL 35c (coin) for post. & hdg. for ILLUSTRATED CATALOG

Showing all models 8' to 23' including accessories, paints, etc.

All you need to build your own.

U-MAK-IT PRODUCTS
DELAND, FLA. - DEPT. 12



do-2



DIAL ANY DADO WIDTH... IN SECONDS

FOR PROFESSIONAL PRECISION...only with a COMET QUICK-SET DADO! Cut to a maximum depth of 3/4". Dial the exact width (from 1/4" to 1 3/8"), without removing the tool from the arbor. Watch the balanced, tool-steel COMET blades cut perfect dados, rabbets and ploughs...on any table or radial arm saw. Use COMET for quick, professional precision... stays sharp 5 times longer! If not at your local dealer, order direct by check or money order. **19.95 PREPAID**

COMET MANUFACTURING CO., Dept. PM 1

2033 Santa Fe Avenue, Los Angeles 21, California
a division of The Siegler Corporation

NEW MODEL CHANGE OVER SALE

NOW
\$9.95
WAS \$24.95



Shipped
Complete
As Shown
Less Blade

8" TILT ARBOR POWER SAW

1958 MODEL NOW SOLD BELOW COST
BLADE TILTS • TABLE REMAINS LEVEL

Heavy duty all cast iron and steel construction. Precision ground cast iron table. Price includes massive cast iron mitre gauge and patented motor drive that fits any motor. Does everything same as saws costing four times as much — cross cuts, rips, bevels, mitres, dados, cuts compound angles. Adjustable depth of cut; 0" to 2 1/4". Send check or M.O. \$2.00 deposits on C.O.D.'s.

SAVE \$15 ON THIS SPECIAL BARGAIN
DURING OUR MODEL CHANGE OVER

This saw is our 1958 model. Brand new — sent to you in factory sealed cartons. Sold and guaranteed direct from factory to you at a fantastic bargain.

LOOK AT ALL THESE SPECIAL FEATURES

Blade adjusts to any angle up to 50° • Single Hand Wheel Control. Tilts and locks blade with a twist of the wrist • Blade raises and lowers; cuts from 0 to 2 1/4 • Precision-ground cast iron table. Lasts a lifetime. Resists nicking and wear • Patented Motor Mount takes any standard 1/4 or 1/3 h.p. motor • Always keeps belt tight; transmits full power • Massive accurate iron mitre gauge • Saw insert removable for dado heads and other accessories • Heavy long-lasting, all-metal construction • Built for a lifetime • Shipping weight 25 lbs.

FAMOUS AMERICAN IRON CLAD GUARANTEE

Try this famous saw 10 days. If not completely delighted — FOR ANY REASON — return for immediate money back refund. All power tools sent express collect. We reserve the right to refund money if stock is exhausted. Use this handy coupon.

AMERICAN MACHINE & TOOL CO.
ROYERSFORD 52, PA. 1

MAIL COUPON TODAY

American Machine & Tool Co.
Royersford 52, Pa.

Gentlemen: Please send me 8" Tilt Arbor Saw(s) at \$9.95 each. Enclosed is check , M.O. , or send C.O.D. . . . \$2.00 deposit, please. Add \$1. for delivery west of Mississippi.

Name

Address

City Zone State

a bigger house and he wants a bigger car. You can't change that.

QUESTION: A favorite with the Detroit detractors at the moment is sex symbols. Is there any deliberate attempt to put sex symbols in cars?

WALKER: Absolutely not.

MAGUIRE: A car gets into a face symbol very easily with its headlights that look like eyes and a grille that looks like a mouth. Sometimes you work like a dog for a couple of weeks on a front end and you come in one morning and you've got a mouth with four teeth in it, with eyes over here and a nostril opening in the power dome. It shocks you. You wonder how you could go that far without noticing it.

QUESTION: Why do we need four taillights? They don't tell you anything more than two.

WALKER: They give balance when they're done right. And they are a decoration that makes a little more flash and splash at the rear.

MAGUIRE: Let me say something about the size of taillights. Why shouldn't a taillight be a big thing? When Ford stoplights go on you know it's stopping. When I drive down the highway I miss those big lights if they're not there.

WALKER: Taillights are partly safety and partly styling. They add an exciting element to the design. Of course, you can get bizarre with it if you're not careful.

QUESTION: Why do you insist on hiding the gas filler pipe?

MAGUIRE: Why shouldn't it be concealed? Who has to know where it is? Only the gas man and he knows.

ENGEL: It's just an ugly square shape on the side of a fender. It helps to get it out of sight, smooths up the lines.

MAGUIRE: That's a funny question because it's the kind of question that's hitting us now. It's the "gray flannel" question. It's asked by the same people who write that automatic transmissions are terrible and we should go back to the stick shift. This is the year to be against automobiles. But, good heavens, would those people want to get rid of the automatic oil burner in their homes? Is there merit to shoveling coal? Why stop at the stick shift? Why not go back to the tiller? Why not go back to the horse? Where do you stop?

ENGEL: I can imagine what the car would be like if we designed one to please those people. It sure wouldn't sell.

QUESTION: Is there a lot of circus in this automobile business?

MAGUIRE: I don't like that word. I suppose it's showmanship. We're not merely

(Continued to page 286)

HELP US KEEP THE THINGS WORTH KEEPING

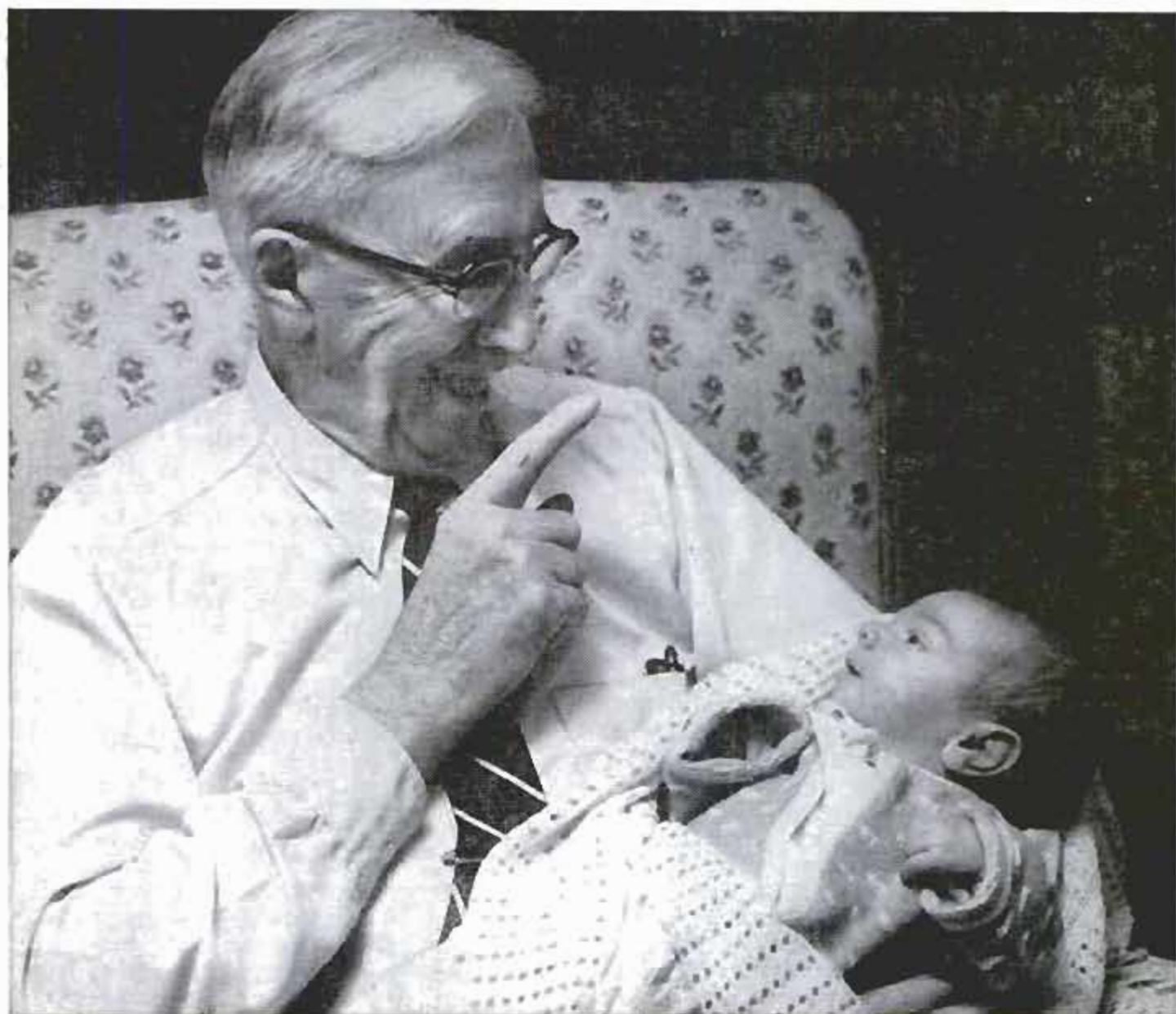

Each of us wants peace for his own precious reasons. But peace costs money. Money for strength to keep the peace. Money for science and education to make peace lasting. And money saved by individuals to keep our economy strong. Each Bond you buy helps provide this money—helps strengthen America's Peace Power. Are you buying enough?

HELP STRENGTHEN AMERICA'S PEACE POWER
BUY U. S. SAVINGS BONDS

The U. S. Government does not pay for this advertising. The Treasury Department thanks, for their patriotic donation, The Advertising Council and this magazine.



problem solvers although we have to solve problems. We design a car and the minute it's done we hate it—we've got to do another one. The 1957 Ford was great, but right away we had to bury it and start another one. We design a car to make the man unhappy with his 1957 Ford along about the end of 1958, so he'll buy another one. Planned obsolescence, I guess. It's a nasty word nowadays, isn't it?

QUESTION: Is it really necessary—this planned obsolescence?

MAGUIRE: It is, if the country is to keep on doing what it's doing.

QUESTION: Are cars going to get any longer?

ENGEL: I would say not. Not much longer.

MAGUIRE: Sounds logical, but I hate to make such a statement.

ENGEL: I'd never say they weren't going to get any lower. I don't know how low they'll go.

QUESTION: Will perhaps all cars be about the same length with the differences being in luxury, in lushness?

MAGUIRE: We're getting close to this now. The new Buick is big, but it doesn't look as big as it did. That's a funny thing. We used to be proud of making a car look longer than it really was. Have we reached the point where the trick is to make a car look shorter than it is?

QUESTION: It appears that the stylist has taken the ball and run with it, leaving the engineer in the shadows. Is this true?

ENGEL: When a person walks into the showroom to look at a new car he doesn't see the engine. Sure, the engine is important, but the customer sees styling first.

MAGUIRE: Engineering is less of a problem than it used to be. Cars run now.

QUESTION: What's the truth about the industry's espionage system, which is supposed to inform each company what the other is doing years in advance?

ENGEL: I don't know anything about it. Styling doesn't have anything to do with it. Any information we get somebody else gives us.

QUESTION: Is espionage widespread?

ENGEL: I don't think it's as big as it's made out to be. I think a lot of it comes when a stylist moves from one company to another. If a couple of guys left here today they could tell General Motors or Chrysler exactly what we're thinking about for '61.

MAGUIRE: We never find out things early enough anyway.

QUESTION: How important will styling be to the success of the small car?

ENGEL: Price is the most important thing on the small car, economy of operation is second and then styling, I would say. The owner is buying transportation and economy, not styling.

MAGUIRE: I'm not so sure. I have never seen a poor man in a Volkswagen yet. I have seen gray-flannel nonconformists in Volkswagens, but I don't think they're after economy.

ENGEL: The Volkswagen is an ugly car, but it's economical and it sells. They haven't changed that thing in 15 years. They've got a good thing there and they probably would ruin it if they changed it. Maybe they're better off not worrying about styling—it's no bed of roses designing a car. When you get into the financing, production and the public taste—it's a real tough problem.

WALKER: That's right. It's not like designing a vacuum sweeper or a TV set. You've got to remember to be "automobiley." That's Maguire's word for it. Engel, here, has the concept of the nice, crisp line that has been characteristic of Ford products. We think that our competitors are becoming aware of the crisp highlights of our concept of styling for the first time this year and we're flattered. ★ ★ ★

Auto Performance Meter Makes Everyone a Test Driver



You can make precise tests of acceleration, braking and economy with an imported accelerometer now being sold in this country. The meter operates on inertia. The faster you accelerate, the greater the swing of the needle. The more effective your brakes, the higher the reading. By keeping a record of the readings when your car is in good tune, you will know when efficiency has dropped enough to warrant another tuneup. It also can give you advance warning of possible brake trouble. For those interested in gasoline economy, it can be used to help you drive in a miserly manner that reduces waste to a minimum.

YOU BUY GUARANTEED QUALITY AT YOUR PROTO DEALERS

No. 100HR



No. 1200 M

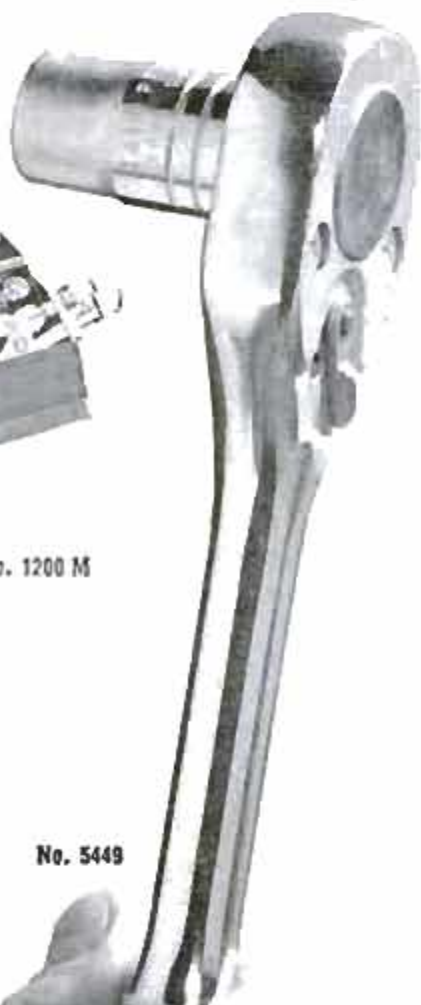

No. 5449

Shown: Proto No. 100HR
Tool Box. Has tote tray
and two compartments.
A popular model.

Proto No. 1200 M, Metric
Combination Wrench Set.
Standard Proto pattern,
forged alloy steel, exact
metric openings, 7 sizes.

Proto No. 5449, Reversible
Ratchet, 1/2" Drive (with
9/16" 12-pt. socket).
Forged, tempered in special
analysis alloy steel.
Full range of sockets,
attachments available.



You can buy 2172 professional tools
from your Proto Dealer... each tool
unconditionally guaranteed to do the
jobs for which it was designed.
Your Proto Dealer regularly stocks
hundreds of these fine tools...
will order others for you.

Proto Dealers include:
Auto Parts and Hardware Stores,
Implement Dealers, Builders
Supply, and others.

Send 10¢ for a complete illustrated catalog to:



2202 Santa Fe Avenue, Los Angeles 54, California

Los Angeles division of Pendleton Tool Industries Inc.
World's Largest Manufacturer of Hand Service Tools.

IN YOUR CAR RADIATOR... GUARANTEED TO STOP RUST!

**WATER STAYS
CRYSTAL CLEAR
FOR OVER
ONE YEAR**

Just one can of
MAC'S NO. 13
removes rust and
scale... prevents
costly repairs. Get
MAC'S NO. 13
today.



**AT SERVICE STATIONS
EVERYWHERE**

MAC'S SUPER GLOSS CO., INC.

Los Angeles 42, Calif. • Cincinnati 26, Ohio

SAWS

PLANES

MOLDS



NEW BELSAW MULTI-DUTY POWER TOOL

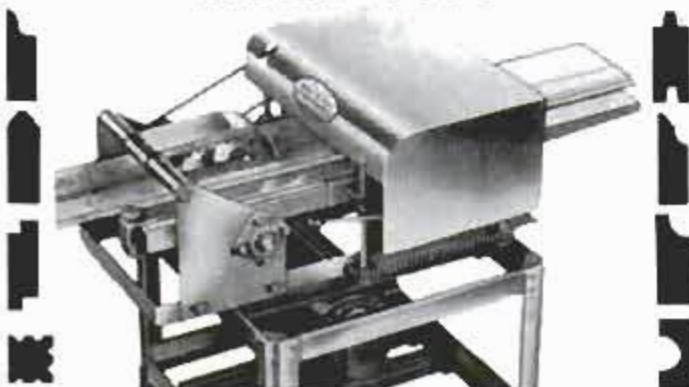

Now you can use this ONE power-feed shop to turn rough
lumber into high-value moldings, trim, flooring, furniture
... ALL popular patterns.

RIP... PLANE... MOLD...

separately or all at once by power-feed... with a one
horsepower motor. Use 3 to 5 HP for high speed com-
mercial output.

FULLY SAFE-GUARDED,

Low Cost... You can own this money-making power tool
for only \$30.00 down payment.

Write TODAY for free Catalog

BELSAW POWER TOOLS • 909 Field Bldg., Kansas City 11, Mo.

Here's What Chrysler Stylists Say

(Continued from page 179)

in the chassis, such as moving the trans-
mission to the rear, but they would be
very costly.

QUESTION: The public seems to be
showing better taste about furniture and
homes these days. And cars too, I think.
But it seems to me that car interiors are
still very garish when compared with liv-
ing rooms. Why are they that way?

EXNER: The type of interior we are do-
ing is what the sales department has in-
dicated that the buyer wants.

SCHMIDT: It's the same story as the ex-
terior-chrome story. We designers would
have very few moldings if we had our way.
But if you put a chromed-up job beside a
plain job in a showroom, in most cases the
car with the brightwork will sell sooner
than the plain one.

EXNER: Perhaps it is the initial im-
pression that sells. Maybe that is where
this extra "busyness" is needed.

SCHMIDT: Remember we are merchan-
dising people. A stylist is here to design
cars that will sell, so we must satisfy the
tastes of most people.

EXNER: Product planners may feel that
the busy design makes the average buyer
think that he is getting more for his money.
But there is a very slow move towards
greater simplicity and we stylists like it.
But we may have to get busy again later.
Look at the appliance business. Washing
machines are simpler to use than ever, but
they are designed to look busy.

QUESTION: A favorite charge of the
iconoclast is that of sex symbolism in styl-
ing. Is there anything to this charge?

EXNER: Absolutely not. Frankly I
think that's coming from people who are
more concerned with that sort of thing
than they should be.

QUESTION: What about the push-but-
ton control? Is it a styling or an engineering
device?

EXNER: It's a combination. It's a very
simple, functional control that meets both
esthetic and functional requirements.

QUESTION: Don't you think all controls
of this type should be standardized?

EXNER: Strictly from a safety stand-
point, I could see that it would be an ad-
vantage to have every transmission control
the same. But if you come out each year
with exactly the same arrangement, some-
body is apt to say this instrument panel
doesn't look much different from my old
one. You have to have new arrangements
to make the panel more attractive, more
exciting.

(Continued to page 290)



ITEM #1010

Shipping wt. 27 lbs. F.O.B. Chicago..... **79.50**

MODEL 700 750 WATTS A. C. Generator F.O.B. Chicago..... 59.50

MODEL 2000 2000 WATT A. C. Generator F.O.B. Chicago... 133.00

GENERAL ELECTRIC HIGH PRESSURE AIR COMPRESSORS

Output — 1000 Lbs. per Sq. In. • For filling aqua-lung tanks • For air brush work • Filling accumulator and air-oil shock struts • Cleaning and testing spark plugs • Hundreds of other uses.



ITEM #461

As released from U.S.A.F. in used, serviceable condition. (Covered by our 30-day guarantee.)

14" L x 9 1/2" H. Shpg. Wt. 15 Lbs. U.S. Gov't paid \$296.00. OUR PRICE... **15.00** F.O.B. Chicago

High pressure air receiver tank for G.E. compressor. Shpg. Wt. 2 Lbs. **4.00**

PRESSURE GAUGE 0 TO 2500 P.S.I. **1.50 EA.**

STAINLESS STEEL TANK

ITEM #63—For Compressors, Tire Inflators, Floats, Buoys, Fluid containers, etc., type G-1, 2100 cu. in. capacity (9 Gals.) 450 P.S.I. Used as Aviators Oxygen Bottles. Strong, but light weight. 24" Long x 12" Dia. 1/4" port at each end. Wgt.—19 lbs. F.O.B. **13.50** ea. for **25.00**



FREE! NEW, BIG CATALOG

VALUE-PACKED PAGES GALORE. Unsurpassed War Surplus and newly manufactured Equipment. Bargains for farm, home, factory, workshop. Write today.

For phone orders call Webster 9-3793

PAGE FOR TILLING PLOWING MOWING

FULL LINE 2 to 9 HP with complete gear drive and reverse.

Free Catalog LOW PRICES EASY TERMS Over 40 Years Experience

FULLY GUARANTEED! Over 60 attachments available!

PAGE 1904 S. 81st STREET MILWAUKEE, WIS.

GET THE HABIT OF READING

OUR CLASSIFIED ADS.

Wonderful Opportunities Amazing Bargains

1 1/2 H.P. HYDRAULIC SPEED REDUCER



ITEM #115 750 R.P.M. 7 1/2" x 7 1/2" x 11 1/2". Output rotation reversible. Shipp. wt. 31 lbs. Complete with 2 qts. of oil and full instructions. F.O.B. Chicago..... **72.50**

OBERDORFER BRONZE CENTRIFUGAL PUMP

For: Fluid Transfer, Sprinkler Boost, Circulating, Marine Coolant

Designed for continuous, heavy service. Carbon bearings require no lubrication. For direct or belt-drive with speeds up to 3450 RPM. All bronze housing and impeller with 1/2" stainless steel shaft. Has 3/4" inlet and outlet.



ITEM #481

Using 1/4 H.P. Motor delivers —

Head in Feet	0	4	6	8	12	16	20
1750 R.P.M.	3.00	2.00	1.25				
3450 R.P.M.	7.25	6.75	6.50	6.25	6.00	5.25	4.25

Regularly \$26.50 **OUR SPECIAL OFFER 8.95** Ea. Ppd. **2 for 17.50**

BRAND NEW! BOLT & WIRE CUTTER

Exclusive: Extendable Handles for Extra Leverage

CADMIUM PLATED. Center cut type bolt cutter for soft or medium hard rods and bolts, alloy wire, and other metals. Cutting edge has equal bevel on each side for extra strength.

FOLDED—It fits into your pocket or tool box—safety latch locks closed when not in use. Capacities: medium hard bolts in thread 3/8"; medium hard metals 5/16". Length closed: 10 3/4"; extended 15 3/4".

A \$9.95 NOW **3.95** 2 FOR **7.00** VALUE ONLY PPD.



ITEM 478

GROBAN SUPPLY CO. Dept. PM-1
1139 S. WABASH AVE., CHICAGO 5, ILL.

NEW! 16 FT. MOLDED FIBERGLASS BOAT KITS



EASILY ASSEMBLED IN ONE EVENING!

SAVE UP TO 60% FREIGHT PAID! FULLY GUARANTEED!

No need to pay extra for a fiberglass boat just because of additional expense of factory assembly. With Luger's simplified, patented assembly procedure, anyone can easily assemble the 3 basic 1-piece molded units (deck, hull, upper bow) into a super-strong, professionally finished, 1-piece fiberglass boat. No need to pay dealer profit either. Buy Luger Fiberglass Boats factory-direct. Luger pays the freight! No hand finishing. Lustrous colors molded in. 3 exciting models. WRITE FOR FREE FULL-COLOR CATALOG.

LUGER INDUSTRIES INC., Dept. GE-1
9200 Access Road, Minneapolis 20, Minn.

FREE Tyler SPYRAL HACKSAW BLADE!

Demonstrate for yourself why Tyler SPYRAL Hack-saw & Coping Saw Blades are America's number 1 choice for making precision & intricate CLEAN cuts of wood, metal, plastic, tubing, etc. Saw in circles, right or left, up or down. Available at your dealer. OFFER LIMITED! Since you will receive your FREE blade from your local dealer, you must fill out the coupon to the right & mail it to us. Offer is not valid unless you give us your name & address as well as that of your dealer. When dealer receives your FREE Tyler Blade, he will notify you by postcard.

MAIL COUPON FOR FREE BLADE!

TYLER MFG. CO., INC., Dept. PM-1
1005 W. Arbor Vitae Ave., Inglewood, Calif.

Your Name _____

Address _____

City & State _____

Name & address of my Saw Dealer is: _____

NEW! LIGHTWEIGHT!

JABSCO

**PORTABLE
SELF-PRIMING
PUMPS**



*Gasoline and
Electric—Up to 2100 GPH*

FOR FARM, HOME, MARINE USE!

- Self-priming • High Capacity • Dependable
- Low Cost • Low Maintenance

JabSCO "Water Mule" 1/2" pumps—Ports threaded externally for 3/4" garden hose and internally for 1/2" pipe thread.

- Electric—1/4 h.p., 110-v. AC motor—660 GPH at 10' Head! Weight 29 lbs!
- Gasoline—2 1/2 h.p., 2-cycle engine—900 GPH at 10' Head! Weight 28 lbs!

JabSCO "Water Buffalo" 1" pumps—Ports threaded internally for 1" pipe thread.

- Electric—3/4 h.p., 110/220-v. AC motor—1500 GPH at 10' Head! Weight 33 lbs!
- Gasoline—2 1/2 h.p., 4-cycle engine—2100 GPH at 10' Head! Weight 31 lbs!

Get more information today! See the Yellow Pages for nearest JabSCO dealer or write direct to:

JABSCO PUMP COMPANY

Dept. PM 1485 Dale Way • Costa Mesa, California





STAR Hack Saw Blades and Frames

... used throughout
industry

- ★ For better, faster metal cutting in your home work-shop or on the job, use the
- ★ Hack Saw Blades preferred by people
- ★ who know—Star. "Handy-Pak" convenience, with card holding one or two
- ★ blades, makes storing and handling easier and safer. Cards give valuable and
- ★ helpful tips on metal cutting. Ⓜ 1483

Star "Lever-Lock" Hack Saw Frames

- ★  automatically position and tension blade.
- ★  high-strength tempered steel back.
- ★  perfectly balanced to make cutting easier.

At all leading hardware stores—be sure and ask for STAR

Send 10¢ in coin for information-filled booklet on metal cutting.

CLEMSON BROS., INC. Middletown N.Y., U.S.A.

SCHMIDT: The whole industry puts the light switch at the extreme left side of the panel so you know where you reach to turn on the lights in the dark. It's not a written law but we all do it—perhaps there will evolve some similar system for push buttons.

EXNER: I think the stylist has a right to put the buttons in a new location if he wants to, providing he can find an equally functional location. He almost has to have this freedom because the dashboard arrangement is never fixed—it changes.

QUESTION: Why is so much effort spent on hiding the gas filler pipe?

EXNER: One reason could be that shapes are more complicated in the quarter panel and you don't have the right kind of surface for placing the filler cap.

QUESTION: Isn't upholstery unnecessarily luxurious for use in the automobile? Shouldn't it be more practical?

SCHMIDT: In general, upholstery is expensive and getting more so. We're going to materials that have bolder, tweedy effects. Instead of putting a lot of trim on the seat as we do today we're coming out with striped materials that have the design right in them.

EXNER: Of course, we put sprays on fabrics so they can be washed. And they are impregnated with solutions so you can spill ice cream on them and still wipe it off. You couldn't do that with most upholstery on your home furniture.

QUESTION: Why must we have such a broad, useless shelf over the dashboard? It reflects sunlight and takes up needed legroom, doesn't it?

EXNER: Just put your hand under there and you'll see there is no wasted room in it. We must leave space for a radio, a speaker, for air-conditioning parts as well as other things.

SCHMIDT: That's proved by the small glove boxes. They are left until last, after all the functional units are located. That is the most complicated area in the body.

QUESTION: Why do we have expensive-looking carpeting in cars? Why not rubber mats?

EXNER: It's not so expensive. A rubber pad would be more practical, but the buyer certainly prefers rugs. They look much better.

QUESTION: Stylists have been saying cars won't get much longer for 10 years now, yet they keep getting longer. Will cars continue to get longer?

EXNER: I really don't feel that they will get much longer. We're asking for fractions of inches now. There won't be the increases in the next five years that

(Continued to page 292)



FOUND! the keys to your repair problems!

THE ORIGINAL PLASTIC ALUMINUM

Hundreds of uses for this amazing metal in putty form. It's mixed, ready to use. Seals, solders, repairs. Applied cold, hardens into metal. Be sure you ask for DURO. **\$1.00**
LARGE 5-1/2 oz. tube only

PLASTIC RUBBER

Amazing NEW latex rubber in putty form. Chemically vulcanizes, molds to any shape. Waterproofs, rustproofs, insulates, repairs, caulks. Repairs ANYTHING made of rubber. **\$1.00**
LARGE 4 fld. oz. tube



Ask about DURO E-POX-E CHEMSTEEL and DURO PLASTIC PORCELAIN
\$1.29 in Canada. Available from all better hardware, auto accessory, variety and paint stores.
For further information write THE WOODHILL CHEMICAL MFG. CO. 1391 E. 34th St., Cleveland 14, Ohio

See newest home improvement products advertised on these pages . . .



Onan Emergency Electric Plants



PORTABLE MODELS
500 to 10,000 watts. Supply plug-in power anywhere!

Start automatically when high-line power is cut off. supply current for lights, heating system, freezer, water pump, stove, all appliances and machines. Prevents losses and hardships. Plant stops automatically when power is restored. Compact, easy to install. 500 to 200,000 watts A.C. Priced from \$319.00.

Write for Free Folder

D. W. ONAN & SONS INC.
3594A UNIVERSITY AVE. S.E. • MINNEAPOLIS 14, MINN.



HERE'S A MONEYMAKER FOR YOU!

make from \$3 to \$6 an hour with the FOLEY SAW FILER

Ask yourself these three questions: 1. Do I really want to get ahead *faster*? 2. How can I do it? 3. Am I willing to use my spare time? If you answer "Yes" to questions 1 and 3—then we have a positive answer for you on No. 2. Men make from \$3 to \$6 an hour sharpening hand, band and circular saws with Foley Saw Filers. No experience needed, to turn out sharp, smooth-cutting saws with this automatic machine. Start in spare time — no canvassing.

HERE'S THE WAY TO START

Read "Money Making Facts" — shows you how others have added hundreds or thousands of dollars to their incomes in this steady, repeat, CASH business. Start your own business in your basement or garage, no overhead, small investment. With *Time Payment Plan* the Foley can more than pay for itself out of profits. Send for "Money Making Facts" — mail coupon now. No salesman will call.

HERE'S PROOF

"When Mr. Patrick got his Foley Saw Filer in March 1946 he made a good and wonderful investment. He has done so well that we bought a house and paid for it, bought a new car, built an addition to our house. Nicest of all, it's all paid for." Mrs. Leslie Patrick.

"I made \$765 last year filing saws, and it sure comes in handy. I do this work in my spare time." —James B. Williams

"Last year's profit amounted to \$3,000. Not so bad for a one-man outfit." —Charles C. Hough.

"I have done 4 or 5 thousand saws in my spare time in the 4 1/2 years since I got the outfit, and they are all coming back with repeat orders." —Len Crego.

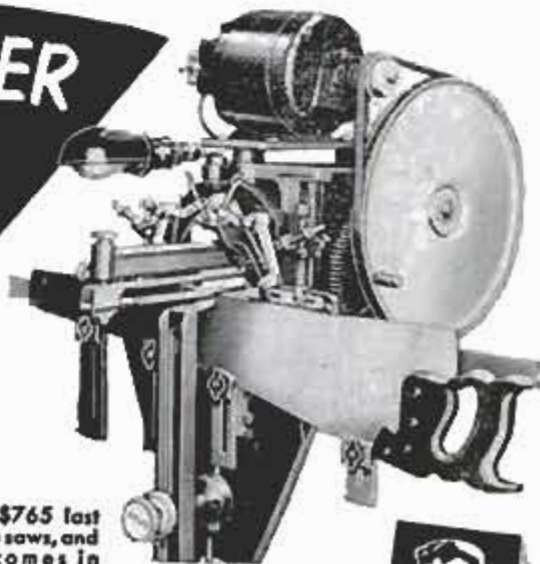

FOLEY MFG. CO., 116-9 Foley Bldg., Minneapolis 18, Minn.
Send me free book "MONEY MAKING FACTS" and Time Payment Plan.

NAME _____

ADDRESS _____

DREMEL MOTO-TOOL THE "POCKET SIZE MACHINE SHOP"

Handiest tool you'll ever own. Its high speed is ideal for precision grinding, polishing, carving, drilling, engraving, de-burring, sharpening, and hundreds of other household and workshop uses. Eliminates time-consuming hand work — gives the finished job a professional look. Weighs only 13 oz.—handles easily as a pencil. Does fine detail work with pin point accuracy. Fastest, most powerful tool of its kind — develops 27,000 RPM. Widely used by tool and die makers, model builders, craftsmen, lab technicians, repair men, gun smiths, schools, etc.

SEE YOUR DEALER or write for FREE catalog on the complete Dremel line of power tools.



MODEL No. 1.....\$14.85
MOTO-TOOL MODEL No. 2.....\$19.95
MOTO-TOOL KIT No. 1.....\$23.50

MOTO-TOOL KIT No. 2 (as shown) Incl. Model No. 2 Moto-Tool, 23 accessories (high-speed steel cutters, grinding wheels, etc.) in a sturdy storage case.....\$27.50

QUALITY POWER TOOLS SINCE 1934

DREMEL MFG. CO. Dept. 119A, RACINE, WIS.

CUT PERFECT GROOVES WITH *Warren* WASHERS ON YOUR SAW BLADE!

You Just DIAL
the Cut Wanted
over 250,000
sets in use!

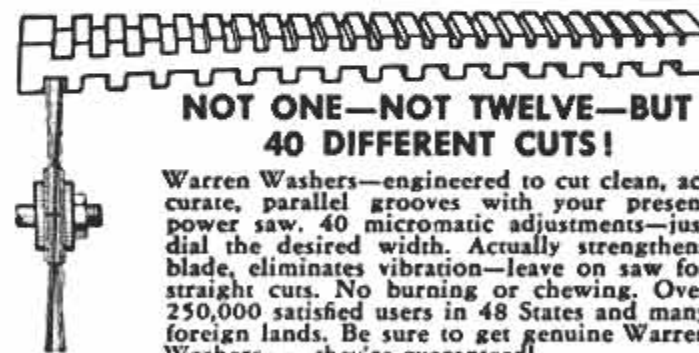

NOT ONE—NOT TWELVE—BUT
40 DIFFERENT CUTS!

Warren Washers—engineered to cut clean, accurate, parallel grooves with your present power saw. 40 micromatic adjustments—just dial the desired width. Actually strengthens blade, eliminates vibration—leave on saw for straight cuts. No burning or chipping. Over 250,000 satisfied users in 48 States and many foreign lands. Be sure to get genuine Warren Washers... they're guaranteed!

FREE! Send for free descriptive booklet. Arbor sizes 1/2", 3/8", 3/4", 1". See your dealer or write direct.

WARREN WASHERS CO.

Dept. 21, Box 98, North End Station, Detroit, Mich.

ONLY
\$4.95
SET

there have been in the past. Maybe we need a little more clearance for bumper protection or for taillight clearance, but that's all.

QUESTION: There seems to be a tendency for all cars to be getting closer together both in size and in luxury. How do you keep your Plymouth from looking more expensive than a Dodge, for example?

SCHMIDT: You put more money into the fabrics, in the carpets, in the engine. The cost factor automatically keeps the cars in proper price categories.

QUESTION: Suppose you came up with a design that was elegant enough for the Imperial yet cost no more to make than a Plymouth. Would you make it an Imperial or a Plymouth?

SCHMIDT: You wouldn't say that just because it was cheaper it was in the Plymouth bracket. If it fits in the Imperial picture you'd make it and spend any money you might save on the rest of the package, on the fabric, the carpeting, the hardware.

EXNER: We call it horsetrading. If we can save \$5 on a rear bumper we might take that money and put it into a more expensive grille. We are given a cost target. We don't have to spend a certain amount on each part of the package, but the total cost must not exceed a certain amount.

SCHMIDT: Elegance usually costs more. Low-price cars often have an inexpensive stamped grille. You touch it and it's sharp. It rattles in the wind. The die-cast grille costs more money and looks more elegant. It adds richness. You feel it and you know it costs more. It's stiffer and doesn't rattle in the wind.

QUESTION: What would you stylists do if the industry gave up its annual styling changes?

EXNER: There would still be plenty of work because there will always be this desire to have something better looking than the other fellow has.

SCHMIDT: We just wouldn't be so rushed.

QUESTION: Will the day come when the automobile will be completely devoted to passenger space, from stem to stern, rather than being divided into engine compartment, greenhouse and trunk?

EXNER: It's always easy to predict in this business because if you live long enough it will probably happen. But that hinges on the size of the power plant.

QUESTION: Do you think engines are coming down in size rather than getting bigger?

EXNER: I think so. They will, I think, get more efficient so they should get smaller. But that's strictly in the prediction department. Strictly a guess. ★ ★ ★

SURPLUS SALE

GOVT SURPLUS
EXCESS INVENTORY
BANKRUPT STOCK

ELECTRIC WATER PUMP

● Hi-capacity small centrifugal. Operates on 12-v DC or AC. Excellent bilge-sump pump; circulating water display; etc. Ball bearing explosion-proof motor 6 to 15 gal. per minute. Outlet 1" O.D. 7" high, 3" diam. Govt. cost \$64. SALE \$9.95 Ppd.

AIR POWERED TREE TRIMMER

● Simply press button. Powerful air cylinder cuts limbs to 3/4" or better. Operates from any small home air compressor. Works on 40-70 lbs. air, 10". Wt. 15 lbs. Reg. list, \$69.50. SALE.....\$8.59 FOB.

GOLF CAR MOTOR

Runs on 6 or 12-v batt. Build golf or car motor. Powerful gear reduction speed 25-80 rpm. Fully reversible. 100a applications. Also makes fine electric winch. Wt 35 lbs. Govt. cost over \$250. SALE.....\$19.41 FOB

AIR COMPRESSOR BARGAINS

For painting, cleaning, tires, control termites. Assemble your own outfit. Lowest prices in U.S.

● DeLuxe Kit. Compressor, tank, gauge, regulator, paint gun, relief valve, fittings, hose, instructions. Wt. 34 lbs. List \$52. SALE.....\$39.49 FOB

● Air Components. Compressor 1-cyl. \$19.95; Air tank, \$8.79; Regulator \$3.95; Pop-off \$1.95; Press. Gauge \$1.89; Finest Paint Gun \$11.95; Auto Switch \$4.75. All Ppd. in U. S.

ARMY POWER PLANTS

● Marvelous buys in new condition Govt. surplus plants and generators. All FOB Lincoln.

● 1000-w, 115-v, 60-c. \$169.72
● 2500-w, 115-v, 60-c. 269.00
● 3500-w, 115/230-v. 298.50
● 3000-w, 115-v, DC Gen. 49.50
● 2000-w, 115-v, AC Gen. 99.70
● 5000-w, 115-v, AC Gen. 291.50

STORAGE BATTERY WINCH

● Powerful fully reversible ball-bearing gear reduction winch. 1000-2000 lb. pull. Use on 6 or 12-v battery. Holds 40' of 1/4" cable. For trucks, docks, boats. Wt. 54 lbs. Govt. cost \$280. SALE.....\$46.75 FOB

GEAR SPEED REDUCER

● 80-to-1 gear reduction unit. 8 roller bearings, multiple gears. Reduces standard motor to 21 rpm - increases torque. Shafts 3/4" input, 1 1/4" output. Power winches, revolving signs, door openings, etc. Govt. cost \$66. SALE.....\$8.49 Ppd.

DIAL PHONE

● Modern hi-efficiency attractive dial phone. Use for extension to main line on private system. Use several for complete private system, etc. Complete with ringer, dial, etc. Work on any system. Govt. cost \$25.00. SALE.....\$9.95 Ppd.

HYDRAULIC EQUIPMENT BARGAINS

Savings to 80%. Build loaders, diggers, presses, etc. All brand new.
● Hydraulic Wagon Unloader... \$29.87 FOB
● Control Valve, 1 or 2 way... 18.00 Ppd.
● Tractor Pump 1000 psi; 12 rpm 45.50 Ppd.
● 12-v Motor & Pump 1000 psi. 13.95 FOB
● 2-Way Cyl. 1 1/2" bore 6" stroke 4.89 Ppd.
Other types, sizes and items. Free catalog

G.E. TELECHRON CLOCK SWITCH

● Marvelous clock-timer switch will turn appliances, heaters, radios, TVs, air conditioners, pumps and electric signs on and off at any pre-set time.
● Finest telechron motor will run on either 110 or 220-v 60-cycle. Switch contacts will handle up to 15 amperes on either 110 or 220-volts. Original cost \$13.50. SALE. \$4.97 Ppd.

SPECIAL OF THE MONTH!

220-Volt to 110-Volt TRANSFORMER

● New Thordarson auto-transformer. Will change 220-volts to 110-volts or vice versa. Many uses in home, industry, farm, etc.
● Can also be used to get 24 or 55 volts from 110-volt-cct. Has multiple taps and other features. Size 6 1/2"x7"x5". Wt. 15 lbs. Capacity 500-watts. Will handle heavy overloads. Govt. cost \$19.50. SALE \$9.74 FOB Lincoln.

SURVEYING-LEVELING INSTRUMENTS

Outstanding buys in leading make leveling, grading, surveying levels and transits. Lowest prices, latest 1950 fully guaranteed models. Satisfaction or money back.
● Farm Level with tripod and case. \$42.65 Ppd.
● Contractor's Level-Transit with tripod and case \$69.49 Ppd.
● Engineers-Surveyors Dumpy Deluxe. Finest lens and mechanism. Complete with tripod, case, etc. \$154.90 Ppd. Full instructions, plumb bob, etc., plus prepaid express to you in USA on all of the above.
● 2-Section 9 1/2' Rod and Target \$11.95 Ppd.
● 2-Section 14' Rod and Target \$19.49 Ppd.

IRRIGATION PUMPS

● 2 1/2". 16,500 gph. Centrifugal. All bronze ball bearing. New. 39 lbs. Govt. cost \$103. SALE.....\$49.50 FOB
Also 1 1/2" 6000 g.p.m. pump. Govt. cost \$62.50. SALE.....\$24.61 Ppd.

FURNACE BLOWER & MOTOR

● Brand new, motor and blower in a single self-contained unit. Ideal for heating, ventilating and air conditioning uses.
● 115-v, 60-c motor with double inlet blower wheel. Displaces 725 cfm at 800 rpm. 7 1/2" diameter blower. 7 1/2"x9 1/4". Overall dim. 13"x10 1/2"x13 1/2". Wt. 23 lbs. List price \$40.75. SALE.....\$24.95 FOB

Order from ad or get new 1959 catalog.
BURDEN SALES COMPANY
303 West "O" St., LINCOLN, NEBR.

Sharpen All Circular Saws with QUICK-WAY

Model PG12
\$19.95
Postage-Paid

IDEAL for home-workshops; carpenters, contractors, QUICK-WAY unit precision sharpeners, joints, gums and retreads all circular saws to 12" diameter. Fits all bench, table and radial saws. Thousands of satisfied users. Send for Circular Make money sharpening saws. Order today \$19.95 postage-paid. Complete Unit with Grinder Wheel. No Extras to Buy. Patented.

FREE Saw Set with Initial Order

QUICK WAY SAW CO., 136 Tompkins Street, Cortland, N.Y.



American citizens are better informed - thanks to Advertising!

FREE GIANT NEW 1959 B-A CATALOG

A COMPLETE BUYING GUIDE FOR EVERYTHING IN

RADIO TV ELECTRONICS

B-A 1959
ANNUAL CATALOG '59

180 KING-SIZED PAGES

EVERYTHING IN RADIO TV AND ELECTRONICS

100'S OF NEW ITEMS LISTED HERE FOR 1ST TIME

21 PAGES OF BARGAINS NOT IN ANY OTHER CATALOG

BURSTEIN-APPLEBEE CO.

Dept. PM, 1012 McGee St., Kansas City 6, Mo.

Send Free 1959 B-A Catalog No. 591.

Name.....
Address.....
City..... State.....

SEND FOR IT TODAY

Do-it-yourself—



**clean your
carburetor...
increase
your gas
mileage**

Gum and varnish deposits build up faster than you think in your carburetor. This kills carburetor efficiency and cuts gas mileage 10% or more. At today's prices, that's a loss of about 3c a gallon.

It's easy to avoid this waste by using Gumout to clean your carburetor. Just add Gumout to your gas tank. Gumout, a special solvent, cleans the fuel lines and carburetor while you drive.

Gumout is used and recommended by carburetor specialists. Try Gumout for smoother engine performance and more miles per gallon of gasoline.

Sold by service stations and auto supply stores everywhere.

GUMOUT DIVISION
Pennsylvania Refining Co.
2671 Lisbon Road
Cleveland 4, Ohio



Fuel injection was virtually abandoned. Only one of the 1959 cars now offers it—Chevrolet. Pontiac and Chrysler dropped it so quietly no noise was heard. American Motors did also (in fact, AM hardly picked it up after its first flurry of publicity early in the 1958 season).

Push buttons went back into the Ford archives as Edsel (which last year was almost synonymous with push buttons) and Mercury decided they weren't worth the extra cost and effort.

Mention of Edsel brings to mind that this car celebrated (with muted horns) its first birthday. It was far from the lusty infant we had been promised at its christening party last year. It had picked a bad year to enter the medium-price field and its dream of 200,000 cars in the first year became a reality of only 63,000 cars.

There was a death, too, in 1958. The great name of Packard was removed from the roster. The Packard car had been buried in Detroit a few years earlier when it was moved, in name only, to South Bend to become a luxurious version of the Studebaker. Now the masquerade has been given up and the name Packard has been put into a crypt beside Hudson and Nash.

But let's not linger in the graveyard. What about 1959? There have been some startling changes in product personalities, perhaps the most radical in history.

There was a time when the rash style leader, the car for the flashy set, was Ford. The Chevrolet was quiet, unobtrusive, substantial, but certainly not rash. Plymouth (after a long career as an old maid) became the glamor girl of 1957 and the young-in-heart turned toward it lovingly. Now what has happened? Ford this year describes itself as the car with "dignity" unlike the "gaudiness or extremism" of its competitors. Chevrolet has switched faces and is now the industry's jazz-wagon. Plymouth is somewhere between. We've had a complete switch of roles—as though you had to learn the cast of characters all over again right in the middle of the third act.

Buick, too, has transmigrated. Gone is its fat, prosperous, overstuffed look, replaced by a sleekness, an alertness, that looks almost indecent in garages of long-time Buick owners.

Pontiac has had a similar change and Cadillac, once dignity on wheels, has entered the spaceship era.

Generally, styling is less "buckeye," less cornball, than in previous years. There is evidence of the increasing maturity of both

(Continued to page 296)

ARCO JIG-SAW

WITH EXCLUSIVE CIRCLE-CUTTER & RIP GAGE

**SAW ANY
SHAPE, ANY
MATERIAL!**

- **STURDY!**
- **SAFE!**
- **ACCURATE!**
- **LOW IN COST!**



\$10⁹⁵
with blade

**GUARANTEED TO FIT
ANY 1/4" DRILL!**



Cut perfect circles & discs (up to 20" diam.) ...
saw straight & true with CIRCLE-CUTTER & RIP GAGE.

Cut
any size
pattern freehand.

Get the professional-look in your "do-it-yourself" projects. "Arco Jig Saw" cuts any pattern in woods, plastics, metals—even cuts 2x4's! Easy to handle—ideal for long panel cuts, ripping & crosscutting. Outperforms the most expensive saws because its Circle-Cutter & Rip Gage permits faster work (no time-consuming set-ups) and you are assured of perfect results every time. Cuts its own starting hole. "Air-Jet" blows away sawdust.

At your dealer or order direct on our **20-DAY MONEY BACK GUARANTEE.** Send check, M.O. rppd! COD + post.

ARROW METAL PRODUCTS CO.

Dept. PM-1, 421 West 203rd St., New York 34, N. Y.

MAKE HOME IMPROVEMENTS NOW

ELECTRIC WELD - BRAZE & CUT

REPAIR MOST EVERYTHING MADE OF METAL



Home Appliances, Auto parts, Farm-garden equipment, toys, Make and repair playground equipment, lawn chairs, tables, ornamental iron work gates, Wascos, etc. Solder, heat, bend, and straighten, with terrific heat from arc torch. Cut and weld up to 1/2" steel plate. A million uses for home, auto, farm, inventors, factories, etc. Works from any home plug-in. Complete with welders mask, arc torch, supply of carbon welding and brazing rods, solder, flux, and complete Welding Instruction Book. Attractive—portable—efficient—durable—1 year guarantee. Wt. only 4 lbs. **SEND ONLY \$3.00** (cash, ck, mo) and pay postman \$9.95 plus COD postage on arrival or send \$12.95 and we will send postpaid. Ideal gift for mechanically minded home owners, relatives, friends. Order now for early delivery. Available only from: **MIDWAY WELDER, Dept. DPM-1, Kearney, Nebraska**

New PAINT SPRAY UNIT

Including Spray Gun
APPROX. ORIGINAL COST \$325
OUR LOW PRICE . . . \$34⁵⁰

Heavy duty compressor for continuous operation, with G.E. or equal H.B. Motor, 110 V., A.C., rated up to 1/4 h.p., develops 1-1/2 h.p., 1-Quart Pressure type gun with round, fan and ceiling spray nozzles, line filter, air gauge, 20 ft. cord & plug, 20 ft. air hose. Sprays paint, lacquer, enamel, insecticides, etc. Paints house, auto, ANYTHING. Operates gun continuously. Instructions furnished. **NOTHING ELSE TO BUY. Wt. 80 lbs.**

ORDER FROM THIS AD.
Money Back Guarantee. Send check or money order.
ILLINOIS MFG. & SUPPLY CO.
1829 S. State Street, Dept. PM1, Chicago 16, Ill.



UNUSUAL BARGAINS

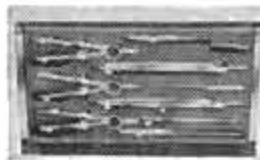

CLOSE MECHANICAL DRAWING SET

**OUT! Regular Price \$18.00
Our Price Only \$6.00 Postpd.**

American mfr. couldn't compete with foreign imports — thus you get a terrific bargain, even far below import prices. 10 handsome pieces in velvet-lined case. Nickel plated brass — precision American-made. We guarantee you'll be satisfied or money refunded.

Stock No. 50.200-H \$6.00 Postpaid

Quantity Price: 5 Sets for \$5.50 each Postpaid
10 Sets for \$5.00 each Postpaid

NEW! STATIC ELECTRICITY GENERATOR

STURDY, IMPROVED MODEL.

See a thrilling spark display as you set off a miniature bolt of lightning. Absolutely safe and harmless. Stands 14" high. Turn the handle and two 9" plastic discs rotate in opposite directions. Metal collector brushes pick up the static electricity, store it in the Leyden jar type condenser until discharged by the jumping spark. Countless tricks and experiments. 24 page instruction booklet included.

Stock No. 70.070-H \$12.95 Postpaid

PORTABLE JR. PLANETARIUM

Battery Operated

Ideal for beginners. Low priced to satisfy the mass interest in the "Geography of Space." Operates on dry cell batteries with bright or medium light intensity. Projects over 60 constellations on ceiling or wall of any darkened room. Complete with flashlight pointer (batteries included)—giant instruction sheet with colorful Constellation Chart.

Stock No. 70.165-H \$9.95 Postpaid

PLANETARIUM — for operation on house current.
Stock No. 70.040-H \$19.95 Postpaid

WRITE FOR FREE CATALOG "H"!

Complete Line of Astronomical Telescope Parts and Assembled Telescopes. Also huge selection of lenses, prisms, war surplus optical instruments, parts and accessories. Telescopes, microscopes, Hand Spectroscopes, Sniperscopes, binoculars, etc. Request Catalog "H"!

ORDER BY STOCK NUMBER SEND CHECK OR MONEY ORDER IN FULL PAYMENT GUARANTEED.
EDMUND SCIENTIFIC CO., BARRINGTON, N. J.

EVERYTHING in TOOLS WOODS materials for the workshop! & SUPPLIES



FINE rare imported and domestic woods, veneers, cabinet lumber, turning blocks, squares and hard-to-get hardware items. Constantine's over 147 years of service to the fine wood trade gives everything you need and want. Craftsmen's manual is a complete source for cabinet woods, lumber, plywood, veneers, inlays, bandings, carving and trim mouldings, upholstery supplies, "hard-to-get" and unusual hardware, wood finishing materials, plans, projects, patterns and "how-to-do-it" articles. **CONTAINS** identification chart of over 60 rare woods classified and reproduced in natural color suitable for framing. Everything available on our famous **SHIP THE SAME DAY** service at no extra cost. No need to hold up a project or suffer delays for material. **SEND 50¢ (refunded on 1st order)** today for copy of our fine manual and we'll include 25¢ wood-finishing manual FREE.

FREE!

Valuable, complete "how-to-do-it" 25¢ Wood Finishing Manual with copy of New Master Manual and bargain book. Write today!

Act Now—Get Your BONUS BOOK FREE*

MAIL COUPON TODAY!

Albert Constantine and Son, Inc.
2056-G Eastchester Rd., New York 61, N. Y.

Enclosed 50¢ (refunded on 1st order) for the new Constantine Catalog. Also send free Constantine's Wood Finishing Manual.

Name _____
Address _____
City _____ State _____



MODERNIZE WITH MARLITE
*the prefinished paneling that cuts
 like wood, stays like new for years*

Beautiful Marlite is quickly installed over old or new walls with ordinary hand tools. The baked melamine plastic finish resists heat, moisture, grease, household acids and stains; needs only an occasional damp cloth wiping. Planks, Blocks, large Sheets are available from your building materials dealer in decorator colors, distinctive wood finishes and marble patterns for any room. Look for the Marlite name on the back of every panel—your guarantee of satisfaction. For free decorating book, write Marlite Division of Masonite Corporation, Dept. 142, Dover, Ohio.

Marlite plastic-finished paneling

2301

ANOTHER QUALITY PRODUCT OF MASONITE® RESEARCH

Mechanic's full-size
 all-steel
TOOL CHEST

ONLY
\$25⁹⁰
 F.O.B.
 ST. PAUL

Here's a home workshop "buy"—the nation's largest full-sized chest! It's heavy duty with 4 big compound-glide drawers—built-in lock—26" x 12½" x 12¼". Baked-on blue-grey finish is grease resistant. Your money back if not satisfied. Protect your tools . . . order now!

PORTA-CAB deluxe tool chest on wheels. Cork linings protect tool finish—extra-deep drawer for power tools. Work-table top. Write for free bulletin and price list describing this and a dozen other Huot chests.

(Huot rhymes with "do it")

HUOT MFG. CO.
 555 No. Wheeler St., St. Paul 4, Minn.

the American stylist and the customers. Glass is everywhere, with problems. Double-wrap windshields cut into the roof, causing annoying reflections on the inside of the glass. Rear windows curve well up into the roof, exposing rear-seat riders to the summer sun like plants in a hothouse. Glass is heavy, boosting car weight. Glass is expensive, boosting costs and insurance rates. But glass makes cars look modern and, the stylists hope, makes them sell.

Manufacturers are trying hard to mollify the customer. Today's cars may be bigger with more sheet metal to take care of, but they don't have to be polished, so permanent are the new paints. At least, that is what the manufacturers claim. It is unlikely that car owners will give up this inexpensive form of recreation, however.

Exhaust systems are made of heavier metal, are coated with noncorrosive materials, are made with double-wall designs to lessen condensation, as companies try to increase the life span of this, the first to go of all parts.

Power steering is more effortless this year. General Motors has moved to the Chrysler concept of a full-time power assist. GM cars handle better than ever due to this and to their lower center of gravity.

Economy is the word of the year. Cars may cost more, but they're cheaper to run, say the ad writers. Refinements in the automatic choke of the 1959 Cadillac increase gasoline mileage by 10 percent. This could save the buyer of that \$6000 machine about \$20 a year—a critical saving, we all know, in the budget of a Cadillac owner! Yet the idea that gasoline economy is so important to the Cadillac owner indicates a trend.

More cars advertise that they use regular gasoline. Last year, they were bragging about their higher compressions, which made use of regular gasolines impossible.

And so the pendulum swings. But the full arc of the swing won't be realized until next fall when the industry presents its first really new car, the first completely new design, the first "we-started-with-a-clean-sheet-of-paper" model since the Model A replaced the Model T.

What this new small car (and there will be at least two of them by 1960) will do to the industry is anybody's guess and certainly you are entitled to make your own.

This reporter's guess is that within five years, these new "small" cars will have become the top-selling models and will bring back a once profitable export business.

As in musical chairs, there may not be enough seats to go around when these new cars take their big chunk of the market. Which makes will be left standing? Now it's your turn to guess! ★ ★ ★



DRAFTING MACHINE For engineers, draftsmen, designers, architects. Portable. Complete with 11 in. x 17 in. hard surface drawing board with scale divided in 50ths to inch and 180 deg. protractor. This unit is not a toy, it's the real McCoy! NEW. While they last—\$10.50 ppd.
*Same as above with 10 in. x 13 in. drawing board—\$9.95 ppd.



WOOD PROPELLER Genuine rock maple radio drone "prop." perfect for den, trophy room, boy's room. Smooth, highly varnished, 30" tip to tip. Clock, barometer or photo can be inserted easily into center (mounting holes provided). Can use to operate ice sleds, etc. Approx. GOVT. COST \$57. NEW. \$4.95 ppd.

"BIG 12" ARC WELDING & BATTERY CHARGING KIT With Deluxe Accessories consisting of one R1 300 Amp Gen., 30' welding cable, welder's adjustable helmet electrode holder, 300 AMP ammeter, 300 AMP shunt, Rheostat, Giant Toggle Switch, 300 AMP reactor coil arc Stabilizer, Voltage Reg., Reverse Current relay, 1 pr. heavy duty welder's gloves. All units guaranteed pre-tested. Approx. GOVT. COST \$750. Most items new—all perfect. \$49.50. *400 AMP Gen. with above accessories—\$64.50.

"SUPER 9" 200 AMP WELDING KIT With Deluxe accessories consisting of one 200 AMP Gen., adjustable helmet, electrode holder, 30' welding cable, rheostat, giant toggle switch, voltmeter, voltage reg., 1 pr. heavy-duty welder's gloves. All units guaranteed pre-tested. Approx. GOVT. COST \$500. Most items new—all perfect. \$38.00.

WELDING CABLE DOUBLE-O, heavy duty, neoprene jacket, fiberglass insulation. NEW. Approx. GOVT. COST \$40. Will handle 400 amps. or better, 50' lengths \$14.50. 100' lengths \$26.00.

NEW! Welding Reactor for above kits. 200 Amp. cap. or better. NEW. \$7.95.

REVERSIBLE REDUCTION GEAR (250-1) tremendous inertia power 6-12-24 volt winch with 2 power takeoffs! Use on boats, trucks, wreckers, etc. Fantastic power for pennies of original cost. Weight 55 lbs. Approx. GOVT. COST \$475.00 NEW—\$14.95.

13 PC. PROTO SNAP-ON MIDGET SOCKET KIT. Consists of 8 Proto sockets from 3/16 in. to 1/2 in. 1 Proto Universal Joint. 1 swivel handle. 1 Tee Bar. 1 pr. chain lock dropped forged adjustable pliers, 1 pr. insulated wire cutters—wire strippers with adjustable gauge marker. Approx. GOVT. COST \$21. While they last—\$7.95 ppd.



FAMOUS NAVY MK14 AIR COMPRESSOR Great for tree, termite, antirush & paint spraying; filling tires, aquariums, etc. Dual & remote control electric receptacles, 115v 60 cycle AC, heavy duty HP. Westinghouse Motor, Direct drive. Water & explosion-proof. Built-in air filter, adjustable pressure setting up to 47 lbs. 3 cu. ft. per min. Self-contained switch. Mounting brackets. These units made under license of Sperry Gyroscopic Co. Wt. 66 lbs. gross. Approx. GOVT. COST \$585; Like NEW. \$21.95.
With portable steel hand cart (shown), rubber wheels, specially constructed for mounting this unit. Incl. 25' rubber air hose, 6' extension cord with plug & fittings. Wt. 76 lbs. Complete with cart—\$26.95.
With new internal pressure spray gun with 3 adjustable spray tips. 1 qt. cap. \$33.95 complete.

\$2940 NAVY AIR-COOLED POWER UNIT Most compact engine ever assembled. Portable, net wt. 150 lbs. 200 Amp. Gen. self-starter capable of delivery of double overload or continuous service at 200 Amps. Mfd. by Ranger Aircraft. 2 cylinder, 4 cycle, 10 HP. 3200 RPM. Fully governed for varying loads. This unit makes one of the finest arc welders obtainable. Also makes excellent boat engine. Shipped complete with rheostat & voltage reg. All units checked & pre-tested in our shop. Complete \$185.
Engine same as above with deluxe welding accessories as follows: rheostat, voltage reg., dry charged 24 V. battery, 50' heavy duty welding cable, 1 electrode holder, 1 hood, pr. of gloves, voltmeter. All this only \$225.

11 PIECE CROWFOOT WRENCH SETS Wrenches snap onto T-bar in 3 different positions. The only wrenches for hard-to-get-to places. Mfd. by Plomb Tool Co. for U.S. Armed Forces. Finest case hardened tool steel. No shop mechanic should be without this set. Approx. GOVT. COST \$47. NEW. \$5.95 ppd.

ELECTRIC PUMP WITH CONTROL UNIT Runs on 12 or 24 V. Centrifugal type. Draws 5.2 AMP'S. Has built-in removable filtering screen. Great for ludge, circulating or sump pump...bat tanks, etc. Pumps 500 GPM. Complete with on and off switch rheostat, 2 speeds 3/4 & 1/2. Mfd. by Ingersoll-Rand. Shpg. Wt. 7 lbs. Approx. GOVT. COST \$195. NEW \$8.95.

HEAVY-DUTY RHEOSTAT Ideal for regulating voltage on electric welders. Rated 5.75 Ohms, 100 Watts with double windings & dual female 25 amp., 125 V. receptacles. 7" H x 5 1/4" D. Shpg. wt. 2 1/2 lbs. Approx. GOVT. COST \$25. Brand New. \$2.25 ppd.

BENDIX GEROTOR PUMP & MOTOR Use wherever fluid pumping required. Excellent for hydraulic installations. Has 3/4" pipe connections, built-in relief valve adjustable up to 1500 lbs. Max. cap. 6 GPM. 1 1/2 H.P., 24 V. motor. Use on 12 to 36 V. Approx. GOVT. COST \$350. NEW \$10.95.

NEW! 1959 CATALOG! BIGGER & BETTER THAN EVER...971 price cuts. 1000's of bargains in war surplus & other items! 100's of pictures! Send 25c in coin for your copy today!
Ppd. prices USA only. Other prices FOB Culver City, Calif. Send cash, check or money order. 50% deposit on COD.

AIRBORNE SALES CO., INC. DEPT. PM 159
8501 Stellar Drive, Culver City, Calif.



NEW! **LAYTRAC RIDING CRAWLER**
OUTWORKS ANY TRACTOR ITS SIZE

LOWEST COST FOR 9.2 H.P.!
Laytrac works where others bog down! No slipping, drifting, tipping or skidding. Ideal for dozing, plowing, field work, logging, easy to operate. Big tractor quality! Borg-Warner 3-speed and reverse transmission, clutch steering, 925 lbs., including blade, floating drawbar, PTO. Guaranteed. Accessories available. At dealers or direct. Write for literature.
LAYTRAC
2548-M1 Airport Way, Seattle 4, Wash.

Tractor less blade, \$895 pp. anywhere in U.S. (Includes PTO and floating drawbar. Blade \$65.)

WHY DEPEND ON SOCIAL SECURITY!



ADD TO YOUR INCOME • UP TO \$5.00/HR. SHARPENING ALL TYPES OF LAWN MOWERS

Modern Manufacturing's precision Lawn Mower Sharpener and Bed Knife Grinder makes it easy for you to earn extra cash on a full or part time basis. Many mowers need sharpening. Do it in your basement or garage. Anyone can learn to operate this sharpener. Write today for free brochure. Dept. 10

\$27500
F.O.B. Pasadena

MODERN MFG. CO.
160 N. Fair Oaks Ave.
Pasadena, Calif.



want **36 to 40**
MORE MILES
from every
tankful of gas?



The 3-in-1 Leadership Fuel Pressure Regulator

Send today for your FREE copy of "The TRUTH About Fuel Pressure Regulators"... the remarkable booklet written by engineers in everyday language that tells for the first time one of the causes of poor gas mileage and how you can really do something about it.
Discover what a fuel pressure regulator is: find out how a simple-to-install, inexpensive, but precision machined device called MILESMaster can put 36 to 40 more miles into every tankful of gas on a money back guarantee! Learn how you can put an end forever to flooding, vapor lock, hard starts: how only \$6.95 and 5 minutes time can smooth rough idling and reduce gumming of piston rings and valves.

MILESMaster MILESMaster, Inc., Dept. 105
1550 E. 74th Pl., Chicago 19, Ill.

Mail this coupon with your name and address in margin. No obligation. Sold only at retail through 40,000 auto service outlets on Money Back Guarantee.

When you want
the finest in Chisels
INSIST ON
SHARK BRAND



THE CHISEL FROM SWEDEN!

Cutting blade
made from world-famous,
tough Swedish Steel.

See Shark Brand at
your hardware dealer.

Write today for this
booklet on the
care and use
of chisels.



Sandvik STEEL INC.

Saw & Tool Division

1704 Nevins Road, Fair Lawn, N. J.

In Canada: P. O. Drawer 1335, Station "O," Montreal 9.

**Combine Corrosion Resistance with
Holding Power . . . Insist on Southern
Screws in the EZ to C[®] Package**

When repairing or replacing, specify
Southern's quality plated screws or bolts
for *permanence*. Wide variety of sizes
and finishes, Phillips or slotted. At your
hardware or building supply store.

REMEMBER —

Only a Screw Holds Like a Screw!
Stock up NOW.

Buy 'em by the box and save.

WOOD SCREWS • STOVE BOLTS • TAPPING
SCREWS • MACHINE SCREWS & NUTS • DRIVE
SCREWS • HANGER BOLTS • CARRIAGE BOLTS



Sold Through
Leading Wholesale Distributors

WAREHOUSES:

New York • Chicago • Dallas • Los Angeles



HITCHING AND PARKING
a one man job with
BULLDOG JACKS

- Adaptable to channel, angle or wood
tongues up to 4" thick.
- Install and move from one piece of
equipment to another easily.
- Both screw type and gear type models
to fit any requirement.

Write for FREE descriptive folder 13 A

HAMMER BLOW TOOL CO.
WAUSAU • WISCONSIN



LOCK-MATIC PLIER

The Plier that
1. Needs No Adjusting

2. You JUST GRIP to lock! A simple pat-
ented locking device locks it automatically on
any size item within its wide range.
 3. IT STAYS LOCKED with full pressure until you touch
the trigger release. A pleasure to use.
- 7 1/2" size, zinc plated \$2.50; nickel plated \$2.95 postpaid.
Satisfaction guaranteed. Order today.



SARVIE TOOL CO., Dept. PM, Alexandria, Minnesota



**CUT ANY SIZE — ANY SHAPE
WITH Spearhead Cutter**

Handy pocket size — cuts leather,
asbestos, rubber, cork, etc. —
round 1/4" to 6" — any size
straight and odd shapes.



Send Check or
Money Order!

935
POSTPAID

ZIMMERMAN PACKING — NORWOOD 12, OHIO

Take the **ache** out of
**GUMS RUBBED SORE
BY FALSE TEETH**

Get quick-soothing relief of sore, throbbing gums
by applying medically-formulated NUM-ZIT *Adult
Strength*. Thousands of false teeth wearers have
already had this blessed relief. Pleasant-tasting
NUM-ZIT eases discomfort while you break in new
false teeth. Works wonders, too, for relief of
toothache, neuralgic pains. Keep it handy for
quick first aid. At all drug counters.

Adult NUM-ZIT

Another fine Purepac product

POPULAR MECHANICS

BRAND NEW GOVT. SURPLUS 1 1/4 H. P. GASOLINE ENGINE

only \$10

F.O.B. Pasadena

Made by Jacobsen!
1 1/4 h.p., 3600 rpm.
2-cycle, ball-bearing
crankshaft, 2" bore,
1 1/2" stroke. Complete with carburetor.
With addition of flywheel and ignition system
(not included), makes an ideal engine for generators,
pumps, lawn mowers, midget cars, etc. Approx. 11" long,
4 1/2" in diameter. Shipping wt. approx. 10 lbs.

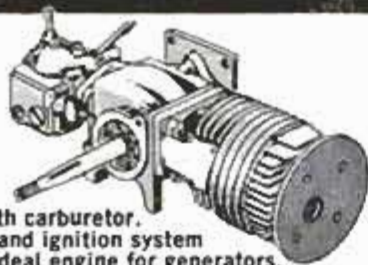

C & H SALES CO.

No C.O.D.'s please.
Send full amount with order.
2176 East Colorado Street
Pasadena, Calif.

NEW Amazonia Accurate Scope-Shot

With 250 hi-velocity
Disintegrating Pellets
... crack like rifle
when they hit!

Precision
SLINGSHOT
Scope-type
sight!

1 / 7 Over 1 million sold!
250 EXTRA Pellets!
98c P.P.

Pure gum
rubber slings. Solid
polished cast aluminum
stock. Beautifully balanced pistol
grip. Rugged, powerful, fits pocket
perfectly! **FREE** shooting manual. Guaranteed.
At dealers or write: **GENERAL SPORTS**
4184-M Apple Street, CINCINNATI 23, OHIO

\$195 P.P.

Pistol No. D-178337

\$150 P.P.

KILLS SMALL GAME!
ROUTS PESTS

Order Now!

Take Correspondence Courses
For a Better Education

SUDS! SCRUBS! RINSES!



Is yours one of the 20 million homes with kitchen sink rinsing sprays of the "automatic" type—those with a thumb control that turns the spray on and off? You can now replace any thumb-control spray with Dish-Quik—the newest automatic spray! Attaches to existing hose in seconds! Dish-Quik not only rinses but suds and scrubs. For fast dishwashing and dozens of daily kitchen chores! Only \$9.95 at plumbing and hardware stores. Write for free booklet on how to replace and repair any automatic spray or hose:
AUTOMATIC SPRAY SERVICE CENTER
1700 E. 58th Place, Los Angeles 1, Calif.

You can earn **BIG MONEY** with these arc welders



LOW COST
EASY TO
USE
READY TO
WELD

AC Shop Type Arc Welder!

Build and repair anything made of metal. This easy to use, low cost AC shop type welder requires no special training or experience. It's a real money-maker for home, garage, farm, plumbing, auto body and repair shop. Lets you weld, cut metal, burn holes, harden surface, etc. Extra profits quickly pay for this new welder. Ask for bulletin A-520.

Combination AC Power-DC Welder

This new 2 in 1 unit lets you weld or have 110/220 volt AC power anywhere independent of power source. Welds or runs tools, lights, motors, etc. An invaluable unit for "standby" emergency power when regular power fails. Operates all types of shop equipment or ideal on farms for operating such equipment as pumps, brooders, milking machines, lights, etc. Ask for bulletin A-279.

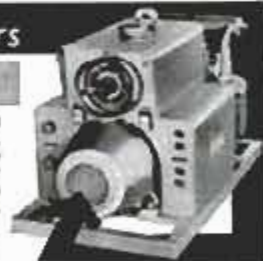

HOBART BROTHERS CO., Box M-19, Troy, Ohio, Ph. FE 2-1223



DRAINS cellars, cisterns, wash tubs; **\$7.95**
IRRIGATES - CIRCULATES - SPRAYS

1,001 uses. Stainless shaft. Won't rust or clog! Use 1/4 HP motor or larger... 3/4 HP for up to 3,000 GPH; 450 GPH 80" high or 1,800 GPH from 25' well, 1" inlet; 3/4" outlet. Counting included free. **\$7.95.**
HEAVY DUTY BALL-BEARING PUMP. Up to 7,500 GPH; or 3,000 GPH from 25' well, 1 1/4" inlet; 1" outlet. **\$12.95**
Postpaid if cash with order. **MONEY BACK GUARANTEE**
Centrifugal and Gear Pumps in All Sizes
LABAWCO PUMPS, Belle Mead 7, New Jersey

Other "BUYS"
Check Here

- 1/4 Ton Utility Auto
- GOLF CARS
- Electric or Gas CAR SNOW PLOW. Balts on.
- Children's Autos

ESHELMAN TRACTORS

LOW AS \$99

TRACTS - PLOW - CULTIVATES - MOWS
DISCS - HARROWS - SNOW PLOW - BELLS
SPRAYS - BELLS - MOWS - CUTS - TRAIL

Eshelman Tractors, Tillers, Riding Rotary Mowers for Better Lawns and Gardens. Advertised in GOOD HOUSEKEEPING. Thousands of satisfied users. Write for Free Literature. DEPT. 2, ESHELMAN, Balto. 2, Md.



WRITTEN FULL YEAR GUARANTEE

SPECIAL OFFER!

Self-Locking Hooks and Fixtures for perforated board

13 OFF!

... IF YOU ACT TODAY!

Today, you can have a starter set of 30 SELF-LOCKING HOOKS AND FIXTURES—the only perforated wall-board fixtures that securely lock themselves in place—a \$1.50 value for only \$1. Bright zinc plated, perfect for use in the kitchen, workshop, tool shed, barn, garage, store or office.

These are the hooks that are guaranteed to stay put; the exclusive Self-Locking feature holds them securely in place without the bother of locking, clips or other makeshift devices. Fill out the order form and send in your dollar and we'll pay postage. (No C.O.D.'s.) Act today; this offer is for a limited time only, as long as stocks of these special starter sets last.

THE KERR WIRE PRODUCTS CO. 933 N. Cicero Avenue, Chicago 51 Illinois
Send Starter Set 1 enclose \$1 (No C.O.D.'s please) U.S. Only 4

NAME _____
ADDRESS _____
CITY & STATE _____
HARDWARE DEALER _____

HI-FI TOOLS

by **UTICA**

Now for the Hi-Fi enthusiast, a complete set of quality hand tools designed for the assembly of Hi-Fi components.

Backed by famous full guarantee. Use UTICA, the tools the experts use.

UTICA DROP FORGE & TOOL DIVISION
Kelsey-Hayes Co., Utica 4, N.Y.



46-4 — midget diagonal

819-12" long shank screwdriver



262-5 1/2 — transverse end-cutter



654-6 — long nose with cutter



778-6 1/2 — needle nose with stiff jaws

► **how to Slash fuel bills 20% —**

GET **BRIDGEPORT INNER-SEAL**
Live Rubber
WEATHERSTRIPPING



Right! You can really save money on fuel bills by putting draft-stopping INNER-SEAL on those costly openings around doors and windows that may be robbing you of \$20 to \$40 a year! Easy to put on... keeps out dirt, water... keeps heat in!

Exclusive patented construction with springy steel wire in lively sponge rubber covered with tough neoprene makes INNER-SEAL seal better, last longer... never gets ragged or brittle. Get INNER-SEAL at hardware stores now! (Pays for itself in fuel savings).

Write for **FREE BOOKLET**
"How to Weatherstrip Your Home"
Dept. PM-19

BRIDGEPORT FABRICS, INC.
BRIDGEPORT 9, CONN.

NEW SURPLUS

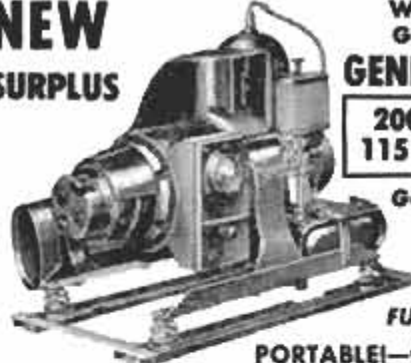

WISCONSIN 4-CYCLE Gas Engine Driven GENERATING PLANT

2000 WATT, 60 Cycle, 115 Volt, Single Phase

Gov't. Cost \$500.00

Only \$219.50 fob

FULL 1-YEAR GUARANTEE

PORTABLE!—fits easily in car trunk!

PAYS FOR ITSELF! Saves time, labor on-the-spot power for CONSTRUCTION, etc., where none is available or expensive to run in. Large enough for Floodlights; Saws; Pumps; and many more labor-saving heavy-duty machines. Ideal as a stand-by emergency power plant to duplicate house current. Plenty of power for lights, refrigerator, deep freeze, oil burner, radio, etc. Specifications below. **CAN'T BE MATCHED** anywhere at this price!

REMOTE CONTROL GOVERNOR increases engine life by allowing engine to run at idle speed when load is removed from Generator.

GENERATOR 2000 Watts, 115 Volts, 17.3 Amps., 60 Cycle, single phase. Overload capacity well above its rated output. Excellent automatic voltage regulation plus Field Rheostat for even closer adjustment. Built-in Volt meter and receptacles.
ENGINE Famous WISCONSIN 5.6 H.P. air cooled engine, 4-cycle. Weather proof high tension magneto with impulse coupling for quick easy starting in any weather. Mechanical Flyball governor. Adjustable carburetor with automatic choke release. Timken roller bearings—self cleaning. Weighs 155 lbs. Over-all dimensions: 29" long, 19" wide, 20" high

SUPPLY LIMITED! IMMEDIATE DELIVERY! ORDER FROM AD

Free Catalog of War Surplus — Wholesale Equipment
ROBERTS ELECTRIC CO., Dept. PM-884, 849 W. Grand Ave., Chicago 22, Ill.



10" TILT/ARBOR SAW
BUILD-IT-YOURSELF
from GIL-BILT KITS-PLANS

Sturdy wood, steel, and aluminum construction. NEW DEPARTURE ball bearings. Capacity and performance of floor saws selling for \$150.00 and up. Plans, all metal parts in kit with 10" comb. blade \$27.40, less blade \$23.95. F.O.B. St. Louis. Detail PLANS-PATTERNS only \$1.00 postpaid.

Build-it-yourself 12" and 18" Bandsaws, 6" Belt Sander, Shaper. Simplified plans, build easily with hand tools only. Advertised and sold for 12 years, over 35,000 units in use. Money back guarantee. **FREE CATALOG.**

GILLIOM POWER TOOLS, Dept. 80-A, Lambert Field, St. Louis 21, Mo.

LAWNMOWER SHARPENERS

Six Machines To Choose From.

The ONLY complete shop-in-one, with built-in work bench, hoist for heavy mowers, and **LIGHTNING-fast bed grinder** for sharpening bed knives in mower. Lapping attachment and narrow grinding head to hollow grind reel blades. The famous **BALTRAK** for rotary blades. Write and experienced shopmen will answer.

TURNER-CLINE MFG. CO.
New address: 906 Virginia Ave., Alamogordo, N.M.

ONE-MAN SAWMILL LOW \$50.00 AS... 50.00 DOWN



Take BELSAW Portable Sawmill right to the trees—turn out valuable lumber for home and farm—sell to local yards—make up to \$50 a day custom sawing for neighbors. BELSAW lasts a lifetime. No crew needed. Power with tractor or auto engine. Beginners get excellent results. Send today for **FREE BOOK.**

BELSAW MACHINERY CO.
3459 Field Bldg. Kansas City 11, Missouri



Works in seconds!
Loosens Rusted Bolts
nuts, screws, "frozen" parts!
LIQUID WRENCH

The super-penetrating rust solvent that quickly loosens rust and corrosion.
AT HARDWARE STORES, GARAGES SERVICE STATIONS, EVERYWHERE
RADIATOR SPECIALTY CO.
Charlotte, N. C.

SAVE UP TO 85% ON SURPLUS HYDRAULICS



SPECIAL BENDIX GEAR PUMP AND MOTOR

Delivers 3-1/2 gallons per minute. Has pressure of 600 PSI. Motor is 1-1/2 HP, 24 V., DC - use on 12 or 32 volts. Has built-in Relief Valve. Parts are 3/4" inlet, 1/2" outlet with standard pipe thread. Ideal for use on electric Hydraulic Lifts, Portable Loaders, etc. **888**

NEW 1000 PSI HYD. PUMP

Originally designed to operate off of a truck or tractor fan belt for powering lift forks or platforms. Pump has built-in 4-way open center control valve. Will operate at 1000 PSI continuously. Has a capacity of 3 GPM at 1200 RPM or 4-1/2 GPM at 1800 RPM. **2750**

4-WAY HYDRAULIC VALVE N-7A-1 SPECIAL 395

Spring loaded, poppet type valve. Pressure balanced. Off in neutral. Has 1/4" internal tube ports. Made to rigid government specs. Cost Gov't approx. \$30.00. SAVE!

HYDRAULIC HAND PUMP HP-3V5U

Reg. Cat. Price \$11.75
Operating pressure 2000 PSI. Has a capacity of 1.5 cu. in. per cycle. Includes a built-in diverter valve for selection of a suction and pressure port for two independent systems. **988**

SPECIAL VICKERS 4-WAY VALVE

A sliding piston type 4-way valve made by Vickers. Closed center in neutral position. Has detents to hold handle in either neutral or extended position. Body is solid brass and has chrome steel piston. Takes pressure up to 3000 PSI. Has 1/2" standard internal pipe ports. **2750**

NO. H-24D, 2000 PSI CYLINDER

PALLEY SPECIAL
A heavy duty steel barreled cylinder. Ideal for hydraulic press work. Has 2-1/2" bore, 7" stroke, 1-5/8" shaft and 19" length. Cost Gov't Approx. \$270.00 Regular Catalog Price \$12.75 **995**

Has a 2-3/8" bore, stroke of 19", shaft 1-1/4", eye-to-eye length 30-3/4". Cost Gov't approx. \$85.00

No. H-53AUSU - Used **1788** Reg. Cat. Price \$21.50
No. H-53ANSU - NEW **2488** Reg. Cat. Price \$31.50

A 1500 PSI cylinder. 1-1/2" bore, 9/16" shaft, adjustable stroke of 1-3/16" to 4-3/8". Length 14-1/2".
Regular Catalog Price \$7.25
Cat. No. H-84ASU NOW!

SPECIAL 395

NEW PALLEY 1500 PSI HYDRAULIC CYLINDER

One of our newly developed line of Hyd. Cylinders. Heavy duty steel construction. Has bores of 1-1/2", 2", 2-1/2", 3", 3-1/2" & 4". Strokes of 2" to 48" at 18,850 lbs. at 1500 PSI. . . . ALSO AVAILABLE IN 3000 PSI

We have World's largest on-the-shelf stock of New & Used Hydraulic Equip. Over 50,000 Hydraulic Cylinders - PLUS our own specially designed line Cylinders, Valves, etc. Write for FREE Hydraulic Catalog No. H-59.

TO ORDER - Send Check or Money Order. 50% deposit with C.O.D.s. All prices F.O.B. Los Angeles Warehouse. Shipments are Freight or Postage Collect.

palleys

2263 E. VERNON AVE., DEPT. PM-19
LOS ANGELES 58, CALIF

SPECIAL GYRO STABILIZER



A Gadgeteer's or Experimenter's has been successfully adapted to control of small boats. Original control vertical or horizontal axis in flight. Has a high speed 6" level, reduction gear train and servo motor. The Gyro is disturbed the electrical control system.

operate the remote servo compensating motors. Takes 24 volt, DC electric current. Originally cost Gov't approx \$3500.00 **1788**

GENTRIFUGAL WATER PUMP

Ideal for draining basements, sumps, flooded areas. Must be primed. Has brass body and rotor. Stainless steel shaft, bearing mounted. 1-1/2" pipe thread inlet, 1-3/4" hose outlet. Delivers 6000 GPM at 1 ft. head at 1800 RPM with a 1/3 HP motor. . . . MOUNT BASE for above pump \$4.25 **1995**

PRECISION SPEED REDUCER

Precision built for Army Gun Control Mechanism. Ideal for Experimenter or Laboratory use. Gear ratio gives approx. 90 RPM with a direct drive 1750 RPM motor. Can be belt driven with any size motor up to 1/2 HP. Case is cast aluminum. Has ball bearings throughout. Will operate conveyors, timing devices, etc. . . . **1475**

85 TO 1 GEAR BOX USED 595 NEW 895

For use where tremendous power at low take-off speed is desired. Drives through a train of 6 gears that rotate on self-lubricating, high speed roller bearings. Take-off shafts are 1-1/4" and 3/8" in diameter. Overall size 6"x4"x2-1/2". Has a 180° offset drive. SAVE at our low prices!

2-SPEED ENERGIZER

Designed originally as an auxiliary power source to actuate an aircraft starter. Has a 2-speed handle grip control to choose 200 or 275 RPM speeds. Heavy duty gear box gives extremely high torque. Uses 110-115 volt AC current. May be easily converted to use as a heavy duty drill, etc. **2750**

SAVE ON AIR TANKS

STAINLESS STEEL G-1 TANKS
Pressure tested to 400 PSI. Ideal for air, acids, chemicals, experimental uses, etc. Has 1/4" pipe ports. Size: 12-1/2" x 24" 2100 cu. in. **1295**
No. G-1U - Used
No. G-1N - NEW . . . \$16.95

F-1 Stainless Steel TANKS - 500 cu. in. capacity. Size: 10"x18" . . . \$10.95

J-1 Large Volume AIR or CHEMICAL STORAGE TANKS
Has 18,000 cu. in. capacity (77 gallons). All stainless steel. Size: 24" x 45" high. Worth \$150. No. J-1 ONLY **9950**

D-2 Steel AIR TANKS - Tested to 400 PSI. Capacity 500 cu. inches. Size: 6-1/2"x24".
D2-C Carbon Steel - NEW **595**
D2-CU Carbon Steel - USED \$4.95
D2-S Stainless Steel . . . \$9.95
F-2 TANKS - Same as D-2 with a 1000 cu. in. cap. Size: 6"x45".
F-2C Carbon Steel . . . \$6.95
F-2S Stainless Steel . . . \$10.95

LEAR ELECTRIC 18 TO 1 MIDGET HOIST

For use in Opening Garage Doors, on Boats, in Shop, Labs, etc. Will run off of 110 V. AC current when transformer (shown below) is used to step-up from 24 V. AC. Reversible motor turns at 9000 RPM. Has 18 to 1 gear box. Take-off shafts set length of travel or can be inactivated for continuous use. Magnetic Clutch. **575**
115 Volt TRANSFORMER - For use with above hoist . . . \$3.45

MULTI-STREAM SELF-CLEAN SHOWER HEAD

Flip the lever to adjust for coarse or fine spray. All brass with chrome finish. Easy-to-install. \$6.98 val. **344**

AUTOMATIC RETOOTHING MACHINE MAKES NEW PROFITS for HAND SAWS

Cuts new teeth in 50 seconds—any size 4 to 16 points. Old teeth fall off as chips. Easy to operate. A perfect job.

BURR MFG. CO.
8933-J VENICE BLVD.
LOS ANGELES 34, CALIF.

WELD BRAZE SOLDER CUT

Acclaimed by thousands of Homeowners, Mechanics and Hobbyists as the welder of 1001 uses. Easily operated from properly wired 110 volt AC or DC line. The ideal gift with a life-long use. . . . Order today on 10 day money back guarantee.
FOUR-WAY WELDER CO., Dept. F2-A
1810 S. Federal St. • Chicago 16, Ill.



4WAY ONLY \$14.75
i.o.b. factory
WELDER
Complete with Twin Carbon Arc Torch and accessories . . . to handle all metal work.

BARGAIN BILIZER

...the Dream. Has
...the rubber con-
...designed to
...of plane a
...bottle
...When
...will



HORIZONTAL DRILL PRESS

8" TILTING TABLE SAW

30" LATHE

TRY SUPERSHOP FREE
Factory To You — \$79.95

Think of the fun you'll have and the money you'll save with your own big capacity workshop. Picture yourself sawing with the 8" ball bearing saw. Or drilling in steel with the vertical drill press. You bore with the horizontal drill—exclusive with SUPERSHOP. You sand with the 8" disc sander. You turn with the 30" lathe. You sharpen tools on the 5" grinder.

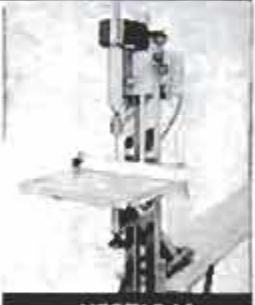

VERTICAL DRILL PRESS

You are invited to TRY SUPERSHOP FREE. We will pay all shipping expense. Write for full details of this amazing FREE TRIAL PLAN. Mail postcard now.

Power Tools Division • **115 Yates Ave.**
UNITED INDUSTRIES, Inc. • **Beloit, Wis.**

START A BUSINESS

this quick way



FOR ROTARY POWER MOWER BLADES

The Foley 314 Grinder puts a perfect cutting edge on all rotary power mower blades.



with these 2 machines you can sharpen ALL HAND AND POWER LAWN MOWERS

Here's a business you can start in spare time, and begin to make a CASH PROFIT right away. The Foley Lawn Mower Sharpener handles up to 3 or 4 reel type mowers per hour. Prices run \$2.00 to \$3.00 for hand mowers. \$5.00 to \$8.00 for power mowers. You get 99c profit out of each dollar.

With the Foley Grinder you can sharpen rotary power mower blades, rip, cross-cut and combination circular saws, dado heads, ice skates, knives, scissors, shears, all sharp-edged tools.



FREE PLAN tells how to put yourself right into a home business that will pay you \$3 to \$6 an hour. Send coupon today for **FREE BOOK** on how to sharpen power mowers and Special Combination Money Saving Offer. No obligation—no salesman will call.

FOLEY MFG. CO., 187-9 Foley Bldg., Minneapolis 18, Minn.
Send Free Plan on lawn mower business and Special Combination Offer.

NAME _____
ADDRESS _____

AMAZING PERSONAL POCKET RADIO



GUARANTEED—FOR YOUR LIFE!
FOR AS LONG AS YOU OWN IT! NO TUBES, BATTERIES, TRANSISTORS OR ELECTRICAL PLUG-INS NEEDED! WILL NEVER RUN DOWN or TURN OUT! SMALLER THAN A PACK OF CIGARETTES! RECEIVES LOCAL RADIO STATIONS ANYTIME—ANYWHERE YOU GO! Easy to use! Tuner, NO DANGLING LEAD! TONES. HAS BUILT-IN SPEAKER PHONE! Black gold plastic cabinet, semi-conductor wave detector. NOT IMPORTED. MADE AND GUARANTEED BY AMERICANS—You can always get service. **SEND ONLY \$2.00** (bill, c.b. m.) and pay postman \$4.00 COD (postage on arrival or send \$6.00 for post-paid delivery. SENT COMPLETE READY TO LISTEN WITH LIFE GUARANTEE—NOTHING EXTRA TO BUY EVER! FREE LONG DISTANCE ANTENNA if you order now. Available only from: **MIDWAY COMPANY Dept. WPM-1 KEARNEY, NEBR.**

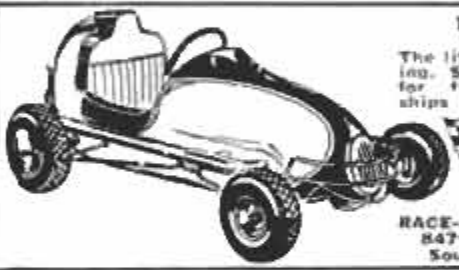

1/4 MIDGETS

The little league of family racing. \$449.00 complete. Write for free literature. Dealerships now available.



RACE-CRAFT MIDGET CARS
8476 E. Garvey Boulevard
South San Gabriel, Calif.



DOES TOUGH JOBS WHILE YOU RIDE!

PLOW • DISC • MOW • TILL

A new sized tractor made especially for farms and suburban acreage. Comfort, Ease, Hicrow, Fast, Built-in, FLOW SHOW, Spray, Low, Mounts beautiful spray (pulls 3 mowers). Over 20 quick change implements. Safe to operate even for 10 year child. 9 hp. All gear drive. 8-W-4 tapered transmission. clutch. 2400000, 770 lbs. Uses regular automotive parts. Easy operation to maintain low cost. Ready to drive. 100% Satisfaction guaranteed. Thousands in use.

Write for **FREE CATALOG TODAY!**
COUNTRY SQUIRE TRACTOR CO.
P.O. Box 107-K1, Muskego, Wis.

Three Faces of Crippling



Birth Defects Arthritis Polio

JOIN THE
MARCH OF DIMES

■■■■ TOWARD GREATER VICTORIES ■■■■