

POPULAR MECHANICS

MAGAZINE

WRITTEN SO YOU CAN UNDERSTAND IT

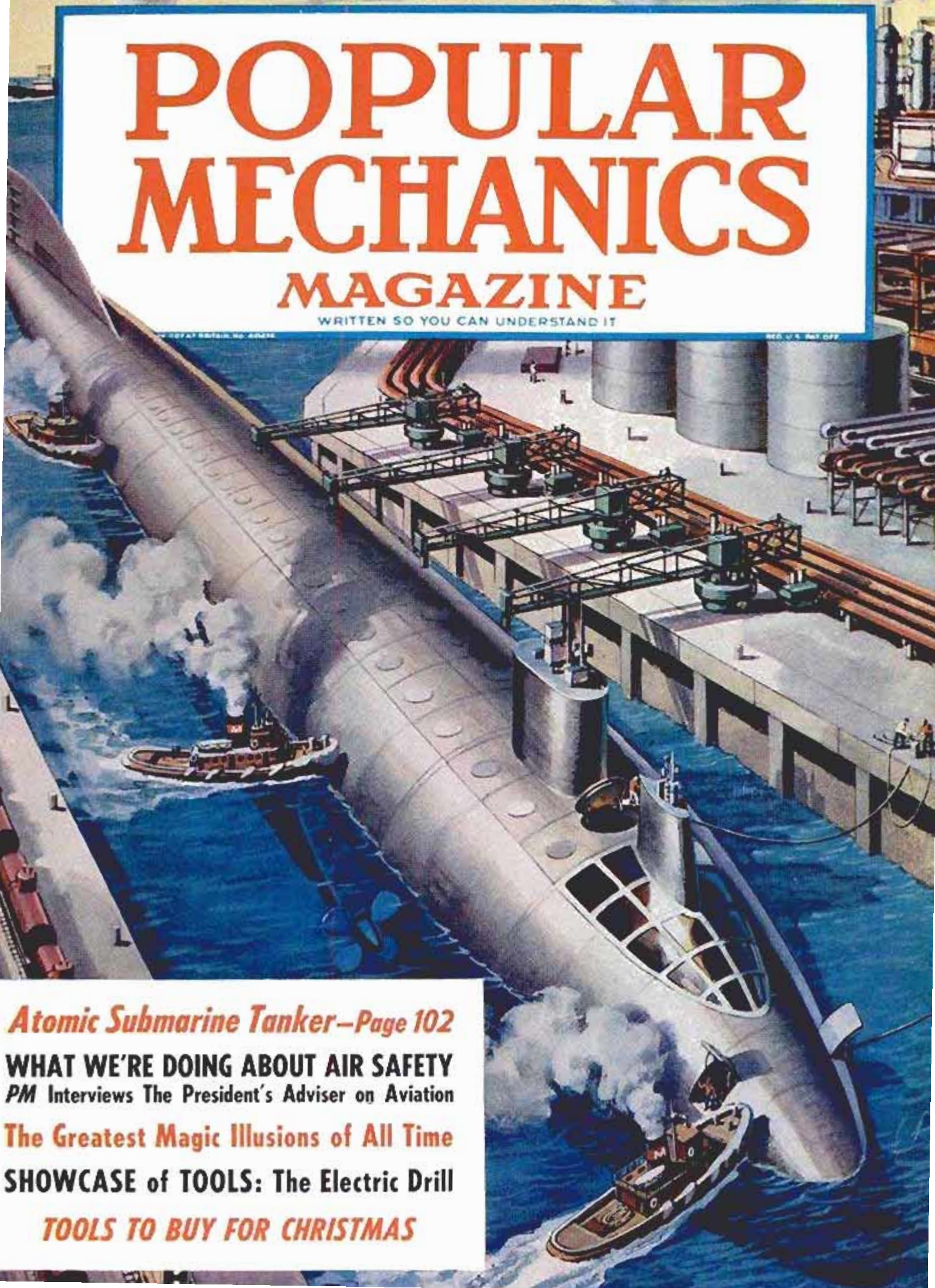

Atomic Submarine Tanker—Page 102

WHAT WE'RE DOING ABOUT AIR SAFETY
PM Interviews The President's Adviser on Aviation

The Greatest Magic Illusions of All Time

SHOWCASE of TOOLS: The Electric Drill

TOOLS TO BUY FOR CHRISTMAS



Give yourself **2 MONTHS** VACATION WITH PLAY!

Count your "days off" from May through October. Most people have 65—two months of playtime you can make the most wonderful days of your life!

Isn't this the time to turn your family gift-giving into one glorious, fun-filled venture? Mark your calendar for memorable days with an Evinrude . . . fishing secluded waters . . . skiing in sun and spray . . . picnicking . . . swimming . . . cruising in the friendly company of boating people who know how to live!

Do what *more* families are doing this Christmas . . . give your family fun afloat

with the finest power afloat! See the new '59 Evinrudes . . . most advanced motors in 50 years . . . with new thermostat control . . . new sound-sealed cushioned power . . . 8 smartly-styled new models from 3 to V4 50 hp! See them at your Evinrude dealer (he's listed in your phone book under "Outboard Motors") where easy time payments can turn dreams into reality. Ask for new '59 catalog, or write: **EVINRUDE MOTORS**, 4392 N. 27th Street, Milwaukee 16, Wisconsin. *A Division of Outboard Marine Corporation. In Canada: Mfd. by Evinrude Motors, Peterborough.*



EVINRUDE

QUIET OUTBOARD MOTORS



The Bel Air 4-Door Sedan with Body by Fisher

NOTHING'S NEW LIKE CHEVY'S NEW!



... and just look at the Impala Sport Coupe.

One look tells you '59 Chevrolet has a whole new slant on driving, from the overhead curve of its windshield to the sheen of its Magic-Mirror finish—a new acrylic lacquer that does away with waxing and polishing for up to three years.

But to discover all that's fresh and fine you must relax in Chevy's wider seats, feel the loungelike comfort of its new interior, experience the hushed tranquillity of its smoother-than-ever ride.

Once on the road you'll also find such basic benefits as bigger, better cooled brakes, a

quieter, solidly built Body by Fisher, new easy ratio steering.

Your Chevrolet dealer's waiting now to show you the car that's shaped to the new American taste. . . . Chevrolet Division of General Motors, Detroit 2, Michigan.



What America wants, America gets in a Chevy!

This One



NOW...A Top-Quality Sander Priced for Every Home Workshop

It out-performs ten men working at hand sanding—and does a better job! With the new Porter-Cable Model 165, you can refinish doors, boats, windows, furniture . . . put a fine surface on wood, plastics, metal, composition . . . save those hours now wasted on tedious hand sanding.

The Porter-Cable Model 165 weighs only 7½ lbs., evenly balanced to give more control with less fatigue. You can use it in any position—horizontally, vertically, or overhead. It takes standard 2½", 2¼", or 2" belts, and moves the belt fast—to dissipate heat and permit high cutting speed. Improved tracking mechanism keeps the belt perfectly aligned, easily adjusted by a knurled knob. You can change belts in seconds. A patented device keeps them at proper tension.

Other high-quality features include a powerful 5½ amp. motor, neoprene-nylon drive belt and precision spur gears for full power, specially-lubricated ball and sleeve bearings, neoprene-covered drive pulley to prevent slippage. Safety is provided by recessed single-pole slide switch, 3-wire cord with safety ground adapter, and heavy-gauge polished aluminum frame.



You get all this and more for only \$49.95! See and try the Model 165 sander at your Porter-Cable Dealer's now. Its performance—and price—make it a "must" for all your woodworking.

Only \$49⁹⁵

Porter-Cable
Quality Power Tools

PORTER-CABLE MACHINE COMPANY
814B Marcellus Street, Syracuse 4, N.Y.

Popular Mechanics Magazine

Registered in U. S. Patent Office and Canada

Address all communications to: 200 E. Ontario St., Chicago 11, Ill.

H. H. WINDSOR, Founder

H. H. WINDSOR, JR., Editor and Publisher

Managing Editor

RODERICK M. GRANT

Assistant Managing Editor

WAYNE WHITTAKER

Shop Notes and Crafts Editor

JAMES R. WARD

Associate Editors, General Features

CLIFFORD B. HICKS

ARTHUR R. RAILTON, Automotive

KENNETH N. ANDERSON

Associate Editors, Shop Notes and Crafts

WAYNE C. LECKEY W. CLYDE LAMMEY

Radio-Television, Electronics Editor

LOTHAR STERN

Assistant Editors

SHELDON A. MIX, General Features

JAY W. HEDDEN, EARL WOBCEK, Crafts

JOHN DALEN, ARLENE HIRSCH, Makeup

Art Staff

FRANK BEATTY, Director

HENRY NEHRBASS, Assistant Director

RICHARD A. POTTS, Art Editor

Eastern Editor

RICHARD F. DEMPEWOLFF

Room 4102, Empire State Bldg., New York City 1

Western Editor

THOMAS E. STIMSON, JR.

Suite 1010, 3460 Wilshire Blvd.
Los Angeles 5, Calif.

London Manager

DOUGLAS W. WEDDERSPOON

Eagle House, Jermyn St.,
London S.W. 1, England

Director, Bureau of Information

ALLAN CARPENTER

Advertising Offices

Chicago: 200 E. Ontario St., Whitehall 4-0100;
New York: Empire State Bldg., 350 Fifth Ave.,
LONGacre 5-7580; Detroit: General Motors
Bldg., TRinity 5-8711; Cleveland: Hanna
Bldg., 1422 Euclid Ave., PROspect 1-0456; Los
Angeles: 3460 Wilshire, DUmkirk 2-8458; San
Francisco: Russ Bldg., 235 Montgomery St.,
Yukon 2-0823.

Published monthly by Popular Mechanics Company,
200 E. Ontario St., Chicago 11, Ill. H. H. Wind-
sor, Jr., president; Wm. Harrison Petrledge, exec.
vice-pres.; Franklin S. Forsberg, operations vice-
pres.; D. F. Windsor, vice-president and secretary-
treasurer; H. H. Windsor III, vice-president; W. T.
Windsor, vice-president; Joseph R. Buell, Jr., ad-
vertising manager; Alan M. Deyoe, circulation
manager. Single copy in the United States and
Canada, 35 cents; subscription rates in the United
States and possessions, Canada, and countries of
the Pan-American Postal Union, 1 year \$3.50; 2
years, \$6.00; 3 years, \$8.00. To all other coun-
tries add \$1.00 a year over United States prices
for overseas postage. If you plan to move, notify us
at least 30 days in advance so you will not miss
an issue. Give both your old and new addresses.
Entered as Second Class Matter, September 15,
1903, at the Post Office at Chicago, Illinois, under
Act of March 3, 1879. Entered as Second Class
Matter at Post Office Dept., Canada. Registered
as Second Class Matter at the Post Office at
Mexico, D.F., Mexico, June 20, 1950.
Copyright 1958 by Popular Mechanics Company,
Copyright under International Copyright Union,
Copyright in France. All rights reserved under
Pan-American Copyright Union. Printed in the
United States of America.

FOREIGN EDITIONS:	MECANIQUE POPULAIRE (French)	MECANICA POPULAR (Spanish)	POPULAE MEKANIK (Danish)	POPULAR MEKANIK (Swedish)	POPULARE MECHANIK (German)
-------------------	------------------------------	----------------------------	--------------------------	---------------------------	----------------------------

Volume 110

DECEMBER 1958

Number 6

In This Issue...

What We're Doing About Air Safety	- - -	65
Six-Minute Ride Into Space	- - -	71
Medicine's New Electronic Wizardry	- - -	76
Down Deep for Salt	- - -	82
"They Don't Make 'em Like They Used to"	- - -	86
Iron Horse? It's Stainless Steel	- - -	94
The Greatest Magic Illusions of All Time	- - -	97
Atomic Submarine Tanker	- - -	102
More '59 Cars: Lincoln, 106; Edsel, 107; Mercury	- - -	108
Have Dinner in the Middle Ages	- - -	112
Teen-Age Fliers	- - -	116
The Battle of the Orchards - Farmer Fights Frost	- - -	120
Centipede House	- - -	129
Strange Ships for Strange Cargo	- - -	138

For the Craftsman...

Sofa Goes Modern	- - -	149
Make Your Own Pole Lamp	- - -	154
"Grow" Your Own Christmas Trees	- - -	158
Sectional Ottomans	- - -	166
Modeling the French Chebec - Part II	- - -	170
Christmas Safety Hints	- - -	178
Showcase of Tools - Drill Presses	- - -	186
Turning a Radius	- - -	193
Mortise and Tenon Joinery	- - -	198

Regular Departments...

Do You Know This Old-Timer? (Quiz)	- - -	12	
Detroit Listening Post	91	Solving Home Problems	162
What's New for Your Home	126	Shopping for Tools	201
Radio, TV and Electronics	145	Clinic for Homemakers	210

Turn to detailed index on page 58. Sources of additional information on items in this issue are shown on the Where-to-Find-It List, available without charge by writing the Bureau of Information, Popular Mechanics, 200 E. Ontario St., Chicago 11, Ill.

Next Month...

... brings the annual 50-page auto section. An outstanding feature will be double-size paintings in full color of "The Heroic Years of the Automobile," the era of adventure when goggled motorists literally raced around the world. There'll be a full run-down of the '59 cars, an exclusive interview in which top stylists strike back at their critics, and an engineer's evaluation of the numerous gadgets that are supposed to increase the performance of your car

Now... See in spite of



BRACE YOURSELF! Here comes another driver who hasn't dimmed his lights. He's 175 feet away. Your vision of your side of the road is "washed out" by his glare. Then after you pass,

it takes precious seconds for your eyes to re-adjust to the reduced light, and you still can't see the road ahead clearly. It's like entering a dark theatre on a sunny day!

New G-E SUBURBAN Headlamps have

No other 2-headlamp system ever gave you as much light *in the low beam* as new General Electric SUBURBAN Headlamps. And you *need* more light in the low beam when meeting oncoming cars—even if the other driver dims his lights and has them aimed properly.

This new General Electric low beam fila-

ment is *optically centered* in the reflector—gives a "built-in spotlight" effect, puts more light where you need it to make passing easier and safer. Helps you recover your vision more quickly when the other car has passed.

Have a pair of new G-E SUBURBAN Headlamps installed and aimed by your

the other car's lights!



NOW YOU CAN SEE in spite of the other car's lights—better than ever before, because you have new G-E SUBURBAN Headlamps. Their "built-in spotlight" effect in the low beam pro-

jects more light along the right shoulder, helps keep your eyes on your side of the road. Now you can spot that fallen box at the 200-foot mark—which you *couldn't* see with old headlamps.

a "built-in spotlight" ..in the low beam!

dealer, garage or service station! General Electric Co., Miniature Lamp Dept., Nela Park, Cleveland 12, Ohio.



Special low-beam filament shield lets you see better in fog, rain or snow.

Upper beam reaches far and wide for safer driving on open road.

Progress Is Our Most Important Product
GENERAL  ELECTRIC

DECEMBER 1958



**SOME
LUCKY
GUYS...**

Pressure applied to handles of Proto's "Multi-Plier" increases ten times at the jaws.

**YOU'LL
PREFER
PROTO
PROFESSIONAL
PLIERS**

Some lucky guys are going to get Proto No. 234 MultiPliers for Christmas. They may have other pliers, but not one like this. The patented MultiPlier is **2 TO 4 TIMES MORE POWERFUL** than ordinary pliers; does more jobs better; adjusts to four basic positions; holds, turns, squeezes with tremendous compound leverage. Forged alloy steel. Polished chrome plate. Proto professional tools are wonderful, lasting gifts!

**At your Auto Parts, Builders
Supply, and Hardware Stores.**



2209 Santa Fe Ave.
Los Angeles 54, Calif.

ACROSS THE DESK



To the Editor:

My hat's off to Fangio (*PM*, Aug. 1958), a truly great and humble driver, a real sport, a real person.

About the only development of any significance as a result of racing in this country is an automotive tire for high speed and high temperature applications.

Edward Kramer,
Cincinnati, Ohio

☆ ☆ ☆

To the Editor:

Three out of every four "English" automobiles imported into the U.S.A. are really *American*.

The Vauxhall concern is owned by, and run by, your countrymen, who also design those "English" cars! Really Editor, since when was Henry Ford an Englishman? We do not like any of these cars anyway.

Rolls Royce makes a *real English* car. Here's hoping Art Railton will own one.

T. Atkins,
Nottingham, England

☆ ☆ ☆

To the Editor:

I enjoyed your article, "They Learn to Fly in High School," in the October issue.

A very successful school, similar in operation, was established some time prior to 1936 in Helena, Mont. The instigator and instructor . . . was Bill "Pop" Farner, who . . . worked hard to establish what I believe was the first high school to teach actual flight.

Our plane was a 125-horsepower Fleet II biplane and it cost each student \$3 per hour to fly. Many of the fellows soloed . . . many flew in World War II . . . and some didn't come back. Many of our class are now in maintenance repair and manufacturing of aircraft.

John D. Ballard, President,
El Gato Rental & Supply, Inc.
Los Gatos, Calif.

☆ ☆ ☆

To the Editor:

I just finished reading "Alaska — 'Big Land' of Contrasts" (*PM*, 1958). I am an Alaskan and I want to thank you for the best article on my country since statehood . . .

Might interest you to know I was born in Nulato, where they had many massacres and much fighting with the Koyukuks

(Continued to page 10)

Satisfied with my PRESENT PAYCHECK? NOT ME!!



TODAY, you are probably earning enough to get by—enough to provide your family with life's necessities, and perhaps you are depositing a few extra dollars in the bank.

BUT are you content with just earning a living wage? Do you say "Someday I'll really get a break and go right on to the top." THAT'S WISHFUL THINKING!

You know that the "breaks" go to the man or woman who is *prepared* to take advantage of them—to the person who can fill the better job and who is worth more money. He makes the "breaks" instead of waiting for them.

DO YOU QUESTION YOUR OWN ABILITY?

There is a field of business which has never been overcrowded—it's the ACCOUNTING FIELD. And the demand for skilled accountants—men and women who really know their business—is increasing. State and Federal legislation requires much more efficient accounting from business. Corporations are in constant need of expert counsel in matters relating to Auditing, Cost Accounting, Business Law, and Federal Income Tax. Men who prove their qualifications in this important branch of business are promoted to responsible executive positions—given an opportunity to earn real salaries. The range is \$5,000 to \$10,000 a year—even to higher income figures.

WHY BE SATISFIED WITH YOUR PRESENT JOB?

Why accept mediocre pay when right in your own home you can acquire the necessary training to advance rapidly in the profitable, growing field of Accounting.

Under the LaSalle Problem Method you can acquire a thorough knowledge of Accounting, master its fundamental principles, become expert in the practical application of those

principles—without losing an hour from work or a dollar of pay.

Your training will be under the supervision of organization and management specialists, Attorneys and Certified Public Accountants. Preliminary knowledge of bookkeeping is not necessary. We train you from the ground up—Basic Accounting right on up through the Certified Public Accountant training.

SO RIGHT NOW—TODAY

If you are ambitious—if you are interested in a high-paying career—investigate the opportunities in this profitable field.

FREE SAMPLE LESSON

Decide today to send for LaSalle's Accounting Lesson Number One, also FREE book, "Opportunities in Accounting." In it you will find complete information on the opportunities which are open to those qualified, and you will learn how you can prepare yourself for a better job and more money. NO OBLIGATION. MAIL THE COUPON TODAY.

ACCREDITED MEMBER, NATIONAL HOME STUDY COUNCIL

FIFTY YEARS OF QUALITY TRAINING

MAIL THE
COUPON
TODAY!

OVER 4,500 CPAs
HAVE BEEN TRAINED
BY THE LA SALLE
PROBLEM METHOD

-----SEND FOR FREE BOOKS-----



LaSalle Extension University

— A Correspondence Institution —

Dept. 1264 H, 417 S. Dearborn St., Chicago 5, Ill.
Please send me, free of all cost or obligation, Free sample lesson, and your illustrated book, "Opportunities in Accounting."

Name.....Age.....

Address.....

City, Zone, State.....

SKIPPED ME AGAIN!



POOR BURT! HE MISSED OUT ON THAT PROMOTION AGAIN!

I WAS DETERMINED TO MAKE GOOD IN MY JOB...BUT DETERMINATION, I FOUND, WAS NOT ENOUGH!

I HAD PLENTY OF EXPERIENCE. AND THE BOSS SEEMED TO LIKE ME. I LACKED JUST ONE THING—**TRAINING!**



SORRY, BURT! I KNOW YOU'VE WORKED HERE LONGER. BUT TED HAS THE SPECIAL TRAINING WE NEED. YOUR CHANCE WILL COME ...SOMEDAY!

I.C.S. IS THE OLDEST AND LARGEST CORRESPONDENCE SCHOOL IN THE WORLD. 256 COURSES. PERSONALIZED INSTRUCTION, CAREER GUIDANCE, EASY-PAY PLAN. DIPLOMA TO GRADUATES.

SIX MONTHS LATER... I.C.S. SENT MY BOSS REGULAR REPORTS OF MY PROGRESS. THEN ONE MORNING...

BURT, I'VE JUST MADE YOU THE ASSISTANT MANAGER OF YOUR DIVISION...AT \$15 MORE A WEEK. AND THE WAY YOU'RE GOING NOW, THIS IS JUST THE BEGINNING.



GOSH! THANKS MR. TAYLOR!

I GOT IT, HONEY! I GOT THE PROMOTION! OUR MONEY WORRIES ARE OVER! TODAY'S OUR LUCKY DAY!

TODAY AND THE DAY YOU MAILED THAT I.C.S. COUPON!



WHY NOT MAKE THIS YOUR LUCKY DAY? LET I.C.S. PUT YOU ON THE ROAD TO MORE PAY, RAPID ADVANCEMENT, REAL JOB SECURITY. HERE'S THE FAMOUS COUPON. MAIL IT NOW!

I WAS TIRED OF WAITING FOR "SOMEDAY."
I MADE UP MY MIND TO ACT! I'D GET THE
TRAINING I NEEDED...SOMEHOW!
JANE HAD A SUGGESTION...

I CAN'T QUIT MY
JOB AND GO BACK TO
SCHOOL! AND I SURE
DON'T WANT THAT
NIGHT CLASS
ROUTINE IN
THE CITY!

WHY NOT STUDY
AT HOME?...THE
WAY DAD DID...
WITH I.C.S.



JANE SHOWED ME AN I.C.S.
ADVERTISEMENT IN POPULAR
MECHANICS. THERE WAS THE
FAMOUS COUPON. AND THERE WAS
EXACTLY THE COURSE I WANTED..

SAY, THEY'LL SEND ME
A CAREER KIT FREE...
THREE BIG SUCCESS
BOOKS.

DAD SAYS
HE NEVER
WOULD
HAVE BEEN
MANAGER IF IT
WEREN'T
FOR I.C.S.



FREE!

I. C. S. CAREER KIT CONSISTING OF...

- 1 "HOW TO SUCCEED"
32-PAGE GOLD MINE
- 2 CAREER CATALOG...
OPPORTUNITIES IN YOUR
FIELD.
- 3 SAMPLE LESSON (MATH)
SHOWS I.C.S. METHOD.

For Real Job Security—Get an I. C. S. Diploma! I. C. S., Scranton 15, Penna. Accredited Member, National Home Study Council

INTERNATIONAL CORRESPONDENCE SCHOOLS



BOX 90299M, SCRANTON 15, PENNA.

(Partial list of 259 courses)

Without cost or obligation, send me "HOW TO SUCCEED" and the opportunity booklet about the field BEFORE which I have marked X (plus sample lesson):

- | | | | | |
|--|--|--|--|---|
| <p>ARCHITECTURE and BUILDING CONSTRUCTION</p> <ul style="list-style-type: none"> <input type="checkbox"/> Air Conditioning <input type="checkbox"/> Architecture <input type="checkbox"/> Arch. Drawing and Designing <input type="checkbox"/> Building Contractor <input type="checkbox"/> Building Estimator <input type="checkbox"/> Carpentry and Millwork <input type="checkbox"/> Carpenter Foreman <input type="checkbox"/> Heating <input type="checkbox"/> Interior Decoration <input type="checkbox"/> Painting Contractor <input type="checkbox"/> Plumbing <input type="checkbox"/> Reading Arch. Blueprints <p>ART</p> <ul style="list-style-type: none"> <input type="checkbox"/> Commercial Art <input type="checkbox"/> Magazine & Book Illus. <input type="checkbox"/> Show Card and Sign Lettering <input type="checkbox"/> Sketching and Painting <p>AUTOMOTIVE</p> <ul style="list-style-type: none"> <input type="checkbox"/> Automobiles <input type="checkbox"/> Auto Body Rebuilding and Refinishing <input type="checkbox"/> Auto Engine Tuneup <input type="checkbox"/> Auto Technician | <p>AVIATION</p> <ul style="list-style-type: none"> <input type="checkbox"/> Aero-Engineering Technology <input type="checkbox"/> Aircraft & Engine Mechanic <p>BUSINESS</p> <ul style="list-style-type: none"> <input type="checkbox"/> Accounting <input type="checkbox"/> Advertising <input type="checkbox"/> Business Administration <input type="checkbox"/> Business Management <input type="checkbox"/> Cost Accounting <input type="checkbox"/> Creative Salesmanship <input type="checkbox"/> Managing a Small Business <input type="checkbox"/> Professional Secretary <input type="checkbox"/> Public Accounting <input type="checkbox"/> Purchasing Agent <input type="checkbox"/> Salesmanship <input type="checkbox"/> Salesmanship and Management <input type="checkbox"/> Traffic Management <p>CHEMICAL</p> <ul style="list-style-type: none"> <input type="checkbox"/> Analytical Chemistry <input type="checkbox"/> Chemical Engineering <input type="checkbox"/> Chem. Lab. Technician <input type="checkbox"/> Elements of Nuclear Energy <input type="checkbox"/> General Chemistry <input type="checkbox"/> Natural Gas Prod. and Trans. <input type="checkbox"/> Petroleum Prod. and Engr. <input type="checkbox"/> Professional Engineer (Chem) <input type="checkbox"/> Pulp and Paper Making | <p>CIVIL ENGINEERING</p> <ul style="list-style-type: none"> <input type="checkbox"/> Civil Engineering <input type="checkbox"/> Construction Engineering <input type="checkbox"/> Highway Engineering <input type="checkbox"/> Professional Engineer (Civil) <input type="checkbox"/> Reading Struc. Blueprints <input type="checkbox"/> Structural Engineering <input type="checkbox"/> Surveying and Mapping <p>DRAFTING</p> <ul style="list-style-type: none"> <input type="checkbox"/> Aircraft Drafting <input type="checkbox"/> Architectural Drafting <input type="checkbox"/> Drafting Machine Design <input type="checkbox"/> Electrical Drafting <input type="checkbox"/> Mechanical Drafting <input type="checkbox"/> Sheet Metal Drafting <input type="checkbox"/> Structural Drafting <p>ELECTRICAL</p> <ul style="list-style-type: none"> <input type="checkbox"/> Electrical Engineering <input type="checkbox"/> Elec. Engr. Technician <input type="checkbox"/> Elec. Light and Power <input type="checkbox"/> Practical Electrician <input type="checkbox"/> Practical Lineman <input type="checkbox"/> Professional Engineer (Elec) <p>HIGH SCHOOL</p> <ul style="list-style-type: none"> <input type="checkbox"/> High School Diploma | <ul style="list-style-type: none"> <input type="checkbox"/> Good English <input type="checkbox"/> High School Mathematics <input type="checkbox"/> Short Story Writing <p>LEADERSHIP</p> <ul style="list-style-type: none"> <input type="checkbox"/> Industrial Foremanship <input type="checkbox"/> Industrial Supervision <input type="checkbox"/> Personnel-Labor Relations <input type="checkbox"/> Supervision <p>MECHANICAL and SHOP</p> <ul style="list-style-type: none"> <input type="checkbox"/> Diesel Engines <input type="checkbox"/> Gas-Elec. Welding <input type="checkbox"/> Industrial Engineering <input type="checkbox"/> Industrial Instrumentation <input type="checkbox"/> Industrial Metallurgy <input type="checkbox"/> Industrial Safety <input type="checkbox"/> Industrial Safety <input type="checkbox"/> Machine Design <input type="checkbox"/> Machine Shop Practice <input type="checkbox"/> Mechanical Engineering <input type="checkbox"/> Professional Engineer (Mech) <input type="checkbox"/> Quality Control <input type="checkbox"/> Reading Shop Blueprints <input type="checkbox"/> Refrigeration and Air Conditioning <input type="checkbox"/> Tool Design <input type="checkbox"/> Tool Making <p>RADIO, TELEVISION</p> <ul style="list-style-type: none"> <input type="checkbox"/> General Electronics Tech. | <ul style="list-style-type: none"> <input type="checkbox"/> Industrial Electronics <input type="checkbox"/> Practical Radio-TV Eng'g <input type="checkbox"/> Practical Telephony <input type="checkbox"/> Radio-TV Servicing <p>RAILROAD</p> <ul style="list-style-type: none"> <input type="checkbox"/> Car Inspector and Air Brake <input type="checkbox"/> Diesel Electrician <input type="checkbox"/> Diesel Engr. and Fireman <input type="checkbox"/> Diesel Locomotive <p>STEAM and DIESEL POWER</p> <ul style="list-style-type: none"> <input type="checkbox"/> Combustion Engineering <input type="checkbox"/> Power Plant Engineer <input type="checkbox"/> Stationary Diesel Engr. <input type="checkbox"/> Stationary Fireman <p>TEXTILE</p> <ul style="list-style-type: none"> <input type="checkbox"/> Carding and Spinning <input type="checkbox"/> Cotton Manufacture <input type="checkbox"/> Cotton Warping and Weaving <input type="checkbox"/> Loom Fixing Technician <input type="checkbox"/> Textile Designing <input type="checkbox"/> Textile Finishing & Dyeing <input type="checkbox"/> Throwing <input type="checkbox"/> Warping and Weaving <input type="checkbox"/> Worsted Manufacturing |
|--|--|--|--|---|

Name _____ Age _____ Home Address _____
 City _____ Zone _____ State _____ Working Hours _____ A.M. to P.M. _____
 Occupation _____

Canadian residents send coupon to International Correspondence Schools, Canadian, Ltd., Montreal, Canada. . . . Special tuition rates to members of the U. S. Armed Forces.

'Dream Jobs' for Wide-Awake Men

Willing to Train at Home in Spare Time



**AMERICA IS SHORT
100,000 MECHANICS
AND 25,000 SHOPS**

Tie this for opportunity! Right now, America needs 100,000 newly-trained auto mechanics. By 1966, when

90 million vehicles will be on the road, America will be short 600,000 mechanics! *Pay is tops:* In larger cities, it averages \$3.00 an hour. Isn't it time you learned this well-paid, fascinating, secure trade? You can if you try, because the CTI method is easy, fast, sure. It trains you at home—in all phases of auto overhaul and service. *Mail coupon for full information.*

Get Experience Using Tune-Up Kit & Tools

(included with training)



CTI sends you a Tune-Up Kit, the kind that skilled mechanics use to locate engine troubles. You receive a compression Tester; Vacuum Gauge & Fuel Pump Tester; Ignition Timing Light; portable steel case. You also get mechanic's tools, including socket set. You acquire *experience* using kits.



Many Earn Cash During Training

CTI lessons can pay off soon after you enroll. So practical is CTI training that many students make money fixing cars. Some get jobs in local shops working evenings and week-ends. Others start a repair service on their own. Either way, you could well earn enough to pay tuition, buy shop equipment, and perhaps fatten your savings account. CTI will encourage you to acquire experience—as well as cash—with your training.

DIESEL MECHANICS OR BODY-FENDER REBUILDING

instruction is also yours—at no additional cost. But get all the facts on CTI training. Discover how we train you in Tune-Up; Overhaul; Electric, Cooling & Lubricating Systems; Power Brakes; Power Steering; Automatic Transmissions; Clutches. Mail coupon for 2 free booklets.—Commercial Trades Institute, Chicago 26, Ill.

MAIL TODAY • TWO FREE BOOKS

COMMERCIAL TRADES INSTITUTE

1400 GREENLEAF AVENUE DEPT. A-957
CHICAGO 26, ILLINOIS

Mail me your two opportunity booklets: *Big Money in Auto Mechanics*; and *Sample Lesson*. Both FREE.

Name _____ Age _____

Address _____

City _____ Zone _____ State _____



(Continued from page 6)

(also the town's name) about 18 miles up the Yukon. Many are the exciting stories my Russian mother used to relate to me.

Once she said the town of Nulato was plundered and raided, leaving only four people who escaped to the Kaiyuh Hills. A woman carrying a child managed to escape by hiding in a garbage can.

Alvin Manook,
China Lake, Calif.

☆ ☆ ☆

To the Editor:

This is a snapshot of a clock case we made from the plan by John Bergen in your *Popular Mechanics What to Make and How*



to Make It, 1957. The case is 7 feet 3½ inches tall and made of solid walnut. We are very proud of it—think it is worth several times the \$155 it cost us.

Mr. and Mrs. J. Herman Neese,
Graham, N. C.

To the Editor:

We have no phone in the house, but our next door neighbor always obliges us by allowing its use.

If he is away with his house locked, we can still hear the telephone ring. If any of my three particular friends have an urgent call to make to me, we use the following prearranged "call signal."

My first friend puts the receiver down

(Continued to page 14)



J. E. SMITH, Founder
National Radio Institute
Over 40 Years' Experience
in Training Ambitious Men

I Will Send You A **SAMPLE LESSON FREE** to show you how easy, practical it is to **Train at Home for Good Television-Radio Jobs**



America's Fast Growing Industry Offers You Good Pay Plus a Bright Future

People look up to and depend on the Technician, more than ever before. Offices, plants, homes everywhere—are obliged to buy his knowledge and services. His opportunities are great and are increasing. At home, and in your spare time, you can learn to do this interesting, satisfying work, qualify for important pay. No experience is needed. You train in your own home—keep your present job while learning.

Make \$10, \$15 a Week Extra
NRI students find it easy to start fixing sets for friends soon after enrolling. Many who start in spare time soon build profitable, full time TV-Radio businesses.

Television's Growth is Making More Jobs, Prosperity

Right now, a solid, proven field of opportunity for good pay is servicing the millions of Television and Radio sets now in use. Hundreds of TV and Radio stations on the air offer interesting jobs for Operators and Technicians.

Mail Coupon—Find Out About This Tested Way to Better Pay

You don't have to know anything about electricity or Radio to succeed with NRI courses. Mailing the coupon may be one of the important acts of your life. Do it now. Reasonable tuition, on low monthly payments available. Let us send you an actual lesson. Judge for yourself how easy it is to learn. A 64-page catalog gives details of opportunities and training. Address: **NATIONAL RADIO INSTITUTE, Dept. BNA Washington 16, D.C.**



You Learn by Practicing with Equipment NRI Sends



Clearly written, well-illustrated NRI lessons teach TV-Radio-Electronics principles. Also, *without extra charge*, you get NRI kits developed especially to give you actual practice with TV-Radio equipment. You build, test, experiment with actual Television-Radio receiver or broadcasting circuits, build, use testing equipment. All equipment is yours to keep. In your own home you gain knowledge, develop skills needed for jobs in this vast industry.

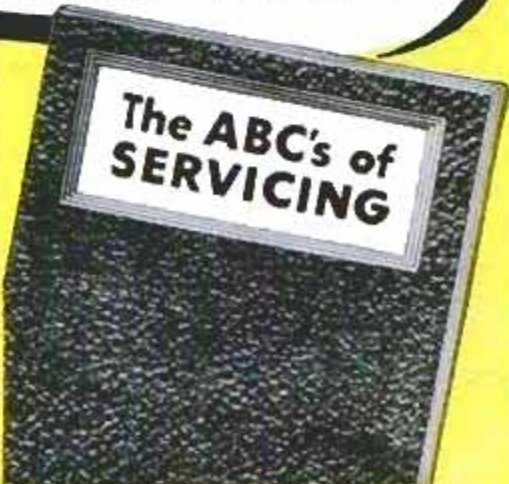

NRI Trained These Men



"I have my own Radio-TV business and my income has provided me with financial security. Business is great. I can't keep up with the work."—**EDWARD M. DUDEK, Chicago, Ill.**

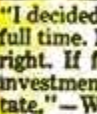

"I decided to quit my job and do TV work full time. I love my work and am doing all right. If fellows knew what a wonderful investment NRI is, they would not hesitate."—**W. F. KLINE, Cincinnati, Ohio.**



"Thanks to NRI, I operated a successful Radio repair shop. Then I got a job with WPAQ, later WBOB and now am an engineer for WHPE."—**VAN W. WORKMAN, High Point, N. Carolina.**



MAIL COUPON FOR SAMPLE LESSON and 64-PAGE CATALOG

Good for Both—FREE

NATIONAL RADIO INSTITUTE, Dept. BNA, Washington 16, D. C.

Mail me Sample Lesson and 64-page Book, FREE. (No salesman will call. Please write plainly.)

Name _____ Age _____
Address _____
City _____ Zone _____ State _____

ACCREDITED MEMBER NATIONAL HOME STUDY COUNCIL



U.S. Forest Service photo

Do You Know This Old-Timer?

This brings back the good old days, when roughing it was really roughing it—and maybe even more fun than in these days of crowded tourist camps in the national parks. The car you should recognize: It had a distinctive shape that

everyone knew a generation ago. The photograph was taken in the Cibola National Forest in New Mexico in 1924. And take a good safety tip from these campers—chock your wheels against a sturdy pine. The car? Turn to page 216.

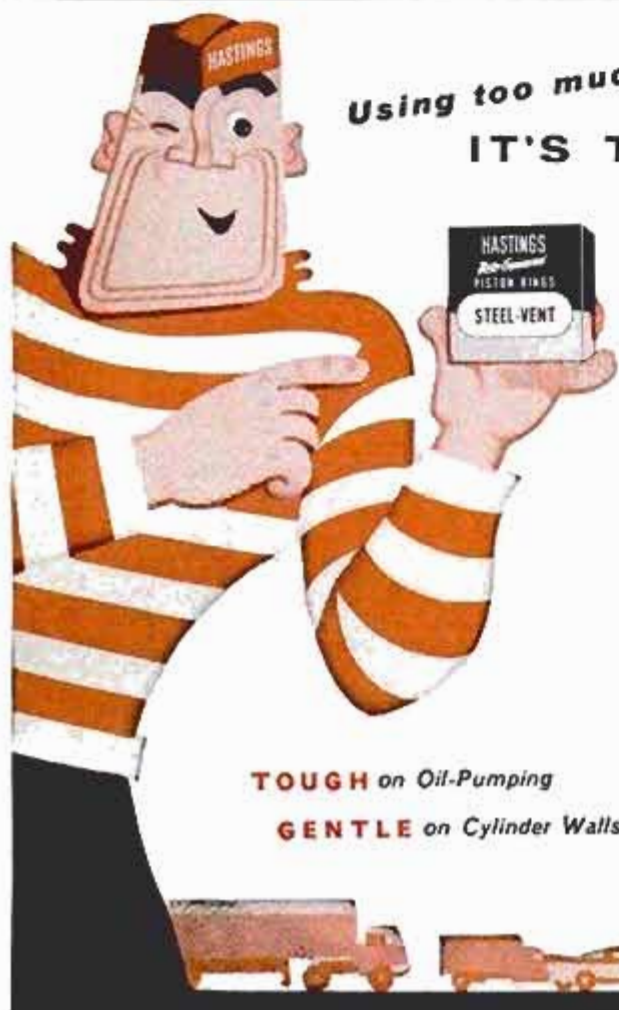

Using too much oil and gas?
IT'S TIME FOR

HASTINGS

- Watch out when your car uses too much oil! It's your first sign of worn-out piston rings. And worn-out piston rings mean power drop-off—costly wastage of gas and oil—expensive repairs later on.

The sooner you act, the less it will cost. See your motor specialist the minute oil-pumping warns you there's trouble ahead. When he recommends new piston rings, ask him for Hastings. They're engineered exclusively for replacement service . . . to provide the additional lubrication worn engines need . . . to stop oil-pumping, save gasoline, restore lost performance.

Get new car power and performance from your present car—with Hastings. Truly your best investment for many thousands of extra miles of trouble-free driving pleasure. Hastings Manufacturing Company, Hastings, Michigan. Piston Rings, Oil Filters, Casite, Spark Plugs.

TOUGH on Oil-Pumping
GENTLE on Cylinder Walls

HASTINGS
PISTON RINGS

U.S. Patent Nos. 2614892, 2712271



INVENTORS

Learn how to protect your invention. The U. S. Patent Laws provide that any new and useful art, machine, article of manufacture, or composition of matter, or any new and useful improvement thereof, may be patented if the act of invention is involved. Therefore, every inventor with a valuable invention should take advantage of the Patent Laws and proceed for patent protection in order to safeguard his rights.

A patent gives the inventor the exclusive right to prevent others from making, using, or selling the invention claimed in the patent for a period of seventeen years.

The Patent Laws were enacted for the benefit of the inventor to give him protection for the features of his invention which are patentable. These features must be properly and concisely set forth and claimed in a formal application for patent, in order to comply with the requirements of the Patent Laws. For that reason, unless the inventor is familiar with patent matters, he should engage a competent registered patent attorney or agent to represent him: We are registered to practice before the U. S. Patent Office and are prepared to serve you in the handling of your patent matters.

A specially prepared booklet entitled "Patent Guide for the Inventor", containing detailed information with respect to patent protection and procedure, together with a "Record of Invention" form will be promptly forwarded to you without obligation upon request.

CLARENCE A. O'BRIEN & HARVEY JACOBSON

Registered Patent Attorneys

81-M DISTRICT NATIONAL BUILDING

WASHINGTON 5, D. C.

(Continued from page 10)

after five successive ringing-tone buzzes. Two minutes thereafter, he once again allows five successive ringing-tones and immediately places the receiver down. The other two friends follow six and seven ringing-tones each. With a little practice all my family members seem to count the ringing-tones instinctively each time.

I then immediately go down the street to the nearest grocer and call up the particular friend.

Mrs. Perin Phiroze Bilimoria,
Ahmedabad, India.

☆☆☆

Three-Motor Vacuum

Glen W. Swihart of Greenland, Ark., has developed a tri-engine vacuum cleaner for dance floors, roller skating rinks and similar large areas. Equipped with three $\frac{3}{4}$ -horsepower motors, it cleans a path 33 inches wide and has 83 feet of extension cable for traveling over wide floors. The center motor produces vacuum and also drives three rows of nylon bristles, while the other motors are used only to add suction. Five Alnico magnets in front of the sweeper pick up metal particles from the floor.

(Continued to page 34)

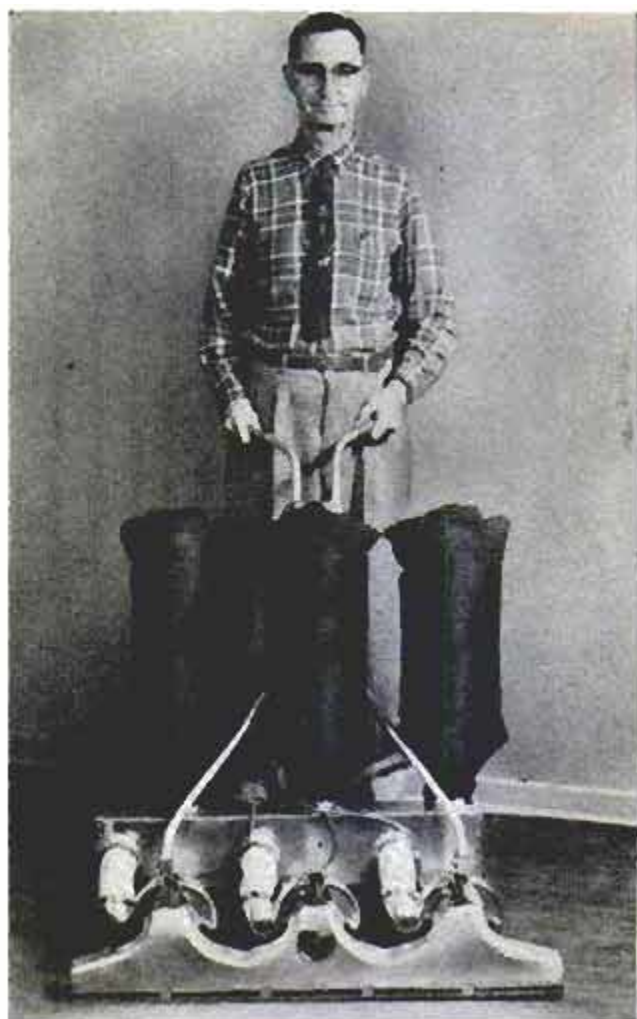

CLEANS YOUR CARBURETOR while you drive...

Hard starting, stalling, high gas consumption and poor performance all come from a dirty, gummed-up carburetor. And every carburetor gets dirty—inside. GUMOUT dissolves gum and varnish deposits quickly and completely. You just add GUMOUT to your gas tank every two or three months. It cleans as you drive! There's nothing like GUMOUT. Available at all autosupply stores, or wherever automotive products are sold.

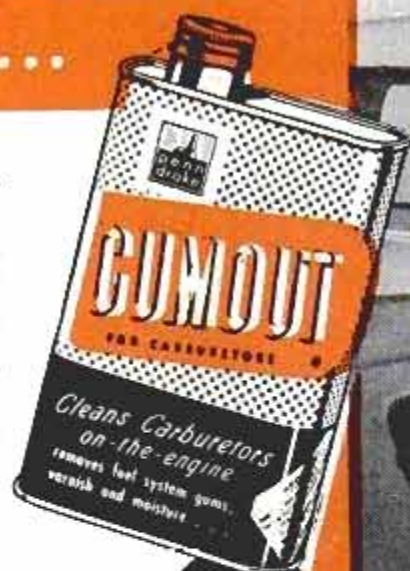

8-OZ.
89c



GUMOUT is great for power mowers, too. Insures trouble-free operation, full power.

PINT
\$1.50

Write for FREE 46-page Carburetor Handbook.

GUMOUT DIVISION - Pennsylvania Refining Co., 2671 Lisbon Road, Cleveland 4, Ohio

THIS is how you train at home to become a SERVICE ENGINEER in the Air Conditioning and Refrigeration industry...

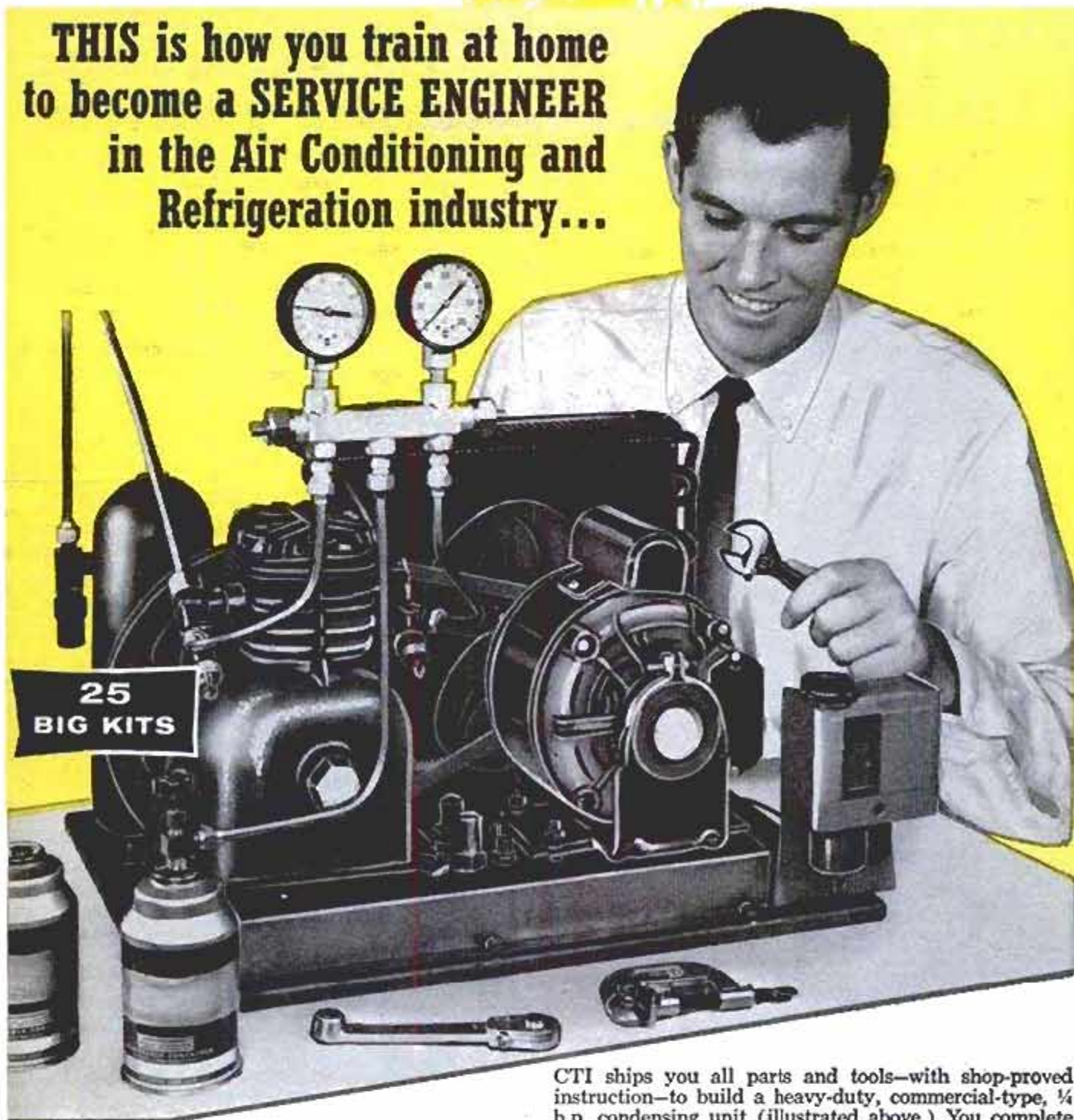

An old industry offers bright new opportunities

Almost any industry has jobs for men with special skills. In many cases, good pay and steady work are the rule. Yet—would you be happy in being a repairman all your life? Wouldn't you rather have a job that presents a challenge—still bigger money—an opportunity to grow?

Listen, if you are ambitious to *keep climbing*: The air conditioning and refrigeration industry is growing so fast that 20,000 newly-trained technicians are needed each year. They can come only from the technical schools. Because installation and repair work is important, graduates may expect high pay and security right from the start. That's not all. *A well-trained technician has a great opportunity to develop into a Service Engineer.* As a matter of fact, 90 percent of all refrigeration engineers are former repairmen!

If you seek a *career*, not just a job, get into air conditioning and refrigeration. Your first step is to gain skill and knowledge. Learn at home by practicing with 25 big kits that CTI sends. Acquire experience as you train.

CTI ships you all parts and tools—with shop-proved instruction—to build a heavy-duty, commercial-type, 1/4 h.p. condensing unit (illustrated above.) You complete 23 field-type projects—do 10 trouble-shooting jobs. You make home a training center!

So practical is CTI training that many students earn extra cash in spare time soon after they start. They make calls on their own, or get part-time jobs with local appliance dealers or air conditioning contractors.

But read the complete story. It is told in a new CTI catalog. *Just fill out and mail coupon below for your copy.* Sample lesson included. No cost nor obligation—Commercial Trades Institute, Chicago 26, Ill.

COMMERCIAL TRADES INSTITUTE

1400 GREENLEAF AVENUE
CHICAGO 26, ILLINOIS

DEPT. R-537

Send catalog, *Success in Air Conditioning & Refrigeration*, and
Lesson Sample. Both FREE.

Name _____ Age _____

Address _____

City _____ Zone _____ State _____



Make More Money Soon Fixing Electric Appliances

Train at Home in Spare Time



Better Pay—More Opportunities

Get into a field where there is important work and opportunity for the trained man. Millions of electric appliances are sold every year. Every wired home now has an average of 8. Many of them need service and repair. Owners pay well to have them fixed quickly, properly. This is your opportunity for a better job, your own part time or full time business. NRI can give you the training you need, at home, in your spare time.

Spare Time Earnings Start Soon

Soon after starting you will be able to earn extra cash fixing toasters, clocks, fans, vacuum cleaners, etc., for neighbors and friends. Keep your job while learning and earning. Put spare time to work for you. Work in your basement, garage, spare room. You'll be amazed how easily, quickly you, too, can start earning many extra dollars. NRI shows you how. Even before you finish training your spare time earnings may pay for the course and equipment.

NRI Sends Tester to Learn and Earn

You need proper equipment to service today's automatic appliances. With this course you get parts to build professional type, multi-use Appliance Tester. You learn to use it. Takes guess work out of servicing. Mail coupon for FREE book and Sample Lesson. See how easy it is to learn. Find out about NRI—a school that for more than 40 years has been training men, through home study, for success, good pay jobs. Our reputation, record, experience back up this course. Write now to NATIONAL RADIO INSTITUTE, Dept. AN8, Washington, D. C.



FREE Lesson and Book
Mail this NOW!

NATIONAL RADIO INSTITUTE
Dept. AN8, Washington 16, D.C.

Send me Lesson and Book Free. No Salesman will call.

Name.....Age.....

Address.....

City.....Zone.....State.....

ACCREDITED MEMBER NATIONAL HOME STUDY COUNCIL

Shrinks Hemorrhoids New Way Without Surgery Stops Itch—Relieves Pain

For the first time science has found a new healing substance with the astonishing ability to shrink hemorrhoids and to relieve pain—without surgery.

In case after case, while gently relieving pain, actual reduction (shrinkage) took place.

Most amazing of all—results were so thorough that sufferers made astonishing statements like "Piles have ceased to be a problem!"

The secret is a new healing substance (Bio-Dyne®)—discovery of a world-famous research institute.

This substance is now available in *suppository or ointment form* under the name *Preparation H*.® Ask for it at all drug counters—money back guarantee. *Reg. U.S. Pat. Off

Now! TEST YOUR OWN TV & RADIO TUBES for filament breaks



All of Them—Even Picture Tube

Nearly half of TV service calls are due to defective filaments. Tester shows if filaments are good. Insert tube in tester. Light shows if tube is burned out. Easy, safe to use. One service call saved pays for tester. Metal case. AC or DC. Checks fuses, appliances, etc. Only \$3.98 ppd. or C.O.D. plus charges. Guaranteed. Model \$4.98. Instructions, Guaranteed.

GEIGER ENGINEERING CORP., Dept. AB-110
6349 N. Western Ave., Chicago 45, Ill.

"YOU ARE UNDER ARREST!"



Help Bring Crooks to Justice Through Scientific
CRIME DETECTION!

We have taught thousands this exciting, profitable, pleasant profession. Let us teach you in your own home. Learn Fingerprinting, Firearms Identification, Police Photography, Secret Service Methods thoroughly, quickly, at small cost. Over 800 of all American Bureaus of Identification employ I.A.S. students or graduates. Write for FREE "Blue Book of Crime."
(A Correspondence School Since 1916)

INSTITUTE OF APPLIED SCIENCE, 1920 Sunnyside Ave., Dept. 1359, Chicago 30, Ill.



150X POCKET MICROSCOPE

Scientifically made this amazing pocket microscope magnifies 150 times. Explore the micro-world of plants, animals, minerals. Complete with 2 prepared slides, extra slides, tubes for liquid specimens and light concentrator. We guarantee your satisfaction. \$1.50 Ppd. Supply limited.

J. D. Clinton, 35 N. Broadway, Mt. Clemens 2, Mich.

JEEP OWNERS

RE-POWER NOW WITH A V-8 ENGINE — Use
FORD • CHEVROLET • MERCURY
in 2 or 4 Whl. Dr. Jeeps, Jeepssters, Sta-Wgn. Trucks, M. J. and Kaiser cars. Conversion Kits \$43.25 to \$59.85. If you want fast action tell us which engine you wish to use, give us year, Model (2 or 4 Whl-Dr) of your vehicle. Send Min. \$15.00 Dep. and we will ship correct kit, Bal. COD. Send full amt. for prepaid shipment. Wire, phone or write for free details. Also Kits for FORD 6 engines.

HOOSIER MACHINE PRODUCTS CO.
312 S.E. 6th St. Phone CR 6-3442 Pendleton, Oregon, U.S.A.



**HOTTEST THING ON
Jeep FRONT WHEELS**

STOP FRONT DRIVE DRAG IN 2 W. D. Warn Hubs on your 4 w. d. disengage the front drive in 2w.d., give it double-duty value with free-wheeling 2 w. d. economy, performance, plus normal 4 w. d.—automatically, with Warn Lock-O-Matics, manually with Warn Locking Hubs. See your dealer soon!
WARN MFG. CO., INC.
Riverton Box 6064-A12, Seattle 88, Wn.

INVENTORS

If you believe that you have an invention, you should find out how to protect it. The first step is to have a search made of the prior pertinent U. S. patents. If a report on this search indicates that the invention appears patentable you can apply for a patent, and the specifications and claims should be prepared.

The firm of McMorrow, Berman & Davidson, with offices in Washington, D. C., is qualified to take the necessary steps for you. We can make a preliminary search on your invention, advise you whether we think it can be patented, and prepare your application for patent.

Unless you are fully familiar with the U. S. Patent Laws, we recommend that you engage the services of a Registered Patent Attorney to protect your interests. The patent laws are *your* laws. A patent gives you the right to prevent others from making, using or selling the invention claimed in your patent for a period of 17 years.

Use these patent laws for your protection. Investigate whether your invention can be patented. If you have what you believe to be an invention, we suggest that you have this firm make a search for you.

Send for a copy of our Patent Booklet entitled "How To Protect Your Invention," containing information about patent protection and patent procedure. Along with this we will also send you an "Invention Record" form, for your use in writing down and sketching details of your invention. We will mail them promptly. No obligation. They are yours for the asking.

McMORROW, BERMAN & DAVIDSON

Registered Patent Attorneys

PATENTS • COPYRIGHTS • PATENTS

1354 VICTOR BUILDING, WASHINGTON 1, D. C.

LET CAR EXPERTS GUIDE YOUR HANDS THROUGH ANY AUTO REPAIR



**QUICKLY--
EASILY--RIGHT!**

**FREE
7-DAY
TRIAL**



**Brand New--Covers
All These Makes**

- | | |
|-------------|-------------|
| Buick | Jeep |
| Cadillac | Lincoln |
| Chevrolet | Mercury |
| Chrysler | Nash |
| Clippor | Oldsmobile |
| Continental | Packard |
| Ce Soto | Plymouth |
| Dodge | Pontiac |
| Geasel | Rambler |
| Ford | Studebaker |
| Indecon | Thunderbird |
| Imperial | Willlys |

**Same FREE Offer
On MOTOR'S Brand-New
Truck Repair Manual**

Covers EVERY job on EVERY popular make gasoline and Diesel truck made since 1949. For FREE 7-Day Trial, check the proper box in coupon.



SUPPOSE you had an automobile factory engineer standing right beside you . . . guiding your hands through every step of even the toughest car repair job! Think how you'd "whiz through" every job! No wonder, then, 2,500,000 MOTOR'S Auto Manuals have been sold. No wonder so many thousands of beginners and expert mechanics alike are already using MOTOR'S brand-new AUTO REPAIR MANUAL. It shows you, in step-by-step words and pictures, factory-approved repair procedures for fixing ANY part of ANY car, 1949 through 1958!

No guesswork! MOTOR'S Manual "starts from scratch" . . . leads you through entire job with easy step-by-step directions, clear "how-to" pictures. Tells WHERE to start, what TOOLS to use, how to remove, repair and replace parts. You CAN'T go wrong.

1000 Big ILLUSTRATED Pages
NEW, REVISED, ENLARGED Edition contains the "meat" from 175 OFFICIAL shop manuals — simplified for YOU in Over 1,000 big pages, 23,436 essential repair specifications. More than 2,500 "this-is-how" pictures, 225,000 services and repair facts. Leads beginners every step of the way. Time-saving factory repair procedures for experts. Used by U. S. Army and Navy.

Try Book FREE 7 Days

Just mail coupon. (Attach it to postcard if you wish.) Make manual PROVE what it's got. Unless you agree this is the greatest time and work saver ever—return book in 7 days, pay nothing. Mail coupon to: MOTOR Book Dept., Desk 1M, 250 W. 55th St., New York 19, N. Y.

**MAIL COUPON NOW FOR 7-DAY FREE TRIAL
(Attach to Postcard if More Convenient)**

MOTOR BOOK DEPT.
Desk 1M, 250 W. 55th St., New York 19, N. Y.

Rush to me at once (check box opposite book you want):
 MOTOR'S New AUTO REPAIR MANUAL. If O.K., I will remit \$2 in 7 days, \$2 monthly for 2 months and a final payment of \$1.95 (plus 35c delivery charge) one month after that. Otherwise I will return the book postpaid in 7 days. (Foreign price, remit \$10. in cash with order.)

MOTOR'S New TRUCK REPAIR MANUAL. If O.K., I will remit \$3 in 7 days, and \$2 monthly for 3 months, plus 35c delivery charges with final payment. Otherwise I will return book postpaid in 7 days (Foreign price, remit \$21 cash with order.)

Print Name..... Age.....

Address.....

City..... Zone..... State.....

Check box and save 35c delivery charge by enclosing WITH coupon in envelope entire payment of \$7.95 for Auto Manual (or \$9 for Truck Manual.) Same return-refund privilege.



**college graduates
get ahead faster!**

You see it in your own city. They have higher incomes . . . advance more rapidly. Grasp your chance for a better life. Industrial growth . . . automation . . . technical advances create career opportunities for engineers, accountants, management experts. Share rewards awaiting college men. Important firms visit campus regularly to employ Tri-State College graduates. Start any quarter in this world-famed college. Approved for veterans.

Bachelor of Science degree in 27 months

In Mechanical, Civil, Electrical (Electronics or Power Major), Chemical, Aeronautical Engineering. In 36 months a B.S. in Business Administration (General Business, Accounting, Motor Transport Management majors). Superior students may accelerate. 36-weeks course in Drafting. Intensive program: technical fundamentals stressed; comprehensive courses with more professional class hours. Small classes: personalized instruction. Enrollment limited. Preparatory courses. Beautiful campus. Well-equipped, new and modernized buildings and laboratories. Enter Jan., Mar., June, Sept. Earnest, capable students (whose time and budget require accelerated courses and modest costs) are invited to write Jean McCarthy, Director of Admissions, for catalog and book "Your Career in Engineering and Commerce."



TRI-STATE COLLEGE

4128 College Avenue . . . Angola, Indiana

**REAL ESTATE
BE A BROKER**

PAYS BIG! SEND FOR FREE, BIG, ILLUSTRATED CATALOG NOW! Graduates report making substantial incomes. Start and run your own business quickly. Men, women of all ages, learn easily. Course covers Sales, Property Management, Appraising, Loans, Mortgages, and related subjects. STUDY AT HOME or in classrooms in leading cities. Diploma awarded. Write TODAY for free book! No obligation.

**FREE
BOOK
TELLS
NOW**

Approved for World War II and Korean Veterans
WEAVER SCHOOL OF REAL ESTATE (Est. 1936)
2020R Grand Avenue Kansas City, Mo.

BRONZE FOUNDRY



Schools • Home Workshops • Inventors

Make your own castings of aluminum, copper, bronze, silver. Foundry sets are available in three sizes including 2400 Deg. F. blast furnaces. \$26.50; \$33.50; and \$46.00 f.o.b. Marysville or Lakewood. Free Circular.

KANSAS CITY SPECIALTIES CO. DEPT. P-12, P.O. BOX 6022, MARYSVILLE, KANSAS



Print Your Own

Cards, Stationery, Advertising, Circulars, labels, photo and movie titles, church work, tags, etc. Save money. Sold direct from factory only. Raised printing like engraving, too.

Own a Printing Business

Print for Others, Good Profit. Have home shop. Junior press \$15; Senior \$29 up. We supply everything. Easy rules. Pays for self in short time. Write for free catalog of outfits and all details.
KELSEY PRESSES, C-37 Meriden, Conn.

MEN PAST 40

**Afflicted With Bladder Trouble,
Pains in Back, Hips, Legs,
Nervousness, Tiredness.**

If you have these troubles, particularly bladder trouble, then your condition may be traced to Glandular Inflammation . . . a constitutional disease. Neglect of this condition often leads to premature old age and sometimes incurable malignancy.

The Excelsior Medical Clinic has a New Free Book that tells how thousands of men have been successfully treated here at Excelsior Springs for Glandular Inflammation by NON-SURGICAL Methods. They found soothing relief and a new outlook in the future of life.

This Free Book may prove of utmost importance in your life. Write Today. There is no obligation.

Excelsior Medical Clinic, Dept. B6129, Excelsior Spgs., Mo.

**NOW...GET
EVERYTHING
YOU NEED TO
PREPARE TO EARN
REAL MONEY IN**

ELECTRONICS

RADIO • TELEVISION • RADAR, etc.

**One of
Today's
BRIGHTEST
Opportunity Fields!**



Today's great Electronics field offers you a chance of a lifetime to prepare for highly interesting work and a wonderfully promising future! With so many new developments coming up in Electronics, opportunities for trained men were never brighter. Send coupon for details.

Right in your own home you may now get one of today's most interesting . . . **PRACTICAL WAYS** to prepare for a good job or your own business in Electronics. No previous technical experience or advanced education are needed! DeVry Tech brings you a unique **3-WAY COMBINATION** of texts, home movies and real equipment—the same type of basic equipment as found in our well-equipped Chicago and Toronto Laboratories.

EMPLOYMENT SERVICE

. . . helps you get started toward a good job, or toward advancement in the company you now work for. **FREE** to all graduates.

EARN WHILE YOU LEARN

DeVry Tech's practical program helps you to earn **EXTRA MONEY** in your spare time, servicing Radio and TV sets.

Your Guide

to PROFITABLE JOB OPPORTUNITIES

See how **YOU** may get ready for such opportunities as:

- TV-Radio Broadcast Technician
- Color Television Specialist
- Radar Operator • Laboratory Technician
- Airline Radio Man • Computer Specialist
- Quality Control Manager
- Your Own Sales & Service Shop

. . . **PLUS MANY OTHERS**

"One of North America's
Foremost Electronics
Training Centers"

Accredited Member of
National Home
Study Council



DeVRY TECH INSTITUTE

Formerly DeForest's Training, Inc.
CHICAGO 41, ILLINOIS

300 EXPERIMENTS

Build over 300 practical projects from many shipments of Radio-Electronic parts. You build and operate TV-Radio circuits . . . wireless microphone . . . and many other major projects—all designed to provide outstanding practical experience at home.



HOME MOVIES

Thanks to this exclusive home training aid, many important fundamentals quickly become "movie clear." Now you can actually see electrons on the march and other "hidden actions"—a wonderful advantage that is almost like having a teacher at your side.



BUILD YOUR OWN TEST EQUIPMENT

As part of your home laboratory projects, you **BUILD** and **KEEP** a fine quality 5-inch **COLOR OSCILLOSCOPE** and a **Jewel Bearing VACUUM TUBE VOLT-METER**. You will find this equipment ideal for helping you earn in your spare time while a student—and later when working full time in the field.



BUILD AND KEEP A BIG 21-INCH TV SET

For added practical experience, you can also build and keep this quality 21-inch **TV SET** that provides TV reception at its finest (DeVry Tech also offers another home training without the TV set).



SEND FOR FACTS TODAY!

DeVRY TECHNICAL INSTITUTE
4141 Belmont Avenue, Chicago 41, Ill., Dept. PM-12-0

Please give me your **FREE** booklet, "Electronics and YOU," and tell me how I may prepare to enter one or more branches of Electronics.

Name _____ Age _____

PLEASE PRINT

Street _____ Apt. _____

City _____ Zone _____ State _____

Canadian residents address DeVry Tech of Canada, Ltd.
626 Roselawn Ave., Toronto 12, Ont.

2046

Inventors

The following are the usual preliminary steps to take toward patent protection.

You are advised first, to make a disclosure of your invention. Date, sign and have this document witnessed by two or more persons who are capable of understanding your invention. The "Evidence of Invention" form mentioned below, we offer as a convenience in making your disclosure and in starting action leading toward patent protection.

Mail your disclosure to the registered patent attorney or agent whom you select to assist you, together with a letter authorizing him to conduct a

preliminary search among previously granted U. S. patents for similar types of invention. He then prepares for you a report on the probable patentability of your invention and, if the report is favorable, recommends the further course you should take.

This firm is registered to practice before the U. S. Patent Office and is available to assist you in the preparation and prosecution of patent applications. We shall be glad to send you without obligation, the "Evidence of Invention" disclosure form mentioned above and our instructive booklet, "Patent Protection for Inventors".

VICTOR J.
EVANS & Co. *Merlin M. Evans*
REGISTERED PATENT ATTORNEY
430 - P MERLIN BUILDING, WASHINGTON 6, D. C.

Make \$5⁰⁰ an Hour CASH PROFIT THE DAY YOU START!



START YOUR OWN BUSINESS AT HOME... SHARPEN HOUSEHOLD, GARDEN AND SHOP TOOLS IN SPARE TIME

Now you can turn spare time into Big Cash Profits with new Belsaw Sharp-All. Sharpen knives, scissors, shears, snips, ice skates, mower blades, hedge trimmers, grass whips, axes, chisels, screw drivers, scrapers and saws... just about any household, garden and shop tool. Your own CASH business with no inventory. No calls to make. No experience needed.

Learn how easily you can start your own spare time business. Amazing low cost easy-payment plan. Send postcard for FREE BOOK.

BELSAW SHARP-ALL CO
719 Field Bldg. • Kansas City 11, Missouri



High School Course at Home Many Finish in 2 Years

Go as rapidly as your time and abilities permit. Course equivalent to resident school work — prepares for college entrance exams. Standard H. S. texts supplied. Diploma. Credit for H. S. subjects already completed. Study subjects if desired. High school education is very important for advancement in business and industry and socially. Don't be handicapped all your life. Be a High School graduate. Start your training now. Free Bulletin on request. No obligation.
American School, Dept. H945, Drexel at 58th, Chicago 37

STUDY TO BE A DOCTOR of Psychology or Metaphysics

Obtain a Ph.D., M.A., or Ph.D. Be a Teacher, Lecturer or Accredited Practitioner. Teach others how to achieve Health, Happiness and Contentment. Chartered by State. Correspondence Courses only. Write for FREE book telling how.

THE NEOTARIAN FELLOWSHIP
Desk B, Pickwick Building Kansas City 6, Missouri



WAR SURPLUS BARGAINS

\$500,000.00 INVENTORY
for QUICK LIQUIDATION

Surplus items — hundreds of them for home, shop, factory, farm and outdoor use. New items, used items, reconditioned items—all at tremendous savings—all priced for quick sale.

Page After Page of Values

This big catalog shows page after page of amazing money saving values. Write for your copy today. Send 10c to cover postage, mailing, etc. Write today! SEND TODAY FOR YOUR COPY

10c

STARK'S 212 W. Madison St.
Dept. PM-5812
CHICAGO 6, ILL.

NOW!
at a price
you can afford!

MAKE MORE MONEY in TELEVISION RADIO-ELECTRONICS

**BETTER...MORE COMPLETE...LOWER COST...
WITH NATIONAL SCHOOLS SHOP-METHOD
HOME TRAINING!**

BETTER... Training that is proved and tested in Resident School shops and laboratories, by a School that is the **OLDEST** and **LARGEST** of its kind in the world.

MORE COMPLETE... You learn **ALL PHASES** of *Television-Radio-Electronics*.

LOWER COST... Other schools make several courses out of the material in our **ONE MASTER COURSE**... and you pay **more** for less training than you get in our course at **ONE LOW TUITION!**

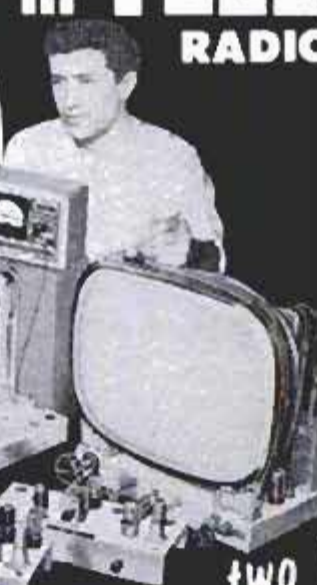

These **FREE** books will show you how!

You get all information by mail... You make your own decision... at home! **NO SALESMAN WILL CALL**

TOP PAY... UNLIMITED OPPORTUNITIES LIFETIME SECURITY CAN BE YOURS!

You are needed in the Television, Radio, and Electronics industry! Trained technicians are in growing demand at excellent pay—in **ALL PHASES**, including Servicing, Manufacturing, Broadcasting and Communications, Automation, Radar, Government Missile Projects.

NATIONAL SCHOOLS SHOP-METHOD HOME TRAINING, with newly added lessons and equipment, trains you in your spare time at home, for these unlimited opportunities, including many technical jobs leading to supervisory positions.

YOU LEARN BY BUILDING EQUIPMENT WITH KITS AND PARTS WE SEND YOU. Your National Schools course includes thorough *Practical* training—**YOU LEARN BY DOING!** We send you complete standard equipment of professional quality for building various experimental and test units. You advance step by step, perform more than 100 experiments, and you build a complete TV set from the ground up, that is yours to keep! A big, new TV picture tube is included at no extra charge.

EARN AS YOU LEARN. We'll show you how to earn extra money right from the start. Many of our students pay for their course—and more—while studying. So can you!

RESIDENT TRAINING AT LOS ANGELES

If you wish to take your training in our Resident School at Los Angeles, the world's TV capital, start **NOW** in our big, modern Shops, Labs and Radio-TV Studios. Here you work with latest Electronic equipment - professionally installed - finest, most complete facilities offered by any school. Expert, friendly instructors. Personal attention. Graduate Employment Service. Help in finding home near school - and part time job while you learn. Check box in coupon for full information.

LESSONS AND INSTRUCTION MATERIAL ARE UP-TO-DATE, PRACTICAL, INTERESTING. Every National Schools Shop-Method lesson is made easy to understand by numerous illustrations and diagrams. All instruction material has been developed and tested in our own Resident School Shops, Laboratories and Studios.

SEND FOR INFORMATION TODAY... it can mean the difference between **SUCCESS** and failure for you! Send for your **FREE BOOK** "Your Future in Television-Radio-Electronics" and **FREE Sample Lesson.** Do it **TODAY**, while you are thinking about your future. It doesn't cost you anything to investigate!

GET THE BENEFITS OF OUR OVER 50 YEARS EXPERIENCE

Approved for
GI Training



NATIONAL SCHOOLS
Los Angeles 37, Calif.

YOU GET...

- 19 Big Kits—**YOURS TO KEEP!**
- Friendly Instruction and Guidance
- Job Placement Service
- Unlimited Consultation
- Diploma—Recognized by Industry
- **EVERYTHING YOU NEED FOR SUCCESS!**

SHOP-METHOD HOME TRAINING COVERS ALL PHASES OF INDUSTRY

1. Television, including Color TV
2. Radio AM & FM
3. Electronics for Guided Missiles
4. Sound Recording and Hi-Fidelity
5. FCC License
6. Automation and Computers
7. Radar & Micro-Waves
8. Broadcasting and Communications

NATIONAL TECHNICAL SCHOOLS

WORLD-WIDE TRAINING SINCE 1905

MAIL NOW TO
NATIONAL SCHOOLS, Dept. RB-128
4000 S. FIGUEROA ST., LOS ANGELES 37, CALIF.
Rush free TV-Radio "Opportunity" Book and sample lesson. No salesman will call.

NAME _____ AGE _____
ADDRESS _____
CITY _____ ZONE _____ STATE _____
 Check if interested **ONLY** in Resident School training at Los Angeles.
VETERANS Give date of Discharge _____

DRAFTSMEN



CASH BIG PAY CHECKS!

Train Now for more success, greater security

LEARN AT HOME IN SPARE TIME (or at college in Chicago)

Check the want ads in any newspaper—SEE the big-pay opportunities open to you as a draftsman. What's more, you can learn this well-paid, prestige profession at home—quickly, easily! No special talent needed. Get complete, step-by-step Chicago Tech lessons in the mail, spend a few pleasant hours studying each week. In a short time you'll be a well-trained draftsman, ready to take your pick of many good jobs. Act now!



Free Information—Mail Coupon Today!

Get FREE TRIAL LESSON plus information about C.T.C. practical training. Learn what successful Chicago Tech graduates say about high pay and opportunities in drafting. No charge, or obligation.

CHICAGO TECHNICAL COLLEGE

5-216 Tech Bldg., 2000 So. Michigan Ave. Chicago 16, Illinois

Mail me FREE lesson with facts about big opportunities in DRAFTING.

Name _____ Age _____

Address _____

City _____ Zone _____ State _____

EARN \$100 A WEEK AND UP

BE AN AUTO-DIESEL MECHANIC—EARN WHILE YOU LEARN

Many of our graduates earn \$100 a week and up. You learn fast in our school and shops because you learn with tools on real equipment. Experienced instructors explain WHY and show you HOW, then you DO IT YOURSELF. One of the best equipped technical schools in the United States. Thirty-nine years' experience training men. Successful graduates in 48 states and many foreign countries. Approved for veterans. Day and evening classes. Free bulletin—write today. **NASHVILLE AUTO-DIESEL COLLEGE** 226 7th Ave. N., Dept. 86, Nashville, Tenn.

FLOATING FLASHLIGHT LUMINOUS GLOWS IN THE DARK

For camping, sailing, fishing, hunting and boating... you can't beat BRIGHT STAR!



- Completely waterproof • Red lens ring • Stronger than any metal flashlight • 3-way chrome-on-brass switch • Spare bulb holder • Bulb shock absorber • Metal belt loop • Equipped with Bright Star batteries—the strongest, longest-lasting made.

IMMEDIATE DELIVERY! GIFT PACKAGED! Only \$3.95 postpaid with check or money order—COD orders plus postage. Money back within 10 days if not fully satisfied.

Dept. PM • Russell Electric Company, 420 Lexington Ave., New York 17, N. Y.

LEARN MEAT CUTTING



Train quickly in 8 short weeks at Toledo for a bright future with security in the vital meat business. Big pay, full-time jobs—HAVE A PROFITABLE MARKET OF YOUR OWN! Pay after graduation. Diploma given. Job help. Thousands of successful graduates. Our 36th year! Send NOW for FREE catalog. No obligation. GI approved. NATIONAL SCHOOL OF MEAT CUTTING, Dept. 50-L, Toledo 4, Ohio



119 JIG SAW PATTERNS

FULL-SIZE... trace on wood and saw out. Clever, ORIGINAL designs, things you can make to SELL. Wall shelves, lawn signs, planters, book ends, others. postpaid

BURGESS VIBROCRRAFTERS, INC.

Rush \$1 today. DEPT. C-83, Grayslake, Illinois

HANDWRITING ANALYZE

You can analyze handwriting—at home, in your spare time. No interference with job or social life. Win more pay, social recognition, prestige! Men and women both needed now. Complete lesson and answer service. Personalized instruction. Handsome, suitable-for-framing Diploma to graduates!

I.G.A.S. is the oldest and only grapho analysis school in the world! Lesson (2) Free Entrance Examination (3) Full Color 48-page Success Book. Absolutely No Obligation—Adults only.

INTERNATIONAL GRAPHO ANALYSIS SOCIETY, INC. DEPT. 36 SPRINGFIELD, MISSOURI

LAW FREE BOOK THE LAW TRAINED MAN

Write today for a FREE copy of illustrated law book, "THE LAW-TRAINED MAN," which shows how to earn the professional Bachelor of Laws (LL.B.) degree through home study of the famous Blackstone Law Course. All necessary books and lessons provided. Moderate cost; convenient monthly terms. Write for FREE law training book today.

Blackstone School of Law, 307 N. Michigan Ave.

Founded 1890

Dept. 59, Chicago 1, Illinois

Helps You Overcome FALSE TEETH Looseness and Worry

No longer be annoyed or feel ill-at-ease because of loose, wobbly false teeth. FASTEETH, an improved alkaline (non-acid) powder, sprinkled on your plates holds them firmer so they feel more comfortable. Avoid embarrassment caused by loose plates. Get FASTEETH at drug counters everywhere.



"I Earn \$25⁰⁰ per Hour"*

Spray with Suede!

\$1 Worth of Materials Brings You \$18—You pocket the profits!

WHAT IS FLOK-KRAFT?

If you've ever touched real suede or velvet — you know how Flok-Kraft feels and looks. Now, at last this beautiful new 3-dimensional finish, developed after years of experience, can be sprayed on anything — transforming ordinary things into expensive masterpieces of beauty. You must see it to believe it, so mail coupon below and receive free samples.



FREE SAMPLES — MAIL COUPON NOW!

*Here is Mr. J. F. K. with a few of the items he has sprayed with Flok-Kraft. He is now earning \$25.00 per hour (\$400 for 16 hours work) just showing companies how to spray new Flok-Kraft.

your business grows, work full time — hire others to work for you. At first, do it all in your own home — a corner of your basement, garage, dining room, service porch or kitchen is all the space you need.

LEARN IN A FEW DAYS

Almost immediately you can learn Flok-Krafting and start earning money. It's fun, fascinating — we guide you with simple step-by-step instructions. No overhead, no expensive equipment, no experience necessary either.

JOIN THESE MEN AND WOMEN

who have already started. "Earning \$10,000 year from spare time start" Mr. Mover, Ore.; "Got \$52.50 doing auto trunks in four hours — earned \$13 per hour" J. O., Mo.; "Swamped with orders already" W. F., Colo.; "Got \$100 job first day" C. H. E., Md.; "Quick \$140 order from store — 5 other orders in 4 hours" H. G. R., Wisc.



Make old (even broken) radio and TV cabinets look better than new. Spray average size cabinet in 15 minutes with 34¢ worth materials and charge at least \$10.00.

COVERS AND BEAUTIFIES FABRICS, METALS, GLASS, PLASTER, WOOD, PLASTIC — any surface! Huge profits are waiting to be tapped in this tremendous new field. Over 5,000 big profit uses. Spray lamps, figurines, greeting cards, signs, automobile accessories, shoes, hats, card tables, toys, furniture, draperies, ceilings, walls — anything! Flok-Kraft makes old, damaged and worn objects beautiful and saleable — makes new things worth more. You can even spray cheap butcher paper and make it look like velvet-suede, and sell it for gift-wrapping paper.



400% profit possible just spraying figurines, toys — hundreds of other items with beautiful Flok-Kraft. Work at home — spare time!



\$1000.00's are earned by individuals each year spraying Christmas trees with colorful Flok-Kraft. Flok-Krafted greeting cards are big business. Buy regular cards and spray them at home — sell for twice your price.

WE FURNISH EVERYTHING YOU NEED

We offer to furnish you complete easy-to-understand instructions in addition to materials that enable you to start at once. All sent at our risk because we want to start new Flok-Krafters in every area.

HELP FILL HUGE GROWING DEMAND

Imagine, there is a possible 20 Million Dollars worth of Flok-Krafting to be done. Get your share! Be first in your area to fill urgent orders that come from stores, offices, homes, neighbors, gift shops, architects, auto dealers, etc. Learn how to get orders by mail order.



ALL 3 FREE!

Just mail coupon below and receive ACTUAL USE-ABLE SAMPLES, BOOKLET of 50 HOME-BUSINESS OPPORTUNITIES and CONFIDENTIAL DETAILS — all sent free!

Copyright 1958



Recondition worn automobile interiors (doors, trunks, dashboards, seats, etc.) with Flok-Kraft. Just spray it on — works like magic!

RAINBOW OF COLORS

Amazing Flok-Kraft rayon and cotton fibers are now available in over 24 brilliant colors — even the amazing fluorescent "glow" colors that attract attention.

START AT HOME — SPARE TIME

Here's a rare opportunity to own your own business. Start small spare time — add to your present income. Then, as

FREE SAMPLES — RUSH COUPON TODAY!

COAST INDUSTRIES (Home Business Division) Dept. B-12
15127 S. Broadway, Los Angeles 61, California

I am interested. I enclose no money. Rush Free Samples, Home-Business booklet and confidential details. I understand these are all sent absolutely free and no salesman will call.

Name _____ Age _____

Address _____

City _____ Zone _____ State _____

Our references: your local bank & trust Co. We are members of the Los Angeles Chamber of Commerce.

**"TOOK IN \$217
FIRST 10 DAYS"**

Some make more, some less...

We help you to start Your Own All-Year Business

Make Big Money! With our easily operated, highly efficient Wall Washer, Charles Stelle took in \$217 in first ten days. E. L. Goss took in more than \$10,000 in one year. G. H. Jones wrote, "I made a net profit of \$1200 on one job." And no wonder—this machine washes walls 6 times faster and better than by hand and with no mess—no drop cloths needed.



Your Money Making Opportunity • We want more men to go into this profitable business for themselves and enjoy independence—freedom from layoffs and bosses. Customers everywhere—homes, offices, schools, churches, hotels, etc. How much you earn depends largely on you. What you take in is mostly profit. No need to rent shop or office; operate from home. Can start spare time until your full time is justified.

LOSE NO TIME—SEND COUPON TODAY FOR ALL THE FACTS

FREE BOOK! MAIL COUPON TODAY!

VON SCHRADER MFG. CO.
W10 "W" Pl., Racine, Wisconsin

Send at once (no obligation) your FREE booklet containing information about your WALL WASHING MACHINE and how I can start my own permanent, profitable business.

Name _____
Address _____
City _____ Zone _____ State _____

**New Table Top Invention Puts You In...
PROFITABLE RUBBER
STAMP BUSINESS**

Home Operators now make \$9.40 AN HOUR in business once monopolized by a few big companies

Special rubber stamps bring high prices—cost only pennies to make on new, low-cost table top machine. Take 27 cents worth of material, make perfect stamps, the kind businesses and offices now buy by the dozen at \$1.80 each. Make up to \$9.40 an hour. Start in spare time in your own home. Run machine on kitchen table using ordinary electrical outlet. Make any kind of stamp. We'll send you free information without obligation about this established, highly profitable business, now open to individuals for the first time. For free information send name today on a post card to Rubber Stamp Div., 1512 Jarvis Ave., Dept. R-2-P, Chicago 26, Ill.



HIGH WAGES!

High Wages can be yours as an Operating Engineer of heavy construction equipment! Learn NOW to operate our diesel engined bulldozers, draglines, cranes, back hoes, scrapers and motorgraders! Machines of major manufacturers are used in our training program. Contractors need trained operators and pay high wages to our graduates. We invite comparison and inspection of the nation's original construction equipment operator's training schools.

Veterans: Ask about GI benefits!
Write today for free school catalogue
No obligation, to either address

**THE NATIONAL SCHOOLS
of HEAVY EQUIPMENT OPERATION**

Dept. DM-3
P.O. Box 8243, Charlotte, N. C. • P.O. Box 527, Weiser, Idaho

Learn ACCOUNTING
Business Administration

Bookkeeping, secretarial and allied subjects at home in your spare time or attend nationally approved resident school. Write for FREE Success Book giving complete details on courses, plans, rates and employment opportunities. G.I. approved. Write Dept. A.

**Hills BUSINESS UNIVERSITY AND
EXTENSION SCHOOL**
619 W. MAIN ST. OKLAHOMA CITY 2, OKLAHOMA

BLACK LIGHT brings you

AN AMAZING NEW HOUSE NUMBER!
Mysterious BLACK LIGHT RADIATION! Easily read at 100 ft! Beautiful, quality unit, moderate price! Install yourself!

WRITE FOR FREE ILLUSTRATED LITERATURE
MODERN CONTROLS CORP.
P. O. Box 128 • Centerline, Mich.

make your own Gems 36⁵⁰

The Gem Maker comes complete with all necessary equipment, including a super-charged diamond blade for sawing, and all the wheels for grinding, shaping and polishing; also complete instructions. The complete equipment as shown, less motor and belt for only \$36.50, f.o.b., Burlington, Wisconsin. Write today for information and literature.

B&I MANUFACTURING CO.
Dept. P. Burlington, Wis.



RUPTURED

BE FREE FROM TRUSS SLAVERY

Surely you want to THROW AWAY TRUSSES FOREVER, be rid of Rupture Worries. Then Why Do you put up with wearing a griping, chafing and unsanitary truss the balance of your life? If you do, it will NOT be through necessity but through choice on your part.

Now there is a new modern Non-Surgical treatment that is designed to permanently correct rupture. These Non-Surgical treatments are so certain, that a Lifetime Certificate of Assurance is given. Write today for our New FREE Book that gives facts that may save you painful, expensive surgery. Tells how non-surgically you may again work, live, play, love and enjoy life in the manner you desire. There is no obligation. Excelsior Medical Clinic, Dept. H6124, Excelsior Springs, Mo.

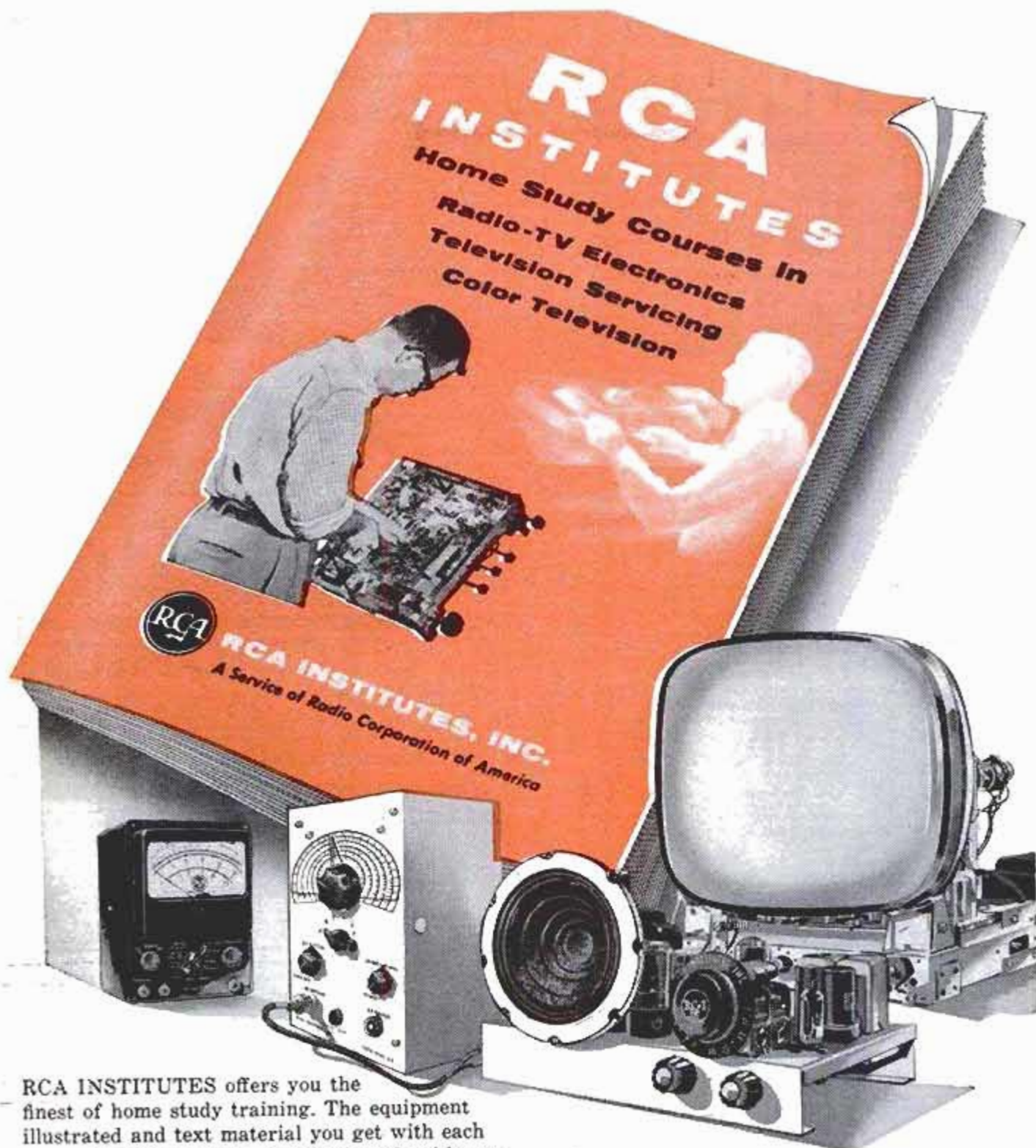

RCA INSTITUTES offers you the finest of home study training. The equipment illustrated and text material you get with each course is yours to keep. Practical work with very first lesson. Courses for the beginner and the advanced student. Pay-as-you-learn. You need pay for only one study group at a time.

**Send for this
FREE Book Now** 

[RESIDENT SCHOOL courses in New York City offer comprehensive training in Television and Electronics. Day and evening classes start four times each year. Detailed information on request.]

RCA INSTITUTES, Inc. Home Study Dept. PM-128

A Service of Radio Corporation of America

350 West Fourth Street, New York 14, N. Y.

Without obligation, send me FREE 52 page CATALOG on Home Study Courses in Radio, Television and Color TV. No salesman will call.

Name..... please print

Address.....

City..... Zone..... State.....

Korean Vets! Enter discharge date.....

CANADIANS — Take advantage of these same RCA courses at no additional cost. No postage, no customs, no delay. Send coupon to: RCA Victor Company, Ltd., 5001 Cote de Liesse Rd., Montreal 9, Quebec

To save time, paste coupon on postcard.

ACCORDION PRICES SMASHED

SAVE 1/2
AND EVEN MORE ON
NEW '59 MODELS

**5 DAYS
FREE
TRIAL!**



**FREE BONUS
GIFTS**
for promptness
• E-Z Lessons
• Music Stand
• DeLuxe Case
• other gifts, too!

**MONEY BACK
GUARANTEE**

**FREE
COLOR
CATALOGS**
and wholesale
prices

Hurry! Get in on these sensational values in world's finest Italian-made accordions! Play the most popular instrument of all... for fun, leadership and profit! Over 40 newest models of glorious tone and breathtaking beauty offered at amazing low prices—save 50% and more! Buy direct from world's leading dealer. Small down payment; easiest terms on balance. Extra bonus gifts FREE if you buy during sale. Trade-ins accepted. Try before you buy on FREE 5-Day NO-RISK PLAN. Satisfaction guaranteed or money back. Lifetime guarantee!

RUSH COUPON TODAY! See how easily you can own and play a fine accordion. Rush coupon for big new COLOR Catalogs and lowest wholesale prices, ALL FREE! No obligation. Write now!

Accordion Manufacturers and Wholesalers Outlet, Dept. R-128
2003 W. Chicago Av. Chicago 22, Ill.

Accordion Manufacturers and Wholesalers Outlet
2003 W. Chicago Av., Dept. R-128, Chicago 22, Ill.
Send FREE Color Catalogs and wholesale prices.

NAME _____
ADDRESS _____
CITY _____ Zone _____ STATE _____

\$2.95 OR 2 FOR \$5.00!

TESTED AND GUARANTEED
Write for free list on all types of telephones.
Shipments F.O.B. Simpson, Pa.
TELEPHONE ENGINEERING CO., Dept. 1288, Simpson, Pa.

Tells How You Can Learn to MOUNT BIRDS!



FREE BOOK

Learn At Home

Men, Boys, Hunters, Fishermen, mount and save your lovely wild-game trophies. Be a Taxidermist. Mount Birds, Animals, Heads, Fish, Ten skins. YOU learn easily, quickly in spare time. Have a grand home-museum. The finest and the greatest hobby known, for sportsmen. Fun, real profits.

FREE BOOK

Yes, FREE, Beautiful strange, valuable Book, telling all about Taxidermy. Contains over 100 beautiful game-pictures. And it's yours FREE, if you rush your request. You can mount all kinds of wild-game, and common specimens too. We can positively TEACH YOU, So GRASP this opportunity. RUSH letter or postal for this amazing FREE BOOK. Don't delay. State your AGE, N. W. SCHOOL OF TAXIDERM, 2512 Elwood Bldg., Omaha 2, Neb.

**MAKE MORE \$ IN
SPARE TIME HOURS!**

Use "IDEAL"
Lawnmower Sharpener

New attachment makes Model 300 "Ideal" a perfect reel and rotary blade grinder—also sharpens shears, other tools! Ideal's exclusive "hook" grinding method insures quick, easy results every time. Compare all facts and you'll buy "Ideal"—leading mower sharpener for 55 years. Make more money—write for free catalog.



Sharpens All Mowers

• REEL TYPE • HAND
• ROTARY • POWER

The FATE-ROOT-HEATH Co., Dept. PM-12, Plymouth, Ohio



FREE CATALOG

**ADD UP TO 25 POUNDS
of SOLID MUSCLES** if you pay NOTHING

\$10 BODY MOLD course included FREE with DAN LURIE BARBELLS. Only DAN LURIE BARBELLS and "Body Mold" courses produce such amazing results. 15 minutes a day can make you a bigger man. Send today for details. Order now at lowest factory price.

50 lb. set \$8.98 • 100 lb. set \$14.98

150 lb. set \$21.98 • 200 lb. set \$27.98

Semisteel sets approx. 10% higher. Extra wts. 14c per lb. Send 50¢ cash, balance C.O.D. F.O.B. Plant.

DAN LURIE BARBELL CO., 52M-12 Bristol St., Dept. 850M, Bklyn. 12, N.Y.

GET INTO ELECTRONICS

V.T.I. training leads to success as technicians, field engineers, specialists in communications, guided missiles, computers, radar, automation. Basic & advanced courses in theory & laboratory. Assoc. degree in 28 mos., B.S. obtainable. ECPD accredited, G.I. approved. Graduates with major companies. Start Feb., Sept. Dorms, campus, H. S. graduate or equivalent. Catalog.

VALPARAISO TECHNICAL INSTITUTE
DEPT. D VALPARAISO, INDIANA

DeLuxe METAL Pocket Rubber Stamp

\$2

Custom Made, Chrome Plated, Indestructible. "Finger-Tip" Control. Self-locking case. 3-line text 1 1/2" x 2" area. Inked pad. Our regular, popular Nickel Plated Stamp, without DeLuxe Features, still only \$1



Send Check or Money Order. Mailed POSTPAID
SAMUEL H. MOSS, Inc., 36 E. 23rd St., N.Y.C. 10 Dept. MEC-12



SEND FOR THIS FREE!

Make money. Know how to break and train horses or ponies. Write today for this book FREE, together with special offer of a course in Animal Breeding. If you are interested in Gaiting and Riding the saddle horse, check here (). Do it today—now.

BEERY SCHOOL OF HORSEMANSHIP
Dept. 11012 Pleasant Hill, Ohio

GIANT 6 FOOTERS

59c



Wow! Genuine Neoprene government surplus (never used)... giant 6 ft. across, 21 ft. around... at a fraction of original cost. Durable. Can paint on advertising message, inflate and fly. Visible for miles. Great for attracting crowds to fairs, openings, school pranks, gas stations. Fun for young and old in backyards or picnics, at the beach, etc. use as water markers & buoys. Order today — 59c, 2 for \$1.

Special 13' — \$1.95 ea.
15' — \$2.95 ea.

Calif. Res. Add Sales Tax. We pay postage on prepaid orders.

FRANK SALES 3930 SUNSET BLVD., DEPT. PM1288
LOS ANGELES 29, CALIF.

POPULAR MECHANICS

WHAT ALL AUTO MECHANICS WANT TO KNOW

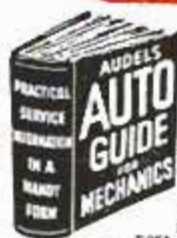

This Big Practical Book gives full information, with working diagrams, covering the principles, construction, ignition, service and repair of modern cars, trucks and buses.

Diesel Engines, Hydraulic and Fluid Drives Fully Explained.

A complete guide of 1696 Pages, with over 1500 Illustrations showing inside views of working parts, with instructions for service jobs. Completely up-to-the-minute! Priced at only \$6.

CIRCLE No. 1 IN COUPON

HOW TO FIX HOME APPLIANCES

REFRIGERATORS WASHERS TOASTERS DRYERS IRONERS RANGES VACUUM FREEZERS

Many other GAS AND ELECTRIC APPLIANCES

Handy Reference for Electric & Gas Servicemen, Mechanics, Dealers and Home-owners. Explains clearly and simply how to locate troubles, how to test, reassemble and connect. Wiring diagrams, 1000 Facts. Easy to read. Answers ALL your questions. 864 Pages. Illustrated. Only \$6.

CIRCLE No. 2 IN COUPON



TV TELLS HOW TO ANSWER RADIO RADIO TV QUESTIONS SERVICE LIBRARY

HERE IS LATE INFORMATION IN A MANDY FORM FOR RADIO AND TELEVISION REPAIRMEN, SERVICEMEN AND STUDENTS

TWO COMPLETE VOLUMES - 1568 Pages - 1095 Illustrations and Diagrams, 1001 Questions and Answers on Modern T.V. Radio, Electronic Devices, INCLUDES TRANSISTORS & Transistor Circuits, Rectifiers, Record Changers, P.A. Systems, Phonograph Pick-ups, F.M., Auto Radio, Short Wave.

Basic principles, Construction, Installation, Operation, Troubleshooting, How to get Sharp, Clear T.V. Pictures, Install Aerials, How to Test, Explains COLOR SYSTEMS, Methods of Conversion, Terms, etc. Includes Ultra High Frequency. Quick ready reference or use as a home study course. Only \$8 for BOTH volumes.

CIRCLE No. 3 IN COUPON

KNOW YOUR TRUCK

THE TRUCK & TRACTOR GUIDE for Mechanics & Drivers, Foremen, Helpers, Owners, Trouble Shooters, Farmers, etc. Covering Gas & Diesel Motor Principles - Construction - Operation - Maintenance - Repair - Brakes - Service of all Parts. 1376 Pages. FULLY ILLUSTRATED. Index. Only \$5.

CIRCLE No. 5 IN COUPON

PLUMBERS AND STEAMFITTERS GUIDES

Practical Trade Assistant & Reference Set. Explains in plain language and by clear illustrations, diagrams, charts, graphs and pictures the principles of modern plumbing practice including Pipe Fitting and Air Conditioning. 4 Vols. - 2624 Pages - 3642 Diagrams & Illustrations. Only \$8 for the complete set of 4 vols.

CIRCLE No. 6 IN COUPON

PAINTING & DECORATING MANUAL

Inside Trade information on outside and inside work, how to mix paints, preparation of surfaces, paper hanging, wood finishes, tools, synthetic paints, color (with color chart), spray equipment, costs, estimating, etc. A COMPLETE guide to interior painting and decorating. 464 Pages. Fully Illustrated. Only \$2.

CIRCLE No. 7 IN COUPON

7-DAY FREE EXAMINATION

SEND NO MONEY - Pay the postman nothing! We are glad to send you any of the Audel Guides for absolutely FREE examination in your own home. We take all the risks and leave all the decisions up to YOU. There is no obligation! If you decide to keep the books of your choice you may pay for them under our astounding easy-pay plan of only \$2 a month.

HERE IS ALL YOU DO

IT'S EASY TO ORDER: In the No-Risk Mail Order Coupon at the right just draw a circle around the number of Audel Guides you want us to send you for FREE EXAMINATION. We will send them to you at once to help you build a brighter future by increasing your SKILL. If for any reason at all you are not COMPLETELY satisfied, return the books to us, and this will end the matter! NO STRINGS OR CATCHES TO THIS OFFER.

THEO. AUDEL & CO.
49 West 23rd Street, New York 10, N.Y.

CARPENTERS AND BUILDERS GUIDES



PRACTICAL STOREHOUSE OF MODERN CONSTRUCTION INFORMATION (4 vol. set) for carpenters and all woodworkers. Explains in easy language and by profuse illustration principles, advances, short cuts, trade secrets, all based on the NEWEST information.

Vol. 1 - Tools, steel square, saw filing, joinery, furniture, etc.; Vol. 2 - Builders' mathematics, drawing plans, specifications, estimates, etc.; Vol. 3 - House and roof framing, laying out, foundations, etc.; Vol. 4 - Doors, windows, stair building, millwork, painting, etc. 4 vols. 1904 Pages. 3700 Illustrations. Whole set only \$6.

CIRCLE No. 8 IN COUPON

PRACTICAL ELECTRICITY

A COMPLETE HANDBOOK - Quick, simplified, ready reference. Complete instruction and practical information on the rules and laws of electricity - Maintenance of Machinery - A.C. and D.C. Motors - Armatures - Wiring Diagrams - House Lighting - Power Wiring - Meters - Batteries - Transformers - etc. Simple to understand. 1520 Pages. 2600 Illustrations. Priced at \$5.

CIRCLE No. 4 IN COUPON

DIESEL

ALL THERE IS TO KNOW ABOUT MODERN DIESEL ENGINES - Basic principles, starting valves, timing, fuel pumps, fuel injection compressor, air compressors, pistons, cylinders, lubrication, cooling systems, etc. Answers on operation, calculations. 640 Pages. Fully Illustrated. Priced \$3.

CIRCLE No. 9 IN COUPON

WELDERS GUIDE

Covers Electric, Oxy-acetylene, Argon, Thermit, Union-bolt welding for sheet metal, spot and pipe welds, pressure vessels and aluminum, copper, brass, bronze and other metals. Airplane work, surface hardening, hard facing, cutting, brazing, etc. 608 Pages. Fully Illustrated. Only \$3.

CIRCLE No. 10 IN COUPON

MATHEMATICS MADE EASY

A COMPLETE HOME STUDY COURSE - Starting with the first principles of arithmetic, advancing step by step through the various stages of mathematics, including the rules and calculations for mechanical and electrical problems. New EASY correct methods. Includes plane and solid geometry, trigonometry, algebra, calculus, etc. Practical tests, reference tables and data. How to use slide rule. 752 Pages. 550 Illustrations. Priced at only \$3.

CIRCLE No. 11 IN COUPON

NEW MACHINISTS AND TOOLMAKERS HANDBOOK

MODERN MACHINE SHOP PRACTICE - 5 PRACTICAL BOOKS IN ONE. New from cover to cover. Tells how to set up and operate lathes, screw and milling machines, shapers, drill presses and all other machine tools. A COMPLETE INSTRUCTOR AND REFERENCE BOOK. 1728 Pages. Fully Illustrated. Priced at only \$6.

CIRCLE No. 12 IN COUPON

WIRING DIAGRAMS

This book gives the practical facts on wiring of electrical apparatus. It explains clearly and SIMPLY how to wire apparatus for all fields of electricity. Each diagram is complete and self-explaining. Know your HOOK-UPS! 304 Pages. Illustrated. Only \$2.

CIRCLE No. 13 IN COUPON

REFRIGERATION & AIR CONDITIONING

FOUR BOOKS IN ONE - based principles, wiring, operation, repair of: 1. Household Refrigeration. 2. Special Refrigeration Units. 3. Commercial & Industrial Refrigeration. 4. Air Conditioning Systems. A GOLD MINE of essential information. Completely up-to-date. 1260 Pages. Fully Illustrated and Indexed. Priced at only \$5.

CIRCLE No. 14 IN COUPON

THE NEW ELECTRIC LIBRARY

A COMPLETE ENCYCLOPEDIA explaining in the simplest terms the fundamental principles, rules and applications of applied electricity.

A COMPLETE COLLEGE EDUCATION! Fully illustrated with diagrams and sketches, calculations and tables for ready reference. Questions and answers. Trial tests for practice study and review. All based on the most modern theory.

- Vol. 1 - Principles and rules of electricity, magnetism, armatures, repairs. No. 15
- Vol. 2 - Dynamoelectric Motors, construction, installation, maintenance, etc. No. 16
- Vol. 3 - Testing instruments and tests, storage battery construction and repairs. No. 17
- Vol. 4 - Alternating current, power factor, alternators, transformers. No. 18
- Vol. 5 - A.C. Motors, windings, maintenance, converters, switches, fuses, etc. No. 19
- Vol. 6 - Relays, condensers, regulators, rectifiers, meters, switchboards, etc. No. 20
- Vol. 7 - Wiring, house light and power, circuits, high

tension, plans, code, etc. No. 21

- Vol. 8 - Railways, signals, elevators, ignition, etc. No. 22
- Vol. 9 - Radio, telephone, telegraph, television, motion pictures. No. 23
- Vol. 10 - Refrigeration, illumination, welding, x-ray, electrical appliances, Index. No. 24

7,000 fully illustrated pages. Priced at only \$20 for the ENTIRE SET. Also sold individually for \$2 each.



ALL TYPES OF BLUEPRINT READING

How to read scales, the standard symbols, detail and assembly prints, working drawings, short cuts, hints and suggestions. THE MAN WHO CAN READ BLUEPRINTS IS IN LINE FOR A BETTER JOB. This book gives you the secret language, step by step in easy stages. 448 Pages. Very Fully Illustrated. Priced at \$3.

CIRCLE No. 25 IN COUPON

MASONRY & BUILDERS GUIDES

A PRACTICAL ILLUSTRATED 4 VOL. SET - Explaining in clear, simple language and profuse illustration, principles, advances, short cuts, trade secrets, based on modern practice - including how to figure and calculate various jobs.

- Vol. 1 - Brick work, bricklaying, bonding, designs.
- Vol. 2 - Brick foundations, arches, tile setting, estimating.
- Vol. 3 - Concrete mixing, placing, forms, reinforced stycco.
- Vol. 4 - Plastering, stone masonry, steel construction, blueprints.

4 Vols. 1440 Pages. 2067 Illustrations. Complete Set only \$8.

CIRCLE No. 26 IN COUPON

ELECTRIC MOTORS

THIS GUIDE covers the construction, hook-ups, control, maintenance and trouble shooting of all types of motors. Includes armature winding. Explains entire subject in great detail in simple language. Over 1055 Pages of information. 617 Diagrams. All types of motors fully illustrated and indexed for ready reference. Priced at only \$5.

CIRCLE No. 27 IN COUPON

OIL BURNERS

New, complete, explaining in detail both domestic and industrial oil burners. Includes electrical hook-ups and wiring diagrams. Fully covering the theory, construction, installation, operation, testing, wiring and repair of all equipment. Indexed for ready reference. Over 416 Pages. 320 Illustrations and Diagrams. Only \$2.

CIRCLE No. 28 IN COUPON

ADDITIONAL IMPORTANT TITLES

The following Audel Guides are all the best in their fields, written in clear simple fashion, all lavishly illustrated. Circle the numbers wanted in the MAIL ORDER COUPON below. All books are sent for FREE EXAMINATION.

- No. 29 SHEET METAL PATTERN LAYOUTS 1152 Pages... \$7.50
- No. 30 SHEET METAL WORKERS HANDBOOK 448 Pages... 2.00
- No. 31 MECHANICAL DRAWING GUIDE 192 Pages... 2.00
- No. 32 MECHANICAL DRAWING AND DESIGN 480 Pages... 3.00
- No. 33 ELECTRICIAN'S EXAMINATIONS 272 Pages... 2.00
- No. 34 ELECTRICIAN'S EXAMINATIONS 272 Pages... 2.00
- No. 35 ELECTRIC POWER CALCULATIONS Page 480... 3.00
- No. 36 ELECTRIC DICTIONARY 9000 Terms... 2.00
- No. 37 POWER PLANT ENGINEERS GUIDE 1568 Pages... 5.00
- No. 38 ENGINEERS AND FIREMANS EXAMS 244 Pages... 2.00
- No. 39 OPERATING ENGINEERS LIBRARY 3 Books Set... 1.00
- No. 40 PUMPS, HYDRAULICS AND AIR COMPRESSORS 1760 Pages... 6.00
- No. 41 HOUSE HEATING GUIDE 1008 Pages... 5.00

MAIL THIS NO-RISK COUPON TODAY!

THEO. AUDEL & CO. - Self Improvement Publishers Since 1879 - P12 1 2 3 4 5 6
49 W. 23rd Street, New York 10, N.Y.

Please mail me for 7 days' FREE EXAMINATION the books I have circled at right. I agree to mail \$2 in 7 days on each book or set ordered and to further mail \$2 a month on each book or set ordered until I have paid the purchase price, plus shipping costs. If I am not completely satisfied with my Audel Guides I may return them.

NAME _____	7	8	9	10	11
ADDRESS _____	12	13	14	15	16
OCCUPATION _____	17	18	19	20	21
	22	23	24	25	26
	27	28	29	30	31
	32	33	34	35	36
	37	38	39	40	41

SAVE SHIPPING COSTS! Check here if you enclose complete payment with order. We pay postage charges. You have some return privilege.

Just Pick the Kind of Body YOU Want

CHECK THE COUPON BELOW

...Prove to Yourself How EASILY You Can Have It... Almost Overnight!



Just tell me, in coupon below, the kind of body you want—and I'll give it to you SO FAST your friends will be amazed! "Dynamic Tension," my easy, 15-minutes-a-day method, can make your chest and shoulders bulge . . . your arms and legs surge with power . . . your whole body feel "alive!"

FREE 32-page Illustrated Book

32 pages on how "Dynamic Tension" changed me from a 97-lb. weakling into "World's Most Perfectly Developed Man"—and what it has done for others. Mail coupon NOW! Charles Atlas, Dept. B12, 115 E. 23rd St., N. Y. City 10.



CHARLES ATLAS, Dept. B12,
115 East 23rd St., New York 10, N. Y.

Dear Charles Atlas—Here's the Kind of Body I Want:
(Check as many as you like)

- | | |
|---|---|
| <input type="checkbox"/> Slimmer Waist, Hips | <input type="checkbox"/> More Powerful Arms, Grip |
| <input type="checkbox"/> Broader Chest, Shoulders | <input type="checkbox"/> More Powerful Legs |
| <input type="checkbox"/> More Weight, Solid | <input type="checkbox"/> Better Energy, Sleep |

Send me, absolutely FREE, a copy of your famous book showing how "Dynamic Tension" can make me a new man. 32 pages, crammed with photographs, answers to vital questions, and valuable advice. No obligation.

Name _____ Age _____
Address _____
City _____ Zone _____ State _____

How Much Do YOU Want to Make?

\$15²⁰
AN HOUR?



"For every hour I have devoted to PRESTO, I find that I have earned an average of \$15.20 an hour."
William Wydallis, Ohio

\$37.78



"Friday morning in 15 minutes I had orders for 18 PRESTOS. (Profit \$37.78) By Friday evening 2 dozen were sold and orders taken for a dozen more. I had made a net profit of \$75.56 the first day."
Richard Meade, Ohio

In 15 Minutes?

\$1,000⁰⁰ A MONTH?



"I'm making more than \$1,000 a month with PRESTO—and I haven't touched bottom yet."
Charles Kama, Texas

Salesmen Rave About "Sell on Sight" PRESTO Fire Extinguisher

Wouldn't you like to make the kind of money these successful men made? Then rush name, address NOW for Sales Kit, amazing moneymaking plans, full story of "Miracle Midget" super-effective PRESTO Fire Extinguisher everyone needs, wants, BUYS from you at only \$4.95, while you make liberal profit on each one. If you wish, request full-size Demonstrator PRESTO—only \$3.00 plus postage, C.O.D. charges. Or enclose \$3.00 now and we pay postage. Helos get fast orders—may be returned for FREE refill as often as you wish. Write TODAY!

MERLITE INDUSTRIES

114 East 32nd St., Dept. P-155, New York 16, N. Y.
In Canada: Mopa Co., Ltd., 371 Dowd St., Montreal 1, P.Q.

EXTRA! ANOTHER Scoop!

SENSATIONAL **NEW** BENJAMIN BB REPEATERS...
The Only Repeating Gun on the Market with...
Piggy-Back SHOT MAGAZINE

★ BENJAMIN SUPER 100 SHOT BB CO. GAS RIFLE \$14.95
★ BENJAMIN SUPER 100 SHOT BB AIR RIFLE \$21.95

THE REVOLUTIONARY NEW GRAVITY FEED ACTION THAT LOADS BB AMMUNITION automatically!

A shot is placed in firing position each time bolt is pulled back and closed. Finest quality. Powerful—Accurate—Economic—Use indoors or out. New Bar-V sight.

No. 3600 Benjamin Super 100 Shot BB Gas Rifle, No Pumping... Auto Loading. →
No. 3600CS DeLuxe Gas Rifle with Custom Stock—\$17.95
No. 3100 Benjamin Super 100 Shot BB Air Rifle with Regular Stock, Economical—\$21.95
No. 3100CS DeLuxe Air Rifle with Custom Stock—\$24.95

BENJAMIN AIR RIFLE CO.
806 MARION ST. ST. LOUIS 4 MO. U.S.A.

Secrets of VENTRILOQUISM Now Revealed!



Easy to learn in 60 to 90 days with our Home Study Course. **RESULTS GUARANTEED.** Make Money! Be Popular! Have Fun! Big Opportunity! Radio, Television, Stage Appearances! For FREE Information regarding price and terms WRITE: You must state your age. **NAHER HOME COURSE OF VENTRILOQUISM** Box 36, Studio PH-12, Kensington Station Detroit 24, Michigan

75 POWER TELESCOPE \$398

NEW 3 in one telescope, 3 variable 25X 45X-75X magnification. Brass bound. 25 power for ultra bright images. 45 & 75 power for long range. Guaranteed to bring distant stars, moons, objects, sports 75 times closer.

Most powerful scope sold anywhere near this amazing low price. American made, 5 sections. Opens 36", closes 1 ft.; contains 4 ground & polished lenses. Can also be used as powerful compound microscope. Mass production enables us to offer telescope complete at \$3.98 postpaid. Money back guarantee.

CRITERION CO., Dept. PMB 64, 331 Church St., Hartford, Conn.

MEN WANTED

Earn \$100 Per Week and up
AUTO DIESEL MECHANICS

Master a trade with a future—learn Auto-Diesel mechanics in our shops. You learn with tools on real equipment. Earn while you learn. Many of our graduates earn \$100 per week and up. No previous experience necessary. Day and night courses. Approved for veterans. Write for free bulletin.

NASHVILLE AUTO-DIESEL COLLEGE

226 7th Ave., N., Dept. 73

Nashville 3, Tenn.



TIRE SALE

FREE PASS. TUBE

25 YEARS IN BUSINESS AT THE SAME ADDRESS

Seeing is believing—IF YOU GO SHOPPING YOU'LL END HERE. Be Wise, try one! You'll buy more. **GUARANTEE BOND** given with each used tire sold. SEND AD.

600x16	\$5.32	670x15	\$5.32	650x16(6)	\$8.42	800x15	\$6.32
600x16(6)	7.62	710x15	5.52	750x16(6)	9.52	820x15	6.92
650x16	5.92	760x15	5.92	640x15	5.42	700x16(6)	9.22
750x14	8.52	800x14	9.52	1100x20	20.92	1100x22	21.22
700x16(8)	10.02	700x20	11.92	750x17	14.42	825x20	19.92
750x16(8)	12.72	750x20(10)	15.62	600x20	10.32	900x20	15.92
700x17	11.42	750x20(8)	13.62	650x20	11.92	1000x20	20.42

12 MOS. WRITTEN GUARANTEE. WHITE WALLS \$1.00 EXTRA
"EXTRA SPECIAL" TOP QUALITY all size 4-ply pass. FREE TIRE with 2 or more of those. W.W. \$8.82 EA.
\$1.00 Extra — GIANT TIRE SALE.

SNOW TIRES \$8.62 AND \$6.32 ANY SIZE
BLACK WALL PASS.
SUBURBANITE OR TOWN & COUNTRY TREAD
Thousands of tires shipped all over the U.S.A. All tires shipped F.O.B. Phila. Send Check or M.O. with this ad. Dept. 2, No. C.O.D.
STANDARD 834 N. Broad St., Philadelphia 30, Pa.

Train for a **GOOD JOB**
and a **REAL FUTURE** in

Electricity Electronics

in New Shop-Labs of
COYNE



Largest, Oldest and Best Equipped School of its Kind in U.S. Train in the **NEW COYNE SHOP-LABS** for a better job in Electricity-Electronics—a field that offers a world of opportunities now and in the years ahead. In industry—in the home—New developments and fabulous growth are creating increasing job opportunities. **AUTOMATION ELECTRONICS**—one of the more recent applications of Industrial Electronics to manufacturing processes—promises to create additional demands for trained Electrical-Electronics men such as we have never seen. Send for details.

LARGEST, OLDEST AND BEST EQUIPPED SCHOOL OF ITS KIND IN U.S.

YOU TRAIN IN CHICAGO—Practical work plus technical training. No advanced education or previous experience needed. Lifetime Employment Service to Coyne Graduates.

START NOW—PAY LATER. New liberalized credit terms and Finance Plans pay most of tuition after graduation. Part-time employment service to students.

COYNE ELECTRICAL SCHOOL

CHARTERED NOT FOR PROFIT

1501 W. Congress Parkway, Chicago, Dept. 98-3E

SEND FOR FREE BOOK. "Guide to Careers" and all information will come by return mail. No obligation and no salesman will call, so mail coupon in envelope—paste on postal card—write to address below.



Coyne Electrical School
Dept. 98-3E—New Coyne Building
1501 W. Congress Pkwy., Chicago 7, Ill.
Send **FREE BOOK** and details of the training you offer in Electricity-Electronics.

Name _____

Address _____

City _____ State _____

(I understand no Salesman will call.)



SHEET METAL MACHINES

Brakes form angles, locks, pans, etc. Quick eccentric clamp. All steel construction.

15"–16 gauge steel.....	\$28.00
36"–22 gauge steel.....	\$37.00
48"–24 gauge steel.....	\$52.00
Floor stand.....	\$ 8.00
15"–24 gauge Folder.....	\$17.50
36" Pan and Box brake.....	\$60.00
1/4 x 3 Adjustable Bender.....	\$14.00
16 gauge 7" Bench Shear 3 adj. gauge.....	\$16.50
30"–20 gauge Curve Former.....	\$12.00

ORDER DIRECT OR SEND FOR FREE CATALOG

VYKE MFG. CO., P-4158 Jason St., Denver 11, Colo.

ARMCHAIR ADVENTURE CAN BE EXCITING



With a **NATIONAL NC-60 SPECIAL Shortwave Radio Receiver** you can explore the four corners of the earth, sail the seven seas, cross, in the comfort of a favorite chair, the six continents to visit 260 foreign lands. Enjoy standard broadcast too, with this powerful new radio receiver. Suggested price only \$59.95. Write for literature and name of nearest dealer.

JOIN THE NATIONAL ASSOCIATION OF ARMCHAIR ADVENTURERS

SEND 50c for membership certificate and exciting new book on shortwave listening—tells when, where, how to listen, provides log for listing countries you hear. SEND 50c to:

NATIONAL CO., INC., MALDEN 48, MASS.



NEW! for 4-wheel drives

FREE-LOCK Auto-Lock HUB



The Hub a Child can engage

Willys • Dodge • GMC • International • Ford
Chevrolet • Land Rover • Marmon Herrington

A revolutionary advancement. Merely set arrow to "in" position and Walk away! It's simple, safe, sure! Ruggedly constructed of finest tool steel by aviation precision standards. Fully guaranteed 1 year.

If dealer cannot supply, write for literature and prices

FREE-LOCK CORPORATION

6301 NORTH FEDERAL BLVD., DEPT. C • DENVER 21, COLORADO



ATOMOTRON

First Model Atom Smasher!

NOW \$995 up

See and learn the wonders of Nuclear Physics and Electricity with miniature high-voltage generator. Make artificial lightning... pitb balls defy gravity, propellers turn at a distance. Only 6" high. Produces up to 75,000 volts, 2-inch sparks, yet is absolutely safe for the youngest child. Illustrated operation manual included.

COMPLETE WITH FOLLOWING APPARATUS

- Paper Strand Cluster
- Electric Wind Unit
- Neon Light Wand
- Smog Control Unit
- Field Reaction Rotor
- Plastic-encased Pitb Ball

Atomotron, battery operated, runs for hours on 2 flashlight cells. Ship. wt. 1 lb. \$ 9.95
 Atomotron operated by sturdy, 110-volt motor, accepted by UL. Ship. wt. 4 lbs. 19.95
 Atomotron, kit form, AC motor, needs only screw-driver to assemble. Ship. wt. 3 lbs. 14.95

Other Available Instruments:

3-in-1 Electromagnet, \$14.95; Optics Kit, \$39.95; Raymaster Cloud Chamber, \$32.50; Physics Kit, \$39.50; Spintharoscope, \$2.00; Gravity Torsion Balance, \$151.00; Isotope Analyzer, \$100.00; Tesla Coil, \$98.00; Ultrasonics-Sonar Demonstrator, \$115.00.

Cash, check or M.O. Plus P.P. costs. (In Calif. add 4% sales tax)

ATOMIC LABORATORIES
 3086 CLAREMONT AVE., BERKELEY 5, CALIFORNIA

EARN **\$20.00** PER HOUR EVERY HOME, FURNITURE STORE, HOTEL, OFFICE, A PROSPECT!

REMOVE CIGARETTE BURNS — DEEP SCRATCHES from FURNITURE, HARDWOOD FLOORS, FINE WOODWORK. Like new in minutes. Easily done with my new method. Fill with melted lacquer stick. Rub to perfection without damage to surrounding area with patented "Smoother" #2793477.

SEND NOW FOR COMPLETE FURNITURE KIT. ILLUSTRATED INSTRUCTIONS GUARANTEED SUCCESS. ACT TODAY—BE FIRST IN YOUR TERRITORY. FULL PRICE.....\$12.95.

HOME PROJECTS

1617 Balboa Way • Burlingame, California

PLAY RIGHT AWAY!

Even If You Don't Know a Note of Music Now

Now it's EASY to learn any instrument. No boring exercises. Start playing real pieces by notes right away. Amazing progress at home, in spare time. No teacher. Few cents per lesson. 1,000,000 students! Write for FREE BOOK. U. S. School of Music, Studio 3012, Port Washington, N.Y. No salesman will call. (Our 60th successful year!)



GROW MINIATURE TREES FREE! SEEDS & PLAN



New Fascinating HOBBY or HOME-BUSINESS OPPORTUNITY! Learn little-known techniques for growing living "Ming" Trees only inches high. Beautiful Elm, Cherry, Orange, Cypress, Peach, etc., that BLOSSOM AND BEAR TINY TASTY FRUIT. Help fill demand for these sensational dwarfed Trees. FREE SEEDS (8 kinds) and Plan. State your age. Write: MINIATURE TREE NURSERIES, Dept. K-12, (Home-Growers Division) Gardena, Calif.

New-FANTASTIC-BUSINESS-AND HOBBY

PLASTIC FORMING MACHINE PROFITS OF \$1000 A MONTH NOW POSSIBLE.....

with HOBBY-VAC

you can create thousands of original metallic gold, silver and copper 3-D items at a cost of about 10c each. The possibilities of creating salable items are almost unlimited.



HOBBY-VAC Forms - Draws - Vacuum Packs - Bubble Packs . . . Reproduces in brilliant metallic and colored plastic 7"x7". See actual photos.

- ★ Pictures ★ Signs ★ 3-D Plaques ★ Coasters ★ Dishes
- ★ Baby Shoes ★ Relief Maps ★ Toys ★ Medallions
- ★ Christmas Cards and hundreds of other items

HOBBY-VAC is guaranteed to make you more money or give you more genuine creative pleasure for your investment, whether you are 9 or 90, boy or girl. HOBBY-VAC will reproduce from natural objects. No dies required. HOBBY-VAC is simple to operate. Just plug into 110 volt service, and your vacuum cleaner. Machine size 12"x15"x20".

HOBBY-VAC including sample and 12 sheets of assorted plastic costs only \$39.50

MATERIAL KIT, including 12 picture frames, and plastic sheets of assorted colors to make 100 items (more than enough to repay original cost) \$10.00



If not completely satisfied, return within 10 days for full refund.

Please send me, promptly, by prepaid Parcel Post
 HOBBY-VAC—\$39.50 MATERIAL KIT—\$10.00
 (please print) My check money order enclosed
 Name _____
 Address _____
 City _____ State _____

ORBIT of CALIFORNIA
 211 LOS MOLINOS
 SAN CLEMENTE, CALIFORNIA
 POPULAR MECHANICS

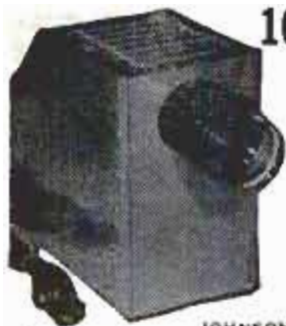

100X Magnifying Projector

— Enlarges Pictures, Printing, & Objects! — Full Color!

NEW! Electric Magna-Vue Optical Instrument projects & enlarges clippings, pictures, sketches, objects in full natural color, correctly & readable. Project on wall, screen or table. **MAGNIFIES 100 AREAS.** Enlarges any material up to 3 1/4 x 4 in. to 32 x 40 in. For home, school, class, business, shop use. Also make signs, sketches easy from any copy. Enamelled steel, 10x7 1/2 in. high. Quality 2" focusing lens. Operates on standard 110 volt current. Money back guarantee. Price Postpaid..... **\$4.98**

JOHNSON SMITH CO., Dept. 736, Detroit 7, Mich.

Catalog of 2900 Novelties 10c

New Send 10c for amazing catalog of novelties, live animals, scientific supplies, hobbies, funmakers, planes & boats, looms, magic tricks, joke articles, unusual seeds, gadget timesavers, cameras, optical goods, projectors, movies, lucky jewelry, religious novelties, disguises, musical instruments, stamps, coins, puzzles, fortune tellers, radios, auto & bike accessories, telescopes, magnifiers, compasses, banks, smokers' gadgets, artists' supplies, printing sets, engines, motors, shockers, knives, billfolds, guns, rifles, sports, books, games, plants, etc. Send 10c. Dept. 736 Detroit 7, Michigan

STOP RADIO & TV NOISES INSTANTLY!

NEW ELECTRONIC DESIGN



Bell-Tronic line filter eliminates noisy interference caused by motor appliances, autos, oil burners, etc. Simply plug radio or TV cord into filter and filter into wall socket. Send \$1. Add 25c for P.P. & Handling. No C.O.D. Try 5 days. Money back guarantee.

\$1

Tube Wholesalers, Dept. B-PM, Box 61, Baldwin, L.I., N.Y.

SIGN PAINTING

Home-Study Course — Only \$5.95

Teaches you commercial sign painting and sign building as it is being done TODAY in leading shops all over the country. Complete practical course for self-instruction. Shows latest methods of truck lettering, office doors, wood letters, reflecting signs, plastics, sprayed signs, gold leaf, silk screen process, up-to-date alphabets, money-making business information, etc.

SATISFACTION GUARANTEED OR REFUND! Contains all the instruction of a high-priced correspondence course. Full price, only \$5.95, postpaid. Or C.O.D. plus postage. No risk—order today. Satisfaction or money back! Order "Sign Painting Course." NELSON-HALL CO., 210 S. Clinton St., Dept. 2MS-2, Chicago 6, Ill.



TAFT CRUISER KITS

DEPT. PM-1258

FREE 40 pg. Color CATALOG

18 ft. Sedan Cruiser \$490.00 frt. inc.

All models 18 ft. cruisers... Big complete line of runabouts, fishing boats. NO WONDER WE'VE SOLD SO MANY!

TAFT MARINE WOODCRAFT
636 - 39th Ave. N.E., Minneapolis, Minn.

FORTUNES IN DIVING

Train at Home in Spare Time

Write Today for Amazing Free Booklet

Here is one of the greatest opportunities of our time. Make big money fast in Skin and Lung Diving. Trained divers needed in hundreds of industries and by government. Build a successful business of your own. Hourly rates among highest paid in any field. Training program by E. R. Cross, world famous master diver. Get the facts now. Mail coupon for **FREE BOOKLET TODAY!**

DIVEMASTER, Dept. PM-128

5637 W. 63rd Place, Chicago 38, Ill.

Send me free information about Diving.
Name _____ Age _____
Address _____
City _____ State _____



94.6% OF BAILEY GRADUATES ARE EMPLOYED AT TOP PAY IN THE FIELDS WHICH THEY WERE TRAINED!



DIESEL-AUTO MECHANICS DESPERATELY NEEDED!

We have a far greater demand for our students than we can fill!

We can show you an actual waiting list of leading companies throughout the world who have tried Bailey graduates — found them outstanding, and are coming back for more!

Bailey Graduates are Successful . . . RECEIVE BIG PAY — HAVE SECURE FUTURE!

The Famous Bailey Course prepares you for BOTH Diesel and Gasoline Mechanics.

This is a must—due to the advent of using Diesel principles, such as 'Fuel Injection' on passenger cars . . . use of gasoline engines for starting Diesel engines, etc. You learn all this at Bailey in the amount of time ordinarily required to learn just one of these subjects, **ALL FOR THE PRICE OF ONE.**

Don't be satisfied with a 'futureless', one-type job — learn how you can make big money now! Write today for Free Booklet that takes you on a step-by-step camera tour through our spacious, modern shops — See Bailey students in action as they Learn-by-doing with the Famous Bailey Method of training!

We provide you with housing and part time jobs while in school, plus nation-wide placement service for graduates.

BAILEY Technical SCHOOLS

1634 S. GRAND ST. LOUIS 4, MO.

MAIL TODAY!

Please mail immediately this free booklet without obligation.

FREE BOOKLET



Name _____
Address _____
City _____ State _____

APPROVED FOR VETERAN . . . NON-VETERAN

EARN MORE-LEARN AUTO DIESEL MECHANICS

OR TRAIN WITH OTHER GREER DIPLOMA COURSES

- | | |
|--|---|
| <input type="checkbox"/> AUTO MECHANICS | <input type="checkbox"/> REFRIGERATION |
| <input type="checkbox"/> DIESEL MECHANICS | <input type="checkbox"/> AIR CONDITIONING |
| <input type="checkbox"/> BODY & FENDER REPAIR | <input type="checkbox"/> MACHINIST TRADE |
| <input type="checkbox"/> GAS-ARC WELDING | <input type="checkbox"/> ADVANCED MACHINIST |
| <input type="checkbox"/> PIANO TUNING & REPAIR | |

Skilled men are needed in every part of the country. Earn top pay in established shops or start your own business. Greer's expert instruction and actual shop training teaches you how. You learn by doing—quick, easy courses using the latest tools and equipment. Day, evening and part time instructions available.

Job placement and convenient living accommodations are yours while training. Contact GREER'S FREE JOB PLACEMENT SERVICE when you enroll if you wish part time or full time employment.

ENGINEERING DEGREE COURSES

- | |
|--|
| <input type="checkbox"/> DIESEL AUTOMOTIVE ENGINEERING 27 MOS. |
| <input type="checkbox"/> REFRIGERATION & AIR COND. ENGINEERING 18 MOS. |
| <input type="checkbox"/> WELDING ENGINEERING 18 MOS. |

All Courses Approved Civ. or G.I.

Please rush me free literature on the trade indicated, at no obligation.

NAME _____ AGE _____

STREET _____

TOWN _____ ZONE _____ STATE _____

Established 1902

GREER SHOP TRAINING

Box 1, 2236 S. Michigan Ave.
Chicago 16, Illinois

MEN WANTED AT ONCE!

to train for big pay jobs as
**RADIO-TELEVISION
SERVICE
TECHNICIANS**



**Learn & Earn
in Spare Time
At Home**

New Plan!

... Just \$6 starts you on
lifetime Radio-TV Career

Who's making the big money
today? Who will make even
more in the future? It's the

trained Radio-Television Technician... the man who knows how to fix and service Radio, Hi-Fi and TV sets! Find out how you can learn this interesting well-paid job in your spare hours at home. For a limited time... just \$6 enrolls you for complete, up-to-date Sprayberry Training... including valuable home shop practice with many kits we supply. We help you earn extra cash servicing sets while learning. No experience needed. Rush coupon for new 60-page catalog, special sample lesson, both FREE. No salesman will call.

SPRAYBERRY ACADEMY OF RADIO-TELEVISION
Dept. 10-P, 1512 W. Jarvis Ave., Chicago 26, Illinois

Sprayberry Academy of Radio-Television
Dept. 10-P, 1512 Jarvis Ave., Chicago 26, Ill.
Mail FREE SAMPLE LESSON and Big Book.

NAME _____

ADDRESS _____

TOWN _____ Zone _____ STATE _____

**RUSH
COUPON
Today!**

ENJOY YOUR OWN BUSINESS

Start earning at once—No special experience required

A shop in
itself—
automatic,
foolproof.



Down payment;
Balance in low
monthly payments
from earnings.

STAND-ALL Model 7

SHARPENS 10 types of
saws, including rip and
crosscut handsaws,
hacksaws, bandsaws,
circular saws.

RETOOTHs saws of 5
to 16 point size.

CROWNS—adjusts to
any standard crown.

HOOKS from -5 to 21
degrees.

BEVELS from 0 to 30
degrees.

SMITH-NIELSEN EQUIPMENT CO., Mfr. of Saw Grinders
902 N. NORMANDIE — SPOKANE, WASH. — FA 8-6680
Teletype SP13

'How to Make Money with Simple Cartoons'



A book everyone who likes to draw
should have. It is free; no
obligation. Simply address

**FREE
BOOK**

CARTOONISTS' EXCHANGE
Dept. 912-D Pleasant Hill, Ohio

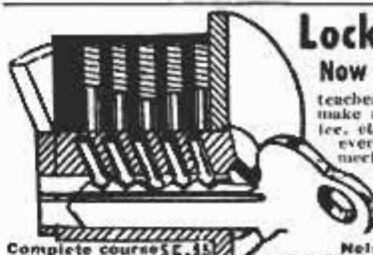

Locksmithing AND KEY MAKING

Now Made Easy! Practical up-to-date course

teaches you how to pick locks, de-code,
make master keys, repair, install, serv-
ice, etc. New self-instruction lessons for
every handyman, homeowner, carpenter
mechanic, service station operator, fix-
it shop, hardware dealer, gun-
smith. 53 easy illustrated lessons.
Full price only \$5.95 postpaid;
or C.O.D. plus postage. Satis-
faction or refund guaranteed.

Complete course \$5.95
... now only \$3.95

Nelson-Hall Co., Dept. MS-2
210 E. Clinton Chicago 6, Ill.

YES! SEND



directly
to my door
every month

I am enclosing

- \$3.50 for 1 year
 \$8.00 for 3 years

name _____

address _____

city _____

zone _____

state _____

Hand this order to your newsdealer or send it to
POPULAR MECHANICS
200 East Ontario St. Chicago 11, Ill.

**You Can Be a Local
Manufacturer of
CAVITEX**

**SUPERFINE
MASONRY**

Local production explains why Cavitex can offer so much in quality for so little money, yet is so generous in profit potentials. It's a case of streamlined manufacturing—processing local materials for local building—cutting out the high costs of freight and distribution.

Cavitex creates new standards of beauty—in size, proportion and color. "Puts emphasis on the horizontal." Cored-out design for lighter weight and greater insulation values. Available in 8-inch and 4-inch.

Hundreds of territories are available to men looking for a local manufacturing enterprise. Franchise privileges. Responsible operators can obtain basic equipment on attractive rental terms. The Cavitex industry is sponsored by a million-dollar company backed up by fifty years of experience and reputation. Write or wire at once for "Opportunity, Unlimited" and tentative reservation of territory.



W. E. DUNN MFG. CO.
409 W. 24 St., Holland, Mich.

X-6

**"\$7,108.50 First Year
SERVICING RADIATORS!"**

— Hank Moner, Newcastle, Wyo.
Make good money servicing auto-truck-tractor radiators with new Inland 1-Piece Radiator Shop. Easy to test, clean and repair radiators. Inland, world's largest radiator equipment mfr., trains you free. Small down payment starts you. Proved merchandising assures volume. Profitable dept. for garage or service station. Write
INLAND MFG. CO., Dept. PM-12, 1108 Jackson St., Omaha 2, Nebr.



NEW!

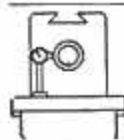

— **JOB TESTED KNOW-HOW** —
**MACHINE TOOL RECONDITIONING
& THE ART OF HAND SCRAPING** (3rd printing)
SEND FOR FREE FOLDER DESCRIBING
ILLUSTRATED MANUAL FOR MACHINISTS
MACHINE TOOL PUBLICATIONS, 382 Holly Ave., Saint Paul 2, Minn.



1000 AND 1 USES!

Pliobond by
GOOD YEAR

Super-glues "anything to anything" — super-quick!
At chain, hardware and hobby stores everywhere.
Pliobond—T.M. The Goodyear Tire & Rubber Company, Akron, Ohio

Exclusive Double-Bearing HEAVY-DUTY PUMPS
IRRIGATE • DRAIN • CIRCULATE • SPRAY
Use 1/4 HP motor or larger . . . 1 HP for up to 7,500 GPH; 1,000 GPH 60' high; or 3,000 GPH from 25' well. 1 1/4" inlet; 1" outlet. Stainless shaft.
TYPE X—2 oil-less bronze bearings. Won't rust. . . . **\$10.95**
TYPE XG—Ball bearing model. . . . **\$12.95**
Postpaid if cash with order. Rush your order today
MONEY BACK GUARANTEE
Centrifugal and Gear Pumps in All Sizes
LABAWCO PUMPS, Belle Mead 2, N. J.

INVESTIGATE ACCIDENTS

Train quickly in your own home for repeat income in the exciting, secure Claim Investigation and Claim Adjusting field. Our students and graduates are already earning \$4, \$5, \$6 an hour extra SPARE TIME — and up to \$10,000 a year Full Time. You need NO prior experience or higher education. Your age does NOT matter.

**HERE IS YOUR CHANCE FOR ACTION
AND REAL JOB SECURITY**

As a trained Claim Investigator you will (1) INVESTIGATE FACTS and (2) DISTRIBUTE MONEY as the representative of wealthy organizations.

No other business offers you greater opportunities for success and security. Here's why: The huge, rapidly expanding Claim Investigation and Adjusting Profession right now distributes more money than any other service industry. And it's growing fast. Over 200 MILLION ACCIDENTS must be investigated this year for Insurance Companies, Airlines, Railroads, Steamship Lines, and Government Offices.

MAIL NOW for FREE BOOK ➔

SEND TODAY for Big, FREE, Illustrated Catalog. Learn the exciting facts about Universal Schools' low cost training. No obligation. No salesman will call. GI APPROVED.



UNIVERSAL SCHOOLS
6801 Hillcrest Ave.
Dept. PM-12, Dallas 5, Texas
Please rush me your FREE book on Claim Investigation. This does not obligate me and no salesman will call.
Name _____ Age _____
Address _____
City _____ Zone _____ State _____
Approved by Government for Korean Veterans

ENGINEERING

DEGREE IN 27 MONTHS

B. S. DEGREE IN

Aeronautical, Chemical, Civil, Electrical, Mechanical and Electronic Engineering (inc. Radio and TV)

Also B.S. DEGREE in 36 mo. in Mathematics, Chemistry, Physics (inc. Nuclear Physics), Engineering Science prep. courses. Thorough, practical program. Individualized instruction emphasized. Government approved for G.I.'s.

Keeping pace with progress in science and engineering

Spacious campus; 20 buildings; dorms, gym, playing field. Modern, well-equipped laboratories including new physics lab and wind tunnel. Low tuition. New terms start quarterly. Enter December, March, June or September. Big demand for graduates. Students from 48 states and 40 foreign countries. Many earn a major part of their college expenses in this large industrial center. Send coupon for free catalog and full information. Enroll now!

INDIANA TECHNICAL COLLEGE

5128 E. Washington Boulevard, Fort Wayne 2, Indiana

Please send me free information on 27 MO. B.S. DEGREES in:

Aeronautical Chemical Civil Electrical
Mechanical Electronics

on 36 MONTH B.S. DEGREES in:
Mathematics Chemistry Physics

Name _____

Address _____

250 POWER



Telescope Lens Kit

only \$3.49 postpaid

Conquer Space, Explore the Universe, Planets, Moon Craters, New Stars, etc. Complete lens kit consists of 80 inch focal length ground and polished objective lens, eyepiece lenses for 50 POWER, 100 POWER, 150 POWER, 200 POWER, 250 POWER, and all necessary lens fittings. Easy to make from simple step by step instructions. (Tripod and mount not included.) Money back guarantee.

BUSSE SALES CO., Hartford, Conn., Dept. PM-75

The PERFECT RECORD GIFT for the HOBBYIST HI-FI FAN and RAILROAD ENTHUSIAST

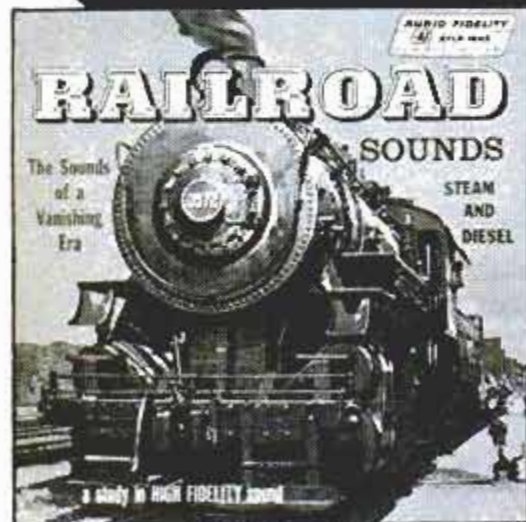

AFLP 1843 \$5.95

Here, in superb high fidelity, are the romantic, nostalgic sounds of the railroad of yesteryear . . . sounds of a vanishing era!

write for free catalog

also available on Stereodisc AFSD 5843 — \$6.95

AUDIO FIDELITY, INC.

770 Eleventh Ave.,

Dept. PM, New York 19, N. Y.

Highest Bridge

One of our readers living at Vichy, France, sends us this photograph of a bridge near Vichy which he describes as "the highest railroad viaduct in the world."

"Besides the highest government turnover in the world," he writes, "we do not



have many world records left in France, so the thing might be worth mentioning before it is too late."

The "Viaduc des Fades" — Fairies Viaduct — is located between Clermont-Ferrand and Montlucon and was built between 1900 and 1908. It spans a valley at 435 feet above the river Sioule, is 1542 feet long and its longest span is 472 feet. Two granite-masonry piers, the highest 305 feet high, support the standard-gauge railroad bridge.



To the Editor:

Enclosed is a photograph of a lawn-mower-motor-powered car built for twins. It has automatic clutch, brakes, chain drive and bumpers.

J. Wright,
23825 Hedgewood,
Westlake, Ohio.



HARCO BLACK LIGHT KIT

MAKES ANY OBJECT "GLOW COLOR BRIGHT" IN THE DARKEST DARK, AS THO BY MAGIC!

GIVES FANTASTIC FLUORESCENT EFFECTS. TONS OF SCIENTIFIC FUN FOR ALL THE FAMILY!

4 WATT KIT CONTAINS
1 bulb (9/16" diam x 5 3/4" L.) with light filter, A ballast, Starter, Linecord & plug. Easy diagram, 9 blk lite color chalks, 3, 2 oz. bottles blk lite water colors (primary colors).

Cat. No. PM-78 **\$6.95** ppd.
4 Watt kit without colors (PM4517) **\$2.98** ppd.

8 WATT KIT COMPLETE
Same as 4 watt except bulb is 9/16 x 11 3/4" L.

Cat. No. PM-79 **\$7.95** ppd.
8 Watt kit without colors (PM4519) **\$3.98** ppd.

115 V., 60 cycle operation. Delivers ultra-violet light in region between 3100 to 4000 A.

Send Ck. or M.O. for Prompt shipment. Satis. Guar.

HERBACH & RADEMAN INC.

Dept. PM1258 1204 ARCH ST. PHILA. 6, PENNA.
SEND 10c FOR LARGE GIFT CATALOG

**EARN
WHILE
YOU
LEARN**
SEND
FOR FREE
BOOKLET



Be a LOCKSMITH

Learn fascinating, profitable trade from experts in spare time at home! Age no disadvantage. Year 'round, steady income. Full or part time. Practical, illustrated lessons. Make money even while learning! All materials and special tools supplied.

INSTITUTE OF LOCKSMITHING, Dept. 112-8
150 Park Ave. East Rutherford, N. J.
Lic. by N. J. State Board of Ed. Apprvd. for Vets



MECHANICAL DENTISTRY

A profession offering unlimited opportunities. Most modern and complete course embracing every branch from Plate to Porcelain Work, which prepares you to work for Dentists or start your own business. Individual instruction—practical training in day or night school. No books—no classes. Catalog upon request.

McCARRIE SCHOOL OF MECHANICAL DENTISTRY
207 N. Broad Street Dept. R3 Philadelphia 7, Penna.



WANT MORE MONEY? GET INTO PHOTOGRAPHY

Coast to coast, high-paying jobs in photography are waiting for people with that "know-how" to fill them. You can quickly, easily qualify at home with the world-famous NYI Learn-by-Doing Method. Write today for free catalog. Also resident training in N. Y. 49th Year. Approved for Vets.

NEW YORK INSTITUTE OF PHOTOGRAPHY
Dept. 49 10 West 33 St. New York 1, N. Y.

SHORTHAND IN

Famous **SPEEDWRITING** shorthand. 120 wpm. No symbols; no machines; uses ABC's. Easiest to learn, write and transcribe. Low cost. For business and Civil Service. Over 350,000 graduates. Typing available. 36th Year. Train at home or at schools in over 400 cities. Write for **FREE** booklet to:

Speedwriting
Dept. 1512-8
55 W. 42 St., N.Y. 36, N.Y.

6 WEEKS



HOME-IMPORT BUSINESS

Men, women. Make big profits buying low cost imports abroad (see examples at left) and selling to friends, stores or by mail order. Famous world trader guides you—shows you how to find thousands of exotic imports for full or spare time business, how to **pocket profits in advance on foreign drop shipment plan**. Full details **FREE!** Airmail reaches us overnight. Write Today!
MELLINGER CO., 1717 Westwood
Dept. P25C LOS ANGELES 24, CALIFORNIA

YOU BRIGHTER FUTURE IN AUTO MECHANICS AND DIESEL



HE IS NOW
SHOP FOREMAN

Your spare time
pays off **BIG**
with our world-famous
SHOP TESTED®
Home Training



HE OWNS
HIS OWN
REPAIR SHOP

MAKE YOUR FUTURE AS BRIGHT AS THEIRS

In a matter of months, you can quit your no-future job for a big-pay, big-future career as an Auto-Diesel Mechanic. Free Illustrated Book gives you the facts. Send coupon below. No Obligation. No Salesman will call.

All Phase Training

N. T. S. students become skilled, all-around mechanics. Crystal-clear lessons, Shop-Tested manuals, real professional equipment, make it easy to learn. Big equipment kits, yours to keep. Earn as you learn... we show you how. Graduate Advisory Service.

N.T.S. Training is Better, More Complete, Lower Cost BETTER...

Because training is **SHOP-TESTED** in Resident School Shops & Labs. **MORE COMPLETE**... You learn all phases of Auto Mechanics & Diesel. **LOWER COST**... One low tuition covers entire cost of course and all equipment.

Unlimited Opportunities

Trained mechanics make top money...are in demand at dealer shops, garages, large bus and truck lines, construction projects, government labs, factories, and many others.

YOU GET AND KEEP ALL THIS PROFESSIONAL EQUIPMENT



• Complete set of master mechanic tools & tool box.



• Meter analyzing set - 4 test units in metal case.



• Socket Wrench Set with fittings for all engines.

NATIONAL TECHNICAL SCHOOLS

WORLD WIDE TRAINING SINCE 1905
4000 SO. FIGUEROA ST., LOS ANGELES 37, CALIF., U. S. A.



FREE!

Illustrated Fact Book
& Actual Lesson

Mail coupon now.

Complete TV-Radio Electronics training also available.

RESIDENT TRAINING at Los Angeles!

If you wish to take Resident Training at Los Angeles, in our Big, Modern Shops & Labs, check special box in coupon for full information.

(Regis. Appl. for)

NATIONAL TECHNICAL SCHOOLS

WORLD-WIDE TRAINING SINCE 1905

MAIL NOW TO
NATIONAL TECHNICAL SCHOOLS, Dept. DB-128
4000 S. FIGUEROA ST., LOS ANGELES 37, CALIF.

Send for **FREE** Auto-Diesel Opportunity Book and actual Lesson.

NAME _____ ADR _____

ADDRESS _____

CITY _____ STATE _____



Member



YOUR
NEIGHBORHOOD
NEEDS AN
**ELECTRICAL
APPLIANCE**



TROUBLE SHOOTER

Men needed to repair and service
all kinds of Electrical Appliances—
**AUTOMATIC WASHERS · DRYERS
IRONS · VACUUMS · TOASTERS
REFRIGERATORS · FANS · HOME
FREEZERS · AIR CONDITIONERS**
—home and industrial motors, etc.,
also home and industrial wiring.

Big, Year-'Round Profits!
HELP US FILL HUGE DEMAND

MODERN BIG PROFIT ONE-MAN BUSINESS
YOURS AT HOME — SPARE OR FULL TIME.

No previous experience needed. New, visual "Shop-Practice" method quickly shows you how. Hundreds of plain-as-day "How to" photos and drawings make it easy. A corner of garage, porch, attic, or basement is all the space needed. No costly leases—no big overhead. We show you how to make business come to you.

BIG MONEY, SECURE FUTURE—INDEPENDENCE.

F. V. in N. Y. says, "I made \$600 in 3 months while studying." T. E. H. in W. Va. says, "Made \$14 a day while learning."

EVERYTHING FURNISHED—including BIG TOOL KIT
Instructions are complete and include a Tool Kit and Appliance Tester. Everything furnished to help you build your own big-profit business at home. Our new 30-day income plan shows you how to start making money almost at once. Send no money—just your name and address on coupon below. I will rush you FREE complete success plan with full details. Do it NOW—BE FIRST!

PACIFIC TRAINING SCHOOL, Dept. PMS812
11029 So. Vermont Ave., Los Angeles 44, Calif.

PACIFIC TRAINING SCHOOL, Dept. PMS812
11029 So. Vermont Ave., Los Angeles 44, Calif.

Gentlemen: Rush me postpaid your FREE plan for success in the Appliance Repair Business and the Free Book Entitled "The Appliance Repair Business and You" and remember I am under no obligation.

Name _____
Address _____
City _____ Zone _____ State _____

NEW 30-DAY INCOME PLAN!

Shows you how
to start your own
Big Profit Business
without investment
—no big overhead

Send
for this
FREE
BOOK!
AIR MAIL
COUPON NOW!



LEARN UPHOLSTERY

in your spare time
run your own
business AT HOME

BE YOUR OWN BOSS

Earn more from the start while learning! Set up your own profitable business at home, enjoy steady income, independence—You're in demand—in good times and bad in the booming field of Custom Furniture Upholstery. **EARN WHILE YOU LEARN . . . the easy UTS way.**

Right off you start with tools, complete frames, fabrics, materials, ALL FREE with your practical, N. Y. State-approved UTS course. You learn skilled professional custom upholstery, reupholstery, furniture finishing, repairs; to make slip covers, window cornices, cushions, draperies in your spare time. Send for FREE Illustrated Book, Sample Lesson

Get ready for well-paid job, steady work and big profits as your own boss. Also Training in N.Y. School. APPROVED FOR VETERANS.

MAIL COUPON TODAY. No obligation.

UPHOLSTERY TRADES SCHOOL,
Dept. GX-310, 721 Broadway, N. Y. 3

Please send me FREE book with FREE Sample Lesson. No obligation—no salesman will call. Home Study In N.Y. School

Name _____
Address _____
City _____ Zone _____ State _____
 Check if Korean Veteran

INVENTORS

PROTECT YOUR INVENTION BY A
U. S. PATENT. SEND FOR FREE
"INVENTION RECORD" FORM AND
"PATENT INFORMATION
EVERY INVENTOR SHOULD HAVE."

CARL MILLER
REGISTERED PATENT ATTORNEY
WOOLWORTH BLDG., 36th FLOOR, 128A
NEW YORK CITY

INVENTORS

Whether an invention is patentable can be substantially determined by a search of the U. S. Patent records. Without obligation, write for information explaining the steps you should take to secure a patent.

JOHN N. RANDOLPH
Registered Patent Attorney
801 Victor Building, Washington 1, D.C.



INVENTORS

U. S. Patents protect your inventions. Our free book of "Instructions on Patent Procedure for Inventors," also "Certificate of Invention" form sent without obligation.

C. A. SNOW & CO.
REGISTERED PATENT ATTORNEYS
428 SNOW BUILDING WASHINGTON 1, D. C.

INVENTORS

Send for
PATENT INFORMATION
Book and
INVENTOR'S RECORD
without obligation

GUSTAVE MILLER
128-PM WARNER BUILDING
WASHINGTON 4, D.C.

**REGISTERED PATENT
ATTORNEY**
ASSOCIATE EXAMINER
U.S. PAT. OFF. 1922-1929
Patent Attorney & Advisor
U. S. NAVY DEPT. 1930-1947
PATENT LAWYER

INVENTORS

I shall be pleased to furnish you,
upon request, with full information
relative to patent procedure—without
any obligation on your part.

PATRICK D. BEAVERS
Registered Patent Attorney
934 Victor Building Washington 1, D.C.

Help Fight TB



Buy Christmas Seals

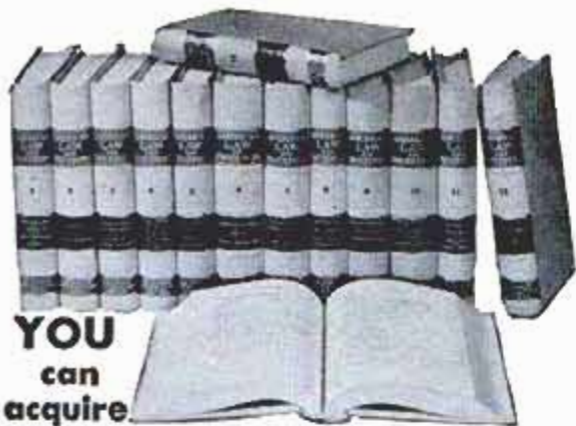

YOU
can
acquire

LAW NIGHTS AT HOME! L.L.B. DEGREE

Legally trained men win higher positions and bigger success in business and public life. Greater opportunities now than ever before.
More Ability: More Prestige: More Money We guide you step by step. You can train at home during spare time. Degree of LL.B. We furnish all text material, including 14-volume Law Library. Low cost, easy terms. Get our valuable 48-page "Law Training for Leadership" and "Evidence" books FREE. Send NOW.
**LASALLE EXTENSION UNIVERSITY, 417 South Dearborn Street
A Correspondence Institution Dept. 1264L Chicago 5, Ill.**

A POSTCARD CAN PUT YOU IN A FINE BUSINESS!

Rush Card TODAY for FREE OUTFIT!

Get into highly profitable, repeat-order shoe business! Sell new line of Air-Cushion comfort shoes to friends, neighbors, folks at work! Over 210 dress, sport, work, safety shoe styles for men, women. Never sold by stores. Just 2 easy orders a day—in spare time—bring you \$217 extra income a month! No investment. Rush name and address TODAY for FREE SELLING OUTFIT!
MASON SHOE, Dept. F-419, Chippewa Falls, Wis.



THERE'S MONEY IN CARTOONS!

Internationally known instructor, RAYE BURNS, will teach you HOW to CREATE ORIGINAL CARTOONS at home that you may SELL! Course contains 26 lessons and over 600 illustrations. Cost of course is very low. Send name and address for free details.

RAYE BURNS SCHOOL, Dept. P, Box 3583, CLEVELAND, OHIO

GROW HERBS FOR US!
AT HOME— IN YOUR SPARE TIME

Help fill our huge demand—used in expensive medicines. Easy to grow indoors or out—multiply rapidly. Year around Profitability! You grow 'em—we buy 'em! We supply everything you need. Free rare seeds and revealing plan is yours free for the asking. Be one of the first to profit—rush name and address to: **NATIONAL HERB EXCHANGE, Dept. A-12 Gardena, Calif.**

FREE SEEDS Write

I'll Send You This Handsome SAMPLE CASE—FREE



and Show You How to Make Up to \$30.00 in a Day

Mail coupon for this Free Tailoring Sample Case packed with 100 beautiful, big-value suits and overcoat fabrics. Take orders from friends, fellow-workers, others, for fine quality, made-to-measure clothes. Pocket big cash profits in advance. Because wearing our suits and overcoats brings more orders, we make it easy for you to get your own clothes without the cost. No experience is needed. **SATISFACTION GUARANTEED. SEND NO MONEY.** Just fill out and mail coupon—today!

**PIONEER TAILORING COMPANY, Dept. H-1116
CONGRESS & THROOP STREETS - CHICAGO 7, ILLINOIS**

**PIONEER TAILORING CO., Dept. H-1116
Congress & Throop Sts., Chicago 7, Ill.**

Dear Sir: I WANT A MADE-TO-MEASURE SUIT TO WEAR AND SHOW, without paying 1c for it. Rush details and Sample Kit of actual fabrics, ABSOLUTELY FREE.

NAME _____ AGE _____
ADDRESS _____
CITY _____ STATE _____

TRAIN AT HOME

in Your Spare Time or in the Great Allied School

1338-42 South Michigan Ave.
Chicago 5, Ill.

DRAFTING—All Branches
• Mech. • Structural • Aeronautical

ENGINEERING
• Industrial Engineering
• Tool Engin. & Designing

ELECTRONICS

AUTO MECHANICS

AIR CONDITIONING
Refrigeration—Heating & Cooling

TOOL & DIE MAKING
Machinist Trade

Choose the Allied Way for Best Pay

SEND FOR FREE BOOKS

Prepare for the best jobs in your spare time at home. With ALLIED'S practical home study program you can progress so rapidly that big new opportunities will soon be open to you. Students planning a career in engineering can begin their training in short courses at Home or at Allied Institute and continue progressively toward an Engineering Degree in 31 months. Allied is approved by Industry, National Home Study Council, Department of Education, Office of Public Instruction, State of Illinois, U. S. Department of Justice.

ALLIED INSTITUTE OF TECHNOLOGY,
1338-42 South Michigan Ave., Dept. PM-128, Chicago 5, Ill.

Send me without obligation information on your courses:

- | | |
|---|--|
| <input type="checkbox"/> MECHANICAL DRAFTING | <input type="checkbox"/> AUTO MECHANICS |
| <input type="checkbox"/> STRUCTURAL DRAFTING | <input type="checkbox"/> ELECTRONICS |
| <input type="checkbox"/> AERONAUTICAL DRAFTING | <input type="checkbox"/> AIR CONDITIONING |
| <input type="checkbox"/> INDUSTRIAL ENGINEERING | <input type="checkbox"/> REFRIGERATION |
| <input type="checkbox"/> TOOL & DIE DESIGNING | <input type="checkbox"/> TOOL & DIE MAKING |
| <input type="checkbox"/> HOME STUDY | <input type="checkbox"/> RESIDENT |
| <input type="checkbox"/> VETERAN | <input type="checkbox"/> NON-VETERAN |

NAME _____ AGE _____

ADDRESS _____

CITY _____ COUNTY _____ STATE _____

SPACE ERA IS HERE! SEE THE SATELLITES . . . MOON ROCKETS!

AMAZING TELESCOPE BUYS AND OTHER OPTICAL BARGAINS



See the Stars, Moon, Planets Close Up!

3" ASTRONOMICAL REFLECTING TELESCOPE

60 to 160 Power — Famous Mt. Palomar Type! An Unusual Buy!



Assembled—Ready to use! You'll see the Rings of Saturn, the fascinating planet Mars, huge craters on the Moon, Star Clusters, Moons of Jupiter in detail. Galaxies! Equatorial mount with lock on both axes. Aluminized and overcoated 3" diameter high-speed $f/10$ mirror. Telescope comes equipped with a GOX eyepiece and a mounted Barlow Lens, giving you 60 to 160 power. Low-cost accessory eyepiece available for power up to 320. An Optical Finder Telescope, always so essential, is also included. Sturdy, hardwood, portable tripod. Valuable STAR CHART and 272-page "Handbook of Heavens."

Stock No. 85.050-H \$29.95 postpaid

4 1/4" ASTRONOMICAL TELESCOPE!

UP TO 270 POWER!



With this scope you can see everything as above but with greater power plus will split finer stars. Mirror has twice the light gathering power. Mirror guaranteed to give theoretical limit of resolution. Rack and pinion focusing, hardwood tripod, real equatorial mounting—only one adjustment follows stars! Aluminum tube. 6 power finder telescope. 2 standard size eyepieces and mounted Barlow lens give you powers of 40X, 90X, 120X, and 270X. Low-cost accessory eyepiece available for power up to 540. Free handbook and Chart. Shipping weight 25 lbs. Stock No. 85.006-H \$74.50 f.o.b.

TAKE PHOTOS of the MOON

Through Your Telescope with EDMUND CAMERA HOLDER for TELESCOPES



Bracket attaches permanently to reflecting or refracting telescopes. Removable rod holds camera over eyepiece to take pictures of Moon . . . or terrestrial telephoto shots of distant objects.

White metal projection screen permits you to see the sun spots! Includes brackets, 28 3/4" rod, projection screen, screws, directions. Order Stock No. 70.162-H \$9.95 Postpaid (Send Check or M.O. — Money-Back Guarantee)

SALE! TERRIFIC WAR SURPLUS BARGAIN! AERIAL CAMERA LENSES



Gov't. Cost \$1218—Now Low as \$39.50 Used Made by B & L and E.K.—24" F.L. $f/6$, in 23" long Lens Cone. Use as long range, Big Bertha Telephoto lens—for Richest field (wide field, low power) telescope, etc. Lenses are 4" dia.—precision 4-element type. Aero Tessar and Aero Ektar (no choice). Easily removed. Diaphragm ($f/6$ to $f/22$) is included. Opens approx. 1" to 3 1/2". Lens and cone—wt. 25 lbs. Sturdy carrying trunk—wt. 26 lbs.

Stock No. 85.059-H 24", used. Price \$39.50 f.o.b. Utah
Stock No. 85.060-H 24", new. Price \$59.50 f.o.b. Utah

MECHANICAL DRAWING SET

Regular Price \$18.00
Our Price Only \$6.00 Postpd.

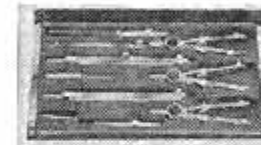

10 handsome pieces in velvet-lined case. Nickel plated brass—precision American-made. Set contains 5 1/2" Swedish Ruling Pen, 5 1/2" Compass, Lengthening Bar for Compass 3 3/4", Interchangeable Pen for Compass 3 3/4", Center Wheel 3" Bow Pen, Center Wheel 3" Bow Pencil, Center Wheel 3" Bow Divider, Adjusting Screw Driver, Spare Parts Container with Leads and Points. We guarantee you will be satisfied or money refunded.

Stock No. 50.200-H \$6.00 Postpaid
Quantity Price: 5 sets for \$5.50 each Postpaid
10 Sets for \$5.00 each Postpaid



New! 2 in 1 Combination! Pocket-Size 50 Power MICROSCOPE and 10 Power TELESCOPE

Useful Telescope and Microscope combined in one amazing, precision instrument. Imported! No larger than a fountain pen. Telescope is 10 Power. Microscope magnifies 50 Times Sharp focus at any range. Handy for sports, looking at small objects, just plain snooping. Send Check or M.O. Satisfaction Guaranteed. Order Stock No. 30.059-H \$4.50 Postpd.

STEREO MICROSCOPE



American-Made Instrument at Over 50% Saving. Up to 3" Working Distance—Erect Image—Wide 3-Dimensional Field. Used for inspections, examinations, counting, checking, assembling, dissecting. 2 sets of objectives on rotating turret. Standard pair of wide field 10X Kellner Eyepieces give you 23 power and 40 power. Helical rack and pinion focusing. 10-DAY TRIAL . . . Complete satisfaction or your money back. Order Stock No. 85.056-H. Full price . . . \$99.50 f.o.b. Barrington, N.J. (Shipping wt. approx. 11 lbs.) Send Check or M.O.

TELESCOPE CAMERA

Ideal for taking shots through telescopes of moon, stars—terrestrial telephoto shots. Uses sheet film. 4-element lens. Included with camera:—Film holder, 2 1/4" x 3 1/4"; yellow filter; cable release; 3 1/4" x 4 1/2" piece ground glass. Camera box size is 3 x 4 x 5". Tube that fits eyepiece holder is 5" long, 1 1/4" O.D. for standard telescopes. Precision German-made shutter, speeds of T., B., 1 sec., 1/2, 1/5, 1/10, 1/25, 1/100 and 1/200. Also has delayed action shutter release. Stock No. 70.166-H \$39.50 Postpaid



ERECT IMAGE LOW POWER MICROSCOPE

5X, 10X, 20X

\$80.00 Value — Only \$19.95



Extremely sturdy with rack and pinion focusing, color corrected optics, turnable microscope body for inclined viewing, three different powers, long working distance under objectives, sufficient eye relief for easy viewing. Made from war surplus optical instrument so that you actually get \$80.00 of value. Weighs 4 lbs., 13" high. 10-DAY FREE TRIAL! Accessory objectives available for powers of 15X, 30X, 40X.

Stock No. 70.172-H \$19.95 Postpaid

PORTABLE JR. PLANETARIUM

Battery Operated



Ideal for beginners. Low priced to satisfy the mass interest in the "Geography of Space." Operates on dry cell batteries with bright or medium light intensity. Projects over 60 constellations on ceiling or wall of any darkened room. Complete with flashlight pointer (batteries included)—giant instruction sheet with colorful Constellation Chart.

Stock No. 70.165-H \$9.95 Postpaid
PLANETARIUM — for operation on house current.

Stock No. 70.040-H \$19.95 Postpaid

NEW! STATIC ELECTRICITY GENERATOR



See a thrilling spark display as you set off a miniature bolt of lightning. Absolutely safe and harmless. Stands 14" high. Turn the handle and two 9" plastic discs rotate in opposite directions. Metal collector brushes pick up the static electricity, store it in the Leyden jar type condenser until discharged by the jumping spark. Countless tricks and experiments. 24 page instruction booklet included.

Stock No. 70.070-H \$10.95 Postpaid

FREE CATALOG-H

Yours for the asking

America's No. 1 source of supply for experimenters, hobbyists. Complete line of Astronomical Telescope parts and assembled Telescopes. Also huge selection of lenses, prisms, war surplus optical instruments, parts and accessories. Telescopes, microscopes, satellite scopes, binoculars, infrared sniperscopes, etc.

REQUEST CATALOG-H



ORDER BY STOCK NUMBER. SEND CHECK OR MONEY ORDER. SATISFACTION GUARANTEED!

EDMUND SCIENTIFIC CO., BARRINGTON, NEW JERSEY

**WORLD'S
BEST
WANT-AD
MEDIUM**

CLASSIFIED ADVERTISEMENTS



Advertisements in this section \$1.25 per word, each insertion, minimum 10 words, payable in advance.

To be inserted under proper classification, copy must be in our office the

20th of the second month preceding date of issue

F. W. Johnson, Manager, Classified Advertising

Popular Mechanics Magazine, 200 East Ontario Street, Chicago 11, Illinois

YOU'LL PROFIT

By reading and answering the classified ads in this section. Hundreds of opportunities for you to make and save money

AUTOMOBILES, MIDGET CARS

FIBERGLASS Bodies for children's cars. Racers, sportcar. Literature 25¢. Amroc Engineering, Island Park, N. Y.

NON-Profit organization offers automobile catalogs, old, modern and foreign; dealer books, glossy photographs, service manuals; free motor magazines. Write to get on free mailing list. Auto Maniacs, Stockbridge, Mich.

SUPERIGNITIONER: Starting, pep, mileage \$4.50. Vartypers, IBM's, Kaisers, barbells. EG, Elmsford, N. Y.

WORLDWIDE Old car club literature free. Send stamp Worldwide Car Club, Department A, Box 20749, Los Angeles 6, Calif.

FABULOUS New midget racer. Build yourself. Complete plans. Send \$3.00 to Bobcat, 606 So. Main, Council Bluffs, Iowa.

DISTRIBUTOR Wanted. Can earn \$1,000 wk. Fast selling midget race cars. Fully assembled 2½ h.p. engine, 10" tires, 2-wh. brake, roll bar, clutch. Costs \$88. Sells at \$189. Rents at \$20 hr. Write My-On, 407 N. Maple Dr., Beverly Hills, Calif.

MIDGET Car. Plans and pricelist of parts 35¢. B. Sypher Co., Sta. F., Toledo, Ohio.

NEW 1959 Automobiles—To 25% off retail. Meder, 550-PM Fifth Avenue, New York City 36.

BOOKS: Hundreds of subjects. Big 1958 book catalog—10¢. Popular Mechanics Press, 200-BC East Ontario St., Chicago 11.

AUTO SUPPLIES AND EQUIPMENT

1959 GIANT Auto parts catalog. Thousands scarce accessories stores don't have. Gadgets, custom equipment. Send 25¢ postage (refundable). Newhouse Automotive Industries, 5805-PM-12 Beverly, Los Angeles 22, Calif.

AUTO Shop welding repair training in world's largest non-profit welding school. Catalog free. Hobart Welders, Box M-1281, Troy, Ohio.

PARTS Model A, older V-8s. Express needs. Matco, Box 135, San Pedro, Calif.

DEMINERALIZED Water for batteries, steam irons, laboratory work. Send 25¢ (refundable first order). Metro Service, Box 111, Ridgewood, N. J.

CAR Radios—New, used. \$5.00 up. Everything automotive, new, used. American Auto Parts, 2127 E. Washington, Indianapolis, Indiana.

CRANKSHAFT Grinder. Hand operated makes bearings fit without taking engine apart. \$3.75. Literature. L. D. McGee, 719 Cascade St., Wenatchee, Wash.

1909-1934 NEW Ford parts. Catalog 25¢. Mark, Layton, New Jersey.

1959 EDITION. It's new! It's different! Get world's largest auto accessories and parts catalog, save up to 50%. 308 pages, over 85,000 items for 1920 to 1959 models including Hollywood accessories, custom styling and hi-speed equipment. All parts and accessories for all cars and trucks. We have that hard to get part. Jam packed with bargains. Completely illustrated. Send 25¢ (refundable). J. C. Whitney, 1919 PM-11 Archer, Chicago 16, Ill.

AMAZING! Automobile coin dispenser. \$1.00. Tolls, parking. Free information. Carcoin, Box 6838, Kansas City 30, Mo.

CHRISTMAS Special values. Free listing. Ledbetter Enterprises, 1015 West 17th, Texarkana 4, Texas.

JEEP Owners—V-8 conversions. Read Jeep Owners ad, page 16.

TEN Gas-saving tips, 10¢. Bayer, 938 Betty, Neenah, Wis.

JEEP Tops. Convertible tops. Free catalogue. Mor-Nan, Box 141, Beverly, Mass.

SUPREME Racing camshafts. Cleveland Hone & Mfg. Co., 8816 Harkness, Cleveland 6, Ohio.

RING-Valve job while driving, \$6.00. Free details. Motaloy, Grantham, Penna.

PUT Pep in your car. Details free. Automotico, 1727 Ninth Avenue, San Francisco 22, California.

REVOLUTIONARY Gasoline saver device! Particulars, send 10¢, refundable. Grable Enterprises, 26314 Normandy, Roseville, Michigan.

BARGAIN. Exciting Little Library booklets, 25¢ each. How to use tools, painting, welding, home improvement, games, models, plastics, lamp making, glass blowing, boats, photographs. Free Little Library catalog. Popular Mechanics Press, 200-LB East Ontario St., Chicago 11.

SAVE Money on Jeep and army truck parts. Large inventory. Catalogs for Jeep or G.M.C. owners. American Auto Parts Co., 1830 Locust, Kansas City, Mo.

FREE! New catalog. Speed, power, mileage increasing equipment. Discounts! Almqvist Engineering, Milford PM5, Penna.

NEW And used parts at savings. Complete guaranteed parts service for all models cars and trucks, 1924 and later. Largest in the West. Jeep and army parts specialists. Newest type shifting hubs for all jeep and all military and latest production front end drive vehicles. \$27.50 and up. Write. Pioneer Auto and Truck Parts Co., 734 W. 13th Avenue, Denver 17, Colo.

AUTOMOTIVE Books. Send for 1958 book catalog—10¢. Popular Mechanics Press, 631 N. St. Clair St., Chicago 11.

NEW Redmond 6-volt heater-defroster motors, \$2.00 postpaid. With 12-volt adapter, \$2.75. Lee Mfg., 10630 Hillhaven, Tujunga, Calif.

AUTO TRAILERS

BUILD Your own 7'x12' house trailer. Double bed, sink, propane, cabinets, complete as the \$975.00 trailers. No special tools required. Material available everywhere for less \$190.00. Mail \$2.00 for complete instructions and blue prints. D.&M. Co., Box 101A, Wheatland, Okla.

TRAILER Building guide, supply catalog \$1.20. Blueprint booklet floor plans, 60¢. Kamcraft, Box 1153, Milwaukee 1, Wis.

BUILD Expanding eight foot trailer. Accommodates five. Literature 10¢. FraMa: Company, Wilmington, Mass.

MOTORCYCLES, BICYCLES, MOTORSCOOTERS AND SUPPLIES

1000 MOTORCYCLE Bargains at giveaway prices. World wide parts service. We trade for anything. Catalog 25¢. Bunico, 146-BK, Covington, Virginia.

HEADQUARTERS, Motorcycles, ample supplies. Ask us, 813 Ohio, Wichita Falls, Texas.

WORLDWIDE Motorcycle club literature free. Send stamp Worldwide Motorcycle Club, Department A, Box 20749, Los Angeles 6, Calif.

MICRO—Midget \$15, motorscooter \$20, motorbike \$5, less engines. Engines \$4 up. Go cart \$60. (Mailorder only). Send 25¢, (35¢ for first class mailing) for 32-page directory-catalogue number 86, listing these and hundreds of other bargains in midget cars, motorscooters, homebuilders parts, plans, etc. Midget Motors Directory, Athens, Ohio.

HARLEY - Davidsons — Used bargains. New, used parts, accessories for all models. Bulletin, catalog 25¢. Knuth's (Factory Dealer), 1753 Muskego, Milwaukee, Wis.

RECONDITIONED Motorcycles and motors. Chromium accessories. Complete stock Indian parts. Expert rebuilding. Fast service. Indian Motorcycle Sales, Kansas City 27, Missouri.

RACING Power cams for Cushman, Whizzer, Mustang, Hiawatha, Continental. Send your cam and \$10. Weber Cams, Box 33175, Los Angeles 33, Calif.

AVIATION

BOOKS, Aviation. Free catalog. Aero Publishers, 2162-PM-12 Sunset, Los Angeles 26, California.

UNUSUAL Flying platform. Scale drawings, description, \$2.00. Shelby Industries, Box 516-Y, San Anselmo, California.

HELICOPTER, Kits, plans. Free brochure. Adams, Box 6642-H, Lakewood, Calif.

BOOKS: Hundreds of subjects. Big 1958 book catalog—10¢. Popular Mechanics Press, 200-BC East Ontario St., Chicago 11.

HELICOPTER Mechanics urgently needed. Train at home. Southern Cross Helicopter Institute, 345 SIP, Jersey City 6, N. J.

PRINT, Full color Boeing B-47 in flight, authentic reproduction of official U. S. air force photograph. Size 20 x 30. Send \$1.00 ppd. to Preferred Prints, Dept. M, P. O. Box 408, New York 36, New York.

AIRLINE Careers. Starting salary \$3400 up. Short, easy course. G.I. approved. Free catalog B. McConnell Airline School, 1030 Nicollet, Minneapolis, Minnesota.

AVIATION Surplus bargain catalogue. One dime. Box 22PM8, Thomasville, Penna.

SMALL Helicopters theory and guide manual. Drawings. Construction data. \$2.00. Sandhill Aircraft, Box 336, Atkinson, Nebraska.

PROPELLERS, Plans, supplies for airboats and snowplanes. Latest designs. Prompt delivery. Catalog 25¢. Banks-Maxwell, Box 3301E, Ft. Worth 5, Texas.

ELECTRICAL SUPPLIES

APPLIANCE Parts wholesale. Catalogue 25¢. Selco, 26 South 20 Street, Birmingham 3, Alabama.

SHORT Circuits—Pin-pointed within 5 feet, or your \$4.50 back. Own a pocket size Dynamic Short Locator. Dynamic, 509-1D8 Main St., Harwich Port, Mass.

BOOK 200 Electric stunts \$1.00. Kutting, 28278 Arastradero, Los Altos, Calif.

ELECTRIC Pencil: Engraves all metals \$2.00. Beyer Mfg., 10511-H Springfield, Chicago 43.

FREE Fluorescent lighting catalog. Inexpensive kits, parts, fixtures. Shoplite, 650M Franklin, Nutley 10, New Jersey.

LAMP, Electrical parts, wholesale. Thousands of items for repairing, converting. Catalog 25¢. Brown Lamp, Box 305, Clayton 5, Mo.

HOUSE Wiring—Electrical repairs. Booklet. Send for 1958 book catalog—10¢. Popular Mechanics Press, 633 N. St. Clair, Chicago 11.

LAMPS—Parts catalog containing wiring instructions, 25¢. Gyro Lamps, 3438P N.W. 54 Street, Miami, Fla.

WELDING, SOLDERING, PLATING

NEW All-in-one oxyacetylene outfit welds sheet, plate; cuts heavy steel; heats, brazes. Uses interchangeable tips. Portable, easy to operate. Complete with instructions. \$84.50. Gas cylinders on special moneysaving plan. Write for free information: Dept. M, Linde Company, 30 East 42nd Street, New York 17, New York.

FREE Factory catalog. Welders, welding accessories. Build 350 ampere welder from aircraft generator. Plans 10¢. LeJay Manufacturing, Minneapolis, Minn.

WELDERS, 110/220, \$39.50. Morris, 1070 Inner Drive, Schenectady 3, New York.

PLATING Equipment, supplies. Complete line of anodes, solutions. Home workshops, industrial sizes. Hollywood Bronze Supply, Dept. C, 1624 East First, Los Angeles 33, California.

FREE Catalog, welders, welder kits. Build 300-ampere welder using aircraft generator, plans 25¢. Agents wanted. Dunbar Manufacturing, Minneapolis 8, Minn.

MACHINERY, TOOLS, SUPPLIES

POWERFUL Hack saw attachment for 1/2" drills. Lifetime guarantee. \$5.45. Williams, 904 61st Terrace, North Kansas City 16, Mo.

NEW Spark plugs, 65¢ postpaid. State make, model. Smith, Box 448, Quanah, Texas.

PRECISION Tools, pipe fitter tools, \$500 value for \$150. Private party. Send for list. Chas. Rattner, 90 LaSalle St., New York 27, N. Y.

WEASEL Parts. You build your snow tractor. Symington's, Union Bay Place, Seattle 5, Wash.

NEW Grip locking wrench, and vise. Both adjustable, trigger release. Circular free. Manufactured by Travis Tool Company, Sidney, Iowa.

WHOLESALE Tool catalog. Send \$1.00. Yuhas, P.O. Box 5363, Detroit 11, Mich.

ENGINES, MOTORS, DYNAMOS

WINDING Data, 275 motors, single and three phase, \$1.10. Data Company, Box 7631, Kansas City 28, Mo.

REWIND Motors yourself. Complete instructions \$1.00. Lewis Mfg., Howell, Michigan.

DIESEL Injector parts wanted. GM51-71-110. Bares, 7120 Carnegie, Cleveland 3, Ohio.

ALTERNATING Current generators, 750 watt, \$42.50, twincylinder compressors with 1/2 horse \$22.00; motors, 1 horse, \$38.50. Butler, 1885 Milwaukee, Chicago.

BOATS, OUTBOARD MOTORS

BOAT Plans—Full size patterns, frame kits. Modern inboards and outboards for amateur builders. Complete new catalog 50¢ or specify requirements. Glen Designs, 9152 Rosecrans, Bellflower, California.

FREE Catalog! Boat kits, trailers, fiberglass, marine hardware. Luger Industries, Dept. M-12, 9200 Access Rd., Minneapolis 20, Minnesota.

ALUMINUM Boat kits \$99.50. Fishing, runabouts, Catalog 10¢. Pepco, Tishomingo, Oklahoma.

BOAT, 14 Ft. Fiberglass outboard. Mahogany trim, only \$395 f.o.b. Toledo. Free catalog. Bock Boats, Inc., Toledo 2, Ohio.

260 POWERBOAT Plans, patterns, catalog 50¢ postpaid. Marinecraft, Box 161-M, Brighton, Mass.

ALUMINUM Boat kits, save 50% literature 10¢. Alumakit, Box 42, Beverly 13, Massachusetts.

BOAT Leaking? Make it dry. Fiberglass covering kits, molding supplies. Aqua Glas, Box 99, Altadena, Calif.

STEAM Boats, cars. Build with our engines, folder 25¢. Tiny Power, Corvallis, Oregon.

FIBERGLAS Permanent boat waterproofing. Special 25% discount. Complete kits, \$9.45 up. Guaranteed materials. Easy application. Full instructions. Free literature. Ajax Plastics, Dept. PM, P.O. Box 1323, Fort Worth, Texas.

MARINE Conversions. Ford, Chevrolet, Jeep engines. Catalog 25¢. Lehman Manufacturing Company, 972D Broad Street, Newark 2, New Jersey.

BUILD Small boats. Send for 1958 book catalog—10¢. Popular Mechanics Press, 633 N. St. Clair St., Chicago 11.

PROPELLERS, Plans, supplies for airboats, snowplanes. Catalog 25¢. Banks-Maxwell, Box 3301F, Ft. Worth 5, Texas.

SAVE Money. New, used outboard motor parts. Send wants. Stamp appreciated. Outboard Motor Mart, 229-M State, Boston 9, Mass.

NEW, Used, rebuilt marine motors. Marine conversions, fittings. Free catalog. Stokes Marine Supply, Dept. 24, Coldwater, Michigan.

FULL Size, cut-to-shape boat patterns, blueprints, 7 1/2-38 feet. Big new 88 pg. illustrated "Build a Boat" catalog of naval architect-designed cruisers, runabouts, skiffs, outboard boats, sailing, racing, houseboats, 50¢. "How to Build a Boat" booklet, \$2.50. Hardware and equipment catalog, \$2.00. Cleveland Boat Blueprint Co., Dept. A-66, Box 1651, Cleveland, Ohio.

I want to send you proof of the wonderful pulling power of Popular Mechanics classified pages. What's your proposition? Write me today. Include literature if possible. F. W. Johnson, Manager Classified Advertising, Popular Mechanics Magazine, 200 E. Ontario St., Chicago 11, Ill.

MARINE Conversion, Willys to Cadillac, engines, kits and parts. Catalogue and conversion hints free. Barr Marine, 2706 Castor Avenue, Philadelphia 34, Penna.

ATHLETIC EQUIPMENT, BODY BUILDING COURSES

STRENGTH, Health, muscles. Gain, reduce. Amazing guaranteed discovery uses only a rope! Free booklet. Ropercise, 4834-A Art Street, San Diego 15, California.

KARATE Kung-Fu. Deadliest oriental defensive system. Power that splits planks, masonry bare-handed. Profusely illustrated manual \$3.98. J. Yim Lee, 771 Sacramento St., San Francisco, Calif.

JUDO Defeat bullies—36 lessons \$1.00. 1112 Tipton St., High Point, N. Car.

DON'T Be pushed around. Profusely illustrated home training manuals show how to defeat bullies. Police wrestling; American Judo; lightning Jiu-jitsu; \$1.00 each, all three \$2.00. C. B. Dudley, Athens, Ga.

FREE Muscle building information. Body-Tone, Box 638B, North Miami, Florida.

BARBELLS, Dumbbells. Courses. Booklet 10¢. Good Barbell Co., Siloam Springs, Arkansas.

SPORTING GOODS, GUNS, FISHING TACKLE, ARCHERY, TRAPPING

FREE—Wholesale catalog. Beads, Spinners. Lure parts. Sinkers molds. Jigs, Reels, FinnySports (ME), Toledo 6, Ohio.

CANNED Heat. Send one dollar for 12 cans postpaid. Paco, Box 3742A, Seattle, Washington.

154 PAGE Catalog—A real "dream book" for fishermen! It's free! Netcraft Company, Dept. B12, Toledo 13, Ohio.

GLACIER Park fishing and visitor's guide. '59 edition. Self guiding manual, lots pictures. \$2 ppd. Charles Green, Coram, Montana.

SPINNING Spool, new fishing outfit. \$5.95. Princess Gifts, Ridgeville, S. C.

COLUMBUS Game for pond or pool. Mac's Hobby Ranch, P.O. Box 14, Dalls-town, Penna.

SOUVENIR Florida buck and fishing guide 35¢, 3 for \$1.00. Gay's Standard, West Main, New Port Richey, Florida.

KILL Submersed water weeds which foul up motor propellers, tangle fishing gear and choke irrigation ditches with R-H Granular Weed Rhap-20. Inexpensive, easy to use, sure results. For details write Reesor-Hill Corporation, Box 36PM, Jacksonville, Arkansas.

CROSSBOWS—Hunting bows! Factory direct prices. JayCo, Box 1355, Wichita, Kansas.

FREE—Giant 1958 wholesale sporting goods catalog. Lowest wholesale prices. Complete line of cameras, sporting goods, appliances, outdoor items, toys. Write today, Santa Fe Distributing Co., 1321 Main St., Dept. PM, Kansas City, Mo.

MOLDS For fisherman's sinkers, jigs, squids, casting and spinning lures. Free catalog. Sweet's Molds, Tonawanda 1, New York.

5000 BARGAINS, Firearms, binoculars, war relics. Catalog 50¢. Smith Firearms, Runnemed, N. J.

AMAZING Wholesale sporting catalog. Save 70%. Tremendous selections. Econ-O-Mart, Whippany 2, New Jersey.

BUY Wholesale! 100,000 nationally advertised products. Appliances, cameras, sporting goods, housewares, watches, typewriters, tools, clothing, etc. Discounts to 80%. Buy-Rite, Box 258, Hawthorne 29, New Jersey.

JAP Rifle altering to 30-06, \$6.00. Jap-shells, \$3.95. Catalog 10¢. T. P. Shop, West Branch 11, Mich.

GUNS! 5,000 Guns! British Enfields \$13.95, \$29.95! Springfield \$39.95! Lugers, Krag, Colts, Kentuckies, elephant guns! Bargain catalog 50¢. Agramonte's, Yonkers 2-G, N. Y.

GUN Bargains! Scopes and mounts, 30% off! Loading tools, binoculars, gun bargains! Catalogs, 25¢. Discounts Unlimited, Box 38, Hastings on Hudson, N. Y.

EARTHWORMS, CRICKETS, FROGS

RAISE Earthworms for profit or for your own use. Write for free folder. Angler's, P.O. Box 265, Malibu, Calif.

FREE Details, literature. Raise red hybrid earthworms. Campbell's Fishbait, Fort Payne, Alabama.

GUARANTEED Market! Earn ready cash raising fishworms for us! Backyard, garage, basement! We buy your crop! Exciting details free! Oakhaven-56, Cedar Hill, Texas.

DO-It-Yourself booklets, 32 different home and hobby projects. Send for 1958 book catalog 10¢. Popular Mechanics Press, 631 N. St. Clair St., Chicago 11.

TAXIDERMY

FREE Book tells how you can learn taxidermy and tanning. Fascinating, profitable hobby. Send postal. No obligation. State age. Northwestern School, Dept. 2592, Omaha 2, Nebr.

BINOCULARS, TELESCOPES, MICROSCOPES, MAGNIFIERS

DYNASCOPES—Sensational new reflector telescopes. Send for details. Criterion Co., Dept. DP 51, Hartford, Conn.

POWERFUL Stand magnifier—10 diopter. Mounted on solid base with adjustable ball socket, \$4.25. Fitzgerald, Box 1764, Longview, Texas.

BINOCULARS, Telescopes, microscopes, terrific values \$3.98 up. Request free money-saving catalog. Criterion, Dept. F73, Hartford, Conn.

BINOCULARS—Importers closeout. Only \$1.00. Worth much more. Moneyback guarantee. Universal Trading Company, P.O. Box 3103, St. Louis 5, Mo.

BUILD Your own reflector telescopes. Complete kits; mirrors, eyepieces, tripods, all other accessories. Request free illustrated literature. Criterion Manufacturing, Dept. DPM 48, Hartford, Conn.

ASTRONOMICAL Reflecting telescopes. Full 3" diameter precision mirror. Completely assembled, \$14.95. Send for free literature. Space Age Equipment, 421 Fontenelle, S.E., Grand Rapids 8, Mich.

SPECIAL Sale, amazing prices precision binoculars. Folder, "Binocular Selecting," catalog free. Prentiss Importers, Mercury Bldg., West Los Angeles 25, Calif.

ANOTHER First—The Escope 5" reflector completely assembled, 115X \$59.95. Free information. Esco Products, Oakridge, N. J.

AMAZING New telescope. Free circular. Telescope Sales, 3562 Third, Detroit 1, Michigan.

REFLECTOR Telescope kits \$7.25 (3") to \$175. (12"). Mirrors, cells, focusing mounts, tripods, eye systems. Anything, everything in telescopes. Optics, also binoculars, microscopes, optical instruments. Free catalog. Also ready to use telescopes from \$25. Esco Products, Oakridge, N. J.

WAR Surplus bargains: Millions of lenses, instruments, telescopes, binoculars, components and complete line of astronomical telescope items. World's greatest optical market-place! Send only \$1.00 for beginner's 10-lens kit and big instruction booklet stock 2-CH. Write for catalog CH free! Edmund Scientific Co., Barrington, New Jersey.

REFLECTING Telescope, 60X, completely assembled \$29.75. Guaranteed observatory clearness. Free information. Skyscope, P.O. Box 55, Brooklyn 28, N. Y.

REFRACTOR And reflector telescopes. Also mirrors, lenses, tripods, etc. Free illustrated catalog. Suffolk Science, Mattituck, N. Y.

FREE 48 Page science catalog. Optical, biological. Research Scientific, 126M West 23rd St., New York City 11.

PLANTS, SEEDS, BULBS, NURSERY AND GARDEN SUPPLIES

GROW Dwarf trees! Pot, sell. Instructions and seeds 35¢. Mail Order Specialties, 1439PM-6 Sabraton Ave., Morgantown, W. Va.

SEED. Blue spruce, magnolia, red barberry, pyracantha, Rose of Sharon, mimosa, lilac, Norway maple, buttonwood, others. Bill Wentzell, Elmer, New Jersey.

WORLD'S Greatest cash crop. Free information. Write Ginseng Gardens, Asheville, N. C.

PETS—DOGS, BIRDS, RABBITS, HAMSTERS, ETC.

HAMSTERS—Golden: Young, \$3.00 pair, breeders, \$4.00 pair. New mutation, \$5.00 pair. Adirondack Hamstery, Prospect 20-Z, New York.

INCREASE Rabbit profits. Read "National Rabbit Raiser Magazine," 422-D South 6th Street, Minneapolis 15, Minnesota. Year, \$2.00.

GERMAN Shepherd puppies by Rin Tin Tin's son. Lookout Kennels, Jacksonville, Texas.

BIRDS, Animals. Every description. Catalog \$1.00 (refundable). Jungleland, Laurel Hill, Florida.

CROWS Make comical talking pets. Only \$4.95 and express. Logston's Box 3045, Fort Worth, Texas.

SHELTIES (Miniature collies) AKC champion pedigree. Astolat Kennels, Kunkletown 5, Penna.

PURE White pedigreed police puppies. Also bred females. Ansonia Kennels, McHenry, N. Dak.

GOLDEN Hamsters—Pedigreed breeders \$3.85 pair. Literature. Moore's Hamster Ranch, Shepherdstown 25, West Virginia.

EARN \$10,000 Yearly raising Angora rabbit wool for us. Information 25¢ coin. American Angora Company, Malta 12, Montana.

RAISE Rabbits successfully by knowing facts. 48 page illustrated book describing 25 breeds. Housing, feeding, breeding, marketing, etc. Plus bulletin. 25 cents. American Rabbit Association, 36 Arba Building, Pittsburgh, Penna.

MAKE Money raising chinchillas, mink, nutria, rabbits, cavies for us. Free catalog. Keeney Brothers, New Freedom 2, Penna.

HAMSTERS—Ideal pets, \$2.95 pair. Free booklet. Jer-Fre's Hamstery, 2216 East Broadway, Muskegon 13, Mich.

STRAIGHT Cooners! World's oldest kennel. Combination hounds, rabbit, fox, beagles, deerhounds, bird dogs. Puppies of all breeds. Prices reasonable. Trial. Free catalogue. Raccoon Mountain Kennels, Box 464, Boaz, Alabama.

RAISE Rabbits on \$500 month plan. Plenty markets. Free details. White's Rabbitry, Delaware, Ohio.

SPORTSMEN: World's largest kennels offers 500 bird dogs, straight cooners, combination hounds, beagle hounds, rabbit hounds, small squirrel dogs, fox and deer hounds. Catalogue free. Smokey Mountain Kennels, Cleveland, Tennessee.

FUR BEARING ANIMALS

GENUINE Lacosta nutria. Originated, developed, proven, trade-marked by Voight Farms, Atlanta 2, Texas.

NUTRIA Facts free. Mutations reasonable. Surley Nutria Farm, Mansfield 5, Texas

MINK Raising information free. Complete. Lake Superior Mink Farm, Superior, E.E.I. Wisconsin.

RAISE Mink: Free booklet, pen plans, inside secrets, feed, care. Mink are money makers. Investigate today. Lawrence Moggard, Brigham City 12, Utah.

FARMS, FARM LANDS, REAL ESTATE

FLORIDA Grove and home! Only \$8,500! Completely fenced, all-tillable 14-acre rancho! In beautiful citrus belt! 4-acre citrus grove. Deep well. Partly-furnished 4-room home, bath. Garage. 1/4 mile fishing lake, mile town. 45 Tampa. Exciting retirement package at \$8,500, half down. Prompt possession! Free winter catalog, bargains coast to coast! United Farm Agency, 2825-PM Main St., Kansas City 41, Mo.

CENTRAL Florida lakefront home sites, \$795 at \$15 monthly. Literature. Grace Parker, Paisley, Florida.

FLORIDA Homesites—Big, beautifully wooded, \$290. Only \$10 monthly. Free brochure. Write today! Wendell Wood, Fountain, Florida.

FLORIDA 2 1/2 Acres, near Gulf; 50 foot elevation, \$795.00; \$15.00 down and month. Russell Hancock, Realtor, Brooksville, Florida.

FLORIDA. All types of property. Low taxes. Realtor Cummins, Eustis.

FREE Strout catalog! Farms, homes, businesses, resorts, retirement properties. Over 3000 values in 36 states. 58 years' service. World's largest! Write Strout Realty, 7-MP S. Dearborn, Chicago 3, Ill.

LAKEFRONT. Highway, acreage and trailer lots, from \$295.00. Fifteen central Florida developments. Monthly terms. Box 3905, DeLand, Florida.

FREE Florida Silver Springs Ocala folder. Homesites \$595.00, \$10.00 month. Write Silver Springs Guaranty Land & Title Corporation, 366 WP, Eight Mile, Detroit 20, Michigan.

OZARK Specialty farms. Terms. Description mailed free. 20 years service. Armstrongs, Shook, Missouri.

OPPORTUNITIES! Government land. U. S., Alaska, Canada. Sledge Surveys, Macon, Mississippi.

HOMESITES \$15 Monthly—California's finest garden section. Morro Bay's scenic shores. Wonderful fishing, boating, Fertile soil, softest water, temperate climate, congenial community. Free literature. Richard Otto, Department M, San Luis Obispo, California.

FLORIDA. Nice homesites, \$345 at \$10 monthly. Folder free. Howard Vernor, DeLand, Florida.

FLORIDA Gulf-front subdivision—75-foot lots, paved streets, easy walk to Gulf of Mexico, Grand Lagoon, marina, \$24.75 down, \$23.20 monthly. No comparable location so inexpensive. Brochure free. Sam E. Hearn, Broker, Inc., Box 177-E, Panama City Beach, Florida.

FLORIDA—Potterfield Garden Acres Section M, first addition, a new West Coast subdivision. Close to bathing, boating, fishing, parks, on Gulf Mexico and cities. High, dry, finest climate. Live better for less. Full 1/2 acre tracts only \$795.00 and only \$10.00 month. More information. G. B. Potterfield, Union Bldg., Charleston, West Virginia.

FARM MACHINERY AND SUPPLIES

SENSATIONAL Garden tractor. Hoes between plants and rows, including strawberries. Eliminates hand hoeing. Standard in size, yet entirely different. Patent 2742840. Also tills. Fantastic offer to first few inquiries. Auto Hoe, DePere 68, Wis.

PROFITABLE OCCUPATIONS

INVESTIGATE Accidents—Earn \$750 to \$1,000 month. Thousands of airlines, insurance companies, steamship lines urgently need claim investigators. We train you home spare time. Placement counsel and help. Free book! No obligation. Write: Universal Schools, T-12, Box 8202, Dallas 5, Texas.

SHARPEN Scissors, pinkers. Inexpensive machine. Sharpening supplies. Blackhaws, Sheldahl, Iowa.

MAGAZINE Subscriptions—Largest commissions. Bonus. Qualified Agency, 451RA Kingston, Brooklyn 25, N. Y.

YOUR Own income tax business tax service. Licensed training. Union Institute, Hoboken (2S), N. J.

BECOME A notary public! Worthwhile earnings! Details: Van Browning, Broken Arrow, Oklahoma.

DEMONSTRATE Regulation pool tables. Retail \$139.50. Cost \$99.50. No canvassing. Kit furnished. Musselman Co., Kalamazoo, Mich.

BE A clown. Profitable. Free details. Al Wheeler, Box 7755, Washington 4, D. C.

GROW Mushrooms. We buy mushrooms and pay high prices. Use cellar, shed and outdoors. Spare, full time, year round. We sell 100% pure cultured mushroom spawn. Free book. Mushrooms, Dept. 99, 254 Admiral Way, Seattle, Wash.

HOME Mailorder beginner's opportunities catalog, 10¢. Carnahan Bros., 9610 Acacia, Fontana, Calif.

WANT To make big money. Sparetime or full. Be a checker. Let us inform you. Send one dollar to: Goery's, 53 Fairview Blvd., Toronto, Ont.

HOUSEWIVES. Others, \$30-\$100 weekly sparetime assembling and distributing rockhound jewelry. Vikingcraft T, Inglewood 4, California.

BE Appointed state notary public now. Details. Marina House, 1029 Superba, Venice, Calif.

POULTRY Raising a real gold mine. Million dollar plan. Get free details. Stark, 14321 Wentworth, Chicago 27.

MUSHROOMS Quicker, easier, cheaper. "Magic" preplanted trays. Newest facts free. Spawm \$1.00. Luxur, 641 South 19th, Newark 3, N. J.

MAILORDER Magazine with instructive articles, tips, sources, new products, 25¢. E. J. Thompson, Box 94-P, Salinas, Calif.

OVER \$1,000.00 Monthly, U. S. tax exempt! Work in Latin American for American companies. All skills required. Direct information on opportunities, conditions, companies employing. New report! Airmailed, \$3.00. Paul B. Smith, Apartado 172, Maracaibo, Zulia, Venezuela.

FORTUNES Made by prospectors. We teach you. Recognize valuable mineral deposits in your home area. Free details. Modern Prospector, 3433 Essex Road, Cheyenne, Wyoming.

BUY Wholesale! 100,000 nationally advertised products. Appliances, cameras, sporting goods, housewares, watches, typewriters, tools, clothing, etc. Discounts to 80%. Buy-Rite, Box 258, Hawthorne 3, New Jersey.

MAKE Flexible molds. Cast plaques, figurines. Free sample. Tooker, 1045-M Fairview, Hamilton, Ohio.

AUCTIONEERING—Home study course. Diploma granted. Auction School, Ft. Smith, Ark.

MONEY Plans! "Secret Journal." Grandpa, two daughters made \$2500 first month! Work home. Publiccos, Oceanside, Calif.

BAKE New greaseless doughnuts in kitchen. Sell stores. Free recipes. Michael Ray, 2605 South 15th, Minneapolis 7, Minn.

FREE Book "505 Odd, Successful Businesses." Work home. Pacific, Oceanside, Calif.

SAVE Money! Buy wholesale! Free catalog general merchandise. Norris, 487-M Broadway, New York City.

MAKE Money writing short paragraphs. Information free. Barrett, Dept. CX-27, 7464 No. Clark, Chicago 26.

BECOME Independent with your own franchise business. Thousands earning handsome incomes. Request interesting facts today. National Franchise Reports, PM-528, 333 North Michigan, Chicago 1.

FREE Book "990 Successful, Little-Known Businesses." Work home. Plymouth, 1610-43 Street, Brooklyn 4, N. Y.

RAISE Pheasants on \$100 week plan. Little capital and space can make you independent. Free details. Great Central System, Columbus 1, Kansas.

BUY Wholesale! 25,000 nationally advertised products. Get amazing dealer catalogs. Complete details free. American Wholesalers, 1841B Levee, Dallas 7, Texas.

BOOKS, PERIODICALS, PICTURES, POSTCARDS

FREE Catalog! Many subjects! Treasure-Site Book Company, 6990 Aberdeen, Upper Company, Penna.

AMAZING Free catalog British books. Any subject. Transbooks, Box 1-PLD, Wantagh, N. Y.

FREE: Catalogs—Hundreds of subjects! Sun Long, Box 382, Lockport, N. Y.

RARE Magazines, catalog 15¢. Nationwide Exchange, Box 4373-P, San Antonio 7, Texas.

WANTED! Old automobile catalogs on: automobiles, magnetos, lamps, coil assy's, body details, etc. A. Petrillo, 2817 Lake Ave., Rochester 12, N. Y.

MAGAZINES, Comics. Wholesale-retail catalogue 10¢. Stamps or coins. Backdates, 1181 E. Lombard, Baltimore 2, Md.

FREE Catalog. Self-help books. Write: Wilshire, 8721 Sunset, Los Angeles 46P.

"SCIENCE Milestones." Records march of science starting 400 years before Christ, right up to date. Amazing facts revealed. 312 pages packed with startling information that will thrill you. A real history of science. \$5.00. Literature free. Popular Mechanics Press, 200-SM East Ontario St., Chicago 11, Ill.

BOOKFINDERS! All subjects. Send wants! Jaher Book Service, 183 Hazelwood Drive, Westbury, N. Y.

OUT-Of-print books at lowest prices! You name it, we find it! Fast service. No obligation. International Bookfinders, Box 3003-PM, Beverly Hills, Calif.

EXCITING Catalog packed with books covering most everything. Think of it—From cover to cover you will find described and illustrated hundreds of books telling how to fix and how to build almost anything. How to remodel your home; do your own decorating, plumbing, electrical work, carpentry, painting, furniture making and refinishing. How to build your own boat, home workshop tools. Best books on photography, welding, hobbies, homecraft. How to make a home freezer. Send now for 1958 book catalog—only 10¢. Popular Mechanics Press, 200-BC E. Ontario St., Chicago 11, Ill.

GAMES, TOYS, NOVELTIES

"DOODLE-It." Exciting card game. Guaranteed. Postpaid \$1.00. Christmas gifts. Cards, Box 8187, Asheville, N. Car.

MAGIC TRICKS, PUZZLES, JOKER NOVELTIES

IMPOSSIBLE. Yet you, yes you, can assemble or disassemble this puzzle right before their eyes. Send 50¢. Capp, Harper Station, Box 118, Detroit 13.

"VENTRILOQUISM Selftaught"—Complete book 25¢. Greenview, Box 61-AD, Whitestone 57, New York City.

SANTA Claus masks, costumes, beards (wholesale discounts)! Box 1352-C, Philadelphia 5.

STINK Bombs, super-potent! 50/\$1.00, 300/\$5.00. "Amoro-Trix," Philadelphia 44.

FREE Large catalog magic, sensational Houdini escapes, novelties. Write Heaney Magical Co., Oshkosh, Wisconsin.

108 MAGIC Tricks you can do, illustrated, plus giant catalogue pseudo mind-reading, spooks. \$1.00. Nelson, 336 South High, Columbus, Ohio.

3000 TRICKS, Pocket, parlor, stage. World's finest magic catalog (408 pages). \$2.50. Kanter's, M-1311 Walnut, Philadelphia 7.

FASTEST Service to magicians for over 30 years. Send 10¢ for Douglas famous catalog. 500 tricks, containing magic for pocket, parlor, stage, with balls, coins, cards, cigarettes, ropes, silks, apparatus. Douglas Magician, Dept. 10, Dallas, Tex.

"VENTRILLO," Voice-thrower 25¢. Ventriloquist puppet 75¢. Box 971-PM, Philadelphia 5.

VENTRILOQUISM, easiest method. Details free. Smith, 2125 N. Bigelow, Peoria, Ill.

WHOLESALE! Thirty 10¢ trick novelties \$1.00! (Profits!) 1746-PM Market, Philadelphia 3.

3100 NOVELTIES, Jokes, tricks, gadgets, funmakers, hobbies. Big catalog 10¢. Johnson-Smith, D-491, Detroit 7.

WORLD'S Finest professional magic. Joker novelties. Giant illustrated catalog 10¢. Top Hat, Evanston 12, Illinois.

BE A magician! Large professional catalog of latest tricks. 35¢. Ireland, C-109 North Dearborn, Chicago 2, Illinois.

SMOKEBOMBS, Gigantic! 25¢. 7—\$1.00. (Nonpoisonous.) 4463-PM Greene, Philadelphia 44.

COINS, TOKENS, CURRENCY

44 DIFFERENT Coins, \$1.00. 44 different bills, \$1.00. Oddehon, Box 482, St. Louis, Mo.

LINCOLN'S 1911D, 1915D, 1916D, 1917D, 1922D. All \$1.00, prepaid. United, 2 Cranston, Providence, R. I.

OLD Money wanted. Will pay \$1,000.00 for 1894 dime. S. mint, \$5,000.00 for 1913 Liberty head nickel (not buffalo). Big premiums paid for all rare coins. Send 5¢ for large coin folder. May mean much profit to you. Numismatic Co., Box 750-A, Costa Mesa, Calif.

MEXICO Gold and silver. Beautiful, interesting, unusual coins. Free list. Joe, Box 1305, Pecos, Texas.

COINS From Formosa, Vatican, etc., plus foreign banknote, 10¢ with coin approvals. Littleton Coin Company, Littleton S1, New Hampshire.

FREE List! U. S. coins. Best prices! Hugh's, Box 361-A, Hickory, N. C.

GOLD Coins. Selling list 25¢. Cook, Box 181, Jackson 5, Mississippi.

WANTED Foreign paper money. Canada coins. Civil war books. Harry Kelso Antiques, Pittsburg, Kansas.

COIN Cleaners—Mix your own with cheap chemicals obtained from your druggist. Laboratory tested formulas, \$1.00. Guaranteed. Colonial Laboratories, Pittsburgh 18, Penna.

JAPAN, India, Austria, Finland's coins, 10¢. Jolie, 126M, Roslyn Heights, New York.

INDIAN Cents 25 different \$3.00. Rhode, 105 Windsor, Reading, Penna.

COMPLETE Set peace dollars, 24 in all, in national album \$75.00 on approval. Everyone should have this set. Watch value grow. Harmon's, 1742 McDonald Lane, New Albany, Ind.

40 DIFFERENT Foreign coins \$1.00. Claud Denney, 3406 S. Harwood, Dallas 15, Texas.

6 DIFFERENT Foreign coins, plus huge bargain catalog. Alfred Szego, Box 187, Jackson Heights 72, New York.

SPECIAL—Lincoln set from 1953 to 1958, uncirculated, for \$1.00 postpaid. Six sets for \$5.00. Nicholas Coins, P.O. Box 157, Livingston, N. J.

SIXTEEN Page price list of U.S.A. and Canadian coins free. Selling prices on thousands of coins and supply items. Bryson Inc., 612A White, Toledo 5, Ohio.

TWENTY Different Indian cents \$2.50; free discount list. Collector's Bargains, New Hope, Penna.

U. S. large cents, 2 different \$2. 6 for \$4.95. Delmaco, Box 1123, Wilmington 99, Del.

\$5.00 CATALOGUE Value rare American coins \$1.25; big foreign assortment \$1.25; ancient Roman coin \$1.00. Coins, 328 Eleventh, West Bend, Wis.

\$4,000.00 FOR 1913 Liberty head nickel. Uncirculated dollars 1804-1839, 1893-S, 1895-P, 1903-O pay \$100.00-\$5,000.00. Certain dates Lincoln cents before 1932, \$125.00; flying eagle cents, \$500.00; Indian cents, \$175.00; dimes before 1943, \$2,000.00; quarters before 1924, \$1,500.00; half dollars before 1929, \$3,000.00; 2¢ pieces, \$125.00; 3¢ pieces, \$150.00; half-dimes, \$1,500.00. Hundreds of others worth \$10.00, \$1,000.00. Canadian coins, 1921, 5¢ silver, \$100.00. 1875 quarters, \$100.00. 1921, 50¢, \$750.00. Wanted: 20¢ pieces, gold coins, paper money, etc. Our large illustrated guarantee buying-selling catalogue, giving complete allcoin information, send \$1.00. Purchase catalogue before sending coins. Worthycoin Corporation (K-220-C), Boston 8, Massachusetts.

SPECIALS! Whitman handbook listing, illustrating, pricing all U. S. coins, \$1.00. Large cent before 1850, \$1.00. Ten diff. Indian head cents \$1.00. Six diff. "V" nickels, including 1883, \$1.00. First U. S. commemorative half dollar, \$1.00. Amazing "CCC" coin cleaner, \$1.00. All six \$5.00. Coin Care Corp., 1627-A West Anaheim, Long Beach 13, Calif.

LINCOLN Cents: special Xmas fine condition. 1911-S, \$2.40; 1914-S, \$1.35; 1910-S, \$1.25; 1912-S, \$2.00; 1913-S, \$1.50; 1926-S, \$1.00. R. J. Berry, Box 306, Westminster, Calif.

32 PAGE Illustrated informative coin list, 10¢. Stoney, 280 Washington, Boston 8, Mass.

OBsolete U. S. coins. 10 different Indian cents (1899-1908) 69¢; 10 different Liberty head nickels (1900-1911) \$1.79; large cent before 1857, \$1.00; flying eagle cent 1857, \$1.75; copper nickel Indian cent, 3¢; nickel and half-dime, all before 1873, \$2.00; 1859, 1860 and 1862 copper nickel Indian cents, \$3.00; bust type half dollar before 1838, \$3.00. Satisfaction guaranteed. Empire State Coin & Stamp Co., Empire State Building, New York City.

INDIAN Cent plus Bargain Lists 10¢. Hutchinson's, Box 4747, Philadelphia 34, Penna.

LINCOLN Cents—1916-S, 1917-S, 1918-S, 1921-S, 1923-S, 1924-S all for \$2. Gasser's, Box 34615, Los Angeles 34, California.

25 LINCOLN Pennies 1909 to 1940 \$1.00. Box 222, Howard Beach 14, N. Y.

STARTER Collections. 20 different Indian cents, \$2.50. 13 different liberty nickels \$2.50. 20 different Barbour dimes in folders, postpaid \$5.00. Prager, 470 27th Avenue, San Francisco, Calif.

ILLUSTRATED Retail foreign coin catalogues. Gold coins. 800 different. Price 50¢. Silver, copper coins. 3000 different. Price 50¢. James Randall, Box 2205N, Fort Lauderdale, Florida.

COMMEMORATIVE Half dollar uncirculated \$1.00. Bargain lists free. Sayers, 1000 Unaka, Johnson City, Tennessee.

1959 GIANT U. S. coin catalogue 25¢. Ace, 107 N. Dearborn, Chicago 2.

GOLD U.S. and foreign coins wholesale. Free listing. Samuel Kisin, 720 Flushing Ave., Brooklyn 6, N. Y.

GOLD Bargains—\$5, \$11.95; \$10, \$22.95; \$20, \$43.95; 9 nice \$1.00 to \$10.00 gold coins on elegant solid-gold chain-bracelet (\$325.00 value) \$359.50. Paying top prices \$1.00 to \$50.00 gold, all other rare coins. Any quantity. Send list for free offer. World's greatest retail catalogue \$1.00 (deductible on first \$10.00 order). Bebee's, 4514 North 30th, Omaha 11, Nebraska.

LARGEST Coin magazine. 300 pages, 40¢. Scrapbook, 7320-J Milwaukee, Chicago 31.

"EAGLET" Numismatic Magazine, 25¢, subscription \$2 year. 229 South 11th, Newark 7, N. J.

GET Profit and pleasure in collecting old coins. Send 15¢ for 68-page illustrated coin catalog. You'll be delighted with it. Send for it now. B. Max Mehl, Box 750-B, Costa Mesa, Calif. Oldest rare coin establishment in U.S. Established 59 years.

RAREST CC mint dollar 1885 uncirculated \$5.00. Illustrated catalogue 25¢. Schultz, Salt Lake City 10, Utah.

BARGAINS. U.S. coins: 1893 Columbian world's fair half dollar, \$1.00. Ten different Indian pennies, 75¢. Two-cent piece, and 3-cent piece, \$1.00. Gold ¼ eagle, \$9.00. Gold ½ eagle, \$12.50. Beautiful coin bracelet, \$1.00. Many coins available. What do you need? Rare Coin Company, 31 North Clark, Chicago 2.

COMPLETE United States coin bargain lists, Indianhead cent, 10¢. Economy Sales, 156-A Dean, Mansfield, Mass.

STAMP COLLECTING

FREE! Giant bargain catalog—New edition listing thousands of bargains including U. S. and B. N. A. stamps, packets, mixtures, albums, accessories and supplies; sent with beautiful approvals. Jamestown Stamp, Dept. E128PM, Jamestown, N. Y.

GHANA Free with approvals. Frank Hergit, 2884 Bailey, Buffalo 15, N. Y.

GIANT Approvals, thousands different, 1¢ and 2¢ each. Wahl's Stamp Exchange, 7008P Farragut, Chicago 31, Ill.

FLAGS And Spa mint complete \$1.00 to approval applicants. Smith, 6 Greencroft, Champaign, Illinois.

FREE Gift to approval applicants. Stampco, 5151 Princeton, Memphis 17, Tenn.

FIERCE Jungle animal, snake stamps, 10¢. Marshall, Box 451-H, Long Beach, Calif.

U. S. 150 different \$1.00. Walter Ure, 2926 Stewart, Kansas City 4, Kansas.

300 DIFFERENT Given free with approvals. Particulars. Windsor Stamps, 8834 Cornell Avenue, Chicago 17.

125 DIFFERENT United States \$1.00. Approvals. Utechts, 1143D North Keeler, Chicago 51.

FREE! 50 Different Netherlands; colorful, inexpensive approvals, Elkhart, Box 33, Elkhart, Indiana.

105 DIFFERENT Worldwide from Liberia, Macao, etc., cataloging over \$2.75 only 10¢. Approvals. Goliath, Bethlehem J1, New Hampshire.

FREE 40 Exotic giant pictorials! Free 144-stamp worldwide mix! Free stamp newspaper! Free illustrated bargain lists! With approvals. Rush 10¢ for postage. Philatelics, Dept. R, New Paltz, N. Y.

WHOLESALE. Dealer selling out. Enclose \$1.00 for assortment. Limit five offers. Ederington Stamps, Warren, Ark.

50 DIFF. Peru to approval applicants 20¢ for mailing. C. I. Yuotz, Mountville, Pennsylvania.

\$25.00 CATALOG Value, contains better foreign, airmails, South America. None under 10¢ catalog value. All different. Only \$3.00. Ed's Stamp Service, 159 Frey Lane, Belleville, Ill.

ISRAEL 10 Different free to approval applicants. Morrel, 203 Fenimore St., Brooklyn 25, N. Y.

WOW! 110 All different Germany 10¢. Zeppelins, semi-postals, airmails, high values, etc. Giant catalog, bargain lists included with beautiful approvals. Jamestown Stamp, Dept. A128PM, Jamestown, N. Y.

GIANTIC Collection free. Includes triangles, early United States, animals, commemoratives, British Colonies, high value pictorials, etc. Complete collection plus big illustrated magazine all free. Send 5¢ for postage. Gray Stamp Company, Dept. PM, Toronto, Canada.

MIXTURES—1000 Foreign or United States, \$1.00 each. Missions Warehouse, Box 386, St. Petersburg, Florida.

100 DIFFERENT Pictorials 5¢, approvals. Hope, 142 Emeline Street, Providence 6, R. I.

BEAUTIFUL 2¢ Approvals! Thousands varieties! Marshall, Box 451-PM, Long Beach, Calif.

FREE Stamps. 15 cents handling. Stevens, 126 Wing, Newark, Ohio.

VIETNAM, Laos, Pezzan, others with exciting inexpensive approvals 10¢. R&R Stamps, Box 7, Walnut Ridge, Ark.

SUPERIOR Worldwide mission mixture. Amazing variety! Six ounces \$1.50. Pound \$3.75. Bay Nielsen, 4545B Harvard, Montreal 28, Canada.

MEXICO, 25 Beautiful 10¢. Approvals. Salsman, Box 702, Berkeley, Calif.

50 DIFFERENT Stamps free! Approvals. Marford, Box 48, Queens Village 29, New York.

PENNY Approvals! Regardless catalogue! Kloster, 4164—52nd St., San Diego 5, Calif.

1000 DIFFERENT Scandinavia \$14.95. Sluis, Box 3874, Thornton 16, Colorado.

INTERESTING Packet free. Approvals. Farley Stamps, 204 Tanguy, Logansport, Indiana.

50 DIFFERENT United States commemoratives 10¢ with approvals. Jack Clancy, Box 2187, Portland 14, Oregon.

FREE Surprise packet with worldwide approvals. Kaw Stamps, Box 355, Topeka, Kansas.

1¢ TO 3 Cent approvals in envelopes. Schnoebelen, Columbiana, Ohio.

WOW! 1,200 Every one different, only \$1.00. No approvals follow. Act now. Send \$1.00. Carter, P.O. Box 4576, Jacksonville 1, Fla.

INDONESIA—15 Different 10¢. Approvals. United, Box 6, Baldwin, New York.

MONACO—50 Beautiful stamps \$2.00 bill. Lamy, Domats (Yonne), France.

FREE 1958 Illustrated U. S. price list. H & S, 45-PM Bromfield, Boston, Mass.

ADD Countries to your collection! 50 colorful stamps from 50 different countries. Send 1 dime. Bargain approvals accompany. Richards Co., Box 73, Battle Creek, Michigan.

THOUSANDS OF exciting stamps, all different, yours for 1¢, 2¢ each. Fill your album for pennies! Big collection sent for free examination. Shafer, 3520 St. Martin's, Cincinnati 11, Ohio.

TRADE Your duplicates toward our approvals! (Foreign only.) Complete detailed information, 10¢. (Refundable.) Variety Stamp Service, Box 98-P, Newton Highlands 61, Mass.

25 COUNTRIES Collection 10¢. Approvals. Ray, 321 South Cicero, Chicago 44.

60 DIFFERENT U. S. (30 commemoratives) 25¢. No approvals. Seidenberg, Appleton, Wisconsin.

HUNGARY. Latest flower triangles, free! Approvals. William Deems, 226f Race, Ravenswood, West Virginia.

100 DIFFERENT Mexico, \$1.60. Gray's, 105 West Elm, Phoenix, Arizona.

BERNADETTE'S Vision, world's first sputnik, plus 50 other fine stamps absolutely free when requesting our interesting approvals. Stamp Imports, Peterborough, Canada.

MAKE 20 Filter cigarettes for 9¢. Facts free. Moberly, 954, Owensboro, Kentucky.

WORLDWIDE Stamp assortment 25¢. Approvals. Taylors, Buffalo Gap, Texas.

SPUTNIK; Egyptian jets; Israel musician; minute-man; etc., with purchases. Details, approvals. Stamp Farm, M2-7, Oxford, Wis.

MYSTERY Mixture received from missions all over the world. Over 300 exotic stamps. Colorful assortment. No approvals. Send 10¢. Worldostamps, 8203-ME Grubb Road, Silver Spring, Maryland.

100 DIFFERENT Pictorials 10¢. Approvals accompany. E. McMillan, 916 No. Sierra Bonita, Hollywood 46, Calif.

BULGARIA: Fifty different exciting pictorials. Animals, trucks, flowers. This valuable collection, only 15 cents with approvals. Boger, Box 152, North Wales, Penna.

CANADA, 50 Different including dollar totem, 10¢ to approval applicants. Maritime, Box 662, Saint John, N. B.

U. S. bargain, 100 different 25¢, 50 different commemoratives 25¢, Both 40¢. Request approvals. Stamps, Box 37, Kennebunk, Maine.

20 ATTRACTIVE Sets \$1.00. Approvals. Klondike, 682 Jefferson, Elgin, Illinois.

AIRMAILS—Forty-nine different, 10¢. Approvals. Valley's, Box 414B, Spring Valley, California.

1000 DIFFERENT \$1.00. Approvals. Jacobsen, 4395-C Broadway, New York 40, N. Y.

64 PAGE Deluxe U. S. illustrated list free. Stone, 260 Washington, Boston 8, Mass.

WORLDWIDE Stamps, 1000-\$1.00, includes pictorials, commemoratives. No approvals follow. Guaranteed. Harrison's Stamps, 1435 First Avenue, Oakland 6, Calif.

GERMANY. Fantastic collection commemoratives, pictorials, Hitlers, occupations, etc., only 25¢ to general approval applicants. K. I. Noble, 38-48 Victoria, Fair Lawn, N. J.

TRADE Stamps by mail. Receive a tremendous list of collectors wanting to trade by mail. Your name also sent to hundreds of collectors only 50 cents. Stamp Pals, Box 117M, Long Beach, N. Y.

FREE 60 Different stamps to collectors requesting approvals. Stanley Zajac, 159 Emerson Ave., Toronto, Canada.

VATICAN City special! Pope Pius XII, saints, churches, Swiss guards, holy shrines. 25 all different \$1.00. 50 all different \$2.50. Genuine values. No approvals. Worldostamps, 8203 Grubb Road, Silver Spring, Maryland.

FINE Used U.S. and foreign approvals at bargain prices. Selected to match your collection. Laclede Stamps, 4973A Columbia, St. Louis 9, Mo.

150 DIFFERENT Used U. S. commemoratives, \$1.00. Gray, 1417 10th St., Moline, Illinois.

HONG Kong, 25 different, 25¢. Foreign approvals. Spicka, 518 No. 85th, Omaha 14, Nebraska.

INDIA. Only 10¢ for 50 different, catalogued \$1.14. Penn Stamp, P.O. Box 303, Philadelphia 5, Penna.

1000 DIFFERENT, \$1.00 With approvals. Louis Golden, 6721 Eastwood, Philadelphia 49, Pennsylvania.

500 ALL Different stamps \$1.00. Walker Stamp Company, Louisville 14, Ky.

FABULOUS! Five exciting packets, Malta, Mozambique, Paraguay, etc., plus story and replica famous 1840 Mulready plus terrific offers and Value-Pak approvals. Only 10¢. Westgate Stamp Company, 5 Centre St., Hempstead, New York.

100 DIFFERENT 10¢ With approvals. Roger Davis, 525 Main St., New York Mills, N. Y.

FREE U. S. stamps. 1943 flag, commemoratives included in collection of 25 different, plus valuable \$5.00 stamp. All for 10¢ mailing charge. Approvals. Willett Co., Box 338-A, Yorktown Heights, N. Y.

WORLDWIDE, 50 All different, absolutely free, just to introduce our incomparable approvals. Kent Stamp Company, GPO Box 87, Brooklyn, N. Y.

ALBUM Only 10¢! Hundreds of spaces! Stampmart Company, Hartford 1, Conn.

U. S. approvals. Low prices. Eagle Stamps, Romine Ave., Pittsburgh 26, Penna.

ECONOMICAL 1/2¢-3¢ Approvals. 33,000 varieties. Dresel, Box 128-N, West Englewood, New Jersey.

UNITED States commemorative collection containing 33 different—10¢. Approvals. White, 516-A Avenue L, Brooklyn 30, New York.

SELL Your surplus good grade stamps. Write, describing fully what you have. Vanroy Shirk, Lebanon, Pennsylvania.

AMAZING Offer! 200 United States stamps—including commemoratives, airmails, high denominations to \$1.00. Only 10¢ to approval applicants! Illustrated bargain lists free. Mystic Stamp Co., Dept. 80, Camden, New York.

100 STAMPS, 10¢ With approvals, Smith, 508A Brooks, College Station, Texas.

OLD Scarce U.S. seconds on approvals. Slight imperfections, lowest prices. Hershfield, Clintonhill Sta., Newark 8, N. J.

100 OLD United States between 1861 and 1935, \$1.00. Roush Stamps, 51 Chestnut, Mansfield, Ohio.

UNITED States approvals. Select copies, used—mint. Kingsbury, Fairfax, Vermont.

OLD U.S. flags, famous Americans, commemoratives with approvals plus gift, 10¢ handling. Metropolitan Stamps, Box 312MA, Jackson Heights, N. Y.

LOOK! Six different Queen Elizabeth mint sets! Dominica, Gibraltar, Virgins, etc. 21 bicolors—25¢! Attractive approvals! Gannon Stamps, Box 931, Canton 1, Ohio.

10 CANAL Zone 25¢. Approvals, Merkel Stamps, 30 Grandview, South Hadley Falls, Mass.

15 MINT French colonies free! Inexpensive approvals accompany. White Mountain Stamp Service, Bethlehem, New Hampshire.

9 BICOLORED Armenia, value 50¢, free! Exciting approvals accompany. Tropicana, Box 449-M, Hollywood, Fla.

168 BICOLORED World flags and monograms, 10¢. Exciting approvals accompany. Dee, Box 926, Ormond Beach, Florida.

FREE Pictorial packet! Includes bicolors, flowers, Andorra, Iceland, Togo, Malta, Singapore, birds, sports, other fine stamps. Send 10¢ for handling. Approvals. Champlain, Isle La Motte, Vermont.

FREE Sample! Interesting, informative, illustrated. National Stamp News, Anderson, South Carolina.

200 DIFFERENT Argentina \$1.00. Doc Shoentfelt, 259 Belmont, Mansfield, Ohio.

FREE Packet! Angola, Azores, Mongolia, Nepal, Palestine. Fascinating approvals. Coral, Box 7095 (Ludham), Miami 55, Florida.

STAMPS For collectors. Robert A. Arthur, 920 Third, Seattle 4, Wash.

TWO \$5.00 U.S. postage stamps free to approval buyers. Send dime for postage, details. Irwin Stamp Co., Box 11-55, Brooklyn 30, N. Y.

135 DIFFERENT U.S. commemoratives \$1.00; 50, 25¢. Approvals. Harold Holub, 18 East 198th St., New York 68, N. Y.

STEAL The show! Display prize-winning first-day covers, beautifully hand-colored. Sample free with approvals. Overseas Malters, Hicksville, N. Y.

U.S. Stamps. Giant bargain catalog 10¢. Raymax, 35-VZ Maiden Lane, New York City 38.

TERRIFIC U.S. list free! Bailey, 45 Bromfield, Boston 8-G, Mass.

U.S. Commemoratives: 141 different \$1; 201 different \$2. Lists free. Moseley, 6 Hanley Downs, St. Louis 17, Missouri.

225 STAMPS For only 10¢! This mammoth value includes airmails, pictorials; stamps from strange countries cataloging up to 25¢ each! Also approvals. Mystic Stamp Company, Camden 80, New York.

WEIRD Diamond shape coffee stamps. Lovely flower triangle! First American big commemorative. Greenland, idol dancer, etc. Free with approvals. Capital Stamp Co., Ferrysburg 2, Mich.

25 DIFFERENT Commemoratives 1893 up 10¢. U.S. approvals. K&B, Box 70, Brooklyn 23, N. Y.

SELL Stamps to our readers. Your ad in this space will be read by thousands of stamp buyers. I'll prove that to you. Write now for Folder "S." F. W. Johnson, Classified Advertising Manager, Popular Mechanics, 200 E. Ontario St., Chicago 11, Ill.

INTRODUCING Our better United States approvals, we offer 15 United States stamps including Columbian, Pan-Pacific, famous American, airm, others; only 10¢. Ocean Stamps, Box 64-PM, Brooklyn 29, New York.

UNITED States price list, 116 pages, price 25¢. Mark Hanna, 335 Fifth Ave., Pittsburgh 22, Penna.

"JESUS Christ" collection. Scarce valuable religious stamps, \$1.00 retail value. Yours only 35¢ with approvals. Chester Garlanger, 1019 Pearl St., St. Joseph, Mich.

14,000 DIFFERENT! Amazing new plan builds your collection systematically, country by country. Only 50¢ weekly. Free details. L. G. Ware, Stepney 75, Conn.

U. S. Mint flag set, complete, \$1.00. Free list. Brooks, 2323 Avenue X, Brooklyn 35, New York.

FREE 50 Worldwide introducing inexpensive approvals. University Stamps, P.O. Box 95, Tamiami Station, Miami 44, Florida.

40,000 VARIETIES Available on approvals. 1¢ upwards. Kelgwin, Box 933B, Daytona, Florida.

11 MINT Sets—Soldiers, flowers, heroes, planes, 10¢. Worldstamps, 8203-PM, Grubb, Silver Spring, Maryland.

307 WORLDWIDE Different stamps only 10¢. Approvals. Niagastamp, St. Catharines 671, Ontario.

FREE! Ghana's "Nkrumah" stamp! Approvals. Keating, 2520-P Boulevard, Jersey City, New Jersey.

STAMP Zoo including kookaburra, zebu, kangaroo, koalabear, rhinoceros 10¢. Approvals. Linstamp, St. Catharines 618-A, Ontario.

5 DIFFERENT Cacheted first day covers, \$1.00. Crest, Box 197, So. Orange, N. J.

FRESHMEN, Sophomores, beginners. Solid bargain. Korea 102-5, catalog 68 cents, only 15 cents, when requesting good modest priced approvals. No junk. O. L. Dixon, 8716 Alameda, Ysleta, Texas.

102 DIVERSIFIED Worldwide stamps 10¢. Approvals. Linstamp, St. Catharines 618, Ontario.

U.S., Canada price list over 100 pages, 700 illustrations, 10¢. Thom, 4808—15th Avenue, Minneapolis 17, Minnesota.

FREE! Over 100 different, \$2.50 value, including space satellite, Israel, British, U. S., first U. N., Siberia. Approvals, catalogue. Send 25¢ for mailing. Gatewood, Box 346, Winston-Salem, N. C.

20 BRITISH Pictorials 10¢. Approvals. Van, Box 981, Columbus, Mississippi.

SPACEOPHOBIA? Send 10¢ for Monaco Olympic diamonds and approval cure. BKJ, Astor, Boston 23, Mass.

RED Russia—28 all different unused, high catalog, 5¢. Approvals. Hamilton, 912 North Mesa, El Paso, Texas.

103 DIVERSIFIED British colony stamps only 10¢. Approvals. Niagastamp, St. Catharines 671-A, Ontario.

508 DIFFERENT Worldwide from Madagascar, Macao, Guinea, etc., cataloguing over \$15 only 35¢. Approvals. Littleton Stamp Company, Littleton Q1, New Hampshire.

ANTIQUES, RELICS, INDIAN GOODS, CURIOS

4 PERFECT Arrowheads \$1.00. Smith, 841 N. Tacoma, Indianapolis 1, Indiana.

ILLINOIS—Stayschunneyedenteeekayshun. Selling: Hundreds of Confederate items. Historical, Civil War, Revolutionary, Indian War muskets, rifles, insignias, pistols, pepperboxes, swords, bayonets, flasks, bullet molds, duelling pistols, 50,000 Indian relics, 10,000 coins, Confederate money. Thousands agates, fossils, mineral specimens, deerheads, steerhorns, tomahawks, bo-wood, gold dollars, Kentucky rifles, frontiers. Illustrated catalog 35¢. Heidke, Wenona, Illinois.

INDIAN Relics, baskets, weapons. Lists 10¢. Rush, 34, Belvidere, N. J.

ANCIENT Grooved stone tomahawk \$3.00. Indian relic list free. Lear's, Glenwood, Arkansas.

SCALPING Knife, spearhead, thunderbird \$4.00. Catalog free. Arrowhead, Glenwood, Arkansas.

PRECIOUS STONES, MINERALS

PRECIOUS White jade, black garnet, agatized cedar, seven other rare specimens \$2.00. Old Prospector, Canyon, Calif.

GEMSTONES, Thirty, \$4.00. Minerals. Write Reed's, 4930B Palo Alto SE, Albuquerque, New Mexico.

FIND Hidden treasures in your own backyard, spare time, weekends. Get free information about sources, bargains, vital data from the jewelry industry's biggest suppliers. Write for free booklet! Grieger's, Dept. A-89, Pasadena 4, California.

MINERAL Specimens for collectors. Rough and cut gems. Jewelry mountings. Choice quality, large variety, lowest prices. List free. Plummer's, 4720 Point Loma Ave., San Diego 7, Calif.

ROCKHOUNDS—Visit rockhound paradise. Circular. Heike's Agate Shop, Wenona, Illinois.

AGATES, Jade, gems. Free list. Northwest Gems, 2819 North Warner, Tacoma 7, Washington.

BOOKS On gems. 48-page illustrated catalogue 25¢. Willems, Box 1515-A, Chicago 90.

CUT Gems, make jewelry—For profit or fun. 100 page magazine tells how; where to get supplies. Sample 25¢ or request free literature. Lapidary Journal, Del Mar 2, Calif.

"GEMS & Minerals Magazine," largest rock hobby monthly. Field trips, "how" articles, pictures, ads. \$3.00 year. Sample 25¢. Box 687A, Mentone, California.

TWELVE New Mexico minerals \$2.00, six fluorescents \$1.00, five crystallized minerals \$1.00, fools gold 35¢. Minerals, Winston, New Mexico.

SAPPHIRE And four more uncut gems, \$1.00. Ten polished gems, baroque-shaped, \$1.00. Free gem list. Lapidary catalogue, 25¢. O'Brien's, 1116M Wilcox, Hollywood 38, Calif.

SEMI-Precious uncut gems. Ten different for \$1.00. Request list 26. Prospectors Shop, 201 San Francisco, Santa Fe, New Mexico.

EARTH Science, the rockhounds national magazine. Subscription \$2.00. Sample 35¢. Box 1357-PM, Chicago 90, Ill.

HOBBIES AND COLLECTIONS

KILNS-Rogers electric hobby for ceramics. Best kiln made. All sizes. Fairchild Ceramic Supply, Freeland, Penna.

WANTED Cigarette, tobacco cards. Write Charles Bray, East Bangor, Penna.

20 MATCHBOOKS Plus surprise gift from fabulous Las Vegas. Send \$1.00, P.O. Box 342, Phoenix, Arizona.

OREGON Beach agates, 20 assorted polished \$1.00. Robert Brandt, Sweet Home, Oregon.

INCOME And gifts from two hobbies, \$2.00 each. Martha Dawson, 620 Santa Rosa Ave., Berkeley, California.

INVENTING Can be an interesting and profitable hobby. Write for complete particulars. Institute of American Inventors, Dept. 40-E 635-F St., N.W., Washington 4, D. C.

COLLECTORS Matchbook covers. 100 different unused, \$1.00. Catalog 25¢. Album \$3.00. Charles Edelman, 1311-C East 84, Cleveland 3, Ohio.

SAMPLE Nazi medal with ribbon, 50¢. Swastika embroidered emblem, 25¢. Catalog, 25¢. Hobbies, Box 71B, Rockaway Park 94, N. Y.

DO-It-Yourself booklets, 32 different home and hobby projects. Send for 1958 book catalog 10¢. Popular Mechanics Press, 631 N. St. Clair St., Chicago 11.

NAZI Insignia, 12 different, \$1.00. Illustrated lists 15 cents. Hobbyland, Calgary, Canada.

CAMERAS, PHOTO SUPPLIES

FREE Photographic bargain book. Thousands of new and used bargains in photographic equipment and supplies. Dept. 1-D9, Central Camera Company, 230 S. Wabash Ave., Chicago 4, Illinois.

GIANT 180,000 Lumen flashbulbs, 24—\$5.00. Engineering. Box 26, Dayton 19, Ohio.

BROWNIE Movie camera \$19.95; Norelco men's shaver \$12.95. Tremendous discounts, photo equipment, appliances. Free catalog. Mailers Mart, Pelham 1, New York.

PHOTOGRAPHERS Wanted, part time. Write, PCI, Dept. M, Glen Echo, Md.

PHOTOGRAPHY For pleasure or profit. Learn at home. Practical basic training. Long established school. Free booklet. American School of Photography, 835 Diversey Pkwy., Dept. 3441, Chicago 14.

PHOTO FINISHING

2 FREE Enlargements from your negative on portrait paper with this advertisement and 10¢ for handling. Special Christmas card prices. Big Pic, Jefferson City 1, Mo.

SAVE Money. Kodacolor developed with 8 prints \$2.70; 12 prints \$3.70. Reprints 25¢ each. Money Saver Photo, Box 97, San Lorenzo, Calif.

TWELVE Exposure rolls 49¢. Wallets 20¢ for \$1.00. Lincoln Studios, Dept. K, Box 13, Lincoln, Nebr.

FIFTY Photostamps \$1.00, negative, print, M. Levinger, 261 Bedford Hills, New York.

ENLARGEMENTS, Heavyweight, six 5x7's or three 8x10's \$1.00. Jack Koons, Huntington Mills, Penna.

ENLARGEMENTS, Any size. 8x10, 35¢; 11x14, 75¢; 16x20, \$1.75. Guaranteed. Enlargements Unlimited, 203 Woodward, Buffalo 14, N. Y.

FREE Kodacolor film developing. Pictures, 25¢ each; 12 exposure roll, only \$3; 8 exposure, \$2. Color Studio, Box 701C, Springfield, Mo.

8-HOUR Service on deluxe jumbo prints. 8-exposure roll developed and 8 jumbo prints 40¢, 12 exposure 55¢, 16 exposure 70¢; 35mm, 20 exposure 75¢, 36 exposure \$1.25. Jumbo deckle reprints 5¢ each. Contact prints made if specified. Bay Photo Service, P.O. Box 210, Oakland, California.

NEW Negative and three jumbo prints from your snapshot. \$1.00. Ferrell's, 2873 Exter, Mobile, Ala.

3-DAY Service on beautiful personalized Christmas cards from your photo or negative. Write for free sample and information. Lincoln Studios, Dept. K, Box 13, Lincoln, Nebraska.

KODACHROME Processing by Kodak. 8mm. roll or 35mm., 20 exp., \$1.35. Prompt service. Write for mailers and prices. Color Pix, Dept. P, CPO Box 30, Kingston, N. Y.

TWO Beautiful prints from each picture on roll. 8 exposure 45¢; 12 exposure 55¢. Thirty-seven years of satisfied customers. Quick service. Lens Photos, Dept. J4, Janesville, Wis.

MINOX, All subminiatures negative processing, 40¢; each print, 6¢. Flash Foto, Box 36-MS, Brooklyn 4, N. Y.

LAMINATE Crystal clear plastic to 24x29 1/2 without machine. Trial kit \$1.00. Dealers invited. Volvo, Cresskill, N. J.

SUPERIOR Quality. Prompt service. 8 jumbos in album 40¢. 16 contacts 50¢. Jumbo reprints 5¢. Satisfaction guaranteed. Also complete color film finishing service. Write for free circulars and mailers. Fast-X-Foto, Box A, Jersey City, N. J.

MOTION PICTURES AND SOUND EQUIPMENT

SOUTHSEAS—2x2 Colorslides, catalogue, sample 30¢. Avery Colorslides, 4818 Placidia Avenue, North Hollywood, Calif.

8MM Home movies. Special offer. Regular \$1.95, 50 ft. \$1.00. Cartoons, travel, comedies, animals. Send \$1.00. Movieland, Box 10-M, Van Nuys, Calif.

16MM Sound films. Bargain bulletin. Duquette, 97-T Snow, Fitchburg, Mass.

FREE! Blackhawk's big sale catalog 8mm., 16mm. movies, 2"x2" color slides. Biggest selection anywhere! Projectors, cameras, supplies. Big discounts! Get free, every three weeks. 12-page newspaper size bargain list! Blackhawk Films, Davenport 14, Iowa.

MOVIE Camera film: 8mm. roll \$1.50. 16mm. 100' \$3.00. Free processing. Better Films, 742 New Lots, Brooklyn, N. Y.

BOOKS: Hundreds of subjects. Big 1958 book catalog—10¢. Popular Mechanics Press, 200-BC East Ontario St., Chicago 11,

3,000 8-16MM. Movie films. Free catalogues. International, Greenvale, N. Y.

SAVE 50%! Guaranteed-fresh color, b.&w. movie film! 8mm., 16mm. Free catalog! Ego-R, 47th Holly, Kansas City 12, Missouri.

FREE Catalog. Save dollars. Fresh 8mm., 16mm. b&w and color film. Home processing equipment. Superior Bulk Film Company, 448 No. Wells, Chicago 10.

16MM. Sound, projectors, films. Sale, rental, exchange. Visit store or write for catalog. National Cinema, 71 Dey St., New York City.

HIGHEST Trade-in allowances towards Ampex, Concertone, Crown, Ferrograph, Presto, Pertron. Components, accessories catalog. Boynton Studio, 10-PM Pennsylvania, Tuckahoe, N. Y.

MUSIC AND MUSICAL INSTRUMENTS

SONGWRITERS—Outstanding, ethical offer. Hibbler, C-5, 6808 Oleander, Chicago 31, Illinois.

POEMS Wanted for musical setting and recording. Send poems. Free examination. Crown Music Company, 49-C West 32 Street, New York 1.

INTERESTED in songwriting? Send for free copy of new magazine, "Songwriter's Report." Songwriter's Report, Dept. A, Box 1371, Nashville, Tenn.

ITALIAN Piano accordions at big savings. Free catalog. Max Carbonari, 227 Harrison, Dept. A, Oak Park, Illinois.

PLAY Piano by ear—New 16 lesson copyrighted system. Mail \$1.00 for complete course or post card for free details. Doyle Studios, P.O. Box 432, Macon, Georgia.

ACCORDION Repair Guide \$3. How to Build Accordions \$5, satisfaction guaranteed. Compl. instr., charts, patterns. Imported reeds \$55 set, accessories. Fischer, Box 402, Bellingham, Wash.

SWISS Musical movements. Mechanical, electrical. Spielman, 131 West 42nd, New York City 36.

1958 ACCORDIONS Wholesale—10 day trial. Free catalog. American Accordion Center, 5329 PM-12 Belmont, Chicago.

SONGWRITERS: We are helping our members to get their songs placed with publishers and record companies. National Songwriter's Guild, 15H Raymonde Circle, Ormond Beach, Florida.

SEND Poems wanted. Free examination. Send poems. McNeil, Master of Music, 1112 PM Wilshire, Santa Monica, Calif.

SONGS And poems wanted. U. S. Music, Box 222A, Belmont, Mass.

ACCORDIONS—1959 Models. Lowest wholesale prices. Save up to 75%. Free home trial. Trades accepted. Big color catalog free. Accordion Manufacturers, Box R, 2003 Chicago, Chicago 22.

SAXOPHONES, Clarinets, trumpets, trombones from factory. Save 50%. Free catalog. Libro Music Center, 591 Chapel St., New Haven, Conn.

ELECTRIFY Player pianos and reed organs. Lee Mfg., 10630 Hillhaven, Tujunga, Calif.

SUCCESSFUL Songwriting. Free booklet. Complete instruction. Write: Box 277, Van Nuys, Calif.

PHONOGRAPH Records cheap, postpaid. Catalogue. Paramount, Box 242-M, Williamsport, Penna.

ELECTRIC Guitars, amplifiers, wholesale. Free catalog. Carvin PMM, Covina, California.

WANTED! Poems, lyrics, songs, ideas. Bengol, 93 Jefferson, Chelsea 50, Mass.

SWISS Musical movements, \$1.90. Helax, 218 W. 72nd St., New York City 23.

VIOLIN Makers supplies. Free catalog. 309 W. Fourth, Los Angeles 13.

ACCORDIONS, Wholesale to everyone. Save up to 60%. All national known brands. Free catalogue. Del Principe, 29 South Cicero, Chicago 44.

SONGS Into dollars. Share \$33 million dollars yearly for new songwriters, song poets. Any subject, songs composed, published, promoted by largest firm. Information, appraisal free. Send Nordyke Music Publishers, 6000 Sunset, Hollywood 28 PM, California.

FREE Wholesale musical instrument catalog. Complete lines of instruments and accessories. Nationally famous brands. Strauss Music Company, Clifton 70, New Jersey.

SONGPOEMS And lyrics wanted. Mail to: TinPan Alley, Inc., 1650 Broadway, New York 19, N. Y.

POEMS Wanted for new songs and recording. Immediate consideration. Send poems. Songcrafters, Box 6145, Acklen Station, Nashville, Tenn.

POEMS Wanted for musical setting and recording by America's largest song studio. Send poems. Free examination. Five Star Music Masters, 630 Beacon Building, Boston.

VIOLINMAKERS, Repairers. Fine tone wood, and all violin supplies. Send for free wholesale new price list. International Sales, 414-MPM E. Baltimore St., Baltimore 2, Maryland.

RADIO, TELEVISION AND ELECTRONICS

FIX Your own TV the easy way and save 80%! Send 10¢ for new TV trouble shooter chart, showing which tubes to replace. We'll include latest wholesale tube price list free. Zalytron Tube Corp., Dept. PM, 220 W. 42nd St., New York City.

PERSONAL Phone radio, assembled, \$3.50. Wave-powered super kit, April PSM, \$6.50. Telepower, Wheaton, Maryland.

RADIO Course only \$22.95. Includes all tubes, parts, tools, instructions. Write for full information. Progressive "Edu-Kits" Inc., Dept. 561-B, 1186 Broadway, Hewlett, New York.

BUILD Your own hi fidelity kits. Details. Arkay Dist. Co., P.O. Box 581, Church St. Sta., New York City, N. Y.

DISTANCE Crystal set plans. 30¢. Laboratories, 1131-C Valota, Redwood City, California.

CRYSTAL Radio kit with phone \$3.00; plans, catalogue free. Clearco Crystal Company, 2966 N. 4th, Milwaukee 12, Wis.

ELECTRIC Guitars, amplifiers, wholesale. Free catalog. Carvin, PMR, Covina, California.

HI-FI components, recorders, tape, records. Wholesale catalog free. Audio Fair, 1793M 1st Avenue, New York 28, N. Y.

GOVERNMENT Surplus radios, parabolic reflectors, snooperscopes, mine detectors, parts. Catalog 10¢. Meshna, Malden 48, Mass.

RECORDERS, HI-FI. Free wholesale catalogue. Carxon, 215-PM East 88, New York City 28.

TAPE Recorders, hi fi components, tapes. Unusual values. Free catalog. Dressner, 69-02M 174 St., Flushing 65, N. Y.

SIMPLE Television repairs. Marvelous booklet or book. Send for 1958 book catalog—10¢. Popular Mechanics Press, 633 N. St. Clair St., Chicago 11.

BUSINESS OPPORTUNITIES

START A profitable business sharpening scissors, pinking shears, on precision electric machine. No experience necessary. Eastsharpe, 4221-B Rocky River Drive, Cleveland 35, Ohio.

ATTENTION: Mail order operators and list buyers! Half million current, live "opportunity seekers." Names on gummed labels. Special test offer \$8 per thousand. Richton Company, 231 Wyoming, Maplewood 1, New Jersey.

FREE! Get the facts on starting your own mail order business. Write: Mail Order Publications, 5204—37th St. North, St. Petersburg 34, Florida.

GROW Mushrooms. For pleasure. In boxes, lawns, pastures, grasslands, farmlands, gardens. Send \$1.00 for spawn, instructions. Thomas Company, D. 3604—30th S.W. Seattle, Wash. Copyright © 1958.

WAXES Floors without wax. New invention. No more floor wax to buy. Sensational seller. Samples sent on trial. Kristee 104, Akron, Ohio.

NEW! Robinson's Sewing Machine Service Manual. 579 illustrations. 144 pages. Earn to \$5.00 hour. Price \$6.25. Where to buy wholesale. Write Lee Robinson, Book Nook Bldg., Walla Walla, Wash.

BECOME Bookkeeper, tax expert! Revolutionary easy simplified method. Quick earnings. Earn home full or sparetime. Easytax, 1036A S. LaBrea, Los Angeles 19, Calif.

GROW A living miniature forest or orchard (only inches high) that bears tasty tiny fruit at home. Learn amazing dwarfing secrets! Fascinating hobby. Profitable home-business opportunity. Free seeds and plan. (State your age.) Miniature Nurseries, Dept. DR, Gardena, California.

BE A home manufacturer. Make the highest profits. Our sales organization gets the orders, helps sell your products. Build luggage and cases for 1001 needs. We supply instructions, supplies, everything. Work full, sparetime. Details free. Abaris, 807-S12 Sunset Blvd., Los Angeles 12, Calif.

NEW Patented exclusive designed filtered smoking pipe. Excellent Christmas gifts. Send no money. Pay postman \$5.00. Nargu, 777 Bayside, Detroit 17, Michigan.

OPERATE Profitable mail order business. Write Walter Service, 4159A East 112th, Cleveland 5, Ohio.

MAKE Extra money. Cash commissions. Everybody buys easy-to-sell advertising book matches. Union label. All sizes. Cuts for all businesses. Powerhouse selling kit free. Steady repeat business. No experience necessary. Superior Match Co., Dept. MX-1258, 7528 S. Greenwood, Chicago 19.

START Your own business on credit (U.S. and Canada). Be your own boss. 1425 Dealers sold \$5,000 to \$32,000 in 1957. We supply stocks, equipment on credit. 200 home necessities. Sales experience unnecessary. Pleasant profitable business backed by world-wide industry. Write Rawleigh's, Dept. L-U-PPM, Freeport, Ill.

GROW Expensive herbs for us! Big profits home-business of your own. Year around profitability! We supply everything necessary! Send for free rare seeds and revealing plan. (State your age.) National Herb Exchange, Dept. DR, Gardena, Calif.

HOME-Import mail order business—Import profitable items below wholesale. Experience and product investment unnecessary. Full, spare time. Famous world trader guides you. Free list "157 Imports," details. Mellinger P70C, Los Angeles 24.

"50 NEW Home-Business Ideas" booklet. Sample free. Spray exotic Velvet-Suede on anything. Flockcraft-DR, Los Angeles 61.

BRUSH Plating outfits for plating articles in the home and shop. No tanks necessary, silvering mirrors, spare or full time. Free particulars. Gunmetal Co., Ave. H, Decatur, Ill.

BEFORE Starting any mailorder business read "Mailorder Laws and Regulations" and "Mailorder Rules for Beginners." \$2.00. Licenses, taxes, legal requirements explained. Tasker, Box 3131, Alexandria, Virginia.

PROFITABLE Notary public licenses available your state now. Write Notarizers', 3230-MC Stoner, Los Angeles 66, Calif.

\$250.00 WEEK Profit possible. Earn at home spare time with fascinating printing method. \$5 starts you. Send no money now. Free confidential facts and valuable samples. Screen-Print DR, Los Angeles 61.

INVISIBLE Reweaving: \$5 in one hour possible reweaving burns, tears, moth-holes. Spare-full time. Free details. Skilweave, Dept. SC-1612, 335 W. Madison, Chicago 6.

QUICK Money! "Repairing Car Batteries." At home! Easy too! Free details! Batteryman, Penrose, Colorado.

GROW Mushrooms. We buy mushrooms and pay high prices. Use cellar, shed and outdoors. Spare, full time, year round. We sell 100% pure cultured mushroom spawn. Free book. Mushrooms, Dept. 172, 2954 Admiral Way, Seattle, Wash.

MANUFACTURER Fishing lures, plastic, none better. 20 models pennies. Free circular. Quaker, 3514-24 N. Lawrence, Philadelphia 40, Penna.

FLEXIBLE Rubber molds for plaster and Marble figurines. Sample and large illustrated catalog 25¢, refunded on first order. K-C Novelties, Dept. 85, Southampton, Mass.

FREE Sharpening manual. Good money servicing cutters, saws, cutlery. Thousands doing it. Treyco, North Tonawanda, N. Y.

OPERATE Collection agency. Gold mine opportunity. Lifetime business. Be respected. Franklin Credit, Roanoke, Va.

MEN — Women: Profitable homework, typing, mailing; forms supplied. Permanent setup \$1.00, refundable. Interstate, 37 Besch, Albany 9, N. Y.

COSTS \$4—Retails \$1.00. Needed automotive product. You manufacture, distribute, easily. Everything furnished. Wilson, 505-C, Princeton, W. Va.

MAKE 20 Filter cigarettes for 9¢. Facts free. Moberly, 950, Owensboro, Kentucky.

SUCCESS, Independence. New process halves cost. Service Business, 8262 4th N.E., Seattle 15, Wash.

WANTED: Home producers, to be subcontractors. Cast plastic products for manufacturers in our clearing house service. Thousands of easily made items required. Cash in at home, without previous experience. Plastic Service Associates, Dept. 12-PM, East Boston 28, Massachusetts.

LEARN Fascinating hobby-business, engraving plastics! New engraving-carving-pantograph attachment, "Dupliscaler," uncovers exciting profitunities! Details, sample 15¢. Desco Distr'a., 5262-D Van Nuys, Van Nuys, Calif.

LEARN Make terrazzo monuments. Terrific profits. Material available locally. No expensive machinery. Granitex Monuments, Box 262, Dyersburg, Tennessee.

BECOME Finance specialist. Handsome profits. Tucker Associates, 3633 Warder N.W., Washington 10, D. C.

FRANCHISES Available, automotive and construction products never before offered. Hudson T. Marsden Mfg. Co., Inc., 645 Beahan Road, Rochester 11, New York.

DO It yourself. Make \$200 week or more selling photo-film or novelty items by mailorder. Free details. Amoa, 6349-B North Western, Chicago 45, Ill.

EXPORT-Import business made easy. Complete setup service, not just instructions. Hermes, 152 West 42, New York City 36.

EARN Extra money at home in spare time. Exciting income plan. Details free. W. E. Hull, 1923 Berkley, Dallas 24, Texas.

CURIOSITY Never killed a mail order dealer. Write Frank Griffin, 6739 Third, Brooklyn 20, N. Y.

MAKE Your fortune with food specialties. Thousands have. 20 page course explains. Ayner, 4406 Cottage, St. Louis 13, Mo.

LARSTONE, World famous foolproof, formula, stucco paint, patching, floor leveler, etc. Unlimited profits. Free information. 3419 9 East, Salt Lake City 6, Utah.

DISTRIBUTORS wanted for portable metal buildings. Sell through hardware stores, farm implement dealers. Quickly assembled, easily sold. Great demand. Hardware dealers gladly accept small display model, we furnish. You pay dealer commission on every full size building he sells from model. Complete line and sizes of metal buildings starting at 3'x4'. Buildings can be knocked down, easy to deliver. You can start your distributorship under a \$200 investment. Write Amity Metal Products, 7011 W. Archer Avenue, Chicago 38.

FIND Money in your mailbox. Start your own mail order business. Experience unnecessary. Mail order experts show you how. Write for information. Richton Company, 157M, Maplewood, New Jersey.

EARN Up to \$150 week. Business opportunities galore. Send 25¢ for information. Thowe, Dept. PM10, 643 McLaughlin, San Antonio 11, Texas.

MUSHROOMS Quicker, easier, cheaper. "Magic" preplanted trays. Newest facts free. Spawm \$1.00. Luxur, 641 South 19th, Newark 3, N. J.

LEARN Sewing machine repairing. To \$125 weekly. Sparetime. Supplies. Add to present business. Shipping from Chicago. New York, Los Angeles. Write today! Taylor Service, Box 2126, San Bernardino, Calif.

NEED More money? Sharpen saws and lawnmowers. Spare time or full time. For free details and terms, write Max Mfg. Co., 138 Stockton Ave., San Jose 26, Calif.

HOW To operate a printing brokerage. Complete instructions \$2.00. G & A Sales, P.O. Box 3466-K, Mdse. Mart, Chicago 54, Ill.

SELL Information! Sample moneymaking publications: 25¢. Rainone Publications, Middle Village 79, New York.

MAIL Trade magazine has moneymaking opportunities galore. Sample 25¢. Donovan, 79-PM Greenbelt, Levittown, New York.

FREE "Franchise profit letter" describes nationwide opportunities. Exclusive distributorships, dealerships, agency operations. Write today. National Franchise Reports, W-528, 333 North Michigan, Chicago 1.

TREMENDOUS Possibilities in home mail order. I retired after five years. Plan and help given absolutely free. Norris Cole, 217 West 49th, Bradenton, Florida.

MONEY Raising earthworms. Instruction booklet 40¢. Organic Gardens, Mountainburg, Arkansas.

OPERATE Your own home mail order business, it's profitable. Write. Webb Imports, Pico Rivera, Calif.

OPERATE Mailorder folio business. Free details. Ballard's, 1323 Winter, Louisville 4, Ky.

BOOMING Business. Ground floor opportunity. Free booklet. Stone-Craft, Box 856-A, St. Louis, Mo.

MAKE Signs. Just nail on. Hoag's Sign Letters, 507 E. Chicago Blvd., Tecumseh, Michigan.

SELL By mail profitably. Beginner's manual gives tested methods. 25¢. Alfano, 19 Pine, Closter, New Jersey.

\$34.70 **TWO** Hours. Manufacturing concrete products. No selling. Carlayne Castings, 1803 Fremont, Rapid City, South Dakota.

TO \$100.00 Weekly. Sparetime, home operated mailorder business. Successful beginner's plan. Everything supplied. Lynn, 10420-M National, Los Angeles 34.

LEARN Real estate by listening to records. Lee Institute, Brookline 46, Mass.

CAMERA Owners! Earn \$50.00 weekends! Instructions \$1.00, information free! Kline, 935-PM North Austin, Chicago 51, Illinois.

COLORGLAZED Concrete pottery made without molds. Patented method. Cemetery products, novelties, tiles. Basement leak-sealing. Money-making projects. Booklet, details free. Men only. National Potteries Company, Grand Rapids, Minnesota.

PIANO Tuning learned quickly at home. Tremendous field! Musical knowledge unnecessary. Information free. Empire School of Piano Tuning, Champaign, Ill. (Founded 1935).

WANT To make big money at home? \$10.00 profit in an hour possible with invisible mending. Make tears, holes, disappear from clothing, fabrics. Steady year-round demand from cleaners, laundries, homes. Details free. Fabricon, 6234 Broadway, Chicago 40, Illinois.

\$70 **WEEKLY**—Home, spare time. Simplified mail bookkeeping. Immediate income—easy! Auditax, 34757A, Los Angeles 34.

MINK Raising information free. Complete. Lake Superior Mink Farm. Superior, EE1, Wisconsin.

MAKE Flexible molds. Cast plaques, figurines. Free sample. Tooker, 1045-R Fairview, Hamilton, Ohio.

NATURAL Molding rubber, extra thick. Free sample. W. Wooley, 1016-A Donald, Peoria, Illinois.

I want to send you proof of the wonderful pulling power of Popular Mechanics classified pages. What's your proposition? Write me today. Include literature if possible. F. W. Johnson, Manager Classified Advertising, Popular Mechanics Magazine, 200 E. Ontario St., Chicago 11, Ill.

INCOME With garden golf. Motivated archery ranges. Brockway, Box 3924, Portland 8, Oregon.

YOUR Own high profit business. Sell name brands, full or part time. No inventory, no investment. More than 2,000 name brand items; lowest wholesale prices. Watches, jewelry, cameras, hi-fi radios-phonos, appliances, housewares, hardware, power tools, luggage, musical instruments, garden equipment, sporting goods, toys, many others. 8 floors of name brands. Million dollar inventory. Orders shipped complete within 24 hours! Send for free, beautifully illustrated catalog now! Separate dealer price list. H. B. Davis Corp., Dept. 11, 145 W. 15 St., New York 11, N. Y.

MONEYMAKING Vending machines. Catalog. Rake, 607 Spring Garden, Philadelphia 23, Penna.

OPERATE Profitable mailorder business! Write: Bond, 1637-H West Vernon, Phoenix, Arizona.

AVAILABLE—Professional mailorder procedure, fully legal, profitable, economical. Since 1930. Free outline. Personal Profit Plans, 333 North Michigan, Chicago 1.

SELL The Hertel Blue Ribbon pictorial Bible containing all the features necessary for complete Bible information. 1958 edition, top commission. International Book Co., 322 N. Market, Wichita 1, Kansas.

THE All profit offer plus my big mail 30¢. Satisfaction guaranteed! Crews, Box 58, Valrico, Florida.

\$400.00 MONTHLY Raising redworms, mealworms, crickets. Clean soilless method. Free brochure. Charlie Morgan, 116E. Bushnell, Florida.

CANDIED Popcorn and potato chip equipment. Eakins, Box 933-A8, Springfield, Ohio.

RAISE Rabbits on \$500 month plan. Plenty markets. Free details. White's Rabbitry, Delaware, Ohio.

SALES-By-Mail could be your opportunity. Valuable food for thought free. Rawson Wood, 3974 Milwaukee, Chicago 41.

MONEY Plans! "Secret Journal." Grandpa, two daughters made \$2500 first month! Work home. Publicco, Oceanside, Calif.

11,000 NEW Prospects daily. Baby record books, shoes, albums. Sell mailorder. Use our literature. Write: No-Co-Ro, Capitola, California.

BAKE New greasless doughnuts in kitchen. Sell stores. Free recipes. M. Ray, 3805 South 15th, Minneapolis 7, Minnesota.

FIX Typewriters. Inexpensive home course teaches factory secrets. Free booklet. Athey, Tarentum, Penna.

PLATE Baby shoes, jewelry, gifts, bronze and colored pearl. Free booklet. Platex, 11029 South Vermont, Los Angeles 44.

COPUBLISH Mail Sale Advertiser, leading mail order paper. Details, latest copy, dime. Vanroy Shirk, Lebanon, Penna.

FREE Catalog. Contains hundreds of businesses, farms and income properties throughout U.S., Canada. Specify type and location desired. Deal direct with owners. U. I. Buyers Digest, 1608 Hillhurst, Dept. PM-3, Los Angeles 27, Calif.

MOTEL Supplies business and mailorder to institutions. New! High income. Investigate. Hermes Advertising, 152-C West 42, New York City 36.

BRONZE Baby shoes: Instructions, equipment and mountings for genuine electroplating process. Largest supplier of all plating equipment, supplies. Free catalog. Hollywood Bronze Supply, Dept. B-3, 1624 East First, Los Angeles 33, Calif.

I Got rich in the dry cleaning business with no investment, so can you. Free details. Write: Imperial School of Dry Cleaning, Dept. PMC, 1700 Touhy Avenue, Chicago 26, Illinois.

BUY Wholesale! 30-80% discounts! Nationally famous brands. Typewriters, housewares, appliances, watches, furniture, musical instruments, cameras, tools, etc. Consolidated Distributors, Clifton 1, New Jersey.

QUICK Profits, with no capital! Take orders for magazines your neighbors like, want. Make cash on the spot! We show how with free kit. Get yours now. Write McGregor Magazine Agency, Dept. 310, Mount Morris, Ill.

FREE Book "505 Odd, Successful Businesses." Work home. Pacific, Oceanside, Calif.

FREE Folio "\$5,000-\$45,000. Unlimited Vacations." No merchandise. Unknown! Work home, sparetime! Haylings, Carlsbad, Calif.

MAKE \$46 From square foot plywood; jig saw necessary. Free details. Woodart, Bridgewater, Mass.

GROW Orchids at home. Profitable, fascinating. Successful home grower explains special light, temperature and humidity conditions orchids need. Free! Full details. Orchids, 100 S. Vermont, Los Angeles 4.

FREE Book "990 Successful, Little-Known Businesses." Work home. Plymouth, 1610-43 Street, Brooklyn 4, N. Y.

REBUILD Batteries; repair dolls; make rubber stamps. "75 Ideas" free. Universal, Box 1076-A, Peoria, Ill.

BUY Direct from factories—Appliances, cameras, watches! Free details! Cam Company, 6810PM—20th Ave., Brooklyn 4, N. Y.

PLASTERCRAFT Molds, liquid rubber, plasters, flocks, candle supplies. Catalog and manual free. Blue Rapids Supply. Blue Rapids, Kansas.

LIQUID Molding rubber, free sample. Shellcraft supplies. Chaney's, 1907-A East Road, Jacksonville 11, Fla.

\$5,000 YEARLY. Spare time at home. Nothing to buy. No local selling. Dignified. Guaranteed. Home Harvest, 1933 Lakeview Road S.W., Albuquerque, N. Mex.

NEW Home-import mail order profitability! Your mailbox stuffed with money! No selling. No experience. No investment. We supply everything. Free details. Mail Order Distributors (Import Division), 15201 South Broadway, Los Angeles 61A11, Calif.

MONEYMAKING OPPORTUNITIES

AMAZING Successes through franchises! Become exclusive franchise holder your territory. Information rushed. National Franchise Reports, MP-528, 333 North Michigan, Chicago 1.

MANUFACTURE Rubber stamps. Complete shop under \$100.00. Helms Stamp Co., Bristol, Tenn.

WEAVE Rugs—Make good profits! No experience necessary! Free catalog, sample card, and low prices on carpet warp, rug filler, looms, parts, inexpensive beam counter. If you have loom, advise make, weaving width please. OR. Rug Company, Dept. X893, Lima, Ohio.

GROW Miniature trees for pleasure or profit. Complete course for \$2.00 prepaid plus free training pot and seeds. Details free. J & J Nurseries, P.O. Box 205, Canandaigua, N. Y.

START Profitable mailorder business! Home. Beginners follo \$1.00. Refund if not satisfied. Details free. James Thompson, 75 Ridge Avenue, Youngstown 2, Ohio.

MAKE \$5,000 Yearly sparetime raising mink, chinchillas, nutria, etc. Free booklet reveals proved plans. Write: Furs, 588 Mt. Pleasant Road, Toronto 1, Canada.

POSSIBLE Big steady income. Copyrighted 50/50 profit sharing plan. No selling. Work home. Full or part time. Free plan. Colburn Specialty Sales, 940 East Broadway, Phoenix, Arizona.

HUGE Profits! Manufacture concrete fence posts. Send \$2.00 for plans, instructions. Cretepost, Box 38, Windsor, N. Y.

\$15,000-\$20,000 ANNUALLY. Own business. Particulars, \$1.00. Raby, 733 River, Ypsilanti, Michigan.

HOW To make money—Over 150 plans \$1. Catlin, 68 North Ellsworth, San Mateo 8, California.

GROW Mushrooms. We buy mushrooms and pay high prices. Use cellar, shed and outdoors. Spare, full time, year round. We sell 100% pure cultured mushroom spawn. Free book. Mushrooms, Dept. 173, 2954 Admiral Way, Seattle, Wash.

PERFUMES. Literature, quantity prices. Malord Sales, Box 88, Pekin, Ill.

WIN Contests. Complete information, 10¢. Spence, Box 11569, St. Petersburg, Fla.

NEW Magazine shows you how to operate profitable mailorder business. Free details. Mailorder Income, 2639-217 Howard, Chicago, Illinois.

SELL Books by mail, 400% profit. Royal, Box 368-X, Cleveland 27, Ohio.

OREGON Opportunities magazine. Money-making products, businesses, farms, imports. Year \$1. Sample 25¢. 227 2nd, Corvallis, Oregon.

ALWAYS Broke? Send for our home budget. Free information. Budget Plan, Box 481, St. Louis 66, Mo.

\$50.00 WEEKLY Possible mailing catalogs. Roe, 1657 Gregory, Chicago 40, Ill.

\$15,000 YEARLY Income possible, at home, in respectable field. 3 hours weekly attention. No experience necessary. Detailed plan. Send 10¢. Columbia Enterprises, 8203-PM Grubb Road, Silver Spring, Maryland.

RAISE Earthworms for health and profit. Instructions \$1. Edith, Terra-Vermis, Allegan, Michigan.

MUSHROOMS Quicker, easier, cheaper. "Magic" preplanted trays. Newest facts free. Spawn \$1.00. Luxur, 641 South 19th, Newark 3, N. J.

10 WAYS To make money with an automobile. \$1.00. Vannemond, Box 284, South Haven, Michigan.

JOIN The prosperity parade with a mail order bookshop in your own home. Valuable information free. Practical Publications, 3974-F Milwaukee, Chicago 41, Ill.

FREE Plan and help. Home mail order. A. Cole, 217 West 49th, Bradenton, Florida.

START Successful home mail order business. Plan and personal help absolutely free. Johns, Box 1013, North Little Rock, Arkansas.

SELL Titania gems. Far more brilliant than diamonds. Catalog 10¢. Diamonite, 2420-M 77th, Oakland 5, California.

MEN—Women! Start money-making plastic laminating business at home in spare time. Material that costs 11¢ brings back \$2.50. No canvassing or selling but mail orders bring in \$20 a day. Write for full particulars free. Rush name on postcard to Warner, Room CL-2-L, 1512 Jarvis, Chicago 26, Ill.

SELL Information by mail. 10-to-1 profit ratio. Valuable suggestions free. Rawson F. Wood, 3974 Milwaukee, Chicago 41.

MAKE Money writing short paragraphs! No tedious study. I tell you what to write, where and how to sell; and supply list of editors buying from beginners. Many small checks add up quickly. Write to sell, right away. Send for free facts. Benson Barrett, Dept. C-27-X, 7464 Clark, Chicago 26.

START Big-pay business at home in spare time. No experience needed to operate little table-top machine for bronzing baby shoes. Make \$5.46 profit on every pair. Full particulars free. Send postcard to Mason, 1512 Jarvis, Room CM-2-L, Chicago 26, Ill.

EARN Money evenings copying and duplicating comic cartoons for advertisers. Adservice, Argyle 1, Wisconsin.

BUY Wholesale! 30-80% discounts! Nationally famous brands. Typewriters, housewares, appliances, watches, furniture, musical instruments, cameras, tools, etc. Consolidated Distributors, Clifton 2, New Jersey.

BOOKS: Hundreds of subjects. Big 1958 book catalog—10¢. Popular Mechanics Press, 200-BC East Ontario St., Chicago 11.

\$100.00 WEEKLY. Raise redworms soilless way. Charlie Morgan, Bushnell, Fla.

WIN Contest money. General Contest Bulletin gives hundreds of tips. Lists current contests, rules. Sample magazine 25¢. General Contests, 1609 1/2 East 5th, Duluth 12, Minnesota.

MAKE Money, operating mail order business, selling business cards. Vosacek Printing, 4444A Ute, San Diego 17, Calif.

CIGARETTES—Improved roller makes 20 for 9¢. Facts free. Moberly, Box 821, Owensboro, Kentucky.

FREE Folio "\$5,000-\$45,000, Unlimited Vacations." No merchandise. Unknown! Work home, sparetime! Haylings, Carlsbad, Calif.

READ Progressive Mailtrade, the magazine that tells how to make money by mail. Dime brings sample and special offer. Progressive Mailtrade, Box 357, Sheboygan, Wisconsin.

MAIL Order rules for beginners. Book \$1.00. Central Trading Co., Box 254, Sudbury, Ontario, Canada.

PREPARE Tax returns—Remunerative! Write Taxbus, 6196 Walnut, Omaha 6, Nebraska.

EASY To start rubber stamp business at home in spare time. Make up to \$9.80 an hour without experience. Facts free. Write to Roberts, 1512 Jarvis, Room CR-2-L, Chicago 26.

FORMULAS, PLANS, ETC.

100 SELECTED Formulas \$1. Catalog free. Ogg Laboratories, 4314 Downing, Tampa 3, Florida.

10,000 FORMULAS \$5.00. Universities-libraries endorsed. A. Hanlon, Malvern, Penna.

MONEY-Saving formulas. Send 10¢ (refundable) for list. Enterprise Products, Box 8573B, Oklahoma City 14, Okla.

FORMULAS For latest money-making discoveries. New! Good! Valuable literature free! Miller, Chemist, 1517-D, Tampa, Florida.

FORMULAS; All kinds, latest, best. Literature free. Kemixal, Park Ridge, Ill.

LATE, Modern manufacturing formulas. List free. Moon Chemical, Martville, New York.

PLASTICS

NEW Liquid casting plastic, clear, colors. Embed real flowers, butterflies, photos, coins. Send 25¢ for two handbooks "How to Cast Liquid Plastics" and "How to Make Extra Money at Home." Castolite, Dept. P-101, Woodstock, Illinois.

PLASTICS! New, do-it-yourself casting and molding materials. Crystal clear for embedding specimens, ivory, ebony, marble and colors for jewelry, novelties and industrial castings. Illustrated catalog 25¢. Castacraft Corp., Dept. D-67, P.O. Box 555, Palo Alto, California.

ELECTRIC Laminating kit. Hobby or profit. Burr, 330 East Center St., Kalamazoo, Mich.

LAMINATING Plastics. Plastic sheets, vinylite, acetate, plexiglas. Free catalogues. Arthur Blank & Co., 44 Causeway, Boston 14, Mass.

CASTING; Mold supplies. Catalog 25¢. Gel, Box 261, Union, N. J.

PHOTO-Seal. Complete electric laminating kit for wallet size photo's, cards. \$14.95. Refills available. Therm Appliance, St. Charles, Illinois.

PLEXIGLAS. Square foot cost, 1/16", \$1.20; 1/8", \$1.52; 3/16", \$1.86; 1/4", \$2.21; 3/8", \$3.23; 1/2", \$4.36. Colors add 10%. Send 15¢ for postage. Aristocrat Plastics, 23 Sussex Avenue, Newark, N. J.

LAMINATING Supplies. Free price list. Solomson, 46 Cornhill, Boston 8, Mass.

BOXES, Plastic. Free list. Althor, 170 Bay 23 Street, Brooklyn, N. Y.

LEARN Plastics fabrication for spare time income. Low cost home training now available. Write for free booklet. Interstate Training Service, Dept. D-3, Portland 13, Ore.

PLASTICS—Plexiglas, acetate, vinylite, polyester, fiberglass, epoxy, styrofoam, polyethylene, mold materials, cements, supplies. Instructive, informative wholesale-retail catalog, 25¢. Gem-O-Lite, 5527 Cahuenga, North Hollywood, Calif.

CHEMISTRY

CHEMICALS In small quantities; laboratory apparatus, glassware. Catalog 25¢. Winn Chemicals, 124M West 23 St., New York 11, N. Y.

CHEMICALS And equipment for rocket research and investigational use. Catalog 25¢ (refundable). Central Rocket Company, Waupaca, Wis.

AMAZING New book of science experiments, formulas, and catalogue of laboratory supplies. Only 25¢. National Scientific Co., Dept. PM-12, 500 West Road, Lombard, Illinois.

CHEMISTRY—Science magazines. Literature free. Lankton, Box 5126C-21, Lansing, Mich.

CHEMICALS, Supplies, 54 page catalog, 25¢. Laboratory Sales, Box 161-A, Brighton, Mass.

BOOKLETS! Chemistry, Physics, Astronomy, Science, Relativity, Electricity, Radio, Light, Tables, Mathematics, 10¢ each. Franks, 3121 South Racine, Chicago 8.

MICROSCOPE Slides, anatomical. Free list. Bay, 409 Roosevelt Way, San Francisco 14, California.

EXPERIMENTERS: Bargains galore catalog, 25¢ (refundable). Hagenow Laboratories, Manitowoc, Wisconsin.

CHEMICALS And apparatus for industrial, analytical, and private laboratories. Catalog 25¢. Dept. M-50, Biological Supply Co., 1176 Mt. Hope Ave., Rochester 20, N. Y.

ILLUSTRATED Catalog: Chemistry, mineralogy, biology 25¢. Tracey Laboratories, Evanston, Illinois.

AGENTS WANTED

AGENTS—Sideline, students sell rubber stamps, 3 lines—name, street, city. Costs you \$1. Sample \$1 refunded 5 orders. Dean Shop, 1189 N. Grand Ave., Baldwin, N. Y.

FUNMAKERS, Gifts. Wholesale catalog free. Samples 25¢. Dohn-GE-Marks, Broadview, Ill.

60% PROFIT On cosmetics—Famous nationally advertised Hollywood cosmetics pay 60%. Make \$25 day up. Hire others. For free samples, details, write Studio Girl, Glendale, Calif. Dept. 12812G.

STRANGE Dry window cleaner. Sells like wild. Replaces messy rags, liquids. Simply glide over glass. Samples sent on trial. Kristee 55, Akron, Ohio.

NATIONAL Family Altar Bibles. Sell on sight! National Bible Study Society, 3348 Bishop St., Toledo 6, Ohio.

YOUR Own profitable repeat business. Experience unnecessary. Everybody needs vitamins. Hire others. Full, sparetime, earnings unlimited. Retirement income plan. Send \$2.25 for details and 30-day supply high potency multiple vitamins (each tablet contains 36 nutritional vitamins, minerals). Retail: \$3.98, \$21.60 dozen. Finest available at any price. Renhill Products, Newark 12, New Jersey.

DAMASCENE Earrings! Exotic orientalism. Huge profit. OHGA, PM130, Sigakenkusatu, Japan.

\$25 DAY, Easy. New fire extinguisher. Retail \$2.95. Profit \$2.00. Free sales kit. Edconco, 115 East 44th Street, Dept. P12, New York 17, New York.

EIGHTY Million prospects! Sample and complete details \$1.00. Sell stores or direct. Lee Products Company, Box 32, Winterset, Iowa.

UNLIMITED Profits. Sell our musical cigarette lighters and other imported lighters. Free information from Whitey Martin Associates, Box 246, Ft. Madison, Iowa.

PROVEN Profit opportunity! New patented Safe-T-Vault. Handy size. Convenient one-way deposit slot for cash, valuables. Indestructible iron, easy to mount, fire resistant. Enormous market in trucks, cars, homes, offices, hotels. A "must" near every store cash register. Popular price. Sell direct or to dealers. Allied Mfg. & Sales Co., 3101 W. Grand Ave., Chicago 22.

100% PROFITS! Movitex sign kit makes changeable posters, display cards, bulletins on-the-spot. Molded 3-dimensional plastic letters fit snugly into perforated panels. Permanent, stainless, washable. Many sizes. Sell to stores, offices, factories, etc. Rush \$2.50 for complete demonstrator kit 1/2 inch letters and panel (\$5.50 value) or ask for free details. Pryor Marking Products, Dept. P, 434 S. Wabash, Chicago 4, Ill.

BIG Profits. Stamp social security plates, key protectors. Sample 50¢. Catalog free. General Products, 188-PM State, Albany 10, N. Y.

FREE Sample! Beautiful feather pictures. Send 12¢ stamps mailing. Sylviak, Apartado 9036, Mexico 1, D. F.

EARN \$12,000 Yearly—Only two sales daily. World's best seller, The Holy Bible. Illustrated. Protestant or Catholic. Margaret's, P.O. Box 92, Hazleton 7, Penna.

BUY Wholesale! 25,000 nationally advertised products. Get amazing dealer catalogs. Complete details free. American Wholesalers, 1841DC Levee, Dallas 7, Tex.

EASY Handwork makes fast-selling useful articles. Sample free. Sunmade Company, Brockton 64, Massachusetts.

\$13.50 HOURLY Profits possible. Introducing 5 valuable farm books your area. Published by Popular Mechanics. Farmers buy on sight. Details free. Popular Mechanics Press, 200 E. Ontario, Dept. 64-B, Chicago.

BE The Popular Mechanics representative in your neighborhood and earn big profits in your spare time. Write Popular Mechanics Magazine, Room 305M, 200 E. Ontario St., Chicago 11.

EXCLUSIVE Territories! Hottest automotive item ever! \$1.00 seller, up to 300% profit. Fantastic demonstrator. Sell retail and wholesale. Maco Products, Falls Church 4, Virginia.

TOP Action ball point pens, 9 for \$1.00. Refills 20 for \$1.00. Bonomo, 54 Jefferson, Brooklyn 6, N. Y.

YOUR Ad in this space will get some good agents for you. Yes, I'll prove it. Write for Folder "A" right now. F. W. Johnson, Classified Advertising Manager, Popular Mechanics Magazine, 200 E. Ontario St., Chicago 11, Ill.

BUY Wholesale! 30-80% discounts! Nationally famous brands. Typewriters, housewares, appliances, watches, furniture, musical instruments, cameras, tools, etc. Consolidated Distributors, Clifton 4, New Jersey.

GOLDMINE Of 600 money makers. Free copy. Specialty Salesman Magazine, Desk 5B, 307 North Michigan, Chicago 1, Ill.

CHAMPION, AC. Autolite spark plugs. Reconditioned, guaranteed. Sells on sight service stations, garages, car lots. 100% profit. Free sample. City Motors, 2913-E Fannin, Houston 2, Texas.

TILE Agents wanted, sell floor and wall tile, sparetime. Chicago's largest tile wholesaler. Catalogue and samples upon request. Century Supply, 3005-P N. Austin, Chicago 34.

PRINTING, Advertising salesmen—Excellent moneymaking sideline selling decalcomania name plates, small quantities. Automobile initials, sign letters. Free samples. Ralco, XL, Boston 19, Mass.

GOLD Or silver letters, numbers. Windows, doors, trucks, 1" to 6". 500% profits. Free samples. Atlas-T, 544 West 79th, Chicago 20.

AGENTS—300% Profit selling genuine gold window letters; stores and offices. Free samples. Metallic Sign Letter Co., 1217-D West Newport, Chicago.

YOUR Own business—Used suits \$1.50, overcoats 65¢, mackinaws 35¢, shoes 12½¢, ladies coats 30¢, dresses 15¢. Enormous profits. Catalog free. Nathan Portnow Associates, 2109-AA Roosevelt Road, Chicago 8.

EXCLUSIVE Line of personal initialed buckles, belts, cap badges, 3000 emblems. Hook-Fast, Dept. FM, Roanoke, Va.

FOG-Stop windshield cloth. Instantly removes blurry mist, frost, sleet, snow. Stops windshield fogging. Samples sent on trial. Kristee 52, Akron, Ohio.

BUY IT WHOLESALE

BIG Multicolor wholesale catalog! Housewares, appliances, clothing, silverware, cookware, luggage, binoculars, shavers, radios, phonographs, cameras, projectors, recorders, typewriters, sewing machines, furniture, power tools, toys, sporting goods, watches, diamonds, jewelry, automobiles, etc. Name brands. Huge discounts. Postcard: Selbyco, Decatur 163, Illinois.

NATIONALLY Advertised merchandise, below wholesale. Catalog 50¢. Refundable first order. Ware's, Box 225, Rosemond, California.

BUY Wholesale! Useful merchandise from 10¢! Catalog 10¢. Wong's, 966-A Hoe, New York City 59.

REMINGTON Rollelectric, \$25.00 postpaid. Check, money order. B. Cooper, Box 178, Marietta, Ga.

ACCORDIONS Wholesale! Save 1/2. Home trial. Free catalog. Accordion Warehouse, Dept. 128-RW, 2003 Chicago, Chicago 22.

LP Records \$1.25. Kaster Music, Room 309, 707 S. Broadway, Los Angeles, Calif.

HANDMADE Western boots, Jodhpurs, Wellingtons. Free catalog. Western Saddlery, Box 7302, El Paso 1, Texas.

LESS Than wholesale! Brand names! Catalog 25¢. Richeo Products, 2511E Prairie, Evanston, Illinois.

GUARANTEED 17J new gold Swiss watches \$10.00, \$60.00 dozen. Wholesale catalogs \$1.00, refundable. Millen 791-A East 160th Street, Bronx 56, New York City.

MOST Unusual catalog—Gift included, 25¢ (refundable). Seegay, Box 10126, San Antonio 21, Texas.

WHOLESALE! 30,000 Items! "Free Wholesale Plan." United Wholesalers, 1265-M Broadway, New York 1, N. Y.

LUBRICATING Oils and petroleum products. Highest quality, send for listings. Moderne Oils, Lyceum Bldg., Tarrytown, N. Y.

NEON Window signs—Custom made. Save 50%. Salesmen invited. Neon Tube Co., 1758 South Cleveland Ave., Canton 6, Ohio.

RONSON '66' Electric shavers \$11.66! Watches \$5.99! Transistor radios \$6.95! All new! Free catalog describes these and hundreds of other bargains. Appliances, toys, jewelry, tools, novelties, all at sell-out prices! Meridian Trade Corp., Dept. M, Box 1236, Cincinnati 1, Ohio.

BUY Wholesale! 30-80% discounts! Nationally famous brands. Typewriters, housewares, appliances, watches, furniture, musical instruments, cameras, tools, etc. Consolidated Distributors, Clifton 3, New Jersey.

USED And new watches \$2 up. Free list. Southern Watches, 5-PM So. Wabash, Chicago 3.

BUY Wholesale! 100,000 nationally advertised products. Appliances, cameras, sporting goods, housewares, watches, typewriters, tools, clothing, etc. Discounts to 80%. Buy-Rite, Box 258, Hawthorne 4, New Jersey.

LARGEST Wholesale supply source in U.S.! Furniture, clothing, appliances, housewares, automobiles and accessories, tools, sporting goods, hobby supplies, farm equipment, imports, new products, bargain merchandise. Free details. Associated Wholesalers, Box 52-DD, Burlington, Iowa.

FREE Wholesale catalog! Christmas gifts, toys, appliances, etc. Big savings! Housewares Distributors, 1216-P West 79th Street, Chicago 20, Illinois.

BUY Wholesale! 25,000 nationally advertised products. Get amazing dealer catalogs. Complete details free. American Wholesalers, 1841C Levee, Dallas 7, Texas.

ELECTRIC Guitars, amplifiers, wholesale. Free catalog. Carvin PMW, Covina, Calif.

SALESMEN—DISTRIBUTORS

TAKE Over your area—Agents, dealers, farmers, make \$125 up weekly selling nationally advertised Campbell's Go-Green liquid fertilizer concentrates. No investment. Everything free. Campbell Co., (Est. 1928), Rochelle 5, Illinois.

SALESMEN: Sell ten fast selling items to gas stations. Write: Arrow Co., 291 East 7th St., St. Paul, Minn.

AD Match sales! Your own business, without investment! Sell for world's largest direct selling manufacturer of advertising matchbooks. Big spot cash commission. Start without experience. Our tested sales kit tells you where and how to get orders. Men, women, part or fulltime. Match Corporation of America, Dept. PM-108, Chicago 32.

\$400.00 EVERY Week. Sell two duplicates a day. Print five colors each turn of the crank. Vari-Color, Box PM-31, Shawnee, Oklahoma.

MAKE Extra money. Cash commissions. Everybody buys easy-to-sell advertising book matches. Union label. All sizes. Cuts for all businesses. Powerhouse selling kit free. Steady repeat business. No experience necessary. Superior Match Co., Dept. M-1258, 7528 S. Greenwood, Chicago 19.

MAKE Money! Take big profit orders, famous fruit trees. Including sensational discovery, Starkrimson Delicious apple! Also dwarfs, shrubs, roses, vines. Sales outfit free. Stark Bro's, Desk 30169, Louisiana, Missouri.

BIG Moneymaking opportunity. Exclusive line uniforms, jackets, pants, shirts, coveralls, sportswear. Advertising embroidered. Every business prospect. Get selling outfit free! Master Co., Dept. H-10, Ligonier, Indiana.

100% PROFIT. Fast easy money! Take orders for Sweet Georgia Brown cosmetics. Colored people buy quick. Free sample. Valmor, Dept. MU, 2451 Michigan, Chicago 16.

AMAZING Opportunity. New low priced fire alarm protects homes, farms, offices, factories, etc. No wiring, hangs like picture. Pays up to \$1,100 a month. Free kit, Merlite (Alarm Div.), 114 E. 32nd St., Dept. F-668, New York 16, N. Y.

WILL You wear new suits and topcoats without one penny cost and agree to show them to friends? You can make up to \$30.00 in a day even in spare time, without canvassing. Stone-Field, 532 South Throop Street, Dept. H-926, Chicago 7, Illinois.

MAKE Extra money. Cash commissions. Easy to sell advertising balloons. Sample kit only 50¢. Refundable with first order. Hall & Riggans, New Castle, Penna.

FACTORY Representative, new winter product. Free sample. Reardon Products, Peoria, Ill.

SALESMEN—Big money every day showing nationally known drain cleaner. No chemicals. Nothing like it. Minute demonstration. Commissions paid daily. Sample furnished. Campbell Co., (Est. 1928), Rochelle 604, Illinois.

IT Ain't sellin'—Just servicing! Take over your area as our service distributor keeping retail stores supplied. Nationally advertised 28-year old line pays you 66 2/3% mark-up. For samples and highly successful plan, write Novo, Inc., 1166-T Milwaukee, Chicago 22, Illinois.

'AREO-Record' imported projectile game: free details. Sample game \$2.00. Perkins, 4001 Robert, Cleveland 9, Ohio.

MAKE \$50.00 Daily, selling hand painted portraits. Write Portraits, 402-48 Hazlett, Baltimore 29, Maryland.

\$520 MONTH Part time. Tool rentals. Leslie, 525 Selby, St. Paul 2, Minn.

MAKE Big money. Sell Spray Polish, vitamins, other fast sellers. HB Chemicals, Decatur, Alabama.

SELL Proven gas and oil additive. Unique selling program and selling helps furnished. Will make Koatsal a steady repeat item. Send \$2.00 for trial order. Koatsal Inc., P.O. Box 250, La Crosse, Wis.

IF You're interested in making money in selling, see the hundreds of exceptional opportunities in Salesmen's Opportunity Magazine. Send name for your copy, absolutely free. Tell us what you're selling now. Opportunity, 848 N. Dearborn, Dept. 17, Chicago 10, Illinois.

EMPLOYMENT INFORMATION

FLORIDA Jobs available. Classified ads. \$1.00. Box 1781, Tampa, Fla.

MIAMI—Classifieds \$1.00. Free guide book, city map. La Tassa, Box 6123, Surfside 54, Florida.

JOBS \$400 Month. Merchant marine. Write: Box 1804-T, Paterson, N. J. Beginners only.

JOBS Overseas! Reply to B-109, Hub Station, New York 55, N. Y.

CALIFORNIA! Employment, opportunities, 15 page booklet, state map included. \$1. Chesley Distributors, 2339M University Avenue, San Diego 4, California.

JOBS, Ships, \$100 weekly beginners. Travel, adventure. Details free. Seaman's Service, Box 17-M, Brooklyn 8, New York.

THOUSANDS Of better jobs now available every kind, men-women, exclusive report \$3.00. Specify. Retailers, 734 Neil St., West Covina, Calif.

JOBSEEKERS. Key to job hunting wisdom. Myers, Box 425-M, Detroit 31.

FOREIGN Employment information. Make big money in Europe, Africa, South America, Canada, Alaska, Far East. Transportation paid. Construction workers, clerks, truck drivers, etc. Travel, adventure. Complete information application blanks, sent by return mail. Send \$2.00 to Foreign Bureau, P.O. Box 512, New Orleans, Louisiana.

AMAZING New job service. We'll recommend you to companies seeking workers in all categories on our official business stationery. Send \$3.00 for job list and complete application service. Write Jobs, Dept. A-3, Box 125, Rugby Station, Brooklyn 3, N. Y.

AMERICAN Overseas jobs. High pay, men, women. Transportation paid. Free information. Write Transworld, Dept. 9D, 200 West 34th St., New York City.

COMING To Florida? Send for complete report, jobs, salaries, cost of living. Information you need. \$2.00. Survey, 904 Chamber of Commerce Bldg., Miami 32, Fla.

BOOMING Latin America! Mexico, Venezuela, Brazil, etc. Salaries over \$1,000.00 monthly U. S. tax exempt. All skills required. Direct information on opportunities, conditions, American companies employing. New report! Airmailed. \$3.00. Paul B. Smith, Apartado 172, Maracaibo, Venezuela.

BIGGER, Uninterrupted income. Earnings-proven method shows, brings best jobs, rapid advancement, security. Free details. Valon, Box 9235, Chicago 90, Ill.

COPYRIGHTED Reports. Best paying jobs with travel, adventure, promotions. Construction, aviation, shipping, oilfields, laborers, clerical, trades, supervisory, factory, unusual opportunities. Skilled, unskilled. Foreign, stateside. Men, women. Only \$2.00 (\$2.25 airmail) (c.o.d.'s accepted), including registration-advisory service. Satisfaction guaranteed. Included free: Special reports on Alaska, Venezuela, South American opportunities, husband and wife foreign jobs. Research Services, Suite 514-PM Meramec Building, St. Louis 5, Missouri.

FOREIGN Jobs—Latin America, Alaska, Canada, up to \$1500 monthly. Up-to-date 1958 foreign service directory gives complete information; hot list of firms hiring for military and civilian construction, aircraft, oil, exporters-importers, mining. How-when-where to apply. 11th successful year. \$1.00. Global Reports, Box 8873-S, Los Angeles 8, Calif.

FREE Information—U.S.A. overseas jobs. High pay, transportation. Futures Unlimited, Dept. M, 215 West 34th Street, New York City 1.

STEAMSHIP And yachting jobs traveling foreign countries. Davenport, 1354-A31, GPO New York 1, N. Y.

ALASKA—Complete job information. Weekly employment reports. Airmailed. \$1.00. Alaska Unlimited, Box 197, Ketchikan, Alaska.

ALASKA. Employment, living, travel, 5 1/2 years' recent experience. Full information. \$1.00. Clark, 7724 Gaston, Ft. Worth 16, Texas.

JOBS—High pay; U.S.A., So. America, the Islands. All trades. Many companies pay fare. Write Dept. 71J, National Employment Information, 1020 Broad, Newark, N. J.

ALASKA Hourly scale: Laborers \$4.15, truck drivers \$4.45; carpenters \$4.38; plumbers \$5.00; electricians \$5.00. Construction projects awarded over \$335,000,000.00. Names and addresses of companies hiring; total contract awarded; location; wage scale; also information regarding homesteading. Send \$1.00 to Alaska Employment Opportunities, Box 1032, Anchorage, Alaska.

CALIFORNIA Jobs. Laborers, truck drivers, etc. Send \$1.00 to V. J. Harold, 1715 Speyer, Redondo Beach, Calif.

SPECIAL SERVICES

PERSONALIZED: Stationery, labels, jewelry, photo stamps, novelties. Free information. Miles Crafts, 630 Baychester Sta., New York 69, New York.

ATTORNEY At Law! Manuel Borja Vargas, Box 1305, Tijuana, Mexico.

ENGINEERING Consultant, college graduate, 15 years experience. Available for consult or for manufacture representative on any problem in mechanical engineering. Write P.O. Box 9358, Akron, Ohio.

INFORMATION On anything. Ferguson Research Specialists, 116-14 141 St., South Ozone Park 36, N. Y.

WHAT Do you want to find? If sold in U.S., or imported, we will locate best sources for you. Mandeville Source Finders, 465 Olympia Road, Pittsburgh 11, Penna.

EDUCATIONAL AND INSTRUCTION

'HOW To Train Horses'—A book everyone who likes horses or ponies should have. Free. No obligation. Simply address Beery School of Horsemanship, Dept. 11012-C, Pleasant Hill, Ohio.

COMPLETE Your high school at home in spare time with 61-year-old school. Texts furnished. No classes. Diploma. Information booklet free. American School, Dept. X945, Drexel at 58th, Chicago 37, Illinois.

ENGINEERING Degrees earned through home study. Electronics, electrical, mechanical, civil, physics. When writing, specify course desired. Residence classes also available. Pacific International University, 5719-B Santa Monica Boulevard, Hollywood 38, California.

DRAFTSMEN—Designers earn big pay. Home training offered by not-for-profit organization. Free information for interested men. Write ATS-C13, 850 E. 58th, Chicago.

LEARN Civil and criminal investigation at home. Earn steady good pay. Institute of Applied Science, 1920 Sunnyside, Dept. 169, Chicago 40, Ill.

LEARN Physical therapy, massage. Diplomas. Drugless Therapy Institute, Fruitland 11, Idaho.

MASTER Watchmaking at home. Free sample lesson. Chicago School, 2328-YM, Milwaukee, Chicago 47.

ANALYZE Handwriting for profit, pleasure, self-understanding. TV, radio, newspaper columns, teaching, lecturing, court work, counseling. Men, women, spare time up to \$50 an hour. Amazing opportunities. Sample lesson free. Must be 21. IGAS, Inc., 45, Springfield 4, Missouri.

WELDERS Earn big money. Easy to learn arc, gas, automatic welding. New equipment, low cost training in non-profit school. GI approved, free booklet. Hobart Welding School, Box M-1282, Troy, Ohio.

LEARN Garment altering, repairing. Operate home tailor shop. Sample lesson, 25¢. Poulin Tailors, Penacook, N. H.

FINGERPRINTING Course with diploma \$12.00. School of Fingerprinting, Box 185, Fairfield, Alabama.

EARN Degrees by correspondence courses: Associate of Arts, Bachelor of Arts, also Bachelor of Science in Business Administration. Pacific International University, 5719-D, Santa Monica Boulevard, Hollywood 38, California.

FINISH High School at home, spare time. No classes. Diploma awarded. Write for free catalog. Wayne School, Catalog HF-89, 2527 Sheffield, Chicago 14.

DRAFTING, Design, blueprint reading. Good paying. Easy to learn at home. Minimum age 17. Write Utilities Engineering Institute, Dept. TC-14, 2525 Sheffield, Chicago 14.

CASH For correspondence courses. (Buyers and sellers.) Gem, Dept. 12-M, Linwood, New Jersey.

VOICE Secrets! Information! Free! Studio, 14356H South Jersey, Norwalk, California.

SECRET Investigations. Experience unnecessary. Investigators particulars free. George Wagner, M125 West 86th, New York City 24.

HOW to cut hair at home. Photos, drawings, instructions. \$2.00 postpaid. Carter, 8721 E. Garvey, So. San Gabriel, Calif.

LEARN Chinese at home. Six-month course. Doctor degree. Free catalogue. Chinese Language Institute, P.O. Box 270, Taipei, Formosa.

HOME Study. 32 commercial, industrial subjects. Modest registration fee. Tuition when satisfied. Free bulletin. Automent, 2166 Market, San Francisco 14, Calif.

INCREASE Your vocabulary. Book containing 1700 select words, easily learned. \$1. Ternowski, 366 Conklin Avenue, Binghamton, New York.

ART—Draw for the fun of it! Low cost training. Director. Cartoons-of-the-Month, Roslyn, New York.

FREE Booklet. How to make money with astrology. Profitable career. Study home. Bachelor's, Master's, Doctor's degree. Ford, Box 193, Williamsport, Penna.

INEXPENSIVE Correspondence courses—Science, arts, psychology, engineering. Earn diplomas, degrees, colleges abroad. Aurecas, Central Valley, New York.

USED Correspondence courses, educational books bought, sold, catalog free. Vernon, Summerville, Ga.

SING, Speak with power. Self-training records. Amazing! Canfield, 2018-A Fifth Avenue South, Minneapolis 4, Minnesota.

INTERNATIONAL Perpetual peace calendar 25¢. 334 Kings Court, West Palm Beach, Florida.

LEARN Old time fiddle playing, quickly, easily. Play for square dances. Complete course \$3.00. Satisfaction guaranteed. Old Time Fiddle, Mt. Marion 2, N.Y.

LEARN While asleep! Exciting details free. Research Association, Box 24-NN, Olympia, Washington.

BE An investigator. Write for free details. State age. National Detective Academy, Dept. P, P.O. Box 1082, Scottsdale, Arizona.

EARN Degree. Free bulletin. Home-study only. Midwestern Bible School, 1060 Broadripple, Indianapolis.

STUDY To be a doctor of psychology, metaphysics, divinity or philosophy. Correspondence courses only. The Neotarian Fellowship, Desk 9, Kansas City 6, Mo.

STUDY For Doctor's degree of psychology, metaphysics and divinity. Correspondence courses only. College of Divine Metaphysics, Dept. P-M, 2811 North Illinois, Indianapolis 8, Indiana.

PIANO Tuning pays. Big money in spare time. Learn at home in 30 days. No musical knowledge necessary. Phonograph, records, tools and instructions furnished. Personal instructions available. Free catalog. Capital Piano Tuning School, 3160 S.W. 16th Court, Fort Lauderdale, Fla.

WANT A diesel job? New opportunities to increase income. Higher pay. More money. We can help you qualify. Tools. Shop method home training. Write today! Diesel, Tractor, Heavy Equipment Division, Interstate Training Service, Dept. B-2, Portland 13, Oregon.

HIGH School diploma at home. Licensed teachers—Approved materials. Southern States Academy, Box 5344-MX, Station E, Atlanta, Georgia.

BOOKKEEPERS! Increase your earnings! Operate your own simplified "Dollar-A-Week" bookkeeping and tax service. Full or spare time. Details free. No obligation. Ellis, Box 200, Cedar Grove, North Carolina.

LEARN Appliance service and repair. Motors, washers, refrigeration, cleaners, everything. Free booklet. Armstrong, 11027-A South Vermont, Los Angeles 44.

BE A real estate broker. Study at home. Write for free book today. GI approved. Weaver School of Real Estate, 2018P Grand, Kansas City, Missouri.

USED Correspondence courses and books sold and rented. Money back guarantee. Catalog free. (Courses bought.) Lee Mountain, Pisgah, Alabama.

EARN While you learn. Auto and diesel mechanics master this top paying trade. Many graduates earn \$100 a week and up. Approved for Korean veterans. For free information write Dept. No. 256, Nashville Auto-Diesel College, Nashville 3, Tenn.

PHYSICAL Therapy and massage. Home training. Practice privately or work with doctors and hospitals. Free catalogue. National Institute, Desk 4, 159 E. Ontario, Chicago, Ill.

INVESTIGATOR Training. Phillips Secret Service System, 1917-B North Kenneth, Chicago 39.

PIANO Tuning pays. Learned easily at home. GI approved. 59th year. Free booklet. Niles Bryant School, Dept. P, 3731 Stockton, Sacramento 20, Calif.

LEARN Physical therapy, massage. Diplomas. Drugless Therapy Institute, Fruitland, Idaho.

LEARN Blueprint reading at home. Insure your job. Higher income and advancement. Madison Technical School, 118 Merlham Drive, Dept. PM, Madison 5, Wisconsin.

ASTROLOGY—Palmistry. Complete courses are offered on these subjects. For information write The Reno School, 1001 Glendale Blvd., Box 356, Los Angeles 26, Calif.

PROFESSIONAL Investigators correspondence school. Badge, diploma, future. Box 41197, Los Angeles 41, Calif.

AUCTIONEERING Pays big; write Western College of Auctioneering, Box 1458, Billings, Montana.

BOOKS, Free general catalog, 100 pages. Text, vocational, educational, instructional subjects. Millions of volumes, new and used. Bargain prices. Books bought, Est. 1902. Long's College Book Co., Dept. PM, Columbus 1, Ohio.

BE A real estate broker. Study at home. Send for free catalogue. Midwest School of Real Estate, 68 North Chicago Street, Joliet, Illinois.

PLAYS, STORIES, MANUSCRIPTS

OWN Every copy published. Free folder. William-Frederick, 391 East 149th, New York City 55.

WANTED: Book manuscripts, all subjects considered. Greenwich Book Pub., Attn. Mr. Zealand, 489 Fifth Ave., New York City.

WANT Your book published? Learn how we publish, advertise, promote, distribute. Many successes. Free booklet PM. Vantage, 120 West 31, New York City. Midwest office: 220 S. Michigan Ave., Chicago, Ill.

ADVERTISING AGENCIES, LETTER WRITERS, FOR ADVERTISERS

ARIZONA Birth-marriage lists, gummed labels \$7.00—1000. P.O. Box 342, Phoenix.

CLASSIFIED Mailing lists, write for our literature. Gorgo Mailers, Box 151, Toledo 10, Ohio.

BEFORE Advertising—Get instructive Ad-Guide and newspaper-magazine rate-book, free. Chicago Advertising Agency, Chicago 4.

ADVERTISING, Result-getting ads prepared, placed newspapers, magazines, radio, anywhere! Lowest rates. Catalogue free. Baker Advertising Agency, 189 W. Madison, Chicago 2.

"AMAZING New Book"—"Profits From Classified Advertising." Tells how and what to advertise. Be sure to read this book before you invest one cent in advertising. Write for your copy now. Just send 10¢ for postage and handling. W. Johnson, Classified Advertising Manager, 202 East Ontario Street, Chicago 11, Illinois.

MAILING Lists most any classification \$5.00 1000. Your circulars mailed with ours \$4.00 1000. Write for our literature. Dixie Mailers, King, N. C.

ADVERTISE: 24 Words, 100 Canadian newspapers \$5.50. Lists free. Advertising Bureau, 10511-C Springfield, Chicago 43.

NOW Ready: New, amazing Classified Advertising Record Book—prepared especially for classified advertisers. Here is a book that tells you instantly whether or not your advertising in any publication is paying you real results. You can tell immediately how many inquiries each publication produced—how much cash received from every ad. Spaces are provided for the name and address of the publication, date of issue, space used, rate, cost of ad, key number, etc. You have a complete record of each publication right before your eyes. Plenty of space to keep accurate record of 28 separate publications. You can have a copy by sending only 10¢ for cover postage and handling. Send for your copy now. W. F. Johnson, Classified Adv. Mgr., Popular Mechanics Magazine, 204 E. Ontario Street, Chicago 11, Illinois.

CARTOONING, COMMERCIAL ART, SHOWCARD & SIGN PAINTING, TATTOOING

"HOW To Make Money With Simple Cartoons." A book everyone who likes to draw should have. It is free; no obligation. Simply address Cartoonists' Exchange, Dept. 912-C, Pleasant Hill, Ohio.

GRAPHIC Handicrafts. Literature free. Sample lettering pen 25¢. Bamberger Bros., P.O.B. 127, Cathedral Station, New York City 25.

YOU Can entertain with chalk talks. Catalog 10¢. Balda The Cartoonist, Oshkosh, Wis.

LEARN Sign painting at home. Free talent test. Ben Kerns, Box 812-PM, Greenville, S.C.

LEARN Sign painting with fascinating system. Straley, 410 S. Western, Springfield, Ohio.

LEARN Profitable, fascinating tattooing. Illustrated information \$1. Zeis, 728-C Leslie, Rockford, Illinois.

RUBBER STAMPS AND OFFICE SUPPLIES

FINEST Quality! 3 lines \$1.00; stock words, 3 for \$1.50. Little By Little, 1201-P Riverside, Indianantic, Florida.

SELF-Inking three line pocket stamp. \$1.00. Schnell's Shop, Nokomis, Ill.

3 LINE Pocket stamp with pad 38¢, 3 for \$1.09. 10 or more 36¢ each. Free catalog, quotations. Esco Print, PPLA, 1240 Lockland, Dayton 4, Ohio.

4 LINES \$1.00. Economy Rubber Stamps, 726 East Grayson, San Antonio 10, Texas.

THREE Line office type or pocket case rubber stamp, \$1.00. W. S. Atherton, Box 61, Randolph, Massachusetts.

NEW! Rubber stamp catalog. Campfield, 14 Beaufort Circle, Springfield 4, Mass.

POCKET Stamps, 3 lines, \$1.00 postpaid. Self-inking, guaranteed. W.J.W. Specialty, 8464 Manhattan, Detroit 11, Michigan.

J LINES \$1. Skips Rubber Stamp, 302 E. 9th, Big Spring, Tex.

POCKET Stamp, 3 lines, \$1.00. Nasberg, 1-B Blanchard Road, Monson, Maine.

TYPEWRITERS, DUPLICATORS, OFFICE DEVICES

RECONDITIONED Typewriters, duplicating, printing devices. \$25.00 up. Supplies. Appliances. DixieGraph, King, N. C.

PRINTING, MULTIGRAPHING, MIMEOGRAPHING, GUMMED LABELS

SIMULATED Engraved business cards, \$4.25 per 1000. Tax and delivery included anywhere in U.S. Kurz, 8524 Katherine, Panorama City, California.

OFFSET Printing: 1,000, 8 1/2 x 11, \$5.50. Fast! Art, advertising, varityping, folding. Promotion-M12, 385 Broadway, New York City 13.

125 PERSONAL Business cards. \$1.00 postpaid. Michiana Press, Bridgman, Mich.

YOUR Name and address printed on gummed labels. 1000-3 lines \$1.00; 15¢ each extra line. 1/2 x 1 1/2. Print clearly. No c.o.d.'s. Addison Mail Order, PMA-12, 1840 Addison, Chicago 13.

EMBOSSING Printing at lowest prices. Choice of ink, type, set-up. Samples free. Rayborg, 810 West 18th, Erie, Penna.

1000 NAME And address labels in plastic box \$1.00. Heights Industries, Capitol Heights, Maryland.

MIMEOGRAPHING: Quality work, low prices. California Mimeo Service, Simi, Calif.

500 (8 1/2 x 11) HAMMERMILL Letterheads \$3.95. Taylor, Box 72, Brentwood, Md.

100 WATERMARKED 8 1/2 x 11 Letterheads and 100 6 3/4 envelopes, printed any color, \$2.00. H. Hudson, Centredale 11, R. 1.

FREE Catalog postpaid printing, rubber stamps. DM Press, Sebastopol, Calif.

ECONOMICAL Business-personal printing. Free literature. Vail, 334, Hicksville, N. Y.

NAME And address stickers, 1000-\$1.00. J. B. Mott, P.O. Box 602, Lovelock, Nev.

BUSINESS Printing. Top quality. Bottom prices. A. Hanlon, Malvern, Penna.

SIMULATED Engraved business cards, post cards. Sales, 17 South 9th, Wilmington, N. C.

MULTILITHED Qualified letters for less than mimeographing. Get facts, samples, prices. Perkins Printing Service, Fremont, Nebraska.

1,000 STATEMENTS \$2.98. Business cards \$1.98. letterheads \$4.98. Woodprint, Romeo, Michigan.

500 ENVELOPES Printed, #6 3/4-\$3.50 postpaid. Statements same. Stanley Press, Lake Katrine, New York.

QUALITY Printing, photo-engravings. Letter press, offset, color. Own plant. Lowest prices. Write: Herron, 119 Lafayette Street, New York 13, N. Y.

1,000 BUSINESS Cards. Raised letters. \$3.50. Samples. Pioneer, Island Park PM12, New York.

1000 LETTERHEADS - 4 1/4 x 8 1/2. \$4.95. Thompson, 16105 Delrey, Cleveland 28, Ohio.

PRINTING - Rubber stamps. Bargain prices. Free brochure. Miles Crafts, Baychester Station, New York 69, New York.

FREE Book about photo offset with 1,000 8 1/2 x 11 only \$5.50. Advergraphic, 121 E. 27th St., New York City 16.

BUSINESS Printing. Samples. Prices free. Howprint, 723-G Eunice, Webster Groves 19, Missouri.

COLOR Mimeographing-Letters, price list, samples. A. M. Letter Shop, 2190 Harkins, Menlo Park 6, Calif.

MIMEOGRAPHING-Letters, pricelists, formulas, instructions. Lowest prices. Lem's Letter Shop, 5710 Stanton, Detroit 8.

1500 PERSONALIZED 5/8 x 1 1/4 Labels \$1.00. Your 3 line name and address printed with blue ink on fine quality white gummed paper. Money back guarantee. Hamilton-Ward, Dept. 10B, Westfield, Mass.

ADS Running under this heading sell printing. Ask me for proof. I'll gladly send you amazing facts. Ask for Folder "P." F. W. Johnson, 200 E. Ontario St., Chicago 11, Ill.

OFFSET Printing: 24-hour service. \$6.75, 1000, 8 1/2 x 11. National Letter, 251 West 42 St., New York City 36.

FREE Unusual catalog. Business, personal printing. Instant service. Bariskill, 1715 Julian, El Cerrito, California.

BUSINESS Cards with glamour. Reasonable. Samples free. Heavener's, Colmar, Penna.

100 LETTERHEADS, 100 6 3/4 Envelopes \$2.00 postpaid. Spicher Printing, 1230 Church Street, Indiana, Pennsylvania.

PRINTING OUTFITS AND SUPPLIES

RUBBER Stamp making presses, hydraulic operated, electrically heated. Sizes 5"x8", 8"x12", 10"x15", starting outfits. All kinds supplies. Custom Manufacturing, 507-P N. Jefferson, Springfield, Mo.

MAKE Your own self-molding rubber stamps and printing cuts. Plexirubber, Argyle 1, Wisconsin.

DO Your own printing. Save money. Simple rules. We supply everything. Print for others; good profit. Raised printing like engraving too. Have home shop. Details free. Kelsey Presses, V-11, Meriden, Connecticut.

PATENT ATTORNEYS

INVENTORS-If you believe you have an invention, you should find out how to protect it. The firm of McMorrow, Berman & Davidson with offices in Washington, D. C., is qualified to take the necessary steps for you. Send for copy of our patent booklet "How to Protect Your Invention." We will also send you an "Invention Record" form. No obligation. They are yours for the asking. McMorrow, Berman & Davidson, Registered Patent Attorneys, 1344 Victor Building, Washington 1, D. C.

INVENTORS - Take these preliminary steps toward patent protection. Sketch and describe your invention. Sign, date and have this disclosure witnessed by two people who understand your invention. Have us make a preliminary search among U.S. patents already granted for similar types of invention. We report on the probable patentability of your invention and recommend your further course of action. Write for our instructive booklet, "Patent Protection for Inventors" and convenient "Evidence of Invention" disclosure form. Victor J. Evans & Co., 431-P Merlin Building, Washington 6, D. C.

INVENTORS: Learn how to protect your invention. Unless the inventor is familiar with patent matters, he should engage a competent registered patent attorney or agent to represent him. We are registered to practice before the U. S. patent office and prepared to serve you in handling your patent matters. "Patent Guide for the Inventor" containing detailed information concerning patent protection and procedure with "Record of Invention" form will be forwarded to you upon request—without obligation. Clarence A. O'Brien & Harvey Jacobson, Registered Patent Attorneys, 81B-K District National Building, Washington, D. C.

C. A. Snow & Co.—M477, Snow Building, Washington 1, D. C. Registered Patent Attorneys. Write for information.

INVENTORS: Without obligation, write for information explaining the steps you should take to secure a patent. John Randolph, Registered Patent Attorney, 803 Victor Bldg., Washington 1, D. C.

"INVENTOR'S Guide" and "Record of Invention" free on request. Frank P. Lederhann, Registered Patent Attorney, 154 Nassau Street, New York City.

INVENTION Record form free and "Patent Information Every Inventor Should Have." Carl Miller, Registered Patent Attorney, Woolworth Building, New York.

FOR INVENTORS

INVENTORS, Make money using royalty free patents, inventions, ideas, products. Introductory manual, \$1.00. Midwest, Ludlow Falls, Ohio.

MEXICO Patent trademark searches \$8.00. Procedures, accurate information. Translations, applications. Write Miss H. Perales, P.O. Box 755, Mexico 1, D. F.

INVENTORS—Send for free Patent Information book and Inventor's Record. Registered Patent Attorney, Associate Examiner, Patent Office 1922-29, Patent Attorney & Advisor, Navy Department 1930-47. Gustave Miller, 128A Warner Building, Washington 4, D. C.

INVENTORS—This firm is registered to practice before the United States Patent Office and available to assist you in the preparation and prosecution of your patent application. "Patent Protection for Inventors" booklet containing detailed information and steps to take toward patent protection sent promptly upon request. No obligation. Victor J. Evans & Co., 432-P Merlin Building, Washington 6, D. C.

INVENTORS—If you believe you have an invention, you should find out how to protect it. The firm of McMorrow, Berman & Davidson with offices in Washington, D. C., is qualified to take the necessary steps for you. Send for copy of our patent booklet "How to Protect Your Invention." We will also send you an "Invention Record" form. No obligation. They are yours for the asking. McMorrow, Berman & Davidson, Registered Patent Attorneys, 1345 Victor Building, Washington 1, D. C.

INVENTORS! Have you good patentable ideas? Write Mr. Metzler, 11 West 42nd, New York City.

DRAWINGS Made for searches, invention records, patents. Free literature. Norvall Riggs, Box 3906, North Las Vegas, Nevada.

PATENT Searches, including copies of nearest patents, \$6.00. Reports airmailed within 48 hours. More than 100 registered patent attorneys use my service. For free invention protection forms, write Miss Ann Hastings, P.O. Box 176, Washington 4, D. C.

INVENTORS—Save high fees! Let me show you how to prepare and file your own application for U. S. patent. Everything ready to fill in and file. For free "Registration Form," write Miss Claire Arden, 806 Wm. Penn Annex, Philadelphia 5, Penna.

WE Have the markets if you have the ideas. Harvey Engineers, Cambridge 1, Maryland.

INVENTION Record form free and "Patent Information Every Inventor Should Have." Carl Miller, Registered Patent Attorney, Woolworth Building, New York.

INVENTORS. Don't sell your invention patented or unpatented until you receive our offer. Write Cowgill, Box 298, Marion, Ohio.

INVENTORS: Information on patent procedure furnished on request, without obligation. John Randolph, Registered Patent Attorney, 802 Victor Bldg., Washington 1, D. C.

INVENTORS: Test the commercial value of your patented or unpatented inventions, quickly and inexpensively. Write for free information. Institute of American Inventors, Dept. 40-B, 635-F St., N.W., Washington 4, D. C.

PATENT Searches \$6.00. 48-hour airmail service. Invention protection forms free. Write Patent Engineering Service, 711 14th Street N.W., Washington 5, D. C.

INVENTIONS Pay inventors when profitable sales are certain from constructions soundly patented, and wise steps taken to reach the best markets. I help inventors to make the most profit with low definite fees for all services. Searches \$15. 30 years experience as patent-development engineer, U.S. and foreign patents secured. Joseph O'Brien, 132 Nassau Street, New York 38, N. Y.

INVENTORS: Learn how to protect your invention. Unless the inventor is familiar with patent matters, he should engage a competent registered patent attorney or agent to represent him. We are registered to practice before the U. S. Patent Office and prepared to serve you in handling your patent matters. "Patent Guide for the Inventor" containing detailed information concerning patent protection and procedure with "Record of Invention" form will be forwarded to you upon request—without obligation. Clarence A. O'Brien & Harvey Jacobson, Registered Patent Attorneys, 81A-K District National Building, Washington, D. C.

PATENT Searches \$6.00. 48-hour service. Free invention protection forms. Write Raymond L. Smith, Patent Searcher, 620 Sheraton Building, Washington 5, D. C.

INVENTIONS WANTED

INVENTORS: Cash for your ideas. World wide facilities. Write: Allt Investments, Box 538, Terminal A, Toronto 1, Canada.

INVENTIONS Needed immediately for manufacturers. For additional information write Kessler Corporation, 512-1W, Fremont, Ohio.

INVENTIONS Wanted for manufacturers. Free details. Write Allen, 712 Davis Bldg., Dallas 2, Tex., Dept. C.

INVENTORS—Turn your talents into immediate cash! Join Inventors of America. Write National Headquarters, 3136-A Sylvia Avenue, Toledo 13, Ohio.

INVENTIONS Bought and sold. Write: Your I.D.E.A., Incorporated, Box 8627, Oklahoma City, Oklahoma. Bonded and licensed.

ARE You interested in offers from reliable manufacturers for your invention? Patented, unpatented, Harvey Engineers, Cambridge, Maryland.

INVENTORS. Don't sell your invention patented or unpatented until you receive our offer. Write Cowgill, Box 298, Marion, Ohio.

INVENTIONS Wanted: Patented, patent pending. 27 years experience promoting inventions. National Service Bureau, 3120 Meramec, St. Louis 18, Mo.

INVENTIONS Wanted now by my manufacturer-clients. Patented, unpatented. Write Gilbert Adams, Patent Broker, 80-S Wall Street, Financial District, New York City.

INVENTORS: Hundreds of manufacturers have requested our assistance in locating marketable new products. Complete information free. Institute of American Inventors, Dept. 40-D, 635-F St. N.W., Washington 4, D. C.

INVENTIONS Wanted. Patented; unpatented. Tremendous manufacturers lists. Global Marketing Service, 2420 77th, Oakland 5, California.

PATENTS FOR SALE

METAL Picnic item, patented. Springer, 1118 Crest Lane, Lancaster, Penna.

MANUFACTURING

MODELS—Small lot manufacturing. Metals, plastics, etc. Milburn, Burlington, Kentucky.

MODELS, MODEL SUPPLIES

POWER Models. Unusual steam, gasoline and traction engines, fittings, metals. Walking beam engine. Comprehensive catalog \$1.00. Chas. Cole, Ventura, Calif.

ROCKETS! Five new plans including fuel formulae. 1 Two stage, 4.5 mile altitude. 2. Parachute return, 21" length. 3. Electrical ignition, 1.5 mile altitude. 4. 1,600' altitude. Less than \$1.00 builds it. 5. Fiber tube construction, experimental design. Any two, \$1.00. All five \$2.40. J. Sargent, Carleton College, Northfield, Minn.

NEW Rocket handbook provides illustrated, exact instructions. Make single and multiple stages. Fuels explained. Complete \$3.00. Central Rocket Company, Waupaca, Wis.

NOT A toy! 24" solid fuel aluminum rocket kit, parachute return. Easily assembled. Educational. Carries payload, flies hundreds of times. \$12.75 postpaid. Details free. Advance Engineering, 2416 North Prairie, Dallas 4, Texas.

MINIATURE Engines, gas and steam. Build them on your metal lathe using our castings, blueprints. Also available, machined steam engine kits ready to assemble. Illustrated catalogue 15¢. Octura Models, Box 536-PM, Park Ridge, Illinois.

WORKING Steam engines, boilers, tractors, fittings. Catalog \$1.00. Tiny Power, Corvallis, Oregon.

BUILT-UP authentic jets, antique airplanes for hobby. Xmas. World famous kit catalog 10¢. Clevemodell, 4508M59 Lorain, Cleveland 2, Ohio.

ROCKET. Fuel, 0,000 feet. Instrumented. Plans \$1. Rocketry, Spencer, Iowa.

SHIP Models and yacht supplies complete. Large 68 page catalogue 50¢. Bill Wild's, 510 East 11 St., New York City 9.

SHIP Models. Most complete line in New England. Kits, fittings, plans, books, tools, engines, motors. 1958 illustrated catalog 35¢. James Bliss & Co., Inc., Dept. SM, 342 Atlantic Ave., Boston 10, Mass.

SHIP And yacht model fittings; blueprints. Send 35¢ for illustrated catalog listing hundreds of items. A. J. Fisher, 1002-1 Etowah Ave., Royal Oak, Mich.

SHIP Model kits, fittings and plans including clippers, trawler, fishermen, frigates, privateer, etc. Towboat of 1900 for HO gauge \$3.95. 1958 catalog 25¢. Model Shipways, Box 85, Bogota, N. J.

LIONEL Trains. Big discounts. Bulletin free. Catalog 25¢. Mack Bros., 3043P Chicago Ave., Chicago 22.

SEND For big 312-page hobbycraft catalog with thousands of hobby items. Planes, trains, boats, crafts. Send \$1 to Petey-Q Model Sales, 519-A Davis St., Evanston, Ill. \$1 refunded with first order of \$5 or more.

BALSA Wood and model aircraft. 40-page catalog 25¢. Sig Co., Montezuma, Iowa.

HOME CRAFTSMEN

"PRACTICAL Violin Making" with patterns \$1.00. Supplies. Chelsea Fraser, 2025 Stark, Saginaw 4, Mich.

SHELLCRAFT Jewelry supplies, findings, rhinestones. Illustrated catalog 25¢. The Shell Mart, 870 First Ave. No., St. Petersburg 1, Florida.

WE Sell sea shells, 15 assorted \$1.10. Andy Shells, Box 607, Sarasota, Florida.

CONSTRUCT Practical \$40.00 solar barbecue for \$10.00. Cook without flames. No ashes. Complete easy instructions. \$3.00. Shelby Industries, Box 516-Y, San Anselmo, California.

LEATHERCRAFT. Send 10¢ for new 102-page catalog of tools, supplies, kits, including metalcrafts, enameling, ceramics, all other crafts. Complete stock. Reasonable. Since 1910. Sax Bros., Dept. PM-12, 1111 N. 3rd, Milwaukee, Wis.

120 JIGSAW Patterns, full size \$1. Jigcraft, O'Fallon 512, Missouri.

FREE "Do-it-yourself" leathercraft catalog. Tandy Leather Company, Box 791-Y26, Fort Worth, Texas.

MOSAICS. Illustrated catalog and instructions 25¢ (refunded on first order). Mosaic-Arts Co., 7197-P5, Pittsburgh 13, Penna.

101 PATTERNS Of smart gifts, novelties, shelves, action windmills plus "Make Money Jig Sawing." \$1.00. Mastercraft, 125M, 7041 Olcott, Chicago 31.

GUITAR Making books, plans, imported woods, tools. List 10¢. Store, 510 East 11th Street, New York 9, N. Y.

FREE Do it yourself woodcraft catalogue. Formica at lowest prices. Woodcrafter's Supply Co., Box 844, Evergreen Park, Ill.

BEAUTIFUL Walnut and cherry lumber, rough or surfaced. Free price list. Midland Lumber Co., P.O. Box 124, St. Joseph, Mo.

8 PIECE Furniture touch up kit. \$1.95 post paid. Hollyer, 82 Brigham Rd., Worcester 9, Mass.

FREE Seashells catalog. Instruction book 35¢. Secor's, Bradenton, Florida W.

WOODWORKING And cabinetmaking course for beginning and advanced home craftsmen. Only complete low-cost home training program available. Write for free booklet. Interstate Training Service, Dept. G-3, Portland 13, Ore.

2430 ARTIST-Drawn patterns, new catalog 10¢. Craftplans, 1322-A Wabash, Chicago 5.

REMODEL Your own home. Save hundreds of dollars. New, amazing book shows you how. Written so you can understand it. Step by step instructions make it easy. Fully illustrated. 400 photographs, hundreds of diagrams, 160 pages. \$3.50. Literature 10¢. Popular Mechanics Press, 200-RH East Ontario St., Chicago 11, Ill.

LEARN Art metalcraft and jewelry making. Complete, inexpensive, home training course now available. Special tools and materials furnished. Write for free booklet. Interstate Training Service, Dept. L-3, Portland 13, Oregon.

KNOCKDOWN Cedar chests and lumber. Free price list. Bedford Lumber Company, Shelbyville, Tennessee.

LEATHERCRAFT. Imported and domestic leather, tools, kits. Complete catalog 25¢. Midas, Box 1255, Dept. J8, Huntington Park, Calif.

HOME Workshop books. Send for 1958 book catalog—10¢. Popular Mechanics Press, 631 N. St. Clair St., Chicago 11.

FREE Leathercraft catalog. Quality kits, leathers, tools. Handicrafters, Box 427, Montrose, California.

STYLECRAFT "Pretraced" leather kits. Handbags, billfolds, filigree belts. Patterns on leather. Just carve, assemble and lace. "Pre-carved" kits also available. Send 25¢ for catalog, free folder. Refunded first order. Apache Leather Company, 2304 E. Washington St., Phoenix, Arizona.

DO IT YOURSELF

ROCKIN' Rocket plans for kids' Christmas! \$1.00, stamped self-addressed envelope. ABC Company, 306 Ness Building, FM, Salt Lake City 1, Utah.

BUY Picture frames from us in mitered pieces, you do gluing and nailing yourself. Save big money on frames, also get free delivery. Chesapeake Picture Frame Co., Box 533, Baltimore 3, Maryland.

MOUNT Your own deer horns. Complete kit with instructions. Only \$5.95 prepaid in U. S. Conaways, Box 7261PM, San Antonio 10, Texas.

EVERLASTING Welder from junk. Fain Electric, R13, Ft. Worth 5, Texas.

FINE Leather upholstery and table tops. Details and samples, 10¢. Money, 506 2nd Ave., New York City.

GRANDFATHER Clock movements, barometers, blueprints, kits. Wholesale catalog 25¢. Mason-Sullivan, Noroton, Conn.

WATCHES, OLD GOLD, JEWELRY

HIGHEST Cash paid for old gold, jewelry, gold teeth, diamonds, watches, silver. Mail articles today. Information free. Chicago Gold Refining Co., 6 E. Monroe, Dept. 958, Chicago 3.

WATCH And clock repairing books. Free catalog. North American, 2320-AZ Milwaukee, Chicago 47, Illinois.

CLOCKS, Watches, timers, cigaret lighters repaired. Reliable. Bensen, 408 Mills, Joliet, Illinois.

DIAMOND Jewelry. Free merchandise. Literature. Aristocrat, 349 Salem, Billerica, Mass.

FAST Cash for old gold, jewelry. Diamonds. Write or mail articles. Right Refiners, 1600-G Heyworth Bldg., Chicago 2.

WATCHMAKERS Journal contains instructions in watch repairing. Sample copy 25¢. Dean Co., Box 3218-M, Daytona Beach, Fla.

JEWELRY And watches. Free wholesale catalog. Closeout Benrus Wristalarm. Retail \$92.50-\$119.00. New York Jewelry Mart, 43 Stratford Ave., Williston Park, New York.

WATCHES, Benrus, guaranteed new. Men's Sea Atlas retails \$75.00, our price \$39.00. Ladies' Sheree retails \$59.50, our price \$36.00. Taxes included. Mears Supply, Dept. p-1, 2403 W. Church St., Orlando, Fla.

COSTUME Jewelry supplies, settings, rhinestones, etc. 88 page illustrated catalog. 25¢. Milady, Box 1328, G.P.O., New York City.

FREE Catalog. Costume jewelry parts. Supplies. Reasonable prices. Fast service. Guaranteed quality. Unique merchandise. Folsom's, Box 52, Medford 55, Mass.

WATCHMAKERS'—Jewelers' requirements: Correspondence courses. Catalog. surprise package \$1.00. Bengal, Culver City, California.

SPORTSMAN Special, 17 jewel watch. Waterproof, shockproof, sweep second hand, stainless back. \$13.95 postpaid. Satisfaction or refund. Wide World, Box 1336, Palm Springs, California.

RAZORS, BLADES, SHARPENING

100 FINEST Swedish steel double-edge blades \$1.49. Crestline, 2010 73rd Court, Elmwood Park 35, Illinois.

FOR THE HOME

NEW. Ironing safety, folding rack. Locks on board, holds iron, \$1.00. Fleming Mfg. Co., 3240 N.W. 27 Ave., #47, Miami 42, Fla.

WORLD'S Smallest Bible 50¢. Three \$1.00. Brookman, 1025 Sutter Bldg., San Francisco 9, Calif.

OF INTEREST TO WOMEN

FREE Big wholesale catalog of Mexican imports. Save up to 50% on hand tooled briefcases, billfolds, fish scalers, hunting knives, etc. Also many gift items for women. Northern Import, Reed City 7, Michigan.

DOWWRITE® Pocket adding machine. Use while shopping. \$2.00. Dowrite, Box 754, Atlanta 1, Ga.

60% PROFIT On cosmetics — Famous nationally advertised Hollywood cosmetics pay 60%. Make \$25 day up. Hire others. For free samples, details, write Studio Girl, Glendale, Calif., Dept. 12812G.

PERSONALIZED Pencils 50¢ dozen; 5 doz \$2.00. Paulson's, Elkins, Arkansas.

EVERYBODY Likes hickory smoked hams and bacon. Make excellent gifts. Write Boyd's Ozark Mountain Hams, Galena, Missouri.

"8 MISTAKES Parents Make." Every parent should have this new book about child training. It is free; no obligation. Simply address Parents Association, Dept. 6712, Pleasant Hill, Ohio.

EXQUISITE Laces, braids, embroideries, 40 yards, \$1.25. Pounds. Nairia Edwards, Rt. 1, Box 46-B, Sylacauga, Ala.

SELL Fine fabrics. Get yours wholesale. Box 863, Norwalk, Conn.

SHOPPING Bag, knitted cord, fits into handbag, many uses, \$1.00. IPA, Box 3051, Santa Barbara, Calif.

HAWAIIAN Type "Muu-Muu" dresses \$10. Please include your height measurement. Inez James, 86 Westlawn Avenue, Daly City, California.

PERSONAL

LOANS By mail. Borrow \$50 to \$500 for any purpose. Employed men and women over 25, eligible. Confidential, no co-signers. Up to 2 years to repay. Low monthly payments. Supervised by Nebraska banking department. Loan application sent free in plain envelope. Give occupation. American Loan Plan, City National Bank, Dept. PM-12, Omaha 2, Nebraska.

BORROW Money by mail. \$100-\$600. Anywhere. Air mail service. Postal Finance, 200 Keeline Building, Dept. 658X, Omaha 2, Nebraska.

FREE! Full month's trial supply 20-element vitamin-mineral food supplement. Send 25¢ to help cover mailing cost. Unconditionally guaranteed. MacNeal & Dashnau, Box 3651-PM, Philadelphia 25, Penna.

GET Out of debt without borrowing. Send \$1.00 for complete details. Valor Credit Adjusters, 511 Locust, St. Louis 1, Mo.

SAVE 50% On vitamins. New, free catalogue lists all brands, formulas, prices. Compare and save. State vitamins now using. Vitamin Specialties, Box 4435-A, Philadelphia 40, Penna.

FREE! Your handwriting individually analyzed by competent grapho analyst; plus free book, "Secrets Your Handwriting Reveals." A \$5.00 value! Enclose only \$1.00 for shipping and handling. Fountain Services, Dept. J4, 2011 Hudson, Denver 7, Colo.

INTERESTED In southern California? Send \$2 for my 3800 word letter which has vitally important information for you. Ed. Norman, P.O. Box 27034, Los Feliz, Hollywood 27, California.

HEADLITE Brand of refined coal oil, grooms hair, aids dry scalp, pleasant he-man odor, big 6 oz. bottle \$1.00 postpaid. Headlite Products, P.O. Box 569, Glen Cove, N. Y.

FREE Bible helps. Postage appreciated. John Gizen, Prelate, Sask., Canada.

BIBLE Questions answered. Stamped envelope. Bylon, 17167 Bentler, Detroit 19, Michigan.

"YOU Can find out!" Confidential information developed, any matter, person, anywhere. Officially licensed. Established 1922. Equitable Service Bureau, 15 Maiden Lane, New York City.

GAIN Self confidence, memory power, magnetic personality by recordings. Invisible Psychologist, Box 24-NN, Olympia, Washington.

FREE! Exciting details about living happy worry-free life in beautiful bargain paradises. Get away from jobs, jitters, debts and dullness. Whether you are eighteen or eighty live like a king on a shoestring. Wealth or savings unnecessary. Unusual methods of securing ample income anywhere revealed. Travel, relax, live luxuriously. Have villa, servants, etc. Lower than depression prices. Enjoy hunting, fishing, all sports and cultural pursuits. Lead leisurely contented life among friendly considerate people. Postcard brings free literature. Belmont Publications, Wyckoff 141, New Jersey.

REMAILING SERVICE

LETTERS, Greeting cards remailed from New York, world's greatest city, 25¢, 5 for \$1.00. Reairmails 40¢, 3 for \$1.00. Frank, P.O. Box 523, New York City 7.

REMAILS 25¢. Monthly \$2.00. Classifieds \$1.00. Zer, Box 4282, Washington 12, D. C.

LETTERS Retailed from Peabody, Mass. 25¢ each. DuCra Service, Box 205, Peabody, Mass.

HAVE Fun with friends. 10 Connecticut scenic postal cards plus remailing \$1.00. Louis Rudolph, Route 2, Uncasville, Conn.

SAN Francisco confidential address \$2.00 monthly. Kent Remailing Service, Box 4606-12.

DO You need a mailing address? Use 1101 E. Juan Linn, Victoria, Texas. Write for information.

FUN Galore! Use our Hawaiian address as your address. \$3.00 month. Write: Fobel, 617-F Kuaaina, Kailua, Hawaii.

LETTERS Retailed 25¢. Monthly \$3.00. Weintraub's, Box 1481, New Orleans 5, Louisiana.

MEXICO. Retails 25¢. Color postcards 10¢. Tourist newspapers 25¢. Mexico Memo 22, Morelos 516-15, Guadalajara, Mexico.

RENT A confidential re-mailing, receiving-forwarding address. Agents since 1950. Details free. William McLaughlin, 800 Stewart, Columbus 6, Ohio.

AFRICA Retails \$1.00. Forwarding \$3.00 quarterly. Goodwin, Box 9652, Johannesburg.

REMAILING, 25¢. Forwarding \$3.00 monthly. Los Angeles classified 50¢. Carter, 8721 E. Garvey, So. San Gabriel, Calif.

LETTERS Retailed 25¢. Fava, 1712 S.W. 1st St., Miami 35, Fla.

LETTERS Retailed 25¢. Jerry Love, 1419 E. 83rd, Los Angeles 1, Calif.

LETTERS Retailed with romantic post-mark 25¢. \$3.00 a month. J. B. Mott, P.O. Box 602, Lovelock, Nevada.

REMAILS 25¢. Phoenix, Scottsdale, area. H. E. Bullis, 7237 North Canyon Way West, Phoenix, Arizona.

REMAILS 20 Cts. Colorful cards, something different, and amazing booklet 50 cts. Persil, 436 New York Ave., Brooklyn 25, N. Y.

MAIL Service, for information. Sutton Service, Box 462, Northwest Sta., Kansas City 4, Kansas.

SECRET Mail address, \$3 month. Hedg-peth, Box 830, Alhambra 23, Calif.

HOUSTON Retails 25¢. Monthly \$3.00. Remailing Services, Box 12112, Houston, Texas.

FLORIDA Retails 25¢. Receiving-forwarding \$3.00 month. Box 1781, Tampa.

REMAILS 50¢. Information \$1.00. Frank Pozo, Neptuno 632, Havana, Cuba.

REMAILS 25¢. Receiving, forwarding \$3.00 monthly. Hale, Box 1, Glenmont, N. Y.

DEPENDABLE Service, seven cents. Box 1746, Yuma, Ariz.

WORLDWIDE Personalized remailing-receiving-forwarding. Amazing rates! Intercontinental Courier Service, Box 3316-PM, San Francisco 19, Calif.

REMAILS 25¢. Monthly \$3. Rex Co., Box 5831, Baltimore 8, Maryland.

KETCHIKAN, Alaska re-mails 25¢. \$3.00 monthly. Classifieds \$1.00. Alaska Unlimited, Box 197, Ketchikan, Alaska.

HAVE Your Xmas cards postmarked from Santa. 25¢ each, 5 for \$1.00. H. Schwanz, St. Maries, Idaho.

TACOMA Remailing 25¢. \$3.00 month. Sund, 3602 Ferdinand, Tacoma 7, Wash.

NEW York City re-mails, 25¢. Mermelstein, Box 395, Times Square, New York City 36.

CHRISTMAS Cards remailed 25¢. Bill Ellis, Box 63, Santa Claus, Indiana.

TREASURE FINDERS

SEARCHING For treasure? Coins, bullets, M-scope locates them for you. Lightweight, transistors, Fiberglass case. Easy terms. Catalog. Fisher Research, Dept. C-1, Palo Alto, Calif.

GOLD-Silver detectors. Geiger counters Violites for tungsten, etc. Best available. Guaranteed. Information free. Delectron, 5528 Vineland Ave., North Hollywood, California.

FIND Buried treasure, gold and silver, with Goldak's sensational 3 1/2 lb. "find-it" locator, only \$64.50. Write for free literature on complete line of mineral, metal locators; Geiger and scintillation counters. Goldak, 1541 W. Glenoaks Blvd., Glendale, Calif.

TREASURE! Exciting handbook 25¢. Locators, Howe, 811 Kansas, Atchison, Kansas.

NEW—Extremely light weight economical transistorized metal detectors. Waterproof search head. Kit or assembled models. Geiger counters and mineralights. Free literature. Electronic Applications, Dept. M, P.O. Box 8, Arlington, Virginia.

FOR SALE—MISCELLANEOUS

TERRIFIC Buy. New surplus drift sights, 63" long, loaded with lenses, prisms, recording mechanism; used in atomic research to view inside radioactive areas. Hundreds of uses. Cost gov't. \$500. Our special price \$40. Supply limited. Marshfield Airways, Inc., Marshfield, Mass.

HEARING Aid batteries, wholesale. Free list. Habs, Box 51, York, Penna.

DECALS. U.S.A., V.P.W., Lions, Rotary, others. Box 2504, Nyack, N. Y.

WANTED—MISCELLANEOUS

GOLD, Silver, platinum, old jewelry, diamonds, watches, spectacles, wanted. Highest prices paid immediately. Information free. Wilmot's, 1067 W. Bridge, Grand Rapids 4, Michigan.

QUICKSILVER, Platinum, silver, gold. Ores analyzed. Wholesale Terminal, Norwood, Mass.

SCRAP Mercury (quicksilver) containers supplied — Tantalum, tungsten, silver, platinum. Metallurgical Products Company, Established 1909. 35th & Moore Sts., Philadelphia 45, Penna.

MISCELLANEOUS

LEGAL Form for making a will, \$1.00. Curtis, Folio Publications, 1412 Great Northern Bldg., Chicago 4, Illinois.

ROCKET Supplies. Nozzles, nose cone, tubes, fuse. Send 10¢ for catalog to Alana Manufacturing Company, Mineral Point, Penna.

HOBBY Wall cartoon picture, 8-10, \$1.00. Roger Roberts, Worthington, Mass.

WANT Industry? Sure method. Details. Martecs, Box 118, Lebel, Ont., Canada.

PUNCHBOARDS, Catalog 10¢. DeLuxe Sales, Blue Earth, Minn.

HUGE Tarantula, scorpion; \$2.00. Preserved. Dezzo, 1465-PM Fern, Vista, Calif.

BARGAIN Merchandise. Every description, low prices, great savings. Catalog free. Kleintops, 501 Main, Ogdensburg, N. J.

SKYSCRAPER-Heel footwear! Photo catalog, \$1.00. Pinecraft, Box 442-R, Hollywood 28, Calif.

RECEIVE Mails, magazines, samples. Your name in numerous mailing lists 25¢. Greenwood, Box 1116-KE, New York City 8.

FREE Vitamin catalogue—Quality capsules, potent formulas for better, healthier living. Feel younger, more vigorous. Buy direct, save! Vitacenter, Drawer 2318-P, Detroit 31.

BARGAIN Necessities. Catalog free. Miller, P.O. Box 104, Findlay, Ohio.

DESERT Illustrations, authentic stories on lost mines, ghost towns, gem fields, wildlife, Southwest living. Send \$1 for 5 back issues to Desert Magazine, Palm Desert, Calif.

TV Photo lamp. Cattle scenes 12x5 inches. Only \$4.95 prepaid in U.S. Conways, Box 7261PM, San Antonio 10, Tex.

CIGARETTES—Improved roller makes 20 for 9¢. All types pipe tobaccos. Facts free. Moberly, Box 910, Owensboro, Ky.

BUY Wholesale. Send 25¢ for information. Lee Products Company, Box 32, Winterset, Iowa.

SADDLES, Boots, Western wear, leather goods. Free catalog; Silver Spur, Box 1785-N28, Fort Worth, Texas.

RECEIVE Magazine samples, mails, catalogues. Bargains from everywhere. Get listed 25¢. Rorick, Cincinnati 26, Ohio.

START Own religious radio program. Details free. Hughes, Suite 129, 9735 Wilshire, Beverly Hills, Calif.

REAL Bargains for the whole family. Catalogs free. Vance Sales Co., 510 Hill Place, National City, California.

VITAMINS, Save 40%. Lists free. Pharmacist, 17886 Jos. Campau, Detroit 12.

SOLAR Motor. Operates in sunlight to 3000 r.p.m. Educational, proves man can harness power from outer space. Send \$2.00. P.O. 4035, Pasadena, California.

WRITE With your left hand. Instructions 30¢. Levinsohn, R.F.D. Box 207-A, North Sea Road, Southampton, N. Y.

KORKY! Saves you money, time and worry. Guaranteed. Send for free details to, Korky: 8924 W. Bush Lake Rd., Minneapolis 20, Minn.

100,000 PRODUCTS Wholesale—Free catalog! Send postcard: Econ-O-Mart, Whippany 15, New Jersey.

BUY Wholesale! 100,000 nationally advertised products. Appliances, cameras, sporting goods, housewares, watches, typewriters, tools, clothing, etc. Discounts to 80%. Buy-Rite, Box 258, Hawthorne 2, New Jersey.

CESSPOOLS, Septic tanks, clogged drains. How they function and how to keep them working. Free literature. Chemical Cesspool & Drain Cleaning Co., Boston 34, Mass.

BUY Wholesale! 25,000 nationally advertised products. Get amazing dealer catalogs. Complete details free. American Wholesalers, 1841D Levee, Dallas 7, Texas.

YOUR Name wanted. We'll send 1000 publishers, mailers, wholesalers your name, on our list one year 25¢. Dixie Mailers, King, N. C.

HUMOROUS Cards, plenty of laughs, 25¢. Stoddard's, 4164 Byron, Chicago 41.

SUPER Memory overnight! Success guaranteed! Bijou, Box 1727-M, Hollywood 28, California.

HOW To remodel, basement, attic. Booklet or book. Send for 1958 book catalog—10¢. Popular Mechanics Press, 633 N. St. Clair St., Chicago 11.

JAPAN! Buy direct. Catalogue, 24 pages. Kimonoes, novelties, gifts, etc. Prices, mfrs' list, business informations. Send \$1.00. Clarence Yamagata, 202 Naka 7 Bldg., Marunouchi, Tokyo.

FREE! Exciting details about living happy worry-free life in beautiful bargain paradises. Get away from jobs, jitters, debts and dullness. Whether you are eighteen or eighty live like a king on a shoestring. Wealth or savings unnecessary. Unusual methods of securing ample income anywhere revealed. Travel, relax, live luxuriously. Have villa, servants, etc. Lower than depression prices. Enjoy hunting, fishing, all sports and cultural pursuits. Lead leisurely contented life among friendly considerate people. Postcard brings free literature. Belmont Publications, Wyckoff 142, New Jersey.

WORLD'S Smallest Bible 50¢. Three \$1.00. Brookman, 1025 Sutter Bldg., San Francisco 9, Calif.

INVESTMENT Opportunities advertised. Complete classified section Las Vegas, Nevada, daily newspapers yours for \$1.00. Box 4282, Las Vegas, Nevada.

100 POUND SET \$12.80

BARBELLS

140-Pound, CHROME DELUXE Barbell-Dumbbell set only \$19.80. This is our feature set and is the finest ever manufactured.

Training with adjustable weight is the BEST way to keep fit; the ONLY way to develop great strength and a perfect body. As the oldest and best equipped barbell company, BUR gives value and prices no one can equal.

SEND FOR FREE CATALOG
BUR BARBELL CO.
Lyndhurst 9, New Jersey

Extra Plates Only 12c Pound

"Hoppy" SPLIT-IMAGE TRANSIT
The Most Revolutionary LEVEL & INCLINE MEASURE Ever Made!

This simple yet amazingly accurate instrument indicates level and measures incline down to a fraction of an inch. Makes bubble type or string levels obsolete. It not only indicates level, but shows exactly how much correction is needed. Just one person, using the split-image transit and target supplied with it, can perform any levelling, incline-measuring job quickly, easily, accurately—measures inclines down to the thinness of a dime at 25 feet. So accurate, it can be used instead of expensive surveying equipment for most grading and construction work.

IDEAL FOR: Leveling & Grading, Model Train Tables, Contour Plotting, Carpentry, Brick Laying, Cement Work, Surveying, Gut-tering, Foundation Work, Patio Building, Yard Grading, Fencing, Plumbing, Terracing, Duct Installation, Shelving, Irrigation, Do-it-Yourself-Jobs, Table Leveling, Flooring, Masonry Work, Drainage Work.

\$6.95 p.p.d.

Send Check or Money Order. If COD, fees extra. **MONEY BACK GUARANTEE**

SCOTT MITCHELL HOUSE, INC. Dept. F-12, 415 South Broadway YONKERS, NEW YORK

FREE GIANT NEW 1959 B-A CATALOG

A COMPLETE BUYING GUIDE FOR EVERYTHING IN

RADIO TV ELECTRONICS

BA 1959
ANNUAL CATALOG 5VI

SINCE 1937

BURSTEIN-APPLEBEE CO.

Dept. PM, 1012 McGee St., Kansas City 6, Mo.

Send Free 1959 B-A Catalog No. 591.

Name.....

Address.....

City..... State.....

180 KING-SIZED PAGES

EVERYTHING IN RADIO TV AND ELECTRONICS

100'S OF NEW ITEMS LISTED HERE FOR 1st TIME

21 PAGES OF BARGAINS NOT IN ANY OTHER CATALOG

SEND FOR IT TODAY!

ENGINEERING DEGREE IN 27 MONTHS

INDIANA TECHNICAL COLLEGE

B.S. Degree. Aero., Chem., Civil, Elec., Mech. & Electronic Engineering (inc. Radio, TV), 36 mo. B.S. degree in Math., Chem., Physics. Prep courses. Demand for grads. Spacious campus, 20 bldgs.; dorms, auditorium, gym. Low rate. Earn board. G.I. approved. Enter Dec., March, June, Sept. Catalog.

1612 E. Washington Blvd.
Fort Wayne 2, Indiana
Keeping pace with progress

HYDRAULIC JACK REPAIRS

Earn While You Learn at Home

Millions of jacks in gas & auto-service stations, truckers, body-shops, riggers, factories, farms need servicing. We show you **HOW**—easy step by step directions—what tools to use. **EARN UP TO \$5 an hour**, in spare time, in your own basement or garage. Start your own business **NOW**. Write for folder No. PM-12 & free bonus offer.

Institute of Hydraulic Jack Repair
P.O. Box 50, Bloomfield, N. J.

\$198

EXACT REPLICA U. S. MARINE GRENADE

As Used in Hand Combat

Get a real bang when you toss this replica of a Marine grenade. Starts ex-G.I.'s. Explodes automatically 4-seconds after pulling pin as it strikes ground. Can't break. Heavy gauge steel firing mechanism. Uses standard caps. Can be exploded over and over. Real collector's item. Comes complete with instructions. **Send \$1.98 plus 25¢ shipping charge—cash, check or money order to: Standard American Suppliers, Inc. Grenade Dept. PM-12, One Park Ave., New York 16, N. Y.**

SKILLS FOR AMERICA

A CAREER GUIDANCE SERVICE FOR ALL READERS
by POPULAR MECHANICS MAGAZINE

IT has been said that *Popular Mechanics* editorially reflects the skills of America by reporting the progress of man's industry, discovery, the mechanical arts, crafts and science. At the same time, *Popular Mechanics* develops skills for America by helping its readers train their hands and minds to acquire skills and knowledge of practical value.

Through our editorial and advertising pages, tens of thousands of people have acquired the knowledge needed to direct their lives into skilled and technical careers and professions.

We recognize that our responsibility to readers who seek broader horizons of opportunity is even greater in these days of rapid technological progress. *Popular Mechanics* is dedicated to helping its readers develop themselves to higher abilities and to find sources of guidance and learning. For this purpose, *Popular Mechanics* created SKILLS FOR AMERICA, a career guidance service for all readers. We offer this valuable service to you, if you, like many of us, are searching for success. We believe it will help you obtain additional resources of knowledge and skills needed to command high salaries and good jobs.

SKILLS FOR AMERICA is a two part program consisting of special articles published each month in *Popular Mechanics* and a career guidance booklet published twice yearly.

Part 1 — MONTHLY EDITORIAL SERIES

Since September 1957, *Popular Mechanics* has featured every month two page articles containing valuable information on careers with advancement opportunities in position and salary, employment outlook, education and skill requirements for jobs, and industrial manpower needs. This series has included the following careers and subjects in addition to many others.

The Engineering Technician
The Automobile Mechanic
Television-Radio-Electronics
Business Professions—Accounting
The Engineering Draftsman
Science and Industry Mobilize For The
Future—Your Part In This Technical Age

Career opportunity articles in future issues will include, among others:

Nuclear Energy Occupations
Heavy Equipment Operator
Refrigeration-Air Conditioning Technician

All SKILLS FOR AMERICA articles are written to acquaint you with careers in which the greatest employment and job success opportunities exist today and in the future. By following these editorials each month, you may discover the career which best suits you and thus open the door to your own personal success.

Part 2 — CAREER GUIDANCE BOOKLET

Our career development booklet SKILLS FOR AMERICA is available to you for the asking as a service of *Popular Mechanics*. Valuable details on 38 different skills and professions which are in greatest demand by industry are given in this booklet. It also tells how to achieve personal advancement.

Your copy of SKILLS FOR AMERICA is reserved for you. Write us now requesting it. Address a post card to:

POPULAR MECHANICS MAGAZINE
Dept. SFA-63
200 E. Ontario St., Chicago 11, Ill.

If you desire career guidance, or feel you would like additional training or information relating to the career of your choice, we suggest you follow the SKILLS FOR AMERICA editorial series every month in *Popular Mechanics* and send for our informative booklet.

SKILLS FOR AMERICA is written with you in mind . . . your future, and what you can do with it, as a service of *Popular Mechanics Magazine*.



... TURN CONCRETE INTO GOLD!



MAKE UP TO \$75 A DAY IN YOUR OWN BUSINESS

If you want to have your own business — to start a business on your own — here's your big opportunity! New high speed, low cost General block machine produces up to 1,000 concrete blocks a day. Sell all you make to builders, supply houses, and others for homes, factories, buildings, garages. Cash in on the building boom! You can make profits of 100% to 150% — up to \$75. a day! General block machine equipped with 1/2 h.p. electric motor — or can be supplied with gasoline engine — works anywhere, in little space, indoors or out. Operates from ordinary house light socket. Simple, foolproof 3 step operation — so easy a child can do it. Makes superior 3 core blocks any size from 4" to 12". Also makes chimney, sash, corner and other types. Blocks meet any building code anywhere in the country. Materials — sand, water, cement, available anywhere. Simple illustrated operating instructions and mixing formulae for cement and cinder blocks supplied with each machine. Write for FREE folder with full information.

MOTOR DRIVEN

R. L. T. of New York City reports: "MY GENERAL BLOCK MACHINE PAID FOR ITSELF IN FIRST 2 WEEKS!" Hundreds now in use the world over! Write for FREE details today!

EXTRA

Amazing illustrated book gives floor plans for 6 sensational concrete block bungalows. Tells how to lay blocks, lay out building lines, mix concrete, build steps, porch and concrete floors all at great savings. Written by experts. Can save many times the cost of the machine! Get it now! No strings attached. Send \$1.

BOOK SENT FREE IF YOU BUY MACHINE.
\$1 REFUNDED IF YOU BUY LATER.

GENERAL ENGINES CO.

DEPT. M-128, ROUTE 130, THOROFARE, N. J.



Only \$1 Prepaid

TASOPE PHOTO-ENGRAVING PLANTS



Material Cost Of This Cut 3/4c Selling Price \$1.00 And Up

Establish your own profitable PHOTO-ENGRAVING business. Make cuts for newspapers, printers, and advertisers. Make etched name plates, plaques, etc. Instructions furnished, no experience necessary. Sold direct from factory since 1931. First five hundred cuts sold locally or by mail will pay for plant and pay you well for your time. Write for FREE catalog.

TASOPE, DEPT. PM12, AURORA, MO.

BIG PAY JOBS for men who qualify in DIESEL



TRAIN NOW FOR A DIESEL FUTURE. Steady, high-pay jobs await men qualified in Diesel, Tractor, and Heavy Equipment. Are you qualified for job and advancement opportunities in this fast-growing field? You can qualify!

COMPLETE DIESEL COURSE NOW AVAILABLE. If you are ambitious and want to get ahead in this big money field, you'll want to know about the complete Diesel home training course now offered by Interstate Training Service. Covers all phases of operation, repair, service. Easy to master in spare time. No interference with present job. Up-to-the-minute. Regularly revised to cover new developments. We invite comparison of material offered. Advisory placement service for our students.

YOU OWE IT TO YOURSELF to investigate Interstate Training Service Diesel Training. Thousands agree it has helped them to better jobs...better pay. It can do the same for you!

WRITE FOR FREE INFORMATION TODAY

INTERSTATE TRAINING SERVICE, Portland 13, Ore.
Please see that I receive FREE 24-page book, "Getting Ahead In Diesel." (A-3)



NAME _____ AGE _____
ADDRESS _____
CITY _____ ZONE _____ STATE _____

CAR OWNERS!

Make Your Own Repairs

Save Money with these Expert How-To Books from

POPULAR MECHANICS



MANUAL FOR FORD OWNERS

Get the most out of your Ford... and do the work yourself! This brand new edition of the Manual for Ford Owners covers every mechanical operation and even includes a special section on trouble shooting on the road. The book explains how various moving parts of the Ford operate, what can possibly go wrong... and what to do about it if it does. Devotes considerable space to exclusive Ford features such as Fordomatic transmission. This is complete and official factory information, specially and comprehensively presented for the layman who may or may not have auto experience. Good maintenance of your Ford is not only desirable for your own convenience, safety and pleasure... but also pays off at trade-in time.

Covers all models 1950 to 1958. **\$3.95**



MANUAL FOR PLYMOUTH OWNERS

If you're a Plymouth owner... order a copy of this new Plymouth Manual and keep it handy in your glove compartment. It's the best insurance you can buy for keeping your car in tip top condition. Enables you to meet any road emergency. Today's cars, Plymouths included, are complex machines... many parts and areas can give trouble under certain conditions. The Plymouth Manual, carefully and thoroughly indexed, can help you locate the trouble and provide the solution in short order. Has hundreds of tips on Plymouth maintenance and suggestions for keeping performance at a peak. Written by C. E. Packer, Member of the Society of Automotive Engineers, in close cooperation with Chrysler Corporation engineers. This book will help you enjoy your fine Plymouth car even more than you thought possible.

Covers all models 1950 to 1957. **\$3.95**



MANUAL FOR CHEVROLET OWNERS

To be published in April. Will help every Chevrolet owner save on repair bills and get the kind of top performance the factory designers intended. To be written by long-experienced automotive engineer, C. E. Packer with the aid of General Motors Factory engineers. Every word will be official factory information, covering your Chevrolet from bumper to bumper. Explains what can go wrong and how to diagnose every condition. Explains the repair procedure thoroughly to save you time and money. Hundreds of photos, drawings and "exploded" views will aid in understanding the carefully written text. Vitally helpful whether or not you have mechanical experience. Completely indexed for easy reference. Order your copy now. We'll send immediately upon publication.

Covers all models 1950-1958. **\$3.95**



AUTO REPAIR MANUAL

This book was prepared by a panel of experts to apply to every make, model and year of car. With hundreds of photographs and diagrams it explains exactly how your car is supposed to run, just why it breaks down, how to repair it and how to prevent breakdowns in the future. Covers both automatic and manual transmissions; tells the "why" of the 12-volt ignition, explains motor tune-up, brakes, cooling systems, ignition-distributor, lubrication, etc. Tells how to buy a used car; how to build your own car cooling system; how to save money on auto vacations...and many more time-saving, money-saving articles. Over 500 illustrations, drawings and photographs.

\$2.95

Satisfaction Guaranteed or Your Money Back

POPULAR MECHANICS PRESS, Dept. 1258
200 E. Ontario St., Chicago 11, Ill.

RUSH books I have checked below. If not pleased, I can return in good order within seven days for full refund.

- Remittance enclosed. Send C.O.D.: U.S.A. only.
 Ford Manual Plymouth Manual Chevrolet Manual
 Auto Repair Manual

Name _____

Address _____

City _____ Zone _____ State _____



WORLD'S LOWEST PRICED CALCULATOR! NOT \$3.95
NEW! NEW! NEW! But **\$1.97**
 Only **\$2.02** in Penna. including 3% Tax

TOM THUMB ADDING MACHINE

With beautiful Leatherette carrying case. MADE IN AMERICA BY AMERICANS. Beware of cheap imported imitations. ADDS UP TO ONE BILLION - 1,000,000,000. SUBTRACTS - MULTIPLIES - DIVIDES. Mistake Proof • Positively 100% Accurate • Lightning Fast • Shock Proof Solid Steel Mechanism • GUARANTEED FOR YOUR LIFETIME. Ideal for Housewives, Shoppers, Students, Engineers and Tax work. Take it to the Super Market—Save \$\$\$ every week. We pay postage if you send check, cash or money order—or just send your name & address and pay postman \$1.97 plus postage. Immediate Delivery—10 Day Free Trial—Satisfaction Guaranteed or money refunded by return mail. **SPECIAL GIFT OFFER—3 Machines for only \$4.99**

AGENTS WANTED—Make easy money selling a Top Quality Calculator at our unbelievably low price.

TOM THUMB ADDING MACHINE
 P.O. BOX 5066 Dept. D-18 Philadelphia 1., Penna.



"HOW TO MAKE MONEY
 IN
Mobile Radio Maintenance"

AUTHORITATIVE GUIDEBOOK
 ABOUT THE BOOM IN TWO-WAY MOBILE-RADIO:
 GIVES FACTS, FIGURES, PAY RATES.
WRITE TODAY! **FREE**



LAMPKIN LABORATORIES, INC. Mobile Div. BRADENTON, FLA.

Finish HIGH SCHOOL AT HOME

Complete 4 Yrs. in 12 Months

Learn More! Earn More! Enter professional or technical schools. Advance Socially. Live a Happier, Fuller Life. Individual Courses or complete schedule. **WRITE FOR SCHOOL BULLETIN.**

ACADEMY FOR ADULTS
 30 W. Washington, Dept. PM-128, Chicago, Ill.

MAIL ORDER BUSINESS

How to Start a Profitable Business of Your Own at Home or in a Small office. Amazing new instruction course shows you how to run a good mail order business, spare time or full time. Up-to-date, practical training—a treasure-house of the best plans and practices being used TODAY by successful operators. **Only \$5.95, Complete—Satisfaction Guaranteed!** This is BIG. You get 34 money-making lessons in 5 separate volumes, all in one shipment. You must be satisfied or your money back immediately. Full price only \$5.95, postpaid—or COD plus postage. Nothing more to pay! Order "Mail Order Course" today.

Nelson-Hall Co., 210 S. Clinton St., Dept. 9MS-2, Chicago 6, Ill.



LEARN WHILE YOU SLEEP!

Improve mind, body and personality with amazing new university-tested method. \$2.00 rushes 100 page fact-filled illustrated book of complete instructions. Satisfaction guaranteed. Free folder on request. Sleep-Learning Research Ass'n. Box 24 Olympia, Wash.



ARTHRITIS—RHEUMATISM
VITAL FACTS EXPLAINED

FREE DESCRIPTIVE BOOK

How crippling deformities may be avoided. This amazing FREE BOOK explains why ordinary methods give only temporary relief—if that. Describes a drugless method of treatment successfully applied in thousands of cases. Write for this 36-page FREE BOOK today. No obligation.

BALL CLINIC, DEPT. 756, EXCELSIOR SPRINGS, MO.

NO JOB WORRIES

PLASTEX INDUSTRY needs manufacturers on small scale for big production of Lamps, Clock Stands, Art Goods, Novelties in Plastic Marble imitation. No experience necessary. Age material makes regular 10¢ store sellers. Moulds furnished for fast production. Small investment brings good profit. **BIG WHOLESALE ORDERS NOW BEING PLACED.** Ambitious men have chance for real prosperity and job security. Our NEW FREE booklet will interest and benefit you.

PLASTEX INDUSTRIES, Dept. A
 3400 Third Ave. New York 56, N.Y.



choose a career in
MECHANICAL ENGINEERING

Bachelor of Science Degree—4 yrs.
Associate in Applied Science Degree—2 yrs.



Prepare for a rewarding career as an engineer or engineering technician at the Milwaukee School of Engineering—located in the machine shop of the world. At MSOE, you can earn an Associate in Applied Science degree in 2 years, or continue without loss of credit to your Bachelor's degree in 4 years.

All courses are approved by an Industrial Advisory Committee. Previous training and experience are evaluated for credit. Scholarships and part-time work available. Placement service for graduates.

New Classes Begin in SEPTEMBER, JANUARY, MARCH, and JUNE

- Choose from these courses:
- MECHANICAL ENGINEERING**
 BSME degree in 4 years
 Plant Engineering, Metallurgical or Industrial Technology
 - ENGINEERING TECHNICIAN**
 AAS degree in 2 years
 Air Conditioning, Metallurgical or Industrial Technology
- For more information, mail coupon today!



MILWAUKEE SCHOOL OF ENGINEERING

Dept. PM-1258, 1025 N. Milwaukee St., Milwaukee 1, Wisconsin

Send FREE career booklet (please print)

I am interested in..... (name of course)

Name..... Age.....

Address.....

City..... Zone..... State.....

I am I am not eligible for veterans educational benefits..... (discharge date)

World
Wide

OWN a Nationally Advertised Business



Even if now employed, we'll personally train you, furnish all equipment & supplies, and show you how to clear **\$8,750** the first year on **2 jobs a day.**

START PART TIME—operate from home. We furnish everything and locally train you to run your OWN business. Become an expert in "on-location" carpet-upholstery cleaning, using unique ABSORPTION process backed by Parents' Mag. Seal and leading mfgs. Aerated foam removes dirt, grease. No scrubbing, soaking, shrinkage. Four other services, soil retarding, mothproofing, flameproofing and spotting increase your profits on each job. Business grows from repeat orders and recommendations.

WE HELP YOU GROW—Hdqtrs. is interested in your personal success. When you write or phone, you get prompt, individualized counsel by staff of experts who help develop your business. **National Advertising** in House Beautiful, House & Gardens, others creates demand and tells readers to contact you thru Yellow Pages; campaign in trade magazines as Furniture Retailer, Floor Covering Profits, others targets retailers to become your agents. 25 regular services include Copyright, Tested Ads, Promotional Materials, Conventions, Monthly Magazine, Lab. Research, others. **Send for FREE BOOKLETS now!**

"OWN a Business" Coupon

DURACLEAN CO., 8-16D Duraclean Bldg., Deerfield, Ill.

Please rush free booklets with full details of how I may OWN a growing, lifetime business.

Name _____

Address _____ County _____

City _____ State _____

Kits for Christmas! GENIAC COMPUTER KIT

You can construct over 125 different circuits and machines that compute, reason, solve puzzles and demonstrate a wide variety of basic computer circuits with the GENIAC® electric brain construction kit. Thousands of schools, colleges, industrial firms and private individuals have bought GENIACS since we first brought them on the market.



GENIAC set up to do a problem in check valve research

We have recently added a circuit for composing music, which gives us special pleasure because it was designed by a 16 year old boy who learned about computers from his GENIAC®. Dozens of other youngsters have created their own designs for computing circuits, used GENIACS in their school projects and established a solid foundation of information on computers with GENIACS.

Each kit comes complete with Beginners Manual, Study Guide, instructions for building all the machines and circuits, rack (exclusive with our GENIAC), parts tray, and our complete question answering service. When you buy a GENIAC you are buying a first course in computer operation.

Each kit comes with a one week money back guarantee if you are not satisfied.

Price of Kit complete with parts tray, rack, all components, manuals and texts \$19.95 (postpaid in U. S., add 80c west of Mississippi). (\$2.00 outside United States.)

SCIENCE RESEARCH KITS, INC., Dept. PM-128
108 E. 16th St. New York 3, N. Y.

WHERE-TO-BUY-IT INDEX

AUTOMOTIVE

Hybrid car body.....	125
Highway cattle train.....	143
Automobile batteries have replaceable cells (Aut-O-Cel Co., P.O. Box 220, Des Moines, Iowa).....	208

AVIATION

Huge tower tests de-icer on helicopter.....	84
Cargo-carrying helicopter powered by gas-turbine engines....	92
Flying ambulance saves lives.....	96
"Clover leaf" speed brakes fold out of fuselage.....	105
Jet pilots "fly" in simulator.....	118
Big wind tunnel tests jet's wiper.....	125
Jet tests de-ices by making own ice.....	125
Air Force tests air-breathing "Goose" missile.....	128

CONSTRUCTION

Foamed silica makes lightweight insulation material (Pittsburgh Corning Corp., One Gateway Center, Pittsburgh 22, Pa.).....	92
Telescoping boom pushes and pulls roller on steep grades....	93
Scoop-bucket has "snapper lip" that automatically opens and closes.....	105
Modular units enclose porch.....	124

FARMING

Counter clips to egg basket (Antonoff Products, 1697 Western Reserve Rd., Poland 4, Ohio).....	75
Root plowing changes wasteland to grassland (Caterpillar Tractor Co., Peoria, Ill.).....	81
Farm-size dryer saves wet crops (John Deere and Co., Moline, Ill.).....	128

MISCELLANEOUS

"Sun-tan tree".....	62
Control panel for hospital bed (Minneapolis-Honeywell Regulator Co., Minneapolis, Minn.).....	70
Waterborne power mower clears vegetation from lakes.....	75
Battery-powered eraser (Ellendale Assoc., Box 401, Park Ridge, Ill.).....	84
Slide rule predicts weather (Wind 'n' Weather Slide Rule, 33 Snell St., Hillbrook, Mass.).....	84
Barge splits into sections for overland truck trips (Eugene Welding Co., Marysville, Mich.).....	93
High-level visit to hospital.....	104
Built-in shower bathes old tree.....	115
Filter quiets exhausts (Air-Maze Corp., Cleveland 28, Ohio).....	119
Branding iron for tools (Janden, P.O. Box 1448, Chicago 90).....	119
Green spray tints lawn (Luminal Paints Div., National Chemical and Mfg. Co., 3617 S. May St., Chicago 1).....	128
Tape-recorded instructions replace assembly diagrams (Westinghouse Electric Corp., Pittsburgh, Pa.).....	133
Coach lantern replica helps greet season (Noma Lites, Inc., 55 W. 13th St., New York City 11).....	133
Miniature missile transporter equipped with 13-inch rocket (Ny-Lint Tool and Mfg. Co., Rockford, Ill.).....	133
Huge Ferris wheel goes up in six hours.....	136
Quick-inflating raft has boarding deck (United States Rubber Co., 1230 Ave. of the Americas, New York City 20).....	137
This organ has pipes made of cardboard.....	137
Milk packaged in odd-shaped cartons for Japanese.....	144

OUTDOOR SPORTS

Electric drill scales fish (Jaco Mfg. Co., Lakewood, Ohio)....	75
It moves on ice or water.....	85
Underwater spotlight pressurized for 250 feet (Burgess Battery Co., Freeport, Ill.).....	119

SCIENCE

Giant atomic sub tanker.....	103
Human cell model is 12 feet high.....	104
Unit "speaks" code on Teletype signal.....	104
Inexpensive oil from shale.....	114
Lightweight oxygen set carried on shoulder.....	119
Lamp flashes 120 times a second.....	137
Frozen blood.....	208
Flies kill grasshoppers.....	208

WHAT'S NEW FOR THE HOME

Toll call computer.....	126
Gas heater mounted in wall or window.....	126

(Continued to page 60)



PAY 1¢ on the DOLLAR for 1000's of Useful Items of U. S. GOV'T SURPLUS

**AT THE LOW, LOW PRICES
PAID AT GOV'T SURPLUS SALES**

Jeps.....\$223	Tractors.....\$68
Trucks.....\$212	Motors.....994
Boats.....\$5.90	Airplanes.....\$366
Fork-lifts.....\$197	Typewriters.....\$6.80
Compressors.....\$9.69	Generators.....\$8.78

You BUY DIRECT from U. S. Government at TREMENDOUS savings. Eliminate middlemen—Save BIG MONEY! Pay as LOW as 1c on the dollar or less. Our Directory Gov't Surplus Sales lists 100's Army, Navy, Air Force Gov't Surplus Depots. Many of them right in your own back yard. BUY JEEPS, sports equipment, hunting, fishing and photographic equipment and supplies, radio, electronic and electrical equipment, trucks, boats, airplanes, Plumbing, hardware, office equipment & supplies. Tools, machinery, furniture. We DO NOT sell jeeps or other surplus. This indexed book tells how to buy Gov't Surplus direct. No dealer profits to pay. Get on the gravy train while you can. Send \$1 TODAY for "Gov't Surplus Directory" to **AVIATION SURPLUS, Dept. PM-12, Box 789, York, Pa.**



FREE

MUSCLE BUILDING INFORMATION

*Sensational New Methods
Less Time—Less Effort—Better results*
BODY-TONE, Box 638, North Miami 61, Fla.

ANCOPOWR 1/4" ELECTRIC DRILL \$11.95

Jacobs Key Chuck • 5 Alloy Steel Gears
• 900 RPM Full Load • 1600 RPM No
Load • 7 Ft. Cord & Plug • UL Approved
1/2" DRILL ALSO AVAILABLE \$24.95

Send Check or M.O. Money Back Guarantee \$23.95 retail value
(Illinois residents include 3% sales tax)



ANCHOR WIRE & MFG. CO. 2118 W. VAN BUREN ST., CHICAGO 12, ILL.



*For extra income
or career... learn*

WATCH REPAIRING

at home the low cost Sweeney Way

Modern, simplified shop method starts you making repairs right away on Swiss and American watches. No previous experience needed. No age limit. Low terms. FREE sample lesson without obligation. Write today.

CHICAGO SCHOOL OF WATCHMAKING
2330 N. Milwaukee Ave. Dept. 1128 Chicago 47, Ill.

TRADE SECRETS REVEALED HOW TO TURN CONCRETE INTO GOLD



You've seen them all over the country... concrete bird baths, garden seats, flower boxes, aproning electricity, and many other items that add charm around the house and lawn. They're made by enterprising people, just like you, from our **COPYRIGHTED ALUMINUM MOLDS.** It's easy. It's fun. It's profitable.

Send \$2.00 today for this 42-page "How to" book, 20 pages of clear instructions. Valuable trade secrets. Over 250 items beautifully pictured (with description, dimensions, and prices of molds). Rushed to you by first class mail.

CONCRETE MACHINERY CO., INC
HICKORY 4, NORTH CAROLINA

Name _____
Address _____

**HOW TO
TURN
CONCRETE
INTO
GOLD**

PREPARE FOR BETTER JOB, BIGGER PAY IN SPARE TIME AT HOME

Today, choose the job you want—and prepare for it in time you might otherwise waste. Or if you are already in the work you like best, start training now for quicker promotion and increased pay. During the past 61 years AMERICAN SCHOOL has helped ambitious people to reach higher goals. Check subject that interests you and mail coupon for full information.

AMERICAN SCHOOL, Dept. G945, Drexel at 58th, Chicago 37, Ill.

Without obligation, please send FREE and postpaid, full particulars about the subject checked below.

- | | | |
|--|---|---|
| <input type="checkbox"/> Accounting | <input type="checkbox"/> Contracting | <input type="checkbox"/> Mechanical Engineering |
| <input type="checkbox"/> Apprenticeship Courses | <input type="checkbox"/> Diesel Technician | <input type="checkbox"/> Mechanical Technology |
| <input type="checkbox"/> Architecture & Building | <input type="checkbox"/> Drafting—Building | <input type="checkbox"/> Metalworking Courses |
| <input type="checkbox"/> Automotive Technician | <input type="checkbox"/> Drafting—Machine | <input type="checkbox"/> Plumbing—Practical |
| <input type="checkbox"/> Better Foremanship | <input type="checkbox"/> Electrical Engineering | <input type="checkbox"/> Private Secretary |
| <input type="checkbox"/> Blueprint Reading | <input type="checkbox"/> Electricity—Practical | <input type="checkbox"/> Retail Merchandising |
| <input type="checkbox"/> Bookkeeping | <input type="checkbox"/> Electronics—Industrial | <input type="checkbox"/> Salesmanship—Outside |
| <input type="checkbox"/> Business Management | <input type="checkbox"/> HIGH SCHOOL COURSES | <input type="checkbox"/> Sheet Metal Work |
| <input type="checkbox"/> Civil Engineering | <input type="checkbox"/> Machinists | <input type="checkbox"/> Tool Making |

NAME _____
HOME ADDRESS _____
CITY _____ STATE _____
OCCUPATION _____ AGY _____

Accredited Member NATIONAL HOME STUDY COUNCIL

MAIL COUPON NOW

WHAT SECRET POWER DID THIS MAN POSSESS?



BENJAMIN FRANKLIN
(A Rosicrucian)

WHY was this man great? How does anyone—man or woman—achieve greatness? Is it not by mastery of the powers within ourselves? Know the mysterious world within you! Attune yourself to the wisdom of the ages! Grasp the inner power of your mind! Learn the secrets of a full and peaceful life!

Benjamin Franklin—like many other learned and great men and women—was a Rosicrucian. The Rosicrucians (NOT a religious organization) first came to America in 1694. Today, headquarters of the Rosicrucians send over seven million pieces of mail annually to all parts of the world. Write for YOUR FREE COPY of "The Mastery of Life"—TODAY. No obligation. No salesmen. A non-profit organization. Address: Scribe A.R.H.

THIS BOOK FREE!



The ROSICRUCIANS
SAN JOSE • (AMORC) • CALIFORNIA

—SEND THIS COUPON—

Scribe A.R.H.
The ROSICRUCIANS (AMORC)
San Jose, California

Please send me the free book, *The Mastery of Life*, which explains how I may learn to use my faculties and powers of mind.

Name _____

Address _____

City _____

(Continued from page 58)

Electric knife sharpener.....	126
Kitchen broiler.....	126
Acetate plastic covers for photos.....	127
Electric dryer.....	127
Cordless time switch.....	127
Metallic trim tape.....	127

Radio-Television, Electronics

Hi-fi trends.....	145
Gift suggestions for the hi-fi enthusiast.....	146
Stereophonic portable (Motorola Inc., 4545 Augusta Blvd., Chicago 51).....	146
Shelf-size speaker enclosure (Q-Sonics, Inc., Syracuse, N. Y.).....	146
WR-8 Speaker (Sonotone Corp., Elmsford, N. Y.).....	146
Stereo conversion kit (Garrard Sales Corp., Div. of British Industries Corp., Port Washington, N. Y.).....	146
High-fidelity turntable kit (Rek-O-Kut Co., Inc., 38-19 108th St., Corona 63, N. Y.).....	146
New 12-in-1 lab kit (Allied Radio Corp., 100 N. Western Ave., Chicago 80).....	146
Regenerative receiver kit (Lafayette Radio, 165-08 Liberty Ave., Jamaica 33, New York).....	146

Craftsman and Shop Notes Index

CHRISTMAS SUGGESTIONS

Decorating hints for a more attractive Christmas tree.....	177
Christmas-safety hints.....	178
Christmas shopping for tools.....	201
Belt and pad sanders.....	201
Drill and driver attachment.....	201
Carbide-tipped scriber.....	201
Wood-lathe attachment.....	201
Adjustable wrench.....	202
Portable paint sprayer.....	202
Drill-bit holder.....	202
Portable electric hammer.....	202
Household toolkit for the ladies.....	203
Disk sander.....	203
Toolkit in a pocket knife.....	203
Combination hand vise and bench vise.....	203
Jigsaw kit.....	203
Ruler square.....	204
Drill kit.....	204
Portable power tools.....	204
Sanding block.....	204

FARMING

Electric fence is portable.....	156
Tall corn dusted from high frame.....	156
Charred posts don't decay.....	164
Livestock chute floor hinged to adjust to various truck heights.....	164
Barnyard gate can be raised to swing over snowdrifts.....	168
Hydraulic lift on drawbar eases work for tractor operator.....	168

HOUSE AND HOME

Plywood replaces damaged plaster on ceiling.....	153
Make your own pole lamp.....	154
Locked shelf in medicine cabinet assures caution.....	157
Repair loose joints of door.....	164
Knockdown bookcase easy to store or transport.....	185
Loosening paint-locked sash.....	196

MISCELLANEOUS

Preheated air cleaner speeds starting of car in cold weather.....	156
Turtle TV stool.....	165
Pencil "graphite" quiets wooden wheels of toddler's wagon.....	177

OFFICE, SHOP AND STORE

String and modified compass aid in drawing accurate ellipse.....	157
Bracket on small drawing board "clamps" it to dictation slide.....	160
Use bow-tie clip as a note holder.....	168
Notebook ring on measuring tape permits easier handling.....	184

PHOTOGRAPHY

Photographic prints flattened with costfree equipment.....	160
Film agitator.....	161
Improvised miniature reflector for photoflash close-ups.....	181
Silicone preparations renew leather on camera equipment.....	181

(Continued to page 62)

NOTICE—It is the intention of this magazine to provide its readers with information regarding the latest developments in the mechanical arts. Except where otherwise indicated, this magazine has no information as to any unexpired patents in respect of the developments reported herein. In the event that commercial use is to be made of any of the developments reported herein, it is suggested that legal counsel be consulted to avoid liability for patent infringement. It is not the purpose of this magazine to encourage patent infringement but, as indicated, it is the intention of this magazine to report on the latest developments in the mechanical arts.

Get into... PLASTIC LAMINATING AT HOME!



THIS MAN... is taking out of the machine a Plastic Sealing Job—ordered by mail—only 11¢ in material cost brings back \$2.59 in cash by mail. Capacity of machine: **\$25.00 profit per hour of operation.**

Get **ORDERS** and **CASH** from your mailman—do work in **SPARE TIME** at home—or expand into **FULL TIME** business. Send coupon for Free facts about the newest and most fascinating of all home operated businesses. For the first time a simplified machine brings the fabulous profits of **Plastic Sealing** and **Plastic Laminating** within the reach of the small operator. Anyone can learn to operate the machine with a few minutes practice—then with our **Magic Mail Plan** can get mail orders pouring in daily with cash in every envelope. **No canvassing—no selling.** We even

Make up to \$5 an Hour..
MAGIC MAIL PLAN!

supply the circulars you mail to bring back cash and orders. Don't waste a minute. Rush your name. We'll send you **FREE** and postpaid, pictures, prices, details, and all the facts you need to start. Mail coupon or send name on postcard. **No charge.** Warner Electric Co., 1512 Jarvis Av., Dept. L-2-P, Chicago 26, Ill.

Make Thousands of Beautiful Art Creations
COSTUME JEWELRY • CIGARETTE BOXES
TRAYS • CANDLESTICKS • COASTERS
LAMP BASES • BOOK ENDS...ALL IN
SPARKLING COLORED PLASTIC



WARNER ELECTRIC CO., 1512 Jarvis Av.
Dept. L-2-P, Chicago 26, Ill.
At no cost to me, please rush complete details postage prepaid. I am under no obligation.

Name _____
Address _____
City _____ Zone _____ State _____

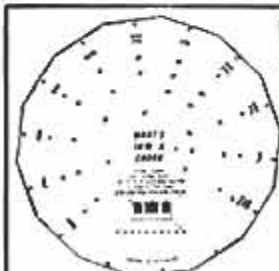

Play Organ-Piano?

Professional or not, this ingenious wheel adds to your talent the first time you use it. Turn to any key and find all eleven basic chords. Use easy-to-read Chord-Dial as bass clef to melodies. Excellent for composer, student, amateur or professional. Can't roll off stand, handy size

\$1.25

CHORD-DIAL, P.O. Box 631, Inglewood, Calif.



SALE! 13 Pc. Set of Chrome Vanadium Drills!

Terrific value from W. GERMANY. 13 Chrome Vanadium Drills from 1/16th thru 1/2 inch by 64ths, in Metal Indexed jacket for finger-tip selection. Drill thru woods, plastics, aluminum, iron, even STEEL. Send check, cash or m.o. for prompt **FREE** delivery. Money back guarantee. While supply lasts. No. 13 \$1.77

\$5.95 Val.

\$1.77

THORESEN, Inc., Dept. 6-N-13
585 Water St., New York 2, N. Y.

GET THE HABIT OF READING OUR CLASSIFIED ADS.
Wonderful Opportunities Amazing Bargains

RUPTURE!



An amazing Air-Cushion Invention allows body freedom at work or play. Light, neat, cool, sanitary. Durable, cheap. Day and night protection helps Nature support weakened muscles gently but surely. No risk. Sent on Trial! Write NOW for free Booklet and Proof of Results. All correspondence confidential.

BROOKS COMPANY, 143 State St., Marshall, Mich.

TOOLS WHOLESALE

\$100 PUTS YOU IN BUSINESS

Start your own business, sell tools to your friends and neighbors, or buy tools for your own use and **SAVE MONEY \$\$\$**

A MILLION DOLLAR INVENTORY AT YOUR FINGERTIPS. NO STOCK TO CARRY. ORDER AS YOU NEED IT.

Send \$1. for Tool Catalog today. **BUY AT WHOLESALE PRICES.** Extra \$25.00 profit on your accumulated purchases. \$1.00 is refunded if you are not 100% satisfied with our offer.

SILVO HARDWARE CO., Dept. PM12
107 Walnut St., Phila. 6, Pa.

THOUSANDS!! of Nationally Advertised items of Hand Tools, Power Tools, Machinist Tools, Tool Chests, Paint Sprayers, Light Fixtures, Appliances, Guns, Gifts, Toys and other items too numerous to mention.

WE SHIP COAST TO COAST Wholesale Discounts up to 50% OFF



Become A --- BUILDING CONTRACTOR!

MAIL COUPON for FREE BROCHURE

Simplified home study training program. Learn every phase of building, estimating, contracting. Fortunes are made in this line of work every year. Use spare hours—no interference with present work. Diploma awarded. Low tuition rates.

AMERICAN TECHNICAL SOCIETY
Dept. BH-128, 850 E. 58th Street, Chicago 37, Ill.

Please send me your **FREE** Brochure and full details of your building, estimating and contracting training program.



Name _____ Age _____
Address _____
City _____ State _____

EARN UP TO \$100. A DAY

Start at home and have two incomes.

Tired of Being A Slave?

If you have two good hands and one good eye, you can become an expert in a few hours, keep your present job and earn up to \$50.00 in one evening while learning a real sound lifetime business. You can begin in spare room, garage or basement. Nothing like it offered anywhere. Don't miss the opportunity of a lifetime. For full details and illustrated booklet in beautiful color send 25¢ to cover cost of mailing.

MURALAMA ARTS
P.O. BOX 271 SEDONA, ARIZONA

OPERATE EARTH MOVING EQUIPMENT



Learn to operate bulldozers, cranes, motor scrapers, crawler tractors, draglines, off-highway dump trucks, etc., on 1,700 acre Greer Training Area 60 miles S.W. of Chicago, Ill. on Route 66. Courses include operation, equipment care, preventive maint., stake reading, etc. Minimum classroom instruction. You learn by actually operating the equipment. You may specialize on individual equipment at rates beginning from \$195 (100 hours). Usual courses (200 hours) completed in 4 weeks. Classes start every Monday. Reserve your space today.

MECHANIC TRAINING

Complete Mechanics Course covering Diesel engine transmissions; torque converters; fuel injection systems; track assemblies; final drive assemblies; steering systems; idlers; rollers; power transfer systems; cable control systems; hydraulic control cylinders & welding pertaining to heavy equipment such as bulldozers, scrapers, loaders, off-highway trucks, etc. Course time—540 hours—10 weeks. Convenient payment plan. Write for details.



Greer TECHNICAL INSTITUTE
ATT: M. L. Hutch, Box 278, Braidwood, Ill.

Strong drive-in hooks.....	162
Where to grip a flowerpot when painting.....	162
Serving trays kept from falling.....	162
Parts of spare electrical receptacle kept together.....	162
Venetian-blind pull made easy to identify.....	163
Minimize danger of tiny fingers being crushed in door.....	163
Temporary clothes rod.....	163
Bookmark stays put.....	163
Wire serves as bead-stringing needle.....	163

WORKSHOP HINTS

Hidden metal in used lumber detected with aid of magnet.....	152
Gaskets cut to exact size by using ball-peen hammer.....	152
Worn half-moon key replaced with one cut from washer.....	152
Clear-plastic sandwich boxes make ideal parts "cabinet".....	153
Modeling clay aids nailing.....	160
Taper-shank drill chuck is substitute pin vise.....	160
Use turnbuckle to tighten belt of platform-mounted motor.....	164
Swing joint in pipeline accommodates expansion.....	168
C-clamp prevents nails from splitting small lumber.....	168
Stepstool with handle eliminates stooping.....	169
Indented surfaces give tooth to flat glue joints.....	176
Grease-gun plunger rod locked with pliers.....	176
Magazine page substitutes for missing try square.....	181
"Jammed" plug of power tool acts as safety precaution.....	184
Record size of dry cell inside flashlight case.....	184
Two C-clamps hooked together to span wide workpiece.....	184
Speed sander-plate changing by punching holes in paper.....	184
Simple method for determining the center of a circle.....	185
Hardwood dowel in soft stock provides turning center.....	192
Gun fitting on grease cup permits easier filling.....	192
Notched board serves as guide for drilling spaced holes.....	197
Drill "chucked" in lathe center.....	197
V-block forms drill guide.....	197
Jam nut holds bolt centered in clamp jaw of the lathe steady rest.....	197
Steel angles cut accurately by sawing from heel first.....	200
Spare motor brushes are stored in power-tool handles.....	200
Stock shouldered accurately with simple jig on grinder.....	200

Free! **ALLIED'S**
MONEY-SAVING 1959
ELECTRONIC SUPPLY CATALOG

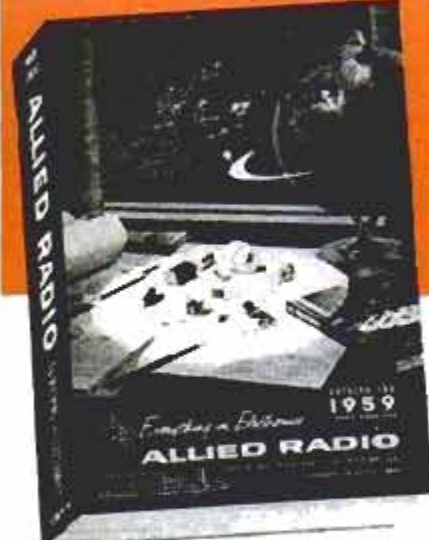

452
value-packed
pages

send for it!

SAVE
ON EVERYTHING
IN ELECTRONICS

EASY TERMS
AVAILABLE

WORLD'S LARGEST STOCKS

Here is the complete guide to everything in Electronics for Experimenters, Builders, Amateurs, Servicemen, Engineers and Hi-Fi enthusiasts:

- Amazing Build-Your-Own KNIGHT-KITS
- Everything in STEREO Hi-Fi
- Hi-Fi Music Systems & Components
- Recorders & Phono Equipment
- Public Address & Paging Systems
- TV Tubes, Antennas, Accessories
- Amateur Station Equipment
- Latest Test & Lab Instruments
- Industrial Electronic Supplies
- Parts, Tubes, Transistors, Tools & Books

SAVE on everything in Electronics at ALLIED—get fast, dependable service, expert personal help, guaranteed satisfaction. Send today for your FREE 1959 ALLIED Catalog.

Everything in Electronics
From One Reliable Source

OUR 38th YEAR



Send for
FREE
Catalog

ALLIED RADIO

- ALLIED RADIO, CORP., Dept. 5-M8
- 100 N. Western Ave., Chicago 80, Ill.
- Rush FREE 1959 ALLIED 452-Page Catalog

Name _____

Address _____

City _____ Zone _____ State _____

"Sun-Tan Tree"

Vacationers at a new resort hotel in Santa Monica, Calif., can get a quick even tan from a new "sun-tan tree." The tree is a metal framework with aluminum-foil "leaves" which reflect the sun's rays onto the sunbather. The vacationer must be careful, though; if all the "leaves" are focused on one spot, they provide enough heat to boil water in 20 minutes!

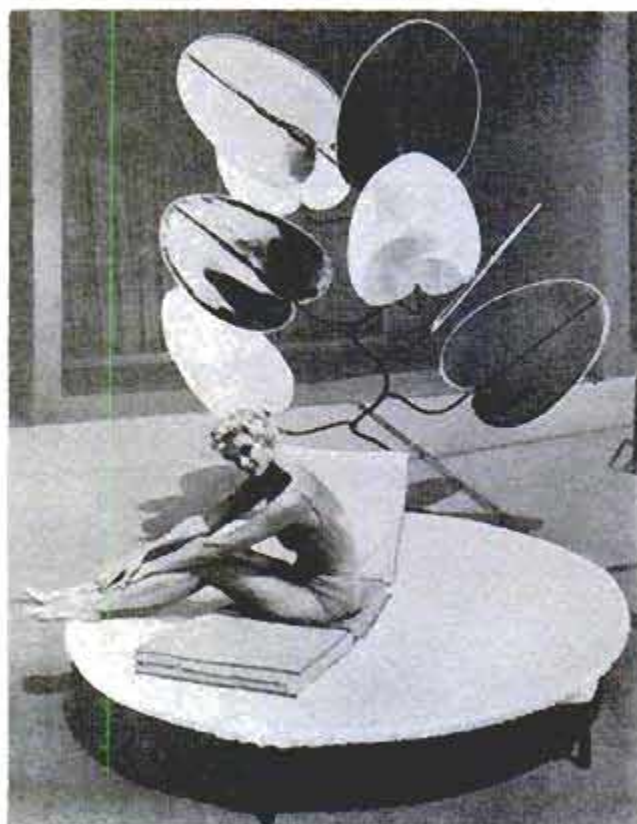

is your
**MILLION
DOLLAR**
idea
gathering
dust?

**NATIONAL INSTITUTE of
REGISTERED IDEAS, Inc.**

Rm. 1, Institute of Science Bldg.,
Media (Suburban Phila.), Penna.

This nation-wide service can help your ideas make money for you. Probably the toughest thing about having an idea is getting someone to listen. Millions of dollars worth of valuable ideas are gathering dust because their originators can't get them into the hands of the companies who can use them. NIRI has already solved this problem for many people like you — analyzing and evaluating their ideas, marketing them, advising originators on the protection of their ideas, and helping them get the best possible price. We will be glad to give you our bank, legal and Better Business Bureau references, if you wish. For further details, fill in the coupon.

Note to industry: get in touch with us for details on how this unique service can be of value to you.

CLIP COUPON TODAY FOR THIS INFORMATIVE NEW BOOKLET

The Service
for People with
Salable Ideas



← **FREE** —

Please send me your folder for people with ideas.

Name _____

Address _____

City _____ Zone _____ State _____

"MINIATURE MACHINE SHOP

No Bigger Than A Typewriter, Outperforms Machines Many Times its Size!

That's what a popular publication says about UNIMAT in their 3 page feature story in the May issue. If you want a reprint of this story plus complete information about this amazing 10 in 1 combination precision tool write to:



AMERICAN EDELSTAAL, Inc.

UNIMAT DIV., DEPT. 3128, 350 BROADWAY, NEW YORK 13

TRIGONOMETRY \$1.49
(SIMPLIFIED) POSTPAID

Solve trigonometry problems rapidly, the easy way. New booklet illustrates and explains new method for solving right-angle triangles with speed and accuracy. No figures or formulas to memorize. A most useful booklet handy to have. Complete with tables of natural functions, and solutions to oblique-angle triangles. Send for yours today. Send check or M.O. No C.O.D.

I. T. C., INC.

3315 YORKSHIRE RD., DEPT. B-2, CLEVELAND 18, OHIO

FIX OUTBOARD MOTORS

**POWERMOWERS, AND ALL SMALL
2 & 4-CYCLE GASOLINE ENGINES**

MAKE EXTRA MONEY — or, repair your own equipment and SAVE! Fully illustrated, easy-to-understand, Home Study Course. Write today for FREE information.

LINCOLN TECHNICAL INSTITUTE
SUITE 12E, 472 MARKET STREET, NEWARK 5, N. J.



SUPER JU JITSU

Now get tough double quick! A course of instruction in the art of practicing and using this method of applying LIGHTNING-QUICK Super Ju Jitsu. Be Dangerous! These amazing lessons show you how it's done . . . in a big illustrated home-study course. The weapons are just your BARE HANDS—they can be used effectively if you know how and practice the art. Easy to learn; quick. Full 76-lesson course only \$5.95 postpaid—or COD, plus postage. Satisfaction or your money back guaranteed! Order "super Ju Jitsu Course."

NELSON-HALL CO., 210 S. Clinton, Dept. BMS-2, Chicago 6, Ill.

ENGINEERING



Photo of Heald Students in Electrical Laboratory

Enroll Now for New Term

Heald College Ranks FIRST West of the Mississippi in "Who's Who in America"

Send for FREE Information

Heald Engineering College
Est. 1863

Van Ness at Post, Dept. P.M. San Francisco, California

American Industry Steps Up Its Demand for Trained Engineers. Train Now at Healds BACHELOR OF SCIENCE DEGREE, 27 MONTHS

Degree Courses:

- Radio-Electronic Eng.
- Electrical Engineering
- Highway Engineering
- Mechanical Engineering
- Structural Engineering
- Civil Engineering
- Architecture

Diploma Courses:

- TELEVISION Color TV
- Radio-Electronic Tech.
- Industrial Electronic Tech.
- Tool & Die Design
- Architectural Drafting
- Mechanical Drafting
- Structural Drafting

Approved for Veterans

NAME _____
STREET _____
CITY _____
STATE _____

"Most Women Wouldn't Dare!"

Says Mrs. S. Claus
Giftway Drive, North Pole

Would your wife? Frankly, most women wouldn't dare pick out a tool for a Christmas present and feel sure it's the one that hubby really wants. Well, here's the perfect solution — for you, and for her. For you — it's the new 2.7 amp, 1114 Power Drill that drives a complete workshop with matched attachments. For her — it's a happy shoppers world if you get real "sneaky" and check the tools you want in this ad and leave it on her kitchen counter.

Christmas hints by

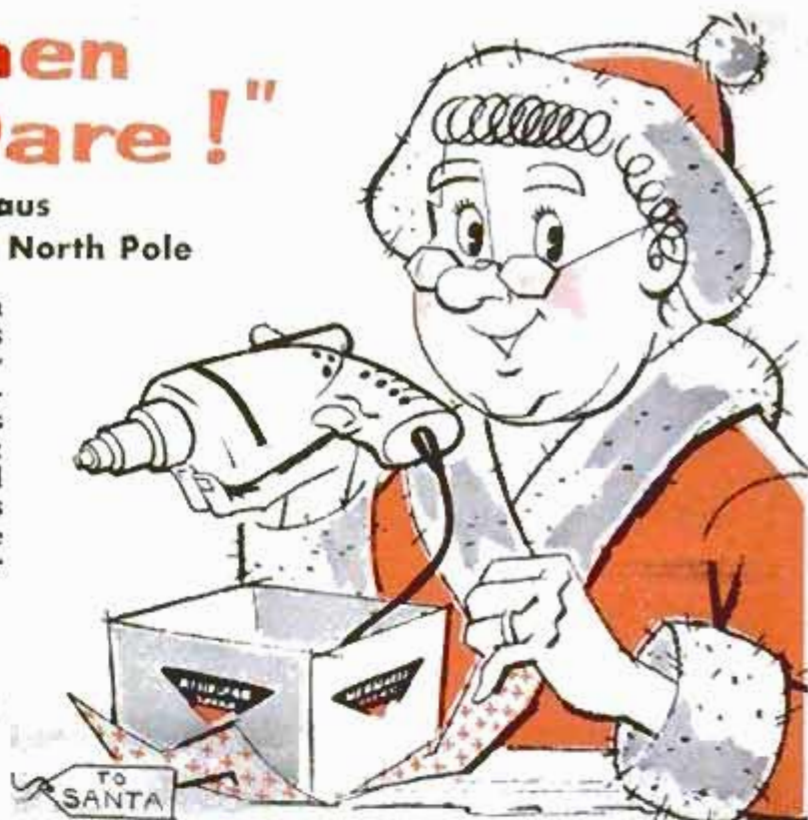

(Insert your name here)

THE DRILL THAT DRIVES A WORKSHOP!

 1114 1/4" Power Drill \$22.95	 Drill Press Vise, \$5.95	 Orbital Sander Attachment \$15.50	
 Bench Sander Attachment \$9.95	 Jig Saw Table \$1.95	 Portable Saw Attachment \$13.50	 Floor Polisher Attachment \$29.95
 Bench Stand \$1.95	 7-to-1 Speed Reducer, \$13.50	 Drill Press Stand \$15.95	 Bench Grinder Attachment \$7.95
 Portable Jig Saw Attachment \$12.50	 Hedge Trimmer Attachment \$12.95		



**VERY
Special
GIFT**

Famous "big brother" of the 1114 Drill — the "888" Dyno-Mite Power Unit. Packs a full 1/3 H.P. Drives attachments shown above and more besides. Costs only \$39.95 completely equipped as 3/8" drill, 6" disc sander, and 6" polisher.

MILLERS FALLS COMPANY
Dept. PM-26, Greenfield, Massachusetts

IT'S A PLANE!



IT'S A FILE!

EXTRA BLADE FREE □

The Plane-R-File is handy in every home. Handle reverses to make either a plane or file. AND, for Christmas only, there's an extra tungsten carbide blade worth 89¢ included free. Total cost: just \$3.49.



"PM Highlights"

POPULAR MECHANICS

DECEMBER 1958

WRITTEN SO YOU CAN UNDERSTAND IT
VOL. 110 NO. 6

What We're Doing About Air Safety

An exclusive interview with Elwood R. Quesada, Administrator of the new Federal Aviation Agency, Chairman of the Airways Modernization Board, and Special Assistant on Aviation to the President



QUESTION: Mr. Quesada, is our current system of traffic control obsolete?

MR. QUESADA: It is, to a large extent. It is manual, and these days one should have at least a semiautomatic system.

Q: Does this mean, then, that it is dangerous to fly today?

MR. QUESADA: No, it is not dangerous to fly. Air

Experimental TV-type display "remembers" past track of aircraft up to 30 minutes for traffic controllers

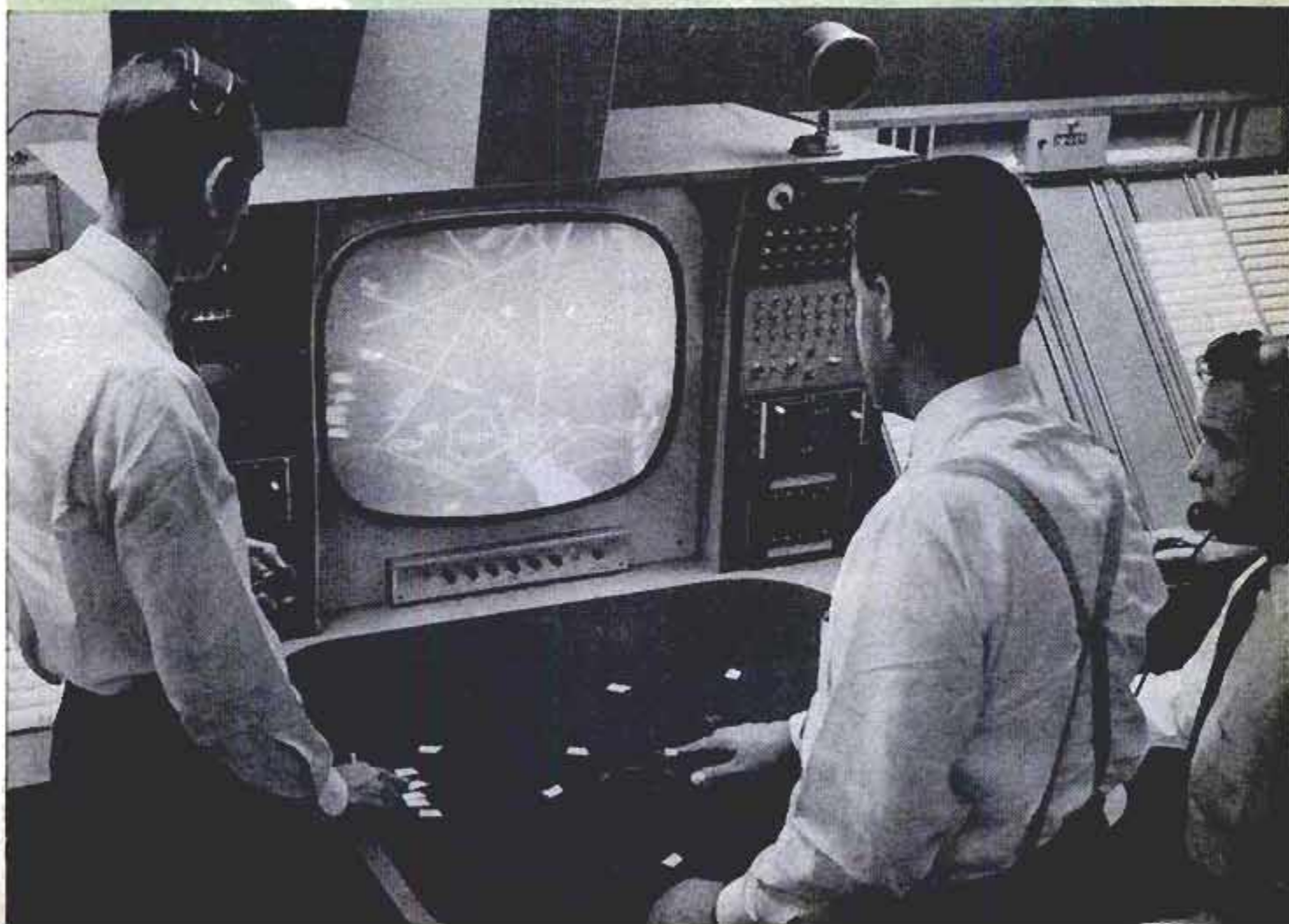

This is what the pilot saw as he approached Washington National Airport under the old system of lighting

transportation continues to be the safest mode of transportation. The obsolescence of the system causes delays to the public more than anything else — delays in departure and in holding before arrival.

Q. What are the most frequent causes of air accidents?

MR. QUESADA: Pilot error, more than any other one cause; more than mechanical error.

Q: In other words, the shortcomings of our air-traffic-control system are not responsible for any accidents?

MR. QUESADA: I would say that the procedures of air-traffic control are not a significant or even a minor contributor to air-traffic accidents.

Q: The president of the Airline Pilots Association has stated, "The system facilities for handling air traffic are now inadequate and have been inadequate for some time." Do you care to comment on that?

MR. QUESADA: I agree with him thoroughly. The Airways Modernization Board is devoting itself to that problem and that problem alone.

Q: Are you convinced that, as of now, everything is being done that can be done to prevent further military-civilian accidents?

MR. QUESADA: I guess an absolute answer is that we are never doing everything. I guess there is always something more. We are always trying to improve, and I am afraid we will never reach the absolute. I do feel that all of the interested parties are doing their best to reduce the hazards which exist.

Q: How much correlation is there right now between the airlines and the military services on instrument-flight rule and visual-flight rule operations?

MR. QUESADA: Well, contrary to general belief, the military services conform to Civil Aeronautics Administration regulations, and that includes both instrument and visual-flight rules. However, in recent months the military has voluntarily re-

stricted itself to rules that are more stringent than the rules governing the civil operators.

Q: What is the so-called "see and be seen" concept by which pilots are currently operating while under visual-flight rules.

MR. QUESADA: The see-and-be-seen concept is one in which the pilot in a particular plane must, by the use of his own eyes, provide the necessary surveillance in that area through which his plane is going to travel. He must be able to avoid collision by the application of his own sight. Also, his plane must be visible to others in the same area. Now, with today's rapidly increasing speeds, the see-and-be-seen philosophy is in some cases outmoded.

Q: When two jets approach each other head on, how long do the two pilots have to react to avoid a collision?

MR. QUESADA: It varies with the angle at which the planes are approaching and their speeds. Also, the pilot's angular vision is a factor. Suffice to say here, the pilot has scant seconds to see the other plane, calculate whether the two planes are on a collision course, and then respond to his decision by changing course if necessary. And we just cannot count on this as a solution. There must be other solutions.

Q: Are the newly developed fluorescent paints of any value?

MR. QUESADA: The principle of enhancing the see-and-be-seen technique by the application of paints is of value. It would be a disservice if I left the impression that it was *the* solution. It is of definite value and I would forecast that it is going to be applied on an increasing scale.

Q: Do you think the airlines will use these paints?

MR. QUESADA: I think the airlines will eventually apply the fluorescent paints to their planes.

Q: Minneapolis Honeywell is reportedly testing a system that will make aircraft visible at twice the normal distance, even in the daytime. Are you familiar with it?

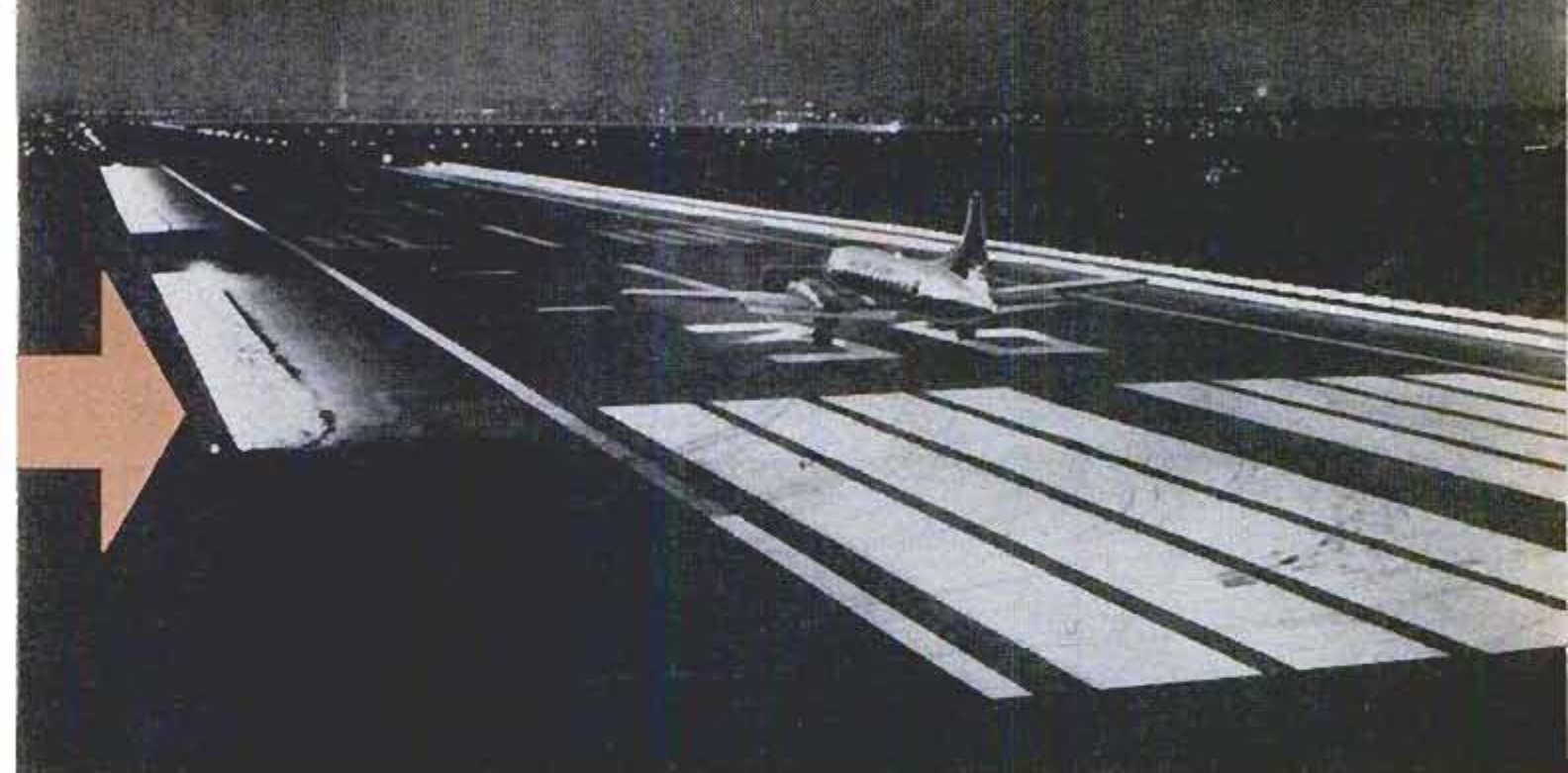

New lighting system has 272 very-high-output fluorescent lamps in eight-foot fixtures along the runway

MR. QUESADA: I am familiar with the effort on their part to develop a high-visibility light using the strobe principle.

Q: This light would be used even in daytime?

MR. QUESADA: Even in daytime it will be visible. The fundamental principle is that you store up a lot of energy and then expend it in a short span of time. Thus you produce a great deal of light and supposedly it will attract attention.

Q: Are there any satisfactory anticollision instruments now in existence, carried in the aircraft, which will warn the pilot of an impending collision?

MR. QUESADA: The best instrument carried by the aircraft continues to be the eyes of the crew. There is no instrument now available that warns of a collision with sufficient reliability.

Q: Is there any research under way on such an instrument?

MR. QUESADA: A great deal. We have three or four programs ourselves. Also,

private companies are developing such equipment. Aerojet General has an infrared device that in the minds of some appears promising. The Air Transport Association—an association of all the airlines—is not only encouraging but assisting in the development of such devices.

Q: Mr. Quesada, just what are the functions of the Airways Modernization Board?

MR. QUESADA: The functions of the board are described in the law. They are quite precise. First, the board is a joint military-civil activity. It is a research and development activity designed to develop devices essential to the modernization of the nation's aviation facilities. Its primary task is to develop a semiautomatic system for the management of air traffic to replace the present manual system.

Q: Congress recently passed a bill creating a Federal Aviation Agency, and the President subsequently appointed you administrator. What will be the functions of the new agency, and what will happen

At left airspace now required for one plane. HIDAN navigation system might permit 60 planes in same space

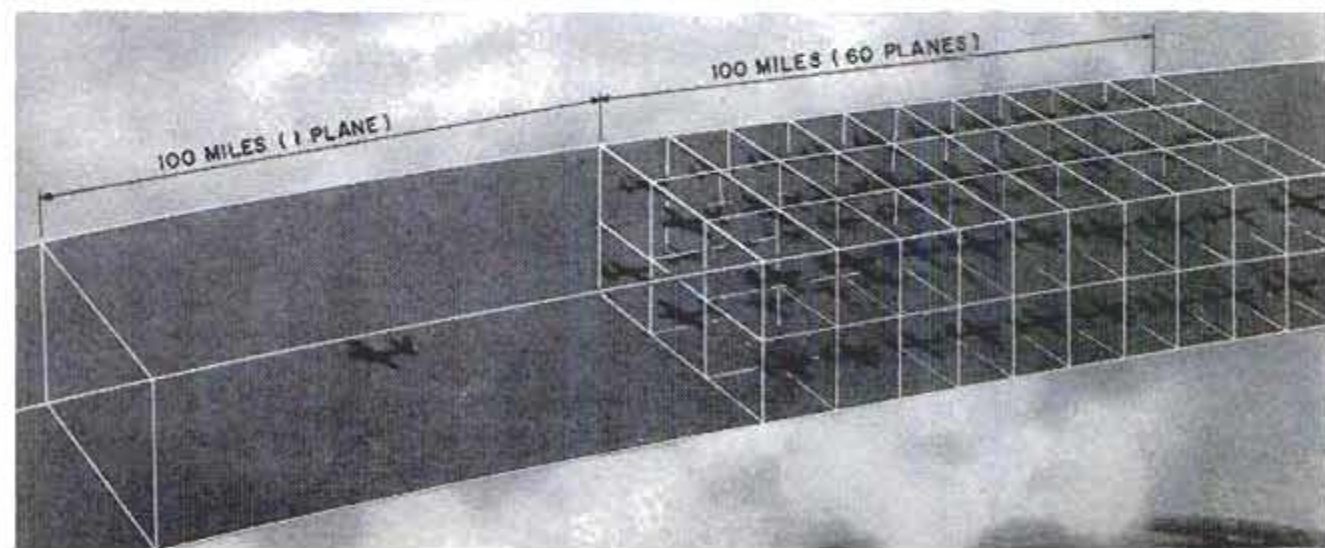

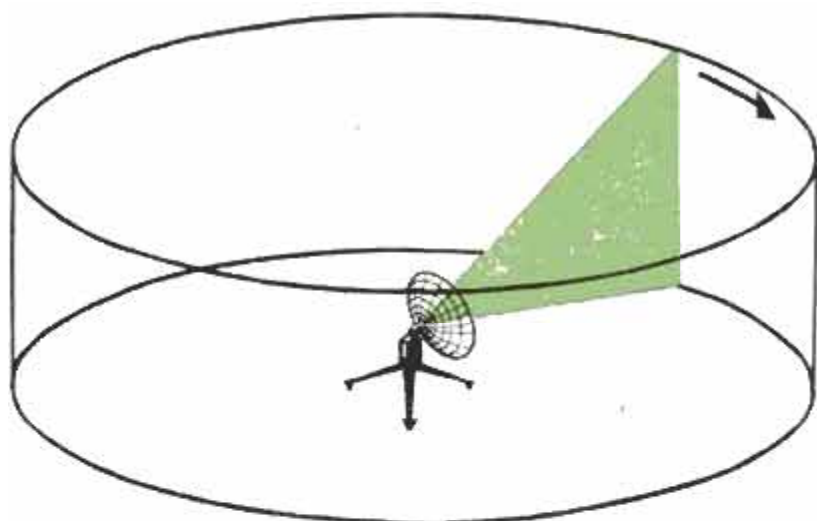

Terminal radar now in use shows only direction and distance of planes by blips on the black viewing screen

to the Airways Modernization Board?

MR. QUESADA: The new Federal Aviation Agency will absorb the Airways Modernization Board lock, stock and barrel. It will absorb the personnel, it will absorb the functions, and it will absorb the funds. The Agency will also absorb the Civil Aeronautics Administration. It will also absorb many functions that are now in the Department of Defense. The Department of Defense is performing the function of the management of air traffic essential to its own needs, and those functions will, as quickly as it is prudent to do so, be transferred to the Federal Aviation Agency. There are certain functions of the Civil Aeronautics Board that will be transferred to the Federal Aviation Agency, but the CAB will retain its own independence.

Q: What are the difficulties of developing and operating a system of air-navigation facilities for both civil and military aircraft?

MR. QUESADA: Well, I would say the primary difficulty is the technical complexity. The fact that you have radar and can "see," in effect, does not solve the problem. It only creates it. You have to take this data that the radar develops, and turn it into useful data. That requires a complex system of processing. Now, the second difficult problem is to satisfy all the users. It must be clear to you that each user is going to exaggerate and push hard for his own demands.

Q: How many flights, both civil and military, are there on a weekday?

MR. QUESADA: Estimates run from 100,000 to 200,000 per weekday.

Q: Do you foresee a time when identical traffic-control equipment will be carried on civil and military planes?

MR. QUESADA: I don't visualize identical airborne equipment, but I do feel that we can develop equipment that will be compatible with the same ground circuit.

Q: In view of the increasing speeds, then, do you see a time when all aircraft will be under ground control at all times, with the obvious exception of military aircraft on a military mission?

MR. QUESADA: Well, let me state that as far as the AMB is concerned, we intend to develop a system that is applicable to military and civil aircraft alike, in war and peace, that would permit us to eliminate airways entirely. All high-performance aircraft would be under surveillance at all times and under positive control. Hence the airways could be eliminated. However, we must make special provision for low-performance general aviation aircraft to permit them to operate with equal facility and ease.

Q: The AMB has announced as one of its goals an automatic ground-air-ground communications system. What will it do?

MR. QUESADA: As an example, take a message that would consume, say, a minute of spectrum time if it were transmitted orally. By the application of this new technique, this message is compressed to, we will say, a millisecond and put in digital form, then transmitted. Then on the receiving end it is stretched, in effect, and turned back into meaningful language. What you really save is time on any given frequency. You could have a thousand people use a frequency almost concurrently, which is one of your very, very serious problems.

Q: This equipment would encode the information itself?

MR. QUESADA: Encode it, transmit it and decode it. It will be a real contribution if it is successful.

Q: How far along is it?

MR. QUESADA: We hope to have a working model in less than a year. It is under contract with RCA.

Q: You mentioned that it is no longer humanly possible to absorb this information and make the necessary judgments.

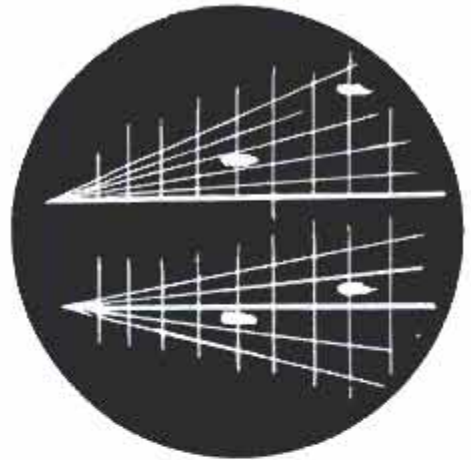
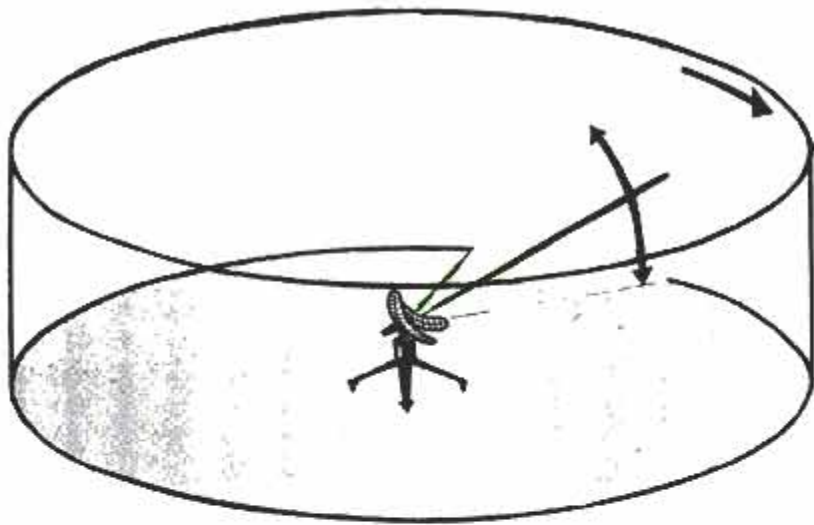

Three-dimension radar would oscillate up and down, showing direction, distance and altitude of each plane

This infers the use of an electronic computer?

MR. QUESADA: The electronic computer is going to be the platform upon which our whole data-processing system is based.

Q: Are computers now in use on the airways?

MR. QUESADA: They will be soon. The computer that is about to be used on the airways really serves the function of printing the traffic controller's flight strip. There is one under development that will, in addition to printing the flight strip, anticipate or "read out" conflict before it occurs. We have under development computers still more sophisticated that will store many

more bits of information. Such computers should be ready in experimental form in a couple of years. They will permit you to call out, as an example, all flights that are at 18,000 feet. They will permit you to call out all flights that are within a certain radius of a certain point. They will permit updating of flight plans from last reports without any manual input whatsoever. These techniques are not new but the application of them to this task is new.

Q: Color radar and 3-D radar have been suggested as useful instruments. Are they under development?

MR. QUESADA: We are giving some

(Continued to page 254)

Computers may take over many duties of controllers, who now follow each plane's course with flight strips



Civil Aeronautics Administration photo



Photos courtesy Minneapolis-Honeywell Regulator Co.

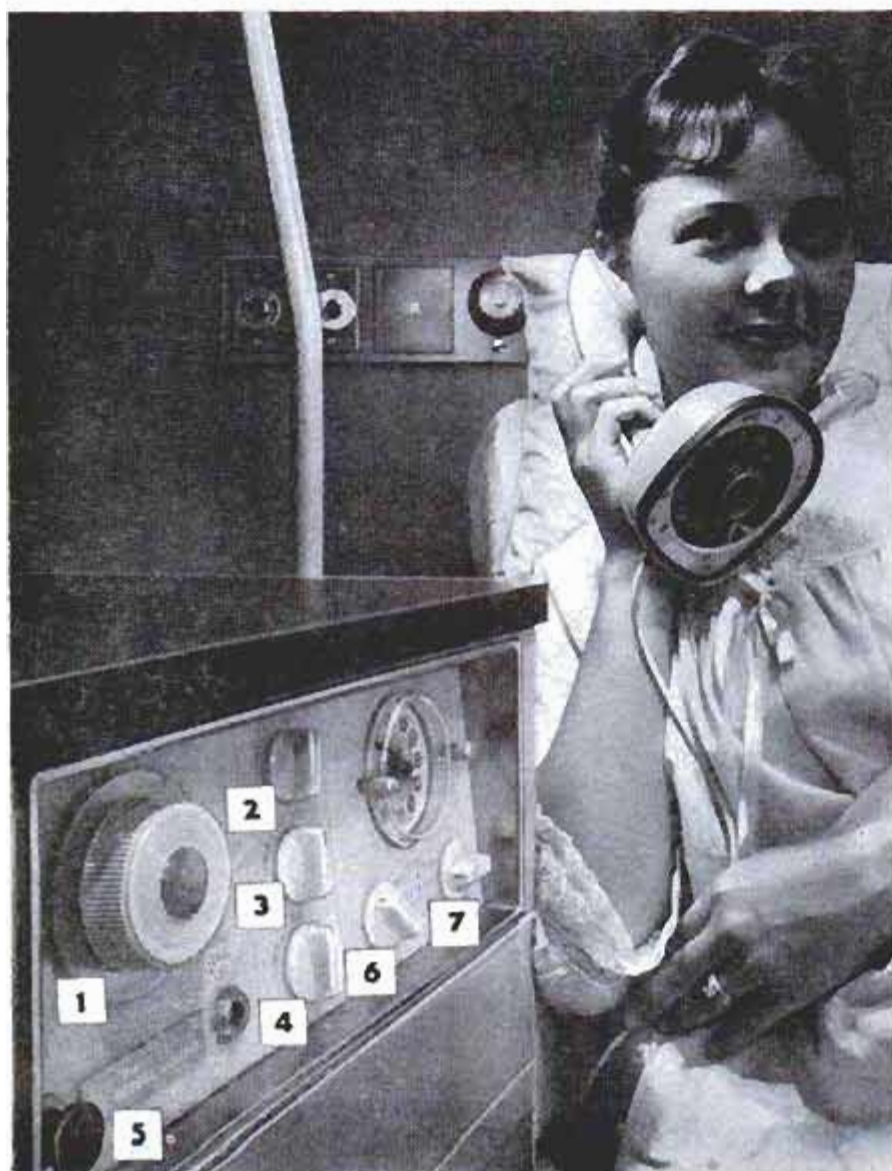

Control Panel For Hospital Bed

FROM A POSITION of flat-on-the-back, a hospital patient able to reach the switches on an automatic bedside control can regulate the temperature or air conditioning (No. 1 on photograph); raise or lower the back rest (2), the knee rest (3), or the height of the bed (4); summon a nurse (5); turn the electric lights on or off (6), and open or close window drapes (7). The robot hospital helper features a self-contained one-piece telephone with the dialing section built into the base and controls which allow the patient to operate radio and television sets or an intercom link with the nurses' station. The equipment also can be used in a closed TV circuit allowing the patient to see and talk with visitors not permitted in the room.

SIX-MINUTE RIDE INTO SPACE



X-15 Pilot Scott Crossfield

Here's what it will be like to rocket more than 100 miles into the sky. The X-15, our first manned space vehicle, is scheduled for its epochal climb early in 1959

By Richard F. Dempewolf

WHEN TEST PILOT Scott Crossfield of North American Aviation, buckles on the 4000-mile-per-hour X-15 "space research" plane for its first trial flight, he will be wearing the most fantastic "outer garment" ever tailored for a human being. Seen by the public for the first time a few weeks ago, when it rolled out on North American's ramps in El Segundo, Calif., the gleaming aircraft looked exactly like what it really is — a man-carrying, recoverable ballistic rocket.

More than 50 feet long, with 22-foot wingspan, the 31,275-pound ship has a unique wedge-shaped bulge along each side. Inside these sweeping finlike appendages of beryllium (to resist friction heat), are all the control cables, wires, hydraulic plumbing and lines. The fuselage itself, behind the pilot, is fully occupied by the big 60,000-pound-thrust XLR-99-RMI jet engine, capable of multiple air starting and variable thrust, and by massive tanks—one for gas-generating fuel, and two for necessary tons of explosive fuel components for the engine: Liquid oxygen and ammonia. More than half the fat fuselage (four feet across at the tail) is occupied by the massive cylinders for these liquids. Special forward-tilting, dish-shaped baffles inside them will prevent "surging," which could throw the ship off balance and send it flipping through space like a leaf in a gale.

Early in 1959, the wicked-looking vehicle is scheduled for a series of hair-raising flights. Its human pilot will be encased in an alumi-

nized-fabric "space" pressure suit and lashed to a form-fitting seat in a cramped, insulated and refrigerated cockpit. Once the X-15 is dropped from the underbelly of a B-52 some six miles in the sky, he'll flick an ignition switch and jam back into his seat as the single-barrel rocket engine behind him explodes into life and gives

For more than a year, Crossfield has made simulated flights in a giant centrifuge equipped with an X-15 control panel

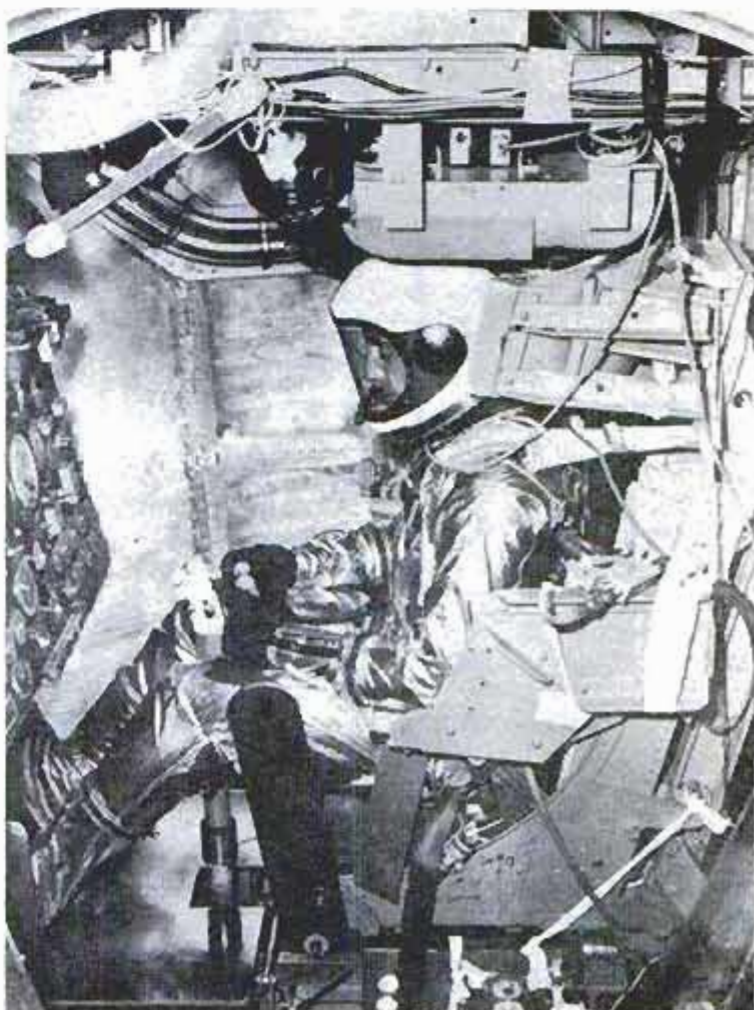

him a 60,000-pound "kick in the pants." With his face sagging and heart laboring to pump blood as heavy as molten metal, a 150-pound man like Crossfield will suddenly weigh 600 pounds as he roars vertically upward on a scorching column of blue shock waves for a total of six minutes of powered flight. At Mach 6 plus (4000 miles per hour or better), he will be rammed to an altitude of considerably more than 100 miles. Crossing the perigee tracks of the manmade satellites, he will skim the fringes of outer space in a weightless state for about five minutes as his craft arcs over into a powerless glide and plummets earthward. As he plunges back into the atmosphere, the skin of his rocket spaceship will, according to Air Force experts, "glow red like steel in a blacksmith's forge" along the leading edges of the stub wings and around the bluntly pointed nose. Skin temperatures will soar to 1000 degrees Fahrenheit. Some 500 miles after starting above Wendover Field, Utah, and 18 minutes later, the X-15 will skid to a smoky 284-mile-per-hour landing, probably on a dry lake bottom somewhere in the desert. It will land on steel shoes attached to short struts that pop out of the after-fuselage section. A conventional nose wheel will keep it from turning turtle. If all goes well, the X-15 will make many such trips under the guidance of a group of "hot" test pilots who have been training for the job for more than a year: Scott Crossfield and Alvin White for North American (builder of the plane;) Joseph Walker and Neil Armstrong, test pilots for NASA (National Aeronautics and Space Administration; formerly NACA); and captains Robert White and Robert Rushworth for the Air Force, which is supplying most of the estimated \$100,000,000 for the program.

No One Knows What Will Happen

The new research plane, along with two others like it now under construction, is our first manned space probe, a combined effort of the Air Force, Navy, NASA and U. S. industry. Its primary mission is to explore the myriad problems of spaceflight. These include things such as stability and controllability of the rocket ship. Nobody knows what will happen to a man-guided craft at hypersonic speeds within or outside the earth's atmosphere. What effect will the searing plunge into the earth's atmosphere have on ship and pilot? This will be the first time any man has been subjected to the inferno of re-entry friction. The effects of sustained weightlessness also will get a good going over.

To do its pioneering job, the X-15's design is, of necessity, a far cry from the general concept of an "airplane." Its thick

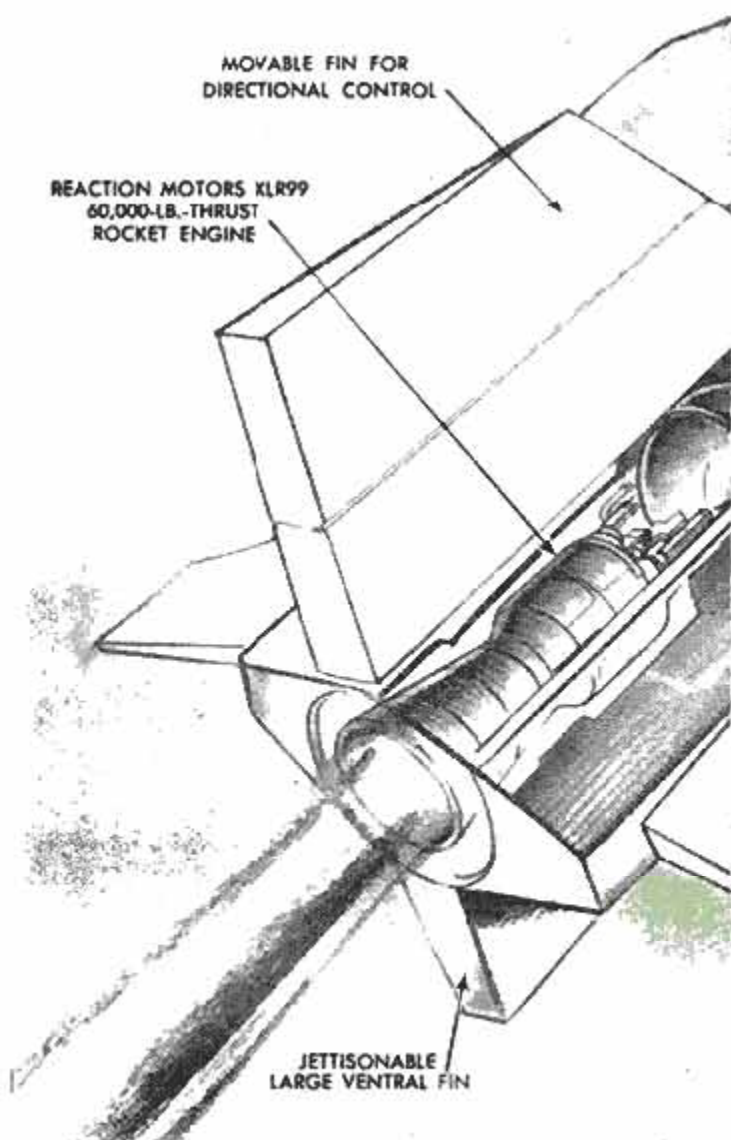
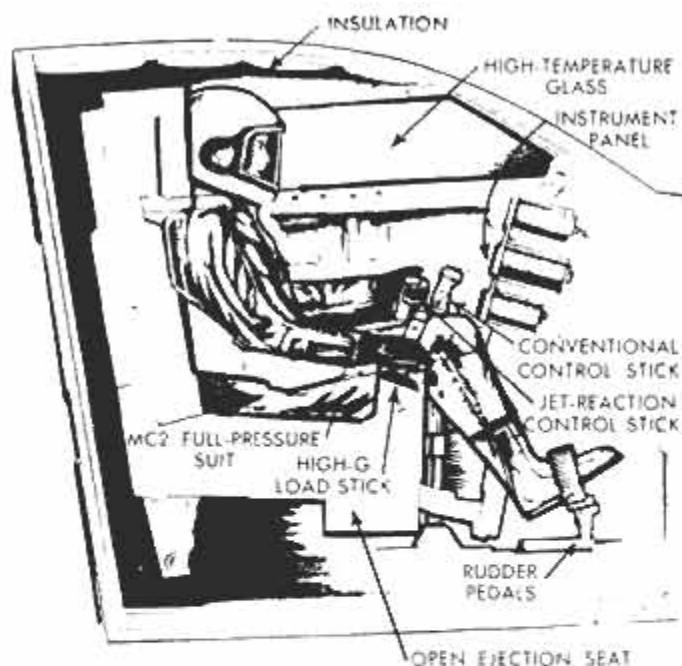

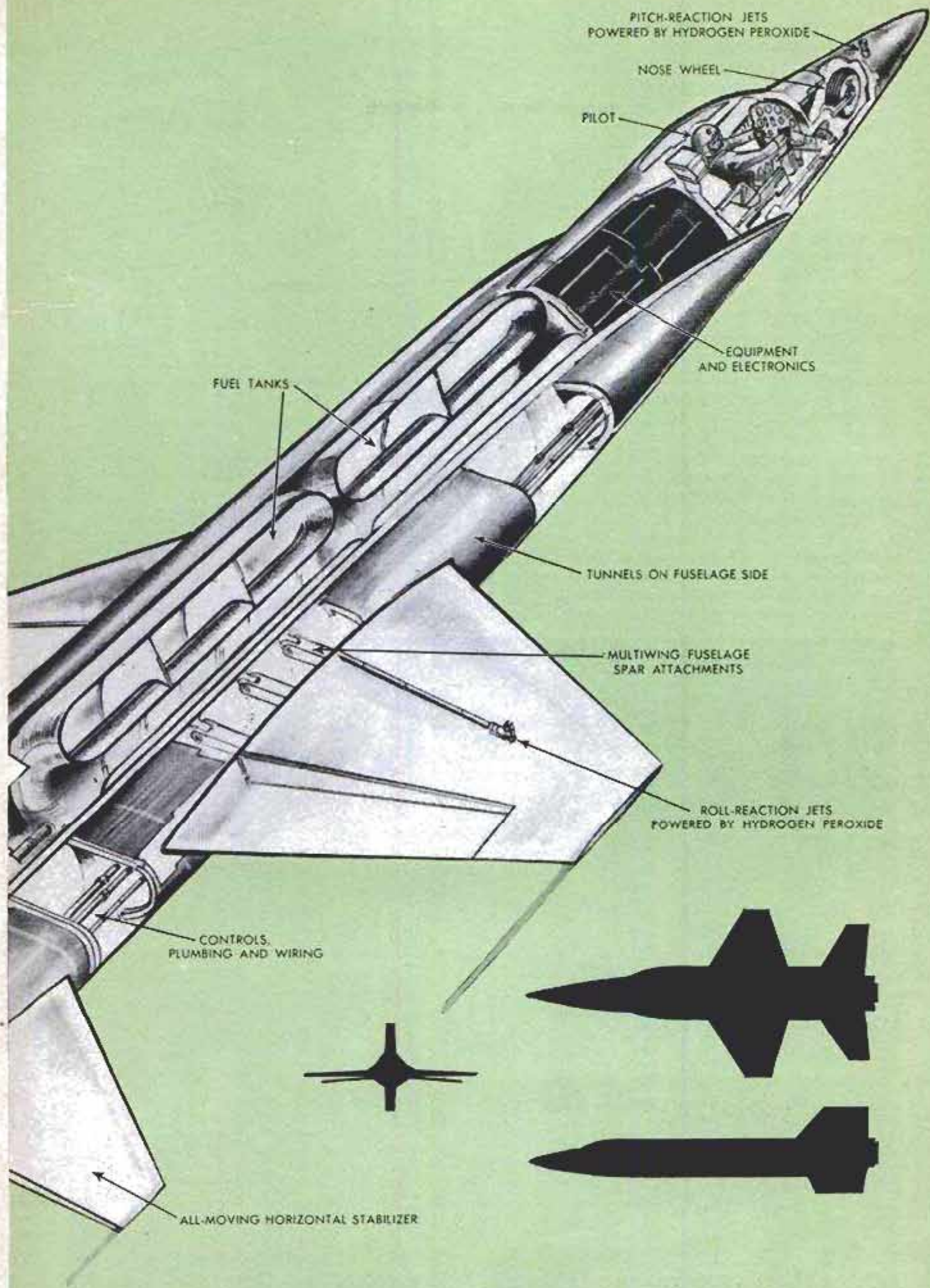

chunky wings, set far back on the fuselage, spread like a pair of goodly oak stumps in order to stay put under the incredible buffeting they'll get as the ship bursts through the atmosphere going and coming. Roots end in five A-frames that bolt solidly to the fuselage. Tail surfaces look more like thick, wedge-shaped doors for a bank safe than delicate control surfaces. Instead of a pair of horizontal stabilizers and a single vertical-rudder fin, X-15 has four tailfins—just as a good rocket should. The stabilizers slope downward like the wings of a gull taking off. The fourth member is a vertical fin jutting downward beneath the elevators. This fin will be jettisoned just before landing. The empennage is of the "flying tail" type, so-called because each tail surface (except the under fin) turns as a unit for steering in the thin upper air. This

(Continued to page 246)

Shown below is the pattern that Scott Crossfield is scheduled to fly early next year in the X-15. His plane, right, may transport him at speeds of 4000 miles per hour

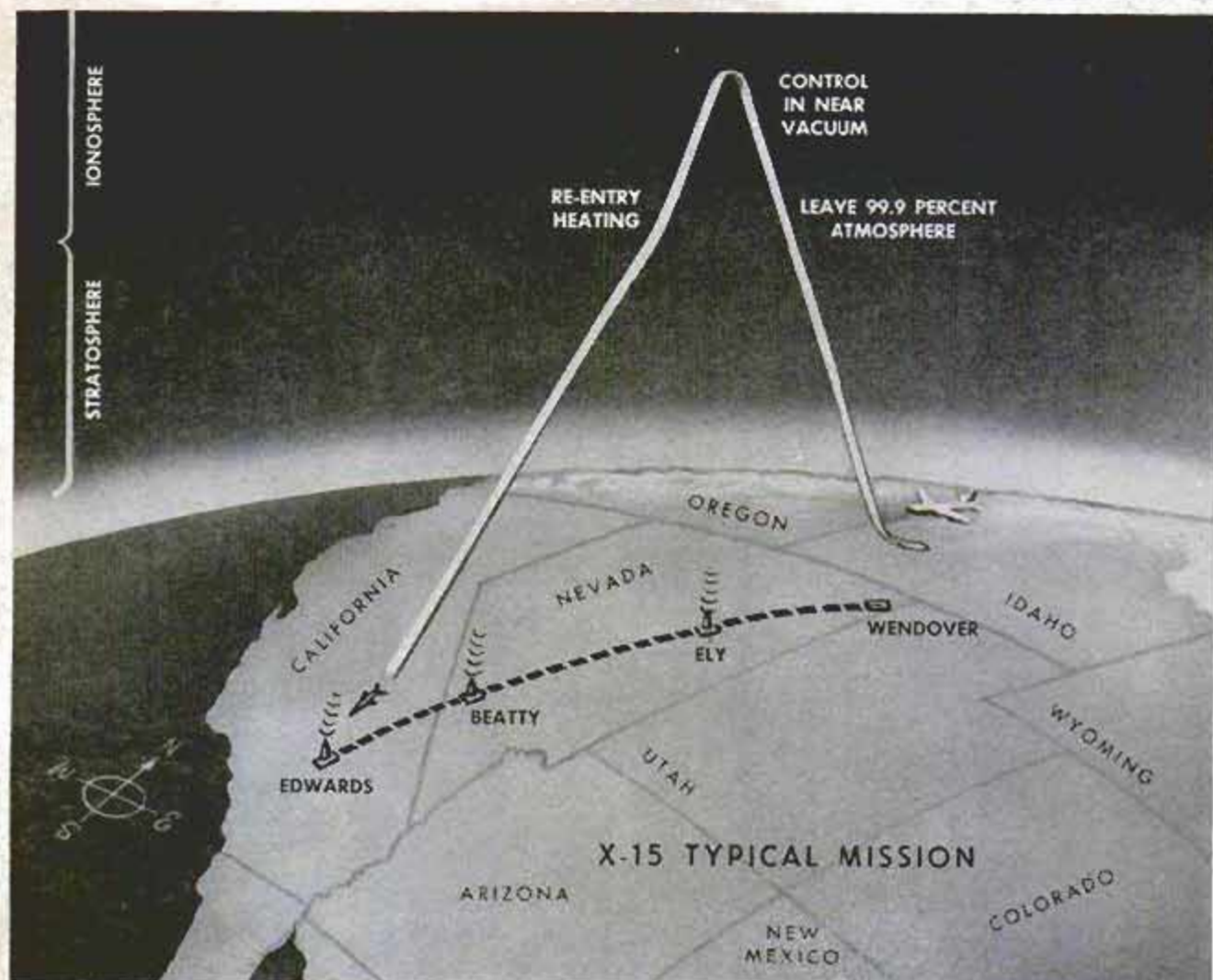



Waterborne Power Mower Clears Vegetation From Lakes

Designed for the Ohio State Division of Wildlife is a pontoon-mounted mower that cuts heavy vegetation on lakes and ponds. It can cut six feet deep and clear an aver-

age of 30 acres per day. A 10-horsepower engine turns a paddlewheel drive at the rear. The propeller-steered mower can turn around in less than its own length.

Electric Drill Scales Fish

Anglers can slip a new fish scaler into an electric drill and clean their catch in short order. Made of nylon, the scaler has 72 teeth that whisk off the scales without tearing the skin. The tool will fit any 1/4-inch drill chuck.

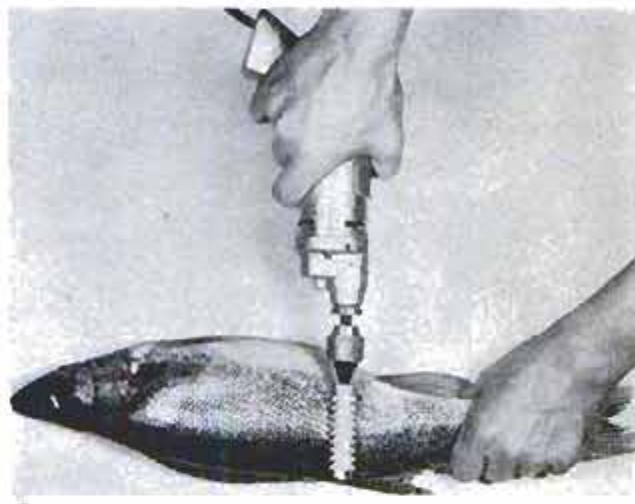

Counter Clips to Egg Basket

Every time a farmer puts another egg in the basket he pushes his thumb against a lever on the handle and a counter totals the eggs collected. The counting device is grooved to fit the hand and can be transferred from one basket to another.



Number, Please!

Whenever you write us to

- Renew your subscription
- Change your address
- Order your own or a gift subscription

. . . In fact, whenever you write us,

PLEASE INCLUDE YOUR CITY POSTAL ZONE NUMBER IN YOUR ADDRESS

*This insures better delivery.
It helps you and it helps the postman.*

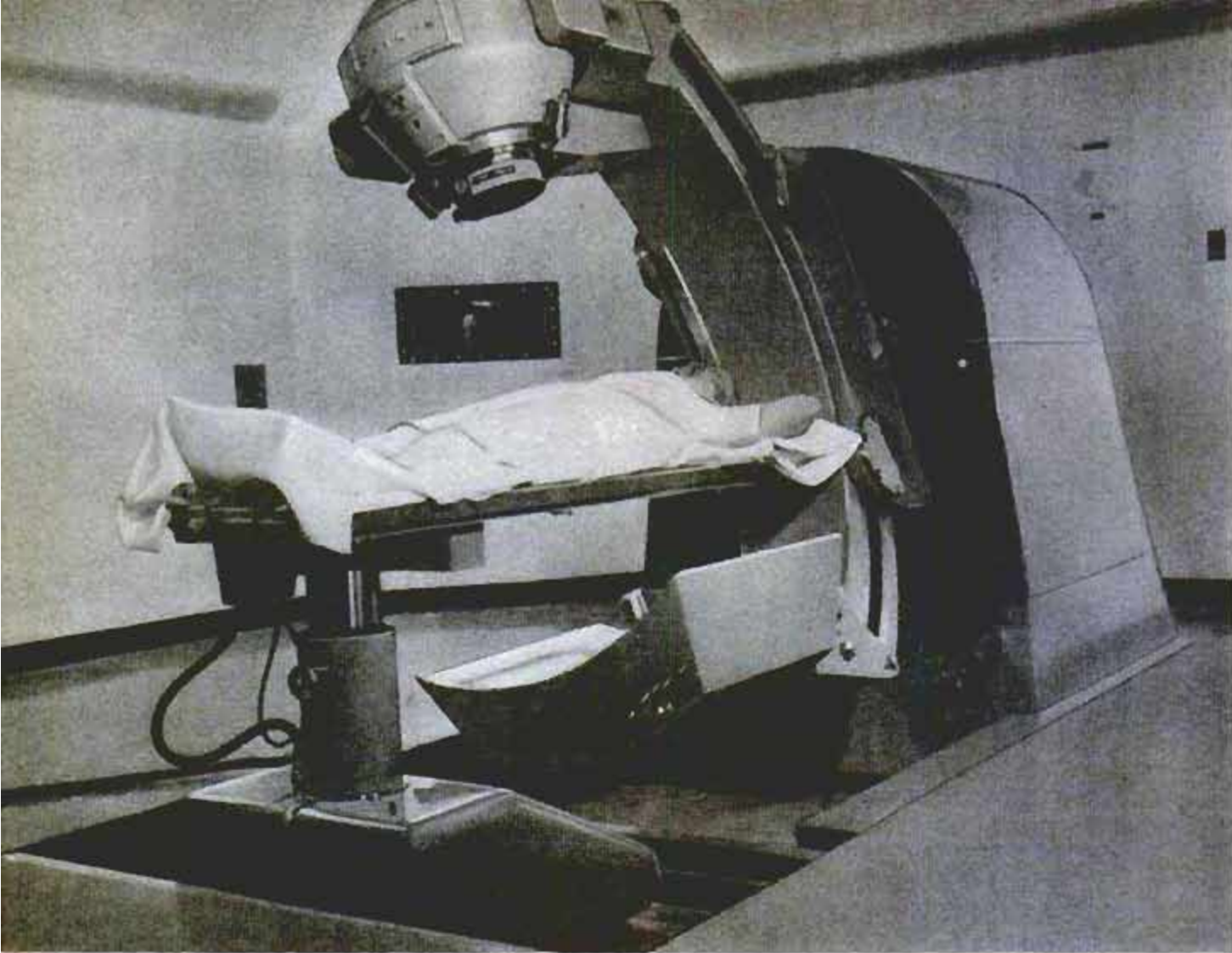

Rotation therapy machine, energized with radioactive cobalt, is operated by nurse seen through window

MEDICINE'S NEW

Reprinted in Reader Digest
December 1958

By J. D. Ratcliff

Vineyard Haven, Mass.

IT WAS PAST MIDNIGHT when a dramatic chain of events got under way in Boston's Beth Israel Hospital. The heart of a patient, who had undergone serious abdominal surgery, faltered and failed. There was no surgeon immediately available to open the chest and attempt to massage the heart back into activity. Under ordinary circumstances the case would have been concluded with a notation on hospital records: "Patient died quietly in his sleep." This time the story had a different ending.

The moment the heart stopped beating wires taped to the body announced the fact

to a machine at the bedside. Response was immediate. A bell started ringing to summon a nurse. Long before she arrived the machine was taking resuscitative measures. It began shooting 60-volt electricity at the rate of 60 bursts a minute into two wafer-sized electrodes strapped to the patient's chest with a rubber belt. Thus electrically jarred, the heart started beating again, soon picking up normal rhythm. Two weeks after this close brush with death the patient went home, fully recovered.

This machine—the automatic heart pacemaker — is a sample of the extraordinary

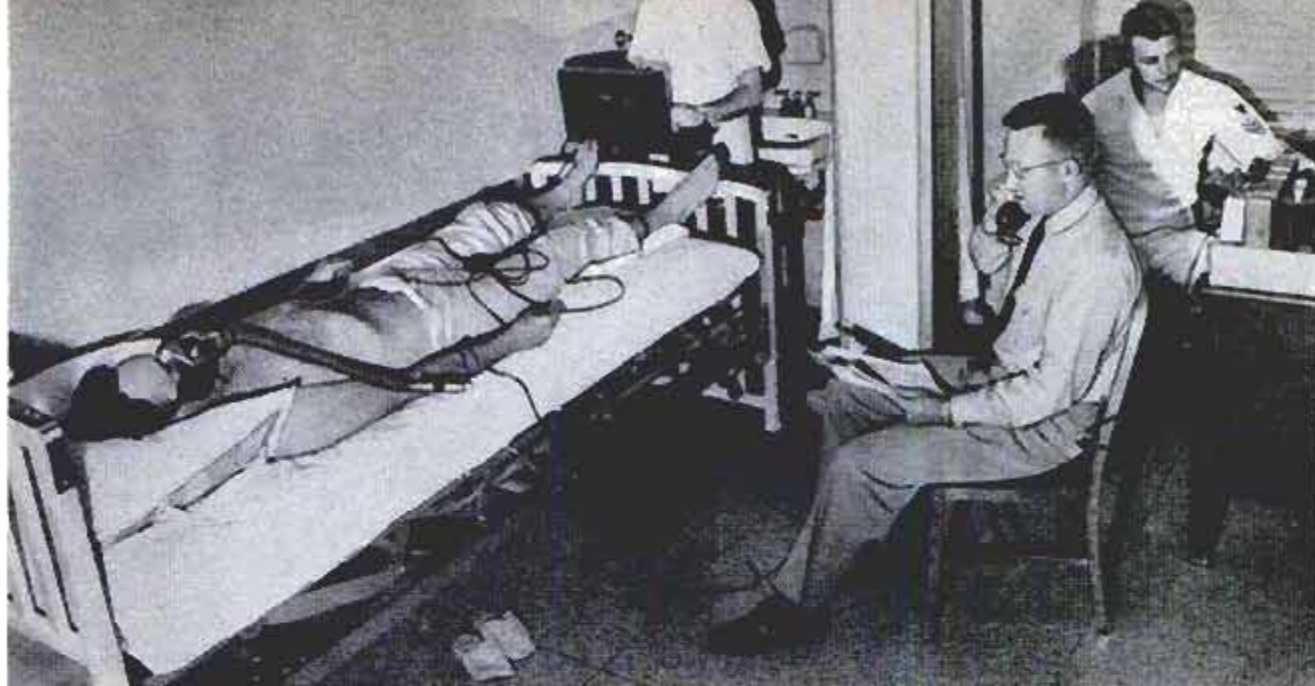

Electronic telemetering permits doctors 1000 miles away, below, to study patient at Navy Hospital, above

electronic devices which each year play a larger role in medicine. For years now, physicians have known that life is largely an electrical phenomenon. Heart, brain and muscles send out faint but detectable electrical messages which tell vivid stories of their functioning. Electrocardiographs, encephalographs and myographs have become standard diagnostic tools. Far wider use of electronic machines is now at hand. The pacemaker, developed by Dr. Paul M. Zoll of Boston's Beth Israel Hospital, is a dramatic example.

Recently, Mayo Clinic researchers put new electronic knowledge to work to add a new safety factor to surgery. In checking depth of anesthesia, physicians usually depend on external signs — pulse, blood pressure, eye dilation and such. Brain waves are a far more sensitive indicator. The Mayo men utilized this fact in building a virtually automatic anesthesia machine. If the patient is on the point of awakening it administers more drug or gas, if sleep is too deep it turns off valves.

Brain-wave machines are also helpful in diagnosing a number of disorders — epilepsy, tumors, injury, for example. But in borderline cases the lines are often difficult to interpret. A research project jointly conducted by the Massachusetts Institute of Technology and Boston's Massachusetts General Hospital is using an approach that may eventually lead



The electronic thermometer, demonstrated below, quickly determines a patient's temperature with high degree of accuracy





Photo courtesy Zenith Radio Corporation

X-ray-image amplifier, developed by The Rauland Corporation, allows doctors to watch heart on TV screen

to feeding tape-recorded brain waves into a computing machine which will automatically separate them into diagnostic patterns.

Many of the new electronic devices are designed to simplify burdensome laboratory procedures, save the time of overworked technicians. The sanguinometer, recently developed by the Sloan-Kettering Institute and Radio Corporation of America, is a sample. (Several other companies have developed similar devices.) In effect,

Another X-ray amplifier, developed by RCA, produces image bright enough to be viewed in lighted room



it is a closed-circuit TV system. Its job: making blood counts. The machine scans a blood sample, feeds findings into a computer. In seconds the count is completed.

This same type of machine is finding jobs elsewhere — making bacterial counts in municipal water supplies and in dairies, and checking airborne pollen. It may even play a big role in cancer detection. Cancer cells tend to be larger than normal cells — the difference is readily detected by sensitive scanning tubes. Why not use this means of detecting cancer cells shed from the lungs in sputum, from the uterus into vaginal secretions, from kidneys and bladder in urine? Potentially, this machine opens the way for quick, inexpensive screening tests that might save tens of thousands of lives each year.

Sensitive fingers of physicians palpate—feel—the exterior of the body in an attempt to locate trouble within—enlarged livers, spleens, glands, for example. Electronic fingers are infinitely more sensitive, far more penetrating. With ease they can find small brain tumors hidden in the dark recesses of the head.

Exactly locating such tumors has always been a major problem. If a surgeon cut too freely in his search he courted grave consequences—erasing memory patterns and doing other permanent brain damage. Electronic devices now pinpoint tumors.

A number of chemicals, notably arsenic, have a tendency to concentrate in tumor



Scientists show how medical information broadcast by "radio pill" inside patient is picked up with antenna

tissue. In a new procedure, radioactive arsenic is injected in the bloodstream. Within an hour it concentrates in the tumor. The radiation it showers off is picked up by scintillation counters moved about the head. Results are recorded in the form of dots on paper, and the blackest concentration is the tumor.

This work was done at M.I.T. Researchers at the same institution are now busy with a radical new means of treatment for brain tumors. Boron, like arsenic, has a tumor affinity. After boron injections patients are subjected to a bombardment of neutrons from an atomic pile. This causes the boron to shower off alpha particles which travel a fraction of an inch. Thus, radiation lethal to cancer cells is generated *inside* the tumor with little or no damage to surrounding tissue.

The electrocautery device has become an essential surgical tool. One touch from the tip of this instrument makes a pinpoint burn which seals off oozing capillaries that obscure surgical fields. Similarly, a "radio knife" which cuts by making a hair-line burn seals off blood vessels as it goes. It is particularly useful in highly vascular tissue such as the brain or the liver.

Another spectacular application for electronic heat is now develop-

ing. Brain injury caused by poison, accidents, disease, often results in Parkinson's disease — the shaking palsy that is often accompanied by grave personality changes. Some time ago surgeons found that if one small brain area were destroyed Parkinson's often magically vanished. Alcohol injections into the area sometimes did the job, but another method which may be far better is at hand. Through a minute drill hole in the skull, two cobweb-fine wires are introduced into the brain. When current is turned on, the area is burned out

Color television is adapted to microscopic study of tissues. Picture is transmitted to doctors or students in other rooms

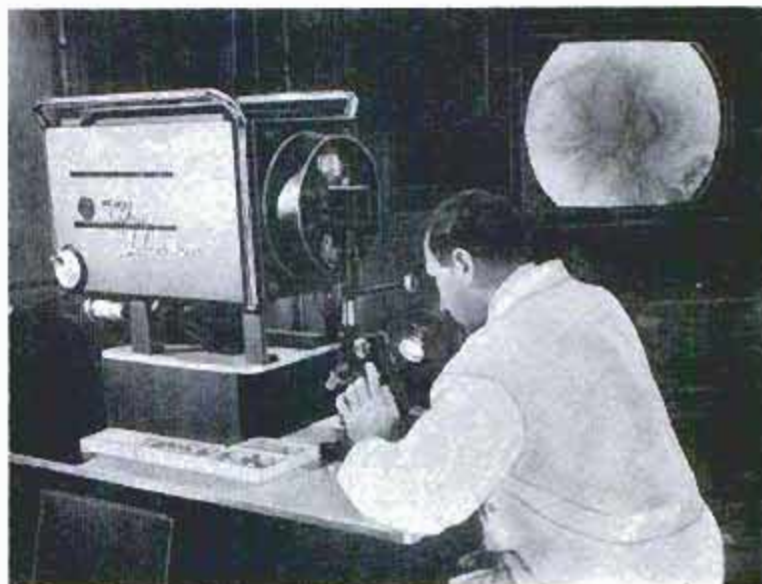

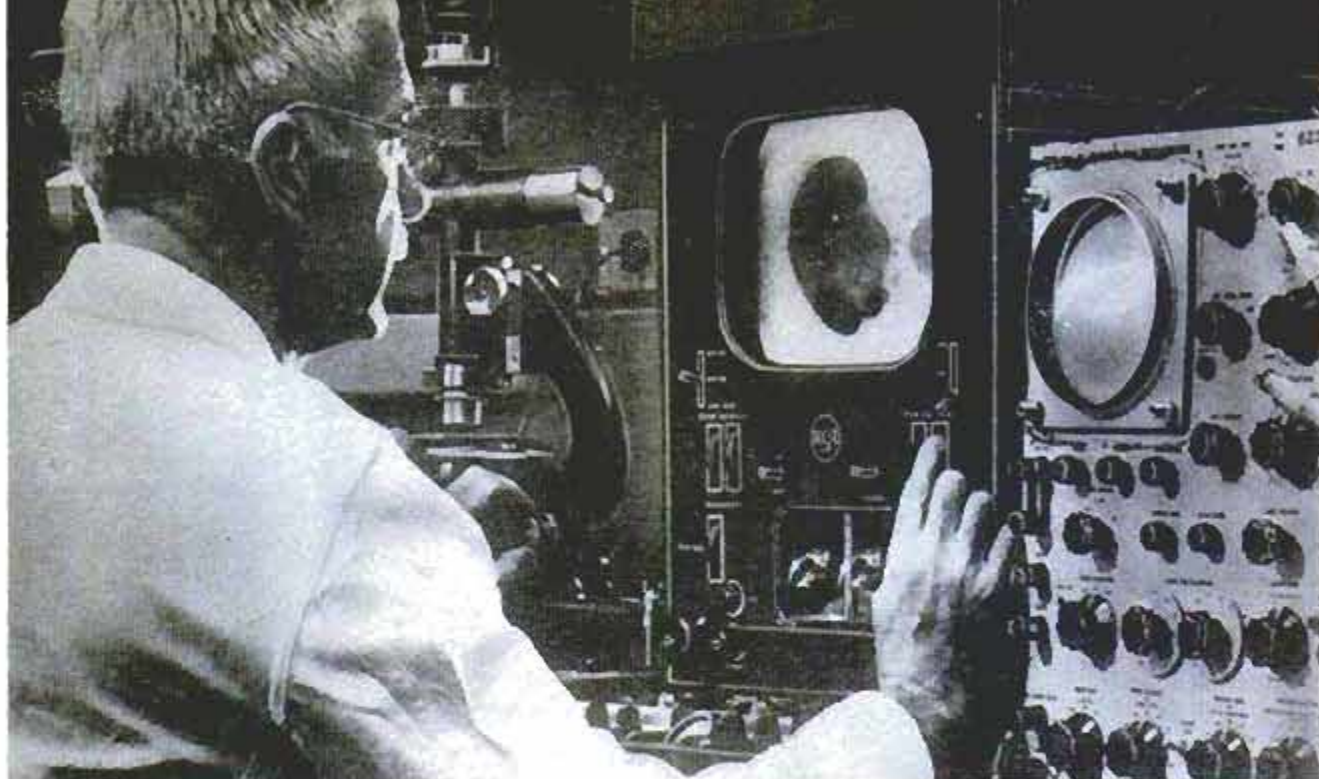

Ultraviolet-sensitive TV camera enables researchers to observe chemical activity within living cells

—frequently resulting in dramatic cures.

At one time detachment of the retina, the image gatherer in the back of the eye, led almost inevitably to blindness. If caught early enough today it is 75 per cent curable — thanks largely to an electronic device. In effect, the device is an electronic spot welder. Small bolts of electricity make pinpoint burns which refasten the retina securely in place.

In ever-increasing quantity, electronic devices are finding their way into hospitals and operating rooms. The oximeter, for ex-

ample, gives anesthetists an exact measure of oxygen in the blood of sleeping patients. Supersensitive temperature measurers are coming into wide use. One, a needle-fine instrument, utilizes transistors to give instant temperature readings in any organ during surgery.

Another electronic device with fascinating possibilities is a new supersensitive stethoscope. In ultra-quiet rooms they are able to pick up heart murmurs far too faint to be heard by conventional means, thus

(Continued to page 234)

Cardiac pacemaker, developed by Dr. Paul M. Zoll of Boston's Beth Israel Hospital, guards heart beat

Laboratory technician makes quick electronic count of blood cells. TV monitor checks microscope focus





Caterpillar Tractor Co. photos

In one operation, machine destroys trash vegetation, prepares the soil for seeding and sows grass seed

Root Plowing Changes Wasteland to Grassland

DURING THE LAST 20 years, hundreds of millions of acres of once-lush grazing area in the Southwest have degenerated into arid tracts of wasteland where only mesquite, creosote bush and prickly pear will grow. Various attempts to reclaim the land had little success. Now a machine has been developed that is bringing lost acres back into production with a one-operation treatment. It consists of a huge three to five-ton plow with shares shaped like delta wings to kill the trash vegetation and break up the soil so it will retain water. As the plow prepares the soil, a blower box feeds

grass seed through the tractor's exhaust pipe. This technique is known commonly as "root plowing." One Texas rancher has had amazing results in root plowing 60,000 acres of land, every foot of which was arid and parched. Now it supports stirrup-high grass that has increased his per-acre beef production by 500 percent. The reconditioned soil also was able to absorb all of the abnormally heavy rainfall which pelted the area recently. The root plow is pulled through the soil at a depth of 8 to 16 inches, depending upon the kind of vegetation. The blades pull out the lateral roots.

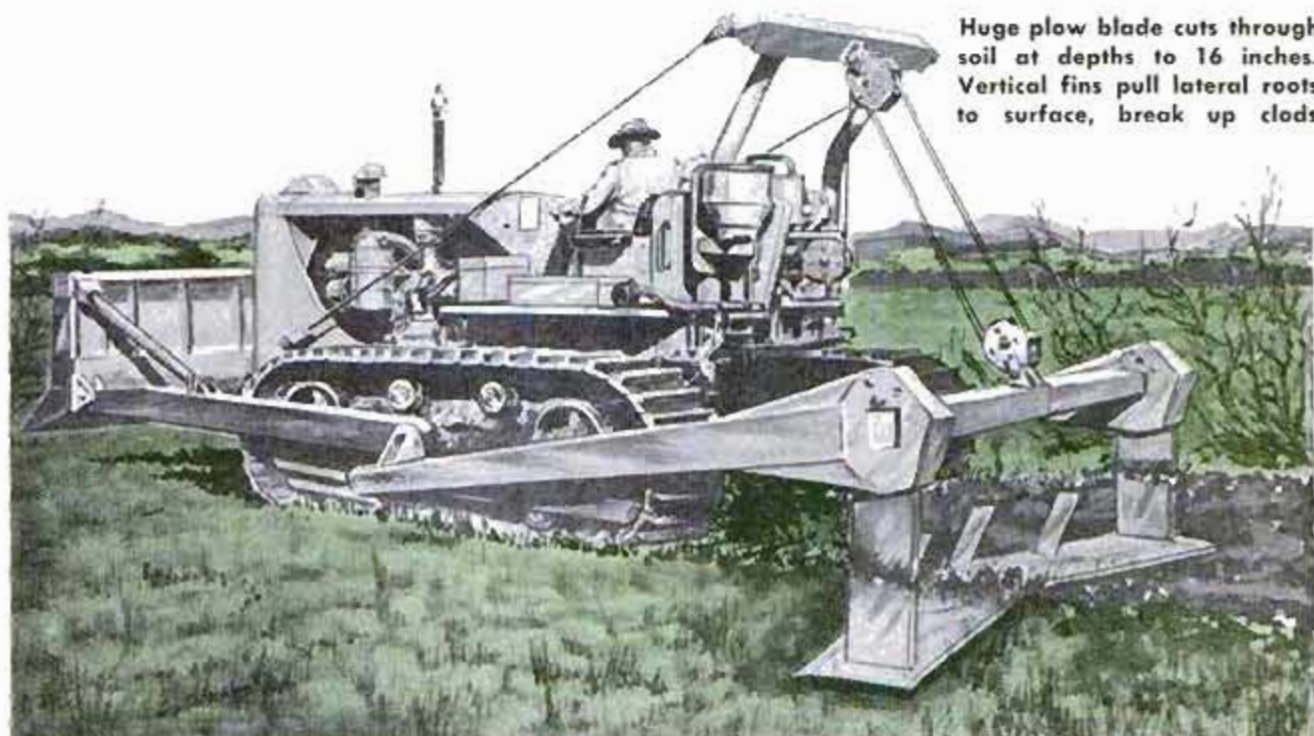

Huge plow blade cuts through soil at depths to 16 inches. Vertical fins pull lateral roots to surface, break up clods

DOWN DEEP FOR SALT

By Austin Stevens

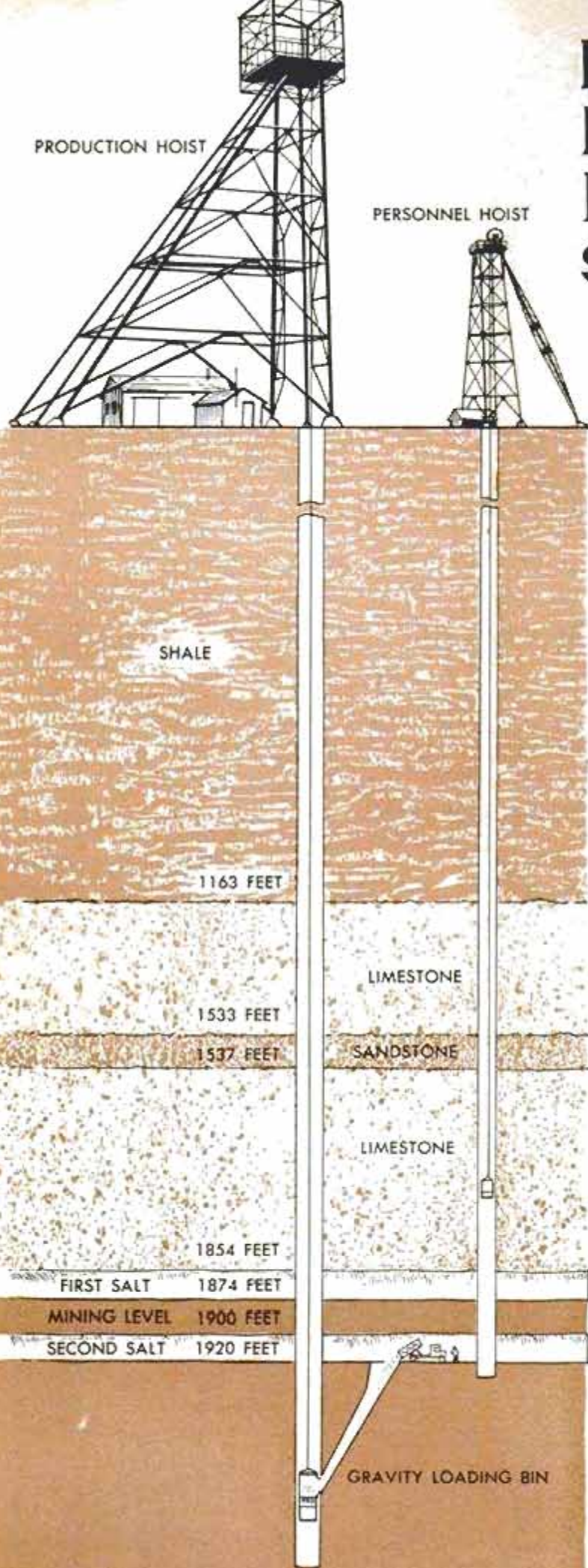

TWO SHAFTS lead to what is believed to be the deepest salt mine in the world near Grand River, Ohio, northeast of the city of Cleveland.

The multimillion-dollar objective of the Morton Salt Company is 1920 feet underground—a 20-foot vein of high-grade commercial salt. Much of it will find its way into the chemical industry, and for melting ice on roads and streets.

A lot of development work remains to be done before the company can begin producing the 500 tons of salt per hour which is their goal.

The production shaft at the Fairport Harbor Mine, through which the salt will be hoisted, is 16 feet in diameter and will be sunk below the level of the salt vein to allow gravity loading. A few hundred feet away is a 12-foot access shaft for personnel and equipment.

Network of "Roads"

After the salt vein is reached, the next step is to tunnel a systematic network of "roads" leading into a series of "salt rooms." Power and ventilation facilities will be added later.

Construction crews are also building a mill and warehouse on the surface, where the salt will be crushed, screened, processed and stored for shipment.

When the mine goes into operation, diesel trucks and loading equipment will be taken underground to help carve out the great salt caverns, leaving huge pillars to support the roof. About 50 percent of the salt deposit will be left as supporting columns among the rooms, which may extend for miles from the shafts. ★ ★ ★



Tremendous rooms are carved into the salt, all connecting with this main corridor. In time, the mined area will be so vast that miners will have to be carried by underground truck to the room in which they work

Scenes in existing salt mines will be duplicated in the newest and deepest mine. Below, a self-propelled drill carriage drills a pattern of holes for dynamite charges, which will blast loose huge sections of salt

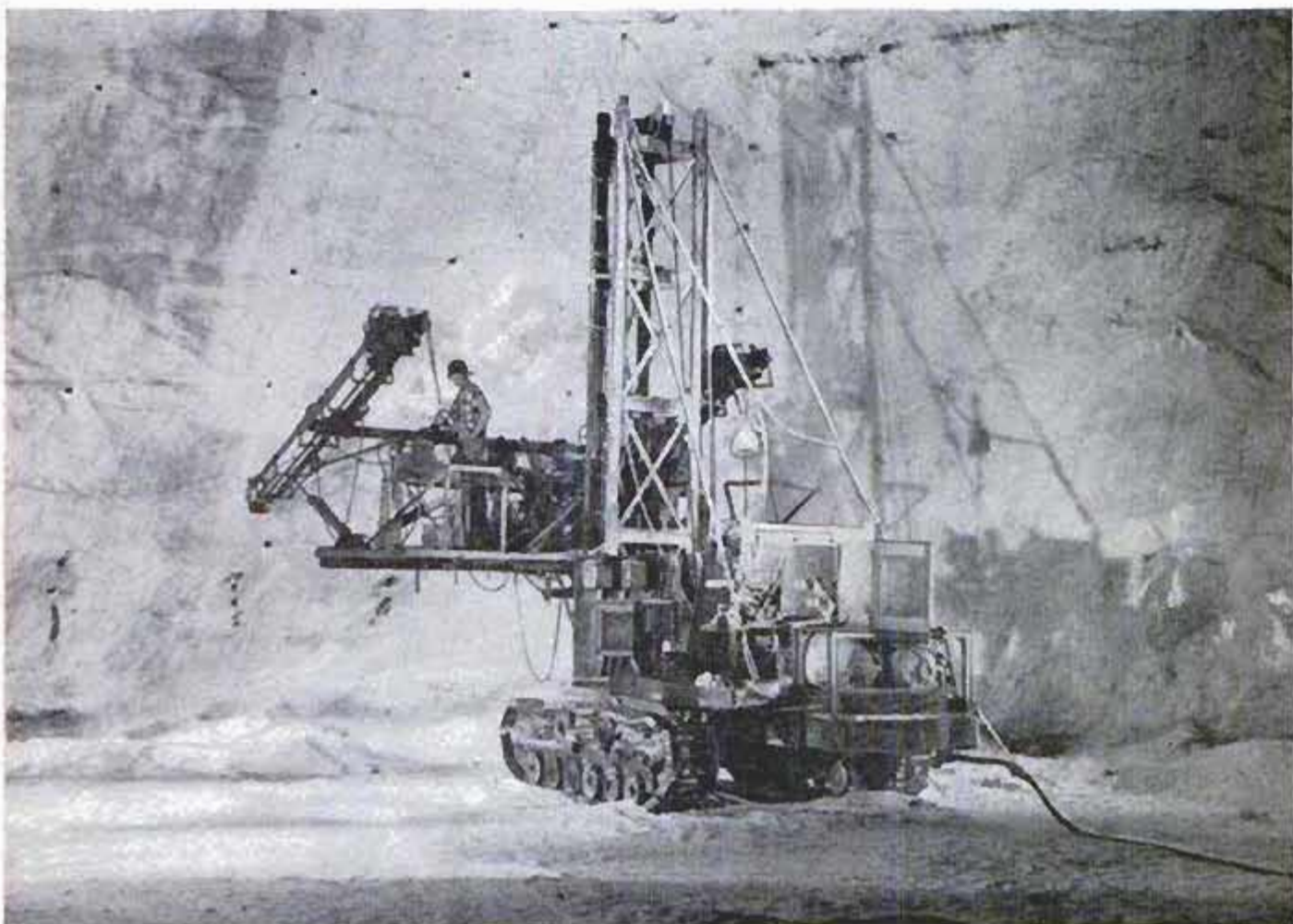



Huge Spray Tower Tests De-Icer on Helicopter

It wasn't cold enough around Bell Helicopter's plant in Fort Worth, Tex., so engineers went up to Canada to test a new

electrothermal de-icing system for helicopters. The copter was flown into a freezing spray created by an icing tower.

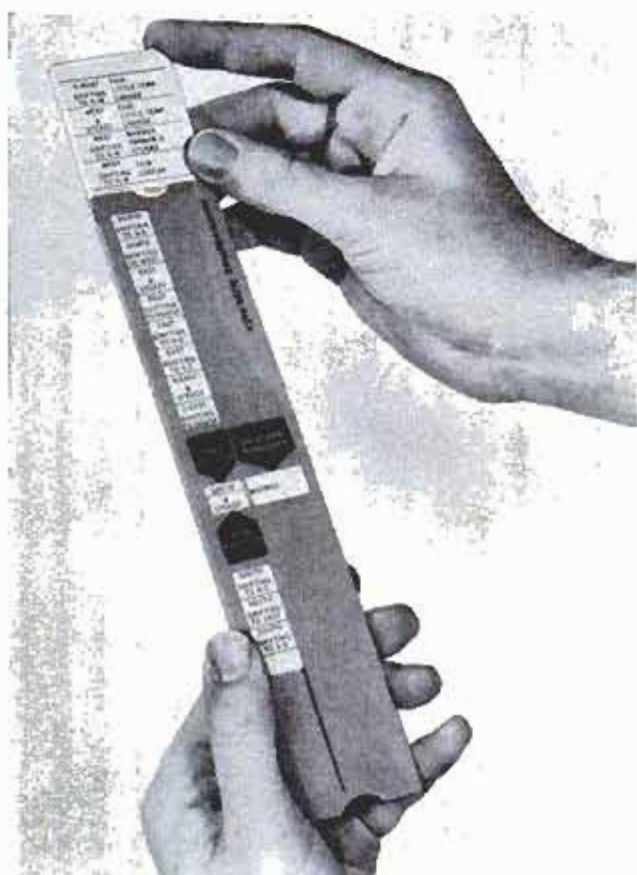

Slide Rule Predicts Weather

Designed for boaters, fishermen and hunters, a new slide rule tells what kind of weather to expect. You set the slide according to the direction and variation of the wind and read the forecast through a slot next to the wind setting.

Battery-Powered Eraser

Small enough to fit in the palm of the hand, a new portable electric eraser works on flashlight batteries. It will remove an entire line, yet has a point so small it will erase single letters without a shield.



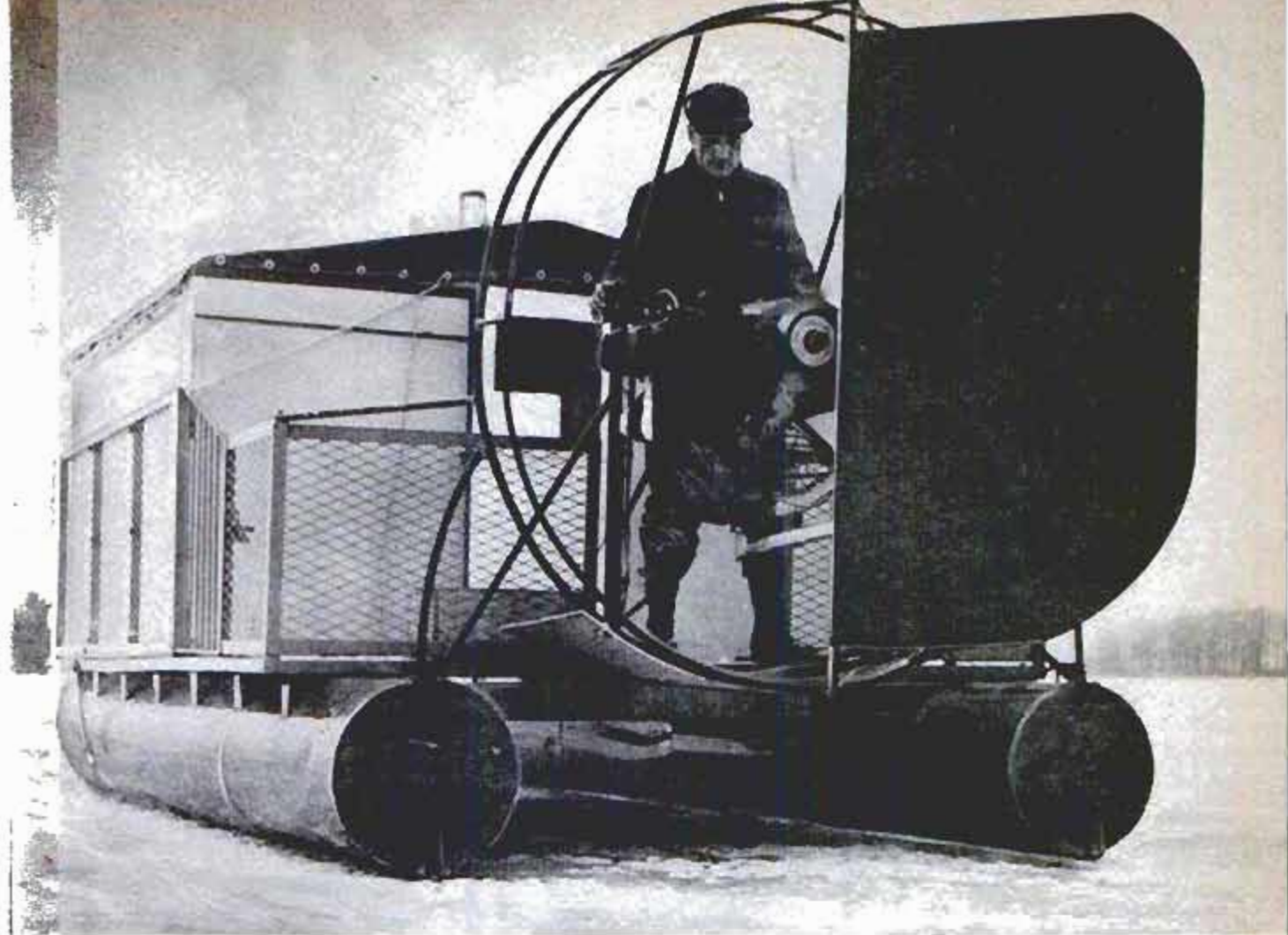

Guide Willey checks airplane engine before moving across Lake Erie ice. Below, boat crosses open water

It Moves on Ice or Water

WHEN DALE WILLEY, an ice-fishing guide in the Bass Islands, wants to move to a better fishing spot, he just starts the 80-horsepower airplane engine on the stern of his shanty. The propeller on the engine will push the shanty over the ice at speeds up to 70 miles per hour. Willey's self-propelled fishing shanty also has pontoons so the fishermen and equipment won't plunge into the chilly waters of Lake Erie if the ice breaks. The eight-by-eight-foot shanty has a coal stove and four holes in the floor for ice fishing. Willey built the mobile shanty on the Ohio mainland and drove it over 12 miles of ice and water to Middle Bass Island, where he lives. Runners on the pontoons enable the craft to climb on ice from the water.

Holes are chopped in ice, then sled boat is moved above holes

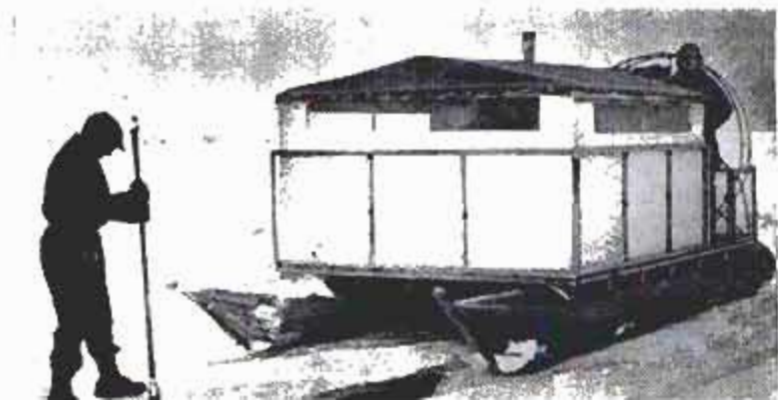

Another type of sled boat powered by airplane engine has runners under metal hull



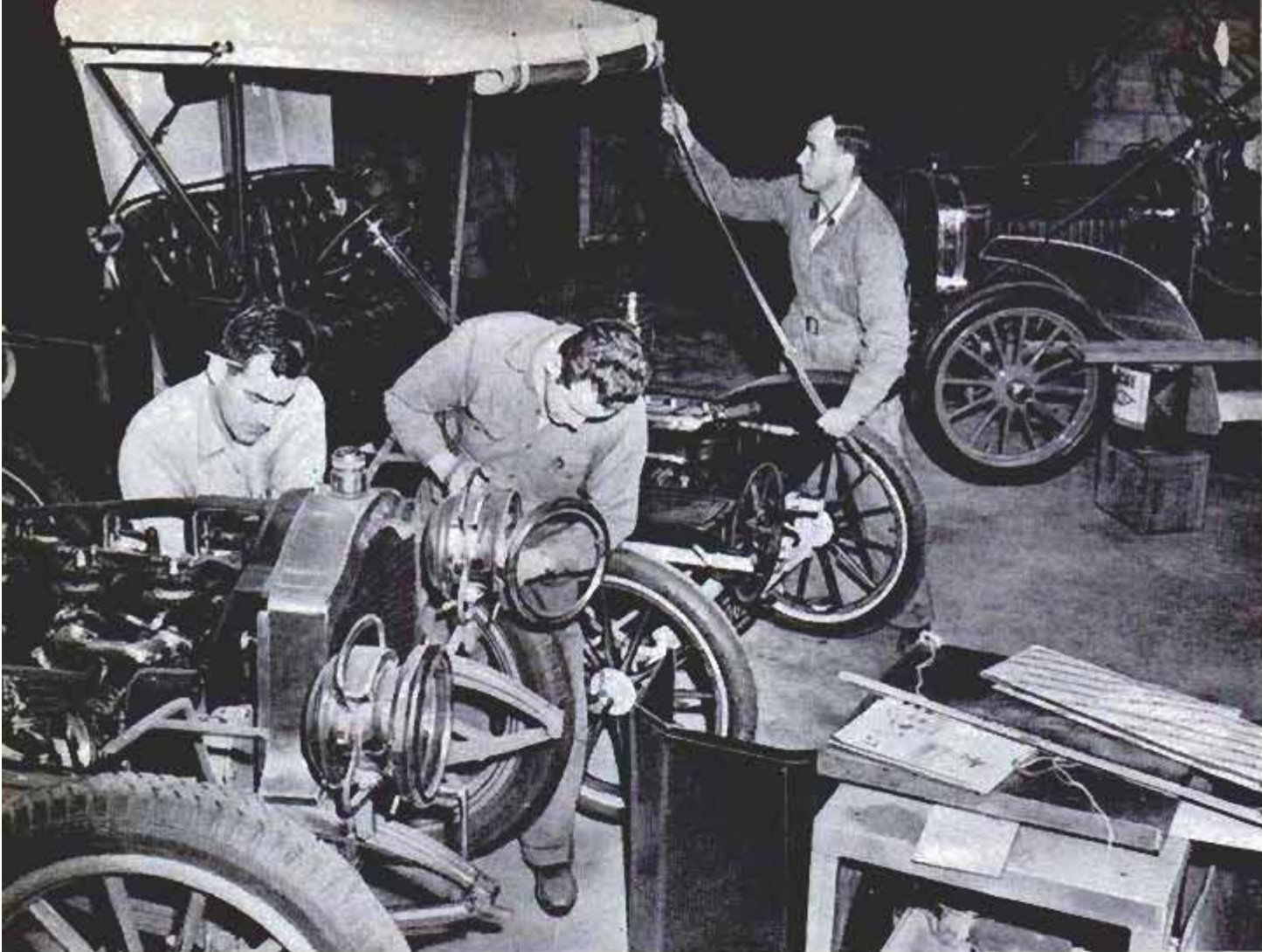

Left to right are a 1907 Thomas Flyer, 1908 Model S Ford and 1906 Type 12 Pope Toledo being restored

"They Don't Make 'em

By
Paul R. Hayes

The familiar lament of the antique-car fan put Leonard Davis in business. He started by restoring his own Model T; now he runs a busy clinic for old-timers



MASTER-MECHANIC Leonard Davis won't put a wrench to your Cadillac unless it's, say, a 1905 model. His shop caters only to the rarest cars in the world—the proud, brass-bound veterans dating to a half century ago.

Other garages may do an occasional antique restoration, some even as a regular sideline, but Davis' establishment at Drayton Plains, near Pontiac, Mich., is one of the few businesses in the country that exist solely on the servicing and rebuilding of old cars.

"And it all started with a Model T," Davis says.

The second of nearly a score of antique cars he has owned, the "T" was a fenderless

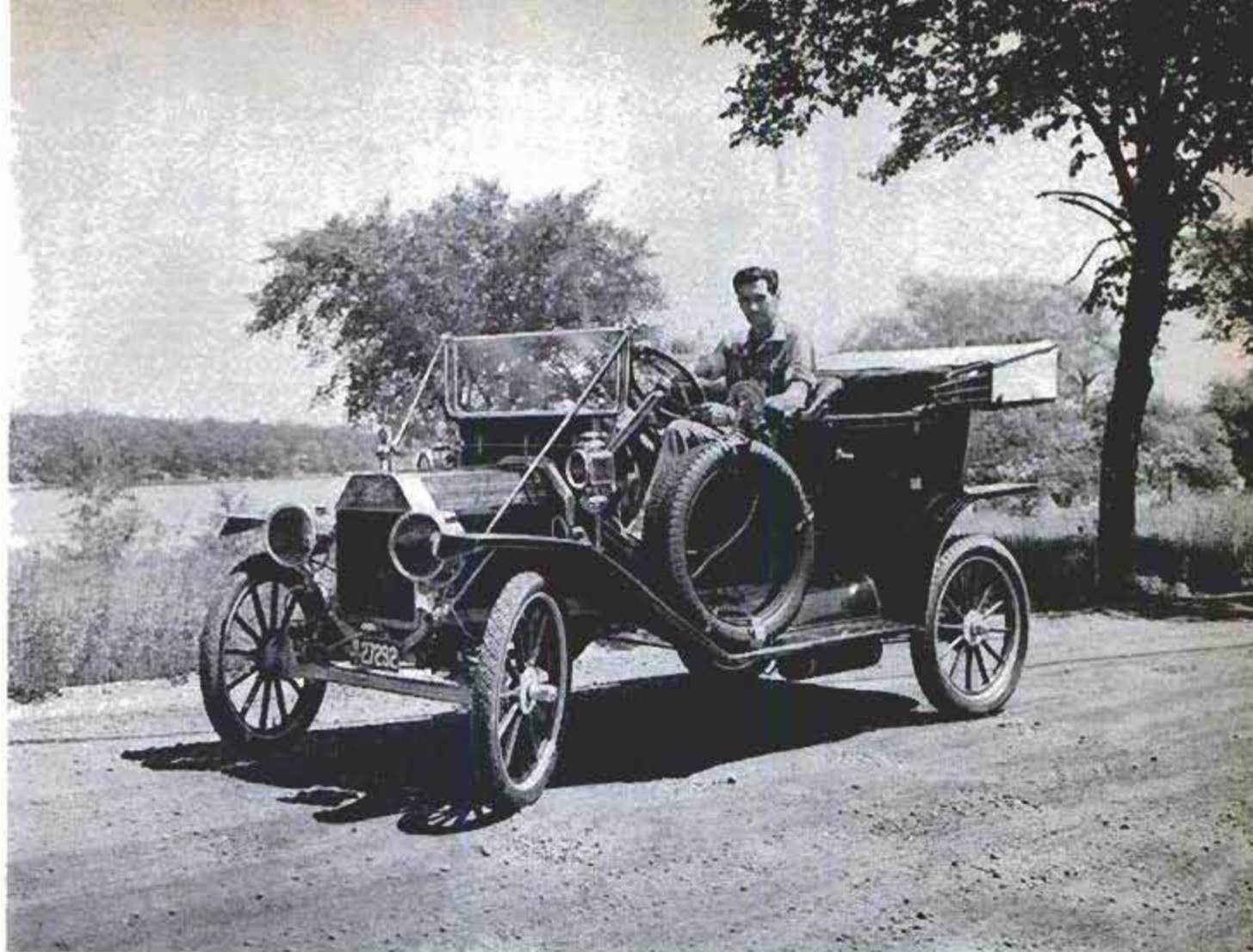

The old-timer that started Leonard Davis in antique-car business was this 1911 Model T; Davis is at wheel

Like They Used to...

shambles when he hauled it into his service station in 1948.

It emerged countless hours later, gleaming with a shroud of maroon enamel, but-toned red-leather upholstery in the original factory pattern and a set of four fenders Davis had painstakingly hammered from sheet steel.

Those fenders and their faithful reproduction to the last bead of "old Henry's" handiwork excited local enthusiasts and started a parade of antique-car owners seeking advice and service.

An unassuming man of 39 whose taciturnity evaporates when the conversation swings to the brass radiator and Prest-O-Lite era, Davis' talents soon won so much word-of-mouth advertising that the relics of horseless-carriage days crowded the gas-pump customers from the cash register.

"Something had to give," he recalls.

It did, four years later, when he moved into a new concrete-block building between

his home and service station and Davis and one employee set about making a living from a hobby. Since then, two other enthusiasts have joined the staff.

All mechanics extraordinary — they can spin a brass headlamp, shape a top bow or wheel spoke and hand-form an intricately curved metal panel. They also are artists with spray gun, striping brush and upholsterer's needle.

At first, the time-worn machinery Davis returned to the road came from Michigan, then Indiana and Ohio. Today it hails from as far away as Long Island and arrives on the hook of a wrecker, on trucks, trailers and railroad cars, sometimes in crates and sometimes it even shudders up the driveway under power.

That driveway is so well traveled that the customer with a bucket of antique bolts waits five or six months before Davis can begin sorting it out.

"Another 800 to 1000 hours after that,"



One of Davis' assistants, Roger Gallidan, attaches horn to steering column of a 1903 Model A Ford



Davis uses a sewing machine to fasten binding to the rear curtain of a 1906 Type 12 Pope-Toledo

Davis says, "usually gets the job done."

Those hours, however, frequently are spread over five or six months.

"Locating parts takes time," he explains. "And sometimes we wind up making them—things like gears, pistons, lamps."

That frustrating hunt for parts, combined with more pressing jobs, kept an extremely rare Paige-Daytona speedster in his shop for six years before the scars of 88,000 miles were erased. The "Thunderbird" of 1922, it was a canary yellow two-seater with drawer-type outrigger for a third passenger. Powered by a six-cylinder, L-head Continental engine, this model went into limited production after a stripped version of the Detroit-built Paige set a speed mark at Daytona Beach, Fla.

Paige-Daytonas are the exceptions, although Davis ordinarily averages only five restorations a year. This is a deceptive figure unless it is related to the constant traffic for service and repairs on "roadable" cars which gets priority, accounts for a third of the shop's time and the same percentage of the dollar volume.

Early Fords — including a 1905 Model F which is one of Davis' favorites — lead the transient parade although there are frequent visits by Buicks, Oldsmobiles, Packards, Cadillacs and occasional calls by such less well-known breeds as American Scout, Jackson, Paterson and Sears.

In various stages of restoration are a high-wheeled Sears Motorbuggy marketed by mail in 1908; a 1910 Paterson; a 1905 curved-dash Olds; a 1906 Type 12 Pope Toledo; a 1904 Peerless and Davis' own sturdy Thomas Flyer that is a duplicate of the famous New York-to-Paris race winner of 1908.

The Flyer is the first of three "greats" he wants in his own garage. The other two are the Pope-Toledo and any Pierce-Arrow.

"The Pierce," he says with reverence, "was the cleanest-engineered car made. Even the rear-axle housings were machined."

Cars that have had the full Davis treatment include one of the two 1917-18 Olympians known to exist; a trio of Ford Torpedo speedsters as well as numerous Model T, R,

This Model 10 E Buick of 1909 is typical of the condition of many of the antique cars sent to Davis' shop for rebuilding

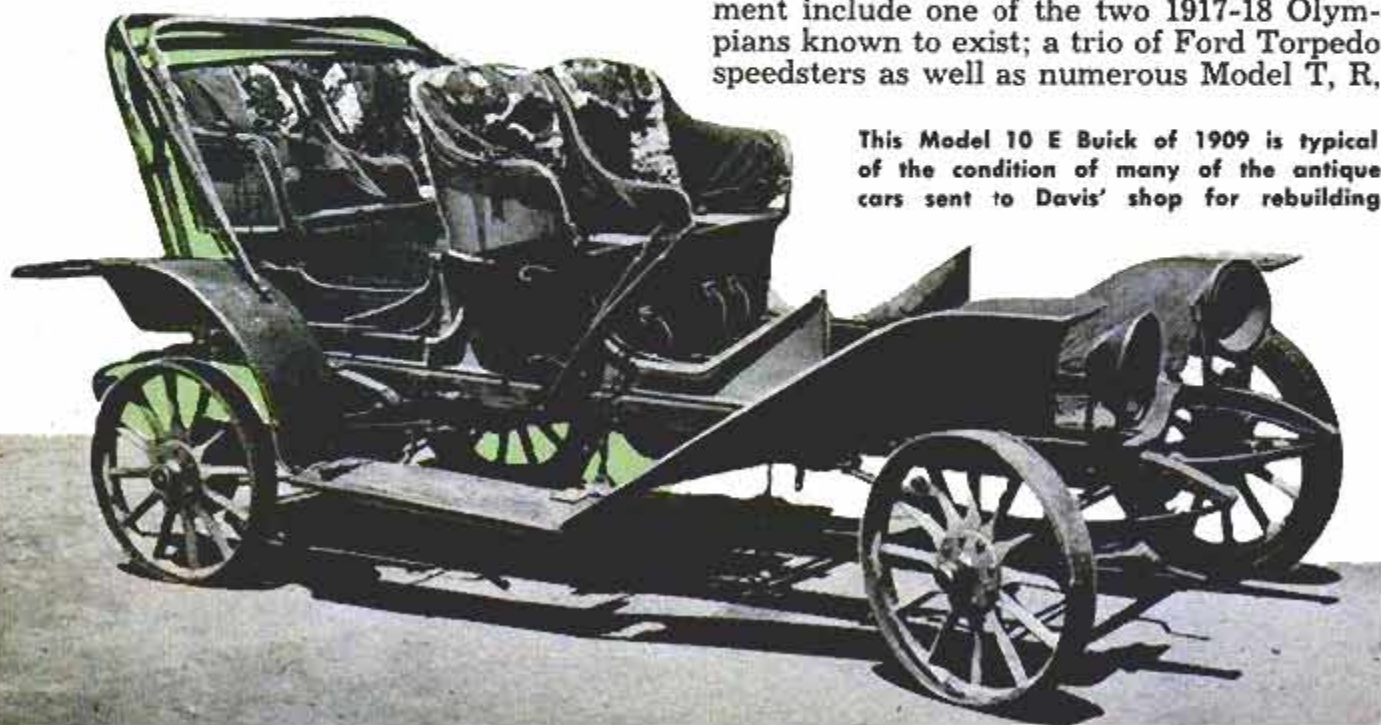

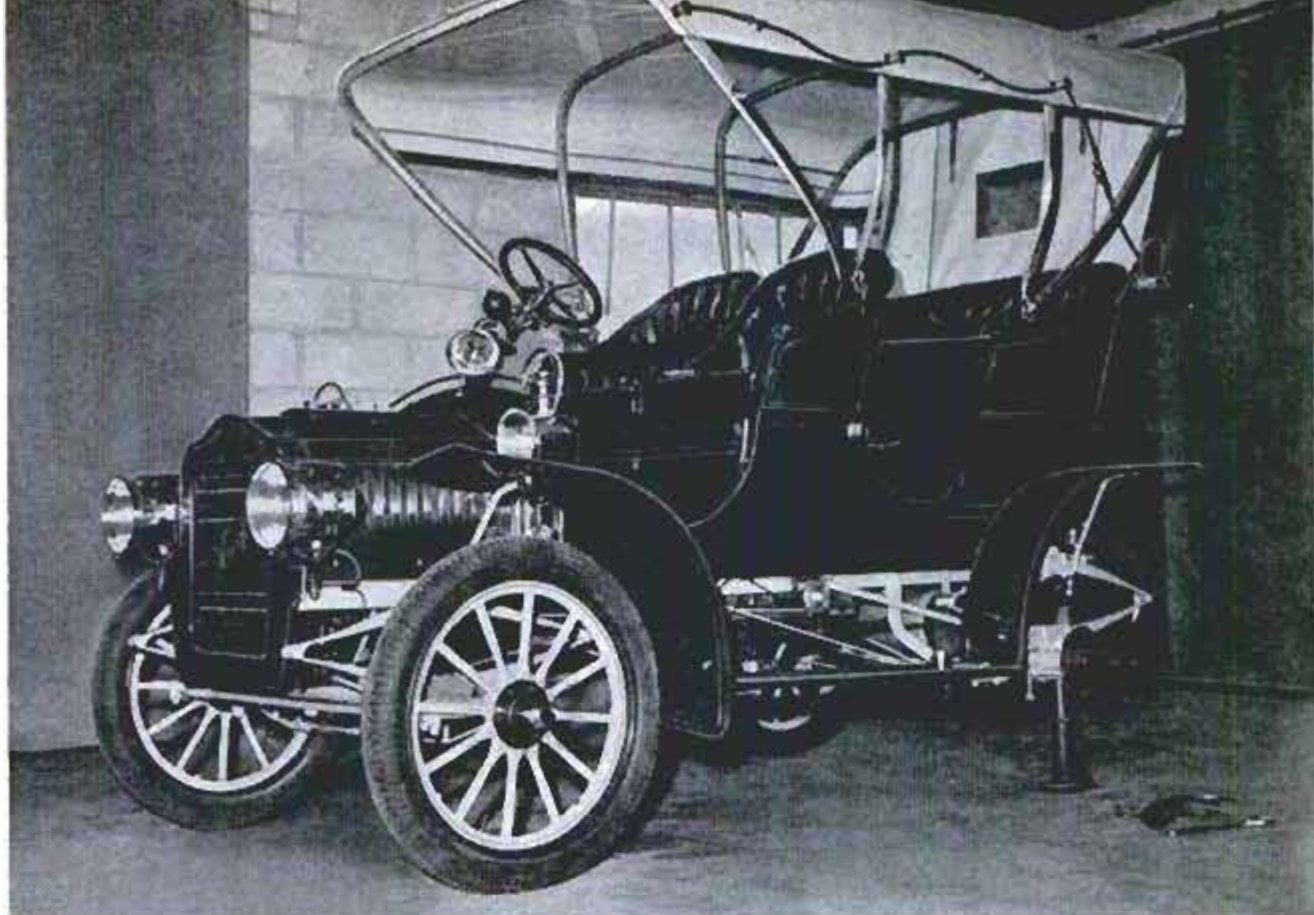

Here is a 1905 Model F Ford awaiting a left rear wheel. Old wheel spokes are reproduced by cabinetmaker

S and Ns; a couple of 1910 Buicks; a Vauxhall, vintage of 1926; the Paige-Daytona; a 1903 Cadillac and a 1910 Model 36 Pierce-Arrow.

"Then there was the 1911 Olds Limited, a service job," Davis says. "That was a monster. It had 44-inch tires and stood nine feet high with the top up. There were two steps from the running board into the tonneau. The pistons were like buckets and the six of them added up to an engine that was five feet long. And behind all that there was still twelve feet of automobile."

The Limited also was one of the most expensive cars, originally, that Davis has serviced. It delivered for \$4500 upward in 1910-12. Probably the least expensive to roll from his shop was a 1923 Ford that could be driven into the garage for about \$300.

The setting for these miracles of rejuvenation is crowded when more than six cars are on the ground floor. A lathe, drill press and milling machine flank a workbench that stretches almost the full length of one wall. Hanging overhead are nearly 100 brass lamps, horns and other articles of trim awaiting refinishing. By contrast, a glass-fronted cabinet on another wall contains a few dozen

Another assistant, Theodore Tedder, works on a 1908 Model S Ford engine. This engine has twin ignition, with two spark plugs for each cylinder

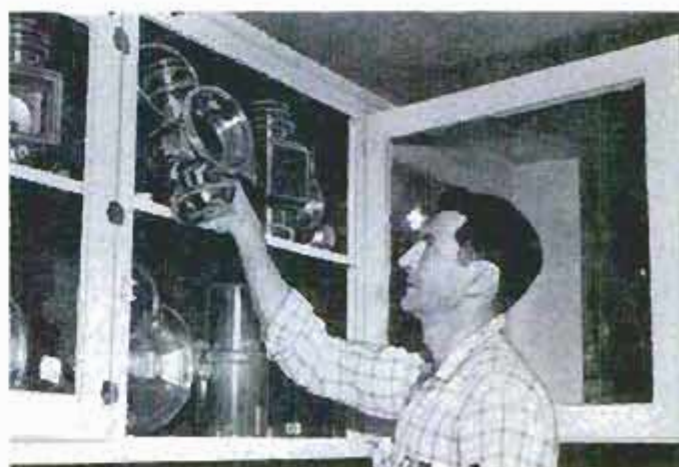

Storage cabinet holds part of "inventory" of brass headlamps and fittings. About 100 more hang from ceiling



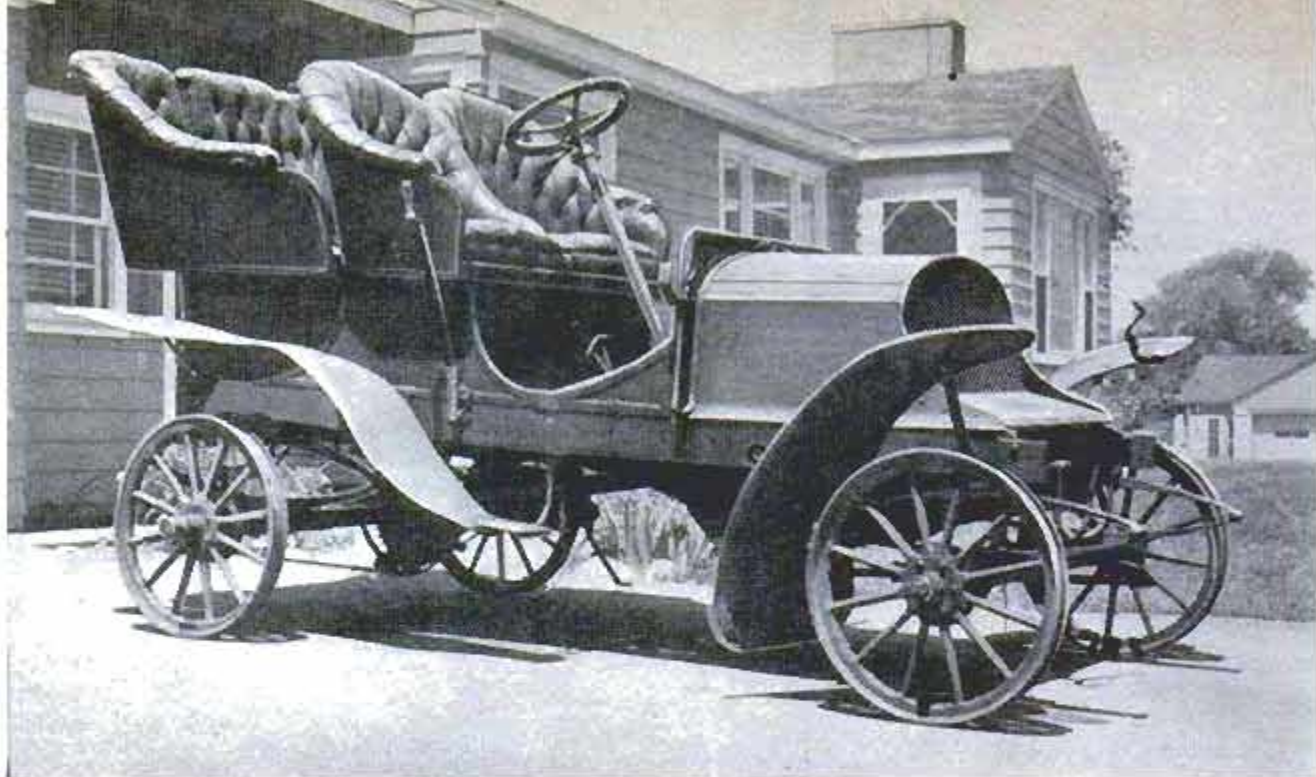

This 1905 air-cooled Franklin is in nearly original condition, despite lack of "shoes"



Flat aluminum sheet, above, is being curved into a rear fender. Below, the crankshaft is being removed from 1906 Locomobile



highly polished brass pieces ready to be replaced on some customer's prized antique.

An ell off this main workroom is used for paint spraying and a recently completed addition will house a woodworking shop.

Upstairs are two more rooms. One contains a cutting table, sewing machine and other essentials of a well-equipped upholstery shop. Until Davis mastered the knack of sewing a straight seam, his wife, Peg, held forth here fashioning tent-size tops taut enough to bounce a coin, and leather upholstery — averaging two to five hides per car.

The second room is filled with chassis, top bows, seats, wheels, springs, even engines and other bits and pieces of perhaps half a dozen automobiles that have been surveyed and found too incomplete for immediate restoration. Lamps, fenders and radiators are the most frequent victims of time but it isn't unusual for an entire body or engine to be lacking or unserviceable.

Every candidate for restoration is catalogued to see what's there and, more important, what isn't. Only then is the body lifted from the chassis and the interior carefully stripped to serve as a pattern for new upholstery. Rotted sections of the wood body framing are removed and reassembled

(Continued to page 240)

IT HAS THE quietest, smoothest, air-cooled engine ever built. That's the verdict of those who have driven the new General Motors' small car.

Three of the six-cylinder engines have been produced thus far for test. All are aluminum die castings. No cylinder liners are used. The aluminum alloy (the real secret of the engine) is the product of egg-headed research at GM's Technical Center, which is beginning to pay off handsomely on the money GM put into it.

The first test engine did very poorly, say insiders. Gloom was everywhere. Changes were made and the second version went through a 25,000-mile durability run like nothing. No problem, no wear, nothing but good news. Like new when torn down. The third engine is now undergoing a longer, more arduous durability test.

This horizontal opposed, air-cooled Six means a new era in engine design is ahead. It also pushes the still-too-expensive gas turbine into the even dimmer future. (Anyway, the turbine would be no good for around-town use and is suitable only for long-distance cars.)

For All GM Cars?

This new GM engine design can be built in sizes to power everything from the Cadillac down to the new small car. You can expect to see it in all General Motors cars within three, maybe two years. Everybody realizes that engines are too big, too heavy, too complex—the new designs will be simple.

The noise problem (supposedly inherent in air-cooled designs) has been licked. The engine is quieter, better balanced, more watch-tickish than anything you've seen. The whole project has been an engineer's delight and will prove what U. S. engineering can do when allowed to dig into something deeper than a push-button heater.

Chevrolet will build the car. Property has been bought for the new facilities. Major components (all of which are new and not shared with any other car) will be built in new plants. Actual assembly will be done in the existing Chevrolet facilities.

Production techniques for the small car could revolutionize the industry. The brains at the Tech Center have come up with some fabulous cost-cutting ideas. A whole new era is opening up here also.

The new car will be in the dealers' showrooms before the end of September 1959. It will not be called a Chevrolet, although there may be the name Chevrolet somewhere in the title (like Chevrolet Corvette). A battle currently is raging as to who is going to sell it.

Chevrolet wants it exclusively, but the



By Art Railton

other divisions, realizing how weak GM's imports, the Opel and Vauxhall, will be against this new competition, want to sell it, too.

Price is expected to be \$1900 and up. Remember now that all the foregoing is based on the existing state of affairs. If the situation changes, these plans could be changed (or even shelved). But that is unlikely—and it grows more unlikely with each passing day.

What About Foreigners?

General Motors now realizes that there is money, big, big money, in small cars. Why should the foreigners get it all?

With General Motors in, what happens to the foreign-car business? (A bigger and more important question from General Motors' viewpoint is what will happen to the used-car business?)

The new GM small car will make it necessary for foreign manufacturers to get competitive in styling and in the niceties. Owners may be willing to put up with inadequate heaters, slow windshield wipers, uninspired interiors and other minor debits to get a small, fun-to-drive car today. But when GM offers them the small car plus all the niceties we thin-blooded Americans have grown accustomed to, things may be different. In any case, the public will be the winner as competition stiffens.

Volkswagen is believed to be aware of and even getting ready for the upcoming battle. VW is rumored (just rumored) to have a new car in the works for 1960—a car especially aimed at appealing to the American market. It won't replace the present model, but is expected to augment it.

New car or not, VW is expected to have a new (and additional) engine for 1960—probably a new transmission with synchromesh first gear, too. Also rumored is that the present VW will be retained with some lessening of luxury to allow its prices to be cut so sharply that it will be far below GM's car in price.

Looks like an exciting year ahead, no?



Cargo-Carrying Helicopter Powered by Gas-Turbine Engines

Three gas-turbine engines, mounted in parallel, power McDonnell Aircraft's new utility cargo helicopter. In the unique propulsion system, developed after seven years' experimentation, compressed air

from the turbines is ducted through the rotor assembly and along the blades to burners on each blade tip. Here fuel is injected and burned to provide the power. The plane can climb 3000 feet a minute.

Foamed Silica Makes Lightweight Insulation Material

Pure silica foam is a versatile new material that is finding uses in chemistry, electronics, nuclear energy and other fields. It is produced in lightweight blocks that can be sliced with a knife and molded

or cut into various shapes. Because it can withstand temperatures from 450 degrees below zero to 2200 degrees above, it is used in high and low-temperature test chambers and blast furnaces as insulation material.

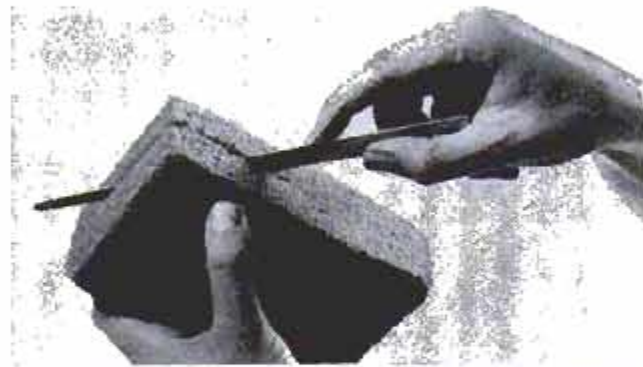

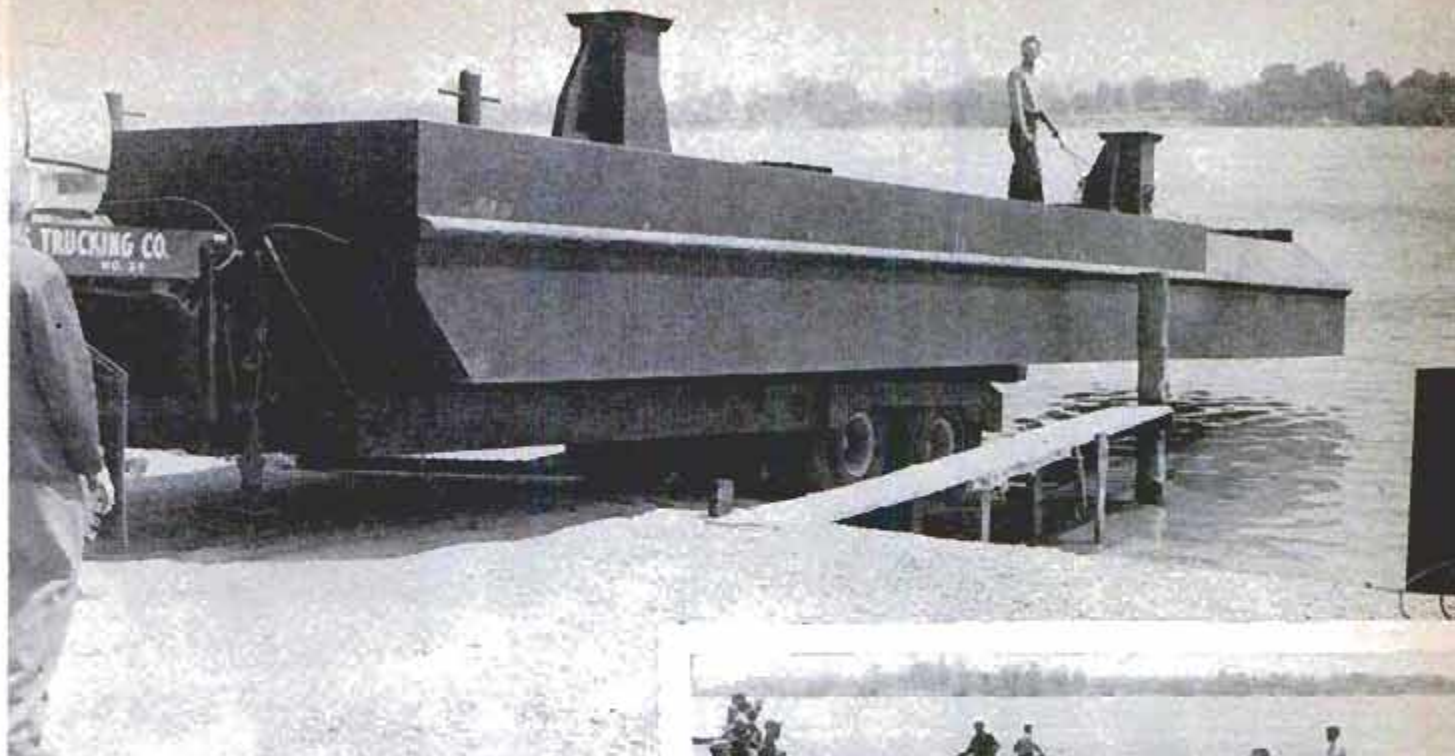

Barge Splits Into Sections For Overland Truck Trips

When the owners of a dredging firm in New Baltimore, Mich., want to move from one inland lake or waterway to another, they simply split their steel barge into two sections. Each 25,000-pound section is loaded on a truck trailer and transported overland. The barge is reassembled by dropping four piano-type-hinge pins into place between the 10-by-50-foot sections. For working directly over sunken craft, the sections can be separated to any desired distance.



Telescoping Boom Pushes and Pulls Roller on Steep Grades

Compacting the fill on a bridge approach in California posed a problem for the contractor. Hand compaction was too expensive and a conventional road roller couldn't

be used on the steep grade. The problem finally was solved by attaching a 1500-pound roller to a telescoping boom. The boom moves the roller across the fill.



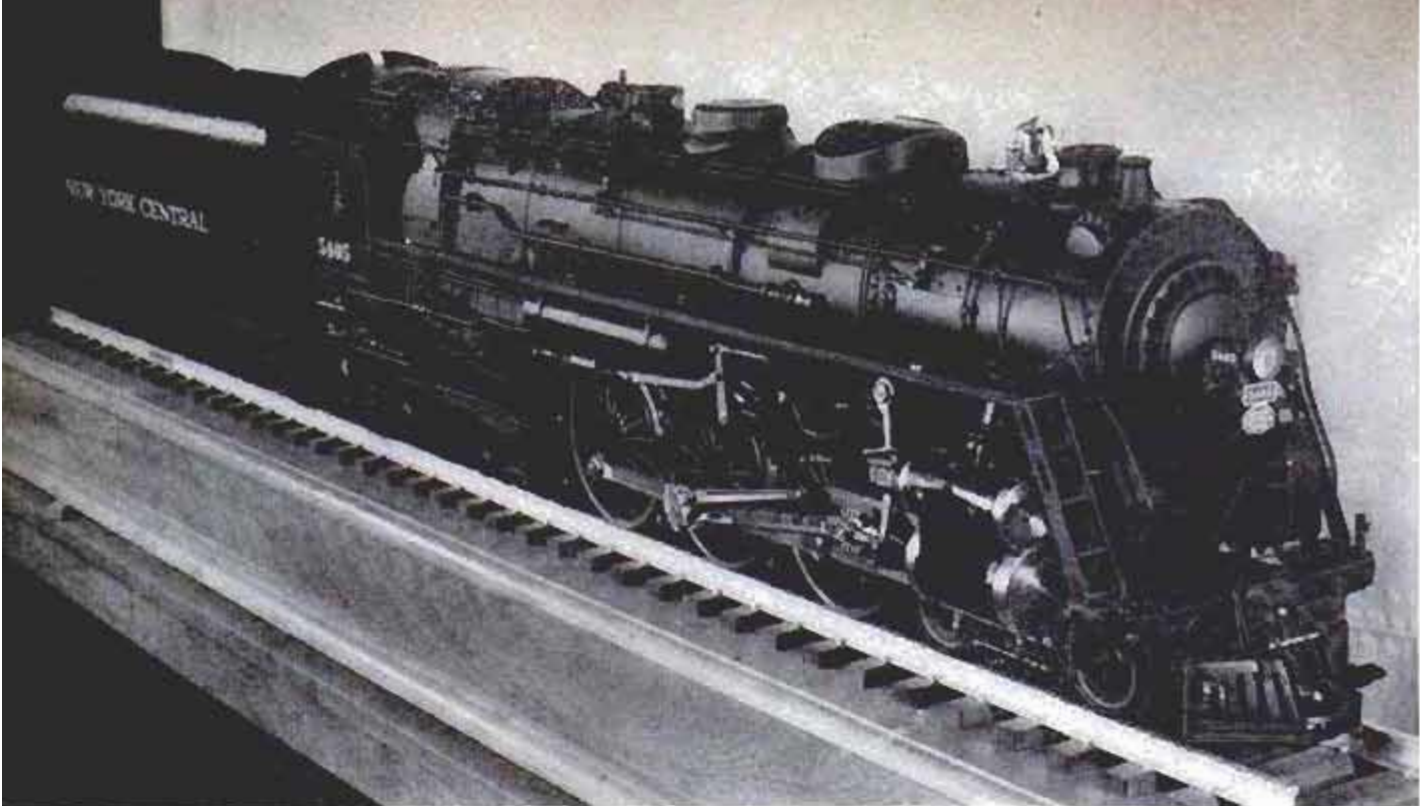

It took four years to build this six-foot, stainless-steel model of the Hudson 4-6-4 steam locomotive

IRON HORSE?

It's Stainless Steel and Handmade

By Sheldon A. Mix
PHOTOS BY JOE FLETCHER

The engineer's controls have been reproduced exactly. On the firebox are workable butterfly doors



AFTER WORKING HOURS one day, Chicago machinist Clarence La Caeyse went down to his basement and started building a model of a steam locomotive. Four years or about 4000 work hours later, he was done.

But this was not an ordinary model-building project. Most locomotives constructed on the scale of La Caeyse's— $\frac{3}{4}$ inch to the foot—are made of steel or copper. La Caeyse built his mainly of stainless steel, a much harder material to work with than the other two. What's more, La Caeyse is a perfectionist. Working from plans and a photograph, he insisted on accuracy in producing his six-foot model of the New York Central's famous Hudson 4-6-4. He succeeded even down to the nonskid tread plates and the ash pan under the firebox.

La Caeyse made his own patterns for most of the castings used in constructing the engine. All the valves and fittings are handmade. So are the tiny screws. He used hundreds of them, ranging in size from 00-90 (about .030 in diameter, or three times the diameter of a human hair) to one-quarter inch. Putting rivets in place

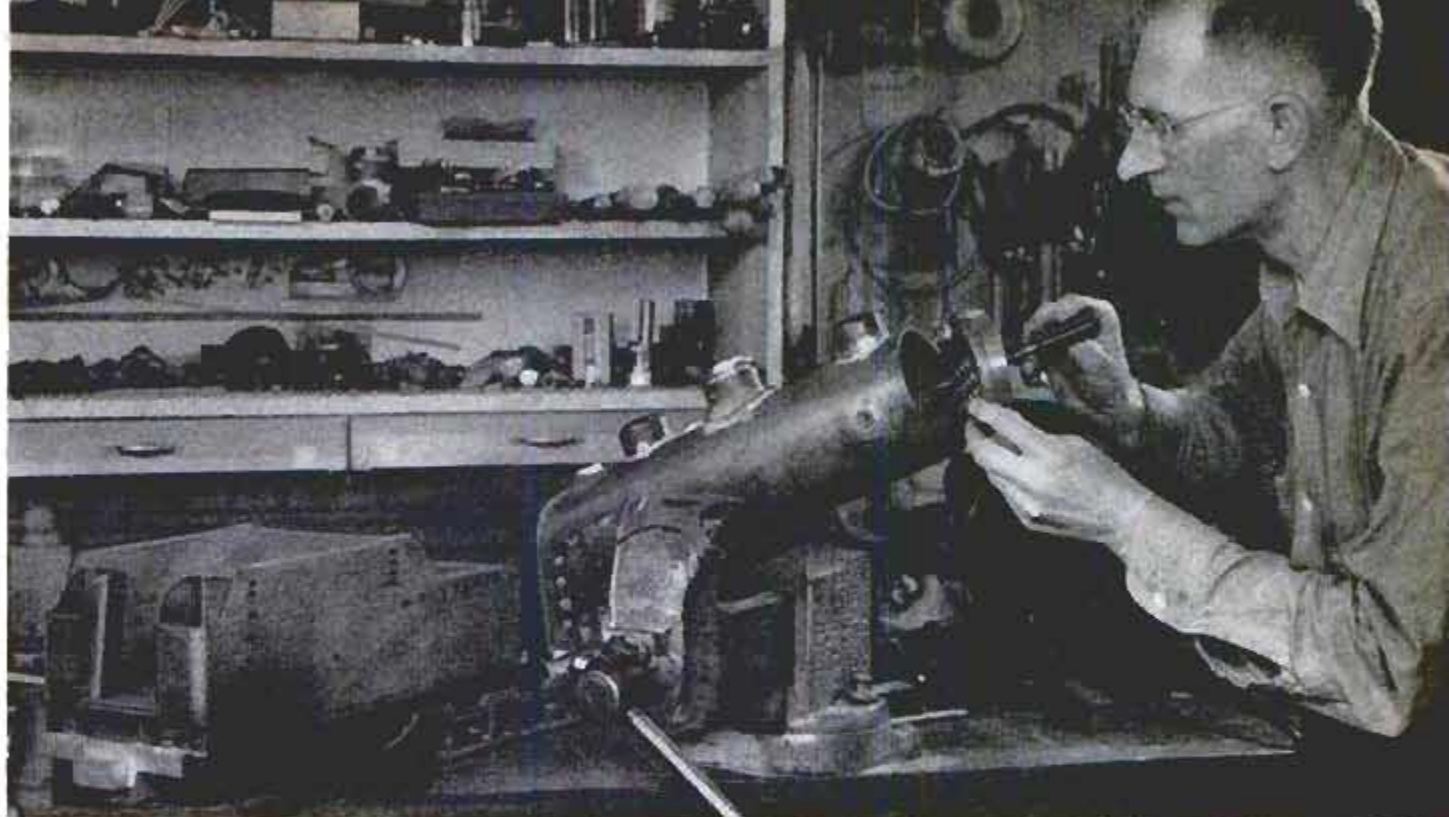

Builder of several gas engines, Clarence La Caeyse is now at work on a switch engine he'll run outdoors

was also minute and painstaking work. Each hole was center-punched and drilled. The firebox has shaking grates made up in two sections so the grates can be operated in the front or rear part of the box.

All fabrication of the locomotive and tender is either silver-soldered or welded. The wheels are suspended on leaf springs working through equalizer bars and levers. The water pump that feeds the boiler is a two-cylinder, double-action engine. Valves and cylinders are lubricated with pressure-feed oil pumps. Current for the headlight is supplied by a steam-turbine

La Caeyse spent about \$100 on the boiler and parts. All tubes and bolts are welded with stainless steel

generator that La Caeyse built himself.

Owner of a well-equipped basement workshop, La Caeyse did most of his work on his lathe, shaper, milling machine and drill press. He didn't keep a record of how much money the project cost, but knows he spent about \$100 on the boiler and parts. He has never taken his 4-6-4 out of the basement where it stands on an elevated piece of track. He has built a fire in the boiler just once—before he painted the locomotive and tender. La Caeyse is now working on a switch engine that he hopes to run outside. ★ ★ ★

All valves and fittings that went into the model Hudson 4-6-4 were patterned and made by La Caeyse

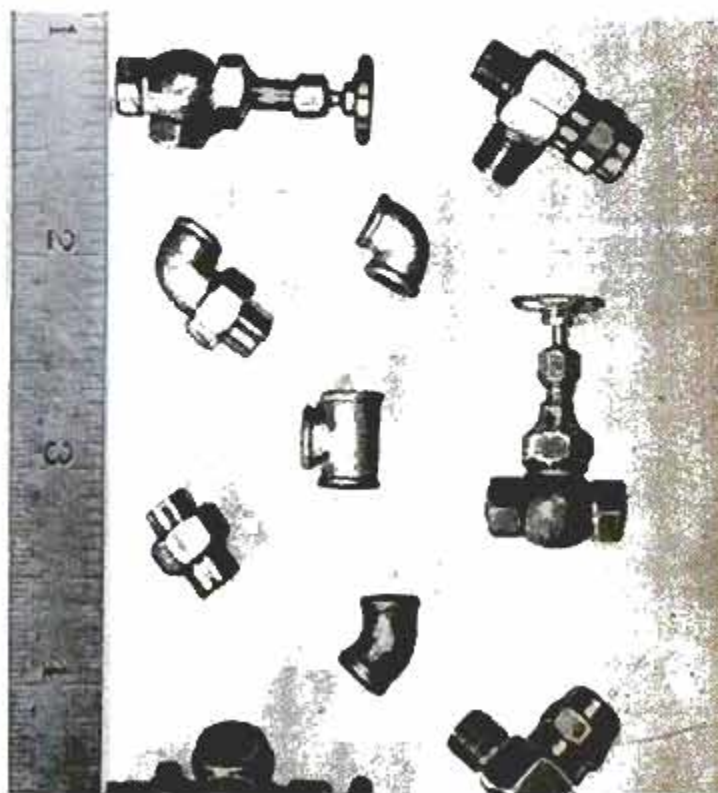
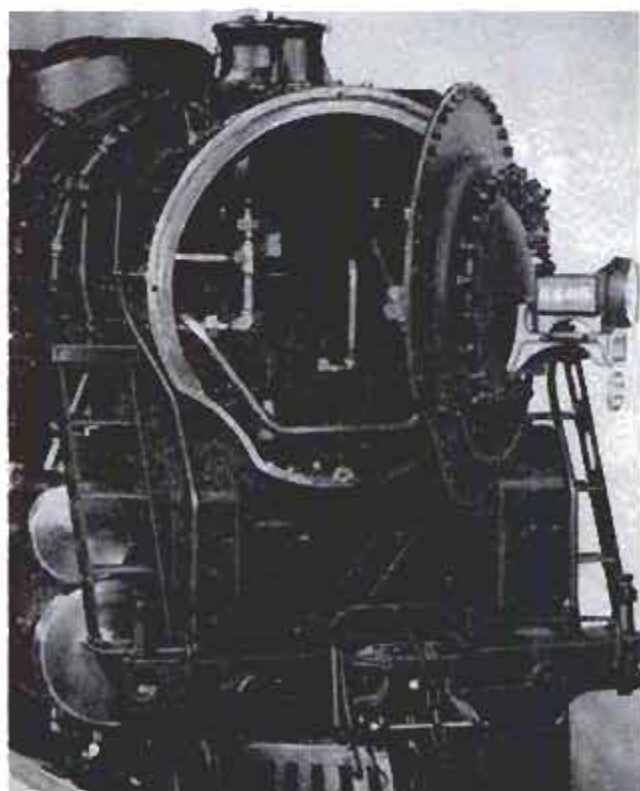



Arriving at the scene of an accident, an ambulance helicopter lands on city street



Patients are transported in compartments attached to sides of copter. Patient space is inside bubble of some helicopters

Flying Ambulance Saves Lives

WHIRLING BLADES may soon replace screaming sirens at the scene of an accident. A number of hospitals in the Los Angeles area have provided space for a helicopter landing area near the emergency entrance. Because the helicopter can take off and land vertically, a 40 by 40-foot space is sufficient for a heliport. Almost any city street is wide enough for landing. Ambulance trips that might require one or two hours on congested highways can be made in a fraction of that time by lifesaving helicopters.

The 40 by 40-foot platform on roof of Santa Monica hospital serves as heliport. Ramp leads to elevator

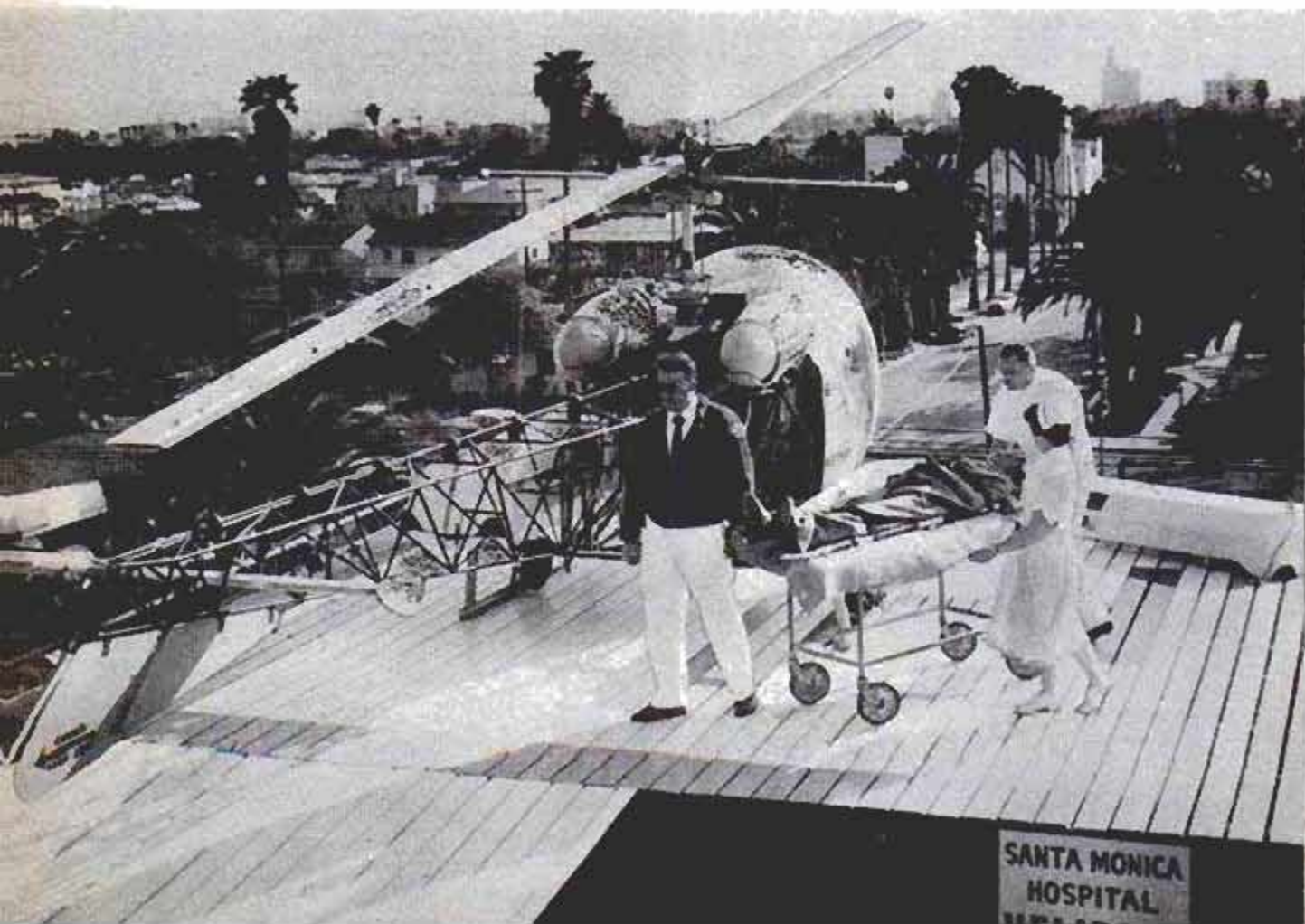

MILBOURNE CHRISTOPHER, shown here levitating a beautiful assistant with the greatest of ease, is acclaimed by magicians themselves to be the foremost historian of magic. His immense reference library covers 5000 years of hocus-pocus, and his Manhattan apartment is the largest museum of magic in existence. In addition, Christopher is one of the greatest of contemporary wizards and is past president of the Society of American Magicians

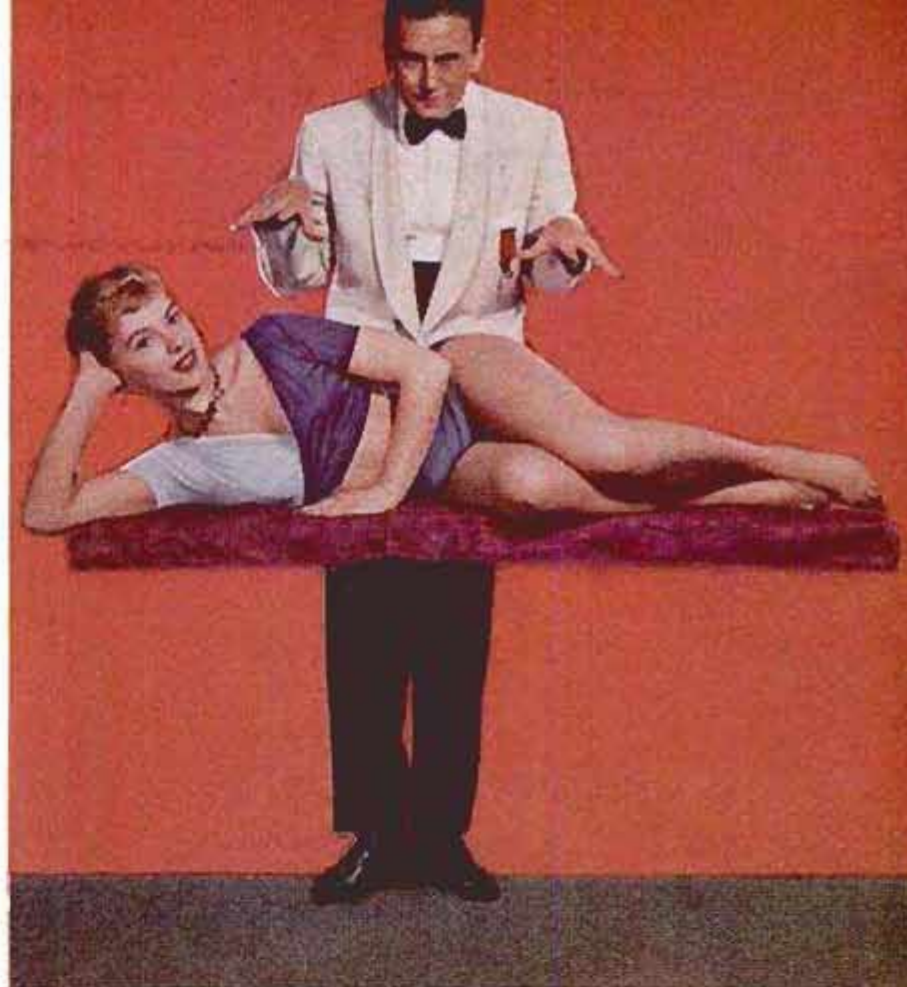

PART I

I Call These **THE GREATEST MAGIC ILLUSIONS OF ALL TIME**

By Milbourne Christopher

MAGICIANS ARE the scientists of show business. They perform their baffling illusions by camouflaging the principles of nature. Spectators who take for granted such 20th-century wonders as TV, atomic energy and satellites, are still flabbergasted by the seemingly incredible feats of modern Merlins.

As an historian of magic as well as a professional magician, I have frequently been asked to describe the greatest illusion of all time. I can't limit magic to a single illusion. But I will nominate *several* of the greatest illusions, with variations.

In many cases, the secrets of these illusions have endured, though their inventors

died long ago. A modern magician may still baffle us with one of the same illusions that mystified our ancestors, updated and given a personal flourish. However, the scientific or mechanical principle of the illusion may have remained the same for decades or even for centuries.

First let me define an illusion. A small trick is *not* an illusion, though it may be equally baffling. An illusion is a spectacular stage mystery involving humans, large animals or massive objects. Show a small box empty and produce a bowl of water—that's a trick. Show a huge box empty and conjure up a man on a motorcycle—that's an illusion!

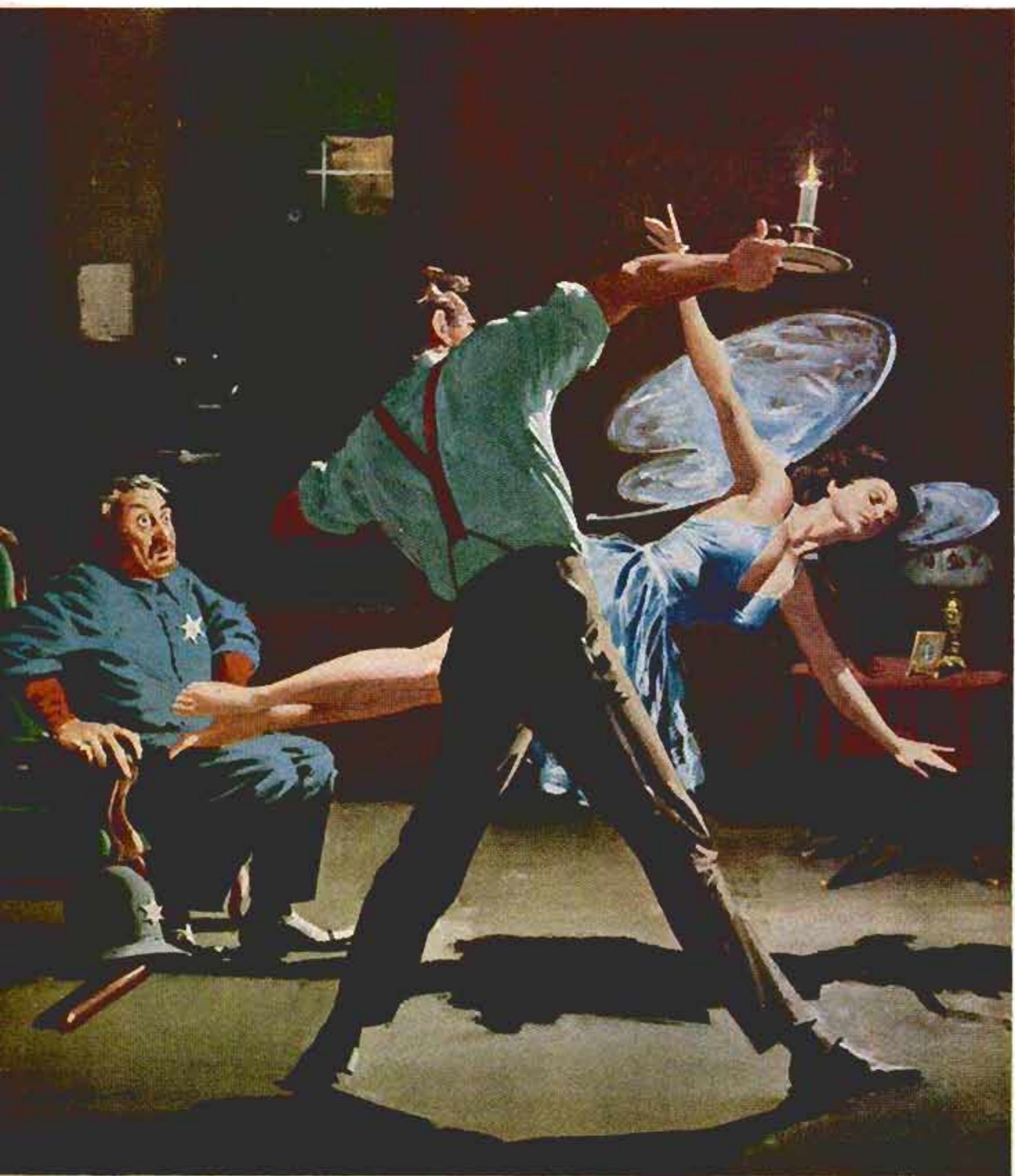

Suspicious London bobby was the first spectator to see David Devant's startling illusion, "The Mascot Moth"

Here, then, are my nominations for the greatest illusions in the history of magic.

One of the most famous—and certainly one of the greatest illusions—is vivisection, or sawing a girl in two. Take a look at the absolutely baffling refinements that have been given to this well-known mystery.

The most ancient mystery of this type dates back almost 5000 years. Dedi, an

Egyptian hocus-pocus expert, astounded Cheops, the Pharaoh who built the Great Pyramid, by severing the head of an ox, then mystically reuniting the animal. Later generations of mystery men added extra interest by using humans for their deceptive decapitations. Dr. Lynn, who flourished in the late 1800s, advertised he would "cut up a man at each performance." He



Bearded DeKolts made his wife disappear in view of audience. Newspapers proved no trap doors were used

did, too, slicing off legs, arms and head. As a matter of fact, he cut up the same man for 20 years!

P. T. Selbit, the British wizard, introduced the modern version of this spine-chilling sensation in 1921. The plot was simple and sensational. A pretty girl, tied in place inside a wooden box, was sawed in half, then mysteriously restored.

The whine of the wicked saw as it ripped through the wood was first-rate theater. As soon as the saw dropped free, metal plates were inserted on each side of the cut, and the two sections of the box were pulled apart. The audience usually was too stunned to applaud until the sections had been rejoined, the girl's bonds released and she emerged smiling—in one piece.



"Onaip" was a staggering illusion in which a piano and pianist revolved in midair during musical number

A few months after Selbit's triumph, Horace Goldin performed the illusion in this country—except that he used a form-fitting box, and the girl's head, hands and feet protruded through holes. The public was so eager to see this miracle of magic that Goldin soon had six magicians touring under his management. In less than a year, more than 100 illusionists were topping

theater bills as far away as Calcutta with the lure of this feat of surgical sorcery.

Goldin stirred up public interest by parking an ambulance in front of the theater. Sometimes he hired a group of men, dressed them as undertakers with white gloves and frock coats, and had them march solemnly through city traffic to the theater lobby.

Horace Goldin was a master at sawing an assistant in half, one of the most famous and spectacular of all stage illusions. All other magicians placed the girl in a closed box, but Goldin simply had her lie on a plank throughout his surgical sorcery

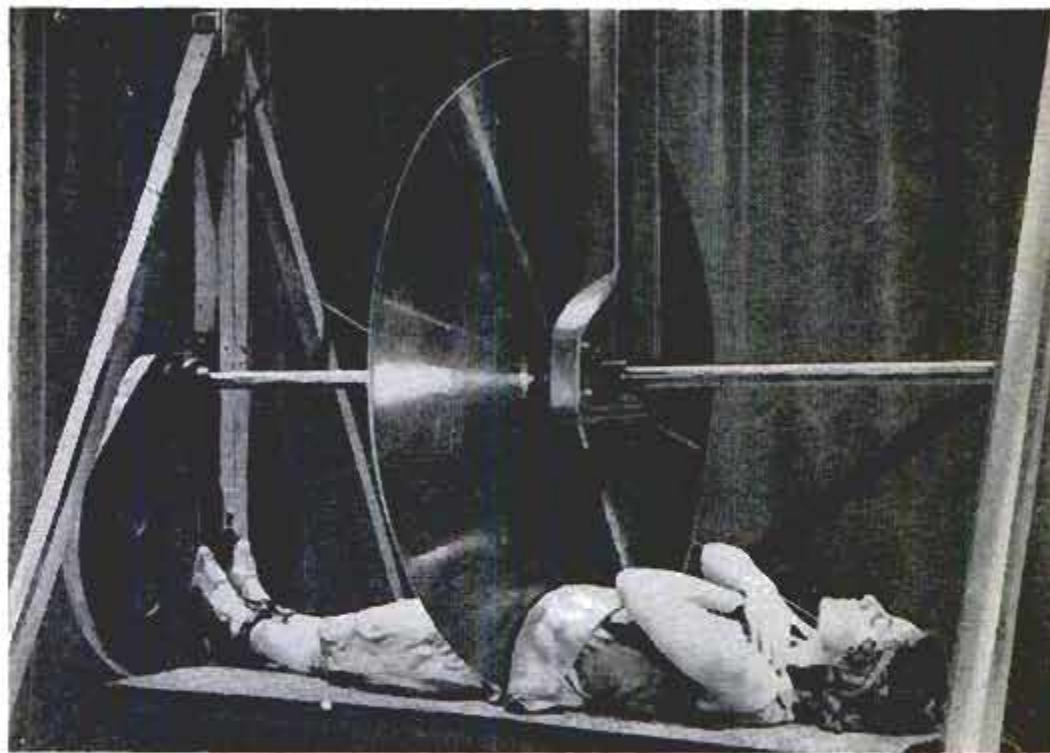

I imagine you believe the secret of this illusion is hidden inside the box. Well, the last time I saw Goldin perform it in London 20 years ago, he had a new version. The box simply was discarded. His beautiful assistant reclined on a plank, all of her body in full view. Goldin, ever the master showman, ran a huge power-driven saw through her midsection. As in the earlier illusion, he brought the surgery to a successful conclusion when the girl bowed from the waist and walked to the wings—still very much in one piece.

Last year I arranged for Sorcar, the Indian illusionist, to fly here from Calcutta to perform on NBC-TV's "Festival of Magic." Network officials were shocked to learn that he finished his special variation by leaving the girl in two widely separated pieces as the curtain fell—a grisly touch that seems to delight audiences in some other parts of the world. He graciously agreed to effect the usual happy ending here.

Audiences usually suspect elaborate boxes or cabinets. Everyday props used in an illusion make the mystery doubly effective. During Blackstone's evening of wizardry, a girl crawled into a row of tires held upright by a simple rack raised from the stage.

Casually, the illusionist lifted the tires one by one and rolled them to a waiting assistant on the far side of the stage. The girl was gone. Meanwhile, the assistant had stacked the tires one on top of the other. A line was let down from above. Out from the tower of tires was pulled the same girl who had vanished a moment before.

A place high on the list of the greatest

illusions must go to "Onaip." In April 1908, patrons of the New York Hippodrome rubbed their eyes in amazement when a man, seated at a piano, rose into the air. Not just the man, the piano, too! When the two were about five feet off the floor, the piano and the man turned upside down and began revolving at a speed of about 40 revolutions a minute. And, all the while, the man played lilting music.

For several years this staggering illusion toured from coast to coast in the United States. Then, in 1911, "Onaip" was presented with an East Indian setting. The wizard appeared in lavish robes and hypnotized one of his assistants. Burning incense added mysticism. After the hypnotized subject was led to the piano, he began to play. His stool was taken away. Still he played, sitting in space. Then the levitation and spinning in the air began. As the piano and player turned, a gigantic hoop was passed over them to show that no wires were employed.

To demonstrate how easily the eye can be tricked, did you notice anything familiar about the name of the illusion—"Onaip"? It's "piano" spelled backwards.

Richiardi, Jr., the young Peruvian illusionist, recently presented one of the most novel levitations ever conceived. A small boy falls asleep over the wheel of his miniature motor car. Richiardi waves his hands over the car. Slowly it rises until it is several feet in the air. A hoop is passed over the suspended car and its youthful occupant. More passes from Richiardi and the car sinks back to the stage. The youngster wakes up and drives the car offstage.

(Continued to page 214)

THE PROPOSED SUBMARINE TANKER COMPARED TO SCALE WITH THE U. S. SUBMARINES NAUTILUS AND TRITON



TANKER APPROXIMATELY 800 FEET

NAUTILUS 300 FEET

TRITON 447 FEET

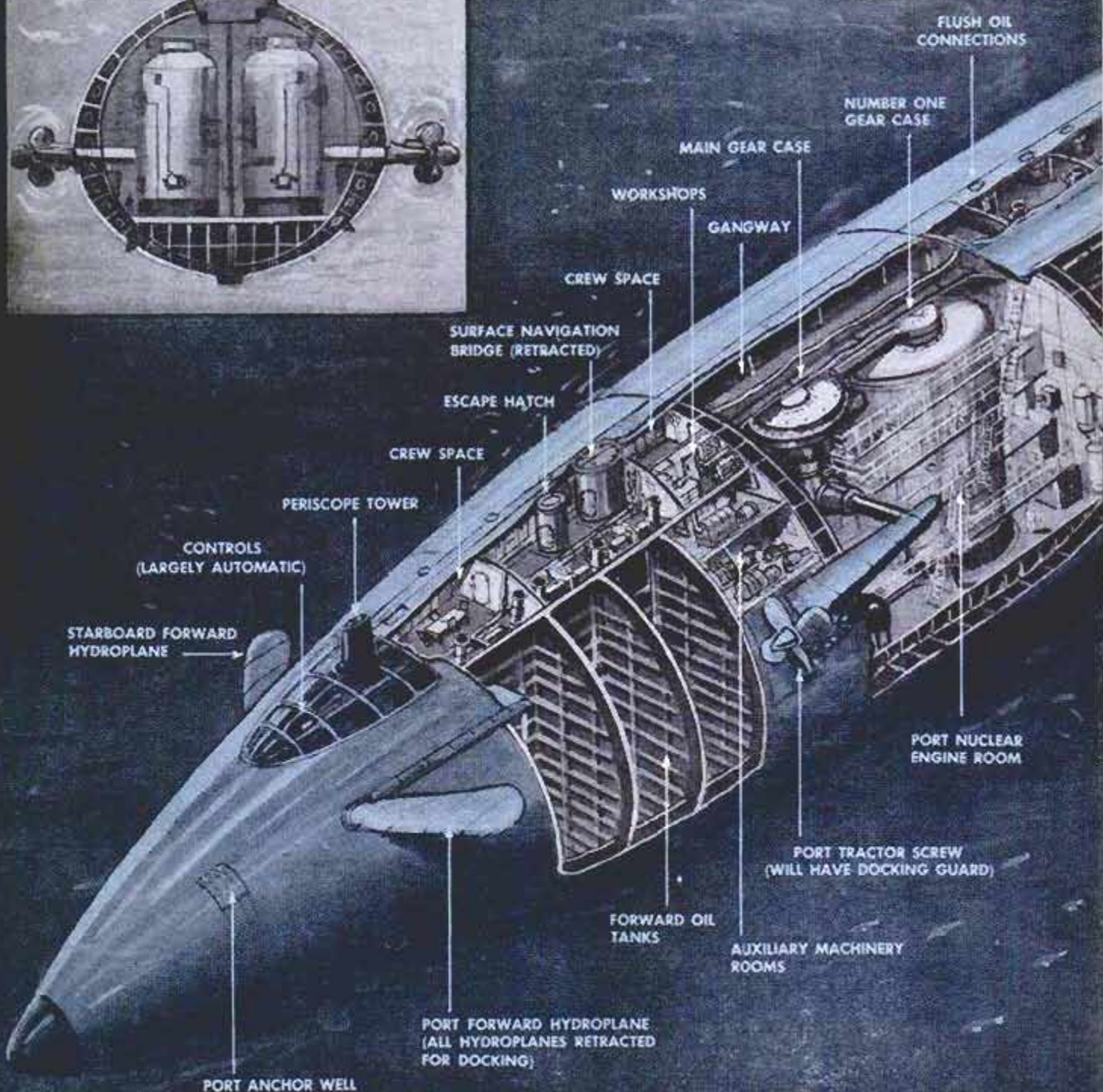
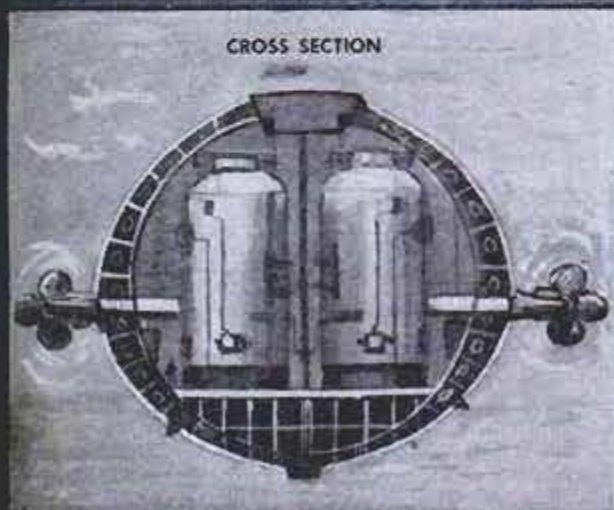

FLUSH OIL CONNECTIONS

NUMBER ONE GEAR CASE

MAIN GEAR CASE

WORKSHOPS

GANGWAY

CREW SPACE

SURFACE NAVIGATION BRIDGE (RETRACTED)

ESCAPE HATCH

CREW SPACE

PERISCOPE TOWER

CONTROLS (LARGELY AUTOMATIC)

STARBOARD FORWARD HYDROPLANE

PORT NUCLEAR ENGINE ROOM

PORT TRACTOR SCREW (WILL HAVE DOCKING GUARD)

FORWARD OIL TANKS

AUXILIARY MACHINERY ROOMS

PORT FORWARD HYDROPLANE (ALL HYDROPLANES RETRACTED FOR DOCKING)

PORT ANCHOR WELL

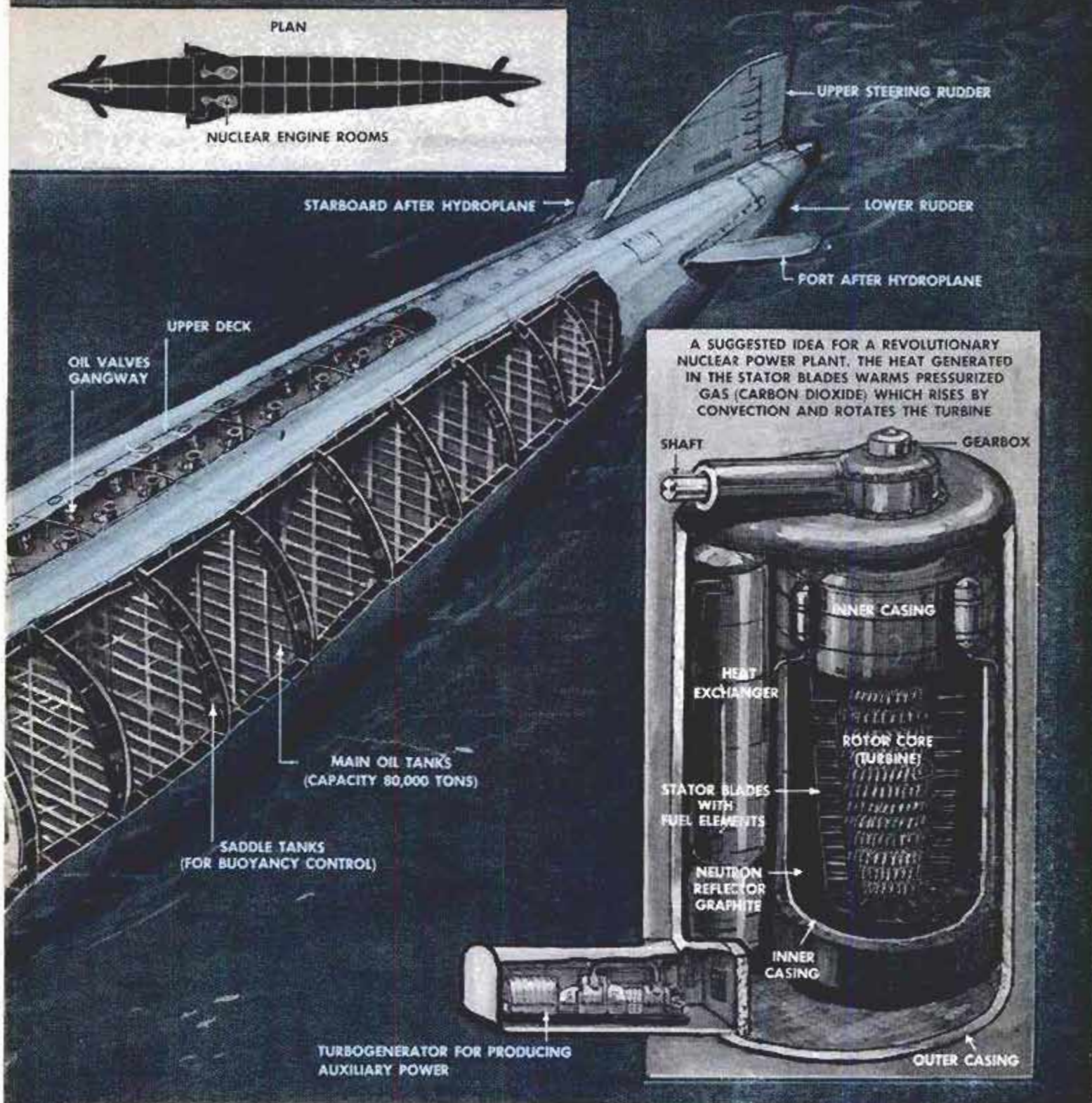

A SUGGESTED IDEA FOR A REVOLUTIONARY NUCLEAR POWER PLANT. THE HEAT GENERATED IN THE STATOR BLADES WARMS PRESSURIZED GAS (CARBON DIOXIDE) WHICH RISES BY CONVECTION AND ROTATES THE TURBINE

GIANT ATOMIC SUB TANKER

Text and Drawing
by G. H. Davis,
Noted British Artist

USING A NEW TYPE of nuclear power plant, a submarine tanker being designed by Britain's Mitchell Engineering Company would be capable of carrying 80,000 tons of oil at speeds far in excess of any submarine yet built. Model tests of the vessel have been made in the 600-foot experimental tank of Saunders-Roe Limited, famous aircraft and ship-builders. Details of the nuclear power plant have been a jealously guarded secret, but it will not use the present

round-about method of producing power from the atom. One suggestion is that power may be produced more directly by incorporating fuel elements in the fixed blades of a turbine engine. Heat from the blades would cause pressurized gas to rise by convection, rotating the turbine. It is believed the power plant could drive the tanker at the great speed of 40 to 50 knots. A crew of about 12 men would be sufficient as many of the controls would be automatic. ★ ★ ★



High-Level Visit To Hospital

Talk about rising to the occasion! Seven-year-old Mike Stamon of Seattle, Wash., was determined to visit his younger brother Korey, a patient in the hospital. However, hospital rules prohibit children from visiting patients. Mike persuaded his father to raise him to the third-floor level on a telescoping construction boom. The platform was maneuvered until Mike was right outside Korey's window. From this perch, Mike and his father could wave to Korey.

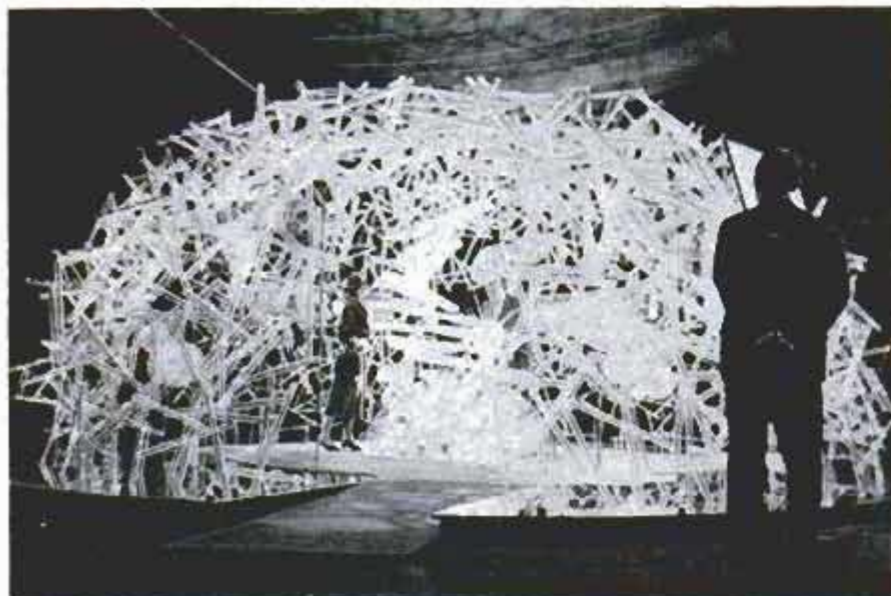

Human Cell Model Is 12 Feet High

More than a million times the size of a human body cell is a three-dimensional plastic model 24 feet in diameter and 12 feet high. Almost a mile of plastic tubing and a mile of electric wiring were used in building the model. The plastic tubing represents cytoplasm; yellow plastic balloons represent fat globules. Pulsation of a blue light at the base adds an appearance of "life."



Unit "Speaks" Code On Teletype Signal

Coded information can be "spoken" by an electronic instrument. Words and phrases are prerecorded and stored on the instrument's memory drum. They are triggered when a teletypewriter operator presses certain keys. Since a coded electronic signal is simpler to transmit than voice, the instrument may solve major problems in aircraft, ground and point-to-point communications.



"Clover Leaf" Speed Brakes Fold Out of Fuselage

Republic's F-105B fighter bomber, shown taxiing with its brake chute open, is equipped with a new type of braking apparatus. This consists of "clover leaf" speed brakes located on the tail of the plane. Forming the last 36 inches of the fuselage while in flight, the brakes are in four sections and open or close to four positions. In the normal cruise position the petals of the brakes are closed; with afterburner operating, they are slightly open. As a speed brake, the two side petals remain open, while the top and bottom petals are closed. In the slow-flight position, all four petals are open. The airflow over the wing and tail surfaces is not disturbed by the open brake petals. The F-105B is powered by a 15,000-pound-thrust turbojet engine and is in the Mach 1-plus class. It is armed with a single 20-millimeter cannon.

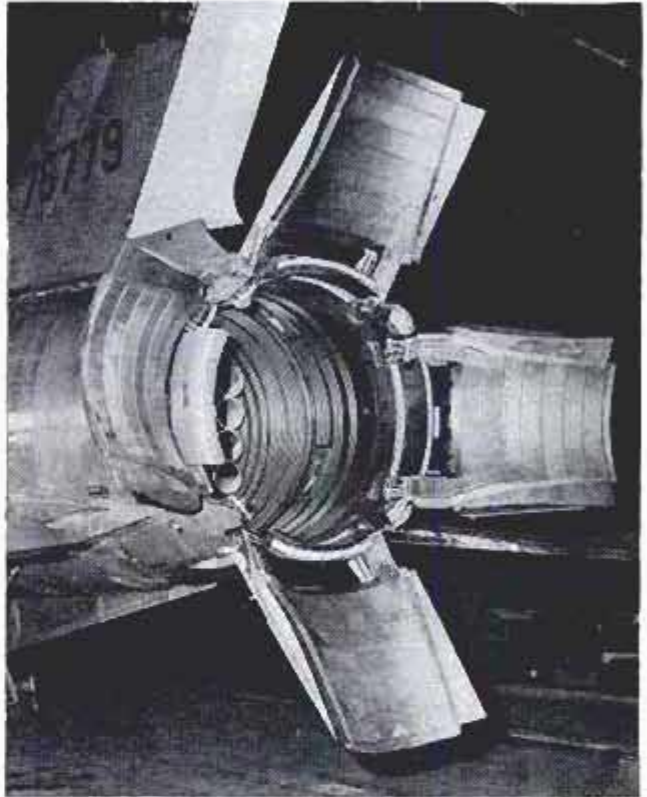

Scoop-Bucket Has "Snapper Lip" That Automatically Opens and Closes

Operating automatically, the "snapper lip" of a scoop-bucket remains open while the bucket digs into a load, then clamps shut until the load is dumped. When the bucket dumps its load, the lip opens to a

width that can be adjusted by a tension spring. The snapper lip enables the bucket to handle a full load and at the same time prevents any of it from spilling over onto a roadway.





Lincoln simplified its front end by placing the diagonal headlamps in the upturned ends of U-shaped grille



Lincoln's transom. Below, major elements of the rear suspension

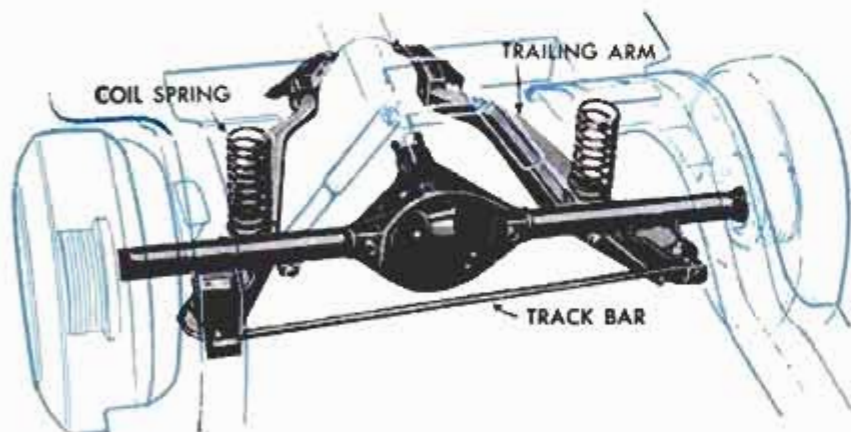

Continental Mark IV continues its reverse-slant, movable rear glass. Taillights look like huge push buttons



LINCOLN

LINCOLN IS SHORTER—not much, but even two inches shorter is news these days.

Any unit body has an inherent problem of noise transmission. Lincoln has licked the problem and the car is as quiet as a conventional-frame design. They tuned and dampened exhausts, weighted and balanced the prop shaft, revised the junction of rear axle and trailing arms. Reinforcing strainers now reduce sheet-metal drumming.

For rustproofing, Lincoln this year dips its bodies in primer paint all the way to the belt line. The engine, a carry-over from 1958, has been "honed and sweetened," say the engineers.

Lincoln's plush model, the Continental, is now the Mark IV. Styling changes on both are limited to front and rear transoms—the latter being Lincoln's forte.



Lower headlights, more horizontal emphasis in grille, flashier brightwork, mark 1959 Edsel Corsair hardtop

EDSEL

CHANGES? Edsel for 1959 has a barrel of them.

It now comes in one size only. The new wheelbase is 120 inches, two inches longer than last year's small Edsels, four inches shorter than the big models.

Only two series are offered, Ranger and Corsair. Three V8 engines are available, displacements being 292, 332 and 361 cubic inches. All but the biggest thrive on regular gasoline.

Also available is a six-cylinder engine (adopted from Ford). It's a "delete option." Order it, and you get a price cut of \$80 or so.

Even the push buttons in the steering wheel are gone. So is the pie-plate speedometer. Big concern is with mechanical reliability, not gimmicks. Exhausts are coated for long life, wiring clips rubberized to protect insulation and quick-disconnect plugs make electric circuits foolproof.



Ranger sedan is same size inside and out, but less expensive than Corsair. Differences are in trim, seat design and engine



Villager wagon comes as two or three-seat model. Weight distribution on wagons is 50-50, giving good traction on ice or snow

Push buttons are gone. Transmission control is lever (arrow). Buttons were too expensive and troublesome

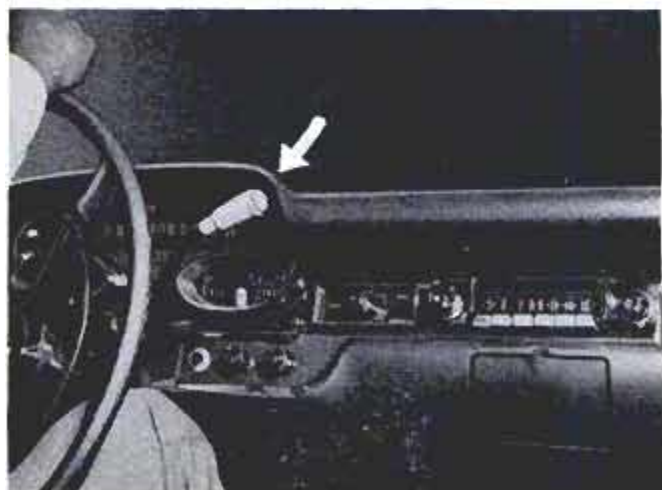

Multiple taillights are mounted lower than last year's horizontal design. Third lens is backup light





Park Lane models, like this four-door hardtop, have a distinctive "torch" mounted in rear-fender cavity

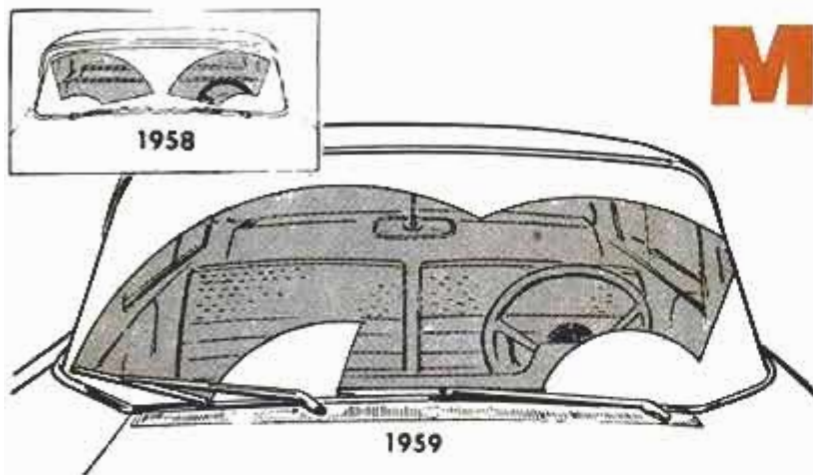

Mercury now has electric wipers that operate in unison and their sweeps overlap each other to eliminate all unwiped center area

MERCURY

MERCURY has plenty to talk about in 1959. Changes run all the way from a new frame to a different system of windshield wiping. Interiors are roomier as stylists have increased front-seat legroom as much as six inches to get rid of what the Mercury publicists euphoniously call "cockpit claustrophobia."

Wheelbases are now 126 inches on Monterey and Montclair (four inches longer than last year) and 128 inches on the Park Lane (three inches longer). Over-all lengths are increased by similar amounts.

Front and rear treads are wider for greater stability. Antidive has been added to the front suspension by tilting the upper arms. It's the first time Mercury has used antidive.



Wagons have lockable storage compartment under rear floor. Below, new dash increases front-seat room

Flexible joint in steering shaft (circle) absorbs road shock and prevents binding due to misalignment

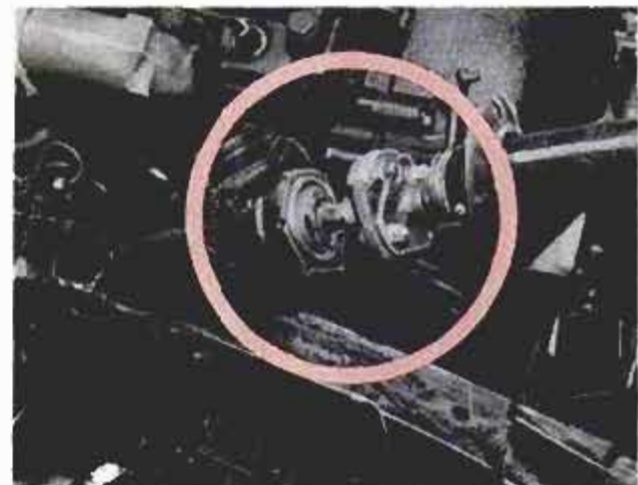

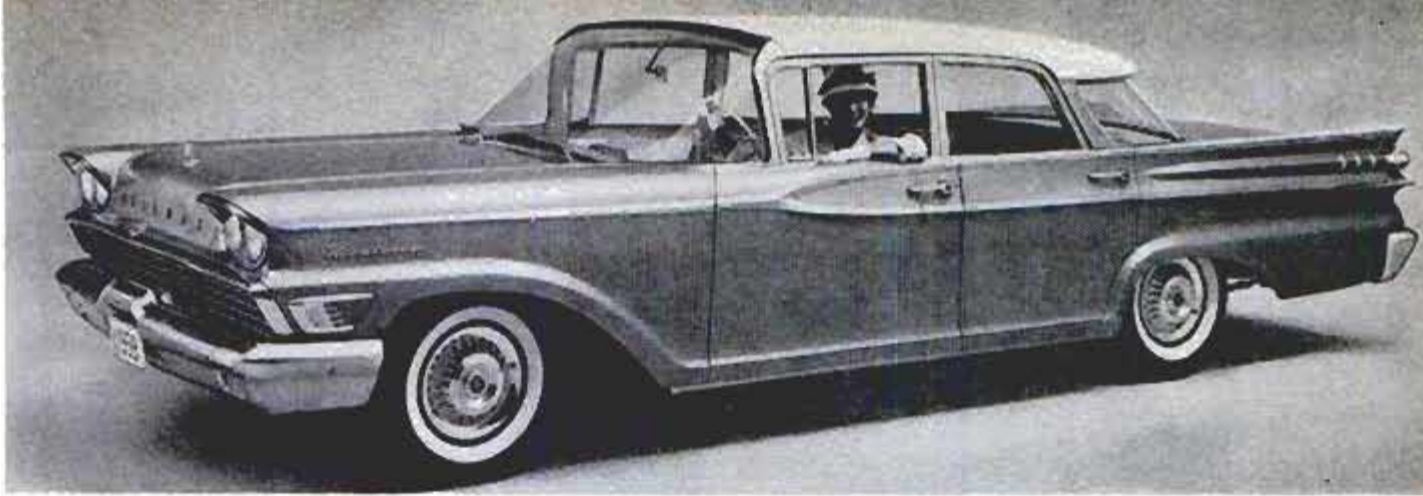

Monterey sedan has a flatter roof. Pencil-shaped "projectile" is now formed by rear-fender sheet metal

The longer frames had their "cow belly" width increased by six inches over 1958. Rebound bumpers of butyl rubber (previously natural rubber) smother the jounce without throwing the absorbed energy back, just as your fist sinks into a chunk of putty. This added damping action results in a better ride under extreme conditions.

You'll recognize these new models as Mercurys despite the all-new body shells and frames. The distinctive crisp styling theme introduced by Mercury in 1957 has been retained

Two roof styles are offered. The hardtop roof curves rearward blending smoothly into the large back window. A flatter roof on sedan models has a cantilever extension that overhangs the rear window.

By moving the dash forward and lowering the belt line of the body, stylists have added a wide-open feeling to the interior, especially for front-seat passengers. The transmission hump and rear-floor tunnel are smaller this year, increasing the passenger room and comfort. There's more room for the feet in the back seat, too, as the sill is four inches narrower providing increased flat area within the step-down cavity. Entrance room is improved by the four-inch-longer front doors on sedan models.

Windshields wrap upward into the roof and now have 60 percent more glass than before.

Mercury's projectile theme is retained on the rear quarter panels and, in fact, is enhanced by the sheet-metal sculpturing.

The new parallel-wipe blades (which operate in unison, left to right), clear a continuous area, leaving no unwiped central triangle to block vision. Electric wipers are standard.

Mufflers are aluminized inside

and zinc-plated outside to double expected life. Tailpipes are of heavier gauge steel.

Engines come in the following displacements: 312 cubic inches, 383 cubic inches and 430 cubic inches. The 383 engine can be ordered with an economy two-barrel carburetor. An economy automatic transmission (a two-speed design) is optional.

Push-button control of the automatic transmission has been discontinued. Power steering has reduced load and its pump is integral on the two big engines. ★ ★ ★



Spare mounts forward to increase handy-to-get-at trunk area. After all, when did you last need a spare? Below, frame cross-member over rear axle is curved heavy-gauge sheet metal instead of box girder. It is lighter, stronger, requires less height

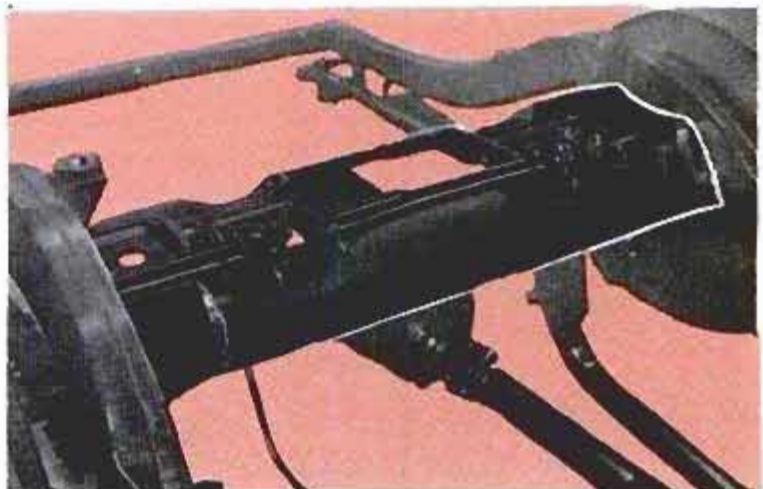



B-52 Skims Tree Tops in Low-Level Flight Experiments

Maneuvering a half-acre of airplane below tree-top level at a speed of 600 miles per hour was part of a recent test for B-52 jet bombers. The flights were made along

the Oregon and Washington coasts to test the efficiency of equipment designed originally for high-altitude use. At times the crew flew at altitudes below 200 feet.



"Birdcage" Home For Fire Lookout

Lightning, porcupines and ants have caused forest fire lookouts in Idaho to abandon their wooden towers and build steel ones. Ants and porcupines attacked the wood, which was unsafe during storms.

Waterproof Radio

Even after 15 hours of immersion in salt water a lightweight two-way radio will broadcast signals up to 100 miles. It's designed for air-sea rescue work. Spring-return switches on the side can be worked by a downed flier wearing heavy gloves.

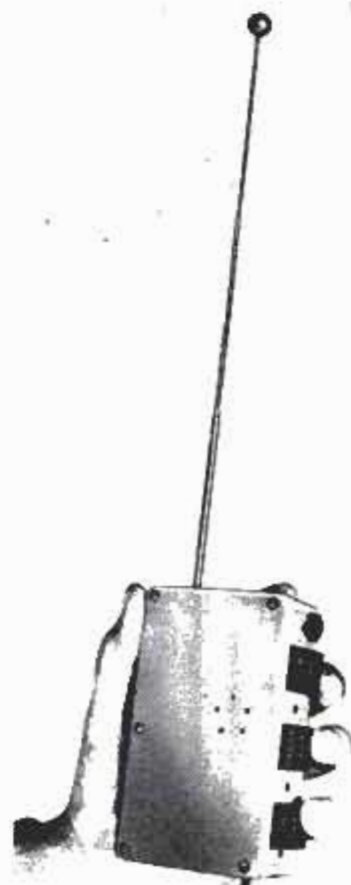

NUCLEAR ROCKET ENGINE GETS FIRST TESTS

CAN NUCLEAR ENGINES power rockets? That question may be answered soon on the Nevada desert. There a new \$10,000,000 installation will be used to test "Kiwi," the first atomic power plant designed for rockets. It is regarded as the forerunner of nuclear spaceship motors. Kiwi will be loaded on a flatcar and pushed by radio-controlled locomotive into a test cell. There it will automatically engage plugs and leads to measuring devices. An engineer in the control building will bring the reactor up to heat and admit hydrogen, which will rush through a rocket nozzle. After the test, Kiwi will be hauled to a disassembly area.

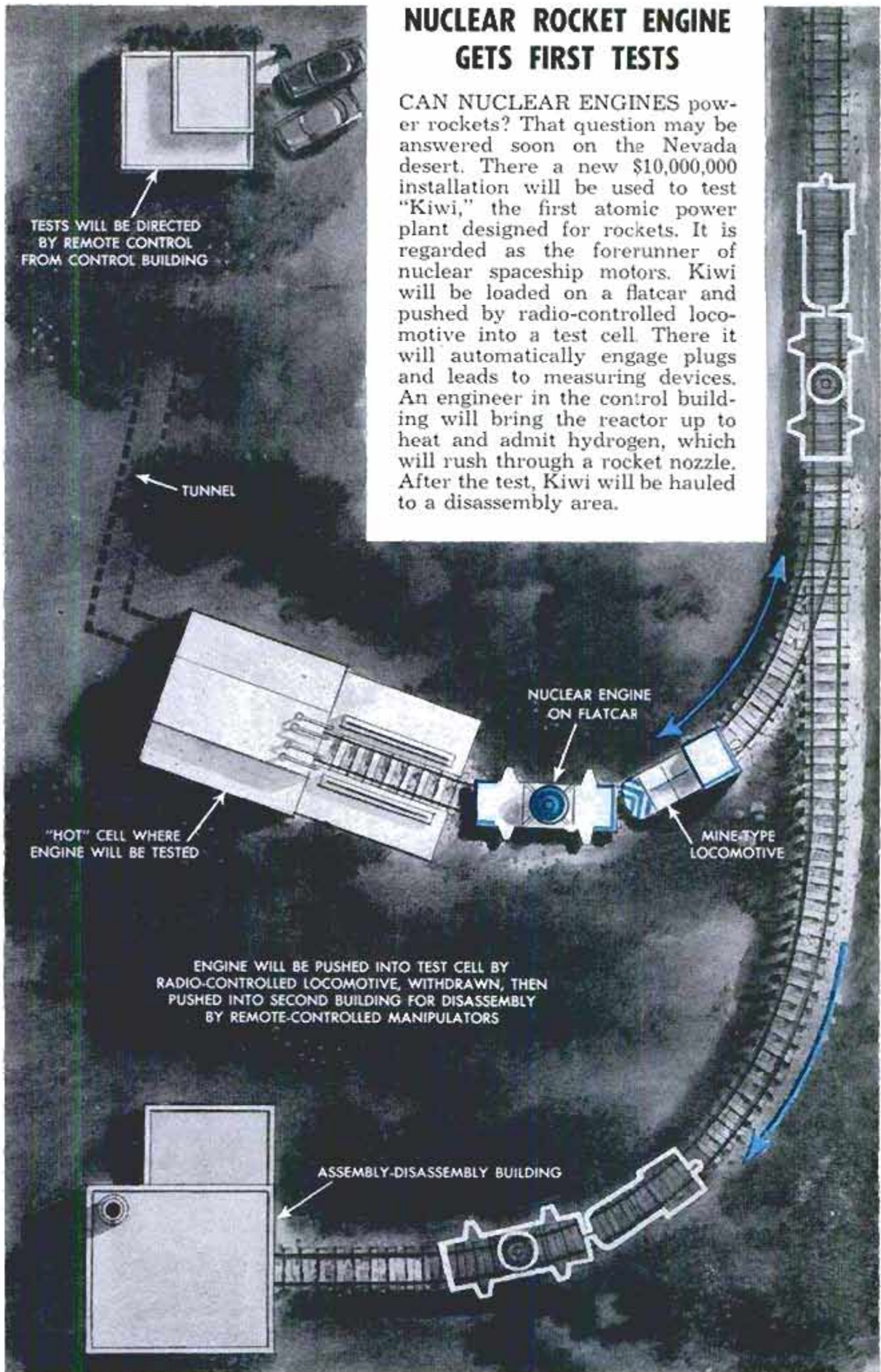



In front of the Green Gables restaurant in Phoenix, Sir Launcelot and his charger bow to arriving guests

Have Dinner in

By Robert M. Hyatt

When a party's table is ready, the puppet "king's jester" announces the news from his niche at the bar



A VISIT to Phoenix's Green Gables restaurant is like flipping the pages of Sir Walter Scott. You're transported back to legendary times, when men were stalwarts in steel plate and women were glad of it. Here, in a walled medieval castle, you are introduced to a new experience in dining, built into a million-dollar business by a man with a dream and a childhood love of fairy tales.

He is Robert E. Gosnell, who 20 years ago was a \$160-a-month bank teller. Supplementing his meager income by raising vegetables at night and selling them in front of the bank before and after working hours, he bought 12 acres of land, borrowed \$20,000 and plunged into the restaurant business.

His first cafe was a frame structure he built entirely by himself. Business was so poor in the beginning that he coaxed his aunt and her sewing-circle friends to sit around the tables and pretend that business was looking up. When it actually did, its optimistic owner started dreaming bigger dreams. A few years later his present \$300,000 "castle" was opened for business.



Dressed with meticulous accuracy, some of the cast of employees wait to welcome people to the Middle Ages

the Middle Ages

The fantasy of this beautiful eating place cannot be ignored in a city famed for its Western atmosphere. Approaching it from a mile away, you can see great torches flaming on the gateposts. When you drive through them you leave the modern world behind. Sir Launcelot, in chain mail and astride a white charger, meets you and beckons with his lance. Your car is whisked away by a lad in forest green. Trumpeters announce your arrival.

Inside, stone walls and dark-beamed ceilings make an appropriate setting for a collection of armor, crossbows, broadswords and pikes. So authentic are the interior appointments—both weapons and architecture—that art directors of the Phoenix public schools list Green Gables as one of the art tours recommended for students.

While you're enjoying a predinner cocktail, a stained-glass window opens and the "king's jester" pops out and tells you that your table is ready.

If a friend has tipped off some facts about you to the host, this puppet jester can be quite a heckler. He'll wisecrack, listen to

(Continued to page 232)

A guest gets into the Green Gables spirit by trying on a headpiece styled after the medieval fashion



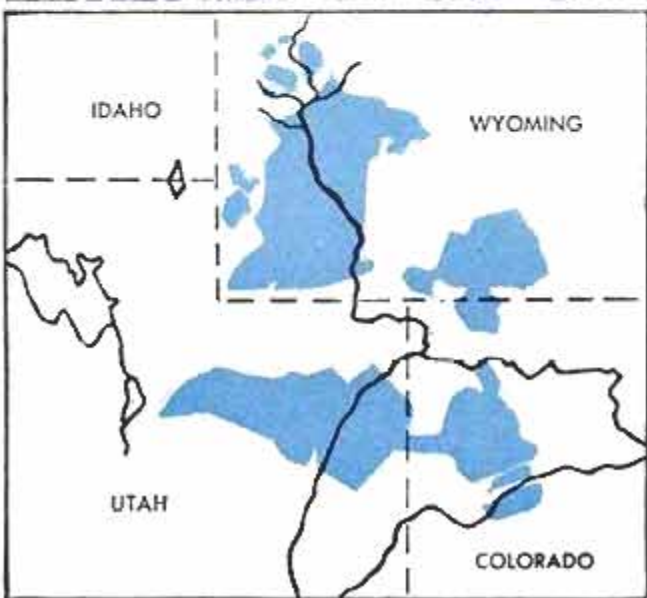

Map shows some of the larger oil-shale deposits. Oil shale has been found in at least half the states. Model below shows process in which heated metal or ceramic balls "cook" oil out of the crushed shale



Rugged terrain of northwestern Colorado has vast deposits of shale that now can be made to yield oil

Inexpensive Oil From Shale

VAST OIL-SHALE DEPOSITS can be made to yield fuel at low cost through a process developed at the Denver Research Institute. Crushed shale is heated in a retort with hot walnut-size balls made of metal or ceramic. The heat drives off the hydrocarbons locked in the shale. Colorado alone has 1.5 trillion barrels of shale oil—50 times the nation's crude-oil reserve.

Pilot plant has been operating for nine months to prove value of process for obtaining oil at low cost

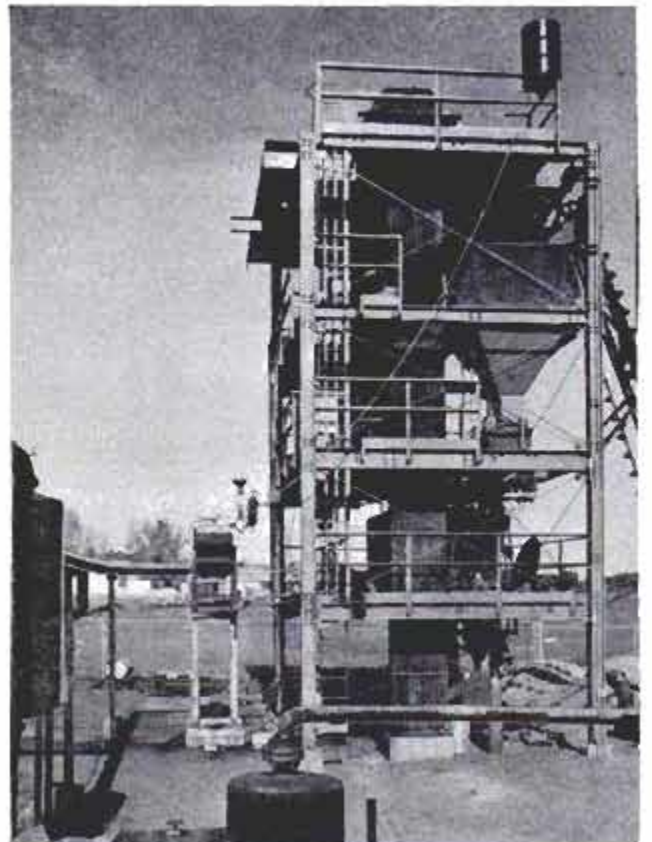
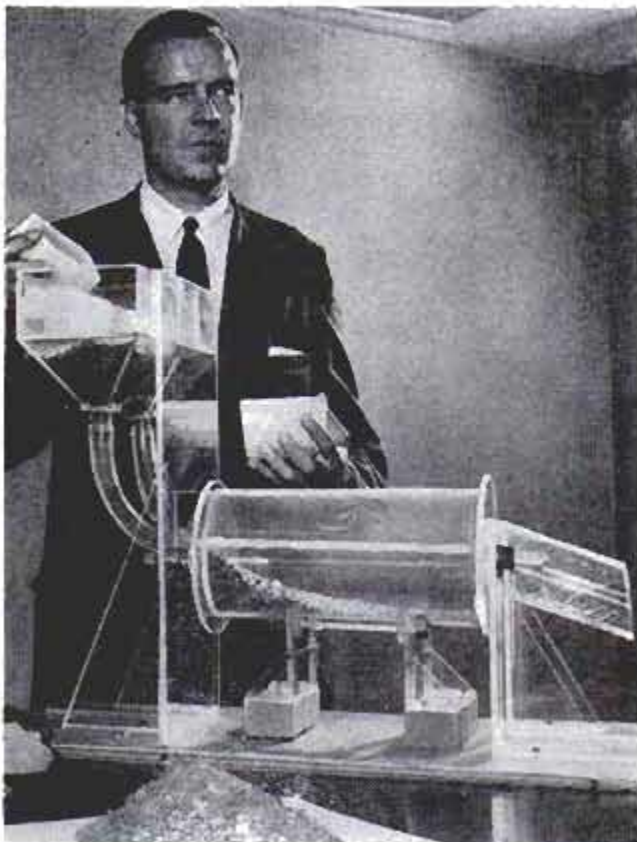

Built-in Shower Bathes Old Tree

RAIN OR SHINE, a huge redwood tree in Palo Alto, Calif., gets a twice-a-month bath from its own built-in shower. The tree, 136 feet tall, is more than 1000 years old. It was California's first living landmark, appearing on maps as early as 1776. However, it has been plagued with troubles in recent years. The historic tree is out of the fog belt, its natural range. Also, the water table has steadily dropped, it has lost limbs, and part of the top fell off. Finally the Palo Alto Park Department decided to help out the old tree. A pipe was run up the trunk and a shower head installed 10 feet above the treetop. A Jeep-mounted pump sends water up the pipe for two hours twice a month. Today the tree looks better than it has in 20 years.

Pipe runs up the ancient trunk, ending in shower head

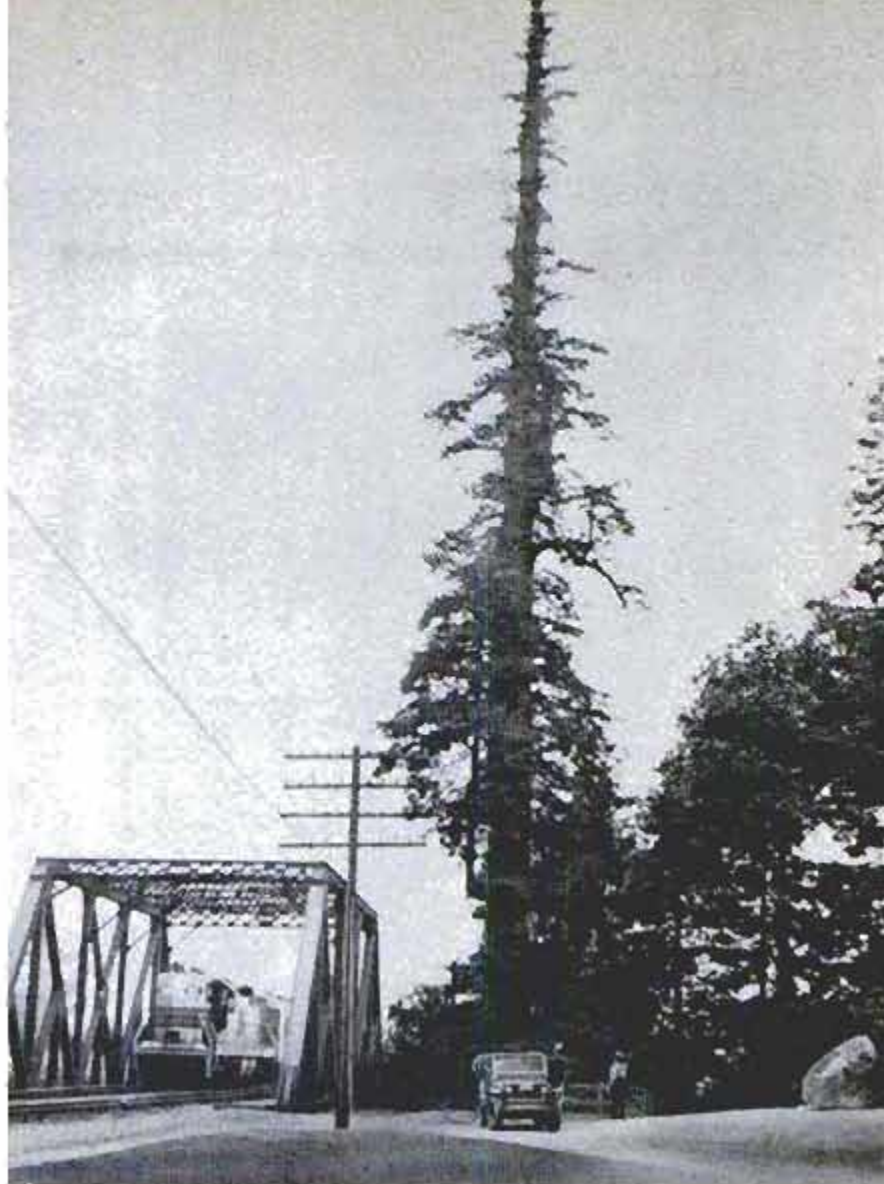

More than 1000 years old, the 136-foot tree has been a living landmark in California since 1776. A falling water table has caused recent damage.

Twice each month, a hydraulic pump mounted on a Jeep sends water up the pipe to give tree a shower bath. Special hydrant is located at base of the tree.

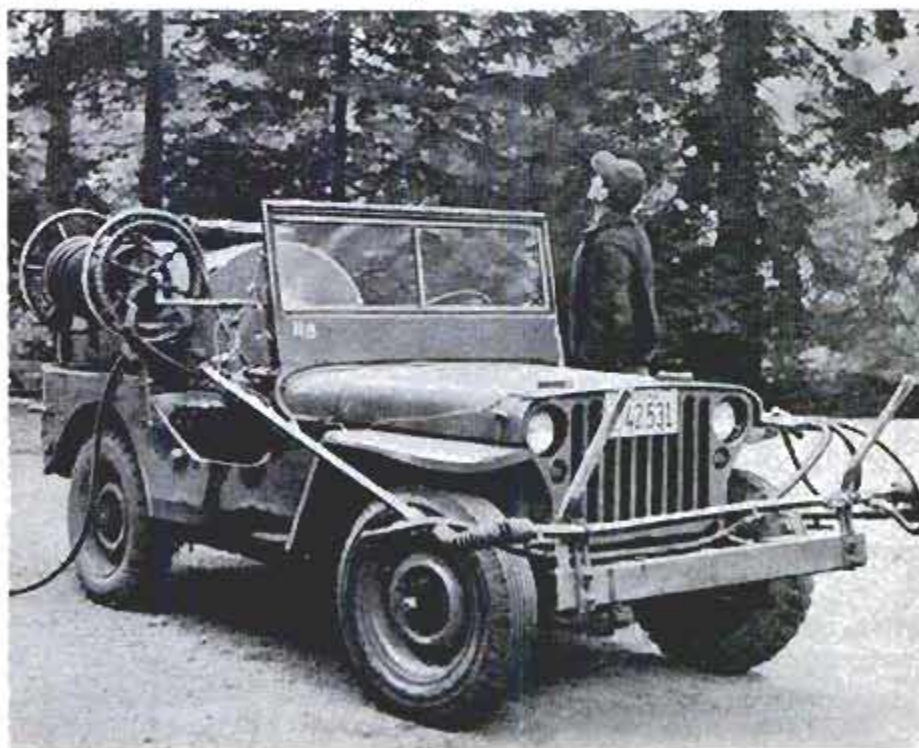



Chief Pilot Jim Holden "flies" the Vitannia-420 simulator, located in the basement of his parents' house

TEEN-AGE FLIERS—

*They Built Their Own Flight Simulator
To Tour the World in a Basement*

By Irving Petite

FIVE SEATTLE YOUTHS have about 700 hours of flying time to their combined credit, yet not one has a pilot's license.

They have "flown" to most of the world's airports, yet they have not been out of the basement of the L. E. Holden home near

the Seattle-Tacoma International Airport.

Holden is a Link Trainer instructor for United Air Lines pilots.

His son Jim, 18, is captain of a simulator that occupies a corner in the Holden basement and makes "training flights" possible. It was built by Jim with the aid of his



As chief flight engineer, Dick Grande occupies a compartment just behind pilots



At the *Vitannia's* entrance, Co-Pilot John Block, Dick Grande and Jim Holden, left to right, talk about their next "flight"

father and several classmates from Highline High School and is an exact model of an airplane cockpit with its instruments and controls.

It simulates a four-engine turboprop plane patterned after Great Britain's Vickers Vanguard.

"The boys have approximately \$100 worth of parts and materials in the simulator—together with uncounted hours of labor," said Holden.

Labor meant not only assembling the parts and instruments but also shopping for bargains at aircraft-surplus establishments. Many instruments were donated by pilots and mechanics.

Kept Cost Down

"We kept the cost down," Jim said. "We had to buy quite a few lights and switches, the windshield plastic and some plywood. But many parts were given to us and we bargained for others. We have B-24 throttles, a main panel and seats from a C-46, one panel from a Link Trainer and a panel from a PBV.

"Ernie Gunnison, a United Air Lines radioman, hooked up the radio microphones for us," Jim said. An airlines electrician installed vibrators, which approximate engine sounds at various speeds.

Accuracy in Procedure

After observing a flight in the simulator, a pilot said, "It is revealing to watch the accuracy with which they go through all procedures—filing a flight plan, pretake-off check, clearance with the control tower and so on through the entire flight."

The simulator had its beginnings eight

years ago when Jim Holden was 10. It began as a bomber mockup, later rebuilt as a DC-4 transport simulator.

Log Flights for Two Years

Frank Martin, who now lives in Hong Kong, where his father is a dispatcher for Pan American World Airways, helped build the simulator. They kept a log of flights for their *global* airline for two years, then the present crew rebuilt the simulator as a Vickers Vanguard.

The present crew, captain Jim Holden, copilots John Block and Randy Schmoyer, chief flight engineer Dick Grande and chief navigator Doug Downs, all plan to become pilots except for Grande, who wants to be a dispatcher.

The fliers named their simulator *Vitannia-420* because it combines Vanguard's features with a few from the Bristol Britannia.

It's Serious Business

Flying the *Vitannia-420* is a serious undertaking. "We know the importance of close attention to detail," Jim said. "We had one near accident when we ran out of fuel between Los Angeles and San Francisco. Our copilot took us on a heading of 31° instead of 310°. We made a safe emergency landing but it was a good warning to us."

The young men all know how to use computers and air charts.

They get in actual flying time, too. Jim plans to get his private pilot's license soon. Both he and Dick Grande have done glider flying with the Air Scouts, and Jim has considerable time as student in a light plane. ★ ★ ★



Simulator is a detailed replica of the DC-8 jetliner cockpit, with identical instruments and flight controls

Jet Pilots "Fly" in Simulator

Without ever leaving the ground, a jet pilot now can make a complete "flight." A jet-aircraft simulator, used by United Air Lines to train pilots, can duplicate real flights. The pilot sits in a cockpit identical

Pilot views a projected image of a runway on a TV screen. Picture changes as he maneuvers simulator

to that of the new DC-8 jetliner. As he "flies" the plane, he views the terrain and runways on a closed-circuit-TV screen. The picture in front of him changes in the way he maneuvers the simulator.

Huge relief map is scanned by television camera, which moves in response to the pilot's controls





Lightweight Oxygen Set Carried on Shoulder

Hospital patients can now carry oxygen around on their shoulders. A portable set weighs just three pounds two ounces, and is easy to operate by hand. Its self-sealing cylinder can be changed quickly by unscrewing the control head.

Filter Quiets Exhausts

Air exhausts can be silenced by fitting a tiny noise filter to discharge ports or piping. Suitable for motors, vacuum pumps or pneumatic brakes, the silencer breaks up the shock waves as compressed air is exhausted into the atmosphere.

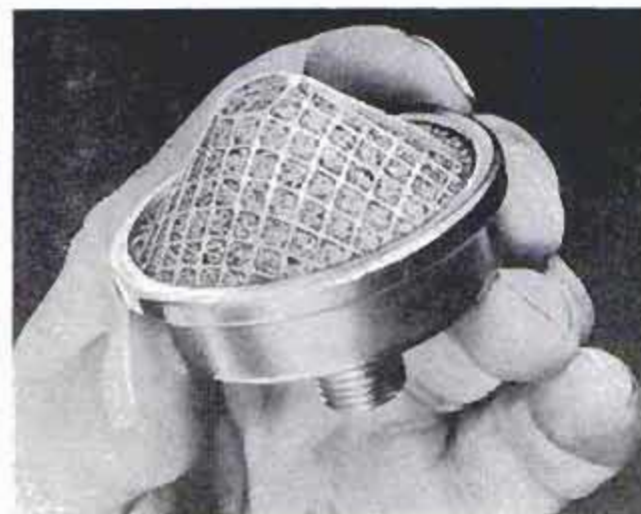

DECEMBER 1958



Underwater Spotlight Pressurized for 250 Feet

Safe underwater illumination is possible with a spotlight whose unified battery and case has been pressurized so it can function to depths of 250 feet. The battery power pack is leakproof and the unit has double-chrome protection of all metal parts.

Branding Iron for Tools

Brand your initials in your tools and sports equipment. A personalized branding iron contains Gothic letters $\frac{3}{8}$ inch high. They are custom cast in solid bronze. The iron's head is heated over a flame, then pressed into the material to be marked.

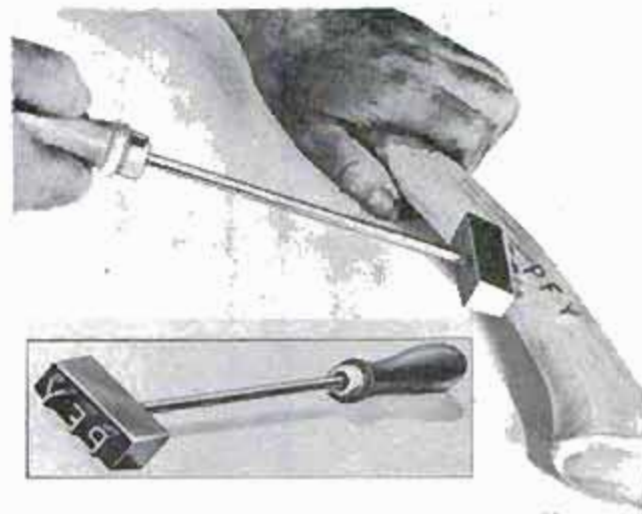

119



When frost threatens, mobile flame thrower ignites heaters scattered over 50 acres of California orchard

The Battle of the Orchards—

Hailstorms are controlled by small generators which consume coke impregnated with silver-iodide particles



FARMER FIGHTS FROST

By F. Leland Elam

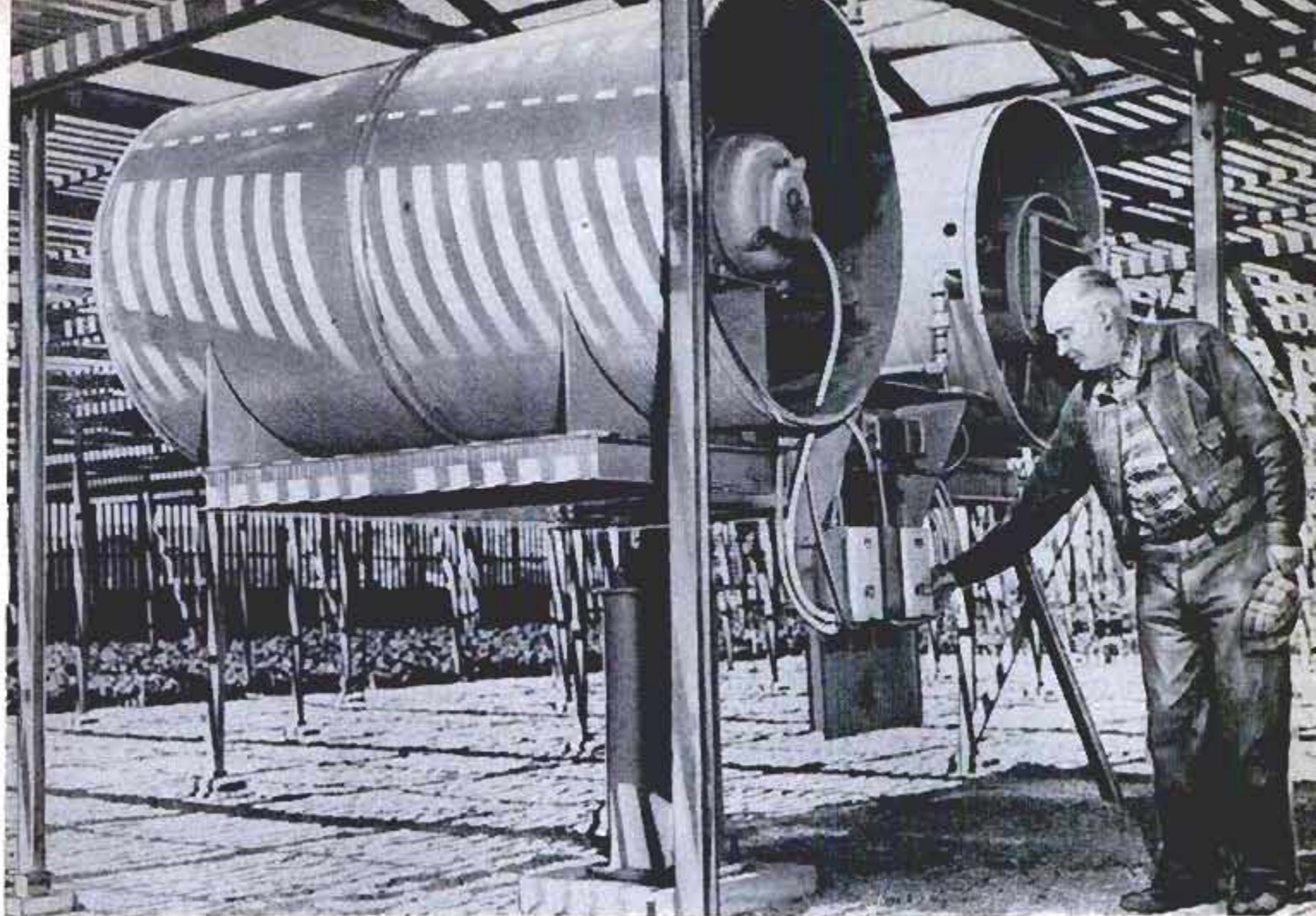

The two heat tunnels, above, have fans that force warm air in opposite directions as unit rotates slowly

THERE'S A WAY to do it better—find it!" That was the philosophy that drove Thomas A. Edison toward immortality. That same philosophy is driving the farmer, assisted by inventive men, in his desire to find the best ways to control the weather so it will not cause billions of dollars in damage annually to crops.

Farmers have fought the destruction created by freezing temperatures since man began to learn about the weather. For decades they have had to rely on dirty oil-

burning smudge pots, burning automobile tires and, more recently, wind machines on towers designed to move warm air from above the orchard to the freezing areas at ground level.

Science has opened up new frontiers. Now giant machines spew out hot air in massive quantities and whip it across the crops to raise the temperature to a safe level. Hailstones are destroyed before they can damage fruit, by ground generators and airplanes that send silver iodide into

Similar to the heat-tunnel unit at the top of the page is this "heatmobile" that protects 20-acre orchard

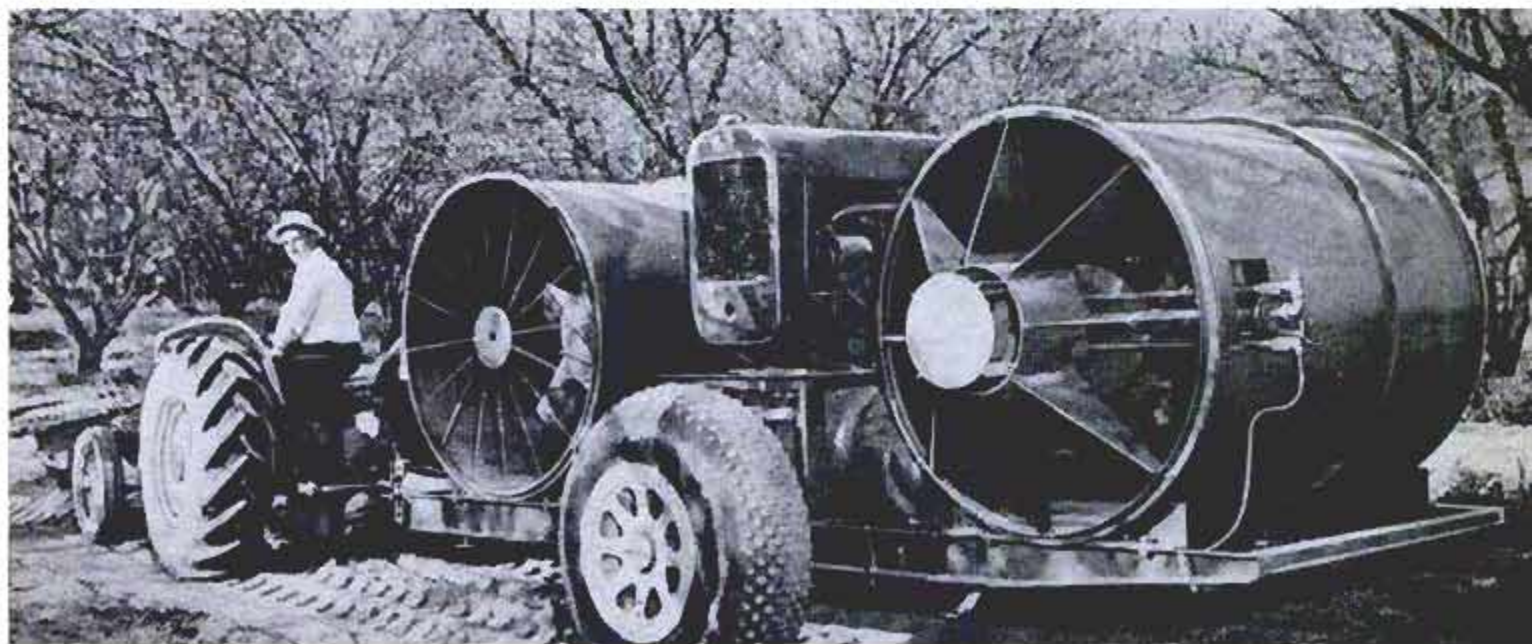

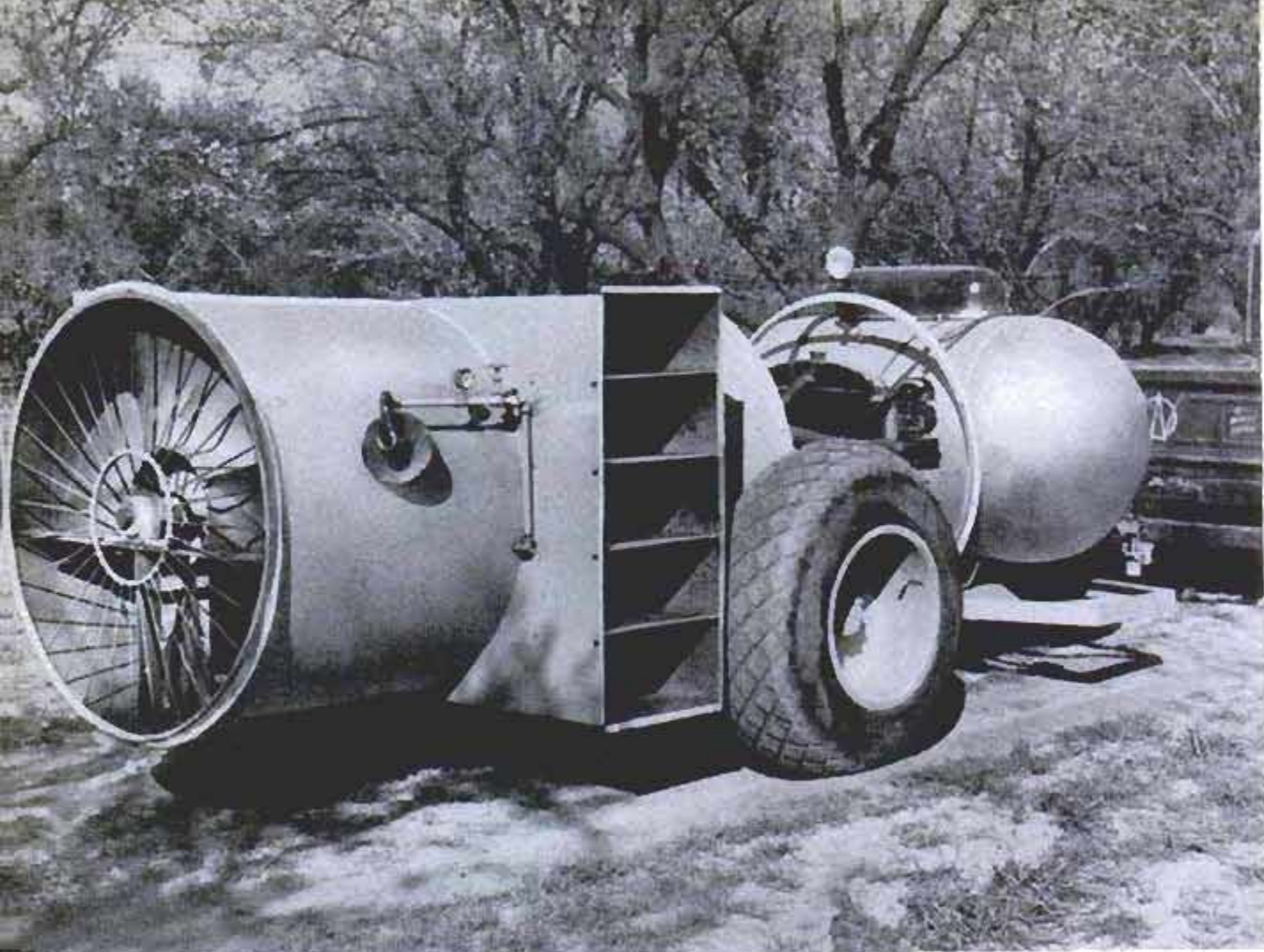

Another model of mobile heater burns butane, has fan vents on both sides, airplane tires for soft ground

Smudge pot with fan reduces smoke, uses fuel more efficiently. Fan blows toward burner in the bucket



the clouds. Helicopters whip the rainwater off ripening fruit so it will not crack when the sun comes out.

Frost is probably the most destructive. It hits fast in the middle of the night over wide areas and its destruction can be total. Hail can be as damaging but its destruction is generally localized.

One of the newest machines for frost control is a portable "heatmobile," developed by M. R. Robinson of San Martin, Calif. It is pulled through orchards or fields by Jeep or tractor. It consists of two butane-burning furnaces and two four-bladed fans, set in four-foot-high tunnels at each end of the trailer. A 75-horsepower industrial engine between them develops the necessary power. The fans face in opposing directions to distribute air from both sides of the trailer, pushing out four million B.T.U.s in a per-minute volume of 160,000 cubic feet of air. They protect up to a distance of 400 feet.

When the temperature drops close to 32 degrees, normally around two a.m., the farmer climbs out of bed, lights the heaters, starts the engine, and drives into the dark orchard to continue for about five hours a course designed to give maximum protection to every tree.

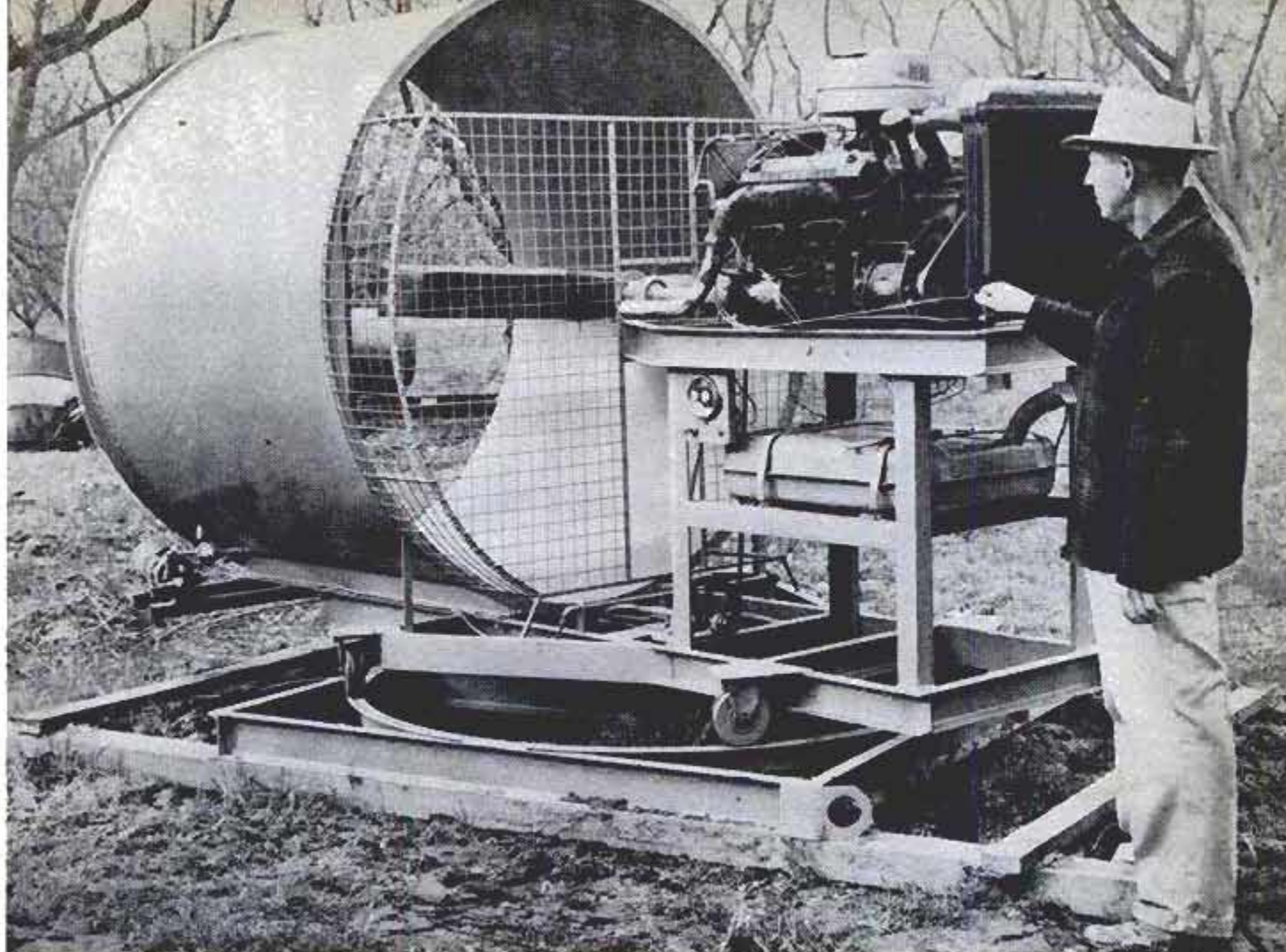

This air distributor rotates on a steel track as heat is forced over 10-acre area. Unit is towed on skids

"The rate of travel brings the outfit to the same point every seven minutes when traveling at four miles per hour," Robinson explains. "It will hold the temperature in the orchard at three to four degrees above freezing."

In most important fruit and row-crop growing areas the weather bureau, working with cooperating farmers, has a frost-warning system that makes possible detailed broadcasts by radio and television, advising what frost conditions can be expected.

In an area to be serviced by such forecasts temperature and dew-point stations are set up on strategic ranches. The farmer learns how to read the instruments, record the findings and phone them to the weather bureau each day at 4:30 p.m. After this information is diagnosed and coordinated, the frost-warning expert can predict what the temperature and dew-point condition will be in the area around each station.

To eliminate the all-night vigil, the farmer places thermometers at strategic points and connects them to a warning bell which awakens him when the temperature drops close to 32 degrees.

If, like Rodney Vertrees of Wheatland,

Calif., the orchardist has some frost-control device that does not have to be towed, he can start it working, then keep an eye on it from the warmth of his house.

Vertrees has developed a heated-air distributor that is mounted on skids and can be towed to an operational site. It revolves on a steel track once every five minutes to send the hot-air flow to every corner of the 10 acres that it is capable of protecting.

A steel tunnel directs the air developed from a 72-inch prop, originally designed

(Continued to page 226)

Latest method of cloud seeding employs silver-iodide fuzees which are ignited by controls in cockpit

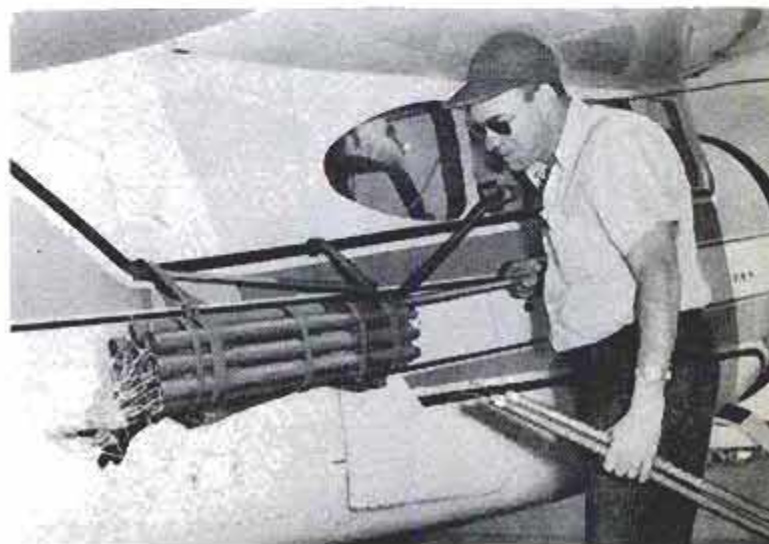



Modular Units Enclose Porch

ABOUT TWO THIRDS of the work involved in framing and installing porch-enclosure windows can be saved by using prefabricated components. Framing of the porch in the photograph below was completed in one morning with window-and-wall components. The windows are glued and nailed to the framing members at the factory. The modular units are tilted up, one by one, nailed to the floor and to the header. The units also are joined together by corrugated fasteners on the inside and nailing on the outside.



Big Wind Tunnel Tests Jet's Wiper

Manmade rainstorms with velocities up to 200 miles per hour were generated in a wind tunnel to test a windshield-wiping system designed for the Air Force's new F-105 fighter-bombers. The system washes extremely hot air of 300 to 700 degrees Fahrenheit over the front of the cockpit canopy, literally drying the rain before it reaches the windshield. The hot air is drawn from the jet's huge engine and is fanned over the canopy by a specially designed duct-and-nozzle arrangement.



Hybrid Car Body

Attracting a lot of attention around Wethersfield, England, is a "custom" car body synthesized by a U.S. Air Force officer. Beginning with a Ford Anglia chassis, Lt. Col. Edward Risher added a cut-down Chevrolet hood, the rear windshield from an American Ford and Austin Bantam wheels. As a final touch, Col. Risher used two wing tanks from a T-33 jet trainer.



Jet Tests De-icer By Making Own Ice

To test the de-icer on Boeing's 707 jet airliner, a Venetian-blind-type water-spraying system was attached to the plane's No. 3 engine. The system's 109 nozzles shot water directly at the engine, and ice formed quickly on the cowling. The de-icing system was turned on after the ice had reached a thickness of one quarter inch. The ice disappeared in less than half a minute.

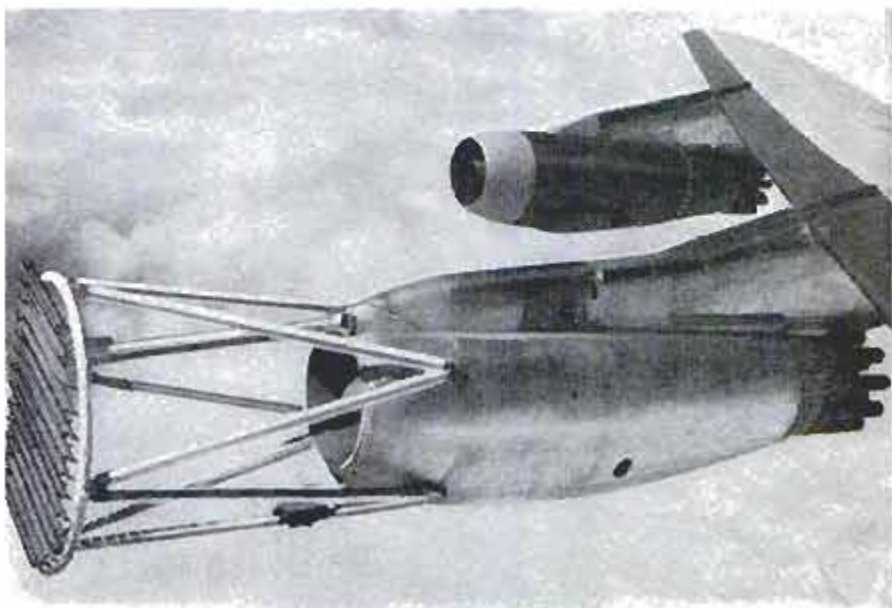



WHAT'S NEW FOR Your Home



TOLL CALL COMPUTER tells you how much those incoming and outgoing long-distance telephone calls are costing. You simply select the base rate—for three minutes—by turning the rate wheel, then set the timer for the full 15 minutes. An arrow in the rate bar points to the mounting charges while you talk
B. C. Moses, 5134 Mercer Ave., P.O. Box 6352, Houston 5, Tex.



GAS HEATER, upper left, is mounted in wall or window. It uses no air or oxygen in room itself, drawing air from outside. Products of gas combustion are power-vented outdoors. Unit has temperature control and two blowers—one for circulating heat, one for carrying outside air into combustion chamber
Suburban Appliance Co., P.O. Box 206, Whippany, N. J.



ELECTRIC KNIFE SHARPENER, left center, hones blade at 7200 strokes per minute. Precision guides insure sharpening at correct angle. Operating on 115-volt, 50-60-cycle alternating current, the device is held by hand and can sharpen knives of all sizes. It has ivory plastic case and russet vinyl panels
Burgess Vibrocrafters, Inc., Graylake, Ill.

KITCHEN BROILER provides outdoor charcoal-type meat and fowl preparation inside house. Meat or fowl is held between vertical racks. Food broils on both sides simultaneously and automatically, sealing in juices and flavor. Shrinkage is cut down. Taste is similar to that of meat or fowl broiled over coals
Norge News Bureau, Merchandise Mart Plaza, Chicago 54.

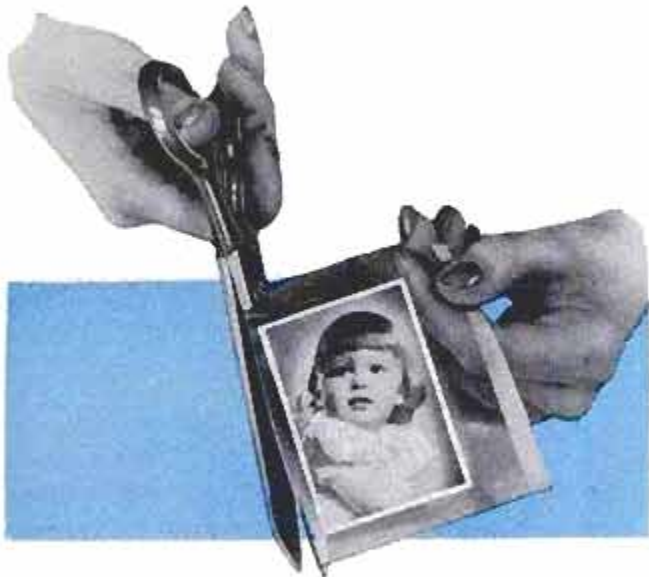

ACETATE PLASTIC COVERS for protecting photos and cards against soiling and tearing can be made from do-it-yourself kits. Back of photo or card is pressed onto sheet of acetate coated with sensitive adhesive. Uncoated acetate is placed over face of card or photo, then is trimmed to size with scissors.

~~Gelanox Corp. of America, 180 Madison Ave., New York City 16.~~

*American Klear-Vue Plastics Inc.
Maspeth, New York*

ELECTRIC DRYER, upper right, takes no more space than a medicine cabinet and accommodates items often laundered in bathroom. It uses a 325-watt heating unit and four-inch suction fan. Hot air is drawn through cabinet and goes out louvers at bottom of door. Dryer can serve as auxiliary heater.

Louver Mfg. Co., 3601 Wooddale Ave., Minneapolis 16, Minn.



CORDLESS TIME SWITCH, right, remembers for you and makes all electrical household appliances automatic. It can be plugged into outlets over kitchen counter and workbench, or behind furniture and appliances. Portable switch has electrical rating of 120 volts and 60 cycles and a 24-hour time range.

Paragon Electric Co., Two Rivers, Wis.

METALLIC TRIM TAPE can be easily applied to shelves, ashtrays, telephones, refrigerators, automobiles, etc. Flexible as ribbon, this self-adhering tape can be cut with scissors. It is applied with slight pressure after removal of protective backing. Tape retains luster and will not tarnish, fade or rust.

Marglo, Inc., New Britain, Conn.



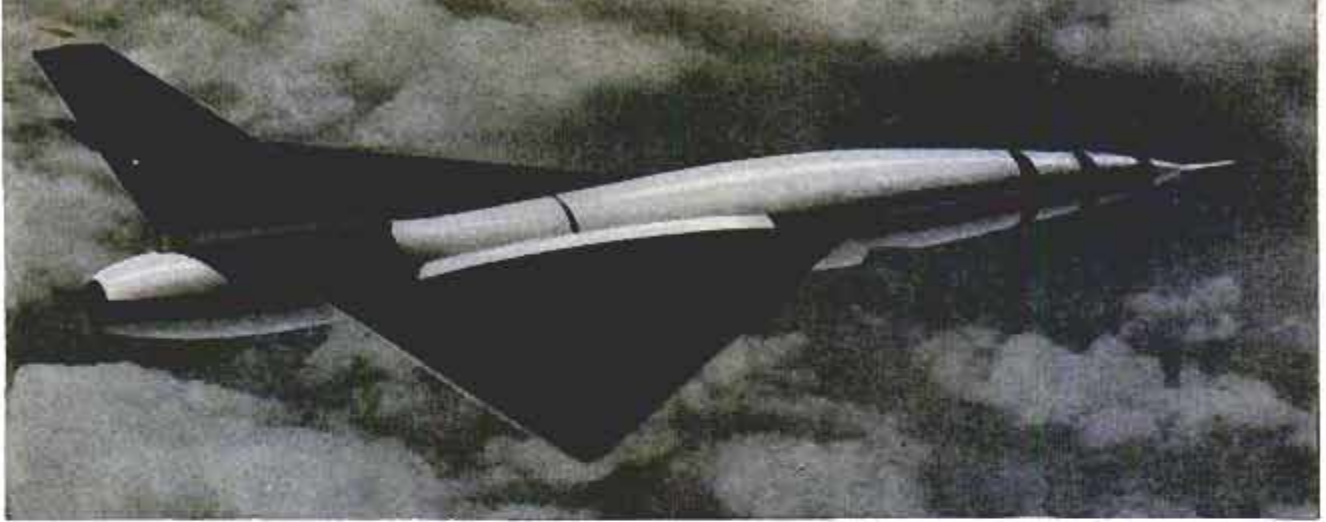

Air Force Tests Air-Breathing "Goose" Missile

One of the air-breathing missiles being added to the Air Force arsenal is called the Goose. Although its performance data and specifications remain classified, the

Goose was photographed recently on a test flight at Cape Canaveral, Fla. The Fairchild Aircraft Division is the prime contractor for the long-range missile weapon.

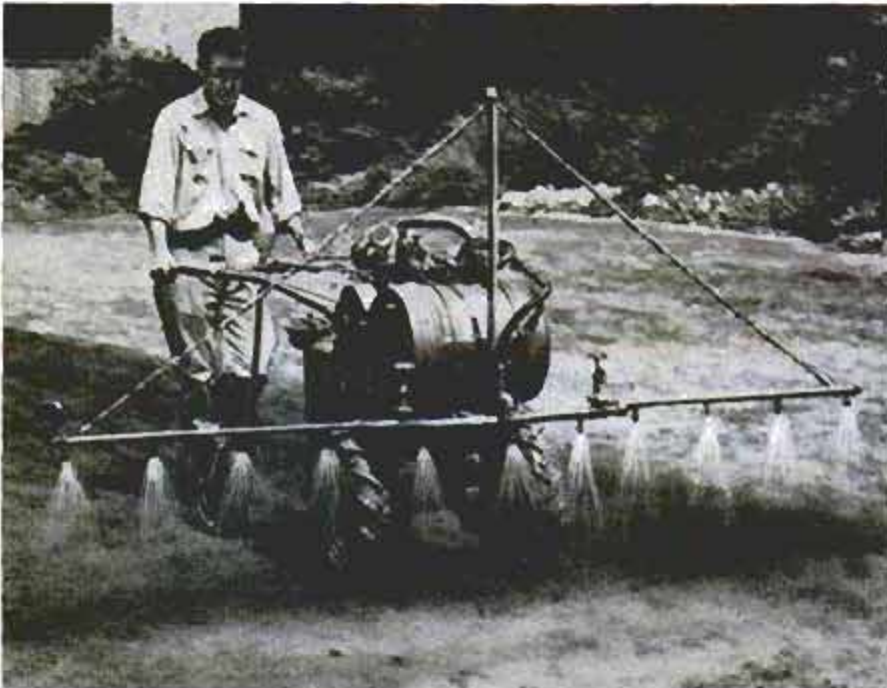

Green Spray Tints Lawn

Homeowners who have been plagued by lawn grasses that turn brown in late summer can restore the natural color with a green tint. The tint is sold as a concentrate that is mixed with water and sprayed on the discolored areas. It dries in 15 minutes and does not rub off or track. The turf coloring does not damage shrubbery, trees, bordering plants or growing grass, according to the manufacturer. It does not harm children or pets.



Farm-Size Dryer Saves Wet Crops

Artificial drying can save farm crops during a wet harvest season or allow early harvesting in a normal season, while field losses are low. A portable batch-type blending dryer now available for farms produces four million B.T.U.s of heat per hour to remove excess moisture from shelled corn, sorghum, soybeans, wheat, barley and oats. The unit has a 34-inch fan.

CENTIPEDE HOUSE

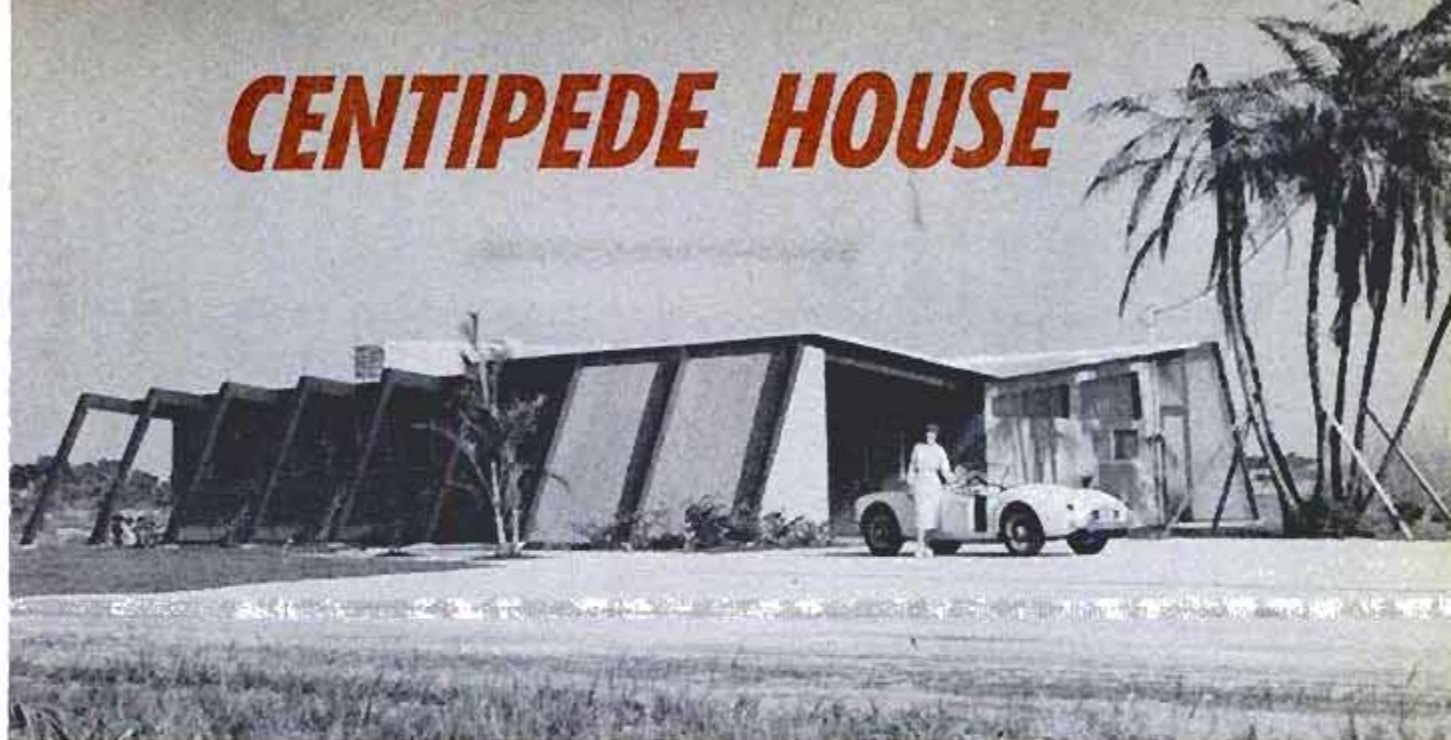

Like the legs of a centipede, outriggers support roof of this unique house perched beside a Florida lagoon

By Max Hunn

FORTY-FIVE MINUTES of sketching in the wee hours of the morning led architect Nelson A. Faerber, of Naples, Fla., to develop a house design with a unique exterior and an interior tailored for informal semitropical living.

Few who see the one-bedroom, two-bath

house in the Vanderbilt Beach section of this Florida community can resist coining their own name for the residence. It has been called the "Centipede House," "Butterfly Mansion," "Lazy M," and "Spider"—each somewhat descriptive of the unusual design. The house appears to be

Glass walls made of nine-foot sliding panels, and the screened area beyond create indoor-outdoor effect





Screened outriggers across length of house provide an outdoor-living area 11 feet wide and 64 feet long

crouching on its many "legs" at the edge of a picturesque lagoon.

The design, however, is not for show but for practical reasons. The lot Mr. and Mrs. Percy Rheume, of Detroit, Mich., purchased for their winter-retreat home, had unusual dimensions: 68 feet fronting on the lagoon, 140 feet across the back, 120 feet on one side and 144 feet on the other. Basically, they desired a place for informal,

Multiuse area with adjoining second bath also can serve as guest room. There are few interior partitions

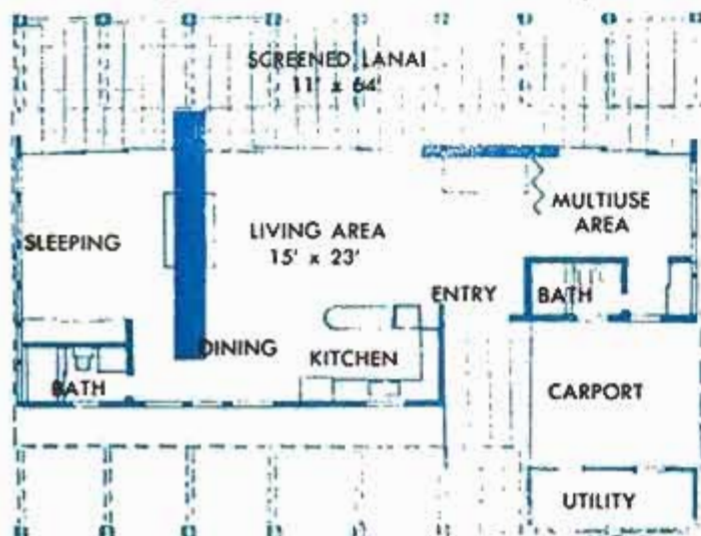

semitropical living, where they could retreat from the pressures and routine of a large city. This to architect Faerber meant lots of lounging space and maximum utilization of indoor-outdoor living areas.

Architect Faerber worked out a simple open-plan design, permitting a vast expanse of glass wall facing the lagoon. This necessitated a design which would eliminate the usual need for exterior walls bearing the weight of the roof.

Outriggers—which create the centipede appearance of the exterior—solved the problem. By suspending the center beams from 18 outriggers, he eliminated any necessity for the walls bearing the roof load. The outriggers, first prefabricated on the site and then tilted into place, are two two-by-eights with a six-inch wood block between. The roof beams and the supporting outriggers are spaced eight feet apart.

One entire side of the house is enclosed with sliding glass walls, except for two stone areas—one a background for an indoor planter at the entry, and the other a wall between the sleeping area and the rest of the house. This wall has a two-way fireplace opening into both bedroom and living areas, as well as an outdoor barbecue grill.



Breakfast bar adjoins the compact and modern kitchen area which is handy to the informal-dining section

There are 435 square feet of one-quarter-inch plate glass in the nine-foot-tall panels which are mounted in aluminum frames and are on rollers. The glass walls can be moved to provide the maximum circulation of air. This entire side of the house is screened on the outriggers, providing an outdoor-living area 11 by 64 feet.

Exterior and interior wood paneling is of red cypress, making a pleasing contrast with the rough Tennessee crab-orchard stone. Ceiling beams are exposed. Everything about this house is planned to create an atmosphere of luxurious and informal living. Although the house, which cost less than \$25,000 exclusive of the lot, landscaping and architect's fees, is considered a one-bedroom residence, a 10 by 16-foot multipurpose area may be closed off to serve as a guest room. The second bathroom is adjacent to this area.

Architect Faerber used the butterfly-roof style in

order to achieve the maximum height on the nonload-bearing exterior walls. Although designed for a warm climate, the house plan can be utilized wherever a picturesque view is available and informal living desired. Of course, double-thickness, insulating glass would be used if the house were built in a northern climate.

Faerber says he conceived the basic form for this unusual house design in 45 minutes. However, he was uncertain of his

Outriggers are enclosed beside carport to form utility room. This view also shows windows of bath and multiuse area, plus big porch





Interior wall of stone (only major wall in the house) divides living and sleeping areas and has a two-way fireplace which also opens into master bedroom. Glass wall at the right overlooks a picturesque lagoon

Outriggers shown at the back—or is it the front?—of the house are made of two by eights and support entire weight of the roof. Exterior walls here are to kitchen and dining area



clients' reaction to the unconventional approach. When they came into his office, he jokingly told them: "I've finished your design," and showed them several rough pencil sketches.

The Rheumes studied the sketches briefly, and asked: "When can the drawings be completed and construction started?"

At first, Faerber thought his ears were playing tricks on him; then he realized that his clients had a full appreciation of contemporary architecture.

"I'll rush the drawings," he promised them, "and you'll be living in the house before the snow flies in Detroit. Sure you don't want to make any changes?"

"No changes," said the Rheumes.

The house was finished 120 days later.

Faerber is convinced that in architecture, as well as in the other arts, the simplest and most logical solution to a design problem frequently turns out to be the best—even if it is a bit on the revolutionary side. ★ ★ ★

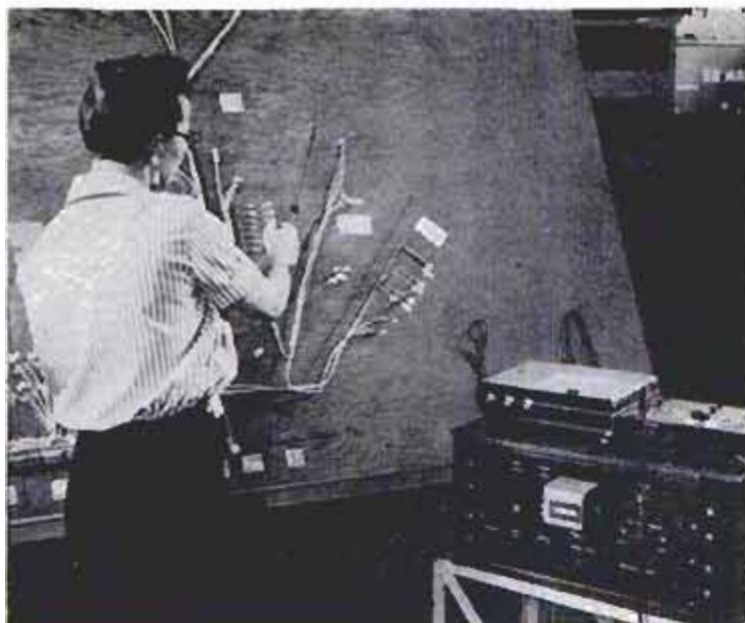

Tape-Recorded Instructions Replace Assembly Diagrams

Complicated electrical-assembly work can be performed by employees without printed instructions. The step-by-step instructions are recorded on magnetic tape

and transmitted to the employee through a hearing-aid type instrument. The woman at left is wearing one of the tiny earphones. The engineer is recording instructions.

Coach Lantern Replica Helps Greet Season

Something different in the way of Christmas lighting is a replica of an Old English coach lantern. It's 15 inches high and contains an electric lamp designed like a red candle. Use it indoors or out.



Miniature Missile Transporter Equipped With 13-Inch Rocket

Spaceminded youngsters can bring a little of the Cape Canaveral atmosphere into the home with a miniature guided-missile carrier. The carrier is a replica of the vehicles used to deliver missiles to launching pads, according to the Toy Guidance Council. It comes with a 13-inch "missile."



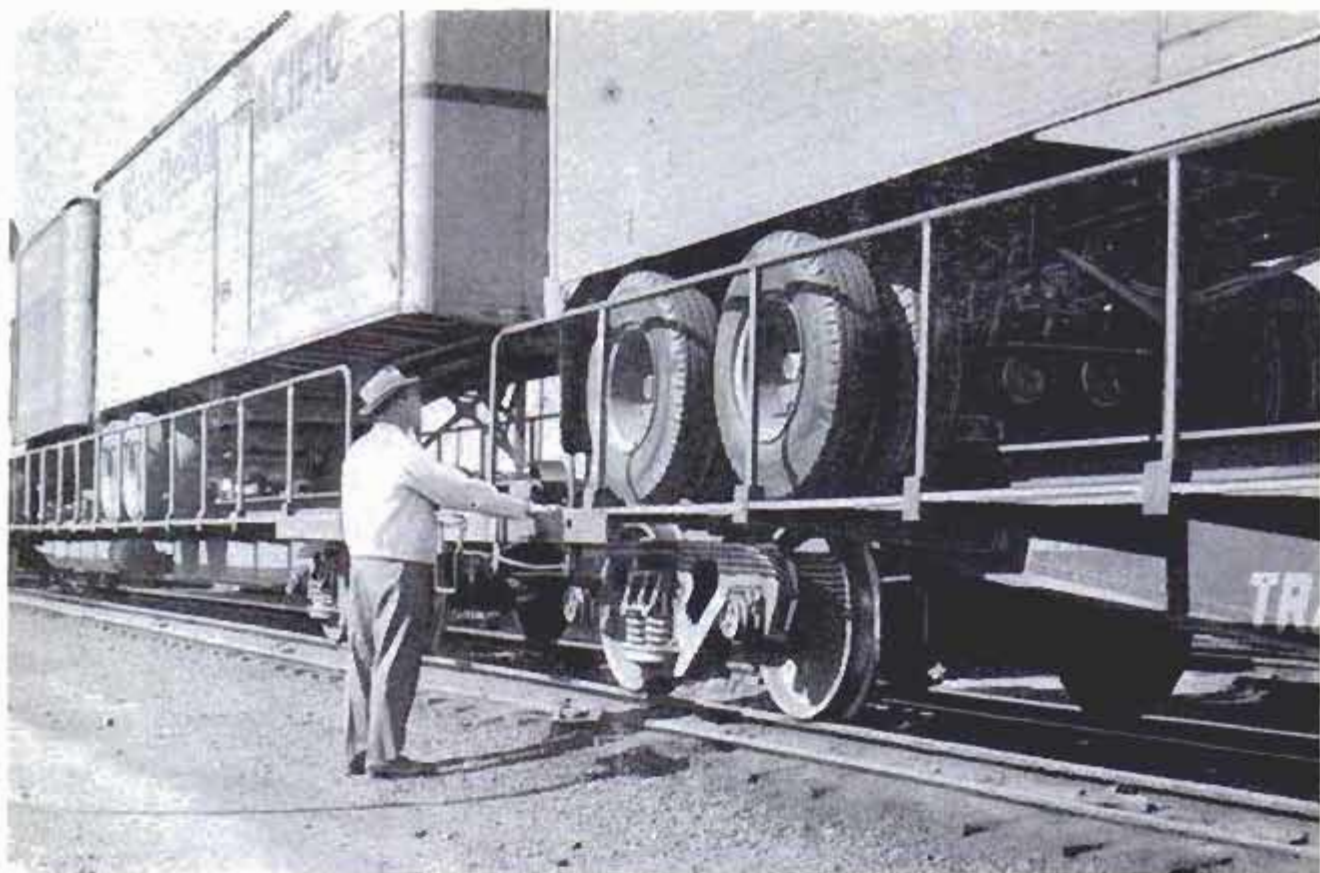

In Roseville, Calif., flatcars with backbones of "I" beams get checked before long haul to Los Angeles

By
Leo Rosenhouse

Piggyback Trailers

RIDING THE WESTERN rails on the piggyback freight circuit are flatcars with a new look: They are light, long, and specially designed for "trailer on flatcar" service. What sets these new piggyback cars apart from other flatcars is their distinctive "backbone"—a pair of parallel I-beams that serve as rails on which trailers ride, using their own flanged dolly wheels. The process is considered revolutionary by railroad men.

The new piggyback flatcars were developed from a French design and are now becoming familiar along the San Francisco-Los Angeles route of the Southern Pacific Coast line. This large railroad system now has 150 of the new piggybacks in operation, making it the largest fleet of its kind in the West.

When the first piggyback cars made their appearance a few years ago, it was the intention of the railroads to take truck trailers to destination points on flatcars to escape highway congestion. The program worked so well that the larger railway sys-

tems quickly adopted these unusual cars.

The Southern Pacific constructed a pilot model of the new piggyback flatcar at its Sacramento, Calif., shops in March, 1957. A successful tryout led to the construction

Auxiliary bars on piggyback platform enable trailers to be guided over centering device seen between bars



POPULAR MECHANICS

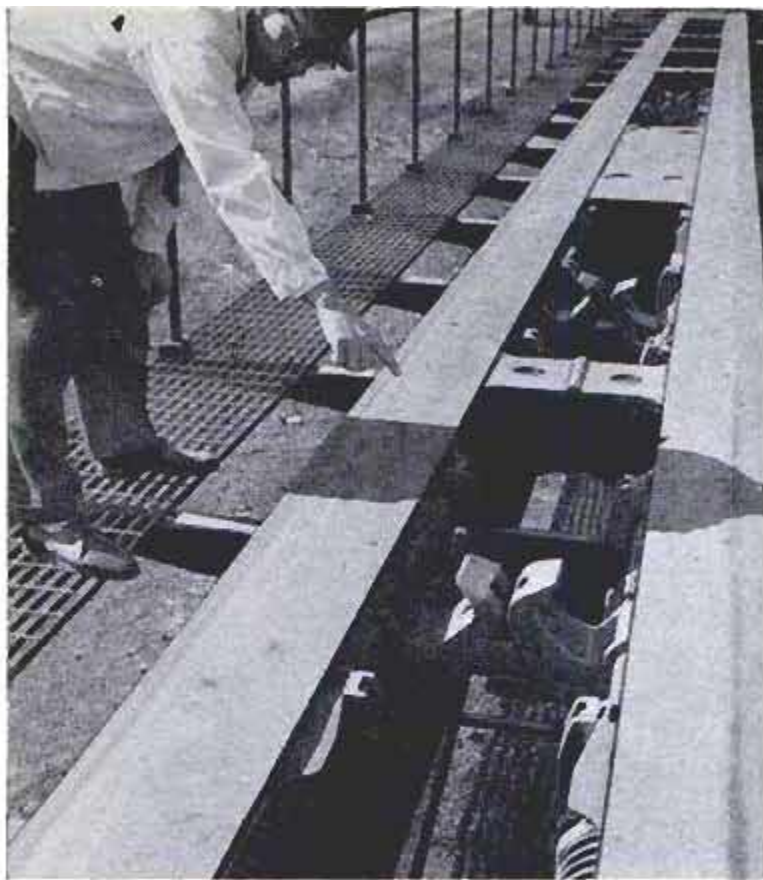

Clamps inside parallel "I" beams grip framework of trailers

Ride I-Beams

of its large piggyback fleet just a short three months later.

"Essentially, the new car is just a set of I-beams—or rails—forming the frame and wheels," explains W. G. Peoples, Southern

Trailer rides flatcar rails on small metal flanged wheels mounted inside trailer's rubber-tired wheels

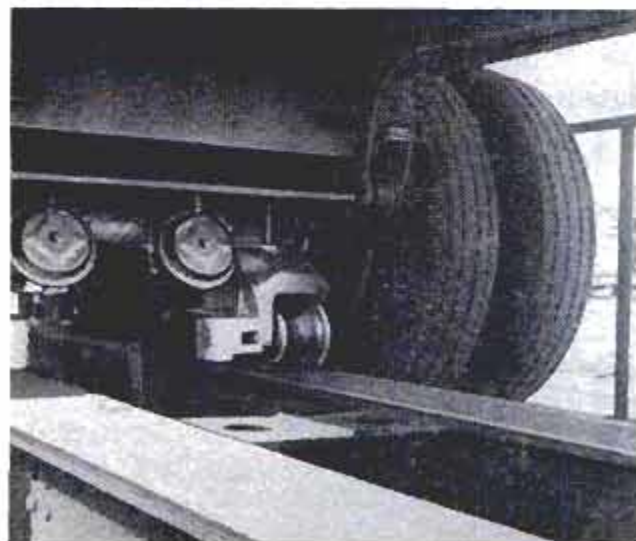

Pacific vice-president in charge of freight traffic. "It is longer, lighter and easier to load, and it only takes one minute to tie down a trailer. That compares to six minutes with conventional flatcars."

Designers have given the piggyback flatcars a streamlined appearance and in so doing have virtually done a form-fitting job for the railroads. The cars are 18,000 pounds lighter than present flatcars and are 79½ feet in length, making them 26 feet longer than the typical flatcar.

Standard cars can carry one 35-foot highway trailer, or two 24-footers," Peoples says. "The new cars are built for two 35-foot or three 24-foot trailers."

To load a trailer from road to rail, the trailer is driven to a loading ramp, where a tractor unit backs it over an automatic centering device. The trailer then rides down the piggyback flatcar on small metal wheels mounted on the inside of the rubber-tired wheels of the trailer. The tractor, which is part of the hauling unit, has the same wheel construction.

The trailer is carefully guided down the center I-beam by these wheels of metal that are flanged to keep them from leaving the I-beam. The rubber tires of the trailer do not touch the flatcar. Each trailer is made secure to the piggyback car by a hand-operated clamp

that grips the trailers' dolly wheel assembly rigidly against the I-beam. Shock to the trailer is minimized by shock-absorbing units incorporated in the piggyback flatcars. ★ ★ ★

"I" beams run length of car. Platform walk is of webbed steel and rails are lightweight construction

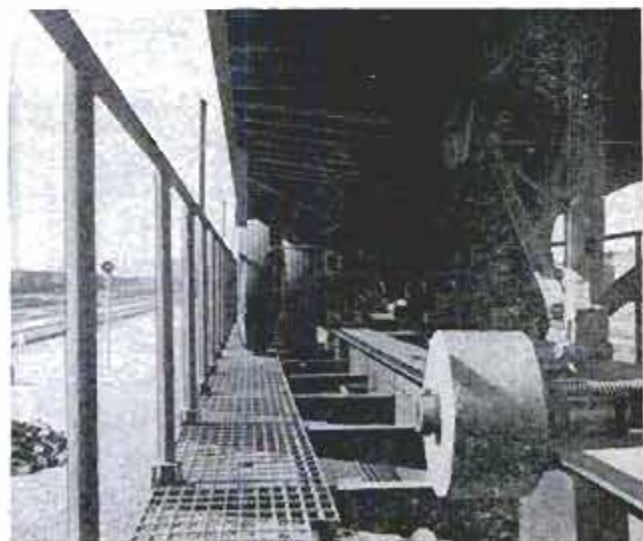



Partially unloaded, the big wheel starts to go up. A minimum of 70 kilowatts is needed to operate unit

Wheel is anchored to the trucks that haul it. Made almost entirely of aluminum, the wheel will handle a 12,800-pound load



Huge Ferris Wheel Goes up in Six Hours

TALK ABOUT portability! One of the world's largest Ferris wheels can be unpacked and set up, ready for business, in less than six hours. In the same length of time it can be dismantled and packed into four semitrailers.

Actually two wheels in one, the unit towers 90 feet from the ground to the highest seat pivot. It can handle 96 passengers at one time and has a total capacity of about 20,000 people a day.

Except for the steel axles and seats, the Ferris wheel is made entirely of aluminum. More than half a mile of green and gold fluorescent tubes decorate it.

The Ferris wheel has been tested with a 400-pound load in each seat, and handled the 12,800-pound total load with ease. The rig is so designed that no stakes or guy wires are fastened to the ground. Supporting cables are attached to three trucks, and the unit itself is anchored to three trailers.

Want to buy such a Ferris wheel? This one cost \$225,000.

Quick-Inflating Raft Has Boarding Deck

Pull the lanyard of a new life raft, and 30 seconds later the raft will be fully inflated, including a special boarding platform. The raft, made by U.S. Rubber, is designed for yachts and commercial vessels. It folds into a carrying case measuring three feet long and weighing 130 pounds. When the case is tossed into the water, a tug on the lanyard starts the inflation. Complete inflation takes 30 seconds, but the raft can be boarded via the special platform within 15 seconds. A canopy gives protection from heat and cold. The raft carries 10 persons.

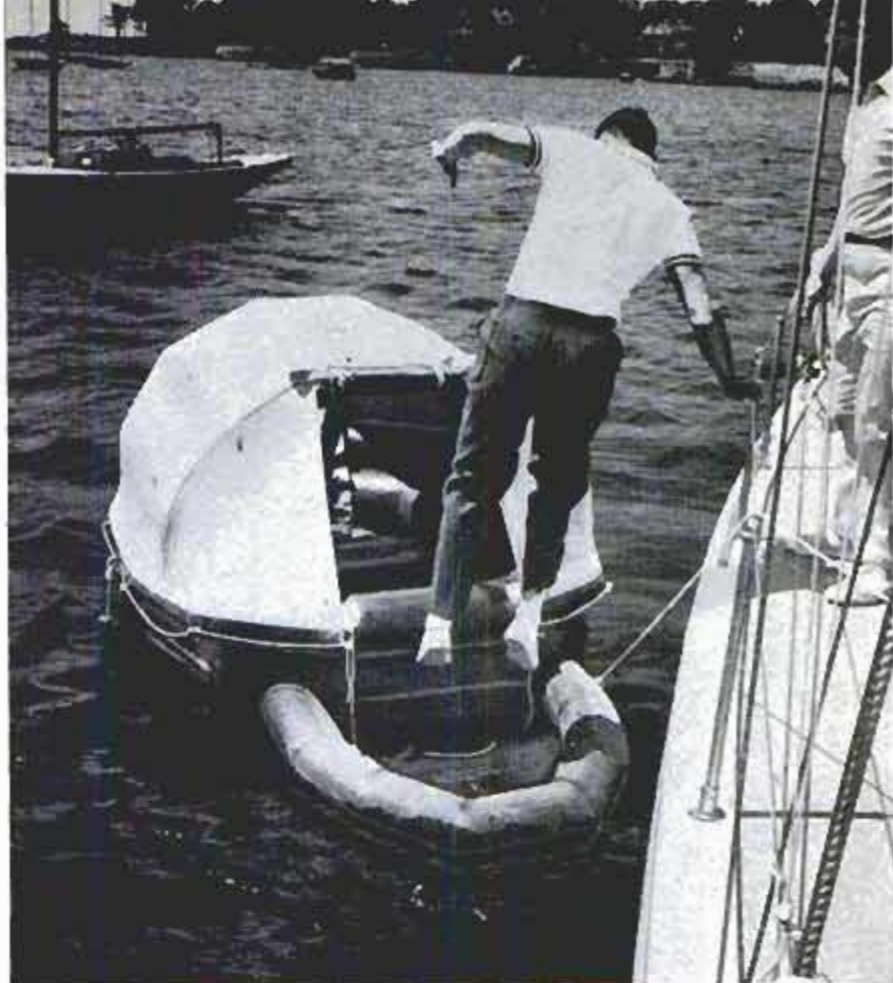

This Organ Has Cardboard Pipes

Organ pipes made of cardboard? Yes—rolled cardboard. The builder of the instrument followed plans devised by the renowned 18th century Italian organ maker, Casparini. The 20th century organ maker is a musical medic from Singen, Germany, and his patients refer to him as "The Singing Doctor."



Lamp Flashes 120 Times a Second

Because it makes 120 brief flashes each second, a new pulsed xenon arc lamp developed by General Electric can be used for stop-motion photographs. However, it was designed primarily for the printing and lithographing industries. Each flash is so brief the lamp actually is off more than it is on, but the light appears continuous.

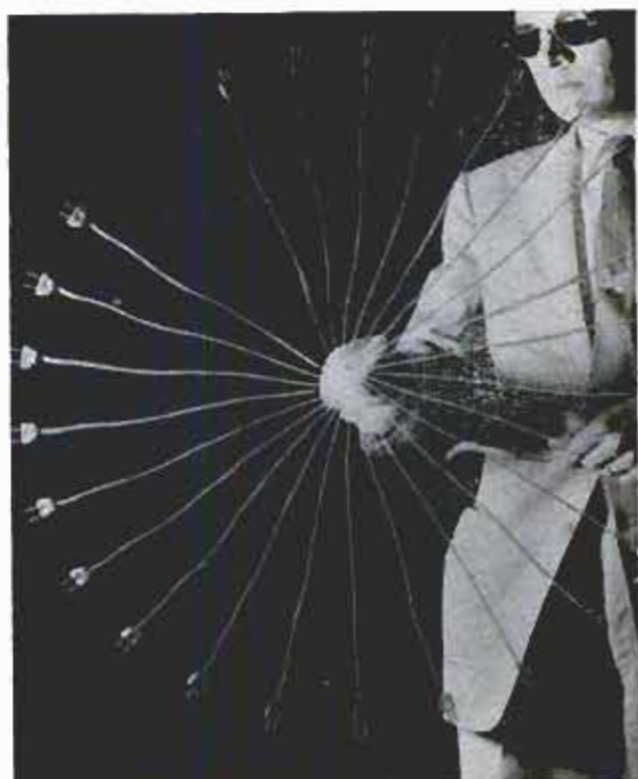

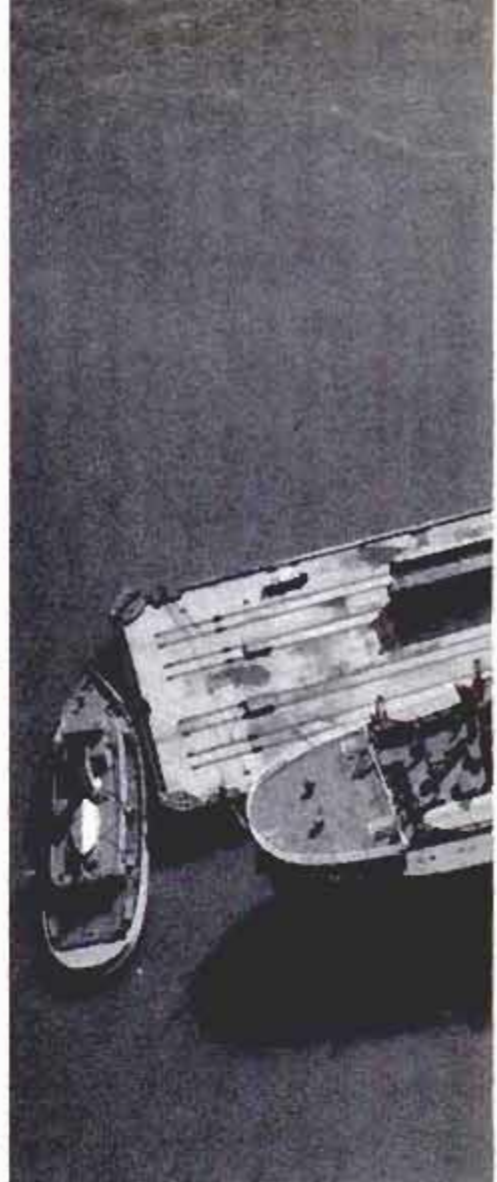
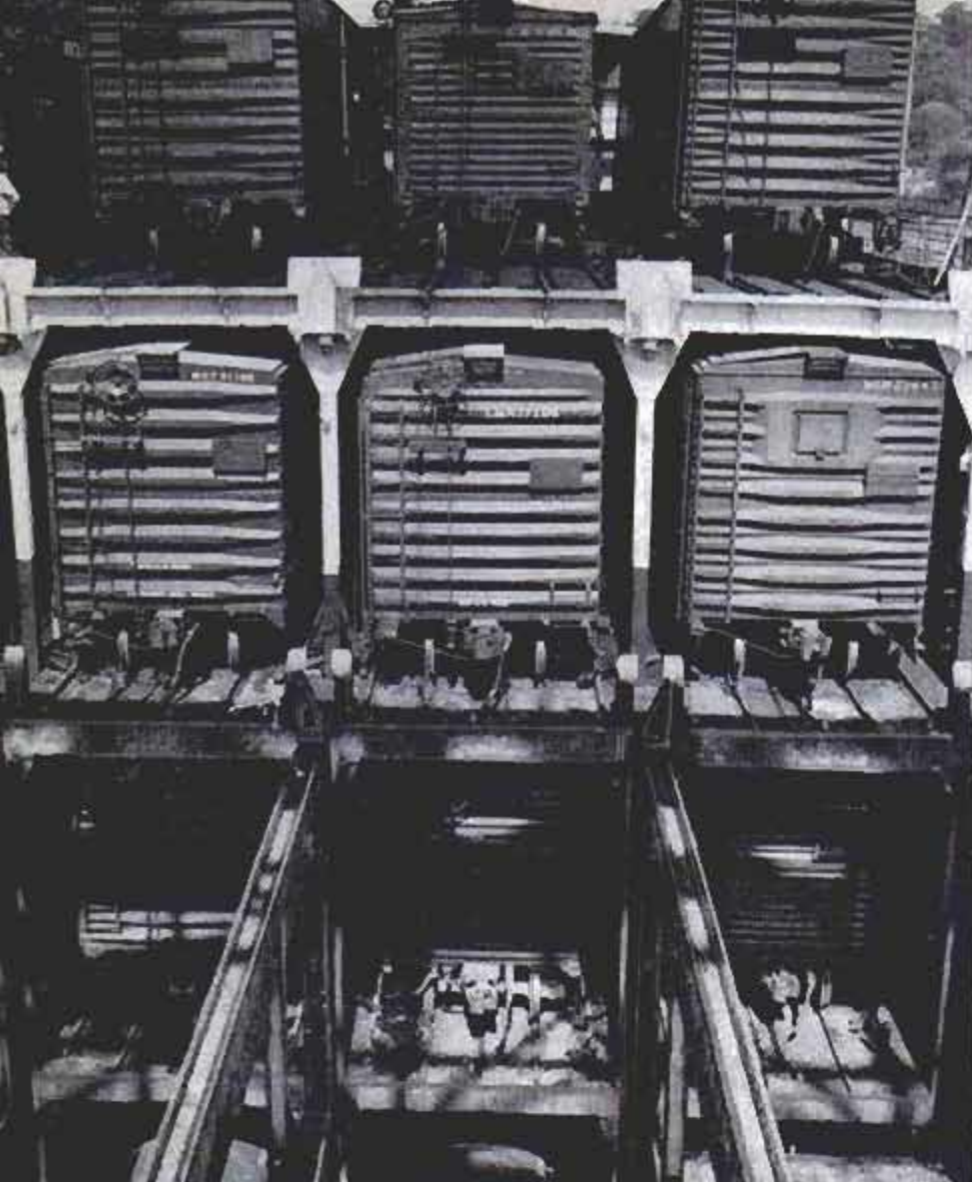

Cross-section of the *Seatrain* hatchway shows three of the ship's four decks filled with freight cars

Reprinted
"PM Highlights"

Strange Ships

By Capt. W. D. Brinckloe, USN

IN JUNE, 1942, the mechanized columns of Field Marshal Rommel's crack Afrika Corps ambushed the British Eighth Army in the Libyan Desert, smashing the greatest part of Montgomery's armor which stood between the Desert Fox and the road to Cairo. A month later a German U-boat caught a relief convoy south of Bermuda and ripped open the vitals of the freighters carrying the precious replacement tanks. Into the breach, with Rommel massing for the final drive and time running out, was thrust the seagoing train carrier SS *Seatrain Texas*. Her cavernous belly was crammed with tanks scraped by emergency Presidential order from American arsenals. Speed was her only protection against enemy wolf-packs. The coastwise car ship, built two years earlier to carry freight cars between New York and Texas, finished a harrowing 35-day trip around the Cape of Good Hope to Suez in time to throw her priceless cargo into a winning flight before El Alamein and become the heroine of the day.

LIFTING CRADLE FITS INTO RECESS IN PIER TO ALLOW CARS TO BE ROLLED ON AND OFF

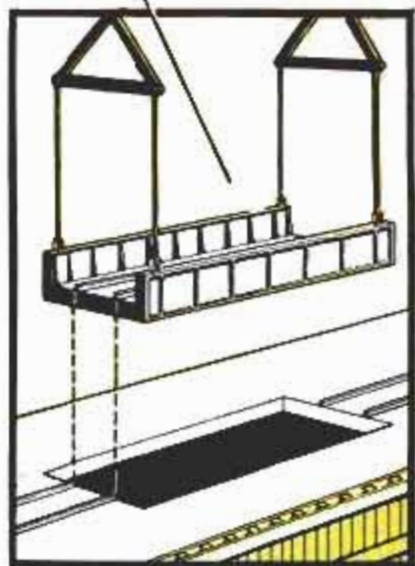

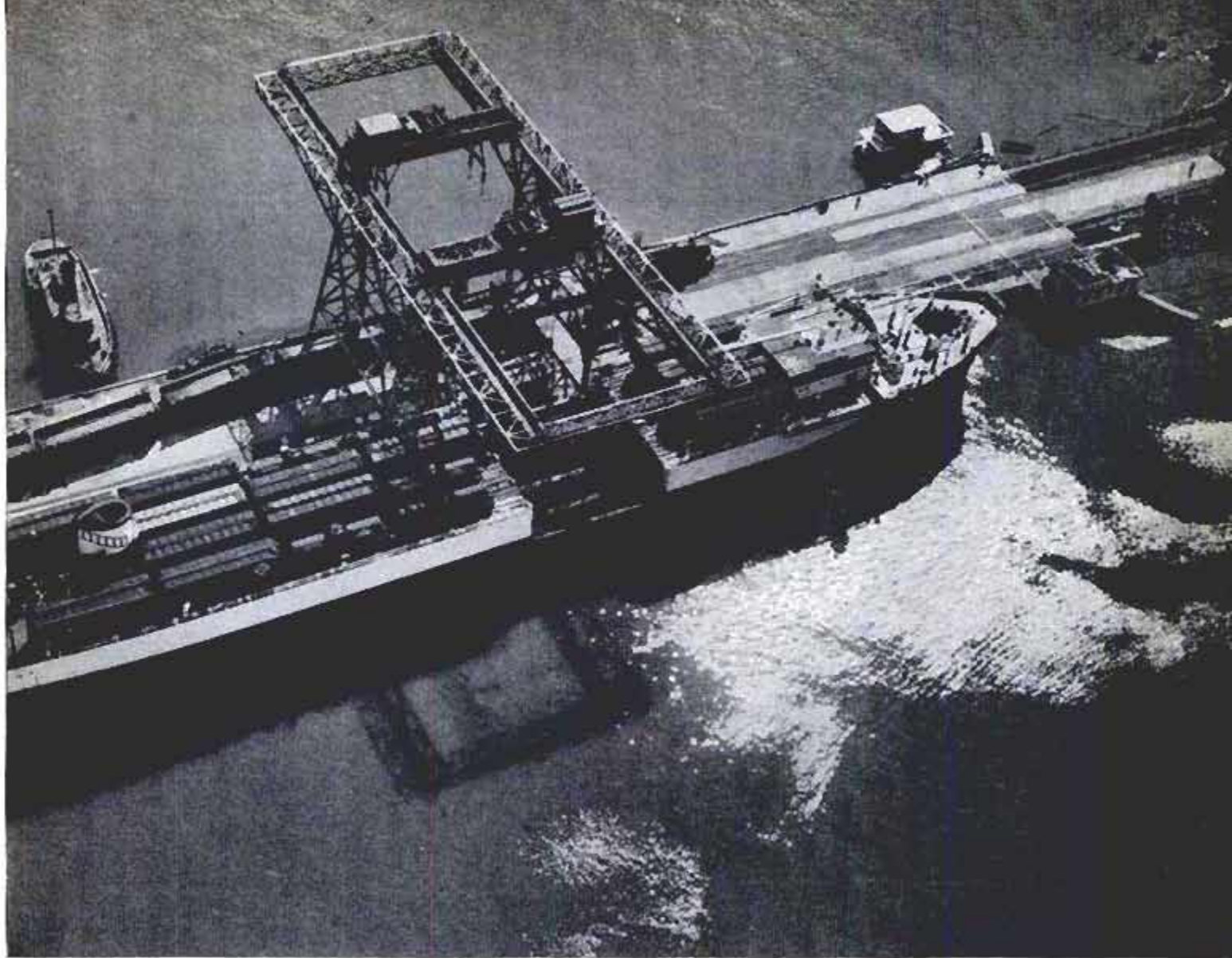

Giant crane at Edgewater, N. J., loading pier extends over hold of the Seatrain for lifting freight cars

for Strange Cargo

CARS ARE SECURED AT CORNERS BY WHEEL CHOCKS, JACKS AND TURNBUCKLES

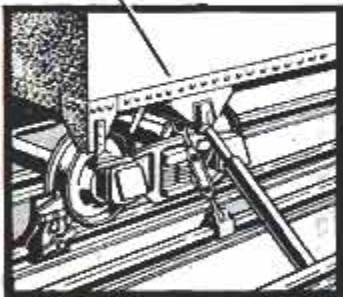

125-TON CAR-LIFTING CRANE LOCATED ON PIER

HINGED MASTS FALL FORWARD TO ALLOW SHIP TO MANEUVER UNDER CRANE

SEATRAIN LOADING

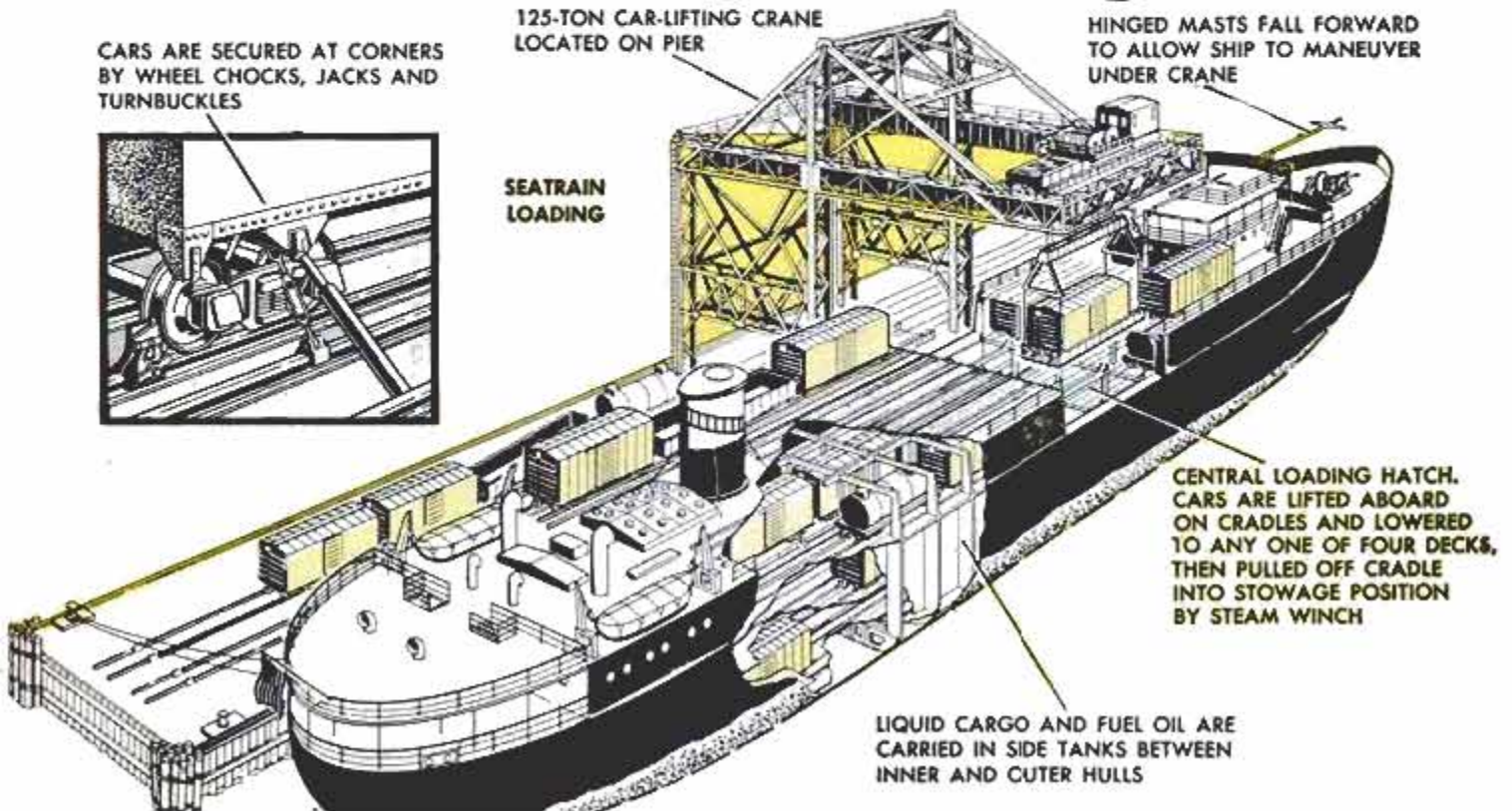

CENTRAL LOADING HATCH. CARS ARE LIFTED ABOARD ON CRADLES AND LOWERED TO ANY ONE OF FOUR DECKS, THEN PULLED OFF CRADLE INTO STOWAGE POSITION BY STEAM WINCH

LIQUID CARGO AND FUEL OIL ARE CARRIED IN SIDE TANKS BETWEEN INNER AND OUTER HULLS

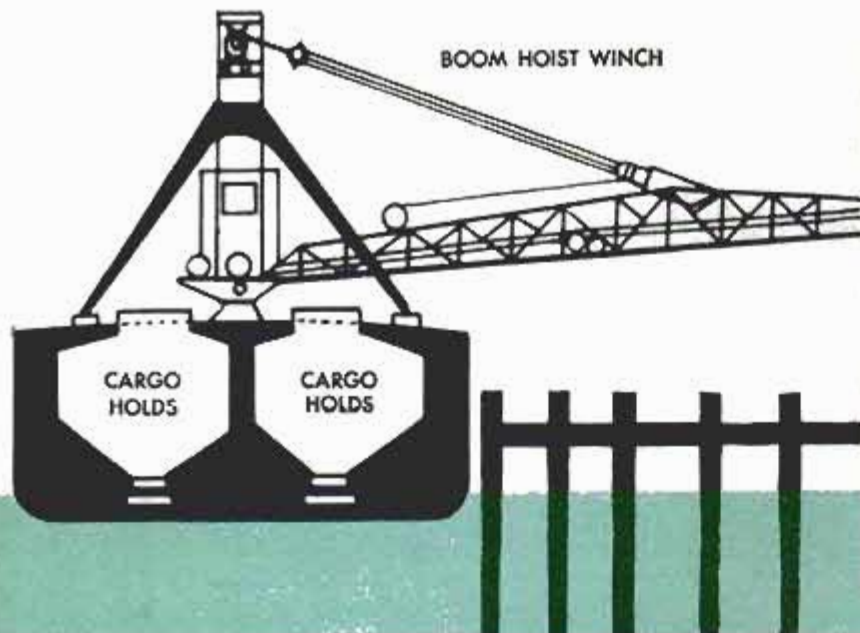
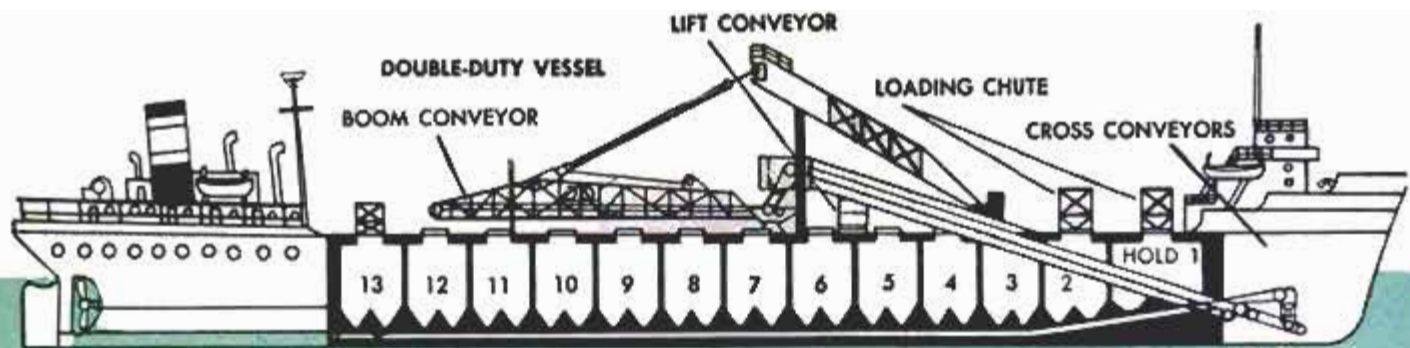

Courtesy of Hewitt-Robins Rubber Co. and E. I. du Pont de Nemours & Co.

The *Sinclair Petalora*, world's first ore-oil tanker, carries 67,000 tons of ore or 447,600 barrels of oil

The desert fighting is over (we hope), six ocean-going "carfloats" of Seatrain Lines are still busy. With the help of 125-ton cranes at various terminals these ships can disgorge 100 loaded freight cars in 10 hours. Their specialized talents are always available to serve the nation in time of emergency.

The muscle-bound seatrain, easily toting cargoes too outsized for other carriers, is one of a growing sorority of seagoing ladies designed for strange cargoes.

Take the *SS Angelo Petri*, a ship that made seafaring history on her first voyage. Though never destined to bear combat arms like the redoubtable *Seatrain Texas*, she carries a cargo often more welcome than weapons to beleaguered troops. The \$7,000,000 *Angelo Petri* is America's first wine ship. The 22,000-ton ship looks from the outside like many another tanker, albeit a spotless one, but inside she is new clear through. Her 2,500,000-gallon cargo rides in 26 chromium-nickel stainless-steel vats. Every valve and pump, every foot of wine piping, is stainless. Cofferdams surround each vat on top, bottom and sides, so 26 different flavors of wine can be kept separate, with never a drop intermixed. Ships are naturals for wine transport, ac-

ording to president Louis Petri, because their gentle motion keeps air, the greatest enemy of wine, from mixing with the cargo. As each vat empties, a twin-nozzle device lowers into the tank and jets a high-pressure steam-and-water blast on the interior.

Fruit Industries recently placed in service the *SS Tropicana*, the world's first bulk orange-juice tanker. Ultimately she'll hold nearly 1.5 million gallons of the yellow nectar in tanks pillowed with 6½ inches of foaming glass. This insulation, plus vacuum-packing the juice at 2½ pounds below atmospheric pressure, delivers the tasty cargo at a frosty 30 degrees F. with flavor intact. She pumps 22,000 golden gallons per hour, surely the fastest anybody ever poured orange juice out of a can. The cheapest, too; her \$15,000 tab for bringing a load from Florida to New York compares with \$265,000 to do the same by refrigerated truck.

The *Marian P. Billups*, whose profile resembles a souped-up hot rod with the hood off, carries butane, propane and ammonia for the Tropical Gas Company at the unheard-of cargo-tank pressure of 250 pounds per square inch. Her belly is crammed with 18 enormous steel bottles whose domes poke up through her deck like cylinders



This 530-foot wine tanker, *Angelo Petri*, is the first ship of its kind under U. S. flag. It has 26 vats

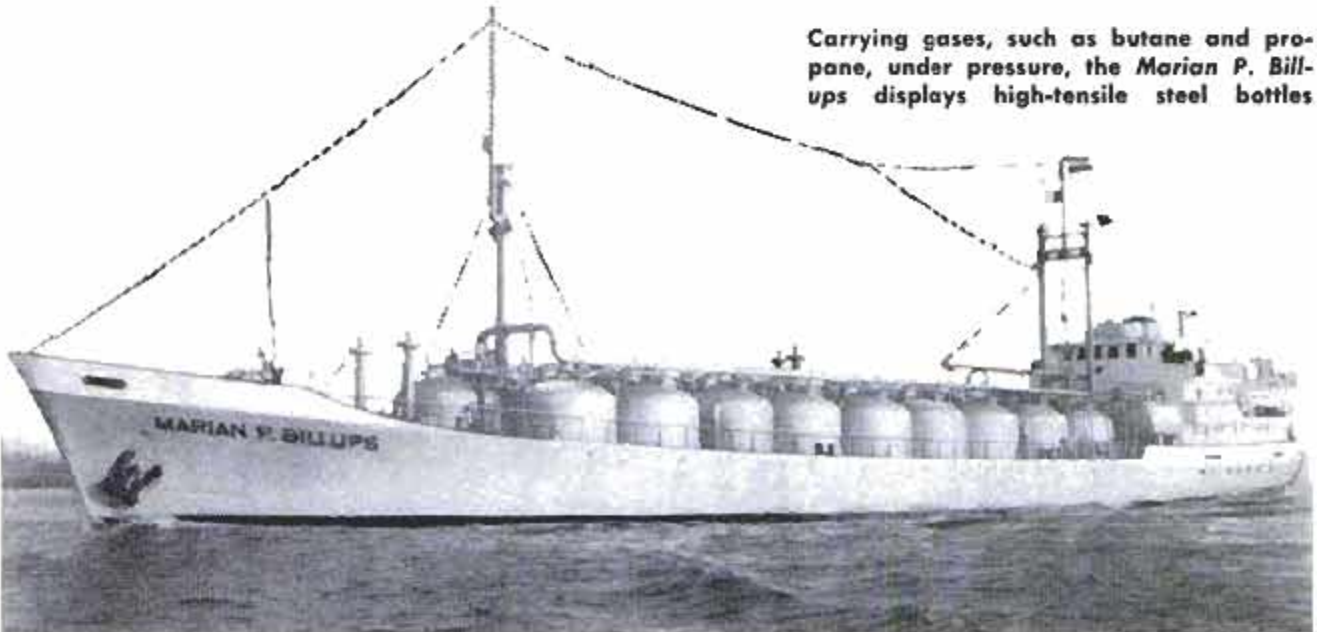

Carrying gases, such as butane and propane, under pressure, the *Marian P. Billups* displays high-tensile steel bottles

An icebreaker hull was put on the *Alatna* so the tanker can make deliveries in Arctic to military posts





Sleek is the word for the 285,000-barrel tanker *Cities Service Baltimore* which unloads in just 15 hours

of a gigantic marine engine. The *Bil-lups* would be an economic cripple for conventional cargoes but, like the bumblebee, who flies nicely despite aerodynamic theory, this 13,000-barrel gas carrier is supremely efficient for her special purpose.

Another useful "oddball" is the 590-foot *Duncan Bay*, rated a tanker but carrying the world's oddest liquid cargo — wood pulp. Other ships bring down Canadian pulp in dry bales, but the *Duncan Bay* pumps it aboard in a watery slurry like thin quicksand. When she discharges, propeller agitators whirl away in the tanks like giant eggbeaters to keep the pulp

mixed. In addition to speeding cargo handling, papermen say wet pulp makes stronger paper.

Some tankers still carry oil, of course, but even among oilers there are specialists. With the new SS *Cities Service Baltimore* it's variety. No smutty black-oil workhorse she; her gleaming tanks simultaneously handle 10 grades of "clean products," two grades of lubricating oils and—just to keep her hand in—1800 tons of black. She can pump off all of these varieties separately in 15 hours.

Then there's the *Alatna*, first tanker

(Continued to page 218)

View aft on the *Duncan Bay* shows some of its nine tanks and pumphouses for unloading liquid wood pulp

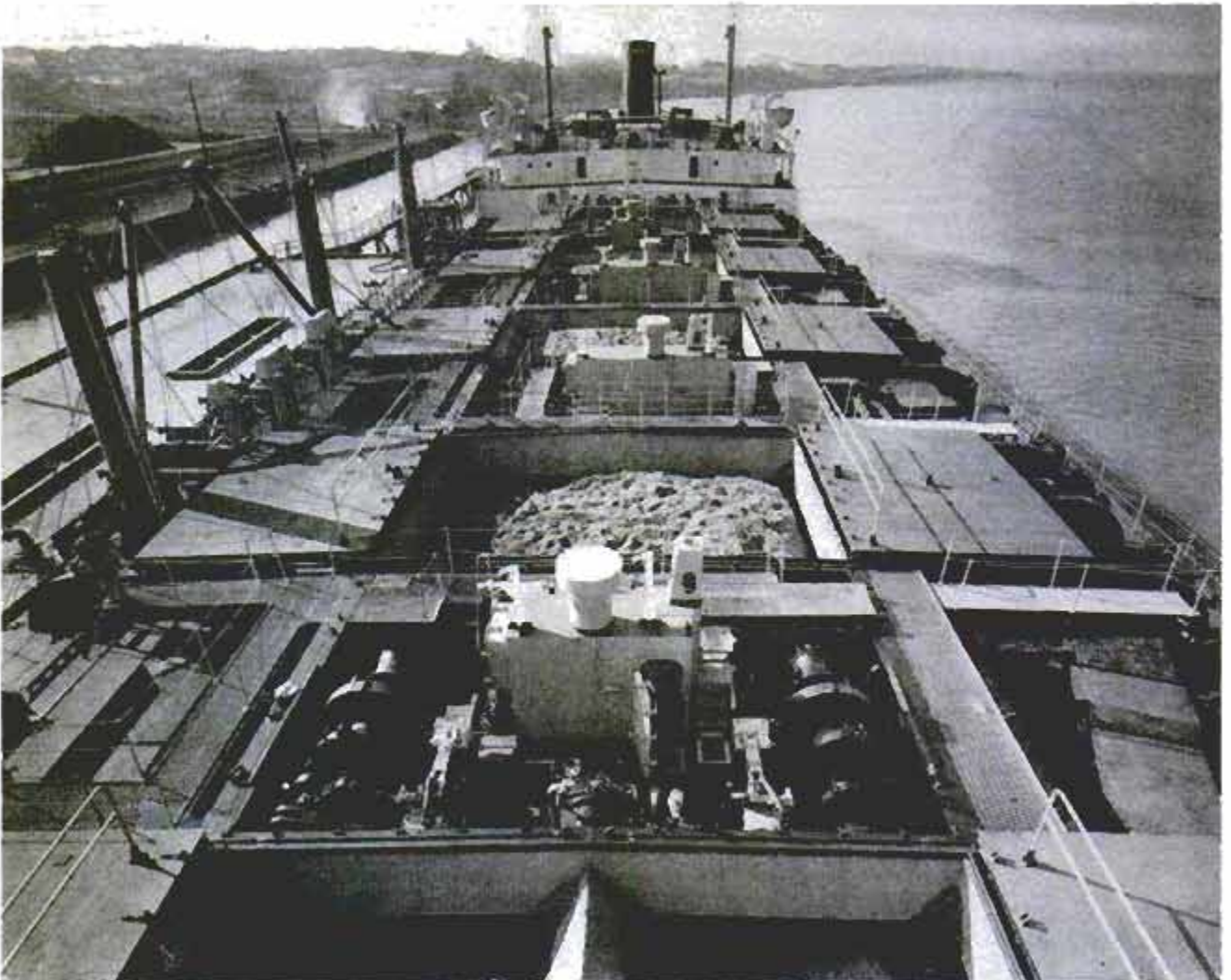



Highway Cattle Train

TRUCK AND TRAILER units up to 145 feet long are used to move cattle to market from Australia's Northern Territory. The highway trains travel in pairs and each train carries up to 100 head of cattle. The entire unit has 42 wheels and each of the trailers is steered individually by a tow-bar so that it follows in the tracks of the truck, or prime mover. The truck is powered by a six-cylinder supercharged Rolls Royce diesel engine which develops 275 horsepower. The trucks have power steering and air brakes. The trains average about 15 miles per hour, including stops, on runs to Mount Isa, in Queensland.



Machines that make milk containers from rolls of coated paper are behind workers in Japanese dairy



Cost of bottles once made milk a luxury in Japan. Inexpensive distribution makes it available to all

Milk Packaged in Odd-Shaped Cartons for Japanese

LOW-COST DISTRIBUTION of milk to Japanese families has been made possible by development of plastic-coated paper containers. The polyethylene-coated paper arrives at the dairy in rolls and is sterilized by ultraviolet light. Then it is formed into a tube and the seam is heat-sealed. The

tube is filled with milk and pairs of electrically heated jaws, operating under pressure, squeeze the tubing into a chain of tetrahedrons. The four-sided containers are cut from the chain and rushed to the retailers. The consumer clips off a corner and pours the milk into a glass.

Japanese housewife opens milk tetrahedron by cutting corner. Heavy paper is coated on inner surface with polyethylene which has been sterilized

Consumer can insert a straw or pour the milk into a glass



HI-FI TRENDS

By Lothar Stern

IF YOU haven't seen it yet, chances are that you soon will. "It" is the new RCA-developed tape magazine with its contents—the equally new, prerecorded 4-track tape. Together, these two developments are likely to have as great an impact on the high-fidelity field as has the evolution of the stereo disc.

Just as it began to look as though the low-cost stereo records would drive stereo tapes right out of the competitive market, the tape industry pulled a few surprises of its own. From the laboratories came reports of new equipment capable of recording four separate tracks of information on a $\frac{1}{4}$ -in. ribbon of tape. Furthermore, it was claimed that these tapes could provide the same fidelity at a speed of only $3\frac{3}{4}$ i.p.s. as existing 2-track tapes at a speed of $7\frac{1}{2}$ i.p.s. The result—four times as much playing time for the same basic tape cost, with no compromise of quality.

Almost before this news could be properly digested, Ampex demonstrated its new equipment capable of handling 4-track tapes as well as the conventional ones. The demonstration was impressive. Even the skeptics were convinced. The 4-track, slow-speed tape used for the demonstration was, indeed, capable of high-fidelity performance.

Then RCA dropped the clincher. Almost casually, RCA officials unveiled a slim plastic container which they introduced as a newly perfected tape magazine. Simultaneously, they revealed an entirely new automatic recorder, Fig. 3, designed especially for magazine-loaded 4-track tapes. And, it was announced, RCA would soon release a large selection of magazine-loaded

(Continued to page 222)

Radio Television Electronics



Fig. 3. RCA's magazine loaded 4-track tape recorder may alter complexion of high fidelity systems. Fig. 1. Prototype version of Motorola's magazine-loaded mechanism is part of a complete hi-fi console. Trim has been removed to show location of record and playback heads. Fig. 2. Pentron's recorder plays 4-track tape magazines and can be used to record and play back regular $7\frac{1}{2}$ i.p.s. 2-track tapes



GIFT SUGGESTIONS

FOR THE HI-FI ENTHUSIAST



STEREOPHONIC PORTABLE, ingeniously styled, combines compactness with stereo flexibility. "Wings" housing speakers swing open or detach completely from main unit. Dual amplifier gives 20 watts power



SHELF-SIZE SPEAKER ENCLOSURE with precut mounting board for limited-space stereo installations. Available in 6 finishes, unit is designed for Sonotone 8-in. speaker with 55-15,000-cycle response

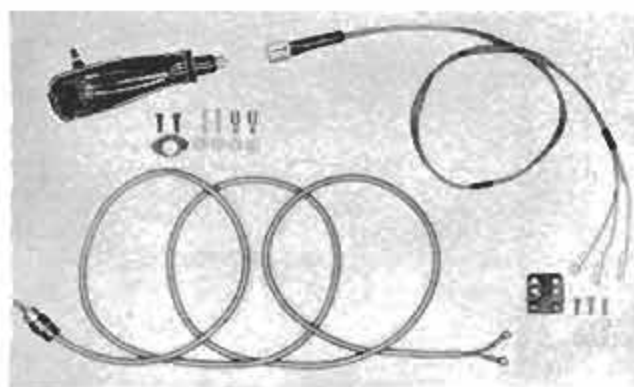

STEREO CONVERSION KIT permits rapid rewiring of popular Garard record players for stereo. Includes diagrammed instructions for screwdriver installation



HIGH-FIDELITY TURNTABLE KIT for the do-it-yourself audio hobbyist. Designed for single-speed (33 $\frac{1}{3}$ RPM) operation. Assembly time is about 30 minutes

FOR THE RADIO EXPERIMENTER

NEW 12-IN-1 LAB KIT permits construction of 12 practical and instructive electronic circuits. Profusely illustrated manual describes construction and circuit theory. Safe even for children and beginners

REGENERATIVE RECEIVER KIT covers frequencies from 550 kc. to 30 mc. in four bands. Easy-to-build, 3-tube set with built-in speaker is ideal for beginning radio amateurs as well as for short-wave listeners

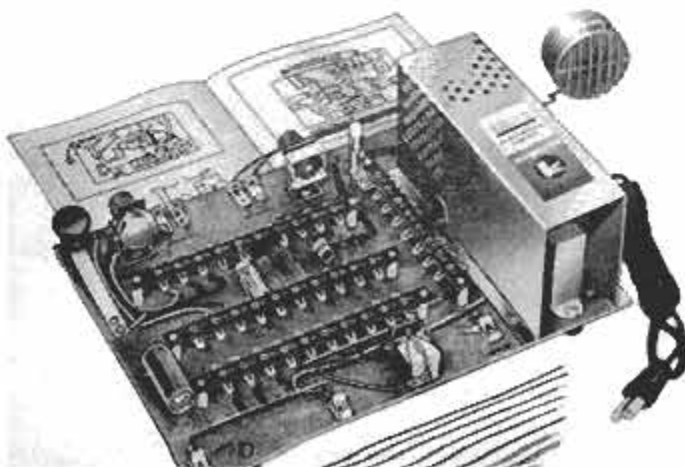

Build

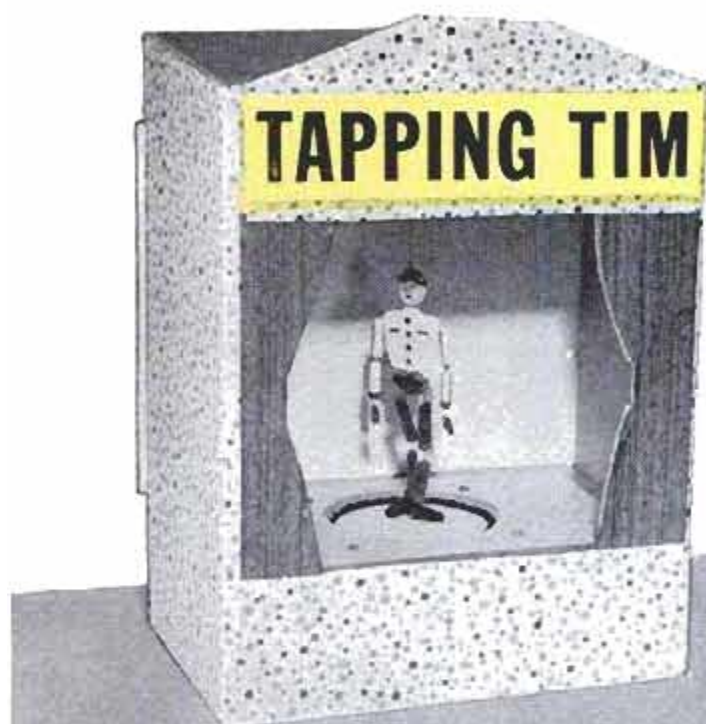

The Electronic Tap Dancer

By E. G. Louis

TAPPING TIM, the electronic tap dancer, combines the eye-appeal of color with the romantic appeal of electronics to provide a low-cost toy with high play value. "Tim" is a colorful puppet performing an exciting tap dance in his own private theater. He dances to any type of music, whether the piece is Bach or bebop, but is at his liveliest best to music like rock and roll, which has an accentuated beat.

Although designed originally for a small child, Tapping Tim can provide fun and entertainment for the whole family. A three-year old, for example, will enjoy simply watching the puppet dance. An older child can participate in the "show" by making up scenery cards and stage props. A still older child may wish to try his hand at assembling his own puppets. And, of course, the child's father will find considerable pleasure in assembling the basic toy.

The dancer is made of individual pieces of light balsa wood. His theater is formed of ordinary corrugated cardboard and his stage is an inverted cigar box. A vibrating

cardboard disk powered by a salvaged or bargain-priced 4 to 6-in. PM loudspeaker is his dancing platform. Motivating power is obtained from the electrical signal of a radio, phonograph or TV set which supplies the musical accompaniment.

Construction details are shown on the following page, but these need not be rigorously followed. The puppet may be anything from a hula dancer to a spaceman but keep it light in weight so that little power is needed to set it into lively action.

In operation, "Tim" is suspended from a support brace centered above the dancing platform. A piece of thread attached to the puppet's head is fitted into a narrow slot cut into the support brace with a razor blade. The height of the puppet is adjusted so that its feet rest flat but lightly on the dancing platform. A length of 2-wire lamp cord is used to connect the voice coil of the theater speaker in parallel with that of a radio, phonograph or TV speaker. Volume of the latter is then adjusted until the puppet begins its merry dance. ★ ★ ★

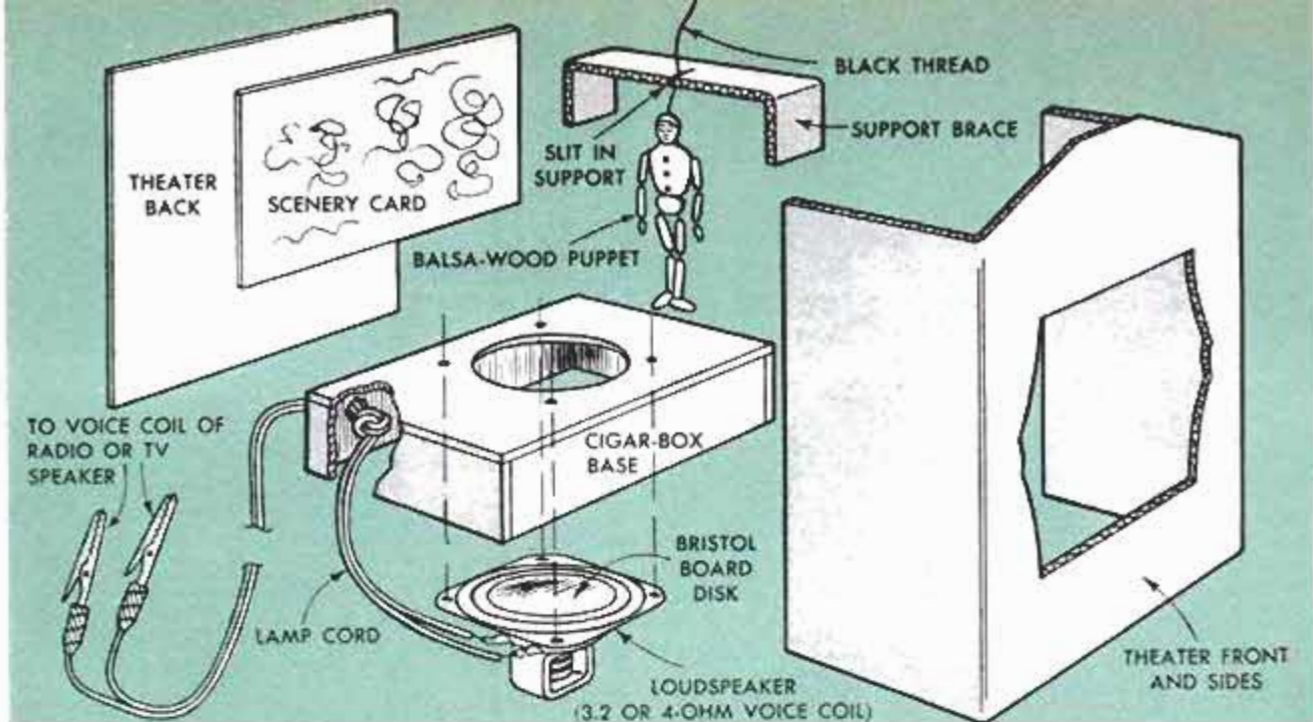

Exploded diagram of theater. Lamp cord clipped to voice coil of radio speaker transmits energizing signal

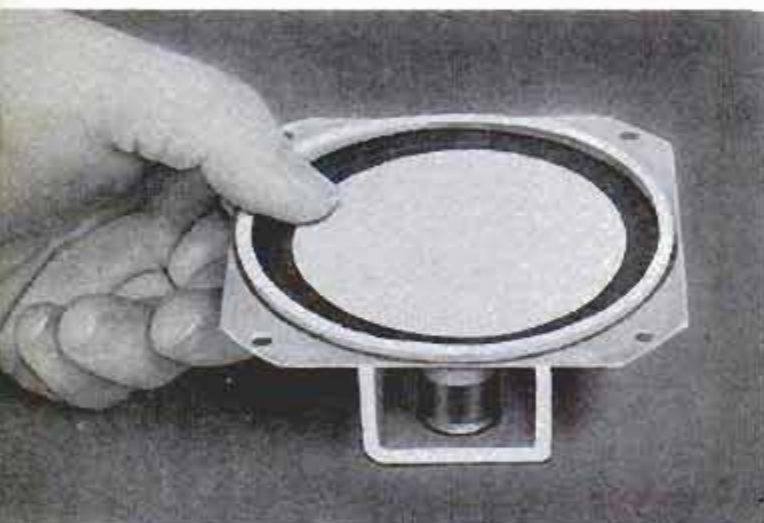

Above: Bristol-board disk is rubber-cemented to speaker cone just inside corrugated portion of cone



Cigar box forms theater base. Previously prepared speaker is mounted from below with screws and nuts

Below: Puppet parts are joined with short lengths of black thread inserted in cement-filled pinholes

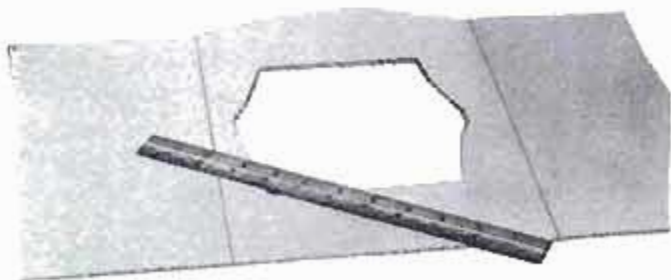
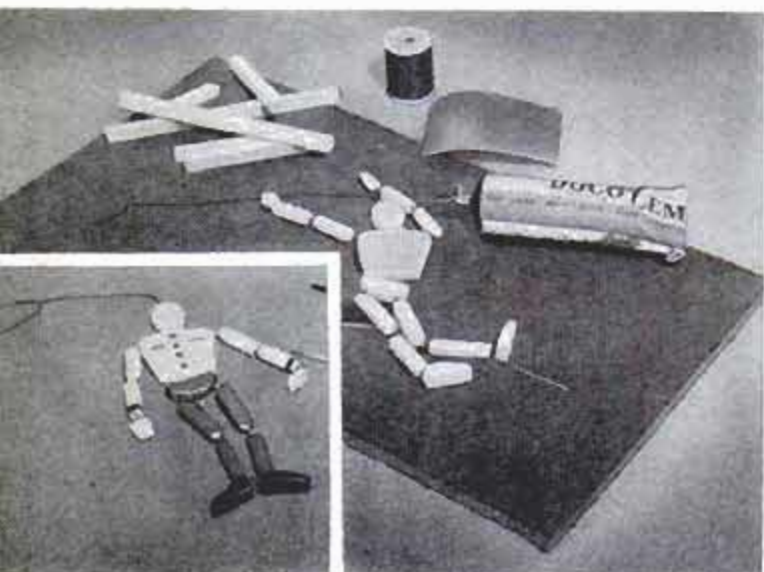

Corrugated cardboard serves as theater front and sides. Razor blade is used for cutting and scoring

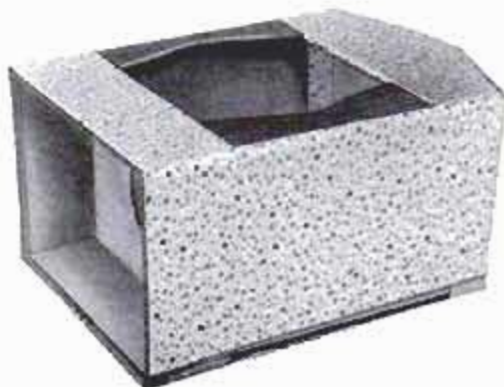

Cardboard theater can be painted or covered with adhesive-backed plastic material. Slot between side and back permits insertion of scenery cards

(14711)-60



SOFA GOES MODERN

By Willard Allphin

NO NEED TO PROP the cushions against a wall with this modern version of the studio couch. It has a back all its own to make it a free-standing sofa. All cushions are loose so they can be reversed for even wear, and when the back is finished like the rest of the wooden frame, the piece is presentable all around when used as a fireside sofa.

Second-grade birch was purposely selected for the original because of its dark sap streaks, but any hardwood of your choice can be used. Inner parts that are not exposed can be of the cheapest scrap stock. Fig. 1 details the complete frame. In studying its assembly, you'll notice that construction centers around a flat rectangular



Nicely finished all around, sofa can be used away from wall and in front of fireplace, like this

frame which supports the springs. This consists of five pieces which are lapped at the corners and the center and joined with glue and screws. Cleats are added next, keeping them flush with the outer edges of the frame. Since these cleats are provided for attaching the facing members to the four sides of the frame with screws from

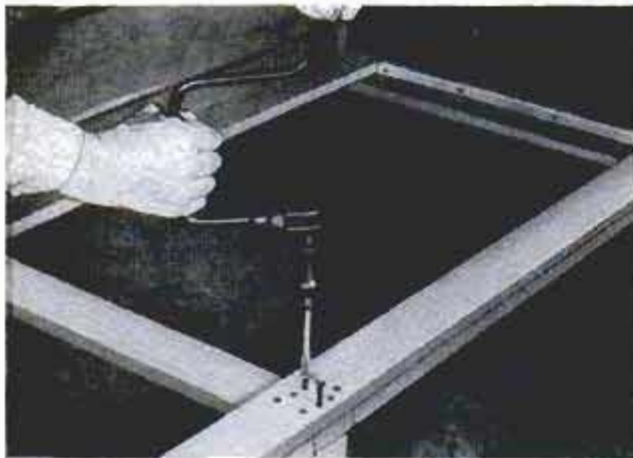
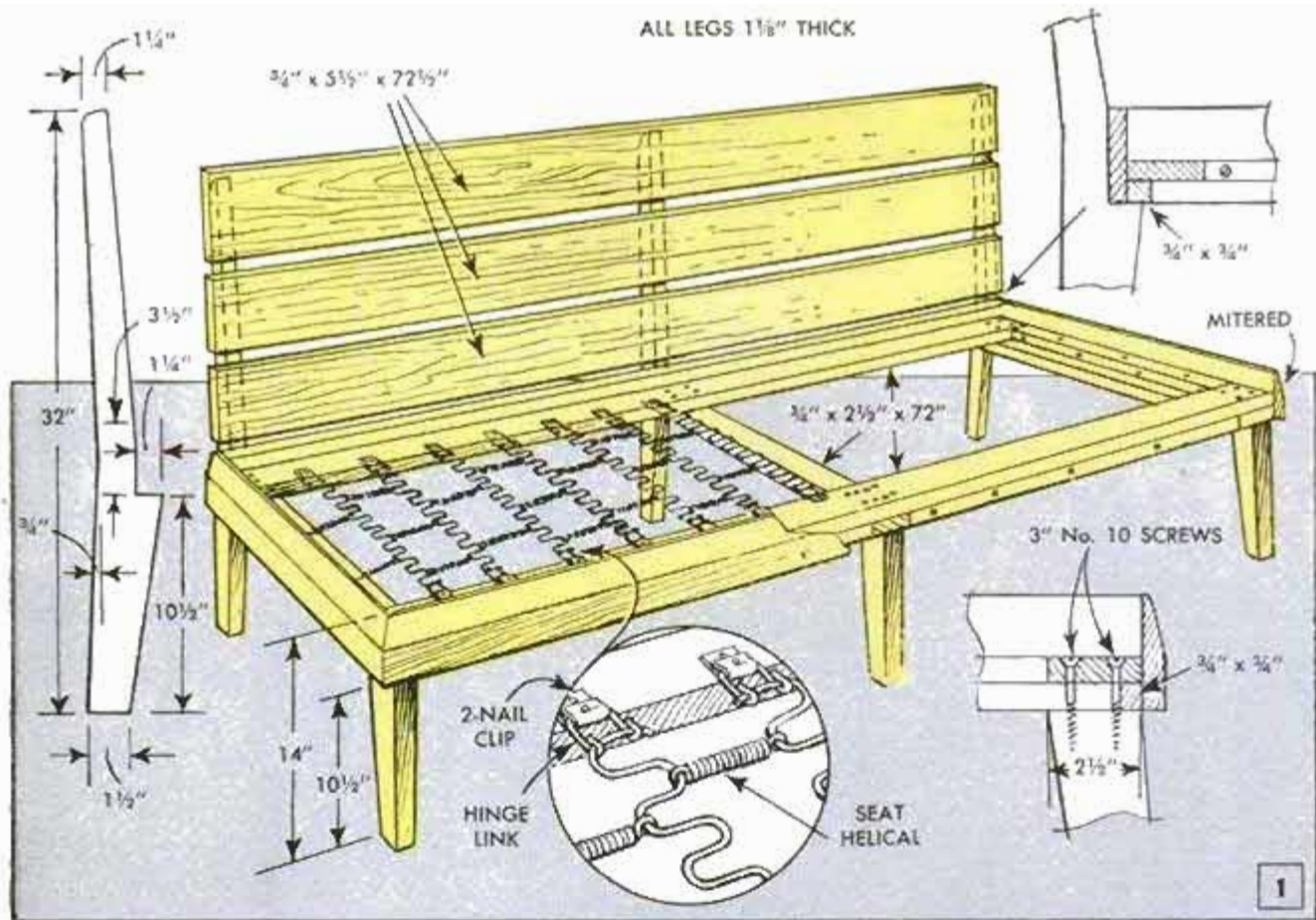

Above, glue, plus several long screws, are used to anchor front legs solidly. Below, screws through topside cleats hold end facing members to frame

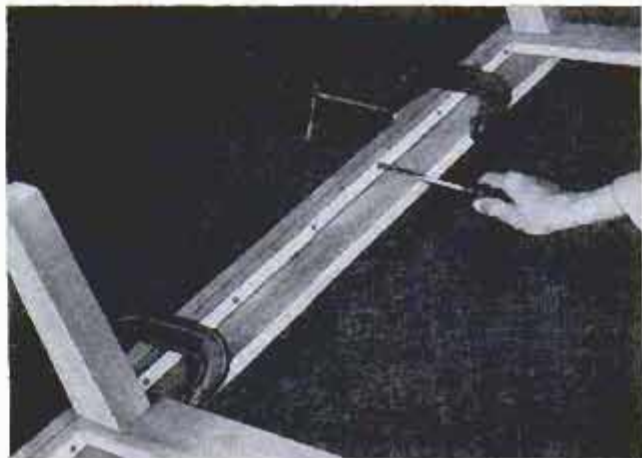

Above, screws through underside cleats hold front and back members. Below, screws holding backboards to legs are capped with plugs, trimmed flush

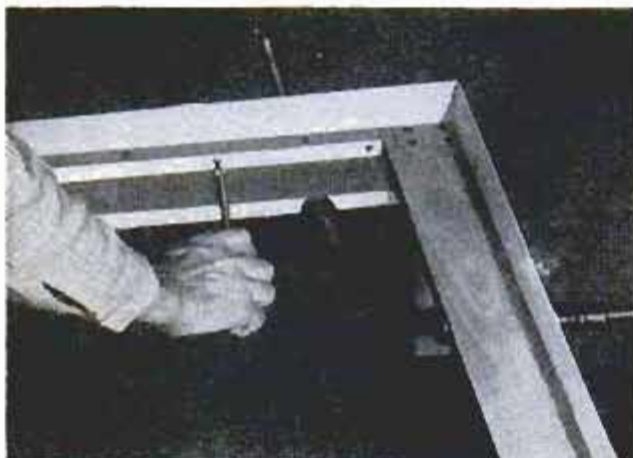

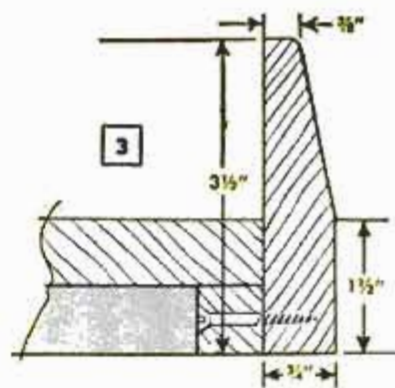
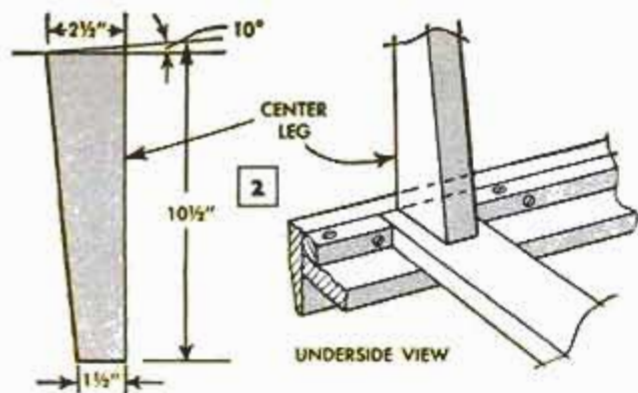

the inside, Fig. 3, it is best to drill screw holes through the cleats every 4 in. or so before installing.

Material for the four facing members is ripped $3\frac{1}{2}$ in. wide and then three of the pieces are beveled on the face side. This is done by tilting the saw blade the required amount and running the stock through on edge in the manner shown in the photo below Fig. 3. Only the two front corners are mitered since the end members extend past the back member and lap the side of the legs. The members are positioned even with the bottom of the cleats, coating them with glue and clamp-

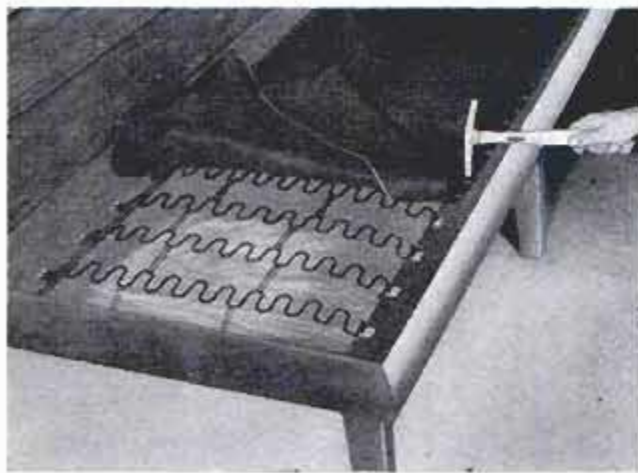

Above, after frame is sprung with No-Sag springs, springs are covered with denim. Below, foam-rubber scraps, cemented together, form built-up cushion pads



ing in place before turning the screws home. Two screws, later capped with wooden screw plugs, are driven through into the end grain of the flat back member.

The back legs are dimensioned in Fig. 1. These, as well as the shorter front legs, are cut from $1\frac{1}{8}$ or $1\frac{1}{4}$ -in. stock, either laminated or solid. The notched portion of each leg fits against the flat facing member and is glued and screwed to it. These screws, as well as those which are used to hold the backboards to the legs, are also covered with wooden screw plugs, trimmed flush. The three front legs are dimensioned as in Fig. 2, and are attached to the frame with glue and several long screws driven down into the legs from the top. A couple of 3-in. dowels could be used here instead of screws, boring the holes down through into the legs from the top after gluing and clamping the legs in position.

No-Sag springs make it easy to spring the frame, following manufacturer's instructions. The springs are covered with upholsterer's denim. All the cushions are made 5 in. thick from two layers of $2\frac{1}{2}$ -in. foam rubber, cemented together. The three individual back cushions measure 18 x 24 in., while the single seat cushion is made 26 x 72 so it will lie inside the facing members of the frame. By sewing slide fasteners in the cushion covers, they can be removed for cleaning. ★ ★ ★



Hidden Metal in Used Lumber Detected With Aid of Magnet

When running used lumber through a circular saw there is always the chance of damaging the blade, even though all visible nails have been removed. Some nails or other fasteners may have been broken off and are hidden below the surface of the lumber. Others may simply have been driven below the surface. To detect these hidden metal objects, suspend a small magnet on a cord and move it along the plank. When it reacts to show the presence of steel, place it on the surface of the wood to pinpoint the location.

Often, while checking lightweight oil in a warm engine, it is difficult to see the oil line on the dip stick. An easy way to correct this situation is to make a series of dents along the dip stick with a punch. The oil retained in the dents will be visible under any conditions.

Gaskets Cut to Exact Size by Using Ball-Peen Hammer

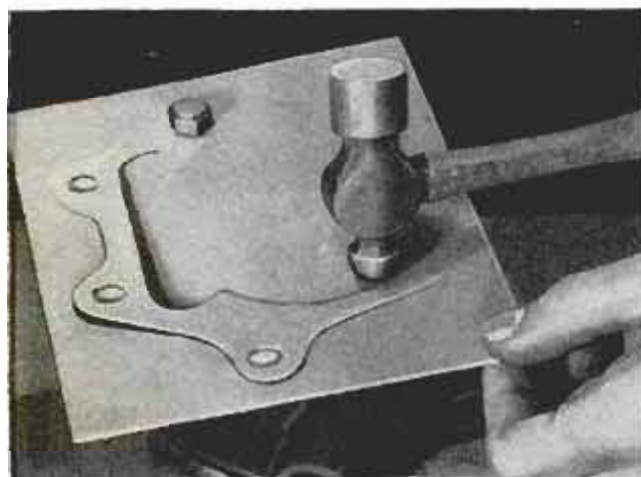

Small paper or composition gaskets can be cut quickly and accurately by placing a blank of the gasket material over the surface on which the gasket is to fit, and then tapping lightly along the edges of the metal with the ball end of a ball-peen hammer. If bolt holes are to be cut, make them first and insert a bolt or two to prevent the gasket from shifting while it is being cut. If an edge is not cut through completely, slit it with a sharp knife, rather than attempting to realign the paper on the metal. Also, avoid hammering too much on metal edges that might be damaged or distorted by the action.

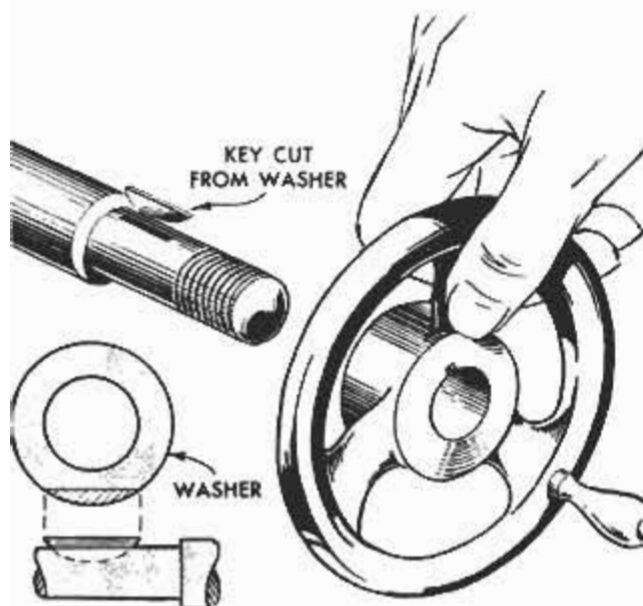

Worn Half-Moon Key Replaced With One Cut From Washer

When the half-moon key on a shaft fitted with a handwheel became badly worn, one machinist improvised a substitute key from a heavy steel washer. The key was cut from the edge of the washer, as indicated, then filed slightly to provide a tight fit in the keyway. An improvised key such as this should not be used where there is appreciable torque, as it would shear easily.

Frank LaSaracina, New York City.

☞ To maintain the natural beauty of exterior redwood surfaces, use redwood stain. Pigmented penetrating stain is good for new work as well as on old work.

Plywood Replaces Damaged Plaster on Ceiling

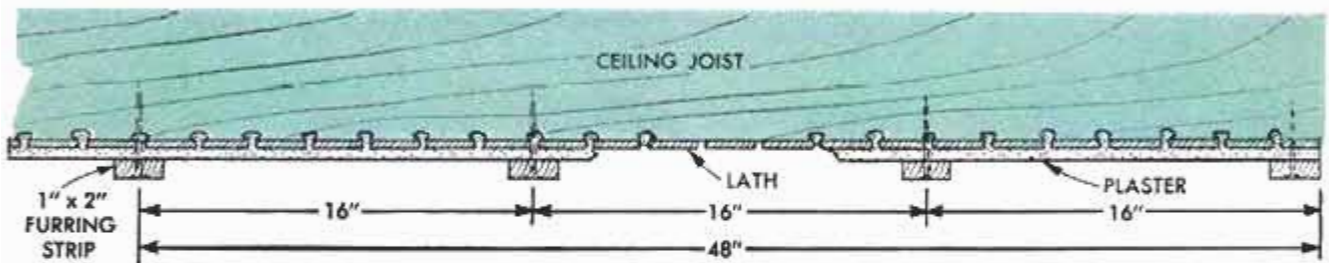

Loose, cracked plaster in a ceiling is not only unsightly, but can be dangerous. Falling plaster, loosened by vibration, settling or excessive moisture, can cause injury to people and property. An inexpensive method of repairing that does not involve the time and expense of replastering the ceiling completely is to cover it with 4 x 8-ft. sheets of $\frac{1}{4}$ -in. plywood. Interior-type fir plywood is used where moisture is not a problem. If a moisture condition exists, exterior-grade plywood should be used. When covering a ceiling, first knock off all loose plaster. Then nail strips of 1 x 2 furring over the entire ceiling, nailing through the plaster into the joist. The furring strips

should be at right angles to the joists and on 16-in. centers. In areas where plaster has fallen away, it may be necessary to use shims under the strips. The plywood sheets now are nailed to the furring strips, using 4d finishing nails, spaced not more than 6 in. apart. The plywood can be painted with any type interior paint to match that used on the walls of the room. Or, for a plastered effect, it can be painted with a heavy coating of texture paint that then is smoothed with a flat cellulose sponge. When dry, this surface can be given a coat of paint to either match or contrast with the walls of the particular room.

Douglas Fir Plywood Association.

Clear-Plastic Sandwich Boxes Make Ideal Parts "Cabinet"

Plastic boxes, of the type used for carrying sandwiches, make ideal storage containers for nails, screws and other small parts used in a workshop. The boxes stack easily so that four or five of them require a minimum of shelf space.

☐ Noise from a leaky faucet can be silenced until repairs are made by tying an old nylon stocking around the faucet so the water can run down the stocking instead of dripping.

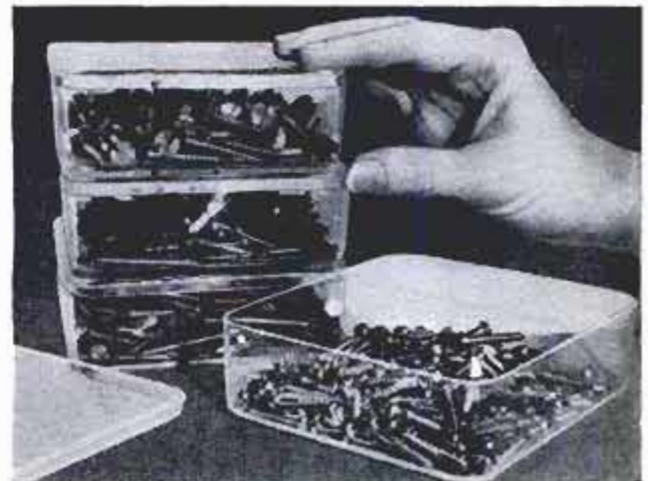

Make Your Own POLE LAMP

By Ronald L. Anderson

FOR EFFECTIVE HIGHLIGHTING of special areas of interest in your living-room decor, here is a pole lamp with a cluster of three spotlights that you can make in a few evenings. Except for the spotlights, which are purchased ready-made, the lamp is made from stock materials using hand tools and a portable power drill as illustrated. Aluminum tubing is used for the pole of the lamp, with extension legs made of brass tubing and dowel stock fitted in the ends. The upper leg is spring-loaded like a pogo stick, so that the lamp pole can be gently wedged between the floor and ceiling at any desired location. To move the lamp you need only pull up on the pole and swing the lower end of it to one side.

To make the lamp, cut an 8-ft. length of 1¼-in. aluminum tubing to size and drill it to take the lights and fittings for the legs as indicated in Fig. 1. Then the upper and lower leg assemblies are made and installed in the tubing as detailed in Figs. 3 and 4. Note that the upper leg is not secured to the end dowel piece, to permit cylinderlike movement while both dowel pieces of the lower leg are secured to the pole and to the leg so that it remains in a fixed position. A 2-in. drain plug fastened to each leg end as in detail A, provides a nonslip contact with floor and ceiling. Wooden handles, shaped and cut to fit the contour and size of light shades, may be bolted to them for easier turning when hot, detail B and Fig. 2. ★ ★ ★

Handles for lamps are formed from walnut stock and bolted to shades with 1-in. stove bolts countersunk

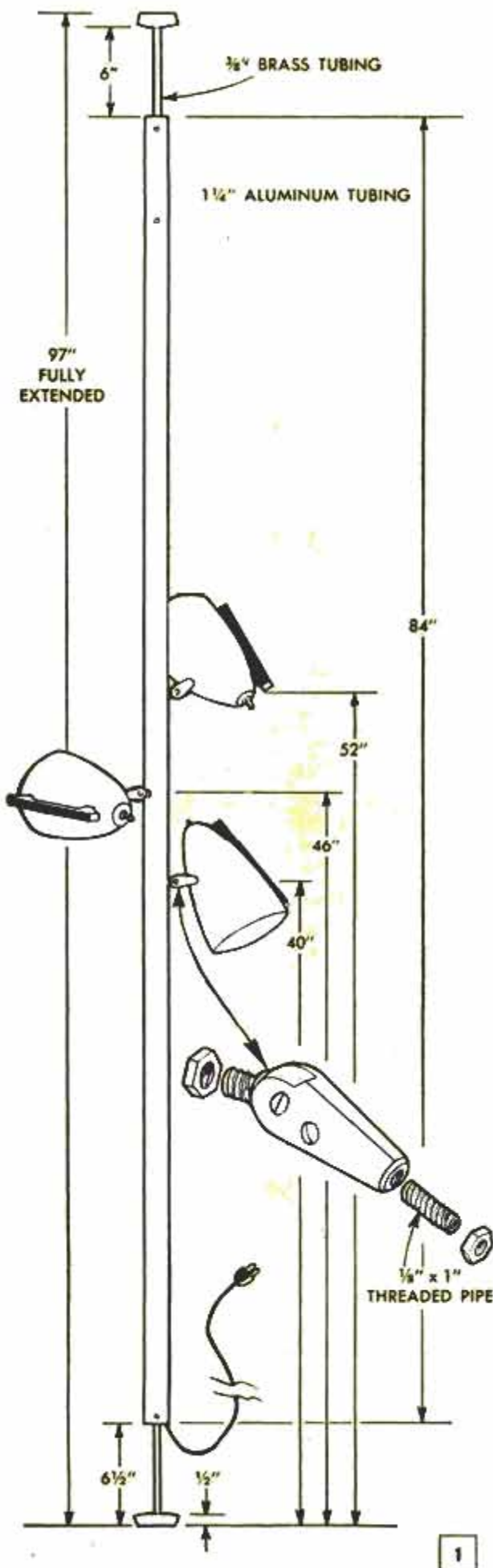

1

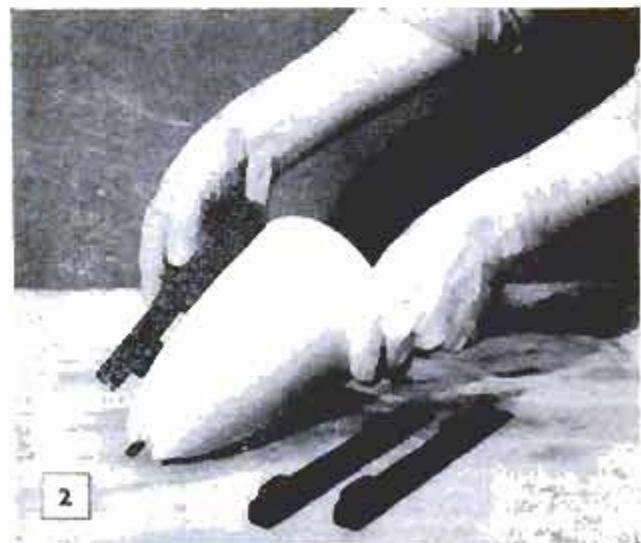

2

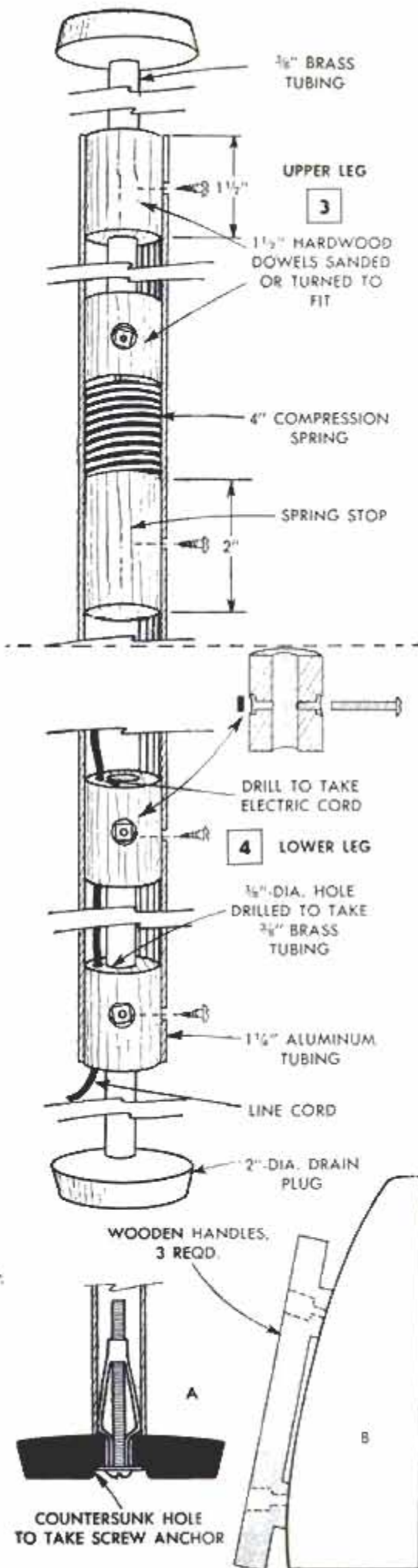



Electric Fence Is Portable

Rearranging pasture area is no trick with this portable electric fence. Each post is a steel rod welded to a disk with a length of rod allowed to project below the disk. Stepping on the disk forces the rod into the ground to set the post. Insulators are bolted to each post.—A. M. Wet-tach, Mt. Pleasant, Iowa.

☐ To prevent bathroom mirrors from losing their reflective qualities more quickly than mirrors in other parts of the home, remove them from their frames and seal the backs against moisture with shellac.

Preheated Air Cleaner Speeds Starting of Car in Cold Weather

Preheating the carburetor air cleaner was the method used by one motorist as an aid to quicker starting in cold weather. The air cleaner was removed from the car the night before, taken into the house and placed on a radiator. In the morning, with the aid of gloves, the air cleaner was replaced on the carburetor and the engine started as quickly as the driver could reach

the seat. Air drawn into the carburetor was warmed by the cleaner, causing the gasoline to vaporize for quick firing. Although the cleaner quickly chilled in the cold air, the engine would be running well by then. The cleaner then was tightened onto the carburetor. Oil-bath air filters must be handled carefully to prevent spilling oil.

Andy Vena, Philadelphia, Pa.



Tall Corn Dusted From High Frame

To control corn borers in tall corn, one farmer mounted a tractor-type crop duster on a high frame made from welded lengths of pipe. The hitch to the tractor drawbar also was pipe, being braced on both sides with lengths of smaller-diameter pipe. The lower ends of the hoses on the duster were fastened to a steel flat attached to the duster frame with U-bolts. Loosening the U-bolts permitted the bar to be adjusted in height. The duster auger is powered through a chain-and-sprocket.

Locked Shelf in Cabinet Assures Caution

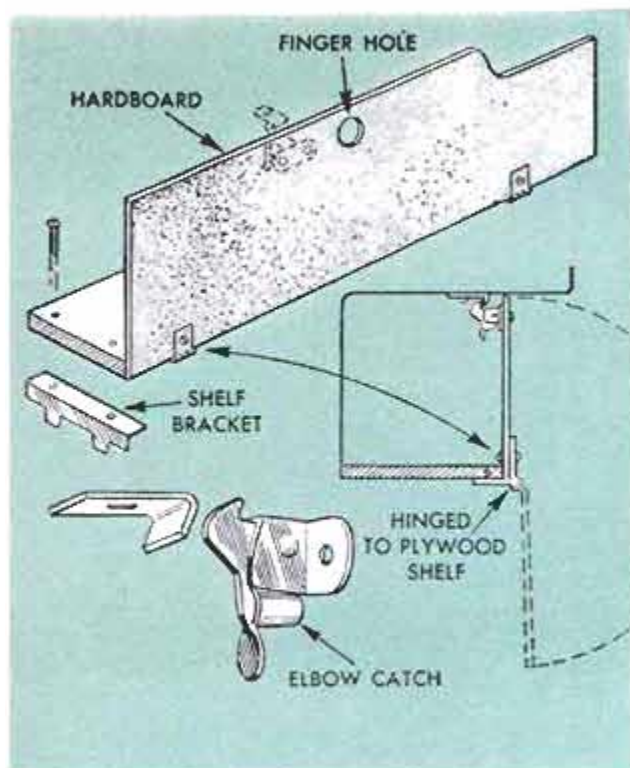

This locked shelf front effectively keeps certain items in your medicine cabinet away from inquisitive youngsters, and also prevents possible errors by inattentive adults. Yet, it can be opened quickly and easily by those who know how it works. The $\frac{1}{8}$ -in. hardboard front is hinged to a $\frac{1}{4}$ -in. plywood shelf, which is fastened to shelf brackets with small machine screws. A finger hole at the top center of the front gives an adult access to an elbow catch positioned as indicated. Because the shelf

must be out of finger reach of children, it should replace the present top shelf, or be positioned above it. This location has the added advantage of permitting the elbow catch to be fastened to the inside surface of the top of the medicine cabinet. While the locked-front arrangement is generally effective for its purpose, it may not be completely tamperproof against clever, determined youngsters. Therefore, poisons should be stored elsewhere under a suitable lock, and with proper identification.

String and Modified Compass Aid in Drawing Accurate Ellipse

Drawing an ellipse by the usual method of using a string and two straight pins as points is not always completely satisfactory. The pins are difficult to press into a drawing board, and have a tendency to bend and move as the ellipse is drawn. A better method is to use a dividers or compass from a drafting set. In the latter case, the lead tip is replaced with a point, and the legs of the compass are adjusted so that each tip is vertical, providing vertical columns around which the string can pass. The compass points press easily into the board, and the instrument can be held firmly in position.

☐ A six-part wire drinking-glass carrier is a handy and attractive rack for small potted plants, and has the added advantage of permitting the plants to be carried as a group to the kitchen to be watered.

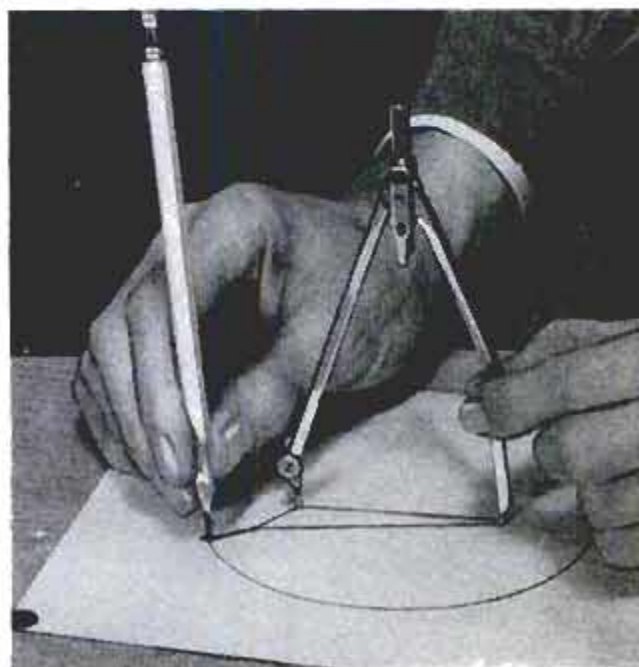

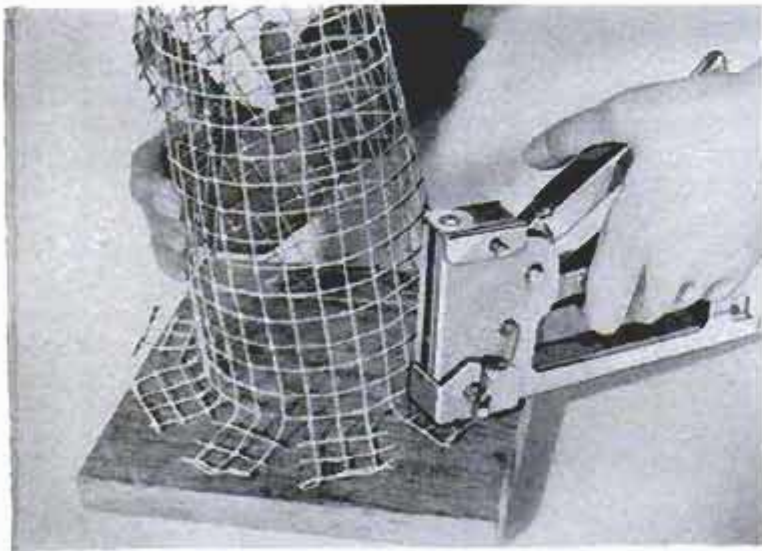

Above, hardware-cloth cone is stapled to base, Below, tree is started from the bottom, using largest branches first



BRANCHES AND TWIGS cut from the top of a Christmas tree to make it fit under a ceiling need not simply be discarded; they are ideal material for making miniature trees for other locations inside and outside a home. Perhaps you have decided, this year, not to have a full-size tree. In that case, purchase a bundle of branches from a Christmas-tree lot and make a tree of any size you desire. A small, "portable" tree can be formed by shaping a piece of $\frac{1}{2}$ -in. hardware cloth into a rough cone-shape and tacking or stapling it to a base of plywood or solid stock, as shown in the photo at the left. The ends of branches then are fitted into the openings in the cloth, beginning at the bottom of the cone. Use the largest branches at the bottom, shorter ones as you go up the tree to assure a natural shape. Any areas that look sparse can be filled in with scraps of branches and the smaller twigs. When decorating this little tree, keep in mind that proportions are important. Large ornaments and decorations will make your tree look absolutely undersize and awkward. Since there is a tendency to overdecorate a small tree be careful to avoid crowding the branches with too

YOUR OWN CHRISTMAS TREES



many ornaments and lights. Use small ornaments, keeping the same ratio of ornament size to tree size as with a full-size tree. Finish off the tree with a star or small angel, and perhaps a few small pine cones. Your tree now can be placed wherever you wish it to be. It will look fine as a centerpiece for a dining-room table or do just as well on a table near the front door where your guests can see it as they enter. Place it in a window where passers-by also can enjoy it. For this location, illuminate it with a string of the miniature bulbs that are wired through a transformer that causes the lights to wink on and off in a friendly fashion.

The second tree to be made of branches is based on a triangle of heavy cardboard, plywood or hardboard. Over this is stapled hardware cloth to receive the ends of the branches, in the same manner as the portable tree. For the start of this tree, use one large branch the full length of the triangle, as shown in the lower photo at right. Smaller branches and twigs then are placed around this larger branch to fill out and form the tree. This tree can be used either inside or outside a home, but looks best when fastened to an outside wall, as shown. If the triangle is made of cardboard, it should be varnished or painted when used outside. The color should be a green that will not look unnatural with the green of the tree branches. Ornaments and decorations for an outside tree also should be chosen more carefully, as anything that weathers easily would not be suitable. Interior-type lights could be used on the tree if it were protected under a porch roof or door canopy. Exterior-type Christmas-tree lights probably would be too large for this size of tree. As an alternate method of lighting, locate an outdoor spotlight so it shines on the tree. Move the light about, to determine what position provides the best effect, and then provide a base to which the light can be attached securely. ★ ★ ★



Finished miniature tree, above, is topped by tall ornament, just as though it were a full-size tree

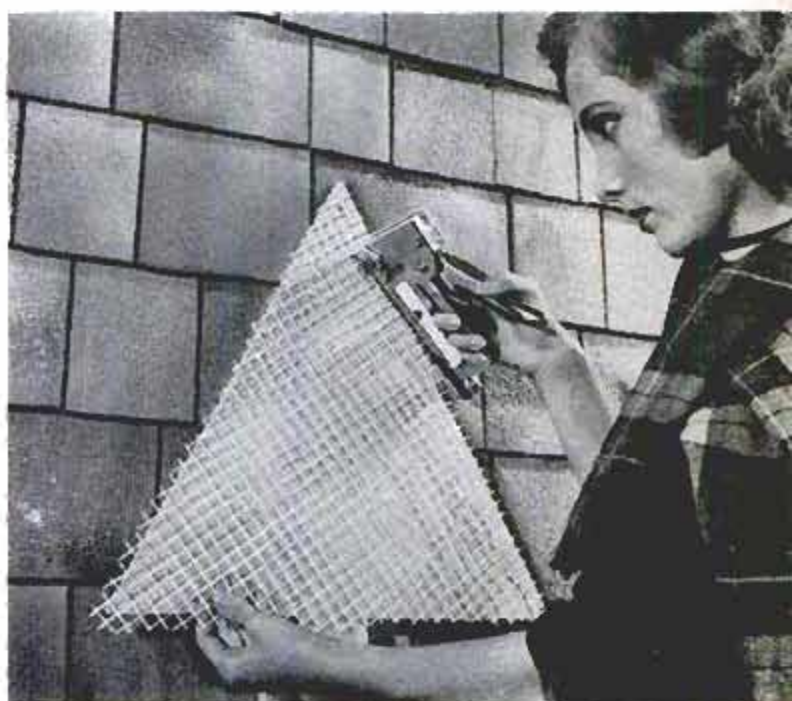

Above, base for this type miniature Christmas tree is hardware cloth stapled to triangular-shaped cardboard, plywood or hardboard. Below, one large branch is "trunk" of tree, small branches fill out rest





Bracket on Small Drawing Board "Clamps" It to Dictation Slide

Attaching a U-shaped length of flat steel to one end of a drawing board will permit it to be slipped over the end of the dictation slide in a desk and held at a convenient angle. If a T-square is used, which might strike the flat, set it flush with the edges of the board and countersink the screws.

Modeling Clay Aids Nailing

If you run into a situation where it is almost impossible to hold a nail while starting it, press a lump of modeling clay over the spot into which the nail is to be driven. Then press the point of the nail into the clay and start hammering. After the nail has been struck a few times the clay can be removed and the nail driven flush. The clay will adhere to any surface.

Photographic Prints Flattened With Costfree Equipment

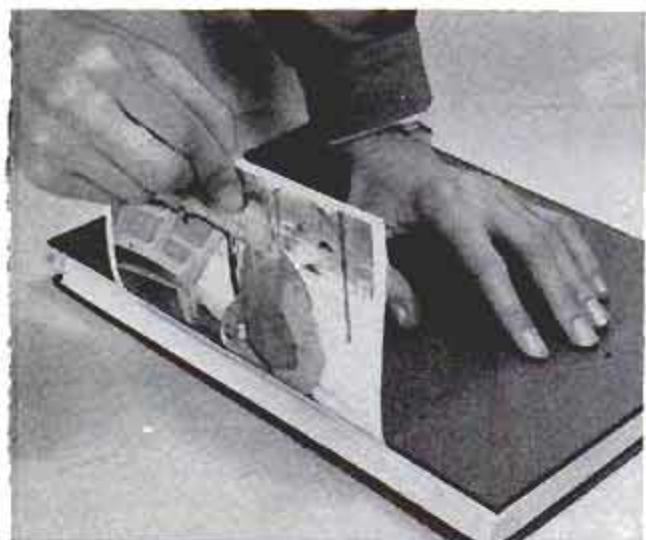

An effective method of flattening curled photographic prints with a minimum chance of cracking the emulsion, is to place each print, emulsion-side down, between the pages of a large book. The print then is grasped at the edge and pulled out of the book at a sharp upward angle as shown, while a light pressure is exerted on the book cover. Repeat this process several times, reversing the print edge for edge, to assure that the full surface of the print is flattened. Photoprints treated in this manner compare favorably with prints straightened in a commercial print flattener and, most important for the amateur photographer, at no cost at all for equipment to do the job.



Taper-Shank Drill Chuck Is Substitute Pin Vise

When no pin vise is available, short lengths of round stock that need to be filed, drilled or worked on in any manner can be held in a regular drill chuck. The chuck is held in a vise by using two wooden blocks. The blocks first are clamped together and a hole drilled to center between them. Because the hole is undersize, the blocks "crush fit" around the chuck.

F. L. Rush, Columbus, Ohio.

When patching a plastered wall, brush the edges of the old plaster with varnish. When the varnish has dried to a tacky stage, apply the patching plaster.

FILM AGITATOR

By L. H. Georger

AGITATION OF FILM tanks during developing no longer need be a manual operation when this powered agitator is used. Power is provided by a $\frac{1}{125}$ -hp. electric motor that runs at a constant 1550 r.p.m. on 110 volts. These motors are available at hobby shops and some toy stores. Speed reduction is taken care of by two 144-tooth metal gears and two fiber pinion gears purchased at a radio shop. The motor is bolted to a mounting block, as indicated, and the block is screwed to a wooden breadboard or suitable piece of plywood. Maple is used for the bearing blocks in which $\frac{1}{4}$ -in. steel rods rotate as shafting for the gear assemblies. An eccentric, which can be a turned shape, or simply a straight bar, is fitted on the end of the final shaft. A connecting rod cut from $\frac{1}{4}$ -in. rod runs from the eccentric to the film-tank holder. A roll-film tank is fitted on a holder, photo A, the top of which pivots when pulled and pushed by the rod. The tank for cut film is fitted in a bracket cut and shaped from sheet metal that is bolted to an L-shaped rod as shown in photo B.

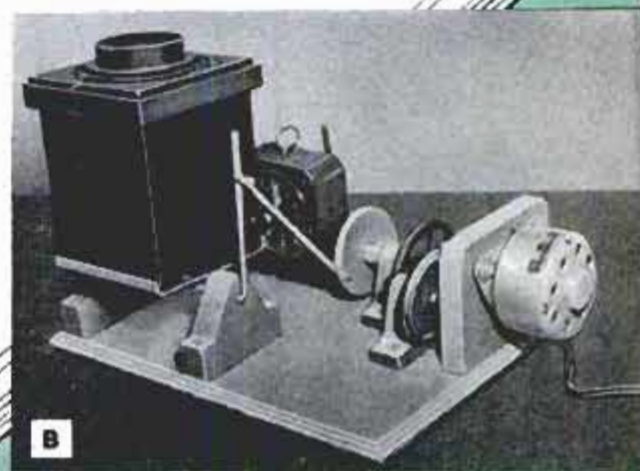
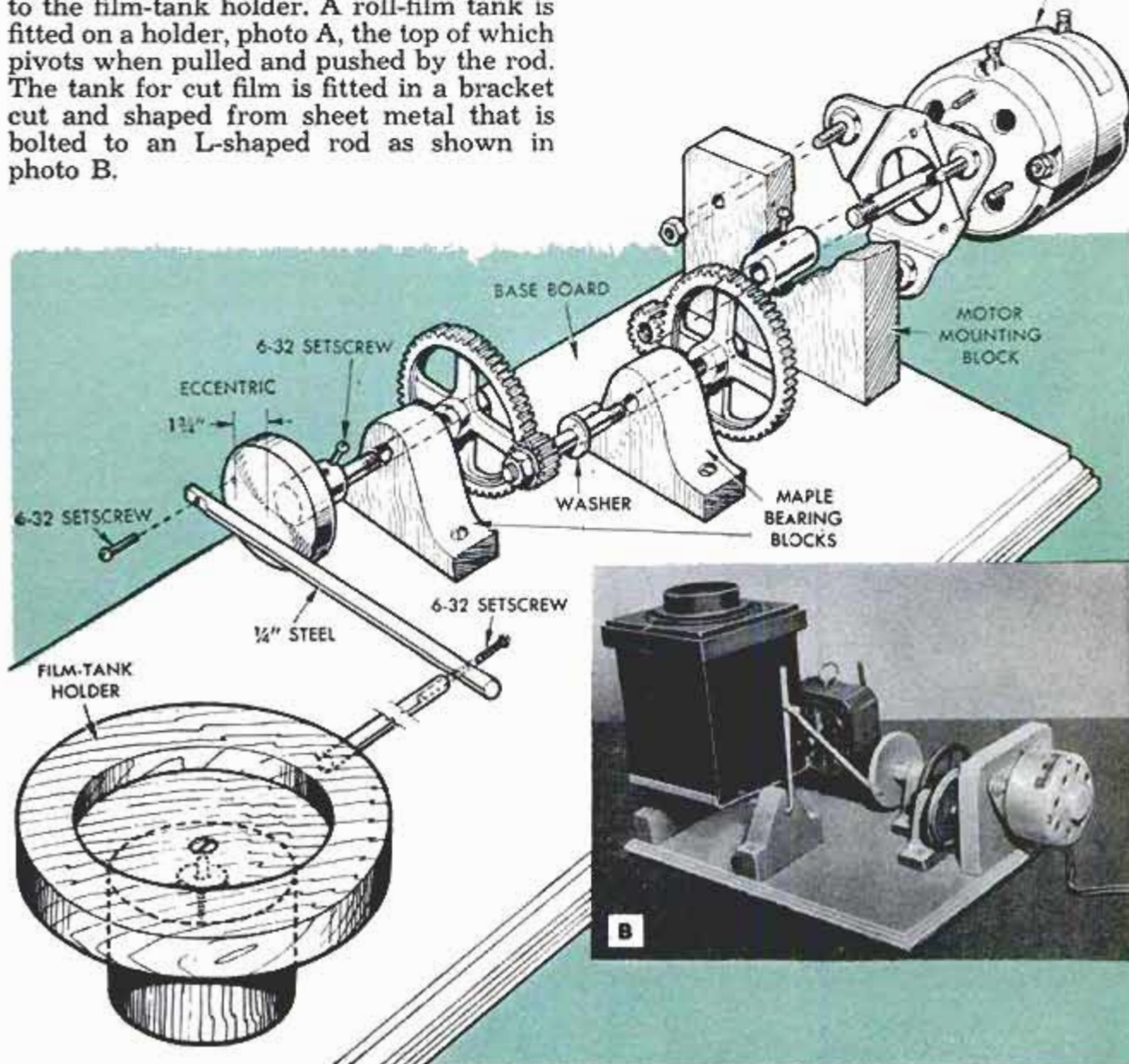
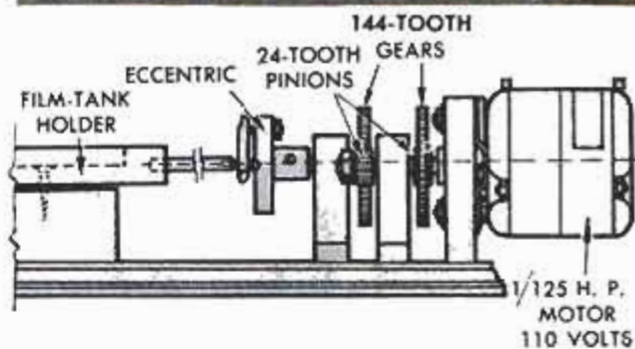
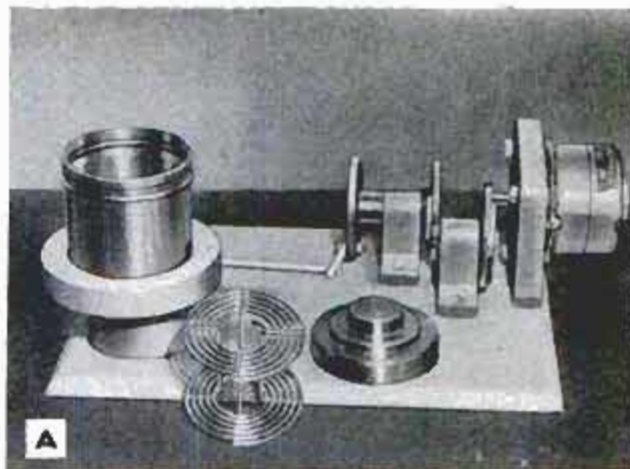

Solving HOME PROBLEMS

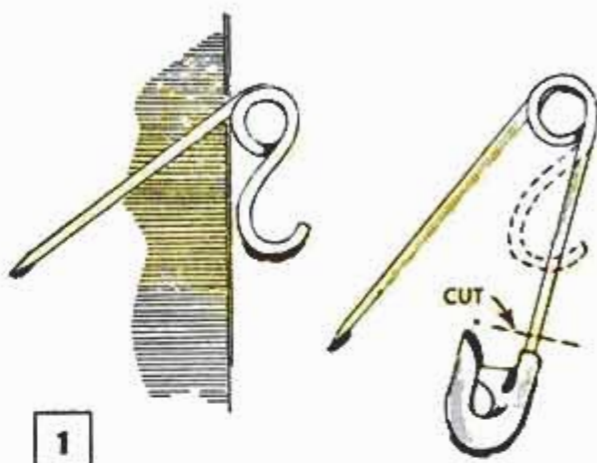

1. STRONG DRIVE-IN HOOKS for hanging both large and small wall pictures can be improvised by altering common safety pins. Cut off and bend upward as indicated to form hooks, then drive into plaster

2. WHERE TO GRIP a flowerpot when painting it is no problem if a cork is pressed in the drain hole in the bottom to provide a knob. This lets you turn the pot, as well as pick it up, without touching the paint



3. SERVING TRAYS have a habit of falling down when leaned in a cupboard. This won't happen if a short section or two of rubber tubing is slitted lengthwise and then slipped over the edge of each tray

4. A RUBBER BAND is all it takes to keep the parts of a spare electrical receptacle together for future use. The band is merely stretched around the two mounting screws which in turn hold the backplate

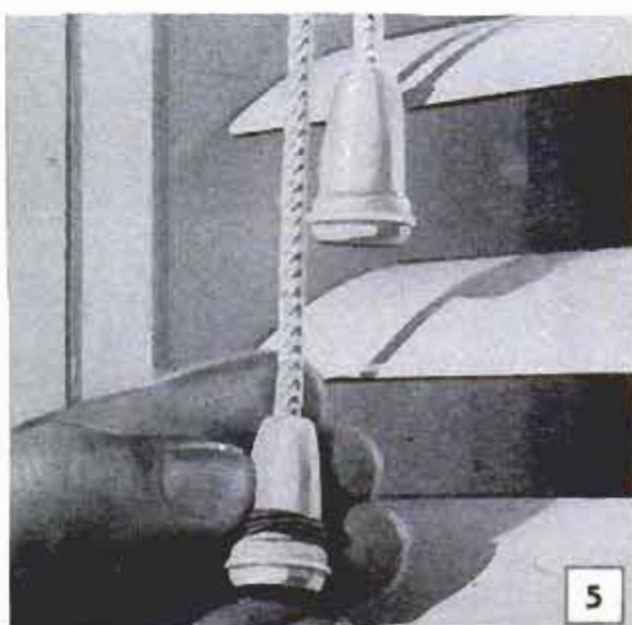

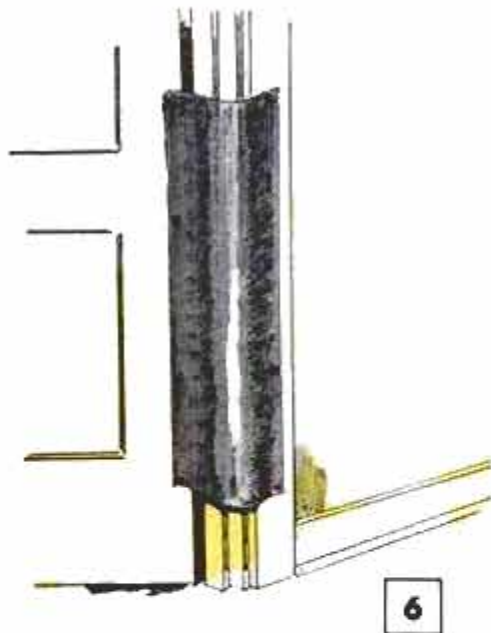

6

5. YOU'LL KNOW AT A GLANCE which pull on a Venetian blind tilts it up and which down if one pull is identified by wrapping a rubber band around it. You can find it in a darkened room by feeling band

6. EVER-PRESENT DANGER of tiny fingers being crushed in a door is minimized by covering an area along the hinged side with two strips of inner-tube. Tack strips to opposite sides, leaving more play in one



7

7. TEMPORARY CLOTHES ROD for hanging freshly ironed clothing consists of dowel with a screw hook in each end to engage screw eyes driven into wall and outer edge of door at a convenient height

8. BOOKMARK STAYS PUT when taped to the inside back cover. This king-size one measures 1 in. wide and 16 in. long and is cut from an old felt hat. Two strips of cellulose or adhesive tape hold it in place

9. WHEN A NEEDLE IS TOO LARGE for restringing beads, an extra-fine one can be formed from one strand of wire found in electric lamp cord. Fold strand in half, place thread between bend and twist

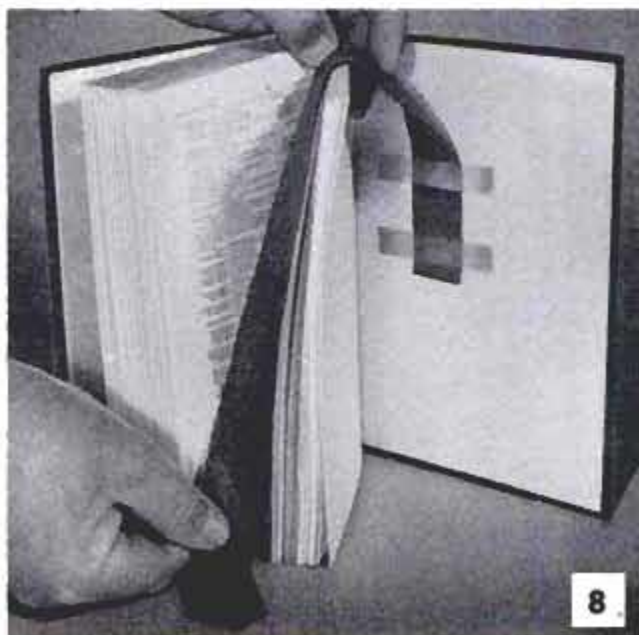

8

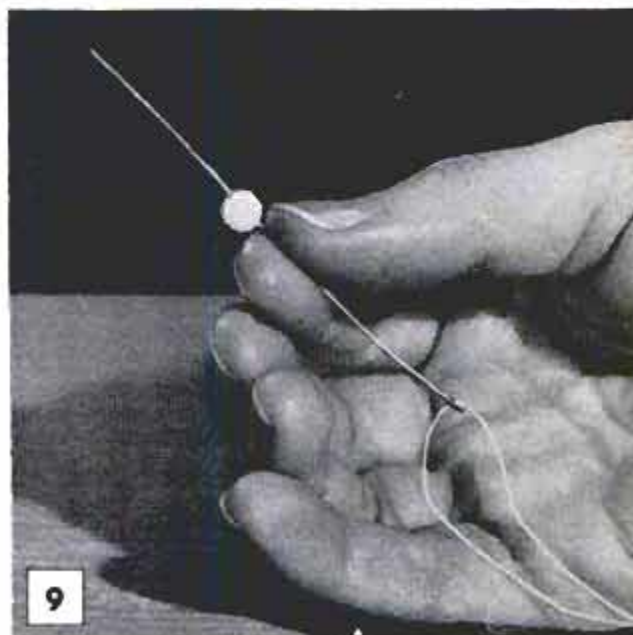

9



Charred Posts Don't Decay

Lightly charring the staple locations on new cedar fence posts is recommended by one farmer as a means of preventing decay at these places, which might result in loosening of the staples. A gasoline blowtorch used in the manner shown in the drawing at left is best for this purpose.

G. E. Hendrickson, Argyle, Wis.

Repair Loose Joints of Door

An effective way of permanently repairing an old door that has opened at the joints is to place bar clamps across the door and close the joints to their former tightness when new. Then with the clamps still in place, drive two or three wood screws through the stiles and into the tenons, positioning them about $\frac{1}{2}$ in. from the joints. Countersink the heads of the screws and cover them with wood putty.

Livestock Chute Floor Hinged to Adjust to Various Truck Heights



To permit easier loading of livestock, one farmer added an adjustable floor section to the end of the loading chute as shown in the photo. The outboard end of this section can be raised or lowered to any one of three elevations to match the bed of the truck backed up to it. The hinge on the section consists of a series of 2-in. sections of $1\frac{1}{4}$ -in. pipe welded to lengths of flat steel that are bolted to the underside of the floor section and to the post on each side. A 1-in. steel rod with a cross rod welded to one end for a handle, is inserted in the pipe sections to serve as a pin.

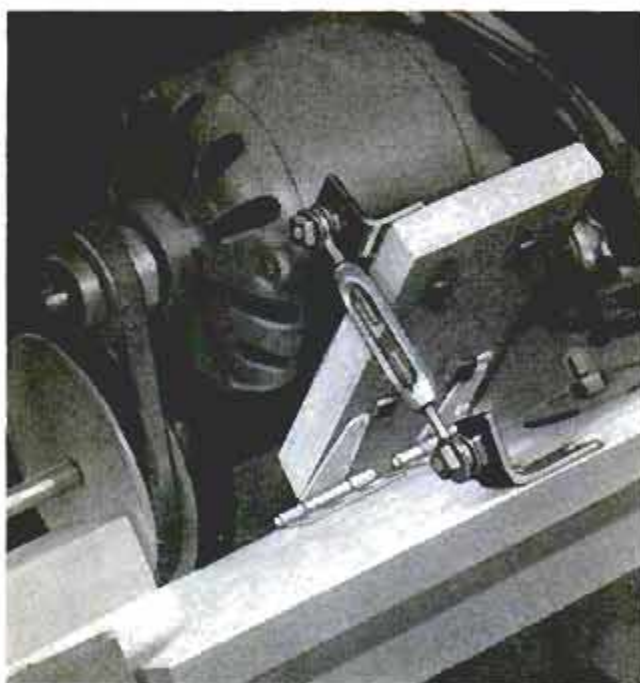

Use Turnbuckle to Tighten Belt Of Platform-Mounted Motor

Belt tension for a fractional-horsepower motor is easily adjusted when the motor is mounted on a platform that swings on hinges at one end and is held in tilted position at the other end by means of a turnbuckle as in the photo at left. For larger than $\frac{1}{2}$ -hp. motors, a turnbuckle should be attached to each side of the platform for better support and to prevent vibration.

Hugh Lineback, Stillwater, Okla.

☞ When scouring with steel wool, you can avoid getting fragments of steel in your fingers by using a length of garden hose as a holder. Insert steel wool in one end of the hose and push it through the hose as it wears away.



SECTIONAL OTTOMANS

By Ronald L. Anderson

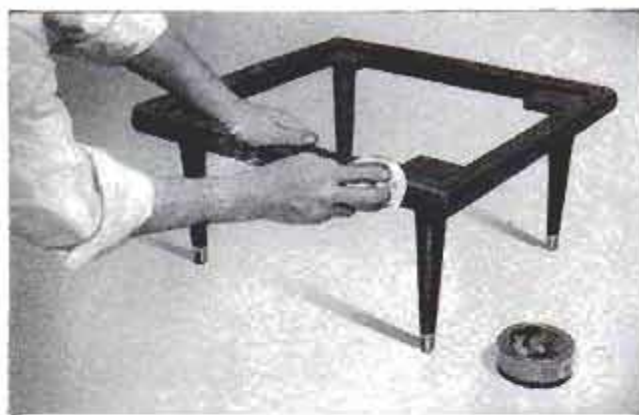

STYLED WITH A LOOK of the popular "Danish contemporary," these sectional ottomans combine their beauty with low cost and versatile utility. They can be grouped for best viewing of TV by the youngsters, then moved out of the way when not in use. At parties they simply are picked up and located where a guest wishes to sit. Their light weight will be appreciated especially by a housewife when she moves them around while cleaning. Despite their smooth, modern appearance, stock-milled lumber is used for the frames of these ottomans, and the legs are purchased ready-made. If you have some cushions left from a discarded sofa, they will cost you nothing, but even when it is necessary to buy the cushions, the finished cost of the units will be only a fraction of what they would cost if purchased. Foam-rubber cushions in many sizes are available, and can be covered with slipcovers that are fitted with zippers to permit easy removal for washing or cleaning.

The frame for each ottoman is made from handrail stock, ordinarily used for just that purpose by builders. One side of the stock is flat, which makes it simple to align and cut the mitered corners. The flat side also fits firmly against the table of a saw for cutting the 5-in.-long grooves in the ends of each frame member. Plywood

corner blocks are fitted in these grooves as shown in the detail, and glued in place. Inside dimensions of an ottoman frame should be the same as the dimensions of the cushion used. This permits the cushion to be positioned by the frame edges when the supporting webbing sags slightly under the weight of a person. Double check the sizes of sofa cushions, some are longer than they are wide.

After each frame has been glued, assembled and squared, let it stand until the glue has dried thoroughly. Any imperfections in the mitered joints now are filled with wood putty. Next, metal leg brackets are screwed to the corner blocks. Keep brackets as close to the frame members as possible, to increase the strength of the finished assembly. Now sand the frame and legs and stain to suit. In the matter of staining: Handrail is available in either oak or white pine. If a light oak finish is preferred for both legs and frame of the ottomans, use oak legs and oak handrail. For walnut, mahogany, cherry or any darker finish, white-pine handrail can be used, along with less expensive gumwood legs. The length of the legs is up to the individual builder. On the original ottomans, legs 10 in. long were used.

After the stain is well set, apply a coat of shellac that is sanded lightly when dry. Finally, apply paste wax. The final step in construction of the ottomans is to staple or tack cloth or plastic webbing to the frames. This webbing is available at most department stores, upholstery shops and mail-order houses. About 8 yd. of webbing will be required for each frame, this length allowing a little extra for doubling the ends of the webbing where it is tacked or stapled. Draw the webbing as tightly as possible, using a stretcher because it will sag slightly in use. ★ ★ ★



Above, three of the ottoman units grouped together. Below, a single unit, showing its neat construction

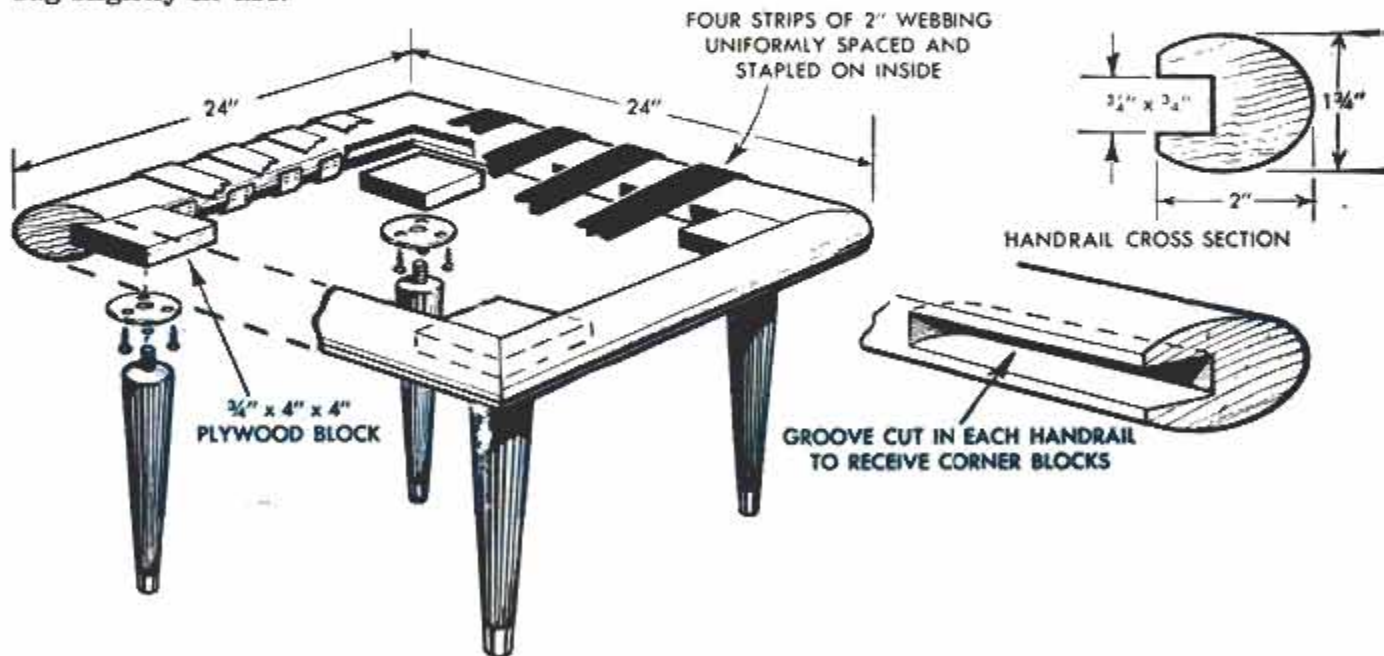
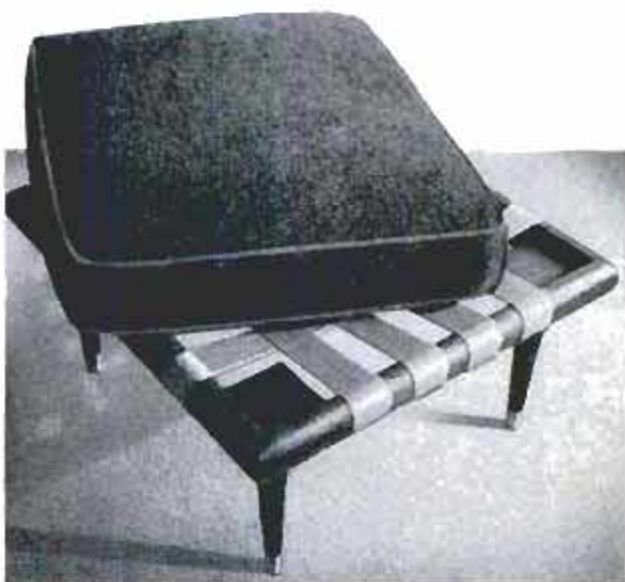

Barnyard Gate Can Be Raised to Swing Over Snowdrifts



Here is what one farmer did to eliminate a lot of backbreaking work opening a heavy gate in deep snow. Two U-shaped pieces of flat steel fitted around a 3 x 6 upright, with notches cut at selected elevations and bolted to the gate as shown, permit the gate to be raised to clear most snow depths that occur. A concrete counterweight, on the end of the lever which is pivoted on the upright, aids changing the elevation of the gate. The gate can also be raised to allow hogs to pass under it to an adjacent feedlot.—Donald K. O'Brien, Gahanna, Ohio.

Swing Joint in Pipeline Accommodates Expansion

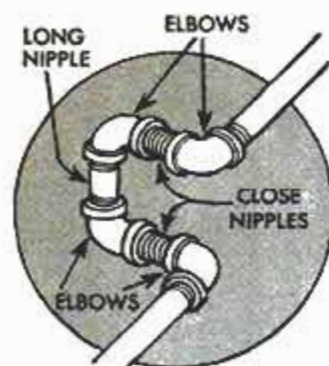

When a long run of hot-water pipe has rigid connections at both ends, an expansion joint should be installed in one end to allow for contraction and expansion. If a manufactured expansion joint is not available

and a flexible joint is not desired, a swing joint can be improvised from elbows and nipples such as the one shown.

Hydraulic Lift on Drawbar Eases Work for Tractor Operator

Laborsaving controls installed on this tractor permit the operator to lift the drawbar hydraulically or shift it from side to side when desired. This ease of handling the drawbar is especially handy when plowing rolling land and when moving wide farm machinery through gates.

Use Bow-Tie Clip as Note Holder

If you like to have notes convenient to the work, here is a means of quickly placing them wherever desired. Simply remove the double clip from a ready-made bow tie, clamp the notes in one end and clamp the other end to the work.

Courtney Schwertz, Madison, Wis.

C-Clamp Prevents Nails From Splitting Small Lumber

To prevent splitting the end of a small piece of lumber that is being nailed, tighten a C-clamp on it as shown in the drawing. After the nails are driven, the clamp may be removed without danger of the wood splitting. Pilot holes should be drilled before driving nails in the ends of hardwood lumber.

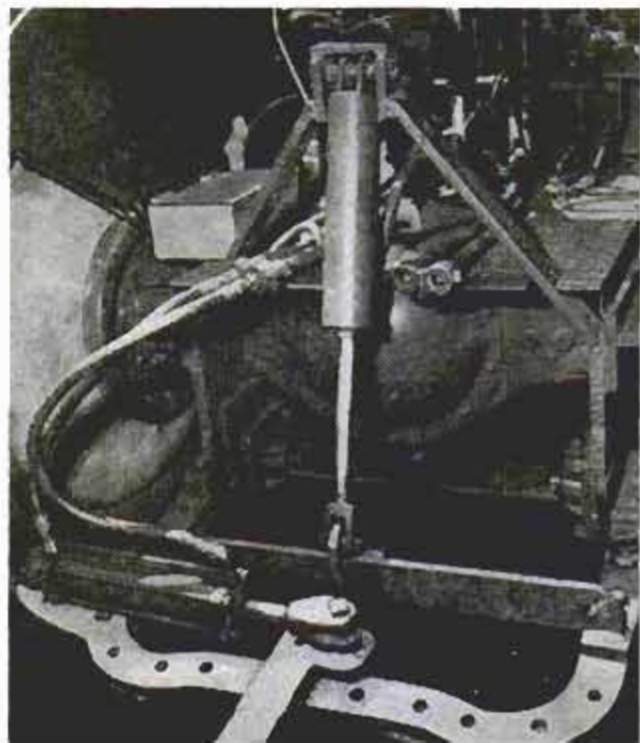

Stepstool With Handle Eliminates Stooping

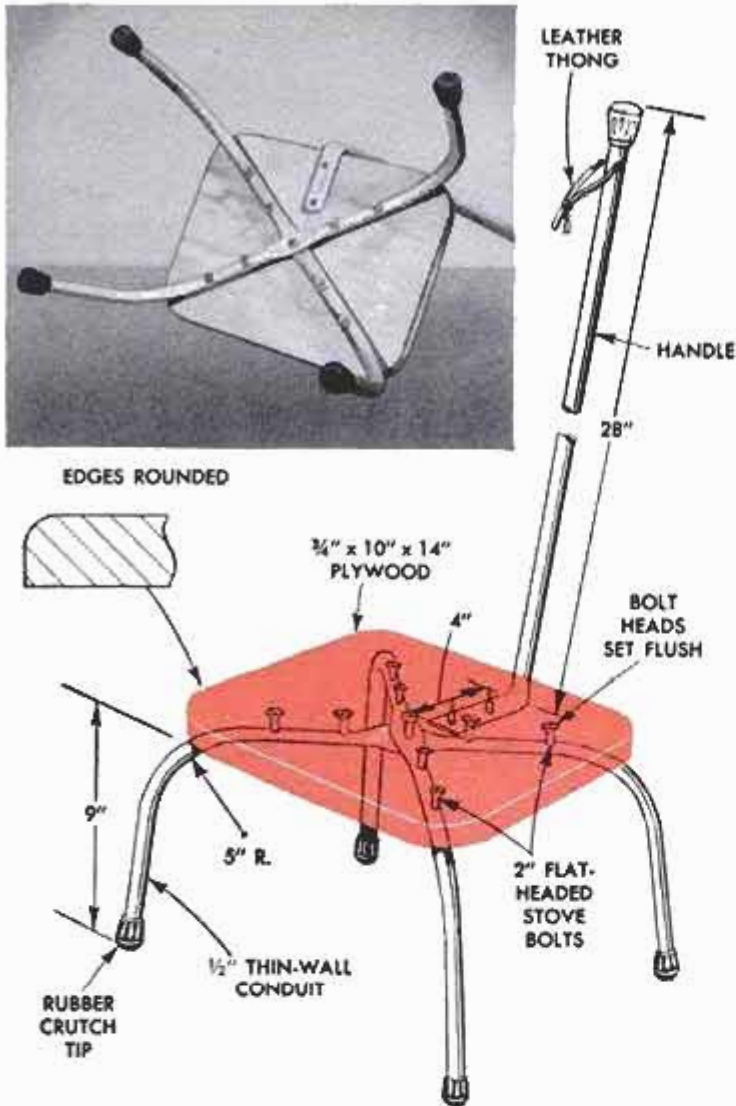

There are always a number of shelves and cabinets around the home that are just out of reach, so that a stepstool is needed. Here is such a stool, having the added advantage of a handle that eliminates the need for stooping to pick it up. A leather thong passed through a hole near the upper end of the handle permits the stool to be hung up out of the way when not needed. The top of the stool is a 10 x 14-in. piece of $\frac{3}{4}$ -in. plywood with the upper edges rounded and the corners cut to a 2-in. radius. The legs of the stool are two 41-in. lengths of $\frac{1}{2}$ -in. thin-wall electrical conduit. They are bent as indicated, using a tubing bender, which can be rented from a hardware store. After the legs are bent,

they are flattened at the center and fastened together and to the stool top with $\frac{1}{8}$ x 2-in. flat-headed stove bolts. The bolt heads are countersunk in the stool top. A 32-in. length of the conduit is used to make the handle, 4 in. of one end being flattened and drilled for two screws. The flat then is bent so it is slightly greater than at right angles to the handle and bolted to the bottom of the stool. If this handle shows signs of bending while being used, it is suggested that a short diagonal brace be fitted between it and the stool top. After the top, legs and handle are painted, a piece of rubber matting is cemented to the stool top. Crutch tips are fitted to legs and handle. Ronald L. Anderson, Minneapolis 20, Minn.

If the head of a hammer has become rounded, you will have difficulty driving a nail, as the head will slip off the nail when contact is made. To restore maximum efficiency to the hammer, clamp it in a vise and level the face with a file.

To prevent bottles and jars from tipping in the refrigerator, while standing on the wire shelves, cut pieces of plastic screening to fit the shelves and anchor them in place. The mesh in the screening gives ample circulation.

MODELING THE FRENCH

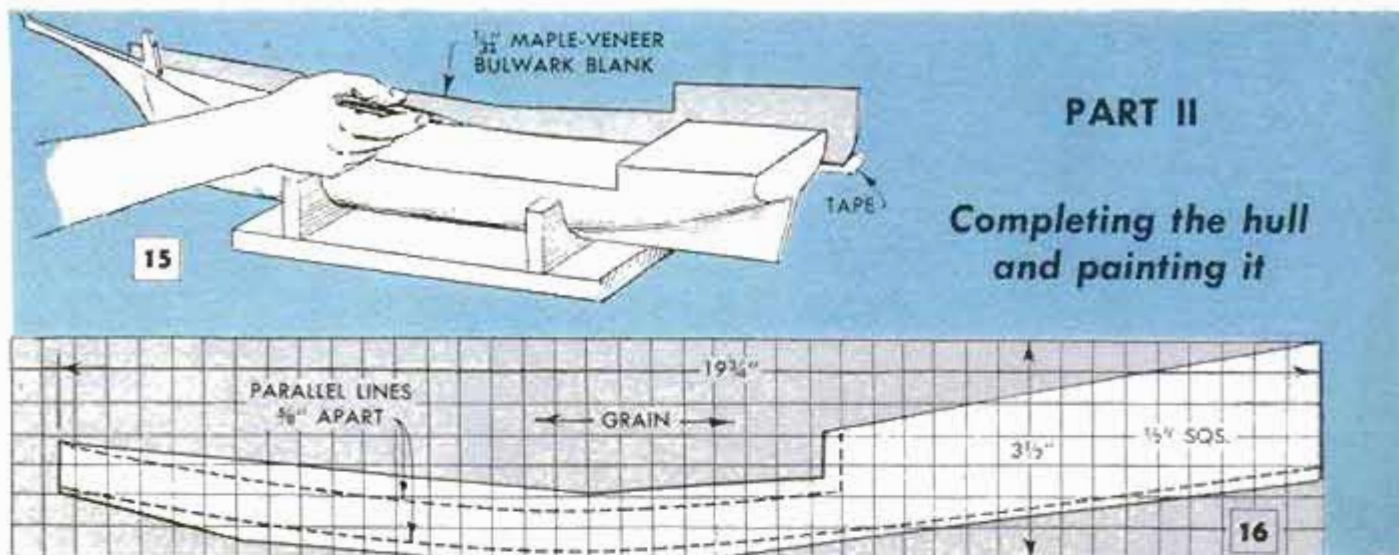

BECAUSE of continued references to station lines in building the model *Chebec* (the first installment last month) they should be marked on masking tape stuck to the deck centerline and to the keel to keep from marking the finished hull. Use a good grade of waterproof glue, applying it to bare wood but not to painted or other finished surfaces. Glued parts should be held together firmly until dry. Short sections of lill or ribbon pins ($\frac{1}{2}$ and $\frac{3}{8}$ in. long and having diameters of No. 72 and 74 drills respectively) are used for reinforcing in addition to glue. These are merely pressed gently into soft wood but pilot holes are needed in hardwood.

To make wood strips pliable for bending, use a simple steamer, such as shown in Fig. 17. In lieu of tiny twist drills you can make substitutes from needles by grinding the eye end as in Fig. 17. A pin vise is needed to hold them. Because of unavoidable slight differences between any two models made from the same plans, it's best

to make paper patterns of parts first so you can check for fit, and then make the parts accordingly.

Waterway Strips and Deck Finish

Waterway strips, as shown in Figs. 20, 21 and 22, are glued to the main deck $\frac{1}{32}$ in. from the sides, thus providing a corner to glue in the bulwarks. The waterway strips extend from station 6 to a point $\frac{9}{16}$ in. ahead of station V where the forward breastwork comes, as indicated in Figs. 14, 19 and 23. Before proceeding, clean the deck with 2-0 sandpaper and stain it a light oak. Apply a coat or two of clear varnish or lacquer, rubbing this down with fine steel wool when dry. This helps to keep the deck clean. Don't coat the waterway strips however. When you glue fittings to the finished deck later, remove some finish as necessary to assure good adhesion.

Bulwark Blanks

Bulwarks are the continuation of a

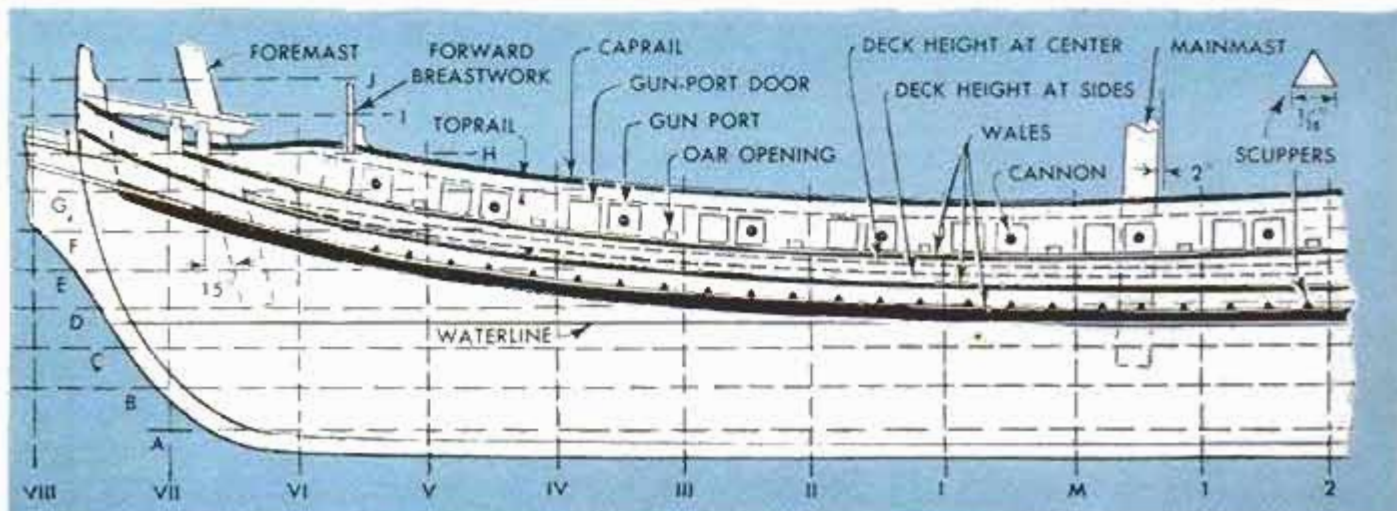

CHEBEC

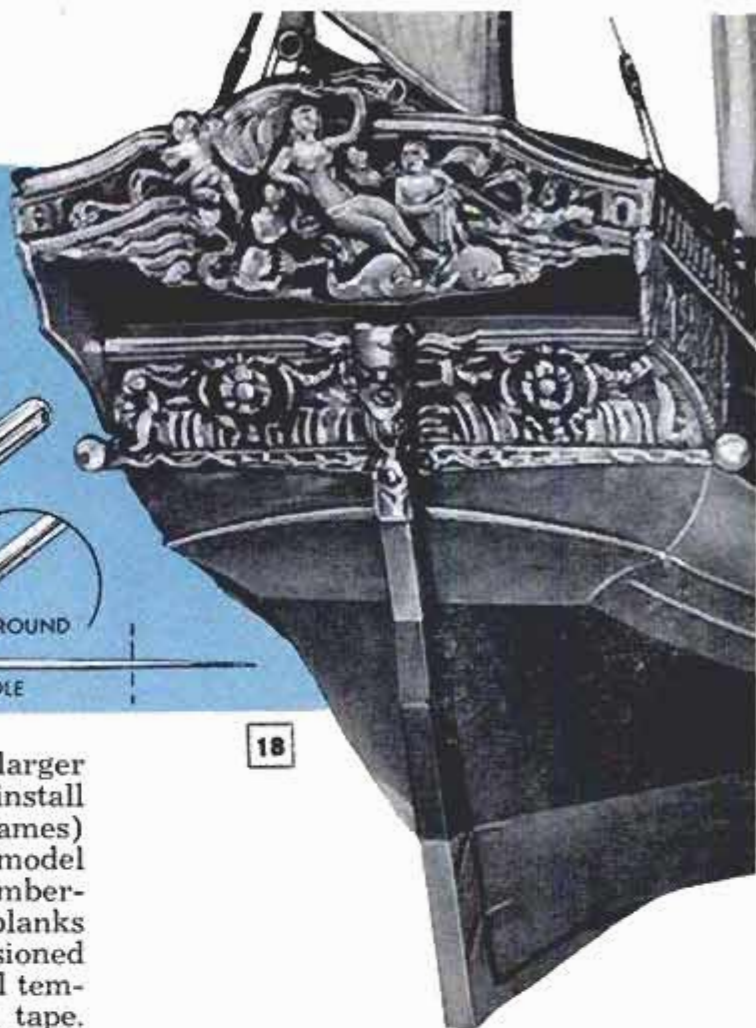
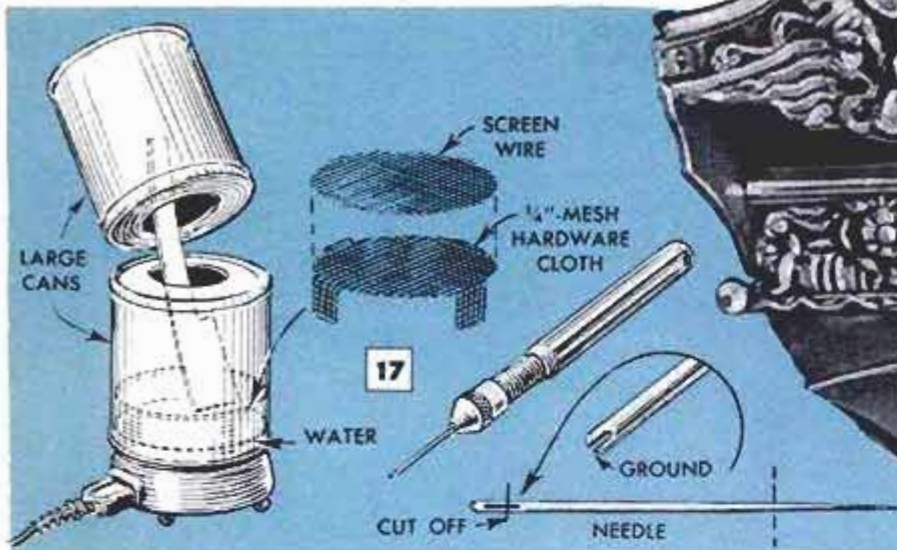

ship's side above its deck. On models larger than this one it is customary to first install timberheads (ends of the ship's frames) and then the bulwarks. But for this model the sequence is just reversed as the timberheads are so small. Cut two bulwark blanks from $\frac{1}{32}$ -in. maple veneer as dimensioned in Fig. 16, and attach these to the hull temporarily with self-adhering drafting tape. Trace the deck line with a sharply pointed pencil, Fig. 15, letting enough veneer project above it to include the finish cutting lines. Also mark the location of the gun-axis dots along the deck edges, on the bulwark blanks.

After removing the blanks, mark a continuation of the deck line aft of station 6 on them, and also a curved line parallel to this and $\frac{5}{8}$ in. or slightly more above the deck line forward of station 6. Also draw a vertical line up from the upper curved line at station 4. All of these lines are shown dotted in Fig. 16. Lay off the $\frac{1}{4}$ -in. square gun ports from the gun-axis marks,

PORTFOLIO OF PLANS

Popular Mechanics offers the serious modelmaker plans for building four other famous French ship models, namely the *La Sablaise*, a sailboat, *Jeanne D'Arc*, a training cruiser, *Marie Jeanne*, a fishing boat and the *Le Terrible*, a light cruiser. For a free descriptive brochure on these plans and their prices, write to Popular Mechanics Co., Dept. 80, 200 E. Ontario, Chicago 11.

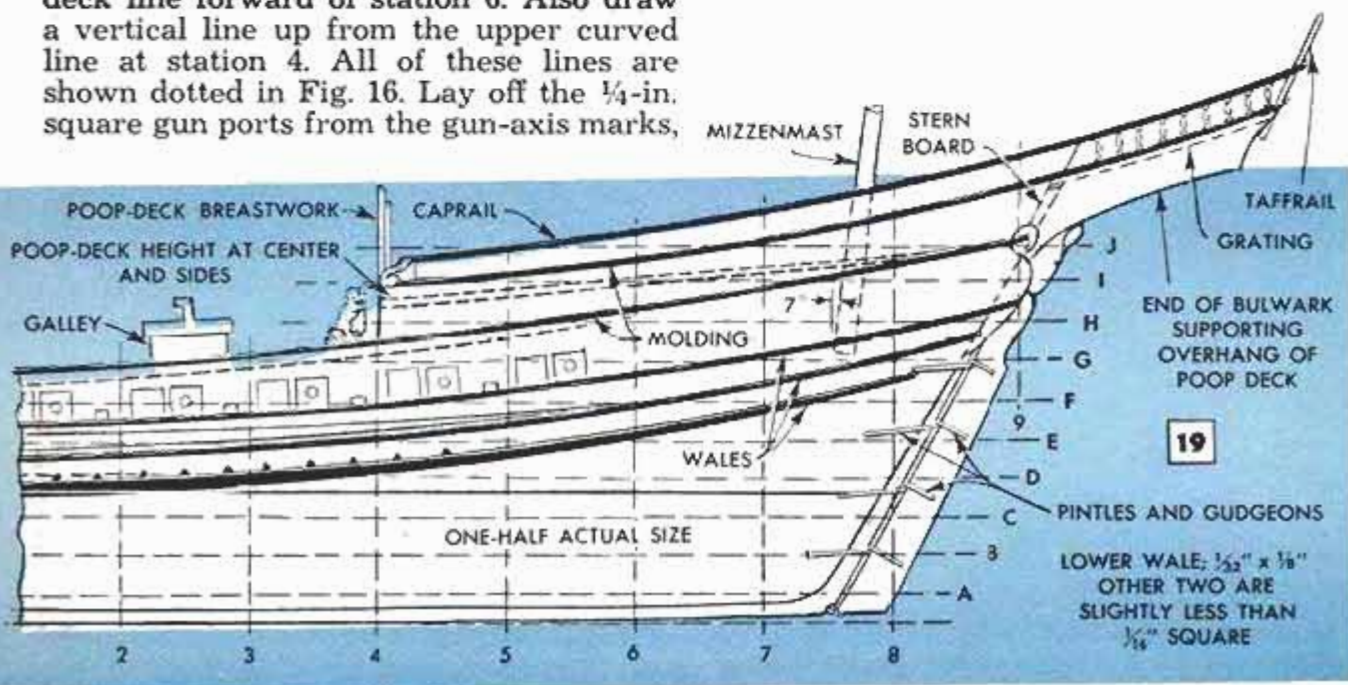

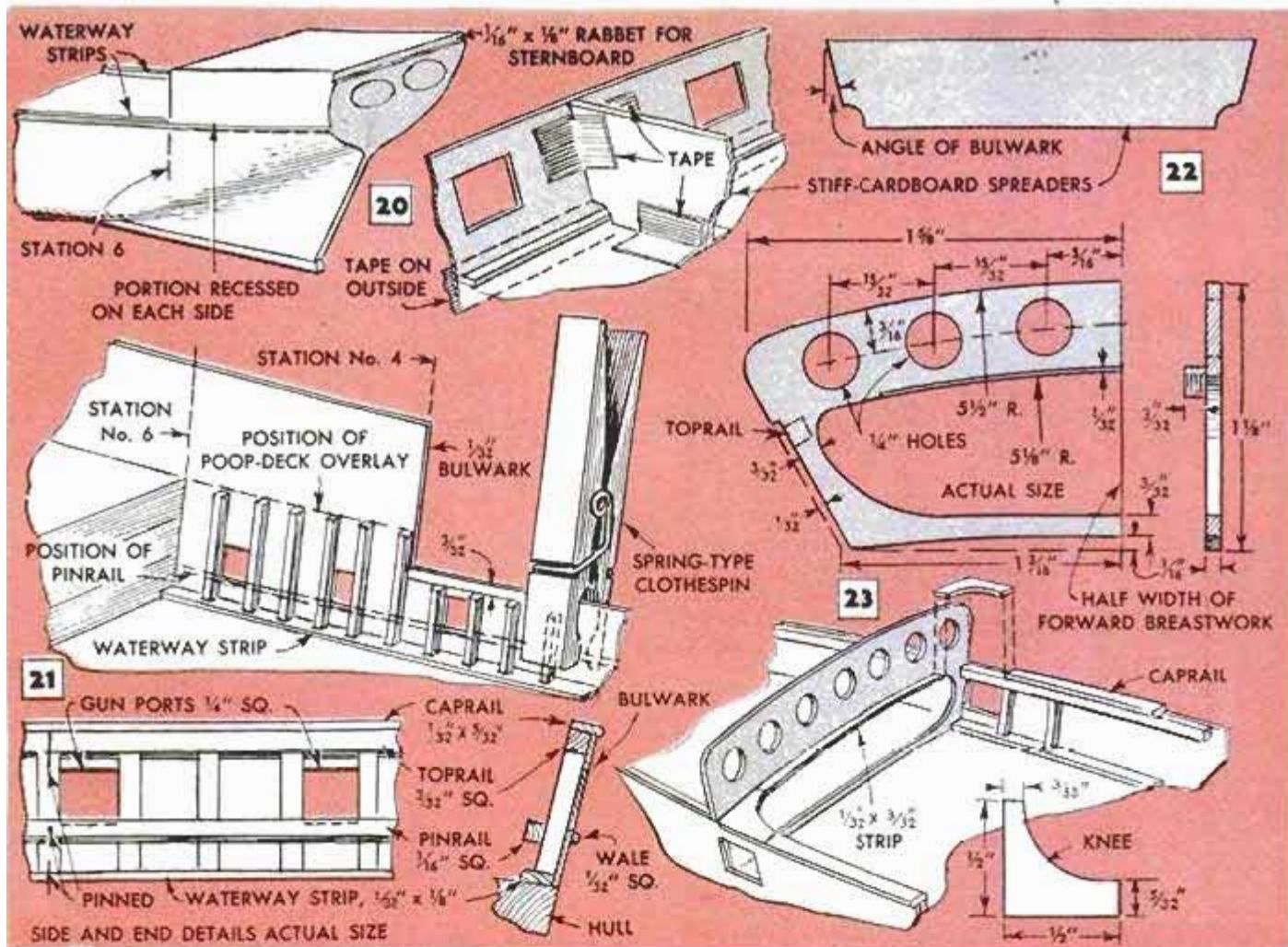

their lower edges coming $\frac{7}{32}$ in. above the deck line and parallel to it. When cutting veneer, hold the knife against suitable straight and curved guides. Later the gun-port doors are glued on the outside of the hull as in Fig. 19.

Recessing Hull for Bulwarks

Now hold the bulwarks in position against the hull, fastening them with tape so you can make a knife cut in the hull accurately along their lower edges aft of station 6. Then remove the bulwarks and recess the area above the cut $\frac{1}{32}$ in. as in Fig. 20, checking this with the contour templates. These will have to be trimmed at the bottom to touch the keel if the ship is not removed from the cradle. Also cut a rabbet in lift J for the sternboard, Fig. 20. Glue and pin little triangular blocks on each side of the stemson as in Fig. 24, to provide gluing surface for the bulwarks.

Bulwark Flare

Prepare five stiff cardboard (or tempered hardboard) spreaders, Fig. 22, to hold the bulwarks temporarily at stations IV, II, M, 2 and 4, at the proper flare. The length and angle of the ends can be determined from Fig. 9 of Part I, making allowance for bulwark thickness. The for-

ward breastwork, Fig. 23, also braces the bulwarks and therefore is made at this time. First outline its shape, then drill the holes and saw the internal cutout before cutting it to shape on the outside.

Installing the Bulwarks

Replace the bulwarks and hold them in position with tape applied ahead of station 4. Glue their aft ends to the recessed areas of the hull, clamping suitably for maximum contact. Next, using a toothpick, apply glue between the bulwarks and the waterway strips. Then adjust the spreaders and tape them to deck and bulwarks as in Fig. 22 before the glue sets. The spreaders are not removed until the bulwarks are adequately braced by the timberheads. Also glue the forward breastwork to the deck and to the bulwarks, holding it in position securely with tape. If a firm contact between bulwarks and hull is not maintained at all points by the tape, use a few lill or ribbon pins. Glue the bulwarks to the stemson last. To avoid accidental breakage of the bulwark ends that project beyond the poop deck, screw a wood block to the latter temporarily to fit snugly between them, and tape together.

As shown in Fig. 21, timberheads between stations 4 and 6 extend up to the

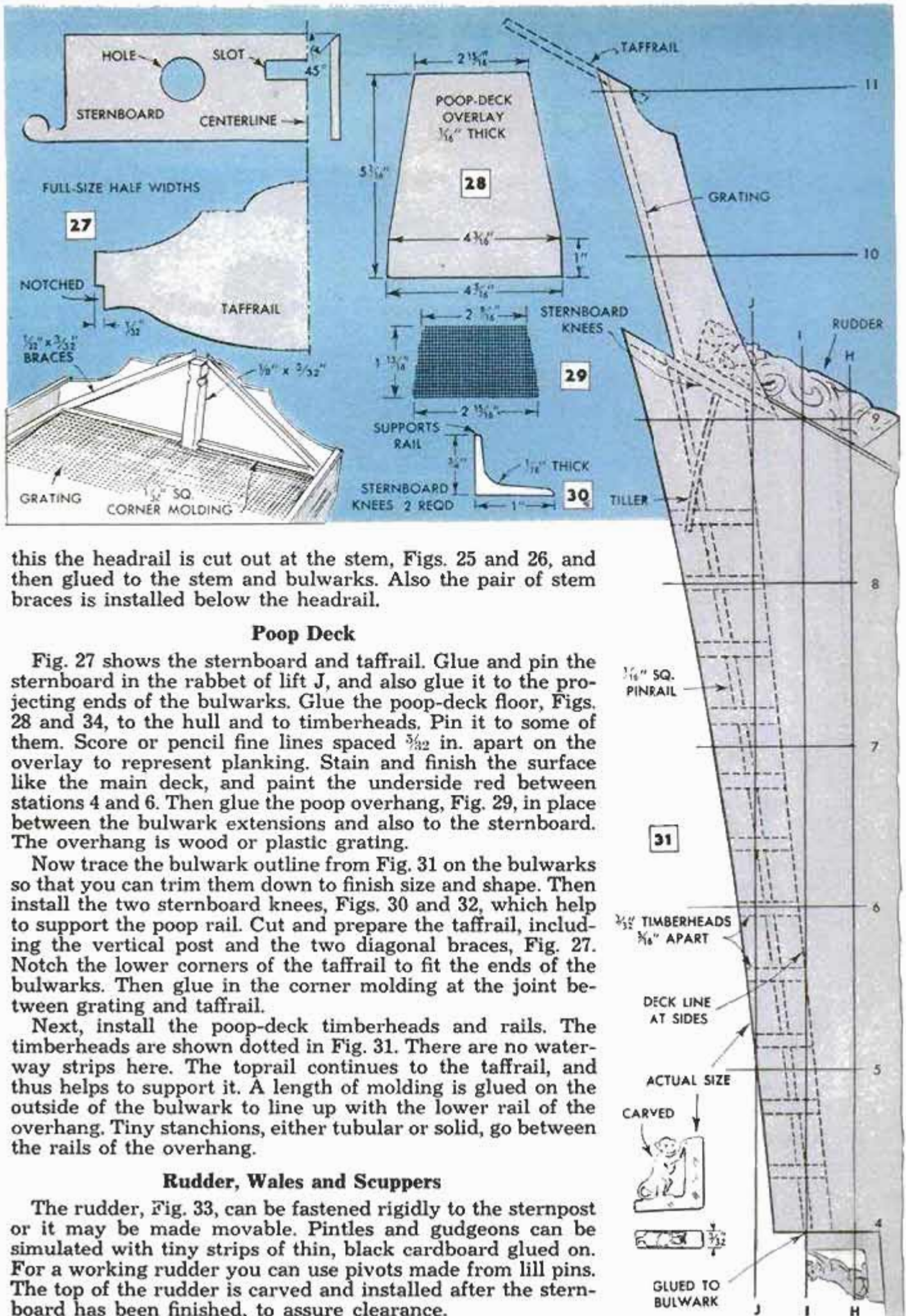

this the headrail is cut out at the stem, Figs. 25 and 26, and then glued to the stem and bulwarks. Also the pair of stem braces is installed below the headrail.

Poop Deck

Fig. 27 shows the sternboard and taffrail. Glue and pin the sternboard in the rabbet of lift J, and also glue it to the projecting ends of the bulwarks. Glue the poop-deck floor, Figs. 28 and 34, to the hull and to timberheads. Pin it to some of them. Score or pencil fine lines spaced $\frac{3}{32}$ in. apart on the overlay to represent planking. Stain and finish the surface like the main deck, and paint the underside red between stations 4 and 6. Then glue the poop overhang, Fig. 29, in place between the bulwark extensions and also to the sternboard. The overhang is wood or plastic grating.

Now trace the bulwark outline from Fig. 31 on the bulwarks so that you can trim them down to finish size and shape. Then install the two sternboard knees, Figs. 30 and 32, which help to support the poop rail. Cut and prepare the taffrail, including the vertical post and the two diagonal braces, Fig. 27. Notch the lower corners of the taffrail to fit the ends of the bulwarks. Then glue in the corner molding at the joint between grating and taffrail.

Next, install the poop-deck timberheads and rails. The timberheads are shown dotted in Fig. 31. There are no waterway strips here. The top rail continues to the taffrail, and thus helps to support it. A length of molding is glued on the outside of the bulwark to line up with the lower rail of the overhang. Tiny stanchions, either tubular or solid, go between the rails of the overhang.

Rudder, Wales and Scuppers

The rudder, Fig. 33, can be fastened rigidly to the sternpost or it may be made movable. Pintles and gudgeons can be simulated with tiny strips of thin, black cardboard glued on. For a working rudder you can use pivots made from lill pins. The top of the rudder is carved and installed after the sternboard has been finished, to assure clearance.

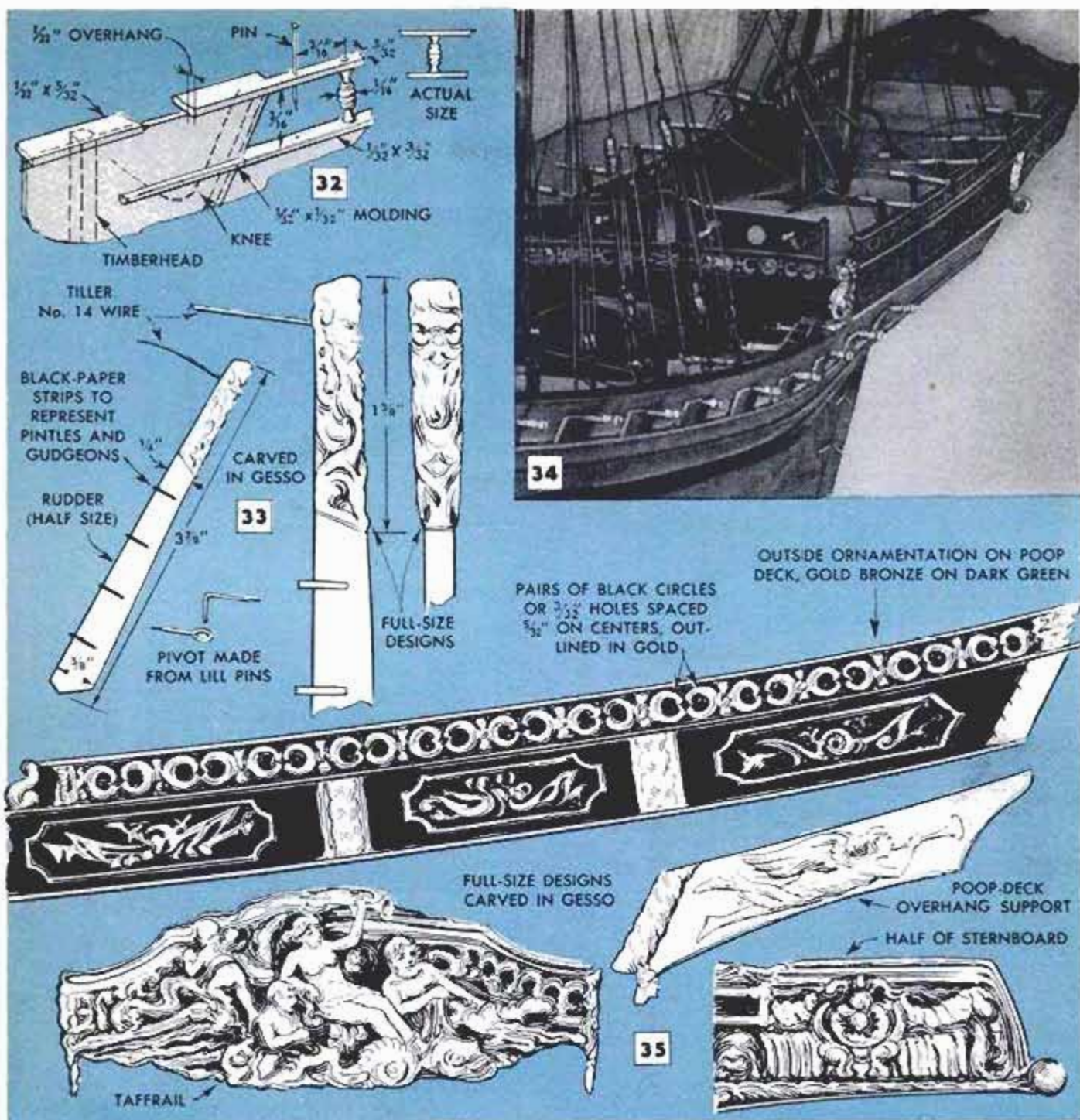

In addition to the molding on the outside of the poop deck as indicated in Fig. 19, three wales are glued to the hull from stem to stern. Tiny triangular holes along the top edge of the lower wales are scuppers, which were originally used to discharge water from the deck. Gun-port doors are glued to the outside of the bulwarks after the surface of the hull has been finished.

Painting and Ornamentation

Use semigloss enamel and varnish. It's best to paint parts like the inside of the bulwarks before you add other parts as these may interfere with painting. Most fittings to be made separately are painted before installing them. Mark the waterline as given in Fig. 19, with a pencil held hori-

zontally on a block of proper height. Fill cracks, dents and gouges in the hull with wood putty before finishing it. The outside is light oak stain and black enamel, then covered with flat or satin-effect varnish. Oar openings, also indicated in Fig. 19, can be simulated by finely painted lines.

The designs on the poop deck are shown full size in Fig. 35 so that you trace them. The narrow band just below the top rail may be perforated with pairs of connecting holes, which come between the timberheads, or they can be simulated with black paint. Parts to be carved (sternboard, taffrail, poop-overhang support and top part of rudder) are first overlaid with a $\frac{1}{16}$ -in. coating of gesso, which when dry can be cut neatly. It is obtainable at paint stores.

Figs. 18 and 35 show the stern carvings. Although these can be coated simply with gold bronze, it is better to use gold leaf. This adheres to slightly tacky glue size or thinned varnish. Other carved ornaments, similarly finished, are the monkeys adjacent to the ladders to the poop deck, Fig. 31, the top of the rudder, Fig. 33, and the stem figurehead, Fig. 26, which is a monkey head.

Colors of parts already made and to be made are as follows: Chinese red: The inside of the bulwarks up to the top rails; the underside of the poop deck; the stanchion supporting the edge of the poop deck; the ladders up to their platforms; inside of the sternboard, taffrail and bulwark extensions; turned stanchions of the railing of the poop-deck overhang; forward breastwork; poop-deck breastwork above the lower ornamental band; inside of the gunport doors; gun carriages; hatchway frames; tiller; deck cleat; braces at the stem under the headrail; inside of the long boat except the well which is white. Black: Outside of the hull between the waterline and top edge of the lower wales; part of the bowsprit that comes over the stem; the stemson and the attached foremast bracing; the hawse-guide posts; bolster plates and crossrail; ladder platforms adjacent to the poop deck; all top rails of bulwarks as well as the joining knees and cross strip on the aft side of the forward breastwork; the diagonal braces inside of the taffrail; the poop spar and its guardrail; the yards of all masts; the masthead blocks and 1/2 in. sections of masts just above the decks; upper outside of the long boat to its waterline. Dark leaf green: The background of the gold-bronze designs on the sides of the poop deck and along the lower edge of the poop breastwork. Light oak stain and varnish: Decks; the outside of the hull and bulwarks below and above the black areas; most of the masts and the fore portion of the bowsprit; gratings; hatch covers; outside of the long boat below its waterline. Gold: Use extra-fine gold bronzing powder for the guns unless you are using brass guns and then just lacquer them. Also use bronzing powder for the designs on the green panels. Although this can be used on all carved parts, gold leaf is preferable for these.

(To be continued)

If you are planning to paint the varnished woodwork in your home, don't make the mistake of painting it without first applying a coat of regular undercoat. If you omit the undercoat, you run the chance of the stain bleeding through the paint, as well as having the old varnish crack or "alligator."

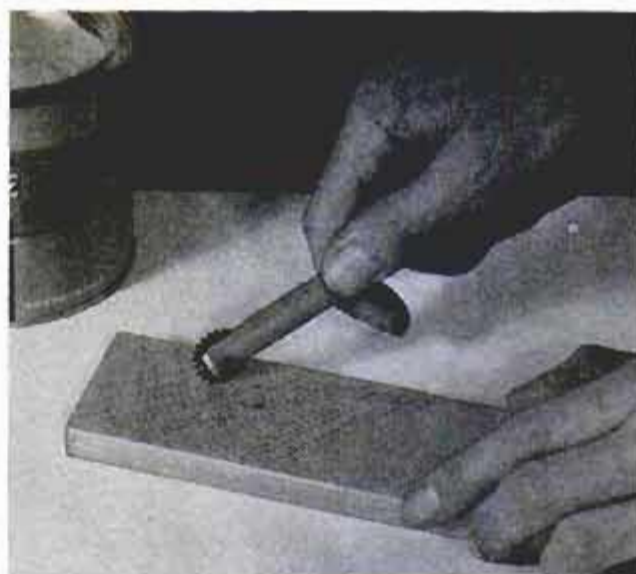

Indented Surfaces Give Tooth To Flat Glue Joints

Roughened surfaces always make stronger glue joints than smooth surfaces since most of the glue is squeezed out when clamping pressure is applied. A good way to roughen flat surfaces that are to be glued back-to-back is to use a dressmaker's tracing wheel or a tool made by cross-pinning a clock-gear wheel in the slotted end of a dowel. Running the tool back-and-forth across the mating surfaces produces countless indentations which form pockets to trap the glue when clamping pressure is applied. Besides resulting in a stronger bond, there's less glue wasted.

H. Hanscom, Elmhurst, Ill.

Grease-Gun Plunger Rod Locked With Pliers

When filling a grease gun having a disappearing filler ram, there is the possibility of the plunger rod becoming disengaged from its retaining slot, permitting grease to be forced from the barrel. Such an occurrence results not only in loss of grease but in a messy cleanup job. To prevent this, the plunger rod can be locked securely with locking pliers when the gun is being filled, eliminating any chance of the plunger rod being released.



Decorating Hints for a More Attractive Christmas Tree

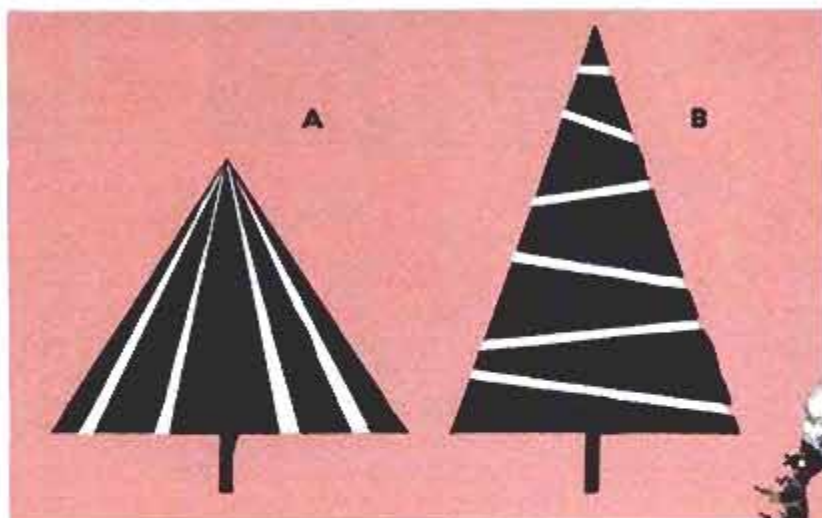

When trimming a Christmas tree, you can utilize a fundamental rule of clothing fashion, which is to accent the opposite. If the tree is tall and slender, decorating lines should be horizontal, detail B, while a short, full tree calls for vertical accents, detail A. Trim a tree from the top down. If you start at the bottom and work up, you are in your own way and take a chance of knocking down the tree. After the star, angel or other tree-top ornament is firmly in place, string the lights. To assure an even distribution of lights and to avoid a spotty look, professionals use a formula: Tree height in feet x the width of the tree at the base x 3. As an example: A tree 6 ft. high and 4½ ft. wide at the base would use the equation $6 \times 4\frac{1}{2} \times 3$, which equals 81 lights. When the lights have been positioned, add "continuous" decorations, such as strings of popcorn. Follow with glass



ornaments, snowballs, candy canes and similar decorations. Aluminum or lead tinsel is added last, a single piece at a time. An optional finishing touch would be to spray the tree with artificial snow.

Noma Lites, Inc.

Pencil "Graphite" Quiets Wooden Wheels of Toddler's Wagon

If your youngster's wooden-wheeled wagon rolls out some earsplitting squeaks, lubricate it with a pencil. Rub the pencil on a piece of sandpaper to produce some powdered graphite, then use a sheet of rolled-up paper to apply it as shown.

Dull Plastic Surface Polished With Toothpaste and Powder

Plastic that has become dulled can be given a high polish by using dentifrices as buffing compounds. Make a paste of a small amount of tooth powder and water and rub this mixture on the plastic with a piece of felt. The powder will remove small scratches and marks from the plastic surface. Then using another piece of felt, apply toothpaste, wet it slightly and buff.

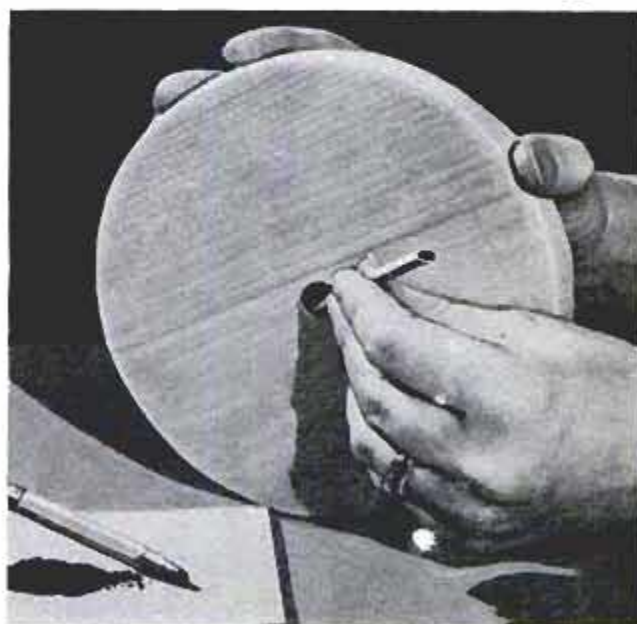

CHRISTMAS-SAFETY



Above, unlike broad-leafed trees, evergreens used for Christmas trees are easy to set on fire, even when green. Keep tree away from heat sources and away from exit door as safety precaution. Below, use sturdy stepladder when decorating large tree. Avoid using makeshift supports, such as chairs and stools



By Russ Whitaker

DURING THE RUSH of holiday preparations around the home, don't overlook the simple rules of safety. To do so may mean exposing yourself and your family to situations that are potentially dangerous, such as smoking next to an easily ignited Christmas tree or using flammable materials for a candle centerpiece as illustrated in this article. Using lights with defective wiring may result in a short circuit that could set the tree on fire. When the needles begin to drop from the tree, it is a serious fire hazard and should be removed from the house at once. An adequate base should be provided for a large tree, and in addition, the upper end should be guyed to nearby window frames or other convenient objects to prevent children from accidentally pulling it over. Be sure that toys you buy for children are safe. Playthings such as roller skates or a tricycle should be in the right size range for the child. When purchased too large, they can be a hazard. ★★ ★

Below, after Christmas presents have been opened, remove all the wrapping materials and dispose of them in incinerator. It is hazardous to burn large quantities of paper at once in an open fireplace



HINTS



Right, spark from cigarette can easily ignite Christmas tree. Locate chairs and ashtrays a safe distance from tree and other evergreen decorations to avoid such fire hazards. Locate tree away from draperies and other easily flammable furnishings to prevent fire from rapidly spreading should it break out



Above, be sure toys that are bought for children are of safe design. Vehicular playthings, such as roller skates and tricycle, should be of proper size for the child to avoid unnecessary falling accidents. Instruct the child in proper use and care of toy to avoid injury to himself and possibly to others

Right, position and set up your Christmas tree securely so that it cannot topple over to cause an electrical short or do other damage. A small tree can be held in place on a low table by clamping one of the legs of the base with a C-clamp as shown

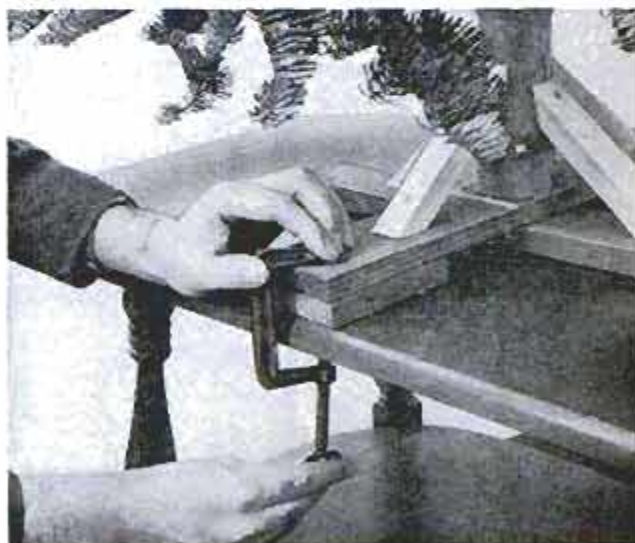



Above, strings of Christmas-tree lights are fine for outlining roof of house but be sure to use only outdoor type. Also, outdoor-service receptacles should be provided on outside of house for plugging in such lights and other electrical devices to be used outside (see "Protect Your Christmas Lighting," *Popular Mechanics*, December 1956, pages 192-195)



Above, candle centerpiece should not be made of materials that burn readily. A draft can easily blow the flame of low-burning candle into an arrangement such as the one shown, setting it on fire. Keep evergreens and other combustible materials well away from candles to be lighted. Below, fasten all lamps to tree limbs so they can't come in contact with foliage



Above, secure top of large tree to window frame or other moldings with guy wires to prevent it from accidental tipping

Below, before arranging lights on Christmas tree, inspect and test wiring of each string for defects that may cause short circuits. Repair defective strings or replace them



Improved Miniature Reflector For Photoflash Close-Ups

Occasionally an improvised device does a job so well that it becomes a permanent part of a hobbyist's equipment. Such is the case with this miniature photoflash reflector. The original problem that required its use was to shoot a close-up at 3 ft. with high-speed film, and a No. 5 flash bulb. This lamp-and-film combination, with a standard reflector, would require shooting at $\frac{1}{400}$ sec. at f. 46. The limit of the camera was $\frac{1}{400}$ sec. at f. 32. Less light on the subject, by using a smaller reflector was the answer. A blank utility-box cover was used as the reflector, and a tool clip was screwed to it. The clip then fitted over a flash-bulb adapter, as indicated, that was inserted in the regular flash gun. With this setup, the f. number was cut in half to .22, and the exposure was perfect. In the final print, the shadows gave the effect of multiple flash, due to the reflections from the flanged edges of the box cover. The cover was not polished, but left its natural, dull finish.

Frank P. Fritz, Bensenville, Ill.

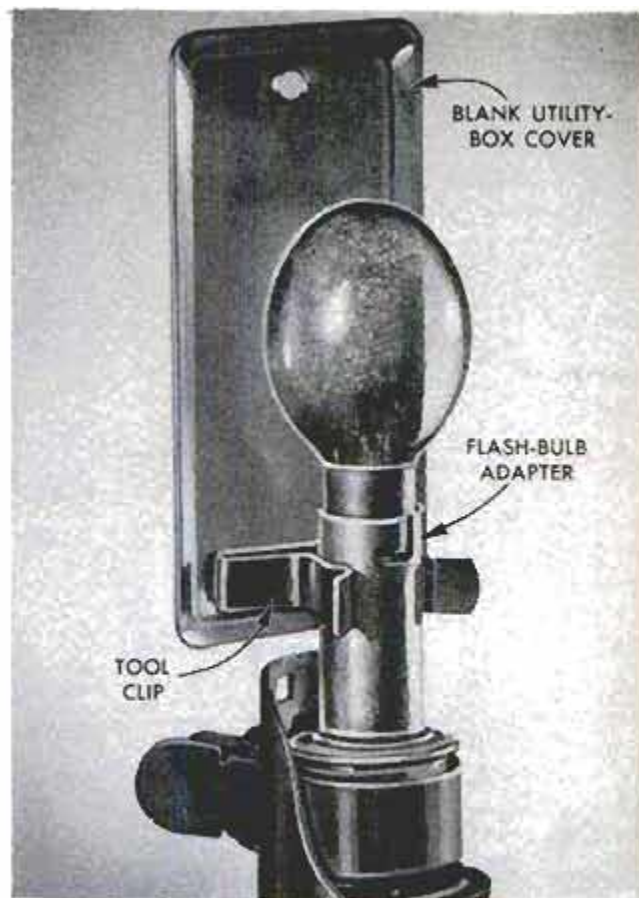

Silicone Preparations Renew Leather on Camera Equipment

Leather cases for camera equipment, as well as the leather on cameras themselves, can be renewed and made to resist moisture, mildew and the wear of handling if treated with one of the silicone shoe preservatives. The clear liquid simply is brushed on, a single coat being sufficient, and allowed to dry overnight.

☐ Before applying paint to a wall from which wallpaper has been removed, make sure that all paste and sizing has been cleaned from the plaster so that it does not cause the paint to peel.



Magazine Page Substitutes for Missing Try Square

Have you ever been doing a woodworking job and discovered that your square was missing? Just pick up a magazine and tear out a page. These pages are trimmed quite accurately at right angles and if used carefully can substitute for a square. Hold one edge of the page on the edge of the work, and mark along the adjacent edge.

William Swallow, Brooklyn, N. Y.

☐ To clean battery hydrometers use a mixture of detergent, 1 tbs., and baking soda, 1 tbs., dissolved in lukewarm water, 1 pt. Draw the mixture into the hydrometer and let it stand for 30 min. Rinse with water.

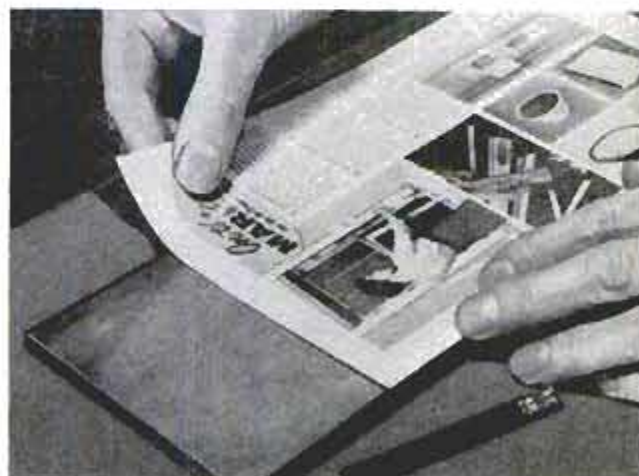

HOW TO MAKE

soon will find yourself proficient enough to be able to place fancy bows on all the packages you gift wrap.

In Fig. 1 is shown the step-by-step method of making a "magic" bow. First, a length of ribbon is formed into a fairly large loop. Second, the loop is flattened in such a manner that the loose end of the ribbon is even with the end of the flattened loop. The third step requires the flattened loop to be folded in half and a diagonal cut made across each corner at the fold. A narrow ribbon or cord then is tied around the resulting V-notches when the ribbon is unfolded, as shown in the fourth step. The ribbon is refolded, and the open loops are pulled through each other for the fifth step. The pulled-through loops then are shaped with your hands and positioned to result in the flower-like bow shown in the sixth step in Fig. 1.

The French bow in Fig. 2 is formed by "piling" a number of loops one on top of the other, then tying the loops at the center with the loose ends of the ribbon. The resulting pattern of loops is pulled out to form the bow as shown in the right-hand detail. The elongated bow, shown below in Fig. 2 is started in the same manner as the French bow, but some of the loops of the bow are cut so there are a number of loose ends. The dahlia bow, lower, right-hand detail, Fig. 2 also is formed in the same way as the French bow. Then all the loops are cut diagonally at their centers to provide a leaflike appearance.

The tailored bow at the top of Fig. 3 is formed much like the French bow, with loops being piled one on the other, but each succeeding loop is made slightly shorter than the preceding one. The free ends of the ribbon are spread out as shown and the bow tied at the center with a small



YOU PROBABLY HAVE been delighted, at one time or another, to receive a gift-wrapped package that was made especially attractive by having one or more ribbon bows on it. Quite likely you wished that you, too, could tie such bows, but hesitated to try because they seemed so intricate. As with many things that seem complicated, the bows actually are fairly easy to make. They do require time and patience, and not all the first few attempts will be completely satisfactory, but you

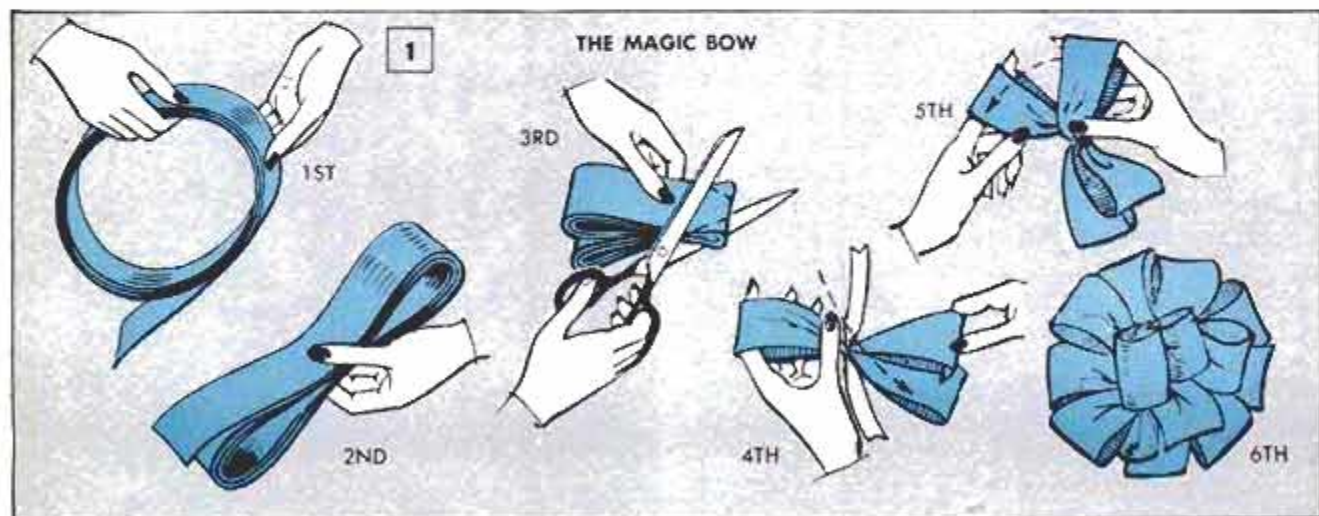

RIBBON BOWS

ribbon, or with a cord. The latter is available with strands of silver, gold and other colors woven into it, so it adds to the attractiveness of the bow. The carnation bow in Fig. 3 is started like the magic bow in Fig. 2. After the loops are pulled through each other they are grasped in the hand and cut with the scissors to simulate the petals of a carnation. For the daisy bow, fairly wide ribbon is used. The bow is started by piling a number of loops, which then are tied at the center. The loops are pulled through each other and the finished bow is held at the center by a thumbtack or a small hatpin. The latter is best when attaching the bow to a package. As shown in the detail, the two-in-one bow is simply a flattened roll of ribbon that then is folded off-center and cut across the corners to form V-notches, as for the magic bow. Being off-center, the notches, when tied, cause the bow to have one end longer than the other. The loops of this bow also can be pulled apart for a different effect. Tying the informal bow starts by looping the ribbon around your thumb. Loops then are formed as shown. The bow can be left loose and fastened to a package with cellulose tape, or the ends of the ribbon can be pulled through the loop formed on the thumb, and the bow tied firmly.

After you have tied a number of the bows shown here, you might design some of your own. Using two different colors of ribbon for one bow is one method of modifying the designs shown. Bows of the same type tied with narrow ribbon will appear to be different when tied with wide ribbon. Using both wide and narrow ribbon, as well as two colors also makes for different appearance.

The bows presented here were reproduced from an instruction sheet issued by Minnesota Mining and Mfg. Co. ★ ★ ★

#1

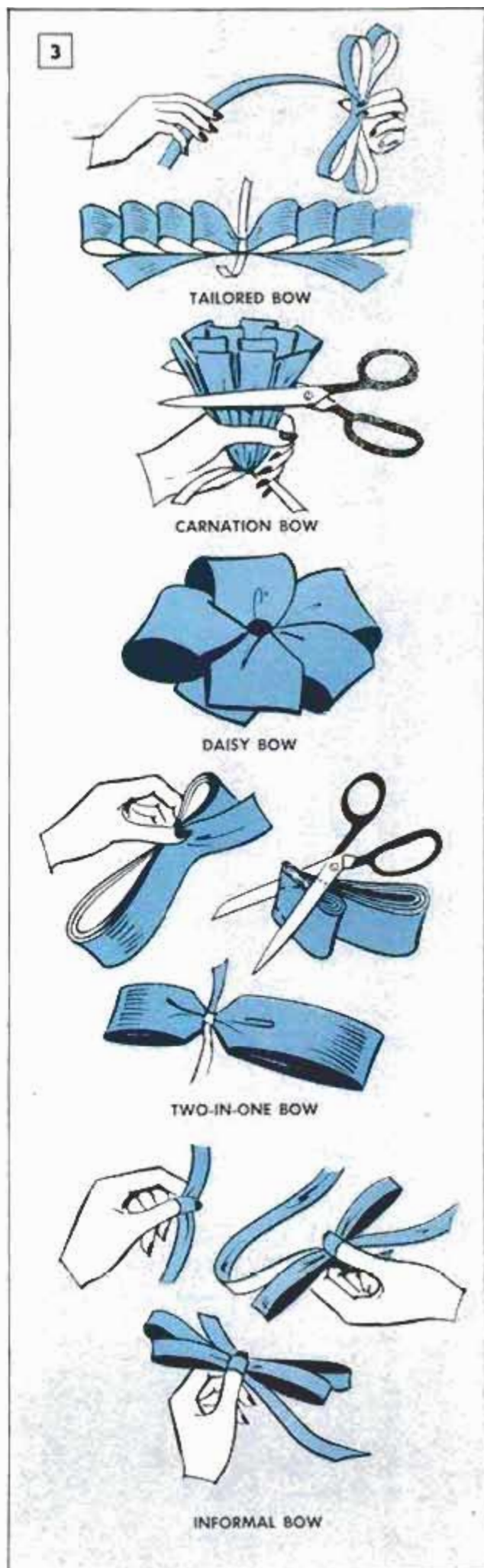
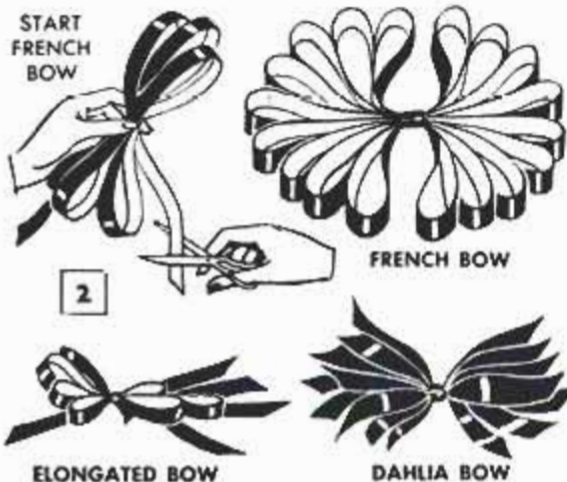

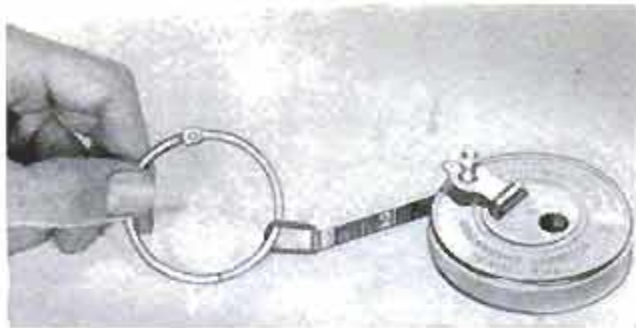

Notebook Ring on Measuring Tape Permits Easier Handling

It is a lot easier to pull out a long measuring tape when the usual small metal loop in the end is fitted with a larger notebook ring as shown. The ring also will fit over a fairly large-size stake, so the tape end will be firmly anchored while the tape is reeled out and pulled taut.

"Jammed" Plug of Power Tool Acts as Safety Precaution

If a power tool is not to be plugged in without an extra precaution, as, for example, when a switch malfunctions and stays in the "on" position, this simple stunt will be a constant reminder. Slip a short piece of insulated wire through the holes in the prongs of the plug.



Record Size of Dry Cell Inside Flashlight Case

Dry cells should be removed from a flashlight case when they are worn out, to prevent corrosion. However if new dry cells are not purchased immediately, there is a chance that you might forget the size. To eliminate this problem, write the size on a piece of adhesive tape fitted inside the flashlight case near the end.

Two C-Clamps Hooked Together To Span Wide Workpiece

When a piece of work is too wide for one C-clamp to span, two clamps sometimes can be hooked together to do the job as shown in the photograph. The method cannot be used when extreme clamping pressure is required, although the pads can be tack-welded together temporarily for easier handling of the clamps.

Hugh Lineback, Stillwater, Okla.

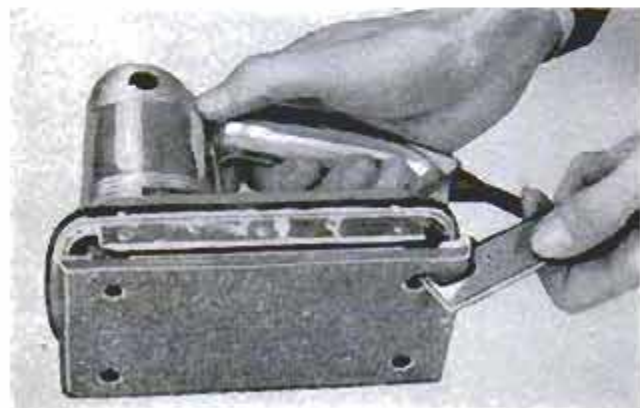
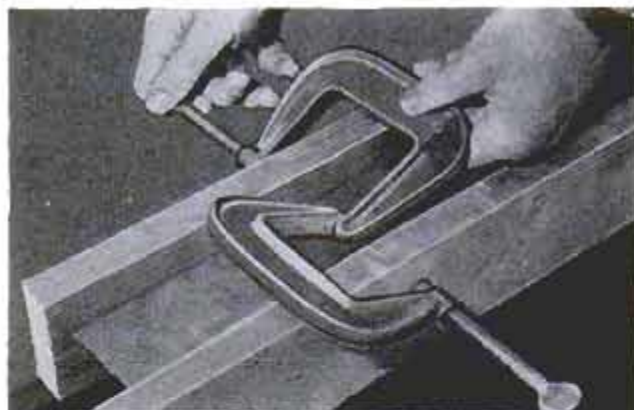

Speed Sander-Plate Changing By Punching Holes in Paper

When using a portable electric sander that has both orbital and oscillating plates, it is necessary to remove the sandpaper each time the plates are changed, because the paper covers the openings through which the screws are reached. You can reduce plate-changing time by punching holes in the paper at the locations of the screws, so the wrench can reach them without need for removing the paper.

Knockdown Bookcase Easy to Store or Transport

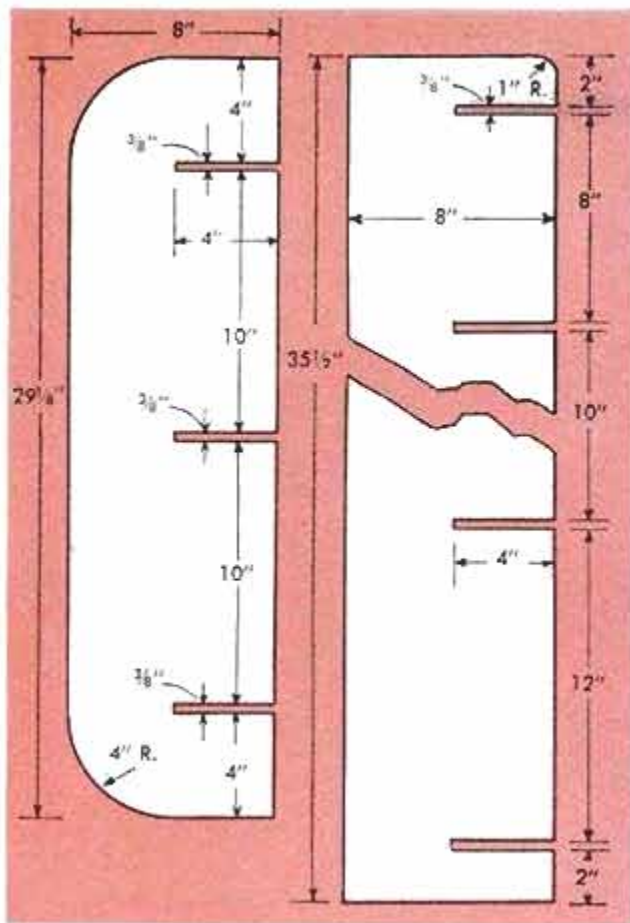

Modern in appearance, with the added advantage of being easily taken apart for transport or storage, this bookcase with "interlocking" construction will meet the needs of most students. The three vertical partitions and four shelves are cut from $\frac{3}{8}$ -in. plywood, making this an inexpensive piece of furniture. It is important that the slots cut halfway through all members of the bookcase be a uniform $\frac{3}{8}$ in., so they

fit together tightly. The fit between members should be such that a rubber mallet must be used to drive them tight or loosen them. If looseness develops from shrinkage or wear, four angle brackets screwed to the shelves and vertical partitions at the outer corners will restore rigidity. An alternate method is to nail a sheet of hardboard or plywood across the back edges of the bookcase.

Simple Method for Determining the Center of a Circle

Locating the center of a circular object when a compass is not at hand can be done with a sheet of paper and pencil. Place the circular object on a sheet of paper and trace around it with a pencil. Next, cut out the circle and fold it in half as shown. Fold the paper once more, creasing it well. Now, open the paper and spread it flat. The intersection of the creases is the center of the circle. An alternate method, slightly more accurate because the pattern is not cut out, is to trace the circle on translucent tracing paper. The pattern is folded in the same manner as when opaque paper is used, and the center is determined by the intersection of the creases. The unfolded pattern then is placed on the circular object and the center marked.

Henry Hollander, Newark, N. J.

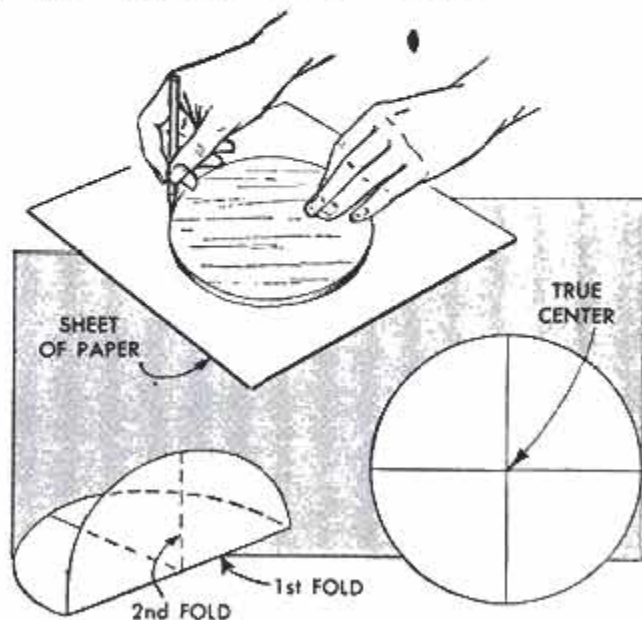

SHOWCASE OF TOOLS

This is the third in a series of articles to aid readers in determining sizes and types of tools best suited to their needs. Tools shown are intended to give readers a "showcase" view of various units available in workshop sizes. Picturing tools in this series does not constitute approval or disapproval of them by *Popular Mechanics*.



Primary purpose of a drill press is drilling holes of various diameters in wood and metal but it is adaptable to other jobs

DRILL PRESSES

By E. R. Haan

A DRILL PRESS can be one of the most useful power tools in your shop. Either floor or bench type, depending on space and preference, it's a versatile tool. Besides drilling holes as in Figs. 1 and 6, it will cut round or square-end mortises, Fig. 4, do routing, rabbeting, straight and curved shaping, cut flutes, beads, plugs and dovetail joints, plane, carve and sand. In metalworking it will mill, tap, file, grind, and scratch-brush. Inexpensive accessories are available for these extra jobs.

Construction and size: A drill press consists of a rigid verti-column on a suitable

base, a worktable that clamps on the column and is adjustable for height and tilt, and the working mechanism or head attached to the top of the column. The base of most drill presses is surface-ground to provide an extra table for jobs requiring more depth than provided when using the regular table. Usually the motor is mounted on the head so it is on the opposite side of the column. This position not only serves to balance the head but also permits the use of a short V-belt. The belt runs on two cone pulleys, providing different speeds, which is highly essential in drilling. To

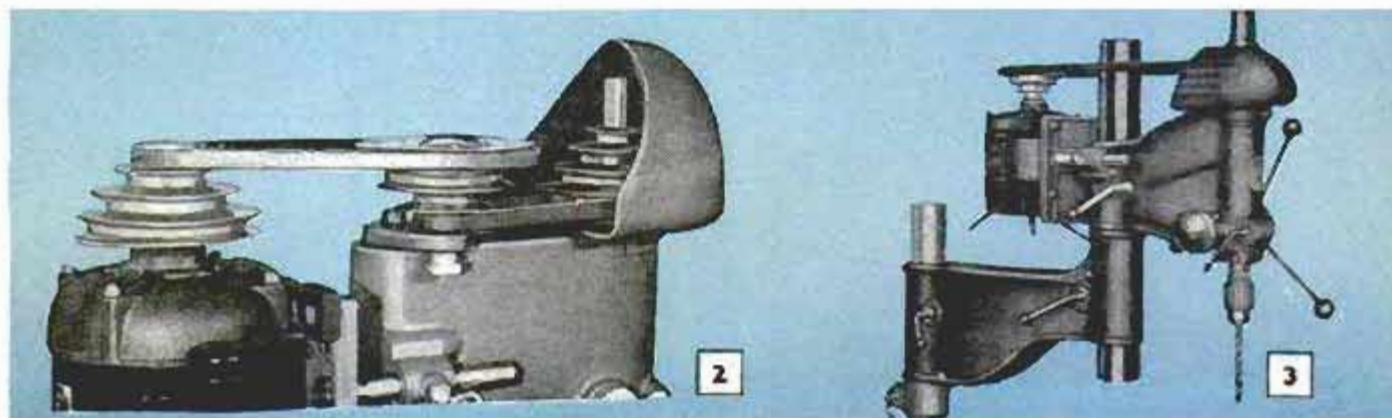

further increase the number of speeds, a variable-speed attachment or a counter-shaft can be added to the head as in Fig. 2.

The vital part of the head is the spindle. This is positioned vertically and rotates in bearings in a sleeve, or "quill." The quill can be moved downward by means of a feed lever to bring the drill or other tool into the work. It is automatically retracted by means of a coil spring, which usually is adjustable for tension. The quill can be locked at any point along its travel and the extent of its downward travel can be limited by means of an adjustable stop. The upper portion of the spindle is grooved or splined to fit a key or spline in the cone pulley at the top of the head. This permits the spindle to move up and down in the pulley while both are rotating.

Size of a drill press is expressed in terms of the diameter of a circle that it can drill centrally. Thus an 11-in. drill press can drill a hole in the center of an 11-in. disk; has a 5½-in. clearance between the column and the drill point. Sizes of home-workshop drill presses such as are shown on the following pages, vary from 10 to 17 in. To increase the distance between the column and the spindle of a drill press, a radial arm, Fig. 3, can be added on some machines.

Spindles and spindle adapters: Some manufacturers supply interchangeable spindles to increase the usefulness of drill presses. The kind generally furnished with a drill press may have a threaded or a tapered lower end on which the chuck fits. Some spindles have an enlarged end with a tapered or a straight sleeve. The first is designed for taper-shank drills used where extreme accuracy is desired. The second accommodates straight-shank drills, wood-boring bits, router bits and small sanding drums having shanks of the same diameter as the sleeve, and these are held securely with setscrews. Either special spindles or adapters are used for molding cutters. Adapters are fastened to a regular spindle or are held in a chuck. Similarly, spindles or adapters having a fixed and a movable collar are available to hold grinding wheels, buffers and scratch brushes.

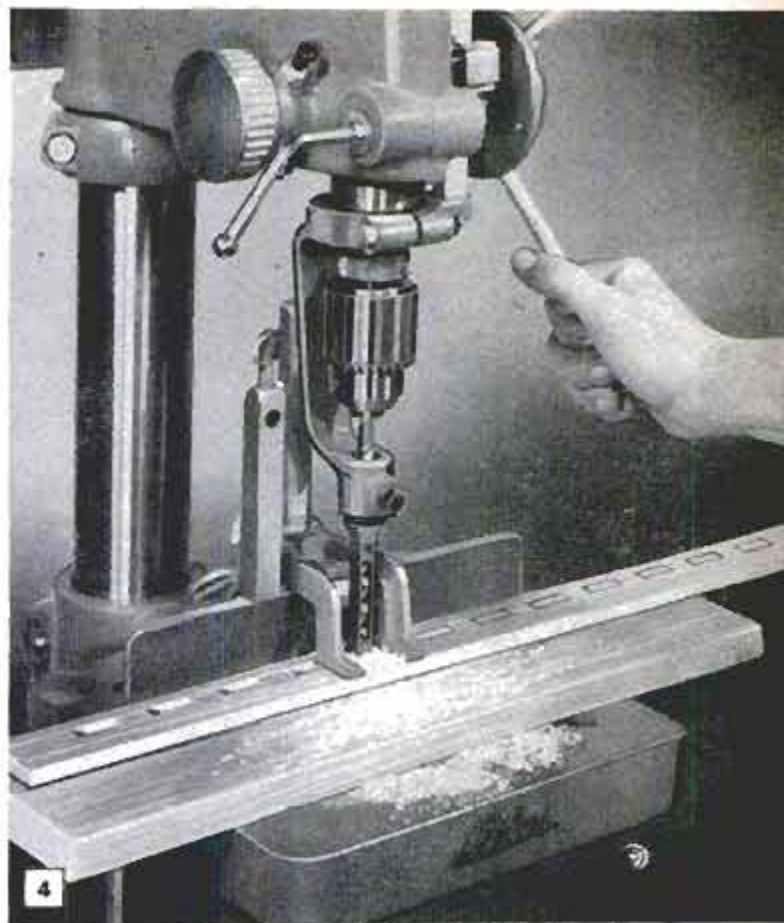
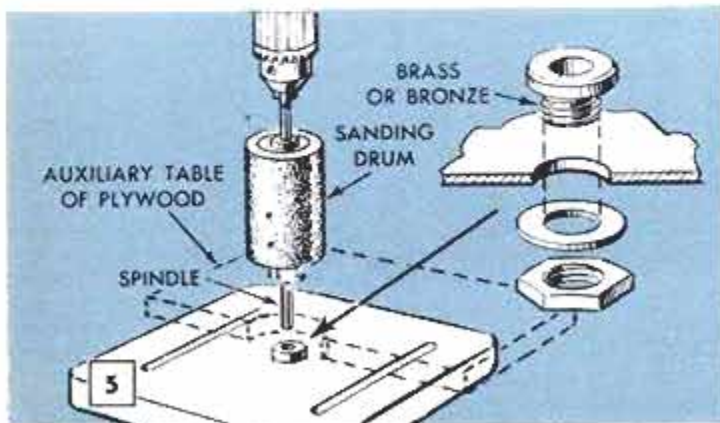

Photo courtesy Atlas Press Co.

Hollow-chisel mortising attachments for square-end mortises are supplied for all shop-size drill presses

When drilling metal, especially small parts, it's always best to hold the work in drill-press vise

Photo courtesy South Bend Lathé Works





CINCINNATI LATHE & TOOL CO.

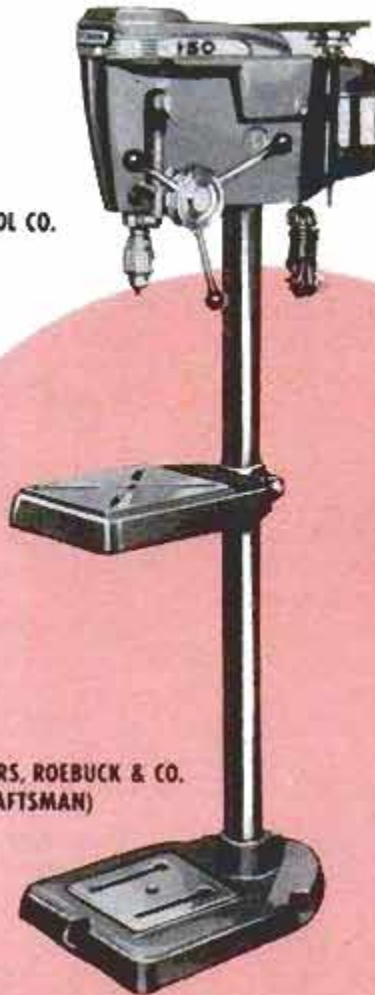

SEARS, ROEBUCK & CO.
(CRAFTSMAN)



ATLAS PRESS CO.

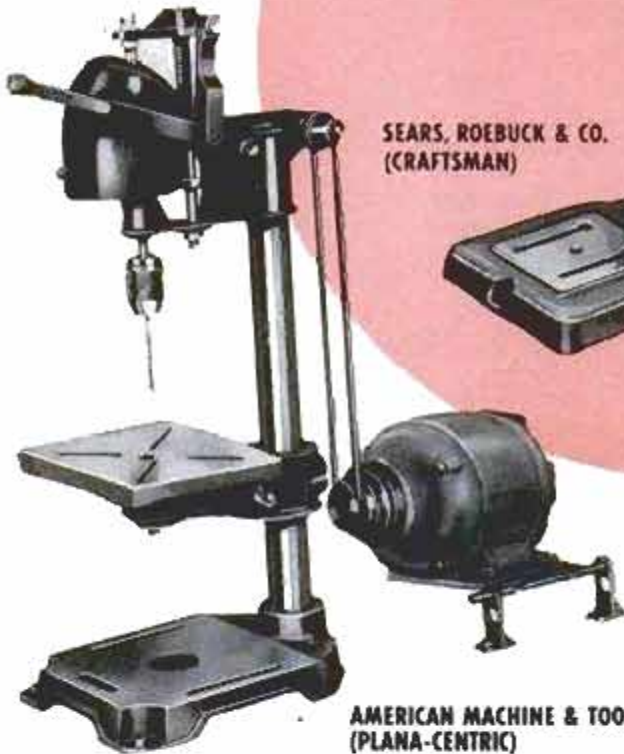

AMERICAN MACHINE & TOOL CO.
(PLANA-CENTRIC)

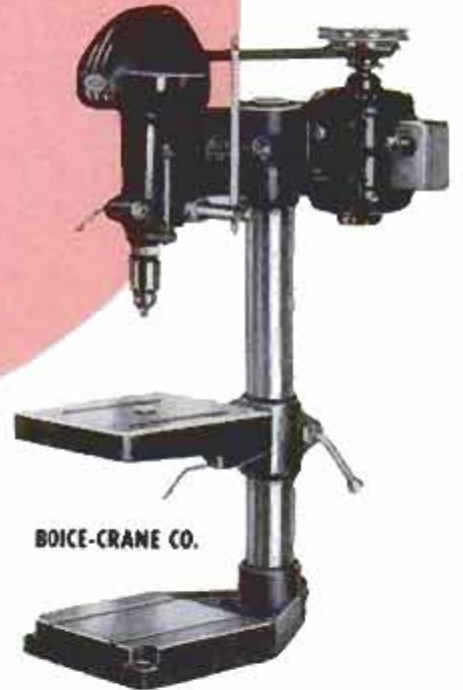

BOICE-CRANE CO.

SPECIFICATIONS		B - BENCH TYPE				F - FLOOR TYPE				HSM = HIGH-SPEED MODEL				LSM = LOW-SPEED MODEL			
TRADE NAMES AND SOURCES	ATLAS				BOICE - CRANE		CINCINNATI ROYAL		CRAFTSMAN DUNLAP		SEARS ROEBUCK (Not Shown)				DARRA - JAMES		
TYPE	B	B	B	F	B	F	B	F	B	B	F	B	F	B	F	B	
SIZE (Dia. of circle drilled centrally)	11 $\frac{1}{4}$	12 $\frac{3}{4}$	15	15	15	15	16 $\frac{1}{2}$	16 $\frac{1}{2}$	12 $\frac{1}{2}$	13 $\frac{1}{2}$	13 $\frac{1}{2}$	15 $\frac{1}{2}$	15 $\frac{1}{2}$	12	12	15	
SPEEDS (Spindle r.p.m.)	FOUR, 700 TO 4150	FOUR, 580 TO 5200	HSM—FOUR, 580 TO 5200 LSM—FIVE, 400 TO 4400		HSM—FIVE, 500 TO 5500 LSM—FIVE, 425 TO 3340		HSM—FIVE, 410 TO 4840 LSM—FIVE, 342 TO 4033		NINE, 765 TO 4000	NINE SPEEDS 610 TO 5000				TEN SPEEDS 862 5 TO 3450			
CHUCK TO TABLE, Max.	12 $\frac{3}{8}$	11	12	41	11 $\frac{1}{2}$	41	13	43 $\frac{1}{2}$	7 $\frac{1}{8}$	10	40 $\frac{1}{2}$	13 $\frac{1}{2}$	38 $\frac{1}{8}$	9 $\frac{1}{8}$	44	15	
CHUCK TO BASE, Max.	13 $\frac{1}{4}$	14 $\frac{1}{2}$	16	46	18	47 $\frac{1}{2}$	17	47 $\frac{1}{2}$	9 $\frac{1}{2}$	14	45 $\frac{1}{2}$	18	44 $\frac{1}{2}$	12 $\frac{1}{2}$	48 $\frac{1}{2}$	18	
SPINDLE TRAVEL	2 $\frac{3}{8}$	3	4	4	4	4	4 $\frac{1}{2}$	4 $\frac{1}{2}$	3	3 $\frac{1}{2}$	3 $\frac{1}{2}$	4	4	3	3		
TABLE SIZE	7 $\frac{1}{2}$ x7 $\frac{1}{2}$	8x9	10x10	10x10	10x11	10x11	10x10 $\frac{1}{2}$	10x10 $\frac{1}{2}$	7 $\frac{1}{2}$ x7 $\frac{1}{2}$	9x9	9x9	10x10	10x10	7 $\frac{1}{2}$ x8 $\frac{1}{2}$	7 $\frac{1}{2}$ x8 $\frac{1}{2}$	8 $\frac{1}{2}$ x9	
OVER-ALL DIMENSIONS	Weight	30 $\frac{3}{8}$	36	36	66	38 $\frac{1}{2}$	67 $\frac{1}{2}$	40	71 $\frac{1}{2}$	26 $\frac{3}{8}$	31 $\frac{1}{2}$	62 $\frac{3}{8}$	36	65 $\frac{1}{2}$	29	66	
	Width	9 $\frac{1}{2}$	11	13 $\frac{1}{2}$	16			16 $\frac{1}{2}$	16 $\frac{1}{2}$	10 $\frac{1}{2}$	11 $\frac{1}{2}$	15	12 $\frac{1}{2}$	18 $\frac{1}{2}$	10 $\frac{1}{2}$	13	
	Depth	22	24	24 $\frac{1}{2}$	27			31 $\frac{1}{2}$	31 $\frac{1}{2}$	15 $\frac{1}{2}$	16 $\frac{1}{2}$	21 $\frac{1}{2}$	19	24	23 $\frac{1}{2}$	24	
BEARINGS	BRONZE	BALL	BALL	BALL	BALL	BALL	BALL	BALL	1 BALL, 3 BRONZE	BALL	BALL	BALL	BALL	1 THRUST AND 4 BRONZE			
COLUMN DIA.		2 $\frac{1}{2}$	2 $\frac{3}{4}$	2 $\frac{3}{4}$	2 $\frac{3}{4}$	2 $\frac{3}{4}$	3	3	1 $\frac{1}{2}$	2 $\frac{1}{4}$	2 $\frac{1}{4}$	2 $\frac{3}{4}$	2 $\frac{3}{4}$	1 $\frac{1}{2}$	1 $\frac{1}{2}$		



DELTA POWER TOOL DIV.
ROCKWELL MFG. CO.

TOOL KRAFT
TOOLCRAFT CORP.
(DARRA-JAMES)

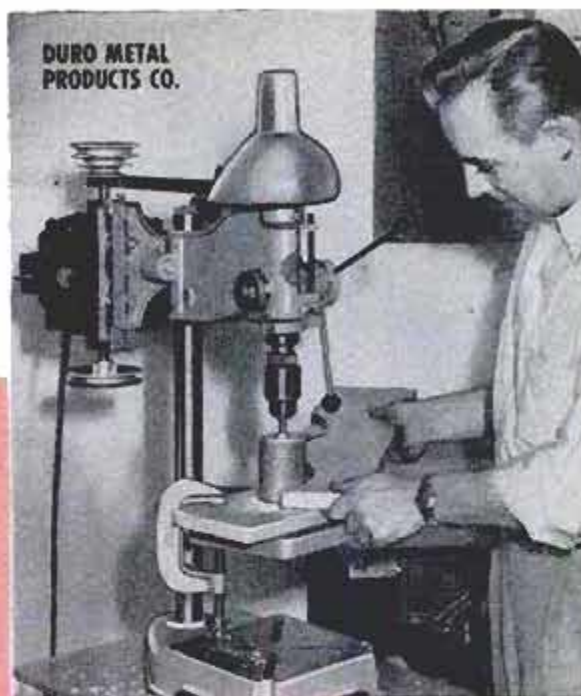

DURO METAL
PRODUCTS CO.



MAGNA POWER
TOOL CORP.

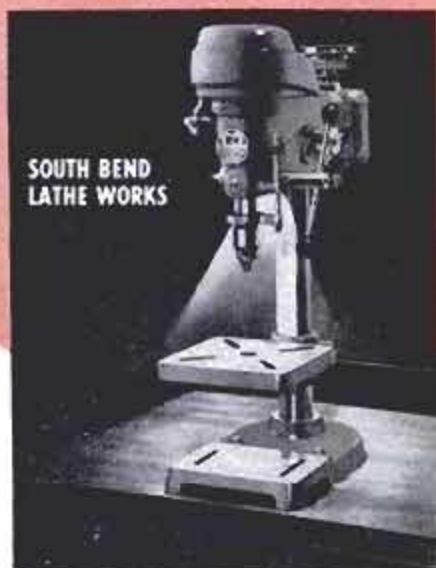

SOUTH BEND
LATHE WORKS



SPRUNGER BROS., INC.

DRILL PRESSES LISTED ARE DESIGNED FOR USE OF 1/2" CHUCKS

DELTA				DURO MASTER	MAGNA	PLANA- CENTRIC	POWR-KRAFT WARDS (Not Shown)	SOUTH BEND		SPRUNGER			
B	B	F	F	B	B	B	B	B	F	B	B	B	F
11	14	14	17	14	12 1/2	10	12 1/2	14 1/4	14 1/4	12	14	15	15
FOUR, 700 TO 4700	HSM-FOUR, 680 TO 4600 LSM-FOUR, 470 TO 1950	HSM-5, 700-4250 LSM-5, 385-2240	FOUR, 780 TO 3800				FOUR, 800 TO 3800	FOUR, 720 TO 4325		NINE SPEEDS 600 TO 5200			
11	12%	43 1/2		10%		13 1/2		11 3/4	40%	9 1/4	9 1/4	13 1/4	41 1/4
14 1/4	18%	48 1/2		13 1/4	18		18	16	45 1/4	12%	12%	18 1/4	46 1/4
3%	4 1/16	4 5/16	5	3%	3	2 1/4	3	4	4			4 1/4	4 1/4
8 1/2 x 9	10 x 10 1/2	10 x 10 1/2	11 x 12	7 1/2 x 7 1/2	10 x 10		8 x 8	10 x 10	10 x 10	7 x 8	8 x 9	9 x 9	9 x 9
33 1/2	37 1/2	68 1/2	47%	33	33	25 1/2	33			29	29	38 1/2	66 1/4
11 1/4	13%	15%	23 1/2		11 1/2		11 1/2			9%	10%	11%	15
19	24 1/4	24%	36 1/16		23		23			15	15 1/2	18	20
2 BRONZE, 1 BALL	BALL	BALL	BALL	1 BALL, 4 BRONZE	BALL	BALL AND BRONZE	BALL	4 BALL	4 BALL	1 BALL, 4 BRONZE	BALL	BALL	BALL
1%	2%	2%	3%	1%	2		2	2%	2%	2	2	2 1/4	2 1/4

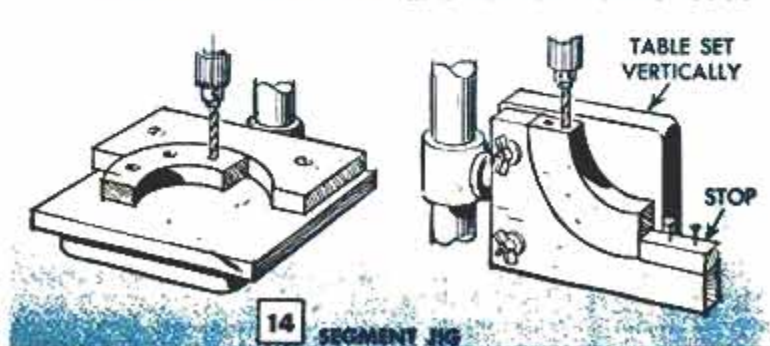
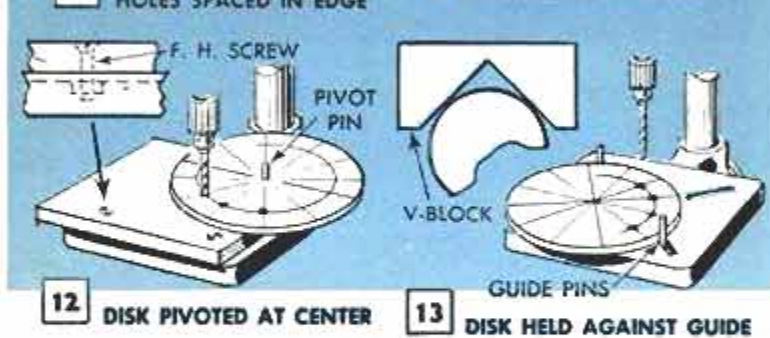
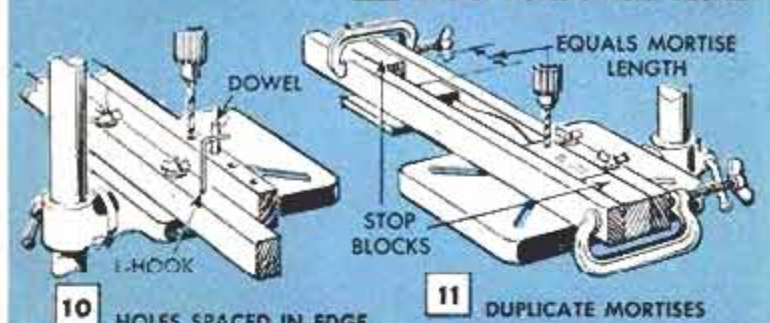
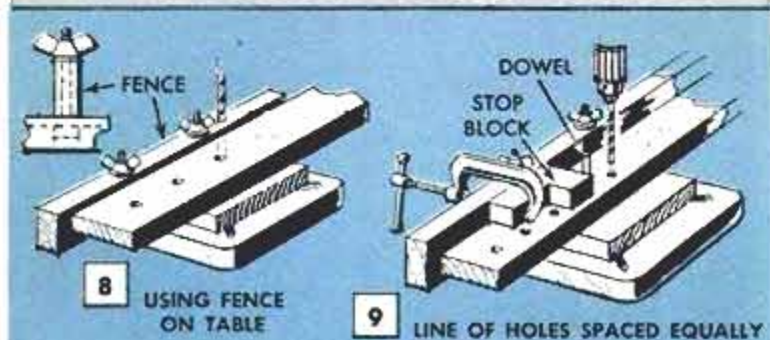
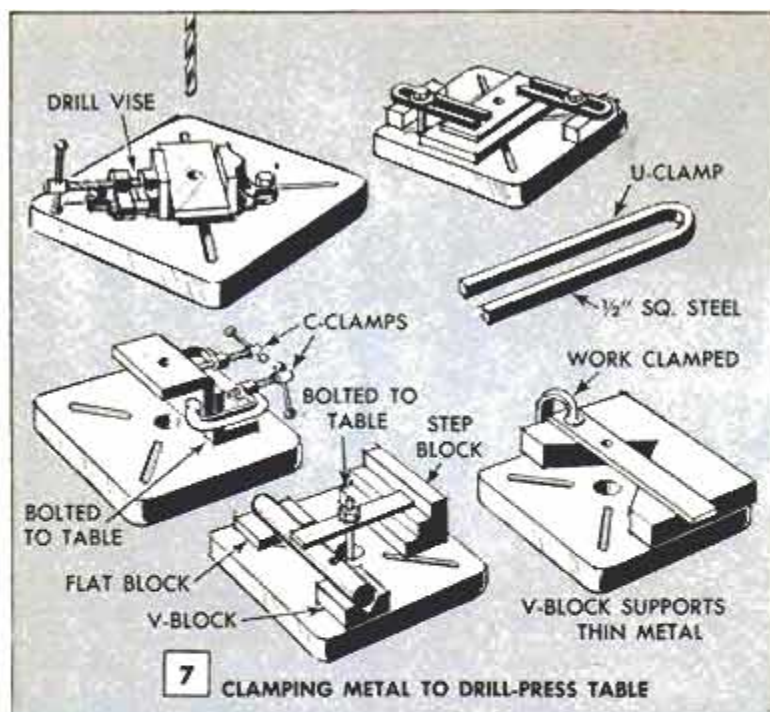

In any operations that involve side thrust between the tool and work, it is highly important to have the tool mounted either in a chuck or attached to the spindle so that it cannot loosen and cause injury. Also, on operations involving side thrust, maximum accuracy is assured, and wear on the spindle bearings can be minimized by using a spindle or an adapter that will fit a bearing attached to the drill-press table as in Fig. 5.

Accuracy of a drill press depends on the straightness of the spindle, the proper fit of a spindle in its bearings, and right-angle, spindle-to-table alignment. A bent or sprung spindle can sometimes be corrected, but generally requires replacement. Worn bearings and a spindle that permits excessive play should be replaced. Misalignment of a spindle with the table usually can be corrected by shimming the latter.

Operating hints: To avoid ragged holes from a bit breaking through wood and other soft materials, always support the work on a piece of smooth wood, plywood or hardboard of sufficient thickness. Whenever possible adjust the table so that its center hole is in alignment with the drill, or bit. This will prevent possible damage to the table in case the drill or bit penetrates the piece of wood placed under the work. A wood-boring bit used in a drill press should have a brad point rather than a screw point so that the feed can be controlled. When routing, shaping, sanding and grinding, where cutting is done on the side of a tool, the work is fed against the direction of rotation. If a larger work area is required than that furnished by the table, an auxiliary table, Fig. 5, can be made of 3/4-in. plywood, attaching it with machine screws to the regular table.

Don't attempt to drill metal without first center-punching it after making an accurate layout to required measurements. Center-punching prevents the drill from wandering. Then run the drill at approximately the required speed for its size and for the material being drilled. Some manufacturer's instruction booklets contain tables of speeds for varying size drills

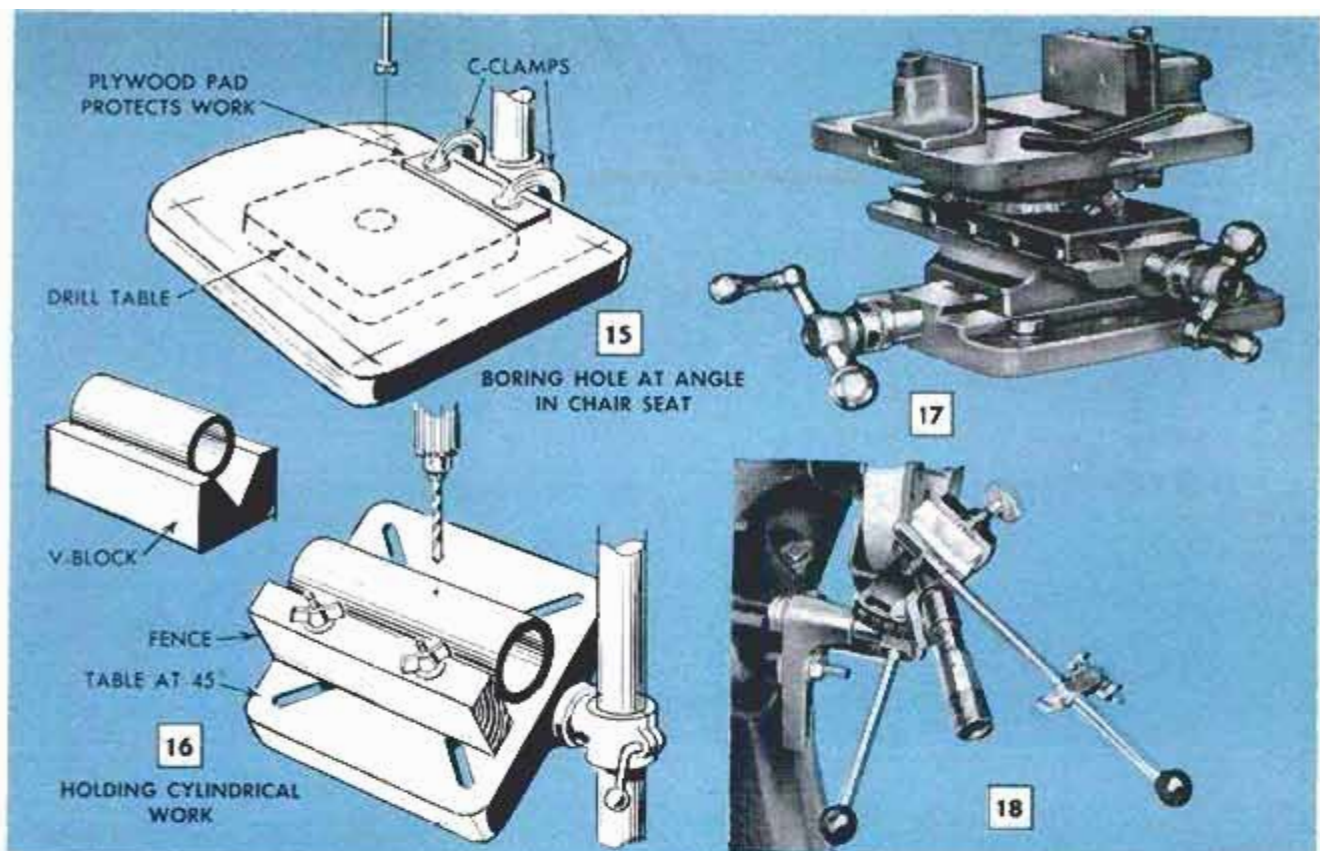

Atlas Press photos

and different materials. Keep the drill tip lubricated, feeding it with rather light pressure. If a drill bit does not cut readily it generally needs sharpening. This is done by grinding and requires considerable accuracy to produce the right angles and clearances. Some manufacturers make special jigs, such as the one shown in Fig. 18, that greatly simplify accurate grinding of drill bits.

As a rule, metal to be drilled, especially small work, should be clamped securely to the table instead of holding it by hand. Although work can be held by hand when using small size drills, there is always the risk of injury that may result from the drill catching in the work, especially when it breaks through. Then the work is likely to slip out of your fingers and rotate with the drill. This happens unexpectedly and can cause a painful injury. Fig. 7 shows a number of ways of holding work securely on a drill-press table. Small parts can be held in a drill vise bolted to the table. Avoid placing thin stock on separate supports spaced widely apart. This allows the metal to spring under pressure of the drill, causing it to bind or make an elliptical hole. Mount the metal so that the supporting points will be close to the drill. This often is done conveniently by using a block having a V-shaped cutout. For accurate milling and surface-grinding operations, a universal compound vise, Fig. 17, is needed.

Work setups: For drilling holes or routing in a straight line on a piece of straight-edged stock, use a fence clamped to the

table as in Fig. 8. To space the holes equidistantly, clamp a block to the fence, Fig. 9. This serves as a stop for a dowel slipped into the hole previously drilled. For drilling equidistant holes in the edges of straight stock, the setup shown in Fig. 10 is used. For duplicating mortises in a number of similar pieces, you can use a fence with stops at both ends, Fig. 11.

For drilling holes or routing a groove near the edge of a disk having a center hole, pivot the disk as in Fig. 12. If the disk has no center hole, rotate it against two guide pins (nails or dowels), or against a V-shaped block, Fig. 13. When so drilling or routing a segment or a circle, use a guide having a matching curve, Fig. 14. To drill radial holes into the edge of a disk, use a V-block or two pins on a block clamped to the table tilted to the vertical position. When drilling radial holes in the edge of a segment of a circle, use a rest having a matching curvature, which is clamped to the drill-press table tilted to the vertical position. For boring dowel holes in ends of such segments so they can be joined to others, use a support with a stop as in the right-hand detail, Fig. 16.

When boring holes at angles, lock the table at the required angle of tilt and clamp the work to it, Fig. 15, using a pad of plywood or hardboard to prevent marring the work with the clamps. Cylindrical work should always be mounted in a V-block, Fig. 16, or between the table and a fence, set at an angle as shown in the right-hand detail. ★ ★ ★

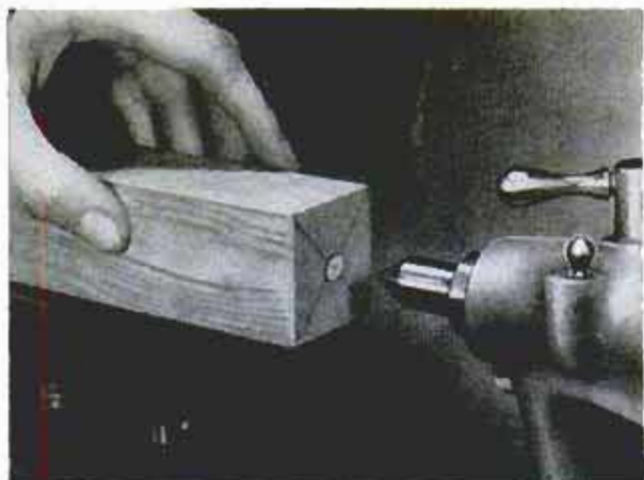

Hardwood Dowel in Soft Stock Provides Turning Center

When softwood stock is mounted in a lathe for turning, the dead center sometimes is forced too far into work, causing the wood to split. If it does not split, the work sometimes is thrown off-center by undue resistance between the center and the wood. To avoid this, drill a hole in the end of the stock and drive in a short hardwood dowel. The dead center now can be pressed into the hardwood which provides a bearing surface so the work can be handled as a piece of hardwood.

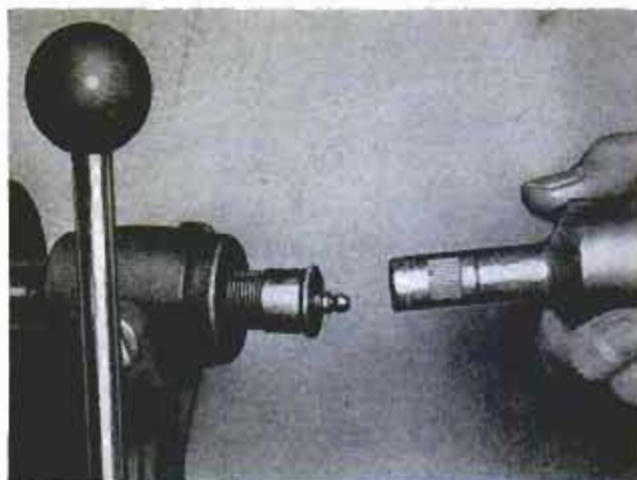

Gun Fitting on Grease Cup Permits Easier Filling

By screwing a pressure grease fitting into a tapped hole in the cap of a grease cup, it can be filled easily by using a standard grease gun, eliminating the usually messy job. So that the cup will be filled completely, the cap is unscrewed as far as possible before filling. If a suitable tap is not available, some of the hardened-metal fittings will cut their own threads when they are screwed into undersized holes that are drilled into the caps of the grease cups.

R. Hanscom, Elmhurst, Ill.

PM Books for Boys and Girls to help them know about Science

MR. WIZARD'S SCIENCE SECRETS, by Don Herbert. The star of the famous TV program seen coast-to-coast weekly on more than 60 stations has written this educational and entertaining book that will help in school and through a whole lifetime. The book is just like his unusual program and just as intriguing. It contains more than 150 of his television experiments, in word and picture. Answers thousands of "how" and "why" questions children ask on the human body, gravity, flight, heat and radiation, electricity, etc. It's facts with fun—so fascinating and interesting children never tire of learning.

264 pages. \$3.50

THE BOY SCIENTIST, by John Lewellen. An up-to-the-minute introduction to the exact sciences, bursting with facts every modern boy wants to know. Written and illustrated with such clarity that even complex principles are quickly grasped by the young mind. This book won for Popular Mechanics Company the 1955 award of the Thomas Alva Edison Foundation as publisher of "The Best Children's Science Book." A truly outstanding work.

264 pages. \$3.95

SCIENCE MILESTONES, from the *Science Digest* series. A record of the march of science which will fire the imagination, and inspire youngsters in their pursuit of scientific knowledge. Contains dramatic revelations of 60 important individuals whose contributions, from 400 B.C. to the present, are landmarks in the history of science. This book is as fascinating as fiction, as factual and revealing as a laboratory report. Beautifully illustrated and printed.

312 pages. \$5.00

The books above are ideal as birthday gifts, Christmas presents or for general reading for the scientific-minded youngster. Each is authoritative, clearly presented and illustrated, quality printed and bound, as you would expect from the publishers of Popular Mechanics Magazine. You and your children must be pleased or your money back. Send check or money order today for the books of your choice to—

Popular Mechanics Press, Dept. 1258
200 E. ONTARIO STREET • CHICAGO 11, ILLINOIS



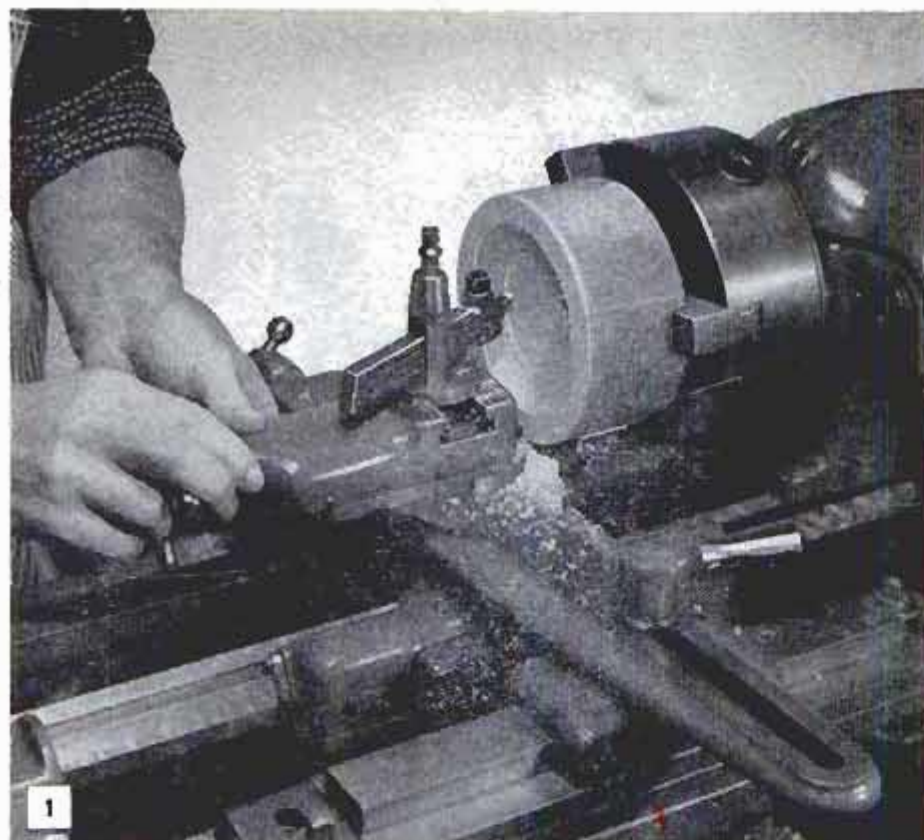

TURNING A RADIUS

By Sam Brown

YOUR METAL-TURNING LATHE shows its versatility as a machine tool when it is adapted to turnings other than the conventional between-centers, faceplate and chucking operations. Turning a radius is one of these out-of-the-ordinary jobs. There are two methods commonly used. In the first, the compound is swiveled to move the cutting tool in the required radius. The second method utilizes a radius bar to move the lathe carriage through the desired arc. The latter method is best for making matched concave and convex shapes having a shallow curvature.

Swiveling the compound: In this method the screws or bolts holding the compound are loosened, allowing it to be rotated by hand around the compound swivel pin. Figs. 1 and 2 show how a concave curve is cut, the compound swivel pin being located at the exact center line of work. Infeed for successive cuts is done with the compound feed. The setup for a convex curve or ball shape is somewhat similar, except in this case the swivel pin must be exactly under the center of curvature of the work, Fig. 3.

Turning with the compound swivel is done with the pivot

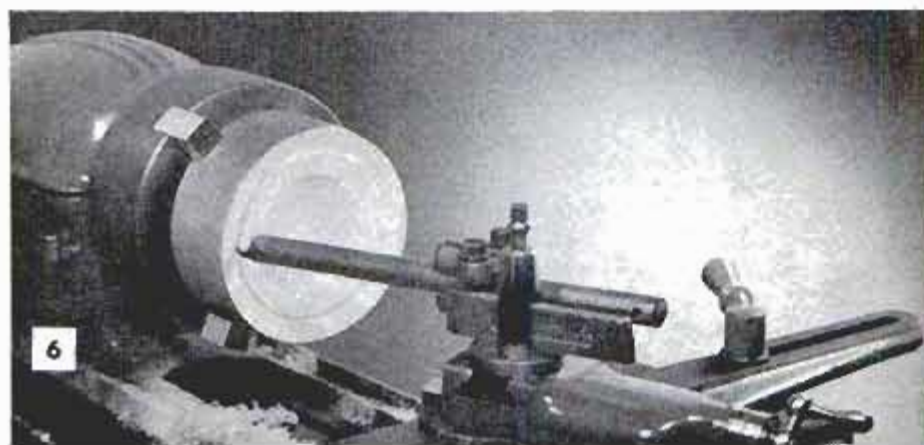

SHOP NOTES

SUCCESSIVE CUTS
COMPOUND SWIVEL PIN

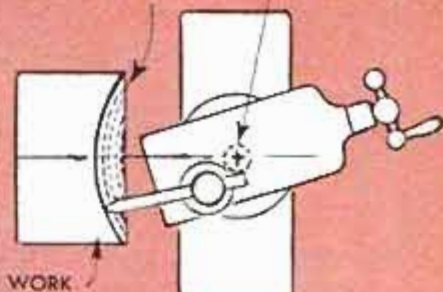

2 CONCAVE—TOOL IS AHEAD OF COMPOUND SWIVEL PIN

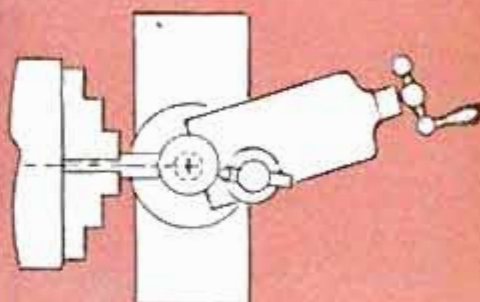

3 BALL—TOOL IS BEHIND COMPOUND SWIVEL PIN

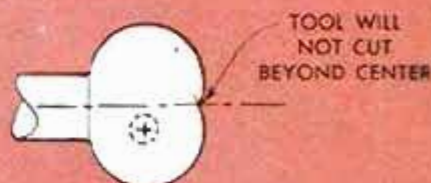

4 PIVOT OFF CENTER TOWARD OPERATOR

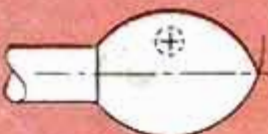
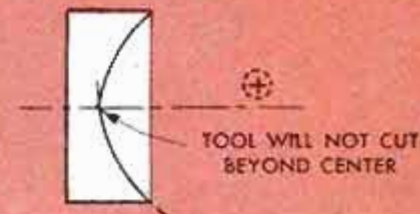

5 PIVOT OFF-CENTER AWAY FROM OPERATOR

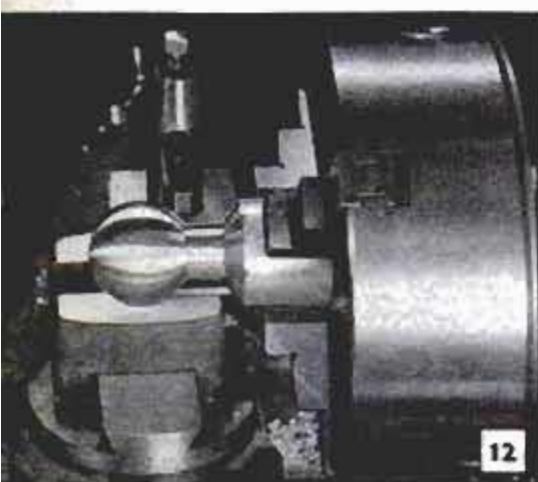
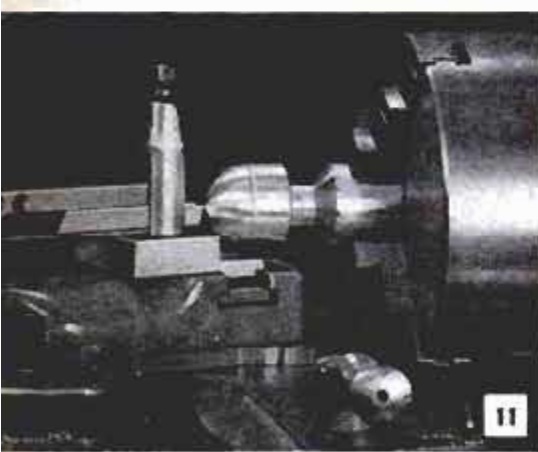
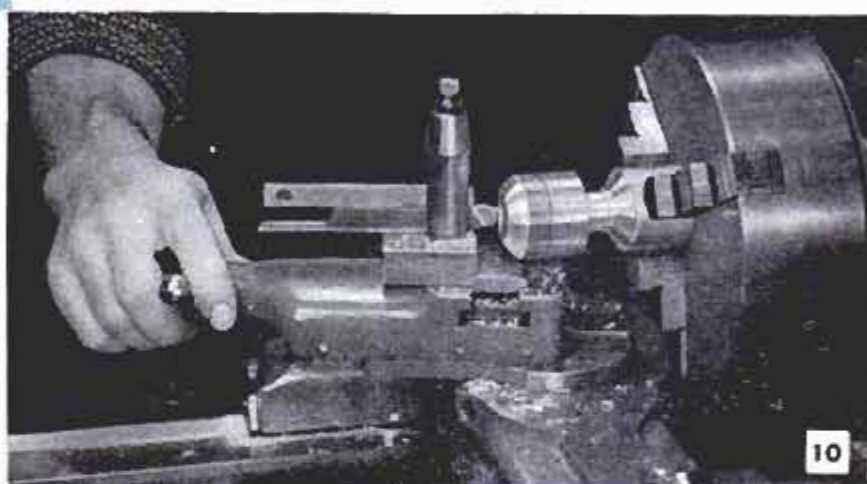
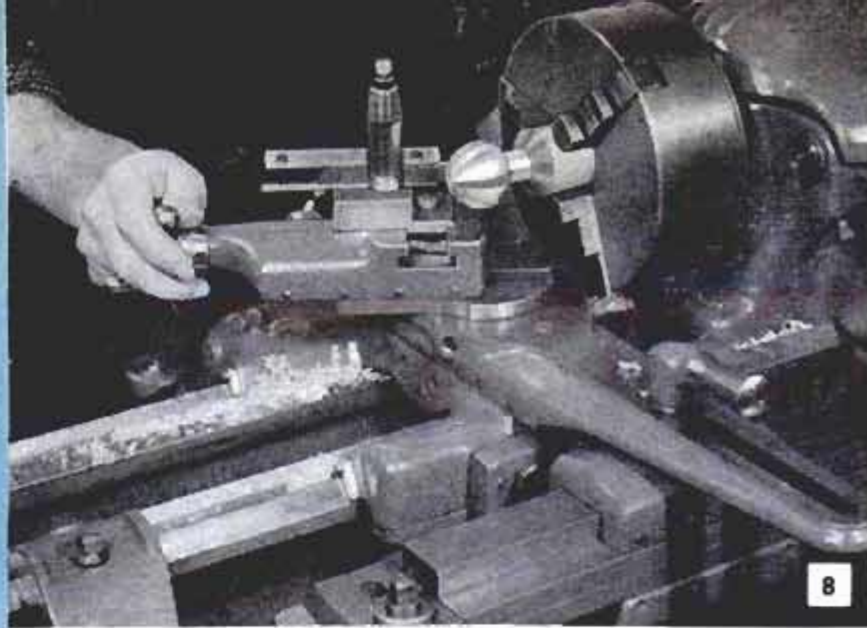
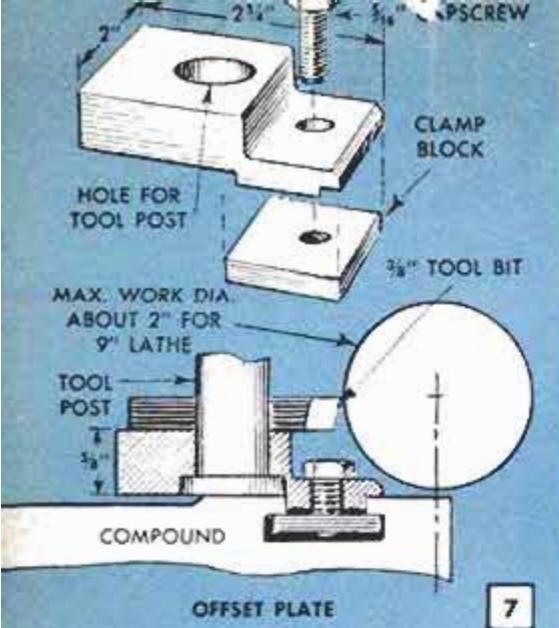

pin on the work center line but at times an off-center position is useful, Figs. 4 and 5. The position of the cross slide needed to center the compound pin should be permanently marked to avoid repetitious setup operations.

When making a concave cut, the pivot pin is centered crosswise and is located at a distance from the work equal to the desired radius of cut. The minimum radius is determined by how close you can get the compound to the work; the maximum radius is limited only by how much tool extension can be used without chatter. If the job is a turning in wood or plastic, you can get out as much as 9 or 10 in. from the work with a 5/8-in. boring bar, Fig. 6.

The most popular use of the compound-swivel technique is the turning of small balls, Fig. 8. The radius of such work depends on how much travel is available at the compound. On the 9-in. lathe pictured, balls up to about 7/8 in. diameter can be turned without extra setups or attachments. An offset plate made up as in Fig. 7 increases the work range to the maximum diameter which will swing over the compound—in this case, 2 in.

The work is first rough-turned to cylindrical shape, after which the carriage is clamped in position with the compound swivel under the work center line, Fig. 9. Ball turning then proceeds, using the compound infeed for successive cuts. On a first job, it is somewhat simpler to cut only the outer half of the ball, as shown in Figs. 10 and 11. To turn the half of the ball nearest the headstock, the tool should be moved toward the headstock and also angled toward the headstock. The second half of the ball is then

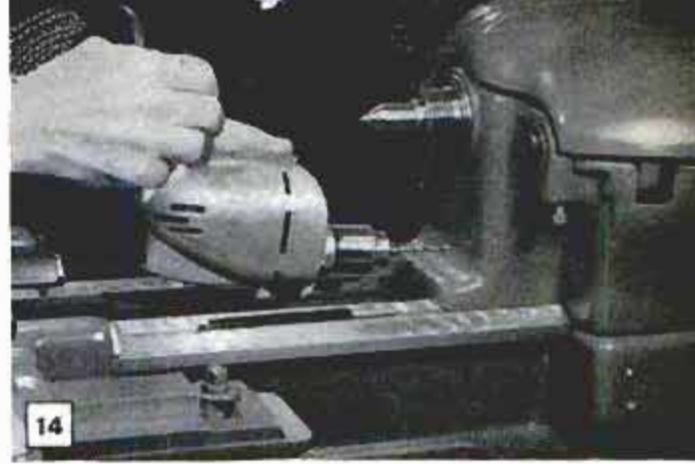
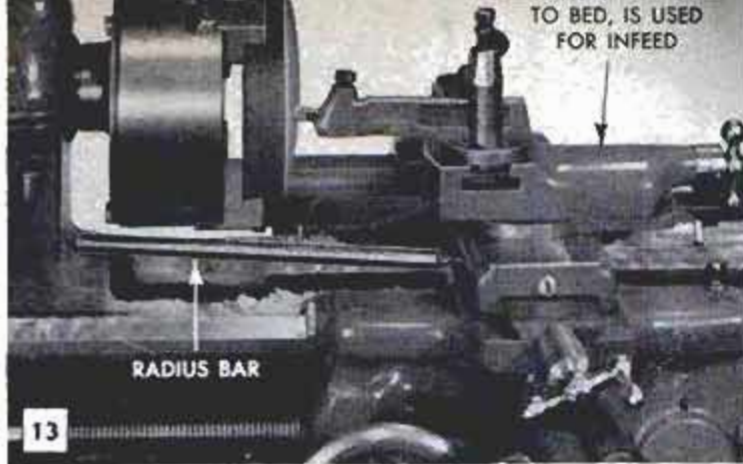

turned, Fig. 12, also Fig. 8. You can sweep around the whole surface of the ball for a final cleanup cut.

Using a radius bar: A radius bar is a pointed metal rod with a length equal to the radius you want to cut. For a convex cut, one end of the bar fits into a small hole spot-drilled in the headstock, while the other end goes into a hole spot-drilled in the cross slide, Fig. 13. Just the tip of a 1/8-in. drill is all you need for the pivot holes, Fig. 14. The compound is in the parallel position and is used for infeeding successive cuts. The work feed is done with the cross slide; as this is moved in, the radius bar forces it away from the headstock, causing the tool to follow an arc of the same radius as the length of the radius bar. The carriage should be held by light pressure on the handwheel to keep the radius bar in place.

A good minimum length for a radius bar is about 3 in. This short length will not span the distance to the headstock and needs a pivot block clamped across the lathe bed to carry the pivot hole, Fig. 15. A long radius bar permits only light cuts to be taken due to distance from the work, Fig. 13. A solution to this is to locate the pivot holes at points which will allow the tool to be placed closer to the work; Fig. 17 shows the radius bar working from an offset on the lathe headstock, allowing the tool to be placed at

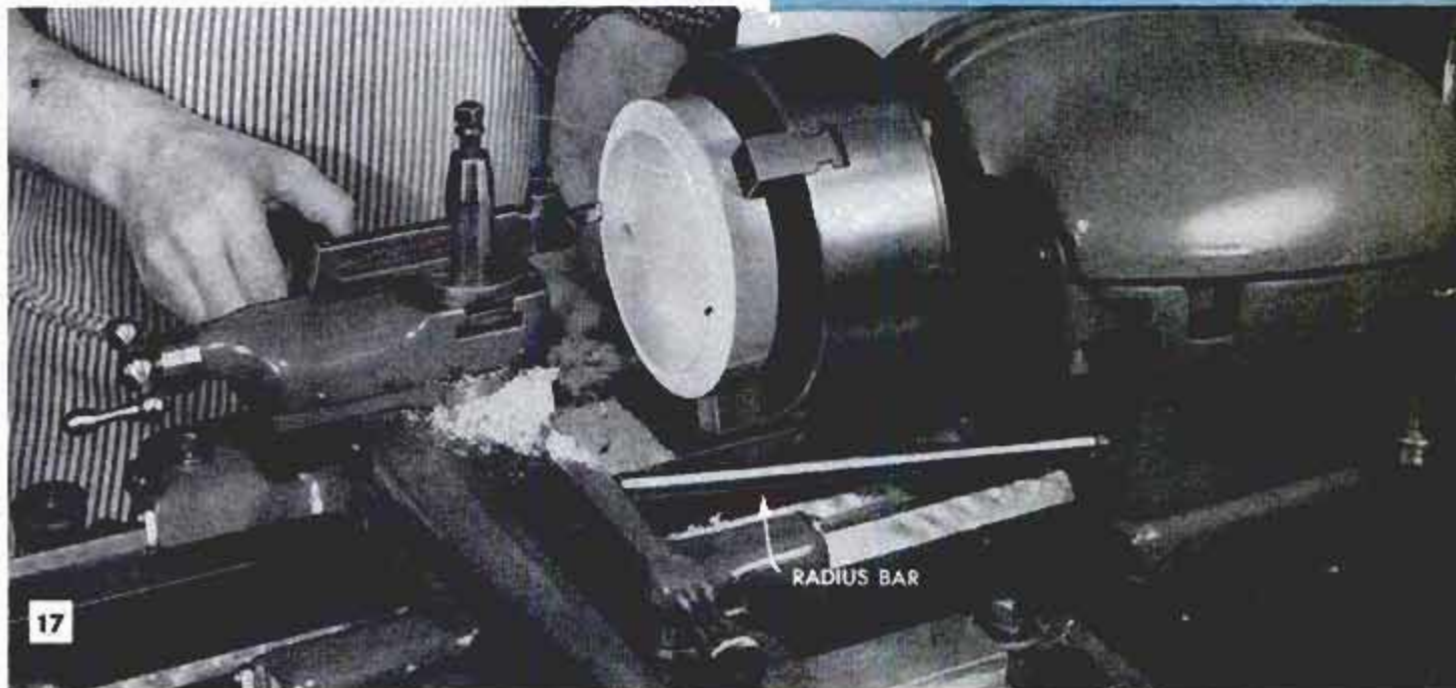
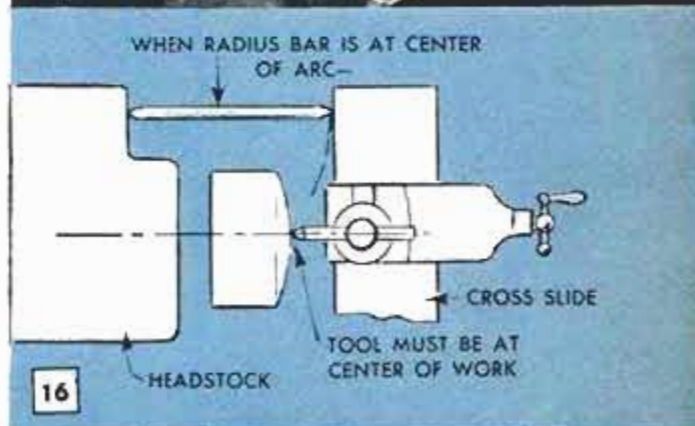
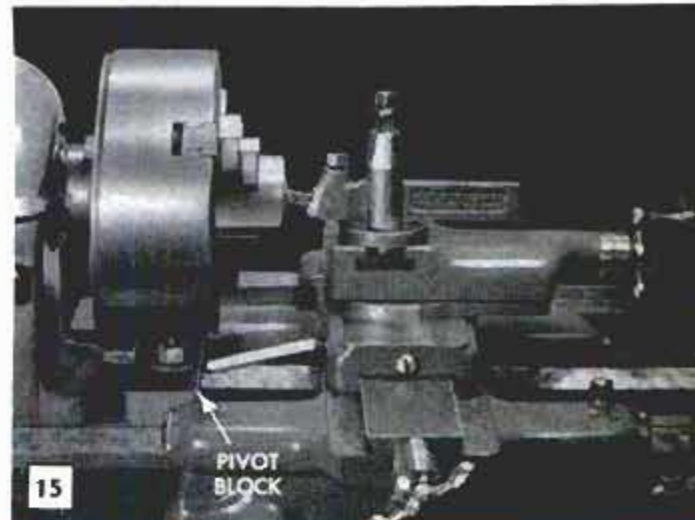

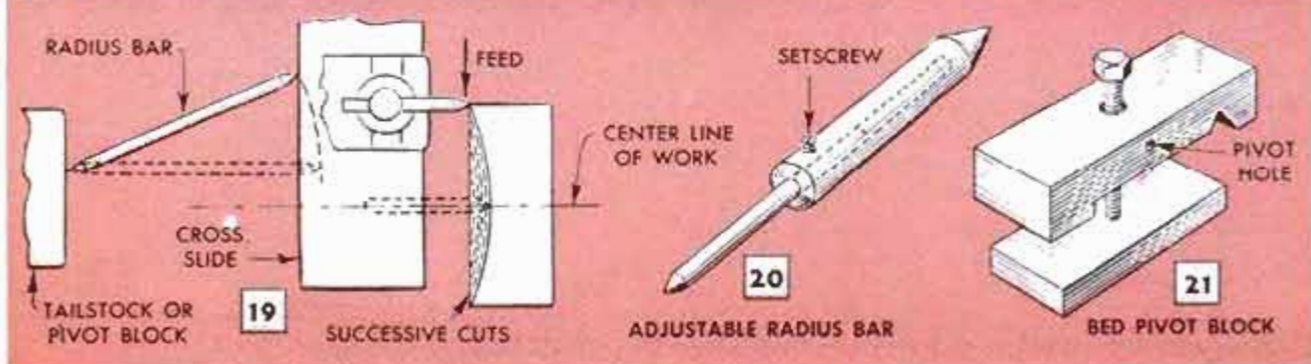
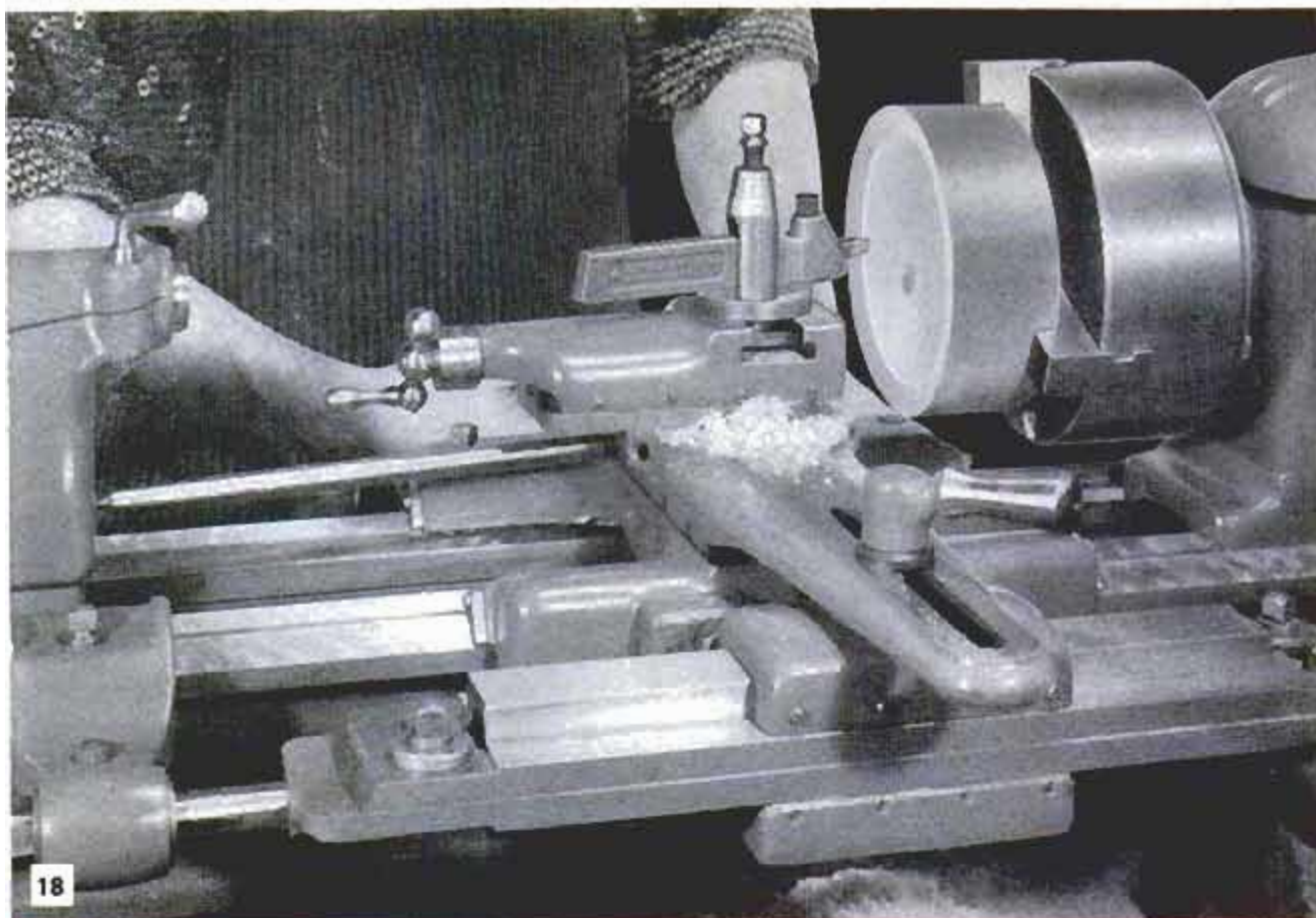

a normal distance from work. An important point in using a radius bar is shown in Fig. 16: When the bar comes to the center of its arc, the tool must at the same time come to the center of the work. To obtain this relationship, the cross slide is moved to bring the radius bar parallel to the lathe bed, after which the tool is adjusted on the compound to center on the work. The radius bar itself can be in any convenient location; external pivot points entirely apart from the lathe are used for some operations requiring a long radius.

When the radius bar is pivoted from the tailstock end of the lathe, the resulting cut will be concave, Fig. 18. The use of the same radius bar produces matching surfaces. Here again the general rule of having the radius bar at the center of its arc at the same time the tool is at work center must be followed, Fig. 19.

If you make extensive use of radius bars,

an adjustable type, Fig. 20, will save time. The bed pivot block, Fig. 21, can be used for either convex or concave cuts, and the block can also be used as mounting base for arms to locate external pivot points when needed. ★ ★ ★

Loosening Paint-Locked Sash

Fresh paint that creeps between the sash frame and the stops can lock a window sash solidly and pose a real problem in loosening it without damage. If you move the sash an hour or so after painting you can easily break the paint seal and avoid trouble, but if you forget and find the sash stuck fast, here's a way to loosen it without damage: Force the blade of a putty knife between the sash and the stop all the way around the sash frame to break the paint seal.

Ted M. Fenn, Skokie, Ill.

Notched Board Serves as Guide For Drilling Spaced Holes

Spacing holes equally and in line by eye alone is a neat trick—if you can do it. This notched board or strip automatically spaces the holes and at the same time keeps them in line. Determine the spacing of holes required, then cut the notches accordingly, each to a depth of approximately half the diameter of the bit to be used. Place the notched strip and the work in the bench vise and position the two so that the holes will come in the desired location. Bore the same number of holes as there are notches, then if more holes are called for, shift the work and guide.

G. E. Hendrickson, Argyle, Wis.



Drill "Chucked" in Lathe Center

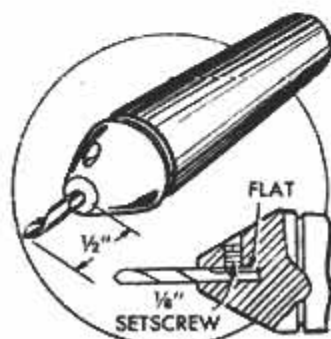

Smaller twist drills in letter and fractional sizes are easily broken and just as easily lost. One shop eliminates losses and discards by mounting broken drills in a lathe center as detailed. They are then utilized as

pilot drills in lathe work that calls for exceptional accuracy on small parts.

Emile Germain, Oswego, N. Y.

V-Block Forms Drill Guide

A practical guide for drilling transverse holes in round stock is readily made from a discarded V-block. Center a row of holes of graduated sizes through the block as detailed. To use,

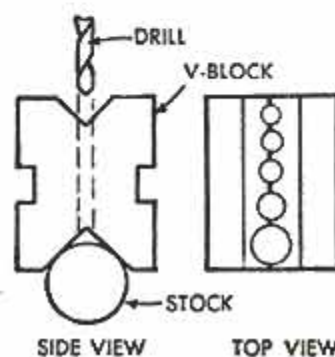

clamp the stock in two V-blocks, place the guide on top of the work and lower the drill bit into the correct hole.—Bruce D. Stewart, Winder, Ga.

Jam Nut Holds Bolt Centered in Clamp Jaw of Lathe Steady Rest

Occasionally it becomes necessary to remove and replace a lathe steady rest without disturbing work between centers. It is then that the loose clamp bolt becomes a problem, as the nut must be removed. Also, when replacing the rest it's handy to have the bolt centered and locked in place, especially in a slotted clamp jaw. By now, of course, you know the trick—simply place a washer of suitable size over the bolt, center it in the slot and run down a jam nut. The stunt also helps to hold the clamp jaw in line when you loosen the nut to slide the rest along the lathe bed.

We Apologize

In our October issue Mr. John Yellott was inadvertently credited as the author of the article on "Solar Water Heaters." The statement in this article "Water weighs about 13 lb. per gal." should have read "A storage tank when full weighs about 13 lb. per gal. of capacity."

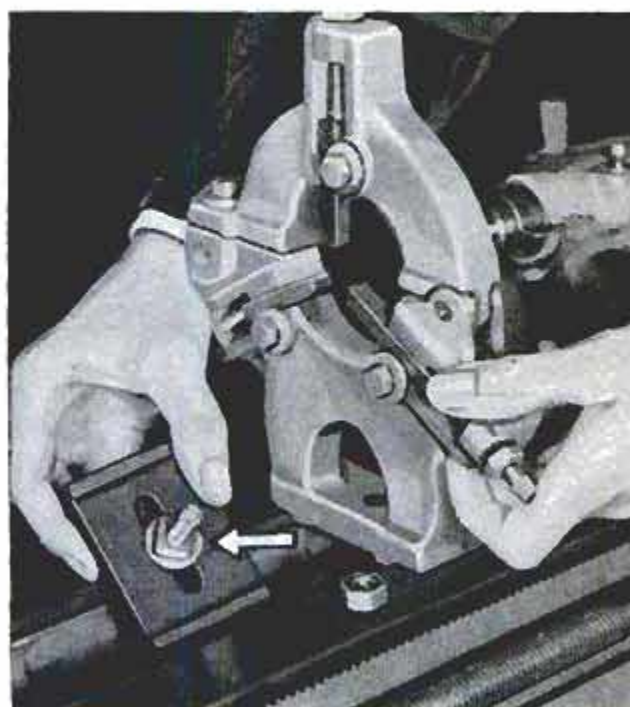

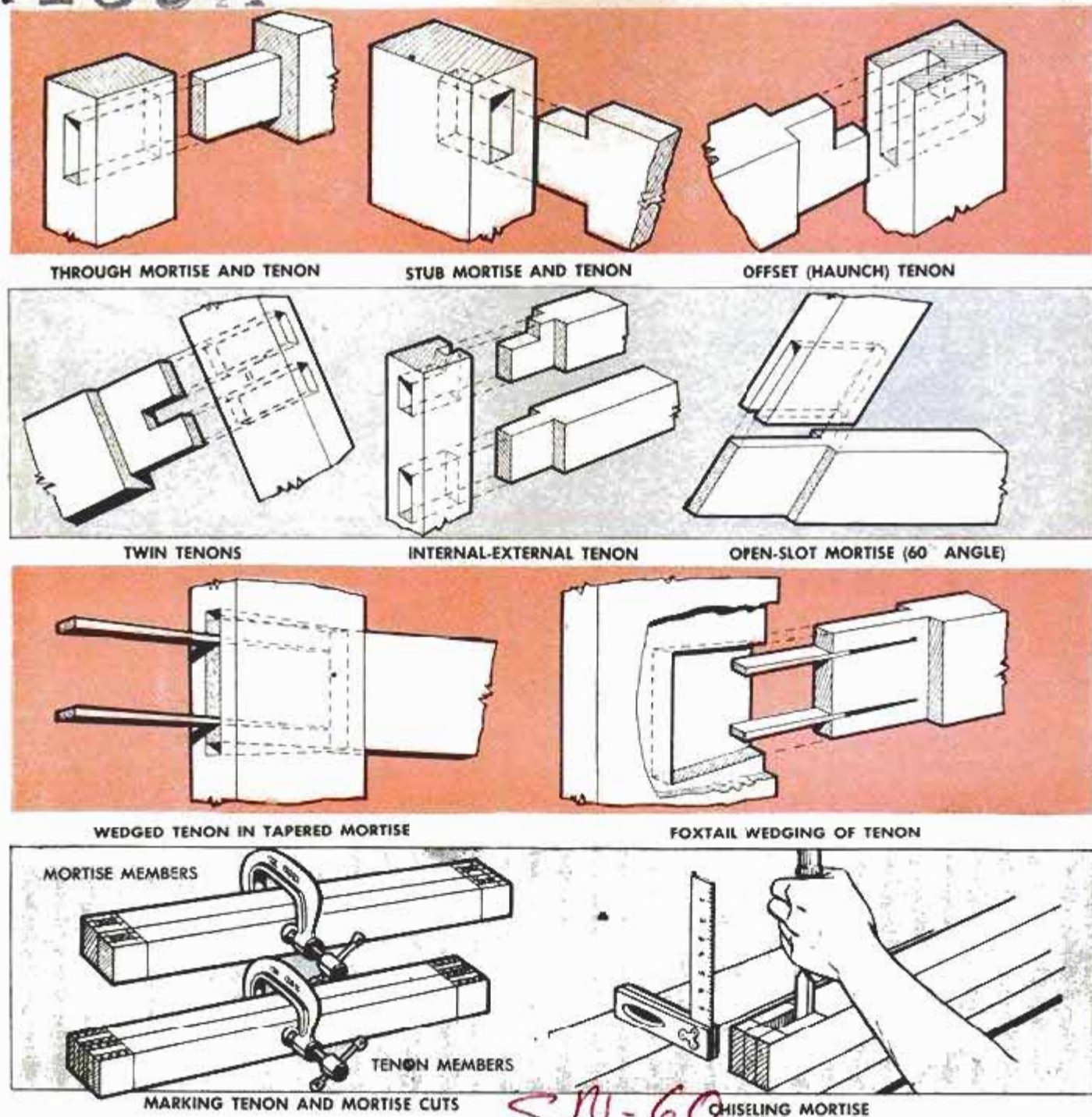

Mortise-and-Tenon Joinery

SEVERAL OF THE JOINTS detailed above and on the opposite page were used by early cabinetmakers, or joiners as they were then known, for joining rails to posts and legs in cabinet and chair framing. To simplify the handwork involved in making tenons on rails many joiners made tenons the full width of the stock as shown. Only later did it become a general practice to house the tenon fully by making cheek and shoulder cuts on both edges of the stock as well as the faces, as is common practice today. The mitered stub tenon, or housed tenon, is an example of present-day practice, as it can be made completely by machine methods, or by hand, and is

almost universally used in cabinet framing which requires mortising. Nearly all the joints detailed are used by craftsmen when making reproductions or copies where all construction details must be followed. The strength of the mortise-and-tenon joint is dependent on accurate fitting. No amount of glue will compensate for poor fitting of the parts. Craftsmen who have a drill press and a circular saw will not, of course, be interested in the hand methods detailed, but those who must make the joints by hand will be well repaid for the little extra time necessary to obtain an accurate fit of the parts.

C. W. Woodson, Chicago, Ill.

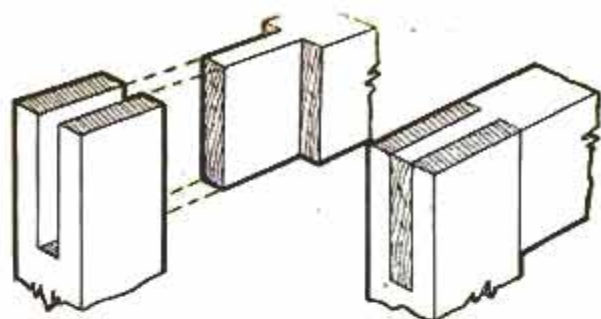

OPEN-SLOT MORTISE

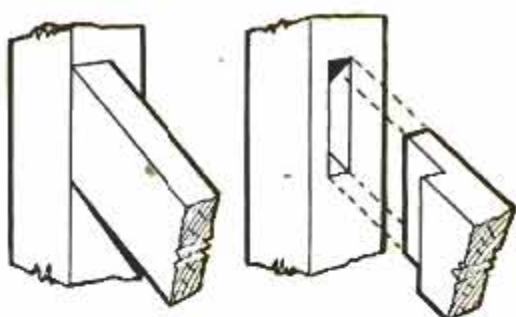

BAREFACED TENON

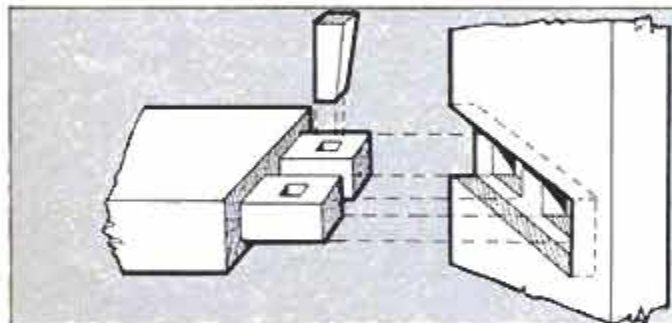

TUSK TENON WITH WEDGE

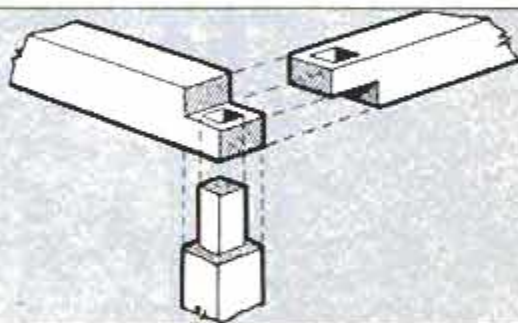

RAILS TENONED TO POST

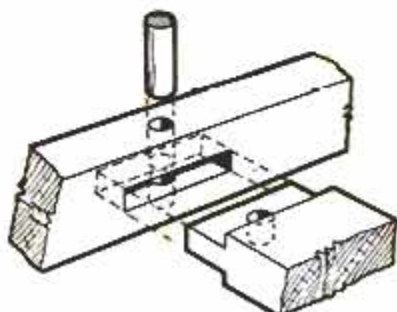

PINNED MORTISE AND TENON

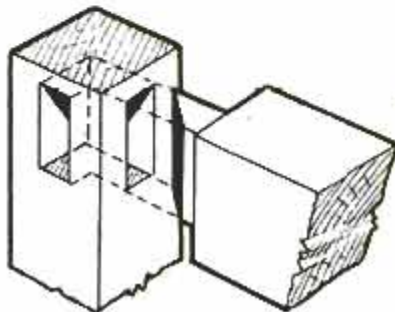

MITERED STUB TENON

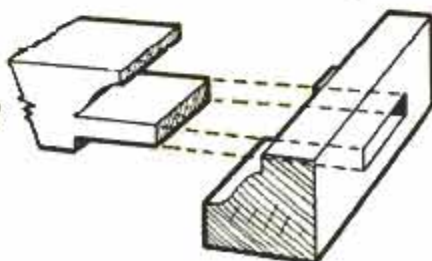

SCRIBED JOINT (TENONED)

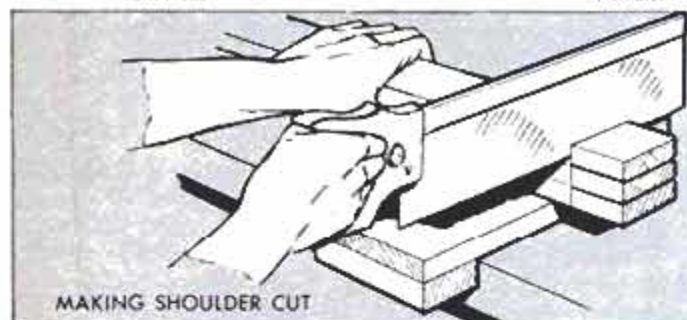

MAKING SHOULDER CUT

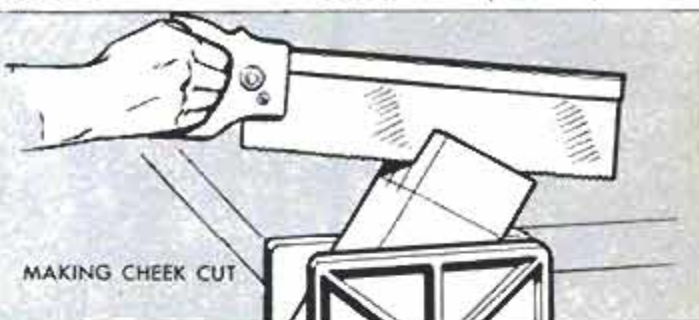

MAKING CHEEK CUT

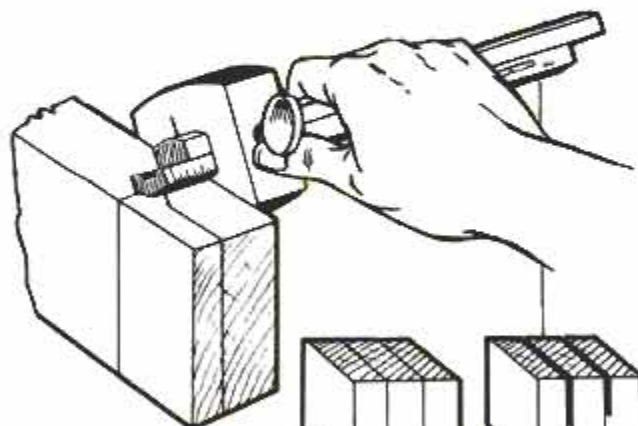

LAY OUT WITH MORTISE GAUGE



TENON LAYOUT



SAW CHEEK CUTS IN WASTE





Steel Angles Cut Accurately By Sawing From Heel First

You will cut steel angles much more accurately with a hacksaw if you start at the heel of each angle, rather than cutting the webs individually as is done ordinarily. Also, because both webs are cut at the same time, fewer saw strokes are required. Because more teeth are contacting metal, the saw strokes will be smoother. When metal angles are held as shown in a machinists' vise, the jaws do not hold the angle, rather the throats of the jaws clamp the angle between them and up against the lower edge of the jaws.

Keep the air cleaner clean on your car to assure proper engine function. Chances are that if the outside of the cleaner is dirty, so is the inside. Let the engine idle as you remove the cleaner. If the engine picks up speed as the cleaner is loosened, you can be sure that it is dirty to the point of impairing proper function.

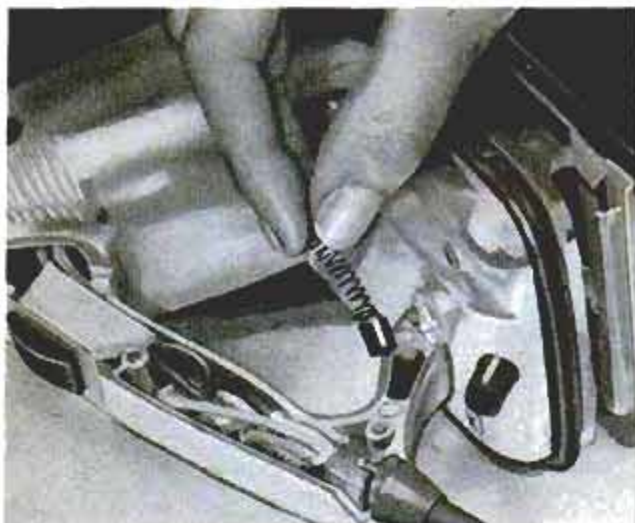

Spare Motor Brushes are Stored In Power-Tool Handles

Spare brushes can be stored in the handle of an electric drill motor, sander or other portable power tool where they will always be on hand when needed. Remove one half the handle as shown and insert the brushes in a convenient opening. The brush springs will keep them from rattling.

☞ To repair small holes or tears in inlaid linoleum, fill them with a paste made of spar varnish and pulverized bits of the linoleum. When mixture hardens completely, sandpaper surface of the patch.

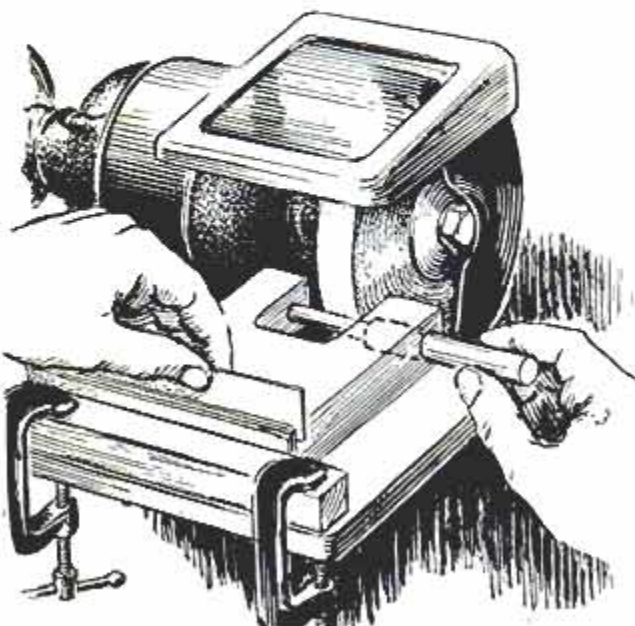

Stock Shouldered Accurately With Simple Jig on Grinder

Grinding down the end of round steel stock concentric with its axis, as when reducing the diameter of a drill-bit shank to fit a small-capacity chuck, can be done accurately with this setup. First cut a U-shaped hardwood block to hold the work. One leg of this block is bored for a sliding fit of the work, the other acts as a stop to assure shouldering the work at right angles to its axis. A stop block of $\frac{3}{4}$ -in. plywood now is clamped to the grinder tool rest. In grinding, the block holding the work is kept against the stop block, but is advanced gradually toward the grinding wheel by inserting thin cardboard strips between the stop block and workholder.



Christmas SHOPPING FOR TOOLS

1. BELT AND PAD (ORBITAL) SANDERS have wide applications in preparatory smoothing and finishing of wood, metal and plastic. These sanders, one orbital and one belt type, have several special features such as out-of-the-way cords, quick-acting abrasive tensioning and locking devices and frames designed for flush sanding. The belt sander takes 3-in. belt, the pad sander an abrasive sheet 7-1/16 x 3-5/8 in.

Stanley Electric Tools, Div. of Stanley Wks., New Britain, Conn.

2. DRILL AND DRIVER ATTACHMENT for use with portable electric drills reduces drill speed 7 to 1 and greatly increases power through a planetary gear train enclosed in the housing. Designed primarily for driving screws the unit also can be used for heavy-duty drilling simply by replacing the driver bit with a suitable chuck. With this speed-reducing unit portable drills will handle larger bits

Supreme Products Corp., 2222 S. Calumet Ave., Chicago 16

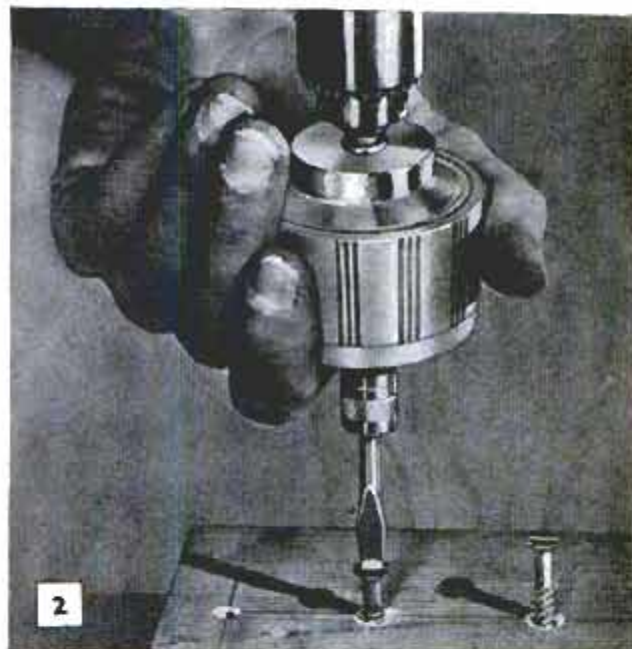

3. CARBIDE-TIPPED SCRIBER looks like a knife but it works like a scriber on plastic laminates and other similar hard, rigid materials. Specially ground tip scores deep when run along a straightedge, permits materials to be broken easily along scored line. All-metal construction with a handle shaped to fit the hand and give a firm grip for sure control when scribing. Full instructions are included with the scriber

Score-Away, Box 95, Grove City, Ohio

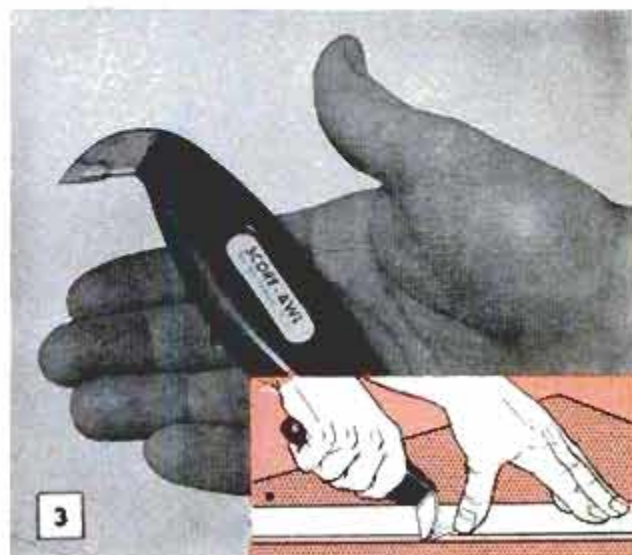

4. WOOD-LATHE ATTACHMENT for radial saw can be attached to the machine table and driven by belt from the saw motor as pictured, or it can be mounted individually on a bench and driven by a separate motor. In individual setup motor can be positioned back of lathe headstock or below it as desired. The lathe comes complete with V-belt, pulley for 5/8-in. motor shaft, 3 3/4-in. faceplate and tool rest

DeWalt Div., American Mach. & Foundry Co., Lancaster, Pa.

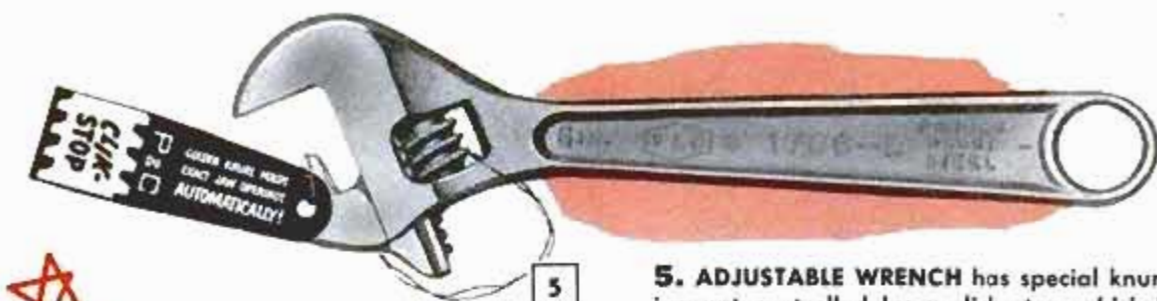
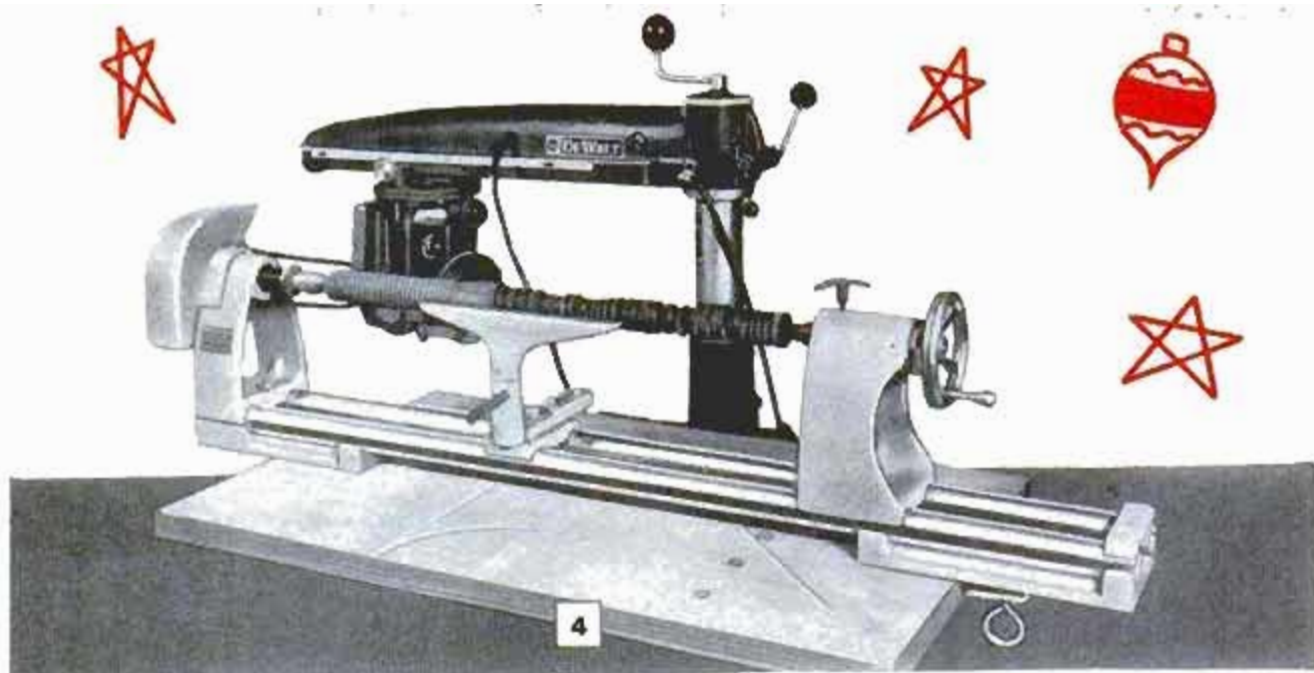

5. ADJUSTABLE WRENCH has special knurled adjusting nut controlled by a click stop which holds jaws in position once they are adjusted to fit a nut or cap screw. No slipping and no continued adjustment of the jaws when you're working in a tight place. Comes in 5 sizes ranging from 4 to 12 in. Head is extra-thin, permitting work in places most wrenches will not reach. Wrench is polished and chrome-plated

P & C Tool Co., P.O. Box 5926, Portland 22, Ore.



6. PORTABLE PAINT SPRAYER is specially designed for applying the new multicolor finishes on plaster, masonry, wood trim, metal and brick, on exterior as well as interior work. Piston-type compressor with direct-connected motor converts easily and quickly from low pressure for multicolor work to high pressure for spraying conventional paints. Compressor runs at motor speed, provides ample pressure steadily

Campbell-Hausfeld Co., 5082 Railroad Ave., Harrison, Ohio



7. DRILL-BIT HOLDER comes in two sizes, No. 29 which holds a complete set of 29 drill bits from 1/16 to 1/2 in. by 64ths and No. 60 which holds a 60-piece set of number drills in sizes from 1 to 60 inclusive. Drill sizes are stamped on body of holder. A witness mark on the rotating top enables you to turn top and release drill bit of size required. Tap-drill, body-drill sizes also are stamped on holder

Keystone Ferrule and Nut Co., Box 11, Burlington, Wis.

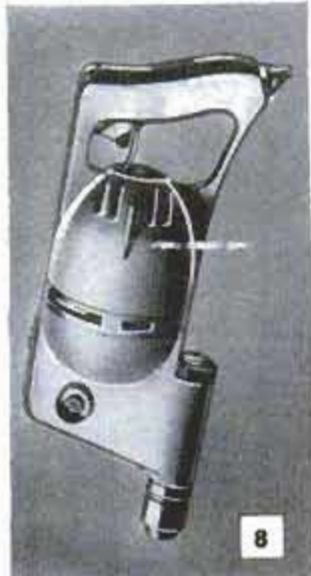

8. PORTABLE ELECTRIC HAMMER operates on an entirely new principle, is light and easily handled, weighs only 8 1/2 lb. Takes 40 different types of chisels and other tools for drilling in concrete, cutting sheet metal, driving speed nuts, removing scale from metal tanks without undue vibration or recoil. It's portable-electric-drill size which makes it easy to control and maneuver in the hard-to-get-at places

Modern Mfg. Co., Inc., 680 Davisville Rd., Willow Grove, Pa.

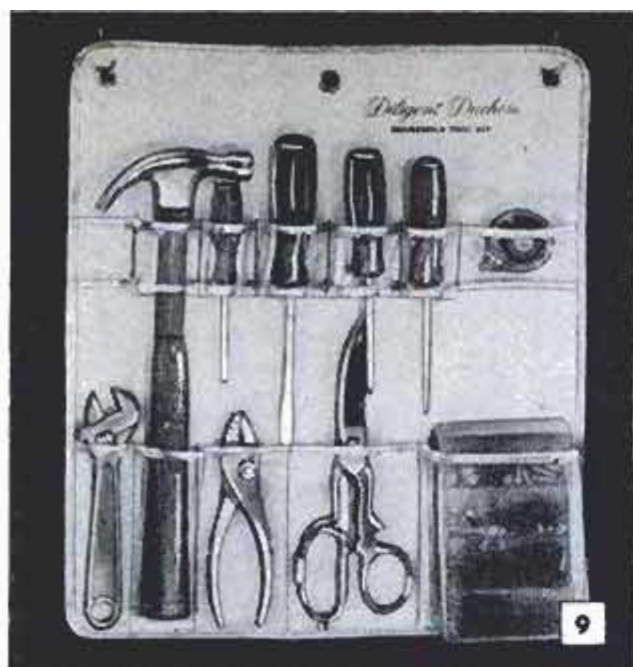

9

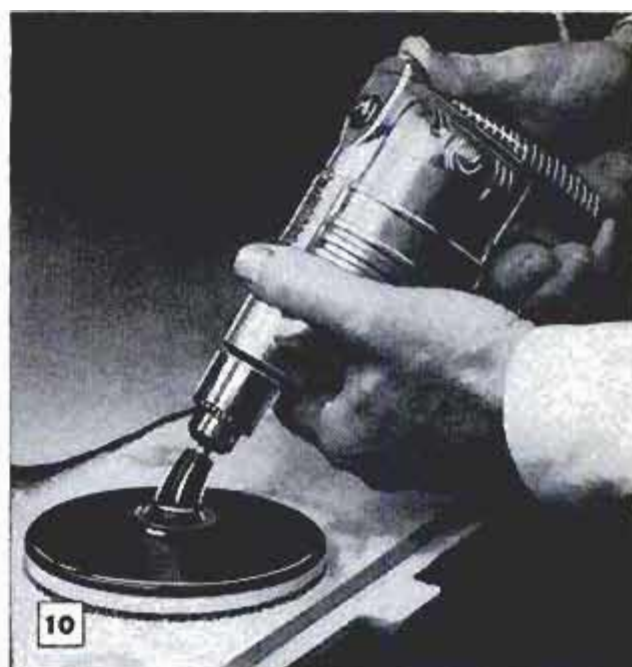

10

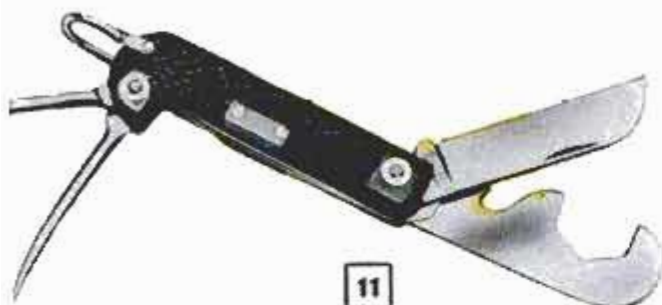

11

9. TAILORED FOR THE LADIES, this household toolkit is an ideal gift for the homemaker who makes some of her own minor repairs. Tools are best quality, and are chrome or gold plated. Tough plastic handles are impregnated with glitter to add a feminine touch

Pendleton Tool Industries,
2200 Santa Fe Ave., Los Angeles 54, Calif.

10. DISK SANDER designed for use with portable drills is made with a flexible shank which permits it to operate at an angle as great as 30 deg. with surface of work. Sands smooth without leaving deep circular scratches on surface or hard or soft woods

The Flexan Corp., 3949 N. Normandy Ave., Chicago 34

11. TOOLKIT IN A POCKET KNIFE features a screwdriver (blade type), a Phillips driver, a wrench, bottle decapper, etc., in addition to regular pocketknife blade. Small and lightweight, it carries easily in the pocket, or from chain or cord to prevent loss

Tor Heyerdahl Co., 825 Lander St., Boise, Idaho

12. COMBINATION HAND VISE AND BENCH VISE is so designed that it can be detached from bench clamp and used as a hand vise for holding small parts securely for freehand operations. Vise jaws are 1½ in. wide, open about 3 in., swivel to any desired position

Lushington Tool & Gauge Co., Ltd., Hailsham, Sussex, England

13. JIGSAW KIT can be assembled by purchaser and driven by any ¼-hp. motor. Has a capacity of 15½ in. from blade to frame. Arms and frame are of hardwood. Metal parts are balanced for smooth operation. Length of stroke is 15/16 in., Bearings are bronze

Henlon Corp., Vestal, N. Y.

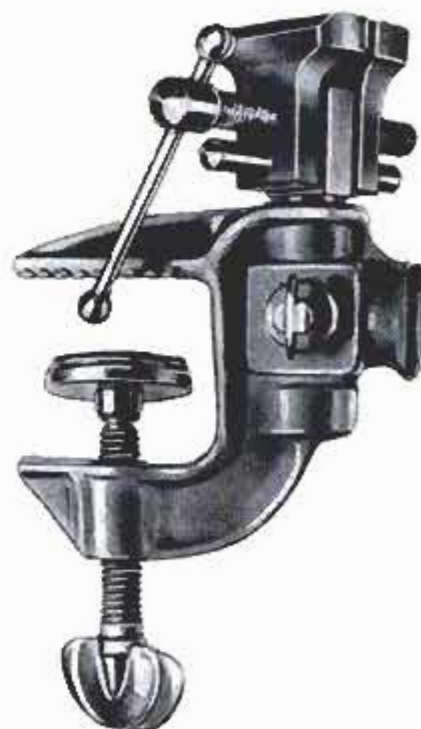

12

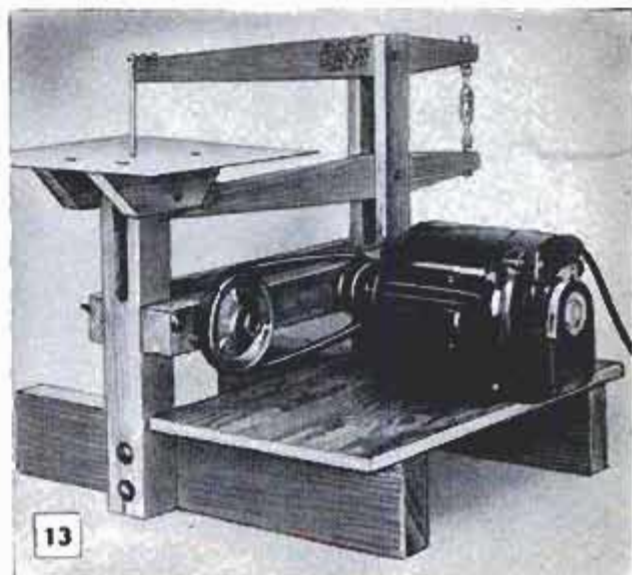

13



14

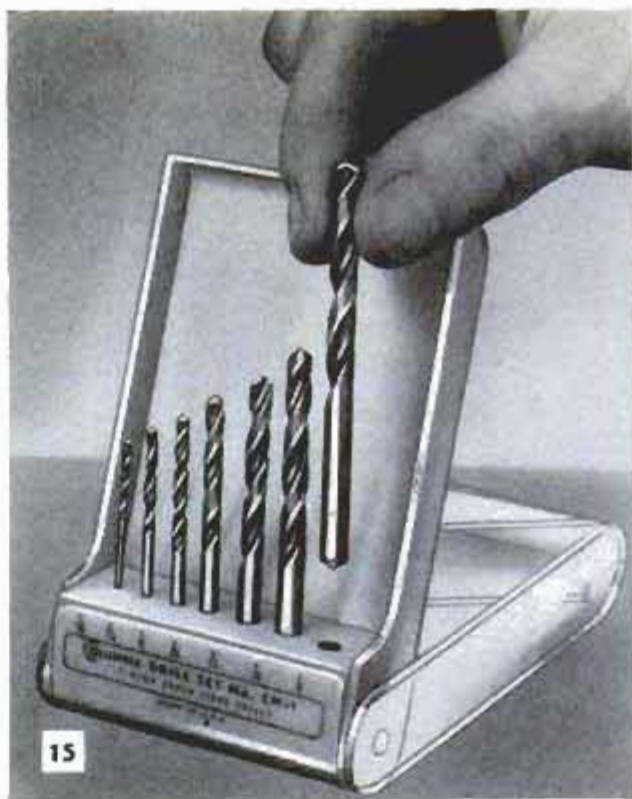

15

14. RULER SQUARE is fitted with a prism for drawing perpendicular lines optically. When placed over a penciled or inked line the prism shows it broken until the edge of the ruler is brought to the 90-degree position, that is, perpendicular to the line already inked. Then the inked (or penciled) line appears straight when viewed through prism. Graduated on one edge in inches, on the other in millimeters

Kiva Products, Inc., 550 Hill Ave., Glen Ellyn, Ill.

15. DRILL KIT comes in a neat, folding plastic case, or holder, that closes tightly to prevent loss of individual drill bits and damage by rust. The cover of the case pivots in such a way that when opened the case can be set up as a handy bench stand while drills are in use. Five sets of drills are offered in these unusual holders, the sets coming in assortments of seven, ten or thirteen high-speed bits

Columbia Drill Co., 123 W. Ontario St., Chicago 10

16. NEW FEATURES distinguish these three portable power tools designed for carpenters, trimmers, woodworking shops and home craftsmen. Units have been designed with special attention to balance, an important detail in power tools that are operated free-hand. Oscillating sander is direct drive, operates at 8500 r.p.m., saber saw at 4000 strokes per minute. Novel belt-changing device is feature of belt sander

Peninsula Tool Co., Menominee, Mich.

17. SANDING BLOCK holds up to 20 sheets of abrasive, uses standard 9 x 11-in. sheets, each cut into 3 pieces of equal size. Split hardwood block folds as in inset. To load block, ends of stacked abrasive sheets are inserted in slots cut in ends of block. When straightened, halves of block are held in position by U-shaped pin, or key, sharpened ends of which pierce abrasive and hold it under tension

Peter Rain Co., 404 Elm Park Ave., Elmhurst, Ill.

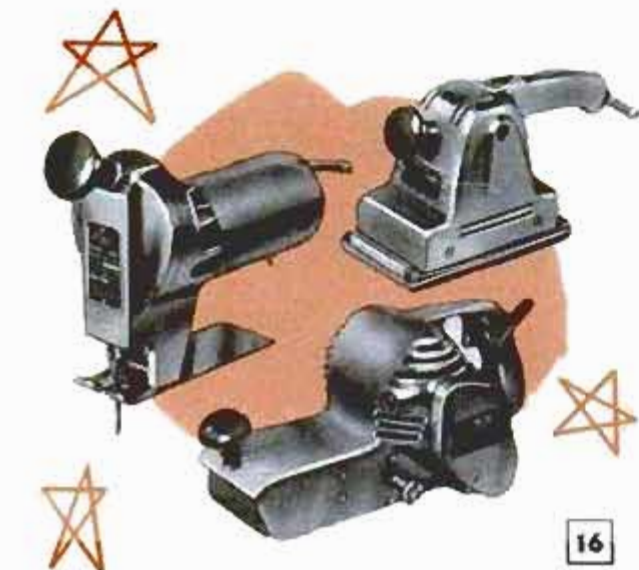

16

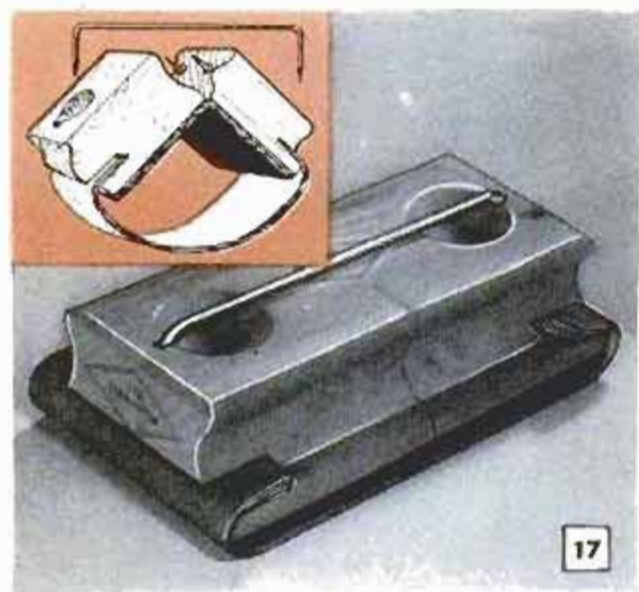

17

HAPPY THE HOME

full of wonderful gifts like these!



The nicest gifts keep on giving

Look for
**POPULAR MECHANICS
CHRISTMAS DISPLAYS**
at dealers everywhere

Select several
for your home
and family
from the
many exciting
pages in
this issue



Open this new Kodak Signet 80 Camera *first*, and start taking 35mm color slides. Has exposure meter, rangefinder, $f/2.8$ lens. Accepts wide-angle (\$57.50), telephoto (\$69.50) lenses, multiframe finder (\$17.50). Signet 80 Camera with $f/2.8$ lens, \$129.50.

Kodak gifts say

Open me first!

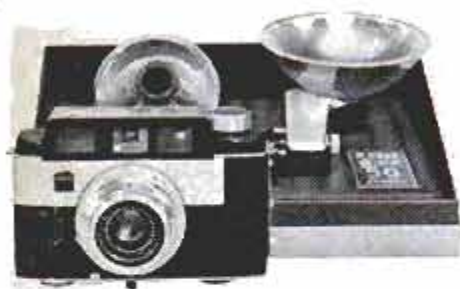

Kodak Signet 50 Camera has built-in light meter, EV-linked lens-shutter, $f/2.8$ lens; with flashholder, two reflectors, \$82.50.

Brownie Starflash Outfit — for snapshots and *color slides*, too! Built-in flashholder, bulbs, batteries and film. Only \$9.95.

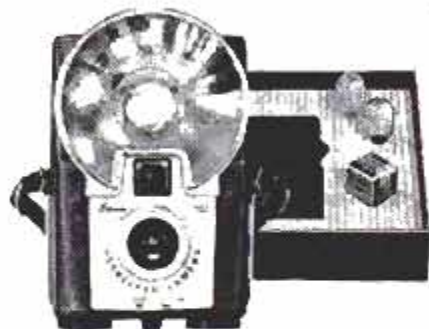

Kodak Duaflex IV Flash Outfit — everything for snapshots, indoors and out! Camera, flashholder, bulbs, batteries, film, \$24.95.



Kodak Cavalcade Projector is completely automatic! Changes slides by itself. Steel jackets protect slides. 500 watt, $f/2.8$ lens. \$149.50.



Many photo dealers offer terms as low as 10% down. Prices are list, include Federal Tax, are subject to change without notice. See Kodak's "The Ed Sullivan Show" and "The Adventures of Ozzie and Harriet"

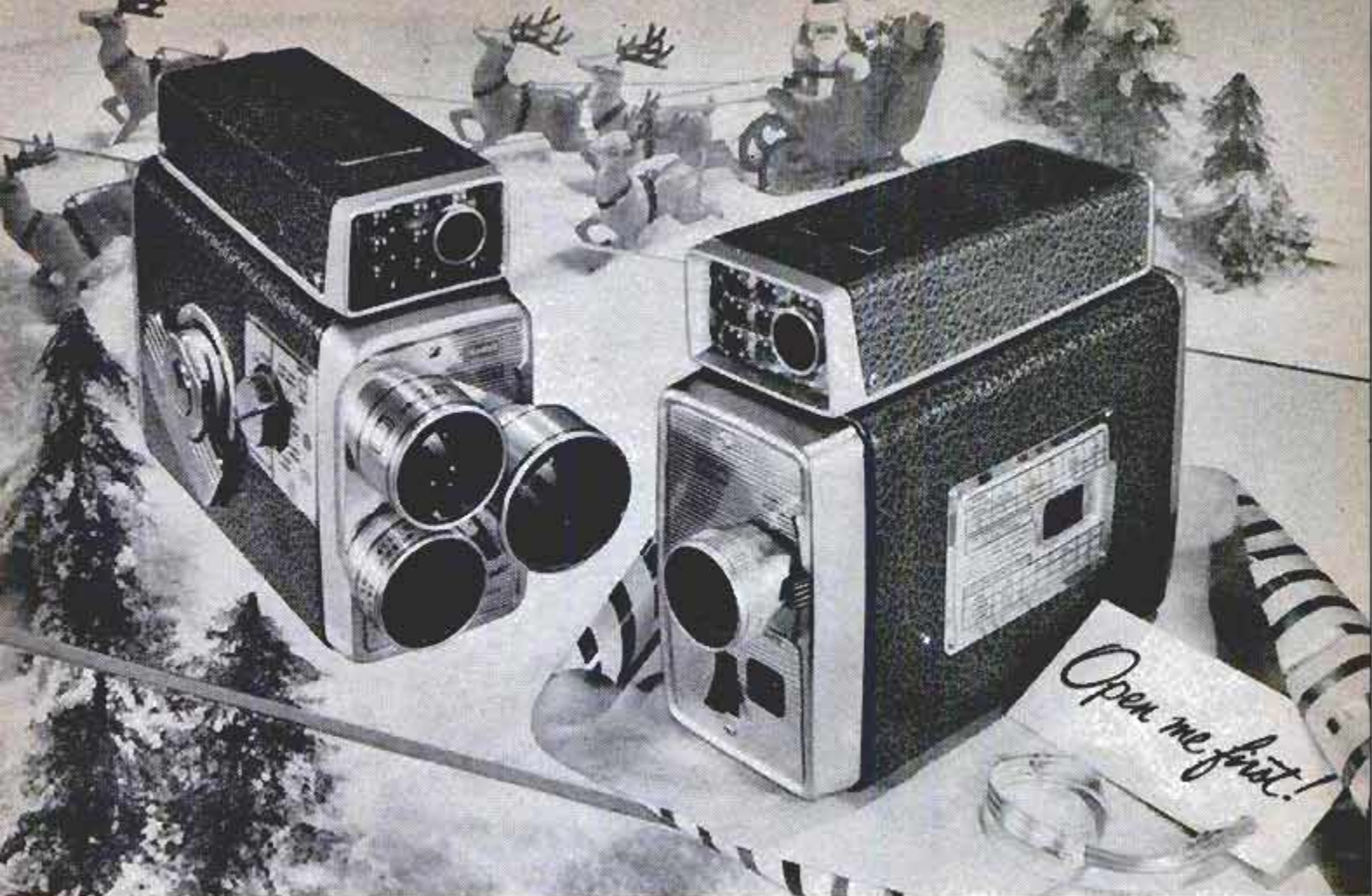

Open the new Scopesight Brownie Movie Camera *first*, and capture all the action and color. Built-in exposure meter always shows you when exposure is correct. Single-lens model, \$79.50. Turret model, \$99.50.

...and save Christmas fun in pictures!

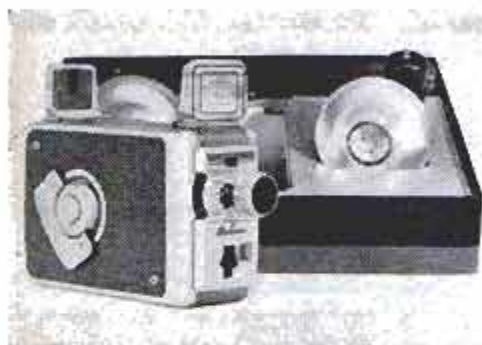

Brownie Movie Camera Kit, $f/2.3$ —8mm color movies, indoors and out, with one setting! Complete with light bar, cord, lamps, \$39.95.



Brownie 300 Movie Outfit—8mm camera with $f/2.3$ lens, and projector for showings up to 3 feet wide, reverse, "stills," too. \$97.45.

Brownie Movie Camera, Turret $f/2.3$ (8mm)—Lowest priced ever! Takes regular, wide-angle, telephoto shots. *Easy to use.* \$59.50.

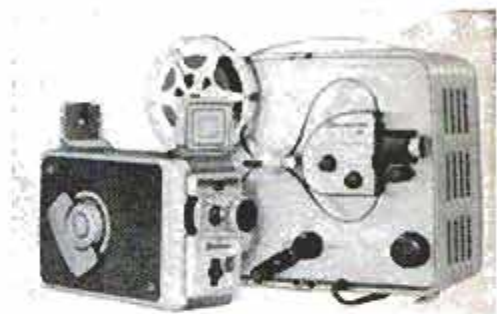

Kodak Showtime 8 Movie Projector—shows movies up to 5 feet wide! Built-in dry splicer. 750w lamp, "stills," reverse. \$174.50. 500w model, \$123.50.



EASTMAN KODAK COMPANY, Rochester 4, N.Y.

Kodak
TRADEMARK

Automobile Batteries Have Replaceable Cells

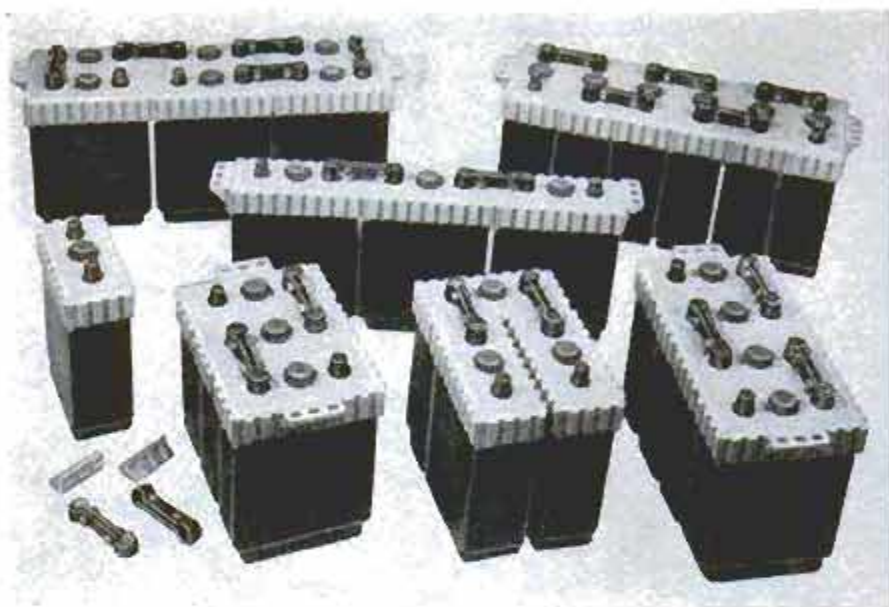

Now you can carry a spare cell for your auto battery as you carry a spare tire. The individual cell units are available in two sizes that can be combined into 6 and 12-volt batteries to replace 19 different battery sizes now used in cars and trucks. The cells fit together with dovetail grooves on all sides, then are locked with metal bars clamped to connecting posts. It is said they eliminate replacement of entire batteries because of one cell failure.

Frozen Blood

Whole blood now can be frozen, held indefinitely, then used in transfusions. The technique may put an end to the chronic blood-supply shortage. The blood is processed in a fractionator, and a preservative—glycerol—is added. Then the blood is frozen. When it is to be reused, it is thawed and glycerol removed in wash solutions.

Flies Kill Grasshoppers

Parasitic flies that destroy grasshoppers may eventually control the agricultural pest. The female of one type of fly deposits a larva in the leg muscle of the grasshopper. The larva eats its way through the grasshopper. Entomologists report that in a limited area of California, this fly has virtually wiped out grasshoppers.

A RUGGED HUNTER —
WHAT A SHOT!

AND SOMETHING ELSE
THIS GUY HAS GOT —

SMELLS GRAND!
PACKS RIGHT! SMOKES SWEET!
CAN'T BITE!

HIS PIPE
HAS HIT THE
MARK
WITH ME!

SIR WALTER
RALEIGH,
NATURALLY!

FREE!
BOOKLET ON PIPE CARE. WRITE
SIR WALTER RALEIGH, DEPT. 1210-L
LOUISVILLE, KY.

SIR WALTER
RALEIGH

CHOICE
KENTUCKY
BURLEY
EXTRA AGED

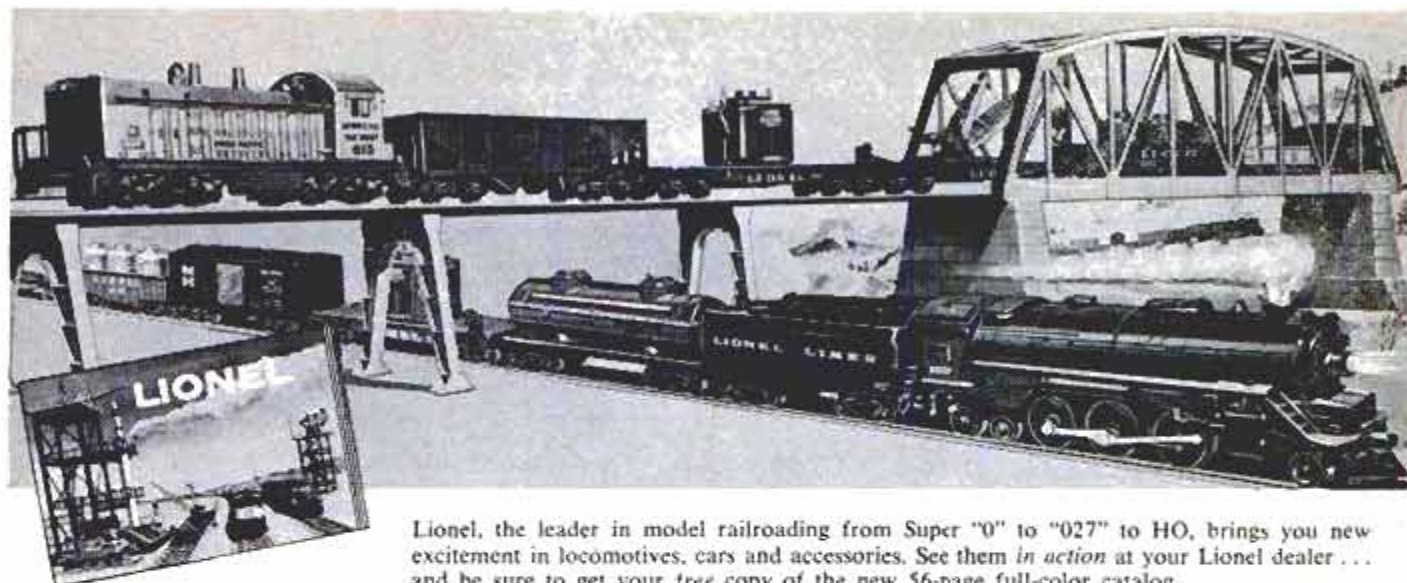

Lionel, the leader in model railroading from Super "0" to "027" to HO, brings you new excitement in locomotives, cars and accessories. See them *in action* at your Lionel dealer . . . and be sure to get your *free* copy of the new 56-page full-color catalog.

LIONEL . . . Railroading Action at its Best!

No. 175 ROCKET LAUNCHER—It duplicates accurately the firing procedure used for earth satellite launching. Set includes motorized launching tower, illuminated remote control panel with count-down mechanism and firing button, launching platform, rocket with safety foam nose cone. (Car not included.)

\$17.95

No. 2329 VIRGINIAN RECTIFIER-TYPE ELECTRIC—Here's the proudest addition to Lionel motive power! Built from actual GE blueprints of new electric locos. Lionel's model has a pantograph which can be made to operate from overhead wires, headlights on both ends, horn and Magne-Traction. \$35.00



NEW

No. 6175 ROCKET CAR—Carries rocket with nose cone made of polyurethane foam for safety. \$5.95

NEW

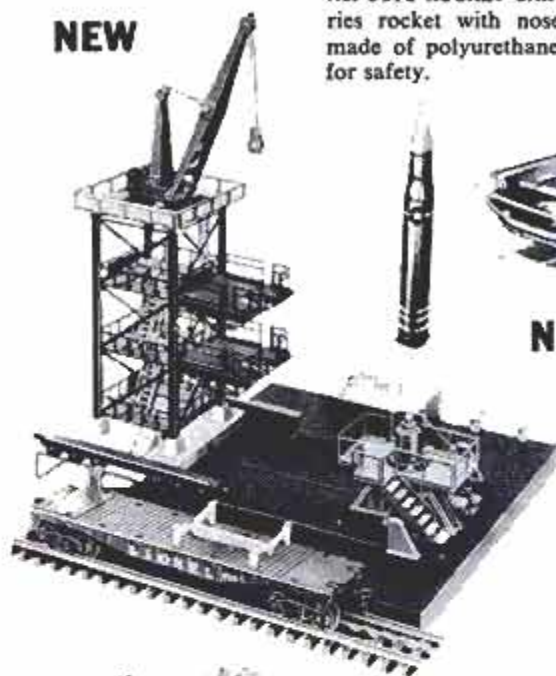

No. 68 EXECUTIVE INSPECTION CAR—Just like cars used by railroad executives, this motorized station wagon has four extra flanged wheels for riding on railroad track. Operates forward or backward by remote control. \$12.95

NEW



NEW

No. 52 FIRE FIGHTING CAR—An exciting Lionel motorized unit! As car speeds to "fire," red light flashes on and off. When car strikes bumper or other object, it reverses direction and helmeted fireman swivels with high-pressure nozzle. \$12.95



LIONEL . . . for the newest in HO!



Discriminating hobbyists will want to see Lionel's 1958 line. Eight ready-to-run train outfits come complete with power pack, re-railer and uncoupling track. All locos

are equipped with headlights. New to HO exclusive rolling stock, exciting new accessories and an assortment of power units make this the greatest HO line ever!

The Lionel Corporation, 15 East 26th Street, New York 10, N. Y.

Be sure
it's a genuine
CHANNELLOCK

Only
Channellock
has this
reinforced
edge for
greater
strength.

Only
Channellock
has undercut
interlocking
non-slip
channels.

LOOK
FOR THIS
TRADE
MARK

Why? Only Channellock has undercut, interlocking channels that can't slip no matter how tight you grip. Only Channellock has the reinforced tension edge to withstand maximum gripping force. These exclusive features have made the Channellock No. 420 the first choice of skilled mechanics everywhere. So be sure you get only genuine Channellock pliers. Look for the trademark on the handle.

ASK YOUR TOOL SUPPLIER FOR CHANNELLOCK PLIERS — BY NAME



CHAMPION DeARMENT TOOL COMPANY
MEADVILLE, PENNSYLVANIA

Clinic for Homemakers



As a service to our readers in solving the hundreds of problems pertaining to a home—inside or out—the editors of *Popular Mechanics* invite you to present your problems to The Clinic Editor for help and advice. Address your questions to The Clinic Editor, *Popular Mechanics Magazine*, 200 East Ontario Street, Chicago 11, Ill.

Noncoloring Finish

Q—How can I finish light-colored wood in its natural color without changing the appearance and detail of the grain and without darkening the wood? Clear shellac and varnish finishes darken the wood for some reason. Is there a finishing material available that won't change the color?—H.S., Md.



A—One reason ordinary clear finishes appear to darken the wood is simply because they change the light-reflecting properties of the surface. Several applications of paste wax alone on close-grained woods such as maple and birch probably will change the original color least of any. Some new finishing materials are available which are of the oilfree type and are applied in two stages from two containers, the first application forming a base for the second finishing coat. Also, special lacquers are available, known as "padding" lacquers, which are applied with a cloth pad in a manner similar to the older method of French polishing. The oilfree finishes and the padding lacquers do not darken light wood appreciably and do not yellow with age. Of course, it should be remembered that the wood itself, and particularly certain pieces of the same kind of wood, will tend to darken somewhat with age. Also, the noncoloring properties of the finish are affected to some extent by the condition of the surface over which they are applied. New wood must be sanded to a satin-smooth surface and all scratches must be removed, as the scratches made by coarse sanding absorb the finish and tend to give the effect of discoloration of the surface.

Insulating Duct

Q—I have a warm-air heating system and as I have added a small room to my five-room home, I will need to install a heating duct nearly 20 ft. long. My contractor says that insulation is not necessary but it seems to me that a wrapping of asbestos would lower heat loss. Am I right?

—W. N., Okla.



A—We assume you are referring to a forced-warm-air heating system installed in a basement. Your contractor is right in the sense that any thin, noncellular material is of little value in insulating against heat loss from warm-air ducts

(Continued to page 212)

"His and Hers" Tape and Rule Set



only \$5²⁹

AT YOUR HARDWARE STORE
(ACTUAL \$6.39 VALUE)

No more "By guess
and by gosh" with
this unusual gift idea

FOR HIM... a 50-foot Lufkin steel tape that's so practical for home projects. He'll use it to lay out a patio, locate property lines, measure rooms for wall-paper or flooring. It's perfect for those difficult, longer distances.

FOR HER... a 6-foot Lady's Man rule in pastel-colored case, just the right size for her purse or sewing basket. She'll use it 101 different ways... from measuring her waistline to cooking (with a temperature chart on the back).



THE **LUFKIN** RULE COMPANY
TAPES · RULES · PRECISION TOOLS
BAGINAW, MICH. · MIDDLETOWN, N.Y. · BARRIE, ONT.

MADE ONLY BY *Craftsman*

THE ORIGINAL PACKAGED BOAT KITS

• World's Largest Line—New Fiberglass Hulls. Over 200 styles Boats—Kits, Formed-Hulls, Semi & Custom finished. All types: Fringe, Cruisers, Racers, Inboards, Outboards. Easy to build. Professional results. Dealers - Agents Inquire.

CREDIT TERMS

Send 25¢ for 3-Color Catalogs 52 pg. Kit Catalog plus 20 pg. Hardware and 8 pg. Armor Glass books. (SPECIAL OFFER!) All 3-colored CATALOGS plus "Boating Handbook"... all for \$1.

CUSTOM • CRAFT



★ BOAT PLANS, PATTERNS FRAME PACS

• Over 400 Plans—Patterns, Frame Pak Kits, Prams, Kayaks, Racers, Runabouts, Catamarans, Cruisers - In-Outboards (6' to 40') Wood, Plywood and Steel. Send 35¢ for 120 pg. Plan Catalog. Catalog plus "Boat Building Handbook"... Send \$1.00.

Buffalo 71, N. Y.

YOUR **TIME** IS IMPORTANT!

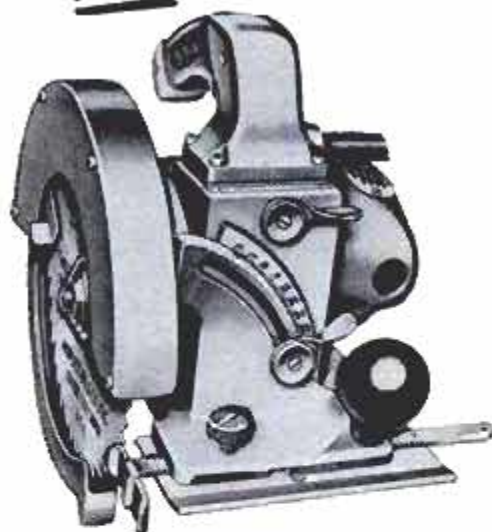

Time is money. And that's the sound dollars and cents reason for owning this modern, powerful, Sioux Electric Saw.

Home projects take shape in a hurry—like the new recreation room, the new garage, the extra bedroom.

Your Sioux Saw hurries things along, and pays for itself in a hurry too!



Look for SIOUX in the yellow pages under "Electric Tools"

Write for Free Catalog



1000's of ITEMS in WOODS

Constantine's CATALOG FOR CRAFTSMEN

Tools, Materials & Supplies

THIS BIG, new 126 page catalog and "how-to-do-it" book has everything for the woodworker and hobbyist, all at lowest prices. Complete source of supply for fine, rare imported and domestic woods, veneers, turning blocks and squares. Inlays, bandings, moldings, carvings, upholstery supplies and wood finishing materials, hand and power tools. Thousands of items to choose from. Unusual hardware for every purpose. Exclusive wood identification chart of over 60 woods named and reproduced in natural color. Hundreds of illustrations, "how-to-do-it" articles, projects and plans.

FREE 25¢ WOOD FINISHING MANUAL with your copy of our Catalog for Craftsmen. Send only 50¢ today (refunded on 1st order) and will include FREE with your copy of our big catalog our special 25¢ wood finishing book. Write today!

ALBERTSON CONSTANTINE AND SON, INC.
2056-F Eastchester Road New York 61, New York.

ALBERTSON & CO., INC. SIOUX CITY, IOWA, U.S.A.

FREE 12-page catalog of gifts the sportsman wants for Christmas



Read all about the finest line of rifles, shotguns and scopes that Mossberg ever offered—new features, top values, perfect gifts to give, or to receive. TODAY, send for the catalog. Make your selections. Then, see your local Mossberg dealer, and give somebody (maybe yourself) a mighty Merry Christmas.

Wonderful Values like these

22 Cal. De luxe Single Shot

New, safer, hammerless, closed-breech action. Convenient loading platform. Ultra-safe safety. Takes all 3 popular 22's.

MODEL 320K \$1795

410-Gauge, Single Shot Shotgun

A real beauty. Fast, top loading. Thumb-operated safety. Full choke barrel. Weight 5½ lbs. Nicely balanced.

MODEL 173 \$2495

Prices \$1.00 higher west of Rockies.

Mossberg

for accuracy

O. F. MOSSBERG & SONS, INC.
89712 St. John St., New Haven 5, Conn.

Sirs: Please send me your new Catalog of Christmas gifts for sportsmen.

NAME _____

STREET _____

CITY _____

STATE _____

(Continued from page 210)

in a basement. However, if the duct extends a part of the distance in the basement and then passes into a crawl space, insulation of this portion of the duct might be worthwhile if the distance it extends beyond the basement is 5 ft. or more. If less, insulation of the duct extension would hardly seem worth the labor and time involved. Warm air is forced through the ducts at comparatively high velocity and this tends to reduce loss to the minimum.



Chimney-Flue Stain

Q—I have an older home of brick with chimneys built into the end walls. In one end the flue comes down to the first floor, the other to the second floor. Recently I painted the brick walls white and now a dark stain shows along the line of both flues on the outside. How can this be corrected? —H. K., Pa.

A—Unfortunately, a solution to this problem is not always simple, especially where the structure is old and the bricks which form the flue have become permeated with stain-producing elements which are activated in the presence of moisture. You did not say whether the chimneys are in use and, of course, this makes it rather difficult for us to outline a procedure which might have a fair chance of success. In general, if the chimneys are no longer in use, then the flues should be thoroughly cleaned to remove all loose mortar and soot and capped to keep out rain and snow. In this procedure it is advisable not to cap the top end of the flue tightly, but rather use a tile chimney pot of the type that will shed water. Then clean the outside surface of the wall, covering all the stained area, with a wire brush, point up the mortar joints and finish with a coat of white asphaltum or white creosote. The reason for this suggestion is that it costs much less to carry out than the alternative which is removing the bricks which form the outside wall of the flue and bricking up solid to the ridge.

Cleaning Old Marble

Q—I have an old marble-topped chest of drawers and there are two quite dark-colored stains on the top near the center. These appear to be old and I do not know what caused them. There is a light diagonal scratch near one corner. Also, the entire top is a yellowish color. Is it possible to restore this top to something near its original appearance?—B. G., Va.

A—Often the marble tops of old pieces were waxed for protection. Probably this accounts for the yellowish color you mention. A soft cloth dampened in pure turpentine will remove the wax. Then, as a first step, scrub the marble with a mild detergent, using a fiber brush. This treatment should remove embedded dirt and possibly some of the discoloration. Wash off with clear water to remove all traces of the detergent. Usually stains on marble form some pattern on the surface and often this gives one a clue as to what caused the stain originally. However, you say you do not know what caused the stains, so perhaps it is best to treat these as simple stains and apply what marble refinishers call a "poultice." To make a poultice use about three thicknesses of blotting paper (white blotting paper), stack these and then pour about a tablespoonful or so of hydrogen peroxide (hair-bleach strength) at the center. Add a few drops of household ammonia. Place the blotters with the wetted area directly over the stain and lay a piece of glass over them. Leave in place 12 to 24 hr. Then remove and again wash with clear water. Examination will show whether it is necessary to repeat the process. If the stain is old and deeply embedded it is quite likely that more than one application will be necessary to remove it entirely. You can polish out the light scratch on the top with 8-0 abrasive paper. Use water on the surface to prevent the abrasive from clogging.

a model for every use... all with
**Quality,
 Performance,
 Long Life!**

Sunbeam
 ELECTRIC TOOLS



ELECTRIC HAND SAW
 Rips, crosscuts, cuts circles and scrolls. With rip guide and blade.

\$45.00

*Pro. model—\$55.00



CIRCULAR SAW
 1 1/4 H.P. motor, 6 1/2" blade cuts faster, easier—even 45° bevels. \$58.95; 3-conductor cord. \$59.95

*Pro. model—\$69.75



ELECTRIC SANDER
 Lightweight, well balanced. Fast, easy abrasive change—no tools needed. \$39.50

*Pro. model—\$49.75

DRILLMASTER

1/4" DRILL gives you

ALL these advantages

- More power, faster drilling
 - Lightweight, cooler running
 - Higher torque, greater efficiency
 - Powerful Sunbeam built motor with geared chuck \$25.95, with key chuck \$27.95
- Pro. model—25% more power; 15 foot, 3-conductor cord. \$42.50



DRILLMASTER
 1/2" DRILL

Easy to handle, Lightweight

Ideal spindle speed and extra power to perform better. Easy one-hand operation. Removable end and pipe handles. Powerful Sunbeam built motor.

\$52.50

Professional model—more powerful 4.3 amp. motor 15 foot, 3-conductor cord. \$65.00



QUICK SANDER
 Fast, lightweight... easy grip handle. With sensational Quick Sander Abrasive. \$2.95



GRINDER-SANDER-HONER
 3 tools in one! Grind, sand, hone. Powerful Sunbeam motor gives up to 1/2 H.P. \$54.50



1/4" DRILL KITS
 Highest quality accessories. You can drill, sand, grind, polish, sharpen, etc. from \$29.95

Give Sunbeam and you give the finest. Electric Tools, The Modern Gift for Men.

Made by **Sunbeam**

famous for Mixmaster, Shavemaster, etc. Sunbeam Corporation, Dept. 233, Chicago 50, Ill.; Canada: Toronto 18

DOES TOUGH JOBS WHILE YOU RIDE!
 PLOW • DISC • MOW • TILL

COUNTRY SQUIRE TRACTOR

A man used tractor made especially for farms and suburban acreage. Cultivate, rake, harrow, plow, bulldoze, PLOW SNOW, spray, sow. Mainline beautiful lawn (pull 3 mowers). Over 20 quick change implements. Safe to operate (even for 10 year olds), 9 hp. All gear drive. 8-W 4 speed transmission, clutch, differential 770 lbs. Uses regular automotive parts. Easy, economical to maintain. Low cost. Ready to drive. 100% Satisfaction guaranteed. Thousands in use.

Write for FREE CATALOG TODAY!
 COUNTRY SQUIRE TRACTOR CO.
 P.O. Box 107-K12, Muskego, Wis.

Genuine Polyethylene
NEW ALL-PLASTIC 2-PIECE BAIT BUCKET
 Won't Rust, Rattle or Dent

A BETTA-BAIT BUCKET WITH "LID-O-MATIC"

Bucket Floats

- Lid Closes Automatically
- 8-Quart Capacity

Postage prepaid
\$5.95
 or send \$1.00 Bal. C.O.D.
 Money-back Guarantee

ORDER TODAY
BETTA-BAIT BUCKET CO.
 Dept. G, 420 10th Ave., Palmetto, Florida
 Manufactured by a fisherman for fishermen

Christmas Treat
 for
THE-MAN-OF-THE-HOUSE
 Deluxe
CUSHION GRIP
 SCREWDRIVERS by
Bridgeport

Gift Set

A pleasure to give or receive... and a pleasure to use! Four most-needed CUSHION GRIP Screwdrivers in handsome red and gold gift package. Only \$5.50 retail at Hardware stores. Tested and Approved by Mechanics.

- 50% greater Turning Power.
- Blisterproof, resilient neoprene handle.
- Super Comfortable.
- Alloy tool steel blades
- Fully guaranteed.

Bridgeport Hardware Manufacturing Corporation
 Bridgeport 5, Conn.



banks, interior decorators,
costumes, cranes, refrigerators
whatever you need —



Advertisers displaying this emblem make your shopping easy.

The Greatest Magic Illusions Of All Time

(Continued from page 101)

One of the greatest illusions involving a disappearance was invented by Buatier DeKolta. The bushy-bearded Frenchman spread a newspaper on the stage to prove no trap doors were used. Upon the paper he placed a chair, and invited his wife to sit down. Then he covered her with an opaque cloth. A moment later, when he whisked away the cloth, his wife was gone. Later he added another touch. Not only did the wife vanish, but so did the cloth!

Devant Dreams an Illusion

How do magicians devise their illusions? David Devant dreamed his most popular one. The next morning his wife told him she had awakened during the night and saw him get up, light a candle and stare at it intently for several minutes. Finally he blew out the flame and crawled back in bed.

Devant didn't remember this, but he did remember a fascinating dream. He had been dashing across the stage in pursuit of a girl dressed as a moth. He carried a candle in a holder, and flickering flame drew the moth closer and closer. Suddenly the flame flashed out toward the figure, and the moth disintegrated.

The idea haunted him. He drew up plans for the apparatus to duplicate his dream, and a friend built it. The equipment was set up in a photographic studio. The only time Devant could rehearse was after his regular show. It was nearly midnight when he arrived for his first rehearsal. He rapidly went through the preliminary actions until a policeman interrupted the illusion with a knock on the door. The bobby had heard strange shouts and, peering through a window, had seen stranger actions.

The British magician allayed the man's suspicions that he might be practicing witchcraft, sat him down and made him the first spectator ever to that most baffling illusion, "The Mascot Moth."

DeKolta's Last Illusion

But for my money, one of the greatest illusions of all time was the last great illusion of the fabulous DeKolta. The "story" was simplicity in itself, which made it even more spectacular. When DeKolta walked onstage he carried a small satchel. In the satchel, he said, was his wife. He opened the satchel. Out came a die—a cube measuring only eight inches on all sides. He put the die on a thin platform, which was raised

(Continued to page 216)



Something **NEW**
for your Christmas List!

5 POWER TOOLS IN ONE DREMEL MOTO-SHOP

- 1 JIG SAW 
- 2 DISC SANDER 
- 3 BUFFING WHEEL 
- 4 BENCH GRINDER 
- 5 FLEXIBLE SHAFT 

**A complete workshop—
for the family, hobbyist, or craftsman**

The amazing new Dremel Moto-Shop is the most versatile multi-purpose tool ever invented. Has 1,001 home and shop uses. Basically, it's a 15" Jig Saw with a unique power take-off to which you simply connect other attachments. It then converts to a disc sander, bench grinder, buffing wheel, and a flexible-shaft machine . . . all powered by a BALL-BEARING ROTARY MOTOR.

And this professional-quality, portable power shop can be set up practically anywhere — basement workshop, kitchen counter or card table. Weighs only 12 lbs. As a Jig Saw, it will cut 1 3/4" wood, 18 gauge copper, 1/16" steel — all with same blade. Foolproof blade guard makes it absolutely

safe — even for children. Handles everything from bird-houses to full-size furniture.

The flexible shaft is a complete machine shop in itself. Use it for sharpening, grinding, polishing, drilling, carving. Collet capacity 1/64" to 1/8". Other attachments have hundreds of home and shop uses.

Moto-Shop is the perfect "ALL FAMILY" workshop — safe for even mom and the children. Helps build a close father-son relationship.

See Your Power Tool Dealer for a Demonstration Today!

Model 57 Moto-Shop. Includes Jig Saw with disc sander attachment only. Other attachments can be added later . . . **\$33.95**

Deluxe Model 57 Moto-Shop with all attachments shown - **\$49.95**

Price of attachments only, if purchased separately . . . **\$19.95**

QUALITY POWER TOOLS SINCE 1934

DREMEL MFG. CO., Dept. 118M, Racine, Wisconsin

Write for **FREE Catalog**



D-33

THE CHRISTMAS GIFT FOR LIFETIME ENJOYMENT

WELD, BRAZE



SOLDER, CUT

ANYONE CAN WELD AT HOME

Homeowners, mechanics, farmers, hobbyists! Make repairs at home, farm or shop on fenders, bodies, bicycles, machinery—almost anything of metal. No experience needed. Welder comes complete with twin carbon arc-torch and accessories at low, low price. Operates from any properly wired 110 V. A.C. or D.C. line. Order from this ad. 10 day money back guarantee. Literature on larger equipment FREE.

FOUR-WAY WELDER CO., Dept. F2-N, 1810 S. Federal St., Chicago 16

FOUR-WAY

WELDER
of 1001 uses
only **\$1475**

F.O.B. FACTORY

WELDER



HANDLED WITH GLOVES!

Wearing protective gloves, this girl gently stacks Federal-Mogul engine bearings on a magnetized bar. Next step—final plating for these “jewels of the engine.”

in engine bearings . . .

FEDERAL-MOGUL means FINE PERFORMANCE

Only the *best* precision insert bearings are good enough for today's high-demand automotive engines.

Research, design and quality-controlled production are *proved* in service. Good mechanics know this . . . that's why they specify and install Federal-Mogul service bearings.

Remember—in engine reconditioning, Federal-Mogul means fine performance. Ask your mechanic!



FEDERAL-MOGUL SERVICE
Division of Federal-Mogul-Bower Bearings, Inc.



from the stage so the audience could see under it. Standing at a distance, DeKolta gestured toward the cube. Immediately it expanded to 20 times its original size.

Loud applause!

DeKolta bowed slightly, then with the aid of an assistant lifted the giant die. Seated under it was his wife!

Ovation!

Most historians of magic say that DeKolta's fabulous device was destroyed after his death in 1903. Actually it now has an honored place in my apartment. DeKolta's widow took it back to her native England. The wife of Will Goldston, a noted magic dealer, purchased it and presented the illusion for a few months. When she retired, Houdini bought it. Houdini performed it at least once (I have the show-bill). He left it to his brother, Hardeen. Hardeen sold it to Edgar Pelkin, a magician in the Midwest. A few years ago I bought it from Pelkin.

The leather case Houdini made for the DeKolta equipment still holds it. Someday soon I plan to add the illusion to my show so today's audiences can see again the unbelievable mystery which astounded their grandparents.

In my opinion, several other illusions should be numbered among the greatest of all time. I'll describe them next month—and tell you why the “Indian Rope Trick” isn't Indian, isn't done with a rope, and isn't a trick!

(Continued next month)

Study of the magnetization of certain rocks shows that the North Pole used to be in a position on the earth's crust now occupied by Abyssinia.

Do You Know This Old-Timer?

(answer to quiz, page 12)



1923 Essex Coach



now's the time for
DAP

CAULKING COMPOUND

Stop drafts, heat loss, water damage with DAP Caulking Compounds. Seal around windows and door frames—fill joints and cracks—for a snug, comfortable home. Get cartridges, cans or collapsible tubes at hardware, paint or building supply dealers. Ask about other famous DAP products, too.



DICKS-ARMSTRONG-PONTIUS, inc.
Dayton 3, Ohio



Give the gun all can shoot
Christmas morning...



New Crosman Portable Metal Shooting Kit with Built-in Target Model 150 PK.

New Crosman 10-Shot Repeater Model 400

Real guns, powered with safe, non-toxic CO₂ gas, for shooting right in and around the home. Real gun accuracy... factory-tested to group shots within 1/2-inch at 25 feet! Here is fun for *all* the family. Rifles, pistols, gas-powered, air-powered. At sporting goods stores everywhere; or write Crosman Arms Co., Inc., Dept. PM-24, Fairport, N.Y. for *free* literature.

Crosman World's Leading Manufacturer of Pellet Rifles and Pistols
Power Without Powder **PELLGUNS**

In Canada: Crosman Arms (Canada) Ltd. Toronto.
In Mexico: Armas Deportivas, Crosman De Mexico S. A. Manuel Maria Contreras 78, Col. San Rafael, Mexico 4, D. F.

Now you can get the motor used to power millions of America's most popular appliances...

EMERSON ELECTRIC

**multi
duti
MOTORS**



For 68 years Emerson-Electric motors have been the first choice of leading appliance manufacturers. Now, Emerson-Electric is offering you these famous motors, engineered with *you* in mind. Twenty-one different designs from 1/4 to 1 H.P. Get yours today, or write for Free Catalog No. M-189. The Emerson Electric Mfg. Co., St. Louis 21, Mo.

EMERSON-ELECTRIC



For Your Home, Shop or Commercial Use

of St. Louis... Since 1890

SOUTH BEND

Builds Top Performance into...

BENCH SHAPERS

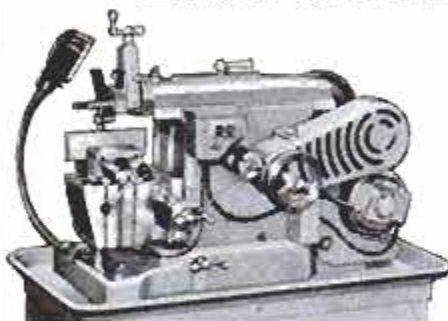

- 7" stroke.
- 42 to 195 strokes per minute.
- .002" to .012" power cross feeds.
- With built-in work light.

Exclusive with South Bend

South Bend is the only 7" Shaper with pressure lubrication. This assures long years of trouble-free, profitable production.

PEDESTAL GRINDERS



- More work clearance around wheels.
- Motor in pedestal—lessens vibration, protects motor.
- 8" or 10" wheels.

DRILL PRESSES



- 14" precision.
- With stamina for years of dependable service.
- Free-floating spindle, no misalignment.
- Bench, floor, multiple spindle types.

NEW CATALOG

Also shows engine and toolroom lathes, turret lathes, milling machines and attachments. WRITE.

SOUTH BEND LATHE
SOUTH BEND 22, INDIANA
Building Better Tools Since 1906



Up to 24 months to pay.

Strange Ships for Strange Cargo

(Continued from page 142)

built from the keel up for Arctic operations. Put in service to supply far-north military outposts, this 300-foot bruiser can keep the seas under the most rigorous polar-weather conditions. Her hull is girded by a waterline armor belt of high-tensile steel, and she has the crushing bow contour and beefed-up rudder and props of an ice-breaker. Her rugged steam-de-iced cargo gear works in high winds at 65 below zero. Her lightweight aluminum lifeboats have attached runners for ice travel. She has an elevated heliport on the poop deck aft, fitting her for the increasing use of helicopters in Arctic operations. Down below she carries sleds, track-type snow vehicles, Yukon stoves and Arctic survival gear.

Pan Atlantic Steamship Company's *Ideal-X* was born a tanker, but you wouldn't know her now. Bethlehem installed a full-length upper deck on which she piggybacks 58 loaded trailer bodies, each carrying a 40,000-pound load. The company has installed special unloading equipment at New York and Houston that makes this hybrid ship highly profitable.

Mightiest of the tankers-plus, and a new idea threatening to outdate present bulk-carrier fleets, is the big SS *Sinclair Petroleum*. This 790-foot giant is an oil tanker going and an ore carrier coming, her novel design licking the empty return trip that steals bulk-carrier profits. Largest tanker afloat from her christening in November 1955 until the mammoth *Universe Leader* took that honor a year later, she remains the world's largest oil-ore carrier. She makes an oil run from the Persian Gulf to Marcus Hook, Pa., then to Venezuela to load ore for Japan, then full circle to the gulf—a 91 percent payload run compared with the usual 50 percent.

The immense Niarchos tanker building at Bethlehem Quincy Shipyard will be the world's largest. This 940-foot colossus with a 106,500-ton dead-weight will heft an unbelievable 825,000 barrels of oil and can steam nonstop around the world. She'll scrape bottom in a 50-foot channel, rendering obsolete harbors around the world and necessitating offshore lighterage at many ports—but the load of oil she totes makes it all worthwhile.

You wouldn't recognize the lowly wartime Liberty ship these days. The Maritime Commission's experimental *Thomas Nelson* had a face lifting that replaced her cargo booms with mechanical cranes that purr across the deck on geared tracks. This is the general-cargo ship's first new look in

(Continued to page 220)



Build this attractive hutch easily and economically with Western Pine Region woods

Here's a piece of furniture that will be a welcome addition to your home. You can turn it out at a reasonable cost with Western Pine Region woods. And if you want to give it an authentic antique finish...brush on a solution of potassium permanganate, singe with a blowtorch, and apply a coat of clear varnish.

You'll find straight-grained, soft-textured Western Pine Region woods easy to work with hand or power tools. They're always well dried and seasoned, take any paint or stain with ease, or can be waxed and rubbed to a natural glow.

For your next remodeling or furniture job, contemporary or traditional, choose Western Pine Region woods. You'll find them in knotty or clear patterns. Talk it over with your lumber dealer. He'll be glad to give you an estimate.



FREE! "Friendly Home Ideas" — 85 photographs, many in color, feature traditional and contemporary ideas for building, decorating and remodeling with Western Pine Region woods. Write for your copy to WESTERN PINE ASSOCIATION, Dept. 314-N, Yeon Bldg., Portland 4, Ore.



Western Pine Association

member mills manufacture these woods to high standards of seasoning, grading and measurement
 Idaho White Pine • Ponderosa Pine • Sugar Pine
 White Fir • Incense Cedar • Douglas Fir • Larch
 Red Cedar • Lodgepole Pine • Engelmann Spruce

Today's Western Pine Tree Farming Guarantees Lumber Tomorrow

Jiffy SAWHORSE BRACKETS
 NO NAILS NO SCREWS NO BOLTS
 Now a sawhorse in a jiffy! Just use Jiffy Brackets and 2x4s. Sold by hdw. and bldg. supply stores everywhere, or order direct. \$1.95 A pair. Higher W. Coast
GRAND HAVEN STAMPED PRODUCTS CO.
 Grand Haven, Mich.

Wash or scrape old paint off with
HEAVY-BODIED KLEAN-STRIP

KING MIDGET
 More power, beautiful styling. New Features. Still World's Lowest Priced Car. Drive it for 75c a week. Rider agents wanted. Earn your own car.

2 GREAT AUTO BARGAINS
 King Midget Junior chassis, finely engineered, ready to run. Agents wanted. Send 25c for 32 page picture book, full details, dealers price on both cars. Or send \$1 (refunded first order) for this and Service Manual, plus Repair Manual and 15 5x7 photos of car and factory.
MIDGET MOTORS CORPORATION, ATHENS 1, OHIO

NEW! Evans POWER-TAPE

No More Pushing Blade Back Into Case!

Here's the greatest single mechanical advance in steel tape history! Press the button gently with your thumb — blade returns smoothly. You control the speed. Release the button — blade stops instantly. No "creep," no lost measurements! Chrome-plated case, GIANT sliding end hook — for inside-outside measuring. White steel blade, marked in inches and feet-and-inches — no figuring! Free Tenite carrying case with magnifying lens.

Unconditionally Guaranteed
 6, 8, 10, or 12 ft. lengths
 Get POWER-TAPE today!
 Available only at hardware stores

Only \$1.89 (10 ft.)

Evans RULE CO. Elizabeth, N. J. Montreal, Que.

half a century. (Incidentally, streamlining her seacow shape with a 20-foot extension and repowering with black-oil diesels raised her from a lumbering 10 knots to 17½, and gives our vast reserve Liberty fleet a new strategic value.) Another Liberty, dubbed simply *Yag 40*, has a huge "bird bath" perched 60 feet high atop a slender king post in which she collects the most elusive cargo ever manifested—radioactive dust from atomic explosions. She steams ghostlike through the test area by radio control, with no one on board. For lower-level tests she can be controlled from a watertight cubicle in the center of a flooded cargo hold (for shielding), where in the skipper can see television pictures transmitted from the engineering gauge board and from a trainable camera on the mast. The USCGC *Courier*, a Liberty turned seagoing broadcasting station and equipped with the most powerful transmitters of their kind afloat, relays the Voice of America behind the iron curtain. And Liberty *John L. Sullivan* is propelled by four Pratt and Whitney T34 airplane engines mounted on deck. This is to test the practicability of an air-propeller-driven cargo ship without vulnerable underwater propeller and rudder for use in mined or debris-laden waters.

The seas abound with other miscella-

neous freaks. There is the whale-ship, floating factory of the polar seas; her wartime sister, the Landing Ship Dock, whose capacious open stern admits, not helpless whales for the flensing, but scrappy landing craft for refit or ocean transit to an enemy beach; and the new 500-foot USNS *Comet*, a deepwater roll-on-and-off ship that carries all the rolling stock for a combatant military division. The latter is unloaded over side ramps or through her huge stern port onto offshore lighters. There is the ever-growing *Cliffs Victory* that started out 454 feet long, was lengthened to 620 feet and has just grown again to 716 feet. There is Western Pacific's *Las Plumas*, whose 225-foot stern and 150-foot bow were built separately and floated downriver to the sea for mating; her bow has a unique 60-inch steering propeller that swivels like an outboard. The Army's *John U. D. Page* is a 340-foot beach discharge lighter with tanker hull; this amphibious research project has a vertical axis propeller and a 1000-ton retractor ram. The bulk salt carrier *Cecile Erickson* has a deck that is all hatch—one giant opening nearly 200 feet long, alongside which run crawler cranes to spoon out the white cargo. And the much-publicized new roll-on-roll-off *Carib Queen* beckons the way to a possible revolution in cargo handling. ★ ★ ★

MAKES ANY HANDYMAN HANDIER

BERNZ-O-MATIC® METAL CARRY-ALL TORCH KIT



Torch+pencil burner unit+utility burner head+soldering tip+flame spreader+flint sparklighter, plus FREE metal kit, all for...

\$9⁹⁵



Distinctively Gift Wrapped

One compact kit includes the famous instant-flame Bernz-O-Matic Torch plus accessories for little to large jobs—from lighting fires to laying tiles to finishing furniture. Gift-shop for your Carry-All Torch Kit in its special holiday wrap at your nearby hardware or department store now!

OTTO BERNZ COMPANY • ROCHESTER, NEW YORK

IN CANADA OTTO BERNZ CO., L.W., Toronto 10. Prices slightly higher in Canada.

DOES ALL THIS AND MORE...



Solders



Removes putty



Burns off paint



Thaws frozen pipes



Splices wires, cables



Take Pride in Your Projects?
BE SURE YOU USE

Southern
SCREWS and BOLTS

Fine workmanship deserves only the finest components. That's why craftsmen who take pride in their projects are specific about Southern Screws and Bolts when stocking up on fasteners.

Be sure you specify Southern Screws or Bolts when you need quality fasteners made in USA. Available in all good hardware and building supply stores.



Write for **FREE Screw Chart** showing how to select and use wood screws and tapping screws, how to drill pilot holes, etc., etc.

Address: **Southern Screw Company, Box 1360 Statesville, N. C.**



BUY GREAT NECK HAND TOOLS

... for long-lasting performance

Precision Balanced NAIL HAMMER



One-piece, forged steel, rubber-cushioned, no-slip grip

GREAT NECK SAW MFRS., Inc.

MINEOLA, N. Y. — SEE YOUR LOCAL STORE

ON WINTER ROADS..

HE WHO Never HESITATES
IS Never LOST

DRIVE ASSUREDLY WITH HULL AUTO COMPASS

At your dealer's or write for literature. \$5.50 and \$6.95



HULL MFG. CO. P.O. Box 246-D-12, Warren, Ohio

Find **HIDDEN TREASURES**

GOLD, SILVER, PRECIOUS METALS with the Famous Model 27 Metal Detector. Lightweight, ultra-sensitive, low cost. None finer. Also **GEIGER COUNTERS** for uranium and the **VIOLITE** for tungsten. **INFORMATION FREE**

THE *Detectron* CORP.

5528 Vineland Ave., No. Hollywood, Calif.



Automatic Saw Set...

MAKE EXTRA PROFITS!

Set 400 teeth per minute on hand or band saws, 4 to 16 point, with the BeMaCo Automatic Saw Set. Fast, accurate, true hammer-anvil action sets teeth uniformly, eliminates tooth breakage. Used profitably by saw shops and manufacturers everywhere. Every machine positively guaranteed! Write for details—today!



BEAVER MFG. CO.

PO Box 434

800 1515 AVENUE • INGLEWOOD, CALIF.

Saw Machine Division 37-C

In Time for Christmas Gift Giving

A New Precision Instrument for Leveling and Incline Measurement

HOPPY

SPLIT IMAGE TRANSIT



Only **\$6.95**

Optional—also available for the thousands of Hoppy Transits now in use—sturdy carrying case \$3.25

Accurate, Inexpensive, Simple to Operate

Easy as a camera to operate! One man—ALONE—can do leveling and incline measuring. Accurate to a fraction of an inch. Many uses on the job and around the house.

Carpentry Leveling	Contour Plowing	Guttering
Patio & Terracing	Brick Laying	Drainage
Duct Installation	Yard Grading	Masonry
Foundation Work	Irrigation	ETC.

Guaranteed Product Satisfaction



If not available at your Building Supply or Hardware Dealer, write directly to:

HOPKINS MANUFACTURING CORP.

Dept. PM-1

Emporia, Kansas

Another Quality Product by HOPPY

Hi-Fi Trends

(Continued from page 145)

tapes, providing up to 1 hour of stereo music, at prices ranging from \$4.95 to \$9.95—a decrease of almost 50 percent from present costs.

The implication was unmistakable. The sizable reduction in stereo-tape prices would place them in direct competition with stereo discs and would pave the way towards mass acceptance of tape as a means for high-fidelity home entertainment. But that was only part of the story.

The tape magazine eliminated all of the inconveniences normally associated with tape-recorder operation. There were no reels to thread and no rewinding at the end of the tape run. The magazine simply plugged into its special machine, as quickly and easily as a record slips onto a turntable, and the mechanism did the rest.

As the tape within the magazine traveled in a forward direction, two of the four pre-recorded tape tracks were reproduced by stacked, quarter-track tape heads. At the end of the tape run, the mechanism automatically reversed its direction and changed the tape-head configuration. Thus, as the tape was being rewound, the second set of tape tracks was being reproduced.

This completely automatic operation could produce up to a full hour of stereo, or two hours of monaural (using all four tracks individually) playing time.

There was also a semiautomatic machine which operated in essentially the same manner. The principal difference was that with this machine the magazine had to be turned over at the end of the forward tape run in order to reproduce the information recorded in the opposite direction—just as a record must be turned over to play the other side. Both machines, however, could be used for recording stereo or monaural programs as well as for the reproduction of prerecorded tapes.

Several months prior to this demonstration, it was revealed, RCA had released specifications and technical data for the tape magazine to other interested manufacturers. The results of this became almost immediately apparent. In close succession, Motorola, Inc., and the Pentron Corp. exhibited their versions of the magazine-type recorders, see Figs. 1 and 2. The Pentron unit, in addition to being able to play 4-track stereo tape magazines, could also record and play back in the conventional 2-track, 7½ i.p.s. mode. Pentron also announced that all of its open-reel recorders produced later than mid-August would

(Continued to page 224)

News about the Carter Automotive Training Program



If you qualify, you can attend
a Carter School in your area

Trained auto mechanics are in short supply, and each year the shortage grows. That can mean steady work at good pay, because if you are a Carter School graduate you will have a thorough training in engine tune-up, fuel systems and auto electrics. Complete intensive training course includes carburetion, circuits, trouble diagnosis.

To qualify for a school in your area you should now be regularly employed in automotive service work, or in an establishment offering engine tune-up service.

Primarily, we are interested in young men who are "engine enthusiasts," who recognize the automotive service field as offering a life-time career.

● Write us, stating your background and tell us why you want this training. You may qualify!

Carter Carburetor, Div. of QCF Industries, Inc.
Dept. 820M • St. Louis 7, Missouri

READY CUT HOMES

\$2150 AND UP DIRECT FROM MILL

YOU SAVE the items which help make today's building cost expensive: high labor cost, contractor's profit and overhead, insurance, architect's fees. Cut-to-Fit eliminates usual lumber and material waste, also costly mistakes. Anyone can assemble. Simple, easy-to-follow plans furnished and each part numbered. Complete with all lumber, roofing, nails, glass, hardware, paint, doors, windows. Freight paid. Low-cost building plans sold separately if desired. 57 Homes and Floor Plans.

**5 EASY PAY PLANS
COLOR CATALOG**

Send  **25c**



INTERNATIONAL MILL & TIMBER CO.
Dept. PM128 Bay City, Mich.

10" TILT/ARBOR SAW BUILD-IT-YOURSELF from GIL-BILT KITS-PLANS



Sturdy wood, steel, and aluminum construction. NEW DEPARTURE ball bearings. Capacity and performance of floor saws selling for \$150.00 and up. Plans, all metal parts in kit with 10" comb. blade \$27.40, less blade \$23.95, F.O.B. St. Louis. Detail PLANS-PATTERNS only \$1.00 postpaid.

Build-it-yourself 12" and 18" Bandsaws, 6" Belt Sander, Shaper, Simplified Bandsaw, build easily with hand tools only. Advertised and sold for 11 years, over 33,000 units in use. Money back guarantee. **FREE CATALOG.**

GILLIOM POWER TOOLS, Dept. 80-M, Lambert Field, St. Louis 21, Mo.

GEARS

In Stock - Immediate Delivery
Gears, speed reducers, sprockets, thrust bearings, flexible couplings, pulleys, etc. A complete line is carried in our Chicago stock. Can also quote on special gears of any kind. Send in your blueprints and inquiries.

Send for Complete Catalog No. 10
CHICAGO GEAR WORKS
440-50 N. Oakley Blvd., CHICAGO 12, ILL.



WOOD FINISHING made easy



- seals, primes, finishes.
- dries in 30 minutes
- completely trouble-free

Wherever paints are sold

DEFT 1826 W. 54th St., Los Angeles 62, Calif.

Sharpen All Circular Saws with QUICK-WAY

Model PG12
\$19.95
Postage-Paid

IDEAL for home-workshops; carpenters, contractors, **QUICK-WAY** unit precision sharpeners, joints, gums and retools all circular saws to 12" diameter. Fits all bench, table and radial saws. Thousands of satisfied users. Send for Circular Make money sharpening saws. Order today \$19.95 postage-paid. Complete Unit with Grinder Wheel. No Extras to Buy. Patented.

FREE Saw Set with Initial Order

QUICK WAY SAW CO., 136 Tompkins Street, Cortland, N.Y.

WORLD'S THINNEST UTILITY PLIER



An amazingly versatile tool. Its unusual thinness, extreme strength and exceptional gripping power are equalled by no other 12 ounce tool. The reason is illustrated below.

Grips flat, square, hex or round objects. Jaws are adjustable to four positions up to 1 1/2" capacity. Rust resistant zinc plating.

"CRESTOGRIP"
PLIER No. P210
\$3.00 RETAIL

COMPARE

THESE ACTUAL DIMENSIONS

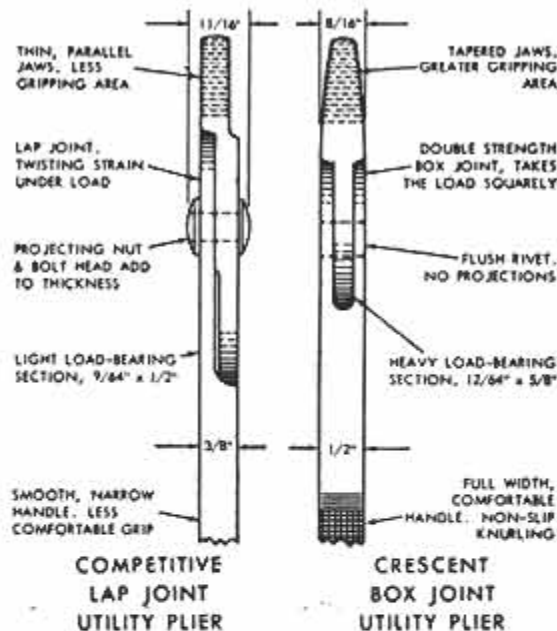

COMPETITIVE
LAP JOINT
UTILITY PLIER

CRESCENT
BOX JOINT
UTILITY PLIER

CRESCENT TOOLS

Give Wings to Work

Crescent is our trade-mark, registered in the United States and abroad, for wrenches and other tools. Sold by leading distributors and retailers everywhere and made only by

CRESCENT TOOL COMPANY, JAMESTOWN, N. Y.

**Bore 35 standard holes
with just one tool**

**New IRWIN
Expansive Bit**

lets you dial your size

Just turn the dial and you're set to go with this new Irwin Expansive bit. No hunting for the size you need. Fits all hand bit braces. Clean, fast, accurate boring action from $\frac{7}{8}$ " to 3"—35 standard hole sizes in all!

And what a really fine precision tool to own. It's drop-forged from special bit steel, heat treated full length, machined for accuracy and sharpness, highly polished, too. Two cutters supplied with each bit. Model No. 21 with $\frac{5}{8}$ " to 1 $\frac{3}{4}$ " boring range also available. Ideal for home handyman, professional woodworker, or farm. See your independent hardware dealer soon.



IRWIN

Wilmington, Ohio

the original solid
center auger bit
•
screw drivers
screw driver bits

**HE CAN BUILD IT HIMSELF for CHRISTMAS
buckboard'n buggy**



Detailed plans make it easy for a boy to build himself (with a little help from Dad or big brother) in a few hours! Fun . . . drives like a real car . . . push it, coast, or add power (any old gasoline motor up to 2 $\frac{1}{2}$ hp). Strong wood chassis, steel undercarriage, 10" rubber wheels, full 66" long, 17" wide. Will hold up to 175 lb. driver. Do-It-Yourself Kit, everything included, ready to assemble . . . \$64.50
No sawing — painting — drilling.

**MAYO
BROS.**

Satisfaction Guaranteed
All prices F.O.B. Fairport
Illustrated brochure on request.
Fairport, N. Y. Dept. PM-4

reproduce 4-track prerecorded tapes as well as the regular 2-track recordings.

Clearly, the tape-recorder industry was preparing for the change. By mid-September, at the Chicago High Fidelity Show, more than a half-dozen manufacturers exhibited new equipment capable of 4-track tape reproduction. There were tape-transport mechanisms and complete recorders, but all of them were of the open-reel variety which, like the pace-setting Ampex, were compatible with present-day 2-track tapes.

Simplicity vs. Compatibility

The trend is apparent. It seems that we will have two new types of tape recorders—the open-reel, 4-track-play, 2-track-play/record units and the magazine-loaded, 4-track-play/record kind. Both have obvious advantages and disadvantages, but both are likely to be with us until the laboratory claim of equal fidelity for 4-track tapes has been substantiated or refuted by actual field experience.

But where are the new 4-track stereo tapes? At the time of this writing, the initial delivery date for the first of RCA's stereo magazines has been postponed. While RCA still hopes to deliver the magazines and magazine-loaded recorders in time for Christmas, other sources predict that they will not be available in quantity until some time next year. By then, there should be a sufficient number of compatible open-reel players in use to give 4-track tapes a real quality test. If they prove to be as good as their 7 $\frac{1}{2}$ i.p.s. predecessors, their rapid and enthusiastic acceptance is a foregone conclusion.

This means that present equipment will have to be converted to 4-track operation. Ampex, in anticipation, has already announced a conversion kit for its 2-track equipment. Other manufacturers are certain to follow suit. The converted recorders won't handle the tape magazines, but they will prevent obsolescence of present tape libraries.

How great an effect the new tapes and tape magazines will have on the over-all hi-fi picture is hard to predict. Certainly the competitively priced stereo tapes will secure the position of the tape recorder as a major component of high-fidelity systems. The operating simplicity of magazine-type equipment and the possibility of recording off-the-air and live programs will appeal to nontechnical hi-fi fans who have not previously considered the inclusion of tape recorders. All indications are that the stereo record, far from replacing stereo tape, will be hard-pressed to hold its own. ★ ★ ★

BOAT KITS

8'-18': 50 Models
\$41.75 up;
Frt. Pd.
EASY MONTHLY
PAYMENTS



FREE COLOR CATALOG

Cruisers, convertibles, runabouts, fishing. Easily assembled by anyone. FREE Catalog has natural color photos, complete details, Fiberglass, accessories hardware, paint. Write Today.

LUGER INDUSTRIES, INC., Dept. B-12
9200 Access Road, Minneapolis 20, Minnesota

NEW, IMPROVED CALCULATOR FOR WOODWORKERS only 25c

Instantly gives information on lumber, nails, concrete mixes, painting materials, etc. Convenient, simple to read. Just set dial for nail specifications, to convert linear to board feet, find bit sizes for screws, compare characteristics of woods. 6" diameter heavily varnished cardboard. Send 25c, no stamps, please to Greenlee Tool Co., 2112 Columbia Avenue, Rockford, Illinois.

ONE-MAN SAWMILL AS LOW AS \$50.00 DOWN

Take BELSAW Portable Sawmill right to the trees—turn out valuable lumber for home and farm—sell to local yards—make up to \$50 a day custom sawing for neighbors. BELSAW lasts a lifetime. No crew needed. Power with tractor or auto engine. Beginners get excellent results. Send today for **FREE BOOK**.

BELSAW MACHINERY CO.
3459 Field Bldg. Kansas City 11, Missouri

BUILD FINE GRANDFATHER CLOCK NOW

The simple sensible **SPEEDE Red-i-Kut** way as thousands have—**FOR YOURSELF OR SELL AT A GOOD PROFIT. SAVE HUNDREDS OF DOLLARS. SHOP TESTED PLANS "SPIRIT OF THE CENTURY"** Narrow waist 83" tall or stately straight side "**SPRIT OF AMERICA**." **EASY-TO-FOLLOW photopack! PLANS & LIFE SIZE PATTERNS** tell all—plus **MOVEMENT BROCHURE \$4.00** up, of heavy brass weight (Kuempel original) Westminster, tube **BELL** chime, movements, gorgeous bronze-silver **MOVING MOON** dials, 3/4" solid-mahogany Jiffy Joint-Kwik-Bilt case kits. Send \$1.00 today—both plans **RUSH \$1.50** as folks have for over forty years.

Kuempel Chime Clock Works, 214 Kuempel Bldg., Minneapolis 16, Minn.

MONEY... IN HIDDEN TREASURES

Find it... with a **GOLDAK Treasure Finder**. Send for **FREE** literature on complete line of mineral & metal locators, underwater detectors, etc., priced as low as \$64.50.

In celebration of its 25th year, **GOLDAK CO.** introduces new transistor instruments for greater sensitivity—less weight—low cost flashlight batteries. Write for information today!

GOLDAK CO. 1942-12 GLENOAKS BLVD., GLENDALE, CALIFORNIA

Works in seconds!

Loosens Rusted Bolts nuts, screws, "frozen" parts!

LIQUID WRENCH

The super-penetrating rust solvent that quickly loosens rust and corrosion.

AT HARDWARE STORES, GARAGES SERVICE STATIONS, EVERYWHERE

RADIATOR SPECIALTY CO.
Charlotte, N. C.

BUILD THE BEST!

build quality money-saving

knigh^t-kits

A PRODUCT OF ALLIED RADIO



see them all in

ALLIED'S 1959 ELECTRONIC SUPPLY CATALOG

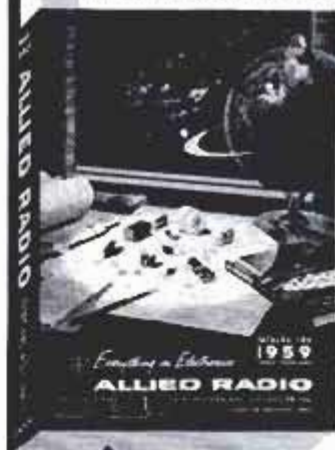

free

**BUILD YOUR OWN!
IT'S EASY—IT'S FUN—
SAVE UP TO 50%**

452
value-packed
pages



HAM KITS



HOBBY KITS



INSTRUMENT KITS



HI-FI KITS

SAVE on Everything in Electronics



WORLD'S LARGEST STOCKS: Everything for Experimenters, Builders, Amateurs, Servicemen, Engineers, Hi-Fi enthusiasts. Get more for your money in Hi-Fi systems and components, including latest Stereo; save on build-your-own **KNIGHT-KITS**; recorders and tape; Amateur station equipment; TV tubes, antennas, accessories; test instruments; industrial electronic equipment—plus the world's largest stocks of parts, tubes, transistors, tools and books. Send today for your **FREE 1959 ALLIED Catalog!**

EASY TERMS AVAILABLE

ALLIED RADIO

Everything in Electronics at Lowest Prices

our 38th year

send for
FREE
Catalog

ALLIED RADIO CORP., Dept. 24-M8
100 N. Western Ave., Chicago 80, Ill.

Rush **FREE** 1959 ALLIED 452-Page Catalog.

Name _____

Address _____

City _____ Zone _____ State _____



Try Dragon-Skin



Thousands of tiny cutting edges punched into thin sheet steel make a marvelous tool that "sands," and "rasps" wood, plastics, soft metals swiftly, easily, and absolutely without clogging. Just 75¢ on holder as shown; replacement sheets for a quarter.



A "professional secret" is this Red Devil Glazier's Chisel, a heavy brute that's the *only* easy way to clean out hard old putty. \$6.75 to \$8.00 depending on which of 5 sizes you pick.



To cut circles in glass, glass shops use one of 5 different models of Red Devil Circle Glass Cutters. If 2"-24" diameter gives you enough latitude, you can get a dandy for \$5.00.



You don't have to buy machinery to keep your floors beautiful. Thousands of dealers are ready to rent you a Red Devil Floor Polisher for around a dollar a day—and to sell you one if you like it for as little as \$54.95.

It's always best to buy where Red Devil Tools are sold, for wider choice, top quality, correct "how-to" advice. 4573

Free booklet, "How To Cut Glass."
Address Dept. (B12)

Red Devil Tools.

Union, N. J., U. S. A.

World's largest manufacturer of painters' and glaziers' tools.

Farmer Fights Frost

(Continued from page 123)

for use on ice boats and swamp buggies. A 120-horsepower industrial engine supplies the power. A giant fin "straightens out" the air, eliminating undesirable swirling. Maximum directional concentration of air is the result.

"Heat is a must," Vertrees says. "Mounted at the tunnel exit there are two butane burners, each with a five-million-B.T.U. capacity. This heat will raise the orchard temperature at least three degrees and protect about 900 trees."

The Hiller Helicopter Co. of Palo Alto, Calif., has designed a helicopter that offers frost protection. It is a ramjet-powered machine which cruises orchard tops and blows hot air from the ramjets on the tips of the rotor blade down into the trees.

Smudge-Pot Era Ending

They have also introduced an efficient groundbound ramjet blade that sits atop a 35-foot steel pylon. It turns 360 degrees every eight minutes and handles 15 acres.

The frost-protection system on the John Stinson farm, at Delhi, Calif., uses 27 fan-blown smudge pots, each mounted in a seven-foot-high tower. A two-cycle power-mower engine turns a fan blade mounted above a smudge pot and topped off by a deflector plate. The fan causes better combustion of fuel and less smoke. One unit can produce a four-degree rise in temperature, and two to four units are used to the acre.

The days of the old smudge pot and burning automobile tires to create heat in a cold orchard are nearing their end. The giant clouds of black smoke that darken the sky and hide the sun; the soot that settles on everything and even creeps into homes eventually will be in the past. It will take time, however, for many farmers still like the heat that comes from the smudge pot. The more progressive ones are using heaters that do not spew as much smoke and radiate heat more efficiently.

"While they do an efficient job, the heaters, like the smudge pot, are time consuming and tedious to service and keep operating," says Ben Gage, a Durham, Calif., farmer. "They must be burning within 30 minutes after the lowest safe temperature is reached. It takes 10 men to accomplish this on 50 acres."

One Man Does Job of Ten

The task has been reduced to a minimum by the lighting device developed by Gage. Riding on a tractor moving at about 20

(Continued to page 228)

Everything for the Craftsman!



WRITE FOR NEW 132 PAGE

WOOD AND HOME WORKSHOP CATALOG

Finest Domestic and Imported Woods
... Mouldings, Hardware, Tools ...
ALL AT LOW MONEY-SAVING PRICES!

Your complete wood buying guide and project book. Craftsman is your best, most complete source of finest kiln-dried domestic and rare imported woods, beautiful wood inlays, colorful bandings, matched plywoods, embossed mouldings, carved ornaments, newest woodworking tools... "hard to find" cabinet hardware and fittings... more than 1500 items! Packed with newest scroll saw patterns, project ideas and money making plans. Enclose 25¢ (refunded with first order) to help pay mailing, handling cost. Write:

Upholstery Materials;
New Tools; Lamp Parts;
Metal and Wood Legs;
Cabinet Hardware;
Music Boxes; Archery
and Water Ski Kits.
Over 1500 Items

CRAFTSMAN WOOD SERVICE COMPANY, Dept. A-12
2729 SOUTH MARY STREET - CHICAGO 8, ILLINOIS



NEW HONEYWELL DECORATOR LIGHT SWITCH!



Change it
any way,
any time



to match
your room's
decor!



THE TRANSPARENT decorator plate on the new Honeywell TAP-LITE* snaps off for easy decorating, cleans easily. Just wipe with a damp cloth. Simple to install. TAP-LITE has screwless terminals. Easy to operate. Tap, it's on. Tap, it's off! Switch and plate \$1.95 at all leading retail stores.

MINNEAPOLIS Honeywell



First in Control

*Trademark

Ngwtkyhnad...*

apd! †

*New Greaseless Way
To Keep Your Hair
Neat All Day...
† And Prevent Dryness!

Try new Vitalis® with V-7®

DRAINS cellars, cisterns, wash tubs; **\$7.95**
IRRIGATES - CIRCULATES - SPRAYS



1,001 uses. Stainless shaft. Won't rust or clog! Use 1/8 HP motor or larger... 3/4 HP for up to 3,000 GPH; 450 GPH 80' high; or 1,800 GPH from 25' well. 1" inlet; 3/4" outlet. Couplings included free. **\$7.95.** HEAVY DUTY BALL-BEARING PUMP. Up to 7,500 GPH; or 3,000 GPH from 25' well. 1 1/2" inlet; 1" outlet. **\$12.95** Postpaid if cash with order. MONEY BACK GUARANTEE. Centrifugal and Gear Pumps in All Sizes. LABAWCO PUMPS, Belle Mead 7, New Jersey

SEE
YOUR
HARDWARE
DEALER

He's showing the amazing new portable drill attachment that's got the entire tool world talking... It's Supreme's

VERSAMATE

... reduces speed, boosts power sevenfold. Drives any screw!

MAKE THIS A "SCIENCE" XMAS - GIVE WILSON'S MOTORS & KITS

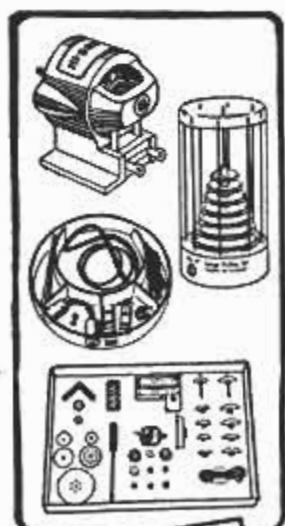

Wilson's battery-operated motors and power kits will make recipients both happy and better informed on today's big topic—SCIENCE. Select from these exciting gifts — and MAIL ORDER TODAY FOR BEFORE XMAS DELIVERY.

- *No. 8-100 Hi-Drive Motor, 3-6V. \$2.50
- No. 9-100 Same for 12V. \$3.00
- *No. 3-100 Tiny Atom Motor, 1 1/2-3V. \$2.00
- For 6 V. \$2.50 For 12 V. \$3.00
- No. 3113N Tiny Atom motor assembly kit with many acc. . . . \$3.50
- No. 14 Adjustable shaft support kit \$3.00
- *No. 77 Set of 7 large pulleys. . . \$3.00
- *No. 26 Couplings kit. \$1.50
- No. 3700 Large accessories kit \$3.00
- *No. 700 Super-Power kit with motor and all accessories. . . \$10.00
- No. 3000 Vari-speed gear unit. . \$4.00
- No. 1049 Gear train with Hi-Drive motor No. 8-100. . . \$5.95
- Same with No. 9-100 Motor. . \$6.45
- * Item illustrated. Ask for FREE Cat.



For quick delivery see your local dealer — or order direct

WILSON'S OF CLEVELAND

425 Lakeside Ave., N.W. • Cleveland 13, Ohio

LOOKS COOLER - IS COOLER!



\$2.50

AIR COOLED VIKING

DR. GRABOW PIPES • GREENSBORO, N. C.

how to Slash fuel bills 20% -

GET
BRIDGEPORT
INNER-SEAL
Live Rubber
WEATHERSTRIPPING



Right! You can really save money on fuel bills by putting draft-stopping INNER SEAL on those costly openings around doors and windows that may be robbing you of \$20 to \$40 a year! Easy to put on keeps out dirt, water keeps heat in!

Exclusive patented construction with springy steel wire in lively sponge rubber covered with tough neoprene makes INNER-SEAL seal better, last longer... never gets ragged or brittle. Get INNER-SEAL at hardware stores now! (Pays for itself in fuel savings).

Write for FREE BOOKLET "How to Weatherstrip Your Home" Dept. PM-12



BRIDGEPORT FABRICS, INC.
BRIDGEPORT 9, CONN.



Hand-rubbed finish
without rubbing

McCLOSKEY HEIRLOOM®

The specially developed finish for antiques,
furniture, wall cabinets and paneling

Flows on silken smooth, leaves no brush marks,
never a sheen variation. Heirloom is extremely
pale, nonyellowing, nonstaining—sets up dust-
free in 1 to 2 hours, hardens overnight.

Send for free booklet, "How
to Finish Furniture, Wall Cab-
inets and Paneling with HEIR-
LOOM Varnishes."

McCLOSKEY VARNISH CO.

Dept. 213, 7600 State Rd.
Philadelphia 36, Pa.



SANTA SAYS:

"A WONDERFUL HOBBY
WORKSHOP GIFT!"

NOW 40 DIFFERENT CUTS ON YOUR SAW WITH *Warren* DADO SAWING WASHERS

Cut clean, accurate, parallel grooves—40
widths, any angle. No chatter, burning,
chewing—or sanding. Eliminates vibration—
strengthens blade. No screws to fuss with.
Simply dial width with Micromatic adjust-
ment. Leave on blade for straight cuts. Sizes
to fit your arbor— $\frac{1}{2}$ ", $\frac{3}{8}$ ", $\frac{1}{4}$ ", 1". A perfect
gift for woodworkers. See your dealer or write.

Send for Free Booklet

ONLY **\$4.95**
PER
SET

WARREN WASHERS CO.

DEPT. 32 • BOX 98 • NORTH END STATION • DETROIT • MICH.

miles per hour and using a lighting tool, he
takes the place of 10 men and lights the
heaters on 50 acres in 30 minutes.

Mounted on his tractor is a tank filled
with a mixture of two parts of kerosene and
one part of gasoline. Air pressure forces
it out a hose to a torch that has a tip similar
to that of an acetylene cutting torch. On
its outer end is a cup where burning igniter
fuel is maintained. Pressure on the torch
trigger sends a flaming jet of fuel into the
open door of the heater, lighting the oil in
its base.

The art of hail suppression is still new
with much to be learned about it, and
methods of control to be developed. Specialists
in this work contract with fruit
growers to seed clouds to prevent hail
damage in a given target area. One of the
most successful operators of such programs
is the Water Resources Development Cor-
poration of Denver, headed by Dr. Irving
Krick.

Attack Hail From Ground

"Storms that may produce hail are seed-
ed both from the ground and from air-
planes," explains meteorologist Richard
Clark of the Water Resources office in
Sacramento, Calif. "Hail forms in mois-
ture-laden, cooled clouds which have very
few particles on which moisture can con-
dense. When conditions are right these
particles collect moisture which freezes
and forms hailstones. The fewer the par-
ticles the larger the hailstones become."

To prevent the formation of large hail-
stones, the weather modifiers introduce
millions of tiny particles of silver iodide
into the atmosphere. Each attracts drop-
lets of moisture which fall as snow or soft
hail; or if the temperature near the earth
is above freezing, they turn to rain. Fruit
damage is eliminated.

The ground-level attack is from gener-
ators which are capable of directing silver-
iodide particles into the atmosphere. Gen-
erators are located at strategic places in
and around the target areas, with outlying
ones being as much as 60 miles away so
clouds can be attacked systematically be-
fore they reach the protected area. In
California the fruit areas of adjacent Sacra-
mento, Placer and El Dorado counties re-
quire 97 generators to protect them.

Generators are operated by persons who
must always be present, with a telephone
available. They may be ranchers, store
keepers, service-station operators, or
housewives.

To set the generator working the opera-
tor pours special small-sized coke impreg-
nated with silver iodide into a hopper.

(Continued to page 230)

Now! a Swingline hi-compression Staple Gun for only \$4.95

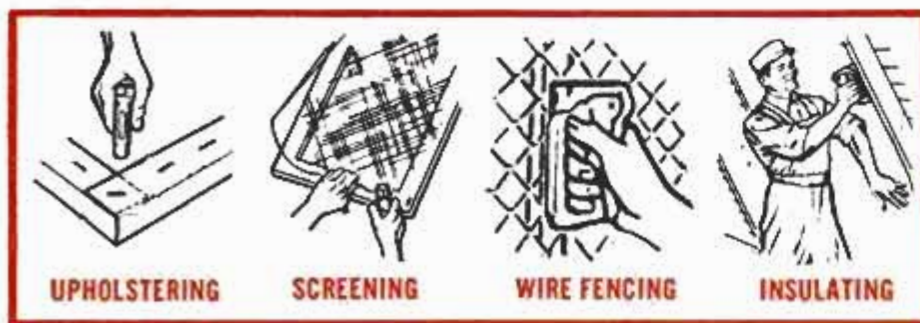
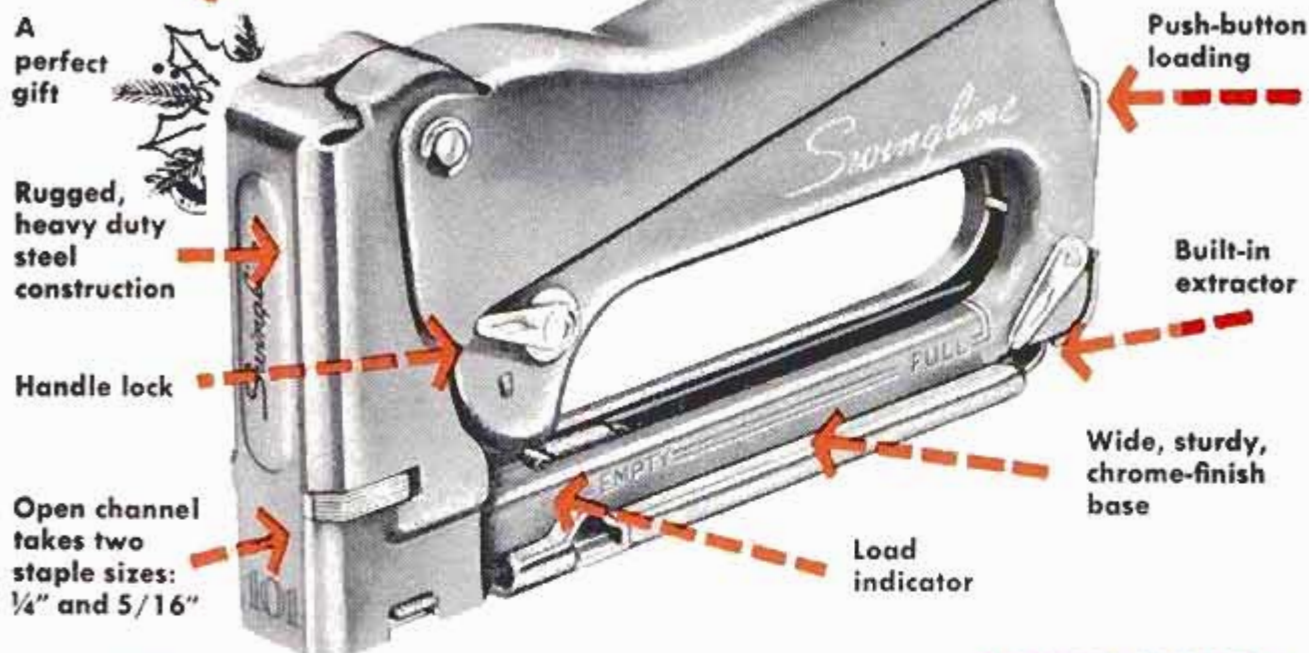

PERFORMS HUNDREDS OF HOUSEHOLD JOBS!

- carpentry
- draperies
- window shades
- carpeting
- shelf trimming
- TV antenna
- plaster walls
- valances, etc.

The most indispensable tool you can give any home handyman for Christmas...at a low, low price! Compact, powerful, capable, this SWINGLINE staple gun will deliver as much driving power as machines twice its size and weight. A precision tool that drives two-legged staple-nails flush with a powerful thrust, holds tight! Lightweight, maneuverable, balanced for tireless use. Choice of Gray, Red, Green in attractive gift wrapper. Insist on SWINGLINE with push-button loading at better hardware, stationery and department stores!

Swingline®

FREE!
Send for information,
16-page booklet
"Tips for Tacking".



INC., LONG ISLAND CITY 1, NEW YORK

World's Largest Manufacturer of Staples for Home and Office!

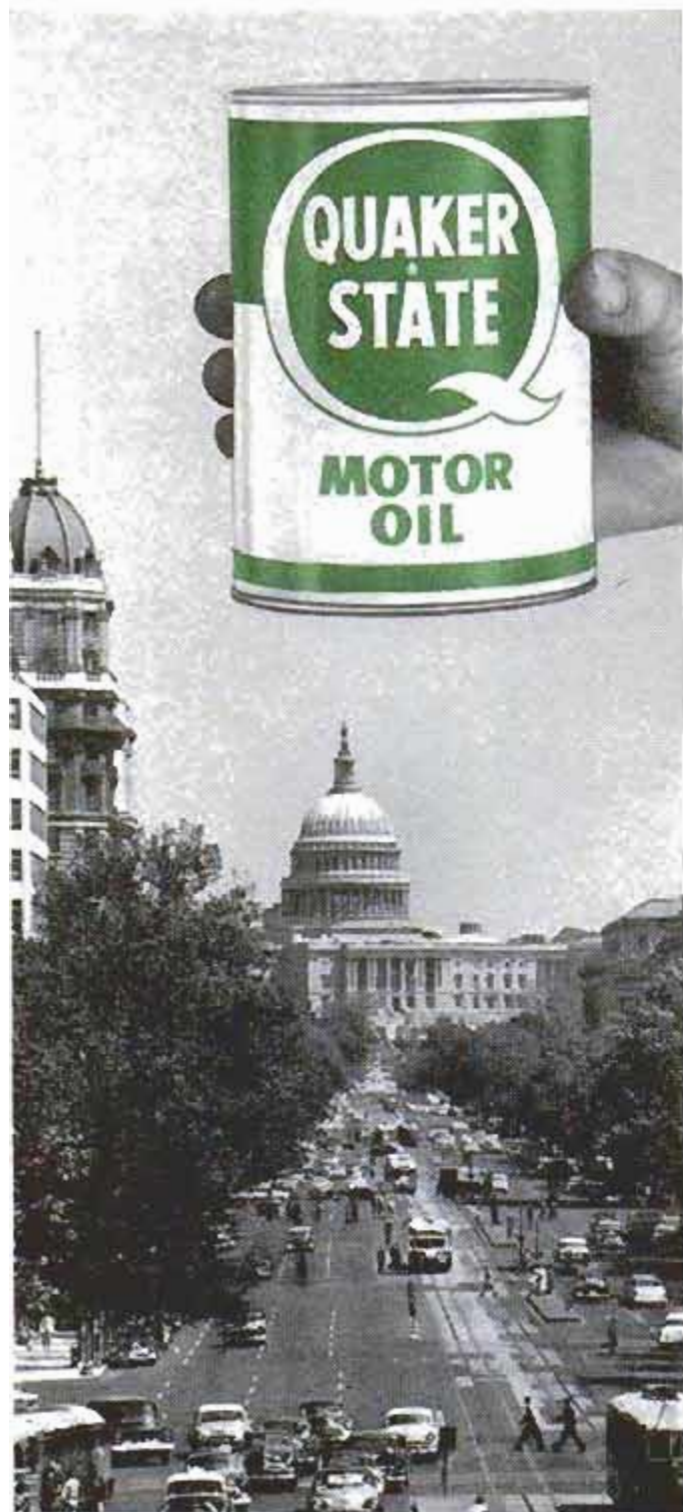

WASHINGTON, D. C.

Big news on the road today is Quaker State! Skillfully refined from only the purest Pennsylvania oil stocks, Quaker State Motor Oil lasts longer, keeps engines cleaner, protects against costly repairs. In the long run, this top quality lubrication means greater economy for you! Always ask for **Quaker State**...it's the best motor oil money can buy!

QUAKER STATE OIL REFINING CORPORATION, OIL CITY, PA.
Member Pennsylvania Grade Crude Oil Association

Coke is augered slowly into a small blast furnace that burns it at a temperature of 2500 degrees and releases submicroscopic silver iodide. Air currents lift them into the clouds and divide the freezing activity. A generator will release particles at a rate of 30,000,000,000,000,000 per minute.

Fuzee Replaces Many Generators

Airplanes go aloft to add silver iodide to clouds. Generators are used in planes but recent development of a 21-inch fuzee impregnated with the silver iodide and capable of releasing as many particles as 400 generators, is proving more efficient.

The fuzees are placed in groups of 10 in a battery of tubes mounted on each side of the plane. One, all, or any combination can be ignited electrically from the cockpit. Each will burn 20 minutes. They can be spread out over nearly seven hours of seeding time.

"To get hail control, it is not just a matter of looking at the clouds and deciding to turn on the generators," Clark explains. "The entire weather picture must have the attention of experienced meteorologists."

The weather is watched minutely through reports coming in constantly over teletypewriter machines, both from national and local weather stations. A storm is followed from the first day it appears on the weather charts and it is studied as it progresses. By the time it reaches the project area the meteorologist knows almost everything there is to know about it—the intensity, water content, air circulation, how much precipitation is resulting from its passage and, finally, where it will go next. If necessary, generators are put to work.

Hail Control Pays Off

Reports from all the areas protected in California, Oregon and Washington in the last three years reveal that crops valued at many millions of dollars have been saved from hail damage. The period has been one of extra-heavy storm activity in which hail has been a predominant feature outside the protected target areas, giving an indication of what could have happened inside the crop area.

The farmer is looking forward to the time when rain-making methods are perfected so he can say to cloud seeders, "I need 25 percent more rain this month," and they will go out and get him what he wants.

In the meantime they are keeping in mind the quip by Mark Twain that "everybody talks about the weather but nobody does anything about it." They are proving that today the quip would be incorrect.

★ ★ ★

1. Open the foldout page

2. Insert this sheet with

1. Front side touching the free page

2. Arrow pointing to the fold

3. Slice the folded edge

4. Close the page and slip-sheet

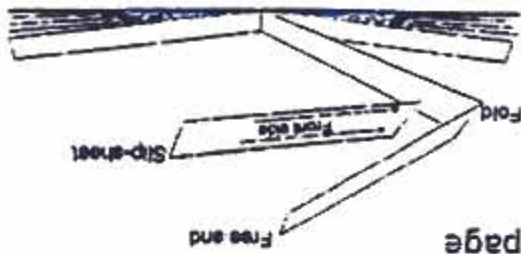

Inverted Foldout slip-sheet

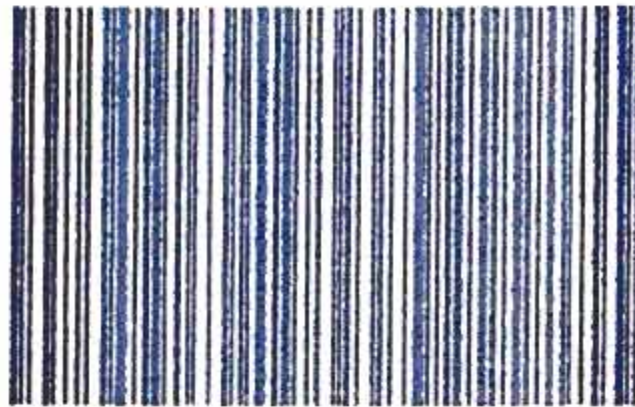

GbsSlipSheet-001



Folded edge of the page

Foldout slip-sheet

1. Open the foldout page
2. Insert this sheet with
 1. Front side touching the free page
 2. Arrow pointing to the fold
3. Slice the folded edge
4. Close the page and slip-sheet

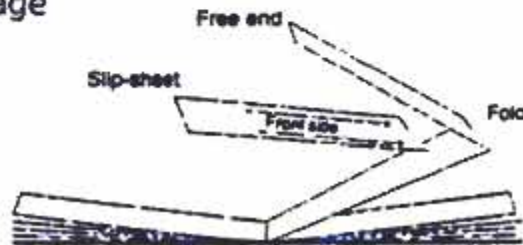

1. Follow instructions on the other side

Inverted Back



GbsSlipBack-0018

Back

1. Follow instructions on the other side



IT'S A SAW



IT'S A JIG SAW



IT'S A SANDER



IT'S A FLOOR POLISHER

IT'S THE FIRST TOOL EVER POWERED SPECIFICALLY TO DRIVE ATTACHMENTS

INTRODUCING BLACK REVOLUTIONARY POWER



SA
U
T

INT

Grip the new B&D
... turn it on and
power! It's the first
ately built with a
stamina necessary
tained, demanding
attachments. Use
with any of Black

Black P

SEE R
MONEY

Have Dinner in the Middle Ages

(Continued from page 113)

your replies and answer back. Sometimes he gets into a verbal hassle with the entertainer. It's all done by a public-address system that synchronizes his mouth with syllables.

Throughout the restaurant, the perfection of detail, from the coats of arms set in the terrazzo floor to the gleaming weapons and authentic costumes worn by the employees, is the result of Gosnell's early love of fairy tales and ancient history.

Perhaps the real secret of Gosnell's success is hard work, meticulous attention to detail and a theory that the public likes to be romanced while dining.

He is 100 percent a do-it-yourself man. He built his restaurant entirely from a sketch he made himself. He personally laid more than 500 tons of stone. All art work and other interior decorations were executed from his original drawings. Many mechanical innovations of his have gone into Green Gables.

Gosnell built expensively, but with an eye toward keeping operation and maintenance costs low. His 50 employees, mostly men, have been on the payroll almost since he started. They include the musicians, all of whom he hired individually, according

to their special talents. Gosnell, who can take over on the fiddle or piano when the need arises, coaches his musicians in intricate tunes seldom heard by moderns. As a result they can strike up strange ballads heard in the 15th century, as well as currently popular numbers.

Ever since it opened, Green Gables has staged unique private parties, often for celebrities of screen, stage and TV, political figures and top industrialists.

As a fillip to many of these affairs, Robin Hood and his men "raid" the party, lifting money and valuables. Often there are photographers who record every phase of the clambake. Later, each guest is presented with an album containing photos, guest list, script of the play, the honored person's life history and other mementos.

Such parties are lavish, and when given *carte blanche* on cost, Gosnell spares no expense to make them headline affairs. His prop department is almost as well stocked as a movie studio's. No party-giver ever knows just what is going to happen.

Gosnell has proved that the average person has a love of the make-believe, that his childhood enjoyment of fairy tales and folklore can be recalled when he dines. "It's the inherent desire in all of us to be children again, if only for a moment," he believes. ★ ★ ★

Compact...yet roomy
—that's **English!**

And it's got
real **FORD** "go"!



Up to 35 miles per gallon with this Prefect model

Compare its low price with any other leading import!

Slip easily through traffic, park in places most cars must pass by. Yet four people ride in comfort. For further information write: Imported Car Sales, Ford

Motor Co., 34 Exchange Place, Jersey City 2, N. J.

Made in England for Ford Motor Co., Dearborn, Mich. Sold and serviced in the U. S. by its selected dealers.



POPULAR MECHANICS

Known brands are known values



WHEN you see a Brand Name that you know, it's like the face of a friend. It inspires confidence.

In fact, Brand Names are built on confidence. You and your neighbors dictate the standards a Brand Name product must meet to consistently deliver the value and service you want.

A respected Brand Name is a manufacturer's most valuable asset and he protects it by constantly testing and bettering his product.

A Brand Name is the maker's guarantee of satisfaction which is *doubly endorsed* by the dealer who sells it.

For dependable quality and consistent satisfaction you will do better with the brands you know best; get to know those you see advertised in this magazine.

To get the most for your money buy by *Brand Name* and be sure!

A Brand Name is a maker's reputation



BRAND NAMES FOUNDATION, INC.
437 FIFTH AVENUE, NEW YORK 16, N.Y.

DECEMBER 1958



first on every
Fisherman's
List!

THE FINEST
TACKLEBOX MADE!

My Buddy TACKLEMASTER

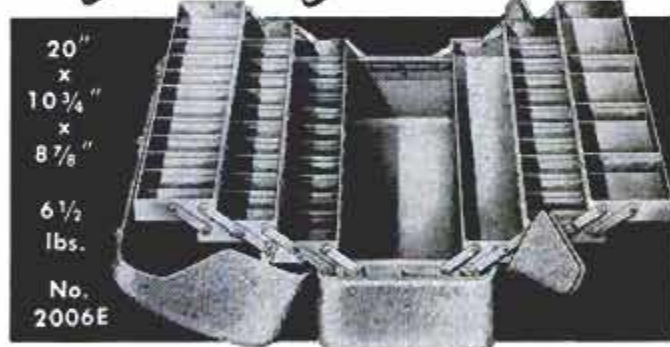

20"
x
10 3/4"
x
8 7/8"

6 1/2
lbs.

No.
2006E

Think of it! 49 compartments plus roomy box bottom to hold all your gear. Drawn from one piece embossed pebble grained aluminum. Cantilevered aluminum trays for quick action. Best friend a fisherman ever had.

SEE THEM AT YOUR FAVORITE SPORTING GOODS DEALER
FALLS CITY DIVISION

Stratton & Terstegge Co., Inc.

P. O. Box 1859 • Louisville, Ky.

Lenk
FIRE
EXTINGUISHER

MAKE IT A
SAFE
CHRISTMAS



\$1.98

LIST PRICE

AT
HARDWARE
DEALERS
EVERYWHERE

MODEL
NO. 72

LENK MFG. CO.
FRANKLIN, KY.

233

NEW! INDOOR- OUTDOOR THERMOMETER BY HONEYWELL

Here's a unique new way to watch weather—“LOOKOUT” by Honeywell, world's largest control manufacturer. Outside, a precisely calibrated mercury tube senses exact outdoor temperatures; inside, a spiral bi-metal gives accurate indoor readings. Sturdily constructed of lifetime plastic. Factory sealed to insure accuracy, resist dirt and dust. Designed by Henry Dreyfuss to harmonize with any decor. Easy to install; easy to read.



\$6.95 GIFT PACKAGED AT BETTER
DEALERS EVERYWHERE

pull the trigger...

spray paint

7 times faster than brushing!



Speedy Sprayer ONLY
\$32.00
less motor

Paints anything from a house to a toy. Saves its cost on the first major job! Speedy Sprayer does in minutes what brushing takes hours. Finish is smooth, flawless. Uses any 1/4 h.p. motor with 1/2" shaft. No. 780 Outfit—10 ft. air hose, tire chuck, quart gun, less motor, only \$32.00. Every workshop should have it. At leading stores.

Free! Write for "How To Spray" Booklet and folder.

W. R. BROWN CORPORATION
Specialists in Portable Paint Sprayers for Over 37 Years
2635 N. NORMANDY AVENUE, CHICAGO 35, ILL.



True blood pressure is measured by inserting pressure transducer, at catheter end, into blood stream

Medicine's New Electronic Wizardry

(Continued from page 80)

detecting heart disease in its earliest stages.

A further use for the new stethoscope is on the horizon. During birth a baby is in imminent peril of oxygen starvation. Its heart must beat rapidly to get maximum benefit from its meager supply. The new stethoscope monitors the infant heartbeat during delivery. If the heart fails, quick surgery can save a life.

A foreign-body locator has developed from wartime mine detectors. Moved over the body, it exactly locates safety pins swallowed by children, metal fragments from industrial accidents and such.

One of the most promising applications of electronics is in the research field. Cytologists (students of cells) are hampered in their work by the fact that these basic fragments of life are transparent. To be visible at all, cells must be stained, and staining usually kills them. Scientists at the Rockefeller Institute for Medical Research and RCA engineers at the David Sarnoff Research Laboratory have developed apparatus which makes living cells clearly visible. Invisible ultraviolet light of three

(Continued to page 236)

Metal bar on legs detects forces of heart action, sends electronic signal proportional to the forces

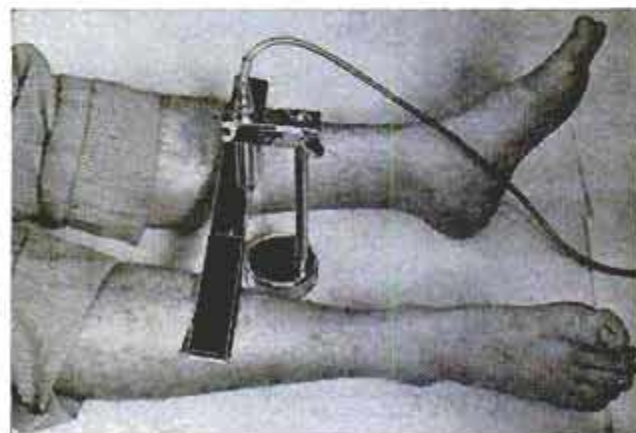

makes shopping for men
so **EASY**...



Look no further! Acclaimed by millions as the world's most useful hand tool, Vise-Grip—handsomely boxed for Christmas—is one tool he'll use every time! For home repairs, shop work, the outdoors! It's a whole tool kit by itself: Super-pliers, all-purpose wrench, clamp, hand vise, and wire cutter! Only

\$2.15 to \$2.95 at your hardware store. Ask for the new VISE-GRIP with Easy Release.

PETERSEN MFG. CO., Dept. PM-12, DeWitt, Nebr.



America is a Better
America —
thanks to Advertising!

WHY DEPEND ON SOCIAL SECURITY!



ADD TO YOUR INCOME • UP TO \$5.00/HR. SHARPENING ALL TYPES OF LAWN MOWERS

Modern Manufacturing's precision Lawn Mower Sharpener and Bed Knife Grinder makes it easy for you to earn extra cash on a full or part time basis. Many mowers need sharpening. Do it in your basement or garage. Anyone can learn to operate this sharpener. Write today for free brochure. Dept. 10

\$27500
F.O.B. Pasadena

MODERN MFG. CO.
160 N. Fair Oaks Ave.
Pasadena, Calif.

NOW CUT HOLES & DISCS IN SECONDS!



"ARCO HOLE-SAW" with New Automatic "SLUG-EJECTOR"

Exclusive "Slug-Ejector" pops out discs immediately—therefore works 3-times faster than other hole saws selling for twice as much. 4-shatterproof blades easily exchanged to cut 1", 1 1/2", 2" & 2 1/2" holes thru 3/4" stock. **\$5.95**

No. 650 HOLE-SAW as above but with 7 blades to cut 1", 1 1/4", 1 1/2", 1 3/4", 2", 2 1/4" & 2 1/2" holes. **\$7.95**

At your dealer or order direct on our **20-DAY MONEY BACK GUARANTEE**. Send check, M.O., ppd., COD + post.

ARROW METAL PRODUCTS CO.
Dept. PM-12, 421 West 203rd St., New York 34, N. Y.

STEEL—BRASS—ALUMINUM



ASSORTMENTS 12" & 36" Length

NO. 1—Cold Rolled Steel ROUNDS: 3/16"; 1/4"; 5/16"; 1/2"; 3/4" diameters. Ideal for shafting & machining.
NO. 2—Steel CHANNELS: 1" x 1/2" x 1/8"; 2" x 1" x 1/2". Steel ANGLES: 1/2" x 1/2" x 1/8"; 1" x 1" x 1/2". Steel FLATS: 1/2" x 1/4"; 1" x 1/2"; 2" x 1/2". Fine for fabrication.
NO. 3—BRASS ROUNDS: 3/16"; 1/4"; 1/2" diameters. ALUMINUM ROUNDS: 3/16"; 1/4"; 3/8"; 1/2" dia.
NO. 4—VANADIUM TOOL STEEL Annealed: 1/4" Sq.; 1/2"; 3/8"; 1/2"; 3/4" dia. Used to make your own cutting tools, punches, etc.
NO. 5—Soft BRASS SHIM & SHEETS: .002"; .003"; .008"; 1/64"; 1/32"; 1/16" Thick. 6" width x 6" or 12"
NO. 6—Bright STAINLESS STEEL SHEETS: 1/64"; .025"; 1/32"; 3/64" Thick. 6" width x 6" or 12".
CASE HARDENING COMPOUND: Hardens mild steel. In 1 lb. can, with instructions.

L-5 METALS, BOX 6544, Cleveland 1, Ohio

- I enclose _____ for Assortments checked
- NO. 1 (12")—\$3.95
 - NO. 2 (12")—\$4.95
 - NO. 1 (36")—\$7.95
 - NO. 2 (36")—\$9.95
 - NO. 3 (12")—\$4.95
 - NO. 4 (12")—\$4.95
 - NO. 3 (36")—\$9.95
 - NO. 5 (6")—\$3.95
 - NO. 6 (6")—\$3.95
 - NO. 5 (12")—\$7.85
 - NO. 6 (12")—\$7.85
- CASE HARDEN COMPOUND — \$3.95**

ALL ITEMS SENT POSTPAID

NAME _____
ADDRESS _____
CITY & STATE _____

Other Assortments — Send for Prices

ORDER YOURS NOW



A PARKER HACK SAW for any day in the week

The Parker model you want, saws easier, holds blades more rigidly, and fits your pocketbook. Unconditionally Guaranteed.

Manufacturers of World-Famous Trojan Saw Blades and Frames

PARKER MANUFACTURING CO.
WORCESTER 1, MASS., U. S. A.

do-2



DIAL ANY DADO WIDTH... IN SECONDS

FOR PROFESSIONAL PRECISION...only with a COMET QUICK-SET DADO! Cut to a maximum depth of $\frac{3}{4}$ ". Dial the exact width (from $\frac{1}{4}$ " to $\frac{13}{16}$ "), without removing the tool from the arbor. Watch the balanced, tool-steel COMET blades cut perfect dados, rabbets and ploughs...on any table or radial arm saw. Use COMET for quick, professional precision... stays sharp 5 times longer! If not at your local dealer, order direct by check or money order. 19.95 PREPAID

COMET MANUFACTURING CO., Dept. PM 12
2033 Santa Fe Avenue, Los Angeles 21, California
a division of The Siegler Corporation



Faster and more accurate than the eye, blood counter tabulates equivalent of 100 samples in 25 seconds

wavelengths illuminates the cells under a microscope. Specially built TV tubes then translate the ultraviolet into visible red, blue, green. Thus, living cells stand out in brilliant color. For the first time it is possible to see intricate life processes at work.

The same group not long ago came up with another promising development — a "radio pill." In effect, the pill is a tiny broadcasting station — less than an inch long and $\frac{3}{8}$ inch in diameter. Attached to a string, swallowed, and allowed to pass through the digestive tract, it gathers and broadcasts pressure readings. It is expected to shed new light on the body's basic physiology, and to be helpful in diagnosing a number of diseases.

Electronic "Vision"?

In one possibly prophetic experiment in the field of ophthalmology, a phototube was hooked to the visual cortex of the brain of a woman totally blind for 18 years. When a light was flashed in front of the tube it fed a minute electric current into the brain. The woman "saw" the flash of light. Whether this apparatus can be refined to produce exact images remains to be seen.

One of the most promising and potentially far-reaching developments now under way is the work of a French research man, Dr. Francois Paycha of Paris. Diagnosis of many diseases has become a matter complex enough to baffle even the most gifted physicians. Paycha's solution: Use an electronic computer. Symptoms are punched on a card which the machine matches with coded stored knowledge.

Paycha tried his idea with remarkable success on diseases of the cornea, the normally transparent covering of the eye's pupil. As a starter he gave the computer a

(Continued to page 238)

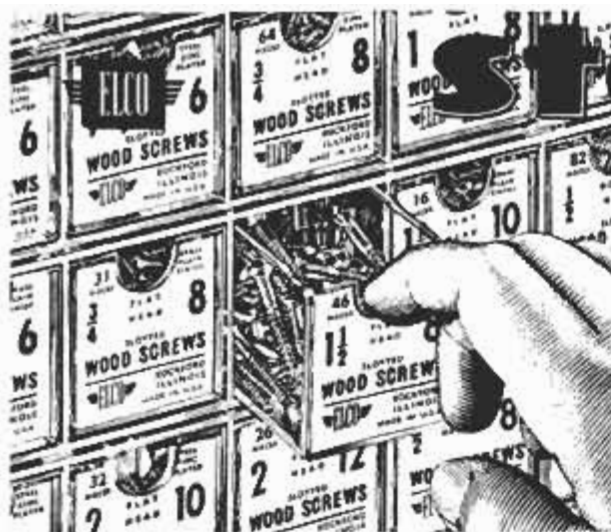

stock your shop

WITH STANDARD TOP QUALITY SCREWS, BOLTS, AND NUTS. [®]
 GENEROUS QUANTITIES IN CLEAR PLASTIC BOXES — 59¢ PER BOX.
 USE DRAWER RACKS — 59¢ EACH — FOR NEAT HANDY SHOP STORAGE.
 CAN BE STACKED OR MOUNTED IN MANY PRACTICAL WAYS.
 LOOK IN YOUR STORE FOR THESE 'STOCK YOUR SHOP' BOXES.
 A PRODUCT OF ELCO TOOL & SCREW CORP., ROCKFORD, ILLINOIS.
 MANUFACTURERS OF FASTENERS FOR INDUSTRY SINCE 1922.

LAWNMOWER SHARPENERS

Six
Machines To
Choose From.

The ONLY complete shop-in-one, with built-in work bench, hoist for heavy mowers, and lightning-fast bed grinder for sharpening bed knives in mower. Lapping attachment and narrow grinding head to hollow grind reel blades. The famous BALTRAK for rotary blades. Write and experienced shopmen will answer.

TURNER-CLINE MFG. CO.
 New address: 906 Virginia Ave., Alamogordo, N.M.

ELECTRIC WELD - BRAZE & CUT

REPAIR MOST EVERYTHING MADE OF METAL



Home Appliances, Auto parts, Farm-garden equipment, toys. Make and repair playground equipment, lawn chairs, tables, ornamental iron work gates, wagons, etc. Solder, heat, bend, and straighten, with terrific heat from arc torch. Cut and weld up to 1/2" steel plate. A million uses for home, auto, farm, inventors, factories, etc. Works from any home plug-in, complete with welders mask, arc torch, supply of various welding and brazing rods. Home, flux, and complete Welding Instruction Book. Attractive — portable — efficient — durable — 1 year guarantee. Wt. only 4 lbs. **SEND ONLY \$3.00** COD postage on arrival or send \$12.95 plus we will send postpaid. Ideal gift for mechanically minded home owners, relatives, friends. Order now for early delivery. Available only from: **MIDWAY WELDER, Dept. DPM-12, Kearney, Nebraska**

Heavy Duty Type ALLEN PUNCH PRESSES

Model BY-5
5 ton
\$199.50
for less motor

Hundreds of Different Model combinations
1 to 12 ton capacities
Moderate in price
Fully guaranteed

See your supply dealer or write for Free catalog giving complete information and prices on our Heavy Duty Punch Presses.

ALVA ALLEN INDUSTRIES, Dept. PM, Clinton, Mo.

GENUINE ALNICO MAGNETS

AMAZING. PERMANENT. NON-ELECTRIC. HIGHLY PRACTICAL. Conduct interesting experiments. Hundreds of uses. Retrieve valuable steel items such as guns, tackle from fresh or salt water; tools from tanks & drains. **GUARANTEED.** Try any magnet one week. Money back if you are not well-pleased.

No. M-710 (Wt. 53 oz.) Has pull of 225 lbs. on steel block	\$18.00
No. M-625 (Wt. 70 oz.) Has pull of 125 lbs. on steel block	\$10.00
No. M-575 (Wt. 18 oz.) Has pull of 75 lbs. on steel block	\$7.00
No. M-500 (Wt. 13 oz.) Has pull of 50 lbs. on steel block	\$5.00
No. M-300 Kit of Flat Bars 5 Pairs (10 Magnets)	\$3.00
No. M-250 Kit of Round Rods 5 Pairs (10 Magnets)	\$2.50
No. M-47 Hot Pad Magnets, 10 for \$1.00	\$0 for \$4.87
No. M-35 Hobbyist assortment of 8 small magnets	\$1.50

Send M.O. or check. We pay postage. Sorry no C.O.D.'s.

MIAMI MAGNET COMPANY, 3240 N.W. 27th Ave., Miami 42, Fla.

Onan Emergency Electric Plants

Start automatically when high-line power is cut off, supply current for lights, heating system, freezer, water pump, stove, all appliances and machines. Prevents losses and hardships. Plant stops automatically when power is restored. Compact, easy to install. 500 to 200,000 watts A.C. Priced from \$319.00.

PORTABLE MODELS
 500 to 10,000 watts. Supply plug-in power anywhere!

Write for Free Folder

D. W. ONAN & SONS INC.
 3592A UNIVERSITY AVE. S.E. • MINNEAPOLIS 14, MINN.



SNOW REMOVAL

With Steering Sulky and Self Starter

- Powerful Gravely Tractor—with push-button Starter, New Steering Sulky and Snowblower—make snow removal almost child's play!
- You can blow snow — deep or light, wet or dry — wherever you want it, with fingertip maneuverability. 48" Snow Plow also available. 30 year round attachments... All on Easy Pay Plan.

Write today for FREE 24-page "Power vs Drudgery" Booklet!



GRAVELY TRACTORS, INC.
 BOX 1263 DUNBAR, W. VA.

FIELD-TESTED SINCE 1922

NEW! Dish-Quik[®] REPLACES ANY THUMB-CONTROL SPRAY!

EASY TO INSTALL!



**ALL-PURPOSE SPRAY
SUDS, SCRUBS
and RINSES!**

ONLY \$9.95 fair trade
Deluxe Replacement Unit—
attaches to your existing hose

Dish-Quik makes quick work of dishes and a dozen other kitchen tasks! Even scrubs out the sink—yet your hands never touch hot, soapy water! To spray-rinse with hottest water, just press the thumb lever; or, tap the button for an instant flow of rich, foamy suds. Uses any good liquid detergent; holds two-day supply. Rugged, all-nylon brush gets dishes, pots and pans really clean! Fully guaranteed.

DO YOU HAVE A SPRAY THAT CAN BE REPLACED WITH DISH-QUIK?



The answer is "yes", if your spray has a thumb control. Almost all sink sprays do have thumb controls. These sprays come in many shapes; but they are all known as "automatic sprays", so-called because they spray automatically when the thumb control is pressed.



Anyone can replace any automatic spray. Simply unscrew the old spray, then...



attach Dish-Quik to the same hose.

Now it's easy to repair or replace any automatic (thumb-control) spray! Dish-Quik is one of the new, official replacements, standardized to replace any old or worn-out automatic spray. In addition to Dish-Quik, the deluxe replacement, you can also choose Rinse-Quik, the standard replacement, for rinsing only. Replacement hoses and accessories also available. If you do not have a thumb-control spray, you cannot use these replacements. You can, however, install a new kitchen faucet equipped with your choice of Dish-Quik or Rinse-Quik.

Ask for Dish-Quik and Rinse-Quik
Wherever Plumbing Goods Are Sold

MAIL COUPON TODAY FOR FREE BOOKLET

AUTOMATIC SPRAY SERVICE CENTER, Dept. 36
1700 East 58th Place, Los Angeles 1, Calif.

Please send free 16-page booklet telling how to repair and maintain automatic sprays and how to install new kitchen faucets that are equipped with these sprays.

NAME _____

ADDRESS _____

CITY _____

ZONE _____

STATE _____

basic store of knowledge — 800 specific symptoms of cornea disease. In one trial Dr. Andre Dubois-Poulsen, a top French ophthalmologist, fed the machine symptoms of a particular patient. Back came five possible diagnoses. "One," he said, "was my original diagnosis, but there were others of rare diseases which I should have considered, but which had not occurred to me."

Says Paycha: "The machine will not replace the doctor's memory. But it will supply him with a priceless supplementary electronic memory." He sees no reason why more elaborate card systems should not be developed to diagnose all disease. International Business Machines scientists tend to agree. Dr. V. K. Zworykin of RCA foresees the possibility of big diagnostic centers with giant computers. Physicians facing difficult problems would send in symptoms by wire and could have replies back in a matter of minutes.

The mating of electrical science with medicine may well be one of the significant accomplishments of our day. Results so far achieved have been great—more exact diagnosis, better surgery, greater research opportunity. Impressive as these accomplishments are, they will almost surely be dwarfed by things that lie ahead. ★ ★ ★

Polyethylene Bar Bells Have Sand-Filled Weights

Bar bells with hollow weights made of polyethylene are now available for muscle-building programs. The weights can be filled with water, or dry or wet sand to adjust lifting weight anywhere from 2 to 20 pounds. The basic bar bell consists of a 32-inch aluminum bar with two large 8-inch weights and four smaller 5 $\frac{3}{8}$ -inch weights for each end.

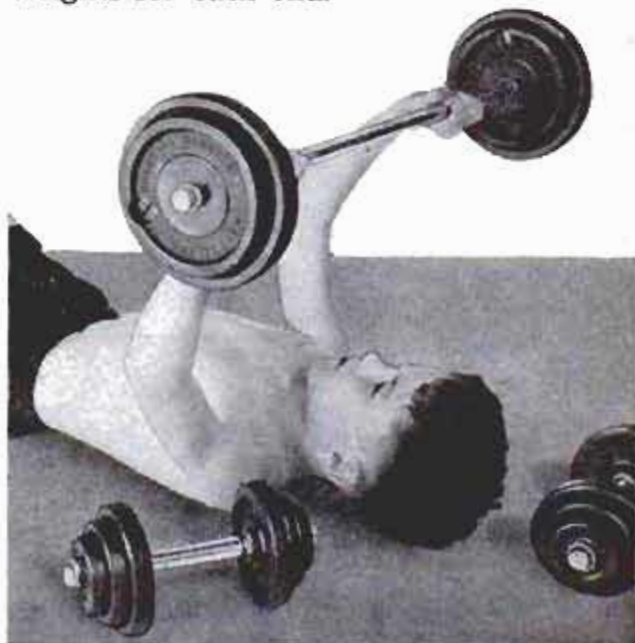

THE CHRISTMAS GIFT FOR LIFETIME ENJOYMENT
WELD IN A JIFFY! IT'S DYNAMIC



Now any one can weld, cut, braze or solder almost any metal quick, safe and easy with this professional type welder. Make repairs in home or shop and farm; repair auto bodies and fenders, build wrought iron furniture, railings, fences, etc. — 1001 metal items. No previous experience necessary. Designed to operate on any properly wired 110 V. A.C. line. Order today! Literature on larger industrial equipment on request.

EASY PAY PLAN

Low down payment. Pay as you USE. Money back guarantee. Act now!

only **\$38.50** l.o.b.
 Factory

DYNAMIC WELDER COMPANY, 1808 S. Federal St., Dept. D2-N, Chicago 16, Ill.

DO MORE PLANING JOBS WITH LOW COST BELSAW

LOW DOWN PAYMENT EASY TERMS



Exclusive MONEY-MAKING Features: Full 12 3/4" x 6" capacity • Power feeds at 14' to 34' a minute • Provides for Grinding Knives in the Cutter-head • Attachments for Jointing, Rabbling, Tongue, Matching, Groove. Convert low cost rough lumber into high priced stock. Easy to make flooring and popular patterns. Send Today for FREE Literature and Prices.

Belsaw Machinery Co., 2059 Field Bldg., K.C. 11, Mo.

RUST REMOVED

from all metals—including large and small machine parts, factory and home tools, kitchen appliances, golf clubs, fishing gear, aircraft, marine and auto engines, etc. Unconditionally guaranteed. RUST-X removes rust—will produce a bond surface that will anchor paint. No oiling or waxing needed to prevent further rusting. Nonflammable—safe—easy. Money back guarantee. 8 oz. bottle \$1.25 postpaid.

RUST SALES CO., P.O. BOX 44284, MIAMI, FLORIDA

FREE AMAZING NEW BOOK "HOW TO ANSWER ADS"

how to answer ads

Never before have you seen anything like this. Tells you in simple language the correct way to answer ads. Gets you quicker replies—better results, and greater satisfaction. Will save you time and money and it's ABSOLUTELY FREE. No obligation whatever. Every reader of advertising should have this booklet. Send a postcard for your copy NOW. F. W. JOHNSON, Popular Mechanics Magazine, Room 600-A, 204 East Ontario Street, Chicago 11, Ill.

CUT ANY SIZE — ANY SHAPE WITH Spearhead Cutter

Handy pocket size — cuts leather, asbestos, rubber, cork, etc. — round 1/4" to 6" — any size straight and odd shapes.



935 POSTPAID

Send Check or Money Order!

ZIMMERMAN PACKING — NORWOOD 12, OHIO



For Many Uses! Metal Turning Lathe

Only \$49.95 F.O.B. Lansing, Ill. 15 1/2" bed with 4 1/2" swing 7" between centers. Satisfaction Guaranteed.

Rosemoor Manufacturing Co. Box 147J, Lansing, Ill.

FREE FOLDER Write for it today!

AUTOMATIC RETOOTHER for HAND SAWS

MAKES NEW PROFITS

Cuts new teeth in 50 seconds — any size 4 to 16 points. Old teeth fall off as chips. Easy to operate. A perfect job.



BURR MFG. CO. 8933-D VENICE BLVD. LOS ANGELES 34, CALIF.

Send For Free Literature

New PAINT SPRAY UNIT



U.S. GOV. SURPLUS

Including Spray Gun
 APPROX. ORIGINAL COST \$325
 OUR LOW PRICE... **\$34.50**

Heavy duty compressor for continuous operation, with G.E. or equal B.B. Motor, 110 V., A.C., rated 1/10 h.p., develops up to 3/4 h.p. 1-Quart. Pressure type gun with round, fan and ceiling spray nozzles. Line filter, air gauge, 20 ft. cord & plug, 20 ft. air hose. Sprays paint, lacquer, enamel, insecticides, etc. Paints house, auto, ANYTHING. Operates gun continuously. Instructions furnished. NOTHING ELSE TO BUY. Wt. 80 lbs.



ORDER FROM THIS AD. Money Back Guarantee. Send check or money order. **ILLINOIS MFG. & SUPPLY CO.** 1829 S. State Street, Dept. PM12, Chicago 16, Ill.

ADJUSTABLE CORNER and SPLICING CLAMP

makes a perfect mitering vise

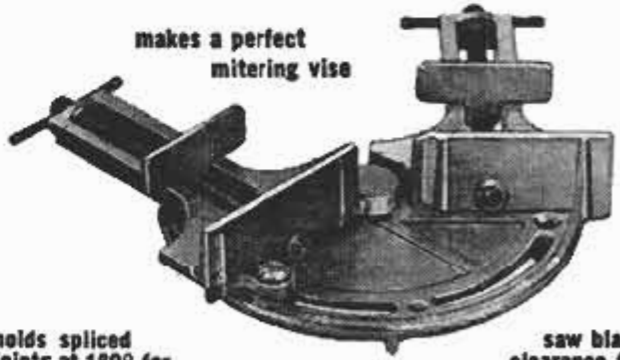

holds spliced joints at 180° for gluing or nailing. adjusts to any angle. correcting mitre cuts

saw blade clearance for



This clamp can hold, at any angle, frames, screens, shadow boxes, storm windows, trim, mitre or butt joints for nailing, stapling, gluing or splicing. Clamp consists of two screw clamps attached to a metal base. One clamp is stationary, the other swings a full 180°. Unlike obsolete clamps which cover corners; this corner clamp fully exposes the top and side of two pieces so that nails or screws can be easily driven into joint. Screw clamps open to 3" to hold different widths and thicknesses at same time. Two countersunk holes provided if fastening clamp to work bench is desired. Precision-cast, made of highly polished special aluminum alloy, lightweight and strong. Each \$1.75 Price of two for joining two corners at once... **\$3.35** Order by mail. Satisfaction guaranteed. We pay delivery. Write for free catalog of fine tools.

DRUMCLIFF COMPANY DEPT. 337 TOWSON 4, MARYLAND

NEVER AT THIS LOW PRICE!
GENUINE 150-POWER
ACHROMATIC TELESCOPE

with Achromatic Lens and
 4-POWER FINDER attached

ONLY
\$18.95
 PREPAID



EXTRA BONUS GIFTS:

- 273 page book, "Handbook of the Heavens"
- Magic Star Finder Dial
- 220X & 400X Eyepiece lenses

5 Magnifications 18X-35X-65X-85X-150X
 Brings the Moon, Planets, Stars, Satellites, People
 150 times Closer, Clearer, Sharper

Never before has an ACHROMATIC 150X telescope with range finder and tripod sold for anywhere near this amazing low price! Now you can not only explore the heavens and bring the moon, planets, stars, satellites 150 times closer, but you can observe all distant objects, people, ships too, because all pictures are erect, not upside down as in all astronomical telescopes. The kind of needle-sharp color-free viewing only a genuine achromatic lens can bring you. Ready for immediate use. 5 precision lenses bring you viewing at 18X-35X-65X-85X-150X. Tubes extend to 43" made of bakelite, finished in camera bellows black, trimmed with gleaming brass. 4 power finder scope (30mm Lens) mounted on main tube is feature usually found on more expensive telescopes—brings difficult objects on target before observing with main scope. For extra stability 5 ft. hardwood folding tripod is equipped with heavy cast iron head fitted with Criterion's famous 360 degree all aluminum mount that locks instantly in any position. Obtainable only from Criterion Co. shipped prepaid. 4 famous gifts—273 page book "Handbook of the Heavens," Magic star finder dial that aids in locating stars ANYWHERE at ANYTIME of the year. 220X & 400X eyepiece lenses included free for experiments. You must be completely satisfied with this super offer or your money back in full. Shipped Complete, nothing else to buy at amazingly low price of **\$18.95**. Without tripod **\$14.95**. Send Cash, Check, or Money Order today
 Dept. PMA27, CRITERION CO., 331 Church St., Hartford, Conn.

POCKET SIZE BLOW TORCH

only
\$1.95
 with charger

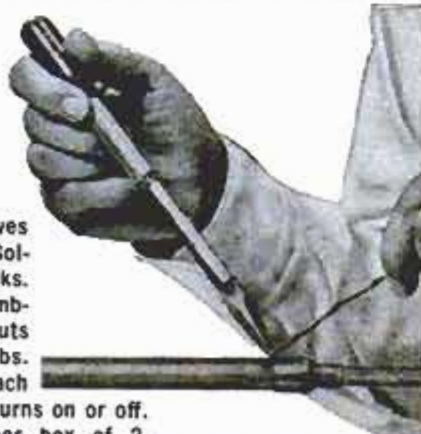

Butane gas blow torch gives intense 3500° flame. Solders, brazes, fixes leaks. Perfect for wiring, plumbing, loosening frozen nuts and bolts, 1001 odd jobs. Carry in your pocket. Each

charger lasts 1/2 hour, turns on or off. Extra chargers, 49¢ per box of 2. Get Jet King Butane Blow Torch at hardware stores. Or, send check or money order, we pay postage. For \$1 more (total \$2.95), get Soldering Kit; torch, tip, 3 feet cored solder, extra charger. Good for TV, radio, jewelry.

* Add \$1.00 in Canada

KIDDE MANUFACTURING CO., INC., Dept. PM-124
42 FARRAND ST., BLOOMFIELD, N. J.

Send me _____ JET KING BLOW TORCHES @ 1.95 ea.*

Send me _____ JET KING SOLDER KITS @ 2.95 ea.*

Send me _____ Boxes of Extra Chargers @ .49 per box.

My check, _____ money order, _____ for \$ _____ is enclosed

NAME _____

STREET _____

CITY _____

STATE _____

MONEY BACK GUARANTEE

**They Don't Make 'em Like
 They Used To**

(Continued from page 90)

as a pattern for new cut by a Pontiac cabinet maker who also turns out top bows, dashboards, seat frames and wheel spokes. With new framing in place, rusted-out body panels are replaced by new ones hand-formed of aluminum or sheet steel.

Chassis are sandblasted and repainted; engines and drive trains disassembled and checked for wear. Cracked cylinder heads and water jackets will have been brazed,



Holes are drilled in flat aluminum sheet that will become new rear fender for 1906 model Pope-Toledo

broken gears replaced and, where necessary, parts cast from virgin metal when the engine is buttoned up again.

Wheels, often with only the hub and rim salvable, are respoked and finished off with the delicate striping that makes them works of art. Tires pose less of a problem than formerly, now being available from Firestone and the Gehrig Tire Company of Fort Wayne in the original tread design for nearly all antiques.

Intuitive Sense of "Feel"

Although most veteran cars were of straightforward and uncomplicated design, reassembly calls for that intuitive sense of "feel" for manufacturers' specifications rarely are available. One exception turned up last year, however, when a Baby Fiat was in the shop.

(Continued to page 242)

Sale! This Outstanding **ENCYCLOPEDIA** Every Child Will Treasure

and Use—for Over **60% OFF!**



12 Beautiful Volumes—3,072 Informative Pages—Over 5,000 Pictures, Photos, Charts, Diagrams—Hundreds of Subjects and Projects Children Want to Know About and Do!

**POPULAR
MECHANICS**
JUNIOR
Do-It-Yourself
ENCYCLOPEDIA

Regularly \$19.95 . . . Now Only \$6.95!

We need the warehouse space, giving you the bargain opportunity of many a year! On a first come, first served basis, you can have for your children a wealth of information they will treasure and use for years to come—and which will be invaluable throughout a lifetime. Advertised previously in Popular Mechanics for \$19.95, you can obtain this set now at a \$13.00 saving!

What The Set Is

Popular Mechanics Junior Encyclopedia is a compilation—in 12 beautifully bound volumes—of everything that active, curious boys and girls want to know about. Packed into more than 3,000 pages are fascinating ideas for games, crafts, sports, practice in elementary electricity and electronics, mechanical devices, outdoor and indoor equipment and a vast number of other "do-it-yourself" ideas. More than 5,000 pictures, charts, diagrams and tables provide unending hours of interest and creativity, with complete detailed information for carrying out every imaginable project from simple sewing or taxidermy to complex power-driven equipment.

How It Benefits Your Children

Here is basic training in personal resourcefulness that will prove so valuable in later years. Your children learn the best way of all—by doing it themselves—and every project is fun to build and

challenging enough to foster real pride of accomplishment.

Their new knowledge pays off in immediate greater self-confidence and poise, and provides a wide range of worthwhile interests that will last through a lifetime. You give them a headstart in school, in life and the art of living.

Yet these volumes don't look like "teaching" volumes at all. They cover hundreds of subjects to intrigue and delight any child (a few illustrated at left). They're easy to read, with large type, thousands of pictures and diagrams, and each one has immediate interest for children sixteen, twelve, as young as eight years! The set is one of the finest educational, character-building assists you can give your boy and girl in their crucial formative years.

Leading Educators Say —

"The wealth of material presented is fascinating . . . the most comprehensive collection of practical informative material ever assembled in book form for children."

"It (the set) appears to be entirely unique. I am sure that any boy or girl will find many things of interest and will also learn a great deal from it."

"I believe these books are wonderful achievements. Teachers of handicrafts, parents wishing to share their children's interest and forward them, all youth leaders will find them invaluable."

PLACE YOUR ORDER NOW!

A limited number of sets available. We cannot make this offer again.

POPULAR MECHANICS PRESS • Dept. 1258 • 200 E. Ontario St., Chicago 11

Ship at once, charges prepaid, Popular Mechanics Junior Do-It-Yourself Encyclopedia—12 matching volumes.

I enclose check or money order for full payment of \$6.95 (a saving of \$13.00 from regular price).

Name _____

Address _____

City _____ Zone _____ State _____



From Volume 2
"CAMPING"—
pp. 271-289



From Volume 3
"DRIVING YOUR CAR"—
pp. 342-387

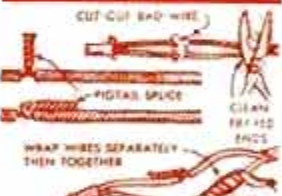

From Volume 3
"ELECTRICAL REPAIRS"—
pp. 617-628



From Volumes 3-4
"OUTDOOR GAMES"—
pp. 754-812



From Volume 5
"HORSEMANSHIP"—
pp. 1232-1241



From Volume 9
"SEWING"—
pp. 2289-2296



From Volume 10
"TAXIDERMY"—
pp. 2516-2534



From Volume 11
"TOYS YOU MAKE"—
pp. 2692-2813

WELD — SOLDER ANYTHING FAST!

THE WORLD'S MOST POWERFUL
MINIATURE SOLDERING IRON MENDS
AND REPAIRS 1001 ITEMS IN A JIFFY

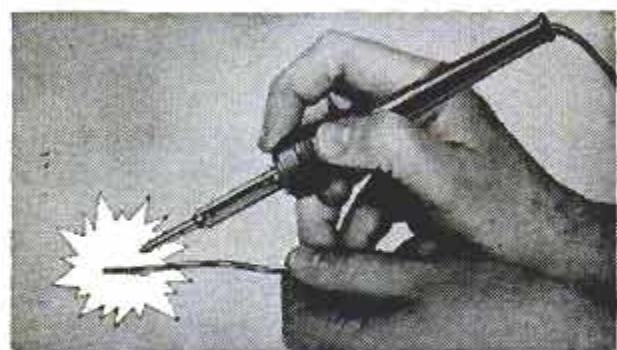

AMAZING "MIGHTY-MITE SOLDER-ETTE" SAVES HUNDREDS OF DOLLARS IN REPAIRS . . . FIXES EVERYTHING FROM TV SETS TO TOYS! You can save up to \$25.00 the very first time you use your Solder-Ette. Stop paying expensive repair bills. Precision engineered, Solder-Ette permits you to make thousands of household and shop repairs in a jiffy! Repair appliances, TV & Radio Sets, lamps, electrical wiring, motors, toys, jewelry, etc. Easy-grip handle is heat-proof. Modern design permits use in even most crowded spots. Copper alloy tip screws into super-heat element, permitting easy replacement. Complete with quality line cord. 25 Watts 110-120V AC/DC. FULLY GUARANTEED. If not delighted return within 10 days for full refund. Send \$2.98 Postpaid plus 25¢ for PP & handling.

Sorry, no C.O.D. Tube Wholesalers Co., Dept. S-PM
Box 61, Baldwin, L.I., N.Y.

Compact!
Battery-
Powered!



The JabSCO "Water Puppy" Pump fills a practical need for outdoorsmen and Do-It-Yourselfers everywhere. Designed for years of hard service, the "Water Puppy" features bronze housing and flexible neoprene impeller. Trouble and maintenance free! Ports threaded externally for $\frac{3}{4}$ " garden hose, internally for $\frac{3}{8}$ " pipe thread.

See the "Water Puppy" Pump today! At your dealer or write direct. 6-volt — \$26.50 12-volt — \$27.50
24-volt — \$28.00 32-volt — \$28.50

JABSCO PUMP COMPANY

Dept. PM • 1485 Dale Way • Costa Mesa, California

• **For Boating**

Bilge pumping,
water systems,
bait tanks,
washdowns

• **Trailer**

Water systems

• **Camping**

Gear, auto
and child washing

"We had a complete factory manual, a beautiful job," Davis recalls with a wry grin. "Only it wasn't much help. It was printed in Italian."

Pictures, past experience, careful charting in taking the vehicle apart and common sense guide Davis and his crew in fitting the old monarchs together. On those rare occasions when all else fails and a problem develops, a note to a "helper"—any one of the thousands of fellow members in the Veteran Motor Car Club, the Antique Automobile Club of America or the Horseless Carriage Club—brings a tide of information and the latest owner improvisa-



New aluminum fender is clamped into position on antique car. Some fenders are shaped from sheet steel

tions. This clan, one of the most closely knit in the world, also is the mine in which needed parts often are found.

Then, too, it is not uncommon for enthusiasts who own tool and machine shops, foundries and plating concerns, to put their facilities at the disposal of a fellow member. Davis concedes a couple of cars probably never would have left his shop under power if two antique car fanciers in Detroit had not come to his rescue.

One Car Rebuilt Twice

Davis, too, has been the rescuer. Last year, in reply to an SOS from a western museum, he dismantled the engine of his 1903 Rambler and shipped off its single cylinder to be used as a pattern for casting a new one so the institution could effect its own restoration.

The 1911 Model T that changed his life now has its second set of Davis-made fenders; the car was rebuilt a second time after

(Continued to page 244)



2500 WATT A. C. ELECTRIC GENERATOR

115-Volt, 60-Cycle
A.C., Single Phase

Government Cost \$250.00

Brand New SURPLUS
Fully **GUARANTEED**

Only **\$125.00**
fob

Ideal as a permanent or stand-by unit for electricity IDENTICAL to your house current. Perfect for farms, camps, aboard ship, oil fields, mines, etc. Easily handles lights, refrigerator, deep freeze, oil burner, radio; power for saws, floodlights, drills, pumps, etc. ALL BALL BEARING! Operates at 3600 RPM. Drive with 5 HP or larger engine—or use power take-off. Voltage self regulating. Standard base mtg. Two outlets. Size: 13" long, 8" dia. Wgt. 65 lbs. Delivers 2500 Watts CONTINUOUSLY!

SUPPLY LIMITED! ORDER DIRECT FROM AD
Free Catalog of other Surplus, Hydraulics

ROBERTS ELECTRIC CO., Dept. PM-877, 849 W. Grand, Chicago 22



TOWARD GREATER VICTORIES



JOIN THE MARCH OF DIMES



Build-Your-Own 2½ h. p. gasoline engine! CLINTON LITTLE INJUN KIT

- Big, 2½ h.p. air-cooled, gasoline engine ready for assembly.
- Use it to power junior sports cars, scooters, ice sleds, merry-go-rounds, home workshops.
- Educational, safe, practical. Boys and men learn the secrets of mechanical energy.
- Complete, detailed photographic instructions for assembly.

CLINTON ENGINES CORPORATION
CLINTON, MICHIGAN • MAQUOKETA, IOWA

**IF YOUR
DEALER
CAN'T SUPPLY
YOU—ORDER
DIRECT!**

Clinton Engines Corporation, Department A
Clinton, Michigan

Send me _____ Clinton Little Injun Kits at \$49.95 each.
(Michigan residents add 3% sales tax.) My check or money order
for _____ is enclosed.

Name _____

Address _____

City _____ State _____

DELTA SAVINGS REMINDER COUPON

SAVE \$21.00

Take this coupon to your Delta dealer...
for \$21.00 savings on the purchase of this
famous Delta circular saw!

REG. PRICE **\$138.00**

SPEC. PRICE **\$117.00**

YOU SAVE \$21.00

Low Down Payment—
Easy Terms

See your Delta dealer
— listed under
"TOOLS" in the Yellow
Pages—or visit lead-
ing department, hard-
ware, or building
supply stores. Rockwell
Manufacturing Co.,
Delta Power Tool Div.,
502M N. Lexington Ave.,
Pittsburgh 8, Pa.



(Cat. No. 34-003)

Delta 9" tilting arbor
circular saw with exten-
sion wings and steel
stand.

Prices and savings slightly higher west of the Rockies.

DELTA POWER TOOLS

another fine product by

ROCKWELL



DELTA SAVINGS REMINDER COUPON

SATISFACTION



Know the satisfaction that
comes from using a fine prod-
uct, built to last. Free Catalog
to Machinists and Toolmakers.
GERSTNER TOOL CHESTS
458 Columbia St., Dayton 7, Ohio

WRITE FOR **ESHELMAN** FREE CATALOG

SAVE MONEY.
Check Items Wanted:

GARDEN TRACTORS
Low as \$99.

¼ TON UTILITY
AUTOMOBILES

CHILDREN'S AUTOS
with Gasoline Engines.

GOLF CARS
Electric or Gas.

CAR SNOW PLOW
Bolts on Front Bumper

Some dealerships still available. Write For Free Catalog
ESHELMAN CO., Dept. FC212, Baltimore 2, Md.



95 different parts, can be as-
sembled in one evening, into
this powerful 2½ h.p. engine.

NOW! Adjustable CORNER CLAMP



AND MITERING VISE
Securely holds mitered or butt joints at 90° angle, or any angle, for nailing, stapling, gluing and splicing. ADJUSTS TO ANY ANGLE. Used for Picture frames, Screens, Storm windows, Shadow boxes, or any place where wood is joined. **\$1.75 PPD.**

SAW SHARPENING IS EASY

Super Filer No. 11 joints and sharpens hand and circular saws 6" to 10" with all teeth correct in height, depth, pitch, bevel. When file hits steel roller, teeth are finished. Saw runs true with no side pull. Includes 8" file. **\$9.95 PPD.**



FREE LITERATURE

"**TRU-CIRCLE**" saw set automatically sets teeth at 10° or more. **\$2.95 PPD.**

MONEY BACK GUARANTEE

A. D. McBURNEY, 5908 Hollywood Blvd., Hollywood 28, Cal., Dept. A-128

AMAZING NEW PERSONAL POCKET RADIO



GUARANTEED—FOR YOUR LIFE!
FOR AS LONG AS YOU OWN IT! NO TUBES, BATTERIES, TRANSISTORS OR ELECTRICAL PLUG-INS NEEDED! Will never run down or burn out! SMALLER THAN A PACK OF CIGARETTES! RECEIVES LOCAL RADIO STATIONS ANYTIME—ANYWHERE YOU GO! Easy thumb tuner. NO DANGLING EARPHONES! HAS BUILT-IN SPEAKER PHONE! Black gold plastic cabinet, semi-conductor wave detector, NOT IMPORTED. MADE IN U.S.A.

AND GUARANTEED BY AMERICANS—You can always get service. bill, ck, mo) and ps) postman \$1.99 C.O.D. **SEND ONLY \$2.00** postage on arrival or send \$3.00 for post-paid delivery. SENT COMPLETE READY TO LISTEN WITH LIFE GUARANTEE—NOTHING EXTRA TO BUY EVER! FREE LONG DISTANCE ANTENNA if you order now. Available only from: **MIDWAY COMPANY Dept. WPM-12 KEARNEY, NEBR.**

NOW! Set Up Your Own Complete Photographic Workshop—The Beseler DREAM DARKROOM



Opens a World of FUN and SATISFACTION

Now you and all the members of your family can enjoy the fun of one of America's leading pastimes. Here is the only complete quality darkroom kit ever produced . . . ready to be used in your home at once. The Beseler Dream Darkroom Kit contains everything necessary to establish your own modern darkroom. Includes the world-famous Beseler 23C Enlarger, plus easel, tank, trays, solutions . . . over 22 components to bring you a really outstanding photographic workshop. Worth \$287.00 but offered to you now as a complete kit for ONLY \$195.00. (\$206 Denver West)

Write for FREE Booklet, "Fun In the Darkroom".

CHARLES BESELER CO 206M South 18th St. East Orange, N.J.
Please send me FREE booklet, "Fun In the Darkroom."

Name _____
Address _____
City _____ Zone _____ State _____

being virtually demolished in a collision while on an antique-car tour. In reproducing fenders, Davis cuts the blank from sheet metal, puts in the bead and welds on stiffening edges. Forty to fifty hours labor has been invested by the time the fenders are ready for the enamel. And "Henry" would swear the set of four had been stamped at his own Highland Park plant unless the bill was attached.

The casual visitor who innocently consigns all old automobiles to the junkyard finds no rusting iron, no abandoned bodies staring at the sky at the Davis shop. Skeletons awaiting "inventory" and consignment to the loft or restoration are wrapped in tarpaulins behind the shop. Even Davis' ranch home, just across the drive, contains priceless tonnage — some of it owned by customers, more by Davis himself.

Fans Include Women

A 1930 Austin and a 1939 American-Bantam roadster, a 1910 Paterson and a 1905 air-cooled Franklin fill the garage; the breezeway shelters two or three more vintage pieces, including a Brush, while a basement garage houses the remains of the Rambler, parts of the 1908 Maxwell his wife is restoring as her own antique car and, under dust covers, Davis' maroon Ford.

Although all charges for rebuilding and repair are based on time and material — parts being billed at cost—the luxury of owning an antique car really isn't restricted to the wealthy, as one young woman from Pontiac can attest.

Delivers Cadillac in Pieces

She had a yen for a Cadillac but, unlike many young things, hers was for a 1903 model she delivered in pieces to Davis. Her take-home pay as an employee of a spark-plug plant wasn't enough to finance the full treatment. Yet eight months later she drove away in her Cadillac, as good as the day it first left Henry Leland's assembly line.

Davis worked out a deal whereby she did much of the work herself to hold down the cost. She spent her weekends sanding and cleaning woodwork and stripping those components she could handle physically. In addition, she logged more than 5000 miles of travel to locate missing parts, helped in the reassembly and probably knew more about the innards of a Cadillac, 1903 model at least, than any other woman in America.

More important, to Davis, there was another bonafide member of an ever-growing fraternity that owns and loves some of the most romantic machinery ever to roll down the pike. ***

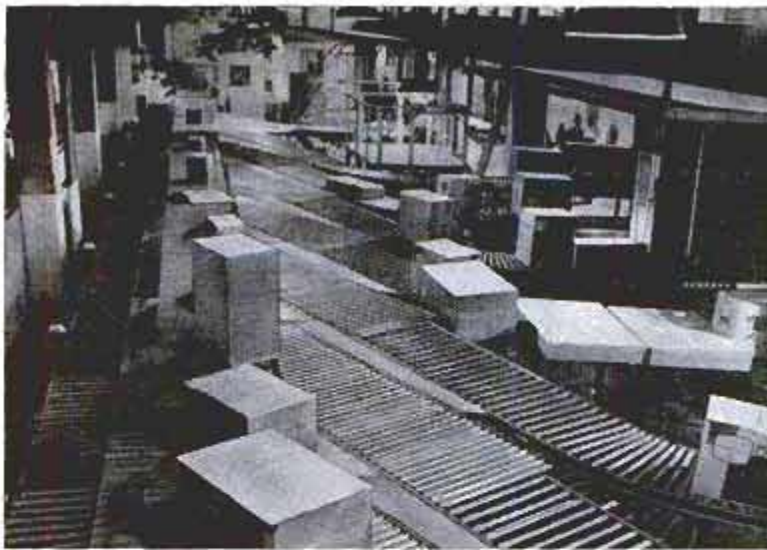

180-Foot Conveyor Measures and Sorts Packages

Packages are sorted for 15 different distribution points by electronic controls on a 180-foot-long conveyor of the Railway Express Agency at Long Island City, N.Y. A code letter representing one of the distribution points is marked on a package before it is placed on the conveyor. When the marked package passes a control booth, an operator pushes a key corresponding to the mark. At the same time, a battery of

photoelectric cells measures the length of the package. The information is relayed to a synchrotimer. At a synchronized time, as the package reaches the proper distribution line, a number of steel fingers guide the package to the line. The photograph at the left shows the boxes being guided along to the distribution lines. In the photograph at the right, an operator pushes keys corresponding to marks on the packages.



ELECTRIC POWER UNIT

With this Electric Power Unit you can run most any miniature thing. It will run a small car, train, power tools, erection sets, cranes, derricks, models, gadgets, etc.

It consists of electric motor, (flashlight battery operated) a clever wheel hub reducing mechanism for more power, a very tricky reversing electric spring switch, eyeleted arm for a thin cable, base, screws, nuts, wire, pulley, other parts, etc. Includes directions for easy assembly.

You can also make and operate such fun-giving gadgets as an automatic electric doughnut dunker, a floor drop picker-upper, an upstair-down stairs note carrier, a cat teaser, etc.

Send \$1.00 to Nelson Sales Co., Box 248C, Wellesley Hills 81, Mass. for this unit. No letter necessary. Just print plainly your name and address. MONEY BACK GUARANTEE. ORDER TODAY.



YELLOW JACKET UTILITY PUMP

USE FOR

- Cellars • Pits
- Cisterns • Ponds
- Basements • Sump Pits
- Wash Tubs
- Laundry Trays
- Irrigates Gardens
- Sprays
- Fill Tanks • Barrels
- Draw Well Water

\$8.95
Postpaid

PUMPS WATER FAST

DIRECT DRIVE OR PULLEY DRIVE

MONEY BACK GUARANTEE

Use 1/2 or 3/4 H.P. Motor

Stainless steel shaft—oilless bearing, cadmium plated screws, outlet can be positioned nine different ways. Send \$8.95 check or money order to:

SIoux CHIEF MFG. CO., INC.
41 Shawnee Ave., K. C., Kans.

FOR CHRISTMAS... GIVE A

Delta

ELECTRIC LANTERN

20 GREAT MODELS TO CHOOSE FROM. SEE YOUR HARDWARE OR SPORTING GOODS DEALER SOON.

Delta Electric Co.
Marion, Ind.



POWERlite

World-famous 6-volt electric lantern. Shoots 800-ft. spotlight from side — wide-spread floodlight from top. Made to last. **\$585**



POWER-KING

A 12-volt powerhouse Shoots a brilliant, far-reaching beam. **\$750** Adjustable head



FLASHING POWERTOP

Compact. Head swivels 180°. Bright spotlight. Flashing red top is visible for 1/2 mile. **\$595** 6-volt.

Prices do not include batteries



Delta LIGHTS THE WAY



GIVE
a
Happy
Christmas
through
The Salvation Army

CORNELIUS HIGH PRESSURE AIR COMPRESSOR

1500 - 2000 P.S.I.

Excellent For Filling Aqua Lungs, Air-Brush Work, Machine Shops, etc. 3 cylinder, 3 stage compressor, complete with 27 V. DC. 20 Amp. motor with fan. Rated 1500 P.S.I. continuous duty, 2000 P.S.I. intermittent. Includes Pressure Switch in Base. As released by Air Force in used, serviceable condition. Covered by our 30-day GUARANTEE. 11 1/2" L x 7" H x 9" W. Ship. Wght. 12 lbs. Lim- ited Offer. FOB CHGO. **22.50 EA.** High Pressure Air receiver Tank 12" L x 2 1/2" D. 4.00 High Pressure Air gauge 0-2500-11 1/2" D. 1.00



ITEM
549

SURPLUS BRAND NEW! BOLT & WIRE CUTTER

Exclusive: Extendable Handles for Extra Leverage

CADMIUM PLATED. Center cut type bolt cutter for soft or medium hard rods and bolts, alloy wire, and other metals. Cutting edge has equal bevel on each side for extra strength.

FOLDED—It fits into your pocket or tool box—safety latch locks closed when not in use. Capacities: medium hard bolts in thread 3/8"; medium hard metals 5/16". Length closed: 10 3/4"; extended 15 3/4".

A \$9.95 NOW 3.95 2 FOR VALUE ONLY PPD. \$7.00



ITEM
478

FREE, NEW CATALOG

VALUE-PACKED PAGES GALORE. Unsurpassed War Surplus and newly manufactured Equipment. Bargains for farm, home, factory, workshop. Write today.

GROBAN SUPPLY CO. (Dept. 1139 E. WABASH AVE. PM-12) CHICAGO 5, ILLINOIS

Six-Minute Ride Into Space

(Continued from page 74)

is in place of the small rudder and elevator sections you find on a conventional plane.

Guiding the X-15 through the fringes of the earth's atmospheric blanket will be no picnic for the pilot. Under the pressure of four or five g's, his arms will be like lead weights. He'd have trouble just lifting them, let alone making them move controls. So, while the ship thunders through its six-minute phase of incredible acceleration, the pilot won't need to use his arms at all. They'll be anchored by acceleration forces in form-fitting grooves on the armrests of his seat. He will manipulate aerodynamic controls of the ship by means of a "high-g stick" just off the end of his right armrest. Using only finger and wrist motion, he'll be able to guide the craft. A conventional stick for normal flight inside the atmosphere is in the usual center position. Outside the earth's atmosphere, even the "flying tail" will be useless, since there will be nothing for a rudder or elevator to "bite." Actually, once the ship moves into the near-vacuum of space, it will follow a true ballistic curve. But to keep it from tumbling end-over-end, or spinning around the X-15 has a unique system of small control jets.

A Fingertip Operation

Up forward, on the top and underside of the nose, one set of jets will counteract any tendency of the craft to pitch (up-and-down nose movement). Rolling will be controlled by upward-pointing jets in each wingtip. The tiny jets, fueled by hydrogen peroxide and a chemical catalyst that produces an explosively expanding vapor, will be controlled by means of finger switches perched atop a third stick off the pilot's left armrest.

Inside his tiny cockpit space, well forward in the nose of the craft, the pilot will have a spectacular view of sky and earth, even though the narrow confines of his pointed windshield and two tiny side lights present the smallest possible surface to the outdoors. Reason: His face will be unusually close to the high-temperature glass panels. In effect, the V-shaped panels will serve him like a giant pair of sun goggles. The entire windshield and canopy assembly are a single unit—hinged and jettisonable.

Actually, the pilot will have little time for earth-gazing. He'll be too busy watching instruments, making mental and visual observations as he thunders through sound barrier, thermal "thicket" and controllability barrier (region of hypersonic flight

(Continued to page 248)

Go Kart

has a new
4-color
brochure



fun on wheels - for everyone!

Send 25c for postage & handling to Go Kart Mfg. Co. Dept. PM-12, 152 E. Huntington Dr., Monrovia, Calif.

You can rely on products
advertised in PM



NEW · REVOLUTIONARY · EXCLUSIVE TO ALL CAR AND TRUCK OWNERS

The AC-ACon-O-Mizer

A New Device Vastly Superior to Any Fuel Pressure Regulator on the Market Today

- Provides greater fuel economy
- Minimizes flooding, stalling and fuel waste
- Gives correct fuel pressure at ALL Driving Speeds
- Incorporates a unique double diaphragm principle
- Has built-in acetone gasoline filter
- Insures smoother and more economical operation
- Fits both cars and trucks
- Easy to install

ORDER YOURS TODAY

CARBURETOR AND IGNITION COMPANY
199 W Englewood Ave., Englewood, N. J.

Name _____
Address _____
City _____ Zone _____ State _____
Make Car _____ Year _____
Model _____

For more economical and happier driving **\$9.90** only...
Send cash, check or M.O. — Full money back guarantee.

**now we're
getting
some place!**

We're making solid gains in the fight against cancer, in the research laboratory, in the hospital and in the home. Ten years ago medical knowledge was able to save only 1 in 4 lives — today it's saving 1 in 3.

New surgical techniques, diagnostic methods, and an informed public are important reasons for these gains.

More and more people have learned that many cancers are curable if detected in time. And, sensibly, more and more people have formed the life-saving habit of an annual health checkup. They know it's living insurance against cancer!

AMERICAN CANCER SOCIETY

FREE! LAFAYETTE'S

**1959
CATALOG**

260 GIANT-SIZED PAGES



CONTAINS

HUNDREDS OF EXCLUSIVE LAFAYETTE ITEMS NOT IN ANY OTHER CATALOG OR AVAILABLE FROM ANY OTHER SOURCE—SEND FOR YOUR COPY NOW!

See the newest and finest in Stereo Tuners, Amplifiers, Cartridges and Music Systems

Everything in Electronics

**The Complete Catalog
Featuring The Best Values
Obtainable**

• TAPE RECORDERS • PUBLIC ADDRESS SYSTEMS • AMATEUR EQUIPMENT • INDUSTRIAL SUPPLIES • RADIO & TV TUBES AND PARTS • INSTRUMENTS • TELESCOPES, BINOCULARS, MICROSCOPES & CAMERAS

LEADERS IN HI-FI

The most complete electronic supply catalog crammed full of everything electronic at our customary down-to-earth money-saving prices.

**OUR
38th**

The largest selection of hi-fi components and systems; greatest savings on Lafayette endorsed "best-buy" complete systems.

YEAR

**EASY PAY TERMS AVAILABLE —
10% DOWN — UP TO 18 MONTHS TO PAY**

**CUT OUT
AND PASTE
ON POST
CARD**

Lafayette Radio P. O. Box 511
JAMAICA 31, N. Y.
DEPT. LL

Send FREE LAFAYETTE Catalog 590

Name

Address

City..... Zone..... State.....

The NEWEST and FINEST: Buck's 400 Series



CHROME EDGE CHISELS

You get: ★ The Finest Cutting Edges
★ Tough Tenite II Handles
with Inserted Steel Caps
★ Rust Proof Tools

Plastic pocket Kit—
4 Sizes \$10.30

Most complete line of Chisels,
Gauges and Carving Tools

CATALOG AVAILABLE!

BUCK BROS. INC.
RIVERLIN WORKS MILLBURY, MASS.

1" \$2.90
3/4" \$2.70
1/2" \$2.40
1/4" \$2.30

\$47,983 IN ORDERS

FROM 12 WORD AD

Read This Amazing Story

Sounds like a fairy tale—but it's TRUE. It happened to an advertiser in Popular Mechanics Classified Section. Write for this amazing story NOW. It's free. F. W. JOHNSON, 202-CM E. Ontario St., Chicago 11, Ill.

INCREASE HOME VALUE—MAKE NEEDED IMPROVEMENTS NOW

HOW TO GET THOSE "BIG PROFIT" WELDING JOBS



(A) Shop Type Transformer

(B) Weld and Power Combination

(C) Home Work Shop Model

HOBART BROS. CO., Box M-128, Troy, Ohio, Phone FE 2-1223

Have a paying business of your own!

You're just a step away from a profitable welding business of your own. Hobart has just the unit for you—low cost—real money makers. Machines illustrated give you an idea of the wide selection to choose from. You can also build your own if you desire with a generator only and good used auto engine. Do top quality work right away—welding is in big demand throughout the country. Investigate today. Get complete information. No obligation.

✓ CHECK HERE

A B C

Build Your Own

Put name and address in margin of this ad and mail.

in which a plane's controls refuse to function normally and the aircraft may drop like a high-speed bullet). His control of fuel flow will be limited, to prevent him from accidentally exceeding human tolerance of thrust. Since most altitude and navigational instruments are useless at the speeds and heights that X-15 will pierce, the ship will carry inertial navigation: A triple-gyro stabilized platform that constantly maintains its position in space. Hooked to an electronic brain, this instrument will have cockpit "read out" dials that will tell the pilot at any instant of flight exactly where he is, the attitude of the ship, and his speed.

Strung along the flight course down on earth, a chain of radar stations dubbed "Project High Range" will telemeter every second of the flight. Instruments in the plane will tell ground observers where the flight is, how fast it's moving, whether it is flipping end-over-end, skidding sidewise or upside down. It will collect continuous temperature readings from 90 different parts of the ship, and keep tab of the pilot's breathing, heart action and pulse.

Protect Pilot From Heat

Aerodynamic heating, as the ship rockets through the earth's air envelope, has had plenty of attention from the X-15 designers—for protection of craft as well as pilot. The ship's skin and frame consist of the highest heat-resistant metals: Titanium, stainless steel and Inconel-X, a nickel alloy. Aluminum appears only where parts will not be subjected to the searing blast. More than 65 percent of the X-15 is welded; only 35 percent is riveted or bolt-fastened. All skins and sheets in the structure are chemically milled or "sculptured"—a new weight-saving method of using acid to remove excess metal from nonstressed members, giving it the appearance of broadloom carved in a free-form pattern.

"The X-15," according to North American's chief engineer, Harrison Storms, "will get as hot as an ordinary bedroom would with 80 floor-furnaces going full blast." Not only will the pilot's cabin be insulated against this heat, but liquid nitrogen, at 300 degrees below zero Fahrenheit, will circulate through the walls, and cool the electronic gear. The same frigid fluid will circulate through the pilot's suit, and pressurize it. Oxygen, supplied separately to the helmet, will be sealed off from the liquid frost.

Air Force experts point out that, in all probability, X-15's plunge through the thermal "reef" in the sky will be something like "passing your finger through a candle

flame." So quickly will the ship pass through this phase that metal-melting heat will have no time to work its softening destruction. But if anything should foul up—a too steep, too shallow, or off-kilter dive into the thermal barrier—the ship could start tumbling. If it did, at the scorching re-entry speed that X-15 will be traveling, the fantastic deceleration and the wildly flaying and whipping forces brought to bear would tear it to shreds in one explosive instant.

It'll Be Like Stone-Skipping

Current plans call for a "skip re-entry" in which the pilot will repeatedly bounce his craft off the top layers of atmosphere—like a flat stone skimmed across a pond—until its speed has diminished enough for a "cool" transit. But some experts believe the ship would build up far more sustained heat this way, which could not be dissipated during the bounces into space. The plane would get hotter and hotter on each successive dip.

There's no escape capsule in the X-15. Experts believe that the ship itself is a better protection to the pilot. Once powered flight ceases, the craft will be outside the atmosphere on a preordained trajectory. If he popped out in a capsule, the detached pilot would simply be in another vehicle following a similar path through space—in an even higher arc. Hence, X-15's pilot will just hang on until the ship has entered the atmosphere, where he can eject his seat at lower speeds that won't tear him apart. The X-15's ejection seat is equipped with stabilizing fins that tend to hold it upright and counteract rotational forces until the chute can be released. The pilot's suit is blastproof.

Can They Take It?

Can human beings take the kind of punishment that the X-15 will dish out? For more than a year, Crossfield, the 36-year-old former Navy flight instructor and father of five, and the other test pilots who'll follow him, have actually been "flying" the X-15 under startlingly realistic conditions in the Navy's human centrifuge at Johnsville, Pa.

There, on the end of a 50-foot arm, in a steel capsule fitted out exactly like the cockpit of the actual plane, each of these men has been whirled on dozens of flights into "space." The gigantic merry-go-round is spun by a 4000-horsepower motor. Dynamic controls, picking up pilot responses from the cockpit, change the speed, attitude or direction of the capsule on the end of the great arm, programming it through

(Continued to page 250)



DON'T THROW IT AWAY — FIX IT WITH

Plastic Steel[®] 80% STEEL

AS EASY TO USE AS MODELING CLAY. Hardens in two hours — holds permanently. Can be filed, sanded and painted. PLASTIC STEEL bonds iron, steel, brass, aluminum, wood, concrete, etc., to itself or each other.

LEAKING RADIATOR? — PLASTIC STEEL mends radiators, pipes, tanks and appliances in minutes. No special tools needed. Requires no heat or pressure — will harden under water.

CAR REPAIRS — Save money on auto repairs with PLASTIC STEEL. Fix torn fenders, cracked engine blocks, leaking gas tanks.

PLASTIC STEEL has a million uses around the home, garage or farm. 3 convenient home kits — 98c, \$1.89 and \$3.95 AT LEADING HARDWARE STORES.

DEVCON CORPORATION

175 ENDICOTT STREET, DANVERS, MASS.

WORLD WIDE SHORT WAVE RADIO



HEAR THE WORLD!—ANYTIME—ANYWHERE
Hear Europe, Africa, Russia, Australia, South America—ANYWHERE IN THE WORLD ANYTIME! Gets ALL foreign radio stations .55 mc. to 42 mc. Not much larger than a postcard—Wt. only 4 lbs! Gets regular American stations—All Radio Amateur bands—Ships at sea, Airplanes, Police, Citizens Radio—Most Everything! NOTHING LIKE THIS MIDGET ALL-WAVE RADIO ANYWHERE ELSE EVEN AT \$100.00! No AC plug-ins needed. Wonderful for home, traveling, scouting, Radio Amateurs—EVERYONE! YOU'LL HEAR THE WHOLE WORLD TALKING!

SEND ONLY \$5.00 (cash, ck, mo) and pay postman \$24.95 COD postage on arrival

or send \$29.95 for postpaid delivery. (USA only). COMPLETE WITH BUILT-IN SPEAKER AND DIE STAMPED METAL CABINET, pull-out antenna, all tubes, broadcast coil and set of self-contained, long life batteries. READY TO OPERATE! NOTHING ELSE TO BUY! GET YOUR WORLD WIDE MIDGET RADIO NOW! Guaranteed! AVAILABLE ONLY FROM: **WESTERN RADIO, Dept. BPM-12, KEARNEY, NEBR.**



American citizens are
better informed —
thanks to Advertising!



PHOTO COURTESY GENERAL DYNAMICS CORPORATION, ELECTRIC BOAT DIVISION

Aboard the Atom-Powered TRITON

Starrett[®] TOOLS

In the sea-going machine shop aboard the *Triton*, newest and largest atomic-powered submarine, STARRETT tools will help maintain this 447-foot, twin-reactored craft on long undersea voyages. Always the first choice of skilled craftsmen, STARRETT tools also helped set precision standards that made it possible for over 500 companies across the nation to contribute to the building and fitting out of the *Triton*.

Choose the right tools for your job or hobby from the complete line of Starrett mechanics' hand measuring tools and precision instruments, dial indicators, dial gages, steel rules, steel tapes, hacksaws, hole saws, band saws, band knives and precision ground die and flat stock.

Big New Catalog — FREE. Describes and illustrates over 3000 Starrett Tools. Send the coupon.



STARRETT TOOLS are carried by leading Industrial Supply Distributors and Hardware Tool Stores.

THE L. S. STARRETT COMPANY
Dept. AP, Athol, Mass., U. S. A.

Please send my free copy of the big new Starrett Catalog No. 27.

Name

Occupation

Address

City Zone State

SERVICE FOR YOUR B&D TOOLS



For genuine B&D repairs check Yellow Pages under "Tools-Electric" for address of nearby Black & Decker

FACTORY SERVICE BRANCH

Free tool inspection when requested • Genuine B&D parts used • Factory-trained technicians • Standard B&D Guarantee at completion of recommended repairs • Fast service, reasonable cost, always.

Or write for address of nearest of 48 branches to: *The Black & Decker Mfg. Co., Dept. S5012, Towson 4, Md.*

Black & Decker
QUALITY ELECTRIC TOOLS

SAVE 1/2 OR MORE

Build this six transistor portable radio

No other portable gives you so many features at such a low price: 4" x 6" speaker, 500 to 1000 hr. battery life, two-tone molded plastic case, plus high quality, all-transistor circuit.

\$29⁹⁵



IT'S EASY, FUN, EDUCATIONAL

No special tools or skills required. Clearly illustrated step-by-step instructions guarantee your success—and you learn about electronics the easy way—BY DOING!

SEND FOR FREE CATALOG

..... Describing nearly 100 other "do-it-yourself" HEATHKITS for hobby, hi-fi, ham radio or professional.



HEATH

pioneer in
"do-it-yourself"
electronics

COMPANY

BENTON HARBOR 17, MICH.



a subsidiary of Daystrom, Inc.

name _____

address _____

city & state _____

the entire flight profile that X-15 will follow on its reach into space.

Wearing the complete pressurized suit they'll don for the real thing, the men manipulate the same controls and watch the same instruments that the actual ship will have. They're subjected to the tremendous forces of takeoff acceleration, feel the haymaker punch in the midriff they'll get at rocket burnout, the quiet soaring through the silence of outer space, and the frightening oscillations they'll encounter on re-entering the atmosphere.

Pilots Can Black Out

In some of the tests, pilot error and sometimes emergency aircraft "malfunction" programmed into the "flight"—have led to exceeding human or aircraft tolerances, and the make-believe X-15 has "crashed," according to the computer, without harm to the pilot. On a few occasions pilots have blacked out under excessive g's.

Such simulated flights have led to important changes in the instrumentation and control structure of the actual plane. More important, according to one Navy official, X-15 pilots behind the controls on an actual flight will have the comfortable feeling that they're been there before.

What the real ship will prove, nobody knows yet. With few changes, according to the Air Force, X-15 could be put into orbit with a human crew—making it a true manned earth satellite. The Department of Defense has officially stated that the X-15 research vehicle is, indeed, one of several projects investigating manned space flight toward an ultimate goal—the highly secretive Project Dyna-Soar. This program, a contraction of "dynamic soaring," is a joint Air Force-industry project to develop a manned vehicle capable of circling the globe in two hours. It will be designed for use as a weapons system, bomber or reconnaissance vehicle. Circumnavigating earth in a true satellite orbit in outer space, it will be capable of coming back home at any time the crew decides its mission is accomplished. ★★

Enzyme Removes Hair From Animal Hides

Hair can be removed quickly from animal hides through use of an enzyme, according to the U.S. Department of Agriculture. The hides, after pretreatment in salt water, are soaked in an enzyme solution. This seems to affect a layer in the hide which helps to anchor the hair.



Pocket-Size Radar Alarm

Exposure to high-intensity radar beams can be avoided by use of a pocket-size radiation detector. A person wearing the device in the vicinity of airborne radar is given a warning through a hearing-aid-type earphone as he nears the transmitter.



Every \$1 sends a 22 lb. Food Crusade package to the world's hungry thru CARE, New York 16

Only a Ready-Cut
Liberty Home
offers you so much



Space. Quality. Beauty

Get more home for less money with a Liberty Ready-Cut Home. 57 exciting designs from \$2465 to \$7926. **Build it yourself or be your own contractor.** World's original manufacturer of Ready-Cut Homes **guarantees** you highest quality kiln-dried lumber machine-cut to exact size, all siding, shingles, hardware, paints, windows, doors, flooring, etc. . . . plus complete building plans. Save on labor, save on material and contracting costs. You pay no salesman or architects fees. **Write us today!**

Easy to Finance. As Little as \$150 Down
Materials Shipped Freight Prepaid.

Send 25c for
EXCITING 56-PAGE
COLOR CATALOG

Mail to: LIBERTY HOMES
1290 LAFAYETTE AVE.
BAY CITY, MICH.

NAME _____

ADDRESS _____

POWER TOOLS MAKE YOUR WORK EASY

DON'T COME UNGLUED!
use

Clarke's
PUSH-BUTTON
WHITE GLUE

Handiest glue to use.
Just push the button.
Extra-Strong Dries Clear!
Ideal for wood, paper,
china, etc.

Flamemaster Div. Dyna-Therm
Chem. Corp., Culver City, Calif.



FREE Tyler SPYRAL HACKSAW BLADE!

MAIL COUPON FOR FREE BLADE!

TYLER MFG. CO., INC., Dept. PM-12
1005 W. Arbor Vitae Ave., Inglewood, Calif.

Your Name _____

Address _____

City & State _____

Name & address of my Saw Dealer is: _____

Demonstrate for yourself why Tyler SPYRAL Hack-saw & Coping Saw Blades are America's number 1 choice for making precision & intricate CLEAN cuts of wood, metal, plastic, tubing, etc. Saw in circles, right or left, up or down. Available at your dealer. **OFFER LIMITED!** Since you will receive your FREE blade from your local dealer, you must fill out the coupon to the right & mail it to us. Offer is not valid unless you give us your name & address as well as that of your dealer. When dealer receives your FREE Tyler Blade, he will notify you by postcard.



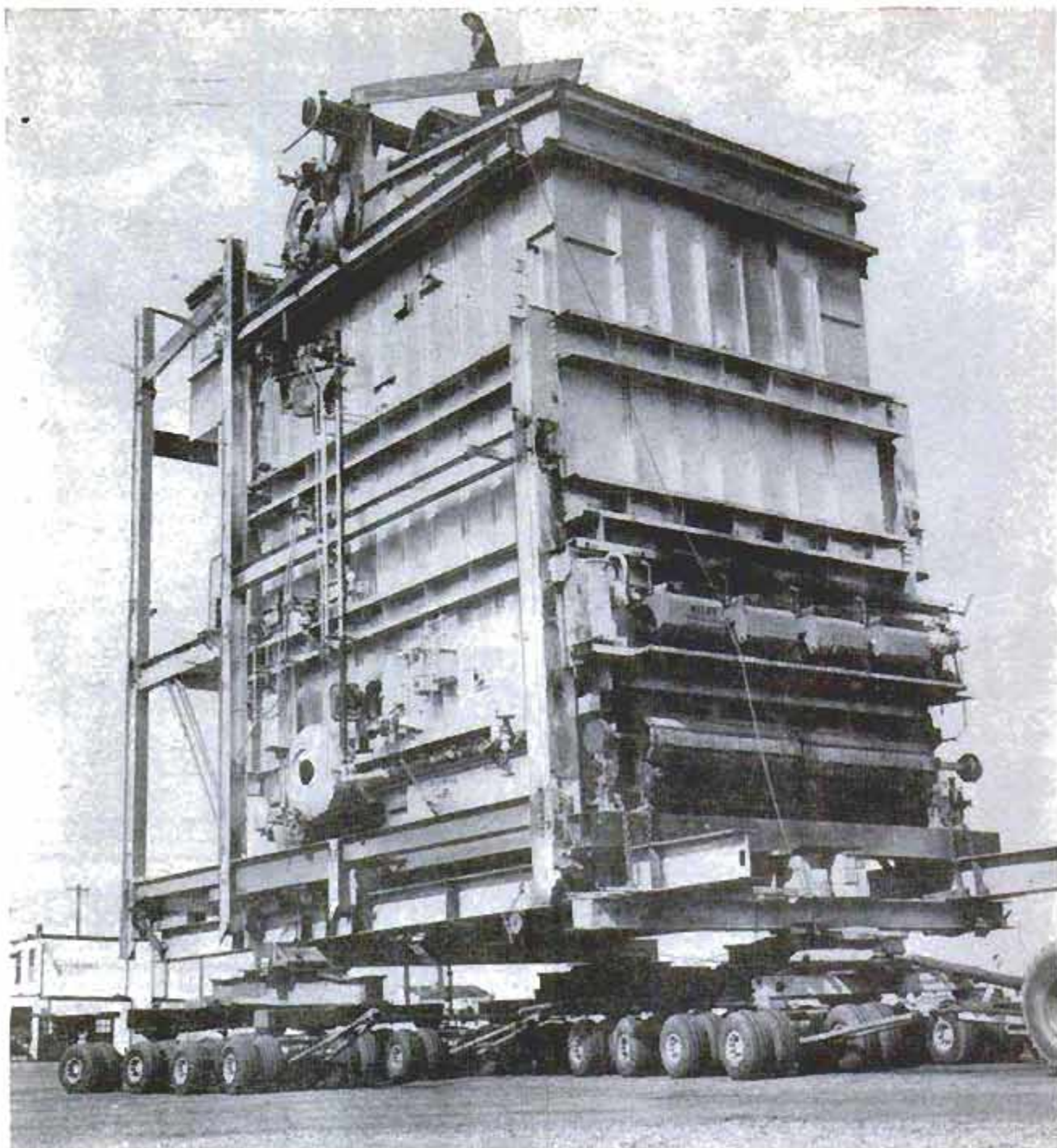

200-Ton Boiler Moved 26 Miles in One Piece

They said it couldn't be done—but engineers decided to try anyway, and succeeded in transporting the largest boiler ever moved in one piece. The boiler weighs 200 tons and was moved on 96 tires. As high as a three-story building and heavier than

100 automobiles, it was rolled 26 miles from one production area to another at the Atomic Energy Commission's plant at Hanford, Wash. Large boilers such as this are usually moved in pieces. The maneuver saved taxpayers \$200,000.

Three-Mile Hole in Sea Floor Will Show Earth's History

Scientists are planning to bore a three-mile hole in the ocean's floor to get a history of the earth from its very beginning. The drilling is to be done from an ocean-going vessel and is to penetrate through several layers of sediment, the basalt layer

and finally into the upper mantle. Study of samples obtained from the bore hole will replace speculation with facts about the earth's density, radioactivity, age, isotopic makeup and composition, bulk and mineral phases.



Snake River Dam Harnesses 360,000 Kilowatts

ELECTRICITY now streams into the Pacific Northwest from Brownlee Dam, a 360,000-kilowatt hydro project in the Hell's Canyon reach of the Snake River. The rock-fill embankment is at center, flanked

on the Idaho side, left, by a powerhouse and on the Oregon side by a concrete spillway. Upstream are costly migrant-fish facilities, first of their kind to conserve salmon and steelhead fingerling runs.

MODEL CHANGEOVER SALE! 1958 MODEL—BELOW COST!

8" TILT ARBOR SAW

BLADE TILTS—TABLE REMAINS LEVEL

Heavy duty all cast iron and steel construction. Precision ground cast iron table. Price includes massive cast iron mitre gauge and patented motor drive that fits any motor. Cross cuts, rips, bevels, mitres, dadoes, cuts compound angles — everything expected of saws costing four times as much. Depth of cut adjustable; 0" to 2 1/4" — table always level. Send check or M.O. \$2.00 deposits on C.O.D.'s.



SPECIAL BARGAIN — This saw is our 1958 model. Each saw is brand new — sent to you in factory sealed cartons. Sold and guaranteed direct from the factory to you at a fantastic bargain.

FREE 10 DAY TRIAL — MONEY BACK GUARANTEE

Try this famous saw 10 days. If you are not satisfied that it does the work of any tilt arbor saw, regardless of price, return for immediate money back refund.

Sent Express Collect.

We reserve right to refund money if stock is exhausted

AMERICAN MACHINE & TOOL CO.
ROYERSFORD 59, PA.

ALSO NEW LAPSTRAKE KITS

U-MAK-IT BOAT KITS

FIRST AND OLDEST
KIT BOAT
MANUFACTURER

Most complete line of PRAMS,
ROWBOATS, OUTBOARDS, CABIN
CRUISERS and new Lapstroke kits.

MAIL 35c (coin) for post. & hdlg.
for ILLUSTRATED CATALOG

Showing all models 8' to 23'
including accessories, paints, etc.

All you need to build
your own.

U-MAK-IT PRODUCTS
DELAND, FLA.— DEPT. 12



BANKAR

auto vault

PROTECT MONEY

and valuables while traveling. Ideal
for salesmen, doctors, construction
workers and trailer owners.

Send for FREE
Folder TODAY!

BANKAR CO., 1220 Broadway, Oakland 12, Calif.

Name _____

Address _____

City _____

State _____

What We're Doing About Air Safety

(Continued from page 69)

consideration to the application of color radar. However, I'd rather focus on the other part of the question, specifically 3-D radar. 3-D radar is one of our highest priority programs. Unless we can develop 3-D radar for application to the terminal problem — the airport problem — the possibilities of solving that problem are very dim. 3-D radar is a must to us. The military establishment has spent a vast sum of money on the development of 3-D radar, with modest success. When I say modest success, I mean that as a compliment, because the technical complexities of 3-D radar are terrific. The military's effort in the development of 3-D radar has been focused on surveillance at extreme ranges up to 200 to 300 miles. Our requirement is up to 50 to 75 miles. Right away when you reduce the range requirement from 300 to 75 miles, you reduce the complexities to about one tenth of those that confront the military establishment. Hence our problem is going to be materially easier. We hope that we can develop one of their programs, or conceivably two, to a conclusion to solve our problem.

Q: Why is the development of 3-D radar so vital?

MR. QUESADA: Radar now gives us only range and azimuth. This is really of little use to us. There are so many targets in the terminal area that the data which radar now gives us adds to the confusion rather than solving it, at least to some extent. We very often, for example, assume that there is a conflict between two planes because they are on the same azimuth and appear to be on the same range, when in fact they may be 10,000 feet apart. One could be at 10,000 feet altitude and the other at 20,000 feet, and there is no conflict at all. But we cannot determine that with existing radar. So, as I said before, this adds to the confusion. 3-D radar in the terminal area would give you the range, azimuth and altitude thus permitting you to solve the problems of air-traffic management intelligently rather than intuitively.

Q: What is the recently announced HIDAN system?

MR. QUESADA: HIDAN, developed by General Precision Laboratory, is airborne equipment. As a matter of fact, I have flown an aircraft equipped with it. I was very pleased with its potential. Its fundamental purpose is to give you an accurate reading at all times of the speed at which you are traveling, how far you have progressed along your track, your position in respect

(Continued to page 256)

SURPLUS SALE

GOVT. SURPLUS
EXCESS INVENTORY
BANKRUPT STOCK

ELECTRIC & GOLF CAR MOTOR



• Powerful Govt. gear reduction motor. Make self, boys, invalids electric car. Go anywhere, fast, efficient. Reversible. Runs on 6 or 12 volt battery.
Cost \$205. Wt. 37 lbs. SALE...\$15.72 FOB

DIAL PHONE



• Modern hi-efficiency attractive dial phone. Use for extension to main line on private system. Use several for complete private system, etc. Complete with ringer, dial, etc. Work on any system. Govt. cost \$25.00. SALE...\$9.95 Ppd.

AIR COMPRESSOR BARGAINS



For painting, cleaning, tires, control terminals. Assemble your own outfit. Lowest prices in U.S.



• DeLuxe Kit. Compressor, tank, gauge, regulator, paint gun, relief valve, fittings, hose, instructions. Wt. 34 lbs. List \$52. SALE...\$39.49 FOB

• Air Components. Compressor 1-cyl. \$19.95; Air tank, \$8.79; Regulator \$3.95; Pop-off \$1.95; Press. Gauge \$1.89; Finest Paint Gun \$11.95; Auto Switch \$4.75. All Ppd. in U. S.

ARMY POWER PLANTS

• Marvelous buys in new condition Govt. surplus plants and generators. All FOB Lincoln.



• 1000-w, 115-v, 60-c... \$169.72
• 2500-w, 115-v, 60-c... 269.00
• 3500-w, 115/230-v... 298.50
• 3000-w, 115-v, DC Gen. 49.50
• 2000-w, 115-v, AC Gen. 99.70
• 5000-w, 115-v, AC Gen. 291.50

HYDRAULIC EQUIPMENT BARGAINS

Savings to 80%. Build loaders, diggers, presses, etc. All brand new.

• Blackhawk Hand Hyd. System \$23.95 FOB
• Control Valve, 1 or 2 way... 18.00 Ppd.
• Tractor Pump 1000 psi, 12 gpm 45.50 Ppd.
• 12-v Motor & Pump 1000 psi... 13.95 FOB
• 2-Way Cyl. 1 1/2" bore 6" stroke 4.80 Ppd.
Other types, sizes and items. Free catalog

STORAGE BATTERY WINCH

• Powerful fully reversible, ball-bearing gear reduction winch. 1000-2000 lb. pull. Use on 6 or 12-v battery. Holds 40' of 1/4" cable. For trucks, docks, boats. Wt. 34 lbs. Govt. cost \$280. SALE...\$46.75 FOB



GEAR REDUCTION POWER MULTIPLIER

• The most versatile and useful power device we have ever handled. Has tremendous torque. Drive with any fractional horsepower AC or DC motor. Consists of gear unit and motor mtr. base. Output speed 3 to 10 RPM depending on size motor pulley.
• Makes wonderful wagon unloader, moving belt conveyor, grain auger, dock winch, grindstone drive, etc. Wt. 42 lbs. Govt. cost of gears over \$200. SALE...\$29.79 FOB

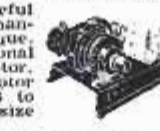

FURNACE BLOWER & MOTOR

• Brand new, motor and blower in a single self-contained unit. Ideal for heating, ventilating and air conditioning uses.
• 115-v, 60-c motor with double inlet blower wheel. Displaces 725 cfm at 800 rpm. 7" diameter blower, 7 7/8" x 3 1/4" overall dim. 13" x 10 1/2" x 2 1/4". Wt. 23 lbs. List price \$40.75. SALE...\$24.95 FOB



115-V AC and 30-V DC GENERATOR

• Air Corp ball bearing unit. Puts out 115-v, 1500-w, 800 cycle. AC and 30-v, 75 amp DC.
• Makes good small welder, battery charger or will furnish 115-v for lights, stove, iron, etc. Size 6"x9"x15". Wt. 50 lbs. Full instructions. Govt. cost over \$200. SALE...\$17.67 FOB



HYDRAULIC SPEED REDUCER

• Variable hydraulic speed reducer. Any speed from 0 to 750 rpm by simply throwing a lever. Handle up to 1 1/2 h.p. Use for midret cars, shop band saws, etc. Govt. cost \$400. SPECIAL...\$47.81 FOB



SPECIAL OF THE MONTH!

G. E. TELECHRON CLOCK SWITCH

• Marvelous automatic clock-timer switch will turn appliances, heaters, radios, TV's, air conditioners, pumps and electric signs on and off at any pre-set time.
• Clock can be set to skip any day or days of the week. For example, Sat. or Sun. or 2-day week-end.
• Finest telechron motor will run on either 110 or 220-volt 60-cycle. Switch contacts will handle up to 15 amperes on either 110 or 220-volts. Original cost \$13.50. SALE...\$4.97 Ppd.



OUTBOARD MOTORS

• Dealer's overstock brand new original outboards, leading make Scott outboards. Late 1957 and 1958 models. Full features. Factory guarantee. Limited quantity. 30% discount from Natl. Adv. List prices.

• Sizes available 3.6 hp, 5 hp, 7 1/2 hp, 10 hp and 22 hp. Brand new, original cartons.

GEAR SPEED REDUCER

• 80-to-1 gear reduction unit. 8 roller bearings, multiple gears. Reduces standard motor to 21 rpm—increases torque. Shafts 3/8" input, 1 1/4" output. Power winches, revolving signs, door openers, etc. Govt. cost \$66. SALE...\$8.49 Ppd.



SURPLUS WATER HOSE

• Marvelous buy now 20-ft. lengths, 1 1/4" diam. (inside) with threaded pipe nipples. Stand pressure to 75 lbs. Wt. 12 lbs. List \$18.50. SALE...\$7.69 Ppd.



IRRIGATION PUMPS

• 2 1/2", 16,500 gph. Centrifugal. All bronze ball bearing. New, 39 lbs. Govt. cost \$101. SALE...\$49.50 FOB
Also 1 1/2" 6000 g.p.m. pump. Govt. cost \$62.50. SALE...\$24.61 Ppd.



Order from ad or get new 1959 catalog.
BURDEN SALES COMPANY
814 West "O" St., LINCOLN, NEBR.

Help Fight TB



Buy Christmas Seals



TEST Circuits, Fuses, Outlets easily, quickly, safely. Shockproof. Pull fuses 10 to 100 Amp.
THE GIFT SUPREME FOR CHRISTMAS

TEST-PLIERS

STAR FUSE CO., 233 Canal St., New York 13, N. Y.

NEW MAGIC RADIO WALKIE TALKIE!



YOUR OWN POCKET SIZE RADIO STATION! BROADCASTS TO ANY HOME OR CAR RADIO WITHOUT WIRES OR HOOKUPS! Wt. only 5 oz. Telescoping antenna. Powerful Translator—microphone, break-in switch! Runs for weeks on self-contained flashlight batteries. Durable plastic case. With this Radio Talkie you CAN TALK TO YOUR FRIENDS UP TO A BLOCK OR MORE AWAY!—Or talk between cars! INSTANT OPERATION! Just push button to talk! **NO LICENSE NEEDED.** Uses inductive field magnetic radiation. Useful and real fun in a million ways! GUARANTEED TO WORK. 1 YEAR SERVICE GUARANTEE.
SEND ONLY \$3.00 (cash, ck, mo) and pay postman \$9.98 COD postage or send \$12.99 for prepaid delivery. COMPLETE READY TO OPERATE with instructions and hundreds of ways and tricks for broadcasts thru any radio you desire. Price may go up soon, so get your NEW POWERFUL RADIO WALKIE TALKIE NOW. Available only from: **WESTERN RADIO, Dept. RPM-12, KEARNEY, NEBR.**

you can always BE SURE OF A JOB

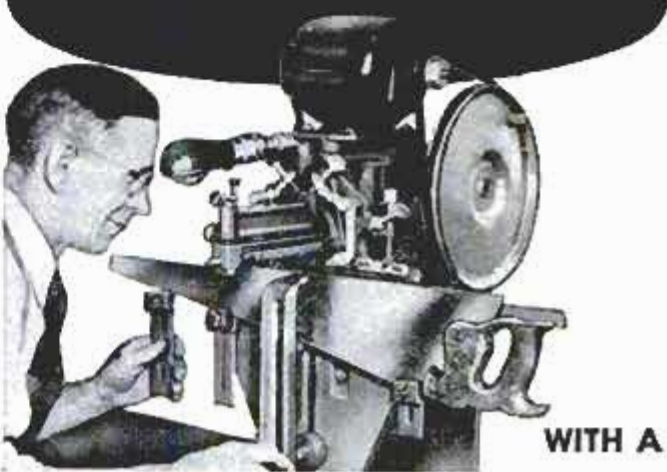

WITH A FOLEY SAW FILER

Have you been laid off—or afraid you may be? If you want security, plus a bigger income too—don't look for a job—start your own spare time business. In his first 2 months J. P. Robitaille earned \$300 with his Foley Saw Filer. From his starting day R. T. Hart made \$600 in 4 months. Frank P. Layne wrote—"In our town of 2,800 instead of 200 to 300 saws I did over 1,500 the first year, averaging about \$1.50 each."

FREE booklet "MONEY MAKING FACTS" shows you how to get business. The Foley sharpens hand, band and circular saws. Use our Time Payment Plan—pay for the machine out of your CASH profits. Send coupon today—no obligation, and no salesman will call.

FOLEY MFG. CO., 1243-B Foley Bldg., Minneapolis 18, Minn.
Send Free Booklet and Time Payment Plan on Foley Saw Filer.
Name _____
Address _____
City _____ State _____



to a track that you have predetermined as desirable.

Q: Does the equipment automatically transmit this information to the ground?

MR. QUESADA: No, it doesn't. It is information that would be airborne; it could be transmitted to the ground but the equipment as I observed it did not include a communications system between air and ground.

Q: You think this may well be a valuable piece of equipment?

MR. QUESADA: It offers a great deal of promise.

Q: The CAA recently announced three superairways. How are they working out?

MR. QUESADA: Oh, I understand they are working out quite well.

Q: Does this mean, then, that we will have more of these superairways?

MR. QUESADA: It is definitely planned that this philosophy will be extended to other areas and particularly on the north-to-south traffic arteries. The application of so-called "express highways" is an immediate solution and an immediate help to our current problems. I would like to make it clear that I would visualize a system that would eventually permit us to abolish airways completely. It won't happen for at least 10 years.

Q: What are the new jets going to mean in terms of the airport itself? Must runways be longer?

MR. QUESADA: The runway requirement for jets is somewhat over the existing runway requirements. However, most of the cities where jet operations are contemplated in the immediate future have runways able to accommodate jet transports. There are some other problems that are equally as pressing and please don't think that the runway problem is not a pressing one. But there are others, too. Ground handling equipment is one. There is just no doubt but that certain communities, which logic says should be served by jets, must expand their airport facilities. But the major hubs now are adequate for them.

Q: Are you doing any work on the noise problems of jet airports?

MR. QUESADA: No, we are not. The National Advisory Committee for Aeronautics has a very extensive program in this area. I guess their program runs into many millions of dollars. It is not our intention to duplicate it even if we could. But at the present time we could never compete with their skill in this area. Likewise the various companies, Boeing and Douglas to my certain knowledge, are spending a great deal of money, all of which is their own, and a great deal of time, in

noise-abatement programs on the ground. They know they must do something in order to sell their product. They are having some success.

Q: Getting back to runways for a moment, what are high-speed turnoffs? Are they of help? Are they safe?

MR. QUESADA: The high-speed turnoff program was one of the AMB's first programs with tangible results. High-speed turnoffs are essential to modern airport operations. If you can get the airplane off the runway in 20 to 40 seconds, it is clear that it is a vast improvement over getting the airplane off the runway in 60 to 70 seconds.

Q: It is a clear runway, and not a clear "gate" that counts?

MR. QUESADA: It is getting the airplane off the runway in order that another airplane can use it. Now you must understand that much of our stacking in the vicinity of the airport is because we can't bring in the planes fast enough. If we can reduce the time on the runway of any one plane, it is clear then that we can increase the speed at which we can bring them in and we then reduce the stacking. The high-speed turnoff is not dangerous, certainly, unless it is misapplied. We have made actual measurements that will indicate at what speeds certain planes can turn off. For example, according to our calculations based on the Boeing KC-135 measurements, that aircraft should be able to turn off the runway at 4900 feet from the touchdown spot and at speed of 60 miles per hour, under typical, average flight conditions. The results of the high-speed program are now being applied at Idlewild.

Q: What other AMB research is in the works?

MR. QUESADA: We are in the act of purchasing a TV-type runway simulator as a means of developing visual aids, and it will go into our experimental center within a matter of months. It will permit us to simulate and test various configurations of approach and runway lighting, runway marking, things like that.

Q: Speaking of lighting, are there any new developments there?

MR. QUESADA: Yes. A great deal of effort has gone into runway lighting. The Washington airport has one of the most advanced runway-lighting systems in the country if not the world. I understand it is turning out to be quite successful. There are several other programs under way. As a matter of fact, a couple of men from the AMB are going to Europe to look at some systems over there. We ourselves have developed a device that offers some promise.

(Continued to page 258)



Colorado A & M College photo

Funnel Dispenses Poison Bait

Farmers and stockmen on Western range lands have a new weapon in their fight against pocket gophers. A new funnel-shaped container dispenses poison bait into gopher tunnels. The operator thrusts a probe on the container into the ground near a fresh mound until it drops into a tunnel.

PAINT MIXED Any Color



Specially mixed brushing lacquer (not an automobile paint). Your choice—outside paint—flat paint—semi-gloss or gloss enamel. ONLY \$6.55 per gallon—\$2.50 per quart postpaid. No C.O.D.s. Send check with order and sample of paint to be matched (not cloth).

GILL PAINT FACTORY

Established 1900
Box 271 Wisconsin Rapids, Wisconsin

WAR SURPLUS

GADGETEERS — ENGINEERS — R&D LABS.

30 Pages of U. S. Govt. surplus Radio, Radar, Aerial Photo, Electronic Test equip., Microphones, Head sets, Armament, Instruments. PAGE AFTER PAGE OF FANTASTIC SAVINGS.

SEMLER INDUSTRIES, INC. **25c**
6919 LANKERSHIM BLVD.
NORTH HOLLYWOOD, CALIF. Send Today



PROTECT YOUR CAR WITH

Latest and best automotive products
—you'll find them advertised in PM.

NEW Remington POWER DRILL GIFT KITS



One of these gift kits featuring Remington's Model 149DL de luxe 1/4" drill—unmatched in its price class for power and styling—is right to give or receive this Christmas.

K-2. Drill and 9 high-speed drill bits...only \$32.45.*

K-3. Drill with rubber backing pad, adapter, polishing bonnet, sanding discs plus 9 high-speed drill bits... only \$34.45.*

K-4. Drill and jig-saw attachment... only \$49.90.*

See these fine kits at your dealer's now. Remington Arms Company, Inc., Bridgeport 2, Connecticut—famous for quality since 1816.



*Prices and specifications subject to change without notice. Prices slightly higher in Canada.

FREE! NEW fully illustrated catalog of Remington drills, saws, sanders and other power tools. Send coupon today.

Remington Arms Company, Inc., Bridgeport 2, Conn. PM-12

NAME _____

ADDRESS _____

CITY _____ ZONE _____ STATE _____

HAVE FUN!

SAVE MONEY



TRY SUPERSHOP FREE
Factory To You — \$79.95

Think of the fun you'll have and the money you'll save with your own big capacity workshop. Picture yourself sawing with the 8" ball bearing saw. Or drilling in steel with the vertical drill press. You bore with the horizontal drill — exclusive with SUPERSHOP. You sand with the 8" disc sander. You turn with the 30" lathe. You sharpen tools on the 5" grinder.



VERTICAL DRILL PRESS

You are invited to TRY SUPERSHOP FREE. We will pay all shipping expense. Write for full details of this amazing FREE TRIAL PLAN. Mail postcard now.

Power Tools Division • **114 Yates Ave.**
UNITED INDUSTRIES, Inc. **Beloit, Wis.**

NEW
 Universal - Positioning
TOOL HOLDER

\$1495
 Freight Paid

SPECIFY CUTTER SIZE AND TOOL POST OPENING WHEN ORDERING

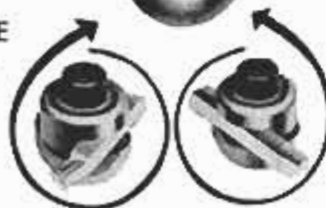

Makes Your Lathe More Versatile

- Holds square or round tool bits or boring bars (carbide tip or high-speed steel) $\frac{3}{16}$ " to $\frac{3}{8}$ " in ANY horizontal position in a complete circle.
- Does the work of at least six old-fashioned fixed position holders and eliminates having separate holders for each type cutter.
- Rotating clamping cap and forged shank hold tool in perfect grip, no chatter when cutting.

AA-8858

MAXWELL INDUSTRIES, INC.
 493 East 5th Avenue • Ashtabula, Ohio

It is quite simple and quite inexpensive. It consists of a flat light that is easily attached to a runway and permits the airplane to run over it.

Q: Run over the light?

MR. QUESADA: Run right over the light without damage to it. However, I don't want to appear to be too optimistic on this. Only tests will prove whether this is applicable. The CAA system as applied to Washington has certainly proved to be helpful.

Q: Looking a little bit into the future, what in your estimation would be the best possible system of traffic control? Will EVERY plane be under control? If so, what type of equipment can we look for?

MR. QUESADA: I think that it is within the state of the art to provide a traffic control system that will be applicable to the vast majority of our aircraft and will eventually permit takeoff at random and control thereafter in an automatic or semi-automatic manner. It will be conflict-free and will permit an aircraft to fly to its destination on the shortest possible course and while en route be reasonably assured that other aircraft which are likewise flying from point to point on the shortest possible course, are managed in a manner that permits each to proceed without interruption to the other. However, it is clear that a system such as this will require all aircraft—all users of our airspace—to cooperate and respond to directions.

Q: This applies to private planes?

MR. QUESADA: Including private planes. When conflict occurs, the system will solve it by giving or directing a new course to one of the aircraft in conflict, or both. I visualize that the terminal area will eventually reach a degree of sophistication that permits semiautomatic approaches to touchdown in a very, very rapid order. It will eliminate, if not completely, almost completely, any necessity for delays or stacking.

Q: Does this presuppose that humans are NOT involved in giving the necessary orders?

MR. QUESADA: Humans will be involved. The power of decision will be theirs.

Q: You think this is important?

MR. QUESADA: Highly important.

Q: The system could not be operated satisfactorily without human intervention?

MR. QUESADA: No it couldn't. ★ ★ ★

Ⓢ Synthetic lubricant to be used by the airlines in jet operations costs two dollars per quart, and 8.4 gallons of it will ride from New York to Paris on a four-engined, 575-mile-per-hour Boeing 707 Jet Clipper.

WAR SURPLUS AND OTHER **SAVE UP TO 90%**

USE YOUR CAR, TRUCK, BOAT FOR MOBILE AC POWER SUPPLY

110 V. 60 cycle AC Gen. 3600 RPM. This versatile generator can be adapted to any engine. Carry your own AC power wherever you go on land or sea. Great for contractors, farmers, fire dept., Civil Defense, wherever emergency AC power is desired. Rugged construction. Tremendous overload capacity. Dual plug-in receptacles, mounts quickly and easily on engine and is driven from fan belt. Both units supplied with dash mount type control panel—with light and voltmeter. Also included is remote control cable and all mounting brackets. NEW. 100% guaranteed.

Model A-2 — 1350 watt — \$ 99.50
Model A-3 — 2500 watt — \$129.50



FAMOUS NAVY MK14 AIR COMPRESSOR

Great for tree, termite, airbrush & paint spraying; filling tires, aquariums, etc. Dual & remote control electric receptacles. 115v 80 cycle AC, heavy duty HP. Westinghouse Motor. Direct drive. Water & explosion-proof. Built-in air filter, adjustable pressure setting up to 47 lbs. 3 cu. ft. per min. Self-contained switch. Mounting brackets. These units made under license of Sperry Gyroscope Co. Wt. 66 lbs. gross. Approx. GOVT. COST \$585. Like NEW. \$21.95.

With portable steel hand cart (shown), rubber wheels, specially constructed for mounting this unit. Incl. 25' rubber air hose, 6' extension cord with plug & fittings. Wt. 76 lbs. Complete with cart—\$26.95.

With new internal pressure spray gun with 3 adjustable spray tips. 1 qt. cap. \$33.95 complete.

"DELUXE 11" ARC WELDING KIT

Consists of 160-250 AMP Gen., voltage reg., ammeter, shunt, adjustable helmet, electrode holder, pr. welder's gloves, 30' welding cable, reactor coil, giant toggle switch, rheostat. Approx. GOVT. COST \$650. All units guaranteed pre-tested. \$34.95 complete.



"SUPER 9" 200 AMP WELDING KIT

With Deluxe accessories consisting of one 200 AMP Gen., adjustable helmet, electrode holder, 30' welding cable, rheostat, giant toggle switch, voltmeter, voltage reg., 1 pr. heavy-duty welder's gloves. All units guaranteed pre-tested. Approx. GOVT. COST \$500. Most items new—all perfect. \$26.00.



WELDING CABLE DOUBLE-O, heavy duty, neoprene jacket, fiberglass insulation. NEW. Approx. GOVT. COST \$40. Will handle 400 amps. or better. 50' lengths \$14.50. 100' lengths \$26.00.

NEW! Welding Reactor for above kits. 200 Amp. cap. or better. NEW. \$7.95.

140-1 REDUCTION GEAR For beaching boats, winches, hoists. Ideal for motor in golf or boy's electric car. DC motor & clutch. Easily reversible wiring diagram furnished. Hi torque, 1st speed. Runs on 6-12 or 24 V. Wt. 65 lbs. gross. Approx. GOVT. COST \$300. Like NEW. \$12.00. Matched splined gear for above—\$3.00 ea. *225-1 Reduction Gear—\$13.50



11 PIECE CROWFOOT WRENCH SETS

Wrenches snap onto T-bar in 3 different positions. The only wrenches for hard-to-get-to places. Mfd. by Plomb Tool Co. for U.S. Armed Forces. Finest case hardened tool steel. No shop mechanic should be without this set. Approx. GOVT. COST \$47. NEW. \$5.95 ppd.

REVERSIBLE RATCHET WRENCH

Hi torque. Delivers tremendous leverage. 4' handle with reversible ratchet. 4 hexagon nut sockets, 2 3/8", 2 9/16" & 3 1/8". Mfd. by Lowell. Approx. GOVT. COST \$215 per set. Wt. 50 lbs. NEW. Only \$9.95 per set.



WOOD PROPELLER

Genuine rock maple radio drone "prop." perfect for den, trophy room, boy's room. Smooth, highly varnished, 30" tip to tip. Clock, barometer or photo can be inserted easily into center (mounting holes provided). Can use to operate ice sleds, etc. Approx. GOVT. COST \$57. NEW. \$4.95 ppd.

SPECIAL ON \$4770 NAVY AIR-COOLED POWER UNITS

Tremendous power package. Can be used as a portable or stationary unit. Makes terrific welder. 30D-1A Lawrence, 24V. 2 Cylinder opposed 4 cycle 10 1/2 H.P. Complete with various generators. Net wt. 180 lbs. Gross wt. 250 lbs. Like NEW. With 140 Amp, 24 V. Gen. — \$125. With 200 Amp. Gen. — \$137.50. With AC-DC NEAs, DC side 24 V., 200 Amps; AC side 10.5 Amps. 800 cycle — \$142.50. 300 Amp. Gen. — \$142.50. Engine only \$127.50.

BENDIX GEROTOR PUMP & MOTOR

Use wherever fluid pumping required. Excellent for hydraulic installations. Has 3/4" pipe connections. Built-in relief valve adjustable up to 1500 lbs. Max. cap. 6 GPM. 1 1/2 H.P., 24 V. motor. Use on 12 to 36 V. Approx. GOVT. COST \$30. NEW \$10.95.



MICROMETERS

Black crackle finish frame. Easy-to-read graduations in .001. NEW. 0-1" cap. \$2.69 ppd. 1-2" cap. \$3.79 ppd.

NEW! 1959 CATALOG! BIGGER & BETTER THAN EVER... 971 price cuts, 1000's of bargains in war surplus & other items! 100's of pictures! Send 25c in coin for your copy today! Ppd. prices USA only. Other prices FOB Culver City, Calif. Send cash, check or money order. 50% deposit on COD.

AIRBORNE SALES CO., INC. DEPT. PM 1258
8501 Stellar Drive, Culver City, Calif.

ONE BIT FOR ALL

Handiest drill bit made. Use on any electric drill, lathe, drill press, etc. Made of finest American hi-speed steel. 3 1/2" long, 1/2" diameter. Has 2" side-cutting section. Cuts steel, wood, plastic, aluminum, etc. 3 types—specify types wanted. (1) All purpose, (2) Wood, (3) Heavy metal. \$2.45 each—3 for \$7.00—Postpaid. Money back guaranteed. Buy from your dealer or send check or Money Order and name of favorite tool dealer TODAY. (Makes ideal gift.)

... DRILL
SAW • REAM
CUT



**BEAVER
HI-SPEED-SAW
DRILL BITS**

Jobber & Dealer
Inquiries Invited

BEAVER DRILL & TOOL CO., 3008-J McGee Trafficway, Kansas City, Mo.

MAKE A FOLDING TABLE, DESK, COUNTER or WORK BENCH with FOLDAWAY BRACKETS

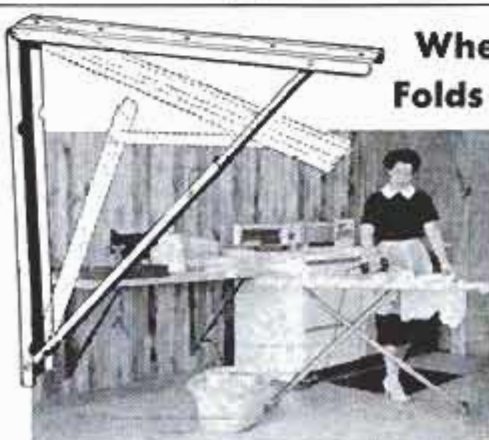

When Not in Use Folds Away Against the Wall

Now you can install that extra table any place... quickly, easily, without sacrificing valuable space... with KANT-SAG FOLDAWAY Brackets. Easy to mount on any wall, brackets fit any wood top from 24" x 32" to 32" x 80". Complete with hardware and instructions, brackets have brown crackle finish, built-in safety lock and support over 600 lbs. static load.

TO MAKE AMERICA'S MOST VERSATILE TABLE

Order your FOLDAWAY Brackets today!
\$9.95 pair, ppd.
(Top Not Included)

Prompt Shipment... Money Back Guarantee
Send check or money order to:

UNITED STEEL PRODUCTS CO.
DEPT. P-13
P.O. Box 6570, Minneapolis 20, Minn.

- A Few of the Popular Uses:
- Hobby Table
 - Laundry Counter
 - Repair Bench
 - Study Desk
 - Snack Bar
 - Sewing Center

thrills excitement

PERHAPS A CAREER!

POPULAR
MECHANICS

There's Adventure BOOKS

SEND YOUNG MINDS
SOARING INTO THE
AMAZING REALM
OF SCIENCE

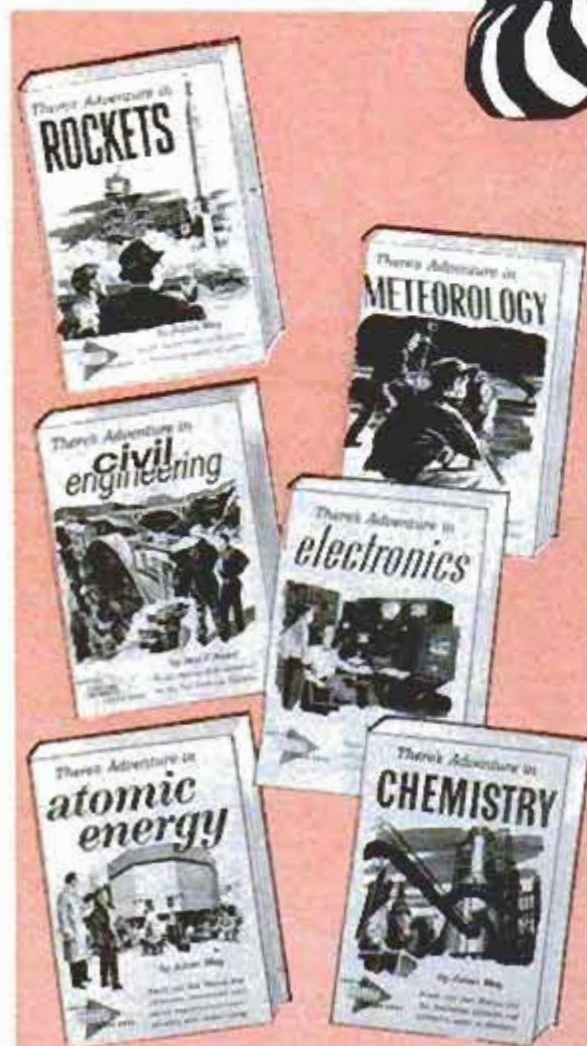

IMPORTANT TO THE CHILD . . . TO AMERICA . . .
TO THE FREE WORLD. Prefaces by outstanding
experts. Each book contains exciting
experiments for boys 11-17.

Now any boy can find fascinating fun (and a career, too) in the wonderful world of Science! . . .

- **There's Adventure in ROCKETS.** Rockets . . . headline news today and tomorrow . . . capture the imaginations of American boys. Here, in thrilling fiction style, facts about careers in rocket and missile engineering are accurately described. Illustrated. 170 pps. . . . **\$2.95**
- **There's Adventure in METEOROLOGY.** Where does weather originate? What causes weather phenomena? How are long-range forecasts made? Young Sam and Randy Morrow learn the exciting answers, discover adventure in Meteorology. Illustrated. 170 pps. . . . **\$2.95**
- **There's Adventure in CIVIL ENGINEERING.** What boy doesn't enjoy learning how bridges, tunnels and highways are designed and built? Randy and Sam Morrow do, and so will boys who follow their vivid adventures in civil engineering. Illustrated. 170 pps. . . . **\$2.95**
- **There's Adventure in ELECTRONICS.** Randy and Sam find adventure—and perhaps a career in this exciting field. Many careers in electronics are discussed and each helps to acquaint the boy with the equally exciting opportunities. Fast-paced, yet factual. Illus. 170 pps. . . . **\$2.95**
- **There's Adventure in ATOMIC ENERGY.** The Atomic Age is here and youth is reaching for simple, understandable information. Here it is, presented as exciting fiction, yet factually correct. Explains career possibilities, whets his desire to go farther. Illustrated. 174 pps. . . . **\$2.95**
- **There's Adventure in CHEMISTRY.** The mysteries of Chemistry unfold through the adventures of typical American boys. As thrilling fiction, yet scientifically sound, the book provides understanding of the career requirements and opportunities in Chemistry. Illustrated. 156 pps. **\$2.95**

ORDER NOW FOR CHRISTMAS GIVING

Popular Mechanics Press, Dept. 1258, 200 E. Ontario St., Chicago 11

At \$2.95 each (remittance enclosed), send me

- ROCKETS METEOROLOGY CIVIL ENGINEERING
 ELECTRONICS ATOMIC ENERGY CHEMISTRY

Name _____

Address _____

City _____ Zone _____ State _____

the Super PAL-MASTER RIFLESCOPES

U.S. FITS ALL RIFLES
COMPLETE WITH MOUNT

2 1/2 POWER 14⁹⁵
 35 ft. field at 100 yds.

4 POWER 15⁹⁵
 30 ft. field at 100 yds.

6 POWER 16⁹⁵
 20 ft. field at 100 yds.

WHEN ORDERING SPECIFY MAKE & MODEL NUMBER OF YOUR RIFLE.

for TARGET BENCH REST or HUNTING
 A rugged, precision made riflescope to fit your every need. Has positive internal type Windage & Elevation Adjustments with direct reading, click type knobs. Cross Hair Reticle remains centered at all times. Lenses are finest optical glass. All lenses are color corrected, distortion free and hard coated to meet U.S. Army standards. The Ocular lens has a precision indexed fast focus adjustment. Objective lens adjusts for finer sighting. 3/4" barrel is rust proof blued steel. Will stand recoil from the heavy caliber rifles. Mount included will fit ALL U.S. and most foreign military rifles. Weight: 6ozs. Eye Relief: 2" to 3-1/2". W/Instructions.

SPECIAL 60 to 450 Power MICROSCOPE

With **NEWLY DEVELOPED SUB-STAGE LIGHT** which **ELIMINATES NEED for ANY EXTERNAL LIGHT SOURCE.**

Another Palley Optical Bargain. Ideal for scientific inclined Boys & Girls, Adults, Home labs, etc. Has precision ground and polished lenses. Two interchangeable eyepieces of 6X and 15X - Triple revolving turret with 10X, 20X and 30X lenses - Patented sub-stage mirror with self-contained light for use without external light source plus large sub-stage mirror for use with external light source when desired - All metal body which inclines through 90° - Fitted wood case and 3 glass slides. Order **WHILE STOCKS are COMPLETE!**

HAS 60, 120, 150, 180, 300 and 450 POWER MAGNIFICATION

FREE with MICROSCOPE
 8-PIECE DISSECT SET. Has Scalpel, Scissors, 6 Slides, Tweezers, Magnifying Glass, etc. **12⁹⁵**

12 DIFFERENT PREPARED SLIDES With purchase of any microscope in ad. 12 Slides purchased separately . . . \$2.95

12 SLIDES FREE! INCLUDE: INSECTS SPICES - FLOWERS

NEW DRAFTETTE

Professional type, scientifically designed Drafting Machine. Ideal for use in the Office, Classroom, Art Studio, Workshop, Home, etc. **SMALL ENOUGH TO FIT IN YOUR BRIEFCASE!** Made of black anodized aluminum with sharp white markings. Comes with 11" x 17" drawing board. Weighs only 2 1/2 pounds. **6⁹⁵**

4 inch IMPORTED SLIDE RULE

Non-warping bamboo with scales on a white nitrate face. Face scales are A, B, C, D and K. Other side has S, L & T scales. In Case. **2⁹⁵**

5 inch IMPORTED SLIDE RULE

Same scales as above rule . . . **3⁹⁵**

10 inch LOG-LOG DECIMAL TRIG IMPORTED SLIDE RULE

Professional Log-Log, Decimal Trig Slide Rule. Non-warping top quality bamboo - 2-color scales on white nitrate facing. Scales are L, LL1, DF, CF, CH, CI, C, D, LL3 & LL2 on one side. Other side LLO, LLOO, A, B, K, CI, C, D, S, ST & T. With cursor and 16 pg. book. **10⁹⁵**

TRIPLE TURRET MICROSCOPE

Perfect GIFT for STUDENT - AMATEUR SCIENTIST

Has fine precision ground and polished lenses. Triple revolving objective lens turret allows choice of 100X, 200X or 300X magnification. Has right and left hand rack & pinion adjustment. All-metal body inclines through 90°. Has sub-stage mirror and comes in fitted wood case. **7⁸⁸**

2-SPEED ANGLE-BUFFER DRILL ATTACHMENT

NEW 5⁹⁵

For Buffing & Sanding! Buffs at 1/2 Drill Speed Sands at Double the Drill Speed!!

Slip into drill Chuck and it's ready to use. Convert any elect. drill into a right angle buffer & sander. Has steel gears, self lubricating lifetime bearings, left or right large handle. Includes 5" rubber head & adapter, 5 1/2" wool polisher, 6 sand discs.

8 POWER ELBOW TELESCOPE

10⁸⁸
 COST GOVT \$150.00

Has 2" objective lens, Kellner eyepiece & Amici erecting prism. Illuminated cross hair, 3 built-in filters. Field 325 ft. at 1000 yds. Eyepiece alone worth \$12.

9-IN-1 SWISS ARMY TYPE KNIFE

NEW ONLY 1⁷⁸

9 tools in one! A Jack Knife, Scissors, Saw, Can Opener, Screwdriver (Phillips head), Awl, Bottle Opener, standard Screwdriver and a Paring Knife. Finest, rugged steel blades. Easy-to-open. **SAVE**

3400 RPM 1/2 HP POWER SAW NEW

RIPS - CROSSCUTS CUTS A FINISHED 2x4 LIKE A KNIFE THROUGH BUTTER

NOW 19⁹⁵

Rugged, professional type, adjustable saw. Will cut any angle from 0 to 45°. Has adjustable (0 to 6") rip fence. Safety trigger switch on handle. Full 1/2 HP Universal AC-DC, 110-120 V., 60 cycle motor. Weighs only 6-1/2 pounds. A \$49.50 VALUE.

SPECIAL DOUBLE ACTION HYDRAULIC CYLINDERS

Has a 2-3/8" Bore, Stroke of 19", Shaft 1-1/4", Eye-to-Eye length 30-3/4". Gov't cost approx. \$85.00

No. H-53AUSU - Used **17⁸⁸** Reg. Cat. Price \$21.50

No. H-53ANSU - NEW **24⁸⁸** Reg. Cat. Price \$31.50

Has Bore of 2-3/8", adjustable stroke 7-3/8" - 9-5/8", Shaft 7/8", Length 20".

No. H-17JUSU - Used **7⁸⁸** Reg. Cat. Price \$10.75

No. H-17NSU - NEW **14⁸⁸** Reg. Cat. Price \$19.75

R-1 GENERATOR

16⁹⁵

COST GOVT Approx. \$200

Designed for Gov't aircraft. Easily converted for Arc Welder. Rated 300 Amps, 24-32 V., DC. Has 3750 to 4000 RPM with counterclockwise rotation. 3/4" splined shaft, Arc Welder convert insts. on request.

1500 PSI HP-3 HYDRAULIC HAND PUMP

ONLY 6⁹⁵

Operates at 1500 PSI. Displaces 0.19 GPM at 30 cycles per min. Capacity 1.5 cu. in. per cycle. Has a built-in return flow check valve. Cost Gov't Approx. \$80.00 **SAVE!**

HOIST

1000 LBS.

Drive is a 21 to 1 gear ratio. Has an automatic ratchet type brake. The 40" extension arm with a 3" pulley at the end makes this an ideal "swing-around" hoist for truck or platform loading. Comes with 12 ft. of 3/16" dia. high tensile strength steel cable on the drum. Overall length is 50". Easily portable. **22⁵⁰**

CENTRIFUGAL WATER PUMP

Ideal for draining basements, sumps, flooded areas. Must be primed. Has brass body and rotor. Stainless steel shaft. Bearing mounted. 1-1/2" pipe thread inlet, 1-3/4" hose outlet. Delivers 6000 GPM at 1 ft. head at 1800 RPM with a 1/3 HP motor. . . . **19⁹⁵**

MOUNT BASE for above pump \$4.25

WELDING REACTOR

Has iron core wound with No. 4 wire. Will stand load of 400 Amps. Use with generators shown here **10⁹⁵**

THROTTLE CONTROL SOLENOID - Use as welder or motor control. Has 5" shaft, 1" travel. Specially priced **7⁹⁵**

"V" BELT PULLEY ADAPTER to adapt V-Belts to use on generators. . . . \$27.50

24 Volt RHEOSTAT for use as welder output control. 5 variable outputs. Only \$2.95

No. H-V13USU SPECIAL 4-WAY VALVE

A sliding piston type valve with built-in relief valves to limit the cylinder stroke. Pressure balanced in neutral position with fluid return when not in use. Has 5/8" AC tube ports. . . . **7⁸⁸**

ELECTRIC VARIABLE SPEED HYDRAULIC TRANSMISSION

Designed originally to be used in pairs for controlling movement of 40mm guns. Each unit complete with variable displacement hydraulic pump & motor - integrally mounted inside an oil reservoir. Has a 5/8 HP 220 V., 60C., 3-phase, 3425 RPM motor - an elect. differential Selsyn motor is part of the transmission. Ideal for remote control of machinery, etc.

MANUAL CONTROL 138⁸⁸ | REMOTE CONTROL 148⁸⁸

TO ORDER - Send Check or Money Order. 50% deposit with C.O.D.s. All prices F.O.B. Los Angeles Warehouse. Shipments are Freight or Postage Collect.

Palley's
 2263 E. VERNON AVE., • DEPT. PM-128
 LOS ANGELES 58, CALIF.



Fighting Whirlybird Packs Many Weapons

Something new in the Army's arsenal is the H-34A Choctaw helicopter which has been equipped with 2.75-inch rockets to suppress ground fire. The copter carries 40 of the 2.75 rockets, plus five-inch antitank, antisubmarine rockets, two 20-mm. cannon, three 50-caliber and six 30-caliber machine guns. In combat, the armed whirlybird would hover near the ground, pop up to fire its rockets, and drop down again to the relative safety of ground level.

Heart Beats Via Telephone Aid Medics' Consultations

Human heart sounds and electrocardiograph readings can be transmitted accurately over the telephone for consultations between specialists by a device developed at the University of Kansas Medical Center. A five-pound transistorized unit is attached directly to the patient by standard lead wires and placed next to the telephone mouthpiece. No wires connect the electrocardiograph and phone.

World's Lowest Temperatures Recorded at Antarctica

If Antarctica's supercold temperatures are not enough for you, try the air above that icy continent. Russia's Sovietskaya base has reported a record ground temperature of 124.1 degrees below zero Fahrenheit; the base is 12,000 feet above sea level. On July 16, 1958, a U. S. Weather Bureau balloon soaring 13 miles above the South Pole radioed a temperature of 135.4 degrees below zero,

FREE PLAN tells how to start your own business FILING SAWS

Here is a steady repeat CASH business you can start in your own basement or garage in your spare time and make from \$3 to \$6 an hour. You can file hand, band and cross-cut circular saws on the Foley Saw Filer. No eyestrain—no experience needed. "The first

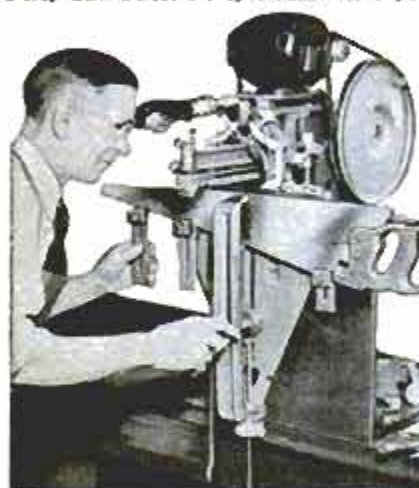

saw I sharpened with my Foley Filer came out 100%,"—writes Clarence E. Parsons.

Every saw you sharpen with the Foley Saw Filer brings you more customers. "I rented a two-car garage and have all the work I can do." —Charles H. Smith.

FREE BOOK

Shows How to Start
Send coupon today for "Money Making Facts" and time payment plan. No salesman will call.

SEND COUPON FOR FREE BOOKS

FOLEY MFG. CO., 1216-8 Foley Bldg.
Minneapolis 18, Minn.

Send me free book "Money Making Facts," and Time Payment Plan.

Name _____

Address _____

FOLEY
SHARPENING
PRICE
GUIDE



MONEY
MAKING
FACTS

1/4 MIDGETS
The little league of family racing. \$449.00 complete. Write for free literature. Dealerships now available.

RACE-CRAFT

RACE-CRAFT MIDGET CARS
8476 E. Garvey Boulevard
South San Gabriel, Calif.

NOW! HEAT THAT COLD ROOM WITH A...
McLarty Automatic Booster Fan

Simply attach the McLarty Automatic Booster Fan in the pipe leading to the cold room. Screw control to dome or lay on top of furnace and plug in. Control runs fan when furnace is warm. Wonderful for basements and extra rooms or to assist your present blower. For 8 to 12 inch square or round pipe. Quality fans since 1936.

COMPLETE \$17.95 POSTPAID
CHECK OR MONEY ORDER FAN ONLY \$11.95
McLARTY SYSTEMS DICKMAN RD. AT 36TH ST. BATTLE CREEK, MICHIGAN

INVEST IN—

U.S. SAVINGS BONDS

SAFE AS AMERICA

AMERICA'S BEST JET STEAM MASTER

Now, a super efficient portable steam generator that produces live steam at 100 lbs. pressure in 60 seconds from a cold start! Produces large volume of high pressure steam on 2 pints of fuel oil. Instantly cleans sticky grease, dirt, rust, old paint, etc. on implements and farm machinery. Pays for itself in a few weeks. Sterilizes soil. Sterilizes as it cleans—milk equipment, etc. Fully automatic—oil fired with new, built-in lifetime bronze water circulating pump. Draws water from faucet or bucket. Simple and safe—anyone can use it; built-in safety valve. Complete with 12 ft. of hi-pressure steam hose and new triple efficiency steam gun that automatically mixes in soap solution if desired. Wt. 250 lbs. Item #463. **Special factory price... \$349.50**



ELECTRIC HOIST

2000 lb. CAPACITY. A fortunate purchase from the Air Force enables us to offer these powerful 2000 lb. electric cable hoists at a fraction of their value. Perfect for material handling, hoist hoists, elevators, lifting on assembly lines, etc. Two separate 22 ft. lift cables with independent controls permit leveling the load and controlling it perfectly. Rugged ball bearing motors of geared down design 110 volts. Available for A.C. or D.C. Please specify. Makes a terrific portable hoist with our #273 D.C. light plant at \$197.75. Offered at less than 33% of regular cost (hook not included). Wt. 145 lbs. A.C. Model, item #47A... **\$149.50**
D.C. Model, item #47B... **\$129.50**

Rugged, ball bearing WINCH

Sturdy ball bearing winch—super tough aluminum alloy construction. Powered by an easy starting 2 3/4 HP Briggs gas engine thru gear reduction drive—it exerts up to 3000 lbs. of terrific force for hoisting, mating, or pulling. Combination gear and pulley reduction results in tremendous multiplication of engine power. Idler pulley clutch arrangement and built-in drum brake (with ratchet hand lever) enables operator to ease loads down gently and lock at any point desired. Drum handles 400 ft. of #5 cable or 600 ft. of #3 cable. Ideal for contractors, farm implement trailers and unlimited other uses! (Item 795) Wt. 125 lbs. only... **\$149.50**



HEAVY DUTY model same as above but with big Industrial Clutch... **\$169.50**
HAND WINCH—Same winch with large crank handle for extra leverage and 2 speed drive. (Item 794) Wt. 60 lbs... **\$59.50**

SPECIAL DEALS

MINE DETECTOR for detecting buried pipes, wires, sewers, etc. Carrying case and fresh batteries included... **\$49.50**
AIR HAMMER for hammering dents out of auto bodies. Complete with 2 different shaped arms and 5 pumping cycles. Hammer can also be used without arm for chiselling and drilling, etc. Uses 4 cfm at 60 psi... **\$39.50**
SCREW JACK—10 ton Simplex Jack, 1 3/4" screw, 18" lift. Reg. price \$29.50... **\$9.50**
Special Price
HYDRAULIC PRESS, 9 ton press for pushing, bending, straightening, etc... **\$69.50**
SCREW PRESS, 9 ton capacity with 21" throat. Complete with adjustable table... **\$49.50**
EXTENSION CORD, 2 cond. #14, Neoprene—100 ft... **\$6.95**
2 cond. #12, Neoprene covered—100 ft. **\$7.95**
3 cond. #10, Neoprene covered—100 ft. **\$13.95**
INTERCOM SET, Powerful loud talking intercom set powered by 4 flash light batteries which last for 6 months. Good up to 1,000 ft. Complete with 2 stations—250 ft... **\$11.95**
PORTABLE BLOWER, powered by 2.2 Briggs Gas engine. Used for ventilating man holes, tanks, or any ventilating purpose. Complete with 20 ft. of 4 in. flexible pipe... **\$99.50**
EXHAUST FANS—Heavy duty, powered by sealed explosion proof motors, mounted in steel frames. Ideal for ventilating spray booths, barns, taverns, etc... **\$29.75**
20" fan only... **\$19.50**
FURNACE BLOWER, 10 in. steel, handles 1800 CFM. Requires 1/4 HP motor. Outlet size is 1 1/8" by 1 1/4"... **\$29.50**

GET MASTER MECHANIC'S BEDROCK FACTORY PRICES

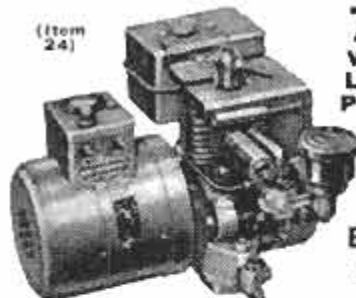

700 WATT LIGHT PLANT

PUSH BUTTON START

115 v. 60 cyc. AC Powered by a rugged 2.2 HP. easy starting Briggs engine. No wiring necessary; just plug in and operate. Plenty of current for any oil burner, freezer, brooder, emergency lights, etc. which require up to 700 watts. Ideal for television and radios. Complete with voltmeter and built-in winding to charge 6 v. auto batteries. (Item 24) Wt. 75 lbs. Easily fits in car trunk. Be prepared if storm knocks out power lines... **\$143.50**
Regular \$275.00 value...
1200 Watt Plant (Item 45) same as Item 24 but larger generator and engine with 50% greater output... **\$199.50**
We make every type and size of light plants. Write giving us your requirements!

Double Acting Hydraulic Cylinder



A powerful retractor unit, by Massey Harris which develops both a pushing and a pulling action. Will push 8,100 lbs., with a 1000 PSI pump pressure. Cylinder is 3 3/8" O.D. with 6 1/2" stroke—standard heavy duty clevises on both ends. Has standard 1/2" pipe thread openings. Can be used for lifting buckets or blades, raising or lowering implements, hydraulic presses, etc. Can also be used as an air cylinder. (Item 802) Wt. 17 lbs. Reg. \$68 value. Special... **\$14.95**

OTHER DOUBLE ACTING CYLINDERS
6" stroke—1 1/2" bore... **\$ 8.95**
8" stroke—3" bore... **34.00**
10" stroke—3" bore... **34.80**
16" stroke—3" bore... **43.00**
24" stroke—3" bore... **47.50**
42" stroke—5" bore... **75.00**
60" stroke—5" bore... **125.00**

We have all sizes of cylinders available.
HYDRAULIC CONTROL VALVE—4 way open center valve with built-in adjustable relief. Controls 1 double or 2 single acting cylinders. Equalizing feature permits easy control even under heavy loads. 3/4" pipe thread on inlet & outlet. 1/2" on cylinder outlets. Easily mounted, finger tip control. Wt. 16 lbs. (Item 822)... **\$21.95**

HYDRAULIC PUMP drive from tractor power take off or with separate engine or motor. Capacity is 8 GPM at 800 RPM—has 3/4" shaft with keyway... **\$39.50**
HYDRAULIC HOSE COUPLERS Connect or disconnect hydraulic lines without loss of oil. 1/2" pipe threads. (Item 819) per set **\$3.95**

SPEED SELECTOR, Heavy duty made by B. F. Goodrich for industrial use. Provides instant speed selection. Employs reliable planetary system—no power losses. 1-2 HP size... **\$89.50**

SPEED REDUCER, gear type with ball bearing drive provides speed reduction or increase as great as 100 to 1. Suitable for 1/2 HP... **\$19.95**

BATTERY CHARGING GENERATOR SET, 750 watt, charges 12 or 24 volt batteries, made by DELCO. Engine runs at 1800 RPM. Makes a potent cold weather motor starting unit as well as a fast charger... **\$119.50**
MOTOR-GENERATOR SET—115 v. 3KW D.C., output with 5 HP-3ph. direct connected motor. Ideal for magnetic chucks, variable speed motors, or electro-plating; complete with controls... **\$349.50**

ALUMINUM CONVEYOR—ball bearing skate wheel type, 12" wide, 8 ft. sections & 4 ft. sections. Hook together to form any length desired. Very light and strong... **\$34.50**
8 ft. section (Wt. 40 1/2)... **\$17.50**
4 ft. Section (Wt. 20 1/2)... **\$17.50**

ELECTRIC WATER PUMP—Centrifugal pump—1" pipe thr.—direct connected to heavy duty sealed 1 1/2 v. A.C. motor. Ideal for draining tanks, transferring fluids, etc. Capacity 800 g.p.m. Reg. \$79.50. Special... **\$29.50**

FOOT VALVE—for above pump... **\$1.95**
WATER PUMP, self-priming pump coupled to a 2.2 HP Briggs engine. Delivers 600 GPH. Pump has both garden hose thread & 1" pipe thread... **\$79.50**

LESS THAN WHOLESALE

1500 WATT PLANT
115v. 60 cyc. AC Push Button Start. Powered by a 4 HP. Clinton engine. Combines big output with easy portability. Provides emergency power for operating any oil burner, sump pump, freezer, television lights, communications systems, etc. which require up to 1500 watts. (Item 22). Wt. 110 lbs. Reg. \$475 value. Factory price... **\$239.50**
1750 Watt Plant Powered by 4.5 Briggs engine. Electric starting & battery charging built-in. Factory price... **\$279.50**
2500 WATT PLANT—Push Button Start (Item 21) 110/120 v. 60 cyc. A.C. A rugged powerful plant. Reg. \$645. Spec. **\$329.50**
3500 Watt Plant Push Button Start (Item 23) 115 v. 60 cyc. AC. Similar to above, but larger and 33% more capacity. Wt. 270 lbs. Reg. \$769. Factory Price... **\$379.50**
DUAL VOLTAGE 110/220 for Item 21 or 23—\$30 additional.



HEATING & VENTILATING FAN



(Item 10) Easily installed in furnace pipes. Forces even heat to all rooms. Over range removes kitchen smoke and odors. Powerful, continuous duty motor, 110-120v. AC. Mount in wall or ceiling to ventilate any area. Quiet, super-efficient fan moves huge volume of air. (400 to 600 CFM.)
8" Pipe, wt. 5 lb... **\$6.85**
9" Pipe, wt. 6 lb... **\$7.85**
10" Pipe, wt. 7 lb... **\$8.85**
12" Pipe, wt. 8 lb... **\$9.85**
HEAVY DUTY FAN. Semi-enclosed motor, suitable for spray booths, restaurant exhausts, poultry houses, etc. 10" Fan, wt. 8 lbs. (Item 10E)... **\$11.95**
12" Fan, wt. 10 lbs. (Item 10D)... **\$12.95**
HIGH SPEED BARN FAN similar to above, but larger, high speed motor moves huge volume of air.
12" Fan (Item 10C)... **\$14.95**
14" Fan (Item 10G)... **\$17.95**

RUBBER HOSE



Genuine Neoprene Hose—outlets ordinary rubber 3 to 1. Reinforced with super tough cotton cord plies—set completely flexible. Equipped with standard thread male and female fittings. Pump water for irrigation, stock tanks, home, barn, fire fighting, etc.—or pump gas and fuel oil. Volume factory prices—save more than 60%!

Size	Price	Size	Price
1 1/2"x10'	5.95	1 1/2"x30'	29.50
1 1/2"x10'	7.95	2"x10'	16.50
1 1/2"x20'	10.95	2"x10'	9.50*
1 1/2"x25'	13.95	2"x14'	21.50
1 1/2"x50'	24.95	2"x50'	47.50
1 1/2"x100'	49.95	2 1/2"x10'	21.75*
1 1/2"x10'	10.95	2 1/2"x17'	37.50
1 1/2"x25'	14.75	3"x10'	28.50*
*Discharge Hose		4"x15'	44.95

MASTER D.C. ARC WELDER

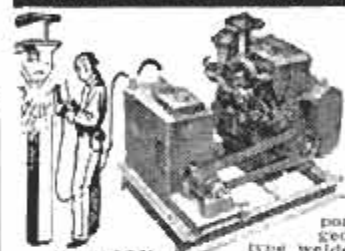

Easy To Use

Now! a portable rugged, industrial type welder with terrific performance, just at a price hundreds of dollars less than you'd expect. Senior model made for years of trouble-free, continuous service. High capacity DC welding unit enables you to tackle any job with confidence—easily welds anything up to 2" plate using from 1/16" to 1/4" rods. Built-in stabilizer and cooling system makes arc easy to strike and hold. Dual control rheostat provides low heat soldering, braising and welding from 30 to 300 amps. Complete with instructions, guarantee and triple V-belt or flat pulley. Easy to hook up and easy to operate.
WELDER ONLY — DUAL CONTROL MODEL. Same as above, but drive with your tractor, jeep or gas engine of 14 HP or more. (Item 38a.) Wt. 110 lbs. \$450 value... **\$119.50**
WELDER ONLY — INDUSTRIAL MODEL same as above but with ceramic rotary type rheostat providing 74 different heat settings for all types of welding (Item 38b)... **\$139.50**
\$500.00 value...
COMPLETE POWER MASTER (Illustrated above) powered by a 16 hp., air cooled Wisconsin engine. Wt. 480 lbs. (Item 28c) Complete with welder costing \$1200... **\$449.50**
Factory Special...
WELDING KIT Two 10 ft. leads, welding helmet, electrode holder, ground clamp. Sold only with welder at... **\$10.50**

Send check or M.O. Prices f.o.b. Factory. 10 day Money back guarantee. SEND 10c for... **MASTER MECHANIC MFG. CO., DEPT. A120 Burlington, Wis.**



PICK YOUR OWN SUCCESS STORY FROM THIS PAGE

These are the true stories of people who seemed trapped in routine, low-pay shaky jobs. Handicapped by lack of proper training, they couldn't get the things they wanted out of life—more money, a job they liked, security and happiness.

They are a small sample of the thousands of men and women—young and old—who turn to I. C. S. for help. Their will-to-learn plus I. C. S. training have changed the course of their lives.

Are you discouraged with your job and pay and feel you can't improve yourself because of lack of specialized education? Well, these men and women were in the same boat. With I. C. S. training, one of these success stories could be about you.

I. C. S. is the oldest and largest correspondence school. 277 courses. Business, industrial, engineering, academic, high school. One for you. Direct, job-related. Bedrock facts and theory plus practical application. Complete lesson and answer service. No skimping. Diploma to graduates.

For Real Job Security—Get an I. C. S. Diploma! I. C. S., Scranton 15, Penna. Accredited Member, National Home Study Council



Wins \$3000 contest—"After my I. C. S. courses I secured a new position," says Mr. Cecil Rhodes. "My income has more than doubled and I recently won a \$3000 sales contest."



From clerk to Assistant Estimator, thanks to I.C.S. "Any way you look at it," writes Mrs. Edna James, "the time and money one spends for I. C. S. Courses will be repaid a thousandfold."



As a college graduate, I found I.C.S. very valuable. Robert Lee took the I. C. S. Course in Advertising, is now Promotion Manager for a large corporation. "I. C. S. got me started on the way up," he says.



From \$152 to \$395 a month—"I.C.S. made my engineering work more interesting," Frank Bachtik tells us. "I was a Jr. Draftsman making \$152 a month. My present income is \$395.25 a month."

3 FREE BOOKS—a 36-page pocket-size guide to advancement, a gold mine of tips on "How to Succeed." Also a big catalog outlining opportunities in your field of interest and a sample I.C.S. lesson (Math.).

INTERNATIONAL CORRESPONDENCE SCHOOLS



BOX 92299M, SCRANTON 15, PENNA.

(Partial list of 259 courses)

Without cost or obligation, send me "HOW to SUCCEED" and the opportunity booklet about the field BEFORE which I have marked X (plus sample lesson):

- | | | | | |
|--|---|---|--|---|
| <p>ARCHITECTURE and BUILDING CONSTRUCTION</p> <ul style="list-style-type: none"> <input type="checkbox"/> Air Conditioning <input type="checkbox"/> Architecture <input type="checkbox"/> Arch. Drawing and Designing <input type="checkbox"/> Building Contractor <input type="checkbox"/> Building Estimator <input type="checkbox"/> Carpentry and Millwork <input type="checkbox"/> Carpenter Foreman <input type="checkbox"/> Heating <input type="checkbox"/> Interior Decoration <input type="checkbox"/> Painting Contractor <input type="checkbox"/> Plumbing <input type="checkbox"/> Reading Arch. Blueprints <p>ART</p> <ul style="list-style-type: none"> <input type="checkbox"/> Commercial Art <input type="checkbox"/> Magazine & Book Illus. <input type="checkbox"/> Show Card and Sign Lettering <input type="checkbox"/> Sketching and Painting <p>AUTOMOTIVE</p> <ul style="list-style-type: none"> <input type="checkbox"/> Automobiles <input type="checkbox"/> Auto Body Rebuilding and Refinishing <input type="checkbox"/> Auto Engine Tuneup <input type="checkbox"/> Auto Technician | <p>AVIATION</p> <ul style="list-style-type: none"> <input type="checkbox"/> Aero-Engineering Technology <input type="checkbox"/> Aircraft & Engine Mechanic <p>BUSINESS</p> <ul style="list-style-type: none"> <input type="checkbox"/> Accounting <input type="checkbox"/> Advertising <input type="checkbox"/> Business Administration <input type="checkbox"/> Business Management <input type="checkbox"/> Cost Accounting <input type="checkbox"/> Creative Salesmanship <input type="checkbox"/> Managing a Small Business <input type="checkbox"/> Professional Secretary <input type="checkbox"/> Public Accounting <input type="checkbox"/> Purchasing Agent <input type="checkbox"/> Salesmanship <input type="checkbox"/> Salesmanship and Management <input type="checkbox"/> Traffic Management <p>CHEMICAL</p> <ul style="list-style-type: none"> <input type="checkbox"/> Analytical Chemistry <input type="checkbox"/> Chemical Engineering <input type="checkbox"/> Chem. Lab. Technician <input type="checkbox"/> Elements of Nuclear Energy <input type="checkbox"/> General Chemistry <input type="checkbox"/> Natural Gas Prod. and Trans. <input type="checkbox"/> Petroleum Prod. and Engr. <input type="checkbox"/> Professional Engineer (Chem.) <input type="checkbox"/> Pulp and Paper Making | <p>CIVIL ENGINEERING</p> <ul style="list-style-type: none"> <input type="checkbox"/> Civil Engineering <input type="checkbox"/> Construction Engineering <input type="checkbox"/> Highway Engineering <input type="checkbox"/> Professional Engineer (Civil) <input type="checkbox"/> Reading Struc. Blueprints <input type="checkbox"/> Structural Engineering <input type="checkbox"/> Surveying and Mapping <p>DRAFTING</p> <ul style="list-style-type: none"> <input type="checkbox"/> Aircraft Drafting <input type="checkbox"/> Architectural Drafting <input type="checkbox"/> Drafting Machine Design <input type="checkbox"/> Electrical Drafting <input type="checkbox"/> Mechanical Drafting <input type="checkbox"/> Sheet Metal Drafting <input type="checkbox"/> Structural Drafting <p>ELECTRICAL</p> <ul style="list-style-type: none"> <input type="checkbox"/> Electrical Engineering <input type="checkbox"/> Elec. Engr. Technician <input type="checkbox"/> Elec. Light and Power <input type="checkbox"/> Practical Electrician <input type="checkbox"/> Practical Lineman <input type="checkbox"/> Professional Engineer (Elec.) <p>HIGH SCHOOL</p> <ul style="list-style-type: none"> <input type="checkbox"/> High School Diploma | <ul style="list-style-type: none"> <input type="checkbox"/> Good English <input type="checkbox"/> High School Mathematics <input type="checkbox"/> Short Story Writing <p>LEADERSHIP</p> <ul style="list-style-type: none"> <input type="checkbox"/> Industrial Foremanship <input type="checkbox"/> Industrial Supervision <input type="checkbox"/> Personnel-Labor Relations <input type="checkbox"/> Supervision <p>MECHANICAL and SHOP</p> <ul style="list-style-type: none"> <input type="checkbox"/> Diesel Engines <input type="checkbox"/> Gas-Elec. Welding <input type="checkbox"/> Industrial Engineering <input type="checkbox"/> Industrial Instrumentation <input type="checkbox"/> Industrial Metallurgy <input type="checkbox"/> Industrial Safety <input type="checkbox"/> Machine Design <input type="checkbox"/> Machine Shop Practice <input type="checkbox"/> Mechanical Engineering <input type="checkbox"/> Professional Engineer (Mech) <input type="checkbox"/> Quality Control <input type="checkbox"/> Reading Shop Blueprints <input type="checkbox"/> Refrigeration and Air Conditioning <input type="checkbox"/> Tool Design <input type="checkbox"/> Tool Making <p>RADIO, TELEVISION</p> <ul style="list-style-type: none"> <input type="checkbox"/> General Electronics Tech. | <ul style="list-style-type: none"> <input type="checkbox"/> Industrial Electronics <input type="checkbox"/> Practical Radio-TV Eng'g <input type="checkbox"/> Practical Telephony <input type="checkbox"/> Radio-TV Servicing <p>RAILROAD</p> <ul style="list-style-type: none"> <input type="checkbox"/> Car Inspector and Air Brake <input type="checkbox"/> Diesel Electrician <input type="checkbox"/> Diesel Engr. and Fireman <input type="checkbox"/> Diesel Locomotive <p>STEAM and DIESEL POWER</p> <ul style="list-style-type: none"> <input type="checkbox"/> Combustion Engineering <input type="checkbox"/> Power Plant Engineer <input type="checkbox"/> Stationary Diesel Engr. <input type="checkbox"/> Stationary Fireman <p>TEXTILE</p> <ul style="list-style-type: none"> <input type="checkbox"/> Carding and Spinning <input type="checkbox"/> Cotton Manufacture <input type="checkbox"/> Cotton Warming and Weaving <input type="checkbox"/> Loom Fixing Technician <input type="checkbox"/> Textile Designing <input type="checkbox"/> Textile Finishing & Dyeing <input type="checkbox"/> Throwing <input type="checkbox"/> Warming and Weaving <input type="checkbox"/> Worsted Manufacturing |
|--|---|---|--|---|

Name _____ Age _____ Home Address _____

City _____ Zone _____ State _____ Working Hours _____ A.M. to P.M. _____

Occupation _____ Canadian residents send coupon to International Correspondence Schools, Canadian, Ltd., Montreal, Canada. . . . Special tuition rates to members of the U. S. Armed Forces.

Superior's New Model 70 UTILITY TESTER®

FOR REPAIRING ALL ELECTRICAL APPLIANCES and AUTOMOBILE CIRCUITS

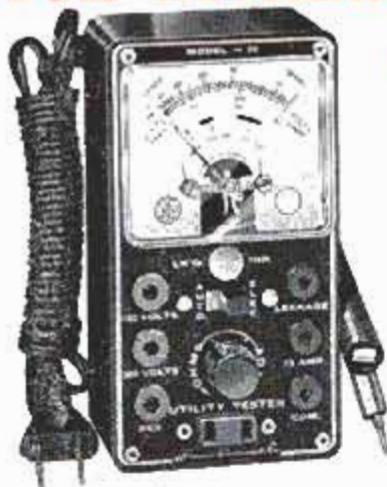

As an electrical trouble shooter the Model 70:

- Will test Toasters, Irons, Broilers, Heating Pads, Clocks, Fans, Vacuum Cleaners, Refrigerators, Lamps, Fluorescents, Switches, Thermostats, etc.
- Measures A.C. and D.C. Voltages, A.C. and D.C. Current, Resistances, Leakages, etc.
- Will measure current consumption while the appliance under test is in operation.
- Incorporates a sensitive direct-reading resistance range which will measure all resistances commonly used in electrical appliances, motors, etc.
- Leakage detecting circuit will indicate continuity from zero ohms to 5 megohms (5,000,000 ohms).

As an Automotive Tester the Model 70 will test:

- Both 6 Volt and 12 Volt Storage Batteries • Generators • Starters • Distributors
- Ignition Coils • Regulators • Relays • Circuit Breakers • Cigarette Lighters • Stop Lights • Condensers • Directional Signal Systems • All Lamps and Bulbs • Fuses
- Heating Systems • Horns • Also will locate poor grounds, breaks in wiring, poor connections, etc.



INCLUDED FREE This 64-page book—practically a condensed course in electricity. Learn by doing.

Just read the following partial list of contents: What is electricity? • Simplified version of Ohms Law • What is wattage? • Simplified wattage charts • How to measure voltage, current, resistance and leakage • How to test all electrical

appliances and motors using a simplified trouble-shooting technique.

- How to trace trouble in the electrical circuits and parts in automobiles and trucks.

Only **\$15⁸⁵**
Model 70 comes complete with 64 page book and test leads.

Superior's New Model 82

A truly do-it-yourself type

TUBE TESTER

TEST ANY TUBE IN 10 SECONDS FLAT!



- 1 Turn the filament selector switch to position specified.
- 2 Insert it into a numbered socket as designated on our chart (over 600 types included).
- 3 Press down the quality button—

THAT'S ALL! Read emission quality direct on bad-good meter scale.

FEATURES:

- Tests over 600 tube types
- Tests OZ4 and other gas-filled tubes.
- Employs new 4" meter with sealed air-damping chamber resulting in accurate vibrationless readings.
- Use of 22 sockets permits testing all popular tube types and prevents possible obsolescence.

- Dual Scale meter permits testing of low current tubes.
- 7 and 9 pin straighteners mounted on panel.
- All sections of multi-element tubes tested simultaneously.
- Ultra-sensitive leakage test circuit will indicate leakage up to 5 megohms.

Production of this Model was delayed a full year pending careful study by Superior's engineering staff of this new method of testing tubes. Don't let the low price mislead you! We claim Model 82 will outperform similar looking units which sell for much more—and as proof, we offer to ship it on our examine before you buy policy.

Model 82 comes complete, housed in portable, hand-rubbed oak cabinet with removable cover. Only

\$36⁵⁰

SHIPPED ON APPROVAL NO MONEY WITH ORDER — NO C. O. D.

Try any of the above instruments for 10 days before you buy. If completely satisfied then send down payment and pay balance as indicated on coupon. **No Interest or Finance Charges Added!** If not completely satisfied return unit to us, no explanation necessary.

MOSS ELECTRONIC, INC.

Dept. D-546, 3849 Tenth Ave., New York 34, N. Y.

Please send me the units checked on approval. If completely satisfied I will pay on the terms specified with no interest or finance charges added. Otherwise, I will return after a 10 day trial positively cancelling all further obligation.

Name

Address

City Zone State

All prices net. F.O.B., N.Y.C.

Model 70 Total Price \$15.85
\$3.85 within 10 days. Balance \$4.00
monthly for 3 months.

Model 82 Total Price \$36.50
\$6.50 within 10 days. Balance \$6.00
monthly for 5 months.

MAKES EVERY KIND OF CUT

*in
many
kinds
of
materials*

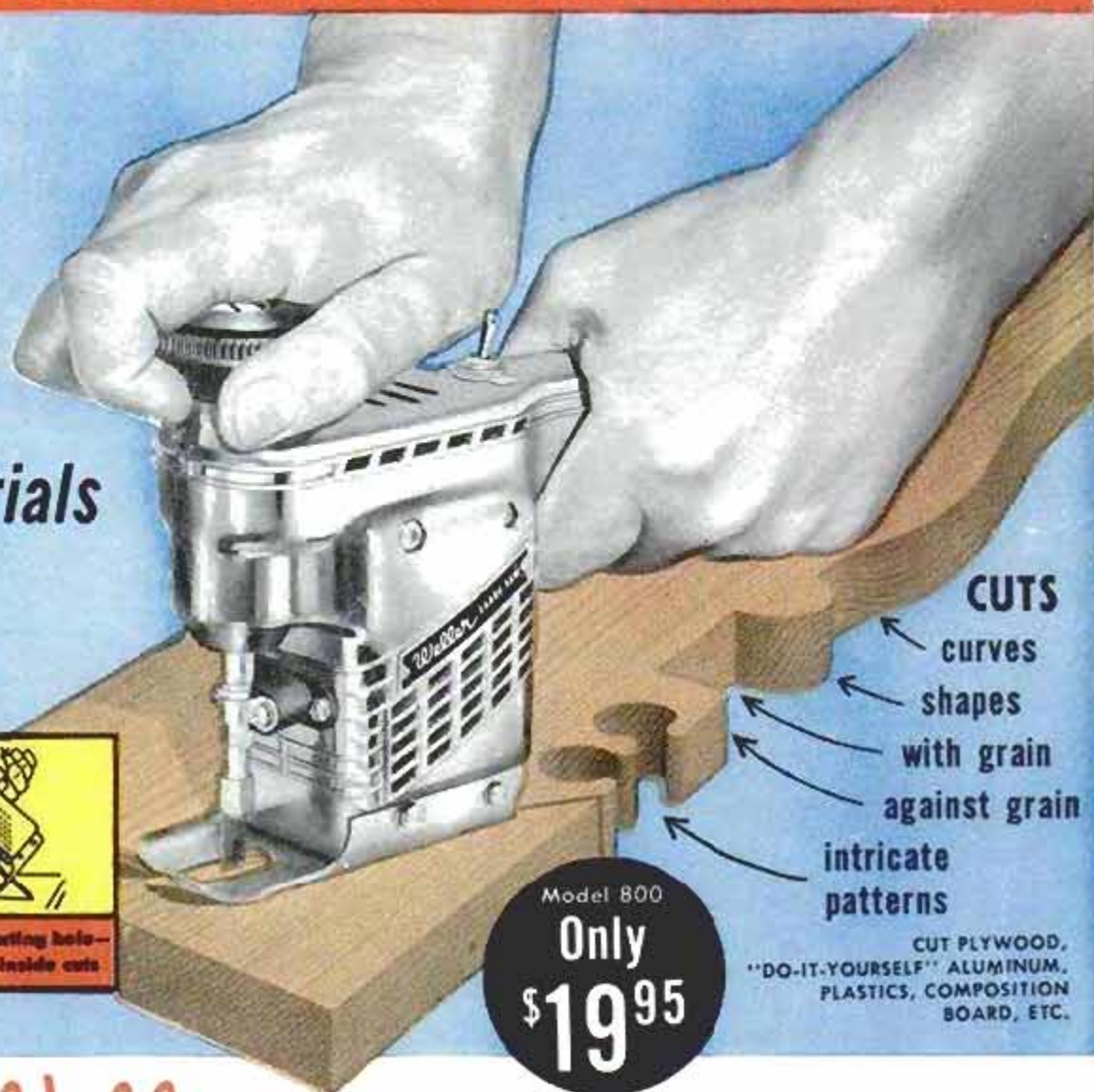

CUTS
curves
shapes
with grain
against grain
intricate
patterns

CUT PLYWOOD,
"DO-IT-YOURSELF" ALUMINUM,
PLASTICS, COMPOSITION
BOARD, ETC.

Model 800

Only
\$19⁹⁵

Weller **SABRE SAW** *portable jig saw*

Here's 7 saws in 1 in a handsome, streamlined polished aluminum housing. Truly portable, use it anywhere... never needs lubrication.

The Weller Sabre Saw offers power and performance found only in saws costing much more. And it has many exclusive

features; such as its strain-relief design that eliminates blade breakage.

Smooth, steady cutting is provided by reciprocating motor... no gears to wear or parts to replace. Supplied with 3 special blades for fine work, rough cutting and metal, and blade adjustment wrench. Guaranteed for one year.

Weller

Popular **POWER SANDER** at \$16.95 is
ideal companion tool to Weller Saw



ELECTRIC CORPORATION, Easton, Pa.