

NOV. 1958

16 PAGES ON THE '59 CARS

35 CENTS

POPULAR MECHANICS MAGAZINE

REG. TRADE MARK GREAT BRITAIN No. 4108

UNDERSTAND IT

REG. U.S. PAT. OFF.



FORD

CHEVROLET



PLYMOUTH



Six Pages of
CHRISTMAS GIFT IDEAS

Build Your Own
HI-FI STEREO AMPLIFIER

How to Plan Your Workshop



GALE

BUCCANEER

Smart, tough, and terrific

The dramatic new 35 hp. Sovereign by GALE is an exciting outboard motor, equally at home at a swank club anchorage or on the racing waters of a North Woods river!

This handsome husky, in spray-white and black, comes with trim, functional lines and smart styling—and underneath, *pure* power!

Yet it takes no time at all to master mighty Sovereign! Start it with a quick, easy turn of a key. The hot-

test spark of any outboard motor comes from GALE's Magic Magneto.

In fact, starting improves with age. The points wear evenly. And the Magic Magneto never wears out. With gentle fingertip control, send Sovereign racing at over 30 m.p.h., or tame it down to a slow idle.

GALE offers a model for your every need, in 3, 5, 12, 25 and 35 hp. . . . Write to us today for the name of your nearby GALE Buccaneer dealer, and a free catalog.



35 H.P. BUCCANEER BY



Announcing the United States Army's Graduate Specialist Program 1958 ~ 1959

The Purpose: This program is offered to provide qualified high school graduates with the technical schooling which will enable them to join the Army's key group of specialists, its select team of experts in every field from electronics to rocketry and guided missiles.

The Program: This plan offers young men their choice of 107 technical training courses—young women, their choice of 26. These courses are conducted at special Army schools which utilize the most modern technical facilities and equipment available. All instructors are experts in their fields. Completion of schooling qualifies young men and women as skilled specialists—ready to begin careers in their chosen specialties.

The Qualifications: To qualify as a Graduate Specialist, you must pass certain qualification and aptitude tests and be a high school graduate. However, you may apply while you are still in your senior year and, if qualified, enter the program after graduation. It is advisable to apply early, since quotas for each course are limited and qualified applicants are selected on a first-come-first-served basis.

The Procedure: To apply for the Graduate Specialist Program, visit your local Army Recruiting

Station. Your Army Recruiter will give you an enlistment screening test. After passing this initial qualification test, you will be interviewed by the Recruiter who is an experienced counselor. He will discuss your academic background and interests with you. Based on your own abilities and desires, he will help you select a first choice course and two alternates. If quotas for your first choice course are filled, you may still become a Graduate Specialist in one of your selected alternates. Your Army Recruiter will then forward your application for processing. You will later receive a formal letter notifying you that a place in a course of your choice is waiting for you. Not until after high school graduation and shortly before your course begins will you actually enlist, and then only for three years. Before enlistment, you will take two final tests, the Armed Forces Qualification Test and the Army Qualification Battery. After making qualifying scores in these tests relating to your particular chosen field, you are ready to enlist as an Army Graduate Specialist.

The Benefits: Through this unique program, today's Army offers qualified high school graduates an outstanding educational opportunity—a tremendous headstart toward a successful specialist's career—as well as the chance to join the Army's select group of key personnel.

*Get choice, not chance,
in
Today's Army*

Choose Your Graduate Specialist Schooling From 107 Courses Like These

Guided Missile Electrical Equipment Repair	Construction Drafting
Radar Repair	Construction Surveying
Microwave Radio Equipment Repair	Motion Picture Photography
Aircraft Components Repair	Neuropsychiatric Procedures
Engineer Equipment and Maintenance	Dental Laboratory
Atomic Weapons Electronics	Medical Laboratory Procedures
	Photographic Laboratory Operation

This One



THKW-346-937P

Popular Mechanics Magazine

Registered in U. S. Patent Office and Canada

Address all communications to: 200 E. Ontario St., Chicago 11, Ill.

H. H. WINDSOR, Founder

H. H. WINDSOR, JR., Editor and Publisher

Managing Editor
RODERICK M. GRANT

Assistant Managing Editor
WAYNE WHITTAKER

Shop Notes and Crafts Editor
JAMES R. WARD

Associate Editors, General Features
CLIFFORD B. HICKS
ARTHUR R. RAILTON, Automotive
KENNETH N. ANDERSON

Associate Editors, Shop Notes and Crafts
WAYNE C. LECKEY W. CLYDE LAMMEY

Radio-Television, Electronics Editor
LOTHAR STERN

Assistant Editors
SHELDON A. MIX, General Features
JAY W. HEDDEN, EARL WOBECK, Crafts
JOHN DALEN, ARLENE HIRSCH, Makeup

Art Staff
FRANK BEATTY, Director

HENRY NEHRBASS, Assistant Director
RICHARD A. POTTS, Art Editor

Eastern Editor
RICHARD F. DEMPFWOLFF
Room 4102, Empire State Bldg., New York City 1

Western Editor
THOMAS E. STIMSON, JR.
Suite 1010, 3460 Wilshire Blvd.,
Los Angeles 5, Calif.

London Manager
DOUGLAS W. WEDDERSPON
Eagle House, Jermyn St.,
London S.W. 1, England

Director, Bureau of Information
ALLAN CARPENTER

Advertising Offices

Chicago: 200 E. Ontario St., Whitehall 4-0100;
New York: Empire State Bldg., 350 Fifth Ave.,
LONGacre 5-7580; Detroit: General Motors
Bldg., TRinity 5-8711; Cleveland: Hanna
Bldg., 1422 Euclid Ave., PRospect 1-0456; Los
Angeles: 3460 Wilshire, DUnkirk 2-8458; San
Francisco: Russ Bldg., 235 Montgomery St.,
Yukon 2-0823.

Published monthly by Popular Mechanics Company,
200 E. Ontario St., Chicago 11, Ill. H. H. Wind-
sor, Jr., president; Wm. Harrison Petridge, exec.
vice-pres.; Franklin S. Forsberg, operations vice-
pres.; D. F. Windsor, vice-president and secretary-
treasurer; H. H. Windsor III, vice-president; W. T.
Windsor, vice-president; Joseph R. Ewell, Jr., ad-
vertising manager; Alan M. Deyoe, circulation
manager. Single copy in the United States and
Canada, 35 cents; subscription rates in the United
States and possessions, Canada and countries of the
Pan-American Postal Union, 1 year \$3.50; 2
years, \$6.00; 3 years, \$8.00. To all other coun-
tries add \$1.00 a year over United States prices
for overseas postage. If you plan to move, notify us
at least 30 days in advance so you will not miss
an issue. Give both your old and new addresses.
Entered as Second Class Matter, September 15,
1903, at the Post Office at Chicago, Illinois, under
Act of March 3, 1879. Entered as Second Class
Matter at Post Office Dept., Canada. Registered
as Second Class Matter at the Post Office at
Mexico, D.F., Mexico, June 20, 1950.
Copyright 1958 by Popular Mechanics Company,
Copyright under International Copyright Union.
Copyright in France. All rights reserved under
Pan-American Copyright Union. Printed in the
United States of America.

FOREIGN EDITIONS:	MECANIQUE POPULAIRE (French)	MECANICA POPULAR (Spanish)	POPULAER MEKANIK (Danish)	POPULAR MEKANIK (Swedish)	POPULARE MECHANIK (German)
-------------------	------------------------------	----------------------------	---------------------------	---------------------------	----------------------------

Volume 110	NOVEMBER 1958	Number 5
------------	---------------	----------

In This Issue...

Detroit's Year of Decision - - - - -	81
<i>Chevrolet, 82; Ford, 84; Plymouth, 86; Pontiac, 88; Dodge, 90; Chrysler, 92; Imperial, 93; Thunderbird, Corvette, 94; Rambler, American, 95.</i>	
Who Said the Blimp Is All Through? - - - - -	98
Christmas Shopping Section - - - - -	106
A House Full of Built-ins - - - - -	113
Stern-Wheelers Ply the Congo - - - - -	118
Salt-Water Battery - - - - -	124
Underground Missile Base - - - - -	128
Alaska—"Big Land" of Contrasts - - - - -	132
Road Block Ahead! - - - - -	138
Look Who's Coming in by Plane! - - - - -	146
Model Trains of Paper—and They Run - - - - -	152
Radio, TV and Electronics - - - - -	157
<i>A High-Fidelity Stereo Amplifier</i>	

For the Craftsman...

Stool Converts to TV Chair - - - - -	161
Modeling the French Chebec—Part I - - - - -	168
Animated Christmas Displays - - - - -	177
Christmas Decorating Ideas - - - - -	182
Glamorize Your Christmas Candles - - - - -	186
Slave Anode Arrests Corrosion - - - - -	190
Hobbyist Microfilms His Records - - - - -	194
Your Home Workshop - - - - -	197
<i>16 pages of planning a well-ordered home shop</i>	
True Holes With Woodboring Bits - - - - -	214

Regular Departments...

Do You Know This Old-Timer? (Quiz) - - - - -	14
Detroit Listening Post - - - - -	104
Solving Home Problems - - - - -	174
Clinic for Homemakers - - - - -	224

Turn to detailed index on page 74. Sources of additional information on items in this issue are shown on the Where-to-Find-It List, available without charge by writing the Bureau of Information, Popular Mechanics, 200 E. Ontario St., Chicago 11, Ill.

Next Month...

WHY THESE TRAGIC AIR COLLISIONS? PM went to presidential adviser, General Quesada, for an interview in the December issue on "What We're Doing About Air Safety." . . . Next month, too, you'll see the new small Studebaker. . . Houdini and Thurston are gone, but their magic lives on. America's foremost authority on magic today, Christopher, reveals in December his choice of the "Greatest Illusions of All Time," with full color illustrations.



How we retired in 15 years with \$300 a month

"Strange, I remember it so clearly—and more than 15 years seems just a short while ago. For it's only thanks to what happened Christmas 1941 that we're living in Florida today, with our income guaranteed for life.

"That holiday afternoon we'd invited some people in, and as we waited, Dot and I sat by the living-room fire reading. Christmas always made me kind of stop and take stock, I guess. And *this* year I was turning forty. *I'm not getting any younger*, I thought, as I leafed through Life magazine.

"For years we'd cherished a favorite dream, Dot and I. Someday I was going to retire. We'd sell the house and move to Florida. Get just a *little* place where we'd be out in the sun all year. We'd get off the treadmill and have time for living.

"But we'd stopped talking about it lately. For we hadn't banked much money. At almost forty, nearly half my working

life was behind me. So I began to wonder that afternoon . . . *Must I just live and work and die . . . doing the same thing every day?*

"It was what I was thinking, I suppose, that made me notice the page that said, 'You don't have to be rich to retire on an income.' I read it through. There *was*, it said, a way for an ordinary salaried man to get a lifetime income and retire. The Plan was called the Phoenix Mutual Retirement Income Plan. With it, I could get a guaranteed income of \$300 a month beginning when I reached 55. To do it, I needed only one thing—fifteen or twenty good earning years ahead. I'll look into it, I decided, cutting out the coupon.

"Soon my mail brought a booklet telling about Phoenix Mutual Plans. Yes, one was just right for me.

"Looking back, 1941 seems like yesterday. We saw the war come and go with all its worries.

Again and again I was thankful we had our Phoenix Mutual Plan.

"Well, Christmas 1956 rolled around—and we had a party. I was almost 55 and set to retire. Soon after, my first Phoenix Mutual check for \$300 arrived. We got a good price for our house, packed, and drove to Florida.

"We found just the little house we had dreamed of. And month after month the postman hands us our pay check. We're financially independent, and will be *for life*."

Send for Free Booklet

This story is typical. Assuming you begin at a young enough age, you can plan to have an income of \$100 to \$300 a month or more—starting at age 55, 60, 65 or older. Send the coupon and receive, by mail and without charge, a booklet which tells about Phoenix Mutual Plans. Similar plans are available for women. Don't put it off. Send for your copy now.

ESTABLISHED 1851

PHOENIX MUTUAL

Retirement Income Plan

GUARANTEES YOUR FUTURE

OVER 100 YEARS OF LIFE INSURANCE PROTECTION
FOR BUSINESS AND FAMILIES

COPYRIGHT 1958, BY PHOENIX MUTUAL LIFE INSURANCE COMPANY

PHOENIX MUTUAL LIFE INSURANCE CO.
274 Elm Street, Hartford 15, Conn.

Please send me, without obligation, your free 28-page book showing new retirement income plans.

Plan for Men

Plan for Women

Name _____

Date of Birth _____

Business Address _____

Home Address _____

Now... See in spite of



BRACE YOURSELF! Here comes another driver who hasn't dimmed his lights. He's 175 feet away. Your vision of your side of the road is "washed out" by his glare. Then after you pass,

it takes precious seconds for your eyes to re-adjust to the reduced light, and you still can't see the road ahead clearly. It's like entering a dark theatre on a sunny day!

New G-E SUBURBAN Headlamps have

No other 2-headlamp system ever gave you as much light *in the low beam* as new General Electric SUBURBAN Headlamps. And you *need* more light in the low beam when meeting oncoming cars—even if the other driver dims his lights and has them aimed properly.

This new General Electric low beam fila-

ment is *optically centered* in the reflector—gives a "built-in spotlight" effect, puts more light where you need it to make passing easier and safer. Helps you recover your vision more quickly when the other car has passed.

Have a pair of new G-E SUBURBAN Headlamps installed and aimed by your

the other car's lights!

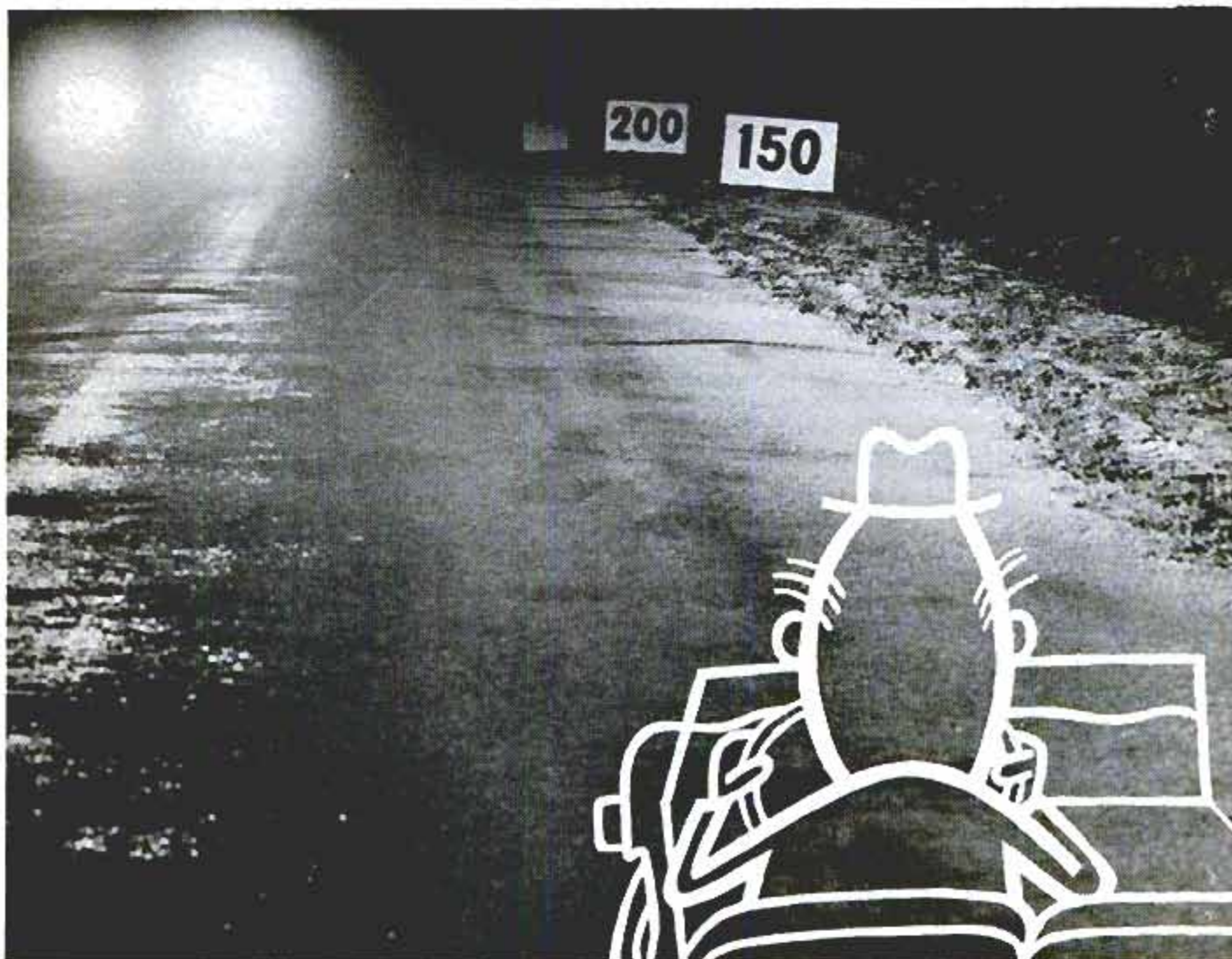

NOW YOU CAN SEE in spite of the other car's lights—better than ever before, because you have new G-E SUBURBAN Headlamps. Their "built-in spotlight" effect in the low beam pro-

jects more light along the right shoulder, helps keep your eyes on your side of the road. Now you can spot that fallen box at the 200-foot mark—which you *couldn't* see with old headlamps.

a "built-in spotlight"..in the low beam!

dealer, garage or service station! General Electric Co., Miniature Lamp Dept., Nela Park, Cleveland 12, Ohio.

Progress Is Our Most Important Product

GENERAL  ELECTRIC



Special low-beam filament shield lets you see better in fog, rain or snow.

Upper beam reaches far and wide for safer driving on open road.

BIG

COMFORTABLE HANDLES



Proto "BET'R-GRIP"® screwdriver handles give you extra gripping power, reduce fatigue. Result: more work with less effort.

ANOTHER REASON YOU'LL
PREFER
PROTO
PROFESSIONAL
SCREWDRIVERS



Long, short or special types—you'll find exactly the screwdriver you want in the big Proto Line.

Proto screwdrivers are precision-designed, built to last longer. The alloy steel blades are heat treated their entire length. Plastic handles have extra deep flutes to prevent slippage and rolling. Wood handles are octagon shaped for sure grip, made of tough hardwood and (in most cases) protected by a ferrule and steel cap. At your dealers, be sure to pick Proto screwdrivers—they'll make your work easier. Send 10¢ for 84 page catalog describing entire line to Proto Tools, 2209 Santa Fe Ave., Los Angeles 54, Calif.

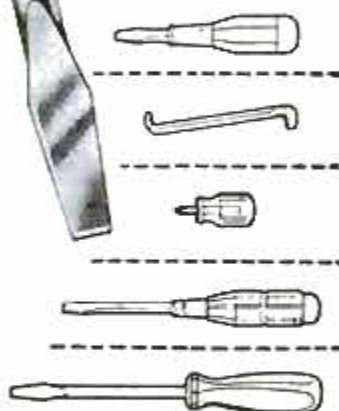

ACROSS THE DESK



To the Editor:

Reading your caption "These Rocketeers Play Safe" in the September 1958 issue of *Popular Mechanics*, there is no doubt Joseph E. Brown is referring to the safe handling of rockets.

As an employee of a Telephone Company, trained in safety practices (in this case) on the proper use and handling of extension ladders, I shudder to think of the disciplinary action a company supervisor would take if a ladder as shown in this picture was used by one of his subordinates.



Under no circumstances shall a ladder be used with a side rail cracked or broken; and a ladder of sufficient length shall be such that the work can be performed when standing not higher than on the fourth rung from the top.

Footing and angle of ladder could not be determined from this photograph, however I feel I would be remiss in my duties if I neglected to comment on this photograph.

I must add I enjoy reading *Popular Mechanics*, and this is constructive criticism only.

W. A. McDermid,
Cooksville, Ontario, Can.

(Continued to page 10)

WHAT HAPPENS WHEN A MAN DECIDES TO DO SOMETHING! ABOUT HIS FUTURE!

The proven rule of "learn more to earn more" took M.E.F. (name on request) from a position of truck driver to that of an accounting executive in sixteen months. Listen to what M.E.F. says:

"I was driving a truck—working long hours and not making much money. I had a burning desire to better myself in life, and decided to enroll with LaSalle. I went along driving my truck days and studying nights and got my first break after completing 35 assignments. I took a cost accounting position. Within one month after starting full-time, I received my first raise, thereafter followed more. One of the greatest thrills of my life came just nineteen months after I started with LaSalle. When our firm opened up a branch office, I was assigned to take charge of the Accounting Department and my salary has doubled."

M.E.F. took a proved road to success—and his letter is typical of the thousands we have in our files from men and women in all walks of life.

YOU DESERVE SUCCESS

There is no reason why you can't win success through LaSalle's Accounting Training. Today the demand for good accountants far exceeds the supply. This spells real opportunity to the man who is prepared.

You need no special talents to become a success in Accounting. You do not even need a preliminary knowledge of bookkeeping. All you need is the will to work—to achieve success perhaps years sooner.

Under the LaSalle Problem Method you can acquire a thorough knowledge of Accounting—you can master its fundamental principles—become expert in the practical application of those principles. You learn by doing—without losing any time from your present work. You train directly under the supervision of a competent staff of Certified Public Accountants and accounting experts.



TWO FREE BOOKS

We offer you a FREE SAMPLE LESSON so that you can *prove to yourself* that you can master Accounting—quickly, thoroughly—in spare time at home. You'll see exactly how LaSalle's famous "problem method" works . . . how you are led step-by-step through actual accounting work—learning by doing and not by study of theory alone. Along with the sample lesson you will receive FREE the valuable book, "Opportunities in Accounting." It explains how we train you from the ground up—or from where you are now—according to your individual needs.

Send the coupon RIGHT NOW. Don't lay it aside and say you'll do it later. It can be the means of your SUCCESS—perhaps larger success than you have ever dreamed. At least it's worth considering.

ACCREDITED MEMBER, NATIONAL HOME STUDY COUNCIL



LaSalle Extension University

— A Correspondence Institution —

Dept. 1164H, 417 S. Dearborn St., Chicago 5, Ill.

Please send me, free of all cost or obligation, a sample lesson in Accounting . . . also, your latest illustrated book, "Opportunities in Accounting."

Name Age

Address

City, Zone, State

BURIED ALIVE!



SIX YEARS ON THE SAME JOB WITH NEVER AN ACCIDENT...
AND THEN ONE MORNING...

2 A CAVE-IN PUT ME SIX FEET UNDER FOR SIX LONG MINUTES



3 IN THE HOSPITAL, I HAD PLENTY OF TIME TO THINK



4 I'D PASSED OVER DOZENS OF I.C.S. ADS IN POPULAR MECHANICS. BUT I SAW THIS ONE IN A NEW LIGHT



FREE!

I.C.S. CAREER KIT
Send coupon now...
get all three books

INTERNATIONAL CORRESPONDENCE SCHOOLS
BOX 21299L
SCRANTON 15, PA.

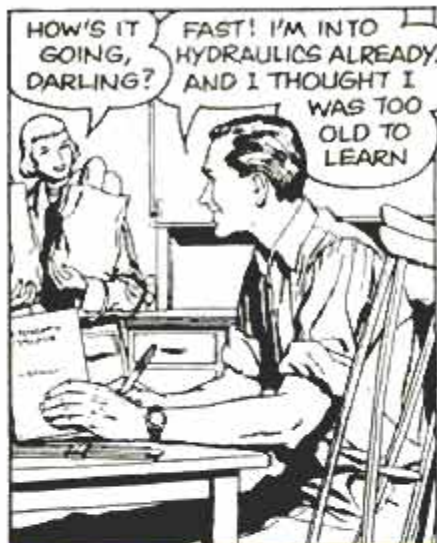

5 SIGNING UP FOR THAT I.C.S. COURSE WAS THE SMARTEST THING I EVER DID

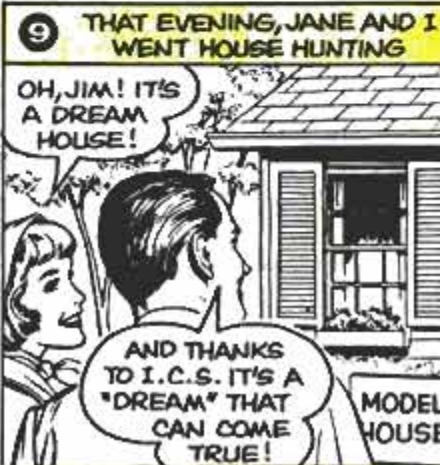
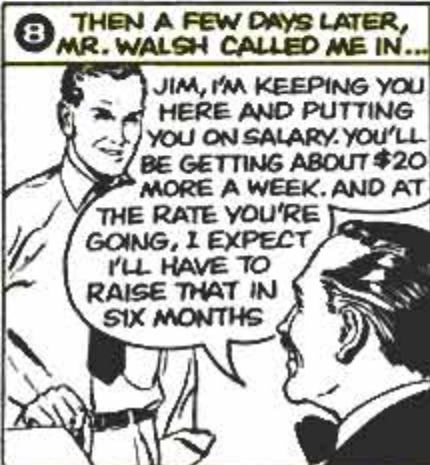

HERE'S WHERE YOU COME IN! LET I.C.S. SHOW YOU THE WAY TO MORE PAY, RAPID ADVANCEMENT, REAL JOB SECURITY! MAIL THIS COUPON TODAY!

- 1** "HOW TO SUCCEED" A 32-page gold mine of ideas
- 2** CAREER CATALOG Opportunities in the field that interests you most
- 3** SAMPLE LESSON (MATH) Shows the famous step-by-step I.C.S. teaching method



INTERNATIONAL CORRESPONDENCE SCHOOLS



BOX 21299L, SCRANTON 15, PENNA.

(Partial list of 259 courses)

Without cost or obligation, send me "HOW TO SUCCEED" and the opportunity booklet about the field BEFORE which I have marked X (plus sample lesson):

- | | | | | |
|--|---|--|---|--|
| <p>ARCHITECTURE and BUILDING CONSTRUCTION</p> <ul style="list-style-type: none"> <input type="checkbox"/> Air Conditioning—Refrig. <input type="checkbox"/> Architecture <input type="checkbox"/> Architectural Interiors <input type="checkbox"/> Building Contractor <input type="checkbox"/> Building Estimator <input type="checkbox"/> Building Maintenance <input type="checkbox"/> Carpentry and Mill Work <input type="checkbox"/> Heating <input type="checkbox"/> Painting Contractor <input type="checkbox"/> Plumbing <input type="checkbox"/> Reading Arch. Blueprints <p>ART</p> <ul style="list-style-type: none"> <input type="checkbox"/> Cartooning <input type="checkbox"/> Commercial Art <input type="checkbox"/> Fashion Illustrating <input type="checkbox"/> Magazine Illustrating <input type="checkbox"/> Show Card and Sign Lettering <input type="checkbox"/> Sketching and Painting <p>AUTOMOTIVE</p> <ul style="list-style-type: none"> <input type="checkbox"/> Auto Body Rebuilding <input type="checkbox"/> Auto Elec. Technician <input type="checkbox"/> Auto-Engine Tune Up <input type="checkbox"/> Automobile Mechanic | <p>AVIATION</p> <ul style="list-style-type: none"> <input type="checkbox"/> Aeronautical Engineering Jr. <input type="checkbox"/> Aircraft & Engine Mechanic <p>BUSINESS</p> <ul style="list-style-type: none"> <input type="checkbox"/> Advertising <input type="checkbox"/> Bookkeeping and Accounting <input type="checkbox"/> Business Administration <input type="checkbox"/> Business Correspondence <input type="checkbox"/> Public Accounting <input type="checkbox"/> Creative Salesmanship <input type="checkbox"/> Federal Tax <input type="checkbox"/> Letter-writing Improvement <input type="checkbox"/> Office Management <input type="checkbox"/> Professional Secretary <input type="checkbox"/> Retail Business Management <input type="checkbox"/> Sales Management <input type="checkbox"/> Stenographic-Secretarial <input type="checkbox"/> Traffic Management <p>CHEMISTRY</p> <ul style="list-style-type: none"> <input type="checkbox"/> Analytical Chemistry <input type="checkbox"/> Chemical Engineering <input type="checkbox"/> Chem. Lab. Technician <input type="checkbox"/> General Chemistry <input type="checkbox"/> Natural Gas Prod. & Trans. <input type="checkbox"/> Petroleum Engineering <input type="checkbox"/> Plastics <input type="checkbox"/> Pulp and Paper Making | <p>CIVIL, STRUCTURAL ENGINEERING</p> <ul style="list-style-type: none"> <input type="checkbox"/> Civil Engineering <input type="checkbox"/> Construction Engineering <input type="checkbox"/> Highway Engineering <input type="checkbox"/> Reading Struct. Blueprints <input type="checkbox"/> Sanitary Engineering <input type="checkbox"/> Structural Engineering <input type="checkbox"/> Surveying and Mapping <p>DRAFTING</p> <ul style="list-style-type: none"> <input type="checkbox"/> Aircraft Drafting <input type="checkbox"/> Architectural Drafting <input type="checkbox"/> Electrical Drafting <input type="checkbox"/> Mechanical Drafting <input type="checkbox"/> Mine Surveying and Mapping <input type="checkbox"/> Plumbing Drawing and Estimating <input type="checkbox"/> Structural Drafting <p>ELECTRICAL</p> <ul style="list-style-type: none"> <input type="checkbox"/> Electrical Engineering <input type="checkbox"/> Electrical Maintenance <input type="checkbox"/> Electrician <input type="checkbox"/> Contracting <input type="checkbox"/> Lineman <p>HIGH SCHOOL</p> <ul style="list-style-type: none"> <input type="checkbox"/> Commercial <input type="checkbox"/> Good English <input type="checkbox"/> High School Subjects <input type="checkbox"/> Mathematics | <p>LEADERSHIP</p> <ul style="list-style-type: none"> <input type="checkbox"/> Foremanship <input type="checkbox"/> Industrial Supervision <input type="checkbox"/> Leadership and Organization <input type="checkbox"/> Personnel-Labor Relations <p>MECHANICAL AND SHOP</p> <ul style="list-style-type: none"> <input type="checkbox"/> Gas—Electric Welding <input type="checkbox"/> Heat Treatment <input type="checkbox"/> Metallurgy <input type="checkbox"/> Industrial Engineering <input type="checkbox"/> Industrial Instrumentation <input type="checkbox"/> Industrial Supervision <input type="checkbox"/> Internal Combustion Engines <input type="checkbox"/> Machine Design—Drafting <input type="checkbox"/> Machine Shop Inspection <input type="checkbox"/> Machine Shop Practice <input type="checkbox"/> Mechanical Engineering <input type="checkbox"/> Quality Control <input type="checkbox"/> Reading Shop Blueprints <input type="checkbox"/> Refrigeration <input type="checkbox"/> Sheet Metal Worker <input type="checkbox"/> Tool Design <input type="checkbox"/> Toolmaking <p>RADIO, TELEVISION</p> <ul style="list-style-type: none"> <input type="checkbox"/> Industrial Electronics <input type="checkbox"/> Practical Radio TV Eng'ng <input type="checkbox"/> Radio and TV Servicing <input type="checkbox"/> Radio Operating | <ul style="list-style-type: none"> <input type="checkbox"/> Television Technician <p>RAILROAD</p> <ul style="list-style-type: none"> <input type="checkbox"/> Air Brake Equipment <input type="checkbox"/> Car Inspector <input type="checkbox"/> Diesel Engineer & Fireman <input type="checkbox"/> Section Foreman <p>STEAM AND DIESEL POWER</p> <ul style="list-style-type: none"> <input type="checkbox"/> Combustion Engineering <input type="checkbox"/> Diesel—Elec. <input type="checkbox"/> Diesel Eng's <input type="checkbox"/> Electric Light and Power <input type="checkbox"/> Stationary Fireman <input type="checkbox"/> Stationary Steam Engineering <p>TEXTILE</p> <ul style="list-style-type: none"> <input type="checkbox"/> Carding and Spinning <input type="checkbox"/> Cotton, Rayon, Woolen Mfg. <input type="checkbox"/> Finishing and Dyeing <input type="checkbox"/> Loom Fix'g <input type="checkbox"/> Textile Des'g <input type="checkbox"/> Textile Eng'g <input type="checkbox"/> Throwing <input type="checkbox"/> Warping and Weaving <p>MISCELLANEOUS</p> <ul style="list-style-type: none"> <input type="checkbox"/> Domestic Refrigeration <input type="checkbox"/> Marine Engineering <input type="checkbox"/> Ocean Navigation <input type="checkbox"/> Professional Engineering <input type="checkbox"/> Short Story Writing <input type="checkbox"/> Telephony |
|--|---|--|---|--|

Name _____ Age _____ Home Address _____

City _____ Zone _____ State _____ Working Hours _____ A.M. to P.M. _____

Occupation _____

Canadian residents send coupon to International Correspondence Schools, Canadian, Ltd., Montreal, Canada. . . . Special tuition rates to members of the U. S. Armed Forces.

Still dreaming about a good job and more pay?



WAKE UP TO YOUR OPPORTUNITIES IN

Auto Mechanics

PRACTICAL NEW WAY TO TRAIN AT HOME

Don't rely on *luck* to make your dreams come true! Be practical and depend on *training*. As a skilled man, you can step into a good, top-pay job—enjoy security—and even open a shop. Your best bet is to become an auto mechanic. *That's the big opportunity field today.* Over 60 million cars and trucks are on the road, and all require maintenance. At least one-third are in the heavy-repair class. There's so much work that 50,000 mechanics are needed! It's easy to learn this trade at home. Find out *how* by mailing coupon below.



EARN MONEY IN SPARE TIME as you train. Many students repair cars for neighbors; others get jobs in local garages; some open shops by the time they graduate. You can learn-and-earn because CTI offers practical *Shop-System* training.

DIESEL MECHANICS OR BODY-FENDER REBUILDING is included at no extra cost. Only CTI offers this extra choice. Get this fully-rounded mechanic's training. *Send coupon for two free books.*



YOU PRACTICE WITH THIS TUNE-UP KIT

Kit includes a Compression Tester, a Vacuum Gauge and Fuel Pump Tester, an Ignition Timing Light, and a portable steel case. These professional instruments help you locate engine troubles, let you get useful practice. You keep this kit!

MECHANIC'S TOOLS TOO
You'll use these tools to get real experience. They'll increase your interest, stamp you as a "pro." You'll earn spare time cash with them. No extra cost for tools—you keep them.



MAIL COUPON TODAY!

MAIL TODAY FOR 2 FREE BOOKS

COMMERCIAL TRADES INSTITUTE
1400 Greenleaf Ave., Chicago 26
Dept. A-938

Send your new Auto Mechanics book and Sample Lesson. BOTH FREE.

Name _____ Age _____

Address _____

City _____ Zone _____ State _____



(Continued from page 6)

To the Editor:

We have noted with interest the photographs appearing on page 114 of your August 1958 issue, of a boat constructed by welding two 1948 auto hoods together.

I recently examined a similar boat that had been constructed by welding together two 1947-48 Hudson hoods, and powered by a two-horsepower inboard Marine engine. The examination was made following recovery of the boat after it had sunk in

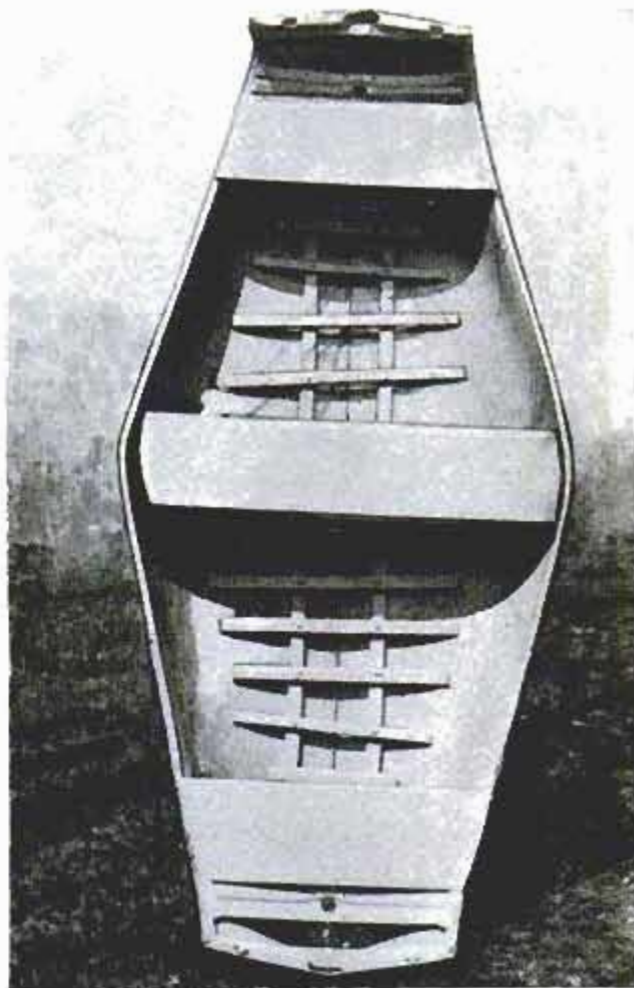

Photo of boat built of auto hoods, reprinted from August issue, inspired letter of safety man Daughtrey

approximately 30 feet of water and its operator drowned.

Investigation of the accident disclosed that the operator was accompanied by three children weighing an estimated total of 145 pounds making a total live-weight load of 310 pounds and reducing the freeboard to less than four inches along the gunwales. Witnesses stated that the children leaned over the side, causing the boat to ship water toward the bow. The bow immediately went under and the boat sank. The youngsters, wearing life jackets, were rescued. The operator did not have this protection and drowned in attempting

(Continued to page 12)



J. E. SMITH, Founder
National Radio Institute
Over 40 Years' Experience
In Training Ambitious Men

I Will Send You A
SAMPLE LESSON FREE
to show you how easy, practical it is to
Train at Home for Good
Television-Radio Jobs



America's Fast Growing Industry Offers You Good Pay Plus a Bright Future

People look up to and depend on the Technician, more than ever before. Offices, plants, homes everywhere—are obliged to buy his knowledge and services. His opportunities are great and are increasing. At home, and in your spare time, you can learn to do this interesting, satisfying work, qualify for important pay. No experience is needed. You train in your own home—keep your present job while learning.

Make \$10, \$15 a Week Extra

NRI students find it easy to start fixing sets for friends soon after enrolling. Many who start in spare time soon build profitable, full time TV-Radio businesses.



Television's Growth is Making More Jobs, Prosperity

Right now, a solid, proven field of opportunity for good pay is servicing the millions of Television and Radio sets now in use. Hundreds of TV and Radio stations on the air offer interesting jobs for Operators and Technicians.

Mail Coupon—Find Out About This Tested Way to Better Pay

You don't have to know anything about electricity or Radio to succeed with NRI courses. Mailing the coupon may be one of the important acts of your life. Do it now. Reasonable tuition, on low monthly payments available. Let us send you an actual lesson. Judge for yourself how easy it is to learn. A 64-page catalog gives details of opportunities and training. Address: **NATIONAL RADIO INSTITUTE, Dept. BMA Washington 16, D.C.**

You Learn by Practicing with Equipment NRI Sends

Clearly written, well-illustrated NRI lessons teach TV-Radio-Electronics principles. Also, *without extra charge*, you get NRI kits developed especially to give you actual practice with TV-Radio equipment. You build, test, experiment with actual Television-Radio receiver or broadcasting circuits, build, use testing equipment. All equipment is yours to keep. In your own home you gain knowledge, develop skills needed for jobs in this vast industry.

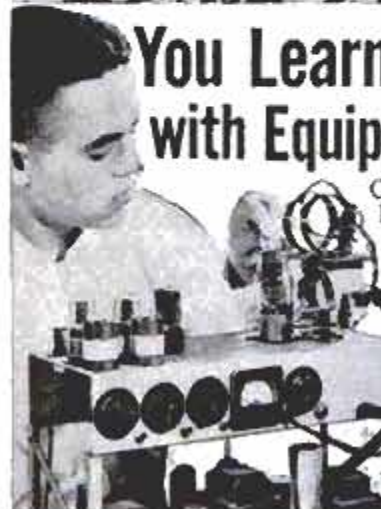

NRI Trained These Men



"I have my own Radio-TV business and my income has provided me with financial security. Business is great. I can't keep up with the work."—EDWARD M. DUDEK, Chicago, Ill.

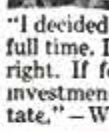

"I decided to quit my job and do TV work full time. I love my work and am doing all right. If fellows knew what a wonderful investment NRI is, they would not hesitate."—W. F. KLINE, Cincinnati, Ohio.



"Thanks to NRI, I operated a successful Radio repair shop. Then I got a job with WPAQ, later WBOB and now am an engineer for WHPE."—VAN W. WORKMAN, High Point, N. Carolina.



MAIL COUPON FOR SAMPLE LESSON and 64-PAGE CATALOG

Good for Both—FREE

NATIONAL RADIO INSTITUTE, Dept. BMA, Washington 16, D. C.

Mail me Sample Lesson and 64-page Book, FREE. (No salesman will call. Please write plainly.)

Name _____ Age _____

Address _____

City _____ Zone _____ State _____

ACCREDITED MEMBER NATIONAL HOME STUDY COUNCIL



The Dark Continents of Your Mind

DO YOU struggle for balance? Are you forever trying to maintain *energy, enthusiasm, and the will to do*? Do your personality and power of accomplishment ebb and flow—like a stream controlled by some unseen valve? Deep within you are minute organisms. From their function spring your emotions. They govern your *creative ideas and moods*—yes, even your enjoyment of life. Once they were thought to be the mysterious seat of the soul—and to be left unexplored. Now cast aside superstition and learn to direct intelligently these *powers of self*.

Accept this Free Book

Let the Rosicrucians, an age-old fraternity of thinking men and women (not a religion), point out how you may fashion life as you want it—by making the fullest use of these little-understood *natural faculties* which you possess. This is a challenge to make the most of your heritage as a human. Write for the Free Book, "The Mastery of Life." Address: Scribe A.H.D.

The ROSICRUCIANS

San Jose (AMORC) California

(Continued from page 10)

to get the youngsters to shore. The accident occurred in a quiet cove and in calm water.

Causes of the accident are believed to have been possible overload, limited freeboard, and lack of sealed buoyancy chambers or buoyant material capable of assuring flotation of boat and passengers. Since the boat shown in the photograph in your magazine apparently does not have sealed air chambers or buoyant material, we thought you might be interested in our accident, particularly since use of your boat for duck hunting will very likely result in someone's standing in the boat to shoot, and probably other movement without regard for the hazard involved.

Wm. W. Daughtrey,
Safety Director,
Fort Gordon, Va.

☆ ☆ ☆

To the Editor:

We have read with interest "Boston Sees the Stars in Hi-Fi" in the September issue of your magazine.

The article begins with the statement that the old Zeiss optical plant, which built the projectors in most of the world's great planetaria, is "serving the Russians." Paragraph 6 contains the phrase: "Rather than go behind the Iron Curtain to purchase a Zeiss machine . . ."

These statements are incorrect and detrimental to the interest of Carl Zeiss, evacuated to West Germany by the American Army before the city of Jena was turned over to the Russians. Since then Carl Zeiss has been located in Oberkochen, Württemberg, West Germany. There a new plant is in operation employing over 5000 people, under the direction of the old management, and with the help of many scientists, engineers, and workers formerly employed at the Jena works. The creator of the planetarium idea and inventor of the Zeiss Planetarium, Professor Dr. Walther Bauersfeld, having celebrated his 50th year with Carl Zeiss, is still one of the directors of the firm in West Germany.

At Oberkochen, the Zeiss planetarium instrument has been further developed, and a new model has been constructed which incorporates numerous technical improvements and amplifications. One of the improvements over the prewar Zeiss instrument is the use of 42 special projectors for the 42 brightest stars.

Four modern Zeiss planetarium instruments, manufactured in West Germany, have in recent years been installed, i.e., in

(Continued to page 18)

INVENTORS

Learn how to protect your invention. The U. S. Patent Laws provide that any new and useful art, machine, article of manufacture, or composition of matter, or any new and useful improvement thereof, may be patented if the act of invention is involved. Therefore, every inventor with a valuable invention should take advantage of the Patent Laws and proceed for patent protection in order to safeguard his rights.

A patent gives the inventor the exclusive right to prevent others from making, using, or selling the invention claimed in the patent for a period of seventeen years.

The Patent Laws were enacted for the benefit of the inventor to give him protection for the features of his invention which are patentable. These features must be properly and concisely set forth and claimed in a formal application for patent, in order to comply with the requirements of the Patent Laws. For that reason, unless the inventor is familiar with patent matters, he should engage a competent registered patent attorney or agent to represent him. We are registered to practice before the U. S. Patent Office and are prepared to serve you in the handling of your patent matters.

A specially prepared booklet entitled "Patent Guide for the Inventor", containing detailed information with respect to patent protection and procedure, together with a "Record of Invention" form will be promptly forwarded to you without obligation upon request.

CLARENCE A. O'BRIEN & HARVEY JACOBSON

Registered Patent Attorneys

81-L DISTRICT NATIONAL BUILDING

WASHINGTON 5, D. C.

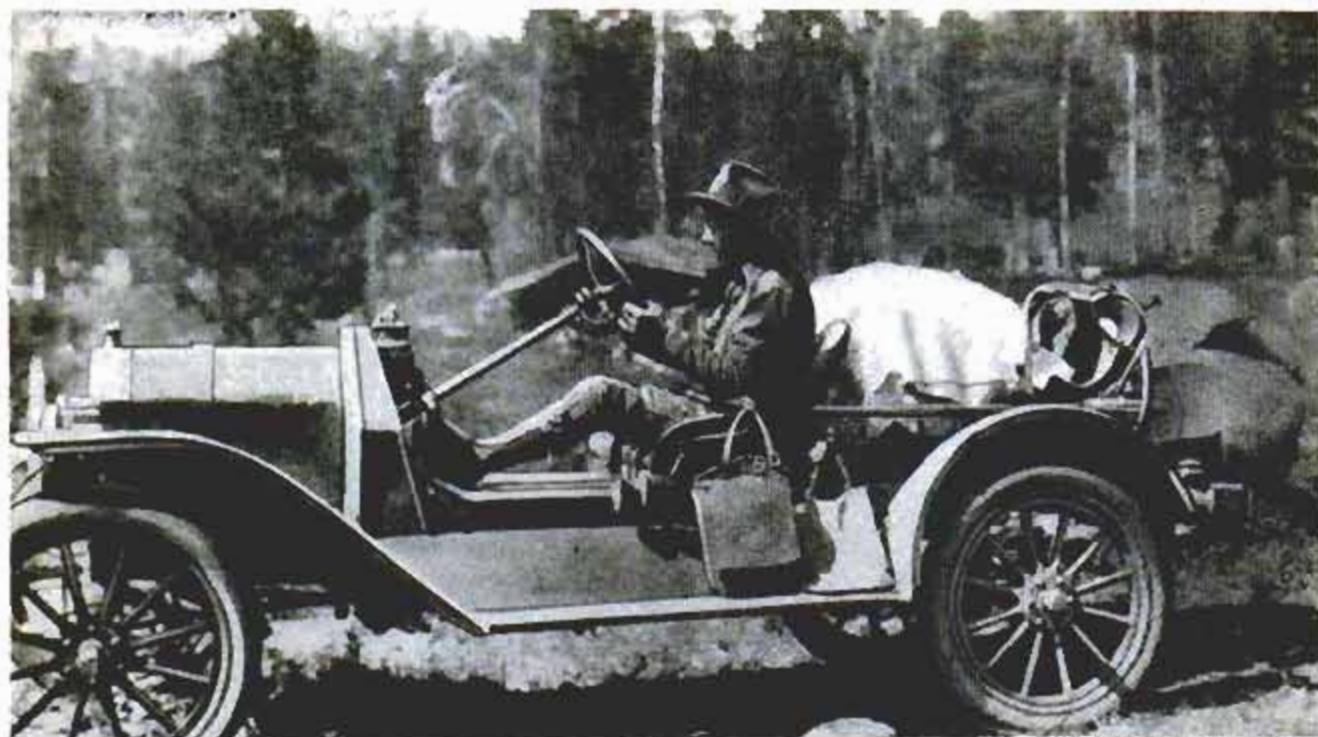

U.S. Forest Service photo

Do You Know This Old-Timer?

This bit of ancient history was captured on film somewhere in the Bighorn National Forest in Wyoming. Subject: a forest ranger at work, 1919. Magnificent country—and a magnificent

car, in its day. Most old-timers, looking at the radiator cap, will think it's a Ford; but is it? Obviously someone has taken liberties with its body. One guess—then turn to page 250.

Be Your Own Boss in the Profitable Excavating Business!

EARN UP TO \$1,000 AND MORE PER MONTH

Wherever you live, you'll find plenty of profitable work the whole year 'round for this versatile outfit . . . not just a "trencher" but an all-purpose excavating machine! Custom operators everywhere are making big money with Sherman Power Diggers. ONE BOUGHT A FARM WITH JUST THREE YEARS' PROFITS! Work for builders, contractors, utilities, and municipalities on such jobs as septic tanks and drainfields, sewer lines, fuel tank installations, foundations and footings, gas and water lines, field tilling and many others. The Sherman Power Digger mounted on a Ford Tractor travels quickly from job to job, digs at a fraction of the cost of manual labor. It's simple to operate, easy to maintain, built to last.

Send now for information about the easy-to-get jobs for your Sherman Power Digger. Let us tell you—without obligation—how you can go into business for yourself with an investment of less than \$5000. Or make a small down payment and pay the balance from earnings.

SHERMAN PRODUCTS, Inc.
Dept. 1736 Royal Oak, Michigan



Send Now for FREE LITERATURE!

Sherman Products, Inc.
Dept. 1736 — Royal Oak, Michigan

Send me information on how I can get into the excavation business on my own.

NAME _____

ADDRESS _____

CITY _____ STATE _____

**NOW! PREPARE FASTER —
EASIER AT HOME FOR A
PROFITABLE FUTURE IN...**



**YOU USE FILMS
and PROJECTOR**



**YOU GET 16
SHIPMENTS OF PARTS**



**YOU GET
VALUABLE TEXTS**



**YOU WORK OVER
300 PROJECTS**



**YOU GET EFFECTIVE
EMPLOYMENT SERVICE**

Electronics

RADAR — TELEVISION — RADIO

**With the aid of DeVRY TECH'S
Exclusive Training Films**

**No Previous Technical Experience
Or Advanced Education Required!**

**MEN
17-55**

Thousands of men who have clipped and mailed DTI coupons during the past 27 years have found Electronics a "magic door to opportunity." Today they hold good jobs in such fascinating and profitable fields as Television, Guided Missile Control, Airborne Electronics, Radio, Radar, Automation Electronics, etc. Many are also doing well in businesses of their own.

DeVry Tech has helped them, why not you? Prepare at home to make real money in a promising field, where your days can be filled with absorbing interest. Simply do what thousands are glad they did: Clip the coupon below and mail it now.

Here's Everything You Need!

Little wonder DeVry Tech's training methods get outstanding results! Everything is packaged into "learning units" designed for the man who has no advanced education, no previous technical experience. Lessons are prepared in step-by-step booklets with interesting text, simplified diagrams, clear pictures. Then, you learn by seeing! DeVry Tech's exclusive training movies make important points picture clear. See electrons on the march and other hidden actions—a wonderful training advantage. You learn by doing from 16 kits of electronic parts. You set up your own home laboratory, do 300 training projects, get the practical experience that helps make the DeVry Tech trained man welcomed in Electronic Companies all over the nation. That's why thousands of men are today glad they sent in that coupon. Why don't you?

DeVry Tech's Exclusive Training Movies Are Almost Like Having a Teacher in Your Home!

This "Opportunity Guide" FREE!

It's packed with exciting information about job opportunities in this wonder field of ELECTRONICS. If you're anxious to start MOVING AHEAD, mail the coupon NOW!

*Electronics
and
YOU*

MAIL THIS COUPON NOW

DeVRY TECHNICAL INSTITUTE
4141 Belmont Avenue, Chicago 41, Ill., Dept. PW-11-0
I would like your FREE booklet, "Electronics and YOU," and tell me how I may prepare to enter one or more branches of Electronics.

Name _____ Age _____

PLEASE PRINT

Street _____ Apt. _____

City _____ Zone _____ State _____

2048 Canadian residents address DeVry Tech of Canada, Ltd.
626 Roselawn Ave., Toronto 12, Ontario

"One of North America's Foremost
Electronic Training Centers"

Accredited Member National Home Study Council



RESIDENTIAL TRAINING ALSO OFFERED

Train in DeVry
Tech's Great Labora-
tories in Chicago
or Toronto. Write
for Information.

DeVRY TECHNICAL INSTITUTE

Formerly DeForest's Training, Inc.
CHICAGO 41, ILLINOIS

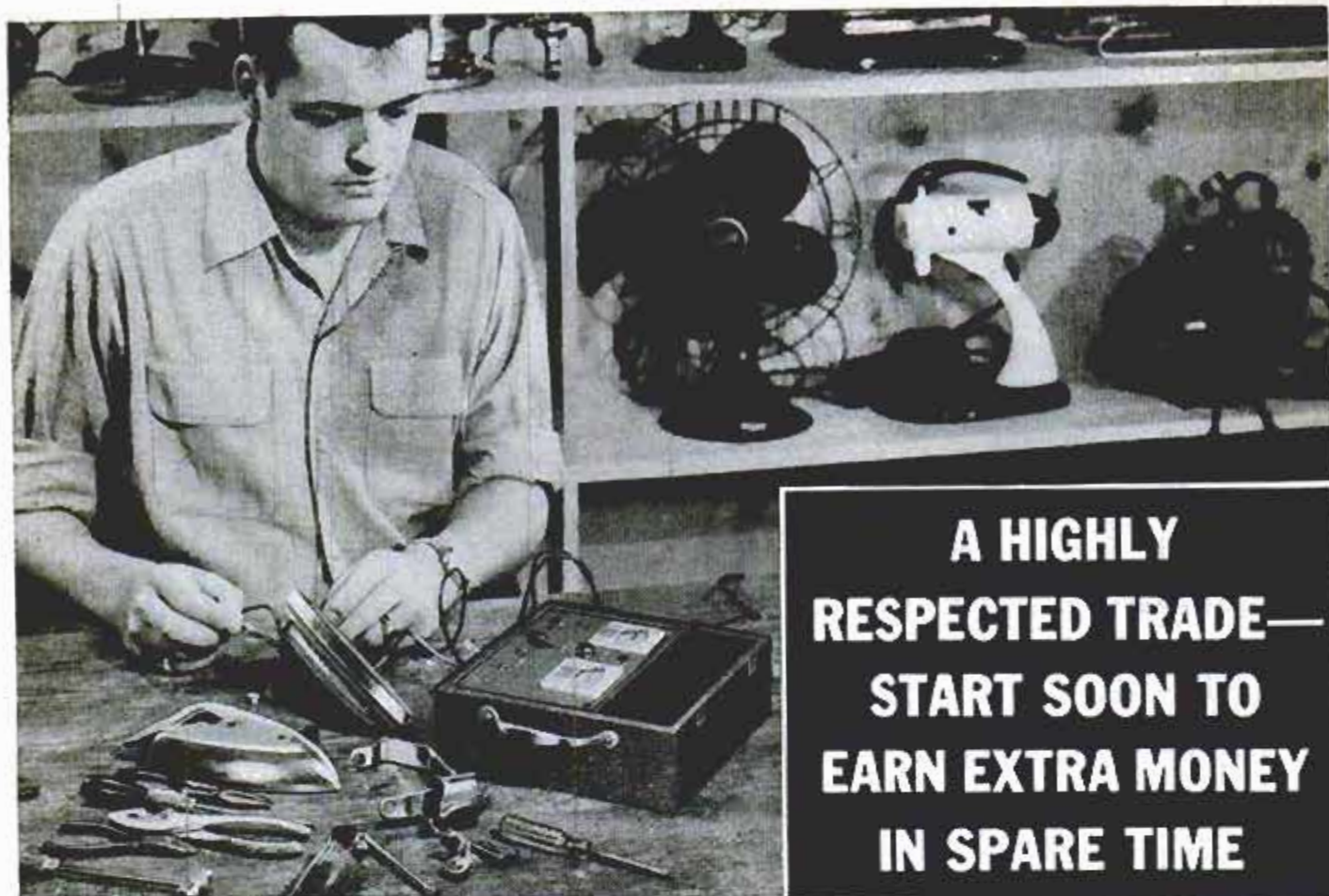

**A HIGHLY
RESPECTED TRADE—
START SOON TO
EARN EXTRA MONEY
IN SPARE TIME**

Learn at Home IN YOUR SPARE TIME to Fix Electrical Appliances

To build a better future, get into a field where there's much important work and the security that comes from knowing a good trade. Servicing electrical appliances offers that OPPORTUNITY. Every wired home has many electrical appliances and millions and millions of new appliances are sold every year. Owners pay well to keep them in repair. That's making a fast-growing need for trained men.

Add To Your Income Starting Soon Need For Service Technicians Increasing

Make extra money in your spare time. Start soon to fix electric toasters, fans, clocks, vacuum cleaners, and other electric appliances for your neighbors and friends. Work in your basement, garage or spare room. It's easy to increase your earning power—to pay for your training many times over—to have extra money to buy things you need.

Learn and Earn with Multi-Use Tester Built with Parts We Send

This course includes the parts to build a portable, sturdy Appliance Tester that helps you locate electrical defects quickly and easily. You use it to learn and do actual electrical appliance repair jobs. If you want better pay learn this good trade. No need to give up your present

job. You can train at home in your spare time for only \$3.00 down and \$6.00 a month. A small price to pay for increased earnings, a more secure future. Paste coupon below on a postal or mail in envelope for free book and sample lesson. Address **National Radio Institute, Dept. AM8, Washington 16, D. C.**

**MAILING THIS
COUPON MAY START
YOU TO SUCCESS
LESSON AND BOOK
FREE**



NATIONAL RADIO INSTITUTE, Dept. AM8, Washington 16, D. C.

Please send me Electric Appliance Training lesson and book free. (No salesman will call.)

Name Age

Address

City Zone State

ACCREDITED MEMBER NATIONAL HOME STUDY COUNCIL

INVENTORS

If you believe that you have an invention, you should find out how to protect it. The first step is to have a search made of the prior pertinent U. S. patents. If a report on this search indicates that the invention appears patentable you can apply for a patent, and the specifications and claims should be prepared.

The firm of McMorrow, Berman & Davidson, with offices in Washington, D. C., is qualified to take the necessary steps for you. We can make a preliminary search on your invention, advise you whether we think it can be patented, and prepare your application for patent.

Unless you are fully familiar with the U. S. Patent Laws, we recommend that you engage the services of a Registered Patent Attorney to protect your interests. The patent laws are *your* laws. A patent gives you the right to prevent others from making, using or selling the invention claimed in your patent for a period of 17 years.

Use these patent laws for your protection. Investigate whether your invention can be patented. If you have what you believe to be an invention, we suggest that you have this firm make a search for you.

Send for a copy of our Patent Booklet entitled "How To Protect Your Invention," containing information about patent protection and patent procedure. Along with this we will also send you an "Invention Record" form, for your use in writing down and sketching details of your invention. We will mail them promptly. No obligation. They are yours for the asking.

McMORROW, BERMAN & DAVIDSON

Registered Patent Attorneys

PATENTS • COPYRIGHTS • PATENTS

1353 VICTOR BUILDING, WASHINGTON 1, D. C.



**MEN! Make up to
\$1,000⁰⁰
IN A MONTH!**

without "SELLING"

Sensational Demand for Low-Priced Fire Alarm PLUS Sure-Fire "No-Selling" Plan Offers Ambitious Men Huge Profit Opportunities

AMAZING NEW INVENTION



Even beginners who never sold anything in their lives are cleaning up unbelievable profits with the first practical effective, low priced Fire Alarm ever invented . . . needed, wanted in homes, factories, offices, stores, on farms, for boats, everywhere. Professional salesmen are making biggest profits in years! Later in this ad I'll tell you about the plan that's producing orders for 1 to 12 Fire Alarms per sale from 8 out of 10 prospects . . . without selling. Here are the facts about the Fire Alarm. It hangs on the wall like a picture—no wiring, no installation. It's always on guard . . . It 'smells' a fire before danger point. When temperature rises, Fire Alarm goes off automatically, howls loud warning that can be heard 1/5 mile, wakes up soundest sleeper, give precious time to put out fire, call fire department, or escape. And it sells for only \$4.95 with profit up to \$2.70 on each one.

**Nearest Thing to
AUTOMATION SELLING**



With our field-tested plan customers sell themselves. No cold canvassing. No hard selling. It's the nearest thing to 'Automation Selling.' Imagine a sales plan even a child can use successfully because the sales tools we give you (and which you leave with your prospects) do all your selling even while you sleep! No room here to give you all the details but if you want big money fast rush the coupon now.

**Make This
Lighted-Match
Demonstration**

Sensitive! Lighted match triggers Alarms in 3 seconds.

Free Sales Kit

Send no money. Just rush coupon below for all the exciting moneymaking facts, complete Illustrated Sales Kit, everything you need to make money your first day. Learn how selling only 20 Fire Alarms a day pays

**Made \$26.52
in 3 Hours!**

"Received first shipment about noon. Worked 3 hours and made \$26.52 profit. It's a terrific seller!"
—Stanley



you \$1,000.00 profit in a month. No competition anywhere. Get in on the ground floor now. Rush this coupon.

MERLITE INDUSTRIES, Inc.

(ALARM DIVISION)

114 E. 32nd St., Dept. 5-15R

New York 16, N. Y.

ALVIN WESLEY, Sales Manager
Merlite Industries, Inc. (Alarm Division)
114 E. 32nd St., Dept. 5-15R New York 16, N. Y.

Rush FREE SALES KIT and full details about your "No-Selling" plan which gives me opportunity to make up to \$1,000.00 in a month without cold canvassing and hard selling—automatically. I am not obligated.

Name _____

Address _____

City _____ Zone _____ State _____

In Canada: Mopa Co., Ltd., 371 Dowd St., Montreal 1, P.Q.

(Continued from page 12)

Sao Paulo, Hamburg, Tokyo and London. During the current year new West German Zeiss planetaria are being erected in Johannesburg and in Caracas.

W. Schlipp,
Carl Zeiss, Inc.,
New York City.

☆☆☆

To the Editor:

I was much interested in your article in the August *Popular Mechanics*, ("Miracles Ahead on Your Telephone") because for a long time I have been trying to persuade telephone companies to work out and install what in my opinion is the most needed improvement in telephones it is possible to imagine, but all I get is a lot of scientific gobbledygook!

The improvement would be this: install a small signal bulb on the receiver that lights up while you are talking and pulsates intermittently whenever some one is trying to get you on the line—a busy signal that you can see!

There would be no sound, and you would not be interfered with in your conversation, but you would know that some one was trying to get you, and you could use your own judgment as to whether you wanted to end your conversation and switch yourself onto the "invader" or ignore him.

Give this a little thought and I am sure you will see many valuable uses for this device. Most valuable one, probably, is when you are trying to get your residence from the office and get a never-ending "busy." Your wife, or whoever is causing the jam, will have a pointed urge to switch over—to "accommodate" you or, more likely, not to miss some scuttlebutt from some friend of hers. At any rate, it would induce the long-winded to cut it short as someone is trying to get on the line.

Claude Schaffner,
New Haven, Conn.

☆☆☆

Our Apologies

The names of Mr. and Mrs. Henry Myers of 3695 Denair St., Pasadena, Calif., and Mr. Welden Allen of 3685 Denair St., Pasadena, Calif., were inadvertently omitted from the article entitled "Animated Christmas Displays" starting on page 177 of this issue. We wish to express our thanks to Mr. and Mrs. Myers for permission to picture and describe the novel and unusual display shown on page 178 and the very attractive display on page 180. Our thanks go to Mr. Allen for the parachuting Santa Claus display pictured on page 179.

Make your break NOW for a BETTER job, MORE money



TRAIN AT HOME FOR EASY SUCCESS IN REFRIGERATION & AIR CONDITIONING

The time is ripe for you to get into the big, fast-growing Refrigeration and Air Conditioning field. The industry needs 20,000 newly-trained mechanics each year! Over 150 million units are in use today—and over 6 million new installations are being made annually. Plenty of work at top pay! Fine opportunities to open a business! Mail coupon for facts on how to break in—but fast.

You learn fast because you practice with real equipment—Get experience!

No need to attend a distant resident school—to leave your family or quit your present job! Learn quickly at home in spare time by practicing with 23 kits that CTI sends. You build a refrigerator, freezer, air conditioner or milk cooler. You do 10 trouble-shooting projects—get field-type experience.

CTI trains you in months—not years—eliminates a long period of low-pay apprenticeship. Training the CTI way is fun—not a chore. It's fascinating to prepare yourself for a fine income and security—in an uncrowded field where trained men are desperately in demand—where opportunities are great!

A terrific opportunity to be your own boss



Thousands of CTI graduates have gone in business. The refrigeration and air conditioning industry is ideal for this purpose. You can open an appliance store, too. Coupon will bring full details.



R. C. ANDERSON
President
CTI

23 BIG KITS
to build
AIR CONDITIONER
REFRIGERATOR
FREEZER or
MILK COOLER

You build a heavy-duty, commercial-type, 1/4 h.p. compressor (above). You assemble this unit in easy stages with kits that CTI sends. At left are photos of just two of the 23 kits. One shows mechanic's tools; the other depicts a motor, fan, pulley, other service tools. CTI practical training kits develop skill, provide experience, speed training!

CTI students are making good

"I have been very busy. Had an offer to work for an appliance dealer but it looks like I'll be in business for myself before long!"—Frank Fuller, Wells, N. Y. . . . "Am now working in the field. Earn \$40 more per month than before."—Frank Krotzer, Houston, Texas. . . . "I not only got a job, but today am foreman, earning \$60 a week more than before I enrolled."—E. E. Hughes, Chicago. . . . "Have my own business. Only problem is: Too much business!"—Conrad King, Cynthia, Ky. You can do as well as these men!



MANY STUDENTS EARN MONEY DURING TRAINING

Soon after enrolling, many students do repair work in spare time. Some get part-time jobs, others make calls "on their own." Advanced students have even opened shops. With their earnings, many students pay tuition, buy additional equipment, have enough left to bank. Mail coupon for details on how to earn as you learn. No cost nor obligation.



"TRAINING YOU CAN TRUST"

This is the home of CTI, one of the world's great home study schools. Over 40,000 graduates.

COMMERCIAL TRADES INSTITUTE
1400 Greenleaf Avenue • Chicago 26, Illinois

MAIL TODAY FOR FREE BOOK AND SAMPLE LESSON

COMMERCIAL TRADES INSTITUTE

1400 GREENLEAF AVENUE DEPT. R-531
CHICAGO 26, ILLINOIS

Tell me how I can qualify for a better job or a business of my own. Send booklet, Success in Air Conditioning & Refrigeration, and Lesson Sample, both FREE.

Name _____ Age _____

Address _____

City _____ Zone _____ State _____



Inventors

If you consider your invention valuable, take these necessary preliminary steps promptly to protect it by applying for a United States patent.

Sketch and describe your invention. (For convenience in starting action on your invention, use "Evidence of Invention" form offered below.)

Sign, date and have this invention disclosure witnessed by two people capable of understanding your invention.

Have us make a preliminary search among U. S. patents already granted for similar types of invention.

We then prepare a report for you on the probable patentability of your invention and recommend your further course of action.

This firm is registered to practice before the U. S. Patent Office. We are available to assist you in the preparation and prosecution of your application for patent.

We shall be glad to send you promptly and without obligation, an instructive booklet—"Patent Protection for Inventors"—and our convenient "Evidence of Invention" form.

VICTOR J. EVANS & Co. *Merlin M. Evans*
REGISTERED PATENT ATTORNEY
430-M MERLIN BUILDING, WASHINGTON 6, D. C.



college graduates get ahead faster!

You see it in your own city. They have higher incomes . . . advance more rapidly. Grasp your chance for a better life. Industrial growth . . . automation . . . technical advances create career opportunities for engineers, accountants, management experts. Share rewards awaiting college men. Important firms visit campus regularly to employ Tri-State College graduates. Start any quarter in this world-famed college. Approved for veterans.

Bachelor of Science degree in 27 months

In Mechanical, Civil, Electrical (Electronics or Power Major), Chemical, Aeronautical Engineering. In 36 months a B.S. in Business Administration (General Business, Accounting, Motor Transport Management majors). Superior students may accelerate, 36-weeks course in Drafting. Intensive program: technical fundamentals stressed; comprehensive courses with more professional class hours. Small classes; personalized instruction. Enrollment limited. Preparatory courses. Beautiful campus. Well-equipped, new and modernized buildings and laboratories. Enter Jan., Mar., June, Sept. Earnest, capable students (whose time and budget require accelerated courses and modest costs) are invited to write *Jeas McCarthy, Director of Admissions, for catalog and book "Your Career in Engineering and Commerce."*



TRI-STATE COLLEGE

4118 College Avenue • • • Angola, Indiana

GET GOV'T JOB!



High Salary — Security — Sick Leave Vacations with Pay — Generous Pensions

Train now . . . prepare yourself for civil service examinations. Hundreds of thousands of jobs available each year—federal, state, municipal. This wonderful Home-Study Course tells you which jobs YOU can qualify for. Then helps you prepare yourself for the civil service exams you select. Completely self-instructing! These interesting lessons help you toward hundreds of big-pay government

jobs, including: postal carrier, investigator, carpenter, clerk, accountant, customs-inspector, engineer, foreign service, policeman, railway postal clerk, typist, etc.

SATISFACTION GUARANTEED OR FULL REFUND!
Contains same instruction material as high-priced correspondence courses. Complete price only \$6.95, postpaid. Or C.O.D. plus postage. No risk—order today. Satisfaction or money back. Order "Civil Service Course," Nelson-Hall Co., 210 S. Clinton St., Dept. 4LS-2, Chicago 6, Ill.



THERE'S
MONEY
IN

CARTOONS!

Internationally known instructor, RAYE BURNS, will teach you HOW to CREATE ORIGINAL CARTOONS at home that you may SELL! Course contains 26 lessons and over 600 illustrations. Cost of course is very low.

Send name and address for free details.

RAYE BURNS SCHOOL, Dept. P, Box 3583, CLEVELAND, OHIO

Free Book on Arthritis And Rheumatism

HOW TO AVOID CRIPPLING DEFORMITIES

Explains why drugs and medicine give only temporary relief and fail to remove the causes; tells all about a specialized non-surgical, non-medical treatment which has proven successful since 1919. Write for this 36-page FREE BOOK today.

BALL CLINIC Dept. 756 Excelsior Springs, Mo.

WRITE WITH A RUBY!

- Sensational new German Fountain pen
- has rolling jewel tip for velvet smooth writing with regular liquid inks.
- An excellent drafting aid using India ink. "Writes dry" —
- No refills to buy! Makes carbon copies. A superb signature pen for executives.

A
PRACTICAL
EXOTIC FOR
THOSE WHO
PRIZE THE UNUSUAL.

Contemporary Deluxe
(illustrated).....\$4.00

Continental, in European
styling.....\$3.50

Send today cash, check or
money order to:

INTERNATIONAL ENTERPRISES

P.O. Box 8121 • Dallas 5, Texas
(Postage paid on prepaid orders)



NOW!
at a price
you can afford!

MAKE MORE MONEY in TELEVISION RADIO-ELECTRONICS

**BETTER...MORE COMPLETE...LOWER COST...
WITH NATIONAL SCHOOLS SHOP-METHOD
HOME TRAINING!**

BETTER... Training that is proved and tested in Resident School shops and laboratories, by a School that is the **OLDEST** and **LARGEST** of its kind in the world.

MORE COMPLETE... You learn **ALL PHASES** of *Television-Radio-Electronics*.

LOWER COST... Other schools make several courses out of the material in our **ONE MASTER COURSE** and you pay more for less training than you get in our course at **ONE LOW TUITION!**



These
two FREE books will
show you how!

You get all information
by mail... You make
your own decision... at
home! **NO SALESMAN
WILL CALL**

TOP PAY... UNLIMITED OPPORTUNITIES LIFETIME SECURITY CAN BE YOURS!

You are needed in the Television, Radio, and Electronics industry! Trained technicians are in growing demand at excellent pay—in **ALL PHASES**, including Servicing, Manufacturing, Broadcasting and Communications, Automation, Radar, Government Missile Projects.

NATIONAL SCHOOLS SHOP-METHOD HOME TRAINING, with newly added lessons and equipment, trains you in your spare time at home, for these unlimited opportunities, including many technical jobs leading to supervisory positions.

YOU LEARN BY BUILDING EQUIPMENT WITH KITS AND PARTS WE SEND YOU. Your National Schools course includes thorough *Practical* training—**YOU LEARN BY DOING!** We send you complete standard equipment of professional quality for building various experimental and test units. You advance step by step, perform more than 100 experiments, and you build a complete TV set from the ground up, that is yours to keep! A big, new TV picture tube is included at no extra charge.

EARN AS YOU LEARN. We'll show you how to earn extra money right from the start. Many of our students pay for their course—and more—while studying. So can you!

RESIDENT TRAINING AT LOS ANGELES

If you wish to take your training in our Resident School at Los Angeles, the world's TV capital, start **NOW** in our big, modern Shops, Labs and Radio-TV Studios. Here you work with latest Electronic equipment—professionally installed—finest, most complete facilities offered by any school. Expert, friendly instructors. Personal attention. Graduate Employment Service. Help in finding home near school—and part time job while you learn. Check box in coupon for full information.

LESSONS AND INSTRUCTION MATERIAL ARE UP-TO-DATE, PRACTICAL, INTERESTING. Every National Schools Shop-Method lesson is made easy to understand by numerous illustrations and diagrams. All instruction material has been developed and tested in our own Resident School Shops, Laboratories and Studios.

SEND FOR INFORMATION TODAY... it can mean the difference between **SUCCESS** and failure for you! Send for your **FREE BOOK** "Your Future in Television-Radio-Electronics" and **FREE Sample Lesson.** Do it **TODAY**, while you are thinking about your future. It doesn't cost you anything to investigate!

GET THE BENEFITS OF OUR OVER 50 YEARS EXPERIENCE

Approved for
GI Training



NATIONAL SCHOOLS
Los Angeles 37, Calif.

YOU GET...

- 19 Big Kits—**YOURS TO KEEP!**
- Friendly Instruction and Guidance
- Job Placement Service
- Unlimited Consultation
- Diploma—Recognized by Industry
- **EVERYTHING YOU NEED FOR SUCCESS!**

SHOP-METHOD HOME TRAINING COVERS ALL PHASES OF INDUSTRY

1. Television, including Color TV
2. Radio AM & FM
3. Electronics for Guided Missiles
4. Sound Recording and Hi-Fidelity
5. FCC License
6. Automation and Computers
7. Radar & Micro-Waves
8. Broadcasting and Communications

NATIONAL TECHNICAL SCHOOLS

WORLD-WIDE TRAINING SINCE 1905

MAIL NOW TO
NATIONAL SCHOOLS, Dept. RB-118
4000 S. FIGUEROA ST., LOS ANGELES 37, CALIF.
Rush free TV-Radio "Opportunity" Book and sample
lesson. No salesman will call.

NAME _____ AGE _____

ADDRESS _____

CITY _____ ZONE _____ STATE _____

Check if interested **ONLY** in Resident School training at Los Angeles
VETERANS Give date of Discharge _____

THORESEN'S MILLION DOLLAR

THORESEN UNDERSUIT

Insulated with Curtiss-Wright's

CURON

LIST PRICE **11⁸⁸**
 \$39.95



**Keeps You Warmer Even
 in 72 DEGREES
 Below Freezing!**

New 1959 Thoresen Undersuit with amazing Curon that OUTWARS, OUTWEARS and OUTDATES all other insulated undersuits on the market—even those that cost up to THREE TIMES MORE!

You've read about the wonders of Curon in magazine and newspapers . . . you've seen its superiorities demonstrated on television . . . you've heard leading commentators talk about it on radio . . . now famous THORESEN'S, for the very first time, offers you its premium-quality Undersuit fully insulated with miracle new Curon at a BIG DISCOUNT! List price: \$39.95 . . . Thoresen cuts price to \$11.88.

Developed by the famed Curtiss-Wright Research Laboratories at a cost of thousands of dollars, Curon is lighter than wool, lighter than alpaca, lighter than down, lighter than lamb's wool, lighter than sheep wool, lighter than nylon, dacron and other synthetic materials—YET WARMER THAN ALL OF THEM! Your Warm-Air Undersuit with Curon weighs only ounces yet gives same protection as 20 lbs. of heavy garments! Featherweight. Move about freely in it. No itch. No bulk. Shrink-proof. It can be washed, scrubbed, rubbed, dry cleaned, pressed, steamed. Never loses its shape. Won't mat or bunch or stretch. Can be worn in normal room temperature without sweating by Hunters, Trappers, Police Officers, Letter Carriers, Outdoor Workers. Great for men over 35. Keeps you nice and warm in cold, damp weather—YET YOU WEAR LESS OUTER GARMENTS!

Sizes: Small (36-38); Medium (40-42); Large (44-46); Extra Large (48-50).

No. 350 \$11.88

Deluxe Model with zipper openings, special dinstitching, only \$2 more.
 No. 350-D \$13.88

Curon gives you LESS WEIGHT . . . LESS BULK . . . BETTER FASHION . . . GREATER COMFORT . . . LONGER LIFE — the 5 advantages every sportsman, every hunter wants in his insulated undersuit! Curon weighs only half as much as the finest quilted synthetic interlining YET STOPS MORE COLD . . . keeps you far warmer even in 72 degree below freezing! Curon is a full 35% more effective as an insulator than the finest animal-fibre-textiles that weigh up to FIVE TIMES AS MUCH! In damp and moist cold the insulating superiority of Curon is even more pronounced. Curon is so soft and pliable that you can easily squeeze a full square yard to the size of a tennis ball . . . release it and Curon literally flows back to its original shape. The fashion built into the garment will always remain there!

This Insulated Vest Feels Warmer Than 5 Sweaters!

FREE Home Trial

Insulated with Curtiss-Wright's

CURON 577

Made to Sell for \$12.95

New 1959 hunting vest with genuine CURON INSULATION for extra warmth and protection—made to retail for \$12.95 in better sporting goods stores everywhere—yours for only \$5.77 direct! Feather-light yet warmer than 5 wool sweaters, say many wearers. Extra-large non-rust Zipper that won't freeze. Two huge roomy pockets with inside ELASTIC SHELL LOOPS. Washable. Dries Fast. Keeps shape. Curon insulation by world-famous Curtiss-Wright. Dustproof. Mothproof. Full purchase price refunded if you don't agree it's easily worth TWICE THE PRICE WE ASK! RED, BROWN or YELLOW. Extra Small (32-34); Small (36-38); Medium (40-42); Large (44-46); Extra Large (48-50). No. 53 . . . Slashed to only \$5.77.



New Pocket Adding Machine Adds & Subtracts to ONE BILLION!

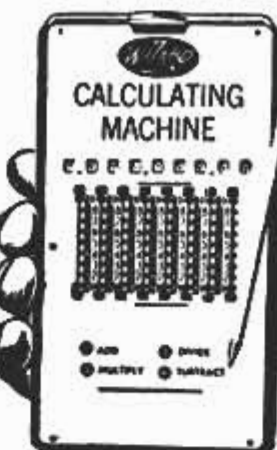

• 100% Accurate
 • Imported from West Germany
 • Sold Only by Thoresen's

1⁹⁸

Others pay \$3.98 for machines that calculate to 999,999. Wizard Calculator goes to ONE BILLION — yet costs \$1.98! Get more, pay less. Mechanism of Korium steel. Sleek, slim. Fits pocket. Unbreakable in normal use. Never makes a mistake. Press numbers; see totals pop into view like cash register. 101 uses. Tally scores, statements; check homework; use at market to tally purchases as you take them off shelves. Know your bill before you reach checkout counter. 3 1/2 million pocket machines in use here and abroad. Get yours now. No. 118 \$1.98

DELUXE Executive Model in vinyl carrying case finished in morocco-grain with built-in Memo Pad. Only \$2.98. Order by No. 118-D.

SMALLEST PORTABLE RADIO in the WORLD!

• NO TUBES! • NO BATTERIES! • NOTHING TO PLUG-IN!

NEVER WEARS OUT
 FITS POCKET or PURSE! **4⁹⁹**

So tiny—tucks away in pocket or purse. Carry with you everywhere—only 5 ounces! No batteries. No tubes. No plug-in. Completely personal ear-phone reception. Genuine crystal germanium diode rectifier NEVER WEARS OUT—works even when power failure makes other radios go dead! Enjoy thrilling programs, music, sports, news without 1c cost for batteries, tubes, etc. Not a kit. Comes complete—ready to operate. Precision-made, with earphone to give you private listening without disturbing others—even in bed! Smart waterproof carrying case included. Wonderful gift for over-active boys and girls because it WON'T BREAK like expensive tube radios. Get yours now on FREE home trial. No. 1820 \$4.99



NOW—Your Own Brand of Cigarettes for Only 9c PER PACK!

Smoke 200 Cigarettes FREE during your 10-day home trial



Enjoy premium-quality cigarettes as good or BETTER than brand you now smoke yet pay—NOT 30c a pack. NOT 20c, but only 9c! Smoke king size or regular, plain or filter tip. How is this value pos-



sible? The Korium Cigaret-Maker is the answer. Turns out THOUSANDS of cigarettes. Do not confuse with wartime roll-your-own gadgets. This Korium Model is precision-made and follows, in essence, same firmly-packed principles as \$100,000 cigaret machines used by big companies in Va., N. Car., etc. Operating machine easy as A-B-C. Pour in tobacco, slip in paper, press down—and presto—you have cigarette in your hands in less than 2 seconds! Send now for this "little cigarette factory" and we'll include enough FREE Corsaire tobacco for 200 cigarettes—complete carton! Also free Handsome styrene cigarette case. After 10 days, if not satisfied, your money back in full. But smoke 200 cigarettes FREE with our compliments. Keep the case FREE too. You can't go wrong. (Additional tobacco may be purchased from us.) Order by No. 85 \$4.98

SALE OF CHRISTMAS GIFTS!

The Multi-Protected Watch UNBREAKABLE Mainspring 7⁹⁸ Water, Dust, Shock Resist



Just arrived from Switzerland! New multi-protected watch for men of action. 7 super features not found in ordinary watches. 1. Unbreakable Mainspring. 2. Shock protected. 3. Water Resistant. 4. Raised Luminous Metal Dial. 5. Sweep Second Hand. 6. Stainless Steel Screw Back. 7. Thoresen's Unlimited Guarante

tee. Watch guaranteed for lifetime of this firm! FREE adjustments, oiling, service, repairs! Regularly \$17.98 but price SLASHED during this Christmas sale to only \$7.98 plus 80c Federal tax. TOTAL: \$8.78. DeLuxe Model (illus.) with metal expansion band. Only \$9.98 plus \$1 Fed. tax. TOTAL: \$10.98. No. 221

Price Reduced on Hi-Power Electric Paint Sprayer

Famous Hi-Power Automatic Electric Paint Sprayer. Kit at our lowest price ever. New model. New powerful motor pump. New adjustable MAGIC SWIVEL NOZZLE, sprays UP, DOWN, SIDEWAYS without tilting jar! STAINLESS Steel & Brass parts. Rust-proof 25-oz. jar. Cuts painting time up to 75%. Do average room in less than hour. Press button & spray. No stiff arms or sore muscles from carrying sloppy, dripping brushes. Paint screens, walls, ceilings, floors, cabinets; refinish furniture, etc. Gets into cracks, rough surfaces that brush can't

even reach! Completely safe—easier to clean than brush! Approved by professionals. Takes deodorants, lacquers, disinfectants, polishes, etc. Mothproof clothes, spray plants, paint car, etc. Same type formerly adv. on TV for \$19.95—now SLASHED to new low \$7.99. Hi-Power Model sold only by mail, only by us. No. 95.

SPECIAL
DeLuxe Model with JEWELLED Tip for fine, precision work. Built-in COPPER FILTER, heavy-duty electric cord. Same features as in \$24.95 models. New only \$9.99. No. 95-D.



7⁹⁹
Same type form.
adv. on TV for
\$19.95

Insulate Your Home with these Plastic STORM WINDOWS



Formerly 49c each
19 1/2c

Why pay up to \$14.00 each for glass storm windows when you can insulate with famous Trans-Kleer for pennies. Enjoy big fuel savings too. Transparent like glass yet Trans-Kleer won't shatter, rattle, break or peel. Not affected by rain, snow, cold. Install in minutes. No nails, no

screws, no tools. Just cut & fit window, press on with Adheso border tape—that's all Trans-Kleer put on from INSIDE. For airing, just lift & press down again. Shipped in rolls measuring 34"x432", enough for 10 windows. 2 million sold at \$4.95—now reduced to \$1.98 (19 1/2c per window.) Trans-Kleer sold only by Thoresen's. No. 74 . . . 1 kit \$1.98, 2 kits (20 windows) \$3.93.

FREE: 90 feet roll of Adheso border tape

13-Piece Set of Chrome Vanadium DRILLS

Lists: 1⁸⁸
5.98

From West GERMANY

13 precision chrome vanadium drills from 1/16th thru 1/2 inch by 64ths, enclosed in handy metal indexed jacket for quick selection. Drill thru woods, plastics, aluminum, iron, even thick-gauge STEEL! You'll get years of service from these hi-speed drills. \$5.98 value. No. 13 . . . \$1.88.

GIANT 108 Sq. Ft. Drop Cloth \$1⁰⁰

Huge 8x12 sheet of tough, durable plastic (108 sq. feet) for only \$1. Protects carpets, floors, upholstery, outdoor furniture. Used by car mfrs. to protect 1959 models. Use as drop cloth when painting, to make transparent auto seat covers, furniture slip covers, etc. Cut with shears; heat-seal with electric iron. Dust, grease, stain resistant. Waterproof. No. 4, 108 sq. ft. \$1; 3 sheets for \$2.65.

7 X 35 BINOCULARS

Advertised
at
\$24.95

9⁹⁸

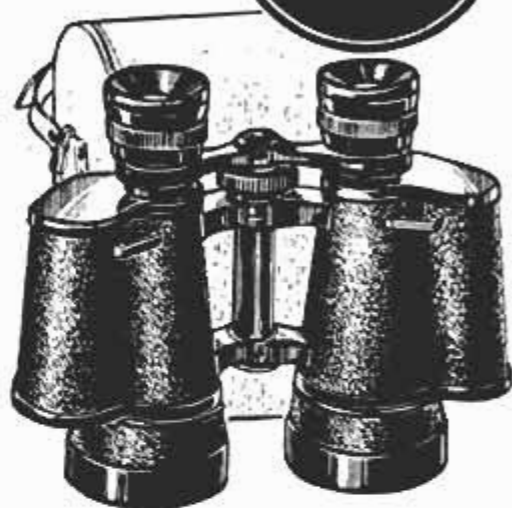

Fabulous Value from America's BIGGEST Importer of Binoculars!

We've sold more than ONE MILLION binoculars in recent years, but this is our most fabulous value, Precision-made Hi-Power 7x35 Binoculars—nationally advertised at \$24.95—now REDUCED to only \$9.98 plus tax. Highest optical craftsmanship. Meticulously ground coated lenses. Full power without distortion or color breakdown. Made of cast metal with pebble grain, jet black covering. Smoother center focusing. Rugged yet lightweight. View for hours WITHOUT ARM FATIGUE. Excellent light transmission permits viewing in moonlight. Pigskin case, shoulder straps, four slide-on protective lens covers included at NO extra charge.

Take these binoculars on hunting, fishing, outdoor trips, on sightseeing tours with family and friends. Use them as often as you like for 10 full days. If you're not 100% satisfied, your money is refunded.

No. 171—\$9.98 plus \$1 Fed. Tax. Total \$10.98.

THORESEN, INC., Dept. 6-M
585 Water St. New York 2, N. Y.

Mail Coupon! Prompt Delivery! Money Back Guaranteed!
THORESEN, Inc., Dept. 6-M,
585 Water Street, New York 2, N. Y.

RUSH items below. My money back if I'm not satisfied with 10-day trial.

- Check or money order enclosed. Ship postage paid.
 Send C.O.D. plus postage and C.O.D. fee. (Enclose \$1 deposit.)

Number	Quantity	ARTICLE	Price

PRINT NAME _____

ADDRESS _____

TOWN OR CITY & ZONE _____ STATE _____

Canadian: Address THORESEN, Ltd., 439 King Street West, Toronto 28, Ont.

DRAFTSMEN



**CASH BIG
PAY CHECKS!**

**Train Now for
more success,
greater security**

**LEARN AT HOME IN SPARE TIME
(or at college in Chicago)**

Check the want ads in any newspaper—SEE the big-pay opportunities open to you as a draftsman. What's more, you can learn this well-paid, prestige profession at home — quickly, easily! No special talent needed. Get complete, step-by-step Chicago Tech lessons in the mail, spend a few pleasant hours studying each week. In a short time you'll be a well-trained draftsman, ready to take your pick of many good jobs. Act now!



Free Information—Mail Coupon Today!

Get **FREE TRIAL LESSON** plus information about C.T.C. practical training. Learn what successful Chicago Tech graduates say about high pay and opportunities in drafting. No charge, or obligation.

CHICAGO TECHNICAL COLLEGE

P-216 Tech Bldg., 2000 So. Michigan Ave.
Chicago 16, Illinois

Mail me **FREE** lesson with facts about big opportunities in **DRAFTING**.

Name _____ Age _____

Address _____

City _____ Zone _____ State _____

**EARN \$100
A WEEK AND UP**

**BE AN AUTO-DIESEL
MECHANIC — EARN
WHILE YOU LEARN**

Many of our graduates earn \$100 a week and up. You learn fast in our school and shops because you learn with tools on real equipment. Experienced instructors explain WHY and show you HOW, then you DO IT YOURSELF. One of the best equipped technical schools in the United States. Thirty-nine years' experience training men. Successful graduates in 48 states and many foreign countries. Approved for veterans. Day and evening classes. Free bulletin—write today.

NASHVILLE AUTO-DIESEL COLLEGE
226 7th Ave. N., Dept. 86, Nashville, Tenn.

FREE! Fabulous Collection from
SOUTH of the BORDER



Get this big, valuable collection of genuine, all-different postage stamps from the exciting land of the mysterious Amazon . . . scarce airmails, gorgeous commemoratives, giant-sized stamps picturing wild horses, covered wagons, action-packed fights, native war heroes: **PLUS** sensational train stamp, beautiful "Christ of the Andes"; many others. **EXTRA!** Bargain Catalog, "Collectors' Manual" plus other exciting offers for your inspection. Enclose 10¢ for mailing expenses . . . **ACT NOW!**
JAMESTOWN STAMPS, N118PM JAMESTOWN, N.Y.



**Mr. "N" Made \$9,700 Last Year By
Selling Just 20 KEEP/SAFEs a Month!**

Like Mr. "N" you can profit with **KEEP/SAFE**—the fine personal safe that undersells all others. Only safe sold direct. 95% of homes, farms and small businesses are prospects. \$30 to \$71 profit per sale, plus bonuses up to \$12 a safe. Choice territory, chance to become district agent. **FREE DEMONSTRATOR!** Get details, giving address including county.

JOHN D. BRUSH & CO., INC.
575 West Ave. Rochester 11, N. Y.

REAL ESTATE BE A BROKER

PAYS BIG! SEND FOR FREE, BIG, ILLUSTRATED CATALOG NOW! Graduates report making substantial incomes. Start and run your own business quickly. Men, women of all ages, learn easily. Course covers Sales, Property Management, Appraising, Loans, Mortgages, and related subjects. **STUDY AT HOME** or in classrooms in leading cities. Diploma awarded. Write **TODAY** for free book! No obligation.

Approved for World War II and Korean Veterans
WEAVER SCHOOL OF REAL ESTATE (Est. 1936)
2020R Grand Avenue Kansas City, Mo.



KELSEY
PRESSSES

Print Your Own

Cards, Stationery, Advertising, Circulars, labels, photo and movie titles, church work, tags, etc. Save money. Sold direct from factory only. Raised printing like engraving, too.

Own a Printing Business

Print for Others, Good Profit. Have home shop. Junior press \$15; Senior \$29 up. We supply everything. Easy rules. Pays for self in short time. Write for free catalog of outfits and all details.
KELSEY PRESSES, C-37 Meriden, Conn.

JEEP OWNERS

**RE-POWER NOW WITH A V-8 ENGINE — Use
FORD • CHEVROLET • MERCURY**
in 2 or 4 Whl-Dr. Jeeps, Jeeps, Jeeps, Sta-Wgn, Trucks, M. J. and Kaiser cars. Conversion Kits \$43.25 to \$59.85. If you want fast action tell us which engine you wish to use, give us year, Model (2 or 4 Whl-Dr) of your vehicle. Send Min. \$15.00 Dep. and we will ship correct kit, Bal. COD. Send full amt. for prepaid shipment. Wire, phone or write for free details. Also Kits for **FORD 6 engine.**

HOOSIER MACHINE PRODUCTS CO.
312 S.E. 6th St. Phone CR 6-3442 Pendleton, Oregon, U.S.A.



WARN HUBS

**HOTTEST THING ON
Jeep FRONT WHEELS**

STOP FRONT DRIVE DRAG IN 2 W. D.
Warn Hubs on your 4 w. d. disengage the front drive in 2 w. d., give it double-duty value with free-wheeling 2 w. d. economy, performance, plus normal 4 w. d.—automatically, with Warn Lock-O-Matics, manually with Warn Locking Hubs. See your dealer soon!
WARN MFG. CO., INC.
Riverton Box 6064-A11, Seattle 88, Wn.



RCA INSTITUTES



OFFERS YOU THE FINEST OF HOME STUDY TRAINING



COURSE I
RADIO-TV ELECTRONICS
 COURSE II
TV SERVICING
 COURSE III
COLOR TV

The equipment illustrated and text material you get with each course is yours to keep. Practical work with very first lesson. Courses for the beginner and the advanced student. Pay-as-you-learn. You need pay for only one study group at a time.



SEND FOR THIS FREE BOOK NOW

Resident School courses in New York City offer comprehensive training in Television and Electronics. Day and evening classes start four times each year. Detailed information on request.

RCA Institutes, Inc. Home Study Dept. PM-118
 A Service of Radio Corporation of America
 350 West Fourth Street, New York 14, N. Y.

Without obligation, send me **FREE 52 page CATALOG** on Home Study Courses in Radio, Television and Color TV. No Salesman will call.

Name.....
 Please print

Address.....

City.....Zone....State.....

Korean Vets! Enter discharge date.....

CANADIANS—Take advantage of these same RCA courses at no additional cost. No postage, no customs, no delay. Send coupon to:

RCA VICTOR COMPANY, LTD.
 5001 Cote de Liesse Rd., Montreal 9, Que.

To save time, paste coupon on postcard

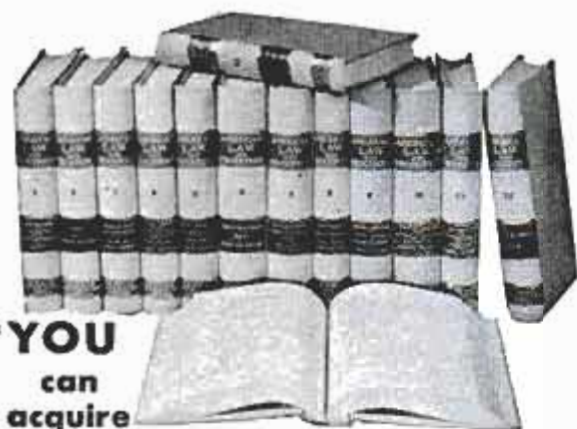

**YOU
can
acquire**

**LAW NIGHTS AT HOME!
LL. B. DEGREE**

LaSalle's famous Law Library—used as reference in many Law libraries and Law offices—has enabled thousands to master Law surprisingly fast, in spare hours at home, for business and professional advancement.

These 14 remarkable volumes, compiled by leading professors and lawyers, cover the whole basic field of Law in condensed, orderly, simplified manner.

You advance rapidly with this great library, plus special lectures furnished. We guide you step-by-step with personalized Problem Method of instruction . . . you learn by doing—handling legal problems—not by memorizing rules.

Send for two FREE booklets, "Law Training for Leadership," and "Evidence," answering questions about Law and its value to you, and telling how LaSalle Law graduates are winning rapid advancement in business and public life. Mail coupon below. No obligation.

**LA SALLE EXTENSION UNIVERSITY
A Correspondence Institution**

417 S. Dearborn St. Dept. 1164L Chicago 5, Ill.

Send me your two FREE booklets described above, without obligation.

Name..... Age.....

Street.....

City, Zone & State.....



HIGH WAGES!

Make big pay in the construction industry as an operator of Bulldozers, Draglines, Shovels, Back Hoes, Scrapers and Motor Graders. Learn these skills NOW! Machines of major manufacturers are used in our training program. Contractors need operators of earthmoving machines and pay high wages to our graduates. Don't be satisfied with just a job . . . learn a career!

VETERANS: Ask about G.I. Benefits!

Write TODAY for FREE School Catalog, no obligation, to either address

**THE NATIONAL SCHOOLS
of HEAVY EQUIPMENT OPERATION**

DEPT. D-24

P.O. Box 8243, Charlotte, N.C.

P.O. Box 527, Weiser, Idaho

\$8 750 FIRST YEAR—IN YOUR OWN BUSINESS



Start Part Time—We Furnish Everything

We locally train you to run your own business, furnish all equipment and supplies to clean and moth-proof rugs and upholstery on location by world-wide process. No shop needed, you become quickly established. Just 2 average jobs a day bring \$8,750.00 NET profit in year. Employ others and multiply your earnings. A member of world's largest organization of its kind you are backed by National Advertising, receive 25 regular services to help build your business. You'll be only one in town whose process bears famous Parents' seal. Business grows rapidly due to recommendations and repeat jobs. EASY TERMS. Send TODAY for fascinating FREE BOOKLET with complete details.

DURACLEAN CO.

8-16N Duraclean Building • Deerfield, Illinois

Makes \$216 A MONTH IN SPARE TIME!



M. M. REARICK SAYS:

"I average up to \$216.00 A Month...operating my Belsaw Sharp-All after work and on Saturdays."

Turn spare time into Big Cash Profits with new Belsaw Sharp-All. No experience needed to sharpen knives, scissors, shears, ice skates, mower blades, hedge trimmers, axes, chisels and circular saws . . . Learn how easily you can start your own spare time business. Amazing low cost easy-payment plan. Send Postcard for FREE BOOK. BELSAW SHARP-ALL CO 719 Field Bldg., Kansas City 11, Mo.

SHORTHAND in

6 WEEKS

Famous SPEEDWRITING shorthand. 120 words per minute. No symbols; no machines; uses ABC's. Easiest to learn, write and transcribe. Lowest cost. For business and Civil Service. 350,000 graduates. Typing available. 36th year. Write for FREE booklet to: SCHOOL OF

© 1937

Speedwriting
Dept. 1511-B, 55 W. 42 St., New York 36

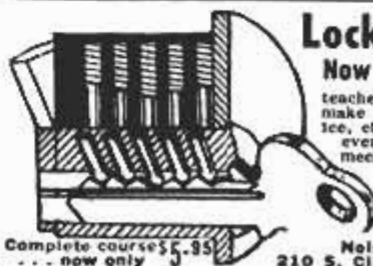

Locksmithing AND KEY MAKING

Now Made Easy! Practical up-to-date course

teaches you how to pick locks, de-code, make master keys, repair, install, service, etc. New self-instruction lessons for every handyman, homeowner, carpenter, mechanic, service station operator, fix-it shop, hardware dealer, gunsmith. 53 easy illustrated lessons. Full price only \$5.95 postpaid; or C.O.D. plus postage. Satisfaction or refund guaranteed.

Complete course \$5.95 . . . now only 210 S. Clinton Nelson-Hall Co., Dept. LS-2 Chicago 6, Ill.

RUPTURED

BE FREE FROM TRUSS SLAVERY

Surely you want to THROW AWAY TRUSSES FOREVER, be rid of Rupture Worries. Then Why Do you put up with wearing a griping, chafing and unsanitary truss the balance of your life? If you do, it will NOT be through necessity but through choice on your part.

Now there is a new modern Non-Surgical treatment that is designed to permanently correct rupture. These Non-Surgical treatments are so certain, that a Lifetime Certificate of Assurance is given. Write today for our New FREE Book that gives facts that may save you painful, expensive surgery. Tells how non-surgically you may again work, live, play, love and enjoy life in the manner you desire. There is no obligation. Excelsior Medical Clinic, Dept. H6124, Excelsior Springs, Mo.

WHAT ALL AUTO MECHANICS WANT TO KNOW



This Big Practical Book gives full information, with working diagrams, covering the principles, construction, ignition, service and repair of modern cars, trucks and buses.

Diesel Engines, Hydromatic and Fluid Drives Fully Explained.

A complete guide of 1696 Pages, with over 1500 Illustrations showing inside views of working parts, with instructions for service jobs.

Completely up-to-the-minute! Priced at only \$6.

CIRCLE No. 1 IN COUPON

HOW TO FIX HOME APPLIANCES

REFRIGERATORS WASHERS TOASTERS DRYERS IRONERS RANGES YACUUMS FREEZERS

Many other GAS AND ELECTRIC APPLIANCES

Handy Reference for Electric & Gas Servicemen, Mechanics, Dealers and Homeowners. Explains clearly and simply how to locate troubles, how to test, reassemble and connect. Wiring diagrams, 1000 Facts, Easy to read. Answers ALL your questions. 864 Pages. Illustrated. Only \$6.

CIRCLE No. 2 IN COUPON



HERE IS LATE INFORMATION IN A HANDY FORM FOR RADIO AND TELEVISION REPAIRMEN, SERVICEMEN AND STUDENTS

TWO COMPLETE VOLUMES - 1568 Pages - 1085 Illustrations and Diagrams. 1001 Important Facts and Figures on Modern T.V. Radio, Electronic Devices, INCLUDES TRANSISTORS & Transistor Circuits, Rectifiers, Record Changers, P.A. Systems, Phonograph Pick-ups, F.M., Auto Radio, Short Wave,

Basic principles, Construction, Installation, Operation, Repairs, Trouble Shooting. How to get Sharp, Clear T.V. Pictures. Install Antennas, How to Test, Explains COLOR SYSTEMS, Methods of Conversion, Terms, etc. Includes Ultra High Frequency. Quick ready reference or use as a home study course. Only \$8 for BOTH volumes.

CIRCLE No. 3 IN COUPON

KNOW YOUR TRUCK

The TRUCK & TRACTOR GUIDE for Mechanics & Drivers, Foremen, Garagemen, Helpers, Owners, Trouble Shooters, Farmers, etc. Covering Gas & Diesel Motor Principles - Construction - Operation - Maintenance - Repair - Brakes - Service of all Parts. 1376 Pages, FULLY ILLUSTRATED. Index. Only \$5.

CIRCLE No. 5 IN COUPON

PLUMBERS AND STEAMFITTERS GUIDES



Practical Trade Assistant & Reference Set. Explains in plain language and by clear illustrations, diagrams, charts, graphs and pictures the principles of modern plumbing practice including Pipe Fitting and Air Conditioning. 4 Vols. - 2624 Pages - 3642 Diagrams & Illustrations. Only \$8 for the complete set of 4 vols.

CIRCLE No. 6 IN COUPON

PAINTING & DECORATING MANUAL

Inside Trade information on outside and inside work; how to mix paints, preparation of surfaces, paper hanging, wood finishes, tools, synthetic paints, color (with color chart), spray equipment, costs, estimating, etc. A COMPLETE guide to easier, better painting and decorating. 464 Pages. Fully Illustrated. Only \$2.

CIRCLE No. 7 IN COUPON

7-DAY FREE EXAMINATION

SEND NO MONEY - Pay the postman nothing! We are glad to send you the Audel Guides for absolutely FREE examination in your own home. We take all the risks and leave all the discounts up to YOU. There is no obligation if you decide to keep the books of your choice you may pay for them under our astounding easy-pay plan of only \$2 a month.

HERE IS ALL YOU DO

IT'S EASY TO ORDER: In the No-Risk Mail Order Coupon at the right just draw a circle around the number of Audel Guides you want us to send you for FREE EXAMINATION. We will send them to you at once to help you build a brighter future by increasing your SKILL. If for any reason at all you are not COMPLETELY satisfied, return the books to us, and that will end the matter! NO STRINGS OR CATCHES TO THIS OFFER.

THEO. AUDEL & CO.

49 West 23rd Street, New York 10, N.Y.

NOVEMBER 1958

CARPENTERS AND BUILDERS GUIDES



Practical STOREHOUSE OF MODERN CONSTRUCTION INFORMATION (4 vol. set) for carpenters and all woodworkers. Explains in easy language and by profuse illustration principles, advances, short cuts, trade secrets, all based on the NEWEST information.

Vol. 1 - Tools, steel square, saw filing, joinery, furniture, etc.; Vol. 2 - Builders' mathematics, drawing plans, specifications, estimates, etc.; Vol. 3 - House and roof framing, laying out, foundations, etc.; Vol. 4 - Doors, windows, stair building, millwork, painting, etc. 4 vols. 1904 Pages. 3700 Illustrations. Whole set only \$8.

CIRCLE No. 8 IN COUPON

PRACTICAL ELECTRICITY

A COMPLETE HANDBOOK - Quick, simplified, ready reference. Complete instruction and practical information on the rules and laws of electricity - Maintenance of Machinery - A.C. and D.C. Motors - Armatures - Wiring Diagrams - House Lighting - Power Wiring - Meters - Batteries - Transformers - etc. Simple to understand. 1520 Pages. 2600 Illustrations. Priced at \$5.

CIRCLE No. 4 IN COUPON

DIESEL

ALL THERE IS TO KNOW ABOUT MODERN DIESEL ENGINES - Basic principles, starting valves, timing, fuel pumps, fuel injection compressor, air compressor, pistons, cylinders, lubrication, cooling systems, etc. Answers on operation, calculations. 640 Pages. Fully Illustrated. Priced \$3.

CIRCLE No. 9 IN COUPON

WELDERS GUIDE

Covers Electric, Oxy-acetylene, Thermit, Unionmelt welding for sheet metal, spot and pipe welds, pyroclastic welds and aluminum, copper, brass, bronze and other metals. Airplane work, surface hardening, hard facing, cutting, brazing, etc. 608 Pages. Fully Illustrated. Only \$3.

CIRCLE No. 10 IN COUPON

MATHEMATICS MADE EASY

A COMPLETE HOME STUDY COURSE - Starting with the first principles of arithmetic, advancing step by step through the various stages of mathematics, including the rules and calculations for mechanical and electrical problems. New EASY correct methods. Includes plane and solid geometry, trigonometry, algebra, calculus, etc. Practical tests, reference tables and data. How to use slide rule. 752 Pages. 550 Illustrations. Priced at only \$3.

CIRCLE No. 11 IN COUPON

NEW MACHINISTS AND TOOLMAKERS HANDBOOK

MODERN MACHINE SHOP PRACTICE - 5 PRACTICAL BOOKS IN ONE. New from cover to cover. Tells how to set up and operate lathes, screw and milling machines, shapers, drill presses and all other machine tools. A COMPLETE INSTRUCTOR AND REFERENCE BOOK. 1728 Pages. Fully Illustrated. Priced at only \$6.

CIRCLE No. 12 IN COUPON

WIRING DIAGRAMS

This book gives the practical facts on wiring of electrical apparatus. It explains clearly and SIMPLY how to wire apparatus for all fields of electricity. Each diagram is complete and self-explaining. Know your HOOK-UPS! 304 Pages. Illustrated. Only \$2.

CIRCLE No. 13 IN COUPON

REFRIGERATION & AIR CONDITIONING

FOUR BOOKS IN ONE - basic principles, servicing, operation, repair of: 1. Household Refrigeration. 2. Special Refrigeration Units. 3. Commercial & Industrial Refrigeration. 4. Air Conditioning Systems. A GOLD MINE of essential information. Completely up-to-date. 1360 Pages. Fully Illustrated and Indexed. Priced at only \$6.

CIRCLE No. 14 IN COUPON

THE NEW ELECTRIC LIBRARY

A COMPLETE ENCYCLOPEDIA explaining in the simplest terms the fundamental principles, rules and applications of applied electricity.

A COMPLETE COLLEGE EDUCATION!

Fully illustrated with diagrams and sketches, calculations and tables for ready reference. Questions and answers. Trial tests for practice study and review. All based on the most modern theory.

Vol. 1 - Principles and rules of electricity, magnetism, armatures, repairs. No. 15

Vol. 2 - Dynamos, DC Motors, construction, installation, maintenance, etc. No. 16

Vol. 3 - Testing instruments and tests, storage battery constr. and repairs. No. 17

Vol. 4 - Alternating current, power factor, alternators, transformers. No. 18

Vol. 5 - A.C. Motors, windings, maintenance, converters, switches, fuses, etc. No. 19

Vol. 6 - Relays, condensers, regulators, rectifiers, meters, switchboards, etc. No. 20

Vol. 7 - Wiring, house light and power, circuits, high

tension, plans, code, etc. No. 21

Vol. 8 - Railways, signals, elevators, ignition, etc. No. 22

Vol. 9 - Radio, telephone, telegraph, television, motion pictures. No. 23

Vol. 10 - Refrigeration, illumination, welding, X-ray, electrical appliances, Index. No. 24

7,000 fully illustrated pages. Priced at only \$20 for the ENTIRE SET. Also sold individually for \$2 each.

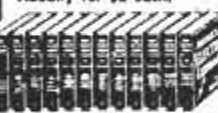

ALL TYPES OF BLUEPRINT READING

How to read scales, the standard symbols, detail and assembly prints, working drawings, short cuts, hints and suggestions. THE MAN WHO CAN READ BLUEPRINTS IS IN LINE FOR A BETTER JOB. This book gives you the secret language, step by step in easy stages. 448 Pages, Very Fully Illustrated. Priced at \$3.

CIRCLE No. 25 IN COUPON

MASONS & BUILDERS GUIDES

A PRACTICAL ILLUSTRATED 4 VOL. SET - Explaining in clear, simple language and profuse illustration, principles, advances, short cuts, trade secrets, based on modern practice - including how to figure and calculate various jobs. Vol. 1 - Brick work, bricklaying, bonding, designs. Vol. 2 - Brick foundations, arches, the setting, estimating. Vol. 3 - Concrete mixing, placing forms, reinforced stucco. Vol. 4 - Plastering, stone masonry, steel construction, blueprints. 4 Vols 1440 Pages. 2067 Illustrations. Complete Set only \$8.

CIRCLE No. 26 IN COUPON

ELECTRIC MOTORS

THIS GUIDE covers the construction, hook-ups, control, maintenance and trouble shooting of all types of motors. Includes armature winding. Explains entire subject in great detail in simple language. Over 1056 Pages of information, 617 Diagrams. All types of motors fully illustrated and indexed for ready reference. Priced at only \$3.

CIRCLE No. 27 IN COUPON

OIL BURNERS

New, complete, explaining in detail both domestic and industrial oil burners. Includes electrical hook-ups and wiring diagrams. Fully covering the theory, construction, installation, operation, testing, servicing and repair of all equipment. Indexed for ready reference. Over 416 Pages. 320 Illustrations and Diagrams. Only \$2.

CIRCLE No. 28 IN COUPON

ADDITIONAL IMPORTANT TITLES

The following Audel Guides are all the best in their fields, written in clear simple fashion, all lavishly illustrated. Circle the numbers wanted in the MAIL ORDER COUPON below. All books are sent for FREE EXAMINATION.

No. 29 SHEET METAL PATTERN LAYOUTS. 1152 Pages. \$7.50	
No. 30 SHEET METAL WORKERS HANDBOOK. 468 Pages. 2.00	
No. 31 MECHANICAL DRAWING GUIDE. 192 Pages. 2.00	
No. 32 MECHANICAL DRAWING AND DESIGN. 490 Pages. 3.00	
No. 33 ELECTRONIC DEVICES. 304 Pages. 3.00	
No. 34 ELECTRICIANS EXAMINATIONS. 272 Pages. 2.00	
No. 35 ELECTRIC POWER CALCULATIONS. Page 480. 3.00	
No. 36 ELECTRIC DICTIONARY. 9000 Terms. 3.00	
No. 37 POWER PLANT ENGINEERS GUIDE. 1568 Pages. 3.00	
No. 38 ENGINEERS AND FIREMANS EXAMS. 344 Pages. 2.00	
No. 39 OPERATING ENGINEERS LIBRARY. 3 Book Set. 12.00	
No. 40 PUMPS, HYDRAULICS AND AIR COMPRESSORS. 1760 Pages. 6.00	
No. 41 HOUSE HEATING GUIDE. 1008 Pages. 3.00	

MAIL THIS NO-RISK COUPON TODAY!

THEO. AUDEL & CO. - Self Improvement Publishers Since 1879 - P-11

49 W. 23rd Street, New York 10, N.Y.

Please mail me for 7 days' FREE EXAMINATION the books I have circled at right. I agree to mail \$2 in 7 days on each book or set ordered, and to further mail \$2 a month on each book or set ordered until I have paid the purchase price, plus shipping costs. If I am not completely satisfied with my Audel Guides I may return them.

NAME _____	1	2	3	4	5	6
ADDRESS _____	7	8	9	10	11	
OCCUPATION _____	12	13	14	15	16	
	17	18	19	20	21	
	22	23	24	25	26	
	27	28	29	30	31	
	32	33	34	35	36	
	37	38	39	40	41	

SAVE SHIPPING COSTS! Check here if you enclose complete payment with order. We pay postage charges. You have same return privilege.

Some make more, some less:

F.E.DORAN reports:

\$1050
gross in single
MONTH
in my own business



Start your own business!

Here's YOUR chance to start a money-making, year 'round business of your own and make the success you've dreamed about.

G. R. Adcock took in \$102 in one day. O. W. Hare landed a \$750 hotel job. J. S. Corbit grossed \$279.50 his first month. Homes, hotels, offices, clubs, offer you big profit possibilities. Auto upholstery also.

NO SHOP OR OFFICE NECESSARY • You clean furniture on customers' premises. No hauling, no high rents. Supplies inexpensive; you operate from your own home. What you take in is mostly profit.

If you want to be your own boss—free from lay-offs and strikes, we will help you to start and succeed.

This is not a lease proposition. You own the machine, you work when and where you please and all the money you take in is your own.

Mail
Coupon
Today
for
FREE
Book

VON SCHRADER MFG. CO.
E10 "D" Pl., Racine, Wisconsin

Without obligation rush your FREE booklet about how I can start my own permanent, profitable electric Upholstery Cleaning business.

Name _____
Address _____
City _____ Zone _____ State _____

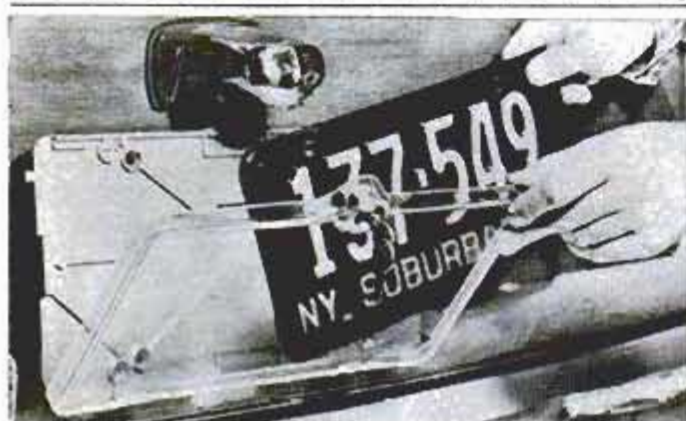

LOCKABLE CAR PLATE HOLDER PROTECTS YOUR LICENSE PLATE FOR YEARS

New patented "JIFI" license plate holder ends all trouble in removing rusty nuts, bolts in changing license plates. Made of Eastman's tenite butyrate material completely encasing 6 x 12 license plate. Keeps it new, bright and clean. No sharp corners or edges. Guaranteed resistant to rain, snow, sun, salt water, road oils, etc. Won't rust, chip, crack, or wrinkle. Equipped with Illinois lock, only tool needed to change plates is your key. Wonderful gift.

GET YOURS TODAY . . . only \$3.75 each
or two for \$6.95 postpaid U.S.A.

ORDER DIRECT FROM MANUFACTURER—CHECK OR MONEY ORDER

JIFI INDUSTRIES INC.

2333 SPRING STREET, WEST LAWN, READING, PENNA.



TIRE SALE

SPECIAL!
EVERYBODY
MAY DEDUCT
10% off
ON EVERY
TIRE

FREE
PASS.
TUBE

25 YEARS IN BUSINESS
AT THE SAME ADDRESS

GUARANTEE BOND given with each used tire sold. We guarantee the amount of service you pay for. SEND AD.

YOU CAN'T
LOSE!!

600x16	\$5.82	670x15	\$5.82	650x16(6)	\$8.92	800x15	\$7.32
600x16(6)	8.92	710x15	5.82	750x16(6)	8.92	820x15	7.62
650x16	6.82	760x15	5.92	640x15	3.52	700x16(6)	9.32
750x14	9.92	800x14	9.32	1100x20	20.32	1100x22	21.82
700x15(6)	\$11.92	700x20	\$11.92	750x17	\$14.42	825x20	\$19.92
750x16(8)	12.72	750x20(10)	15.72	800x20	12.42	900x20	19.92
700x17	13.72	750x20(8)	13.62	650x20	11.92	1000x20	42

12 MOS. WRITTEN GUARANTEE. WHITE WALLS \$1.00 EXTRA

"EXTRA SPECIAL" TOP QUALITY all size 4-ply pass. FREE TIRE with 2 or more of these. W.W. \$8.82
\$1.00 Extra — GIANT TIRE SALE. EA.

SNOW TIRES \$9.22 AND \$8.22 ANY SIZE
BLACK WALL PASS.

SUBURBANITE OR TOWN & COUNTRY TREAD
Thousands of tires shipped all over the U.S.A. All tires shipped F.O.B. Phila. Send Check or M.O. with this ad. Dept. 2. No C.O.D.
STANDARD 634 N. Broad St., Philadelphia 30, Pa.



SPUTNIKS I & II FREE!
BRUSSELS FAIR STAMPS

Fabulous collection of stamps showing: SPUTNIK I IN ORBIT SPUTNIK 2 IN ROCKET FLIGHT STRATOSPHERE BALLOON, METEOR. Station, Radio Telescope, actual TV set, TV station, Microscope, Microbe Hunter, BRUSSELS FAIR SET showing puppets, etc. All this is yours

Free, to introduce our bargain approval offers. EXTRA: 48 PAGE STAMP DICTIONARY included. Send 10c to cover mailing costs.
STAMPEX CO., Box 47-HM, White Plains, N. Y.

**ENGINEERING
DEGREE IN
27 MONTHS**

B.S. Degree, Acro., Chem., Civil, Elec., Mech. & Electronic Engineering (inc. Radio, TV). 36 mo. B.S. degree in Math., Chem., Physics. Prep courses. Demand for grads. Spacious campus. 20 bldgs.; dorms, auditorium, gym, Low rate. Earn board. G.I. approved. Enter Dec., March, June, Sept. Catalog.
1611 E. Washington Blvd.
Fort Wayne 2, Indiana
Keeping pace with progress

INDIANA TECHNICAL COLLEGE

BUY WHOLESALE
25,000 ITEMS — CATALOG 50c
B. MATTHEWS, 1480-W2 BROADWAY, N.Y. 36, N.Y.

HOW YOU CAN RETIRE WITH AN INCOME



• Now you can enjoy leisurely living with a welcome income. Start YOUR OWN BUSINESS AT HOME with TREYCO Grinding Equipment. Sharpen knives, cutters, saws, scissors, clippers, tools, and make up to \$5 per hour. Write for free money-making plan.

TREYCO PRODUCTS 334 NIAGARA AVE.
N. TONAWANDA, N.Y.

10" Slide Rule

ONLY 98¢ postpaid

ANYONE WHO UNDERSTANDS SIMPLE 7TH GRADE ARITHMETIC CAN USE THIS STANDARD SLIDE RULE!
Be modern — use this quick easy way of figuring. For business men, students, carpenters, machinists, salesmen, printers and engravers, office workers, farmers, merchants, time keepers, plumbers, electricians—everyone who does figuring can save time and labor with this slide rule.

FREE Illustrated Instruction book shows you how to get correct answers instantly without pencil and paper. (You get BOTH slide rule and instruction book for only 98c postpaid. Satisfaction guaranteed or refund.)
NELSON-HALL CO., 210 S. Clinton, Dept. 3LS-2, Chicago 6

It's Like Having Auto Factory Experts Right Beside You...

SHOWING YOU

HOW TO FIX ANY PART OF ANY CAR!



**NOW—Whether You're a Beginner
or an Expert Mechanic—You Can
"Breeze Through" ANY Auto Repair Job—
QUICKLY — EASILY — RIGHT!**

SUPPOSE you had an automobile factory engineer standing right beside you . . . guiding your hands through every step of even the toughest car repair jobs! Think how you'd "whiz through" every job! No wonder, then, that 2,500,000 MOTOR'S Auto Manuals have been sold. No wonder so many thousands of beginners and expert mechanics alike are already using MOTOR'S Brand-new AUTO REPAIR MANUAL. It shows you, in step-by-step words and pictures, factory-approved repair procedures for fixing ANY part of ANY car listed here — 1949 through 1958!

No guesswork! MOTOR'S Manual "starts from scratch" — leads you through entire job with easy directions. You CAN'T go wrong!

OVER 1000 BIG PAGES —
OVER 2900 PICTURES

NEW, REVISED, ENLARGED Edition covers everything you need to know to fix any of the more than 600 car models built since 1949! Over ONE THOUSAND giant pages, 2,900 "This-is-How" pictures, Over 291 "Quick-Check" charts — more than 23,436 essential repair specifications. Over 225,000 service and repair facts. Plus a big handy Trouble-Shooting section!

Even a green beginner mechanic can do a good job with this giant manual before him. And if you're a top-notch mechanic, you'll find short-cuts that will amaze you. No wonder this guide is used by the U. S. Army and Navy! No wonder hundreds of thousands of men call it the "Auto Repair Man's Bible!"

Engineers from every automobile plant in America worked out these time-saving procedures for their own motor car line. Now the editors of MOTOR have gathered together this wealth of "know-how" from over 176 Official Shop Manuals and "boiled it down" into crystal-clear terms in one handy indexed book!

EVERYTHING YOU NEED TO KNOW

Includes ALL Automatic Transmissions, Air Suspension, Power Steering, Power Brakes, Carburetors, Fuel Pumps, Starting Motors, 12-Volt Systems, Generators, Voltage Regulators, Distributors, Axles, etc. Factory Specifications and Adjustment Tables, Tune-up Charts, Tables of Measurements and Clearances, Overhauling and Replacement Facts — and MUCH MORE.

Brand New! Covers All These Makes

Buick	Jeep
Cadillac	Lincoln
Chevrolet	Mercury
Chrysler	Nash
Clydes	Dodge
Continental	Packard
De Soto	Plymouth
Dodge	Pontiac
Edsel	Rambler
Ford	Studebaker
Hudson	Thunderbird
Imperial	Willys

TRY BOOK **FREE**
FOR A WHOLE WEEK

TRY THIS BOOK 7 DAYS FREE!

Just mail coupon. (Attach it to postcard, if you wish.) When postman brings book, pay nothing. First, make it show you what it's got! Unless you agree this is the greatest time- and work-saver you've ever seen — return book in 7 days, pay nothing. Mail coupon to MOTOR Book Dept., Desk 11, 250 West 55th St., New York 19, N. Y.

MOTOR'S AUTO REPAIR MANUAL

CARBURETOR

GENERATOR

FUEL PUMP

STEERING GEAR

BRAKES

DISTRIBUTOR

AUTOMATIC
TRANSMISSIONS

STARTING MOTORS

STARTER SWITCHES

AIR CONDITIONERS

IGNITION

MUCH MUCH MORE!

MAIL COUPON NOW FOR 7-DAY FREE TRIAL (Attach to Postcard if More Convenient)

MOTOR BOOK DEPT.

Desk 11, 250 W. 55th St., New York 19, N. Y.

Rush to me at once (check box opposite book you want):

MOTOR'S New AUTO REPAIR MANUAL. If O.K., I will remit \$2 in 7 days, \$2 monthly for 2 months and a final payment of \$1.95 (plus 35¢ delivery charges) one month after that. Otherwise I will return the book postpaid in 7 days. (Foreign price, remit \$10 cash with order.)

MOTOR'S New TRUCK REPAIR MANUAL. If O.K., I will remit \$3 in 7 days, and \$2 monthly for 3 months, plus 35¢ delivery charges with final payment. Otherwise I will return book postpaid in 7 days. (Foreign price, remit \$11 cash with order.)

Print Name _____ Age _____

Address _____

City _____ Zone _____ State _____

Check box and save 5¢ shipping charge by enclosing WITH coupon in envelope entire payment of \$7.95 for Auto Manual (or \$9 for Truck Manual). Same 7-day return-refund privilege applies.

Same FREE Offer On MOTOR'S Brand-New Truck Repair Manual

Covers every job on every popular make gasoline and Diesel truck made since 1949! Over 2000 pictures, 882 big pages, FREE 7-Day trial. Check proper box in coupon.





BE YOUR OWN MUSIC TEACHER

Send for Free Book Telling How Easily You Can Learn Piano, Guitar, Accordion, ANY Instrument This EASY A-B-C Way



NOW IT'S EASY to learn music at home. No tiresome "exercises." No teacher; just **START RIGHT OUT** playing simple pieces. Thousands now play who never thought they could. Our pictured lessons make it easy as A-B-C to learn to play popular music, hymns, classical, and any other music. Low Cost. One million students including TV Star Lawrence Welk. (Our 60th year.)

Mail Coupon for FREE BOOK

Find out why our method can teach you quickly, easily, inexpensively. Write for FREE Book. No obligation. No salesman will call. Mention favorite instrument. Mail coupon today.

U. S. SCHOOL OF MUSIC
Studio 3011,
Port Washington, N. Y.



U. S. SCHOOL OF MUSIC, Studio 3011, Port Washington, N. Y. Please send me Free 36-page Illustrated Book. I would like to play (Name instrument).

Instrument _____ Have you Instrument? _____

Name _____ (Please Print)

Address _____

City _____ Zone _____ State _____

NEVER AT THIS LOW PRICE! GENUINE 150-POWER ACHROMATIC TELESCOPE

with Achromatic Lens and
4-POWER FINDER attached
ONLY \$18.95
PREPAID



EXTRA BONUS GIFTS:

- 273 page book, "Handbook of the Heavens"
- Magic Star Finder Dial
- 220X & 400X Eyepiece lenses

5 Magnifications 18X-35X-65X-85X-150X
Brings the Moon, Planets, Stars, Satellites, People
150 times Closer, Clearer, Sharper

Never before has an ACHROMATIC 150X telescope with range finder and tripod sold for anywhere near this amazing low price! Now you can not only explore the heavens and bring the moon, planets, stars, satellites 150 times closer, but you can observe all distant objects, people, ships too, because all pictures are erect, not upside down as in all astronomical telescopes. The kind of needle-sharp color-free viewing only a genuine achromatic lens can bring you. Ready for immediate use. 5 precision lenses bring you viewing at 18X-35X-65X-85X-150X. Tubes extend to 43" made of bakelite, finished in camera bellows black, trimmed with gleaming brass. 4 power finder scope (30mm Lens) mounted on main tube is feature usually found on more expensive telescopes—brings difficult objects on target before observing with main scope. For extra stability 5 ft. hardwood folding tripod is equipped with heavy cast iron head fitted with Criterion's famous 360 degree all aluminum mount that locks instantly in any position. Obtainable only from Criterion Co. shipped prepaid. 4 famous gifts—273 page book "Handbook of the Heavens," Magic star finder dial that aids in locating stars ANYWHERE at ANYTIME of the year. 220X & 400X eyepiece lenses included free for experiments. You must be completely satisfied with this super offer or your money back in full. Shipped Complete, nothing else to buy at amazingly low price of \$18.95. Without tripod \$14.95.

Send Cash, Check, or Money Order today
Dept. PMA26, CRITERION CO., 331 Church St., Hartford, Conn.

LEARN APPLIANCE REPAIR IN SPARE TIME AT HOME



START YOUR OWN BUSINESS
\$0,000,000 POTENTIAL CUSTOMERS

New shop-method, home-training system gives you electrical know-how that used to take years to learn. Learn by building valuable testing kits, repairing your own and neighbors' appliances. Appliance repairmen often charge on the basis of \$5.00-\$6.00 an hour!

FREE BOOK



FREE ILLUSTRATED BOOK

Shows you how you learn every phase of electrical appliance repair. How to make money while you learn. Write today for your FREE copy.

CHRISTY TRADES SCHOOL

Dept. D-6803, 3214-16 W. Lawrence Ave., Chicago 25

"HOW TO MAKE MONEY IN Mobile Radio Maintenance"

AUTHORITATIVE GUIDEBOOK
ABOUT THE BOOM IN TWO-WAY MOBILE-RADIO:
GIVES FACTS, FIGURES, PAY RATES.
WRITE TODAY!



FREE

LAMPKIN LABORATORIES, INC. Mobile Div. BRADENTON, FLA.

HANDWRITING ANALYZE

You can analyze handwriting—at home, in your spare time. No interference with job or social life. Win more pay, social recognition, prestige! Men and women both needed now. Complete lesson and answer service. Personalized instruction. Handsome, suitable-for-framing Diploma to graduates!

I.G.A.S. is the oldest and only grapho analysis school in the world! Lesson (2) Free Entrance Examination (3) Full Color 48-page Success Book. Absolutely No Obligation. Adults only.
INTERNATIONAL GRAPHO ANALYSIS SOCIETY, INC.
DESK 36 SPRINGFIELD, MISSOURI

FIX OUTBOARD MOTORS

**POWERMOWERS, AND ALL SMALL
2 & 4-CYCLE GASOLINE ENGINES**

MAKE EXTRA MONEY—or, repair your own equipment and **SAVE!** Fully illustrated, easy-to-understand, Home Study Course. Write today for **FREE** information.

LINCOLN TECHNICAL INSTITUTE
SUITE 11E, 472 MARKET STREET, NEWARK 5, N. J.

LAW FREE BOOK

**THE LAW
TRAINED
MAN**

Write today for a **FREE** copy of illustrated law book, "THE LAW-TRAINED MAN," which shows how to earn the professional Bachelor of Laws (LL.B.) degree through home study of the famous Blackstone Law Course. All necessary books and lessons provided. Moderate cost; convenient monthly terms. Write for **FREE** law training book today.

Blackstone School of Law, 307 N. Michigan Ave.
Founded 1890 Dept. 58, Chicago 1, Illinois

Now Many Wear FALSE TEETH With Little Worry

Eat, talk, laugh or sneeze without fear of insecure false teeth dropping, slipping or wobbling. **FAST-TEETH** holds plates firmer and more comfortably. This pleasant powder has no gummy, goopy, pasty taste or feeling. Doesn't cause nausea. It's **alkaline** (non-acid). Checks "plate odor" (denture breath). Get **FAST-TEETH** at drug counters everywhere.



I'd like to give this to my fellow men... while I am still able to help!

I was young once, as you may be—today I am older. Not too old to enjoy the fruits of my work, but older in the sense of being wiser. And once I was poor, desperately poor. Today almost any man can stretch his income to make ends meet. Today, there are few who hunger for bread and shelter. But in my youth I knew the pinch of poverty; the emptiness of hunger; the cold stare of the creditor who would not take excuses for money. Today, all that is past. And behind my city house, my

summer home, my Cadillacs, my Winter-long vacations and my sense of independence—behind all the wealth of cash and deep inner satisfaction that I enjoy—there is one simple secret. It is this secret that I would like to impart to you. If you are satisfied with a humdrum life of service to another master, turn this page now—read no more. If you are interested in a fuller life, free from bosses, free from worries, free from fears, read further. This message may be meant for you.

By Victor B. Mason

I am printing my message in a magazine. It may come to the attention of thousands of eyes. But of all those thousands, only a few will have the vision to understand. Many may read; but of a thousand only you may have the intuition, the sensitivity, to understand that what I am writing may be intended for you—may be the tide that shapes your destiny, which, taken at the crest, carries you to levels of independence beyond the dreams of avarice.

Don't misunderstand me. There is no mysticism in this. I am not speaking of occult things; of innumerable laws of nature that will sweep you to success without effort on your part. That sort of talk is *rubbish!* And anyone who tries to tell you that you can *think* your way to riches without effort is a false friend. I am too much of a realist for that. And I hope you are.

I hope you are the kind of man—if you have read this far—who knows that anything worthwhile has to be *earned!* I hope you have learned that there is no reward without effort. If you have learned this, then you may be ready to take the next step in the development of your karma—you may be ready to learn and use the secret I have to impart.

I Have All The Money I Need

In my own life I have gone beyond the need of money. I have it. I have gone beyond the need of gain. I have two businesses that pay me an income well above any amount I have need for. And, in addition, I have the satisfaction—the deep satisfaction—of knowing that I have put more than three hundred other men in businesses of their own. Since I have no need for money, the greatest satisfaction I get from life, is sharing my secret of personal independence with others—seeing them achieve the same heights of happiness that have come into my own life.

Please don't misunderstand this statement. I am not a philanthropist. I believe that charity is something that no proud man will accept. I have never seen a man who was worth his salt who would accept

something for nothing. I have never met a highly successful man whom the world respected who did not sacrifice something to gain his position. And, unless you are willing to make at least half the effort, I'm not interested in giving you a "leg up" to the achievement of your goal. Frankly, I'm going to charge you something for the secret I give you. Not a lot—but enough to make me believe that you are a little above the fellows who merely "wish" for success and are not willing to sacrifice something to get it.

A Fascinating and Peculiar Business

I have a business that is peculiar—one of my businesses. The unusual thing about it is that it is needed in every little community throughout this country. But it is a business that will never be invaded by the "big fellows". It has to be handled on a local basis. No giant octopus can ever gobble up the whole thing. No big combine is ever going to destroy it. It is essentially a "one man" business that can be operated without outside help. It is a business that is good summer and winter. It is a business that is growing each year. And, it is a business that can be started on an investment so small that it is within the reach of anyone who has a television set. But it has nothing to do with television.

This business has another peculiarity. It can be started at home in spare time. No risk to present job. No risk to present income. And no need to let anyone else know you are "on your own". It can be run as a spare time business for extra money. Or, as it grows to the point where it is paying more than your present salary, it can be expanded into a full time business—overnight. It can give you a sense of personal independence that will free you forever from the fear of lay-off, loss of job, depressions, or economic reverses.

Are You Mechanically Inclined?

While the operation of this business is partly automatic, it won't run itself. If you are to use it as a stepping stone to independence, you must be able to work with your hands, use such tools as hammer and screw driver, and enjoy getting into a pair of blue jeans and rolling up your sleeves. But two hours a day of manual work will keep your "factory" running 24 hours turn-

ing out a product that has a steady and ready sale in every community. A half dollar spent for raw materials can bring you six dollars in cash—six times a day.

In this message I'm not going to try to tell you the entire story. There is not enough space on this page. And, I am not going to ask you to spend a penny now to learn the secret. I'll send you all the information, free. If you are interested in becoming independent, in becoming your own boss, in knowing the sweet fruits of success as I know them, send me your name. That's all. Just your name. I won't ask you for a penny. I'll send you all the information about one of the most fascinating businesses you can imagine. With these facts, you will make your own investigation. You will check up on conditions in your neighborhood. You will weigh and analyze the whole proposition. Then, and then only, if you decide to take the next step, I'll allow you to invest \$15.00. And even then, if you decide that your fifteen dollars has been badly invested I'll return it to you. Don't hesitate to send your name. I have no salesmen. I will merely write you a long letter and send you complete facts about the business I have found to be so successful. After that, you make the decisions.

Does Happiness Hang on Your Decision?

Don't put this off. It may be a coincidence that you are reading these words right now. Or, it may be a matter that is more deeply connected with your destiny than either of us can say. There is only one thing certain: If you have read this far you are interested in the kind of independence I enjoy. And if that is true, then you must take the next step. No coupon on this advertisement. If you don't think enough of your future happiness and prosperity to write your name on a postcard and mail it to me, forget the whole thing. But if you think there is a destiny that shapes men's lives, send your name now. What I send you may convince you of the truth of this proverb. And what I send you will not cost a penny, now or at any other time.

VICTOR B. MASON
1512 Jarvis Ave., Suite M-2-M
CHICAGO 26, ILLINOIS

Check the Kind of Body You Want



Charles Atlas

... and I'll Show You How EASILY You Can Have It!

Just tell me, in coupon below, the kind of body you want—and I'll give it to you SO FAST your friends will be amazed! "Dynamic Tension," my easy, 15-minutes-a-day method, will make your chest and shoulders bulge... arms and legs surge with power... your whole body feel "alive!"

FREE BOOK Learn how I became "World's Most Perfectly Developed Man" — Mail coupon! CHARLES ATLAS, Dept. 811, 115 East 23 Street, New York City 10, N. Y.

CHARLES ATLAS, Dept. 811, 115 East 23rd St., New York 10, N. Y.

Dear Charles Atlas: Here's the Kind of Body I want: (Check as many as you like)

- | | |
|--|--|
| <input type="checkbox"/> More Weight—Solid—in The Right Places | <input type="checkbox"/> Powerful Arms, Legs, Grip |
| <input type="checkbox"/> Broader Chest, Shoulders | <input type="checkbox"/> Slimmer Waist, Hips |
| | <input type="checkbox"/> Better Sleep, More Energy |

Send me absolutely FREE a copy of your famous book showing how "Dynamic Tension" can make me a new man—32 pages, crammed with photographs, answers to vital questions, and valuable advice. No obligation.

NAME _____ AGE _____
(please print or write plainly)

ADDRESS _____

CITY _____ STATE _____

LEARN PLASTICS FABRICATION AT HOME!

Complete Low-Cost Home Training Course NOW Available

There's exciting opportunities for you in Plastics Fabrication. Fun and relaxation as a hobby! Big money as a spare or full-time business! Course teaches you how to make molded, cast, internally carved colored plastic jewelry, toys, furniture, novelties, signs. Professionally prepared. Used by Manual Training and Industrial Arts Teachers. Earn as you learn. All materials furnished. For men, women.

Accredited Member National Home Study Council



SEND FOR FREE BOOKLET



INTERSTATE TRAINING SERVICE
Dept. C-3, Portland 12, Oregon
Send Free Booklet on Plastics Home Training Course.

Name _____
Address _____
City _____ Zone _____ State _____



LEFAX TECHNICAL DATA BOOKS

POCKET SIZE • LOOSE LEAF

Printed on loose leaf, 8 hole, 6 3/4"x3 3/4" bond paper, each book contains about 140 pages of technical data, condensed, accurate, essential, for engineer, technical worker, teacher, student, business man

\$1.25 each

Architecture	Surveying Tables	Machine Design	Radio
Home Heating	Highway Eng'g.	Machinist's Data	Television & FM
Illumination	General Math	Mech. of Materials	Electricity, AC
Electrician's Data	Math Tables	Pwr. Trans. Mach.	Electricity, DC
Builder's Data	Physics	Thermo. Tbls. & Charts	AC Motors and Generators
Lumber Data	Trig-Log Tables	Phys. & Thermo-dynamic Data	Conversion Tabl.
Air Conditioning	Gen'l Chemistry	Chemical Tables	Steel Forms
Building Constr.	Analytic Chem.	Metallurgy	Welding Data
Reinf. Concrete	Meth'l Drawing	Hydraulics	Transformers, Relays & Meters
Piping Data		Metals	
Surveying			

Write for FREE catalogs (2000 listings). See how helpful LEPAX can be to you. Send \$1.25 book, or \$6 for any five books to LEPAX PUBLISHERS, Dept. PM-118, PHILADELPHIA 7, PA.

500 PRINTED NAME & ADDRESS LABELS 25¢



500 Gummed Labels printed with ANY name and address, 25c per set! 4 sets (same printing or all different) \$1.00! Padded, Two-tone jewel-type plastic gift boxes only 10c extra, 4 for 25c. Order as many or as few sets and boxes as you want. Only 25c per set. Money-back guarantee!

WESTERN STATIONERY, Dept. 961, Topeka, Kan.



"\$7,108.50 FIRST YEAR SERVICING RADIATORS!"

— Hank Kontor, Newcastle, Wyo.

Make good money servicing auto-truck-tractor radiators. Easy to learn. Inland, world's largest radiator equipment mfr., offers complete package — equipment, merchandising, "pays-for-itself" financing, free training. Small down payment on equipment starts you. Profitable dept. for garage or service station. Write INLAND MFG. CO., Dept. PM-11, 1108 Jackson St., Omaha 2, Nebr.

YES! SEND



directly to my door every month

- I am enclosing
- \$3.50 for 1 year
- \$8.00 for 3 years

name _____

address _____

city _____ zone _____ state _____

Hand this order to your newsdealer or send it to
POPULAR MECHANICS
200 East Ontario St. Chicago 11, Ill.

Send me this postage-paid coupon...
I'll help you build your big-pay future in
TELEVISION!

radio-electronics



**AS SOON AS YOU'RE READY, WE'LL HELP YOU GET THE
JOB YOU WANT—OR START IN A BUSINESS OF YOUR OWN!**

GOOD YEARS ARE AHEAD FOR YOU, if you train **NOW** for top pay in Television-Radio-Electronics. This is the field that grows bigger, more rewarding with each day's newspaper headlines. When you have Industrial Training Institute help plan and build your exciting future for you, you fit yourself for Big Success and Independence.

While you're training, you can also be earning extra money doing repair work if you like. As soon as you're fully trained, you can choose between two mighty attractive careers:

1. The big-pay job you want in Television-Radio-Electronics. We'll help you to get it! Or—
2. A highly-profitable Radio-TV Shop of your own. We'll help you by showing you the best ways to operate your own Sales and Service Shop!

Television-Radio-Electronics holds the greatest Opportunities for you. And Industrial Training Institute is the organization that gives you practical training—right in your own home, without making you give up your job or go away. Then we help you put that training to work, making a big, secure income for yourself.

Find out now if you have the ambition to qualify. Send this Postage-Paid Coupon—just cut it out and drop it in the mail box. No stamp or envelope needed. You'll get (1) FREE important booklet, "Good Years Ahead For You." (2) "How I.T.I. Helps You To Career or Business." (3) Your personal appraisal form that tells us whether you qualify for this outstanding Opportunity. **CLIP AND MAIL THE COUPON NOW**—your opportunity to step ahead in life is at an all-time high right now. There is time to get ready—but no time to waste!

You get the
parts and
skill to build
all of this
equipment and
much more!



Put your future
in good hands!

**CLIP—
MAIL COUPON
NO STAMP
OR ENVELOPE
NEEDED**

Mr. Clifford Smith, President
Industrial Training Institute
Send me FREE information
about how I can enjoy the
rich rewards offered trained
men in Television-Radio-
Electronics.

**INDUSTRIAL TRAINING
INSTITUTE**
Dept. 7 • 2150 West Lawrence
Chicago 25, Illinois

FROM:

Your Name

Address

Town State

No
Postage Stamp
Necessary
If Mailed in the
United States

BUSINESS REPLY CARD
FIRST CLASS PERMIT NO. 186 • Chicago, Illinois

MR. CLIFFORD SMITH, President
INDUSTRIAL TRAINING INSTITUTE
DEPT. 7
2150 WEST LAWRENCE
CHICAGO 25, ILLINOIS

EARN MORE - LEARN AUTO DIESEL MECHANICS

OR TRAIN WITH OTHER GREER DIPLOMA COURSES

- | | |
|--|---|
| <input type="checkbox"/> AUTO MECHANICS | <input type="checkbox"/> REFRIGERATION |
| <input type="checkbox"/> DIESEL MECHANICS | <input type="checkbox"/> AIR CONDITIONING |
| <input type="checkbox"/> BODY & FENDER REPAIR | <input type="checkbox"/> MACHINIST TRADE |
| <input type="checkbox"/> GAS-ARC WELDING | <input type="checkbox"/> ADVANCED MACHINIST |
| <input type="checkbox"/> PIANO TUNING & REPAIR | |

Skilled men are needed in every part of the country. Earn top pay in established shops or start your own business. Greer's expert instruction and actual shop training teaches you how. You learn by doing—quick, easy courses using the latest tools and equipment. Day, evening and part time instructions available.

Job placement and convenient living accommodations are yours while training. Contact GREER'S FREE JOB PLACEMENT SERVICE when you enroll if you wish part time or full time employment.

ENGINEERING DEGREE COURSES

- | |
|--|
| <input type="checkbox"/> DIESEL AUTOMOTIVE ENGINEERING 27 MOS. |
| <input type="checkbox"/> REFRIGERATION & AIR COND. ENGINEERING 18 MOS. |
| <input type="checkbox"/> WELDING ENGINEERING 18 MOS. |

All Courses Approved Civ. or G.I.

Please rush me free literature on the trade indicated, at no obligation.

NAME _____ AGE _____

STREET _____

TOWN _____ ZONE _____ STATE _____

Established 1902

GREER SHOP TRAINING

Box K, 2236 S. Michigan Ave.
Chicago 16, Illinois

"I'M MAKING MORE THAN \$1000 a Month Haven't Touched Bottom Yet!"



C. KAMA

—reports Charles Kama, Texas, one of many who are "cleaning up" with orders for PRESTO. Science's New Midget Miracle Fire Extinguisher. So can YOU!



Amazing new kind of fire extinguisher. Tiny "Presto" does job of bulky extinguishers that cost 4 times as much, are 8 times as heavy. Ends fires fast as 2 seconds. Never corrodes.

Guaranteed for 20 years! Over 3 million sold! Sells for only \$4.95.

Show it to civil defense workers, owners of homes, cars, boats, farms, etc., and to stores for resale—make good income. H. J. Kerr reports \$20 a day. Wm. Wydallis \$15.20 an hour. FREE Sales Kit. No obligation.

MERLITE INDUSTRIES, Dept. P-15R

PRESTO DIV., 114 E. 32 St., New York 16, N.Y.

Canada: Mopa Co., Ltd., 371 Dowd St., Montreal 1, P.Q.

Shrinks Hemorrhoids New Way Without Surgery Stops Itch—Relieves Pain

For the first time science has found a new healing substance with the astonishing ability to shrink hemorrhoids and to relieve pain—without surgery.

In case after case, while gently relieving pain, actual reduction (shrinkage) took place.

Most amazing of all—results were so thorough that sufferers made astonishing statements like "Piles have ceased to be a problem!"

The secret is a new healing substance (Bio-Dyne*)—discovery of a world-famous research institute.

This substance is now available in suppository or ointment form under the name Preparation H.* Ask for it at all drug counters—money back guarantee. *Reg. U.S. Pat. Off

Learn ACCOUNTING Business Administration

Bookkeeping, secretarial and allied subjects at home in your spare time or attend nationally approved resident school. Write for FREE Success Book giving complete details on courses, plans, rates and employment opportunities. G.I. approved. Write Dept. A.



**Hills BUSINESS UNIVERSITY AND
EXTENSION SCHOOL**
619 W. MAIN ST., OKLAHOMA CITY 2, OKLAHOMA

TASOPE PHOTO-ENGRAVING PLANTS



Material Cost
Of This Cut 3/4¢
Selling Price
\$1.00 And Up

Establish your own profitable PHOTO-ENGRAVING business. Make cuts for newspapers, printers, and advertisers. Make etched name plates, plaques, etc. Instructions furnished, no experience necessary. Sold direct from factory since 1931. First five hundred cuts sold locally or by mail will pay for plant and pay you well for your time. Write for FREE catalog.

TASOPE, DEPT. PM11, AURORA, MO.

MONEY in DONUTS

Make new, smashless donuts. Start in kitchen. No smoke. Sell stores. HALF PROFIT. Cash daily. Free recipes. No obligation. Write! MARTIN RAY CO., 3605 SO. 15th AVENUE, MINNEAPOLIS 7, MINN.

HYDRAULIC JACK REPAIRS



Earn While You Learn at Home

Millions of jacks in gas & auto-service stations, truckers, body-shops, riggers, factories, farms need servicing. We show you HOW—easy step by step directions—what tools to use. EARN UP TO \$5 an hour, in spare time, in your own basement or garage. Start your own business NOW.

Write for folder No. PM-11 & free bonus offer

Institute of Hydraulic Jack Repair
P.O. Box 50, Bloomfield, N. J.

SEWS LEATHER

AND TOUGH TEXTILES LIKE A MACHINE

With SPEEDY STITCHER Automatic Sewing Awl, anyone can quickly and skillfully sew or repair anything made of LEATHER, CANYAS, NYLON, PLASTIC, or other heavy materials. Sews firm, even lock-stitches like a machine. Gets into hard-to-reach places. Specially made for heavy duty sewing on LUGGAGE, FOOTWEAR, RUBS, AWNINGS, SAILS, SADDLERY, UPHOLSTERY, OVERALLS, AUTO-TOPS, SPORTS GEAR, and other tough sewing jobs. Here's the handiest tool you'll ever own. Will save you many times its small cost. Comes ready for instant use . . . complete with bobbin of waxed thread and 3 different types of diamond-pointed needles. Easy-to-follow directions will make you an expert in minutes. Extra needles and waxed-thread always available. Save money, send \$1.98 for post-paid delivery. If C.G.D., \$1.98 plus postage. MONEY BACK GUARANTEE.



SPORTSMAN'S POST

366 Madison Ave., Dept. A-87, New York 17

ONLY 1.98



Colorcretors are Needed Everywhere

C-9



More Colorcretors are needed to supply growing demand for the enduring, colorful beauty possible only from Colorcrete. Time-worn concrete, stucco and other old or new masonry walls are quickly transformed into clean freshness from a selection of 30 tints, tones and shades. Cementitious base—tough, tenacious, enduring. Colorcrete is applied under pneumatic air pressure by authorized Colorcretors. Machine is easy to operate and readily mobile. Opens up opportunities for men of modest capital. Broad markets with high income potentials. Write for Opportunity Book.

COLORCRETE

COLORCRETE INDUSTRIES, INC.
570 Ottawa Ave., Holland, Mich.



SAVE MORE on BLATT THE SNOW TIRE KING!
GOOD YEAR SUBURBANITE
FIRESTONE TOWN & COUNTRY & OTHERS

FREE TUBE WITH EACH TIRE. Your choice—factory retreaded and slightly used. We buy carloads for spot cash, you save!
\$6.52 any 15" or 16"
GUARANTEED 2 WINTERS
Whitewalls \$2 Extra

NOVEMBER SPECIAL! BRAND NEW SNOW TIRES

First Quality • Not 2nds • Not Recaps • Not Used • All Other Sizes
600-16 | \$70-15 | 710-15 | 760-15 | 3 WINTERS WEAR GUARANTEED
\$12.19 | \$12.50 | \$13.52 | \$15.65 | Fed. Tax included. Buy & Save now!

MARV and BLATT 6th and Spring Garden St. Philadelphia, Pa. Send Check or M.O. & this Ad for rush shipment. FOB Phila. I personally select your tires as if my future depended on it. BLATT famous for 43 years in TIRES.

MAIL ORDER BUSINESS

How to Start a Profitable Business of Your Own at Home or in a Small office. Amazing new instruction course shows you how to run a good mail order business, spare time or full time. Up-to-date, practical training—a treasure-house of the best plans and practices being used TODAY by successful operators. Only \$8.95. Complete—Satisfaction Guaranteed! This is BIG. You get 34 money-making lessons in 5 separate volumes, all in one shipment. You must be satisfied or your money back immediately. Full price only \$5.95, postpaid—or COD plus postage. Nothing more to pay! Order "Mail Order Course" today. Nelson-Holl Co., 210 S. Clinton St., Dept. 9LS-2, Chicago 6, Ill.



ONE DOLLAR

BRINGS YOU

1958 - 1959

Dealers **WHOLESALE** Cost

of

AUTOMOBILES

all models BOX 331, BERKELEY
AUTO-DEX-PM CALIFORNIA

Save 1/2 on New ACCORDIONS



Over 40 Exciting 1959 Models From Italy...
Buy on Easy Terms!

5-DAY FREE TRIAL

Reggie Dambek
"Miss Chicago"
Famed TV Model

- Professionals
 - Students
 - Teachers
- ...all over the U. S. A. agree "you get more for your money at A. M. W. O."

FREE BONUS GIFTS

- Free Lessons
 - Music Portfolio
 - DeLuxe Case
 - Year's Music Supply
 - Music Stand
 - Your Name in Chrome
- MANY OTHER GIFTS FOR PROMPTNESS

Now—amazing savings on the world's finest Italian-made accordions! Play the most popular instrument of all—for FUN, LEADERSHIP and PROFIT! We're offering your choice of over 40 exciting brand-new imported models of glorious tone and startling beauty at LOWER PRICES! You save 50% and more! Buy direct from world's leading exclusive accordion dealer. Valuable extra BONUS GIFTS FREE if you buy during this sale. Big allowance for your trade-in. Your satisfaction guaranteed or your money back! Try and examine before you buy on our FREE 5-DAY NO-RISK PLAN. Lifetime guarantee!

TRADE-IN

your old accordion on brand-new model—top allowance. Free Appraisal.

MONEY BACK GUARANTEE

Find out what the accordion can do for you! Find out how easily you can own the accordion you've dreamed about. See and read about all the wonderful new features of these famous-make accordions manufactured by Italy's master craftsmen. Rush coupon now for big new COLOR CATALOGS and lowest wholesale prices—FREE! No obligation. No salesman will call. Write today—

Accordion Manufacturers and Wholesalers Outlet
Dept. R118, 2003 West Chicago Avenue, Chicago 22, Illinois

FREE Accordion Manufacturers & Wholesalers Outlet
Dept. R118, 2003 W. Chicago Ave., Chicago 22, Ill.

Rush color catalogs and wholesale prices—Free!

Name _____

Address _____

City _____ Zone _____ State _____

Mail Coupon

Not everyone does as well, but T. N. CODY,
who started a business of his own, reports...

For 12 months I've averaged

\$800

per month income

— most of it clear profit for me!



Many men have discovered how to be independent, to be free of layoffs and bosses. C. G. Naples grossed more than \$200 his first week. A father-son combination grossed \$44,000 their second year. H. Lemon says, "I netted \$133 in one 8-hour day."

How much you make depends largely on you. You need no special skill, no large investment. Start part time if you wish.

NO SHOP NECESSARY • Our Electric Deterger shampoos rugs, carpets right on floor—removes dirt and grime and helps to show their natural color and beauty. So efficient and safe it is used by largest railroads and hotels.

This is not a lease proposition.

You own the machine, you work when and where you please and all the money you take in is your own. No risk. Machines fully guaranteed.

Mail
Coupon
Today
for
FREE
Book

VON SCHRADER MFG. CO.,
E10 "R" Pl., Racine, Wis.

Without obligation send me FREE booklet about your RUG DETERGER and tell me how I can start my own permanent, profitable business.

Name _____
Address _____
City _____ Zone _____ State _____



Exclusive Double-Bearing HEAVY-DUTY PUMPS

IRRIGATE • DRAIN • CIRCULATE • SPRAY
Use 1/4 HP motor or larger . . . 1 HP for up to 7,500
GPH; 1,000 GPH 60' high; or 3,000 GPH from 25' well.
1 1/4" inlet; 1" outlet. Stainless shaft.

TYPE X—2 oil-less bronze bearings. Won't rust. . . . \$10.95

TYPE KB—Ball bearing model. . . . \$12.95

Postpaid if cash with order. Rush your order today

MONEY BACK GUARANTEE

Centrifugal and Gear Pumps in All Sizes

LABAWCO PUMPS, Belle Mead 2, N. J.

STATEMENT REQUIRED BY THE ACT OF AUGUST 24, 1912, AS AMENDED BY THE ACTS OF MARCH 3, 1933, AND JULY 2, 1940 (Title 39, United States Code, Section 233), SHOWING THE OWNERSHIP, MANAGEMENT, AND CIRCULATION OF Popular Mechanics Magazine published monthly at Chicago, Ill., for October 1, 1958.

1. The names and addresses of the publisher, editor, managing editor, and business managers are: Publisher, Popular Mechanics Company, 200 E. Ontario St., Chicago 11, Ill.; Editor, H. H. Windsor, Jr., 200 E. Ontario St., Chicago 11, Ill.; Managing editor, R. M. Grant, 200 E. Ontario St., Chicago 11, Ill.; Exec. V.P., W. H. Pettridge, 200 E. Ontario St., Chicago 11, Ill. 2. The owner (if owned by a corporation, its name and address must be stated and also immediately thereunder the names and addresses of stockholders owning or holding 1 percent or more of total amount of stock. If not owned by a corporation, the names and addresses of the individual owners must be given. If owned by a partnership or other unincorporated firm, its name and address, as well as that of each individual member, must be given.) Popular Mechanics Company, 200 E. Ontario St., Chicago 11, Ill.; H. H. Windsor, Jr., 200 E. Ontario St., Chicago 11, Ill.; H. H. Windsor, Jr., Trustee for H. H. Windsor III and Wm. T. Windsor, 200 E. Ontario St., Chicago 11, Ill. 3. The known bondholders, mortgagees, and other security holders owning or holding 1 percent or more of total amount of bonds, mortgages, or other securities are: (If there are none, so state.) City National Bank and Trust Company of Chicago, 205 South LaSalle St., Chicago 90, Ill. 4. Paragraphs 2 and 3 include, in cases where the stockholder or security holder appears upon the books of the company as trustee or in any other fiduciary relation, the name of the person or corporation for whom such trustee is acting; also the statements in the two paragraphs show the affiant's full knowledge and belief as to the circumstances and conditions under which stockholders and security holders who do not appear upon the books of the company as trustees, hold stock and securities in a capacity other than that of a bona fide owner. 5. The average number of copies of each issue of this publication sold or distributed, through the mails or otherwise, to paid subscribers during the 12 months preceding the date shown above was: (This information is required from daily, weekly, semiweekly, and triweekly newspapers only.) Not daily publication. H. H. Windsor, Jr., Editor. Sworn to and subscribed before me this 5th day of September, 1958. Harry P. Cera, Notary Public. (My commission expires March 7, 1960.)

INVENTORS

PROTECT YOUR INVENTION BY A U. S. PATENT. SEND FOR FREE "INVENTION RECORD" FORM AND "PATENT INFORMATION EVERY INVENTOR SHOULD HAVE."

CARL MILLER

REGISTERED PATENT ATTORNEY

WOOLWORTH BLDG., 36th FLOOR, 118A
NEW YORK CITY



INVENTORS

U. S. Patents protect your inventions. Our free book of "Instructions on Patent Procedure for Inventors," also "Certificate of Invention" form sent without obligation.

C. A. SNOW & CO.

REGISTERED PATENT ATTORNEYS

428 SNOW BUILDING WASHINGTON 1, D. C.

INVENTORS

Whether an invention is patentable can be substantially determined by a search of the U. S. Patent records. Without obligation, write for information explaining the steps you should take to secure a patent.

JOHN N. RANDOLPH

Registered Patent Attorney

801 Victor Building, Washington 1, D. C.

INVENTORS

Send for **REGISTERED PATENT**
PATENT INFORMATION **ATTORNEY**
Book and

INVENTOR'S RECORD
without obligation

ASSOCIATE EXAMINER
U. S. PAT. OFF. 1922-1929

GUSTAVE MILLER

Patent Attorney & Advisor

118-PM WARNER BUILDING
WASHINGTON 4, D. C.

U. S. NAVY DEPT. 1930-1949
PATENT LAWYER

GET THE HABIT OF READING

OUR CLASSIFIED ADS.

Wonderful Opportunities Amazing Bargains

TELLS HOW TO SELL YOUR INVENTION

If you have an invention that you believe has merit, write us at once for copy of copyrighted booklet "How to Go About Selling Your Invention." We work with manufacturers, and booklet reveals present markets, qualities of a saleable invention, current royalty rates being paid by manufacturers. Booklet is FREE, is offered to encourage new ideas we might submit to manufacturers. Just send name (no drawings, please) to Kessler Sales Corporation, Dept. D-511, Fremont, Ohio

INVENTORS

I shall be pleased to furnish you, upon request, with full information relative to patent procedure—without any obligation on your part.

PATRICK D. BEAVERS

Registered Patent Attorney

934 Victor Building Washington 1, D. C.

New Table Top Invention Puts You In... **PROFITABLE RUBBER STAMP BUSINESS**

Home Operators now make
\$9.40 AN HOUR in busi-
ness once monopolized by
a few big companies

Special rubber stamps bring high prices—cost only pennies to make on new, low-cost table top machine. Take 27 cents worth of material, make perfect stamps, the kind businesses and offices now buy by the dozen at \$1.80 each. Make up to \$9.40 an hour. Start in spare time in your own home. Run machine on kitchen table using ordinary electrical outlet. Make any kind of stamp. We'll send you free information without obligation about this established, highly profitable business, now open to individuals for the first time. For free information send name today on a post card to Rubber Stamp Div., 1512 Jarvis Ave., Dept. R-2-M, Chicago 26, Ill.



GET LATEST OFFICIAL AIRCRAFT PHOTOS

SPECIAL INTRODUCTORY OFFER!

1. 4 3 1/2 x 5 photos, world's fastest jets.
 2. 4 3 1/2 x 5 World War II planes.
 3. 4 3 1/2 x 5 of Rockets, Missiles.
 4. 1 8x10 Boeing B-52 Jet Bomber.
 5. 1 8x10 Lockheed F-104A Starfighter.
- Only 25c a set. Send \$1 for all 5.
(\$2 value)

Illust. CAT. with order. Money back guar.



AVIATION PHOTO EXCHANGE

DEPT. PE BOX 75084
LOS ANGELES 5, CALIFORNIA

BLACK LIGHT brings you

AN AMAZING NEW HOUSE NUMBER!

Mysterious BLACK LIGHT RADIATION! Easily read at 100 ft! Beautiful, quality unit, moderate price! Install yourself!

WRITE FOR FREE ILLUSTRATED LITERATURE

MODERN CONTROLS CORP.

P. O. Box 128 • Centerline, Mich.

250 POWER

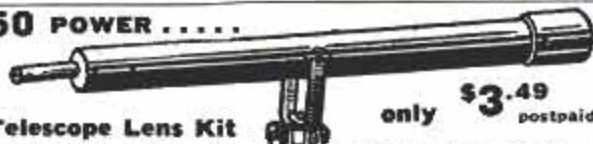

Telescope Lens Kit

only \$3.49
postpaid

Conquer Space. Explore the Universe. Planets, Moon Craters, New Stars, etc. Complete Lens Kit consists of 80 inch focal length ground and polished objective lens, eyepiece lenses for 50 POWER, 100 POWER, 150 POWER, 200 POWER, 250 POWER, and all necessary lens fittings. Easy to make from simple step by step instructions. (Tripod and mount not included.) Money back guarantee.

BUSSE SALES CO., Hartford, Conn., Dept. PM-74

SIGN PAINTING

Home-Study Course — Only \$5.95

Teaches you commercial sign painting and sign building as it is being done TODAY in leading shops all over the country. Complete practical course for self-instruction. Shows latest methods of truck lettering, office doors, wood letters, reflecting signs, plastics, sprayed signs, gold leaf, silk screen process, up-to-date alphabets, money-making business information, etc.

SATISFACTION GUARANTEED OR REFUND!
Contains all the instruction of a high-priced correspondence course. Full price, only \$5.95, postpaid. Or C.O.D. plus postage. No risk—order today. Satisfaction or money back! Order "Sign Painting Course." NELSON-HALL CO., 210 S. Clinton St., Dept. 2LS-2, Chicago 6, Ill.

NEW 1958 CATALOG

BOAT KITS

200 MODELS—SAVE 2/3

EASY TO BUILD—Designed for the amateur. Over 200 Models. Prows to Cruisers, 8 to 21 ft. Formed hulls

Semi and Custom finished. Save 50%... Now NEW

Sea Ray Molded FIBERGLAS BOAT KITS. Truly professional results. NO upkeep. SAVE 2/3 assembly time. 12 to 16 ft. Utilities and Runabouts. SEND 35c for 64 page Boat Kit & 24 page Sea Ray Catalogs. SEND \$1.00 for both plus "Boating Handbook". Dealers inquire for franchise.

BOAT PLANS & PATTERNS Frame-Pac Kits

World's largest selection; over 200 plans, full-size patterns, frame-pac kits! Designed strictly for amateurs! All types: prows, kayaks, racers, runabouts, catamarans, houseboats, cruisers — inboard-outboard 6-40' wood-plywood-steel! Send 35c for PLAN CATALOG Catalog PLUS "Boatbuilding Handbook" \$1.00

WRITE NOW! CUSTOM CRAFT, BUFFALO 7L, N. Y.

These men are getting practical training in..

ELECTRICITY

ELECTRONICS ON REAL

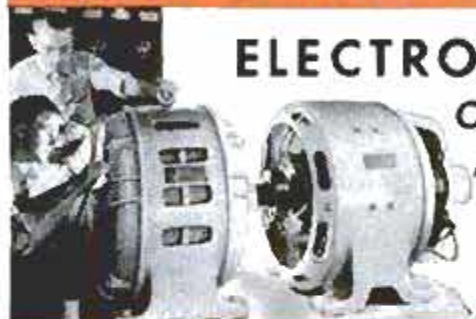

A.C. and D.C. Motors
Generators
Switchboards
Controllers
Appliances
Electronic Units

TELEVISION

COLOR-TV ON REAL

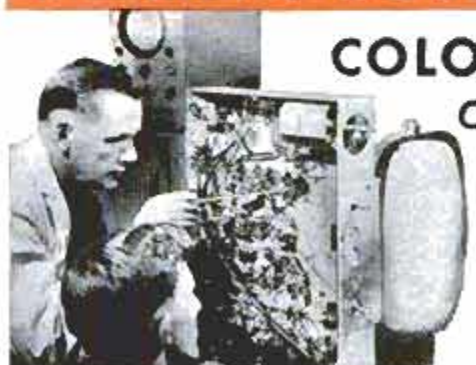

Television Receivers
Including Color TV
AM and FM Radios
Auto Radios
Test Equipment

Train in Great Shops of

COYNE

in Chicago — Prepare for a better job and a real future in TOP OPPORTUNITY FIELDS. Train on real full-size equipment at COYNE where thousands of successful men have trained for nearly 60 years — largest, oldest, best equipped school of its kind — est. 1899. Trained instructors show you how, then do practical jobs yourself. No previous experience or advanced education needed. Employment Service to Graduates.

START NOW—PAY LATER — Liberal Finance and Payment Plans. Pay most of tuition later. Part-time employment help for students. Frequent starting dates. GET FREE BOOK — "Guide to Careers in ELECTRICITY-ELECTRONICS and TELEVISION-RADIO" — no obligation; no salesman will call. Vets and Non-Vets get vital facts now.

R. W. COOKE JR., Pres. **COYNE** FOUNDED 1899
ELECTRICAL SCHOOL

Chartered Not For Profit

500 So. Paulina Street Chicago 12, Dept. 88-3C

MAIL COUPON TODAY

COYNE ELECTRICAL SCHOOL Dept. 88-3C
500 S. Paulina St., Chicago 12, Ill.

Send BIG FREE book and details of your training offer by return mail. I am interested in:

Electricity-Electronics Television-Radio

Name _____

Address _____

City _____ State _____



FREE!
NEW ISSUE
**QUEEN ELIZABETH
STAMPS**
and illustrated
booklet

Rush coupon today! Exciting, generous NEW offer of beautiful, hard-to-get stamps — some not even cataloged yet. These NEW Elizabeth II stamps have never been given before, now yours FREE. From world's newest country, Ghana; Pitcairn Islands, Kenya, Cook Islands, Ascension, many others. All genuine, all different, mint and used — so new you'll add them all to your collection. Other offers for inspection plus free "Stamp Collector's Guide". Offer limited. RUSH name, 10c for postage, handling to GARCELON STAMP CO., Dept. 11PMQ, Calais, Maine.

GARCELON STAMP CO., Dept. 11PMQ
Calais, Maine. Rush FREE NEW Elizabeth Stamps, Collector's Guide, other offers. Enclosed 10c for postage, handling. (PLEASE PRINT)

Learn to **MOUNT BIRDS**

Tan SKINS, Make Up FURS
Be a Taxidermist. We teach you at Home. Mount Birds, Animals, Pets, Game Heads, Fish. Save your hunting trophies! decorate home and don't **MAKE MONEY**. Mount and Krometan for others. Big spare-time profits.

FREE BOOK 100 game pictures, 48 pages - Hunters. Get this wonderful book. It's **Now Free**. Send postcard **TODAY**. State AGE. **NORTHWEST TAXIDERMIST SCHOOL**, Dept. 2511, Omaha, Nebraska

Get **Your** **First Class Commercial F.C.C. LICENSE**

The key to better jobs and higher pay in electronics is a 1st class commercial (not amateur) F.C.C. license—Federal Gov't evidence of your qualifications as an operator-technician. We train you quickly—by mail or in resident classes. Get your 1st class F.C.C. license in 12 weeks—NO previous training necessary. Our schools are located in Hollywood, Washington, and Seattle. Write to either one of the addresses shown below for our FREE booklet, Careers in Electronics, which gives complete details of our training.

GRANTHAM SCHOOL OF ELECTRONICS, Desk 87-S
1505 N. Western Ave. OR 821—19th Street, N.W.
Hollywood 27, Calif. Washington 6, D.C.

Now! TEST YOUR OWN for filament breaks
TV & RADIO TUBES

All of Them — Even Picture Tube
Nearly half of TV service calls are due to defective filaments. Tester shows if filaments are good. Insert tube in tester. Light shows if tube is burned out. Easy, safe to use. One service call saved pays for tester. Metal case. AC or DC. Checks fuses, appliances, etc. Only \$3.98 ppd. or C.O.D. plus charges. Deluxe Model \$4.98. Instructions. Guaranteed.

GEIGER ENGINEERING CORP., Dept. AB-100
6349 N. Western Ave., Chicago 45, Ill.

A TRADE THAT PAYS IN MANY WAYS
CLOCK AND WATCH REPAIR
Wide Choice of Opportunities in Precision Instrument Fields for the Trained, Skilled Watchmaker. Aviation, Electronics, Defense, and other Technical Fields. Watchmakers are Rated High by Industrial Personnel. Write today for your Copy of "THE VITAL ROLE OF THE WATCHMAKER IN DEFENSE."

KANSAS CITY SCHOOL OF WATCHMAKING
1226 Admiral Blvd. Kansas City 6, Missouri

"YOU ARE UNDER ARREST!"
Help Bring Crooks to Justice Through Scientific **CRIME DETECTION!**

We have taught thousands this exciting, profitable, pleasant profession. Let us teach you in your own home. Learn Fingerprinting, Firearms Identification, Police Photography, Secret Service Methods thoroughly, quickly, at small cost. Over 800 of all American Bureaus of Identification employ I.A.S. students or graduates. Write for FREE "Blue Book of Crime."
(A Correspondence School Since 1916)

INSTITUTE OF APPLIED SCIENCE, 1920 Sunnyvale Ave., Dept. 1358, Chicago 30, Ill.

SAVE \$\$\$

U.S. GOV'T. SURPLUS

Look at the amazing bargains that have been made!

LIFE BOAT	\$12.00
TRACTOR	75.00
GRINDER	4.69
TYPEWRITER	7.51
SHAPER	15.00
FREEZER	50.00
DUMP TRUCK	76.77
SPRAY PAINTER	15.25
MOTOR	4.00

PAY AS LITTLE AS 1¢ ON THE DOLLAR for Hunting, Fishing, Camping, Sporting Equipment; Photographic Equipment and Supplies; Radio and Electronic Equipment; Amphibious Trucks, Jeeps, Boats, Motors, Binoculars; Plumbing, Electrical Equipment; Cars, Power Tools, Machinery, Chemicals, Furniture, Office Equipment and Supplies, Scrap, etc.

Our dated bulletin, "Government Surplus Sales," lists hundreds of valuable surplus items for direct purchase from U. S. Government by sale, bid, auction. **THIS IS NOT A DIRECTORY OF DEPOTS** but a current listing of immediately available merchandise. Rush \$1.00 today for latest bulletin (or \$2.00 for 3 issues; \$8 for 12).

GOVERNMENT SURPLUS SALES, P.O. Box 169, Dept. PM118, East Hartford, Conn.

DISTRIBUTORS

Now It Can be Sold!

Latest battery development now available for local distribution. The BOROLYTE Battery with BORON-COMPOUNDED ELECTROLYTE and iron-clad 7 year warranty.



Advanced offer of exclusive territories makes possible your ground-floor participation in newest development for booming automotive replacement market. No charge for territory, but you will be required to purchase reasonable inventory. Good character and business ability necessary. Write, wire or telephone for full details.

International Tire & Rubber Co.

2126 S. La Brea — WEBster 6-2255 — Los Angeles 16, Calif.

Finish **HIGH SCHOOL** AT HOME

Complete 4 Yrs. in 12 Months

Learn More! Earn More! Enter professional or technical schools. Advance Socially. Live a Happier, Fuller Life. Individual Courses or complete schedule. WRITE FOR SCHOOL BULLETIN.

ACADEMY FOR ADULTS
30 W. Washington, Dept. PM-118, Chicago, Ill.

FREE GERMAN STEEL HUNTING KNIFE



4-INCH BLADE

We give you handiest hunting and fishing knife you've ever had! Has 4-INCH LONG highly tempered steel blade—VERY SHARP! Attractive handle. We send knife FREE to acquaint you with our below-wholesale bargains. Please send 25c for handling. NO LIMIT—but send 25c handling for each knife. Order TODAY!
HUNTING KNIFE, Dept. K-357, Box 881, St. Louis, Mo.

EARN WHILE YOU LEARN



Be a **LOCKSMITH**

Learn fascinating, profitable trade from experts in spare time at home! Ago no disadvantage. Year 'round, steady income. Full or part time. Practical, illustrated lessons. Make money even while learning! All materials and special tools supplied.

INSTITUTE OF LOCKSMITHING, Dept. 111-8
150 Park Ave. East Rutherford, N. J.

Ltd. by N. J. State Board of Ed. Apprvd. for Vets

SEND FOR FREE BOOKLET

MEN PAST 40

Afflicted With Bladder Trouble, Pains in Back, Hips, Legs, Nervousness, Tiredness.

If you have these troubles, particularly bladder trouble, then your condition may be traced to Glandular Inflammation . . . a constitutional disease. Neglect of this condition often leads to premature old age and sometimes incurable malignancy.

The Excelsior Medical Clinic has a New Free Book that tells how thousands of men have been successfully treated here at Excelsior Springs for Glandular Inflammation by **NON-SURGICAL** Methods. They found soothing relief and a new outlook in the future of life.

This Free Book may prove of utmost importance in your life. Write Today. There is no obligation.

Excelsior Medical Clinic, Dept. B6129, Excelsior Spgs., Mo.

94.6% OF BAILEY GRADUATES ARE EMPLOYED AT TOP PAY IN THE FIELDS WHICH THEY WERE TRAINED!



DIESEL-AUTO MECHANICS DESPERATELY NEEDED!

We have a far greater demand for our students than we can fill!

We can show you an actual waiting list of leading companies throughout the world who have tried Bailey graduates — found them outstanding, and are coming back for more!

Bailey Graduates are Successful . . . RECEIVE BIG PAY — HAVE SECURE FUTURE!

The Famous Bailey Course prepares you for **BOTH Diesel and Gasoline Mechanics.**

This is a must—due to the advent of using Diesel principles, such as 'Fuel Injection' on passenger cars . . . use of gasoline engines for starting Diesel engines, etc. You learn all this at Bailey in the amount of time ordinarily required to learn just one of these subjects, **ALL FOR THE PRICE OF ONE.**

Don't be satisfied with a 'futureless', one-type job — learn how you can make big money now!

Write today for Free Booklet that takes you on a step-by-step camera tour through our spacious, modern shops — See Bailey students in action as they Learn-by-doing with the Famous Bailey Method of training!

We provide you with housing and part time jobs while in school, plus nation-wide placement service for graduates.

BAILEY Technical SCHOOLS

1634 S. GRAND

ST. LOUIS 4, MO.

MAIL TODAY!

Please mail immediately this free booklet without obligation.

FREE BOOKLET



Name.....

Address.....

City.....

State.....

APPROVED FOR VETERAN . . . NON-VETERAN

SAVE 1/2 OR MORE

Build this six transistor portable radio

No other portable gives you so many features at such a low price: 4" x 6" speaker, 500 to 1000 hr. battery life, two-tone molded plastic case, plus high quality, all-transistor circuit.

\$29⁹⁵



IT'S EASY, FUN, EDUCATIONAL

No special tools or skills required. Clearly illustrated step-by-step instructions guarantee your success—and you learn about electronics the easy way—BY DOING!

SEND FOR FREE CATALOG

..... Describing nearly 100 other "do-it-yourself" HEATHKITS for hobby, hi-fi, ham radio or professional.



HEATH COMPANY

pioneer in "do-it-yourself" electronics

BENTON HARBOR 17, MICH.

subsidiary of Daystrom, Inc.

Name _____
address _____
city & state _____

... TURN CONCRETE INTO GOLD!

MAKE UP TO \$75 A DAY IN YOUR OWN BUSINESS

If you want to have your own business — to start a business on your own — here's your big opportunity! New high speed, low cost General block machine produces up to 1,000 concrete blocks a day. Sell all you make to builders, supply houses, and others for homes, factories, buildings, garages. Cash in on the building boom! You can make profits of 100% to 150% — up to \$75 a day! General block machine equipped with 1/2 h.p. electric motor — or can be supplied with gasoline engine — works anywhere, in little space, indoors or out. Operates on ordinary house light socket. Simple, foolproof 3 step operation — so easy a child can do it. Makes superior 2 size blocks any size from 4" to 12". Also makes chimney, sash, corner and other types. Blocks meet any building code anywhere in the country. Materials — sand, water, cement, available anywhere. Simple illustrated operating instructions and mixing formulae for cement and cinder blocks supplied with each machine. Write for FREE folder with full information.

MOTOR DRIVEN

R.L.T. of New York City reports: "MY GENERAL BLOCK MACHINE PAID FOR ITSELF IN FIRST 2 WEEKS!" Hundreds now in use the world over! Write for FREE details today!

EXTRA Amazing illustrated

book gives floor plans for 6 sensational concrete block bungalows. Tells how to lay blocks, lay out building lines, mix concrete, build steps, porch and concrete floors all at great savings. Written by experts. Can save many times the cost of the machine! Get it now! No strings attached. Send \$1.

BOOK SENT FREE IF YOU BUY MACHINE.
\$1 REFUNDED IF YOU BUY LATER.

GENERAL ENGINES CO.

DEPT. M-118, ROUTE 130, THOROFARE, N. J.

HOW TO BUILD YOUR OWN CONCRETE BLOCK HOME
Only \$1 Prepaid

\$1 BRINGS YOU \$18

Discover Flok-Kraft and Earn \$\$\$\$\$ AT HOME

Earn up to \$15.00 per hour spare time. Amazing new Velvet-fiber spray instantly makes any object (Lamps, Radio & TV Cabinets, Figurines, Signs, Auto dash boards, toys, furniture, draperies—anything) worth expensive \$\$\$\$ Prices... like magic, you can spray anything with this beautiful new suede-like finish that feels like rich Velvet.

EARN UP TO \$300.00 PER WEEK SPARE TIME

Imagine, materials cost only 3¢ per square foot. (Average TV or radio cabinet can be beautifully sprayed with this startling new 3-dimensional Velvet finish in 15 minutes at a cost of only 34¢ in materials. Your charge for this job is at least \$10.00.)

REPRESENTATIVES IN YOUR AREA URGENTLY NEEDED

Own your own business. Work at home in your spare time. Help fill the huge growing demand for this amazing new beautiful Velvet-fiber finish. Orders come from stores, offices, homes, architects, auto dealers,—everywhere. Possible \$20,000,000.00 worth of jobs to be done. Investigate today—be first in your area! Actual samples in 16 Radiant Colors, Booklet of 50 Home Business Opportunities and Confidential Details all sent free! Send No Money. Write: Coast Industries, Los Angeles 61, Calif., Dept. B-11.



ADD UP TO 25 POUNDS OF SOLID MUSCLES or you pay NOTHING

\$10 BODY MOLD course included FREE with DAN LURIE BARBELLS. Only DAN LURIE BARBELLS and "Body Mold" courses produce such amazing results. 15 minutes a day can make you a bigger man. Send today for details. Order now at lowest factory price.

50 lb. set \$8.98 • 100 lb. set \$14.98

150 lb. set \$21.98 • 200 lb. set \$27.98

Semisteel sets approx. 10% higher. Extra wts. 14¢ per lb. Send 50¢ cash, balance C.O.D. F.O.B. Plant.

DAN LURIE BARBELL CO., 52M-11 Bristol St., Dept. 8591, Bklyn. 12, N.Y.

TAFT CRUISER KITS



FREE 40 pg. Color CATALOG

18 ft. Sedan Cruiser \$490.00 frt. inc.

All models 18 ft. cruisers...

Big complete line of runabouts, fishing boats. NO WONDER WE'VE SOLD SO MANY!

DEPT. PM-1158

TAFT MARINE WOODCRAFT
636 - 39th Ave. N.E., Minneapolis, Minn.

2 FOR \$19.95 MAGNETO HANDSET INTER-COMM

(rebuilt). For house to barn etc., included 100 ft. of wire and 4 batteries. Additional wire 1¢ per ft. Any number can be connected in same line. Write for FREE List. All shipments FOB Simpson, Pa.

TELEPHONE ENGINEERING CO.
DEPT. 1188 SIMPSON, PA.

BIG NEW WHOLESALE CATALOG FREE!

WRITE TODAY FOR FREE CATALOG SEND POSTCARD

NOW! Save Up to 50% on Nationally Advertised Gifts

Use this big, new FREE CATALOG to buy all kinds of gifts and merchandise for yourself, family, friends, neighbors. Terrific saving on big-name items. Also, make money spare time taking orders from others!

EVERGREEN STUDIOS
Dept. 57 Box 846 CHICAGO 42, Ill.

Help Fight TB



Buy Christmas Seals

POPULAR MECHANICS



For extra income
or career... learn

WATCH REPAIRING

at home the low cost Sweeney Way

Modern, simplified shop method starts you making repairs right away on Swiss and American watches. No previous experience needed. No age limit. Low terms. FREE sample lesson without obligation. Write today.

CHICAGO SCHOOL OF WATCHMAKING
2330 N. Milwaukee Ave. Dept. 1118 Chicago 47, Ill.

75 POWER TELESCOPE \$3.98

NEW 3 in one telescopes, 3 variable 25X 45X-75X magnification. Brass bound, 25 power for ultra bright images 45 & 75 power for long range. Guaranteed to bring distant stars, moons, objects, sports 75 times closer.

Most powerful scope sold anywhere near this amazing low price. American made, 5 sections. Opens 36", closes 1 ft.; contains 4 ground & polished lenses. Can also be used as powerful compound microscope. Mass production enables us to offer telescope complete at \$3.98 postpaid. Money back guarantee.

CRITERION CO., Dept. PMB 63, 331 Church St., Hartford, Conn.

NEED EXTRA INCOME?

Make extra income this year selling IRON MIKE—the portable power hacksaw. Precision made, exclusive features, attractively priced, long profits. Sells fast to farmers, contractors, etc.

Why wait? Write now to

ARCO MANUFACTURING CO.
Dept. PM-2 Grand Forks, N. Dak.

MECHANICAL DENTISTRY

To make Crowns, Plates, Bridgework, etc., for Dentists. Easy practical way to learn mechanical dentistry at home in spare time. FULL EQUIPMENT OF TOOLS AND MATERIALS INCLUDED WITH COURSE. Low tuition. Easy terms. Write for FREE BOOK about this money making profession that is not affected by machine age.

MCCARRIE SCHOOL OF MECHANICAL DENTISTRY
207 N. Broad St., Dept. 82, Philadelphia 7, Pa.

'How to Make Money with Simple Cartoons'

A book everyone who likes to draw should have. It is free; no obligation. Simply address

CARTOONISTS' EXCHANGE
Dept. 911-D Pleasant Hill, Ohio

FLY YOUR OWN HELICOPTER

Simple to fly — build it yourself, with engine or as inexpensive glider type which can be mounted on floats or boat. Order 3-view drawing, specs and photo of Glider for \$1 or motor powered Gyro-Copter \$2. Ask about detailed plans and construction kits.

BENSEN AIRCRAFT CORP., Dept. PM-118
P. O. Box 2746, Raleigh, N. C.

Send \$1 or \$2

Name _____
Address _____

TRAIN AT HOME

in Your Spare Time or in the Great Allied School

1338-42 South Michigan Ave., Chicago 5, Ill.

DRAFTING—All Branches
• Mech. • Structural • Aeronautical

ENGINEERING
• Industrial Engineering
• Tool Engin. & Designing

ELECTRONICS

AUTO MECHANICS

AIR CONDITIONING
Refrigeration — Heating & Cooling

TOOL & DIE MAKING
Machinist Trade

Choose the Allied Way for Best Pay

SEND FOR FREE BOOKS

Prepare for the best jobs in your spare time at home. With ALLIED'S practical home study program you can progress so rapidly that big new opportunities will soon be open to you. Students planning a career in engineering can begin their training in short courses at Home or at Allied Institute and continue progressively toward an Engineering Degree in 31 months. Allied is approved by Industry, National Home Study Council, Department of Education, Office of Public Instruction, State of Illinois, U. S. Department of Justice.

ALLIED INSTITUTE OF TECHNOLOGY,
1338-42 South Michigan Ave., Dept. PM-118, Chicago 5, Ill.

Send me without obligation information on your courses:

<input type="checkbox"/> MECHANICAL DRAFTING	<input type="checkbox"/> AUTO MECHANICS
<input type="checkbox"/> STRUCTURAL DRAFTING	<input type="checkbox"/> ELECTRONICS
<input type="checkbox"/> AERONAUTICAL DRAFTING	<input type="checkbox"/> AIR CONDITIONING
<input type="checkbox"/> INDUSTRIAL ENGINEERING	<input type="checkbox"/> REFRIGERATION
<input type="checkbox"/> TOOL & DIE DESIGNING	<input type="checkbox"/> TOOL & DIE MAKING
<input type="checkbox"/> HOME STUDY	<input type="checkbox"/> RESIDENT
<input type="checkbox"/> VETERAN	<input type="checkbox"/> NON-VETERAN

NAME _____ AGE _____

ADDRESS _____

CITY _____ COUNTY _____ STATE _____

YOUR NEIGHBORHOOD NEEDS AN ELECTRICAL APPLIANCE



TROUBLE SHOOTER

Men needed to repair and service all kinds of Electrical Appliances—**AUTOMATIC WASHERS - DRYERS - IRONS - VACUUMS - TOASTERS - REFRIGERATORS - FANS - HOME FREEZERS - AIR CONDITIONERS**—also home and industrial wiring.

Big, Year-'Round Profits!
HELP US FILL HUGE DEMAND

MODERN BIG PROFIT ONE-MAN BUSINESS YOURS AT HOME — SPARE OR FULL TIME.

No previous experience needed. New, visual "Shop-Practice" method quickly shows you how. Hundreds of plain-as-day "How to" photos and drawings make it easy. A corner of garage, porch, attic, or basement is all the space needed. No costly leases—no big overhead. We show you how to make business come to you.

NEW 30-DAY INCOME PLAN!
Shows you how to start your own Big Profit Business without investment—no big overhead

BIG MONEY, SECURE FUTURE—INDEPENDENCE.
F. V. in N. Y. says, "I made \$800 in 3 months while studying." T. E. H. in W. Va. says, "Made \$14 a day while learning."

EVERYTHING FURNISHED—Including BIG TOOL KIT
Instructions are complete and include a Tool Kit and Appliance Tester. Everything furnished to help you build your own big-profit business at home. Our new 30-day income plan shows you how to start making money almost at once. Send no money—just your name and address on coupon below. I will rush you FREE complete success plan with full details. Do it NOW—BE FIRST!

Send for this **FREE BOOK!** *The Appliance Repair Business and You*
AIR MAIL COUPON NOW!

PACIFIC TRAINING SCHOOL, Dept. PM5811
11029 So. Vermont Ave., Los Angeles 44, Calif.

PACIFIC TRAINING SCHOOL, Dept. PM5811
11029 So. Vermont Ave., Los Angeles 44, Calif.

Gentlemen: Rush me postpaid your FREE plan for success in the Appliance Repair Business and the Free Book Entitled "The Appliance Repair Business and You" and remember I am under no obligation.

Name _____
Address _____
City _____ Zone _____ State _____

HOME-IMPORT BUSINESS



Men, women. Make big profits buying low cost imports abroad (see examples at left) and selling to friends, stores or by mail order. Famous world trader guides you—shows you how to find thousands of exotic imports for full or spare time business, how to pocket profits in advance on foreign drop shipment plan. Full details FREE! Airmail reaches us overnight. Write Today!

MELLINGER CO., 1717 Westwood
Dept. P25B. LOS ANGELES 24, CALIFORNIA

WAR SURPLUS BARGAINS!

WAR SURPLUS BARGAINS

\$500,000.00 INVENTORY for QUICK LIQUIDATION

Surplus items—hundreds of them for home, shop, factory, farm and outdoor use. New items, used items, reconditioned items—all at tremendous savings—all priced for quick sale.

Page After Page of Values

This big catalog shows page after page of amazing money-saving values. Write for your copy today. Send 10¢ to cover postage, mailing, etc. Write today! **SEND TODAY FOR YOUR COPY**

10c

STARK'S 212 W. Madison St.
Dept. PM-5811
CHICAGO 6, ILL.

High School Course at Home

Many Finish in 2 Years

Go as rapidly as your time and abilities permit. Course equivalent to resident school work—prepares for college entrance exams. Standard H. S. texts supplied. Diploma. Credit for H. S. subjects already completed. Single subjects if desired. High school education is very important for advancement in business and industry and socially. Don't be handicapped all your life. Be a High School graduate. Start your training now. Free Bulletin on request. No obligation.

American School, Dept. H845, Drexel at 58th, Chicago 37

For Many Uses!

Metal Turning Lathe
Only **\$4995**
F.O.B. Lansing, Ill.
15 1/4" bed with 4 1/2" swing.
7" between centers.
Satisfaction Guaranteed.



FREE FOLDER
Write for it today!

Rosemoor Manufacturing Co.
Box 147J, Lansing, Ill.

LAWNMOWER SHARPENERS

Only completely modern shop equipment in the world. 6 Machines. Your choice production or light weight. **LIGHTNING** sharpens bed knives in mower. Write. Experienced shop men will answer.

TURNER-CLINE MFG. CO.
New address: 906 Virginia Ave., Alamogordo, N.M.

ELECTRIFY OIL LAMPS

SIMPLE . . . No Tools Needed

Just unscrew old burner and replace with NALCO Solid Brass Adapter. No. 1 or No. 2, medium or candelabra bases. Complete with switch and cord . . . **\$2.75 postpaid**

NALCO 1594 North 13th St., St. Louis 6, Missouri



YOU CAN MAKE MONEY

MAKING CASES

'CAUSE WE HELP YOU SELL 'EM



I'll teach you all the secrets of manufacturing cases in your home. Cases for salesmen, doctors, scientists, manufacturers, hi-fi bugs, camera enthusiasts, sportsmen, etc. You'll be able to fill the increasing demand for custom made cases—for luggage repairs. Yes! You'll be able to make extra money for yourself, for your family—for all your extra needs.

Work sparetime at first—then build up to full time making cases—making money. I'll help you with every bit of Sales Assistance at my command—with National Advertising to help bring orders to you, wherever you live. Write TODAY, for full FREE details about our no risk plan.

ABARSI CASECRAFT 807 SUNSET BOULEVARD
Dept. A11, Los Angeles 12, Calif.

BOAT KITS

8'-18": 50 Models

\$41.75 up;
Frt. Pd.

EASY MONTHLY
PAYMENTS



FREE COLOR CATALOG

Cruisers, convertibles, runabouts, fishing. Easily assembled by anyone. FREE Catalog has natural color photos, complete details, Fiberglass, accessories hardware, paint. Write Today.

LUGER INDUSTRIES, INC., Dept. B-11

9200 Access Road, Minneapolis 20, Minnesota

Design Your Own Transformers

Simple-to-use book (208 pages, 47 charts) details EVERY STEP and HOOK-UP for winding, reconnecting and testing transformers. No engineering or math needed. Tells you how to design standard and auto-transformers, current and potential transformers, starting compensators, DC balance coils for 3-wire generators, Saturable Core Reactors, and many others. For designs from 50 VA to 100 KVA. Used in industry, research, \$25. Send check or m.o. 10-day money back guarantee.

DATARULE PUBLISHING CO.

P.O. Box 69

Scarsdale, N. Y.

MEN WANTED

Master a trade with a future -- learn Auto-Diesel mechanics in our shops. You learn with tools on real equipment. Earn while you learn. Many of our graduates earn \$100 per week and up. No previous experience necessary. Day and night courses. Approved for veterans. Write for free Bulletin.

Earn \$100 Per
Week and up
AUTO DIESEL
MECHANICS

NASHVILLE AUTO-DIESEL COLLEGE

226 7th Ave., N., Dept. 75

Nashville 3, Tenn.



— JOB TESTED KNOW-HOW — MACHINE TOOL RECONDITIONING & THE ART OF HAND SCRAPING (3rd printing)

SEND FOR FREE FOLDER DESCRIBING
ILLUSTRATED MANUAL FOR MACHINISTS
MACHINE TOOL PUBLICATIONS, 382 Holly Ave., Saint Paul 2, Minn.

NO JOB WORRIES

PLASTEX INDUSTRY needs manufacturers on small scale for big production of Lamps, Clock Stands, Art Goods, Novelties in Plastic Marble imitation. No Experience necessary. Vac material makes regular lit store sellers. Methods furnished for fast production. Small investment brings good profit. BIG WHOLE-SALE ORDERS NOW BEING PLACED. Ambitious men have chance for real prosperity and job security. Our NEW FREE booklet will interest and benefit you.

PLASTEX INDUSTRIES, Dept. A

3400 Third Ave. New York 56, N.Y.

FORTUNES IN DIVING Train at Home in Spare Time

Write Today for Amazing Free Booklet

Here is one of the greatest opportunities of our time. Make big money fast in Skin and Lung Diving. Trained divers needed in hundreds of industries and by government. Build a successful business of your own. Hourly rates among highest paid in any field. Training program by E. R. Cross, world famous master diver. Get the facts now. Mail coupon for FREE BOOKLET TODAY!

DIVEMASTER, Dept. PM-118

5637 W. 63rd Place, Chicago 38, Ill.

Send me free information about Diving.

Name _____ Age _____

Address _____

City _____ State _____

Interesting, Pictorial FREE BOOKLET

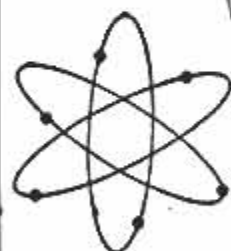
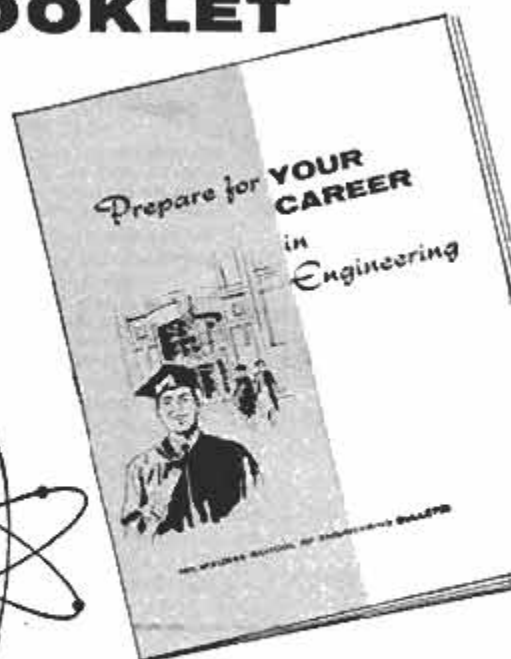

to help you decide on
your career in

ELECTRONICS RADIO-TV COMPUTERS

Here is a graphic story about preparing for your career as an engineer or engineering technician in electronics, radio, television, computers, etc. Booklet tells about:

- Wide variety of job opportunities
- Courses offered, degrees you can earn
- Pictures of the Milwaukee School of Engineering and its facilities
- Recreation and fraternities
- Scholarships; part-time work

— plus other interesting and informative facts to help you make a sound decision on your career.

MS-90

Milwaukee School of Engineering

— dedicated to serving young men and industry

SEND COUPON TODAY!

Milwaukee School of Engineering

Dept. PM-1158, 1025 N. Milwaukee St., Milwaukee, Wis.

Please send me free new booklet
"Prepare for Your Career in Engineering"

I'm interested in _____

(name of course)

Name _____ Age _____

Address _____

City _____ Zone _____ State _____

I am I am not eligible for veterans educational benefits. (discharge date) _____

FREE! LAFAYETTE'S

1959
CATALOG

260 GIANT-SIZED PAGES

CONTAINS

MUNDREDS OF EXCLUSIVE LAFAYETTE ITEMS NOT IN ANY OTHER CATALOG OR AVAILABLE FROM ANY OTHER SOURCE—SEND FOR YOUR COPY NOW!

See the newest and finest in Stereo Tuners, Amplifiers, Cartridges and Music Systems

• TAPE RECORDERS • PUBLIC ADDRESS SYSTEMS • AMATEUR EQUIPMENT • INDUSTRIAL SUPPLIES • RADIO & TV TUBES AND PARTS • INSTRUMENTS • TELESCOPES, BINOCULARS, MICROSCOPES & CAMERAS

The most complete electronic supply catalog crammed full of everything electronic at our customary down-to-earth money-saving prices.

The largest selection of hi-fi components and systems; greatest savings on Lafayette endorsed "best-buy" complete systems.

EASY PAY TERMS AVAILABLE — 10% DOWN — UP TO 18 MONTHS TO PAY

Everything in Electronics

The Complete Catalog Featuring The Best Values Obtainable

LEADERS IN HI-FI

OUR

38th

YEAR



Lafayette Radio

P.O. Box 511
JAMAICA 31, N. Y.
DEPT. LJ

Send FREE LAFAYETTE Catalog 590

Name

Address

City Zone State

REPAIR OIL BURNERS!



... solve oil heat problems of all kinds

Save real money by handling your own home oil heat maintenance — from cleaning and adjusting to making any needed repair or replacement! Earn good pay by doing this work for others! Rinehart's new 400-page manual DOMESTIC OIL BURNERS AND OIL HEAT trains you for fast, accurate service on all types. In addition, you learn all about oil burner controls: how to make heat loss surveys of homes; and how to design the best, most economical heating systems accordingly. Also includes full details on firing rates; chimneys & drafts; piping; wiring, etc. Over 300 pictures, diagrams and charts help make every step perfectly clear. A complete, easily understood course in handy Duo-spiral bound book form for only \$6.95. Send coupon today. Money-back guarantee protects you fully.

JUST OUT!

A complete training guide for HOME OWNERS STUDENTS SERVICEMEN FUEL DEALERS BUILDERS, etc.

— PRACTICE 10 DAYS ... free! —

Dept. PM-118, Rinehart & Co., Inc.,
232 Madison Ave., New York 16, N. Y.

Send DOMESTIC OIL BURNERS & OIL HEAT home training manual for 10-day examination. If I like book, I will then send \$6.95 (plus postage) in full payment, or return book and owe you nothing. (SAVE! Send \$6.95 with order and we pay postage. Same 10-day return privilege with money refunded.)

Name

Address

City, Zone, State

OUTSIDE U.S.A. — Price \$7.45 cash with order only.
Money back if you return book in 10 days.

BARBELLS
140-Pound, CHROME DELUXE Barbell-Dumbbell set only \$19.80.
This is our feature set and is the finest ever manufactured.
Training with adjustable weight is the BEST way to keep fit; the ONLY way to develop great strength and a perfect body. As the oldest and best equipped barbell company, BUR gives value and prices no one can equal.
SEND FOR FREE CATALOG
BUR BARBELL CO.
Lyndhurst 9, New Jersey

100 POUND SET \$12.80
Extra Plates Only 12c Pound

HUNTING & TARGET BOW \$37.50 RETAIL VALUE \$60.00
HUGH RICH, world famous Hollywood sportsman and archer says: "This semi-finished BO-KIT is equal in quality and performance to any bow at any price."
Complete with bow string and printed instructions. Shaped, tillered and aligned. Needs only minor filing and sanding to finish. Maple laminations and BOTUFY fiberglass. MONEY BACK GUARANTEE.
GORDON PLASTICS, INC., Bow Division
5328 Banks Street San Diego 10, California

ART LEARN AT HOME!
Enjoy glamorous high-pay career or profitable hobby. Learn Commercial Art, Illustrating, Cartooning Fashion Art, Lettering, T.V., etc. We train you at home, in spare time. 22-pc. art outfit given with first lesson at no extra cost. Write for FREE Book describing easy low-cost method. No obligation. No salesman will call on you. Washington School of Art, Studio 1411, Port Washington, N. Y. (Estab. 1914)

Find HIDDEN TREASURES
GOLD, SILVER, PRECIOUS METALS with the Famous Model 27 Metal Detector. Lightweight, ultra-sensitive, low cost. None finer. Also GEIGER COUNTERS for uranium and the VIOLITE for tungsten. INFORMATION FREE
THE *Detectron* CORP.
5528 Vineland Ave., No. Hollywood, Calif.

*After the city,
Before the state
The ZONE keeps your mail
From being late*

★ ★ ★

The Post Office has divided 106 cities into postal delivery zones to speed mail delivery. Be sure to include zone number when writing to these cities; be sure to include your zone number in your return address — after the city, before the state.

95% PROFITS YEAR 'ROUND

Be your own boss, Operate a SIMPLEX lawn-mower sharpening service in your community. One compact machine grinds all mowers, sharpens cutlery. Low investment, 95% profit. Pays for itself in average month.

SIMPLEX

—4 Machines in One!
Reel Grinder—sharpens any mower reel in or out of mower.
Bed Knife Grinder—grinds with either round or cup wheel.

Rotary Blade Grinder—hollow grinds any rotary mower blade.
Cutlery Knife Grinder—sharpens cutlery, tools, scissors.

Send for free, money-making details!

The FATE-ROOT-HEATH Company - Dept. PM11, Plymouth, Ohio

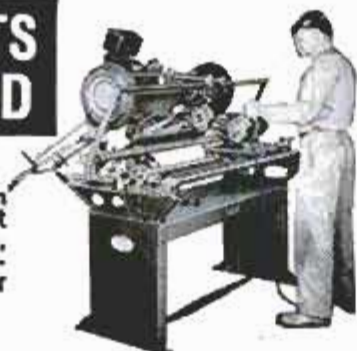

ENGINEERING



Photo of Heald Students in Electrical Laboratory

American Industry Steps Up Its Demand for Trained Engineers. Train Now at Healds

BACHELOR OF SCIENCE DEGREE, 27 MONTHS

Degree Courses:

- Radio-Electronic Eng.
- Electrical Engineering
- Highway Engineering
- Mechanical Engineering
- Structural Engineering
- Civil Engineering
- Architecture

Diploma Courses:

- TELEVISION Color TV
- Radio-Electronic Tech.
- Industrial Electronic Tech.
- Tool & Die Design
- Architectural Drafting
- Mechanical Drafting
- Structural Drafting

Approved for Veterans

Enroll Now for New Term
Heald College Ranks FIRST West of the Mississippi in "Who's Who in America"

Send for FREE information

Heald Engineering College

Est. 1893

Van Ness at Post, Dept. P.M. San Francisco, California

BECOME AN EXPERT IN

TRAFFIC and TRANSPORTATION

Traffic men earn \$4,000 to \$10,000 and up. Thousands of firms need experts on rates, tariffs, regulations. We train you thoroughly in spare time at home for executive traffic jobs. Personal training under traffic authorities. Write for free book "Traffic and Transportation."

LASALLE Extension University, 417 So. Dearborn St. A Correspondence Institution Dept. 1164T Chicago 5, Ill.

TOOLS and HARDWARE WHOLESALE!

Start Your Own Business

Sell nationally advertised tools to your friends and neighbors. Also for your own industrial and institutional use. New giant wholesale catalog has room for only your name on it. You get all the orders and reorders. A MILLION DOLLAR INVENTORY AT YOUR FINGERTIPS. NO STOCK TO CARRY. ORDER AS YOU NEED IT! . . . Electric drills, saws, sanders, micrometers, snips, tool boxes, vises, motors, trowels, wrenches, socket sets, chisels, mitre boxes, squares and many others too numerous to mention. WHOLESALE DISCOUNTS UP TO 50% off . . . Send \$1 deposit and get the new giant wholesale catalog. Your \$1 is credited to your first purchase or refunded if not 100% satisfied. Write NOW!

U. S. SUPPLY CORP., Dept. 194 149 Church St., N. Y. 7, N. Y.

HUGE PROFITS!
MORE MONEY!

Get up to
50%
off

NAME _____
STREET _____
CITY _____
STATE _____

SALE 20 X 50

REGULARLY \$74.50
SAVE \$44.50!

High powered, -whisper-weight (27 oz.) color corrected, Achromatic binoculars. 7" high EZ to hold, EZ to focus. Instant finger-tip adjustment. Made in Japan. Hard Coated thruout. USE 30 DAYS. If not satisfied - return for refund. Add \$1 postage, handling. Add 10% Tax. UNITED BINOCULAR CO., 9043 S. Western, CRF-2708, Chicago 20, DEALERS WANTED



c.o.d.'s require \$2 deposit.

LEARN MEAT CUTTING AT NATIONAL

Pay After Graduation



The steady dependable trade of Meat Cutting taught easily in 8 short weeks. YOU LEARN BY DOING under actual meat market conditions in big modern school at Toledo.

For beginners or men with experience. Get a profitable store of your own. Remember, PEOPLE MUST EAT! Big pay jobs. Free employment help. Thousands of successful graduates.

Buying, cutting, percentage, pricing, advertising, selling, etc. A complete retail meat education. National School established 35 years. Get National training NOW. Pay your tuition in easy weekly

payments after you graduate. Send coupon for FREE 52 page school catalog — TODAY. G.I. approved.

National School of Meat Cutting, Inc., Dept. 50-K, Toledo 4, Ohio

Send me your FREE school catalog on National Training at Toledo in Meat Cutting, Meat Merchandising and Self Service Meats. No obligation. No salesman will call.

Name _____ Age _____

Address _____

City _____ State _____

Approved for Veterans



MEN! Get this Book

FREE!

Just Mail Coupon
Tells how you can become a well-paid Radio-Television Service Technician in a few short months in spare hours at home **EARN WHILE YOU LEARN!**

The man who knows how to service and repair RADIO and TELEVISION sets is king today. This is the big pay field where many more men are needed at once to fill the jobs now going begging. It doesn't matter what you've done before or what kind of work you're doing now... you can learn Radio-Television at home during spare time. Earn good money fixing sets part time while learning! The time-proved Sprayberry Plan gives you the practical experience you need, working with kits we send you. Build Radios, Testers, TV—all yours to keep. New 60-page book gives all the facts... plus actual sample lesson... all free! Rush coupon. No salesman will call.

SPRAYBERRY ACADEMY OF RADIO-TELEVISION
Dept. 10-N, 1512 Jarvis Ave., Chicago 26, Ill.

RADIO TELEVISION Sample Lesson

Also FREE!

Along with book, we'll send you an actual sample lesson to read and study. See how easily you can learn Radio-Television, even without a bit of previous experience.

Sprayberry Academy of Radio-Television
Dept. 10-N, 1512 Jarvis Ave., Chicago 26, Ill.
Mail FREE SAMPLE LESSON and Big Book.

RUSH COUPON Today!

NAME _____
ADDRESS _____
TOWN _____ ZONE _____ STATE _____



DO YOU WORK WITH COLD FEET? ALL DAY?

Now at last a new modern, low priced electric foot warmer that will keep you healthy, happy and comfortable.
HELP PREVENT COLDS WITH... ELECTRO MAT

Check stand cashiers, secretaries, assembly line workers, housewives, office workers, theatre cashiers, machine operators, telephone operators, and many others throughout the country are now singing the praises of the Electro Mat. There is no further need to work all day with cold feet. Many colds, causing absenteeism and irritability, can be directly traced to cold feet. *Safe and Economical*

Size 14" x 21" light-weight portable

Consumes less power than a 75 watt light bulb. Mail your check or money order today for **ONLY**

\$7.95
Delivered

PETERSON RUBBER MAT CO.
5508 N. Halifax Arcadia, California

Please send me _____ Electro Mats at \$7.95 each
IMPORTANT SAVING!
If 2 or more ordered, price is only \$6.95 each.
 C.O.D. Enclose \$1.00 deposit with order.
 Prepaid

Name _____
Address _____
City _____ State _____

PLEASE PRINT CLEARLY

Mail Order Pays BIG!

NEW METHOD STARTS YOU NOW!

Men-women, your opportunity for big cash profits in mail order. World renowned mail order master, B. L. Mellinger, now reveals secrets of his lifetime success. Tells you inside facts that have brought him a fortune from modest beginning at home. *First real guide* of its kind to mail order money making — shows you short-cuts to success. **New method endorsed by top mail order authorities** shows you how to get best products for full or spare time mail order business, how to pocket profits in advance, how to get free ads, how to start from home with no previous experience or investment in products. Write for full details—**ALL FREE!** Air mail reaches us overnight.
MELLINGER, INC., Dept. P25B
1715 WESTWOOD, LOS ANGELES 24, CALIF.

Yours FREE!

BRONZE FOUNDRY



Schools • Home Workshops • Inventors

Make your own castings of aluminum, copper, bronze, silver. Foundry sets are available in three sizes including 2400 Deg. F. blast furnaces. \$26.50; \$33.50; and \$46.00 f.o.b. Marysville or Lakewood. Free Circular.

KANSAS CITY SPECIALTIES CO. DEPT. P-11, P.O. BOX 6022, MARYSVILLE, KANSAS

STUDY TO BE A DOCTOR of Psychology or Metaphysics

Obtain a Pa.D., Ma.D., or Ph.D. Be a Teacher, Lecturer or Accredited Practitioner. Teach others how to achieve Health, Happiness and Contentment. Chartered by State. Correspondence Courses only. Write for FREE book telling how.

THE NEOTARIAN FELLOWSHIP
Desk 8, Pickwick Building Kansas City 6, Missouri

MAKE TREMENDOUS PROFITS

Have fun! Earn Big Money! Cast plaster figurines, bookends, plaques, novelties at home in your spare time with X.L. rubber molds! **NO EXPERIENCE NEEDED!** Models and rubber for 3 molds, only \$1.50 ppd. Send 25c (refunded with order) for 40 page catalog now!
PLASTIC ARTS STUDIO 3403 S. MADISON, DEPT. PM2 MUNCIE, INDIANA

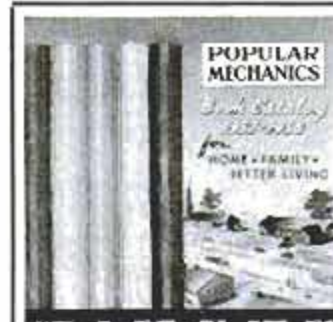

FREE!*

POPULAR MECHANICS

BIG BOOK CATALOG

Pictures and Describes

95 Different Books to Help Save Time and Money on

- home improvement and maintenance
- new homes and garages
- automobile repair and purchase
- tool purchases, use, upkeep
- workshop planning and projects
- hi-fi, television, radio, other equipment
- crafts and hobbies of all kinds
- farm equipment and animals

PLUS Books of fun and education for Boys and Girls. Sport Books. Books of activities and enjoyment for the Entire Family — and many, many more!

28 large pages, beautifully illustrated and printed in two-colors, fully indexed by subject and title for fast, easy reference. Catalog is free of charge. However, please enclose 10c to cover forwarding costs.

Popular Mechanics Press, Dept. 115B, 200 E. Ontario St., Chicago 11, Ill.

RUSH big PM Book Catalog. I enclose 10c in coin to cover all handling, addressing and postage charges.

Name _____
Address _____
City _____ Zone _____ State _____



PAY 1¢ on the DOLLAR

for 1000's of Useful Items

U. S. GOV'T SURPLUS

BUY DIRECT from U. S. Government at TREMENDOUS savings! Eliminate the middleman—save big money! Pay as low as 1¢ on the dollar or less. Our Directory Gov't Surplus Sales lists 100's of Army, Navy, Air Force and other government surplus depots. Many of them right in your own back yard. Buy sports equipment, hunting, fishing and photographic equipment and supplies, radio, electronic and electrical equipment, trucks, boats, jeeps, airplanes. Plumbing, hardware, office equipment supplies. Power tools, machinery, furniture. WE DO NOT sell jeeps or other surplus. YOU BUY DIRECT from Uncle Sam. No dealer profits to pay. This book tells you how to buy Gov't Surplus. Send for your copy today. Directory is indexed for quick information. Answers your questions. Tells you how to buy. Get on the gravy train while you can. Send \$1 today for "Gov't Surplus Directory" to
Aviation Surplus Center, Dept. PM-11, Box 789, York, Pa.

AT THESE LOW PRICES PAID AT RECENT GOV'T SALES

Jeeps.....\$223 Tractors.....\$68
 Trucks.....\$212 Motors.....294
 Boats.....\$5.90 Airplanes....\$366
 Fork-lifts....\$197 Typewriters..\$6.80
 Compressors \$9.69 Generators...\$8.78
 Gear Reducers 974 • Hydraulic cylinders \$1.01 • Transmissions \$7.80
 Over 3 Billion War Surplus sold every year!

"MINIATURE MACHINE SHOP

No Bigger Than A Typewriter, Outperforms Machines Many Times Its Size!" That's what a popular publication says about UNIMAT in their 3 page feature story in the May issue. If you want a reprint of this story plus complete information about this amazing 10 in 1 combination precision tool write to:



AMERICAN EDELSTAAL, INC., UNIMAT DIV., Dept. 3118, 350 B'way., N.Y. 13

WANT MORE MONEY? GET INTO PHOTOGRAPHY

Coast to coast, high-paying jobs in photography are waiting for people with that "know-how" to fill them. You can quickly, easily qualify at home with the world-famous NYI Learn-by-Doing Method. Write today for free catalog. Also resident training in N.Y. 49th Year. Approved for Vets.

NEW YORK INSTITUTE OF PHOTOGRAPHY
 Dept. 49 10 West 33 St., New York 1, N.Y.

MONEY in WORMS

Sell 20,000 fishworms per week @ \$4 per 1000 from a bed 3 feet wide and 6 feet long. We teach you how to raise and where to sell fishworms and crickets. Write for free literature.
 CARTER WORM RANCH, PLAINS, GEORGIA

Make your own Gems 36.50

The Gem Maker comes complete with all necessary equipment, including a super-charged diamond blade for sawing, and all the wheels for grinding, shaping and polishing; also complete instructions. The complete equipment as shown, less motor and belt for only \$36.50, f.o.b. Burlington, Wisconsin. Write today for information and literature.

B&I MANUFACTURING CO.
 Dept. P. Burlington, Wis.

NOW... This Truly Professional Telescope!
 YOURS AT THE LOWEST PRICE EVER!

with 50, 120, 175, 375 Power

3 INCH REFLECTING TELESCOPE

Serious minded astronomer acclaim this exciting professional telescope as the top buy of the year! 3" primary objective tube is mounted on rigid 3 ft. tripod with equatorial and alt-azimuth mount. Extra fine adjustments assured with positive Friction and Lock Control Handles on each axis. Ventilated J. F. 13 mirror aluminum and overcoated is guaranteed to resolve to Dawes limit. 4X finder scope easily locates all targets. Ideal for observing man made satellites, stars, planets etc. with razor sharp definition. Fully assembled and guaranteed.

Now: Only \$24.95 f.o.b. MATTITUCK, N.Y. (Sant Express. Shipping wgt: 11 lbs.) SORRY, NO C.O.D.'s

Free 273 page "Handbook of the Heavens" and Star Finder Dial included with each order!

SUFFOLK SCIENCE SERVICE Dept. PM-11, MATTITUCK, N.Y.

LOOKS COOLER- IS COOLER!



\$2.50
 AIR COOLED
VIKING

DR. GRABOW PIPES • GREENSBORO, N. C.

PREPARE FOR BETTER JOB, BIGGER PAY IN SPARE TIME AT HOME

Today, choose the job you want—and prepare for it in time you might otherwise waste. Or if you are already in the work you like best, start training now for quicker promotion and increased pay. During the past 61 years AMERICAN SCHOOL has helped ambitious people to reach higher goals. Check subject that interests you and mail coupon for full information.

AMERICAN SCHOOL, Dept. G845, Drexel at 58th, Chicago 37, Ill.
 Without obligation, please send FREE and postpaid, full particulars about the subject checked below.

- | | | |
|---|--|--|
| <input type="checkbox"/> Accounting
<input type="checkbox"/> Apprenticeship Courses
<input type="checkbox"/> Architecture & Building
<input type="checkbox"/> Automotive Technician
<input type="checkbox"/> Better Foremanship
<input type="checkbox"/> Blueprint Reading
<input type="checkbox"/> Bookkeeping
<input type="checkbox"/> Business Management
<input type="checkbox"/> Civil Engineering | <input type="checkbox"/> Contracting
<input type="checkbox"/> Diesel Technician
<input type="checkbox"/> Drafting—Building Trades
<input type="checkbox"/> Drafting—Machine Trades
<input type="checkbox"/> Electrical Engineering
<input type="checkbox"/> Electricity—Practical
<input type="checkbox"/> Electronics—Industrial
<input type="checkbox"/> HIGH SCHOOL COURSES
<input type="checkbox"/> Machinists | <input type="checkbox"/> Mechanical Engineering
<input type="checkbox"/> Mechanical Technology
<input type="checkbox"/> Metalworking Courses
<input type="checkbox"/> Plumbing—Practical
<input type="checkbox"/> Private Secretary
<input type="checkbox"/> Retail Merchandising
<input type="checkbox"/> Salesmanship—Outside
<input type="checkbox"/> Sheet Metal Work
<input type="checkbox"/> Tool Making |
|---|--|--|

NAME _____ OCCUPATION _____ AGE _____
 HOME ADDRESS _____ STATE _____
 CITY _____

Accredited Member NATIONAL HOME STUDY COUNCIL

MAIL COUPON NOW



EXTRA! ANOTHER Scoop!

SENSATIONAL NEW

BENJAMIN BB REPEATERS...
The Only Repeating Guns on the Market with...

\$14.95

Piggy-Back SHOT MAGAZINE

*** BENJAMIN SUPER 100 SHOT BB CO. GAS RIFLE, \$14.95**
*** BENJAMIN SUPER 100 SHOT BB AIR RIFLE, \$21.95**

THE REVOLUTIONARY NEW GRAVITY FEED ACTION THAT LOADS BB AMMUNITION automatically!

A shot is placed in firing position each time bolt is pulled back and closed. Finest quality. Powerful—Accurate—Economic. Use indoors or out. New Bar-V sight.

FREE Ask for Catalog All Models Benjamin Single Shot and Repeaters... Cal. BB or 177 or 22. ALSO, SPECIAL OFFER ON HUNTING AND FISHING KNIVES, ETC.

No. 3600 Benjamin Super 100 Shot BB Gas Rifle, No Pumping... Auto Loading. — \$17.95
No. 3600CS Deluxe Gas Rifle with Custom Stock — \$17.95
No. 3100 Benjamin Super 100 Shot BB Air Rifle with Regular Stock, Economical. — \$21.95
No. 3100CS Deluxe Air Rifle with Custom Stock — \$24.95

BENJAMIN AIR RIFLE CO.
805 MAPION ST. ST. LOUIS 4, MO. U.S.A.

The Backyard

PLAYBOY MOTOR SCOOTER

The newest fun for Junior. His own personal motor vehicle. Safe, quiet. Simple as a sidewalk bike. A 7-year-old can learn in minutes. The ideal birthday gift.

FOR ADULTS, TOO!

Stows easily in plane or boat. Only 42 pounds. Ride it on the patio. A barrel of fun for your guests. The girls will simply love it. See it at your local cycle dealer's.

Folder on Request

HAP ALZINA \$119.95 f.o.b.

3074 Broadway Dept. PM Oakland, Calif.
Dealer Inquiries Invited

SUPER JU JITSU

Now get tough double quick!

A course of instruction in the art of practicing and using this method of applying LIGHTNING-QUICK Super Ju Jitsu. Be Dangerous! These amazing lessons show you how it's done... in a big illustrated home-study course. The weapons are just your BARE HANDS—they can be used effectively if you know how and practice the art. Easy to learn! quick. Full 76-lesson course only \$5.95 postpaid—or COD, plus postage. Satisfaction or your money back guaranteed! Order "super Ju Jitsu Course."

NELSON-HALL CO., 210 S. Clinton, Dept. 8LS-2, Chicago 6, Ill.

I'll Send You This Handsome SAMPLE CASE—FREE

and Show You How to Make Up to \$30.00 in a Day

Mail coupon for this Free Tailoring Sample Case packed with 100 beautiful, big-value suit and overcoat fabrics. Take orders from friends, fellow-workers, others, for fine quality, made-to-measure clothes. Pocket big cash profits in advance. Because wearing our suits and overcoats brings more orders, we make it easy for you to get your own clothes without the cost. No experience is needed. **SATISFACTION GUARANTEED.**

SEND NO MONEY. Just fill out and mail coupon—today!

W. Z. GIBSON, INC., 500 South Throop Street DEPT. G-516 CHICAGO 7, ILLINOIS

W. Z. GIBSON, INC., Dept. G-516
500 S. Throop St., Chicago 7, Ill.

Dear Sir: I WANT A MADE-TO-MEASURE SUIT TO WEAR AND SHOW, without paying for it. Rush details and Sample Kit of actual fabrics, ABSOLUTELY FREE.

NAME _____ AGE _____

ADDRESS _____

CITY _____ STATE _____

Secrets of VENTRILOQUISM
Now Revealed!

Easy to learn in 60 to 90 days with our Home Study Course. **RESULTS GUARANTEED.** Make Money! Be Popular! Have Fun! Big Opportunity! Radio, Television, Stage Appearances! For FREE information regarding price and terms WRITE: You must state your age. Bureau Catalog 25c.

MAKER HOME COURSE OF VENTRILOQUISM
Box 36, Studio PM-11, Kensington Station Detroit 24, Michigan

DeLuxe METAL Pocket Rubber Stamp

Custom Made. Chrome Plated. Indestructible. "Finger-Tip" Control. Self-locking case. 3-line text 1 1/2" x 2" area. Inked pad. Our regular, popular Nickel Plated Stamp, without DeLuxe Features, \$1 still only. **Send Check or Money Order. Mailed POSTPAID**

\$2

SAMUEL H. MOSS, Inc., 36 E. 23rd St., N.Y.C. 10 Dept. MEC-11

GENUINE 360 POWER 3" REFLECTING TELESCOPE

COMPLETE WITH 50X, 120X, 150X, 360X magnifications. 4X finder scope, folding tripod, plus "Handbook of Heavens" & Magic Star Finder

Only **\$26.95**

Never before a precision reflecting telescope sold with all these features, for anywhere near this low price. Professional observations guaranteed with this powerful astronomical telescope. Equipped with special WIDE-ANGLE lens for observing satellites, stars, nebulae, comets, Saturn's rings, Jupiter, Mars, Moon's detail, other celestial phenomena with observatory clearness, amazing closeups guaranteed on all objects. Will "split" close double stars. Acclaimed by experts optically & scientifically correct, for serious astronomical work. Completely assembled ready to use. Eyepieces give full range of powers, 50X, 120X, 150X, 360X. 3 inch f12.5 mirror aluminized & overcoated, guaranteed to resolve to Dawes limit. Special ventilated aluminum mirror housing for use in all climates. 3' hardwood folding tripod. Equatorial, alt-azimuth mount compensates for earth's rotation & permits automatic tracking of astronomical objects. Take long range photos with ordinary box camera. 36" Bakelite phenolic tube. 4X finder scope sights target fast. Completely portable; scope instantly removable from tripod for easy storage & carrying to remote areas. Included with this amazing precision instrument, 270 page book "Handbook of the Heavens," Magic Star Finder. Satisfaction guaranteed or money refunded. Sent complete, nothing else to buy at amazing low price of **\$26.95**. Send cash, check, or money order. Shipped by express F.O.B. Shipping weight 10 lbs. Dept. DPM 7, OPTIK INSTRUMENTS CO., 509 Fifth Ave., N. Y. 17, N. Y.

HOW TO BREAK and TRAIN HORSES

SEND FOR THIS FREE!

Make money. Know how to break and train horses or ponies. Write today for this book FREE, together with special offer of a course in Animal Breeding. If you are interested in Gaiting and Riding the saddle horse, check here (). Do it today—now.

BEERY SCHOOL OF HORSEMANSHIP
Dept. 11011 Pleasant Hill, Ohio

GIANT 6 FOOTERS

59c

Wow! Genuine Neoprene government surplus (never used)... giant 6 ft. across, 21 ft. around... at a fraction of original cost. Durable. Can paint on advertising message, inflate and fly. Visible for miles. Great for attracting crowds to fairs, openings, school proms, gas stations. Fun for young and old in backyards or picnics, at the beach, etc. use as water markers & buoys. Order today — 59c — \$1 for \$1.

Special 13' — 1.95 ea.
Calif. Res. Add Sales Tax.
We pay postage on prepaid orders.

FRANK SALES 3930 SUNSET BLVD., DEPT. PM1158 LOS ANGELES 29, CALIF.

Open and Close Your Garage Door

—from the seat of your car!

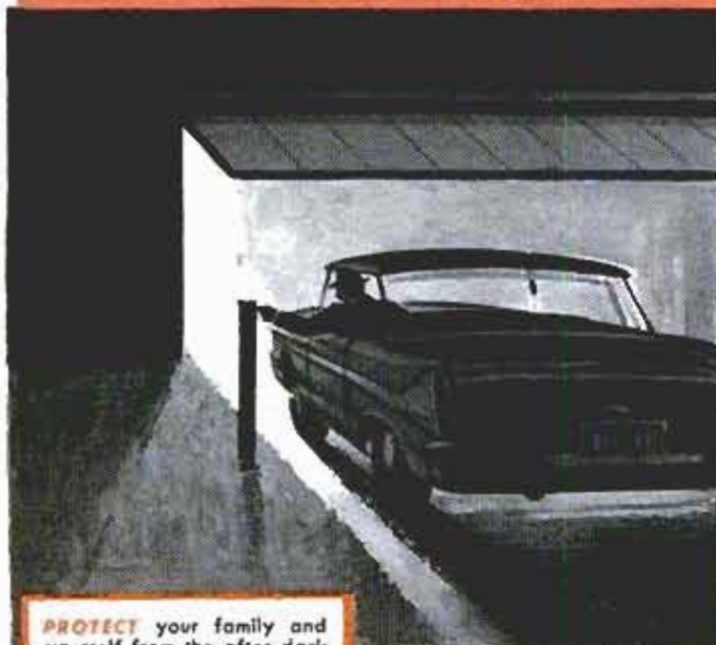

PROTECT your family and yourself from the after dark danger of holdup—or worse.



PROTECT the driver from the discomforts of exposure to rain, snow, or freezing winds.



PROTECT against danger of back injuries often caused by raising heavy doors.



Full "Do-it-yourself" Details by Mail

ALL FREE!

Send no money—just your name—on a postcard or the coupon. Complete diagrams, descriptions, and price list of parts will be mailed entirely free. There is no charge now or at any other time for this "do-it-yourself" information, and if you decide to install a DORLIFT, you can order the complete kit by mail at low direct-from-factory price.

At last—AN AUTOMATIC GARAGE DOOR OPENER

anyone can afford!

Just reach out of your car window and turn a key in the Postlock. Your garage door opens instantly, smoothly, and, as it raises, your garage is flooded with light.

Drive in, and touch the convenient wall switch. The door closes and locks, and the garage light goes off. The DORLIFT light is independent of your regular garage lights.

When you are ready to drive out of the garage, touch the wall switch to open the door. As you go past the Postlock, reach out and turn the key. The garage door closes smoothly and fully and **LOCKS IN POSITION**. It cannot be opened from outside without the key.

Never expose yourself to weather, to danger of back strains, or to the danger of attack by a hidden prowler.

SAFE—SIMPLE—EASY TO INSTALL

DORLIFT is an engineering triumph. A sturdy screw mechanism, powered by a full 1/4 H.P. motor, operates the door. As an exclusive safety feature, the garage door, in coming down, or going up, will stop instantly if obstructed. Children and pets cannot be injured by it. If stopped by any obstacle the door will reverse direction immediately when switch in post-lock or garage is activated.

Send your name today. DORLIFT is so flexible it can be fitted to almost every popular type and size of residential garage door. Strong enough to lift a double door, or two single doors in tandem. Can be installed in an afternoon.

DIAGRAMS—PARTS PRICE LIST—FREE!

Get the diagrams—Free. Get the descriptions of installation—FREE. Get the list of parts supplied and the direct-from-factory prices—FREE. No salesman will call. You decide whether you want the advantages of DORLIFT—then order by mail at factory prices.

You'll be providing real three-way protection for yourself and your family. And you'll be the envy of your neighbors. Send your name today. Find out how little it will cost to have this modern convenience and protection.

WELLS-GARDNER CO., Dept. 211
2701 N. Kildare Ave., Chicago 39, Ill.

Wells-Gardner Company, Dept. 211
2701 N. Kildare Ave., Chicago 39 Ill.

Gentlemen: Please mail me absolutely free and postage prepaid the DORLIFT do-it-yourself diagrams, list of parts supplied, and direct-from-factory price list. It is understood that there is no charge for this information now or at any other time and that no salesman will call on me. If I am interested I will order the "Do-it-Yourself" kit by mail.

Name _____

Address _____

City _____

RR or Zone _____ State _____

40 AUTOMOBILES — \$1.00 For All



The Toy Value of the year! Included are Foreign Sports Cars, American Convertibles, Hard Tops, Sedans, and each car is branded with its own name!

- All Cars Are 3 Dimensional, Not Flat Cut-Outs.
- Precision Styled and Scaled from Bumper to Bumper.
- Made of Indestructible Material
- Brilliantly Colored and Finished Throughout.
- Tremendous Selection, Each Marked by Make.

LOOK WHAT YOU GET!

- | | | |
|------------|--------------|---------------|
| • JAGUAR | • FORD | • SUNBEAM |
| • MERCEDES | • PONTIAC | • PACKARD |
| • BUICK | • RAMBLER | • HUDSON |
| • NASH | • M.G. | • CHEVROLET |
| • LINCOLN | • PLYMOUTH | • MERCURY |
| • CHRYSLER | • OLDSMOBILE | • THUNDERBIRD |
| • FIAT | • DE SOTO | • VOLKSWAGEN |
| • CORVETTE | • DODGE | • CADILLAC |

Will give kids of all ages—weeks of fun and pleasure. Any child can now own a perfect miniature replica of his Dad's car. Fully assembled and ready to roll into games, for Special Events, Gifts, Auto Races or displays — garaging and parking. Educational too, for children will recognize the original models on the road. Never have you seen such value for only \$1.00. All 40 cars handsomely gift packaged. Order now! Send only \$1.00 for each collection of 40 cars. Add 25c per set for postage and handling. Special! 5 complete sets \$4.00 (plus \$1.00 postage and handling costs). Sorry no C.O.D.'s.

MONEY BACK GUARANTEE SPORT CARS, DEPT. C-139, 220 FIFTH AVENUE, NEW YORK 1, N. Y.

Grant "THE RING LEADER"

(Established 1922)



1. Careful side-sealing of this Top Compression ring, with its special "dishing" action builds and holds power.
2. Grants double oil carrying second Compression ring maintains an even distribution of oil on cylinder walls and doubly insures compression sealing.
3. Grants great oil carrying ring controls excess oil due to a unique dovetailed design. It's long been used to gain drag-free liveliness and to correct sluggish engine conditions.

WANT TO MAKE YOUR CAR RUN SMOOTHER?

Top flight car owners and engineers use Grant Piston Rings to establish speed and economy records. More information on these people is available by dropping us a line. We'll send you FREE interesting proof with pictures. You'll be glad you did... we're waiting for your letter.

Grant
PISTON RINGS

GRANT and GRANT, 243 N. Westmoreland Ave., Los Angeles 4, Calif.
Gentlemen, Send me a copy of your "PROPER CYLINDER WALL PREPARATION"

NAME _____
ADDRESS _____
CITY _____ STATE _____



OPERATE EARTH MOVING EQUIPMENT



Learn to operate bulldozers, cranes, motor scrapers, crawler tractors, draglines, off-highway dump trucks, etc., on 1,700 acre Greer Training Area 60 miles N.W. of Chicago, Ill. on Route 66. Courses include operation, equipment care, preventive maint., stake reading, etc. Minimum classroom instruction. You learn by actually operating the equipment. You may specialize on individual equipment at rates beginning from \$195 (100 hours). Usual courses (200 hours) completed in 4 weeks. Classes start every Monday. Reserve your space today.

MECHANIC TRAINING

Complete Mechanics Course covering Diesel engine transmissions; torque converters; fuel injection systems; track assemblies; final drive assemblies, steering systems; idlers; rollers; power transfer systems; cable control systems; hydraulic control cylinders & welding pertaining to heavy equipment such as bulldozers, scrapers, loaders, off-highway trucks, etc. Course time—540 hours—10 weeks. Convenient payment plan. Write for details.



Greer TECHNICAL INSTITUTE

ATT: M. K. Mutch, Box 278, Braidwood, Ill.

Pocket Transistor Radio

"Hit Parade"
Mighty Midget



\$7.95

Low Price!
Smart Design!
Marvelous Reception!
Wonderful Xmas Present!

Size of cigaret package, yet thrilling performance. Weighs only 3 ounces. Listen while traveling, at ball game, in home or office or school. Includes Hi-Fi speaker-phone for private listening. Modern two-tone moulded plastic case, red with gold metal grille. Complete broadcast band. On-off switch one end. Uses 2 standard penlight cells (included). Guaranteed. **\$7.95** Complete, ready for immediate playing. Postpaid Only. . . .
J. ANSON SMITH & CO. Dept. 668 Detroit 7, Michigan

Catalog of 2900 Novelties 10c

Send 10c for amazing catalog of novelties, live animals, scientific supplies, hobbies, funmakers, planes & boats, looms, magic tricks, joke articles, unusual seeds, gadget timeavers, cameras, optical goods, projectors, movies, lucky jewelry, religious novelties, disguises, musical instruments, stamps, coins, puzzles, fortune tellers, radios, auto & bike accessories, telescopes, magnifiers, compasses, banks, smokers' gadgets, artists' supplies, printing sets, engines, motors, shockers, knives, billfolds, guns, rifles, sports, books, games, plants, etc. Send 10c.
JOHNSON SMITH & CO. Dept. 668 Detroit 7, Michigan

SEND ME



every month so I am sure to see each new issue. Here's

- \$3.50 for 1 year
 \$8.00 for 3 years

name _____
address _____
city _____ zone _____ state _____

Hand this order to your newsdealer or send it to
POPULAR MECHANICS
200 East Ontario St. Chicago 11, Ill.

PAINT STRAIGHT or CURVED LINES with Sensational PAINT PEN

DECORATE Furniture, Interiors, Autos, Bikes, Model Planes, Boats, Toys, Linoleums, Wall Board, etc.
 PAINTS on wood, glass, plastic, ceramics, metals, fabrics and paper. Use any color paint, glue, tempera, textile paint or underglaze: secure clean, professional decorative lines. No clog or smear.



(MASTER) Single 1/16" Stripe Model. **\$125**
 From Your Dealer Only.
 Other single stripe models:
 1/64" 1/32" 3/64" 5/64"
 3/32" 1/8" only \$1.75 ea. Extra tips 90c each, Extra 1/4" tip \$1.20.

SPECIAL: Complete Set (Pen and all 7 tips) Only **\$500** Single Line.

MPRS. ask about heavy duty, precision industrial and production stripping tools.
FOR DEALERS: Fast profitable seller; attractive display; write for money-making details.
PAINTERS, CRAFTSMEN: "Professional" results every time with this time-saver.

Double Stripe Model-w/s combination \$3.25 C.O.D. Postage Collect.
WENDELL MFG. CO., 4234 LINCOLN AVE., DEPT. 346 CHICAGO 18, ILL.

TOOLS WHOLESALE

Start your own business, sell tools to your friends and neighbors, or buy tools for your own use and **SAVE MONEY \$\$\$**

A MILLION DOLLAR INVENTORY AT YOUR FINGERTIPS. NO STOCK TO CARRY. ORDER AS YOU NEED IT.
 THOUSANDS!! of Nationally Advertised items of Hand Tools, Power Tools, Machinist Tools, Tool Chests, Paint Sprayers, Light Fixtures, Appliances, Guns, Gifts, Toys and other items too numerous to mention.
 WE SHIP COAST TO COAST Wholesale Discounts up to 50% OFF
 Dept. PM11 107 Walnut St., Phila. 6, Pa.

FREE EARN '59 NEW CAR SELLING AUTOMOTIVE ACCESSORIES

Make 300% profit full or part time, & earn BONUS new car. Sell high profit line newest auto accessories. Your lifetime business, own exclusive area. **CLYDE & CO.,** 120-F East 82, New York 28, N. Y.

MECHANICAL DRAWING SELF-TAUGHT

It's easy to learn this important ability by yourself. Increase your value, knowledge—and income! Mechanical drawings are accurate, clear representations of objects drawn for the purpose of enabling carpenters, mechanics, contractors, factories, to make them. This book—"Mechanical Drawing Self-Taught" by Jerome S. Meyer—teaches you the use of drawing instruments, how to draw to scale, how to letter, and how to make all kinds of shop or working drawings. Book is 96 pages, 6x9 inches, just published—**ONLY \$1.00.** Money Back Guarantee. Order from:
GLOBE PUBLISHING CO., 830 BROADWAY, DEPT. P-11 NEW YORK 3, NEW YORK

YOU BRIGHTER FUTURE IN AUTO MECHANICS AND DIESEL



Your spare time pays off **BIG** with our world-famous **SHOP TESTED®** Home Training



MAKE YOUR FUTURE AS BRIGHT AS THEIRS
 In a matter of months, you can quit your no-future job for a big-pay, big-future career as an Auto-Diesel Mechanic. Free Illustrated Book gives you the facts. Send coupon below. No Obligation. No Salesman will call.

All Phase Training

N. T. S. students become skilled, all-around mechanics. Crystal-clear lessons. Shop-Tested manuals, real professional equipment, make it easy to learn. Big equipment kits, yours to keep. Earn as you learn... we show you how. Graduate Advisory Service.

N.T.S. Training is Better, More Complete, Lower Cost BETTER...

Because training is **SHOP-TESTED** in Resident School Shops & Labs. **MORE COMPLETE...** You learn all phases of Auto Mechanics & Diesel. **LOWER COST...** One low tuition covers entire cost of course and all equipment.

Unlimited Opportunities

Trained mechanics make top money...are in demand at dealer shops, garages, large bus and truck lines, construction projects, government labs, factories, and many others.

YOU GET AND KEEP ALL THIS PROFESSIONAL EQUIPMENT



- Complete set of master mechanic tools & tool box.
- Motor analyzing set - a test units in metal case.
- Socket Wrench Set with fittings for all engines.

NATIONAL TECHNICAL SCHOOLS
 WORLD-WIDE TRAINING SINCE 1905
 4900 S. FIGUEROA ST., LOS ANGELES 37, CALIF., U. S. A.



RESIDENT TRAINING at Los Angeles!
 If you wish to take Resident Training at Los Angeles, in our Big Modern Shops & Labs, check special box in coupon for full information.

FREE! Illustrated Fact Book & Actual Lesson
 Mail coupon now.
 Complete TV-Radio Electronics training also available.

NATIONAL TECHNICAL SCHOOLS
 WORLD-WIDE TRAINING SINCE 1905

MAIL NOW TO
NATIONAL TECHNICAL SCHOOLS, Dept. DB-118
 4000 S. FIGUEROA ST., LOS ANGELES 37, CALIF.
 Send for FREE Auto-Diesel Opportunity Book and actual Lesson.

NAME _____
 ADDRESS _____
 CITY _____ STATE _____



Member

GIVE a Happy Christmas through The Salvation Army

SPACE ERA IS HERE! SEE THE SATELLITES

MOON ROCKETS!

AMAZING TELESCOPE BUYS AND OTHER OPTICAL BARGAINS



See the Stars, Moon, Planets Close Up!

3" ASTRONOMICAL REFLECTING TELESCOPE

60 to 160 Power — Famous Mt. Palomar Type! An Unusual Buy!



Assembled—Ready to use! You'll see the Rings of Saturn, the fascinating planet Mars, huge craters on the Moon, Star Clusters, Moons of Jupiter in detail. Galaxies! Equatorial mount with lock on both axes. Aluminized and overcoated 3" diameter high-speed f/10 mirror. Telescope comes equipped with a 60X eyepiece and a mounted Barlow Lens, giving you 60 to 160 power. Low-cost accessory eyepiece available for power up to 320. An Optical Finder Telescope, always so essential, is also included. Sturdy, hardwood, portable tripod. Valuable STAR CHART and 272-page "Handbook of Heavens."

Stock No. 85,050-H \$29.95 postpaid

4 1/4" ASTRONOMICAL TELESCOPE!



UP TO 270 POWER!
With this scope you can see everything as above but with greater power plus will split finer stars. Mirror has twice the light gathering power. Mirror guaranteed to give theoretical limit of resolution. Rack and pinion focusing, hardwood tripod, real equatorial mounting—only one adjustment follows stars! Aluminum tube. 6 power finder telescope. 2 standard size eyepieces and mounted Barlow lens give you powers of 40X, 90X, 120X, and 270X. Low-cost accessory eyepiece available for power up to 540. Free handbook and Chart. Shipping weight 25 lbs.

Stock No. 85,006-H \$74.50 f.o.b.

TAKE PHOTOS of the MOON Through Your Telescope with EDMUND CAMERA HOLDER for TELESCOPES



Bracket attaches permanently to reflecting or refracting telescopes. Removable rod holds camera over eyepiece to take pictures of Moon . . . or terrestrial telephoto shots of distant objects.

White metal projection screen permits you to see the sun spots! Includes brackets, 28 3/4" rod, projection screen, screws, directions. Order Stock No. 70,162-H \$9.95 Postpaid (Send Check or M.O. — Money-Back Guarantee)

MAKE YOUR OWN ASTRONOMICAL TELESCOPE

See December, 1957 issue of POPULAR MECHANICS—Pages 188-192. 4 1/4" MIRROR KIT—Contains ready-to-use 4 1/4" diameter concave, aluminized objective mirror, lenses for 1" focal length eyepiece, and aluminized first surface diagonal mirror.

Order Stock No. 50,074-H Price \$16.25 postpaid Same as above except 3" diam. mirror—

Stock No. 50,081-H \$9.95 postpd. We have additional eyepieces, tubes, tripods, in fact everything you need to build telescopes.

New! 2 in 1 Combination! Pocket-Size 50 Power MICROSCOPE and 10 Power TELESCOPE

Useful Telescope and Microscope combined in one amazing, precision instrument. Imported! No larger than a fountain pen. Telescope is 10 Power. Microscope magnifies 50 Times Sharp focus at any range. Handy for sports, looking at small objects. Just plain snoothing. Send Check or M.O. Satisfaction Guaranteed. Order Stock No. 30,059-H \$4.50 Postpd.

DIRECT MEASURING POCKET MICROSCOPE — 50 POWER

Fountain pen size, makes direct reading measurements; for checking small parts and dimensions under powerful magnification. Precision, glass etched reticle calibrated for measurements up to 1/10" by .001" divisions.



STOCK NO. 30,225-H \$7.95 Postpd.

BUILD A SOLAR ENERGY FURNACE

A fascinating new field. Build your own Solar Furnace for experimentation—many practical uses. Easy! Inexpensive! Use scrapwood! We furnish instructions. This sun powered furnace will generate terrific heat—2000° to 3000°. Fuses enamel to metal. Sets paper aflame in seconds. Use our Fresnel Lens—14 3/4" diameter . . . f.l. 14".

Stock No. 70,130-H . . . Fresnel Lens . . . \$ 6.00 Postpd.

ORDER BY STOCK NUMBER . SEND CHECK OR MONEY ORDER . SATISFACTION GUARANTEED!

EDMUND SCIENTIFIC CO., BARRINGTON, NEW JERSEY

STEREO MICROSCOPE



American-Made Instrument at Over 50% Saving. Up to 3" Working Distance—Erect Image—Wide 3-Dimensional Field. Used for inspections, examinations, counting, checking, assembling, dissecting. 2 sets of objectives on rotating turret. Standard pair of wide field 10X Kellner Eyepieces give you 23 power and 40 power. Helical rack and pinion focusing. 10-DAY TRIAL . . . Complete satisfaction or your money back. Order Stock No. 85,056-H. Full price . . . \$99.50 f.o.b. Barrington, N.J. Shipping wt. approx. 11 lbs. Send Check or M.O.

TELESCOPE CAMERA

Idea. for taking shots through telescopes of moon, stars—terrestrial telephoto shots. Uses sheet film. 4-element lens. Included with camera:—Film holder, 2 1/4" x 3 1/4"; yellow filter; cable release; 3 1/4" x 4 1/2" piece ground glass. Camera box size is 3 x 4 x 5". Tube that fits eyepiece holder is 5" long, 1 1/4" O.D. for standard telescopes. Precision German-made shutter, speeds of T. B., 1 sec., 1/2, 1/5, 1/10, 1/25, 1/100 and 1/200. Also has delayed action shutter release. Stock No. 70,166-H \$39.50 Postpaid



REPLICA GRATING — LOW, LOW COST

It's here—after decades of effort! Replica Grating—on film—at very low price. Breaks up white light into full spectrum colors. An exciting display, 13,400 lines per inch, running long way on film 8" wide—grating area 7 1/2". Thickness about .005". Dispersion about 24°. Use it for making spectroscopes, for experiments, as a fascinating novelty. First time available such large size—so cheaply. Comes in clear-plastic protector.

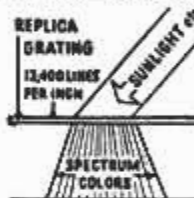

Stock No. 40,267-H—piece 8" x 11" \$1.50 postpd.
Stock No. 50,180-H—piece 8" x 6 ft. \$5.95 postpd.

SALE! TERRIFIC WAR SURPLUS BARGAIN! AERIAL CAMERA LENSES



Gov't. Cost \$1218—Now Low as \$39.50 Used Made by B & L and E.K.—24" F.L. f/6, in 23" long Lens Cone. Use as long range, Big Bertha Telephoto lens—for Richest field (wide field, low power) telescope, etc. Lenses are 4" dia.—precision 4-element type, Aero Tessar and Aero Ektar (no choice). Easily removed. Diaphragm (f/6 to f/22) is included. Opens approx. 1" to 3 1/2". Lens and cone—wt. 25 lbs. Sturdy carrying trunk—wt. 26 lbs.

Stock No. 85,059-H . . . 24", used. Price \$39.50 f.o.b. Utah
Stock No. 85,060-H . . . 24", new. Price \$59.50 f.o.b. Utah

SALE! WIDE ANGLE ERFLE EYEPIECE

Tremendous bargain! 1 1/2" f.l.! Focusing metal mount is 2-11/16" in diameter. Consists of 3 coated achromats. 65° field. Govt. cost over \$100. Use these with the 24" f.l. Aerial Camera Lenses to make a 16 power wide field telescope, etc.



Stock No. 50,178-H only \$9.95 Postpaid

HAND SIGHTING LEVEL

Described in Popular Mechanics March 1958 issue, page 212 Sight it like a Telescope. Gives you a level line of sight, for laying out gardens, drives, new construction, ditches, etc. Complete instructions included.



Stock No. 105-H \$2.50 postpaid

FREE CATALOG-H

Yours for the asking

America's No. 1 source of supply for experimenters, hobbyists. Complete line of Astronomical Telescope parts and assembled Telescopes. Also huge selection of lenses, prisms, war surplus optical instruments, parts and accessories. Telescopes, microscopes, satellite scopes, binoculars, infrared sniperscopes, etc.



REQUEST CATALOG-H

**WORLD'S
BEST
WANT-AD
MEDIUM**

CLASSIFIED ADVERTISEMENTS



Advertisements in this section \$1.25 per word, each insertion, minimum 10 words, payable in advance.

To be inserted under proper classification, copy must be in our office the

20th of the second month preceding date of issue

F. W. Johnson, Manager, Classified Advertising

Popular Mechanics Magazine, 200 East Ontario Street, Chicago 11, Illinois

YOU'LL PROFIT

By reading and answering the classified ads in this section. Hundreds of opportunities for you to make and save money

AUTOMOBILES. MIDGET CARS

FABULOUS New midget racer. Build yourself. Complete plans. Send \$3.00 to Bobcat, 606 So. Main, Council Bluffs, Iowa.

BOY'S Midget car, power driven. Complete kit furnished. Amazing low cost. For literature, write Arnold-Dain Corp., Box 3, Mahopac, N. Y.

HUNDREDS Of automobile catalogs. Old, modern, foreign; glossy photographs; shop manuals; dealer books; free motor magazines listed by non-profit corporation. Write to get on free mailing list. Auto Maniacs, Stockbridge, Mich.

BIG Money industrial car finish protection secret. Detroit's best for Detroit's finest. Free circular. Correct Products, Box 85, Detroit, Michigan.

MIDGET Car. Plans and pricelist of parts 35¢. B. Sypher Co., Sta. F., Toledo, Ohio.

NEW 1959 Automobiles—To 25% off retail. Meder, 550-PM Fifth Avenue, New York City 36.

BOOKS; Hundreds of subjects. Big 1958 book catalog—10¢. Popular Mechanics Press, 200-BC East Ontario St., Chicago 11.

BUYING A new automobile? Professional shoppers methods \$2.00. Refund guaranteed. Evenhouse, 1041-B N. Kedvale, Chicago 51, Ill.

POWERED Midget car. Built with old reel power lawn-mower. Low cost, efficient, attractive. Absolutely complete easy to read plans \$3.00. DeKalb Mower & Service Co., 2814 E. College Ave., Decatur, Georgia.

"DIAGNOSING Troubles in Automotive Engines, Ignition and Electrical Systems." \$1. Buice, 122 E. Cambridge, College Park, Georgia.

DISTRIBUTOR Wanted. Can earn \$1,000 wk. Fast selling midget race cars. Fully assembled 2½ h.p. engine, 10" tires, 2-wh. brake, roll bar, clutch. Costs \$88. Sells at \$189. Rents at \$20 hr. Write My-On, 407 N. Maple Dr., Beverly Hills, Calif.

AUTO SUPPLIES AND EQUIPMENT

1959 GIANT Auto parts catalog. Thousands scarce accessories stores don't have. Gadgets, custom equipment. Send 25¢ postage (refundable). Newhouse Automotive Industries, 5805-PM-11 Beverly, Los Angeles 22, Calif.

REPAIR And customize automobiles, boats, etc., with Bondit. Quart \$3.85. Glassgo. Browns, Alabama.

JEEP Tops. Convertible tops. Free catalogue. Mor-Nan, Box 141, Beverly, Mass.

SUPREME Racing camshafts. Cleveland Hone & Mfg. Co., 8816 Harkness, Cleveland 6, Ohio.

RUN Your automobile without spark plugs. Details free. Discount Distributors, 8189 Heather, Fontana, Calif.

ENGINES, Chevrolet, Ford, Plymouth, Oldsmobile, Buick, etc. Near new. Reasonably priced. Free details. Ledbetter Enterprises, 1015 West 17th, Texarkana 4, Texas.

NEW Four cylinder Ford parts. Catalog 25¢. Mark, Layton, N. J.

RING-Valve job while driving, \$6.00. Free details. Motaloy, Grantham, Penna.

FORD T and A parts? Try best source old model parts, all makes. Wisnesky Auto, Milwaukee 7.

REVOLUTIONARY Gasoline saver device! Particulars, send 10¢, refundable. Orable Enterprises, 26314 Normandy, Roseville, Michigan.

BARGAIN. Exciting Little Library booklets. 25¢ each. How to use tools, painting, welding, home improvement, games, models, plastics, lamp making, glass blowing, boats, photographs. Free Little Library catalog. Popular Mechanics Press, 200-LB East Ontario St., Chicago 11.

SAVE Money on Jeep and army truck parts. Large inventory. Catalogs for Jeep or G.M.C. owners. American Auto Parts Co., 1830 Locust, Kansas City, Mo.

FREE! New catalog. Speed, power, mileage increasing equipment. Discounts! Almqvist Engineering, Milford PMS, Penna.

NEW And used parts at savings. Complete guaranteed parts service for all models cars and trucks, 1924 and later. Largest in the West. Jeep and army parts specialists. Newest type shifting hubs for all jeep and all military and latest production front end drive vehicles. \$27.50 and up. Write, Pioneer Auto and Truck Parts Co., 734 W. 13th Avenue, Denver 17, Colo.

AUTOMOTIVE Books. Send for 1958 book catalog—10¢. Popular Mechanics Press, 631 N. St. Clair St., Chicago 11.

NEW Redmond 6-volt heater-defroster motors, \$2.00 postpaid. With 12-volt adapter, \$2.75. Lee Mfg., 10630 Hillhaven, Tujunga, Calif.

AUTO Accessory and parts catalog. 1959 edition, all new! 308 pages. Save up to 50%. 85,000 items, including Hollywood accessories, hi-speed equipment, rebuilt engines, all parts and accessories for all cars and trucks! Hard-to-get parts! Send 25¢ (refundable). J. C. Whitney, 1919 PM-11 Archer, Chicago 16, Ill.

TRUCK Seat covers. Heavy truck leatherette. Factory fit. Easily installed. Brown, maroon, grey, green. Also heavy canvas. \$12.00 set. Cushion only, \$7.00. Postpaid. C.o.d.'s accepted. State color, make, year. Industrial Covers, 3240 Flora, Kansas City 9, Mo.

PUT Pep in your car. Details free. Automotico, 1727 Ninth Avenue, San Francisco 22, California.

PERSONALIZED Chrome nameplates. Script type. \$5.00 each ppd. Print name desired clearly. Custom Nameplates, 258 West High Terrace, Rochester 19, N. Y.

JEEP Owners — V-8 conversions. Read Jeep Owners ad, page 24.

AUTO TRAILERS

TRAILER Building guide supply catalog \$1.00. Blueprint booklet floor plan 40¢. Kamcraft, Box 1153, Milwaukee 1, Wis.

TWO Wheel camper. Lowest priced. Sleeps 4-6. Write! Economi-Traveler, Dept. P.M., 13100 West Cleveland, Waukesha, Wis.

BUILD Expanding eight foot trailer. Accommodates five. Literature 10¢. Framar Company, Wilmington, Mass.

PICKUP Coaches. Trailer blueprints. Literature 10¢. Comstock Trailers, Parsons, Kansas.

MOTORCYCLES. BICYCLES. MOTORSCOOTERS AND SUPPLIES

MICRO-Midget \$15, motorscooter \$20, motorbike \$5, less engines. Engines \$4 up. Go cart \$60. (Mailorder only). Send 25¢, (35¢ for first class mailing) for 32-page directory-catalogue number 86, listing these and hundreds of other bargains in midget cars, motorscooters, homebuilders, parts, plans, etc. Midget Motors Directory, Athens, Ohio.

HARLEY - Davidsons — Used bargains. New, used parts, accessories for all models. Bulletin, catalog 20¢. Knuth's (Factory Dealer), 1753 Muskego, Milwaukee, Wis.

RECONDITIONED Motorcycles and motors. Chromium accessories. Complete stock Indian parts. Expert rebuilding. Fast service. Indian Motorcycle Sales, Kansas City 27, Missouri.

PARTS. New, used. List 10¢. Ballak, 811 N. 9th, St. Louis 1, Mo.

RACING Power cams for Cushman, Whizzer, Mustang, Hiawatha, Continental. Send your cam and \$10. Weber Cams, Box 33175, Los Angeles 33, Calif.

AVIATION

UNUSUAL Flying platform. Scale drawings, description, \$2.00. Sheby Industries, Box 516-U, San Anselmo, California.

HELICOPTER Mechanics urgently needed. Train at home. Southern Cross Helicopter Institute, 345 SIP, Jersey City 6, N. J.

PRINT, Full color Boeing B-47 in flight, authentic reproduction of official U. S. air force photograph. Size 20 x 30. Send \$1.00 ppd. to Preferred Prints, Dept. M, P. O. Box 408, New York 36, New York.

SKYCOPTER—New design. 3-4 bladed control heads. Factory engineered, tested rotorcraft components. Catalog \$2.00. Skyway Engineering, 202 East Palmer, Indianapolis 25, Indiana.

HELICOPTER. Plans, components, for sale. Adams, Box 6042-M, Lakewood, Calif.

BOOKS, Aviation. Free catalog. Aero Publishers, 2162-PM-11 Sunset, Los Angeles 26, California.

BUY Surplus aircrafts; fuselages; assemblies; aircraft engines; helicopters; instruments; electronics; radiotelephones; misc. Buy direct now from U. S. Government. Depot list and procedure \$1.00. Brody, Box 8-PM, Sunnyside 4, New York City.

AIRLINE Careers. Starting salary \$3400 up. Short, easy course. G.I. approved. Free catalog B. McConnell Airline School, 1030 Nicollet, Minneapolis, Minnesota.

AVIATION Surplus bargain catalogue. One dime. Box 22PM8, Thomasville, Penna.

SMALL Helicopters theory and guide manual. Drawings. Construction data. \$2.00. Sandhill Aircraft, Box 336, Atkinson, Nebraska.

PROPELLERS, Plans, supplies for airboats and snowplanes. Latest designs. Prompt delivery. Catalog 25¢. Banks-Maxwell, Box 3301E, Ft. Worth 5, Texas.

BOOKS; Hundreds of subjects. Big 1958 book catalog—10¢. Popular Mechanics Press, 200-BC East Ontario St., Chicago 11.

BATTERIES, GENERATORS

EDISON Nickel storage batteries. Any voltage, any amperage. Unconditionally guaranteed. Power plants, generators, motors. Literature. Hawley Smith Co., Croton Falls 1, N. Y.

"**BATTERY** Repair Manual" \$3.00. Bayer, 938 Betty Ave., Neenah, Wis.

ELECTRICAL SUPPLIES

ELECTRIC Pencil; Engraves all metals \$2.00. Beyer Mfg., 10511-H Springfield, Chicago 43.

SHORT Circuits—Pin-pointed within 5 feet, or your \$4.50 back. Own a pocket size. Dynamic Short Locator, Dept. P, 509 Main St., Harwich Port, Mass.

FREE Fluorescent lighting catalog. Inexpensive kits, parts, fixtures. Shoplite, 6500 Franklin, Nutley 10, New Jersey.

LAMP, Electrical parts, wholesale. Thousands of items for repairing, converting. Catalog 25¢. Brown Lamp, Box 305, Clayton 5, Mo.

HOUSE Wiring—Electrical repairs. Booklet. Send for 1958 book catalog—10¢. Popular Mechanics Press, 633 N. St. Clair, Chicago 11.

LAMPS—Parts catalog containing wiring instructions. 25¢. Gyro Lamps, 3438P N.W. 54 Street, Miami, Fla.

WELDING, SOLDERING, PLATING

ACETYLENE Welding outfits, new \$54.50, arcwelders \$56.50. Eagle Welding, Dept. P.M., 5085 Broadway, Chicago 40, Ill.

WELDERS, 110/220, \$39.50. Morris, 1070 Inner Drive, Schenectady 3, New York.

PLATING Equipment, supplies. Complete line of anodes, solutions. Home workshops, industrial sizes. Hollywood Bronze Supply, Dept. C, 1624 East First, Los Angeles 33, California.

FREE Catalog, welders, welder kits. Build 300-ampere welder using aircraft generator, plans 25¢. Agents wanted. Dunbar Manufacturing, Minneapolis 8, Minn.

MACHINERY, TOOLS, SUPPLIES

DO You value your hands and fingers! Woodworkers and hobbyists, don't take a chance with power saws and jointers! One slip and a life of regret! Send for Grip Guard today! This new and patented safety tool will prevent such accidents. Price only \$5.95. Send check or m.o. Safe Tool, Inc., 319 Merchant Street, Ambridge, Penna.

DON'T Cuss saw blade. Check rip fence with Fence-Allner. Insures straight cuts. \$1.00 postpaid. Money back guarantee. Lee Tools, Box 22, Rochester 17, N. Y.

WEASEL Parts. You build your snow tractor. Symington's, Union Bay Place, Seattle 5, Wash.

NEW Grip locking wrench, and vise. Both adjustable, trigger release. Circular free. Manufactured by Travis Tool Company, Sidney, Iowa.

SURPLUS Socket wrenches, half price. Davis, 1680-A Texas, Shreveport, La.

SUBSCRIBE To Government Surplus Weekly. Lists all sales. Buy jeeps, trucks, boats, tents, tires, etc., direct from government. Next 10 issues \$2. Government Surplus, Paxton 20, Illinois.

WHOLESALE Tool catalog. Send \$1.00. Yuhas, P.O. Box 5363, Detroit 11, Mich.

SURVEYING INSTRUMENTS

NEW And guaranteed factory rebuilt transits and levels, sale or rent, with purchase option. We will repair, trade or buy old instruments. Write for list M-811. Warren-Knight & Co. (Manufacturers of Surveying Instruments), 136 N. 12th St., Philadelphia 7, Penna.

ENGINES, MOTORS, DYNAMOS

PAINT Sprayers, navy surplus \$300.00 unit \$34.50, free folder. IMSCO, 1829 South State, Chicago 16.

WINDING Data. 275 motors, single and three phase, \$1.10. Data Company, Box 7631, Kansas City 28, Mo.

REWIND Motors yourself. Complete instructions \$1.00. Lewis Mfg., Howell, Michigan.

GAS Engines; Briggs Stratton. From \$29.95. Brand new. Details free. Northern, 172 Merrimac Street, Boston 14, Mass.

DIESEL Injector parts wanted. GM51-71-110. Bares, 7120 Carnegie, Cleveland 3, Ohio.

ALTERNATING Current generators, 750 watt, \$42.50, twincylinder compressors with 1/2 horse \$22.00; motors, 1 horse, \$38.50. Butler, 1885 Milwaukee, Chicago.

BOATS, OUTBOARD MOTORS

FIBERGLAS Permanent boat waterproofing. Special 25% discount. Complete kits, \$9.45 up. Guaranteed materials. Easy application. Full instructions. Free literature. Ajax Plastics, Dept. PM, P.O. Box 1323, Fort Worth, Texas.

MARINE Conversions. Ford, Chevrolet, Jeep engines. Catalog 25¢. Lehman Manufacturing Company, 972D Broad Street, Newark 2, New Jersey.

BUILD Small boats. Send for 1958 book catalog—10¢. Popular Mechanics Press, 633 N. St. Clair St., Chicago 11.

BOAT Plans—Full size patterns, frame kits. Modern inboards and outboards for amateur builders. Complete new catalog 50¢ or specify requirements. New speedboat inboard hardware catalog 25¢. Glen Designs, 9152 Rosecrans, Bellflower, Calif.

MAKE Fiberglass boats without molds. Simple instructions, drawings \$3.00. Tremendous profits. Ken Hobbs, Fitzgerald, Ga.

PROPELLERS, Plans, supplies for airboats, snowplanes. Catalog 25¢. Banks-Maxwell, Box 3301F, Ft. Worth 5, Texas.

SAVE Money. New, used outboard motor parts. Send wants. Stamp appreciated. Outboard Motor Mart, 229-M State, Boston 9, Mass.

FIBERGLAS Boat covering, molding supplies. Buy direct and save! Write for literature, samples. Aqua Glas, Box 99, Altadena, Calif.

NEW, Used, rebuilt marine motors. Marine conversions, fittings. Free catalog. Stokes Marine Supply, Dept. 24, Coldwater, Michigan.

FULL Size, cut-to-shape boat patterns, blueprints, 7 1/2-38 feet. Big new 88 pg. illustrated "Build a Boat" catalog of naval architect-designed cruisers, runabouts, skiffs, outboard boats, sailing, racing, houseboats, 50¢. "How to Build a Boat" booklet, \$2.50. Hardware and equipment catalog, \$3.00. Cleveland Boat Blueprint Co., Dept. A-66, Box 1651, Cleveland, Ohio.

I Want to send you proof of the wonderful pulling power of Popular Mechanics classified pages. What's your proposition? Write me today. Include literature if possible. F. W. Johnson, Manager Classified Advertising, Popular Mechanics Magazine, 200 E. Ontario St., Chicago 11, Ill.

FORDS And Jeeps 100% marine engines with famous Convo-Kits. Deluxe catalogue 25¢ coin. Oscomotors, 3627B Lawrence, Philadelphia 40, Penna.

FREE Catalog! Boat kits, trailers, fiberglass, marine hardware. Luger Industries, Dept. M-11, 9200 Access Rd., Minneapolis 20, Minnesota.

MARINE Conversion, Willys to Cadillac, engines, kits and parts. Catalogue and conversion hints free. Barr Marine, 2708 Castor Avenue, Philadelphia 34, Penna.

260 PLANS. Patterns. Large powerboat catalog, 50¢. Marinecraft, Box 161-M, Brighton, Mass.

ATHLETIC EQUIPMENT, BODY BUILDING COURSES

FREE Muscle building information. Body-Tone, Box 638B, North Miami, Florida.

NEW Body, health, strength, muscles. Gain, reduce. Any age. Easy! Amazing guaranteed discovery uses only a rope! Free details. Ropercise, 4834 Art. Studio 1-A, San Diego 15, California.

BARBELLS, Dumbbells, Courses. Booklet 10¢. Good Barbell Co., Siloam Springs, Arkansas.

JUDO, 125 Pages, 186 illustrating photographs, \$1.00. C. Marshall Company, Dept. 2F, Payne Road, Bethel, Connecticut.

JIU-Jitsu; deadly oriental fighting art. Defeat bullies. Profusely illustrated home training manual. Only \$1.00. C. B. Dudley, Athens, Ga.

KARATE Kung Fu, deadly oriental defense. Power that breaks planks barehanded. Illustrated manual \$3.98. Jas. Yim Lee, 584 Valle Vista Ave., Oakland 10, California.

BEGINNERS' Muscle courses 25¢. Advanced 12 courses \$2.00. Sid's System, Southgate, California.

SPORTING GOODS, GUNS, FISHING TACKLE, ARCHERY, TRAPPING

KILL Submersed water weeds which foul up motor propellers, tangle fishing gear and choke irrigation ditches with R-H Granular Weed Rhap-20. Inexpensive, easy to use, sure results. For details write Reasor-Hill Corporation, Box 36PM, Jacksonville, Arkansas.

CROSSBOWS—Hunting bows! Factory direct prices. JayCo, Box 1355, Wichita, Kansas.

BUCK Lure—\$2.00 postpaid. Write: Davy Bracken, R.D. #1, Ligonier, Penna.

BUY Wholesale! 25,000 nationally advertised products. Get amazing dealer catalogs. Complete details free. American Wholesalers, 1841A Levee, Dallas 7, Texas.

GUNS, Swords, knives, daggers, flasks. Large list 25¢ coin. Ed Howe, Coopers Mills 52, Maine.

FREE—Giant 1958 wholesale sporting goods catalog. Lowest wholesale prices. Complete line of cameras, sporting goods, appliances, outdoor items, toys. Write today. Santa Fe Distributing Co., 1321 Main St., Dept. PM, Kansas City, Mo.

MOLDS For fisherman's sinkers, jigs, squids, casting and spinning lures. Free catalog. Sweet's Molds, Tonawanda 1, New York.

BIG Money raising crickets and 12 inch African fishworms. Free literature. Carter Ranch, Plains, Georgia.

5000 BARGAINS. Firearms, binoculars, war relics. Catalog 50¢. Smith Firearms, Runnemeade, N. J.

AMAZING Wholesale sporting catalog. Save 70%. Tremendous selections. Econ-O-Mart, Whippany 2, New Jersey.

BUY Wholesale! 100,000 nationally advertised products. Appliances, cameras, sporting goods, housewares, watches, typewriters, tools clothing, etc. Discounts to 80%. Buy-Rite, Box 258, Hawthorne 29, New Jersey.

NEW USAF surplus. Rubber suits, rippers, pockets \$4.95. Cost government \$42.50. D3A gloves \$3.50. Lightweight bushjackets \$4.95. Nylon mountain tents \$15.00. Size? Fritz, 7819 Madison, Cleveland 2.

"**WORMS**"—Hundreds in minutes electrically. Make from scrap in 15 min. Safe. Plans \$1.00. Whitmore Tool Co., Portland, Conn.

REGULATION Pool tables \$99.50. Free circular. Musselman Mfg., Kalamazoo, Mich.

OUTDOORSMEN! The most lightweight, practical heating unit ever offered. Send only \$2.00 to Great Northern Industries, Box 5164, Grosse Pointe Branch, Detroit 36, Michigan. No c.o.d.'s.

JAP Rifle altering to 30-06, \$6.00. Jap-shells, \$3.95. Catalog 10¢. T. P. Shop, West Branch 11, Mich.

GUNS! 5,000 Guns! British Enfields \$13.95, \$29.95! Springfield \$39.95! Lugers, Krags, Colts, Kentuckies, elephant guns! Bargain catalog 50¢. Agramonte's, Yonkers 2-G, N. Y.

FAMOUS E-Z Kamper now available in kit form. All pre-cut. Assembles into finest collapsible camping trailer built. See dealer or write E-Z Kamper, Loyal, Wisconsin.

GUN Bargains! Scopes and mounts, 30% off! Loading tools, binoculars, gun bargains! Catalogs, 25¢. Discounts Unlimited, Box 38, Hastings on Hudson, N. Y.

EARTHWORMS, CRICKETS, FROGS

CAROLINA Frog farms free brochure. How raise giant food frogs. Write: Distributor, P.O. Box 3556, Baltimore 14, Md.

GUARANTEED Market! Earn ready cash raising fishworms for us! Backyard, garage, basement! We buy your crop! Exciting details free! Oakhaven-56, Cedar Hill, Texas.

BIG Money raising fishworms and crickets. We teach you how to raise and where to sell. Free literature. Bedrun redworms, 3000, \$6.50; 10,000, \$19.95. Carter Redworms, Plains, Georgia.

RAISE Earthworms for health and profit. How-to \$1. Terra-Vermis Gardens, Allegan, Michigan.

DO-It-Yourself booklets, 32 different home and hobby projects. Send for 1958 book catalog 10¢. Popular Mechanics Press, 631 N. St. Clair St., Chicago 11.

BINOCULARS, TELESCOPES, MICROSCOPES, MAGNIFIERS

SPECIAL Sale, amazing prices precision binoculars. Folder, "Binocular Selecting," catalog free. Prentiss Importers, Mercury Bldg., West Los Angeles 25, Calif.

ANOTHER First—The Scope 5" reflector completely assembled, 115X \$59.95. Free information. Esco Products, Oakridge, N. J.

AMAZING New telescope. Free circular. Telescope Sales, 3562 Third, Detroit 1, Michigan.

DYNASCOPES—Sensational new reflector telescopes. Send for details. Criterion Co., Dept. DP 50, Hartford, Conn.

REFLECTOR Telescope kits \$7.25 (3") to \$175. (12"). Mirrors, cells, focusing mounts, tripods, eye systems. Anything, everything in telescopes. Optics, also binoculars, microscopes, optical instruments. Free catalog. Also ready to use telescopes from \$25. Esco Products, Oakridge, N. J.

WAR Surplus bargains: Millions of lenses, instruments, telescopes, binoculars, components and complete line of astronomical telescope items. World's greatest optical market-place! Send only \$1.00 for beginner's 10-lens kit and big instruction booklet stock 2-CH. Write for catalog CH free! Edmund Scientific Co., Barrington, New Jersey.

REFLECTING Telescope, 60X, completely assembled \$29.75. Guaranteed observatory clearness. Free information. Skyscope, P.O. Box 55, Brooklyn 28, N. Y.

REFRACTOR And reflector telescopes. Also mirrors, lenses, tripods, etc. Free illustrated catalog. Suffolk Science, Mattituck, N. Y.

BUILD Your own reflector telescopes. Complete kits; mirrors, eyepieces, tripods, all other accessories. Request free illustrated literature. Criterion Manufacturing, Dept. DPM 47, Hartford, Conn.

FREE 48 Page science catalog. Optical, biological. Research Scientific, 126M West 23rd St., New York City 11.

BINOCULARS, Telescopes, microscopes, terrific values \$3.98 up. Request free money-saving catalog. Criterion, Dept. P72, Hartford, Conn.

PLANTS, SEEDS, BULBS, NURSERY AND GARDEN SUPPLIES

GROW Dwarf trees! Pot, sell. Instructions and seeds, 35¢. Mail Order Specialties, 1439-PM-5, Sabraton Ave., Morgantown, W. Va.

WORLD'S Greatest cash crop. Free information. Write Ginseng Gardens, Asheville, N. C.

TAXIDERMMY

FREE Book tells how you can learn taxidermy and tanning. Fascinating, profitable hobby. Send postal. No obligation. State age. Northwestern School, Dept. 2592, Omaha 2, Nebr.

PETS—DOGS, BIRDS, RABBITS, HAMSTERS, ETC.

CASH Prizes for best dog letters! Free information. Hurry! Robertson, Box 6838, Kansas City 30, Missouri.

PURE White pedigreed police puppies. Also bred females. Ansonia Kennels, McHenry, N. Dak.

HAMSTERS—Golden: Young, \$3.00 pair, breeders, \$4.00 pair. New mutation, \$5.00 pair. Adirondack Hamstery, Prospect 20-Y, New York.

RAISE Rabbits for us—Profitable, easy. Particulars free. Grinsteeds, Edwardsville, Illinois.

SHELTIES (Miniature Collies) AKC champion pedigree. Astolat Kennels, Kunkletown 5, Penna.

WILD Animal pets. Mammals, birds, reptiles, amphibians. Catalog 10¢. Ray Singleton, Rattlesnake, Fla.

SKUNKS, Reptiles, hawks, raccoons. Illustrated catalogue, 25¢. Trails End Co., St. Stephen, S. C.

HAMSTERS—Pairs, golden \$2.75. Albinos \$3.75. Free literature. Edgewater Hamstery, 106 Carter, Goshen, Indiana.

RAISE Rabbits. Send 35¢. Free breeding stock offer, marketing, housing information. A. Johnson, 683, Kansas City 41, Mo.

MONKEY'S \$22.50. Baby raccoons, de-scented skunks, pigmy skunks, alligators. Animals, birds, reptiles. All kinds. Free list. Thompson Wild Animal Farm, Clewiston, Fla.

GOLDEN Hamsters—Pedigreed breeders \$3.85 pair. Literature. Moore's Hamster Ranch, Shepherdstown 25, West Virginia.

EARN \$10,000 Yearly raising Angora rabbit wool for us. Information 25¢ coin. American Angora Company, Malta 12, Montana.

RAISE Rabbits successfully by knowing facts. 48 page illustrated book describing 25 breeds. Housing, feeding, breeding, marketing, etc. Plus bulletin, 25 cents. American Rabbit Association, 36 Arba Building, Pittsburgh, Penna.

MAKE Money raising chinchillas, mink, nutria, rabbits, cavies for us. Free catalog. Keeney Brothers, New Freedom 3, Penna.

WE Pay \$3.50 lb. dried. Grow mushrooms, cellar, shed and outdoors. Spare, full time, year round. We have 25,000 customers. Free book. Washington Mushroom Ind., Dept. 171, 2954 Admiral Way, Seattle, Wash.

HAMSTERS — Ideal pets, \$2.95 pair. Free booklet. Jer-Fre's Hamstery, 2216 East Broadway, Muskegon 13, Mich.

STRAIGHT Cooners! World's oldest kennel. Combination hounds, rabbit, fox, beagles, deerhounds, bird dogs. Puppies of all breeds. Prices reasonable. Trial. Free catalogue. Raccoon Mountain Kennels, Box 464, Boaz, Alabama.

RAISE Rabbits on \$500 month plan. Plenty markets. Free details. White's Rabbitry, Delaware, Ohio.

SPORTSMEN: World's largest kennels offers 500 bird dogs, straight cooners, combination hounds, beagle hounds, rabbit hounds, small squirrel dogs, fox and deer hounds. Catalogue free. Smokey Mountain Kennels, Cleveland, Tennessee.

FUR BEARING ANIMALS

MINK Raising information free. Complete. Lake Superior Mink Farm, Superior, E.E.I. Wisconsin.

RAISE Mink: Free booklet, pen plans, inside secrets, feed, care. Mink are money makers. Investigate today. Lawrence Molder, Brigham City 12, Utah.

FARMS, FARM LANDS, REAL ESTATE

TRAILER Park, \$280 mo. plus home, 14 spaces, shade trees, near Lake Walker, \$5,000 down. F.P. \$15,500.00. A. A. Allen, Hawthorne, Nevada.

\$4,000 MOUNTAIN Home! Out west of the Great Divide in the beautiful Yampa River country! 6,200-ft. elevation! Man alive, deer, elk, bear, trout, and scenic surroundings that money can't buy! Nearly level 2 acres with 108-ft. frontage on state highway, good location for tourist court, hunters' camp, sporting goods and grocery business. Good 3-room house, gas heat, hot and cold running water, wonderful view. Garage. 20x30 barn for saddle horse, family cow or pack animals. Retire here and be the envy of your friends! Going for only \$4,000 with easy, easy terms! Free winter catalog, bargains coast to coast! United Farm Agency, 2825-PM Main St., Kansas City 41, Mo.

FLORIDA. All types of property. Low taxes. Realtor Cummins, Eustis.

FLORIDA. Free! Business lot 50 x 250-ft., fronting U. S. highway 301 in booming Tampa Bay area, given free with purchase of 5-acre garden tract at Willow Shores, Florida. Within 20-mile radius of Tampa, Bradenton, St. Petersburg, Sarasota. Oil-edge investment for planned retirement and profits from rising land values. Lush, rich soil for vegetable farming and orange groves. Tomato growers in vicinity make \$1,000 an acre. Fronts on river and major highway from the north to Florida west coast. Pre-development price only \$499 per acre; total \$2495 for 5 acres. Convenient terms; 4 years to pay. Write today for brochure and plat map, and attach \$10 to reserve your 5-acre tract and free highway-front business lot for your approval. Deposit refunded on request within 30 days. Gulf Coast Land and Title Company, Dept. PM11, 632 South Tamiami Trail, Sarasota, Florida.

FREE Strout catalog! Farms, homes, businesses, resorts, retirement properties. Over 3000 values in 36 states. 58 years' service. World's largest! Write Strout Realty, 7-MP S. Dearborn, Chicago 3, Ill.

LAKEFRONT, Highway, acreage and trailer lots, from \$295.00. Fifteen central Florida developments. Monthly terms. Box 2005, DeLand, Florida.

ALASKA. Finest six color map 34" x 44 1/2", roads, large scale inserts. \$2.00 postpaid. Report on Alaskan homesteading opportunities, regulations, areas, G.I. advantages. \$1.00 postpaid. Dushane, Box 147, South Gate, California.

FLORIDA: 2 1/4 Acres, near gulf. 50 foot elevation. \$795.00, \$10.00 down and month. Russell Hancock, Realtor, Brooksville, Fla.

FLORIDA Security campsites \$80. \$5 monthly, warranty deeds. Thompson, Sandisfield, Mass.

FREE Florida Silver Springs Ocala folder. Homesites \$595.00, \$10.00 month. Write Silver Springs Guaranty Land & Title Corporation, 366 WP, Eight Mile, Detroit 20, Michigan.

OZARK Specialty farms. Terms. Description mailed free. 20 years service. Armstrongs, Shook, Missouri.

OPPORTUNITIES! Government land, U. S., Alaska, Canada. Sledge Surveys, Macon, Mississippi.

HOMESITES \$15 Monthly—California's finest garden section. Morro Bay's scenic shores. Wonderful fishing, boating. Fertile soil, softest water, temperate climate, congenial community. Free literature. Richard Otto, Department M, San Luis Obispo, California.

FLORIDA. Nice homesites, \$345 at \$10 monthly. Folder free. Howard Vernon, DeLand, Florida.

FLORIDA Gulf-front subdivision—75-foot lots, paved streets, easy walk to Gulf of Mexico, Grand Lagoon, marina. \$24.75 down. \$23.20 monthly. No comparable location so inexpensive. Brochure free. Sam B. Hearn, Broker, Inc., Box 177-E, Panama City Beach, Florida.

FLORIDA Homesites—Big, beautifully wooded, \$2.90. Only \$10 monthly. Free brochure. Write today! Wendell Wood, Fountain, Florida.

FLORIDA — Potterfield Garden Acres Section M, first addition, a new West Coast subdivision. Close to bathing, boating, fishing, parks, on Gulf Mexico and cities. High, dry, finest climate. Live better for less. Full 1/2 acre tracts only \$795.00 and only \$10.00 month. More information. G. B. Potterfield, Union Bldg., Charleston, West Virginia.

FARM MACHINERY AND SUPPLIES

SENSATIONAL Garden tractor. Hoes between plants and rows, including strawberries. Eliminates hand hoeing. Standard in size, yet entirely different. Patent 2742840. Also tills. Fantastic offer to first few inquiries. Auto Hoe, DePere 68, Wis.

PROFITABLE OCCUPATIONS

MARKETS For guinea pigs, squabs, angora wool, mink pelts, ginseng root, golden seal root, pigeons, rabbits, rabbit pelts, etc. \$2.00. Stanley Gratz, 2025-3rd St. No., Minneapolis 11, Minn.

MAGAZINE Subscriptions—Largest commissions. Bonus. Qualified Agency, 451QA Kingston, Brooklyn 25, N. Y.

HOUSEWIVES, Others. \$30-\$100 weekly sparetime assembling and distributing rockhound jewelry. Vikingcraft L, Inglewood 4, California.

MAILORDER Magazine with instructive articles, tips, sources, new products. 25¢. E. J. Thompson, Box 94-P, Salinas, Calif.

NIGHTCRAWLERS, Redworms raising, soilless method. Three Oaks Ranch, Dresden, Tenn.

100 DIFFERENT Jobs at home. Details free in English or French. Business C.P., 174 St-Sauveur, Quebec, Canada.

OVER \$1,000.00 Monthly, U. S. tax exempt! Work in Latin American for American companies. All skills required. Direct information on opportunities, conditions, companies employing. New report! Airmailed, \$3.00. Paul B. Smith, Apartado 172, Maracaibo, Zulia, Venezuela.

WE Pay \$3.50 lb. dried. Grow mushrooms. Cellar, shed and outdoors. Spare, full time, year round. We have 27,000 customers. Free book. Washington Mushroom Ind., Dept. 99, 2954 Admiral Way, Seattle, Wash.

MUSHROOMS Quicker, easier, cheaper. Newest facts free. Spawn \$1.00. Luxur, 641 South 19th, Newark 3, N. J.

HOME Mailorder beginner's manual, sources, methods, opportunities. 25¢. Carnahan Bros., 9610 Acacia, Fontana, Calif.

FORTUNES Made by prospectors. We teach you. Recognize valuable mineral deposits in your home area. Free details. Modern Prospector, 3433 Essex Road, Cheyenne, Wyoming.

BUY Wholesale! 100,000 nationally advertised products. Appliances, cameras, sporting goods, housewares, watches, typewriters, tools, clothing, etc. Discounts to 80%. Buy-Rite, Box 258, Hawthorne 3, New Jersey.

MAKE Flexible molds. Cast plaques, figurines. Free sample. Tooker, 1045-M Fairview, Hamilton, Ohio.

AUCTIONEERING—Home study course. Diploma granted. Auction School, Ft. Smith, Ark.

MONEY Plans! "Secret Journal." Grandpa, two daughters made \$2500 first month! Work home. Publiccos, Oceanside, Calif.

BIG Money raising fishworms and crickets. Free literature. Carter Wormery, Plains, Georgia.

BAKE New greaseless doughnuts in kitchen. Sell stores. Free recipes. Michael Ray, 3605 South 15th, Minneapolis 7, Minn.

FREE Book "505 Odd, Successful Businesses." Work home, Pacific, Oceanside, Calif.

WE Pay \$3.50 lb. dried. Grow mushrooms. Cellar, shed and outdoors. Spare, full time, year round. We have over 25,000 customers. Free book. Washington Mushroom Ind., Dept. 99, 2954 Admiral Way, Seattle, Wash.

SAVE Money! Buy wholesale! Free catalog general merchandise. Norris, 487-M Broadway, New York City.

MAKE Money writing short paragraphs. Information free. Barrett, Dept. CX-27, 7464 No. Clark, Chicago 26.

EARN \$240.00 A month at home, spare time doing only two \$5.00 invisible mending jobs a day. Big money paid for service that makes cuts, tears disappear from fabrics. Steady demand. Details free. Fabricon, 6236 Broadway, Chicago 40, Ill.

BECOME Independent with your own franchise business. Thousands earning handsome incomes. Request interesting facts today. National Franchise Reports, PM-528, 333 North Michigan, Chicago 1.

FREE Book "990 Successful, Little-Known Businesses." Work home. Plymouth, 1810-43 Street, Brooklyn 4, N. Y.

RAISE Pheasants on \$100 week plan. Little capital and space can make you independent. Free details. Great Central System, Columbus 1, Kansas.

BUY Wholesale! 25,000 nationally advertised products. Get amazing dealer catalogs. Complete details free. American Wholesalers, 1841B Levee, Dallas 7, Texas.

BOOKS, PERIODICALS, PICTURES, POSTCARDS

MAGAZINES, Comics. Wholesale-retail catalogue 10¢. Stamps or coins. Backdates. 1181 E. Lombard, Baltimore 2, Md.

FREE Catalog. Self-help books. Write Wilshire, 8721 Sunset, Los Angeles 46P.

"SCIENCE Milestones." Records march of science starting 400 years before Christ, right up to date. Amazing facts revealed. 312 pages packed with startling information that will thrill you. A real history of science. \$5.00. Literature free. Popular Mechanics Press, 200-SM East Ontario St., Chicago 11, Ill.

JOHN Friend, bookfinder, can get the books you want. Free search service. Box 2570PM, Long Beach 1, California.

RARE Magazines, catalog 10¢. Nationwide Exchange, Box 1375-P, San Antonio 6, Texas.

BOOKFINDERS! All subjects. Send wants! Jaher Book Service, 183 Hazelwood Drive, Westbury, N. Y.

OUT-Of-print books at lowest prices! You name it, we find it! Past service. No obligation. International Bookfinders, Box 3003-PM, Beverly Hills, Calif.

FREE Catalog. Fascinating—revealing subjects. Bookmaster, 2432 Fernwood, San Jose 9, California.

10 VOLUMES World's best classics. Poe's Masterpieces of Mystery, the House of Seven Gables, Tom Sawyer, Travels of Marco Polo, Shakespeare's Masterpieces, Pride and Prejudice, Silas Marner, A Tale of Two Cities and Autobiography of Benjamin Franklin. \$8.95 postage prepaid. Guaranteed! Poff Mail Order Company, 2111 6th Ave., Beaver Falls, Penna.

BURIED Treasure books, maps, exclusively. Free catalog. Map 445 lost treasures, \$1.00. Foul Anchor, Rye 2, N. Y.

FRANCE Press, Apartado 3498, Havana, Cuba, can supply interesting books in English. Indicate your specific subjects.

ENCYCLOPEDIA. 20,000 Subjects, 1000 illustrations, 1496 pages, a real bargain at \$2.95. Postpaid. 10 day money back guarantee, excellent Christmas gifts. Free catalog. Jane's, 900 S. 14, Longview, Texas.

AMAZING Free catalog British books Any subject. Transbooks, Box 1-PLC Wantagh, N. Y.

BIBLE, World's smallest, only 29¢. Catalogues included. Gladiolus, printing, gadgets. Robinsons, Sebastopol, Calif.

EXCITING Catalog packed with books covering most everything. Think of it—From cover to cover you will find described and illustrated hundreds of books telling how to fix and how to build almost anything. How to remodel your home; do your own decorating, plumbing, electrical work, carpentry, painting, furniture making and refinishing. How to build your own boat, home workshop tools. Best books on photography, welding, hobbies, homecraft. How to make a home freezer. Send now for 1958 book catalog—only 10¢. Popular Mechanics Press, 200-BC E. Ontario St., Chicago 11, Ill.

GAMES, TOYS, NOVELTIES

BINGO Makes money everywhere. Complete supplies. Warwick Press, Warwick, Rhode Island.

WHOLESALE Toys, catalogue 10¢. Harold Osterhout, Red Oaks Mill Road, Poughkeepsie, N. Y.

MAGIC TRICKS, PUZZLES, JOKER NOVELTIES

"STINKY" Burning stink bomb. Potent. 48/\$1. Kits, 1452 Drake, San Pablo 10, California.

108 MAGIC Tricks you can do, illustrated, plus giant catalogue pseudo mind-reading, spooks. \$1.00. Nelson, 336 South High, Columbus, Ohio.

BE A clown, for fun or profit. Free details. Wheeler Enterprises, Box 7755, Washington 4, D. C.

279 MAGIC Tricks only 15¢. Bookmaster, 2432 Fernwood, San Jose 6, Calif.

3000 TRICKS, Pocket, parlor, stage. World's finest magic catalog (408 pages). \$2.50. Kanter's, M-1311 Walnut, Philadelphia 7.

137 ASSORTED Joker novelties, tricks, puzzles, \$1.00! Box 1352-J, Philadelphia 5.

PASTEST Service to magicians for over 30 years. Send 10¢ for Douglas famous catalog, 500 tricks, containing magic for pocket, parlor, stage, with balls, coins, cards, cigarettes, ropes, silks, apparatus. Douglas Magicland, Dept. 10, Dallas, Tex.

"VENTRILLO," Voice-thrower 25¢. Ventriloquist puppet 75¢. Box 971-PM, Philadelphia 5.

VENTRILLOQUISM, easiest method. Details free. Smith, 2125 N. Bigelow, Peoria, Ill.

WHOLESALE! Thirty 10¢ trick novelties \$1.00! (Profits!) 1746-PM Market, Philadelphia 3.

3100 NOVELTIES, Jokes, tricks, gadgets, funmakers, hobbies. Big catalog 10¢. Johnson-Smith, D-491, Detroit 7.

STINKERS, (El Skunko), 35 for \$1.00. Potent! (Harmless!) "Ameri-Trix," Philadelphia 44.

PROFESSIONAL Catalog, 175 pages, 25¢. Williams, 900 Plymouth, Ellwood City, Penna.

WORLD'S Finest professional magic, Joker novelties. Giant illustrated catalog 10¢. Top Hat, Evanston 12, Illinois.

BE A magician! Large professional catalog of latest tricks. 35¢. Ireland, C-109 North Dearborn, Chicago 2, Illinois.

SMOKEBOMBS, Gigantic! 25¢. 7—\$1.00. (Nonpoisonous.) 4463-PM Greene, Philadelphia 44.

PROFESSIONAL Vanishing card trick only 25¢. Magic, Route 2, Box 359-A, Panama City, Florida.

LIGHTED Candle from pocket trick (including 100 refills) \$1.00. Lonergan, 672 North Dearborn, Chicago 10, Illinois.

WOODEN Nickel, catalog, trick, 15¢. Magico (1,500,399 tricks, jokes). Box 4373-P, San Antonio 7, Texas.

COINS, TOKENS, CURRENCY

OLD Money wanted. Do you know that coin collectors pay up to \$500.00 for certain U.S. cents? And high premiums for all rare coins? We buy all kinds. Send 5¢ for large coin folder. May mean much profit to you. Numismatic Co., Box 750-A, Costa Mesa, Calif.

STARTER Collections, 20 different Indian cents, \$2.50, 13 different liberty nickels \$2.50, 20 different Barbour dimes in folders, postpaid \$5.00. Prager, 470 27th Avenue, San Francisco, Calif.

PENNIES Wanted. Send 25¢ for list and free foreign coin. Wayne Coin Company, 1205 California Ave., Fort Wayne, Indiana.

\$4,000.00 FOR 1913 Liberty Head nickel. Uncirculated dollars 1804-1839, 1893-S, 1895-P, 1903-O pay \$100.00-\$5,000.00. Certain dates Lincoln cents before 1932, \$100.00; Flying Eagle cents, \$500.00; Indian cents, \$140.00; dimes before 1943, \$2,000.00; quarters before 1924, \$1,000.00; half dollars before 1905, \$1,000.00; 2¢ pieces, \$100.00; 3¢ pieces, \$130.00; half-dimes, \$500.00. Hundreds of others worth \$10.00-\$1,000.00. Canadian coins, 1921 5¢ silver, \$100.00. 1875 quarters, \$75.00, 1921 50¢, \$500.00. Wanted: 20¢ pieces, gold coins, paper money, etc. Our large illustrated guarantee buying-selling catalogue, giving complete all-coin information, send \$1.00. Purchase catalogue before sending coins. Worthy-coin Corporation, K-288-C, Boston 8, Massachusetts.

UNCIRCULATED Silver dollars, 1879-O through 1885-O, \$2.50 each. Butts, East F, Torrington, Wyo.

\$100.00 FOR Certain Indianheads, Lincoln pennies \$75.00. We buy all rare coins. Booklet listing prices, 25¢. Lincoln Coins, D-29, Glendale, Arizona.

ILLUSTRATED Retail foreign coin catalogues. Gold coins, 800 different. Price 50¢. Silver, copper coins, 3000 different. Price 50¢. James Randall, Box 2205N, Fort Lauderdale, Florida.

COMMEMORATIVE Half dollar uncirculated \$1.00. Bargain lists free. Sayers, 1000 Unaka, Johnson City, Tennessee.

1959 GIANT U. S. coin catalogue 25¢. Acc. 107 N. Dearborn, Chicago 2.

CASH For old coins. Illustrated 38 page catalog 50¢. Herget, 2884 Bailey, Buffalo 15, N. Y.

COIN Collector's greatest magazine and wooden nickel 10¢. Lawrences, Anamosa, Iowa.

INDIA, Switzerland, Finland, Austria's coins 10¢. Jolie, 126, Roslyn Heights, New York.

60 ASSORTED Coins, \$1.00. 60 assorted bills, \$1.00. Oddehon, Box 482, St. Louis, Mo.

LINCOLN'S 1923S, 1924S, 1925S, 1926S, 1927S All \$1.00 prepaid. United, 2 Cranston, Providence, R. I.

GOLD U.S. and foreign coins wholesale. Free listing. Samuel Kisin, 720 Flushing Ave., Brooklyn 6, N. Y.

GOLD Bargains—\$5, \$11.95; \$10, \$22.95; \$20, \$43.95; 9 nice \$1.00 to \$10.00 gold coins on elegant solid-gold chain-bracelet (\$325.00 value) \$259.50. Paying top prices \$1.00 to \$50.00 gold, all other rare coins. Any quantity. Send list for free offer. World's greatest retail catalogue \$1.00 (deductible on first \$10.00 order). Bebee's, 4514 North 30th, Omaha 11, Nebraska.

30 DIFFERENT Better foreign coins, including some larger pieces; some older issues. \$1.00. Alfred Szego, Box 187, Jackson Hgts. 72, New York.

SHOCKINGLY Low prices. U. S. coins. Free list. Hugh's, Box 361, Hickory, N. C.

FREE. Lowest price list. Cut-Rate Coin, 2073 Dauphin, Mobile, Alabama.

LARGEST Coin magazine. 200 pages, 40¢. Scrapbook, 7320-J Milwaukee, Chicago 31.

CARSON City brilliant uncirculated silver dollars 1860 to 1885. Complete set six \$21.95. J. Grove Loser, Steelton, Penna.

GENUINE Nazi coin—10¢. Manor Coins, Box 505, Dunbar, West Virginia.

JOIN "Coins of the Year" club. Receive sets yearly. Box 376, Magnolia, Arkansas.

CASH For your coins! U. S. coins found in your change bring high prices. "The Hand-Book of U. S. Coins," 1959 edition, illustrates, describes and lists the prices dealers pay for every coin ever minted in the United States. \$1.10 postpaid. Empire State Coin & Stamp Co., Empire State Bldg., 350 Fifth Ave., New York 1, N. Y.

INDIAN Head cents, two different only 10¢. Approvals, Littleton Coin Company, Littleton R1, New Hampshire.

"EAGLET" Numismatic Magazine. 25¢, subscription \$2 year. 229 South 11th, Newark 7, N. J.

GENUINE Wooden nickels, centennials, celebrations, 100 different \$3.50. Four (5¢ to giant \$1.00) Confederate wooden nickels, 50¢. Woodnic, Box 4373-P, San Antonio 7, Texas.

ENGLISH Coronation Crown of 1953. Beautiful portrait of Queen Elizabeth II on horseback. Size of silver dollar in original lucite holder. Specially priced at \$2.00 postpaid. Empire State Coin & Stamp Co., Empire State Bldg., 350 Fifth Ave., New York 1, N. Y.

TWENTY Different Indian cents \$2.50; three different flying eagles \$5.75; discount list. Collector's Bargains, New Hope, Penna.

CASH For Canadian, American coins, catalogue information. list 25¢. Bourse, Box 274, Ft. Wayne, Ind.

GET Profit and pleasure in collecting old coins. Send 15¢ for 68-page illustrated coin catalog. You'll be delighted with it. Send for it now. B. Max Mehl, Box 750-B, Costa Mesa, Calif. Oldest rare coin establishment in U.S. Established 59 years.

RAREST CC mint dollar 1885 uncirculated \$5.00. Illustrated catalogue 25¢. Schultz, Salt Lake City 10, Utah.

32 PAGE Informative U.S. illustrated coin list 10¢. Stoney, 192 Washington, Boston 8, Mass.

BARGAINS, U.S. coins: 1893 Columbian world's fair half dollar, \$1.00. Ten different Indian pennies, 75¢. Two-cent piece, and 3-cent piece, \$1.00. Gold ¼ eagle, 89.00. Gold ½ eagle, \$12.50. Beautiful coin bracelet, \$1.00. Many coins available. What do you need? Rare Coin Company, 31 North Clark, Chicago 2.

COMPLETE United States coin bargain lists, Indianhead cent, 10¢. Economy Sales, 156-A Dean, Mansfield, Mass.

INDIAN Cent plus Bargain Lists 10¢. Hutchinson's, Box 4747, Philadelphia 34, Penna.

LINCOLN Cents—1916-S, 1917-S, 1918-S, 1921-S, 1923-S, 1924-S all for \$2. Gasser's, Box 34615, Los Angeles 34, California.

SAN Francisco mint closed! The 1955 cents and dimes are in short supply and great demand. The pair brilliant uncirculated for 25¢. Free coin lists. Bryson Incorporated, 612A White, Toledo 5, Ohio.

LINCOLN Cents: 1921-S, 1923-S, 1924-S, 1925-S, 1926-S, 1928-S, 1933-D, 1927-S, only \$3.00. Berry, Box 306, Westminster, California.

SPECIALIZING In Indian, Lincoln cents, never undersold. Wholesale, retail. Crystal Coin, Box 22, Greenwood, Mass.

25 LINCOLN Pennies 1909 to 1940 \$1.00. Box 222, Howard Beach 14, N. Y.

STAMP COLLECTING

STEAL The show! Display prize-winning first-day covers, beautifully hand-colored. Sample free with approvals. Overseas Mailers, Hicksville, N. Y.

FAMOUS—Famous American set. Flag set, national parks set, and presidential set to \$5. Send 10¢ for 15 of the above stamps plus full particulars and approvals. Park Row Stamp Co., Inc., 145 Nassau St., New York City 38, Dept. 804.

MOZAMBIQUE Butterflies, Liberia birds, picturesque French colonies, others. Colorful assortment, 10¢. Approvals. Dopko, 3482 Laura Lane, Riverside, California.

MINT U.S. at face! Older commemoratives only. Send 25¢ for all different packet with first selection mint U.S. approvals. Western, Box 1689P, Salinas, California.

FREE! 25 South America. 10¢ handling. Approvals included. Mid-States Stamps, White River, South Dakota.

OLD U.S., flags, famous Americans, commemoratives with approvals plus gift, 10¢ handling. Metropolitan Stamps, Box 312MA, Jackson Heights, N. Y.

LOOK! Six different Queen Elizabeth mint sets! Dominica, Gibraltar, Virgins, etc. 21 bicolors—25¢! Attractive approvals! Cannon Stamps, Box 931, Canton 1, Ohio.

STRAITS Settlements: 25 different 10¢ with approvals. Norge, Ho-Ho-Kus, N. J.

10 CANAL Zone 25¢. Approvals. Merkel Stamps, 30 Grandview, South Hadley Falls, Mass.

15 MINT French colonies free! Inexpensive approvals accompany. White Mountain Stamp Service, Bethlehem, New Hampshire.

FREE! 25 Egypt, 5¢ handling, approvals. Bellet, Mapledale, Hazel Park, Mich.

UNITED Nations. Five different 10¢. Approvals, Anderson, 1112 Harrison, San Francisco 3, Calif.

FIFTY Different United States. Obsolete and current. 10¢. Ed Keller, Library, Pennsylvania.

FREE—Your choice any volume Scott's international albums. 1959 Scott's complete catalogues, even Master Global albums free when you buy our sensational foreign approvals. Bargain Stamps, Redlands, Calif.

TERRIFIC U. S. list free! Bailey, 45 Bromfield, Boston 8-G, Mass.

U.S. Commemoratives: 141 different \$1; 201 different \$2. Lists free. Moseley, 6 Hanley Downs, St. Louis 17, Missouri.

FREE—Valuable U.S.A.! (1) Scarce genuine postage stamp picturing first U.S.A., issued in 1847! (2) Big collection 30 all-different United States; ancient 19th century, valuable \$1 stamp, etc. (3) Collection beautiful commemoratives. (4) Collectors guide; big 64-page bargain catalog including all U.S. postage issues; other exciting offers! Send 10¢ for mailing expenses. Harrisco, 4167 Transit Bldg., Boston 17, Mass.

APPROVAL Applicants—1030 different. \$1.00. Klondike, 682 Jefferson, Elgin, Ill.

STAMPS For collectors. Robert A. Arthur, 920 Third, Seattle 4, Wash.

90,000 STAMPS Sale: Big lot \$1. Extra special with free album \$2. Giant assortments. Album. \$5. Persil, 436 New York Ave., Brooklyn 25, N. Y.

1000 STAMPS World wide \$1.00. Includes pictorials, commemoratives, etc. No approvals follow. Guaranteed. Harrison Stamps, 1435 - 1st Ave., Oakland 6, Calif.

TWO \$5.00 U. S. postage stamps free to approval buyers. Send dime for postage, details. Irwin Stamp Co., Box 11-55, Brooklyn 30, N. Y.

TERRIFIC Value. Eight complete mint sets 10¢ with approvals. Beatis, 58 Glenagar, Islington, Ontario, Canada.

COLLECTION From fifty different countries, only 10¢ with approvals. Nade's, 6316 Crescentville, Philadelphia 20, Penna.

SOUVENIR Sheets Czechoslovakia 1937 plus Japan 1947, 10¢ with approvals. Kingman, 30 Empire, Yonkers 4, N. Y.

135 DIFFERENT U. S. commemoratives \$1.00; 50, 25¢. Approvals. Harold Holub, 18 East 198th St., New York 68, N. Y.

WANTED—Stamp collections, accumulations. Murray Gold, 62-95P Saunders, Rego Park 74, N. Y.

FREE 50 Worldwide introducing inexpensive approvals. University Stamps, P.O. Box 95, Tamiami Station, Miami 44, Florida.

SPUTNIK, Comet, telescope, ships, flowers, sports, animals, from exotic Ruanda, Congo, Camerouns, Somaliland; many others. Terrific all-different collection! All giant pictorials! To introduce approvals. Rush 10¢! Philatelia, Dept. K, New Paltz, New York.

FREE United States price list. Carlos Elbert, 31450 N. River Road, Mt. Clemens, Michigan.

1000 DIFFERENT With approvals. Jacobson, 4395-C Broadway, New York 40, N. Y.

U.S. Stamps. Giant bargain catalog 10¢. Raymax, 35-VZ Maiden Lane, New York City 38.

MINT U.S. commemoratives, 23 diff. \$1.00, 40 diff. \$2.00, 60 diff. \$3.00. Hobby Service Co., Box 194, Franklin Square, N. Y.

GIANT Approvals, thousands different. 1¢ and 2¢ each. Wahl's Stamp Exchange, 7008P Farragut, Chicago 31, Ill.

GIFT! Beautiful Tokelau Islands first set to approval applicants. Deane, Box 45-371, Miami, Florida.

FREE Pictorial packet! Includes bicolors, flowers, Andorra, Iceland, Togo, Malta, Singapore, birds, sports, other fine stamps. Send 10¢ for handling. Approvals. Champlain, Isle La Motte, Vermont.

FREE Sample! Interesting, informative, illustrated. National Stamp News, Anderson, South Carolina.

200 DIFFERENT Argentina \$1.00. Doc Schoenfelt, 259 Belmont, Mansfield, Ohio.

FREE Packet! Angola, Azores, Mongolia, Nepal, Palestine. Fascinating approvals. Coral, Box 7095 (Ludlum), Miami 55, Florida.

FREE! 55 Different world; colorful, inexpensive approvals. Elkhart, Box 33, Elkhart, Indiana.

9 BICOLORED Armenia, value 50¢, free! Exciting approvals accompany. Tropicana, Box 449-M, Hollywood, Fla.

168 BICOLORED World flags and monograms, 10¢. Exciting approvals accompany. Dee, Box 926, Ormond Beach, Florida.

39 COLORFUL Pictorials from 39 different countries. Send only 10¢ in coin. Approvals accompany. Robert J. Clark, Box 28-P, Wilmette, Illinois.

U. S. Mint flag set, complete, \$1.00. Free list. Brooks, 2323 Avenue X, Brooklyn 35, New York.

FREE! 50 British Empire. 5¢ handling, approvals. Kensington Stamps, Buffalo 15, N. Y.

TRADE Your duplicates toward our approvals. (Foreign only.) Details free. Variety Stamps, Box 98-T, Newton Highlands 61, Mass.

100 DIFFERENT 10¢ With approvals. Roger Davis, 525 Main St., New York Mills, N. Y.

FREE U. S. stamps. 1943 flag, commemoratives included in collection of 25 different, plus valuable \$5.00 stamp. All for 10¢ mailing charge. Approvals. Willett Co., Box 338-A, Yorktown Heights, N. Y.

WORLDWIDE. 50 All different, absolutely free, just to introduce our incomparable approvals. Kent Stamp Company, GPO Box 87, Brooklyn, N. Y.

1500 DIFFERENT Worldwide stamps \$1.00. Valued over \$20.00. Universal, Box 6, Kenosha 5, Wisconsin.

14,000 DIFFERENT! Amazing new plan builds your collection systematically, country by country. Only 50¢ weekly. Free details. L. G. Ware, Stepany 75, Conn.

64 PAGE U.S. catalog free. Stone, 192 Washington, Boston 8, Mass.

INTRODUCING Our better United States approvals, we offer 15 United States stamps including Columbian, Pan-Pacific, famous American, airm, others; only 10¢. Ocean Stamps, Box 64-PM, Brooklyn 29, New York.

UNITED States price list, 116 pages, price 25¢. Mark Hanna, 335 Fifth Ave., Pittsburgh 22, Penna.

FREE! 25 Different pictorials. Approvals. Marford, Box 48, Queens Village 29, New York.

FREE 1958 Illustrated U. S. price list. H & S, 45 Bromfield, Boston, Mass.

ALBUM Only 10¢! Hundreds of spaces! Stampmart Company, Hartford 1, Conn.

U. S. approvals. Low prices. Eagle Stamps, Romine Ave., Pittsburgh 26, Penna.

ECONOMICAL 1/2¢-3¢ Approvals, 33,000 varieties. Dresel, Box 128-N, West Englewood, New Jersey.

UNITED States commemorative collection containing 33 different—10¢. Approvals. White, 516-A Avenue L, Brooklyn 30, New York.

SELL Your surplus good grade stamps. Write, describing fully what you have. Vanroy Shirk, Lebanon, Pennsylvania.

AMAZING Offer! 200 United States stamps — including commemoratives, airmails, high denominations to \$1.00. Only 10¢ to approval applicants! Illustrated bargain lists free. Mystic Stamp Co., Dept. 80, Camden, New York.

100 STAMPS, 10¢ With approvals. Smith, 508A Brooks, College Station, Texas.

OLD Scarce U.S. seconds on approvals. Slight imperfections, lowest prices. Hernefield, Clintonhill Sta., Newark 8, N. J.

100 OLD United States between 1861 and 1935, \$1.00. Roush Stamps, 51 Chestnut, Mansfield, Ohio.

UNITED States approvals. Select copies, used—mint. Kingsbury, Fairfax, Vermont.

ICELAND 10 Different beautiful stamps for only 10 cents to applicants for our good old fashioned approvals. Old Colony Stamp Co., Dept. A, Milford, Connecticut.

225 STAMPS For only 10¢! This mammoth value includes airmails, pictorials; stamps from strange countries cataloging up to 25¢ each! Also approvals. Mystic Stamp Company, Camden 80, New York.

WEIRD Diamond shape coffee stamps. Lovely flower triangle! First American big commemorative. Greenland, idol dancer, etc. Free with approvals. Capital Stamp Co., Ferrysburg 2, Mich.

25 DIFFERENT Commemoratives 1893 up 10¢. U. S. approvals. K&B, Box 70, Brooklyn 23, N. Y.

SELL Stamps to our readers. Your ad in this space will be read by thousands of stamp buyers. I'll prove that to you. Write now for Folder "S." F. W. Johnson, Classified Advertising Manager, Popular Mechanics, 200 E. Ontario St., Chicago 11, Ill.

FREE! Wonderful, new 84 page U. S. catalog. Handling 10¢. Norrisco, Milwaukee 7, Wis.

THOUSANDS Of exciting stamps, all different, yours for 1¢, 2¢ each. Fill your album for pennies! Big collection sent for free examination. Schaefer, 3520 St. Martin's, Cincinnati 11, Ohio.

WOW! 110 All different Germany 10¢. Zeppelins, semi-postals, airmails, high values, etc. Giant catalog, bargain lists included with beautiful approvals. Jamestown Stamp, Dept. A118PM, Jamestown, N. Y.

11 MINT Sets—Soldiers, flowers, heroes, planes, 10¢. Worldostamps, 8203-PM, Grubb, Silver Spring, Maryland.

1000 MIXED Worldwide 50¢. Dorlen Sales, Box 21, Galesburg, Illinois.

TERRIFIC Stamp bargain! Israel, Iceland, Vatican assortment—Plus exotic triangle set. Also fabulous British Colonial accumulation. Plus large stamp book. All four offers free. Send 10¢ to cover postage. Empire Stamp Corp., Dept. PM, Toronto, Canada.

AIRMAILS—Forty-nine different, 10¢. Approvals. Valley's, Box 414M, Spring Valley, California.

307 WORLDWIDE Different stamps only 10¢. Approvals. Niagastamp, St. Catharines 671, Ontario.

FREE! Ghana's "Nkrumah" stamp! Approvals. Keating, 2520-P Boulevard, Jersey City, New Jersey.

FREE! Giant bargain catalog—New edition listing thousands of bargains including U. S. and B. N. A. stamps, packets, mixtures, albums, accessories and supplies; sent with beautiful approvals. Jamestown Stamp, Dept. E118PM, Jamestown, N. Y.

102 DIVERSIFIED Worldwide stamps 10¢. Approvals. Linstamp, St. Catharines 618, Ontario.

FREE Mystery surprise packet with approvals. Dancer, B75-P3, Mansfield, Ohio.

SENSATIONAL United States offer! 50 different large commemoratives, including Wright brothers airmail. Only 25¢. Fifty ways to brighten new or old collections. Approvals. Garcelon, Calais 58, Maine.

FREE! Large illustrated catalog listing U.S., U.N., B.N.A., Br. Cols.; sets, singles, packets. Coins and special offers. Extra "How To Recognize Rare Stamps." Kenmore, Milford C962, New Hampshire.

FREE 25 Different U.S. Send 10¢ for handling. Buckley, 5406 Gallatin, Rodgers Heights, Md.

\$1 FOR A dime! 25 gorgeous mint beauties including complete Liberia commemorative set, catalog \$1, only 10¢. Approvals. Allmendinger, Warner, N. H.

INTERESTING Free bonuses accompany each approval selection from: Collier, Chamblee, Ga.

50 DIFFERENT British Colonials 10¢. Approvals. Robert Seargeant, Mendon, New York.

50 DENMARK, 10¢ With approvals. Salsman, Box 702, Berkeley, Calif.

100 DIFFERENT Pictorials, retail price \$2.00, for 25¢ with purchase from our low-priced approvals. Reiner, 6428 Morningside Drive, Kansas City 13, Mo.

"JESUS Christ" collection. Scarce valuable religious stamps. \$1.00 retail value. Yours only 35¢ with approvals. Chester Garlanger, 1019 Pearl St., St. Joseph, Mich.

WORLD Approvals. Big selections. Fast service. Smith, 8 Greencroft, Champaign, Illinois.

5 DIFFERENT Cacheted first day covers. \$1.00. Crest, Box 197, So. Orange, N. J.

100 DIFFERENT U.S.—50¢. Approvals. Utechs, 1143D North Keeler, Chicago 51.

100 DIFFERENT U.S. 25¢. Approvals. Faivre, Box 1862, Tampa, Florida.

DEALERS—Wholesale list. Postage 4¢. Frank, 5031 Queensberry, Baltimore 15, Maryland.

TERRIFIC! 2¢ Approvals. Thousands varieties! Marshall, Box 451-N, Long Beach, Calif.

ZOOLOGY In postage stamps. Free booklet. No approvals. Walter Kazaks, 234 East 58th Street, New York City 22.

LINDNER Hingeless albums. Yearly supplements. Free catalog, sample. Lindner, Box 552m, Freehold, N. J.

BEAUTIFUL Stamp albums and stamps. Send 20¢ for catalogue. New-Way Stamp, Lawrence, Massachusetts.

GORGEOUS Guatemala. 3 bicolors and price list 10¢. Kent, Box 99, White Bear 13, Minnesota.

100 WORLDWIDE With approvals 5¢. Herget, 2884 Bailey, Buffalo 15, N. Y.

U.S., Canada price list over 100 pages, 700 illustrations, 10¢. Thom, 4808—15th Avenue, Minneapolis 17, Minnesota.

MINT Famous Americans. 28 values, \$2.00. Dolinco, 31 Parkrow, New York City 38.

110 DIFFERENT Including airmails, commemoratives, pictorials, 10¢ approvals. Bourque, 289 Crescent St., Sarnia, Ontario.

VALUABLE Rhodesia Nyassaland mixture, 10¢. Erickson, 736 Cottage, St. Paul 6, Minnesota.

FRESHMEN. Sophomores, beginners. Solid bargain. Korea 102-5, catalog 68 cents, only 15 cents, when requesting good modest priced approvals. No junk. O. L. Dixon, 8716 Alameda, Ysleta, Texas.

40,000 VARIETIES Available on approvals. 1/4¢ upwards. Keigwin, Box 933B, Daytona, Florida.

GIANT Diamond, midget triangle, Timor, 15 beautiful topicals, 26 others, 10¢ with approvals. Carpenter, P.O. Box 310, Claremont, Calif.

STAMPLIFT. Now you can separate hopelessly stuck down stamps to mint condition. Satisfaction guaranteed. \$3.00. Wilson Stamp Company, 134 So. Central Ave., Ramsey, New Jersey.

MONACO Nudes (3) 5¢. Approvals. Hannay's 473 Myrtle, Albany 8, N. Y.

UNITED States. \$1.00 buys four fine unused airmails. #C7-#C10. Approvals accompany. Whiton Paine, Westport 11, Connecticut.

FREE! Over 100 different, \$2.50 value, including space satellite, Israel, British, U. S., first U. N., Siberia. Approvals, catalogue. Send 25¢ for mailing. Gatewood, Box 346, Winston-Salem, N. C.

VISION Of Lourdes, world's first sputnik, and world-wide packet of 50 free with interesting approvals. 5¢ handling. Stamp Imports, Peterborough, Ontario, Canada.

SUDAN Airmails—Brilliant 1950 bicolors, flown copies, catalog value 80¢. Yours for just 20¢ with attractive British colonial approvals. Mehl, 1201 Nowland, Peoria, Ill.

STAMP Zoo including kookaburra, zebu, kangaroo, koalabear, rhinoceros 10¢. Approvals. Linstamp, St. Catharines 618-A, Ontario.

500 FINE Mixed U. S. 15¢. Wright, 201M Mealey, Hagerstown, Maryland.

20 BRITISH Pictorials 10¢. Approvals. Van, Box 981, Columbus, Mississippi.

UNMOUNTED Approvals. Thousands at 1¢, 2¢. Plenty pictorials. Casto, Box 357, Dunbar, West Virginia.

SPACEOPHOBIA? Send 10¢ for Monaco Olympic diamonds and approval cure. BKJ, Astor, Boston 23, Mass.

A Good deal. U. S. stamps at 1/2 to 1/3 catalogue on approval. We pay postage. Harris, 3017 Brighton 7 Street, Brooklyn 35, N. Y.

LAOS Elephants, 10 cents with approvals. Delval, P.O. Box 142, Palmyra, New Jersey.

50 LARGE U. S. commemoratives 10¢ with approvals. Jack Clancy, Box 2187, Portland 14, Ore.

BAHAWALPUR UPU complete set free with approvals. Taconic Stamps, Box 1371, Ancram, New York.

ITALY—100 Different 10¢ with approvals. DeRespinis, G.P.O. Box 771A, New York 1, N. Y.

PRICE List, foreign and U. S. No approvals. Stamps, 5000 Miami, St. Louis 9, Mo.

HUNGARY—Aviation diamonds: Migs. gliders (8) given. Approvals. William Deems, 226e Race, Ravenswood, W. Va.

FREE! 105 Different with approvals. Martin, 2120 Bentley, Los Angeles 25, Calif.

200 DIFFERENT British Colonies 50¢. Approvals. Jewells Stamps, Tamaqua, Penna.

BURMA Set free. Approvals. W-B Stamps, Wilkes-Barre, Penna.

RED Russia—28 all different unused, high catalog. 5¢. Approvals. Hamilton, 912 North Mesa, El Paso, Texas.

103 DIVERSIFIED British colony stamps only 10¢. Approvals. Niagastamp, St. Catharines 671-A, Ontario.

508 DIFFERENT Worldwide from Madagascar, Macao, Guinea, etc., cataloguing over \$15 only 35¢. Approvals. Littleton Stamp Company, Littleton Q1, New Hampshire.

BEAUTIFUL Pictorial set, 25 large U.S. commemoratives, foreign mixture, outstanding approvals. All for only 50¢. Cowtown, Box 10352A, Fort Worth 14, Texas.

FIRST Day cover approvals! Aircraft, Artmaster. Included free: valuable airmail flight cover. Myers, Coopersburg, Penna.

RUSSIA Sputnik; Egyptian jets; first U.N. set; packets; surprises with purchases. Details, approvals. Stamp Farm, M2-6, Oxford, Wis.

STAMP Finder, world map and encyclopedia of stamp issuing countries only 5¢. Approvals. Goliath, Bethlehem K1, New Hampshire.

ANTIQUES, RELICS, INDIAN GOODS, CURIOS

FIND Battle relics, cannon balls, coins, silverware, with M-Scope locators. Newest features. Easy terms. Catalog. Fisher Research, Dept. C-1, Palo Alto, Calif.

ILLINOIS—Stayschunneydenteeekayshun. Selling: Hundreds of Confederate items. Historical, Civil War, Revolutionary, Indian War muskets, rifles, insignias, pistols, pepperboxes, swords, bayonets, flasks, bullet molds, duelling pistols, 50,000 Indian relics, 10,000 coins, Confederate money. Thousands agates, fossils, mineral specimens, deerheads, steerhorns, tomahawks, bo-wood, gold dollars, Kentucky rifles, frontiers. Illustrated catalog 35¢. Heike, Speedway, Wenona, Illinois.

ANCIENT Grooved stone tomahawk \$3.00. Indian relic list free. Lear's, Glenwood, Arkansas.

4 PERFECT Arrowheads. Smith, 841 N. Tacoma, Indianapolis 1, Indiana.

SCALPING Knife, spearhead, thunderbird \$4.00. Catalog free. Arrowhead, Glenwood, Arkansas.

PRECIOUS STONES, MINERALS

MINERAL Specimens for collectors. Rough and cut gems. Jewelry mountings. Choice quality, large variety, lowest prices. List free. Plummer's, 4720 Point Loma Ave., San Diego 7, Calif.

ROCKHOUNDS—Visit rockhound paradise. Circular. Heike's Agate Shop, Wenona, Illinois.

AGATES, Jade, gems. Free list. Northwest Gems, 2819 North Warner, Tacoma 7, Washington.

BOOKS On gems. 48-page illustrated catalogue 25¢. Willems, Box 1515-A, Chicago 90.

CUT Gems, make jewelry—For profit or fun. 100 page magazine tells how; where to get supplies. Sample 25¢ or request free literature. Lapidary Journal, Del Mar 2, Calif.

"GEMS & Minerals Magazine," largest rock hobby monthly. Field trips, "how" articles, pictures, ads. \$3.00 year. Sample 25¢. Box 687A, Mentone, California.

TWELVE New Mexico minerals \$2.00, six fluorescents \$1.06, five crystallized minerals \$1.06, fools gold 35¢. Minerals, Winston, New Mexico.

SAPPHIRE And four more uncut gems, \$1.00. Ten polished gems, baroque-shaped, \$1.00. Free gem list. Lapidary catalogue, 25¢. O'Brien's, 1116M Wilcox, Hollywood 38, Calif.

SEMI-Precious uncut gems. Ten different for \$1.00. Request list 25¢. Prospectors Shop, 201 San Francisco, Santa Fe, New Mexico.

EARTH Science, the rockhounds national magazine. Subscription \$2.00. Sample 35¢. Box 1357-PM, Chicago 90, Ill.

HOBBIES AND COLLECTIONS

INVENTING Can be an interesting and profitable hobby. Write for complete particulars. Institute of American Inventors, Dept. 40-E 635-F St., N.W., Washington 4, D. C.

COLLECTORS Matchbook covers. 100 different unused, \$1.00. Catalog 25¢. Album \$3.00. Charles Edelman, 1311-C East 84, Cleveland 3, Ohio.

SAMPLE Nazi medal with ribbon, 50¢. Swastika embroidered emblem, 25¢. Catalog. 25¢. Hobbies, Box 71B, Rockaway Park 94, N. Y.

DO-It-Yourself booklets, 32 different home and hobby projects. Send for 1956 book catalog 10¢. Popular Mechanics Press, 631 N. St. Clair St., Chicago 11.

NAZI Insignia, 12 different. \$1.00. Illustrated lists 15 cents. Hobbyland, Calgary, Canada.

MINIATURE Soldiers. Over 700 different sets to choose from. Catalog 15¢. Willard Snyder, 1809 Ranstead St., Philadelphia 3, Penna.

CAMERAS, PHOTO SUPPLIES

FREE 72 Page photographic bargain book. Thousands of new and used bargains in photographic equipment and supplies. Complete optical department, binoculars, telescopes, microscopes, magnifiers. Dept. 1-N, Central Camera Company, 230 So. Wabash Ave., Chicago 4, Illinois.

PHOTOGRAPHY For pleasure or profit. Learn at home. Practical basic training. Long established school. Free booklet. American School of Photography, 835 Diversey Pkwy., Dept. 3441, Chicago 14.

BROWNIE Movie camera \$19.95. Norelco men's shaver \$12.95. Tremendous discounts, photo equipment, appliances. Free catalog. Mailers Mart, Pelham, New York.

YOUR Color transparency placed in new personalized greeting card. When open picture brightens. Dept. PM, Filmdex, Sand Lake, N. Y.

PHOTO FINISHING

FREE Kodachrome film developing. Pictures, 25¢ each; 12 exposure roll, only \$3; 8 exposure, \$2. Color Studio, Box 701B, Springfield, Mo.

8-HOUR Service on deluxe jumbo prints, 8-exposure roll developed and 8 jumbo prints 40¢, 12 exposure 55¢, 16 exposure 70¢; 35mm. 20 exposure 75¢, 36 exposure \$1.25. Jumbo decklegrade reprints 5¢ each. Contact prints made if specified. Bay Photo Service, P.O. Box 210, Oakland, California.

FAST Film service. Black and white: 8 exposure 40¢; 12 exposure 60¢; 20 exposure \$1.00. Reprints 5¢. Kodachrome; Processing 90¢. Prints 32¢ each. Anscochrome, Ektachrome \$1.40; Kodachrome \$1.50. Mounted. Finest quality over 40 years. Mailers. Mail Order Photo Service, Box 297, Watertown, Wisconsin.

PHOTO Christmas cards made from your own snapshot negatives. Truly personal and distinctive. 25 cards \$1.85; 100 for \$6.00 including envelopes. Your name imprinted 75¢ extra. Send your negative for free sample and choice of styles. Photo-Mail, Box 216-MK, New York 10, N. Y.

100 PHOTO Stamps \$1.25. Send picture or negative. Box 44815, Los Angeles.

NEW Negative and three jumbo prints from your snapshot, \$1.00. Ferrell's, 2873 Exter, Mobile, Ala.

3-DAY Service on beautiful personalized Christmas cards from your photo or negative. Write for free sample and information. Lincoln Studios, Dept. K, Box 13, Lincoln, Nebraska.

PERSONAL Photo Christmas cards, including envelopes, 25 for \$1 plus 35¢ shipping. Write Christmas Cards, Box 106, Brooklyn 20, N. Y.

KODACHROME Processing by Kodak. 8mm. roll or 35mm., 20 exp., \$1.35. Prompt service. Write for mailers and prices. Color Pix, Dept. P, CPO Box 30, Kingston, N. Y.

PROFESSIONAL Quality Ektachrome-Anscochrome processing \$1.00. Kodachrome 8mm-35mm \$1.25. Write for mailers. National Color Corporation, Box 12155C, Atlanta 5, Georgia. Box 8370C, Chicago 90.

TWO Beautiful prints from each picture on roll. 8 exposure 45¢; 12 exposure 55¢. Thirty-seven years of satisfied customers. Quick service. Lens Photos, Dept. J4, Janesville, Wis.

MINOX, All subminiatures negative processing, 40¢; each print, 6¢. Flash Photo, Box 36-MS, Brooklyn 4, N. Y.

SPECIAL—10 Christmas cards from your negative for \$1.00. Complete in colorful Christmas folder. Enclose 35¢ for packing and mailing. Delta Photo Service, Box 6131, University, Alabama.

TWELVE Exposure rolls 39¢. Wallets 20 for \$1.00. Lincoln Studios, Dept. K, Box 13, Lincoln, Nebr.

LAMINATE Crystal clear plastic to 24x29½; without machine. Trial kit \$1.00. Dealers invited. Volvo. Cresskill, N. J.

SUPERIOR Quality. Prompt service. 8 jumbos in album 40¢, 16 contacts 50¢. Jumbo reprints 5¢. Satisfaction guaranteed. Also complete color film finishing service. Write for free circulars and mailers. Fast-X-Photo, Box A, Jersey City, N. J.

MOTION PICTURES AND SOUND EQUIPMENT

FREE! Blackhawk's big sale catalog 8mm., 16mm. movies, 2"x2" color slides. Biggest selection anywhere! Projectors, cameras, supplies. Big discounts! Get free, every three weeks. 12-page newspaper size bargain list! Blackhawk Films, Davenport 14, Iowa.

MOVIE Camera film: 8mm. roll \$1.50, 16mm. 100' \$3.00. Free processing. Better Films, 742 New Lots, Brooklyn, N. Y.

5,000 8-16MM. Movie films. Free catalogues. International, Greenvale, N. Y.

SAVE 50%! Guaranteed-fresh color, b.&w. movie film! 8mm., 16mm. Free catalog! Eso-R, 47th Holly, Kansas City 12, Missouri.

BOOKS; Hundreds of subjects. Big 1958 book catalog—10¢. Popular Mechanics Press, 200-BC East Ontario St., Chicago 11.

3MM Home movies. Close-outs. Regular \$1.95, 50 ft. \$1.00. Cartoons, travel, comedies, animals. Send \$1.00. MovieLand, Box 10-M, Van Nuys, Calif.

THE Best European source for slides, magazines and movies. Sample \$1. Catalogue free. Publiart, Singel 135, Amsterdam, Holland.

FREE Catalog. Save dollars. Fresh 8mm., 16mm. b&w and color film. Home processing equipment. Superior Bulk Film Company, 448 No. Wells, Chicago 10.

16MM. Sound, projectors, films. Sale, rental, exchange. Visit store or write for catalog. National Cinema, 71 Dey St., New York City.

SOUTH Seas—2x2 color slides. Sample, catalogue, 30¢. Avery Color Slides, 4818A Flacidia, North Hollywood, Calif.

6MM. Sound films. Sold, exchanged. Duquette, 97-T Snow, Fitchburg, Mass.

8MM. Kodachrome rentals 19¢. Catalog dime. Cooper's Mart, Eaton, Ohio.

HIGHEST Trade-in allowances towards Ampex, Concertone, Crown, Pergraph, Presto, Pentron. Components, accessories catalog. Boynton Studio, 10-PM Pennsylvania, Tuckahoe, N. Y.

FEATURES For sale. Religious films for rental. Also 8mm. Request listings. Cairo Home Movies, Kenosha, Wisconsin.

MUSIC AND MUSICAL INSTRUMENTS

WANT To make an accordion? Complete instructions with charts, systems, patterns \$5.00. Nothing left out. Money back guarantee. Fischer, Box 402, Bellingham, Wash.

1958 ACCORDIONS Wholesale—10 day trial. Free catalog. American Accordion Center, 5329 PM-11 Belmont, Chicago.

RECORDS, Hi-Fi. Big discounts. Neelson, Box 211, Wall Street, New York City 5.

SWISS Musical movements, Mechanical, electrical. Spielman, 131 West 42nd, New York City 36.

ACCORDIONS—1959 Models. Lowest wholesale prices. Save up to 75%. Free home trial. Trades accepted. Big color catalog free. Accordion Manufacturers, Box R, 2003 Chicago, Chicago 22.

SONGS And poems wanted. U. S. Music Studios, Box 222A, Belmont, Mass.

SAXOPHONES, Clarinets, trumpets, trombones from factory. Save 50%. Free catalog. Libro Music Center, 591 Chapel St., New Haven, Conn.

ELECTRIFY Player pianos and reed organs. Lee Mfg., 10630 Hillhaven, Tujunga, Calif.

SUCCESSFUL Songwriting. Free booklet. Complete instruction. Write: Box 277, Van Nuys, Calif.

SONGWRITERS! Don't mail poems or songs anywhere! Write for safe procedure! Song Service P, 333 West 56th, New York City 19.

PHONOGRAPH Records cheap, postpaid. Catalogue. Paramount, Box 242-M, Williamsport, Penna.

ELECTRIC Guitars, amplifiers, wholesale. Free catalog. Carvin P.M.M., Covina, California.

POEMS Wanted for new songs. Top artist records. Immediate consideration. Zeal Studios, P. O. Box 152-P, Jackson Heights 72, New York.

WANTED! Poems, lyrics, songs, ideas. Bengol, 93 Jefferson, Chelsea 50, Mass.

SWISS Musical movements, \$1.90. Helax, 218 W. 72nd St., New York City 23.

VIOLIN Makers supplies. Free catalog. 309 W. Fourth, Los Angeles 13.

ACCORDIONS, Wholesale to everyone. Save up to 60%. All national known brands. Free catalogue. Del Principe, 29 South Cicero, Chicago 44.

WRITE Songs. Big money and reputation. Write for information. J. Gordon Pub. Co., 4700 South California Avenue, Chicago.

SONGS Into dollars. Share \$33 million dollars yearly for new songwriters, song poets. Any subject, songs composed, published, promoted by largest firm. Information, appraisal free. Send Nordyke Music Publishers, 6000 Sunset, Hollywood 28 PM, California.

SONGPOEMS And lyrics wanted. Mail to: TinPan Alley, Inc., 1650 Broadway, New York 19, N. Y.

POEMS Wanted for new songs and recording. Immediate consideration. Send poems. Songcrafters, Box 6145, Acklen Station, Nashville, Tenn.

YOUR Songs arranged and recorded for publisher's presentation. For information write: Vance Studios, 3409 Grand Ave., Oakland, Calif.

POEMS Wanted for new songs. Send poems. Immediate consideration. Crown Music Company, 49-C West 32 Street, New York City.

FREE Demonstration records. Complete music service for songwriters. Jerry Colonna, Box 888M, Burbank, Calif.

FREE Wholesale musical instrument catalog. Complete lines of instruments and accessories. Nationally famous brands. Strauss Music Company, Clifton 70, New Jersey.

POEMS Wanted for musical setting and recording by America's largest song studio. Send poems. Free examination. Five Star Music Masters, 630 Beacon Building, Boston.

VIOLINMAKERS, Repairers. Fine tone wood, and all violin supplies. Send for free wholesale new price list. International Sales, 414-MPM E. Baltimore St., Baltimore 2, Maryland.

RADIO, TELEVISION AND ELECTRONICS

BUILD Your own hi-fidelity kits. Details. Arkay Dist. Co., P.O. Box 581, Church St. Sta., New York City, N. Y.

FIX Your own TV the easy way, and save 80%! Send 10¢ for new TV trouble shooter chart showing which tubes to replace. We'll include latest wholesale tube price list free. Zalytron Tube Corp., Dept. PM, 220 West 42nd Street, New York City.

RADIO Course only \$22.95. Includes all tubes, parts, tools, instructions. Write for full information. Progressive "Edu-Kits" Inc., Dept. 560B, 1186 Broadway, Hewlett, New York.

AMAZING Long distance pocket radio. Complete \$14.95. Postpaid. Tomart Co., 4322 Mt. Vernon Rd., Cedar Rapids, Iowa.

CRYSTAL Radio kit with phone \$3.00; plans, catalogue free. Clearco Crystal Company, 2966 N. 4th, Milwaukee 12, Wis.

ELECTRIC Guitars, amplifiers, wholesale. Free catalog. Carvin, PMR, Covina, California.

TRANSISTOR Radio, lightweight, compact, complete with batteries and earphone, \$6.98. James LeCzel, Box 67, Bell, Calif.

HI-FI components, recorders, tape, records. Wholesale catalog free. Audio Fair, 1799M 1st Avenue, New York 28, N. Y.

RADIO Kits—Shortwave \$3.50; broadcast band \$2.00. Alliance, 2059 60th, Brooklyn 4, N. Y.

FREE! Giant bargain catalog. Transistor, "Sun" radios, kits, portables, audio, electronics, photographic, optics, tools, household. Write Lectron, 131M Everett Ave., Chelsea, Mass.

GOVERNMENT Surplus radios, parabolic reflectors, snooperscopes, mine detectors, parts. Catalog 10¢. Meshna, Malden 48, Mass.

SENSATIONAL New satellite radio kit. Free circular. Seery, North Conway, N.H.

SAVE Money on all types radio and TV tubes! 100% guaranteed! Brand new! Write United Radio, Box 1000, Newark, N. J.

CRYSTAL Radio builders. Write to Hulet, 305 Hope, Lakewood, New Jersey.

RECORDERS, Hi-Fi. Free wholesale catalogue. Carston, 215-PM East 88, New York City 28.

TAPE Recorders, hi fi components, tapes. Unusual values. Free catalog. Dressner, 69-02M 174 St., Flushing 65, N. Y.

SIMPLE Television repairs. Marvelous booklet or book. Send for 1958 book catalog—10¢. Popular Mechanics Press, 633 N. St. Clair St., Chicago 11.

BUSINESS OPPORTUNITIES

PLEASURE, Profit, making simple ornamental water fountains for gardens, yards. Details free. Littleford Fountains, 627 Truitt Street, Salisbury, Maryland.

10% TO 20% Below wholesale! New portable typewriters, business machines, office equipment, watches, jewelry, gifts. You can sell at wholesale and profit! Bard Distributing Company, 4138K Bailey, Cleveland 13, Ohio.

UP TO \$20 daily spare time sharpening scissors, pinking shears with amazing electrically-driven machine. Experience unnecessary. Eastsharp, 4221-A Rocky River Drive, Cleveland 35, Ohio.

PLASTERERS I need you. Great discovery. Help me to double and better your pay. The most beautiful cement work, with colored grain you have ever seen. Free details. A. B. Research Eng., Attn: Mr. Burski, 1940 Winona, Chicago 40, Ill.

BIG Money—Operate own fix-it shop. Service household appliances, motors, mowers, saws, skates, etc. Free book. Christy Trades School, A-7203, 3214 Lawrence, Chicago 25.

MONEY Raising earthworms. Instruction booklet 40¢. Organic Gardens, Mountainburg, Arkansas.

\$500.00 TO \$1,000.00 Month possible. Let us prove it. Experience unnecessary. Associated Income Tax Service, Box 355-J, Broken Arrow, Oklahoma.

HARMLESS, Quarter-acre electric insect control. No gasses. Three daily sales \$300 weekly. Sing Sing Bug Chair, Box P63, Lake Leelanau, Michigan.

MAIL Trade magazine has moneymaking opportunities galore. Sample 25¢. Donovan, 79-PM Greenbelt, Levittown, New York.

FREE "Franchise profit letter" describes nationwide opportunities. Exclusive distributorships, dealerships, agency operations. Write today. National Franchise Reports, W-528, 333 North Michigan, Chicago 1.

TROPICAL Fish—For fun and profit. Every town of 5000 or over needs a dealer-breeder. Buy supplies at wholesale. Send ten cents for colored pictures of 55 fish, plus free price list and booklet. "Make Money Raising Tropicals." Tropicals, Box 9093, Long Beach, California.

SELL By mail profitably. Beginner's manual gives tested methods. 25¢. Alfano, 19 Pine, Closter, New Jersey.

\$34.70 TWO Hours. Manufacturing concrete products. No selling. Carlayne Castings, 1803 Fremont, Rapid City, South Dakota.

START Home mail order business! We supply catalogs, names. Fill your orders. Give personal help. Write: House of Seven, Dept. A, Box 382, Torrance, Calif.

MAKE Your fortune with food specialties. Many have. People must eat. Instructions. Ayner, 4406 Cottage, St. Louis 13, Mo.

"MAILORDER Laws and Regulations" and "Mailorder Rules for Beginners." Learn about necessary licenses, different taxes, legal requirements, etc. Both books, \$2.00. "Simplified Mailorder Book-keeping System," \$1.00 additional. Tasker, Box 3131, Alexandria, Virginia.

MUSHROOMS Quicker, easier, cheaper. Newest facts free. Spawn \$1.00. Luxur, 641 South 19th, Newark 3, N. J.

MONEYMAKING Vending machines. Catalog. Rake, 607 Spring Garden, Philadelphia 23, Penna.

OPERATE Profitable mailorder business! Write: Bond, 1637-H West Vernon, Phoenix, Arizona.

\$400.00 MONTHLY Raising redworms, mealworms, crickets. Clean soilless method. Free brochure. Charlie Morgan, 116E, Bushnell, Florida.

CANDIED Popcorn and potato chip equipment. Eakins, Box 933-A8, Springfield, Ohio.

RAISE Rabbits on \$500 month plan. Plenty markets. Free details. White's Rabbitry, Delaware, Ohio.

SALES-By-Mail could be your opportunity. Valuable food for thought free. Rawson Wood, 3974 Milwaukee, Chicago 41.

MONEY Plans! "Secret Journal." Grandpa, two daughters made \$2500 first month! Work home. Publicco, Oceanside, Calif.

TO \$100.00 Weekly. Sparetime, home operated mailorder business. Successful beginner's plan. Everything supplied. Lynn, 10420-M National, Los Angeles 34.

LEARN Real estate by listening to records. Lee Institute, Brookline 46, Mass.

CAMERA Owners! Earn \$50.00 weekends! Instructions \$1.00, information free! Kline, 935-PM North Austin, Chicago 51, Illinois.

COLORGLAZED Concrete pottery made without molds. Patented method. Cemetery products, novelties, tiles. Basement leak-sealing. Money-making projects. Booklet, details free. Men only. National Potteries Company, Grand Rapids, Minnesota.

PIANO Tuning learned quickly at home. Tremendous field! Musical knowledge unnecessary. Information free. Empire School of Piano Tuning, Champaign, Ill. (Founded 1935).

WANT To make big money at home? \$10.00 profit in an hour possible with invisible mending. Make tears, holes, disappear from clothing, fabrics. Steady year-round demand from cleaners, laundries, homes. Details free. Fabricon, 6234 Broadway, Chicago 40, Illinois.

\$70 WEEKLY—Home, spare time. Simplified mail bookkeeping. Immediate income—easy! Auditax, 34757A, Los Angeles 34.

MINK Raising information free. Complete. Lake Superior Mink Farm. Superior, EEL, Wisconsin.

MAKE Flexible molds. Cast plaques, figurines. Free sample. Tooker, 1045-R Fairview, Hamilton, Ohio.

NATURAL Molding rubber, extra thick. Free sample. W. Wooley, 1016-A Donald, Peoria, Illinois.

I want to send you proof of the wonderful pulling power of Popular Mechanics classified pages. What's your proposition? Write me today. Include literature if possible. F. W. Johnson, Manager Classified Advertising, Popular Mechanics Magazine, 200 E. Ontario St., Chicago 11, Ill.

BIG Money raising fishworms and crickets. Free literature. Carter Farms, Plains, Georgia.

11,000 NEW Prospects daily. Baby record books, shoes, albums. Sell mailorder. Use our literature. Write: No-Co-Ro, Capitola, California.

BAKE New greaseless doughnuts in kitchen. Sell stores. Free recipes. M. Ray, 3605 South 15th, Minneapolis 7, Minnesota.

FIX Typewriters. Inexpensive home course teaches factory secrets. Free booklet. Athey, Tarentum, Penna.

PLATE Baby shoes, jewelry, gifts, bronze and colored pearl. Free booklet. Platex, 11029 South Vermont, Los Angeles 44.

COPUBLISH Mail Sale Advertiser, leading mail order paper. Details, latest copy, dime. Vanroy Shirk, Lebanon, Penna.

FREE Catalog. Contains hundreds of businesses, farms and income properties throughout U.S., Canada. Specify type and location desired. Deal direct with owners. U. I. Buyers Digest, 1608 Hillhurst, Dept. PM-3, Los Angeles 27, Calif.

WE Pay \$3.50 lb. dried. Grow mushrooms. Cellar, shed and outdoors. Spare, full time, year round. We have 25,000 customers. Free book. Washington Mushroom Ind., Dept. 172, 2954 Admiral Way, Seattle, Wash.

FREE Book "505 Odd, Successful Businesses." Work home. Pacific, Oceanside, Calif.

MARKETS Everywhere. Make artistic concrete birdbaths, pottery. Chemical coloring. Home workshop. Stucco-rock walls. Hundred varieties. Hollywood Cementcraft, 8527-K Wonderland, Hollywood 46, Calif.

FREE Folio "\$5,000-\$45,000. Unlimited Vacations." No merchandise. Unknown! Work home, sparetime! Haylings, Carlsbad, Calif.

MAKE \$46 From square foot plywood; legsaw necessary. Free details. Woodart, Bridgewater, Mass.

GROW Orchids at home. Profitable, fascinating. Successful home grower explains special light, temperature and humidity conditions orchids need. Free! Full details. Orchids, 100 S. Vermont, Los Angeles 4.

LEARN Sewing machine repairing. To \$125 weekly. Sparetime. Supplies. Add to present business. Write today! Taylor Service, Box 2126, San Bernardino, Calif.

MAKE Money selling recipes and household hints by mail. Information free. Barrett, Dept. CA-27, 7464 No. Clark, Chicago 26.

MOTEL Supplies business and mailorder to institutions. New! High income. Investigate. Hermes Advertising, 152-C West 42, New York City 36.

BRONZE Baby shoes: Instructions, equipment and mountings for genuine electroplating process. Largest supplier of all plating equipment, supplies. Free catalog. Hollywood Bronze Supply, Dept. B-3, 1624 East First, Los Angeles 33, Calif.

I Got rich in the dry cleaning business with no investment, so can you. Free details. Write: Imperial School of Dry Cleaning, Dept. PMC, 1700 Touhy Avenue, Chicago 26, Illinois.

BUY Wholesale! 30-80% discounts! Nationally famous brands. Typewriters, housewares, appliances, watches, furniture, musical instruments, cameras, tools, etc. Consolidated Distributors, Clifton 1, New Jersey.

QUICK Profits, with no capital! Take orders for magazines your neighbors like. Want. Make cash on the spot! We show how with free kit. Get yours now. Write McGregor Magazine Agency, Dept. 310, Mount Morris, Ill.

BUY Wholesale! 100,000 nationally advertised products. Appliances, cameras, sporting goods, housewares, watches, typewriters, tools, clothing, etc. Discounts to 80%. Buy-Rite, Box 258, Hawthorne 1, New Jersey.

BUY Direct from factories—Appliances, cameras, watches! Free details! Cam Company, 6810PM—20th Ave., Brooklyn 4, N. Y.

PLASTERCRAFT Molds, liquid rubber, plasters, flocks, candle supplies. Catalog and manual free. Blue Rapids Supply, Blue Rapids, Kansas.

LIQUID Molding rubber, free sample. Shellcraft supplies. Chaney's, 1907-A East Road, Jacksonville 11, Fla.

SHARPEN Scissors, pinkers. Inexpensive machine. Sharpening supplies. Blackhaws, Sheldahl, Iowa.

HOME Mail order business opportunity! We supply everything. Fill your orders. Guide you. Eastern, Box 142, Boston, 24-C, Massachusetts.

EVERYBODY Likes candy—Make professionally home. Instruction, tools, supplies. Details free. (Our 49th year.) Ragsdale Candies, B107, East Orange, New Jersey.

EARTHWORMS, Easily raised. Spare-time. Profitable, amazing information free. Superior, Box 286, Dyersburg, Tenn.

UNLIMITED Import—Export opportunities! Earn big money from home. No experience. Capital unnecessary. Free, import bulletin. Foreign Traders, 7814-B Forsyth, St. Louis 5.

JUST Off the press! Robinson's Sewing Machine Service Manual. 579 illustrations. 144 pages. Earn to \$5 per hour. Price \$6.25. Lee Robinson, Book Nook Bldg., Walla Walla, Wash.

MAKE Extra money. Cash commissions. Everybody buys easy-to-sell advertising book matches. Union label. All sizes. Cuts for all businesses. Powerhouse selling kit free. Steady repeat business. No experience necessary. Superior Match Co., Dept. MX-1158, 7528 S. Greenwood, Chicago 19.

1200 ITEMS Drop shipped. Wholesale circulars-catalogs supplied. Davenport Distributors, GPO Box 1354-O, New York 1, N. Y.

SERVICE Stores spare time with rack and displayed products. Hundreds! No selling. Write: Forbes Advertising, P. P. Box 1466-c, East St. Louis, Ill.

INVISIBLE Reweaving: \$5 in one hour possible reweaving burns, tears, moth-holes. Spare-full time. Free details. Skillweave, Dept. SC-1611, 335 W. Madison, Chicago 6.

FREE! Copies mailorders we receive! You can get lifetime repeats too. Write, Arthur E. Jones Industries, G.P.O. 5620, Pittsburgh 7, Pennsylvania.

"HOW To Build Your Own Mail Order Business." Get the facts! Informative booklet, 25¢. Satisfaction guaranteed. Mail Order Publications, 5204 37th Street North, St. Petersburg 33, Florida.

EARTHWORMS Bring dollars! Illustrated booklet, 35¢. Literature free. Publisher Cutler, Reading, Pennsylvania.

OPERATE Mailorder folio business. Free details. Ballard's, 1323 Winter, Louisville 4, Ky.

MOTEL Supplies mailorder business. Full setup service. Hermes Advertising, 152-C West 42, New York City 36.

TREMENDOUS Possibilities in home mail order. I retired after five years. Plan and help given absolutely free. Norris Cole, 217 West 49th, Bradenton, Florida.

MAKE Money growing orchids at home. Inexpensive to start. Full details free. Beatrice Makranzy, Box 1776P, Miami 10, Fla.

WANTED: Home producers, to be subcontractors. Cast plastic products for manufacturers in our clearing house service. Thousands of easily made items required. Cash in at home, without previous experience. Plastic Service Associates, Dept. 11-PM, East Boston 28, Massachusetts.

FREE Document "Business Goldmine." Get free national advertising of your product or service. Profits unlimited. Write: Di-Carr Publicity, 1525 S. 48th Court, Cicero 50, Illinois.

MAKE A good living sharpening saws and lawnmowers. Thousands of our machines in use. Free literature. Max Manufacturing Co., 138 Stockton Ave., San Jose, Calif.

INCOME With garden golf. Motivated archery ranges. Brockway, Box 3924, Portland 8, Oregon.

YOUR Own high profit business. Sell name brands, full or part time. No inventory, no investment. More than 2,000 name brand items; lowest wholesale prices. Watches, jewelry, cameras, hi-fi radios-phonos, appliances, housewares, hardware, power tools, luggage, musical instruments, garden equipment, sporting goods, toys, many others. 8 floors of name brands. Million dollar inventory. Orders shipped complete within 24 hours! Send for free, beautifully illustrated catalog now! Separate dealer price list. H. B. Davis Corp., Dept. 11, 145 W. 15 St., New York 11, N. Y.

"50 NEW Home-Business Ideas" booklet. Sample free. Spray exotic Velvet-Suede on anything. Plockcraft-NR, Los Angeles 61.

YOU'LL Make money making cases at home because we help you sell. Build luggage and cases for 1001 needs. We supply instructions, supplies, everything! Work full, sparetime. Details free. Abarai, 807-S11 Sunset Blvd., Los Angeles 12, Calif.

HOME-Import mail order business—Import profitable items below wholesale. Experience and product investment unnecessary. Full, spare time. Famous world trader guides you. Free list "157 Imports," details. Mellinger P70B, Los Angeles 24.

GROW A living miniature forest or orchard (only inches high) that bears tasty tiny fruit at home. Learn amazing dwarfing secrets! Fascinating hobby. Profitable home-business opportunity. Free seeds and plan. (State your age.) Miniature Nurseries, Dept. NR, Gardena, California.

START Your own business on credit (U.S. and Canada). Be your own boss. 1425 dealers sold \$5,000 to \$32,000 in 1957. We supply stocks, equipment on credit. 200 home necessities. Sales experience unnecessary. Pleasant profitable business backed by world-wide industry. Write Rawleigh's, Dept. K-U-PPM, Freeport, Ill.

BOOKKEEPERS, Accountants. Operate a bookkeeping service. Part or full time. Amazing simplified system. Wonderful money-making opportunities. Complete information free. National Bookkeeping Publishing Co., Suite 307, 3435 Broadway, Kansas City 11, Mo.

NEW Home-import mail order profitability! Your mailbox stuffed with money! No selling. No experience. No investment. We supply everything. Free details. Mail Order Distributors (Import Division), 15201 South Broadway, Los Angeles 61A11, Calif.

GET Started in country and western music. Radio. Records. Television. Your own band. Send 30¢ for helpful booklet. Country Music, Inc., P.O. Box 685c, Gaffney, S. C.

PROFITABLE Operative mail order business. Write! Heritage, 210-PM11 Fifth Avenue, New York 10, N. Y.

LET Us put you into business! We supply product, plan, advertising. You employ salesmen. Terrific profits! Repeats! Private labels! Vitamins, 4801A Cedardale, Wichita 10, Kansas.

SELL The Hertel Blue Ribbon pictorial Bible containing all the features necessary for complete Bible information. 1958 edition, top commission. International Book Co., 322 N. Market, Wichita 1, Kansas.

THE All profit offer plus my big mail 39¢. Satisfaction guaranteed! Crews, Box 53, Valrico, Florida.

GROW Expensive herbs for us! Big profits home-business of your own. Year around profitability! We supply everything necessary! Send for free rare seeds and revealing plan. (State your age.) National Herb Exchange, Dept. NR, Gardena, Calif.

CLEANS Windows without mess. Strange dry cleaning-cloth. Replaces liquids. Windows gleam. Samples sent on trial. Kristee 103, Akron, Ohio.

AUTOMOTIVE Accessories—300% profit. Steiner, 156TB West 86, New York 24, New York.

MEN, Women—Big paying, mail operated, national collection agency. Confidential homework system \$1.00. Interstate, 37 Besch, Albany 9, New York.

LEARN Enjoyable hobby-business engraving plastics! New "Dupliscale,"—engraving attachment, uncovers countless profitibilities! Details, sample 10¢. Desco Distr's., 5262-V Van Nuys, Van Nuys, Calif.

AVAILABLE—Professional mailorder procedure, fully legal, profitable, economical. Since 1930. Free outline. Personal Profit Plans, 333 North Michigan, Chicago 1.

UNLIMITED Opportunities, manufacturing and distributing, automotive and household products. Tremendous profits. Christians, Box 7799, Fairmount Sta., Kansas City 22, Mo.

OPERATE Profitable mailorder business. Write Rocky Service, 6740 Waterworks Rd., Norfolk 2, Virginia.

"HOW To Conduct a Profitable Mail Order Business" folio, 25¢. Buy merchandise below wholesale. Catalog 25¢ (refundable). Martin's Service, 742-D Francisco Blvd., San Rafael, Calif.

MANUFACTURE At home, shampoo, cleaner, detergent. No special equipment needed. \$1.00 brings you four industrial formulas with suppliers' names. Chemco, Box 22, Hochelaga, Montreal, Canada.

\$250 WEEK Cleaning venetian blinds. Patented machinery. Free literature. Robinson, 7213B Indianapolis 1, Indiana.

LIQUID Marble—Colorful, glossy! Molded, brushed, sprayed! Particulars free. Marbleizing Service, Edwardsville, Illinois.

BUSINESSMAN'S Hitparade. First time offered! Spectacular! Free! Oakwood, Philadelphia 26.

COSTS 8¢—Retail \$1.00. Needed automotive product. You manufacture, distribute, easily. Everything furnished. Wilson, 505-B, Princeton, W. Va.

FREE Sharpening manual. Good money servicing cutters, saws, cutlery. Thousands doing it. Treyco, N. Tonawanda, N. Y.

AMAZING Mailorder business opportunity! Tremendous profits! National, 2696 So. 10th, Fresno 25, Calif.

BE Appointed state notary public. Write Notary Public's, 3230-MB, Stoner, Los Angeles 66, Calif.

FREE Book "990 Successful, Little-Known Businesses." Work home. Plymouth, 1610-43 Street, Brooklyn 4, N. Y.

SELL Books by mail. 400% profit. Royal, Box 368-X, Cleveland 27, Ohio.

REBUILD Batteries; repair dolls; make rubber stamps. "75 Ideas" free. Universal, Box 1076-A, Peoria, Ill.

CASH From sawdust, tin-cans, newspapers. Over 200 methods. Instructions \$1.00. Charles Company, 12-XAT, Norwood, Ohio.

CHRISTMAS Offering of imported gifts, shipped direct to you. Quality imports afford wonderful profit-making opportunities. Also, nationally manufactured merchandise at large discounts. Merchandise sold on approval. Request literature. K.T.C., P.O. Box 455, Bryn Mawr Branch, Seattle 88, Wash.

\$300-\$600 PROFIT Per month. Coin-operated laundry business that runs itself. Factual report, only \$1.00. Satisfaction guaranteed. Laundries, Inc., P.O. Box 366, Ardmore, Oklahoma.

OPERATE Your own home mail order business, it's profitable. Write. Webb Imports, Pico Rivera, Calif.

WE Pay \$3.50 lb. dried. Grow mushrooms. Cellar, shed and outdoors. Spare, full time, year round. We have 27,000 customers. Free book. Washington Mushroom Ind., Dept. 172, 2954 Admiral Way, Seattle, Wash.

\$5,000 YEARLY. Spare time at home. Nothing to buy. No local selling. Dignified. Guaranteed. Home Harvest, 1933 Lakeview Road S.W., Albuquerque, N. Mex.

MAILORDER Envelope business. No investment. Omaha Envelope, 4721-E California, Omaha 32, Nebr.

BEAUTIFUL Oriental silk-paintings 13" x16". Best sellers at \$4.90. Sample \$2.90. Doz. \$29.00. Armin Lehmann, 45 Christopher, New York 14, New York.

BOOMING Business. Ground floor opportunity. Free booklet. Stone-Craft, Box 856-A, St. Louis, Mo.

MAKE Signs. Just nail on. Hoag's Sign Letters, 507 E. Chicago Blvd., Tecumseh, Michigan.

NOTICE—Mail order experts invite you to share their "know-how." Start your own successful mail order business. Experience unnecessary. Send \$1 for valuable detailed brochure. Richton Company, 157A, Maplewood, New Jersey.

MONEYMAKING OPPORTUNITIES

FREE Plan and help. Home mail order. A. Cole, 217 West 49th, Bradenton, Florida.

EASY Cash from odd items. Free details. Stark, Box 9897, Houston 15, Texas.

ELEVEN Ways to earn at home, no selling, free details. Sanders Company, 1762 Euclid, Lincoln, Nebr.

STEREO High fidelity. Be a home sales dealer. Big profits. Write Dept. HSD, Dynamic Electronics, Box 188, Forest Hills, N. Y.

FUNMAKERS, Gadgets. Wholesale catalog free. Exciting samples 25¢. Dohn-GD-Marks, Broadview, Ill.

FREE. Moneymaking plans. Work home. Zinke Publishers, 39, Savoy, Illinois.

START Successful home mail order business. Plan and personal help absolutely free. Johns, Box 1013, North Little Rock, Arkansas.

SELL Titania gems. Far more brilliant than diamonds. Catalog 10¢. Diamondite, 2420-M 77th, Oakland 5, California.

WE Pay \$3.50 lb. dried. Grow mushrooms. Cellar, shed and outdoors. Spare, full time, year round. We have 25,000 customers. Free book. Washington Mushroom Ind., Dept. 173, 2954 Admiral Way, Seattle, Wash.

MEN—Women! Start money-making plastic laminating business at home in spare time. Material that costs 11¢ brings back \$2.50. No canvassing or selling but mail orders bring in \$20 a day. Write for full particulars free. Rush name on postcard to Warner, Room CL-2-L, 1512 Jarvis, Chicago 26, Ill.

SELL Magic mixing balls (49¢ value) \$3.00 dozen postpaid. BJ&R Sales Company, Box 9206, Tulsa, Oklahoma.

SCHOOL Seniors—Make money. Sell classmates aptitude testing. Commissions, bonus. Details free. Guidance Associates, 115 Haypath Road, Plainview 1, New York.

SELL Information by mail. 10-to-1 profit ratio. Valuable suggestions free. Rawson F. Wood, 3974 Milwaukee, Chicago 41.

MAKE Money writing short paragraphs! No tedious study. I tell you what to write, where and how to sell; and supply list of editors buying from beginners. Many small checks add up quickly. Write to sell, right away. Send for free facts. Benson Barrett, Dept. C-27-X, 7464 Clark, Chicago 26.

START Big-pay business at home in spare time. No experience needed to operate little table-top machine for bronzing baby shoes. Make \$5.46 profit on every pair. Full particulars free. Send postcard to Mason, 1512 Jarvis, Room CM-2-L, Chicago 26, Ill.

EARN Money evenings copying and duplicating comic cartoons for advertisers. Adservice, Argyle 1, Wisconsin.

MUSHROOMS Quicker, easier, cheaper. Newest facts free. Spawm \$1.00. Luxur, 641 South 19th, Newark 3, N. J.

EASY To start rubber stamp business at home in spare time. Make up to \$9.80 an hour without experience. Facts free. Write to Roberts, 1512 Jarvis, Room CR-2-L, Chicago 26.

MANAGING Money-raising campaigns for churches, hospitals, institutions; pays unusual fees. Short spare time course backed by 35 years experience. John Arbogast, 229 East Mason Avenue, Alexandria, Virginia.

\$50.00 WEEKLY Possible mailing merchandise catalogs. Roe, 1657P Gregory, Chicago 40, Ill.

\$36-\$200 WEEKLY. Plating baby shoes, making jewelry, novelties, etc. at home. Details free. JO-Ca Electroplater, 7840-D Northwest Sixth Court, Miami 50, Florida.

\$5,000.00 ANNUALLY Possible for you in mailorder. Free information. Ransie, Box 1719-A, Richmond 14, Virginia.

WANT To make big money at home? \$10.00 profit in an hour possible with invisible mending. Make tears, holes, disappear from clothing, fabrics. Steady year-round demand from cleaners, laundries, homes. Details free. Fabricon, 6260 Broadway, Chicago 40, Illinois.

AMAZING Successes through franchises! Become exclusive franchise holder your territory. Information rushed. National Franchise Reports, 333 North Michigan, Chicago 1.

FREE Particulars and proofs from our many customers who are making money with our brush plating outfit that requires no tanks and formulas for silvering mirrors of all kinds, metal and wood finishes, silver plate and polish and 50 other money making formulas. Write today. Gun Metal Co., Ave. H, Decatur, Illinois.

BIO Profits quick! Make and sell costume jewelry. Details free! Modern Craft, Box 11088-M, St. Petersburg 33, Florida.

\$15,000 PROFIT In one year possible, on \$5.00 weekly. Fabulous but true. Minimum of attention, respectable field. 15% profit can be guaranteed. Experience unnecessary. Proof, complete detailed plan, only \$1.00. Satisfaction or refund. Columbia Enterprises, 8203-P, Grubb Road, Silver Spring, Maryland.

BUY Wholesale! 30-80% discounts! Nationally famous brands. Typewriters, housewares, appliances, watches, furniture, musical instruments, cameras, tools, etc. Consolidated Distributors, Clifton 2, New Jersey.

BOOKS; Hundreds of subjects. Big 1958 book catalog—10¢. Popular Mechanics Press, 200-BC East Ontario St., Chicago 11.

\$100.00 WEEKLY. Raise redworms soilless way. Charlie Morgan, Bushnell, Fla.

WIN Contest money. General Contest Bulletin gives hundreds of tips. Lists current contests, rules. Sample magazine 25¢. General Contests, 1609½ East 5th, Duluth 12, Minnesota.

MAKE \$200.00 Monthly spare time with jigsaw. Free details. Elkman, 346F North Summit, Sioux Falls, South Dakota.

MAKE Money, operating mail order business, selling business cards. Vosacek Printing, 4444A Ute, San Diego 17, Calif.

CIGARETTES—Improved roller makes 20 for 9¢. Facts free. Moberly, Box 821, Owensboro, Kentucky.

FREE Folio "\$5,000-\$45,000. Unlimited vacations." No merchandise. Unknown! Work home, sparetime! Haylings, Carlsbad, Calif.

READ Progressive Mailtrade, the magazine that tells how to make money by mail. Dime brings sample and special offer. Progressive Mailtrade, Box 357, Sheboygan, Wisconsin.

BIG Money raising, fishworms and crickets. Free literature. Carter Hatchery, Plains, Georgia.

NEW Magazine shows you how to make mailorder pay. Free details. Mailorder Income, 5451-2 Foster, Skokie, Illinois.

PRICES? Save on jewelry parts. Bracelets 6 for \$1.00. Free catalog. Jewelforms, Box 6, Rancho Mirage, California.

MAIL Order rules for beginners. Book \$1.00. Central Trading Co., Box 254, Sudbury, Ontario, Canada.

PREPARE Tax returns—Remunerative! Write Taxbux, 6196 Walnut, Omaha 6, Nebraska.

PLAN Your spare time now to suit yourself. \$40-\$75 weekly; \$1.00 guaranteed. Mopo, Box 104, Hannibal, Missouri.

MAKE Money gathering roots, herbs, weeds, leaves, tree seeds, flowers, plants! Over 200 varieties! Listed buyers for all you can ship! Easy! Pleasant! Get free book! Revealing beginners packet, 25¢. Fortune Mart, 221-A Lincoln, Worcester 5, Mass.

GROW Miniature trees for pleasure or profit. Complete course for \$2.00 prepaid plus free training pot and seeds. J & J Nurseries, P.O. Box 205, Canandaigua, N. Y.

WE Pay \$3.50 lb. dried. Grow mushrooms. Cellar, shed and outdoors. Spare, full time, year round. We have 27,000 customers. Free book. Washington Mushroom Ind., Dept. 173, 2954 Admiral Way, Seattle, Wash.

MAKE Money fast at home. Thirty money back guaranteed plans \$1.00. Parsons, 232 N. Viceroy, Azusa, Calif.

JOIN The prosperity parade with a mail order bookshop in your own home. Valuable information free. Practical Publications, 3974-F Milwaukee, Chicago 41, Ill.

EXPORT—IMPORT

OPERATE International import mail-order business. Free details. Union Importers, Box 65, Longmont, Colorado.

FORMULAS, PLANS, ETC.

100 FORMULAS, \$1. Booklet free. Ogg Laboratories, 4214 Downing, Tampa 3, Fla.

FORMULAS For latest money-making discoveries. New! Good! Valuable literature free! Miller, Chemist, 1517-D, Tampa, Florida.

FORMULAS; All kinds, latest, best. Literature free. Kemixal, Park Ridge, Ill.

PRACTICAL Formulas. Lists free. Cummings, Chemist, Gordon Ave., Syracuse 4, N. Y.

LATE, Modern manufacturing formulas. List free. Moon Chemical, Martville, New York.

PLASTICS

PHOTO-Seal. Complete electric laminating kit for wallet size photos, cards. \$14.95. Refills available. Therm Appliance, St. Charles, Illinois.

PLASTICS! New, do-it-yourself casting and molding materials. Crystal clear for embedding specimens, ivory, ebony, marble and colors for jewelry, novelties and industrial castings. Illustrated catalog 25¢. Castacraft Corp., Dept. N-67, P.O. Box 555, Palo Alto, California.

NEW Liquid casting plastic, clear, colors. Embed real flowers, butterflies, photos, coins. Send 25¢ for two handbooks "How to Cast Liquid Plastics" and "How to Make Extra Money at Home." Castolite, Dept. M-101, Woodstock, Illinois.

VACUUM Forming. New process used by manufacturers. Instructions, plans \$1.00. Box 742, Galesburg, Ill.

ELECTRIC Laminating kit. Hobby, gift, or profit. Burr, 330 East Center St., Kalamazoo, Mich.

PLASTIC Molders supplies. Catalog 25¢. Gel, Box 261, Union, N. J.

PLASTIC Sheets. All types, plexiglas, acetate, vinylite, laminating plastics, and supplies. Covers, folders. Free price list catalogues. Arthur Blank and Co., 44 Causeway, Boston 14, Mass.

PLEXIGLAS. Square foot cost. 1/16", \$1.20; 1/8", \$1.52; 3/16", \$1.86; 1/4", \$2.21; 3/8", \$3.23; 1/2", \$4.36. Colors add 10%. Send 15¢ for postage. Aristocrat Plastics, 23 Sussex Avenue, Newark, N. J.

LAMINATING Supplies. Free price list. Solomson, 46 Cornhill, Boston 8, Mass.

BOXES, Plastic. Free list. Althor, 170 Bay 23 Street, Brooklyn, N. Y.

LEARN Plastics fabrication for spare time income. Low cost home training now available. Write for free booklet. Interstate Training Service, Dept. D-3, Portland 13, Ore.

PLASTICS—Plexiglas, acetate, vinylite, polyester, fiberglass, epoxy, styrofoam, polyethylene, mold materials, cements, supplies. Instructive, informative wholesale-retail catalog, 25¢. Gem-O-Lite, 5527 Cabuenga, North Hollywood, Calif.

CHEMISTRY

NEW "Magic Chemistry" experiment book. Over 300 experiments, 100 illustrations. Send \$1.87 and receive a free chemical catalog. Winn Chemical Company, 124M West 23 Street, New York 11, New York.

CHEMICALS, Supplies, new catalog. 25¢. Laboratory Sales, Box 161-A, Brighton, Mass.

MICROSCOPE Slides, anatomical. Free list. Bay, 409 Roosevelt Way, San Francisco 14, California.

EXPERIMENTERS: Bargains galore catalog, 25¢ (refundable). Hagenow Laboratories, Manitowoc, Wisconsin.

CHEMICALS And apparatus for industrial, analytical, and private laboratories. Catalog 25c. Dept. M-50, Biological Supply Co., 1176 Mt. Hope Ave., Rochester 20, N. Y.

ILLUSTRATED Catalog: Chemistry, mineralogy, biology 25¢. Tracey Laboratories, Evanston, Illinois.

BOOKS! "Visualized Chemistry," 364 pages, illustrated, \$1.20. "Visualized Physics," \$1.20. "Visualized Science," \$1.15. Information free. Franks, 3121 South Racine, Chicago 8.

AMAZING New book of science experiments, formulas, and catalogue of laboratory supplies. Only 25¢. National Scientific Co., Dept. PM-11, 500 West Road, Lombard, Illinois.

CHEMISTRY—Science magazines. Literature free. Lankton, Box 5126C-20, Lansing, Mich.

AGENTS WANTED

INTERNATIONALLY Advertised. Represents. Stores, offices, homes buy every time. Free particulars. Halencor, 6 Cedar Ave., Vineland, N. J.

FREE Sample. Polyethylene protective gloves. Terrific business. Give-away item. Bev-Lo Distributing, 3728 W. 87 Place, Chicago 29, Illinois.

60% PROFIT On cosmetics—Famous nationally advertised Hollywood cosmetics pay 60%. Make \$25 day up. Hire others. For free samples, details, write Studio Girl, Glendale, Calif. Dept. 128110.

TOP Action ball point pens, 9 for \$1.00. Refills 20 for \$1.00. Bonomo, 54 Jefferson, Brooklyn 6, N. Y.

AGENTS—\$400 To \$800 monthly selling brand new health aid. Fast repeat orders. Warfield, Dept. 3D, 630 Stanley Ave., Brooklyn 7, New York.

FREE Sample! Beautiful feather pictures. Send 12¢ stamps mailing. Sylviak, Apartado 9036, Mexico 1, D. F.

EARN \$12,000 Yearly—Only two sales daily. World's best seller, The Holy Bible. Illustrated. Protestant or Catholic. Margareta's, P.O. Box 92, Hazleton 7, Penna.

BUY Wholesale! 25,000 nationally advertised products. Get amazing dealer catalogs. Complete details free. American Wholesalers, 1841DC Levee, Dallas 7, Tex.

EASY Handwork makes fast-selling useful articles. Sample free. Sunmade Company, Brockton 64, Massachusetts.

ENJOY Big spare-time profits getting new and renewal subscriptions for all popular magazines from friends, neighbors, churches, etc. Build your own business. Start now. Free catalog. Complete information and supplies. National Publications Company, Dept. PM, 4055 Wilshire Blvd., Los Angeles 5, California.

PRINTING. Advertising salesmen—Excellent moneymaking sideline selling decalcomania name plates, small quantities. Automobile initials, sign letters. Free samples. Raico, XL, Boston 19, Mass.

GOLD Or silver letters, numbers. Windows, doors, trucks. 1" to 6". 500% profits. Free samples. Atlas-T, 544 West 79th, Chicago 20.

AGENTS—300% Profit selling genuine gold window letters; stores and offices. Free samples. Metallic Sign Letter Co., 1217-D West Newport, Chicago.

YOUR Own business—Used suits \$1.50, overcoats 65¢, mackinaws 35¢, shoes 12½¢, ladies coats 30¢, dresses 15¢. Enormous profits. Catalog free. Nathan Portnoy Associates, 2109-AA Roosevelt Road, Chicago 8.

EXCLUSIVE Line of personal initialed buckles, belts, cap badges, 3000 emblems. Hook-Fast, Dept. PM, Roanoke, Va.

\$13.50 HOURLY Profits possible, introducing 5 valuable farm books your area. Published by Popular Mechanics. Farmers buy on sight. Details free. Popular Mechanics Press, 200 E. Ontario, Dept. 64-B, Chicago.

BE The Popular Mechanics representative in your neighborhood and earn big profits in your spare time. Write Popular Mechanics Magazine, Room 305M, 200 E. Ontario St., Chicago 11.

EXCLUSIVE Territories! Hottest automotive item ever! \$1.00 seller, up to 300% profit. Fantastic demonstrator. Sell retail and wholesale. Maco Products, Falls Church 4, Virginia.

YOUR Ad in this space will get some good agents for you. Yes, I'll prove it. Write for Folder "A" right now. P. W. Johnson, Classified Advertising Manager, Popular Mechanics Magazine, 200 E. Ontario St., Chicago 11, Ill.

BUY Wholesale! 30-80% discounts! Nationally famous brands. Typewriters, housewares, appliances, watches, furniture, musical instruments, cameras, tools, etc. Consolidated Distributors, Clifton 4, New Jersey.

CASH Commissions at once, taking orders for magazines every family wants! No experience needed. For free money-making kit, with everything you need, write McGregor Magazine Agency, Dept. 300, Mount Morris, Ill.

GOLDMINE Of 600 money makers. Free copy. Specialty Salesman Magazine, Desk 5B, 307 North Michigan, Chicago 1, Ill.

TREMENDOUS Profits! Every man, woman and child a customer. Used suits \$1.50, pants 35¢, dresses 20¢, shoes 20¢. Operate from store, home, car. Free catalog. Superior, 1250-A Jefferson, Chicago 7.

FOG-Stop windshield cloth. Instantly removes blurry mist, frost, sleet, snow. Stops windshield fogging. Samples sent on trial. Kristee 52, Akron, Ohio.

REAL Diamond rings. Nationally advertised. Sell direct. Make big middleman's profit. No investment. Experience unnecessary. Free catalog, details. Gleamlight, 111-B8 North Columbus, Mount Vernon, N. Y.

SELL Decals, bumper signs. Top commissions. Box 2223, Paterson, New Jersey.

CHAMPION, AC, Autolite spark plugs. Reconditioned, guaranteed. Sells on eight service stations, garages, car lots. 100% profit. Free sample. City Motors, 2913-E Fannin, Houston 2, Texas.

SENSATIONAL! Make \$50.00 Day. Write for details. National Distributing, Dept. PM, 1751 W. Flagler Street, Miami 35, Fla.

TILE Agents wanted, sell floor and wall tile, sparetime. Chicago's largest tile wholesaler. Catalogue and samples upon request. Century Supply, 3005-P N. Austin, Chicago 34.

MEN, Women, make money spare time plus new car given to producers as bonus. Amazing hostery guaranteed to wear without holes, snag and runs, or replaced free. For example, lovely 60 gauge nylons, guaranteed for as long as 1½ years, or replaced free. Write Wilknit, 17811 Wash., Greenfield, Ohio.

\$1,000.00 A Month for making dramatic 3-second demonstration of amazing lightweight Presto fire extinguisher. New chemical used by Airforce snuffs out fires instantly. Only \$4.95. Terrific commissions. Millions want it. Free kit. Merlite, 114 E. 32nd, Dept. P-56R, New York City 16.

YOUR Own business! Automatic income! Amazing vitamin distribution plan. Free details. Aero Advertising, 1635 W. Bolivar, Milwaukee 15, Wis.

MONEYMAKERS. Hosiery, handbags, neckties, rugs, watches, typewriters, televisions. Simms, Warwick, N. Y.

DAMASCENE Earrings! Exotic orientalism. Huge profit. Ohga, PM124, Sigakokusatu, Japan.

SEEKING New products? Get my outfit 47 money-making specialties. Latest conveniences for home, car. Send no money. Just your name. Kristee 54, Akron, Ohio.

"GEM-16" Camera \$2.00. Free literature! Gem Corporation, CPOB 545, Tokyo.

SOMETHING New! Imported hand painted tile pictures in hand carved frame. Bullfight action, landscapes, typical Mexican scenes, exciting colors. Complete assortment. Free brochure. California Imports, 1436 Ellsmere, Los Angeles 19, Calif.

FREE Sample razor blade, from Germany. Revolutionary accomplishment. First time in U.S.A. Agents wanted. Paul Weil, Dept. B19, Box 157, New York City 31.

\$25 DAY, Easy. New fire extinguisher. Retail \$2.95. Profit \$2.00. Free sales kit. Edconco, 115 East 44th Street, Dept. P11, New York 17, New York.

FABULOUS Profits. Pictures of birds made with real feathers in breathtaking colors. Free brochure. California Imports, 1436 Ellsmere, Los Angeles 19, Calif.

ANTI-Fog sells in winter like hoops in summer! Remit \$1.00 today; sell profitable Anti-Fog tomorrow! Merix, 1021 East 55th Street, Chicago 15, Ill.

BEAUTIFUL Feather pictures! Free details. Sample 20¢ stamps. Apartado 1668, Mexico 1, D. F.

BIG Profits. Stamp social security plates, key protectors. Sample 50¢. Catalog free. General Products, 188-PM State, Albany 10, N. Y.

FABULOUS Profits with (exclusive) new "dooropener." "Measure Miser" dial changes recipe fractions for any number servings. Attractive. Every housewife needs! Trial sample: 3/\$1.00. Details free. Measure Miser, Dept. A, Box One, Dishman, Spokane 63, Washington.

BUY IT WHOLESALE

FREE Wholesale catalog! Christmas gifts, toys, appliances, etc. Big savings! Housewares Distributors, 1216-P West 79th Street, Chicago 20, Illinois.

UP To 70% off, nationally advertised merchandise, 106 page catalog, over 4,000 items, \$1.00. Refundable first order. Keystone Industries, 1311 Morse, Chicago 26, Illinois.

BUY Wholesale! 30-80% discounts! Nationally famous brands. Typewriters, housewares, appliances, watches, furniture, musical instruments, cameras, tools, etc. Consolidated Distributors, Clifton 3, New Jersey.

USED And new watches \$2 up. Free list. Southern Watches, 5-PM So. Wabash, Chicago 3.

BUY Wholesale! 100,000 nationally advertised products. Appliances, cameras, sporting goods, housewares, watches, typewriters, tools, clothing, etc. Discounts to 80%. Buy-Rite, Box 258, Hawthorne 4, New Jersey.

LARGEST Wholesale supply source in U.S.! Furniture, clothing, appliances, housewares, automobiles and accessories, tools, sporting goods, hobby supplies, farm equipment, imports, new products, bargain merchandise. Free details. Associated Wholesalers, Box 52-DD, Burlington, Iowa.

FREE Catalog—Including over 100 multi-color pages of appliances, luggage, jewelry, power tools, office equipment and giftwares. No deposit, no obligation. Write now for your free copy. The Supply Company, Box 150, North Manchester, Indiana.

LESS Than wholesale! Brand names! Catalog 25¢. Richeo Products, 2511B Prairie, Evanston, Illinois.

WHOLESALE! How to obtain over 100 free wholesale catalogs. Thousands nationally advertised products. Wholesale Buyers, Tegethoff Building, Clayton 5-PF, Missouri.

MEXICAN'S Leading manufacturers wholesale catalog of leather goods for gifts. 50¢. Imports, Box 287, Lebanon, Penna.

BUY Your TV and radio tubes wholesale. Send today for our latest free catalog of tubes, batteries, components. All top quality, all priced to save you plenty! Zalytron Tube Corp., 220 West 42nd Street, New York City.

HANDMADE Western boots. Wellingtons, jodhpurs. Free catalog. Western Saddlery, Box 7302A, El Paso, Texas.

BUY Wholesale! 25,000 nationally advertised products. Get amazing dealer catalogs. Complete details free. American Wholesalers, 1841C Levee, Dallas 7, Texas.

FREE Wholesale catalog. Durham & Renfro, 3707 Gaston, Dallas, Texas.

ACCORDIONS Wholesale! Save ½. Home trial. Free catalog. Accordion Warehouse, Dept. 118-RW, 2003 Chicago, Chicago 22.

BIG Multicolor wholesale catalog! Housewares, appliances, clothing, silverware, cookware, luggage, binoculars, shavers, radios, phonographs, cameras, projectors, recorders, typewriters, sewing machines, furniture, power tools, toys, sporting goods, watches, diamonds, jewelry, automobiles, etc. Name brands. Huge discounts. Postcard: Selbyco, Decatur 162, Illinois.

BULOVA, Benrus watches, men, ladies' like new. \$4.95 up. Folder, 200 illustrations, free. Cosmos, 81 E. 125th St., New York City, Dept. 142.

WHOLESALE! 30,000 Items! Big discounts! United Wholesalers, 1265-M Broadway, New York 1, N. Y.

ELECTRIC Guitars, amplifiers, wholesale. Free catalog. Carvin PMW, Covina, Calif.

SALESMEN—DISTRIBUTORS

BIG Moneymaking opportunity. Exclusive line uniforms, jackets, pants, shirts, coveralls, sportswear. Advertising embroidered. Every business prospect. Get selling outfit free! Master Co., Dept. H-09, Ligonier, Indiana.

IT Ain't sellin'—Just servicing! Take over your area as our service distributor keeping retail stores supplied. Nationally advertised 27-year old line pays you 66% mark-up. For samples and highly successful plan, write Novo, Inc., 1166-F Milwaukee, Chicago 22, Ill.

AD Match sales! Your own business, without investment! Sell for world's largest direct selling manufacturer of advertising matchbooks. Big spot cash commission. Start without experience. Our tested sales kit tells you where and how to get orders. Men, women, part or fulltime. Match Corporation of America, Dept. PM-107, Chicago 32.

GET New shirt outfit free. Make \$90.00 weekly on 5 average orders a day. Famous quality made-to-measure dress and sport shirts at \$3.95 up sell fast to all men. No experience needed. Full or part time. Write: Packard Shirt Co., Dept. 732, Terre Haute, Ind.

I'LL Show you how new shoe discoveries can pay you up to \$960 monthly on 8 easy orders a day! 230 unusual shoe, jacket styles! No investment, just rush postcard, receive free business outfit. Start spare time. Macon, Chippewa Falls, K-113, Wis.

JUST Invented, automatic perpetual calendar. Bargain advertising medium. Lawrence, 334 Kings Court, West Palm Beach, Florida.

MAKE Extra money. Cash commissions. Everybody buys easy-to-sell advertising book matches. Union label. All sizes. Cuts for all businesses. Powerhouse selling kit free. Steady repeat business. No experience necessary. Superior Match Co., Dept. M-1158, 7528 S. Greenwood, Chicago 19.

AMAZING Opportunity. New low priced fire alarm protects homes, farms, offices, factories, etc. No wiring, hangs like picture. Pays up to \$1,100 a month. Free kit. Merlite (Alarm Div.), 114 E. 32nd St., Dept. P-66R, New York 16, N. Y.

IF You're interested in making money in selling, see the hundreds of exceptional opportunities in Salesmen's Opportunity Magazine. Send name for your copy, absolutely free. Tell us what you're selling now. Opportunity, 848 N. Dearborn, Dept. 17, Chicago 10, Illinois.

WILL You wear new suits and topcoats without one penny cost and agree to show them to friends? You can make up to \$30.00 in a day even in spare time, without canvassing. W. Z. Gibson, Inc., 500 S. Throop St., Dept. G-626, Chicago 7, Ill.

\$1056 MONTHLY Selling kit of three sensational new products for cars, trucks, tractors. High repeat, nonseasonal. Free sales kit and details. Conklin, Inc., 5626 Nokomis Station, Minneapolis, Minnesota.

QUICK Cash—Selling hand painted portraits in living color. Excellent commissions! Write Portraits, 402-38 Hazlett, Baltimore 29, Maryland.

\$1,000.00 A Month for making dramatic 3-second demonstration of amazing lightweight Presto fire extinguisher. New chemical used by Airforce snuffs out fires instantly. Only \$4.95. Terrific commissions. Millions want it. Free kit. Merlite, 114 E. 32nd, Dept. P-66R, New York City 16.

MAKE Money! Take big profit orders, famous fruit trees. Including sensational discovery, Starkrimson Delicious apple! Also dwarfs, shrubs, roses, vines. Sales outfit free. Stark Bro's, Desk 30159, Louisiana, Missouri.

SELL "All" business forms. Excellent side line. Every office or shop a prospect. Salesbooks, register machines, continuous forms, snap-outs. Write: Associated Lithographers, Inc., 215 East Third Street, Des Moines 9, Iowa.

CALENDARS, Advertising novelties, matches. All styles, including religious, varnished. 12 sheet, girls. Hundreds of advertising novelties, book matches, etc. Fleming Calendar Co., Sales Division, 6539 Cottage Grove, Chicago 37, Ill.

100% PROFIT. Fast easy money! Take orders for Sweet Georgia Brown cosmetics. Colored people buy quick. Free sample. Valmor, Dept. MP, 2451 Michigan, Chicago 16.

EMPLOYMENT INFORMATION

SAN Francisco Sunday classified \$1.00. Box 697, Palo Alto, Calif.

JOBS Overseas! Janeczek Development Co., 1090 Hub Station, New York 55, N. Y.

COPYRIGHTED Reports. Best paying jobs with travel, adventure, promotions. Construction, aviation, shipping, oilfields, laborers, clerical, trades, supervisory, factory, unusual opportunities. Skilled, unskilled. Foreign, stateside. Men, women. Only \$2.00 (\$2.25 airmail) (c.o.d.'s accepted), including registration-advisory service. Satisfaction guaranteed. Included free: Special reports on Alaska, Venezuela, South American opportunities, husband and wife foreign jobs. Research Services, Suite 514-PM Meramec Building, St. Louis 5, Missouri.

FOREIGN Jobs—Latin America, Alaska, Canada, up to \$1500 monthly. Up-to-date 1958 foreign service directory gives complete information; hot list of firms hiring for military and civilian construction, aircraft, oil, exporters-importers, mining. How-when-where to apply. 11th successful year. \$1.00. Global Reports, Box 8873-S, Los Angeles 8, Calif.

FREE Information—U.S.A. overseas jobs. High pay, transportation. Futures Unlimited, Dept. M, 215 West 34th Street, New York City 1.

STEAMSHIP And yachting jobs traveling foreign countries. Davenport, 1354-A31, GPO New York 1, N. Y.

ALASKA—Complete job information. Weekly employment reports. Airmailed. \$1.00. Alaska Unlimited, Box 197, Ketchikan, Alaska.

AUSTRALIA! Trades needed. Latest information; employment, housing, assisted-passage scheme, \$2.00 to T. Weeks, 111 Domain Road, South Yarra, Melbourne.

ALASKA, Employment, living, travel. 5½ years' recent experience. Full information, \$1.00. Clark, 7724 Gaston, Ft. Worth 16, Texas.

MIAMI, Florida jobs plentiful. Classified ads \$1.00. Box 331, South Miami 43, Fla.

CHICAGO Jobs, classifieds \$1.00. GJC Service, 803 West Sheridan Road, Chicago 13, Illinois.

NEW York City! Latest want-ad section from leading newspaper. \$1.00. Brady, 30 Academy Lane, Oakdale, N. Y.

JOBS—High pay; U.S.A., So. America, the Islands. All trades. Many companies pay fare. Write Dept. 71J, National Employment Information, 1020 Broad, Newark, N. J.

ALASKA Hourly scale: Laborers \$4.16; truck drivers \$4.45; carpenters \$4.38; plumbers \$5.00; electricians \$5.00. Construction projects awarded over \$335,000,000. Names and addresses of companies hiring; total contract awarded; location; wage scale; also information regarding homesteading. Send \$1.00 to Alaska Employment Opportunities, Box 1032, Anchorage, Alaska.

MEN, Women, U.S.A., foreign jobs. High pay. Construction, clerical, etc. Transportation paid. Free information. International Reports, P.O. Box 621, San Jose, California.

FLORIDA Job opportunities in fast growing Sarasota. Sunday classifieds mailed. \$1.00. Box 4503, Sarasota, Florida.

FAST Growing Arizona! Job opportunities airmailed, \$2.00. Petersen, Box 11312, Phoenix.

CALIFORNIA! San Francisco, Los Angeles, San Diego; jobs, housing, business opportunities. 15 page booklet; state map included. Satisfaction or money refunded. \$1 postpaid. Chesley Distributors, 2339-M University Avenue, San Diego 4, California.

MIAMI Beach, Miami, job opportunities. Airmailed \$1.75. Chamar Service, Box 594, Hialeah, Fla.

FABULOUS Job and business opportunities in the largest metropolis in the world. For full listings send \$1.00. Stacey Bureau, Box 1289, New York 1, N. Y.

COMING To Florida? Send for complete report, jobs, salaries, cost of living. Information you need. \$2.00. Survey, 904 Chamber of Commerce Bl., Miami 32, Fla.

BOOMING Latin America! Mexico, Venezuela, Brazil, etc. Salaries over \$1,000.00 monthly U. S. tax exempt. All skills required. Direct information on opportunities, conditions, American companies employing. New report! Airmailed, \$3.00. Paul B. Smith, Apartado 172, Maracaibo, Venezuela.

\$10,000 ANNUALLY. Positions in printing industry. Details \$2. Harrell, P.O. Box 310, Hot Springs, Ark.

ENJOY Life—Work Miami. Complete current job listings air mailed upon request. Send \$1.00. Jobs, P.O. Box 34-931HH, Miami, Fla.

AMERICAN Overseas jobs. High pay, men, women. Transportation paid. Free information. Write Transworld, Dept. 8D, 200 West 34th St., New York City.

BIGGER, Uninterrupted income. Earnings-proven method shows, brings best jobs, rapid advancement, security. Free details. Valon, Box 9235, Chicago 90, Ill.

NOW Ready. Latest up to date world wide job listing of current jobs. Also the truth about the Alaska oil development. How to homestead government land. \$2 airmail. Alaska Opportunities, Box 768, Anchorage, Alaska.

SPECIAL SERVICES

SPEECHES, Information—Any subject. Reasonable. Ford, 16105 Delrey, Cleveland, Ohio.

RESEARCH, Dissertations, translations. College level. Experienced, reasonable. Aurea, Central Valley, New York.

PERSONALIZED Especially for you. Stationery, labels, jewelry. Free information. Miles Crafts, 630 Baychester Sta., New York 69, New York.

NEWSPAPERS. Any city 45¢, Sundays 75¢. Philippe Bernheim, Box 1362, Fall River, Mass.

INVESTIGATIONS—Private, confidential. Experienced personnel. Write Special Services, Box 439, Charleston, S. C.

INFORMATION On anything. Ferguson Research Specialists, 116-14 141 St., South Ozone Park 36, N. Y.

WHAT Do you want to find? If sold in U.S., or imported, we will locate best sources for you. Mandeville Source Finders, 405 Olympia Road, Pittsburgh 11, Penna.

EDUCATIONAL AND INSTRUCTION

ANALYZE Handwriting for profit, pleasure, self-understanding. TV, radio, newspaper columns, teaching, lecturing, court work, counseling. Men, women, spare time up to \$50 an hour. Amazing opportunities. Sample lesson free. Must be 21. IGAS, Inc., 44, Springfield 4, Missouri.

SING, Speak with power. Self-training records. Amazing! Canfield, 2018-A Fifth Avenue South, Minneapolis 4, Minnesota.

INTERNATIONAL Perpetual peace calendar 25¢. 334 Kings Court, West Palm Beach, Florida.

LEARN Old time fiddle playing, quickly, easily. Play for square dances. Complete course \$3.00. Satisfaction guaranteed. Old Time Fiddle, Mt. Marion 2, N.Y.

LEARN While asleep! Exciting details free. Research Association, Box 24-NN, Olympia, Washington.

BE An investigator. Write for free details. State age. National Detective Academy, Dept. P, P.O. Box 1082, Scottsdale, Arizona.

EARN Degree. Free bulletin. Homestudy only. Midwestern Bible School, 1060 Broadripple, Indianapolis.

STUDY To be a doctor of psychology, metaphysics, divinity or philosophy. Correspondence courses only. The Neotarian Fellowship, Desk 9, Kansas City 6, Mo.

STUDY For Doctor's degree of psychology, metaphysics and divinity. Correspondence courses only. College of Divine Metaphysics, Dept. P-M, 2811 North Illinois, Indianapolis 8, Indiana.

WE Pay \$3.50 lb. dried. Grow mushrooms. Cellar, shed and outdoors. Spare, full time, year round. We have 25,000 customers. Free book. Washington Mushroom Ind., Dept. 174, 2954 Admiral Way, Seattle, Wash.

HIGH School diploma at home. Licensed teachers—Approved materials. Southern States Academy, Box 5344-MX, Station E, Atlanta, Georgia.

BOOKKEEPERS! Increase your earnings! Operate your own simplified "Dollar-A-Week" bookkeeping and tax service. Pull or spare time. Details free. No obligation. Ellis, Box 200, Cedar Grove, North Carolina.

LEARN Appliance service and repair. Motors, washers, refrigeration, cleaners, everything. Free booklet. Armstrong, 11027-A South Vermont, Los Angeles 44.

BE A real estate broker. Study at home. Write for free book today. GI approved. Weaver School of Real Estate, 2018P Grand, Kansas City, Missouri.

USED Correspondence courses and books sold and rented. Money back guarantee. Catalog free. (Courses bought.) Lee Mountain, Pisgah, Alabama.

EARN While you learn. Auto and diesel mechanics master this top paying trade. Many graduates earn \$100 a week and up. Approved for Korean veterans. For free information write Dept. No. 250, Nashville Auto-Diesel College, Nashville 3, Tenn.

PHYSICAL Therapy and massage. Home training. Practice privately or work with doctors and hospitals. Free catalogue. National Institute, Desk 4, 159 E. Ontario, Chicago, Ill.

INVESTIGATOR Training. Phillips Secret Service System, 1917-B North Kenneth, Chicago 39.

EARN College degrees, correspondence. Metropolitan University, Box 86-M, Glendale 5, California.

WANT A diesel job? New opportunities to increase income. Higher pay. More money. We can help you qualify. Tools. Shop method home training. Write today! Diesel, Tractor, Heavy Equipment Division, Interstate Training Service, Dept. B-2, Portland 13, Oregon.

COLLEGE Correspondence courses, for Doctor of Psychology, Metaphysics, Divinity. Catalogue. Dr. Dorothy B. Arnheiter, Forest Park, Greenwood Lake, New York.

PIANO Tuning pays. Big money in spare time. Learn at home in 30 days. No musical knowledge necessary. Phonograph, records, tools and instructions furnished. Personal instructions available. Free catalog. Capital Piano Tuning School, 3160 S.W. 16th Court, Fort Lauderdale, Fla.

HOME Study. 32 vocational subjects. Low tuition. Free bulletin. Automet Study System, 2166 Market, San Francisco 14, Calif.

PIANO Tuning pays. Learned easily at home. GI approved. 59th year. Free booklet. Niles Bryant School, Dept. P, 3731 Stockton, Sacramento 20, Calif.

ENGINEERING Degrees earned through home study. Electronic, electrical, mechanical, civil, physics. When writing, specify course desired. Residence classes also available. Pacific International University, Colleges of Engineering, Physics, and Business Administration, 5719-B, Santa Monica Boulevard, Hollywood 38, Calif.

SWEDISH Massage. Home study, diploma. Dr. Swanson, Illinois licensed vocational school, 3809 Alta Vista Terrace, Chicago.

LEARN Physical therapy, massage. Diplomas, Drugless Therapy Institute, Fruitland, Idaho.

SECRET Investigation. Experience unnecessary. Investigators particulars free. George Wagner, M125 West 86th, New York 24.

LEARN Mineralogy and lapidary art at home. Diploma course. Earn big profits making costume jewelry. Free catalogue. Mineral Science Institute, Desk 2, 159 East Ontario, Chicago 11.

LEARN Arc, gas, heliarc welding spare time at home. Big pay trade. Easy practical training covers metallurgy, latest techniques, short cuts, metal repairs, etc. Free booklet. Write Utilities Engineering Institute, Dept. WC-18, 2523 Sheffield, Chicago 14.

LEARN Blueprint reading at home. Inquire your job. Higher income and advancement. Madison Technical School, 118 Merlham Drive, Dept. PM, Madison 5, Wisconsin.

OPERATE Local collection agency. Pays big! Free bulletin. Franklin Credit, Roanoke, Virginia.

MASTER Watchmaking at home. Free sample lesson. Chicago School, 2328-YL Milwaukee, Chicago 47.

ASTROLOGY—Palistry. Complete courses are offered on these subjects. For information write The Reno School, 1001 Glendale Blvd., Box 356, Los Angeles 26, Calif.

AUTO Mechanics earn big pay. Home training offered by not-for-profit organization. Free information for interested men. Write ATS-C7, 850 E. 58th, Chicago.

WELDERS Earn big money. Easy to learn arc, gas, automatic welding. New equipment, low cost training in non-profit school. GI approved, free booklet. Hobart Welding School, Box M1181, Troy, Ohio.

LEARN Fiction writing. Success guaranteed. Hutchison, 4304 Trueland, Fort Worth, Texas.

TOP Prices paid for used correspondence courses. C. B. Dudley, Athens, Ga.

LEARN Civil and criminal investigation at home. Earn steady good pay. Institute of Applied Science, 1920 Sunnyside, Dept. 168, Chicago 40, Ill.

COMPLETE Your high school at home in spare time with 61-year-old school. Texts furnished. No classes. Diploma. Information booklet free. American School, Dept. X845, Drexel at 58th, Chicago 37, Illinois.

"HOW To Train Horses"—A book everyone who likes horses or ponies should have. Free. No obligation. Simply address Beery School of Horsemanship, Dept. 11011-C, Pleasant Hill, Ohio.

BECOME Tax consultant. Licensed home training. Union Institute, Hoboken 2R, N. J.

PROFESSIONAL Investigators correspondence school. Badge, diploma, future. Box 41197, Los Angeles 41, Calif.

TRANSFORM Yourself via imagistics. Free amazing brochure. Box 2847 (H-11), Ocean Park, Calif.

AUCTIONEERING Pays big; write Western College of Auctioneering, Box 1458, Billings, Montana.

LEARN Faster using Modern Memory. Box 452, Petaluma, Calif. Details free.

MIDWEST Engineering School. Home study. Fifth big year. New streamlined courses. Reduced rates. 10923 Hillcrest, Hickman Mills 34, Missouri.

BOOKS, Free general catalog, 100 pages. Text, vocational, educational, instructional subjects. Millions of volumes, new and used. Bargain prices. Books bought. Est. 1902. Long's College Book Co., Dept. PM, Columbus 1, Ohio.

HELP Yourself to abundant living. Our courses have aided students to richer, fuller lives. Learn secret of contentment, happiness. Earn degrees Ps.D., Ms.D. Write for free book. College of Universal Truth Correspondence School, 23-C E. Jackson, Chicago.

LEARN How to cut hair at home. Photos, drawings and instructions guaranteed as advertised, \$2.00 postpaid. Carter, 8721 E. Garvey, So. San Gabriel, California.

ANNOUNCE For television. Earn more money. Study at home. Enjoy prestige, success, happiness. Unlimited opportunities for young and old. Write for free information today. Tel-Announcer, Studio 1L, 5408A Camp Bowie Blvd., Fort Worth 7, Texas.

ARE You interested in guiding your child? Are you having problems beyond your endurance? Is your child starting life the right way and you wish to keep him so? Why don't you correspond with us (gratis) or take our course (paid) on how to guide your child? Write to Rev. Dr. JVP Sarmiento, Colegio Divino Salvador, San Salvador, El Salvador, C. A.

GET Rich scientifically. Amazing proven technique. Guaranteed. Free aptitude test. Frederick Lane Associates, 7912 Curragh Avenue, Burnaby 1, British Columbia.

BE A real estate broker. Study at home. Send for free catalogue. Midwest School of Real Estate, 68 North Chicago Street, Joliet, Illinois.

PLAYS, STORIES, MANUSCRIPTS

WANTED: Book manuscripts, all subjects considered. Greenwich Book Pub., Atten. Mr. Zealand, 489 Fifth Ave., New York City.

WANT Your book published? Learn how we publish, advertise, promote, distribute. Many successes. Free booklet PM. Vanlage, 120 West 31, New York City. Midwest office: 220 S. Michigan Ave., Chicago, Ill.

ADVERTISING AGENCIES, LETTER WRITERS, FOR ADVERTISERS

FREE! 1958 Advertisers Rate and Data Directory. 52 pages! E. H. Brown Advertising Agency, 20 N. Wacker, Chicago 6.

ADVERTISING, Result-getting ads prepared, placed newspapers, magazines, radio, anywhere! Lowest rates. Catalogue free. Baker Advertising Agency, 189 W. Madison, Chicago 2.

"AMAZING New Book"—"Profits From Classified Advertising." Tells how and what to advertise. Be sure to read this book before you invest one cent in advertising. Write for your copy now. Just send 10¢ for postage and handling. W. Johnson, Classified Advertising Manager, 202 East Ontario Street, Chicago 11, Illinois.

MAILING Lists most any classification \$5.00 1000. Your circulars mailed with ours \$4.00 1000. Write for our literature. Dixie Mailers, King, N. C.

ADVERTISE: 24 Words, 100 Canadian newspapers \$5.50. Lists free. Advertising Bureau, 10511-C Springfield, Chicago 43.

NOW Ready: New, amazing Classified Advertising Record Book—prepared especially for classified advertisers. Here is a book that tells you instantly whether or not your advertising in any publication is paying you real results. You can tell immediately how many inquiries each publication produced—how much cash received from every ad. Spaces are provided for the name and address of the publication, date of issue, space used, rate, cost of ad, key number, etc. You have a complete record of each publication right before your eyes. Plenty of space to keep accurate record of 28 separate publications. You can have a copy by sending only 10¢ to cover postage and handling. Send for your copy now. W. P. Johnson, Classified Adv. Mgr., Popular Mechanics Magazine, 204 E. Ontario Street, Chicago 11, Illinois.

WRITER Specialist: Whether you need one letter, a three line ad, or a complete article it will pay you to place your problem in my hands. More than thirty years experience assure you the results you want at amazingly low cost. Write me today, outline your problem and you'll get a prompt, courteous reply. No obligation of course. Arthur King Goodman, 8629 Oriole, St. Louis 15, Mo.

ADVERTISING Ratebook leading newspapers, magazines, free. Chicago Advertising Agency, Chicago 4.

CARTOONING, COMMERCIAL ART, SHOWCARD & SIGN PAINTING, TATTOOING

LETTERING Pens, Linoprint tools. Free catalog. Bamberger Bros., P.O.B. 127, Cathedral Station, New York City 25.

YOU Can entertain with chalk talks. Catalog 10¢. Balda The Cartoonist, Oshkosh, Wis.

LEARN Sign painting at home. Free talent test. Ben Kerns, Box 812-PM, Greenville, S.C.

LEARN Sign painting with fascinating system. Straley, 410 S. Western, Springfield, Ohio.

PAINT Signs—Master die cut, outline letter patterns. Complete assortment 1½" to 12" high, prepaid \$2.00. Eyerly, 583, Newton, Iowa.

LEARN Profitable, fascinating tattooing. Illustrated information \$1. Zeis, 728-C Leslie, Rockford, Illinois.

"HOW To Make Money With Simple Cartoons." A book everyone who likes to draw should have. It is free; no obligation. Simply address Cartoonists' Exchange, Dept. 911-C, Pleasant Hill, Ohio.

RUBBER STAMPS AND OFFICE SUPPLIES

NEW! Rubber stamp catalog. Campbell, 14 Beaufort Circle, Springfield 4, Mass.

POCKET Stamps, 3 lines, \$1.00 postpaid. Self-inking, guaranteed. W.J.W. Specialty, 8464 Manhattan, Detroit 11, Michigan.

3 LINES \$1. Skips Rubber Stamp, 302 E. 9th, Big Spring, Tex.

FAST Quality service! 3 lines \$1.00. Indexed; guaranteed. Little By Little, 1201-P Riverside, Indianialantic, Florida.

POCKET Stamp, 3 lines, \$1.00. Nasberg, 1-B Blanchard Road, Monson, Maine.

ADVERTISE on a stamp. New! Details free. Michael O'Connor, Hastings, Minn.

TYPEWRITERS, DUPLICATORS, OFFICE DEVICES

RECONDITIONED Typewriters, duplicating, printing devices, \$25.00 up. Supplies. Appliances. DixieGraph, King, N. C.

PRINTING, MULTIGRAPHING, MIMEOGRAPHING, GUMMED LABELS

INEXPENSIVE Business printing, samples. Beecher Printing, 7495 Beecher Rd., Flint 4, Mich.

300 PRINTED 6 1/2 x 9 1/2 Catalog envelopes, \$5.00 postpaid. Schultheis, Box 449; Irwin, Penna.

FREE Catalog, better printing. Quick, reasonable. Innes Printing, 160 Alabama, Lexington, Ky.

100 8 1/2 x 11 LETTERHEADS Or 100 No. 10 envelopes \$1.25. A. Malack, 10530 Edbrooke, Chicago 28, Ill.

MIMEOGRAPH Like printing with photo stencils, inserts. Stencil-Pix, Box 72, White Plains, North Station, N. Y.

FREE Illustrated catalog postpaid printing. DM Press, Sebastopol, California.

2000 NAME And address labels \$1.50 in plastic box. Three lines only. Send \$1.50 with order to: A. Repensky, Box 1483, Grand Central Station, New York City 17.

1,000 BUSINESS Cards. Raised letters, \$3.50. Samples. Pioneer, Island Park PM-11, New York.

YOUR Name and address printed on gummed labels, 1000-3 lines \$1.00, 15¢ each extra line. 1/2 x 1 3/8. Print clearly. No c.o.d.'s. Addison Mail Order, PMA-11, 1840 Addison, Chicago 13.

NAME And address labels, 1 1/2 x 1 1/2", gummed, plastic boxed, 1000, \$1.00; 3000, \$2.00 (3 different names). Postpaid. Excellent Christmas gifts. Free catalog. Jane's, 900 S. 14, Longview, Texas.

BUSINESS Printing. Free price list, samples. Hickman Company, Coalgate, Oklahoma.

OFFSET, 1,000 8 1/2 x 11, \$4.75. Details. Alpine, Box 1151a, Los Altos, California.

FREE Unusual catalog. Business, personal printing. Instant service. Bariskill, 1715 Julian, El Cerrito, California.

100-8 1/2 x 11 LETTERHEADS \$2.00 Postpaid. Samples dime. R. Cook, (PM) 818 West Gift, Peoria, Illinois.

OFFSET Printing: 1,000, 8 1/2 x 11, \$5.50. Fast! Art, advertising, varityping, folding. Promotion-M11, 385 Broadway, New York City 13.

BUSINESS - Personal printing, labels, rubber stamps. Price list. Brose, Box 86-PM, Bergen Station, Jersey City 4, N. J.

MIMEOGRAPHING. Quality work, lowest prices! 1516 Sinaloa Road, Simi, Calif.

500 BUSINESS Cards free with order for 500 8 1/2 x 11 letterheads, 500 6 3/4 envelopes, \$10.95. Campbell's, Dept. D, Box 185, Arvada, Colorado.

BUSINESS Cards with glamour. Reasonable. Samples free. Heavener's, Colmar, Penna.

100 LETTERHEADS, 100 6 3/4 Envelopes \$2.00 postpaid. Spicher Printing, 1230 Church Street, Indiana, Pennsylvania.

EMBOSSSED Letterheads, envelopes, 100 each, \$3.00. Estimates, anything. Universal Arts, Scotch Plains, New Jersey.

1,000 EMBOSSSED Business cards \$3. Giant printing catalog free. Steinbergen, 1274J Stebbins, New York City 59.

CATALOGUES Printed 1 1/2¢ apiece, free price list. Copen Press, 105 Court Street, Brooklyn, N. Y.

500 ENVELOPES Printed, #6 3/4-\$3.50 postpaid. Statements same. Stanley Press, Lake Katrine, New York.

BUSINESS Printing. Samples. Prices free. Howprint, 723-G Eunice, Webster Groves 19, Missouri.

COLOR Mimeographing—Letters, price list, samples. A. M. Letter Shop, 2190 Harkins, Menlo Park 6, Calif.

ENVELOPES, Cards, letterheads. Low postpaid prices, samples. Press, Box 548, Mountain Home, Idaho.

MIMEOGRAPHING—Letters, pricelists, formulas, instructions. Lowest prices. Lem's Letter Shop, 5710 Stanton, Detroit 8.

1500 PERSONALIZED 3/8"x1 1/4" Labels \$1.00. Your 3 line name and address printed with blue ink on fine quality white gummed paper. Money back guarantee. Hamilton-Ward, Dept. 10B, Westfield, Mass.

ADS Running under this heading sell printing. Ask me for proof. I'll gladly send you amazing facts. Ask for Folder "P." F. W. Johnson, 200 E. Ontario St., Chicago 11, Ill.

OFFSET Printing: 24-hour service. \$6.75, 1000, 8 1/2 x 11. National Letter, 251 West 42 St., New York City 36.

100 LETTERHEADS (8 1/2 x 11 Watermarked) and 100 6 3/4 envelopes, printed carefully, \$2.00. Postpaid. Race Printers, Hudson, New York.

QUALITY Commercial printing. Reasonably priced. Samples. Porter Printing, 123 E. Robinson, Jackson, Michigan.

PRINTING OUTFITS AND SUPPLIES

TYPE Cases from manufacturer. Catalog. King McKay Company, 23179 Telegraph Road, Detroit 41, Michigan.

MAKE Your own self-molding rubber stamps and printing cuts. Plexirubber, Argyle 1, Wisconsin.

DO Your own printing. Save money. Simple rules. We supply everything. Print for others; good profit. Raised printing like engraving too. Have home shop. Details free. Kelsey Presses, V-11, Meriden, Connecticut.

PATENT ATTORNEYS

INVENTORS: Learn how to protect your invention. Unless the inventor is familiar with patent matters, he should engage a competent registered patent attorney or agent to represent him. We are registered to practice before the U. S. patent office and prepared to serve you in handling your patent matters. "Patent Guide for the Inventor" containing detailed information concerning patent protection and procedure with "Record of Invention" form will be forwarded to you upon request—without obligation. Clarence A. O'Brien & Harvey Jacobson, Registered Patent Attorneys, 81B-K District National Building, Washington, D. C.

C. A. Snow & Co.—M427, Snow Building, Washington 1, D. C. Registered Patent Attorneys. Write for information.

INVENTORS: Without obligation, write for information explaining the steps you should take to secure a patent. John Randolph, Registered Patent Attorney, 303 Victor Bldg., Washington 1, D. C.

"INVENTOR'S Guide" and "Record of Invention" free on request. Frank P. Ledermann, Registered Patent Attorney, 154 Nassau Street, New York City.

INVENTION Record form free and "Patent Information Every Inventor Should Have." Carl Miller, Registered Patent Attorney, Woolworth Building, New York.

INVENTORS—Take these preliminary steps toward patent protection. Sketch and describe your invention. Sign, date and have this disclosure witnessed by two people who understand your invention. Have us make a preliminary search among U.S. patents already granted for similar types of invention. We report on the probable patentability of your invention and recommend your further course of action. Write for our instructive booklet, "Patent Protection for Inventors" and convenient "Evidence of Invention" disclosure form. Victor J. Evans & Co., 431M Merlyn Building, Washington 6, D. C.

INVENTORS—If you believe that you have an invention, you should find out how to protect it. The firm of McMorrow, Berman & Davidson is qualified to take the necessary steps for you. Send for copy of our patent booklet "How to Protect Your Invention" and "Invention Record" form. No obligation. McMorrow, Berman & Davidson, Registered Patent Attorneys, 1343 Victor Building, Washington 1, D. C.

FOR INVENTORS

INVENTORS—Send for free Patent Information book and Inventor's Record. Registered Patent Attorney, Associate Examiner, Patent Office 1922-29, Patent Attorney & Advisor, Navy Department 1930-47. Gustave Miller, 118A Warner Building, Washington 4, D. C.

INVENTORS—This firm is registered to practice before the United States Patent Office and available to assist you in the preparation and prosecution of your patent application. "Patent Protection for Inventors" booklet containing detailed information and steps to take toward patent protection sent promptly upon request. No obligation. Victor J. Evans & Co., 432-M Merlyn Building, Washington 6, D. C.

INVENTORS—If you believe that you have an invention, you should find out how to protect it. The firm of McMorrow, Berman & Davidson is qualified to take the necessary steps for you. Send for copy of our patent booklet "How to Protect Your Invention" and "Invention Record" form. No obligation. McMorrow, Berman & Davidson, Registered Patent Attorneys, 1342 Victor Building, Washington 1, D. C.

PROTECT Your invention. Be safe! Save! File your own patent application. Foust, Box 647, Springfield 1, Missouri.

DRAWINGS Made for invention records, searches, patents. Free literature. Norvel Riggs, Box 3906, North Las Vegas, Nevada.

INVENTORS—Save high fees! Let me show you how to prepare and file your own application for U. S. patent. Everything ready to fill in and file. For free "Registration Form," write Miss Claire Arden, 806 Wm. Penn Annex, Philadelphia 5, Penna.

INVENTORS—Turn your talents into immediate cash! Join Inventors of America. Write National Headquarters, 3136-A Sylvania Avenue, Toledo 13, Ohio.

WE Have the markets if you have the ideas. Harvey Engineers, Cambridge 1, Maryland.

INVENTION Record form free and "Patent Information Every Inventor Should Have." Carl Miller, Registered Patent Attorney, Woolworth Building, New York.

INVENTORS. Don't sell your invention patented or unpatented until you receive our offer. Write Cowgill, Box 298, Marion, Ohio.

INVENTORS: Information on patent procedure furnished on request, without obligation. John Randolph, Registered Patent Attorney, 802 Victor Bldg., Washington 1, D. C.

INVENTORS: Test the commercial value of your patented or unpatented inventions, quickly and inexpensively. Write for free information. Institute of American Inventors, Dept. 40-B, 635-P St., N.W., Washington 4, D. C.

PATENT Searches \$6.00. 48-hour airmail service. Invention protection forms free. Write Patent Engineering Service, 711 14th Street N.W., Washington 5, D. C.

PATENT Searches, including copies of nearest patents, \$6.00. Reports airmailed within 48 hours. More than 100 registered patent attorneys use my service. For free invention protection forms, write Miss Ann Hastings, P.O. Box 176, Washington 4, D. C.

PATENT Searches \$6.00. 48-hour service. Free invention protection forms. Write Raymond L. Smith, Patent Searcher, 620 Sheraton Building, Washington 5, D. C.

INVENTIONS Pay inventors when profitable sales are certain from constructions soundly patented, and wise steps taken to reach the best markets. I help inventors to make the most profit with low definite fees for all services. Searches \$15. 30 years experience as patent-development engineer, U.S. and foreign patents secured. Joseph O'Brien, 132 Nassau Street, New York 38, N. Y.

INVENTORS: Learn how to protect your invention. Unless the inventor is familiar with patent matters, he should engage a competent registered patent attorney or agent to represent him. We are registered to practice before the U. S. Patent Office and prepared to serve you in handling your patent matters. "Patent Guide for the Inventor" containing detailed information concerning patent protection and procedure with "Record of Invention" form will be forwarded to you upon request—without obligation. Clarence A. O'Brien & Harvey Jacobson, Registered Patent Attorneys, 81A-K District National Building, Washington, D. C.

INVENTIONS WANTED

INVENTIONS Bought and sold. Write: Your I.D.E.A., Incorporated, Box 8627, Oklahoma City, Oklahoma. Bonded and licensed.

ARE You interested in offers from reliable manufacturers for your invention? Patented, unpatented. Harvey Engineers, Cambridge, Maryland.

INVENTORS, Don't sell your invention patented or unpatented until you receive our offer. Write Cowgill, Box 298, Marion, Ohio.

INVENTIONS Wanted: Patented, patent pending. 27 years experience promoting inventions. National Service Bureau, 3120 Meramec, St. Louis 18, Mo.

INVENTIONS Wanted now by my manufacturer-clients. Patented, unpatented. Write Gilbert Adams, Patent Broker, 80-S Wall Street, Financial District, New York City.

INVENTORS: Hundreds of manufacturers have requested our assistance in locating marketable new products. Complete information free. Institute of American Inventors, Dept. 40-D, 635-F St. N.W., Washington 4, D. C.

INVENTIONS Wanted. Patented; unpatented. Tremendous manufacturers lists. Global Marketing Service, 2420 77th, Oakland 5, California.

INVENTORS: If you have an invention for sale, patented or unpatented, write for free brochure outlining manufacturers' requirements, royalty rates. Kessler Corporation, 511-IW, Fremont, Ohio.

HAVE Your inventions produced and marketed in Australia and New Zealand. Prompt personal attention. Write, Rudd, Box 2305, Christchurch, New Zealand.

PATENTED And unpatented inventions sold on commission basis. Inventions, Box 292, Kansas City 41, Missouri.

SUPERIOR Promotions. Patented; unpatented inventions. Information booklet, free. Superior, 338-344 North Rodeo, Beverly Hills, Calif.

FREE—"Vital Information Every Inventor Needs Before Selling Invention." Brown, 141-A Broadway, New York City.

INVENTIONS Wanted for manufacturers. Free details. Write: Allen, Dept. C, 712 Davis Bldg., Dallas 2, Tex.

PATENTS FOR SALE

FOR Sale—Patent structure of the Eaton Roller & Mfg. Co. Principals only. Jean R. Peck, 300 North Meridian, Eaton, Ind.

MANUFACTURING

WANTED Manufacturer to make small molded plastic cover. Crescent City Electric, 4524 Dryades St., New Orleans, Louisiana.

KITS You assemble to your specifications. SunLong, Box 382, Lockport, N. Y.

NO Job too small. Experimental, high precision, models, parts, gauges, tools. Free estimate. Henry Herman, 350 Hewes Street, Brooklyn 11, N. Y.

TOOL And die making. Low cost precision work. Davis, Box 777, Phoenix, Ariz.

MODELS—Small lot manufacturing. Metals, plastics, etc. Milburn, Burlington, Kentucky.

MODELS, MODEL SUPPLIES

SEND For big 312-page hobbycraft catalog with thousands of hobby items. Planes, trains, boats, crafts. Send \$1 to Petey-Q Model Sales, 519-A Davis St., Evanston, Ill. \$1 refunded with first order of \$5 or more.

BALSA Wood and model aircraft. 40-page catalog 25¢. Sig Co., Montezuma, Iowa.

SHIP Models. Most complete line in New England. Kits, fittings, plans, books, tools, engines, motors. 1958 illustrated catalog 35¢. James Bliss & Co., Inc., Dept. SM, 342 Atlantic Ave., Boston 10, Mass.

SHIP And yacht model fittings; blueprints. Send 35¢ for illustrated catalog listing hundreds of items. A. J. Fisher, 1002-1 Etowah Ave., Royal Oak, Mich.

SHIP Model kits, fittings and plans including clippers, trawler, fishermen, frigates, privateer, etc. Towboat of 1900 for HO gauge \$3.95. 1958 catalog 25¢. Model Shipways, Box 85, Bogota, N. J.

LIONEL Trains. Big discounts. Bulletin free. Catalog 25¢. Mack Bros., 2043P Chicago Ave., Chicago 22.

NEW Rocket plans with illustrated catalog of tubes, nose cones, fuel materials, etc. 25¢ (refundable). Central Rocket Company, Waupaca, Wisconsin.

MINIATURE Engines: Gasoline and steam. Build them on your 8" or 9" lathe. Illustrated catalog, listing castings, blueprints, fittings, etc., only 15¢. Octura Models, Box 536-PM, Park Ridge, Illinois.

POWER Models. Unusual steam, gasoline and traction engines, fittings. Metal rods, sheet, tubes. Comprehensive catalog \$1.00. Chas. Cole, Ventura, Calif.

LIVE Steam model locomotive catalog 25¢. Friends Steam Models, Topsfield 1, Mass.

SCALE Model materials for building model homes and architectural buildings of any type, 1/4" and 1/8" scale. Send 25¢ for catalog. A & B Model Builders, 454 Donovan Road, Kansas City, Kansas.

MODEL Builders Cyclopedias—Missiles, rockets, railroads, airplanes, boats, crafts, guns, autos, tools, engines and parts. 310 fully illustrated pages. 25,000 items! National Sales, Box 143, DuBois, Penna.

HOME CRAFTSMEN

NEW Catalog of Shelburne Museum woodworking tool collection. 300 pictures. Send \$2.75. Shelburne Museum, Box 1, Shelburne, Vermont.

BUILD Solar cooker. Complete plans, details. \$3.00. Shelby Industries, Box 516-V, San Anselmo, California.

8 PIECE Furniture touch up kit. \$1.95 post paid. Hollyer, 82 Brigham Rd., Worcester 9, Mass.

KNOCKDOWN Cedar chests, also over fifty kits. Catalog 25¢. Giles Kendall Co., Huntsville 2, Alabama.

REDWOOD Patio table plans. \$1.00. Table, 5517 Fairdale, Houston, Texas.

120 JIGSAW Patterns plus alphabets \$1. Jigcraft, O'Fallon 511, Missouri.

NEW Big illustrated catalog. Supplies for leathercraft, metalcraft and numerous small inexpensive crafts. Prompt shipments. Top values. Latest ideas. Send 10¢ today to J. C. Larson Co., Dept. 8227, 820 S. Tripp, Chicago 24.

LEATHERCRAFT. Send 10¢ for new 102-page catalog of tools, supplies, kits, including metalcrafts, enameling, ceramics, all other crafts. Complete stock. Reasonable. Since 1910. Sax Bros., Dept. PM-11, 1111 N. 3rd, Milwaukee, Wis.

FREE Seashells catalog. Instruction book 35¢. Secor's, Bradenton, Florida W.

BUY Picture frame moldings at wholesale, actually less than cost of raw lumber. All styles and widths. Free delivery. Write for price list. Chesapeake Picture Frame Co., Box 533, Baltimore 3, Maryland.

101 PATTERNS Of smart gifts, novelties, shelves, action windmills plus "Make Money Jig Sawing." \$1.00. Mastercraft, 115M, 7041 Olcott, Chicago 31.

METAL Castings available first time for decoration, gifts, novelties, cookware. Materials furnished. "Do-it-yourself." Catalog 10¢. Art Metal Co., Dept. PM, 808-10th Ave. N., Nashville 4, Tenn.

WOODWORKING. Build remarkable line of kitchen play appliances for your children. Nothing like it on the market. Send \$1.00 for complete set of four plans. Pla-A-Way, 632 Brighton, Toledo 9, Ohio.

BUILD "Flexi-Trailer"—Anyone can do it easy! Use as box, flat, boat, or camping trailer. Converts in one minute! Complete plans \$4.50. Write for details. Outdoor Industries, R. 4, Excelsior, Minn.

WALNUT And cherry lumber, squares, etc. Send for new free price list. Midland Lumber Company, P.O. Box 124, St. Joseph, Mo.

SELECTED Philippine mahogany, shaped as per order. Repeco, Box 1979, Manila, Philippines.

WOODWORKING And cabinetmaking course for beginning and advanced home craftsmen. Only complete low-cost home training program available. Write for free booklet. Interstate Training Service, Dept. G-3, Portland 13, Ore.

2430 ARTIST-Drawn patterns, new catalog 10¢. Craftplans, 1322-A Wabash, Chicago 5.

GOLDPLATED Findings, imported rhinestones, all colors including Aurora Borealis, free catalog. Sextons, 416 Potomac, Buffalo 13, N. Y.

REMODEL Your own home. Save hundreds of dollars. New, amazing book shows you how. Written so you can understand it. Step by step instructions make it easy. Fully illustrated, 400 photographs, hundreds of diagrams. 160 pages. \$3.50. Literature 10¢. Popular Mechanics Press, 200-RH East Ontario St., Chicago 11, Ill.

GUITAR Making, books, plans, imported woods, tools. Free list. Store, 510 East 11th Street, New York 9, N. Y.

KNOCKDOWN Cedar chests and lumber. Free price list. Bedford Lumber Company, Shelbyville, Tennessee.

LEARN Art metalcraft and jewelry making. Complete, inexpensive, home training course now available. Special tools and materials furnished. Write for free booklet. Interstate Training Service, Dept. L-3, Portland 13, Oregon.

LEATHERCRAFT. Imported and domestic leather, tools, kits. Complete catalog 25¢. Midas, Box 1255, Dept. J8, Huntington Park, Calif.

HOME Workshop books. Send for 1958 book catalog—10¢. Popular Mechanics Press, 631 N. St. Clair St., Chicago 11.

FREE Leathercraft catalog. Quality kits, leathers, tools. Handicrafters, Box 427, Montrose, California.

STYLECRAFT "Pretraced" leather kits. Handbags, billfolds, filigree belts. Patterns on leather. Just carve, assemble and lace. "Precarved" kits also available. Send 25¢ for catalog, free folder. Refunded first order. Apache Leather Company, 2804 E. Washington St., Phoenix, Arizona.

DO IT YOURSELF

HOME Building cost estimator \$1.00. Dialaway, Box 3, Greendale Station, Worcester, Mass.

GRANDFATHER Clock movements, barometers, blueprints, kits. Wholesale catalog 25¢. Mason-Sullivan, Noroton, Conn.

WEASEL Parts. You build your snow tractor. Symington's, Union Bay Place, Seattle 5, Wash.

BLACK Forest pendulum clock kit \$3.50. Leroba Company, Vidor, Texas.

FREE Booklet on do-it-yourself termite control. Send stamp for postage to: Compass Research, 701-M Investment Building, Pittsburgh 22, Pennsylvania.

MODERNIZE Your kitchen by mail. Write: Varble's Originals, Harlingen, Texas.

BUILD Water softeners, automatics or manuals, for yourself and others. Save 50%. All parts and instructions furnished. Write for complete details. Premier, 1133 Manchester, South Bend, Ind.

MAKE Money building sewing cabinets and chest plans \$1.00. Write: Plans, 1610 W. 5th Street, Marshfield, Wis.

DANCING Learned at home. Audiostep records teach anyone. Cha Cha, Fox Trot, Waltz. Free brochure. Carter Dance Records, 635 South La Brea, Los Angeles, 36, Calif.

LIVING Picture shadow boxes. Plans 50¢. Woods, Wyoming 31, Penna.

CUT Gift costs! Give exciting balloon lamps, planters. Cast yourself, in minutes, for pennies! Send \$1.00 for instructions. Nomoid, 20330 Whitlock, Dearborn, Mich.

MOUNT Your own deer horns. Complete kit with instructions. Only \$5.95 prepaid. Conaways, Box 7261PM, San Antonio 10, Texas.

WATCHES, OLD GOLD, JEWELRY

FAST Cash for old gold, jewelry, diamonds. Mail articles or write for information. Right Refiners, 1600-A Heyworth Bldg., Chicago 2.

COSTUME Jewelry supplies, settings, rhinestones, etc. 84 page illustrated catalog. 25¢. Milady, Box 1328, G.P.O., New York City.

HIGHEST Cash for old gold, broken jewelry, gold teeth, watches, diamonds, silverware, spectacles, platinum, mercury. Free information. Rose Refiners, Heyworth Building, Chicago 3.

FREE Folder. New costume jewelry supplies. Modern Craft, Box 11088-R, St. Petersburg 33, Florida.

FREE Catalog. Costume jewelry parts. Supplies. Reasonable prices. Fast service. Guaranteed quality. Unique merchandise. Folsom's, Box 52, Medford 55, Mass.

WATCHMAKERS' — Jewelers' requirements: Correspondence courses, Catalog, surprise package \$1.00. Bengal, Culver City, California.

WATCH And clock repairing books. Free catalog. North American, 2320-AY Milwaukee, Chicago 47, Illinois.

GOLD, Silver, platinum, old jewelry, diamonds, watches, spectacles, wanted. Highest prices paid immediately. Information free. Wilmot's, 1067 W. Bridge, Grand Rapids 4, Michigan.

HIGHEST Cash paid for old gold, jewelry, gold teeth, diamonds, watches, silver. Mail articles today. Information free. Chicago Gold Refining Co., 6 E. Monroe, Dept. 858, Chicago 3.

EASY To make costume jewelry. Rhinestone kit including catalog \$1.00. Catalog only. 10¢. J & M Novelties, Dept. CM-3, Box 173, Broadview, Illinois.

SPORTSMAN Special. 17 Jewel watch. Waterproof, shockproof, sweep second hand, stainless back. \$13.95 postpaid. Satisfaction or refund. Wide World, Box 1336, Palm Springs, California.

WATCHMAKERS' Tools, materials, supplies, watches, Catalog. Gales, Box 1000, Chicago 90, Illinois.

DIAMONDS: Flawless, full cut, registered, mounted, discounted. Write House of Marshall, Lyons 41, New York.

FOR THE HOME

WORLD'S Smallest Bible 50¢. Three \$1.00. Brookman, 1025 Sutter Bldg., San Francisco 9, Calif.

NEW Design stops sticking toilet tank balls. \$1. Nocar, Box 22242, Houston 27, Texas.

OF INTEREST TO WOMEN

MAKE Big profits with your sewing machine. Literature free. Doswell-G. Box 2360, Norfolk 1, Virginia.

FREE—Big new wholesale catalog! Up to 50% saving for you, family, friends on nationally known gifts, jewelry, toys, appliances, Christmas cards, etc. Also make money selling part time! Write: Evergreen Studios, Box 846D, Chicago 42, Ill.

DRESSES 24¢; Shoes 39¢; men's suits \$4.95; trousers \$1.20. Better used clothing. Free catalog. Transworld 164-S Christopher, Brooklyn 12, N. Y.

SELL Fine fabrics. Get yours wholesale. Box 863, Norwalk, Conn.

WE Pay \$3.50 lb. dried. Grow mushrooms. Cellar, shed and outdoors. Spare, full time, year round. We have 25,000 customers. Free book. Washington Mushroom Ind., Dept. 176, 2954 Admiral Way, Seattle, Wash.

CAKE Decorating, chocolate dipping, professional candymaking, thrilling new home business, hobby. No experience necessary. Your kitchen brings you top money from weddings, birthdays, parties, banquets, all occasions. Learn spare time, your home, any age. Free facts. Candy & Cake, Dept. 165, Fallbrook, Calif.

SHOPPING Bag, knitted cord, fits into handbag, many uses, \$1.00. IFA, Box 3051, Santa Barbara, Calif.

60% PROFIT On cosmetics — Famous nationally advertised Hollywood cosmetics pay 60%. Make \$25 day up. Hire others. For free samples, details, write Studio Girl, Glendale, Calif. Dept. 12811G.

GOOD Money in weaving. Weave rugs at home for neighbors on \$89.50 Union loom. Thousands doing it. Booklet free. Carcraft Co., Polk St., Boonville, N. Y.

SAVE Money. Make your own cosmetics, proven formulas. \$1.00. 5517 Fairdale, Houston, Texas.

HAWAIIAN Type "Muu-Muu" dresses \$10. Please include your height measurement. Inez James, 86 Westlawn Avenue, Daly City, California.

EVERYBODY Likes hickory smoked hams and bacon. Make excellent gifts. Write Boyd's Ozark Mountain Hams, Dept. 3, Galena, Missouri.

RAISE Cash! Profit to 300%! Make, sell, artificial flowers, novelties, jewelry. Greeting cards, Bibles, books, etc. Wholesale catalog 10¢. Profitkrafts, 4508T38 Lorain, Cleveland 2, Ohio.

PERSONAL

LOANS By mail. Borrow \$50 to \$500 for any purpose. Employed men and women over 25, eligible. Confidential, no co-signers. Up to 2 years to repay. Low monthly payments. Supervised by Nebraska banking department. Loan application sent free in plain envelope. Give occupation. American Loan Plan, City National Bank, Dept. PM-11, Omaha 2, Nebraska.

FREE Bible helps. Postage appreciated. John Gizen, Prelate, Sask., Canada.

CENT-A-Day vitamins. America's greatest value. 365 tablets \$3.65. Save 200%. Cent-A-Day Vitamins, Abington, Penna.

BORROW Money by mail. \$100-\$600. Anywhere. Air mail service. Postal Finance, 200 Keeline Building, Dept. 658V, Omaha 2, Nebraska.

FREE Vitamin catalogue — Feel better, more vigorous, younger. Protect your health. Potent formulas, quality capsules, like doctors, hospitals buy. Buy direct, save! Vitacenter, Drawer 2318-P, Detroit 31.

BIBLE Questions answered. Stamped envelope. Bylon, 17167 Bentler, Detroit 19, Michigan.

"YOU Can find out!" Confidential information developed, any matter, person, anywhere. Officially licensed. Established 1922. Equitable Service Bureau, 15 Maiden Lane, New York City.

GAIN Self confidence, memory power, magnetic personality by recordings. Invisible Psychologist, Box 24-NN, Olympia, Washington.

ENJOY Health. Free booklet. Nutrition. 152-PM Kearny, San Francisco, Calif.

GET Out of debt without borrowing. Send \$1.00 for complete details. Valor Investment Co., 511 Locust, St. Louis 1, Missouri.

PAY Your bills now. Borrow \$100 to \$600 cash by mail. Easy, quick, private. Repay in small monthly installments over 20 months. Your payments may run 1/2 less than now; have money left over to spend. Loan order blank mailed free in plain envelope. Advise amount needed. State Finance Co., 323 Securities Bldg., Dept. E-1, Omaha 2, Nebr.

THIS is the answer to juvenile delinquency. Scheall, 263-P, Duluth, Minnesota.

FREE! Exciting details about living happy worry-free life in beautiful bargain paradises. Get away from jobs, jitters, debts and dullness. Whether you are eighteen or eighty live like a king on a shoestring. Wealth or savings unnecessary. Unusual methods of securing ample income anywhere revealed. Travel, relax, live luxuriously. Have villa, servants, etc. Lower than depression prices. Enjoy hunting, fishing, all sports and cultural pursuits. Lead leisurely contented life among friendly considerate people. Postcard brings free literature. Belmont Publications, Wyckoff 141, New Jersey.

REMAILING SERVICE

CHRISTMAS, Florida. Your Christmas cards mailed from there. \$1.00. Marcy, 201 Trismen, Winter Park, Florida.

REMAILING Receiving-forwarding address for rent. Details free. William McLaughlin, 800 Stewart, Columbus 6, Ohio.

DEPENDABLE Service, seven cents. Box 1746, Yuma, Ariz.

WORLDWIDE Personalized remailing-receiving-forwarding. Amazing rates! Intercontinental Courier Service, Box 3316-PM, San Francisco 19, Calif.

REMAILS 25¢. Monthly \$3. Rex Co., Box 5831, Baltimore 8, Maryland.

PANAMA Or Canal Zone remails 50¢. Reairmails \$1.00. Levin, P.O. Box 2942, Cristobal, C. Z.

REMAILING 25¢. Monthly \$2.00. OJC Service, 803 West Sheridan Road, Chicago 13, Illinois.

HOUSTON Remails 25¢. Monthly \$3.00. Remailing Services, Box 18114, Houston, Texas.

KETCHIKAN, Alaska re-mails 25¢. \$3.00 monthly. Classifieds \$1.00. Alaska Unlimited, Box 197, Ketchikan, Alaska.

MAIL Received-forwarded. \$3 month. Hedgpeth, Box 830, Alhambra 23, Calif.

HAVE Your Xmas cards postmarked from Santa. 25¢ each, 5 for \$1.00. H. Schwanz, St. Maries, Idaho.

TACOMA Remailing 25¢. \$3.00 month. Sund, 3602 Ferdinand, Tacoma 7, Wash.

NEW York City remails, 25¢. Mermelstein, Box 395, Times Square, New York City 36.

REMAILING, 25¢ Receiving, forwarding \$3.00 monthly. Los Angeles classified 50¢. Carter, 8721 E. Garvey, So. San Gabriel, California.

TEXAS Remails 25¢. Monthly rates. Smith, Box 448, Quanah, Texas.

REMAILS 25¢. Monthly \$3.00. Re-air-mails \$1.00. Laubscher, Box 77, Ladybrand, South Africa.

SAN Francisco confidential address \$2.00 monthly. Kent Remailing Service, Box 4606-11.

TREASURE FINDERS

FIND Buried treasure, gold and silver, with Goldak's sensational 3 1/2 lb. "find-it" locator, only \$64.50. Write for free literature on complete line of mineral, metal locators; Geiger and scintillation counters. Goldak, 1541 W. Glenoaks Blvd., Glendale, Calif.

TREASURE! Exciting handbook 25¢. Locators, Howe, 811 Kansas, Atchison, Kansas.

GOLD, Silver, metal detectors, Geiger counters, violites. Six new guaranteed models. None finer. Information free. Detectron, 5528 Vineland, North Hollywood, California.

NEW—Extremely light weight economical transistorized metal detectors. Waterproof search head. Kit or assembled models. Geiger counters and mineralights. Free literature. Electronic Applications, Dept. M, P.O. Box 8, Arlington, Virginia.

FOR SALE—MISCELLANEOUS

HEARING Aid batteries, wholesale. Free list. Habs, Box 51, York, Penna.

ILLUSTRATED Catalogue. Unusual gifts. 25¢. Myco, Dept. PM118, Runnemed, New Jersey.

GRAB-Bag, Miscellaneous lot purchased items of various values. Send \$2.00 to Grab-Bag, Box 161, Waco, Texas.

DECALS. U.S.A., V.P.W., Lions, Rotary, others. Box #504, Nyack, N. Y.

VITAMINS — Health products, bargain prices. Wandas, 6531 Euclid, Cleveland 3, Ohio.

VACUUM Cleaners. Latest canister and Rolleasy models. Not rebuilt. All famous makes. Prices start \$19.00. List free. Arlin, 5001 North Third, Philadelphia 20, Pennsylvania.

WANTED—MISCELLANEOUS

RARE—Unusual mail order items. Babcock, 412 Lulu, Wichita, Kansas.

QUICKSILVER, Platinum, silver, gold. Ores analyzed. Wholesale Terminal, Norwood, Mass.

SCRAP Mercury (quicksilver) containers supplied — Tantalum, tungsten, silver, platinum. Metallurgical Products Company, Established 1909, 35th & Moore Sts., Philadelphia 45, Penna.

MISCELLANEOUS

100,000 PRODUCTS Wholesale — Free catalog! Send postcard: Econ-O-Mart, Whippany 15, New Jersey.

BUY Wholesale! 100,000 nationally advertised products. Appliances, cameras, sporting goods, housewares, watches, typewriters, tools, clothing, etc. Discounts to 80%. Buy-Rite, Box 258, Hawthorne 2, New Jersey.

17J WATCHES \$10.00. Catalog 10¢. Southwestern Imports, 1306 South Darlington, Tulsa 12, Okla.

SUPER Memory overnight! Success guaranteed! Bijou, Box 1727-M, Hollywood 28, California.

RECEIVE Magazine samples, mails, catalogues, offers from everywhere. Get listed 25¢. Rorick, Cincinnati 28, Ohio.

BOOKS On antiques and their prices. Free circular! P. Warman Publishers, Uniontown, Penna.

CESSPOOLS, Septic tanks, clogged drains. How they function and how to keep them working. Free literature. Chemical Cesspool & Drain Cleaning Co., Boston 34, Mass.

HAND Painted, original, humorous Christmas cards. Top quality, new, distinctive. Eight all different, \$2.00, postpaid. Guaranteed as represented. R. D. Frost, 260 Vine St., San Jose, Calif.

WE Pay \$3.50 lb. dried. Grow mushrooms. Cellar, shed and outdoors. Spare, full time, year round. We have 25,000 customers. Free book. Washington Mushroom Ind., Dept. 175, 2954 Admiral Way, Seattle, Wash.

BUY Wholesale! 25,000 nationally advertised products. Get amazing dealer catalogs. Complete details free. American Wholesalers, 1841D Levee, Dallas 7, Texas.

YOUR Name wanted. We'll send 1000 publishers, mailers, wholesalers your name on our list one year 25¢. Dixie Mailers, King, N. C.

HOW To remodel, basement, attic. Booklet or book. Send for 1958 book catalog—10¢. Popular Mechanics Press, 633 N. St. Clair St., Chicago 11.

AMAZING! See your own brain? In 30 seconds, believe it or not, look inward instead of outward. Anyone with eyesight may do it. Be the center of interest with your friends. You can't believe it. Send only one dollar with return address, anywhere in U. S. or Canada. Offer limited. Hurry! Sykic See—by Arts & Metals, 73 East 7th St., Salt Lake City, Utah.

BIZARRE Fashions! Illustrated catalogue. \$1.00. René, Box 2804-R, Hollywood 28, Calif.

GIANT Tarantula, scorpion; \$2.00. Preserved. Dezso, 1465-PM Fern, Vista, Calif.

FREE Twelve skewers with book of 20 home-style Hawaiian recipes. Sent postpaid \$1. Jon Jay, Box 3521D, Toledo 8, Ohio.

I Plan paying for long education quickly. Will consider anything perilous, tedious, etc. 21 and single. Qualifications supplied. Norman Nikodym, 115 W. Blvd. N., Rapid City, S. D.

INTERESTING Mails—Your mailbox will be filled in the months ahead for only 25¢ coin. Get listed now. Paramount Malls, P.O. Box 308, Bethlehem, Penna.

GREETINGS Unlimited. Illustrated catalog \$1.00. E. Dorsey, 1215 E. Raymond, Indianapolis 3, Ind.

JAPAN: Buy direct. Catalogue, 24 pages. Kimonos, novelties, gifts, etc. Prices, mfrs.' list, business informations. Send \$1.00. Clarence Yamagata, 202 Naka 7 Bldg., Marunouchi, Tokyo.

MEMORY Lane perfume, atomizer. \$1.00. Bordeaux, Box 56, Buffalo 22, N. Y.

FREE! Exciting details about living happy worry-free life in beautiful bargain paradises. Get away from jobs, jitters, debts and dullness. Whether you are eighteen or eighty live like a king on a shoestring. Wealth or savings unnecessary. Unusual methods of securing ample income anywhere revealed. Travel, relax, live luxuriously. Have villa, servants, etc. Lower than depression prices. Enjoy hunting, fishing, all sports and cultural pursuits. Lead leisurely contented life among friendly considerate people. Postcard brings free literature. Belmont Publications, Wyckoff 142, New Jersey.

SELL! Buy! Trade! Read. "Trading Post Magazine" 25¢. Thorne's, 525-B Dewey, Jackson, Michigan.

PRENGOSI Stained glass ornaments. Quarter. Five, one dollar. Cinderella, Rye, Colorado.

WORLD'S Largest martin houses. 60 to 420 nests. Description 10¢. Martins, Box 77, Riverside, Ill.

SADDLES, Boots, Western wear, leather goods. Free catalog: Silver Spur, Box 1785-N27, Fort Worth, Texas.

LUMINOUS Name plate, 1 1/4" x 3 3/4", limit 15 letters, for car, home, office. \$1.50 postpaid. Satisfaction guaranteed or money back. Excellent Christmas gifts. Free catalog. Jane's, 900 S. 14, Longview, Texas.

ELECTRIC Spray guns. Formerly \$9.95. Now \$5.95 postpaid. The Landing Company, Whitestone 57, New York.

CIGARETTES—Improved roller makes 20 for 9¢. All types pipe tobaccos. Facts free. Moberly, Box 910, Owensboro, Ky.

WORLD'S Smallest Bible 50¢. Three \$1.00. Brookman, 1025 Sutter Bldg., San Francisco 9, Calif.

BEAUTIFUL Mexican feather picture folders made into Xmas cards. Sample 25¢. Lillart Co., Box 965, Scottsdale, Ariz.

RECEIVE Opportunity mails, free samples, moneymaking plans, offers. Year 25¢. Results guaranteed. Stankus, 5219 So. Artesian, Chicago 32, Illinois.

JOBBER'S Catalog. Key chains, balloons, 10¢ novelties. Burke Associates, Manchester, Mass.

GENUINE Four-leaf clovers! 5 for \$1. Jakiela, 2644-PC N. Western, Chicago 47.

TV Photo lamp. Cattle scenes 12x5 inches. Only \$4.95 prepaid. Conaways, Box 7261PM, San Antonio 10, Texas.

INVESTMENT Opportunities advertised. Complete classified section Las Vegas, Nevada, daily newspapers yours for \$1.00. Box 4282, Las Vegas, Nevada.

PERPETUAL Calendar tells day of week for any given date, \$1.00. Box 20900, Los Angeles.

FUNNY Cards, plenty of laughs, 25¢ per set. Stoddard, 4164 Byron, Chicago 41.

DYNAMIC! "Eight Steps to Greatest Power in the World!" Shows how author followed to achieve \$10,000.00 income at 24. \$15,000.00 at 26! Reveals eight basic steps for releasing "world's greatest power" in your life for abundance, happiness, success! Based on time-tested teachings! Practical! Inspiring! Different! Order your copy today! \$2.00 complete! Henry Marlowe, Publisher, 8815-A Gaston Parkway, Dallas 18, Texas.

LEARN WHILE YOU SLEEP!



Improve mind, body and personality with amazing new university-tested method. \$2.00 rushes 100 page fact-filled illustrated book of complete instructions. Satisfaction guaranteed. Free folder on request. Sleep-Learning Research Ass'n. Box 24-N Olympia, Wash.

GET INTO ELECTRONICS

V.T.I. training leads to success as technicians, field engineers, specialists in communications, guided missiles, computers, radar, automation. Basic & advanced courses in theory & laboratory. Assoc. degree in 29 mos. B.S. obtainable. ECPD accredited. G.I. approved. Graduates with major companies. Start Feb., Sept. Dorms, campus. H. S. graduate or equivalent. Catalog.

VALPARAISO TECHNICAL INSTITUTE
DEPT. D VALPARAISO, INDIANA

Become A --- BUILDING CONTRACTOR!

MAIL COUPON for FREE BROCHURE

Simplified home study training program. Learn every phase of building, estimating, contracting. Fortunes are made in this line of work every year. Use spare hours—no interference with present work. Diploma awarded. Low tuition rates.

AMERICAN TECHNICAL SOCIETY
Dept. BH-118, 850 E. 58th Street, Chicago 37, Ill.

Please send me your FREE Brochure and full details of your building, estimating and contracting training program.

Name _____ Age _____
Address _____
City _____ State _____



FREE

GIANT NEW 1959 B-A CATALOG



A COMPLETE BUYING GUIDE FOR EVERYTHING IN
RADIO TV ELECTRONICS
BA 1959
ANNUAL CATALOG 194
SINCE 1927

- 180 KING-SIZED PAGES
- EVERYTHING IN RADIO TV AND ELECTRONICS
- 100'S OF NEW ITEMS LISTED HERE FOR 1ST TIME
- 21 PAGES OF BARGAINS NOT IN ANY OTHER CATALOG

BURSTEIN-APPLEBEE CO.
Dept. PM, 1012 McGee St., Kansas City 6, Mo.
 Send Free 1959 B-A Catalog No. 591.

SEND FOR IT TODAY

Name _____
Address _____
City _____ State _____

For Ambitious Men

*Here's a plan for your
personal success*

Are You Searching for Success?

If you are a man in search of success, the next few reading moments may be among the most important of your life!

You want prestige, increased income, job security, an assured future. Everyone wants these things for they represent a better life.

And they can be yours. You can *earn* success. All you need to do is *take action*.

Success follows naturally from two steps, which are equally important:

1. **You must make the basic decision to succeed.**

If you are aware of the importance of making this decision, then you are well on your way to achieving success. You are far ahead of some people, who simply aren't willing to earn success. Really, they say, it's much easier to drift along in this old rut. It may not be a comfortable rut, but why change? We're getting by. Besides, we're "too busy" to make any extra effort.

The lives of thousands of successful men—those who have climbed out of the "rut"—show an amazingly similar pattern. They weren't satisfied—*so they made a decision*. In each man's life there was a moment—perhaps the same as this moment in yours—when he *decided to succeed*. From somewhere deep inside himself he drew an overwhelming determination. He *would* succeed. From that moment he focused all his energies in a single direction—to succeed in his chosen career.

In most cases, once he had made this all-important decision, he found that the sacrifices were small compared to the rewards. Indeed, most of these successful men found that there were no real sacrifices, that work toward their goal became *fun*, that every new step upward brought a new challenge.

But first they had to make the decision to succeed. Only you can make this basic decision for yourself. No one can make it for you. And it must be made without any reservations.

2. Once you've made this decision, only one thing remains to be done: **You must take action.**

The key to success is *action*. Only by do-

ing something can you succeed. The world is made up of many people who "get by" in their less-than-comfortable rut, and a few people who *perform* to lead the others. You can be one of these leaders.

What sort of action? Obviously the first step is to **train yourself for your career**. No one ever has enough training. It is a recognized phenomenon that the more training and education a person gets, the more eager he is to learn. Whether you dropped out of high school or earned a doctor's degree in college, the best action you can take toward your goal in life is to obtain still more intensive training.

What Success Can Mean

A BETTER JOB: The average American production worker uses more than \$12,000 worth of equipment in doing his job; the executive's responsibility runs into the millions. That's why employers are insisting on men adequately trained for the job. The trained man doesn't make costly mistakes.

GREATER SECURITY: U.S. Department of Labor statistics show that in times of recession, those men who have the least education and training, in general, are the ones that are laid off first. Highly trained men retain their jobs. The greater your training, the greater will be your security in your job.

FASTER PROMOTION: Automation is bringing about an increase in the number of skilled jobs. The men with sound basic educations will be promoted to fill them. Men with skills as a result of education and training are important. Employers are first to recognize this fact.

RAPID ADVANCEMENT in the Armed Forces: It costs up to \$8200 for the Armed Forces to train each specialist, and \$125,000 to train a jet pilot. Naturally men with strong educational backgrounds are selected.

PRESTIGE: The educated man is looked up to in his community. His opinions are sought. And his opinions are valuable because he has been educated. Such a man becomes a leader in his community.

GREATER INCOME: Department of Commerce figures show that the average high-school graduate can expect to make almost \$50,000 more during his life than the man who dropped out of school after the eighth grade. The college graduate can expect \$100,000 more than the high-school graduate.

Education Needed for Success

Education has always been the foundation upon which successful careers were built. In the past, of course, a man might be highly successful without formal education—but only because he educated himself.

In these days of rapid technological progress, education no longer is just important, *it is essential*. The speed of development in recent years is almost beyond comprehension. We not only are making progress at a phenomenal rate, but that rate is constantly accelerating.

To progress today, to achieve, to fulfill his goal in life, man must develop his capabilities to the utmost—he must become educated.

Each man has a choice. He can continue his education—no matter what his circumstances—to further his career. Or he can continue to “get by” in his less-than-comfortable rut.

Millions of successful men not only recognize the importance of education, but they have learned that the pursuit of knowledge is an adventure of the highest sort. Learning is downright fun.

Ask the successful chemist, who sees a strange new world in the reactions in his laboratory. Ask the mathematician, who sees the beauty of the universe in his figures. Ask the artist, who feels a kinship with the masters.

Or ask the young family man who, tired of the drudgery of an everyday job, studies a few hours each night to prepare himself for his job of the future. He knows that there's a challenge to learning, that each lesson can be an intellectual adventure of a sort he had never experienced before, that the process of learning is something to be savored and enjoyed late at night in the lonely but exciting presence of his own awakened mind.

Steps Toward Success

1. Decide on your goal. You may now be working in a particular field, and feel the need for increased training. You may want to switch fields completely. Examine your interests, your abilities. If you're mechanically inclined, maybe engineering is for you. Are you a radio ham? You may turn out to be an electronics technician. Make a study of various occupations. Compare your abilities and interests with the work involved. Then select your goal.

2. Study the school ads in this and subsequent issues of *Popular Mechanics*. The schools represented here are among the finest in the United States. They have

helped students succeed for generations. They offer complete educational programs, from basic high school courses and trade courses to post-graduate college courses.

3. Select a school, then enroll promptly. Here are some of the types of schools you should consider:

Vocational or trade schools. These institutions offer intensive training in specific skills and certain professions. They teach a student how to do a particular job well.

Technical institutes. These schools offer technical programs based upon the principles of science and engineering. They teach the logical processes to be used in solving problems, and provide intensive background knowledge. Programs of study are not usually as long as professional schools of engineering. Graduates of these schools frequently become engineering technicians, though they may also become professional engineers.

Correspondence schools. If circumstances don't permit you to study full time at a residence school, by all means consider home-study courses. More than 1½ million persons are taking home-study courses at this moment. Employers have been among the first to recognize the value of home-study courses. More than 5500 firms now have agreements with correspondence schools to train their personnel. You study when you have time, but your instructor gives you individual attention. You are in a class by yourself!

4. Write to Popular Mechanics for a free copy of our fact-filled career guidance book. **SKILLS FOR AMERICA** contains valuable details on over 35 occupations including educational requirements and employment outlook. Contents include information important to you in building your career. Address post card now to:

POPULAR MECHANICS MAGAZINE
Dept. SFA-62, 200 E. Ontario St., Chicago 11, Illinois

Ask for
free copy of
SKILLS FOR AMERICA

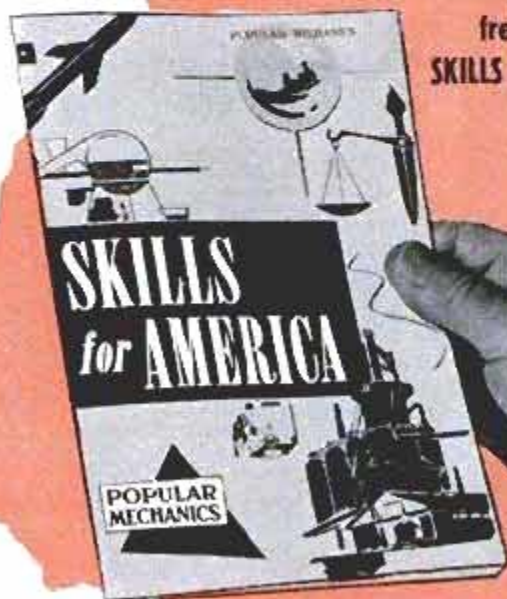

ENGINEERING Home Study Courses

CCOURSES written by world authorities in all branches of engineering. Step-by-step instructions using methods proved successful by thousands of our graduates. One hour each day in your spare time will start you off to higher pay, security, prestige. Check the course you are interested in and we will send you a complete outline of the course with a booklet describing the Institute and our advanced methods of teaching. Send to: Canadian Institute of Science and Technology Ltd., 696 Century Bldg., 412, 5th St. N.W. Wash., D.C.

Civil Eng.
Surveying
Architecture
Forestry
Mining
Structural
Mechanical Eng.
Industrial Eng. & Management
Refrigeration
Heating
Drafting
Plastics
Electrical Eng.
Radio
Electronics
Television
Aeronautical Eng.
Aircraft Engineer
Navigation
General Education
Chemical
Mathematics
Journalism
Accounting

NAME.....

ADDRESS.....

CITY..... STATE.....

Course Interested In.....

Canadians: Send to Canadian Institute of Science & Technology Limited, 696 Garden Bldg., 263 Adelaide St. West, Toronto, Ontario.

LEARN UPHOLSTERY

in your spare time
run your own
business
AT HOME



FREE BOOK WITH COURSE!

FREE BOOK
with sample lessons

with course

YOU MAKE
SLIPPER CHAIR



CLUB CHAIR



OTTOMAN

PLUS SLIP COVERS
Yours to Keep or Sell

BE YOUR OWN BOSS

Earn more from the start! Set up your own profitable business, in your own home, enjoy steady income, independence for life. You're in demand—in good times and bad—in the booming field of Custom Furniture Upholstery. Right off you start learning and earning with tools, complete frames, fabrics and materials, included **FREE** with practical UTS course. You learn skilled professional custom upholstery, re-upholstery, furniture finishing, repairs, how to make beautiful slip covers, window cornices, cushions and draperies. **EARN WHILE YOU LEARN**, in your sparetime **AT HOME**... the UTS easy way.

FREE ILLUSTRATED BOOK—FREE SAMPLE LESSON
Get ready for well-paid job and big profits, from steady work, as your own boss, running your own business. Mail coupon **NOW** for **FREE BOOK!** Training in N. Y. School also available.
APPROVED FOR VETERAN TRAINING

UPHOLSTERY TRADES SCHOOL
Dept. GS-310, 721 8'way, N. Y. 3, N. Y.
Please send me **FREE** book, "Your New Way to a Successful Career," and **FREE** sample lesson. No obligation—no salesman will call.
 Home Study N. Y. School Training

Name.....
(Please Print Plainly)
Address.....
City..... Zone..... State.....
 Check if Korean Veteran

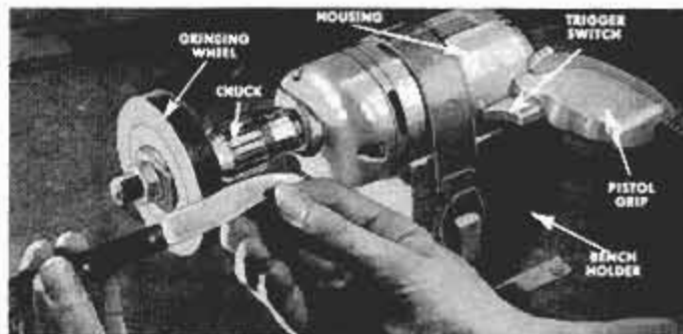

Illustration from *Getting Started with Power Tools*

Get the Most Out of Your Home Workshop! Add Many Dollars to the Value of Your Home!

It's Easy, Safe and Fun with these POPULAR MECHANICS TOOL BOOKS...



GETTING STARTED WITH POWER TOOLS

This brand-new Popular Mechanics book shows how to equip your shop with power tools and how to use your equipment to best advantage. Even with a few basic power tools you can make improvements to your home worth thousands of dollars... and have worlds of fun doing the job! Easy to understand text plus scores of illustrations enable even the novice home craftsman to choose the best power tools for his purpose and help him become an accomplished craftsman in a short time. Discusses every type of power tool as well as portable power tools. Tells how to lay out your shop for greatest efficiency. Stresses safety procedures that benefit the experienced operator. Added data on attachments for making your tools do multiple work.



60 POWER TOOLS and HOW TO BUILD THEM

It's a fact... using scrap metal, odds and ends of pipe fittings and other "useless" discarded materials you can assemble almost any kind of power or home workshop tool you may need... at a bare minimum of cost. This valuable book shows you how and gives you exact step-by-step instructions for assembly. A few of the 60 projects described include: a jig saw from an old sewing machine; drill press from pipe; another drill press from old auto parts; wood shaper from plywood and pipe; double-duty sander; scroll saw; thickness planer; multiple blade handsaws; power hacksaw; motorized hand planer; flexible belt sander and many more. In all, there are 340 explicit how-to-do-it pictures to make the job even easier.



HOW TO USE HAND TOOLS

Few people realize how many useful, money-saving functions even the basic, simplest hand tools can perform. With your hand tools properly guided, you can make countless home repairs. This book by Popular Mechanics editors is packed with important hand tool information. Learn the 30 basic hand tools and what to look for in choosing yours. You'll see exactly what each tool can do for you. Correct use is shown for handsaws, wood chisels, gouges, planes and scrapers; hammers, screw drivers, clamps, files, snips, etc. Additional chapters on ordering screws, nails, lumber... plus 17 interesting projects you can build with hand tools. This is an important book for the experienced as well as beginner home craftsman.



PLANNING YOUR HOME WORKSHOP

Probably no other book ever written contains so much practical and valuable information on home workshop layout and maintenance. This book shows you how to set up a shop on a limited budget; how to avoid costly mistakes by buying the right tools; what sizes and types to select for your own needs; the basic "big six" power tools; and what hand tools to buy for your workshop. Covers many good floor plans to suit available space and facilities. Includes a section on furniture building and other projects. Has more than 450 photos and 100 detailed scale drawings, many in color... includes a tool buying guide. Edited by Sam Brown, author of many books on the home workshop and advisor to power tool manufacturers, it will answer your problem with sound, experienced advice.

ONLY \$2.95 EACH

Hundreds of work hints, short cuts, safety tips to benefit the amateur and skilled craftsman alike. Satisfaction guaranteed or your money back. All books sent prepaid. Order now.



POPULAR MECHANICS PRESS
Dept. 1158, 200 E. Ontario St., Chicago 11, Ill.

RUSH book(s) I have checked below. If not pleased I can return in good order within seven days for full refund.

Remittance enclosed Send C.O.D.: U.S.A. only
 Getting Started with Power Tools 60 Power Tools
 Hand Tools Home Workshop

Name.....
Address.....
City..... Zone..... State.....

Get into... PLASTIC LAMINATING AT HOME!



THIS MAN...
... is taking out of the machine a Plastic Sealing Job — ordered by mail — only 11¢ in material cost brings back \$2.58 in cash by mail. Capacity of machine: \$28.00 profit per hour of operation.

Get **ORDERS** and **CASH** from your mailman—do work in **SPARE TIME** at home—or expand into **FULL TIME** business. Send coupon for Free facts about the newest and most fascinating of all home operated businesses. For the first time a simplified machine brings the fabulous profits of **Plastic Sealing and Plastic Laminating** within the reach of the small operator. Anyone can learn to operate the machine with a few minutes practice—then with our **Magic Mail Plan** can get mail orders pouring in daily with cash in every envelope. **No canvassing—no selling.** We even

Make up to \$5 an Hour.
MAGIC MAIL PLAN!

supply the circulars you mail to bring back cash and orders. Don't waste a minute. Rush your name. We'll send you **FREE** and postpaid, pictures, prices, details, and all the facts you need to start. Mail coupon or send name on postcard. No charge. Warner Electric Co., 1512 Jarvis Av., Dept. L-2-M, Chicago 26, Ill.

Make Thousands of Beautiful Art Creations
COSTUME JEWELRY • CIGARETTE BOXES
TRAYS • CANDLES/TICKS • COASTERS
LAMP BASES • BOOK ENDS...ALL IN
SPARKLING COLORED PLASTIC



WARNER ELECTRIC CO., 1512 Jarvis Av.
Dept. L-2-M, Chicago 26, Ill.
At no cost to me, please rush complete details postage prepaid. I am under no obligation.

Name _____
Address _____
City _____ Zone _____ State _____

Help Fight TB



Buy Christmas Seals

PEE WEE BATTERYLESS "LIFETIME" RADIO

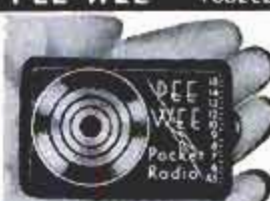

REALLY WORKS — FOR LIFE!

Works **WITHOUT TUBES, BATTERIES OR ELECTRICAL PLUG-INS.** Will never run down or burn out! World's smallest, **SMALLER THAN A PACK OF CIGARETTES!** GUARANTEED TO RECEIVE LOCAL RADIO STATIONS ANYTIME—ANYWHERE YOU GO! Sensational new Ferrite Selective Tuner—Ferro-Crystal diode, Super SPEAKER-PHONE, durable black and gold plastic case.

SEND ONLY \$2.00 (bill, ck, mo) and pay postman \$4.99 COD postage on arrival or send \$6.99 for postpaid delivery. **SENT COMPLETE READY TO LISTEN WITH LIFETIME GUARANTEE.** Nothing extra to buy—ever. Available only from: **MIDWAY COMPANY Dept. WPM-11 KEARNEY, NEBRASKA**

PROTECTS FURNITURE, CARS, APPLIANCES, ETC

2 GIANT PLASTIC SHEETS \$1

216 SQ. FT. IN ALL

Twice as much as others give you.

Others charge \$1.00 for **ONE** big 9 x 12-ft. size transparent, one-piece, no seam Plastic Cloth, but our price is only **\$1.00** for **TWO!** Tremendous number of uses—wonderful for covering cars, boats, bicycles, baby carriages, appliances, indoor or outdoor furniture, rugs, fans, air conditioners, tools, houseware, etc. Perfect for covering walls, floors, steps, furniture, when papering, painting, washing walls, etc. Make Aprons, Tablecloths, Auto Seat Covers, Furniture Slip Covers, etc. Cuts easily with scissors. Can be pieced or sealed together without sewing. Waterproof, greaseproof. Never needs washing or ironing—just wet and rinse. **STRONG** and tear-resistant. You **MUST** be thrilled, or money refunded! Send \$1.00 plus 25¢ for pstg. & hdlg. or \$1.25 in all for each **TWO** 9 x 12-ft. (216 sq. ft.) sheets. Order Now!

CAR COVER

FURNITURE COVER

STORM WINDOW

DROP CLOTH

PAYS FOR ITSELF ON WINTER'S FIRST COLD DAY

ZERO START

\$10.95
and up
COMPLETE

Head Bolt Heater

\$11.95
and up
COMPLETE

Tank Type Heater

\$4.95
COMPLETE

Dip Stick Heater

America's Quality-Known ENGINE HEATERS

- Guaranteed **FAST STARTS**
- Instant upper cylinder lubrication
- Immediate comfort
- Maximum gas mileage
- New car operation and efficiency.

Save hundreds of dollars in costly winter repair bills, towing bills, time losses... add years of "new engine" performance to your car. *Easy installation.*

There's a **ZERO-START Engine Heater** Tailored for your car... truck... or tractor

Ask your dealer or order from this ad:

PHILLIPS MANUFACTURING CO., INC.
2816 Aldrich Avenue South • Minneapolis, 8 Minnesota

L & M COMPANY
Dept. PL-60 • Box 881 • St. Louis, Mo.

free!

ALLIED'S
MONEY-
SAVING 1959

ELECTRONIC SUPPLY CATALOG

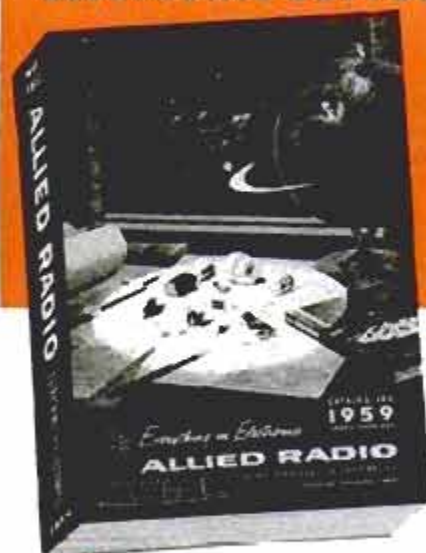

452
value-packed
pages

send for it!

SAVE

ON EVERYTHING
IN ELECTRONICS

EASY TERMS
AVAILABLE

WORLD'S LARGEST STOCKS

Here is the complete guide to everything in Electronics for Experimenters, Builders, Amateurs, Servicemen, Engineers and Hi-Fi enthusiasts:

- Amazing Build-Your-Own KNIGHT-KITS
- Everything in STEREO HI-FI
- Hi-Fi Music Systems & Components
- Recorders & Phono Equipment
- Public Address & Paging Systems
- TV Tubes, Antennas, Accessories
- Amateur Station Equipment
- Latest Test & Lab Instruments
- Industrial Electronic Supplies
- Parts, Tubes, Transistors, Tools & Books

SAVE on everything in Electronics at ALLIED—get fast, dependable service, expert personal help, guaranteed satisfaction. Send today for your FREE 1959 ALLIED Catalog.

Everything in Electronics
From One Reliable Source

OUR 38th YEAR

Send for
FREE
Catalog

ALLIED RADIO

- ALLIED RADIO, CORP., Dept. 5-L8
- 100 N. Western Ave., Chicago 80, Ill.
- Rush FREE 1959 ALLIED 452-Page Catalog

Name _____

Address _____

City _____ Zone _____ State _____

WHERE-TO-BUY-IT INDEX

AVIATION

- Plane tilts wing to take off, land (Vertol Aircraft Corp., Morton, Pa.) 105
- "Roman" radio helmet for jet plane handlers shuts out noise 121
- Navy fighter goes into combat at more than 1500 m.p.h. 127
- Dummies are "fall guys" for pilot bailout tests (North American Aviation, Inc., Los Angeles 45, Calif.) 130
- Tiny engine blades "rolled and coined" (General Electric, Schenectady 5, N. Y.) 150

AUTOMOTIVE

- Balance weights hidden by hubcap (General Supply Co., 1920 McGee Trafficway, Kansas City, Mo.) 97
- Tire valve indicator tells if pressure is low (Frebank Co., 711 W. Broadway, Glendale 4, Calif.) 127
- Wind-resistant tarpaulin fastens to track on side of truck (Shultz Mfg. Co., Inc., 801 Dakota, Wahpeton, N. D.) 136
- Plane passengers' ramp mounted on small truck (Bil-Jax, Inc., Archbold, Ohio) 144
- Wind-up automobile clock set into horn button 150

BOATING AND FISHING

- Anglers find fish by listening to their "conversation" (Engineering Research Corp., Linwood at Dalzell, Shreveport, La.) 105
- Unmanned boats moored in Pacific gather data on tuna 130
- Single-lever control for outboard motor (West Bend Aluminum Co., Hartford, Wis.) 244

FARMING

- Farmer builds own rotary cutter and hay dryer from scrap auto parts 131
- Self-propelled baler gives operator top view of work (New Holland Machine Co., New Holland, Pa.) 144
- Feed mill on wheels grinds and blends grains on the farm (Daffin Mfg. Co., Lancaster, Pa.) 155

MISCELLANEOUS

- Harmonica works like player piano (Johnson Smith Co., 6615 E. Jefferson, Detroit 7, Mich.) 78
- Safety fan vents fumes (Tru-Scale, Inc., 254 Laura, Wichita, Kans.) 116
- Antique clock replicas assembled from kits (Rarewood Craft Kit Co., Palatine, Ill.) 121
- Milady deftly changes costume inside umbrella 122
- Plastic house built in Japan 123
- Danish eggs dated to insure freshness 123
- Aluminum siding for houses has plastic-foam backing (Siding Div., Alisco, Inc., Akron, Ohio) 131
- Ball-point pen has built-in light (Silver Bells Ltd., P. O. Box 982, Carmel, Calif.) 131
- German "ski pony" gives fast ride 136
- 4000 letters handled in hour (Pitney-Bowes, Inc., Stamford, Conn.) 136
- Power unit on wheels substitutes for permanent substation 137
- Awning-type storm sash opens with window (Storm Window Div., Alisco, Inc., Akron, Ohio) 137
- Italy's pots-and-pans band 143
- Firefighters use combination stretcher and ladder 151
- Air-conditioning, electric lights and veranda: It's a dog's life 156
- Hydrofoil experiments aim for one-day ocean crossing 156
- Radar traps get better 262

ROCKETS AND MISSILES

- Foot soldiers get big boost from rocket-powered jump belts (Reaction Motors Div., Thiokol Chemical Corp., Danville, N. J.) 97
- Centrifuge tests reactions to rocket flight (Knlep Associates, Grist Mill Rd., R. D. 1, Dover, N. J.) 116
- Model rockets probe space mysteries 117
- Eight-jet missile bomber can span oceans and return without refueling 117
- Missile poses for photo as it re-enters atmosphere 145

PHOTOGRAPHY

- Experimental photo flashbulbs carry "battery" in metal base 131
- "Sunglasses" for camera eliminate reflections (Enteco Industries Inc., 610 Kosciusko, Brooklyn 21, N. Y.) 137
- Heat takes place of darkroom (Charles Beseler Co., East Orange, N. J.) 155
- Cellophane-lined cardboard box is temporary developing tray 193

SCIENCE

- Effect of fallout on food varies with rainfall 78
- Telegraph transmitter operates automatically (Western Union, 60 Hudson St., New York City 13) 127
- Chemical sets crease in wool 127
- Rubberlike metal crystal is rigid digit when heated 130

(Continued to page 76)

41 SPECIAL TWIST DRILLS \$2.00

ppd



Genuine, Hi-Grade, Carbon Tool Steel Hardened, Brand-New

Less Than 5c Ea.

FOR HAND OR ELECTRIC DRILL:

Hobbyists! Homeowners! Carpenters! Here's a terrific opportunity to get 41 brand-new, carbon tool-steel twist drills for less than 5c each! Sells for up to \$6 in stores . . . but all 41 yours for only \$2 on this unusual offer. You get about 5 each of all most-used sizes from needle-sizes 1/16" up to and including 1/4". Use with hand or electric drills. Tempered cutting edges easily bite through steel, aluminum, iron, wood or plastic. Each drill hardened and designed to give many drillings. Precision made! Imported! To insure getting yours via return mail . . . ORDER TODAY!

DRILLS AND SAWS ANY SHAPE!

Supreme DRILSAW



\$1.00
ppd

Simply insert the amazing Drilsaw into the chuck of your 1/4" electric drill and you're ready to cut any shape you desire. Lower portion of Drilsaw acts as regular 1/4" drill which easily bores thru wood, plaster, plastics, plywood and similar materials. Then, after penetration, the multiple keen cutting edges of the Drilsaw cleanly and speedily cut in any direction you move. Cut circles, triangles, zig-zags, any conceivable shape you wish—in seconds!

Send Check or Money Order. If COD, fees extra.

MONEY BACK GUARANTEE

SCOTT MITCHELL HOUSE, INC. Dept. F-11, 415 So. Broadway, Yonkers, N.Y., Greenleaf 6-3900

150X POCKET MICROSCOPE



Scientifically made this amazing pocket microscope magnifies 150 times. Explore the micro-world of plants, animals, minerals. Complete with 2 prepared slides, extra slides, tubes for liquid specimens and light concentrator. We guarantee your satisfaction. \$1.50 Ppd. Supply limited. J. D. Clinton, 35 N. Broadway, Mt. Clemens 2, Mich.

POWER TOOLS MAKE YOUR WORK EASY

MECHANICAL PENCIL CALCULATOR

NEW INVENTION



MATH-WIZ pencil calculator gives answers to unlimited addition, subtraction, basic multiplication and square root (up to 10M) problems. (Indirect division.) Easy to operate. Comes in gold anodized sturdy aluminum casing. Unique Xmas gift for young and old alike. Only \$2.95. NO COD. JACK WEISER, Dept. 1, 1233 S. Fairfax Ave., Los Angeles 19, Calif.

Not a Slide Rule

Kits for Christmas! GENIAC COMPUTER KIT

You can construct over 125 different circuits and machines that compute, reason, solve puzzles and demonstrate a wide variety of basic computer circuits with the GENIAC® electric brain construction kit. Thousands of schools, colleges, industrial firms and private individuals have bought GENIACS since we first brought them on the market.



GENIAC set up to do a problem in check valve research

We have recently added a circuit for composing music, which gives us special pleasure because it was designed by a 16 year old boy who learned about computers from his GENIAC®. Dozens of other youngsters have created their own designs for computing circuits, used GENIACS in their school projects and established a solid foundation of information on computers with GENIACS.

Each kit comes complete with Beginners Manual, Study Guide, instructions for building all the machines and circuits, rack (exclusive with our GENIAC), parts tray, and our complete question answering service. When you buy a GENIAC you are buying a first course in computer operation.

Each kit comes with a one week money back guarantee if you are not satisfied.

Price of Kit complete with parts tray, rack, all components, manuals and texts \$19.95 (postpaid in U. S., add 80c west of Mississippi). (\$2.00 outside United States.)

SCIENCE RESEARCH KITS, INC., Dept. PM-118, 108 E. 16th St. New York 3, N. Y.

TURN CONCRETE INTO GOLD



You've seen them all over the country—concrete bird baths, garden seats, flower boxes, appealing statuary, and many other items that add charm around the house and lawn. They're made by enterprising people, just like you, from our COPYRIGHTED ALUMINUM MOLDS. It's easy. It's fun. It's profitable.

Send \$2.00 today for this 82-page "How to" book, 20 pages of clear instructions. Valuable trade secrets. Over 250 items beautifully pictured (with description, dimensions, and price of molds). Rushed to you by first class mail. CONCRETE MACHINERY CO., INC. HICKORY 3, NORTH CAROLINA

Name _____
Address _____

**HOW TO
TURN
CONCRETE
INTO
GOLD**

FEET TIRE, ACHE, PAIN?

These symptoms are nearly always traceable to weak, fallen arches or flatfoot. With exercise and the proper Dr. Scholl Arch Support for that condition, you'll have quick relief and enjoy real walking ease again.

Thin, light, flexible. \$1.50 pair, up.

Expertly fitted at Shoe, Dept. Stores and Dr. Scholl's Foot Comfort® Shops.

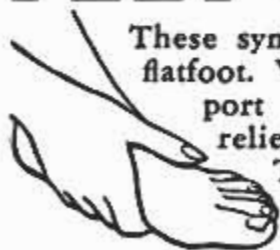

Dr. Scholl's ARCH SUPPORTS

There is a Dr. Scholl Foot Comfort® Appliance or Remedy for Every Common Foot Trouble
NOVEMBER 1958

If You Want To STOP SMOKING

Airline Pilot Tells How!



Roger Don Rae is a senior pilot for TWA. He says: "Bantron allowed me to stop smoking without noticing it. Today I am free of the habit. I tell all my friends who want to stop smoking—try Bantron!"

Here at last is a safe, new product, developed at a great American University, that has helped thousands stop smoking. In a series of clinical tests, published in a leading Medical Journal*, scientists reported that 4 out of 5 men and women who wanted to quit smoking stopped within 5 days when they took Bantron.

And the Bantron way is so easy and pleasant! Just take 3 Bantron tablets a day, after meals, for four days. Then only 2 a day until all desire to smoke leaves you. 80% are "Free" in 5 to 10 days.

Taken as directed Bantron is perfectly safe. It acts as a substitute for the nicotine in your system which gives you a craving for tobacco. Now at drug stores without prescription. Price \$1.25.

Bantron

BRAND

Smoking Deterrent Tablets
A Campana Product

*Copies available to doctors on request.



The Foley Saw Retoucher cuts perfect new teeth right over old ones in less than 1 minute, without removing saw handle. Makes filing easy. Takes all hand saws 4 to 16 points per inch. Relieves eye-strain. No experience needed.

FREE Foley Price Guide of saw sharpening charges. A valuable chart of actual prices. Send coupon today. No salesman will call.

FOLEY MFG. CO. 1170-B FOLEY BLDG.
MINNEAPOLIS 10, MINN.
Send FREE Price Guide and Foley Retoucher circular.

Name _____

Address _____

(Continued from page 74)

Antibiotic sweaters to have treated fibers.....	130
Earth's magnetic field "erased" for ore studies.....	144
Sand fibers may be used to build spaceships.....	150
Extra-high-voltage system scheduled to transmit 750,000 volts.....	151
"Sea power" generates electricity in Japan.....	155
Small artificial heart fits inside body.....	236
Tiny electronic tube in laboratory stage.....	256
How fast is g?.....	258

Craftsman and Shop Notes Index

AUTOMOTIVE

New spark plug burns hotter and cleaner at low speeds.....	163
Ignition key concealed on car kept clean by foil wrapping.....	188
Emergency ignition repair.....	216

HOUSE AND HOME

Removing wall stud.....	163
Lamp table.....	164
Free-form coffee table.....	167
Household cement repairs damaged spots in pile fabrics.....	185
Brass switch plates renewed with sheet-plastic material.....	185
Paint roller stored in milk carton.....	185
Glamorize your Christmas candles.....	186

MISCELLANEOUS

Pendant on slide fastener permits grasping with glove.....	163
Bicycle horn warns customers of service-cart approach.....	188
Christmas-tree ornaments from used flash bulbs.....	188
"Traveling" crib and playpen.....	189
Hardboard template is handy drawing aid.....	192
Practical supports act to level house trailer.....	192
Metal tread for threshold.....	193
Ship-model mountings from drawer pulls.....	213
U-clamp latch holds double gate rigidly together.....	216
Side door on machine shed eases storage problem.....	216

PHOTOGRAPHY

Pretreated photo sponges absorb water readily.....	166
Square or round shadow cast by print-dodging tool.....	166
Emergency retouching frisket made with rubber cement.....	166
Meter and filters carried along with your camera case.....	166

SHOPPING FOR TOOLS

Manually operated bender.....	218
Drill bit is carbide-tipped.....	218
Contour scriber.....	218
Tube cutter.....	218
Adjustable motor base.....	218
Aluminum solder.....	218
Heavy-duty chain vise.....	218
Milling attachment for mounting on lathes.....	218
Ball-bearing lathe center.....	218
Optical gauge.....	220
Counterbore screw.....	220
Speed converter.....	220
Portable masonry saw.....	220
Shaft-mounted speed reducers.....	220

SOLVING HOME PROBLEMS

Wobbly table can be leveled.....	174
Short of hanger space?.....	174
Stamps kept handy.....	174
Mop and pail help control leaf fires.....	174
Stand umbrella upright in closet.....	174
Handy place to keep scissors.....	174
Coat hooks made decorative.....	174
Hanging a large picture made easy.....	174
Glass marble ideal darning egg for mending gloves.....	174

WORKSHOP HINTS

Breaking sharp edges.....	163
Steel dowels locked securely by upsetting metal in notch.....	163
Hand tapper is adjustable for working at an angle.....	176
"Safe" edge on regular file.....	176
Keeping loose caster in place.....	176
Accurate tenons cut on dowels with this simple jig.....	176
Glass cutter used as tracing tool for copperwork.....	185
Metal strip secures screw in oversize hole.....	188
Extension on cement tube reaches difficult places.....	188
Sample holes in hardboard facilitate bit selection.....	196
Knife sharpener is handy tool for deburring sheet metal.....	196
Steel angles drilled with aid of V-blocks.....	213
Work supported for saber saw.....	213
Auxiliary tank for grindstone.....	216
Bench jointer from a rasp.....	217
Adjustable depth stop controls spotfacing cut.....	217
Tapered wedge steadies lathe toolholder.....	217

NOTICE—It is the intention of this magazine to provide its readers with information regarding the latest developments in the mechanical arts. Except where otherwise indicated, this magazine has no information as to any unexpired patents in respect of the developments reported herein. In the event that commercial use is to be made of any of the developments reported herein, it is suggested that legal counsel be consulted to avoid liability for patent infringement. It is not the purpose of this magazine to encourage patent infringement but, as indicated, it is the intention of this magazine to report on the latest developments in the mechanical arts.



Every \$1 sends a 22 lb. Food Crusade package to the world's hungry thru CARE, New York 16

PORTABLE BATTERYLESS RADIO SET \$4.98

NEW MIDGET PORTABLE RADIO \$4.95 as small as a pack of cigarettes. Gives amazingly clear reception. No tubes, no batteries, ready to operate. Nothing to replace, just connect to any ground, nothing to plug in! Operates indefinitely! Includes Hearing aid type earphone. Weighs only 4 ounces. Uses Germanium Crystal Diode principle. You get a Lifetime Written Guarantee! Listen to music, weather reports, news, sports, etc., while in bed without disturbing anyone. Give as gifts to bed-ridden patients. Money Back Guarantee! Send \$4.95 cash, check or M.O. to Diode Co., Dept. 60, 403 Market St., Newark, N. J.



FREE AMAZING NEW BOOK "HOW TO ANSWER ADS"

how to answer ads

Never before have you seen anything like this. Tells you in simple language the correct way to answer ads. Gets you quicker replies—better results, and greater satisfaction. Will save you time and money and it's ABSOLUTELY FREE. No obligation whatever. Every reader of advertising should have this booklet. Send a postcard for your copy NOW. F. W. JOHNSON, Popular Mechanics Magazine, Room 600-A, 204 East Ontario Street, Chicago 11, Ill.

ENGINEERING DEGREE IN 27 MONTHS

B. S. DEGREE IN

Aeronautical, Chemical, Civil, Electrical, Mechanical and Electronic Engineering (inc. Radio and TV)

Also B.S. DEGREE in 36 mo. in Mathematics, Chemistry, Physics (inc. Nuclear Physics). Engineering Science prep. courses. Thorough, practical program. Individualized instruction emphasized. Government approved for G.I.'s.

Keeping pace with progress in science and engineering

Spacious campus; 20 buildings; dorms, gym, playing field. Modern, well-equipped laboratories including new physics lab and wind tunnel. Low tuition. New terms start quarterly. Enter December, March, June or September. Big demand for graduates. Students from 48 states and 40 foreign countries. Many earn a major part of their college expenses in this large industrial center. Send coupon for free catalog and full information. Enroll now!

INDIANA TECHNICAL COLLEGE

5118 E. Washington Boulevard, Fort Wayne 2, Indiana

Please send me free information on 27 MO. B.S. DEGREES in:

Aeronautical Chemical Civil Electrical
Mechanical Electronics

on 36 MONTH B.S. DEGREES in:

Mathematics Chemistry Physics

Name _____

Address _____



This Integrated Mechanism is the Reason Why V-M Stereo Record Changers Outsell All Others

Public opinion is the best recommendation for V-M automatic record changers. Listeners by the millions rely on this beautifully simplified



mechanism—the heart of every V-M changer—for years of flawless performance. Model 1201—'Stere-O-Matic'® Automatic 4-Speed Changer with patented drive motor,

Stereo Cartridge and Stylus. \$50 (Slightly higher in the West.) V-M Corporation, Benton Harbor, Michigan.

the **Voice**  of **Music**®

Superior's New Model 70 UTILITY TESTER® FOR REPAIRING ALL ELECTRICAL APPLIANCES MOTORS • AUTOMOBILES • TV TUBES

As an electrical trouble shooter the Model 70:



- Will test Toasters, Irons, Broilers, Heating Pads, Clocks, Fans, Vacuum Cleaners, Refrigerators, Lamps, Fluorescents, Switches, Thermostats, etc.
- Will test all TV tubes for open filaments, inter-
element shorts, burned out tubes, etc.
- Measures A.C. and D.C. Voltages, A.C. and D.C. Current, Resistances, Leakage, etc.
- Will measure current consumption while the appliance under test is in operation.
- Incorporates a sensitive direct-reading resistance range which will measure all resistances commonly used in electrical appliances, motors, etc.
- Leakage detecting circuit will indicate continuity from zero ohms to 5 megohms (5,000,000 ohms).

As an Automotive Tester the Model 70 will test:

- Both 6 Volt and 12 Volt Storage Batteries • Generators • Starters • Distributors • Ignition Coils • Regulators • Relays • Circuit Breakers • Cigarette Lighters • Stop lights • Condensers • Directional Signal Systems • All Lamps and Bulbs • Fuses • Heating Systems • Horns • Also will locate poor grounds, breaks in wiring, poor connections, etc.

Model 70 comes complete with 44 page book written in plain easy-to-understand language. Explains laws of electricity, how to proceed with repairs of appliances and automobile circuits, how to test TV tubes, etc.

\$15.85 SHIPPED ON APPROVAL NO MONEY WITH ORDER—NO C.O.D.

Try it for 10 days before you buy. If completely satisfied then send \$3.85 and pay balance at rate of \$4.00 per month for 3 months — No Interest or Finance Charges Added! If not completely satisfied, return to us, no explanation necessary.

MOSS ELECTRONIC, INC., Dept. D-533, 3849 Tenth Ave., N.Y. 34, N.Y. Please rush me the Model 70. If satisfactory I agree to pay \$3.85 within 10 days and balance at rate of \$4 per month until total price of \$15.85 plus postage is paid. If not satisfactory, I may return for refund of amount.

Name _____
Address _____
City _____ Zone _____ State _____

YOU could be your own boss!

**Run an automotive wholesale
distributing company of your own!**

If you were a Bowes distributor you would be a successful small business man enjoying the profits of your own hard work. You would have a better home, a better car and could afford to send the kids to college.

What's more you would, as your own boss of such a company, get the kind of satisfaction that you couldn't find working for somebody else. You'd be selling to service station operators and garage owners—fellows much like yourself, who always wanted to run a small business of their own too. You would be handling a nationally advertised line of automotive products which your customers must have to run their business.

For people like you who have seriously thought about running their own business, the Bowes "Seal Fast" Corporation has prepared a booklet, "So You Want To Be Your Own Boss!" In it a number of different small businesses you might be interested in are described and compared as to work, investment and possible profits.

This booklet also tells why Bowes is now offering a few men the chance to become one of their distributors.

If you're not afraid of hard work and can make a reasonable investment you may get a chance to become one of these distributors with a "protected" territory.

If Bowes picks you, you will be thoroughly trained until you are well on your way to a substantial and secure income.

Clip the coupon below and send it in now for your free copy of our booklet, "So You Want To Be Your Own Boss!"

CLIP THIS

Mr. Charles E. Bowes, President
The Bowes "Seal Fast" Corporation
Dept. 2902, 5902 E. 34th St.
Indianapolis 18, Indiana

Please send me a copy of "So You Want To Be Your Own Boss!" Also tell me without obligation how I can go into business for myself as a Bowes Distributor.

Name _____ Age _____

Address _____ Phone _____

City and State _____

the famous "500" line  of car care products



Harmonica Works Like Player Piano

Twenty tuned reeds in a plastic case provide rich tones from a roll-playing harmonica. Like a pocket-size player piano, air is blown through the rolls as they turn past the reeds. To make music, you just blow and crank.

Effect of Fallout on Food Varies With Rainfall

Contamination of food by radioactive fallout from nuclear explosions is greater in the Amazon Basin than in the United States—though there is five times as much fallout in the United States. This is explained by the unusual weather conditions in the tropics, according to the American Chemical Society. For example, concentration of strontium-90, considered the most hazardous form of atomic debris, is generally three times as high in the United States as in the Southern Hemisphere. But the heavy tropical rainfall brings strontium-90 down from the upper atmosphere. And over the years it also has washed some of the calcium out of the soil. Both these factors tend to increase strontium in food crops and milk. This is because strontium is chemically related to calcium and tends to replace it in crops and in bone structure. This happens especially when calcium levels in the soil are low.

When the submarine *Nautilus* made the first trip under the polar ice pack, its crew viewed the underside of the ice on a 21-inch TV monitor connected to a camera mounted in a pressurized steel capsule at the top of the conning tower.

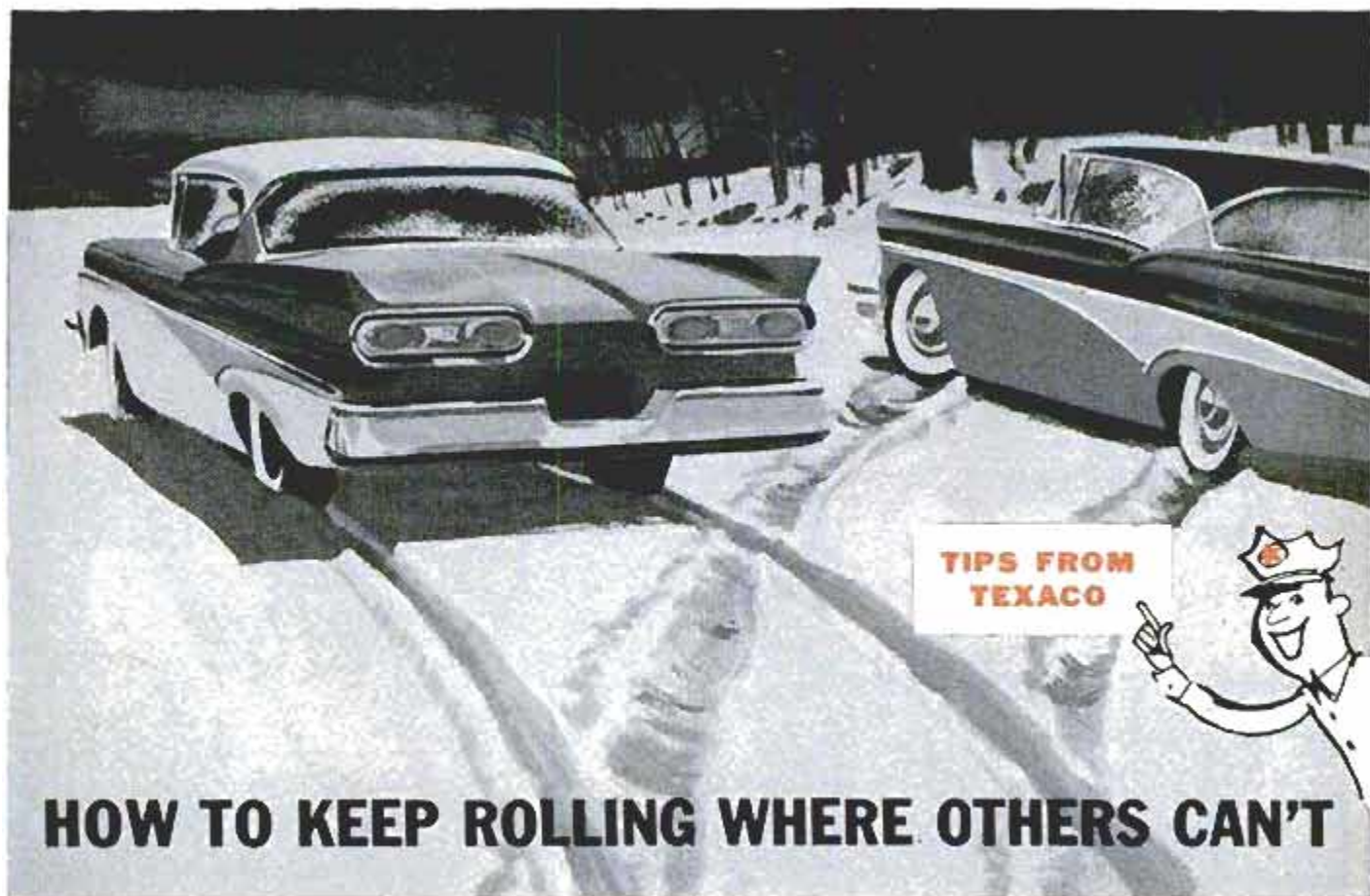

HOW TO KEEP ROLLING WHERE OTHERS CAN'T

GETTING where you are going over icy roads and other treacherous surfaces is all a matter of taking simple precautions and some easy-to-learn driving know-how.

First of all, proper gas pedal, brake pedal and steering wheel handling will prevent mishaps. The rule is, *make no sudden moves!* Drive as if you were balancing a full glass of water on your dashboard. That means

slow down, turn and accelerate gently . . . *g-e-n-t-l-y*. Try not to come to a complete stop—especially on an upgrade—you may have difficulty starting again.

What's more, even if you use tire chains or snow tires all winter, carry a dozen or so small paper bags filled with sand. They'll start you moving when nothing else will. Just throw sand under each rear wheel and go.

How to Safe-T check your engine against winter

**GUARANTEED
PROTECTION!**

**THE FINEST
ANTI-FREEZE
YOU CAN BUY!**



Use Texaco PT Anti-Freeze! You protect your engine against winter *eight ways* with Texaco PT Anti-Freeze:

1. *Safe-T checks against freezing, down to the temperature level you select.*
2. *Safe-T checks against evaporation.*
3. *Safe-T checks against corrosion.*
4. *Safe-T checks against rust.*
5. *Safe-T checks against boil-away, even on warm days.*
6. *Safe-T checks against foaming.*
7. *Safe-T checks against hose rot.*
8. *Safe-T checks against deposits.*

Texaco PT is the only anti-freeze with a nationwide guarantee of protection—honored under the Texaco star in all 48 states. It's the finest anti-freeze you can buy!

**TEXACO DEALERS
IN ALL 48 STATES**

Texaco Products are also distributed in Canada, Latin America, and Africa



Since 1903...

**PARTNER
IN PROGRESS to the
AUTOMOTIVE
INDUSTRY**



IMPERIAL—one of the outstanding motor cars using Perfect Circle piston rings for original equipment.

Behind the world-wide preference for Perfect Circle products is a history of more than half a century of PC engineering leadership—and more. There's a history, too, of unceasing creative research and scores of contributions to the advances achieved by the automotive industry, year after year.

You benefit from the PC heritage of leadership every

time you buy a car, truck or tractor equipped with Perfect Circle piston rings or other components that bear the mark of Perfect Circle. And you're sure to benefit when you ask for Perfect Circle piston rings when it's time to overhaul your engine. Perfect Circle Corporation, Hagerstown, Ind.; The Perfect Circle Co., Ltd., Don Mills, Ontario, Canada.

**PERFECT CIRCLE
PISTON RINGS**

AUTO-PILOT

a new
dimension
in driving ...



Auto-Pilot—a product of Perfect Circle research and engineering—prevents unintentional speeding in city, country and turnpike driving, yet keeps full engine power at your instant command. Lets you keep your eye on the road—and off the speedometer. Provides "robot throttle," permitting restful highway cruising with your foot off the accelerator pedal. Available now on the magnificent 1959 Chrysler and Imperial motor cars. Auto-Pilot is manufactured by the Speedostat Division of Perfect Circle Corporation.

More 1959 Cars Debut in DETROIT'S YEAR OF DECISION

Your reaction to these new cars may determine the auto industry's course for the next 10 years

By Arthur R. Railton

WHO'S RIGHT? The big boys like General Motors who believe the public's reluctance to buy 1958 cars was due to the recession, to a lack of confidence in the future, to the need for more enticing, exciting designs?

Or the little boys like American Motors who believe that the public did not buy the 1958 cars because they were too big, too expensive, too luxury loaded?

Who's right?

Economists, product planners, stylists, engineers, all want to know. The only person who can tell them is you. What you do in the next four or five months will answer the question.

Your answer will make 1959 a year of decision. It could chart the industry's course for years to come.

If you like and buy the bigger 1959 cars with their flat roofs, double-wrap windshields, tremendous rear-glass areas, lower seats, bigger fins, longer rear decks and more luxurious interiors, you'll disprove those critics of Detroit who have been ranting wildly all year.

If you don't like these cars and if you prove it by buying Ramblers, foreign cars or the soon-to-be-announced small Studebaker, you'll force the big boys to reassess their position and to rechart their course.

General Motors is betting that the critics are wrong and is making it easy for you to help prove it. The new GM cars, from Chevrolet up, are fresh, alive and handsome. They are bigger, lusher and better looking than ever. That makes the choice a clear one: You can make your decision on clear-cut alternatives. The choice is whether you want comfortable, dependable transportation alone or whether you insist on glamor, prestige and a lifted morale as well as good transportation.

Rambler is betting with the critics (although it hedges somewhat with its Ambassador models which give no additional interior room for people or luggage despite a longer wheelbase and body). Convinced that the public wants sensible, neat designs that provide transportation and not transmutation, American Motors is offering cars virtually unchanged from 1958.

Chrysler and Ford are in a high-noon position somewhere between AM and GM. After an admittedly

(Continued to page 252)

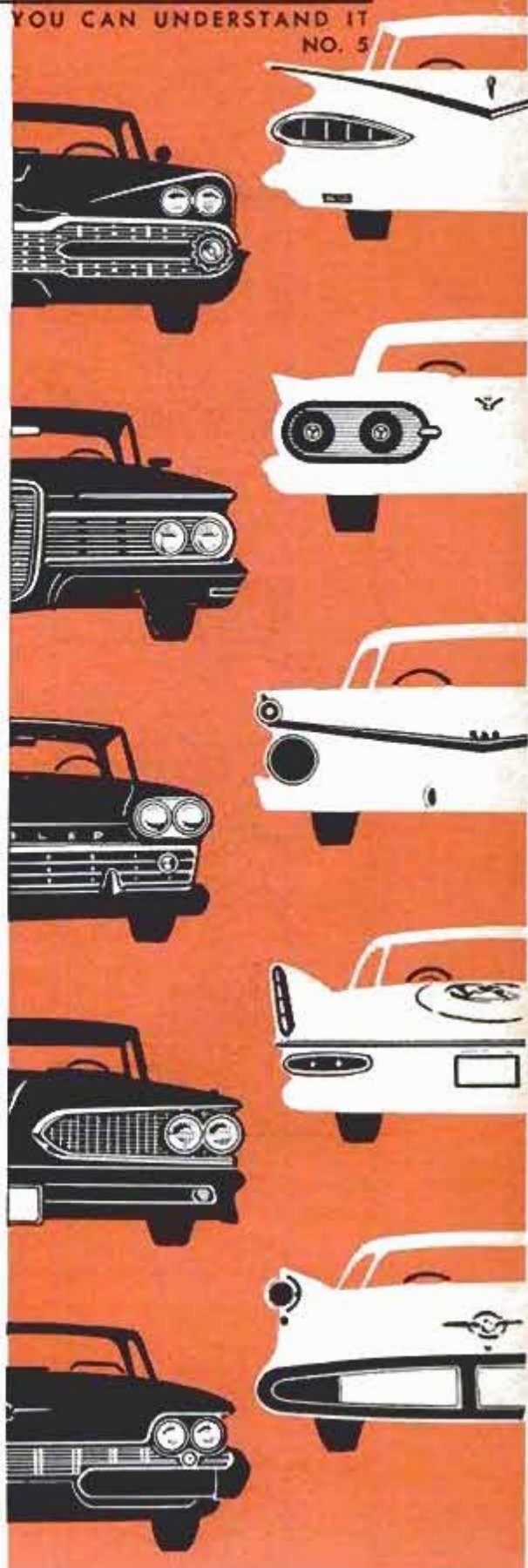

CHEVROLET

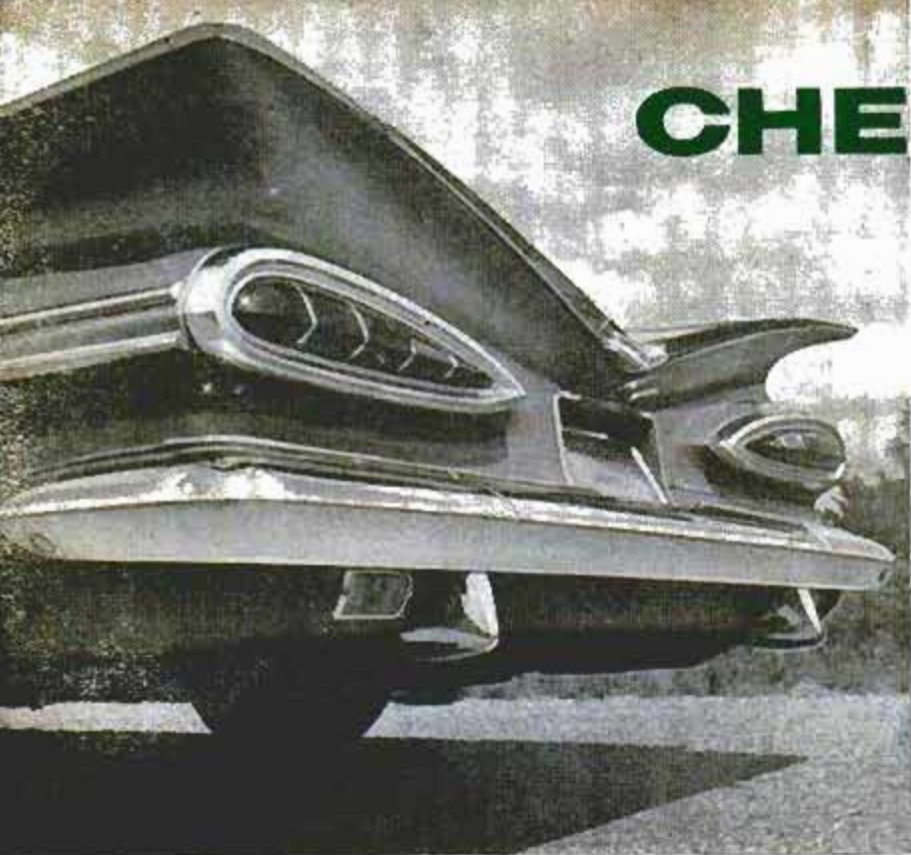

Backup lights are mounted below a plain, straight-across bumper. Gas filler opening is behind the license plate

STYLING IS THE THING with the new Chevrolet, as with all GM cars for 1959. Its low, flaring rear end is as expansive as the deck of an aircraft carrier and looks almost as wide from the driver's seat.

Horizontal taillights squint, like giant cat's eyes, from under chrome eyebrows.

At the front, two sets of paired headlamps are set as low as the law allows to accentuate the road-hugging design. Consequently, they provide better lighting in fog. Over the simple, unobtrusive grille, two wide nostrils serve as air intakes for the engine compartment. Tucked in their outer corners are turn-indicator lights.

Engine changes are minor. A new camshaft and changed carburetor metering in the Six mollify the public's demands for more

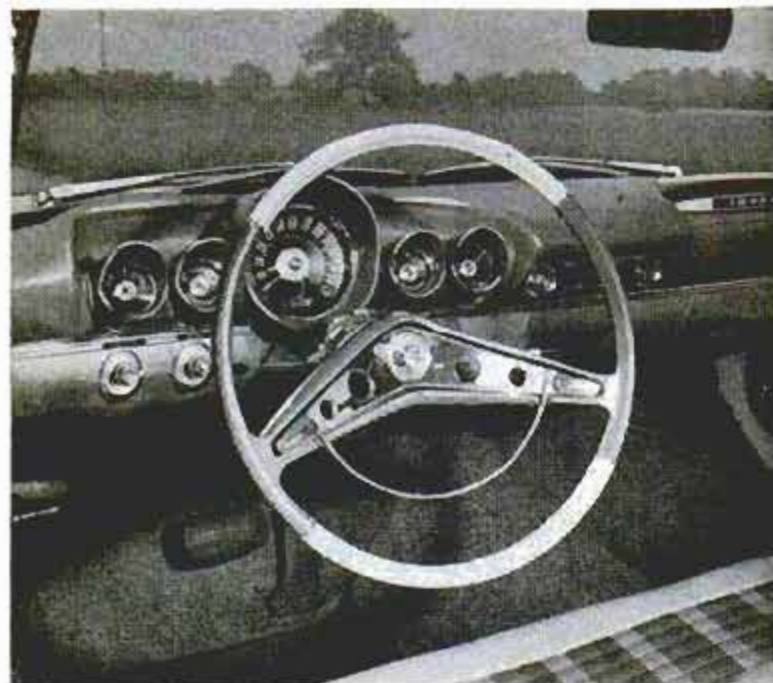

Holes in boomerang-shaped wheel spokes provide a racing-car character to the car. Horn ring has thumb button near rim



Slots in the wheels and extra-cost wheel covers create a flow of air to cool brakes

Visibility is limitless in the flat-roof model of the Impala four-door hardtop with wrap-around rear glass





Flat, flaring wings at the rear of the Impala convertible make it look several feet longer than it is

miles per gallon. The camshaft provides a shorter valve overlap, reducing waste at low engine speed. As a result, horsepower is cut to 135 from last year's 145—thus the pendulum swings back.

In the two V8 engines, horsepower is unchanged (185 and 250). Rear-axle ratio is now 3.08 to 1 with the big engine, instead of 3.36 to 1 and here, too, economy is up slightly at the expense of performance.

Steering effort with power assist has been reduced markedly. The over-all ratio of the manual steering unit is up, reducing effort here too, while increasing wheel wind. A flexible coupling in the steering

shaft isolates the wheel from road shocks.

Ride is softened from the firmer 1958 package. Cornering stability suffers somewhat, but there is no feeling of loss of control. Tar strips and small road bumps are swallowed up without fuss and noise levels inside the car are much lower.

Brakes are improved by 27 percent more lining area. Front shoes are $\frac{3}{4}$ inch wider, rear shoes $\frac{1}{4}$ inch wider. Long slots in the wheels direct air over the larger drums to speed heat dissipation. Air suspension is optional again, as is fuel injection. Chevy also offers the highest compression in the business: an optional 11 to 1. ★ ★ ★



Station wagons have no upper tailgate. Glass winds down into lower half of door manually or electrically (option)

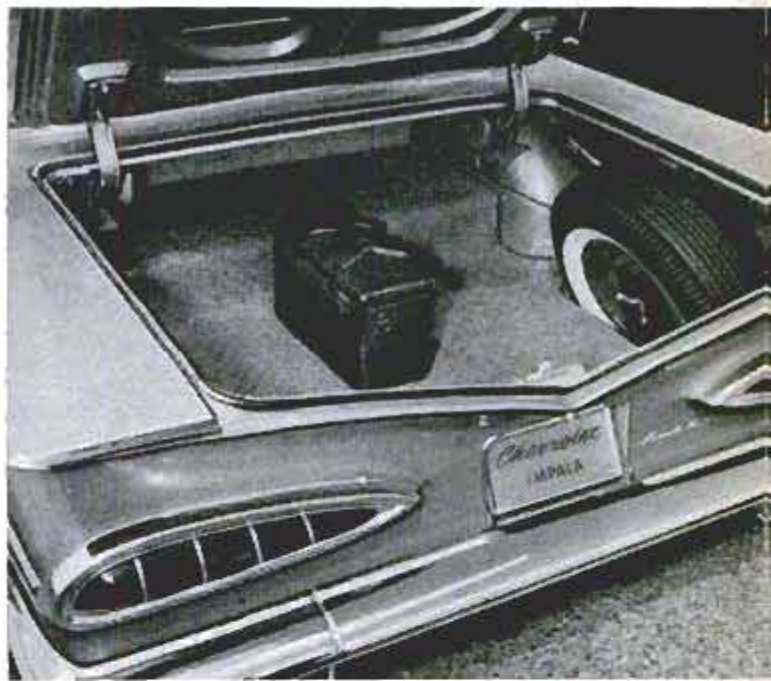

Trunks are bigger than ever. Chevrolet's has a high sill over which you must lift your luggage

Rear window and double-wrap windshield of Impala hardtop are huge. Roof seems almost postage-stamp size



FORD

YOU'LL HAVE no trouble recognizing the 1959 Ford—it has the Ford personality all over its new sheet metal. But changes go deeper than is apparent—they perhaps herald a bold change in philosophy.

For the first time in years, horsepower has been reduced in the interest of economy on two of the four Ford engines (the 1959 ratings are 145, 200, 225 and 300 horsepower compared to 145, 205, 240 and 300 in 1958). Torque is reduced on all four engines also.

Compression ratios are decreased across the board. All except the power-pack 352-cubic-inch optional V8 now use regular gasoline which, Ford says, saves as much as a dollar a tankful.

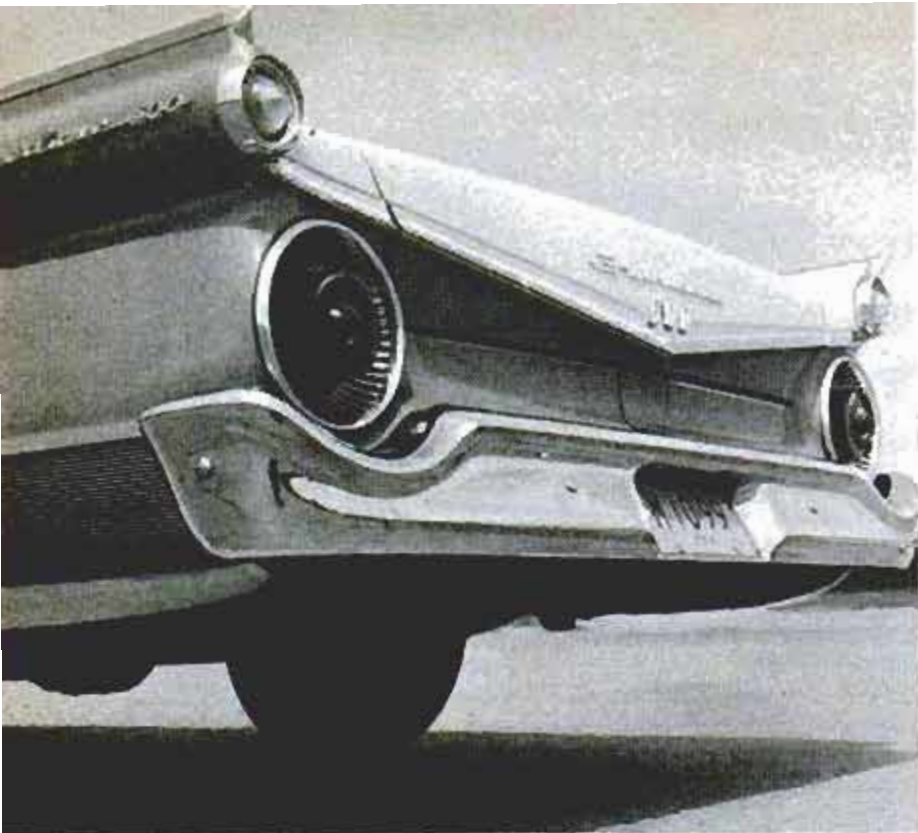

You don't have to be told this is a Ford—the big saucerlike taillights identify it. The two upper lenses are backup lights



Ford continues its neat, uncluttered dash, but has replaced the curved shroud with a straight one like the rest of the industry

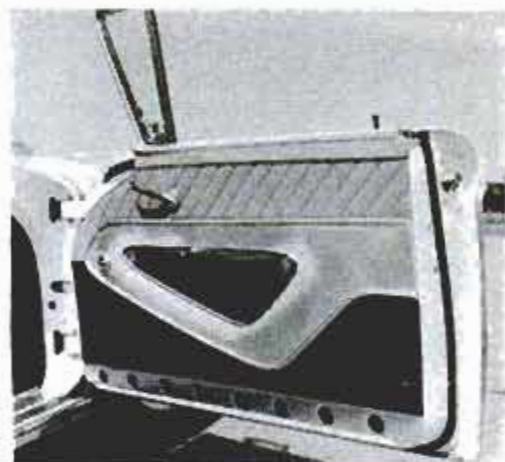

Holes in door panel are decorative only, but would be ideal place for reflectors

Although rumors of competition are heard often, Ford still has the only retractable hardtop in the industry





Ford says its cars, like this Fairlane Sedan, have "dignity and quiet good looks," with no excessive curves

A low-cost two-speed automatic transmission with 105 fewer parts than the regular three-speed Cruise-O-Matic is available as Ford moves closer to the soon-to-come day when the automatic transmission will be included at no extra cost. The new transmission weighs 22.8 percent less. However, total car weight is up at least 150 pounds. Other economy-related items include a full-flow oil filter which permits

4000 miles between oil changes. Aluminum-coated mufflers have asbestos insulation to reduce rusting caused by condensation to give a life expectancy of two years.

The cars are longer, all being on the big 118-inch wheelbase this year. Custom models are six inches longer, Fairlanes one inch longer, all are 208 inches over-all. They are 1.4 inches narrower and interior dimensions are somewhat reduced. ★ ★ ★

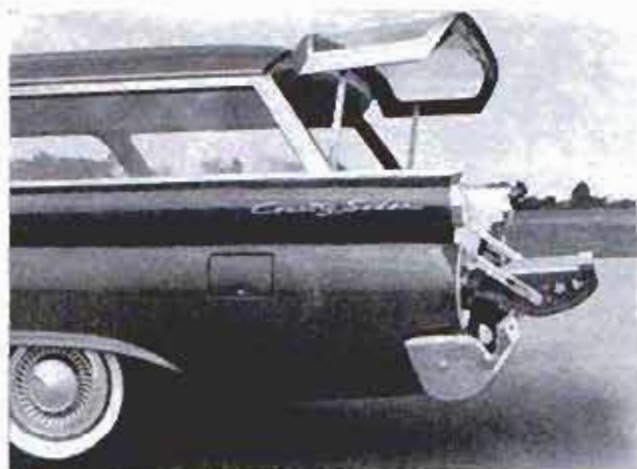

Unlike most competitors (which use roll-down rear glass), Ford has a two-section tailgate on wagons

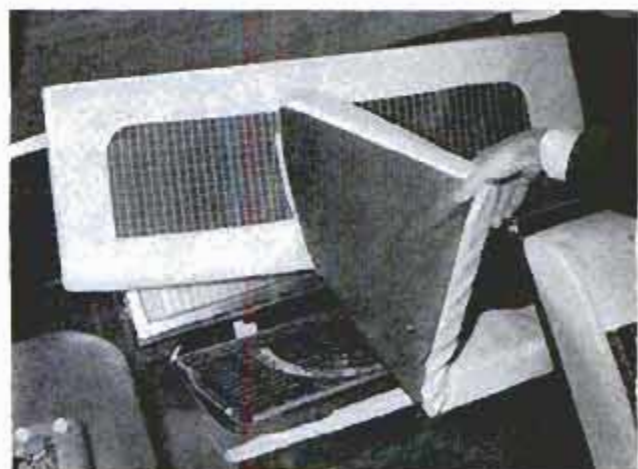

Third seat of the wagon folds into floor. Secret of it is the use of removable foam-rubber seat cushions

Country Sedan has 52 percent of its weight on back wheels, making it a great car for driving on icy roads





From the rear, the obvious change in the Plymouth is this thin fin shape and the horizontal taillight

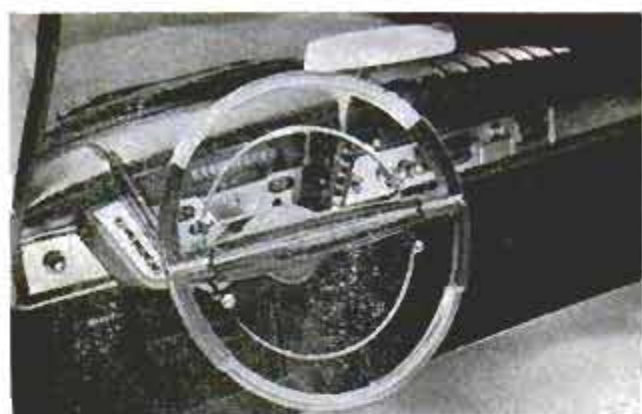

Completely new is the dashboard with transmission push buttons arranged diagonally to left of wheel

THIS YEAR'S "hot one" may be the 1959 Plymouth. It has a big V8 optional engine of 361-inch displacement (biggest in its field) that puts out 305 horsepower and 395 pound feet of torque.

Of course, this souped-up V8 with four-barrel carburetor, dual exhausts, dual breaker points, heavy-duty valve springs and special camshaft is optional at extra cost. The regular V8 gets 230 horsepower out of 318 inches (a power-pack version develops 260 horsepower).

If you prefer economy to power you can order a special penny-pinching rear axle (at no extra cost) that is said to increase gasoline mileage as much as 10 percent.

Top model in the line this year is the Sport Fury, which comes only as a hardtop (below) and convertible



Styling changes are extensive despite the use of a carryover body shell. The front-end treatment is all new with scalloped eyebrows over dual headlamps and an eggcrate grille. At the rear, changes include taillights that are now horizontal beneath the slender chrome-edged fins. You may, at extra cost, have a dummy spare-tire cover embossed in your trunk lid, *a la* Imperial.

Over-all length is 208.2 inches, an increase of 2.2 inches, due entirely to the extended bumpers. Width has been reduced to 78.0 inches.

Push buttons for automatic-transmission cars are now arranged vertically alongside the instrument grouping. A similar vertical row of buttons on the right side of the dash controls the power-operated heater and ventilating system.

Also optional on Plymouths for 1959 is a combination air-and-steel suspension system. Torsion bars are retained in front (shortened and slimmed out slightly) and an air-bag system has been added to supplement the regular leaf springs in the rear at extra cost. It is in the rear where most load leveling is needed.

Since this is the principal attribute of air suspension, Plymouth (and Chrysler) feels that bags are not needed up front. With this system, the steel springs will still support the load if necessary, eliminating any possibility of breakdown should the air system fail.

Swivel front seats are standard on the Plymouth Sport Fury for ease of entry and exit.

Plymouth has dropped the series name

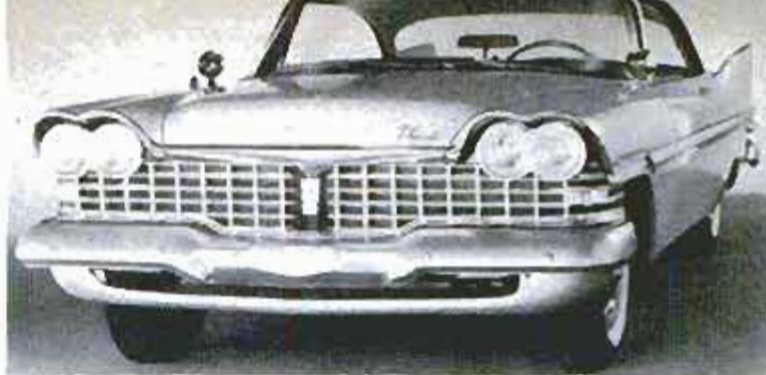

Distinctive are Plymouth's scalloped front fenders which, along with its eggcrate grille, provide a fresh look to the front end



Available at extra cost is a dummy spare-tire cover that is embossed on the trunk lid. The canted tailfins are new also

REDESIGNED ANCHOR POINTS

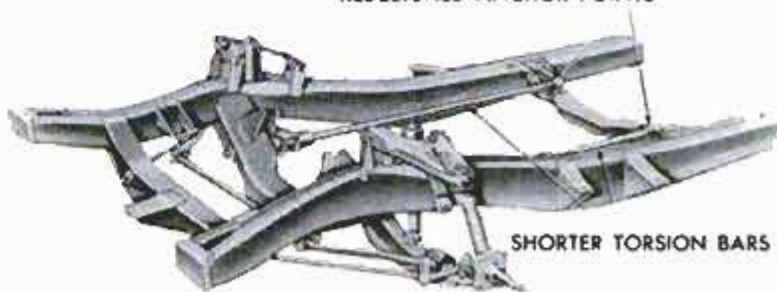

SHORTER TORSION BARS

Torsion bars are retained in front, but have been shortened and thinned out somewhat. Air bags are available on the rear wheels

Plaza and now the models are arranged in this order (from bottom to top): Savoy, Belvedere, Fury, Sport Fury (the Sport Fury series includes only two models, a convertible and a two-door hardtop). ★★★

New for the wagon trade is a ceiling-mounted air conditioner. A lockable luggage space is also optional



PONTIAC



Winding country roads are a pleasure in the easy-to-handle, road-hugging Star Chief four-door hardtop

YOU HAVE PLENTY of choice in Pontiac this year—horsepowers range from 215 on a special economy V8 to 345 on the optional triple-carburetor V8.

Despite this broad range, all engines share the same displacement of 389 cubic inches. The special economy version is an indication of the changing trends in Detroit thinking. It has a smaller carburetor to provide a leaner fuel mixture. Its special camshaft has reduced valve overlap for minimum fuel waste. The rear-axle ratio of 2.87 to 1 adds to its miserliness.

Handling is excellent. The car has a confident sure-footedness due, along with other things, to a tread that is increased

nearly five inches in width. The wider tread, incidentally, also reduces underhood temperatures and improves engine accessibility, something mechanics will enjoy even more than owners.

Brakes have been improved by increasing the lining area nearly 10 percent and also by the addition of a cooling flange to the front drums.

Pontiacs come in two wheelbases: The 122-inch Catalina (213.7 inches over-all) and the 124-inch Star Chief and Bonneville (220.7 inches over-all). However, in one of Detroit's great mysteries, the smaller model of the series has more interior room than the big ones. ★ ★ ★

Pontiac has a highly styled rear-end treatment with twin fins on each fender. This is a Catalina hardtop





Bonneville convertible has bucket seats in front, stylishly contoured. Wide dash shroud eliminates windshield reflections



Stylists keep playing hide and seek with gas-station workers. Here's the gas cap



Spare tire lies flat. Ledge covers the rear axle. This is the "small" Catalina trunk, the others have even more luggage room



Roof of four-door hardtop extends beyond the tremendous wrap-around rear glass

Station wagon has an optional rear-facing third seat and its back window rolls down into the tailgate





Most noticeable new feature on the 1959 Dodge Coronet four-door sedan is its bold slanting "eyebrows"

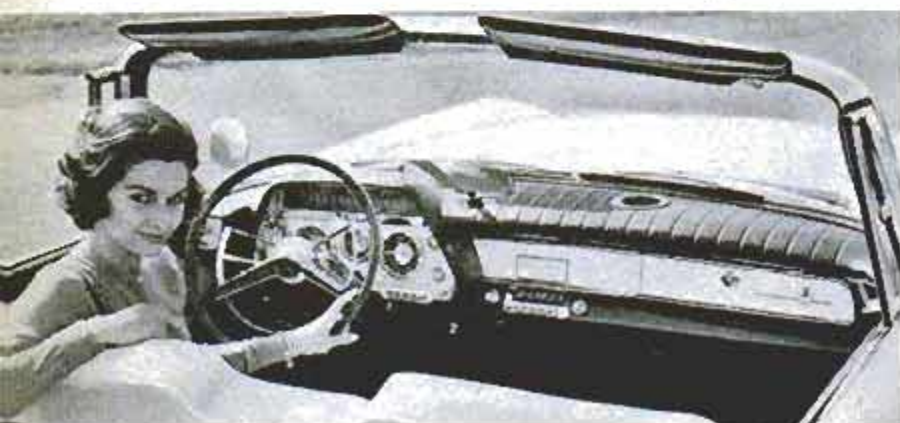

Above, Dodge now has vacuum-actuated controls for the heater. Push buttons for the control are located to the right of wheel. Below, oblique chrome shrouds wrap around jet-tube taillights



Dodge offers two four-door wagons. This one is the Custom Sierra model with a rear-facing third seat

DODGE

DODGE STYLISTS have given the front end of the 1959 models an all-new look with its bold slanting headlamp eyebrows and a wider, oval-shaped aluminum grille.

At the rear changes are not so great, but the Dodge character is retained with enlarged swept fins and jet-tube taillights.

A new roof on four-door hard-top models has a slightly raised rear section which permits the rear seat to be moved backward inside the greenhouse. This move increases rear-seat legroom as much as three inches with little or no loss in headroom. The rear window on this model is 15 percent larger than previously.

Dodge has four different engines again this year. Lowest on the power list is the six-cylinder L-head engine of 230-cubic-inch displacement. It develops 135 horsepower and has an 8.0 to 1 compression ratio. Changes on this engine are minor.

The 326-cubic-inch V8 is all new for Dodge this year and it has a 9.2 to 1 compression and two-bar-





Its famed sweptwing design more emphatic than ever, the Custom Royal convertible looks as sleek as a jet

rel carburetor. Its output is 255 horsepower.

Next up the list is the 361-cubic-inch V8 which is the powerful D-500 version used last year. It develops 295 horsepower with a two-barrel carburetor, 305 horsepower with a four-barrel carburetor.

Biggest Dodge engine this year is the 383-cubic-inch V8 which comes in two models: One puts out 320 horsepower; the other puts out 345 horsepower with two four-barrel carburetors, a special camshaft and heavier valve springs.

An aluminized dual-exhaust system is optional at extra cost on most models. Some models have it as standard equipment.

Over-all length has been increased by 3.5 inches (it is now 217 inches), width is greater by 1.7 inches (now 80 inches). Dodge's wheelbase is still 122 inches.

Interiors have been restyled and push-button heater controls are optional as are electronic headlight dimmers and automatic rear-view mirror tilters. The steering wheel is flatter on the top half than the bottom so it could be raised to provide more room under the wheel without blocking vision of short drivers. ★ ★ ★



Swivel front seats are optional on Custom Royal models. All Dodges have added padding in the center of rear seat this year

Four-door hardtops have a new stepped roof which is slightly higher in the rear for more interior room





Two-tone roof and new front end are changes on the 1959 Chrysler. This is the Windsor two-door hardtop



Completely fresh is the rear-end styling. Bumper is more massive this year and has a recessed anodized-aluminum insert

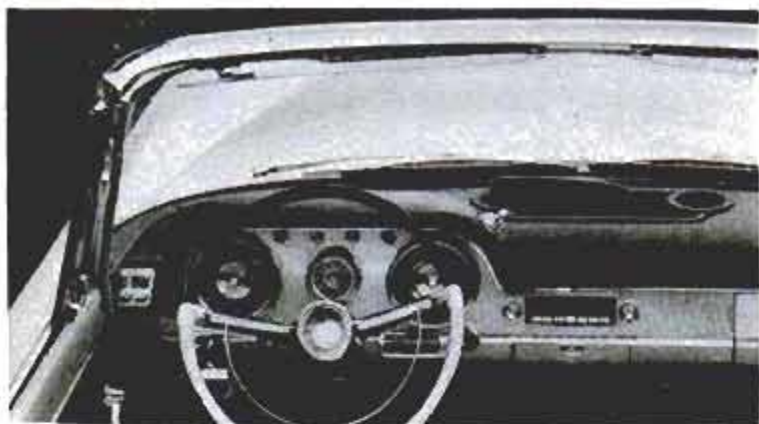

Above, top is smaller than bottom half of wheel, allowing it to be positioned higher for more legroom without blocking vision. Below, rear of hardtop roof is stepped up for added room

CHRYSLER

CONTINUING its trend-setting style, Chrysler redesigned its front and rear while adding a fresh look to its roof. Anodized-aluminum grilles wrap around front fenders.

Under the sheet metal, Chrysler has a new V8, replacing the heavier and more expensive hemispheric-head engine with its two rocker-arm shafts. The new single-rocker-arm-shaft V8 comes in two sizes: 383 cubic inches in the Windsor and Saratoga; 413 cubic inches in the New Yorker and 300E. Horsepowers are 305 and 325 on the small engine, 350 on the New Yorker and 380 on the muscular 300E.

Exterior dimensions are about the same, except for the Windsor being 1.5 inches shorter. Interior room is the same except for a healthy 3-inch addition to rear-seat legroom on four-door hardtops and a small increase in kneeroom under the steering wheel.

Swivel seats, rear-view mirrors that dim themselves, push-button heaters and air suspension as a supplement to rear leaf springs are available on all models. ★ ★ ★





Principal styling change is the front grille which has been emboldened to make the car look lower

IMPERIAL

IMPERIAL CONTINUES its luxury look, enhancing it with a stainless-steel roof on Landau models (at extra cost). The unpainted roof panel looks like brushed aluminum and yet is strong and durable.

Another styling change is the front grille that gives the front end a bolder, lower appearance. For identity reasons, the Imperial's well-known rear-end styling is virtually unchanged, although the bumper has been redesigned. Last year's very popular dummy spare-tire cover on the trunk lid is continued but now that Plymouth offers a similar option, it is expected that the plain trunk lid will become more popular with Imperial buyers.

Interior room is increased somewhat by a lowered floorpan in the rear-seat area. This required a minor frame modification and provides added legroom for rear-seat passengers.

Comfort is stressed as a 2½-inch foam-rubber padding is used on front and rear seats.

All models have the completely new Chrysler V8 of 350 horsepower and 413 cubic inches. This engine is approximately 100 pounds lighter than the double-rocker-shaft V8 it replaces and yet delivers more power at lower engine speeds.

Admirers of the soft, luxury ride will be pleased with the 11-inch tires on the 1959 Imperial. These tires, biggest in the industry, run on 16 pounds of air and smother road bumps like soft balloons.

Above, Imperial has a stainless-steel roof option this year. Its rear-end styling is much the same as previously. Right, heater controls are operated by these push buttons

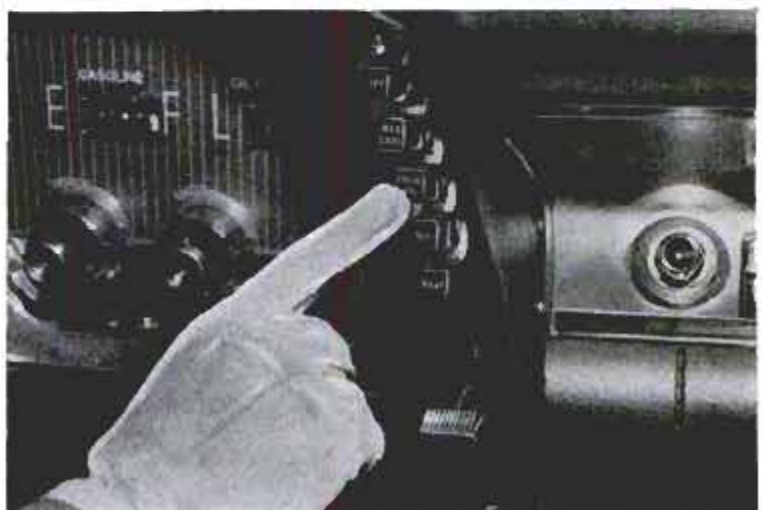



THUNDERBIRD

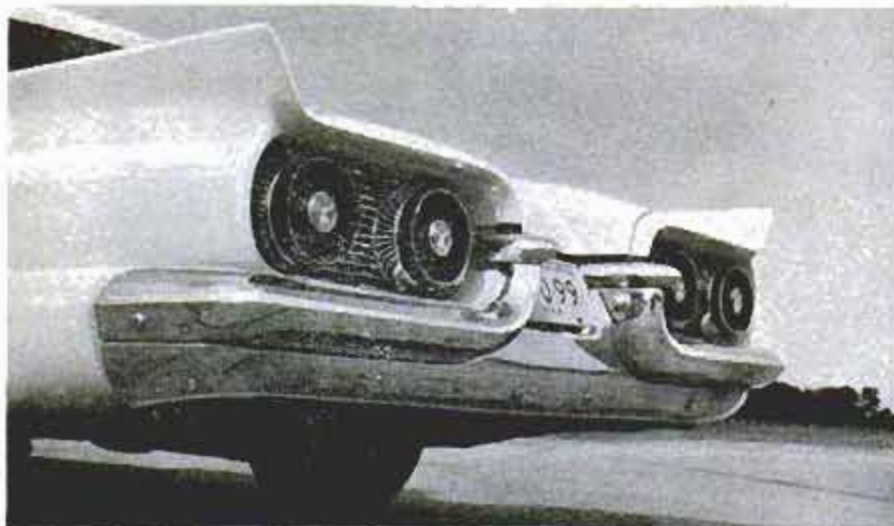

AFTER A MOST successful year (37,892 were built), the Thunderbird has virtually no changes for 1959. Experts will notice that brightwork inside the grille is different as it is in the decorative insert behind the taillights.

Another minor change is that the instruments now have black numerals on white (last year, white on black). Natural leather upholstery is optional this year for the first time.

Coil springs have been replaced at the rear by leaf springs, making track bars unnecessary and providing more dampening action due to friction characteristics of leaves. Ride and handling are said to be improved by the change.

Engines are a 352-cubic-inch V8 of 300 horsepower and an optional 430-cubic-inch V8 (probably from Lincoln).



CORVETTE



CHANGES are minor in the 1959 Corvette, the car that proves Detroit can build a top-drawer sports car when it really wants to.

Engines are unchanged from 1958 with horsepowers ranging from 230 to 290, no small feat with a 283-cubic-inch engine. Radius rods have been added to the rear suspension to resist axle-housing torque reactions. Brakes now have better cooling and an optional lining gives superior antifade characteristics. The optional four-speed transmission has a manually controlled reverse-gear lockout.

Styling changes are limited to the removal of those washboard ribs from the hood and interior refinements which include a storage bin just below the passenger's grab bar. Seats have been contoured for more "bucket" effect. Brightwork on the rear deck has been removed. Brake-lining area has been increased by wider brake shoes at the rear.

RIDING A wave of success, American Motors offers 1959 models that are only slightly changed. A new rear door eliminates last year's awkward junction of tailfin and door panel.

The front grille is new



RAMBLER • AMERICAN

and is die-cast in two pieces to minimize repair bills if it is damaged.

Economy of operation continues to be of major concern. The 127-horsepower Six has a glass carburetor bowl to permit accurate checking of float level. Available is a dual-throat carburetor to increase horsepower to 138.

The Rebel V8 has 215 horsepower, unchanged from 1958 while the Ambassador V8 develops 270 horsepower.

Revived is the American two-door station wagon. The American two-door sedan is continued. Both are up-dated versions of the 1955 Rambler.

Separate front seats are available at extra cost so one seat can be moved forward while the other is pushed back. A removable headrest makes sleeping in the reclining seats easier than ever.



Top, Rambler four-door hardtop and under it the Ambassador station wagon. Notice the less abrupt rear-fin line. Below, the revived American wagon



Headrest for the separately adjustable front seats looks like a you-know-what

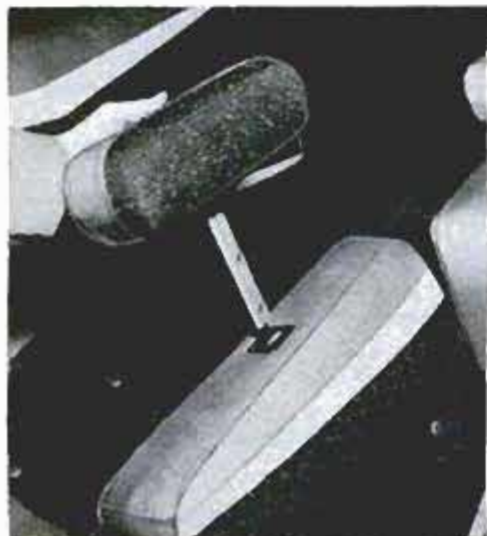

Glass bowl of the economy carburetor (shown here with air filter removed) permits the mechanic to adjust float level accurately



What Is and What Isn't New for 1959

ENGINE	CHASSIS	STYLING
AMERICAN —No change	No change	Two-door sedan revived. Sedan model unchanged.
BUICK —LeSabre: Higher compression; displacement unchanged. Others: Bigger bore, longer stroke, higher compression.	New frame, air bags at rear only, improved brakes, easier steering, redesigned track bar.	All-new body. Longer, lower, wider. A completely new Buick personality.
CADILLAC —Higher compression, bigger displacement due to longer stroke. Improved automatic choke.	Modified frame, easier steering, improved shocks, transmission simplified by dropping rear pump.	All-new body. Little (if any) longer, but lower, wider. Front has Caddy image, rear has spaceship look.
CHEVROLET —Six has been detuned for more economy. Two V8s unchanged; 11 to 1 compression optional—industry's highest.	Longer wheelbase, modified frame, easier steering, brakes improved, air suspension optional.	All-new body. Longer, wider and lower. Completely fresh personality.
CHRYSLER —All-new V8 of single-rocker-shaft design. Bigger displacements, more power, lighter weight.	Frame unchanged. Air bags optional rear only. Torsion bars shortened and thinned.	Front and rear changes. Body shell retained. New roof offset adds rear-seat room in hardtop.
DE SOTO —Displacements up, bores increased, compression unchanged. Valves larger on two big engines.	Frame unchanged. Air bags optional rear only. Torsion bars shortened and thinned.	Front and rear changes. Body shell retained. New hardtop roof improves rear-seat room.
DODGE —Six unchanged. New V8 added for Coronet. Others have enlarged version of previous engine.	Frame unchanged. Air bags optional rear only. Torsion bars shortened and thinned.	Big change in front. Body shell retained. Rear-seat legroom in hardtop increased.
FORD —All engines unchanged except compression lowered for more economy on regular gasoline. Power down some.	Frame unchanged. Air suspension no longer available. All models on 118-inch wheelbase.	All-new body. Slightly longer, lower and narrower. Retains Ford personality.
IMPERIAL —All-new V8. Bigger displacement, more power, less weight.	Minor frame changes to fit new floor pan. Torsion bars redesigned. Air bags optional rear.	Front end restyled. Body shell retained. Improved rear-seat room. New stainless-steel roof.
OLDSMOBILE —Eighty-Eight unchanged, others restroked for more displacement and power. Automatic choke improved.	Major changes in frame. Wider tread, "98" wheelbase down slightly, others up slightly. Brakes improved.	All-new body. Now "98" has larger interior than others. Trunks bigger. Bodies longer, wider, lower.
PLYMOUTH —Six cylinder unchanged, standard V8 also. Power-option V8 has more displacement, bigger bore.	Frame unchanged. Air bags optional rear wheels. Torsion bars shortened, and thinned.	Important front and rear styling changes. Body shell unchanged. Interiors new.
PONTIAC —Displacement up sharply by increased stroke. Power range from 215 to 345 hp. Economy V8 offered.	Modified frame. Wheelbases unchanged. Tread wider by almost five inches. Brakes enlarged.	All-new body, all-new personality. Longer, wider and lower.
RAMBLER —All engines unchanged except for economy carburetor on Six.	No change	Front grille restyled. Rear doors redesigned.
CORVETTE —No change	Radius rods added to rear suspension. Brakes much improved.	Almost unchanged. Some bright-work removed, ribs taken off hood. Interior refined.
THUNDERBIRD —Standard engine unchanged. Optional 430-cu.-in. V8 available.	Leaf springs replace coils at rear. Unit body continued.	Minor trim changes only both inside and out.



Foot Soldiers Get Big Boost From Rocket-Powered Jump Belts

Even the infantry may be rocket-propelled in the near future. Rocket-powered jump belts being tested would enable a foot soldier to leap from a landing craft to cover

or to jump over a pillbox. The rocket nozzles (arrows) don't interfere with the soldier's actions. But they help him leap 20 feet with a 50-pound pack on his back.

Balance Weights Hidden by Hubcap

Tire-balancing weights, normally crimped to the wheel rim, can now be concealed beneath the hubcaps. Two weights slide between two concentric rings in a holder that is bolted to the wheel by the regular lugs. Wing-nuts lock the weights in place when the location needed for balancing has been determined by a static-balance test. Once the setting is determined by the test, the balancer can be removed and reinstalled without retesting, as is necessary for tire changes.

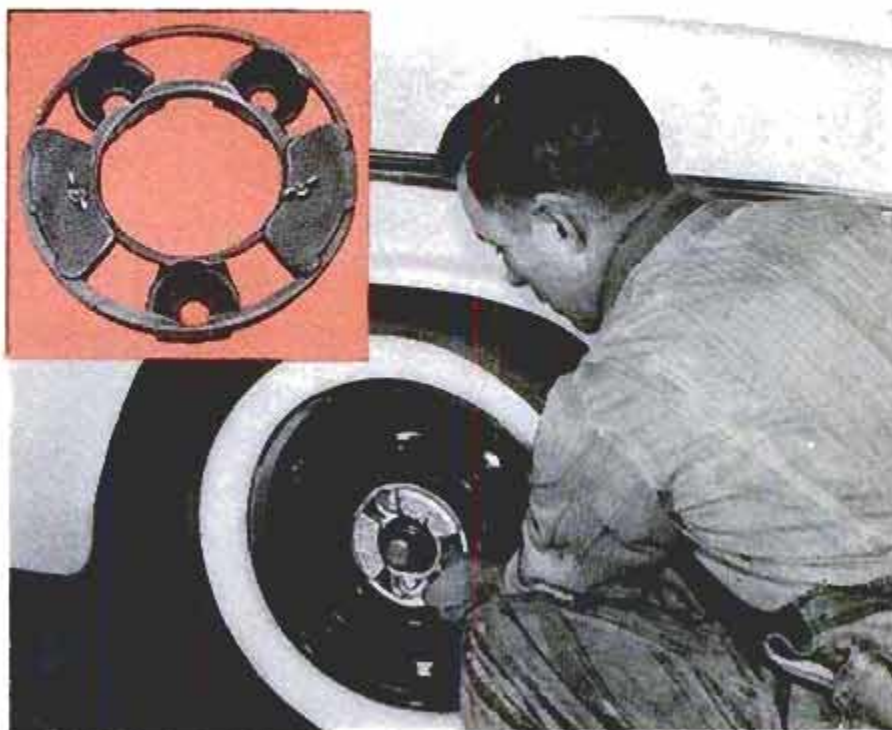



Goodyear photo

The world's largest nonrigid airship, the ZPG-3W, is shown above Akron on its maiden flight last July

Who Said the Blimp

The three airshipmen at left observe the search radar while the man at the scope looks for air contact

Official U. S. Navy photograph



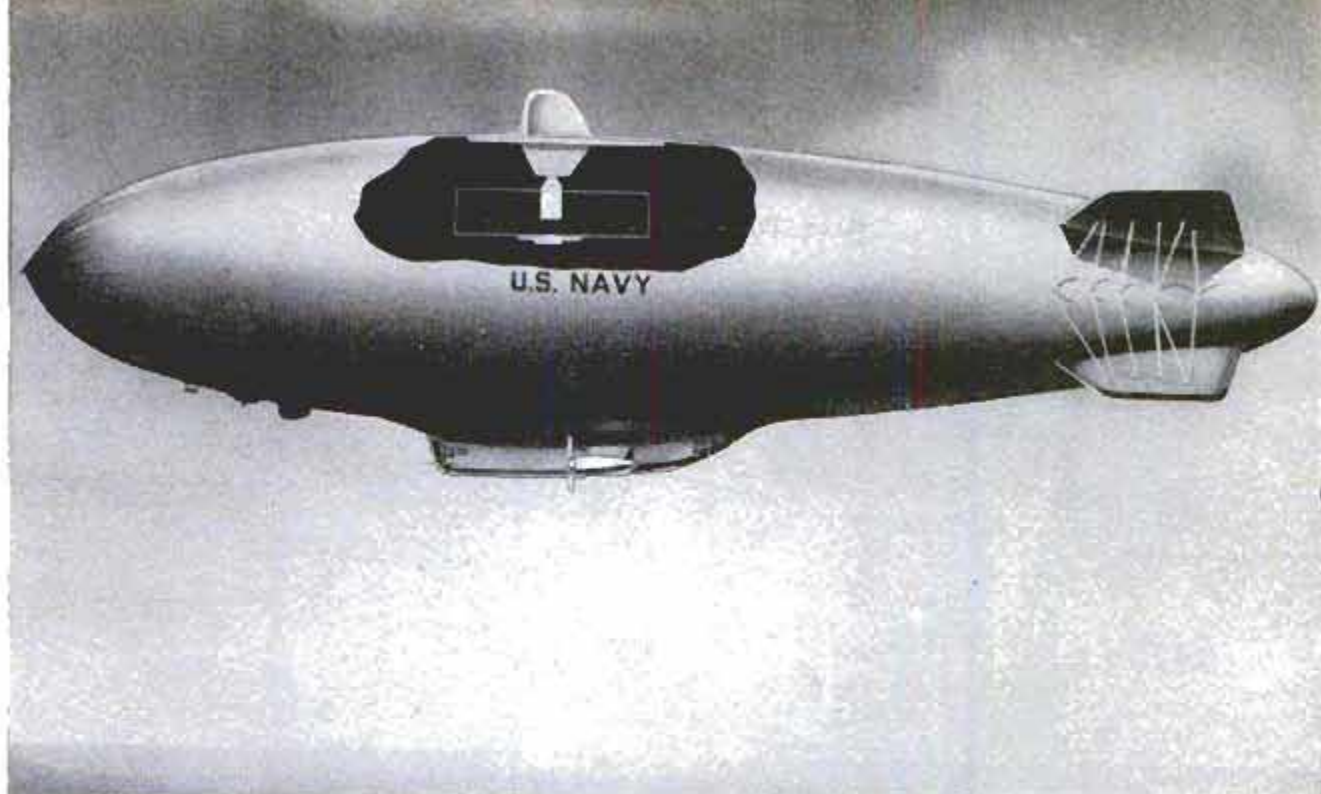

"Bump" on top of blimp houses height-finder antenna. Horizontal antenna (cutaway) scans 360-degree horizon

Reprinted "PM Highlights"

By

Walter E. Burton

IT LOOKS AS IF the airship, which has been regarded by some persons as the problem child of the Air Age, is going to survive the newer Electron-Missile-Atom Age. In fact, there are many who believe that it is just now reaching its greatest potential as a military device—that conceivably a lone blimp on a dull patrol mission over a stormy sea could save America from surprise attack.

The airship of today—there are dozens of them in use—is, in numerous ways, vastly different from those in the public eye a generation and more ago when lighter-than-air history then being written by the airships *Akron*, *Macon*, *Graf Zeppelin* and *Hindenburg* was often tinged with tragedy.

So far as is known on the footlight side of the Iron Curtain, there are only two places in the world where airships are being produced. The principal builder is Goodyear Aircraft Corporation's plant in Akron, Ohio. Recently two blimps for commercial purposes were reported under construction at Friedrichshafen, Germany.

There are a number of bases from which blimps are flying, for the nonrigid airship is a part of the defense ring that watches for hostile actions. Such lighter-than-air watchdogs are operated by the United States Navy. In addition, Goodyear still uses a blimp or two for commercial flying—advertising, aerial photography, passenger

carrying and sometimes police work. There are no rigid, or true Zeppelin-type, airships in use.

The 10 days from January 15 to 25, 1957, brewed just about the ugliest weather seen in 75 years along the New England coast. By coincidence, this was the period and locale chosen to test the weather endurance of ZPG-class patrol blimps. In a sea area 200 miles off Boston, each participating airship, loaded with radar gear and other equipment, was on duty 24 hours at a stretch. A sandstorm was just about the only type of weather phenomenon the blimps did not encounter. They fought mile-a-minute winds, rain, sleet, snow, fog and ice. Yet not a single minute was lost from the patrol schedule, and no ship was unable to complete its mission—even though, during the test period, there were times when all heavier-than-air traffic was grounded in the region.

The success of this test led to an even more ambitious one. Two months later, a Goodyear ZPG-2 patrol blimp, carrying nearly one million cubic feet of helium gas in its bag, made a continuous flight, under power, for 264.2 hours (11-plus days) from South Weymouth, Mass., across the North Atlantic to the European coast, southward along Europe and part of Africa, then back across the South Atlantic to Key West. Total travel was 9456 miles—all without



Crewmen of a ZPG-2W take it easy between watches. Blimps move smoothly, experience few bumps and jerks

refueling. Chief complaint of the crew, composed of members of a test unit of the Office of Naval Research, was that there were no facilities for showers or baths aboard!

An early warning airship is jammed with equipment of all kinds. Here a crewman loads a marker flare



Last July the ZPG-3W, first of a new and larger class of nonrigid airships for airborne early-warning picket patrol, made its maiden flight in Akron. The largest non-rigid airship ever built, the ZPG-3W is about 50 percent larger than the ZPG-2.

The new airships being built at Akron have to be large, for they will carry the heaviest array of radar equipment ever sent into the skies to watch for possible invaders. Each ship will hold 1.5 million cubic feet of helium, 50 percent more than the capacity of the biggest blimp that had previously been in service; and it will be close to two city blocks long.

The modern nonrigid airship is as different from its ancestors of 25 to 30 years ago as is the modern automobile in comparison with cars of that period. Here are some of the airship's advances, as outlined by Goodyear Aircraft officials:

The Bag, or Envelope. Research has been going on constantly in an effort to improve the rubberized fabric used for confining the gas that gives the airship nearly all its lift (some aerodynamic lift is produced by rapid movement of the bag through the air). For a while after the last World War, rubberized three-ply cotton was used, then was replaced by less heavy two-ply cotton. Now cotton has given way to synthetic

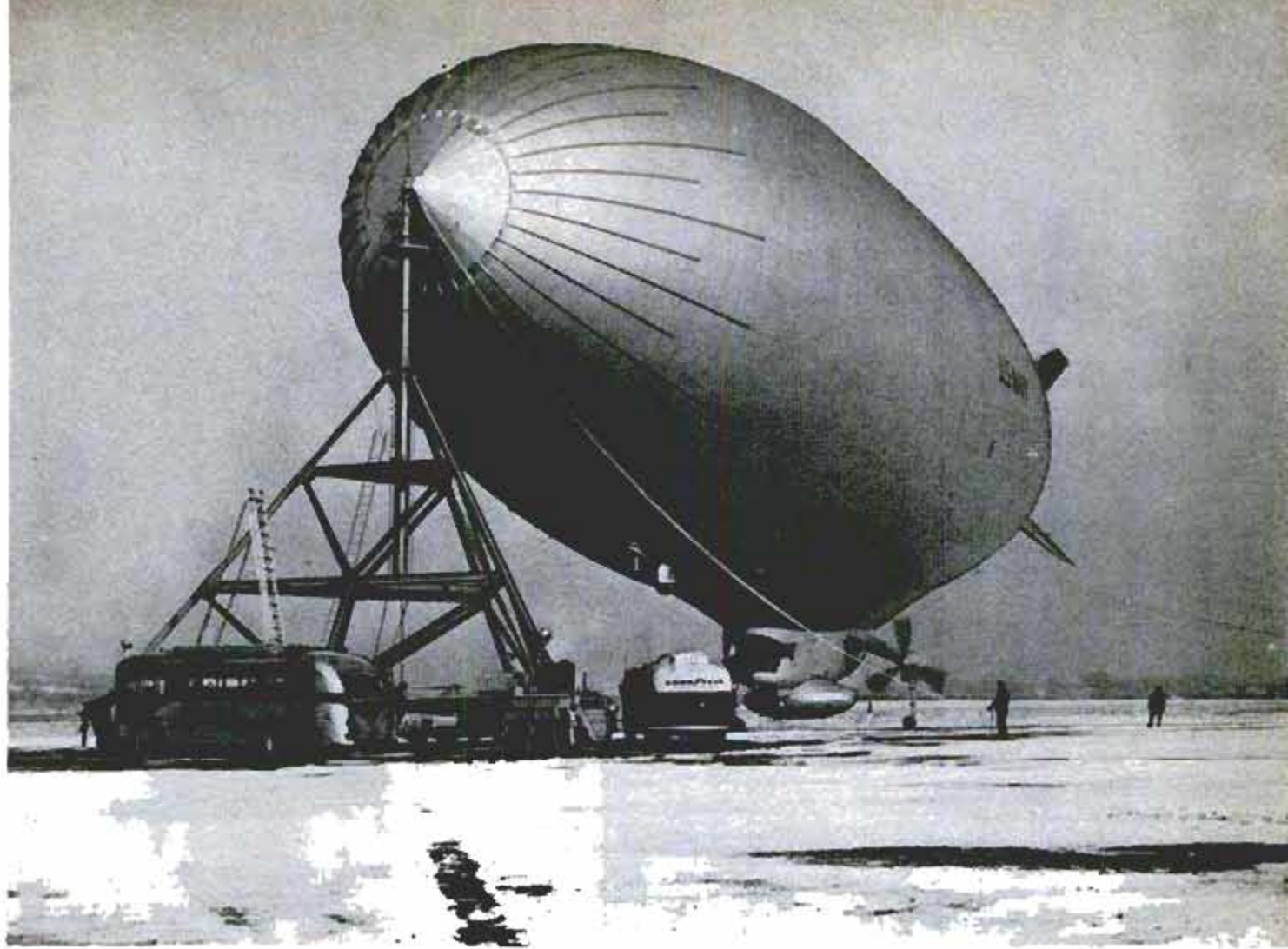

Last year a blimp similar to this ZPG-2W set a record by flying 11 days nonstop, without refueling

fabrics. A rubberized Dacron envelope (two-ply) weighs, per unit area, only about 60 percent as much as a three-ply cotton type, 75 percent as much as two-ply cotton. For some reason not yet fully understood, the Dacron bag material has a remarkable ability to hold helium—so much so that, in a year's time, helium needed to replace that lost by diffusion and other causes equals no more than a single filling of the bag. The Dacron bag material is said to be so strong mechanically that an inch-wide strip can support two overweight men.

The Car. In earlier days, a blimp car was a fabric-covered tubular-steel affair. Now it is of airplane-type construction, made largely of a "sandwich" material consisting of two thicknesses of 0.008-inch sheet aluminum having between them $\frac{1}{4}$ inch of either balsa wood or aluminum honeycomb. The cabin of a ship such as a ZPG-2 has two decks. The lower one is the work level, and contains control equipment and electronic and other military gear. The upper level is occupied by living quarters. To reduce the boredom of long flights, designers have tried to provide most of the comforts of home — food freezer, well equipped galley, a wardroom for cards and other relaxation. Living compartments are finished in gay colors.

Power Plants. The two engines are of latest-design reciprocating type, are gasoline-driven and so mounted that they can be serviced and repaired in flight. They drive variable-pitch propellers that can be instantly feathered or reversed. The pilot of today's airship no longer has to worry about prop control: He sets his engines for a certain speed, say 1600 revolutions per minute; then automatic controls alter the propeller pitch so that the engine speed remains constant no matter what the ship's speed requirements.

Likewise, other ship controls have been given the pushbutton treatment. The modern blimp has "power steering," for servomechanisms move the tail-control surfaces: No longer does the pilot have to spin an elevator-control wheel or tug to move stubborn cables. Nor does he have to be constantly concerned with pressure inside the helium bag. He merely sets a dial for the pressure desired, such as two inches of water. A newly developed device then automatically maintains this pressure within a tolerance of .050 inch of water. Because blimp pilots often are also airplane pilots, standard airplane controls and instruments are used wherever possible, and are grouped as on airplanes.

(Continued to page 248)



Hardtop illustrates the functional, yet attractive, lines of the Lark. Grille beside lights is heater intake

STUDEBAKER

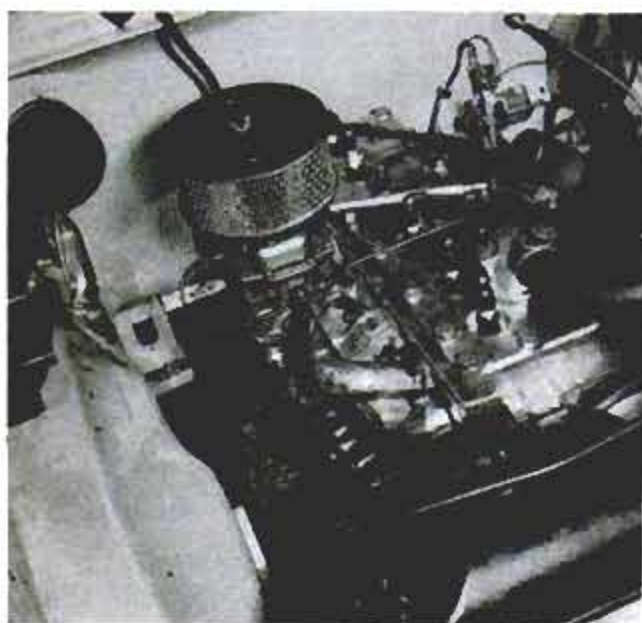

WHAT DO YOU want in a new car? A home away from home? A place in the sun? Fins and flash to make neighbors bug-eyed? If so, the Studebaker Lark is not for you.

But if you want a vehicle that seats six in nonluxurious comfort, that parks in the garage and still leaves room for bikes and garden tools, that is designed for low first cost, low operating costs, then you'll be interested in the Lark.

It's small. Over-all, only 175 inches. That's less than 15 feet and it makes a 20-foot garage look like an airplane hangar. Overhang is 26 inches in front, 40 inches in the rear, about a foot less than most cars

Studebaker's flat-head six is not revolutionary, nor complex (back-yard mechanics will be glad to know)

Front and rear bumpers are interchangeable, so are left and right taillights. This is the four-door sedan





Two-door sedan is lowest-price Lark. Door and center post are only recognizable carryovers from last year

in front, nearly two feet less in the rear.

Inside it is surprisingly roomy. It seats six in reasonable comfort. You won't rattle around in it, but there are few new cars that seat six in comfort these days. This one has better midseat comfort than most.

Two engines are available. The L-head six with 169.6 cubic inches develops 90 horsepower. The V8 comes in two versions: A 180-horsepower model with dual-barrel carburetor, and a 195-horsepower model with four barrels. This latter is a bomb and pushes you deep into the cushions when you floor the throttle. It will hit 100 without fuss, if you're interested. Most people aren't these days.

But Studebaker isn't selling canned heat. It offers sensible transportation as it fights back with what it feels a growing number of buyers wants.

Styling is carefully thought out to reduce repair costs. All fenders bolt on, for example. Front and rear bumpers are inter-

Trunk is not voluminous, but is adequate. Spare lies flat. Fenders bolt on (three bolt holes are visible)

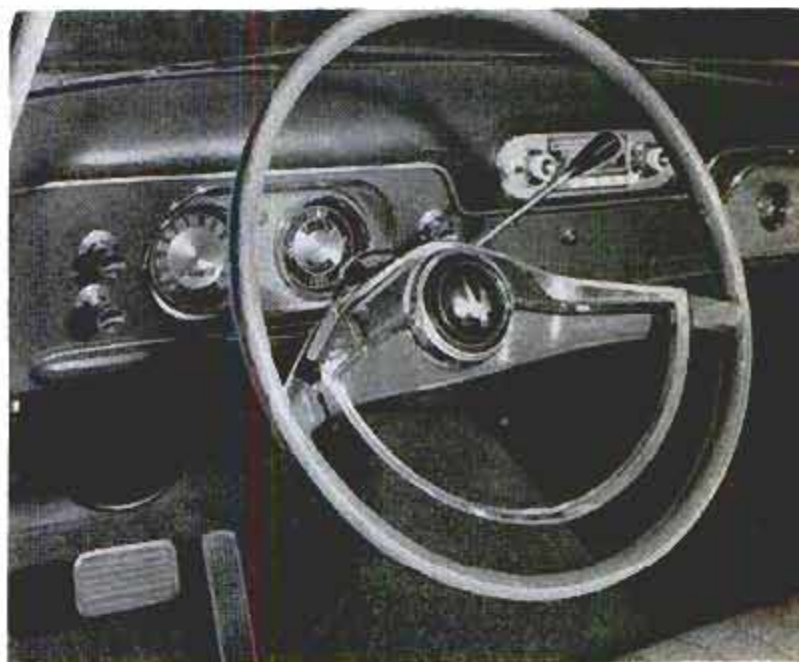

Simple dashboard is easy to read. Smaller body seems much tighter, more stable than previous Studebakers

Gas goes here. Trunk's high sill may be awkward when loading, but it's an important structural part





Station wagon has 113-inch wheelbase, 184.5-inch over-all length. Other models share 108.5-inch wheelbase



Small as it is, the wagon can be bought with a rear-facing third seat that folds down into floor when not being used

changeable (dealers like this). Tail-lights, too, are interchangeable, left and right. Chrome is noticeably absent. The grille is simple and easily replaced. There isn't even any hood ornament. The only brightwork is a strip that runs around the body to protect the paint in close parking and also to hide body joints.

By chopping off most of its overhang, Studebaker proves the old law of the vibrating reed—the shorter the reed, the less the vibration. The shortened car is tight and rattlefree.

Steering is easy and precise. The brakes are excellent.

The Six has a new combustion chamber design, increased compression (8.3 to 1) and a shorter stroke. Carburetors are new on all engines.

Economy should be around 25 miles per gallon although *PM* makes no tests of preproduction prototypes, preferring to test the car *you* buy instead of a hand-built model.

Studebaker continues the Hawk line in the coupe. It has the same engine choices as the Lark. ★ ★ ★

Still available is the Silver Hawk coupe. Reclining seats are optional on this and all Lark models this year

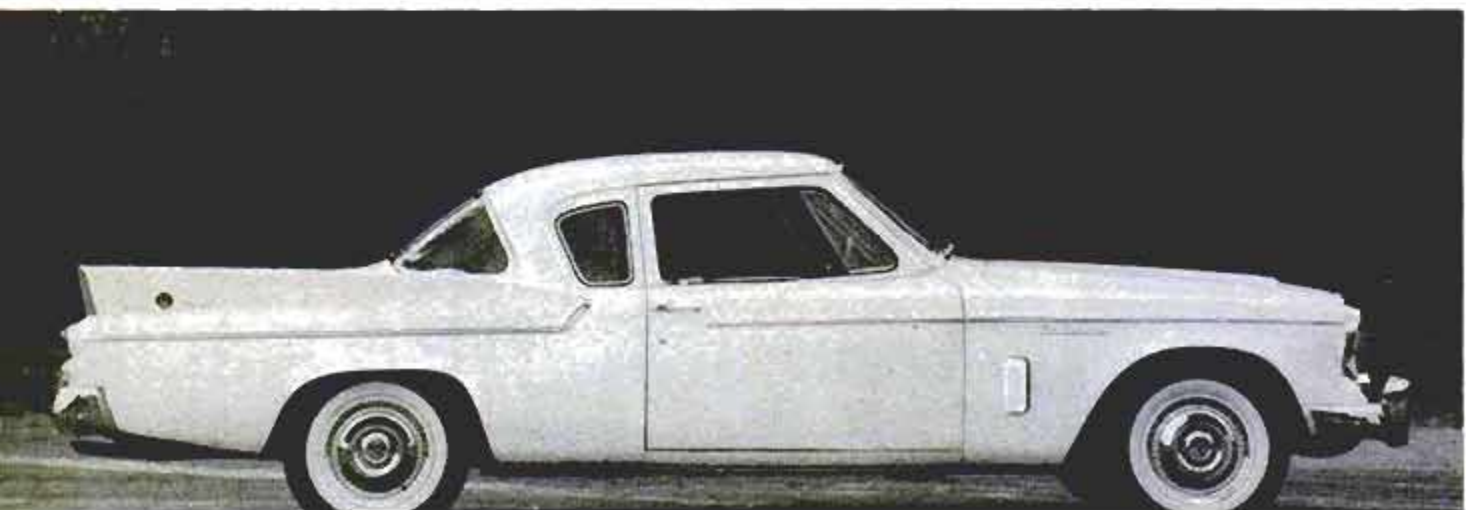

Plane Tilts Wing To Take Off, Land

Vertol Aircraft Corporation's Model 76 tiltwing craft takes off and lands like a helicopter and flies forward like a fixed-wing plane. The tilt-wing concept could eliminate the need for many large airports, for planes designed on this principle can operate from heliports or from unimproved plots of ground. It is believed that future versions of the Vertol tilt-wing craft will be able to attain speeds in the 350-450-miles-per-hour range. This would give the tilt-wing plane a decided advantage over the helicopter, with its current speed record of 162.7 miles per hour. Military tilt-wing craft could be used as fast assault transports and for observation, reconnaissance and rescue missions.



Anglers Find Fish by Listening to Their "Conversation"

Anglers now can find fish by eavesdropping on them. Using a new hydrophone, the angler can listen to fish "talk." Research indicates that each species of fish makes a characteristic sound, according to the manufacturer. The fisherman lowers the hydrophone into the water, listens on earphones, and drops his hook at a favorable spot.

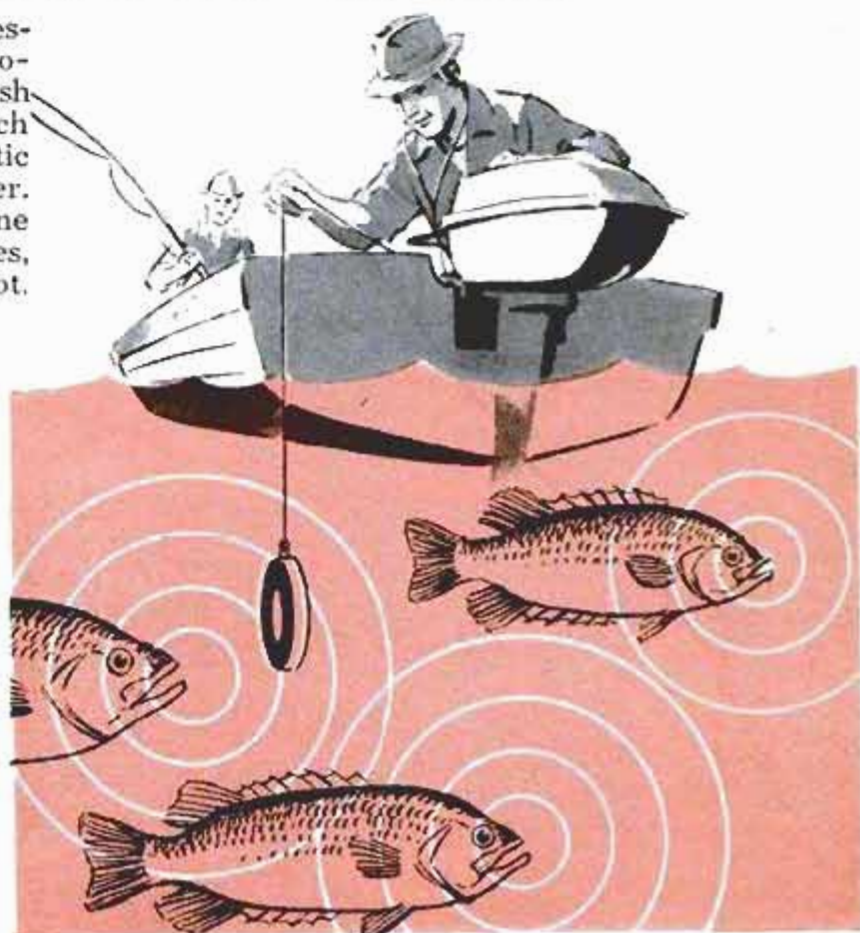



EASY LOADING CAMERA, above, eliminates problems of threading 35-millimeter film. The film cartridge is dropped into place and the leader is injected into the take-up chamber. Camera has $f/2.8$ lens
Eastman Kodak Company, Rochester 4, N. Y.

SOLAR-POWERED RADIO, left, has tiny silicon wafers in top of case to convert sunlight into electricity. It will operate indoors under light of a 100-watt incandescent bulb, or on a four-volt mercury battery
Hoffman Electronics Corp., 3761 S. Hill St.,
Los Angeles 7, Calif.

Shop Here

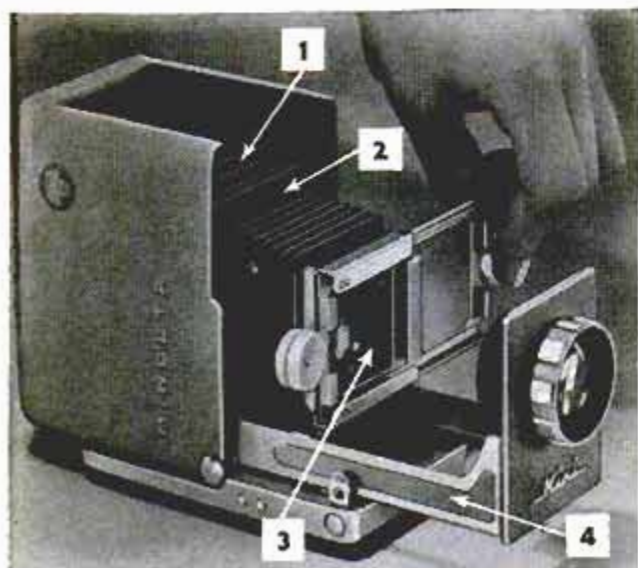

TURTLE CLOCK, above, has "educated" plastic turtle that points its head at correct time as it floats on water-covered dial. Gold anodized aluminum case contains jeweled eight-day clock movement. Magnets cause turtle to follow concealed arm of the clock
Swiss Harmony, Inc., 844 W. Adams St., Chicago 7



POCKET-SIZE PROJECTOR has wide-angle lens that makes a big picture. It unfolds like bellows-type camera from light-shielding case, 1. Condenser holder, 2, is behind condenser lens, 3, which moves on rail, 4. It accommodates either film strips or slides
FR Corp., 952 Brook Ave., New York City 51

ELECTROSTATIC AIR PURIFIER removes up to 95 percent of pollen, dust or smoke particles in the room. Three-speed fan circulates air past a removable and washable filter which attracts particles from air electrically. Unit also can be set in window
Coolerator Div., McGraw-Edison Co., 704 N. Clark St.,
Aubion, Mich.

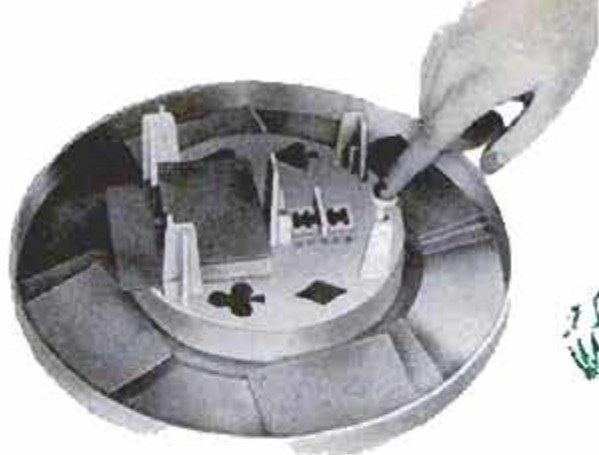

CARD SHUFFLER breaks up as many as three decks of cards and deals from two to six hands. Dealing is controlled by plastic knob as unit is revolved. To change the number of hands, a small lever is reset

Dayo Products Co., 200 S. Orchard Ave., Dayton, Ohio

SKEWER SUSPENSION for indoor or outdoor barbecues allows radiant heat to penetrate meat as torsion cord winds and unwinds. Reflector is adjustable to speed cooking. Up to 25 skewers can be attached

Mrs. Dorothy Damar, 768 Damar Bldg., Elizabeth, N. J.



PORTABLE ELECTRIC ORGAN, developed in Europe for homes, small churches or outings, has a range of four complete octaves. The instrument produces a smooth rich tone and uses 110-volt house current. Carrying case has legs which form a table for organ

M. Hohner Inc., 351 Fourth Ave., New York City 10

PHOTO SLIDE BINDER makes it possible to bind projection slides between glass in 30 seconds. The device binds with one-half inch adhesive tape. The edges and corners are sealed smoothly by rubber rollers. Rubber suction cups hold binder to any surface

Mack's Industries, Inc., Waterloo, Iowa

PORTABLE DISHWASHER has a drop-leaf countertop that adds four feet of working area to a kitchen. The dishwasher can be rolled up to the table after a meal and loaded with dishes, then rolled back to the kitchen, connected to the sink and turned on

Waste King, Corp., Los Angeles, Calif.





PORTABLE DRYER, above, is basically an electric space heater and room fan. But it also can be used as a hand or hair dryer, to speed up drying of paint and varnish, or used as a darkroom drying aid

American-Refrigeration Export Corp.,
39 Broadway, New York City 11

BRIEF CASE BARBECUE grill will cook 50 hot dogs or eight steaks at a time. But it folds into a package only two inches thick. Half of the case is a charcoal firebox, the other half is a side table

K. G. Niblack Co., 100 Huntington Ave.,
Buffalo 14, N. Y.

Shop Here



ELECTRONIC FLASH unit for amateur photographers eliminates need for a separate power pack. All necessary components are built into the handle and lamphead. It works off three D-size batteries, or a.c. house current

Heiland Div., Minneapolis-Honeywell Regulator Co.,
5204 E. EVANS AVE. DENVER, COLO. Minneapolis, Minn.

STEAK TESTER has a built-in red signal light that tells you when it's time to remove the cooked cut from the grill. You just dial your choice of well done, medium or rare, and adjust the device for steak thickness

Scott Thermo-Meter Corp., 1195 Brooks Ave., Rochester 10, N. Y.

PHOTOENGRAVED CUFF LINKS are made from your own favorite snapshot or drawing. The exact details of the picture are reproduced on a metal surface one inch square

Gray Products, 2037 Maycrest Ave., South Pasadena 2, Calif.



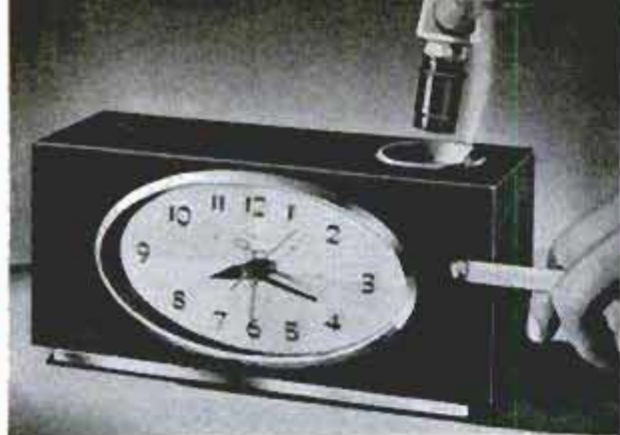

ELECTRIC LIGHTER is built into the top of electric clock and uses house current, stepped down to six volts. Like a car's dash lighter, it draws power only when heating. It's equipped with safety fuse

The Ingersoll Co., Bristol, Conn.

SOLAR STOVE develops a temperature of 400 degrees in five minutes. On a clear day, the metal and plastic unit will cook four hamburgers in less than 10 minutes. The only fuel needed is sunlight

Phillips Corp., Salem, Mass.



for Christmas

SERVING CART folds flat when not in use. The cart is finished in black enamel and gold anodized aluminum. It has room on two trays for food and dishes for small garden or patio parties, or for indoor buffet meals

Trimble, Inc., Rochester 10, N. Y.

SLIDE-RULE WATCH has standard watch dial with sweep second hand plus a built-in circular slide rule that can be used for multiplying, dividing, figuring interest or percentages. Slide rule dials are turned by knobs

Wakmann Watch Co., Inc., 13 West 47th St., New York City 30





BATTERY-DRIVEN CAR has aircraft-type steering wheel, forward-reverse switch, hand brake and foot throttle. Car carries 250 pounds of children or parents

Giant Piston Ring Co., 241 N. Westmoreland Ave., Los Angeles 4, Calif.



SATELLITE TRAIN holds "moon" in orbit above launching platform as it travels 0-gauge layout. Has radar, searchlight cars, "space research" caboose

Kusan-Auburn, Inc., Nashville, Tenn.



Shop Here



MOON ROCKET is built from plastic model kit which includes a launching pad with movable arms, a detailed cockpit with three "spacemen" and two ground crewmen. Finished model is 14 inches high. Its three stages can be separated for a simulated flight

Revell, Inc., 4223 Glencoe Ave., Venice, Calif.

WORKING MODEL of the Navy's TBF Avenger features a revolving gun turret with a machine gun that swivels, retractable landing gear, folding wings and a bomb bay that releases a torpedo. Parts of kit were copied from Navy's original blueprints

Monogram Models, Inc., Chicago 32
3421 W. 48th Place.



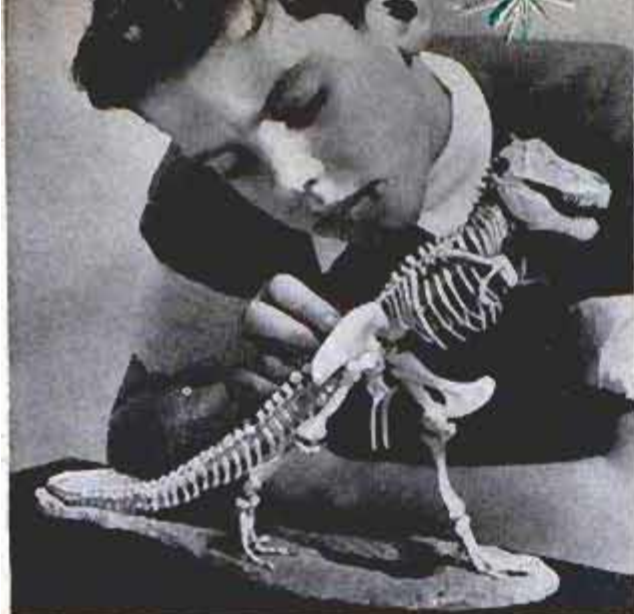

BUILD-IT-YOURSELF DINOSAUR is assembled from kit of 46 plastic pieces. Finished 16-inch model is lifelike replica of huge reptile
 Ideal Toy Corp., 200 Fifth Ave., New York City 10



ROCKET LAUNCHER duplicates firing procedure of Army's earth satellites. Set includes motorized launching tower, illuminated control panel and rocket with foam-plastic nose
 The Lionel Corp., 15 E. 26th St., New York City 10

or the Youngsters

BICYCLE SPEEDOMETER works by air pressure on same principle as aircraft speed indicators. Orifice at front of instrument allows entry of air which blows against fan blade to move spring-mounted needle on dial. Back of instrument is "taillight red" plastic
 Sinko Mfg. & Tool Co., Chicago 31

MINIATURE BOWLING GAME challenges your ability to score strikes and spares on an area about the size of a bridge table. The pins and ball are made of hard wood. You swing ball, suspended on a chain from an overhead boom. Scoring is same as in regular bowling
 7310 W. Wilson Ave.
 Oak Corp., 2045 Cambridge Hwy., Detroit, Mich.

GROWING MIRROR was inspired by custom in many families to measure height of children on a wall or door. Frosted edging at side of mirror has half-inch calibrations up to five feet and space to mark child's growth. Marks are removed with damp cloth
 ARE WHERE'S-TO-FIND-IT LIST
 Donnelly-Kelley, Glass Co., Holland, Mich.

CHILDREN'S CHORES can be posted on a tablet form designed for easy hanging in the kitchen, den or youngsters' rooms. Intended to instill dependability at a tender age, chart lists such items as "Clean Room," "Brush Teeth" and space for small fry names
 The Patrick Co., 734 15th St., N.W., Washington 5, D. C.

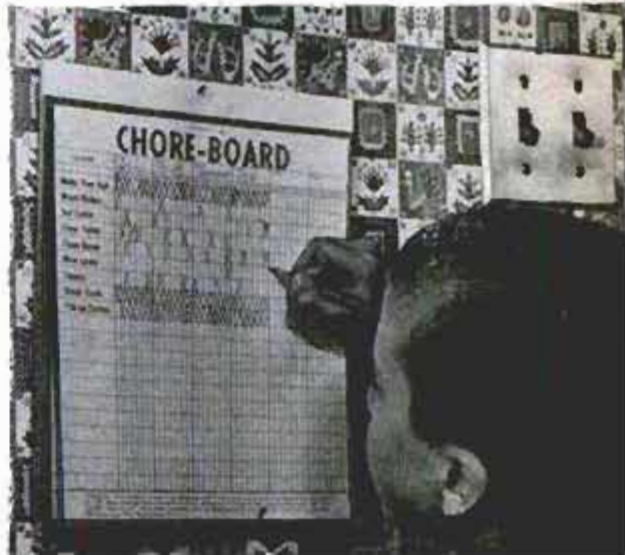
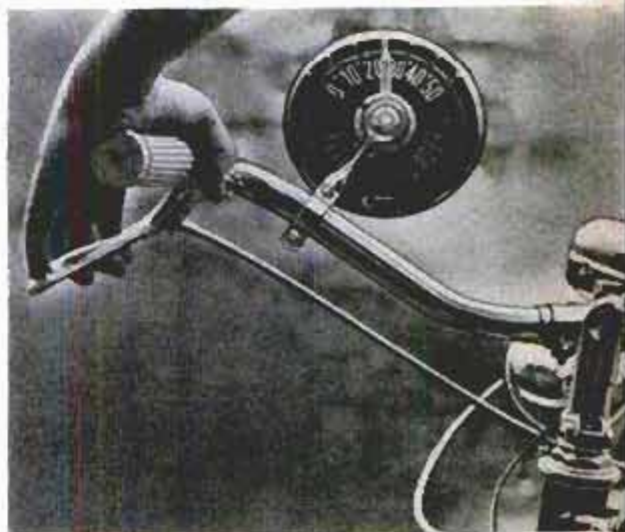

Fighting the Fire Ant

By John Krill

BACK IN the 1920s, a ship from South America docked at Mobile, Ala. Besides discharging her cargo, the vessel discharged a group of insect passengers which were destined to become a major headache. The insects were fire ants. Hated and feared by all animal life, the fire ants also devoured and destroyed vegetation. They found the new land much to their taste and multiplied at a prodigious rate. So widespread has the pest become that Congress has ordered the Department of Agriculture to take control measures.

Individually, the fire ant is insignificant in appearance. It is about one fourth inch long and reddish in color. Its bite stings like the burn from an ember. On humans the sting causes painful boillike sores.

Using the same unspectacular pattern that allowed it to gain a foothold in Mobile, the fire ant ranged far and wide until it was established in nine Southern states. The pests traveled on trucks, trains, cars and airplanes. They drifted on logs and debris in streams and rivers. They flew and they crawled as their numbers multiplied incessantly. After mating, the queens cast off their wings and started new colonies.

The pests invade homes and devour all meats, butter, bread, cheese and sugar;



Photos courtesy U. S. Department of Agriculture
Busy ants devour an unopened bud of an okra plant. Their big appetites also send them underground to attack potato crops

often they eat holes in clothing. Helpless wild and domestic animals are attacked. Newly born creatures unable to run are especially vulnerable. Voraciously feeding below and above the ground, the pests cause untold damage to vegetable crops such as corn, potatoes, okra, eggplant and melons. Forage crops, fruit trees and shrubs, nursery stock, grasses and cereal crops all fall victim to the ant's hunger.

They build great, hard-crustured mounds on lawns and cultivated lands. Where fields are heavily infested with the pests, farmers are finding it difficult to hire harvest workers. The ants attack man viciously. Small wonder then that field workers refuse to enter such areas. Control of the insects by individual property owners saw some preliminary success. But soon the pests began spreading at such a rate that individual effort was no longer an effective check. It was found that community action was needed for effective control of the fire ant.

Now federal action will insure control. Aircraft are being used in heavily infested agricultural areas. Hand application is doing good work in populated areas. The weapons are heptachlor and dieldrin. The battle will not be won with a single attack. It will take several years and the battleground will cover some 20 million acres.

Fire ants build large, hard-crustured mounds in cultivated fields. Mounds can make it impossible for farmers to operate mechanical equipment





United States Plywood Corp. photos

"Hi-fi or TV?" This Glen Cove couple has a choice in the built-in entertainment corner of their family room

HOW CAN YOU CHANGE a modest home into a show-place? One young family who owns a \$19,000 home in Glen Cove, Long Island, N. Y., has the answer. It's built-ins for every room and almost every wall. Of course it helps if you are a Vienna-born cabinet maker and designer, but the Glen Cove do-it-yourselfer says that most of his projects can be built by a man with average skill. One of his most ingenious built-ins is a 16-foot wall unit in the family room which conceals the radio, TV and hi-fi sets, a complete sewing center, and a fold-up bed behind folded doors. The TV rests on a heavy-duty Lazy Susan bracket which slides out so the set may be viewed from any part of the room. Records are stored in a cabinet below the TV and the speaker housing is built behind grillwork next to the set. Drawers, a fold-out worktable,

Folding doors of 16-foot storage wall in family room conceal TV, sewing unit, bed

A HOUSE FULL OF BUILT-INS

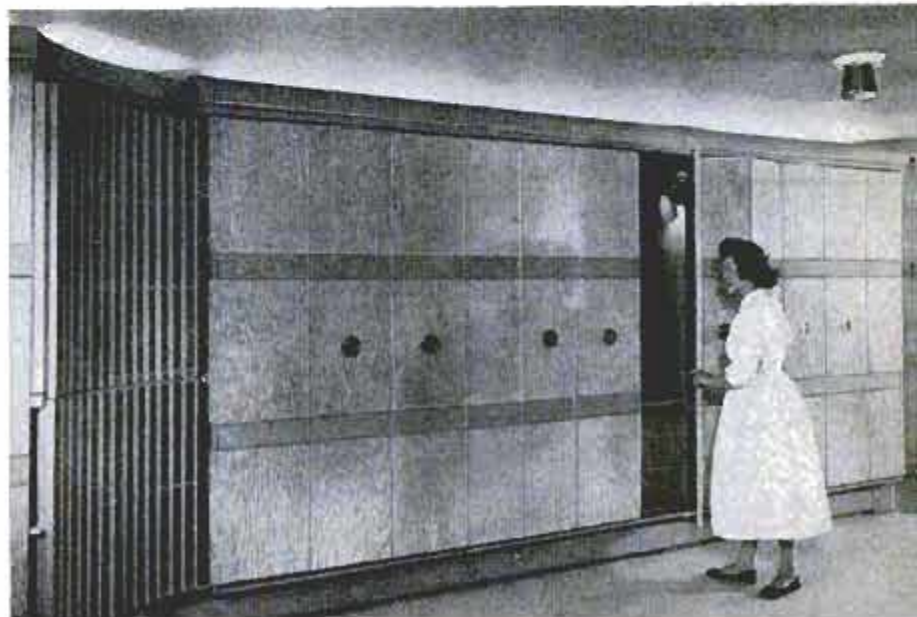



In the boys' room, tracks for toy train are mounted on board which folds into wall, becoming chalkboard

ironing board and storage for 100 spools of thread on perforated panels are found in the 5½-foot sewing center. The wall bed has shelves and cabinets built into its compartment to provide storage space for bedding and a guest's belongings. The boys' bedroom features a two-tiered bunk bed with a third bed concealed in a drawer at

There's a place for everything around the 12-foot workbench. Perforated multileaved racks along the wall give access to tools

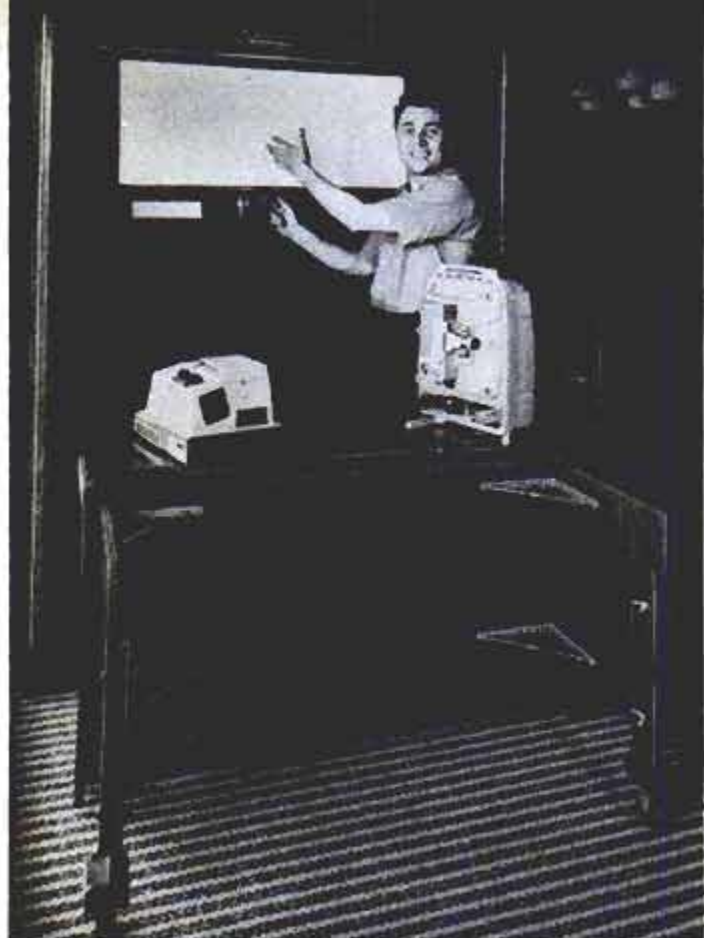

Out of this built-in rolls table to hold movie or slide projector; screen pulls down like window shade

the bottom. There's also a chalkboard that folds down from the wall to form a platform for a model train. An inconspicuous cabinet in the living room holds a motion-picture projector and screen. The projector is set in a custom-built table that can be rolled out, and the screen pulls down like a curtain. The basement workshop has

Owner demonstrates built-in guest room with fold-up bed and storage area in back



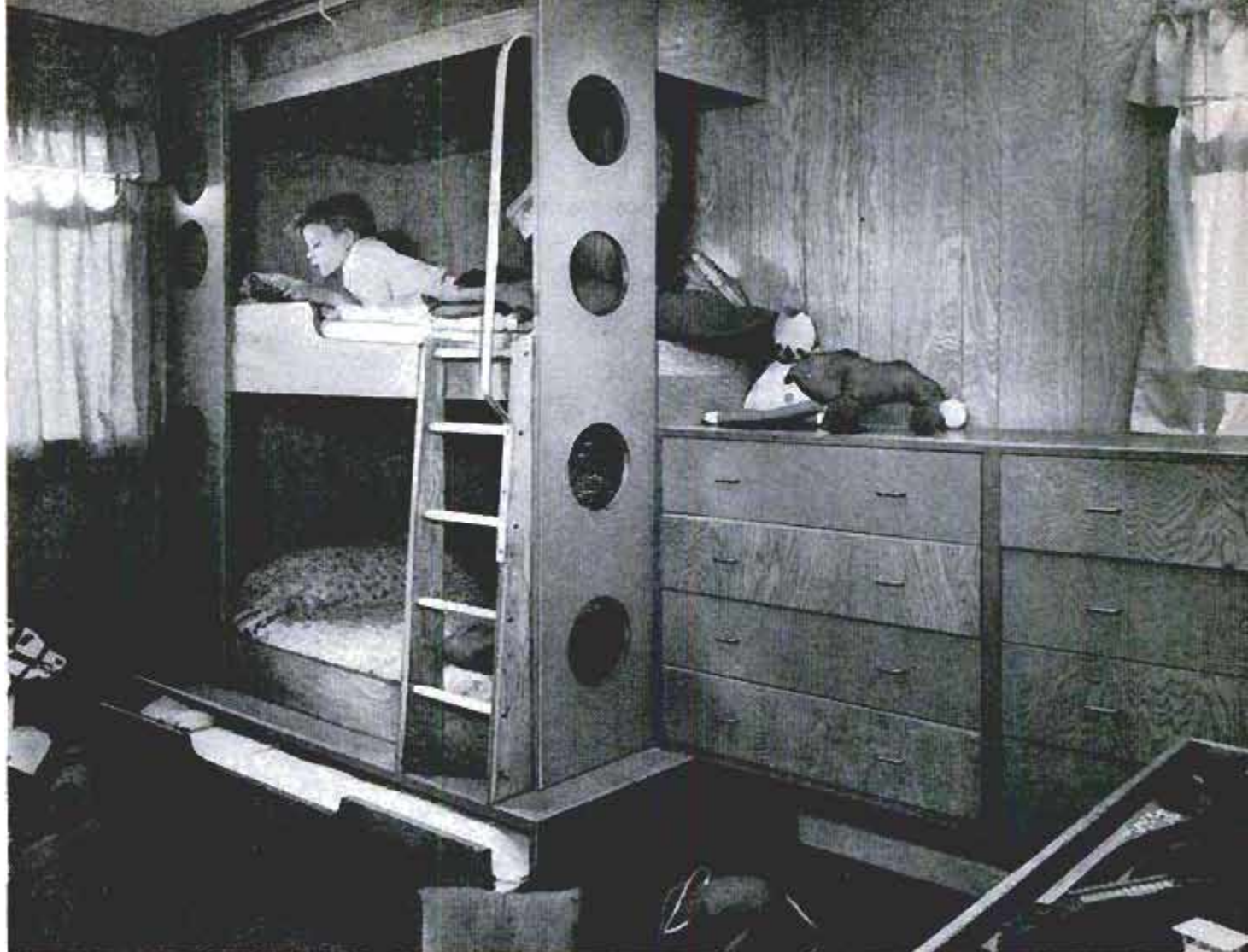

Drawer pulls out from beneath the bunk beds in boys' room to provide a third bed for young overnight guest

a 12-foot bench made of pine plywood with cabinets over and under the bench providing 60 cubic feet of storage space. A storage wall is built around the washer and dryer in the laundry, so all necessary articles are within a few steps. Floor-to-ceiling cabinets in the basement are used for summer storage of blankets and winter clothes. Among the other built-ins around the house are a hideaway refreshment bar, a 10-foot couch and end table combination, and a compact spare bathroom in a space $4\frac{1}{2}$ by 6 feet. Most of these built-ins are made of plywood and the paneling and facing are of United States Plywood Corporation's Weldwood panels in a variety of woods. ★ ★ ★

Built-in sewing center in family room is replete with fold-out ironing board and worktable, lots of storage space and a rack to hold thread

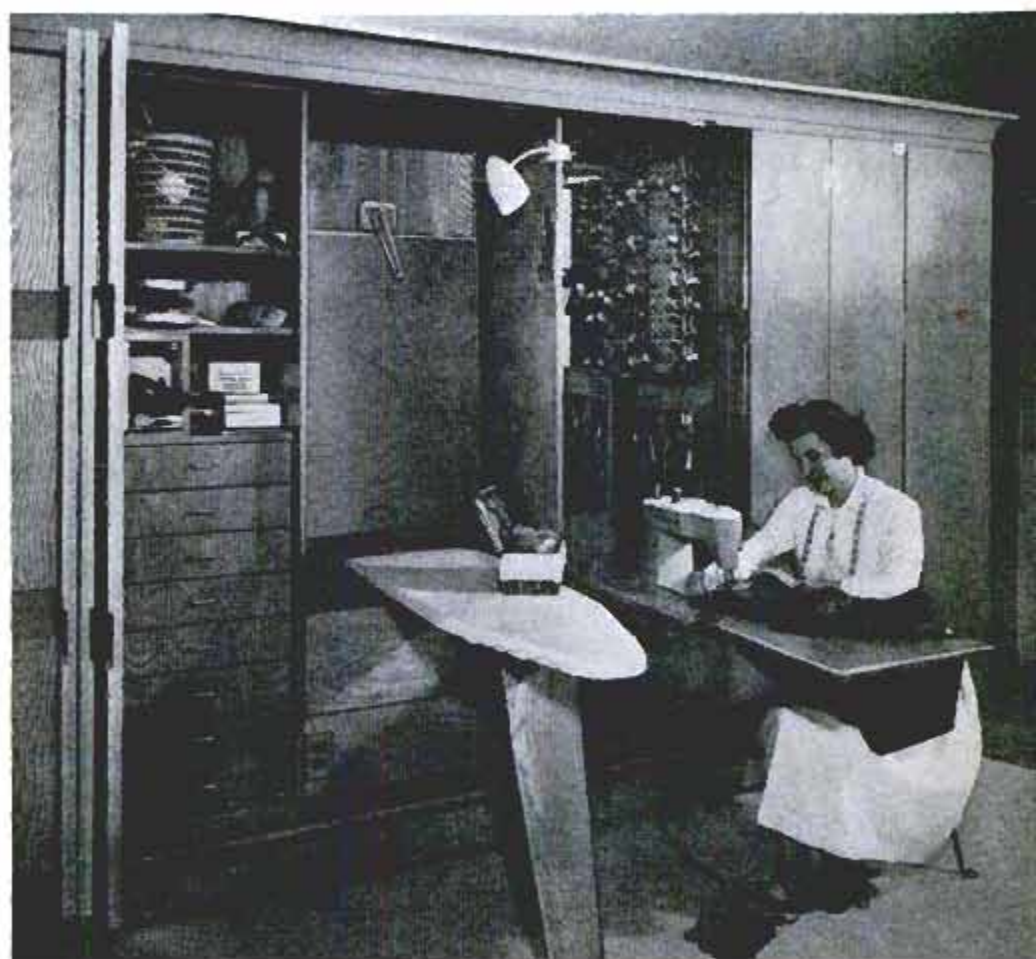

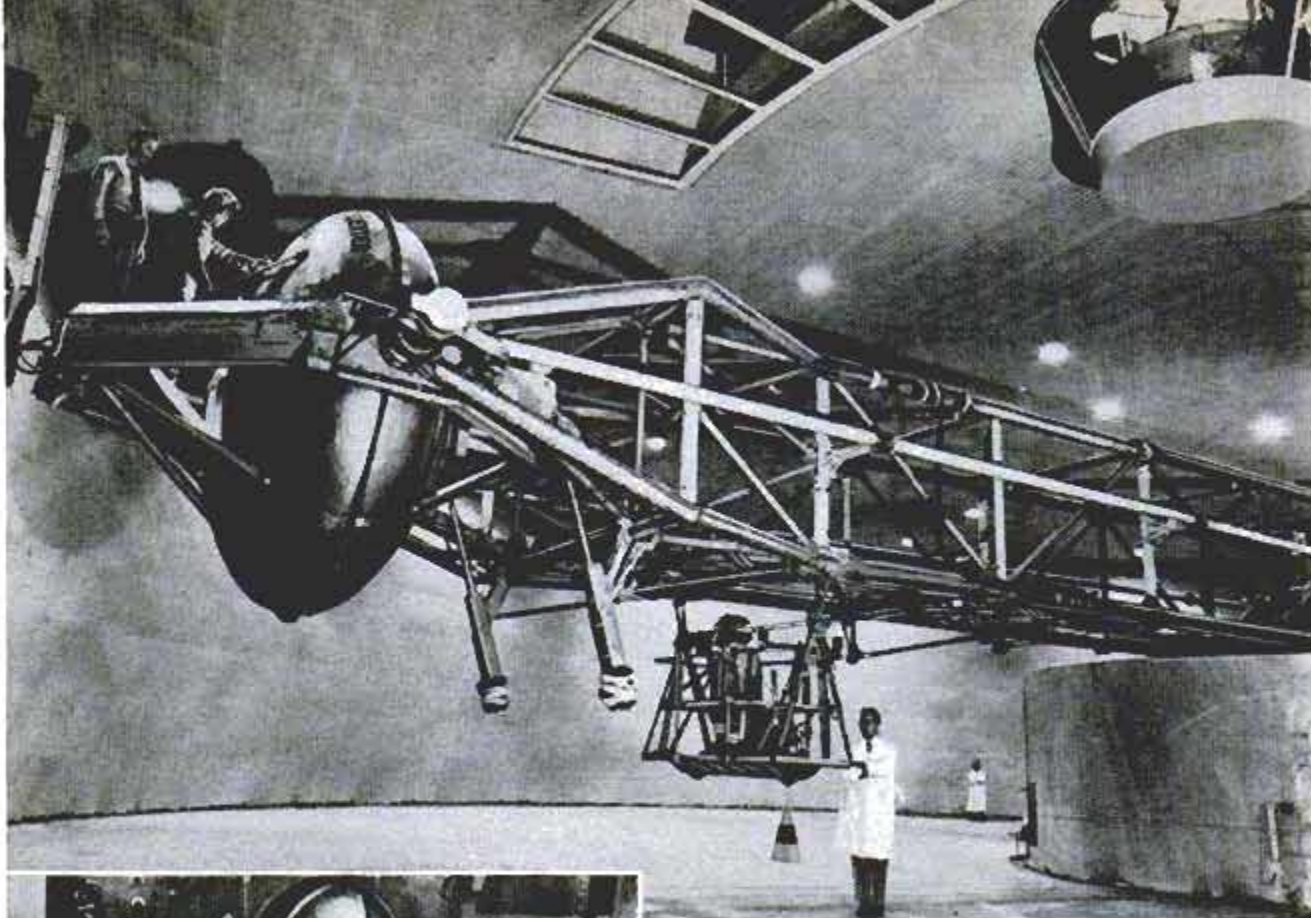

Centrifuge Tests Reactions To Rocket Flight

Man's reactions to the crushing forces of rocket flight are tested in a giant human centrifuge. The pilot sits inside a gondola located on the outer end of a 50-foot tubular-steel arm. He has a full complement of instruments and controls, and around him are devices for observing his physical condition. The gondola is tumbled end-over-end and sideways at various speeds and in many patterns. Cameras record how the pilot "sags" during "flight."



Safety Fan Vents Fumes

Air blows in the same direction, regardless of the direction of blade rotation, from a new, all-plastic fan. The cone-shaped blowers are being installed in some industrial plants because the design prevents accidental reverse flow of toxic fumes. Since it has no spark-creating metal exposed, the fan lessens the danger of fire or explosion from volatile vapors. The new fan is expected to replace propeller-type fans in some furnaces and air conditioners.

Model Rockets Probe Space Mysteries

Solid-fuel rockets are used to launch research models hundreds of miles above the earth in search of scientific knowledge. Models attain speeds as high as 11,000 miles per hour (Mach 16). Shock-resistant telemetering devices inform ground-receiving stations about such things as aerodynamic heating and stability. In a five-stage firing the first two rockets are fired early to gain altitude. Atmospheric re-entry facts are gained by delaying firing of the third stage until the vehicle has reached the re-entry angle. Stages three, four and five will then be fired to drive the test body at very high speeds through the atmosphere. The fifth stage contains the instrumented model, which usually tests a new design.

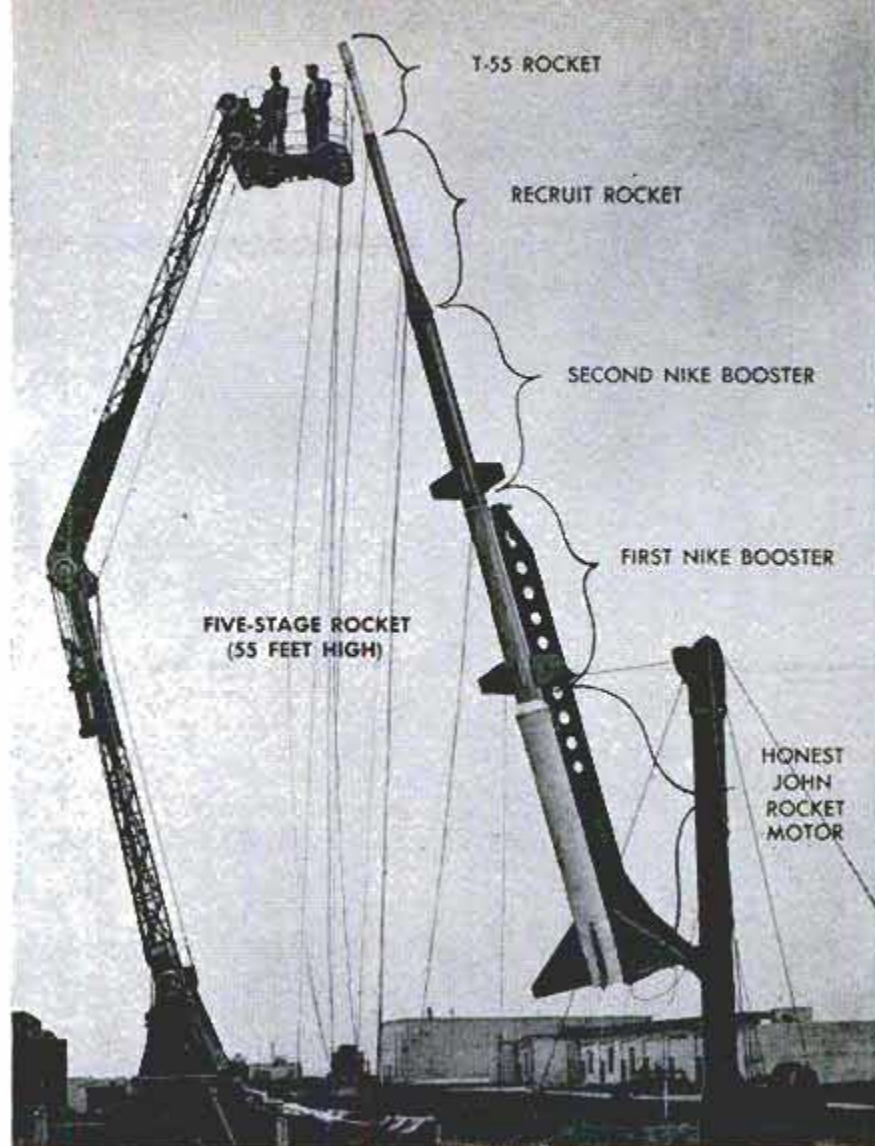

Eight-Jet Missile Bomber Can Span Oceans and Return Without Refueling

America's first missile-platform bomber, the Boeing B-52G, can span oceans and return to its U. S. base without refueling. The eight-jet, 450,000-pound bomber will carry two air-to-surface missiles that can be released hundreds of miles from their targets. Greater target altitude and climb

performance were gained by redesigning the wings, reducing the vertical stabilizer to 40 feet, 8 inches, and by using Pratt & Whitney J57-P-43W engines. Other changes from the original B-52 are the wing tanks, broader tail and hooded cockpit. The B-52G carries a bomb load plus the missiles.





This busy river boat on the Congo pushes two barges and also pulls two converted hulls filled with palm oil

STERN-WHEELERS PLY THE CONGO

By Lyn Harrington

PHOTOS BY RICHARD HARRINGTON

RUSHING FROM MOUNTAINS and meandering through swamps of the Belgian Congo, the Congo River is the outstanding river system of Africa. It carries much more shipping than the Nile. With its tributaries, the Congo provides some 9000

Congoese, their dugouts loaded with fruits and vegetables to sell, swarm over boat as it nears shore



miles of navigable waterways, of which 2000 miles are accessible to vessels of over 800 tons.

River boats and barges transport passengers and freight into the hinterland, carry out other passengers and products of the interior, such as mineral concentrates, palm oil and forest products.

Between Leopoldville and Stanleyville, 1077 river miles, the Congo makes a great arc, twice crossing the equator. Where navigation is interrupted by rapids, a railway carries cargo around the swift water to the Upper Congo.

Otraco (Office Transport Coloniaux) operates the river network with true Belgian efficiency, in freight, passenger and personnel service. Powerful electric cranes load and unload freight at the river ports. The ships are equipped with radar and short-wave radio and, with the aid of powerful searchlights on the bridge, they travel day and night. There is weekly service up the Congo from Leopoldville to Stanleyville, and less frequent service up the tributary rivers, such as the Ubangi and the Kasai.

The Congo is a busy water highway, with big three and four-deck diesel-powered stern-wheelers pushing loaded barges ahead of them. Very few other craft are seen on the river, apart from the dugout canoes of the Congoese. For over 1000 miles the river twists and widens within its banks. The volume of water in the

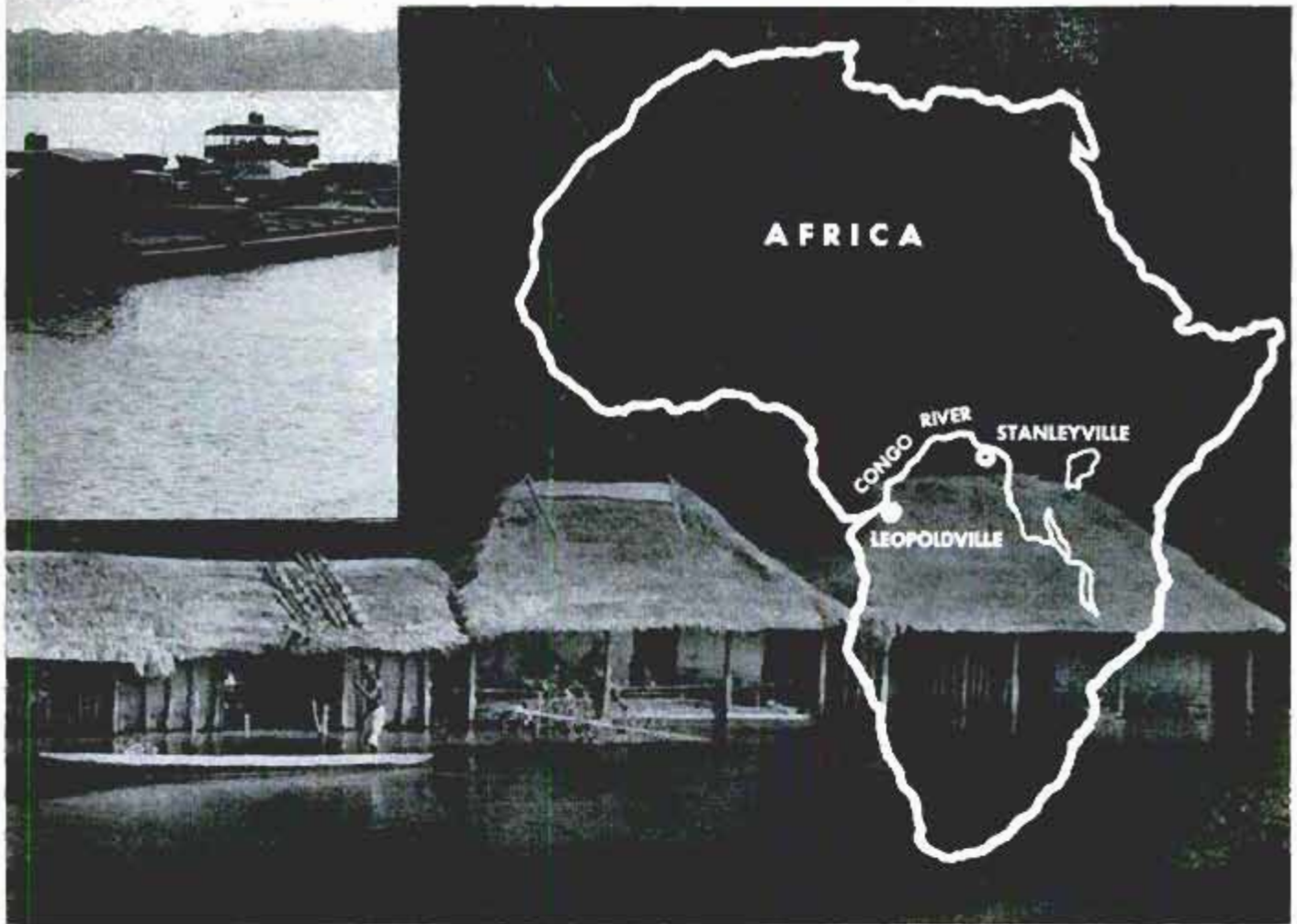

By the end of the rainy season, the Congo floods the porches of homes along the river, and families keep dugouts moored to pillars of their houses for ready use. In dry season, crocodiles appear on the sandbars

An older stern-wheeler pauses at a stop on the Congo to take on a load of wood, which is used for fuel. This boat is manned entirely by Congoese. In the background is a plantation where palm oil is produced





The *Baron Liebrechts* docks at Lulonga to deliver freight and passengers. Stops along the river are very short

Congo does not vary greatly, although at the end of the dry season, sandbars show up, usually adorned with crocodiles and hippos.

At times, a stern-wheeler moves close enough to the Congolese houses for passengers to peer inside. Elsewhere the river widens to 20 miles. Africans paddle their dugouts to the boat, to sell fruit and cassava to the crew and second-class passengers,

Congolese are employed wherever possible in river navigation and eventually become skippers of boats

or to buy smoked fish from the crew.

On the lower river, the ship encounters floating islands of water hyacinth, introduced to the Congo around 1950. This weed entangles itself around the propellers and is a nuisance to navigation. Eradicators are working on every tributary stream and, at Lisala, every river boat and barge is closely examined to make sure the weed is not being carried upstream. ★ ★ ★

Determined saleswoman brings cassava, wrapped in banana leaves, aboard a barge for sale to crew



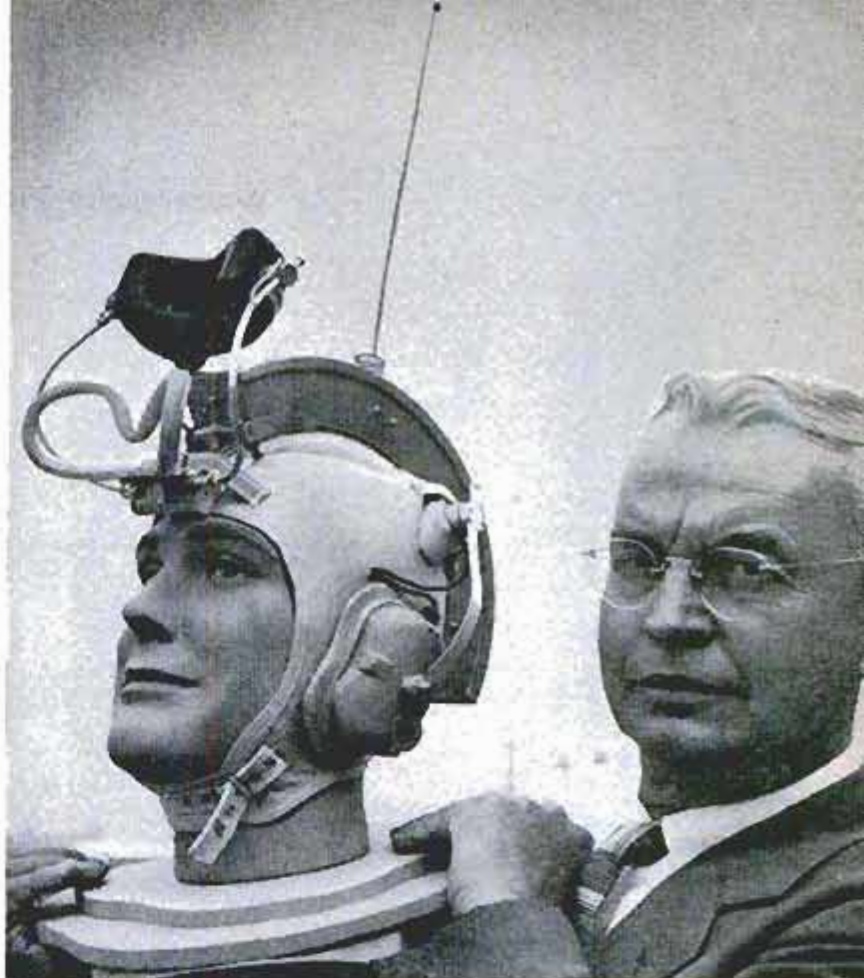

"Roman" Radio Helmet for Jet Plane Handlers Shuts out Noise

Radio helmets that allow aircraft handlers to talk and listen even when nearby jets turn on their afterburners are being tested for use on the flight decks of aircraft carriers. The helmet is padded with plastic to reduce the impact of noise that sometimes exceeds 135 decibels and is intended to be worn with padded clothing that protects other parts of the body from the damaging effects of intense sound. A transistorized transmitter-receiver is contained in

a curved headpiece that clamps over the helmet and is immediately detachable for replacement when its self-contained batteries need recharging. The circuitry is equipped with an automatic noise-actuated volume control. The entire unit, which resembles the helmet of an ancient Roman gladiator, weighs four pounds and was designed by the Navy Electronics Laboratory at San Diego. It's intended for use in deck areas where jet noise is loudest.

Antique Clock Replicas Assembled From Kits

Authentic replicas of antique clocks can be assembled without special tools from kits of precut parts. The kit contains a preassembled electric-clock unit. The case parts are cut from furniture woods—cherry, maple, walnut or mahogany. One of the clocks can be built in an evening.

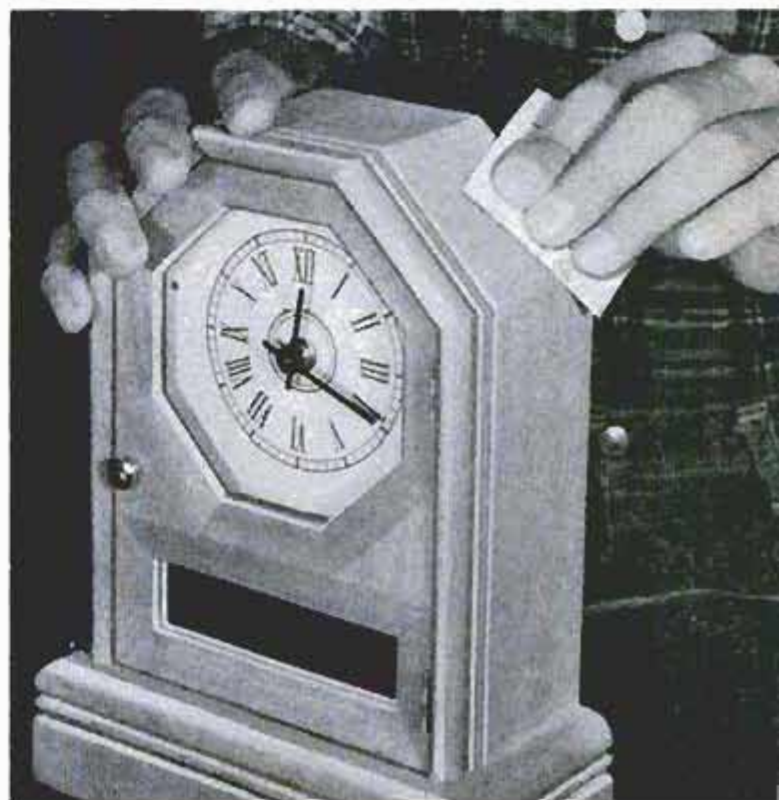
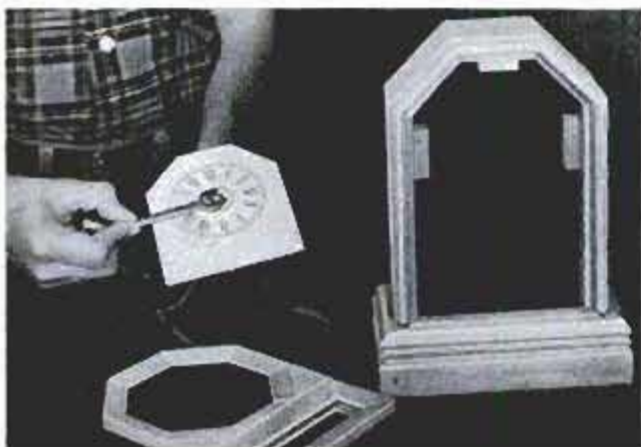



Milady Deftly Changes Costume Inside Umbrella

Now the sack look has come to beach umbrellas! Holding a new German-made umbrella above her head, milady unfurls

an opaque "bag" around her body. Then she performs deft operation of changing into her swimming suit—with one hand!

Tools Cut Auto Mufflers and Free

Muffler removal can be speeded with new pipe-cutting and heating tools. The cutter adjusts to pipes $1\frac{3}{4}$ to $2\frac{1}{2}$ inches in diameter. It leaves no burrs and can fit into tight spots. Its jaw opening is con-

Rust-Locked Pipes by Heating

trolled by the handle. The heating tool can free pipes locked to the muffler by rust, and it has a 1350-watt high-heat tubular element that breaks the rust weld in three to five minutes.





Plastic House Built in Japan

Japanese artist H. Igami believes that inexpensive houses will be built entirely of plastic in the near future. To prove his point, he constructed a home in Kyoto with plastic floors, ceilings, window sash, curtains and furniture. The house contains no steel, lumber or concrete. Igami reports the house is fireproof, quakeproof and moistureproof, easy to heat and to clean. Igami made even the kitchen utensils of plastic.

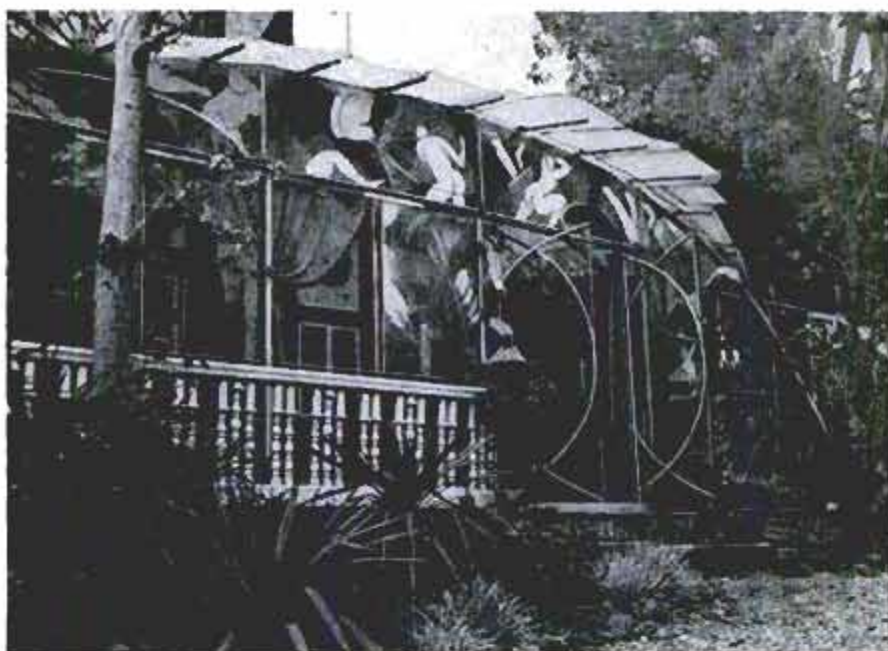

Danish Eggs Dated To Insure Freshness

Eggs in Denmark are dated weekly so that the buyer can tell whether they are fresh. The dating is done in egg-stamping plants under government supervision. An egg is stamped with a code number—like "Z3 45 67." The "Z3" is the code number of the egg exporter. The week in which the grading took place is identified by the "45," and "67" represents the station where the grading and packing took place.

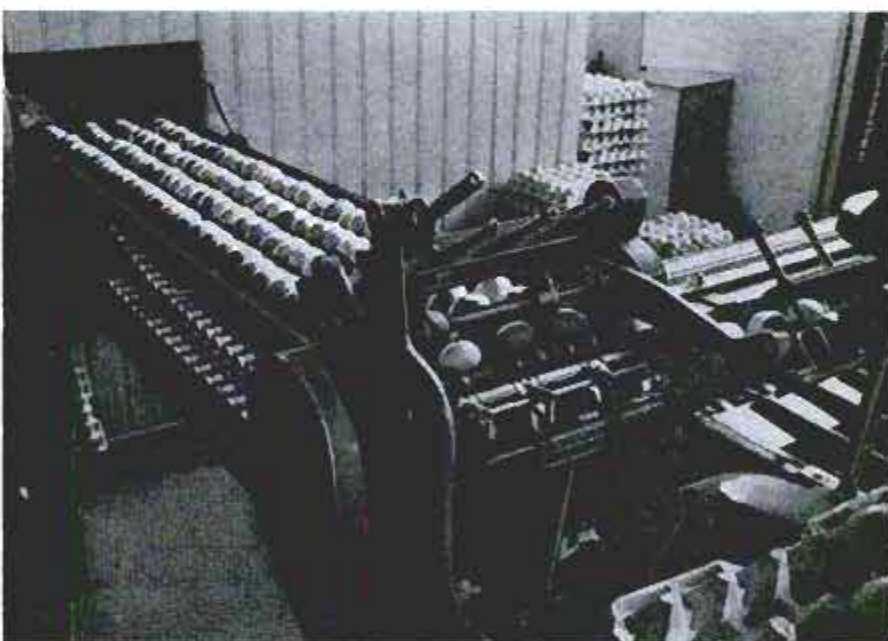

Salt - Water

A NEW KIND of electric battery that uses sea water as its electrolyte is operating half a dozen robot-instrument stations anchored off the coast of Lower California. The batteries produce steady current for three months or more without service and are good for many additional months if the sea water is renewed occasionally during that time.

Not only do the batteries power the oceanographic instruments and recorders at each floating station, they supply the current for the steady white lamps and powerful strobe flashers that serve as warnings to shipping. A radar reflector on each station also serves to keep shipping away.

Each cell of the new sea-water battery contains two parallel plates, one of magnesium metal and the other of porous carbon. Sea water, or even salt water, is used as the electrolyte. Each cell delivers one ampere at one volt under load. The battery was developed by Dow Chemical Company and the Scripps Institution of Oceanography from original studies made by Manuel Sanz of North American Aviation.

Scientists at Scripps believe the battery will come into wide use for offshore and other remote locations where long-lived and relatively inexpensive power sources are required. They point out that a two-cell sea-water battery that weighs only a third as much as an ordinary two-volt

Drawing shows untended instrument skiff anchored in deep waters. Sea-water battery powers instruments

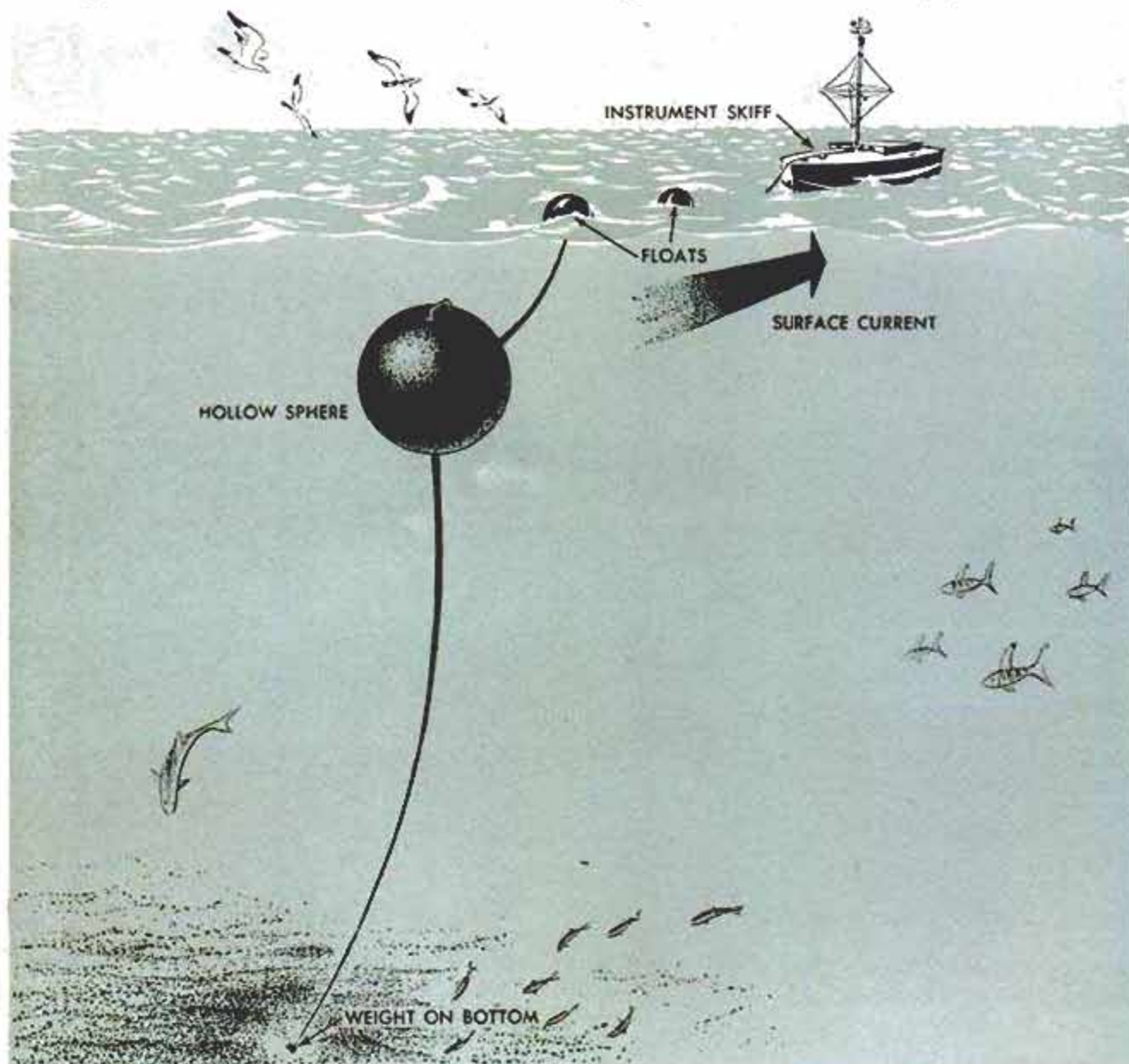

Battery

By Ewart Thomas

marine storage battery delivers 14 times as much energy before servicing or replacement is required.

The new battery isn't rechargeable. Instead, its magnesium anode is replaced when it has been consumed. More frequently, the electrolyte must be replaced so as to remove the sludge that builds up from the bottom of the cells. For its extra-long-life batteries, Scripps uses relatively huge electrodes in tanks that are deep enough to postpone the action of the sludge.

The battery is one of a family of batteries known as the air-depolarizing type. In this form, magnesium slowly goes into solution, producing hydrogen ions that travel to the

carbon cathode, thus creating the electrical current. However, the carbon surface would almost immediately become blocked, or polarized, by the hydrogen except for the fact that the carbon is porous. Air diffuses down through the carbon and yields oxygen that combines with the hydrogen to form water, allowing the electrical effect to continue. The battery literally breathes air and it is necessary for the upper end of the carbon cathode to remain dry and exposed to the atmosphere.

For convenience the battery elements are installed in waterproof wooden cases but in one experiment at Scripps a slot was cut into the hull of a small boat and the elements of a cell were fitted through

Technician rigs radar reflector on mast of skiff which serves as robot instrument station for oceanographers



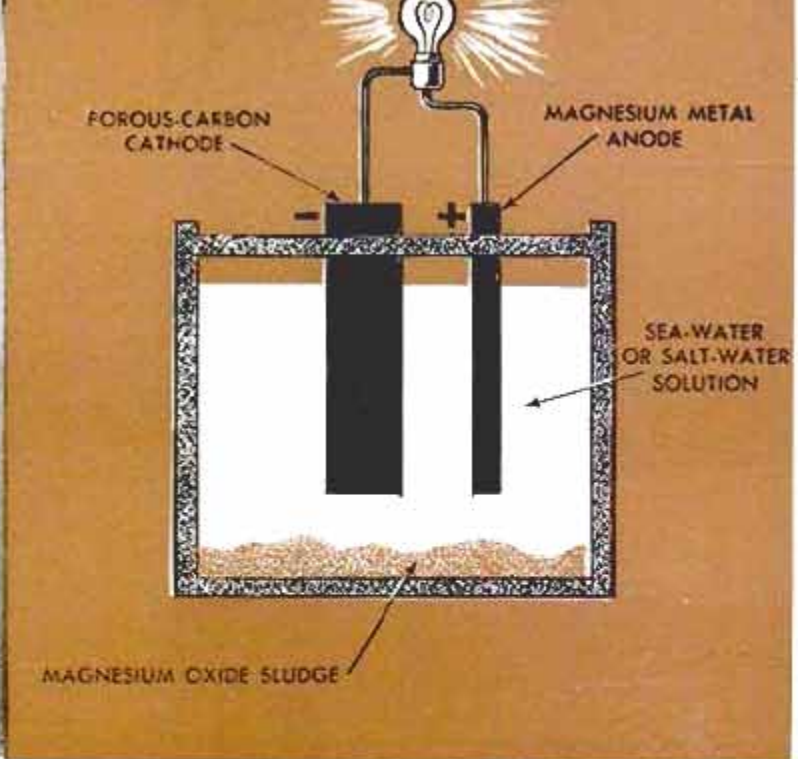
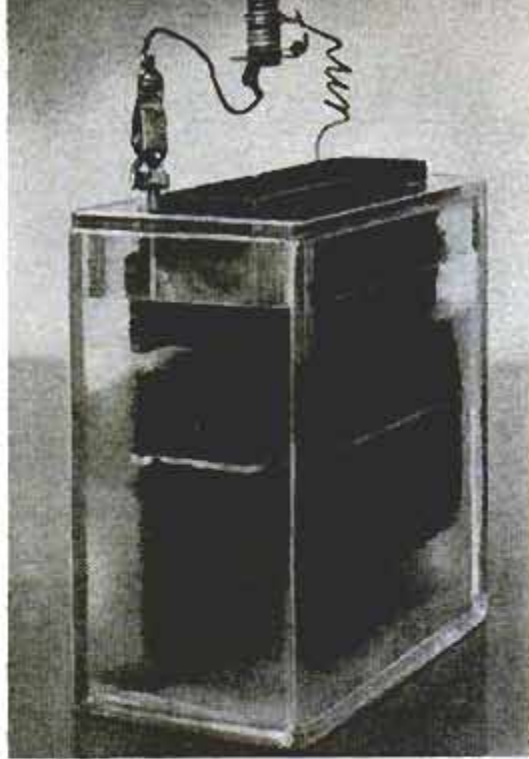

Drawing shows elements of sea-water battery. Three-percent salt solution can be used instead of sea water

the hole, projecting down into the ocean. The cell worked perfectly. In another experiment the investigators placed six groups of elements in series in a slot in the hull. A full six volts was not obtained due to partial "internal" shorting in the ocean water, though the power loss was reduced to some extent by placing wide plastic partitions between the pairs of elements.

The type of magnesium known as tooling plate is commonly used as anode ma-

terial and is generally available. Porous carbon is not on the general market. It is available, however, in the form of the special cathodes used for such air-depolarizing cells as National Carbon's CG-500 railway signal battery, and for air cells used to power rural radio-telephone circuits. In place of sea water an electrolyte consisting of a three-percent solution of common table salt in ordinary water works very well.

The offshore oceanographic stations that Scripps is maintaining on the Pacific consist of 14-foot decked skiffs with instruments that constantly measure wind direction and velocity, air temperature, and the sea temperature at five different depths. All this information is continuously recorded on rebuilt traffic-counting devices.

The skiffs are moored in water as deep as 12,000 feet by a new deep-mooring technique that allows them to float freely on the surface in spite of currents that otherwise tend to drag deeply anchored objects below the surface. In the new method, a buoyant spherical tank is moored below the strong surface currents, being attached to a weight on the ocean floor by a single strong

(Continued to page 256)

Assembling one of the large cells that will deliver steady current for three months. Elements will be placed in the waterproof wooden case

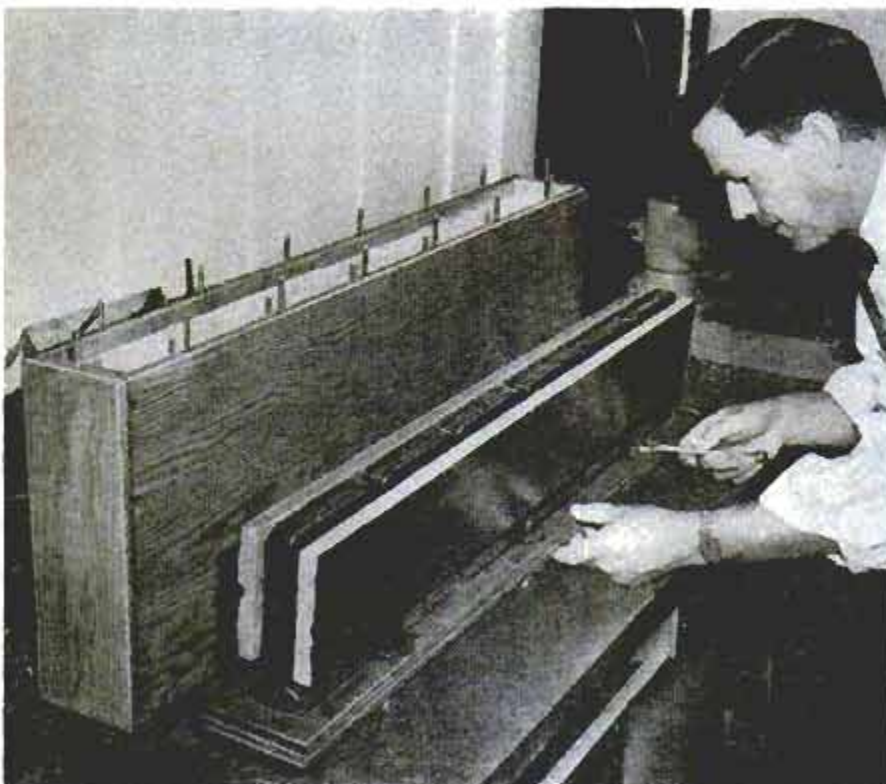

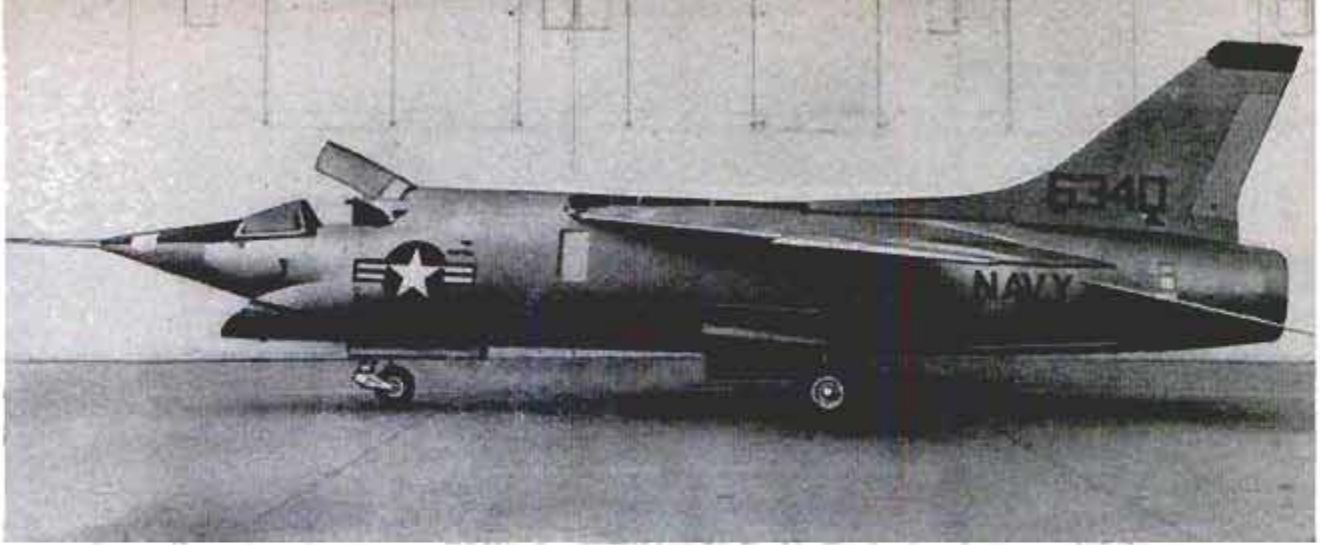

Navy Fighter Goes Into Combat at More Than 1500 M.P.H.

Chance Vought's Crusader III, a Mach 2, Navy push-button fighter, is capable of combat at more than twice the speed of

sound. It can also perform space-edge duty above 95 percent of the earth's atmosphere. It is armed with guided missiles.

Tire Valve Indicator Tells If Pressure Is Low

Tiny indicators attached to the tire valves on your car can tell you at a glance whether the tires are properly inflated. The indicator has a small red button that pops out $\frac{3}{16}$ inch to indicate that the amount of tire pressure is okay. When the button disappears into the indicator, this means a loss of six or more pounds of pressure. The device is preset to specified pressures of 40 to 105 pounds for truck tires with five-pound increments, and 22 to 34 pounds for automobiles with two-pound increments.

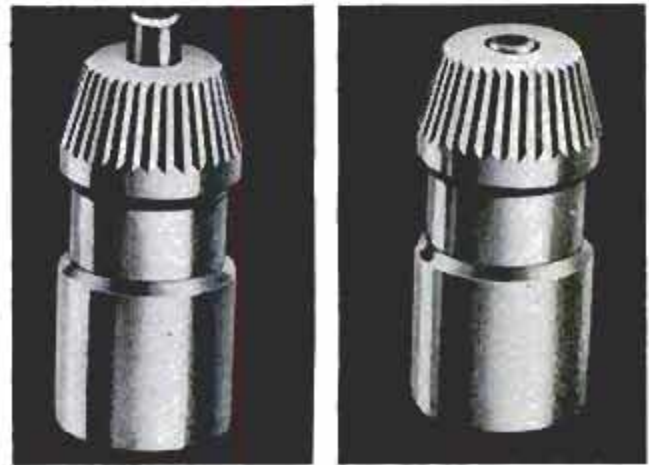

Telegraph Transmitter Operates Automatically

Western Union now uses a robot facsimile telegraph transmitter that feeds messages to itself mechanically and transmits them automatically in picture form. At the destination, a facsimile recorder receives and cuts off the message automatically, then readies itself for the next message. The device is called a flat-bed facsimile machine because messages are placed on a flat surface for transmission instead of being wrapped around a drum. Rollers draw messages through the machine automatically. The machine can handle messages of any length and up to $8\frac{1}{2}$ inches in width.



Chemical Sets Crease in Wool

Treating wool garments with a chemical solution developed in Australia reportedly will make the clothing's creases hold even in a rainstorm. The solution, which costs about 13 cents a garment, is applied to the fabric before the creases are set permanently with steam. The process was demonstrated recently in New Zealand.

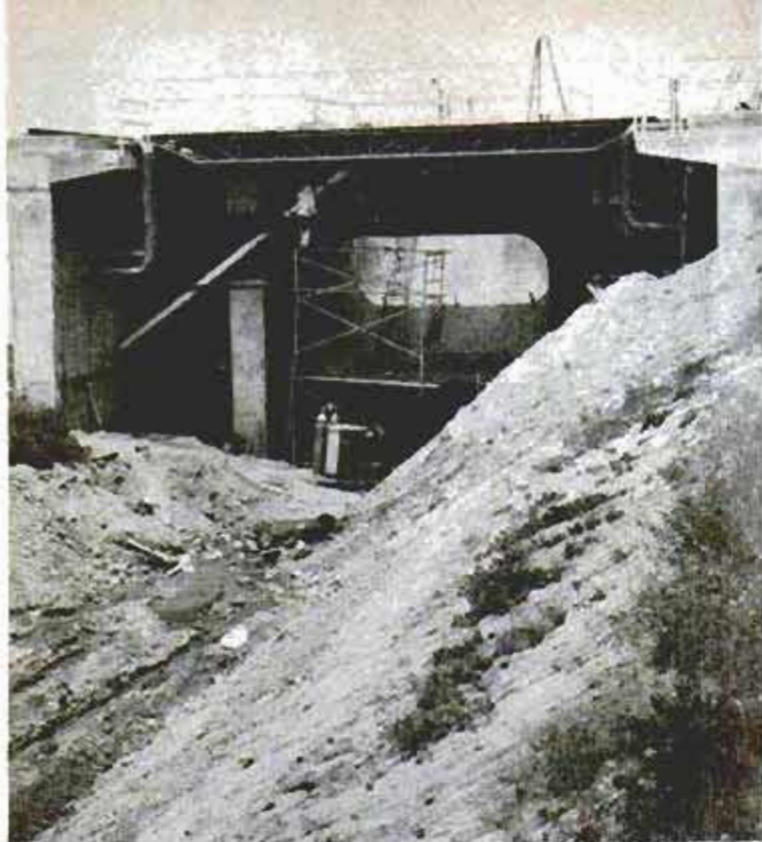

Launching pad for Atlas ICBM is flush with terrain. Opening below pad is flame deflector; cooling water flows into ditch

SOMETIME NEXT YEAR near Point Sal on the California coast an armored coverplate will move to one side, and a huge Titan intercontinental ballistic missile will slowly rise from its 150-foot concrete shaft. At ground level the enormous rocket will balance on the pad of its launching elevator for a few seconds, then with a tremendous blast of flame and sound it will climb upward, heading for the west Pacific beyond Wake Island.

There will be no witnesses nearby. Observers and technicians in a control room 75 feet below the surface will watch the flight by radar, television and possibly infrared.

The underground fueling, servicing and launching facility for Titan is being rushed to completion now at Vandenberg Air Force Base. It is an example of a "hardened" site, designed to resist anything except a direct nuclear blow. A near miss would leave the site unscathed. When completed there will be room for storing and assembling rockets underground, buried tanks to hold large quantities of fuel and oxidizer,

Underground Missile Base

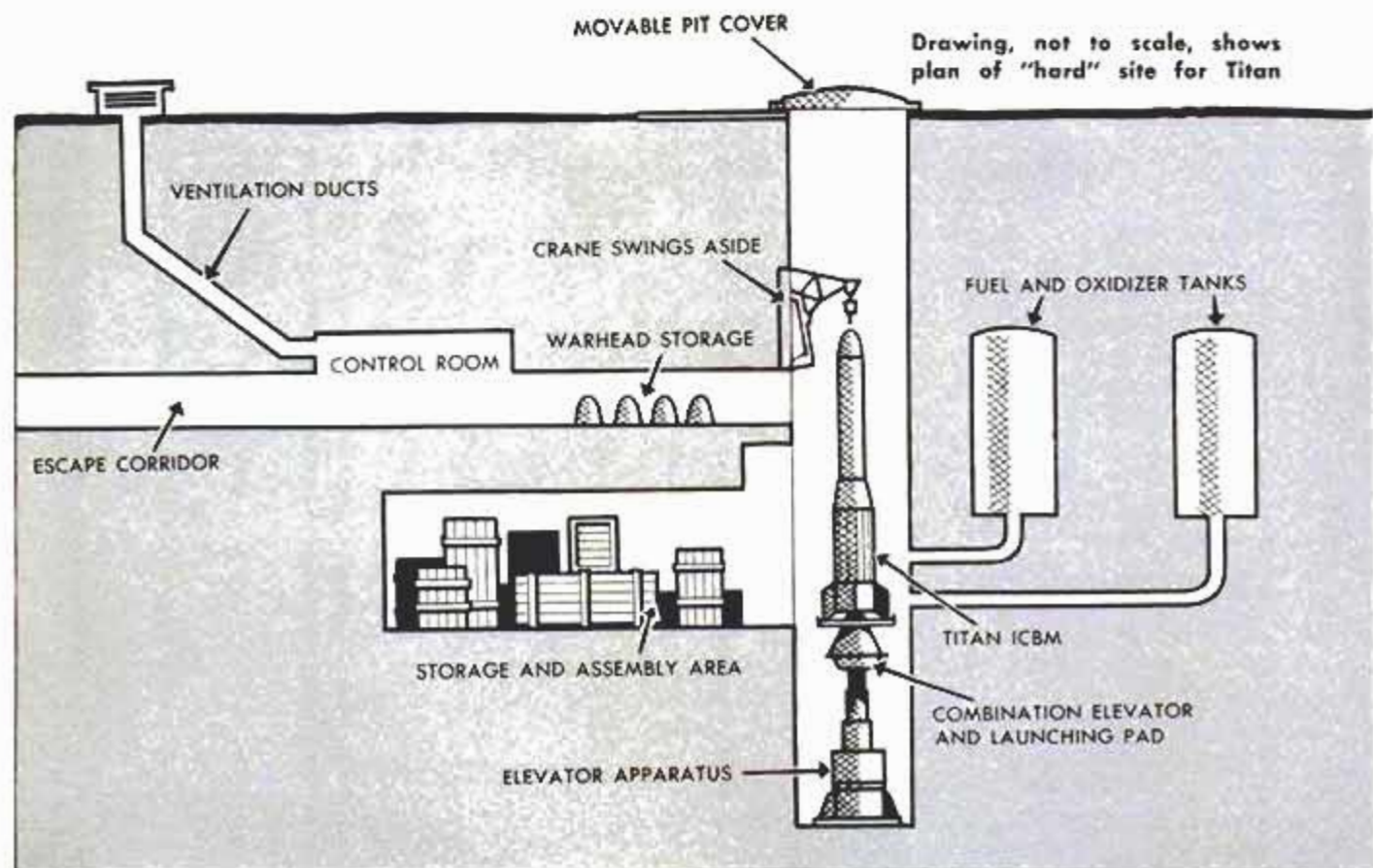

possibly underground living quarters for missile crews.

Later on, "hard" sites for the Minuteman rocket will be built at Vandenberg. This missile, still in the design stage, uses a solid fuel and requires no lengthy preparation time. "Countdown with a Minuteman," says one missile expert, "consists of one word. Go!"

Each Minuteman will be literally buried in the earth, at the bottom of a deep shaft, and launched from the bottom of the shaft. There will be no elevating mechanism to lift it to the surface, no buried fuel tanks. Compared to present liquid-fueled rockets, the solid-propellant rockets will be relatively simple and possibly far more reliable.

The new rocket base is the training area for Strategic Air Command's 1st Missile Division. More than that, it is the site from which giant missiles, satellites

(Continued to page 258)



Air Force technician works manual pump to open escape hatch. An Atlas blockhouse, below, is partially beneath ground level



Map shows new Pacific Missile Range for space vehicles "too big" to be fired safely from Cape Canaveral. Fan-shaped area extending to south is path for satellites orbiting over poles

TITAN RAISED TO LAUNCHING POSITION

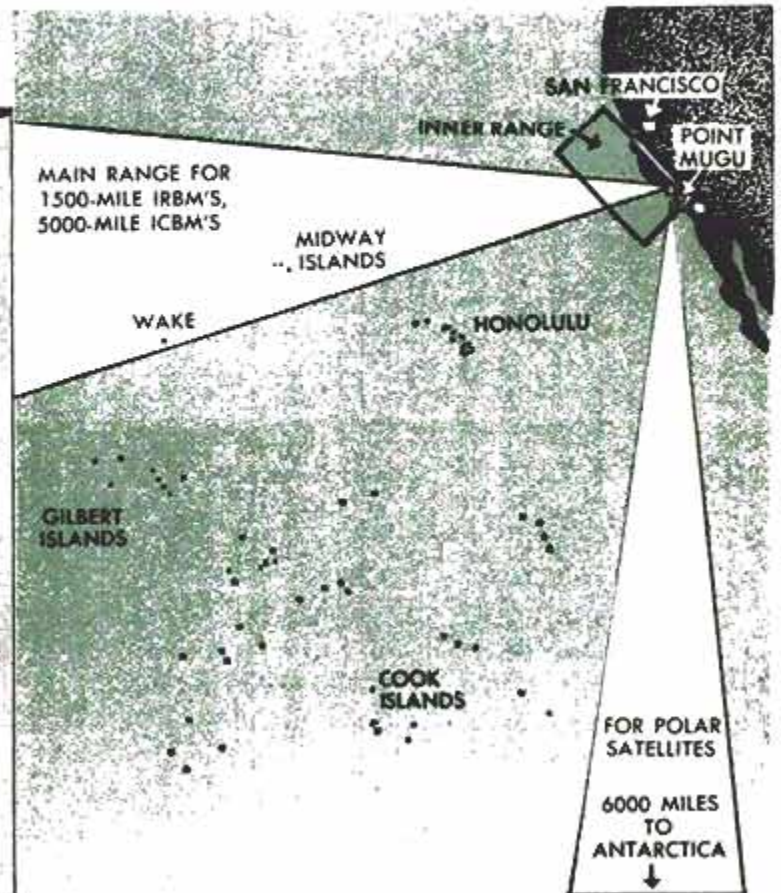
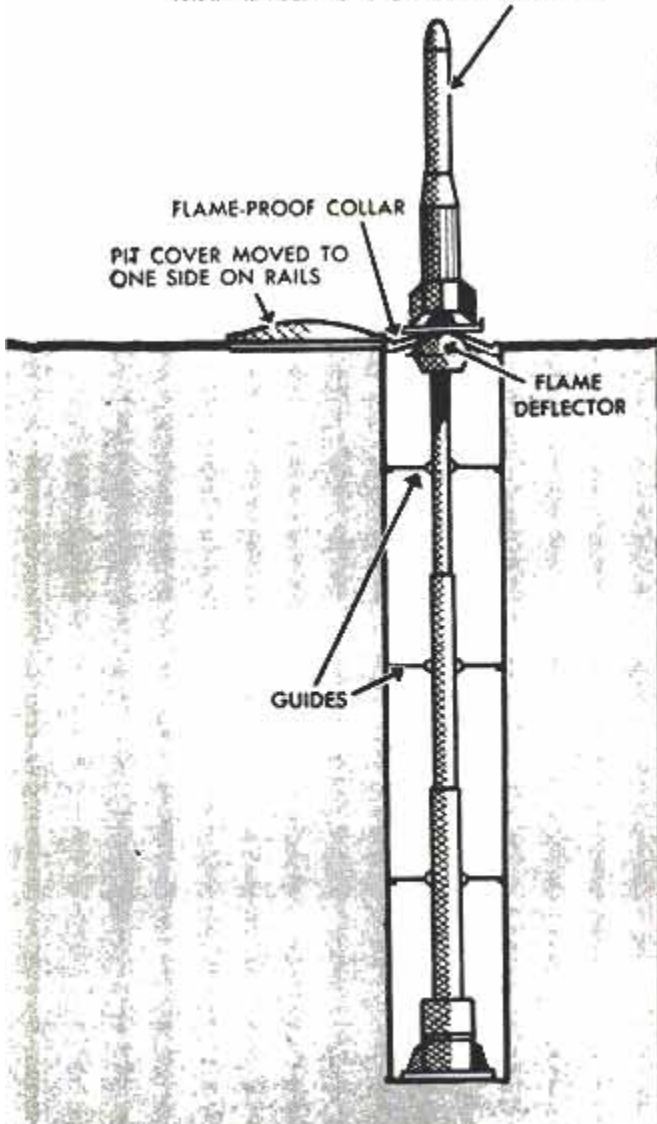

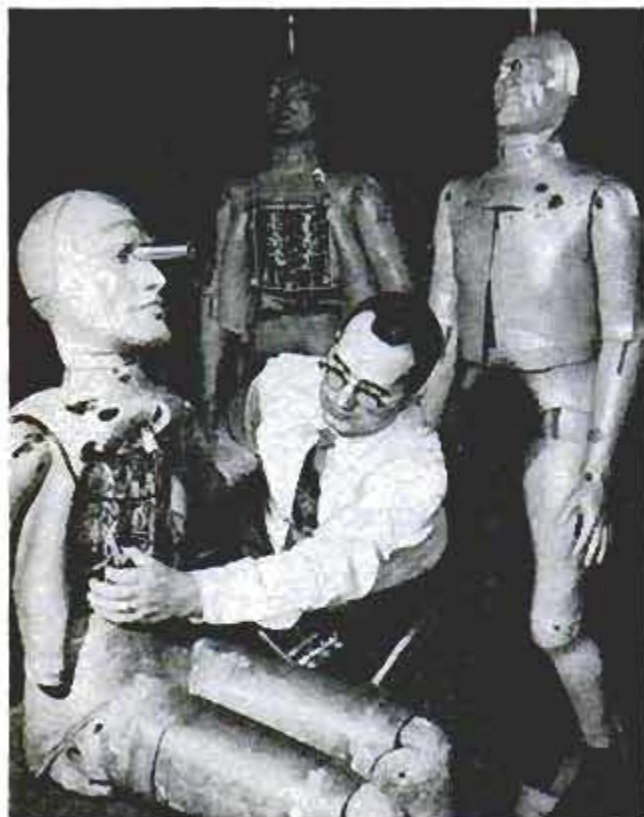

Dummies Are "Fall Guys" For Pilot Bailout Tests

Mannequins with rubber skins and built to conform to the shape, size and weight of human airplane pilots are being used by North American Aviation, Inc., to study high-speed bailout problems. Electronic equipment in the chest and stomach cavities records a wide variety of information that will help get pilots back to earth safely in case of an aircraft failure.



Rubberlike Metal Crystal Is Rigid Digit When Heated

Scientists at the University of Illinois are investigating the properties of an alloy that bends like rubber at normal temperatures but becomes straight and rigid when heat is applied, as from a match or cigarette lighter. The alloy is composed of gold and cadmium. A single crystal of the metal forms a bar that will lift 10 times its own weight under the influence of heat.

Unmanned Boats Moored in Pacific Gather Data on Tuna

Sixteen-foot, unmanned boats have been moored in the Pacific for tuna-fish research. Anchored to old railroad wheels in water 2000 to 3500 feet deep, the boats carry instruments that gather information on currents, winds, tides, temperatures and ocean food life. They carry a radar reflector aboard to protect them against collision and help "mother" ships to locate them for data collection and repairs.

Antibiotic Sweaters To Have Treated Fibers

Antibiotic sweaters and skirts may result from an invention enabling mills to weave neomycin into both natural and synthetic fibers. The antibiotic textiles can be washed and ironed without loss of the antibiotic. Neomycin applied to the textile fibers with the new process adheres uniformly to the fibers and is capable of a continuing antibacterial action.

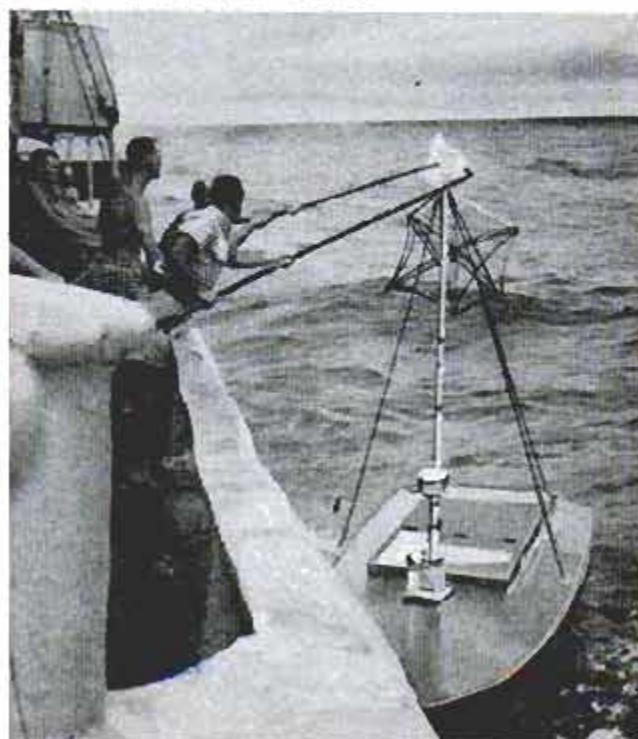



Ball-Point Pen Has Built-in Light

Campers, travelers and photographers who sometimes need to make memos or notations in darkness or under poor lighting conditions may get an assist from a ball-point pen with a built-in light. The plastic cover of the device can be removed, converting it into a pocket flashlight. Ball-point pen refills are available and the lighting unit takes standard-type batteries.

Number, Please!

Whenever you write us to

- Renew your subscription
- Change your address
- Order your own or a gift subscription

. . . In fact, whenever you write us,

**PLEASE INCLUDE YOUR CITY POSTAL
ZONE NUMBER IN YOUR ADDRESS**

*This insures better delivery.
It helps you and it helps the postman.*

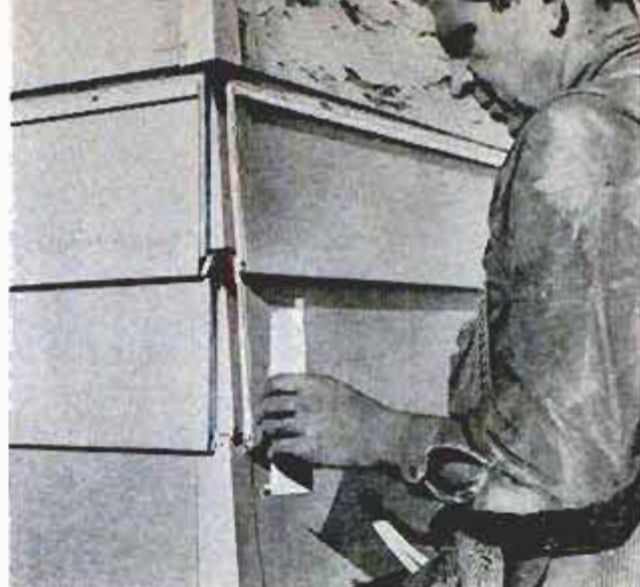

Aluminum Siding Has Plastic-Foam Backing

Aluminum lap-siding backed by expanded plastic foam is available for house building, repair and remodeling. One man can install the siding on a house in about the same time it would take him to apply paint. In addition to light weight, the siding has superior insulating and moisture-dissipating properties. The backing is $\frac{3}{8}$ inch thick. It will not shrink, rot or warp, and it resists termites and other vermin that may attack wood siding.

Experimental Photo Flashbulbs Carry "Battery" in Metal Base

Self-powered photographic flashbulbs are being developed at the Battelle Memorial Institute. The bases of the flashbulbs contain primary cells made of alternating layers of magnesium foil, paper and silver-plated copper. When the sandwich-like cells are moistened with a few drops of water, enough power is produced to flash a bulb for a period of 20 minutes. The bulbs are still in the experimental stage and not available commercially.

Farmer Builds Own Rotary Cutter and Hay Dryer From Scrap Auto Parts

Scrap automotive parts are converted into efficient farm implements by Louis Baker of Beallsville, Pa. Baker has built a rotary hay cutter and a steam-heated hay dryer with scrap materials. Heart of the rotary cutter is an old truck differential mounted vertically on a framework. To the differential is welded a regular automotive universal joint which serves as a hitch to the tractor's power take-off. The heating unit of the hay dryer consists of an old residential, coal-fired, steam-heating boiler, complete with attached stoker. Steam from the boiler is piped through a panel of 10 old auto radiators which have been brazed into a unit. An industrial fan

draws air through the radiator panel and exhausts it into a vented tunnel through the hay.



Reprinted in 1974

ALASKA

“BIG LAND”



Since the Klondike strike of the 1890s, more than \$700,000,000 worth of gold has been found in Alaska

THE LATE GENERAL Billy Mitchell, who gained a niche in history by correctly forecasting the significance of air power, also made this prediction: “Whoever holds Alaska will hold the world.”

Mitchell’s canny insight showed him the future strategic importance of polar air routes. But the prediction had no more impact than a damp sponge on a window when he made it in 1935. Alaska then was believed by many people to be the legendary land of “Dangerous Dan McGrew” where sourdoughs scooped gold dust out of mountain streams and raced dog sleds across endless glaciers.

At that time the total population of the territory, around 60,000 including Indians and Eskimos, would have made a city smaller than Terre Haute, Ind.

Matanuska Valley has fertile farm lands which produce fabulous vegetable crops during long summer days





Superimposed on map of United States, Alaska would stretch from border to border and coast to coast. Fur, fishing and mining are top industries in this state where totem poles and dog teams are as common as TV

A generation later, as Alaska cuts its statehood teeth, a *cheechako*, or tenderfoot, would find this vast, last frontier has indeed become the keystone of global strategy that Billy Mitchell envisioned. Big Air Force bases have been established—Eielson and Ladd at Fairbanks and Elmendorf at Anchorage. Army units are stationed at Fort Richardson, Big Delta and at Port Whittier (where a single building recently was completed at a dollar cost approaching the original purchase price of Alaska). Navy installations are located at Kodiak Island, Adak and Fairbanks. Numerous radar units are scattered over the rugged terrain of this polar crossroads.

Every fourth person among the 213,000 residents of our 49th state is a military man or one of his dependents. Like the permanent citizens, they are fully aware of Alaska's vital security role. The former owners of this land, the Russians, have air and missile-launching bases just beyond the Bering Strait. At the Diomed Islands, the United States and the U.S.S.R. are separated by only 2.4 miles of water.

The United States acquired Alaska from Russia in 1867 for \$7,200,000 in gold. Although the price of the area—as big as Texas, California and Montana combined—amounted to only two cents an acre, the

deal was bitterly opposed by many Congressional leaders. They thought the land was worthless.

According to history books, the Czar also considered Alaska a liability and had tried for nearly 12 years to peddle it. After the Crimean War started, the Czar feared that Great Britain might seize Alaska before it could be sold.

Americans, still licking the wounds of the Civil War, also objected to Russian demands that the payment be made in gold. Neither nation was aware that Alaska was loaded with mineral wealth. Since the Klondike strike of the 1890s, nearly \$700,000,000 in gold has been taken out of Alaska. The streams and mines now yield \$8,000,000 worth of gold each year. And there's still a bank in Nome that will cash a poke of gold dust!

Besides gold, Alaska has deposits of most of the 33 strategic and commercially valuable minerals, such as tin, mercury, chromium, copper, zinc, platinum, tungsten and antimony. Uranium production began in 1957 and a dozen oil companies have leased millions of acres for exploration. The first oil well is producing 900 barrels a day. A huge iron deposit has been found at Klukwan. And Alaska coal mines yield about

(Continued to page 228)

Eighty percent of all fur seals in the world live on the Pribilof Islands, off the west coast of Alaska



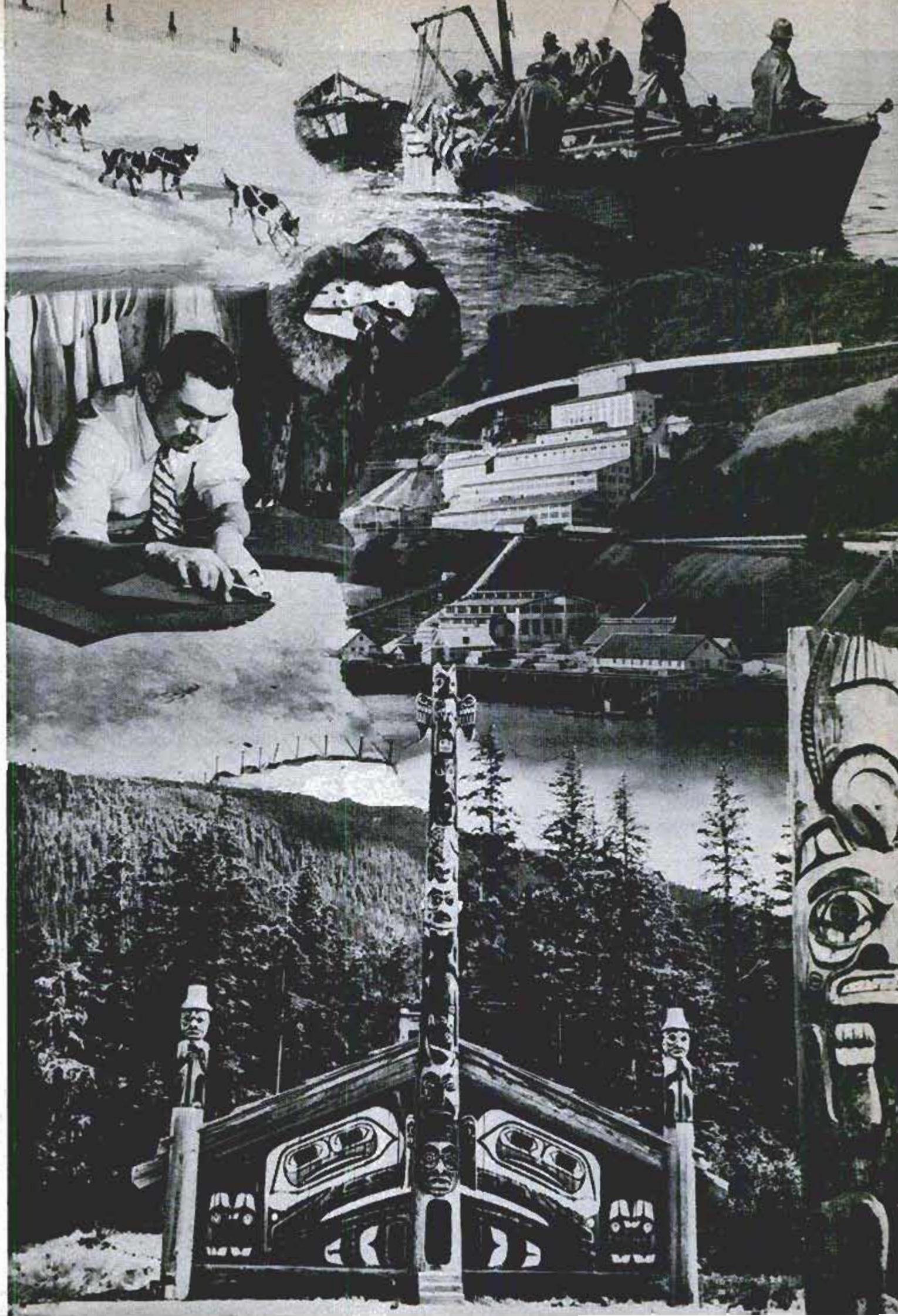



German "Ski Pony" Gives Fast Ride

Winter sports fans in West Germany now go skijoring over level stretches of snow at speeds up to 40 miles per hour behind a machine called a "ski pony." The propeller-driven machine is mounted on a single ski and is equipped with long handlebars. The skiers grasp the handlebars and the ski pony tows them over the snow. The engine can be controlled by a switch on the handlebars. The machine also can be used as a ski lift on grades of up to 10 degrees.

Wind-Resistant Tarpaulin Fastens to Track on Side of Truck

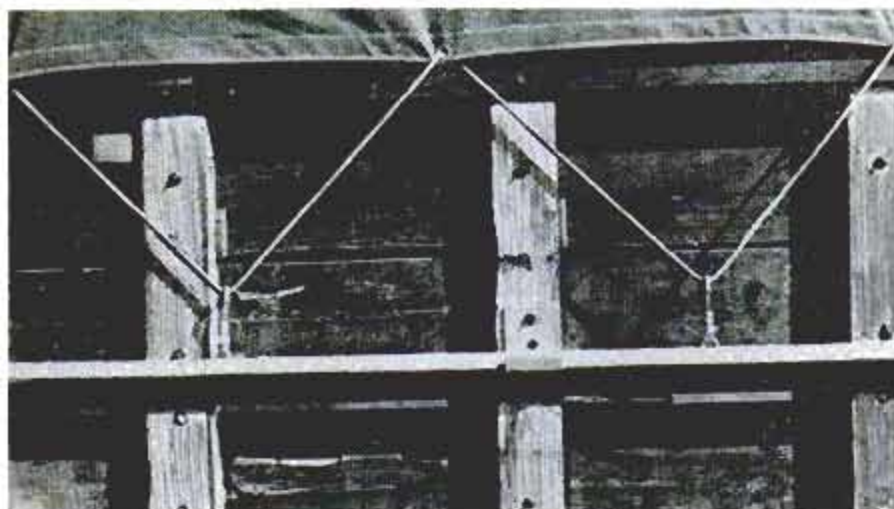

Truck tarpaulins stay securely in place when their ropes are connected by snap fasteners to tracks on either side of the truck box. The tracks are pipes with slots along the top. At the truck's rear, the ropes are hooked to a cable attached to a coil spring under the box. Tension on the cable keeps ropes tight on both sides. Unhooked, the tarpaulin can be slid forward quickly.



4000 Letters Handled in Hour

Letters can be folded and stuffed into envelopes at a rate of 4000 per hour by a small electrically driven machine. The folder-inserter does the work eight times faster than it can be done by hand. Two enclosures can be inserted in each envelope simply by putting the material through the machine twice, or several pieces can be inserted in one operation by nesting them together in advance. The folding unit of the machine will handle eight different folds.



Power Unit on Wheels Substitutes for Permanent Substation

Montana's Hill County has a mobile electric substation for use while permanent substations are shut down for maintenance. The rolling substation can "step down"

33,500 or 67,000 volts to 24,940, 14,400, 12,470 or 7200 volts. It has a forced-oil-cooled transformer, disconnect switches, lightning arresters and reclosers.

Awning-Type Storm Sash Opens With Window

Both the storm sash and primary awning-type window can be opened and closed from inside the house when the storm unit is attached to the sash. This new type of storm window can be added to most houses without special alterations. The sash is made of aircraft aluminum and is surrounded by vinyl weatherstripping. When the primary window is opened or closed with the inside controls, the storm sash moves with it.

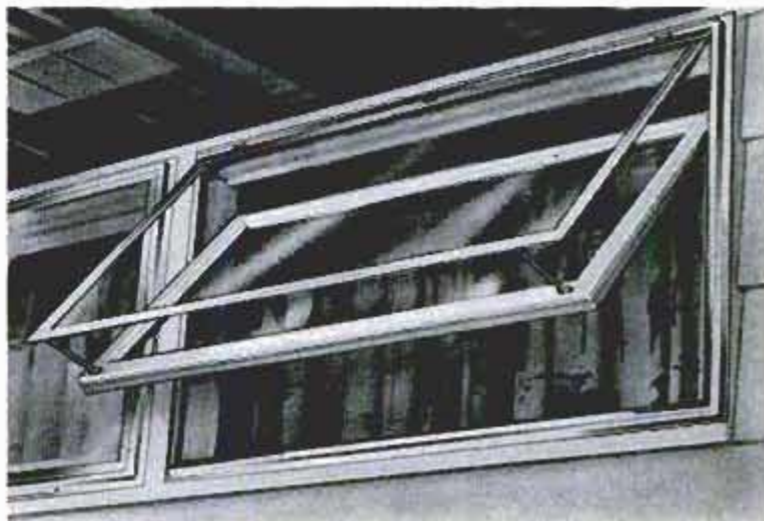

"Sunglasses" for Camera Eliminate Reflections

Attached to the front of a reflector on flash guns or electronic flash lamps, a polarizing unit acts as "sunglasses" for a camera. The unit polarizes the light to eliminate glare, reflections and hot spots from photographs. Used with color film, the polarizing unit heightens the vividness of colors without distorting their values. The unit can be attached to any reflector that is 5¼ inches in diameter or smaller. Two clip-on metal rods hold the unit in position for use.

☛ Inflated with nitrogen instead of air, airplane tires have been exposed to nuclear radiation without detrimental effect.



PERCENTAGES

Chart of accidents caused by mechanical failure shows faulty brakes as chief cause

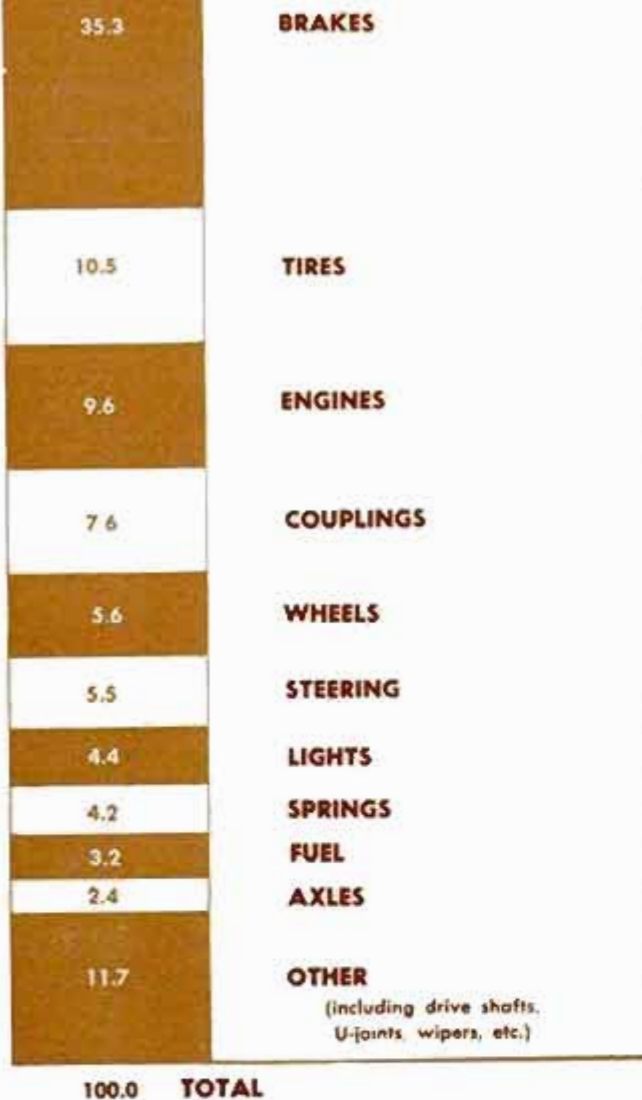

Alert ICC inspector slaps out-of-service sticker on the windshield of a truck having unsafe brakes. This brings quick repairs by the truck owners



ROAD



THE HIGHWAY INSPECTORS...

By Thomas E. Stimson, Jr.

CHARLES SANDS, truck safety inspector for the Interstate Commerce Commission, walked over to the heavily loaded truck and trailer that had stopped at the road block. He climbed up, opened the driver's door, and grabbed the wheel to balance himself.

"Your front right tire is too thin for safety," he told the driver. "There are no brakes on your front wheels, and your steering is dangerously loose. I'm putting an out-of-service tag on this rig until it's made safe to drive."

The trucker was amazed. "I've been planning to change that tire," he admitted,

BLOCK AHEAD!

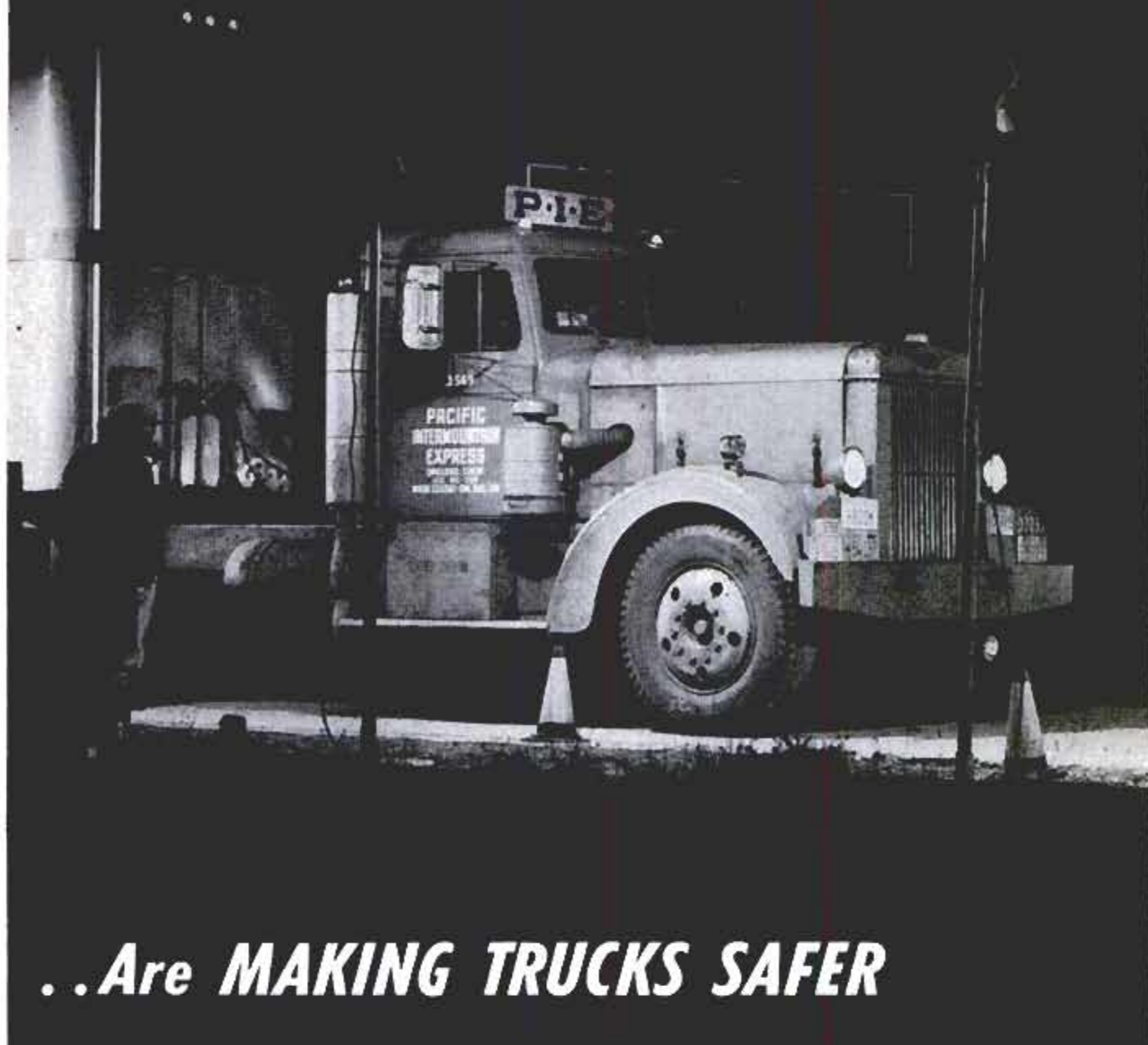

..Are **MAKING TRUCKS SAFER**

Truck inspection proceeded far into the night at Dunsmuir, Calif., in vast safety check conducted by state

"but who told you about the steering? And how do you know about the brakes?"

Sands told him. He had simply looked at the truck while it was slowing down. He could see there were no brakes in front. And when he took hold of the steering wheel he gave it a partial turn. The movement was rough and play was too great.

Sands works for the motor-carrier-safety section of the ICC. His job is to check the mechanical safety of the commercial vehicles that carry merchandise across state borders or that transport the same merchandise inside a state.

Before he finished with the truck, Sands

found other safety violations that he entered on his compliance check sheet. The truck took twice the legal distance to come to a stop. Half a dozen lug nuts were missing from its wheels. A brake hose was so frayed it was ready to burst. The driver's medical certificate was out of date. And the driver's log, showing time off and time at the wheel, had no entries for the last two days.

This truck was in bad shape but it wasn't too exceptional. Of 12,018 trucks inspected by the ICC in a recent nationwide check, 2427 were judged "so imminently hazardous to operate as to be likely to



Highway patrol officers check weight of load on each axle of huge log carrier during "round up" at Dunsmuir

Inspector Charles Sands of ICC checks air lines between tractor and semitrailer for signs of wear on the rubber. Lines must be suspended to avoid rubbing



Brake tester clamped to running board of truck shows speed at which brakes were applied and stopping distance. Brakes on this truck were in excellent shape





Inspectors use special apparatus to check transmission time for the air to reach farthest brakes on big truck

cause an accident" and were put out of service until repairs had been made. The ratio was one dangerous truck in every five.

The ICC is cracking down on unsafe trucks because commercial carriers are an important part of highway traffic and when a truck is in an accident the wreck is often a disastrous one. (Mechanical faults in private cars may be just as numerous but the ICC has no control over these.)

Especially, these days, the ICC is concerned with brakes. There have been too many headlines like "Brakes Snap on Mountain, Truck Kills 5" and "Brakes Gone, Truck Derails Train, 5 Killed." In the ICC checkup above, more than half the trucks that were inspected had faulty braking systems.

When Sands inspects a truck he merely walks around it, climbs up in the cab, and crawls underneath a couple of times. He needs no more than 10 minutes. Yet in that time his trained eyes and ears have checked more than 50 items, ranging from windshield wipers and horn to the rear clearance lights and the rear crash bar that prevents a low automobile from ramming underneath the truck during a rear-end collision.

Special-purpose vehicles such as acid tankers, household vans, gasoline tankers and pressure vessels for hauling butane are all protected by extra regulations and require special inspection.

A gasoline tanker, for instance, must have "overturn protection" on top. It must have a weak shear section in its discharge pipe that will break on impact. The tank must be equipped with an inner valve that is opened only when cargo is being discharged. In addition, there must be a fore-and-aft cable the whole length of the tank so that the driver can yank either end to close the discharge valve in case of fire. A fusible link that melts in the heat of a fire and automatically closes the valve is another requirement.

Nimble ICC inspector must climb in and out, over and under for checkup. It takes 10 minutes



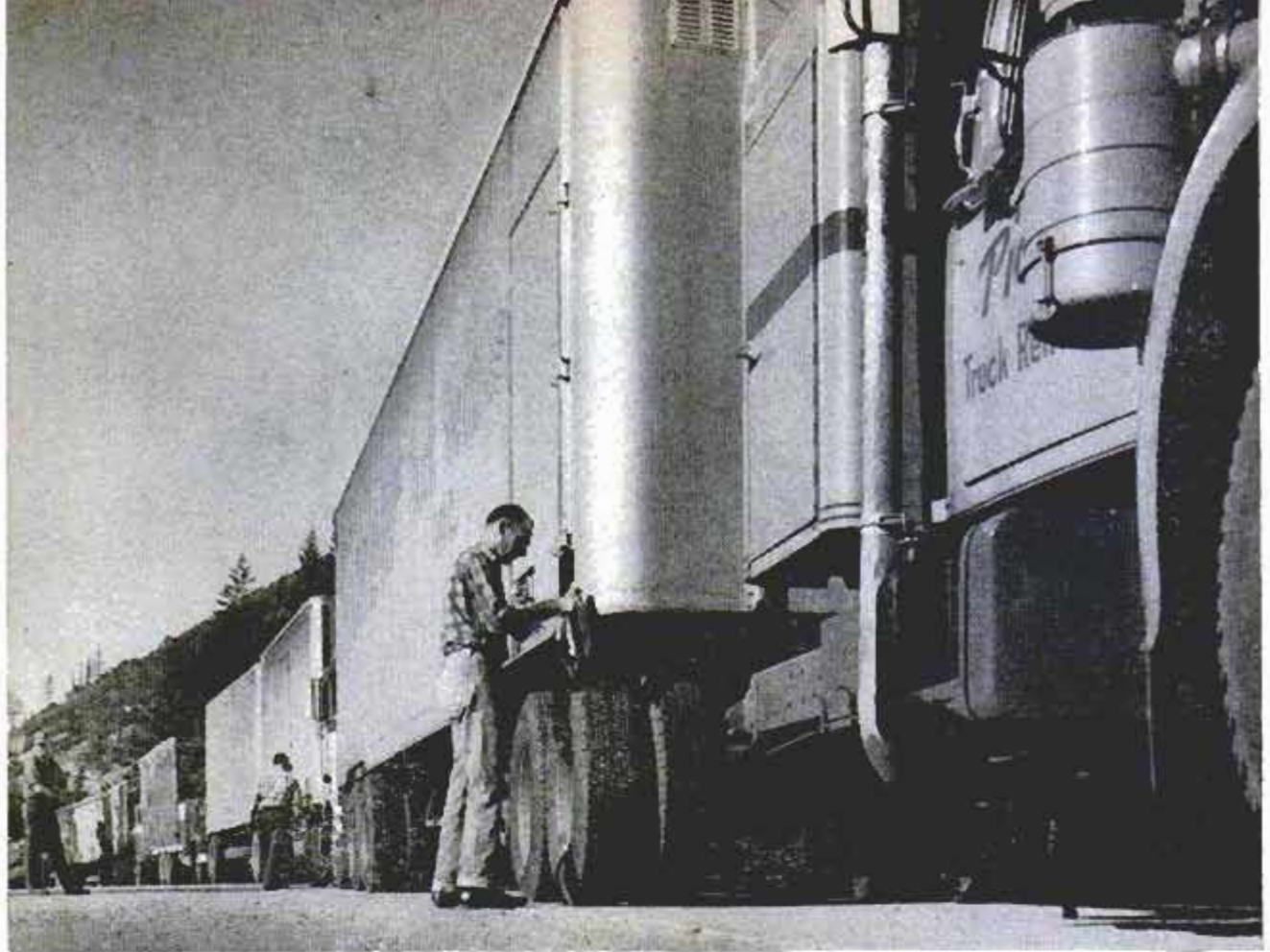

Giants of the highway lined up awaiting safety inspection—many drivers welcome this for own protection

All vehicles receive a thorough inspection of their braking systems. The ICC rule is that a truck must be able to stop in 30 feet from 20 miles per hour, regardless of load. The average passenger car can stop in 20 feet or less from the same speed. As originally built, most truck-braking systems conform to the rule. But the brakes of a big 30-ton rig are complicated and need diligent maintenance. Too, some trucking companies tend to overload their brakes by carrying excessively heavy loads.

Crawling under a truck, Sands inspects every brake drum and shoe. He checks all air lines for abrasion and wear. Up in the cab with a stop watch, he measures the air

leakage in the booster system while the driver keeps the brake applied. Next, he has the driver run down the air pressure to make sure that the low-pressure warning device is operating. This may be a buzzer or a bright light or a small flag that drops down in front of the driver's eyes.

He inspects the check valve between the compressor and storage tank, that prevents backflow if the line breaks. If there is a trailer, he looks for the tractor-protection valve. If the air line to the trailer breaks, this protection valve plugs the line so that air is still available to the tractor brakes. Next Sands crawls under the trailer itself

(Continued to page 260)

Crash bar below the bed of this truck satisfies a safety rule to prevent low car ramming underneath

Beneath truck, inspector Sands looks at condition of brake-cylinder hose attached to vacuum brakes

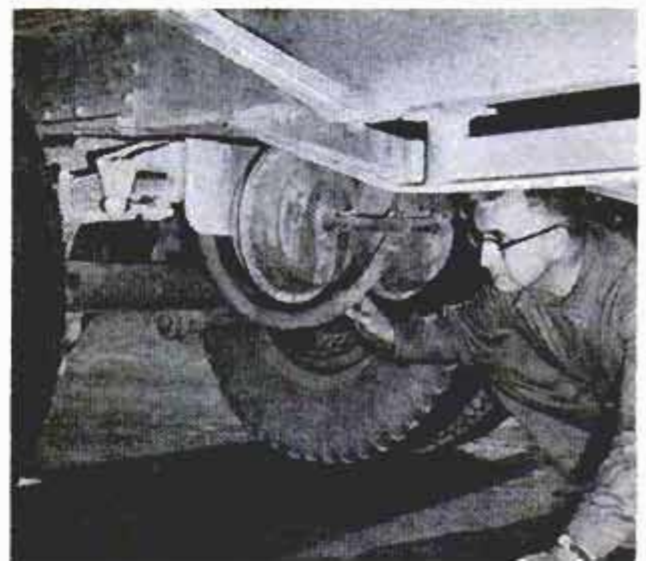
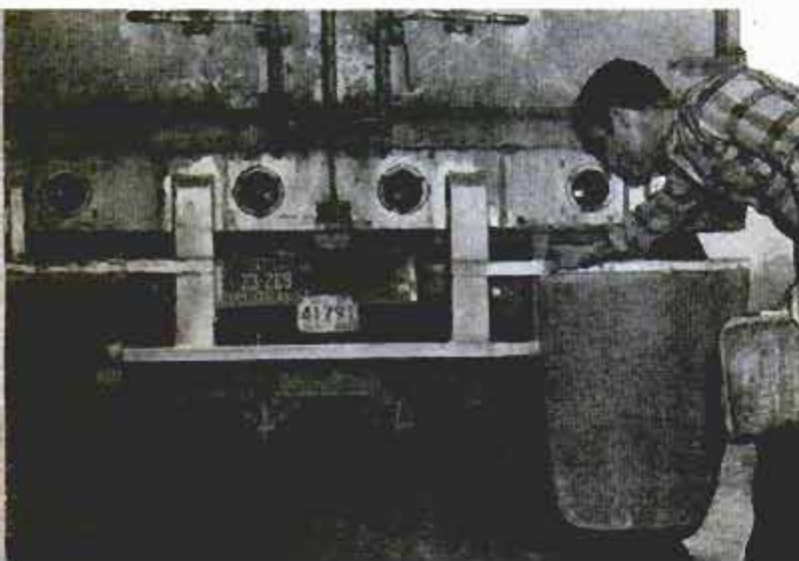

Italy's Pots-and-Pans Band



Music from this coffee grinder is a popular concert feature

HAVE YOU ever heard the plaintive strains of "O Sole Mio" as written for coffee grinder and frying pan? It begins with a soft pizzicato from the cheese graters as the conductor of the La Racchia orchestra lowers the big spoon in his right hand. The spoon is the baton for maestro Emilio Casagrande who directs the straw-hatted musicians as they produce melodies from kitchen utensils and other household items. The concerts of La Racchia, which translates roughly as "the ugly one," have been very popular in Italy, where the band was organized several years ago. The pots-and-pans band became famous after a television appearance. A stovepipe with spoons for keys has a tone vaguely reminiscent of a saxophone. A grill is strummed like a guitar. And flasks are wielded like maracas. Coffee grinders and knives produce a special effect while a trill is coaxed from a frying pan. The band hopes to make a tour of the United States.

Now, a-one and a-two, and keep an eye on maestro's "baton"

For a real cool performance, there's nothing like a hot solo improvised on a barrel

Robust rhythm is produced by the grill-guitar and a saxophone from a stovepipe

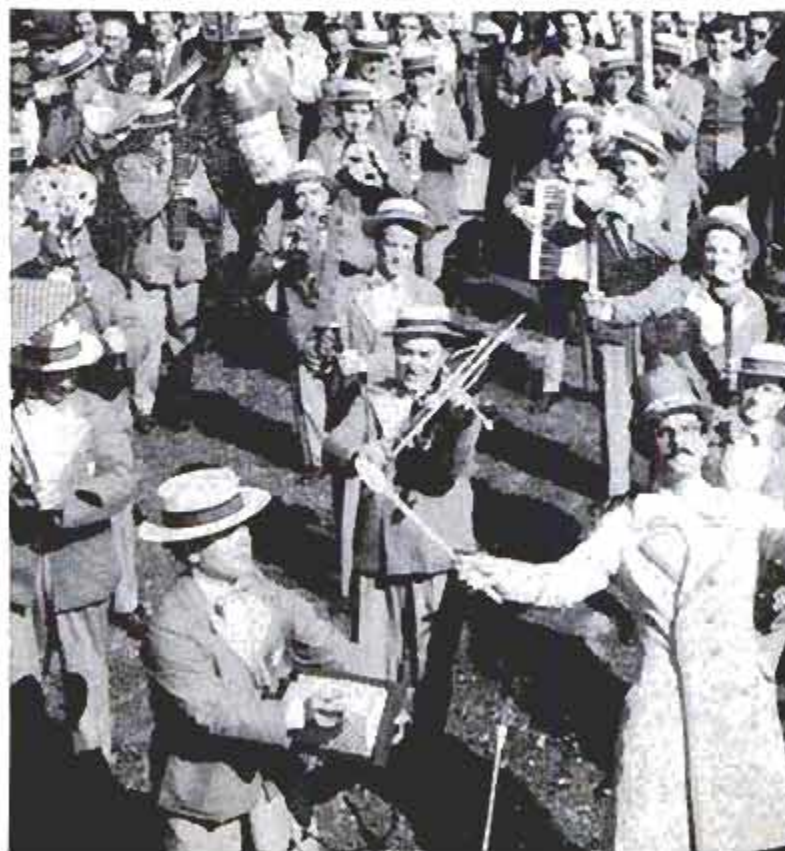



Self-Propelled Baler Gives Operator Top View of Work

Roaming the hayfields now is a self-propelled baler, the first of its kind. From his seat the operator can see every phase of the baling operation. One lever on the control panel controls ground speed, another

baling speed. Powered by a 51-horsepower engine, the New Holland baler has an output of up to 400 bales per hour. There are four forward speeds, and ground speed is independent of baling speed.



Plane Passengers' Ramp Mounted on Small Truck

Airline passengers can deplane onto a ramp mounted on a pickup truck. The mobile ramp is operated by a hydraulic lift and can be raised or lowered to match the level of the plane's door. This adjustment is controlled from the truck's cab by the driver. Also driver-controlled are hydraulic stabilizers that are lowered to the ground beneath the front and rear of the truck. A rubber buffer at the front of the ramp prevents marring of the plane while the unit is being used.

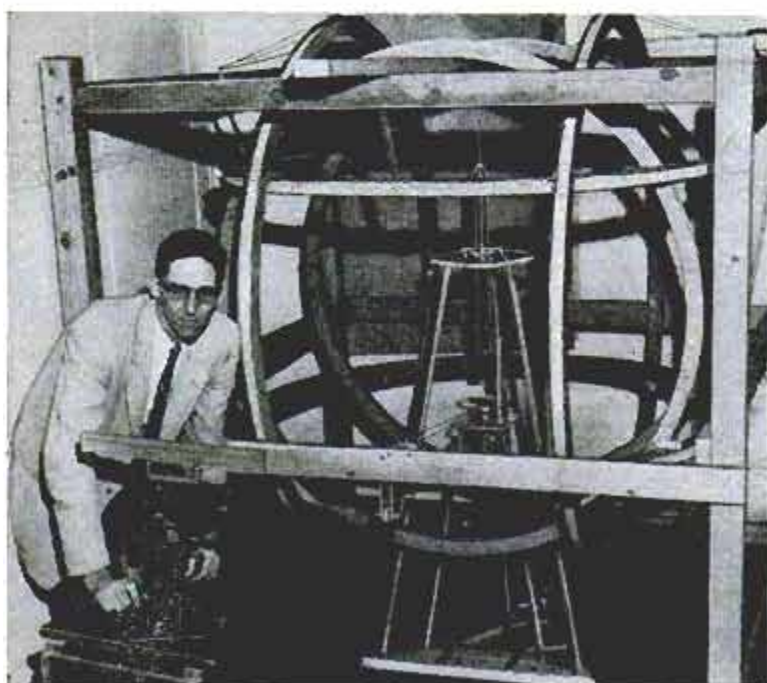

Earth's Magnetic Field "Erased" for Ore Studies

Prospectors who locate ore deposits by aerial surveys will be aided by a new instrument that analyzes the magnetic properties of minerals. The device, an astatic magnetometer, has six electric coils around a suspension mechanism in a plastic tube. When current passes through the coils, the earth's magnetic field is reduced to zero within the instrument. The magnetic flow and intensity in the specimen twist the mechanism in the tube, and the effects are measured. The direction of magnetic flow tells the age of the ore, which assumed the direction of the earth's magnetism at the time the ore was formed.

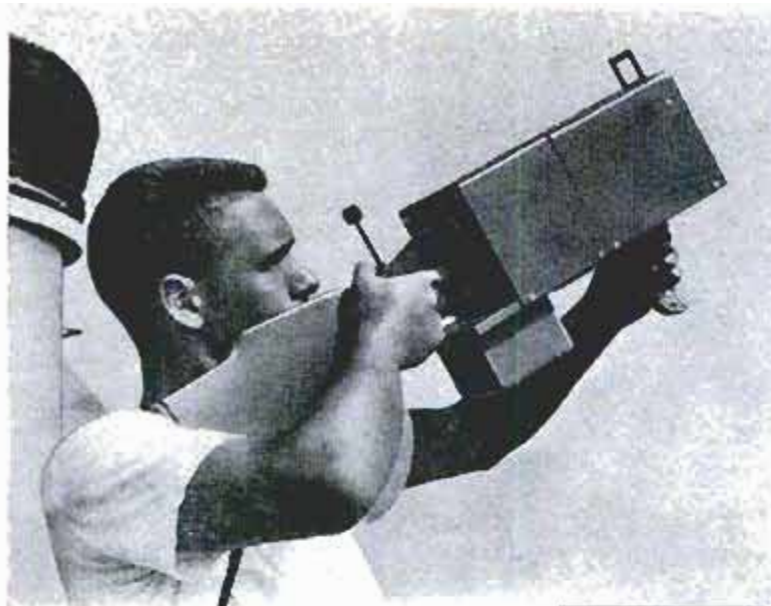

Special radiometer, aimed like a gun, was used to measure radiation during re-entry

FOR THE FIRST TIME, photographs have been taken of the spectacular re-entry of a Jupiter missile. The missile was fired from Cape Canaveral, Fla. Fifteen minutes later and 1500 miles away, scientists aboard a Navy ship photographed the missile as it re-entered the atmosphere at 9000 miles per hour. Three parts of the missile—the nose cone, the rocket body and the instrument package—glowed so brilliantly that the ship, about 50 miles away, was perceptibly illuminated.

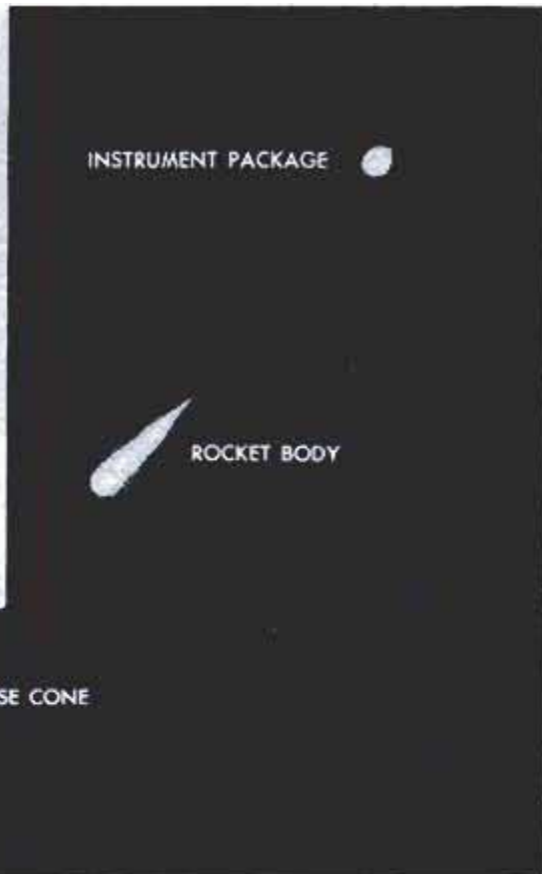

Unusual photo shows three glowing parts of the Jupiter missile

Missile Poses for Photo As It Re-Enters Atmosphere

Six cameras were mounted as a unit on the destroyer's guns for stabilization against roll and pitch
Barnes Engineering Co. photos

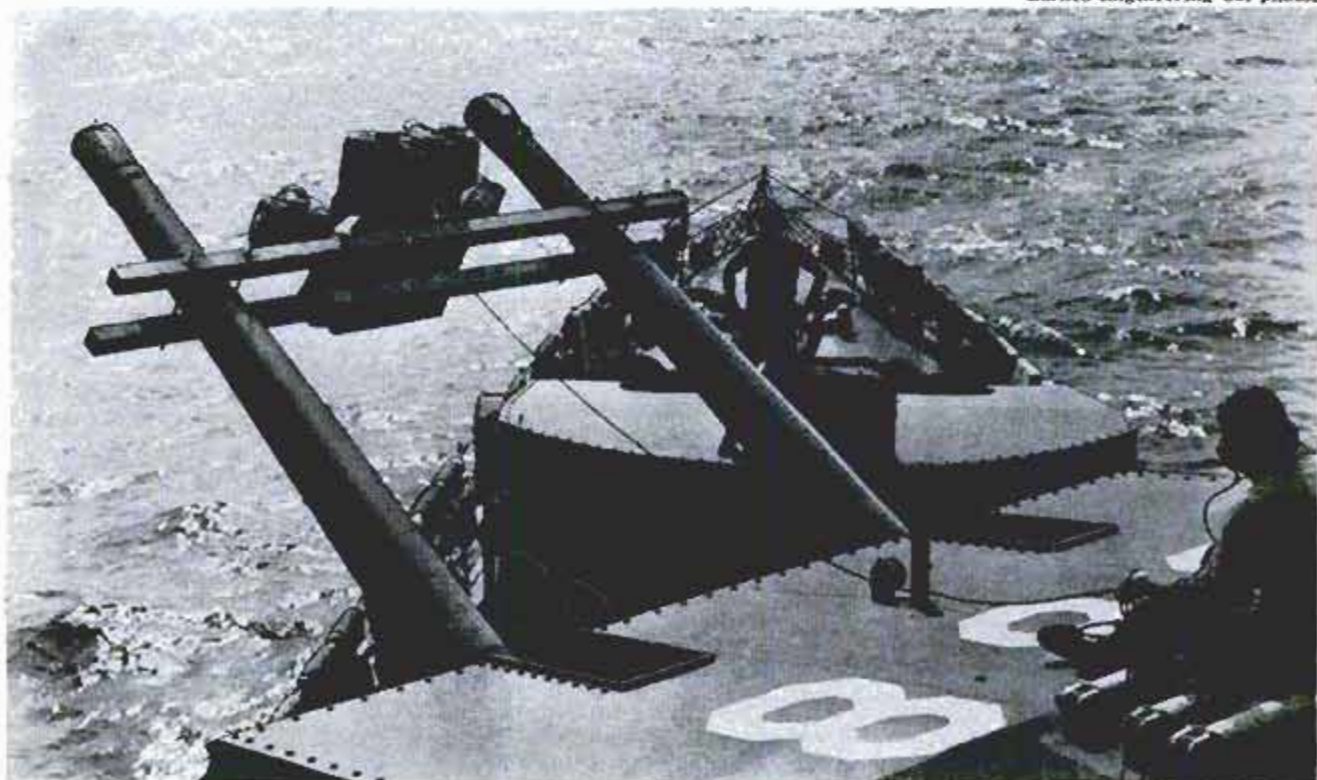

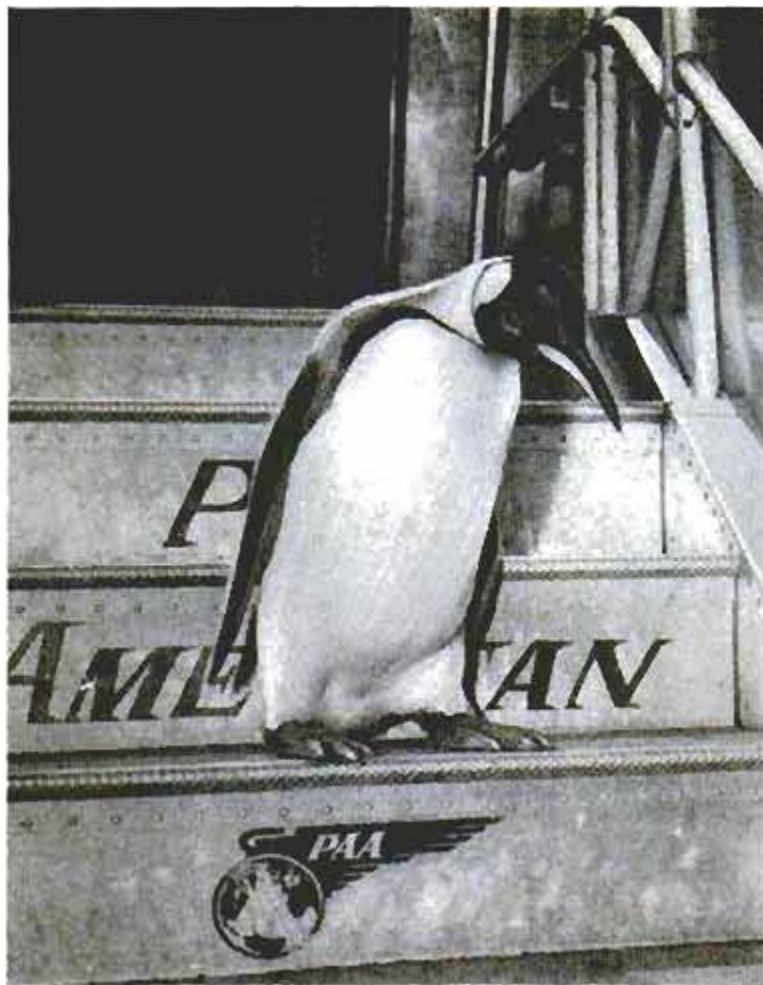

Penguins usually sag when they deplane into New York's heat

THE TRANSPORTING of animals is becoming an important part of the airlines' business.

As one example, Pan American World Airways carries 30,000 animals a year—not counting some seven million baby chicks, two million canaries and several million tropical fish.

The wild-animal cargo ranges from sloths and anteaters to baby elephants (up to 1100 pounds) and pygmy hippopotami. Domestic animals are also transported. A single plane might fly a herd of 16 Brahman cattle or 12 Texas quarterhorses.

An extensive amount of research and observation went into the build-up of the animal-carrying business. KLM Royal Dutch Airlines was a notable pioneer in the field. Developing its animal service under the direction of Dr. J. C. W. Hesse, veterinary surgeon associated with Utrecht University in Holland, KLM scheduled numerous trips for its animal-transport planes so that Dr. Hesse and his staff could observe flight reactions of the various species and make tests, such as measur-

LOOK WHO'S

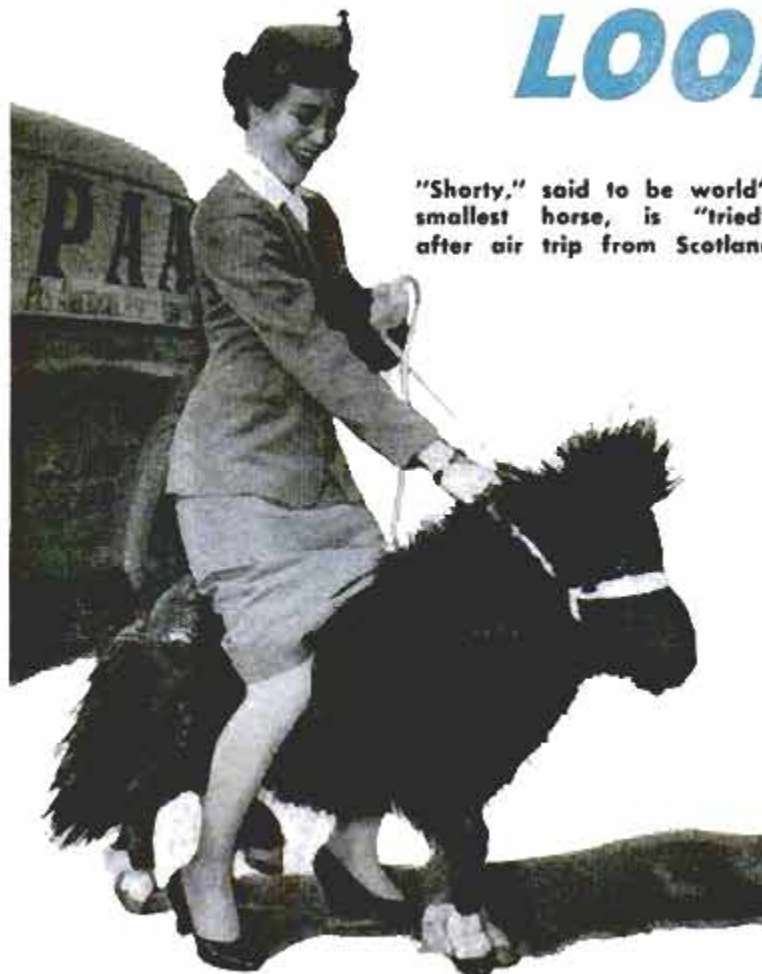

"Shorty," said to be world's smallest horse, is "tried" after air trip from Scotland

ing the oxygen and moisture content of the air. Besides having a hand in the design of special airborne cages, Dr. Hesse concluded his research by supervising the preparation of KLM's "Manual for the Carriage of Live Animals." The book is crammed with more than 100 pages of directives and it's the guidebook of KLM's animal attendants at all major stops.

Just what did Dr. Hesse and his staff learn about animals in the air? For one thing, most animals seem to prefer air travel to ocean voyages. Birds can tolerate a limit of 36 hours aloft, and require light. They won't eat if lodged in a dark cargo area. Snakes, on the other hand, like it dark. They snooze peacefully throughout the entire flight and require neither food nor water.

Baby elephants are tractable but gregarious chaps that prefer to travel in pairs. Otherwise they



Photo courtesy Seaboard and Western Airlines

A shipment of monkeys arrives from Siam. Monkeys prefer that tigers do not ride on same plane with them

COMING IN BY PLANE!

By John Franchey

Pan American Airways photo

get lonely and are likely to become nervous in flight. After considerable experimenting with other animals, it was discovered that the ideal traveling companion for a single young pachyderm is a small white chicken—white in deference to the elephant's notoriously poor eyesight. After a day or two of preflight acquaintance, Dumbo becomes quite attached to the chicken and lets it perch on his head. At the first trace of skittishness during flight, the attendant ties the chicken to one of the elephant's legs. The effect is miraculous. So fearful is Dumbo of crushing his tiny pal to death that he quickly calms himself.

Most disliked and feared by his fellow passengers is the tiger. A mere whiff of him is enough to send the monkeys into conniptions

This chimp, who hails from warm clime, doesn't care for New York's winter weather





Lion cubs awaiting veterinary inspection at New York airport find no shortage of feminine attention

and set the parrots and macaws squawking. This problem is disposed of by assigning the tiger to the tail section of the plane, where fans keep his scent downwind and impossible to detect.

The thoroughbred race horse is probably the most fractious of all air travelers. He starts balking near the entrance of the plane and has to be enticed aboard either by a lead pony or patient persuasion. Once airborne, however, in a box stall that permits him to stand in perfect comfort but prevents him from kicking, he soon settles down.

Air transport of thoroughbreds has made trans-Atlantic racing possible. For several

This young hippo weighs just 50 pounds, but planes are equipped to move baby elephants weighing 1100

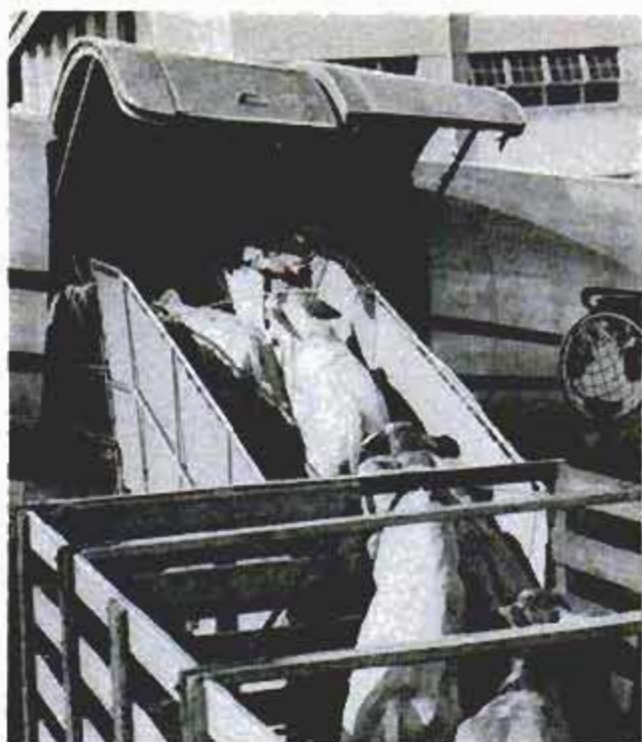

Sixteen Brahman cattle from Texas board plane in Miami for Havana. They weigh 500 pounds each

years, Pan American has carried the entire field of European entries to the International Race at Laurel. Horses can compete the day after an ocean crossing by air, although an extra day or two are usually provided. This means that an owner can run his horse in England or on the Continent one day, ship him to the United States aboard a Clipper the next day, race him there and have him back home again—all within a week or 10 days.

Do any of the airborne animals try to escape? Dr. Hesse reports that the anteater has freedom on his mind during the entire trip. He spends most of his time hurling himself against the sides of the crate in

Elephants' preference for companionship is respected. If there's just one, he rides with a chicken





Like a job as animal handler? Here's a KLM Royal Dutch Airlines handler getting to know a honey bear

which he's transported. His crate is built especially strong for just that reason.

Hardest of the animals is the day-old chick. He needs no attention at all and can go three days without food, existing on what he's stored in his gullet while breaking out of his shell.

Tropical fish are no bother either. They're carried in large plastic bags filled with water. Once oxygen is pumped into the bag and sealed, the fish are all set.

Other animals need a good deal of care. Seals and walrus, for instance, can't tolerate long dry spells, so between hops they are given a long soaking with a hose.

This stowaway monkey survived a trip at 20,000-foot altitude. He hid in luggage



Flying from Chile to Florida, an immigrant ibis named Willie gets his "vittles" from a PAA cargo hostess

Dr. Hesse also found out that most dogs seem to be a settling influence, while cats are a disturbing element, particularly when there are race horses aboard. The presence of a cat on the plane may make the horse nervous and irritable. The only way to be sure is to introduce the two animals formally before take-off and observe the horse's reaction. If it's favorable, the cat is placed aboard.

Birds, strangely enough, don't mind having cats aboard. And, stranger still, cats never seem aware of the presence of their favorite prey, although there may be hundreds of them on the same plane. ★ ★ ★

Seals and walrus can't stand long dry spells. That's why it's necessary to hose them down thoroughly before a flight



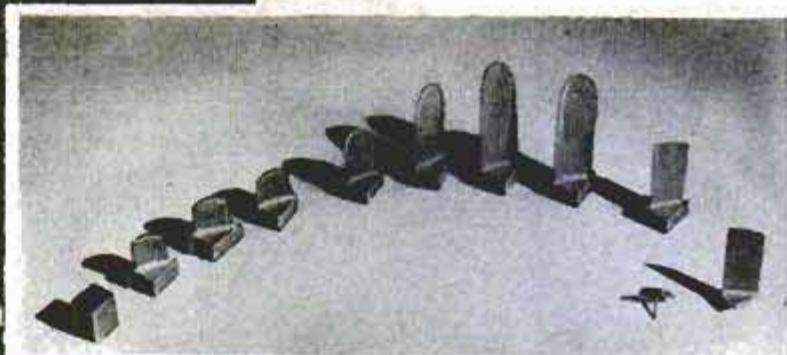
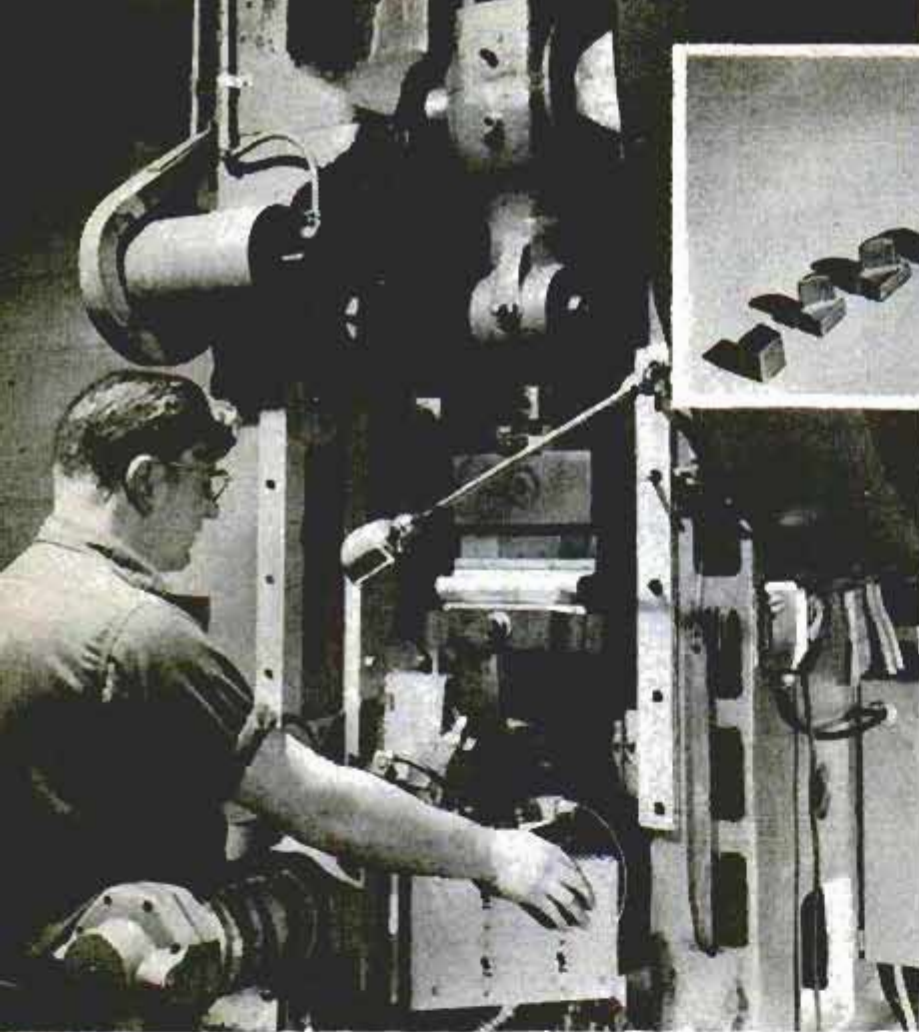

Tiny Engine Blades "Rolled and Coined"

Blades for aircraft engines are now produced by General Electric Co., by a process called "roll and coin." The process includes as many as 40 individual operations, including extrusion, rolling, coining and trimming. The blade starts as a rectangular slug. An attachment, fitted to a conventional press, holds a piece of metal in position under pressure. Roll dies then form the foil portion of the metal, after which the dies revolve and roll out the air-foil portion of the blade.

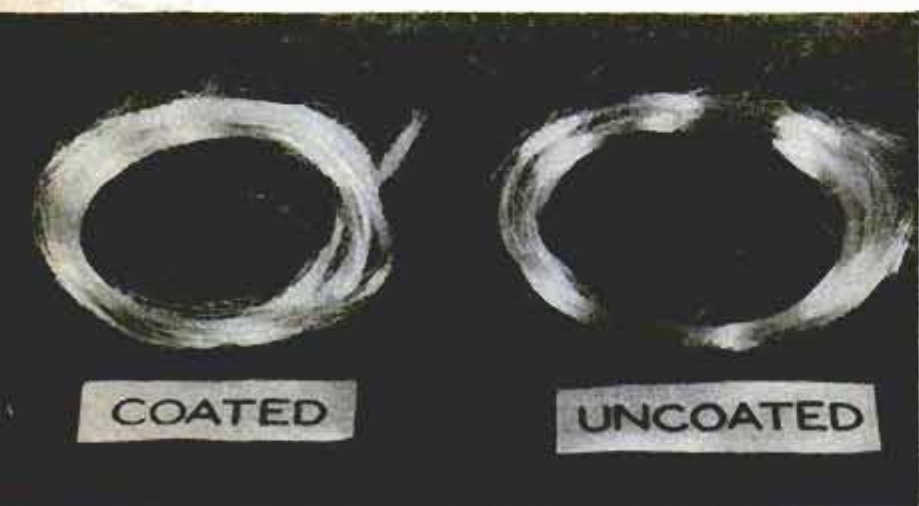

Sand Fibers May Be Used To Build Spaceships

Continuous fibers can now be drawn from silica, or sand. The hair-thin fibers are stronger than steel. Coated with metal, they may someday be used to form hulls of boats and shells of spaceships. In tensile strength, fiber samples test more than 600,000 pounds per square inch. It is estimated that the fibers can withstand temperatures of 1000 degrees centigrade. Most metals melt or weaken at this heat.



Wind-up Automobile Clock Set Into Horn Button

Motorists have a clock at their fingertips when their car is equipped with a timepiece inside the horn button. The clock, actually a 17-jewel watch, is not electric, being wound by a stem on one side of the button. Manufactured in Germany, the clock replaces the horn button on Volkswagens and DKW models built since August 1955. A button on the rim turns on a light behind the face of the clock.



Firefighters Use Combination Stretcher and Ladder

England's firemen are using a combination stretcher-ladder. The unit is 7 feet 8 inches long and 1 foot 7½ inches wide. Used as a stretcher, the unit includes a

canvas container and crossover straps. Several sections can be joined together quickly to form a long ladder. The unit is made of aluminum alloy with curved rungs.

Extra-High-Voltage System Scheduled to Transmit 750,000 Volts

General Electric plans to build a system that will transmit power at the highest voltages in history—750,000. A model tower (below left) has been built to 1/25 scale.

The full-size tower will be 160 feet high and 180 feet wide. Gigantic bushings such as the one below—for a 650,000-volt transformer—will be used in the new system.





Photo courtesy Model Railroaders

This diesel locomotive weighs 12 pounds and is able to pull more than 18 passenger cars



Only 7½ inches long, this model is made of Strathmore board, with metal trucks and poles

A ¼-inch scale model of a trolley used on Illinois Terminal System

Windows are drawn on Strathmore, cut out with blade and formed with wood rod and sandpaper

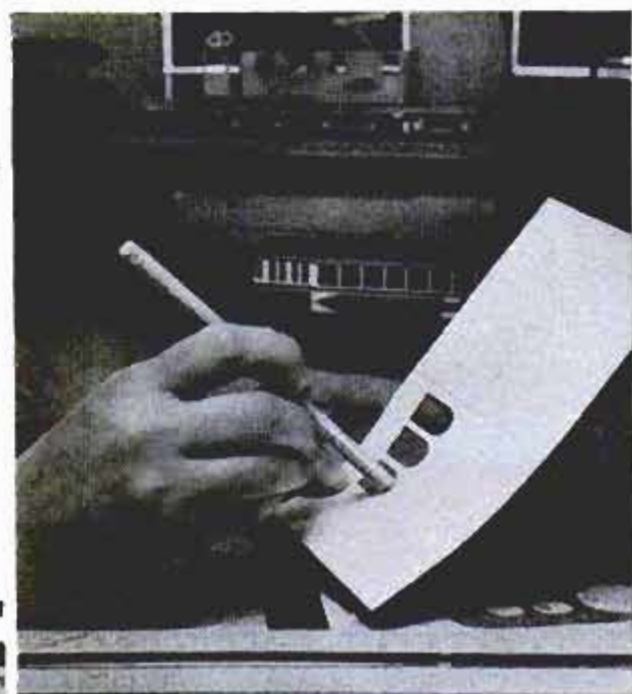

MODEL TRAINS OF PAPER

... and They Run

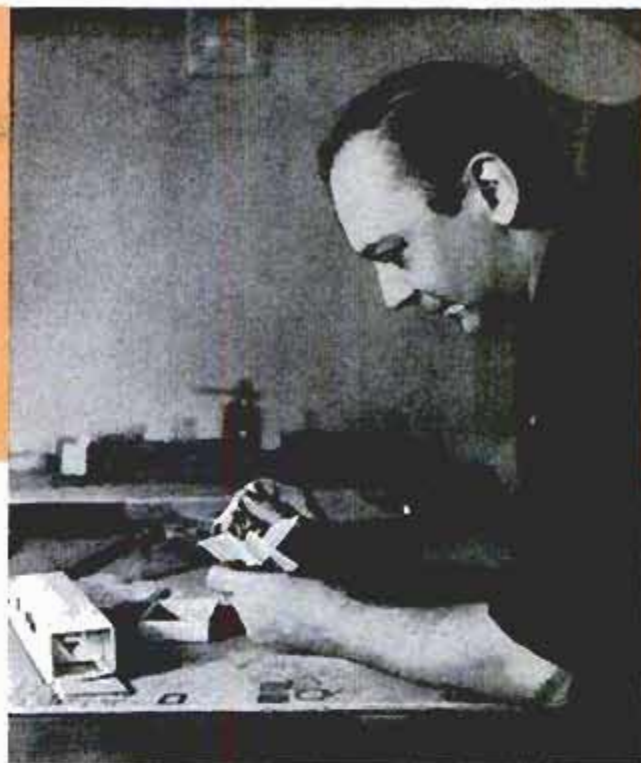

A model builder by trade, William Clouser of St. Louis puts his deft touch to an electric trolley

By Robert Hegge

YOU MEAN THESE models are built from paper?" This amazement is often expressed to model railroader William Clouser of St. Louis, Mo. While other hobbyists build models out of metal or plastic, Clouser constructs his from paper or Strathmore board. He says these are the best materials for model-building purposes.

Using one to four-ply Strathmore board, Clouser fashions perfect models in both

HO and O gauge. He works from blueprints, often the very ones used in construction of the prototype. All of his models are noted for their accuracy and ultrafine detail. If something is on the blueprint, you can sure it will be on Clouser's model.

He uses no special tools, only a single-edge razor blade, steel straightedge and sandpaper. He uses his head also—it's his outstanding tool.

Clouser inserts bulb in model of 1927 trolley. Inside walls of headlight housing are chrome plated

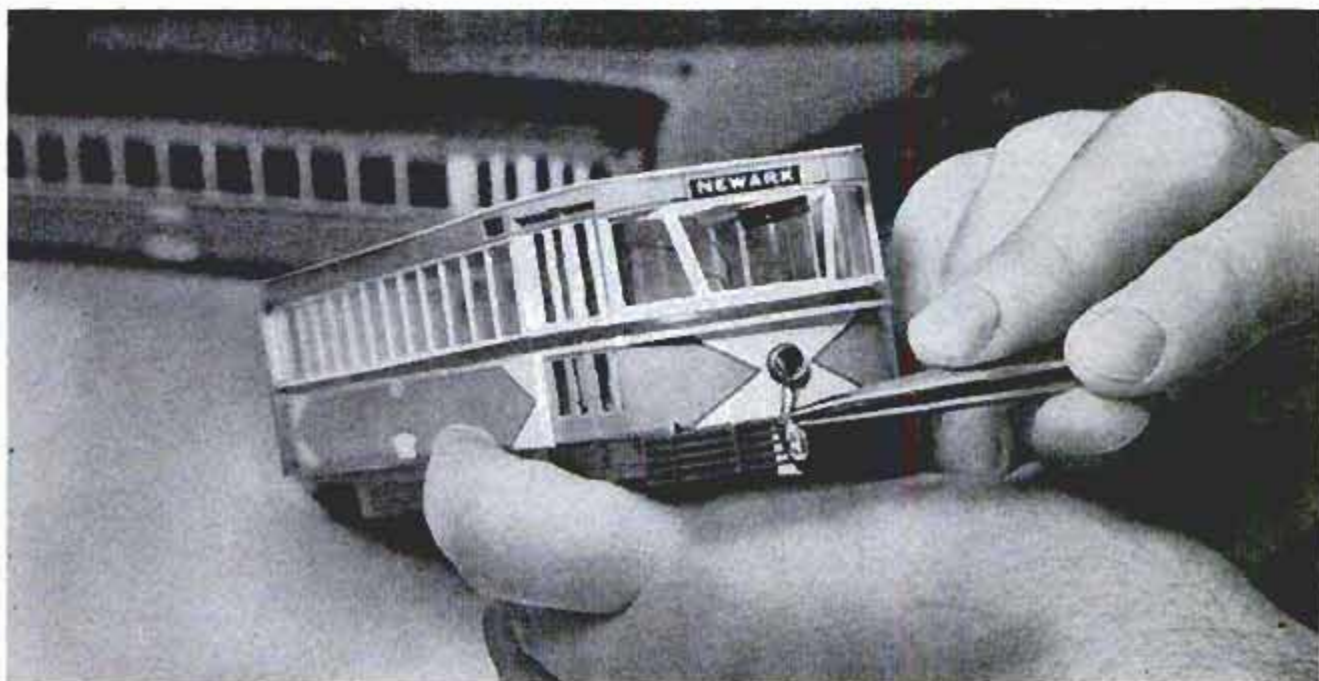

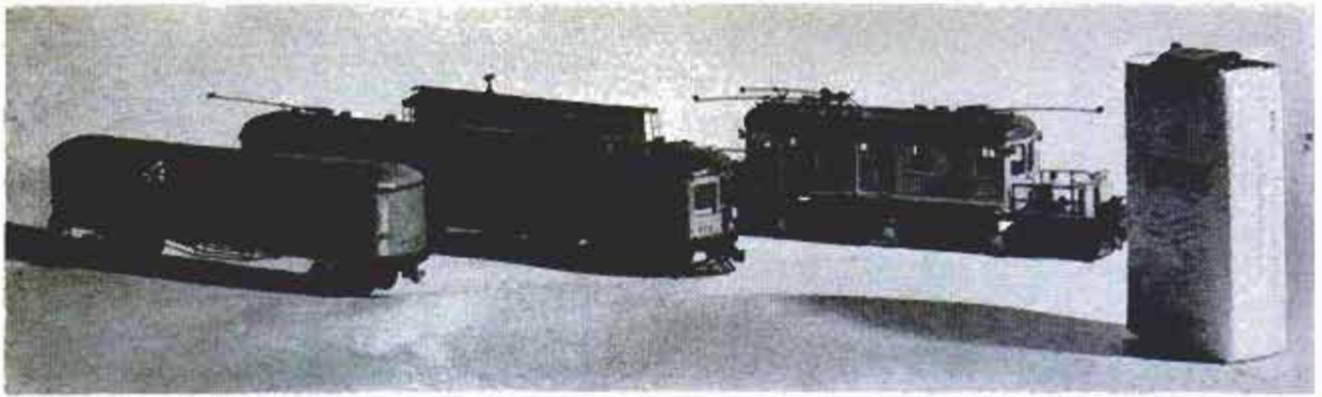

These HO-gauge models are as detailed as larger ones. The four-truck model pulls more than 25 freight cars



It took 750 hours to build this train, made from one to four-ply Strathmore board. Its scale is 1/4-inch

All the models are built to run, and the locomotives will pull as many freight or passenger cars as their prototypes. The cars are weighted to insure proper traction and often weigh as much as seven pounds.

Building model trains since 1945, Clouser now builds industrial models for St. Louis firms. He recently produced a 1/4-inch scale model of a trolley system that operated in the 20s.

Does paper-building represent any special problem? In working with metal or wood, models require no painting except for the sake of appearance. A paper model, on the other hand, must be primed and sprayed when finished so it doesn't warp.

Bill Clouser thinks that more model builders would work with paper if they knew what excellent results are possible with this method. ★ ★ ★

To compare progress of smaller details, Clouser checks model against a photograph of the prototype

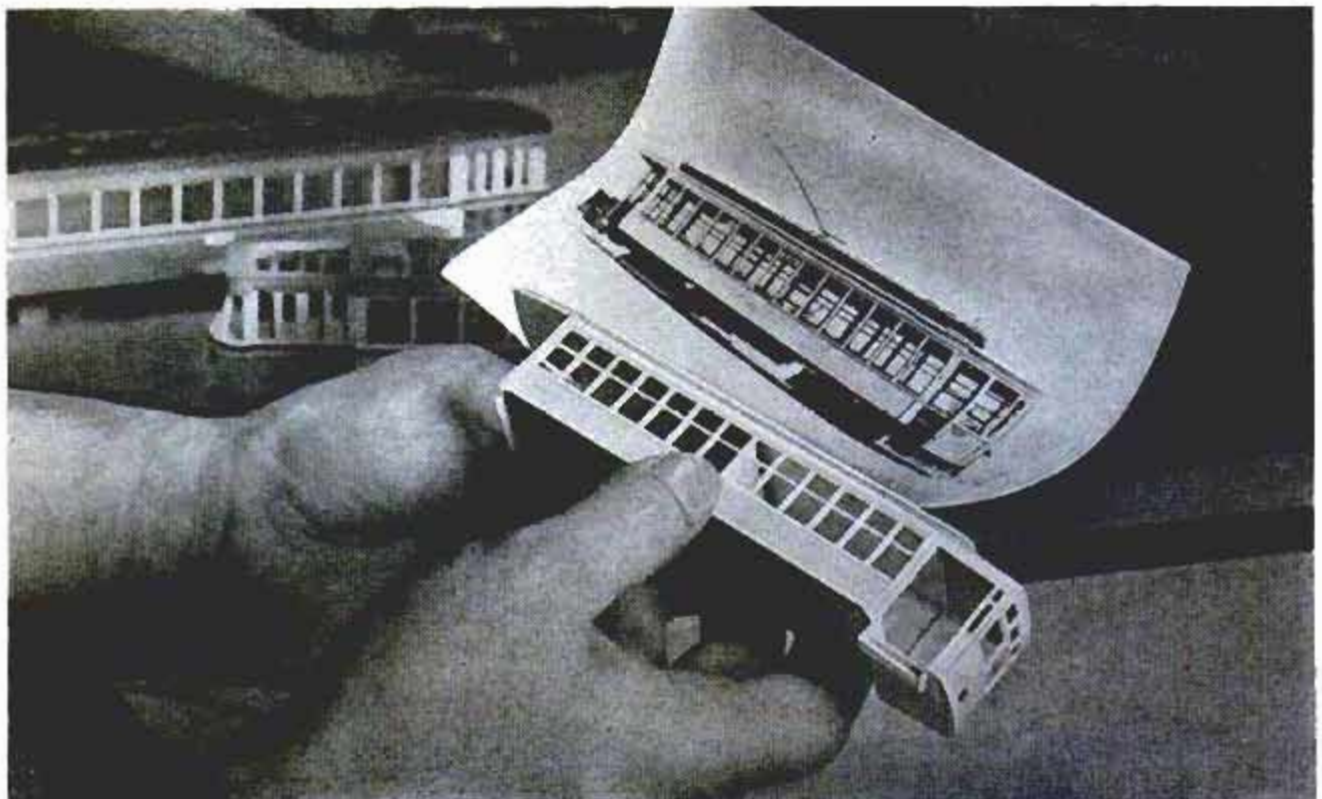



Feed Mill on Wheels Grinds and Blends Grains on the Farm

Mobile feed-processing plants now drive into a farmyard and convert a ton of the farmer's own grain into concentrate-fortified and molasses-blended feed in about 10

minutes. Flexible metal tubing "pipes" the finished poultry or livestock feed by pneumatic pressure into the farm's bins up to 40 feet above the diesel-powered mill.

Heat Takes Place of Darkroom

No darkroom is needed to copy black-and-white negatives from color slides, or projection transparencies from black-and-white negatives by a new heat process. The film can be processed in ordinary room light by dipping it in boiling water. No photographic chemicals are required. The special film is coated with a chemical sensitive only to light at the ultra-violet end of the spectrum, such as the light from a mercury vapor lamp. Since the emulsion contains no silver nitrate, it is free of grain. A device similar to a contact printer is available to produce negatives or positives.

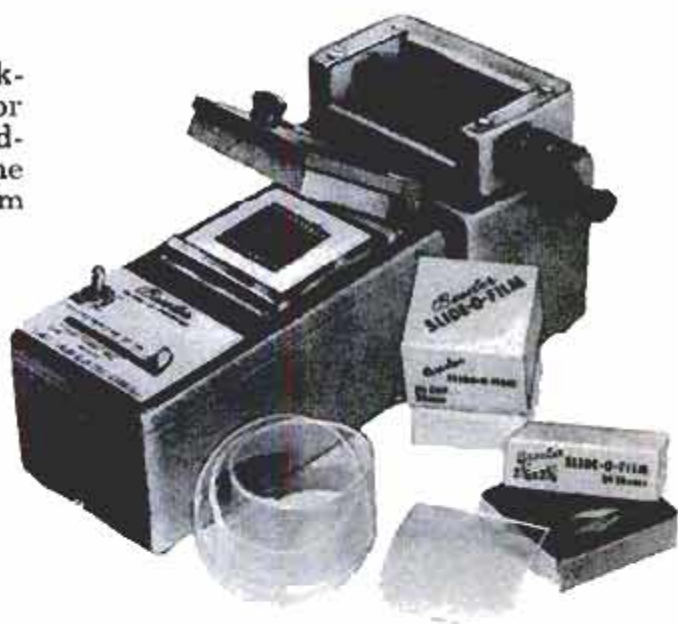

"Sea Power" Generates Electricity in Japan

Military engineers in Japan are experimenting with a device that converts the force of ocean waves into electrical power. The mechanism, which has produced up to 50 watts of electricity, consists of a float connected through a series of pulleys and gears to an electric generator on the shore. As the waves move the float up and down, the action is transmitted through a cable to the generator on the shore. The single float is only three feet long and about 18 inches wide but a larger unit may be tested soon.

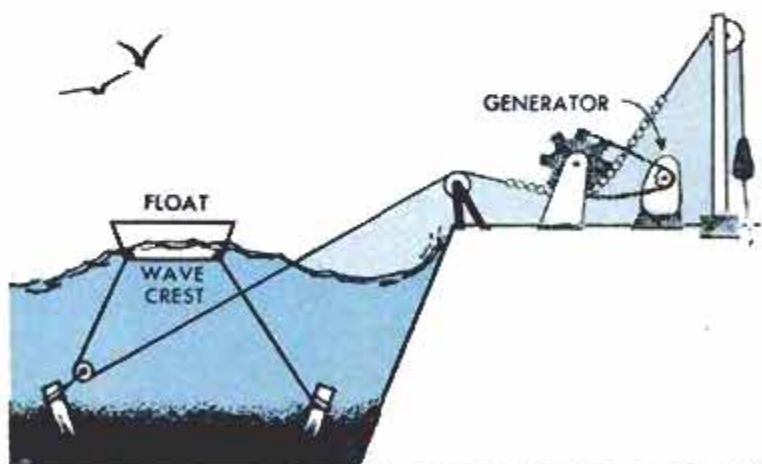



Hydrofoil Experiments Aim for One-Day Ocean Crossing

Ships that cross the ocean in one day may be developed from hydrofoil experiments by the Grumman Aircraft Engineering Corporation. The use of hydrofoils, or "sea wings," is not new but applications previously were confined to small vessels. The Grumman study involves craft of up

to 3000 tons that could travel 4500 miles without refueling. The researchers believe a "winged" vessel with a speed of around 115 miles per hour would require less recreation space per passenger than a slower liner. The hydrofoil shown is an experimental Navy craft.

Air-Conditioning, Electric Lights and Veranda: It's a Dog's Life

Crestfallen people may insist, "It's a dog's life." But for Scotty McDonald, a toy collie in Minneapolis, Minn., life is doggoned good. Residing in a pine-paneled bungalow designed especially for her, Scotty has many refinements of human living:

Electric lighting, an elevated veranda and three distinct temperature zones controlled by a thermostat. For summer living, this lucky canine has the comforts of air conditioning. And how many humans have a perfumed bed? Scotty does.

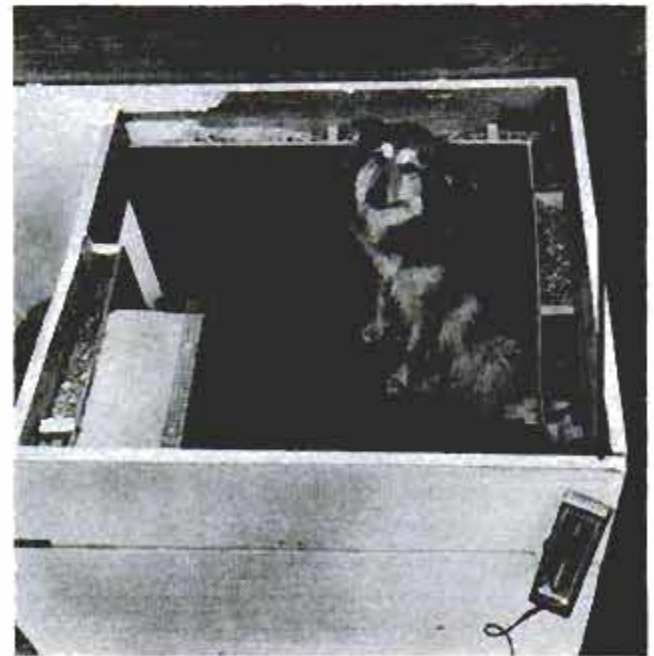
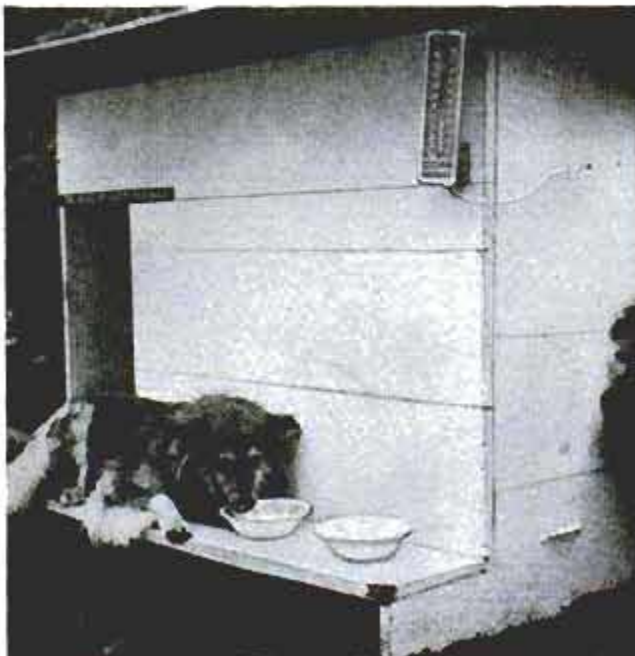

Voltage & Power
Stereo Amplifier

For Hi-Fi Enthusiasts
and Audio Hobbyists

A HIGH-FIDELITY STEREO AMPLIFIER

Radio Television Electronics

By Otto Fried

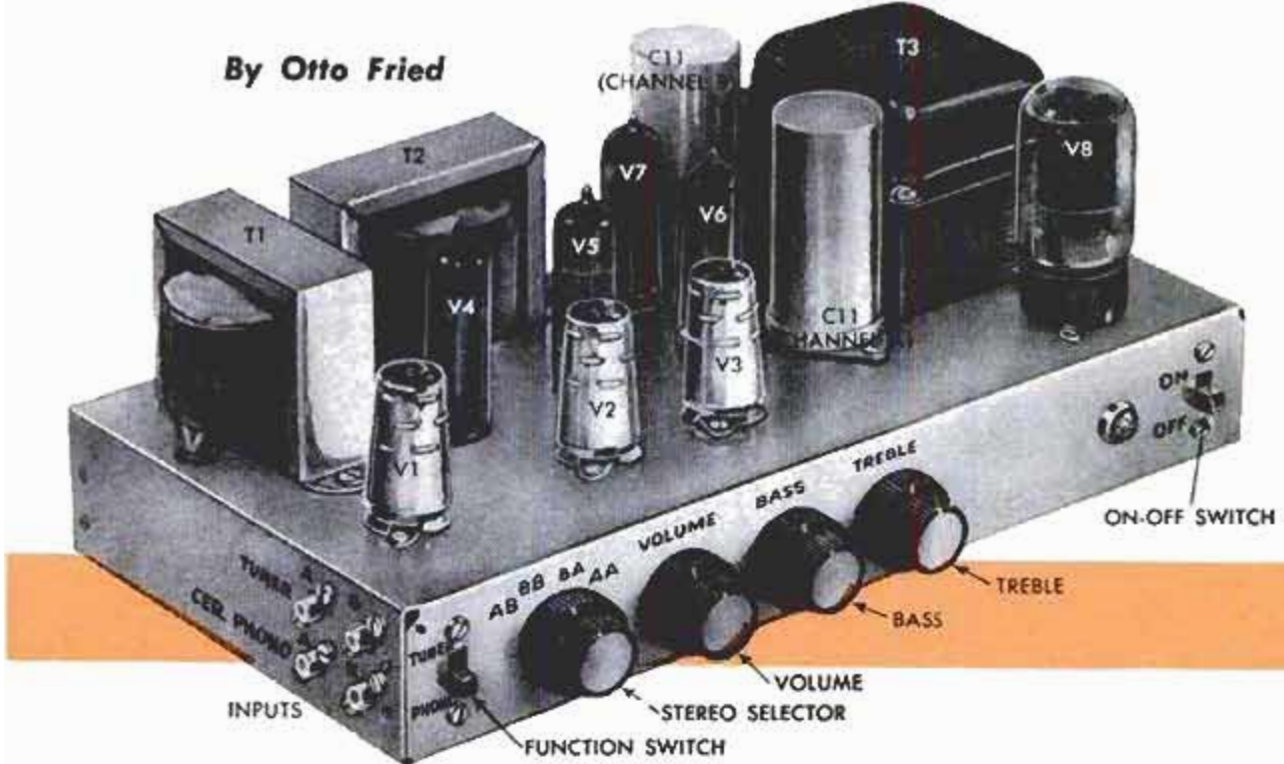

IF YOU LIKE MUSIC but have so far resisted the temptation to scrap your present phonograph in favor of high fidelity—don't listen to stereo! But, if you already have exposed yourself to the stereo record, you may as well start planning the location of your two speakers—for, no doubt, you will have succumbed to the spell of three-dimensional sound and, whatever your past resistance to hi-fi, it will have been shattered by the magic of stereo.

But stereo, particularly high-fidelity stereo, is likely to be expensive. The dual amplifier and speaker requirements for stereophonic sound reproduction are not compatible with low cost, and the price of a really good stereo system is considerably higher than that of a comparable monaural unit. Money-saving short cuts are possible, of course. For little more than the cost of a stereo cartridge, almost any good monaural phono system can be converted to stereo by employing the amplifier and speaker of a suitable radio or TV set as the second channel (see "Stereo Music at Low Cost," *Popular Mechanics*, October 1958). But the inadequacies of such con-

versions, both from a standpoint of fidelity and operating convenience, will soon become apparent. The only uncompromising path to money-saving high-quality stereo is to dust off the tool box and build some of the necessary components yourself.

The amplifier described here, actually two amplifiers in one, combines stereo flexibility with true high-fidelity performance. While not "cheap," its construction cost is far below that of commercially assembled units with similar specifications, and its design is such that a more experienced hobbyist should have little difficulty in duplicating the original model.

No tricky circuitry here. No critical adjustments, hard-to-get parts or added frills which increase costs and complicate operation. Just a straightforward circuit of a dual amplifier, using a common power supply, with sufficient power to fill even the largest living room with clean, undistorted sound.

Why a Stereo Amplifier Is Different

The principal difference between a stereo amplifier and a monaural one is the fact that the former has two complete and

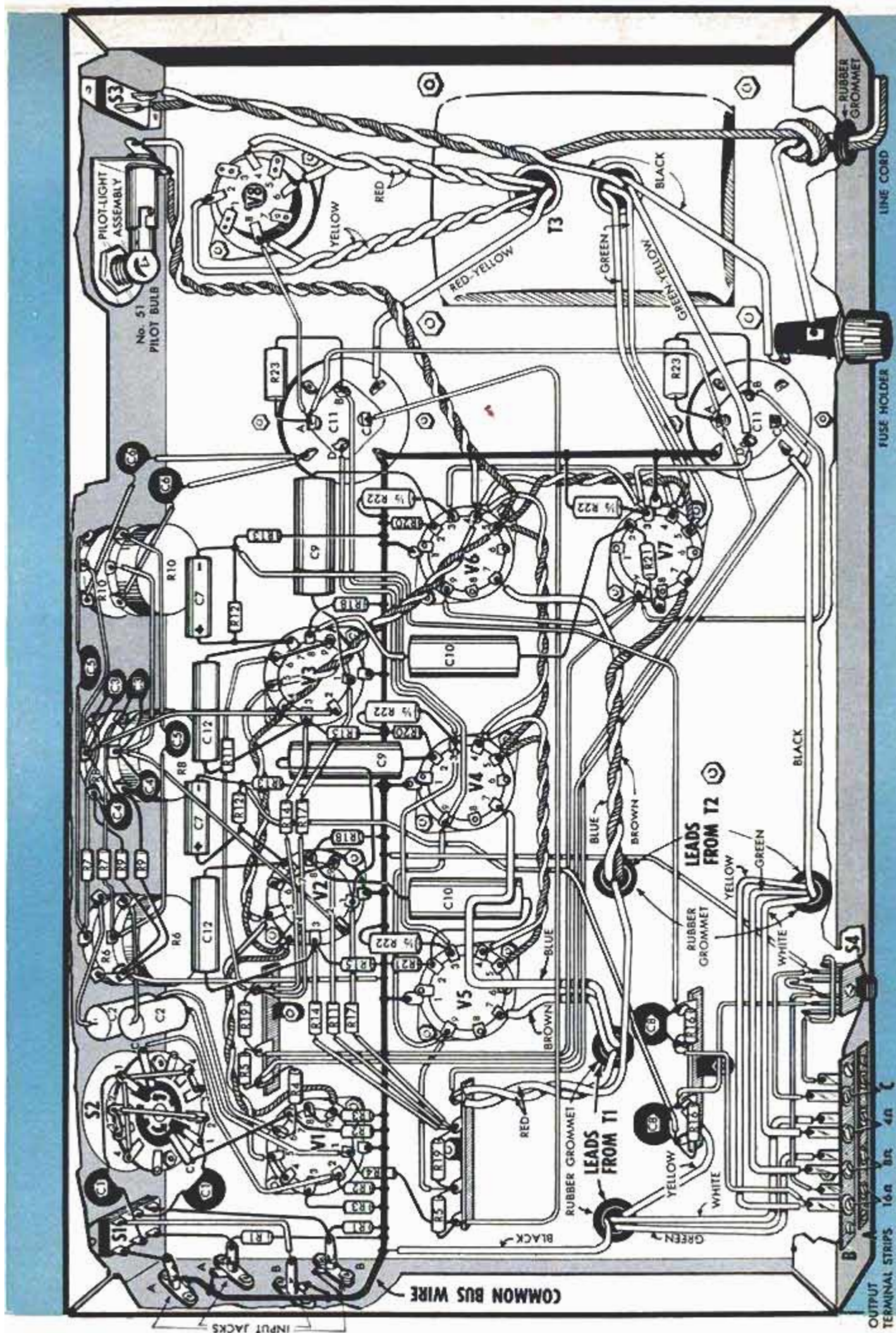

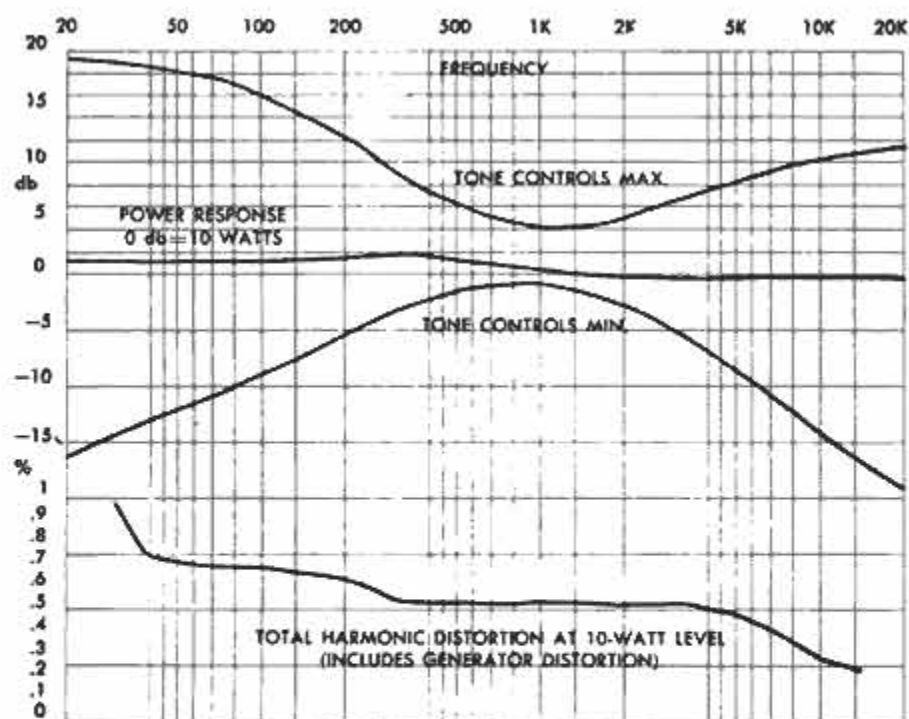

SPECIFICATIONS

RATED POWER—

10 watts per section

FREQUENCY RESPONSE—

20-20,000 c.p.s. ± 1 db

HUM AND NOISE—

68 db below rated power

TOTAL HARMONIC

DISTORTION—

See curve

SENSITIVITY—

0.3 volt

independent amplifier channels. There are, however, other differences which contribute to operating convenience and stereo flexibility. These are associated with the input switching arrangement and can readily be seen from the schematic diagram on page 158.

Note that the amplifier has four input jacks. Two of these, labeled TUNER and CER. PHONO, are associated with the A amplifier channel while their counterparts are associated with channel B. The TUNER jacks are intended to receive the output plugs from separate AM and FM tuners, and the CER. PHONO jacks receive the two separate output cables from a ceramic phono cartridge.

With switches S1 and S2 in the positions shown, one TUNER input jack is connected to amplifier channel A and the other to channel B. This permits the reception of stereophonic broadcasts which are available in many sections of the country on a limited but regular basis. With S1 in the CER. (down) position, the two elements of a stereo phono cartridge are connected to separate amplifier channels for the reproduction of stereo records. This same position gives excellent results when playing monaural records with the stereo cartridge. While monaural records cannot produce true stereo sound, the use of two amplifiers and speakers adds a pseudo-stereo effect which can be surprisingly realistic.

The stereo selector switch, S2, has four positions. Its function in the first or AB position has just been described. In the second position, labeled BB on the front panel, the switch applies the signal from the B TUNER jack to both amplifier sections simultaneously. This inserts the pseudo-

stereo effect to the program of whatever tuner is connected to this jack. The pseudo-stereo effect can be further enhanced by unbalancing the separately variable tone controls, thus applying a predominance of bass tones to one speaker and accentuated "highs" to the other.

Position BA is often called "stereo reverse." For stereo material, this position effectively reverses the two halves of the orchestra, either to place them in their proper perspective, or purely for demonstration purposes.

Finally, the AA position of the switch applies the signal from tuner A to both amplifier sections to give monophonic reproduction from tuner A.

Other stereo requirements included in the amplifier are separate volume controls for each channel and independently variable bass and treble controls. These permit balancing of the two stereo signals and compensating for possible variations in the response of the two speakers.

A phase-reversal switch, S4, is included to permit instantaneous reversal of one of the speaker voice coils. With any multiple-speaker system it is essential that all speaker cones vibrate exactly in step with each other. If a given signal were to cause one cone to move forward and the other backward, cancellation of the signal would occur in some parts of the room. Switch S4 provides a quick, convenient means for phasing the two speakers. A slow trip around the room while listening to a monaural signal source will leave little doubt as to which is the correct switch setting.

The performance of any amplifier can

(Continued to page 240)



CHAIR



STOOL



STORAGE

STOOL CONVERTS TO TV CHAIR

LIFT THE LID of this ordinary looking footstool and it becomes a novel TV chair almost as quickly as you can say John Bergen, top furniture stylist who designed it. In addition to its double-duty feature, it affords handy storage space for sewing, a book or two or your playing cards. The interior view, Fig. 1, shows how the folding back is supported in the open position by hooking under a rabbeted hardwood crossrail. When in the closed position, the back folds flush inside the stool. Two $\frac{1}{4}$ -20 stove bolts, turned into Teenuts from the inside, pivot the chair back. These are special nuts which serve as threaded bushings and which mount almost flush on the outside. It is important in drilling the pivot holes in both the back chair and stool sides that they be positioned exactly as indicated. Best way to assure this is to clamp the back (before it is upholstered) to the stool in its open position and drill through both at one time from the outside. Fig. 2 details the construction of the back. You'll

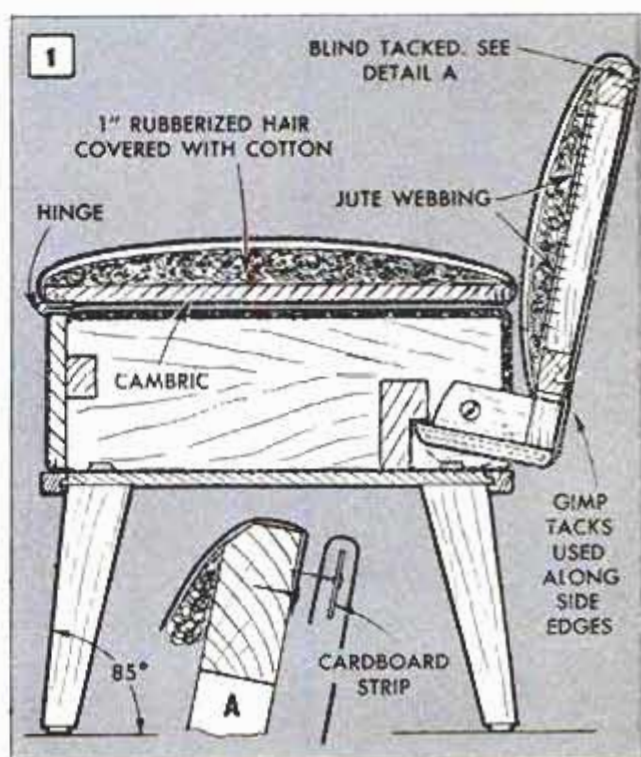



Half-lapped frame members for the folding back are rabbeted crosswise and then ripped to right width

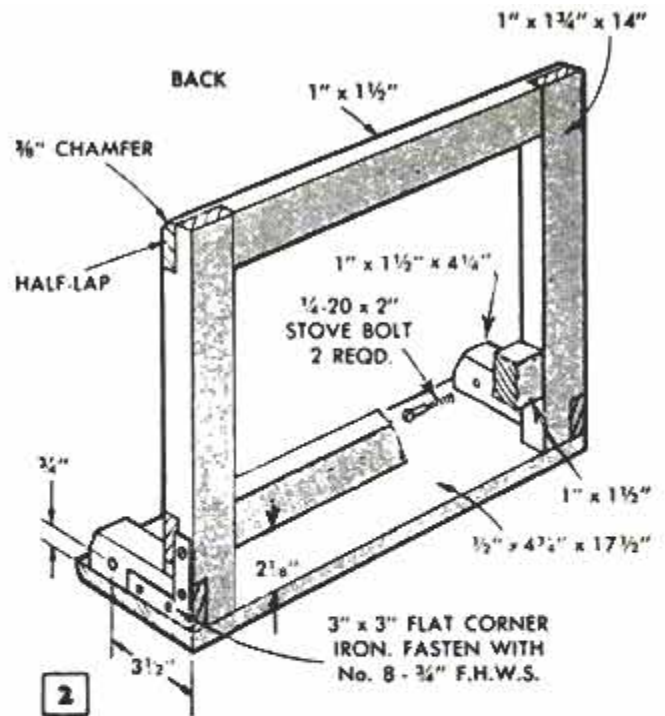

2

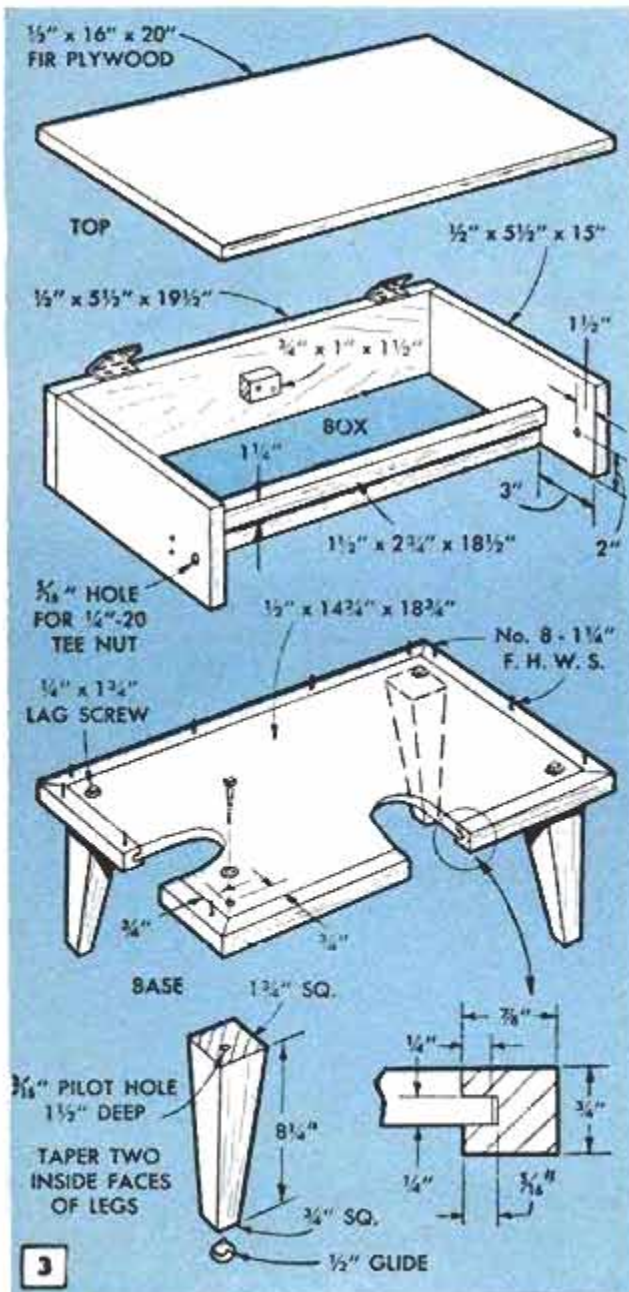

3

notice that the members are half-lapped and strengthened at the corners with flat corner irons. The rear side board of the box is made narrower than the others so the back will swing clear of the bottom and the heads of the lag screws which fasten the legs. Regular jute furniture webbing is applied to the face side of the back, interlacing two strips one way and three the other. Fold the webbing at the ends so you tack through two thicknesses.

The rest of the stool is made following the details in Fig. 3. Since the edges of the base are left exposed, the plywood edges are faced with hardwood edging. This fits over rabbeted edges, is mitered at the corners and is the same stock as the legs. The legs are splayed in just one direction, starting out by angle-cutting the ends 85-deg. and then tapering two adjacent faces from 1 3/4 in. sq. at the top to 3/4 in. sq. at the bottom. Glue, plus lag screws, fasten the legs. The box part of the stool is "up-

MATERIAL LIST

Fir Plywood

- 1 pc. 1/2" x 16" x 20"—Lid
- 1 pc. 1/2" x 14 3/4" x 18 3/4"—Bottom
- 2 pcs. 1/2" x 5 1/2" x 15"—Sides
- 1 pc. 1/2" x 5 1/2" x 19 1/2"—Front
- 1 pc. 1/2" x 4 3/4" x 17 1/2"—Back

Hardwood

- 1 pc. 3/4" x 7/8" x 72"—Bottom edging
- 4 pcs. 1 3/4" x 1 3/4" x 8 1/4"—Legs
- 1 pc. 1 1/2" x 2 3/4" x 18 1/2"—Rabbeted rail
- 1 pc. 3/4" x 1" x 1 1/2"—Stop block
- 2 pcs. 1" x 1 3/4" x 14"—Back posts
- 2 pcs. 1" x 1 1/2" x 17 1/2"—Back rails
- 2 pcs. 1" x 1 1/2" x 4 1/4"—Back blocks

Miscellaneous

- 4 Lag screws 1/4" x 1 3/4" with 1/4" washers
- 2 Hinges 1" or 1 1/4" x 3" open
- 2 Tee nuts 1/4"-20
- 2 Roundheaded stove bolts 1/4"-20 x 2"
- 2 Flat corner irons 3" x 3" with No. 8 x 3/4" screws
- 36' Jute furniture webbing
- 1"-thick rubberized hair for seat and back
- Upholsterer's cotton and cambric
- 1 1/2 yds. upholstery, 54" wide

holstered" on the outside and brought over and around the top and bottom, as well as the end edges, before attaching it to the base from underneath with No. 8-1 $\frac{1}{4}$ -in. flatheaded screws. A study of Fig. 1 will show how the seat and the back are padded and covered. In the case of the back, the front side is upholstered first, covering the webbing with a piece of burlap, then with rubberized hair, then with cotton and finally with fabric. The back is covered (without padding) by blind-tacking the fabric along the top edge first and then bringing it smoothly down around the edge that hooks under the rabbeted cleat. Gimp tacks are used to fasten the fabric along the sides. The back is installed after it is completely upholstered. Cambric is applied to the underside of the upholstered seat to cover the exposed wood. A pair of butt hinges is used to hinge the top, and a hemmed check strap, about 1 in. wide, is added to the lid to keep it from opening too far and breaking off. ★ ★ ★



Pendant on Slide Fastener Permits Grasping With Glove

Sportsmen in heavy winter garb usually find it necessary to remove a glove to grasp the tab of a slide fastener on their jackets. This is not necessary if a pendant is attached to the tab, and you'll find a tear-drop lead fishline sinker makes a neat pull that is easy to grasp with glove or mitten.

New Spark Plug Burns Hotter And Cleaner at Low Speeds

In today's modern high-powered cars, engines are "loafing" at normal highway speeds. At 50 m.p.h. you are traveling at about half the top speed of your car. In congested traffic, your engine slows down and sometimes continues at idle speeds over long periods of time. A spark plug designed strictly for fast driving would probably foul when suddenly plunged into the cooler temperatures of slow speed which allow carbon and oil deposits to accumulate on the firing tips. New developments in spark-plug design, however, are helping to offset these problems. An example of this is the projected core-nose design, which extends the insulator tip farther into the cylinder. It runs hotter at low speeds to help prevent deposits from forming. At high speeds the extended core-nose receives extra cooling from the incoming air-fuel mixture.

Removing Wall Stud

When installing a flush wall cabinet, such as a medicine cabinet, and a portion of a wall stud must be removed, the ticklish job of removing it after sawing it off so as not to damage the plaster on the opposite side, can be accomplished with a hacksaw blade. Here, the blade itself is used to saw off the lath nails driven into the stud. First gently pry the stud away from the lath to let you work the blade through behind it. Then saw back and forth, cutting through each nail as you come to it. It is best to wear gloves to prevent skinned knuckles.

Breaking Sharp Edges

Sharp edges on cabinet work can be removed twice as fast with a V sanding block. Cement the abrasive to the V surfaces so it will conform to the shape of the block. Fine sandpaper works best.

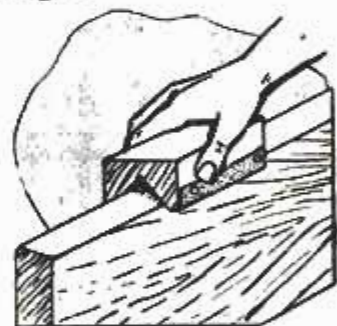

Steel Dowels Locked Securely By Upsetting Metal in Notch

Toolmakers using steel dowels for building jigs and fixtures and also for locating, sometimes find dowel holes slightly oversize in which the dowel is a slip fit rather than the light drive fit required. Rather than discard the work or take the time to turn and grind a dowel to fit, some toolmakers grind a shallow flat on the side of the dowel, insert it in the hole and then punch-mark the metal adjacent to the flat. The resulting projection holds the dowel.

Frank LaSaracina, New York City.

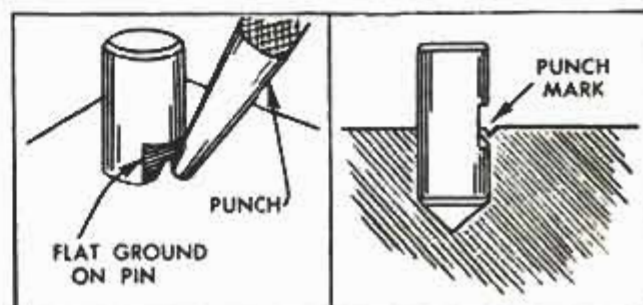

LAMP

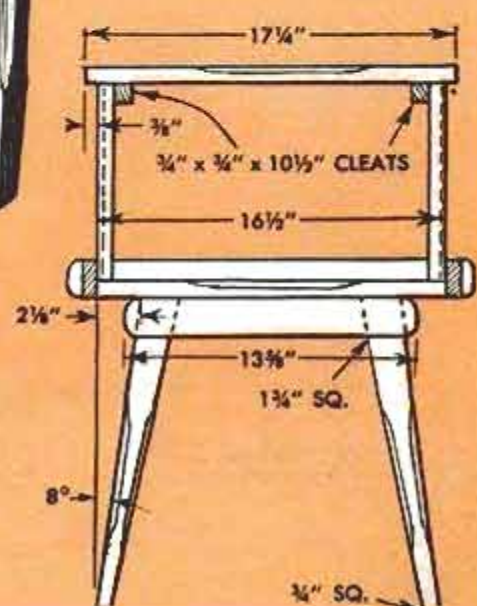
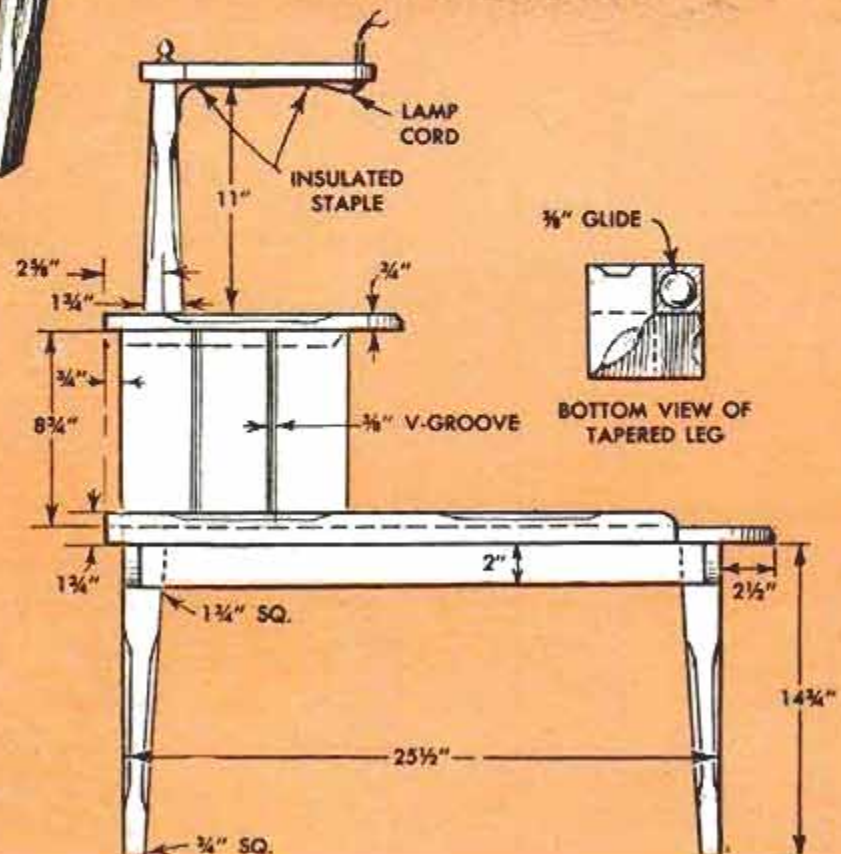
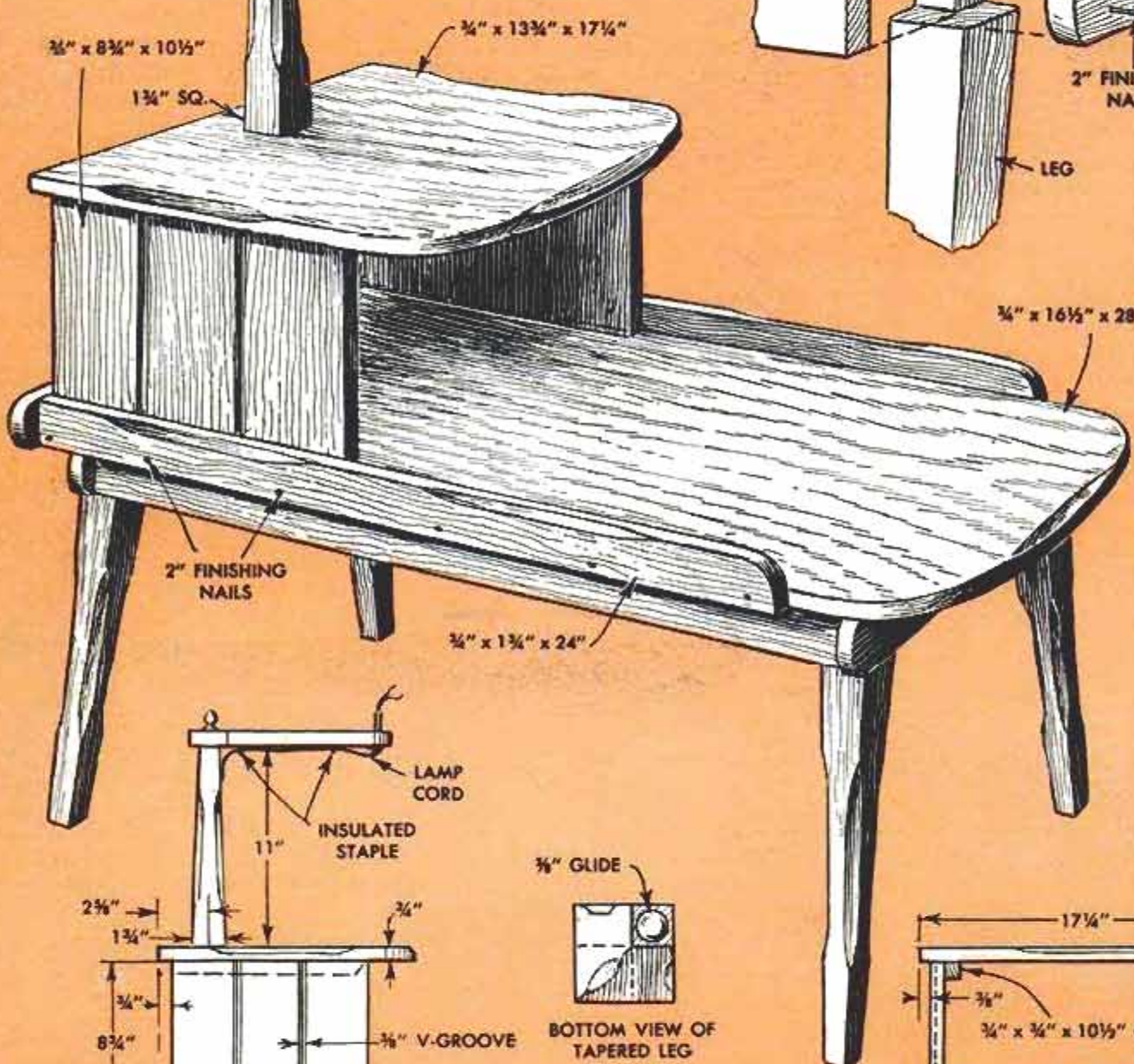
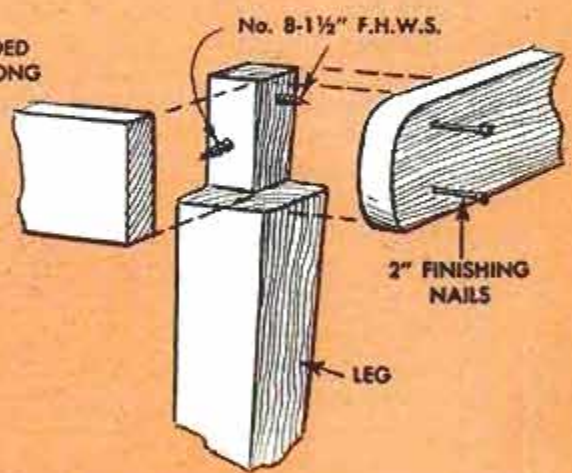
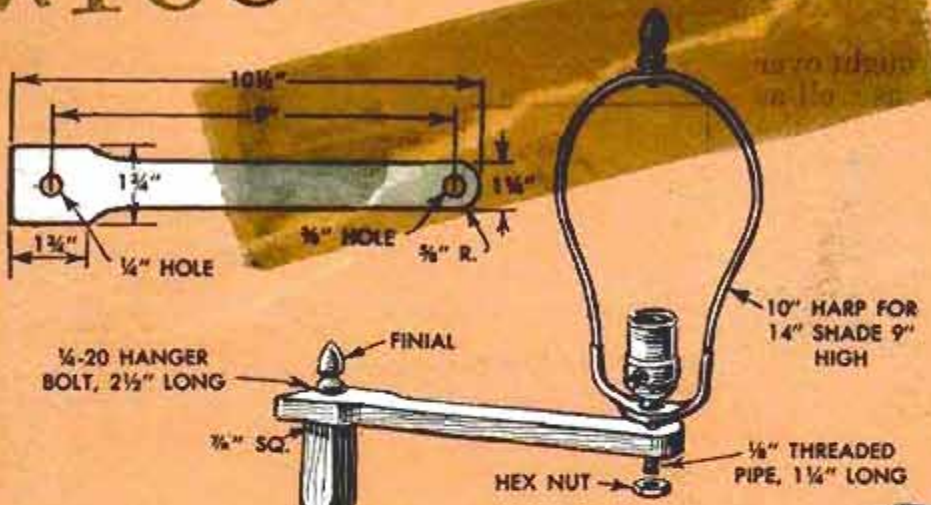

TABLE



IF YOU HAVE a yen toward the warmth and charm of colonial furniture, you'll want to add this quaint-looking piece to your furnishings. It's the perfect accent piece and doubly useful, too, in that it combines a cobbler-bench step table with a handy swinging lamp.

You have a choice of making it from white pine, maple or cherry. Note that the edges are relieved here and there with a chisel to simulate a worn, antique effect. Material for the tops, as well as the sides of the table, must be glued up for width from random widths of solid stock. One end of each top piece is rounded while the opposite end is cut square. Cleats are used to join the sides to the step top, screws from below fasten the sides to the table top. The understructure consists of a 2-in. frame on edge which is attached with screws placed in counterbored holes. You'll notice that the legs are tapered on two faces only and are splayed in just one direction. The upper ends are shouldered to fit the inside corners of the underframing where they are fastened with glue and screws. A short length of $\frac{1}{8}$ -in. electrical

pipe and nut hold the socket at the end of the swinging arm, the cord being stapled to the underside. A standard hanger bolt, which looks like a wood screw at one end and threaded for a nut at the other, is used to pivot the arm to the lamp post. A $1\frac{3}{4}$ -in. apron applied to three sides of the top completes the table. ★ ★ ★

MATERIAL LIST

Note: Lumber may be white pine, maple or cherry. Top and shelf may be of cabinet plywood

Lumber

- 4 pcs.— $1\frac{3}{4}$ " x $1\frac{3}{4}$ " x $15\frac{1}{8}$ "—Legs
- 2 pcs.— $\frac{3}{4}$ " x $2\frac{1}{8}$ " x 24 "—Side leg rails
- 2 pcs.— $\frac{3}{4}$ " x 2 " x $13\frac{3}{8}$ "—Front and back leg rails
- 1 pc.— $\frac{3}{4}$ " x $16\frac{1}{2}$ " x 28 "—Step top
- 2 pcs.— $\frac{3}{4}$ " x $1\frac{3}{4}$ " x 24 "—Step-top sides
- 1 pc.— $\frac{3}{4}$ " x $1\frac{3}{4}$ " x $18\frac{3}{4}$ "—Step-top back
- 2 pcs.— $\frac{3}{4}$ " x $8\frac{3}{8}$ " x $10\frac{1}{2}$ "—Side panels
- 2 pcs.— $\frac{3}{4}$ " x $\frac{3}{4}$ " x $10\frac{1}{2}$ "—Fastening cleats
- 1 pc.— $\frac{3}{4}$ " x $13\frac{3}{4}$ " x $17\frac{1}{4}$ "—Top
- 1 pc.— $1\frac{3}{4}$ " x $1\frac{3}{4}$ " x 11 "—Lamp post
- 1 pc.— $\frac{3}{4}$ " x $1\frac{3}{4}$ " x $10\frac{1}{2}$ "—Lamp arm

Miscellaneous Hardware

- 4— $\frac{3}{8}$ "-dia. furniture glides
- 1— $\frac{1}{4}$ "-20 hanger bolt, $2\frac{1}{2}$ " long
- 1— $\frac{1}{8}$ " threaded pipe, $1\frac{1}{4}$ " long
- 1—Hex nut to fit threaded pipe
- 1—10" lampshade harp
- 1—electric socket, push-button type
- 1—electric-cord plug
- 1—electric cord, 6 ft. long
- 2—lampshade finials
- 1—14"-dia. lamp shade, 9" high

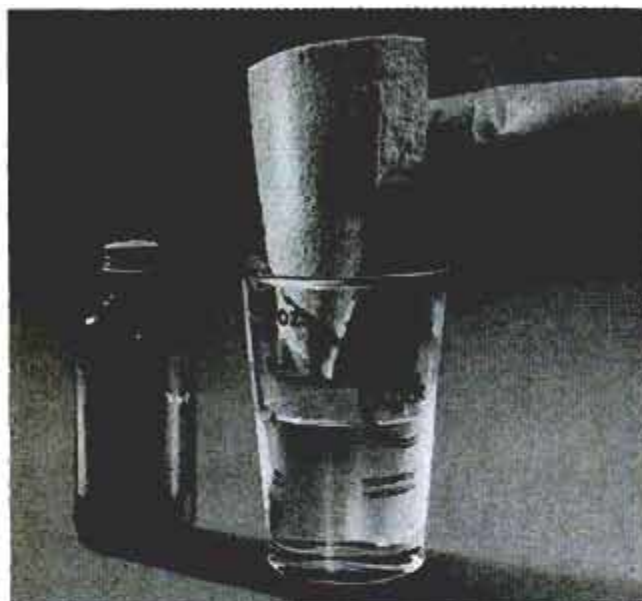

Pretreated Photo Sponges Absorb Water Readily

When cellulose sponges used for photographic purposes become hard, they can be softened so they absorb water readily by pretreating in a solution of several drops of wetting agent mixed with a few ounces of water. After using the sponges, squeeze out the water, dip in wetting solution and wring out again. Treated sponges will dry normally and soften immediately in water.

Emergency Retouching Frisket Made With Rubber Cement

When no frisket paper is available for use on photographs that are to be retouched with an airbrush, rubber cement can be used as an excellent substitute. Two coats of the cement, thinned to working consistency, should be applied to assure complete coverage of the area to be masked. When the retouching has dried, the rubber cement can be removed by "rolling" it off with a soft, dry cloth. As the cement is removed, it also cleans the surface.—Robert L. Hay, Rochester, N. Y.

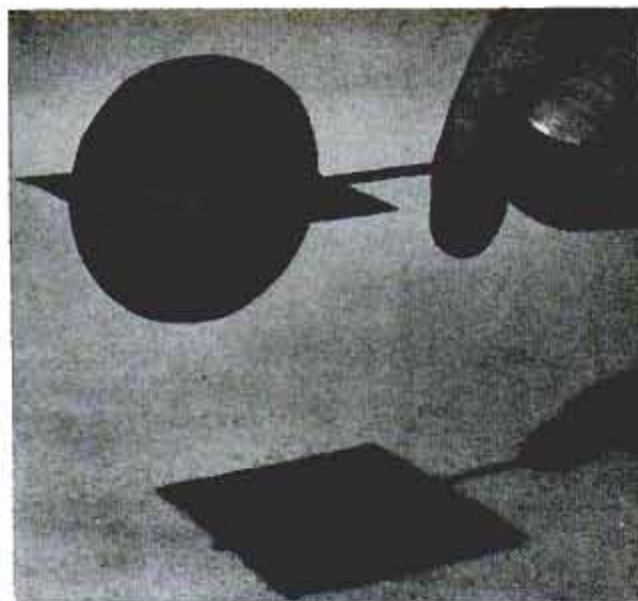
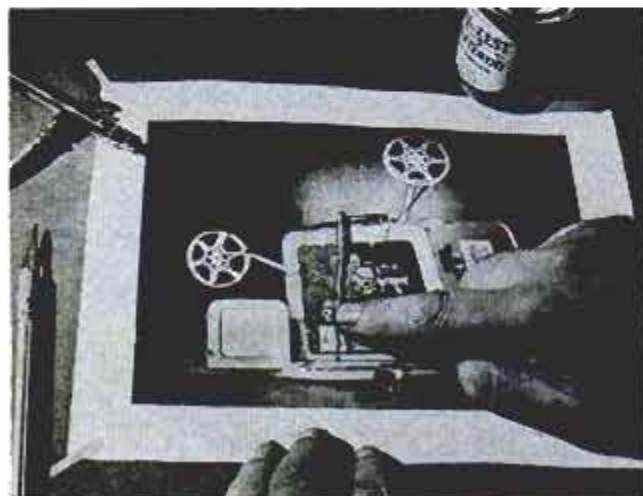

Square or Round Shadow Cast By Print-Dodging Tool

For controlled print exposure while making enlargements, this novel dodging tool can be turned to cast either a square or a round shadow. Cut a square and a round shape from heavy black paper, then cut down the center of each halfway so they may be joined at right angles as shown. Cement them to a length of wire which serves as a handle.

Meter and Filters Carried Along With Camera Case

When you take your camera on location, you can avoid a last-minute search for mislaid equipment, such as a light meter, lens shade and filter case, if these items are kept attached directly to the camera case. Cut slits in the backs of the accessory cases and thread them onto the shoulder strap of the camera case. While you are doing this, it would be a good time to check to make sure the camera strap and buckles are in good condition.

Ron Anderson, Minneapolis, Minn.



10-11-66

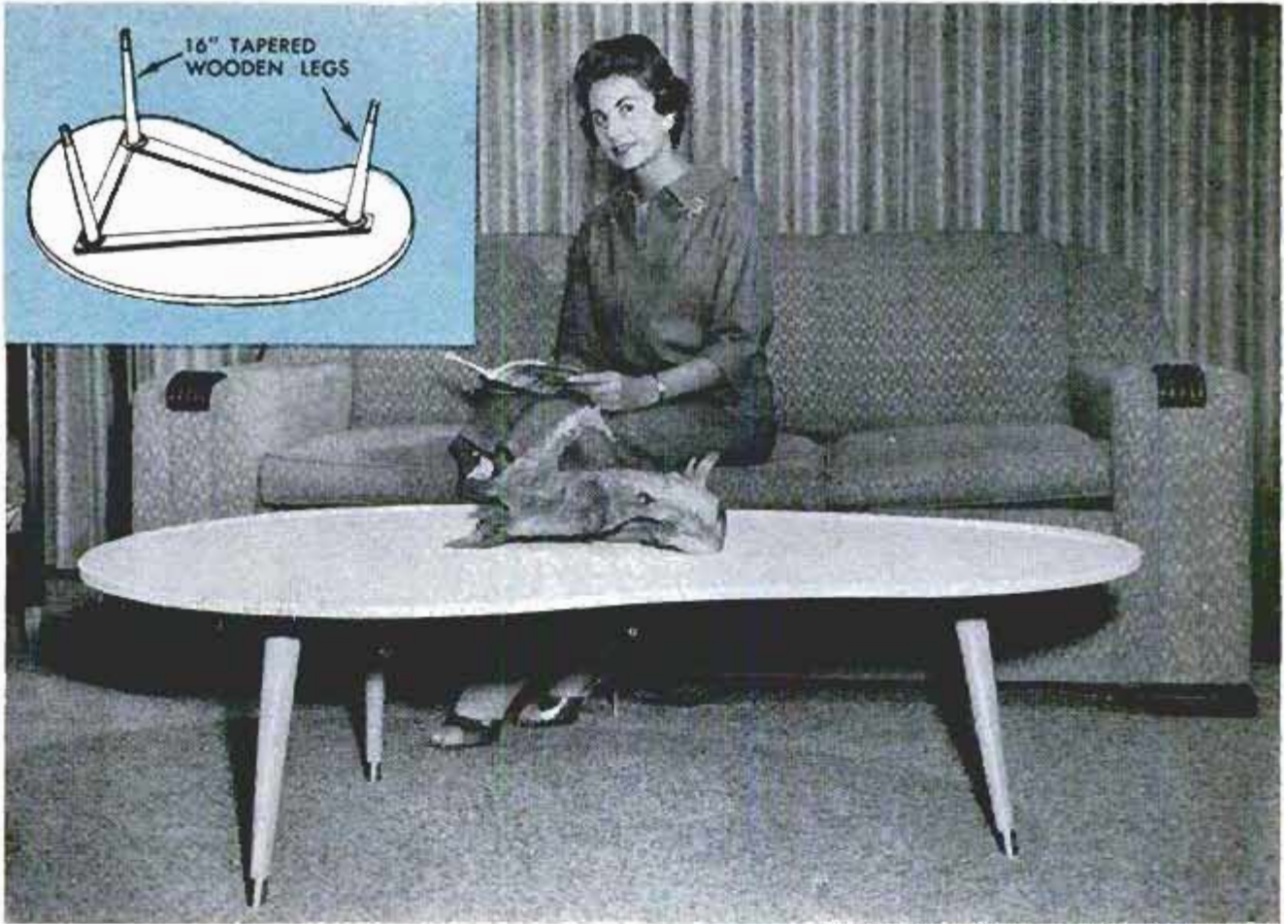

Photos and information courtesy Masonite Corp.

FREE-FORM COFFEE TABLE

THIS MODERNISTIC coffee table, which any homemaker would be proud to have in her living room, can be made in one evening from a 4 x 4-ft. panel of 1/4-in. tempered hardboard and 1 x 3-in. furring stock. The 16-in. tapered wooden legs can be purchased at most lumber-supply stores, or they can be turned from hardwood stock, if suitable wood-turning equipment is available. First make a full-size pattern of the table top on wrapping paper, outlining the positions for the 1 x 3-in. frame and legs as shown in the squared drawing. Then trace an outline of the table top on the hardboard panel and cut it out with a scroll or saber saw. If the cutting is done carefully, most of the 1 1/2-in. border-trim pieces can be cut from material adjacent to the cutout line to save marking and cutting both edges of these pieces. For places where sufficient material is lacking, the trim can be cut from scrap pieces. The inside edge of the trim is given a 10-deg. bevel for easier cleaning before gluing it to the top.

After cutting the framing pieces to size, they are glued to the underside (rough

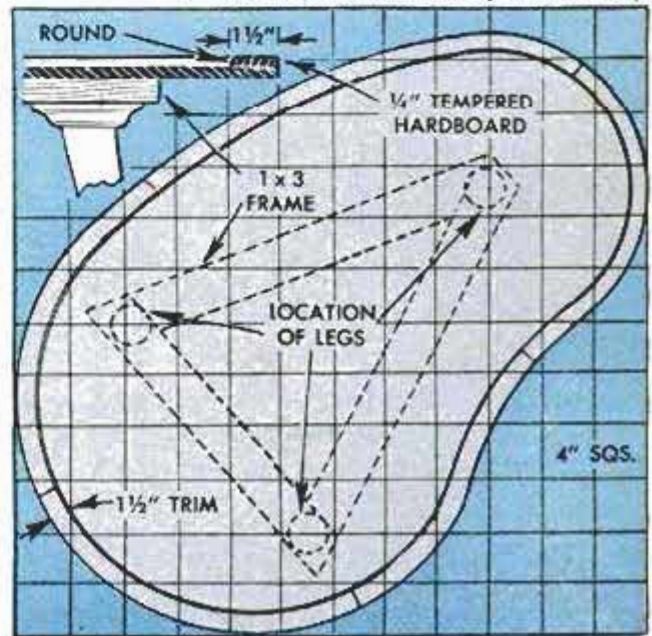

side of the hardboard) of the table top. The framing members strengthen the top and provide a suitable base to which the legs may be attached as indicated in the details. The top can be left in its natural finish and waxed or varnished, or it may be painted to match the decor of the room. More colorful effects can be obtained by covering the top with mosaic tile, which should be glued to the hardboard and grouted. The table shown in the photo was primed and finished with light-colored texture paint.

X432



MODELING THE FRENCH CHEBEC

By E. R. Haan

PART I—Shaping the hull

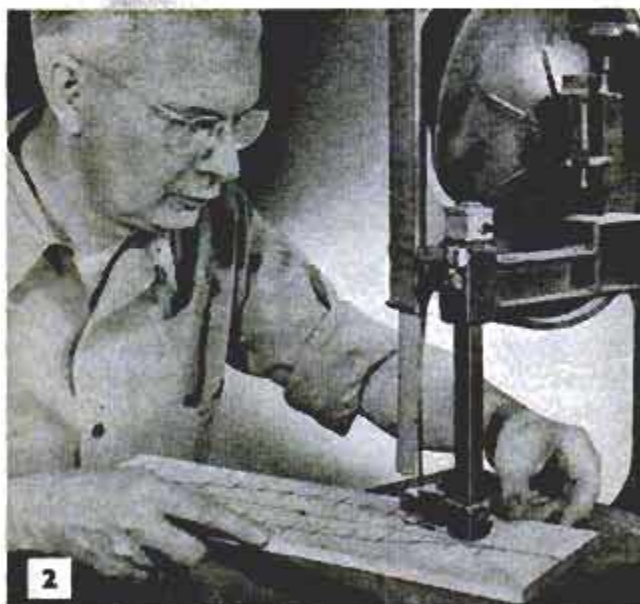

Saw the lifts slightly outside the line. You can use either a bandsaw or jigsaw, even a coping saw

FAITHFULLY reproduced in exquisite detail by skilled craftsmen in the workshops of the French Navy's famous Musee de la Marine in Paris, this beautiful scale model is an authentic copy of the French warship *Chebec* which was one of several of the xebec class that distinguished themselves by many daring exploits during the years from A. D. 1650 to 1700. Highly picturesque and colorful, these beautiful ships somewhat resembled galleys because of their high sterns, but were much easier to maneuver, a definite advantage in naval encounters of that time. After serving magnificently in the Royal Navy, these renowned ships survived nearly another half century as fishing boats. The model shown in Fig. 1 is 26½ in. long, about 1/75 the size of the actual ship, which mounted 24 six-

pounder cannon and 34 two-pounder blunderbusses.

Tracing the Lifts

To model the Chebec start with the lifts, Fig. 3. These are $\frac{1}{16}$ in. thick except lift A which is $\frac{1}{8}$ in. However, you can use a single lift $\frac{1}{16}$ in. thick for both A and B, cutting it to the shape of B.

Cut out Fig. 3, which gives actual-size lift lines. Here, the lift lines ahead of the traverse centerline are superimposed over the lines aft. The former are solid and the latter dotted. They are to be joined end-to-end when traced on a piece of kraft or other strong paper to make a full-length but half-width pattern. Lay the fore half of the printed cutout to register on an 18-in. longitudinal centerline first marked on the kraft paper. Fasten one end of both sheets down on a drawing board with thumbtacks or removable tape. Place carbon paper face down on the paper and also place carbon paper face up under it before fastening the other end of the sheets to the board. Now trace the solid lift lines as well as the station lines and centerlines. Station M is about amidships. Those forward are marked with Roman numerals and those aft with Arabic numerals.

Next, move Fig. 3 down until both the traverse and longitudinal centerlines are in register and continue tracing on the dotted lines with a sharp pencil. Turn the pattern over and adjust it on the opposite side of the centerline to trace the second half width. Lift lines A to F are reproduced completely, but only the fore portions of G and H, and the aft portions of G, H, I and J, according to lengths given in Fig. 6. Saw carefully about $\frac{1}{32}$ in. outside of the lines, best done on a bandsaw as in Fig. 2. Mark the station lines on the edges of the lifts and also the longitudinal centerline at their tips.

Assembling Lifts

You can use $\frac{1}{4}$ or $\frac{3}{8}$ -in. dowels to keep the glue-coated lifts from shifting when squeezed together with clamps. Drill the dowel holes vertically at the centerline $\frac{5}{8}$ in. aft of stations II and 2 so the dowels will be concealed by deck fittings. The holes should not go through the bottom lift. Drill the holes while the lifts are clamped together in perfect alignment, but not yet coated with glue. After drilling, apply waterproof glue and clamp the lifts as in Fig. 4. Partial lifts G, H, I and J at the stern are similarly doweled to the hull at the same time or later.

When the entire assembly has dried overnight, pencil the deck-curvature line on each side. This should be the curvature

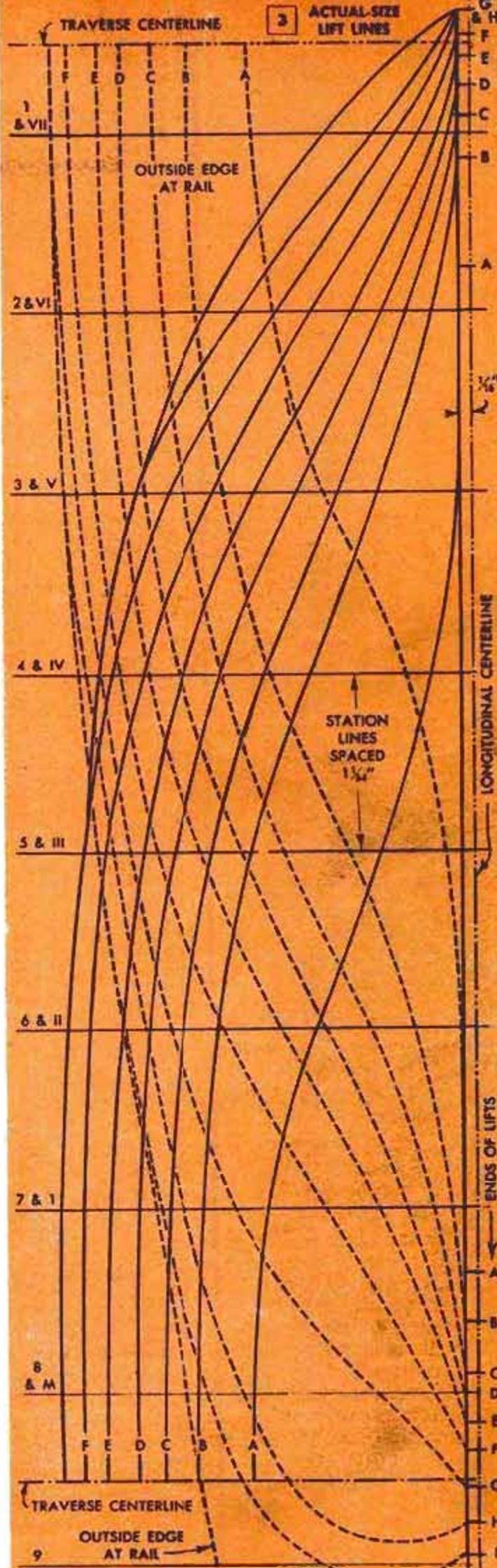

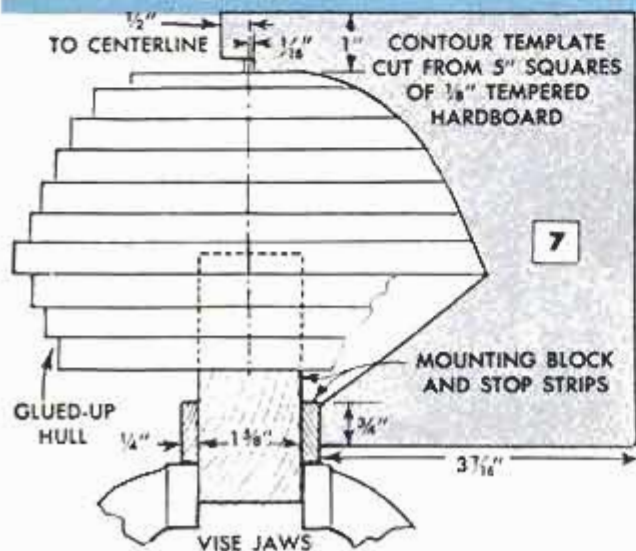
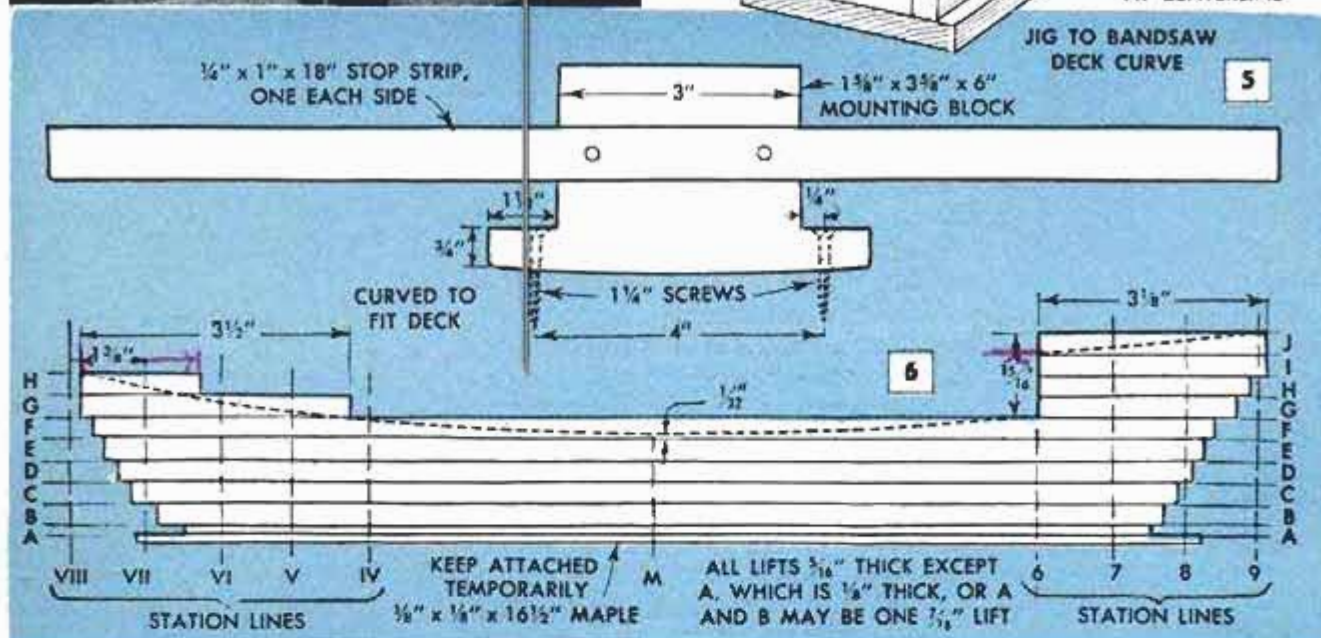
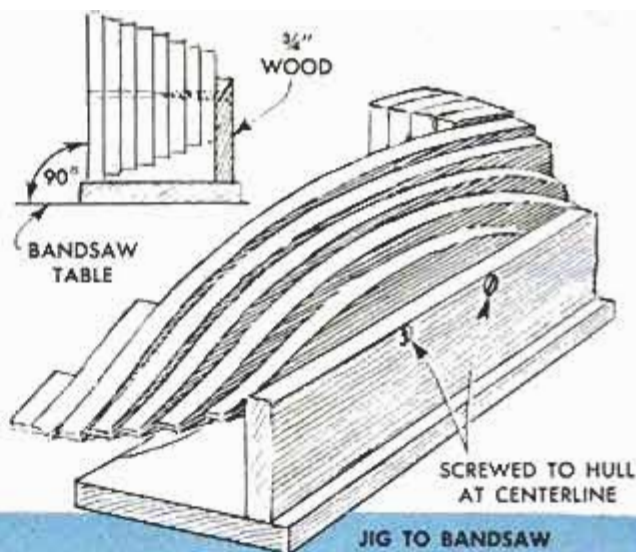
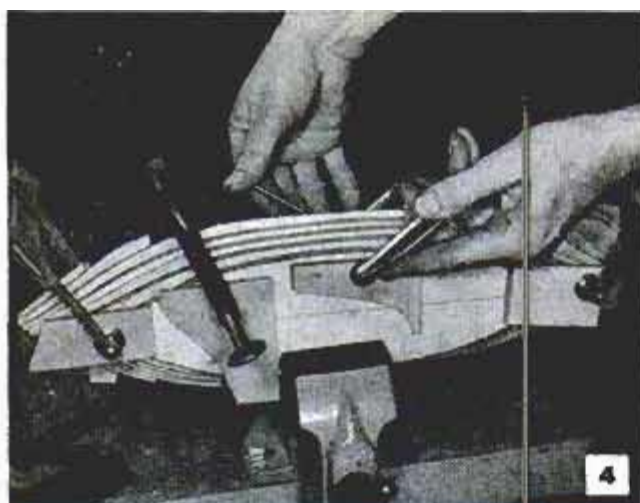

at the deck center as given in Fig. 11. You can bandsaw the curvature by using a jig detailed in Fig. 5. The lower edge of lift F should rest firmly on the base of the jig. The screw holes will be concealed by the keel. After the curvature of both main and poop decks have been cut, lightly restore the centerline and lift lines on the new surfaces so later sanding will remove them. The job of crowning the deck—sloping it toward the sides—is done later.

Fit the hull at the center with a mounting block, Fig. 6. This, when chucked in a vise, holds the hull bottomside up. Drive the two screws 4 in. apart so they enter the hull just aft of the dowels where the screw holes will be covered later. Two straight strips of $\frac{1}{4}$ x 1-in. wood are nailed to the mounting block to serve as stops for using contour templates where hull shape is to be checked. A temporary $\frac{1}{8}$ x $\frac{1}{8}$ -in. keel, and also a stem and sternpost, $\frac{1}{8}$ in. thick, of close-grained hardwood, will serve as guides for dressing down the hull, and also help to prevent cutting away too much wood near them. Pilot holes for brads through these parts prevent splitting. Also mark the station lines on the keel.

Contour Templates

The contour of the hull is checked while shaping it by means of templates. These are cut from 5-in. squares of $\frac{1}{8}$ -in. tempered hardboard. Each template shows the hull curvature from keel to the top of the bulwark at a particular station line. All the contour lines are given in Fig. 9. Trace this pattern on paper from which you can reproduce one contour line on each tem-

plate blank. In doing the latter, the contour line goes up as high as the dot. Then a straight line goes from the dot to point X, and from this a straight line runs parallel to the vertical centerline, $1\frac{1}{16}$ in. from it. Saw alongside the lines in the waste.

Shaping the hull starts with removing excess wood from the lifts with a spokeshave as in Fig. 8. A thumb plane, chisel, gouge and coarse file, whichever is most convenient, can be used as you progress. Start cutting from station M in both di-

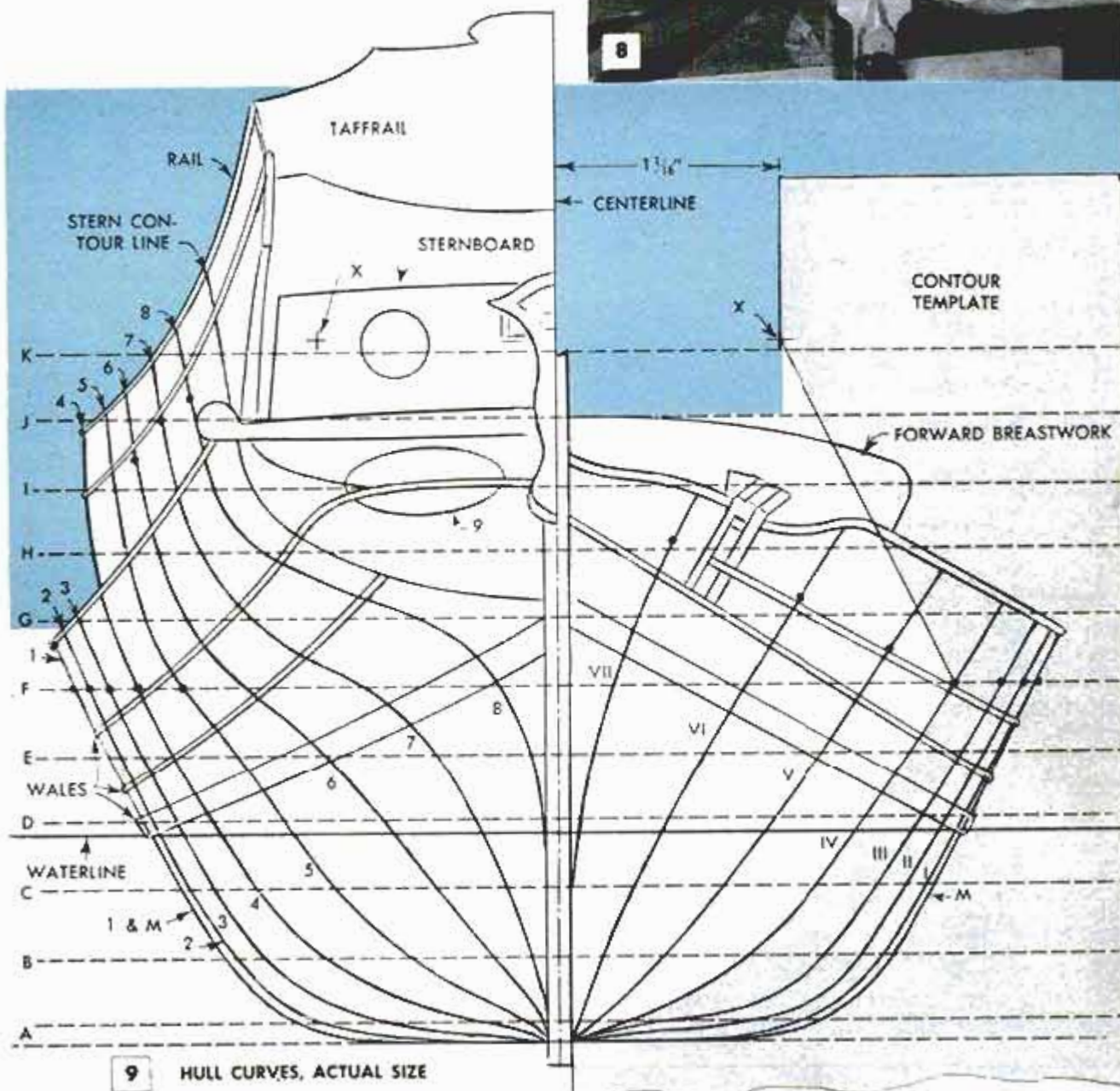
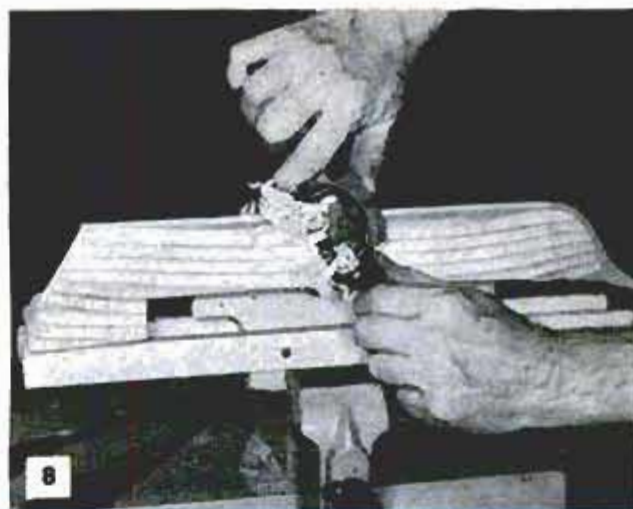

rections, over a distance of several stations. When the final contour is being approached, you can locate high spots by rubbing chalk or crayon on the edges of the templates and moving them sideways a trifle against the hull to mark it. Final finishing is done with Nos. 1, 0 and 2-0 sandpaper. Templates should fit snugly against the keel and the stop strips as shown in Fig. 7 when held at the station lines.

After shaping the hull, remove the tem-

porary keel, stem and sternpost which likely will be marred from cutting. Before substituting the permanent ones, also of close-grained hardwood, taper the bottom of the hull at the centerline a scant $\frac{1}{16}$ in. from station III forward and from station 3 aft, as indicated in Fig. 10. Fasten the new pieces with glue and brads. Before installing the stem, carve the figurehead and notch tip of hull to accommodate the stemson. Stem and stemson need not be

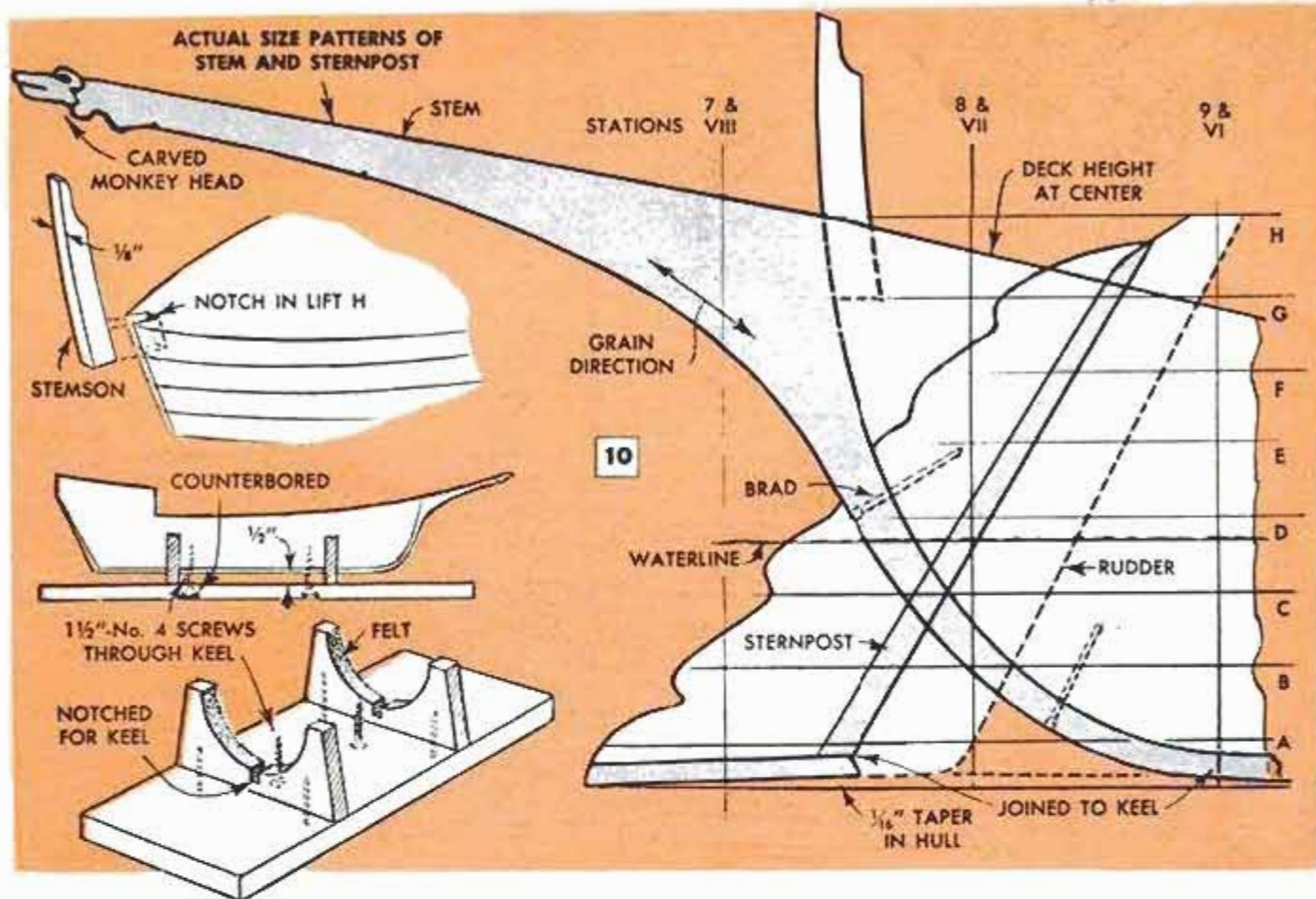

separate pieces as shown in Fig. 10, but may be a single unit cut.

The sternpost and rudder also may be a single piece, in which case this is shaped and installed after the sternboard of the poop deck has been installed. If a separate, movable rudder is desired, it is attached later, and only the sternpost is installed at this time. Following this, remove the mounting block and set the hull in a temporary cradle also detailed in Fig. 10. Its crosspieces fit the hull near stations III and 3. Two slim screws hold the hull and cradle together securely, passing into the keel where mounting pedestals are to be located later.

Deck Crowning

Use a rasp and coarse sandpaper on a block to crown the deck, stroking with the

grain and also inward from the edges, to penciled lines marked on the sides at points indicated in Fig. 11. In the original ship the real deck had a sharp downward incline near the sides and was here covered with a false deck which joined the real deck as shown in Fig. 12. Gratings between cannon drained water to the real deck below where it flowed out through holes (scuppers) in the sides. The planking of the real deck—the center portion—is straight, while that of the false deck is curved as shown in Fig. 14.

Before marking the deck to simulate planking, locate and mark the gratings. First pencil the axis lines of the guns lightly so that sanding will remove the lines. Locate the axis lines as follows: Stick masking tape on the deck at the centerline and then mark on the tape, the center-

11																	
TABLE OF DECK HEIGHTS																	
Station Lines	VII	VI	V	IV	III	II	I	M	1	2	3	4	5	6	7	8	9
Height of Main Deck at Centerline	$G + \frac{3}{32}$	$F + \frac{1}{32}$	$F + \frac{3}{32}$	$E + \frac{1}{16}$	$E + \frac{1}{32}$	$E + \frac{3}{32}$	$E + \frac{1}{16}$	$E + \frac{1}{32}$	$E + \frac{1}{32}$	$E + \frac{1}{16}$	$E + \frac{3}{32}$	$E + \frac{1}{32}$	$E + \frac{1}{16}$	F			
Height of Main Deck at Sides	$G + \frac{1}{32}$	$F + \frac{1}{16}$	$F - \frac{1}{32}$	$E + \frac{1}{16}$	E	$E - \frac{1}{32}$	$E - \frac{1}{16}$	$E - \frac{1}{32}$	$E - \frac{1}{32}$	$E - \frac{1}{16}$	E	$E + \frac{1}{32}$	$E + \frac{1}{16}$	F			
HEIGHT OF DECKS AND AMOUNT OF CROWN GIVEN IN RELATION TO LIFT AND STATION LINES (+ AND - MEANS ABOVE AND BELOW LIFT LINE MENTIONED)											Height of Poop Deck at Centerline		I	$1 + \frac{1}{32}$	$1 + \frac{1}{16}$	J	
POOP DECK LATER PROVIDED WITH $\frac{1}{16}$ " THICK FLOOR WHICH EXTENDS OVER MAIN DECK TO STATION 4											Height of Poop Deck at Sides		$1 - \frac{1}{16}$	$1 + \frac{1}{32}$	$1 + \frac{1}{32}$	J	

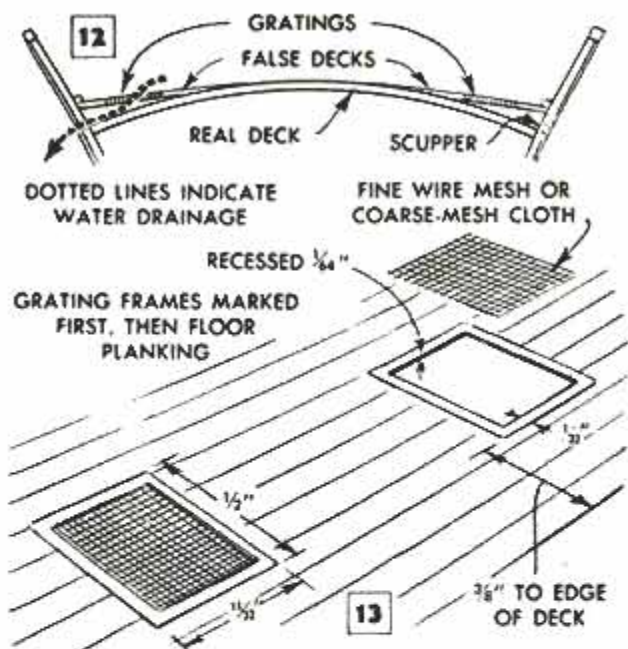

line and the station lines. Lay off the measured distances on the tape (ends of the dotted lines) as shown in Fig. 14, starting from station line M. Make penciled dots along the edge of the deck exactly 1 in. apart, starting halfway between stations M and I. Mark the gun-axis lines from the measured marks on the tape to the corresponding dots at the deck edges.

Marking Gratings and Planking

To mark the grating outlines and the deck planking, use a hard-lead, sharply pointed pencil, or you can score the wood with a scribe. Gratings come midway between the gun-axis lines and about $\frac{3}{8}$ -in. from the deck edge as shown in Fig. 13. Make shallow cuts with a chisel or knife $\frac{1}{32}$ in. inside the outline as indicated in Fig. 13, and recess the center slightly so that the grating will come flush with the deck. For gratings, you can use fine-mesh screen like that found in auto carburetors. This may be painted to match the deck. An alternate material is coarse cloth with an open weave about 34 mesh per inch, and thick enough to simulate the grating. Stiffen the cloth with shellac. Then cut out the gratings and glue them in place, or simulate gratings with pencil lines.

The outermost curved planks along the edges of the deck are $\frac{3}{32}$ in. wide, except the portion beyond the forward breastwork. Here the curved edge plank is wider and is jogged to fit the squared-off ends of the straight deck planks. These should never end as points. All the straight planks of the false decks are $\frac{1}{8}$ in. wide. A score line across the deck exactly where the forward breastwork is to be located separates the curved planking from the straight planking.

(To be continued)

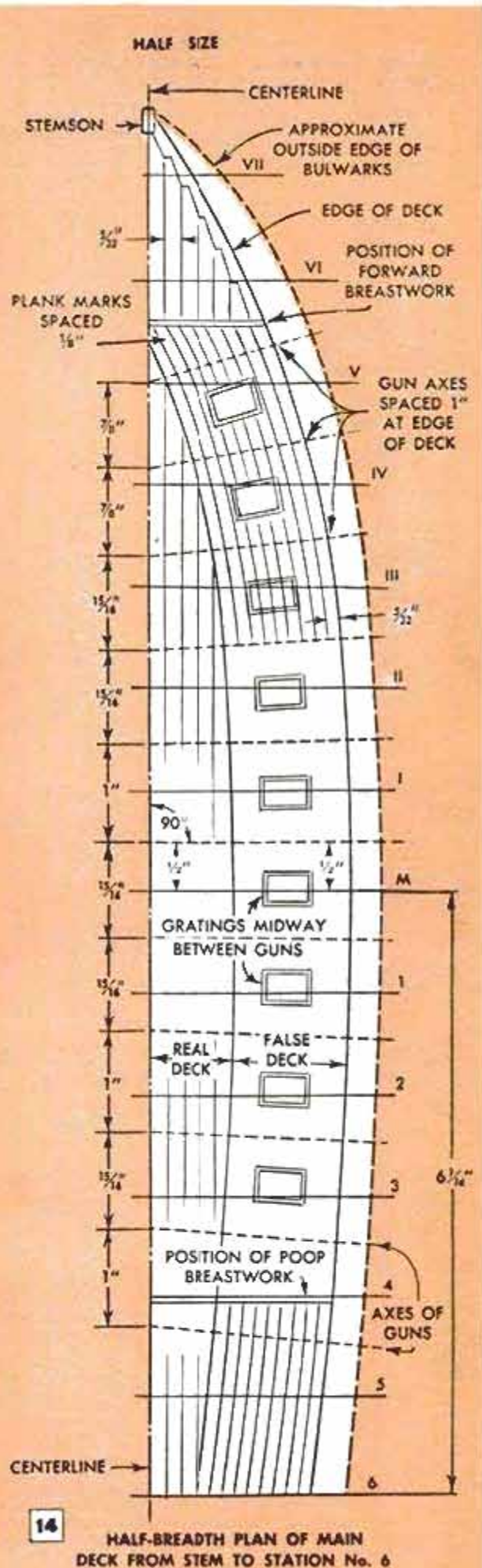

Solving HOME PROBLEMS



1

1. A WOBBLY TABLE fitted with casters often can be leveled with a thin washer. Remove the castor from the short leg and slip the washer over the castor shank. Then reinstall. In most cases, there is enough play in the castor socket to take the washer

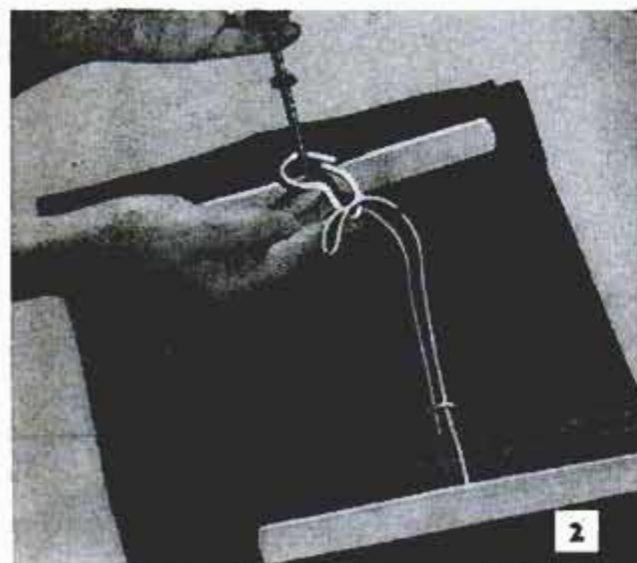

2

2. SHORT OF HANGER SPACE? Make a few S-hooks of wire and use them to gang several trouser hangers together in the manner shown. Hooked around the hanger hook itself, the S-hooks permit two or more hangers to be hung in space normally occupied by one

3. STAMPS ARE AT HAND when you want them if they are kept in your stationery box. A handy pocket in which to keep them can be made by taping a small envelope in the corner of the box lid. A second envelope can be provided for gummed labels

4. KEEP A SCRUB MOP and a pail of water near by when burning leaves. You'll find a wet mop is more effective in snuffing out a small leaf fire that threatens a shrub or fence than by beating with a rug or blanket which often fans and spreads fire

5. STAND AN UMBRELLA in a closet and the chances are you'll find it on the floor the next time you need it. Where an umbrella cannot be hung, a neat nonskid pad for the metal tip is provided by cementing a rubber furniture-leg cup to the floor

6. A GOOD PLACE to keep a pair of scissors and tweezers so you know right where they are is on the back of the medicine-cabinet door. Neat holders for them are improvised by sticking a couple of adhesive bandages to the door to serve as pockets

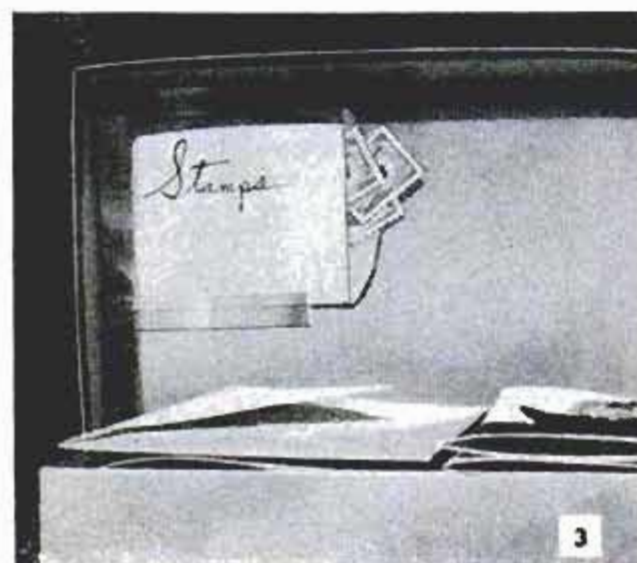

3

7. COAT HOOKS convenient to an entrance are made more decorative and much less conspicuous if centered on cardboard cutouts, such as stars. Make the cutouts about 6 in. and paint both cutout and hook the same color or the star a contrasting color

8. GETTING THE WIRE over the nail when hanging a large picture is less of a problem if you make use of a notched stick. The photo shows a back view for clarity but in actual use you would face the picture and slide the stick upward against wall

9. WHEN DARNING A HOLE in the finger of a glove, you'll make a much neater patch if you mend it over a darning egg. Here a glass marble proves ideal as a miniature "darning egg" since it can be worked into the end of the finger to back up the hole

4



5



6

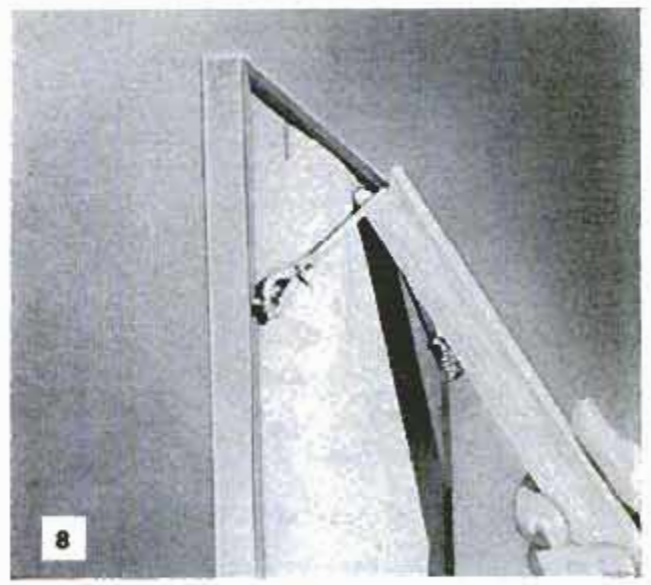
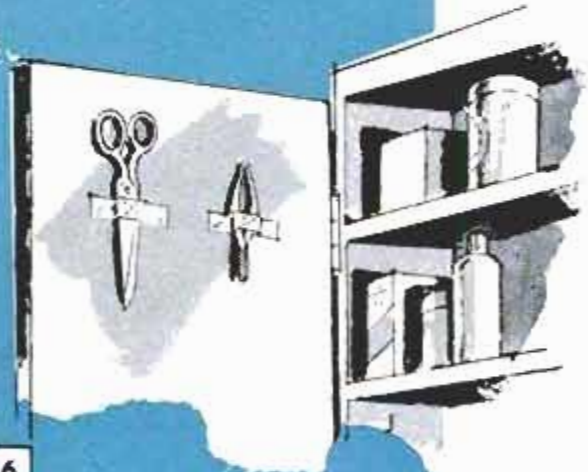

8

7

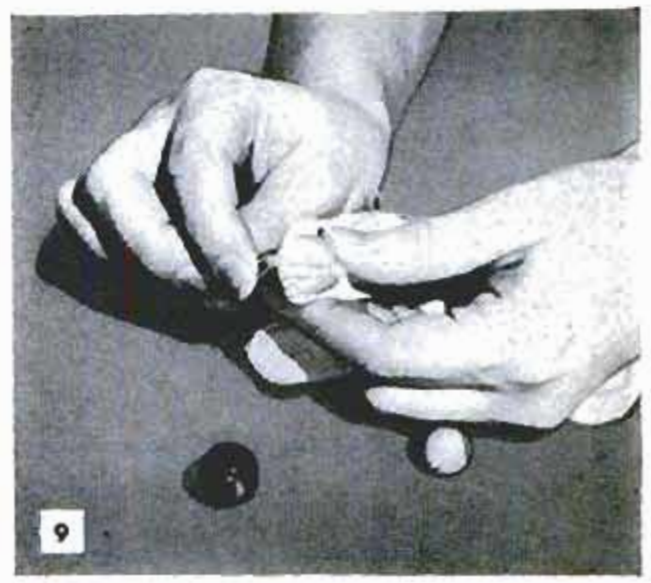

9



Hand Tapper Is Adjustable For Working at an Angle

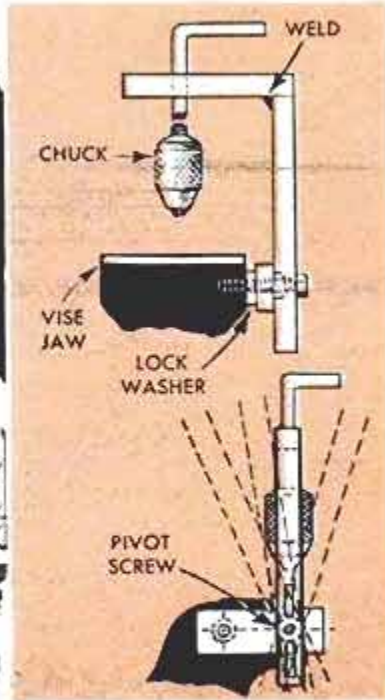

This is the type of tapping jig which is good to have around when one of those unusual threading problems comes up and the job must be done in a hurry without breaking the tap. In addition to ordinary straight tapping, this jig is especially good for starting a tap in holes drilled at an angle or on a sloping surface, as on a casting. The work is held in the vise and the overhead arm, which carries the chuck, is attached to the movable jaw with a capscrew and lock washer. The arm is slotted for vertical positioning.—R. Hill, Columbus, Ohio.

"Safe" Edge on Regular File

When it's necessary to work with a file against a finished shoulder you can prevent scoring and undercutting of the shoulder by placing a strip of masking tape along the edge of the file. The tape covers the cutting teeth on the edge of the file, permitting you to work into the corner.

Keeping Loose Caster in Place

Of course, you've picked up a chair sometime or other and had the loose caster fall out. No use putting it back as it is; it will repeat the performance. With a hacksaw slot the top end of the caster spindle and spread the cut. Snap the caster back in place and it will stay put.

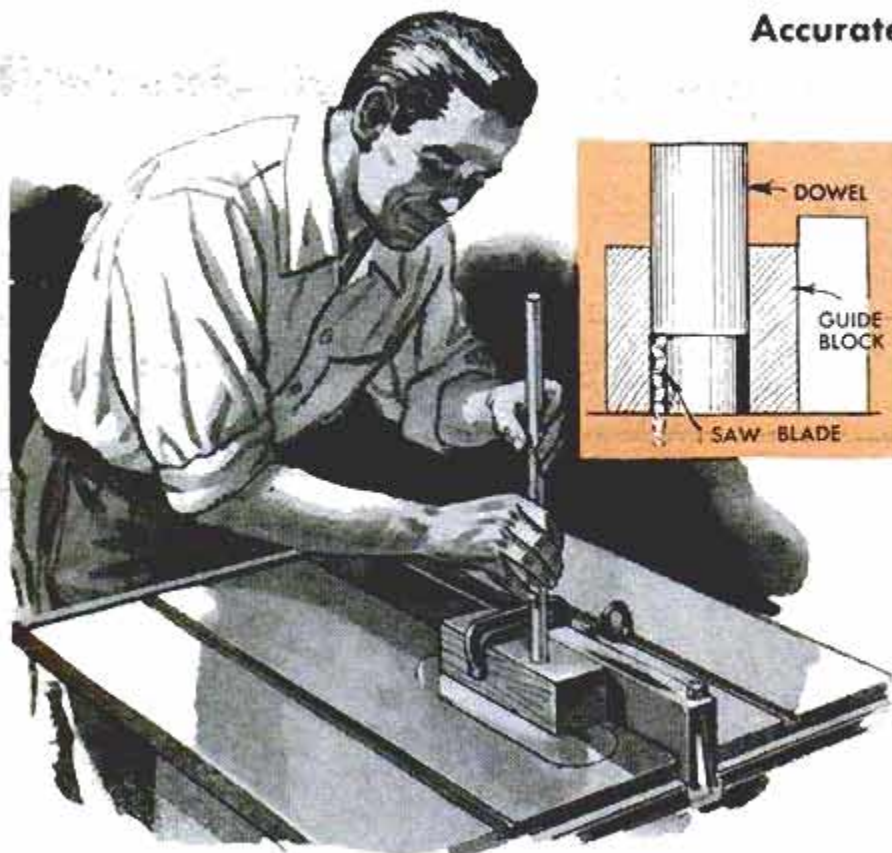

Accurate Tenons Cut on Dowels With This Simple Jig

Suppose you need, say, a dozen dowels of a given size and length with one or both ends tenoned. When you come to think about it, it doesn't look so easy — until you take time to make this novel jig. Then you can do the job in about three seconds per dowel, and factory-accurate, too. Drill a hole through a block of hardwood, the hole the same diameter as the dowels to be tenoned. Sand the hole lightly so that the dowel is an easy fit. Clamp the block to the ripping fence of the table saw. Start the saw and raise it to the correct depth. Then insert the dowel, press down and turn slowly.

ANIMATED CHRISTMAS DISPLAYS



More and more homeowners are finding real competitive fun in trying to outdo their neighbors in producing the most talked about Christmas display in the block

CHRISTMAS REALLY COMES to life when you build animation into your outdoor displays. While many go all out to illuminate their homes and yards, some in a most elaborate manner, it's the animated display that gets the real attention and enthusiastic comment.

The three animated musicians shown above play and sing in a most lifelike manner. The bass fiddler saws back and forth, the mandolin player picks away at the strings and the caroler's head rocks from side to side, all to the accompaniment of a hidden record player. Fig. 1 shows how the head and arms are actuated and driven by an eccentric attached to a small motor mounted on the back of the plywood figures. This fairly simple mechanism can

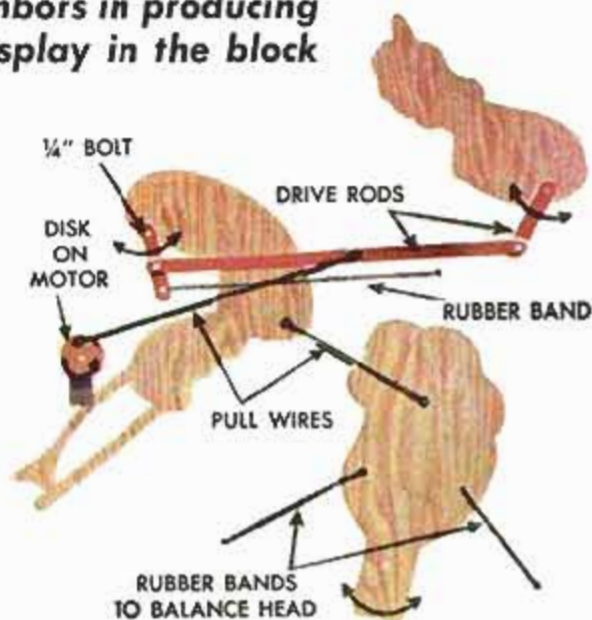

1 DRIVE SYSTEM FOR MUSICIANS



be adapted to a variety of Christmas scenes. Ordinary $\frac{1}{4}$ -in. stove bolts are ample for the axles of the moving parts, and strips of $\frac{1}{4}$ -in. plywood will serve as drive rods. You can shorten or lengthen the action of a moving part by just repositioning the bolt on its drive rod. A 4-in. wooden disk is attached to the motor and a wire looped around a screw in the disk pulls the main drive rod in one direction. A rubber band returns it when the wire slackens. The only critical point in this display is to secure the disk tightly to the motor shaft. This can be done with a pin through the shaft or by screwing the

disk to a small pulley which has a set-screw. The small caroler is nailed to a wooden block on the front of the display, about 3 in. out in front, so his moving head will have ample clearance. Only lighting required is a hidden floodlight in front.

The motor for most animated displays can be very small, but it does need to be one with a reduction gear, to have enough power and to run slowly enough. Fig. 4 shows two such motors that are often found around the home, one a spit motor from the barbecue grill and the other from Junior's toy construction set. Either is fully adequate for most needs.

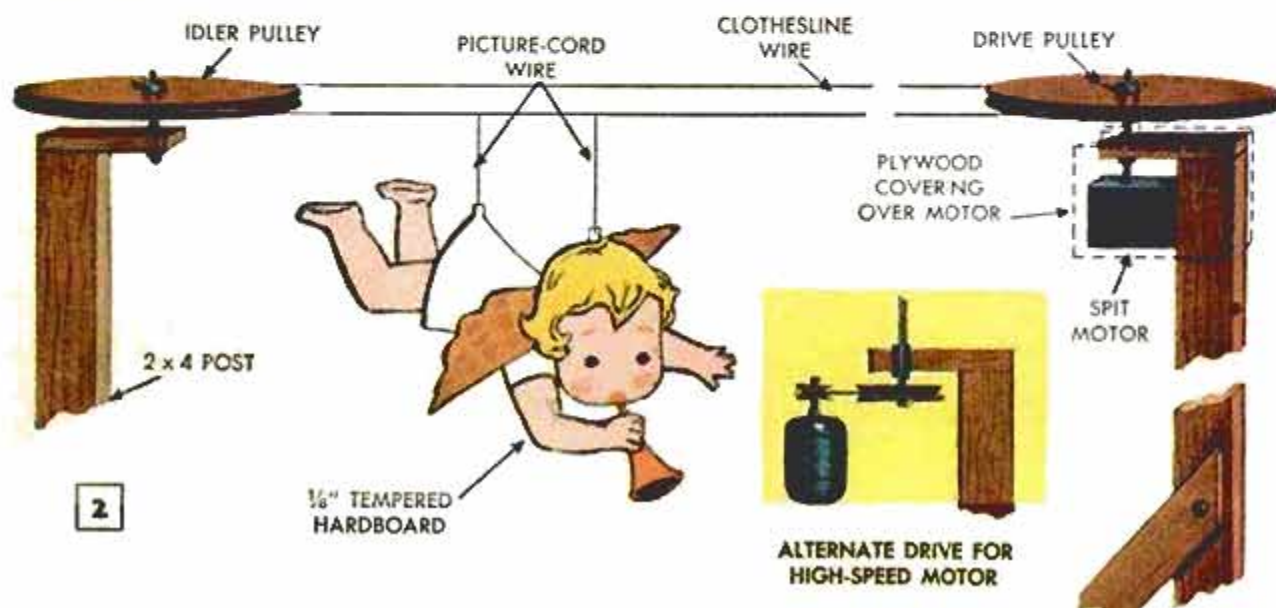



Santa speaks through hidden microphone and speaker. Peephole in nearby garage lets operator observe passersby to extend friendly personal greeting

Fig. 2 shows another simple way to obtain animation. At night, three choir boys sing Christmas carols via a hidden record player, while entranced cherubs fly back and forth overhead. The moving cherubs are attached to a long loop of clothesline wire, which travels around two large wheels mounted on short posts on the roof. Wheels from a child's wagon or the like, minus the tires, or similar ones of $\frac{3}{4}$ -in. plywood, turned and V-grooved on a lathe, will do. Their axles can be ordinary bolts, and a nut on each side will lock the drive wheel to its axle. As the drive of a barbecue spit motor turns at approximately 6 r.p.m., it will give the correct speed when attached direct to the drive axle. The braces for the two 2 x 4 posts are best fastened to the roof in a way they can be moved up or down slightly on the posts to tension the clothesline cable. The motor is boxed in with plywood sides, as shown, to gain rigidity and protection from the weather. Paint the posts and mechanisms black to be inconspicuous at night. The cherubs, "stained glass" church window on the roof and the choir boy assembly below, all are cut from $\frac{1}{4}$ -in. plywood. The window uses colored cellophane for the stained-glass effect and is lighted from behind. The choir boys and the cherubs are floodlighted from the front.

The display detailed in Fig. 5 is a challenge to any radio ham. Santa Claus first appears in a jet plane, flying over the roof.

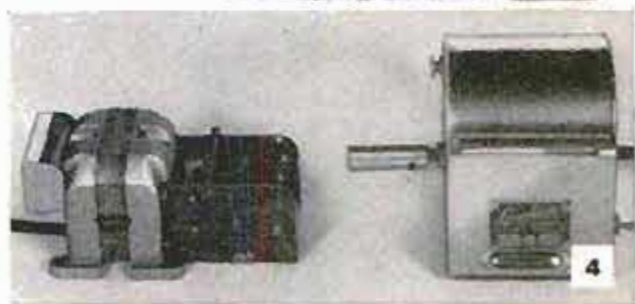

Reduction-gear motors, such as these, are powerful enough to operate your display. One is from barbecue spit, the other taken from a toy construction set

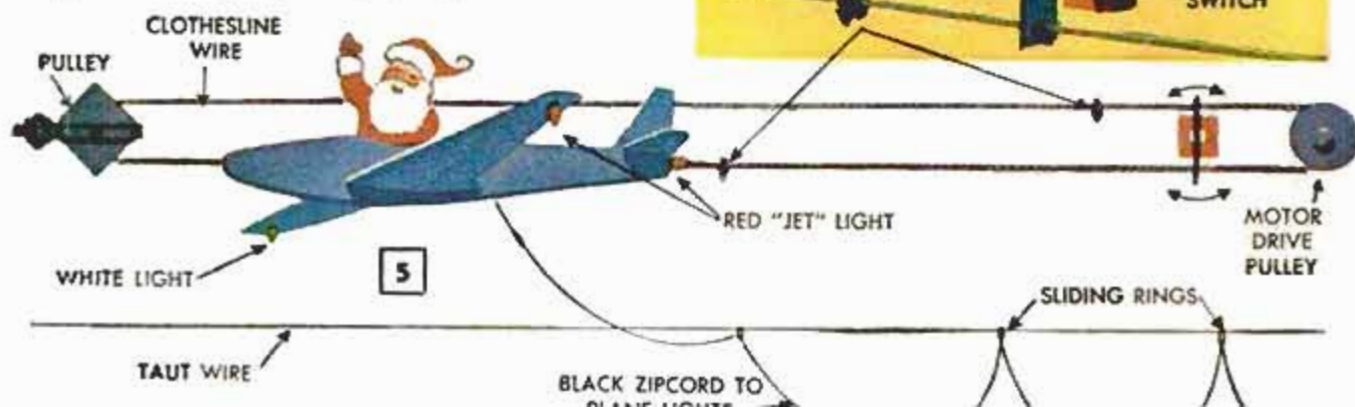



Plenty of animation here. With reindeer prancing impatiently, eager to be off, Mrs. Santa Claus bids fond farewell to jolly husband as figures skate to and fro on nearby pond. Details below show how the figures are animated with drive rods connected to eccentrics attached to small motors. Skaters roll on tracks which are pivoted to rock see-saw fashion

Then he appears in a parachute, floating down to the fireplace, and last appears closeup in front of the fireplace. There he looks out at the crowd of gaping children, singles out some child and says, "Hello, there, little girl in the red hat. What do you want Santa to bring you?" When she tells him, he says he will, then vanishes to arrive again in the plane to greet someone else.

The sequence is accomplished by the jet plane and parachute moving on wires and by switching on and off lights that first reveal the plane, then the descending parachute, then the final closeup scene. Only one light is on at a time. Both a microphone and a speaker are concealed in the fireplace and are wired to the garage or house, where the operator can watch the crowd through a window and pick out someone to address. A record player is

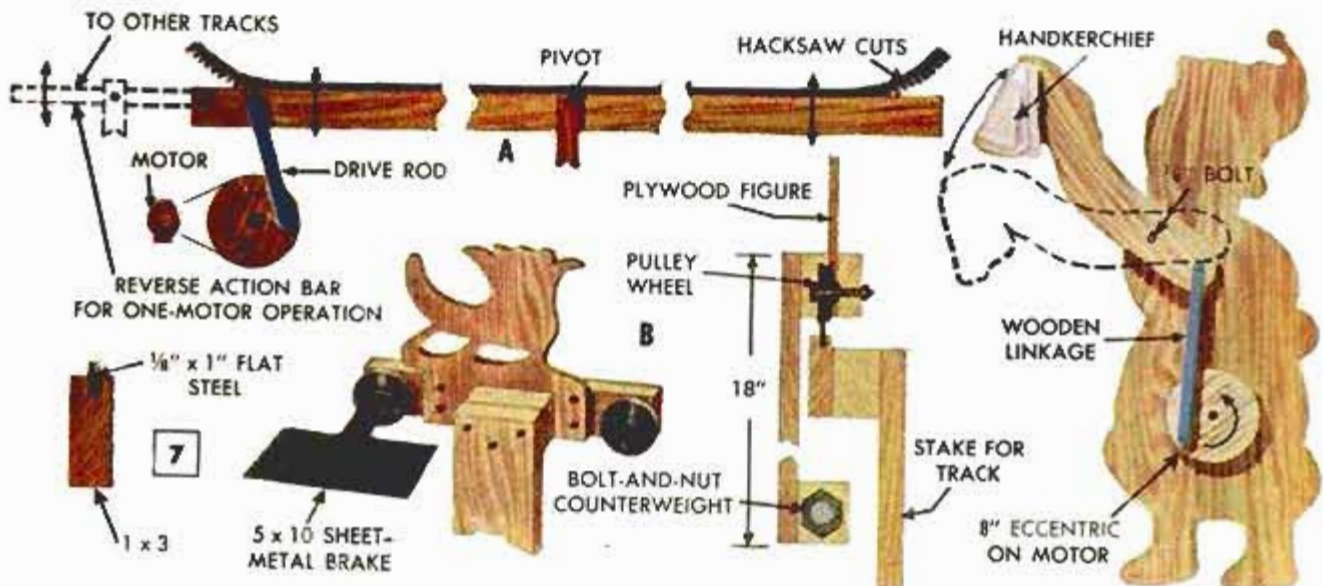
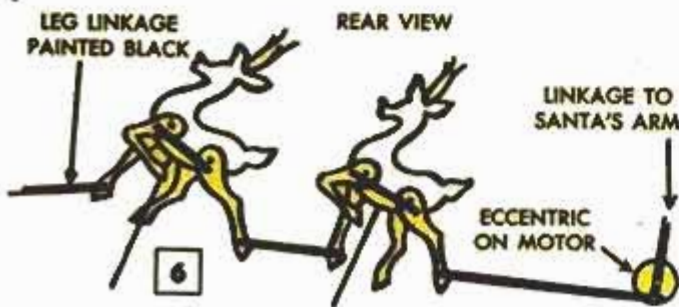

wired into the system, Fig. 3, so Christmas music can be played when the operator tires of the game.

You will need a reversible motor for this type of display. The jet plane and parachute move on loops of clothesline wire, similar to the cherubs except that these are stopped and reversed by a switching arrangement rather than revolve around the pulleys. Depending on the equipment you have available, the timing and lighting of the three different scenes can be controlled by switches in the house or automatically by surplus radio or telephone timers and relays. The fireplace scene and the parachute descent are floodlighted from the front. The jet plane has wing lights and a red "jet" bulb in the rear, powered by a traveling cord.

Activity Galore

Figs. 6 and 7 show how complete an animated display can be. This scene depicts Santa's departure from the North Pole with his load of gifts. Santa waves goodbye while the reindeer prance, eager to start. Mrs. Claus waves a fond response. Three of Santa's helpers celebrate the occasion with a gay skating party behind the snowbank. Bright stars twinkle in the sky above and smoke even rises from the chimney of Santa's house. A concealed loudspeaker connected to a tape recorder inside the house tells Christmas stories to the droves of entranced kiddies (and adults) out front.

The simple drive that activates Mrs. Claus' arm is shown in Figs. 7 and 8. A similar drive on another small motor waves Santa's arm. A drive rod from Santa's motor also animates the reindeer legs as shown in Fig. 6. The three skaters have a different type of action. They roll by gravity on three seesawing tracks, Fig. 7. The tracks can be 10 to 20 ft. long, pivoted at the middle, and can be activated several ways. A small display motor can power each track, or three small surplus reversing-type hydraulic pistons powered by a small pump via a garden hose, can be used to push the tracks up and down. Or one motor or one piston can power the middle track and also the outer two, best done by using a reversing-bar arrangement as shown, so some tracks will be moving up while the other is moving down. If three motors are used, vary the diameter of their drive disks slightly since the skaters will appear more natural if not moving at the same speed and same timing.

How Skaters Work

The skaters roll on pairs of pulley wheels, obtainable from aircraft surplus. A large bolt or other weight counter-



Back view of Mrs. Santa Claus shows how drive rod attached to motor-driven eccentric provides a gently waving movement to arm holding handkerchief

balances each figure from below. To prevent too rapid a motion by the skaters, each is slowed down by bolting a fan brake to one of its pulley wheels. The pulleys roll on the edge of a metal strap in the track, detail B, Fig. 7, and the ends of the track are curved upward to slow the skaters.

Plywood or Hardboard

All the figures and Santa's house are cut on a jigsaw or bandsaw from 1/4-in. plywood or hardboard. The snowbank conceals the tracks and other machinery of the skaters and is formed of chicken wire over a lath-and-lumber framework. The snow is several layers of newspaper, dipped in plaster of paris of the consistency of cream, laid over the wire and, when dry, finished with a coat of flat-white primer which is sprinkled with mica snow while still tacky.

The North Pole in the scene is a 2x4 driven into the ground and covered with stovepipe after which it is striped with paint, using masking tape for a guide. The stars above the reindeer are a string of the new twinkle-type 6-v. tree bulbs strung on fine black wire. The lead deer is Rudolph, of course, and has a red bulb mounted in his nose. The smoking chimney operates by simply concealing a bottle of imitation smoke (titanium tetrachloride) on the back side of the chimney with a bit of rag as a wick in the bottle ★ ★ ★

DECORATING IDEAS

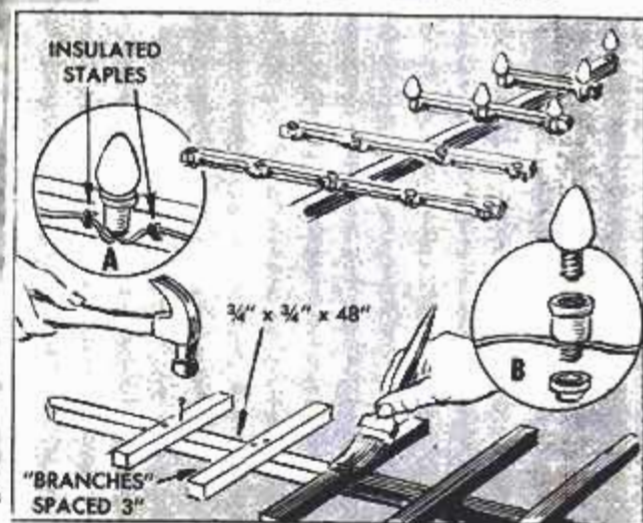
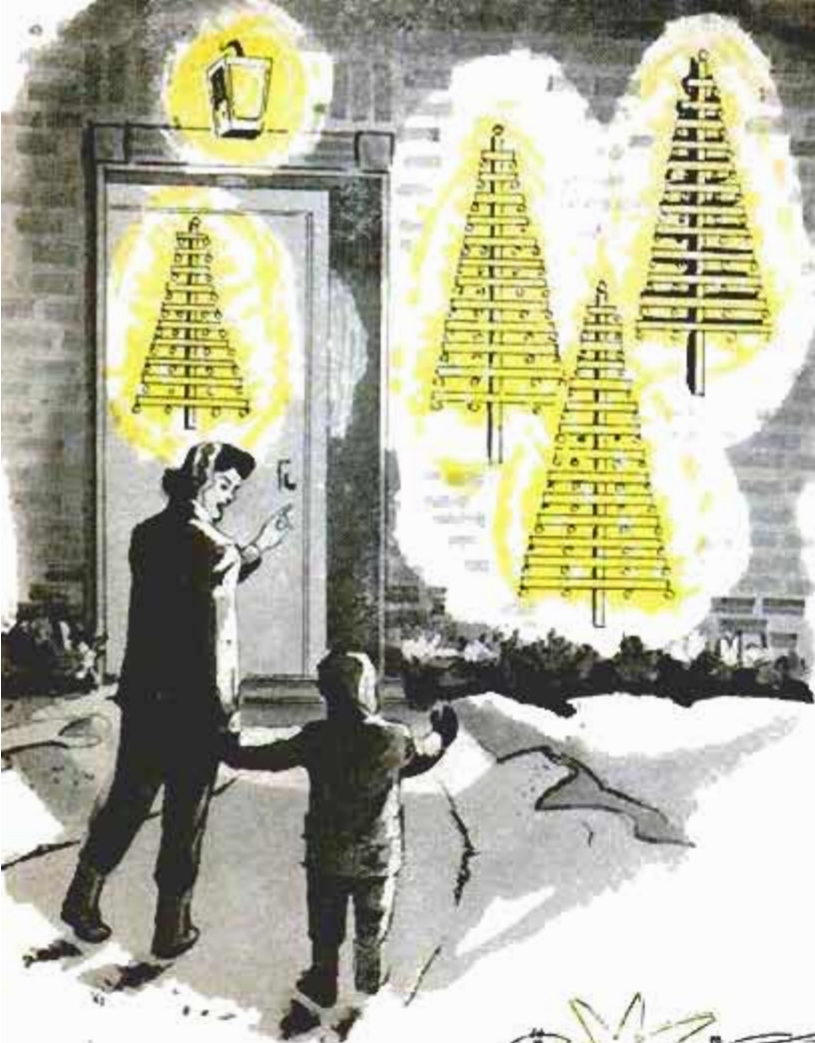

TREE STRING SETS or "add-on" sockets, stapled and taped to branches of wooden Christmas trees, make striking effect when grouped on door and facade of house. Lamps per branch vary from two to six from top to bottom. Floodlighting fills in background

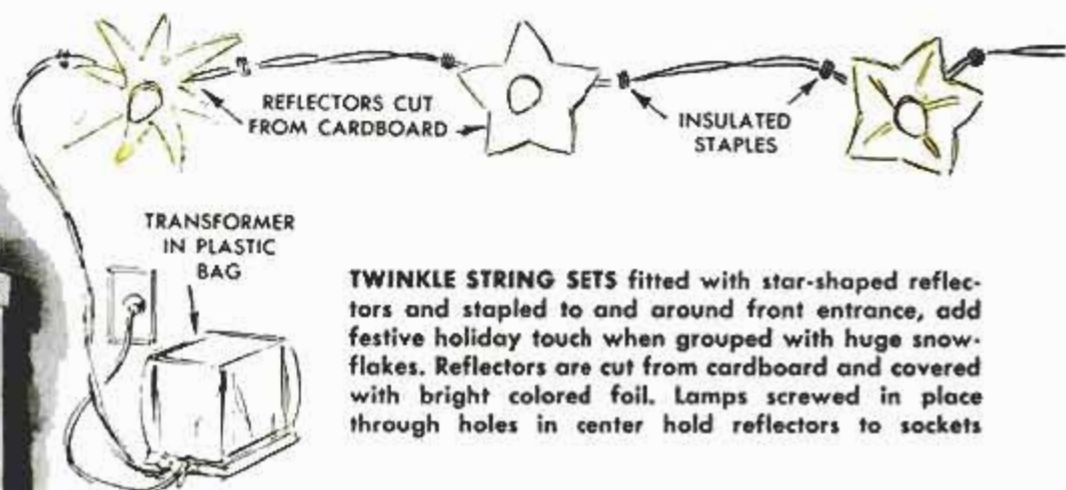

TWINKLE STRING SETS fitted with star-shaped reflectors and stapled to and around front entrance, add festive holiday touch when grouped with huge snowflakes. Reflectors are cut from cardboard and covered with bright colored foil. Lamps screwed in place through holes in center hold reflectors to sockets



KING-SIZE SNOWFLAKES are made by half-lapping two wooden sticks and tacking snowflake patterns of hardboard and cardboard to the top. Lamps are taped to sticks to stand upright and then the whole affair is covered with aluminum foil. Wire and screw eyes are used to mount snowflakes on the front door

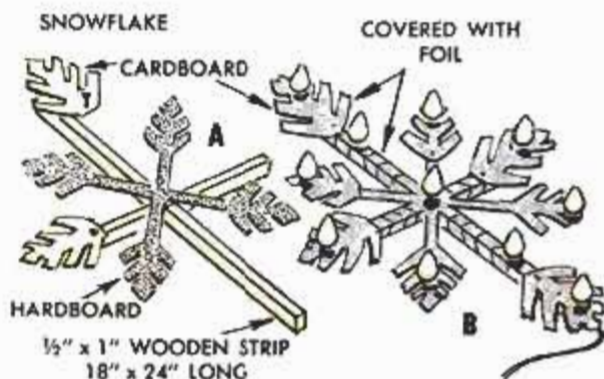

POPULAR MECHANICS



Colored silhouette of tree against white house is obtained by placing plywood cutout between two 150-watt floodlamps. Bore holes in tree for sockets of string lights and support tree in slotted stakes 3½ ft. from wall. Use color roundel on hidden lamp

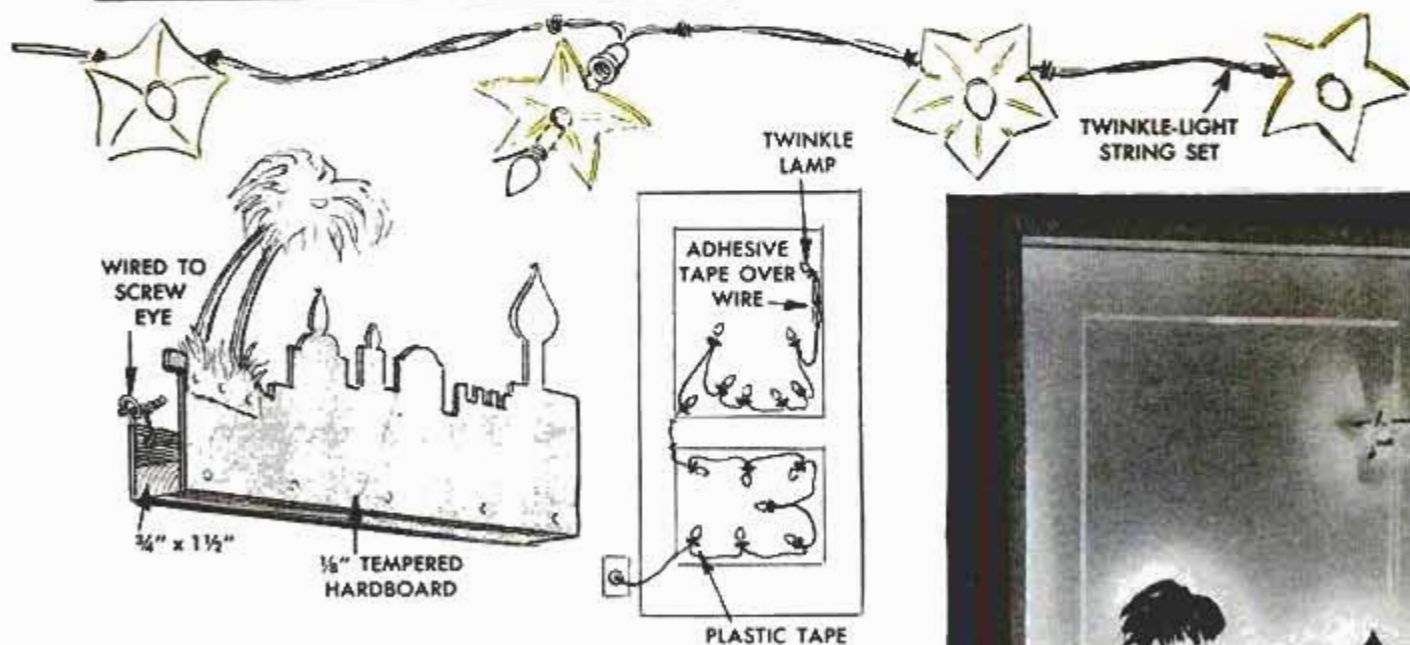

AMONG THESE decorating ideas from General Electric's booklet *New Ways To Say Merry Christmas*, are lighted silhouettes which can be worked up into a most appropriate door display. A good example of this is shown in the photo at the right. Here, the Holy City skyline is jigsawed from hardboard, painted white on the back and black on the front and fastened to a supporting cleat. A 15-lamp string of tree lights is taped to the upper and lower door panels in the position indicated, with a twinkle light being used in the end socket to light the star of Bethlehem. The skyline cutout is hung in front of the upper lights and a Holy Night cutout, set out by a frame, is mounted in front of the lower lights. Bulbs of one color can be used to light the skyline

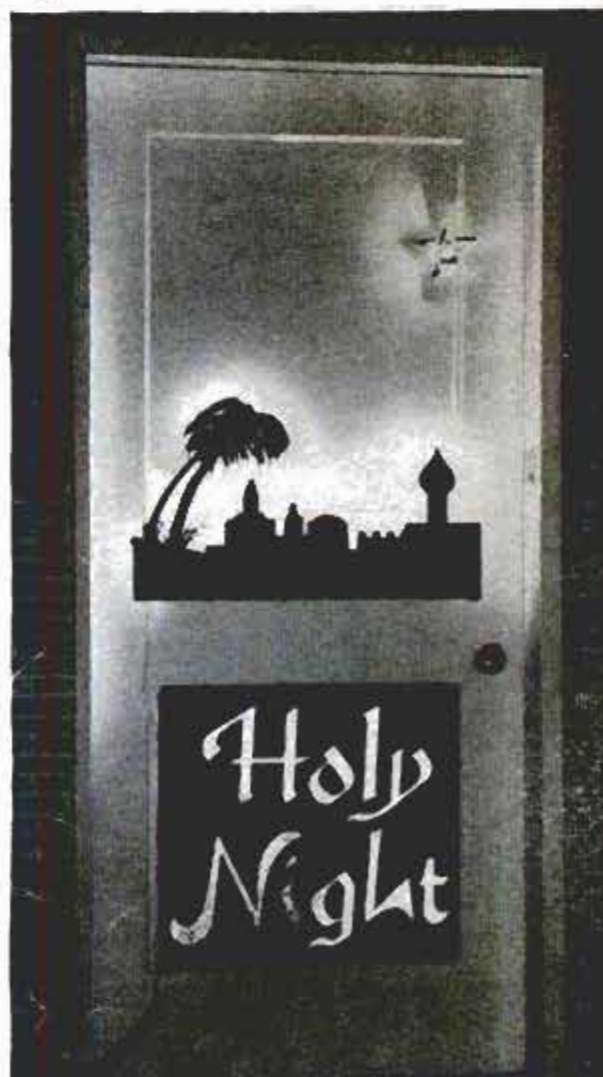

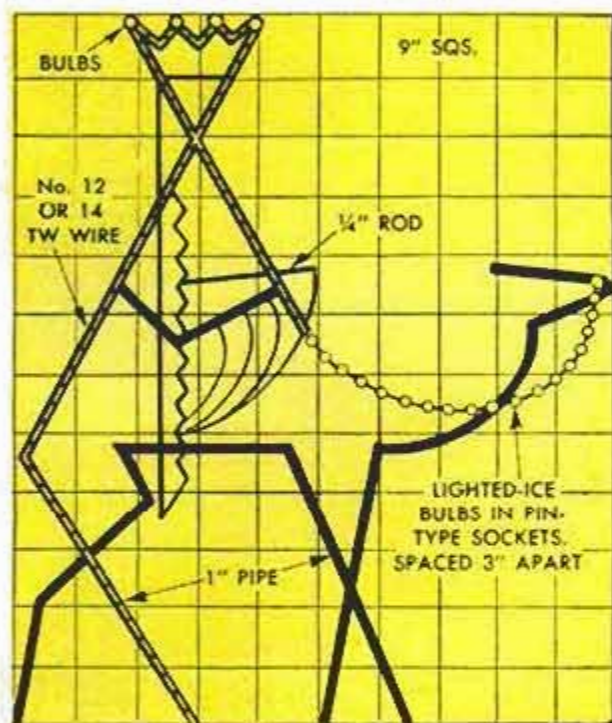
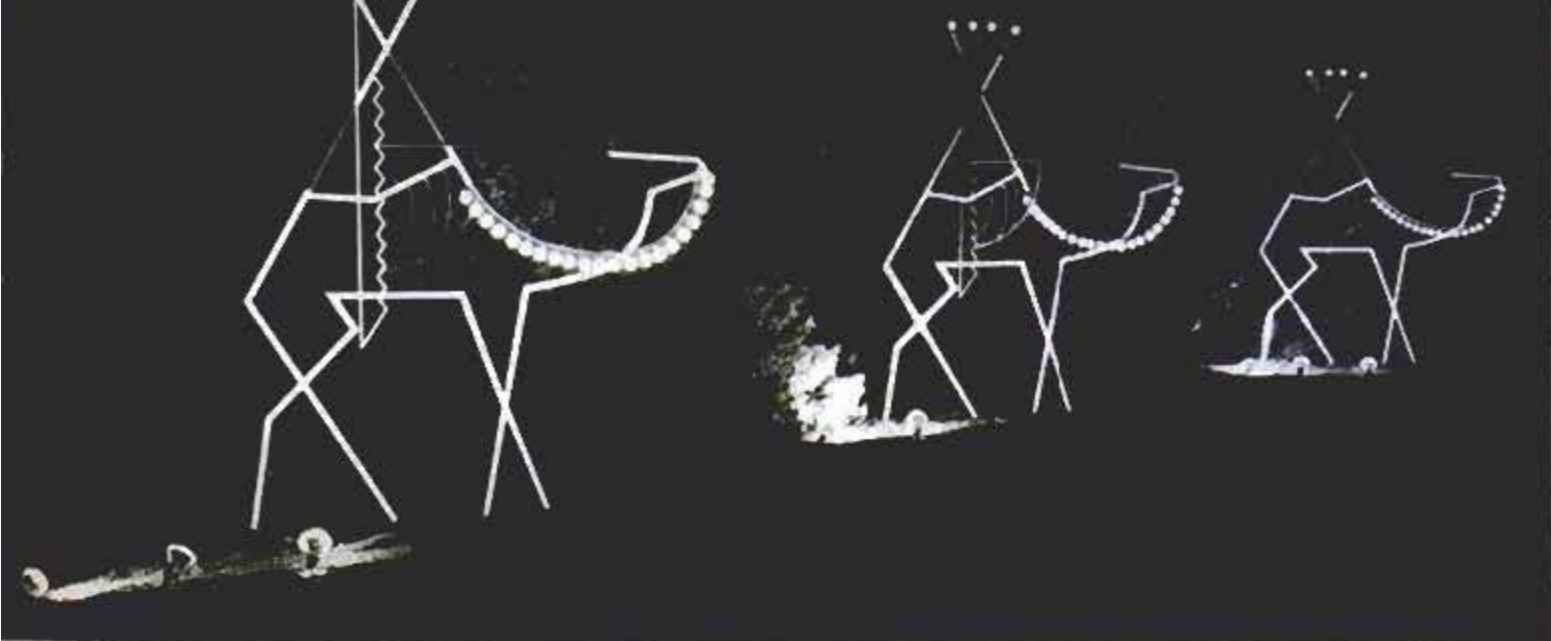

silhouette, another color for the rest. A floodlamp placed 15 ft. away provides over all illumination.

The story of the three wise men is cleverly depicted by figures made principally from 1-in. pipe. Wire leading to the lighted crowns and the camel's reins is brought up inside the pipe framework. Painted white and provided with colored bulbs, the effect is spectacular when floodlighted from the front. The drawing at the left shows how the pipe members are laid out and tack-welded to form the figures.

Another clever display is illustrated below. A neighborhood project and feasible where homes in the block are of the same height. Santa and his eight reindeer, in cutout form, are placed to extend across the roofs of three houses and floodlighted. Connecting reins are formed with a string of pin-on sockets fitted with the new lighted-ice bulbs. The effect is quite startling when viewed from the street. ★ ★ ★



Household Cement Repairs Damaged Spots in Pile Fabrics

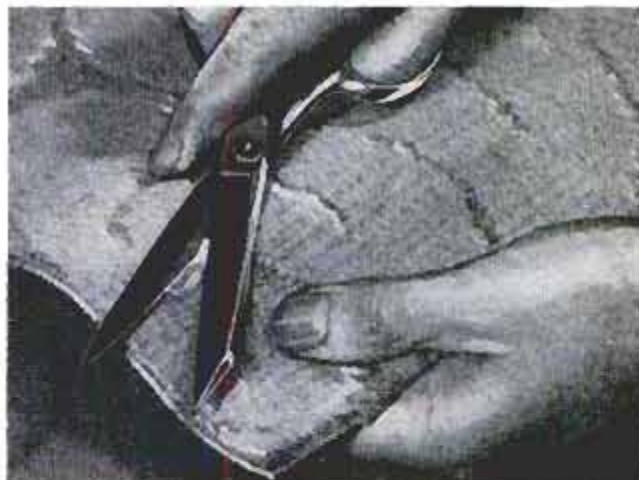

"Bald" spots in long-nap or pile fabrics, of the type used for carpets or coats, can be filled in and made unnoticeable for all practical purposes with the aid of a good grade of household cement, such as Pliobond. The photos show a carpet with a "sculptured" pattern being repaired by this glue method. First, enough tufts of the material are pulled or cut from a scrap piece, or near the edge of the damaged item where it will not matter, to fill the bald area completely. Next, a "prime coat" of the cement is spread on the damaged spot in the material and allowed to dry thoroughly. Now each tuft of the material that has been put aside is picked up with

tweezers and the lower end dipped in cement so that each strand is completely saturated. The tuft then is fitted in position on the dried cement. Additional tufts are cemented in place until the damaged area is filled. When the cement on the tufts has been given plenty of time to set, the upper ends of the tufts, which now should appear as a solid surface, are trimmed to match the height of the adjoining material. For this latter operation a pair of electric hair-cutting clippers would be ideal. A comb could be used to control the cutting height of the clippers, much the same as when they are used for cutting hair. Coarse-cutting clippers would be best.

Glass Cutter Used as Tracing Tool for Copperwork

Ideal for tracing or deepening lines in such handicraft work as sheet copper bas-reliefs, is a discarded glass cutter. The worn wheel of the cutter will not scratch or gouge the metal, as do the usual tracing tools, such as metal scribes or pointed dowels. A pattern can be traced directly by placing the paper over a sheet of metal and running the glass cutter along the lines. Cement the paper so it does not slip.

R. J. DeCristoforo, Los Altos, Calif.

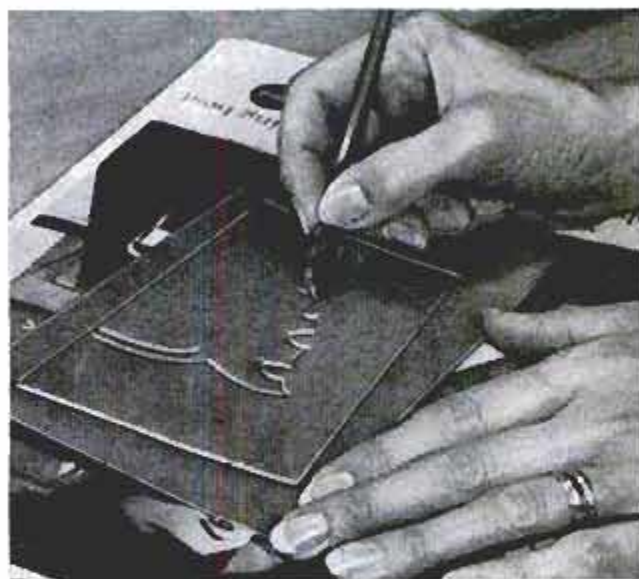

Brass Switch Plates Renewed With Sheet-Plastic Material



Old-fashioned brass switch plates that have become tarnished and unattractive can be given like-new appearance by covering them with one of the new sheet-plastic materials that are backed with contact adhesive for easy application.—O. A. Nelson, Seattle, Wash.

Paint Roller Stored in Milk Carton

After a paint roller has been cleaned and dried, it should be stored so that it remains dustfree and clean. Waxed milk cartons are ideal for this, a quart size being just large enough to accommodate a regular-size roller.—R. M. Woodbury, Natick, Mass.



GLAMORIZE

YOUR CHRISTMAS

CANDLES



YOU CAN GLAMORIZE your everyday candles and decorate special Christmas ones to produce elaborate and colorful centerpieces and other displays, using only a pair of shears, stickpins, sequins and used gift-wrapping material as illustrated. In addition, cutouts from Christmas cards, birthday and Valentine cards, paper place mats and doilies may be attached to candles in a variety of ways. When large-size candles and special shapes are not available locally, they can be made from candle leftovers melted down and poured into paper cartons and other containers, such as was done to produce the large, square-cross-sectioned ones shown on the opposite page. Heavy cotton cord was used as wicking for the latter. Also, candlemaking materials can be obtained from some hobby and craft shops, should you decide to make all of your Christmas candles.

Decorating ready-made candles is easy as shown in the photos at right. After selecting a ribbon of the desired color and width, wrap it around the candle in a spiral as in the two photos at the bottom right of this page. To keep the ribbon in place press a stickpin into each turn, impaling a star-shaped sequin on each pin for added color. The upper end of the ribbon is covered by a sunburst cut from gold-tinted foil. The candle then is positioned on a base by melting a few drops of wax around the bottom of it. To conceal the base, a few colored beads and fir-tree limbs and cones are arranged on top of it. ★ ★ ★

Below, metallic sunburst framed by white paper-doily cutout fastened to dark green candle make regal appearing centerpiece. Candle is held upright by nail driven into it from wood scrap that is completely concealed by covering of fir-tree branches and cones



Above, sunburst cut from aluminum foil is pinned on candle near top to conceal end of metallic ribbon

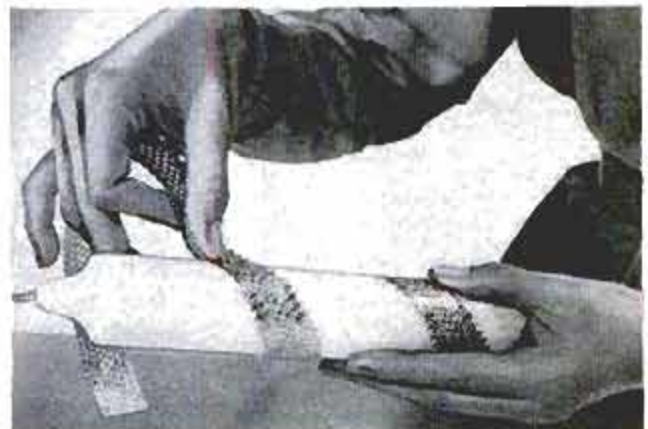

Above, metallic ribbon wound in spiral on candle provides easy means of dressing up plain white candle. Below, sequins are attached to candle with bead-headed pins that also hold ribbon in place



Bicycle Horn Warns Customers of Service-Cart Approach



Shoppers in one small department store are warned of the approach of a service cart by means of a bicycle horn attached to the cart as shown. Alerted in this novel manner, customers willingly step aside to allow the cart to pass, permitting the stock boy to make quick deliveries of merchandise to various departments without colliding with shoppers.

Arthur Tanner, Jr., Poughkeepsie, N. Y.

Ignition Key Concealed on Car Kept Clean by Foil Wrapping

An extra ignition key for emergency use is concealed on the car of one motorist by wrapping the key in aluminum foil and then cementing it to the underside of the hood. To further conceal the foil-wrapped key, it is coated with an opaque adhesive. When needed, the key is pried loose easily with a nail file or other metal object and unwrapped.

Henry Zave, Grand Rapids, Mich.

Metal Strip Secures Screw In Oversize Hole

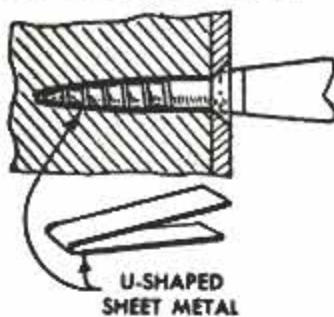

When a screw hole becomes enlarged from the screw constantly working loose, and a larger screw cannot be used, try driving a U-shaped strip of sheet metal in the hole with a center

punch. The metal strip serves as a bushing when the screw is turned into it as shown in the detail. Use lightweight metal for this purpose, such as from a coffee can, and drive the strip completely into the hole.

Frederick H. Durkee, Williamsport, Pa.

Extension on Cement Tube Reaches Difficult Places

To permit applying cement in places that are hard to reach, one hobbyist added this extension to the tube spout. It consists of a small-diameter copper tube that is threaded at one end so it can be screwed into the tube spout which is tapped to take the copper tube. A small wood screw is turned into the open end of the extension to prevent the cement from hardening.



Christmas-Tree Ornaments From Used Flash Bulbs

Here is a way of converting used flash bulbs into colorful Christmas-tree ornaments. First sand the blisters smooth, then spray the bulbs with one or more colors of the type paint sold in pressurized cans, dusting the ornaments with glitter before the paint dries. Use fine wire to hang the bulbs—Bil Toman, Palatine, Ill.

☛ Better light radiation will be obtained from luminous paint that is to be applied over an old painted surface if you first apply a base coat of white lead to the area.

"Traveling" Crib and Playpen

By V. H. Laager

IF YOU HESITATE to travel by car with a toddler because the homes and motels you visit might not have safe sleeping accommodations for him, this portable crib-sides unit is the answer to your problem. The crib sides convert any bed to a crib in a matter of moments, and also can be placed on the floor and used as a playpen. The top and bottom rails of the unit are 1 x 2 stock, the corner posts are 2 x 2s. Standard $\frac{1}{2}$ x 36-in. dowels are cut in half to provide the vertical rods that are fitted in blind holes bored in the top and bottom rails. Position the rods on the shorter sides of the unit so none are located at the center where they would interfere with the strap hinges. Flat steel brackets on the corner posts allow the short sides to fold flat inside the longer ones when the "locking" links are released. The upper ends of the corner posts are rounded, as are the upper edges of the top rails. Four cotton-web straps are used, on the ends of which are sewed or riveted swivel snaps. The snaps are hooked into the bedsprings or frame, then the buckles are adjusted until the straps hold crib sides firmly.

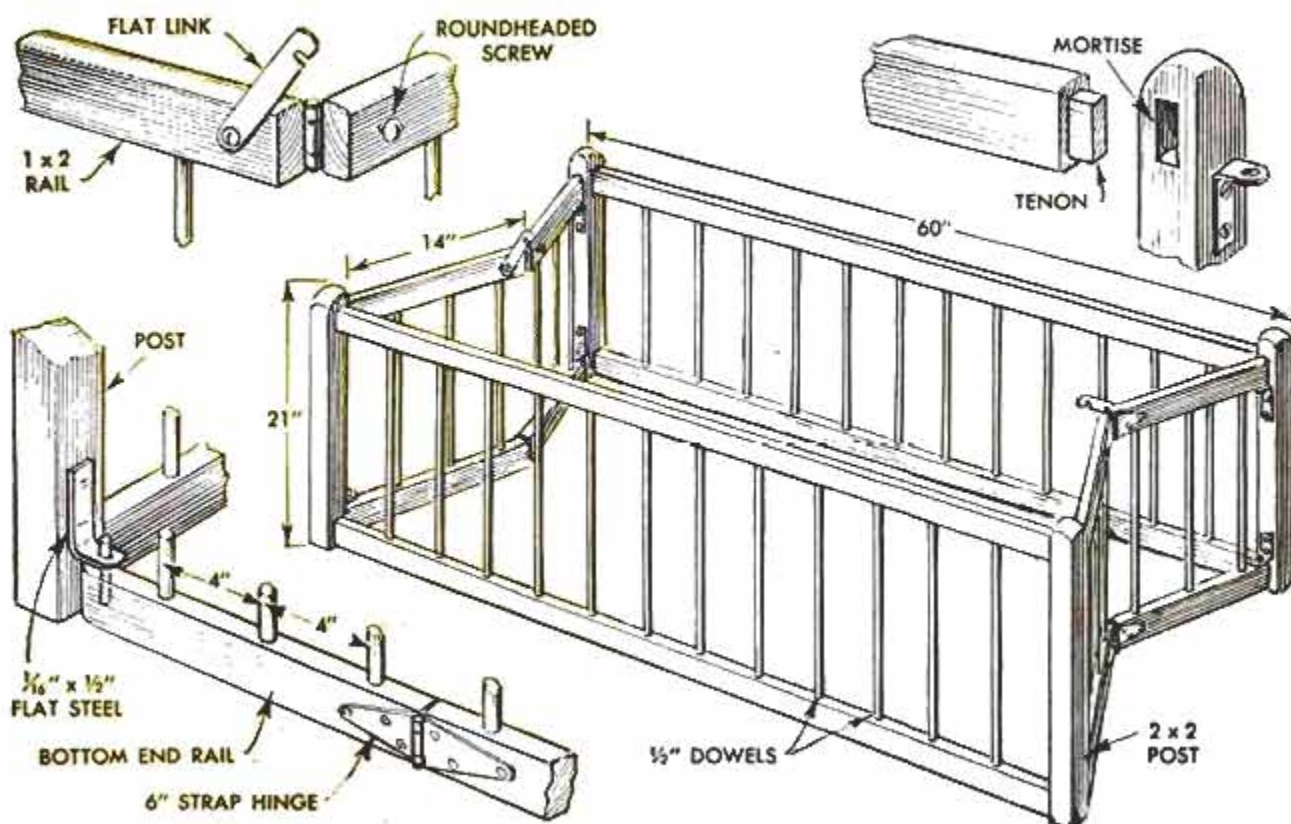

SLAVE ANODE

By James Joseph



1
Above, magnesium anode is packed in quick-wetting backfill that is buried with anode to retain ground moisture, assuring constant flow of electrical current



2
Above, lead wire from magnesium anode is soldered to cleaned surface on sprinkler pipe. Figs. 3 and 4, after backfill is poured around anode, it is saturated with water and completely covered with soil



HERE IS HOW you can minimize corrosion in your hot-water heating and underground sprinkling systems. Simply attach a sacrificial magnesium anode to the system to divert the attack of the corrosion-producing electrical current from the steel tank or pipeline to the magnesium; as illustrated in this article. Copper tanks and pipes usually are not affected to any extent by such electrochemical reaction, called galvanic action. The latter can occur only when dissimilar metals are in direct contact with one another in a slightly acid solution (electrolyte, a situation that is quite the same in a dry-cell battery, Fig. 8. Usually the softer metals that are alloyed with the iron in a tank or pipeline (copper in this case) serve as the cathode part of the electric cell and the iron functions as the anode. The water that comes in contact with them normally contains sufficient impurities to act as an electrolyte, making it possible for electrical current to travel from the anode to the cathode through the medium of the electrolyte. In an unprotected hot-water tank or pipeline this results in loss of the steel metal which appears as rust.

Glass-lined tanks are protected from galvanic action, provided the steel surface remains completely covered throughout their use. To guard against the possibility of voids in the lining material, most heater manufacturers insert a magnesium anode in their tanks as detailed in Fig. 6. Since magnesium acts as an anode when associated with steel, the flow of current is reversed to "eat away" the magnesium anode, instead of tank surfaces that may be ex-



ARRESTS CORROSION

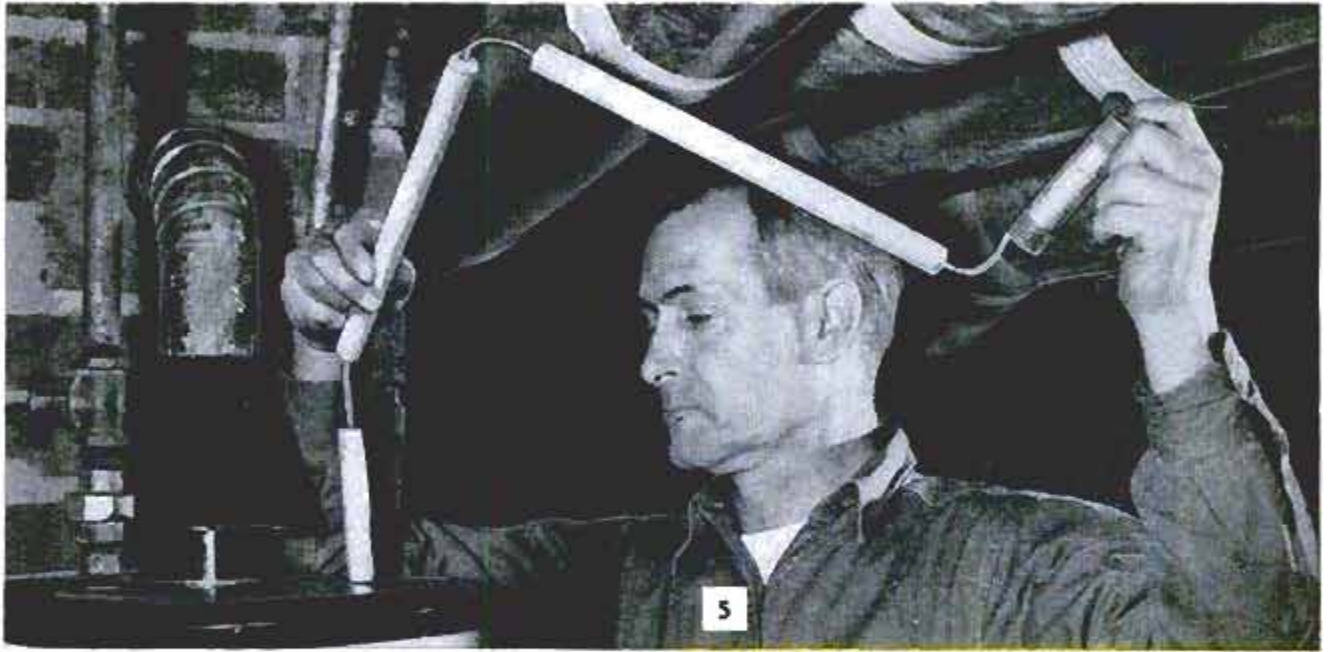

5

posed. Such an anode should last from two to six years, depending upon the amount of electrochemical action in the tank. Then it can be replaced at nominal cost.

If you have an unlined steel tank, it can be protected from rust by installing a magnesium anode in it as shown. Such anodes may be purchased at most large plumbing-supply stores. Easily installed anodes are of two types: Rigid, for locations where there is 4 ft. or more of clearance above the tank; flexible ones for tanks that have less than 4 ft. of overhead clearance. Also, anodes come in various sizes according to the tank's capacity in gallons. Whether rigid or flexible, an anode is a $\frac{3}{4}$ -in.-dia. rod of magnesium cored with a $\frac{3}{32}$ -in. plated-steel wire and equipped with a suspension rod and cage fitting for installing

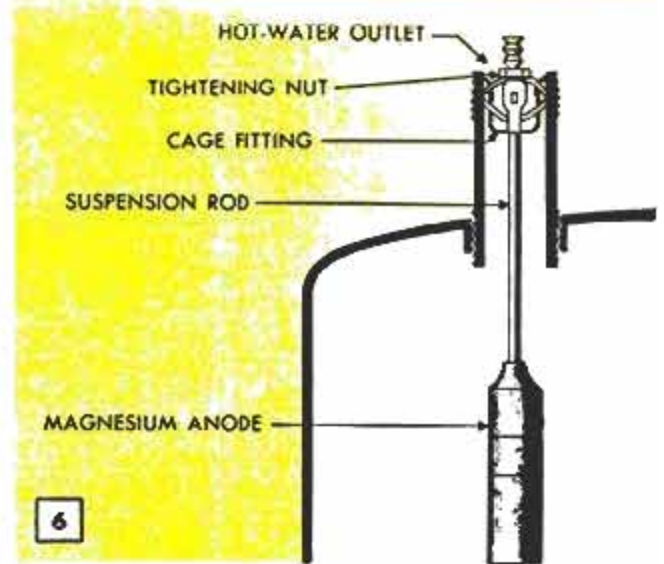

6

Figs. 5 and 6, when there is limited clearance above hot-water tank, flexible magnesium anode is used

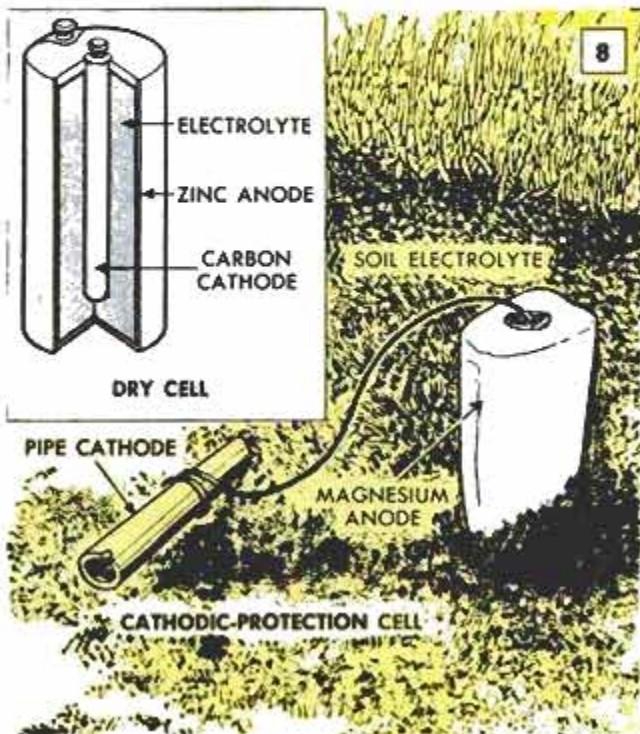

7

the unit in the nipple of the hot-water outlet at the top of a tank.

When installing an anode: First shut off the water supply to the heater and partially drain the tank. Then disconnect the union at the upper end of the nipple, remove the latter and push the hot-water pipe aside to clear the tank opening. Next, lower the anode into the tank, until the cage fitting is flush with the top of the nipple when pressed into the latter, Figs. 5, 6 and 7. Secure the tightening nut on the cage fitting and reconnect the hot-water line to complete the installation. To assure continued protection, the anode should be removed for inspection each year following the second year of the installation. When the magnesium is "worn" nearly to the core metal, it is time to replace the anode.

To provide similar protection for your underground sprinkling system, connect a magnesium anode of the proper size to one of the pipes. Anodes used for this purpose

usually are packaged with a quick-wetting backfill as shown in Fig. 1. When digging a hole for burial of the anode, select a section of the pipe that lies in a moist area, preferably where the sprinkler keeps the ground quite wet. Then expose about 1 ft. of the pipe and scrape bare a few inches of the galvanized coating. Next a hole is dug adjacent to the pipe so that 6 to 8 in. of soil will cover the anode when it is in place. After the lead wire protruding from the top of the anode is soldered to the pipe, the backfill is poured around the anode, Figs. 2 and 3. Then the backfill is thoroughly saturated with water, Fig. 4, and the anode and pipe are covered with soil. Some anodes have a terminal at the top in place of a lead wire, in which case an insulated TW-12 (copper) wire should be brazed to the pipe and the other end fastened to the terminal. Anodes for protecting sprinkling systems against rust may be purchased from companies that sell the systems. ★ ★ ★

Hardboard Template is Handy Drawing Aid

For a handy template for laying out and drawing squares, rectangles, triangles, circles and other geometrical shapes, use a small rectangle of perforated hardboard as shown in the photo. The $\frac{3}{16}$ -in. holes spaced 1 in. on centers are used as guides when spotting and drawing corners and lines. An outer edge can be used as a straightedge. Use a ball-point pen or a pencil with a tip that fits the holes snugly to assure that the point will be at the center of the hole when the pencil is held perpendicular to the template. To draw an arc or circle, one template hole is pivoted around a scribe or other fixed point and the pencil is inserted in another hole located to provide the desired radius. Use two pencils to draw sets of parallel lines.

Walter E. Burton, Akron, Ohio.



Practical Supports Act To Level House Trailer

For a practical means of providing firm support for a house trailer when parking it for overnight or week-end stops, one trailer traveler devised the stabilizing supports shown in the photo below. Four are used, one for each corner of the trailer. Each support is made of a 2 x 4 base member with a group of five notches cut in one side near each end to take the legs of two shorter lengths of 2 x 4s joined together by a heavy hinge. In use, the trailer is unhitched and cranked to a level position. Then the front is lowered slightly to raise the back and the two rear supports are positioned under the trailer. Next the front is cranked slightly above level, the remaining supports are placed under it and the trailer is let down.

W. R. Palmer, Washington, D.C.

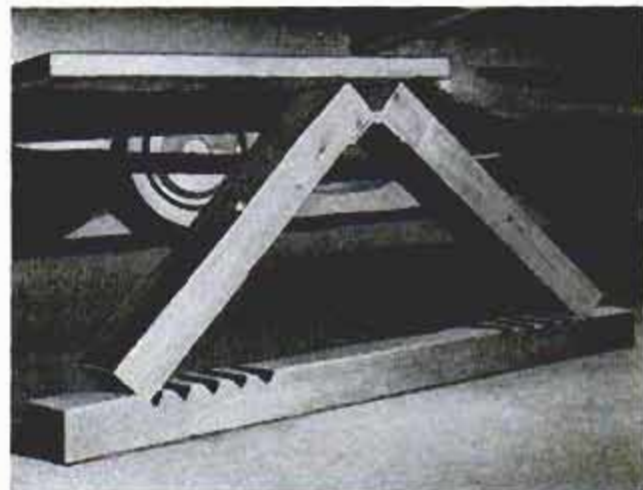

METAL TREAD for THRESHOLD

By E. W. Kraft

If the threshold on the entrance doorway of your house is badly worn, here is an easy way of effecting a permanent repair, provided the remaining wood is in good condition. Simply cut and bend a tread from 16-gauge sheet aluminum or steel to fit over the threshold and screw it into position as in the illustration at right. Sheet metal with a raised pattern on it should be used for this purpose, such as the material

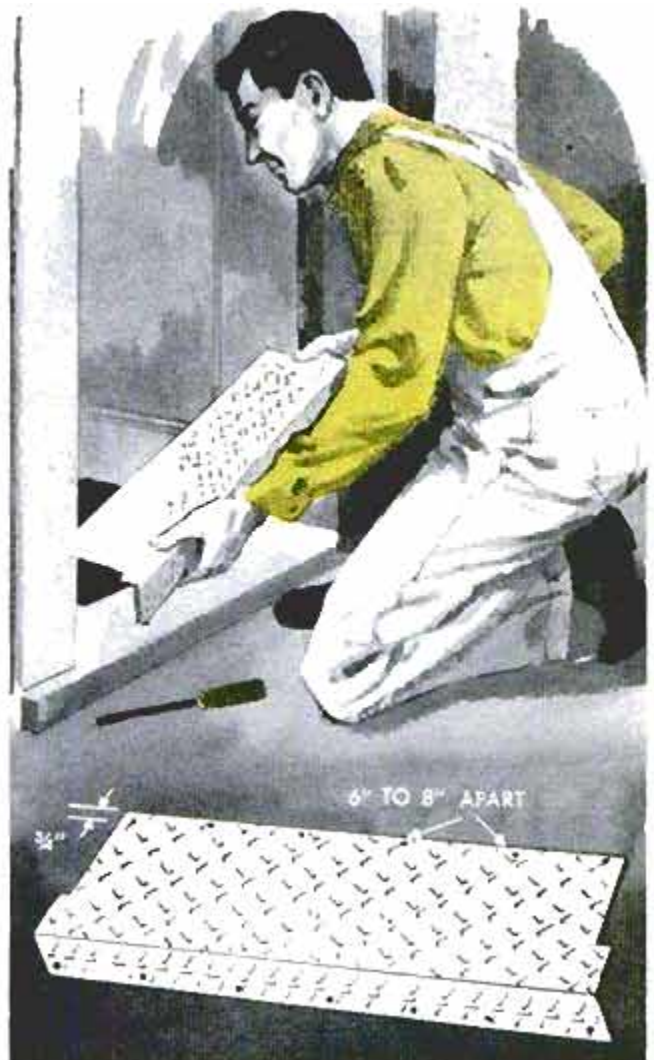
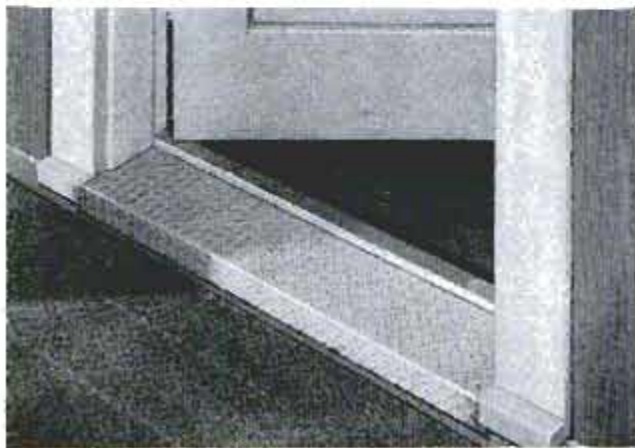

used for making the tread shown in the photo. The first step is to make a full-size pattern of the tread, carefully measuring and cutting it to fit flush with the sides of the doorway and allowing enough material to cover the exposed edge of the threshold. After cutting the tread to size from the sheet metal, drill holes along each side to take No. 6 panhead sheet-metal screws as indicated. Then to permit bending the flange along a straight line, screw the tread cutout to two lengths of scrap lumber but-

ted together at the point the bend is to occur, to serve as backing pieces. A 45-degree bevel must be cut on facing edges of the backing pieces so that a right angle of small radius can be bent in the tread, resulting in a miter joint formed by the backing pieces. One of the latter is clamped in a vise when doing this. Next, remove the backing pieces and screw the tread to threshold. If steel sheet metal is used, completed tread should be coated with a rust-preventive primer and painted.

Cellophane-Lined Cardboard Box is Temporary Developing Tray

When an extra-large developing tray is needed, as when enlarging photos for exhibition, line the lid of a cardboard box of the required size with a sheet of cellophane or other cellulose wrapping material. To keep the cellophane in place, tape the edges to the box at the corners as shown in the photo at right.

☞To prevent accidental upsetting of a paper cup used as a glue pot, thumbtack it to a piece of wood scrap. The latter also permits moving the glue container without touching it with the hands.

G. E. Hendrickson, Argyle, Wis.





Hobbyist Microfilms His Records to Save

IF YOU ARE a hobbyist whose main handicap is lack of space, microfilming might be the ideal solution to your problem. Collections of magazine articles, data sheets, plans and blueprints can be reduced to a few rolls of space-saving film. As an example, 7 ft. of microfilm can contain 56 maps, plans and the like, the minimum original dimensions of which were 30 x 40 in. each. Should one of your hobbies be photography, your 35-mm. camera and some microfilm will provide the basic unit for a microfilming setup that itself occupies a minimum of space. Any photo enlarger is used for reading the film.

The base of the microfilming unit is a 24 x 33-in. sheet of $\frac{3}{4}$ -in. plywood. Close to the edge, at the center of one of the 24-in. sides, screw a $\frac{1}{2}$ -in.-pipe floor flange. Into this flange screw a 48-in. length of pipe threaded on one end. This is the vertical column for the camera arm. Over the column slide a $\frac{3}{4}$ -in. pipe tee that has been reamed for a sliding fit. The tee then is drilled and tapped to accept a $\frac{1}{4}$ -20 thumb-screw that locks the tee in place on the column. Into the tee is screwed a length of pipe that forms the support arm for the camera itself. The length of the arm can vary, but should allow the camera to be positioned above the center of the base.

At the center of each edge of the base,

as shown in the detail, is located a triangular-shaped hardwood block. The diagonal edge of each block is hollowed to accommodate the circumference of a length of $\frac{3}{4}$ -in. tubing. Each of the blocks is attached with glue and two wood screws driven through from the underside of the base. The tubing clamps on the blocks should hold just firmly enough so the tubing can be pulled out easily when the unit is disassembled for storage. The lengths of tubing, which are light standards, are 32 in. long on the original unit, but could be shorter to position the lights closer to the work. Each length of tubing has the lower end cut off at a 45-deg. angle and the upper end flattened and drilled. The upper ends are bolted to flats on which are fastened two light sockets and reflectors. The latter are cut and shaped from light sheet aluminum. Ordinary 100-watt lamps are used, as they last longer than photofloods. The lamp sockets are wired in parallel and fitted with a single switch. Microfilming is done with the camera shutter open, in the dark, or in dim light. The four lights then are turned on by means of the switch for the required number of seconds of exposure. This method eliminates the chance of moving the camera when snapping the shutter. A supplementary close-up lens must be used on a camera when it is used

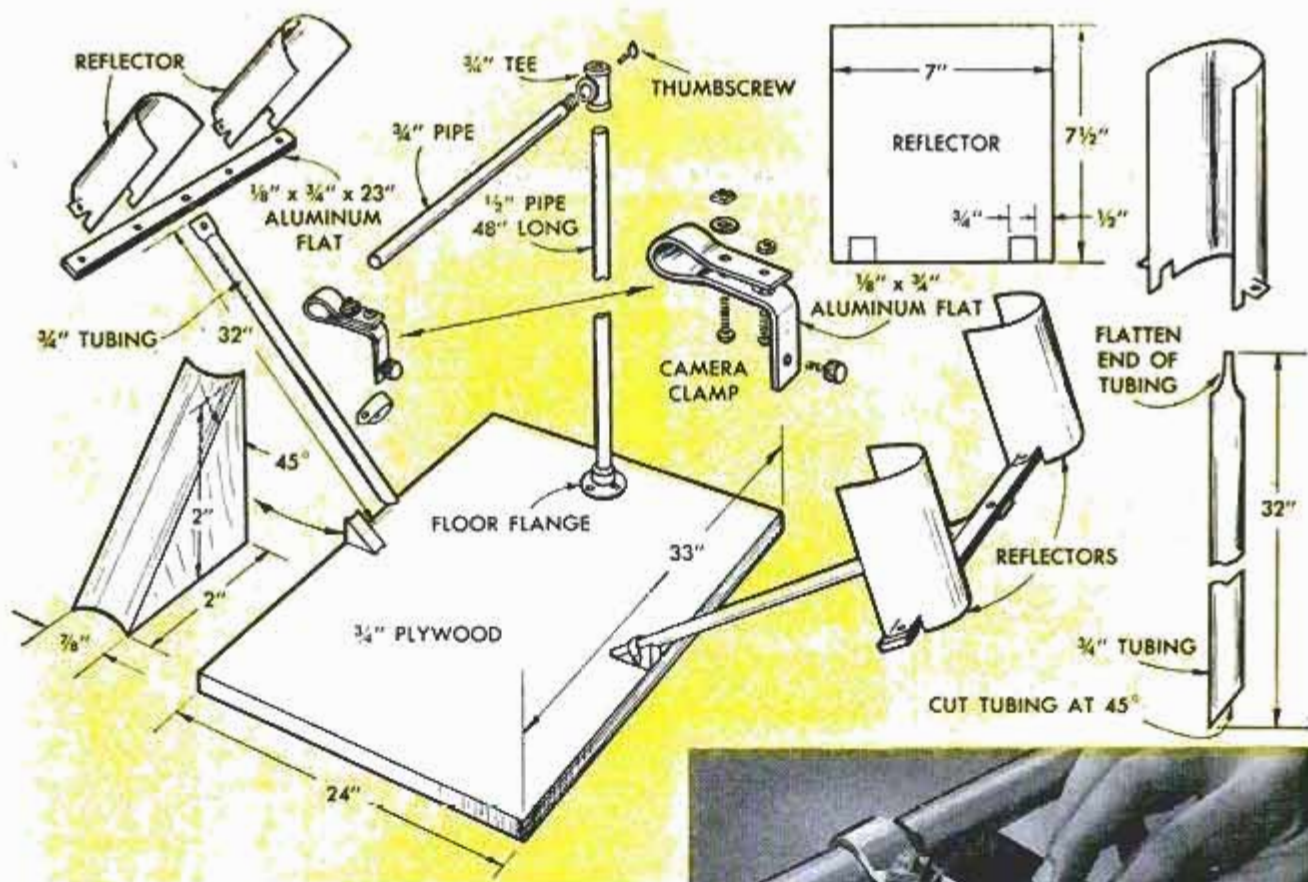

Storage Space By Tracy Diers

for microfilming, and even a slight movement of the camera during the exposure time could cause a blur. Clamping devices for the camera are available at camera-supply stores, or one can be made from aluminum flat as indicated. In either case, the camera must be clamped firmly to the support arm.

To simplify and speed the work, it is helpful to mark a series of lines on the plywood base to indicate standard areas that the camera will cover at a particular height. A file mark also is made on the column to show the corresponding height of the camera arm for a particular area. To determine correct exposure time, set the lens at $f:16$ and shoot at 3, 4 and 5 seconds. Develop the film and note which time gives the correct degree of exposure. This time should not vary while the same lighting is used for all work. ★ ★ ★

Upper photo, clamp shaped from aluminum flat holds camera on support arm, positioned above center of plywood base. Winding film does not move camera

Lamp standards made from 3/4-in. aluminum tubing fit snugly in clamps on triangular blocks, can be pulled loose easily when microfilming unit is stored

Thumbscrew, fitted in hole drilled and tapped at back of 3/4-in.-pipe tee, locks camera-support arm at any required height up and down length of column

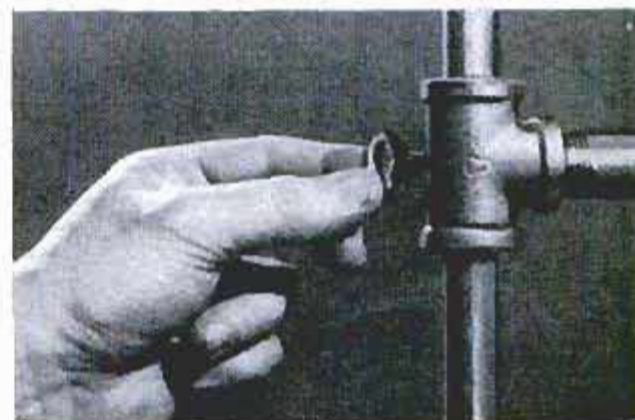

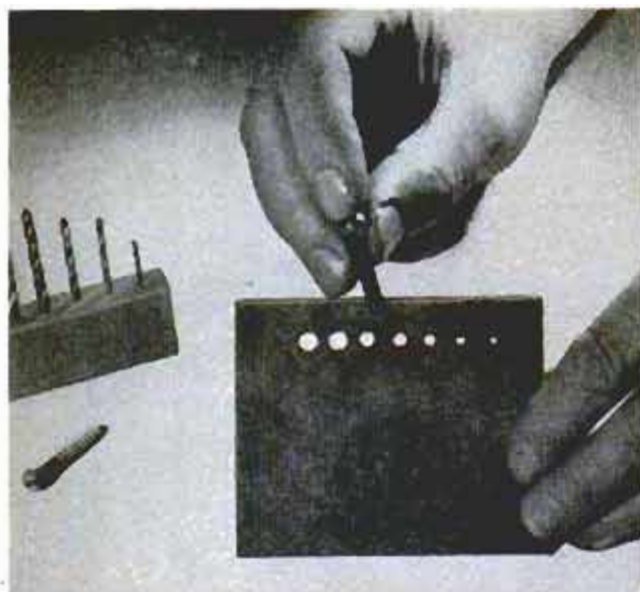

Sample Hole Sizes in Hardboard Facilitate Bit Selection

To avoid the trial-and-error method of selecting the right size bit for drilling holes for bolts or screws of unknown diameters, drill a row of sample holes in a small square of tempered hardboard as shown. Fitting the bolt or screw into the correct hole determines bit size. Mark each hole with the bit size that corresponds to it.
Masonite Corporation



Knife Sharpener Is Handy Tool For Deburring Sheet Metal

An ordinary kitchen knife sharpener, such as the one shown, makes an effective tool for deburring and smoothing the edges of sheet metal. Only a few strokes of the tool are required to remove sharp edges from the metal. If the sharpener has wall-mounting holes, it can be fastened to a wooden block shaped for easy gripping.
Harvey Muller, Danboro, Pa.

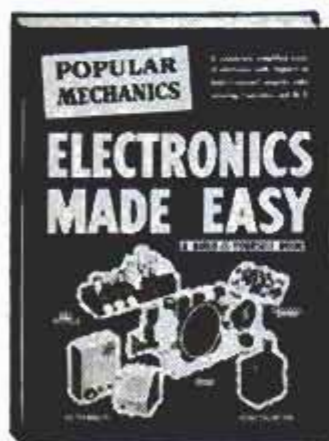

Enrich Your Life With the Marvels of Hi-Fi! Thrill to a Pocket-Size Transistor Radio . . .

Have you been wanting a Hi-Fi set for your home . . . a portable transistor radio no bigger than your hand . . . and any of the other pieces of electronic equipment that are adding so much enjoyment to modern living? Then here's how you can have them, at merely a fraction of the usual purchase price. Using Popular Mechanics' new book—*Electronics Made Easy*—

You Can Make These Electronic Devices Yourself!

This unusually practical book enables you, without any previous experience, to enter the amazing field of electronics for fun or profit. In 192 pages of simple step-by-step instructions and hundreds of illustrations, you learn all about Hi-Fi—exactly what it is and how to build your own Hi-Fi system. You discover how to make the “miracle” transistor radio, how electronic tubes work, how to do radio

servicing, how to use test instruments and make your own, and how to convert old radios into inter-com systems and other devices. It's fun and easy to build your own electronic equipment with the help of this book which contains numerous do-it-yourself projects. Send for your copy of *Electronics Made Easy*. It's your key to the most fascinating hobby of these times **\$3.50** for just.....

Send your order to Dept. 1158

POPULAR MECHANICS PRESS, 208 East Ontario Street, Chicago 11, Illinois

YOUR HOME WORKSHOP

The following 15 pages are devoted to setting up a shop, which may be laid out to hold costs to a minimum if you use it to make spare-time profits. Or, if you desire a shop for recreation purposes, it can be arranged to produce the most inviting environment in which to spend a few hours away from the day's cares. Regardless of the purpose, you are sure to find many suggestions that will be of help.

A WORKSHOP represents a sizable investment, or is likely to eventually. Therefore, its layout and equipping should be planned as carefully and with as much thought as any other sizable investment. A few tools thrown haphazardly on a bench or in a drawer are not conducive to good work or pride of ownership. Yet, the same investment in tools that are neatly arranged in a carefully planned layout have exactly the opposite effect on most of us—we are anxious to use them and create projects with them.

On the following pages *Popular Mechanics* offers many suggestions on planning, wiring, lighting and equipping a home shop. Here you will find answers to such questions as "Where shall I locate a shop—in a room in the house, in the basement, the garage or carport?" "How can I work out a good shop layout in the space available?" And what tools to buy, such as hand tools and power tools, as well as what equipment, such as benches and racks. Also recommended wire sizes, lamps, switches, etc.

PLANNING

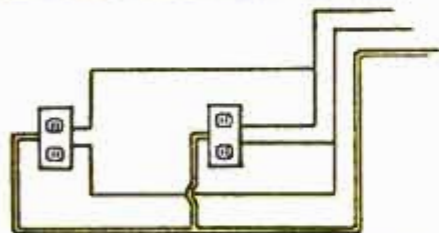

WIRING

HAND TOOLS

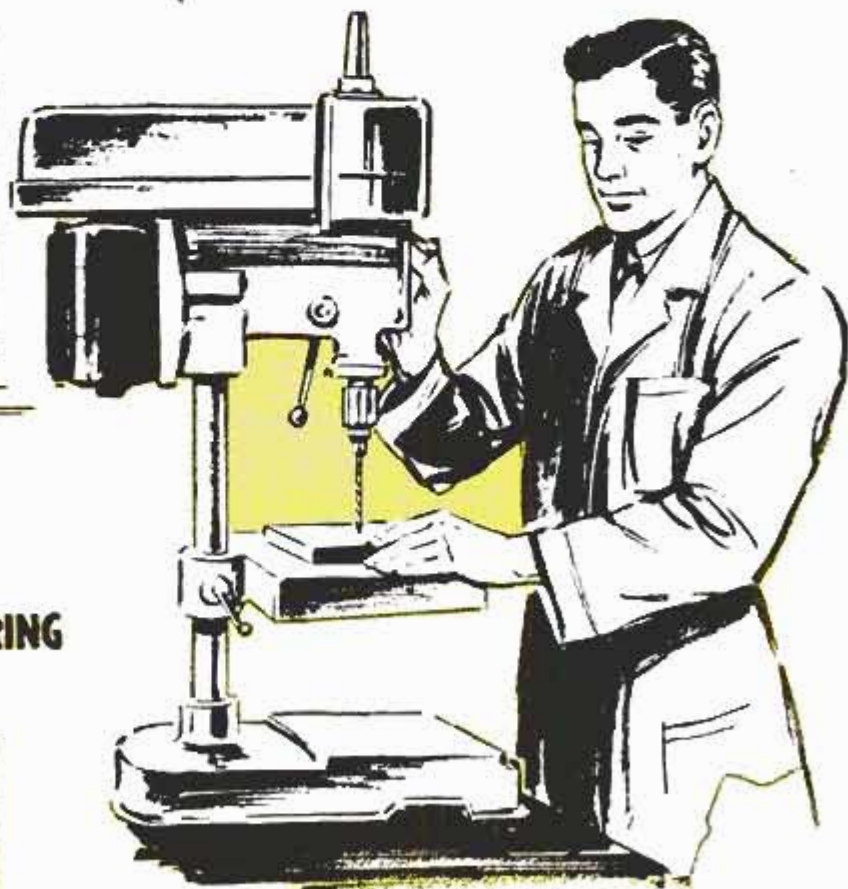

POWER TOOLS



IT'S FUN TO PLAN a workshop as a part of leisure-time living. Your shop can be individual and at the same time practical, suited to the available space and the tools you will need to build home furnishings, make home repairs, build a boat or follow the hobby of your choice. But whether you are planning from scratch for all new shop equipment, or are planning greater efficiency from what you already have or intend to acquire, plan carefully with an eye to the future. Keep in mind that you are not setting up a production line of machines and supplementary tools for repeat operations. A single cabinet project may call for a hundred operations but only a few will be repetitive. Because of this you don't need precise figures and neither

do you need a detailed floor plan; a simple pencil sketch made to a scale of, say, $\frac{1}{2}$ in. equals 1 ft., will do the trick.

The floor plans below and on the opposite page suggest arrangement of equipment in a small, square room and in a long, narrow room. All power tools, with the possible exception of the wood lathe, should be on casters so that they can be moved about to clear the central floor area, or make room at one machine for a special job. Note that on both plans the circular saw-jointer combination tool is given the greatest amount of working space, first, because it is the most-used machine in the shop and second, because there must be an equal amount of workspace all around the unit. Other machines such as the belt

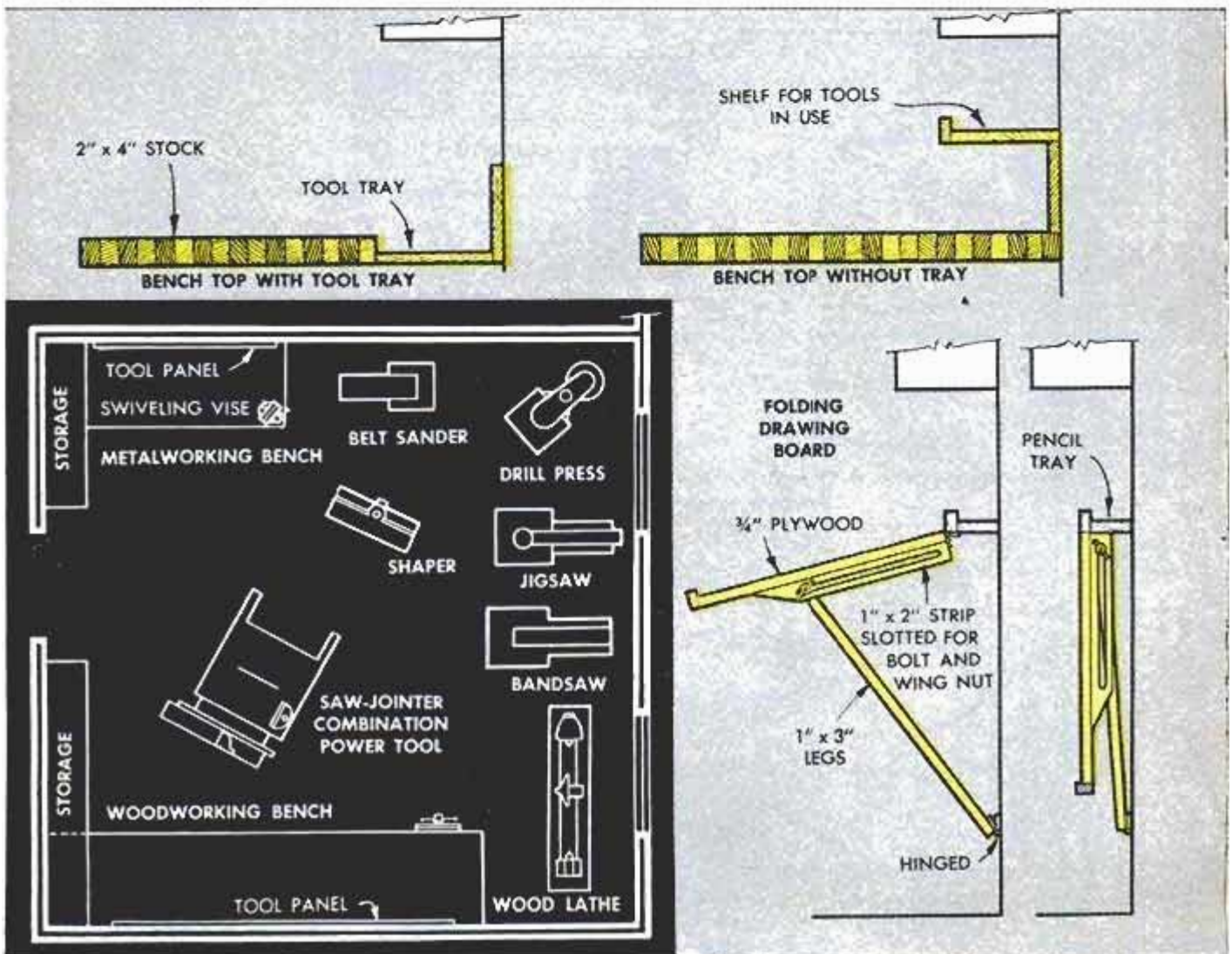

PLANNING

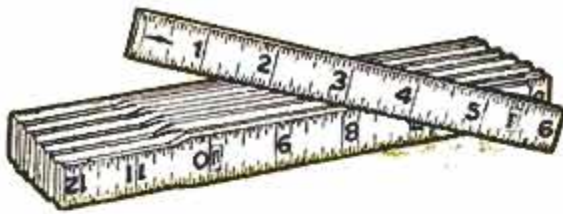

sander, drill press, jigsaw, shaper and band-saw require only a semicircular workspace in front of the machine and for this reason they can be ranged along the walls of the shop. When you have them mounted on casters they can be rolled anywhere on the shop floor for special jobs.

When you plan a workbench, plan big. Note the relative sizes of the workbenches on the two plans. Make the tops as large as the floor space will accommodate. Glue the stock with the edge up and cover with 1/4-in. hardboard attached with contact cement. Tops can be made with or without a tool tray as detailed on the opposite page. If floor space is limited, as in a garage or small room, then think about the two space-saving ideas detailed below. A workbench that is open at the back so that it can slide over a combination power tool is

WORKBENCH OPEN AT BACK

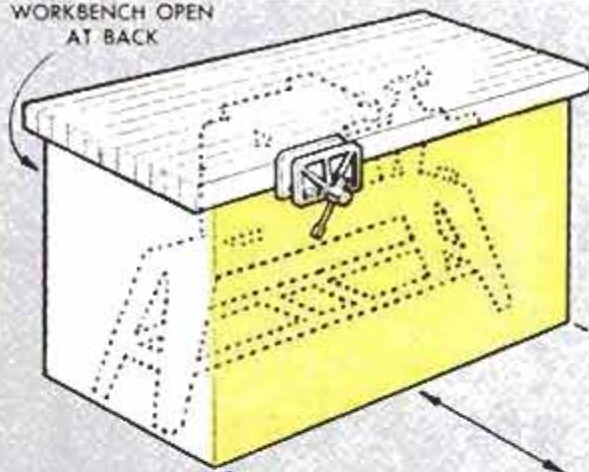

TWO SPACE-SAVING IDEAS FOR COMBINATION POWER TOOLS

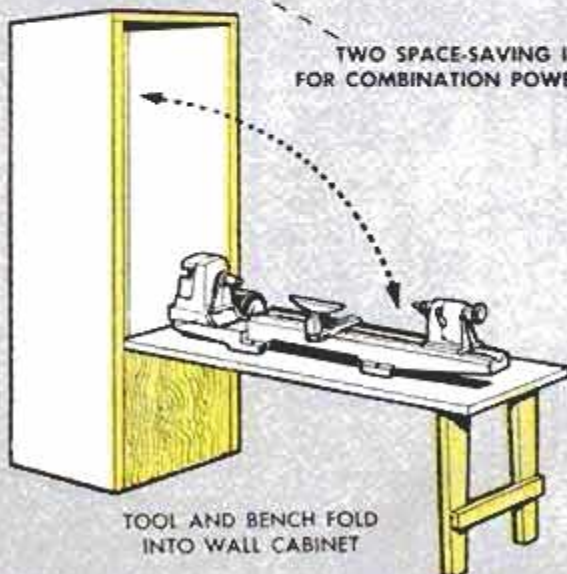

TOOL AND BENCH FOLD INTO WALL CABINET

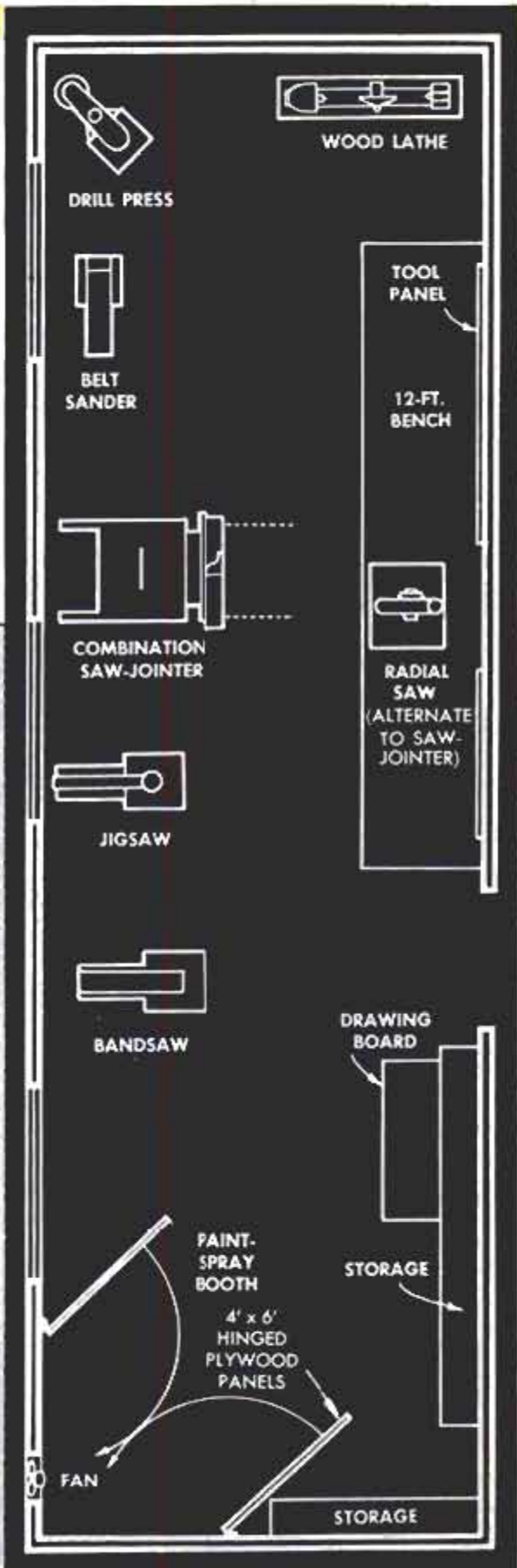

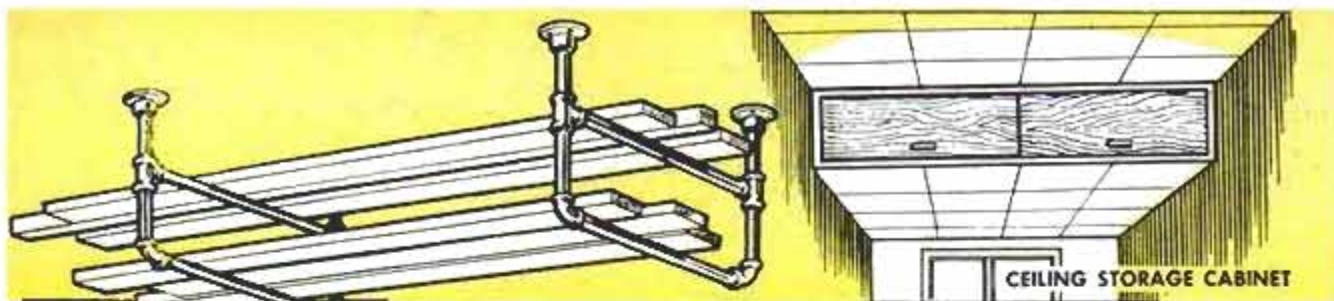

CEILING HANGERS

CEILING STORAGE CABINET

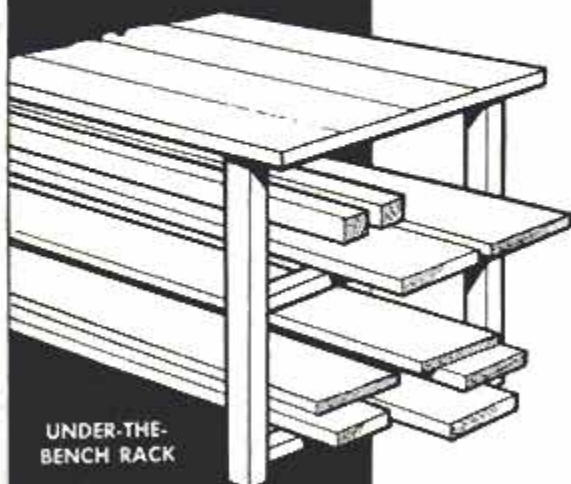

UNDER-THE-BENCH RACK

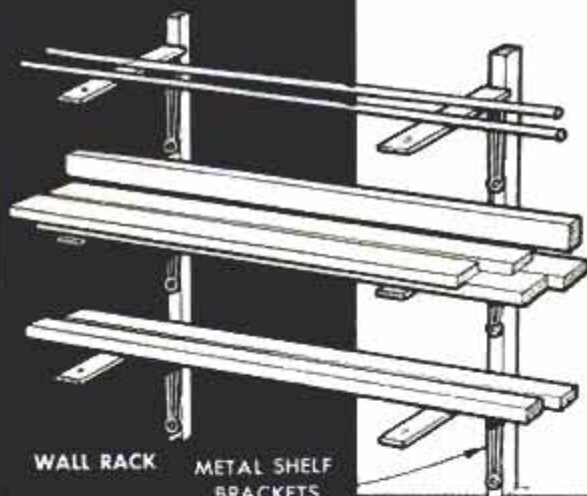

WALL RACK METAL SHELF BRACKETS

a good economizer of space. So is the folding bench that can accommodate a single-purpose tool or a small combination power tool. And while you're thinking about space saving, study the suggestions for utilizing space in a carport and adding to present garage space with a leanto as detailed below and on the opposite page. Where you have room for only a carport shop and no space for conventional power equipment, then consider a portable electric handsaw with a floor stand (available from the manufacturer of your saw). When not used as a stationary unit, the saw can be detached from the floor stand and the latter stored under the bench as pictured. If you're cramped for space in a garage or basement workshop, locate your radial saw near a doorway and place it on a separate bench or stand so that you can slide it out to handle long stock. Of course, you can mount the cabinet or stand on casters and thus gain greater range and easier mobility.

Your bench grinder will be used periodically to sharpen tools but the rest of the time the problem is what to do with it. A simple solution is to bolt the grinder to a square piece of 2-in. stock and lock it in the bench vise when you use it. This arrangement makes a good "stand" and the grinder can be stored anywhere it is out of the way when not in use.

Along about this stage of planning your shop you will encounter the problem of stor-

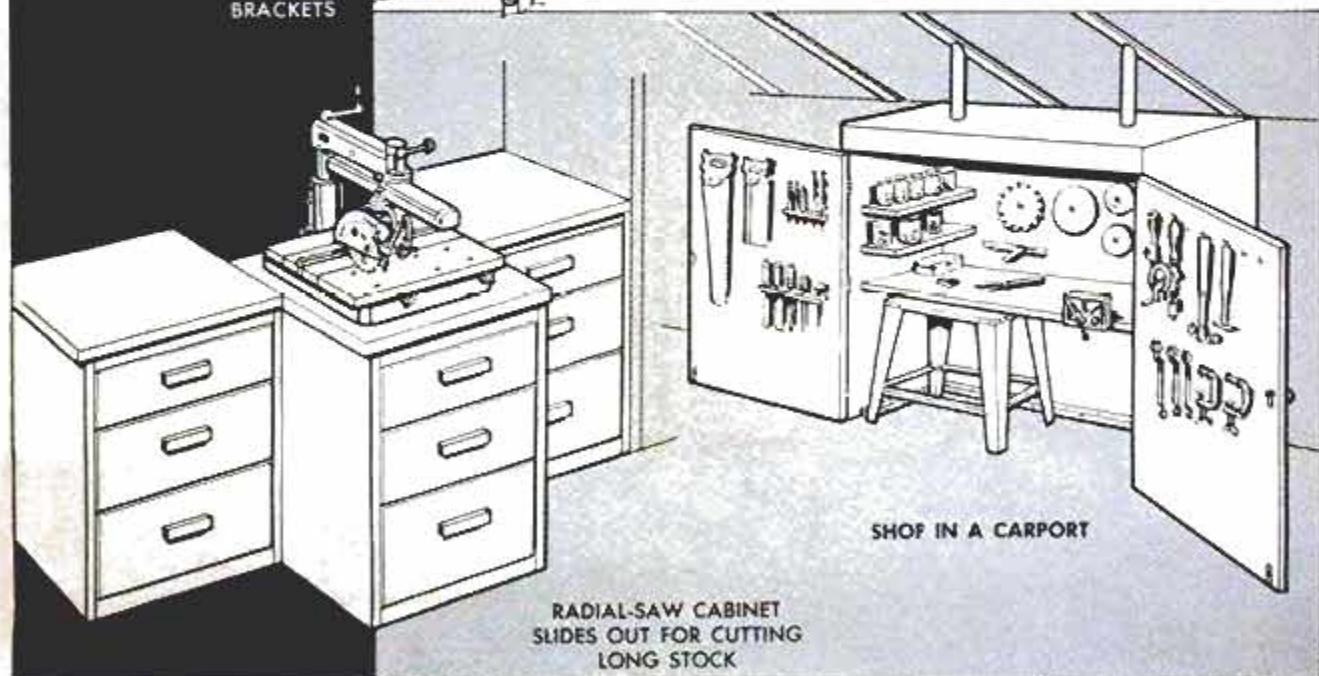

SHOP IN A CARPORT

RADIAL-SAW CABINET SLIDES OUT FOR CUTTING LONG STOCK

PLANNING



age — where to keep lumber, fancy woods, hand tools and the power-tool accessories, finishing materials and all the other items that complete the shop supplies and equipment. Wall racks, ceiling hangers and cabinets generally will take care of the lumber, but just what you do with these storage units on your shop plan will depend on ceiling height and the floor space you have available. Where the ceiling height will permit, hangers and ceiling cabinets, the latter built in like a wide soffit, will provide storage for ordinary lumber and choice hardwoods. If the ceiling is low and the floor space ample, then jot down the sizes and locations of wall racks on your plan, keeping these details in the same scale so that you know what space they will occupy. Wall panels are best for hand tools and power-tool accessories and sectional wall cabinets and racks with adjustable shelves provide for shop supplies and finishing materials. If your plan sketch permits two benches, make or purchase one bench of the open-frame type. Then the open frame can be fitted with cross-pieces and used as a rack for storage of short lengths of lumber. In close quarters, as in the garage leanto, such a bench can be mounted on casters so that it can be moved out into the garage for greater working space.

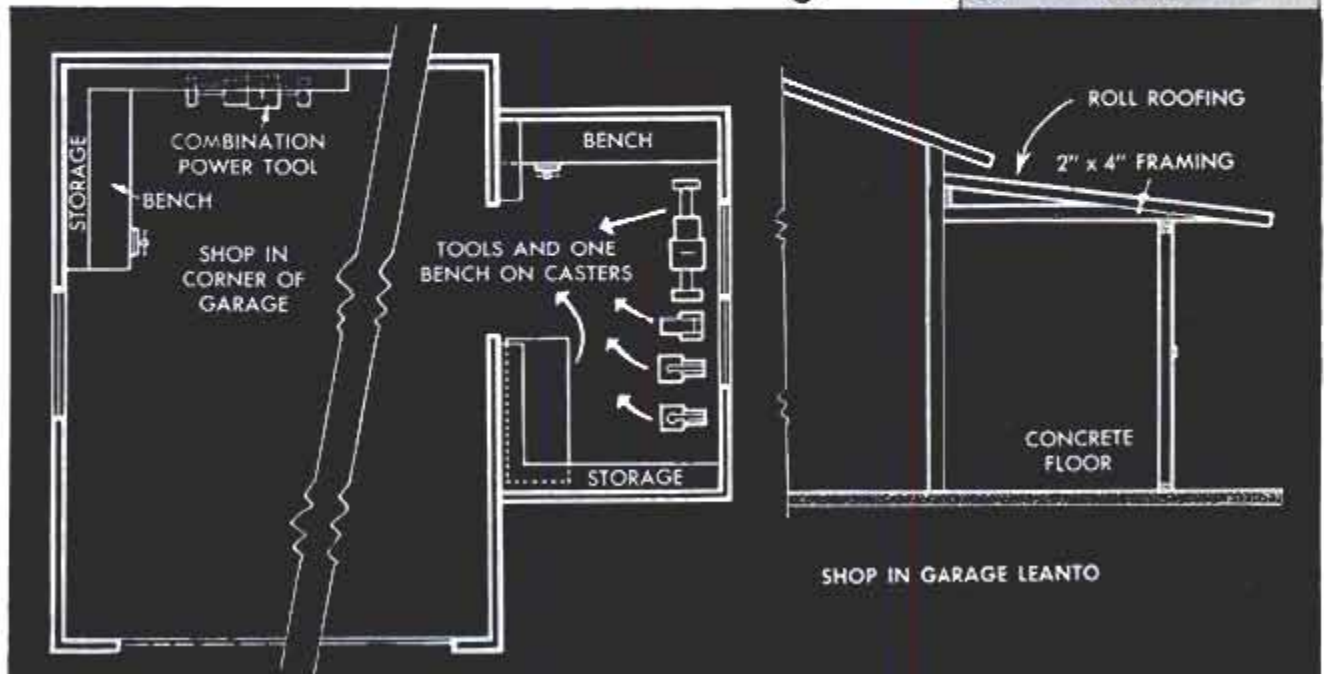
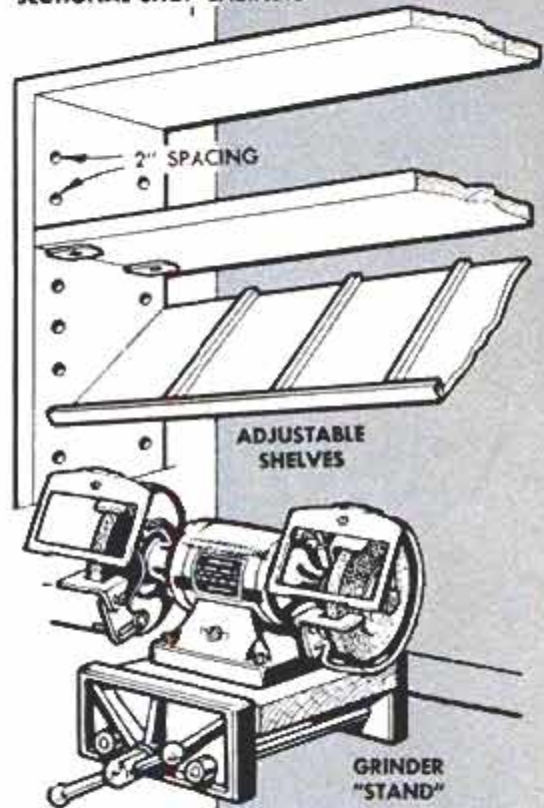

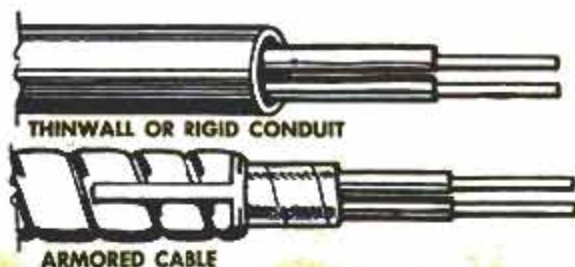

WHEN YOU PLAN WIRING for your shop count on having separate power and lighting circuits. Separate circuits eliminate the hazard of overheated wiring and dimming of shop lights when one of the larger motors is started or is momentarily overloaded. Although the 20-amp. appliance circuit diagrammed below will carry the load of an average household appliance along with that of even a 3/4-hp. saw motor, the load is approaching the maximum permissible on that particular circuit. Add one more appliance or motor and the breaker may trip or a fuse go out.

That's why, at the outset, it's a good idea to plan the installation of the dual 20-amp., 115/230-v. circuit you see diagrammed below and on the opposite page. This 3-wire circuit is ideal for a workshop and as a rule it is more economical than installing two separate power circuits in the conventional manner in either an old or new home-wiring system. By drawing from both black wires of the service entrance, as diagrammed, it gives you two 20-amp., 115-v. power circuits. Split-wired duplex outlets are, of course, necessary in this system. These are the same as ordinary

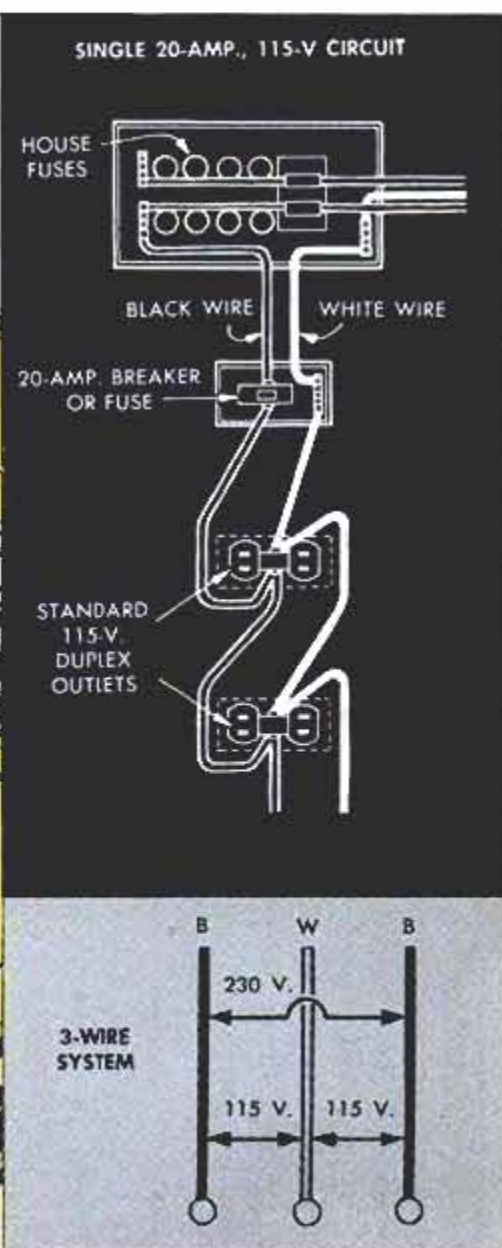
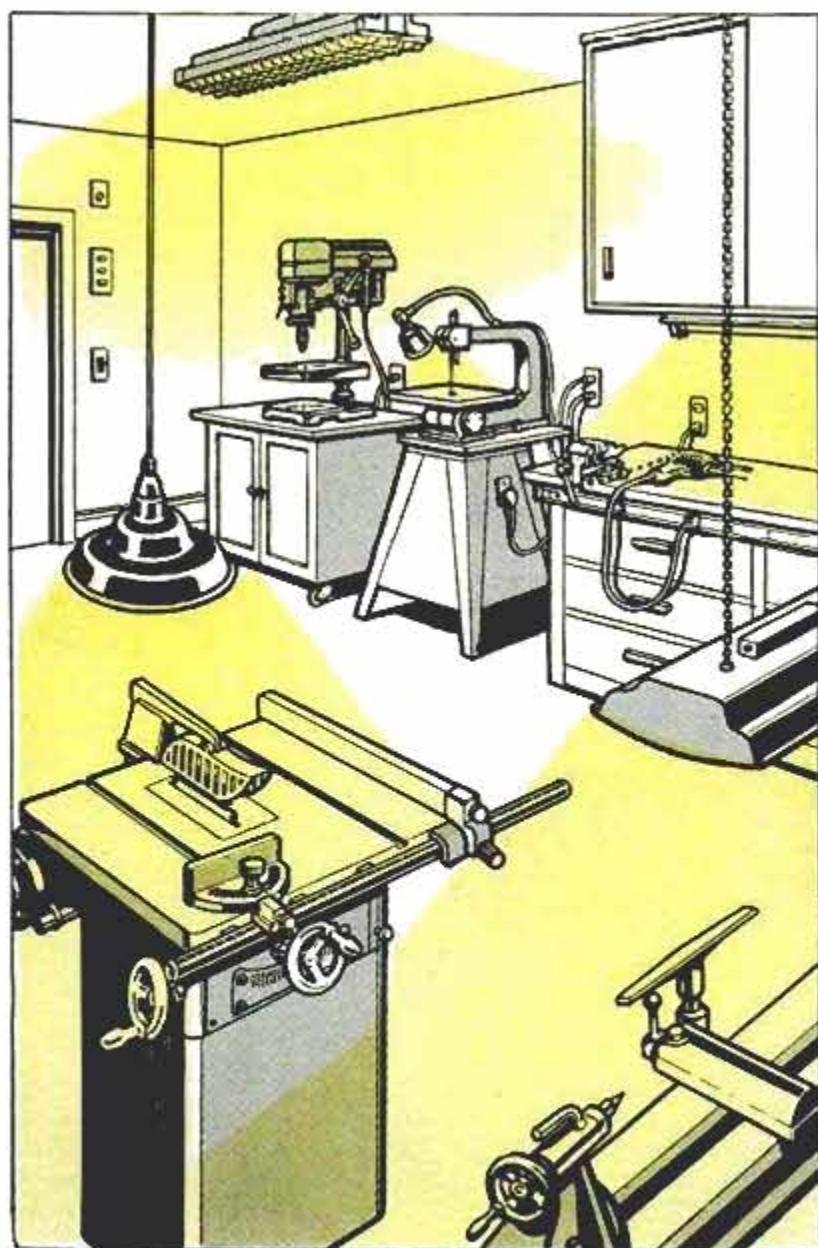



NONMETALLIC CABLE WITH GROUND WIRE

WIRING

duplex outlets except that the two halves are not interconnected. The top half of each outlet usually is kept on one 115-v. circuit and the bottom outlet on the other.

This wiring system gives the greatest flexibility in powering the shop motors. To equalize the load on the two 115-v. circuits of the system, you simply plug the various power tools alternately into the upper and lower halves of the duplex outlets. It also provides a 230-v. outlet for any motor designed to operate on 115 or 230-v. current. Motors $\frac{3}{4}$ hp. and larger operate more efficiently and draw less amperage when powered by the higher voltage.

Adequate shop wiring begins at the service entrance. On older homes especially, the entrance box may be rated at less than 100 amp. and have only two source wires. If this is the case, it should be replaced with an entrance unit having at least a 100-amp. rating. From the entrance box the supply lines can be brought direct to the shop as indicated in the typical shop-wiring diagram on the following page.

Here, the power line can be brought to a fuse box through a key switch, H, or to a breaker, D, in which case the key switch is not needed. The main purpose of the key switch or breaker installation (the latter is to be preferred) is to provide you with a positive means of cutting off all power to the shop tools when you leave the room. Locate the unit near the door and high enough to be well beyond a child's reach. If you do use a fuse box, install plug fuses of the time-delay type.

If the distance from your service entrance to the shop is less than 50 ft., No. 12 wire will do for the power line. But on leads of 50 ft. or more, or when more than one circuit is supplied, then No. 10 wire is the minimum size with No. 8 wire perhaps the best choice. Around shop walls to power outlets No. 12 wire usually is the size recommended. Although not shown on the shop wiring diagram you may wish to use prewired raceway strips which have outlets spaced every 12 in. or so. These often are preferable to indi-

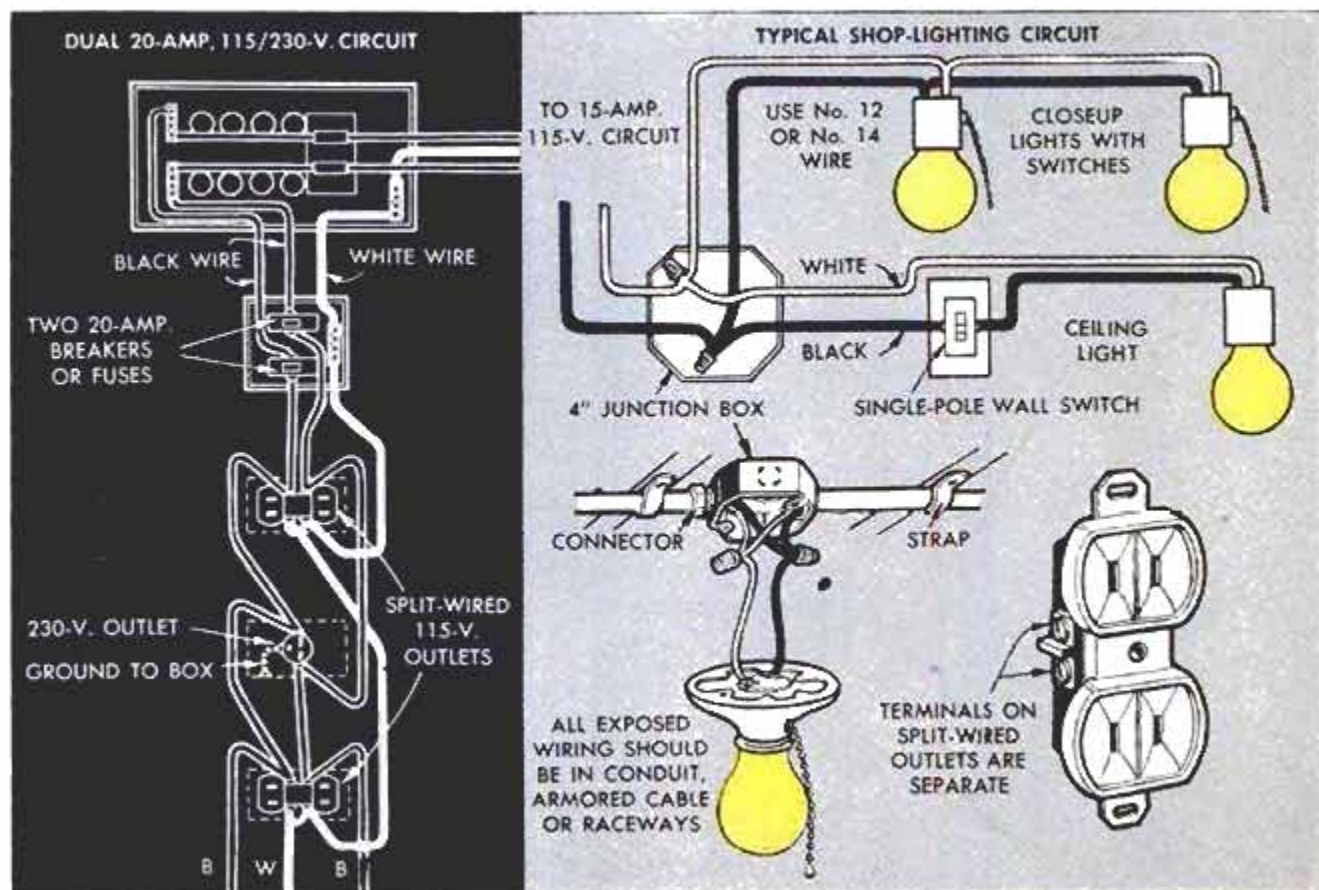

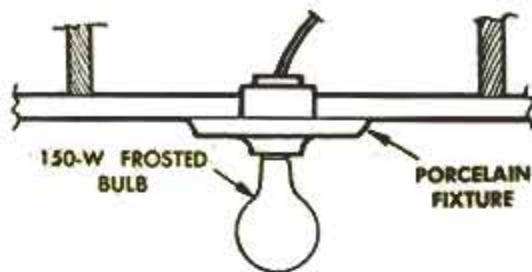

- A—POWER CIRCUITS
- B—SWITCHED LIGHT CIRCUIT
- C—UNSWITCHED LIGHT CIRCUITS
- D—BREAKER BOX
- E—SUPPLY LINES
- F—DROP LIGHTS (OVER BENCHES OR POWER TOOLS)
- G—LARGE FLUORESCENT CEILING LIGHT
- H—KEY SWITCH

TYPICAL SHOP WIRING

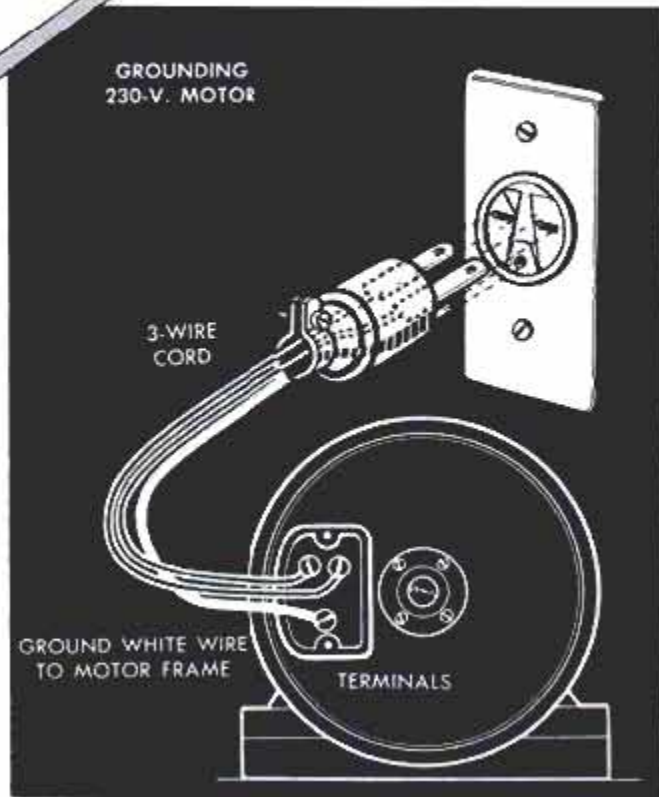
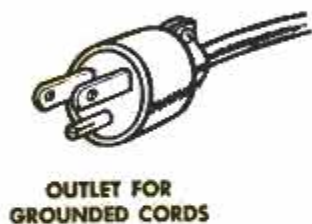
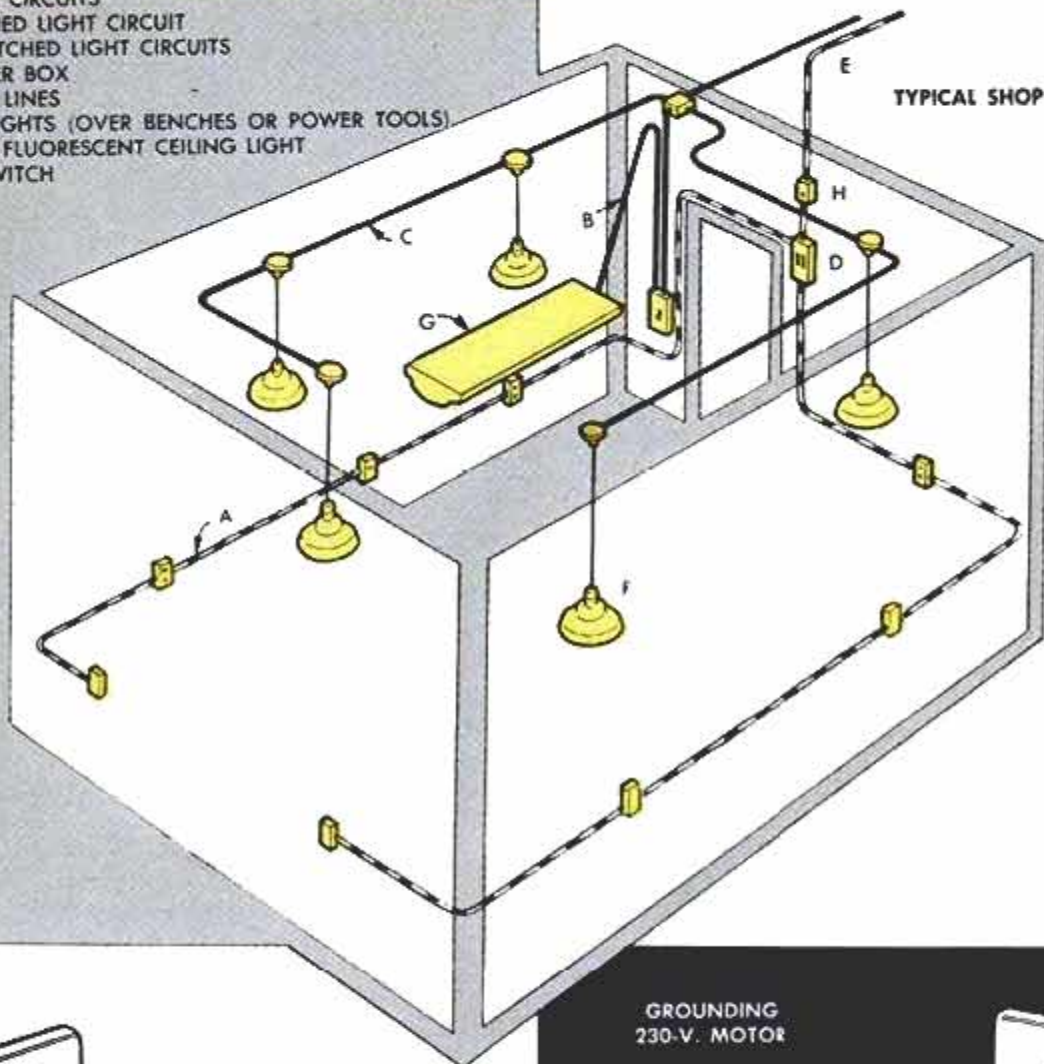

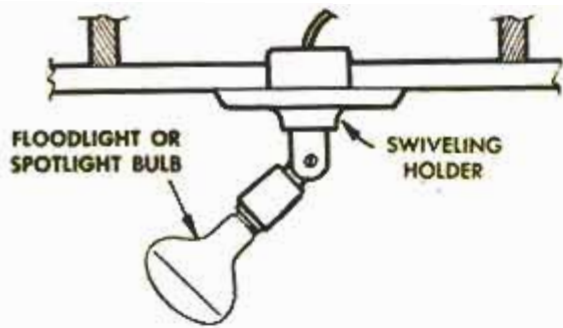

vidual outlets. In any case, power circuits should have continuous grounding.

The manner of lighting the shop is an individual problem. If the ceiling is low, as in a basement, then you may wish to utilize some of the suggested ceiling-light installations detailed on these pages. On the other hand, if the ceiling is high, as in a room in an older home, an unswitched lighting circuit with drops over the individual power tools may prove the best solution. Note the unswitched circuit, C, in the shop wiring diagram. Here only the fluorescent ceiling fixture is on a switched circuit. Individual tool lights are handy for closeup work and traveling lights also are useful in some shop-lighting plans. If the room is long and narrow as on one of the floor plans, you'll need more than one ceiling fixture for adequate general lighting. Don't figure daylight values in your shop-lighting plans. And be sure before installing any shop wiring in either an old or new home to plan the power and lighting circuits to take care of any future additions in power tools or lights. Know your local electrical codes before installing any new wiring.

WIRING

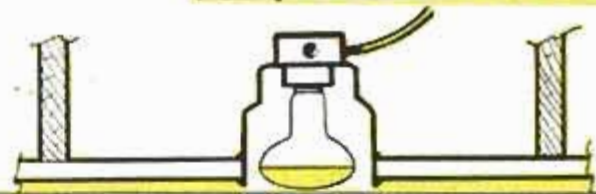

FLOODLIGHT IN RECESSED CEILING FIXTURE

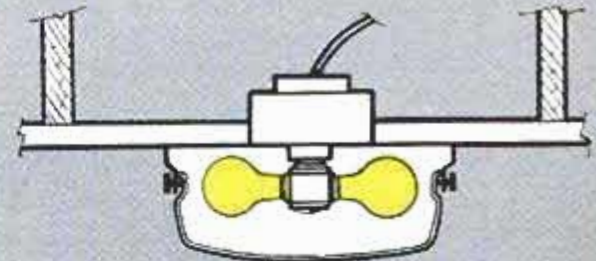

GLASS-BOWL KITCHEN OR BATHROOM FIXTURE IS INEXPENSIVE, GIVES GOOD GENERAL ILLUMINATION

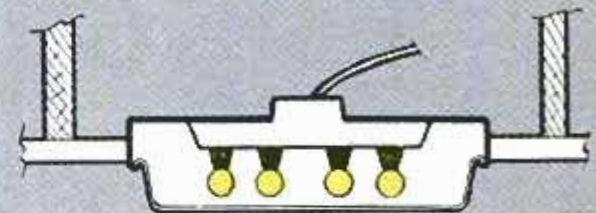

BEST GENERAL SHOP LIGHT IS LARGER RECESSED FLUORESCENT FIXTURE CENTRALLY LOCATED IN CEILING

OPEN FLUORESCENT TUBE UNDER TOOL CABINET

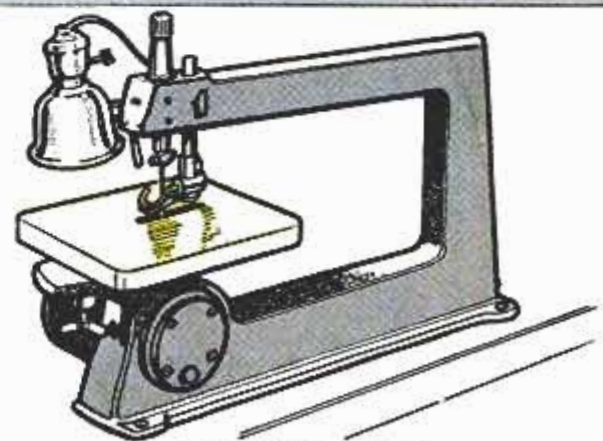
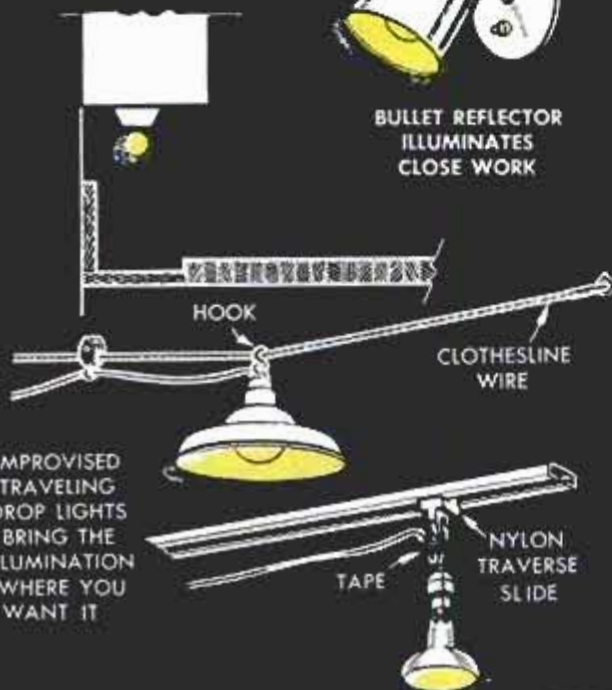

TOOL LIGHT SPOTLIGHTS GAUGE LINES



OPEN REFLECTOR LIGHTS WORKBENCH

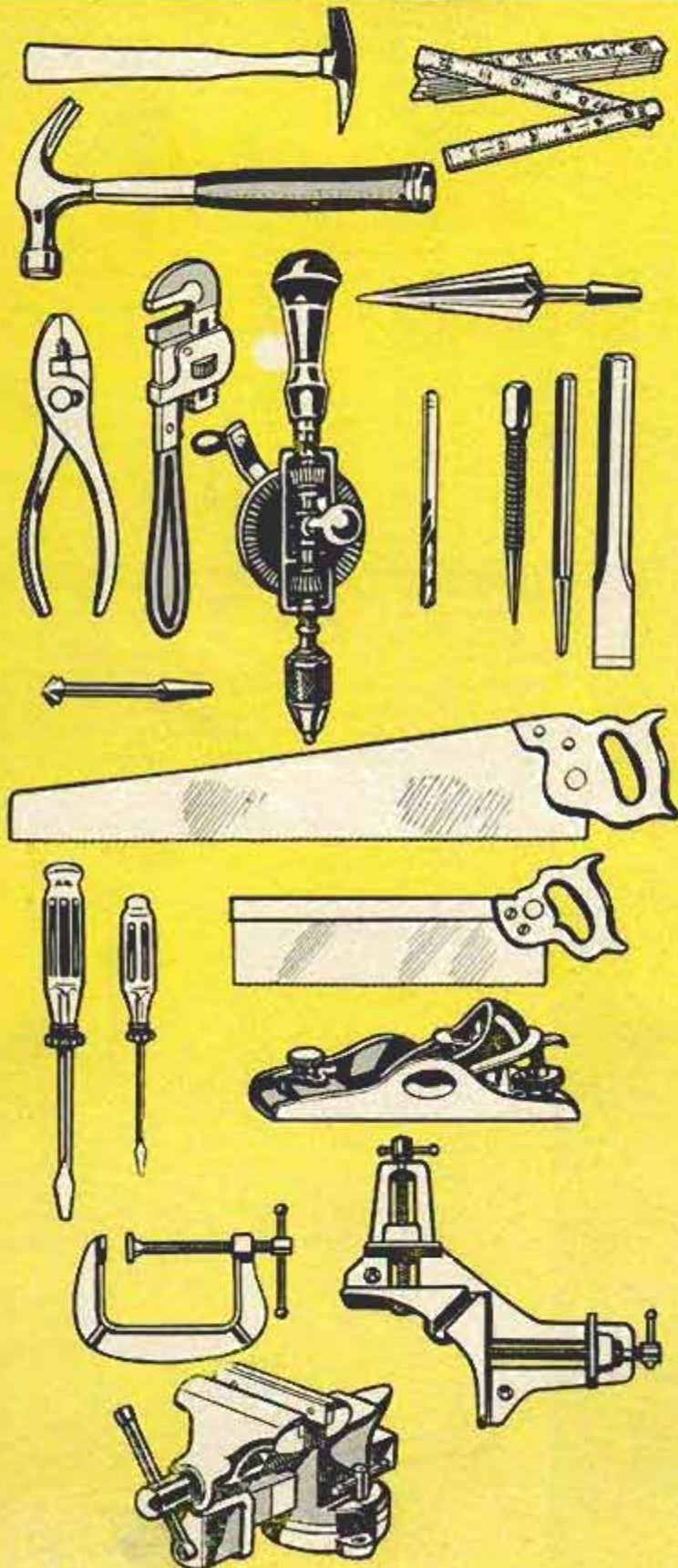

ALTHOUGH MANY HAND tools are supplementary or entirely unnecessary in a shop fully equipped with power tools, some hand tools such as hammers, clamps, rules, wrenches, pliers and vises are indispensable. As an example, if you have a drill press with accessories, you may not need a hand brace and bits. If you already have a jointer and a surfacer, as pictured on the following pages, you can get along without hand planes. If you have a portable circular saw, you may do without a hand saw.

But one should keep in mind that a fairly complete kit of the common hand tools is useful, almost indispensable, in making

Home Repair Toolkit

CURVED-CLAW HAMMER 13-oz. head

SCREWDRIVERS (2" and 4")

6" SLIP-JOINT PLIERS

6-ft. TAPE RULE or **FOLDING RULE**

PUTTY KNIFE with either regular or wide blade

9" ADJUSTABLE WRENCH

10" PIPE WRENCH

HAND DRILL with assorted bits

MARKING GAUGE

CROSSCUT SAW (8 to 10 teeth to the inch)

SOLDERING IRON (100-W. or larger)

10" TRY SQUARE (or combination square)

HACKSAW (for 10" to 12" blade)

1/4" and 1/2" WOOD CHISELS

FOUR 8" FILES WITH HANDLES (one 3-cornered file, one mill file, one each round and half-round)

WISE WITH 2 1/2" JAWS (or woodworking vise with rapid-acting screw)

1/16" NAIL SET

KEYHOLE SAW

CENTER PUNCH

AUGER-BIT BRACE (ratchet type)

AUGER BITS (1/4" to 1/2" by 16ths)

7" BLOCK PLANE

8" SMOOTH PLANE

COMBINATION OILSTONE

C-CLAMPS (two each of 2", 3" and 6" sizes)

LEVEL

KNIFE (with replaceable blades)

SANDING BLOCK (and assorted grades of sandpaper)

HAND TOOLS

those simple home repairs. So, the best thing to do is buy hand tools as you need them unless, of course, you already have a fairly complete kit.

Although a list of hand tools rarely meets all individual requirements, it can serve as a guide from which you can select those you do need. The two lists on these pages are offered as suggestions to help you in making a selection. In some cases you have a choice between tools which have similar applications. One example is the steel (carpenter's) square and the combination square. In most home shops the combination square will serve the purpose. Not all tools listed below are illustrated.

Add These as Needed

MAGNETIC TACK HAMMER

8" SCREWDRIVER

COPING SAW

SET OF OPEN-END WRENCHES (6/16" to 7/8")

8" OR 10" ADJUSTABLE END WRENCH

26" RIPPING SAW

18" BACK SAW (for miter box)

MITER BOX

12-oz. BALL PEEN HAMMER

ADDITIONAL AUGER BITS (1/2" to 1" by 16ths)

EXPANSIVE BIT (5/8" to 1 3/4")

TWIST DRILLS (number sizes 1 to 60, fractional sizes 1/16" to 1/4" or larger)

SOLDERING TORCH (for flame soldering)

ADDITIONAL WOOD CHISELS (3/4" and 1" or larger)

BAR CLAMPS (two 24", two or more 36" or longer)

MITER CLAMPS

SIDE-CUTTING PLIERS

LONG-NOSE PLIERS

11" JACK PLANE

18" FORE PLANE

1/4" AND 1/2" INSIDE OR OUTSIDE GOUGES (or both)

ASSORTED SIZES OF FILES (as needed)

FILE-CLEANING BRUSH

PIN PUNCHES (set of four in graduated sizes)

TAPERED REAMERS (two sizes, 1/8" to 1/2" and 1/4" to 3/8", to fit auger brace)

1/4" AND 1/2" COLD CHISELS

ROSEHEAD COUNTERSINK FOR SCREW-HEADS (to fit auger-bit brace)

BENCH BRUSH

Many tools such as chisels, punches and auger bits are available in sets. Usually these are more useful and more economical to buy.

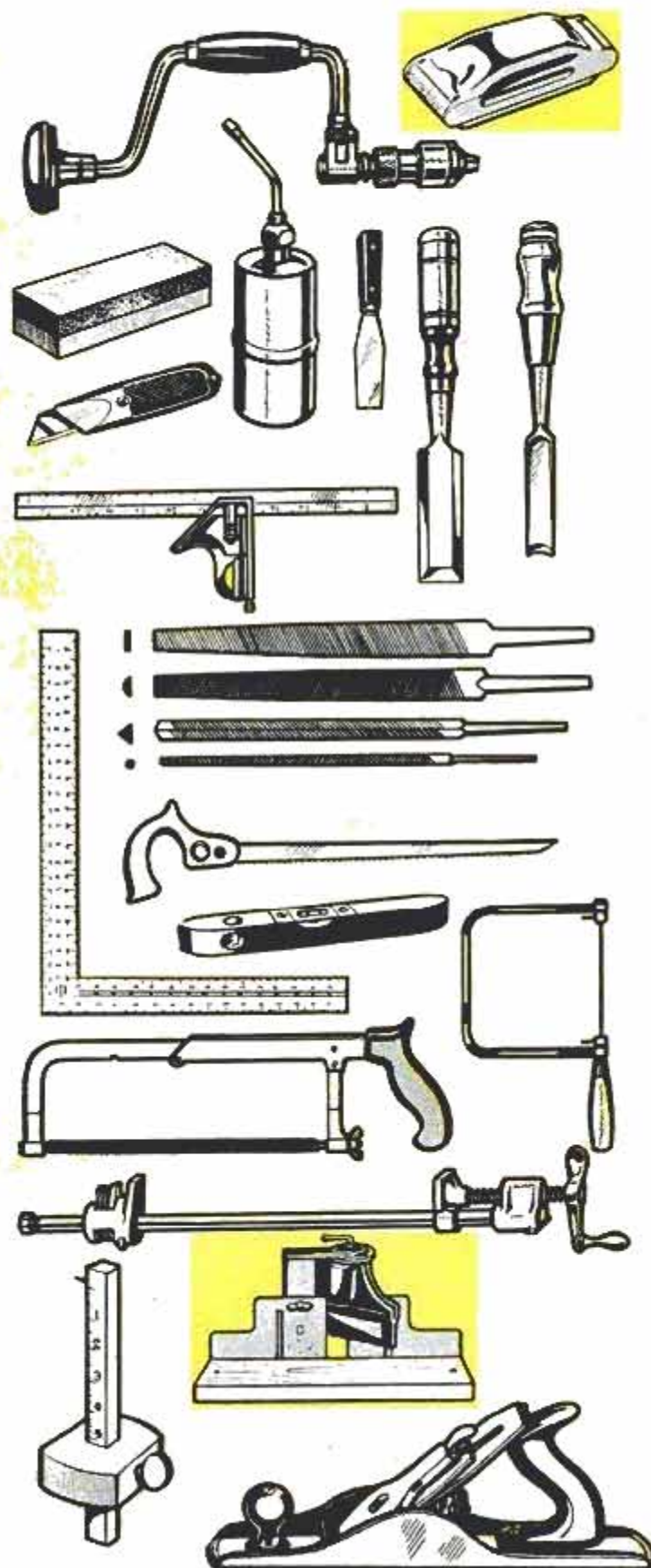



HIGH-SPEED
HAND GRINDER



PORTABLE
ELECTRIC DRILL



BELT
SANDER

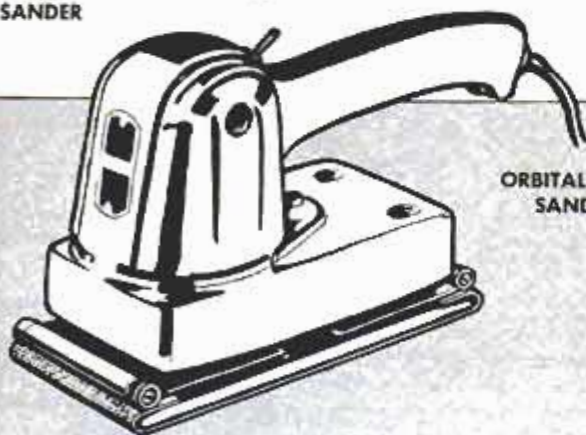

ORBITAL (PAD)
SANDER

PORTABLE
CIRCULAR
SAW

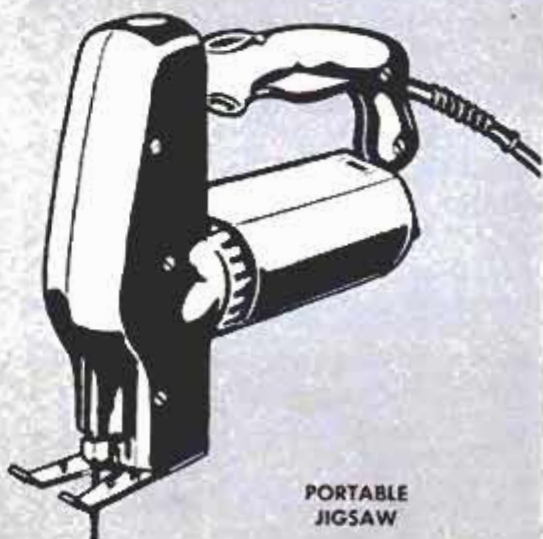
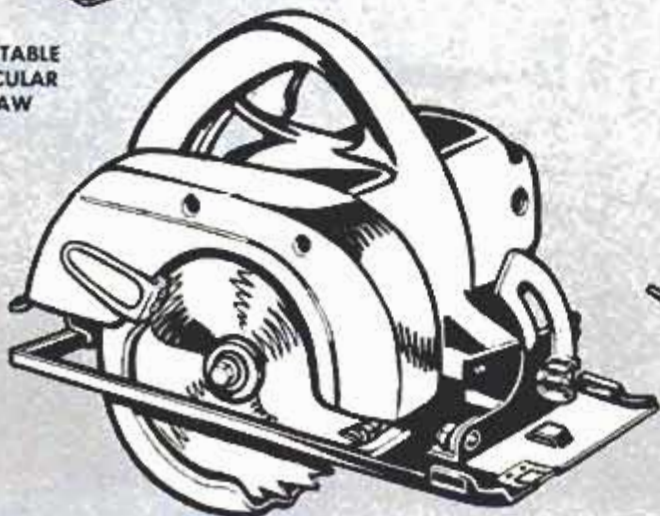

PORTABLE
JIGSAW

IF YOU EQUIP YOUR SHOP with the portable electric tools shown on this page, you can do the common power-tool operations, such as squaring and ripping stock to size, jigsawing scrollwork, drilling, dadoing, and the rough and finish sanding preparatory to finishing the project. That about covers construction of home built-ins, small-boat construction, building a garage or making outdoor furniture. But for cabinetmaking you'll need supplementary hand tools to cut mortises, plane stock to such thicknesses as may be required and joint edges true for gluing stock to wide widths.

One feature of all portable tools, that is, those which are held in the hand when operated, should be kept in mind when planning your shop equipment: the portable power tool is carried to the work. This can be an important time, step and space saver when your shop is small, when the job calls for cutting large sheets of plywood or similar materials, or where the project is being built at some distance from

POWER TOOLS

the shop. Another point in favor of portable tools is the small space required for storing the units when not in use.

Three of the tools shown — the hand grinder, portable drill and circular saw — are available with a range of accessories which make each a small power shop in itself.

But when you plan shop equipment, consider first the range of usefulness of each tool when measured by your individual needs. Think also about how the addition of other power tools can enlarge the scope and range of shop work. If you have the craftsman's feeling for fine cabinetwork, either modern or traditional, you may like the stationary power tools best. For example, with the stationary (bench-type) power tools shown on this page you can do every operation on a cabinet which requires cutting stock to dimension, jointing edges of stock true for gluing to wider widths, planing stock to various thicknesses which may be required, cutting grooves and rabbets, running the straight and curved moldings required by the design, and making any turnings the construction may call for. But to assemble

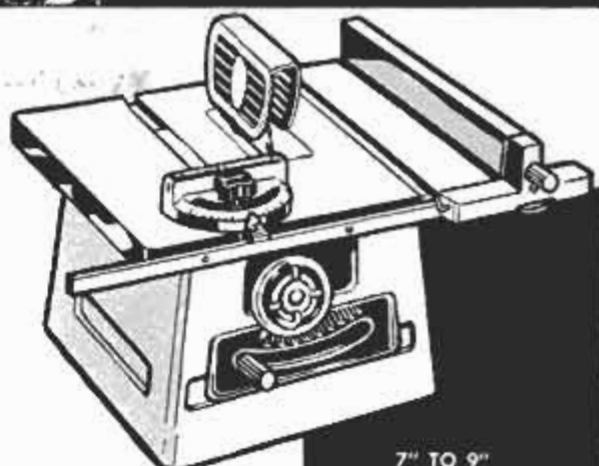

7" TO 9"
CIRCULAR
SAW

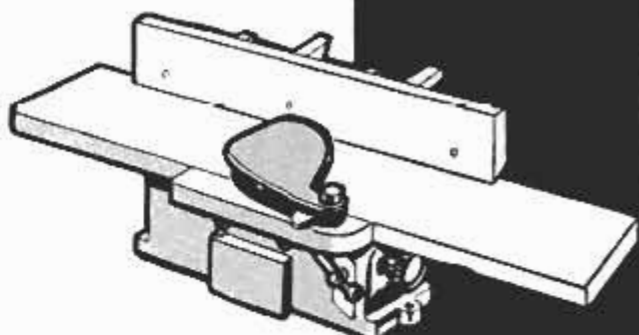

4" OR 6"
JOINTER

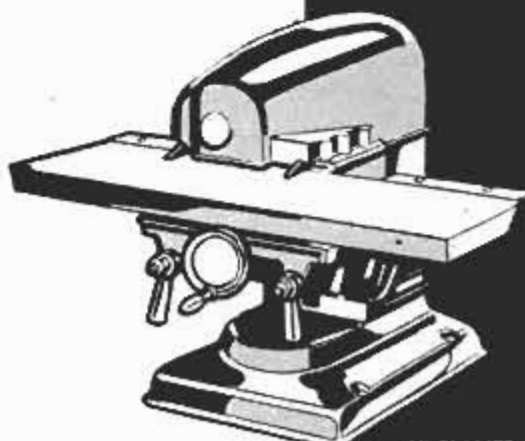

6" PLANER
OR SURFACER

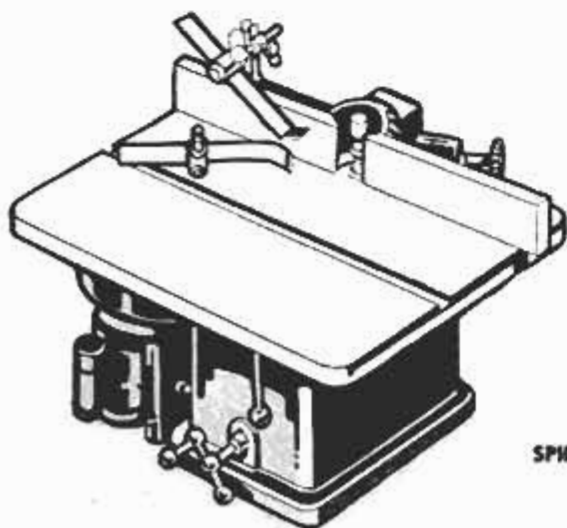

SPINDLE SHAPER

12" WOOD-
TURNING
LATHE

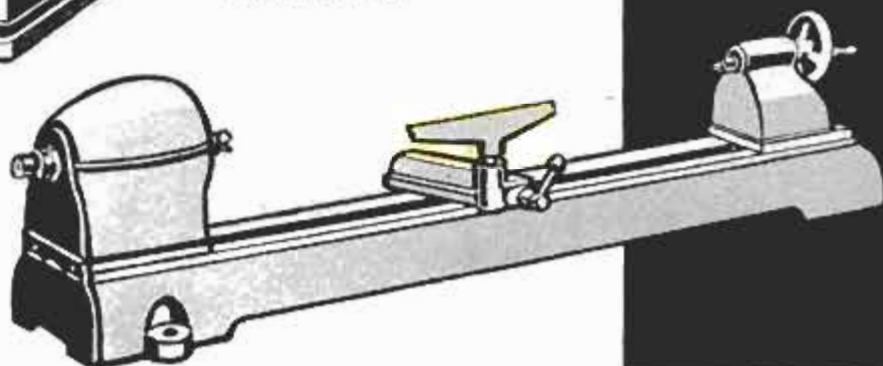

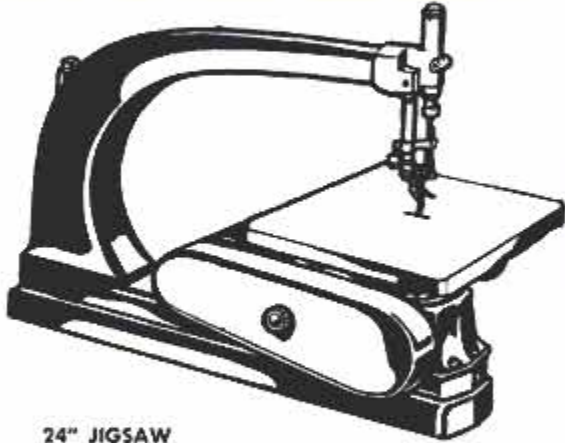

24" JIGSAW

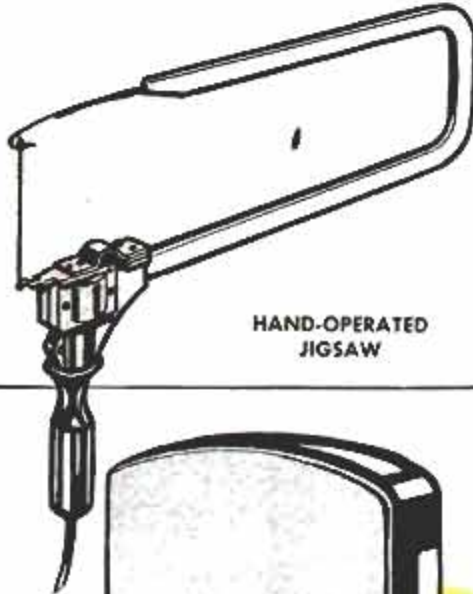

HAND-OPERATED
JIGSAW

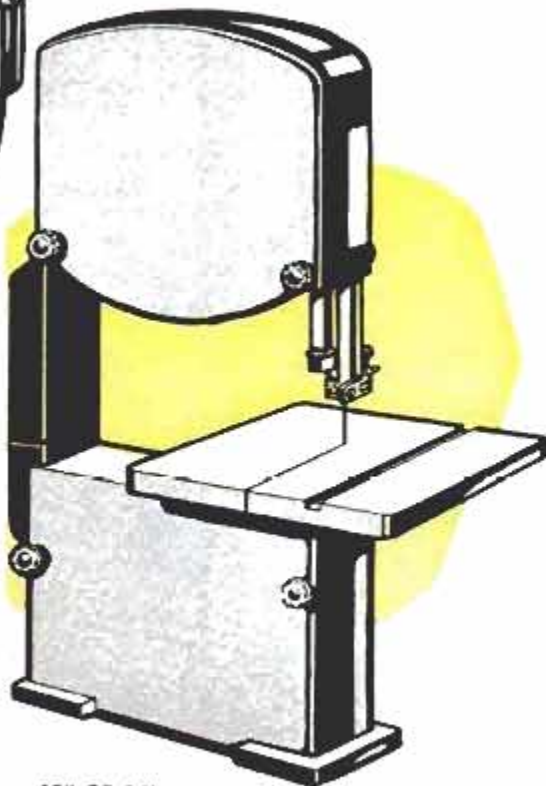

12" OR 14"
BANDSAW

and finish the project you still will need the portable drill, the sanders and also the jigsaw if any curved cuts are required by the design. You also will need chisels and a wooden mallet or hammer to finish the mortises square. Or, you can carry out all these final operations with the supplementary hand tools such as the brace and bits, wood chisels, hand-sanding pads and a coping saw for the curved cuts.

Now to go a step farther toward a complete machine-made project. Add the jigsaw, the bandsaw and the drill press shown on these pages and you have the necessary stationary equipment. The jigsaw and bandsaw will enable you to handle the curved cuts. The bandsaw will make any curved cut starting from the edge of the stock. The jigsaw will make curved cuts starting from the edge and also will make any curved cut which does not permit running in from the edge. The drill press with accessory mortising equipment will handle mortises up to $\frac{1}{2}$ in. wide. Matching tenons are cut on the circular saw.

Now, before going farther there are several points to be noted: The work must be carried to the stationary power unit, never the unit to the work. Also, portable power tools often fit in well with stationary power tools and in some cases can supplant them. For example, suppose you already have all the portable power tools pictured on page 208. The two sanders you will always have

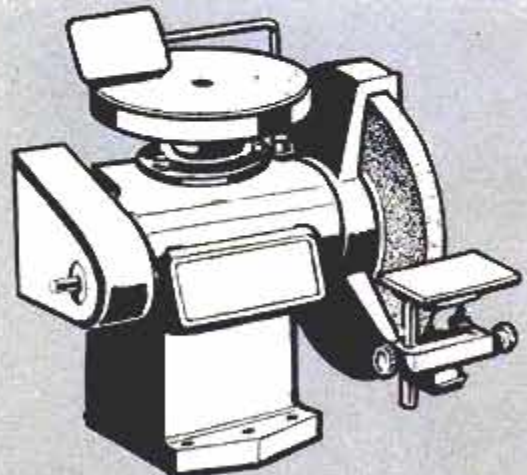

COMBINATION GRINDER
AND HONE

use for; the same is true of the portable drill. The portable jigsaw, as an example, can substitute for both the 24-in. jigsaw and the bandsaw. Although somewhat slower, it will make any common curved cut that can be made with either of these machines on stock up to 2 in. or so in thickness. Of course, the portable unit will not work in as short a radius, due to its saber-type blade, as the conventional jigsaw or bandsaw and the cut will not be quite as smooth. Any portable power tool designed to be operated freehand cannot be expected to equal the fine accuracy of the conventional stationary units where squareness of cut or size are factors. When used with floor or bench stands which are available as accessories, the portable electric drill, circular saw and jigsaw approach the conventional stationary units in accuracy of cut on such common operations as crosscutting, ripping, mitering, drilling and jigsawing. Such portable tools as the sanders do not classify with the others as accuracy of cut is not a factor in their operation. Keep these differences in mind when selecting portable and stationary power tools.

If you're strapped for shop space and there's no practical way to enlarge the working area, then consider a combination power unit such as that illustrated below. Basically it combines a circular saw, drill press and wood lathe in a single stationary floor-type unit. A jointer, bandsaw, jigsaw and paint sprayer are available as accessories for some combination units. Special-purpose tools are the

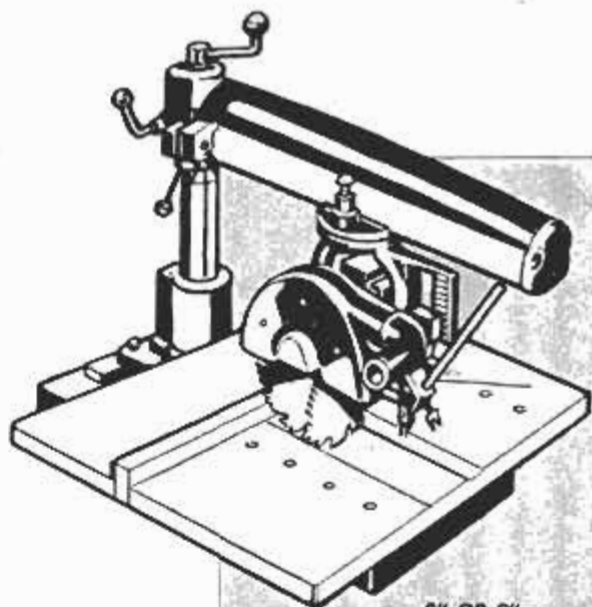

8" OR 9"
RADIAL SAW

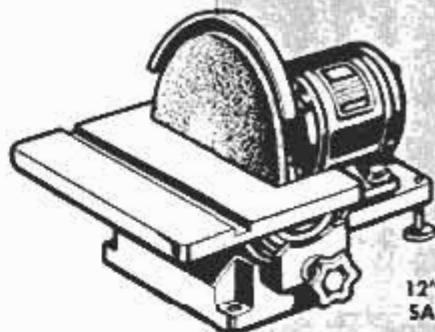

12" DISK
SANDER

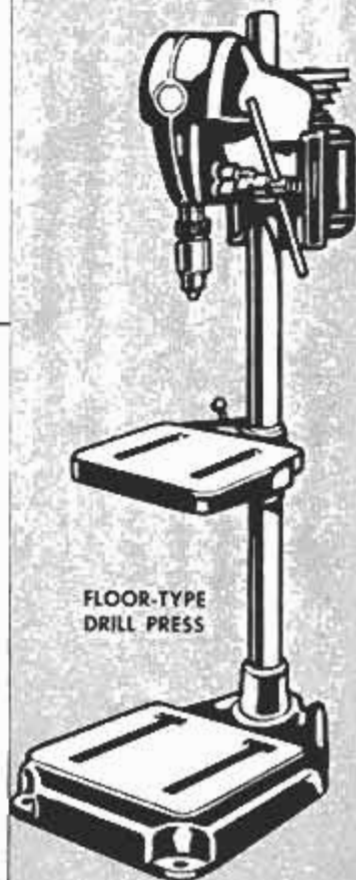

FLOOR-TYPE
DRILL PRESS

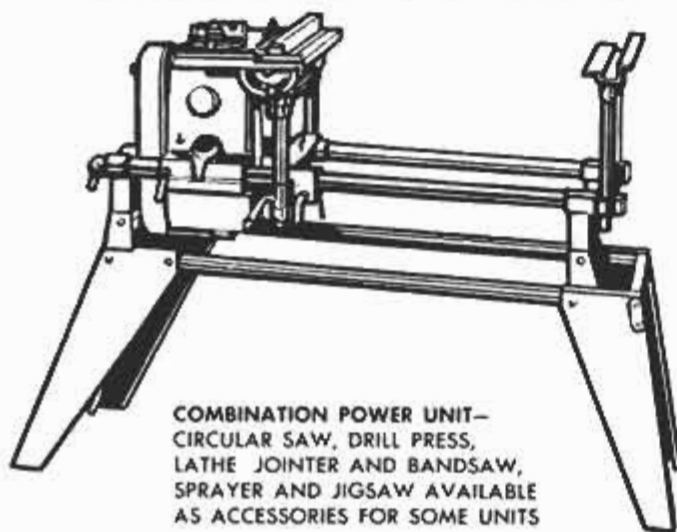

COMBINATION POWER UNIT—
CIRCULAR SAW, DRILL PRESS,
LATHE JOINTER AND BANDSAW,
SPRAYER AND JIGSAW AVAILABLE
AS ACCESSORIES FOR SOME UNITS

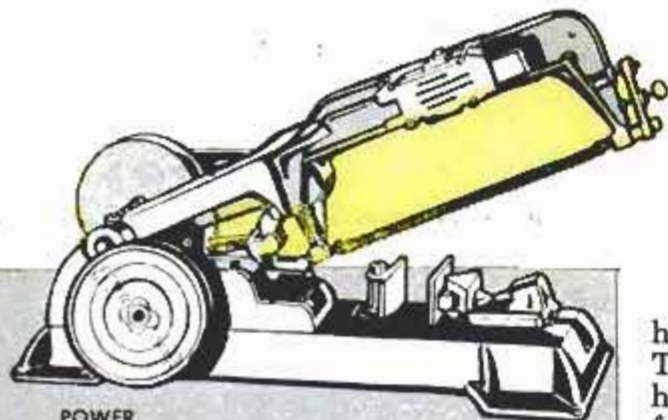

POWER HACKSAW

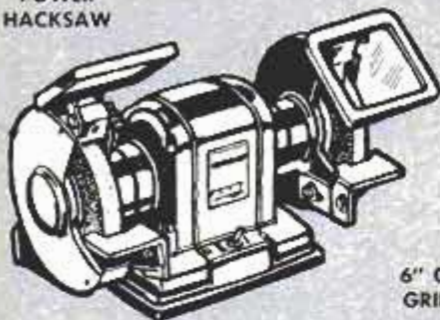

6" OR 8" GRINDER

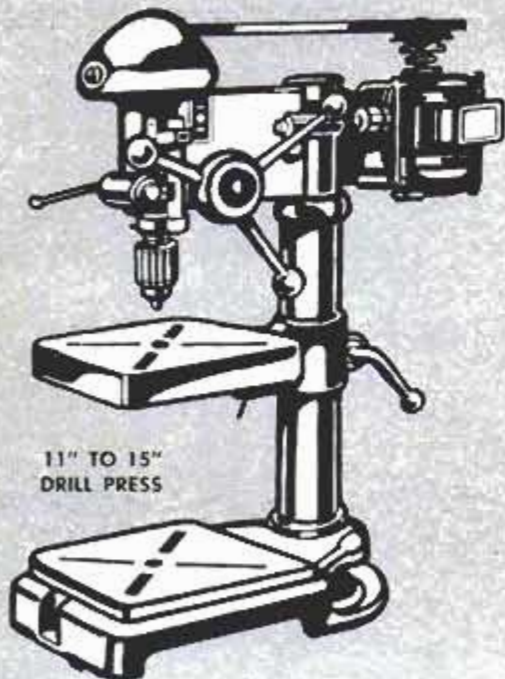

11" TO 15" DRILL PRESS

hand-operated jigsaw and the disk sander. The former is a high-speed jigsaw, hand-held while operated, and especially good for light hobby work on thin stock. You can't beat a disk sander for rounding corners, squaring end grain and truing miters. It's fast and effective for squaring small parts. And, of course, every shop needs a grinder for sharpening tools. There are two types to choose from, the all-purpose type shown at the left and the grinder-hone on page 210.

Many craftsmen, faced with a choice of the table saw or radial saw, for space or budget reasons, would settle for the radial saw. In considering the two machines, the choice is not so much a matter of accuracy or preference; it is more a matter of adaptability of one or the other to the purpose.

A metalworking lathe with accessories available is almost a metalworking shop in itself. The power hacksaw is a timesaving tool if you have much cut-off work on metal rounds, squares and angles. Otherwise a hand hacksaw will serve. The grinder is a must in the metal shop; also, it would be difficult to get along without the drill press, either the bench type shown at the left, or the floor type shown on a preceding page. The drill press will, of course, handle both wood and metalworking jobs. The metal lathe can double as a wood lathe with the use of wood-turning centers and tool rest, but is not as effective as the standard wood lathe. ★ ★ ★

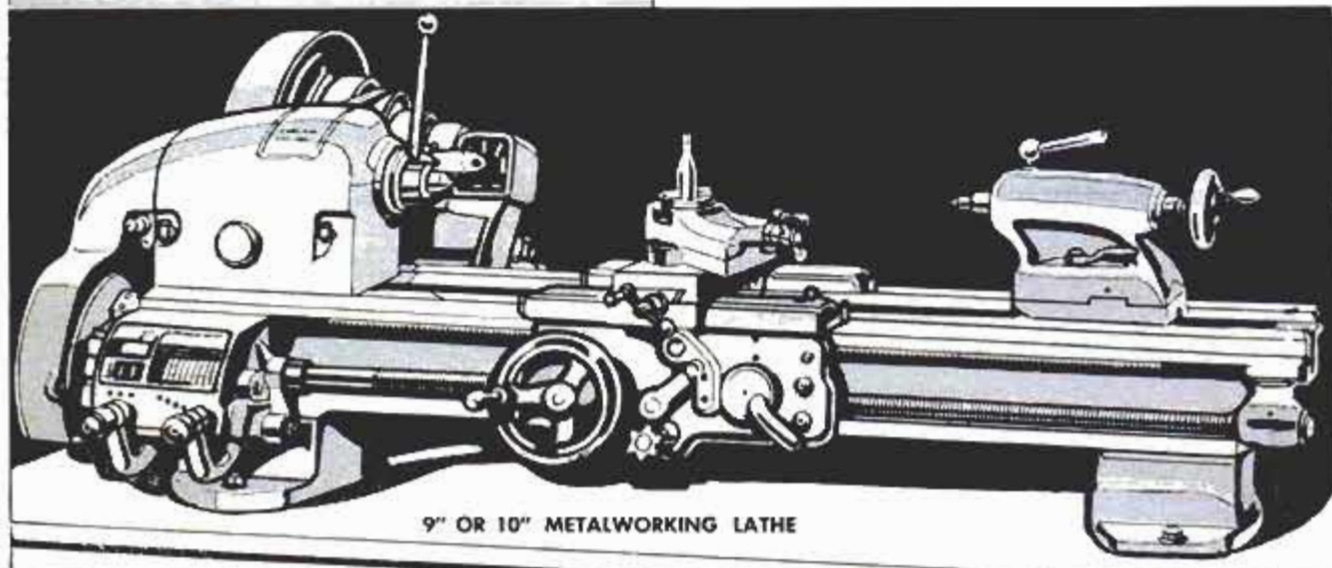

9" OR 10" METALWORKING LATHE

Ship-Model Mountings From Drawer Pulls

Give your ship model a "custom made" mounting by using brass drawer pulls of the type that have a wood screw attached. First cut off the screw, then file or saw a slot in the pull. Dimensions of the slot are determined by the size of the keel on the model. The opposite end of the pull now is drilled and tapped to accept a $\frac{3}{16}$ -in. machine screw, which is used to hold it to the mounting base. The keel of the ship is cemented into the slots.

Otto Merker, Chicago.

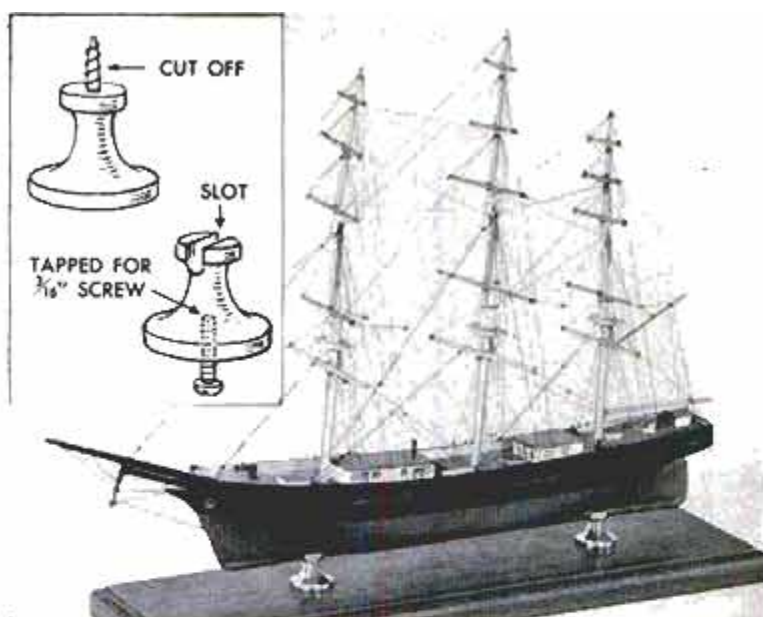

Steel Angles Drilled With Aid of V-Blocks

If you have experienced difficulty in holding steel angle for drilling on a drill press, try using a pair of ordinary V-blocks. For drilling through the inside corner of the angle, place the angle in the V-blocks as shown in detail A. When drilling through the web, position the angle as indicated in detail B. To prevent drilling into the V-blocks, space them apart as shown so the drill will pass between them when it breaks through the angle. Clamp both V-block and angle solidly to the table of the drill press for safety. The clamps have been omitted from the illustrations for the sake of clarity, but definitely should be used.

C. W. Woodson, Chicago.

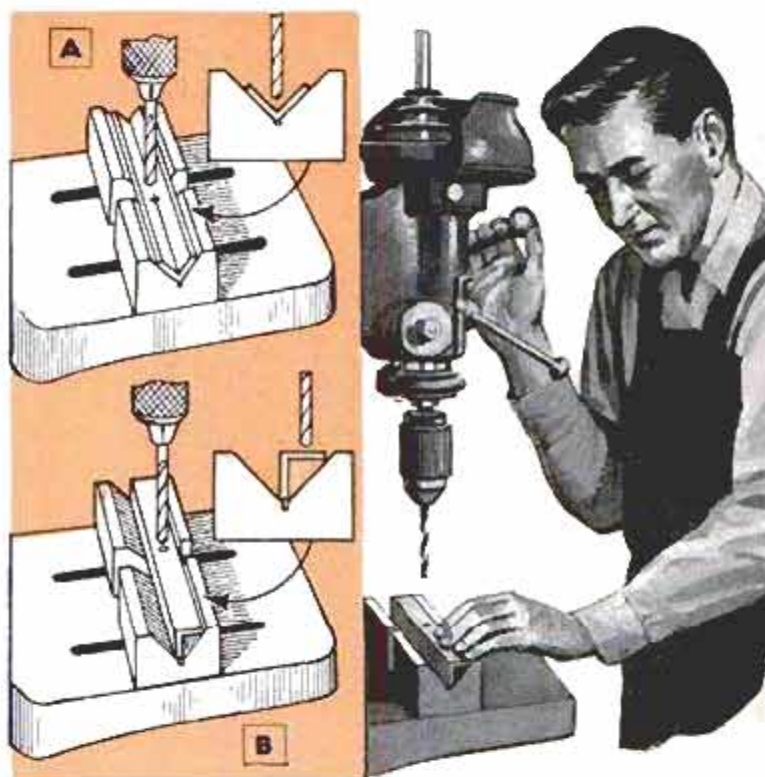

Work Supported For Saber Saw

Using a portable saber saw requires that the work to be cut is supported high enough so the saw blade stays clear of any other surface. This can be accomplished by using a piece of perforated hardboard in which are fitted a number of dowels. The dowels should project $\frac{1}{2}$ in. or more. To make "nonslip" dowels, saw off a number of inexpensive lead pencils near the eraser end. The erasers will hold the work against saw vibration and clear of the blade.





True Holes With Woodboring Bits

By C. W. Woodson

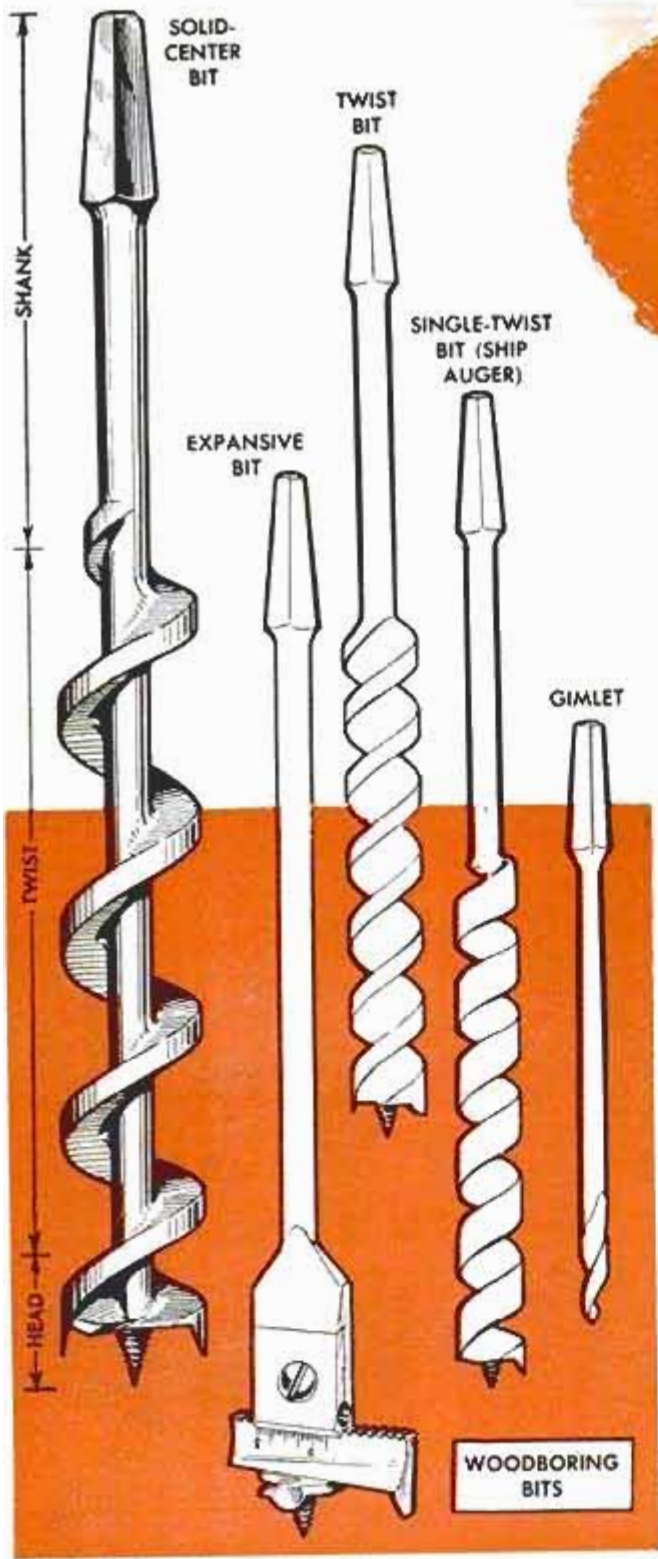

Above, common types of woodboring bits for use in a brace. Below, cutter of expansive bit is adjustable. Right-hand detail shows parts of standard auger bit

AS IT CUTS its way into wood, a woodboring, or auger, bit performs several operations simultaneously. The screw point draws the bit into the wood at a uniform rate, the spurs make a circular cut of a given diameter, the cutters lift the waste and the twist, or auger, carries the chips upward. Common woodboring bits of several types are detailed at the left. These are made with squared and tapered shanks for use in a hand brace. Solid-center and twist bits for use in a brace are regularly supplied in sets from 1/4 to 1 in., rising by 16ths. The expansive bit is designed to bore shallow holes of varying diameters as at A, B and C in the lower left-hand detail. It comes in several sizes. The single-twist bit, also referred to as a single-spiral bit and ship auger, is designed for boring deep holes. A machine bit similar to the brace type pictured also is available. Gimlet bits come in sizes by 32nds, from 1/32 in. up.

Power bits for use in drill presses and portable electric drills are designed for high speeds. Three common types are shown on the opposite page but there are many variations designed for special purposes. The wing-type, or spade-type, bits usually are supplied in sets, the door-lock bit is generally purchased individually. The term "door lock" more often refers to this type of bit made with a squared shank for use in a brace. When made with straight or shouldered shank it is supplied in single and multiple-spur types. The Forstner bit is made with straight shank and also with squared shank. It has a continuous lip which guides the bit and severs the wood fibers ahead of the single cutter. ★ ★ ★

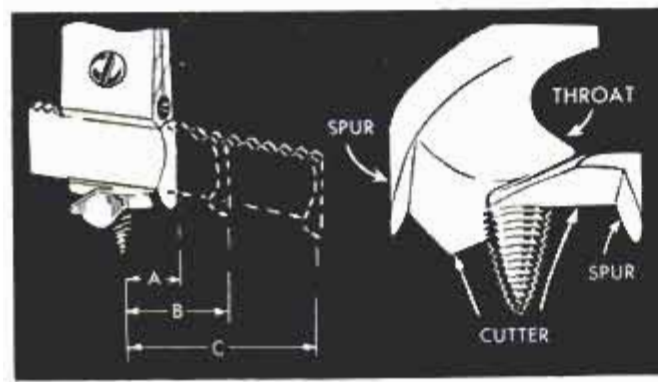

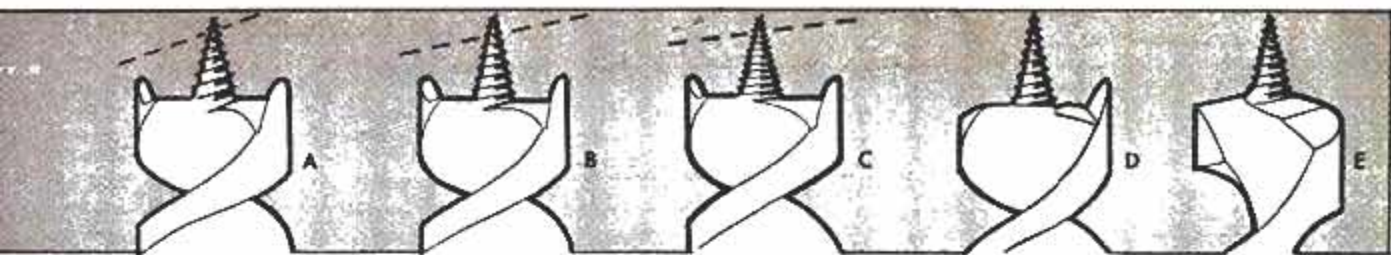

Screw point of auger bit is supplied in various pitches so that feed can be varied to suit type of work. Sharp pitch, detail A, feeds bit rapidly, makes heavy chip in soft wood. Medium-pitch screw, detail B, is used on general-purpose bits. Slow-pitch screw, detail C, feeds bit slowly, is best for use in very hard woods. Detail D shows fast-cutting bit with one spur. Detail E shows a fast-cutting bit without spurs

Below, typical of high-speed bits for use in drill presses and portable electric drills are the three types detailed. Forstner bit comes with 1/2-in. shank, others with 1/4-in. shanks for use in portable drills



Details A, B and C above show how auger bit works. In detail A, screw pulls bit into wood. Detail B, spurs score wood to hole diameter. Detail C, lips cut and lift chips into the throat

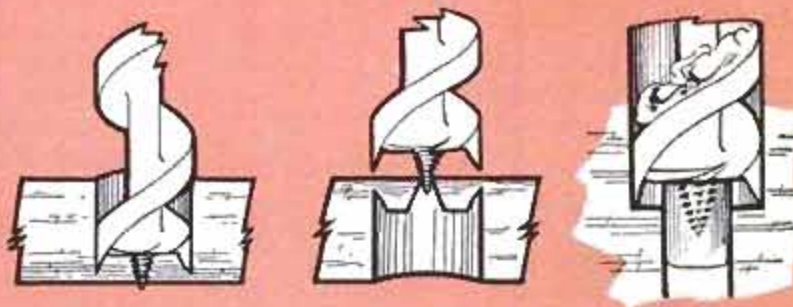
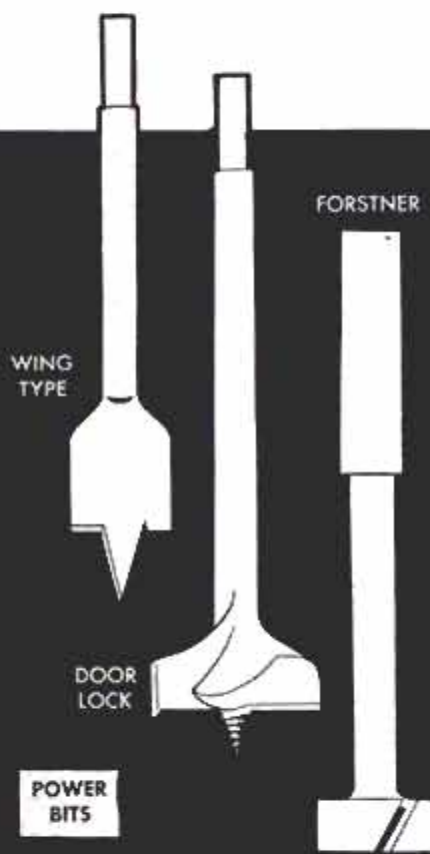

To avoid splintering stock when bit comes through, stop boring when screw projects slightly as at left, above. Withdraw bit, invert stock and bore out waste as in center detail. In counter-boring, bore small hole through. Select short length of dowel to fit small hole and turn onto lead screw to center counterbore

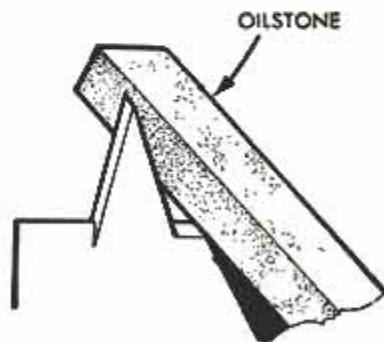
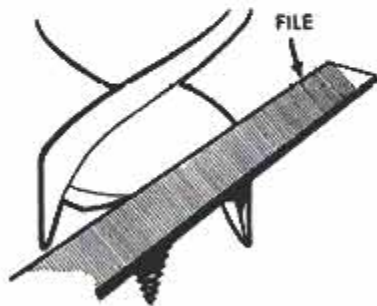
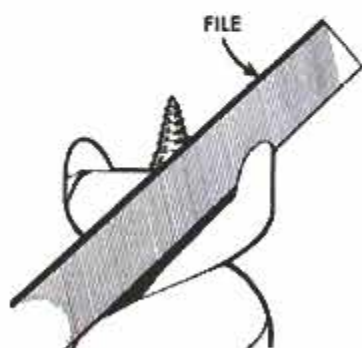

Use a small single-cut file to sharpen spurs and lips of an auger bit or, better still, use an auger-bit file or a Swiss pattern file with a safe edge. Wing-type power bits can be sharpened with a small abrasive stick, or oilstone, as in right-hand detail. Auger bits in larger sizes also can be sharpened with abrasive stick

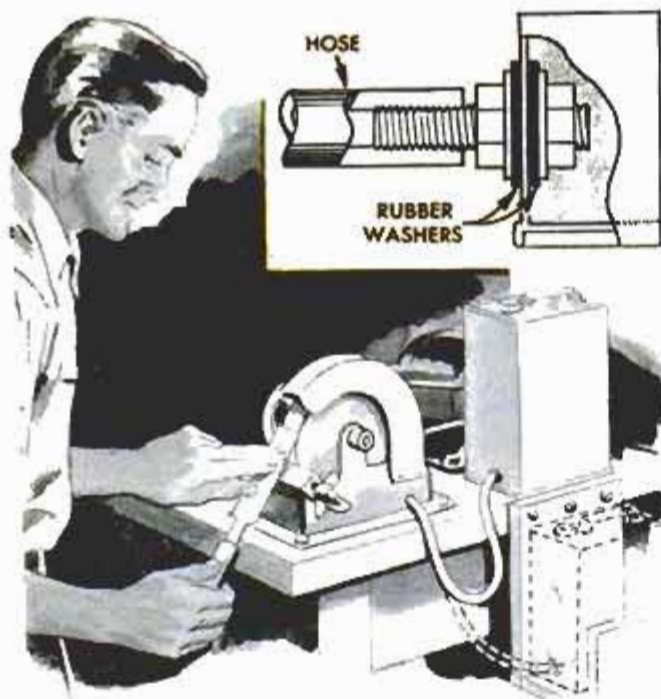

Auxiliary Tank for Grindstone Provides Handy Water Supply

For a convenient means of providing automatic filling and draining of the water reservoir on a wet grindstone, one home craftsman connected an auxiliary water tank to the reservoir as shown. When the tank is placed on top of the workbench, water flows into the reservoir through a small rubber hose, the ends of which are coupled to fittings installed on the tank and reservoir as indicated in the detail. When the tank is placed on the wooden holder screwed to the side of the workbench, the water flows back into the closed tank where it will not evaporate between times of use. Also, the grinding wheel does not become rust-stained as when water remains in the reservoir for long periods of time.

Side Door on Machine Shed Helps Store Farm Implements



Less time and effort are required when storing equipment in the large machine shed on this farm since the owner installed a 16-ft.-wide overhead garage door on one side of the building as shown in the photo. Before installing the overhead door, all machinery had to be backed into the shed through a door at one end, a difficult and time-consuming job. Now most of the equipment is trailed into the building and parked while still hitched to the tractor drawbar, permitting more compact storage of machinery and easier removal.



U-Clamp Latch Holds Double Gate Rigidly Together

To provide a simple locking device for a double gate without a center post, one farmer formed eyes on the ends of a length of steel rod and then bent it into a long U-shaped clamp that is bolted to one of the gates as shown. When swung to engage the gate opposite it, the U-clamp holds both gates rigidly together.

Emergency Ignition Repair

An old but still-serviceable ignition coil is a good spare part to have on hand when your car develops coil trouble on the road. Stored in the trunk for such an emergency, all you have to do is tape the spare coil to a support, disconnect the wires from the bad coil and connect them to the spare one.

M. Robert Beasley, Jackson, Mich.

BENCH JOINTER FROM A RASP

A rasp of the type known as Surform, with multiple cutting edges, can be made to serve as a handy bench jointer for edging small wooden parts. The rasp blade is removed and the frame is attached to a base as in the photo and detail below. Ordinarily, a straight fence screwed to the base with the face at 90-deg. to the rasp blade will serve the purpose, but you can add a tilting fence for beveling thin stock. Just hinge the fence at two points. The quadrant, which locks the fence at any angle, is made by bending a length of coat-hanger wire to form a U-shape, then bending the ends outward at right angles. Assemble a quadrant lock by using a 1/4-in. machine screw, a wing nut, two washers and two spacer nuts.

Metal frame of the rasp is attached to base with small blocks screwed in place. The swinging guard detailed at the right is optional. It does protect fingers in case of a slip

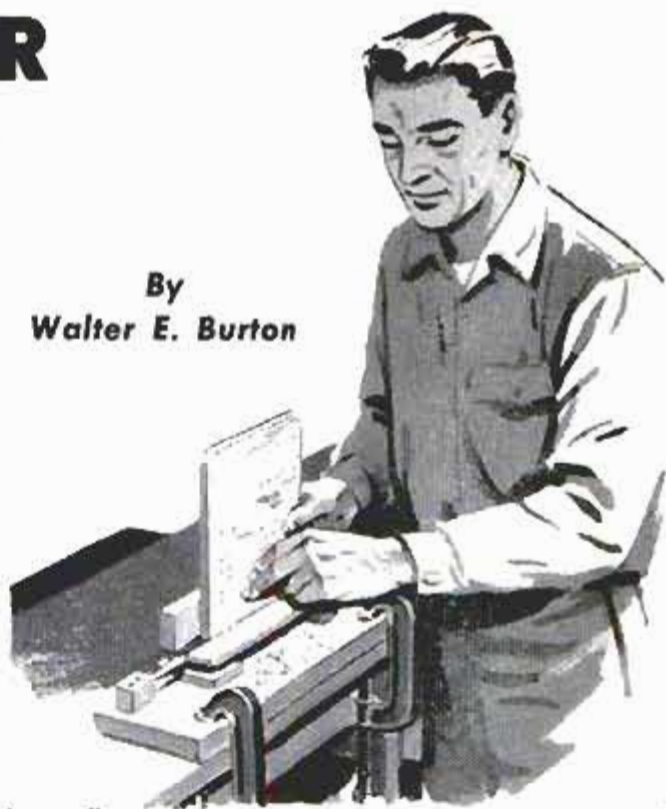

By
Walter E. Burton

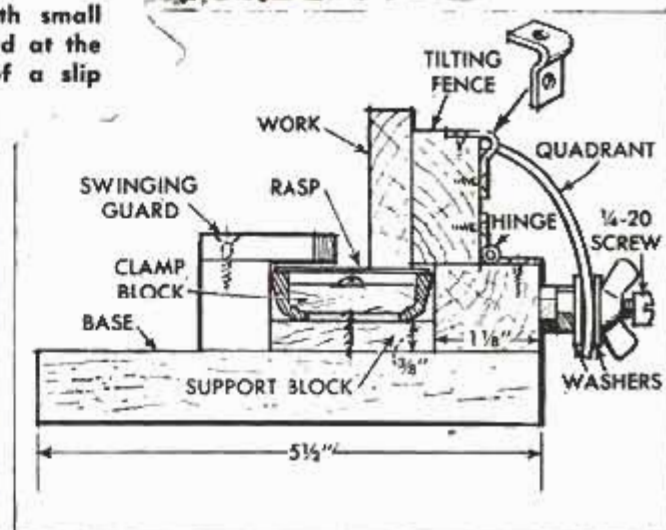
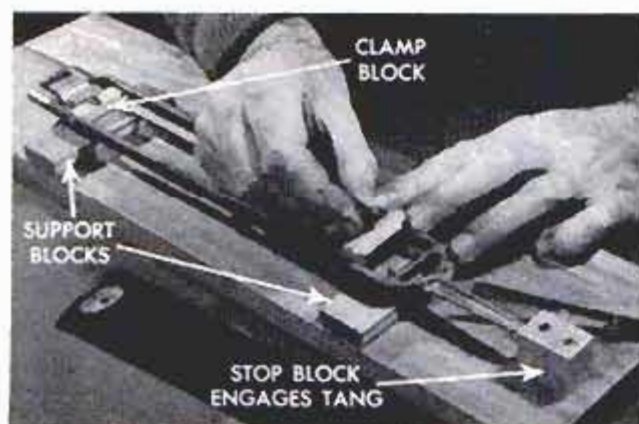

This Adjustable Depth Stop Controls Spotfacing Cut

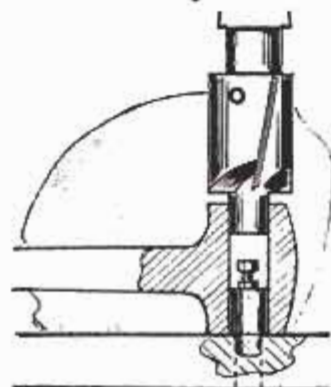

When spotfacing at both ends of a through hole it is in many instances desirable to control the depth of cut accurately. One way is to make a depth stop from a short length of round stock of the same diameter as the

hole to be spot-faced. Center-drill and tap the round for a capscrew. Then the screw is adjusted so that when the pilot on the spotfacing tool engages the head of the screw, the cut will be the correct depth.

F. La Saracina, New York City.

Tapered Wedge Steadies Lathe Toolholder

This wedge-and-angle ring was developed by a machinist to correct stubborn tool chatter on a special machining job. The regular tool-post ring is replaced by a special ring having plane surfaces at an angle as indicated in the detail. The toolholder is supported on a wedge having opposite faces ground at the same angle as the surfaces of the ring. When mounted in the tool post and centered the holder is supported rigidly.

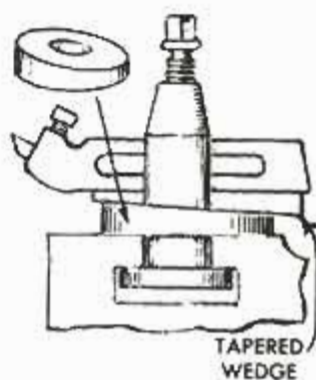

Federico Strasser, Santiago de Chile.

SHOPPING FOR TOOLS

1. MANUALLY OPERATED BENDER makes short work of bending deformed rods of the type used as concrete reinforcement. Bends rods from $\frac{1}{4}$ to $\frac{3}{4}$ in. in diameter. Can be adjusted to produce identical shapes and radii to conform to any building-code requirement
Clyde Mfg. Co., Bridgeway and Turney, Sausalito, Calif.

2. DRILL BIT is carbide-tipped for drilling hardened steels, 40 to 65 Rockwell C, without annealing, reworking and rehardening parts. Bits drill cleanly and to size, often eliminating need for reaming. Available in sizes from $\frac{1}{16}$ through $\frac{3}{4}$ inch
Chicago-Latrobe, 411 W. Ontario St., Chicago 10

3. CONTOUR SCRIBER gives a perfect fit every time when laying linoleum and tile. Scribes precise contour of wall irregularities, trim shapes and pipe diameters on the surface of linoleum or tile before placement. Has extension bar for wide adjustment
Charles Machine Co., Box 63, Springfield, N. J.

4. TUBE CUTTER includes a spare cutting wheel and reamer (inset). Cuts copper, steel and aluminum tubing from $\frac{1}{8}$ to 1 in. outside diameter. During cutting operation, tubing is backed up by two wide rollers which eliminate possibility of deforming tube
Imperial Brass Mfg. Co., 6300 W. Howard St., Chicago 31

5. ADJUSTABLE MOTOR BASE takes motors up to 30 hp. Can be used with variable-speed drives as well as constant-speed drives as it has a special swinging latch to permit changes in sheave diameter. Adjusting screw tightens belts to just the right tension
The American Pulley Co., 4200 Wissahickon Ave., Philadelphia 29, Pa.

6. ALUMINUM SOLDER requires no flux or cleaning of metal. Just heat metal to soldering temperature, 500 deg. F., and apply solder to joint. Also joins copper, brass, galvanized or aluminized metals. Available in rods for home use, in bulk for industrial use
Chemalloy Electronics Corp., Gillespie Airport, Santee, Calif.

7. HEAVY-DUTY CHAIN VISE comes in two sizes to take pipe from $\frac{1}{8}$ to $2\frac{1}{2}$ in. and from $\frac{1}{8}$ to 4 in. Each vise has reversible front and back jaws with an interlocking device which prevents any misalignment
Erie Tool Works, Erie, Pa.

8. MILLING ATTACHMENT for mounting on lathes, milling machines, turret lathes, planers and boring mills has 6 speeds ranging from 200 to 900 r.p.m. Spindle height from base to center line of spindle is 2 in.
Alva Allen Industries, 1001-15 N. 3rd St., Clinton, Mo.

9. BALL-BEARING LATHE CENTER fits over the standard lathe tailstock center and rotates with work. Because rotating center is machined and ground to a close fit over the 60-deg. tailstock center it runs true, takes end and lateral thrust of the work
Stephen De Losa, 365 Union St., Brooklyn, N. Y.

(Continued on page 220)



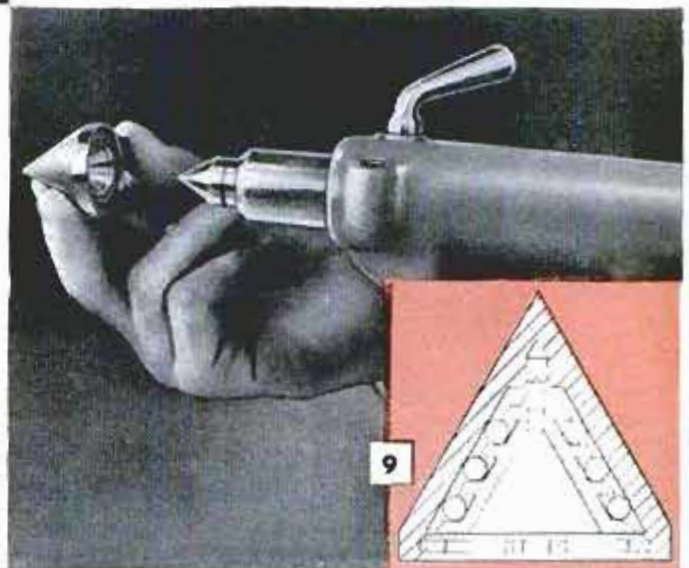
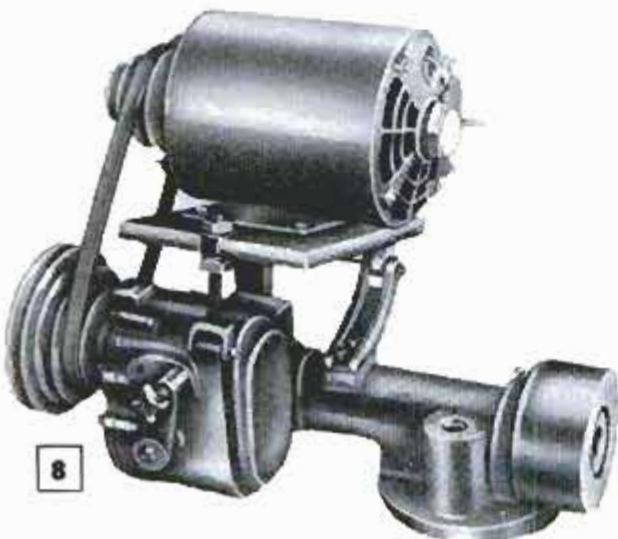
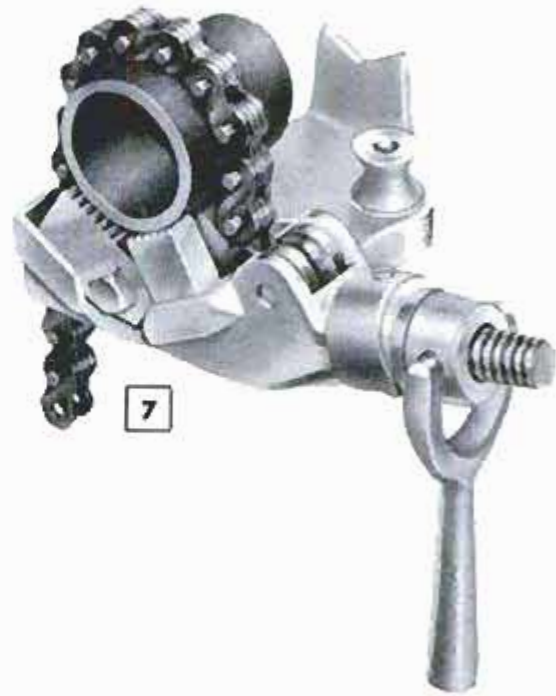
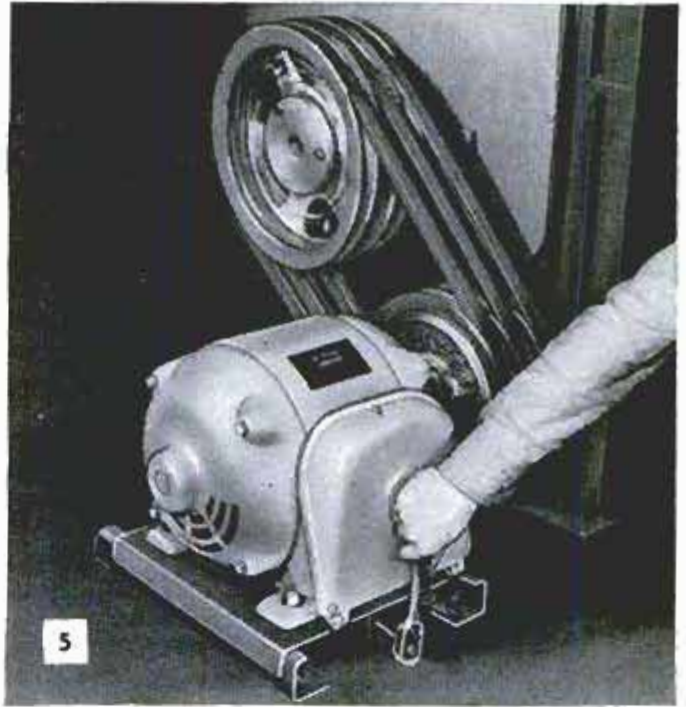
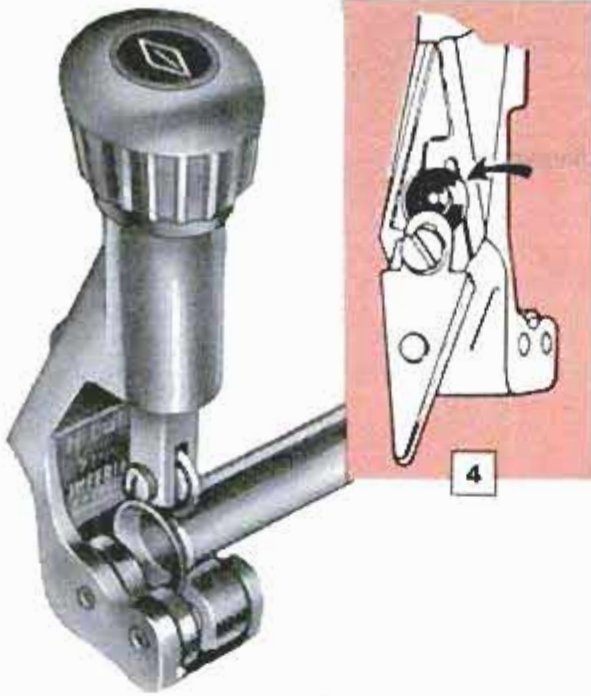

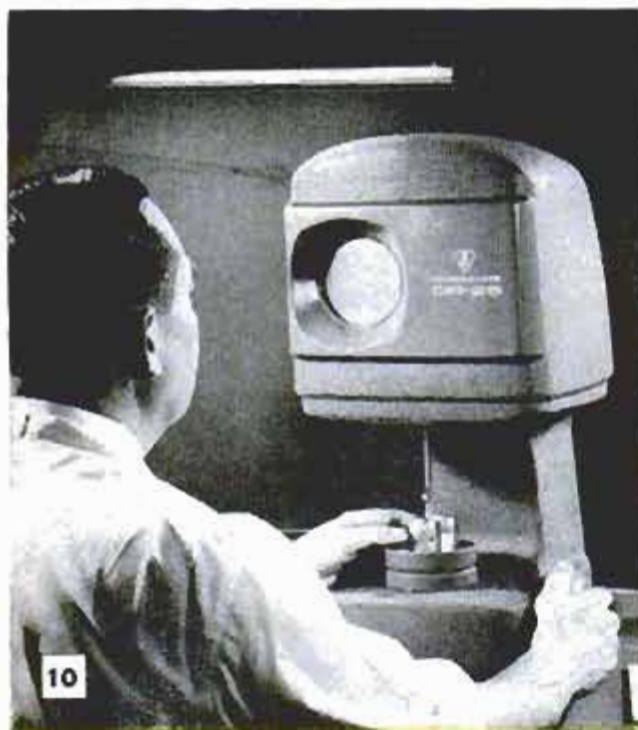

10. OPTICAL GAUGE that reads direct to .0001 over a 3-in. range has been made available for all-purpose inspection and quality control of small, precise parts. Measurements are read directly on illuminated, magnified scale graduated in clearly defined, least-reading intervals of .0001, with accuracy of .000025
The Do-All Company, Des Plaines, Ill.

11. COUNTERBORE SCREW has 12-point head, turns flush into counterbored hole as in right-hand photo. This feature, plus advantages of 12-point, or double-hex, head, makes wrenching in or out easier and more positive in close quarters. Screw head is flanged so that 12-point thin-wall socket fits counterbore snugly
The Ferry Cap & Setscrew Co., 2151 Seranton Rd., Cleveland 13, Ohio

12. SPEED CONVERTER, or speed changer, for drill press mounts entirely within drill-press head. Speed range is from 400 to 7000 r.p.m. Unit includes a balanced 4-step cone pulley, mounting brackets and hardware, locking knob and 17-in. V-belt. Included is reference sheet of speeds for various materials
Toolcraft Corp., Plainfield St., Springfield, Mass.

13. PORTABLE MASONRY SAW cuts bricks, concrete blocks, natural stone and structural tile either dry or wet. Cutting head is adjustable to clear 8-in. materials, takes abrasive, safety or diamond blades, or disks. Head can be removed for easy, one-man handling. Motor is 1/2 hp. (1-hp. motor available) and is dustproof
Robert G. Evans Co., 6024 Troost, Kansas City 10, Mo.

14. SHAFT-MOUNTED SPEED REDUCERS with rated capacities from 1/2 to 40 hp. are now available for maximum power-transmission efficiency in both single and double-reduction units. Automatic overload-release torque arm is built into both units to protect driven machines and motors from shock and overload
Footo Brox, Gear & Machine Corp., 45-45 S. Western Blvd., Chicago

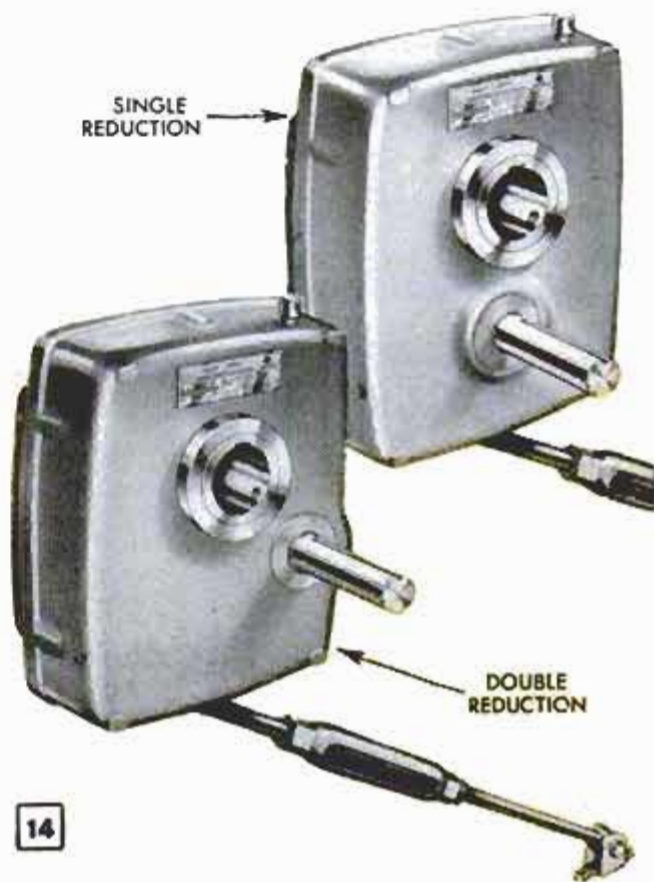
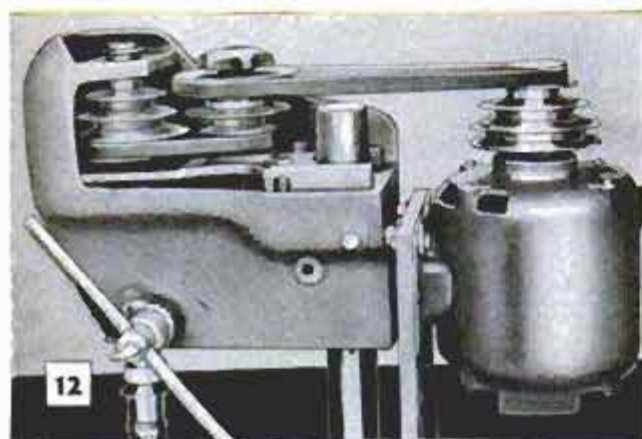
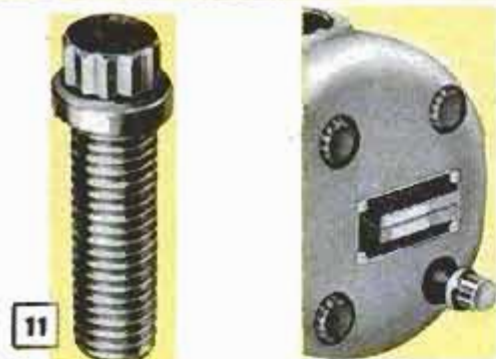

HAPPY THE HOME

full of wonderful gifts like these!



The nicest gifts keep on giving

Look for
**POPULAR MECHANICS
CHRISTMAS DISPLAYS**
at dealers everywhere

Select several
for your home
and family
from the
many exciting
pages in
this issue

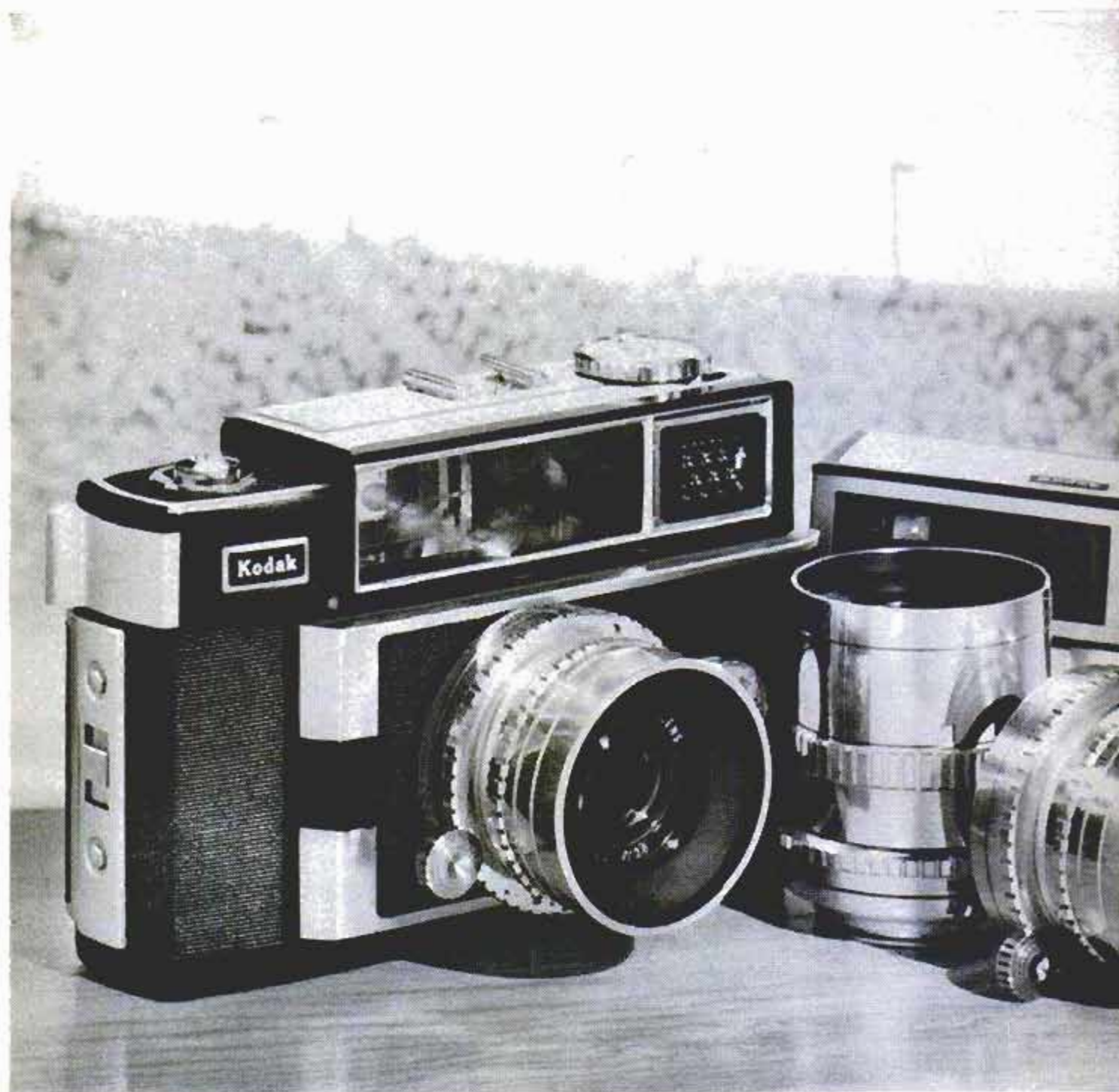

Wide range of photo aids includes wide-angle lens 35mm $f/3.5$, \$57.50; telephoto lens 90mm $f/4$, \$69.50; Multiframe Finder, \$17.50. Many other specialized aids.

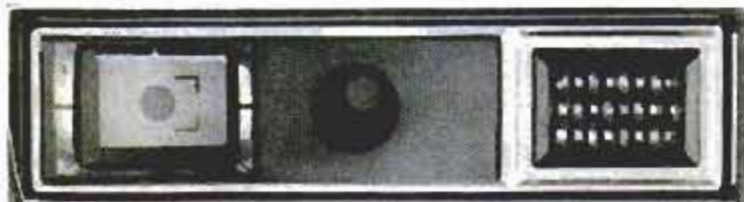

Smartly housed in camera control tower are the expert's devices for superior pictures—big-as-life viewfinder, precision rangefinder, sensitive photoelectric exposure meter.

Kodak
TRADEMARK



Precise exposure control—built-in meter reads the light for you. Simple EV settings. For films 10 to 6400 ASA.



Precise focusing—get sharp pictures at all distances with lens-coupled rangefinder. Just bring images together.

See Kodak's "The Ed Sullivan Show" and "The Adventures of Ozzie and Harriet"

NEW FROM KODAK

The **KODAK SIGNET 80**

**An expert's camera that does everything . . .
so precisely, so easily!**

Many cameras can do all the experts ask—as long as the experts are operating them. Now Kodak, in the American tradition, simplifies fine 35mm photography for expert and beginner alike.

The new Kodak Signet 80 Camera brings you all the rich rewards of photography at its finest: shooting pictures that others find hard to get . . . capturing the best in color . . . in black-and-white . . . action . . . closeup or distant view . . . in good light or bad.

You see your picture in *natural size* in the new eye-level viewfinder. You focus with extreme accuracy, right down to 30 inches with *all* lenses. The built-in photoelectric exposure meter is ultra-sensitive, gives you dependable light readings for even the most critical color film exposures.

You can switch instantly to a wide-angle lens, to capture the broad sweep of a scene . . . or to a telephoto lens, to reach across space for distant subjects.

The fast film advance lets you stay on top of action pictures . . . click off rapid sequence shots. And each time you advance the film, the shutter sets automatically.

The new lenses developed by Kodak for the Signet 80 Camera are made with rare-element glass and are Lumenized. They assure crisp detail and superb color correction in both slides and Kodacolor snapshots.

See your photo dealer now. Ask him to demonstrate the brilliant new Kodak Signet 80 Camera. With 50mm *f*/2.8 lens, \$129.50.

(Prices are list, include any Federal Tax, are subject to change without notice.)

Many photo dealers offer terms as low as 10% down.



Precise view framing—you shoot exactly what you see. Finder always shows your subject in *natural size*.



Instant film loading—you drop the film in—no threading. It's the quickest, simplest 35mm loading ever devised.



Rapid film advance—you can get shots in rapid sequence. Advance film with couple of quick thumb-flicks.



Quick lens interchange—you lift out normal lens instantly—drop in supplementary lens. No tricky mechanical match-up.

EASTMAN KODAK COMPANY, Rochester 4, N.Y.



**NO GUESSING
NO SQUINTING**

*with this
easiest-to-read
of all "mikes"*

Bigger Barrel. Graduation lines are farther apart and numbers are larger for fast, accurate reading.

Exclusive Cam Lock. A flick of your thumb and you lock the setting so it can't be accidentally changed. Prevents costly errors in reading.

Simple Adjustment. Takes only a few minutes. Reading line always stays in original position.

Chrome Clad Finish. Black-filled markings contrast with nonglaring, chrome finish for easier reading in any type of light.



Always buy from your distributor

THE LUFKIN RULE COMPANY

TAPES • RULES • PRECISION TOOLS
SAGINAW, MICH. • MIDDLETOWN, N. Y. • BARRIE, ONT.

Clinic for Homemakers



As a service to our readers in solving the hundreds of problems pertaining to a home—inside or out—the editors of *Popular Mechanics* invite you to present your problems to the Clinic Editor for help and advice. Address your questions to The Clinic Editor, *Popular Mechanics Magazine*, 200 East Ontario Street, Chicago 11, Ill.



Removing Wax

Q—The linoleum in my kitchen is old. I'd like to varnish it but have been told the wax must be removed. It's inlaid linoleum and is still in good condition but it's dull and colorless. I'd like to keep it in service for awhile, but how do I get the wax off?

— I. S., Del.

A—Are you sure the coating to be removed is wax and not varnish? Often it is rather difficult to determine with certainty by the appearance of the floor alone. So it's best to make a simple test in some inconspicuous place on the floor. Apply a few drops of turpentine to the spot selected and rub rather vigorously with a soft cloth. If the linoleum is coated with wax only, the turpentine will soften and remove the wax quite easily. It will not, however, soften varnish of the type usually used on linoleum. If the test shows the coating to be wax, then it can, of course, be removed with the turpentine, but precautions must be carefully followed through. Place a fan near an open window to remove the fumes. Open all doors and windows. If you have a gas range, shut off the pilot, or pilots, if there are more than one. Do only a small area at a time and wash with soap and warm water and wipe dry before applying turpentine to an adjacent area. When the job is finished clean with a fairly strong soap solution and wipe dry. Be sure the floor is thoroughly dry before applying the linoleum varnish. When applying the latter be sure to follow instructions in all details.



Controlling Coke Fire

Q—My hot-water heating plant is an older type and is hand fired. I burn coke and have had difficulty controlling the fire on cold, windy days. My house is full two-story with attic. The chimney is straight and is, of course, higher than average. The boiler

has regular dampers and there are check and turn dampers in the smoke pipe. What can I do to obtain better control of the fire?—W. H., Ohio

A—It's rather difficult to say with certainty without an on the spot examination of the installation. The burning rate of such fuels as coke is affected by so many variable factors that each heating installation is an individual problem. However, we would experiment with the firing routine

(Continued to page 226)

SPECIAL INTRODUCTORY PRICE



\$4.95
COMPLETE

REGULARLY \$5.90

from



NEW PERMA-GRIT* SAND 'N PLANE KIT

works wonders in your home

Completely new Hand-Sander and Sander-Plane really speed through do-it-yourself projects. Each tool has a working surface of Tungsten Carbide particles permanently bonded to steel. Stays sharp for years and years. Ideal for smooth finishing of wood, plastic, wallboard, compositions or leather. Makes removal of paint or varnish easy.

On the "Perma-Grit" Hand Sander, one Tungsten Carbide sheet outlasts hundreds of paper sheets. Sands twice as fast... always ready to use when you need it. Comes in kit with fine grit sheet, but other types also available.

For sanding doors, windows, cabinets, try the "Perma-Grit" Sander-Plane with its convenient handle and front grip. Extremely handy in every workshop—files, sands, planes, shapes or notches. Removes material in half the time as it works forwards and backwards. Reversible blade for fine and coarse work.

*Trademark of SKIL Corporation



NEW! "Perma-Grit" Files

Cut working time in half. Remove material on both forward and backward stroke or in circles. For shaping, filing and notching on flat or curved surfaces of wood, compositions, plastics.

Flat File (Medium 80 grit one side; coarse 46 grit other side).....\$2.25

Contour Files (Coarse or Fine)...\$1.95

"Perma-Grit" 5-in-1 Wheel

For table and radial saws

Saws, sands, shapes, ploughs, dadoes with complete safety. Unlike tooth-type blades, it can't snag or pull—eliminates "kickback." Wide selection of grit types on edge and sides.

8" Diameter.....\$9.95 and \$10.95

10" Diameter.....\$14.95 and \$15.95

"Perma-Grit" Blades also available for portable saws.

For a tight grip
in tight places...



The "Mighty Midget"

CHAN NEL LOCK

No. 424

This "mighty midget" is a natural for a tight grip on small work in hard-to-get-at places. Only 4-1/2" long... drop forged from high grade steel. Four exclusive Channellock precision grooved jaw adjustments... capacity to 1/2". Skilled mechanics say it's one of the handiest pliers in their kits. You'll say so, too!

CHAMPION DEPARTMENT TOOL COMPANY • MEADVILLE, PA.

ASK YOUR TOOL SUPPLIER
FOR A CHANNELLOCK No. 424



Be sure it's a genuine CHANNELLOCK
Look for the trademark on the handle

(Continued from page 224)

that you have been following and we also would make a careful examination of the condition of the boiler grates and also the fit of the fire door and especially the ash door and the lower damper. If these doors do not fit tightly when closed you are almost sure to have some difficulty controlling the fire where a strong draft is present, as in a high chimney on a clear, cold day. If the grates are warped they should be replaced as otherwise it will be difficult to maintain a thin ash bed under the live coals. If the fire door and dampers are loose and the meeting edges of door and opening are rusted and pitted, replace the hinge pins and file the meeting edges square so that the doors close tightly. Then try out a variation of the firing routine with more or less fuel, different damper settings and vary the amount of ashes left on the grates. You may find it necessary to set the check damper so that it never closes entirely when the lower draft is opened.



Fall Feeding Of Lawn

Q—Neighbors and friends tell me to spread plant food on my lawn in the late fall as well as in the spring. They say that plant foods can be spread any time before the ground freezes. But it seems to me that much of this application would wash or leach away. Is there any advantage in this procedure?—N.A., Kan.

A—On the heavier soils containing considerable silt and also clay the loss is negligible, if any at all. The reason for this is that ammonia forms of the nitrogen in complete plant foods supplied for lawn application combine with the clay in the soil. This might be called a temporary combination and is due to the fact that the micro-organisms, which break down ammonia into nitrates in warm soil, are not active when the soil is cold. Because of this the soil acts as a winter storehouse for any application of plant food. This is released in the spring in a form that can be utilized by plants and grasses. Of course, on a sloping lawn you always run a small risk of the plant food being carried to a lower level by a heavy late-fall rain, but this is really the only risk of appreciable loss. Be sure to follow application instructions on the plant-food container in all details. Ordinarily you will not need another application in the early spring.

Decorating Tall Windows

Q—How does one decorate tall windows in an old home? The windows are narrow and the tops of the frames are rounded, or semicircular. Two of these windows are in pairs, the others single. I'd thought of using cafe curtains but don't know how to hang them.—R. C., Nebr.

A—We would have suggested cafe curtains, but you have already thought of them. Perhaps it would be well to try out different positions, the first position covering only the lower sash. Then try at a point higher up, covering about half the upper sash as well as the lower one. We think it likely the latter position will prove to be the best appearancewise.

Air in Water System

Q—I have a pressure water system working from a deep well. Lately I've noticed that when I open a faucet water comes out with sufficient force to splash out of the sink or lavatory. I understand that this is because of excess air in the system, but how can it be corrected and how is the supply of air regulated?—K. H., Ga.

A—All home water systems of the pressure type have some means of supplying air to the pressure tank in measured amounts, or a control unit to release air and maintain a given pressure. Usually this is handled by an air-inlet valve or by an air-volume control unit. When either of these gets out of order, the tank may fill with air or water, depending on what type of control is used. The manual which came with the system will give instructions on how to adjust the unit to give the proper amount of air. If you no longer have the manual, then it is suggested you consult with your local dealer or write direct to the manufacturer.

FORMER SERVICEMEN

with
technical
skills



YOU CAN BE AN IMPORTANT MAN WITH A
GUARANTEED FUTURE...IN THE U.S. AIR FORCE

More than just a technician, the Air Force specialist is a man of responsibility and importance. He is the one the Air Force *depends on* to maintain and operate its increasingly complex equipment. But with this responsibility, he also knows a great sense of pride—and a guaranteed future, both professionally and economically. As a technician, you, too, can have this satisfaction and assurance—in the U.S. Air Force. See your Air Force Recruiter, or mail the coupon.

THE FUTURE BELONGS TO THE AIRMAN

Today and
Tomorrow
you're better off
in the
U.S. AIR FORCE

PASTE ON POST CARD AND MAIL TO:

Prior Service Information, Dept. PM-332
Box 7608, Washington 4, D. C.

Please send me more information on the Air Force Prior Service Program.

Name _____

Address _____ Age _____

City _____ Zone _____ State _____

Alaska "Big Land" of Contrasts

(Continued from page 134)

\$7,000,000 worth of fuel a year. However, exploitation of Alaska's mineral wealth has lagged because of production costs in that region.

Almost everything in Alaska is expensive by standards of the "outside." Nearly all the food has to be shipped in and shipping rates are high because there is comparatively little "back haul," cargo for the return trip. As a result, a housewife may have to pay as much as a dollar a dozen for eggs and up to 50 cents for a quart of milk. Living costs in general average 27 to 56 percent higher than in an "outside" city like Seattle.

Wages are higher, too. But the Alaska Employment Security Commission does not encourage job seekers to travel to Alaska unless they have a "definite job commitment first." Some skilled workers may earn as much as seven dollars an hour in Alaska, but a recent survey showed that 12 percent of the state's labor force was unemployed. The only workers needed in Alaska, according to the commission, are certain professional and technical personnel in engineering and medicine.

In the larger cities, Alaska offers most of the comforts and conveniences of civilization. You can fly to Anchorage (which claims to have more air traffic than Los Angeles, Cleveland or Dallas) on several commercial airlines. At the airport, you can pick up your choice of new cars from a rent-a-car service. And on a drive through the business district you might find yourself in a traffic jam.

Anchorage has more than 30,000 cars on its streets. And, as in the States to the south, many of the drivers are housewives on their way to a supermarket or a beauty shop. Or they may be returning to their homes in modern apartment buildings or contemporary-styled houses topped with TV antennas.

Golf at Midnight

During the summer season, local citizens may be found sun-bathing at Lake Spenard, watching a tennis tournament or playing golf. In fact, Alaska has golf courses where you can play a match at midnight.

For intellectual-type pioneers, Anchorage has a symphony orchestra, a theater workshop, a \$350,000 public library and "Great Books" discussion groups.

Education in the elementary and high schools is rated as good or better than that offered in most stateside communities. Standard achievement tests show that

(Continued to page 230)

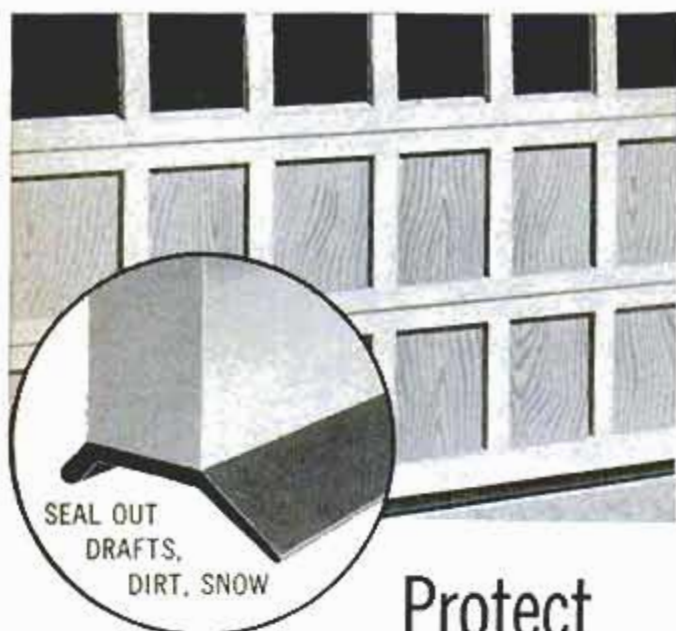

Protect costly garage doors with **STANSTRIP***

Now . . . for less than \$3.00 . . . in less than 10 minutes . . . you can put StanStrip on an 8-foot overhead garage door. And what a difference it makes!

The thick, rubber "pad" cushions the shock of closing . . . prevents damage to doors, spares the windows, ends the crash of closing.

And, just as important, the double lips of StanStrip flex to follow every irregularity in the floor . . . seal the opening completely against dust and dirt, rain and snow. Your garage stays cleaner, drier, warmer. Your car starts easier in winter.

And does it last! You just can't hurt StanStrip. The special rubber compound was developed from hundreds of formulas tested for this purpose. Stays flexible even in coldest weather. Get StanStrip now at hardware and building supply stores.



SEAL HOUSE DOORS, TOO

Ask for DrafTite* . . . an exclusive combination of silicone-treated wool-pile fibers and aluminum. It's the most effective house-door weatherstrip on the market.

*Trademark

The Standard Products Co.
LEXINGTON, KENTUCKY



For clean oil all the time
call for

 **HASTINGS** 

Hastings Oil Filter Cartridges keep oil clean *all the time*, because only Hastings has Densite filtering material.

Densite is different! Millions of selected cotton fibres—pressure packed—trap even the most microscopic dirt particles. Only Densite keeps oil clean from filter change to filter change, when replaced as normally recommended.*

Next filter change, call for Hastings—for clean oil *all the time!* Hastings Manufacturing Co., Hastings, Mich. Also makers of Piston Rings, Casite, Wear Reducer, Spark Plugs.

**Proved by tests
conducted
in accordance
with U.S. Bureau
of Standards
procedures.*

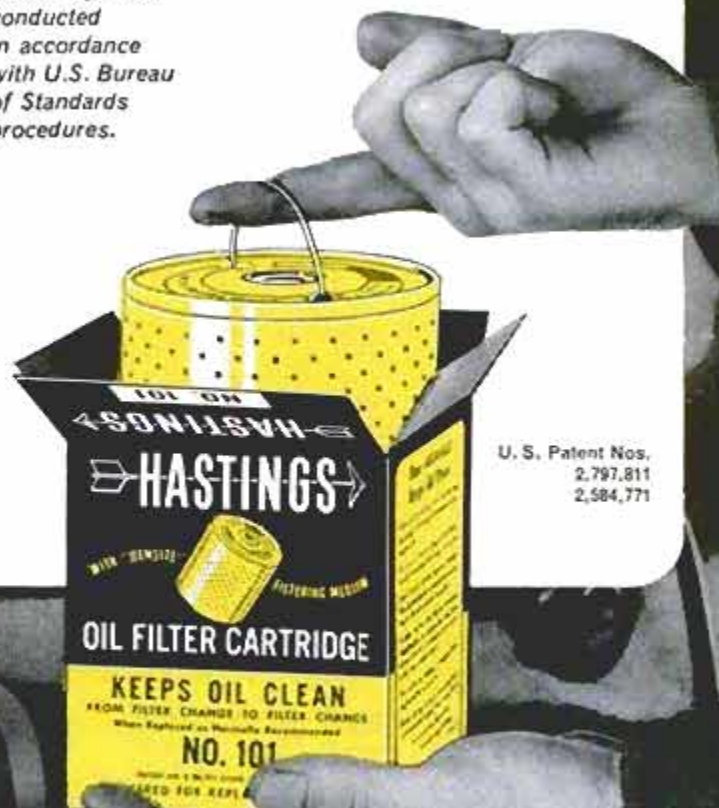

Swings Easy



**Balanced
for
Driving Power**

F-57
Advertised
Consumer
Price
\$5.25

NON-BREAKABLE

Fiber-Glass

HANDLE

Stronger than Steel

Fiber-Glass HANDLE

- light in weight
- will not collapse, bend or break
- will not rust, rot or corrode
- Guaranteed non-breakable in normal use

NEOPRENE COVERED GRIP

- keeps hand from slipping
- resists grease, oil and sweat

PERMABOND® assembly
keeps handles tight

Fayette R. Plumb, Inc., Phila. 37, Pa.

Axes
Files
Hammers
Hatchets

PLUMB®

reading skill of Anchorage pupils is as much as a year and a half ahead of national averages. Alaska has its own university at Fairbanks. Community colleges are operated at Anchorage, Ketchikan and Juneau. A multimillion dollar Alaska Methodist College has been started at Anchorage.

Thriving modern cities at Alaska's northern latitudes are not unusual. By looking at a map of the world, you'll see that Ketchikan is farther south than Moscow, Glasgow, or Riga. Anchorage and Seward are about the same distance from the North Pole as Stockholm, Oslo, Leningrad, or Helsinki.

And, although Alaska has glaciers and winter temperatures of 70 below zero, all of the state isn't buried by ice and snow—even in the long dark nights of January. This newest state, if superimposed on a map of the other 48, would stretch from Northern Minnesota to Western Texas, with two "panhandles" stretching into southern California and Georgia.

As the climate of Minnesota differs from that of Texas and Georgia, so do the various sections of Alaska experience a wide range of climates. Fairbanks has recorded temperatures down to 66 degrees below zero, but in the panhandle areas the winter temperatures are no more severe than in many stateside communities above the Mason-Dixon line. Average January readings at Ketchikan, Sitka, Dutch Harbor and Atka are about 10 degrees warmer than those of the Chicago and Des Moines areas.

Summer temperatures in the 90s have been recorded in many Alaska communities. At Fort Yukon, on the Arctic Circle, the mercury once rose to 100 degrees.

Rainfall ranges from a soggy 151 inches a year at Ketchikan to a semi-arid seven inches at Fort Yukon.

Despite the weather extremes, Alaska apparently is a healthy state; it has the lowest death rate in the nation.

Homestead Farms Available

It's still possible to obtain a 160-acre farm in Alaska under the federal homestead law. But the pioneer farmer of today may find homesteading a formidable task. It takes a good-sized grubstake to establish a "quarter section" farm with modern equipment and living facilities in Alaska. When great-granddad developed his farm on the western prairies, he could get started with the tools and supplies he carried in his wagon and the animals that pulled it. To get started on an Alaska homestead, a farmer may have to buy or rent a bulldozer to clear the timber. And if he damages a couple of expensive farm

(Continued to page 232)



Thor 1/4" SpeedDrill \$22.95
 With free set of 6 quality twist drills

Handles any home drilling need in metal or wood with power to spare. Much more than just a drill. This handy-sized power plant can drive all popular drill attachments—saw, sander, polisher, etc. Geared chuck and 2.5 ampere rating makes Thor model 23 SpeedDrill the best and most rugged tool in the popular price class.



Thor SpeedSander \$27.95

With free metal sanding sheet, never wears out

From boats to bookcases, Thor model 15R Speed-Sander takes the backbreaking work out of refinishing. Smooth orbital action and light weight lets you tape sand and smooth rough plastering with ease. Thor versatility and performance have made it the world's largest selling orbital sander. Thousands in daily professional refinishing use.

Your Christmas bonus!

**GIVE A THOR
 ELECTRIC TOOL**

Get valuable accessories **FREE!**



Thor Jig Saw \$29.95 With free set of 4 jig saw blades

Thor's Jig Saw is the tool which can turn the "do-it-yourselfer" into an artisan. Will make fancy scroll cuts and angle cuts with ease. Handles up to 2" wood . . . tilts both sides to full 45° cuts. Thor model 440 Jig Saw will be your workshop's handiest and most versatile tool. It's the newest and best of its type on the market.

Give a real man's gift . . . professionally-built Thor Power Tools. Get industrial quality at home workshop prices, plus valuable free accessories with each Drill, Sander or Jig Saw. Packages attractively gift wrapped.

Search no further for practical, inexpensive gifts to start a useful hobby or expand a home workshop. Versatile Thor drills, sanders or jig saws are perfect gifts for the man who really knows power tools. Try Thor tools at your dealer's now. SpeedWay Manufacturing Company, La Grange Park, Illinois, division of Thor Power Tool Company, Aurora, Illinois.



THOR POWER TOOL COMPANY
 Aurora, Illinois

World's largest exclusive manufacturer of portable air and electric tools

FREE CATALOG OF NEW MODELS

with features never before
available on any rifles

**Hammerless,
Closed-in Action**



Greatest improvement in the history of bolt action rifles. Greater safety for shooter—better protection for mechanism from damage and dirt—more graceful streamlining.

**Clip Magazine
Automatics Handling
All 3 Lengths
of "22's"**



A convenience never before available in rifles of this kind.

Also—read about Mossberg's new "magic," 3-way clip magazine that adjusts instantly to load Short, Long or Long Rifle cartridges.

And Mossberg's new, high precision sights—S-330 peep and S-320 hooded ramp front. Standard equipment on new rifle models 340B and 346B.

Send coupon today—or see these new years-ahead models at your dealer's.

Mossberg
for accuracy

O. F. MOSSBERG & SONS, INC.
89711 St. John St. New Haven 5, Conn.

Sirs: Please send me catalog describing your new models.

NAME

STREET

CITY

STATE

machines on hidden roots or rocks, he may be out of business before his first crop is harvested.

Nevertheless, there is farm land available in Alaska and the state hopes eventually to produce half the food it needs. The growing season around Juneau, Ketchikan and Wrangell is as long as in much of the Midwest. Farther north, there are fewer frost-free days but, since the summer days are long, farmers are able to grow fabulous vegetable crops. Corn, tomatoes and tree fruits are about the only crops that will not mature in the short season.

The Federal government also will sell for as little as \$2.50 an acre small tracts and homesites to persons who want to establish a resort, fur farm, poultry ranch or filling station.

Whether an Alaskan is watching a television show in Fairbanks, playing golf in Anchorage or milking cows on a Matanuska Valley farm, he cannot escape the frontier atmosphere. He may see parka-clad Eskimos in the city stores, kayaks skimming past moored seaplanes or totem poles behind radio towers. And he is always a short drive and a hike away from a wonderland of hunting and fishing.

Alaska Game Records

Sportsmen who have lingered for hours over lines in the fished-out lakes of the older states would be startled by the catches Alaskans tote home from nearby streams—12-pound silver salmon, 16-pound rainbow trout and Chinook salmon that would crowd a home freezer.

A short trip from Anchorage puts the hunter within gunsight of moose, caribou, deer, bear, mountain goat and white Dall sheep. Inland game birds available include ptarmigan (20-per-day limit) and spruce hen. Mallard, teal and black brant inhabit the coastal waters and lakes.

The federally owned Alaska Railroad takes parties of hunters and fishermen on the morning run from Anchorage and drops them off near their favorite spots. The sportsmen bag their bear or land their trout and return to the tracks in time to flag down the afternoon train returning from Fairbanks.

Hunters also make frequent use of the services of bush pilots for air trips to remote areas where they can shoot Canadian and snow geese, or perhaps polar bear. At least one airborne guide guarantees that his client will return with a pelt.

And Alaska has game to match its size. Record grizzly and brown-bear pelts are in the neighborhood of 11 feet in width. One bull moose had 25-point antlers with a

(Continued to page 234)

NOW! A NEW MUFFLER WITH TWICE THE LIFE!

The new MoPar Sono 4-X muffler uses an advanced design to give you up to 100% longer life. This new MoPar muffler, engineered by Chrysler Corporation, gives you outstanding muffler performance and long-lasting safety; with real economy.

There are five major causes of muffler trouble—and here are the steps Chrysler Corporation engineers have taken to combat them in the MoPar Sono 4-X:

Internal muffler corrosion: A car's engine manufactures about a gallon of water for every gallon of gasoline burned. This water contains enough sulphuric and other acids to quickly corrode the material of an ordinary muffler. The new MoPar Sono 4-X muffler combats this corrosion by means of galvanizing—from the head and shell to the outer wrap.

Internal muffler temperature variations: These are rough on a muffler because water containing diluted acid accumulates in "cold spots," allowing it to corrode muffler metal. The new MoPar Sono 4-X is specifically designed to maintain a uniform temperature throughout, allowing this water to vaporize and be blown out the exhaust.

Engine backfire: Fuel vapor explosions can rip the body seams and tear off the heads of ordinary mufflers. The MoPar Sono 4-X



guards against this danger by means of heads that are spun or rolled into the shell—giving strong, gas-tight interlocking of the shell and head material.

Road shock: The constant flexing of a muffler head and neck during rough driving leads to metal fatigue in ordinary mufflers. In the MoPar Sono 4-X galvanized heads, shell and outer wrap, plus double-locked seam joints, assure highest resistance to metal wear.

External damage: Contact with high road centers, rocks, ice, snow, salt, water, curbs and ramps is the reason many mufflers wear rapidly from the outside. The extra sturdiness and balanced construction of the MoPar Sono 4-X offer the greatest resistance to external damage yet devised in the industry.

To get the most advanced muffler made today, see your Plymouth, Dodge, DeSoto, Chrysler or Imperial dealer, or leading independent repair shop featuring MoPar products. He has the MoPar Sono 4-X in stock now—at competitive muffler prices!

Genuine Chrysler-engineered

MoPar
PARTS & ACCESSORIES

MoPar Division, Chrysler Motors Corporation, Detroit 31, Michigan

New extra-fast cutting **RIGID** No. 315 Tubing Cutter



Capacity
 $\frac{3}{16}$ " to $1\frac{1}{8}$ "

3-Wheel Design

gives quick, clean cuts
even in tightest places!



Compact and light, yet strong, this new No. 315 **RIGID** 3-Wheel Tubing Cutter is extra handy for home use. Just what you need for that hard-to-get-at tubing. No skinned knuckles... no slow hack saw. Cuts copper, brass, aluminum, steel tubing and thin-wall conduit. Handy **RIGID** fold-in reamer protects hands and pockets. Try the new **RIGID** No. 315 and you'll wonder how you got along without it. See and buy it at your Hardware Dealer's.

spread of over six feet. Fishing records include a rainbow trout nearly 35 inches long.

Besides providing recreation and food for Alaskans, the state's fish and wildlife are important sources of income. Fishing is the biggest industry and fur is the third largest source of income, behind mining. Nearly 25,000 people work in Alaska's 100 commercial fisheries which annually produce millions of cases of canned salmon, plus herring, halibut, sablefish, shrimp, crabs and oysters.

Fur Farms Favor Fish

The abundant fish supply also helps support Alaska's fur industry. The state has many licensed fur farmers who raise mink, blue fox and silver fox in captivity. (The Department of Interior suggests there is plenty of room for expansion of this type of enterprise in Alaska.) Fish is a basic food for fur-farm animals and it can be obtained cheaply in southeastern and coastal areas of the state.

Extensive timber resources can support future wood products, pulp and paper industries. The Tongass National Forest alone has over 78,000,000,000 feet of timber, mostly hemlock and spruce. There are forests of birch and other hardwoods in other parts of the state. A \$5,000,000 pulp mill recently was established at Ketchikan.

Hydroelectric dams may eventually beef up Alaskan industries. A Bureau of Reclamation survey of about two-thirds of the state's 580,000 square miles showed there are about 200 likely spots for hydroelectric plants. It has been estimated that Alaska's vast water-power resources could be used to make 50,000,000,000 kilowatt hours of electricity—about three and a half times the annual output of Grand Coulee Dam.

Updating the Data

Besides adding a star to the U. S. flag, the admission of Alaska as a state has required hundreds of changes in various almanacs and encyclopedias. The nation's population and land area figures must be updated to include Alaska. The center of population moves from Kansas to South Dakota; Texas becomes the second largest state and Nevada moves one notch up the population scale, outranking Alaska by about 40,000. Alaska also replaces Nevada as the state with the fewest persons per square mile. And The Union now includes a state which is west of Canada, extends above the Arctic Circle, and is closer to Russia than it is to its neighbor states. In becoming a state, Alaska adds tin mines, volcanoes, the highest mountain in North America (20,320-foot Mount McKinley),

(Continued to page 236)

The Ridge Tool Company • Bryan, Ohio, U.S.A.

Now! Name your deal on the new **SHOPSMITH MARK 2**

**Choose
either
big
saving!**



**Hurry,
offer
good for
limited
time only!**

WE PAY YOUR DOWN PAYMENT

This is not just an ordinary "no down payment" offer. We actually pay your complete down payment for you (on approved credit) up to 10% of the suggested retail price.

Offer expires December 31, 1958

or

SAVE \$30⁰⁰ ON SHOPSMITH ACCESSORIES

Buy SHOPSMITH MARK 2 now and get \$30.00 off on any of these major SHOPSMITH accessories: Jigsaw, Jointer, Bandsaw, Belt Sander or Compressor-Sprayer.

Offer expires December 31, 1958

Only SHOPSMITH features the patented 5-tools-in-one principle



It's an 8" SAW • It's a 12" SANDER • It's a 28" LATHE • It's a HORIZONTAL DRILL — 16½" VERTICAL DRILL

Take advantage of this amazing "Name-Your-Deal" offer—now—at your leading hardware or department store, lumber yard or Montgomery Ward. *Special offer:* Write today for your free copy of the informative booklet, "What to Look For When You Buy Power Tools," to: Yuba Power Products, Inc., Dept. 200-M, 800 Evans Street, Cincinnati 14, Ohio.

\$179⁰⁰ suggested retail price
All-metal bench \$19.95—½ h.p. motor \$34.95
¾ h.p. motor \$46.95



YUBA POWER PRODUCTS, INC.

SHOPSMITH AND MAGNA-LINE TOOLS,
YARDSMITH POWER MOWERS AND TILLERS

YUBA CONSOLIDATED INDUSTRIES, INC.



glaciers, rivers, Indian tribes, and a mass of new wildlife and weather data to any information file about the United States.

Like its sister states, Alaska's geography is marked by names that spell out the history of the region. The name of Alaska, itself, is from the Aleut language and means "The Great Land." Chigof, Baranof and Andreafsky are as Russian in origin as the onion-shaped church steeples in the Aleutian Islands. Prince William Sound and Prince of Wales Island show British influence while such places as El Capitan, Cordova and Valdez are tokens of Spanish conquests. Crooked Creek, Dime Landing, Fishhook, Cold Foot and Purgatory are reminders of the Gold Rush era.

Flour Strike in a Chuck?

The language of Alaskans also shows the influence of the Klondike period. If a miner talks about "flour," for example, he may be referring to gold dust rather than cake recipes. "Hi yu" is not a greeting but a Chinook expression meaning "plenty." A "strike" is an ore discovery and a "chuck" is a stream. A "mukluk" is something you wear on your feet but "muckamuck" is something you eat. And "mush" is a command to a dog team.

It's been a long haul for Alaska from the days when Russians who didn't want the

land finally unloaded it on Americans who were almost equally unenthusiastic about the deal. For 45 years of its "poor relative" history it didn't even rate a territorial status. When statehood was first proposed, in 1916, even Alaskans laughed at the proposal. After World War II, however, the campaign finally gained enough momentum to clear the Congressional hurdle. But Alaska statehood supporters had a constant symbol of encouragement: The state flower is the forget-me-not. ★ ★ ★

Small Artificial Heart Fits Inside Body

Weighing three pounds and operated by a tiny alternating-current motor, a newly developed blood pump can be placed in the body of an animal as a substitute for the heart. The pump and motor are enclosed in a plastic case, with a single wire connection leading outside the body. Dr. B. J. Kusserow of Yale University adds that the pump can be adjusted from 40 to 180 "heartbeats" per minute by changing the voltage.

ⓁBerkelium, a re-created element that probably existed when the universe was formed but died soon after creation, has been isolated in quantities which are large enough to see and to weigh.

SHOPMATE

ALL-NEW TWO-SPEED 2.8 AMP. 3/8" DRILL

FEATURES: powerful 2.8 amp. universal AC/DC fan-cooled motor • electro-mechanical transmission changes speed instantly, electrically • interlocking speed range selector switch • precision geared chuck and key • spindle lock for easy chuck removal • multiple ball thrust bearing • weighs under 6 lbs., perfectly balanced • silver luster finish



2-SPEEDS...
**THE RIGHT SPEED
FOR EVERY DRILLING JOB**
AND YOUR SANDING, POLISHING, SAWING ATTACHMENTS
AT THE FLICK OF A SWITCH!

Here's the world's most revolutionary new drill... the drill that will handle every drilling job! Two separate speed ranges! 2000 rpm for drilling wood, plaster, plastic, and other "light" materials, and 1000 rpm for heavy-duty drilling applications. To change speeds instantly, you merely touch the interlocking electro-mechanical speed range selector switch. And, both speed ranges develop full power for fast, efficient drilling under any conditions!

\$32.95
Complete
Model SD-382

at hardware and building supply dealers or write to . . .

PORTABLE ELECTRIC TOOLS, INC. • 320 WEST 83RD STREET • CHICAGO 20, ILLINOIS



FREE MASONITE PLANS... Easy cut-outs to brighten your home for Christmas!



Big, bright, beautiful cut-outs! Santa and his reindeer to prance across your yard... a Peg-Board® Greeting Card tree... a Nativity scene... snowmen and carolers, angels and choirboys. They're all here, all laid out on a grid pattern. You and the family will have a world of fun tracing these scale patterns on economical, durable Masonite® Primecote® Panels!

JUST ASK YOUR NEIGHBORHOOD LUMBER DEALER

—He has your plans waiting for you now, free plans for all Masonite's Christmas figures. And he has just what you need to bring them to life: Masonite exterior panels. These panels are super-smooth and splinter-free. They cut cleanly, stand firmly. What's more, they're all prime-coated, ready to take on their gay Christmas colors... ready for years of holiday service.

How they'll add to your Christmas spirit —this year and many years to come. These durable Masonite panels take to wintry weather like Santa himself! So act now! Get down to your lumber dealer's... ask him about the full-size tracing patterns for your displays... he'll help you with your plans and materials. Or send the coupon below for complete information.

©Masonite Corporation—manufacturer of quality panel products.



Insist on Masonite
3/4" Primecote
Panels for your
Christmas cut-outs.
They're so easy
to paint... so
weather-resistant
...so inexpensive.

FREE PLANS!

MASONITE® CORPORATION
Dept. PM-11, Box 777, Chicago 90, Ill.
In Canada: Masonite Corporation,
Gatineau, Quebec

Please send me my free Christmas plans and full information about Masonite outdoor panels.

Name.....
Address.....
City.....State.....
Zone.....County.....



Car makers—over *twice* as many car makers (including Rolls-Royce) specify Champion spark plugs—thirty-six different makes in all!



Airlines—*all* of the world's major airlines use Champion spark plugs for the safe, dependable performance the airlines *must* have at any cost!

Q. Why is it that wherever performance is vital—on land, sea or in the air—the experts choose Champion spark plugs?

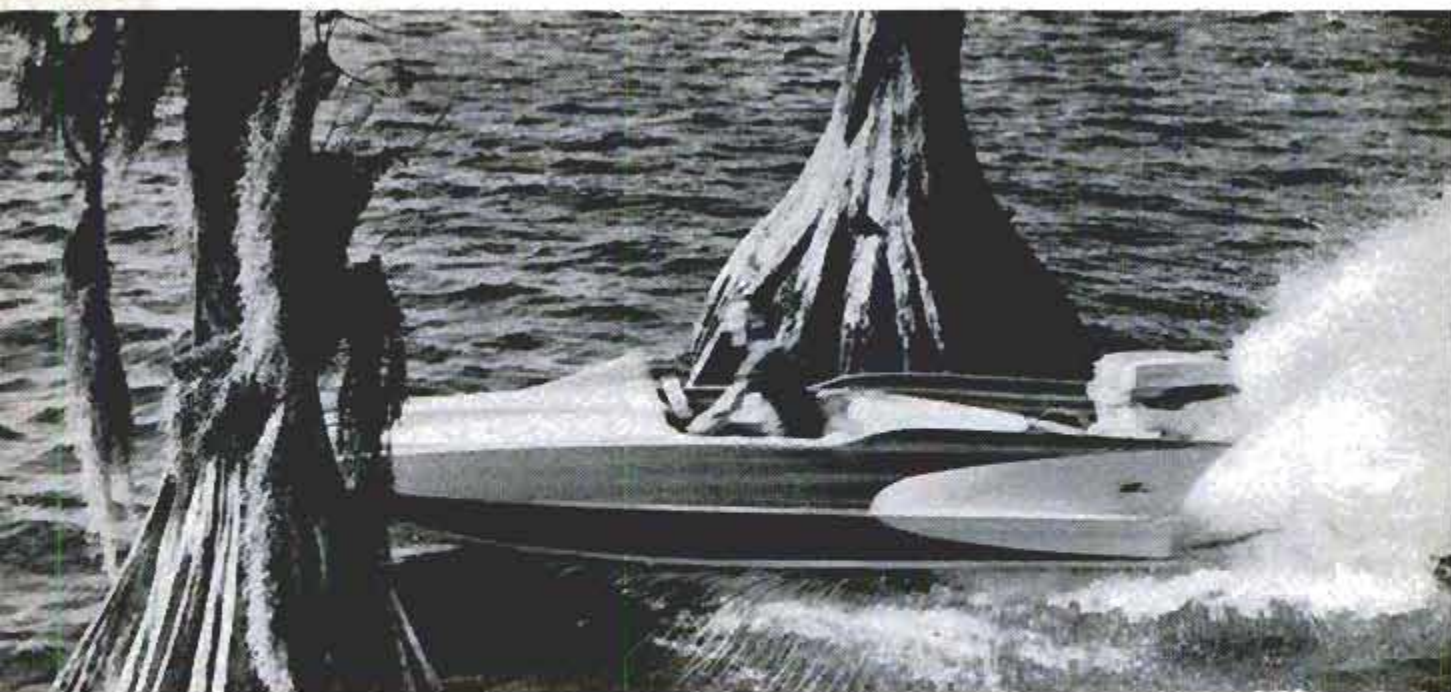

Outboard engines—all the major U. S. manufacturers of outboard engines use Champions for easier, dependable starts, smoother performance.



Racing cars—8 out of the last 9 Indianapolis winners used Champions. And 9 out of 10 *stock* car winners over the past 5 years used Champions!

A. The experts know from experience that you can always depend on Champions. To get the best performance from your car, put in a new set of Champions every 10,000 miles!



CHAMPION

—engineered for every car built by Ford, General Motors, Chrysler, American Motors, Studebaker-Packard and every major foreign maker.

SOUTH BEND

for
PROFITS.....
PRECISION..
PRODUCTION

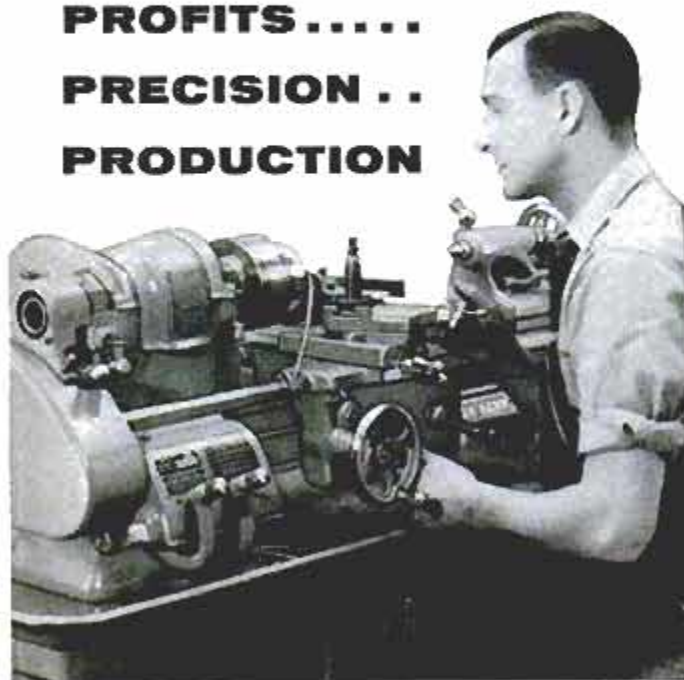

BENCH LATHES-9", 10-K and 10" sizes in independent change gear, quick change gear and toolroom models.

FLOOR LATHES-9", 10-K, 10", 13", 14½", 16" and 16-24" sizes in quick change gear and toolroom models—129" maximum between centers on 16" lathes.

TURRET LATHES-10", 13" and 16" sizes with 1-1/16" collet capacities.

MILLING MACHINE-Vertical spindle type with universal 360° swivel head.

BENCH SHAPER-7" stroke. Only shaper of this size with pressure lubrication system.

DRILL PRESSES-14" precision type in bench, floor and multiple spindle models.

PEDESTAL GRINDERS-8" and 10" wheel sizes. More room for work and for hands.



WRITE FOR CATALOG

Fully describes and illustrates all the features of the above machines plus many tools, attachments and accessories.

SOUTH BEND LATHE
SOUTH BEND 22, INDIANA
Building Better Tools Since 1906



Up to 24
months to pay.

High-Fidelity Stereo Amplifier

(Continued from page 160)

be evaluated from its electrical characteristics and, within the scope of its intended operation, this amplifier leaves little to be desired.

The performance curves and specifications table tell the story at a glance. At its rated power output of 10 watts, each amplifier section has *less than 1% total harmonic distortion over a range from 30 to 14,000 c.p.s.* This assures 20 watts of virtually undistorted power—more than enough for practically any application around the home.

A flat frequency response (within ± 1 db) over the entire audio spectrum, sufficient sensitivity for full power output with any ceramic or crystal stereo cartridge or radio tuner, and an inherent hum and noise level below normal audibility round out the details.

Construction

A 7 x 13 x 2-in. chassis, either steel or heavy-gauge aluminum, will conveniently house all the parts for this stereo amplifier. Placement of chassis-mounted components is shown in the title photograph and in the pictorial diagram. The parts themselves can be used as templates to determine the exact dimensions and positions of the necessary cutouts.

After installing the chassis-mounted parts, solder the heavy bus wire in place. This is grounded to the chassis at the input jacks and terminated at the upright electrolytic capacitors. These should be insulated from the chassis by means of their fiber wafers.

The rest of the wiring, although somewhat crowded in the vicinity of the controls, should present no problems. Start at the input jacks and work toward the power supply, making sure that each wire and part is well soldered to its proper connecting point. Follow the pictorial wiring diagram and use the schematic diagram to check your work after all wiring is finished.

Resistor R22 consists of two separate resistors connected in parallel. In the pictorial, the individual resistors of each parallel combination are labeled "½ R22," to avoid confusion.

A metal bottom plate should be used to cover the bottom of the chassis after all wiring has been completed and thoroughly checked. The bottom plate reduces hum pickup and prevents contact with dangerously high voltages appearing inside the chassis when the amplifier is turned on.

(Continued to page 242)



McKean Blue Jay



Wagemaker Wolverine 17-foot Catalina



Lyman 19-foot Clinker-built Runabout



Chris-Craft Boat Kit

Make this a family boating Christmas

GIVE A BOAT OR BOAT KIT

Now's the time to get the jump on next summer's family boating fun and solve all your family Christmas gift problems at once. Whichever boat you choose, you'll want one that will give you years of dependable service and economical operation. You can be sure of both in a boat made of

Weldwood Royal Marine Plywood. Expressly engineered to exceed the requirements of today's high-speed boats, Weldwood Royal Marine Plywood assures you of top boating enjoyment because it resists impact, withstands rot and fungus, cuts maintenance problems, finishes beautifully, and is guaranteed never to delaminate.



For top family boating fun, visit your boat dealer's before Christmas and select a boat or kit that displays the Weldwood Royal Marine Plywood label.

WELDWOOD® ROYAL MARINE PLYWOOD

Royal Marine Douglas Fir

Royal Marine Duraply®

Royal Marine Philippine Mahogany

Products of UNITED STATES PLYWOOD CORPORATION

 114 branch showrooms in United States and Canada

United States Plywood Corporation
55 West 44th Street
New York 46, New York

M 11-58

Please send me free folders telling me more about

- Sailboats Inboard Boats
 Outboard Boats Boat Kits

Name.....

Address.....

City.....Zone.....State.....

PAINTING TIP NO. 42

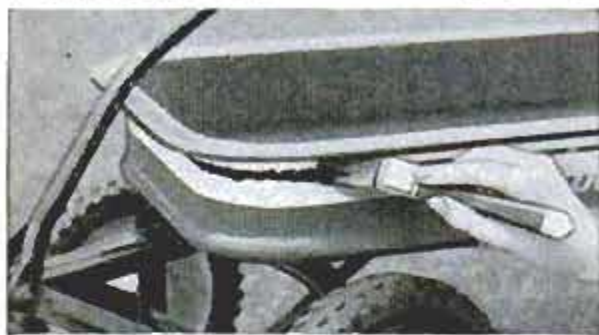

Make professional-looking stripes with "SCOTCH" Brand Masking Tape. Stretchy tape sticks tight, hugs curved surfaces. Paint will not bleed through. After paint has "set", "SCOTCH" Masking Tape strips off easily, leaving a clean, sharp edge. Makes painting quicker, neater with brush, roller or spray. Get "SCOTCH" Brand in the handy cutter-edge carton—35¢, 69¢, 98¢, \$1.69—wherever paint is sold.

Don't run short . . .
BETTER BUY TWO!

Made by
Minnesota Mining & Mfg. Co.
St. Paul 6, Minn.
© 3M Co., 1958



BUILD IT YOURSELF
for your son's Christmas

buckboard'n buggy

Easy to build! Fun to drive! Our detailed plans make it easy to assemble in a few hours. Drives like a real car . . . push it or add power . . . any gasoline motor up to 2½ hp. Strong wood chassis, steel undercarriage, 10" rubber wheels, full 66" long, 17" wide . . . will hold up to 175 lb. driver. Do-It-Yourself Kit—All parts drilled, painted, ready to assemble . . . \$64.50

**MAYO
BROS.**

Satisfaction Guaranteed
All prices F.O.B. Fairport
Illustrated Brochure on request.
Dept. PM-3 Fairport, N. Y.

The amplifier should be turned on only after your loudspeakers have been connected to the terminal strips. Either 4, 8 or 16-ohm speakers may be used, but the phase reversal switch, S4, is wired, as shown, for a 16-ohm speaker. For an 8-ohm speaker, the wire from the junction of R16, C8 and the 16-ohm lead of T1 is connected directly to the 16-ohm terminal rather than S4 and the wire from S4 to the 16-ohm terminal is run, instead, to the 8-ohm terminal. The 8-ohm transformer lead is then soldered to the open lug of S4. Corresponding wiring changes must be made if a 4-ohm speaker is to be used.

Possible Modifications

As it stands, this amplifier was designed to handle the requirements of two radio tuners and a crystal or ceramic stereo phono cartridge. With the function switch, S1, in the CER. PHONO position, the input resistance to both channels is 2.7 megohms, the value of R2. While this value will generally provide good results with all cartridges of this type, manufacturers of some cartridges may specify other resistance values, or even a simple R-C network, for optimum performance. In such cases, R2 should be changed to conform with the manufacturer's recommendations.

Many high-fidelity enthusiasts prefer magnetic phono cartridges to crystal or ceramic units. This amplifier has neither the required gain nor the equalization needed for these low-output cartridges. It is a simple matter, however, to add a stereo preamplifier, or two inexpensive monaural units between the magnetic cartridge outputs and the CER. PHONO inputs of the amplifier. If this is done, the value of R2 should be changed to approximately 1 megohm. The preamplifiers need have no volume or tone controls because these functions are available in the main amplifier.

Now, if you already have a monaural hi-fi system but are planning to convert to stereo, the idea of retiring a perfectly good monaural amplifier in favor of a stereo unit just doesn't make sense. Furthermore, it isn't necessary. What you need is another single-channel amplifier, plus the switching provisions for stereo flexibility. In such a case, you can still build this amplifier, but you can save almost 50% of its construction cost.

Obviously, the B channel of the amplifier will not be needed and you can immediately omit V3, V6 and V7, plus all the associated circuit parts. V1 will still be needed, but no connections need be made to the second triode elements. In addition, the recommended power trans-

(Continued to page 244)

CRAFTSMAN KROMEDGE

taps and dies last longer...

cut cleaner threads easier



sale! \$28.50 40-piece set **\$19.88**

Exclusive at Sears! Jewel-like hard chrome puts an edge on these tools that lasts 3 to 5 times longer than ordinary edges. You always get a cleaner, sharper thread cut with far less effort. 40-piece 17-cut set has up to $\frac{1}{2}$ inch capacity and comes complete in a rugged plastic case that's unbelievably compact—takes 50% less room than wooden cases, weighs 5 pounds less! Buy now and save nearly a third! Only \$2 down on Sears Easy Payment Plan.

Cuts National Coarse (USS) threads $\frac{1}{4}$ -20, $\frac{3}{8}$ -18, $\frac{1}{2}$ -16, $\frac{3}{4}$ -14, $\frac{1}{2}$ -13; National Fine (SAE) $\frac{1}{4}$ -28, $\frac{3}{8}$ -24, $\frac{1}{2}$ -24, $\frac{3}{4}$ -20, $\frac{1}{2}$ -20; machine screw, 4-36, 6-32, 8-32, 10-24, 10-32, 12-24; and $\frac{1}{8}$ in. standard pipe threads. 16 adjustable 1" dies; 1 solid pipe die, adjustable guide die stock, tap-and-reamer wrench, "T" tap wrench, screw pitch gauge and screwdriver. Case has two removable trays.

SEARS, ROEBUCK AND CO. — in Canada at SIMPSONS-SEARS LTD.

SATISFACTION GUARANTEED OR YOUR MONEY BACK



See Craftsman Tools at over 1500 Sears Stores and Catalog Sales Offices or order from Sears Big Catalog.
© 1958 Sears, Roebuck and Co.



EVERY HOME NEEDS

ELMER'S® GLUE-ALL!

Modern plastic glue—ideal for every household use! Try the other *Elmer's* adhesives for plastic laminating, heavy-duty and waterproof gluing! Need glue? Look for Elmer and remember, if it's Borden's, it's got to be good!



former can be replaced with one having a 120-ma. high-voltage rating for a further, substantial cost reduction.

The inputs and the switching circuits, however, should be retained. The wire lead from lug C of S2, normally connected to pin 7 of V1, should, instead, be connected to another phono jack which must be mounted somewhere on the chassis. A shielded cable, terminated on both ends with phono plugs, can then be connected from this jack to the high-impedance input jack of your present amplifier. This arrangement permits both amplifiers to be in use for stereo or monaural applications.

NOTE: Because of the relatively high power supplied by this amplifier, the chassis-mounted parts, as well as the chassis itself, will become quite warm after prolonged operation. This is no cause for alarm, but it does suggest the need for adequate ventilation when the amplifier is mounted behind a panel or in a cabinet.

A table of tube-socket voltage and resistance readings for this amplifier can be obtained by sending a stamped, self-addressed envelope to *Popular Mechanics'* Radio, TV and Electronics Dept. ★★

Single-Lever Control For Outboard Motor

With a new remote single-lever unit the boater has complete control over his outboard at his fingertips. A key switch on the unit starts, stops and locks the motor. Pushing in the key electrically chokes the motor. A single lever shifts the motor to forward, neutral and reverse, and also controls the speed. The control unit is one feature of the new 40-horsepower West Bend motor.

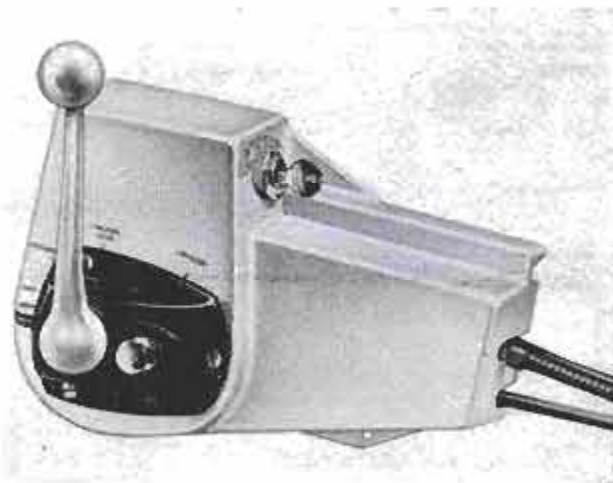

Two University of Michigan entomologists have recorded the sounds of insects on 3,000,000 feet of tape, which amounts to almost 600 miles of cricket, katydid and other insect warblings.



FOR YOUR HOME, STORE OR COMMUNITY PROJECT

Santa waves his welcome... His reindeer romps under a twinkling sky. These and other exciting new Christmas decorations "come alive" to greet friends, customers, community. Big 4'x8' motion displays are yours for less than \$20.00 complete—with Easi-Bild® Patterns.

You buy the pattern for \$3.00; the electric motor and linkage kit for \$9.50; the materials for about \$7.00—all from your lumber dealer. Now you have everything you need to make—by yourself—professional-looking outdoor decorations. (Every year Easi-Bild decorations win prizes in community competitions.)

Easi-Bild Pattern No. 762 (Santa) and No. 764 (Reindeer) feature Homasote Board—the weatherproof, outdoor material that's easy to work and handle. Your lumber dealer stocks Homasote and Easi-Bild Patterns. See him today—or use the coupon.

*T. M. Reg. Easi-Bild Pattern Company

HOMASOTE COMPANY, Trenton 3, N. J.

I enclose _____ for which send the following patterns:
 Santa (Motion)—\$3.00 Madonna—50¢ Choir Boys—50¢
 Jolly Snowmen—50¢ Sleigh—50¢ Nativity Scene—\$5.00
 Reindeer (Motion)—\$3.00 Send name of Homasote Dealer

Name _____

Address _____

City _____ Zone _____ State _____ L-1

IN CANADA: TORONTO, ONT.—P.O. Box 35, Station K—MONTREAL, P.Q.—P.O. Box 20, Station N

Perfect mating of man and machine...



NEW Jet-stream Harley-Davidson sportster *FL*

is a rider's dream come true



SWINGING-ARM REAR SUSPENSION works wonders on good roads and bad. Heavy duty hydraulic shock absorbers help smooth the way.



SURE-SHIFT CLUTCH allows you to shift through gears with lightning speed and ease—trouble-free performance for thousands of miles.



HYDRAULIC FRONT FORK gives comfort action that is as smooth as silk. Long, hydraulically controlled helical springs cushion the ride.

MODERN-DESIGN POWER — 55 cubic inches of V-Power keeps you out in front to stay. Features lightweight, racing-type tappets and large high-performance intake valves.



From its jet-sweep front fender and jet-styled nacelle to gleaming tailpipe, the new Sportster H is the motorcycle of tomorrow — yours today!

But the proof is in the riding. You'll thrill to the jet-away acceleration that never looks back. You'll revel in level luxury — hydraulic forks and swinging-arm rear suspension iron out bumps and rough roads.

And when you want to come down out of the clouds — big, husky brakes stop you gently, safely.

See your Harley-Davidson dealer. One test-ride and you'll decide, it's the Sportster H for you. Or mail coupon for free color literature.



Harley-Davidson

MOTOR CO.
Milwaukee 1, Wisconsin

HARLEY-DAVIDSON MOTOR CO.
Dept. P, Milwaukee 1, Wisconsin

Please send me information on the Harley-Davidson Sportster H.

Name Age

Address



BRAND-NEW!

DISSTON *Dagger* Electric Sabre Saw

- **Cuts faster** with *exclusive* Orbite Action—blade cuts on upstroke, backs away on downstroke. Reduces fraying, blade wear, and need for finish sanding.
- **More cutting power**—because it has the highest output horsepower. 2.75 ampere motor drives it at 3600 strokes per minute.
- **Rips, crosscuts, miters, bevels, scrolls, and plunge cuts** without need for drilled hole. Cuts hardwood 2x4s at 45° angle.
- **Cuts wood, metals and plastics.**
- **Exclusive** conventional saw handle for easier handling and more comfortable grip.

With 10' detachable cord **\$54⁵⁰**

DISSTON *Dauntless* Electric Sabre Saw



—Industrial-capacity sabre saw for professional and heavy-duty use **\$98⁵⁰**

Why these new **DISSTONS**

BECAUSE they're the hottest new products on the power saw market. Engineered for extra power... extra capacity. There's no overheating... no faltering... when you run into rough material. Disston built these saws to be tough, rugged workhorses.

BECAUSE they're precision-built for ease of handling. Grip the comfortable, conventional saw handle. Notice immediately Disston's light weight and perfect balance. It's easy to push... easy to lift... a Disston Power Saw. It's designed and built by craftsmen for the use of other craftsmen.

BECAUSE years of experience in fine tool making have gone into the design and production of Disston Power Saws. Disston craftsmen have

created the world's finest hand saws. (Just ask any carpenter.) Now, they offer you a line of power saws possessing features unknown to other makes.

BECAUSE *exclusive* "Life-Saver" Cords provide added safety features. They are 3-wire cables to provide ground protection. Your Disston Power Saw can be kept separated from the detachable cord, preventing children from operating the saw.

BECAUSE you've got power, capacity, balance, and light weight expertly combined in one line of power saws by saw craftsmen... whose skill and experience have made Disston the world's most famous name in fine tools. *Disston Division, H. K. Porter Company, Inc., Phila. 35, Pa.*

BRAND-NEW!



**DISSTON Discus
Circular Saw**

- **6 1/2" blade**—cuts 2 3/16" at 90°, a full 1 1/4" at 45°.
- **10-ampere rating.**
- **6300 Surface Feet Per Minute** cutting speed—up to 1000 S.F.P.M. more than other saws in the same blade diameter.
- **Positive slip clutch** eliminates kickback and motor burnout.
- **Convenient, easy-to-use levers** control angle of cut from 0° to 45°.

With 10' detachable cord

\$54⁵⁰



**DISSTON Defender
Circular Saw**

For heavy-duty and professional use. Ballbearing. 6 1/2" blade

\$69⁵⁰

are your best power-saw buy!

**NEW DISSTON
DRAGON**

Electric Hedge and Shrubbery Trimmer

with exclusive fixed all-position handle. Exclusive plug-in cord set. Cuts hedge trimming time to a tenth. 1800 cutting strokes per minute.

\$49⁵⁰



Disston . . . A World Famous Name in Tools

H. K. PORTER COMPANY, INC.
DISSTON DIVISION

NEW midget pliers added to KLEIN line



Hardly larger than a package of your favorite cigarettes, these new Klein Midget Pliers will simplify many of those small jobs where space is confined.

Midgets in size but giants in performance, they solve major problems when wiring up electronic assemblies; making model trains, airplanes, automobiles, or in any extremely small or confined work.

These new midgets are additions to the famous Klein line of high-quality pliers that are backed by over a century of manufacturing experience. See your hardware dealer.

No. 257-4 Oblique Cutting Plier	Size 4 in.
321-4½ Long Nose Plier	4½ in.
322-4½ (Without Knurl)	4½ in.
224-4½ End Cutting Plier	4½ in.



Free Bulletin on Klein Pliers

Bulletin 758 lists the many various pliers in the Klein line. A copy is yours for the asking. Write for it today.

Mathias **KLEIN** & Sons
Established 1857 Chicago, Ill., U.S.A.
7200 McCORMICK ROAD • CHICAGO 45, ILLINOIS



Who Said the Blimp Is All Through?

(Continued from page 101)

Maintenance. An airship is a "long endurance" vehicle, and so it must be possible to make equipment repairs in flight. To facilitate this, electronic units are on long cables so they can be pulled out on the cabin floor for servicing. Or they can be disconnected and taken to a repair bench for test and overhaul. In the same way, all other equipment that may require inflight servicing is made easy to reach. The engine man can even change spark plugs, using swung-down cowling as a work platform.

Ground Crews. In earlier days, ground crews of 30 or more nimble men might be needed to handle a small airship in landing or taking off. Today, mobile mooring masts and heavy but extremely mobile ground-handling tractors, operated by a few men, do the job more efficiently. Ships can remain moored to their masts in all sorts of weather, swinging in the wind like huge weathervanes. They can land and take off at almost any airfield.

Equipment. Just about the biggest difference between the newest naval airships and those of a generation and a half ago is in the stuff they carry. An early-warning blimp is jammed with radar and other electronic gear. That is why the bag capacity has had to be increased to the million-and-a-half point: the extra lift is needed for extra gear. In the latest design, a gigantic radar-search antenna revolves inside the airship's bag, thus making the bag a radome. This has necessitated the use of plastic instead of aluminum for the ship's nose cone and adjacent bracing—to minimize reflection of the radar impulses. The only metal at the nose is the "flowerpot" by which the ship is moored.

The big antenna suspended inside the ship's envelope is said to enable the radar to achieve better performance, including greater range, than any other type of airborne installation. Besides, "sea clutter" caused by reflection of radar impulses from nearby waves is lessened. Compared with a plane, an airship is considered a gentle sort of vehicle. It moves smoothly, experiences few sudden bumps or jerks; and because everything is suspended from a gas-filled fabric-and-rubber bubble, the gear is in a naturally cushioned mounting. This reduces wear and tear on delicate electronic equipment, permits more accurate readings and means less time and energy lost in maintenance.

Commercial Uses. The idea of using airships for commercial purposes, such as

(Continued to page 250)

HOW AMERICA'S NUMBER ONE CARBURETOR TAKES THE WORLD'S WORST BEATING IN STRIDE!



Roaring up a severe 27% grade at the proving grounds, Rochester-GM Carburetors meter sufficient fuel for good acceleration while climbing, provide leaner mixtures during descent.



Thousands of actual traffic miles are put on Rochester-GM Carburetors to test their ability to deliver performance and economy on the toughest proving ground of all.

Whether you drive in the wintry blasts of Alaska or in the arid regions of Arizona, your Rochester-GM Carburetor has been torture-tested in the lab, on the proving grounds and over thousands of actual traffic miles to assure dependable service. And your Rochester-GM Carburetor Specialist is factory-trained to keep this precision instrument in perfect adjustment for greater performance, greater economy. See him for the best results from your Rochester-GM Carburetor. *Rochester Products Division of General Motors, Rochester, New York.*



Each Rochester-GM Carburetor is subjected to every imaginable quality control measure to assure you of trouble-free travel on the highway.



America's
number one
original equipment
carburetors

ROCHESTER CARBURETORS

GENERAL MOTORS

carrying pay loads, advertising, aerial photography, exploring and police work, is far from being dead. Almost daily, Goodyear Aircraft people receive inquiries from persons who think an airship would be ideal for certain jobs. What generally stops them is the little matter of money. Airships require capital for building and operating commercially. By comparison, in such military work as antisubmarine patrolling and early-warning watching, they are said to be less expensive than comparable heavier-than-air units. Even if this were not true, the airship still would be considered valuable in defense work, for it is maintained that, on the basis of records of two World Wars, nothing has been found superior to the airship for antisubmarine patrolling, especially in connection with convoys.

In this day of many kinds of missiles, the airship is considered to be virtually no more vulnerable than the airplane. That is, in action involving missiles of tremendous destructive power, it would not matter much whether an aircraft in missile range were traveling with the speed and maneuverability of a plane or with the relative leisure of an airship.

Thus with respect to technical developments, the airship has not been standing still. And because of its new-found abil-

ity to function as a long-range flying radar station, plus its war-proved knack of finding and scaring off or sinking submarines, it seems likely that it will be around for some time to come. ★ ★ ★

☛ A memorial has been erected in Humboldt County, Calif., to a plant-eating beetle that was introduced in 1946 and has since cleared a half million acres of the Klamath weed, deadly to livestock.

Do You Know This Old-Timer?

(answer to quiz, page 14)



1915 FORD



Solder



Thaw frozen pipes



Antique furniture

ALL THIS AND MORE ... you can do with a



Sweat copper fittings



**BERNZ-O-MATIC®
METAL
CARRY-ALL
TORCH KIT**



Torch + pencil burner unit + utility burner head + soldering tip + flame spreader + flint sparklighter, plus FREE metal kit, all for \$9.95

FREE LIFETIME METAL CASE WITH CARRYING HANDLE!



Safe, instant-flame Bernz-O-Matic Torch with four interchangeable accessories make light work of big and little jobs... from starting fires to freeing frozen bolts. Get yours now at your nearby hardware or department store!

OTTO BERNZ COMPANY • ROCHESTER, N. Y.

IN CANADA OTTO BERNZ CO., Ltd., Toronto 10. Prices slightly higher in Canada.

You become a **PRO** the minute you use this versatile tool!



It's the **Porter-Cable** ROUTER!

Make all the perfect advanced cuts that the professional cabinetmakers and carpenters do—cut grooves, dados, mortises for door hinges, rabbet and other intricate joints, cut inlays and table top decorative joints and many other woodworking op-

erations—all with precision and perfectly smooth edges. See it work—ask for a demonstration.

Model 162 Router ½ h.p. \$49.50

Model 100 Router ⅜ h.p. \$57.50



STARTER BIT KIT!

Everything you need for grooving, decorative edging, rabbeting, etc. Straight bit, corner round bit, rabbeting bit and sharpening wheel packed in handy plastic case . . . \$11.55 value—now \$9.95.

Corner Round Bit . . .
for rounding off the edge of any flat wood surface.



Straight Bit . . .
for stock removal, grooving, dadoing, inlay work and relief routing.

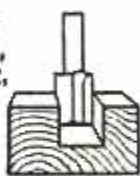

Rabbeting Bit . . .

for making rabbet or step cut for drawers, cupboard doors and other projects.



IT GROOVES, INLAYS, ROUNDS, CORNERS, MORTISES, EDGES . . . CUTS WOOD, METALS, PLASTICS, COMPOSITIONS

**SAWS • BELT SANDERS • FINISHING SANDERS
DRILLS • ROUTERS • PLANES**

In Canada: write Porter-Cable, Ltd., Box 5019, London, Ontario. Canadian prices slightly higher.
In Mexico: CIA. General Distribuidora, S.A., Av. Oaxaca 50, Mexico City, D.F.

Porter-Cable
Quality Power Tools

Porter-Cable Machine Co.
8269 Marcellus St., Syracuse 4, N.Y.



NEW

perma pak

FOR GREENLEE TOOLS

*newest, best way
to buy and keep bits
and chisels... every tool
reaches you factory-sharp
in a permanent container.*

Perma-Pak hangs at your workbench or fits neatly into your tool kit. Sizes boldly labeled to give you instant selection.

Only GREENLEE has Perma-Pak... only Perma-Pak gives you these advantages... and at no extra cost!

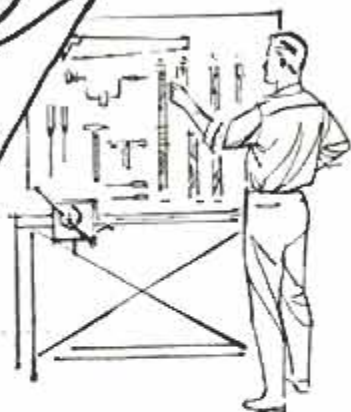

Look for GREENLEE tools in new Perma-Pak at your favorite hardware or building supply dealer.



GREENLEE TOOL CO.

2111 Columbia Avenue, Rockford, Illinois

Detroit's Year of Decision

(Continued from page 81)

disappointing experience with the "advanced" styling of Mercury, Ford's stylists have apparently decided that they went too far too fast. As a result, the entire 1959 line from Ford up is keeping the same image as it has had previously (a formula that, until 1959, GM had been devoted to and prospered with). The new Ford, Edsel, Mercury, Lincoln cars are, to use the words of the Ford stylists, more "automobiley" than GM's "spaceships." They have changed, but the change is evolutionary.

Chrysler, too, has changed. But its changes are small indeed compared with either Ford or GM. Here the decision was undoubtedly influenced more by resources than by philosophy, but the motive matters not. Chrysler, this year, represents the little-or-no-change-at-all school. If you feel that the industry should not make drastic annual changes which artificially "wear out" your investment, you can demonstrate your belief by buying Chrysler (of course, it is only fair to warn you that Chrysler has big plans for 1960).

There you have the lineup. Take your pick and cast your vote. Detroit wants you to stand up and be counted—on the cash registers.

Buy General Motors and you are, to some extent, voting for continuing the fast-moving postwar styling changes for which the industry has been praised by some and condemned by others.

Buy Ford and you are voting for restyling with a retention of character, for a restyling that keeps the over-all image while gradually outdated the sheet metal. It may make you want to own a new model, but you are not disgraced if you don't.

Buy Chrysler and you could almost be considered as voting against the practice of annual styling changes.

Buy Rambler and you will be coming mighty close to agreeing with the critics who claim automobiles have lost their symbolism and that all you want is a good, reliable, neat car which doesn't take up too much space on pavement or in garage.

Finally, if you want to prove that you are completely indifferent to the whole exciting automobile business, you can refuse to buy a car at all and this will confuse the motivation researchers even more.

But, you ask, isn't there some other reason for buying a new car than its styling?

Of course there is, and these 1959 models are offering some (although not many) new engineering refinements to make them more attractive to you, the customer.

(Continued to page 254)

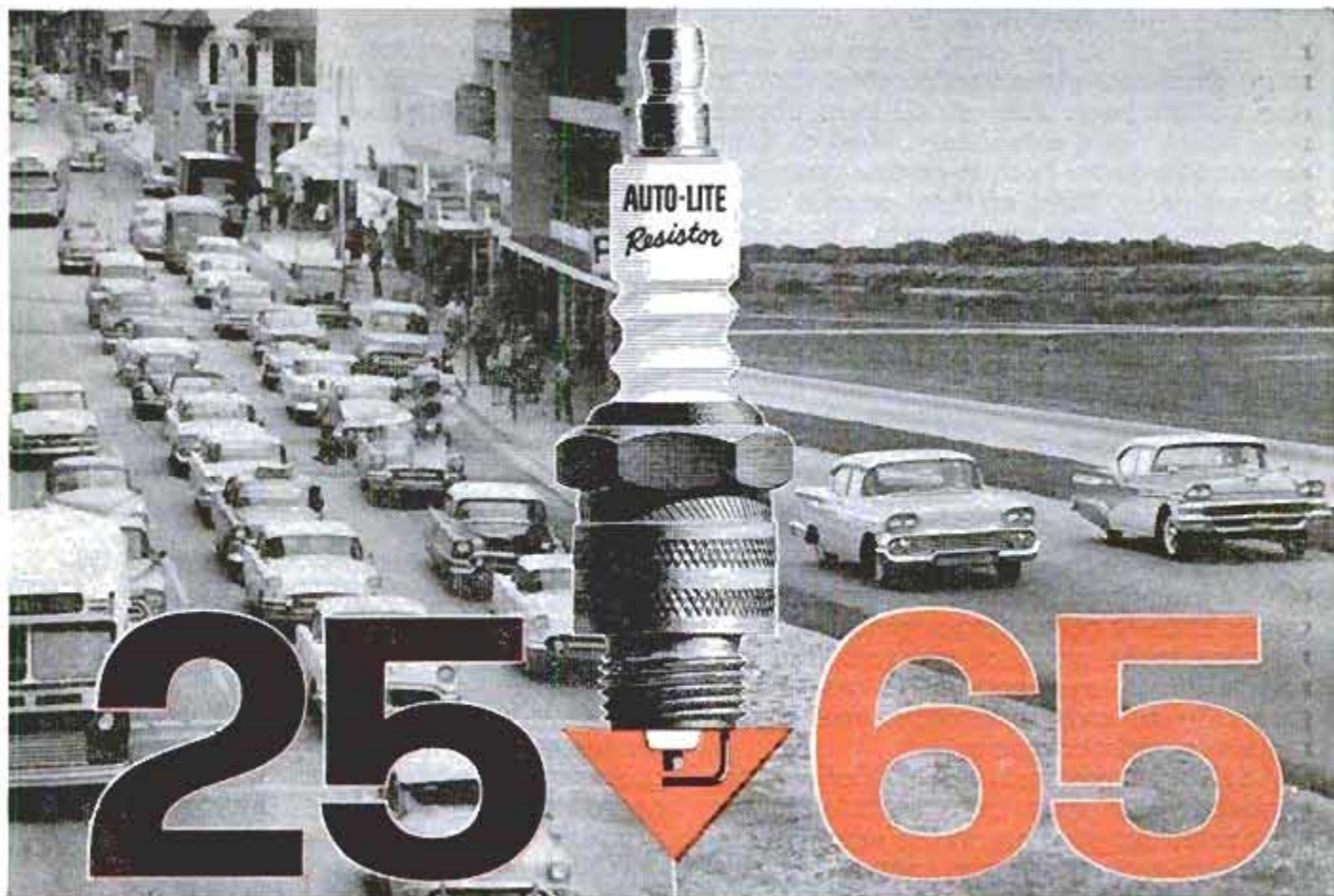

IN TOWN TRAFFIC . . . some spark plugs, designed for high speeds, become fouled and cause misfiring and loss of power when driven at low speeds.

ON THE HIGHWAY . . . some spark plugs, designed for low speeds, misfire causing power loss and invite destructive pre-ignition when driven at high speeds. Why gamble when . . .

Auto-Lite Resistor Spark Plugs with **POWER TIP** "Fire Up" your engine* at all speeds!



If you drive at both town-traffic and highway speeds, here's why you should use Power Tip . . . the first spark plug ignition-engineered for today's engines and today's driving.

YOU CAN SEE
 THE BIG NEW
 DIFFERENCE IN
 SPARK PLUGS!



At low speeds, the projecting Power Tip is in the thick of combustion where it gets hot quicker and stays hot to burn fouling deposits away *clean*. At higher speeds, the projecting tip is in the path of the incoming air-fuel mixture where it stays cooler to effectively *check* power-robbing pre-ignition. Ask your garage or service station to install Auto-Lite . . . the *only* spark plugs with Power Tip . . . and start enjoying top performance and economy from your car at *all speeds*.

*Power Tip, with or without Resistor, is ignition-engineered for overhead-valve V-8 engines and for most overhead-valve 6-cylinder engines in all these cars—Buick, Cadillac, Chevrolet, Chrysler, De Soto, Dodge, Edsel, Ford, Hudson, Imperial, Lincoln, Mercury, Oldsmobile, Nash, Packard, Plymouth, Pontiac, Rambler, Studebaker.

Power Tip protrudes farther into the combustion chamber for better ignition. Fuel burns more evenly and completely to give top performance and economy at *all speeds*.

AUTO-LITE RESISTOR SPARK PLUGS WITH **POWER TIP**

Auto-Lite makes a complete line of spark plugs, including Standard, Resistor, Marine, Small-Engine, Transport, and Aircraft.

Riding qualities have been improved noticeably in all the cars. There has been more emphasis placed on comfort than in any recent year. Almost all cars absorb road shock more completely. Most of them are much quieter both in engine noise and in road noise. Most of them handle more precisely and steer more easily. Their lower center of gravity helps cornering and comfort in the turns.

Although many are heavier, gasoline economy is expected to be about the same or, perhaps, even a little better due to changes in the rear-axle ratios. Acceleration is, therefore, not as good as in 1958, but this is an academic point inasmuch as most drivers never use all the available power anyhow.

Paints are better as almost all companies offer a long-lived finish that they claim requires little or no waxing or polishing (this remains to be seen, of course). Mufflers and tailpipes are expected to last longer generally as most companies use coated metals to resist corrosion.

Additional comfort is provided by the availability of split front seats, whereby the driver can sit close to the wheel, while the front-seat passenger moves his seat back for added legroom. Reclining seats with adjustable headrests are available on AM cars. Swiveling seats are optional on

all Chrysler Corporation cars. These make entry and exit easier and more graceful.

Back-seat passengers will be more comfortable in winter now that GM has found a practical way to pipe hot air into the rear of the car. Flat, narrow ducts run along each side of the transmission hump underneath the carpet and carry the heated air to the back.

Treads are wider on many cars as engineers strive for greater stability on the highway. This added width also improves air circulation around the brake drums and lowers underhood temperatures by allowing a greater volume of air to flow through the engine compartment (Pontiac, for example, with the widest tread of all, claims a drop of 40 degrees under the hood).

Brakes have been improved, both by increasing lining area and by improving air flow across the drums as the industry realizes that the heavier, lower cars require better brakes.

Generally, however, this has been a year for the stylist and your choice of a car will probably hinge more than ever on its appearance. That is why the year 1959 promises to be so interesting.

Whatever you decide to do, do it carefully. The industry, smarting under the sharpest criticism of its history, will be watching and planning. ★ ★ ★

Save \$115⁰⁵ on this \$245 value!

Portable 115 V. power plant only

\$129⁹⁵

FOB Minneapolis
(Shipping weight: 90 lbs.)

1200 watt continuous duty, 60 cycle a.c., complete with 3 hp Briggs & Stratton 4-cycle engine on lift-off mount



**BELOW
DEALER COST!**

Here's the power plant buy of the year! A 1200 watt, 60 cycle a.c. 115 volt generator (with 15 amp. overload fuse and duplex receptacle for 110 volt outlets) complete with 3 hp Briggs & Stratton engine for only \$129.95 fob Minneapolis! Engine and generator are mounted on 14-gauge steel platform with two semi-pneumatic 8-inch wheels for easy transport. Engine lifts off special mounting base (no tools needed) for use on other jobs around your farm, home or cottage. Extra mounting bases are available.

Now you can have your own portable electric power source for use wherever or whenever public power is not available—in the field, or during emergencies caused by floods, hurricanes and other crippling storms. Use the engine alone on a cement mixer, lawn mower, pump, sprayer, saw, golf cart, small car. The engine has full throttle control, oil-bath air cleaner, recoil starter—and it's backed by the new-engine (90 day) Briggs & Stratton guarantee.

Compare and see! This is a \$245 value! You save \$115.05! And it's brand new!

Send check or money order for \$129.95 today to:

POWER SUPPLY, BOX 5106, MINNEAPOLIS 12, MINN.



NEW DELTA "SUPER 900" RADIAL SAW

with honest 1 h. p. motor that develops up to 2 full h. p.!

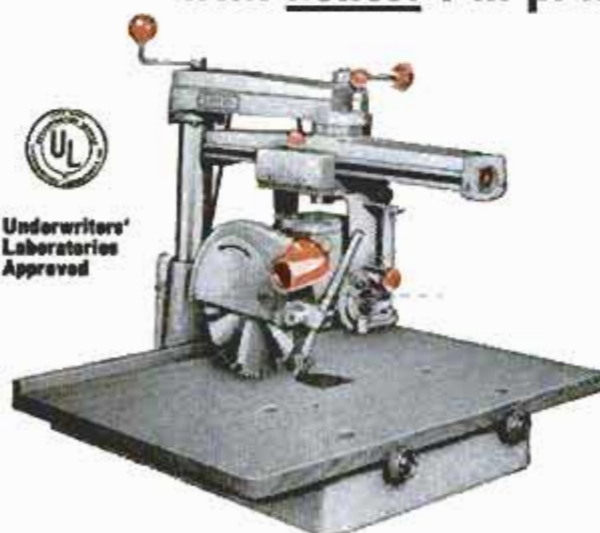

Underwriters'
Laboratories
Approved

It's the guts—not the gimmicks—that count in a radial saw. Delta's new "Super 900" has *honest* power where you need it—at the blade—for greater sustained cutting, faster, smoother working, and safer operation. *More power than any 9" home workshop radial saw ever built!* The "Super 900" is actually a complete, all-purpose workshop. With Delta's *exclusive* "turret arm" action you can swing, spin and tilt the head; any job is easy, even left hand mitering.

See this incomparable new "Super 900" today at your Delta dealer—he's listed under "TOOLS" in the Yellow Pages—or at leading department, hardware or building supply stores. Arrange easy terms to suit you. Rockwell Manufacturing Co., Delta Power Tool Division, 502L N. Lexington Ave., Pittsburgh 8, Pa.

NEW DELTA "SUPER 900": Honest 1 h.p. motor guaranteed for a full year! New "up front" guide fence positioning knobs and easy access controls. Plus exclusive combination of Delta Quality features: double overarm construction, and select edge grain fir table.

DELTA POWER TOOLS

another fine product by

ROCKWELL



**NOT
THIS**



Vibrator gadget

**NOT
THIS**



Piston Makeshift

BUT THIS . . . true professional-type integral 1/4 h.p. Motor-Compressor outfit, complete!



FOR THE MAN WHO TAKES PRIDE IN HIS CRAFTSMANSHIP . . .

SPRAYIT 400

MOTOR-COMPRESSOR

PAINT SPRAYING OUTFIT

IDEAL AIR SOURCE

For Cleaning Small Precision Equipment, T-V Radio Chassis, etc.

Outperforms, outvalues any equally compact sprayer at ANY price!

Nothing else like it! Even beginners get beautiful, professional results immediately! A true precision-tool built by world's largest manufacturer of portable paint spraying equipment, to highest standards of master painters, finishers. Sprays paint, varnish, lacquer, enamel—*anything*. Easier to clean than a brush; paints 4 times faster; gives immeasurably finer, smoother finish. Get *free* facts about the **BIG DIFFERENCE** between *Sprayit 400* and *all other* types commonly sold. Ask at your hardware or paint store—or mail coupon **NOW!**

complete ready to spray \$39⁹⁵
(\$40.95 in 11 western states)

THOMAS INDUSTRIES INC.

Electric Sprayit Division
Sheboygan, Wisconsin, Dept. PM-11

Please tell me all about SPRAYIT "400". Who is my nearest SPRAYIT "400" dealer? No obligation!

Name _____
Address _____
City _____ Zone _____ State _____

Salt-Water Battery

(Continued from page 126)

wire. A mooring line from the underwater buoy ascends to the surface and is attached to the skiff. In effect, the skiff is anchored to the buoy instead of to the weight at the bottom.

In somewhat similar studies on the Atlantic, the Bureau of Standards is preparing to launch a number of free-floating robot weather stations. Basically these are spar buoys with a radio antenna that rises 10 feet above the water. Every six hours each buoy will report the wind direction and speed at its location, the barometric pressure, and the air and water temperatures. This information will be automatically broadcast by a radio transmitter that also gives the identifying code name of the particular buoy. Location of each buoy will be determined by radio triangulation each time it broadcasts its information.

Tiny Electronic Tube In Laboratory Stage

Constructed of layers of titanium and a special ceramic material, electron tubes as small as transistors are being developed in the General Electric Research Laboratory. The new vacuum tube is not much larger than a shirt button but it operates at temperatures of from 900 to 1500 degrees Fahrenheit. The tiny tubes are not yet commercially available.

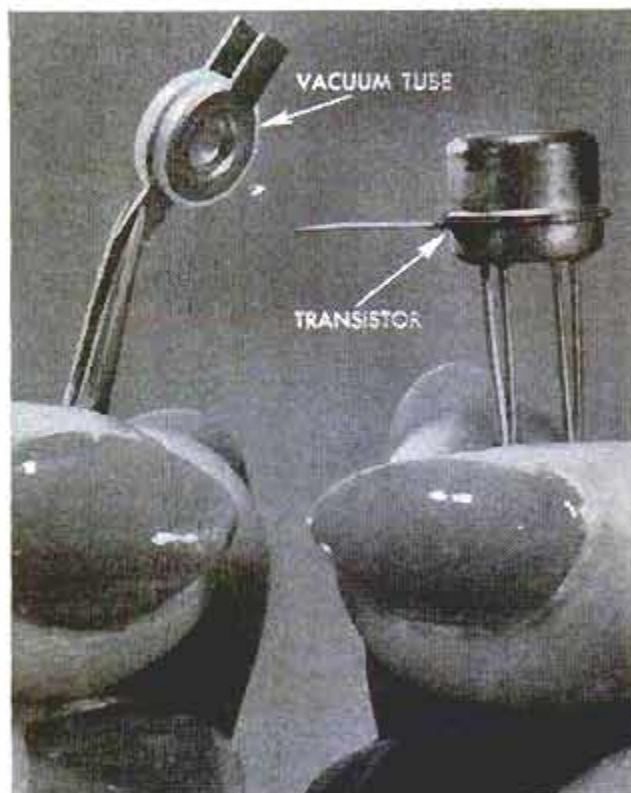

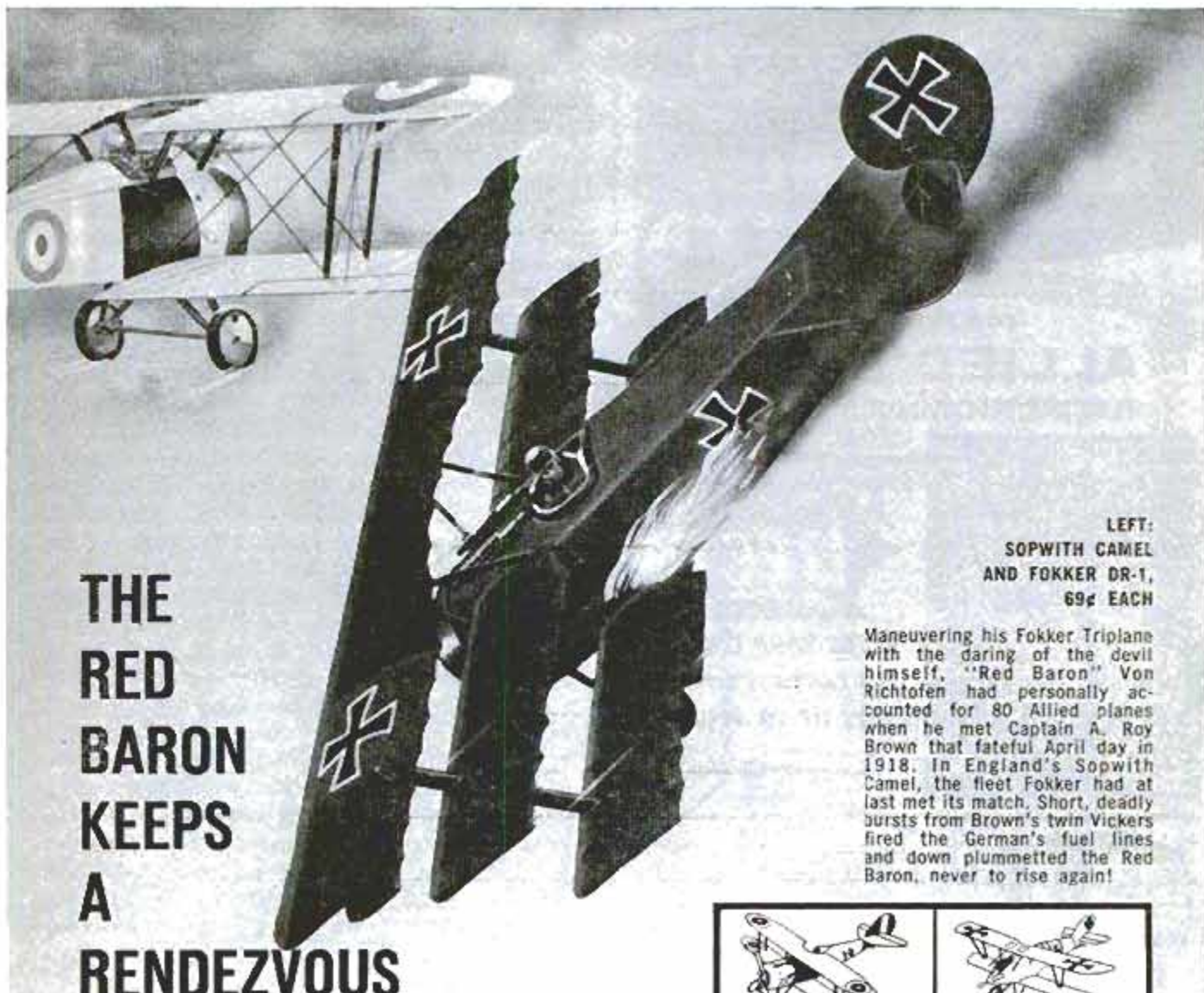

**THE
RED
BARON
KEEPS
A
RENDEZVOUS
WITH
DEATH!**

**LEFT:
SOPWITH CAMEL
AND FOKKER DR-1,
69¢ EACH**













Maneuvering his Fokker Triplane with the daring of the devil himself, "Red Baron" Von Richtofen had personally accounted for 80 Allied planes when he met Captain A. Roy Brown that fateful April day in 1918. In England's Sopwith Camel, the fleet Fokker had at last met its match. Short, deadly bursts from Brown's twin Vickers fired the German's fuel lines and down plummeted the Red Baron, never to rise again!

START BUILDING YOUR COLLECTION NOW!

Aurora makes over 150 model kits—planes, ships, tanks, trucks, figurines, etc.—but its **FAMOUS FIGHTERS OF WORLD WAR I** top the popularity polls. Everybody wants to re-create these super-detailed little battlers and enjoy the devil-may-care yarns that go with them. There are 14 in all, from 69¢ to \$2.49 each, at stores everywhere. Easy to assemble, complete with instructions, crew members, authentic decals and ground panel. It was a time of high adventure, and with Aurora models, *you* are there!



**AURORA PLASTICS CORP.
WEST HEMPSTEAD, NEW YORK**

 NIEUPORT 28	 PFALZ D-3
 SPAD 13	 DE HAVILAND DH-4
 FOKKER D-7	 SCOUT SE-5A
 GOTHA BOMBER	 JENNY JN-4
 DE HAVILAND DH-10	 NIEUPORT 11
 BRISFIT F2B	 ALBATROSS D-3

SEE OVER 150 DIFFERENT KITS IN AURORA'S FULL COLOR, 24-PAGE CATALOG. YOURS FOR THE WRITING AND 10¢ IN COIN

BUILD THE BEST!

build quality money-saving

knight-kits

A PRODUCT OF ALLIED RADIO

see them all in

ALLIED'S 1959 ELECTRONIC SUPPLY CATALOG



free

**BUILD YOUR OWN!
IT'S EASY—IT'S FUN—
SAVE UP TO 50%**



HI-FI
KITS



HAM KITS



HOBBY
KITS

INSTRUMENT
KITS



452

value-packed
pages

SAVE on Everything in Electronics



WORLD'S LARGEST STOCKS: Everything for Experimenters, Builders, Amateurs, Servicemen, Engineers, Hi-Fi enthusiasts. Get more for your money in Hi-Fi systems and components, including latest Stereo; save on build-your-own KNIGHT-KITS; recorders and tape; Amateur station equipment; TV tubes, antennas, accessories; test instruments; industrial electronic equipment—plus the world's largest stocks of parts, tubes, transistors, tools and books. Send today for your FREE 1959 ALLIED Catalog!

EASY TERMS AVAILABLE

our 38th year

ALLIED RADIO

Everything in Electronics at Lowest Prices

send for
FREE
Catalog

ALLIED RADIO CORP., Dept. 24-18
100 N. Western Ave., Chicago 80, Ill.

Rush FREE 1959 ALLIED 452-Page Catalog.

Name _____

Address _____

City _____ Zone _____ State _____

Underground Missile Base

(Continued from page 129)

and space craft that are "too big" to be fired safely from Cape Canaveral in Florida will be launched. It is also an operational site for long-range missile warfare. The base uses the new Pacific Missile Range that consists of two fan-shaped regions spreading over portions of the Pacific. One extends for more than 5000 miles to the west, beyond the Hawaiian Islands, Midway and Wake. The other extends south, all the way to Antarctica. On this last range the earth satellites that are intended to orbit across the poles will be launched.

Already in use at Vandenberg are launching facilities for Atlas ICBMs and for Thor intermediate ballistic missiles. These sites, too, are hard, although not to the extent employed for Titan. As much as possible the sites are built flush with the surface of the ground. Each Atlas launching pad, for example, is at ground level with only the service gantry rising into the air. Storage tanks for fuel and liquid oxygen are beneath, in reinforced-concrete structures. At the Thor IRBM sites, control blockhouses are partially below ground, their roofs buried under mounds of earth.

Vandenberg AFB occupies 64,000 acres near Lompoc, Calif., and adjacent to it the Navy has a 16,000 acre site for testing its own rockets. A main railroad traverses both areas, and launchings will be conducted only when no trains are nearby.

Oxygen men, warhead specialists, rocket electricians, among other specialized missile technicians, already are receiving training at Vandenberg AFB. After specialized studies in their particular fields the men are grouped into launch crews that operate as teams. ICBM teams, upon graduation, will be assigned to the new ICBM sites being prepared at Spokane, Wash.; Cheyenne, Wyo.; Denver, Colo.; Omaha, Neb. and elsewhere. IRBM crews graduated at Vandenberg will be sent to the overseas operational sites for intermediate missiles. ★ ★ ★

How Fast Is g?

Scientists at the National Bureau of Standards are trying to determine exactly how rapidly the speed of a falling object increases. The rate of acceleration of gravity (designated by a small g) is 32.155 feet per second at Washington, D. C. But the figure may be off by eight parts in a million. The scientists hope to cut down the error to one part in a million by dropping a metal bar in a vacuum and timing its fall with the aid of an atomic clock.



NEW HONEYWELL DECORATOR LIGHT SWITCH!



Change it
any way,
any time

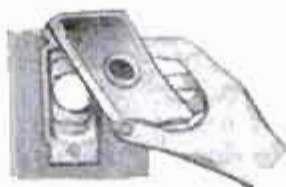

to match
your room's
decor!



THE TRANSPARENT decorator plate on the new Honeywell TAP-LITE* snaps off for easy decorating, cleans easily. Just wipe with a damp cloth. Simple to install. TAP-LITE has screwless terminals. Easy to operate. Tap, it's on. Tap, it's off! Switch and plate \$1.95 at all leading retail stores.

MINNEAPOLIS Honeywell



First in Control

*Trademark

It's Easy to Repair

JEWELRY • CHINA • PLASTICS
KNICK-KNACKS
CERAMICS • POTTERY



WITH
TUFF-BOND
QUICK-SET ADHESIVE

STICKS ALMOST ANYTHING TO ANYTHING

GOODLOE E. MOORE, Incorporated, Danville 10, Illinois

KEEP YOUR WORKSHOP TOOLS SAFE AND ORDERLY



This 7-drawer machinist's chest has a place for every tool. Extra durable heavy gauge steel. Felt lined drawers protect delicate edges... operate easily. Size: 8½" x 13½" x 20¼". \$27.95 at leading hardware stores. Slightly higher west. Other home workshop models from \$1.25 up.

WATERLOO VALVE SPRING COMPRESSOR CO.
Waterloo, Iowa

There is nothing like
the feel of the right gun... or the right tool
and the knowing how
to use it *

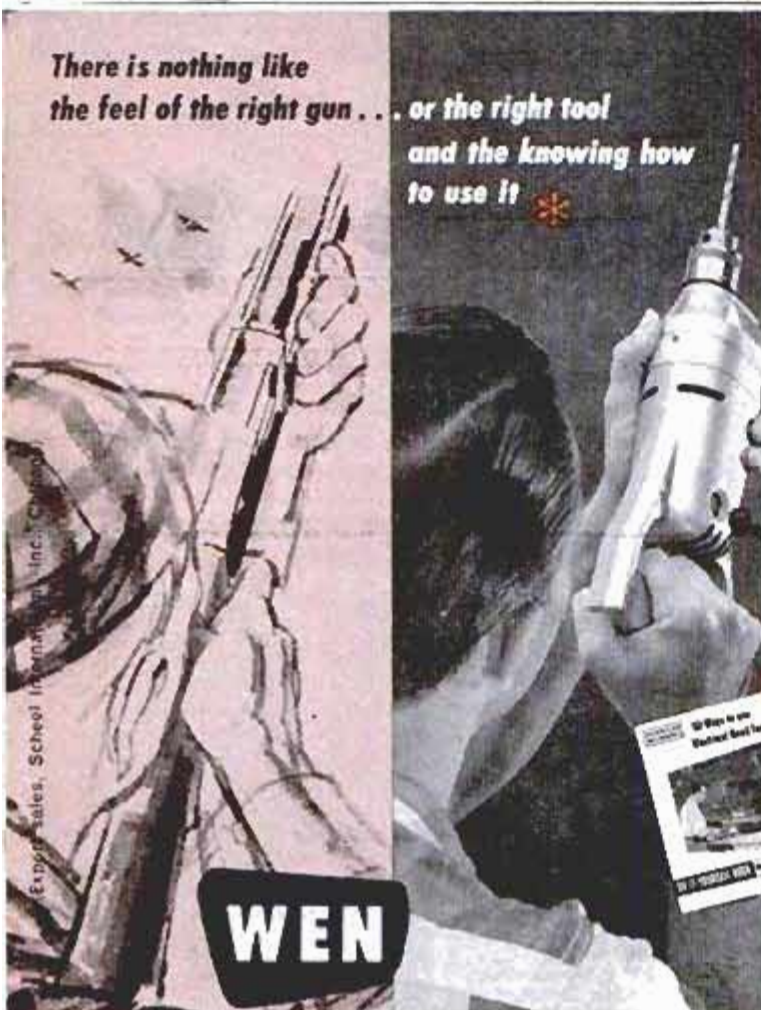

WEN



\$29.95

THE RIGHT POWER SAW—Cuts 2x4's in seconds—cuts ½" steel. Does work of rip, jig, cross cut, scroll, coping, hack, band, keyhole saw. Cuts any shape; straight lines, curves, circles, designs. Makes own starting hole. Saw Kit with saw, rip guide, circle cutting attachment, metal carry-box, 5 blades \$32.95.



\$9.95

THE RIGHT ELECTRONIC SOLDERING GUNS—Ideal for practically all home soldering jobs. Working hot in 2½ to 5 seconds. Long reach, long life tips. Automatic spotlight. Sturdy plastic housings, all perfectly balanced. 6 models—leather-light 100 watt to 250 watt heavy duty. Other guns and kits \$5.95 to \$15.95.



\$29.95

THE RIGHT 2-SPEED, ½" POWER DRILL—Changes from 1000 to 3000 r.p.m.—change is quick, positive, AC/DC motor delivers maximum torque under load. 35 piece Accessory and Toler Kit \$9.95.



\$13.95
to \$19.95

THE RIGHT SANDER-POLISHERS and KITS—Sand, polish any surface—wood, metal, paint, plaster. Gives scratch-free surface. 3 types—fine finishing, general utility, heavy duty.

* THIS COUPON WORTH 25¢

Especially prepared by the Editors of POPULAR MECHANICS, this book "shows" you all the simple tricks of how to get the most out of your power tools... A 50¢ value, simply send this coupon plus 25¢ in Coin only (no stamps, checks, M.O.'s) to:
WEN Products Inc., Box 442, Chicago 90, Ill. Dept. 9

Your Name.....

Street Address or P.O. Box.....

City..... State.....

Road Block Ahead!

(Continued from page 142)

to inspect the separate emergency-braking system that also is required by law. This system automatically applies the trailer brakes if the main air line from the tractor happens to break or if air pressure drops too low.

Straight air is not the only booster system used for brakes. There are straight vacuum systems, air-over-hydraulic systems, vacuum-over-hydraulic, and electric systems. Sometimes there are combinations, such as air brakes for the tractor and vacuum for the trailer. The ICC inspectors are trained to check every combination.

Sands explains that brakes that are in perfect condition can still fail if a driver uses them too much while descending a long hill. At the start they give 100 percent braking, then they begin to fade and shortly the driver has no brakes at all.

The reason is that the brake drums heat up and expand, then the shoes have to travel farther to remain in contact with the drums. Finally the push rods of the booster system reach the end of their stroke and can't push the shoes no farther. At that point the brakes are useless. The safest way to get down a long grade is to use a low gear and apply the brakes sparingly.

To help their drivers, some transportation companies are installing reserve brake indicators on their trucks. This device is actuated by the booster push rod. It flashes a warning light in the cab shortly before the push rod reaches its limit of travel. It tells the driver that his brakes are in a dangerous condition and that he should stop at once to let the drums cool off. The indicator has up to eight warning lights, one for each brake of a truck and trailer or a tractor and semitrailer.

Drivers never know when the ICC will block a highway, or where, or how long the inspection period will last. Sometimes every main road leading into a state is blocked. Sometimes the inspection period lasts for a day, sometimes for a week.

"Word soon gets around after an ICC inspection starts," Sands remarks. "Then we are apt to hear that every big garage for 100 miles down the road is busy making repairs to trucks. That's fine. The more safe trucks we find, the happier we are."

Most truck drivers welcome the safety inspection, for they know their lives are at stake. Sometimes a driver points out a faulty condition that his shop hadn't gotten around to repairing. The driver knows that an adverse report from the ICC will bring fast action.

Recently, the state of California put a

shaw

shoes are designed for men whose feet are part of their job!

Here's a sturdy work oxford, with all the styling, fit and comfort of a dress oxford! Shaw's high value features include full cushion insole heel to toe with metatarsal pad and cushion side arch support . . . oil resistant Neoprene sole . . . steel arch . . . Nylon stitched . . . plus the finest leathers and craftsmanship, in black or Cordovan color. AT STORES EVERYWHERE, or write us for details.



IDEAL FOR

mechanics, filling station men, mailmen, factory workers—anyone who wants comfort and style in a work oxford! Also available as high shoe.

ARCH



Sensibly priced at \$10.95, others \$8.95 to \$12.95.

M. T. SHAW, INC.
Coldwater, Michigan



"37 Years of Quality Shoemaking"

KING MIDGET

More power, beautiful styling. New Features. Still World's Lowest Priced Car. Drive it for 75c a week. Rider agents wanted. Earn your own car.



2 GREAT AUTO BARGAINS

King Midget Junior chassis, finely engineered, ready to run. Agents wanted. Send 25c for 32 page picture book, full details, dealers price on both cars. Or send \$1 (refunded first order) for this and Service Manual, plus Repair Manual and 15 5x7 photos of car and factory.



MIDGET MOTORS CORPORATION, ATHENS 1, OHIO

Carry Your Keys On a

KEY-BAK Key Reel

Your keys are SAFE when you carry them on a KEY-BAK Key Reel. KEY-BAK is pocket-watch size, sturdily constructed. 24" long steel chain; Swedish clock spring reels in keys, keeps them safe and handy at your side. Wear it on the belt! Get KEY-BAK Key Reels from your hardware or key shop.

OVER A MILLION KEY-BAKS SOLD!

WEST OF MISSISSIPPI
Lummis Mfg. Co.
2242 E. Foothill Blvd.
Pasadena, California

EAST OF MISSISSIPPI
CTL Company
1710 W. Stewart Ave.
Wausau, Wisconsin

ONLY \$2.95



roadblock on Highway 99 and made the most comprehensive safety check of commercial vehicles ever conducted. The site of the inspection was at the top of a long, steep grade a few miles north of the town of Dunsmuir. During the past year several trucks had roared down the grade out of control, including one that careened into the business section and killed several people.

For 24 hours, every southbound truck was flagged off the highway and sent along a secondary road where the inspections were made. One hundred and fifty highway-patrol officers, state employees, representatives of the trucking industry, and local law-enforcement officials worked in teams, using \$20,000 worth of test equipment for the check.

Inspection included the following: Load on each axle, number and size of tires, numbers and size of brakes, muffler-noise test with a decibel meter, and a comprehensive mechanical inspection of the whole rig. Brake tests included: Stopping distance with brakes cold, stopping distance with brakes hot at the foot of the grade, brake-drum temperature at the foot of the grade, air-transmission time from tank to farthest brakes, air leak-down time, and number of brake applications required to activate the air-pump governor.

Purpose of the inspection was not only to remove unsafe trucks from the highway before they started down the long grade to Dunsmuir, but to obtain information that would help determine whether additional safety legislation is needed.

Dangerous vehicles don't belong on the highway, despite the fact that mechanical failures are not a leading cause of accidents. Eighty-six percent of all accidents, 13 out of every 15, are caused by faults of drivers. The figure is almost exactly the same for both professional drivers and the driving public.

Sands tells audiences of truck drivers all about the accident that some of them will have in the future. He shows that the seeds of the accident are already present in their minds.

"One of the main reasons a driver has a wreck is bad driving habits," Sands says. "These include passing blind, tailgating, excessive speed for the conditions, lane changing without clearance, and other errors. A driver may get by with a bad habit for months or years; eventually it catches up with him.

"He can avoid the accident by changing jobs and not driving, or by recognizing any bad habits and overcoming them. He has to work at it and build up a pattern of auto-

(Continued to page 262)



HOME WORKSHOP

Protect planes, saws, gauges, power equipment—all other tools.

SPORTSMEN

Store reels, hooks, lures, pistols, rifles, shotguns, etc.



BOAT OWNERS

For compasses, motors, pumps—all corrosive gear.

AMAZING NEW TREATED BAGS PREVENT RUST ON TOOLS, GUNS, REELS, TACKLE!

New Kind of Rust-Prevention Bags Developed for Armed Forces Now Released for Civilian Use

Put anything made of corrosive ferrous metal into one of these new chemically treated bags. No matter how long it is stored, you'll never find a single trace of rust. This miracle is brought about by the impregnation of heavy-duty paper with anti-rust chemicals. This creates a harmless, invisible vapor which, in turn, acts as an impenetrable wall to block out rust and corrosion—for as long as three years! Regardless of weather, humidity or any other rust inducers, protection is guaranteed. Forget the messy oils, greases and smears you may have been using.

These amazing new anti-rust bags are sent to you in assorted sizes for protecting fishing gear, tools, gauges, guns and boating equipment. Large sheets are included for wrapping bulky objects, or they can be cut to use as liners for tool boxes, tackle boxes, gun cabinets, etc.—with guaranteed protection.

SPECIAL INTRODUCTORY OFFER—To acquaint you with the remarkable effects of this amazing new product we will send you: 9 ANTI-RUST BAGS in assorted sizes plus 2 LARGE SHEETS of anti-rust paper plus 1 SPECIAL HAND SAW BAG—all 12 pieces for only \$2.49. Saving just one tool from rust cor-

rosion will more than pay for a full 3 years' supply.

SEND NO MONEY—Just fill in coupon below. When postman delivers your anti-rust package pay him amount of order plus C.O.D. postage. Or save money, send payment with order and we pay all postage charges. You must be convinced that this is the greatest anti-rust product you have ever used or your purchase price will be refunded immediately. **ORDER TODAY** while supply lasts.

MAIL COUPON TODAY

RICH PRODUCTS CO., Dept. 6811
3916 Geraldine Ave., St. Louis 15, Mo.

Please send me the new anti-rust material as checked on guarantee that I must be satisfied or my money will be refunded immediately.

Kits at \$2.49 each. Contains 9 assorted bags plus 2 large sheets and extra hand saw bag.

NAME _____

ADDRESS _____

CITY _____ ZONE _____ STATE _____

Cash enclosed Send C.O.D.
 Send postpaid plus postal charges

RICH PRODUCTS CO., Dept. 6811, 3916 Geraldine Ave., St. Louis 15, Mo.

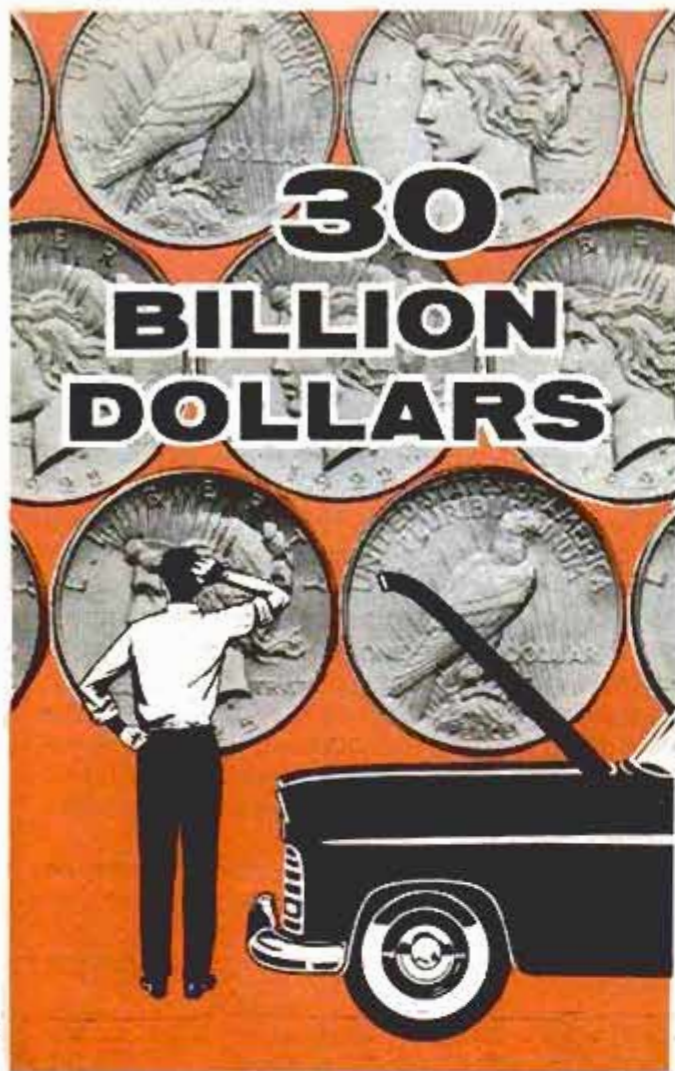

ALL THAT MONEY WILL GO INTO CAR REPAIRS DURING THE NEXT 12 MONTHS—and *you* will have to pay \$425.31 according to a national survey *unless* you start avoiding costly repairs now with Wynn's Friction Proofing.

Oil spots on your garage floor can mean a leaking automatic transmission leading to a repair bill as high as \$150. A tapping in your engine indicates sticking hydraulic valve lifters and expensive repairs. Hard starting and rough idling means wasted gas and oil — sign posts of an engine tune-up, a carburetor job, or both.

Your car will last longer and run better when you use Wynn's Friction Proofing products which are engineered to *fight trouble* and *prevent trouble* in your car's engine, radiator, upper cylinder and transmission.

THE *Proof* IS IN
THE *Performance!*



Also available in Canada and everywhere in the free world.

Wynn Oil Company • 1151 West 5th Street • Azusa, Calif. • U.S.A.

matic good habits stronger than the old pattern.

“Another big reason for driver-failure accidents is inattention. This may be caused by fatigue, liquor or stimulants, turning the head away from the road, or by daydreaming.

“Everyone daydreams at the wheel. The driver's mind is elsewhere much of the time and the ‘automatics’ in his brain are in charge of the truck. This is perfectly all right if the automatics are based on good driving habits and as long as his daydreaming isn't too vivid.

“Here's an incident that happened not long ago. A man who had lost an important business deal was reliving the whole thing in his mind while driving home. He was an experienced driver, but on this trip he changed lanes in such a way that he caused a fatal accident. His own car wasn't touched and he drove home completely unaware of the accident.

“Later, a driver-instruction apparatus was set up with the same highway and the same traffic simulated on its screen. The man was asked to pretend that he was driving home. Meanwhile, one of the men in charge of the test described the business deal to him and sympathized about how he had lost it. What he was trying to do was to put the driver in the same mental state as before. Sure enough, the driver made exactly the same lane change he had before, at the same point on the road, and in the same traffic. If he had been on the highway, the same accident would have been repeated.

“This is a pretty positive demonstration of how a person's private life controls his driving. Inattention, based on daydreaming, is one of the greatest causes of accidents. Professional and nonprofessional drivers alike should guard against it.”

★ ★ ★

Radar Traps Get Better

Traffic officers will get an assist from a radar set developed in England that can spot speeding cars in heavy traffic. One of the major objections to traffic radar has been its inability to discriminate between vehicles in dense traffic. The lightweight British set, using transistors and printed circuits, can provide separate readings on cars only eight feet apart. It is accurate to within one mile per hour and can be set to “lock on” automatically to any individual reading.

☐ In 11 years of operating large atomic plants, General Electric reports that no employee has been injured by radiation.

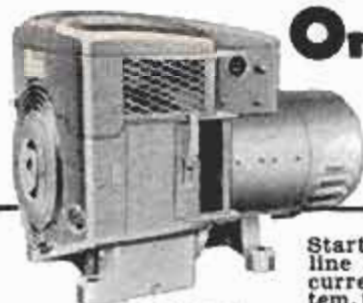

Onan Emergency Electric Plants

Start automatically when high-line power is cut off. Supply current for lights, heating system, freezer, water pump, stove, all appliances and machines. Prevents losses and hardships. Plant stops automatically when power is restored. Compact, easy to install. 500 to 200,000 watts A.C. Priced from \$319.00.

PORTABLE MODELS

500 to 10,000 watts. Supply plug-in power anywhere!

Write for Free Folder

D. W. ONAN & SONS INC.
3590A UNIVERSITY AVE. S.E. • MINNEAPOLIS 14, MINN.

GIVE THAT FAVORITE DRIVER A HULL AUTO COMPASS

Famous for quality and accuracy for a quarter-century. Five colors. Modern styling. Easy to install. A practical gift that lasts for years. Inexpensive. At your dealer's or write for literature.



IDEAL GIFT FOR BOAT OWNERS, TOO

Beaconlite ILLUMINATED \$4.95
Streamline NON ILLUMINATED \$5.50

HULL MFG. CO.

P. O. Box 246-D11, Warren, Ohio



Wash or scrape old paint off with



HEAVY-BODIED KLEAN-STRIP

BUILD FINE GRANDFATHER CLOCK NOW

The simple sensible SPEEDE Red-i-Kut way as thousands have—FOR YOURSELF OR SELL AT A GOOD PROFIT. SAVE HUNDREDS OF DOLLARS. SHOP TESTED PLANS "SPIRIT OF THE CENTURY" Narrow waist 83" tall or stately straight side "SPIRIT OF AMERICA." EASY-TO-FOLLOW photopack PLANS & LIFE SIZE PATTERNS tell all—plus MOVEMENT BROCHURE \$4.00 up, of heavy brass weight (Kuempel original) Westminster, tube BELL chime, movements, gorgeous bronze-silver MOVING MOON dials, 3/4" solid-mahogany Jiffy Joint-Kwik-Bit case kits. Send \$1.00 today—Both plans RUSH \$1.50 as folks have for over forty years.

Kuempel Chime Clock Works, 214 Kuempel Bldg., Minneapolis 16, Minn.

**EASIER
FASTER
BETTER!**



KESTER SOLDER

FREE: "Soldering Simplified" 16-page booklet—Send for your copy today.

For General Soldering

KESTER SOLDER COMPANY
4251 Wrightwood Avenue • Chicago 39, Illinois, U.S.A.

NEW MODEL CHANGEOVER SALE

NOW
\$9.95
WAS \$24.95

8" TILT ARBOR POWER SAW

Shipped Complete As Shown Less Blade

1958 MODEL NOW SOLD BELOW COST BLADE TILTS • TABLE REMAINS LEVEL

Heavy duty all cast iron and steel construction. Precision ground cast iron table. Price includes massive cast iron mitre gauge and patented motor drive that fits any motor. Does everything same as saws costing four times as much—cross cuts, rips, bevels, mitres, dados, cuts compound angles. Adjustable depth of cut; 0" to 2 1/4". Send check or M.O. \$2.00 deposits on C.O.D.'s.

SAVE \$15 ON THIS SPECIAL BARGAIN DURING OUR MODEL CHANGEOVER

This saw is our 1958 model. Brand new—sent to you in factory sealed cartons. Sold and guaranteed direct from factory to you at a fantastic bargain.

LOOK AT ALL THESE SPECIAL FEATURES

Blade adjusts to any angle up to 50° • Single Hand Wheel Control. Tilts and locks blade with a twist of the wrist • Blade raises and lowers; cuts from 0 to 2 1/4" • Precision-ground cast iron table. Lasts a lifetime. Resists nicking and wear • Patented Motor Mount takes any standard 1/4 or 1/2 h.p. motor • Always keeps belt tight; transmits full power • Massive accurate iron mitre gauge • Saw insert removable for dado heads and other accessories • Heavy long-lasting, all-metal construction • Built for a lifetime • Shipping weight 25 lbs.

FAMOUS AMERICAN IRON CLAD GUARANTEE

Try this famous saw 10 days. If not completely delighted—FOR ANY REASON—return for immediate money back refund. All power tools sent express collect. We reserve the right to refund money if stock is exhausted. Use this handy coupon.

AMERICAN MACHINE & TOOL CO.
ROYERSFORD 54, PA.

MAIL COUPON TODAY

American Machine & Tool Co.
Royersford 54, Pa.

Gentlemen: Please send me 8" Tilt Arbor Saw(s) at \$9.95 each. Enclosed is check , M.O. , or send C.O.D. . . . \$2.00 deposit, please. Add \$1. for delivery west of Mississippi.

Name

Address

City Zone State

More cutting power
for 1/4" electric drills

Irwin Speedbor "88"
most revolutionary bit in years

→ Irwin's Exclusive Hollow Ground Point and spade-type cutters bore faster, deeper, cleaner with less power. Try the Speedbor "88" in your small 1/4" electric drill or drill press and see. Get smooth, effortless cutting action in hard or soft woods, plaster, plywood, plastics — even hardrock maple! Forged in one piece from solid bar of high carbon steel, hardened full length to stay sharp. And remember . . . the hollow ground point is exclusive with Irwin's Speedbor "88". Buy individual sizes or sets from your independent hardware dealer.



No. 886-R plastic roll set of 6, sizes 3/8" to 1", only \$4.50



75¢ each
1/4" to 1"
\$1.25 each
1 1/8" to 1 1/2"

IRWIN
Wilmington, Ohio

• the original solid center auger bit
• screw drivers • screw driver bits



Pilotless Helicopter
Can Stay Put in Air

Capable of staying in the air over one location for long periods, an electrically powered pilotless helicopter is powered through a cable leading from a gas-turbine-driven generator on the ground. The plane was developed by Kaman Aircraft for the Navy as a long-duration platform. It is designed to operate automatically and maintain a station at given altitudes.

Fingerprints on Cloth
Exposed by Formaldehyde

No more can criminals destroy their fingerprints merely by wiping door handles and guns. Japanese scientists have found a method for picking up latent prints on paper, cloth or anything else the criminal may have touched. The material being investigated is exposed to fumes of formaldehyde made with radioactive carbon. The formaldehyde combines with the body chemicals left by the fingers. Then the excess formaldehyde is removed and the material is stored in a refrigerator while in contact with a photographic film. The radioactive carbon "exposes" the film. When developed after several days of this exposure, a good photographic image of the hidden fingerprint can be obtained.

☐ Cottonmouth moccasins are receiving injections of radioactive iodine to discover more about the little-known nature of snake venom, a medical scientist at the University of Florida reports.



KING O' LAWN'S GREAT NEW ROTARY MOWER!

25% SMOOTHER... QUIETER



Look at the under-side and see why King O' Lawn is an engineering feat.

PERFECT BALANCE. Delivers more cutting power for less work. Its smooth, perfect performance is the result of five years of design testing to achieve the ideal weight-to-power ratio — the precise balance of cutting blades, drum and housing — and the perfect balance of size and total weight.

POWERFUL • RUGGED

COMPARE. More exclusive features. More quality and workmanship. More years of trouble-free service.

17 NEW MODELS. The hit of the New York Hardware Show. Walk & Riding Rotary & Reel-Type Power Mowers & Edgers. Write for name of nearest dealer — there are over 2,000.

KING O' LAWN, Inc. Box 1068, South Gate, Calif. or 162 Brook St., Elgin, Ill.
A few choice dealer territories available.

1000's of ITEMS in WOODS



Tools, Materials & Supplies

THIS BIG, new 126 page catalog and "how-to-do-it" book has everything for the woodworker and hobbyist, all at lowest prices. Complete source of supply for fine, rare imported and domestic woods, veneers, turning blocks and squares. Inlays, bandings, mouldings, carvings, upholstery supplies and wood finishing materials, hand and power tools. Thousands of items to

FREE! choose from. Unusual hardware for every purpose. Exclusive wood identification chart of over 60 woods named and reproduced in natural color. Hundreds of illustrations, "how-to-do-it" articles, projects and plans. Send only 50¢ today (refunded on 1st order) and will include **FREE** with your copy of our big manual our special 25¢ wood finishing book. Write today!

ALBERT CONSTANTINE AND SON, INC.
2056-E Eastchester Road New York 61, New York.

FREE THE HISTORY OF THE COMPASS SEND FOR YOUR COPY

New DINSMORE Celebrity COMPASSES

in Beautiful GOLD or SILVER

A jeweled, precision instrument—designed for modern cars. Full, indirect illumination. Sharp, clear letters. Silver or gold Celebrity models \$6.95, standard models \$5.45, illuminated \$6.45 **APPROVED BY AUTO MAKERS** Fine Quality Compasses for over 31 Years

DINSMORE INSTRUMENT CO.
1802 Kelso St., Flint 1, Michigan



Write for Folder



FIND THE WOOD STUD IN YOUR WALL WITH A FORD DOWSER BALL

Indispensable when hanging pictures, mirrors, shelves; and when making alterations. The original Stud Finder. **YOU MAY NEED ONE TOMORROW!** The roll of the ball finds the actual STUD in the wall.

NO MAGNETS!

Only \$2.00 post. Money-back guarantee: no C.O.D.'s please. Usual trade discounts to dealers.



\$2.00
POST PAID

FORD PRODUCTS Dept. P-8
PORT CHESTER, N.Y.

ANCOPOWR 1/4" ELECTRIC DRILL \$11.95

Jacobs Key Chuck • 5 Alloy Steel Gears
• 900 RPM Full Load • 1600 RPM No Load • 7 Ft. Cord & Plug • UL Approved
1/2" DRILL ALSO AVAILABLE \$24.95

Send Check or M.O. Money Back Guarantee
(Illinois residents include 3% sales tax)



ANCHOR WIRE & MFG. CO. 2118 W. VAN BUREN ST., CHICAGO 12, ILL.

PUSH-BUTTON MAGIC

Clarke's NU-GLU

EXTRA STRONG FAST DRYING

Ideal WHITE GLUE for WOOD • PAPER • CHINA • PLASTIC • ETC.

Dyna-Therm Chemical Corp., 3813 Hoke Ave., Culver City, Calif.



YOU NEED THESE BASIC TIME AND MONEY SAVERS FOR YOUR HOME SHOP

Atlas 6" JOINTER PLANER



With this superb jointer-planer you can plane, end-joint, tongue, bevel, or rabbet wood of any size with unequalled accuracy, ease and safety. Satin-smooth, ripple-free finish. Larger table and fence, heavier solid-steel cutter-head spindle. This is the jointer-planer you need to give your work that professional quality. Ask any experienced woodworker. Write for descriptive literature.



10" TILT/ARBOR SAW

With this precision ATLAS 10" circular saw you can do almost every basic wood-working operation . . . faster, more accurately, and with greater safety. You can crosscut, rip, miter, dado, and shape with greater ease, precision, and smoothness. Unexcelled for general carpentry, this great saw also gives you versatility you need for fine cabinet work, built-ins, trim, and furniture projects. It's the only saw with rigid triangular arbor support, balanced tilt mechanism, bigger arbor, push-pull depth and angle control, and double-locking lift-off fence with vernier control.

Write FOR FREE CATALOG

Atlas Press Company

11-24 N. PITCHER ST., KALAMAZOO, MICHIGAN



DIAL ANY

DADO WIDTH

...IN SECONDS

do-1



LOOSEN ARBOR NUT
DIAL NEW WIDTH
TIGHTEN ARBOR NUT
... CUT!!!

FOR PROFESSIONAL PRECISION...only with a COMET QUICK-SET DADO! Cut to a maximum depth of $\frac{3}{4}$ ". Dial the exact width (from $\frac{1}{4}$ " to $\frac{3}{4}$ "), without removing the tool from the arbor. Watch the balanced, tool-steel COMET blades cut perfect dados, rabbets and ploughs...on any table or radial arm saw. Use COMET for quick, professional precision... stays sharp 5 times longer! If not at your local dealer, order direct by check or money order. **19.95 PREPAID**

Name

Address

City Zone State

No. of Dados Check Money Order

COMET MANUFACTURING CO a division of The Siegler Corporation
2033 Santa Fe Avenue, Los Angeles 21, California Dept. PM-11

COMET *



Eyeglass Prescription Added to Diving Mask

Water-sports fans who lack normal vision can now buy diving-mask faceplates that contain their prescribed eye corrections. They are being used by persons with astigmatism, nearsightedness or farsightedness, some of whom were previously unable to participate in diving because of poor underwater vision.

TV "Scout" for Icebreaker Looks 35 Miles Ahead

Ice reconnaissance as far as 35 miles away from an icebreaker is now possible through airborne television. The TV pictures are transmitted from a camera aboard a helicopter to two television monitors on the icebreaker—one on the bridge, the other in the combat information center. Thus, officers on the ship are able to make constant evaluation of ice conditions far ahead on the ship's course. The TV monitors clearly show telltale signs indicating the path of least resistance through heavily packed ice. Icebergs and open patches of water are clearly seen on the monitors, and observers on the ship are able to distinguish between old and new ice, pack ice and pressure ridges.

☐ Lemon-candy-flavored multivitamin preparation for children now is available in the form of a heavy syrup that can be squirted from a push-button container.

31 Authentic U. S. Missile Models

Exhibition Stand • 32 Page Missile Book



**NEW
SPACE AGE
HOBBY KIT**

Only
\$2.98

Endorsed and Recommended by
Willy Ley,
World Known
Authority on
Missiles,
Rockets and
Space
Travel.



Atlas	Nike Ajax	Talos
Vanguard	Petrel	Sergeant
Jupiter C	Polaris	Falcon
Redstone	Rascal	Dart
Nike Hercules	Little John	Sidewinder
Thor	Hawk	Genie
Regulus II	Tartar	
Snark	Terrier	
Bomarc	La Cross	
Matador	Rat	
Jupiter	Sparrow	
Corporal	Bullpup	
Honest John		

Have Fun!

Assemble this Fascinating Kit!

"KNOW THE MISSILES" with U. S. Missile Arsenal

Here is the ideal "joint" project for every dad and boy. It's the U. S. Missile Arsenal. 31 detailed scale models — a complete set of all U. S. missiles and satellite launchers in one magnificent Space Age hobby kit. Gives you America's entire missile activity at a single glance. Kit includes permanent identifying exhibition stand with place for each missile and an illustrated 32 page missile book. Stand with missiles in place is 13 x 5 3/4 x 7 1/2 inches. Get a Missile Arsenal for yourself and a boy and KNOW THE MISSILES—know what they are—what they do—how they do it—when you read about them in the news. Easy to assemble. A fascinating project with a vital "sock." Ask for Missile Arsenal by Monogram.



Vanguard — Jupiter C — Atlas — All Included!

Set includes the Vanguard and Jupiter C, satellite launchers; the big Atlas; the winged — Snark, Regulus II, Bomarc, Matador and 24 other missiles. All in same scale.

At Dealers Everywhere

See the Missile Arsenal in stores everywhere. If none in your neighborhood order from address below. Remit regular price, \$2.98 plus 30 cents to partially cover postage and packing expense. Write Monogram Models, Inc., Dept. 13, Chicago 32, Ill.

Monogram

Authentic Missile Model

LIFE-SIZE XMAS CUTOUTS!



EASY TO MAKE! JUST PASTE ON FIR PLYWOOD AND CUT OUT!



Thrill your family and make your home a holiday showplace with these colorful, easy-to-make decorations for lawn, roof or porch. No coloring or drawing. Simply paste durable full-color patterns on fir plywood and cut out with saw. Exterior fir plywood makes giant figures strong, long-lasting. Supply limited, no orders after November 24. Offer good USA only. Sorry, no C.O.D.'s. Order all three—but hurry! All orders shipped prepaid.

Jolly 6' Santa . . . 50¢
6' Long Sleigh . . . 50¢
5' Long Reindeer . . . 50¢



DOUGLAS FIR PLYWOOD ASSN., Dept. 9, Tacoma 2, Wn.

NOW! a hi-compression
staple gun
for only
\$4.95



With Exclusive
Push-button Loading
and Built-In
Staple Extractor.

Indispensable for home use...and never before priced so low! This compact, all steel, powerful SWINGLINE 101 staple gun is ideal for insulation, carpentry, upholstery, screening, wire fencing, plus thousands of other uses. Handle locks to fit pocket. Lightweight, maneuverable, jam-proof! Staple sizes $\frac{1}{4}$ ", $\frac{3}{8}$ ". Send for FREE book—"Tips for Tacking".

Swingline® INC.

Dept. M118 Long Island City 1, New York

Now It's Sunburned Fish!

Did it ever occur to you that fish might suffer from sunburn? They do. In the wild they can dive deep or take to shady spots. In hatcheries it's something to worry about. So the government's Fish and Wildlife Service has been doing some worrying, and its nutrition laboratory at Cook, Wash., has come up with the fact that a diet enriched with niacin will help a sunburned salmon—its skin peeling and discolored, with blisters and lesions—back to health.

Move Over, Laika!

Were spores the first space travelers? Spores of common bacteria and fungi can survive the airless environment of space, according to research at the Wright-Patterson Air Development Center. Such spores were subjected to a vacuum equivalent to that 100 miles above the earth. Beyond that point the atmosphere does vary greatly. The spores survived the exposure for 32 days and showed no evidence of damage or reduction in germination.

Short Cut to Shale Gas

Laboratory experiments indicate Colorado oil shale can be converted directly to heating gas by a process that utilizes up to 100 percent of the active matter in the shale. The present processes, which first convert the shale to liquid oil, use only 80 percent of the active organic matter. In the new one-step process, crushed oil shale is treated with hydrogen under high temperature and pressure.

Atomic Heating Plants For Swedish Homes

Experiments in heating houses with atomic reactors will be started soon in Sweden. The reactors will be buried in underground rock in a suburb of Stockholm and in the city of Vasteras, about 70 miles from Stockholm. Heated water from the reactors will be circulated to the homes. The two reactors also will produce a total of 200,000 kilowatts of electrical energy. The projects will be fueled by natural uranium and moderated by heavy water.

☐ A television lens that can produce a clear picture of flames inside a boiler at temperatures above 2000 degrees Fahrenheit has been developed by General Electric. Housed in a 14-inch steel tube, it is cooled by compressed air.



Hand-rubbed finish
without rubbing

McCLOSKEY HEIRLOOM®

The specially developed finish for antiques,
furniture, wall cabinets and paneling

Flows on silken smooth, leaves no brush marks,
never a sheen variation. Heirloom is extremely
pale, nonyellowing, nonstaining—sets up dust-
free in 1 to 2 hours, hardens overnight.

Send for free booklet, "How
to Finish Furniture, Wall Cab-
inets and Paneling with HEIR-
LOOM Varnishes."



McCLOSKEY VARNISH CO.

Dept. 213, 7600 State Rd.
Philadelphia 36, Pa.

Cut it with WISS



New Wiss Hy-Power Pruning Shears, with specially fitted vinyl grips, cut the toughest limbs with ease. No. 907-G, only seven inches long, \$3.25 at leading hardware, garden supply, and department stores everywhere.

OTHER FINE WISS CUTTING TOOLS

**METAL-MASTER
"AVIATION"
SNIPS**
\$4.25*



Compound-action gives amazing power. Only 10" long! Model M-3 above for straight cuts, shallow arcs. Others for every job.
*Slightly higher Denver & West. Handle grips 35¢ extra.

**TIN SNIPS
NO. V-13**
\$2.25



Only seven inches long, these "mighty midget" snips cut metal, vinyl, rubber, leather. Others 10" to 17" in aviation, combination and solid steel styles.

J. WISS & SONS CO., NEWARK 7, N. J.

World's Largest Manufacturer of Shears, Scissors, Pinking Shears, Skalloping Shears, Metal Cutting Snips and Garden Shears

Compact!
Battery-
Powered!



- **For Boating**

Bilge pumping, water systems, bait tanks, washdowns

- **Trailer**

Water systems

- **Camping**

Gear, auto and child washing



The JabSCO "Water Puppy" Pump fills a practical need for outdoorsmen and Do-It-Yourselfers everywhere. Designed for years of hard service, the "Water Puppy" features bronze housing and flexible neoprene impeller. Trouble and maintenance free! Ports threaded externally for 3/4" garden hose, internally for 3/8" pipe thread.

See the "Water Puppy" Pump today! At your dealer or write direct. 6-volt - \$26.50 12-volt - \$27.50 24-volt - \$28.00 32-volt - \$28.50

JABSCO PUMP COMPANY

Dept. PM • 1485 Dale Way • Costa Mesa, California

Any man will enjoy new

AIRGRATE YELLO-BOLE

1. Smokes sweeter!
Imported briar bowl lined with *real honey*. Starts caking the instant you light up. Hence, no break-in.

2. Smokes drier and healthier! Metal grate condenses moisture, tars, nicotine. No wet heel.

3. Smokes cooler! Air-vented chamber draws in fresh air. Aluminum fins and shank throw off heat, cool the smoke.

Famous honey-lining!

\$295

Extra interchangeable bowls — \$1.50 each

"Icepak" Set—Airgrate Yello-Bole Pipe plus two extra bowls, \$5.95

Other Yello-Bole Pipes, also of imported briar \$1.50 to \$3.50

BY THE MAKERS OF KAYWOODIE PIPES, Dept. Y27, NEW YORK 22

MAKES A HARD RUBBER Mallet IN A MINUTE!

SLIP-ONTM HAMMERHEAD

- ★ 3 SIZES FOR ALL HAMMERS
- ★ GRIPS HAMMERHEAD FIRMLY
- ★ CONTOUR FIT FOR ALL BALL-PEN AND CLAW HAMMERS!
- ★ REMOVABLE
- ★ AT HARDWARE AND AUTO STORES OR WRITE:

98¢ EACH

W. J. RUSCOE COMPANY
483 KENMORE BLVD. AKRON 1, OHIO



Holder for Polaroid Film Available for Press Cameras

Owners of 4 by 5 press or view cameras can get one-minute prints from a new holder for Polaroid Land film packets. The holder does not change the film plane and no readjustment of the ground glass or rangefinder is required. A lever on the holder closes the rollers to break the built-in pod of chemicals which develop the picture in 60 seconds.

Missile Engineers Have Problems

You think you have troubles? Consider the missile engineer. If he builds an intercontinental ballistic missile with more than 300,000 parts—any one of which could fail to operate properly—the ICBM must have an over-all reliability of 99.9999 percent if it is to perform as planned nine times out of ten.

Here are some of the problem factors the engineer faces in planning a missile to operate at supersonic speed above 15 miles altitude: Highly reactive gases such as atomic oxygen, radiation, low atmospheric pressure, 100 times more ozone than at sea level, zero gravity, accelerations up to 60 gs, violent vibrations and temperatures that range within minutes from 65 degrees below zero Fahrenheit to 1200 degrees above zero.

Aircraft De-Icer Available for Cars

Developed originally for aircraft windshields, a British de-icing and demisting device is now available for use on automobiles, ships, refrigerators and the like. It consists of a transparent film of gold and metal oxide, two ten-millionths inch thick, inserted in panels of laminated glass. The film is deposited on the inner face of one sheet of glass so that it is protected and completely insulated in the finished screen. If sufficient voltage is supplied, the film can carry up to 1000 watts per square foot.

THE CHRISTMAS GIFT FOR A LIFETIME ENJOYMENT

NOW! HOME CRAFTSMEN CAN OWN THIS PROFESSIONAL ARC WELDER

EASY TERMS ONLY \$98.50 F.O.B.



FREE
WRITE FOR COMPLETE DETAILS AND EASY-PAY PLAN

Now you can own a Trindl full 125 amp Industrial Welder at a price far less than smaller machines. With a Trindl 125A you can weld metals up to 1/2 inch thick. Operates off either 110 or 220 volt line, properly wired. 16 heat stages from 20 to 125 amps. Make and repair anything of metal around the home, garage, farm or shop, like a professional. No previous experience or training needed. Full "do-it-yourself" instructions with each machine. Complete only \$98.50 f.o.b. factory, or write for details. Trindl manufactures a complete line of heavy duty welding machines. Dealer inquiries invited.

TRINDL PRODUCTS Ltd., Dept. T2-M
1807 So. Clark St., Chicago 16, Ill.



Guaranteed
12 MONTHS IN CONTINUOUS OPERATION

HANDEE

A COMPLETE WORKSHOP IN YOUR HAND



The powerful new Hi-Torque HANDEE grinds, polishes, cuts, saws, engraves, burnishes, cleans. A necessity in every workshop. Works in wood, hardened steel, non-ferrous metals, glass, ceramics. Packed with power and speed (25,000 rpm). Cool running, fits the hand for pencil-point precision. 110 or 220-v. 25 to 60 cycles AC or DC.

with 6 accessories
\$23.95

TOOL OF 1001 USES!
With every type of cutting tool in metal case. **\$32.95**

Order your Handee Today!

CHICAGO WHEEL & Mfg. Co. Dept. PM-11

1101 W. Monroe Street, Chicago 7, Illinois

ALSO NEW LAPSTRAKE KITS

U-MAK-IT BOAT KITS FIRST AND OLDEST KIT BOAT MANUFACTURER

Most complete line of PRAMS, ROWBOATS, OUTBOARDS, CABIN CRUISERS and new Lapstroke kits. MAIL 35c (coin) for post. & hdg. for ILLUSTRATED CATALOG Showing all models 8' to 23' including accessories, paints, etc.

All you need to build your own.

U-MAK-IT PRODUCTS
DELAND, FLA.—DEPT. 12



CASH FILING SAWS

Make \$3 to \$6 an hour spare time — or start a full time business with the

FOLEY SAW FILER



Here is a steady repeat CASH business you can start at home in your basement or garage, while you are working at your regular job. No experience is necessary to turn out perfect cutting saws—"the first saw I sharpened came out 100%. I think the Foley Saw Filer is a marvel of perfection," writes Clarence E. Parsons. No canvassing — every saw you sharpen will bring you new customers. You will find you can make from \$3 to \$6 an hour—\$20 to \$30 a week in your spare time as a starter. "My spare time saw filing business has made me \$952 these first ten months," says R. T. Chapman.

With a Foley Saw Filer you can file all hand saws, also band and cross-cut circular saws. It is easy to operate—simple adjustments—no eyestrain. Patented jointing principle evens up all irregular teeth and makes an old saw cut just like new.

This Free Book "MONEY MAKING FACTS" Shows How To Start

"MONEY MAKING FACTS" shows you how others have added hundreds or thousands of dollars to their incomes and how you can develop into a general repair shop that will be your own business. This is a CASH business with a small investment, no overhead, no stock of goods to carry. Mail coupon now for free book and nation-wide survey of saw sharpening charges. No salesman will call.

FOLEY MFG. CO., 1116-8 Foley Bldg. Minneapolis 18, Minn.

Send me free book "MONEY MAKING FACTS" and Saw Sharpening Price Guide.

Name _____
Address _____
City _____ State _____



Rare, Fancy & Imported Woods... Veneers... Plywoods
Mouldings... Patterns... Hardware... Mosaic Tile
Ornaments... Tools... Archery and Skiing Supplies

Everything You Need in Craftsman's New **WOOD** and Home **Workshop** **CATALOG**

Get Yours! Rush Coupon Today!

132 pages



OVER
1,500
ITEMS

NEW—MOSAIC TILE PROJECTS!

World's Largest Selection of Finest Domestic and Imported Woods... Mouldings, Hardware, Tools—ALL AT LOW MONEY-SAVING PRICES!

Your complete wood buying guide and project book. Craftsman is your best, most complete source of finest kiln-dried domestic and imported woods, beautiful wood inlays, colorful bandings, matched plywoods, embossed mouldings, carved ornaments, newest wood-working tools, "hard-to-find" cabinet hardware; more than 1,500 items! Packed with newest scroll saw patterns, project ideas and money making plans. Enclose 25c (refunded with first order) to help pay mailing and handling cost. Write TODAY to
CRAFTSMAN WOOD SERVICE CO.,
Dept. A11, 2729 S. Mary St., Chicago 8

NEW TOOLS:

Upholstery Materials; Lamp Parts;
Metal and Wood Legs; Cabinet
Hardware; Music Box Movements;
Archery and Water Ski Kits.

CRAFTSMAN WOOD SERVICE CO., Dept. A-11
2729 S. Mary Street, Chicago 8, Ill.

Enclosed find 25c. Rush new CRAFTSMAN WOOD CATALOG.

NAME _____

ADDRESS _____

CITY _____

ZONE _____

STATE _____

Stop Drips Quick with **PIPE WRENCHES!**



You do it fast and easily with tough, special analysis steel P&C Pipe Wrenches. Deeply milled, oil tempered teeth give you real gripping power, prevent slipping, knuckle busting.

Shop from colorful P&C Merchandisers, in 12,000 stores. Send 10c for catalog.

 **TOOL CO.**

Box 5926, Portland 22, Oregon

For Frostbite: Warm Water

Treat frostbite the way Eskimos do—with heat—is the advice of Stanford University medical researchers. Dr. Frederick A. Fuhrman, professor of physiology, and his research-assistant wife, Geraldine, report that a quick-thaw treatment in water of about 108 degrees Fahrenheit reduces the chances of permanent damage to frost-bitten fingers, toes and ears. However, they caution, the frozen part should be immersed in hot water only long enough to raise the temperature of deep tissue to about normal.

☞ In the past few years a number of sheep with golden-hued wool have been born in Australia.

Fast-Growing Algae May Feed Spaceman

Humans on space trips of the future may subsist on a new strain of algae that increases 1000 times a day, compared to ordinary strains that increase only eight times a day. In the presence of sunlight, algae remove carbon dioxide from the air and replenish the oxygen supply while producing nutritious food. Cultures of the new algae are pumped past a pencil-sized lamp that produces light many times the intensity of sunlight, in space-nutrition experiments.

☞ To explore details of tooth and bone structure, the University of Michigan's dentistry school has developed a machine that can grind samples of tooth and bone to approximately 30 microns in thickness—far thinner than a sheet of paper.

Pills for Plants

Gardeners some day may give a "pill" to a wilted cabbage to treat the disease that threatens its life. Scientists at the Connecticut Agricultural Experiment Station are studying ways of fighting rots, blights and other plant diseases with chemicals. They have found that purine compounds will combat virus infections in plants, but the chemicals are still too expensive for use in fields.

☞ A wormlike bug with 700 legs has been found by a Miami, Fla., scientist in Panama. Living under stones or rotting logs, its body consists of 175 segments.

PIPER TRI-PACER
\$7.95

Whee! Look at 'em Fly!
COMET

READY-TO-FLY

ALL-PLASTIC U-Control **GAS MODELS**

Complete with 1958 O. K. Cub Gas Engines, Starters,

Control Handle and Lines



SABRE 44 \$9.95



MUSTANG F-51
\$12.95



Look for them
in your
Dealer's Windows



STARFIGHTER
\$14.95



What a picture! Comet's 4 big-'n-beautiful Ready-to-Fly U-Control Gas Models zooming through the sky—while their youthful "pilots" put them through their paces! Deliberately designed to out-fly, out-value and out-sell them all! In richly color-printed chests.

Upper left: True-to-Scale **PIPER TRI-PACER**, 11 $\frac{3}{4}$ " long—**PLM-30**—\$7.95; Lower left: True-to-Scale **MUSTANG F-51**, 13 $\frac{1}{4}$ " long—**PLM-45**—\$12.95; Lower right: the magnificent **STARFIGHTER**, 19 $\frac{1}{4}$ " long—**PLM-46**—\$14.95; Upper right: sweet-wing **SABRE 44**, 14 $\frac{1}{2}$ " long—**PLM-44**—\$9.95.

Send for these 2 **BIG COMET BOOKS**:
The New 1958 Comet Catalog—20c; shows hundreds of models in color. 20-Page Book—"What Makes An Airplane Fly"—lots of pictures and diagrams—printed in 2 colors—25c.



COMET MODEL HOBBYCRAFT, INC. Dept. 11 501 West 35th Street
Chicago 16, Illinois

DRAINS cellars, cisterns, wash tubs; **\$7.95**
IRRIGATES - CIRCULATES - SPRAYS

1,001 uses. Stainless shaft. Won't rust or clog! Use 1/8 HP motor or larger... 3/4 HP for up to 3,000 GPH; 450 GPH 3/4" inlet; or 1,800 GPH from 25' well. 1" inlet; 3/4" outlet. Coupling included free. **\$7.95**
HEAVY DUTY BALL-BEARING PUMP. Up to 7,500 GPH; or 3,000 GPH from 25' well. 1 1/4" inlet; 1" outlet. **\$12.95**
Postpaid if cash with order. **MONEY BACK GUARANTEE**
Centrifugal and Gear Pumps in All Sizes
LABAWCO PUMPS, Belle Mead 7, New Jersey



Make it fast...
Make it last!

use

SOUTHERN SCREWS!

Ask your hardware or building supply dealer for top quality Southern Screws for every workshop project. Remember... only a screw holds like a screw!

Wood Screws • Machine Screws • Tapping Screws • Dowel Screws • Drive Screws • Stove Bolts • Carriage Bolts • Hanger Bolts



Sold Through Leading Wholesale Distributors

CHANGE SPARK PLUGS REGULARLY

Fabulous full-color **DOW DRAMA MURALS**

Featured in July Popular Mechanics. NOW ONLY \$5.75
See our ad there. POST PAID

TO: MINNESOTA MURALS LeCenter, Minn.
Rush POSTPAID the following full-color Dow Mural.
Remittance enclosed. (Sorry, No C. O. D.) Money back if not satisfied.

Name	Qty.	Size	Price
← Grand Tetons		58" x 38 1/2"	5.75
		174" x 38 1/2"	14.95
		174" x 74"	37.50

Name _____

Print Name and Address Address _____

City & State _____

MODEL 25
Remington
SANDER



**Gives satin finish
in just seconds**

For a professional, satin-smooth finish without tedious hand sanding. Heavy-duty, but light-weight. Special quick-acting clamps make sandpaper changing easy. With sandpaper, 3-conductor cord and adapter. See it at your dealer's . . . only \$49.95.*

FREE CATALOG on full line of Remington Tools. Write: Remington Arms Company, Inc., Bridgeport 2, Connecticut—famous for quality since 1816.



*Specifications and price subject to change without notice. Price slightly higher in Canada.

FREE! NEW fully illustrated catalog of Remington drills, saws, sanders and other power tools. Send coupon today.
Remington Arms Company, Inc., Bridgeport 2, Conn. PM-11

NAME _____

ADDRESS _____

CITY _____ ZONE _____ STATE _____

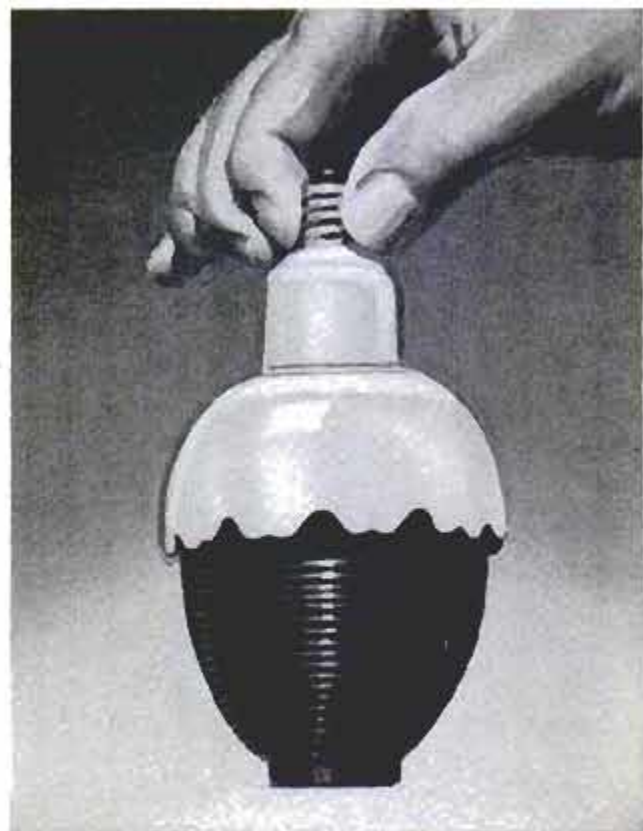

Christmas Tree Light Chimes, Flashes

Colorful lights available for Christmas trees this year contain a chime that rings each time the bulb flashes. The bulb is offset, inside the two-piece plastic case, to make room for a little metal hammer that strikes the edge of a metal chiming dish. The top part of the egg-shaped case is white and the bottom part is supplied in a choice of yellow, blue, red or green. The chime lights also can be used in strings to decorate gardens, patios or recreation rooms.

Fluorine To Power Rockets

Elemental liquid fluorine, the most powerful of all known oxidizing agents, has been harnessed for space-flight rocket propulsion by Bell Aircraft Corporation. So flammable that it will ignite asbestos, leather and even water on contact, liquid fluorine is recognized as the pinnacle in liquid rocket oxidizers.

Nickel May Control Wheat Rust

Botanists at the University of Manitoba, Can., report that tests with various metals indicate that a solution of nickel ions may help curb a wheat disease called stem rust. The disease is caused by a fungus. The scientists added that zinc also has a slight inhibitory effect on wheat rust when used at high concentrations.

HERE'S AN UNUSUAL . . . BUT USEFUL

Christmas Gift

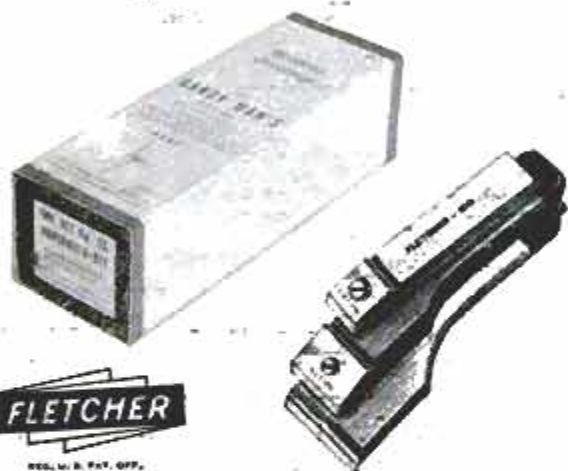

FLETCHER

REG. U. S. PAT. OFF.

For the handyman

No handyman's tool kit is complete without a wood scraper. Here is an opportunity to get a set of three scrapers plus 9 extra blades at a cash saving. Sizes $2\frac{1}{2}$ "", $1\frac{5}{8}$ " and 1". Included is the FLETCHER No. 250 with instantaneous blade release. The set has a special Christmas wrapper.

Buy one or more sets from your dealer. If he cannot supply you, order direct at \$2.25 per set shipped prepaid. Send money order, check or request C.O.D.

**THE FLETCHER-TERRY CO., DEPT. P
FORESTVILLE, CONNECTICUT**

NOW! A CUSHION GRIP NUT DRIVER by Bridgeport

For use in repairing radio, T.V., cars and home appliances. 9 sizes, $\frac{1}{8}$ " to $\frac{3}{8}$ " \$1.00 to \$1.50 ea. Top quality nickel plated forged steel blades. Look for the handy 7 piece set No. 497 ($\frac{1}{8}$ ", $\frac{1}{4}$ ", $\frac{3}{8}$ ", $\frac{1}{2}$ ", $\frac{3}{4}$ ", $\frac{1}{2}$ ", $\frac{3}{8}$ ") at hardware stores.



**50%
GREATER
TURNING
POWER**

- Blisterproof
- Non Slip Grip
- Unbreakable Handle
- Super Comfortable
- Fully Guaranteed

Resilient Neoprene CUSHION GRIP lets you turn nuts tighter with less work - and you don't hurt your hands! Tested & approved by Mechanics.

The Bridgeport Hardware Mfg. Corp., Bridgeport 5, Conn.



Give the gun all can shoot Christmas morning...



New Crosman Portable Metal Shooting Kit with Built-in Target Model 150 PK.

New Crosman 10-Shot Repeater Model 400

Real guns, powered with safe, non-toxic CO₂ gas, for shooting right in and around the home. Real gun accuracy . . . factory-tested to group shots within $\frac{1}{2}$ -inch at 25 feet! Here is fun for *all* the family. Rifles, pistols, gas-powered, air-powered. At sporting goods stores everywhere; or write Crosman Arms Co., Inc., Dept. PM-23, Fairport, N. Y. for free literature.

Crosman World's Leading Manufacturer of Pellet Rifles and Pistols
Power Without Powder **PELLGUNS**

In Canada: Crosman Arms (Canada) Ltd. Toronto.
In Mexico: Armas Deportivas, Crosman De Mexico S. A.
Manuel Maria Contreras 78, Col. San Rafael, Mexico 4, D. F.

NEW! INDOOR- OUTDOOR THERMOMETER BY HONEYWELL

Here's a unique new way to watch weather—"LOOKOUT" by Honeywell, world's largest control manufacturer. Outside, a precisely calibrated mercury tube senses exact outdoor temperatures; inside, a spiral bi-metal gives accurate indoor readings. Sturdily constructed of lifetime plastic. Factory sealed to insure accuracy, resist dirt and dust. Designed by Henry Dreyfuss to harmonize with any decor. Easy to install; easy to read.



\$6.95 GIFT PACKAGED AT BETTER DEALERS EVERYWHERE

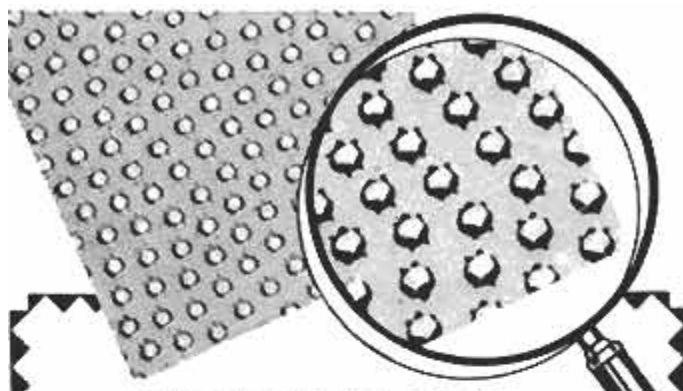

YOU'RE LOOKING AT A PIECE OF
Dragon-Skin

Not one of St. George's souvenirs, but an amazing new cutting tool. A "steel sandpaper" that sands, rasps, smooths.



Use Less "Elbow Grease" when shaping, smoothing, rounding, or cutting slots, because Dragon-Skin cuts fast. New principle: steel sheet is punched to form special cutters—thousands of 'em—to carve away at the work. Cut is smooth and even. No rough sand "grits," no gouging.

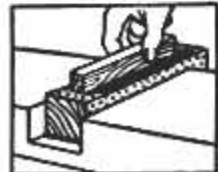

Dragon-Skin Can't Clog like sandpaper, even when you're smoothing softest wood. Chips and dust fall right through the holes. Slap the sheet once and it's clear!



Makes Hundreds of Jobs Easier, and outlasts sandpaper by far. Shapes hard or soft woods, plastics, soft metals... removes paint... at home or at work... on hand or electric sanders. Cut with scissors and wrap around sticks or dowels to make special tools.

1390

LOOK FOR THIS
Dragon Skin
DISPLAY AT YOUR
Red Devil Dealer



75¢ complete with holder
25¢ for single sheets
Also available in full sheets and 1/2-sheets



Red Devil Tools.

Union, N. J., U.S.A.

World's Largest Manufacturer of Painters' and Glaziers' Tools

NEW BELSAW MULTI-DUTY POWER TOOL
SAWS—PLANES—MOLDS



Now you can use this ONE power-feed shop to turn rough lumber into moldings, trim, flooring, furniture... ALL popular patterns. RIP... PLANE... MOLD... separately or all at once with a one HP motor. Use 3 to 5 HP for high speed output. Fully Safe-guarded. Low Cost... You can own this power tool for only \$30.00 down payment. Write TODAY for Free Catalog
BELSAW POWER TOOLS, 909 Field Bldg., Kansas City 11, Mo.



REPAIRS PLUMBING LEAKS!

FILLS AUTO DENTS!

BONDS TO WOOD, METAL, CONCRETE, PLASTICS, GLASS!

Eccobond 26
Epoxy

THE "FIX-ALL" COMPOUND GUARANTEED TO WORK OR DOUBLE YOUR MONEY BACK! New epoxy adhesive & patch material developed for aircraft & missile use sticks anything to anything forever — or double your money back! Send \$2.00 for complete kit (postpaid) to Emerson & Cuming, Inc., Canton, Mass.

1 You can turn one tool into twenty-four **24**

with **Black & Decker** MAGIC SWITCH ATTACHMENTS

CUT ANY SIZE — ANY SHAPE WITH **Spearhead Cutter**

Handy pocket size — cuts leather, asbestos, rubber, cork, etc. — round 1/4" to 5" — any size straight and odd shapes.



Send Check or Money Order!

935 POSTPAID

ZIMMERMAN PACKING — NORWOOD 12, OHIO

"Whistling" by Earth
Recorded on Magnetic Tape

Canadian scientists have recorded the earth's inaudible "whistling" on magnetic tape. Particularly prominent during geomagnetic storms, the subsonic electromagnetic radiations have a frequency range from one tenth to 30 cycles per second. The lowest tone audible to the human ear has a frequency of 15 cycles per second. Recorded on a tape that moves at 1 1/2 inches each second, the tones are made audible by playing back the record at 15 inches a second.

Waterfowl Losing Homes

Many species of waterfowl are disappearing from their nesting areas because of the millions of acres of swamps, marshes and wetlands being reclaimed for farming and industrial purposes. Wetlands in the United States have been reduced by 90 million acres since the 1930s. Wildlife scientists report that of 17 kinds of waterfowl that lived in one marsh in Utah in 1950, six no longer nest there at all and, among those remaining, there are up to two thirds fewer nests.



Stock your shop

WITH STANDARD TOP QUALITY SCREWS, BOLTS, AND NUTS. [®]
 GENEROUS QUANTITIES IN CLEAR PLASTIC BOXES — 59¢ PER BOX.
 USE DRAWER RACKS—59¢ EACH—FOR NEAT HANDY SHOP STORAGE.
 CAN BE STACKED OR MOUNTED IN MANY PRACTICAL WAYS.
 LOOK IN YOUR STORE FOR THESE "STOCK YOUR SHOP" BOXES.
 A PRODUCT OF ELCO TOOL & SCREW CORP., ROCKFORD, ILLINOIS.
 MANUFACTURERS OF FASTENERS FOR INDUSTRY SINCE 1922.

AUTOMATIC RETOOTH

MAKES NEW PROFITS

Cuts new teeth in 50 seconds — any size — to 16 points. Old teeth fall off as chips. Easy to operate. A perfect job.



BURR MFG. CO.
 8933-N VENICE BLVD.
 LOS ANGELES 34, CALIF.

Send For Free Literature

WORLD WIDE SHORT WAVE RADIO



HEAR THE WORLD!—ANYTIME—ANYWHERE

Hear Europe, Africa, Russia, Australia, South America—ANYWHERE IN THE WORLD ANYTIME! Gets ALL foreign radio stations .55 mc. to 42 mc. Not much larger than a postcard—Wt. only 4 lbs! Gets regular American stations—All Radio Amateur bands—Ships at sea, Airplanes, Police, Citizens Radio—Most Everything! NOTHING LIKE THIS MIDGET ALL-WAVE RADIO ANYWHERE ELSE EVEN AT \$100.00! No AC plug-ins needed. Wonderful for home, traveling, scouting, Radio Amateurs—EVERYONE! YOU'LL HEAR THE WHOLE WORLD TALKING!

SEND ONLY \$5.00 (cash, ck, mo) and pay postman \$24.95 COD postage on arrival or send \$29.95 for postpaid delivery. (USA only). COMPLETE WITH BUILT-IN SPEAKER AND DIE STAMPED METAL CABINET, pull-out antenna, all tubes, broadcast coil and set of self-contained, long life batteries. READY TO OPERATE! NOTHING ELSE TO BUY! GET YOUR WORLD WIDE MIDGET RADIO NOW! Guaranteed! AVAILABLE ONLY FROM: WESTERN RADIO, Dept. BPM-11, KEARNEY, NEBR.

LIMITED SUPPLY! Famous Brand Repulsion-Induction



1/2 H.P. Single Phase MOTORS

FULLY GUARANTEED! SAVE OVER \$1975

Order Direct From Ad HALF price for every heavy duty job. 115/230 Vt., 60 cycle 1-year Guarantee.

FREE CATALOG of Motors, Generators, Hydraulics! ROBERTS ELECTRIC CO. Phone Taylor 9-1365 849 W. Grand, Dept. PM-851, Chicago 22

CUT THE BOLT YOU NEED TO ANY LENGTH

HEAT AND BEND TO ANY SHAPE

24" and 36" lengths

7 SIZES

1/4" 3/16" 3/8" 7/16"
 1/2" 5/8" 3/4"

REDI-BOLT

THREADED STEEL RODS

Ask Your Hardware Dealer or Write

REDI-BOLT, Inc., 5330 Indianapolis Blvd., East Chicago, Ind.



Now! NEW EASE IN SNOW REMOVAL

With Steering Sulky and Self Starter

- Powerful Gravelly Tractor—with push-button Starter, New Steering Sulky and Snowblower—make snow removal almost child's play!
- You can blow snow — deep or light, wet or dry — wherever you want it, with fingertip maneuverability. 48" Snow Plow also available. 30 year round attachments . . . All on Easy Pay Plan.

Write today for FREE 24-page "Power vs Drudgery" Booklet!



GRAVELLY TRACTORS, INC.
 BOX 1163 DUNBAR, W. VA.

FIELD-TESTED SINCE 1922

thrills excitement

PERHAPS A CAREER!

POPULAR
MECHANICS

There's Adventure BOOKS

SEND YOUNG MINDS
SOARING INTO THE
AMAZING REALM
OF SCIENCE

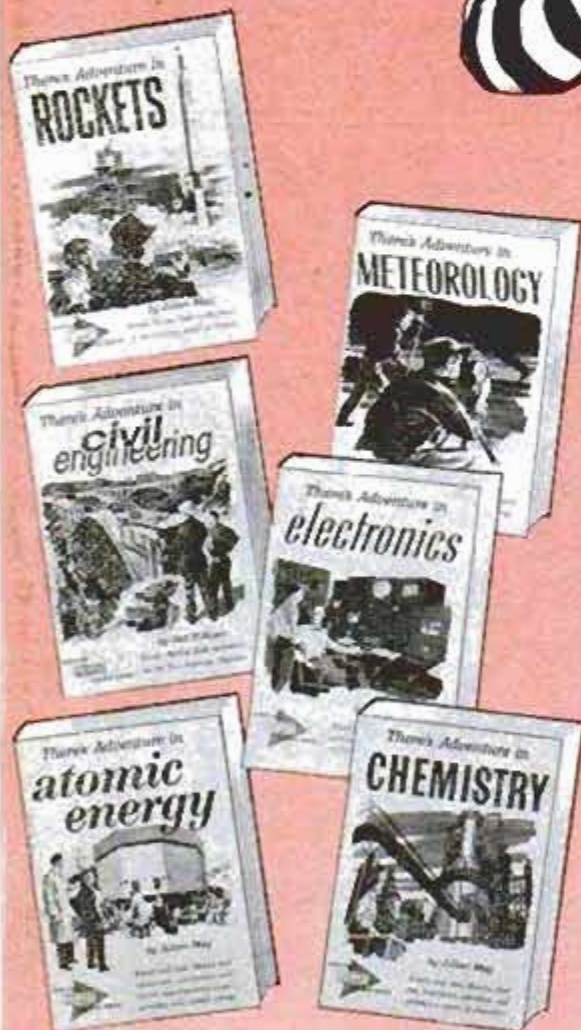

Now any boy can find fascinating fun (and a career, too) in the wonderful world of Science! . . .

- **There's Adventure in ROCKETS.** Rockets . . . headline news today and tomorrow . . . capture the imaginations of American boys. Here, in thrilling fiction style, facts about careers in rocket and missile engineering are accurately described. Illustrated. 170 pps. **\$2.95**
- **There's Adventure in METEOROLOGY.** Where does weather originate? What causes weather phenomena? How are long-range forecasts made? Young Sam and Randy Morrow learn the exciting answers, discover adventure in Meteorology. Illustrated. 170 pps. **\$2.95**
- **There's Adventure in CIVIL ENGINEERING.** What boy doesn't enjoy learning how bridges, tunnels and highways are designed and built? Randy and Sam Morrow do, and so will boys who follow their vivid adventures in civil engineering. Illustrated. 170 pps. **\$2.95**
- **There's Adventure in ELECTRONICS.** Randy and Sam find adventure—and perhaps a career in this exciting field. Many careers in electronics are discussed and each helps to acquaint the boy with the equally exciting opportunities. Fast-paced, yet factual. Illus. 170 pps. **\$2.95**
- **There's Adventure in ATOMIC ENERGY.** The Atomic Age is here and youth is reaching for simple, understandable information. Here it is, presented as exciting fiction, yet factually correct. Explains career possibilities, whets his desire to go farther. Illustrated. 174 pps. **\$2.95**
- **There's Adventure in CHEMISTRY.** The mysteries of Chemistry unfold through the adventures of typical American boys. As thrilling fiction, yet scientifically sound, the book provides understanding of the career requirements and opportunities in Chemistry. Illustrated. 156 pps. **\$2.95**

ORDER NOW FOR CHRISTMAS GIVING

Popular Mechanics Press, Dept. 1158, 200 E. Ontario St., Chicago 11

At \$2.95 each (remittance enclosed), send me

ROCKETS METEOROLOGY CIVIL ENGINEERING
 ELECTRONICS ATOMIC ENERGY CHEMISTRY

Name _____

Address _____

City _____ Zone _____ State _____

IMPORTANT TO THE CHILD . . . TO AMERICA . . .
TO THE FREE WORLD. Prefaces by outstanding experts. Each book contains exciting experiments for boys 11-17.

BUILD WELDER OR LIGHT PLANT **General SALE** **NEW HYDRAULIC CYLINDERS**

AC-DC WELDER KIT #511 G.E. Generator. Makes 1250 Watts A.C. light plant, 200 Amp. D.C. Welder & battery charger. Including helmet, 1 pr. welders gloves, electrode holder, rheostat, switch, voltmeter, R.C. relay, R.P.M. indicator, voltage reg. & instr. all pretested, perfect. **\$38.50**

"PREFERRED" 300 Amp Arc Welding Kit. Consists of one 300 amp. D.C. gen. with all the accessories listed in Kit #511, plus reactor coil arc stabilizer all pretested. **\$46.50**

"ECONOMY BUY" Arc Welding & Battery Charging Kit. Consists of 150-250 amp. gen. reactor coil arc stabilizer, 30' cable, including all the accessories listed in Kit #511 & instruction all pretested. **\$33.50**

"FABULOUS BUY" 200 Amp Welding Kit. Consists of G.E. 200 Amp. gen. plus all the welding accessories listed in Kit #511 & instr. all pretested all perfect. **\$25.00**

New Throttle Control Solenoid & Idling Device for all welder engine control, 1" travel, shaft is 6" long, threaded end #SC-11. **\$6.95.**

V-Belt Pulley Kit. Fits all P-1, G-1, R-1 and AC-DC type generators. Has 2 ball bearing blocks with high speed bearings, three groove V-pulley, Dr. shaft 8" long, and flexible coupling. **\$17.50.**

New Reactor Coil Arc Stabilizer made with #4 S. copper wire for all D.C. generators up to 400 Amps. 7"x5"x4". Wt. 11 lbs. **\$10.95.**

Motor Driven Gear Pump. 270 G.P.H. with integral by pass valve returns oil to input side at 1200 P.S.I., 3 3/4" H.P., 24V. D.C. motor, 230 Amp., 2300 R.P.M. **\$19.50.**

SAVE ON SURPLUS MOTORS

H.P. 24-12V. D.C. Shaft (±20% postage)

1/2	6.5 Amp.	7/32"x2"	2000 RPM	\$5.50
1/4	8 Amp.	5/16"x1"	4000 RPM	\$5.50
1/20	5 Amp.	42:1 ratio	200 RPM	\$4.89
3	200 Amp.	9/16"x1"	2300 RPM	\$8.95

NEW Four Way Open Center Control Valve with built in adj. relief for 1 to 4 D.A. cylinders. 3/8" ports #10060 **\$14.50.** #4811 four way with 2 handles for 1 S.A. cylinder. New **\$8.95**

NEW HYDRAULIC SYSTEM KIT

#400 K. Heavy duty Power Driven. Rated 14,000 lbs. lift. Consists of 2 D.A. hyd. cylinders, 3" bore x 24" stroke, each rated 7000 lbs. with 1000 P.S.I., 1 four way hyd. control valve with built in relief #821, 1 Vickers hyd. pump, 400 G.P.H., 1500 P.S.I., 3750 RPM, 1 hyd. 2 gal. reservoir, 1 Purolator hyd. filter, 1 gauge 0-2000 P.S.I. all hose, & fittings. Value \$184.10, save \$90.00. Kit price **\$94.10.** Kit with two #511 cyl. **\$79.95.**

HYDRAULIC PUMP BARGAINS 1500 P.S.I.

MFG.	TYPE	R.P.M.	G.P.H.	Price
Pesco	Gear	1500	198	\$ 8.95
Pesco	Gear	4300	360	\$12.95
7°	Pesco Gear	.447 cu. in.	270	\$14.50
Stratopower	P. Disp.	.450 cu. in.	400	\$16.50
Vickers	P. Disp.	.410 cu. in.	375	\$15.50
Vickers	P. Disp.	.507 cu. in.	400	\$17.50

GENERAL SALVAGE CO CHECK OR M.O.
2922 E. 27 St., Dept. 99, Kansas City 27, Mo.

Works in seconds!



LIQUID WRENCH

The super-penetrating rust solvent that quickly loosens rust and corrosion.

AT HARDWARE STORES, GARAGES SERVICE STATIONS, EVERYWHERE

RADIATOR SPECIALTY CO.
Charlotte, N. C.

3 oz. CAN 35¢

ONE-MAN SAWMILL LOW \$50.00 DOWN AS... **\$50.00**

Take BELSAW Portable Sawmill right to the trees—turn out valuable lumber for home and farm—sell to local yards—make up to \$50 a day custom sawing for neighbors. BELSAW lasts a lifetime. No crew needed. Power with tractor or auto engine. Beginners get excellent results. Send today for **FREE BOOK**.

BELSAW MACHINERY CO
345 1/2 Field Bldg. Kansas City 11, Missouri

BETTER BUY



U.S. SAVINGS BONDS

for a **BETTER FUTURE**

NOW! Adjustable CORNER CLAMP

AND MITERING VISE

Securely holds mitered or butt joints at 90° angle, or any angle, for nailing, stapling, gluing and splicing. **ADJUSTS TO ANY ANGLE.** Used for Picture frames, Screens, Storm windows, Shadow boxes, or any place where wood is joined. **\$1.75 PPD.**

SAW SHARPENING IS EASY

Super Filer No. 11 joints and sharpens hand and circular saws 6" to 10" with all teeth correct in height, depth, pitch, bevel. When file hits steel roller, teeth are finished. Saw runs true with no side pull. Includes 8" file. **\$9.95 PPD.**

"TRU-CIRCLE" saw set automatically sets teeth at 10° or more. **\$2.95 PPD.**

MONEY BACK GUARANTEE

A. D. MCBURNEY, 5908 Hollywood Blvd., Hollywood 28, Cal., Dept. A-118

Wood Carvers!

"HERE'S THE NEWEST IN THE CARVING FIELD! \$10.95 PER SET! OVERALL LENGTH OF EACH TOOL 6 1/2". PLASTIC HANDLES



6 PIECE CARVING SET

Most Complete Line of Chisels and Gouges

CATALOG AVAILABLE!"

BUCK & BROS. INC.
RIVERLIN WORKS MILLBURY MASS.

FREE Tyler SPYRAL HACKSAW BLADE!

Demonstrate for yourself why Tyler SPYRAL Hack-saw & Coping Saw Blades are America's number 1 choice for making precision & intricate CLEAN cuts of wood, metal, plastic, tubing, etc. Saw in circles, right or left, up or down. Available at your dealer. **OFFER LIMITED!** Since you will receive your **FREE** blade from your local dealer, you must fill out the coupon to the right & mail it to us. Offer is not valid unless you give us your name & address as well as that of your dealer. When dealer receives your **FREE** Tyler Blade, he will notify you by postcard.

MAIL COUPON FOR FREE BLADE!

TYLER MFG. CO., INC., Dept. PM-11
1005 W. Arbor Vitae Ave., Inglewood, Calif.

Your Name _____
Address _____
City & State _____
Name & address of my Saw Dealer is: _____

U-MAKE-IT-TURN

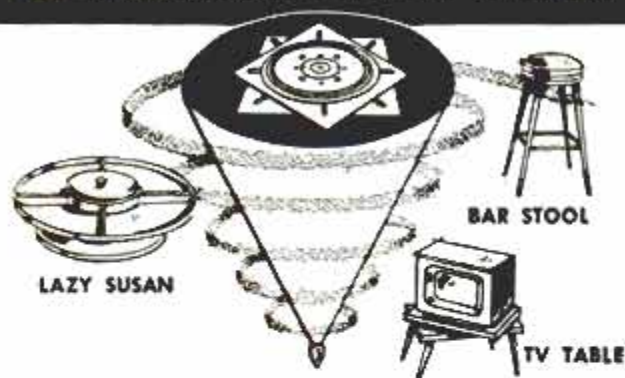

Here's the answer to all your swivel problems, offered at factory prices, with unconditional guarantee. These hand assembled, precision built swivels have revolving steel plates turning 100% on precision ground, dual race, ball bearings. The adjustments are positive and easy.

FILL OUT THE COUPON

MIDDLETOWN manufacturing co.

515 Main Street, Middletown, Kentucky

Ship at once, charges prepaid, the U-Make-It-Turn Swivel, checked below. I enclose check or money order for full payment.

Quantity	Quantity
5" base @ \$2.95 ea. _____	10" base @ \$3.45 ea. _____
7" base @ 3.25 ea. _____	16" base @ 3.95 ea. _____

Name (Print) _____

Address _____

City _____ Zone _____ State _____



Spoons on Rotors Aerate Soil

Twelve steel spoons mounted on rotors and attached to a tiller-tractor shaft do the job of aerating the soil without disturbing the surface of a lawn. The aerifying spoons penetrate hard-packed layers of soil to a depth of 3½ inches, producing a greener and healthier lawn.

Airliner Held Together With Adhesive Tape

Adhesive tape is being used on the wing and tail assemblies, interior panels and other structural parts of America's first prop-jet airliner, the Lockheed Electra. The bond created by the adhesive is said to be more permanent and durable than any other method of attachment. The metal parts are heated to 350 degrees and pressed together with the tape at a pressure of 100 pounds per square inch.

Telescope on Satellite Will Study Stars

Astronomers may put a telescope on an earth satellite to observe the stars from outside the masking of the earth's atmosphere. The telescope would focus radiation from stars so an electronic scanning device can provide an image of an area of the sky at a monitoring station on the ground. The space telescope would be operated by remote control.

☐ The Civil Aeronautics Administration forecasts 55 million U.S. air passengers for 1960 and 70 million for 1970.

Free

BIG CATALOG

NEW & GOV'T. SURPLUS BARGAINS



HYDRAULICS
CYLINDERS
VALVES



GENERATORS
COMPRESSORS



VACUUM
PUMPS



WATER
PUMPS



Send NOW for this
FREE Illustrated



Catalog of Top
Quality Items
at Bargain
Prices



**GROBAN
SUPPLY CO.**

1139 A SO. WABASH AVE., CHICAGO 5, ILL.



"ARCO-SAW"

CUTS 2x4's • CUTS GROOVES • CUTS ANGLES

Build anything from a bookcase to a bungalow with this powerful saw attachment. Fits any 1/4" drill. Rips & crosscuts up to 2" board in one easy cut. Exclusive "Dado-Arbor" swivels sawblade to cut grooves up to 1/2" wide & 1" deep in one cut. Not even a \$100 portable saw has a dado cutter! Graduated gages for ripping, depth & angle cuts. Safety-yoke permits 1-hand operation. Inl. 5" blade. **\$12.95**

At your dealer or order direct on our **20-DAY MONEY BACK GUARANTEE**. Send check, M.O. (ppd) COD & post.

ARROW METAL PRODUCTS CO.

Dept. PM-11, 421 West 203rd St., New York 34, N. Y.



Starrett TOOLS

the perfect gift

**CRAFTSMEN
for MECHANICS
HOBBYISTS**

The man or boy who loves fine tools always welcomes STARRETT tools. Choose the perfect gift for handyman, mechanic, skilled craftsman or hobbyist from more than 3000 STARRETT items — at hardware tool stores or industrial distributors.

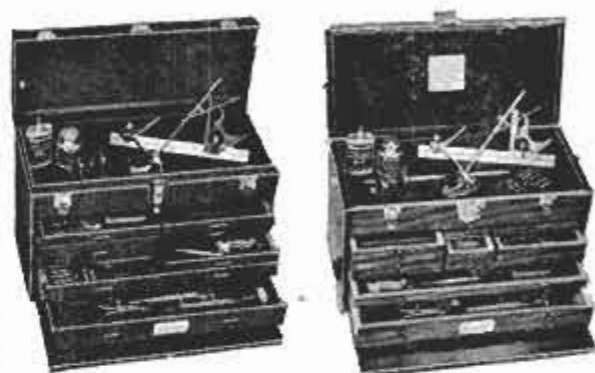

STARRETT TOOL CHESTS

Mechanics' tool chests in wood or metal — available with or without Starrett tools.



The Modern PLASTIC for lasting Home Repairs

PERMANENTLY mends cracks or holes in wood, tile, stone or plaster. Sticks and stays put—Does not chip, shrink or fall out. Easy to use. Economical. Mold it, chisel it, polish or paint it. The big 4-lb. can is obtainable from your lumber, paint or hardware dealer at \$1.40; or will be shipped direct postpaid (in U. S.) for \$1.75. Complete satisfaction guaranteed or your money refunded.

DONALD DURHAM CO.

Box 804-T Des Moines, Iowa



STARRETT MICROMETER
No. 436 0-1"



STARRETT COMBINATION SQUARE
No. 11 12" blade



STARRETT DIAL INDICATOR POCKET GAGE
No. 1010 Range 0-3/8"



STARRETT TOOLMAKERS' HAMMER
No. 815
with magnifying glass

Genuine Polyethylene
NEW ALL-PLASTIC 2-PIECE BAIT BUCKET
Won't Rust, Rattle or Dent

A BETTA-BAIT BUCKET WITH "LID-O-MATIC"

Bucket Floats

Lid Closes Automatically

8-Quart Capacity



Postage prepaid

\$5.95

or send \$1.00 Bal. C.O.D.

Money-back Guarantee

ORDER TODAY

BETTA-BAIT BUCKET CO.

Dept. G, 420 10th Ave. Palmetto, Florida

Manufactured by a fisherman for fishermen

Give a STARRETT Gift Certificate

Make your gift precisely right with a Starrett gift certificate available at your distributor's ... or send for Starrett Catalog No. 27. Use the coupon.



THE L. S. STARRETT COMPANY
Dept. AP, Athol, Mass., U. S. A.

Please send free copy of Starrett Catalog No. 27 describing the many Starrett Tools recommended for Christmas and year-round giving.

Name.....

Address.....

City.....Zone.....State.....

When you want
the finest
in Handsaws
**INSIST ON
SANDVIK**

Extra high
crown,
taper ground
blade of
Sandvik's own
Swedish
Steel.

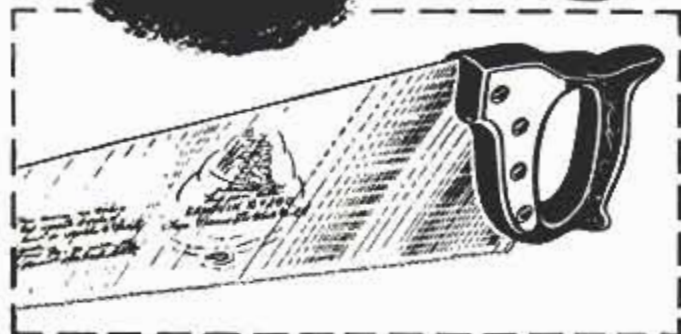

See Sandvik at your
hardware dealer. Write today
for this booklet on the
care and use of hand saws.



Sandvik STEEL INC.
Saw & Tool Division

1704 Nevins Road, Fair Lawn, N. J.

Sandvik Canadian Ltd., P.O. Drawer 1335, Station "O," Montreal 9, Canada

**NEW FIR PLYWOOD
BOAT PLANS**

25¢ ea. ★ Designed by leading naval architects
for style and top performance

★ Specially planned for "do-it-yourself"
construction with fir plywood

Large, easy-to-follow scale plans have step-by-step
illustrated instructions and complete material lists

OUTBOARDS

11' (Plan 35)—Fast, roomy
car-top utility model.

13' (Plan 40)—Ideal for skiing and fishing or family fun.

16' (Plan 55)—Roomy deluxe runabout. Seats 6 in comfort.



CABIN CRUISERS

18' (Plan 60)—Easy-to-build
family day cruiser.

20' (Plan 65)—Sleeps 2. Has galley, head.



ROWBOATS

8' (Plan 30)—Light, all-purpose pram. Takes small outboard.

14' (Plan 45)—Roomy, flat bottom punt for hunting and fishing.

PLANS 25¢ EACH. Order by number. Also write for free folder
describing boats in detail. (Offer good USA only). Douglas
Fir Plywood Association, Dept. 9, Tacoma, Washington.

Use only Exterior plywood (EXT-DFPA®)
for boats. Comes in several sizes, grades—
including premium quality solid-core
"Marine Exterior" for hull construction.

EXT-DFPA



**CAR
OWNERS!**

Make Your Own Repairs Save Money with these Expert
How-To Books from **POPULAR MECHANICS**

MANUAL FOR FORD OWNERS



Get the most out of your Ford . . . and do the
work yourself! This brand new edition of the
Manual for Ford Owners covers every mech-
anical operation and even includes a special
section on trouble shooting on the road. The book
explains how various moving parts of the Ford
operate, what can possibly go wrong . . . and
what to do about it if it does. Devotes consid-
erable space to exclusive Ford features such as
Fordomatic transmission. This is complete and
official factory information, specially and com-
prehensively presented for the layman who may or may not have
auto experience. Good maintenance of your Ford is not only desir-
able for your own convenience, safety and pleasure . . . but
also pays off at trade-in time. **\$3.95**

Covers all models 1950 to 1958.

MANUAL FOR PLYMOUTH OWNERS



If you're a Plymouth owner . . . order a copy of
this new Plymouth Manual and keep it handy in
your glove compartment. It's the best insurance
you can buy for keeping your car in tip top con-
dition. Enables you to meet any road emergency.
Today's cars, Plymouths included, are complex
machines . . . many parts and areas can give
trouble under certain conditions. The Plymouth
Manual, carefully and thoroughly indexed, can
help you locate the trouble and provide the solu-
tion in short order. Has hundreds of tips on
Plymouth maintenance and suggestions for keeping performance
at a peak. Written by C. E. Packer, Member of the Society of
Automotive Engineers, in close cooperation with Chrysler Cor-
poration engineers. This book will help you enjoy your fine
Plymouth car even more than you thought possible. **\$3.95**

Covers all models 1950 to 1957.

MANUAL FOR CHEVROLET OWNERS



To be published in April. Will help every
Chevrolet owner save on repair bills and get the
kind of top performance the factory designers
intended. To be written by long-experienced
automotive engineer, C. E. Packer with the aid
of General Motors Factory engineers. Every
word will be official factory information, cov-
ering your Chevrolet from bumper to bumper. Ex-
plains what can go wrong and how to diagnose
every condition. Explains the repair procedure
thoroughly to save you time and money. Hun-
dreds of photos, drawings and "exploded" views will aid in un-
derstanding the carefully written text. Vitality helpful whether or not
you have mechanical experience. Completely indexed for easy
reference. Order your copy now. We'll send immediately **\$3.95**
upon publication. Covers all models 1950-1958.

upon publication. Covers all models 1950-1958.

AUTO REPAIR MANUAL



This book was prepared by a panel of experts
to apply to every make, model and year of car.
With hundreds of photographs and diagrams it
explains exactly how your car is supposed to
run, just why it breaks down, how to repair it
and how to prevent breakdowns in the future.
Covers both automatic and manual transmis-
sions; tells the "why" of the 12-volt ignition,
explains motor tune-up, brakes, cooling systems,
ignition-distributor, lubrication, etc. Tells how
to buy a used car; how to build your own car
cooling system; how to save money on auto vacations—and many
more time-saving, money-saving articles. **\$2.95**
Over 500 illustrations, drawings and photographs.

Over 500 illustrations, drawings and photographs.

Satisfaction Guaranteed or Your Money Back

POPULAR MECHANICS PRESS, Dept. 1158
200 E. Ontario St., Chicago 11, Ill.

RUSH books! I have checked below. If not pleased, I can re-
turn in good order within seven days for full refund.

Remittance enclosed. Send C.O.D.; U.S.A. only.
 Ford Manual Plymouth Manual Chevrolet Manual
 Auto Repair Manual

Name _____
Address _____
City _____ Zone _____ State _____



SURPLUS SALE

GOVT SURPLUS
EXCESS INVENTORY
BANKRUPT STOCK

AIR COMPRESSOR BARGAINS

For painting, cleaning, tires, control terminals. Assemble your own outfit! Lowest prices in U.S.

- Deluxe 4lt. Compressor, tank, gauge, regulator, paint gun, relief valve, fittings, hose, instructions. Wt. 34 lbs. List \$52. SALE \$39.49 FOB
- Air Components. Compressor 1-cyl. \$19.95; Air tank, \$8.79; Regulator \$3.95; Pop-off \$1.95; Press. Gauge \$1.89; Finest Paint Gun \$11.99; Auto Switch \$4.75. All Ppd. in U. S.

ARMY POWER PLANTS

Marvelous buys in new condition Govt. surplus plants and generators. All FOB Lincoln.

- 1000-w, 115-v, 60-c. \$169.72
- 2500-w, 115-v, 60-c. \$279.00
- 3500-w, 115/230-v. \$298.50
- 3000-w, 1.5-v DC Generator 49.50
- 2000-w, 1.5-v AC Generator 99.70

HYDRAULIC EQUIPMENT BARGAINS

Savings to 80%. Build loaders, diggers, presses, etc. All brand new.

- Blackhawk Hand Hyd. System \$23.95 FOB
- Control Valve, 1 or 2 way, ... 18.00 Ppd.
- Tractor Pump 1000 psi; 12 gpm 45.50 Ppd.
- 12-v Motor & Pump 1000 psi. 13.95 FOB
- 2-Way Cyl. 1 1/2" bore 6" stroke 4.89 Ppd.

Other types, sizes and items. Free catalog

GEAR SPEED REDUCER

• 80-to-1 gear reduction unit. 8 roller bearings, multiple gears. Reduces standard motor to 21 rpm increases torque. Shafts 3/4" input, 1 1/4" output. Power winches, revolving signs, door openings, etc. Govt. cost \$66. SALE \$6.49 Ppd.

DIAL PHONE

Modern hi-efficiency attractive dial phone. Use for extension to main line on private system. Use several for complete private system, etc. Complete with rings, dial, etc. Work on any system. Govt. cost \$25.00. SALE \$9.95 Ppd.

STORAGE BATTERY WINCH

• Powerful fully reversible, ball-bearing gear reduction winch. 1000-3000 lb. pull. Use on 6 or 12-v battery. Holds 40' of 1/4" cable. For trucks, docks, boats. Wt. 54 lbs. Govt. cost \$280. SALE \$46.75 FOB

ELECTRIC CAR MOTOR

• Powerful Govt. gear reduction motor. Make roof, boys, invalids electric car. Go anywhere, fast, efficient. Reversible. Runs on 6 or 12 volt battery. Cost \$295. Wt. 37 lbs. SALE \$19.72 FOB

115-V AC and 30-V DC GENERATOR

• Air Corp ball bearing unit. Puts out 115-v, 1500-w, 800 cycle, AC and 30-v, 75 amp DC. • Makes good small welder, battery charger or will furnish 115-v for lights, stove, iron, etc. Size 8"x9"x15". Wt. 50 lbs. Full instructions. Govt. cost over \$200. SALE \$17.67 FOB

HYDRAULIC SPEED REDUCER

• Variable hydraulic speed reducer. Any speed from 0 to 750 rpm by simply throwing a lever. Handle up to 1 1/2 h.p. Use for midget cars, shop band saws, etc. Govt. cost \$400. SPECIAL \$47.81 FOB

IRRIGATION PUMPS

• 2 1/4", 16,500 gph. Centrifugal. All bronze ball bearing. New. 39 lbs. Govt. cost \$103. SALE \$49.50 FOB

Also 1 1/2" 6000 g.p.m. pump. Govt. cost \$62.50. SALE \$24.61 Ppd.

FURNACE BLOWER & MOTOR

• Brand new, motor and blower in a single self-contained unit. Ideal for heating, ventilating and air conditioning uses. • 115-v, 60-c motor with double inlet blower wheel. Displaces 725 cfm at 800 rpm. 7" diameter blower. 7 3/4"x9 1/4". Overall dim. 13"x10 1/2"x12 1/2". Wt. 23 lbs. List price \$40.75. SALE \$24.95 FOB

SPECIAL OF THE MONTH!

MARINE and POLICE SEARCHLIGHT

High Brilliance Swivel Spot Light with Snap-On "Danger" Filters

- Expensive Govt. unit widely used on boats, cars, by police, fire depts, etc. Amazingly bright 8-inch sealed beam focused spot has over 1-mile range. Finest red, green, amber, etc. filters. Snap over lens for intense color signal. Many civilian uses on boats, cars, yards, farms, etc.
- Attractive rich housing with trigger signaling switch and on-off switch. Unit mounts on 2-way adj. swivel base. Complete with fine carrying case. Govt. cost \$47.50. SALE, 110-v \$7.96 Ppd. 12-v \$7.81 Ppd.

HOME LABORATORY EXPERIMENTAL KIT

• Wonderful scientific educational gift for boys. Make 100+ fascinating experiments. Have your own home laboratory. Build fire-burglar alarms, secret eavesdropping unit, test circuit, electronic theory demonstrations, etc. • Kit consists of high priced Govt. surplus apparatus such as electromagnet, AC motor, relays, AC power reducer. Over 35 units, theory booklets, lab. bench plans, instructions, etc. Wt. approx. 8 lbs. Est. cost over \$40. SALE \$6.71 FOB

ROBOT 115-V AC SELSYNS

• Amazing spectacular precision selsyns. Transmit exact mechanical motion over wires. Used in many top secret military apparatus. When two selsyns are connected together by wires turning shaft at selsyn = 1 cause equal and instantaneous movement of shaft of selsyn = 2. • Make wonderful wind direction and velocity indicator, water level indicator, remote mechanical control, etc. A most fascinating device. Also functions as small 60-c AC generator. Size 4"x5". Wt. 11 lbs. pr. 115-volt 60-cycle type. Govt. cost Pr. \$95. SALE \$7.99 for 2 FOB

Order from ad or get new 1959 catalog.

BURDEN SALES COMPANY
813 West "O" St., LINCOLN, NEBR.

\$275,000,000,000 HIDDEN TREASURE

Find your share NOW with NEW Featherweight (2 lbs.) Economical TRANSPORTORIZED METAL LOCATOR. Waterproof Head. Uses economical penlite cells. UNDERWATER Models also available. FREE literature.

ELECTRONIC APPLICATIONS, Dept. D
Box 8, ARLINGTON 10, VIRGINIA

FREE AMAZING NEW BOOK "HOW TO ANSWER ADS"

how to answer ads

Never before have you seen anything like this. Tells you in simple language the correct way to answer ads. Gets you quicker replies—better results, and greater satisfaction. Will save you time and money and it's ABSOLUTELY FREE. No obligation whatever. Every reader of advertising should have this booklet. Send a postcard for your copy NOW. F. W. JOHNSON, Popular Mechanics Magazine, Room 600-A, 204 East Ontario Street, Chicago 11, Ill.

Shop PM Ads for Exciting Direct-Mail Offers

2 WAY PORTABLE RADIO SET

SENDS — RECEIVES UP TO 10 MILES AS SHOWN with built-in antenna or hundreds of miles with outside antennal Works on 80 and 40 meter (Novice) amateur radio-bands—also Aircraft and overseas broadcast (3 to 8 mc). PORTABLE SELF-CONTAINED POWERED WITH STANDARD PORTABLE RADIO BATTERIES—NO AC PLUG-INS NEEDED! Take it with you every where you go—on trips, vacations, camping—Keep in contact with home, friends. Has 5 watt crystal controlled transmitter—Sensitive Regenerative Receiver. Send-Receive switch. Wt. only 3 lbs. Size, only 6"x4"x4". TESTED — PROVEN — SIMPLIFIED — PRACTICAL — Full information given on quick easy to get license.

SEND ONLY \$3.00 (bill, ck. mo) and pay postman \$12.95 COD postage on arrival or send \$15.95 for postpaid delivery. Complete kit includes all parts, tube, coils, plastohol cabinet, easy instructions. Set of batteries \$3.49; crystal \$1.49. COMPLETELY WIRED AND TESTED POSTPAID \$19.95. A regular \$49.95 value—Order now before price goes up. GUARANTEED—AVAILABLE ONLY FROM: WESTERN RADIO DEPT. BNM-11 KEARNEY, NEBR.

WRITE FOR ESHELMAN FREE CATALOG

SAVE MONEY. Check Items Wanted:

- GARDEN TRACTORS
- Low as \$99.
- 1/4 TON UTILITY AUTOMOBILES
- CHILDREN'S AUTOS with Gasoline Engines.
- GOLF CARS Electric or Gas.
- CAR SNOW PLOW Bolts on Front Bumper

Some dealerships still available.
ESHELMAN CO., Dept. FC211, Baltimore 2, Md.



ARC WELDING WILL PAY YOU big profits

COMES COMPLETE—ready to weld. This potent package of performance welds, cuts, burns holes, hard surfaces, solders, brazes and heats metal. It's an ideal all-around shop welder. The Power/Weld gives you DC for welding AND FURNISHES AC POWER simultaneously. It can also be used to provide emergency AC power. These two welders are bound to help you earn big profits—write for more details today!

HOBART BROS. CO., BOX M-118, Troy, Ohio, Phone FE 21223

LOW COST combination welder and power unit, welds or runs tools, lights, motors. Easy to use... handles all types of electrodes.





RUGGED-SOFT

Full hand control

Tough jobs that need finger freedom call for Wolverine full grain gloves. Triple-tanned buckskin stays soft, even dries soft after soaking. Extra long wear.

Try on a pair at your dealer's.

WOLVERINE GLOVES

Rockford, Michigan
MASTER TANNERS OF UNUSUAL LEATHERS — horsehide — buckskin — pigskin — goatskin

INCREASE HOME VALUE—MAKE NEEDED IMPROVEMENTS NOW

DREMEL MOTO-TOOL THE "POCKET SIZE MACHINE SHOP"

Handiest tool you'll ever own. Its high speed is ideal for precision grinding, polishing, carving, drilling, engraving, de-burring, sharpening, and hundreds of other household and workshop uses. Eliminates time-consuming hand work — gives the finished job a professional look. Weighs only 13 oz.—handles easily as a pencil. Does fine detail work with pin point accuracy. Fastest, most powerful tool of its kind — develops 27,000 RPM. Widely used by tool and die makers, model builders, craftsmen, lab technicians, repair men, gun smiths, schools, etc.

SEE YOUR DEALER or write for FREE catalog on the complete Dremel line of power tools.



MOTO-TOOL KIT No. 2 (as shown) Incl. Model No. 2 Moto-Tool, 23 accessories (high-speed steel cutters, grinding wheels, etc.) in a sturdy storage case.....\$27.50

MODEL No. 1.....\$14.85
MOTO-TOOL MODEL No. 2.....\$19.95
MOTO-TOOL KIT No. 1.....\$23.50

QUALITY POWER TOOLS SINCE 1934

DREMEL MFG. CO. Dept. 128L, RACINE, WIS.

ELECTRIC WELD · BRAZE & CUT

REPAIR MOST EVERYTHING MADE OF METAL

Home Appliances, Auto parts, Farm-garden equipment, toys. Make and repair playground equipment, lawn chairs, tables, ornamental iron work gates, wagons, etc. Solder, heat, bend, and straighten, with terrific heat from arc torch. Cut and weld up to 1/4" steel plate. A million uses for Home, auto, farm, inventors, factories, etc. Works from any home 110 volt plug-in. Complete with dark welders mask, arc torch, supply of carbon welding and brazing rods. Solder, flux, and complete Welding Instruction Book. Attractive—portable—efficient—durable—1 year guarantee. Wt. only 8 lbs. (cash, ck., mo) and pay postman \$9.95 plus **SEND ONLY \$3.00** COD postage on arrival or send \$12.95 and we will send postpaid. Ideal gift for mechanically minded home owners, relatives, friends. Order now for early delivery. Available only from: **MIDWAY WELDER Dept. DPM-11 Kearney, Nebraska**



America is a Better
America —
thanks to Advertising!

AMAZING OFFER... 1958 MODEL

PORTABLE AIR CONDITIONER-BLOWER. IDEAL FOR MACHINE SHOPS, GARAGES, DARK ROOM, BOATS, TRAILERS, ETC.

This special end-of-season sale offers you these 3 1/2 ton (10000 BTU) capacity portable air-conditioners, originally \$595.00, now only \$198.00. Designed for all industrial and residential requirements. Cools, ventilates, dehumidifies, no finer component parts in the world. Completely self contained with thermostatic controls. Requires no installation... wheel it to location and plug in. Will solve any cooling problem. Only \$198 20 left so order today. Write us for free technical literature and pictures. . . .

SYNCO COMPANY, United Artists Bldg., Detroit, Mich.



WHY DEPEND ON SOCIAL SECURITY!



ADD TO YOUR INCOME • UP TO \$5.00/HR. SHARPENING ALL TYPES OF LAWN MOWERS



Modern Manufacturing's precision Lawn Mower Sharpener and Bed Knife Grinder makes it easy for you to earn extra cash on a full or part time basis. Many mowers need sharpening. Do it in your basement or garage. Anyone can learn to operate this sharpener. Write today for free brochure. Dept. 10

MODERN MFG. CO.

160 N. Fair Oaks Ave.
Pasadena, Calif.

\$27500

F.O.B. Pasadena



GENUINE ALNICO MAGNETS

AMAZING, PERMANENT, NON-ELECTRIC, HIGHLY PRACTICAL. Conduct interesting experiments. Hundreds of uses. Retrieve valuable steel items such as guns, tackle from fresh or salt water; tools from tanks & drains. **GUARANTEED.** Try any magnet one week. Money back if you are not well-pleased.

No. M-710 (Wt. 53 oz.) Has pull of 225 lbs. on steel block... \$18.00
No. M-625 (Wt. 70 oz.) Has pull of 125 lbs. on steel block... \$10.00
No. M-575 (Wt. 18 oz.) Has pull of 75 lbs. on steel block... \$7.00
No. M-500 (Wt. 13 oz.) Has pull of 50 lbs. on steel block... \$5.00
No. M-300 Kit of Flat Bars 5 Pairs (10 Magnets)... \$3.00
No. M-250 Kit of Round Bars 5 Pairs (10 Magnets)... \$2.50
No. M-47 Hot Pad Magnets 10 for \$1.00... 50 for \$4.87
No. M-35 Hobbyist assortment of 8 small magnets... \$1.50

Send M.O. or check. We pay postage. Sorry no C.O.D.'s.
MIAMI MAGNET COMPANY, 3240 N.W. 27th Ave., Miami 42, Fla.

Your car needs
MILEAGE MINDER



Fuel pressure
stabilizer
and purifier

• Stops flooding, gives better gas mileage and performance

Paser Manufacturing Co. • 433 Turk • San Francisco

At your auto supplier or write for FREE literature



DOES TOUGH JOBS WHILE YOU RIDE!
PLOW • DISC • MOW • TILL

A man sized tractor made adaptable for farm and suburban acreage. Cultivate, Plow, Mow, Plant, Build, DISC, SNOW, Spray, Sow. Mounted beautiful lawn (cut) 2-mowers. Over 20 disk change implements. Safe to operate (even for 10 year olds). 9 hp. All gear drive. 8 W & 8 speed transmission, clutch, differential 770 lbs. Uses regular automotive parts. Easy maintenance. Lowest cost per hour. 100% Satisfaction guaranteed. Thousands in use.

Write for FREE CATALOG TODAY!
COUNTRY SQUIRE TRACTOR CO.
P.O. Box 107-K11, Muskego, Wis.

LOCKS at ANY ANGLE



STRAIT-LINE
no. 66 adjustable **TRY-SQUARE**

Press button release; blade locks securely at desired angle, or straight for easy carry and storage. All metal, extra durable, and precision built. \$4.80 ea. At your hardware dealers now or send check or M.O. We pay postage.

STRAIT-LINE Products Inc., P.O. Box 557-P, Costa Mesa, Calif.

LOOK! All New - All Precision - All Deluxe SUPERSHOP MODEL X

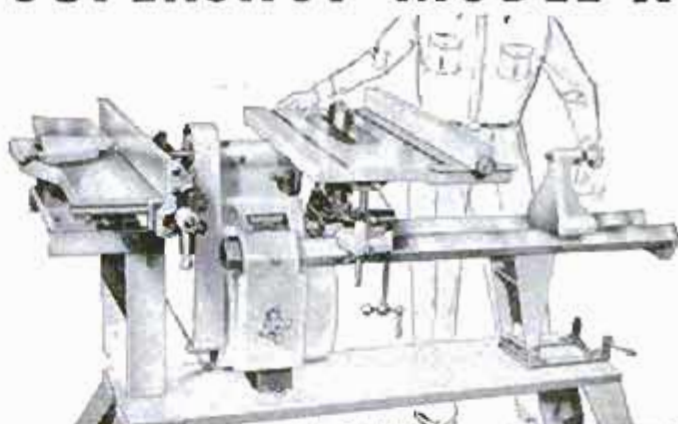

8" SAW

WE PAY ALL
FREIGHT FOR
YOUR FREE
HOME TRIAL

ONLY
\$139.50
EASY
PAY
PLAN



Vert. Drill Press



Hor. Drill Press



8" Sander



30" Lathe



5" Grinder

Never before have you seen so much deluxe, precision-built power tool workshop at any price! Designed for the man who wants the best. Massive cast and precision-machined headstock, self-centering inverted "V" bedways (like precision metal lathes), exclusive non-friction speed changer, extra-large cast and precision-ground saw table. 100% ball bearing, lifetime-lubricated. You save by ordering direct from factory. You are invited to test Supershop Model X in your home FREE. Mail coupon or postcard for FREE brochures, photos, details, specifications, accessory list — and amazing freight prepaid FREE HOME TRIAL PLAN. All free.

MAIL COUPON OR
POSTCARD TODAY

Power Tools Division
UNITED INDUSTRIES, Inc.
113 Yates Avenue
Beloit, Wisconsin

NAME _____

ADDRESS _____

CITY _____

STATE _____

new Lightweight Fiberglas* bathtub



Perfect for shipped prepaid

COTTAGES, CAMPS, TRAILERS ... THAT EXTRA BATH AT HOME!

One man can carry and install the beautiful new Sani-Glas tub... *Lightweight*—as little as 18 lbs. ... *Durable*—built of rugged, chip-proof Fiberglas* ... *Smart Decorator Colors or White*—to mix or match with other fixtures. 2 Sizes—Priced far less than cast iron! Sold with *written guarantee*. *T.M. Reg.

Write Today for **FREE COLOR FOLDER** with specifications and Order Form. Address Dept. P



SANI-GLAS inc.

Amsterdam, N. Y.

Sensational! New!

LIFETIME HANDY SANDER

A Professional Tool

**MAKES SANDPAPER
OBSOLETE!**



**Dura-Grit
Sanding Surfaces
LAST INDEFINITELY!**

Only
\$2.00

Throw away your sandpaper! You'll never need it again! For all your sanding jobs, the amazing Lifetime Handy Sander is guaranteed to give a super-smooth finish in less time. And its sanding surfaces never wear down! Made of amazing new Dura-Grit tungsten carbide—harder than the hardest known steel—that never loses its sharp cutting quality.

Even an amateur can do a professional job.

Solves all your sanding problems for all time. For use on wood, plastics, wallboard, plaster, composition materials. Complete with comfort-grip sanding block and TWO Unlimited Time Guaranteed sanding sheets (coarse grit and fine grit). Perfect Christmas gift for all your friends. Send today and save on special introductory price!

SEND NO MONEY. On arrival, pay postman special introductory price of \$2.00 plus shipping and C.O.D. charges. Or send just \$2.00 now and we ship postpaid. Either way, satisfaction guaranteed or money back. Order several at this special low price.

HANDYMAN TOOL CO.

Dept. N-3

224 W. Huron, Chicago 10, Ill.

POPULAR MECHANICS



Books for the Farmer

- to reduce work
- protect and improve livestock
- increase profits



New Ed. Veterinary Guide for Farmers

Written by farm expert, G. W. Stamm, this amazing book has sold more than a quarter million copies... now completely revised with most modern discoveries and methods fully discussed. Adopted by the U. S. Government for farm training. Used by farmers everywhere to diagnose and treat livestock diseases. Covers virtually every farm animal ailment and tells how to tell one from another; explains treatment or best procedure until the vet arrives. Includes a special, invaluable 12-page diagnostic chart that helps you locate symptoms in short order. A special chapter is devoted to artificial insemination and tells how this breeding method can improve the quality of your herd as well as increase your profits. Noted authorities proclaim this book the finest and most complete guide of its kind available to the farmer and stock raiser. **\$3.95**



New Edition Farm Manual

Helps you step up farm efficiency, improve property appearance and values, increase farm production and income. Every member of the farm family will find something in this book he or she can use to great advantage in farm operation, maintenance and improvement... from the building and care of equipment to painting the farm home and fast freezing of fruit and vegetables. Covers every aspect of farm machinery maintenance... includes detailed plans for building essential equipment from scrap and discarded materials. Even suggests how to mix and pour concrete that will last longer! Here is a book brimming with short cuts, labor-saving ideas and methods that will simplify farm chores and save you money as well. Adopted by State Farm Training Programs. Hundreds of pictures and clearly drawn diagrams. **\$3.50**



Artificial Breeding and Livestock Improvement

Now—the secrets of the key to better livestock revealed by farm editor, G. W. Stamm! The first book in ten years to cover the up-to-date principles and practices of Artificial Breeding... and written in words every farmer and stockman can understand easily and follow surely. This astonishing book presents the true, approved facts on inbreeding, line-breeding and cross-breeding, plus sections on timing, heat periods, how to pick a good dairy cow, how to choose in the field of frozen semen and many other topics of equal interest. Included is a 13-page directory of semen producers, the areas they serve and the breeds of bulls in their studs. If you are a modern livestock producer interested in the best methods and top profits, you simply cannot afford to be without this book for regular reference. **\$3.50**



Developing a Profitable Dairy Herd

Here, in a single, practically written book is everything you want and need to know about profitable dairy herd management. Written by Carnation Farms' Merton L. Moore and E. M. Gildow, D.V.M., there is complete information on feeding, values, fertilization of pastures, also practices, breeding, production, pedigrees, management problems and operating economies, vitamins and many other vitally important subjects. A most interesting chapter covers the showing and selling of cattle. Hundreds of charts, photos, drawings and diagrams leave nothing to the imagination. Whether you raise just a few cows or maintain a huge operation involving hundreds of animals—you'll profit from using this book. **\$3.50**



Hog Profits for Farmers

Hog raising can be highly profitable for the farmer... if proper management and feeding methods are employed. Even if you raise only a few hogs you can make a much bigger profit by applying the suggestions and ideas contained in this outstanding Popular Mechanics book. Written by Dr. W. N. McMillen, it offers down-to-earth, practical money-making information on care and management, feeds and feeding, equipment, marketing, breeds and breeding, judging, showing and sales tips. Contributors include many well-known agricultural experts and renowned college instructors. Only a mere 15 minutes of reading time will show you how to apply the six high points of profitable hog raising to improve your profits immediately. **\$3.50**

Satisfaction Guaranteed or Your Money Refunded.
Place your order now. Use coupon below.



POPULAR MECHANICS PRESS, Dept. 1158
200 East Ontario St., Chicago 11, Illinois

RUSH books I have checked below, if not pleased, I can return in good order within seven days for full refund.

Remittance enclosed. Send prepaid. Send C.O.D.: U.S.A. only

Veterinary Guide Farm Manual Artificial Breeding

Profitable Dairy Herd Hog Profits

Name _____

Address _____

P.O. _____ State _____

WAR SURPLUS AND OTHER **SAVE % 90%**

\$2940 NAVY AIR-COOLED POWER UNIT Most compact engine ever assembled. Portable, net wt. 150 lbs. 200 Amp. Gen. self-starter capable of delivery of double overload or continuous service at 200 Amps. Mfd. by Ranger aircraft. 2 cylinder, 4 cycle, 10 HP, 3200 RPM. Fully governed for varying loads. This unit makes one of the finest arc welders obtainable. Also makes excellent boat engine. Shipped complete with rheostat & voltage reg. All units checked & pre-tested in our shop. Complete \$185.
 Engine same as above with deluxe welding accessories as follows: rheostat, voltage reg., dry charged 24 V. battery, 50' heavy duty welding cable, 1 electrode holder, 1 hood, pr. of gloves, voltmeter. All this only \$225.



FAMOUS NAVY MK14 AIR COMPRESSOR
 Great for tree, termite, airbrush & paint spraying; filling tires, aquariums, etc. Dual & remote control electric receptacles, 115v 60 cycle AC, heavy duty HP, Westinghouse Motor. Direct drive. Water & explosion-proof. Built-in air filter, adjustable pressure setting up to 47 lbs. 3 cu. ft. per min. Self-contained switch. Mounting brackets. These units made under license of Sperry Gyroscope Co. Wt. 66 lbs. gross. Approx. GOVT. COST \$583. Like NEW. \$31.95.

With portable steel hand cart (shown), rubber wheels, specially constructed for mounting this unit. Incl. 25' rubber air hose, 6' extension cord with plug & fittings, Wt. 76 lbs. Complete with cart—\$26.95.
 With new internal pressure spray gun with 3 adjustable spray tips. 1 qt. cap. \$31.95 complete.



"BIG 12" ARC WELDING & BATTERY CHARGING KIT With Deluxe Accessories consisting of one R1 300 Amp Gen., 30' welding cable, welder's adjustable helmet electrode holder, 300 AMP ammeter, 300 AMP shunt, Rheostat, Giant Toggle Switch, 300 AMP reactor coil arc Stabilizer, Voltage Reg., Reverse Current relay, 1 pr. heavy duty welder's gloves. All units guaranteed pretested. Approx. GOVT. COST \$750. Most items new—all perfect. \$46.50. 400 AMP Gen. with above accessories—\$64.50.

REVERSIBLE REDUCTION GEAR (250-1) tremendous inertia power 6-12-24 volt winch with 2 power takeoffs! Use on boats, trucks, wreckers, etc. Fantastic power for pennies of original cost. Weight 55 lbs. Approx. GOVT. COST \$475.00 NEW—\$14.95.



HEAVY-DUTY RHEOSTAT Ideal for regulating voltage on electric welders. Rated 5.75 Ohms, 100 Watts with double windings & dual female 25 amp., 125 V. receptacles. 7" h x 3 1/2" D. Shpg. wt. 2 1/2 lbs. Approx. GOVT. COST \$25. Brand New. \$2.25 ppd.



"SUPER 9" 200 AMP WELDING KIT
 With Deluxe accessories consisting of one 200 AMP Gen., adjustable helmet, elec. trade holder, 30' welding cable, rheostat, giant toggle switch, voltmeter, voltage reg., 1 pr. heavy-duty welder's gloves. All units guaranteed pre-tested. Approx. GOVT. COST \$500. Most items new—all perfect. \$26.00.

WELDING CABLE DOUBLE-O, heavy duty, neoprene jacket, fiberglass insulation. NEW. Approx. GOVT. COST \$40. Will handle 400 amps. or better, 50' lengths \$14.50. 100' lengths \$26.00.

ELECTRIC PUMP WITH CONTROL UNIT
 Runs on 12 or 24 V. Centrifugal type. Draws 5.2 AMPS. Has built-in removable filtering screen. Great for bilge, circulating or sump pump... bait tanks, etc. Pumps 500 GPH. Complete with on and off switch rheostat, 2 speeds (hi & lo). Mfd. by Ingersoll-Rand, Shpg. Wt. 7 lbs. Approx. GOVT. COST \$195. NEW \$8.95.



11 PIECE CROWFOOT WRENCH SETS
 Wrenches snap onto T-bar in 3 different positions. The only wrenches for hard-to-get-to places. Mfd. by Plomb Tool Co. for U.S. Armed Forces. Finest case hardened tool steel. No shop mechanic should be without this set. Approx. GOVT. COST \$47. NEW. \$5.95 ppd.



WOOD PROPELLER Genuine rock maple radio drone "prop." perfect for den, trophy room, boy's room. Smooth, highly varnished, 30" tip to tip. Clock, barometer or photo can be inserted easily into center mounting holes provided. Can use to operate ice sleds, etc. Approx. GOVT. COST \$57. NEW. \$4.95 ppd.

BENDIX GEROTOR PUMP & MOTOR

Use wherever fluid pumping required. Excellent for hydraulic installations. Has 3/4" pipe connections. built-in relief valve adjustable up to 1500 lbs. Max. cap. 6 GPM. 1 1/2 H.P., 24 V. motor. Use on 12 to 36 V. Approx. GOVT. COST \$350. NEW \$10.95.



NEW! 1959 CATALOG! BIGGER & BETTER THAN EVER... 971 price cuts, 1000's of bargains in war surplus & other items! 100's of pictures! Send 25c in coin for your copy today!
 Ppd. prices USA only. Other prices FOB Culver City, Calif. Send cash, check or money order. 50% deposit on COD.



AIRBORNE SALES CO., INC. DEPT. PM 1158
 8501 Stellar Drive, Culver City, Calif.

RUST REMOVED

from all metals—including large and small machine parts, factory and home tools, kitchen appliances, golf clubs, fishing gear, aircraft, marine and auto engines, etc. Unconditionally guaranteed. RUST-X removes rust—will produce a bond surface that will anchor paint. No oiling or waxing needed to prevent further rusting. Nonflammable—safe—easy. Money back guaranteed. 8 oz. bottle \$1.25 postpaid.

RUST SALES CO. P.O. BOX 44284, MIAMI, FLORIDA

NEW! 9.2 H.P. RIDING CRAWLER only \$895 (Blade \$65 extra)

LAYTRAC **Power! Traction!**
 OUTWORKS ANY TRACTOR ITS SIZE
 Ideal for clearing, grading, plowing, field or row crops, yard work. Big tractor ruggedness, quality. Anyone can operate. Borg-Warner 3-speed and reverse trans., cone clutch steering. Tractor with blade, floating drawbar, PTO, ppd. anywhere in U.S. \$960. Wt. 925 lbs. Guaranteed. Accessories available. At dealers or direct. **LAYTRAC, 2548-M11 Airport Way, Seattle 4, Wn.**

Guaranteed BAND SAW BLADES

Order bandsaw blades direct from manufacturer at low factory prices. **Tru-Craft blades** are custom made to fit all bandsaw makes. Fabricated of superior Swedish steel, teeth precision sharpened and set, welded and finished to exact length, ready for installation. Warranted against faulty materials and workmanship... satisfaction or your money back! **Send for price list and order form.**

TRU-CRAFT BLADES

P. O. Box 126 Chicago 90, Ill.

CONCRETE REPAIRS that won't break loose!



LOXON LATEX CONCRETE patches holes and cracks in any kind of masonry... and does it easily, smoothly, permanently. Made of superfine cement and finely ground glassmaker-quality sand mixed with pure liquid latex to provide amazing adhesion. Ideal for repairing foundations, floors, broken steps, brickwork and mortar. Superior to any other type of concrete repair material. At leading paint, hardware, lumber and department stores.

Schupack's Amazing Tool Bargains! Save up to 100%!

ELECTRIC HAND GRINDER
Fits in the palm of the hand and has an air-cooled motor that runs at 20,000 rpm AC or DC at 110 volts. Comes complete with both 3/32 and 1/4 inch coils. **\$11.50 P.P.**

75 Mounted Wheels & Miniature Cutters. Regular \$11.00 value **\$4.50**
For cutting and grinding on mild wood, metal or plastic. Includes 26 mtd. wheels and points on 3/32" shanks; 24 miniature cutters on 3/32" shanks; 25 short shank min. cutters. Will fit all electric drills and hand grinders.

FLEXIBLE SHAFT—ONLY \$6.50
Postpaid. Fits all electric drills & hand power tools. 35 3/4" long. Oilite bearings. Core of specially wound, high carbon steel wire in flexible steel casing. Will accommodate tool shafts up to 1/4" dia. For lathes, electric drills, etc.

2 DRUM SANDERS
With 12 Bands in Assorted Grits. 1/2" dia. x 1" long on 1/4" arbor with 12 hands. **\$1.50 P.P.**
One drum, 1" dia. x 1" long on 1/4" arbor with 6 extra sleeves **\$1.00 P.P.**

10 HIGH SPEED STEEL REAMERS—Straight and Taper Shanks—all brand new and in excellent condition. Reg. \$25 **\$4.50 P.P.** value. 10 for **\$45.00 P.P.**

2 Circular saws. On 2 Mandrels—all at one low price. 1" diameter saws on 1/4" Mandrels. For cutting wood, plastic or soft metals. **\$1.50 P.P.**

12 MOUNTED WHEELS and points on 1/4" Shank. **\$2.95**
36 for \$7.50 P.P.
For grinding on plastic, wood, soft & hard metals. Regular Value \$8.40. 18 Mounted points on 3/32" shank **\$2.50**; 12 mtd. wheels on 1/4" shank **\$3.60**.

7 H.S. and carbon drills from 6" to 12" in length. Assorted sizes up to 1/2" diam. for drilling in hard to reach places. A **\$1.95 P.P.** reg. \$10 val. for only **\$1.95 P.P.**

12 India Silicon Carbide and Arkansas Stones—Squares, Rounds, Triangles. An assortment from 3 1/2" long to 8" long. Fine, medium and coarse. A real \$9.00 value. **\$2.00 P.P.** 12 for **\$24.25 P.P.**

32 H.S. steel drills. Threaded shanks from 3/32" to 1/4". Reg. \$9.50 value. **\$2.00 P.P.** only.

18 Rotary Cutters **\$5.85 P.P.**
\$13.50 value. Assorted size cutters on 1/4" or 3/32" shank. Will fit all hand grinders. Ideal for cutting wood, metal or plastic.

6 Wire Scratch Wheels. 1", 1 1/2", 2" in diam. 4 Tampico buffing wheels, 1 3/4" and 2" diam., and 1/4" arbor for above wheels. **\$2.50 P.P.**

4 Countersinks. Assorted sizes, \$6.00 value **\$2.50 P.P.** for only **\$2.50 P.P.**

50 Assorted Drills. Hi-speed steel & carbon. Up to 1/4" dia. **\$2.75 P.P.**

No. C.O.D.'s. Catalog 10 cents

SCHUPACK SUPPLY CO. 7331 COTTAGE GROVE AVE. DEPT. PM-19 CHICAGO 12, ILL.

New PAINT SPRAY UNIT Including Spray Gun
APPROX. ORIGINAL COST \$325
OUR LOW PRICE... \$34.50
F.O.B. Chicago



Heavy duty compressor for continuous operation, with G.E. or equal B.B. Motor, 110 V., A.C., rated 1/10 h.p., develops up to 1 1/2 h.p. 1-Quart Pressure type gun with round, fan and ceiling spray nozzles. Line filter, air gauge, 20 ft. cord & plug, 20 ft. air hose. Sprays paint, lacquer, enamel, insecticides, etc. Paints house, auto, ANYTHING. Operates gun continuously. Instructions furnished. NOTHING ELSE TO BUY, Wt. 80 lbs.

U. S. GOV. SURPLUS

ORDER FROM THIS AD.
Money Back Guarantee. Send check or money order.

ILLINOIS MFG. & SUPPLY CO.
1829 S. State Street, Dept. PM11, Chicago 16, Ill.



WORRY WON'T CURE CANCER

If cancer is detected in its early, localized stage, the chances for cure are very much better. Play it safe and smart. See your doctor for a checkup every year.

And fight cancer with a check!

Mail it to
CANCER, in care
of your local
post office
—NOW

**AMERICAN
CANCER
SOCIETY**



**CLOGGED SEWERS?
CLEANED INSTANTLY
SAVES PLUMBING BILLS**

CHICAGO—Oct. 1st. Just introduced is a Free Booklet on a New Discovery which enables the Home Owner, Janitor, or Factory Maintenance to clean any Clogged Sewer Drain.

Yet anyone can operate this new Plumbers Flushing Gun which releases air pressure on a solid shaft of water cleaning the most stubborn stoppages up to 200 feet. TOILETS, SINKS, URINALS, BATHTUBS, FLOOR DRAINS, and HOUSE-TO-STREET SEWERS clogged with Grease, Rags, Sand, Roots, and paper melt away instantly when struck by the Hammer-like blow of this new unit.

There is no need to remove wall or pipe, or Grease Trap. A special attachment allows water to flow from the faucet through the Gun while air is released on the pipe. Vents or stacks are no obstacle, as force tends to strike wherever the water lays. But now, what is this Plumbers Flushing Gun worth in **COSTLY PLUMBING BILLS SAVED?** Tear this Ad out—and write your name and address beside it for **FREE BOOKLET**. Obey that urge. No agent will call. A postcard will do (Chicago Phone Kildare 5-1702) **MILLER SEWER ROD CO., DEPT. PM-F, 4640 N. Central Ave., Chicago 30, Illinois.**

DESIRABLE



The Chest for you—if you want skilled workmanship and choice materials. Free Catalog to Machinists and Toolmakers.
GERSTNER TOOL CHESTS
458 Columbia St., Dayton 7, Ohio

THE CHRISTMAS GIFT FOR LIFETIME ENJOYMENT

WELD, BRAZE ANYONE CAN WELD AT HOME



Homeowners, mechanics, farmers, hobbyists! Make repairs at home, farm or shop on fenders, bodies, bicycles, machinery—almost anything of metal. No experience needed. Welder comes complete with twin carbon arc-torch and accessories at low, low price. Operates from any properly wired 110 V. A.C. or D.C. line. Order from this ad. 10 day money back guarantee. Literature on larger equipment FREE.

FOUR-WAY WELDER CO., Dept. F2-M, 1810 S. Federal St., Chicago 16

FOUR-WAY WELDER of 1001 uses only \$14.75
F.O.B. FACTORY
WELDER

SOLDER, CUT

SUPER PAL-MASTER RIFLESCOPE

3/4 inch TUBE DIAMETER



FITS ALL U.S. RIFLES

COMPLETE WITH MOUNT

- 2 1/2 POWER . . . 14.95
2 35 ft. field at 100 yds.
- 4 POWER . . . 15.95
30 ft. field at 100 yds.
- 6 POWER . . . 16.95
20 ft. field at 100 yds.

WHEN ORDERING: specify MAKE & MODEL NUMBER of your rifle.

FULLY GUARANTEED.

for TARGET • BENCH REST or HUNTING
Superb for both Big and Small Game

Make EVERY shot count! Here is a rugged, precision made scope to fit your every need. Made by the finest American Craftsman to top specifications.

UNSURPASSED QUALITY FEATURES:

- 1-WINDAGE and ELEVATION ADJUSTMENTS are positive internal type with direct reading, click type knobs
- 2-RETICLE is newly developed, super-sharp cross-hair—remains centered at all times.
- 3-LENSES are finest quality optical glass. Precision ground and polished, color corrected, no distortion
- 4-ALL LENSES COATED to meet U.S. Army standards
- 5-OCULAR LENS has precision indexed fast focus adjustment.
- 6-OBJECTIVE LENS adjustable for finer sighting.
- 7-BARREL Rust proof blued steel with recessed lenses for sun shade

- 8-RUGGED, DEPENDABLE—Will stand recoil from heavy caliber rifles
- 9-MOUNT INCLUDED in price of the scope will fit ALL U.S. makes and most foreign military rifles now in supply
- 10-WEIGHT 6 ozs. . . EYE RELIEF 2" to 3 1/4"
- 11-COMplete INSTRUCTIONS for mounting scope included.



SPORTS KNIFE 12 Pc. WITH CASE
5-5/8" HANDLE
An ideal GIFT for Hunter, Sportsman, Boy Scout, Camper, Hiker, etc. Eliminates 12 items from your pack. Includes a knife, fork, spoon, draw-knife, bone-saw, fish scaler, scissors, can & bottle opener, cork screw, owl punch, screwdriver and a file. PLUS a genuine leather belt holster.

NAVY FIGHTING KNIFE — Max 6-1/2" hollow ground blade. With holster, \$2.98
FOLDING BAYONET — Swedish Army equip. 7" blade folds into handle, \$1.98
BAYONET SHEATH for above . . . \$1.00

U.S. Army Lentic POCKET COMPASS — Excellent gift for Boy Scouts. . . \$3.49
U.S. Army PORTABLE SHOVEL . . . \$1.98
U.S. Army Portable PICKMATTOCK \$1.29
U.S. Marine MACHETE with 22" Vanadium steel blade. \$1.98

SAVE ON SCIENTIFIC XMAS GIFTS

100 - 200 - 300X MICROSCOPE

Ideal gift for the science student or for use in home lab. Has fine precision ground and polished lenses. A real scientific instrument — NOT A TOY! Triple revolving lens turret allows choice of 100, 200 or 300 power magnification. Has right or left hand rock and pinion adjustments. Body inclines through 90°. Has sub-stage mirror and comes in fitted wood case. A \$14.95 value for . . . **7.88**

12 DIFFERENT PREPARED SLIDES with purchase of any microscope shown here. **FREE!** INSECTS - SPORIS - POLLEN - ETC. Slides separately — 12 for \$2.95



80-600X MICROSCOPE

HAS 80 - 120 - 200 - 300 - 400 & 600 POWER MAGNIFICATION WITH ILLUMINATED SUB-STAGE MIRROR and TRIPLE TURRET

Another Imported Bargain. Now you can change eyepieces from 15X to 10X with a simple shift of the rotating eyepiece turret. Objective lenses are 8X, 20X and 40X all in revolving turret for fast, easy use. All lenses are finest optical glass, precision ground & polished. NEW, PATENTED Sub-stage has built-in light to eliminate need for an external light source. Has a large sub-stage mirror and a revolving variable iris. Fitted case. All-metal body. **16.95**



4 BUCKLE FELT LINED GALOSHES ONLY 2.98
Completely waterproof. A medium weight, all rubber gaiter. Has extra warm felt lining. One piece tongue & 4 buckle closure. Sizes: 8, 9 and 10



U.S. ARMY MUKLUKS NOW 1.69
Keep the feet warm in the coldest weather. Made of waterproof canvas with felt inner soles. Has draw-strings at top, instep and ankles for snug fit. Sizes: Small, Med., Large.



U.S. NAVY FLEECE LINED COAT
Heavy cotton drill specially coated with plastic to make it weatherproof. Lined with a soft, warm sheepskin. Double breasted with a four button closure. Has two slash and two flap pockets. Sizes: 42 through 50. SAVE at . . . **19.95**



U.S. ARMY LIGHT WEIGHT PARKA 14.88
One-piece with hood attached. Has two extra large side pockets. 3/4 length with zipper and button-down storm flap. It's water repellent and wind resistant. Inner liner of soft fur pile. Sizes: Small, Med. or Large.

BINOCULAR BARGAINS

Ideal Xmas Gift for him or her for Football — Marine or Hunting use. Finest Jap. M.L.T.T. (International Inspection Agency) fully approved. **INDIVIDUAL EYE FOCUS . . . \$19.88**
CENTER FOCUS \$22.88
6 POWER 30mm BINOCULAR
An ideal spectator binocular for all types of Sports viewing. **SAVE!**
INDIVIDUAL EYE FOCUS . . . \$15.95
CENTER FOCUS \$18.95
Prices include case and straps.

5 POWER ILLUMINATED MAGNIFIER

NOW 4.69
\$7.95 VALUE
Gives brilliant illumination for precise inspection of any material. . . substance or specimen. The hood contains 1 large 50mm lens and has an internally calibrated scale to show relative size of subject. Metal body holds 2 flashlight batteries.



GENUINE B-15 FLIGHT JACKET ONLY 9.88
Regulation Av Corps type used by WAFA. Body is closely woven Mountain Cloth. Has large Mouton Fur type collar. Full zipper. Knit cuffs & waistband. For Sportswomen & young men. In Size: Small. Color: Olive green.



WHITE ARMY SKI PARKA SPECIAL 3.95
Of white, water resistant twill. Slip-over style. Has 3 buttons at neck and draw string adjust hood. Two slash openings allow access to undergarments. Sizes: Small, Medium or Large

21 TO 1 SPEED REDUCER

Orig. used in Army Gun control mech. Ideal for experimental or lab use. Gear ratio gives 90 RPM with a 1750 RPM direct drive motor. Has ball bearings throughout. Double reduction spur gear drive. **14.75**

18 TO 1 ELECT. ACTUATOR

4.88
Motor turns at 9000 RPM through 18 to 1 gear box. Take-off shafts turn at 500 RPM and drive a ratchet type sprocket. Limit switches set length of travel. Makes an excellent midge hoist. Motor is 24 V. DC., 5-1/2 A.



MULTI-STREAM, SELF-CLEANING, ADJUSTABLE SHOWER HEAD
Just flip the lever to adjust the Multi-Stream head for an invigorating fine spray or a relaxing heavy shower. All brass with heavy Chrome finish. 3" head. **\$6.98 VALUE! EACH 3.44** 3 for Only **10.00**
Easy to install.



PALLEY HYDRAULIC BARGAINS
4-WAY VALVE No. H-V130SU 1500 PSI No. H-48
Piston type with built-in relief valve to limit stroke. Pressure balanced in neutral position with fluid return when not in use. Parts are **7.88**
5-8" AC tube (7/8 x 18 thread). **5.95**
Dbl. Action HYDRAULIC CYLINDER Has a 2" bore — 9" stroke — 7/8" shaft — 14-1/4" length. Another Palley Hydraulic Bargain. Approx. Gov't Cost . . . \$74
Palley Cat. Price . . . \$7.50 **5.95**

SPECIAL 4-SPEED HOBBY MOTOR
Rugged, precision built. For home workshop, barbecue, etc. Used 110 V., 60 cycle current. Four take-offs turn at speeds of 5, 25, 150 and 4000 RPM. SAVE at only. **8.88**

TERMS: Send Check, Cash or Money Order. 50% Deposit with C.O.D.s. Prices F.O.B. Los Angeles, Calif. Warehouse.

palley/s

2263 E. VERNON AVE., DEPT. PM-118
LOS ANGELES 58, CALIF.



NOW! KEEPS DRILLS at Your FINGER TIPS WITH "LAZY SAM" REVOLVING DRILL STAND

Easiest, fastest way yet to locate drills. Drill you want is always in front as stand spins freely on tip-proof base. Compact, yet holds 2 full sets, 1 to 60 and 1/16th to 1/2 by 64ths. Positions marked in large, easy-to-read numbers. Sturdy, metal construction. Complete with table top stand. Mounting brackets available for drill press or wall. Order Now! Cash with order ppd: COD postage extra.

DEPT. PE-11
TASK-AID CORP. 2627 S.E. MOLGATE BLVD.
PORTLAND 2, OREGON

Drill Stand.....\$4.50
Drill Press Bracket..\$2.85
(for 2 1/2" x 4" column)
Wall Bracket.....\$1.95
SAVE! Order all 3 for \$8.95

OLD U.S. REMINGTON BUFFALO GUN & 100 RDS. AMMO all for \$14.95

A once-in-a-lifetime find. Many were purchased by movie studios for westerns. We have a good supply left of old 11MM Caliber Remington single shot military rifles which have been stored for perhaps 50 years. The bores are clean and shootable. The guns are well preserved, not rusty and mechanically perfect with



MARTIN B. RETTING, INC.

11029 Washington Blvd., Culver City 41, Calif.

NEW MAGIC RADIO WALKIE TALKIE!

YOUR OWN POCKET SIZE RADIO STATION!
BROADCASTS TO ANY HOME OR CAR RADIO WITHOUT WIRES OR HOOKUPS! Wt. only 5 oz. Size, 1 1/2 x 2 1/2 x 4 1/2".



Built-in telescoping antenna. Powerful Transistor-sensitive microphone. Frequency setter, break-in switch! Runs for weeks on self-contained flashlight batteries. Durable plastic case. With this Radio Talkie you CAN TALK TO YOUR FRIENDS UP TO A BLOCK OR MORE AWAY! Or talk between two automobiles. INSTANT OPERATION! Just push button to talk! NO LICENSE NEEDED. Uses inductive field magnetic radiation. Useful and real fun in a million ways! GUARANTEED TO WORK. 1 YEAR SERVICE GUARANTEE. SEND ONLY \$3.00 (cash, ck, mo) and pay post-man \$9.98 COD postage or send \$12.99 for prepaid delivery. COMPLETE READY TO OPERATE with instructions and hundreds of ways and tricks for broadcasts thru any radio you desire. Price may go up soon, so get your NEW POWERFUL RADIOWALK BROADCASTER NOW. Available only from: WESTERN RADIO, Dept. RPM-11, KEARNEY, NEBR.

10" TILT/ARBOR SAW BUILD-IT-YOURSELF from GIL-BILT KITS-PLANS



Sturdy wood, steel, and aluminum construction. NEW DEPARTURE ball bearings. Capacity and performance of floor saws selling for \$150.00 and up. Plans, all metal parts in kit with 10" comb. blade \$26.90, less blade \$23.95. P.O.B. St. Louis. Detail PLANS-PATTERNS only \$1.00 postpaid.

Build-it-yourself 12" and 18" Bandsaws, 6" Belt Sander, Shaper. Simplified plans, build easily with hand tools only. Advertised and sold for 11 years, over 33,000 units in use. Money back guarantee. FREE CATALOG.

GILLIOM POWER TOOLS, Dept. 80-L, Lambert Field, St. Louis 21, Mo.

how to Slash fuel bills 20% -

GET
BRIDGEPORT
INNER-SEAL
Live Rubber
WEATHERSTRIPPING

Right! You can really save money on fuel bills by putting draft-stopping INNER SEAL on those costly openings around doors and windows that may be robbing you of \$20 to \$40 a year! Easy to put on... keeps out dirt, water... keeps heat in!

Exclusive patented construction with springy steel wire in lively sponge rubber covered with tough neoprene makes INNER SEAL seal better, last longer... never gets ragged or brittle. Get INNER SEAL at hardware stores now! (Pays for itself in fuel savings).



Write for
FREE BOOKLET
"How to Weatherstrip
Your Home"
Dept. PM-11

BRIDGEPORT FABRICS, INC.
BRIDGEPORT 9, CONN.

Earth Wobble at Poles Confirmed by Computers

High-speed electronic computers have confirmed an 80-year-old theory that the circular wobble of the earth's poles causes small ocean tides. Data for the last 100 years collected from the 11 tide stations in Europe, South America, the United States and the Indian Ocean were fed into the computer, which did the necessary 250 million mathematical computations in 1 1/2 hours. Interpretations of the computed data proved the existence of a polar-created tide, independent of the tides caused by the sun or moon.

Go South, Young Man

Twentieth-century pioneers willing to cope with primitive living conditions may find a prosperous future in a 2000-mile stretch of fertile valleys and plateaus of Colombia. A report published by the Smithsonian Institution says the partly explored region east of the Andean foothills, one of the world's last frontiers, produces bumper crops and may become a "new major source of food for the entire continent."

AMERICA'S BEST JET STEAM MASTER

Now, a super efficient portable steam generator that produces live steam at 100 lbs. pressure in 60 seconds from a cold start! Produces large volume of high pressure steam on 2 pints of fuel oil. Instantly cleans sticky grease, dirt, rust, old paint, etc. off implements and runs machinery. Pays for itself in a few weeks. Sterilizes soil. Sterilizes as it cleans—milk equipment, etc. Fully automatic—oil fired with new, built-in lifetime bronze water circulating pump. Draws water from faucet or bucket. Simple and safe—anyone can use it; built-in safety valve. Complete with 12 ft. of high-pressure steam hose and new triple efficiency steam gun that automatically mixes in soap solution if desired. Wt. 250 lbs. Item 463. **\$349.50** Special factory price.



ELECTRIC HOIST

2000 lb. CAPACITY. A fortunate purchase from the Air Force enables us to offer these powerful 2000 lb. electric cable hoists at a fraction of their value. Perfect for material handling, boat hoists, elevators, lifts on assembly lines, etc. Two separate 22 ft. lift cables with independent controls permit leveling the load and controlling it perfectly. Rugged ball bearing motors of geared down design 110 volts. Available for A.C. or D.C. Please specify. Makes a terrific portable hoist with our #273 D.C. light plant at \$179.50. Offered at less than 33% of regular cost (hook not included). Wt. 145 lbs. A.C. Model, Item 847A. **\$149.50** D.C. Model, Item 847. **\$129.50**



Rugged, ball bearing WINCH

Sturdy ball bearing winch—super tough aluminum alloy construction. Powered by an easy starting 2 1/2 HP Briggs gas engine thru gear reduction drive—it exerts up to 3000 lbs. of terrific force for hoisting materials or pulling. Combination gear and pulley reduction results in tremendous multiplication of engine power. Idle pulley clutch arrangement and built-in drum brake (with rate of hand lever) enables operator to ease loads down gently and lock at any point desired. Drum handles 400 ft. of 3/8" cable or 600 ft. of 1/2" cable. Ideal for contractors, farm implement trailers and unlimited other uses! (Item 795) Wt. 125 lbs. Only. **\$149.50** **HEAVY DUTY MODEL** same as above but with big Industrial Clutch. **\$169.50** **HAND WINCH**—Same winch with large crank handle for extra leverage and hand speed drive. (Item 794) Wt. 66 lbs. **\$59.50**



SPECIAL DEALS

MINE DETECTOR for detecting buried pipes, wires, sewers, etc. Complete case and fresh batteries included. **\$49.50**
AIR HAMMER for hammering dents out of auto bodies. Complete with 2 different shaped arms and 5 bumping dollies. Hammer can also be used without arm for chiseling and drilling, etc. Uses 4 cfm at 60 psi. **\$39.50**
SCREW JACK—16 ton Simpex Jack, 1 1/2" screw, 16" lift. Reg. price \$29.50. **\$9.50**
Special Price
HYDRAULIC PRESS, 9 ton press for pushing, bending, straightening, etc. **\$69.50**
#1671 Special Price
SCREW PRESS, 9 ton capacity with 21" throat. Complete with adjustable table. **\$49.50**
EXTENSION CORD, 2 cond. # 4, Neoprene **\$6.95**
2 cond. #10, Neoprene cover **\$7.95**
3 cond. #10, Neoprene covers **\$12.95**
INTERCOM SET, Powerful loud talking intercom set powered by 4 flash light batteries which last for 6 months. Good up to 1,000 ft. Complete with 2 stations—250 ft. of wire and batteries. **\$11.95**
PORTABLE BLOWER powered by 2.2 Briggs Gas engine. Used for ventilating man boxes, tanks, or any ventilating purpose. Complete with 20 ft. of 4 in. flexible pipe. **\$99.50**
EXHAUST FANS—Heavy duty, powered by sealed explosion proof motors, mounted in steel frames. Ideal for ventilating spray booths, barns, taverns, etc. **\$29.75**
20" fan, only
FURNACE BLOWER, 10 in. wheel, handles 1800 CFM. Requires 1 1/2 HP motor. Outlet size is 1 1/8" by 1 1/4" **\$29.50**

GET MASTER MECHANIC'S BEDROCK FACTORY PRICES



700 WATT LIGHT PLANT

PUSH BUTTON START

115 v. 60 cyc. AC Powered by a rugged 2.2 HP. easy starting Briggs engine. No wiring necessary; just plug in and operate. Plenty of current for any oil burner, freezer, brooder, emergency lights, etc. which require up to 700 watts. Ideal for television and radio. Complete with voltmeter and built-in winding to charge 6 v. auto batteries. (Item 24) Wt. 75 lbs. Easily fits in car trunk. Be prepared if storm knocks out power lines. **\$143.50** Regular \$275.00 value.
1200 Watt Plant (Item 43) same as item 24 but larger generator and engine with 50% greater output **\$199.50**
We make every type and size of light plants. Write giving us your requirements!

Double Acting Hydraulic Cylinder



A powerful cylinder made by Masses Harris which develops both a pushing and a pulling action. Will push 8,100 lbs., with a 1000 PSI pump pressure. Cylinder is 3/4" i.d. with 6 1/2" stroke—standard heavy duty clevises on both ends. Has standard 1 1/2" pipe thread openings. Can be used for tilting buckets or blades, raising or lowering implements, hydraulic presses, etc. Can also be used as an air cylinder. (Item 802) Wt. 17 lbs. Reg. \$68 value. Special. **\$14.95**

OTHER DOUBLE ACTING CYLINDERS
6" stroke—1 1/2" bore. **\$ 8.95**
8" stroke—3" bore. **34.00**
10" stroke—3" bore. **34.80**
16" stroke—3" bore. **43.00**
24" stroke—3" bore. **47.50**
42" stroke—5" bore. **75.00**
60" stroke—5" bore. **125.00**

We have all sizes of cylinders available.
HYDRAULIC CONTROL VALVE—4 way open center valve with built-in adjustable relief. Controls 1 double, or 2 single acting cylinders. Equalizing feature permits easy control even under heavy loads. 3/4" pipe thread on inlet & outlet. 1 1/2" on cylinder outlets. Easily mounted, finger tip control. Wt. 16 lbs. (Item 822). **\$21.95**

HYDRAULIC PUMP drive from tractor power take off with separate engine or motor. Capacity is 8 GPM at 800 RPM—has 3/4" shaft with keyway. **\$39.50**

HYDRAULIC HOSE COUPLERS Connect or disconnect hydraulic lines without loss of oil. 1/2" pipe threads. (Item 819) per set **\$3.95**

SPEED SELECTOR, Heavy duty made by B. F. Goodrich for industrial use. Provides instant speed selection. Employs reliable planetary system—no power losses. 1-2 HP size. **\$89.50**

SPEED REDUCER, gear type with ball bearing drive provides speed reduction or increase as great as 100 to 1. Suitable for 1/2 HP. **\$19.95**

BATTERY CHARGING GENERATOR SET, 750 watt, charges 12 or 24 volt batteries, made by DELCO. Engine runs at 1800 RPM. Makes a potent cold weather motor starting unit as well as a fast charger. **\$119.50**

MOTOR-GENERATOR SET—115 v. 3KW D.C., output with 3 HP-3ph. direct connected motor. Ideal for magnetic chucks, variable speed motors, or electro-plating; complete with controls. **\$349.50**

ALUMINUM CONVEYOR—ball bearing skate-wheel type, 12" wide, 8 ft. sections & 4 ft. sections. Hook together to form any length desired. Very light and strong. 8 ft. section (Wt. 40) **\$34.50**
4 ft. section (Wt. 20) **\$17.50**

ELECTRIC WATER PUMP—Centrifugal pump—1 1/2" pipe thrd.—direct connected to heavy duty sealed 115v. A.C. motor. Ideal for draining tanks, transferring fluids, etc. Capacity 800 g.p.h. Reg. \$70.50. **\$29.50** Special

FOOT VALVE—for above pump. **\$1.95**

WATER PUMP, self-priming pump coupled to a 2.2 HP Briggs engine. Delivers 600 GPH. Pump has both garden hose thread & 1" pipe thread. **\$79.50**

LESS THAN WHOLESALE

1500 WATT PLANT 115v. 60 cyc. AC Push Button Start. Powered by a 4 HP. Clanton engine. Combines big output with easy portability. Provides emergency power for operating any oil burner, sump pump, freezer, television, lights, communications systems, etc. which require up to 1500 watts. (Item 22) Wt. 110 lbs. Reg. \$475 value. Factory price **\$239.50**
1750 Watt Plant Powered by 4 1/2 HP. Briggs engine. Electric starting & battery charging built-in! Factory price **\$279.50**
2500 WATT PLANT—Push Button Start (Item 21) 110/120 v. 60 cyc. A.C. A rugged powerful plant. Reg. \$645. Spec. **\$329.50**
3500 Watt Plant Push Button Start (Item 23) 115 v. 60 cyc. AC. Similar to above, but larger and 33% more capacity. Wt. 270 lbs. Reg. \$760. Factory Price. **\$379.50**
DUAL VOLTAGE 110/220 for Item 21 or 23—\$30 additional.

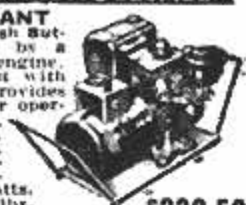

HEATING & VENTILATING FAN

(Item 10) Easily installed in furnace pipes. Forces even heat to all rooms. Over range removes kitchen smoke and odors. Powerful, continuous duty motor, 110-120v. AC. Mount in wall or ceiling to ventilate any area. Quiet, super-efficient fan moves huge volume of air, 400 to 600 CFM. 8" Pipe, wt. 5 lb. **\$7.85**
9" Pipe, wt. 6 lb. **\$7.85**
10" Pipe, wt. 7 lb. **\$8.85**
12" Pipe, wt. 8 lb. **\$9.85**
HEAVY DUTY FAN, Semi-enclosed motor, suitable for spray booths, restaurant exhausts, poultry houses, etc. 10" Fan, wt. 8 lbs. (Item 10E) **\$11.95**
12" Fan, wt. 10 lbs. (Item 10D) **\$12.95**
HIGH SPEED BARN FAN similar to above, but larger, high speed motor moves huge volume of air. 12" Fan (Item 10G) **\$14.95**
14" Fan (Item 10H) **\$17.95**



RUBBER HOSE

Genuine Neoprene Hose—outlasts ordinary rubber 3 to 1. Reinforced with super tough cotton cord plies—yet completely flexible. Equipped with standard thread male and female fittings. Pump water for irrigation, stock tanks, home, barn, fire fighting, etc.—or pump gas and fuel oil. Volume theory prices—save more than 60%.



TERRIFIC VALUES!

Size	Price	Size	Price
1 1/2"x10'	9.95	1 1/2"x50'	29.50
1 1/2"x10'	7.95	2"x10'	16.50
1 1/2"x20'	10.95	2"x10'	9.50*
1 1/2"x25'	13.95	2"x14'	21.50
1 1/2"x50'	24.95	2"x50'	47.50
1 1/2"x100'	49.95	2 1/2"x10'	21.75*
1 1/2"x10'	10.95	2 1/2"x17'	37.50
1 1/2"x25'	14.75	3"x10'	25.50*
*Discharge Hose		4"x15'	44.95

MASTER D.C. ARC WELDER

Easy To Use

(Item 280)

Now a portable rugged, industrial DC welder with terrific performance, yet at a price hundreds of dollars less than you'd expect. Senior model made for years of trouble-free, continuous service. High capacity DC welding unit enables you to tackle any job with confidence—easily welds anything up to 2" plate using from 1/16" to 1/2" rods. Built-in stabilizer and cooling system makes arc easy to strike and hold. Dual control thermostat provides low heat soldering, brazing and welding from 30 to 300 amps. Complete with instructions, guarantee and triple V-belt or flat pulley. Easy to hook up and easy to operate.

WELDER ONLY—DUAL CONTROL MODEL. Same as above, but drive with your tractor, jeep or gas engine of 14 HP or more. (Item 38a) Wt. 110 lbs. \$450 value. **\$119.50**

WELDER ONLY—INDUSTRIAL MODEL same as above but with ceramic rotary type rheostat providing 74 different heat settings for all types of welding (Item 38b) \$500.00 value. **\$139.50**

COMPLETE POWER MASTER (Illustrated above) powered by a 16 hp. air cooled Wisconsin engine. Wt. 480 lbs. (Item 280) Complete with welder costing \$1200. Factory Special. **\$449.50**

WELDING KIT Two 10 ft. leads, welding helmet, electrode holder, ground clamp. Sold only with welder at... **\$10.50**

Send check or M.O. Prices L.o.B. Factory. 10 day Money back guarantee. SEND 10c for **BIG NEW Catalog**

MASTER MECHANIC MFG. CO.,

DEPT. ALT8 Burlington, Wis.

Cast your ballot for a successful future!

256 I.C.S. COURSES



Whether you stand at a machine or sit at a desk . . . whether you're making \$75 a week or \$75 hundred a year . . . whether your interest is Power Plants or Paper Pulp, Advertising or Electronics . . . chances are I.C.S. has exactly the course you need to get ahead.

I.C.S. is not only the oldest and largest correspondence school. It also offers the most courses. 256 in all. Each one success-proved by graduates who rose to top technical and administrative positions. Chief engineers. Superintendents. Foremen. Managers. Executive assistants.

I.C.S. Courses cover bedrock facts and theory plus practical, on-the-job applications. No skimping. Texts

are prepared by leading business and industrial authorities working with I.C.S. editors and educators. They are constantly being reviewed and revised in line with current developments.

As an I.C.S. student, you study in your spare time, set your own pace. No time lost getting to class or waiting for slower students to catch up. If you wish, I.C.S. will make progress reports to your employer. You win recognition as a "comer," one who is ready to move ahead. Thousands of students report pay increases and promotions within a few months of enrollment. All graduates win the coveted, approved I.C.S. diploma.

3 FREE BOOKS! Check the subject that interests you in the coupon below. I.C.S. will rush you (1) a special book outlining your opportunities in this field, (2) the 32-page gold mine of career tips, "How to Succeed," (3) a sample I. C. S. lesson (Math.) demonstrating the famous "I. C. S. Method." "X" MARKS OPPORTUNITY.



For Real Job Security—Get an I. C. S. Diploma! I. C. S., Scranton 15, Penna. Accredited Member, National Home Study Council

INTERNATIONAL CORRESPONDENCE SCHOOLS



BOX 23299L, SCRANTON 15, PENNA.

(Partial list of 259 courses)

Without cost or obligation, send me "HOW TO SUCCEED" and the opportunity booklet about the field BEFORE which I have marked X (plus sample lesson):

- ARCHITECTURE and BUILDING CONSTRUCTION**
- Air Conditioning
 - Architecture
 - Arch. Drawing and Designing
 - Building Contractor
 - Building Estimator
 - Carpentry and Millwork
 - Carpenter Foreman
 - Heating
 - Interior Decoration
 - Painting Contractor
 - Plumbing
 - Reading Arch. Blueprints
- ART**
- Commercial Art
 - Magazine & Book Illus.
 - Show Card and Sign Lettering
 - Sketching and Painting
- AUTOMOTIVE**
- Automobiles
 - Auto Body Rebuilding and Refinishing
 - Auto Engine Tuneup
 - Auto Technician

- AVIATION**
- Aero-Engineering Technology
 - Aircraft & Engine Mechanic
- BUSINESS**
- Accounting
 - Advertising
 - Business Administration
 - Business Management
 - Cost Accounting
 - Creative Salesmanship
 - Managing a Small Business
 - Professional Secretary
 - Public Accounting
 - Purchasing Agent
 - Salesmanship
 - Salesmanship and Management
 - Traffic Management
- CHEMICAL**
- Analytical Chemistry
 - Chemical Engineering
 - Chem. Lab. Technician
 - Elements of Nuclear Energy
 - General Chemistry
 - Natural Gas Prod. and Trans.
 - Petroleum Prod. and Engr.
 - Professional Engineer (Chem)
 - Pulp and Paper Making

- CIVIL ENGINEERING**
- Civil Engineering
 - Construction Engineering
 - Highway Engineering
 - Professional Engineer (Civil)
 - Reading Struc. Blueprints
 - Structural Engineering
 - Surveying and Mapping
- DRAFTING**
- Aircraft Drafting
 - Architectural Drafting
 - Drafting Machine Design
 - Electrical Drafting
 - Mechanical Drafting
 - Sheet Metal Drafting
 - Structural Drafting
- ELECTRICAL**
- Electrical Engineering
 - Elec. Engr. Technician
 - Elec. Light and Power
 - Practical Electrician
 - Practical Lineman
 - Professional Engineer (Elec)
- HIGH SCHOOL**
- High School Diploma

- Good English
 - High School Mathematics
 - Short Story Writing
- LEADERSHIP**
- Industrial Foremanship
 - Industrial Supervision
 - Personnel-Labor Relations
 - Supervision
- MECHANICAL and SHOP**
- Diesel Engines
 - Gas-Elec. Welding
 - Industrial Engineering
 - Industrial Instrumentation
 - Industrial Metallurgy
 - Industrial Safety
 - Machine Design
 - Machine Shop Practice
 - Mechanical Engineering
 - Professional Engineer (Mech)
 - Quality Control
 - Reading Shop Blueprints
 - Refrigeration and Air Conditioning
 - Tool Design
 - Tool Making
- RADIO, TELEVISION**
- General Electronics Tech.

- Industrial Electronics
 - Practical Radio-TV Eng'g
 - Practical Telephony
 - Radio-TV Servicing
- RAILROAD**
- Car Inspector and Air Brake
 - Diesel Electrician
 - Diesel Engr. and Fireman
 - Diesel Locomotive
- STEAM and DIESEL POWER**
- Combustion Engineering
 - Power Plant Engineer
 - Stationary Diesel Engr.
 - Stationary Fireman
- TEXTILE**
- Carding and Spinning
 - Cotton Manufacture
 - Cotton Warming and Weaving
 - Loom Fixing Technician
 - Textile Designing
 - Textile Finishing & Dyeing
 - Throwing
 - Warping and Weaving
 - Worsted Manufacturing

Name _____ Age _____ Home Address _____
 City _____ Zone _____ State _____ Working Hours _____ A.M. to P.M. _____
 Occupation _____

Canadian residents send coupon to International Correspondence Schools, Canadian, Ltd., Montreal, Canada. . . . Special tuition rates to members of the U. S. Armed Forces.



ACon-O-MIZER

Praised for Economy and Performance
by Dealer and Driver Alike!



"I HAVE INSTALLED MORE THAN 50 UNITS," states Mr. William Chapman, Manager of Rouse Brothers Standard Service of Flint, "and my customers invariably report better performance and smoother idling, plus greater gas mileage. They're so satisfied that I couldn't buy back any of the ACon-O-Mizers I've sold!"

"I WOULDN'T TAKE 50 DOLLARS FOR MY ACON-O-MIZER," enthuses Mr. Pat Travers, Michigan Monument Sales Executive. "I frequently take a 300-mile business trip and I've upped my gas mileage, thanks to the ACon-O-Mizer. My car never ran better or smoother!"

AC SPARK PLUG  THE ELECTRONICS DIVISION OF GENERAL MOTORS

"I've tried all types of gas savers but the ACon-O-Mizer is the only one that really paid off," says Pat Travers.



quality products

Used on More New Cars
Than Any Other Brand



“Hottest” fishing news for '59!

From the torrid heat of Corpus Christi, Texas, to the frigid waters of Sitka, Alaska, commercial fishermen put 98 Evinrude test engines through the wringer of practical day-in, day-out work boat use. Behind the scenes, Evinrude engineers ran controlled performance tests in 40° water.

Tests proved all around superiority of Evinrude's new '59 "hot running" thermostat-controlled motors over standard engines. Now all 1959 Evinrudes from 5½ to 50 hp are thermostat-controlled and operate at a constant 140° temperature for peak efficiency at all speeds, all conditions.

Longer Spark Plug Life

In all motors tested, spark plugs lasted 3 to 7 times longer in the thermostat-controlled engines—dramatic evidence of the benefits of faster warm-up, unvarying temperature, and better lubrication.

Smoother Operation

Whether in icy waters in the North, or warm Southern waters, thermostat control gives the new '59 Evinrudes better idling, smoother full-range performance, permits closer engineering tolerances.

Extra Fuel Savings

Under identical operating conditions the thermostat-controlled motors used up to 20% less fuel—a practical demonstration of increased efficiency.

Less Rust and Salt Corrosion

The problems of salt corrosion or rust in bearings or cylinders caused by high humidity are licked by warmer, drier air under the covers.

Longer Engine Life

The 98 Evinrudes tested on the job by commercial fishermen were all run from 1500 to 1800 hours without major maintenance. Many of these fishermen were so impressed they wanted to buy the motor they had been trying to wear out. Longer engine life is a real economy for any fisherman.

The '59 Evinrudes are no "warmed-over" last year's models. They're new hot-blooded thermostat-controlled motors with increased performance.

See '59's finest motors at your Evinrude dealer (listed under "outboard motors" in your phone book). Ask for '59 catalog—or write: Evinrude Motors, 4374 North 27th Street, Milwaukee 16, Wisconsin.

A Division of Outboard Marine Corporation
In Canada: Mfd. by Evinrude Motors, Peterborough



EVINRUDE

QUIET OUTBOARD MOTORS