

# POPULAR MECHANICS

MAZINE

YOU CAN UNDERSTAND IT

REG. TRADE MARK, U.S.

REG. U.S. PAT. OFF.



**OWNERS REPORT ON THE VAUXHALL**

*For the Craftsman*

Beginning an Important Feature for Shop Men:

**SHOWCASE OF TOOLS—  
CIRCULAR SAWS**



**Rocketeers  
Play Safe  
—page 73**



# "Cleaning and waxing my car took 1¼ hours



## with Du Pont's NEW CAR WAX



## ... it's still sparkling after 6 months"

says Bill Dec of Huntington, N. Y., after waxing his '56 Ford with Du Pont New Car Wax. Bill discovered that this new paste wax is as easy to use as a liquid polish, because it cleans, waxes and glazes—all in *one easy application*. Yet it protects with real Carnauba wax, *the toughest wax known*. Proof of protection is the long-lasting gleam. Six months, 12 car washings later, the finish still shows clear reflections of Bill and his wife! Try Du Pont New Car Wax—it makes any good finish look new! At service stations and auto supply stores. Only \$2.00.



BETTER THINGS FOR BETTER LIVING...THROUGH CHEMISTRY



Choose  
Super  
Graphic\*

- Rises
- Tilts forward and backward
- Swings and shifts right and left
- Drop bed

## the practical camera that practically does tricks...

Tricks? Not really! Just practical, precision engineering that provides swings, tilts and shifts that accommodate any photographic situation. Take a look at the Super Graphic's versatility, its flexibility,—close-ups, tele-photo, wide angle—you name it and the Super Graphic can do it. For serious hobby, or serious money-making photographs you owe it to yourself to take a careful look at the Super Graphic.

Super Graphics are available with various lens and shutter combinations starting at \$375. To learn more about this advanced all-new camera and its complete line of accessories see your local Graflex dealer or write Dept. PM-98, Graflex, Inc., Rochester 3, N.Y.

*\*Trade Mark. Prices include federal tax and are subject to change without notice. Slightly higher in Canada.*

**GRAFLEX**

PRECISION  
EQUIPMENT  
**GPE**  
CORPORATION

A SUBSIDIARY OF GENERAL PRECISION EQUIPMENT CORPORATION





For clean oil all the time  
call for

**HASTINGS**

Hastings Oil Filter Cartridges keep oil clean *all the time*, because only Hastings has Densite filtering material.

Densite is different! Millions of selected cotton fibres—pressure packed—trap even the most microscopic dirt particles. Only Densite keeps oil clean from filter change to filter change, when replaced as normally recommended.\*

Next filter change, call for Hastings—for clean oil *all the time!* Hastings Manufacturing Co., Hastings, Mich. Also makers of Piston Rings, Casite, Wear Reducer, Spark Plugs.

*\*Proved by tests conducted in accordance with U.S. Bureau of Standards procedures.*



U. S. Patent  
Nos. 2,797,811  
2,584,771



# Popular Mechanics Magazine

Registered in U. S. Patent Office and Canada

H. H. WINDSOR, Founder

H. H. WINDSOR, JR., Editor and Publisher

Managing Editor

RODERICK M. GRANT

Assistant Managing Editor

WAYNE WHITTAKER

Shop Notes and Crafts Editor

JAMES R. WARD

Associate Editors, General Features

CLIFFORD B. HICKS

ARTHUR R. RAILTON, Automotive

KENNETH N. ANDERSON

Associate Editors, Shop Notes and Crafts

WAYNE C. LECKEY W. CLYDE LAMMEY

Radio-Television, Electronics Editor

LOTHAR STERN

Assistant Editors

SHELDON A. MIX, General Features

JAY W. HEDDEN, EARL WOBECK, Crafts

JOHN DALEN, ARLENE HIRSCH, Makeup

Art Staff

FRANK BEATTY, Director

HENRY NEHRBASS, Assistant Director

RICHARD A. POTTS, Art Editor

Eastern Editor

RICHARD F. DEMPEWOLFF

Empire State Bldg., New York City 1

Western Editor

THOMAS E. STIMSON, JR.

Suite 1010, 3400 Wilshire Blvd.  
Los Angeles 5, Calif.

London Manager

DOUGLAS W. WEDDERSPOON

Eagle House, Jermyn St.,  
London S.W. 1, England

Director, Bureau of Information

ALLAN CARPENTER

Advertising Offices

Chicago: 200 E. Ontario St., Whitehall 4-0100;  
New York: Empire State Bldg., 350 Fifth Ave.,  
Longacre 5-7580; Detroit: General Motors  
Bldg., TRinity 5-8711; Cleveland: Hanna  
Bldg., 1422 Euclid Ave., PRospect 1-0456; Los  
Angeles: 3400 Wilshire, DUnkirk 2-8458; San  
Francisco: Russ Bldg., 235 Montgomery St.,  
Yukon 2-0823.

Published monthly by Popular Mechanics Company,  
200 E. Ontario St., Chicago 11, Ill. H. H. Wind-  
sor, Jr., president; Wm. Harrison Frybridge, exec.  
vice-pres.; Franklin S. Farsberg, operations vice-  
pres.; D. F. Windsor, vice-president and secretary-  
treasurer; H. H. Windsor III, vice-president; W. T.  
Windsor, vice-president; Joseph K. Buell, Jr., ad-  
vertising manager; Alan M. Deyoe, circulation  
manager. Single copy in the United States and  
Canada, 35 cents; subscription rates in the United  
States and possessions, Canada and countries of  
the Pan-American Postal Union, 1 year \$3.50; 2  
years, \$6.00; 3 years, \$8.00. To all other coun-  
tries add \$1.00 a year over United States prices  
for overseas postage. If you plan to move, notify us  
at least 30 days in advance so you will not miss  
an issue. Give both your old and new addresses.  
Entered as Second Class Matter, September 15,  
1903, at the Post Office at Chicago, Illinois, under  
Act of March 3, 1879. Entered as Second Class  
Matter at Post Office Dept., Canada. Registered  
as Second Class Matter at the Post Office at  
Mexico, D.F., Mexico, June 20, 1950.  
Copyright 1958 by Popular Mechanics Company.  
Copyright under International Copyright Union.  
Copyright in France. All rights reserved under  
Pan-American Copyright Union. Printed in the  
United States of America.

FOREIGN EDITIONS:	MECANIQUE POPULAIRE (French)	MECANICA POPULAR (Spanish)	POPULAER MEKANIK (Danish)	POPULAR MEKANIK (Swedish)	POPULARE MECHANIK (German)
-------------------	------------------------------	----------------------------	---------------------------	---------------------------	----------------------------

Volume 110	SEPTEMBER 1958	Number 3
------------	----------------	----------

Address all communications to: 200 E. Ontario St., Chicago 11, Ill.

## In This Issue...

These Rocketeers Play Safe	-	-	-	73
Owners Report on the Vauxhall	-	-	-	82
Treasure Hunt in Navajo Land	-	-	-	89
Festival of the Iron Men	-	-	-	105
Flying Hero of the Alps	-	-	-	124
"Grand Prix" of the Lawn-Mower Racers	-	-	-	130
How We'll Steer in Space	-	-	-	137
Improve Your Wing Shooting	-	-	-	146
Radio, TV and Electronics	-	-	-	152

## For the Craftsman...

Coat and Boot Rack for Your Hall	-	-	-	157
The Merrymaker Snowmobile	-	-	-	160
Photocopying the Easy Way	-	-	-	166
How to Shape Trees	-	-	-	174
Showcase of Tools—Circular Saws	-	-	-	183
Lamps—Interior and Exterior	-	-	-	189

## Regular Departments...

Do You Know This Old-Timer?	-	-	-	22	
Detroit Listening Post	-	97	How Would You Do It!	-	180
Keeping Up With the Atom	-	100	On the Market	-	199
What's New for Your Home	-	142	Shopping for Tools	-	209
Solving Home Problems	-	170	Clinic for Homemakers	-	214

Turn to detailed index on page 66. Sources of additional information on items in this issue are shown on the Where-to-Find-It List, available without charge by writing the Bureau of Information, Popular Mechanics, 200 E. Ontario St., Chicago 11, Ill.

## Next Month...

HOMES AND AUTOMOBILES—two subjects close to the hearts of Popular Mechanics readers—will be highlighted in the October issue. Fifty pages, many in full color, will be devoted to everything in and around the house in the annual Home Section. A new PM home, designed by two top-notch West Coast architects, will be introduced . . . THE FIRST OF THE 1959 CARS will feature Buick, Cadillac, Oldsmobile and DeSoto with pages of photos



*The new age of space is here...*

and the future  
belongs to the  
airman

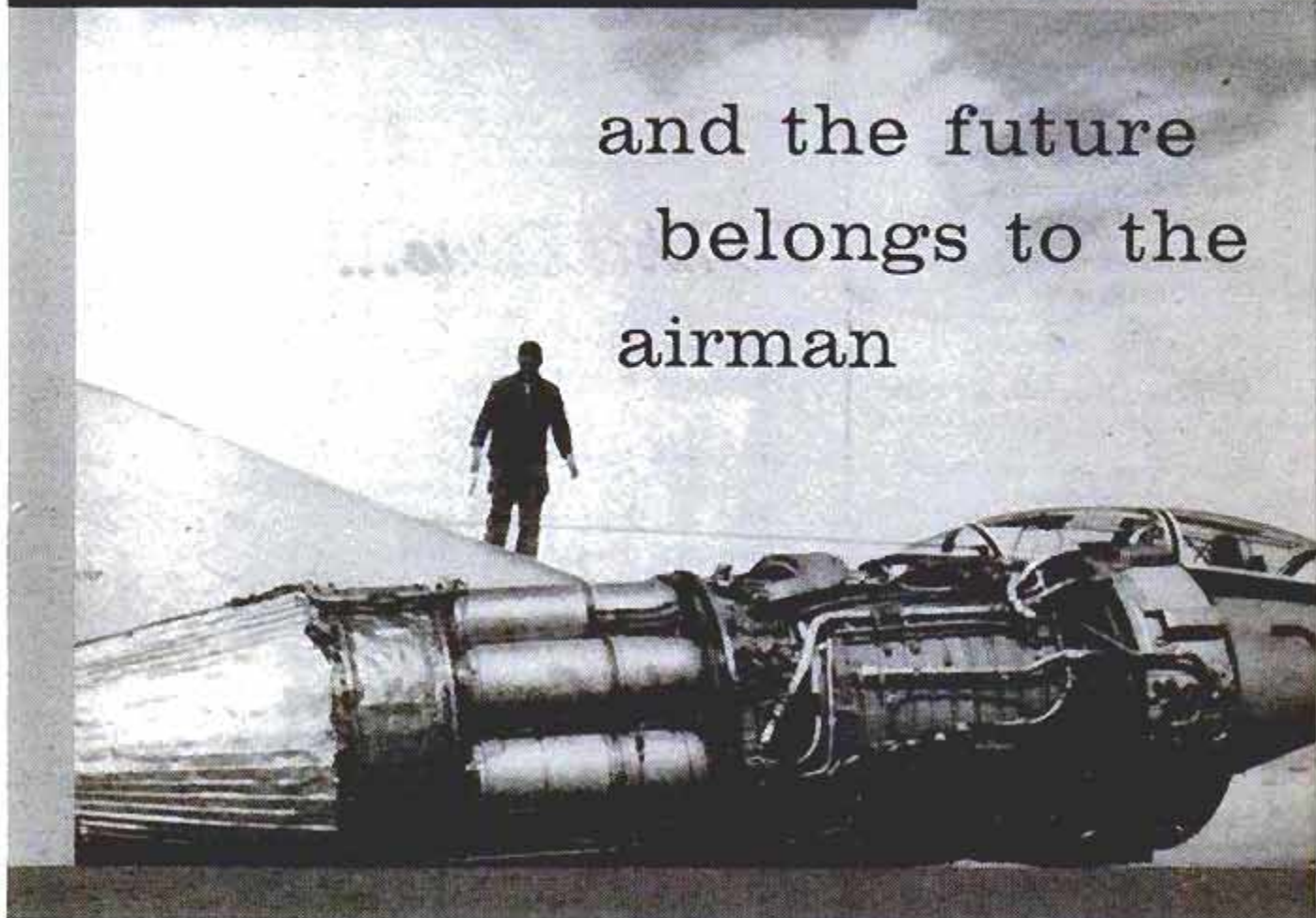

You have read about the early Age of Flight...grown up in the Jet Air Age. Now, as a young man, you stand on the threshold of a new age in which man will conquer outer space. It will be the age of trained technicians—those who have backgrounds in rocketry, jet propulsion, electronics, mechanics and allied fields. And nowhere else is such training so available or so complete today as in the U.S. Air Force. Consider this fact as you plan your future. By joining the Air Force, you will, of course, meet your military obligation. But much more important, you will prepare yourself for unlimited opportunities in the new Age of Space. See your local Air Force Recruiter today—or mail the coupon.

*You go places  
faster in the*

**U.S. AIR FORCE**

**PASTE COUPON ON POSTCARD AND MAIL TO:**

Airman Information, Dept. PM-132  
Box 7608, Washington 4, D. C.

Please send me more information on my opportunities  
in the U.S. Air Force. I am between the ages of 17-34  
and reside in U.S.A. or possessions.

NAME \_\_\_\_\_

ADDRESS \_\_\_\_\_

CITY \_\_\_\_\_ ZONE \_\_\_\_\_ STATE \_\_\_\_\_



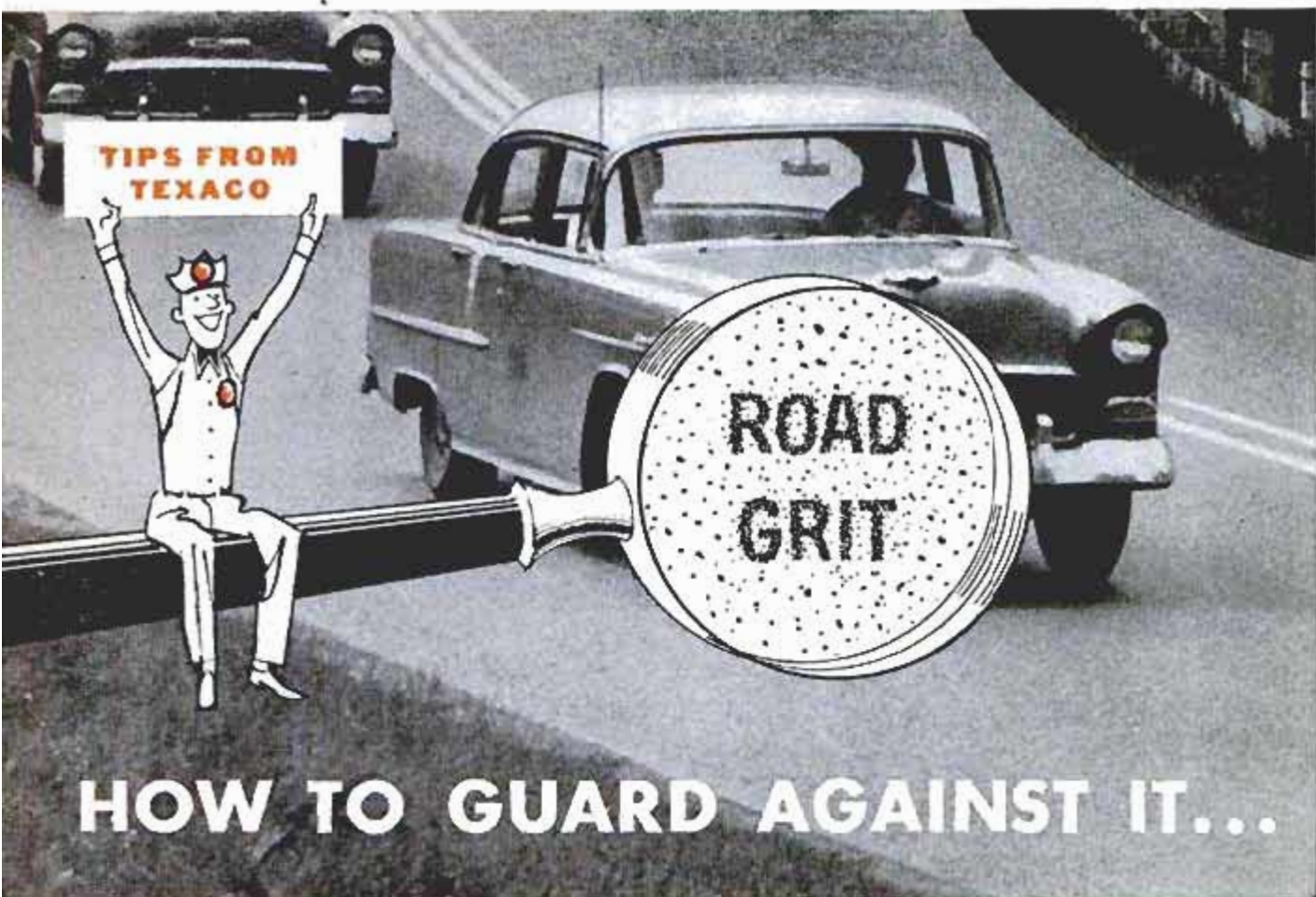

You may not see it but flying road grit gets sucked into every car engine through the air cleaner and crankcase breather pipes.

Hard enough to scratch glass, its destructive particles circulate in the engine oil and tear away the polished surfaces of bearings, cylinder walls and other machined parts. Oil filters can remove only part of it.

The best motor oil your money can buy—

Havoline Special 10W-30—will protect your engine against rust, varnish, acids and carbon, but no oil ever made can keep road grit from damaging your engine. The one and only *sure* way to get grit and other destructive particles out of your engine is to change oil *regularly*—and a good policy is at least every 1,000 miles. Changing your oil regularly is *mighty cheap insurance!*

The oil  
that  
thinks  
for itself



In sizzling summer heat or numbing zero cold, *all-temperature* Havoline Special 10W-30 Motor Oil "thinks for itself" to save you thinking about seasonal grades. Stays light and free-flowing for instant cold starts yet always tough-bodied to offset intense engine heat. It wear-proofs your engine, keeps it clean, gives quicker easier starts, added power, more gasoline mileage. At your Texaco Dealer—the *best friend* your car has ever had.

**TEXACO DEALERS**  
IN ALL 48 STATES

Texaco Products are also distributed in Canada, Latin America, and Africa.



This One



41QJ-XC8-F5ZW



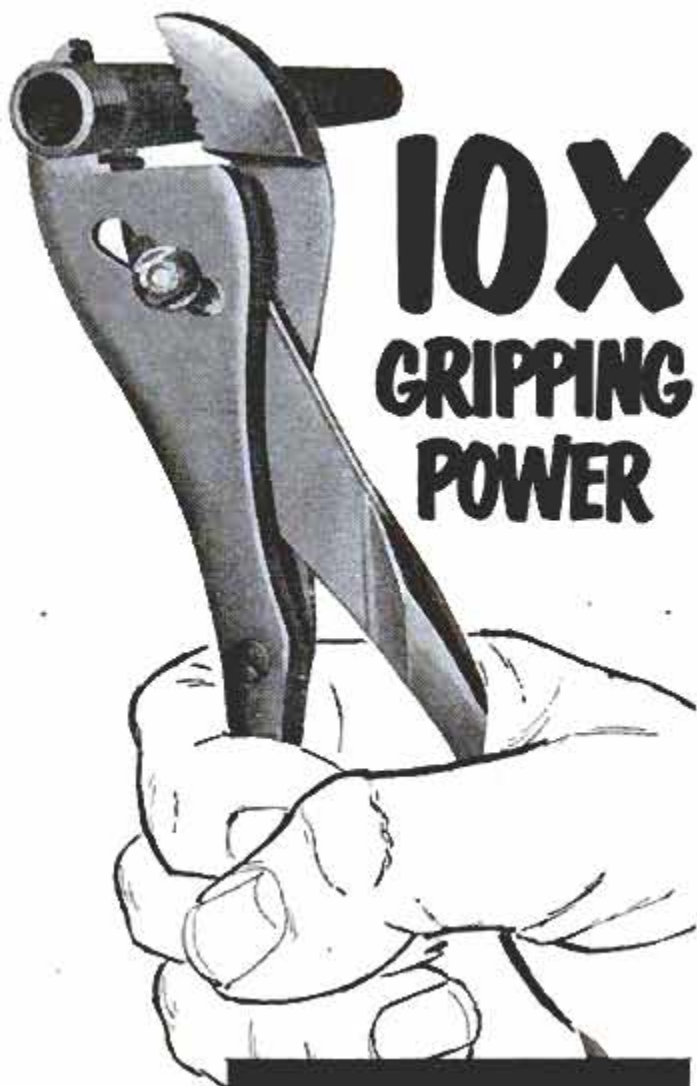

**10X  
GRIPPING  
POWER**

Proto's  
"Multi-Plier"  
increases  
gripping  
pressure  
ten times  
at jaws.

ANOTHER REASON YOU'LL  
**PREFER  
PROTO  
PLIERS**

There's no substitute  
for the right plier. Choose  
the pliers you need at  
your Proto dealer. Send  
10¢ for 84 page catalog  
describing entire line to  
Proto Tool Company,  
2209 Santa Fe Ave.,  
Los Angeles 54, Calif.

PROTO GIVES YOU  
A BIG SELECTION

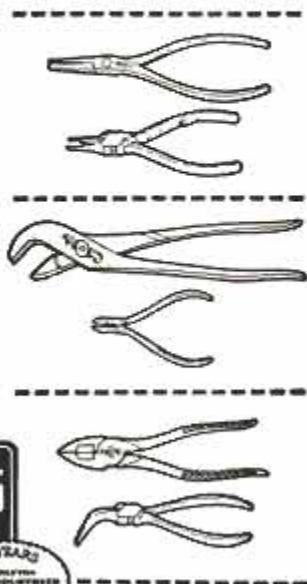

**PROTO TOOLS**  
PROTO means PROFESSIONAL TOOLS

DIVISION OF



## ACROSS THE DESK



### To the Editor:

"School for Prospectors" in the June issue of *Popular Mechanics* interested me more than it would have generally, because it was read by me while looking over a large mineral deposit in the Selkirk Mountain Range of British Columbia.

The area this new find is in is really vast, and it is obvious that 90 percent of the mountainous terrain here has never been seen by man. What this part of the country needs is more hardy prospectors; in the valley where we made our discovery minerals abound, but there are no foot trails and one does well to cover from eight to ten miles in one day's walking. One hundred prospectors could not go over 25 miles of this valley in one year.

I find few men willing to walk any great distance these days; unless they can sit and ride, the trip is off.

In closing I would mention that, like many others, I have always appreciated your fine magazine and hope that you will keep it just about as it is. Articles similar to "School for Prospectors" will be especially appreciated.

L. C. de Kock,  
Nelson, B. C., Can.

☆☆☆

### To the Editor:

On page 12 of July's *Popular Mechanics* you had a picture of a car taken on a by-road (of) Chelan National Forest, Washington. ["Do You Know This Old Timer?"]

The man in the back is my father. He passed away 20 years ago. You can imagine the surprise I got seeing that picture; I thought you would like to know even



(Continued to page 8)



# Satisfied with my PRESENT PAYCHECK? NOT ME!!



TODAY, you are probably earning enough to get by—enough to provide your family with life's necessities, and perhaps you are depositing a few extra dollars in the bank.

BUT are you content with just earning a living wage? Do you say "Someday I'll really get a break and go right on to the top." THAT'S WISFUL THINKING!

You know that the "breaks" go to the man or woman who is prepared to take advantage of them—to the person who can fill the better job and who is worth more money. He makes the "breaks" instead of waiting for them.

## DO YOU QUESTION YOUR OWN ABILITY?

There is a field of business which has never been overcrowded—it's the ACCOUNTING FIELD. And the demand for skilled accountants—men and women who really know their business—is increasing. State and Federal legislation requires much more efficient accounting from business. Corporations are in constant need of expert counsel in matters relating to Auditing, Cost Accounting, Business Law, and Federal Income Tax. Men who prove their qualifications in this important branch of business are promoted to responsible executive positions—given an opportunity to earn real salaries. The range is \$5,000 to \$10,000 a year—even to higher income figures.

## WHY BE SATISFIED WITH YOUR PRESENT JOB?

Why accept mediocre pay when right in your own home you can acquire the necessary training to advance rapidly in the profitable, growing field of Accounting.

Under the LaSalle Problem Method you can acquire a thorough knowledge of Accounting, master its fundamental principles, become expert in the practical application of those

principles—without losing an hour from work or a dollar of pay.

Your training will be under the supervision of organization and management specialists, Attorneys and Certified Public Accountants. Preliminary knowledge of bookkeeping is not necessary. We train you from the ground up—Basic Accounting right on up through the Certified Public Accountant training.

## SO RIGHT NOW—TODAY

If you are ambitious—if you are interested in a high-paying career—investigate the opportunities in this profitable field.

## FREE SAMPLE LESSON

Decide today to send for LaSalle's Accounting Lesson Number One, also FREE book, "Opportunities in Accounting." In it you will find complete information on the opportunities which are open to those qualified, and you will learn how you can prepare yourself for a better job and more money. NO OBLIGATION. MAIL THE COUPON TODAY.

ACCREDITED MEMBER, NATIONAL HOME STUDY COUNCIL

## FIFTY YEARS OF QUALITY TRAINING

-----SEND FOR FREE BOOKS-----

MAIL THE  
COUPON  
TODAY!

OVER 4,500 CPAs  
HAVE BEEN TRAINED  
BY THE LA SALLE  
PROBLEM METHOD



## LaSalle Extension University

— A Correspondence Institution —

Dept. 964H, 417 S. Dearborn St., Chicago 5, Ill.

Please send me, free of all cost or obligation, Free sample lesson, and your illustrated book, "Opportunities in Accounting."

Name.....Age.....

Address.....

City, Zone, State.....



(Continued from page 6)

women read your magazine. My father's name was Charles Howard; he lived in Tacoma, Wash. I will treasure that picture as long as I live. He always had a Dodge car as far back as I can remember. Thanks for printing it.

Mrs. Florence Rudder,  
Bristol, Pa.

☆ ☆ ☆

#### To the Editor:

This Squadron of Civil Air Patrol, Inc., USAF Auxiliary (nonprofit), is blazing the way in Civil Air Patrol and civilian fields with survival training. We have recently undergone an instructor's course in survival under the supervision of Air Force personnel, of Forbes Air Force Base, Topeka, Kansas. In the past several months, we have made field trips for training purposes and have passed the knowledge gained from this experience along to others through CAP and CD Channels as well as directly to the public through displays and talks at public meetings. This training is now required in CAP.

In your January 1956 issue of *Popular Mechanics*, you ran an article entitled "Stay Alive in the Great Outdoors." Although this article is basically for the "week-end explorer," it fits well into sur-

vival anywhere and is soundly based to be used as a guide for emergency survival training since survival is always an emergency and common sense is the only solution. We would like your permission to reproduce the article in whole or in part for use in our work.

FOR THE COMMANDING OFFICER:

Charles R. H. White, 2/Lt.,  
Supply Officer,  
Civil Air Patrol,  
Topeka, Kans.

☆ ☆ ☆

#### To the Editor:

While going through your magazine, as I do monthly, on page 137 of your April 1958 edition there is an article on "Sportsman's Cabin." This cabin is exactly what I need for an addition to my home in Norris City, Ill., as I bought a home for my sister, and for the size family she has the present house is not large enough. . . . This cabin would more than fill her needs.

Can you tell me what company manufactures and sells this cabin or forward this letter to them?

You might be interested to know that your particular magazine is one of the top ten most widely read, discussed and followed in our section here in Korea and I

(Continued to page 10)



Salvage expert with a tough hair problem. Dick Audler of New Orleans "works" under water. Sun, salt air and his helmet punish his hair.



He licks it with Vitalis. Vitalis keeps Dick's hair in condition. His hair never has a greasy look because Vitalis grooms with greaseless V-7.

## New greaseless way to keep your hair neat all day...and prevent dryness

Whether your hair takes a beating under 90 feet of water or your morning shower, you need Vitalis. It keeps hair

in condition . . . prevents dryness. Your hair never looks greasy thanks to greaseless V-7. Use Vitalis every morning.

**New VITALIS® Hair Tonic with V-7®**

ANOTHER FINE PRODUCT OF BRISTOL-MYERS





# BIG JOB BOOM FORECAST!

## Can You Get Ready in Time?

Right now job opportunities are tight all along the line. Economists now predict a period of mild ups and downs. Look for the "big break" to come in the next three years, they say. That's when good jobs will open up as never before. And men who are preparing themselves *now* will ride the crest of the boom.

### DARK OUTLOOK FOR UNSKILLED WORKERS

Those with little or no training will find the going tough. Fewer openings. More competition for existing jobs. The tide is against the unskilled worker. It's getting stronger. Nor will the boom help. The new opportunities will go first to the skilled, next to the semi-skilled.

### BIGGEST DEMAND IN THESE FIELDS

What's ahead? According to the best estimates, here are the industries due for the sharpest employment rise: Heavy transportation equipment. Mechanical, electrical, chemical, aeronautical and highway engineering. Industrial electronics.

All metals. Business services. Natural gas and oil. Paper products. On the other end of the scale, employment may lag in agriculture and leather. Check the trends in *your* field. Are you prepared to switch, if necessary?

### GETTING YOURSELF READY—NOW

All the experts agree: Education, skill, specialized training will net the greatest rewards in the coming boom. The time you spend improving yourself is perhaps the wisest investment you can make *right now*. Your future success and happiness could hinge on your mastering a certain subject or acquiring a special skill. But there are obstacles. You may have a family to support. Or a job to hold down. You may feel you're too old to learn.

### HOW I.C.S. CAN HELP YOU

For the man who can take his training hard and fast—without time off from his job or heavy expense—I.C.S. offers real advantages. A total of 259 courses to choose from (see partial list below). A spare-time

method that lets you progress as rapidly as you're able. Up-to-date, authoritative text material. Thorough, personalized instruction. Industry-recognized diploma to graduates. I.C.S. is the oldest and largest school accredited by the Accrediting Commission of the National Home Study Council. Its long list of successful graduates reads like "Who's Who."

Can you be ready for the next job boom? You can if you act quickly. Your first step: mark and mail the coupon below. What you do right this minute may determine how you make out in the coming boom!

### THREE FREE BOOKS TELL HOW TO MEET NEXT JOB BOOM

Get the details on the fields that offer the best jobs in the immediate future. Get these three valuable books free—(1) "How to Succeed"—pocket-size guide to advancement, (2) Sample lesson (Math.) demonstrating the I.C.S. method, (3) Opportunity catalog on the subject you check in the coupon. Just mail the coupon.

For Real Job Security—Get an I. C. S. Diploma! I. C. S., Scranton 15, Penna. Accredited Member, National Home Study Council

## INTERNATIONAL CORRESPONDENCE SCHOOLS



BOX 87299J, SCRANTON 15, PENNA.

(Partial list of 259 courses)

Without cost or obligation, send me "HOW TO SUCCEED" and the opportunity booklet about the field BEFORE which I have marked X (plus sample lesson):

- |  |  |  |  |   |
|--|--|--|--|---|
| <p><b>ARCHITECTURE and BUILDING CONSTRUCTION</b></p> <ul style="list-style-type: none"> <li><input type="checkbox"/> Air Conditioning</li> <li><input type="checkbox"/> Architecture</li> <li><input type="checkbox"/> Arch. Drawing and Designing</li> <li><input type="checkbox"/> Building Contractor</li> <li><input type="checkbox"/> Building Estimator</li> <li><input type="checkbox"/> Carpentry and Millwork</li> <li><input type="checkbox"/> Carpenter Foreman</li> <li><input type="checkbox"/> Heating</li> <li><input type="checkbox"/> Interior Decoration</li> <li><input type="checkbox"/> Painting Contractor</li> <li><input type="checkbox"/> Plumbing</li> <li><input type="checkbox"/> Reading Arch. Blueprints</li> </ul> <p><b>ART</b></p> <ul style="list-style-type: none"> <li><input type="checkbox"/> Commercial Art</li> <li><input type="checkbox"/> Magazine &amp; Book Illus.</li> <li><input type="checkbox"/> Show Card and Sign Lettering</li> <li><input type="checkbox"/> Sketching and Painting</li> </ul> <p><b>AUTOMOTIVE</b></p> <ul style="list-style-type: none"> <li><input type="checkbox"/> Automobiles</li> <li><input type="checkbox"/> Auto Body Rebuilding and Refinishing</li> <li><input type="checkbox"/> Auto Engine Tuneup</li> <li><input type="checkbox"/> Auto Technician</li> </ul> | <p><b>AVIATION</b></p> <ul style="list-style-type: none"> <li><input type="checkbox"/> Aero-Engineering Technology</li> <li><input type="checkbox"/> Aircraft &amp; Engine Mechanic</li> </ul> <p><b>BUSINESS</b></p> <ul style="list-style-type: none"> <li><input type="checkbox"/> Accounting</li> <li><input type="checkbox"/> Advertising</li> <li><input type="checkbox"/> Business Administration</li> <li><input type="checkbox"/> Business Management</li> <li><input type="checkbox"/> Cost Accounting</li> <li><input type="checkbox"/> Creative Salesmanship</li> <li><input type="checkbox"/> Managing a Small Business</li> <li><input type="checkbox"/> Professional Secretary</li> <li><input type="checkbox"/> Public Accounting</li> <li><input type="checkbox"/> Purchasing Agent</li> <li><input type="checkbox"/> Salesmanship</li> <li><input type="checkbox"/> Salesmanship and Management</li> <li><input type="checkbox"/> Traffic Management</li> </ul> <p><b>CHEMICAL</b></p> <ul style="list-style-type: none"> <li><input type="checkbox"/> Analytical Chemistry</li> <li><input type="checkbox"/> Chemical Engineering</li> <li><input type="checkbox"/> Chem. Lab. Technician</li> <li><input type="checkbox"/> Elements of Nuclear Energy</li> <li><input type="checkbox"/> General Chemistry</li> <li><input type="checkbox"/> Natural Gas Prod. and Trans.</li> <li><input type="checkbox"/> Petroleum Prod. and Engr.</li> <li><input type="checkbox"/> Professional Engineer (Chem)</li> <li><input type="checkbox"/> Pulp and Paper Making</li> </ul> | <p><b>CIVIL ENGINEERING</b></p> <ul style="list-style-type: none"> <li><input type="checkbox"/> Civil Engineering</li> <li><input type="checkbox"/> Construction Engineering</li> <li><input type="checkbox"/> Highway Engineering</li> <li><input type="checkbox"/> Professional Engineer (Civil)</li> <li><input type="checkbox"/> Reading Struc. Blueprints</li> <li><input type="checkbox"/> Structural Engineering</li> <li><input type="checkbox"/> Surveying and Mapping</li> </ul> <p><b>DRAFTING</b></p> <ul style="list-style-type: none"> <li><input type="checkbox"/> Aircraft Drafting</li> <li><input type="checkbox"/> Architectural Drafting</li> <li><input type="checkbox"/> Drafting Machine Design</li> <li><input type="checkbox"/> Electrical Drafting</li> <li><input type="checkbox"/> Mechanical Drafting</li> <li><input type="checkbox"/> Sheet Metal Drafting</li> <li><input type="checkbox"/> Structural Drafting</li> </ul> <p><b>ELECTRICAL</b></p> <ul style="list-style-type: none"> <li><input type="checkbox"/> Electrical Engineering</li> <li><input type="checkbox"/> Elec. Engr. Technician</li> <li><input type="checkbox"/> Elec. Light and Power</li> <li><input type="checkbox"/> Practical Electrician</li> <li><input type="checkbox"/> Practical Lineman</li> <li><input type="checkbox"/> Professional Engineer (Elec)</li> </ul> <p><b>HIGH SCHOOL</b></p> <ul style="list-style-type: none"> <li><input type="checkbox"/> High School Diploma</li> </ul> | <ul style="list-style-type: none"> <li><input type="checkbox"/> Good English</li> <li><input type="checkbox"/> High School Mathematics</li> <li><input type="checkbox"/> Short Story Writing</li> </ul> <p><b>LEADERSHIP</b></p> <ul style="list-style-type: none"> <li><input type="checkbox"/> Industrial Foremanship</li> <li><input type="checkbox"/> Industrial Supervision</li> <li><input type="checkbox"/> Personnel-Labor Relations</li> <li><input type="checkbox"/> Supervision</li> </ul> <p><b>MECHANICAL and SHOP</b></p> <ul style="list-style-type: none"> <li><input type="checkbox"/> Diesel Engines</li> <li><input type="checkbox"/> Gas-Elec. Welding</li> <li><input type="checkbox"/> Industrial Engineering</li> <li><input type="checkbox"/> Industrial Instrumentation</li> <li><input type="checkbox"/> Industrial Metallurgy</li> <li><input type="checkbox"/> Industrial Safety</li> <li><input type="checkbox"/> Machine Design</li> <li><input type="checkbox"/> Machine Shop Practice</li> <li><input type="checkbox"/> Mechanical Engineering</li> <li><input type="checkbox"/> Professional Engineer (Mech)</li> <li><input type="checkbox"/> Quality Control</li> <li><input type="checkbox"/> Reading Shop Blueprints</li> <li><input type="checkbox"/> Refrigeration and Air Conditioning</li> <li><input type="checkbox"/> Tool Design</li> <li><input type="checkbox"/> Tool Making</li> </ul> <p><b>RADIO, TELEVISION</b></p> <ul style="list-style-type: none"> <li><input type="checkbox"/> General Electronics Tech.</li> </ul> | <ul style="list-style-type: none"> <li><input type="checkbox"/> Industrial Electronics</li> <li><input type="checkbox"/> Practical Radio-TV Eng'g</li> <li><input type="checkbox"/> Practical Telephony</li> <li><input type="checkbox"/> Radio-TV Servicing</li> </ul> <p><b>RAILROAD</b></p> <ul style="list-style-type: none"> <li><input type="checkbox"/> Car Inspector and Air Brake</li> <li><input type="checkbox"/> Diesel Electrician</li> <li><input type="checkbox"/> Diesel Engr. and Fireman</li> <li><input type="checkbox"/> Diesel Locomotive</li> </ul> <p><b>STEAM and DIESEL POWER</b></p> <ul style="list-style-type: none"> <li><input type="checkbox"/> Combustion Engineering</li> <li><input type="checkbox"/> Power Plant Engineer</li> <li><input type="checkbox"/> Stationary Diesel Engr.</li> <li><input type="checkbox"/> Stationary Fireman</li> </ul> <p><b>TEXTILE</b></p> <ul style="list-style-type: none"> <li><input type="checkbox"/> Carding and Spinning</li> <li><input type="checkbox"/> Cotton Manufacture</li> <li><input type="checkbox"/> Cotton Winding and Weaving</li> <li><input type="checkbox"/> Loom Fixing Technician</li> <li><input type="checkbox"/> Textile Designing</li> <li><input type="checkbox"/> Textile Finishing &amp; Dyeing</li> <li><input type="checkbox"/> Throwing</li> <li><input type="checkbox"/> Winding and Weaving</li> <li><input type="checkbox"/> Worsted Manufacturing</li> </ul> |
|--|--|--|--|---|

Name \_\_\_\_\_ Age \_\_\_\_\_ Home Address \_\_\_\_\_

City \_\_\_\_\_ Zone \_\_\_\_\_ State \_\_\_\_\_ Working Hours \_\_\_\_\_ A.M. to P.M. \_\_\_\_\_

Occupation \_\_\_\_\_

Canadian residents send coupon to International Correspondence Schools, Canadian, Ltd., Montreal, Canada. . . . Special tuition rates to members of the U. S. Armed Forces.



# HP means High Pay to men who are trained in Auto Mechanics

Now it's easy to learn quickly at home

"America is short 100,000 auto mechanics," a famous mechanics magazine reports. "America needs 25,000 more auto-repair shops," a noted motor executive announces. *Pay is tops:* In larger cities, it averages \$3.00 an hour. *Steady work is assured:* Two-thirds of America's 62 million vehicles are in the "heavy-repair" class.



Why let the lack of training keep you from a better job, higher pay, and lifetime security? No matter if your education is limited—no matter how long you've been out of school—it's easy to learn Auto Mechanics at home in spare time. And, you can *earn* as you *learn*—many students do.

C.T.I. will train you in: Tune-Up and Overhaul; Electric, Cooling, and Lubricating Systems; Power Steering; Power Brakes; Automatic Transmissions; Clutches; Axle and Chassis Repair; etc. But get all the facts from two booklets we have ready for you. *Be sure to mail coupon today for your free copies.*

## Get Experience Using Tune-Up Kit & Tools

(included with training)



CTI sends you a Tune-Up Kit, the kind that skilled mechanics use to locate engine troubles. You receive a compression Tester; Vacuum Gauge & Fuel Pump Tester; Ignition Timing Light; portable steel case. You also get mechanic's tools, including socket set. You acquire *experience* using kits.

**DIESEL MECHANICS OR BODY-FENDER REBUILDING** is yours at no extra cost. Only CTI offers this *extra* choice. You get fully-rounded training in all phases of mechanics.

## Many Students Earn Money as They Train

by taking part-time jobs in local shops or fixing cars "on their own." Many make enough to pay all tuition and buy extra equipment. Some open shops, become independent.

## Get Facts Now—Decide Later MAIL TODAY

Your future is worth looking into. Get facts on job and business opportunities. Mail coupon today—Commercial Trades Institute, Chicago 26, Ill.

**FREE  
BOOKLETS**

### COMMERCIAL TRADES INSTITUTE

1400 GREENLEAF AVENUE DEPT. A-888  
CHICAGO 26, ILLINOIS

Mail me your two opportunity booklets: *Big Money in Auto Mechanics*; and *Sample Lesson*. Both FREE.

Name \_\_\_\_\_ Age \_\_\_\_\_

Address \_\_\_\_\_

City \_\_\_\_\_ Zone \_\_\_\_\_ State \_\_\_\_\_



(Continued from page 8)

imagine in most all other sections. You would be surprised how many ideas we get from this magazine that can be and are used right here in Korea.

M/Sgt. William Hoskins,  
HQ., 314th Air Division.

Ed's NOTE: *Greetings to Sgt. Hoskins around the world in Korea. We're glad his mind is turning to a home in Illinois, and that we could be the agent in finding what he wants.*

☆☆☆

## To the Editor:

In Oconomowoc, Wis., the Cooney-Customs hot-rod club has an unusual public-service project—that of providing free engraving service for automobile owners who want their hub caps inscribed with their auto serial numbers.

Members of the hot-rod club do this for



interested motorists at a local filling station. It is being done with the encouragement of the local police, as putting serial numbers on the hub caps will aid identification in case the caps are stolen. ("Cooney" is the nickname for Oconomowoc.)

Robert J. Higgins,  
Oconomowoc, Wis.

## Business Opportunities

Small businesses interested in obtaining information in regard to privately and government-owned inventions available for manufacture through purchase, licensing or other arrangements should write to the Production Assistance Division, Small Business Administration, Washington 25, D. C. This division sends out a Products List Circular on request every month.



# For a Successful Career in Radio-Television

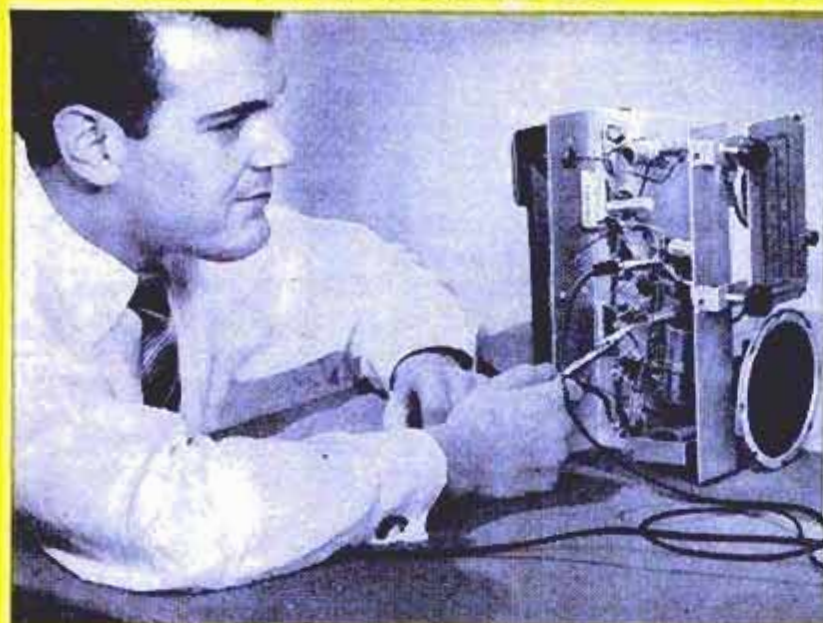

Train at Home in Spare Time with N. R. I. **OLDEST and LARGEST** Home Study Radio-Television School

## N.R.I. Trained These Men

### ENGINEER STATION WHPE

"Thanks to NRI, I operated a successful Radio repair shop. Now I am an engineer for WHPE." VAN W. WORKMAN, HIGH POINT, NORTH CAROLINA



### QUICK SPARE TIME CASH

"Knew nothing about Radio-TV when I enrolled. After 15 lessons started repairing sets. My future looks bright." DONALD B. ACKERMAN, MINNEAPOLIS, MINNESOTA



### HAS OWN TV BUSINESS

"Quit my job to do Television work full time. I love it and do all right financially." WILLIAM F. KLINE, CINCINNATI, OHIO



## Prosperous Fast Growing Industry Offers You GOOD PAY-BRIGHT FUTURE-SUCCESS

It's the trained man who gets ahead—gets the better job, drives a better car, lives in a better home, is respected for what he knows and can do. For a job with a future—find out how you can train at home for Radio-Television.

### TODAY'S OPPORTUNITY FIELD

Training PLUS OPPORTUNITY is the ideal combination for success. And today's OPPORTUNITY field is Radio-Television. Over 125 million home Radios plus 30 million sets in cars, plus 40 million TV sets mean big money for trained Technicians. More than 4,000 Radio and TV broadcasting stations offer interesting and important positions. Color television, portable TV sets, Hi-Fi, assure future growth. Find out about NRI. Since 1914—for more than 40 years—NRI has been training ambitious men

at home in spare time for Radio-TV. With NRI 50-50 method, you study basic principles AND learn by practicing with actual equipment NRI furnishes. You learn with your hands and your head. You get dependable training, backed up by the reputation of the oldest and largest home study Radio-TV school.

### ADD TO YOUR INCOME SOON \$10-\$15 A WEEK IN SPARE TIME

Soon after enrolling many start earning extra money fixing sets. Many open their own full time Radio-TV shops after getting NRI Diploma. MAIL COUPON. Get FREE Sample Lesson and 64-page Catalog showing equipment supplied, outlines of courses, opportunities in Radio-TV. Price is low—terms easy. Address: NATIONAL RADIO INSTITUTE, Dept. 8JA, Washington 16, D.C.

## You Learn Servicing—Broadcasting at Home—By Practicing with Kits N.R.I. Sends

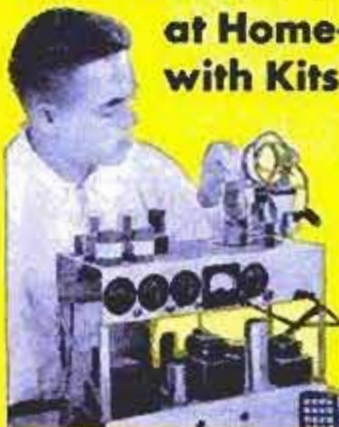

Nothing takes the place of practical experience. That's why NRI training is Learning-by-Doing. With Servicing Course you build Radio shown at top and other equipment. With Communications Course you build Transmitters at left and other equipment. Catalog shows all equipment you get.

Available To **VETERANS** Under G.I. Bills



## SAMPLE LESSON AND CATALOG FREE

### MAIL COUPON TODAY

National Radio Institute

Dept. 8JA, Washington 16, D.C.

Mail me Sample Lesson and 64-Page Catalog FREE. (No salesman will call. Please write plainly.)

Name \_\_\_\_\_ Age \_\_\_\_\_

Address \_\_\_\_\_

City \_\_\_\_\_ Zone \_\_\_\_\_ State \_\_\_\_\_

ACCREDITED MEMBER, NATIONAL HOME STUDY COUNCIL



choose a career in  
**MECHANICAL  
ENGINEERING**

Bachelor of Science  
Degree-4 yrs.  
Associate in Applied  
Science Degree-2 yrs.



Prepare for a rewarding career as an engineer or engineering technician at the Milwaukee School of Engineering—located in the machine shop of the world. At MSOE, you can earn an Associate in Applied Science degree in 2 years, or continue without loss of credit to your Bachelor's degree in 4 years.

All courses are approved by an Industrial Advisory Committee. Previous training and experience are evaluated for credit. Scholarships and part-time work available. Placement service for graduates.

New Classes Begin in SEPTEMBER, JANUARY, MARCH, and JUNE

Choose from these courses:

**MECHANICAL ENGINEERING**

BSME degree in 4 years  
Plant Engineering, Metallurgical or  
Industrial Technology

**ENGINEERING TECHNICIAN**

AAS degree in 2 years  
Air Conditioning, Metallurgical  
or Industrial Technology



For more information, mail coupon today!

**MILWAUKEE SCHOOL  
OF ENGINEERING**

Dept. PM-958, 1025 N. Milwaukee St.,  
Milwaukee 1, Wisconsin

Send FREE career booklet (please print)

I am interested in \_\_\_\_\_  
(name of course)

Name \_\_\_\_\_ Age \_\_\_\_\_

Address \_\_\_\_\_

City \_\_\_\_\_ Zone \_\_\_\_\_ State \_\_\_\_\_

I am  I am not eligible for veterans educational

benefits \_\_\_\_\_  
(discharge date)

**We're Not a Gadget Shop,  
Says the Patent Office**

EDITORIAL DEPT., WASHINGTON STAR

By Irving F. Lash

1174 4 PENN. AVE., WASHINGTON, D.C.

Many years ago some unsung genius invented a gun that fired square bullets to dispose of heathens and round ones to eliminate Christians. Exactly what he had in mind is problematical. Perhaps he intended to make his weapon available to both sides in holy wars. At any rate, the U. S. Patent Office granted the inventor a patent. Regulations governing the issuance of patents were not always as rigid as they are today. Even so, the patent examiner who gave this bizarre invention his and Uncle Sam's stamp of approval likely acted with mental reservations. Unquestionably he fervently hoped the gun would not backfire—on the Patent Office, that is. There is no record that it had official repercussions. Indeed, history fails to note that the weapon was ever used by combatants, or that anybody even bought one.

But when Samuel Colt came along in 1835 with another weapon that was to play a major, if bloody, role in the winning of the West, there was something of a kick-back—a legal one, not the ordinary recoil. Colt's revolver, a six-shooter, plainly offered an immense advantage over the single-shot pistol then in vogue, or even the double-barreled derringer of shorter range. In the hands of men adept with firearms, Colt's invention was visualized as a great timesaver in pushing back the pesky Indians and maintaining law and order in the wide-open towns that sprang up across the continent as pioneering, land-hungry Americans moved steadily westward.

**Colt Is Immediate Success**

Colt had no difficulty obtaining a patent, and his revolver almost immediately became a best-seller. It was a favorite among marshals and sheriffs and, unfortunately, among desperadoes as well. These latter, the gunslingers, professional killers, stagecoach robbers, etc., could buy a Colt as easily as a lawman and often times could use one better. This gave rise to public indignation when the lawless sometimes held sway with the very weapon intended to hold them in check.

The question was posed whether such an invention should be approved by the U. S. Government to the extent of its being patented. It became a federal court issue

(Continued to page 14)



# INVENTORS

**L**earn how to protect your invention. The U. S. Patent Laws provide that any new and useful art, machine, article of manufacture, or composition of matter, or any new and useful improvement thereof, may be patented if the act of invention is involved. Therefore, every inventor with a valuable invention should take advantage of the Patent Laws and proceed for patent protection in order to safeguard his rights.

A patent gives the inventor the exclusive right to prevent others from making, using, or selling the invention claimed in the patent for a period of seventeen years.

The Patent Laws were enacted for the benefit of the inventor to give him protection for the features of his invention which are patentable. These features must be properly and concisely set forth and claimed in a formal application for patent, in order to comply with the requirements of the Patent Laws. For that reason, unless the inventor is familiar with patent matters, he should engage a competent registered patent attorney or agent to represent him. We are registered to practice before the U. S. Patent Office and are prepared to serve you in the handling of your patent matters.

A specially prepared booklet entitled "Patent Guide for the Inventor", containing detailed information with respect to patent protection and procedure, together with a "Record of Invention" form will be promptly forwarded to you without obligation upon request.

---

**CLARENCE A. O'BRIEN & HARVEY JACOBSON**

*Registered Patent Attorneys*

**81-J DISTRICT NATIONAL BUILDING**

**WASHINGTON 5, D. C.**



and was the subject of lengthy deliberations. The Patent Office for a while seemed on uncertain ground and the patent examiner who passed on Colt's weapon might have thought he was about to have his swivel chair shot from under him.

However, the court sustained the validity of the patent, and the reasoning behind the ruling in that case still applies to many other inventions considered of dubious value by skeptics and moralists. The decision, briefly, was that the Patent Office has no excuse to withhold a patent on an invention designed and adapted to produce a good result, even though the same invention, if it falls into the wrong hands, may be utilized to accomplish a bad result.

### Not a Policing Agency

This ruling, cited at length in Walker on Patents, has stood the Patent Office in good stead. The public is sometimes under the impression that the Patent Office should act as a censoring agency, or keeper of the nation's morals. That isn't the case. An invention, patented with the best intentions, which afterward becomes a menace to the public, usually gets the attention of law-enforcement agencies. Fireworks are patented but their use is banned in many communities.

Recently a Washington citizen took of-

fense in the public prints at a gadget he resented. He had been reading a list of patents. Bear in mind that the Capital has its share of juvenile delinquency and street crimes, and anything that promotes same is disapproved by solid citizens. Some persons with an extremely dim view of small fry in general apparently feel that all of them are little monsters—the criminals of tomorrow, if they haven't already arrived. Anything that aids or abets their unsavory matriculation in the kindergarten of crime doesn't set well with the already harassed public.

### Citizen Complains

So the disturbed citizen got off a letter to the editor of *The Washington Star*: "The Patent Office has just issued letters patent covering a toy knife with a bulb in its handle which, when pressed, releases a blood-red fluid as the knife point touches a 'playmate.' The patent description reads: 'Thus the user of the toy will derive additional pleasure from the realistic effect of the bleeding.'

"In this," he wrote, "the United States Government becomes an active partner in making available an unusually horrid instrument of juvenile delinquency. Does not the Commissioner of Patents have the

(Continued to page 16)

for that "Born in the Saddle" look...



# RAMBLER

## Western shirts and jeans

Lithe and lean, tough and trim,  
tapered to a T. Best quality Sanforized denims,  
firmly stitched with Western Orange thread. The real thing  
— and they look it!



**CARWOOD TAILORED**  
Carwood Mfg. Co., Winder, Georgia

POPULAR MECHANICS



**AN INDEX**  
to a  
**BETTER JOB,**  
**A BRIGHTER**  
**FUTURE**

Electronics

Radar

Guided  
Missiles

Television

Micro-Waves

Communications

Radio

Industrial  
Electronics

Computers

Automation  
Electronics

Remote Control  
Systems

Broadcasting

Your Own  
Service Shop



**LET DeVRY TECH PREPARE YOU IN  
SPARE TIME AT HOME AS AN**

# **ELECTRONICS TECHNICIAN**



**NO PREVIOUS TECHNICAL EXPERIENCE  
OR ADVANCED EDUCATION NEEDED!**

Laborers and bookkeepers, store clerks, shop men, farmers, salesmen — men of nearly every calling — have taken the DeVry Tech program and today have good jobs or service shops of their own in Electronics. You don't have to quit your present job. If you are 17 to 55, see how you may get yourself ready for a future in the fast-growing Electronics field.

Whether you prepare at home or in our well-equipped Chicago or Toronto Laboratories, you get sound, basic training in both principles and practice. At home, you use educational movies. You build actual circuits and test equipment. You read simple directions, follow clear illustrations. When you finish, you are prepared to step into a good job in an excitingly different field. You may even start a service shop of your own. Mail coupon for free facts today.

### **Live-Wire Employment Service**



Puts you in touch with job opportunities—or helps you toward a better position in the plant where you are now employed.

### **Draft Age?**

We have valuable information for every man of draft age; so if you are subject to military service, be sure to check the coupon.

**SAMPLE BOOKLET FREE!**  
We'll give you a free copy of an interesting booklet, "Electronics and YOU." See for yourself how you may take advantage of the opportunities in this fast-growing field.



**MAIL TODAY FOR FREE FACTS**

"One of North America's Foremost Electronics Training Centers"



Accredited Member  
of National  
Home Study Council

**DEVRY TECHNICAL INSTITUTE**  
CHICAGO 41, ILLINOIS  
FORMERLY  
**DEFORREST'S TRAINING, INC.**



**DeVry Technical Institute**  
4141 Belmont Ave., Chicago 41, Ill., Dept. PM-9-0

Please give me your FREE booklet, "Electronics and YOU," and tell me how I may prepare to enter one or more branches of Electronics as listed above.

NAME \_\_\_\_\_ AGE \_\_\_\_\_  
Please Print  
STREET \_\_\_\_\_ APT. \_\_\_\_\_  
CITY \_\_\_\_\_ ZONE \_\_\_\_\_ STATE \_\_\_\_\_

Check here if subject to military training.  
1090 DeVry Tech's Canadian Training Center is located at  
626 Roselawn Avenue, Toronto 12, Ontario



# Learn at Home

*in your spare time*

# to Fix Electric Appliances



## Better Pay—More Opportunities

Get into a field where there is important work and opportunity for the trained man. Millions of electric appliances are sold every year. Every wired home now has an average of 8. Many of them need service and repair. Owners pay well to have them fixed quickly, properly. This is your opportunity for a better job, your own part time or full time business. NRI can give you the training you need, at home, in your spare time.

## Spare Time Earnings Start Soon

Soon after starting you will be able to earn extra cash fixing toasters, clocks, fans, vacuum cleaners, etc., for neighbors and friends. Keep your job while learning and earning. Put spare time to work for you. Work in your basement, garage, spare room. You'll be amazed how easily, quickly you, too, can start earning many extra dollars. NRI shows you how. Even before you finish training your spare time earnings may pay for the course and equipment.

## NRI Sends Tester to Learn and Earn

You need proper equipment to service today's automatic appliances. With this course you get parts to build professional type, multi-use Appliance Tester. You learn to use it. Takes guess work out of servicing. Mail coupon for FREE book and Sample Lesson. See how easy it is to learn. Find out about NRI—a school that for more than 40 years has been training men, through home study, for success, good pay jobs. Our reputation, record, experience back up this course. Write now to: National Radio Institute, Dept. AJ8, Washington 16, D. C.



**FREE Lesson and Book**  
Mail this NOW!

**NATIONAL RADIO INSTITUTE**

Dept. AJ8, Washington 16, D.C.

Send me Lesson and Book Free. No Salesman will call.

Name \_\_\_\_\_ Age \_\_\_\_\_

Address \_\_\_\_\_

City \_\_\_\_\_ Zone \_\_\_\_\_ State \_\_\_\_\_

ACCREDITED MEMBER NATIONAL HOME STUDY COUNCIL

discretion to refuse, in the public interest, the issuance of such a patent?"

It was a good question. The Patent Office was queried by *The Star*. At first the Patent Office spokesman appeared taken aback, but he quickly righted himself. "The Commissioner of Patents," he explained, "in granting or refusing patents is controlled by the patent statutes and by United States court decisions interpreting these statutes. The commissioner has no discretion to refuse a patent so long as the application upon which it is based contains a fair description of a device which is a new invention and is useful in some manner. The toy in question, while it could be misused, also could be useful as a stage prop. So long as an invention has proper and legitimate uses, the fact that it may be used illegally or immorally is not sufficient ground to refuse patent protection."

### Gadgets Make News

It is usually what the Patent Office calls "frivolous" types of inventions that catch the eye and lead to disputes about their usefulness. Likewise it gives some readers the idea that the Patent Office is more of a novelty shop than anything else. Gadgets make better copy than cumbersome inventions of much greater value, and thus newspapers and magazines are sometimes inclined to play up frivolous inventions.

This is a tender spot with the Patent Office, which prefers to emphasize its major contributions to the American way of life. But the Patent Office just can't seem to get people to play down gadgets. The Secretary of Commerce himself once unwittingly furthered the misconception that this important agency under his wing is more concerned with patenting items of relative insignificance than it is with weightier matters affecting the Nation's commerce. Not long ago, the Secretary, in making a speech about the great things done by the Patent Office, said: "And just think, only yesterday the Patent Office issued a patent on a new chewing gum guaranteed not to stick to false teeth."

### Business With Men of Science

The Patent Office would rather talk about the big men in science it has done business with, like Thomas Edison, Alexander Graham Bell, Eli Whitney, Cyrus McCormick, Samuel Morse, Robert Fulton and other laboratory greats whose names are known to schoolboys.

They would prefer to discuss the talents of Thomas Jefferson, inventor par excellence, who headed the Nation's first patent committee after President George Wash-

(Continued to page 18)



# INVENTORS

If you believe that you have an invention, you should find out how to protect it. The first step is to have a search made of the prior pertinent U. S. patents. If a report on this search indicates that the invention appears patentable you can apply for a patent, and the specifications and claims should be prepared.

The firm of McMorrow, Berman & Davidson, with offices in Washington, D. C., is qualified to take the necessary steps for you. We can make a preliminary search on your invention, advise you whether we think it can be patented, and prepare your application for patent.

Unless you are fully familiar with the U. S. Patent Laws, we recommend that you engage the services of a Registered Patent Attorney to protect your interests. The patent laws are *your* laws. A patent gives you the right to prevent others from making, using or selling the invention claimed in your patent for a period of 17 years.

Use these patent laws for your protection. Investigate whether your invention can be patented. If you have what you believe to be an invention, we suggest that you have this firm make a search for you.

*Send for a copy of our Patent Booklet entitled "How To Protect Your Invention," containing information about patent protection and patent procedure. Along with this we will also send you an "Invention Record" form, for your use in writing down and sketching details of your invention. We will mail them promptly. No obligation. They are yours for the asking.*

**McMORROW, BERMAN & DAVIDSON**

*Registered Patent Attorneys*

**PATENTS • COPYRIGHTS • PATENTS**

**1351 VICTOR BUILDING, WASHINGTON 1, D. C.**



# DRAFTSMEN



## CASH BIG PAY CHECKS!

Train Now for  
more success,  
greater security

LEARN AT HOME IN SPARE TIME  
(or at college in Chicago)

Check the want ads in any newspaper—SEE the big-pay opportunities open to you as a draftsman. What's more, you can learn this well-paid, prestige profession at home—quickly, easily! No special talent needed. Get complete, step-by-step Chicago Tech lessons in the mail, spend a few pleasant hours studying each week. In a short time you'll be a well-trained draftsman, ready to take your pick of many good jobs. Act now!



Free Information—Mail Coupon Today!

Get FREE TRIAL LESSON plus information about C.T.C. practical training. Learn what successful Chicago Tech graduates say about high pay and opportunities in drafting. No charge, or obligation.

## CHICAGO TECHNICAL COLLEGE

M-216 Tech Bldg., 2000 So. Michigan Ave.  
Chicago 16, Illinois

Mail me FREE lesson with facts about big opportunities in DRAFTING.

Name \_\_\_\_\_ Age \_\_\_\_\_

Address \_\_\_\_\_

City \_\_\_\_\_ Zone \_\_\_\_\_ State \_\_\_\_\_

## Learn To MOUNT BIRDS

**TAN SKINS, MAKE UP FURS**  
As a Taxidermist, we teach you at home. Mount Birds, Animals, Pets, common specimens. Save your hunting trophies; decorate home and den. Make genuine KROME LEATHER, tan and make up furs for sparetime profit. **INVESTIGATE TODAY.**  
**FREE BOOK** 48 pages—tells all about it. Hunters, get your copy.  
It's Now Free. Send post card, state your AGE.  
N. W. SCHOOL OF TAXIDERMISTRY, DEPT. 2509, Omaha, Nebr.



## High School at Home

**MANY FINISH IN 2 YEARS**

No classes. No time wasted going to and from school. Progress as fast as your time and abilities permit. Standard H.S. texts supplied. Thousands enroll each year in this 61-year-old school. Send for FREE descriptive booklet.

AMERICAN SCHOOL, Dept. H-645  
Drexel at 58th St., Chicago 37, Ill.

Without obligation, please send FREE descriptive booklet.

Name \_\_\_\_\_

Address \_\_\_\_\_

Accredited Member National Home Study Council

ington, on April 10, 1790, signed the act of Congress that gave birth to the American patent system. Incidentally, the first patent known to have been issued by the United States turned up a few years ago in a trunk full of old papers given to the Chicago Historical Society. Signed by Washington and Jefferson, then Secretary of State, it was a patent for an improvement in the process of making potash. Jefferson took patent applications home from the office, to look them over and decide whether they were something new and patentable.

### America Still Needs Inventors

Just as America needed inventors in its formative days, so does it need them now. The National Inventors Council, formed in Washington in 1940 by the Secretary of Commerce as a link between the inventive public and the armed forces, welcomes civilian inventions which can be helpful to the military—anything from dehydrated meats to portable death rays.

While Government-sponsored research contributes much toward America's ability to stay abreast or ahead in the arms race, most revolutionary inventions of war have been the ideas of civilians operating independently. Besides Sam Colt's six-shooter, which the Army was glad to get, Eli Whitney, while better known for his cotton gin, invented the first rifle with interchangeable parts. Garand, another thinker in mufti, came up with the famed M-1 rifle. Still other civilians are credited with inventing the screw propeller, smokeless powder and the torpedo.

Dr. Charles F. Kettering, of General Motors, is chairman of the National Inventors Council. He has a few notable inventions to his own credit—such as the self-starter and an auto ignition system, appropriately developed in a barn.

John C. Green, the council's executive director, as well as director of the Office of Technical Services, said recently the Government "isn't getting one third of the ideas that it needs from the general public."

### Army, Too, Wants Inventions

By way of encouraging civilians to submit ideas, the council last year brought up to date a list of 300 technical problems faced by the military. The list includes things which the Army would like somebody to invent. The council will mail it to anyone who asks for it.

Some of the sought-after inventions are a photographic film which will snap a high-speed picture by moonlight; a chemical to harden earth to the consistency of concrete, and a nonmagnetic compass for foot

(Continued to page 20)



# A Practical New Way to End Your Job Worries!

TRAIN AT HOME FOR A SUCCESSFUL FUTURE IN  
**AIR CONDITIONING**  
 AND REFRIGERATION



**R. E. ANDERSON**  
 President

If you want an interesting job that pays real well and offers year-round work—get into Air Conditioning and Refrigeration! It's a big, uncrowded field that is well-established—yet growing fast! Each year over 20,000 newly-trained mechanics are needed. No wonder! Today there are 150 million units in use—and each year over 6 million new air conditioners, refrigerators and freezers are manufactured. All units need periodic service and repair. The pay? It ranks with the best!

Refrigeration mechanics is an easy trade to learn... Especially when you get your training through CTI. You can learn at home in spare time by practicing with commercial equipment. Get all the facts about this wonderful new way to acquire a highly-profitable technical education. Mail coupon today for fact-filled free booklets. No obligation whatever.

**25  
 BIG KITS**

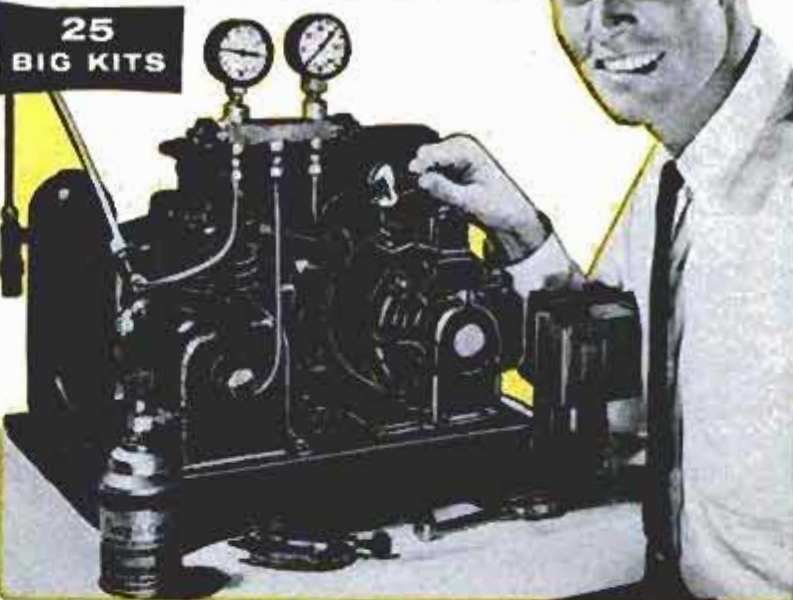

## Easy Way to Start a Business

Own a business—and enjoy independence. Thrill to the satisfaction of being the boss. Give orders—not take them! The refrigeration field is ideal for getting started on your own. You can make friends as you make service calls. In time, you'll have a list of potential customers. You can also sign service contracts with food stores, taverns, restaurants, etc. Thousands of CTI graduates have their own successful small shops.

## Get into Auto Air Conditioning

Experts say that over 400,000 air conditioners are to be installed in autos this year. The field is growing very fast. Already auto shops are advertising for skilled air conditioning mechanics. Opportunities are excellent for starting repair shops. Some day, air conditioners will be standard equipment on cars. So get in on the ground floor now. Our catalog has information on this specialized, profitable field. It's worth looking into.



## You Get Experience as You Train Because You Practice with Commercial Equipment

Another CTI first! You learn by practicing—you get experience as you train—because CTI sends you 25 kits. You get all parts and tools to build a heavy-duty, commercial-type, 1/4 h.p. condensing unit (illustrated above.) You build an air conditioner, freezer, refrigerator, or milk cooler. You complete 23 field-type projects—do 10 service and trouble-shooting jobs! You "boil down" years of apprentice-like training into months. Kit training perfects your skill, provides practical knowledge, assures useful experience, and helps you learn faster! CTI makes your home a training center.

## Earn Extra Cash in Spare Time as You Train

Because CTI training is so practical, you'll soon be making profitable service calls. Perhaps you'll work "on your own." Or, you may prefer to get a part-time job with a local appliance dealer or air conditioning contractor. You can add to your income this way. With extra cash, you can buy additional shop equipment, pay your tuition, even bank money. Be sure to mail coupon for complete details. Act today!—Commercial Trades Institute, Chicago 26, Illinois.

## TYPICAL LETTERS FROM SUCCESSFUL STUDENTS

"I have been very busy. Had an offer to work for an appliance dealer but it looks like I'll be in business for myself before long."  
 —Frank Puller, Wells, N. Y... "Am now working in the field. Earn \$40 more per month than before."  
 —Frank Krotzer, Houston, Texas... "I not only got a job, but today am foreman, earning \$60 a week more than before I enrolled."  
 —E. E. Hughes, Chicago... "Have my own business. Only problem is: Too much business!"  
 —Conrad King, Cynthia, Ky. You can do as well as these men!

## COMMERCIAL TRADES INSTITUTE

1400 GREENLEAF AVENUE DEPT. R-516  
 CHICAGO 26, ILLINOIS

Tell me how I can qualify for a better job or a business of my own. Send booklet, *Success in Air Conditioning & Refrigeration*, and Lesson Sample. Both FREE.

Name \_\_\_\_\_ Age \_\_\_\_\_

Address \_\_\_\_\_

City \_\_\_\_\_ Zone \_\_\_\_\_ State \_\_\_\_\_



**FIRST GET THE FACTS—THEN DECIDE**  
 Mail Coupon Today for 2 Free Booklets



Some make more, some less: T. THORN reports:

**690** gross in single  
**MONTH**  
IN MY OWN BUSINESS!

**Start**  
**YOUR OWN**  
**Business!**



• Here's YOUR chance to start a money-making, year-'round business of your own and make the success you've dreamed about. R. O. Donnelly took in \$40 in seven hours. O. W. Ware landed a \$750 hotel job. R. Traynor grossed over \$450.00 in five days. Homes, hotels, offices, clubs, offer you big profit possibilities. Auto upholstery also.

**NO SHOP OR OFFICE NECESSARY.** You clean furniture on customers' premises. No hauling. No high rents. Supplies inexpensive; operate from your home. What you take in is mostly profit.

• If you want to be your own boss—free from layoffs, strikes and bosses, we will help you to start and succeed. Don't delay...read the facts, then decide for yourself.

**MAIL COUPON TODAY FOR FREE BOOK**

**VON SCHRADER MFG. CO.**  
910 "D" Pl., Racine, Wisconsin

Without obligation rush your **FREE** booklet about how I can start my own permanent, profitable electric Upholstery Cleaning business.

Name \_\_\_\_\_

Address \_\_\_\_\_

City \_\_\_\_\_ Zone \_\_\_\_\_ State \_\_\_\_\_

**ACCORDION PRICES SMASHED**



**SAVE 50%**  
AND MORE DURING  
THIS GREAT SALE

**5 Days' FREE TRIAL**

Hurry! Get in on these sensational accordion values. America's largest exclusive accordion dealer selling out finest brand new accordion overstock! Fabulous savings. Leading brands in more than 30 new models. Small down payment. Easy terms. Trade-ins accepted. Chance of a lifetime.

**FREE**

- for promptness ...
- FREE Lessons
- Music Stand
- Deluxe Case
- Lifetime Guarantee

**FREE COLOR CATALOG**

**& Wholesale Prices**  
Learn how easily you may own and play a fine accordion. Rush name and address for big **FREE** Color Catalog and new low wholesale price list. No obligation. **WRITE TODAY!**

**ACCORDION MANUFACTURERS AND WHOLESALE OUTLET**  
2003 W. CHICAGO AVE., Dept. R-98, CHICAGO 22, ILLINOIS

VICTOR METAL  
NEWPORT, ARK

soldiers who carry metal-laden equipment. The council is willing to examine plans or blueprints for any invention, no matter how fantastic, but it is a bit gunshy on accepting chemicals. It drew the line here after one inventor mailed in a bomb containing itching powder. It was so effective that the men who unpacked it at the Commerce Department were scratching for a long time thereafter.

Newspaper headlines frequently inspire inventions and many ideas for them. Following a series of air crashes, there are always new ideas or plans for instruments to make flying safer. When Germany was bombing Britain from the air during World War II, hundreds of ideas were advanced for detecting invading planes. When German subs were blockading the Atlantic Coast, many inventors submitted plans for warding off or neutralizing torpedoes.

The Government is not alone in encouraging inventors. Private industry often has problems that baffle its own technicians and appeals to brainy ones outside to help. A Newport, Ark., metals company which manufactures 200 million toothpaste tubes each year, sometime ago offered \$5000 to the person who could invent a toothpaste cap that couldn't get lost. Apparently, the company found, that idea was just as elusive as the cap itself. ★ ★ ★

**FIX OUTBOARD MOTORS**

**POWERMOWERS, AND ALL SMALL 2 & 4-CYCLE GASOLINE ENGINES**

MAKE EXTRA MONEY—or, repair your own equipment and SAVE! Fully illustrated, easy-to-understand, Home Study Course. Write today for FREE information.

**LINCOLN TECHNICAL INSTITUTE**  
SUITE 9E, 472 MARKET STREET, NEWARK 5, N. J.

**REAL ESTATE**  
**BE A BROKER**

PAYS BIG! SEND FOR FREE, BIG, ILLUSTRATED CATALOG NOW! Graduates report making substantial incomes. Start and run your own business quickly. Men, women of all ages, learn easily. Course covers Sales, Property Management, Appraising, Loans, Mortgages, and related subjects. **STUDY AT HOME** or in classrooms in leading cities. Diploma awarded. Write TODAY for free book! No obligation.

Approved for World War II and Korean Veterans  
**WEAVER SCHOOL OF REAL ESTATE (Est. 1936)**  
2020R Grand Avenue Kansas City, Mo.

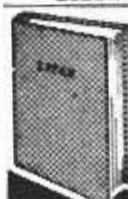

**LEFAX**  
**TECHNICAL DATA BOOKS**  
**POCKET SIZE • LOOSE LEAF**

Printed on loose leaf, 6 hole, 8 3/4" x 3 3/4" bond paper. Each book contains about 140 pages of technical data, condensed, accurate, essential, for engineer, technical worker, teacher, student, business man. **\$1.25 each**

Architecture	Surveying Tables	Machine Design	Radio
Home Heating	Highway Eng'g.	Machinist's Data	Television & FM
Illumination	General Math	Mech. of Materials	Electricity, AC
Electrician's Data	Math Tables	Pwr. Trans. Mach.	Electricity, DC
Builder's Data	Physics	Thermo. Tbls. & Charts	AC Motors and Generators
Lumber Data	Trig-Log Tables	Phys. & Thermo-dynamic Data	Conversion Tabl.
Air Conditioning	Gen'l Chemistry	Metallurgy	Steel Forms
Building Constr.	Chemical Tables	Hydraulics	Welding Data
Reinf. Concrete	Analytic Chem.	Metals	Transformers, Relays & Meters
Piping Data	Mech'l Drawing		
Surveying			

Write for FREE catalogs (2000 listings). See how helpful Lefax can be to you. Send \$1.25 book, or \$6 for any five books to **LEFAX PUBLISHERS, Dept. PM-98, PHILADELPHIA 7, PA.**





# RCA INSTITUTES



# OFFERS YOU THE FINEST OF HOME STUDY TRAINING



**COURSE I  
RADIO-TV ELECTRONICS**  
**COURSE II  
TV SERVICING**  
**COURSE III  
COLOR TV**

The equipment illustrated and text material you get with each course is yours to keep. Practical work with very first lesson. Courses for the beginner and the advanced student. Pay-as-you-learn. You need pay for only one study group at a time.



**SEND FOR THIS  
FREE BOOK NOW**

Resident School courses in New York City offer comprehensive training in Television and Electronics. Day and evening classes start four times each year. Detailed information on request.

**RCA Institutes, Inc.** Home Study Dept. PM-98  
 A Service of Radio Corporation of America  
 350 West Fourth Street, New York 14, N. Y.

Without obligation, send me FREE 52 page CATALOG on Home Study Courses in Radio, Television and Color TV. No Salesman will call.

Name.....  
 Please print

Address.....

City.....Zone.....State.....

Korean Vets! Enter discharge date.....

**CANADIANS**—Take advantage of these same RCA courses at no additional cost. No postage, no customs, no delay. Send coupon to:

**RCA VICTOR COMPANY, LTD.**  
 5001 Cote de Liesse Rd., Montreal 9, Que.

To save time, paste coupon on postcard





U.S. Forest Service photo

## Do You Know This Old-Timer?

This is really too easy. It wears one of the famous names in automotive history. If you can't name it, turn to page 222 for the answer, but before you do let your gaze roam over the neat, functional, chrome-

free lines of this great car, photographed in the Wenatchee National Forest two score years ago. And don't miss those fancy headlights and the very pretty tread patterns on the tires.

**INCLUDED FREE**

Lucky 7  
Foto-carve patterns  
\$1.50 value  
and . . .

Seven issues of *Leather Craftsman*, full of news items, stories, tips and ideas on how-to-make and sell leather items.

## Your Spare Hours Made Profitable

With THIS FOUNDATION of LEATHERCRAFT  
9 TOOLS - 8 Genuine Leather KITS

TOOLING COWHIDE LEATHER KITS—Ready to assemble and tool. Make these beautiful natural leather items for re-sale or your own use. Precision cut, lacing-holes punched, snaps attached, full-size photo-carve pattern and instruction sheet with each Kit.

**NO OTHER CRAFT OFFERS SO MUCH—FOR SO LITTLE INVESTED**

Tandy now offers a complete packaged Leathercraft Kit, with everything you need at a very LOW COST. Leathercraft is easy, profitable, and fun. All you need is a table, your hands, spare time and this Kit.

You can carve and assemble these 9 beautiful practical, quality leather items that have a ready re-sale market. And while you're making 'em, you learn the basic fundamentals of Leathercraft—a hobby that will offer you years of enjoyment and profit.



ALL IN ONE KIT



Write for FREE 100 page Catalog

**Kit 12.95** ppd.  
Cash, Check or M.O.  
**COMPLETE IN THIS BEAUTIFUL STURDY PACKAGE**  
**TANDY LEATHER CO.**  
P. O. BOX 791-HV FORT WORTH, TEX.

WONDERFUL AS A GIFT



**NOW!**  
at a price  
you can afford!

# MAKE MORE MONEY in TELEVISION RADIO-ELECTRONICS

**BETTER...MORE COMPLETE...LOWER COST...  
WITH NATIONAL SCHOOLS SHOP-METHOD  
HOME TRAINING!**

**BETTER...** Training that is proved and tested in Resident School shops and laboratories, by a School that is the **OLDEST** and **LARGEST** of its kind in the world.

**MORE COMPLETE...** You learn **ALL PHASES** of *Television-Radio-Electronics*.

**LOWER COST...** Other schools make several courses out of the material in our **ONE MASTER COURSE**... and you pay more for less training than you get in our course at **ONE LOW TUITION!**



These  
**two FREE books** will  
show you how!

You get all information  
by mail... You make  
your own decision... at  
home! **NO SALESMAN  
WILL CALL**

## TOP PAY... UNLIMITED OPPORTUNITIES LIFETIME SECURITY CAN BE YOURS!

You are needed in the Television, Radio, and Electronics industry! Trained technicians are in growing demand at excellent pay—in **ALL PHASES**, including Servicing, Manufacturing, Broadcasting and Communications, Automation, Radar, Government Missile Projects.

**NATIONAL SCHOOLS SHOP-METHOD HOME TRAINING**, with newly added lessons and equipment, trains you in your spare time at home, for these unlimited opportunities, including many technical jobs leading to supervisory positions.

**YOU LEARN BY BUILDING EQUIPMENT WITH KITS AND PARTS WE SEND YOU.** Your National Schools course includes thorough *Practical training*—**YOU LEARN BY DOING!** We send you complete standard equipment of professional quality for building various experimental and test units. You advance step by step, perform more than 100 experiments, and you build a complete TV set from the ground up, that is yours to keep! A big, new TV picture tube is included at no extra charge.

**EARN AS YOU LEARN.** We'll show you how to earn extra money right from the start. Many of our students pay for their course—and more—while studying. So can you!

### RESIDENT TRAINING AT LOS ANGELES

If you wish to take your training in our Resident School at Los Angeles, the world's TV capital, start **NOW** in our big, modern Shops, Labs and Radio-TV Studios. Here you work with latest Electronic equipment—professionally installed—finest, most complete facilities offered by any school. Expert, friendly instructors. Personal attention. Graduate Employment Service. Help in finding home near school—and part time job while you learn. Check box in coupon for full information.

**LESSONS AND INSTRUCTION MATERIAL ARE UP-TO-DATE, PRACTICAL, INTERESTING.** Every National Schools Shop-Method lesson is made easy to understand by numerous illustrations and diagrams. All instruction material has been developed and tested in our own Resident School Shops, Laboratories and Studios.

**SEND FOR INFORMATION TODAY**... it can mean the difference between **SUCCESS** and failure for you! Send for your **FREE BOOK** "Your Future in Television-Radio-Electronics" and **FREE Sample Lesson**. Do it **TODAY**, while you are thinking about your future. It doesn't cost you anything to investigate!

### GET THE BENEFITS OF OUR OVER 50 YEARS EXPERIENCE

Approved for  
GI Training



**NATIONAL SCHOOLS**  
Los Angeles 37, Calif.

## YOU GET...

- 19 Big Kits—**YOURS TO KEEP!**
- Friendly Instruction and Guidance
- Job Placement Service
- Unlimited Consultation
- Diploma—Recognized by Industry
- **EVERYTHING YOU NEED FOR SUCCESS!**

### SHOP-METHOD HOME TRAINING COVERS ALL PHASES OF INDUSTRY

1. Television, including Color TV
2. Radio AM & FM
3. Electronics for Guided Missiles
4. Sound Recording and Hi-Fidelity
5. FCC License
6. Automation and Computers
7. Radar & Micro-Waves
8. Broadcasting and Communications

## NATIONAL TECHNICAL SCHOOLS

WORLD-WIDE TRAINING SINCE 1905

**MAIL NOW TO**  
**NATIONAL SCHOOLS, Dept. RB-98**  
4000 S. FIGUEROA ST., LOS ANGELES 37, CALIF.  
Rush free TV-Radio "Opportunity" Book and sample lesson. No salesman will call.

NAME \_\_\_\_\_ AGE \_\_\_\_\_

ADDRESS \_\_\_\_\_

CITY \_\_\_\_\_ ZONE \_\_\_\_\_ STATE \_\_\_\_\_

Check if interested **ONLY** in Resident School training at Los Angeles.  
VETERANS: Give date of Discharge \_\_\_\_\_





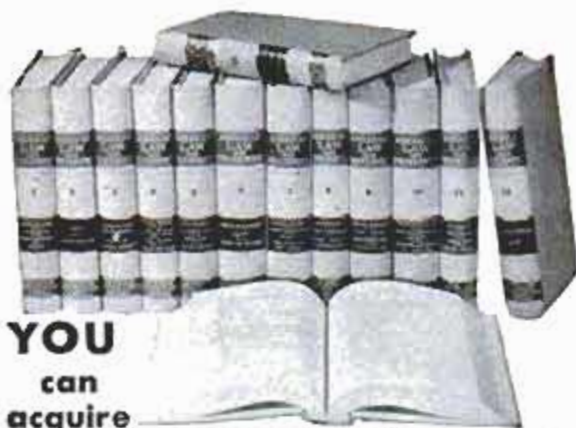

**YOU**  
can  
acquire

## LAW NIGHTS AT HOME! LL. B. DEGREE

LaSalle's famous Law Library—used as reference in many Law libraries and Law offices—has enabled thousands to master Law surprisingly fast, in spare hours at home, for business and professional advancement.

These 14 remarkable volumes, compiled by leading professors and lawyers, cover the whole basic field of Law in condensed, orderly, simplified manner.

You advance rapidly with this great library, plus special lectures furnished. We guide you step-by-step with personalized Problem Method of instruction . . . you *learn by doing*—handling legal problems—not by memorizing rules.

Send for two FREE booklets, "Law Training for Leadership," and "Evidence," answering questions about Law and its value to you, and telling how LaSalle Law graduates are winning rapid advancement in business and public life. Mail coupon below. No obligation.

### LA SALLE EXTENSION UNIVERSITY A Correspondence Institution

417 S. Dearborn St. Dept. 964L Chicago 5, Ill.

Send me your two FREE booklets described above, without obligation.

Name.....Age.....

Street.....

City, Zone & State.....



## HIGH WAGES!

Make big pay in the construction industry as an operator of Bulldozers, Draglines, Shovels, Back Hoes, Scrapers and Motor Graders. Learn these skills NOW! Machines of major manufacturers are used in our training program. Contractors need operators of earthmoving machines and pay high wages to our graduates. Don't be satisfied with just a job . . . learn a career!

**VETERANS: Ask about G.I. Benefits!**

Write TODAY for FREE School Catalog,  
no obligation, to either address

**THE NATIONAL SCHOOLS  
of HEAVY EQUIPMENT OPERATION**

DEPT. D-23

P.O. Box 8243, Charlotte, N.C.

P.O. Box 527, Weiser, Idaho

**BUILD IT  
YOURSELF**  
SO HE CAN DRIVE  
IT HIMSELF!



## buckboard 'n buggy FOR YOUR SON

Snappy orange and black, 66" long, drives like a car, real steering wheel. Push it or add power. Complete unit with 2 HP motor, (speeds up to 20 m.p.h.) ready to uncrate and run..... \$129.50  
Complete unit without motor..... \$ 74.50

**MAYO  
BROS.**

Do-It-Yourself Kit, includes everything, painted, drilled, easy to assemble with full instructions, \$64.50 (No motor). All prices F.O.B. Fairport. Satisfaction guaranteed or money refunded. Write today for illustrated brochure in full color.

FAIRPORT, N. Y.

Dept. PM-1

## GIANT 6 FOOTERS 59c



Wow! Genuine Neoprene government surplus (never used) . . . giant 6 ft. across, 21 ft. around . . . at a fraction of original cost. Durable. Can paint on advertising message, inflate and fly. Visible for miles. Great for attracting crowds to fairs, openings, school proms, gas stations. Fun for young and old in backyards or picnics, at the beach, etc. use as water markers & buoys. Order today — 59c. 2 for \$1.

Special 13' — \$1.95 ea.

Calif. Res. Add Sales Tax.  
We pay postage on prepaid orders.  
3930 SUNSET BLVD., DEPT. PM958  
LOS ANGELES 29, CALIF.

**FRANK SALES**

## FREE GERMAN STEEL HUNTING KNIFE



4-INCH BLADE

We give you handiest hunting and fishing knife you've ever had! Has 4-INCH LONG highly tempered steel blade—VERY SHARP! Attractive handle. We send knife FREE to acquaint you with our below-wholesale bargains. Please send 25c for handling. NO LIMIT—but send 25c handling for each knife. Order TODAY! HUNTING KNIFE, Dept. K-338, Box 881, St. Louis, Mo.

## YOU ARE UNDER ARREST!

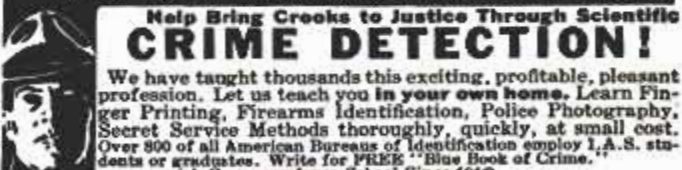

Help Bring Crooks to Justice Through Scientific  
**CRIME DETECTION!**

We have taught thousands this exciting, profitable, pleasant profession. Let us teach you in your own home. Learn Finger Printing, Firearms Identification, Police Photography, Secret Service Methods thoroughly, quickly, at small cost. Over 800 of all American Bureaus of Identification employ I.A.S. students or graduates. Write for FREE "Blue Book of Crime."

(A Correspondence School Since 1916)

INSTITUTE OF APPLIED SCIENCE, 1920 Sunnyside Ave., Dept. 1356, Chicago 30, Ill.

A Trade That Pays in Many Ways

## CLOCK AND WATCH REPAIR

Offered by KCSW'S HOME STUDY Course

Practical, complete training in every phase of clock and watch repair. Many enthusiastic graduates are either employed or in business for themselves. Our method has proved very successful in training those who were not progressing under previous inefficient methods.

**WATCH REPAIR** opens the door to numerous business and trade opportunities. Write today for your copy of "OPPORTUNITIES AHEAD."

Courses in Diamond Setting and Engraving also Offered.

**KANSAS CITY SCHOOL OF WATCHMAKING**  
1226 Admiral Blvd. Kansas City 6, Missouri



Here's the **EASY, Step-by-Step** Way to

# FIX ANY CAR IN A JIFFY!

Engines, Brakes, Transmissions, Rear Ends, Generators—Yes, Any Part

**BRAND-NEW EDITION!**



Now—Whether You're a Beginner or Expert Mechanic—You Can "Lick" Any Auto Repair Job on Any Car built from 1949 Thru 1958

**YES**, now you can fix ANY part of ANY car—quickly, easily, and right! From carburetor adjustment to a complete overhaul, it's easy when you have MOTOR's famous Auto Repair Manual. It's like having a staff of factory experts and MOTOR's field-trained engineers beside you, guiding you every step of the way. No wonder so many thousands of beginner and expert mechanics alike use this step-by-step, illustrated giant manual.

MOTOR's Manual "starts from scratch"—leads you through entire job with easy step-by-step directions, clear "how-to" pictures. Tells you WHERE to start, what TOOLS to use. You just CAN'T go wrong!

**2,900 Pictures! So Complete So Simple, You CAN'T Go Wrong!**

**NEW, REVISED** edition covers everything you need to know to repair any car. Over **ONE THOUSAND** giant pages. 2900 "This-Is-How" pictures lead you every step of the way. 291 "Quick-Check" charts—23,436 essential repair specifications. Over 225,000 service and repair facts on ALL 24 different makes from 1949 thru 1958. Instructions and pictures so clear you can't go wrong! Even a green beginner mechanic can do a good job. And if

you're a top-notch mechanic, you'll be amazed by the time and labor-saving methods!

**The "Meat" of 176 Official Shop Manuals**

The editors have put together the "know-how" from 176 Official Shop Manuals and "boiled it down" into one fully-illustrated easy-to-understand guide.

Here's **ILLUSTRATED** step-by-step guidance on Automatic Transmissions, Air Suspensions, Ignition, Carburetors, Fuel Pumps, Steering Gears, Rear End, Brakes, **PLUS MUCH MORE.**

**SEND NO MONEY**

**Try Book for a Week FREE**

Just mail coupon. (Attach it to postcard

if you wish.) Test book in your garage or shop. **GUARANTEED** to pay for itself in 7 days. If it doesn't, return it, owe nothing. **MOTOR Book Dept., Desk 1J, 250 West 55th St., New York 19, N. Y.**

**USED BY U. S. ARMED FORCES**

**Brand New—Covers All These Makes**

- |             |            |             |
|-------------|------------|-------------|
| Buick       | Edsel Ford | Oldsmobile  |
| Cadillac    | Ford       | Packard     |
| Chevrolet   | Hudson     | Plymouth    |
| Chrysler    | Imperial   | Pontiac     |
| Clipper     | Jeep       | Rambler     |
| Continental | Lincoln    | Studebaker  |
| De Soto     | Mercury    | Thunderbird |
| Dodge       | Nash       | Willlys     |



**Try Book for a Week FREE**

**Beginner Raves About Book**  
"Never knew anything about repairing cars until I got this wonderful book. Easy to see close-up pictures of every part. Has paid for itself time and time again."  
—P. Pomper, Wisc.

**So Does Expert**  
"Have been a mechanic for 25 years. MOTOR's Manual still takes me out of the tight spots. And it's simple enough to be understood by average person."  
—V. Lauria, Nev.

**Same FREE Offer on MOTOR'S New TRUCK MANUAL**

Covers EVERY job on EVERY popular make gasoline truck as well as GM and Cummins Diesels since 1949. For FREE trial, check coupon.

**MAIL COUPON NOW FOR 7-DAY FREE TRIAL (Attach to Postcard if More Convenient)**

**MOTOR BOOK DEPT. Desk 1J, 250 W. 55th St., N. Y. 19, N. Y.**

Rush to me at once (check box opposite book you want):

**MOTOR'S New AUTO REPAIR MANUAL.** If O.K., I will remit \$2 in 7 days, \$2 monthly for 2 months and a final payment of \$1.95 (plus 35¢ delivery charges) one month after that. Otherwise I will return the book postpaid in 7 days. (Foreign price, remit \$10 cash with order.)

**MOTOR'S New TRUCK REPAIR MANUAL.** If O.K., I will remit \$3 in 7 days, and \$2 monthly for 3 months, plus 35¢ delivery charges with final payment. Otherwise I will return book postpaid in 7 days. (Foreign price, remit \$12 cash with order.)

Print Name..... Age.....

Address .....

City..... Zone..... State.....

Check box and save 35¢ shipping charge by enclosing WITH coupon entire payment of \$7.95 for Auto Repair Manual (or \$9 for Truck Repair Manual). Same 7-day return-refund privilege applies.



# Inventors

Take these necessary preliminary steps promptly to protect your invention by applying for a United States patent—

Sketch and describe your invention. Sign, date and have this disclosure witnessed by two people who understand your invention. Have us make a preliminary search among U. S. patents already granted for similar types of invention. We then report to you on the probable patentability of your invention and recommend your further course of action.

Write for our instructive booklet, "Patent Protection for Inventors" and our convenient "Evidence of Invention" disclosure form. No obligation.

**VICTOR J. EVANS & Co.** *Merlin M. Evans*  
REGISTERED PATENT ATTORNEY

430-K MERLIN BUILDING, WASHINGTON 6, D. C.

**"I'M MAKING MORE THAN \$1000 a Month Haven't Touched Bottom Yet!"**



C. KAMA

—reports Charles Kama, Texas, one of many who are "cleaning up" with orders for PRESTO. Science's New Midget Miracle Fire Extinguisher. So can YOU!



Amazing new kind of fire extinguisher. Tiny "Presto" does job of bulky extinguishers that cost 4 times as much, are 8 times as heavy. Ends fires fast as 2 seconds. Never corrodes.

Guaranteed for 20 years! Over 3 million sold! Sells for only \$4.95.

Show it to civil defense workers, owners of homes, cars, boats, farms, etc., and to stores for resale—make good income. H. J. Kerr reports \$20 a day. Wm. Wydallis \$15.20 an hour. FREE Sales Kit. No obligation.

**MERLITE INDUSTRIES, Dept. P-15N**  
PRESTO DIV., 114 E. 32 St., New York 16, N.Y.  
\* CANADA: Mopa Co., Ltd., 371 Dowd St., Montreal 1, P.Q.



## college graduates get ahead faster!

You see it in your own city. They have higher incomes . . . advance more rapidly. Grasp your chance for a better life. Industrial growth . . . automation . . . technical advances create career opportunities for engineers, accountants, management experts. Share rewards awaiting college men. Important firms visit campus regularly to employ Tri-State College graduates. Start any quarter in this world-famed college. Approved for veterans.

### Bachelor of Science degree in 27 months

In Mechanical, CIVIL, Electrical, (Electronics or Power Major), Chemical, Aeronautical, Engineering. In 26 months a B.S. in Business Administration (General Business, Accounting, Motor Transport Management majors). Superior students may accelerate. 36-weeks course in Drafting. Intensive program: technical fundamentals stressed: comprehensive courses with more professional class hours. Small classes: personalized instruction. Enrollment limited. Preparatory courses. Beautiful campus. Well-equipped, new and modernized buildings and laboratories. Enter Sept., Jan., Mar., June. Earnest, capable students (whose time and budget require accelerated courses and modest costs) are invited to write Jess McCarthy, Director of Admissions, for catalog and book "Your Career in Engineering and Commerce."



## TRI-STATE COLLEGE

498 College Avenue • • • Angola, Indiana

### TASOPE PHOTO-ENGRAVING PLANTS



Material Cost Of This Cut 3/4c Selling Price \$1.00 And Up

Establish your own profitable PHOTO-ENGRAVING business. Make cuts for newspapers, printers, and advertisers. Make etched name plates, plaques, etc. Instructions furnished, no experience necessary. Sold direct from factory since 1931. First five hundred cuts sold locally or by mail will pay for plant and pay you well for your time. Write for FREE catalog.

TASOPE, DEPT. PM9, AURORA, MO.

## MEN WANTED

Earn \$100 Per Week and up  
AUTO DIESEL MECHANICS

Master a trade with a future—learn Auto-Diesel mechanics in our shops. You learn with tools on real equipment. Earn while you learn. Many of our graduates earn \$100 per week and up. No previous experience necessary. Day and night courses. Approved for veterans. Write for free bulletin.

### NASHVILLE AUTO-DIESEL COLLEGE

226 7th Ave., N., Dept. 75

Nashville 3, Tenn.

## STUDY TO BE A DOCTOR of Psychology or Metaphysics

Obtain a Ps.D., Ma.D., or Ph.D. Be a Teacher, Lecturer or Accredited Practitioner. Teach others how to achieve Health, Happiness and Contentment. Chartered by State. Correspondence Courses only. Write for FREE book telling how.

### THE NECTARIAN FELLOWSHIP

Desk B, Pickwick Building

Kansas City 6, Missouri



## RECESSIONS? LAYOFFS?

not for **LOCKSMITHS**

LOCKSMITHING is not affected by recessions, layoffs or strikes. Get into this well paying, uncrowded field now. Learn from experts in spare time. Make money while learning. All special tools, equipment supplied. Low rates. Illustrated, easy lessons.

INSTITUTE OF LOCKSMITHING, Dept. P-106  
150 Park Ave. East Rutherford, N. J.  
Lic. by N. J. State Board of Ed. Apprd. for Vets

SEND FOR FREE BOOKLET

## MEN PAST 40

### Troubled With GETTING UP NIGHTS

Pains in Back, Hips, Legs, Tiredness Then your troubles may be traced to Glandular Dysfunction . . . a constitutional disease. Neglect of this condition often leads to premature old age and sometimes incurable malignancy.

The Excelsior Medical Clinic has a New Free Book that tells how thousands of men have been successfully treated here at Excelsior Springs for Glandular Dysfunction by NON-SURGICAL Methods. They found soothing relief and a new outlook in the future of life.

This Free Book may prove of utmost importance in your life. Write Today. There is no obligation.

Excelsior Medical Clinic Dept. 6119, Excelsior Spgs., Mo.



# WHAT ALL AUTO MECHANICS WANT TO KNOW



This Big Practical Book gives full information, with working diagrams, explaining the principles, construction, ignition, service and repair of modern cars, trucks and buses.

**Diesel Engines, Hydrametric and Fluid Drives Fully Explained.**

A complete guide of 1696 Pages, with over 1500 Illustrations showing inside views of working parts, with instructions for service jobs. Completely up-to-the-minute! Priced at only \$6.



# HOW TO FIX HOME APPLIANCES

REFRIGERATORS WASHERS TOASTERS DRYERS IRONERS RANGES VACUUMS FREEZERS

Many other GAS AND ELECTRIC APPLIANCES Handy Reference for Electric & Gas Servicemen, Mechanics, Dealers and Home-owners. Explains clearly and simply how to locate troubles, how to test, reassemble and connect. Wiring diagrams. 1000 Facts. Easy to read. Answers ALL your questions. 864 Pages. Illustrated. Only \$5.



**TV TELLS HOW TO ANSWER RADIO RADIO T.V. QUESTIONS SERVICE LIBRARY**

HERE IS LATE INFORMATION IN A HANDY FORM FOR RADIO AND TELEVISION REPAIRMEN, SERVICEMEN AND STUDENTS

TWO COMPLETE VOLUMES - 1568 Pages - 1085 Illustrations and Diagrams. 1001 Important Facts and Figures on Modern T.V., Radio, Electronic Devices. INCLUDES TRANSISTORS & Transistor Circuits, Rectifiers, Record Changers, P.A. Systems, Phonograph Pick-ups, F.M., Auto Radio, Short Waves.

Basic principles, Construction, Installation, Operation, Shooting. How to get Sharp, Clear T.V. Pictures. Install Aerials, How to Test. Explains COLOR SYSTEMS, Methods of Conversion, Terms, etc. Includes Ultra High Frequency. Quick ready reference or use as a home study course. Only \$3 for BOTH volumes.



# KNOW YOUR TRUCK

The TRUCK & TRACTOR GUIDE for Mechanics & Drivers, Foremen, Garage-men, Helpers, Owners, Trouble Shooters, Farmers, etc. Covering Gas & Diesel Motor Principles - Construction - Operation - Maintenance - Repair - Brakes - Service of all Parts. 1576 Pages. FULLY ILLUSTRATED. Index. Only \$5.



# PLUMBERS AND STEAMFITTERS GUIDES

Practical Trade Assistant & Reference Set. Explains in plain language and by clear illustrations, diagrams, charts, graphs and pictures the principles of modern plumbing practice including Pipe Fitting and Air Conditioning. 4 Vols. - 2624 Pages - 3642 Diagrams & Illustrations. Only \$8 for the complete set of 4 vols.



# PAINTING & DECORATING MANUAL

Inside Trade information on outside and inside work: how to mix paints, preparation of surfaces, paper hanging, wood finishes, tool, synthetic paints, color (with color chart), spray equipment, costs, estimating, etc. A COMPLETE guide to easier, better painting and decorating. 464 Pages. Fully Illustrated. Only \$2.

# 7-DAY FREE EXAMINATION

SEND NO MONEY - Pay the postman nothing! We are glad to send you any of the Audel Guides for absolutely FREE examination in your own home. We take all the risks and leave all the decisions up to YOU. There is no obligation if you decide to keep the books of your choice you may pay for them under our astounding easy-pay plan of only \$2 a month.

# HERE IS ALL YOU DO

IT'S EASY TO ORDER: In the No-Risk Mail Order Coupon at the right just draw a circle around the number of Audel Guides you want us to send you for FREE EXAMINATION. We will send them to you at once to help you build a brighter future by increasing your SKILL. If for any reason at all you are not COMPLETELY satisfied, return the books to us, and that will end the matter! NO STRINGS OR CATCHES TO THIS OFFER.

**THEO. AUDEL & CO.**  
49 West 23rd Street, New York 10, N.Y.  
SEPTEMBER 1958

# CARPENTERS AND BUILDERS GUIDES



PRACTICAL STOREHOUSE OF MODERN CONSTRUCTION INFORMATION (4 vol. set) for carpenters and all woodworkers. Explains in easy language and by profuse illustration principles, advances, short cuts, trade secrets, all based on the NEWEST information.

**CIRCLE No. 8 IN COUPON**

# PRACTICAL ELECTRICITY

A COMPLETE HANDBOOK - Quick, simplified, ready reference. Complete instruction and practical information on the rules and laws of electricity - Maintenance of Machinery - A.C. and D.C. Motors - Armatures - Wiring Diagrams - House Lighting - Power Wiring - Motors - Batteries - Transformers - etc. Simple to understand. 1520 Pages. 2600 Illustrations. Priced at \$5.

**CIRCLE No. 4 IN COUPON**

# DIESEL

ALL THERE IS TO KNOW ABOUT MODERN DIESEL ENGINES - Basic principles, starting valves, timing, fuel pumps, fuel injection compressor, air compressors, pistons, cylinders, lubrication, cooling systems, etc. Answers on operation, calculations. 640 Pages. Fully Illustrated. Priced \$3.

**CIRCLE No. 9 IN COUPON**

# WELDERS GUIDE

Covers Electric, Oxy-acetylene, Thermit, Union-bolt welding for sheet metal, spot and pipe welds, pressure vessels and aluminum, copper, brass, bronze and other metals. Airplane work, surface hardening, hard facing, cutting, brazing, etc. 608 Pages. Fully Illustrated. Only \$3.

**CIRCLE No. 10 IN COUPON**

# MATHEMATICS MADE EASY

A COMPLETE HOME STUDY COURSE - Starting with the first principles of arithmetic, advancing step by step through the various stages of mathematics, including the rules and calculations for mechanical and electrical problems. New EASY correct methods. Includes plane and solid geometry, trigonometry, algebra, calculus, etc. Practical tests, reference tables and data. How to use slide rule. 752 Pages. 550 Illustrations. Priced at only \$3.

**CIRCLE No. 11 IN COUPON**

# NEW MACHINISTS AND TOOLMAKERS HANDBOOK

MODERN MACHINE SHOP PRACTICE - 5 PRACTICAL BOOKS IN ONE. New from cover to cover. Tells how to set up and operate lathes, screw and milling machines, shapers, drill presses and all other machine tools. A COMPLETE INSTRUCTOR AND REFERENCE BOOK. 1728 Pages. Fully Illustrated. Priced at only \$6.

**CIRCLE No. 12 IN COUPON**

# WIRING DIAGRAMS

This book gives the practical facts on wiring of electrical apparatus. It explains clearly and SIMPLY how to wire apparatus for all fields of electricity. Each diagram is complete and self-explaining. Know your HOOK-UPS! 304 Pages. Illustrated. Only \$2.

**CIRCLE No. 13 IN COUPON**

# REFRIGERATION & AIR CONDITIONING

FOUR BOOKS IN ONE - basic principles, servicing, operation, repair of: 1. Household Refrigeration. 2. Special Refrigeration Units. 3. Commercial & Industrial Refrigeration. 4. Air Conditioning Systems. A GOLD MINE of essential information. Completely up-to-date. 1360 Pages. Fully Illustrated and Indexed. Priced at only \$6.

**CIRCLE No. 14 IN COUPON**

# THE NEW ELECTRIC LIBRARY

A COMPLETE ENCYCLOPEDIA explaining in the simplest terms the fundamental principles, rules and applications of applied electricity.

**A COMPLETE COLLEGE EDUCATION!** Fully illustrated with diagrams and sketches, calculations and tables for ready reference. Questions and answers. Trial tests for practice study and review. All based on the most modern theory.

- Vol. 1 - Principles and rules of electricity, magnetism, armatures, repairs. No. 15
- Vol. 2 - Dynamos, DC Motors, construction, installation, maintenance, etc. No. 16
- Vol. 3 - Testing instruments and tests, storage battery constr. and repairs. No. 17
- Vol. 4 - Alternating current, power factor, alternators, transformers. No. 18
- Vol. 5 - A.C. Motors, windings, maintenance, converters, switches, fuses, etc. No. 19
- Vol. 6 - Relays, condensers, regulators, rectifiers, meters, switchboards, etc. No. 20
- Vol. 7 - Wiring, house light and power, circuits, high tension, plans, code, etc. No. 21
- Vol. 8 - Railways, signals, elevators, ignition, etc. No. 22
- Vol. 9 - Radio, telephones, telegraph, television, motion pictures. No. 23
- Vol. 10 - Refrigeration, illumination, welding, x-ray, electrical appliances, Index. No. 24



# ALL TYPES OF BLUEPRINT READING

How to read scales, the standard symbols, detail and assembly prints, working drawings, short cuts, helps, hints and suggestions. THE MAN WHO CAN READ BLUEPRINTS IS IN LINE FOR A BETTER JOB. This book gives you the secret language, step by step in easy stages. 448 Pages. Very Fully Illustrated. Priced at \$3.

**CIRCLE No. 25 IN COUPON**

# MASONS & BUILDERS GUIDES

A PRACTICAL ILLUSTRATED 4 VOL. SET - Explaining in clear, simple language and profuse illustration, principles, advances, short cuts, trade secrets, based on modern practice - including how to figure and calculate various jobs. Vol. 1 - Brick work, bricklaying, bonding, designs. Vol. 2 - Brick foundations, arches, tile setting, estimating. Vol. 3 - Concrete mixing, placing forms, reinforced stucco. Vol. 4 - Plastering, stone masonry, steel construction, blueprints. 4 Vols. 1440 Pages. 2067 Illustrations. Complete Set only \$8.

**CIRCLE No. 26 IN COUPON**

# ELECTRIC MOTORS

THIS GUIDE covers the construction, hook-ups, control, maintenance and trouble shooting of all types of motors. Includes armature winding. Explains entire subject in great detail in simple language. Over 1056 Pages of information. 617 Diagrams. All types of motors fully illustrated and indexed for ready reference. Priced at only \$5.

**CIRCLE No. 27 IN COUPON**

# OIL BURNERS

New, complete, explaining in detail both domestic and industrial oil burners. Includes electrical hook-ups and wiring diagrams. Fully covering the theory, construction, installation, operation, testing, servicing and repair of all equipment. Indexed for ready reference. Over 416 Pages. 320 Illustrations and Diagrams. Only \$2.

**CIRCLE No. 28 IN COUPON**

# ADDITIONAL IMPORTANT TITLES

- The following Audel Guides are all the best in their fields, written in clear simple fashion, all lavishly illustrated. Circle the numbers wanted in the MAIL ORDER COUPON below. All books are sent for FREE EXAMINATION.
- No. 29 SHEET METAL PATTERN LAYOUTS. 1152 Pages... \$7.50
  - No. 30 SHEET METAL WORKERS HANDBOOK. 448 Pages... 2.00
  - No. 31 MECHANICAL DRAWING GUIDE. 192 Pages... 2.00
  - No. 32 MECHANICAL DRAWING AND DESIGN. 480 Pages... 3.00
  - No. 33 ELECTRONIC DEVICES. 300 Pages... 3.00
  - No. 34 ELECTRICIANS EXAMINATIONS. 272 Pages... 2.00
  - No. 35 ELECTRIC POWER CALCULATIONS. Page 480... 3.00
  - No. 36 ELECTRIC DICTIONARY. 9000 Terms... 3.00
  - No. 37 POWER PLANT ENGINEERS GUIDE. 1568 Pages... 3.00
  - No. 38 ENGINEERS AND FIREMANS EXAMS. 544 Pages... 2.00
  - No. 39 OPERATING ENGINEERS LIBRARY. 3 Book Set... 12.00
  - No. 40 PUMPS, HYDRAULICS AND AIR COMPRESSORS. 1760 Pages... 6.00
  - No. 41 HOUSE HEATING GUIDE. 1008 Pages... 3.00

# MAIL THIS NO-RISK COUPON TODAY!

THEO. AUDEL & CO. - Self Improvement Publishers Since 1879 - P-9 1 2 3 4 5 6  
49 W. 23rd Street, New York 10, N.Y.

Please mail me for 7 days' FREE EXAMINATION the books I have circled at right. I agree to mail \$2 in 7 days on each book or set ordered, and to further mail \$2 a month on each book or set ordered until I have paid the purchase price, plus shipping costs. If I am not completely satisfied with my Audel Guides I may return them.

NAME \_\_\_\_\_

ADDRESS \_\_\_\_\_

OCCUPATION \_\_\_\_\_

SAVE SHIPPING COSTS! Check here if you enclose complete payment with order. We pay postage charges. You have same return privilege.



# Just Pick the Kind of Body YOU Want

## CHECK THE COUPON BELOW

...Prove to Yourself How EASILY You Can Have It... Almost Overnight!



Just tell me, in coupon below, the kind of body you want—and I'll give it to you SO FAST your friends will be amazed! "Dynamic Tension," my easy, 15-minutes-a-day method, can make your chest and shoulders bulge . . . your arms and legs surge with power . . . your whole body feel "alive!"



### FREE 32-page Illustrated Book

32 pages on how "Dynamic Tension" changed me from a 97-lb. weakling into "World's Most Perfectly Developed Man"—and what it has done for others. Mail coupon NOW! Charles Atlas, Dept. 89, 115 East 23rd St., N. Y. City 10.



CHARLES ATLAS, Dept. 89,  
115 East 23rd St., New York 10, N. Y.

Dear Charles Atlas—Here's the Kind of Body I Want:  
(Check as many as you like)

- |   |   |
|---|---|
| <input type="checkbox"/> Slimmer Waist, Hips      | <input type="checkbox"/> More Powerful Arms, Grip |
| <input type="checkbox"/> Broader Chest, Shoulders | <input type="checkbox"/> More Powerful Legs       |
| <input type="checkbox"/> More Weight, Solid       | <input type="checkbox"/> Better Energy, Sleep     |

Send me, absolutely FREE, a copy of your famous book showing how "Dynamic Tension" can make me a new man. 32 pages, crammed with photographs, answers to vital questions, and valuable advice. No obligation.

Name \_\_\_\_\_ Age \_\_\_\_\_

(Please Print or write plainly)

Address \_\_\_\_\_

City \_\_\_\_\_ Zone \_\_\_\_\_ State \_\_\_\_\_

## Multi-Million Dollar Business Now Being Split Up Among Home Operators in Small Communities

### Inexpensive Table Top Machine Pays Profits UP TO \$9.20 AN HOUR

The multi-million dollar Rubber Stamp Business is now being taken over by small home operators throughout the U.S. Men and Women who operate this inexpensive machine can turn out large numbers of Rubber Stamps with special wording of all kinds. Only 27¢ worth of material makes a stamp that sells for \$1.80. The machine is easy for anyone to operate. It molds as many as six Rubber Stamps at a time, each with different wording such as names, addresses, notices, stock numbers, prices and other 'copy' needed by offices, factories and individuals. At full capacity, it can earn as much as \$9.20 an hour for the operator! You don't need experience to get into this big profit business at home. We supply everything, including complete instructions and eight ways to get orders for stamps coming in fast. Start making up to \$9.20 in one hour right away. We'll mail full particulars FREE; no salesman will call. Be first in your locality. Rush coupon.



**RUBBER STAMP DIV., Dept. R-2-K, Chicago 26, Ill.**

### RUBBER STAMP DIV., Dept. R-2-K 1512 Jarvis Ave., Chicago 26, Ill.

Please mail all facts showing how I can get started in the profitable Rubber Stamp business at home in spare time. Everything you mail me is FREE and no salesman will call.

NAME \_\_\_\_\_

ADDRESS \_\_\_\_\_

CITY \_\_\_\_\_ Zone \_\_\_\_\_ STATE \_\_\_\_\_

## BE A DIESEL-AUTO MECHANIC EARN \$450 MONTH AND UP

WHY WORK FOR LOW PAY or worry about being laid off? We have a nation-wide waiting list of good pay jobs for our graduates.

THAT'S YOUR GUARANTEE that we offer the best in Diesel-Auto training. Costs less because you get both Diesel and Auto training for the price of one.

WITH OUR PRACTICAL "learn-by-doing" shop practice method, we train you thoroughly in less time.

IF YOU'RE DRAFT AGE:—Our catalog contains information vital to you!

Part-time jobs and housing provided. Write at once for free booklet.

GI APPROVED!

WORLD FAMOUS

**BAILEY TECHNICAL SCHOOLS**  
1634 S. GRAND AVE. · ST. LOUIS, MO.

## "MINIATURE MACHINE SHOP

No Bigger Than A Typewriter, Outperforms Machines Many Times its Size!

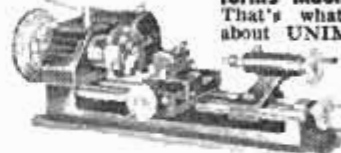

That's what a popular publication says about UNIMAT in their 3 page feature story in the May issue. If you want a reprint of this story plus complete information about this amazing 10 in 1 combination precision tool write to:

AMERICAN EDELSTAAL, INC., UNIMAT DIV., Dept. 398, 350 B'way., N.Y. 13

## MAKE TREMENDOUS PROFITS

Have fun! Earn Big Money! Cast plaster figurines, bookends, plaques, novelties at home in your spare time with X.L. rubber mold! NO EXPERIENCE NEEDED! Models and rubber for 3 molds, only \$1.50 ppd. Send 25¢ (refunded with order) for 40 page catalog now!

**PLASTIC ARTS STUDIO** 3403 S. MADISON DEPT. PM2  
MUNCIE, INDIANA

## earn as TAX EXPERT

\$15  
HOUR

Our students earn as much as \$3,000 in 3 short months preparing income tax returns in spare time. Also operate lucrative year-round Business Tax Service. Digitized home-office business. Experience unnecessary. We train you! help you start. State approved home training program. Write today for free prospectus.

UNION INSTITUTE, 68 Hudson, Hoboken 20N, N. J.

## Shrinks Hemorrhoids New Way Without Surgery Stops Itch - Relieves Pain

For the first time science has found a new healing substance with the astonishing ability to shrink hemorrhoids and to relieve pain — without surgery.

In case after case, while gently relieving pain, actual reduction (shrinkage) took place.

Most amazing of all — results were so thorough that sufferers made astonishing statements like "Piles have ceased to be a problem!"

The secret is a new healing substance (Bio-Dyne\*) — discovery of a world-famous research institute.

This substance is now available in suppository or ointment form under the name Preparation H.\* Ask for it at all drug counters — money back guarantee. \*Reg. U.S. Pat. Off



# NOW READY! McGraw-Hill's New Train-Yourself Course

TELEVISION AND  
RADIO REPAIRING

REPAIRING  
RECORD CHANGERS

PROFITABLE RADIO  
TROUBLESHOOTING

PRACTICAL RADIO  
SERVICING

PROFITABLE  
TELEVISION  
TROUBLESHOOTING

**6 BIG VOLUMES**  
Including  
Home Course  
Outline!  
Shows how  
to Get  
Ahead Fast.

## FIX TV RADIO and RECORD CHANGERS RIGHT AWAY

—even if you've never looked inside a set before!



**AT LAST — at Amazing LOW COST — The Most Complete TV-Radio Repair Course Ever Published. TELLS and SHOWS How to Do Every Job Quickly and Easily — Make GOOD MONEY, Full or Spare Time in the BOOMING Repair Business**

**AFTER 10 YEARS OF PREPARATION** — McGraw-Hill's new 6-Volume Course brings you everything you need to know to "cash in" on the TV-RADIO boom. Over 2,350 pages of money-making "know-how" by top factory engineers and electronic experts. **THREE** giant REPAIR MANUALS tell and show how to FIX every trouble the easy way. **TWO** huge TROUBLESHOOTERS tell exactly WHERE to begin, WHAT tools to use, HOW to "polish off" every job. Complete Home Study Volume guides you every step of the way, tells how to get ahead fast as a repairman — build up your own business, full or spare time, for **BIG PROFITS!**

### EARN While You Learn

Tested — and now used in top schools, and repair shops — Course volumes are simple enough for green beginners, amazed "pros" with new easy methods. Starts you doing simple repairs — and earning money — from very first chapter. ABC pictures and directions make tougher jobs a "snap." Before you finish you can earn many times its cost.

NO previous training needed. NO complicated formulas. **PLAIN ENGLISH**

pictures and directions cover ANY job on EVERY set — tubes, circuits, speakers, new a-c/d-c portables, Color TV, even what to charge for every job!

### BIG MONEY — Spare or Full Time

Forget lack of experience. Forget your age. Over 40 MILLION TV sets, 130 MILLION radios — and the shortage of repairmen — mean big money for you. Course makes it easy to "cash in," spare time or full, start your own business, enjoy your work and a big bank account!

### SEND NO MONEY

Try Course 10 days FREE. (We pay shipping!) If you don't agree it can get you started in a money-making repair business — return it, pay nothing. Otherwise keep it. Earn while you learn; and pay the low cost on easy terms. Mail coupon NOW. McGraw-Hill Book Co., Dept. PM-9, 327 West 41st St., New York 36, N. Y.

Examine  
Entire Course  
**FREE**  
for 10 Days!

### PARTIAL CONTENTS

- 1 Television and Radio Repairing — Testing, repairing, replacing parts, 566 pages. 700 "This-Is-How" pictures, diagrams. By John Markus, Feature Ed., Electronics Magazine.
- 2 Practical Radio Servicing — Easy-to-follow directions, diagrams, drawings — with job sheet for every repair job. 599 pages. 473 illus. By William Marcus, Alex Levy, Electronic Training Experts.
- 3 Profitable Radio Troubleshooting — WHERE to look and WHAT to do for every trouble. How to avoid costly mistakes, handle customers profitably. 330 pages. 153 "how-to" illus. By William Marcus, Alex Levy.
- 4 Profitable TV Troubleshooting — Short-cuts to SPOT and FIX every trouble — fast, for big profits. By Eugene A. Anthony, Service Consultant, General Elec. Co.
- 5 Repairing Record Changers — Step-by-step pictures and directions — how to set up service bench, etc. 278 pages. 202 A-B-C pictures. By Eugene Ecklund, Eng. DuMont Lab., Inc.
- 6 Complete Home Course Outline — Getting started in television and radio servicing. How to get the most out of your Course. How to get ahead FAST. By John Markus.

**THIS AMAZING  
OFFER SAVES  
YOU \$11.85!**

### THIS COUPON SAVES YOU \$11.85

McGraw-Hill Book Co., Dept. PM-9  
327 West 41st St., New York 36, N. Y.  
Send me — postpaid — for 10 DAYS' FREE TRIAL the 6-Vol. McGraw-Hill TV, Radio and Changer Servicing Course. If okay, I'll remit only \$4.95 in 10 days; then \$5.00 monthly for 5 months. (A total savings of \$11.85 on the regular price of the Course and Detect-O-Scopes.) Otherwise, I'll return Course in 10 days; pay nothing.  
ALSO send FREE (to keep whether or not I keep the Course) the 3 TV, RADIO, and CIRCUIT DETECT-O-SCOPE CHARTS, — total value \$3.00.

Name .....

(Please Print Clearly)

Address .....

City .....

Zone No.

(if any) State

CHECK HERE if you prefer to enclose first payment of \$4.95 with coupon. Same easy pay plan; same 10-day return privilege for full refund.

PM-9

**Free** ALL THREE Valuable Repair Aids: TV, RADIO, and  
CIRCUIT Detect-O-Scopes (Total Retail Value \$3.00)



FREE — whether you keep the Course or not — THREE amazing DETECT-O-SCOPE Charts. TV and RADIO Scopes enable you to spot all tube troubles in a jiffy. CIRCUIT Scope spots all circuit troubles. Make fix-it jobs easier, faster. 16 x 21 inches. ALL THREE (worth \$3.00) yours FREE while they last on this introductory offer.



## LEARN TO OPERATE EARTH MOVING EQUIPMENT



Wanted: Men to operate bulldozers, trucks, loaders & scrapers (4 wk.—200 hrs.) \$375; motor graders & compactors (4 wk.—200 hrs.) \$375; 7 wk. combination of above (350 hrs.) \$650; cranes, dragline & backhoe operation (4 wk.—200 hrs.) \$375; construction-type dump truck, trailer dump & off-highway truck course. (2 wks.—100 hrs.) \$195. All courses include preventive maintenance—Special weekend classes Bulldozer Operation—40 hrs. training—2 weekends—\$10 down. Train for Nat'l. Road Bldg. program—60 miles from Chicago—Economical housing & board—Write for details NOW.

## OR BE A CONSTRUCTION EQUIPMENT MECHANIC

Greer trains you to earn top pay. Complete Mechanics Course covering Diesel engine transmissions; torque converters; fuel injection systems; track assemblies; final drive assemblies; steering systems; idlers; rollers; power transfer systems; cable control systems; hydraulic control cylinders & welding pertaining to heavy equipment such as bulldozers, scrapers, loaders, off-highway trucks, etc. Course time—540 hours—10 weeks. Convenient payment plan. Write for details.

Please send FREE information on

- HEAVY EQUIPMENT OPERATORS TRAINING  
 CONSTRUCTION EQUIPMENT MECHANICS TRAINING

Name \_\_\_\_\_ Age \_\_\_\_\_

Address \_\_\_\_\_ Phone \_\_\_\_\_

City \_\_\_\_\_ State \_\_\_\_\_



### Exclusive Double-Bearing HEAVY-DUTY PUMPS

IRRIGATE • DRAIN • CIRCULATE • SPRAY  
 Use 1/4 HP motor or larger . . . 1 HP for up to 7,500  
 GPH; 1,000 GPH 60" high; or 3,000 GPH from 25' well.  
 1 1/2" inlet; 1" outlet. Stainless shaft.

TYPE X—2 oil-less bronze bearings. Won't rust. . . . \$10.95

TYPE XB—Ball bearing model. . . . \$12.95

Postpaid if cash with order. Rush your order today

**MONEY BACK GUARANTEE**

Centrifugal and Gear Pumps in All Sizes

LABAWCO PUMPS, Belle Mead 2, N. J.



C-10  
**Beauty by Colorcrete Can Earn High Incomes**



Beautifying buildings by Colorcrete is a business opportunity awaiting men of modest capital everywhere. Owners of homes, stores, motels, schools—almost any type of construction—are looking for means to give lifetime eye-appeal to drab or dirty concrete, stucco and similar masonry surfaces. Colorcretors can do such jobs, in little time and at little cost, and pocket generous profits. Colorcrete is a cementitious material, applied by air pressure. Tough, tenacious, enduring; 30 colors. Investigate this low-investment enterprise by writing for the Opportunity Book.

COLORCRETE INDUSTRIES, INC. 570 Ottawa Ave., Holland, Mich. **COLORCRETE**

## NEW GRIPSO TOOL KIT

Save Time, Work, Money—4 new Power Action tools do the work of dozens of tools. In handy vinyl holder.



**VICE PLIERS**  
 5 Tools in 1 — 1 ton grip gentle release. One hand adjustment.

**PIPE WRENCH**  
 Press—pull it's open. Push—it's closed. Ratchet action adjustment.

**MULTI-DUTY PLIERS**  
 Multiplies grip 10 times.

**GEAR LOCK PLIERS**  
 Patented power gear grip.

See Your Dealer or Write  
**H. R. BASFORD CO., 235 15th St. San Francisco 3, California**



## HOME-IMPORT BUSINESS . . .

Men, women. Make big profits buying low cost imports abroad (see examples at left) and selling to friends, stores or by mail order. Famous world trader guides you—shows you how to find thousands of exotic imports for full or spare time business, how to pocket profits in advance on foreign drop shipment plan. Full details FREE! Airmail reaches us overnight. Write Today!  
**MELLINGER CO., 1717 Westwood Dept. P259, LOS ANGELES 24, CALIFORNIA**

## GET INTO ELECTRONICS

V.T.I. training leads to success as technicians, field engineers, specialists in communications, guided missiles, computers, radar, automation. Basic & advanced courses in theory & laboratory. Assoc. degree in 29 mos. B.S. obtainable. ECPD accredited, G.I. approved. Graduates with major companies. Start Sept., Feb. Dorms, campus, H. S. graduate or equivalent. Catalog.  
**VALPARAISO TECHNICAL INSTITUTE DEPT. D VALPARAISO, INDIANA**

## MONEY in WORMS

Sell 20,000 fishworms per week @ \$4 per 1000 from a bed 3 feet wide and 8 feet long. We teach you how to raise and where to sell fishworms and crickets. Write for free literature.  
**CARTER WORM RANCH, PLAINS, GEORGIA**



Coast to coast, high-paying jobs in photography are waiting for people with that "know-how" to fill them. You can quickly, easily qualify at home with the world-famous NYI Learn-by-Doing Method. Write today for free catalog. Also resident training in N.Y. 49th Year. Approved for Vets.

**NEW YORK INSTITUTE OF PHOTOGRAPHY**  
 Dept. 49 10 West 33 St., New York 1, N.Y.

## RUPTURED

**BE FREE FROM TRUSS SLAVERY**  
 Surely you want to THROW AWAY TRUSSES FOREVER, be rid of Rupture Worries. Then Why Do you put up with wearing a gripping, chafing and unsanitary truss the balance of your life? If you do, it will NOT be through necessity but through choice on your part. Now there is a new modern Non-Surgical treatment that is designed to permanently correct rupture. These Non-Surgical treatments are so certain, that a Lifetime Certificate of Assurance is given. Write today for our New FREE Book that gives facts that may save you painful, expensive surgery. Tells how non-surgically you may again work, live, play, love and enjoy life in the manner you desire. There is no obligation.  
**Excelsior Hernia Clinic, Dept. 8305. Excelsior Springs, Mo.**







# NOW The Short Cut to Learning You've Been Waiting for



## Learn "By Ear" with the DORMIPHONE

The Scientific Discovery

That Works for You . . .

Awake and Asleep

Now, at last, science gives you an easy shortcut to learning. With this amazing new tool, you "start" to learn while awake—then the university-tested Dormiphone takes over, continues the learning process for you while you go off to sleep.

Do you want to learn a language—memorize a speech or an array of important facts, figures, formulas—Correct your speech—Break bad habits? The Dormiphone is so simple to use, children benefit—so helpful and practical it is used by educators, psychologists, people of all ages, occupations all over the world.

### Break Down Barriers to Learning

Find out HOW the Dormiphone works FOR YOU—how it can help you learn anything in less time, without intensive self-application. Eliminate drudgery—SAVE YOUR TIME—EFFORT. Write for FREE Book, "A New Dimension in Learning," or call for FREE DEMONSTRATION—Get the Scientific Evidence Today.

MODERNOPHONE, INC.  
236-098 Radio City, New York 20, N. Y.

Circle 7-0830

Gentlemen: Please send me your FREE Booklet. I am interested in learning more about the DORMIPHONE and what it can do for me. No obligation—no salesman will call.

If under 18, check here for Special Booklet A.

NAME \_\_\_\_\_

ADDRESS \_\_\_\_\_

CITY \_\_\_\_\_ ZONE \_\_\_\_\_ STATE \_\_\_\_\_

My main interest in the Dormiphone is for:

- |  |   |
|--|---|
| <input type="checkbox"/> Learning a Language | <input type="checkbox"/> Speech Improvement     |
| <input type="checkbox"/> Memorization        | <input type="checkbox"/> Sleep Inducement       |
| <input type="checkbox"/> Habit Correction    | <input type="checkbox"/> School or College Work |

# FREE Sample Lesson in SELLING!

Discover How You Can MAKE BIG MONEY in Selling! How You Can Train at Home for Sales Jobs that Pay up to \$25,000.00 a Year!

If you can talk . . . you can sell—and if you can sell, you can command a five figure income! I can teach you to sell and earn more money with my famous "sell the sizzle" sales methods that have moved products and services for America's biggest companies . . . and have shown thousands of men and women the quick way to selling success.



ELMER  
WHEELER

### LEARN AT HOME—In Spare Time! EARN WHILE YOU LEARN!

Skeptical? Rush your name and address and I'll send you a FREE sample lesson and full details. See for yourself how easy it is to learn and to sell the Elmer Wheeler way. Let me tell you how to add dollars and dollars to your present income while you learn . . . how to turn your training into a big paying job with an unlimited future.

### Write for FREE Sample Lesson and Details!

It doesn't cost a cent to discover what Elmer Wheeler Sales Training can do for you and your future. Just rush your name and address. We'll send you a FREE Sample Lesson and complete, thrilling details. Read what Elmer Wheeler training has done for other salesmen. Discover what it can do for you! The entire, exciting story and a free lesson is yours FREE. Write us today.

ELMER WHEELER SALES TRAINING INST., Dept. J-25  
Home Study Division, 664 N. Michigan Ave., Chicago 11, Ill.

# Make \$5 an Hour CASH PROFIT



## THE DAY YOU START!

Start your own business at Home . . . Sharpen Household, Garden and Shop Tools in Spare Time.

Turn spare time into Big Cash Profits with new Belsaw Sharp-All. No experience needed to sharpen knives, scissors, shears, ice skates, mower blades, hedge trimmers, axes, chisels and circular saws . . . Learn how easily you can start your own spare time business. Amazing low cost easy-payment plan. Send Postcard for FREE BOOK. BELSAW SHARP-ALL CO 719 Field Bldg., Kansas City 11, Mo.



# BARBELLS

140-Pound, CHROME DELUXE Barbell-Dumbbell set only \$18.80. This is our feature set and is the finest ever manufactured.

Training with adjustable weight is the BEST way to keep fit: the ONLY way to develop great strength and a perfect body. As the oldest and best equipped barbell company, BUR gives value and prices no one can equal.

SEND FOR FREE CATALOG.

BUR BARBELL CO.

Lyndhurst 9, New Jersey



# SPUTNIK I & II FREE!

Fabulous collection of stamps showing: Sputnik I in Orbit, Sputnik II in Rocket Flight, Stratosphere Balloon, Meteor, Station, Radio Telescope, actual TV set, TV station, Microscope, Microbe Hunter, Brussels Fair Set showing puppets, etc. All this is yours Free, to introduce our bargain approval offers. EXTRA: 48 Page Stamp Dictionary included. Send 10c to cover mailing cost.

STAMPEX CO., Box 47-HM, White Plains, N. Y.

# SEND ME



every month so I am sure to see each new issue. Here's

- \$3.50 for 1 year  
 \$8.00 for 3 years

name \_\_\_\_\_

address \_\_\_\_\_

city \_\_\_\_\_

zone \_\_\_\_\_

state \_\_\_\_\_

Hand this order to your newsdealer or send it to

POPULAR MECHANICS  
200 East Ontario St. Chicago 11, Ill.





# TIRE SALE

25 YEARS IN BUSINESS  
AT THE SAME ADDRESS

**SPECIAL!**  
Discount  
10% on  
orders for  
Two or  
More used  
tires

**FREE**

**GUARANTEE BOND** given with each used tire sold. We guarantee the amount of service you pay for. **SEND AD.**

**YOU CAN'T LOSE!!**

800x16	\$5.32	670x15	\$5.52	650x16(8)	\$7.52	800x15	\$6.32
800x16(6)	6.92	710x15	5.52	750x16(6)	8.42	820x15	6.92
850x16	5.92	760x15	5.92	640x15	5.42	700x16(6)	9.22
				1100x20	20.92	1100x22	21.22
700x15(8)	\$10.02	700x20	\$11.92	750x17	\$14.42	825x20	\$19.92
750x16(8)	12.72	750x20(10)	15.62	600x20	10.32	900x20	19.92
700x17	11.42	750x20(8)	13.62	650x20	11.92	1000x20	20.42

**12 MOS. WRITTEN GUARANTEE. WHITE WALLS \$1.00 EXTRA**  
**"EXTRA SPECIAL" TOP QUALITY** all size 4-ply pass. **FREE TIRE** with 2 or more of these. **W.W. \$8.82 EA.**  
**\$1.00 Extra - GIANT TIRE SALE.**

Thousands of tires shipped all over the U.S.A. All tires shipped F.O.B. Phila. Send Check or M.O. with this ad. Dept. 2. No C.O.D.  
**STANDARD 834 N. Broad St., Philadelphia 30, Pa.**



## WORLD'S LOWEST PRICED ADDING MACHINE

**Counts up to 999,999,999**  
**IDEAL FOR BUSINESS AND PERSONAL USE - GUARANTEED ACCURATE.** Not a toy. Operates with only a finger flick. Adds, subtracts, multiplies, divides. Counts up to one billion. Pays for itself over and over. **Ideal Gift - for Business, Income Tax and School use.**  
**MONEY BACK GUARANTEE.** Send name and address. Pay postman only \$2.95 plus postage. Beautiful rich-looking Leatherette Case included at no extra cost. Money back in 10 days if not delighted. **AGENTS WANTED.**

**CALCULATOR MACHINE COMPANY**  
P.O. Box 126, Dept. 5-81, Huntingdon Valley, Penna.

Vest Pocket Size  
**FREE TRIAL \$2.95**

**\$3.04 IN PENNA. INCLUDING 3% TAX**

## Learn ACCOUNTING

### Business Administration

Bookkeeping, secretarial and allied subjects at home in your spare time or attend nationally approved resident school. Write for **FREE Success Book** giving complete details on courses, plans, rates and employment opportunities. G.I. approved. Write Dept. A.

**Hills BUSINESS UNIVERSITY AND EXTENSION SCHOOL**  
619 W. MAIN ST. OKLAHOMA CITY 2, OKLAHOMA

## SIGN PAINTING

### Home-Study Course - Only \$5.95

Teaches you commercial sign painting and sign building as it is being done TODAY in leading shops all over the country. Complete practical course for self-instruction. Shows latest methods of truck lettering, office doors, wood letters, reflecting signs, plastics, sprayed signs, gold leaf, silk screen process, up-to-date alphabets, money-making business information, etc.

**SATISFACTION GUARANTEED OR REFUND!**  
Contains all the instruction of a high-priced correspondence course. Full price, only \$5.95, postpaid. Or C.O.D. plus postage. No risk - order today. Satisfaction or money back! Order "Sign Painting Course."  
**NELSON-HALL CO., 210 S. Clinton St., Dept. 235-2, Chicago 6, Ill.**

## JEEP OWNERS

**RE-POWER NOW WITH A V-8 ENGINE - Use FORD • CHEVROLET • MERCURY**  
in 2 or 4 Whl-Dr. Jeeps, Jeepsters, Sta-Wgn, Trucks, M. J. and Kaiser cars. Conversion Kits \$43.25 to \$59.85. If you want fast action tell us which engine you wish to use, give us year, Model (2 or 4 Whl-Dr) of your vehicle. Send Min. \$15.00 Dep. and we will ship correct kit. Bal. COD. Send full amt. for prepaid shipment. Wire, phone or write for free details. Also Kits for FORD 6 engine.

**HOOSIER MACHINE PRODUCTS CO.**  
312 S.E. 6th St. Phone CR 6-3442 Pendleton, Oregon, U.S.A.

## HOTTEST THING ON Jeep FRONT WHEELS

**STOP FRONT DRIVE DRAG IN 2 W. D.**  
Warn Hubs on your 4 w. d. disengage the front drive in 2 w. d., give it double-duty value with free-wheeling 2 w. d. economy, performance, plus normal 4 w. d. - automatically, with Warn Lock-O-Matics, manually with Warn Locking Hubs. See your dealer soon!

**WARN HUBS**  
WARN MFG. CO., INC.  
Riverton Bx 6064-A9, Seattle 88, Wn.

# Make your interest in AUTO MECHANICS & DIESEL PAY OFF!



**OUR FAMOUS SHOP METHOD HOME TRAINING PREPARES YOU FOR BIG TIME PAY AT HOME IN SPARE TIME**

## YOU GET AND KEEP ALL THIS EQUIPMENT

Complete set of professional tools and All-Metal Tool Box. Same top-quality equipment used by expert mechanics everywhere. Use them, display them proudly.

"Motor Analyzing Set" contains Standard Engine Vacuum Fuel Pump Tester, Remote Starter Switch, Modern Timing Light, Standard Compression Tester. Plus compact carrying case & instructions.

Top-quality Socket-Wrench with Fittings. Real professional tools you'll use during your lifetime career in repairing all types of engines, from foreign cars to big diesel jobs.

Nearly 60 million cars and trucks on our roads! If you could talk to owners of garages, service stations and car dealerships (as we do every day), you'd realize America's **DESPERATE NEED FOR TRAINED MECHANICS.**

Take your choice—One modern course prepares you for Auto-Mechanic jobs, Airplane Mechanics, Farm Machinery Repair, all Diesel Jobs, Experimental Labs, Government Work, Engine Specialties, etc. A qualified, **ALL-AROUND Mechanic** always has a good job.

Every phase is **Shop-Tested!** Streamlined lessons, diagrams, manuals are easy to understand. Earn as you learn. Free Graduate Employment Service.

**FREE!**  
**VALUABLE BOOK & SAMPLE LESSON**  
JUST SEND COUPON

**RESIDENT TRAINING AT LOS ANGELES!** If you wish to take Resident Training at Los Angeles, in our big, modern Shops & Labs, check special box in coupon for full information.

**APPROVED FOR GI TRAINING**  
**NATIONAL SCHOOLS**  
Los Angeles 37, California

**NATIONAL SCHOOLS**  
TECHNICAL TRADE TRAINING SINCE 1905  
LOS ANGELES 37, CALIFORNIA

MAIL NOW TO  
NATIONAL SCHOOLS, Dept. DB-98

4000 S. FIGUEROA ST.  
LOS ANGELES 37, CALIF.

Send for **FREE Auto-Diesel Opportunity Book and Sample Lesson.**

NAME \_\_\_\_\_ AGE \_\_\_\_\_

ADDRESS \_\_\_\_\_

CITY \_\_\_\_\_ ZONE \_\_\_\_\_ STATE \_\_\_\_\_

Check if interested **ONLY** in Resident School Training at Los Angeles

VETERANS: Give date of discharge \_\_\_\_\_



# CTI Keeps You Ahead with More New Ideas in

## TV-ELECTRONICS

HOME TRAINING

**YOU GET 20 BIG KITS TO BUILD  
21" TV SET AND TUBE TESTER**

**EARN UP TO \$150 A WEEK** and more as an Electronics Technician. Repair radios and TV sets. Or get into Automation, Communications, Broadcasting, Radar. Over 100,000 jobs are waiting. Wonderful opportunities to go in business.

**TRAIN AT HOME IN SPARE TIME.** We send 20 kits of parts and tools. You learn by practicing—build a 21" TV receiver (with new 110° picture tube) and Tube Tester. Tester is a CTI "first." You also assemble a Power Supply unit, VTVM, and Fixed Frequency Generator. Most students earn as they learn. Many open shops. Mail coupon for free Catalog and Lesson Samples.



NEW!

### MAIL TODAY • TWO FREE BOOKS

Commercial Trades Institute • Dept. T-101  
1400 Greenleaf Ave., Chicago 26, Ill.  
Please send valuable free catalog, *You and Television*, and Lesson Samples.



Name \_\_\_\_\_ Age \_\_\_\_\_  
Address \_\_\_\_\_  
City \_\_\_\_\_ Zone \_\_\_\_\_ State \_\_\_\_\_

## Pocket Transistor Radio

"Hit Parade"  
Mighty Midget



\$7.95

Low Priced  
Smart Design!  
Marvelous Reception!

Size of cigarette package, yet thrilling performance. Weighs only 3 ounces. Listen while traveling, at ball game, in home or office or school. Includes Hi-Fi speaker-phonograph for private listening. Modern two-tone moulded plastic case, red with gold metal grille. Complete broadcast band. On-off switch one end. Uses 2 standard penlight cells (included). Guaranteed. **\$7.95** Complete, ready for immediate playing. Postpaid Only. **JOHNSON SMITH & CO.** Dept. 683 Detroit 7, Michigan

## New Jet Engine Burns Gasoline



Powerful continual thrust for models: boats, cars, planes. No moving parts. Easy to start. Runs on regular gas. 6-in. long. Complete. Only **\$1.49** **JOHNSON SMITH & CO.** Dept. 683 Detroit 7, Michigan

## Catalog of 3100 Novelties 10c

Send 10c for amazing catalog of novelties, live animals, scientific supplies, hobbies, funmakers, planes & boats, looms, magic tricks, joke articles, unusual seeds, gadget time-savers, cameras, optical goods, projectors, movies, lucky jewelry, religious novelties, disguises, musical instruments, stamps, coins, puzzles, fortune tellers, radios, auto & bike accessories, telescopes, magnifiers, compasses, banks, smokers' gadgets, artists' supplies, printing sets, eyeglasses, motors, shockers, knives, billfolds, guns, rifles, sports, books, games, plants, etc. Send 10c (3 for 25c—get for friends!). **JOHNSON SMITH & CO.** Dept. 683 Detroit 7, Michigan

# WAR SURPLUS BARGAINS

**\$500,000.00 INVENTORY  
for QUICK LIQUIDATION**

Surplus items—hundreds of them for home, shop, factory, farm and outdoor use. New items, used items, reconditioned items—all at tremendous savings—all priced for quick sale.

**Page After Page of Values**

This big catalog shows page after page of amazing money saving values. Write for your copy today. Send 10c to cover postage, mailing, etc. Write today! **SEND TODAY FOR YOUR COPY**

10c

**STARK'S** 212 W. Madison St.  
Dept. PM-589  
CHICAGO 6, ILL.

### PLANS FOR CHILD SIZE ELECTRIC MODEL "T"

SIMPLE CONSTRUCTION

- Full size patterns
- For children 4 to 12
- 5 to 7 miles per hour
- Forward and reverse
- 10 to 20 miles per battery charge
- 6 volt auto generator for power — no rewinding

Except for some welding, it can be built with hand tools.

Parts Available  
Plans Dept., Box 44  
Ione, California

PLANS \$2.00

### GEBHARDT MODEL CARS

### CONCRETE BLOCK HOME PLANS

**\$2500 RANCH HOME**

Build your own 25' x 48' Ranch Home complete for \$2500. Forced air heating system available \$295. Contains Liv. Room, kit, three bedrooms, bath, utility room, fireplace, carport, or garage. Blueprints, instructions, and material list \$3.00 ppd. Money back guarantee. Other plans — \$1900 DUPLEX, \$1150 GARAGE APARTMENT, \$950 CABIN. FREE FOLDER.

MEMBER ARKANSAS HOME BUILDERS ASSOC.

**BAILEY BUILDERS, 308 Hiawatha Drive, Little Rock, Ark.**

### BRONZE FOUNDRY

Schools • Home Workshops • Inventors

Make your own castings of aluminum, copper, bronze, silver. Foundry sets are available in three sizes including 2400 Deg. F. blast Furnaces. \$26.50; \$33.50; and \$46.00 f.o.b. Marysville or Lakewood. Free Circular.

**KANSAS CITY SPECIALTIES CO.** (Dept. ) Box 6022, Marysville, Kans. P-9 or Box 7543, Lakewood, Colo.

### Finish HIGH SCHOOL AT HOME

**Complete 4 Yrs. in 12 Months**

Learn More! Earn More! Enter professional or technical schools. Advance Socially. Live a Happier, Fuller Life. Individual Courses or complete schedule. **WRITE FOR SCHOOL BULLETIN.**

**ACADEMY FOR ADULTS**  
30 W. Washington, Dept. PM-98, Chicago, Ill.

### How To Make A New Start

Learn the secret of Prayer that Works. New interpretation of the Bible promotes happiness, health and prosperity. Can solve your problem. Nothing else like it. Write today for free booklet.

**ONTOLOGY FOUNDATION, Box 146P, Homewood, Ill.**



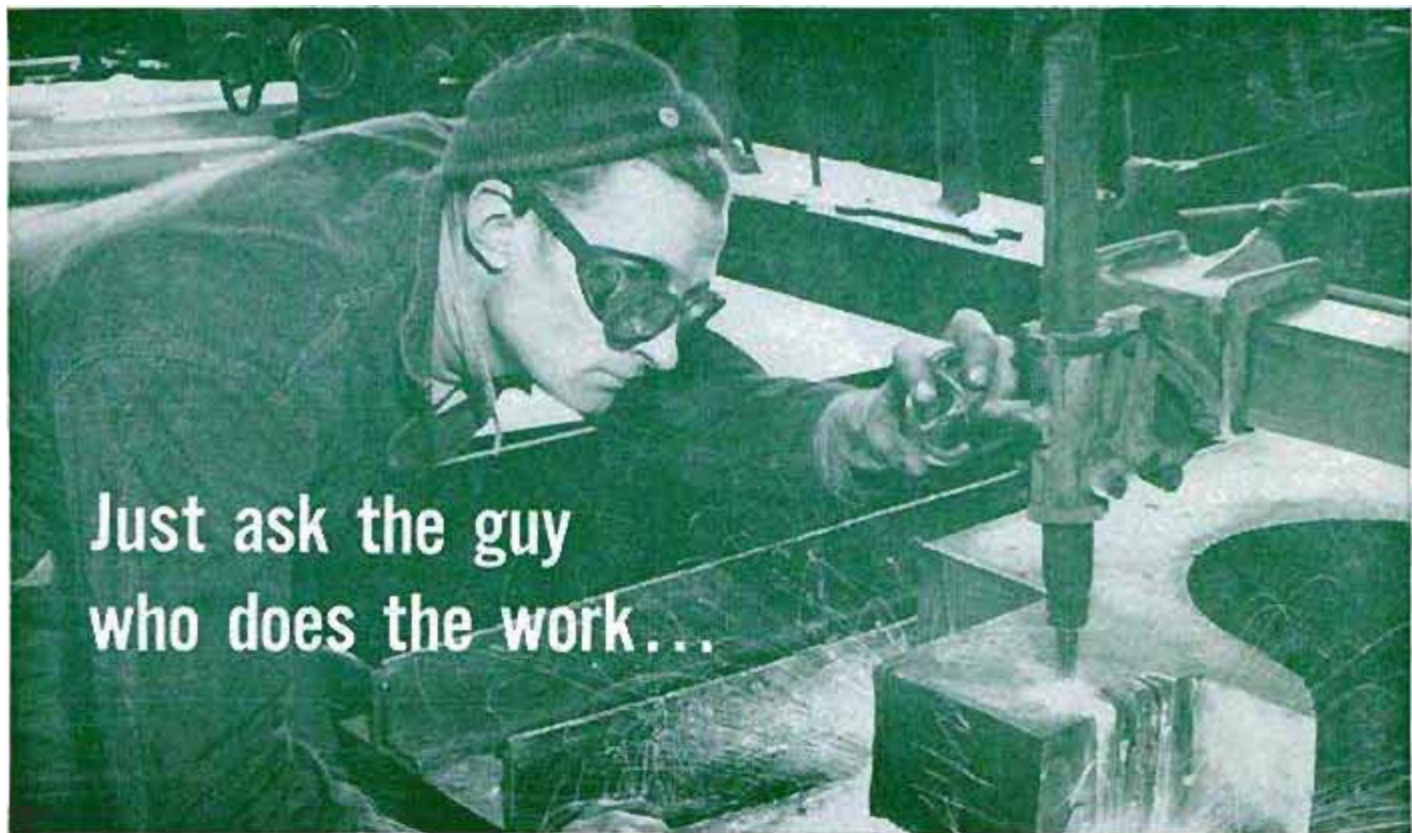

Just ask the guy  
who does the work...

Niagara Falls Machinist says:

"I'm right there! I see how much research, skill and plain hard work goes into today's top products...

**I'm always satisfied most with  
a BRAND that's made a NAME for itself!"**



**MANUFACTURER:** "I'm satisfied it's the most modern, the best of its kind on the market. That's the only way to win satisfied customers—with a top quality product. And, that's the way to keep them, too!"

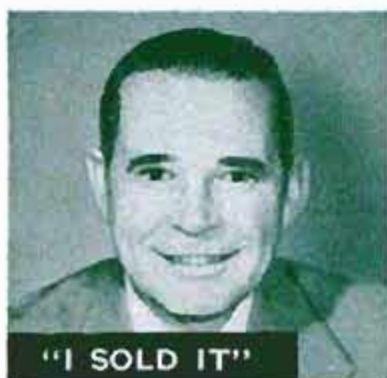

**DEALER:** "I know my customer is really satisfied. That's the way with well-known brands. They offer the latest improvements and widest choice. Name brands certainly save everybody a lot of headaches."



**CUSTOMER:** "I'm satisfied it's the best for my money. I'd be lost without brand names to guide me. My wife and I can even order by phone without taking any risk. We know we're getting what we want."

THE BRANDS YOU SEE ADVERTISED IN THIS MAGAZINE ARE NAMES YOU CAN TRUST!

They stand firmly behind every product and claim they make.

BRAND NAMES FOUNDATION, INC. • 437 FIFTH AVENUE, NEW YORK 16, N. Y.



# Beat This for a New Job!

- ➔ Pays Up To \$100 a week to start!
- ➔ Business Expenses Paid!
- ➔ Car Furnished or mileage paid!
- ➔ We teach you at home in spare time!
- ➔ You can qualify in 6 weeks!

Automobile Claim Investigators are needed in every State in the Union. Last year alone over 25 million auto accident claims had to be settled. *And the Claim Investigator was the Key Man in every case.* There's such a shortage of trained men in this interesting field even a beginner, with spare time home training, can get good pay. Many start at as much as \$400.00 a month—many with a private office, a private secretary, a car for their personal use and *all business expenses paid!* Or you can establish a Claim Investigating business of your own—in spare time—with your home as headquarters. Claim adjusting is easy to learn, too, with my kind of "Brass Tacks" training. For many years, I was senior adjuster and head of a claim office of a company that insures over 5 million automobiles. I know the business from A to Z and can teach you quickly and thoroughly so you will be able to qualify for a Well-Paid Job in a matter of weeks. And your very first check will usually pay for the entire course! Let me send you full information free. No salesman will call and you will not be under the slightest obligation in getting the facts. Mail the handy coupon now to me, Eric P. McNair, President, Liberty School of Claim Investigating, Libertyville, Ill.



## SIMPLY MAIL THE COUPON

ERIC P. McNAIR, President, Dept. 99  
Liberty School of Claim Investigating  
LIBERTYVILLE, ILLINOIS

Please tell me all about how I can quickly become an Auto Claim Investigator in my own area. It is clearly understood that everything you send me now is free and no salesman will call.

MY NAME ..... My Age .....

ADDRESS .....

CITY ..... Zone ..... STATE .....

start a big profit business  
with a small investment  
**EARN UP TO  
\$200 a DAY**

## Manufacturing Exciting New RAINBOW ROCK Concrete Slump Brick in your back yard

Earn big building boom profits with Rainbow Rock, the colorful new building brick that's taking the country by storm. Sell all you can make to contractors, builders, building supply houses. **RAINBOW ROCK CUTS LABOR COSTS BY 1/3!** Amazing low cost machine makes modern slump brick 24" long (3 times the length of ordinary brick) in a variety of widths and pastel colors . . . up to 1500 bricks a day! **NEEDS NO SPECIAL SKILL.** Operates indoors or out. Full instructions and valuable mixing formulae supplied. **YOU CAN START EARNING BIG MONEY NOW. PAY AS YOU PROFIT!** A limited number of machines available on easy payment terms. **NOW** is the time to start. Write today for free literature and full information.

**GENERAL ENGINES CO., INC.**  
Dept. MR-98 — Route 130,  
Thorofare, N. J. — Tilden 5-5401



**STEEL PIER SENSATION**  
Luxurious RAINBOW ROCK fireplace wall in living room of the "Home of the Century" in Atlantic City, N. J.'s Steel Pier . . . acclaimed by over 500,000 Summer, 1953 visitors as the most beautiful they'd ever seen! Endorsed by the Pier's famous architect, William F. B. Koelle.



Makes beautiful, decorative fences, garden walls, garages, outside walls, room separators, etc.

# INVENTORS

PROTECT YOUR INVENTION BY A U. S. PATENT. SEND FOR FREE "INVENTION RECORD" FORM AND "PATENT INFORMATION EVERY INVENTOR SHOULD HAVE."

**CARL MILLER**  
REGISTERED PATENT ATTORNEY

WOOLWORTH BLDG., 36th FLOOR, 98A  
NEW YORK CITY

# INVENTORS

Whether an invention is patentable can be substantially determined by a search of the U. S. Patent records. Without obligation, write for information explaining the steps you should take to secure a patent.

**JOHN N. RANDOLPH**

Registered Patent Attorney  
801 Victor Building, Washington 1, D. C.



# INVENTORS

U. S. Patents protect your inventions. Our free book of "Instructions on Patent Procedure for Inventors," also "Certificate of Invention" form sent without obligation.

**C. A. SNOW & CO.**

REGISTERED PATENT ATTORNEYS  
428 SNOW BUILDING WASHINGTON 1, D. C.

# INVENTORS

Send for  
**PATENT INFORMATION**  
Book and  
**INVENTOR'S RECORD**  
without obligation

**GUSTAVE MILLER**  
98-PM WARNER BUILDING  
WASHINGTON 4, D. C.

**REGISTERED PATENT ATTORNEY**

ASSOCIATE EXAMINER  
U. S. PAT. OFF. 1922-1929  
Patent Attorney & Advisor  
U. S. NAVY DEPT. 1930-1947  
**PATENT LAWYER**

# INVENTORS

I shall be pleased to furnish you, upon request, with full information relative to patent procedure—without any obligation on your part.

**PATRICK D. BEAVERS**

Registered Patent Attorney  
934 Victor Building Washington 1, D. C.



**SAFE AS AMERICA**



# BVI Painting is Easy! Electric PAINT SPRAYER

only **\$12.95** complete  
with built-in motor  
**Fully Guaranteed**

Just plug in, pull trigger and spray paint, varnish, enamel, garden sprays and insecticides, 3 to 7 times faster than painting with a brush! Features sapphire nozzle, instant adjustment for heavy or light spray. Foolproof and trouble-free! Available now at dealers everywhere!

**Burgess Vibrocrafters Inc.**  
Grayslake, Illinois



**ALL NEW "ELECTRIC" MOTOR OIL FILTER**  
**RECLAIMO**  
The World's Wonder Filter

Since 1925 THE UNEQUALLED 4-ACTION PERFORMER  
REMOVES D., F-D., W. A.—OIL Always STABLE.  
FREE "Oil Facts" . . . DEALERS WANTED

RECLAIMO CO., 6251 Touhy, Dept., 10, Chicago 31, Ill. New 1958 PATENT



**"How to Make Money with Simple Cartoons"**

A book everyone who likes to draw should have. It is free; no obligation. Simply address **FREE BOOK**

**CARTOONISTS' EXCHANGE**  
Dept. 99-D Pleasant Hill, Ohio



**REAL SOLAR ENGINE ONLY \$1.75 Ppd.**

Scientific instrument used in Physics laboratories to prove light is power! The vanes will whirl in ordinary room light—turn up to 3000 R.P.M. in sunlight. Even by invisible rays of black light. Fascinating — Educational. Turns forever with no upkeep. Guaranteed.

**J. D. CLINTON, 35 N. Broadway, Mt. Clemens 2, Mich.**



**SALE 20 X 50**  
REGULARLY \$74.50  
SAVE \$44.55!

High powered, whisper-weight (27 oz.) color corrected, Achromatic binoculars, 7" high! EZ to hold, EZ to SALE PRICE ONLY

Use 30 DAYS. If not satisfied return for refund. Add 10% Tax. Add \$1 postage, handling.

**\$29.95**

UNITED BINOCULAR CO., 9043 S. Western, CRF-2508, Chicago 20. DEALERS WANTED

c.o.d.'s require \$2 deposit.



**95% PROFITS YEAR 'ROUND**

Be your own boss, Operate a **SIMPLEX** lawn-mower sharpening service in your community. One compact machine grinds all mowers, sharpens cutlery. Low investment, 95% profit. Pays for itself in average month.

**SIMPLEX**  
—4 Machines in One!  
Reel Grinder—sharpens any mower reel in or out of mower.  
Bed Knife Grinder—grinds with either round or cup wheel.  
Rotary Blade Grinder—hollow grinds any rotary mower blade.  
Cutlery Knife Grinder—sharpens cutlery, tools, scissors.

Send for free, money-making details!  
**The FATE-ROOT-HEATH Company • Dept. PM-9, Plymouth, Ohio**



# TRAIN AT HOME

in Your Spare Time or in the Great Allied School

1338-42 South Michigan Ave.  
Chicago 5, Ill.

**DRAFTING—All Branches**  
• Mech. • Structural • Aeronautical

**ENGINEERING**  
• Industrial Engineering  
• Tool Engin. & Designing

**ELECTRONICS**

**AUTO MECHANICS**

**AIR CONDITIONING**  
Refrigeration — Heating & Cooling

**TOOL & DIE MAKING**  
Machinist Trade

Choose the Allied Way for Best Pay

SEND FOR **FREE** BOOKS

Prepare for the best jobs in your spare time at home. With ALLIED'S practical home study program you can progress so rapidly that big new opportunities will soon be open to you. Students planning a career in engineering can begin their training in short courses at Home or at Allied Institute and continue progressively toward an Engineering Degree in 31 months. Allied is approved by Industry, National Home Study Council, Department of Education, Office of Public Instruction, State of Illinois, U. S. Department of Justice.

**ALLIED INSTITUTE OF TECHNOLOGY,**  
1338-42 South Michigan Ave., Dept. PM-98, Chicago 5, Ill.

Send me without obligation information on your courses:

<input type="checkbox"/> MECHANICAL DRAFTING	<input type="checkbox"/> AUTO MECHANICS
<input type="checkbox"/> STRUCTURAL DRAFTING	<input type="checkbox"/> ELECTRONICS
<input type="checkbox"/> AERONAUTICAL DRAFTING	<input type="checkbox"/> AIR CONDITIONING
<input type="checkbox"/> INDUSTRIAL ENGINEERING	<input type="checkbox"/> REFRIGERATION
<input type="checkbox"/> TOOL & DIE DESIGNING	<input type="checkbox"/> TOOL & DIE MAKING
<input type="checkbox"/> HOME STUDY	<input type="checkbox"/> RESIDENT
<input type="checkbox"/> VETERAN	<input type="checkbox"/> NON-VETERAN

NAME \_\_\_\_\_ AGE \_\_\_\_\_

ADDRESS \_\_\_\_\_

CITY \_\_\_\_\_ COUNTY \_\_\_\_\_ STATE \_\_\_\_\_



**WORLD FAMOUS  
POWERFUL!**

# Black Eagle GERMAN BINOCULARS



Importer's Special!  
OUR **3.98** VALUE

# 88¢

plus 12¢ postage

## FREE

Shoulder Straps  
Magic Lens Cloth

## 10 DAY TRIAL!

## 25 MILE VIEWS!

**9 Times Area Magnification!  
38 mm Unbreakable Lenses!**

We've sold over 1,000,000 binoculars, but this is our greatest low price value. Our reg. \$3.98 Black Eagle German Binoculars now slashed to only 88¢ plus 12¢ for postage & handling. This offer made to win 25,000 new customers. Famous power binoculars with same features as in expensive models. Brings in distant

objects, animals, people, etc. so sharp & clear you'll be amazed! Hi-fi views up to 25 miles away. Synchronized center focusing. Lightweight construction. View for hours without arm fatigue. Full size binoculars. Rush 88¢ plus 12¢ for postage & handling (Total: \$1) for prompt FREE delivery. Money back guarantee. Order direct from famous importer: **THORESEN, Inc., Dept. 6-K-78** 585 Water Street, New York 2, N.Y.

*There's money  
to be made*

## IN THE ORNAMENTAL CONCRETE BUSINESS

Manufacture—and self—ornamental concrete products yourself. Easily, simply produced, here is a low-cost, do-it-yourself project that means money—Big Money.

CMC permanent, light-weight, high quality Aluminum Molds give you both ease of production and copyrighted designs that have set a national record of sales success.

Get the full story of this high profit, low cost business. Send today for your copy of the big, fully illustrated book "How to Turn Concrete into Gold." The clear, easily followed "from start-to-finish instructions" that show you how to produce beautiful, ornamental concrete products. Plus valuable sales and market tips. Catalog of over 200 Specialty Molds. A complete industry manual.



Send \$2.00  
for your  
copy



**CMC** CONCRETE  
MACHINERY  
COMPANY, INC.  
DEPT. PM  
HICKORY, NORTH CAROLINA

## NOW! LEARN... "HAM" RADIO TALK FREE ROUND-THE-WORLD!



Yes, talk anywhere, with your own equipment. Car to home, home to Honolulu, Track Earth Satellites. Be official station your city for life-saving communications during fire, flood, other disaster. Gain lasting respect of civic leaders. Exciting, satisfying. Makes friends, builds popularity.

**EXCITING SHORT CUT TO BIG-PAY CAREERS** Ham radio opens door to important jobs in armed services, missile development, TV, radio. Many radio "hams" now top executives in electronics, related industries. Gov't careers, too! Start now. No previous experience needed. Amazing new "do-it-yourself" technique makes everything easy, prepares you twice as fast! Includes parts to build your own set. Send for **FREE BOOK today sure.** Get thrilling facts that may change your whole life.

**HAM RADIO COURSE**  
Dept. B-179, 1038 S. La Brea, Los Angeles 19, Calif.

## 500 PRINTED NAME & ADDRESS LABELS 25¢



500 Gummed Labels printed with ANY name and address, 25¢ per set! 4 sets (same printing or all different) \$1.00! Padded. Two-tone jewel-type plastic gift boxes only 10¢ extra, 4 for 25¢. Order as many or as few sets and boxes as you want. Only 25¢ per set. Money-back guarantee!

**WESTERN STATIONERY, Dept. 961, Topeka, Kan.**

## EARN UP TO \$10,000 YEARLY LEARN PIANO TUNING & REPAIRING

Now you can be a piano tuner-technician with our sure-fire low cost home study course. No musical knowledge necessary. Piano tuners are taught—Not born. Tuner-technicians greatly in demand. Your business will be operated in your own home. Pay as you learn. Don't miss this opportunity. Write today. No obligation.

**ERIE PIANO SCHOOL, 362 W. 8th St., Erie, Penna.**

## RUBBER STAMPS

Finest Quality Supplies and Equipment for  
manufacturing rubber stamps.

Write for Price List.

**LOUIS MELIND CO.**

3526 N. Clark

Chicago 13

## HYDRAULIC JACK REPAIRS



### Earn While You Learn at Home

Millions of jacks in gas & auto-service stations, truckers, body-shops, riggers, factories, farms need servicing. We show you HOW—easy step by step directions—what tools to use. **EARN UP TO \$5 an hour**, in spare time, in your own basement or garage. Start your own business NOW.

Write for folder No. PM-9 & free bonus offer

**Institute of Hydraulic Jack Repair**  
P.O. Box 50, Bloomfield, N. J.

## I'll Send You This Handsome SAMPLE CASE—FREE



and Show You How to Make  
Up to \$30.00 in a Day

**WRITE** for this FREE Tailoring Sample Case packed with 100 beautiful, big-value suit and overcoat fabrics. Take orders from friends, fellow-workers, others, for fine quality, made-to-measure clothes. Pocket big cash profits in advance. Because wearing our suits and over-

coats brings more orders, we make it easy for you to get your own clothes without 1¢ cost. No experience is needed. **SATISFACTION GUARANTEED.** SEND NO MONEY. Rush your name, address, and age—today!  
**PIONEER TAILORING COMPANY, Dept. D-1116**  
CONGRESS & THROOP STREETS • CHICAGO 7, ILLINOIS



# LEARN MEAT CUTTING AT NATIONAL

Pay After Graduation



The steady dependable trade of Meat Cutting taught easily in 8 short weeks. YOU LEARN BY DOING under actual meat market conditions in big modern school at Toledo.

For beginners or men with experience. Get a profitable store of your own. Remember, PEOPLE MUST EAT! Big pay jobs. Free employment help. Thousands of successful graduates.

Buying, cutting, percentage, pricing, advertising, selling, etc. A complete retail meat education. National School established 35 years. Get National training NOW. Pay your tuition in easy weekly

payments after you graduate. Send coupon for FREE 52 page school catalog — TODAY. G.I. approved.

**National School of Meat Cutting, Inc., Dept. 50-H, Toledo 4, Ohio**

Send me your FREE school catalog on National Training at Toledo in Meat Cutting, Meat Merchandising and Self Service Meats. No obligation. No salesman will call.

Name \_\_\_\_\_ Age \_\_\_\_\_

Address \_\_\_\_\_

City \_\_\_\_\_ State \_\_\_\_\_

Approved for Veterans

## SEWS LEATHER

AND TOUGH TEXTILES LIKE A MACHINE

With SPEEDY STITCHER Automatic Sewing AWI, anyone can quickly and skillfully sew or repair anything made of LEATHER, CANVAS, NYLON, PLASTIC, or other heavy materials. Sews firm, even lock-stitches like a machine. Gets into hard-to-reach places. Specially made for heavy duty sewing on LUGGAGE, FOOTWEAR, RUGS, AWNINGS, SAILS, SADDLERY, UPHOLSTERY, OVERALLS, AUTO-TOPS, SPORTS GEAR, and other tough sewing jobs. Here's the handiest tool you'll ever own. Will save you many times its small cost. Comes ready for instant use . . . complete with hobbins of waxed thread and 3 different types of diamond-pointed needles. Easy-to-follow directions will make you an expert in minutes. Extra needles and waxed-thread always available. Save money, send \$1.98 for post-paid delivery. If C.O.D., \$1.98 plus postage. MONEY BACK GUARANTEE.



SPORTSMAN'S POST

366 Madison Ave., Dept. A-85, New York 17

ONLY 1.98

## BECOME AN EXPERT IN TRAFFIC and TRANSPORTATION

Traffic men earn \$4,000 to \$10,000 and up. Thousands of firms need experts on rates, tariffs, regulations. We train you thoroughly in spare time at home for executive traffic jobs. Personal training under traffic authorities. Write for free book "Traffic and Transportation."

LASALLE Extension University, 417 So. Dearborn St. A Correspondence Institution Dept. 964T Chicago 5, Ill.

## Take the ache out of GUMS RUBBED SORE BY FALSE TEETH

Get quick-soothing relief of sore, throbbing gums by applying medically-formulated NUM-ZIT Adult Strength. Thousands of false teeth wearers have already had this blessed relief. Pleasant-tasting NUM-ZIT eases discomfort while you break in new false teeth. Works wonders, too, for relief of toothache, neuralgic pains. Keep it handy for quick first aid. At all drug counters.

**Adult NUM-ZIT**

Another fine Purepac product

SEPTEMBER 1958

## Especially for APPLIANCE REPAIRMEN! YOU NEED ELECTRIC APPLIANCE SERVICE NEWS

EASN—now in its 8th year—is the Only Publication Serving the ENTIRE Appliance Repair Field.

EASN LISTS sources of supply for parts on all types of household electric appliances, such as washing machines, dryers, irons, vacuum cleaners, ranges, sewing machines, toasters, irons, mixers, coffeemakers, and so forth.

EASN OFFERS a "Buyers' Guide," listed alphabetically by product name, to help you get the parts you need.

EASN ADVERTISERS send free mailings of catalogs and other pertinent market information to subscribers, from time to time.

EASN BRINGS NEWS of appliance repair schools and clinics in your area.

EASN OFFERS free information service to its subscribers; answers many of your "where to get it" questions.



ONLY PUBLICATION SERVING THE ENTIRE APPLIANCE REPAIR FIELD

505 N. LA SALLE ST.

CHICAGO 10, ILL.

### TRIAL OFFER

**ELECTRIC APPLIANCE SERVICE NEWS** (Published Monthly)  
505 N. LaSalle St., Chicago 10, Ill.

GENTLEMEN: Enclosed find  Check  Money Order  Stamps  
 Cash to cover my subscription as I have indicated below:  
 \$1.00 for 5 months trial subscription, or  
 \$2.00 for 1 year  \$3.00 for 2 years  \$4.00 for 3 years

By (Individual) .....

Firm Name .....

Street .....

City . . . . . Zone . . . . . State . . . . .

(Please enclose your business card or letterhead stationery) **PM**



# LEARN UPHOLSTERY

in your spare time  
run your own  
business  
**AT HOME**



FREE TOOLS WITH COURSE!

**FREE BOOK**  
with  
sample  
lessons

with course

**YOU MAKE**  
SLIPPER  
CHAIR



CLUB  
CHAIR



OTTOMAN

**PLUS**  
SLIP COVERS  
Yours to Keep  
or Sell

## BE YOUR OWN BOSS

**Earn more from the start!** Set up your own profitable business, in your own home, enjoy steady income, independence for life. You're in demand—in good times and bad—in the booming field of Custom Furniture Upholstery. Right off you start learning and earning with tools, complete frames, fabrics and materials, included FREE with practical UTS course. You learn skilled professional custom upholstery, re-upholstery, furniture finishing, repairs, how to make beautiful slip covers, window cornices, cushions and draperies. **EARN WHILE YOU LEARN**, in your spare time **AT HOME**. . . the UTS easy way.

### FREE ILLUSTRATED BOOK—FREE SAMPLE LESSON

Get ready for well-paid job and big profits, from steady work, as your own boss, running your own business. Mail coupon NOW for FREE BOOK! Training in N. Y. School also available.

### APPROVED FOR VETERAN TRAINING

UPHOLSTERY TRADES SCHOOL  
Dept. GO-310, 721 E'way, N. Y. 3, N.Y.

Please send me FREE book, "Your New Way to a Successful Career," and FREE sample lesson. No obligation—no salesman will call.

Home Study  N. Y. School Training

Name \_\_\_\_\_ (Please Print Plainly)

Address \_\_\_\_\_

City \_\_\_\_\_ Zone \_\_\_\_\_ State \_\_\_\_\_

Check if Korean Veteran



FREE CATALOG

**ADD UP TO 25 POUNDS**  
of SOLID MUSCLES if you pay NOTHING

**\$10 BODY MOLD course included FREE** with DAN LURIE BARBELLS. Only DAN LURIE BARBELLS and "Body Mold" courses produce such amazing results. 15 minutes a day can make you a bigger man. Send today for details. Order now at lowest factory price. 50 lb. set \$8.98. 100 lb. set \$14.98. 150 lb. set \$21.98. 200 lb. set \$27.98. Semisteel sets approx. 10% higher. Extra wts. 14c per lb. send 50% cash, balance C.O.D. F.O.B. Plant.

DAN LURIE BARBELL CO., 52-M-9 Bristol St., Dept. 859-1, Bklyn. 12, N.Y.

# EARN \$100 A WEEK AND UP

## BE AN AUTO-DIESEL MECHANIC—EARN WHILE YOU LEARN

Many of our graduates earn \$100 a week and up. You learn fast in our school and shops because you learn with tools on real equipment. Experienced instructors explain WHY and show you HOW, then you DO IT YOURSELF. One of the best equipped technical schools in the United States. Thirty-nine years' experience training men. Successful graduates in 48 states and many foreign countries. Approved for veterans. Day and evening classes. Free bulletin—write today.

**NASHVILLE AUTO-DIESEL COLLEGE**  
226 7th Ave. N., Dept. 86, Nashville, Tenn.



For extra income  
or career... learn

# WATCH REPAIRING

at home the low cost Smeazey Way

Modern, simplified shop method starts you making repairs right away on Swiss and American watches. No previous experience needed. No age limit. Low terms. FREE sample lesson without obligation. Write today.

## CHICAGO SCHOOL OF WATCHMAKING

2330 N. Milwaukee Ave. Dept. 198 Chicago 47, Ill.

## Genuine U. S. Navy Surplus Last

ALL NEW GUARANTEED QUALITY

SIZES B to 11 A 7½ to 12 B 7 to 11 EE 6 to 12 D



BLACK  
ONLY **5.95**  
POST  
PAID

- Genuine Goodyear Welt
- Fine Quality Upper Leather
- Oak Bend Leather Outsoles
- Heavy Quality Leather Innersoles
- High Test Rubber Heels

**MAC'S SHOES** 205 So. Peters St.  
New Orleans, La.



## MECHANICAL DENTISTRY

To make Crowns, Plates, Bridgework, etc., for Dentists. Easy practical way to learn mechanical dentistry at home in spare time. FULL EQUIPMENT OF TOOLS AND MATERIALS INCLUDED WITH COURSE. Low tuition. Easy terms. Write for FREE BOOK about this money making profession that is not affected by machine age.

McCARRIE SCHOOL OF MECHANICAL DENTISTRY  
207 N. Broad St., Dept. 80, Philadelphia 7, Pa.

*After the city,  
Before the state  
The ZONE keeps your mail  
From being late*

The Post Office has divided 106 cities into postal delivery zones to speed mail delivery. Be sure to include zone number when writing to these cities; be sure to include *your* zone number in *your* return address — after the city, before the state.



**Nutria.... NEWEST OPPORTUNITY**



New fur-bearing animal now being bred in U. S. Offers huge profits to breeders. This fur is next to Mink NOW in price and will soon surpass it. 15 to 20 young per year. Most easily and economically raised animal known. 1 1/2¢ per day to feed. ANY CLIMATE. disease resistant. The Cabana Marrone strain is obtainable ONLY through Cabana Nutria, Inc., and its authorized dealers and distributors. For free booklet and address of Cabana ranch nearest you write:

**CABANA NUTRIA, INC.**  
Dept. 28, 636 W. Lemon Ave., Arcadio, Calif.

**"TI-NEE" BATTERYLESS TUBELESS LIFETIME RADIO**

"TI-NEE" RADIO IS GUARANTEED TO WORK FOR YOUR LIFETIME! USES NO TUBES, BATTERIES OR ELECTRICAL PLUG-INS. Never runs down! SMALLER THAN A PACK OF CIGARETTES! RECEIVES LOCAL RADIO STATIONS MOST ANYTIME, ANYWHERE WITHOUT EXTRA ANTENNA. Uses semi-conductor crystal diode Hi-Q Tuner. Beautiful black gold plastic cabinet. Built-in Speakerphone.



**SEND ONLY \$2.00** (bills, ck. mo.) and pay postman \$4.99 COD on arrival or send \$6.99 for postpaid delivery. **SEND COMPLETE READY TO LISTEN—NOTHING EXTRA TO BUY** Extra long distance Aerial kit included free to receive stations up to 1,000 miles away. **AMERICAN MADE.** Available only from: **MIDWAY COMPANY, Dept. GPM-9, Kearney, Nebraska**

**PLATE AUTO CHROME**

MAKE MONEY - SAVE MONEY - PLATE ANY OBJECT IN HOME SHOP OR GARAGE!



NOW with our NEW PORTABLE SELF-POWERED ELECTROCHEMICAL outfit. You can easily do your own plating. Not a paint. But a hard durable metal plate, equal to commercial plating. Get your own plating kit with instructions on plating metal and non-metal objects as Tools, Auto Parts, Silverware, Jewelry, Baby Shoes and 1001 other articles with Chrome, Nickel, Copper, Gold, etc. **SEND NO MONEY.** Everything sent C.O.D. for the low price of ONLY \$5.95 or send \$5.95 now and receive it postpaid. Money back in 7 days if not satisfied. **M. Z. SALES CO., Dept. G-25, 113 West 42nd St., New York 36, N. Y.**

**OWN a BUSINESS!**

**Earn \$8,750.00 your First Year!**

Start part time if you wish. We locally train you, furnish everything to clean and mothproof rugs, upholstery on location by world-wide process. Quickly established. No shop needed. Just 2 average jobs a day bring \$8,750 net profit in year. Employ others and multiply profits. You get National Advertising, Parents' Seal, 25 other regular services. Easy terms. Send today for free booklets.

**DURACLEAN CO., 8-169 Duraclean Bldg., Deerfield, Ill.**

**FLY YOUR OWN Bensen HELICOPTER**

Simple to fly — build it yourself, with engine or as inexpensive glider type which can be mounted on floats or boat. Order 3-view drawing, specs and photo of Glider for \$1 or motor powered Gyro-Copter \$2. Ask about detailed plans and construction kits.



**SENSE AIRCRAFT CORP., Dept. PM-98**  
P. O. Box 2746, Raleigh, N. C.

Name \_\_\_\_\_  
Address \_\_\_\_\_

**These men are getting practical training in..**

**ELECTRICITY**

**ELECTRONICS**

**ON REAL**



A.C. and D.C. Motors  
Generators  
Switchboards  
Controllers  
Appliances  
Electronic Units

**TELEVISION**

**COLOR-TV**

**ON REAL**



Television Receivers  
Including Color TV  
AM and FM Radios  
Auto Radios  
Test Equipment

**Train in Great Shops of COYNE**

in Chicago - Prepare for a better job and a real future in TOP OPPORTUNITY FIELDS. Train on real full-size equipment at COYNE where thousands of successful men have trained for nearly 60 years - largest, oldest, best equipped school of its kind - est. 1899. Trained instructors show you how, then do practical jobs yourself. No previous experience or advanced education needed. Employment Service to Graduates. **START NOW - PAY LATER - Liberal Finance and Payment Plans.** Pay most of tuition later. Part-time employment help for students. Frequent starting dates. **GET FREE BOOK - "Guide to Careers in ELECTRICITY-ELECTRONICS and TELEVISION-RADIO" - no obligation; no salesman will call. Vets and Non-Vets get vital facts now.**

B. W. COOKE JR., Pres. **COYNE ELECTRICAL SCHOOL** FOUNDED 1899  
Chartered Not For Profit  
500 So. Paulina Street Chicago 12, Dept. 68-3C

**MAIL COUPON TODAY**

**COYNE ELECTRICAL SCHOOL Dept. 68-3C**  
500 S. Paulina St., Chicago 12, Ill.

Send BIG FREE book and details of your training offer by return mail. I am interested in:

Electricity-Electronics  Television-Radio

Name \_\_\_\_\_  
Address \_\_\_\_\_  
City \_\_\_\_\_ State \_\_\_\_\_



# ENGINEERING



Photo of Heald Student in Electrical Laboratory

American Industry Steps Up Its Demand for Trained Engineers. Train Now at Healds **BACHELOR OF SCIENCE DEGREE, 27 MONTHS**

**Degree Courses:**

- Radio-Electronic Eng.
- Electrical Engineering
- Highway Engineering
- Mechanical Engineering
- Structural Engineering
- Civil Engineering
- Architecture

**Diploma Courses:**

- TELEVISION  Color TV
- Radio-Electronic Tech.
- Industrial Electronic Tech.
- Tool & Die Design
- Architectural Drafting
- Mechanical Drafting
- Structural Drafting

Approved for Veterans

Heald College Ranks **FIRST** West of the Mississippi in "Who's Who in America"

Send for FREE Information Heald Engineering College

Est. 1883 Van Ness at Post, Dept. P.M. San Francisco, California

Enroll Now for New Term

NAME \_\_\_\_\_  
 STREET \_\_\_\_\_  
 CITY \_\_\_\_\_  
 STATE \_\_\_\_\_

## PAINT STRAIGHT or CURVED LINES with Sensational PAINT PEN

DECORATE Furniture, Interiors, Autos, Bikes, Model Planes, Boats, Toys, Linoleums, Wall Board, etc.

PAINTS on wood, glass, plastic, ceramics, metals, fabrics and paper. Use any color paint, glue, tempera, textile paint or underglaze: secure clean, professional decorative lines. No clog or smear.

ORDER NOW Direct or From Your Dealer Only . . . . . **\$125**  
 Other single stripe models:  
 1/64" 1/32" 3/64" 5/64"  
 3/32" 1/8" only \$1.75 ea. Extra tips  
 90c each, Extra 1/4" tip \$1.20.

SPECIAL: Complete Set **\$500**  
 (Pen and all 7 tips) Only Single Line.

Double Stripe Model-w/5 combination \$3.25 C.O.D. Postage Collect.  
**WENDELL MFG. CO., 4324 LINCOLN AVE. DEPT. 344 CHICAGO 18, ILL.**



MFRS. ask about heavy duty, precision industrial and production stripping tools.

**FOR DEALERS:** Fast profitable seller; attractive display, write for money-making details.

**PAINTERS, CRAFTSMEN:** "Professional" results every time with this time-saver.

## YES, you can own a MOTORCYCLE

for only **\$179** and up



Send for FREE ILLUSTRATED LEAFLETS on the world's 10 most exciting motorcycle, moped and scooter values. From 3 to 42 HP. 4 Models under 5 HP (approved by many states for boys at 14). SALES-SERVICE AGENCIES FROM COAST TO COAST



Write today. BERLINER MOTOR CORP., Dept. PM-2, 2432 Grand Concourse, N.Y. 58

## NEW MAGIC RADIO WALKIE TALKIE!

**YOUR OWN POCKET SIZE RADIO STATION!** BROADCASTS TO ANY HOME OR CAR RADIO WITHOUT WIRES OR HOOKUPS! Wt. only 5 oz. Size, 1 1/2 x 2 1/2 x 1 1/2". Built-in telescoping antenna. Powerful Transistor-sensitive microphone, frequency setter, break-in switch! Runs for weeks on self-contained flashlight batteries. Durable plastic case. With this Radio Talkie you CAN TALK TO YOUR FRIENDS UP TO A BLOCK OR MORE AWAY! Talk up to 1 mile or more between two automobiles. INSTANT OPERATION! Just push button to talk! No license needed. Uses inductive field magnetic radiation. Useful and real fun in a million ways! **GUARANTEED TO WORK. 1 YEAR SERVICE GUARANTEE.** SEND ONLY \$3.00. (cash, ck, mo) and pay postman \$9.98 COD postage or send \$12.99 for prepaid delivery. COMPLETE READY TO OPERATE with instructions and hundreds of ways and tricks for broadcasts thru any radio you desire. Price may go up soon, so get your NEW POWERFUL RADI-VOX WALKIE TALKIE NOW. Available only from: **WESTERN RADIO, Dept. RPM-9, KEARNEY, NEBR.**

## BIG MONEY! GOOD FUTURE! HELICOPTER REPAIR—Easy To Learn At Home

Practical, down to earth 10 lesson course, written and supervised by experts teaches you every important phase of repairs and maintenance . . . helps you enter this high-paying field quickly, easily. Write today for FREE details and literature. No obligation.

**SOUTHERN CROSS HELICOPTER INSTITUTE**  
 345 Sip Ave., Dept. PM, Jersey City 6, N.J.

A man needs only one reason . . .



Fight Cancer with a checkup and a check

**AMERICAN CANCER SOCIETY**





## TRAIN TO OPERATE HEAVY EQUIPMENT CONTRACTORS NEED MEN NOW

The big federal and state super highways program is now in progress. Train to operate bulldozers, shovel, motor-grader, scrapers, etc. YOU can make big pay in the construction industry if you learn these skills. NOW contractors WANT our graduates.

Write or call TODAY for full information.

THE MIDDLE-WEST SCHOOL OF HEAVY EQUIPMENT OPERATION  
SAXTON, KENTUCKY  
(Phone Jellico, Kentucky—Harrison 4-6653)



### I Need MANAGERS

FOR SENSATIONAL

## PARTY PLAN

Earn up to \$50 at Each Party!

Hold cosmetic parties. Disclose Hollywood Makeup Secrets. Earn \$50.00 for 3 hours work. Make 60% profit. You hire others. I furnish everything. Rush your name on postcard for full details and free useable samples. Send postcard today, care of:

*Harry Taylor* PRESIDENT

STUDIO GIRL COSMETICS, PARTY DIV. 1289, GLENDALE, CALIFORNIA

# ART

LEARN  
AT  
HOME!

Enjoy glamorous high-pay career or profitable hobby. Learn Commercial Art, Illustrating, Cartooning, Fashion Art, Lettering, T.V., etc. We train you at home, in spare time, 22-pc. art outfit given with first lesson at no extra cost. Write for FREE Book describing easy low-cost method. No obligation. No salesman will call on you. Washington School of Art, Studio 149, Port Washington, N. Y. (Estab. 1914)

## "\$7,108<sup>50</sup> FIRST YEAR SERVICING RADIATORS!"

— Hank Konter, Newcastle, Wyo.

Make good money servicing auto-truck-tractor radiators. Easy to learn. Inland, world's largest radiator equipment mfr., offers complete package — equipment, merchandising, "pays-for-itself" financing, free training. Small down payment on equipment starts you. Profitable dept. for garage or service station. Write

INLAND MFG. CO., Dept. PM-9, 1108 Jackson St., Omaha 2, Nebr.

# RUPTURED?

NEW LASTING RELIEF

## ENJOY NEW FREEDOM.....

of action, amazing peace of mind and comfort at work or play. New pleasures replace rupture pain.

The proven, patented MILLER holds your rupture back Day and Night . . . bringing you new lasting relief as it has thousands of others.

**FREE!** Write for RELIEF FACTS free. Send name and address to:

**FRED B. MILLER, Exclusive Manufacturer**  
DEPT. 1-N HAGERSTOWN, MD.



ENTIRELY DIFFERENT



Easy as A-B-C



# Be Your Own MUSIC Teacher

## PLAY ANY INSTRUMENT

LEARN AT HOME THIS QUICK MONEY-SAVING WAY

Simple as A-B-C. Your lessons consist of real selections, instead of tiresome exercises. You read real notes—no "numbers" or trick music. Some of our 1,000,000 students are band LEADERS. Everything is in print and pictures. First you are told what to do. Then a picture shows you how. Then you play it yourself and hear how it sounds. Soon you are playing your favorite music.

### STOP CHEATING YOURSELF OF THESE JOYS!

Popularity! New friends. Gay parties. Good times. Career. Extra Money. Understand, appreciate and converse about music. Learn lives and compositions of modern and great masters . . . Relax! Banish worries and frustrations. Satisfy self-expression, creative urge. Gain self-confidence.

Mail coupon for Free 36-page illustrated book. Mention your favorite instrument. U. S. SCHOOL OF MUSIC, Studio 309, Port Washington, New York.

FREE  
BOOKLET

U. S. SCHOOL OF MUSIC, Studio 309, Port Washington, N. Y.  
Please send me your FREE 36-page illustrated book. I would like to play \_\_\_\_\_

Name \_\_\_\_\_  
(Please Print)

Address \_\_\_\_\_

City \_\_\_\_\_ Zone \_\_\_\_\_ State \_\_\_\_\_



## can open the door to a BETTER JOB at BIGGER PAY for YOU

TODAY, CHOOSE YOUR CAREER! Then take the first easy step toward preparing for the goal you can reach in spare time at home. Or, if you are in work you like, learn how you can earn quicker promotions and bigger pay. For 61 years AMERICAN SCHOOL has helped many thousands of ambitious people succeed. Think seriously about the subjects listed. Fill in and mail coupon today.

AMERICAN SCHOOL, Dept. G645, Drexel at 58th, Chicago 37, Ill.

Without obligation, send FREE information on the subjects I have checked.

<input type="checkbox"/> Accounting <input type="checkbox"/> Apprenticeship Courses <input type="checkbox"/> Architecture & Building <input type="checkbox"/> Automotive Technician <input type="checkbox"/> Better Foremanship <input type="checkbox"/> Blueprint Reading <input type="checkbox"/> Bookkeeping <input type="checkbox"/> Business Management <input type="checkbox"/> Civil Engineering	<input type="checkbox"/> Contracting <input type="checkbox"/> Diesel Technician <input type="checkbox"/> Drafting—Building Trades <input type="checkbox"/> Drafting—Machine Trades <input type="checkbox"/> Electrical Engineering <input type="checkbox"/> Electricity—Practical <input type="checkbox"/> Electronics—Industrial <input type="checkbox"/> HIGH SCHOOL COURSES <input type="checkbox"/> Machinists	<input type="checkbox"/> Mechanical Engineering <input type="checkbox"/> Mechanical Technology <input type="checkbox"/> Metalworking Courses <input type="checkbox"/> Plumbing—Practical <input type="checkbox"/> Private Secretary <input type="checkbox"/> Retail Merchandising <input type="checkbox"/> Salesmanship—Outside <input type="checkbox"/> Sheet Metal Work <input type="checkbox"/> Tool Making
---	--	--

NAME \_\_\_\_\_ OCCUPATION \_\_\_\_\_  
HOME ADDRESS \_\_\_\_\_ AGE \_\_\_\_\_  
CITY \_\_\_\_\_ STATE \_\_\_\_\_

Accredited Member NATIONAL HOME STUDY COUNCIL



# ARE YOU SEARCHING FOR SUCCESS?

**DO YOU WANT . . .**  
**Better Job Opportunities?**  
**Higher Income? Promotions?**  
**Financial Security for**  
**Yourself and Your Family?**



These, and countless other tangible benefits, are the rewards that come to a successful man. They can readily be yours to enjoy too! Personal success will come to you if you plan your business career carefully, have determination, and take the time to develop your abilities to the utmost.

If you are earnestly searching for success, Popular Mechanics may be able to help you reach your goal through its career guidance booklet . . . **SKILLS FOR AMERICA.**

**SKILLS FOR AMERICA** is a biannual publication issued specifically to help those of our readers who are determined to succeed in business or in a trade. It is available *free* from Popular Mechanics. Its chapters contain valuable information regarding *job opportunities; career planning; and additional training in chosen careers.* For example, it tells:

## Booklet Covers These and Other Skills and Professions

- Electrical Engineer
- Mechanical Engineer
- Nuclear Energy Occupations
- Diesel Mechanic
- Commercial Artist
- Draftsman
- Accountant
- Auto Mechanic
- Engineering Technician
- Electrical Appliance Repairing
- Chemical Engineer
- Lawyer
- Electronics Technician
- Heavy Equipment Operator and many other trades and professions



- What trades and skills are in greatest demand by industry today.
- How to achieve personal advancement.

**SKILLS FOR AMERICA** will help our readers decide on the trade or profession which best suits them. And it will aid readers in planning a course of study to prepare for a chosen vocation.

A new, completely revised edition of **SKILLS FOR AMERICA** is now ready for distribution *free* to Popular Mechanics readers. If you earnestly desire to get ahead; if you want to help yourself to a brighter future . . . then send *now* for the Popular Mechanics self-help, career guidance booklet **SKILLS FOR AMERICA.** Its information may well start you on the road to success!

To obtain your **FREE** copy of **SKILLS FOR AMERICA**, simply fill out the coupon on the opposite page and mail it to Popular Mechanics Magazine.



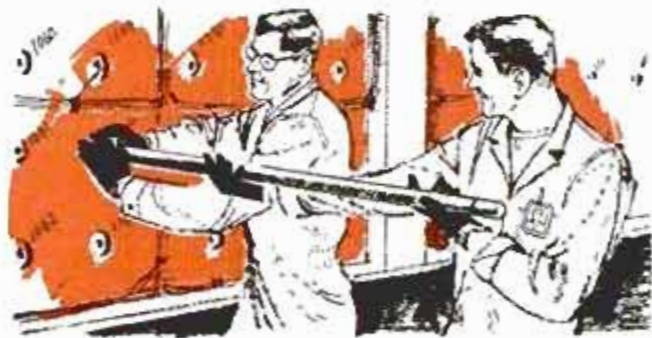
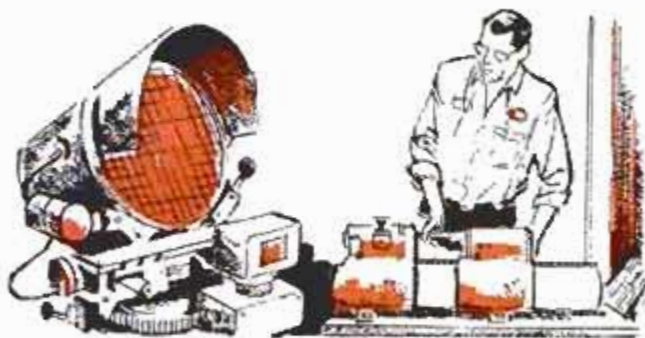
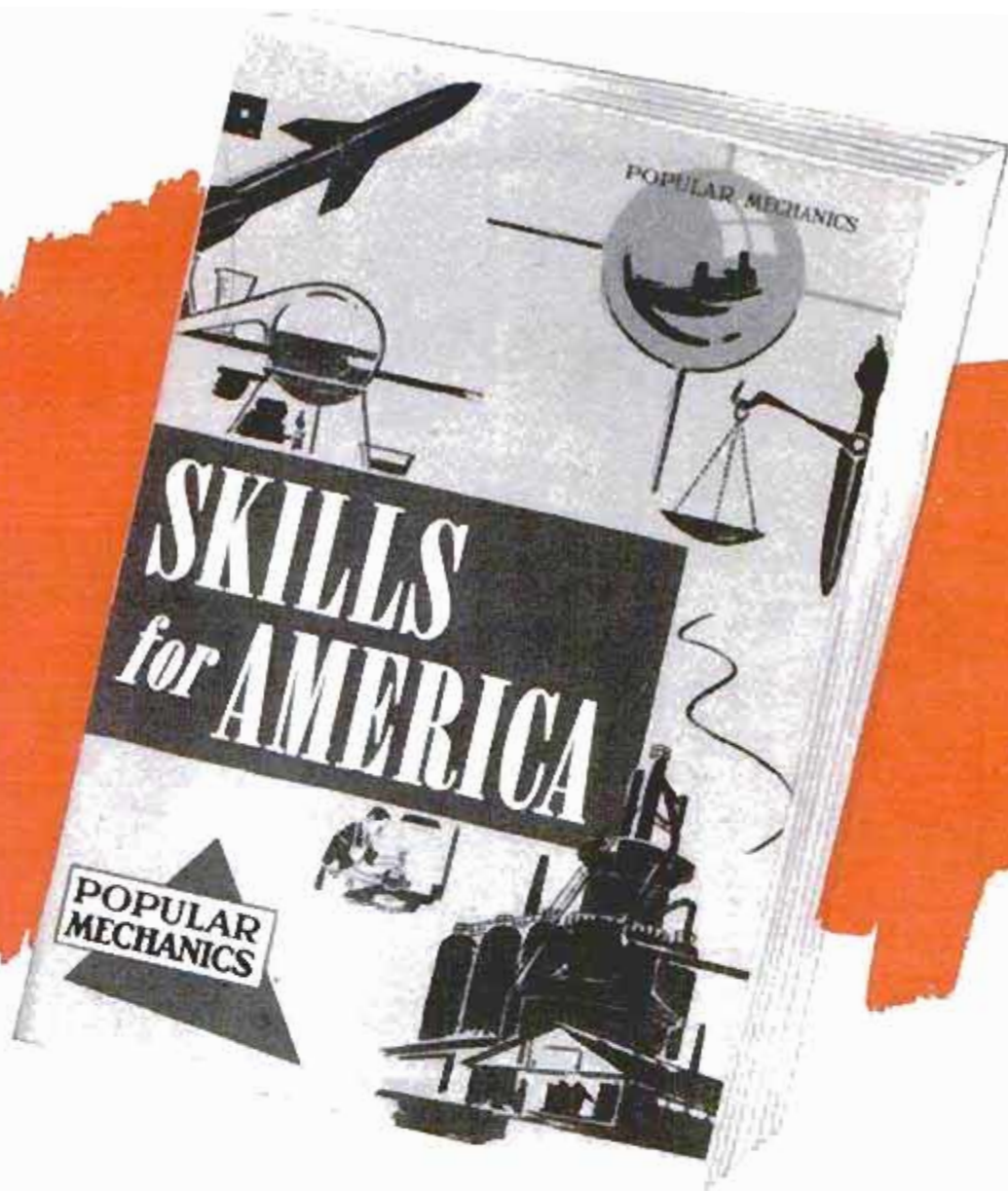

Please send copy of  
Career Guidance Booklet,  
"SKILLS FOR AMERICA" to:

Name \_\_\_\_\_  
(please print)

Street \_\_\_\_\_

City \_\_\_\_\_

State \_\_\_\_\_

### **ATTENTION!**

For copy of "SKILLS FOR AMERICA,"  
mail this coupon right now to:

**POPULAR MECHANICS MAGAZINE  
DEPARTMENT SFA-6  
200 EAST ONTARIO STREET  
CHICAGO 11, ILLINOIS**



# Now 1/2 price!

## SWISS ARMY Type 9-in-1 Knife

Formerly  
**\$1.98**

# 88¢

plus 12c postage

- ★ Awl
- ★ File
- ★ Knife
- ★ Can Opener
- ★ Scissors
- ★ Corkscrew
- ★ Jackknife
- ★ Screwdriver
- ★ Bottle Opener

Moto-Matic Co.,  
585 Water St.  
New York 2, N.Y.

**Korium  
Steel**

**Your Portable  
Work Shop**

9 practical tools in one. Each separate; easy to open & close. No jamming or slipping. Rugged Korium steel. Bone handle. Metal ring. Replaces multitude of tools you can't find when needed. Fits pocket yet opens to almost 5 inches long! Keep in workshop, basement, kitchen, tool shop, car glove compartment. "Lifesaver" in emergencies! Thousands sold at \$1.98—now SLASHED to only 88c plus 12c for postage & handling, while supply lasts. Rush \$1 for prompt delivery anywhere in USA or Canada. (Extra Special: 3 for \$2.75 postpaid). Satisfaction guaranteed or money back. Sold only by mail, only by us, direct to you.

**MOTO-MATIC CO., DEPT. 6-K-114** 585 WATER STREET, NEW YORK 2, N.Y.



**MEN! Get this Book**

# FREE!

**Just Mail Coupon**

Tells how you can become a well-paid Radio-Television Service Technician in a few short months in spare hours at home **EARN WHILE YOU LEARN!**

The man who knows how to service and repair RADIO and TELEVISION sets is king today. This is the big pay field where many more men are needed at once to fill the jobs now going begging. It doesn't matter what you've done before or what kind of work you're doing now... you can learn Radio-Television at home during spare time. Earn good money fixing sets part time while learning! The time-proved Sprayberry Plan gives you the practical experience you need, working with kits we send you. Build Radios, Testers, TV—all yours to keep. New 60-page book gives all the facts... plus actual sample lesson... all free! Rush coupon. No salesman will call.

**SPRAYBERRY ACADEMY OF RADIO-TELEVISION**  
Dept. 10-L, 1512 Jarvis Ave., Chicago 26, Ill.

**Sprayberry Academy of Radio-Television**  
Dept. 10-L, 1512 Jarvis Ave., Chicago 26, Ill.  
Mail FREE SAMPLE LESSON and Big Book.

NAME.....  
ADDRESS.....  
TOWN.....ZONE.....STATE.....

**RUSH  
COUPON  
Today!**

# \$1 BRINGS YOU \$18

**Discover Flok-Kraft and Earn \$\$\$\$ AT HOME**

Earn up to \$15.00 per hour spare time. Amazing new Velvet-fiber spray instantly makes any object (Lamps, Radio & TV Cabinets, Figurines, Signs, Auto dash boards, toys, furniture, draperies—anything) worth expensive \$\$\$\$ Prices... like magic, you can spray anything with this beautiful new suede-like finish that feels like rich Velvet.

**EARN UP TO \$300.00 PER WEEK SPARE TIME**

Imagine, materials cost only 3c per square foot. (Average TV or radio cabinet can be beautifully sprayed with this startling new 3-dimensional Velvet finish in 15 minutes at a cost of only 34c in materials. Your charge for this job is at least \$10.00.)

**REPRESENTATIVES IN YOUR AREA URGENTLY NEEDED**

Own your own business. Work at home in your spare time. Help fill the huge growing demand for this amazing new beautiful Velvet-fiber finish. Orders come from stores, offices, homes, architects, auto dealers,—everywhere. Possible \$20,000.000.00 worth of jobs to be done. Investigate today—be first in your area! Actual samples in 16 Radiant Colors, Booklet of 50 Home Business Opportunities and Confidential Details all sent free! Send No Money. Write: Coast Industries, Los Angeles 61, Calif., Dept. B-9.

# LAW FREE BOOK

**THE LAW  
TRAINED  
MAN**

Write today for a FREE copy of illustrated law book, "THE LAW-TRAINED MAN," which shows how to earn the professional Bachelor of Laws (LL.B.) degree through home study of the famous Blackstone Law Course. All necessary books and lessons provided. Moderate cost; convenient monthly terms. Write for FREE law training book today.

**Blackstone School of Law, 307 N. Michigan Ave.**

Founded 1890

Dept. 56, Chicago 1, Illinois



**Mr. "N" Made \$9,700 Last Year By  
Selling Just 20 KEEP/SAFEs a Month!**

Like Mr. "N" you can profit with KEEP/SAFE—the fine personal safe that undersells all others. Only safe sold direct. 85% of homes, farms and small businesses are prospects. \$30 to \$71 profit per sale, plus bonuses up to \$12 a safe. Choice territory, chance to become district agent. FREE DEMONSTRATOR! Get details, giving address including county.

**JOHN D. BRUSH & CO., INC.**

575 West Ave. Rochester 11, N. Y.

## 75 POWER TELESCOPE \$398

**NEW 3 in one telescopes. 3 variable 25X 45X-75X magnification. Brass bound. 25 power for ultra bright images 45 & 75 power for long range. Guaranteed to bring distant stars, moons, objects, sports 75 times closer.**

Most powerful scope sold anywhere near this amazing low price. American made, 5 sections, & polished lenses. Can also be used as powerful compound microscope. Mass production enables us to offer telescope complete at \$3.98 postpaid. Money back guarantee.

**CRITERION CO., Dept. PMB 61, 331 Church St., Hartford, Conn.**

**MASS PRODUCTION MAKES  
THESE PRICES POSSIBLE!**

Only world's largest boat kit maker can deliver such quality at such prices! Write for free color catalog, kits from \$42.00, frt. inc.

12 ft. FREE COLOR CATALOG! \$99.50 frt. inc.

**TAFT MARINE WOODCRAFT**

Dept. PM-95B 636 39th Ave. N.E. Minneapolis 21, Minn.

**BIG NEW  
WHOLESALE  
CATALOG  
FREE!**

**NOW! Save Up to 50%  
on Nationally Advertised Gifts**

Use this big, new FREE CATALOG to buy all kinds of gifts and merchandise for yourself, family, friends, neighbors. Terrific saving on big-name items. Also, make money spare time taking orders from others!

**EVERGREEN STUDIOS**

Dept. 57 Box 846 CHICAGO 42, Ill.

**Learn BAKING At Home**

Baking is one of America's high industries in wages. Nearly depression-proof. Thorough basic home course lays sound foundation. If you have aptitude, write for FREE BOOKLET, "Opportunities in Commercial Baking." National Baking School, 835 Diversey Pkwy., Dept. 1358, Chicago 14, Illinois







# PAY 1¢ on the DOLLAR for 1000's of Useful Items U. S. GOV'T SURPLUS

## AT THESE LOW PRICES PAID AT RECENT GOV'T SALES

Jeeps.....\$223	Tractors.....\$68
Trucks.....\$212	Motors.....\$294
Boats.....\$5.90	Airplanes...\$366
Fork-lifts....\$197	Typewriters..\$6.80
Compressors..\$9.69	Generators...\$8.78
Gear Reducers 974	Hydraulic cylinders \$1.01
• Transmissions \$7.80	

Over 3 Billion War Surplus  
sold every year!

BUY DIRECT from U. S. Government at TREMENDOUS savings! Eliminate the middleman—save big money! Pay as low as 1¢ on the dollar or less. Our Directory Gov't Surplus Sales lists 100's of Army, Navy, Air Force and other government surplus depots. Many of them right in your own back yard. Buy sports equipment, hunting, fishing and photographic equipment and supplies, radio, electronic and electrical equipment, trucks, boats, jeeps, airplanes. Plumbing, hardware, office equipment supplies. Power tools, machinery, furniture. WE DO NOT sell jeeps or other surplus. YOU BUY DIRECT from Uncle Sam. No dealer profits to pay. This book tells you how to buy Gov't Surplus. Send for your copy today. Directory is indexed for quick information. Answers your questions. Tells you how to buy. Get on the gravy train while you can. Send \$1 today for "Gov't Surplus Directory" to

Aviation Surplus Center, Dept. PM-9, Box 789, York, Pa.



## GET GOV'T JOB!



High Salary — Security — Sick Leave  
Vacations with Pay — Generous Pensions

Train now . . . prepare yourself for civil service examinations. Hundreds of thousands of jobs available each year—federal, state, municipal. This wonderful Home-Study Course tells you which jobs YOU can qualify for. Then helps you prepare yourself for the civil service exams you select. Completely self-instructing! These interesting lessons help you toward hundreds of big-pay government jobs, including: postal carrier, investigator, carpenter, clerk, accountant, customs-inspector, engineer, foreign service, policeman, railway postal clerk, typist, etc.

**SATISFACTION GUARANTEED OR FULL REFUND!**  
Contains same instruction material as high-priced correspondence courses. Complete price only \$6.95, postpaid. Or C.O.D. plus postage. No risk—order today. Satisfaction or money back. Order "Civil Service Course." Nelson-Mail Co., 210 S. Clinton St., Dept. 3J5-2, Chicago 6, Ill.

Up To \$15 AN HOUR  
PRINTING PERSONALIZED  
XMAS CARDS!



Nothing quite like these beautiful personalized Xmas cards. Ideal husband-wife business. Print them in your town and earn up to \$15 an hour. No printing press needed. Easy to do. No experience required. Send for free samples and details.

PRINTS - Box 424-A, Hyde Park, New York

## ENGINEERING DEGREE IN 27 MONTHS

### B. S. DEGREE IN

Aeronautical, Chemical, Civil, Electrical, Mechanical  
and Electronic Engineering (inc. Radio and TV)

Also B.S. DEGREE in 36 mo. in Mathematics, Chemistry, Physics (inc. Nuclear Physics). Engineering Science prep. courses. Thorough, practical program. Individualized instruction emphasized. Government approved for G.I.'s.

Keeping pace with progress in science and engineering

Spacious campus; 20 bldgs.; dorms, gym, playing field. Modern, well-equipped labs including new physics lab and wind tunnel. Low tuition. New terms start quarterly. Enter September, December, March or June. Big demand for graduates. Students from 48 states and 40 foreign countries. Many earn a major part of their college expenses in this large industrial center. Send coupon for free catalog and full information. Enroll now!

## INDIANA TECHNICAL COLLEGE

598 E. Washington Boulevard, Fort Wayne 2, Indiana

Please send me free information on 27 MO. B.S. DEGREES in:

Aeronautical  Chemical  Civil  Electrical   
Mechanical  Electronics

on 36 MONTH B.S. DEGREES in:

Mathematics  Chemistry  Physics

Name \_\_\_\_\_

Address \_\_\_\_\_

## Get info. PLASTIC LAMINATING AT HOME!



**THIS MAN** . . . is taking out of the machine a Plastic Sealing Job—ordered by mail—only 11¢ in material cost brings back \$2.58 in cash by mail. Capacity of machine: \$25.00 profit per hour of operation.

Get ORDERS and CASH from your mailman—do work in SPARE TIME at home—or expand into FULL TIME business. Send coupon for Free facts about the newest and most fascinating of all home operated businesses. For the first time a simplified machine brings the fabulous profits of Plastic Sealing and Plastic Laminating within the reach of the small operator. Anyone can learn to operate the machine with a few minutes practice—then with our Magic Mail Plan can get mail orders pouring in daily with cash in every envelope. No canvassing—no selling. We even

Make up to \$5 an Hour..  
MAGIC MAIL PLAN!

supply the circulars you mail to bring back cash and orders. Don't waste a minute. Rush your name. We'll send you FREE and postpaid, pictures, prices, details, and all the facts you need to start. Mail coupon or send name on postcard. No charge. Warner Electric Co., 1512 Jarvis Av., Dept. L-2-K, Chicago 26, Ill.

### Make Thousands of Beautiful Art Creations

COSTUME JEWELRY • CIGARETTE BOXES  
TRAYS • CANDLESTICKS • COASTERS  
LAMP BASES • BOOK ENDS...ALL IN  
SPARKLING COLORED PLASTIC



WARNER ELECTRIC CO., 1512 Jarvis Av.  
Dept. L-2-K, Chicago 26, Ill.

At no cost to me, please rush complete details postage prepaid. I am under no obligation.

Name \_\_\_\_\_

Address \_\_\_\_\_

City \_\_\_\_\_ Zone \_\_\_\_\_ State \_\_\_\_\_



GET READY FOR THE SPACE ERA! SEE THE SATELLITES . . . THE MOON ROCKETS

# AMAZING TELESCOPE BUYS AND OTHER OPTICAL BARGAINS



See the Stars, Moon, Planets Close Up!

## 3" ASTRONOMICAL REFLECTING TELESCOPE

60 to 160 Power — Famous Mt. Palomar Type! An Unusual Buy!



Assembled—Ready to use! You'll see the Rings of Saturn, the fascinating Planet Mars, huge craters on the Moon, Star Clusters, Moons of Jupiter in detail. Galaxies! Equatorial mount with lock on both axes. Aluminized and overcoated 3" diameter high-speed  $f/10$  mirror. Telescope comes equipped with a 60X eyepiece and a mounted Barlow Lens, giving you 60 to 160 power. Low-cost accessory eyepiece available for power up to 320. An Optical Finder Telescope, always so essential, is also included. Sturdy, hardwood, portable tripod. Valuable STAR CHART and 272-page "Handbook of Heavens."

Stock No. 85,050-H. \$29.50 f.o.b. (Shipping wt. 10 lbs.)

## 4 1/4" ASTRONOMICAL TELESCOPE

UP TO 270 POWER!



With this scope you can see everything as above but with greater power plus will split finer stars. Mirror has twice the light gathering power. Mirror guaranteed to give theoretical limit of resolution. Rack and pinion focusing, hardwood tripod, real equatorial mounting—only one adjustment follows stars! Aluminum tube. 6 power finder telescope. 2 standard size eyepieces and mounted Barlow lens give you powers of 40X, 90X, 120X, and 270X. Low-cost accessory eyepiece available for power up to 540. Free handbook and Chart. Shipping weight 25 lbs.

Stock No. 85,006-H \$74.50 f.o.b.

## MAKE YOUR OWN ASTRONOMICAL TELESCOPE

See December, 1957 issue of POPULAR MECHANICS—Pages 188-192. 4 1/4" MIRROR KIT—Contains ready-to-use 4 1/4" diameter concave, aluminized objective mirror, lenses for 1" focal length eyepiece, and aluminized first surface diagonal mirror.

Order Price  
Stock No. 50,074-H.....\$16.25 postpaid  
Same as above except 3" diam. mirror—

Stock No. 50,081-H.....\$9.95 postpd.  
We have additional eyepieces, tubes, tripods, in fact everything you need to build telescopes.

## New! 2 in 1 Combination! Pocket-Size 50 Power MICROSCOPE and 10 Power TELESCOPE



Useful Telescope and Microscope combined in one amazing, precision instrument. Imported! No larger than a fountain pen. Telescope is 10 Power. Microscope magnifies 50 Times Sharp focus at any range. Handy for sports, looking at small objects, just plain snooping. Send Check or M.O. Satisfaction Guaranteed. Order Stock No. 30,059-H.....\$4.50 Postpd.

## SALE! TERRIFIC WAR SURPLUS BARGAIN! AERIAL CAMERA LENSES



Gov't. Cost \$1218—Now Low as \$39.50 Used Made by B & L and E.K.—24" F.L.  $f/6$ , in 23" long Lens Cone. Use as long range, Big Bertha Telephoto lens—for Richest field (wide field, low power) telescope, etc. Lenses are 4" dia—precision 4-element type, Aero Tessar and Aero Ektar (no choice). Easily removed. Diaphragm ( $f/6$  to  $f/22$ ) is included. Opens approx. 1" to 3 1/2". Lens and cone—wt. 25 lbs. Sturdy carrying trunk—wt. 26 lbs.

Stock No. 85,059-H 24", used. Price \$39.50 f.o.b. Utah  
Stock No. 85,060-H 24", new. Price \$59.50 f.o.b. Utah

## SALE! WIDE ANGLE ERFL EYEPIECE

Tremendous bargain! 1 1/2" f.l.! Focusing metal mount is 2-11/16" in diameter. Consists of 3 coated achromats. 65° field. Gov't. cost over \$100. Use these with the 24" f.l. Aerial Camera Lenses to make a 16 power wide field telescope, etc.

Stock No. 50,178-H.....only \$9.95 Postpaid



## BUILD A SOLAR ENERGY FURNACE



A fascinating new field. Build your own Solar Furnace for experimentation—many practical uses. Easy! Inexpensive! Use scrapwood! We furnish instructions. This sun powered furnace will generate terrific heat—2000° to 3000°. Fuses enamel to metal. Sets paper aflame in seconds. Use our Fresnel Lens—14 1/2" diameter . . . f.l. 14"

Stock No. 70,130-H . . . Fresnel Lens . . . \$ 6.00 Postpd.

## STEREO MICROSCOPE



American-Made Instrument at Over 50% Saving. Up to 3" Working Distance—Erect Image—Wide 3-Dimensional Field. Used for inspections, examinations, counting, checking, assembling, disassembling. 2 sets of objectives on rotating turret. Standard pair of wide field 10X Kellner Eyepieces give you 23 power and 40 power. Helical rack and pinion focusing. 10-DAY TRIAL . . . Complete satisfaction or your money back. Order Stock No. 85,056-H. Full price . . . \$99.50 f.o.b. Barrington, N.J. (Shipping wt. approx. 11 lbs.) Send Check or M.O.

Check, Measure, Inspect with this

## 6 POWER

## POCKET COMPARATOR

(Complete with Leather Case)

MEASURES • Angles • Radii • Circles • Linear—in both decimal inches and millimeters.

Used to check layouts, machining on tools, dies, gauges; to check threads, chamfers, wear on cutting tools, etc.

Stock No. 30,061-H . . . New Low Price . . . \$19.50 Postpd.



## REPLICA GRATING — LOW, LOW COST



It's here—after decades of effort! Replica Grating—on film—at very low price. Breaks up white light into full spectrum colors. An exciting display, 13,400 lines per inch, running long way on film 8" wide—grating area 7 1/2". Thickness about .005". Dispersion about 24°. Use it for making spectroscopes, for experiments, as a fascinating novelty. First time available such large size—so cheaply.

Stock No. 40,267-H—piece 8" x 11" \$1.50 postpd.  
Stock No. 50,180-H—piece 8" x 6 ft. \$5.95 postpd.

## WAR SURPLUS AMERICAN-MADE 7 x 50 BINOCULARS



Big savings! Brand new! Crystal clear viewing—7 power. Every optical element is coated. An excellent night glass—the size recommended for satellite viewing. Individual eye focus. Exit pupil 7mm. Approx. field at 1,000 yds. is 376 ft. Carrying case included. American 7 x 50's normally cost \$195. Our war surplus price saves you real money.

Stock No. 1533-H . . . only \$55.00 postpd. (Tax included)

## DIRECT MEASURING POCKET MICROSCOPE

— 50 POWER

Fountain pen size, makes direct reading measurements; for checking small parts and dimensions under powerful magnification. Precision, glass etched reticle calibrated for measurements up to 1/10" by .001" divisions.

STOCK NO. 30,225-H . . . \$7.95 Postpd.



6X FINDER TELESCOPE—base fits any diameter tube.

Stock No. 50,121-H . . . \$8.00 postpaid

MOUNTED BARLOW LENS—double and triple your telescope's power. For Standard 1 1/4" eyepiece holders.

Stock No. 30,200-H . . . \$8.00 postpaid

## HAND SIGHTING LEVEL

Described in Popular Mechanics March 1958 issue, page 212

Sight it like a Telescope. Gives you a level line of sight, for laying out gardens, drives, new construction, ditches, etc. Complete instructions included.

Stock No. 105-H . . . \$2.50 postpaid



# FREE CATALOG-H

Yours for the asking

America's No. 1 source of supply for experimenters, hobbyists. Complete line of Astronomical Telescope parts and assembled Telescopes. Also huge selection of lenses, prisms, war surplus optical instruments, parts and accessories. Telescopes, microscopes, satellite scopes, binoculars, infrared sniperscopes, etc.

REQUEST CATALOG-H



ORDER BY STOCK NUMBER . SEND CHECK OR MONEY ORDER . SATISFACTION GUARANTEED!

**EDMUND SCIENTIFIC CO., BARRINGTON, NEW JERSEY**



**WORLD'S  
BEST  
WANT-AD  
MEDIUM**

# CLASSIFIED ADVERTISEMENTS



Advertisements in this section \$1.25 per word, each insertion, minimum 10 words, payable in advance.

To be inserted under proper classification, copy must be in our office the

20th of the second month preceding date of issue

F. W. Johnson, Manager, Classified Advertising

Popular Mechanics Magazine, 200 East Ontario Street, Chicago 11, Illinois

## YOU'LL PROFIT

By reading and answering the classified ads in this section. Hundreds of opportunities for you to make and save money

### AUTOMOBILES, MIDGET CARS

NEW 1959 Automobiles—To 25% off retail. Meder, 550-PM Fifth Avenue, New York City 36.

HUNDREDS Of automobile catalogs—Old, new and foreign; dealer books, glossy photographs, service manuals; free motor magazines listed by non-profit club. 4¢ stamp brings mailing list. Auto Maniacs, Stockbridge, Mich.

BOOKS; Hundreds of subjects. Big 1958 book catalog—10¢. Popular Mechanics Press, 200-BC East Ontario St., Chicago 11.

### AUTO SUPPLIES AND EQUIPMENT

FREE Giant auto parts catalog. Thousands scarce accessories stores don't have. Gadgets, custom equipment. Send 25¢ postage (refundable). Newhouse Automotive Industries, 5805-PM-9 Beverly, Los Angeles 22, Calif.

FREE! 1958 Automotive catalog. 260 pages, 75,000 items. Parts of every description for stock cars, hot rods, custom cars, trucks, and station wagons. Save up to 50%. Same day service. Quality guaranteed or money back. Send 25¢ (refundable, first order). J. C. Whitney, 1919 PM-9, Archer, Chicago 16, Ill.

AUTOMOBILE Emergency silent tire chain. Excellent durability. \$2.50 postpaid. Miller, 105 N. Pearl St., Green Bay, Wis.

FOREIGN Domestic antique auto keys. Send lock and \$1.75. Steele Lock Service, Maywood, Calif.

DRIVE Through fog. Auto light contact lenses. Instantly changed. Guaranteed. Set \$1.00. Andrew J. Perlik, 26-A Home-kort Ave., Pittsburgh 29, Penna.

ENGINES, Chevrolet, Ford, Plymouth, Oldsmobile, Buick, etc. New and used, reasonably priced. Free details. Ledbetter Enterprises, 1015 West 17th, Texarkana 4, Texas.

NEW Four cylinder Ford parts. Catalog 25¢. Mark, Layton, N. J.

RING-Valve job while driving, \$6.00. Free details. Motaloy, Grantham, Penna.

CRANKSHAFT Grinder. Hand operated makes bearings fit without taking engine apart. \$3.75. Literature. L. D. McGee, 719 Cascade St., Wenatchee, Wash.

LUCKY Rabbit's foot key chains. 15¢. Box 504, Nyack, N. Y.

OIL Filter refills 10¢. Free particulars. Zenick Products, Box 2461, Los Angeles 54, California.

FORD T and A parts? Try best source old model parts, all makes. Wisnesky Auto, Milwaukee 7.

REVOLUTIONARY Gasoline saver device! Particulars, send 10¢, refundable. Grable Enterprises, 26314 Normandy, Roseville, Michigan.

NEW And used parts at savings. Complete guaranteed parts service for all models cars and trucks, 1924 and later. Largest in the West. Jeep and army parts specialists. Newest type shifting hubs for all jeep and all military and latest production front end drive vehicles. \$27.50 and up. Write, Pioneer Auto and Truck Parts Co., 734 W. 13th Avenue, Denver 17, Colo.

JEOP Owners — V-8 conversions. Read Jeep Owners ad, page 33.

SAVE Money on Jeep and army truck parts. Large inventory. Catalogs for Jeep or G.M.C. owners. American Auto Parts Co., 1830 Locust, Kansas City, Mo.

FREE! New catalog. Speed, power, mileage increasing equipment. Discounts! Almquist Engineering, Milford PM5, Penna.

AUTOMOTIVE Books. Send for 1958 book catalog—10¢. Popular Mechanics Press, 631 N. St. Clair St., Chicago 11.

OFFENHAUSER—1958 Catalog available on all items manufactured and distributed. Only 35¢. Offenhauser Equipment Corp., 5156 Alhambra Ave., Los Angeles 32, Calif.

BARGAIN. Exciting Little Library booklets. 25¢ each. How to use tools, painting, welding, home improvement, games, models, plastics, lamp making, glass blowing, boats, photographs. Free Little Library catalog. Popular Mechanics Press, 200-LB East Ontario St., Chicago 11.

### AUTO TRAILERS

TRAILER Building guide supply catalog \$1.20. Blueprint booklet floor plan 60¢. Kamcraft, Box 1153, Milwaukee 1, Wis.

BUILD Expanding eight foot trailer. Accommodates five. Literature 10¢. Framar Company, Wilmington, Mass.

CABIN Trailer kits. Pleasure or business. Write Burlington Manufacturing Company, Burlington, Iowa.

DON'T Buy anything until you've seen the "new look" in camping. New camp trailer, a new cartop camper, new camp kitchen. Free illustrated brochure. Write: Hellite Trailers, Inc., Dept. P.M., Lodi, California.

### MOTORCYCLES, BICYCLES, MOTORSCOOTERS AND SUPPLIES

MIDGET Car \$25, motorbike \$6, quarter midget \$45, less engines. Whizzer engine \$7, Briggs \$7. Cushman motorscooter \$30. Smith motorcycle \$30, Villiers \$50. (Mail order only.) Send 25¢ (35¢ for first class mailing) for directory-catalogue number 85, listing these and hundreds of other bargains in midget cars, motorscooters, homebuilders parts, plans, etc. Midget Motors Directory, Athens, Ohio.

HARLEY - Davidsons — Used bargains. New, used parts, accessories for all models. Bulletin, catalog 25¢. Knuth's (Factory Dealer), 1753 Muskego, Milwaukee, Wis.

RECONDITIONED Motorcycles and motors. Chromium accessories. Complete stock Indian parts. Expert rebuilding. Fast service. Indian Motorcycle Sales, Kansas City 27, Missouri.

PARTS, New, used. List 10¢. Ballak, 811 N. 9th, St. Louis 1, Mo.

MIDGET Auto \$25.00; 1954 Whizzer \$20.00; Cushman motorscooter \$25.00; motorcycle \$10.00. Rush 25¢ (35¢ first class mail) for new catalog #962 listing amazing bargains in motors, midget cars, motorcycles, motorbikes, construction plans. Associated, Box 534, Toledo, Ohio.

### AVIATION

AIRLINE Careers. Starting salary \$3400 up. Short, easy course. G.I. approved. Free catalog B. McConnell Airline School, 1030 Nicollet, Minneapolis, Minnesota.

AVIATION Surplus bargain catalogue. One dime. Box 22PM8, Thomasville, Penna.

TWO Stage rocket, complete plans \$1.00. Negravce, 615 Scott Ave., Redwood City, Calif.

BOOKS, Aviation. Free catalog. Aero Publishers, 2162-PM9 Sunset, Los Angeles 26, California.

HELICOPTERS Theory, license information, ownership. \$1. Institute, Box 979, Houston 1, Texas.

PROPELLERS. Plans, supplies for airboats and snowplanes. Latest designs, prompt delivery. Catalog 25¢. Banks-Maxwell, Box 3301E, Ft. Worth 5, Texas.

BOOKS; Hundreds of subjects. Big 1958 book catalog—10¢. Popular Mechanics Press, 200-BC East Ontario St., Chicago 11.

BUY Surplus aircrafts; fuselages; assemblies; aircraft engines; helicopters; instruments; electronics; radiotelephones; misc. Buy direct now from U. S. Government. Depot list and procedure \$1.00. Brody, Box 8-PM, Sunnyside 4, New York City.

### ELECTRICAL SUPPLIES

REPAIR. Assemble, service fluorescent fixtures. Free catalog. Shoplite, 650M Franklin, Nutley 10, New Jersey.

ELECTRIC Pencil: Engraves all metals \$2.00. Beyer Mfg., 10511-H Springfield, Chicago 43.

LAMP. Electrical parts, wholesale. Thousands of items for repairing, converting. Catalog 25¢. Brown Lamp, Box 305, Clayton 5, Mo.

HOUSE Wiring—Electrical repairs. Booklet. Send for 1958 book catalog—10¢. Popular Mechanics Press, 633 N. St. Clair, Chicago 11.

LAMPS—Parts catalog containing wiring instructions. 25¢. Gyro Lamps, 3438P N.W. 54 Street, Miami, Fla.



## WELDING, SOLDERING, PLATING

**ACETYLENE** Welding outfits, new \$54.50, arcwelders \$56.50. Eagle Welding, Dept. P.M., 5085 Broadway, Chicago 40, Ill.

**WELDERS.** 110/220, \$39.50. Morris, 1070 Inner Drive, Schenectady 3, New York.

**PLATING** Equipment, supplies. Complete line of anodes, solutions. Home workshops, industrial sizes. Hollywood Bronze Supply, Dept. C, 1624 East First, Los Angeles 33, California.

## MACHINERY, TOOLS, SUPPLIES

**IDEAL** Home outfit! 11 piece handy, compact tool set. Most needed pieces! Most used sizes! Complete with combination apron and tool-roll personalized with your initials! Only \$4.98. Crescent Sales Company, 4063 Tulane Ave., New Orleans 19, La.

**ENGINEERS.** Architects, draftsmen. Divided utility tray, transparent green plastic, spring clips to the drafting machine, \$2.50 postpaid. Designers Travel Tray, Box 374, Burbank, California.

**DAWN** Gage instantly centers round stock for turning or drilling. \$2.95 postpaid. Details free. Dawn Crafts, 215 Commonwealth, Buffalo 16, N. Y.

**FREE** Literature. New precision angle indicator. Levels, plumbs, direct reading, any angle. Used by carpenters, plumbers, masons, electricians, all trades. Blue Star, 320 So. Woodrow, Indianapolis 21, Ind.

**MATERIAL**—Metals, plastics, etc. Any size, shape, quantity. Rough or machined to sketch. All inquiries answered. Supplier, Box 35B, Bloomfield, N. J.

**VACUUM** Hand pumps, 20 ft. lift, water, oils, gasoline. Free catalogue. Jess W. Wright, 18 Thea Lane, Huntington, N. Y.

**GRINDERLAP** Carbide sharpening machine with two re-loadable diamond wheels sharpens carbide tip saws, tools, drills to micro edge tip a minute. Price \$375.00 complete. Write Atco, Box 32, South Haven, Mich.

**PORTABLE** Cement mixer. Free literature. Beran Mfg. Co., 906 Dullnig, San Antonio 10, Texas.

**SURPLUS** Socket wrenches, half price. Davis, 1680-A Texas, Shreveport, La.

**OIL** Drum cement mixer assembly kit. Circular. Nu-Way-Do Co., Newaygo, Mich.

**WHOLESALE** Tool catalog. Send \$1.00. Yuhas, P.O. Box 5363, Detroit 11, Mich.

## SURVEYING INSTRUMENTS

**NEW** And guaranteed factory rebuilt transits and levels, sale or rent, with purchase option. We will repair, trade or buy old instruments. Write for list M-89, Warren-Knight Co. (Manufacturers of Surveying Instruments), 136 N. 12th St., Philadelphia 7, Penna.

## ENGINES, MOTORS, DYNAMOS

**DIESEL** Injector parts wanted. GM51-71-110. Bares, 7120 Carnegie, Cleveland 3, Ohio.

**ALTERNATING** Current generators, 750 watt, \$42.50, twincylinder compressors with 1/2 horse \$22.00; motors, 1 horse, \$38.50. Butler, 1885 Milwaukee, Chicago.

**WINDING** Data. 275 motors, single and three phase. \$1.10. Data Company, Box 7631, Kansas City 28, Mo.

**REWIND** Motors yourself. Complete instructions \$1.00. Lewis Mfg., Howell, Michigan.

## BOATS, OUTBOARD MOTORS

**BOAT** Patterns, frame kits and plans available on Swish as it appeared in Popular Mechanics (see display page 244). Send 50¢ now for our huge catalog listing our modern power boat designs. Glen Designs, 9152 Rosecrans, Bellflower, California.

**FREE** Catalog! Boat kits, trailers, fiberglass, marine hardware. Luger Industries, Dept. M-9, 9200 Access Rd., Minneapolis 20, Minnesota.

**NEW.** Used, rebuilt marine motors. Marine conversions, fittings. Free catalog. Stokes Marine Supply, Dept. 24, Coldwater, Michigan.

**FULL** Size, cut-to-shape boat patterns, blueprints, 7 1/2-38 feet. Big new 88 pg. illustrated "Build a Boat" catalog of naval architect-designed cruisers, runabouts, skiffs, outboard boats, sailing, racing, houseboats, 50¢. "How to Build a Boat" booklet, \$2.50. Hardware and equipment catalog, \$2.00. Cleveland Boat Blueprint Co., Dept. A-66, Box 1651, Cleveland, Ohio.

I Want to send you proof of the wonderful pulling power of Popular Mechanics classified pages. What's your proposition? Write me today. Include literature if possible. F. W. Johnson, Manager Classified Advertising, Popular Mechanics Magazine, 200 E. Ontario St., Chicago 11, Ill.

**FIBERGLAS** Permanent boat waterproofing. Special 25% discount. Complete kits, \$9.45 up. Guaranteed materials. Easy application. Full instructions. Free literature. Ajax Plastics, Dept. PM, P.O. Box 1323, Fort Worth, Texas.

**MARINE** Conversions, Ford, Chevrolet, Jeep engines. Catalog 25¢. Lehman Manufacturing Company, 972D Broad Street, Newark 2, New Jersey.

**BUILD** Small boats. Send for 1958 book catalog—10¢. Popular Mechanics Press, 633 N. St. Clair St., Chicago 11.

**PROPELLERS.** Plans, supplies for airboats, snowplans. Catalog 25¢. Banks-Maxwell, Box 3301F, Ft. Worth 5, Texas.

**KITS**—Build, sell. Water skis, boats and accessories. Make money at home. Send for free catalogue and tips. Hill Mfg. Co., 1901 So. 75 St., West Allis 19, Wis.

**SAVE** Money. New, used outboard motor parts. Send wants. Stamp appreciated. Outboard Motor Mart, 229-M State, Boston 9, Mass.

**MARINE** Conversion, Willys to Cadillac, engines, kits and parts. Catalogue and conversion hints free. Barr Marine, 2706 Castor Avenue, Philadelphia 34, Penna.

**FIBERGLAS** Boat covering, molding supplies. Buy direct and save! Write for literature, samples. Aqua Glas, Box 99, Altadena, Calif.

## ATHLETIC EQUIPMENT, BODY BUILDING COURSES

**JUDO.** 125 Pages, 186 illustrating photographs. \$1.00. C. Marshall Company, Payne Road, Bethel, Connecticut.

**FREE** Muscle building information. Body-Tone, Box 638B, North Miami, Florida.

**NEW** Body, health, strength, muscles. Gain, reduce. Any age. Easy! Amazing guaranteed discovery uses only a rope! Free details. Roperise, 4834 Art, Studio 1-A, San Diego 15, California.

**BARBELLS.** Dumbbells. Courses. Booklet 10¢. Good Barbell Co., Siloam Springs, Arkansas.

**BE** Taller! Coach's "Inch-at-a-Time" system. 50¢. Marty Snyder, Box 195-ETA, Union City, New Jersey.

## SPORTING GOODS, GUNS, FISHING TACKLE, ARCHERY, TRAPPING

**CROSSBOWS**—Hunting bows! Factory direct prices. JayCo, Box 1355, Wichita, Kansas.

**FISH-O-Matic** catches fish automatically. Only 79¢. For free circular write: Lucky Strike Bait Company, 4111 Grant St., Gary, Indiana.

**WATER** Ski shoes. New, tough, soft, neoprene white harness, complete only \$5.95 pair. Wayne Specialties, 1111 Broadway, Fort Wayne, Ind.

**FREE!** Binocular folder. Miniature to 16x50. Arlo, 68 West Merrick, Valley Stream, New York.

**GUNS!** Guns! 10,000 guns! Lugers, Mausers, rare arms, hunting guns. Big bargain catalog! 50¢. Agramonte's, Yonkers 2-O, New York.

**GUNS.** Swords, knives, daggers, flasks. Large list 25¢ coin. Ed Howe, Coopers Mills 52, Maine.

**BUCK** Lure—\$2.00 postpaid. Write: Davy Bracken, R.D. #1, Ligonier, Penna.

**BUY** Wholesale! 25,000 nationally advertised products. Get amazing dealer catalogs. Complete details free. American Wholesalers, 1841A Levee, Dallas 7, Texas.

**FLY** Wallets that float. Discs fit gang hooks. Tackle Box Lining, Dept. PM, Korker, East Green Bush, N. Y.

**FREE**—Giant 1958 wholesale sporting goods catalog. Lowest wholesale prices. Complete line of cameras, sporting goods, appliances, outdoor items, toys. Write today. Santa Fe Distributing Co., 1321 Main St., Dept. PM, Kansas City, Mo.

**WATERPROOF** Leather with amazing Ev-R-Dry! Treat shoes, boots, jackets, holsters, saddlebags, hunting caps. Bottle \$1.00. No c.o.d. R-W Chemical Company, Dept. 17, 2018 Raven, St. Louis 14, Mo.

**JAP** Rifle altering to 30-06, \$6.00. Japshells, \$3.95. Catalog 5¢. T. P. Shop, West Branch 11, Mich.

**MOLDS** For fisherman's sinkers, jigs, squids, casting and spinning lures. Free catalog. Sweet's Molds, Tonawanda 1, New York.

**BIG** Money raising crickets and 12 inch African fishworms. Free literature. Carter Ranch, Plains, Georgia.

**5000 BARGAINS.** Firearms, binoculars, war relics. Catalog 50¢. Smith Firearms, Runnemede, N. J.

**AMAZING** Wholesale sporting catalog. Save 70%. Tremendous selections. Econ-O-Mart, Whippany 2, New Jersey.

**ILLUSTRATED** Trapping secrets, baits, lures, traps, supplies. Catalog 10¢. Pete Rickard, Box 8, Cobleskill, N. Y.

**BUY** Wholesale! 100,000 nationally advertised products! Appliances, cameras, sporting goods, housewares, watches, typewriters, tools, clothing, etc. Discounts to 80%. Buy-Rite, Box 258, Hawthorne 29, New Jersey.

**AT** Last, a safe-way gun and utility rack for pickups, trucks, sedans and wagons. Ideal for rifles and small fire-arms. Mounts neatly above windshield, behind seat or in trunk. Price, \$12.95 plus postage. Write: Phillip W. Jones and Co., P.O. Box 86G, Carmichael, California.

## EARTHWORMS, CRICKETS, FROGS

**CAROLINA** Frog farms free brochure. How raise giant food frogs. Write: Distributor, P.O. Box 3556, Baltimore 14, Md.

**GUARANTEED** Market! Earn ready cash raising fishworms for us! Backyard, garage, basement! We buy your crop! Exciting details free! Oakhaven-56, Cedar Hill, Texas.

**BIG** Money raising fishworms and crickets. Free information. Large hybrid breeder redworms, \$4 per 1000, postpaid with free raising instructions, 5000, \$17.50. Medium size 3000, \$6.50; 10,000, \$19.95. Carter Redworms, Plains, Georgia.

**BED-Run** size Colorado hybrid worms, 5000, \$12.00; 10,000, \$19.50; 20,000, \$37.50; postpaid. Dewey's Worm Ranch, Henderson, Colo.

**AFRICAN** Giant redworms, 100—\$2.00. (Dealers quoted.) Ozark Worm Farm-J, Willow Springs, Missouri.

**DO-It-Yourself** booklets, 32 different home and hobby projects. Send for 1958 book catalog 10¢. Popular Mechanics Press, 631 N. St. Clair St., Chicago 11.

"TROPICAL Wonder" baitworms 4" to 7", 100, \$2.00. Raising booklet 50¢, wholesale. Inquire Rodman's Baits, Willow Springs, Missouri.

## BINOCULARS, TELESCOPES, MICROSCOPES, MAGNIFIERS

**DYNASCOPES**—Sensational new reflector telescopes. Send for details. Criterion, Co., Dept. DP 48, Hartford, Conn.

**WAR** Surplus bargains: Millions of lenses, instruments, telescopes, binoculars, components and complete line of astronomical telescope items. World's greatest optical market-place! Send only \$1.00 for beginner's 10-lens kit and big instruction booklet stock 2-CH. Write for catalog CH free! Edmund Scientific Co., Barrington, New Jersey.

**BINOCULARS.** Telescopes, microscopes, terrific values \$3.98 up. Request free money-saving catalog. Criterion, Dept. P 70, Hartford, Conn.

**REFRACTOR** And reflector telescopes. Also mirrors, lenses, tripods, etc. Free illustrated catalog. Suffolk Science, Mattituck, N. Y.

**FREE** 48 Page science catalog. Optical, biological. Research Scientific, 126M West 23rd St., New York City 11.



**REFLECTOR** Telescope kits \$7.25 (3") to \$175. (12"). Mirrors, cells, focusing mounts, tripods, eye systems. Anything, everything in telescopes. Optics, also binoculars, microscopes, optical instruments. Free catalog. Also ready to use telescopes from \$25. Esco Products, Oakridge, N. J.

**REFLECTING** Telescope, 60X, completely assembled \$29.75. Guaranteed observatory clearness. Free information. Skyscope, P.O. Box 55, Brooklyn 28, N. Y.

**SPECIAL** Sale, amazing prices precision binoculars. Folder, "Binocular Selecting," catalog free. Prentiss Importers, Mercury Bldg., West Los Angeles 25, Calif.

**ANOTHER** First—The Escope 5" reflector completely assembled, 115X \$59.95. Free information. Esco Products, Oakridge, N. J.

**AMAZING** New telescope. Free circular. Telescope Sales, 3562 Third, Detroit 1, Michigan.

**BUY** Direct from manufacturer. Mirrors, kits, lenses, parts for astronomical telescopes. Mirrors, lenses repolished. Price list on request. Kistner, Box 74, Wakefield, New York 66, New York.

**BUILD** Your own reflector telescopes, complete kits; mirrors, eyepieces, tripods, all other accessories. Request free illustrated literature. Criterion Manufacturing, Dept. DPM 45, Hartford, Conn.

### PLANTS, SEEDS, BULBS, NURSERY AND GARDEN SUPPLIES

**GINSENG**, Goldenseal roots bring up to \$14 pound. Full information. F. M. Collins, Viola, Iowa.

**GROW** Dwarf trees! Pot, sell. Instructions and seeds, 25¢. Mail Order Specialties, 1439 PM-4 Sabraton Ave., Morgantown, W. Va.

**WORLD'S** Greatest cash crop. Free information. Write Ginseng Gardens, Asheville, N. C.

### PETS—DOGS, BIRDS, RABBITS, HAMSTERS, ETC.

**HAMSTERS**—Golden: Young, \$3.00 pair, breeders, \$4.00 pair. New mutation, \$5.00 pair. Adirondack Hamstery, Prospect 20-W, New York.

**SQUIRREL** Monkeys \$22.50. Ringtail monkeys \$35.00. Spider monkeys \$25.00, 50% deposit, balance c.o.d. Baby alligators, green Iguanas, side neck turtles, \$3.50 each, postpaid. Box turtles, horned toads \$1.50 postpaid. Full amount with order. Tarpon Zoo, Tarpon Springs, Florida.

**A.K.C.** Registered beagle pups, \$25.00 each. Olie Noblitt, Temple, Okla.

**HAMSTERS**—Finest stock. Pairs, Golden \$2.75, Albinos \$3.75. Free literature. Edgewater Hamstery, 106 Carter, Goshen, Indiana.

**GERMAN** Shepherds, Registered. Large husky pups, \$25 up. Picture 10¢. Onahill Kennels, New Hartford, Conn.

**MOST** Profitable rabbits — Angoras, Chinchillas, New Zealands. Particulars free. Grinsteads, Edwardsville, Illinois.

**EARN** \$10,000 Yearly raising Angora rabbit wool for us. Information 25¢ coin. American Angora Company, Malta 12, Montana.

**LIVE** Texas horned toads, \$1.25 each. Pair, \$2.00. Postpaid, guaranteed. Tex's, Box 253, Brownwood, Texas.

**RAISE** Rabbits successfully by knowing facts. 48 page illustrated book describing 25 breeds. Housing, feeding, breeding, marketing, etc. Plus bulletin, 25 cents. American Rabbit Association, 36 Arba Building, Pittsburgh, Penna.

**MAKE** Money raising chinchillas, mink, nutria, rabbits, cavies for us. Free catalog. Keeney Brothers, New Freedom 2, Penna.

**WE** Pay \$3.50 lb. dried. Grow mushrooms, cellar, shed and outdoors. Spare, full time, year round. We have 25,000 customers. Free book. Washington Mushroom Ind., Dept. 171, 2954 Admiral Way, Seattle, Wash.

**HAMSTERS** — Ideal pets, \$2.95 pair. Free booklet. Jer-Fre's Hamstery, 2216 East Broadway, Muskegon 13, Mich.

**STRAIGHT** Cooners! World's oldest kennel. Combination hounds, rabbit, fox, beagles, deerhounds, bird dogs. Puppies of all breeds. Prices reasonable. Trial. Free catalogue. Raccoon Mountain Kennels, Box 464, Boaz, Alabama.

**RAISE** Rabbits on \$500 month plan. Plenty markets. Free details. White's Rabbitry, Delaware, Ohio.

**SPORTSMEN:** World's largest kennels offers 500 bird dogs, straight cooners, combination hounds, beagle hounds, rabbit hounds, small squirrel dogs, fox and deer hounds. Catalogue free. Smokey Mountain Kennels, Cleveland, Tennessee.

### FUR BEARING ANIMALS

**MINK** Raising information free. Complete. Lake Superior Mink Farm, Superior, EEl, Wisconsin.

**RAISE** Mink: Free booklet, pen plans, inside secrets, feed, care. Mink are money makers. Investigate today. Lawrence Moggard, Brigham City 12, Utah.

### FARMS, FARM LANDS, REAL ESTATE

**FREE** Strout catalog! Farms, homes, businesses, resorts, retirement properties. Over 2900 values in 34 states. 57 years' service. World's largest! Write Strout Realty, 7-MP So. Dearborn, Chicago 3, Ill.

**HOMESITES** \$15 Monthly—California's finest garden section. Morro Bay's scenic shores. Wonderful fishing, boating. Fertile soil, softest water, temperate climate, congenial community. Free literature. Richard Otto, Department M, San Luis Obispo, California.

**FLORIDA.** Nice homesites, \$345 at \$10 monthly. Folder free. Howard Vernor, DeLand, Florida.

**MOTELS.** Free bulletin, 150 bargains, free photos. Continental, 1102 Grand, Kansas City, Missouri.

**\$5,500 RANCH** Opportunity! Out-of-state owner's sacrifice! Abundantly watered 360-acre Ozarks livestock setup with 5 springs, spring branch, 2 ponds! Near good fishing river, excellent hunting territory. On all routes, 2 miles store, 200 acres tillable, balance wooded, 170 now in pasture. Electric-lighted 4-room hilltop home. Barn, concrete-floored granary. Priced low for immediate action. Only \$5,500, less than half down. Free fall catalog, bargains coast to coast! United Farm Agency, 2825-PM Main St., Kansas City 41, Mo.

**2 1/2 ACRES**, Near Gulf of Mexico. High and dry. Russell Hancock, Brooksville, Fla.

**OZARK** Specialty farms. Terms. Description mailed free. 20 years service. Armstrongs, Shook, Missouri.

**OPPORTUNITIES!** Government land. U. S., Alaska, Canada. Sledge Surveys, Macon, Mississippi.

### FARM MACHINERY AND SUPPLIES

**SENSATIONAL** Garden tractor. Hoes between plants and rows, including strawberries. Eliminates hand hoeing. Nothing else like this. Patent 2742840. Also tills. Fantastic offer to first few inquiries. Auto Hoe, DePere 68, Wisconsin.

### PROFITABLE OCCUPATIONS

**INVESTIGATE** Accidents — Earn \$125 week to start. Claim investigators are urgently needed to investigate more than 490,000 accidents daily. Work full time for insurance company, railroad, steamship line, or government office. Or step into your own profitable spare time business. No experience needed. Free book, now! Universal Schools, T-9, Box 8202, Dallas 5, Texas.

**GOLD, Diamonds.** Buy and sell. Big profits. Davis, 1305 Paul, Norfolk 5, Va.

**HOME** Mailorder beginner's manual, sources, methods, opportunities, 25¢. Car-nahan Bros., 9610 Acacia, Fontana, Calif.

**MAGAZINE** Subscriptions—Largest commissions. Bonus. Qualified Agency, 451MA Kingston, Brooklyn 25, N. Y.

**FORTUNES** Made by prospectors. We teach you. Recognize valuable mineral deposits in your home area. Free details. Modern Prospector, 3433 Essex Road, Cheyenne, Wyoming.

**PROFITABLE** Operative mail order business. No obligation! Write! Heritage, 210-D Fifth Avenue, New York 10, N. Y.

**SPARETIME** Money. New plastic laminating to 24x29 1/2 without machine. Trial kit \$1.00. Volvo, Cresskill, N. J.

**BUY Wholesale!** 100,000 nationally advertised products. Appliances, cameras, sporting goods, housewares, watches, typewriters, tools, clothing, etc. Discounts to 80%. Buy-Rite, Box 258, Hawthorne 3, New Jersey.

**MAKE** Flexible molds. Cast plaques, figurines. Free sample. Tooker, 1045-M Fairview, Hamilton, Ohio.

**VENDING** Machines—No selling. Operate a route of coin machines and earn amazing profits. 32-page catalog free. Parkway Machine Corporation, Dept. 25, 715 Ensor Street, Baltimore 2, Maryland.

**AUCTIONEERING**—Home study course. Diploma granted. Auction School, Ft. Smith, Ark.

**MONEY** Plans! "Secret Journal." Grandpa, two daughters made \$2500 first month! Work home. Publicoes, Oceanside, Calif.

**BIG** Money raising fishworms and crickets. Free literature. Carter Wormery, Plains, Georgia.

**BAKE** New greaseless doughnuts in kitchen. Sell stores. Free recipes. Michael Ray, 3605 South 15th, Minneapolis 7, Minn.

**FREE** Book "505 Odd, Successful Businesses." Work home. Pacific, Oceanside, Calif.

**WE** Pay \$3.50 lb. dried. Grow mushrooms. Cellar, shed and outdoors. Spare, full time, year round. We have over 25,000 customers. Free book. Washington Mushroom Ind., Dept. 99, 2954 Admiral Way, Seattle, Wash.

**SAVE** Money! Buy wholesale! Free catalog general merchandise. Norris, 487-M Broadway, New York City.

**MAKE** Money writing short paragraphs. Information free. Barrett, Dept. CX-27, 7464 No. Clark, Chicago 26.

**SKYROCKET** To success via mailorder. Amazing facts revealed. Fortune Enterprises, Addison, Illinois.

**FREE** Book "990 Successful, Little-Known Businesses." Work home. Plymouth, 1610-43 Street, Brooklyn 4, N. Y.

**EARN** \$240.00 A month at home, spare time doing only two \$5.00 invisible mending jobs a day. Big money paid for service that makes cuts, tears disappear from fabrics. Steady demand. Details free. Fabricon, 6236 Broadway, Chicago 40, Ill.

**DOLLARS** From dolls! Doll Hospital School, Studio M 98-D, Los Angeles 49, Calif.

**BECOME** Independent exporting-importing. Act now. Gilcoes, 20 Magnolia, Norwalk, Conn.

**RAISE** Pheasants on \$100 week plan. Little capital and space can make you independent. Free details. Great Central System, Columbus 1, Kansas.

**BECOME** Independent with your own franchise business. Thousands earning handsome incomes. Request interesting facts today. National Franchise Reports, PM-528, 333 North Michigan, Chicago 1.

**100 JOBS.** Details free. English or French. Business, 60 des ormes. Québec 3, P.Q., Canada.

**WHY** Worry about work? Escape jobs forever! Retire securely now. Lead leisurely life. Unusual new book shows how. Postcard brings details free. Belmont, Wyckoff 15, New Jersey.

**BUY Wholesale!** 25,000 nationally advertised products. Get amazing dealer catalogs. Complete details free. American Wholesalers, 1841B Levee, Dallas 7, Texas.

**NEW!** Fabulous profits! Manufacture yourself. Useable samples. Details \$1.00. E&K Co., Box 2123, Fullerton, Calif.

### BOOKS, PERIODICALS, PICTURES, POSTCARDS

**MAGAZINES, Comics.** Wholesale-retail catalogue 10¢. Stamps or coins. Backdates, 1181 E. Lombard, Baltimore 2, Md.

**FREE** Catalog. Self-help books. Write: Wilshire, 8721 Sunset, Los Angeles 46P.

**"SCIENCE** Milestones." Records march of science starting 400 years before Christ, right up to date. Amazing facts revealed. 312 pages packed with startling information that will thrill you. A real history of science. \$5.00. Literature free. Popular Mechanics Press, 200-SM East Ontario St., Chicago 11, Ill.



JOHN Friend, bookfinder, can get the books you want. Free search service. Box 2570PM, Long Beach 1, California.

NATIONAL Geographic Magazines, 1888-1956. Periodical Service, Box 465-PM, Wilmington, Delaware.

RARE Magazines, catalog 10¢. Nationwide Exchange, Box 1375-P, San Antonio 6, Texas.

BOOKFINDERS! All subjects. Send wants! Jaher Book Service, 183 Hazelwood Drive, Westbury, N. Y.

OUT-Of-print books at lowest prices! You name it, we find it! Fast service. No obligation. International Bookfinders, Box 3003-PM, Beverly Hills, Calif.

FREE Catalog! Many subjects! Treasure-Site Books, 6990 Aberdeen, Upper Darby, Penna.

SUBSCRIPTIONS Taken to all magazines. Write: Wm. James, 5758 Magnolia, Riverside, Calif.

10¢ BOOKS, 1890 Titles, Catalog 10¢. Lincoln's, 1501 E. Oklahoma, Enid, Okla.

AMAZING Free catalog British books. Any subject. Transbooks, Box 1-PLA, Wantagh, N. Y.

FREE Catalog. Fascinating—revealing subjects. Bookmaster, 2432 Fernwood, San Jose 9, California.

ROCK-Rock-Rockets! Large, comprehensive volume; profusely illustrated, 128 pages, only \$2.00. Real cool! Fabians, 4370-E Clark, Montreal 18, Canada.

"THE Mechanics of the Mind." Most amazing book in years, \$2.00. Box 165, Biloxi, Mississippi.

ATOMIC Age book, \$1.50. Free literature. Agents wanted. Vetterer, Kings Court, West Palm Beach, Florida.

EXCITING Catalog packed with books covering most everything. Think of it—From cover to cover you will find described and illustrated hundreds of books telling how to fix and how to build almost anything. How to remodel your home; do your own decorating, plumbing, electrical work, carpentry, painting, furniture making and refinishing. How to build your own boat, home workshop tools. Best books on photography, welding, hobbies, homecraft. How to make a home freezer. Send now for 1958 book catalog—only 10¢. Popular Mechanics Press, 200-BC E. Ontario St., Chicago 11, Ill.

### MAGIC TRICKS, PUZZLES, JOKER NOVELTIES

FASTEST Service to magicians for over 30 years. Send 10¢ for Douglas famous catalog, 500 tricks, containing magic for pocket, parlor, stage, with balls, coins, cards, cigarettes, ropes, silks, apparatus. Douglas Magicland, Dept. 10, Dallas, Tex.

"VENTRILLO." Voice-thrower 25¢. Ventriloquist puppet 75¢. Box 971-PM, Philadelphia 5.

VENTRILLOQUISM, easiest method. Details free. Smith, 2125 N. Bigelow, Peoria, Ill.

WHOLESALE! Thirty 10¢ trick novelties \$1.00! (Profits!) 1746-PM Market, Philadelphia 3.

3100 NOVELTIES, Jokes, tricks, gadgets, funmakers, hobbies. Big catalog 10¢. Johnson-Smith, D-491, Detroit 7.

STINKERS, (El Skunko), 35 for \$1.00. Potent! (Harmless!) "Ameri-Trix," Philadelphia 44.

PROFESSIONAL Catalog, 175 pages, 25¢. Williams, 900 Plymouth, Ellwood City, Penna.

WORLD'S Finest professional magic. Joker novelties. Giant illustrated catalog 10¢. Top Hat, Evanston 12, Illinois.

BE A magician! Large professional catalog of latest tricks. 35¢. Ireland, C-109 North Dearborn, Chicago 2, Illinois.

SMOKEBOMBS, Gigantic! 25¢. 7—\$1.00. (Nonpoisonous.) 4463-PM Greene, Philadelphia 44.

TRICK Matches. Cigarette loads. Comic licenses, (26) \$1.00. Jobbers wanted. Pocket stamp 80¢. Collander's, 19½ Crossman, Jamestown, N. Y.

279 MAGIC Tricks only 15¢. Bookmaster, 2432 Fernwood, San Jose 6, Calif.

3000 TRICKS, Pocket, parlor, stage. World's finest magic catalog (408 pages), \$2.50. Kanter's, M-1311 Walnut, Philadelphia 7.

137 ASSORTED Joker novelties, tricks, puzzles, \$1.00! Box 1352-J, Philadelphia 5.

FIFTEEN Tricks complete, sealed \$1.25. Magic Bargains, 4064—39th Ave., Oakland 19, Calif.

BE A clown for fun or profit. Free details on professional instruction. Double W, Enterprises, Box 7755, Washington 4, D. C.

GIANT Ten foot burning Stinky Bomb. Makes 320 disgusting Stinkys, \$1. Kita, 1452 Drake, San Pablo 10, California.

### COINS, TOKENS, CURRENCY

RAREST CC mint dollar 1885 uncirculated \$5.00. Illustrated catalogue 25¢. Schultz, Salt Lake City 10, Utah.

LET'S Get acquainted special—Scarce Lincoln cents 1909vdb, 1916s, 1921s, 1923s, 1924s. 25¢ each or all five \$1.00. Free price lists with order. Reynolds Coin Shop, Kresge Bldg., Flint 2, Michigan.

32 PAGE Informative U.S. illustrated coin list 10¢. Stoney, 192 Washington, Boston 8, Mass.

COINS From Formosa, Vatican, etc., plus foreign banknote, 10¢ with coin approvals. Littleton Coin Co., Littleton 81, New Hampshire.

BARGAINS, U.S. coins: 1893 Columbian world's fair half dollar, \$1.00. Ten different Indian pennies, 75¢. Two-cent piece, and 3-cent piece, \$1.00. Gold ¼ eagle, \$9.00. Gold ½ eagle, \$12.50. Beautiful coin bracelet, \$1.00. Many coins available. What do you need? Rare Coin Company, 31 North Clark, Chicago 2.

COMPLETE United States coin bargain lists, Indianhead cent, 10¢. Economy Sales, 156-A Dean, Mansfield, Mass.

INDIAN Cent plus Bargain Lists 10¢. Hutchinson's, Box 4747, Philadelphia 34, Penna.

COIN Collector's Magazine, large gloss illustrated pages. Sample 25¢. Subscription \$2 year. "Flying Eagle," 229 South 11th St., Newark, N. J.

LINCOLN Cents—1916-S, 1917-S, 1918-S, 1921-S, 1923-S, 1924-S all for \$2. Gasser's, Box 34615, Los Angeles 34, California.

1958 GIANT U. S. coin catalog 25¢. Ace, 107 N. Dearborn, Chicago 2.

SAN Francisco mint closed! The 1955 cents and dimes are in short supply and great demand. The pair brilliant uncirculated for 25¢. Free coin lists. Bryson Incorporated, 612A White, Toledo 5, Ohio.

LINCOLN Cents: 1921-S, 1923-S, 1924-S, 1925-S, 1926-S, 1928-S, 1933-D, 1927-S, only \$3.00. Berry, Box 306, Westminster, California.

3 INDIANHEAD Cents and wholesale coin lists 25¢. Al. Johnson, Box 35, Colorado Springs, Colorado.

ILLUSTRATED Retail foreign coin catalogues. Gold coins. 800 different. Price 50¢. Silver, copper coins. 3000 different. Price 50¢. James Randall, Box 2205K, Fort Lauderdale, Florida.

85 DIFFERENT Lincoln cents in two Whitman folders \$4.35. Annex, 3229 W. 73 St., Cleveland 2, Ohio.

LARGEST Coin magazine, 200 pages, 35¢. Scrapbook, 7320-J Milwaukee, Chicago 31.

100 MEXICAN Coins \$1.00. Coins, 328 Eleventh, West Bend, Wisconsin.

JAPAN, India, Austria, Finland's coins 10¢. Jolie, 126M, Roslyn Heights, New York.

SHOCKINGLY Low prices! U. S. coins. Bargain list only 10¢. Hugh's, Box 361-S, Hickory, N. C.

TWENTY Different Indian cents \$2.50; three different flying eagles \$5.75; discount list, Collector's Bargains, New Hope, Penna.

MAIL Bid list 10¢ brings yours. Mary Streit, Sabetha, Kansas.

44 COINS, \$1.00. 44 bills, \$1.00. Oddehon, Box 482, St. Louis, Mo.

CASH For Canadian, American coins, catalogue information, list 25¢. Bourse, Box 274, Ft. Wayne, Ind.

BRILLIANTIZE Coins safely \$1.00. Dealers needed. Stephenson's, Inc., Ames, Iowa.

WOW! Silver dollars. Brilliant. Uncirculated. Only \$1.50 each! 1879-S, 80-S, 81-S, 82-S, 90-S, 82-O, 83-O, 84-O, 85-O, 78-P, 79-P, 83-P, 84-P, 85-P, 86-P, 87-P, 89-P, 90-P, 96-P, 1922-P, 1925-P. Free, with your order, our new price list! Proof sets. 1958 set only \$2.75, 1957—\$3.00, 1956—\$4.00, 1955—\$6.00, 1954—\$7.00, 1953—\$12.00, 1952—\$18.00, 1951—\$29.00, 1950—\$47.00. Complete set 1950-1958 inclusive, \$120.00. Postpaid. 10-day money-back guarantee of satisfaction. Thousands of other coins in stock. Gold, Silver dollars. Cents, etc. Postal Products Company, Fast Mail Order, Joe Gordon, A.N.A., 5614-MC California Street, San Francisco 21, California.

FREE Lowest price list. Cut-Rate Coin, 2073 Dauphin, Mobile, Ala.

OLD Money wanted. Will pay \$1,000.00 for 1894 dime, S. mint, \$5,000.00 for 1913 Liberty head nickel (not buffalo). Big premiums paid for all rare coins. Send 5¢ for large coin folder. May mean much profit to you. Numismatic Co., Box 750-A, Costa Mesa, Calif.

GOLD Bargains—\$5, \$11.85; \$10, \$22.95; \$20, \$43.95. Exquisite solid-gold coin bracelet (nine nice \$1.00 to \$10.00 gold coins) only \$259.50. World's greatest bargain catalogue \$1.00. (Deductible on \$10.00 order.) Guidebook \$1.75. 10 Whitman folders \$3.50. Paying top prices all gold, rare coins. Any quantity. Bebe's, 4514 North 30th, Omaha 11, Nebraska.

FOUR Scarce Lincoln cents (1911-D, 1912-D, 1913-D, 1926-S) only \$2. Delmaeu, Box 1123, Wilmington 99, Delaware.

WANTED Urgently! Coins! Now we pay even higher prices! Confidential 1959 buying guide, \$1.00. Sullivan, 128-TT Frontier Bldg., St. Paul 1, Minn.

COIN Price list and supply catalogue, 25¢ cash or stamps. Texas Coin Exchange, Inc., 2011 Cedar Springs, Dallas 1, Texas.

GET Profit and pleasure in collecting old coins. Send 15¢ for 68-page illustrated coin catalog. You'll be delighted with it. Send for it now. B. Max Mehl, Box 750-B, Costa Mesa, Calif. Oldest rare coin establishment in U.S. Established 59 years.

### STAMP COLLECTING

PENNY Approvals! Regardless catalogue! Kloster, 4164—52nd St., San Diego 5, Calif.

U.S. commemoratives, beautiful colonials, large airmails, topicals 4¢. Approvals. Bristol, Canton Center, Conn.

125 DIFFERENT United States \$1.00. Approvals. Utechs, 1134D North Keeler, Chicago 51.

CANADA—100 Different \$1.00. Approvals. Herman Epp, Box 280, Kelowna, B.C., Canada.

BRITISH Colonies, United States, general foreign approvals. Big discount for serious collectors. Adults only. Reference please. Jeans Stamps, 42 Evergreen Road, North Fort Myers, Florida.

1000 DIFF. World-wide \$1.25. A. E. Batchelder, 242 Home St., Long Beach 5, Calif.

EXCHANGE Covers world-wide. Particulars plus stamps cataloging \$2.00 only 25¢. Goodkin, Ottawa, Ohio.

DEALERS—Wholesale list. Postage 3¢. Frank, 5031 Queensberry, Baltimore 15, Maryland.

CHINESE—Large, beautiful, 100 different, \$1.00. Wah, 3027 So. Flower St., Los Angeles, Calif.

50 DIFFERENT Argentina, 10¢ with approvals. Smith, 6 Greencroft, Champaign, Illinois.

U.S. Stamps. Giant bargain catalog 10¢. Raymax, 35-VZ Maiden Lane, New York City 38.

FREE! 25 Egypt, 4¢ postage, approvals. Bellet, Mapledale, Hazel Park, Mich.

FRANCE And colonies. Post paid approvals. Glenn McClure, Copemish, Mich.

SPECIALIZING. Belgium, France, Germany, Italy, Netherlands. Postage both ways. R. Graff, Box 43, Lockport, N. Y.

TERRIFIC Stamp bargain! Israel, Iceland, Vatican assortment—Plus exotic triangle set. Also fabulous British Colonial accumulation. Plus large stamp book. All four offers free. Send 10¢ to cover postage. Empire Stamp Corp., Dept. PM, Toronto, Canada.



508 DIFFERENT Worldwide from Madagascar, Macao, Guinea, etc., cataloguing over \$15 only 35¢. Approvals. Littleton Stamp Company, Littleton Q1, New Hampshire.

MINT U.S. commemoratives, 22 diff. \$1.00, 40 diff. \$2.00, 60 diff. \$3.00. Hobby Service Co., Box 194, Franklin Square, N. Y.

FREE! New exciting pricelists. Write: Rowsell, 2425 Maplewood, Royal Oak, Michigan.

STAMP Finder, world map and encyclopedia of stamp issuing countries only 5¢. Approvals. Goliath Company, Bethlehem K1, New Hampshire.

GIANT Approvals, thousands different, 1¢ and 2¢ each. Wahl's Stamp Exchange, 7008P Farragut, Chicago 31, Ill.

GIFT! Beautiful Tokelau Islands first set to approval applicants. Deane, Box 45-371, Miami, Florida.

FABULOUS Foreign or U.S. packets. 25¢. Knopp, Box 1381, Bristol, Conn.

FREE Pictorial packet! Includes bicolors, flowers, Andorra, Iceland, Togo, Malta, Singapore, birds, sports, other fine stamps. Send 10¢ for handling. Approvals. Champlain, Isle La Motte, Vermont.

WOW! 110 All different Germany 10¢. Zeppelins, semi-postals, airmails, high values, etc. Giant catalog, bargain lists included with beautiful approvals. Jamestown Stamp, Dept. A98PM, Jamestown, N. Y.

300 MIXED Worldwide. Over 20 countries 25¢. Brookside, Box 133, Mendon, Mass.

FREE Sample! Interesting, informative, illustrated. National Stamp News, Anderson, South Carolina.

25 PHILIPPINES 10¢. Worldwide approvals. Moffat's, 740-A Milton, Rock Hill, South Carolina.

SCARCE Australian commemoratives collection, 18 different, only one dime. Approvals. Harris, Box 2, Bangor, Penna.

100 WORLD 10¢, 1¢ Approvals. Reise, 2018 Lentz Ave., Union, N. J.

ZANZIBAR Sultans, Nepal gods, 25¢. Approvals. Finley, Box 9106, Suitland, Md.

NEWS! Price lists! Canadian Bulletin 10¢; year \$1.00. Marles, Box 833, Calgary, Canada.

200 DIFFERENT Argentina \$1.00. Doc Schoenfeld, 259 Belmont, Mansfield, Ohio.

"SIMPLIFIED Mailorder Book-keeping System." Recommended for stamp collectors and dealers. \$1.00. Tasker, Box 3131, Alexandria, Virginia.

JAPAN; Next 15 10-yen FDCs \$2.00 bill. Urushihara, 17-1, Denen-Chofu, Tokyo, Japan.

FREE Packet! Angola, Azores, Mongolia, Nepal, Palestine. Fascinating approvals. Coral, Box 7095 (Ludlam), Miami 55, Florida.

COLOSSAL Bargain! Over 100 different stamps including birds, flowers, sports, triangles. Everything 10¢ with approvals. Guy Paquet, Box 189E, Quebec 8, Canada.

FREE 50 Denmark, approvals. Walter Kotowski, 19265 Eureka, Detroit 34, Mich.

APPROVAL Applicants — 1025 different \$1.00. Klondike, 682 Jefferson, Elgin, Ill.

20 BRITISH Pictorials 10¢. Approvals. Van, Box 981, Columbus, Mississippi.

FREE United States illustrated catalog. Bailey, 45 Bromfield, Boston, Mass.

PARAGUAY. 20 Different 10¢. Approvals. Dopko, 3482 Laura Lane, Riverside, California.

FREE! 50 Different. Approvals. Ehrlich, 426 Jefferson Street, N.E., Washington 11, D. C.

100 DIFFERENT U. S. commemoratives, perforation gauge, \$1.00. Moore, 609 Shirley, Norfolk 7, Virginia.

GIANT Diamond, midjet triangle, Timor, 15 mint topicals, 26 others, 10¢ with approvals. Carpenter, P.O. Box 310, Claremont, Calif.

50 U. S. commemoratives. 10¢ with approvals. Jack Clancy, Box 2187, Portland, Oregon.

40,000 VARIETIES Available on approvals. 1/4¢ upwards. Keigwin, Box 933B, Daytona, Florida.

500 FINE Mixed U.S. 15¢. Wright, 201M Mealey, Hagerstown, Maryland.

ALGERIA Air mail set six stamps only 10 cents. Approvals follow. Suncoast, 3601 29th Avenue South, St. Petersburg 11, Fla.

SPACE Stamps, pictorials, U.N., colorful sets Europe and Africa! Only 10¢ with approvals. Dorf, 186 Covington Lane, Woodbury, New Jersey.

FREE! 55 Different world; colorful, inexpensive approvals. Eikhart, Box 33, Eikhart, Indiana.

FREE Beginner's packet! Penny approvals. Moffat's, 740-P Milton, Rock Hill, South Carolina.

AUSTRALIA — Fifty different 5¢. Approvals. Valley's, Box 414P, Spring Valley, California.

FREE! Ghana's first stamp! Approvals. Keating, 2520-P Boulevard, Jersey City, New Jersey.

9 BICOLORED Armenia, value 50¢, free! Exciting approvals accompany. Tropicana, Box 449-M, Hollywood, Fla.

45 DIFFERENT Surprise. Free to approval applicants. Collier, Chamblee, Ga.

MYSTERY Bag stamp collection, 10¢ with approvals. Hill Company, Box 51, Defiance, Ohio.

SPACEOPHOBIA? Let our sets be your cure. BKJ, Astor, Boston 23, Mass.

TREMENDOUS Variety old U.S. flags, famous Americans, commemoratives with approvals plus gift, 10¢ handling. Metropolitan Stamps, Box 312VM, Jackson Heights, N. Y.

KENYA—Queen set of 6, including 1/- value, free. Approvals. Lee Hoover, Box 3594, Portland 8, Oregon.

SPUTNIK Stamp. 50 stamps free with approvals. Baiter, Box 19464, Los Angeles 19, California.

168 BICOLORED World flags and monograms, 10¢. Exciting approvals accompany. Dee, Box 926, Ormond Beach, Florida.

125 DIFFERENT Canada, \$1.00. Continental Stamps, Box 211, St. Sauveur, Quebec 8, Canada.

39 COLORFUL Pictorials from 39 different countries. Send only 10¢ in coin. Approvals accompany. Robert J. Clark, Box 28-F, Wilmette, Illinois.

75 PICTORIALS, Topicals, etc. 5¢. Approvals. Phipps, 10968-P Wellworth, Los Angeles 24.

MINT. Russian sputnik; first U.N. set, U. S. national parks. Earn these, many others, purchasing approvals. Stamp Farm, M2-3, Oxford, Wis.

CANADA, Special, 100 different 50¢ with approvals. Douglas, Hawkesbury, Ontario, Canada.

LARGE U.S. commems on paper, \$4.75 per pound. \$9.00 per two pounds. Wm. Rice, 87 Washington Ave., Kingston 3, N. Y.

A System that brings you 100 to 400 different new stamps of your own choice, each and every week. What every collector has dreamed about. Nothing else like it. This is entirely different. Complete details sent by return mail, merely by sending \$1.00 for one full year's membership or \$1.50 for two years. Las Vegas Stamp Service, 558 Oakey Blvd., Las Vegas, Nev.

LOOK! Six different Queen Elizabeth mint sets! Dominica, Gibraltar, Virgins, etc. 21 bicolors, 25¢! Attractive approvals! Gannon Stamps, Box 931, Canton 1, Ohio.

FREE — Valuable U.S.A.! (1) Scarce genuine postage stamp picturing first U.S.A., issued in 1847! (2) Big collection 30 all-different United States; ancient 19th century, valuable \$1 stamp, etc. (3) Collection beautiful commemoratives. (4) Collectors guide; big 64-page bargain catalog including all U.S. postage issues; other exciting offers! Send 10¢ for mailing expenses. HARRISCO, 4166 Transit Bldg., Boston 17, Mass.

U. S. Mint flag set, complete, \$1.00. Free list. Brooks, 2323 Avenue X, Brooklyn 35, New York.

FREE! 50 British Empire. 5¢ handling. approvals. Kensington Stamps, Buffalo 15, N. Y.

UNITED States, \$1.00 buys 7 fine unused. #643, #645, #646, #651, #657, #680, #688. Approvals accompany. Whiton Paine, Westport 11, Connecticut.

TRADE Your duplicates toward our approvals. (Foreign only.) Details free. Variety Stamps, Box 98-T, Newton Highlands 61, Mass.

1000 DIFFERENT With fine approvals. Request details. Jacobsen, Crompond, N. Y.

100 DIFFERENT 10¢ With approvals. Roger Davis, 525 Main St., New York Mills N. Y.

FREE U. S. stamps. 1943 flag, commemoratives included in collection of 25 different, plus valuable \$5.00 stamp. All for 10¢ mailing charge. Approvals. Willett Co., Box 338-A, Yorktown Heights, N. Y.

FREE! Over 100 different, \$2.50 value, including space satellite, Israel, British, U. S., first U. N., Siberia. Approvals, catalogue. Send 10¢ for mailing. Gatewood, Box 346, Winston-Salem, N. C.

WORLDWIDE, 50 All different, absolutely free, just to introduce our incomparable approvals. Kent Stamp Company, GPO Box 87, Brooklyn, N. Y.

64 PAGE U.S. catalog free. Stone, 192 Washington, Boston 8, Mass.

1000 DIFFERENT Worldwide stamps \$1.00. Valued over \$20.00. Universal, Box 6, Kenosha 5, Wisconsin.

14,000 DIFFERENT! Amazing new plan builds your collection systematically, country by country. Only 50¢ weekly. Free details. L. G. Ware, Stepney 75, Conn.

INTRODUCING Our better United States approvals, we offer 15 United States stamps including Columbian, Pan-Pacific, famous American, airmails, others; only 10¢. Ocean Stamps, Box 64-PM, Brooklyn 29, New York.

UNITED States price list, 116 pages, price 25¢. Mark Hanna, 335 Fifth Ave., Pittsburgh 22, Penna.

TWO \$5.00 United States stamps plus 20 different, 10¢, with United States approvals. Irwin, Box 1105, Brooklyn 30, N. Y.

FREE! 25 Different pictorials. Approvals. Marford, Box 48, Queens Village 29, New York.

FREE 102 Worldwide stamp assortment. Approvals. Send dime for handling. Linstamp, St. Catharines 618, Ontario.

FREE 1958 Illustrated U. S. price list. H & S, 45 Bromfield, Boston, Mass.

ALBUM Only 10¢! Hundreds of spaces! Stampmart Company, Hartford 1, Conn.

U. S. approvals. Low prices. Eagle Stamps, Romine Ave., Pittsburgh 26, Penna.

ECONOMICAL 1/2¢-3¢ Approvals, 33,000 varieties. Dresel, Box 128-N, West Englewood New Jersey.

UNITED States commemorative collection containing 33 different—10¢. Approvals. White, 516-A Avenue L, Brooklyn 30, New York.

SELL Your surplus good grade stamps. Write, describing fully what you have. Vanrey Shirk, Lebanon, Pennsylvania.

AMAZING Offer! 200 United States stamps — including commemoratives, airmails, high denominations to \$1.00. Only 10¢ to approval applicants! Illustrated bargain lists free. Mystic Stamp Co., Dept. 80, Camden, New York.

100 STAMPS, 10¢ With approvals. Smith, 508A Brooks, College Station, Texas.

OLD Scarce U.S. seconds on approvals. Slight imperfections, lowest prices. Hernefield, Clintonhill Sta., Newark 8, N. J.

100 OLD United States between 1861 and 1935, \$1.00. Roush Stamps, 51 Chestnut, Mansfield, Ohio.

UNITED States approvals. Select copies, used—mint. Kingsbury, Fairfax, Vermont.

ICELAND 10 Different beautiful stamps for only 10 cents to applicants for our good old fashioned approvals. Old Colony Stamp Co., Dept. A, Milford, Connecticut.

1-2¢ EACH! Thousands of exciting worldwide stamps. Free examination. Cole, Box 223-A, Buffalo 21, N. Y.

225 STAMPS For only 10¢! This mammoth value includes airmails, pictorials; stamps from strange countries cataloguing up to 25¢ each! Also approvals. Mystic Stamp Company, Camden 80, New York.

100 DIFFERENT Austria, 10¢. Approvals. Aronson, Box F, Newton Centre 59, Mass.



**WEIRD** Diamond shape coffee stamps. Lovely flower triangle! First American big commemorative. Greenland, idol dancer, etc. Free with approvals. Capital Stamp Co., Ferrysburg 2, Mich.

**25 DIFFERENT** Commemoratives 1893 up 10¢. U. S. approvals, K&B, Box 70, Brooklyn 23, N. Y.

**SELL** Stamps to our readers. Your ad in this space will be read by thousands of stamp buyers. I'll prove that to you. Write now for Folder "S." F. W. Johnson, Classified Advertising Manager, Popular Mechanics, 200 E. Ontario St., Chicago 11, Ill.

**FREE!** Wonderful, new 84 page U. S. catalog. Handling 10¢. Norrisco, Milwaukee 7, Wis.

### ANTIQUES, RELICS, INDIAN GOODS, CURIOS

**SCALPING** Knife, spearhead, thunderbird \$4.00. Catalog free. Arrowhead, Glenwood, Arkansas.

**FOUR** Perfect arrowheads \$1.00. Smith, 841 N. Tacoma, Indianapolis 10, Indiana.

**ILLINOIS:** Gesundheit — For sale hundreds of historical firearms, muskets, rifles, revolvers, pepperboxes, swords, bayonets, flasks, bullet molds, duelling pistols, 50,000 Indian relics, 10,000 coins, Confederate bills. Thousands of agates, fossils, minerals, deerheads, steerhorns, tomahawks, bo-wood, gold dollars, Kentucky rifles. Illustrated catalog 35¢. Heike, Bluebell, Wenona, Illinois.

### PRECIOUS STONES, MINERALS

**"GEMS & Minerals Magazine,"** largest rock hobby monthly. Field trips, "how" articles, pictures, ads. \$3.00 year. Sample 25¢. Box 687A, Mentone, California.

**COLLECT** Minerals. Make jewelry. We supply choice mineral specimens, genuine gems, quality mountings, helpful information. Lowest prices. List free. Plummer's, 4720 Point Loma Ave., San Diego 7, Calif.

**MOTHER** Lode nuggets — Copied from natural. Plated with 24 K gold. Ready for charm-bracelets, neck-chains, etc., trading or resale. \$2.00 each, 6 assorted \$10.00. Mother Lode Nuggets, 442 Birch St., Redwood City, Calif.

**SAPPHIRE** And four more uncut gems, \$1.00. Ten polished gems, baroque-shaped, \$1.00. Free gem list. Lapidary catalogue, 25¢. O'Brien's, 1116M Wilcox, Hollywood 38, Calif.

**SEMI-Precious** uncut gems. Ten different for \$1.00. Request list 2¢. Prospectors Shop, 201 San Francisco, Santa Fe, New Mexico.

**EARTH** Science, the rockhounds national magazine. Subscription \$2.00. Sample 35¢. Box 1357-PM, Chicago 90, Ill.

**ROCKHOUNDS:** Free circular. Come visit Heike's rockhound paradise, Wenona, Illinois.

**CUT** Gems, make jewelry—For profit or fun. 100 page magazine tells how: where to get supplies. Sample 25¢ or request free literature. Lapidary Journal, Del Mar 2, Calif.

### HOBBIES AND COLLECTIONS

**INVENTING** Can be an interesting and profitable hobby. Write for complete particulars. Institute of American Inventors, Dept. 40-E, 635-F St., N.W., Washington 4, D. C.

**COLLECTORS** Matchbook covers. 100 different unused, \$1.00. Catalog 25¢. Album \$3.00. Charles Edelman, 1311-C East 84, Cleveland 3, Ohio.

**SAMPLE** Nazi medal with ribbon, 50¢. Swastika embroidered emblem, 25¢. Catalog, 25¢. Hobbies, Box 71B, Rockaway Park 94, N. Y.

**FOREIGN** Matchbooks, many countries, \$2.00. Interspec, Box 804, Hartford, Conn.

**NAZI** Insignia, 12 different, \$1.00. Illustrated lists 15 cents. Hobbyland, Calgary, Canada.

### CAMERAS, PHOTO SUPPLIES

**FILING** Viewing system. Greeting cards. For transparencies. Dept. P.M. Filmdex, East Greenbush, N. Y.

**FREE!** Free! Send for your new 72 page photographic catalog. Over 5,000 new and used items at huge savings. For your free catalog, write to Dept. 129, Central Camera Company, 230 S. Wabash Avenue, Chicago 4, Illinois.

**WORLDWIDE** Color slides, film, processing. Royalpix 8A, 1854, Woodland, Charlotte 5, N. C.

**3-D VIEWER**, Two scenic, \$3.00. Stereo, 1017 E. Pike, Seattle 22, Wash.

**PHOTOGRAPHY** For pleasure or profit. Learn at home. Practical basic training. Long established school. Free booklet. American School of Photography, 835 Diversey Pkwy., Dept. 3441, Chicago 14.

### PHOTO FINISHING

**KODACOLOR** Developed, with prints, 8 exposures, \$2.91; 12 exposures, \$3.99. Mayfair Photos, Box 617, Toledo 1, Ohio.

**2x2** COLOR Slides from your Kodacolor prints, 55¢. Slide Service, Dept. PM, Box 123, Fredonia, Kansas.

**LAMINATE** Crystal clear plastic to 24x29½ without machine. Trial kit \$1.00. Dealers invited. Volvo, Cresskill, N. J.

**PHOTO** Christmas cards made from your own snapshot negatives. Truly personal and distinctive. 25 cards \$1.85; 100 for \$6.00 including envelopes. Your name imprinted 75¢ extra. Send your negative for free sample and choice of styles. Photo-Mail, Box 216-MI, New York 10, N. Y.

**SUPERIOR** Quality. Prompt service. 8 jumbo in album 40¢. 16 contacts 50¢. Jumbo reprints 5¢. Satisfaction guaranteed. Also complete color film finishing service. Write for free circulars and mailers. Fast-X-Photo, Box A, Jersey City, N. J.

**KODACHROME** Processing by Kodak. 8mm. roll or 35mm., 20 exp., \$1.35. Prompt service. Write for mailers and prices. Color Pix, Dept. P, CPO Box 30, Kingston, N. Y.

**8-HOUR** Service on deluxe jumbo prints. 8-exposure roll developed and 8 jumbo prints 40¢, 12 exposure 55¢, 16 exposure 70¢; 35mm. 20 exposure 75¢, 36 exposure \$1.25. Jumbo decklegrade reprints 4¢ each. Contact prints made if specified. Bay Photo Service, P.O. Box 210, Oakland, California.

**TWELVE** Exposure rolls 39¢. Wallets 20 for \$1.00. Lincoln Studios, Dept. K, Box 13, Lincoln, Nebr.

**TWO** Beautiful prints from each picture on roll. 8 exposure 40¢; 12 exposure 50¢. Thirty-seven years of satisfied customers. Quick Service. Lens Photos, Dept. J-4, Janesville, Wis.

**FREE** Roll 120, 620 or 127 Ansco film to introduce our film developing service. Reg. 50¢. 1 to customer. Return ad with order. Specify film size, print name, address and include 15¢ for handling: Imperial Photo, Dept. 27, Box 124, Dyker Heights Station, Brooklyn 28, N. Y.

**PARTICULAR?** 8 Jumbos—40¢. 12, 60¢. Special: 35mm., 36 exposures \$1.45. Intro offer. Flash Foto, Box 36M, Brooklyn 4, N. Y.

### MOTION PICTURES AND SOUND EQUIPMENT

**FREE!** Blackhawk's big sale catalog 8mm., 16mm. movies, 2"x2" color slides. Biggest selection anywhere! Projectors, cameras, supplies. Big discounts! Get free, every three weeks, 12-page newspaper size bargain list! Blackhawk Films, Davenport 14, Iowa.

**FREE**—8-16MM. film and list. Color and b&w movies of all types. Adrian Co., Dept. M, Box 412, Northridge, Calif.

**16MM.** Sound, projectors, films. Sale rental, exchange. Visit store or write for catalog. National Cinema, 71 Dey St., New York City.

**5,000** 8-16MM. Movie films. Free catalogues. International, Greenvale, N. Y.

**MOVIE** Camera film: 8mm. roll \$1.50. 16mm. 100' \$3.00. Free processing. Better Films, 742 New Lots, Brooklyn, N. Y.

**SAVE 50%!** Guaranteed-fresh color, b&w. movie film! 8mm., 16mm. Free catalog! Eso-R, 47th Holly, Kansas City 12, Missouri.

**PROFESSIONAL** Color movies Europe. Russia, America, Box 664, Meriden, Conn.

**FREE** Catalog. Save dollars. Fresh 8mm., 16mm. b&w and color film. Home processing equipment. Superior Bulk Film Company, 448 No. Wells, Chicago 10.

### MUSIC AND MUSICAL INSTRUMENTS

**1958 ACCORDIONS** Wholesale—10 day trial. Free catalog. American Accordion Center, 5329 PM-9 Belmont, Chicago.

**COMPOSE** Beautiful melodies quickly, correctly harmonized, without previous musical training. Guaranteed. \$3. Tune-kit, Box 1813, Abilene, Texas.

**POEMS** Wanted for musical setting and recording by America's largest song studio. Send poems. Free examination. Five Star Music Masters, 630 Beacon Building, Boston.

**ACCORDIONS!** Lowest wholesale prices guaranteed. Save up to 75%. Free home trial. Trades accepted. Free color catalog. Accordion Manufacturers, Dept. 98-R, 2003 W. Chicago, Chicago 22.

**RECORDS, Hi-Fi.** Big discounts. Noelson, Box 211, Wall Street, New York City 5.

**SONGS** and poems wanted. U. S. Music Studios, Box 222A, Belmont, Mass.

**VIOLINMAKERS,** Repairers. Fine tone wood, and all violin supplies. Send for free wholesale new price list. International Sales, 414-MPM E. Baltimore St., Baltimore 2, Maryland.

**SONGWRITERS!** Don't mail poems or songs anywhere! Write for safe procedure! Song Service P. 333 West 56th, New York City 19.

**WANTED!** Poems, lyrics, songs, ideas. Bengol, 93 Jefferson, Chelsea 50, Mass.

**SWISS** Musical movements, \$1.90. Helax, 218 W. 72nd St., New York City 23.

**VIOLIN** Makers supplies. Free catalog. 309 W. Fourth, Los Angeles 13.

**ACCORDIONS,** Wholesale to everyone. Save up to 60%. All national known brands. Free catalogue. Del Principe, 29 South Cicero, Chicago 44.

**WRITE** Songs. Big money and reputation. Write for information. J. Gordon Pub. Co., 4700 South California Avenue, Chicago.

**SONGS** Into dollars. Share \$33 million dollars yearly for new songwriters, song poets. Any subject, songs composed, published, promoted by largest firm. Information, appraisal free. Send Nordyke Music Publishers, 6000 Sunset, Hollywood 28 PM, California.

**SONGPOEMS** And lyrics wanted. Mail to: TinPan Alley, Inc., 1650 Broadway, New York 10, N. Y.

**POEMS** Wanted for new songs and recording. Immediate consideration. Send poems. Songcrafters, Box 6145, Acklen Station, Nashville, Tenn.

**YOUR** Songs arranged and recorded for publisher's presentation. For information write: Vance Studios, 3409 Grand Ave., Oakland, Calif.

**POEMS** Wanted for new songs. Send poems. Immediate consideration. Crown Music Company, 49-C West 32 Street, New York City.

**ELECTRIC** Guitars, amplifiers, wholesale. Free catalog. Carvin P.M.M. Covina, California.

**FREE** Demonstration records. Complete music service for songwriters. Jerry Colonna, Box 888M, Burbank, Calif.

**SONGS** Needed for new record label. Olenik Records, Mount Morris, Michigan.

**FREE** Wholesale musical instrument catalog. Complete lines of instruments and accessories. Nationally famous brands. Strauss Music Company, Clifton 70, New Jersey.

### RADIO, TELEVISION AND ELECTRONICS

**KITS** \$2.98 Each. Resistance box, capacitance box, tube checker. Special! Order 2, get one free. Includes instructions, new parts, surplus case. Free flyer on request. Allkit, Box 98, Midwood Station, Brooklyn 30, N. Y.

**LIGHT** Energized electric generators (photocells) power radios, electric motors (10 cells) or meters for light measurement. Photocells \$1.00 (10 for \$9.00), motors \$2.95 each. Book for amateurs and engineers \$1.50. Send check to John C. Reynolds, P.O. Box 24106, Los Angeles 24, California.



**RADIO Course only \$22.95.** Includes all tubes, parts, tools, instructions. Write for full information. Progressive "Edu-Kits" Inc., Dept. 558B, 1186 Broadway, Hewlett, N. Y.

**CRYSTAL Radio builders,** write Hulet, 305 Hope, Lakewood, New Jersey.

**RECORDERS, Hi-Fi.** Free wholesale catalogue. Carston, 215-PM East 88, New York City 28.

**FREE!** Giant bargain catalog. Transistor, "Sun" radios, kits, portables, audio, electronics, photographic, optics, tools, household. Write Lektron, 131M Everett Ave., Chelsea, Mass.

**TAPE Recorders, hi fi components,** tapes. Unusual values. Free catalog. Dressner, 69-02M 174 St., Flushing 65, N. Y.

**SIMPLE Television repairs.** Marvelous booklet or book. Send for 1958 book catalog—10¢. Popular Mechanics Press, 633 N. St. Clair St., Chicago 11.

**ELECTRIC Guitars, amplifiers, wholesale.** Free catalog. Carvin, PMR, Covina, California.

**CRYSTAL Radio kit \$1.00, preassembled \$1.25, phone \$1.75; catalogue.** Clearco Crystal Company, 2966 North 4th, Milwaukee 12, Wisconsin.

**PROLONG Battery life on your portable radio with converter-charger, only \$3.95.** Delmaco Products, Box 1123, Wilmington 99, Del.

**HEAR London, Moscow.** Shortwave radio kit; complete, \$3.50. Alliance, 2059 60th, Brooklyn 4, N. Y.

### BUSINESS OPPORTUNITIES

**OPERATE Profitable mailorder business!** Write: Bond, 1637-H West Vernon, Phoenix, Arizona.

**\$400.00 MONTHLY Raising redworms, mealworms, crickets.** Clean soilless method. Free brochure. Charlie Morgan, 116E, Bushnell, Florida.

**FREE! Secrets—Dollar making mail plans.** Unknown! Opportunities, Sumas, Washington.

**CANDIED Popcorn and potato chip equipment.** Eakins, Box 933-A8, Springfield, Ohio.

**"EVERYBODY Likes candy"—Make professionally home.** (Our 47th Year.) Ragsdale Candies, B107, East Orange, New Jersey.

**THE Law says, "You must keep records."** Use our "Simplified Mailorder Book-keeping System." Recommended for small businesses, agents, salesmen, self-employed persons, mailorder "beginners," etc. \$1.00. Tasker's, Box 3131, Alexandria, Virginia.

**PROFITABLE Mailorder merchandise business.** Everything supplied. Lester, 2311 Foxhills, Los Angeles 64.

**YOUR Own high profit business.** Sell name brands, full or part time. No inventory, no investment. More than 2,000 name brand items; lowest wholesale prices. Watches, jewelry, cameras, hi-fi radios-phonos, appliances, housewares, hardware, power tools, luggage, musical instruments, garden equipment, sporting goods, toys, many others. 8 floors of name brands. Million dollar inventory. Send for free, beautifully illustrated catalog now! Separate dealer price list. H. B. Davis Corp., Dept. 11, 145 W. 15 St., New York 11, N. Y.

**RAISE Rabbits on \$500 month plan.** Plenty markets. Free details. White's Rabbitry, Delaware, Ohio.

**SALES-By-Mail could be your opportunity.** Valuable food for thought free. Rawson Wood, 3974 Milwaukee, Chicago 41.

**BIG Profits importing, free details!** Mullins, 2029 Long Street, Kingsport, Tenn.

**MONEY Plans! "Secret Journal."** Grandpa, two daughters made \$2500 first month! Work home. Publicoe, Oceanside, Calif.

**REBUILD Batteries; repair dolls; make rubber stamps.** "75 ideas" free. Universal, Box 1076-A, Peoria, Ill.

**TO \$100.00 Weekly.** Sparetime, home operated mailorder business. Successful beginner's plan. Everything supplied. Lynn, 10420-M National, Los Angeles 34.

**LEARN Real estate by listening to records.** Lee Institute, Brookline 46, Mass.

**CAMERA Owners! Earn \$50.00 week-ends!** Instructions \$1.00, information free! Kline, 935-PM North Austin, Chicago 61, Illinois.

**COLORGLAZED Concrete pottery made without molds.** Patented method. Cemetery products, novelties, tiles. Basement leak-sealing. Money-making projects. Booklet, details free. Men only. National Potteries Company, Grand Rapids, Minnesota.

**PIANO Tuning learned quickly at home.** Tremendous field! Musical knowledge unnecessary. Information free. Empire School of Piano Tuning, Champaign, Ill. (Founded 1935).

**WANT To make big money at home?** \$10.00 profit in an hour possible with invisible mending. Make tears, holes, disappear from clothing, fabrics. Steady year-round demand from cleaners, laundries, homes. Details free. Fabricon, 6234 Broadway, Chicago 40, Illinois.

**\$70 WEEKLY—Home, spare time.** Simplified mail bookkeeping. Immediate income—easy! Auditax, 34757A, Los Angeles 34.

**MINK Raising information free.** Complete. Lake Superior Mink Farm. Superior, EE1, Wisconsin.

**MAKE Flexible molds.** Cast plaques, figurines. Free sample. Tooker, 1045-R Fairview, Hamilton, Ohio.

**NATURAL Molding rubber, extra thick.** Free sample. W. Wooley, 1016-A Donald, Peoria, Illinois.

**TREMENDOUS Possibilities in mail order.** I retired after five years. Write Norris Cole, 217 West 49th, Bradenton, Florida.

**VENDING Machines—No selling.** Operate a route of coin machines and earn amazing profits. 32-page catalog free. Parkway Machine Corporation, Dept. 26, 715 Ensor Street, Baltimore 2, Maryland.

**I want to send you proof of the wonderful pulling power of Popular Mechanics classified pages.** What's your proposition? Write me today. Include literature if possible. F. W. Johnson, Manager Classified Advertising, Popular Mechanics Magazine, 200 E. Ontario St., Chicago 11, Ill.

**BIG Money raising fishworms and crickets.** Free literature. Carter Farms, Plains, Georgia.

**11,000 NEW Prospects daily.** Baby record books, shoes, albums. Sell mailorder. Use our literature. Write: No-Co-Ro, Capitola, California.

**BAKE New greaseless doughnuts in kitchen.** Sell stores. Free recipes. M. Ray, 3605 South 15th, Minneapolis 7, Minnesota.

**FIX Typewriters.** Inexpensive home course teaches factory secrets. Free booklet. Athey, Tarentum, Penna.

**PLATE Baby shoes, jewelry, gifts, bronze and colored pearl.** Free booklet. Platex, 11029 South Vermont, Los Angeles 44.

**COPUBLISH Mail Sale Advertiser,** leading mail order paper. Details, latest copy, dime. Vanroy Shirk, Lebanon, Penna.

**FREE Catalog.** Contains hundreds of businesses, farms and income properties throughout U.S., Canada. Specify type and location desired. Deal direct with owners. U. I. Buyers Digest, 1608 Hillhurst, Dept. PM-3, Los Angeles 27, Calif.

**WE Pay \$3.50 lb. dried.** Grow mushrooms. Cellar, shed and outdoors. Spare, full time, year round. We have 25,000 customers. Free book. Washington Mushroom Ind., Dept. 173, 2954 Admiral Way, Seattle, Wash.

**FREE Book "505 Odd, Successful Businesses."** Work home. Pacific, Oceanside, Calif.

**MARKETS Everywhere.** Make artistic concrete birdbaths, pottery. Chemical coloring. Home workshop. Stucco-rock walls. Hundred varieties. Hollywood Cementcraft, 8527-K Wonderland, Hollywood 46, Calif.

**FREE Folio "\$5,000-\$45,000.** Unlimited vacations." No merchandise. Unknown! Work home, sparetime! Haylings, Carlsbad, Calif.

**MAKE \$46 From square foot plywood;** jig saw necessary. Free details. Woodart, Bridgewater, Mass.

**"MAILORDER Laws and Regulations"** and "Mailorder Rules for Beginners." Learn about necessary licenses, different taxes, legal requirements, etc. Both books, \$2.00. Tasker, Box 3131, Alexandria, Va.

**GROW Orchids at home.** Profitable, fascinating. Successful home grower explains special light, temperature and humidity conditions orchids need. Free: Full details. Orchids, 100 S. Vermont, Los Angeles 4.

**\$34.70 TWO Hours.** Manufacturing. No selling. Carlayne Castings, 1803 Fremont, Rapid City, South Dakota.

**MAKE Money selling recipes and household hints by mail.** Information free. Barrett, Dept. CA-27, 7464 No. Clark, Chicago 26.

**MAKE \$50,000.00 Yearly from home.** Informative plans free. Fortune Enterprises, Addison, Illinois.

**LEARN Sewing machine repairing.** To \$125 weekly. Sparetime. Supplies. Add to present business. Write today! Taylor Service, Box 2126, San Bernardino, Calif.

**NO Door-to-door or store selling.** Yet your sales pyramid. Nothing else like it. 70% profit. National, Box 291, Addison, Ill.

**MOTEL Supplies business and mailorder to institutions.** New! High income. Investigate. Hermes Advertising, 152-C West 42, New York City 36.

**BRONZE Baby shoes; Instructions,** equipment and mountings for genuine electroplating process. Largest supplier of all plating equipment, supplies. Free catalog. Hollywood Bronze Supply, Dept. B-3, 1624 East First, Los Angeles 33, Calif.

**EXPORT-Import business made easy.** Complete setup service, not just instructions. Hermes, 152 West 42, New York City 36.

**EXCITING Mail order business.** Something new. Guaranteed money makers. Campbells Service, Millwood, Kentucky.

**BUY Wholesale! 30-80% discounts!** Nationally famous brands. Typewriters, housewares, appliances, watches, furniture, musical instruments, cameras, tools, etc. Consolidated Distributors, Clifton 1, New Jersey.

**QUICK Profits, with no capital!** Take orders for magazines your neighbors like, want. Make cash on the spot! We show how with free kit. Get yours now. Write McGregor Magazine Agency, Dept. 310, Mount Morris, Ill.

**BUY Wholesale! 100,000 nationally advertised products.** Appliances, cameras, sporting goods, housewares, watches, typewriters, tools, clothing, etc. Discounts to 80%. Buy-Rite, Box 258, Hawthorne 1, New Jersey.

**BE A real estate broker.** Study at home. Send for free catalogue. Midwest School of Real Estate, 68 North Chicago Street, Joliet, Illinois.

**FREE Profit opportunity.** New device lets any handyman do professional TV repair. \$200 monthly easily. Electronic Engineering, Dept. BC-179, 1038 So. LaBrea, Los Angeles 19.

**SPECIALIZED Magazines.** Free list. Over 5,100 publications, current copies. Any book. All trades, hobbies. Publications, Box 44C, Franklin, Indiana.

**I Got rich in the dry cleaning business with no investment, so can you.** Free details. Write: Imperial School of Dry Cleaning, Dept. PMC, 1700 Touhy Avenue, Chicago 26, Illinois.

**SHINE Shoes without polish.** New invention. Lightning seller. Shoes gleam like mirror. Samples sent on trial. Kristee 101, Akron, Ohio.

**GUARANTEED Market!** Earn ready cash raising fishworms for us! Backyard, garage, basement! We buy your crop! Exciting details free! Oakhaven-38, Cedar Hill, Texas.

**FUNMAKERS.** Gadgets. Wholesale catalogue free. Exciting samples 25¢. Dohn-GB-Marks, Broadview, Ill.

**1200 ITEMS Drop shipped.** Wholesale circulars. Catalogs supplied. Davenport Distributors, G.P.O. Box 1354-L, New York 1, N. Y.

**INVISIBLE Reweaving:** \$5 in one hour possible reweaving burns, tears, moth-holes. Spare-full time. Free details. Skill-weave, Dept. C-169, 335 W. Madison, Chicago 6.

**START Your own business on credit (U.S. and Canada).** Be your own boss. 1425 dealers sold \$5,000 to \$32,000 in 1957. We supply stocks, equipment on credit. 200 home necessities. Sales experience unnecessary. Pleasant profitable business backed by world-wide industry. Write Rawleigh's, Dept. I-U-PPM, Freeport, Ill.



"50 NEW Home-Business Ideas" booklet. Sample free. Spray exotic Velvet-Suede on anything. Flockcraft-SR. Los Angeles 61.

GROW Expensive herbs for us! Big profits home-business of your own. Year around profitability! We supply everything necessary! Send for free rare seeds and revealing plan. (State your age.) National Herb Exchange, Dept. SR, Gardena, Calif.

\$250.00 WEEK Profit possible. Earn at home spare time with fascinating printing method. \$5 starts you. Send no money now. Free confidential facts and valuable samples. Screen-Print SR, Los Angeles 61.

MAKE Extra money. Cash commissions. Everybody buys easy-to-sell advertising book matches. Union label. All sizes. Cuts for all businesses. Powerhouse selling kit free. Steady repeat business. No experience necessary. Superior Match Co., Dept. MX-958, 7528 S. Greenwood, Chicago 19.

ESCAPE Wage slavery! Start profitable mailorder business. Exciting details! National, 2696 So. 10th, Fresno 25, Calif.

BUY Direct from factories—Appliances, cameras, watches! Free details! Cam Company, 6810PM—20th Ave., Brooklyn 4, N. Y.

HOUSEWIVES. Others. \$30-\$100 weekly sparetime assembling and distributing rockhound jewelry. Vikingcraft E. Inglewood 4, California.

OWN A collection agency. Pays big. Franklin Credit, Roanoke, Virginia.

BEFORE You start your small business. Read Conrad's Scrap Book! Avoid costly mistakes caused by misleading advertising. \$1.00 prepaid. If not satisfied money cheerfully refunded. Conrad Stadick, Searles 2, Minnesota.

BOOKS. Plans, formulas, money making opportunities, correspondence courses. Descriptive literature 10¢. Frost, Box 852, Passaic, N. J.

MEN—Opportunities. Formulas making shampoos, saving coal. Hundreds more. Name yours. Send \$1.00. Monestere, 40 Rhode Island Ave., Somerville 45, Mass.

WANTED: Home producers. to be subcontractors. Cast plastic products for manufacturers in our clearing house service. Thousands of easily made items required. Cash in at home. without previous experience. Plastic Service Associates, Dept. 9-PM, East Boston 28, Massachusetts.

PROFESSIONAL Card reading taught reasonable. Results guaranteed. Winzinger, 7205 33rd St. No., St. Petersburg 14, Fla.

MAILORDER Booklet free. Covers advertising, products, procedures. Smelser, Troy, Missouri.

BIGGEST Money-makers in the field. Acme saw and lawn mower sharpeners. Write for free literature and terms. Max Mfg. Co., 138 Stockton Ave., San Jose 26, California.

36 MINIATURE Autos \$1.98. Play traffic safety. Square, Excelsior, Minn.

DOLLS! Dolls! Dolls! We teach you to repair, make, sell all kinds of dolls and accessories including clothing. Study at home. Earn while you learn. Diploma. Free catalog. Doll Hospital School, Studio M-98, 11826 San Vicente Blvd., Los Angeles 49, Calif.

START Your own nursery. Root cuttings in your home, yard, garden. Amazing Nu-Root material, guaranteed. Root over 400 cuttings at one time. Fill your yard with plants, bushes, trees. Good all year \$2.98. Nu-Root, Box 1525, Biloxi 1, Miss.

AMAZING Profits importing. Act now. Gilcoe, 20 Magnolia, Norwalk, Conn.

SELL By mail profitably. Beginner's manual gives tested methods. 25¢. Alfano, 19 Pine Closter, New Jersey.

SELL Electric garage door operators. T & M Supply, Box 231A, Egg Harbor, New Jersey.

\$125.00 WEEKLY Spare time repairing appliances! Start first day! Details free! Scott, Box 388, Great Neck, New York.

PLASTERCRAFT Molds, liquid rubber, plasters, flocks, candle supplies. Catalog and manual free. Blue Rapids Supply, Blue Rapids, Kansas.

GETTING Nowhere selling? Free information. Nebrick, 30891 Ridgeway Drive, Farmington, Mich.

YOU May be missing the opportunity of your lifetime without knowing it! Alert yourself to profits in the booming franchise field. Distributorships, dealerships, agencies, retail operations available nationwide. Stop looking, start earning! Request interesting details today. National Franchise Reports, W-528, 333 North Michigan, Chicago 1.

BOOKKEEPERS, Accountants. Operate a bookkeeping service. Part or full time. Amazing simplified system. Wonderful money-making opportunities. Complete information free. National Bookkeeping Publishing Co., Suite 307, 3435 Broadway, Kansas City 11, Mo.

LEARN Fascinating hobby-business, engraving plastics! New engraving-carving-pantograph attachment, "DupliScaler." Uncovers exciting profit opportunities! Details, sample 10¢. Desco Distr., 5262-P Van Nuys, Van Nuys, Calif.

MAKE Fortune being wholesale distributor of appliances, jewelry, housewares. We drop ship catalogs, merchandise. Rush postcard for free details. Rickey's, Box 12X, Scottsburg, Indiana.

LIQUID Marble—Colorful, glossy! Molded, brushed, sprayed! Particulars free. Marbleizing Service, Edwardsville, Ill.

OPERATE Mailorder folio business. Free details. Ballard's, 425 East Catherine, Louisville 3, Ky.

FREE: "Profits" — "Flashsheet." Men, women. Capt. Wm. Lewis, Tampa 9, Fla.

MANUFACTURE Toys! Instructions, directory, independence. Benko, 400 E. 66th Street, New York City 21.

INTERNATIONAL Home import mail-order business! Experience unnecessary. Earnings unlimited. Foreign Traders, Meramec Building, St. Louis 5-PD, Mo.

GET Rich scientifically. Choose your job. Amazing proven technique. Guaranteed. Free vocational test. Frederick Lane Associates, 7912 Curragh, Burnaby 1, British Columbia, Canada.

\$5,000 YEARLY. Spare time at home. Nothing to buy. No local selling. Dignified. Guaranteed. Home Harvest, Rt. 3, Box 3491-A, Albuquerque, New Mexico.

LIQUID Molding rubber, free sample. Shellcraft supplies. Chaney's, 1907-A East Road, Jacksonville 11, Fla.

WIN Cadillac bonus, up to \$20,000 year. Amazing new wholesale deal! Strateway, 2114-A, Charlotte 1, North Carolina.

MAIL Order laws and regulations. Anyone operating a mail order business should know the different laws and regulations. Otherwise there is the possibility of fine or prison sentence. Book \$1.00. Central Trading Co., Box 254, Sudbury, Ontario, Canada.

EXTRAORDINARY Opportunity! Retire now! Lead leisurely life. Remarkable book shows how. Free details. Belmont, Wyckoff 16, New Jersey.

MAIL Order advertising agency executive reveals sensational no-risk advertising and merchandise methods. Start in office or home; minimum capital; positive profits. Free details: Impact! 3407 Prospect Avenue, Dept. 11-9, Cleveland 15, Ohio.

INVENTIONS Wanted to fill existing needs. Creative? Free particulars. Woodward, 1221 Edgewood, Havertown, 3-H, Pennsylvania.

CASH From sawdust, tin-cans, newspapers. Over 200 methods. Instructions \$1.00. Charles Company, 12-XAM, Norwood, Ohio.

SHARPEN Scissors, pinkers. Inexpensive machine. Sharpening supplies. Blackhaws, Sheldahl, Iowa.

HOME Mail order business opportunity! We supply everything. Fill your orders. Guide you. Eastern, Box 142, Boston, 24-C, Massachusetts.

BOSS Your own home business. Profits 1,200%-3,000%! Make, distribute, popular shellcraft jewelry. Sells itself wherever displayed! No machinery, equipment. Associate dealers wanted. Details free! Smith, Dept. A, Box 804, Panama City, Florida.

**MONEYMAKING OPPORTUNITIES**

WIN Contest prizes. Contests — Helps. Contests. 25 Earl, Red Bank, N. J.

DOLLARS From dolls! Doll Hospital School, Studio M 98-C, Los Angeles 49, Calif.

WANT To make big money at home? \$10.00 profit in an hour possible with invisible mending. Make tears, holes, disappear from clothing, fabrics. Steady year-round demand from cleaners, laundries, homes. Details free. Fabricon, 6260 Broadway, Chicago 40, Illinois.

MAKE Big easy profits making costume jewelry at home in spare time! Quick, easy to make; easier to sell! Details free! Don-Bar, 3511 W. Armitage, Dept. J-192, Chicago 47, Ill.

MAKE Money gathering roots, herbs, weeds, leaves, tree seeds, flowers, plants! Over 200 varieties! Listed buyers for all you can ship! Easy! Pleasant! Get free book! Revealing beginners packet, 25¢. Fortune Mart, 221-A Lincoln, Worcester 5, Mass.

SELL To Uncle Sam He'll pay you \$35 an ounce for the fine gold in all the junk jewelry you send in (less a small handling and refining charge). Send me your name on a postcard now for full particulars free. Leslie Patton, 335 W. Madison St., Dept. C9-M, Chicago 6.

BIG Paying, mail operated, home collection agency. Start privately, sparetime, earn while you learn. Complete 12-weeks course with confidential details postpaid \$1.00. Interstate, 37 Besch, Albany 9, New York.

\$36-\$200 WEEKLY Plating baby shoes, making jewelry, novelties, etc., at home. Details free. Jo-Ca Electroplater, 7840-D Northwest Sixth Court, Miami 50, Florida.

\$5,000.00 ANNUALLY Possible for you in mailorder. Free information. Ransie, Box 1719-A, Richmond 14, Virginia.

EARN Money at home. Thousands do. "Home Business Digest" tells how. Sample dime. Roycraft, 2263 Sibley Road, Augusta, Georgia.

AMAZING Successes through franchises! Become exclusive franchise holder your territory. Information rushed. National Franchise Reports, 333 North Michigan, Chicago 1.

"MAKE Money with Local Merchants." New manual, \$1.00. Winters, 221 Edson, Lombard, Illinois.

ATTENTION Typewriter owners. Make handsome profits. Write today. Groves Company, 682, Hastings 7, Nebraska.

WHOLESALE Bronzed baby shoe mountings. Equipment, Poster, 1520 Ardmore, Chicago 26.

COINS, New folio. Details 10¢. Patterson, 1916 Elm, New Albany, Indiana.

OPERATE Profitable mailorder business. Write Rocky Service, 6740 Waterworks Rd., Norfolk 2, Virginia.

FREE! Unusual new plan. Shows "How to Retire Without Money." Retire now! Lead leisurely life. Belmont, Wyckoff 17, New Jersey.

MAIL Order plan—Spare time or full time earnings. Details 10¢. Heritage Thrift Foundation, 1400 Davis Building, Dallas, Texas.

LEARN Pest control! \$1000.00 monthly proved. Rid homes, farms, businesses of termites, rodents, pests. New short-cut methods! It's easy, fascinating. Huge demand. Free details. APOCA, Dept. 1L, 15015 Ventura Blvd., Sherman Oaks, Calif.

SELL Information! Sample moneymaking publications! 25¢. Rainone Publications, Middle Village 79, New York.

FREE Particulars and proofs from our many customers who are making money with our brush plating outfit that requires no tanks and formulas for silvering mirrors of all kinds, metal and wood finishes, silver plate and polish and 50 other money making formulas. Write today, Gun Metal Co., Ave. H, Decatur, Illinois.

HUNDREDS Home business opportunities 25¢. Greyhouse, 7000 Monmouth, Ventnor, N. J.

HOTTEST Mail order plan ever! Sell photos, films, art novelties. Huge proven profits! Free details! Profits Unlimited, Dept. 1L, 15015 Ventura Blvd., Sherman Oaks, California.

INCOME Year around in your spare time. Your telephone can earn you a comfortable living with this profit proven plan. Your total investment: Send only \$1.00 with this ad for \$2.00 copyrighted publication. Rush! Limited offer! To Jerry Brennan Associates, Inc., Apt. 101, 1320 Kelton Avenue, Pittsburgh 16, Penna.



\$25.00 WEEKLY. Making orchids at home. Easy, Boycan, Sharon 71, Penna.

FIFTY Proven plans for complete independence at home or travel. Even for large families. Satisfaction guaranteed. Plans \$1.00. Pony Express, 146 So. Macdonald, Mesa, Arizona.

LIKE Adventure, travel? I make over \$750.00 a month plus meals, lodging, and travel expenses, no selling. \$2.00 for complete information how you may do the same. John Lindsey, 2422 So. 162 St., Seattle 88, Wash.

MAKE Money writing short paragraphs! No tedious study. I tell you what to write, where and how to sell; and supply list of editors buying from beginners. Many small checks add up quickly. Write to sell, right away. Send for free facts. Benson Barrett, Dept. C-27-V, 7464 Clark, Chicago 26.

BIG Profits quick! Make and sell costume jewelry. Details free! Modern Craft, Box 11088-M, St. Petersburg 33, Florida.

\$15,000 PROFIT in one year possible. on \$5.00 weekly. Fabulous but true. Minimum of attention, respectable field. 15% profit can be guaranteed. Experience unnecessary. Proof, complete detailed plan, only \$1.00. Satisfaction or refund. Columbia Enterprises, 8203-P, Grubb Road, Silver Spring, Maryland.

BUY Wholesale! 30-80% discounts! Nationally famous brands. Typewriters, housewares, appliances, watches, furniture, musical instruments, cameras, tools, etc. Consolidated Distributors, Clifton 2, New Jersey.

BOOKS; Hundreds of subjects. Big 1958 book catalog—10¢. Popular Mechanics Press, 200-BC East Ontario St., Chicago 11.

OPPORTUNITY Earnings to \$20.00 per hour part, full time proven business, tobacco line. Franchise details. Henford, Dept. PM, P.O. Box 59, Paramus, N. J.

\$100.00 WEEKLY. Raise redworms soil-less way. Charlie Morgan, Bushnell, Fla.

MEN—Women! Start money-making plastic laminating business at home in spare time. Material that costs 11¢ brings back \$2.50. No canvassing or selling but mail orders bring in \$20 a day. Write for full particulars free. Rush name on postcard to Warner, Room CL-2-H, 1512 Jarvis, Chicago 26, Ill.

WIN Contest money. General Contest Bulletin gives hundreds of tips. Lists current contests, rules. Sample magazine 25¢. General Contests, 1609½ East 5th, Duluth 12, Minnesota.

MAKE \$200.00 Monthly spare time with jigsaw. Free details. Elkman, 346F North Summit, Sioux Falls, South Dakota.

MAKE Money, operating mail order business, selling business cards. Vosacek Printing, 4444A Ute, San Diego 17, Calif.

START Big-pay business at home in spare time. No experience needed to operate little table-top machine for bronzing baby shoes. Make \$5.46 profit on every pair. Full particulars free. Send postcard to Mason, 1512 Jarvis, Room CM-2-H, Chicago 26, Ill.

CIGARETTES—Improved roller makes 20 for 9¢. Facts free. Moberly, Box 821, Owensboro, Kentucky.

FREE Folio "\$5,000-\$45,000. Unlimited Vacations." No merchandise. Unknown! Work home, sparetime! Haylings, Carlsbad, Calif.

READ Progressive Mailtrade. The magazine that tells how to make money by mail. Dime brings sample and special offer. Progressive Mailtrade, Box 357, Sheboygan, Wisconsin.

BIG Money raising, fishworms and crickets. Free literature. Carter Hatchery, Plains, Georgia.

SELL Titania gems. Far more brilliant than diamonds. Catalog 10¢. Diamonite, 2420-M 77th, Oakland 5, California.

VENDING Machines—No selling. Operate a route of coin machines and earn amazing profits. 32-page catalog free. Parkway Machine Corporation, Dept. 27, 715 Ensor Street, Baltimore 2, Maryland.

JOIN The prosperity parade with a mail order bookshop in your own home. Valuable information free. Practical Publications, 3974-F Milwaukee, Chicago 41, Ill.

WE Pay \$3.50 lb. dried. Grow mushrooms. Cellar, shed and outdoors. Spare, full time, year round. We have 25,000 customers. Free book. Washington Mushroom Ind., Dept. 173, 2954 Admiral Way, Seattle, Wash.

FREE "4000 Word Report" on new depression-proof business opportunities. Fortune Enterprises, Addison, Illinois.

EASY To start rubber stamp business at home in spare time. Make up to \$9.80 an hour without experience. Facts free. Write to Roberts, 1512 Jarvis, Room CR-2-H, Chicago 26.

MANY Making money at home with profitable hobbies. Send \$1.00 for book that tells how. Mail-Towne, 9 Murray St., New York 7, N. Y.

#### FORMULAS, PLANS, ETC.

LATEST Specialty developments. Free literature plus sample formula. Alphamidwest, LaPorte, Indiana.

PRACTICAL Formulas. Lists free. Cummings, Chemist, Gordon Ave., Syracuse 4, N. Y.

LATE, Modern manufacturing formulas. List free. Moon Chemical, Martville, New York.

FORMULAS For latest money-making discoveries. New! Good! Valuable literature free! Miller, Chemist, 1517-D, Tampa, Florida.

FORMULAS; All kinds, latest, best. Literature free. Kemixal, Park Ridge, Ill.

#### PLASTICS

NEW Liquid casting plastic, clear, colors. Embed real flowers, butterflies, photos, coins. Send 25¢ for two handbooks "How to Cast Liquid Plastics" and "How to Make Extra Money at Home." Castolite, Dept. K-101, Woodstock, Illinois.

LAMINATION Plastics. All types of plastic sheets, vinylite, acetate, plexiglas. Supplies, covers, fabrications. Free price list, catalogues. Arthur Blank & Co., 44 Causeway, Boston 14, Mass.

PLEXIGLAS, Square foot cost, 1/8", \$1.40; 3/16", \$1.75; 1/4", \$2.15; 1/3", \$4.15. Add 10% for colors. Send 15¢ for postage. Plast-O-Matic Co., 1413 Summit Ave., Union City, N. J.

PLASTICS! New, do-it-yourself casting and molding materials. Crystal clear for embedding specimens. Ivory, ebony, marble and colors for jewelry, novelties and industrial castings. Send 25¢ for instructive, illustrated catalog of over 200 materials and accessories. Castacraft Corp., Dept. C-66, P.O. Box 555, Palo Alto, Calif.

SLUSH Mold hollow toys in seconds. Instructions, sample, plastic catalog 25¢. Gel. Box 261, Union, N. J.

PLEXIGLAS, Square foot cost, 1/16", \$1.20; 1/8", \$1.52; 3/16", \$1.86; 1/4", \$2.21; 3/8", \$3.23; 1/2", \$4.36. Colors add 10%. Send 15¢ for postage. Aristocrat Plastics, 23 Sussex Avenue, Newark, N. J.

LAMINATING Supplies. Free price list. Solomson, 46 Cornhill, Boston 8, Mass.

BOXES, Plastic. Free list. Althor, 170 Bay 23 Street, Brooklyn, N. Y.

LEARN Plastics fabrication for spare time income. Low cost home training now available. Write for free booklet. Interstate Training Service, Dept. D-3, Portland 13, Ore.

PLASTICS—Plexiglas, acetate, vinylite, polyester, fiberglass, epoxy, styrofoam, polyethylene, mold materials, cements, supplies. Instructive, informative wholesale-retail catalog, 25¢. Gem-O'-Lite, 5527 Cahuenga, North Hollywood, Calif.

#### CHEMISTRY

MICROSCOPE Slides, anatomical. Free list. Bay, 409 Roosevelt Way, San Francisco 14, California.

CHEMISTRY—Science magazines. Literature free. Lankton, Box 5126-C18, Lansing, Mich.

TROUBLE Locating chemicals? Specialists. Fabian Chemicals, 4370 Clark, Montreal 18, Canada.

CHEMICALS In small quantities. Chemical sets for intermediate and high school students. Catalog 25¢. John H. Winn, 124M West 23 Street, New York 11, N. Y.

800 CHEMICALS, Supplies, catalog, 25¢. Laboratory Sales, Box 161-A, Brighton, Mass.

AMAZING New book of science experiments, formulas, and catalogue of laboratory supplies. Only 25¢. National Scientific Co., Dept. PM-9, 500 West Road, Lombard, Illinois.

EXPERIMENTERS; Bargains galore catalog, 25¢ (refundable). Hagenow Laboratories, Manitowoc, Wisconsin.

CHEMICALS And apparatus for industrial, analytical, and private laboratories. Catalog 25¢. Dept. M-50, Biological Supply Co., 1176 Mt. Hope Ave., Rochester 20, N. Y.

ILLUSTRATED Catalog: Chemistry, mineralogy, biology 25¢. Tracey Laboratories, Evanston, Illinois.

#### AGENTS WANTED

MAKE 100% Profit every time you push a button! Quickie Spray shines all shoes instantly without daubing, brushing, buffing. Be first! Rush refundable dollar for demonstrator, selling kit. Franchises available. James R. Barnett Company, Dept. PM-98, Wellesley Hills 81, Mass.

SHOW Thrilling \$1 values in newest Christmas card assortments, stationery, gifts. Keep up to 50¢ of every dollar. Big line; complete price range. No experience needed. Get assortments on approval. Personal portfolios free. \$1 gift offer. Cardinal, 1400 State, Dept. 79-S, Cincinnati 14.

AMAZINGLY Easy profits from exciting new Christmas cards. 21-card assortment pays 75¢ per box, \$75.00 on hundred. Gift bonuses besides. Outstanding selection cards, novelties, free imprint album. Samples on approval. \$1.25 gift offer. Creative, 4401 Cermak, Dept. 510-J, Chicago 23.

700 WAYS To make money with no selling effort! Pre-tested best selling gifts for men, women, children, the home! Distinctive greeting cards, stationery, novelties, jewelry, cosmetics, toys, gadgets. Make up to 92% profit. Many "exclusives." No minimum order. Samples on approval. Write today for exciting details, free, colorful catalog. Greetings Unlimited, 8-216 Park Square, St. Paul 1, Minn.

\$25 DAY, Easy. New fire extinguisher. Retail \$2.95. Profit \$2.00. Free sales kit. Edconco, 115 East 44th Street, Dept. P9, New York 17, New York.

MEN, Women, make money spare time plus new car given to producers as bonus. Amazing hosiery guaranteed to wear without holes, snag and runs, or replaced free. For example, lovely 60 gauge nylons, guaranteed for as long as 1½ years, or replaced free. Write Wilknit, 1789 Wash., Greenfield, Ohio.

"GET Me some!" prospects say. You got it! Prospects pay. Free details. Aero Advertising, 1635 W. Bolivar, Milwaukee 15, Wis.

CHRISTMAS Cards—Impressive album of personal and business designs, with customer's name imprinted on both cards and envelopes. Deluxe cards that pay deluxe commissions. Prices: 25 for \$3.95 and up. Men or women, club groups or church organizations can easily earn \$300 to \$500, plus bonuses. Old established manufacturer furnishes album of sample cards and selling kit. You can take orders for better Christmas cards! Experience unnecessary. Write Process Corp., Dept. 5-A, 1954 S. Troy, Chicago 23, Illinois.

I'LL Send you free stocking sample newest advancement in hosiery since discovery of nylon. Full-length; stays up without supporters; amazingly comfortable. Patented. Make money fast introducing to friends at 70¢ a pair less than nationally advertised price. American Mills, Dept. 661, Indianapolis, Ind.

NEW Bathroom deodorizer. Hangs on wall. Banishes odors bathroom, kitchen. Lightning seller. Samples sent on trial. Kristee 50, Akron, Ohio.

PERSONALIZED Paper napkins. 8 colors imprinted in gold for parties, weddings, etc. Mail 25¢ for samples (refundable). Star Craft, 1629 Edgewater, Chicago 26, Ill.

PLASTIC Freezer containers. Tremendous profits. Details free. Sample 25¢. Oxoboro Company, 9312 Blaisdell South, Minneapolis 20, Minnesota.

FREE Sample! Beautiful feather pictures. Send 12¢ stamps mailing. Sylviak, Apartado 9036, Mexico 1, D. P.

EARN Real money. Sell wholesale price book listing dealers costs of new cars and accessories. Published at \$7.50. Sample \$1.00. 6 for \$5.30. Pacific Publishing, Box 54005, Los Angeles 54.



**\$25 A Day easy with 60% profit.** Friends and neighbors will thank you for demonstrating new beauty tips and most glamorous ways to use famous Studio Girl Hollywood Cosmetics. Information I send you quickly qualifies you as a beauty adviser so you can make up to \$25 or more a day to start—or \$5.00 an hour for spare time. If you write me today I will include actual samples for which you pay nothing, now or ever. Send name, letter or postcard, to me personally. Harry Taylor, President, Studio Girl Cosmetics, Dept. 1289K, Glendale, Calif.

**MONEY-Makers!** Dollar sample and catalog 25¢. Levine's, 15-X Boulevard Station, New York 59, N. Y.

**Hi-Chrome.** Amazing discovery. Brightens dulled aluminum, doors, windows and chrome. Removes rust like magic. Easily demonstrated. Sells like wildfire. Fast repeats. Tremendous profits. Free sample offer. Hi-Chrome Manufacturing Co., Inc., 326 N. Michigan Ave., Chicago 1, Ill.

**BIG Profits selling neckties.** (\$2.00 values), \$5.95 dozen. Free information. Simms, Warwick, N. Y.

**DAMASCENE Earrings!** Exotic orientalism. Huge profit. Ohga, PM122, Sigakensuatu, Japan.

**WANTED — Fire extinguisher salesman.** Huge profits. Out-O-Matic, 1737-A E. 31st, Denver, Colorado.

**\$400 TO \$800 Monthly.** Brand new product, urgently needed by millions daily. Fast repeat sales. Just take orders, collect profit. Write: Warfield, 630 Stanley Ave., Brooklyn 7, New York.

**FABULOUS Profits.** Pictures of birds made with real feathers in breathtaking colors. Free brochure. California Imports, 1436 Ellsmere, Los Angeles 19, California.

**EARN \$12,000 Yearly—Only two sales daily.** World's best seller. The Holy Bible. Illustrated. Protestant or Catholic. Margareta's, P.O. Box 92, Hazleton 7, Penna.

**ENJOY Franchise profits like thousands are earning.** Write today for fascinating facts. National Franchise Reports, AC-528, 333 North Michigan, Chicago 1.

**MUSIC Christmas cards.** Dorby Music Cards, Box 354, Morristown, New Jersey.

**NEW Car thief signal: Lightning seller.** Samples sent on trial. Northwest Electric, 99, Mitchell, South Dakota.

**TAKE Orders for quality rubber stamps.** 35% commission paid. C. P. Marshall Company, Payne Road, Bethel, Conn.

**BUY Wholesale!** 25,000 nationally advertised products. Get amazing dealer catalogs. Complete details free. American Wholesalers, 1841DC Levee, Dallas 7, Tex.

**BOOK Shows families how to save hundreds!** Immediate returns! What could be in greater demand? Details 10¢. Heritage Thrift Foundation, 1400 Davis Building, Dallas, Texas.

**ENJOY Big spare-time profits getting new and renewal subscriptions for all popular magazines from friends, neighbors, churches, etc.** Build your own business. Start now. Free catalog. Complete information and supplies. National Publications Company, Dept. PM, 4055 Wilshire Blvd., Los Angeles 5, California.

**YOUR Photo on stamps!** Large profits, no investment. Free information. National Photostamp, 309P New York Avenue, Brooklyn 13, N. Y.

**AMAZING New liquid discovery mends, repairs fabrics of all kinds in 60 seconds.** Astounding demonstration. Everyone buys. Free sample offer. White Nu-Sew, Dept. PM-9, 330 S. Wells, Chicago 6, Illinois.

**EASY Handwork makes fast-selling useful articles.** Sample free. Sunmade Company, Brockton 64, Massachusetts.

**1958 SUPERIGNITIONER:** Starting, pep, mileage; Kaisers, mimeographs, IBM's. Varytapers, Multiliths, barbells, EG, Elmsford, N. Y.

**HAWAIIAN Candy, gifts.** Catalogue 20¢. Maier Products, 3109 Waiialae, Honolulu.

**BIG Profits.** Stamp social security plates, key protectors. Sample 50¢. Catalog free. General Products, 188-PM State, Albany 10, N. Y.

**PRINTING.** Advertising salesmen—Excellent moneymaking sideline selling decalcomania name plates, small quantities. Automobile initials, sign letters. Free samples. Ralco, XL, Boston 19, Mass.

**GOLD Or silver letters, numbers. Windows, doors, trucks. 1" to 6". 500% profits.** Free samples. Atlas-T, 544 West 79th, Chicago 20.

**AGENTS — 300% Profit selling genuine gold window letters; stores and offices.** Free samples. Metallic Sign Letter Co., 1217-D West Newport, Chicago.

**YOUR Own business — Used suits \$1.50, overcoats 65¢, mackinaws 35¢, shoes 12½¢, ladies coats 30¢, dresses 15¢.** Enormous profits. Catalog free. Nathan Portnoy Associates, 2109-AA Roosevelt Road, Chicago 8.

**BE The Popular Mechanics representative in your neighborhood and earn big profits in your spare time.** Write Popular Mechanics Magazine, Room 305M, 200 E. Ontario St., Chicago 11.

**RUN A spare-time greeting card and gift shop at home.** Show friends samples of our new 1958 Christmas and all occasion greeting cards and gifts. Take their orders and earn to 100% profit. No experience necessary. Costs nothing to try. Write today for samples on approval. Regal Greetings, Dept. 84, Ferndale, Michigan.

**EXCLUSIVE Line of personal initialed buckles, belts, cap badges, 3000 emblems.** Hook-Fast, Dept. PM, Roanoke, Va.

**\$13.50 HOURLY Profits possible,** introducing 5 valuable farm books your area. Published by Popular Mechanics. Farmers buy on sight. Details free. Popular Mechanics Press, 200 E. Ontario, Dept. 64-B, Chicago.

**EXCLUSIVE Territories!** Hottest automotive item ever! \$1.00 seller, up to 300% profit. Fantastic demonstrator. Sell retail and wholesale. Maco Products, Falls Church 4, Virginia.

**YOUR Ad in this space will get some good agents for you.** Yes, I'll prove it. Write for Folder "A" right now. F. W. Johnson, Classified Advertising Manager, Popular Mechanics Magazine, 200 E. Ontario St., Chicago 11, Ill.

**GOLDMINE Of 600 money makers.** Free copy. Specialty Salesman Magazine, Desk 5B, 307 North Michigan, Chicago 1, Ill.

**TREMENDOUS Profits!** Every man, woman and child a customer. Used suits \$1.50, pants 35¢, dresses 20¢, shoes 20¢. Operate from store, home, car. Free catalog. Superior, 1250-A Jefferson, Chicago 7.

**BUY Wholesale! 30-80% discounts!** Nationally famous brands. Typewriters, housewares, appliances, watches, furniture, musical instruments, cameras, tools, etc. Consolidated Distributors, Clifton 4, New Jersey.

**CASH Commissions at once,** taking orders for magazines every family wants! No experience needed. For free money-making kit, with everything you need, write McGregor Magazine Agency, Dept. 300, Mount Morris, Ill.

#### BUY IT WHOLESALE

**UP TO 70% off,** nationally advertised merchandise, 106 page catalog, over 4,000 items. \$1.00. Refundable first order. Keystone Industries, 1311 Morse, Chicago 26, Illinois.

**BUY Wholesale! 30-80% discounts!** Nationally famous brands. Typewriters, housewares, appliances, watches, furniture, musical instruments, cameras, tools, etc. Consolidated Distributors, Clifton 3, New Jersey.

**MY Six 80% money-saving catalogues.** Amos Mail Order, Yountville, Calif.

**USED And new watches \$2 up.** Free list. Southern Watches, 5-PM So. Wabash, Chicago 3.

**BUY Wholesale! 100,000 nationally advertised products.** Appliances, cameras, sporting goods, housewares, watches, typewriters, tools, clothing, etc. Discounts to 80%. Buy-Rite, Box 258, Hawthorne 4, New Jersey.

**ELECTRIC Guitars, amplifiers, wholesale.** Free catalog. Carvin PMW, Covina, Calif.

**WHOLESALE Automobile catalog—Discounts to 25% or savings to \$1200.00 or more.** Also big multicolor wholesale catalog: Housewares, appliances, binoculars, luggage, radios, phonographs, recorders, projectors, typewriters, sewing machines, furniture, watches, jewelry. Name brands. Huge discounts. Postcard: Selbyco, Decatur 160, Illinois.

**BULOVA, Benrus watches, men, ladies', like new. \$4.95 up.** Folder, 200 illustrations, free. Cosmos, 81 E. 125th St., New York City, Dept. 140.

**ACCORDIONS Wholesale! Save 1/5.** Home trial. Free catalog. Accordion Warehouse, Dept. 98-RW, 2003 Chicago, Chicago 22.

**BUY It wholesale.** Catalog free. Wills, 407 N. Lynn, Champaign, Ill.

**SAVE Up to 50% on nationally advertised guns, fishing equipment, etc.** Save real money. Guaranteed. Send \$1.00 for complete catalog. Refundable. Sportsmen Buying Service, White 9, South Dakota.

**WHOLESALE!** Nationally advertised merchandise. Fabulous profits, savings. Write: Wholesale Buyers, 111 Meramec, St. Louis 5-PD, Missouri.

**30% BELOW Wholesale—Buy from 300-1,000 manufacturers.** Anything. Free details. Henderson's, Box 232, Ralls, Texas.

**SAVE To 80%! Large catalog.** Nationally advertised appliances, jewelry, tools, etc. Richeo Products, 2511 Prairie, Evanston, Illinois.

**BUY Wholesale! Tremendous discounts!** United Wholesalers, 1265-M Broadway, New York 1, N. Y.

**BUY Wholesale! 25,000 nationally advertised products.** Get amazing dealer catalogs. Complete details free. American Wholesalers, 1841C Levee, Dallas 7, Texas.

**WHOLESALE Catalog, clothing, shoes, linens, housewares.** Bostonian, 14-C Dock Square, Boston 8, Mass.

**DISCOUNTS Unlimited!** Weaver K2.5, K3 \$24.25; 7x35 binoculars \$24.25; Bausch & Lomb 2½x8 \$79.60. Guns, reloading, scopes catalog 25¢! Discounts Unlimited, Box 38, Hastings-on-Hudson, N. Y.

**LARGEST Wholesale supply source in U.S.!** Furniture, clothing, appliances, housewares, automobiles and accessories, tools, sporting goods, hobby supplies, farm equipment, imports, new products, bargain merchandise. Free details. Associated Wholesalers, Box 52-DD, Burlington, Iowa.

#### SALESMEN—DISTRIBUTORS

**MAKE Big money selling the Security hand pressure dry chemical fire extinguisher.** Information free. Hurry. Hudson Mfg. Co., Sheridan 6, Michigan.

**IF You're interested in making money in selling,** see the hundreds of exceptional opportunities in Salesmen's Opportunity Magazine. Send name for your copy, absolutely free. Tell us what you're selling now. Opportunity, 848 N. Dearborn, Dept. 17, Chicago 10, Illinois.

**SELL The only Blue Ribbon pictorial Bible containing all the features necessary for complete Bible information.** 1958 edition, top commission. International Book Co., 322 N. Market, Wichita 1, Kansas.

**BUSINESS Kit free!** Postcard puts you in business! Complete line 230 shoe styles, also jackets! New discoveries pay big commissions. No investment. Send for free kit. Mason, Chippewa Falls K-111, Wis.

**SEEKING New products? Get my outfit 47 money-making specialties.** Latest conveniences for home, car. Send no money. Just your name. Kristee 31, Akron, Ohio.

**AD Matches!** Sell amazing designs—10, 20, 30, 40 and 240-light book matches. Bigger spot cash commissions; every business a prospect. Low prices for high quality. Repeats. Start without experience; men, women; full, part time. Buy nothing! Sales kit furnished. Match Corp., Dept. PM-105, Chicago 32, Illinois.

**CALENDARS, Advertising novelties, matches.** All styles, including religious, varnished, 12 sheet, girls. Hundreds of advertising novelties, book matches, etc. Fleming Calendar Co., Sales Division, 6539 Cottage Grove, Chicago 37, Ill.

**MAKE Extra money.** Cash commissions. Everybody buys easy-to-sell advertising book matches. Union label. All sizes. Cuts for all businesses. Powerhouse selling kit free. Steady repeat business. No experience necessary. Superior Match Co., Dept. M-958, 7528 S. Greenwood, Chicago 19.

**MAKE Money!** Take big profit orders, famous fruit trees. Including sensational discovery, Starkrimson Delicious apple! Also dwarfs, shrubs, roses, vines. Sales outfit free. Stark Bro's, Desk 30199, Louisiana, Missouri.

**BRAND New Aerosol products for automobiles and homes.** Fast sales. Big profits. Wype Corporation, 2241a Gravois, St. Louis 4, Missouri.

**GOOD Money selling housewives exclusive new \$1.00 kitchen necessities.** Details free. Lighthouse, 11-B Court, Plymouth, Mass.



**BRAND** New product. 150 million working areas need it today. Excellent for specialty sales, mail order, premium or advertising specialties. Sample 50¢. Information free. Remac Industries Inc., Box 14204-B, Dallas 34, Texas.

**AUTOMATIC** Needle threader. Free details. Timely, Box 596, Toronto, Canada.

**FREE** Information how to sell sharpens, knives and other house and garden tools. Sells for \$2.00, cost you \$1.00. Send for your sample \$1.00. Refundable first order. Noe, F.M. 216 Sunset Road, Elizabethtown, Ky.

**EARN \$300.00** A week selling unique business service. Nationwide, 509-M Fifth, New York City 17.

**NEW** Magnetic nail holder. Patented finger saver. Holds nails, tacks, brads, screws, etc., in hard to reach spots. Guaranteed satisfaction or money back. Sample \$1.00. Dealers wanted. Magnetic Holder Co., P.O. Box 715, San Antonio, Texas.

**AUTOMATIC** Bed warming sheet (patented), you sleep on not under. Beats electric blankets 10 ways, costs half as much. Generous profits. Patented Products Corporation, Danville 9, Ohio.

**WILL** You wear new suits and topcoats without one penny cost and agree to show them to friends? You can make up to \$30.00 in a day even in spare time, without canvassing. J. C. Field & Son, Inc., Dept. D-1826, Harrison & Throop Sts., Chicago 7, Ill.

**IT Ain't sellin'—Just servicing!** Take over your area as our service distributor keeping retail stores supplied. Nationally advertised 27-year old line pays you 66 $\frac{2}{3}$ % mark-up. For samples and highly successful plan, write Novo, Inc., 1166-F Milwaukee, Chicago 22, Ill.

#### EMPLOYMENT INFORMATION

**MEN, Women, U.S.A., foreign jobs.** High pay. Construction, clerical, etc. Transportation paid. Free information. International Reports, P.O. Box 621, San Jose, California.

**AMERICAN** Overseas jobs. High pay, men, women. Transportation paid. Free information. Write: Transworld, Dept. 6D, 200 West 34th St., New York City.

**JOBS! U.S.A.—Overseas!** Construction, aviation, clerical. Transportation free! Addresses \$1.00. Sanchez, 425 East Fifth, Brooklyn 18.

**WHY** Worry about work? Escape jobs forever! Retire securely now. Lead leisurely life. Unusual new book shows how. Postcard brings details free. Belmont, Wyckoff 18, New Jersey.

**JOBS.** Foreign, domestic. \$4,500.00 up plus bonuses. Men, women. All trades. Skilled, unskilled. Free travel, adventure, other advantages. Free information. International Employment Exchange, Box 334-BB, Midtown Station, New York City 18.

**EMPLOYMENT** Bulletin listing overseas, U.S. jobs for men, women. We also provide a brand new service never offered before. We send you official job application forms. You fill them in and return to us. Then we send letters of recommendation on our stationery to employers seeking your particular skills. Amazing results reported. Send \$3.00 for employment bulletin, application blanks. Jobs, Dept. A2, Box 125, Rugby Station, Brooklyn 3, N. Y.

**YACHTING** And steamship jobs traveling foreign countries. Davenport Service, Box 1354-A-14, G.P.O. New York 1, N. Y.

**WANT** An overseas job? Free information. Application form 10¢. Employment Headquarters, 79-H Wall Street, New York City 5.

**JOBS** For navy trained boilermen, machinist mates and electricians. Write: Box 4092, Jacksonville 1, Fla.

**SAN Francisco** Sunday classified \$1.00. Box 697, Palo Alto, Calif.

**JOB-Getting** and advancement. Copyrighted pamphlet \$1.00. Details free. Educators Placement Service, Gainesville, Fla.

**JOBS** Overseas! Janecek Development Co., 1090 Hub Station, New York 55, N. Y.

**TEXAS** Jobs—Dallas classifieds \$1.00. Richardson, 1529 Fairfax, Paris, Texas.

**HIGH** Paying jobs, opportunities, foreign, U.S.A. All trades. Companies pay fare. For information write Dept. 57J, National Employment Information, 1020 Broad, Newark, New Jersey.

**COPYRIGHTED** Reports. Best paying jobs with travel, adventure, promotions. Construction, aviation, shipping, oilfields, laborers, clerical, trades, supervisory, factory, unusual opportunities. Skilled, unskilled. Foreign, stateside. Men, women. Only \$2.00 (\$2.25 airmail) (c.o.d.'s accepted). Including registration-advisory service. Satisfaction guaranteed. Included free: Special reports on Alaska, Venezuela, South American opportunities, husband and wife foreign jobs. Research Services, Suite 514-PM Meramec Building, St. Louis 5, Missouri.

**FOREIGN** Jobs—Latin America, Alaska, Canada, up to \$1500 monthly. Up-to-date 1958 foreign service directory gives complete information; hot list of firms hiring for military and civilian construction, aircraft, oil, exporters-importers, mining. How-when-where to apply. 11th successful year. \$1.00. Global Reports, Box 8873-S, Los Angeles 8, Calif.

**FREE** Information—U.S.A. overseas jobs. High pay, transportation. Futures Unlimited, Dept. M, 215 West 34th Street, New York City 1.

#### SPECIAL SERVICES

**AUSTRALIA.** General information supplied, people, trade, opportunities, statistics. Retainer \$5.00 when applying. Australian Informat., P.O.B. 30, Mascot, N.S.W. Aust.

**BIRTH** Certificates. Guaranteed results. Any state. Millers Service, Inverness, Fla.

**INCREASE** Business—Use our address. Mail-Telephone-Service, 79 Wall St., New York City 5.

**INFORMATION** On anything. Ferguson Research Specialists, 116-14 141 St., South Ozone Park 36, N. Y.

#### EDUCATIONAL AND INSTRUCTION

**LEARN** To remember anything easily. Free particulars. Modern Memory, Box 452, Petaluma, Calif.

**LEARN** While asleep! Exciting details free. Research Association, Box 24-NN, Olympia, Washington.

**BE** An investigator. Write for free details. State age. National Detective Academy, Dept. P, P.O. Box 1082, Scottsdale, Arizona.

**EARN** Degree. Free bulletin. Home-study only. Midwestern Bible School, 1060 Broadripple, Indianapolis.

**STUDY** To be a doctor of psychology, metaphysics, divinity or philosophy. Correspondence courses only. The Neotarian Fellowship, Desk 9, Kansas City 6, Mo.

**STUDY** For Doctor's degree of psychology, metaphysics and divinity. Correspondence courses only. College of Divine Metaphysics, Dept. P-M, 2811 North Illinois, Indianapolis 8, Indiana.

**WE** Pay \$3.50 lb. dried. Grow mushrooms. Cellar, shed and outdoors. Spare, full time, year round. We have 25,000 customers. Free book. Washington Mushroom Ind., Dept. 174, 2954 Admiral Way, Seattle, Wash.

**HIGH** School diploma at home. Licensed teachers—Approved materials. Southern States Academy, Box 5344-MX, Station E, Atlanta, Georgia.

**BOOKKEEPERS!** Increase your earnings! Operate your own simplified "Dollar-A-Week" bookkeeping and tax service. Full or spare time. Details free. No obligation. Ellis, Box 200, Cedar Grove, North Carolina.

**LEARN** Appliance service and repair. Motors, washers, refrigeration, cleaners, everything. Free booklet. Armstrong, 11027-A South Vermont, Los Angeles 44.

**BE** A real estate broker. Study at home. Write for free book today. GI approved. Weaver School of Real Estate, 2018P Grand, Kansas City, Missouri.

**USED** Correspondence courses and books sold and rented. Money back guarantee. Catalog free. (Courses bought.) Lee Mountain, Pisgah, Alabama.

**EARN** While you learn. Auto and diesel mechanics master this top paying trade. Many graduates earn \$100 a week and up. Approved for Korean veterans. For free information write Dept. No. 256, Nashville Auto-Diesel College, Nashville 3, Tenn.

**PHYSICAL** Therapy and massage. Home training. Practice privately or work with doctors and hospitals. Free catalogue. National Institute, Desk 4, 159 E. Ontario, Chicago, Ill.

**INVESTIGATOR** Training. Phillips Secret Service System, 1917-B North Kennebunk, Chicago 39.

**EARN** College degrees, correspondence. Metropolitan University, Box 86-M, Glendale 5, California.

**BOOKS.** Free general catalog, 100 pages. Text, vocational, educational, instructional subjects. Millions of volumes, new and used. Bargain prices. Books bought. Est. 1901. Long's College Book Co., Dept. PM, Columbus 1, Ohio.

**COLLEGE** Correspondence courses, for Doctor of Psychology, Metaphysics, Divinity. Catalogue. Dr. Dorothy B. Arnheiter, Forest Park, Greenwood Lake, New York.

**DIESEL!** Learn to install, operate and maintain all type engines. Spare time. Write for free book. Utilities Diesel Training, Dept. DC-68, 2521 Sheffield, Chicago 14.

**FINISH** High School at home, spare time. No classes. Diploma awarded. Write for free catalog. Wayne School, Catalog HF-87, 2527 Sheffield, Chicago 14.

**MASTER** Watchmaking at home. Free sample lesson. Chicago School, 2328-YJ Milwaukee, Chicago 47.

**"HOW** To Train Horses"—A book everyone who likes horses or ponies should have. Free. No obligation. Simply address Beery School of Horsemanship, Dept. 1109, Pleasant Hill, Ohio.

**STUDY** Law at home! Instruction by attorneys of 25 years experience. Standard text books. Free catalog. Franklin School, Roanoke, Virginia.

**WANT** A diesel job? New opportunities to increase income. Higher pay. More money. We can help you qualify. Tools. Shop method home training. Write today! Diesel, Tractor, Heavy Equipment Division, Interstate Training Service, Dept. B-2, Portland 13, Oregon.

**PIANO** Tuning pays. Big money in spare time. Learn at home in 30 days. No musical knowledge necessary. Phonograph, records, tools and instructions furnished. Personal instructions available. Free catalog. Capital Piano Tuning School, 3166 S.W. 16th Court, Fort Lauderdale, Fla.

**COMPLETE** Your high school at home in spare time with 61-year-old school. Texts furnished. No classes. Diploma. Information booklet free. American School, Dept. X645, Drexel at 58th, Chicago 37, Illinois.

**PROFESSIONAL** Investigators correspondence school. Badge, diploma, future. Box 41197, Los Angeles 41, Calif.

**DRAFTING,** Design, blueprint reading. Good paying. Easy to learn at home. Minimum age 17. Write Utilities Engineering Institute, Dept. TC-12, 2525 Sheffield, Chicago 14.

**LEARN** Civil and criminal investigation at home. Earn steady good pay. Institute of Applied Science, 1920 Sunnyside, Dept. 166, Chicago 40, Ill.

**HELP** Yourself to abundant living. Our courses have aided students to richer, fuller lives. Learn secret of contentment, happiness. Earn degrees Ps.D., Ms.D. Write for free book. College of Universal Truth Correspondence School, 23-C E. Jackson, Chicago.

**HOME** Study. 32 vocational subjects. Low tuition. Free bulletin. Automet Study System, 2166 Market, San Francisco 14, Calif.

**FREE:** Your amazing subconscious—Self achievement via imagistics. Box 2847 (H-9), Ocean Park, Calif.

**PIANO** Tuning pays. Learned easily at home. GI approved. 59th year. Free booklet. Niles Bryant School, Dept. P, 3731 Stockton, Sacramento 20, Calif.

**LEARN** French, Spanish, German, Italian the modern way; with records. Complete course \$4.95. Satisfaction guaranteed. C. B. Dudley, Broad St., Athens, Ga.

**PERSONALIZED** Home study instruction. Doll Hospital School, Studio M 98-A, Los Angeles 49, Calif.

**KNOW** The truth about creating for profit. Details free. D. A. Wing, CPC, Cro-on Road, Newaygo, Michigan.

**WORK** For U. S. gov't! Men-women, 18 to 50. Prepare now for coming Civil Service Exams. For information, write: P.O. Box 37, Milwaukee 8, Wisconsin.



**WELDERS** Earn big money. Easy to learn arc, gas, automatic welding. New equipment, low cost training in non-profit school. GI approved. Free booklet. Hobart Welding School, Box M-981, Troy, Ohio.

**ENGINEERING** Degrees earned through home study. Electronic, electrical, mechanical, civil, physics. When writing, specify course desired. Residence classes also available. Pacific International University, Colleges of Engineering, Physics, and Business Administration, 5719-B, Santa Monica Boulevard, Hollywood 38, Calif.

**LEARN** Barbering at home with Medford's instructions and illustrations. Satisfaction guaranteed. \$2.00 postpaid. P.O. Box 21, Claymont, Delaware.

**VOLTAGE** Regulators, wiring, batteries, all automobiles, simplified checking and adjusting instructions, \$2.00. E. King, Box 18, 2700 N. Lindberg, St. Louis 14, Mo.

**MEN** Wanted age 17 to 55 to train as builders, estimators and contractors at home in spare time. Big pay opportunities. Write for free brochure. ATS-C1, 850 E. 58th, Chicago 37.

**WRITERS**—Get checks instead of rejection slips. Write for trade journals (business publications). Promising opportunity for intelligent new writers. Particulars free. Educational Publications, 216-A West Jackson, Chicago 6, Illinois.

**SELF-Education**, self-improvement books. Lists free. Franks, 3121 South Racine, Chicago 8.

**REMARKABLE** New book. "How to Retire Without Money." Shows men, women how to retire now and lead leisurely life. Free literature. Belmont, Wyckoff 19, New Jersey.

**ANNOUNCE** For television. Earn more money. Study at home. Enjoy prestige, success, happiness. Unlimited opportunities for young and old. Write for free information today. Tel-Announcer, Studio 9A8, 5408A Camp Bowie Blvd., Fort Worth 7, Texas.

#### PLAYS, STORIES, MANUSCRIPTS

**WANTED:** Book manuscripts, all subjects considered. Greenwich Book Pub., Atten. Mr. Zealand, 489 Fifth Ave., New York City.

**WANT** Your book published? Learn how we publish, advertise, promote, distribute. Many successes. Free booklet PM. Vantage, 120 West 31, New York City. Midwest office: 220 S. Michigan Ave., Chicago, Ill.

**FREE!** Writer's market list! If you're interested in writing fiction or articles for leading magazines, or book publishers, Daniel S. Mead, prominent literary agent, has prepared a catalogue of markets which is a "must" item. For free copy write: Daniel S. Mead, 915 Broadway, Dept. PM, New York 10, N. Y.

**MAKE** Money writing features. Amazing book tells how. Free literature. Ben Arid, Hermosa Beach, Calif.

#### ADVERTISING AGENCIES, LETTER WRITERS, FOR ADVERTISERS

**ADVERTISING** Ratebook leading newspapers, magazines, free. Chicago Advertising Agency, Chicago 4.

**FREE!** 1958 Advertisers Rate and Data Directory. 52 pages! E. H. Brown Advertising Agency, 20 N. Wacker, Chicago 6.

**ADVERTISING**, Result-getting ads prepared, placed newspapers, magazines, radio, anywhere! Lowest rates. Catalogue free. Baker Advertising Agency, 189 W. Madison, Chicago 2.

**NOW** Ready: New, amazing Classified Advertising Record Book—prepared especially for classified advertisers. Here is a book that tells you instantly whether or not your advertising in any publication is paying you real results. You can tell immediately how many inquiries each publication produced—how much cash received from every ad. Spaces are provided for the name and address of the publication, date of issue, space used, rate, cost of ad, key number, etc. You have a complete record of each publication right before your eyes. Plenty of space to keep accurate record of 28 separate publications. You can have a copy by sending only 10¢ to cover postage and handling. Send for your copy now. W. F. Johnson, Classified Adv. Mgr., Popular Mechanics Magazine, 204 E. Ontario Street, Chicago 11, Illinois.

**MAILING** Lists most any classification \$5.00 1000. Your circulars mailed with ours \$4.00 1000. Write for our literature. Dixie Mailers, King, N. C.

**30 WORDS**, 3 Magazines, 55,000 circulation, \$3.00. Paramount Press, Atlanta, Missouri.

**ADVERTISE:** 24 Words, 100 Canadian newspapers \$5.50. Lists free. Advertising Bureau, 10511-C Springfield, Chicago 43.

**"AMAZING** New Book"—"Profits From Classified Advertising." Tells how and what to advertise. Be sure to read this book before you invest one cent in advertising. Write for your copy now. Just send 10¢ for postage and handling. W. Johnson, Classified Advertising Manager, 202 East Ontario Street, Chicago 11, Illinois.

#### CARTOONING, COMMERCIAL ART, SHOWCARD & SIGN PAINTING, TATTOOING

**SIGN** Painting with master patterns. Unemployed's depression, bonanza! Eyerly, 583, Newton, Iowa.

**YOU** Can entertain with chalk talks. Catalog 10¢. Balda The Cartoonist, Oshkosh, Wis.

**LEARN** Profitable, fascinating tattooing. Illustrated information \$1. Zeis, 728-C Leslie, Rockford, Illinois.

**LEARN** Sign painting at home. Free talent test. Ben Kerns, Box 812-PM, Greenville, S. C.

**LEARN** Sign painting with fascinating system. Straley, 410 S. Western, Springfield, Ohio.

**LEARN** Sign painting quickly, easily. Expert instruction. Bolger, 148 Concord, River Edge, New Jersey.

**"HOW** To Make Money With Simple Cartoons." A book everyone who likes to draw should have. It is free; no obligation. Simply address Cartoonists' Exchange, Dept. 99-C, Pleasant Hill, Ohio.

#### RUBBER STAMPS AND OFFICE SUPPLIES

**RUBBER** Stamps, 3 lines plastic and office type \$1.00; metal \$1.25. Stock stamps on hand. Job printing. Samples on request. Frank Dahlem, 740 Mulberry St., W. Bridgewater, Penna.

**4 LINE** Rubber stamp \$1.00. Sailors, 537 Conn., Gary, Indiana.

**65¢-3** LINE Cushioned knob, postpaid. Catalog-quotations gladly. Esco, PNA, Dayton 4, Ohio.

**NAME**, Address and pad \$1.00. Jones, 230 W. 10th, Tarentum, Penna.

**NEW!** Rubber stamp catalog. Campfield, 14 Beaufort Circle, Springfield 4, Mass.

**3 LINE** Goldtone metal pocket printer, self-inking. \$1.00. James, Box 346-P, Lawndale, California.

#### TYPEWRITERS, DUPLICATORS, OFFICE DEVICES

**RECONDITIONED** Typewriters, duplicating, printing devices. \$25.00 up. Supplies. Appliances. DixieGraph, King, N. C.

#### PRINTING, MULTIGRAPHING, MIMEOGRAPHING, GUMMED LABELS

**MIMEOGRAPHING**—Letters, pricelists, formulas, instructions. Lowest prices. Lem's Letter Shop, 5710 Stanton, Detroit 8.

**1500** PERSONALIZED  $\frac{1}{2}$ "x $\frac{1}{2}$ " Labels \$1.00. Your 3 line name and address printed with blue ink on fine quality white gummed paper. Money back guarantee. Hamilton-Ward, Dept. 10B, Westfield, Mass.

**MIMEOGRAPHING**, Printing. Top quality. Reasonable prices. Frajimidot, New Lebanon Center, N. Y.

**ADS** Running under this heading sell printing. Ask me for proof. I'll gladly send you amazing facts. Ask for Folder "P." P. W. Johnson, 200 E. Ontario St., Chicago 11, Ill.

**100** EMBOSSED Business cards \$3.99. Free printing price list. Baynas Printing Sales, 8252 W. Lawrence, Chicago, Illinois.

**1,000** THERMOGRAPHED Business cards, black or blue, free cuts, postpaid. \$4.95. Scull's Printing, Wildwood, New Jersey.

**100** QUALITY Business cards \$1.00. Wilcox, 2659 Sunnyknoll, Berkley, Mich.

**SIMULATED** Engraved business cards. Samples. Royal Press, Box 56, Auburndale 66, Massachusetts.

**LOWEST** Prices on your printing. Bold, Dept. 98, 10768 Hiway 71, Kansas City 34, Missouri.

**ILLUSTRATE** Products full color printing. Save 50%. Econokolor, Rockwall, Texas.

**SAVE** Money. First class printing. State requirements. Paramount Press, Atlanta, Missouri.

**OFFSET** Printing: 24-hour service. \$6.75, 1000, 8 $\frac{1}{2}$ x11. National Letter, 251 West 42 St., New York City 36.

**1,000** BUSINESS Cards. Raised letters, \$3.50. Samples. Pioneer, Island Park PM-9, New York.

**EXCELLENT** Printing—Low prices. Postal brings catalog, samples. Demarest Printing-BP8, 3286 Wheeler, Hapeville, Georgia.

**BUSINESS**, Personal printing—Labels, rubber stamps, accessories. Illustrated catalog, free! Brose, Box 86-PM, Bergen Station, Jersey City 4, N. J.

**1000** EMBOSSED Business cards \$3.99 postpaid. Free sample. G. Ziolkowski, 20131 Concord, Detroit 34, Mich.

**FREE** Unusual catalog, air mailed. Business, personal printing. 48 hour service. Bariskill, 1715 Julian, El Cerrito, Calif.

**PERSONALIZED** Printed stationery. 50 sheets, 25 envelopes. \$1.00. Booklet, 50 gifts 10¢. Lenox Gifts, Box 573, Utica 1, N. Y.

**500-6 $\frac{1}{2}$**  ENVELOPES Printed, \$3.50 postpaid. Statements same. Stanley Press, Lake Katrine, New York.

**500** 8 $\frac{1}{2}$ x11 LETTERHEADS On best 20 lb. sulphite bond \$5.00 postpaid. 6 $\frac{1}{2}$  wv. envelopes same. Samples. Hussey Printing Co., Abbeville, Miss.

**BEAUTIFULLY** Embossed business cards mean business for you. Reasonable. Samples free. Heavener's, Colmar, Penna.

**FREE** Catalogs, postpaid printing. Rubber stamps. DM Press, Sebastopol, Calif.

**YOUR** Name and address printed on gummed labels. 1000-3 lines \$1.00; 15¢ each extra line.  $\frac{1}{2}$ " x  $\frac{1}{2}$ ". Print clearly. No c.o.d.'s. Addison Mail Order, PMA-9, 1840 Addison, Chicago 13.

#### PRINTING OUTFITS AND SUPPLIES

**DO** Your own printing. Save money. Simple rules. We supply everything. Print for others; good profit. Raised printing like engraving too. Have home shop. Details free. Kelsey Presses, V-11, Meriden, Connecticut.

**TYPE** Font complete. 12 point Cheltenham bold \$1.20. Philcon Type Foundry, 91 Eagle Point Road, Fox Lake, Illinois.

**RUBBER** Stamp making presses, hydraulic operated, electrically heated. Sizes 5"x8", 8"x12", 10"x15". starting outfits. All kinds supplies. Custom Manufacturing, 507-P N. Jefferson, Springfield, Mo.

**TYPE** Cases from manufacturer. Catalog. King McKay Company, 23179 Telegraph Road, Detroit 41, Michigan.

**MAKE** Your own self-molding rubber stamps and printing cuts. Plexirubber, Argyle 1, Wisconsin.

#### PATENT ATTORNEYS

**INVENTORS:** Protect your invention. Joseph Lindecker, Reg. Patent Attorney, 7839 Kolmar, Skokie, Ill.

**C. A. Snow & Co.—M427**, Snow Building, Washington 1, D. C. Registered Patent Attorneys. Write for information.

**INVENTORS:** Without obligation, write for information explaining the steps you should take to secure a patent. John Randolph, Registered Patent Attorney, 803 Victor Bldg., Washington 1, D. C.

**PATENTS.** "Proof of Invention" free. E. E. Vrooman, Registered Patent Attorney, 507 McKim Building, Washington 5, D. C.

**"INVENTOR'S** Guide" and "Record of Invention" free on request. Frank P. Ledermann, Registered Patent Attorney, 154 Nassau Street, New York City.

**INVENTION** Record form free and "Patent Information Every Inventor Should Have." Carl Miller, Registered Patent Attorney, Woolworth Building, New York.



**INVENTORS:** Learn how to protect your invention. Unless the inventor is familiar with patent matters, he should engage a competent registered patent attorney or agent to represent him. We are registered to practice before the U. S. patent office and prepared to serve you in handling your patent matters. "Patent Guide for the Inventor" containing detailed information concerning patent protection and procedure with "Record of Invention" form will be forwarded to you upon request—without obligation. Clarence A. O'Brien & Harvey Jacobson, Registered Patent Attorneys, 81B-G District National Building, Washington, D. C.

**INVENTORS**—Take these preliminary steps toward patent protection. Sketch and describe your invention. Sign, date and have this disclosure witnessed by two people who understand your invention. Have us make a preliminary search among U.S. patents already granted for similar types of invention. We report on the probable patentability of your invention and recommend your further course of action. Write for our instructive booklet, "Patent Protection for Inventors" and convenient "Evidence of Invention" disclosure form. Victor J. Evans & Co., 431-K Merlin Building, Washington 6, D. C.

**INVENTORS**—If you believe that you have an invention, you should find out how to protect it. The firm of McMorow, Berman & Davidson is qualified to take the necessary steps for you. Send for copy of our patent booklet "How to Protect Your Invention" and "Invention Record" form. No obligation. McMorow, Berman & Davidson, Registered Patent Attorneys, 134-Y Victor Building, Washington 1, D. C.

**INVENTORS:** When you are satisfied that you have invented something of value, write me, without obligation, for information as to what steps you should take to secure a patent. Write Patrick D. Beavers, Registered Patent Atty., 935 Columbian Bldg., Washington 1, D. C.

#### FOR INVENTORS

**SEARCHES**—Put your patent searches in the hands of a registered patent attorney or agent, as he qualifies to give a worthwhile patentability report. Record of invention form upon request and information on patent protection. Patrick D. Beavers, Registered Patent Attorney, 936 Columbian Bldg., Washington 1, D. C.

**INVENTORS**—If you believe that you have an invention, you should find out how to protect it. The firm of McMorow, Berman & Davidson is qualified to take the necessary steps for you. Send for copy of our patent booklet "How to Protect Your Invention" and "Invention Record" form. No obligation. McMorow, Berman & Davidson, Registered Patent Attorneys, 134-X Victor Building, Washington 1, D. C.

**INVENTIONS Pay inventors**—When profitable sales are certain from constructions soundly patented, and wise steps taken to reach the best markets. I help inventors to make the most profit with low definite fees for all services. 30 years' experience as patent-development engineer. U. S. and foreign patents secured. Joseph O'Brien, 132 Nassau St., New York 38, N. Y.

**INVENTORS**—This firm is registered to practice before the United States Patent Office and available to assist you in the preparation and prosecution of your patent application. "Patent Protection for Inventors" booklet containing detailed information and steps to take toward patent protection sent promptly upon request. No obligation. Victor J. Evans & Co., 432-K Merlin Building, Washington 6, D. C.

**INVENTORS.** Inventions needed at once for manufacturers. Cash or royalty. Write Allen, P. O. Box 215, Dallas 21, Texas, Dept. C.

**ATTENTION Inventors** for free information concerning the evaluation of your invention or idea write: Invention Development Company, Box 625, Garden Grove, Calif.

**INVENTORS**—Send for free Patent Information book and Inventor's Record. Registered Patent Attorney, Associate Examiner, Patent Office 1922-29, Patent Attorney & Advisor, Navy Department 1930-47. Gustave Miller, 98A Warner Building, Washington 4, D. C.

**PATENT Drawings made**—Fast confidential service. Norval Riggs, Box 2128, Las Vegas, Nevada.

**POWER Models.** Unusual steam, gasoline and traction engines, fittings, metals. Machined steam engines, put together with hand tools! Comprehensive catalog \$1.00. Chas. Cole, Ventura, Calif.

**SHIP Models** and yacht supplies complete. Large 68 page catalogue 50¢. Bill Wild's, 510 East 11 St., New York City 9.

**INVENTORS, Join Inventors of America.** Turn your talents into immediate cash. Free details. No obligation. Write Inventors of America, 3136-A Sylvania Ave., Toledo 13, Ohio.

**CASH Paid** for substantial improvement of patent 2,118,038. Northwest Development Co., 2570 Marshall, Palo Alto, Calif.

"HOW I Make My Own Free Patent Searches Safely." book \$1. Kubas, 3748 South Home Avenue, Berwyn, Illinois.

**MORE Ideas than money?** Write National M&E, Drawer 1340, St. Louis 1, Missouri.

**WE Have the markets** if you have the ideas. Harvey Engineers, Cambridge 1, Maryland.

**INVENTION Record form** free and "Patent Information Every Inventor Should Have." Carl Miller, Registered Patent Attorney, Woolworth Building, New York.

**INVENTORS, Don't sell your invention** patented or unpatented until you receive our offer. Write Cowgill, Box 298, Marion, Ohio.

**INVENTIONS Wanted** now by my manufacturer-clients. Patented, unpatented. Write Gilbert Adams, Patent Broker, 80-A Wall Street, Financial District, New York City.

**INVENTORS:** Information on patent procedure furnished on request, without obligation. John Randolph, Registered Patent Attorney, 802 Victor Bldg., Washington 1, D. C.

**INVENTORS:** Test the commercial value of your patented or unpatented inventions, quickly and inexpensively. Write for free information. Institute of American Inventors, Dept. 40-B, 635-F St., N.W., Washington 4, D. C.

**PATENT Searches \$6.00.** 48-hour airmail service. Invention protection forms free. Write Patent Engineering Service, 711 14th Street N.W., Washington 5, D. C.

**INVENTORS:** Learn how to protect your invention. Unless the inventor is familiar with patent matters, he should engage a competent registered patent attorney or agent to represent him. We are registered to practice before the U. S. Patent Office and prepared to serve you in handling your patent matters. "Patent Guide for the Inventor" containing detailed information concerning patent protection and procedure with "Record of Invention" form will be forwarded to you upon request—without obligation. Clarence A. O'Brien & Harvey Jacobson, Registered Patent Attorneys, 81A-G District National Building, Washington, D. C.

**PATENT Searches, including copies** of nearest patents, \$6.00. Reports airmailed within 48 hours. More than 100 registered patent attorneys use my service. For free invention protection forms, write Miss Ann Hastings, P.O. Box 176, Washington 4, D. C.

**PATENT Searches \$6.00.** 48-hour service. Free invention protection forms. Write Raymond L. Smith, Patent Searcher, 620 Sheraton Building, Washington 5, D. C.

#### INVENTIONS WANTED

**ARE You interested** in offers from reliable manufacturers for your invention? Patented, unpatented. Harvey Engineers, Cambridge, Maryland.

**SUPERIOR Promotions.** Patented; unpatented inventions. Information booklet, free. Superior, 338-344 North Rodeo, Beverly Hills, Calif.

**INVENTORS, Don't sell your invention** patented or unpatented until you receive our offer. Write Cowgill, Box 298, Marion, Ohio.

**INVENTIONS Wanted:** Patented, patent pending. 27 years experience promoting inventions. National Service Bureau, 3120 Meramec, St. Louis 18, Mo.

**INVENTIONS Wanted** now by my manufacturer-clients. Patented, unpatented. Write Gilbert Adams, Patent Broker, 80-S Wall Street, Financial District, New York City.

**INVENTORS:** Hundreds of manufacturers have requested our assistance in locating marketable new products. Complete information free. Institute of American Inventors, Dept. 40-D, 635-F St. N.W., Washington 4, D. C.

**INVENTIONS Wanted.** Patented; unpatented. Tremendous manufacturers lists. Global Marketing Service, 2420 77th, Oakland 5, California.

**IF Your invention is adaptable** to promoting, we will contract for selling on cash or royalty. Free booklet outlines royalty rates, requirements. Kessler Corporation, 59-1W, Fremont, Ohio.

**INVENTORS, Join Inventors of America.** Turn your talents into immediate cash. Free details. No obligation. Write Inventors of America, 3136-A Sylvania Ave., Toledo 13, Ohio.

#### MANUFACTURING

**EXPERIMENTAL, Small, large lots.** Cast reproductions your miniature, model part badge, charm, etc., from metal pattern. White metal, britannia. Selley, 744-6 Clay, Winter Park 1, Fla.

**MODELS**—Small lot manufacturing. Metals, plastics, etc. Milburn, Burlington, Kentucky.

#### MODELS, MODEL SUPPLIES

**ROCKETS**—Complete instructions for building flying models, \$1.00. Greiner Enterprises, Box 3579, Hamilton Station, Baltimore 14, Md.

**ROCKET Parts, fuel ingredients, plans.** Price list, fuse samples 25¢. Central Rocket Company, Waupaca, Wisconsin.

**ROCKETS**—Build your own working models. Plans for 1/4 to 3 1/2 inch diameter, fuels, electrical firing, one and two stage. All for \$1.00. Dept. M, 4106 Beechiff, Columbia, S. C.

**SEND For big 312-page hobbycraft catalog** with thousands of hobby items. Planes, trains, boats, crafts. Send \$1 to Petey-Q Model Sales, 519-A Davis St., Evanston, Ill. \$1 refunded with first order of \$5 or more.

**SHIP Models.** Most complete line in New England. Kits, fittings, plans, books, tools, engines, motors. 1958 illustrated catalog 35¢. James Bliss & Co., Inc., Dept. SM, 342 Atlantic Ave., Boston 10, Mass.

**BALSA Wood and model aircraft.** 40-page catalog 25¢. Sig Co., Montezuma, Iowa.

**SHIP And yacht model fittings; blueprints.** Send 35¢ for illustrated catalog listing hundreds of items. A. J. Fisher, 1002-1 Etowah Ave., Royal Oak, Mich.

**SHIP Model kits, fittings and plans** including clippers, trawler, fishermen, frigates, privateer, etc. Towboat of 1900 for HO gauge \$3.95. 1958 catalog 25¢. Model Shipways, Box 85, Bogota, N. J.

#### HOME CRAFTSMEN

**GUITAR Making, books, plans, imported woods, tools.** Free list. Store, 510 East 11th Street, New York 9, N. Y.

**LEARN Art metalcraft and jewelry making.** Complete, inexpensive, home training course now available. Special tools and materials furnished. Write for free booklet. Interstate Training Service, Dept. L-3, Portland 13, Oregon.

**KNOCKDOWN Cedar chests and lumber.** Free price list. Bedford Lumber Company, Shelbyville, Tennessee.

**WOODWORKING And cabinetmaking** course for beginning and advanced home craftsmen. Only complete low-cost home training program available. Write for free booklet. Interstate Training Service, Dept. G-3, Portland 13, Ore.

**JUSTOSTOP.** Gets professional results from your power saw. Free brochure. Anderson Company, 1110 West 68th Street, Los Angeles 44, Calif.

**FREE Leathercraft catalog.** Quality kits. Warne Leather Company, Montrose, Calif.

**BUY Picture frame moldings** at wholesale, actually less than cost of raw lumber. All styles and widths. Free delivery. Write for price list. Chesapeake Picture Frame Co., Box 533, Baltimore 3, Maryland.

**FREE Catalog.** 2150 artist-drawn patterns. Craftplans, 1322-A Wabash, Chicago 5.



**NEW Big illustrated catalog.** Supplies for leathercraft, metalcraft and numerous small inexpensive crafts. Prompt shipments. Top values. Latest ideas. Send 10¢ today to J. C. Larson Co., Dept. 8027, 820 S. Tripp, Chicago 24.

**LEATHERCRAFT.** Send 10¢ for new 102-page catalog of tools, supplies, kits, including metalcrafts, enameling, ceramics, all other crafts. Complete stock. Reasonable. Since 1910. Sax Bros., Dept. PM-9, 1111 N. 3rd, Milwaukee, Wis.

**FANCY Walnut and cherry squares,** blocks, etc. Free list. Midland Lumber Co., Box 124, St. Joseph, Mo.

**101 PATTERNS** Of smart gifts, novelties, shelves, action windmills plus "Make Money Jig Sawing." \$1.00. Mastercraft, 95M, 7041 Olcott, Chicago 31.

**BOOKBINDING** And leather-goods preservative. Non-greasy. Prevents drying, cracking, worms. \$4 pint. Lorah, Box 175, Newport, R. I.

**LEATHERCRAFT.** Imported and domestic leather, tools, kits. Complete catalog 25¢. Midas, Box 1255, Dept. J8, Huntington Park, Calif.

**LETTERING Pens, Linoprint tools.** Free catalog. Bamberger Bros., P.O. B. 127, Cathedral Station, New York City 25.

**HOME Workshop books.** Send for 1958 book catalog—10¢. Popular Mechanics Press, 631 N. St. Clair St., Chicago 11.

#### DO IT YOURSELF

**GRANDFATHER** Clock movements, barometers, blueprints, kits. Wholesale catalog 25¢. Mason-Sullivan, Noroton, Conn.

**MOSAIC** Tile tables, new, different, beautiful. Inexpensive, easy. Photographed, step-by-step 12 page booklet shows everything. \$1.00 postpaid. Dept. P.M., J. & H. Mosaics, P.O. Box 3174, North Hollywood, California.

**SAVE** On birthdays, Christmas, etc. Make clever gift lamps, planters. New excitingly easy instructions. Send \$1.25. Nomold, 20330 Whitlock, Dearborn, Mich.

**BUILD** Your own hi-fidelity sets. Details. Arkay Dist. Co., P.O. Box 581, Church St., Sta., New York City, N. Y.

#### WATCHES, OLD GOLD, JEWELRY

**COSTUME** Jewelry supplies, settings, rhinestones, etc. 88 page illustrated catalog. 25¢. Milady, Box 1328, G.P.O., New York City.

**WATCH** And clock repairing books. Free catalog. North American, 2320-AW Milwaukee, Chicago 47, Illinois.

**HIGHEST** Cash paid for old gold, jewelry, gold teeth, diamonds, watches, silver. Mail articles today. Information free. Chicago Gold Refining Co., 6 E. Monroe, Dept. 658, Chicago 3.

**WATCHMAKERS'** Jewelers' supplies, instructions. Catalog 25¢. Bengal Wholesalers, Culver City, California.

**HIGHEST** Cash for old gold, broken jewelry, gold teeth, watches, diamonds, silverware, spectacles, platinum, mercury. Free information. Rose Refiners, Heyworth Building, Chicago 2.

**FREE** Folder. New costume jewelry supplies. Modern Craft, Box 11088-R, St. Petersburg 33, Florida.

**FREE** Catalog. Costume jewelry parts. Supplies. Reasonable prices. Past service. Guaranteed quality. Unique merchandise. Folsom's, Box 52, Medford 55, Mass.

**MECHANICS**—Precision made Mortima watch, 17 jewel, luminous dial, anti-magnetic, shock-resistant, unbreakable mainspring. Water-resistant price \$22.50. F. Robinson Importer, Breckenridge, Minn.

**10 SWISS** Watches \$18.00. Catalog 25¢. Berkowitz, 1150 Castle Hill, New York City 62.

#### RAZORS, BLADES, SHARPENING

**SWEDISH** Steel razor blades, finest quality, 10 shaves per blade, single-double, 10 pkgs. of 5 ea. \$1.00 plus 10¢ postage. Guaranteed. If not satisfied (these are finest blades you have ever used.) send 9 pkgs. back \$1.00 refunded. Order now. Morrisette, P.O. Box 127, San Francisco.

**100 BLUE** Steel double edged razor blades \$1.00. 1000—\$8.00. Jan Enterprises, 2985 Verity Lane, Baldwin, N. Y.

#### TOBACCO, SMOKERS' SUPPLIES

**CIGARS** For less. Free list. Tobacconist, 220 North Clark, Chicago 1.

#### OF INTEREST TO WOMEN

**FREE**—Big new wholesale catalog! Up to 50% saving for you, family, friends on nationally known gifts, jewelry, toys, appliances, Christmas cards, etc. Also make money selling part time! Write: Evergreen Studios, Box 846D, Chicago 42, Ill.

**DRESSES** 24¢; Shoes 39¢; men's suits \$4.95; trousers \$1.20. Better used clothing. Free catalog. Transworld 164-8 Christopher, Brooklyn 12, N. Y.

**SELL** Fine fabrics. Get yours wholesale. Box 863, Norwalk, Conn.

**WE** Pay \$3.50 lb. dried. Grow mushrooms. Cellar, shed and outdoors. Spare, full time, year round. We have 25,000 customers. Free book. Washington Mushroom Ind., Dept. 176, 2954 Admiral Way, Seattle, Wash.

**SELLING** Christmas cards? Double your earnings with exciting, exotic gifts from all over the world! Write for free money-making catalog. Modern Merchandise Co., Dept. J-17, 230 S. Franklin St., Chicago, Ill.

**WANT** Extra cash? Send your name for money-making Christmas card samples on approval. Showing them to friends pays you as much as 50¢ to \$1.25 profit per item. \$150.00 easy! Free personal album; 30th anniversary gift offer. Midwest, 1113 Washington, Dept. 501-W, St. Louis 1, Mo.

**MAKE** Stunning skirts—Finest quality wool-nylon blend. Washable. 60 wide. Rich colors. Save! Samples 10¢. Kroona Fabrics, 2005-PM Taylor, Minneapolis 18, Minnesota.

**TYPISTS** Unlimited profits home business. Juan-Studio, 1-H, P.O. Box 3053, Chicago 54, Ill. Send 10¢.

**STAMPED** Linens for embroidery or painting. Buy direct from manufacturer and save. Send for free catalog. Merrilee, 16 West 19th St., Dept. 331, New York 11, N. Y.

#### PERSONAL

**PAY** Your bills now. Borrow \$100 to \$600 cash by mail. Easy, quick, private. Repay in small monthly installments over 20 months. Your payments may run ½ less than now; have money left over to spend. Loan order blank mailed free in plain envelope. Advise amount needed. State Finance Co., 323 Securities Bldg., Dept. C-1, Omaha 2, Nebr.

**LOANS** By mail. Borrow \$50 to \$500 for any purpose. Employed men and women over 25, eligible. Confidential, no co-signers. Up to 2 years to repay. Low monthly payments. Supervised by Nebraska banking department. Loan application sent free in plain envelope. Give occupation. American Loan Plan, City National Bank, Dept. PM-9, Omaha 2, Nebraska.

**BORROW** Money by mail. \$100-\$600. Anywhere. Air mail service. Postal Finance, 200 Keeline Building, Dept. 658R, Omaha 2, Nebraska.

**FEEL** More vigorous, better, younger. Protect your health. Potent vitamin formulas, quality capsules. Like doctors, hospitals buy. Buy direct, save! Free catalogue. Vitacenter, Drawer 2318-P, Detroit 31.

**ENJOY** Health. Free booklet. Nutrition, 152 Kearny, San Francisco, Calif.

**INFORMATION** About almost any matter or subject. We have the facilities and know-how. Reasonable fee. ITC, P.O. Box 1681, Chicago 90.

**DELUXE** King James Bible, reasonable price, literature. Hanner Sales, 1025 North 51st, Dept. M, Lincoln 4, Nebraska.

**BIBLE** Questions answered. Stamped envelope. Bylon, 17167 Bentler, Detroit 19, Michigan

**"YOU Can find out!"** Confidential information developed, any matter, person, anywhere. Officially licensed. Established 1922. Equitable Service Bureau, 15 Maiden Lane, New York City.

**INTERCEPT** Opportunity! Now, employ strategy of professionals in locating best jobs, answering ads, interview impression, etc. Today's foresight molds tomorrow's outcome. \$1 to Valon, Box 9235, Chicago 90, Illinois.

**GAIN** Self confidence, memory power, magnetic personality by recordings. Invisible Psychologist, Box 24-NN, Olympia, Washington.

**MEN!** Women! Retire securely now in comfortable circumstances. Lead leisurely life. Unusual new book shows how. Postcard brings details free. Belmont, Wyckoff 20, New Jersey.

**HANDWRITING** Analyzed; analyst graduate. B.S. in education, strictly confidential. Know your true self! Vocational suggestions complete analysis \$10.00. Analyst, Box 524, Lompoc, Calif.

**5,000 BOOKS** Free! All subjects. Large directory of free publications \$1. National Publishers, Box 136-A, Washington 4, D. C.

#### REMAILING SERVICE

**REMAILS** 25¢. Receiving, forwarding \$3.00 monthly. Classifieds 50¢. Confidential, 34 Ardmore Road, West Hartford 7, Conn.

**REMAILS** 25¢. Phoenix, Scottsdale, area. H. E. Bullis, 7237 North Canyon Way West, Phoenix, Arizona.

**REMAILING**—Receiving address for rent. Agents since 1950. William McLaughlin, 800 Stewart, Columbus 6, Ohio.

**REMAILING** 25¢. Monthly \$2.00. GJC Service, 803 West Sheridan Road, Chicago 13, Illinois.

**CONFIDENTIAL** Remailing. 25¢ receiving-forwarding \$3.00 monthly. Blace, Box 24J, Genuga Lake, Ohio.

**SECRET** Mail receiving-forwarding system. Hedgpath, Box 830, Alhambra 23, California.

**NEW** York City remails 25¢, monthly \$3.00. Confidential. 10 scenic postcards \$1.00. I. Mermeistein, P.O. Box 395, Times Square Station, New York 36, N. Y.

**REMAILS** 20¢, 6 For \$1. Monthly \$2. Wellington, 101 Oregon, Oswego, Kansas.

**LETTERS** Retailed 25¢. Jerry Love, 1419 E. 83rd, Los Angeles 1, Calif.

**LETTERS** Retailed 25¢. Ronnie Rosebrock, 386 Union St., Southport, Indiana.

**HOUSTON** Remails 25¢. Monthly \$3.00. Remailing Services, Box 18114, Houston, Texas.

**REMAILS** 25¢. Monthly \$2.50. Inquiries invited. Wharton, Box 531, Long Beach, N. Y.

**REMAILS**, 25¢. Receiving-forwarding. \$3.00 monthly. Hale, Box 1, Glenmont, N. Y.

**HAWAII** Receiving-forwarding \$3.00 month. Souvenirs available. Details free. Write: Fobel, 617 Kuaaina Way, Kailua, Hawaii.

**REMAILERS** World Headquarters, 5060 Fair St., Los Angeles 22, Calif. Remailers boost your business. Send stamped self-addressed envelope for quick reply.

**REMAILS** \$1.00. Receiving, forwarding. \$3.00 monthly. Hardy, Box 335, Monrovia, Liberia.

**CONFIDENTIAL** Address. \$3.00 monthly. Intercontinental Courier Service, Box 3316-PM, San Francisco 19, Calif.

#### TREASURE FINDERS

**GOLD, Silver, metal detectors.** Geiger counters for uranium. Vicites. Sensational new fully guaranteed models. None finer. Information free. Detection Corp., 5528 Vineland Ave., North Hollywood, Calif.

**TREASURE!** Coin, bullion, cannon balls, silverware. M-scope locators find them. Newest features. Terms. Catalog. Fisher Research, Dept. C-1, Palo Alto, Calif.

**AMAZING** Profits! Treasure handbook 25¢. Locators. Howe, 811 Kansas, Atchison, Kansas.

**FIND** Buried treasure, gold and silver, with Goldak's sensational 3½ lb. "find-it" locator, only \$64.50. Write for free literature on complete line of mineral, metal locators; Geiger and scintillation counters. Goldak, 1541 W. Glenoaks Blvd., Glendale, Calif.

**TREASURE** Maps, books, information. Free lists. Include \$1.00, receive 6 foot map U.S. 445 treasure locations. Foul Anchor, Rye 2, N. Y.

**FREE** Literature—Light weight, guaranteed metal detectors. Geiger counters and mineralights. Kits and assembled models. Electronic Applications, Dept. M, Box 8, Arlington 10, Virginia.



**FOR SALE—MISCELLANEOUS**

**HEARING Aid batteries, wholesale. Free list. Habs, Box 51, York, Penna.**

**BALL Point refills 8 1/2 cents each. Finest quality silver tip, double ink supply. Will fit every popular selling pen. Send \$1.00 for trial dozen. Arlin, 5001 N. Third, Philadelphia 20, Pennsylvania.**

**ILLUSTRATED Catalogue, unusual gifts, 25¢. Myco, Dept. PM-98, Runnemede, New Jersey.**

**UNUSUAL Xmas gifts—Rosaries, blessed in St. Peters, mailed from Vatican direct to recipient, \$2.50 ea. postpaid. Include donors and recipients name with order. M. Waite, Box 298, Westwood, N. J.**

**WANTED—MISCELLANEOUS**

**SCRAP Mercury (quicksilver) containers supplied — Tantalum, tungsten, silver, platinum. Metallurgical Products Company, Established 1909, 35th & Moore Sts., Philadelphia 45, Penna.**

**QUICKSILVER, Platinum, silver, gold. Ores analyzed. Wholesale Terminal, Norwood, Mass.**

**MISCELLANEOUS**

**SEE Who's knocking with one way door viewer, requiring only 1/2 inch hole. \$2 postpaid. Hicksville Hardware, 114 Woodbury Rd., Hicksville, N. Y.**

**JAPAN: Buy direct, mail-order. Novelties, gifts, kimonoes, lighters, etc. 24 page catalogue, makers' addresses, business information. Send \$1.00. Clarence Yamagata, 202 Naka 7 Bldg., Marunouchi, Tokyo.**

**SAFEGUARD Cash, valuables, records, documents, etc., from theft; fire; floods. Low cost. Free facts. National, 362 South 2nd Street, Brooklyn 11, New York.**

**160 GUMMED Religious stamps, 20 subjects. 25¢. Eden, 587 Shaler, Ridgefield, N. J.**

**70 BIBLE Lessons 25¢. Bulletin, Box 87 Cathedral Station, New York 25, N. Y.**

**SELL! Buy! Trade! Read, "Trading Post Magazine" 10¢. Thorne's, 525-A Dewey, Jackson, Michigan.**

**TRUTH About Florida—Fastest growing state. Facts on business opportunities, home work, housing, etc., including 12 proven money making plans. Send \$1.00. Superior Enterprises, Box 11845-A, St. Petersburg, Florida.**

**MEXICAN Food recipes \$1.00. Chef Paul, 1307 1/2 N. 4th Pl., Lamesa, Texas.**

**JALAPENOS Peppers from Mexico. 7 lb. can prepaid \$2.95. Ramos, Box 13651 Dallas 24, Texas.**

**NEW Snow cone machines. All prices. P.O. Box 7803, Dallas, Texas.**

**AMAZING Chemical product rust-proofs tools, guns, fishing and golf equipment, etc. Pint size, \$1.00. Satisfaction guaranteed. Details free. Robert Cook, 74 Selye Terrace, Rochester 13, New York.**

**EXPOSED! "How to Win Prize Contests" \$1. Guaranteed. Erickson, 250-B McLaughlin, Muskegon, Mich.**

**100,000 PRODUCTS Wholesale — Free catalog! Send postcard: Econ-O-Mart, Whippany 15, New Jersey.**

**BUY Wholesale! 100,000 nationally advertised products. Appliances, cameras, sporting goods, housewares, watches, typewriters, tools, clothing, etc. Discounts to 80%. Buy-Rite, Box 258, Hawthorne 2, New Jersey.**

**17J WATCHES \$10.00. Catalog 10¢. Southwestern Imports, 1306 South Darlington, Tulsa 12, Okla.**

**SEND US wool for blankets. Free literature. West Texas Woolen Mills, 421 Main, Eldorado, Texas.**

**ORNAMENTAL Iron designs. Book of 1700 beautiful, practical designs for railings, columns, etc. Free literature. Cunningham, 3881 South 3200 West, Salt Lake City, Utah.**

**SUPER Memory overnight! Success guaranteed! Bljou, Box 1727-M, Hollywood 28, California.**

**RECEIVE Magazine samples, mails, catalogues, offers from everywhere. Get listed 25¢. Horick, Cincinnati 26, Ohio.**

**WRITE For free catalog. New government surplus-GI self-instruction books. Value over \$7 each. Mathematics, history, foreign languages, accounting, farming, auto mechanics, establishing new business, etc., \$1.00 each postpaid. Choose from over 60 courses. Sual Co., Dept. N, Elsinore, California.**

**CIGARETTES—Make 20 for 9¢. Facts free. Moberly, Box 810, Owensboro, Kentucky.**

**WE Pay \$3.50 lb. dried. Grow mushrooms. Cellar, shed and outdoors. Spare, full time, year round. We have 25,000 customers. Free book. Washington Mushroom Ind., Dept. 175, 2954 Admiral Way, Seattle, Wash.**

**AMAZING Keyless lock childproofs medicine cabinets, cupboards. Guaranteed. Send \$1.65. Whiley, Box 119, Cliffside, New Jersey.**

**DIAL Your profit calculator. Send 25¢ to Calculator, Box 742, Glenview, Illinois.**

**FREE! Unusual new plan. Shows "How to Retire Without Money." Retire securely now regardless of your age or sex. Lead leisurely worry free life. Belmont, Wyckoff 21, New Jersey.**

**BUY Wholesale! 25,000 nationally advertised products. Get amazing dealer catalogs. Complete details free. American Wholesalers, 1841D Levee, Dallas 7, Texas.**

**SADDLES, Boots, western wear, leather goods. Free catalog. Silver Spur, Box 1785 N 25, Fort Worth, Texas.**

**GET Samples, opportunities, magazines, catalogs, offers galore! Your name in 8500 big mail directories, 25¢. Results guaranteed. King's, Moorestown, Ontario, Canada.**

**FREE! Black Forest imported pendulum clock. Information 25¢. Hermsen, 3415 Knox Bronx 67, New York.**

**YOUR Name wanted. We'll send 1000 publishers, mailers, wholesalers your name, on our list one year 25¢. Dixie Mailers, King, N. C.**

**HOW To remodel, basement, attic. Booklet or book. Send for 1958 book catalog—10¢. Popular Mechanics Press, 633 N. St. Clair St., Chicago 11.**

**— JOB TESTED KNOW-HOW —  
MACHINE TOOL RECONDITIONING  
& THE ART OF HAND SCRAPING (3rd printing)  
SEND FOR FREE FOLDER DESCRIBING  
ILLUSTRATED MANUAL FOR MACHINISTS  
MACHINE TOOL PUBLICATIONS, 382 Holly Ave., Saint Paul 2, Minn.**

**THERE'S MONEY IN CARTOONS!**  
Internationally known instructor, RAYE BURNS, will teach you HOW to CREATE ORIGINAL CARTOONS at home that you may SELL! Course contains 26 lessons and over 600 illustrations. Cost of course is very low.  
Send name and address for free details.  
RAYE BURNS SCHOOL, Dept. P, Box 3583, CLEVELAND, OHIO

**Locksmithing AND KEY MAKING  
Now Made Easy! Practical up-to-date course teaches you how to pick locks, de-code, make master keys, repair, install, service, etc. New self-instruction lessons for every handyman, homeowner, carpenter, mechanic, service station operator, fix-it shop, hardware dealer, gunsmith, 53 easy illustrated lessons. Full price only \$5.95 postpaid; or C.O.D. plus postage. Satisfaction or refund guaranteed.  
Complete course \$5.95  
... now only 210 S. Clinton Nelson-Hall Co., Dept. J5-2 Chicago 6, Ill.**

**FREE OUTFIT STARTS YOU IN BIG MONEY SHOE BUSINESS!**



Run your own profitable "shoe store" business from home! Represent fast growing million dollar firm in spare or full time. We give you—FREE—complete Starting Outfit that makes you \$217 EXTRA each month for just 2 easy orders a day. Feature 195 fast-selling dress, sport, work shoe styles for men, women. Air-cushion shoes, many special features! Sizes 2 1/2-15—AAAA to EEEE. Sell to friends and folks where you work. Rush postcard for FREE Outfit!

**MASON SHOE, Dept. F225, Chippewa Falls, Wisconsin**

**Superior's New Model 70 'UTILITY TESTER'®  
FOR REPAIRING ALL ELECTRICAL APPLIANCES  
MOTORS • AUTOMOBILES • TV TUBES**

As an electrical trouble shooter the Model 70:



- Will test Toasters, Irons, Broilers, Heating Pads, Clocks, Fans, Vacuum Cleaners, Refrigerators, Lamps, Fluorescents, Switches, Thermostats, etc.
- Will test all TV tubes for open filaments, inter-connection shorts, burned out tubes, etc.
- Measures A.C. and D.C. Voltages, A.C. and D.C. Current, Resistance, Leakage, etc.
- Will measure current consumption while the appliance under test is in operation.
- Incorporates a sensitive direct-reading resistance range which will measure all resistances commonly used in electrical appliances, motors, etc.
- Leakage detecting circuit will indicate continuity from zero ohms to 5 megohms (5,000,000 ohms).

As an Automotive Tester the Model 70 will test:

- Both 6 Volt and 12 Volt Storage Batteries • Generators • Starters • Distributors • Ignition Coils • Regulators • Relays • Circuit Breakers • Cigarette Lighters • Stop Lights • Condensers • Directional Signal Systems • All Lamps and Bulbs • Fuses • Heating Systems • Horns • Also will locate poor grounds, breaks in wiring, poor connections, etc.

Model 70 comes complete with 48 pages book written in plain easy-to-understand language. Explains laws of electricity, how to proceed with repairs of appliances and automobile circuits, how to test TV tubes, etc.

**\$15 SHIPPED ON APPROVAL  
NO MONEY WITH ORDER—NO C.O.D.**

Try it for 10 days before you buy. If completely satisfied then send \$3.95 and pay balance at rate of \$4.00 per month for 5 months — No Interest or Finance Charges Added! If not completely satisfied, return to us, no explanation necessary.

**MOSS ELECTRONIC DIST. CO.**  
Dept. D-504, 3849 Tenth Ave., N.Y. 34, N.Y.

Please return the Model 70 if satisfactory to pay \$3.95 within 10 days and balance at rate of \$4 per month until total price of \$19.95 plus postage is paid. If not satisfactory, I may return for cancellation of account.

Name \_\_\_\_\_  
Address \_\_\_\_\_  
City \_\_\_\_\_ State \_\_\_\_\_



**WORLD FAMOUS**  
**Black Forest**  
FORMERLY  
**\$3.95**  
**FREE**  
**88¢**  
plus 12¢ postage

**10 INCHES**

**CUTS METAL**  
Supply limited. Rush today!

World's most fabulous hunting knife! Over 100,000 sold for \$3.95. Now this genuine Black Forest Knife yours for only 88 cents. Extra thick, high carbon tempered Korium Steel—can cut thru metals! Sharp enough to shave with. Gives lifetime of rugged service. Hundreds of uses: Skins moose, rabbit, deer; scales fish; cuts hamp, wire, underbrush, branches—even metals! Carves roasts, turkey, steak. Also use for impressive den decoration. 10 inches over-all. Hand forged by legendary sword makers proud of their ancient craftsmanship. Send only 88¢ plus 12¢ postage for prompt delivery. 100% satisfaction guaranteed or money back.  
**THORESEN Inc., Dept. 6-K-76**  
585 Water Street, New York 2, N. Y.

**Secrets of VENTRILOQUISM**  
*Now Revealed!*

Easy to learn in 60 to 90 days with our Home Study Course. **RESULTS GUARANTEED.** Make Money! Be Popular! Have Fun! Big Opportunity! Radio, Television, Stage Appearances! For FREE information regarding price and terms WRITE: You must state your age. Dummy Catalog 25¢.  
**MAHER HOME COURSE OF VENTRILOQUISM**  
Box 36, Studio PM-9, Kensington Station  
Detroit 24, Michigan



**EARN MORE - LEARN**  
**AUTO**  
**DIESEL MECHANICS**

**OR TRAIN WITH OTHER GREER DIPLOMA COURSES**

<input type="checkbox"/> AUTO MECHANICS	<input type="checkbox"/> REFRIGERATION
<input type="checkbox"/> DIESEL MECHANICS	<input type="checkbox"/> AIR CONDITIONING
<input type="checkbox"/> BODY & FENDER REPAIR	<input type="checkbox"/> MACHINIST TRADE
<input type="checkbox"/> GAS-ARC WELDING	<input type="checkbox"/> ADVANCED MACHINIST
<input type="checkbox"/> PIANO TUNING & REPAIR	

Skilled men are needed in every part of the country. Earn top pay in established shops or start your own business. Greer's expert instruction and actual shop training teaches you how. You learn by doing—quick, easy courses using the latest tools and equipment. Day, evening and part time instructions available.

Job placement and convenient living accommodations are yours while training. Contact GREER'S FREE JOB PLACEMENT SERVICE when you enroll if you wish part time or full time employment.

**ENGINEERING DEGREE COURSES**

<input type="checkbox"/> DIESEL AUTOMOTIVE ENGINEERING 27 MOS.
<input type="checkbox"/> REFRIGERATION & AIR COND. ENGINEERING 18 MOS.
<input type="checkbox"/> WELDING ENGINEERING 18 MOS.

All Courses Approved  Civ. or  G.I.

Please rush me free literature on the trade indicated, at no obligation.

NAME \_\_\_\_\_ AGE \_\_\_\_\_  
STREET \_\_\_\_\_  
TOWN \_\_\_\_\_ ZONE \_\_\_\_\_ STATE \_\_\_\_\_  
Established 1902

**GREER SHOP**  
**TRAINING**  
Box 1, 2236 S. Michigan Ave.  
Chicago 16, Illinois



Illustration from *Getting Started with Power Tools*

**Get the Most Out of Your Home Workshop!**  
**Add Many Dollars to the Value of Your Home!**  
*It's Easy, Safe and Fun with these*  
**POPULAR MECHANICS TOOL BOOKS...**

**GETTING STARTED WITH POWER TOOLS**

This brand-new Popular Mechanics book shows how to equip your shop with power tools and how to use your equipment to best advantage. Even with a few basic power tools you can make improvements to your home worth thousands of dollars... and have worlds of fun doing the job! Easy to understand text plus scores of illustrations enable even the novice home craftsman to choose the best power tool for his purpose and help him become an accomplished craftsman in a short time. Discusses every type of power tool as well as portable power tools. Tells how to lay out your shop for greatest efficiency. Stresses safety procedures that benefit the experienced operator. Added data on attachments for making your tools do multiple work.

**60 POWER TOOLS and HOW TO BUILD THEM**

It's a fact... using scrap metal, odds and ends of pipe fittings and other "useless" discarded materials you can assemble almost any kind of power or home workshop tool you may need... at a bare minimum of cost. This valuable book shows you how and gives you exact step-by-step instructions for assembly. A few of the 60 projects described include: a jig saw from an old sewing machine; drill press from pipe; another drill press from old auto parts; wood shaper from plywood and pipe; double-duty sander; scroll saw; thickness planer; multiple blade hand saw; power hacksaw; motorized hand planer; flexible belt sander and many many more. In all, there are 340 explicit how-to-do-it pictures to make the job even easier.

**HOW TO USE HAND TOOLS**

Few people realize how many useful, money-saving functions even the basic, simplest hand tools can perform. With your hand tools properly guided, you can make countless home repairs. This book by Popular Mechanics editors is packed with important hand tool information. Learn the 30 basic hand tools and what to look for in choosing yours. You'll see exactly what each tool can do for you. Correct use is shown for hand saws, wood chisels, gouges, planes and scrapers; hammers, screw drivers, clamps, files, snips, etc. Additional chapters on ordering screws, nails, lumber... plus 17 interesting projects you can build with hand tools. This is an important book for the experienced as well as beginner home craftsman.

**PLANNING YOUR HOME WORKSHOP**

Probably no other book ever written contains so much practical and valuable information on home workshop layout and maintenance. This book shows you how to set up a shop on a limited budget; how to avoid costly mistakes by buying the right tools; what sizes and types to select for your own needs; the basic "big six" power tools; and what hand tools to buy for your workshop. Covers many good floor plans to suit available space and facilities. Includes a section on furniture building and other projects. Has more than 450 photos and 100 detailed scale drawings. Many in color... includes a tool buying guide. Edited by Sam Brown, author of many books on the home workshop and advisor to power tool manufacturers, it will answer your problem with sound, experienced advice.

**ONLY \$2.95 EACH**

Hundreds of work hints, short cuts, safety tips to benefit the amateur and skilled craftsman alike. Satisfaction guaranteed or your money back. All books sent prepaid. Order now.

**POPULAR MECHANICS PRESS**  
Dept. 958, 200 E. Ontario St., Chicago 11, Ill.

RUSH book(s) I have checked below. If not pleased I can return in good order within seven days for full refund.

<input type="checkbox"/> Remittance enclosed	<input type="checkbox"/> Send C.O.D.: U.S.A. only
<input type="checkbox"/> Getting Started with Power Tools	<input type="checkbox"/> 60 Power Tools
<input type="checkbox"/> Hand Tools	<input type="checkbox"/> Home Workshop

Name \_\_\_\_\_  
Address \_\_\_\_\_  
City \_\_\_\_\_ Zone \_\_\_\_\_ State \_\_\_\_\_

**POPULAR MECHANICS**





**One of our BEST Values!**  
**2.9 AMP HEAVY DUTY**  
**1/4" RAM DRILL**  
 with Jacobs Geared Chuck & Key

Reg. \$39.95—Our Price **\$14.95**  
 plus 50c pp. & hdig.

Ask any expert and he'll always say "RAM for Heavy Duty Work." Not just an ordinary 2, 2 1/4 or 2 1/2 amp unit, but a powerful full 2.9 AMP. drill to do every heavy duty job in home, shop or industry. Built to take years of rough-tough use. Newer, more rugged motor gives 1/2" capacity in hard wood and 1/4" capacity in steel with a full load speed of 1200 R.P.M. Durable, mirror finished, lightweight aluminum housing. Features Universal, series wound AC-DC motor; heavy duty multiple thrust ball bearings; automatic release trigger switch with locking pin; 6 ft. 2 conductor, UL approved cord and plug. Standard 115 V. AC-DC. This powerhouse measures 9" in length yet weighs only 3 1/2 lbs. If you've ever needed a drill or find that your present 1/2" job just won't do the things you expect of it, ORDER THIS 2.9 AMP. 1/4" RAM DRILL TODAY! Limited quantities.

Send Check or M.O. C.O.D. fee extra. **MONEY BACK GUARANTEE**

**SCOTT-MITCHELL HOUSE, Inc.** DEPT. F-9, 415 S. BROADWAY  
 YONKERS, NEW YORK



**HIGH SCHOOL DIPLOMA**

Earn a High School Diploma at home! Prepare for better job, more pay. Study in spare time. No classes. Materials furnished. Certified teachers. Valuable diploma awarded. Write Today for Complete Information.  
**SOUTHERN STATES ACADEMY**  
 Box 144A Sta. E Atlanta, Georgia

**"FOREIGN BARGAINS"**

Now! Get Foreign Bargains from all over the world!

- Bargain offers from Germany, Japan, Italy, Hong Kong, India, etc., etc.
- ACTUAL NAMES AND ADDRESSES!
- Complete information on HOW to BUY Direct from Overseas (It's Easy).
- Many overseas firms looking for representatives, salesmen.
- Many offer drop ship items—even complete drop ship illustrated catalogs of foreign products.
- Most offers willing to sell sample units.

Terrific Profits in gay exotic items: 65¢ clock sells for \$5.00! \$1.75 watch sells for \$7.95! Other terrific items too numerous to mention!

Our new paper is worth its weight in gold! Thousands already on our subscription list. A tremendous, exciting new field to operate. Reg. price is \$3.00 per year. SPECIAL INTRODUCTORY OFFER. Just \$2.00 for one year. (Why pay more for courses, books, etc.?)

"FOREIGN BARGAINS"—Box 591-BM, Lynn, Mass.

**Take Correspondence Courses  
 For a Better Education**

**MICRO 6 WAY™**

**New, Versatile, Highly Sensitive Scale  
 for Every ACCURATE Weighing Job**

**The Only Scale that Gives Correct Weights from 1/100 oz. to 11 lbs. and 5/10 gram to 5 kilograms**

MICRO 6 WAY is the new, all-purpose scale for perfectionists in every walk of life—in the hobby shop, factory, office, laboratory, yes, even in the kitchen. MICRO 6 WAY is the only scale ever made that gives both avoirdupois and metric readings so finely graduated, yet will also weigh so much. Actually does the work of six scales, yet sells for less than \$100. No other precision scale does so much yet costs so little.

MICRO 6 WAY is manufactured by Kenneth Smith, world's largest maker of special golf and tennis scales. Sold direct to you on a money-back guarantee. Write TODAY for free brochure that describes in detail this remarkable precision balance. Address Kenneth Smith, 1801-P Baltimore, Kansas City 41, Mo.



PAT. PENDING

**"TOOK IN \$217  
 FIRST 10 DAYS"**

Some make more, some less  
 We help you to start Your  
 Own All-Year Business

**Make Big Money!** With our easily operated, highly efficient wall washer, Chas. Stelle took in \$217 gross in first ten days. E. L. Goss took in more than \$10,000 in one year. E. C. Taber wrote, "I made \$400 gross in two weeks." And no wonder—this machine washes walls 6 times faster and better than by hand. **Your Money-making Opportunity.** Enjoy independence—freedom from bosses, layoffs. Customers everywhere—homes, offices, schools, etc. Expenses low, profits high. No shop necessary; operate from home. Can start spare time until your full time is available.



Lose no time. Get all facts without obligation

**FREE BOOK! MAIL COUPON TODAY!**

- VON SCHRADER MFG. CO.
- 910 "W" Pl., Racine, Wisconsin
- Send at once (no obligation) your FREE
- booklet containing information about your
- WALL WASHING MACHINE and how I can start
- my own permanent, profitable business.
- Name \_\_\_\_\_
- Address \_\_\_\_\_
- City \_\_\_\_\_ Zone \_\_\_\_\_ State \_\_\_\_\_

**NEW - MIDGET SHORT WAVE RADIO**



**WORLD WIDE RADIO—ANYTIME—ANYWHERE!**

Hear Europe, Africa, Russia, Australia, South America—ANYWHERE IN THE WORLD ANYTIME! Gets ALL foreign radio stations .55 mc. to 4.2 mc. Not much larger than a postcard—Wt. only 3 lbs.! Complete with Roll-out antenna. Gets regular American broadcasts All Radio Amateur bands 190-80-40-20-15-10—Ships, Aircraft, Police, Citizens bands—NOTHING LIKE THIS MIDGET ALL-WAVE RADIO ANYWHERE ELSE AT ANY PRICE! No AC plug-ins required! Wonderful for home, traveling, Scouting, Radio Amateurs—ANYONE! YOU CAN HEAR MOST EVERYTHING—EVEN "SPUTNIKS."

**SEND ONLY \$5.00** (bill ck, mo) and pay postman or send \$10.95 for P.P. delivery. Complete easy to wire kit includes all parts, tubes, broadcast coil, cabinet, instructions. Set of batteries \$3.49 extra. COMPLETELY WIRED AND TESTED. POSTPAID IN USA ONLY \$21.95! Worth \$49.95 or more. Get your SPACE RAMBLER now for WORLD-WIDE LISTENING PLEASURE! AVAILABLE ONLY FROM:

**WESTERN RADIO Dept. BRM-9 KEARNEY, NEBRASKA**



free!

ALLIED'S

MONEY-SAVING 1959

ELECTRONIC SUPPLY CATALOG

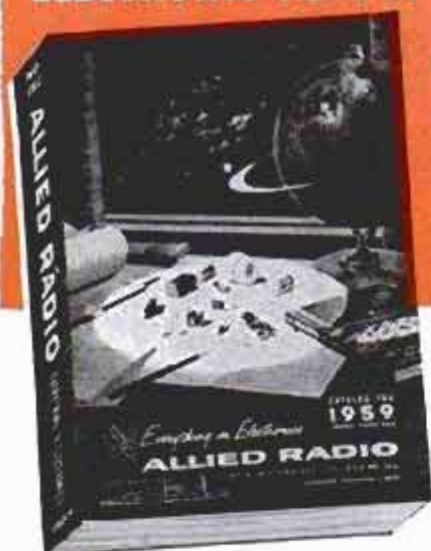

452

value-packed pages

send for it!

SAVE

ON EVERYTHING IN ELECTRONICS

EASY TERMS AVAILABLE

### WORLD'S LARGEST STOCKS

Here is the complete guide to everything in Electronics for Experimenters, Builders, Amateurs, Servicemen, Engineers and Hi-Fi enthusiasts:

- Amazing Build-Your-Own KNIGHT-KITS
- Everything in STEREO HI-FI
- Hi-Fi Music Systems & Components
- Recorders & Phono Equipment
- Public Address & Paging Systems
- TV Tubes, Antennas, Accessories
- Amateur Station Equipment
- Latest Test & Lab Instruments
- Industrial Electronic Supplies
- Parts, Tubes, Transistors, Tools & Books

SAVE on everything in Electronics at ALLIED—get fast, dependable service, expert personal help, guaranteed satisfaction. Send today for your FREE 1959 ALLIED Catalog.

Everything in Electronics From One Reliable Source

OUR 38th YEAR



ALLIED RADIO

Send for FREE Catalog

ALLIED RADIO, CORP., Dept. 5-J8  
100 N. Western Ave., Chicago 80, Ill.

Rush FREE 1959 ALLIED 452-Page Catalog

Name \_\_\_\_\_

Address \_\_\_\_\_

City \_\_\_\_\_ Zone \_\_\_\_\_ State \_\_\_\_\_

## WHERE-TO-BUY-IT INDEX

### AUTOMOTIVE

- Big car? Small car? You may get both..... 81
- Car-door brackets hold long lumber (Kip Co., P.O. Box 235, Livingston, N. J.).....117
- Extension cables replace tow rope for emergency starting (George S. Iredell, Ireton Farm, R.F.D., Zionsville, Pa.)...128
- Mystery: Six passengers but where's the engine?.....140

### AVIATION

- Here's a jet that takes off vertically in horizontal position... 79
- Helicopter flies automatically..... 80
- Loaded supersonic jet propelled into air without touching runway ..... 80
- Sub missile passes test..... 81
- Sikorsky helicopter lands on water—or anywhere (Sikorsky Aircraft, Div. of United Aircraft Corp., Stratford, Conn.).. 96
- British twin-jet plane can deliver nuclear weapons.....104
- Jet helicopter powered by gas turbine (Karman Aircraft Corp., Bloomfield, Conn.) .....112
- East Germans build first medium-range passenger jet.....112
- Hydro-ski enables rubber plane to land and take off on water.117
- Water-fog curtain prevents spread of fire during plane fueling.127
- Monitor listens in on 28 frequencies.....134
- Plane-reservations system gives "electronic" answers.....135
- Electromagnetic detector can locate underwater subs.....136
- Navy and Air Force weapons look alike but they don't act alike .....144
- Build-it-yourself plane available in kit form for just \$1000...150

### CONSTRUCTION

- Nitrogen gas preserves Kansas water pipeline for future drought ..... 87
- Powered wheelbarrow climbs mountain..... 96
- British architect works under hemisphere of glass.....140
- Sidewalk superintendents have ringside seats.....141
- Giant jigsaw radome for Dew Line can be put up in 1½ days.150

### LAWN AND GARDEN

- Switch stops mower (Dunn's Motor Sales, 2410 Bladensburg Rd., N.E., Washington 18, D. C.)..... 79
- Walk-along spray unit covers two-foot swath (O. E. Linck Co. Inc., Clifton, N. J.).....104
- Mower becomes hedge trimmer.....111
- Three-wheeled power mower can cut close to trees (Seminole Mower Co., P.O. Box 1311, Decatur, Ill.).....116
- Fiber mat gives grass seed a good start and retards weed growth (Minnesota Mining and Mfg. Co., 900 Bush Ave., St. Paul 6, Minn.).....116

### MISCELLANEOUS

- Push-button camp wagon..... 93
- A dentist turns sculptor..... 98
- Miniature battery pack has enough power to fire 35 flashbulbs (Anchor Photo Supply Co., 6322 S. Western Ave., Chicago 36) .....101
- Trailers for work and play.....114
- Mighty totem pole begins voyage to London.....127
- Big Italian tanker run by 14,400-hp. motor.....129
- German police call box.....134
- Trailer truck carries tank cars from siding to industrial plant.135
- Newborn babies are television stars on hospital's closed circuit .....136
- Interlocking plastic mat forms into many shapes.....151
- Plastic holder guards Thermos (The American Thermos Prod. Co., Norwich, Conn.).....151

### OUTDOOR SPORTS

- They walk on water! (Charles J. Belden, 16740 Gulf Bend, St. Petersburg 6, Fla.)..... 78
- Fish triggers own fate (Lucky Strike Bait and Lure Co., 4111 Grant St., Gary, Ind.)..... 79
- Kit converts tube into boat (L. Lek, 1600 Mecca Dr., La Jolla, Calif.) .....101
- Portable range gives golfer practice at home (Jack Oliver, Engineers Country Club, Roslyn, L. I., N. Y.).....129
- Improve your wing shooting.....146
- Transparent bait container lures insects into tweezers (C. S. Williamson and Co., Orangeburg, S. C.).....151

(Continued to page 68)



## FREE-A BUSINESS OF YOUR OWN

- Start Spare Time
- No Training Period
- No Investment
- No Stock to Buy

### SUBSTANTIAL MONEY-MAKING OPPORTUNITY

Your Total Cost  
—a 3-cent stamp

All we ask of you is that you like to sell. If you can make a fair living selling anything else, we will show you how to make tremendous profits as a MASTER Work Garment Salesman, and furnish everything you need, free.

MASTER Work Garment salesmen are making thousands of dollars in hundreds of communities all over America. Men who—a year ago—didn't know what a work garment was, are now buying homes and cars with the profits from a MASTER Dealer franchise. Your sales are volume sales, repeat sales, steady-income-to-you sales. Every business in the country is a prospect for uniforms and work clothes with name-and-advertising embroidery. Stores can't compete. MASTER brings you the world's finest, most complete quality lines in new styles and fabrics. We supply everything you need—samples, sales material and guidance. You can start right away in your spare time. Keep present job until you are sure your new business is all we say. Write us today for full details.

**GEO. MASTER GARMENT CO.**  
6-43 WATER STREET, LIGONIER, INDIANA



If  
You  
Want  
To



## STOP SMOKING

### Frank Leahy Tells How!

*Frank Leahy, famous football coach, says: "I recommend Bantron if you have tried, without success, to stop smoking. It positively can help you. You will be amazed with the wonderful results you get!"*

Here at last is a safe, new product, developed at a great American University, that has helped thousands stop smoking. In a series of clinical tests, published in a leading Medical Journal\*, scientists reported that 4 out of 5 men and women who wanted to quit smoking stopped within 5 days when they took Bantron.

And the Bantron way is so easy and pleasant! Just take 3 Bantron tablets a day, after meals, for four days. Then only 2 a day until all desire to smoke leaves you. 80% are "Free" in 5 to 10 days.

Taken as directed Bantron is perfectly safe. It acts as a substitute for the nicotine in your system which gives you a craving for tobacco.

Now at drug stores without prescription. Price \$1.25. **Bantron** BRAND<sup>®</sup> Smoking Deterrent Tablets

\*Copies available to doctors on request. Write Campana Corporation, Batavia, Ill.

ENGINEERING  
DEGREE IN  
27 MONTHS

B.S. Degree, Aero., Chem., Civil, Elec., Mech. & Electronic Engineering (inc. Radio, TV), 36 mo. B.S. degree in Math., Chem., Physics. Prep courses. Demand for grads. Spacious campus. 20 bldgs.; dorms, auditorium, gym. Low rate. Earn board. G.I. approved. Enter Sept., December, March, June. Catalog. 1698 E. Washington Blvd. Fort Wayne 2, Indiana. Keeping pace with progress.

INDIANA TECHNICAL COLLEGE

## FREE AMAZING NEW BOOK "HOW TO ANSWER ADS"

how to  
answer  
ads

Never before have you seen anything like this. Tells you in simple language the correct way to answer ads. Gets you quicker replies—better results, and greater satisfaction. Will save you time and money and it's ABSOLUTELY FREE. No obligation whatever. Every reader of advertising should have this booklet. Send a postcard for your copy NOW. F. W. JOHNSON, Popular Mechanics Magazine, Room 600-A, 204 East Ontario Street, Chicago 11, Ill.

## Sensational New Idea!

Here it is at last!

The "Easy-Going Surface Glider," test proven and guaranteed, especially designed for greatest comfort, convenience, and easy use when working in close quarters under automobile, industrial machinery, buildings, and wherever maintenance work must be done. Strong and sturdy, yet light and flexible! Manufactured from top quality plywood and rugged 14-gauge steel. Lays flat on its back and requires little trunk space. A MUST for every car owner, tradesman, and handyman. Send check or M.O. to:

ONLY 5.45 Post Paid SURFACE GLIDER SALES, 56 Villa St. in U.S.A. Elgin, Ill.



## RUN A CAFE OR DINER

I can show you how to get into this marvelous business. Opportunities plentiful when you know how to proceed. Be independent! Learn every phase of the business from how to get started quickly on small investment to menu planning, food preparations, money-making methods, the 7 ways to finance your first place. 20 fact-filled lessons in course. Study at home. Free trial. Money-back guarantee. Write today for FREE book.

CHICAGO SCHOOL OF RESTAURANT MANAGEMENT

335 W. Madison St., Dept. 359, Chicago 6, Ill.

Please send me, without obligation whatsoever, my free book.

Name \_\_\_\_\_

Address \_\_\_\_\_



## Become A --- BUILDING CONTRACTOR!

### MAIL COUPON for FREE BROCHURE

Simplified home study training program. Learn every phase of building, estimating, contracting. Fortunes are made in this line of work every year. Use spare hours—no interference with present work. Diploma awarded. Low tuition rates.

AMERICAN TECHNICAL SOCIETY  
Dept. BH-98, 850 E. 58th Street, Chicago 37, Ill.

Please send me your FREE Brochure and full details of your building, estimating and contracting training program.

Name \_\_\_\_\_ Age \_\_\_\_\_

Address \_\_\_\_\_

City \_\_\_\_\_ State \_\_\_\_\_





# ELECTRIC MAGNIFIER

Lights up as it magnifies

Powerful imported lens—magnifies five times larger. Extra brilliant light illuminates object viewed—makes even smallest print, tiniest specks, insect, hair, etc., stand out sharper & clearer. Examine stamps, coins, currency, signatures, fingerprints, photos, machine parts, jewelry, etc. Ideal for reading "fine print" in contracts, leases, policies. Originally sold for much more. Our price only 88c plus 12c for postage and handling.



Rush \$1 cash, check or m.o. for prompt delivery in U.S.

Sorry no COD's. Satisfaction guaranteed or money back.

**88c**

THORESEN Inc., Dept. 6-K-610 285 Water Street, plus 12c postage New York 2, N.Y.

**EXTRA! ANOTHER Scoop!**

**SENSATIONAL NEW BENJAMIN BB REPEATERS...**  
The Only Repeating Guns on the Market with... **\$14.95**

**Piggy-Back SHOT MAGAZINE**

**THE REVOLUTIONARY NEW GRAVITY FEED ACTION THAT LOADS BB AMMUNITION automatically!**

A shot is placed in firing position each time bolt is pulled back and closed. Finest quality. Powerful—Accurate—Economic. Use indoors or out. New Bar-V sight.

**FREE** Ask for Catalog All Models Benjamin Single Shot and Repeaters... Cal. BB or 177 or 22. ALSO, SPECIAL OFFER ON HUNTING AND FISHING KNIVES, ETC.

No. 3600 Benjamin Super 100 Shot BB Gas Rifle. No Pumping... Auto Loading. — \$17.95  
No. 3600CS DeLuxe Gas Rifle with Custom Stock — \$17.95  
No. 3100 Benjamin Super 100 Shot BB Air Rifle with Regular Stock. Economical. — \$21.95  
No. 3100CS DeLuxe Air Rifle with Custom Stock — \$24.95

**BENJAMIN AIR RIFLE CO.**  
886 (R) MARION ST. ST. LOUIS 4, MO. U.S.A.

You can rely on products advertised in PM



**SIGN HERE!**

Sign in box. We'll engrave signature on selected briar pipe and send post-paid with 2 pouches of cool-smoking EDGEWORTH. Guaranteed! \$4 value for only \$2 enclosed with this ad. Print name and address on ad margin. Send to—

Larus & Brother Co., Inc., Richmond, Va.



(Continued from page 66)

## SCIENCE

Chemicals in the air detected by infrared.....	87
Contact lenses made with bifocal prescriptions.....	88
Electronic draftsman makes graphs and drawings (Electronics Assoc. Inc., Long Branch, N. Y.).....	88
Rockets drop aluminum chaff to measure wind behavior.....	88
Solar cells power hearing aid (Zenith Radio Corp., 6001 W. Dickens, Chicago 39).....	96
"Bicycle" chemical sprayer speeds weed killer tests.....	104
Six-ounce voice box aids human speech (Rand Development Corp., Cleveland, Ohio).....	116
Radar system checks buses on routes in London.....	123
Scientists discover heaviest element has half life of three seconds.....	123
Engine changes atom heat into electricity.....	128
Portable gas detector (Union Industrial Equip. Corp., 20 Davis Ave., White Plains, N. Y.).....	134
Vest keeps dry cells warm with heat from body (Burgess Battery Co., Freeport, L. I., N. Y.).....	135
Armor of plastic and glass fiber protects man from bullets.....	136
Diary of a manmade "moon".....	141
Complex electron microscope built by teen-ager.....	144
Liquid cargoes travel in big plastic tubes (E. I. du Pont de Nemours and Co., Wilmington, Del.).....	145
Rust-resistant wheat of future developed by atomic scientists.....	222
Infrared defense weapon "too good" to be used.....	224
Ultrasonic waves show inside of eye.....	238
Are there millions of inhabited planets?.....	244

## WHAT'S NEW FOR YOUR HOME

Radiant heat screen.....	142
Electric barbecue.....	142
Louvered door.....	142
Socks dispenser.....	142
Log tongs.....	143
Portable wringer.....	143
Shoe scraper.....	143
Double-mirror cabinet.....	143

## Radio-Television, Electronics

The big switch to stereo.....	152
-------------------------------	-----

## Craftsman and Shop Notes Index

### AUTOMOTIVE

Car-door light-switch control.....	158
Correct warming of engine protects valve lifters.....	164
Sources other than ignition cause noises in car radio.....	168
Rust on stainless steel caused by improper cleaning.....	188
Antifreeze is not reusable.....	192

### FARMING

Adjustable-height sack holder speeds filling with shovel.....	164
Bulldozer blade.....	195
Chute above rack simplifies feeding baled hay.....	195
Attaching rural mailbox.....	195
Light denies corn to raccoons.....	195
Work-saving livestock feeders.....	197
Milk room warmed by heater taken from automobile.....	205
Sliding latch on farm gate is "livestock resistant".....	205

### HOUSE AND HOME

Keep pictures straight.....	159
Ice shell on frozen meats seals in original flavor.....	159
Lamp chimney and pie plate makes hopper bird feeder.....	159
Plywood "plastered" with paint.....	164
Dustproof wall cabinet.....	165
Warped plank door straightened by installing X-member.....	168
Garage-door weather stripping replaced with heater hose.....	168
Wire hook for paint pail has "built in" handhold.....	172
Sagging garage doors repaired after wedges realign them.....	172
Consistency check for pouring concrete sidewalk.....	172
Wetting agent added to water aids removal of wallpaper.....	182
Backflushing with solution stops leak in heating system.....	182
Tighten water-tap handle.....	182
Remove cork with nail.....	182
Method of removing wallpaper utilizes paint roller.....	188
Pencil erasers in stop strip silence rattling door.....	188
Cork inside bottle removed with strip of tape.....	188
Laborsaving leaf carrier.....	192
Amplify door-chime sound.....	192
Low-cost "storm shutter" awning.....	193
Simulated wrought-iron items cut from tempered hardboard.....	194
Initials identify overshoes.....	194
Magnet holds baby pins.....	194

(Continued to page 70)



# Sale! This Outstanding **ENCYCLOPEDIA** Every Child Will Treasure and Use—for Over **60% OFF!**



12 Beautiful Volumes—3,072 Informative Pages—Over 5,000 Pictures, Photos, Charts, Diagrams—Hundreds of Subjects and Projects Children Want to Know About and Do!

**POPULAR  
MECHANICS**  
**JUNIOR  
Do-It-Yourself  
ENCYCLOPEDIA**

Regularly \$19.95 . . . Now Only \$6.95!

We need the warehouse space, giving you the bargain opportunity of many a year! On a first come, first served basis, you can have for your children a wealth of information they will treasure and use for years to come—and which will be invaluable throughout a lifetime. Advertised previously in Popular Mechanics for \$19.95, you can obtain this set now at a \$13.00 saving!

### What The Set Is

Popular Mechanics Junior Encyclopedia is a compilation—in 12 beautifully bound volumes—of everything that active, curious boys and girls want to know about. Packed into more than 3,000 pages are fascinating ideas for games, crafts, sports, practice in elementary electricity and electronics, mechanical devices, outdoor and indoor equipment and a vast number of other "do-it-yourself" ideas. More than 5,000 pictures, charts, diagrams and tables provide unending hours of interest and creativity, with complete detailed information for carrying out every imaginable project from simple sewing or taxidermy to complex power-driven equipment.

### How It Benefits Your Children

Here is basic training in personal resourcefulness that will prove so valuable in later years. Your children learn the best way of all—by doing it themselves—and every project is fun to build and

challenging enough to foster real pride of accomplishment.

Their new knowledge pays off in immediate greater self-confidence and poise, and provides a wide range of worthwhile interests that will last through a lifetime. You give them a headstart in school, in life and the art of living.

Yet these volumes don't look like "teaching" volumes at all. They cover hundreds of subjects to intrigue and delight any child (a few illustrated at left). They're easy to read, with large type, thousands of pictures and diagrams, and each one has immediate interest for children sixteen, twelve, as young as eight years! The set is one of the finest educational, character-building assists you can give your boy and girl in their crucial formative years.

### Leading Educators Say —

"The wealth of material presented is fascinating . . . the most comprehensive collection of practical informative material ever assembled in book form for children."

"It (the set) appears to be entirely unique. I am sure that any boy or girl will find many things of interest and will also learn a great deal from it."

"I believe these books are wonderful achievements. Teachers of handicrafts, parents wishing to share their children's interest and forward them, all youth leaders will find them invaluable."

**PLACE YOUR ORDER NOW!**

A limited number of sets available. We cannot make this offer again.

**POPULAR MECHANICS PRESS • Dept. 958 • 200 E. Ontario St., Chicago 11**

Ship at once, charges prepaid, Popular Mechanics Junior Do-It-Yourself Encyclopedia—12 matching volumes.

I enclose check or money order for full payment of \$6.95 (a saving of \$13.00 from regular price).

Name \_\_\_\_\_

Address \_\_\_\_\_

City \_\_\_\_\_ Zone \_\_\_\_\_ State \_\_\_\_\_

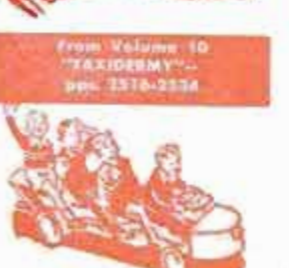
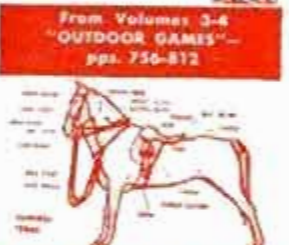
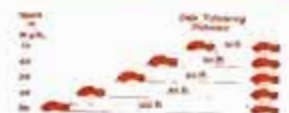



# GIANT PLASTIC CLOTH



over Unused Furniture



Drop cloth when Painting



Cover Cars



Cover Boats

## Protects Cars, Furniture, Appliances!

Huge 9 x 12 sheet of tough, durable polyethylene (108 sq. feet) for only \$1. Protects carpets, floors, upholstery, outdoor furniture, garden tools, bikes, cars, boats, air conditioners, fans, washers, etc. Use as drop cloth when painting; to make transparent auto seat covers, furniture slip covers, etc. You can make up to \$10.00 worth of items from this one huge sheet! All you need is a pair of shears. Cloth is easy to piece together—it heat seals with an electric iron! NO needle or thread! Waterproof! Dust, grease & tear resistant! Wipes clean with damp cloth. One piece, seamless, first quality! Famous Trans-Kleer brand SOLD only by mail. ONLY by us—DIRECT TO YOU! Sorry, NO COD's at this price. Satisfaction guaranteed or money back. Rush check, cash or m.o. for prompt FREE delivery anywhere in USA or Canada!

**THORESEN, Inc., Dept. 6-K-4**  
585 WATER STREET, NEW YORK 2, N. Y.

Rush 108 sq. feet plastic cloth with money back guarantee.

1 for \$1     3 for \$2.65     6 for \$4.98

PRINT

Name \_\_\_\_\_

Address \_\_\_\_\_

## Build and Keep a Powerful AIR CONDITIONER

WHILE YOU LEARN Air Conditioning, Refrigeration and Heating Repair. Complete equipment, tools and valuable Appliance Texter furnished. Men wanted for year 'round jobs as Trained Technicians and Service Men. No experience or high school needed. Age no barrier. Learn at home in spare time with new, original Shop-Plan Course, Catalog FREE. Write today.

Electronic Trades Institute, Box PM-9, 537 S. Dearborn St., Chicago 5, Ill.



## BIG PAY JOBS for men who qualify in DIESEL



**TRAIN NOW FOR A DIESEL FUTURE.** Steady, high-pay jobs await men qualified in Diesel, Tractor, and Heavy Equipment. Are you qualified for job and advancement opportunities in this fast-growing field? You can qualify!

**COMPLETE DIESEL COURSE NOW AVAILABLE.** If you are ambitious and want to get ahead in this big money field, you'll want to know about the complete Diesel home training course now offered by Interstate Training Service. Covers all phases of operation, repair, service. Easy to master in spare time. No interference with present job. Up-to-the-minute. Regularly revised to cover new developments. We invite comparison of material offered. Advisory placement service for our students.

**YOU OWE IT TO YOURSELF** to investigate Interstate Training Service Diesel Training. Thousands agree it has helped them to better jobs...better pay. It can do the same for you!

**WRITE FOR FREE INFORMATION TODAY**

INTERSTATE TRAINING SERVICE, Portland 13, Ore.

Please see that I receive FREE 24-page book, "Getting Ahead in Diesel." (A-3)

NAME \_\_\_\_\_

AGE \_\_\_\_\_

ADDRESS \_\_\_\_\_

CITY \_\_\_\_\_

ZONE \_\_\_\_\_

STATE \_\_\_\_\_

(Continued from page 68)

Cleaning solution fed to brush from attached plastic bottle.....	198
Magnet holds shopping list.....	200
Radio heat softens polish.....	200

### MISCELLANEOUS

Coal for scale-model trains.....	168
Modified corner framing saves time and lumber.....	168
Prairie schooner.....	169
Shooting tips.....	178
Scale easer to read when coated with black crayon.....	179
Yarn used to make pictures on sandpaper drawing board.....	194

### OFFICE, SHOP AND STORE

Trammel made from paper clamps and rules.....	159
Jig made of bricks simplifies "baling" newspapers.....	188
Dulled razor-blade corners "sharpened" with pliers.....	194
Rubber tiles are "place mats" on barber-shop work counter.....	194
Rubber band on gummed labels eliminates curling problem.....	194
Eraser shield for typewriter protects key mechanisms.....	200

### ON THE MARKET

Special cleaner for aluminum.....	199
Plastic ceiling tiles.....	199
Nonflammable paint remover.....	199
Ceramic cabinet hardware.....	199
Window-wall unit aids in construction.....	199

### PHOTOGRAPHY

Photolight standards.....	173
Tape ends of exposed roll film to prevent light streaks.....	179
Bulk developer sealed in convenient packs.....	179
Additional lens taped on camera permits taking closeup shots.....	179

### SHOPPING FOR TOOLS

Roll-up ladder.....	209
Direct-drive chain saw.....	209
Pad sander and jigsaw attachment.....	209
Aluminum pipe wrench.....	210
Power bits for boring holes.....	210
Positioner adapts to manual or automatic welding.....	210
Torque washer.....	210
Measuring machine.....	210
Cross-slide milling table.....	211
Grinding and deburring machine.....	211
Aluminum snips.....	211
Light-staple gun.....	211
Liquid "lockwasher".....	211

### SOLVING HOME PROBLEMS

Easy way to hang pictures.....	170
Doorknob turns easily when hands are wet.....	170
Tubular kitchen chairs kept from scratching walls.....	170
Photo tabs useful for record titles.....	170
Doorstops used as leg extenders for modern sofa.....	171
Dress pattern easy to fold.....	171
Sort hardware in muffin tin.....	171
Tamperproofing plug on electrical appliance.....	171
Frozen-food containers useful to do-it-yourself.....	171

### WORKSHOP HINTS

Pick-up pad for small brads.....	158
Paintbrush bristles reshaped by storing in cardboard holder.....	159
Cost of drill set reduced by buying alternate sizes.....	172
Tape reinforcement on sandpaper prevents edges from tearing.....	172
Notch in adhesive applicator permits accurate spreading.....	172
Scratchproof work surface for cutting aluminum sheet metal.....	182
Tire sections on sawhorses protect work from damage.....	198
Magnet "spots" brass plate.....	198
Wood screw securely anchored with small finishing nail.....	198
Crosswise dowel in plywood holds screw securely.....	198
One-man handling of joist aided by bent nail.....	198
How to test a paintbrush.....	204
Concrete base for shop anvil serves as pipe bender.....	205
Hinges lubricated with soap.....	205
Plug of power tool is locked in workbench drawer.....	208
Washer storage.....	208
Chuck jaw drives lathe dog in emergency setup.....	208
Auxiliary table on bandsaw accommodates miter gauge.....	208
Modified measuring tape has "self marking" feature.....	212
Trouser-cuff nail "pockets".....	212
Adjustable stop on drill press modified for easier action.....	212
V-block on magnetic chuck adds extra holding power.....	212

**NOTICE**—It is the intention of this magazine to provide its readers with information regarding the latest developments in the mechanical arts. Except where otherwise indicated, this magazine has no information as to any unexpired patents in respect of the developments reported herein. In the event that commercial use is to be made of any of the developments reported herein, it is suggested that legal counsel be consulted to avoid liability for patent infringement. It is not the purpose of this magazine to encourage patent infringement but, as indicated, it is the intention of this magazine to report on the latest developments in the mechanical arts.



# HAVE YOU HAD YOUR Fun TODAY?

Everyone's everyday schedule should include time out for fun. All the family will be able to enjoy the thrilling new sport of go karting. The Go Kart 400 is a really potent racing machine powerful enough to pull an adult 40 mph, yet docile enough for a child. Available in knocked-down kit form, the hobbyist will appreciate the quality of the pre-formed chrome moly tubing frame members, pneumatic tires and the now standard Clinton A-400 engine (West Bend 750 optional). Ball bearing wheels and steering linkage are standard in every Kart Kit. Rugged Naugahyde upholstery is but one of the several reasonably priced accessories available to make your stromer a showpiece as well. A new, full color brochure describing many ways of getting the most karting pleasure and containing a complete parts and price list is yours upon receipt of 25¢ to cover handling and postage. See your nearest dealer or write direct to

## Go Kart



KART KIT

**\$129.50**

**Go Kart** MFG. CO., Dept. PM-10, 152 E. Huntington Dr., Monrovia, California

Convert Lawn Mowers into POWER UNITS with this Brand New BRIGGS & STRATTON

**2 3/4 H.P., 4-Cycle Gas Engine**

**SAVE! Reg. Price \$72.00 while they last \$42.50**

POWERS Farm, Home & Industrial Tools • Garden equipment • Pumps • Compressors • Recoil rope starting. Complete, ready to operate. Air cooled. Sure fire ignition. Positive lubrication. **GUARANTEED!**

GOV'T. SURPLUS! **Limited Supply! Order from this Ad!**

Free Catalog! Phone Taylor 9-1365

ROBERTS ELECTRIC CO., 849 W. Grand, Dept. PM-837, Chicago 22

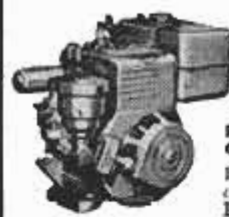

PM-Advertised Schools can provide your best investment — Education!

## YES! SEND

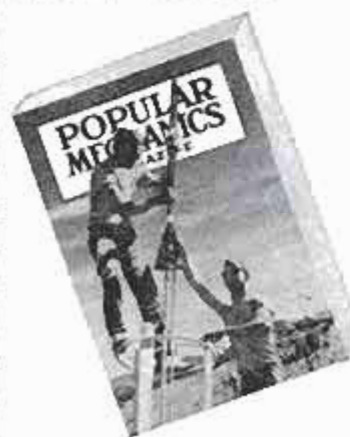

directly to my door every month

I am enclosing

- \$3.50 for 1 year  
 \$8.00 for 3 years

name \_\_\_\_\_

address \_\_\_\_\_

city \_\_\_\_\_ zone \_\_\_\_\_ state \_\_\_\_\_

Hand this order to your newsdealer or send it to

**POPULAR MECHANICS**  
200 East Ontario St. Chicago 11, Ill.

**FREE! 1959 Lafayette Catalog**  
**NEW! 260 GIANT-SIZED PAGES EMBRACING**  
**"EVERYTHING IN ELECTRONICS"**

Send for this value-packed catalog featuring the newest and finest in Stereo Equipment, HI-FI Systems, Tape Recorders, P.A., Electronic, Radio and TV Parts, Tubes, Antennas, Transistor Kits and Miniature Components, Tools, Books, Telescopes, Microscopes, and Amateur Gear—**ALL AT BIGGEST SAVINGS EVER!** A "must" for the economy minded hi-fi lover, experimenter, hobbyist, engineer, serviceman and dealer.

**FULL OF BEST BUYS!**  
**SEND FOR YOUR FREE COPY TODAY**



Name.....

Address.....

City.....Zone.....State.....

PASTE ON POSTCARD AND MAIL

*Lafayette Radio* DEPT. LI P.O. BOX 511 JAMAICA 31, N. Y.

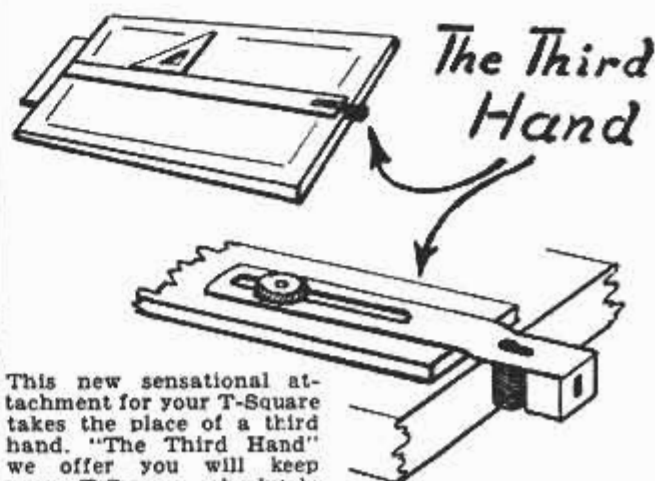

This new sensational attachment for your T-Square takes the place of a third hand. "The Third Hand" we offer you will keep your T-Square absolutely straight on your drafting board and you will have both hands free for your work. You can have your drafting board at any angle.—you move the T-Square as easily as before and it will stay where you put it. It makes your drafting as easy as if you were using a mechanical drafting board. Use it once and you will never do any drawing without it. High school and College students will find their drawing easy and get much better results. This new invention (Pat. Pend.) made of Chrome Plated Steel fits any T-Square and costs only..... **\$2.50** No postage

Send in the coupon today including check or money order.

**CONTINENTAL WIRE SERVICE**

P.O. Box 6349 — Minneapolis 23, Minn.

Please send "THE THIRD HAND" (incl. check or Money Order)

Name.....

Street.....

City.....Zone.....State.....





In fire engines as in motor cars, Champions deliver full-firing power.  
Above: Champion-equipped Mack "pumper" in Garden City Park, L. I.

Q. Why do all the major fire engine makers use Champion spark plugs?

A. Champions give full-firing power. Put new Champions in your car every 10,000 miles. You'll get an *immediate* boost in horsepower...and save gasoline, too!



*World's favorite spark plug—engineered for every car built by Ford, General Motors, Chrysler, American Motors, Studebaker-Packard and every major foreign maker*

**CHAMPION**



# POPULAR MECHANICS

SEPTEMBER  
1958

WRITTEN SO YOU CAN UNDERSTAND IT  
VOL. 110 NO. 3

## THESE ROCKETEERS PLAY SAFE

By Joseph E. Brown

*1408 EDISON BLVD., BURBANK, CALIF.*

WHEN SATELLITES started beeping overhead, thousands of youngsters all over the country launched themselves into a new hobby—rocketry—with or without parental permission.

No doubt about it, amateur rocketry can be extremely dangerous. But rocket clubs which have been in existence for years prove that it also can be reasonably safe—if rigid rules are enforced. Safety precautions, teen-agers have found, don't cut down on the fun; they just cut down on the accidents.

Take a look at a supervised firing of an amateur rocket:

From a steel launching tower anchored

Teen-age rocketeer loads his four-foot rocket on the 10-foot launching stand in the Mojave Desert

*See Nov 58, p. 6*

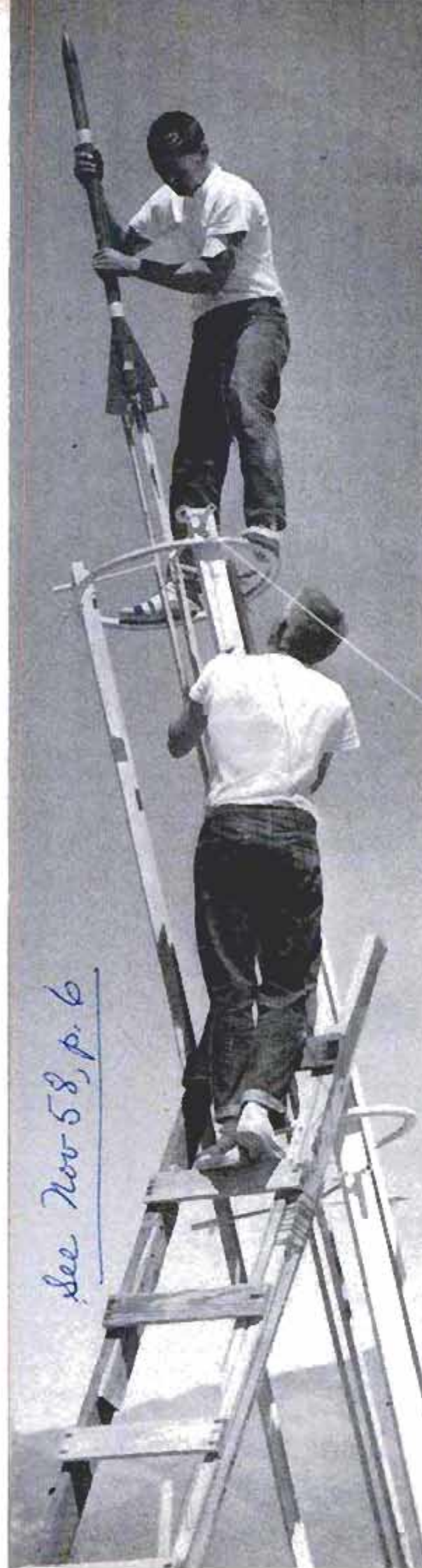





Young member proudly shows rockets he designed. After fueling, the rockets are stored in shed, below

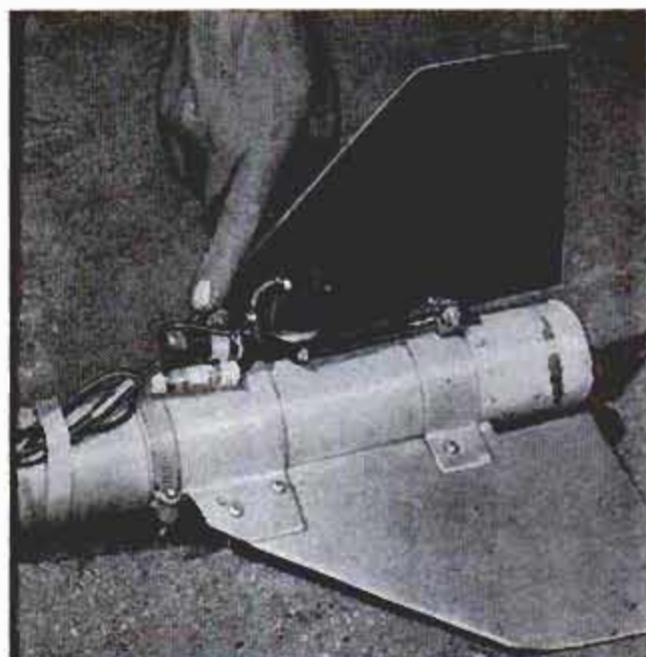

Ingenious mechanism arms the second and third stages of a three-stage rocket as the first stage falls away

to the floor of California's sprawling Mojave Desert, a silvery rocket vaults into the sky, its yellowish smoke trailing behind to mingle with the sagebrush.

Inside a concrete-block building, a tape recorder feels the rocket's heartbeat. Two men, wearing short-wave-radio headsets, wait for reports from tracking teams scattered in the brush. The rocket reaches its summit, hesitates, plunges earthward at 500 miles per hour.

A thousand feet from the launching pad, a crowd huddles in slit trenches behind thick earthen barricades. Earlier, before the missile was triggered by remote control from the safety of the blockhouse, a siren had wailed, a red flag fluttered, a light flashed and a loudspeaker blared intermittent warnings.

The occasion was the annual public firing of the Reaction Research Society of Glendale, Calif., one of the United States' two major nonprofessional rocket groups and an organization which is gaining new members every week.

#### Societies Promote Safety

The elaborate launching precautions—the siren, red light, flag, trenches and loudspeaker—are examples of how far the RRS and its sister societies have gone to promote safety in the field of amateur rocketry.

Since the RRS was organized 15 years ago in southern California, more than 300 rockets have been static tested and fired into flight. Yet the society's accident record in that period is without a blemish.

Unfortunately, all amateurs cannot boast such a record. Back-yard rocketry has bloomed everywhere in the United States.

Garages have become rocket-building





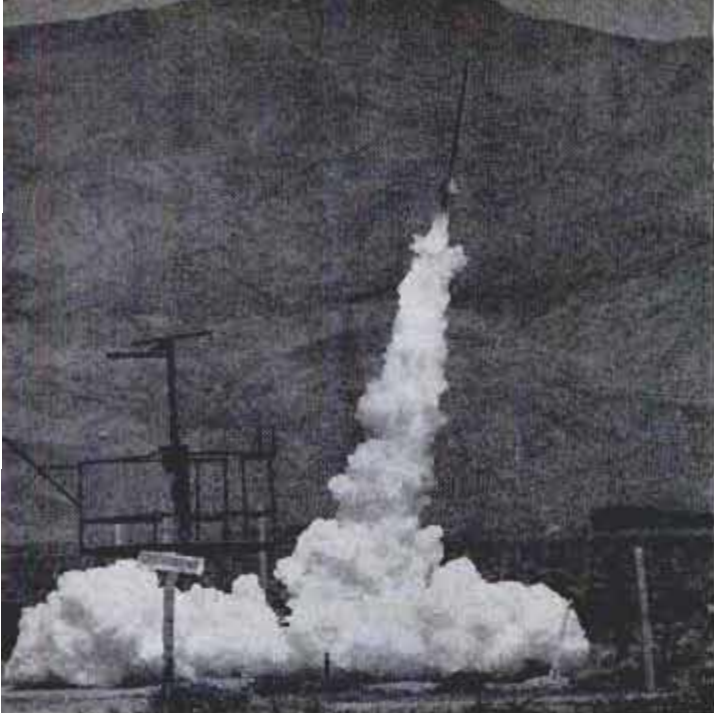

Pay-off question after months of labor: Will it work? Here a homemade rocket blasts off in successful test



Full safety precautions are observed during the critical period when the solid fuel is tamped into place

shops; science classrooms have taken on a space-laboratory air, and homemade missiles are shooting skyward from vacant lots.

#### And So, the Inevitable

With this burst of amateur interest in space, the inevitable has happened. In Texas, a homemade rocket fashioned from water pipe and stuffed with match heads blew up, permanently disfiguring its 14-year-old builder. Two youngsters in New England suffered near-fatal burns when a "dead" rocket reignited. Across the country, safety organizations began demanding action.

Connecticut banned amateur rocketry altogether. Other groups, such as the National Fire Protective Association of Boston, urged laws on a nationwide scale to curb such tragedies.

#### Firings Without Mishaps

Yet today, in the vast open spaces of the West, future scientists banded in groups such as the RRS are firing dozens of rockets every year—within the law—without serious mishap.

The secret?

Supervision, a strict set of rules, and constant enforcement of these rules.

Spectators and cameramen observe launchings behind earthen barricades. The society reserves the right to remove any individual from the test area





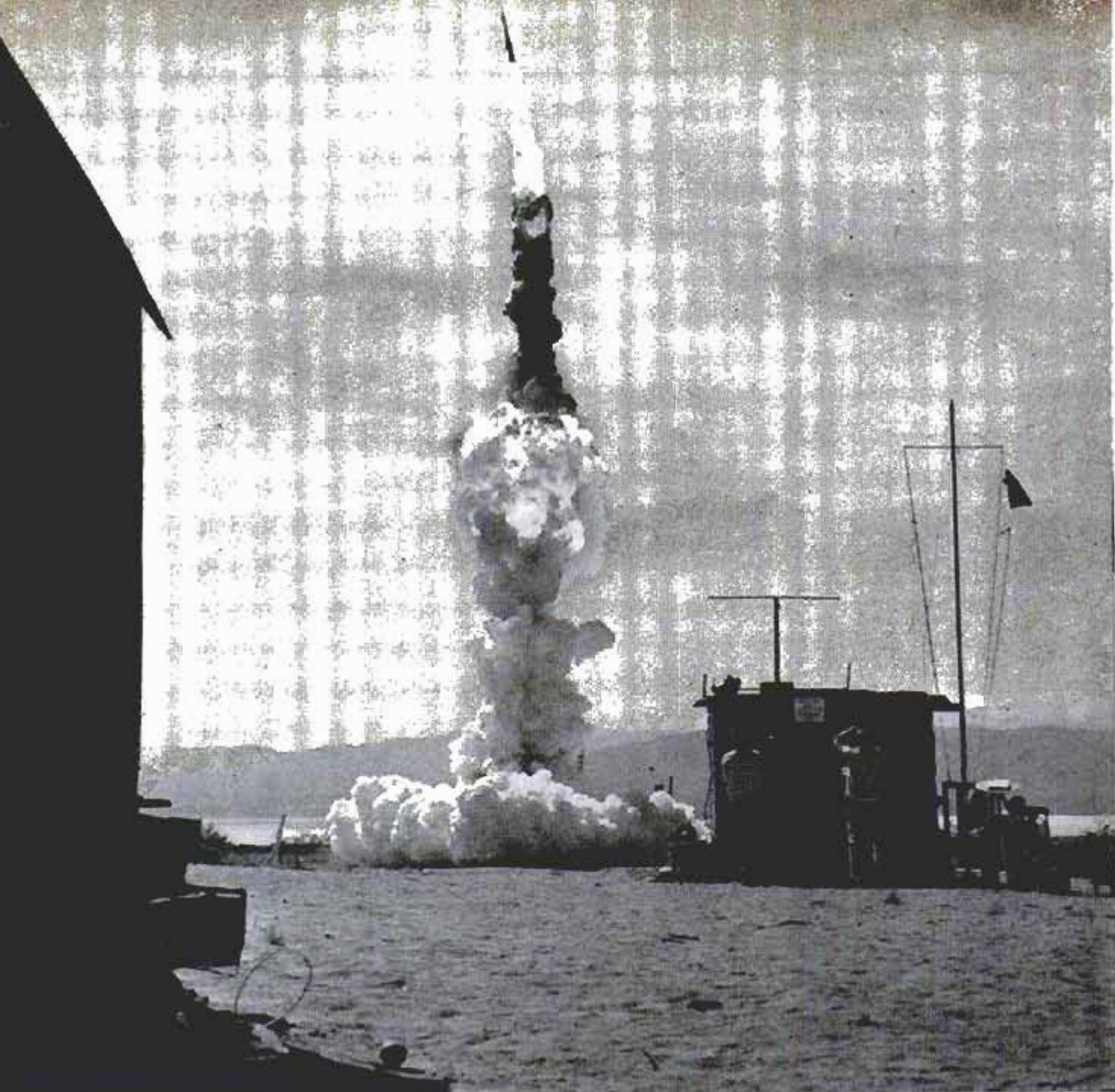

Rocket takes off in perfect test as RRS officials watch from safety of blockhouse 40 feet from launching stand

### POLICY TO BE FOLLOWED AT PUBLIC LAUNCHINGS REACTION RESEARCH SOCIETY REGULATIONS

The Executive Council of the Reaction Research Society has adopted the following policy to be followed at public launchings.

1. No rocket will be fired unless everyone is behind shelter.
2. Only the recovery crew will be allowed in the impact area between firings to find and flag the rocket.
3. The public will be allowed to go into the impact area to observe and photograph the downed rockets only at specified times.
4. The public will not be allowed in the fenced area except at the discretion of those responsible for the firing.
5. No alcoholic beverages will be allowed inside the test area.
6. No firearms will be allowed inside the test area.

#### FIRING PROCEDURE

1. **PREPARATIONS:** Signal, green flag. Spectators may witness and take pictures of activities but must stay clear of fenced areas.

2. **COMMENCE LOADING:** Signals, yellow flag, one blast of siren. All persons not engaged in the test must return to the sheltered area.
3. **ARMING:** Signals, red flag, two blasts of siren. All personnel must be in protected area. The rocket is ready to be fired.
4. **X MINUS ONE MINUTE:** Start of countdown.
5. **15-SECOND WARNING:** Siren and flashing red light. All persons must be behind protective cover during flight.
6. **FIRE:** All persons must remain behind protective cover during firing and be prepared to move to better cover in case of erratic flight.
7. In case of misfire or delay there will be an intermittent blast of the siren. All persons are to remain where they are and instructions will be given over the public address system.

We demand the cooperation of all visitors in observing these regulations and reserve the right to remove any individual from the area.



RRS President Calvin VanWagner, a semiprofessional rocketeer at 18, puts it this way:

"We live safety. There's always an element of danger in rocketry—amateur or professional—but we can at least minimize that danger. We hope to keep groups like the RRS going for a long time.

"At the same time," he adds, "we're trying to discourage the type of amateur rocketry that's given us a bad name."

Safety is written into the bylaws of the California society and carried out to the letter during the periodic private launchings and once-a-year public firings on a 40-acre site leased from the federal government.

RRS rockets range from two and three-inch bulletlike affairs to elaborate two and three-stage missiles equipped with parachutes, cameras and radio transmitters. None has yet gone aloft with a dog aboard; but the next best thing—insects—will take a ride soon on the Mojave.

#### Rocketeers Are Teen-Agers

The designer-builders are, for the most part, teen-agers of colleges and high schools in the Los Angeles area. Most of them will admit what they learn about their hobby—rocket construction, fuses, fuel and firing techniques—isn't new, and that most of their findings are old hat at Cape Canaveral or White Sands.

But the fail-and-try-again persistence reaps big dividends when carried back to school classrooms and laboratories.

VanWagner says, "We could find out from books in a minute what may take us days to learn in the desert. But that's no real achievement. Besides, we may come up with something accidentally that can benefit rocketry in general."

The RRS has been experimenting, for example, with rocket mail: a field which, if properly exploited, could someday become as common as airmail.

The RRS site, about 22 miles northeast of the steaming desert town of Mojave and about 120 miles from Los Angeles, sprawls, along sagebrush-covered terrain from a range of hills on one side

(Continued to page 240)



Inside the blockhouse, crewmen watch the rocket launching through slit windows. Rockets are triggered from this building. Recorder, used for research, picks up sounds of launching



Tracking-team member sights falling rocket and records bearing. Location of the buried rocket can be found by triangulation

Miniature camera is inserted in second stage of three-stage rocket. Burning fuel burns away string, clicking the shutter

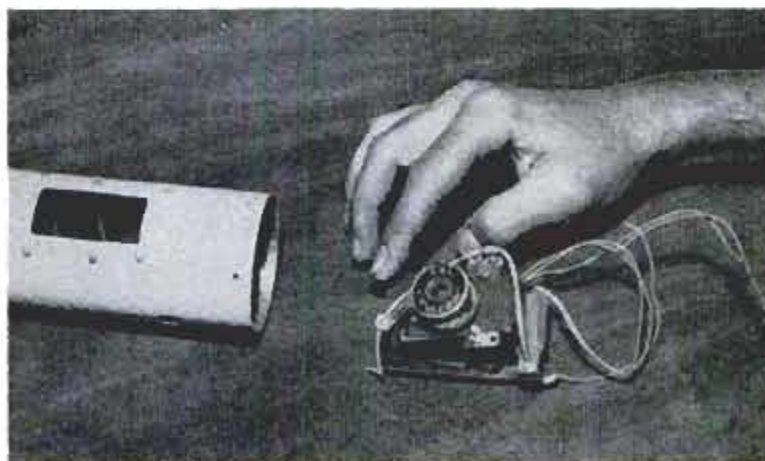





## They Walk On Water!

NOW THE adventurous sportsman can really walk on water! An Austrian ski champion has developed the "skiyak"—an individual "boat" for each foot. Skiyaks, made of aluminum, are carried to the launching area in telescoped sections. There a sportsman assembles the sections and puts on the skiyaks. Special boots fit up over his legs to prevent water from entering the skiyaks. Shoving off into the stream, he balances himself with a double-end paddle, skimming downstream at the speed of the current. In Austria, the fast mountain streams are especially popular for skiyaking, and the sport is attracting many enthusiasts.

Once the skiyaker has donned his pontoon-shaped "shoes," he shoves off into the swirling waters of a stream with only a paddle to keep his balance

Skiyaks are back-packed to launching area, where they are assembled. Special boots make them watertight

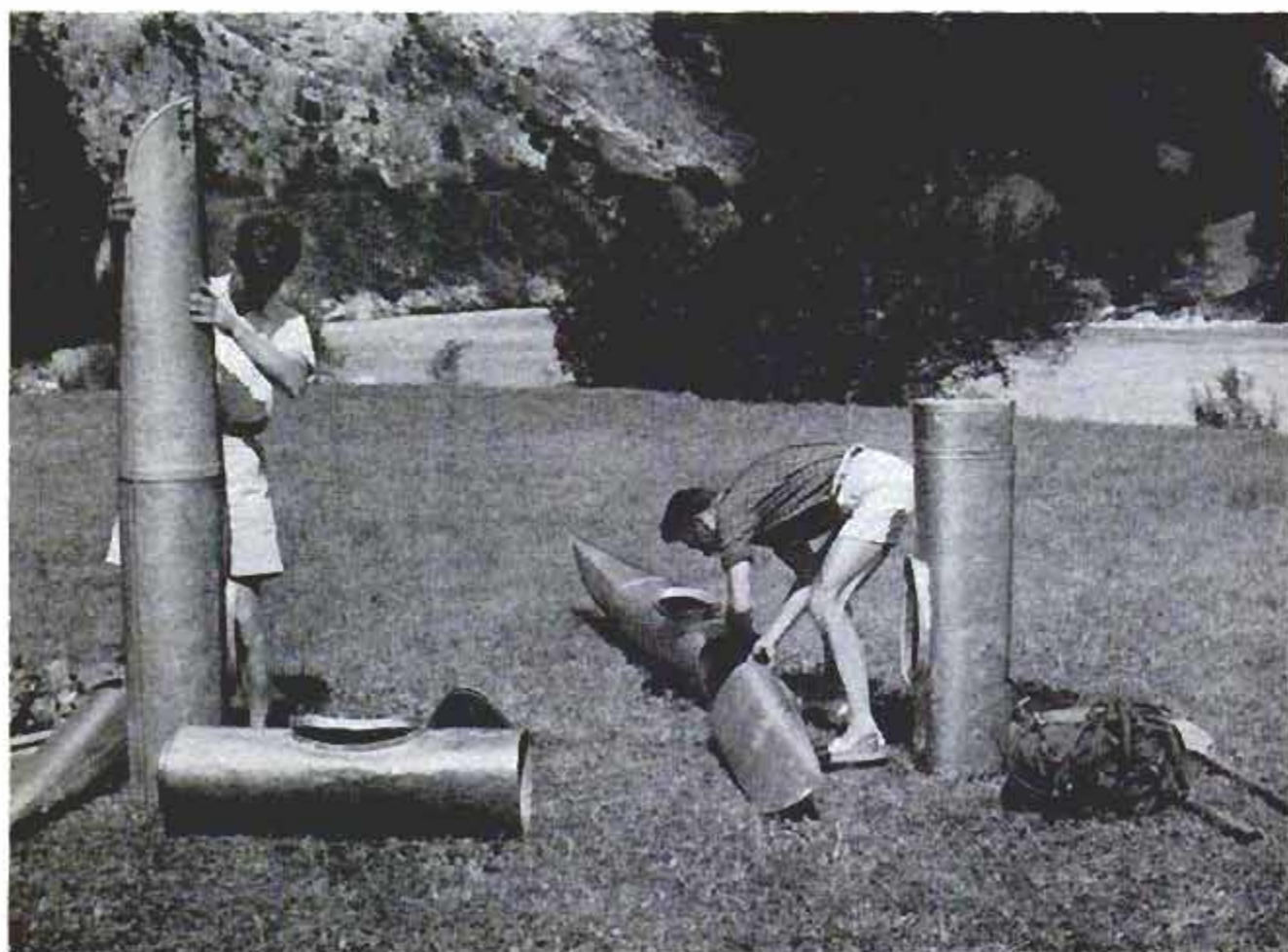



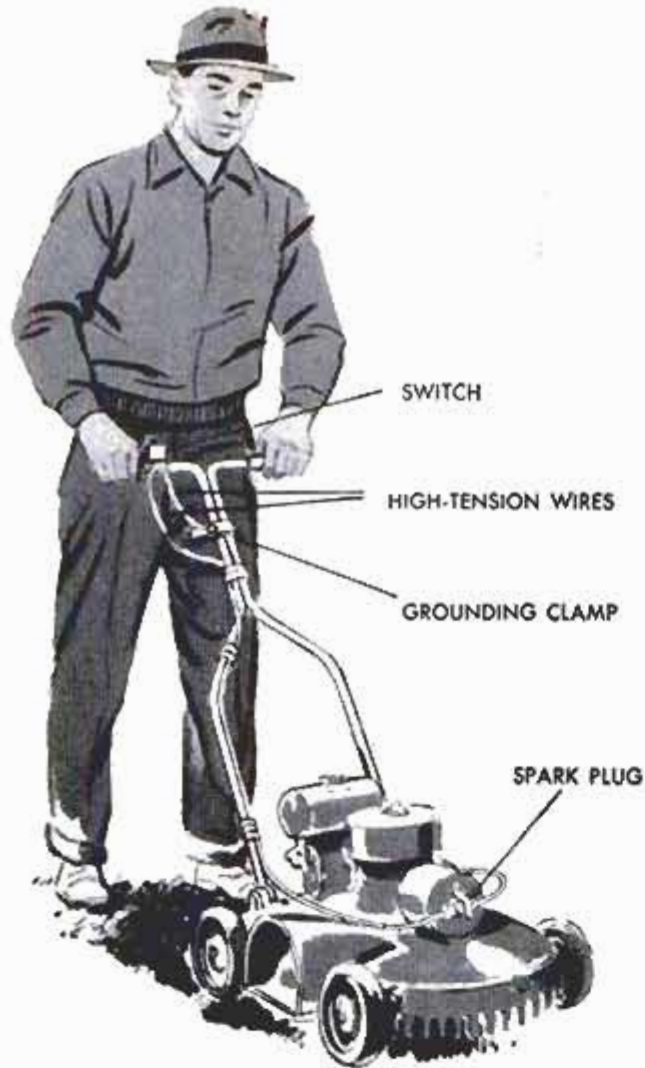

### Switch Stops Mower

If your power mower doesn't have a safety switch that will instantly stop the blades, such a device can be added in a few minutes. One switch on the market is attached to the mower handle. If a mower blade hits an obstacle, you touch the switch and short the ignition by grounding the spark plug.

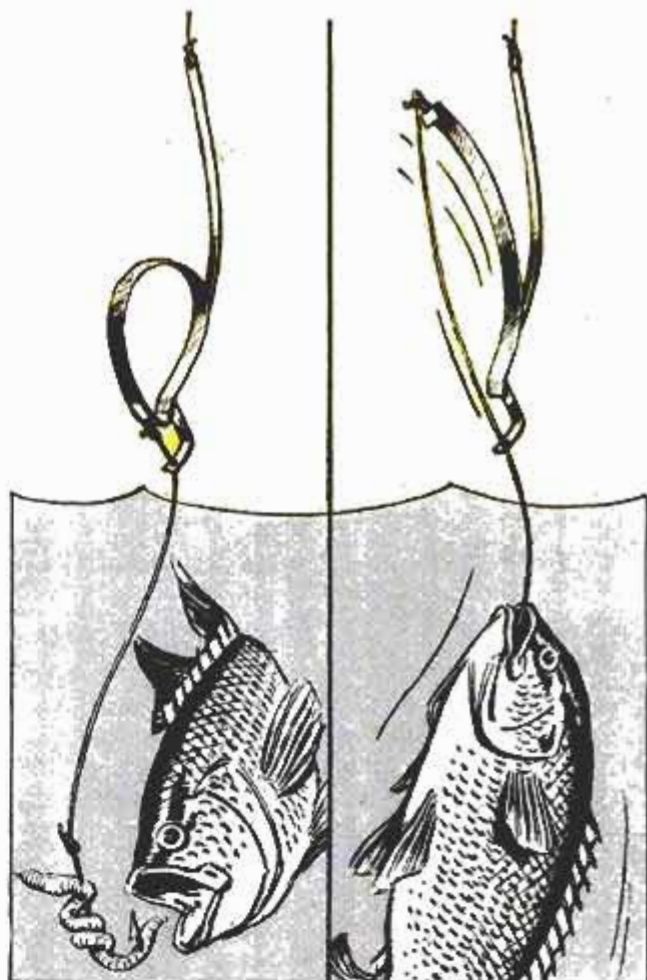

### Fish Triggers Own Fate

In using a trigger device for fishing, you bait your hook, then set the trigger by pulling down the top catch of the spring with the leader and hooking it to the bottom catch (left). The nibbling fish triggers the spring and he's jerked onto the hook (right).

### Here's a Jet That Takes Off Vertically in Horizontal Position

Bell's X-14 rises straight up from the runway in the conventional horizontal position, then flies forward. The X-14's two jet engines provide more than 3500 pounds

of thrust. For take-off, the jet thrust is deflected downward by venetian blind-type vanes installed behind the engines. It is directed rearward for forward flight.







## Helicopter Flies Automatically

Flying during daylight and darkness under instrument-flight conditions, the Navy's new HSS-1N has proved wrong those who said helicopters would never be suited for instrument flying. A major contribution toward this achievement was Sikorsky's development of automatic-stabilization equipment (ASE), an electronic system that relieves the pilot of the necessity of making constant adjustments in helicopter control. The pilot of the HSS-1N can switch on automatic control at 200-foot altitude and 80-knot airspeed.



## Loaded Supersonic Jet Propelled Into Air Without Touching Runway

Using the power of its own engine and the kick of a 130,000-pound-thrust rocket, a combat-loaded F-100D Super Sabre roared off a mobile launcher without ever

touching the runway. It accelerated to 275 miles per hour in less than four seconds. The rocket is attached to the underside of the plane's aft fuselage.





## SUB MISSILE PASSES TEST

Polaris, the Navy's intermediate-range ballistic missile, has proved its "pop up" launching method. Inert, with no warhead or propellant, the missile popped up from its underwater launching tube and shot 100 feet into the air. Because Polaris is designed to be launched from a submerged submarine, a launching system had to be found that would protect the submarine from damage or destruction. In the pop-up system, similar to torpedo launching, the missile is loaded into a tube and is then shot upward by compressed air or other gas. It leaves the submarine without damaging thrust and clears the surface of the water before its fiery power is applied.



## Big Car? Small Car? You May Get Both

If plans of a British architect materialize, the big-small-car controversy will be solved by compromise — you'll have both. The small car will fit in the trunk of the big luxury car, where it is always ready to scoot around congested areas. You'll drive from city to city in the fast, comfortable limousine and park it at the outskirts, then drive downtown in the midget. No, it's not built yet.

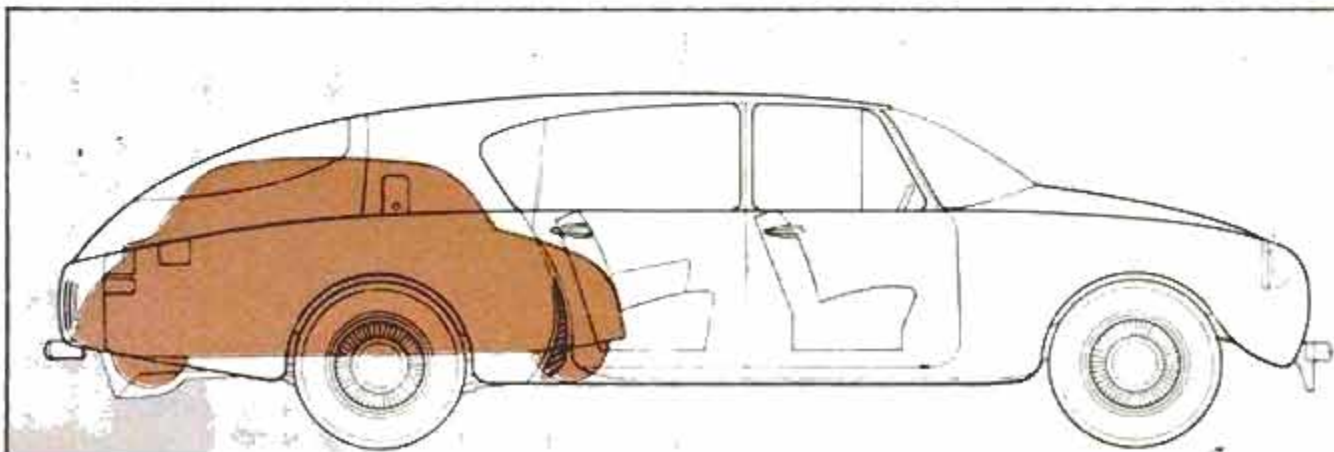
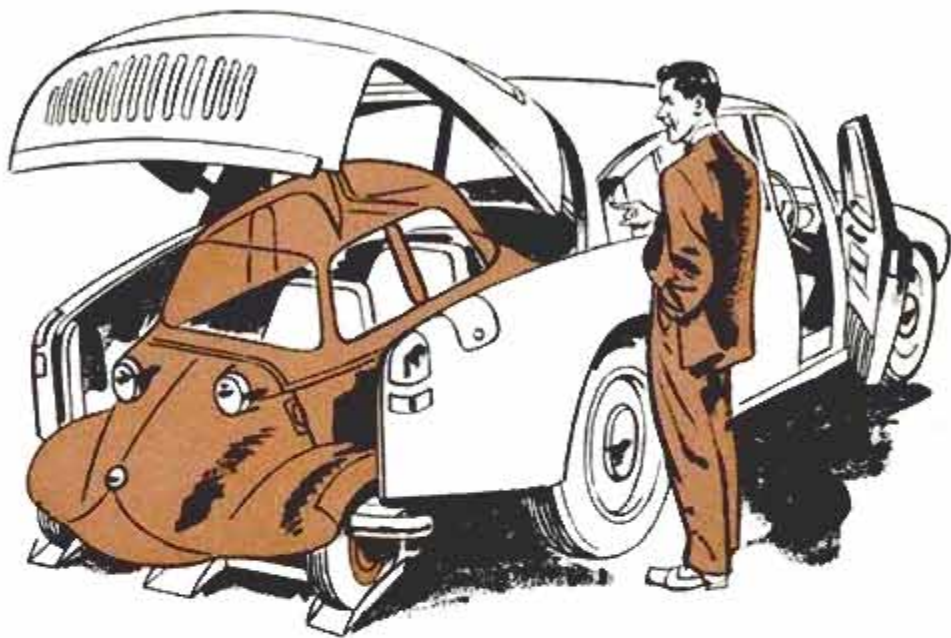





Vauxhall's styling is American. It is a "naturalized" imported car. Owners like this domestic appearance

## VAUXHALL OWNERS PRAISE HANDLING AND ECONOMY

COMMENTS BY  
ART RAILTON,  
PM's AUTO EDITOR

*Is it psychological or mechanical? Detroit would love to know. Of course, there is almost as much of America as of England in the Vauxhall. This is or is not an advantage, depending on the point of view.*

*Detroit is not worried by statements like this. It believes that small-car owners will suddenly "rediscover" America's big cars and marvel at the luxury they've been missing.*

*In normal traffic and highway driving, you can expect about 27 miles per gallon with the Vauxhall—a fuel cost of just over a penny a mile.*

**V**AUXHALL OWNERS are well-satisfied. But then, so are most foreign-car owners that *PM* has surveyed. This is typical of the breed.

Is it because foreign-car buyers expect less from the smaller cars and, therefore, are more easily satisfied? Is it self-justification for nonconformity? Or is it that these simpler cars are more trouble-free and better built? Who can be certain?

Regardless of the reason, the plain fact is that foreign-car owners surveyed in our Owners Report series are more → satisfied than owners of domestic makes.

Only one Vauxhall owner rates his car as "Poor" over-all. Such overwhelming approval is unheard of among American cars—even among the most expensive. The only car that has been given fewer "Poor" ratings is Volkswagen, and it got none at all.

First on the Vauxhall owners' list of best-liked features is handling ease with a whopping 69.9 percent mentioning it.

→ "It handles easily. Its roadability is unbelievable until you actually drive it. I doubt if I ever will want to drive a bigger car again."—Ohio truck driver.

"Easy to handle in traffic. I really enjoy driving now that I have become used to a standard shift."—Tennessee clerk.

"Pleasant to drive. A sensibly proportioned, intelligently engineered and spirited little car."—Maryland mechanical engineer.

"It's sure handy to be able to make a U-turn in the middle of a street without backing and turning two or three times."

—California salesman.

→ Second on the best-liked list is economy.

"I'm an average working man with a less than average





income. The Vauxhall provides the luxury of an American car plus economy."—Ohio factory worker.

"Averaged 27.6 miles per gallon on a round trip from California to Washington, about 1800 miles. Speeds up to 80 miles per hour. Road time: 35 hours."—California bus driver.

"This car averaged 28.7 miles per gallon on regular gasoline for 3387 miles. An ideal commuting car. In traffic it does excellent in high, down to 20 miles per hour."—Massachusetts soldier.

"Biggest joy is almost never buying gasoline! Once every couple of hundred miles I buy less than \$2.50 worth of gas. That's fun."—Illinois secretary.

**Third among the best-liked features is styling.**

"I like its styling very much. It looks similar to American cars only smaller."—Pennsylvania foreman.

"Smart, attractive lines."—New Jersey minister.

"Pretty and conservative. It looks like a car, not a space rocket or a finny monster."—Connecticut housewife.

**Here Are the Complaints**

Although they are generally a satisfied group, the Vauxhall owners have a few gripes. More than a fourth of the owners are entirely content: 28.4 percent making absolutely no complaint at all.

**Most frequently mentioned complaint of all is the comparatively slow pickup, the lack of sufficient power for certain traffic conditions.**

It is interesting to note that most of the owners who complain about this have had their Vauxhalls a comparatively short length of time (have driven fewer than 3000 miles). Among owners who have driven more than 3000 miles, the lack of sufficient power drops to third place on the com-

*Gas economy is a factor in foreign-car sales, but there's more to the trend than that. After all, on a 1000-mile trip you save only about \$5.*

*Will the day ever come when people buy cars the way they buy a furnace—just to perform a necessary function with little or no concern for styling? It seems unlikely.*

*Americans have to learn that a small engine must turn over fast to perform well. We seem to have a humane-society attitude toward engines—as though we feel that it pains an engine to work hard. Nonsense.*

Although the rear seat is comfortable (more so than the front seat), it has limited legroom. Interior of the test car was well finished

Most owners say they get from 24 to 29 miles per gallon in city driving

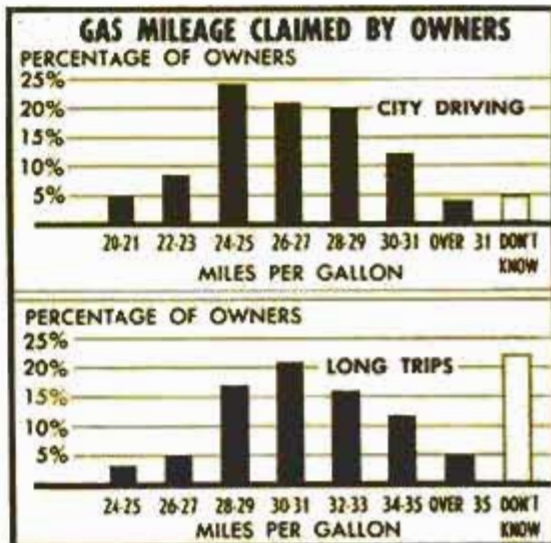

Owners satisfied with gas economy . . . . . 89%  
 Owners not satisfied . . . . . 11%



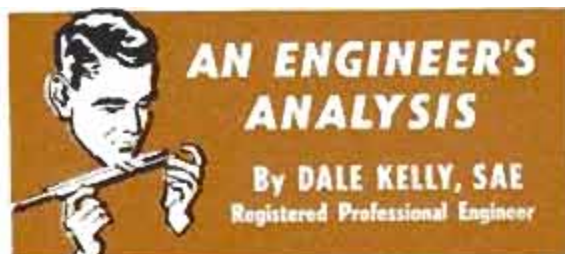

## AN ENGINEER'S ANALYSIS

By DALE KELLY, SAE  
Registered Professional Engineer

## Vauxhall Victor Test Data

**MODEL TESTED:** Four-door sedan with four-cylinder overhead-valve engine. Handshift three-speed transmission.

Rear-axle ratio: 4.125 to 1. Wheelbase: 98 inches. Tires: 5.60 by 13. Weight: 2214 pounds with gas tank half full (54% on front wheels, 46% on rear).

Mileage on car at time of test: 500 miles. Barometer: 29.1 inches. Temperature: 87 degrees F. Payload: 200 lb.

### ACCELERATION TIME FROM STANDING START (in seconds)



Ignition timed for:	0 to 20	0 to 40	0 to 60	0 to 70	1/4 mile
Regular gasoline.....	2.7	10.4	26.5	45.0	23.3

(First gear to 25, second to 45 m.p.h.)

Premium gasoline..... No improvement noted

(Gasoline had following octane ratings by Research method: Regular 90; Premium 97.)

### FUEL ECONOMY (miles per gallon)



Ignition timed for:	Steady 30 m.p.h.	Steady 50 m.p.h.	Steady 70 m.p.h.	Traffic Route
Regular gasoline.....	37.3	29.6	20.9	19.5

(In traffic test, car makes 10 full stops per mile and is driven fast enough to average 15 m.p.h.)

### ESTIMATED AVERAGE ANNUAL GASOLINE BILL: \$113 for 10,000 miles

(Based on exclusive use of regular gasoline.)

### SPEEDOMETER ERROR (miles per hour)



Speedometer reading.....	20	30	40	50	60	70
True speed.....	21	31	40	49.5	59.5	70.5

### ODOMETER ERROR (miles traveled)

Odometer correct within one-half of one percent.



### DRIVER'S VISION

Driver could see part of road 14 feet in front of car, full width of road 16 feet in front of car.

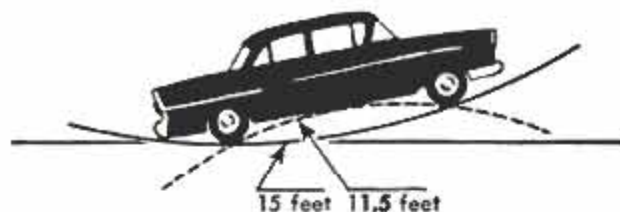

### GROUND CLEARANCE (unloaded car)

Worst dip that could be crossed.....15-ft. radius  
Worst hump that could be crossed.....11.5-ft. radius  
Deepest rut that could be negotiated.....6.5 in.  
Curb clearance for door opening.....13 in.

### MISCELLANEOUS

#### STEERING

Steering-wheel turns for 100-ft. circle.....0.50 turn  
Curb-to-curb turn-circle diameter.....34.5 feet  
Wall-to-wall turn-circle diameter.....36.5 feet  
Steering-wheel turns, lock-to-lock.....3.5 turns

**CENTER OF GRAVITY:** 23.8 inches (unloaded)

#### TRUNK CAPACITY

9 cartons (one cubic foot each)

#### WATER RESISTANCE

Splash-pan: No leaks. Brakes, ignition unaffected.

High-pressure test: Tread too narrow for test to be made.

#### OVER-ALL DIMENSIONS (inches)

Length: 167      Width: 63.5      Height: 59

### OBSERVATIONS

Top speed of car is 75 miles per hour. Speedometer and odometer more accurate than those in any American car tested this year except Cadillac and Imperial.

Hood does not open very high. Anyone working on engine may bump his head if he is not careful. Starting-motor solenoid is so made that, in the not uncommon event of trouble in the starting-switch circuit, the driver can open the hood and operate the solenoid by hand to start the engine.

The car has a better-than-average jack, an unusually complete service manual and a set of tools that will be

helpful to the do-it-yourself owner. Also provided is a small supply of touch-up paint.

The front suspension is similar to the American ball-joint design, but the lower control arm, which carries the weight of the car, has a king pin for steering and horizontal pins to accommodate the up and down motion instead of a ball joint. This is probably more expensive than two ball joints and should hold up better.

Transmission is noisy in reverse.

Gasoline tank holds 9.7 gallons. Gauge read empty when the tank held 1 1/2 gallons.



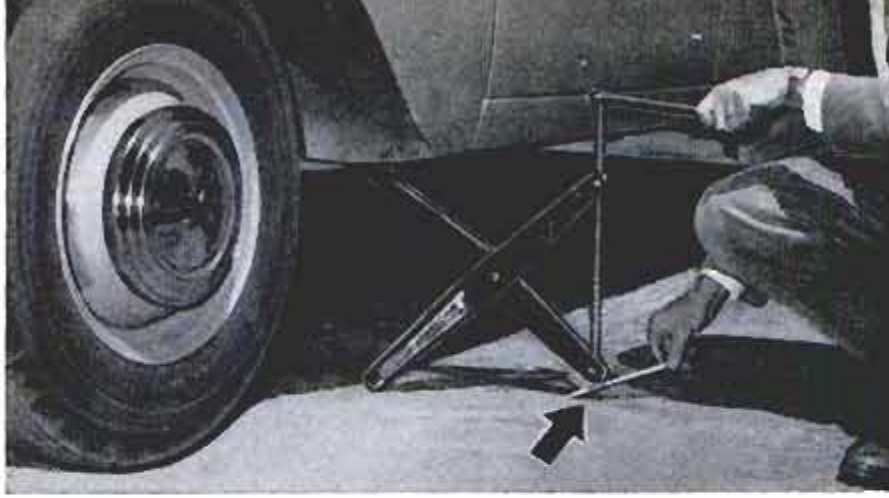

Like many European cars, the Vauxhall has an excellent jack arrangement. Four special jacking points are built into body. Jack stands on only one leg, other leg (arrow) is in the air

complaint list. This more experienced group lists poor workmanship first among the complaints and uncomfortable interiors (seats and legroom) as second.

"It could perhaps have just a bit more power for mountains. Fine for city and level highways."—Nevada airline employee.

"Should have four forward speeds. On long steep grades, not enough power in third, too much in second."—New Jersey civil engineer.

"Needs a little more horsepower for better acceleration."—Indiana cost engineer.

"I'd like a little more power. From my driveway I have to start up a steep mile-long hill. The Vauxhall will accelerate up it in second, but slows down in third."—Connecticut housewife.

**Second on the complaint list (first among those who have driven the Vauxhall over 3000 miles) is poor workmanship, as these quotations describe:**

"Poor-quality paint job. Inferior plating on cast parts. Interior finishing sloppy and of poor quality."—Michigan engineer.

"Delivered before proper servicing. If this make is an example of foreign workmanship, it is no better than our own."—Washington, D. C., owner.

"Workmanship appears slipshod and careless."—Missouri supervisor.

**Third on the list of complaints involves the clutch, brake and accelerator pedals. These are, owners say, too close together.**

"Brake and clutch pedals too small and too close together. Brake pedal too close to accelerator, accelerator pedal too

*Four speeds might solve the problem, but Americans tend to "lug" around in high—something you can't do with a four-speed gearbox.*

*Workmanship on the test Vauxhalls was excellent with no evidence of undue haste. But borrowed test cars are carefully checked by the company, which is not always true of customers' cars.*

*After 500 miles or so, you get used to the narrow, closely spaced pedals, but initially this arrangement may be hazardous. You might depress accelerator along with brake pedal in an emergency. Pedals are very small, feel flimsy underfoot.*

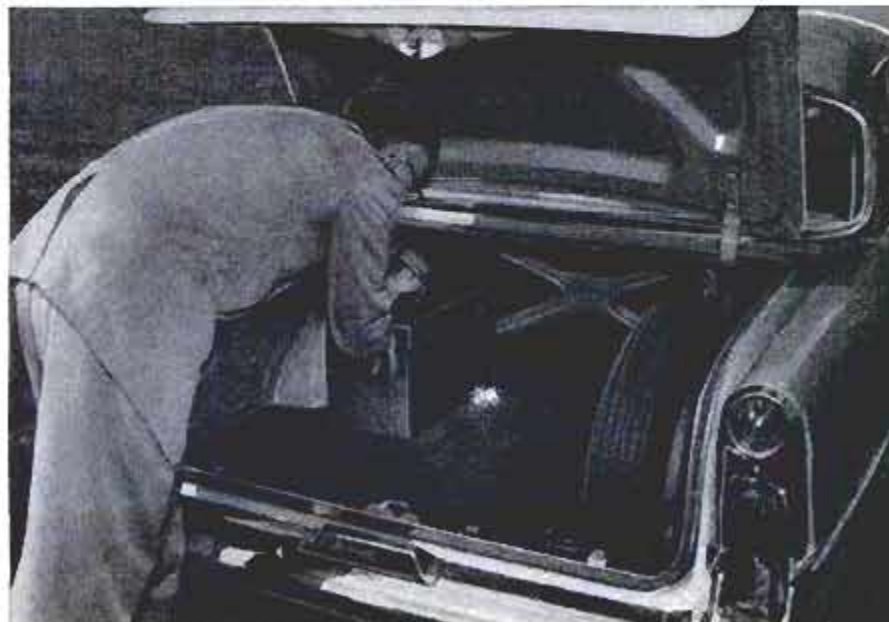

Unlike many European cars, the Vauxhall has a roomy luggage compartment. It is big enough for the luggage of a family of four on a normal vacation trip



Like a stylist's afterthought, the heater is suspended beneath the instrument panel. It moves a large volume of air and makes lots of noise while doing it



straight up. It is not comfortable."—Texas bookkeeper.  
 "I bent the clutch and brake pedals to the left to provide clearance."—New Jersey owner.

### Suggestions to the Industry

Vauxhall buyers are the malcontents, perhaps. They are the people who are turning away from the domestic automobiles. Why? What is their opinion of the American car and what suggestions can they offer for the industry?

→ **First, they say, Detroit should produce a more economical car; second, a smaller car; third, horsepower should be reduced, and fourth, prices should be cut.**

Here are some quotations of suggestions the Vauxhall buyers offer to Detroit:

"I would prefer a domestic-made car, but not of the size and cost now offered the public. Make economical and safe cars over here and I will buy one."—Massachusetts college supervisor.

→ "I'm probably one of the proudest and happiest car owners in America. I found everything I wanted in a car when I got a Vauxhall. What I save in monthly operating expense just about makes my monthly payment."—Pennsylvania salesman.

"Detroit should bring the price of its cars down. It could be done if it stops featuring several engines, innumerable body styles and paint combinations, trim and interior combinations."—New York mathematician.

(Continued to page 246)

How many times have you heard these requests? Detroit hears them too, but until 1960 it must make believe it doesn't.

When salesmen start driving around in the small imports, it's real cause for concern in Detroit.

## SUMMARY OF VAUXHALL OWNERS' OPINIONS

**OVER-ALL RATING: Excellent 80.8% Average 18.8% Poor 0.4%**

### Best-liked features

Handling ease	69.9%
Economy of operation	56.4%
Exterior styling	28.6%
Riding comfort	26.4%
Parking ease	23.4%
Roominess	17.8%
Performance	11.9%

### Most-frequent complaints

None at all	28.4%
Insufficient power	14.9%
Poor workmanship	13.5%
Pedals poorly placed	10.0%
Hard to shift	9.5%
Uncomfortable, cramped	9.0%
Poor dealer service	8.0%
Not enough gas economy	7.5%

### Had trouble with engine?

No trouble	80.2%
Some trouble	18.3%
Considerable trouble	1.5%

### What was engine trouble?

Oil leaks	4.5%
-----------	------

Carburetor	4.0%
Timing	3.0%
Ignition	2.5%

### How is dealer service?

Excellent	51.0%
Average	37.9%
Poor	11.1%

### Would buy from him again?

Yes, would	54.9%
No, would not	13.0%
Undecided, no answer	32.1%

### Difficulty getting parts?

Yes, have had	22.8%
No, have not	51.4%
No need, no answer	25.8%

### Buy foreign car again?

Yes, would buy again	85.6%
No, would not	2.5%
Undecided, no answer	11.9%

### What make was traded?

Pontiac	16.9%
Chevrolet	15.9%
Ford	9.9%
Plymouth	9.0%

Buick	4.0%
All other U.S. cars	21.0%
Foreign make	4.5%
No trade	18.8%

### What make will buy next?

Another Vauxhall	35.6%
Another foreign make	13.9%
Rambler	3.0%
Pontiac	1.0%
Other GM make	2.5%
Ford Motor make	1.5%
Chrysler Corp. make	1.0%
Undecided, no answer	41.5%

### What other car owned?

None, Vauxhall only car	63.3%
Pontiac	8.0%
Other GM make	14.5%
Ford Motor make	5.0%
Chrysler Corp. make	4.5%
Other U. S. make	4.5%
Another foreign car	2.5%

### Approve U. S. styling trend?

Yes, approve	48.0%
No, do not	46.0%
No answer	6.0%





Detector transmits infrared beam, analyzes reflected beam, trips alarm if certain chemicals are detected



## Chemicals in the Air Detected by Infrared

One droplet of a chemical evaporating in a space the size of a living room could be detected by a new alarm system, according to the Army. The device, called LOPAIR, for long-path infrared, also can be used for industrial air-pollution studies. It consists of two units, a detector head and a self-aligning mirror. A tiny amount of contaminant, even a colorless and invisible chemical-warfare agent, would trip the alarm by passing through the infrared beam. The detector head transmits the beam and analyzes the infrared light returned by the mirror.

## Nitrogen Gas Preserves Kansas Water Pipeline for Future Droughts



More than a quarter million cubic feet of nitrogen gas has been pumped into a water pipeline in Kansas to prevent internal corrosion while the line is not in use. The 32-mile pipeline was laid from the Arkansas River to El Dorado, Kans., during a severe drought. The communities of Augusta and El Dorado were faced with the possibility of being completely without water until the emergency pipeline was completed. Although the emergency is over, the pipeline is maintained for possible future water shortages. It took 50 hours to fill the line with nitrogen by pumping the gas from a truck. The truck was connected to valves at Rose Hill, El Dorado and Augusta.



## Contact Lenses Made With Bifocal Prescriptions

By grinding two separate prescriptions into the outside surface, a contact lens can be made bifocal. One prescription, for distance correction, is ground in the center of the lens. The prescription for close work is ground into the surrounding area. To do close work, such as reading, the wearer lowers his eyes.

The contact lens follows the eye downward until the lens meets the lower eyelid. This shifts the lens upward so that the pupil is beneath the reading portion. When the wearer looks up again, he simply blinks and the distance portion centers itself over the pupil. The bifocal contact lens is about the size of an aspirin tablet.

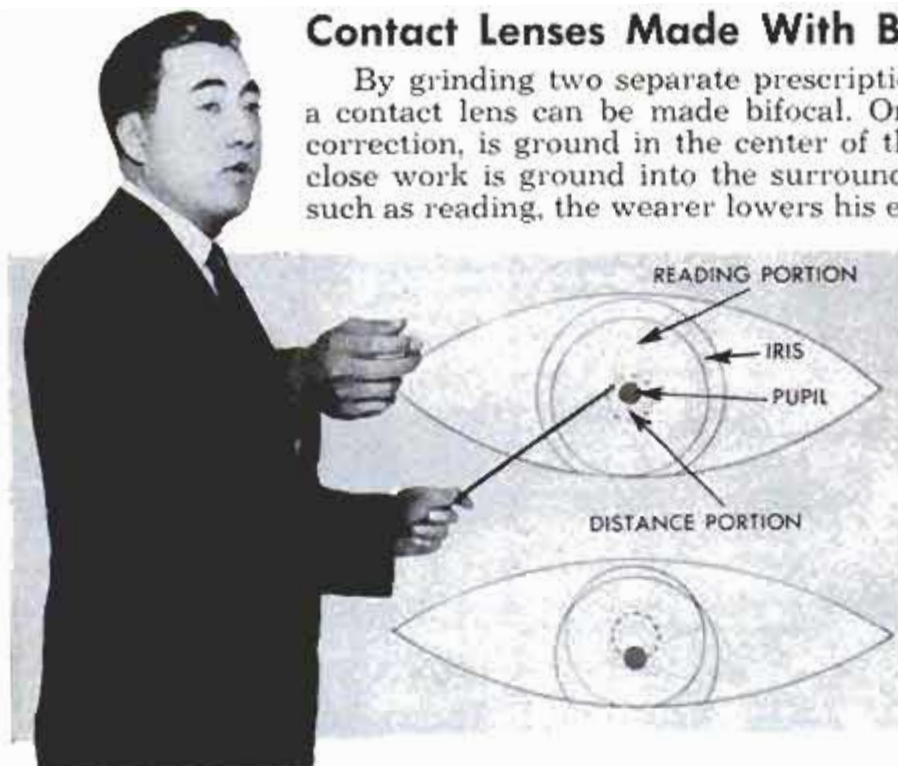

Drawings show bifocal contact lens in distance position, top, and reading position, bottom

## Electronic Draftsman Makes Graphs and Drawings

Architectural and engineering drawings, as well as business graphs, can be plotted automatically by a machine that "reads" data on punched cards and tapes. Fifty times faster than manual-plotting methods, the electronic device needs less than two seconds to translate all the coded data on a punched card, relate it to data on a preceding card and draw a line between two points. The automatic draftsman is expected to aid highway builders because it can draw cross-sections of highways and surrounding terrain from field engineers' calculations, showing the amount of cut-and-fill work required.

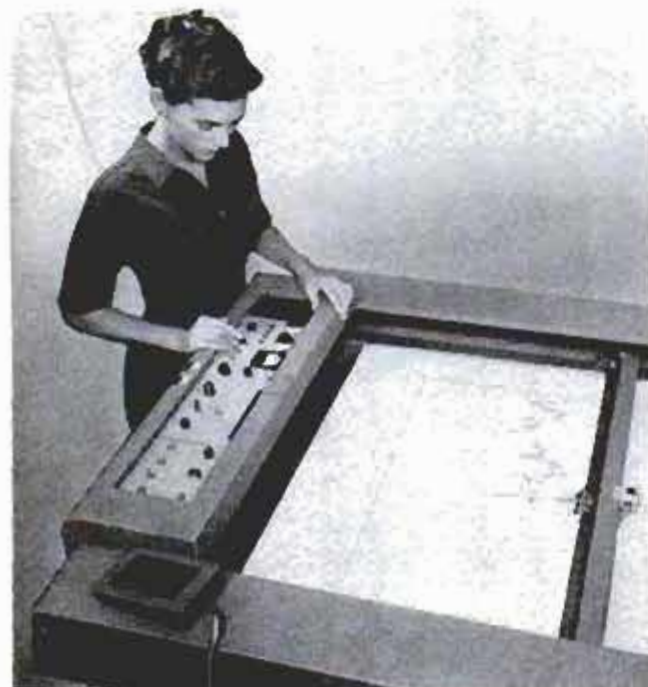

## Rockets Drop Aluminum Chaff To Measure Wind Behavior

Confettilike aluminum chaff can be scattered by rockets to provide scientists with information about wind behavior at high altitudes. The information is needed in delivering intercontinental ballistic missiles on target, and in developing new weather-forecasting theories. The rockets release the small pieces of aluminum more than 50 miles above the earth. Radar tracks the chaff and produces a quick and accurate wind profile. Platforms for launching the rockets are mobile.







With oil-drilling rigs in background, Navajo women card wool, twist yarn, weave rugs in tribal tradition

## TREASURE HUNT IN **NAVAJO LAND**

**Oil-drilling rigs crowd primitive mud houses in a dusty desert basin already rich in uranium ore. And the once impoverished Indians who own the land may become one of the wealthiest tribes**

*By Rafe Gibbs*

**M**ODERN TOOLS and men of science are again making Paradox Basin one of the most aptly named areas in the nation. The basin, which sprawls over the famed Four Corners where Utah, Colorado, Arizona and New Mexico meet, is sage-spotted desert land about as worthless-looking as a rusty horseshoe. Shortly after World War II, however, the basin bore out its name by giving up rich deposits of uranium ore. Now it is producing oil in a strike that may be the biggest.

Because of the remoteness of the area, it costs about \$150,000 to sink a well, compared with the national average of \$77,485, but the producers say that the quality of crude being found justifies the expense. The quantity of production, too, is high. Carter Oil Company's McElmo Creek well alone is producing 2330 barrels a day.

"Our company's pride and joy," said a Carter oilman. He might have added that a well with half that production would look good on a stockholder's report.





Where grass is thin and terrain resembles surface of moon, petroleum companies are making big oil strikes

Wildcatting in untried areas of Paradox Basin has been highly successful. On the average in the industry, only one wildcat in seven strikes oil or gas. But, of six recent wildcats Texaco drilled in the basin, four were considered good producers.

Bidding for oil leases has been spirited. A combine of Ohio Oil, Sun Oil and Pure Oil companies bid \$7,941,000 for a 2500-acre lease.

Texaco has some 30 top-notch producing wells in the Four Corners area, and there are many other companies with multiple producers. Altogether, about 25 companies are actively operating in the basin.

In this land the grass is lean, but the

sheep of the lonely Navajo herders are astonishingly fat. Most of the basin is on the Navajo Reservation and, with oil, the Navajos, who were once one of the country's poorest Indian tribes, may become one of the wealthiest.

Although the basin is now a desert, it was once covered by a great sea. An old Navajo, told that he was living on the floor of a vanished sea, shrugged: "Perhaps the wind dried up the waters."

The wind blows a lot in the basin, all right. Sometimes there seems to be more dirt in the air than on the ground. Even when it is dusty, however, you can see 40 or 50 miles.

Map shows location of oil fields. Pipeline (shown by black line) will carry oil to California refineries



Outside rear-view mirror from car is used to inspect welding before the pipe is lowered into ditch





The inclination of many ancient peoples has been to build their homes on hilltops for protection. But not the Navajos. They avoid the hilltops—for protection. The hilltops are where “the wind spirits dwell, and they cause headaches.”

When the atom bomb was developed at the end of World War II, prospectors fanned out through the Four Corners area and made significant discoveries of uranium-bearing ore. A news dispatch then predicted that “this area may some day be producing half the world supply of uranium.” But the prediction had already come true, in 1898, and had held good for 30 years, until the discovery of radioactive ores in the Belgian Congo.

The person responsible for the early mass-production of uranium-bearing ore never saw the basin. She was Mme. Marie Curie of France.

Carnotite, rich in uranium, was first mined in the basin in 1881—but the miners were interested only in the small amounts of gold they got from the ore. After the Smithsonian Institution discovered the ore contained



Primitive and modern worlds coexist in Paradox Basin where drilling supervisor parks near Indian mud hogan while using mobile radiophone



Rising in the sky like an Indian smoke signal is the plume from a blast marking the test site for another oil well in the sage-spotted desert

Navajo on his pony pauses alongside a well that is equipped with a pumping rig. Tribe has received millions of dollars from oil leases

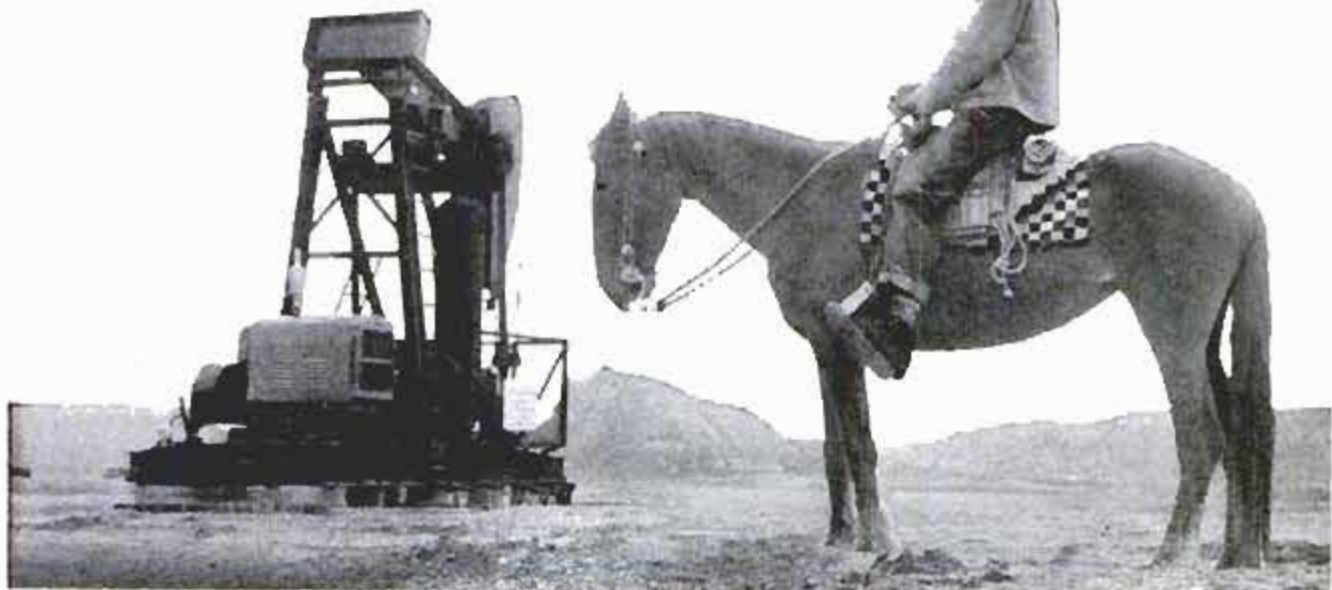





Besides income from oil-company leases of land, many of the Indians earn money from oil-field jobs



Drillers putting down well at Paradox Basin location add another length of drill pipe to the "string"

uranium, several tons were shipped by scientists to the School of Mines in Paris. The ore was delivered to Madame Curie and used by her in experiments that resulted in the extraction of radium.

In 1879, E. L. Goodridge had discovered in the area "streams of oil coming from loose boulders." Some years later, Goodridge came back with a drilling rig, and struck a gusher throwing oil 70 feet high. But the well soon proved to be mostly gush, and was abandoned.

For the modern oil seekers there were no flowing streams, but there were structural surface signs to guide them. And out of this fact grew a paradox in the basin that is paying off.

Ordinarily oil companies in their explo-

rations depend heavily on subsurface studies. Being used extensively in Paradox Basin today are seismographs to measure shock waves traveling downward into the earth. But, in deciding to drill the big strike's first well in 1956, a pioneering company did so without benefit of seismography! The surface signs observed by the company's geologists said there was oil below. They drilled. There was.

The quiet of the basin, in a 20-mile long, egg-shaped area known as the Aneth-Is-may, was quickly and frequently broken by the rumble of trucks carrying instruments, drilling rigs, pipes and casing.

Ordinarily, you can move fastest in a motor vehicle when the air pressure of

(Continued to page 226)

Once well begins to flow, drilling rig is dismantled and moved. A small fence is erected around wellhead  
Photos courtesy of Texas and Shell Oil Company







## Push-Button Camp Wagon

ON THE ROAD, the "push-button camper" appears to be just another station wagon carrying an aluminum boat. But when the driver pulls into a parking area and pushes a button, the "boat" is lifted up and over the side. Touch another button and an auto-top tent opens over a double bed already made-up and equipped with a reading lamp. A third button causes a compact kitchen unit to slide out on the tailgate. The unit includes a sink with hot and cold running water, a two-burner stove and a refrigerator. Still another button thrusts out a canvas canopy to shade the kitchen. The push-button camper was developed by the Ford Motor Company's publications department for experimental purposes.





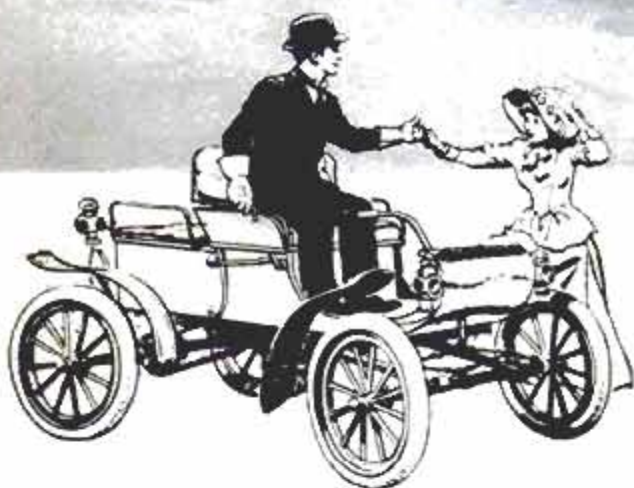

For economy, maneuverability and visibility in a pick-up, you can't beat the "new" American Air Products' 1901 Olds

## THE 1901 OLDS IS BOOMING

By George X. Sand

Here's how the Olds looked when it really was new

**T**HIS PROBABLY will not alarm Detroit too much. The competition is not very threatening to the shiny new models coming out of the Motor City—but there's a tiny boom going on in 1901 models of the "Merry Oldsmobile."

One third smaller than the original, the Starts Olds rolls along on sulky wheels

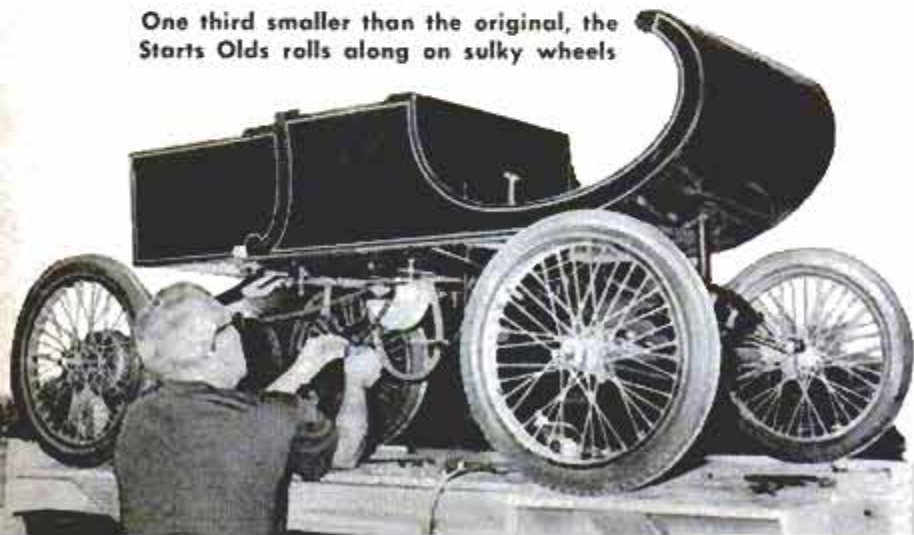

Fort Lauderdale, Fla., is the "motor city" whence come two versions of the 1901 curved-dash Olds. A firm in Canton, Ohio, is preparing to put in its bid for the business of antique lovers with a replica of the 1903 Olds, complete with tiller, 4.8 horsepower engine and nostalgic bulb horn.

American Air Products at Fort Lauderdale is turning out full-size, 93-inch copies of the '01 Olds. Capt. Al Starts of Fort Lauderdale, popular sightseeing-boat operator and inventor, is the impresario of a somewhat smaller but authentic copy of the same car.

John McGrath is head of American Air, a concern which also builds portable iron lungs. Like Al Starts, he decided to



build one of the ancient cars for personal use after falling in love with an original model owned by James Melton, the singer and collector of antique autos. Original parts were no longer available, so both McGrath and Starts had to "tool up" to start their production. When the two private automobiles appeared on the city streets, folks wanted to buy. Starts and McGrath decided to build more, and Starts sold 12 the first time he parked a working model beside the ticket booth where he docks his tourist boat.

The American Air version is "standard" size, 93 inches long. It goes 35 miles per hour, and 60 miles on a gallon of gas. It is powered by a 4-horsepower, 4-cycle, single cylinder L-head air-cooled Clinton engine. This flea-size powerhouse employs ball bearings, but with splash-type lubrication. It boasts a 2<sup>15</sup>/<sub>32</sub>-inch bore and 2<sup>1</sup>/<sub>8</sub>-inch stroke. A Cushman gearbox offers two forward speeds and reverse. A canvas "all weather" top is optional. Price: \$1095, f.o.b. Fort Lauderdale.

All three cars seat two persons and have the modern convenience of self-starters. They have marineplywood bodies mounted on steel frames and springs.

"Nope, we're not crazy," defends Al Starts. "In fact, we can't turn them out fast enough. Car dealers and shopkeepers find it excellent advertising to use them as delivery cars. Housewives love the novelty of shopping or driving to the beach in these cute little gas buggies. They are much safer than scooters, and much easier to park than conventional cars. Old people buy these 'Merry Olds' because they revive memories of youthful days."

The Starts car is scaled about one third smaller than the original Oldsmobile. It has a 54-inch axle, weighs 275 pounds and sells for \$895 f.o.b. (Air freight to New York City from Florida is \$50; no crating required.)

Its 3-horsepower, 4-cycle Continental gas engine (built originally under Government contract for scooter use) provides speeds up to 40 miles per hour. The engine, like the four stainless-steel sulky

(Continued to page 244)

Steering is by tiller. The horn blows if you squeeze it. Lights are electric, but look like oil lamps



How simple can a car be? The Starts company produces these 1901 automobiles on an "assembly line" (background) in Florida

Ohio's version of the 1903 curved-dash Olds sports mudguards. It sells for \$1095 or can be bought in kit form for only \$895







## Powered Wheelbarrow Climbs Mountain

Maintenance crews of the United States Forest Service now get an assist from gasoline-powered wheelbarrows when moving heavy loads of cement and rocks up narrow mountain trails. The powered wheelbarrows were introduced in Kings Canyon National Park, in California, after a severe winter had caused considerable damage to trails, bridges and other facilities. The crews were able to speed up repair work with less strain on the workers with gas-powered wheelbarrows. The equipment consists of a lightweight steel body with a 2½-horsepower engine mounted at the rear. It will carry loads of 250 pounds up steep trails.



## Solar Cells Power Hearing Aid

Silicon solar cells, which make electricity from sunlight, furnish power for a new type of hearing aid. Built into eyeglass frames, the cells need only a small amount of sunlight each day to operate the hearing apparatus. When light is poor, a battery takes over.

## Sikorsky Helicopter Lands On Water—or Anywhere

Built with a flying-boat type of hull, the Sikorsky S-62 can take off and sit down on water, ice, snow and swamp as well as land. The V-shaped bottom of the fuselage is designed to cushion impacts when sitting down on water and to throw spray outwards and down. The floats house the landing gear and resist pitching and rolling while the helicopter rests on the water.

Looking more like a flying boat than a helicopter, the versatile S-62 has blisters down near the hull line, giving the pilot excellent downward visibility





**YOU WON'T BELIEVE** it. Not until you see it, that is. The unbelievable switch in General Motors' automotive image. A revolution has occurred.

The 1959 General Motors styling is completely out of character—the past is forgotten. The slate is wiped clean.

It represents the sharpest break with tradition since Chrysler dumped its shorter-on-the-outside models in 1955.

Replacing GM's historically prosperous, well-fed, overstuffed look is a sleek, crisp airiness that puts GM right into the middle of the 20th century. It's the difference between overstuffed furniture and Danish modern.

Actually, there is comparatively little that is original in the new GM look. By combining the best of Chrysler and Ford with a few new touches, GM has made its previous models as out of date as the four-poster bed.

Last December this column suggested that GM might be getting help from Italian stylists—specifically Farina. GM denied it then and still does, but there's a lot of Italy in its new cars. The 1959 Buick may even please the Society of Industrial Engineers, the most vocal of all Detroit's critics.

### A Big Year for GM

Longer and lower, all GM '59 cars have a lightness, a fleetness that belies their bigness. They drive better, too. The balance is better. They feel more alive, more agile. It should be a great year for the Giant.

But there is no move toward more practical designs at the moment. These cars are bigger and so are the engines. Cars may not be more practical, but they're beautiful. They may not help your budget, but they'll sure lift your morale.

**What will this new GM personality do to Chrysler and Ford? If GM sells over 50 percent of the market with old-fashioned styling (as it is this year), what will it sell when it goes modern?**

Another General Motors bombshell is the exclusive use of acrylic lacquer on all models. This new plastic paint (used on about 25 percent of the GM cars in 1958), the corporation claims, will make waxing and polishing unnecessary forever. But it's unlikely that the public will quickly give up its Sunday recreation of washing and polishing cars. Polishing a new car is as much fun for some as driving it—and lots cheaper. People rarely polish old cars (which need it) and love to polish new cars (which don't) and they probably will continue to, despite this new paint.

### What's Left for '60?

You're probably not interested in 1960, not having seen the 1959 cars yet, but the



By Art Railton

pressure has relaxed in the race for the rear-axle transmission. Earlier, the target was 1960; now it seems to be 1961.

Along with the rear-axle-mounted transmission, you can expect General Motors to replace its Hydra-Matic in 1961. The new job will undoubtedly be a torque converter rather than the four-speed-shift-itself-gear-box variety. Cadillac will probably get its new engine at the same time, although it may be out by 1960.

**Chrysler will have some big surprises in 1960. One just might be a transistorized ignition system and, perhaps, the long-forecast central hydraulic system. One thing appears certain—the 1960 Chrysler styling will do to the industry what its 1957 design did with its emphatic tailfins.**

A revolution may be starting in the Motor City. There's a British taxicab on test there—an Austin four-cylinder diesel cab right from the streets of London.

How's it doing? In the first month, its over-all fuel economy was 28 miles per gallon of diesel fuel (domestic cabs get from 8 to 10 miles per gallon of gasoline). Maintenance is minimized. It is expected to go 100,000 miles without overhaul and to last at least 10 years in daily service. The drivers love it. They're less tired, get no backache thanks to an upright seat. It U-turns anywhere. The passengers praise its ease of entry, roominess, seat comfort and privacy. It costs \$1000 more than a U.S. cab, but operating costs are expected to offset this initial handicap.

**If the foreign cars start cutting into the cab business (there are Mercedes cabs operating in New York City), what next?**

There will be one dream car at the GM Motorama in October. But it won't compete against the 1959 models. It will be an engineering car of the future showing how Detroit will soon eliminate humans from the chores of driving. Soon all you'll have to do is to make the monthly payments. You won't even have the fun of driving the family car!





Oriental influence is reflected in carvings by Dr. Schwartz who obtained many designs during travels



Photos by Three Lions

Most of the work of the dentist-sculptor is in pure ivory which is sliced off a tusk with his bandsaw

## A Dentist Turns Sculptor

**A**FTER A BUSY DAY of drilling teeth, Dr. J. R. Schwartz, a New York City dentist, relaxes by using dental drills to sculpture ivory figures. A comparatively soft material, the ivory is easily worked by the small drill bits. The drill equipment in Dr. Schwartz' home workshop is similar to that used in most dental offices. By using the different types of bits, he ob-

Replica of Rodin's famous statue was carved from a whale's tooth. Next to it is an uncarved whale's tooth



tains varied textural effects. Occasionally, he uses an entire tusk of ivory for a figure. But more often he cuts a slice from the tusk with a bandsaw. And he sketches an outline of his project on the flat surface of the ivory before he begins carving it. In addition to his work with ivory tusk, Dr. Schwartz has carved tiny but elaborate art objects from whale teeth. ★ ★ ★

Incredibly delicate work of Dr. Schwartz is shown in tiny forms carved within forms from solid ivory





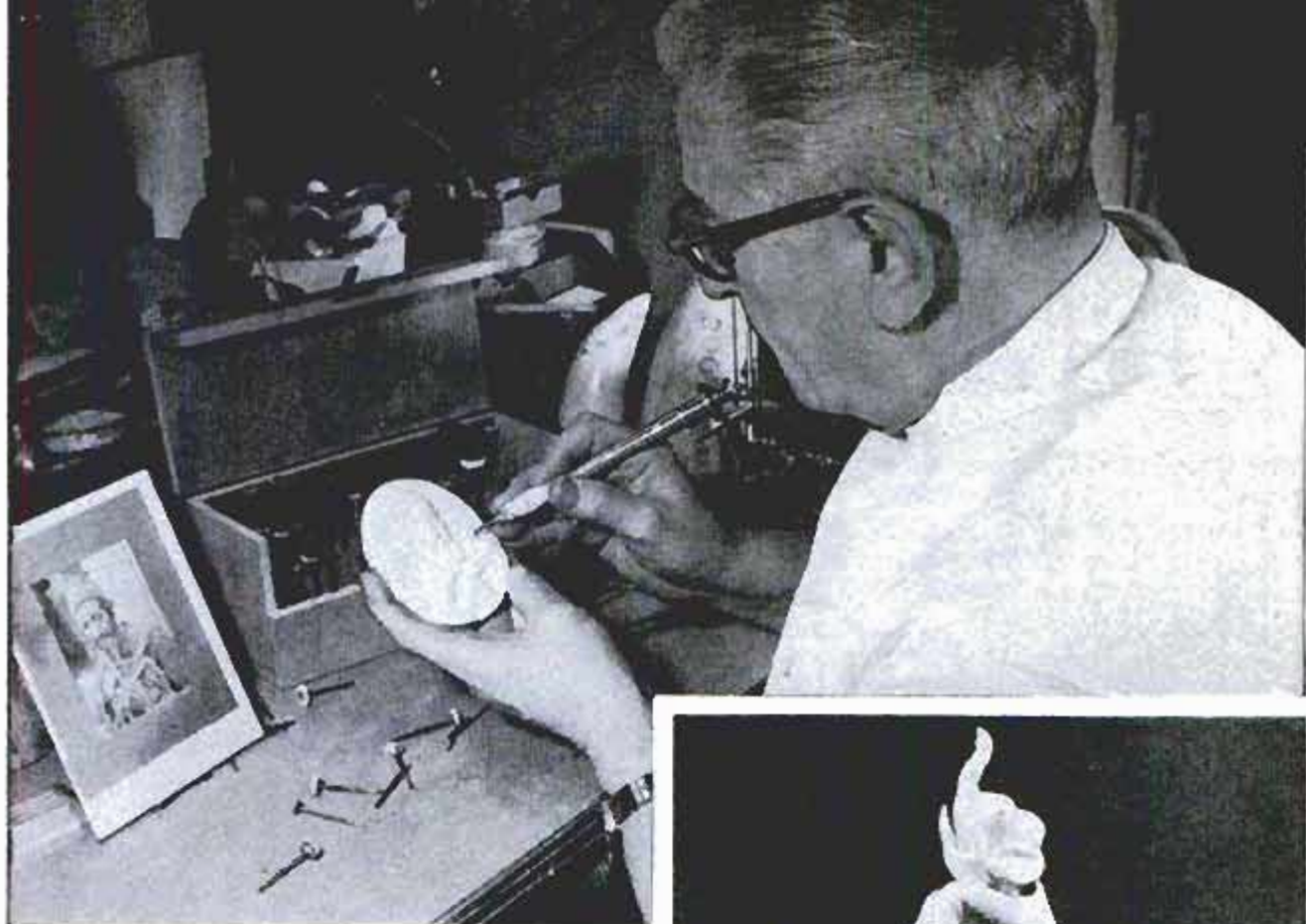

**Dr. Schwartz, using different drill bits for varied textures, carves a face on a slice of tusk. Finished portrait in ivory will be that of man in the photo**

**The pyramid of elephants, at right, was carved by Dr. Schwartz from a solid tusk of ivory. The dentist uses a standard set of drills for his unusual hobby**

**At work on replica of faces of American presidents, originally carved in rock on Mount Rushmore, S. D., Dr. Schwartz manipulates small drill with finesse**

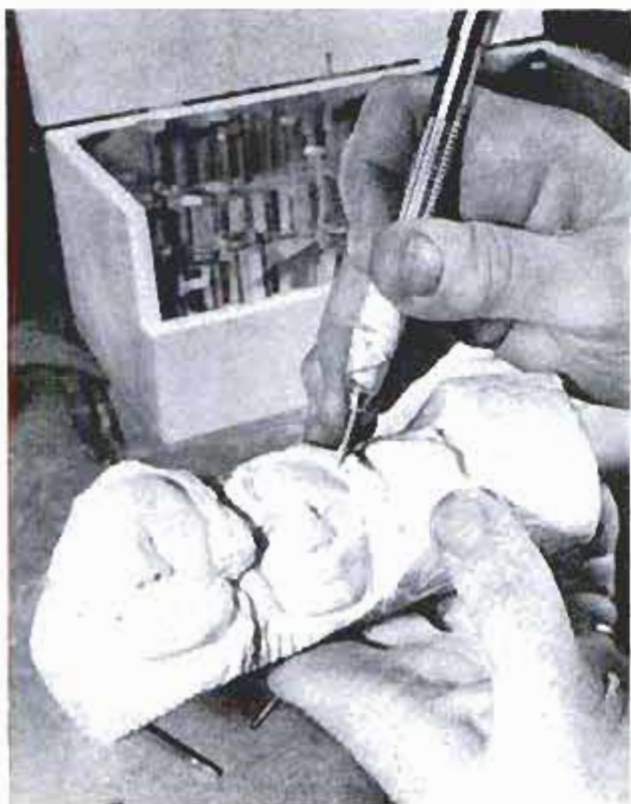



# Keeping up with the ATOM

**YOUR WRIST WATCH** may be exposing you to a significantly high level of radiation. That is the warning of Dr. J. L. Haybittle of the Radiotherapeutic Centre at Addenbrooke's Hospital in England.

Dr. Haybittle borrowed luminous-dial watches from friends and checked them for radiation. They ranged in radium content up to 2.2 microcuries. Assuming that such a watch is worn 16 hours a day, Dr. Haybittle says, the skin would receive nearly two thirds the permissible level of radiation.

Should such watches become more popular, he warns, they would be second only to diagnostic X rays in the amount of radiation they contribute to the gonads.

☆☆☆

**NUCLEAR NOTES:** Bones of babies born in the last six years receive on the average up to five percent more radiation because of fallout than from natural radiation alone. . . . A new high-intensity food irradiator for the Army will contain more radioactive cobalt than all such cobalt now in use in the country. . . . As a result of the successful underground atom-bomb test, the AEC has received eight concrete proposals for industrial applications of such blasts. . . . Nematodes, tiny wormlike parasites of plants, are so resistant to radiation they might be the sole survivors of atomic war, say Department of Agriculture scientists.

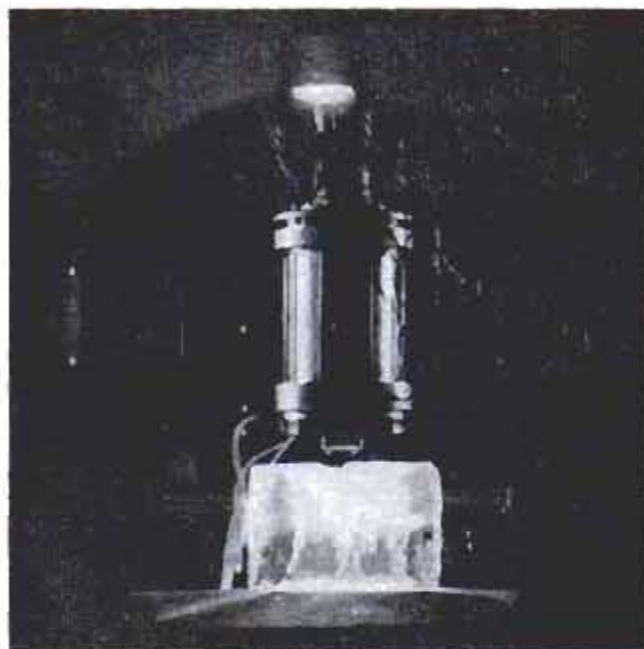

**YOU'RE LOOKING** at a block of ice which is glowing like a big light bulb. The ice gives off a visible glow under the impact of two-million-volt electrons from a high-voltage Van de Graaff accelerator. Westinghouse scientists use the glowing block of ice to demonstrate a new radiation detector which can detect a similar glow in ordinary water and measure the intensity of radiation causing the glow. The heart of the instrument is an "electric eye."

☆☆☆

**NUCLEAR QUOTES:** "We are on the verge of a breakthrough apparently in conversion of heat through thermoelectric couples. We should have something definite on this in a matter of three years."—Rear Adm. A. M. Morgan, Bureau of Ships. . . . "It will not be long in my judgment before we shall witness nuclear explosives being used in situations . . . where conventional explosives are not practical. The mining, petroleum and engineering fields will begin to use a great revolutionary new tool."—Lewis L. Strauss, former chairman, AEC. . . . "I see a real danger in that the rate of basic discoveries is not keeping pace with the rate of utilization, and from a long-range point of view, I am afraid that our intellectual gas tank is beginning to run dry."—Dr. Willard F. Libby, Commissioner, AEC.

☆☆☆

**ATOMIC SCIENCE** is helping preserve a relic of the Bronze Age at left. The huge 45-ton slab is one of the toppled stones at the ancient temple of Stonehenge in England. Envelopes containing film were placed atop the slab. Radioactive sodium was introduced beneath the stone. Gamma rays penetrated the slab to expose the film, revealing any cracks that might prevent the stone from being restored to position.



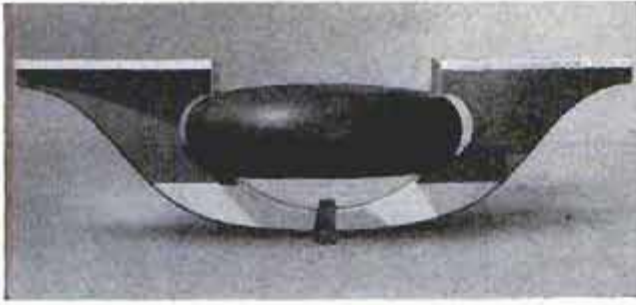

### Kit Converts Tube Into Boat

Children can transform an ordinary inner tube into a miniature boat with a wooden deck and keel that fit around the tube. The small boater sits astride the keel and maneuvers with a double-end paddle. The kit includes a mast, which fits into a socket on the deck, and a sail. With these parts in place the tube is converted into a miniature sailboat.

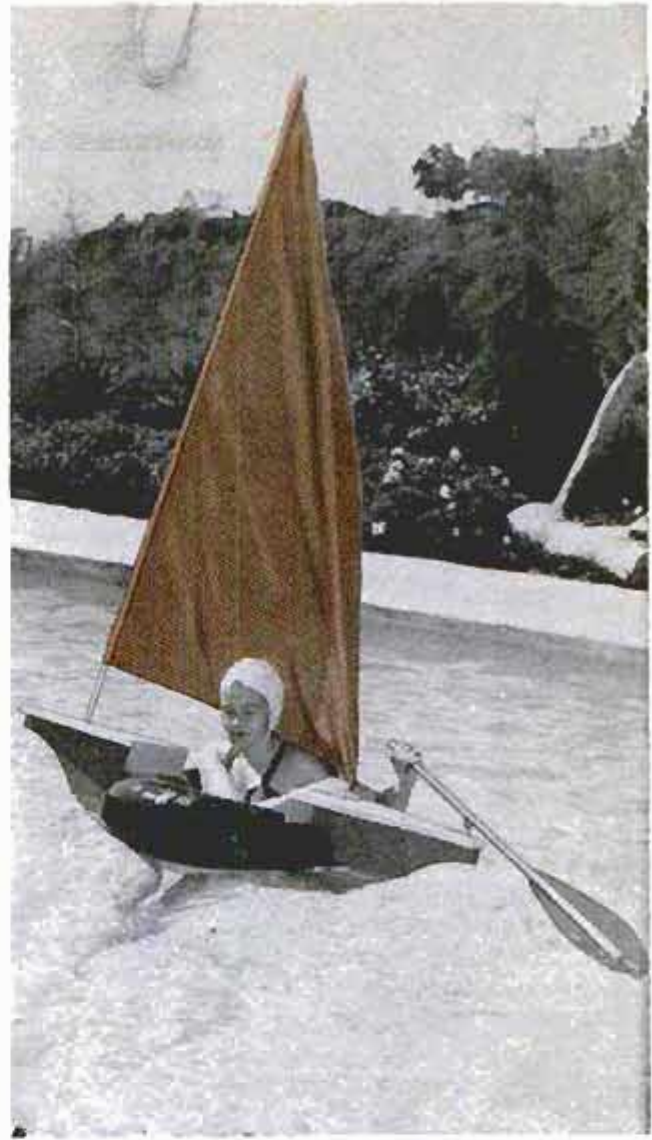

### Miniature Battery Pack Has Enough Power to Fire 35 Flashbulbs

Small enough to slip inside a coat pocket, a pint-size battery pack has enough power to fire as many as 35 flashbulbs wired in series. It uses two 22½-volt batteries and weighs only six ounces. A matching unit of the same size and weighing even less (only 4½ ounces) is an electric eye that will fire flashbulbs or electronic flash units. It is powered by a 15-volt battery. When

the two units are mounted together, the combination becomes a self-contained slave-lamp control actuated by the flash on the camera, capable of setting off one or more extension lights. A small hole in the center of the remote-control unit "sees" the flash of the camera-mounted light and fires the others. The eye can be mounted separately from the extension lamps.





# EVERYBODY IS

By John C. Green

DIRECTOR OF THE OFFICE OF TECHNICAL SERVICES  
AND EXECUTIVE DIRECTOR OF THE NATIONAL INVENTORS  
COUNCIL, U. S. DEPARTMENT OF COMMERCE

THE NOTION that modern invention comes exclusively from richly endowed laboratories peopled with white-jacketed teams of bright young men with doctorates is so prevalent that many a potential inventive genius gives up before he gets started. Education and experience are, of course, important, but the truth is that we cannot create inventive genius with a scholarship fund. The invention of the wheel preceded M.I.T. by thousands of years. The formal education of Thomas Edison was limited to three months in the public schools of Port Huron, Mich.

It is also wrong to assume that great invention is dependent upon great expenditure. Some years ago a distinguished American astronomer received a Congressional grant to enable him to more accurately measure the speed of light. While he was so engaged, a young instructor at Annapolis named Albert A. Michelson clocked the speed of light with astounding accuracy. He had no appropriation and he didn't need one. The instrument he used cost him \$10 to invent and build.

In the last 18 years, since I first became executive director of the National Inventors Council, I have sifted through thousands of descriptions of inventions which might be of use to the armed services. I have been amazed at the number of clever and useful ideas submitted by laymen without technical training or degrees of any kind.

During World War II, the government spent millions to help scientists create and build a new type of proximity fuse, a device that will explode a bomb or projectile when it gets near enough to its target to destroy it. The fuse at length was produced, but it was a secret, and the council didn't know about it at the time.

Later, an 18-year-old boy showed up at the council with the design and components of a proximity fuse. When we submitted it to the armed services, a member of the National Defense Research Committee took me aside and said in surprise: "It's like the one we're testing!"

The Inventors Council does not pass on inventions; it simply examines them to determine whether they may be of practical

use to one or another of the armed services, then forwards them to the service indicated. Many of our most important problems in national defense have nothing to do with abstruse science, but with everyday problems—such as keeping fighting men warm, well-fed and healthy.

Some time ago, a private in the Army wrote us a letter complaining that the bottom of any Army garbage can bulged up in a convex surface, whereas the Army's garbage-can scraper was straight-edged.

"Why not," he groaned, since he was a perpetual K.P., "produce a scraper with an in-curved edge?" We submitted the idea to the Army with a smile. The Quartermaster Corps thought it was wonderful, and immediately adopted it.

I think almost everybody could invent if he knew what we needed.

Arthur Maroth, former chief engineer of Carnegie Hall, New York City, invented a clamp-on pouring spout for paint cans after his wife accidentally slopped enamel all over the floor. Household complaints and accidents have inspired many inventions—dishwashers, automatic clothes dryers and electric mixers. One inventor of my acquaintance is now perfecting a device to keep automatic garbage disposers from chewing up silverware. He began the project the night his wife dropped a butter knife into her disposer.

With the cries of a baby still ringing in his ears, Walter Hunt, 100 years ago, bent a piece of wire into the world's first safety pin, thus taking the sting out of life for millions of infants. All of us are potential inventors—if only we were sensitive to the problems which surround us.

Through inspirational books, most of us have been taught that great inventors have been extraordinary men of extraordinary character and ability. As a matter of fact, they were ordinary folk with extraordinary patience, capacity for work and imagination. Many of them were also extraordinarily irascible and discontented, and comfort-loving.

Maroth once said to one of his machinists, "When you get mad enough at something to kick it or swear at it, you are very close to invention."

Not long afterward, a vacuum-cleaner salesman was demonstrating his cleaner in the machinist's home. The cleaner sucked up one corner of a throw rug and wouldn't let go. Trying to kick the rug loose, the salesman knocked over a telephone stand.



# AN INVENTOR

Then he began to swear. Remembering Maroth's remark about rage and invention, the machinist awoke next morning with the answer: A thumb-operated valve in the handle of the cleaner. Whenever the suction head clung to a rug, a curtain or a cuff link, opening the valve would release it. Elementary? Most inventions are.

When Capt. Eddie Rickenbacker was cast adrift in the Pacific after a plane crash, he tried in vain to attract the attention of a rescue plane. Recently a California garage mechanic brought us a small signal mirror he had devised for his Boy Scouts. It would have solved Captain Rickenbacker's problem and has already saved the lives of many persons cast adrift. It enables the operator to aim a reflected beam of light directly upon a target many miles away, even into the eyes of an airplane pilot or the watch on the bridge of a ship. The inventor simply used a principle taught in every ninth-grade general-science class—"The angle of incidence is equal to the angle of reflection." One scientist in our council examined the model with dismay. "Why on earth didn't we think of that?" he said. "It's so simple."

## Inventors Not All Scientists

Not by any means does an inventor need advanced scientific education. Hedy Lamarr, the actress, invented a guided torpedo. The concert pianist, Josef Hofmann, invented for the automobile and piano industries; Leopold Godowsky, Jr., a violinist (son of the famous pianist), was co-inventor of Kodachrome. He used to test formulas in his bathtub.

Our council has compiled a list of more than 380 technical problems affecting defense which require solution by inventors. Many of them could not even be understood by the average layman. But, by and large, technology is no barrier to most invention. There are principles which have not yet been discovered and the world is full of eager and curious young Newtons on whose heads apples are yet to fall.

There are a lot of things around the house and around the world, which, when put together, may prove to be a third or fourth thing, useful and entirely new. Recently, a young instructor at the Massachusetts Institute of Technology "married" a knife to a ring to make a finger scalpel for heart surgeons. The man who thought of the electric larynx, which enables people with damaged vocal cords to speak,

hit upon his idea while shaving his throat with an electric razor. He observed that the sound of the razor was altered slightly as he silently formed words with his lips. This phenomenon, no doubt, had been observed by countless men, but the inventor thought of those who could not speak.

Ideas for inventions may spring from the most unlikely places. Rudolf Diesel, the great German inventor, got his idea for the first compression ignition engine from a pocket lighter. Vivien Kellems, the Connecticut manufacturer, solved our problem of lifting slippery artillery shells with a steel version of a toy Japanese finger trap. Originally, she had applied the trap to the ends of cables for pulling them through conduits. She first had observed the problem in her own home where she saw with what difficulty two electricians pulled new wires through an old wall. This trick of using something as a substitute for something else betokens the inventive mind.

It is unwise to fasten onto just one idea. Present yourself a problem, then boil over with solutions. There are many tricks in inventing, as there are in other fields. For example, a youngster once said to Dr. Willis Rodney Whitney, founder of General Electric research laboratory:

"If you could help me find a way to take the ink out of old newspapers, I could make a million. There is no known solvent for the ink now used."

"Change the ink," snapped Whitney. "If you can't solve a problem, change the problem."

Learn to take a problem apart before you start to work on it. When faced with any problem, you already know some of the answers. You have to concentrate on the parts of the question you can't answer. Presently, there is little opportunity to work on this sort of project in the typical college curriculum. Even engineering graduates sometimes seem baffled when called upon to do original work in industry or the government.

David L. Purdy, who is in charge of training engineers during their first year with General Electric, told us the biggest failing of his new employees—the graduating crop.

## "He Must Tell Us"

"They don't know how to tackle an inventor's problem," Purdy said. "If you tell a man to make certain routine calculations,

(Continued to page 238)





## British Twin-Jet Plane Can Deliver Nuclear Weapons

Makers of the Blackburn NA 39, Britain's newest military plane, say it has a three-year lead over all other countries. Capa-

ble of delivering nuclear weapons, the bomber is powered by two De Havilland Gyro Junior jet engines. Its speed is secret.

## "Bicycle" Chemical Sprayer Speeds Weed-Killer Tests

University of California scientists have devised a gasoline-powered weed sprayer that enables them to do a month's testing of herbicides in a few days. The sprayer, mounted between two bicycle wheels, automatically changes concentrations of chemicals applied to test plots. This method reduces the time required to determine the correct dosage. Previously, the scientists had to mix separate batches of weed killers and apply them to separate weed plots.

## Walk-Along Spray Unit Covers Two-Foot Swath

Liquid fertilizer, as well as weed and bug killers, can be applied to 1000 square feet of lawn in three minutes with a walk-along sprayer. The sprayer covers a 24-inch-wide swath in a steady stream from a one-gallon container, or from a two or three-gallon tank sprayer. An adjustable chain lock holds the chemical container on the wheeled unit. A built-in stand permits upright storage of the single-wheel sprayer when it is not in use.





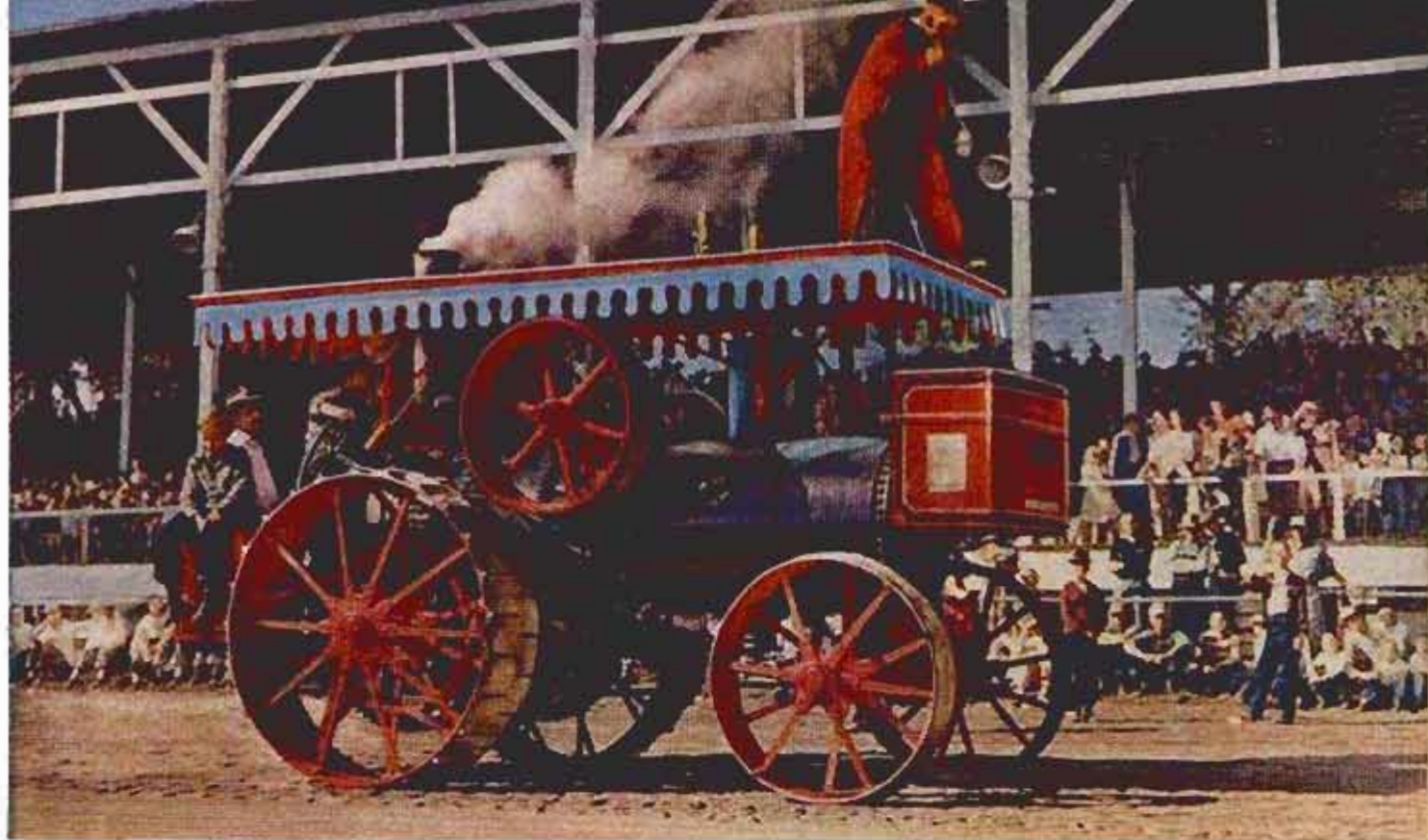

Clown cavorts atop a return-flue Avery, built in 1913 and popular with the crowd because of color scheme

Sparks fly, black smoke plumes from the ancient steamers, the aroma of fried chicken drifts to the threshers from the nearby church dining hall—it's Grandpa's Day at the

1958  
FESTIVAL!  
SEP 3-6, 1958

# FESTIVAL OF THE IRON MEN

IF YOU DRIVE into the typical Midwest town of Mt. Pleasant, Iowa, during early September, you can't miss the overhead banner strung between two lampposts: "FREE—Midwest Old Threshers' Show—FREE." And if you are wise, you'll join the 40,000 other people who follow the arrows out to the smoky fairgrounds over a four-day period.

What you'll see not only will fascinate you, but somehow ease your nerves in these jangled days of H-bombs and sputniks.

The rise of the Mt. Pleasant show and similar old-time threshers' reunions is a paradox. In a time when the historic county fair is struggling to exist, threshers' reunions have taken over fairgrounds and farm lots from Yacolt, Wash., to Hampstead, Md., and are playing to turn-away crowds. The only possible explanation for their

By Clifford B. Hicks

PHOTOS BY A. M. WETTACH

SEE  
JAN 59, 16

"Cavalcade of Power" includes models built precisely to scale. This little rig, including separator, can really thresh grain







Crowds gather as the steamers test their mighty muscles against braking mechanisms that check their horsepower. Old threshermen revive bitter arguments on the merits of each of the engines

Too tall to go under highway bridges, this engine had to have cab and smokestack removed before it could be trucked to the reunion. Rear wheels are three feet wide and seven feet high



No "hands off" signs here. Anyone can don cap, gloves and take over iron-man's seat

phenomenal success is that people love yesteryear. The stars of these shows are the huffing, asthmatic farm machines of Grandpa's generation, and in the cast are the old-time threshermen who operated them for real. The theme of the reunions is unabashed nostalgia.

Nobody can tell you for sure just how many reunions are held across the country, or how many hundreds of thousands of spectators watch in delight. Here at Mt. Pleasant, nobody even keeps track of the gate, which is wide open anyway. Last year somebody made a running check of the cars in the parking lot and discovered license plates from 45 of the states and four Canadian provinces. Planes fly into Mt. Pleasant's little airport from all over the country during the four-day reunion. And like most other reunions, this one is getting bigger every year.

If you're city bred, like as not you've never heard of threshers' reunions, despite their popularity. Before visiting the Mt. Pleasant show, take a brief look at the roots of such reunions.

Those roots go back to the 1880s, when somebody had the bright idea that a railroad locomotive could be run into an oat field without benefit of rails. All the locomotive needed was broad, cast-iron wheels. Once in the field, it became a stationary power plant to thresh grain. The idea worked, and the steam-engine business was born.



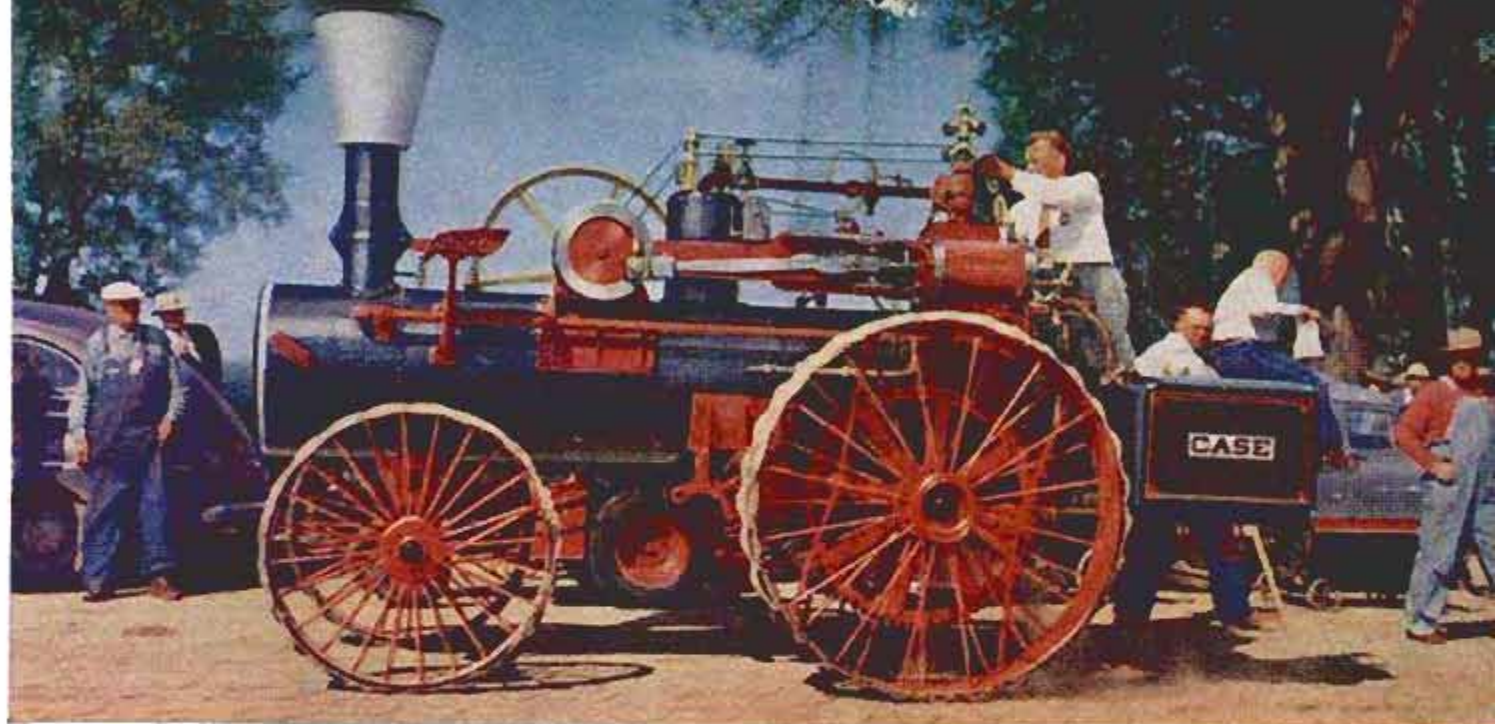

Star of the last reunion was this 1886 Case. Note seat near stack so engine could be pulled by team on road

Those early steamers touched off an agricultural revolution. The big machines were operated by engineers, who soon earned the tag "iron men" and became the greater-than-life heroes of farm lads for miles around. As soon as the steam engine proved itself, farmers and their hands banded together into "threshing rings" to follow the ponderous engine as it chuffed from farm to farm. The iron man was awake soon after midnight to heave coal, hardwood or corncobs into his beloved giant so steam pressure would be up, come dawn, and the envied water boy slept in the shakers of the separator. Hundreds of thousands of men, at one time or another, worked with the steamers. Feeding the threshing gang was the farm wife's biggest chore of the year, and we still say a growing boy "eats like a thresher."

But the old steamer had a relatively short life before it chugged out to pasture behind the barn. Suddenly, in the '20s, came the modern farm tractor with its gasoline engine. Within a span of four or five years the owner of a steamer, once the ruler of the farm roost, found his business melting away to the vanishing point. Each fall, hundreds of the old engines drew a final gasp through their iron lungs. In the '30s you could spot many of these derelicts rusting away behind barns all across the country.

Now comes the hobbyist, the steamer fan. He has a quirk in his mind, and he's the first to admit it. Admit? He can't help talking about it. He's fascinated by the

old steamers, just as others are enthralled by trains and fire engines. Only he's more so, for the steam-engine "buff" will invest thousands of dollars in just one machine. When he finds an old derelict he buys it, repairs it with handmade parts, shines up the brass bell and whistle, and stokes up the ancient contraption to chug again. Occasionally he pays a farmer more for a rusting hulk than the farmer paid for the same machine, brand new, 40 years ago. Steam-engine fans don't make sense, and are proud of it.

By now, all the obvious machines have been restored. Occasionally, though, someone still makes a lucky find. Not long ago

Ancient rig is fired up for a real threshing demonstration. Most of the old steamers are in perfect operating condition







Added features of the reunion are antique cars. Drivers parade them around the track, occasionally staging impromptu races

a buff on an air flight spotted an engine high on a mountain in Wyoming, where it once had powered a sawmill. At great expense he managed to move the 12-ton machine down the trackless mountainside and restore it. Yep, a mighty lucky man. . .

### Homemade Engines

Other buffs, unable to find long-forgotten engines, build their own from scratch and steam proudly through the reunions. Still others build operating scale models, precise right down to the dimensions of the whistle cord and throttle.

The chuff-chuff, toot-toot of a restored engine is an irresistible call to the soul of the old-time iron man or farm hand who once sweated beside such a behemoth. The ponderous hulk of iron is a magnet. Spot a restored steamer and you'll find a gang of old-time threshers threshing over the good old days. In recent years such informal gatherings have blossomed into the reunions. A reunion simply is a gathering of buffs with their restored engines, and the old-time threshermen. (An interesting sidelight is that both buffs and iron men nurse a venomous hatred for the internal-combustion engine. After all, it displaced their beloved steamers.)

This background, of course, doesn't explain the appeal of reunions to thousands of ordinary folk who never saw a steamer in operation before. Nobody tries to explain that appeal. It just is. Wherever steam engines go, their plumes of black smoke draw astonishing crowds. Ordinary folk stand transfixed as they watch a tug of war between two of the tremendous contraptions. They cheer wildly as a group of ancient and cumbersome, but uniquely attractive

Model steam engines really run, and are built precisely to scale, right down to the whistle cord

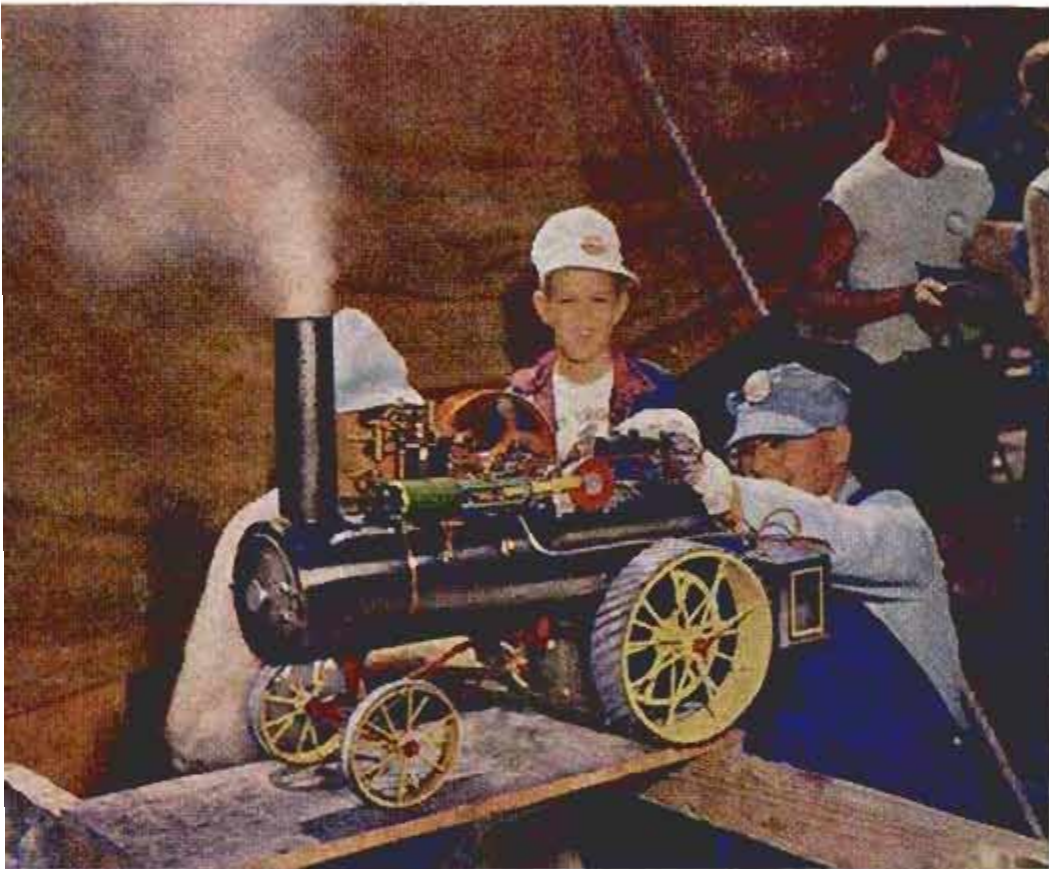





Surprising thing about the reunions is that everyone is fascinated, from family patriarchs to toddlers

steamers chugs ponderously up a 45-degree slope in a hill-climbing race. Confirmed hobbyists and threshermen drift by the hundreds from reunion to reunion, but the great bulk of spectators are folks who take a look in curiosity and remain to become fans themselves.

You can get the smoky flavor of the best of these reunions at Mt. Pleasant. A pall of black smoke covers the fairgrounds. After parking the car, you head for the gate with hundreds of others. Just ahead is a farm family grouped around the patriarch of the clan, a man in his late 70s. Overalls faded, a bright red bandanna around his neck, he stands there straight as a stalk of August corn.

"Now you folks git to lookin'," he orders. "Don't miss that under-mounted Avery. I got to find out whether I'm goin' to drive the Reeves Double Simple in the parade today."

You, too, make a mental note not to miss the undermounted Avery.

#### Popping Steam

Just ahead is a long row of old-time steamers, each puffing a plume of smoke. Here and there steam pops off in a white cloud. Never, in the days of their glory, did these engines look so good. And they are dazzlingly colorful.

Old-timer meets old-timer: An aging iron man gazes nostalgically at a steamer similar to one he once drove. This engine is an undermounted Avery, complete with headlight. Reunions give former engineers a chance to relive the days of their youth

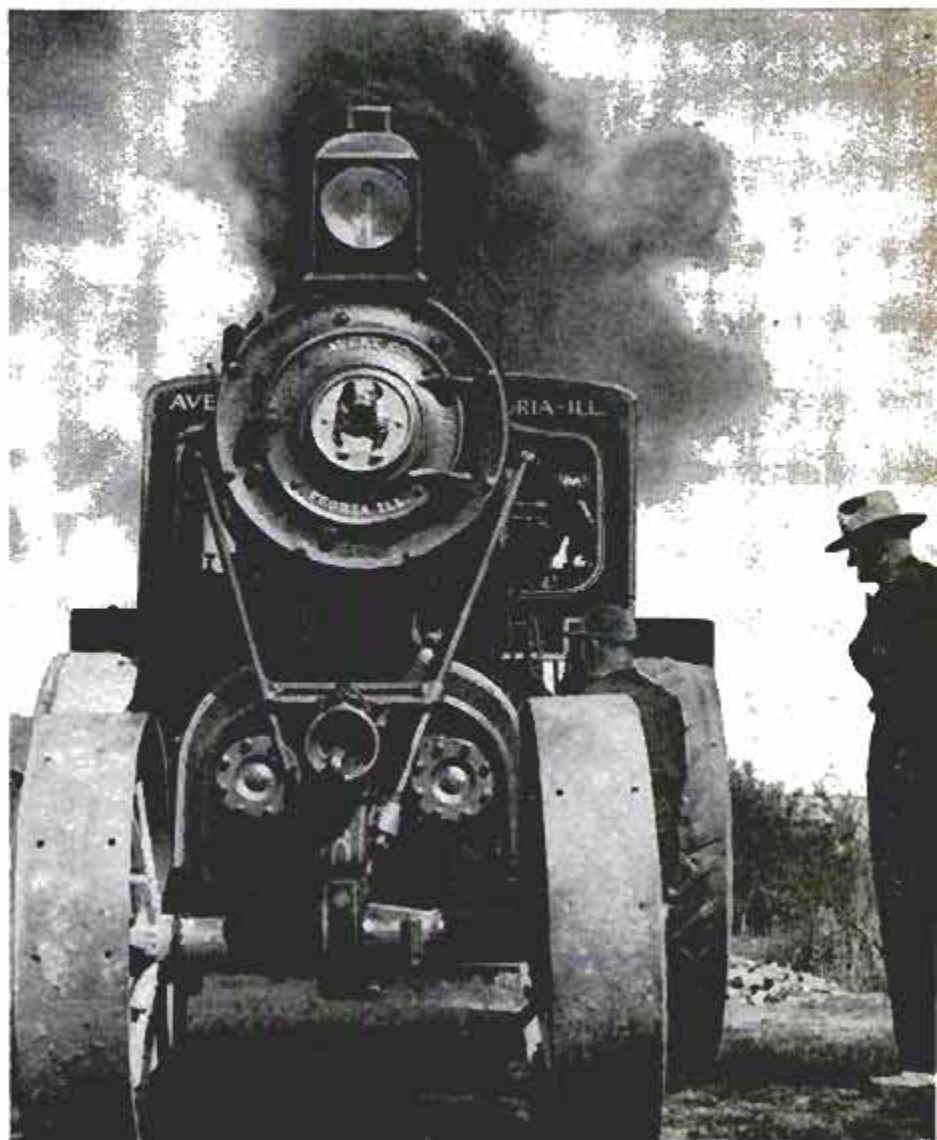





Old shingle mill is belted to a steamer. Then, sawdust flying, it turns out souvenir shingles for the crowd

Coat after rubbed-down coat of paint has been applied, black for the main working parts, shining crimsons, yellows, oranges and blues for the trim. Emblems, some still in existence and some long forgotten, stand out proudly — tigers and elephants, bulldogs and eagles. Brass bells and whistles gleam. Permeating the air even through the smoke is the sharp odor of steam cylinder oil. Every few seconds a whistle screams as an old iron man reaches up a gaitered sleeve to pop off some of the steam that's been building up in his boiler.

### Monster Bucks Wildly

Over in the center of the grounds, a 10-ton monster is bucking wildly as it tests its power against the Baker fan, a machine once used to "run in" steamers at the factory. A belt 125 feet long runs from the steamer's flywheel to the huge four-bladed fan. Air pressure retards the blades; the

Weirdest contraption on display is gas tractor driven from an ordinary buggy. Old vehicle is steered by pulling on the reins

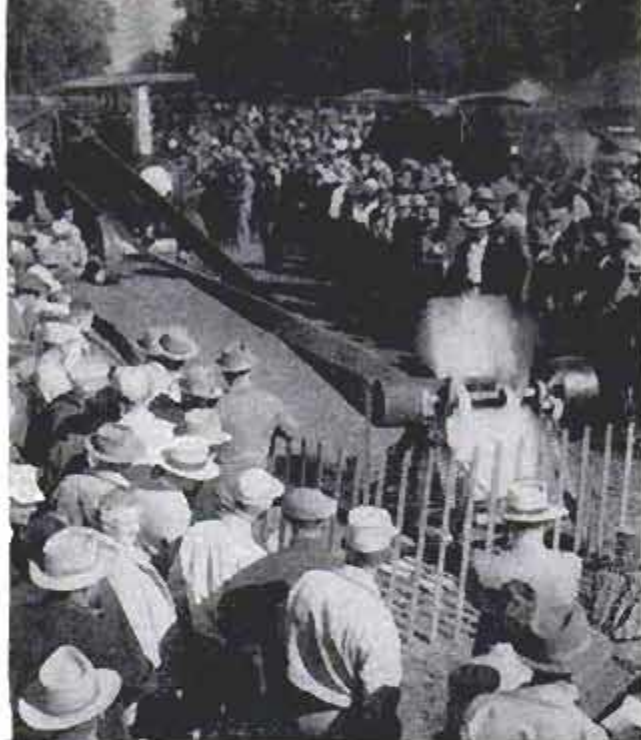

Baker fan, once used to break in engines at factory, now tests the power of each of the old-time monsters

faster the fan spins, the greater the horsepower of the engine.

Here and there other engines are going through their paces. One saws wood. Another cuts shingles. A third runs an old-fashioned threshing machine. Nowhere is there a "hands off" sign, and anyone can climb to the engineer's seat of any of the steamers. You can still read the original lettering on one of the monsters: "Rumley Oil-Pull Tractor. Guaranteed to burn successfully all grades of kerosene."

In one corner of the grounds, a fife and drum corps, most of the men in their 70s, tries to compete with the woeful whistle of the steamers. Over there, graying men tune their instruments for the Old Fiddlers' contest. Just behind them, the annual horseshoe-pitching contest is under way, and not far distant a youngster and an old man lean over a board to determine the checkers champ of the year. Spotted

across the grounds are many of the old farm implements — flails and ground-hog threshers, chaff pilers and hand-fed threshers, self-feeders and shingle mills. In one barnlike building are fascinating displays of antique furniture, pioneer relics, spinning wheels, frontier weapons and collections of old dolls and mechanical banks.

### Everyone Stops to Visit

Nobody is in a hurry (except the wide-eyed kids) so everyone stops to visit with the old threshermen. As you wander along you overhear snatches of down-to-earth conversation: "He got all het

(Continued to page 218)





Trimming a 375-foot hedge by hand required six hours, but rotary-mower rig does the job in five minutes

## Mower Becomes Hedge Trimmer

GIVING A "BUTCH" haircut trim to the top of his 375-foot-long boxwood hedge was quite a chore for Leonard W. Bender of Arcadia, Calif., until he found a novel solution to the problem. Bender built an inverted L-shaped wooden frame to fit over the hedge, which is two feet high and 21 inches wide. Next he removed the wheels from a light rotary lawn mower and placed the lawn mower on the frame. A counterbalance was needed so Bender added a platform to hold an anvil or a sack of sand. The rig is mounted on wheels so he can push it slowly as the mower trims the hedge. The mower also pulverizes the cuttings, so he doesn't have to rake afterwards.

Bender removes wheels from his power mower before putting it on the hedge-trimming rig, an L-shaped wooden frame on wheels







## Jet Helicopter Powered by Gas Turbine

Operating without transmission and clutch, the Kaman K-17 jet helicopter is powered by a gas turbine driving a compressor located in the fuselage. Air from the compressor is ducted through a rotating seal to the rotor hub and out to jet nozzles at the tips of the rotor blades. The rotor is driven by the air expelled from the nozzles.

## East Germans Build First Medium-Range Passenger Jet

East Germany has joined the nations of the world that produce medium-range passenger jets. Its first product was unveiled for public showing in Dresden. Details of the sweptwing craft's performance have not yet been released.





Next Month

# ANNUAL HOME SECTION

50 Pages

California, Here We Come!

With California-style houses sweeping the country . . . glass walls . . . open plan . . . patios galore . . . *Popular Mechanics* asked two noted West Coast architects, A. Quincy Jones and Frederick E. Emmons, to design the

*PM California House*

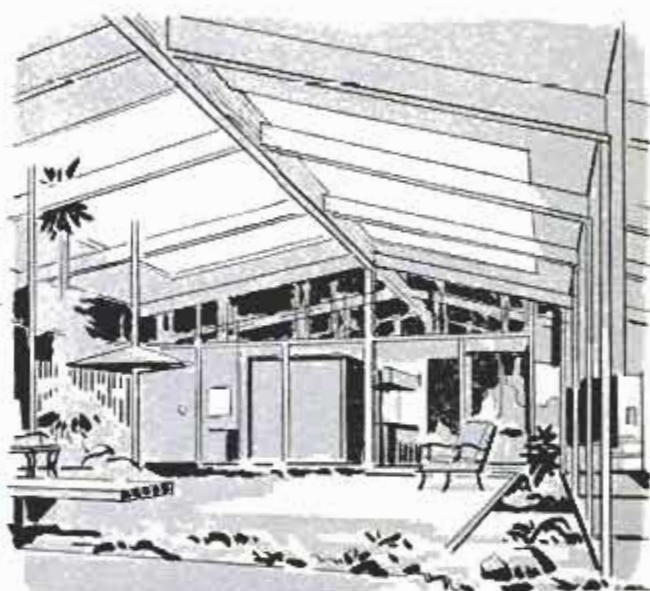

**SEE THIS BEAUTIFUL, LIVABLE HOME IN FULL COLOR**

**Plus Special Features:**

- Should You Buy Modern or Traditional?
- How to Convert a Small Ranch House Into a Two-Story Four-Bedroom Home Without Moving Out of the House
- New Designs for Modern Fireplaces
- Floor Plans That Save Steps
- Houses 'Round the World
- Tips for Remodeling Kitchens
- How to Add a Skylight
- Parade of Homes
- Scores of Stimulating Ideas for Home Planners

*Annual Home Section - October - 50 Pages*



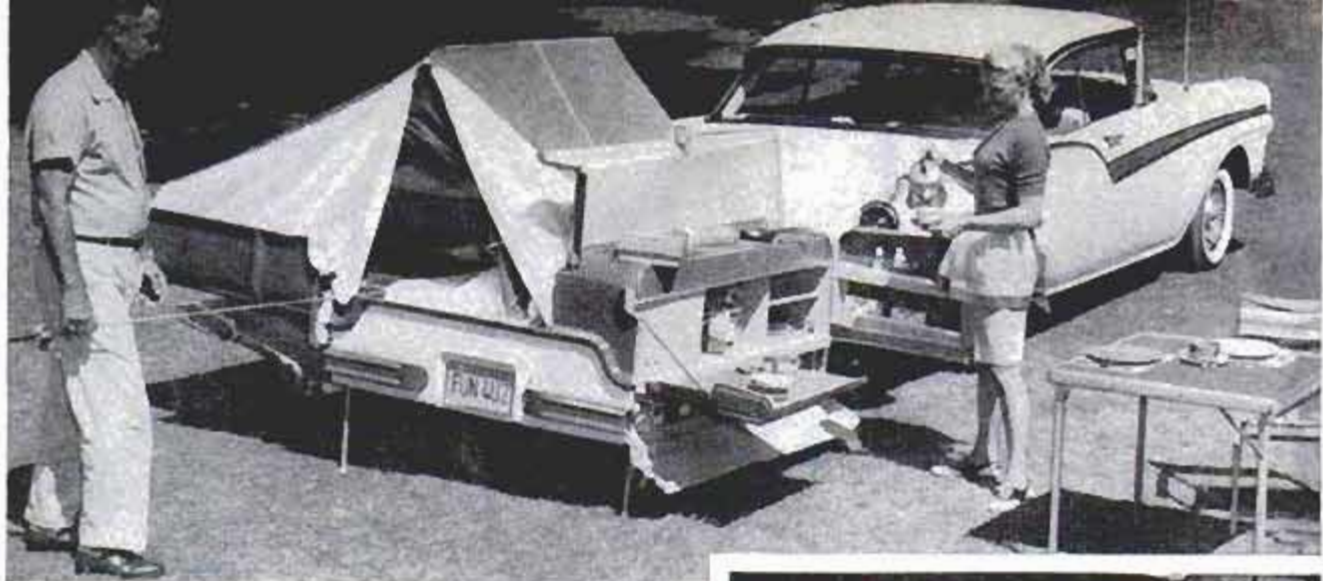

### Trailer Holds Tent and Kitchen

The streamlined trailer at the right opens into the mobile kitchen and sleeping quarters above. Housed in the tent, which has weathertight fastenings and net screening, is a full-size double bed measuring 54 by 72 inches. The kitchen includes a two-burner stove, ice box, table, cupboards and a 10-gallon water tank

Scamper Sales, 644 Aerick, Inglewood, Calif.

## TRAILERS for Work and Play



### Motorcycle Carries Shelter in Sidecar

Owners of motorcycles who like to take long trips don't have to worry about living accommodations. They can carry their sleeping quarters right along with them—fitted neatly in a hinged panel on the motorcycle's sidecar. The panel expands outward and upward, forming the floor and wall base of a man-size shelter. The upper wall and roof sections are raised with tubular supports. Inside the shelter there is ample room for a folding table and two or three chairs. When it's time to go to bed, the table and chairs are replaced by two air-filled mattresses

Surrey Sidecars Ltd., Station Works, Approach Rd., Coulsdon, England

### Unit for Sports Cars

Made of glass fiber, a light-weight trailer designed especially for small cars has a load capacity of 250 pounds. It can accommodate several pieces of luggage or many items of camping equipment—two sleeping bags, a stove, light, food box, cooking utensils, etc. The trailer is only 36 inches high, 42 inches long and 34 inches wide. In unloading his luggage or equipment, the vacationer doesn't need to carry anything very far. He merely detaches the trailer from the car and wheels it to the tent or cottage

Adler Engineering Co.,  
1344 Seabright, Long Beach, Calif.

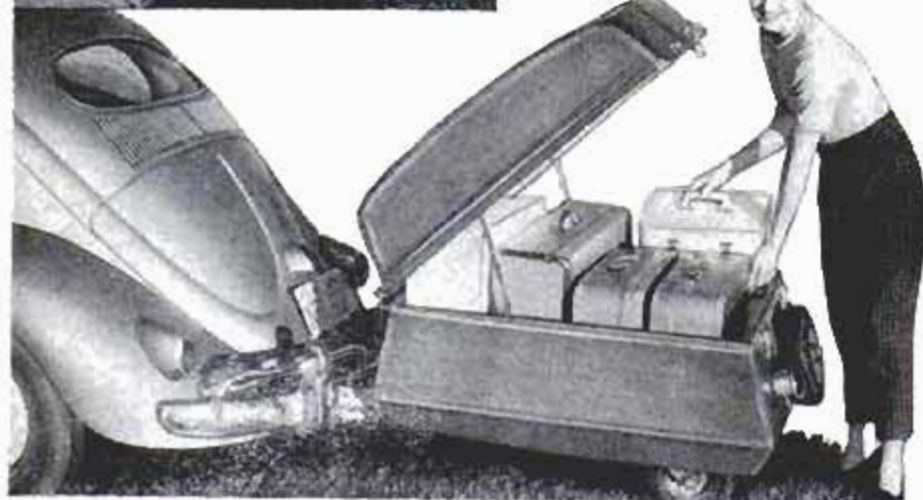





### Trailer Converts to Boat Size

When breakfast is over and the dishes are washed, the trailer at the right is lowered to a height of 47 inches for highway travel. In its closed position, above, the trailer is easy to tow: Air resistance is cut by more than 60 percent, cross-wind sway is reduced and the driver can see the road through his rear-view mirror. Measuring 17 feet, 6 inches in length, the trailer can sleep six persons with its couch-bed units and a large double bed. It has a stove with oven, running water and icebox. Its interior is six feet, four inches high

Odyssey Trailer Co., 3121 S. Oak Ave., Santa Ana, Calif.



### Rack Can Be Stored on Bumper

Here's a trailer with two special features: Versatility and easy storage. Just right for hauling the equipment of the rancher and camper, this trailer also comes in handy on moving day. Or, if you want to transport a racing car or bring home some long pieces of lumber, the four sides of the trailer can be removed. When you've unpacked the load, the trailer can be quickly folded up into a compact unit on the rear bumper. The trailer has a 750-pound capacity and tubular-steel construction. Its box, made of plywood, measures 40 by 50 inches. Included is a high-speed wheel and a horizontal spring

Accessories International, 1931 Blake Ave., Los Angeles 39, Calif.







### Six-Ounce Voice Box Aids Human Speech

Human-voice tones can be reproduced with a transistorized oscillator that weighs only six ounces. The user puts a small tube into his mouth and forms words with his tongue and lips. The battery-powered oscillator can be adjusted to reproduce tones from 90 to 120 cycles, the male fundamental voice range. A model for women has a tone range one octave higher. Tone and volume are individually controlled by the user.

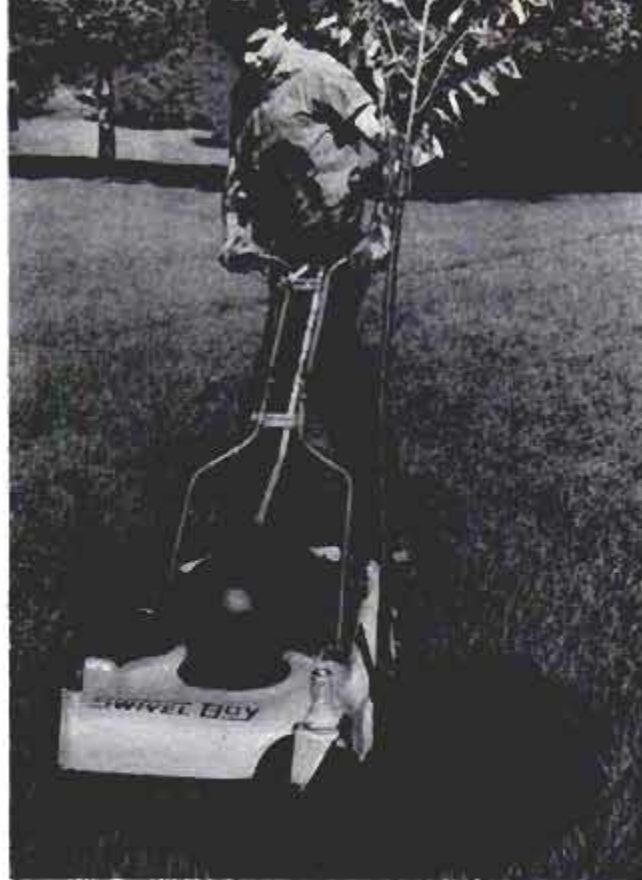

### Three-Wheeled Power Mower Can Cut Close to Trees

You can almost shave the bark off a tree with a three-wheeled power mower. With two swivel wheels and front and side trim, the mower can turn in a circle with a radius the width of the mower. The machine's ability to cut closely comes mainly from its cutting blade extending beyond the housing between the two swivel wheels. The mower has five cutting heights and a 2½-horsepower, four-cycle engine.

### Fiber Mat Gives Grass Seed a Good Start and Retards Weed Growth



Bare spots on the lawn can be patched easily with a green mat of synthetic fibers in which grass seeds are embedded. The mat is applied to soil which has been prepared in the usual manner for seeding. The fibers prevent soil erosion, keep the seeds from washing away, retard weed growth.





## Hydro-Ski Enables Rubber Plane to Land and Take Off on Water

With a hydro-ski attached to the main landing gear, an inflatable rubber aircraft can operate on water as well as on mud and other slick or hard surfaces. The

hydro-ski is fabricated of a lightweight aluminum alloy and can be attached in minutes. Goodyear Aircraft is building 10 one-man units for the Army and Navy.

## Car-Door Brackets Hold Long Lumber

Strong enough to hold 150 pounds, a pair of hook-shaped brackets converts the family sedan into a "truck" for hauling lumber and other long items. The brackets slip on and off easily. On cars with full doors, the bracket mounts entirely on the door. On hardtop models, the upper part attaches to the rain gutter on the roof. The brackets are made of aluminum tubing and can be used on panel trucks and station wagons.





*see 10058, 12*

# BOSTON SEES THE STARS IN HI-FI

By **Volta Torrey**

**T**HE FINEST MODELS of the sky were formerly made in Germany. Now the old Zeiss optical plant, which built the projectors in most of the world's great planetariums, is serving the Russians. But a projector was completed in the United States this year that reproduces the sky's appearance with greater fidelity than ever was attained before, anywhere.

You could see this newest make-believe sky tonight, if you were lucky enough to be invited to sit in during a shake-down cruise—through past and future centuries—of this hi-fi projector in the Boston Museum of Science. On these runs, its builders are making final, delicate adjustments in the three-ton machine's many tiny optical systems. When these trial runs are completed, Boston's new million-dollar planetarium will be opened to the public, probably this month.

The difficulties of simulating the motions, the brightness and the twinkling of the stars has challenged the ingenuity of modelmakers for more than 2000 years. The first Zeiss projector, completed in 1924, only showed the sky as it appears from places north of the equator. Then the Zeiss company added a second spherical projector, so that the sky's appearance

from any point on the earth's surface could be shown. This improved model was so successful that about 25 such projectors were built. You can see the stars as projected by these famous Zeiss machines in planetariums in Chicago, Philadelphia, Los Angeles, New York, Pittsburgh and Chapel Hill, N. C.

Most visitors to these star theaters are so awed by the magnificence of the spectacles they present that small differences between the imitation skies and the real sky are not noticed. But those differences will matter more in the future. Students preparing to track and chart the courses of spaceships will spot them. As more and more artificial satellites of the earth appear, and people we know begin venturing into space, more of us will be bothered by defects that heretofore worried only the astronomers.

A few years ago, San Francisco scholars and craftsmen got together to build a new type of projector for their city's planetarium. Theirs was the first effort in this country to improve on the work of the Germans. The Boston machine is the second American-made rival of the great Zeiss projectors.

John Patterson, the director of Boston's new planetarium, and Frank and John Korkosz of Springfield, Mass., studied the plans of all their predecessors before designing this mid-century model. Patterson is an energetic educator with a passion for precision; the Korkosz brothers previously had built a simpler star projector for their home town. All three had dreamed for years of building a hi-fi star projector. The division of Germany after World War II gave them their chance. Rather than go behind the Iron Curtain to purchase a Zeiss machine, the Boston museum's directors gave the three Yankee workmen the help they needed to show what they could do.

**William Korkosz, son of co-builder of machine, views planetary assembly for Mars, Jupiter, Saturn and Uranus. The planets are projected from rings**

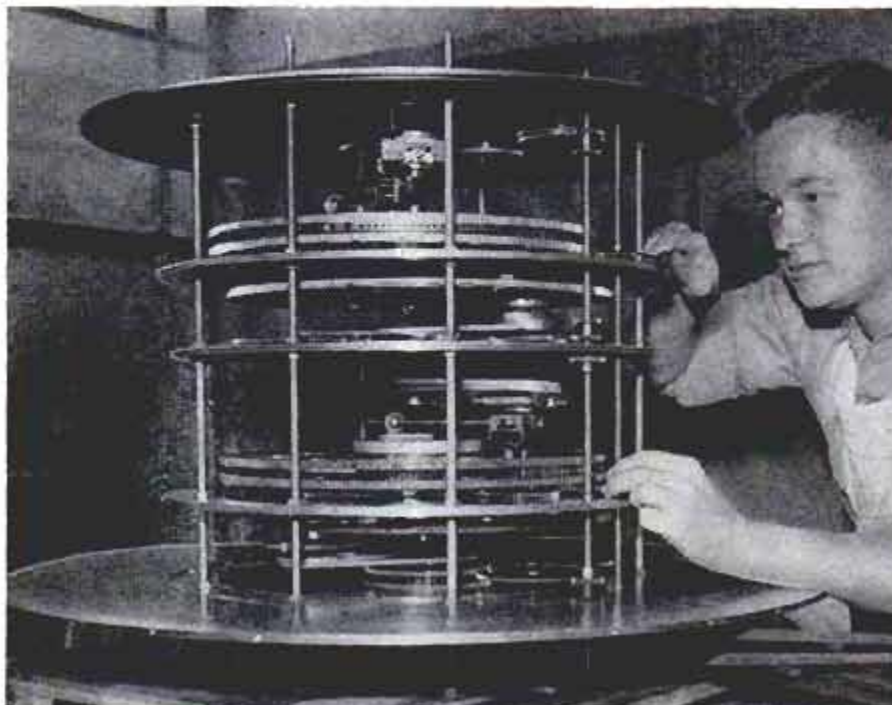



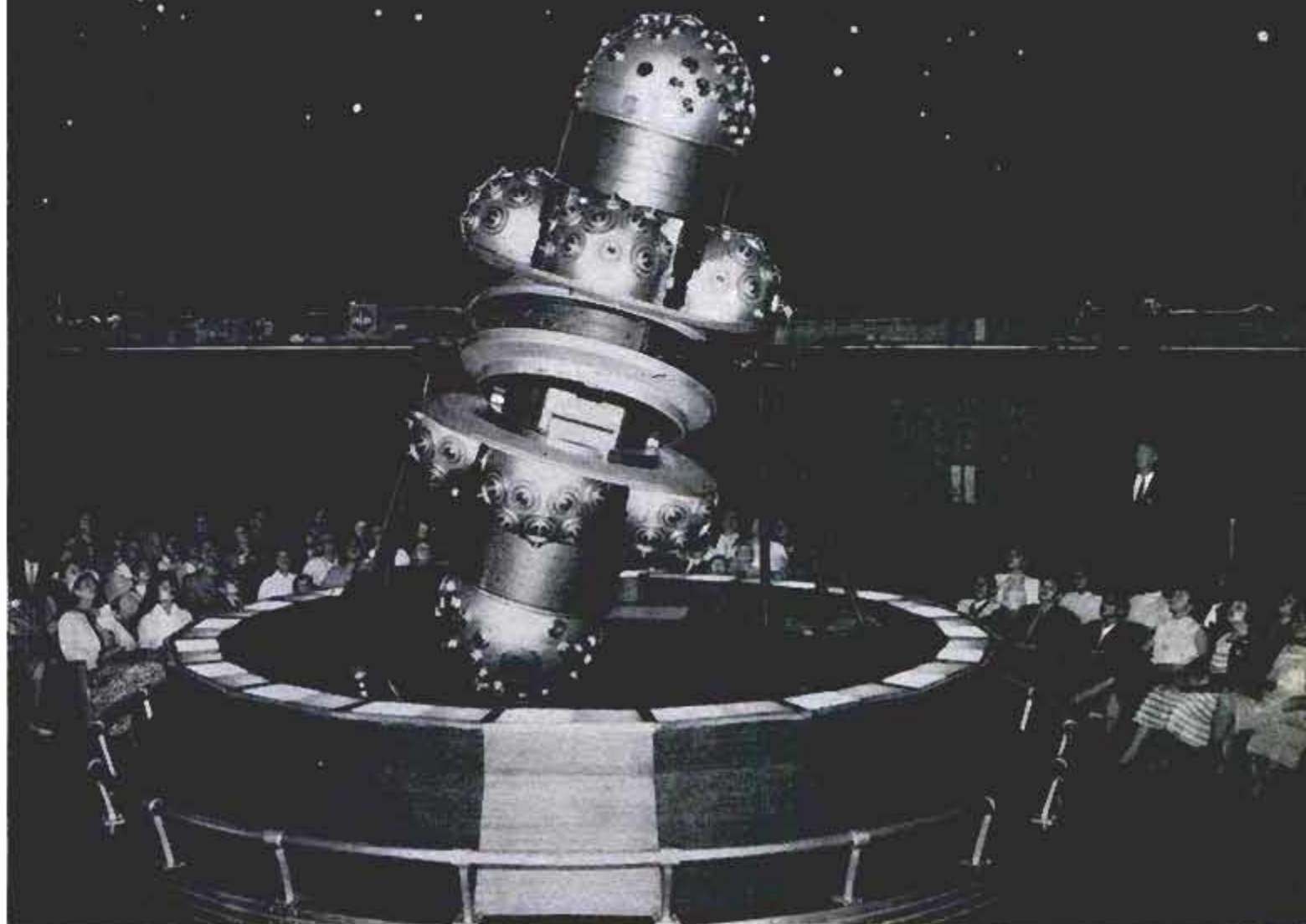

Boston's new projector reproduces the sky's appearance with the greatest preciseness ever attained

The new Korkosz projector differs from the Zeiss company's masterpieces as greatly as a Diesel locomotive differs from the steam locomotives built decades ago. Instead of an open framework and dull black finish, it has a brightly colored anodized aluminum casing—which not only keeps out dust, and thus simplifies maintenance, but also makes it look like a model of a future space station.

As you enter the circular auditorium built to house it, you pass a huge Chesley Bonestell mural depicting a landscape on the moon. Then you find the projector, 13½ feet high, surrounded by seats for nearly 300 persons. It is brilliantly spotlighted like a new car in the center of a motorama. Behind the seats is a reproduction of the skyline outside. This includes the electric signs along the Charles River and the beacons on buildings in Bos-

ton's business district. But this whole circular model sinks out of sight, and other horizons appear, as the projector begins to illuminate the sky. Like the projector, the horizon and a dimensional sound system are controlled from a console at one side.

As your guide dims the light and starts the new projector racing through time, you discover what is meant by fidelity in a planetarium display. You see quickly that the differences in the magnitudes of the stars are more realistic. When the projector has received its final refinement, you will see that the motions of the planets are indicated more accurately and that Uranus is included among the planets for the first time in any planetarium.

This machine, you will discover if you move around, actually has more stars built into it than can be seen from any one seat in the auditorium. Some of the images are



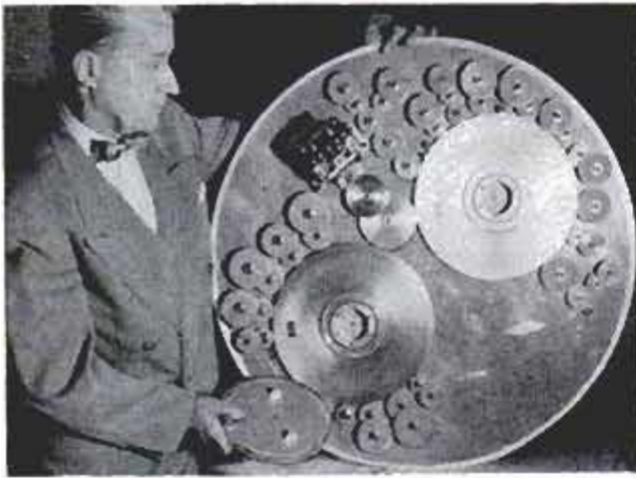

Frank Korkosz shows some of the gearing that controls the stars in the projector. The Korkosz brothers spent more than six years building the machine

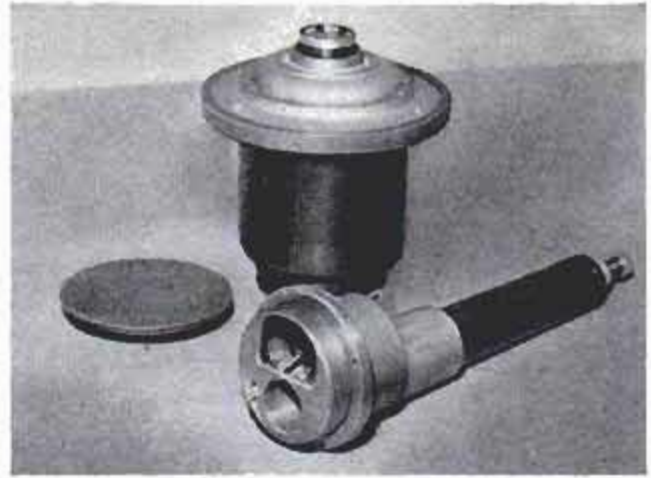

The cylinder in the rear projects a star field; the one in the foreground, a single bright star. The plate is the diapositive for a field of faint stars

so faint that they cannot be seen from across the room. And the brightest stars do not resemble little moons, as they do in many planetariums, but are twinkling pin points such as you see in the real sky. None strikes you in the eye, however, because all vanish as they pass the horizon.

Like the Zeiss machines, the Korkosz projector is really a pair of projection systems—one for the Northern Hemisphere and one for the Southern Hemisphere—on opposite ends of an arm that can be swung around. But whereas the Zeiss projector has a single spherical unit for each hemisphere's stars, this machine has a hemisphere and four quarter-spheres for the stars of each hemisphere. This makes more variations in the illumination possible.

Stars of the first and second magnitude are projected from the hemispheres; those of the third, fourth, fifth and sixth magnitude are projected from the quarter-spheres. For the bright stars, 1000-watt spotlight bulbs are used. For those of the third and fourth magnitude, 500-watt bulbs are used, and for the very faint stars, small bulbs provide the light. Hence, each star appears on the planetarium's dome more nearly the way it appears in the real sky.

There are 120 knobs on the two hemispheres and eight quarter-spheres of the gigantic projector. Each of these knobs is the head of an individual optical-projection unit that covers an area about 20 feet in diameter on the dome of the auditorium. Eighty-eight of these projection units each cast the image of a single star. These are the very bright stars, and the projection unit for each one of them is exactly aligned with the filament of a bright bulb. These units are separately adjusted, so that the position of each of these 88 stars can be depicted with the utmost precision. No compromises are necessary.

These projection units for the bright stars have long-focal-length lenses, and the

widest image cast on the dome overhead is only half an inch in diameter. In other planetariums, some of the bright stars' images are as much as two inches in diameter. These stars also appear to twinkle. This effect has been achieved by permitting wire cages to revolve randomly around the sources of light. The wires intercept the light in approximately the same way that it is intercepted by our atmosphere when we watch the real stars.

If you were patient enough to count the stars on this planetarium's dome, you would find more than 9600. They come in 85 varieties. Most of them are quite faint, and are projected through slides representing star fields. The stars depicted in this way, and the 88 separately projected bright stars, are superimposed on the artificial sky.

To prepare the star fields for the hundreds of faint stars, tiny holes were pricked in tightly stretched aluminum plates. To make these holes, John Patterson had to make 85 needles of the required dimensions in his own workshop, because no such needles are ordinarily manufactured. The holes are accurate to within  $\frac{1}{10,000}$  inch. Some of these 85 needles were used only once. The plate for the stars in one portion of the sky contains only 16 holes, but there are other plates for other parts of the sky that contain up to 500 holes of various sizes. An error in pricking these holes meant that a whole plate had to be redone.

Careful measurements with exposure meters were made to assure that each star field would have the proper brilliance. Then permanent photographic slides were made from the thin aluminum plates in which the holes had been pricked. Between each of these star plates and the source of light in the projector, there is an occulting mechanism. Gravity closes a shutter when the projector is tilted, in such a way that each star blinks out at the horizon.



The 120 knobs on the projector take care of the stars, but the sun, moon and the planets are handled differently. These are separately projected from rings that are placed between the semispheres and the quarter-spheres of the big machine. One pair of rings projects the images of the sun, the moon, Mercury and Venus; another pair provides for the images of Mars, Jupiter, Saturn and Uranus.

Originally, the three builders expected to complete the projector in two years. It has taken them more than six years. They have worked from a stack of blueprints big enough to serve for the building of a skyscraper.

#### Complete at Last

But last winter the final lens was fitted into the big projector in the Korcosz brothers' shop in Springfield, the machine was checked out, and partially disassembled for shipment to the Boston Museum of Science.

The standards the builders had set for themselves were high, and before the job was finished they had to provide for artificial moons. But this was no sweat. They had included 24 extra slip rings and spare circuits to handle satellites. They had also included extra transformers, so that the images of these satellites would correspond in brightness to the images of the real things. Adding Sputnik, Muttnik and Explorer was easy.

But now they wonder if they were far-sighted enough. Will two dozen extra slip rings and circuits suffice for future changes in the sky? What problems will the next generation of planetarium-projector builders have to solve? ★ ★ ★

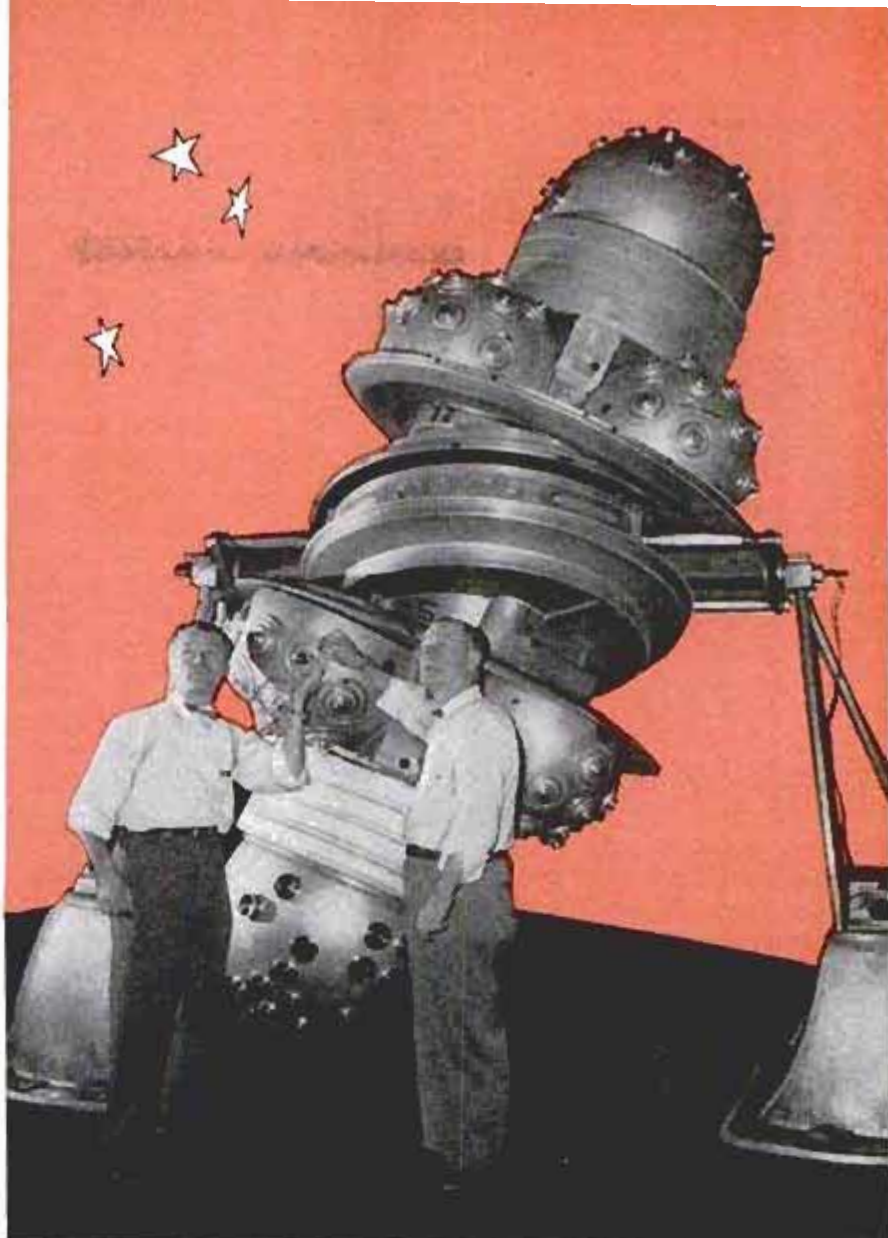

The co-builders of the new projector, John, left, and Frank Korcosz, here adjust one of their machine's scores of separate optical systems

Diapositives used in star fields were photoengraved after thousands of faint stars had been indicated by holes punched in thin aluminum

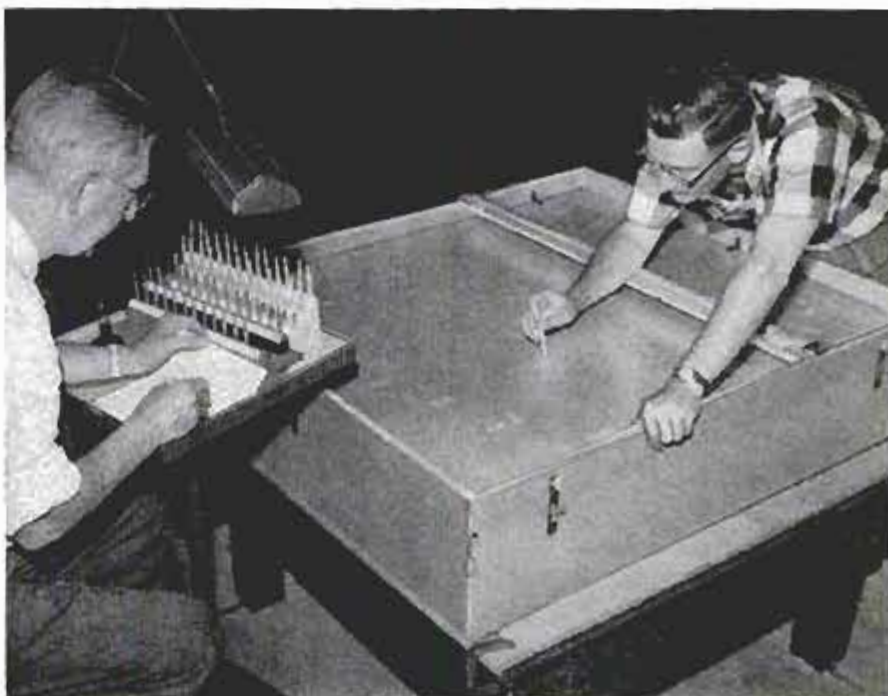



# APALACHICOLA

BIRTHPLACE OF MECHANICAL  
REFRIGERATION

2 MILES

By Ross E. Hutchins

**T**HIS IS THE STORY of a man and an idea that were to change the way of life for a large proportion of the world's population. Not one person in thousands has ever heard the man's name. He was Dr. John Gorrie, and his idea was artificial refrigeration.

Turn back the calendar more than 100 years. The place is Apalachicola, a quiet fishing town on Florida's western Gulf Coast—a new, picturesque subtropical land beset by yellow fever and malaria. Here John Gorrie arrived in 1833. He had graduated from the College of Physicians and Surgeons in New York and had practiced medicine for six years at Abbeville, S. C. There he became interested in

Dr. John Gorrie discovered mechanical refrigeration when the machine he built to cool rooms "iced up"

malaria and, in 1833 accepted a commission as medical officer in charge of the U.S. Marine Hospital at Apalachicola.

Within a year or two he was postmaster, member of the city council, treasurer of the city and territorial administrator, later a director in two banks and part owner of the Mason House, then the largest hostelry in the Territory of Florida. Just when he found time to practice medicine and to experiment with mechanical refrigeration is a mystery. The refrigeration experiments actually were a by-product of another scheme. In the treatment of fever Dr. Gorrie believed that if the patient's temperature could be artificially lowered, the disease would be cured.

With this in mind he attempted to air condition one room in his home by passing a current of air over blocks of ice. This helped, but Dr. Gorrie was not satisfied. Besides, the only ice available was shipped from New England by water and cost over a dollar a pound.

His mind turned to other possibilities. Could he obtain cold by chemical or mechanical means? About 1755 William Cullen had delivered a lecture in England on "cold produced by evaporating fluids, and of some other means of producing cold." John Vallance received the first English patent for the production of cold in 1824. These proposed methods depended on evaporation of fluids, but none of them was practical.

Dr. John Gorrie conducted most of his experiments secretly because it was a com-

Compression machine built by Dr. Gorrie was run by a steam engine; expansion of air absorbed the heat





mon belief that mere man should not tamper too much with what God had created. Only God had ever created ice; it was thought improper for man to attempt it.

The machine Gorrie eventually came up with depended on compression of air, which required energy, and then the expansion of this air, which absorbed energy or heat. The driving power for his cumbersome machine was a wood-burning steam engine; the original is now in the Smithsonian Institution at Washington, D.C., and there is a replica in the Apalachicola court house.

With this extremely unwieldy machine Dr. Gorrie satisfactorily cooled two rooms for his feverish patients. This was the birth of mechanical air conditioning.

The machine had been in successful operation several years when, about 1844, Dr. Gorrie had four patients critically ill. To alleviate their fevers the air-cooling machine operated at full speed over a long period when, one morning, it choked up and stopped. Investigation disclosed that the machine had iced up. Dr. Gorrie was quick to realize the import of the accident, and within a year or two he perfected a small machine that would produce ice in 8 by 10-inch blocks.

About this time the ladies of the local Trinity Episcopal Church decided to stage an ice-cream festival as a fund-raising project. Making the ice cream depended, of course, on an adequate supply of ice, scheduled to arrive by ship. Dawn of festival day arrived, and no sail appeared on the horizon. The festival appeared to be off and the ladies were broken-hearted. Then Dr. Gorrie showed up with a load of sardine cans containing ice. The chief difficulty confronting the astounded and delighted ladies was how to get the precious ice out of the cans!

From here on the story of Dr. John Gorrie follows the typical theme of the early inventor. There were attempts to raise financial backing for his icemaking machine, but they always petered out despite the fact that patents were issued. Most discouraging was the attitude of the public. One Northern editor wrote: "A crank . . . in Apalachicola, Fla., claims he can make ice as good as Almighty God!"

Due largely to his difficulty in marketing the icemaking machine Dr. Gorrie's finances went from bad to worse. On June 16, 1885, he died at Apalachicola, literally a victim of his cold-making machine that was to affect the lives of so many people.

Recognition came late. In 1914 his statue was placed in Statuary Hall at Washington, D.C., and in 1957 the state of Florida erected a memorial building at Apalachicola to house the mementoes of his life. ★ ★ ★



## Radars System Checks Buses On Routes in London

Radars is being used by a London transportation company to report progress of its buses. Fixed scanning units at several check points send out pulsed-light beams that are reflected back by "cats' eyes" when a bus passes by. The cats' eyes are mounted on the side of each bus and give an identifying code number. Their reflected light is detected by a photo-sensitive transistor, converted into longer electric pulses and sent by telephone wire to the central control room where the signals are visually displayed on a route map.

## Scientists Discover Heaviest Element Has Half Life of Three Seconds

Element 102—the world's heaviest element—has been discovered by a team of scientists at the University of California. The isotope of element 102 has an atomic weight of 254 and has a half life of only three seconds. At the same time, the team of scientists disputed the findings of other scientists who stated last year that they had discovered an isotope of 102 by using a different method. The California group said it had duplicated the former experiments without results.

☞ Fluothane, a nonexplosive anesthetic, leaves no adverse side effects and allows patients to emerge rapidly.





Glacier-pilot Hermann Geiger brings in his ski plane for a snow landing high in Switzerland's Alps

## FLYING HERO

On his missions of mercy, Geiger has often risked his life to save trapped and injured mountaineers



**T**HERE IS NO MORE dangerous flying task in the world than trying to land in the towering, treacherous Swiss Alps. Yet this risky feat has become the almost-daily assignment of Hermann Geiger, a 42-year-old aviation instructor in Sion, Switzerland.

Geiger, of course, is no ordinary aviator. He's a pioneer glacier pilot whose mission is to rescue mountain climbers. Popularly known as the "Flying St. Bernard," Hermann Geiger has probably snatched more mountaineers from death than any other man alive.

### Rescues 150 Climbers

Braving tricky mountain gales, sweeping air currents and narrow passes that threaten to smash his small plane against the cliffs at every moment, this hero of the Swiss Alps has rescued more than 150 trapped and injured mountain climbers and skiers, including 20 last year. Many Americans, Germans, Italians, Swiss and Austrians owe their lives to him.

One of the most expert airmen ever to sit in a pilot's seat, Geiger is a modest man who disclaims any special merit or bravery in performing his many outstanding deeds. When flying, he shies away from uniforms and usually wears a tweed suit.





Geiger will land soon and fly these victims of a plane crash in the Swiss Alps to a hospital in Sion

## OF THE ALPS

Bringing a plane down in the "impossible" Alpine terrain was always considered folly. But Geiger, an enthusiastic flier since he was 20, was convinced it could be done.

He devoted himself to the problem of glacier-landing after witnessing the fall of four mountain climbers without being able to help them. He immediately alerted the nearest rescue station, but by the time the rescuers reached the spot of the accident, all four victims were dead. Geiger became obsessed with the idea that he could have saved four lives if he had been able to land.

### Develops Special Ski

His first move was to develop a special retractable ski that he fitted to his Piper Cub. With this landing gear, operated by a hydraulic lift he designed, the plane was able to take off on wheels but come down on skis.

On his first trial, in May 1952, he made four successive landings on the 9240-foot Kanderfirn Glacier. Since then, he has brought his fragile plane down on tiny snow and ice strips high in the Alps more than 15,000 times. Many of the fields have been less than 200-feet long and 100-feet wide. The highest landing was made on the

Landing near the summit of Mt. Titlis (10,000 ft.), Geiger rescues a stranded mountain-climbing party





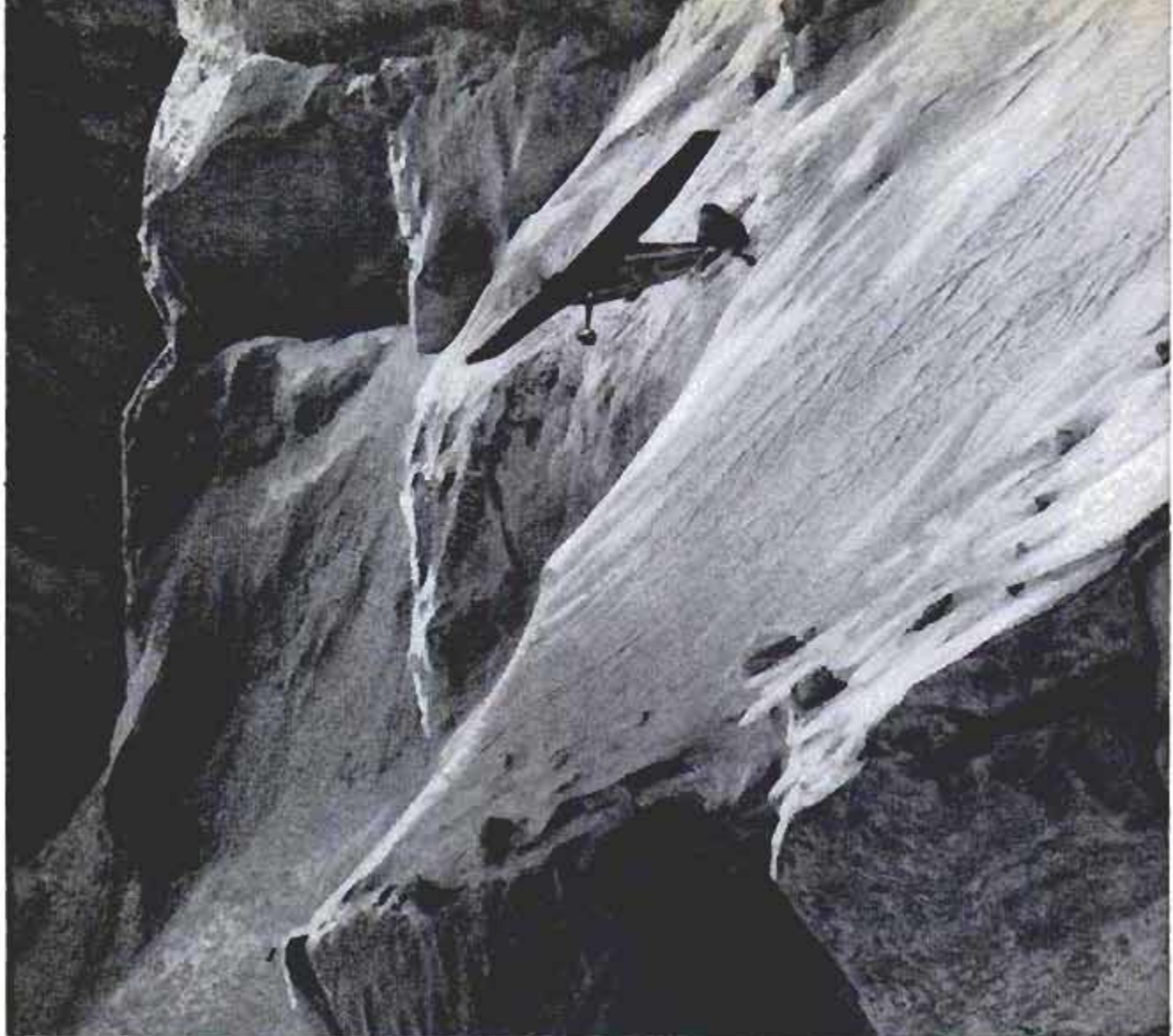

Searching for victims in the Alps is a difficult task, and sweeping air currents make it a perilous one

14,421-foot Monte Rosa glacier, an unofficial high-altitude landing record.

Geiger's principal job is to transport supplies by air to isolated mountain huts, snowbound villages or power projects high in the Alps. Often he defies death to deliver a baby carriage to the wife of a cabin keeper, or carry food and fodder to settlements cut off from the outside world during the winter.

### Supply Runs Start Rescues

It is on many of these supply missions that a rescue operation is initiated. In 1954, he saved eight avalanche victims. Once he spotted a mountain guide holding onto a rope from which two climbers were dangling over a deep ravine. He immediately landed on a nearby glacier and helped the guide to haul the two men to safety.

Most mercy missions are launched by an emergency phone call to Sion Airport, which Geiger operates. Alerted, Geiger takes out the extra seat of his Piper Cub to make room for a stretcher. Usually, the victims find themselves comfortably resting in a Sion hospital bed within two hours after they were first spotted. ★ ★ ★

For landings on snow and ice, Geiger designed a retractable ski that is operated by a hydraulic lift

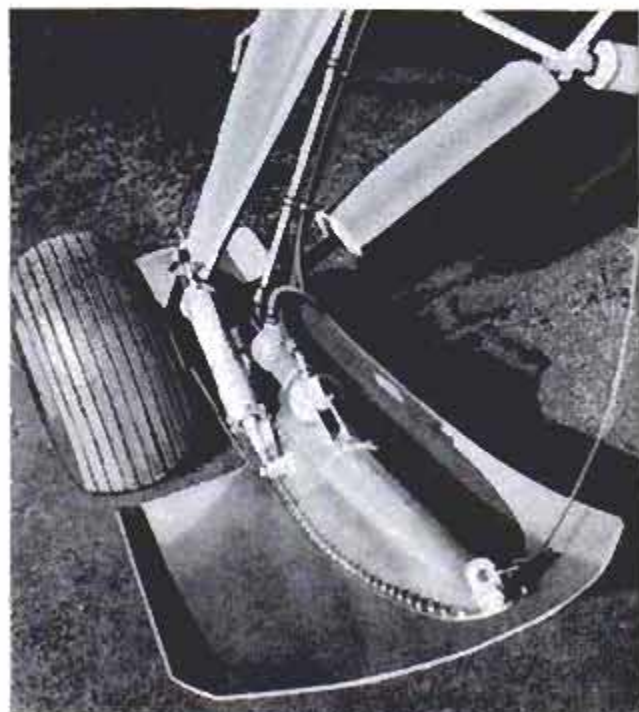



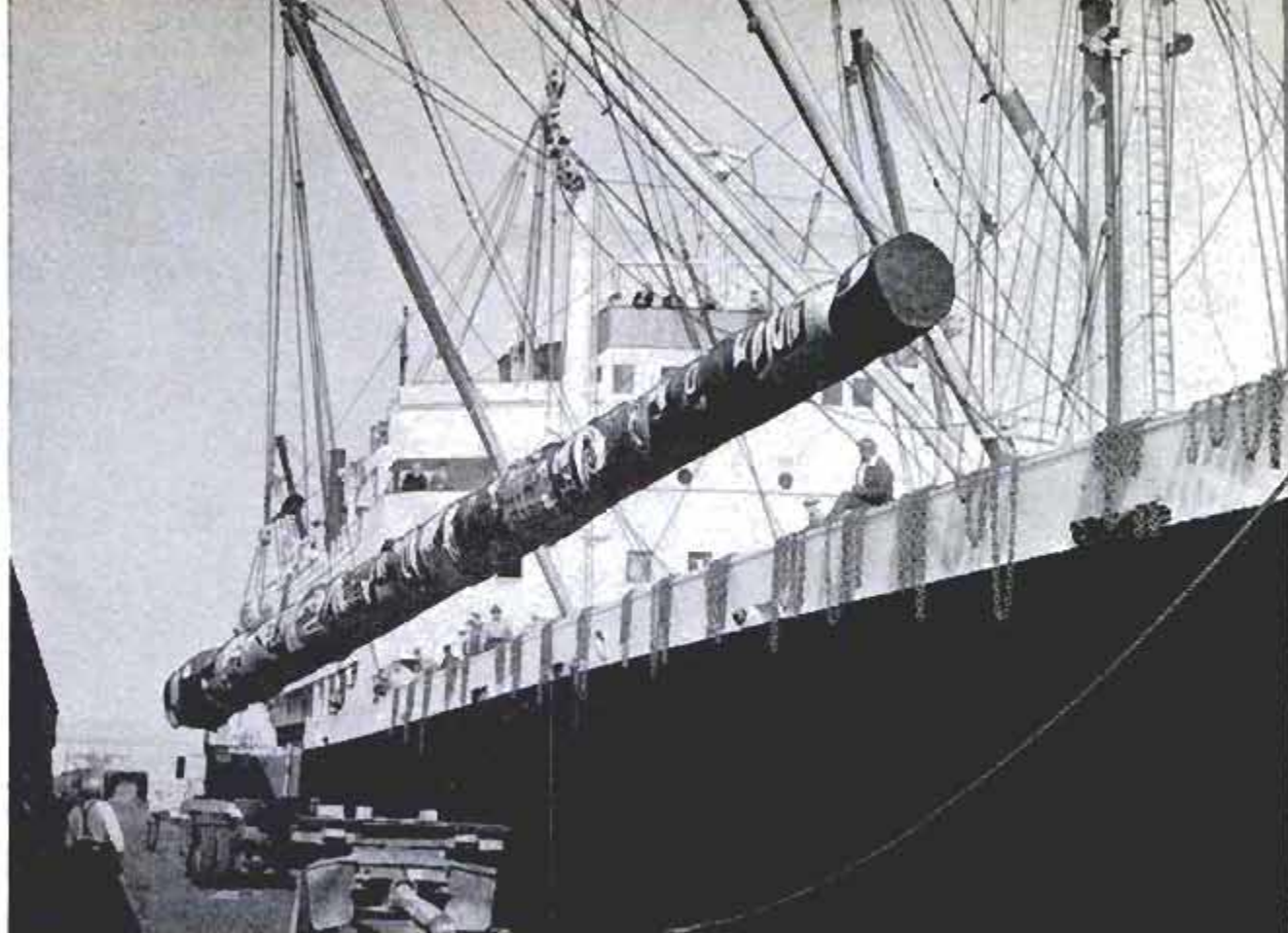

## Mighty Totem Pole Begins Voyage to London

Measuring 100 feet long and weighing 30,000 pounds, a huge totem pole recently was hoisted aboard ship in Canada for its trip to London. The gift from British

Columbia to Queen Elizabeth was carved from a cedar tree 600 years old. Prior to the voyage it was towed 400 miles from Queen Charlotte Isle, where it was carved.

## Water-Fog Curtain Prevents Spread of Fire During Plane Fueling

Each of five airplane fueling positions at Boeing's plant in Renton, Wash., is protected by its own water-fog curtain. In case of fire, the curtains are turned on to pre-

vent the spread of fire and heat to other planes. Each curtain is 155 feet long and consists of 32 alternate wide and narrow-angle spray nozzles.





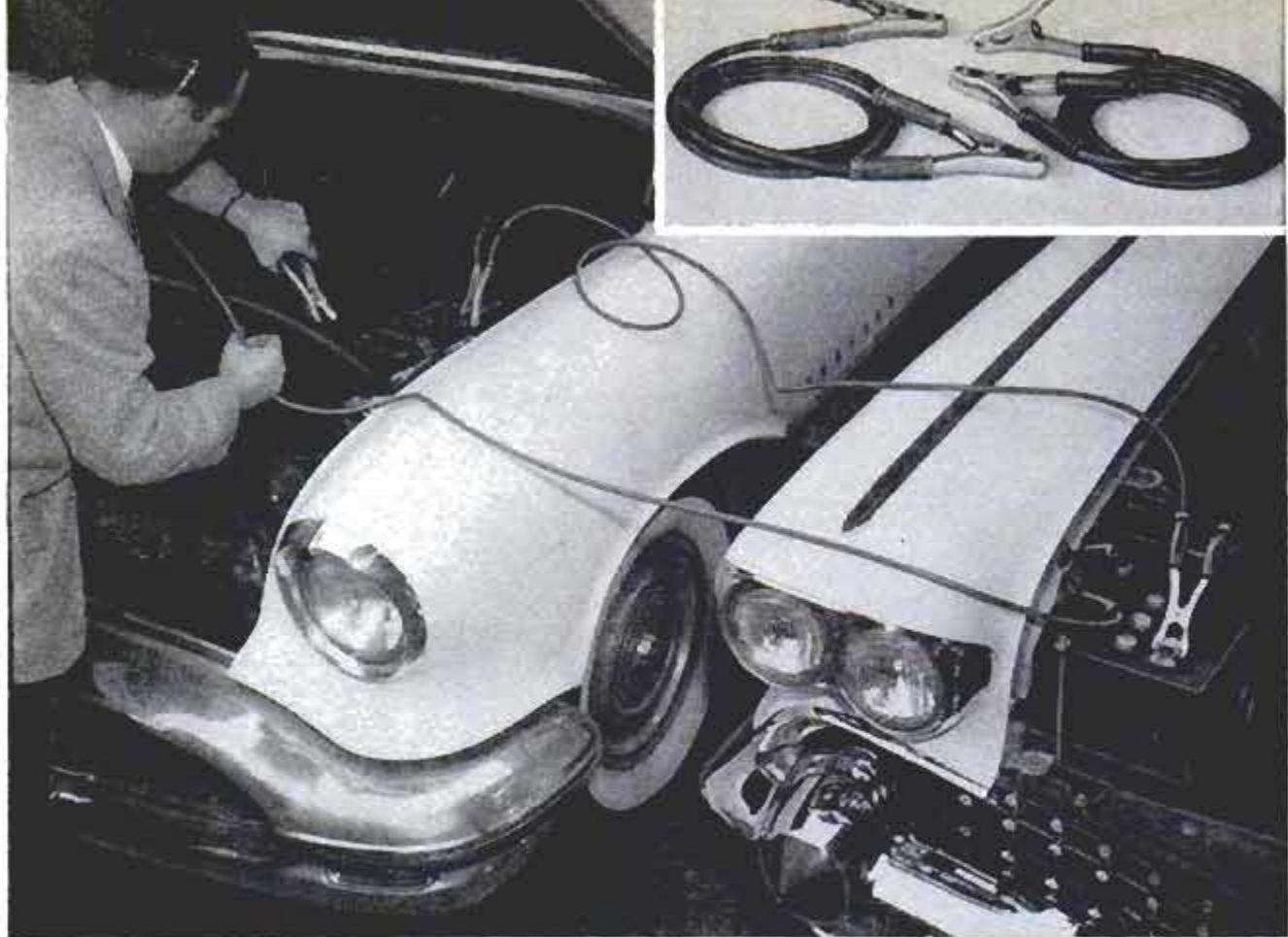

## Extension Cables Replace Tow Rope for Emergency Starting

Carrying a set of booster cables in the trunk of your car may help you avoid a few of the headaches of getting the engine started when your battery is low. With the cables you can "borrow" power from the

battery of another car and have your engine running in seconds. One of the eight-foot cables is used to connect the positive terminals of the two batteries. The other is connected to the negative terminals.



## Engine Changes Atom Heat Into Electricity

Atomic heat is converted directly into electricity in a new engine invented by two professors at the Massachusetts Institute of Technology. Called a thermoelectron engine, the instrument has no moving parts. It consists of two metal plates inside a vacuum tube. One of the plates is heated to about 2200 degrees F. and the other, spaced only  $\frac{1}{1000}$  inch away, to 1000 degrees. Electrons "boil off" the hotter plate onto the cooler one. When the plates are connected by wire outside the tube, electrons are conducted off to perform work. Heat can be provided by ordinary fuels, nuclear fuels or solar energy. One potential use of the thermoelectron engine is in satellites or missiles where weight is a primary consideration. Because the engine operates silently, it might also be used to power military vehicles.



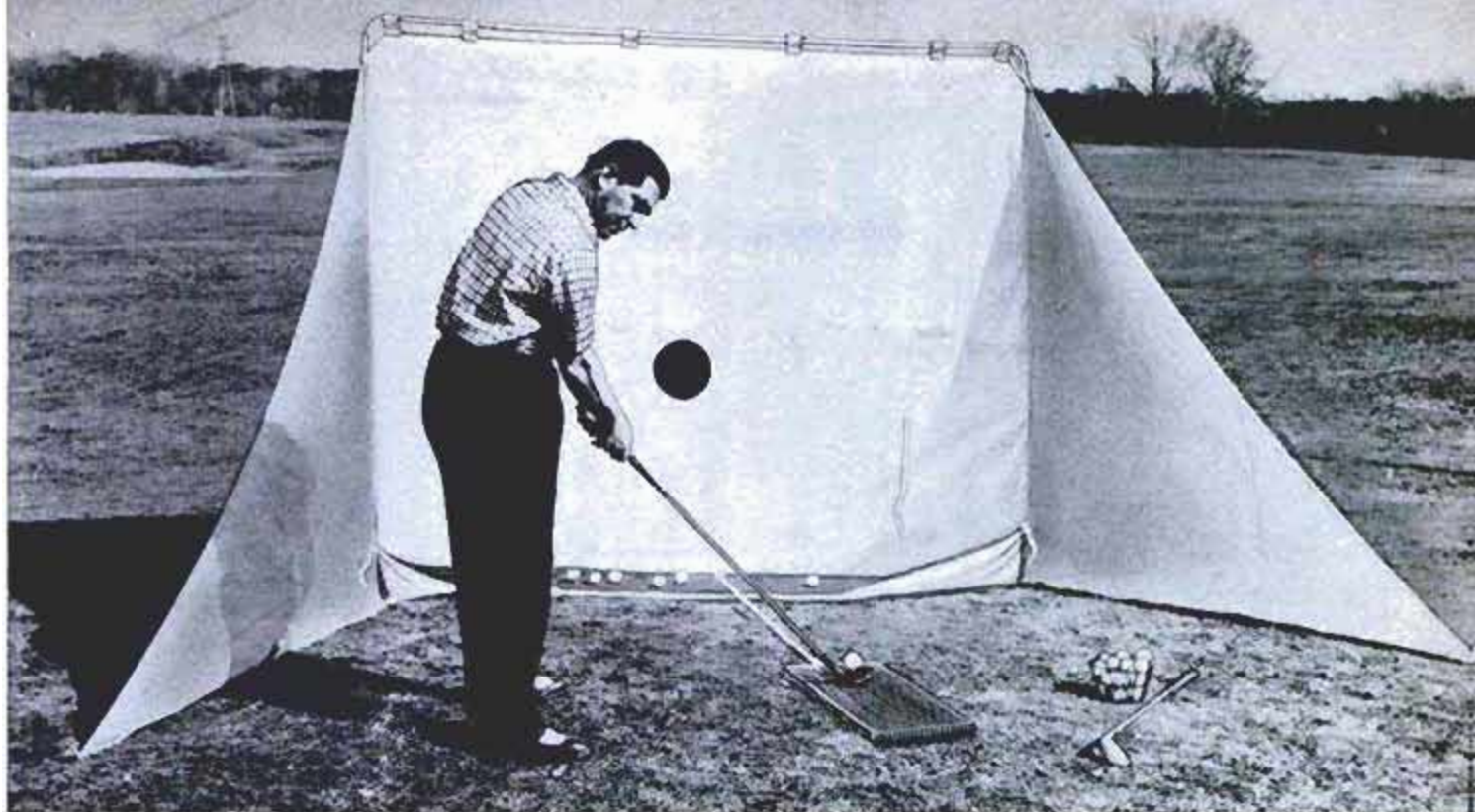

## Portable Range Gives Golfer Practice at Home

Rain can keep a man off the golf course, but it can't stop him from practicing shots at home, outdoors or in the garage or basement. A collapsible golf range can be set quickly. It includes a tee-off mat and an apron pocket that snares balls on the rebound.

## Big Italian Tanker Run by 14,400-Hp. Motor

Italy's biggest tanker, the *Sicilmotor*, is equipped with a 14,400-horsepower Diesel-Fiat motor. Each of the motor's 12 cylinders is 750 millimeters in diameter. The tanker weighs 31,100 tons. A larger motor under construction at the Fiat works has 20,000 horsepower.

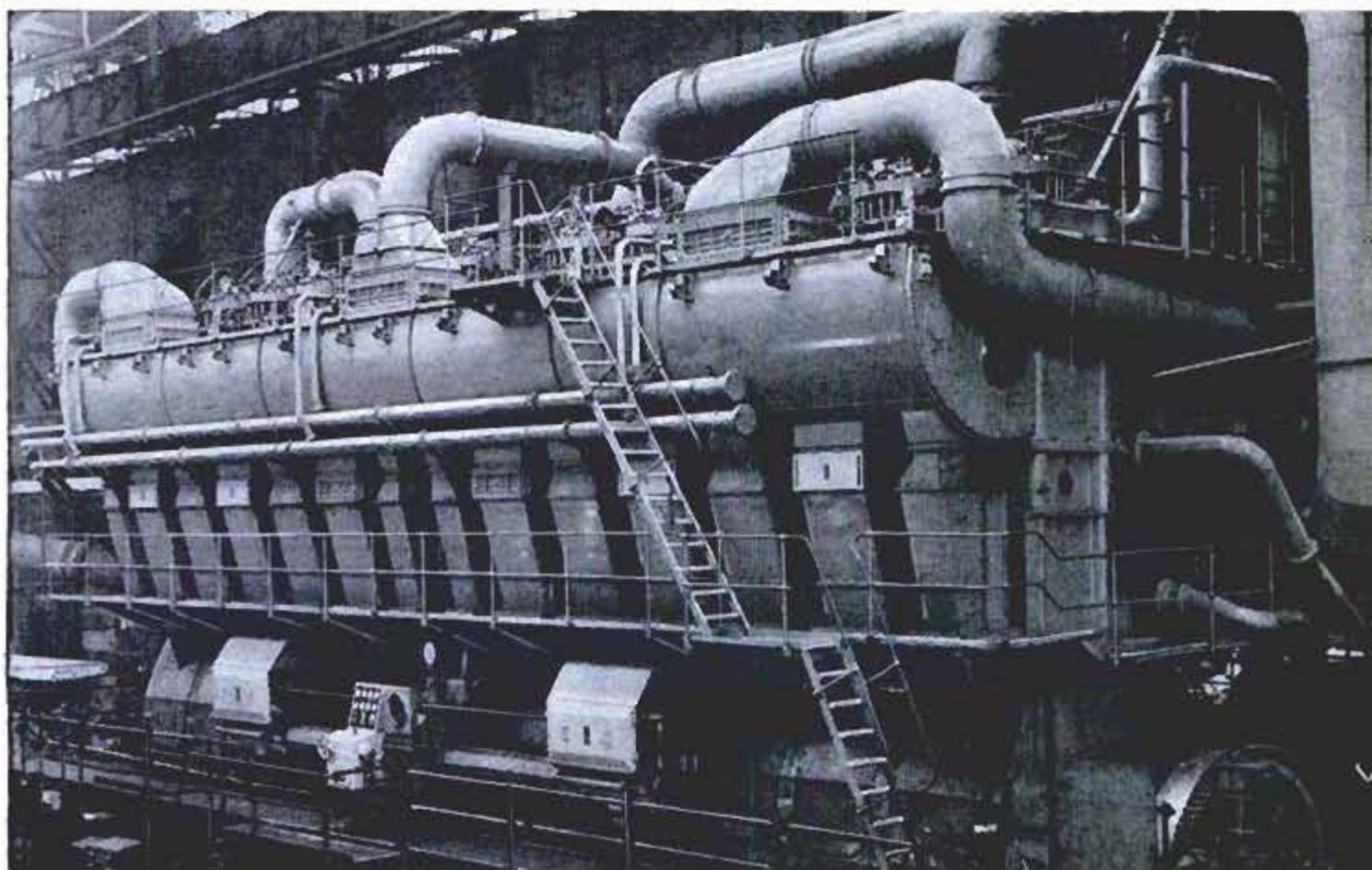





Student racers in Purdue "Grand Prix" round a difficult turn; all wore helmets and cars had roll bars

# "GRAND PRIX" OF THE LAWN-MOWER RACERS

By Bill Brooks

(Photos by Dick Vellinger)

A TRADITION was born at Purdue University on Saturday, May 17, 1958, amid a roar of lawn-mower engines.

Twenty student-made race cars spluttered, skidded and swirled around a special six-tenths-mile racecourse on parking lots and an adjoining street just north of Purdue's new co-recreational gymnasium. It was the Purdue Auto Club's first "Grand Prix" and for more than 2000 onlookers it was a real "ball."

The race began with a Le Mans start (where drivers run to leap into cars) at 3:50 p.m. and was called to a halt at 6:30. The winner's trophy went to the car that made the most laps.

Car No. 1 conked out before it could reach the "pits." Here a worried mechanic anxiously awaits the arrival of crewman with the proper wrench





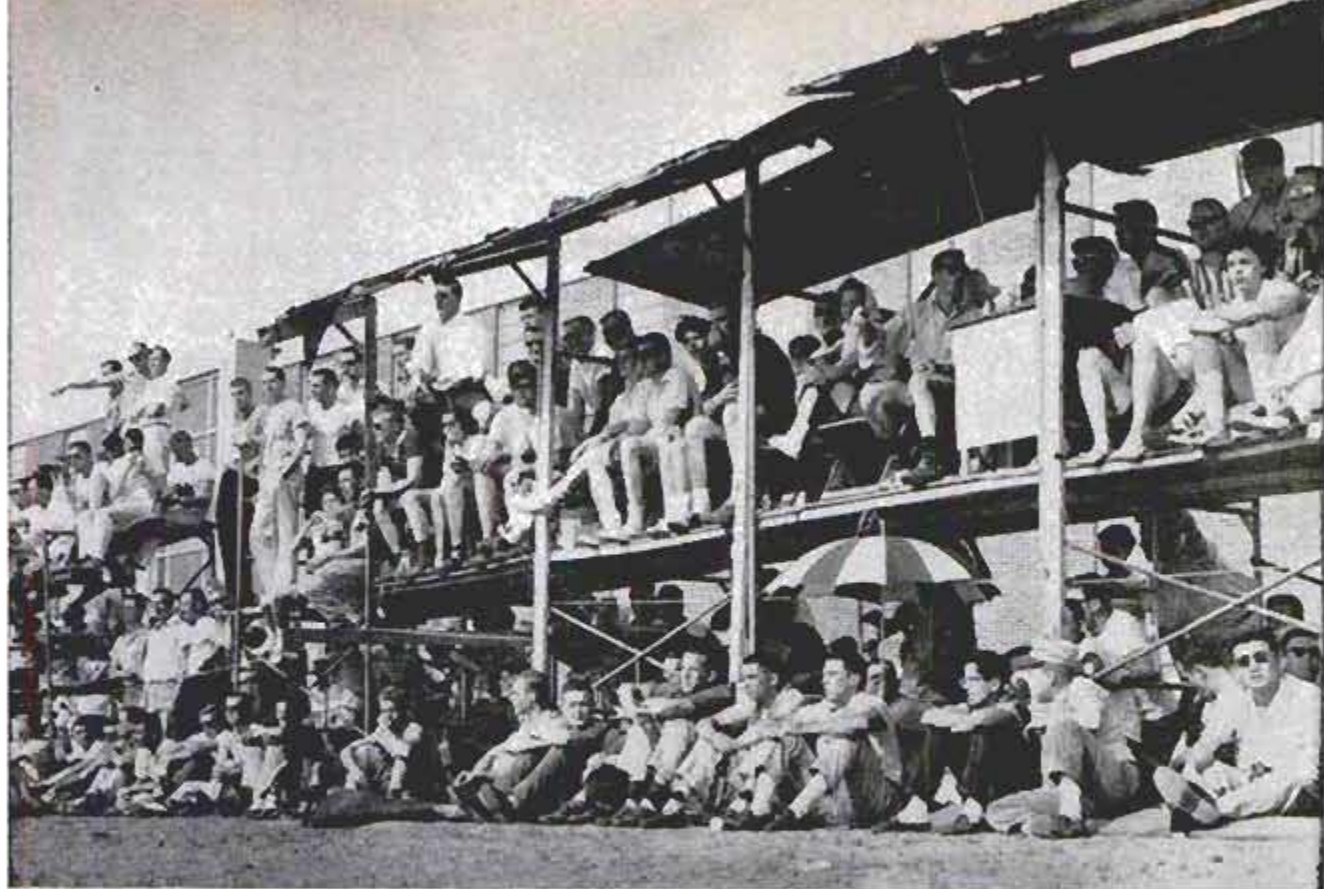

Homemade bleachers on side of the race track held some of the 2000 onlookers attending the "Grand Prix"

The affair, hailed as a roaring success by drivers, mechanics and onlookers, was sponsored by the Purdue student auto club, headed by Roger T. Yule, of Pittsburgh. The original idea belonged to ex-club president Peter Helferich, of Evanston, Ill., who conceived the notion of combining Purdue engineering-school skills with college spirit and the pre-500-mile-race atmosphere. Indianapolis is about 60 miles from Lafayette, Ind., where Purdue is located.

#### "Runts" Made by Students

The "rumbling runts" were all made by students — representing fraternities, residence halls and individual groups (such as one grandly called Northwestern Racing Associates, whose initials, NRA, confused the middle-aged spectators in the crowd). All power units were basically the same— $1\frac{1}{2}$ -horsepower engines normally used on power mowers. Regular pump gas had to

be used and the bore and stroke of engines had to be left untouched. Any other "hopping up" was permissible.

Purdue engineering students reached hitherto unscaled peaks of ingenuity in boosting  $1\frac{1}{2}$  horsepower to 3 and  $3\frac{1}{2}$  horsepower by milling, shaving, grinding, incessant tests, and the introduction of larger carburetors and motorcycle transmissions. Many of the cars had three-speed transmissions and the drivers performed some mighty frantic shifting to keep the rickety ramblers at top speed.

Auto-club officials had arranged things efficiently: Hay bales and traffic cones to mark the course, fire marshals with extinguishers at regular intervals, judges and timers, and chaps with brooms to keep the track swept clean. On hand also, were policemen to keep the cheering spectators behind ropes, and an ambulance to tend the wounded (one gashed ankle and one

It was a clean, if slightly hectic start. Here the drivers had just leaped into their moving cars in best Le Mans style







Left, 10-minute welding job was done with portable outfit in the pit. Car has been turned upside down to expedite repairs. Above, Jack Floyd of SAE fraternity holds up a pit sign for his driver. Students used Speedway signals and many drivers got signs mixed up, adding to the fun

slightly burned hand, both suffered by pit-crew workers).

#### Cars Get Wild Names

Names on the cars were wild and typically collegiate, such as "Silky Sullivan Special," "Built in Disneyland by Mickey Mouse," "Fiji Fury" (with pit crew and drivers' shirts lettered likewise), and one machine of Spartan design labeled simply "SNAFU."

Drivers—there had to be a minimum of five per car—wore football helmets, Air Force-pilot helmets or Indianapolis Speedway-type crash helmets. Each driver usually raced 25 to 30 minutes, then was relieved.

Safety rules were strictly observed. If a car spun or jumped off the racecourse or even touched another car, the yellow or red flag was shown to slow or stop other entries. A car touching anything was immediately summoned to the pits for a checkup. One driver carelessly left his goggles up and was promptly flagged to the pit area for a sharp reprimand.

Worn-out tires were tossed away like stale doughnuts and fan belts littered the pit area like confetti. Bumpers bent, drive-shaft chains snapped, cotter pins sheared off and axles broke. There were five welding outfits in the pits. One axle-welding job consumed only 10 minutes and the car zoomed back into the fray.

One elated crewman shouted: "We did a 10-second fuel change!" He had trotted

alongside his car as it rolled in, engine dead, for a pit stop and had poured in a tankful of gasoline—one quart.

Indianapolis Speedway signals were used but there were titillating variations. The Sigma Alpha Epsilon crew held up a board with "X" on it. The driver sailed blithely by. They chalked "IN" on the board. The driver came in wondering what the "X" meant. No one seemed to know.

Another driver, passing his crew, held up one hand. "What's that signal?" asked a crewman of a mate. "Beats the heck out of me," was the reply. "Let's let him go." And they did.

One sweating driver did a complete lap with half an orange in his mouth. A pit-stopping driver grabbed a soft-drink bottle and had it to his lips before someone yelled: "That's gasoline!"

The Dover Co-op crew, whose car led the race for over an hour, suffered a heart-breaking setback when a tire blew and they discovered the only spare had been left at the residence hall. By the time a crew member ran for the tire and returned, three cars got ahead of Dover who finally finished fourth.

The winners were kissed by Grand Prix student queen Sonya Porter, of Kokomo, and appropriate trophies were presented.

The winning entry was Gables Courts with 133 laps in 2 hours and 40 minutes—80 miles at an average of 30 miles per hour.

"Not bad," said Yule. "Must be some kind of record for lawn mowers." ★ ★ ★



Below, driver John VanSickle of Columbus, Ohio, waits for a signal after a stop at the pit. All of the 1½-horsepower lawnmower engines were "hopped up" to 3½ horses by Purdue's ingenious engineering-class students. Larger carburetors helped



Above, these are the tools rounded up by one pit crew to meet all emergencies. Some of them came in real handy

Jim Moneyhun of Indianapolis drove winning car. Grand Prix queen Sonya Porter stands by with Roger Yule







### German Police Call Box

Residents of some German communities can call police headquarters directly through special telephone units built into cabinets on posts. Microphones in the units, located at outlying intersections, also can be used by police to monitor traffic noises.



### Portable Gas Detector

Approximate concentrations of certain gases in the air can be determined quickly with a hand unit that pumps samples into a small tube of chemicals. The concentration figure is based on color changes in the tube and the number of pump strokes.



### Monitor Listens in On 28 Frequencies

Air-crash investigators can now tell exactly what radio communications had been made between pilots, and between pilots and ground controllers before an accident. A magnetic tape-recording system has been developed that can simultaneously monitor around-the-clock radio communications on 28 frequencies. The voice monitor is built into five six-foot-high cabinets and has two recorders. Its magnetic tape, constantly in use, is  $1\frac{3}{4}$  inches wide, is on reels 19 inches in diameter. One recorder is used at a time. When it is used, an automatic switching device starts the second recorder.





Northwest Orient Airlines photo

### Plane-Reservations System Gives "Electronic" Answers

Airline reservations can be made in a fraction of a second with an automatic electronic reservations system. By pressing buttons, a reservations agent can also tell if a flight will be early, on time or late—and if late, why. The system consists basically of a random-access Univac file computer and a number of "agent sets" linked to the computer either directly or by communications trunk lines.



### Vest Keeps Dry Cells Warm With Heat From Body

Using body heat to keep dry cells warm, a battery vest has been developed by the Army for radio operators on duty in extremely cold weather. Dry-cell batteries are placed in a vestlike garment worn beneath the parka. A cord is used to plug in radios. With the vest, batteries developed for low-temperature use are expected to stay in service 10 times longer in 40-degree-below-zero weather.

### Trailer Truck Carries Tank Cars From Siding to Industrial Plant

In England, tank cars are taken from a railway siding to a nearby industrial plant by a low-level trailer truck. On the trailer's platform is a section of track just long enough to accommodate one car. Height of

the platform is two feet seven inches, coinciding with the level of the shunting spur at the transfer point. This method of filling tank cars provides direct-rail access to any building in the plant.

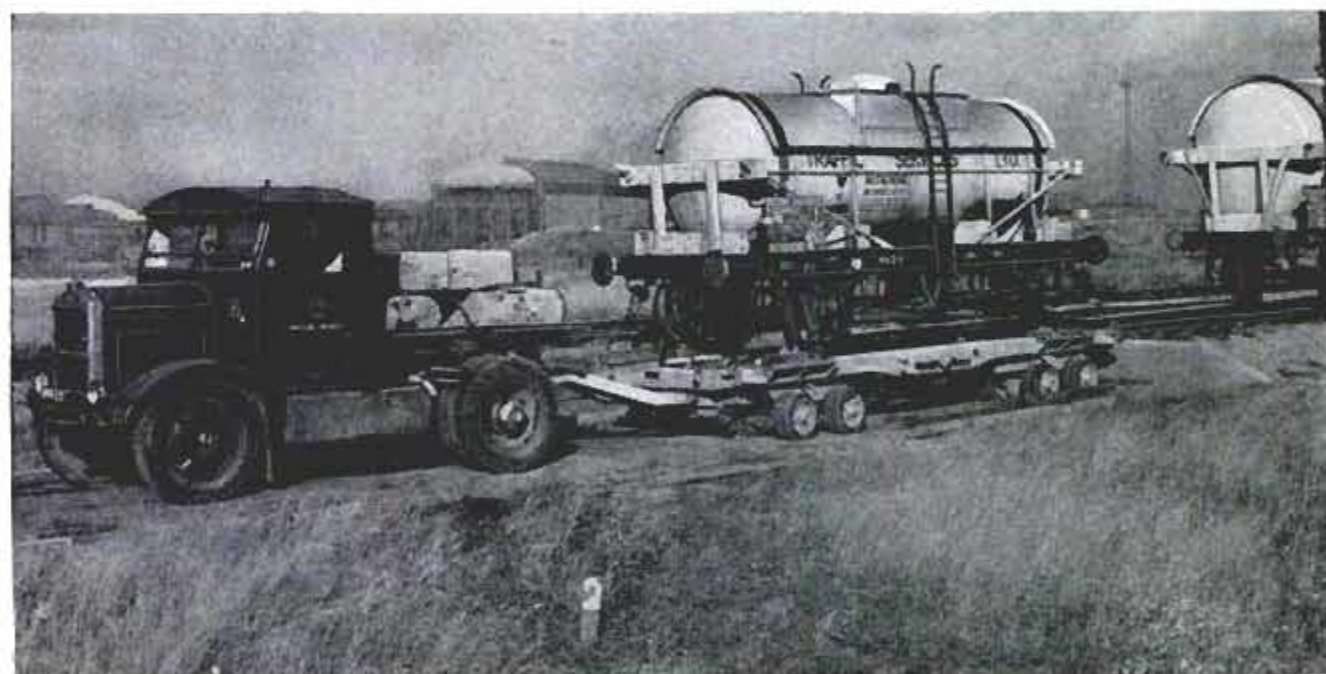





### **Armor of Plastic and Glass Fiber Protects Man From Bullets**

When the shooting was over, inventor Harvey Freeman removed his bulletproof armor and said, "I hardly felt a thing." He

perfected the armor from an alloy of plastic and fiber glass. Freeman calls his invention an "armadillo."

### **Electromagnetic Detector Can Locate Underwater Subs**

Submerged submarines can be detected by an electromagnetic device developed originally for the discovery of base metals. The device makes use of an electronic-tube principle. Called the Orbitron, it is fitted on an S-55 helicopter. Its only visible parts are long antennas that extend fore and aft

from the nose and tail. They are part of the fixed coaxial system that supplies electrical impulses needed to detect ore bodies of metals like zinc, lead and copper. These pulses are transmitted and received coaxially with the direction of the helicopter's flight.

### **Newborn Babies Are Television Stars on Hospital's Closed Circuit**

Fathers in Hialeah, Fla., get their first look at their new offspring by closed-circuit television. A TV camera in the hospital

nursery is connected to a standard receiving set in the waiting room. Visitors switch the set to Channel 6 for the "baby show."





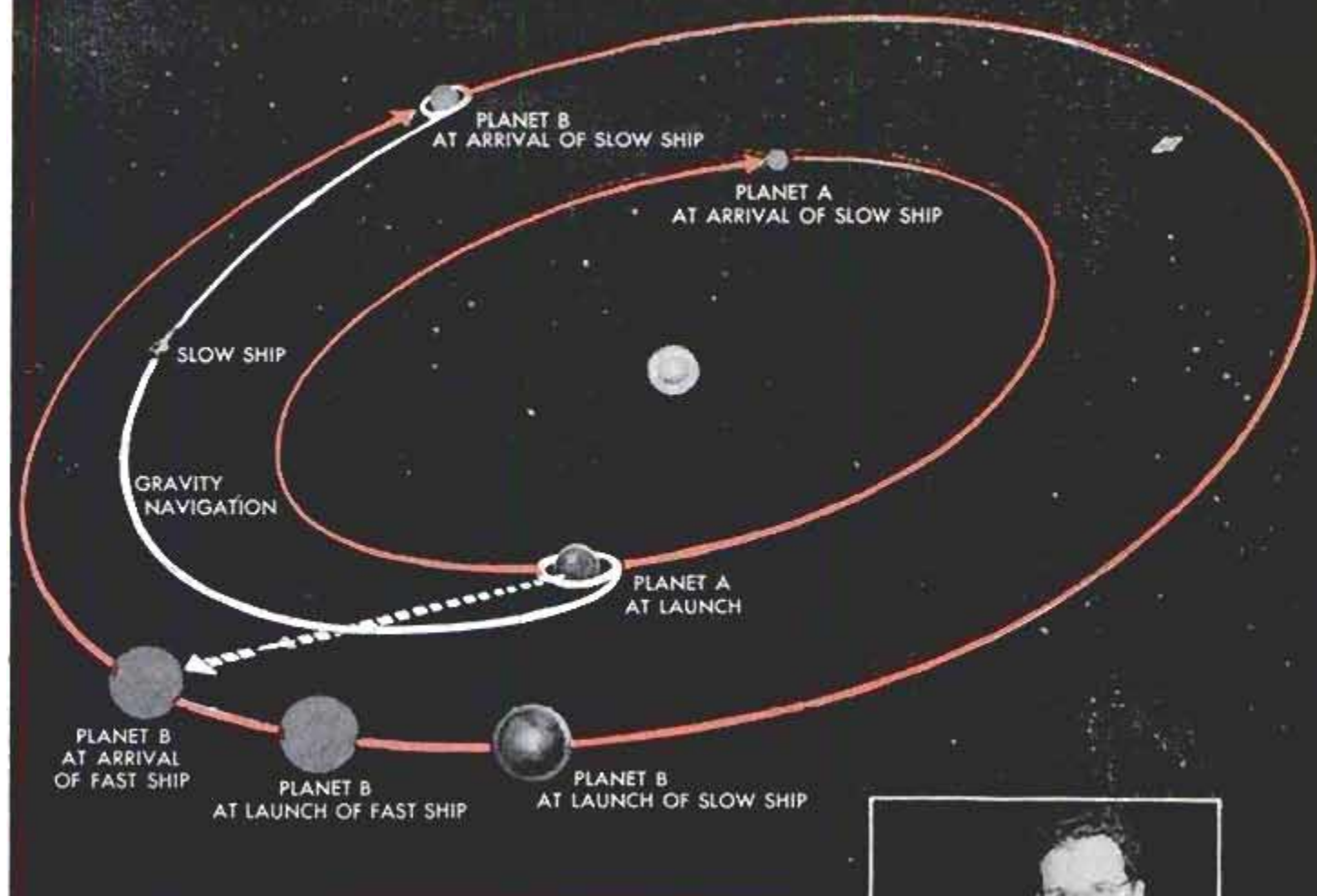

Fig. 1. Drawing shows difference between slow and fast-ship navigation

# HOW WE'LL STEER IN SPACE

*Reprinted "PM Highlights"*

By Dr. Peter A. Castruccio

In his position as Advisory Engineer for Missile Guidance and Space Communications for Westinghouse, the author has probed deeply into questions of how ships can navigate through space



**M**AN WILL CONQUER SPACE. He will travel to the moon, and to other planets in our solar system.

But if he is to succeed in this most dramatic of all human undertakings, he must first solve two great problems. I believe we can reasonably expect solutions to both.

The first of these problems, of course, is to develop power plants powerful enough to push him out into the vastness of space and return him to earth. Travel in space itself requires relatively little power; most of the energy must be spent in overcoming gravitational pull of the earth, and of the moon or other bodies which man has the daring to explore. This initial push requires so much power that today's power

plants are barely equal to the task. Not much power is left available for actual space travel.

For this reason we must use to the utmost any natural forces which are available — and fortunately, powerful sources are available. We can take advantage of these forces in a method known as "gravity navigation."

Imagine, for a moment, that there is a spaceship traveling around the sun at the same speed as the earth travels around the sun. Two forces act on this ship: The pull of the sun and the centrifugal force of the ship's motion. These forces are exactly equal; the ship neither falls toward the sun nor escapes outward. Now imagine that we add a gentle push in the same direction the



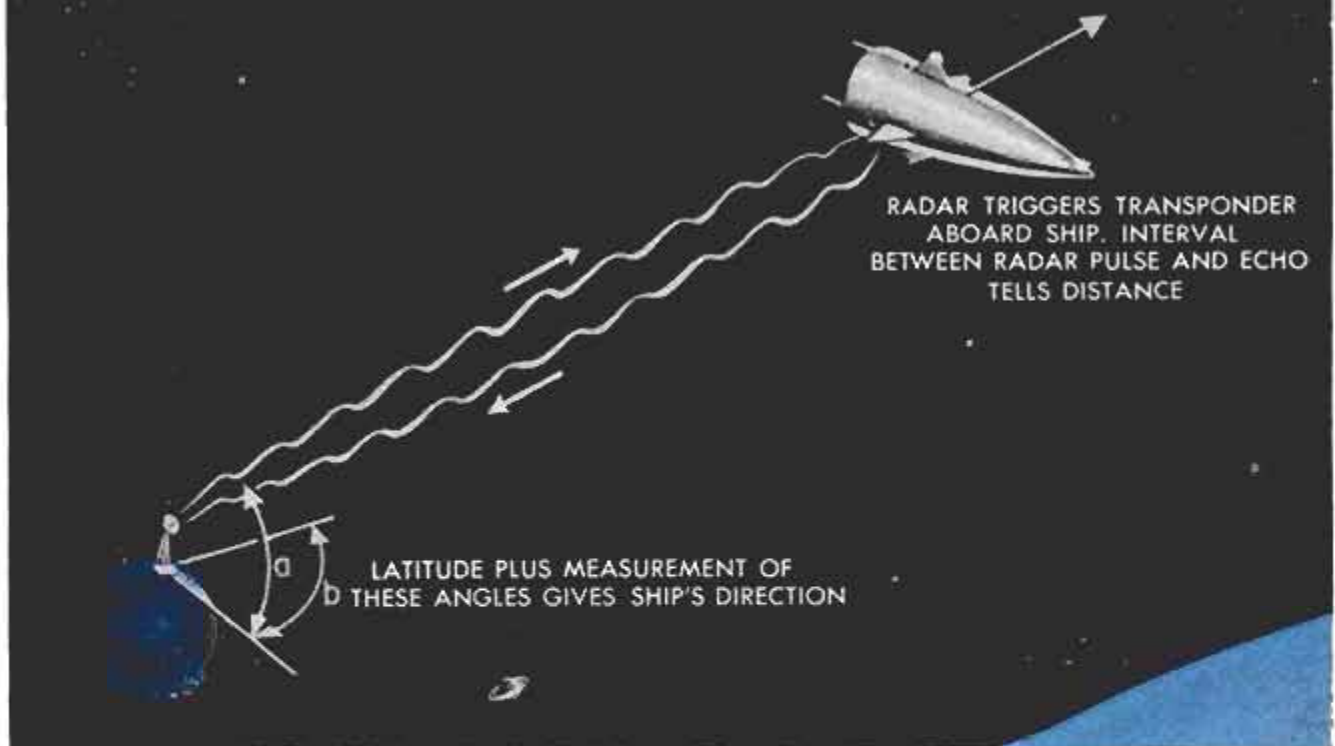
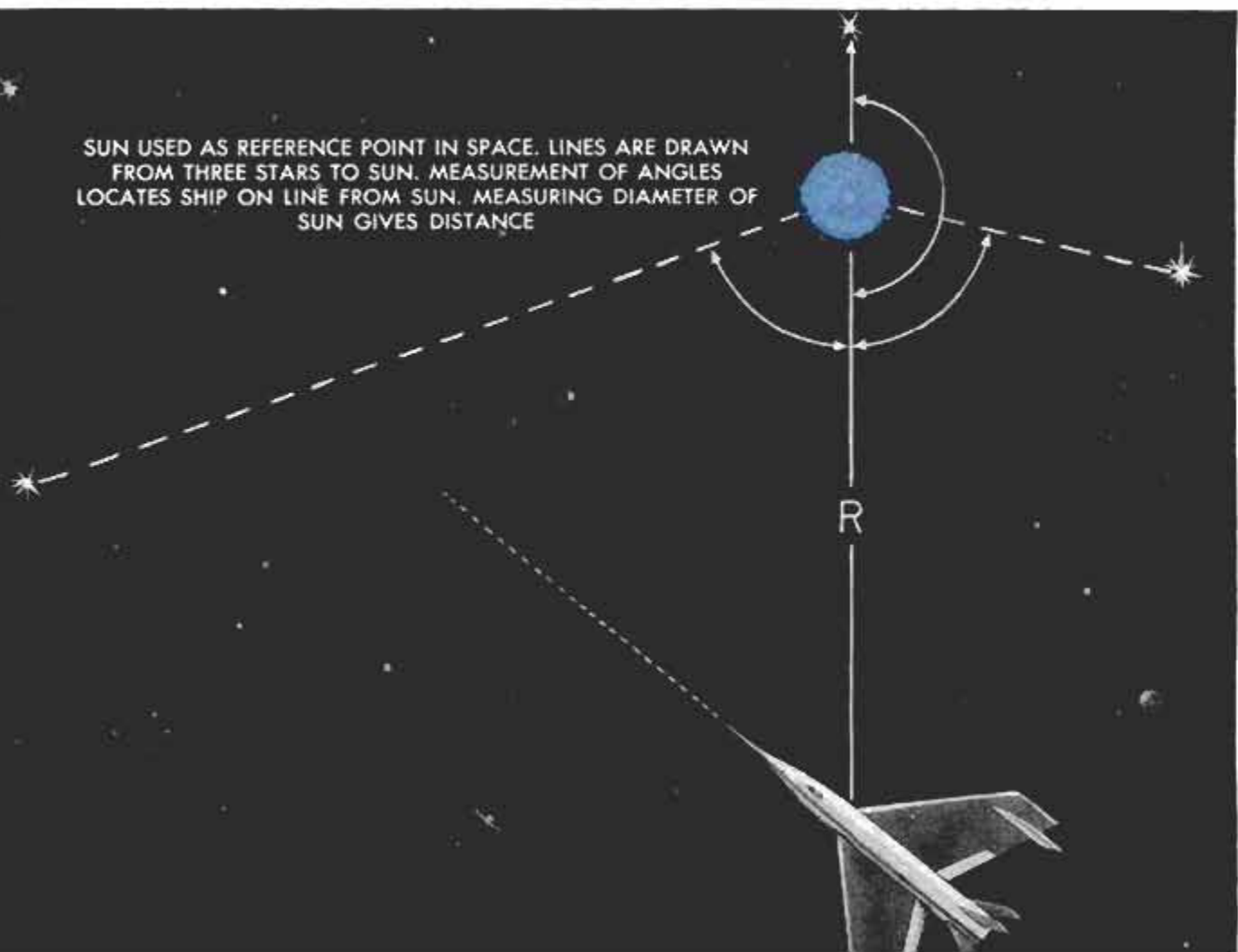

Fig. 2. Measurements of radar signals and their echoes will determine the course and range of the spaceship

ship is traveling. The ship speeds up, its centrifugal force increases, and exceeds the inward pull of the sun. This causes the orbit of the ship to become elongated. The ship now follows an ellipse or oval route through space. The secret of gravity navigation lies simply in making the furthest point of the ellipse coincide with the planet we wish to reach.

Without question we can and will use this system of gravity navigation in the near future. We'll make the trip in two steps. First, the ship will vanquish the pull of the earth by acquiring sufficient speed (some 18,000 miles per hour) to orbit around the earth. As an earth satellite, of course, it will be moving, with the same speed as the earth, around the sun. Next

Fig. 3. Position can be fixed from inside ship by measuring angles of three reference stars and the sun





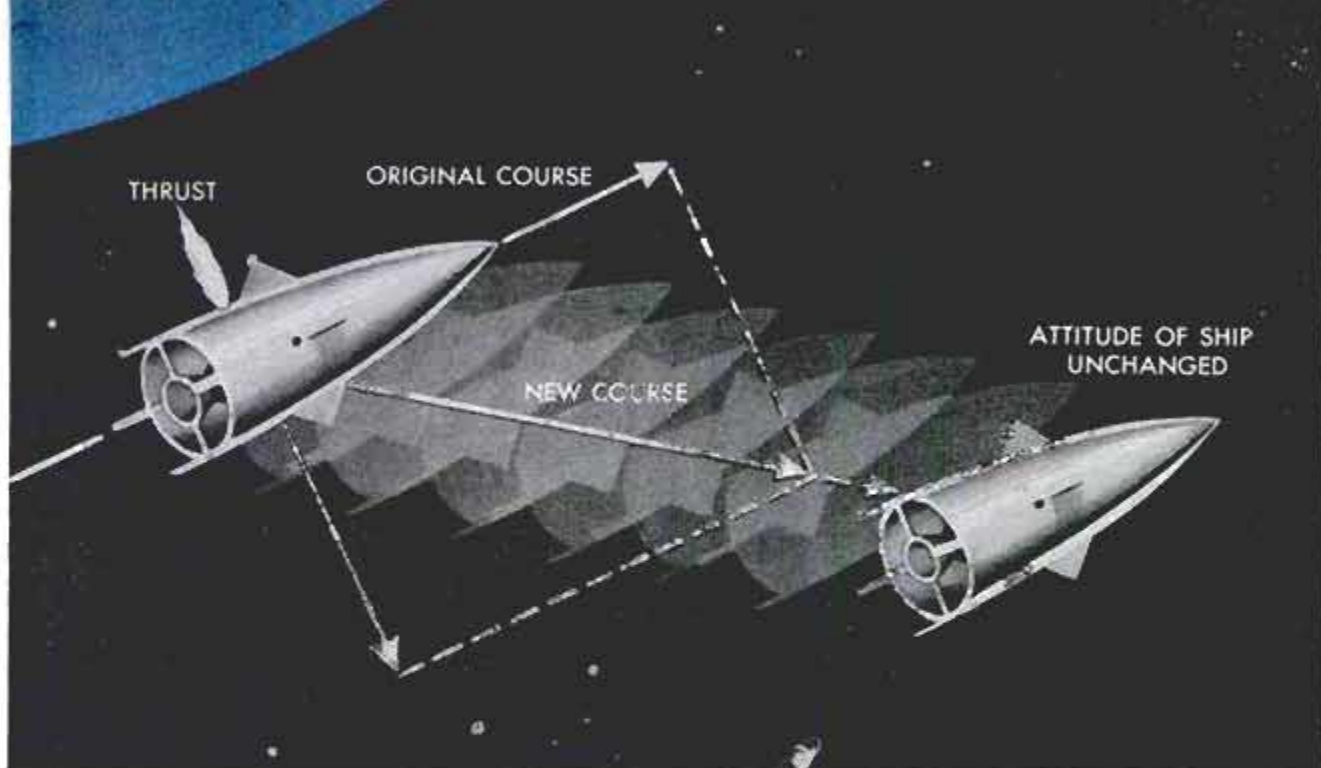

Fig. 4. Spaceship must use rockets to change not only course, as shown above, but also attitude of ship

we'll give it a relatively gentle push at precisely the right instant and in precisely the right direction to send it out on an elliptical orbit around the sun. If the push is exactly right, it will carry the ship to one of the planets, which also is orbiting around the sun. Thus we can use the speed of the earth as a "springboard to space."

Obviously this method is time consuming. The speed of travel is limited, and we must wait possibly months or years for the planets to assume their proper positions for such a voyage. We are in much the same situation as the ancient sailing master, who had to await favorable tides and whose speed was limited by the strength of the wind in the sails.

But as power plants become more power-

ful, space travel will gradually become faster. Eventually gravity navigation will yield to straight-line powered navigation, as shown in Figure 1.

This is the sequence I see in the immediate future, initially with unmanned ships: Orbiting satellites, lunar crash-landings, round trips around the moon, landings on the moon's surface and finally interplanetary missions. Subsequently, but somewhat overlapping this evolution of unmanned space flight, will be travel by man himself in much the same sequence.

#### Extremely Accurate "Aim"

The second of the two great problems to be solved (the first was the development

(Continued to page 230)

Fig. 5. When four antennas on a ship pick up radar signal in phase, ship is in line with radar beam

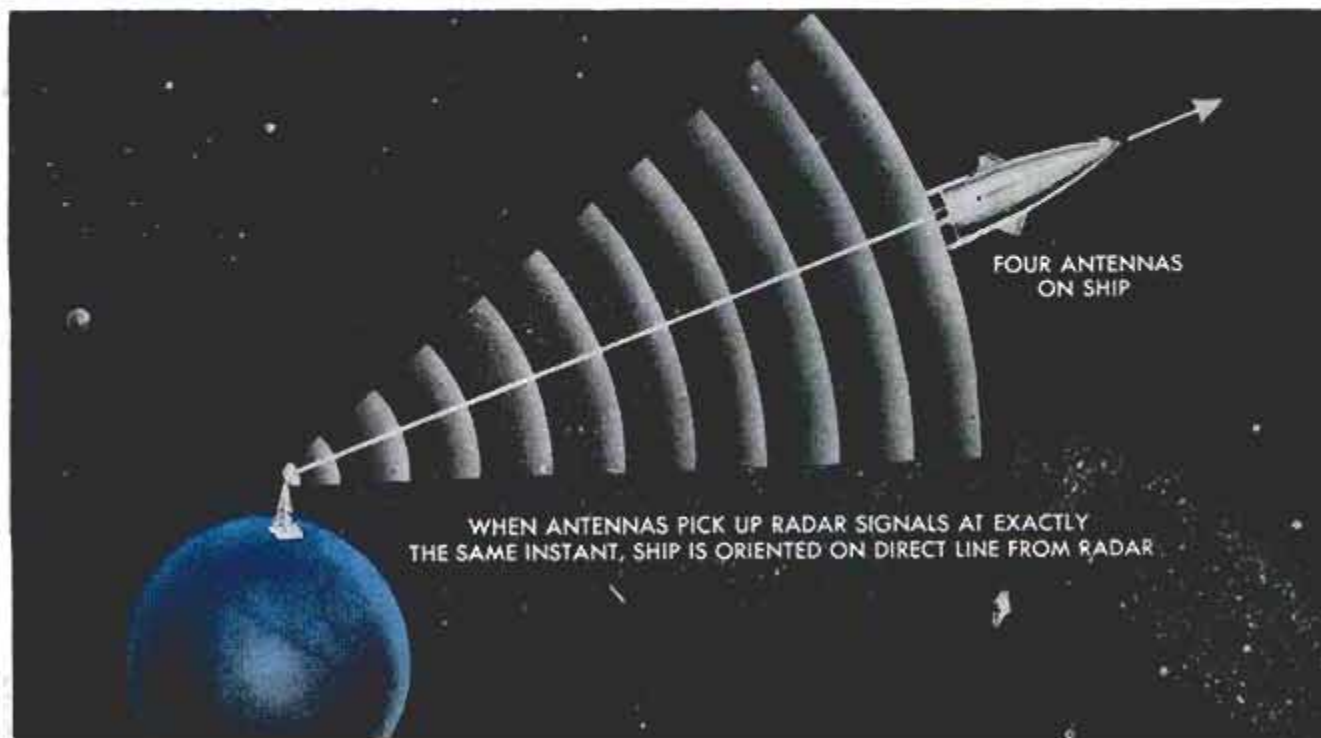





### **Mystery: Six Passengers But Where's the Engine?**

Six persons can ride in a personnel carrier Willys Motors is building for tests by the Army. Curb weight is 1500 pounds and it can carry another 1500 pounds. The seats

fold flush into the floor to form a flat-bed truck. Its four-cylinder, air-cooled aluminum engine is hidden beneath the floor and drives the car at 60 miles per hour.

### **British Architect Works Under Hemisphere of Glass**

Designed by an architect for use as his studio, a dome-shaped structure at Kingston Hill, Surrey, England, is covered with 150 glass triangles. The glass is supported

by a wood frame. Panels can be installed behind the glass triangles where shade or privacy is wanted. The dome was erected in two days by the architect, Hugh Pope.

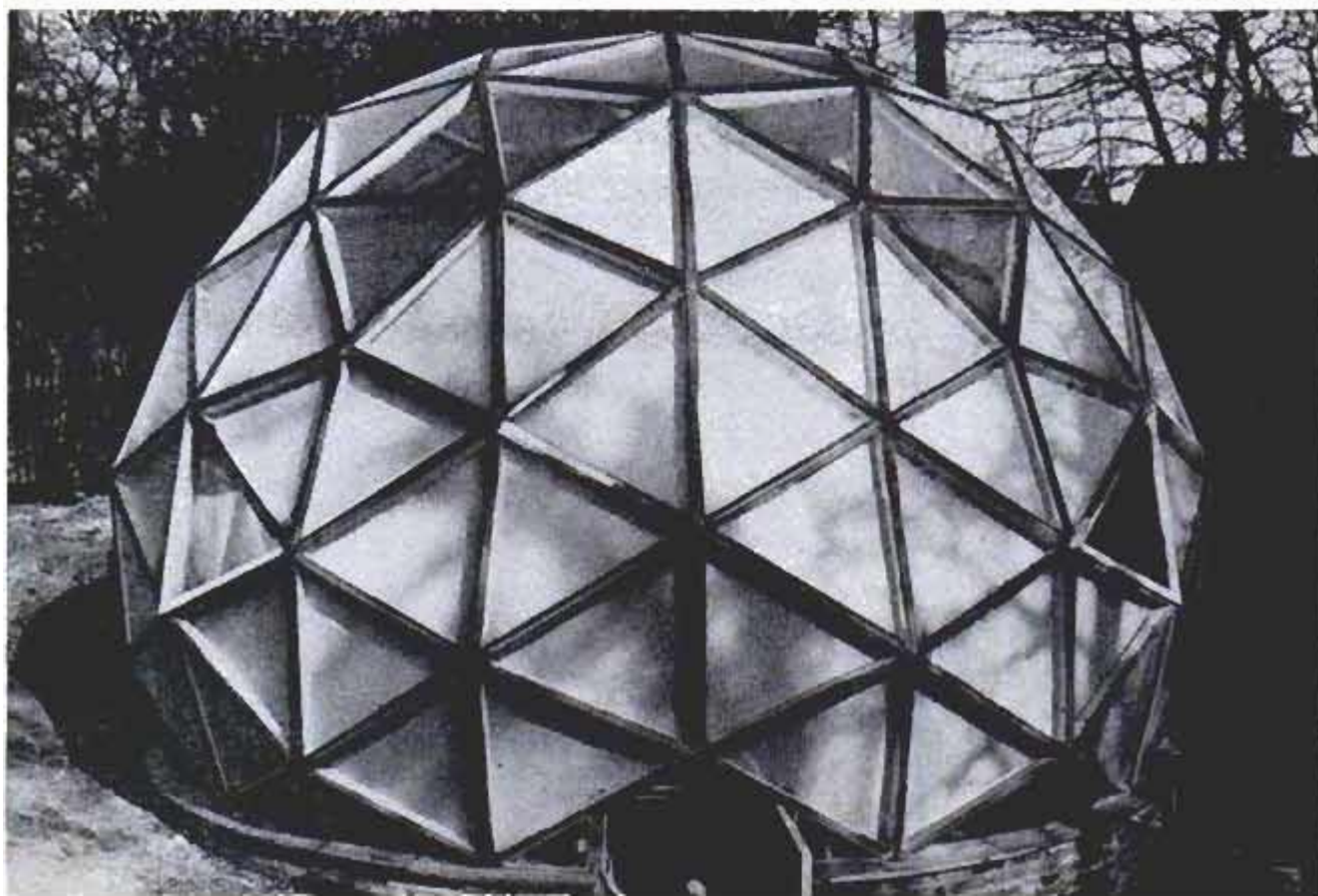



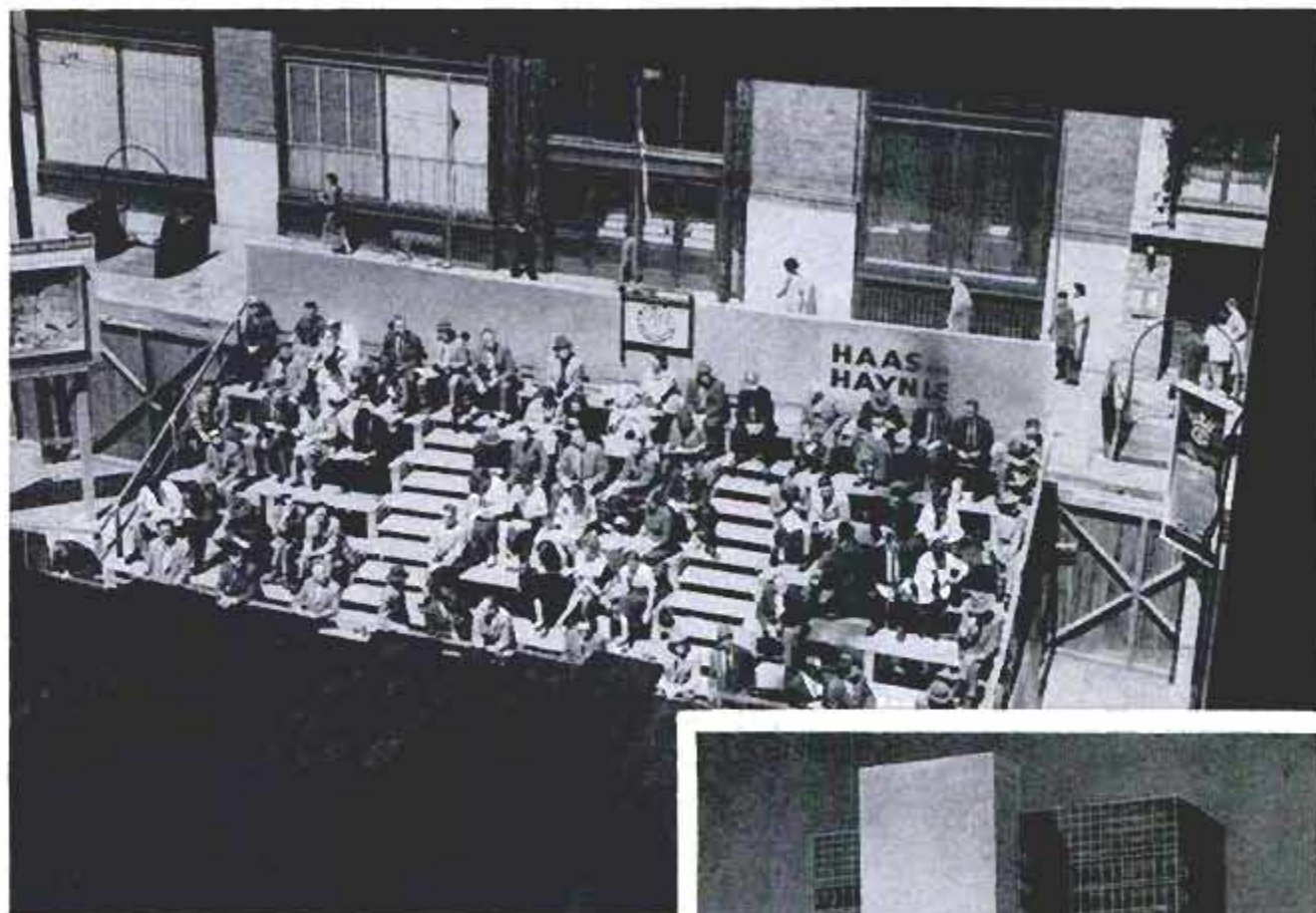

## Sidewalk Superintendents Have Ringside Seats

Amateur engineers and architects in San Francisco get preferred treatment while watching the construction of a \$10,000,000 office building. The sidewalk superintendents are provided with bleachers that seat 100. Two large illustrated signs beside the bleachers show how the completed building will appear. Viewers are issued Sidewalk Superintendent Club membership cards and are notified when special phases of construction are scheduled to begin.



## Diary of a Manmade "Moon"



There's something very astronomical about the U. S. Navy's Vanguard I satellite—and we do mean to pun. Not only is it our highest manmade astronomical "moon," but its travel diary produces astronomical figures.

Dr. John P. Hagen, Vanguard project director, predicts it will stay in orbit for 200 years. The original prediction was for 20 years' flight.

Currently it is circling the earth every 133 minutes at more than 18,000 miles per hour.

At that rate, in 200 years it will have traveled some 31,557,402,000 miles in its 790,912 trips around the world. This would be the equivalent of nearly 170 round trips between the earth and the sun.

Vanguard I travels over 39,900 miles in each orbit and makes the circuit over 10 times a day.

Earth's atmosphere exerts some drag on satellites up to about 400 miles altitude, but Vanguard I is virtually free of this drag because its lowest altitude (perigee) is 405.1 miles and its highest (apogee) is 2463 miles.





**RADIANT HEAT SCREEN** has an automatic thermostat that limits surface temperature of the panels to 150 degrees. The three-panel portable screen is 56 inches tall and about 5 feet wide. It operates on 120-volt house current and uses 1000 watts of power. The panels are finished in charcoal-colored plastic. Pilot light glows when heater is turned on

Arvin Industries, Inc., Columbus, Ind.



**ELECTRIC BARBECUE** uses no charcoal but has permanent ceramic material which glows when grill is connected to 110-volt outlet. The "coals" also sizzle when drippings fall on them from food being prepared on the grill. The amount of heat can be varied from mild warming for biscuits up to high broiling heat for steaks. A rotisserie can be added

Stanthony Corp., 5341 San Fernando Rd. West,  
Los Angeles 39, Calif.

**LOUVERED DOOR**, sometimes called a "New Orleans" door, is described by the manufacturer as an authentic replica of the type of inside door used in old Southern mansions. Made of sugar pine, the door is 1½ inches thick and 6 feet 8 inches high. It's made in two widths, 2 feet 6 inches and 2 feet 8 inches. The doors are trimmed and sanded to take nearly any finish

Louisiana Louvres, 1015 El Centro St., South Pasadena, Calif.

**SOCKS DISPENSER**, below, eliminates clutter of men's socks in dresser drawers. The rolled socks are placed in the dispenser from the top and are removed through a large opening at the bottom. The box holds seven pairs and you can tell what colors and fabrics are available through a slot in the front. The dispenser hangs on a wall or in the closet

Sox Box, El Reno, Okla.

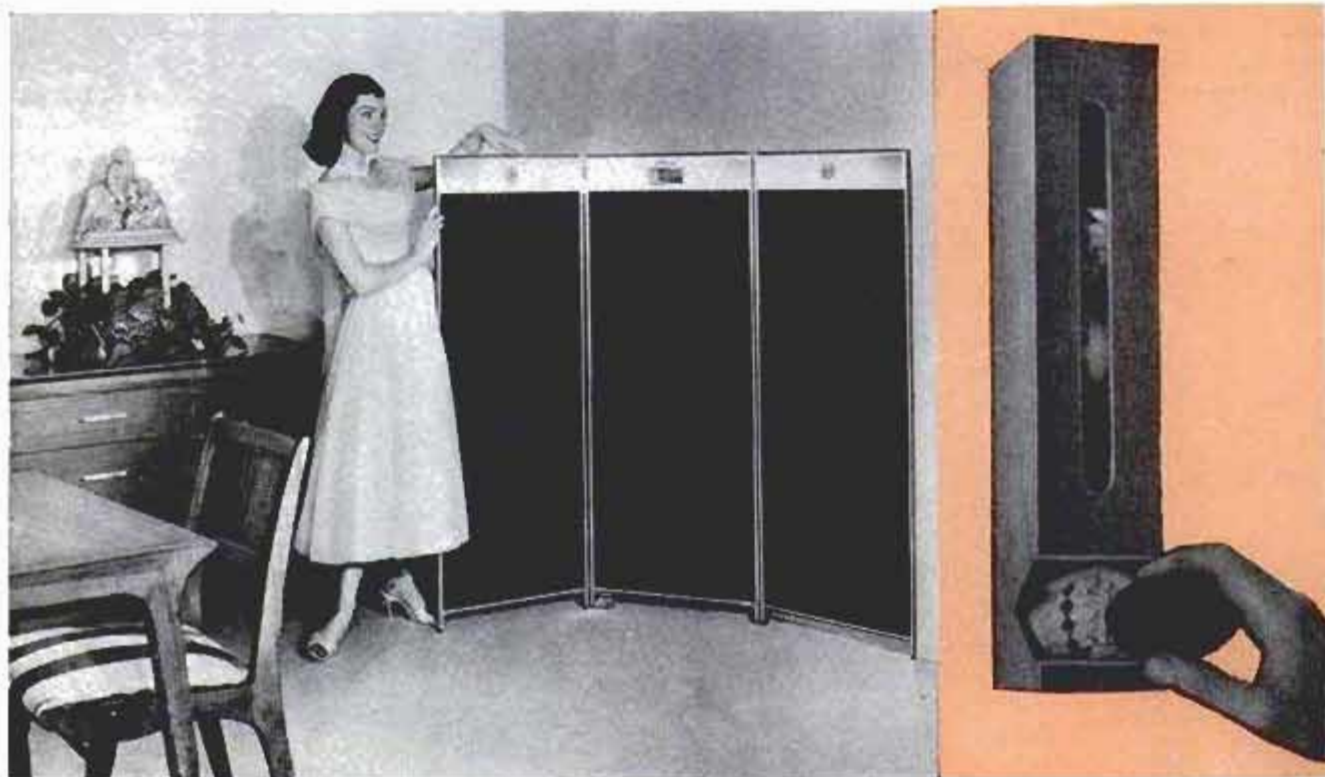



# WHAT'S NEW FOR Your Home

**LOG TONGS** enable the fire builder to carry the firewood with one hand, leaving the other hand free for opening doors and the firescreen. The device has three tongs with small conical points. A free-swinging tong is dropped over the wood, which may be round, flat or split. When lifted, the weight causes the tongs to grip the firewood securely.

John Martin & Sons, 2730 Country Club Blvd., Cleveland 16, Ohio

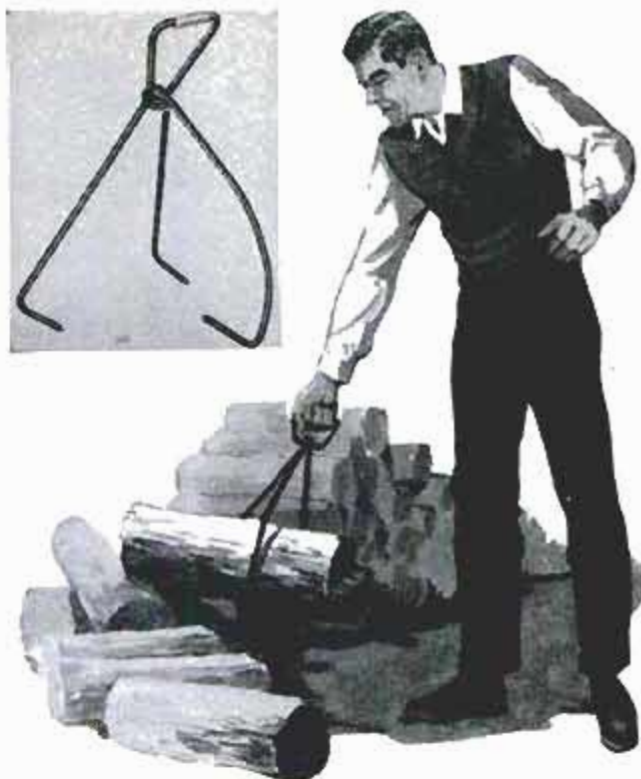

**PORTABLE WRINGER** has suction cups that attach it firmly to glass, tile, enameled or other smooth surfaces. The wet garments are pulled upward with one hand while the other hand is used to turn the handle. The unit has a rustproof metal frame and solid rubber rollers. The wringer can be taken on camping trips or mounted in the kitchen or garage.

R. Hermsen, Dept. PM, 3415 Knox Pl., Bronx 07, N.Y.

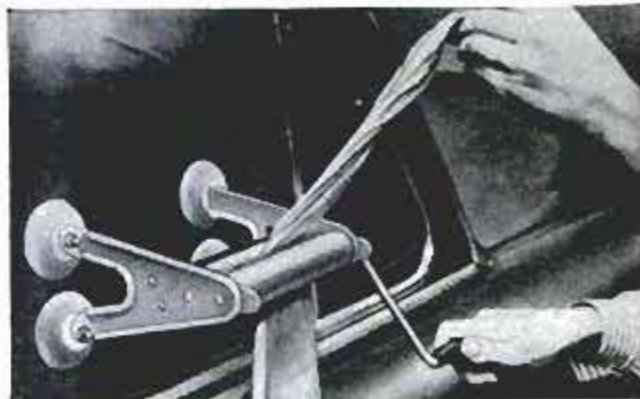

**SHOE SCRAPER**, below, does not have to be fastened to any surface although screws and holes are provided in case the owner wants to mount it in a permanent location. A series of four specially designed cleats allows quick removal of snow or dirt with a few strokes of the foot. The scraper is made of metal with a rubber backing which gives it a skidproof base.

Cashia Mfg. Co., 3213 W. Fifth Ave., Chicago 24

**DOUBLE-MIRROR CABINET** ends the need to hold a hand mirror while viewing the back of the head. The mirrors are attached to the inside surfaces of double doors on a new-model medicine cabinet. The front surfaces of the doors are covered with frameless mirrors which give the effect of one large mirror when the doors are closed. Doors have piano hinges.

Goslee Co., 1500 Brookpark Rd., Cleveland 9, Ohio

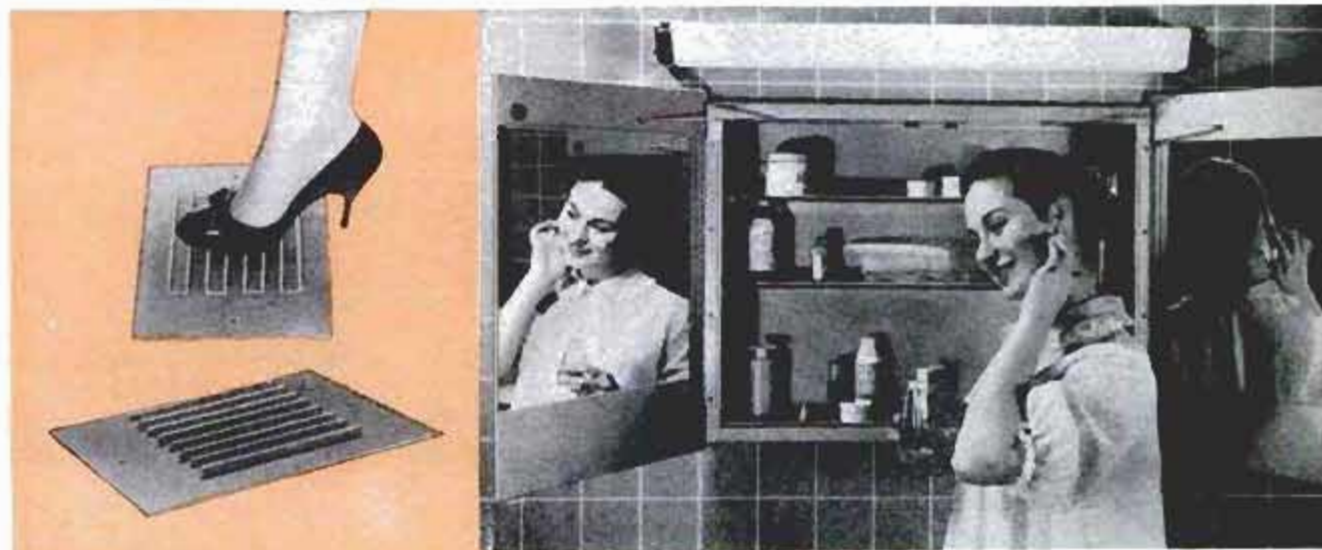





### Complex Electron Microscope Built by Teen-Ager

Seventeen-year-old Glenn Kuswa of Wauwatosa, Wis., built an electron microscope in his basement workshop and can now produce an electron beam and a magnified image. A high school senior, Glenn spent about 1800 hours and \$250 on research, design, machining, assembly and testing. He held down costs by machining parts out of scrap metal from a junk yard, and developing his own electronic circuits from government surplus. The full-scale, 450-pound microscope has won first prize in several junior science competitions.

### Navy and Air Force Weapons Look Alike but They Don't Act Alike

Though they have a marked similarity, the Navy's Chance Vought Regulus II and the Air Force's Lockheed F-104A Starfighter have different roles as defense weapons. The unmanned Navy weapon is a surface-to-surface missile. The other is an

interceptor, called "the missile with the man in it." Both missiles are powered by the General Electric J79 engine. The J79 is rated in the 15,000-pound thrust class and enables both to operate in the Mach 2 range.

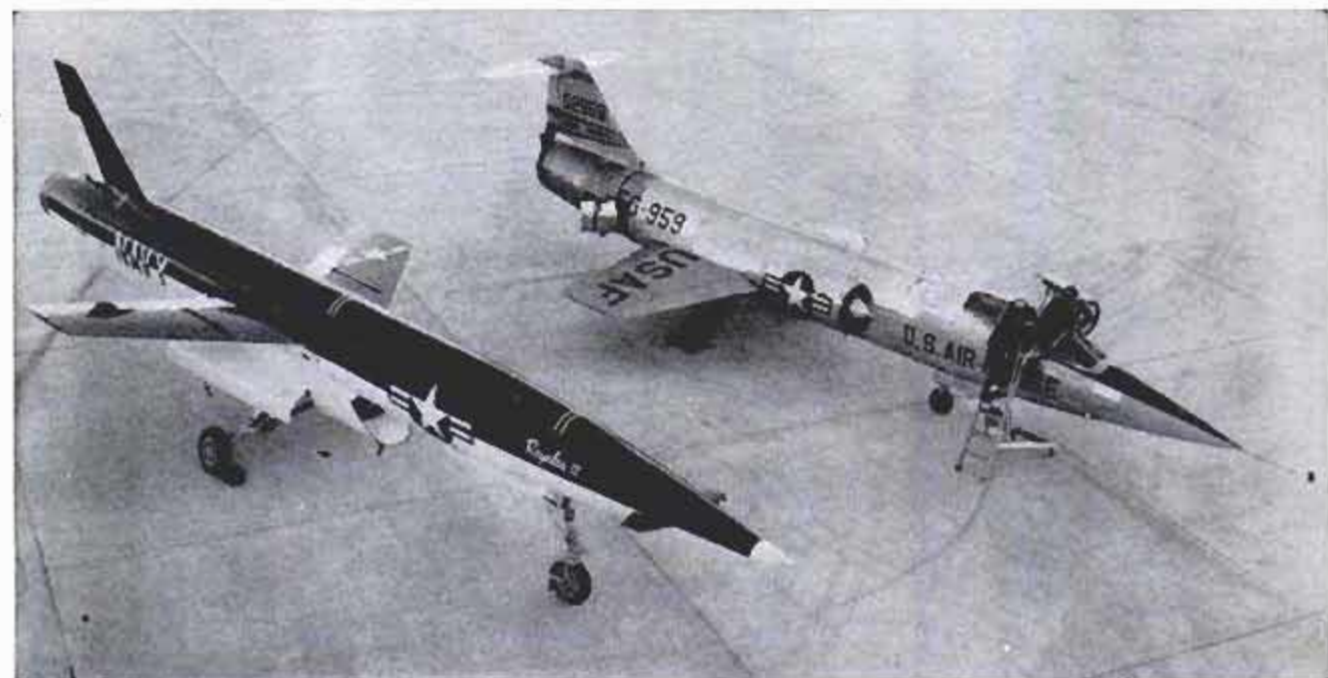





Photos courtesy of E. I. duPont de Nemours & Co., and ~~Rochemol~~ Reichhold Chemicals, Inc.

REICHHOLD

## Liquid Cargoes Travel in Big Plastic Tubes

FLUID COMMODITIES, from molasses to fuel oil, are being shipped in giant "toothpaste tubes" made of plastic or synthetic rubber. The tubes can be carried on flatbed trucks and railway cars or towed through waterways. A German plastic bag has a

capacity of 20,000 gallons. It is 100 feet long and has sealed air compartments for buoyancy. A Neoprene tube made in the United States holds 3800 gallons (top photo) and rolls into a package only two feet thick when empty (lower right).

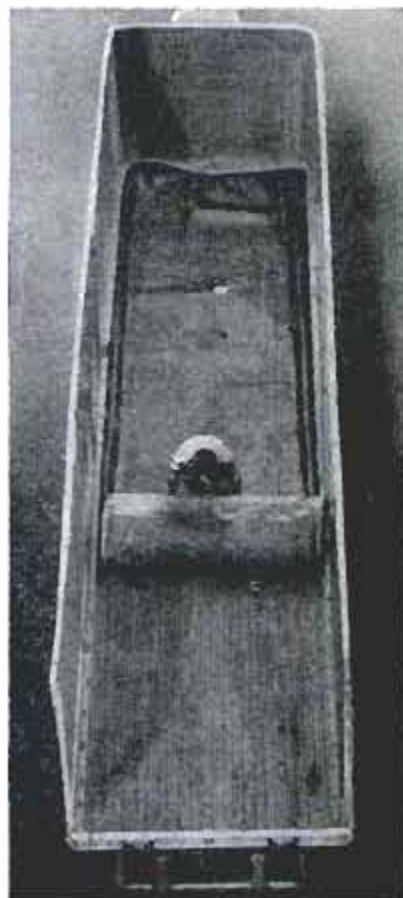
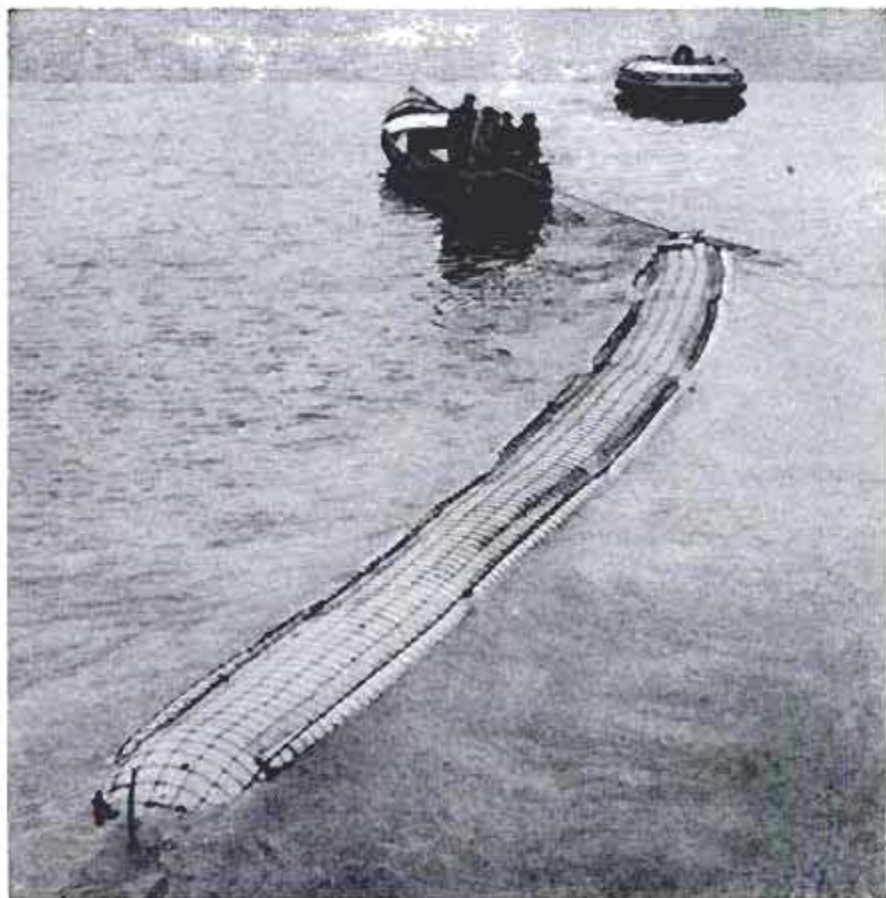





Top moment of hunting: The hike home after a fine day in the field, with birds to prove your prowess

## IMPROVE YOUR

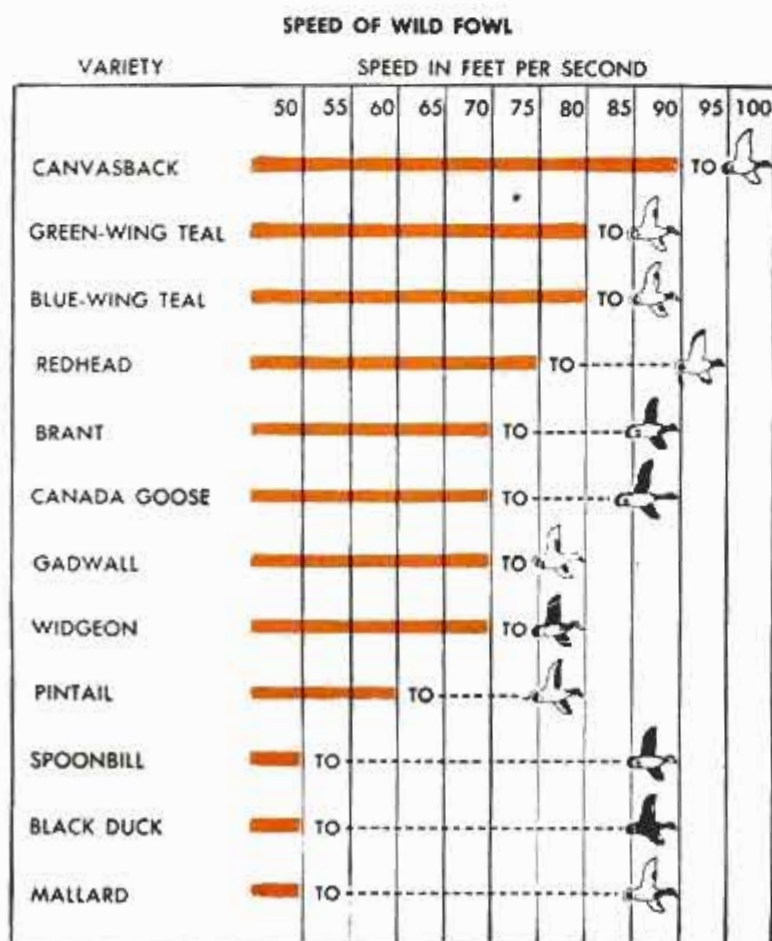

Courtesy Olin Industries

**N**O BIRD HUNTER can score every time. If he could, wing shooting wouldn't carry the challenge and excitement it holds for the thousands of hunters who take to the fields every year.

But any bird hunter, beginner or old-timer, can improve shooting and bring home more birds if he takes steps to correct his weak points. Shooting, like any other sport, calls for practice. Joe Heistand, a farmer of Hillsboro, Ohio, has racked up some of the most impressive records in the history of scattergunners. He says, "Wing shooting is like playing basketball; you don't just practice during the game."

Heistand once broke 1404 consecutive registered clay targets. It's a world record that will likely go untouched for a long time. Last year he won the coveted High Over All at the Grand American

How much to lead depends upon speed of target. Here are typical wild-fowl speeds





In one smooth, uninterrupted movement gunner should place feet, bring up gun, lead the target and fire

## **WING SHOOTING**

By George Laycock

Trap Shoot at Vandalia, Ohio. There's no doubt that he's one of the best shots in the world.

Few hunters can expect to duplicate Heistand's scores, but by checking up on what he and other top shooters have learned about gun handling they can improve their own shooting. And it pays off in hunting satisfaction—more clean kills and fewer clean misses.

"If you shoot enough," says Heistand, "hitting a target becomes almost as automatic as hitting your mouth with your fork." But there's no use shooting a lot unless you shoot properly. The time to figure out what may be causing some of those misses is before you get into the field.

Your whole body, from feet to brain, plays a part in shooting. What you're aiming to do is send a small pattern of shot out at the right time and place to intercept a target. And that takes more than just point and pull.

Your feet should be fairly close together with your right foot 12 to 18 inches behind your left. Your body leans forward slightly, your head is up and your eyes (both of

Left hand should be under gun at a comfortable distance, right elbow held high, stock against cheek

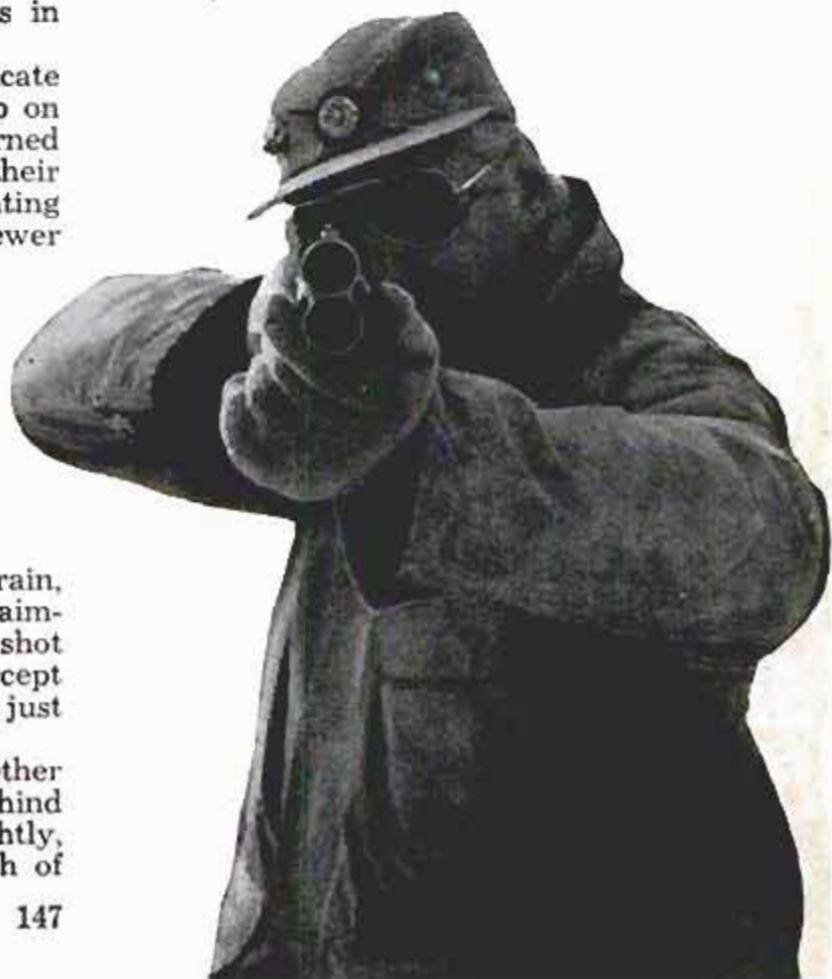





In the "pointing out" method, bring the gun up behind the target, swing through the target to the proper lead, then fire

Feet should move automatically into position, right foot 12 to 18 inches behind left. Body should be leaning slightly forward



which are open, of course) are on the target. Whether you're shooting a clay bird or a feathered target you have to be alert. "One of the most important things," says Heistand, "is to be ready to go through the motions of aiming and firing. With a grouse, for instance, you don't have much time to make up your mind."

### Relax!

Almost as important is being relaxed. This comes with practice; the more you shoot and the more wing shots you've tried, the less tense you're likely to be at the critical moment when a bird appears.

How you hold a gun is highly important to good shooting. Hold it firmly in both hands so that hands and arms absorb some of the recoil. Assuming you are right-handed, the left hand should be under the gun at a distance that feels comfortable. If your left hand is too far out you'll swing too slowly. If it's too close to your body you're likely to swing fast and unsteadily.

Your right eye should be on the target and you should raise the gun into this line of sight. The stock should rest solidly against your right cheek. Raise your right elbow so your arm is approximately parallel with the ground.

Learn to bring the gun up to your cheek instead of bringing your cheek down to the gun. Once the gun is in position, always move it and your head as a unit, so the shot will go where you're looking.

Once you've learned how to handle a gun properly, the problem of hitting fast-moving game is half solved. But the other half can cause trouble, too. Snap shooting is the technique of bringing your gun up and aiming at the spot where you estimate the bird will be when the shot gets there. A far better method is one called "pointing out" the target. Here you determine the direction the bird is flying, swing your gun to your shoulder and cheek, bring the gun up behind the target, pass on through it to get the proper lead, and fire. It's one long, uninterrupted motion. If your calculations were right, shot and bird meet.

At this point you should take a rapid accounting of other factors.





The wing shooter must be both alert and relaxed, ready to point the gun the instant the bird is flushed

Joe Heistand calls it concentration. Actually it's a combination of concentration and past experience. It's almost a sixth sense. You consider what the wind will do to a bird's speed, whether it's climbing, and where it might be headed.

#### Understand Shot Patterns

To know exactly how much you should lead a target you should first understand the pattern of the shot you're sending after it. The killing pattern from a 12-gauge full choke at 40 yards is about 30 inches in diameter. At 30 yards it's only 23½ inches. And it's within this pattern of shot that your target must fly if you're to score. The ideal range for a shot with a gun equipped with full choke is from 30 to 50 yards, for one with modified choke from 26 to 42 yards and for an improved cylinder gun from 19 to 30 yards.

Remember that you'll have to lead every moving target you shoot at unless it is moving straight away from you on an even plane. If you're in doubt about how much to lead, lead more than you think is necessary. Figure your lead from the front of the target. You don't kill a pheasant by shooting through his long beautiful tail feathers.

And of course the distance you'll have to lead your game depends also on its speed at the moment you shoot. A slow-flying bird, for instance one climbing into a head wind, may call for no more lead than half the pattern width. On the other hand a canvasback passing over with the aid of a tail wind may be way out in front of the shot unless you lead it by at least half a dozen pattern widths.

There are several methods you can use to get in a little valuable preseason prac-

tice. Skeet and trap shooting are helpful. Or you and a companion or two can take a hand trap and a box of clay birds out and throw them for each other. One advantage of this is that you can practice any shots that give you trouble.

And now with the basics out of the way you're ready for a try at the real thing. In bird hunting it always helps to have an understanding of the game and what it can be expected to do. "You have to anticipate a bird," says Joe Heistand. "You have to concentrate and expect him to come out where you don't happen to be looking at the moment. You have to be ready."

The bobwhite quail is an ideal target and a real challenge to the gunner. They're most common around the fence rows and heavier cover on our agricultural lands. Once the covey or the single is in the air, don't hurry your shots. These targets usually give you time to aim well, and still bring your birds down within 30 yards, the distance within which most quail are taken. The best size shot for quail is No. 7½ or 8.

The big, gaudy, ringneck pheasant is a tough bird to kill. You need at least a 20-gauge or bigger for hunting him successfully. Use No. 6 shot and don't shoot at him when he's beyond your maximum effective range.

When a pheasant first flushes he spends

(Continued to page 224)

#### UPLAND SHOOTING

	Shot Size
Woodcock and rail.....	8 or 9
Dove, quail, and small winged pests....	7½ or 8
Pheasant, prairie chicken, grouse, rabbit, squirrel.....	4, 5, 6, or 7½
Duck.....	4 or 6
Turkey and large furred vermin.....	BB, 2, or 4

Courtesy Oil Industries





## Giant Jigsaw Radome for Dew Line Can Be Put up in 1½ Days

Standing 40 feet high, the first ground-based laminated radome has been built for Dew Line and other radar bases. It has a 50-foot base diameter and 55-foot equato-

rial diameter. Fire and weather-resistant, the radome can be knocked down and shipped in a C-124 or C-119 aircraft, then erected by six men in 1½ days.

## Build-It-Yourself Plane Available in Kit Form for Just \$1000

You can build a plane for just \$1000. The propeller and Volkswagen engine to power it will cost an additional \$630. Able to cruise at 65 miles per hour, the craft has

wooden wings with single square-section spar to simplify construction. The plane weighs just 360 pounds and takes off and lands at 38 miles per hour.





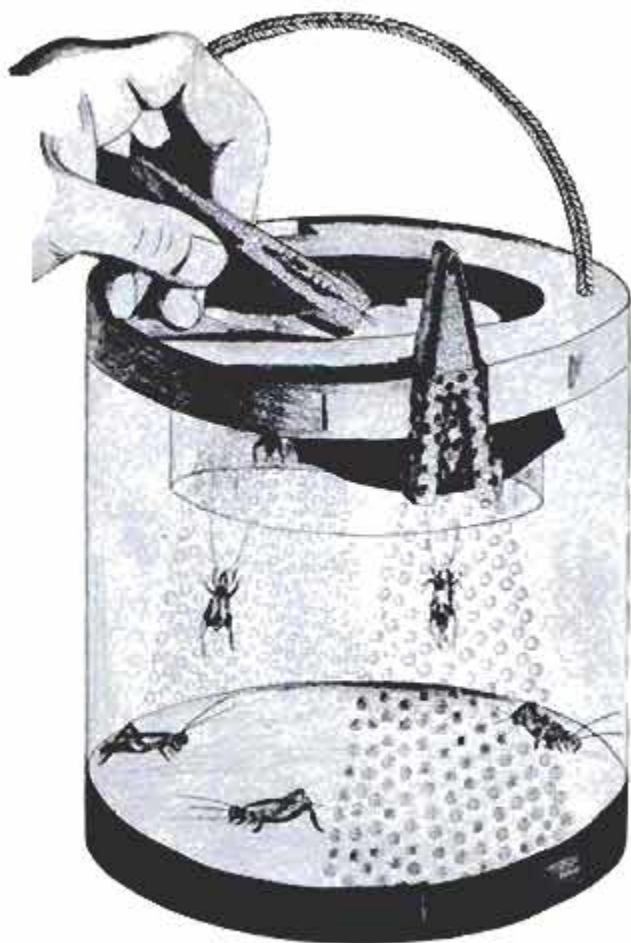

### Transparent Bait Container Lures Insects Into Tweezers

Fishermen can retrieve insects easily when using a transparent bait container. Made of a sheet of plastic, the container has two patterns of holes punched in a pyramidal shape. The holes provide ventilation and are a one-way "street" for the insects. At the top of each pyramid they enter the lips of a tweezer lined with foam plastic. The fisherman removes the tweezer and baits his line.



### Interlocking Plastic Mat Forms Into Many Shapes

Many different sizes and shapes can be formed from a plastic floor mat made in England of four-inch squares with interlocking tabs and slots, the material can be cut with a sharp knife. It comes in eight colors and is especially suitable for car and bathroom floors and for boat decks.

### Plastic Holder Guards Thermos

Safety slogans to the contrary, you can drink while driving, if the drink is coffee and it's kept handy in a vacuum bottle that fits in a holder along-side the driver. Made of an unbreakable plastic, the bottle holder slips between the seat cushions and requires no other attachment. It can be used in either the front or rear seat and will not be jarred loose by road bumps, nor will it tip on fast turns.





# Radio Television Electronics



## *Exciting New Phonograph Records Initiate* **THE BIG SWITCH TO STEREO**

*By Lothar Stern*

**I**N AN ERA boasting such world-shaking advances as atomic power, supersonic aircraft and earth satellites, the mention of a mere phonograph record may seem trivial. In audio circles, however, and to music lovers the world over, the evolution of the stereo disc and the subsequent development of suitable playback equipment is just about the biggest thing that's come along since the advent of high fidelity. For here, at last, is a popular and popularly priced record which combines the perfection of high-fidelity sound with the directional effect and spaciousness of stereo—a combination which promises to remove the last barrier between reproduced music in the home and true concert-hall realism.

To anyone hearing stereo for the first time, the effect is truly dramatic. Almost like magic the entire orchestra seems to be spread out ahead. Gone is the "point source" effect associated with single-channel reproduction. As though a wall with a small hole in the center were suddenly removed from in front of an invisible orchestra, all instruments arrange themselves in their proper relative positions—an illusion so real that the reproduction almost rivals the original rendition as heard from the best seat in the auditorium.

The mechanics of stereophonic perception are simple enough. Consider, for example, the illustration in Fig. 1 which corresponds to ordinary single-channel, or



monaural reproduction. Here a single microphone is placed in front of a large orchestra. The microphone picks up all sound and converts it into a single electrical signal. This signal is then amplified and reconverted into sound waves by a loudspeaker.

But, while a good microphone can translate a complex sound wave into an exact electrical replica, it can not differentiate between sounds coming from either the left or the right. A sound originating at the extreme left, therefore, produces the same electrical output as an identical sound originating at the extreme right. The perception of depth is interpreted merely as a change of intensity so that an instrument playing at some distance away, regardless of its position, sounds as though the instrument were playing directly in front of the microphone at reduced volume. When all sounds of an entire orchestra are converted into a single electrical signal and reproduced through a loudspeaker, the feeling of depth and all indications as to the relative positions of the various instruments are lost.

#### The Illusion of Stereo

Fig. 2 shows a somewhat similar situation involving the use of two separate microphones and two loudspeakers. Here, each microphone covers only one half of the area with some overlap in the center region. Before being applied to the speakers, however, the two individual microphone signals are mixed in a common amplifier. Each speaker, therefore, receives the composite signal as if only one microphone were employed to cover the entire orchestra. This effectively nullifies any advantage gained through the use of two microphones, but it does produce some interesting results. Since each speaker now produces the same sound, a listener midway between the two receives exactly the same signal with his left ear as he does with the right, *just as he would if the sound source were directly in front of him.* But, while the apparent source of sound now shifts to a position between the two speakers, it still contains no trace of the original orchestral "spread."

In Fig. 3 we have the conditions necessary for true stereophonic perception. Again, two microphones and two loudspeakers are employed, but this time each microphone signal is individually amplified by a separate amplifier. As a result, a listener hears the left section of the orchestra reproduced by the left speaker and the right section by the right speaker. The center section which is picked up equally by both microphones produces the same

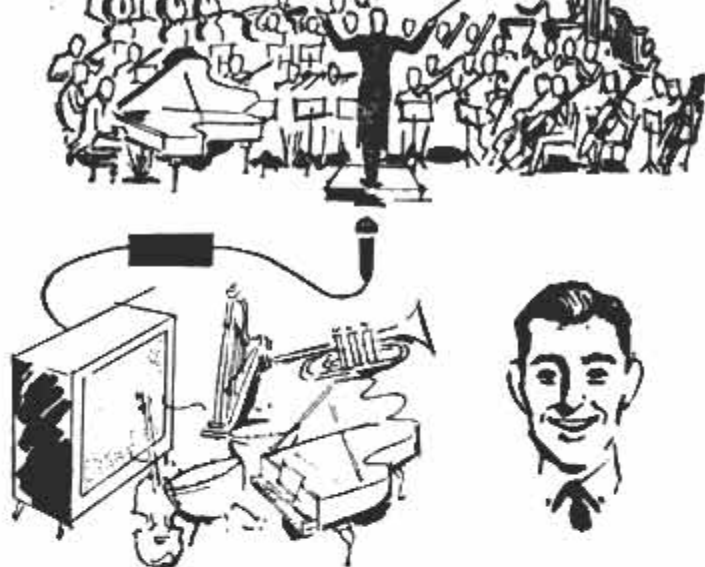

Fig. 1. In ordinary monaural or single-channel reproduction, all sounds from an orchestra are mixed and reproduced through a single speaker. A listener hears all sounds coming from a single point source



Fig. 2, above. When two microphone signals are mixed in one amplifier and reproduced by two speakers, the resultant sound is still a point source but seems to come from a position midway between the speakers. Fig. 3, below. True stereo reproduction requires two separate, independent sound channels





sound from both speakers and seems to be coming from a point directly between the two, just as though the listener were seated directly in front of the orchestra itself.

### Stereo in the Home

Stereo recordings have been with us for quite some time. In recent years all original recordings have been made on magnetic tape using two or more microphones. The output from each microphone is separately recorded on individual tape tracks and the multichannel-tape masters are used to produce commercial stereo and monaural tapes as well as single-channel discs. Today, anyone willing to invest in a stereo-tape player and pay the comparatively high price for stereo tapes can build up a sizable library of musical recordings which present the ultimate in the reproduction of recorded sound.

But sound on tape has not captured the fancy of the multitude of music lovers. The phonograph record still commands a lion's share of the high-fidelity market. And that is why the evolution of the stereo disc is causing such a stir in the musical world.

The concept of stereo sound on discs is not new. As far back as the late '30s a system was developed for recording two separate audio channels in a single record groove. The system used recorded the information received from one microphone in a lateral, left-to-right direction and the information from the other in a vertical, up-and-down direction. In playback, the

pickup cartridge separated the two channels and, feeding each signal to a different amplifier and speaker, produced true stereo sound. But the industry was not yet ready for stereo. Neither the quality of the record material, nor that of the cutting head permitted satisfactory recordings of this type and the system was shelved.

Later, an attempt was made to record stereo on discs by using two separate sets of grooves, each containing the information from a different microphone. This method required two separate and carefully ganged pickup cartridges and was so critical in adjustment that it, too, had to be quickly discarded.

After failure of the separate-groove discs, nothing was heard of stereo records for several years, but interest in stereo reproduction continued to rise. Stereo tapes became available and enjoyed increasing popularity. Radio stations began experimenting with stereo by simultaneously transmitting the same musical programs on AM and FM. The FM station broadcast the audio picked up by one microphone while, at the same time, the signals from another microphone were transmitted via AM. Stereo reception could be obtained by employing both an FM and an AM receiver. Broadcasts of this type are currently available in some sections of the country on a limited basis.

In the last year or two, a system of multiplexing two separate audio channels on a single FM carrier has received considerable attention. With this system, a single

Fig. 4. The Westrex method of cutting stereo discs: Signals from one microphone cause the cutting stylus to cut into the left groove wall, A, at a 45-deg. angle. Signals from the other microphone modulate right groove wall, B. Composite signal, C, causes simultaneous side-to-side and up-and-down groove variations

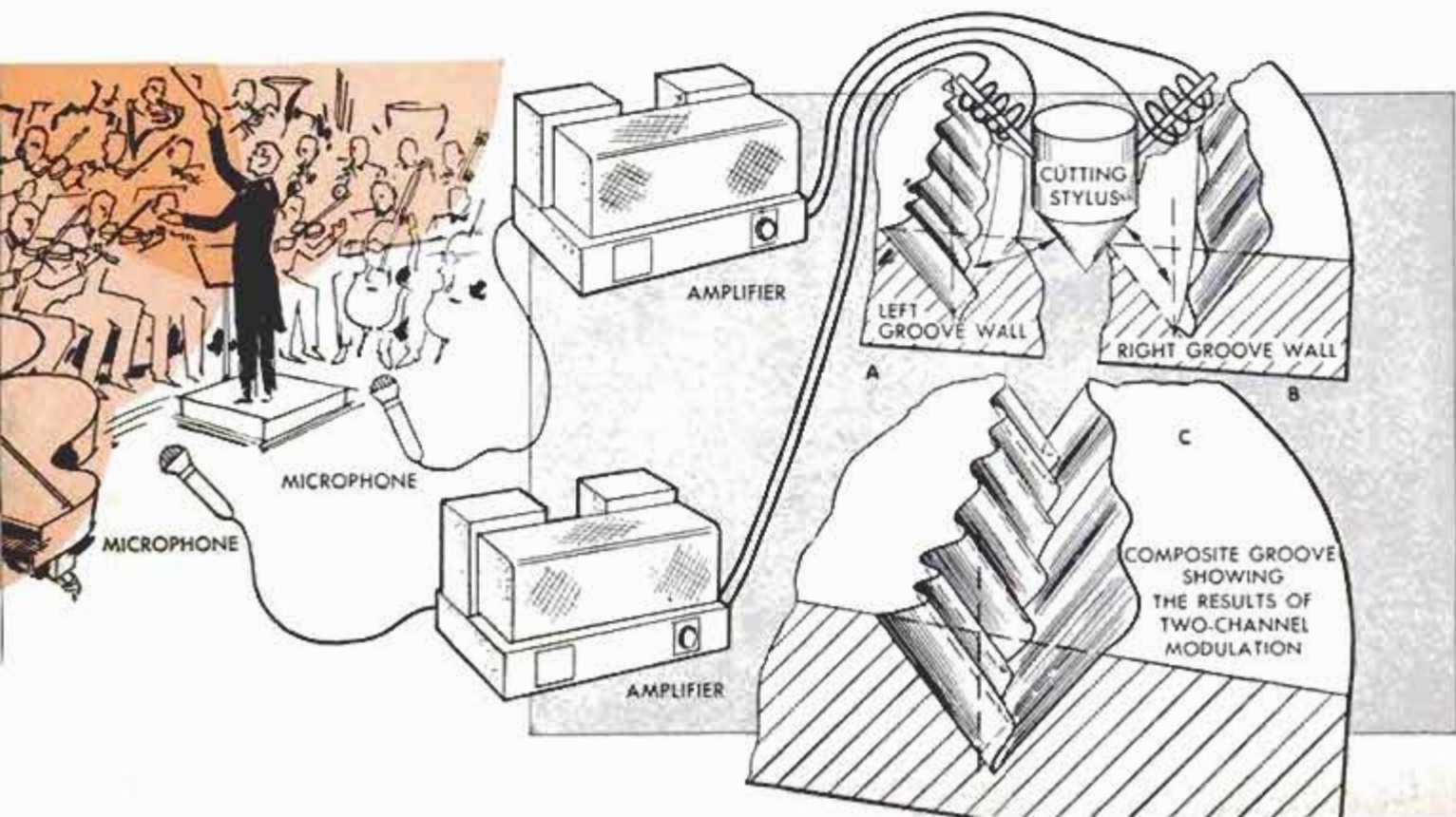



FM receiver in conjunction with an inexpensive multiplex adapter can provide stereo reception. But multiplexing, while seeming to provide the ultimate answer to stereo broadcasts, is still in the experimental stage. When and if this method will finally be adopted for popular stereo purposes still is a matter for speculation.

Finally, toward the end of last year and in the early months of 1958, the demands for a readily available and compatible source of stereo were met. In close succession several companies announced and demonstrated the successful recording of two separate audio channels in a single record groove. It seemed, for a while at least, that the public might be confronted with several types of stereo records, each requiring a different reproducing system. But this time the record industry, remembering the mistakes of earlier years, adopted a standard. By international agreement it was decided to use the system demonstrated by Westrex, the so-called 45-45 system, for cutting all stereo records.

#### How Records Are Cut

The Westrex method of recording is really a modification of the old lateral-vertical system. Instead of driving the cutting stylus in an exact vertical and lateral direction, however, the two applied signals cause the stylus to move diagonally, at 45-deg. angles. In the detail of Fig. 4, a signal applied to the left coil of the cutting head drives the cutter diagonally to the right, causing it to cut deeper into the record and, at the same time, displacing the groove in a lateral direction to the right.

A signal applied to the right-hand coil causes a similar excursion to the left. Thus, the two signals effectively modulate opposite walls of the groove and the result of combining the two actions produces a single groove which is displaced laterally as well as vertically from the norm.

The action of a typical stereo pickup cartridge is illustrated in Fig. 5. Here, use is made of two sensing elements which are mounted at 45-deg. angles. (Ceramic elements are shown here but the same theory also applies to magnetic cartridges. Both ceramic and magnetic units are currently available.) Each element produces maximum output voltage only when flexed in a direction perpendicular to its plane and is insensitive to signals cut the opposite direction. By utilizing the separate output voltages from the two elements, we recover the two separate signals initially supplied by the microphones. When these are applied to individual amplifiers and speakers, we have the necessary requirements for stereo reproduction.

#### Compatibility of Stereo Records

For complete compatibility, the stereo cartridge must be able to reproduce a monaural record as well as stereo discs. This requirement is met by present stereo cartridges without reservations. But, ideally, a stereo record should also be reproducible with a standard monaural cartridge. Here, the situation is somewhat more complicated. Normal monaural cartridges permit the stylus to move easily from left to right as is required for all monaural record

(Continued to page 228)

Fig. 5. Recovering two separate audio channels from single record groove requires two sensing elements in the pickup cartridge and two separate amplifier-and-speaker systems. Voltage output from each element varies with direction of stylus movement. Up-and-down motion produces equal but out-of-phase voltages

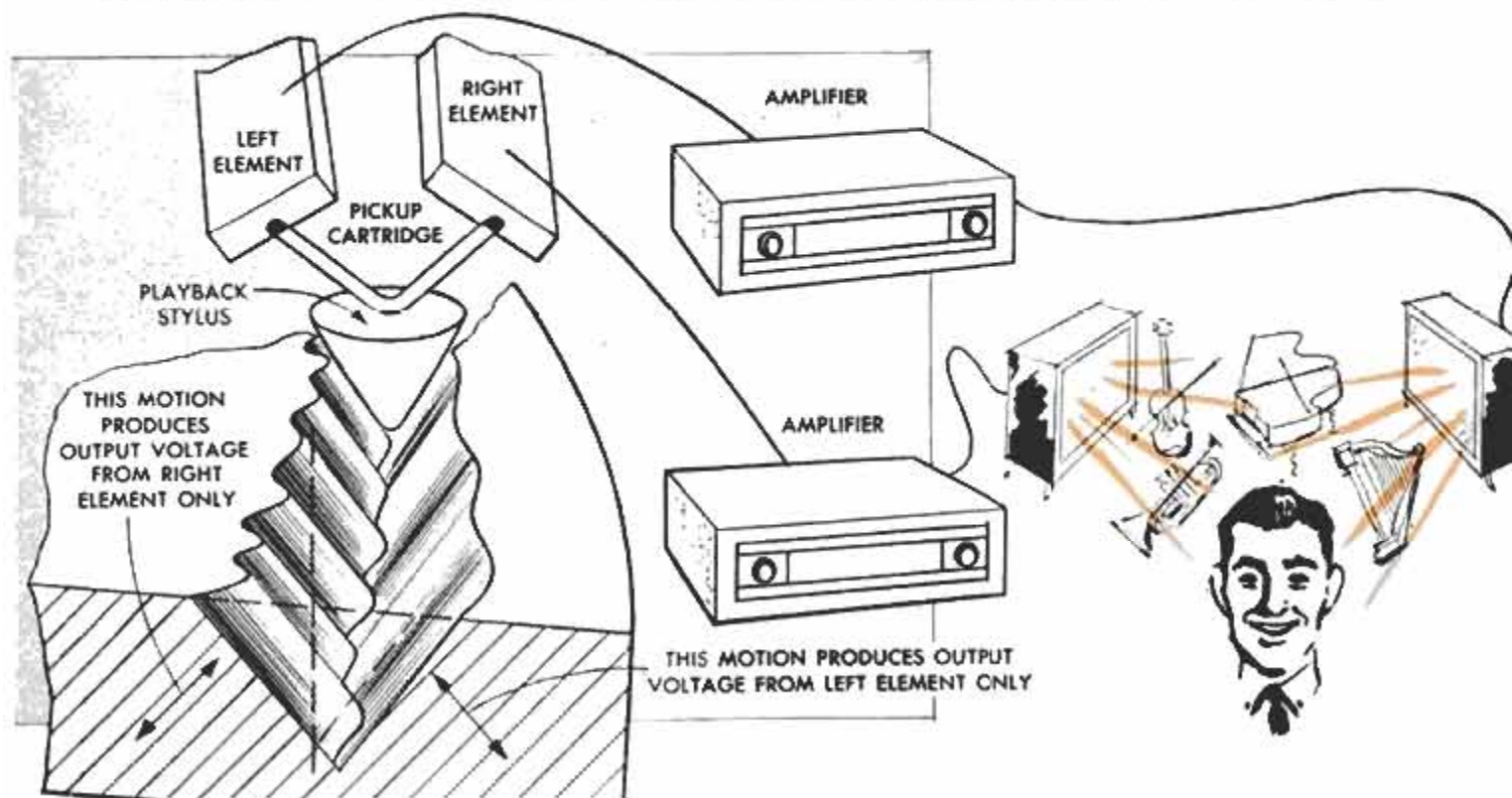





**1. NEW YORK'S PARK POLICE** will soon have a powerful new weapon for combating crime. Patrolmen demonstrate latest radio equipment which enables wearer to summon help from any spot on his beat. Transmitter, left, has a range up to 2 miles and permits instant communications with receiver-equipped officers, right, or with any fixed police radio station  
*Courtesy Radio Corp. of America*

**2. FROM MILAN, ITALY**, comes this new look in television receivers. As one of its contributions to the second U.S. World Trade Fair, Italy presents a TV set with a movable picture tube. Screen can be rotated a full 360 degrees and tilts to any desired angle for easy viewing from any position in the room  
*FIMI, VIA SAUL BANFI #1, SARGANO, ITALY*

**3. LATEST DEVELOPMENT** in home communications is featured in this transistORIZED combination intercom, radio and chime system. Used with up to eight substations, unit permits instant conversation between any rooms in the house. Radio programs may be channeled to any or all rooms and door chimes can be heard with ease from any desired location  
*The Rittenhouse Company, Honeoye Falls, N. Y.*

**4. NEW FM TUNER**, available in kit form, offers a number of "firsts" to do-it-yourself hi-fi enthusiasts. Kit includes completely wired and prealigned "front end," simplifying construction and adjustment. Novel traveling tuning indicator turns into exclamation point when station is correctly tuned in. Advancement design offers drift-free, high-fidelity performance at low cost  
*Electronic Instrument Co., Inc., 33-00 Northern Blvd., Long Island City 1, N. Y.*

**5. ENJOY HI-FI OUTDOORS** with new weatherproof garden speaker. Unbreakable mushroom-shaped top protects back-loaded professional-quality speaker and provides 360-degree tone beam. Speaker connects to any hi-fi amplifier and fits into any setting  
*Shalida Mfg. Co., 156 W. Providencia Ave., Burbank, Calif.*



# COAT AND BOOT RACK FOR YOUR HALL

By John Bergen

WHERE TO HANG the family's everyday coats, hats and boots in a place convenient to all is a problem that faces almost every household. Few homes, if any, have closet space handy to the rear entrance, with the result that youngsters' winter togs and other family wearing apparel are hung almost anywhere. Where there is space in an entry hall, a breezeway or even at the foot of the basement stairs, this "family coat tree" will provide a central place where outer wraps can be hung and stored in neat array. Not only are there racks for boots and rubbers, as well as hats and coats, but there's a roomy holder for several umbrellas.

The drawing below shows how the umbrella and boot rack is made. This part of the complete affair is designed merely to rest on the floor although it can be anchored to the baseboard or wall with a couple of screws to hold it secure. Other than the dowel rods and the panel of perforated hardboard which forms the front of the umbrella compartment, all the parts can be cut from an 8-ft. length of 1 x 10 white pine. The sides and bottom of



Located on a wall, in a breezeway or other location near the rear entrance, this coat and boot rack will provide a handy back-door spot to hang your coats

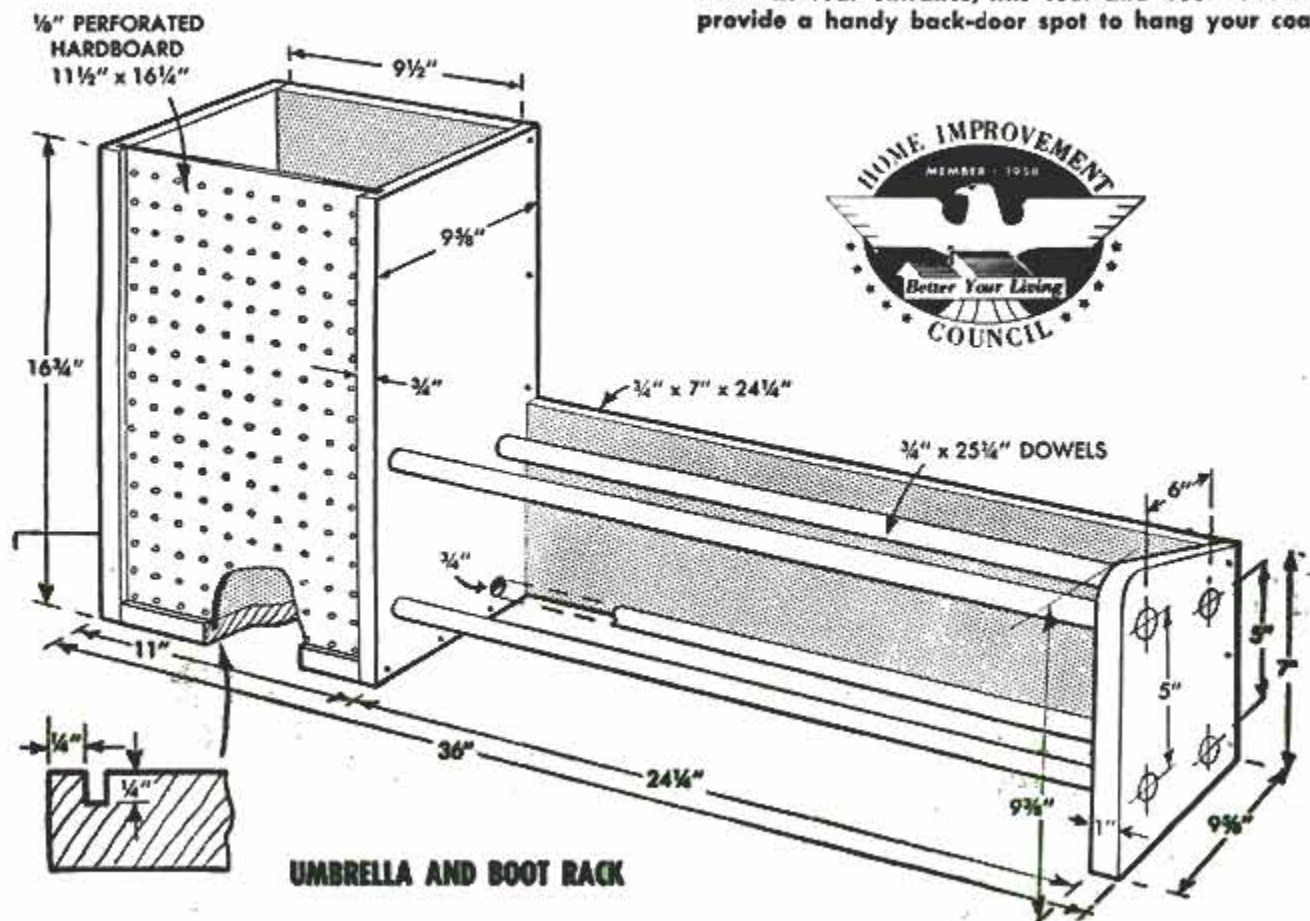



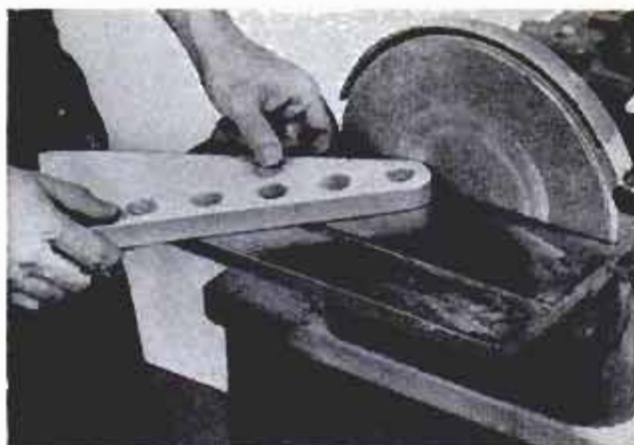

the umbrella compartment are grooved along the front edges to receive the  $\frac{1}{8}$ -in.-perforated-hard-board front which later is glued in the grooves. Holes for the  $\frac{3}{4}$ -in. dowels are bored through the end pieces and the right-hand side piece of the umbrella compartment at one time to assure identical spacing. This is done by

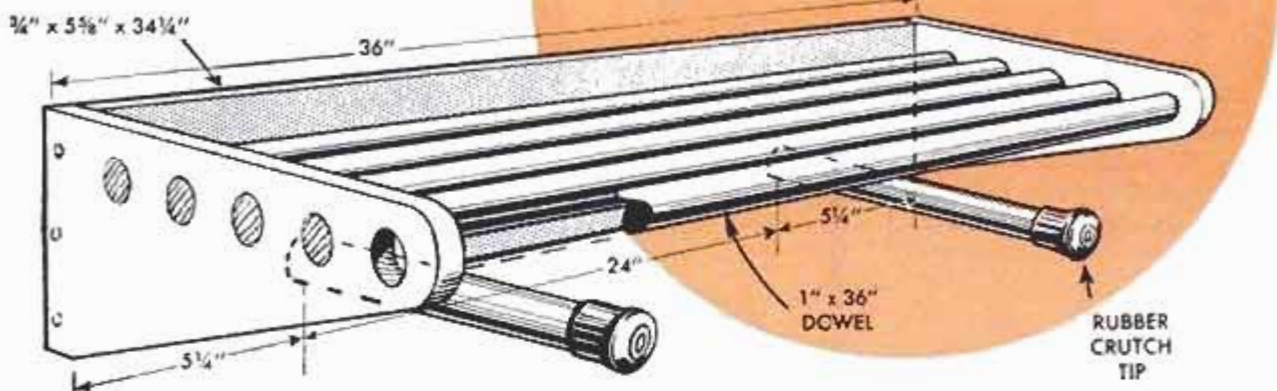

COAT AND HAT RACK

clamping or tacking the two together and boring part way from one side and then from the other to produce clean-cut holes. All the pieces are merely butt-joined, the back board of the rack being glued and nailed to the right-hand side of the umbrella compartment before the latter is assembled. This will permit nailing through from the inside surface.

brackets by driving nails down through the edges and crosswise through the dowels. Locate the rack so the hanging screws will enter wall studs, and mount it so the top of the rack is about  $5\frac{1}{2}$  ft. up from the floor. A metal tray can be placed in the bottom of the umbrella compartment to catch drippings. The units can be painted to match or contrast with the wall. ★ ★ ★

### Car-Door Light-Switch Control

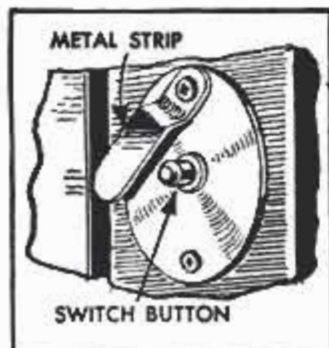

To "lock" car-door light switches in the "off" position to prevent illumination when it is desired to leave the doors open, attach a metal strip to each switch plate. — R. Smith, N. Little Rock, Ark.

### Pick-Up Pad for Small Brads

Small brads or nails are easier to grasp when they are placed on a sponge-rubber-covered wood block as shown in the detail. For best results, use cement for attaching the rubber pad to the block.

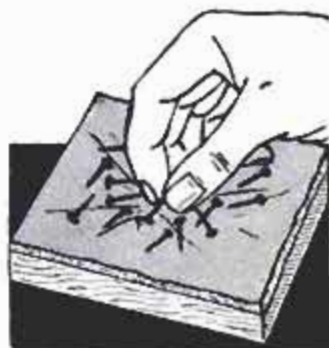



# Trammel Made From Paper Clamps and Ruler

When you need an oversize compass or trammel points, clip two paper clamps to the opposite edges of a yardstick, folding rule or a suitable strip of wood. Locate the clamps the desired distance apart and insert pencils in the holes in each clamp.

Andrew Vena, Philadelphia, Pa.

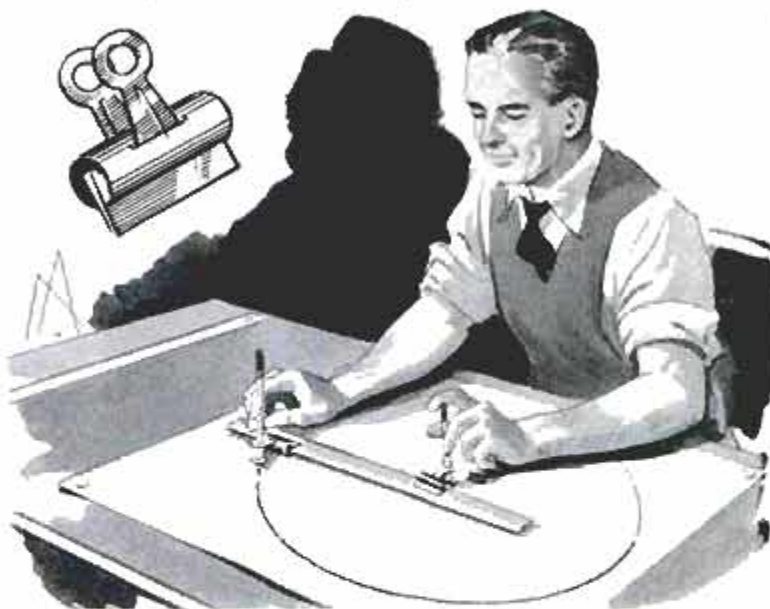

## Keep Pictures Straight

Pictures hung on a wall by means of a wire slipped over a hook will stay straight if tape is wound on both sides of the center of the wire. Allow just enough space between the tape windings to accommodate the hook.

## Ice Shell on Frozen Meats Seals in Original Flavor

Instead of just wrapping and quick-freezing fish fillets, fowl and game in the usual way, improved flavor will result from encasing the pieces in ice. For fish, pack a few fillets in a waterproof milk carton, fill it with water

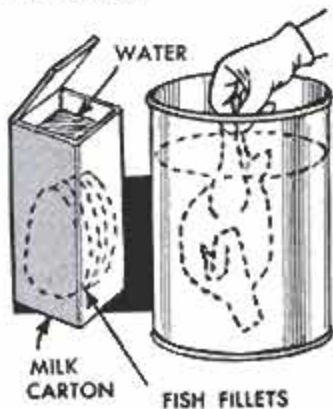

and set it in a freezer. To get equivalent results on fowl and pieces of meat, first freeze them thoroughly, then quickly dip in cold water a few times, completely immersing them to form a shell of ice.

## Paintbrush Bristles Reshaped By Storing in Cardboard Holder

Paintbrushes that have become misshapen sometimes can be restored with the aid of a "pocket" made of stiff cardboard or light sheet metal. After the brush has been cleaned thoroughly, it is fitted into the cardboard pocket and forced into proper shape. Hold the pocket around the brush by means of rubber bands or string. Wrap the shaped brush in paper and store.

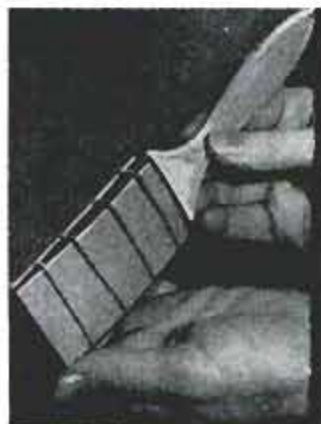

## Lamp Chimney and Pie Plate Make Hopper Bird Feeder

A novel hopper-type bird feeder that lets you see at a glance the supply of seed is improvised quickly from a pie plate, glass lamp chimney, a broomstick and a wooden cover. To refill, you simply lift off the cover. The pie plate is screwed to the lower end of the broomstick after the latter is first drilled crosswise for a smaller dowel on which the chimney rests. A hanging screw eye is driven into the upper end of the broomstick and then a wooden cover, drilled to slip down over the screw eye and broomstick, is fitted with short pieces of half-round molding to center the chimney on the cover.

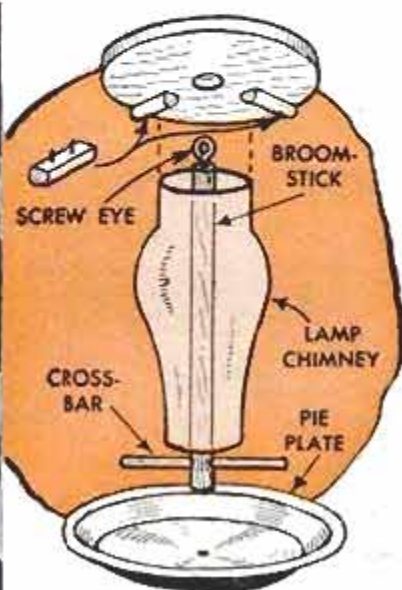
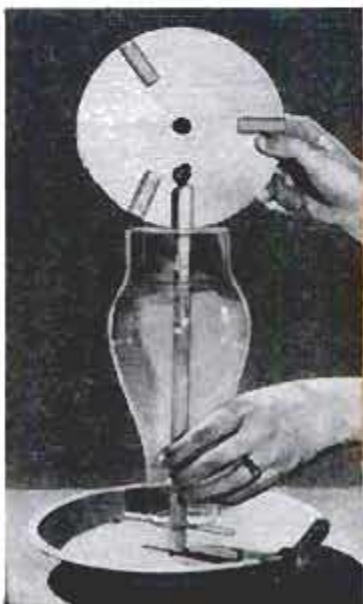



X 627

# SNOWMOBILE

By Wayne M. Judy



Changing the versatile Merrymaker from a snowmobile to a "self contained" trailer that can be hauled at highway speeds behind a car takes only minutes

FOUR WINTERS of hard use around International Falls, Minn., and also in neighboring Canada have proved the Merrymaker snowmobile to be a practical, rugged vehicle ideal for cold climates. The thrust of a propeller driven by a Continental aircraft engine drives the vehicle over snow and ice and, when it is necessary to transport the snowmobile over dry highways, it becomes a "self contained" trailer. In about 15 minutes two men can remove the three runners, install two wheels and the unit hooks to a trailer hitch on a car for quick change of locations at highway speeds. The easy transition from snowmobile to trailer was made possible on the original because it is built on a modified boat-trailer frame. Although it is possible to build the snowmobile from the ground up by using the dimensions and drawings in this article, the modified trailer, which includes the steering mechanism and adjustable clamps for holding the mount of the aircraft motor is available from the Otto P. Miller Trailer Co., Almena, Wis. Use of the modified trailer will considerably simplify construction and save time.

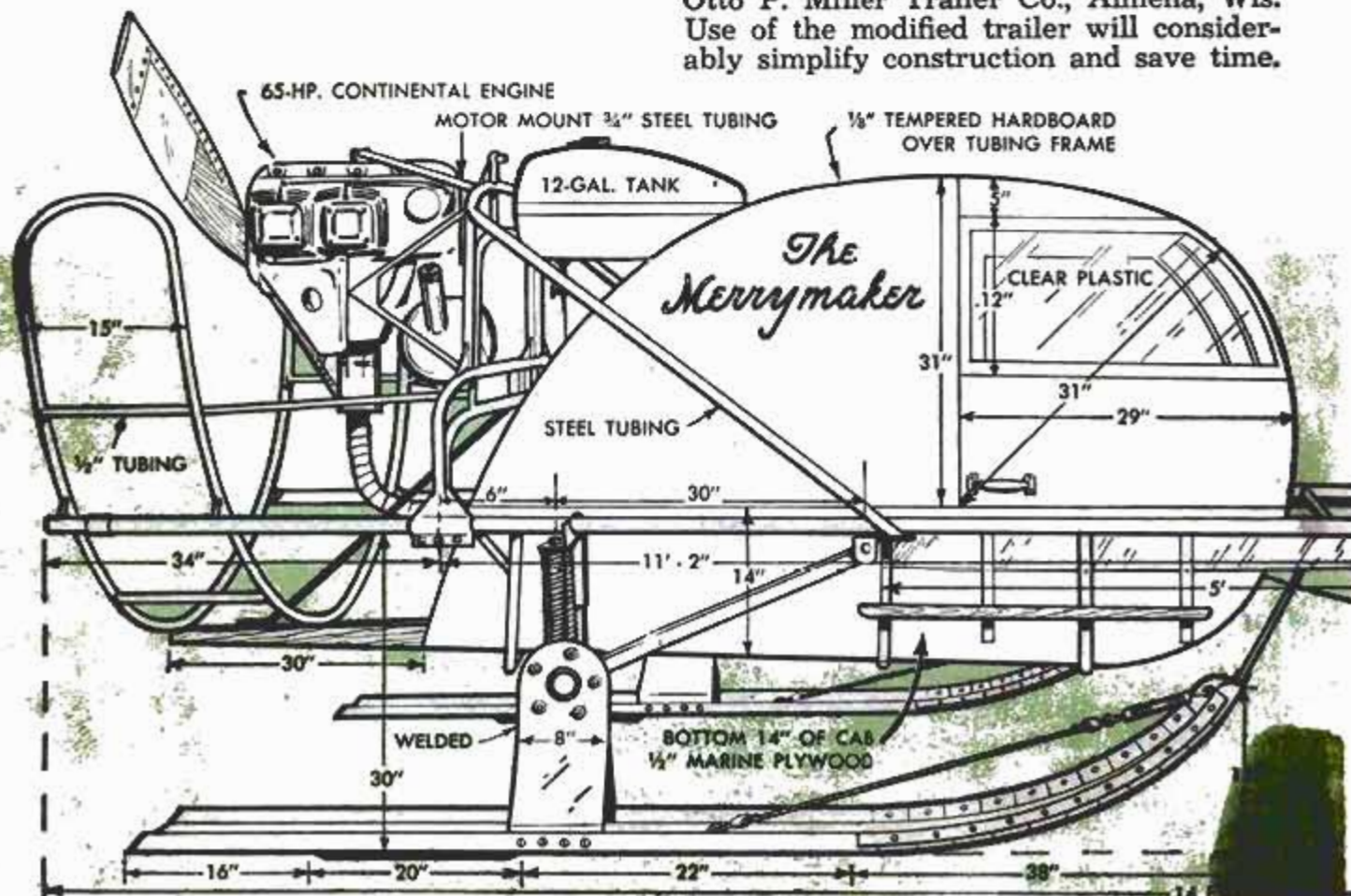





Standard Ford automobile wheels will fit the trailer hubs, and the runners are made to fit on the same hubs. The cab of the snowmobile is made by screwing sheets of hardboard to a frame welded from thin-wall conduit. The lower portion of the cab, as indicated, is made like a boat, of  $\frac{1}{2}$ -in. marine plywood, so the snowmobile will float if it should break through ice and drop into water. Because the greatest amount of weight—the engine, runners and cab—are located to the rear of the vehicle, it will sink down toward the rear.

For this reason it is suggested that the joints at the rear of the cab be sealed with strips of glass-fiber cloth saturated with epoxy-resin. The complete snowmobile with full gasoline tank weighs 840 lb., the "boat hull" portion of the cab will support about 1700 lb. The brake on the steering or "tiller" runner is operated by a heavy nylon cord from the cab. It is slack enough to allow a full swing of the runner. Control of the front runner is by means of cables and a steering-wheel-and-drum assembly designed for a boat. The throttle control

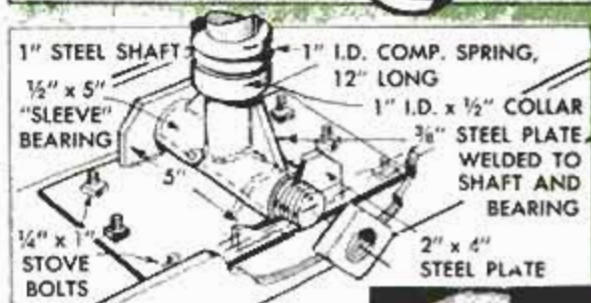
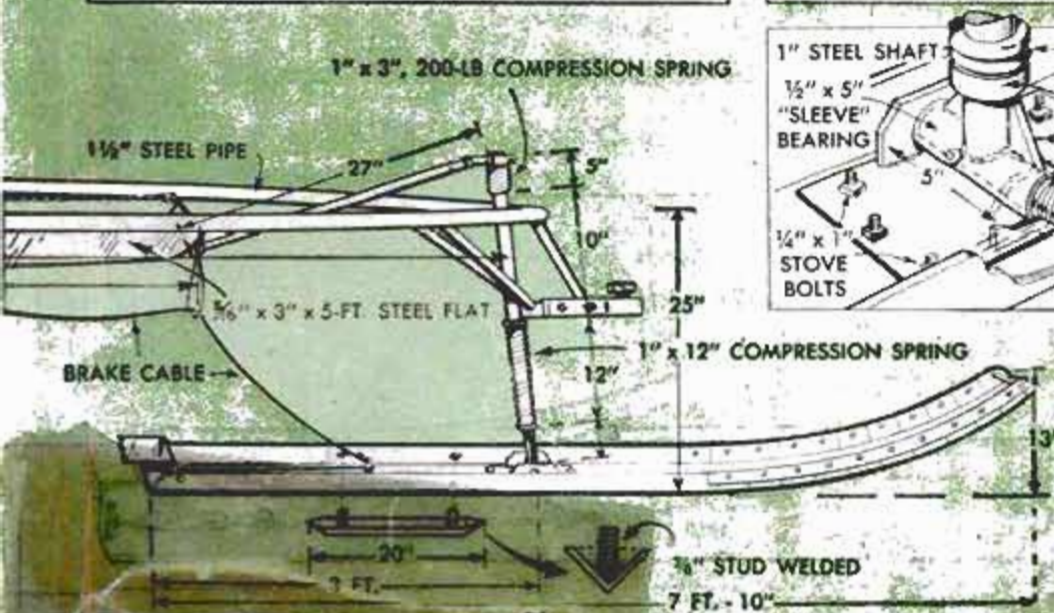
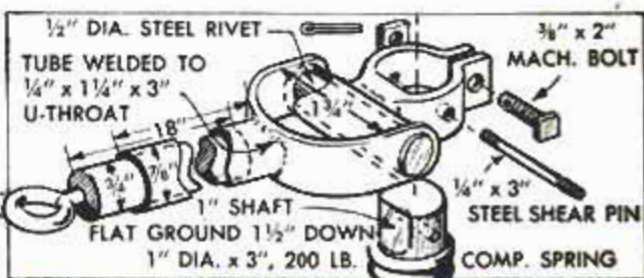
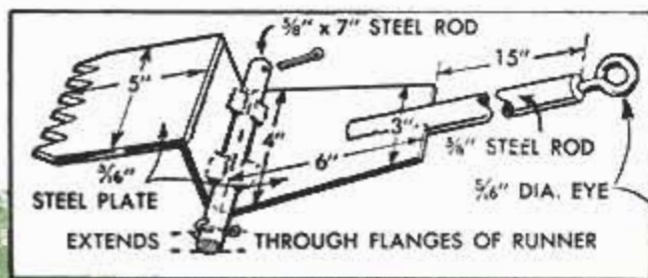



# The Merrymaker **SNOWMOBILE**

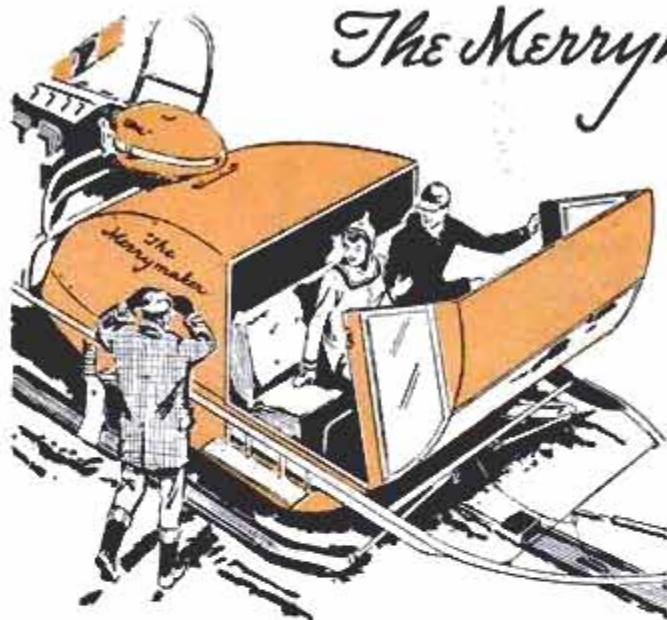

from them with a hammer. Wooden runners would require a lot of scraping.

The bends in the runners are made by first cutting a series of slots  $1\frac{1}{16}$  in. deep,  $1\frac{3}{4}$  in. apart. Steel cables and turn-buckles are used to pull the curves into the runners and hold them. When the forming is complete, a  $\frac{1}{8}$  x  $1\frac{1}{4}$ -in. flat-steel strip is bolted to the outside of each flange to strengthen the bent metal. If cold-forming equipment is available, the notching is not necessary. The turnbuckles and cables are needed on the side runners to counteract the strain of the "tie rods" that run from the tips of the runners to the cross member ahead of the cab. The forward end of the cab that tilts to permit entrance is fitted with a piano-type hinge across its full width. Neither generator nor starter is used, in the interest of saving weight. The engine starts at 40 below zero by hand-spinning the propeller, the twin-impulse magnetos of the engine furnishing excellent ignition even under the extreme temperature conditions on the Canadian border. No heater is used on the original, both to save weight and because it would produce a misting and frosting

also is the type used in a boat, and is spring-loaded to close automatically when released. All three runners are shaped from No. 6061-T6 aluminum-alloy channels. The channels are 7 in. wide with  $2\frac{1}{8}$ -in. flanges, and have a web thickness of .230 in. Aluminum is used for the runners rather than wood, as the metal polishes smooth with use, and ice can be knocked

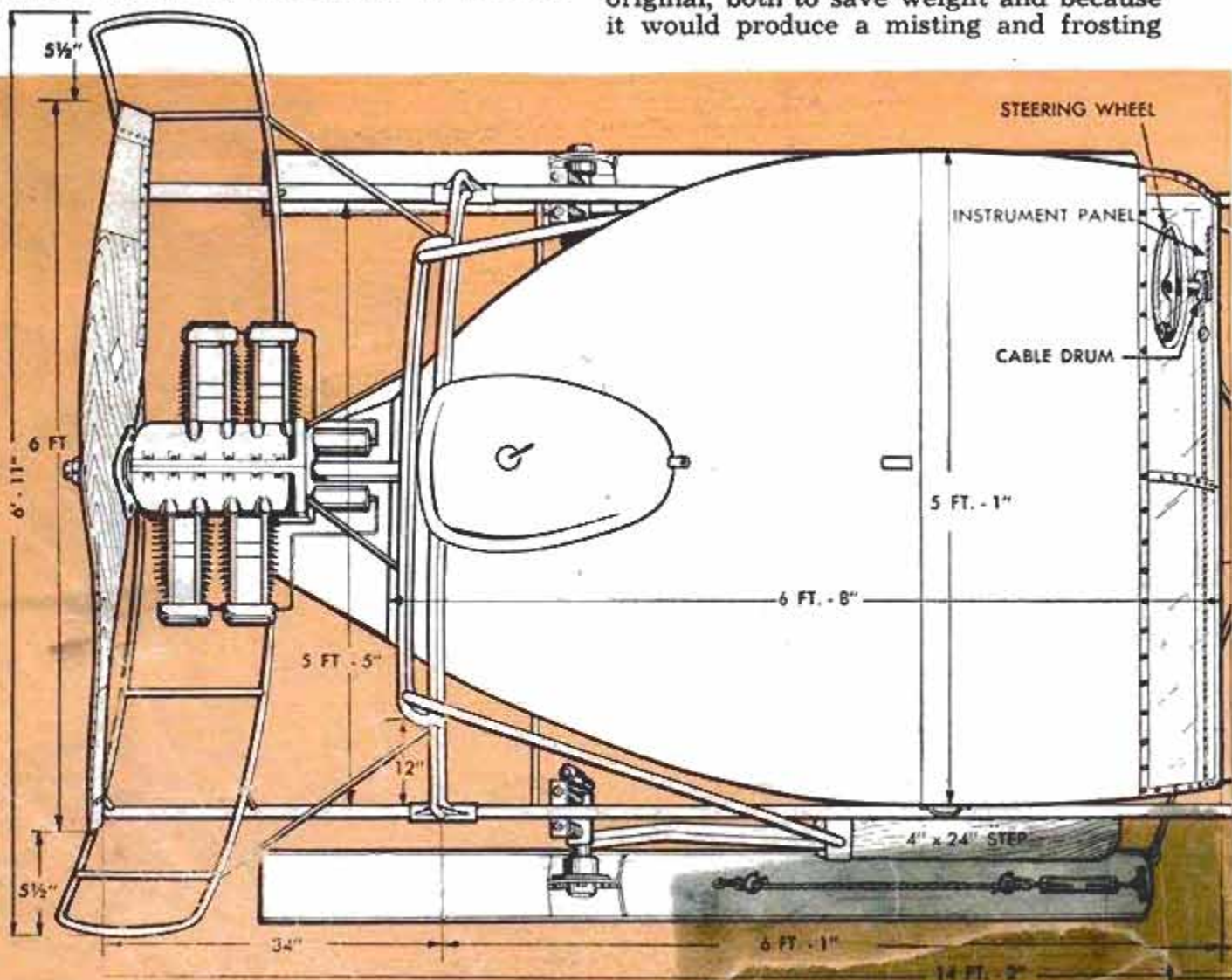





Above, with runners on auto-top carrier and wheels on the hubs of the Merrymaker, the snowmobile is trailered to new location. Below are shown details

of side-runner "tie rods" and suspension system for the hubs. Suspension system is part of unit when trailer is purchased from the manufacturer

problem on windows and windshield. It is possible that a heater drawing fresh air from outside the cab would eliminate the frosting problem. Items such as this will require experimentation by individual builders. The gasoline tank is the type used on farm tractors and has a capacity of 12 gal. A power propeller is used, being 72

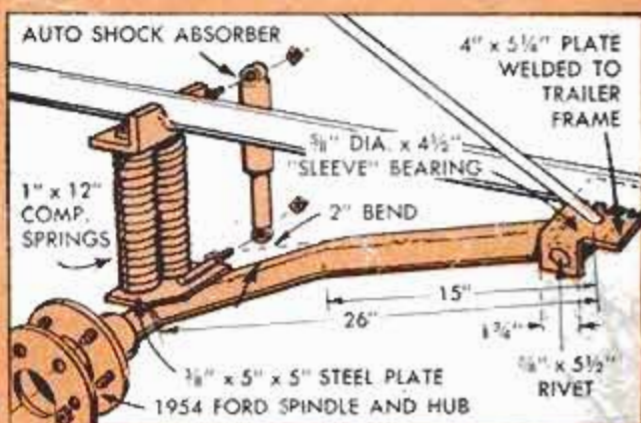
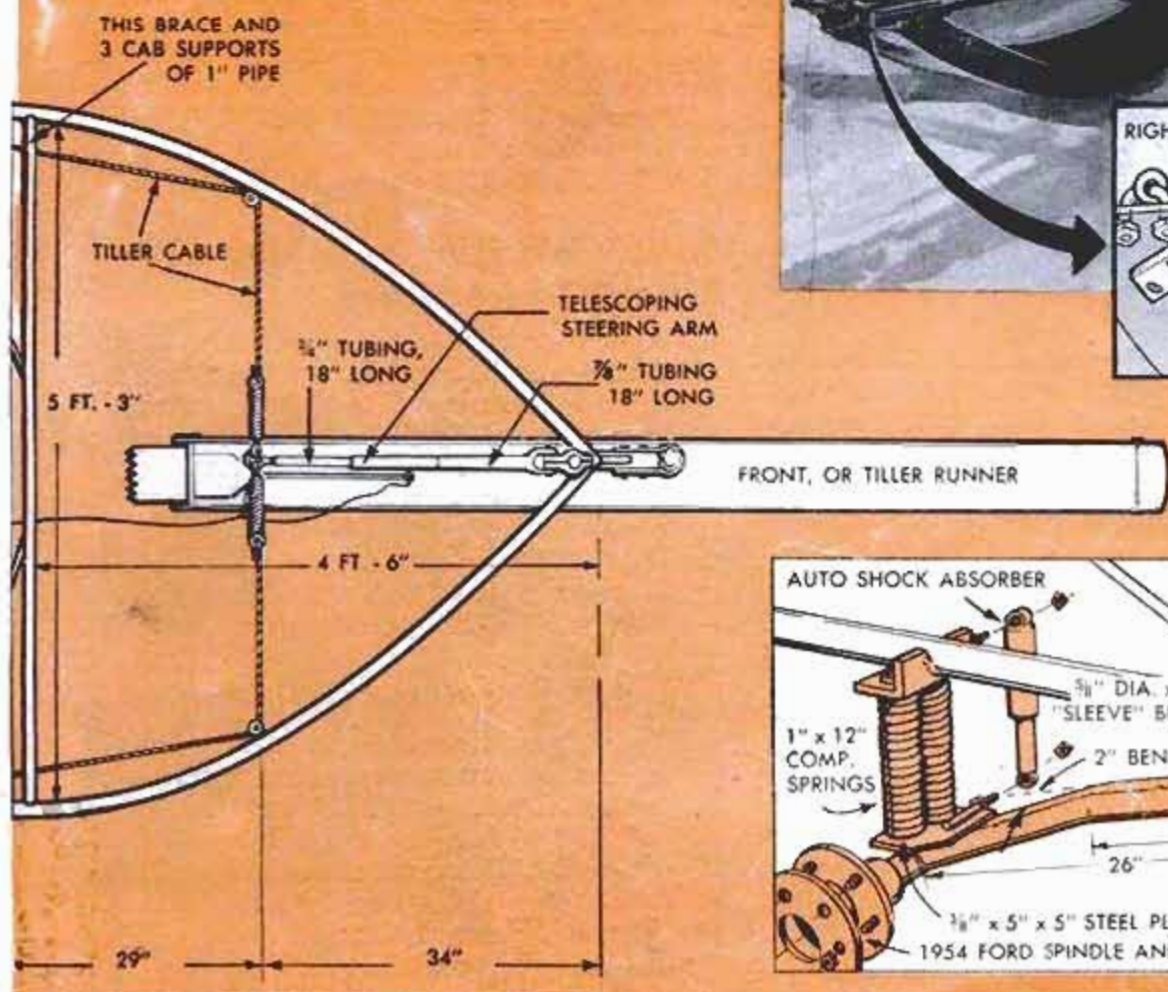
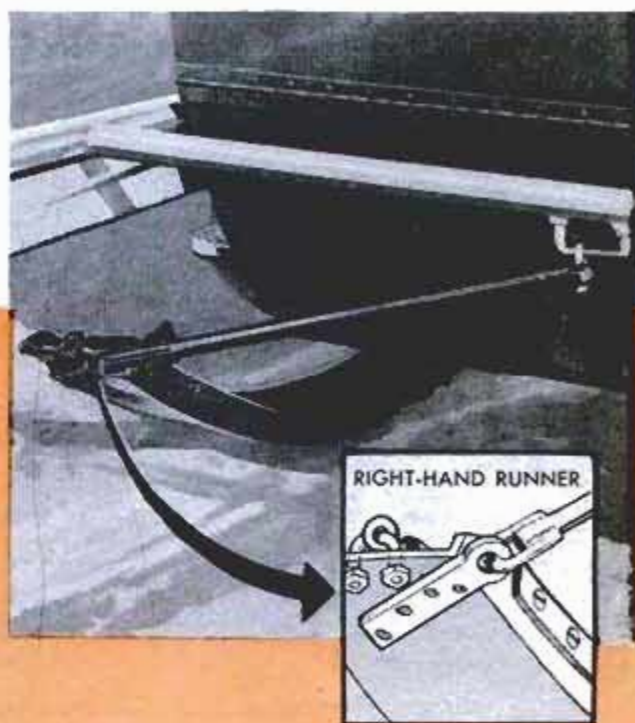



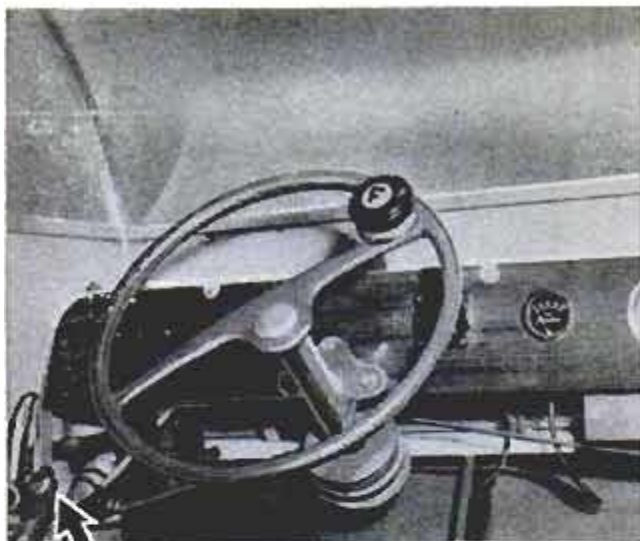

Above and left, steering and throttle mechanisms are types used in boats. Throttle is spring-loaded so it closes when released. In photo below, exhaust is piped through cabin to provide heat. Heater was removed as it caused frost on windshield

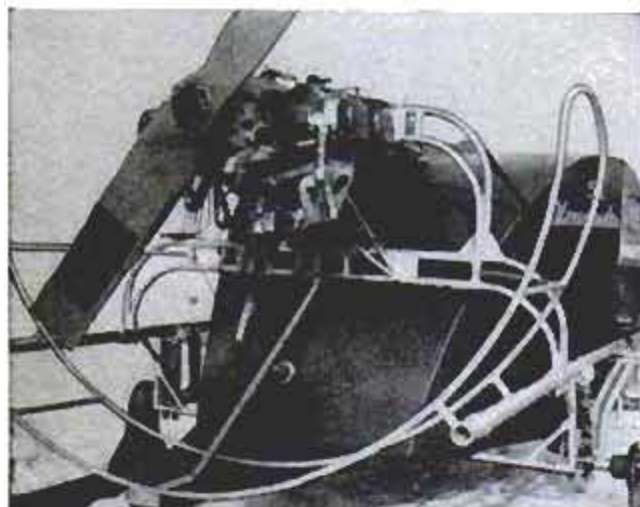

in. long, with a 24 pitch and stainless-steel tips. Banks-Maxwell has this propeller under catalogue Number 670-24. The instrument panel of the cab is a piece of hardwood 5½ in. wide and 60 in. long. It is held in place by a length of ½ x ¾-in. aluminum flat. The bottom edge of the panel is 20 in. above the floor, and there is a tool compartment in place of the usual glove compartment in an auto instrument panel. Auto seats can be used in the Merrymaker to permit seating 4 or 5 persons, although these seats are fairly heavy. Light tubing and plywood could be used to make lightweight seats with foam-rubber cushions. If the snowmobile is to be used as a work vehicle, a single seat for the driver is all that is needed, the rest of the cab being left open for cargo space. Stretchers convert snowmobile to an ambulance. ★ ★ ★



### Adjustable-Height Sack Holder Speeds Filling With Shovel

Sacks can be filled quickly to any height when clamped to this adjustable holder. The base of the holder is a section of wheel rim to which a length of pipe is welded. A smaller pipe that "telescopes" inside has a U-shaped bracket of flat steel welded to it. Four spring-type battery clamps bolted to the bracket hold the sacks. A bolt fitted in holes drilled in the pipes adjusts the height of the holder. To prevent mislaying the bolt, it is held by a length of chain.

### Correct Warming of Engine Protects Valve Lifters

Never race a cold engine, but let it run at fast idle, as determined by the automatic-choke mechanism. This lower speed allows time for oil to circulate completely through the engine. This is especially important for hydraulic valve lifters, because running an engine at high r.p.m. with partially filled lifters could force the plungers into a cocked position in the lifter bodies.

Champion Spark Plug Co.

### Plywood "Plastered" With Paint

If you have a ceiling or wall of plain plywood that you wish to give a plastered appearance, here is an easy method: Paint the surface with a texture paint, brushing it on heavily. Then, carefully "trowel" the surface with a flat sponge while the paint is still wet. When dry it will appear to be a plastered surface.



# DUSTPROOF WALL CABINET

YOUR DELICATE china and other such treasured pieces of art glass, antique ceramics and porcelain will be protected from dust and damage when displayed in a wall cabinet with sliding glass doors, such as the one shown. This cabinet was made of mahogany lumber but any other suitable wood may be used following the construction details shown below. The top and bottom of the cabinet are identical, and assembly is with glue, screws and dowels. Note that screws alone fasten the bottom to the sides and back so that it can be removed to replace the glass doors, should they break. Two mending plates are screwed to back of the cabinet, spaced to permit hanging it on screws or nails driven into wall studs.—Hi Sibley, Nuevo, Calif.

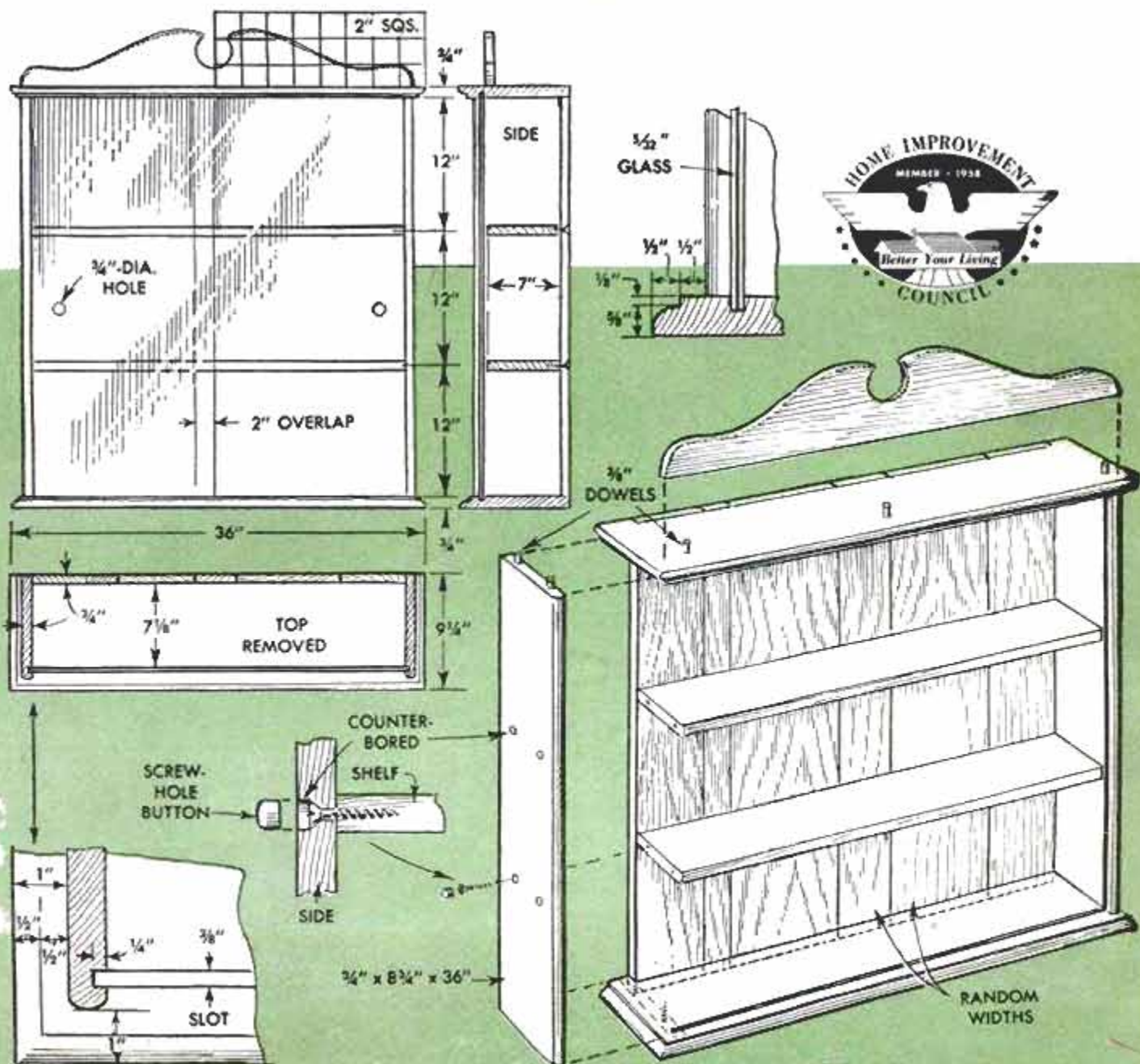



# PHOTOCOPYING *the Easy Way*

By M. Glicksman and R. Schachat

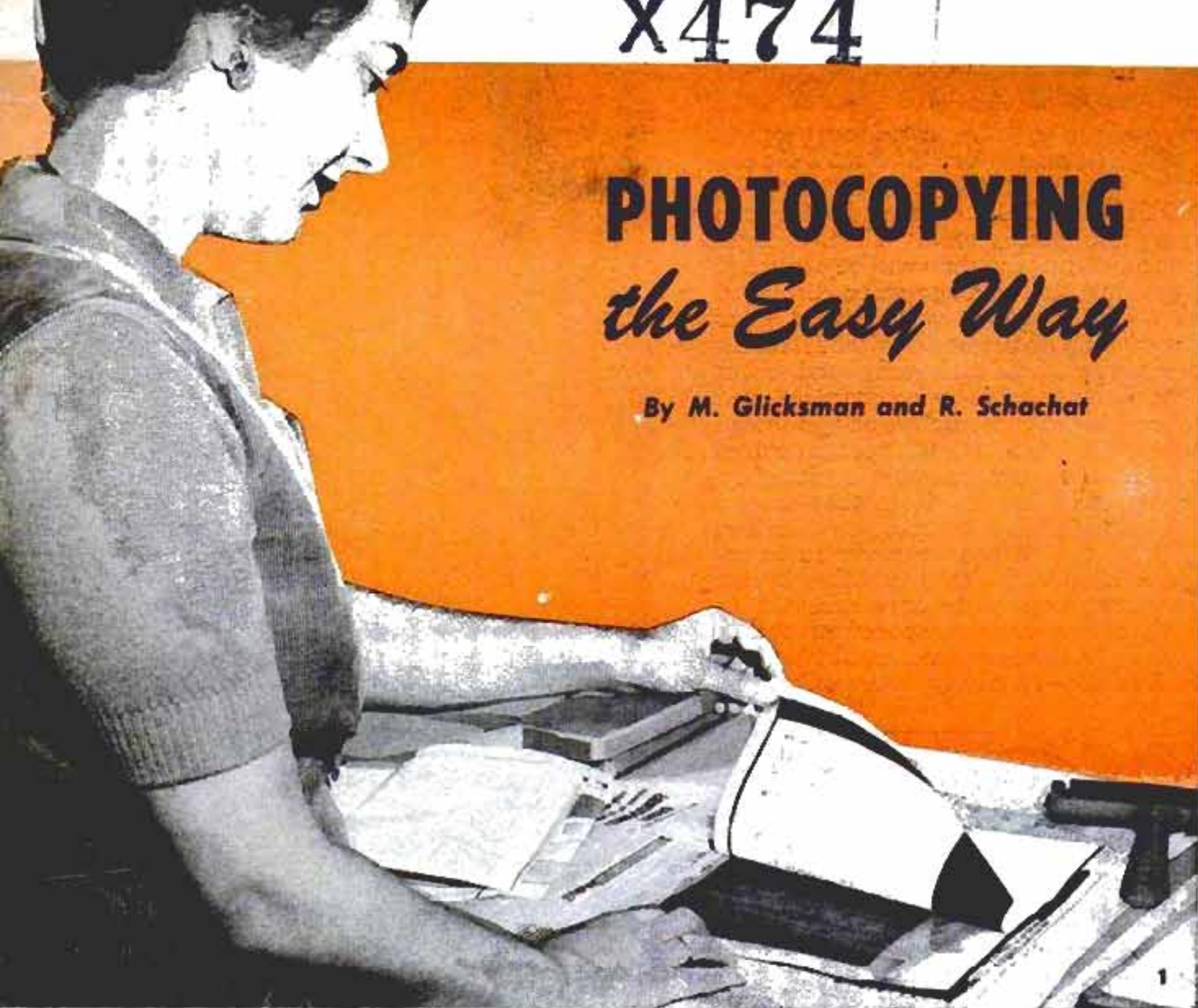

After thorough rolling of negative-positive "sandwich," image is transferred to the positive photocopy

Large-size print-exposure box consists of shallow metal box with six porcelain receptacles screwed to bottom and sheet of opal glass mounted on top

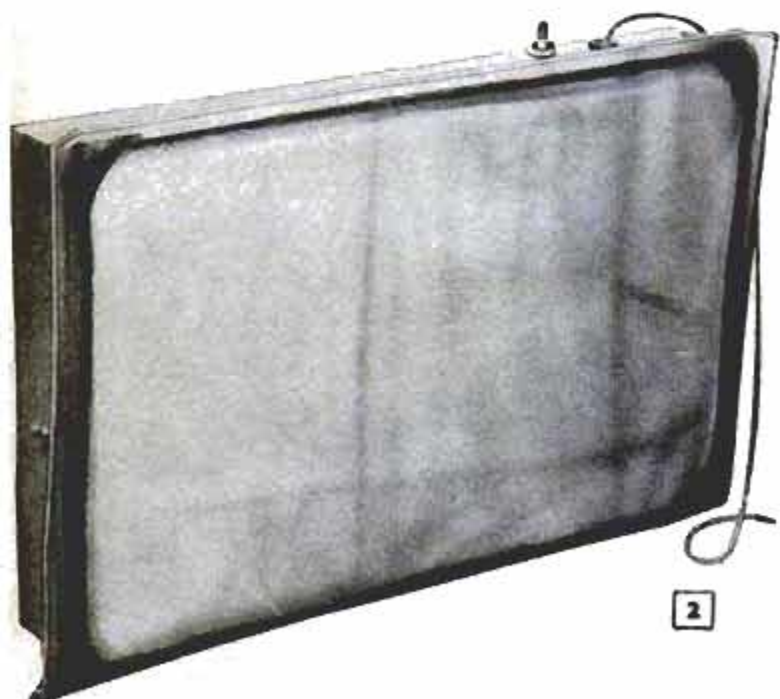

**H**ERE IS A FAST, inexpensive method of making photocopies of important papers, business letters and other items, using a contact-printing box and photocopy paper and developer instead of a complicated camera setup or expensive photocopy equipment. The latter is suitable only for large-volume commercial operations. If you do not have a photographic print box that will take the standard 8½ x 11-in. sheet of typing paper, a suitable one can easily be made from plywood or light-gauge sheet metal, a sheet of opal glass and 6 to 10 porcelain light receptacles and an equal number of 15-watt lamps to be mounted inside. A switch is installed on one side to permit accurate control of exposures. Processing materials that you'll need include high-contrast photocopy negative paper, photocopy positive paper and suitable developer for these papers. The only darkroom equipment needed are developing trays, print tongs, rubber roller and a timer.

Exposing and processing of photocopy papers may be done in any room where



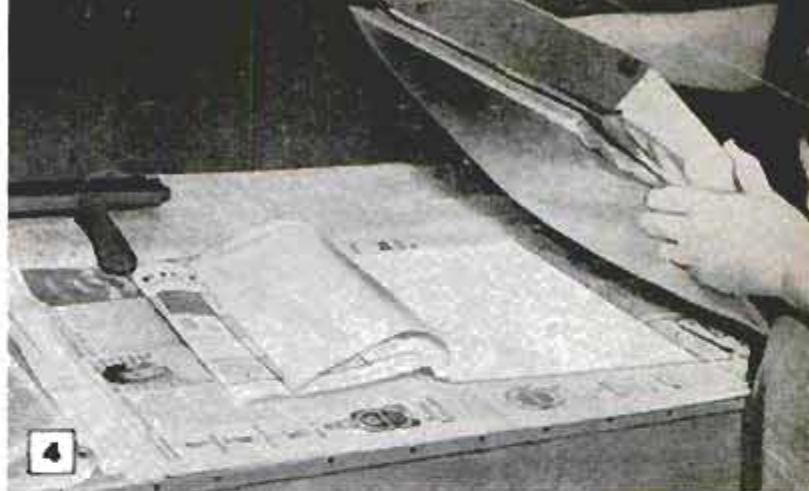
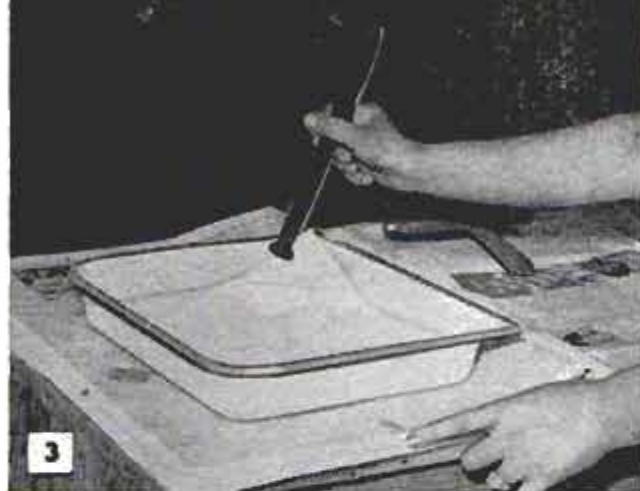

there is no strong light. The first step of the procedure is to place a sheet of positive paper emulsion-side down in a tray of developer and agitate it, Fig. 3. After the paper is thoroughly saturated, it is turned over and left in the tray until needed. Next, the item to be copied is placed on a flat surface and a sheet of negative paper is placed emulsion-side down on it, as in Fig. 4. If the material to be copied is printed on thin paper, it may be necessary to place a sheet of black paper under it to prevent printing on the reverse side from showing through. Then, the printing box is placed on top of the negative paper and an exposure of 10 to 20 seconds is made, depending upon the sensitivity of the paper used and intensity of light source, Fig. 5. After making a few trial exposures, you will be able to determine the correct exposure time for the materials and equipment used. Use test strips when making the trial exposures, and completely process them so they can be mounted on cardboard and the exposure time noted under each. This record may then be used as a reference for photocopying to be done at a later date.

Fig. 3. Positive photocopy paper must be well saturated with developer to assure good print. Fig. 4. Material to be copied is placed on flat surface to obtain complete image when negative is exposed on it



The exposed sheet of negative paper is then placed emulsion-side up on a "pad" of newspapers and the positive paper is removed from the developer. After allowing the latter to drain for a few seconds, it is quickly placed emulsion-side down on the negative paper, with care taken not to drop water on it. Finally, the two sheets are heavily rolled 5 or 6 times to assure complete contact between them as in Fig. 6. After remaining in contact for about 45 sec., the negative and positive are peeled apart and the latter is dried emulsion-side up on the newspaper pad, Fig. 1. If the positive print shows no image, or one with little contrast, decrease the negative exposure time. Should the positive print turn out black, or with white areas that are too dark, increase the exposure time. To correct for a brown-tinted positive, increase the contact time of the negative-positive sandwich. Photocopies that are to be stored longer than a year, should be washed for 10 min. before drying. ★ ★ ★

Above, pressure is applied to print-exposure box to keep all areas of slightly curved surface of book page in contact with it. Fig. 6. Pad of newspapers absorbs water rolled from negative-positive "sandwich"





## Warped Plank Door Straightened by Installing X-Member

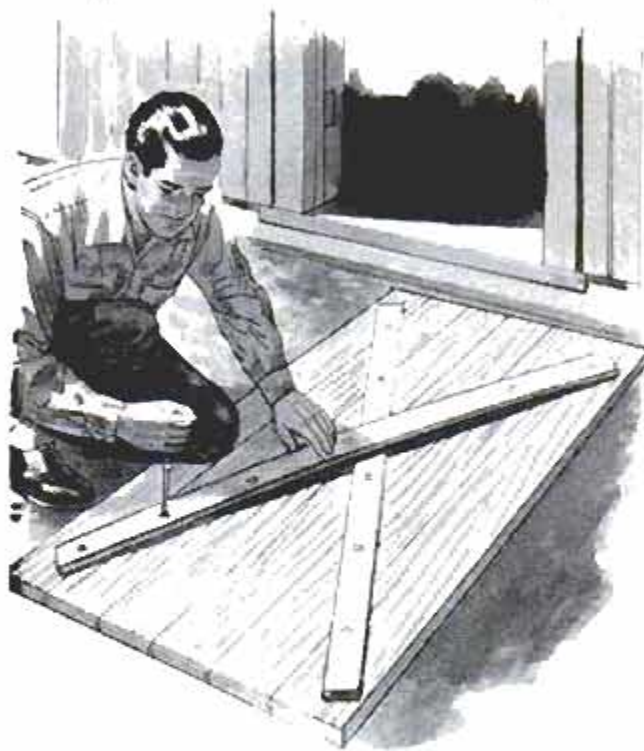

When doors that consist of a number of planks joined edge-to-edge vertically become warped diagonally, they can be pulled flat by installing an X-member of 1 x 2s. The first length of 1 x 2 is screwed across the diagonal that is flat, using a screw in each plank. Over this is fitted another length of 1 x 2 to form the X-shape. The latter member is screwed to the door planks, using one or two screws to each plank as necessary. Start driving the screws from the center of the brace outward, and retighten them several times.

George M. Glavosek, Columbus, Ohio.

## Coal for Scale-Model Trains

Consisting of black, shiny grains, the grit used in sanders designed for automobiles is an ideal size and color for use as coal on a scale-model train layout. The grain size is good for either HO or O gauge, simply representing different grades of coal for each gauge. — Charles E. Cohn, Chicago.

## Sources Other Than Ignition Cause Noises in Car Radio

Before installing additional suppression in the ignition system to remove noises in an auto radio, check other possible sources of interference. A high-pitched whine that varies with engine speed is caused by the generator. If the engine is cut off—radio on—at moderate speed, the whine will persist until the engine coasts to a stop. This condition is corrected by installing a by-pass capacitor between the armature terminal and a ground. (Do not connect it to the field terminal.) Noise caused by the voltage regulator is an irregular, rasping sound that is the result of arcing between the contacts. This sound will disappear below the charging cutout point of the regu-

lator (when the red light goes on, or the ammeter shows no charge) and can be eliminated with a by-pass capacitor at the battery terminal on the regulator. Front-wheel noise occurs usually only in dry weather at speeds over 15 m.p.h. The irregular popping or "rushing" sound generally disappears when the brakes are lightly applied. Static collectors in the hubs or special graphite antistatic powder in the tires solve this problem. A hissing or crackling that occurs when bouncing disturbs the level in the gasoline tank is eliminated by a capacitor across the gasoline-gauge resistance element to a ground.

Champion Spark Plug Co.

## Modified Corner Framing Saves Time and Lumber

Instead of framing the outside corner of a building or room in the conventional manner, with three 2 x 4s plus a 2 x 2 blocking, install the corner members as shown. This method saves time and lumber, and the resulting assembly provides a more rigid set of nailing surfaces than regular construction.

N. M. Pittman, Overton, Tex.

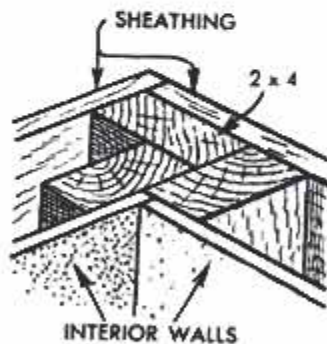

## Garage-Door Weather Stripping Replaced With Heater Hose

After twice replacing rubber weather stripping all along the bottom edge of his steel overhead garage door, one homeowner installed a longer-lasting, much less expensive weather seal. A length of auto-heater hose was slit lengthwise, fitted over the door edge and held in place with sheet-metal screws.

Herb Carrier, Detroit, Mich.

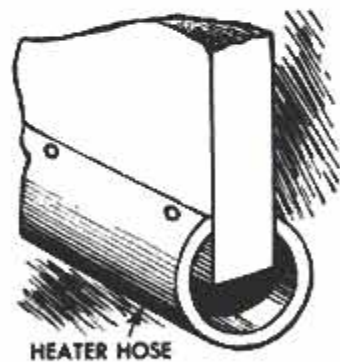



# This Sidewalk Prairie Schooner

will add a touch of realism when your young "wagon master" heads his train west

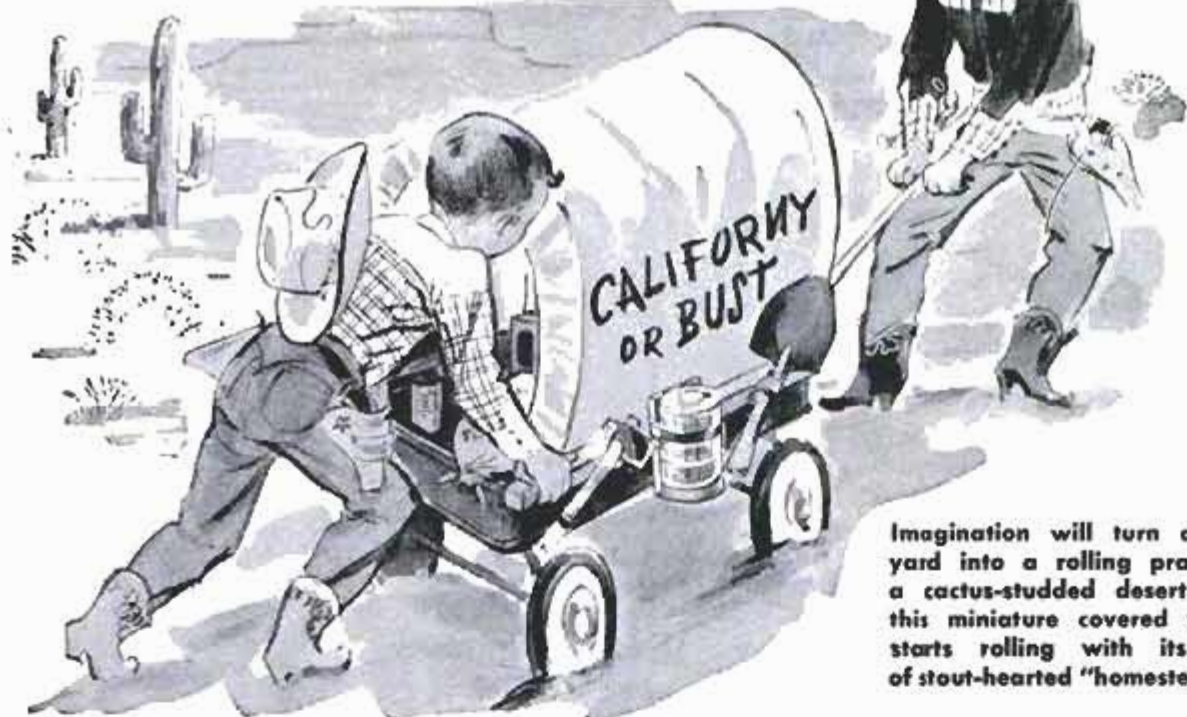

Imagination will turn a back yard into a rolling prairie or a cactus-studded desert when this miniature covered wagon starts rolling with its crew of stout-hearted "homesteaders"

**BOSSING A STRING** of Conestogas through Indian territory years ago was no easy job, but that two-gun cowboy of yours will enjoy it if you make this removable top for his wagon. A frame of 1 x 4s is cut and fitted to the inside of the wagon, and lengths of 2 x 2s are screwed to the long sides of the frame as shown. Holes bored

in the 2 x 2s accommodate the ends of bows bent from 1/2-in. thin-wall conduit to the dimensions given. Note that the end bows slant outward at 5 deg. Hems in the ends of the muslin covering should slip over the end bows. A kitchen canister, painted to resemble a water cask, is ideal for carrying lunches for trail-hungry wagon drivers.

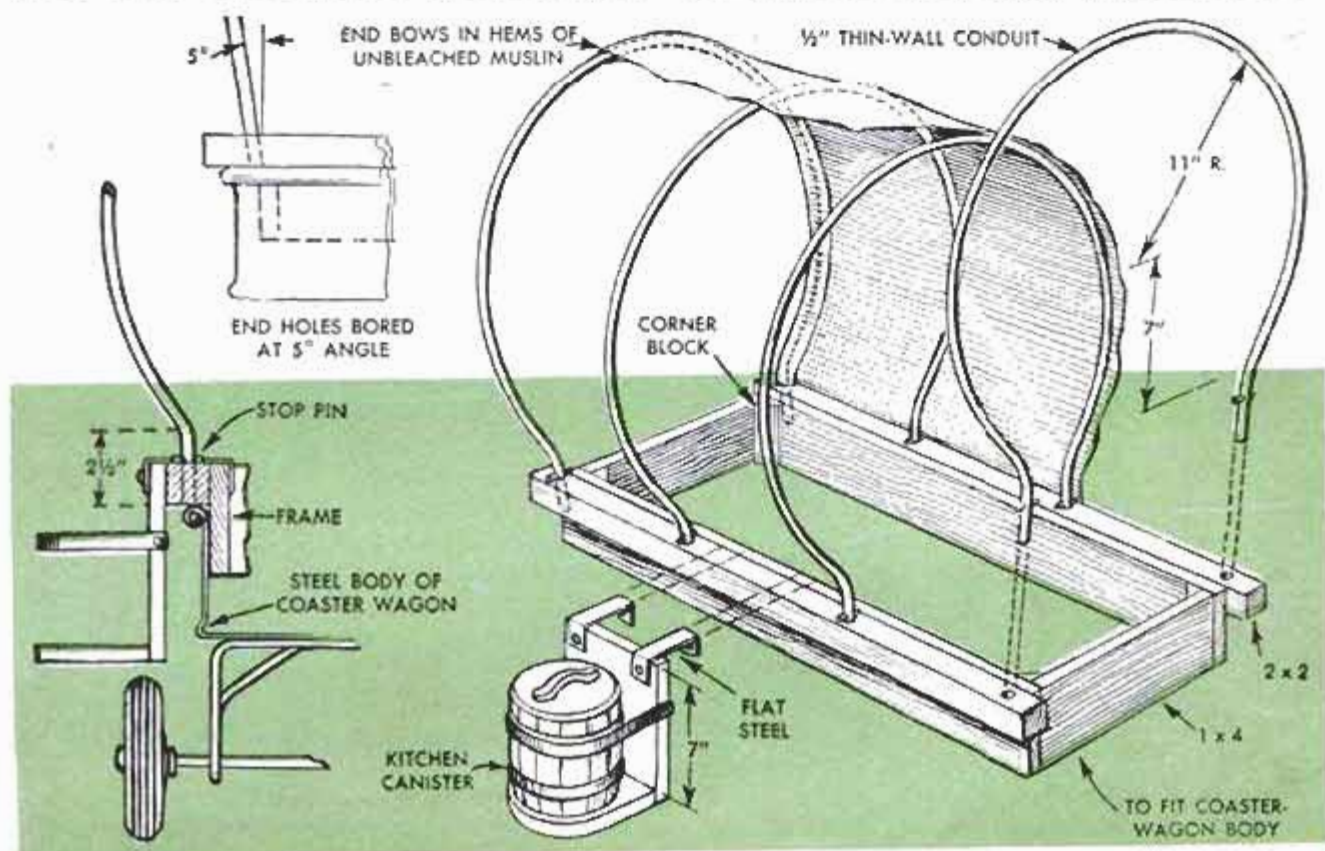





**HANGING A PICTURE** by eye isn't always an easy trick. Drive a tack near one end of a yardstick, hang on corner of frame as "plumb bob"

## Solving HOME PROBLEMS



1

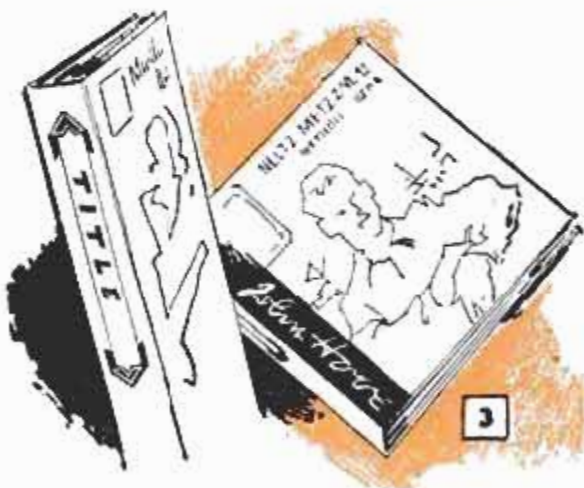

3

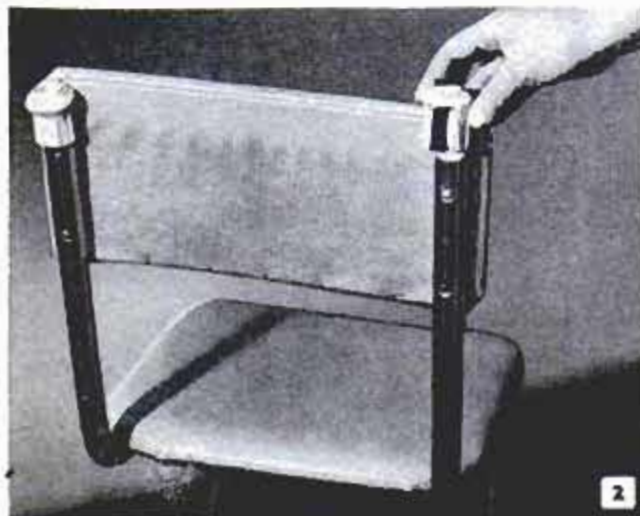

2

**1. LENGTH OF ADHESIVE TAPE** wrapped neatly around a doorknob enables you to turn it easily when your hand is wet. Use a crepe-back tape rather than the flat tape as the former can be pressed into full contact with the curved surface without wrinkling

**2. RUBBER CANE TIPS** or crutch tips slipped over ends of the back uprights of tubular kitchen chairs will eliminate any chance of a deep scratch on the wall. Note that a part of one side of each tip must be cut away to permit forcing it down over the tubing

**3. PHOTO TABS**, the kind you use in an album to hold the corners of prints, can be utilized to hold a list of record titles on backs of your record albums. Then if you change records in the albums at any time just insert new title lists under the photo tabs





4



5



6

**4. NAILS, SCREWS, PICTURE HANGERS, TACKS**—where are they? You can answer the question and solve the problem by sorting these essential household items and placing in a muffin tin, one lot to each compartment. Then you'll always know where they are

**5. TAMPERPROOFING THE PLUG** on an electric appliance or power-tool cord can be done by passing a 1/8-in. stovebolt through holes in prongs. Run two nuts on threaded end and draw tightly so that they lock. Prevents children from plugging in appliance or tool

**6. FROZEN-FOOD CONTAINERS**, made from metal foil, are handy for mixing small quantities of glue, patching plaster and paint. Small ones shaped like pie tins are best for liquids. They eliminate bother of cleaning containers after finishing the job



**7. ORDINARY DOORSTOPS** no longer look like doorstops when you use them as legs or leg extenders on that modern sofa you've been building. With the application pictured to go on, you'll think right away of other similar uses for projects in the planning stage

**8. IF YOU'VE EVER TRIED** to fold a dress pattern so it would go back in the envelope it came in, or keep it in order while in use, you can appreciate this tip. Clip separate sheets to a piece of cardboard and you'll always have the thing under control

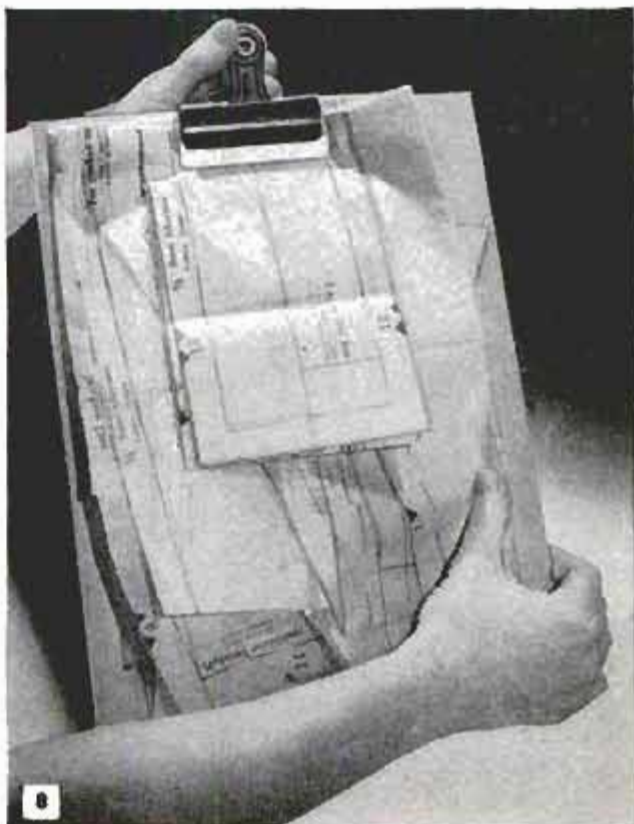

8



## Wire Hook for Paint Pail Has "Built In" Handhold



Because the lower loop is almost closed, this hook for hanging a paint pail from a ladder rung or eaves trough will not slip off the bail. A convenient "handle" eliminates the need for grasping the bail, which often becomes covered with paint. The hook is too long to fall into the paint when the pail is set on a surface.

## Cost of Drill Set Reduced By Buying Alternate Sizes

If you are one of the many craftsmen who would like to own a full set of number drills from 0 to 60 but cannot afford their cost, here is one method of reducing the expense: Buy a half-set of drills, consisting of every other drill in sizes 1 to 59. Because the size difference between consecutive numbers is quite small, a drill one size larger than required will still provide enough metal for good threads when a hole is to be tapped. Alternate drills can be bought singly when needed.

## Tape Reinforcement on Sandpaper Prevents Edges From Tearing

Tears forming in the edges of sandpaper held on a wooden block often make it necessary to discard the paper before the abrasive has worn down. To prevent the tears from forming, apply lengths of 1/2-in. masking or cellulose tape to the back surface of the paper, along the edges that cross the sanding block.

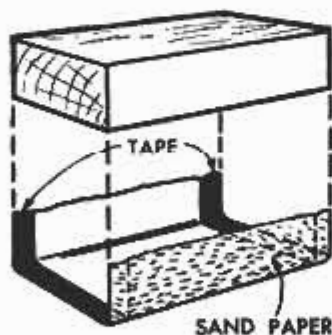

## Sagging Garage Doors Repaired After Wedges Realign Them

Hinge-type garage doors that sag badly can be realigned by first driving a wedge under each one to force it back into the proper position. Hinge screws then are removed, the holes filled with wood putty and the screws reinstalled. A third hinge—if there are only two—is installed midway between the existing two for added strength. A diagonal brace now is screwed solidly to the inside surface of the door. A turnbuckle may be used instead, if future trouble is expected, to permit readjustment. Finally, the wedges are removed and the doors swung to check alignment of hinges and of latches or hasps and staples.

## Consistency Check for Pouring Concrete Sidewalk

To guard against damage to a sidewalk resulting from application of ice-melting chemicals, such as salt or calcium chloride, be sure the concrete mix is the proper consistency when it is poured. If the mix is too thin, the thousands of tiny air bubbles that help the concrete resist the action of such chemicals, will be absent when it hardens. A good check on this is to fill a coffee can with the mix, tamp it with a pencil and then, overturn the container. When the can is removed, the concrete should hold its shape, yet be wet enough to have filled the form without leaving voids.

Nils E. Mockler, Putnam Valley, N. Y.

## Notch in Adhesive Applicator Permits Accurate Spreading

When it is necessary to apply adhesive to the extreme edge of a piece of work, cut a V-notch in the spout of the cement applicator. One "leg" of the notch then is held on the edge of the work and the tube is moved along while the cement is applied — George F. Holden, Chesterfield, England.

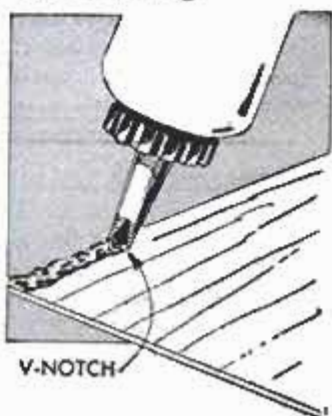



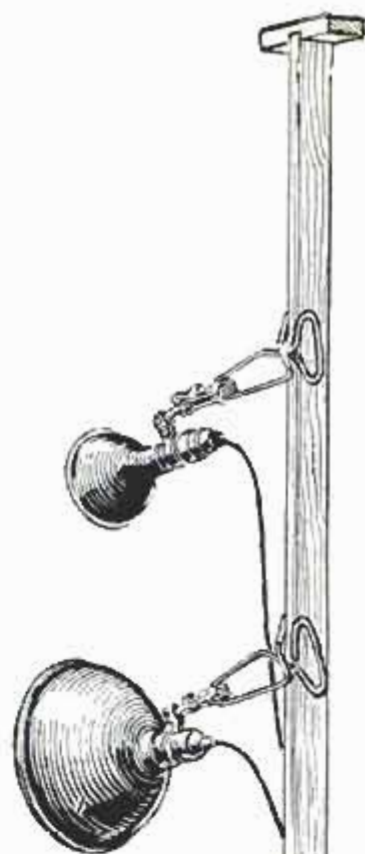

# Photolight Standards

PROVIDING proper indoor lighting for most photographic situations in the home is easy and inexpensive when the required floodlights and spotlights are clamped to floor-to-ceiling standards, such as these. Since the standards are made of inexpensive soft-pine lumber in stock sizes, you can make several of them in an evening for less than half the cost of one manufactured light stand. Each standard consists of an upper and lower leg, both of which are cut from 1 x 3-in. stock and fitted with padded base blocks on the extreme ends as detailed in the drawing. Guide strips nailed to the sides of the upper leg prevent the standard from pivoting at the point of overlap, where the two halves are held in the desired extended position by a bolt and wing nut as indicated. When not in use, the legs are unbolted for compact storage.

P. L. Stotler, Nitro, W. Va.

Below, guide strips on upper leg prevent lower leg from pivoting at overlap point

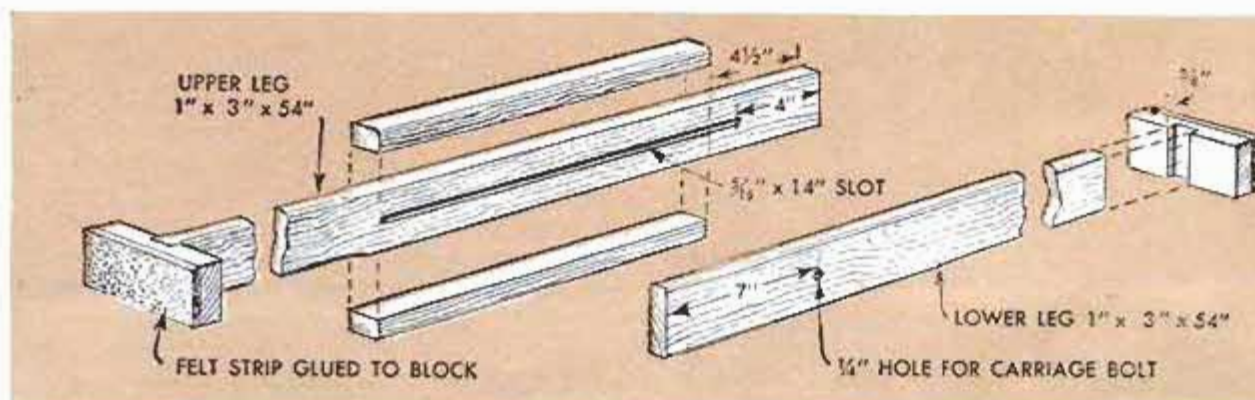





Open space in a tree's foliage is filled and the crotch is reinforced by bending branch from side opposite opening and grafting it on trunk as shown

The vertical-growing branches on one side of young tree are pulled into proper positions with twine tied to ground stake and the base of large limb



X743

*You can grow  
better fruit  
if you learn*

# HOW TO *Shape* TREES

By A. M. Wettach

WHETHER YOU HAVE a few fruit trees or a small orchard, it will pay to know the many corrective measures that can be employed to bring about and maintain yearly production of good quality fruit. To help you do this, growth correcting and grafting methods used by professional orchardists are explained in this article.

The ideal time for grafting and pruning is in the spring just before growth begins. Since a young tree usually grows many more branches than it requires for balanced growth, it is necessary to remove unneeded ones and cut back remaining ones. When doing this, make smooth slanting cuts close to the trunk or branch from which the growth is removed to permit fast healing and quick rain runoff. Branches and shoots that are shortened should be cut off just above a bud to force growth into it. A one-year-old whip or tree should be cut back to a height of 30 in. A branched tree two years and older should be cut back to a leader (main vertical branch) and a shortened shoot which normally becomes one of the side or scaffold branches and prevents formation of a weak crotch. If the tree has several branches, they are cut to various lengths at selected buds as in Fig. 10. This forces new growth into the direction the bud is pointed. At the second spring pruning, shoots on scaffold branches





Tree is reshaped by pulling outer branches into more horizontal position and tying them to stakes as required

are thinned to leave only the horizontal ones. Vertical branches are reduced to 18 in. in height and water sprouts (tender, green growth) are removed. Pruning for the third to fifth years is similar to the second year, except that additional scaffold limbs are selected and the older ones are shaped to leave a leader on each.

When proper or desired tree growth can't be obtained by pruning, scions (new wood, either terminal growth of branches, or sprouts of about  $\frac{1}{4}$  in. diameter and with two to six buds on each) may be grafted to the tree to provide additional growth where needed. Grafting may be done by means of one of the following

Arrows indicate points at which scion was bridge grafted to span damaged area of badly girdled tree trunk. Board shades new graft from direct rays of sun

Two underdeveloped fruit trees are combined to form one strong one by planting one next to other and grafting them together at point indicated by arrow







Above, to prevent tree crotch from splitting, water sprouts growing on right branch have been grafted to trunk. This work must be done when tree is young

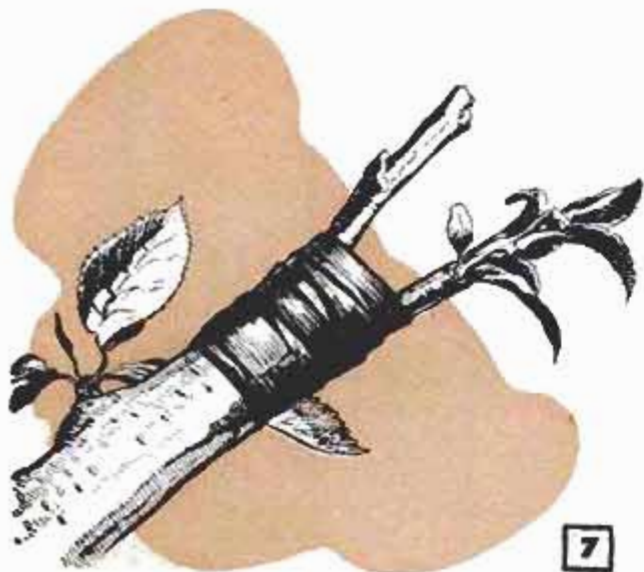

Above, scion of desired fruit tree variety is shown grafted to top-worked branch of less desirable one

Below, small branch from limb on right side of tree is bent and bridge grafted to trunk and other limbs

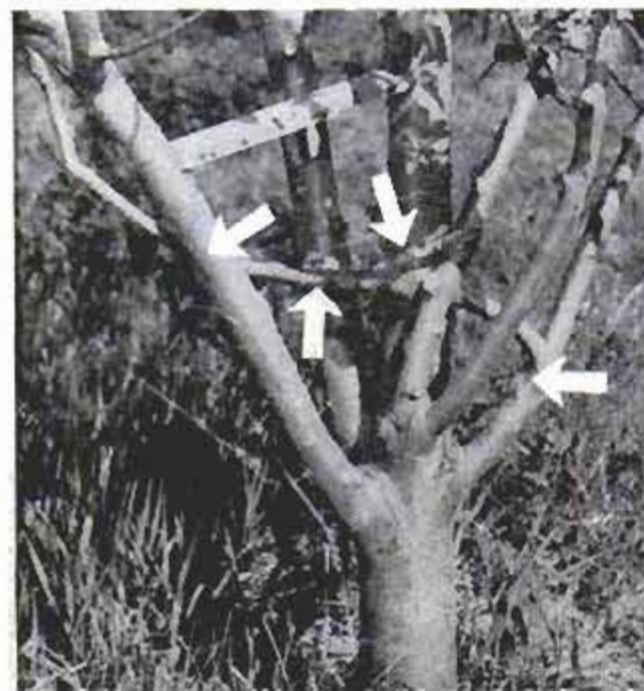

types of joint: whip graft, Fig. 11; cleft graft, Fig. 9; bark graft, Fig. 12, and bridge graft, Figs. 13 and 14. Scions used for this purpose must be cut in winter or early spring from a hardy variety of fruit tree and stored in a cool damp place until used. Scions may also be obtained from most nurseries. A scion that is to produce fruit must be cut from terminal growth, one used for strengthening a crotch, Figs. 6 and 8, or for repairing a damaged trunk, Figs. 4, 13 and 14 may be cut from nonfruiting wood, such as water sprouts. When reinforcing a crotch, a water sprout or small branch found growing on one of the branches is cut back so that its tip can be inserted in a slit cut in the bark of the trunk as indicated in Fig. 6, using the bark-graft method as in Fig. 12. Several crotches on a tree may be strengthened with the same sprout, by bending it to cross several branches and grafting it to them as in Fig. 8. This is done by baring the cambium on the sprout and branch at each contact and binding the sprout in place as in Fig. 1.

Whip grafting may be used for providing additional branches where scanty growth exists, for joining two water sprouts to make a natural brace and for top-working a tree to change the variety of fruit produced by it. This graft is made by joining the scion with the stock (branch to which scion is grafted) as detailed in Fig. 11. When a scion is grafted to stock that is somewhat larger in diameter than itself, the cleft graft is used, Figs. 7 and 9. For stock that is considerably larger than the scion, the bark-graft method is used as in Fig. 12.

Bridge grafting is a method of reuniting the cambium layer on the sides of a tree trunk that has been badly girdled. Figs. 13 and 14 show two ways of doing this. A tree that has insufficient vigor or yielding ability can be improved by planting a young tree next to it and grafting the two trunks together to give it two root systems as in Fig. 5. The cambium layers of the trunks are first exposed at the point of contact and then nailed together. After the trees have grown together, most of the transplanted one's branches are removed.

For successful grafting, it is important that the cambium layer of each member of a joint be in firm contact with the other. Buds on grafted material should point outward so branches that grow from them will be properly placed. All graft joints should be given an airtight covering, such as wax or rubber tape to prevent sap loss.

Fruit-tree branches that grow in a vertical direction can be made to grow laterally by tying them to stakes as in Figs. 2 and 3. This permits sunlight to enter, resulting in more colorful fruit. ★ ★ ★



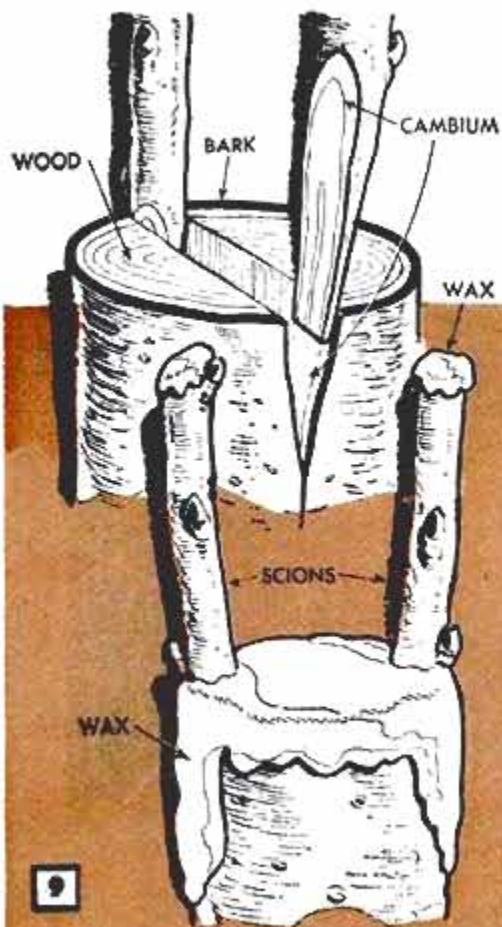

9

10

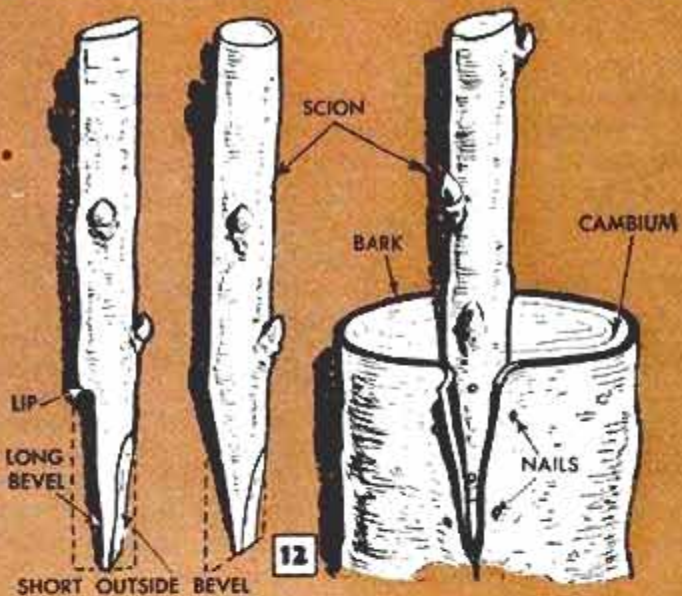
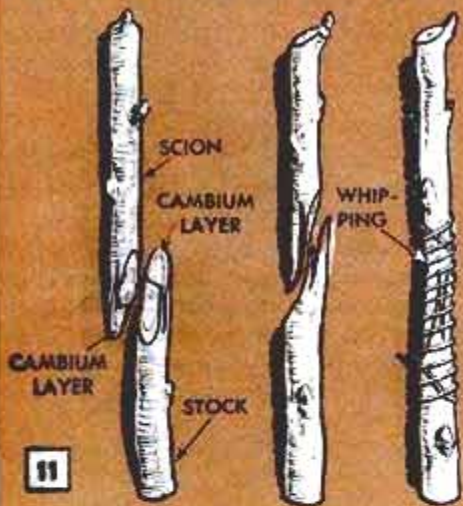

11

SHORT OUTSIDE BEVEL

12

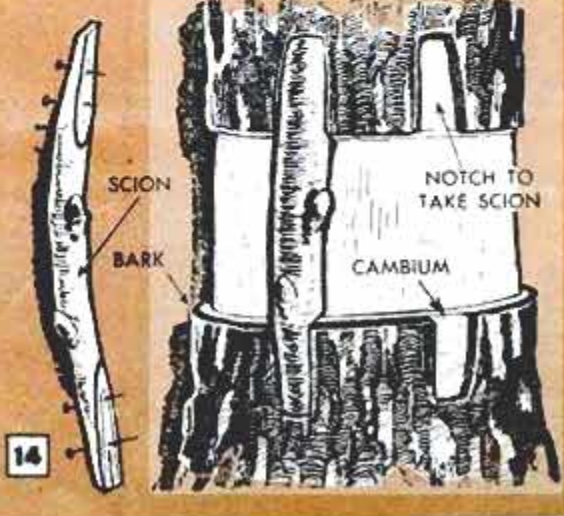
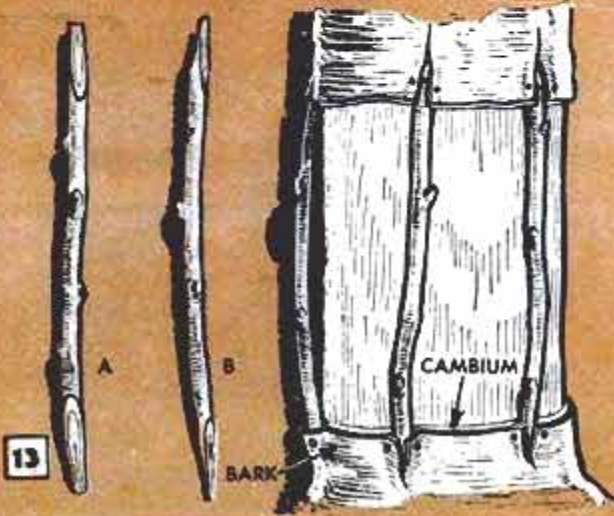

13

14



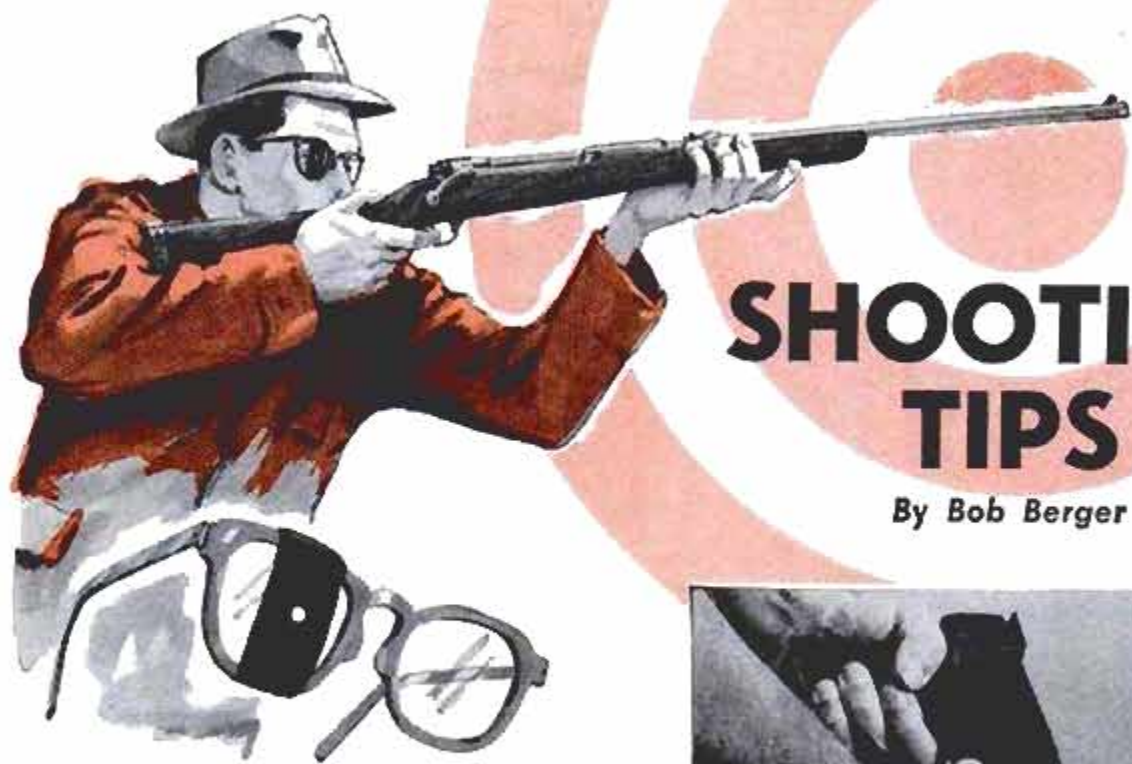

# SHOOTING TIPS

By Bob Berger

IF YOU PARTICIPATE in the fascinating sport of target shooting with a .22 caliber pistol or rifle, one of the following tips may help to solve a problem for you. Shooters who wear glasses sometimes have trouble when using telescopic or iron sights. A strip of black tape, in which a small hole is punched, can be fitted over the lens on the shooting eye. When aligned with the pupil, the hole usually will show the target clearly. A new pistol will not be so likely to rust if given a thin coat of paste wax and buffed to a high polish; it looks well, too. Instead of digging into your pockets or in cartridge boxes, sew belt loops to a tobacco pouch and carry it full of cartridges at your waist. Light glare in your "scope" will be no problem when a sunshade, consisting of a cardboard tube, blackened inside and out, is fitted over the end.



Above, left, tape with hole in it on one lens of eyeglasses sharpens target seen through telescopic sight. Above, pistol is rustproofed, blued finish protected, with coating of paste wax. Below, left, loops sewed to inexpensive tobacco pouch convert it to handy belt-carried cartridge case. Below, cardboard tube, blackened with India ink, is fitted over telescopic sight as effective glare-stopping sunshade

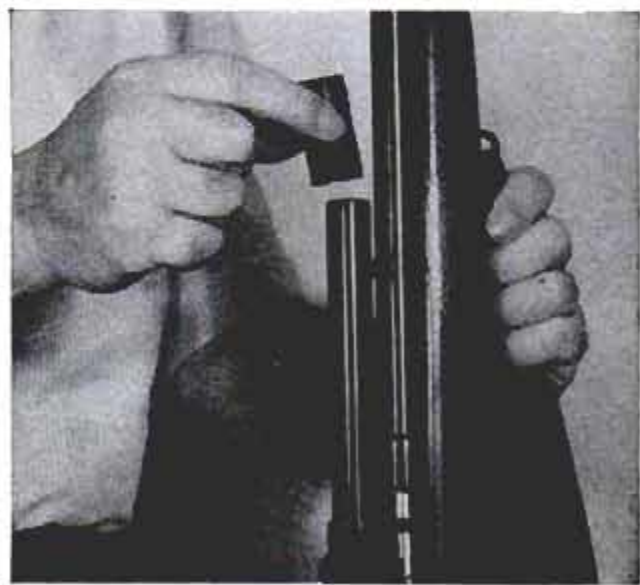
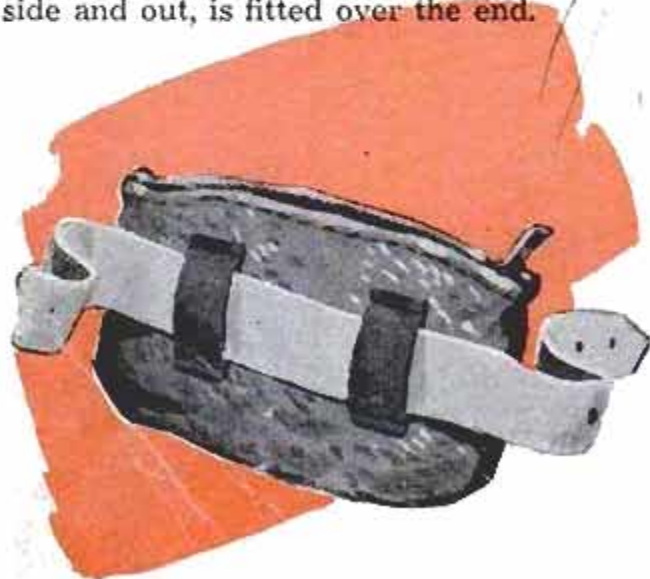



## Scale Easier to Read When Coated With Black Crayon

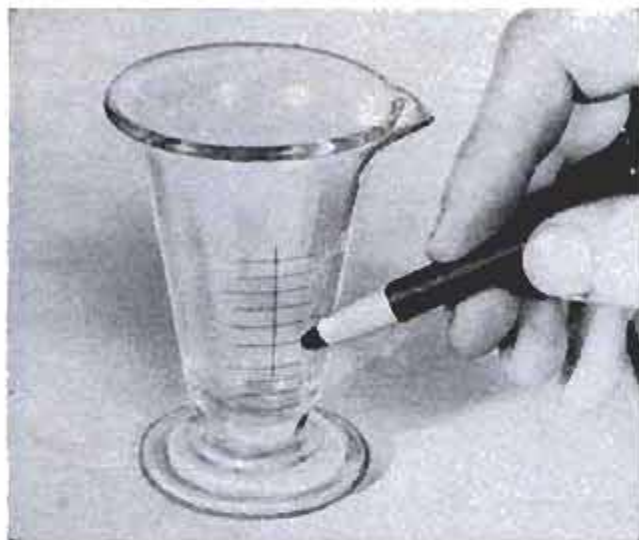

For easier reading of the scale etched or molded on the side of a graduate, fill in the lines and numbers with a black marking crayon, such as used in stores for marking china and glass merchandise. Then, wipe the excess crayon from the unmarked glass and apply one or two coats of clear lacquer on the scale area.

John J. Rea, Urbana, Ill.

## Bulk Developer Sealed In Convenient Packets



If you use powdered photo developer that is available only in cans or packages containing more material than is needed for one mix, the remaining dry chemicals of the two-part formula can be sealed in compartmented waterproof envelopes for future use. An envelope is made by folding in half equal-sized squares of plain paper and mounting tissue, keeping the tissue on the inside. Seal two edges of the paper and tissue with a warm iron to form an open-end envelope. Next, pour in the correct amount of the developer for one mix and seal the envelope across the middle as in the photo. Then add the second part of the formula and seal the top.

SEPTEMBER 1958

## Tape Ends of Exposed Roll Film To Prevent Light Streaks



Light streaks on the edges of roll film, caused by the film winding to one side on the takeup spool, can be prevented by wrapping the ends of the exposed roll of film with masking tape as shown in the photo above. Turn the ends of the tape back on itself about  $\frac{1}{2}$  in. to provide a tab for easy removal in the darkroom.

Ben Perry, Ketchikan, Alaska.

## Additional Lens Taped on Camera Permits Taking Closeup Shots



To take closeup shots with an inexpensive camera, tape the lens from a spare camera on the lens of the camera used as shown in the photo. The second lens must be about the same diameter but not necessarily of the same focal length as the one on the camera used. If your camera doesn't have a focusing back, it will be necessary to determine the new focusing distances before loading it. To do this, tape a square of ground glass or tracing paper to the open back of the camera and focus on an object for each of the close-up distances to be used. Mark the new scale on a strip of tape applied over the existing scale.

Ken Murray, Colon, Mich.

179





## REPAIR TIPS YOU SHOULD KNOW

By Enno R. Haan

**M**ANY PROBLEMS arise daily around the home to test the skill and ingenuity of the do-it-yourselfer, especially when "tricks of the trade" that make the job easier, are unknown to him. Illustrated in this article, are suggestions on how to handle some of these problems.

It is hard to start and maintain a good stand of grass on a steep bank between lawn levels. A gradual slope will eliminate this difficulty but, if this is not desired, as when the level effect of a foundation planting is to be maintained, use a simple retaining wall of flagstones, Fig. 1. This

provides a pleasing accent, yet serves to retain the sharp incline. Lay the stones loosely without bedding them in cement.

If rainwater collects in a window well and runs into the basement, provide a drainage area of crushed stone and open joint drainage tile immediately under the well retainer to absorb the water as shown in Fig. 2. A flat stone should be placed against the end of the tile in the well area to prevent the crushed stone from filling it.

To repair leaks in valley flashing of a cedar-shingled roof, bend sheet-metal squares of the required size to a diagonal

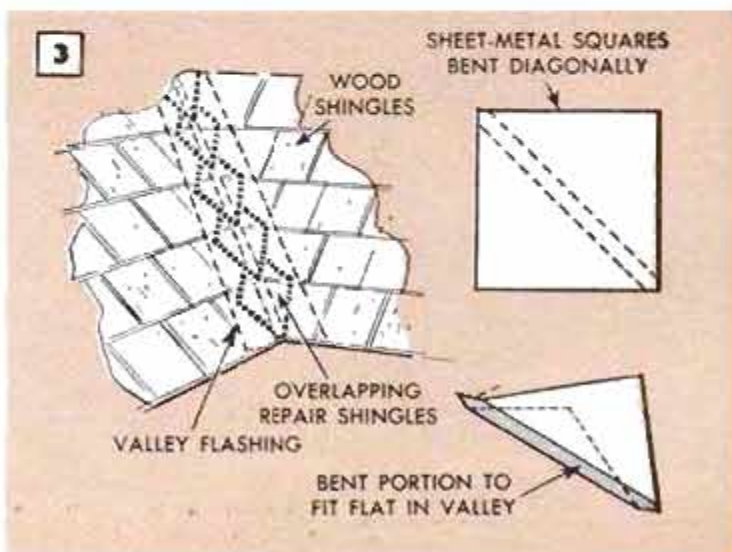
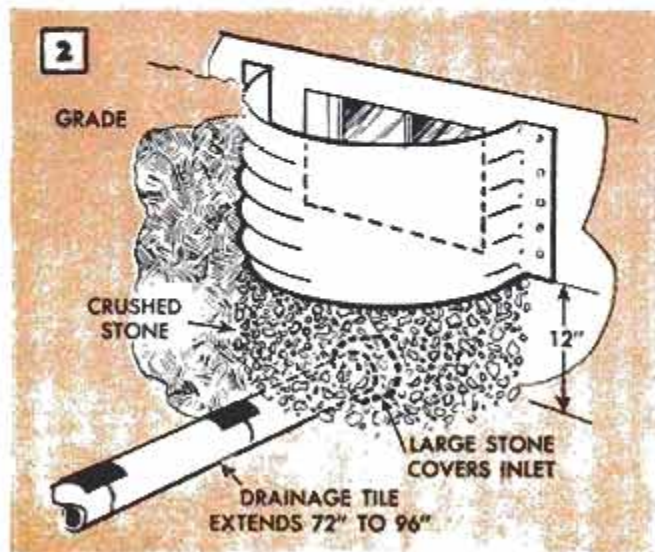



shape and tap them upward under the butt ends of the shingles so they extend about 3 in. or more under the next course as in Fig. 3. No nails should be used to hold the repair shingles in place.

An annoying creak in a hardwood floor may be fixed by carefully locating the spot where creaking occurs and drilling a tiny pilot hole through the floor to take a spirally fluted flooring nail, Fig. 4. Drive the nail well into the subfloor, setting the head slightly below the floor surface for filling with wood putty later. You may need to drive several nails in this manner to stop a large area from squeaking. For more effective and easier insecticide spraying of the underside of foliage, use a power-operated sprayer, or couple the spray attachment of your vacuum cleaner to a hand sprayer as in Fig. 5, if your vacuum is so equipped. Basswood roll shades on a screened porch can be kept from blowing inward by tying two retaining cords to screw eyes turned in the upper and lower crossrails of each screen as indicated in Fig. 6. There should be enough slack in the cords for lowering and raising the shades.

Since the cutting edges of paint-scraper blades are slightly hooked for efficient cutting, they can't be properly sharpened by filing or grinding. The correct procedure is shown in Fig. 7. After squaring the cutting edge with a file, a 45-deg. bevel is filed on it, detail A. Then, the edge is extended by rolling it with a steel rod, after which it is burnished—first, at a 45-deg. angle and then at a 75-deg. angle to form the hooked edge. For a square-edge scraper, both sides of the edge are burnished at an 85-deg. angle as in detail C.

A wooden combination door that is bowed along the latch edge can be permanently straightened by screwing a steel angle to the edge as in Fig. 8. For proper closing clearance, saw or plane  $\frac{1}{8}$  in. off the door width to take the angle. ★ ★ ★

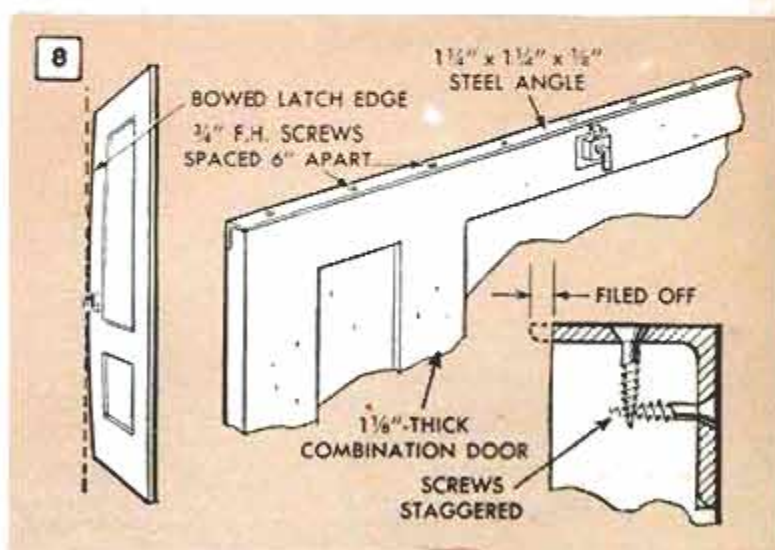
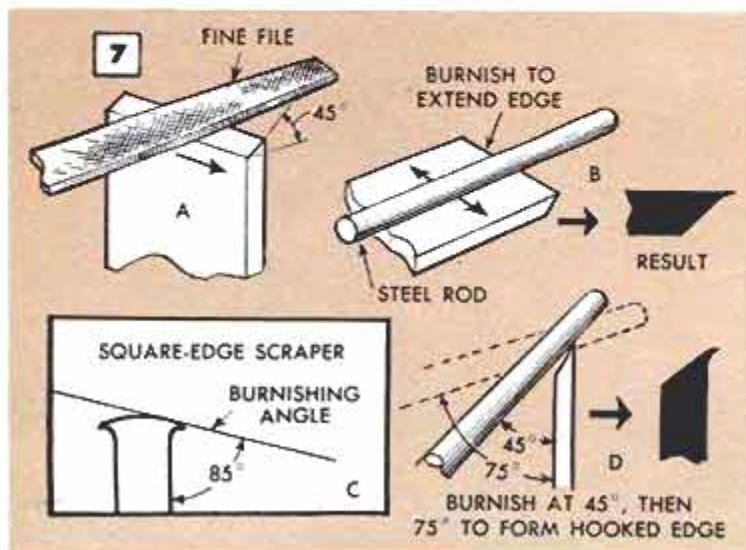
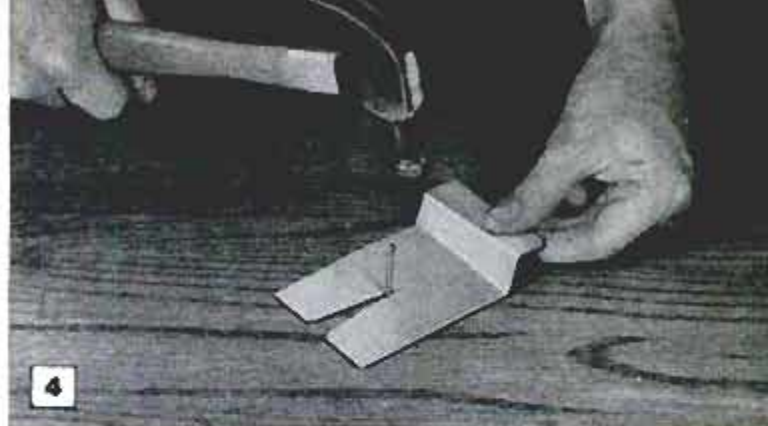



## Scratchproof Work Surface for Cutting Aluminum Sheet Metal



To protect the surfaces of aluminum sheet metal from becoming scratched when cutting it, one home craftsman nailed a short length of corrugated galvanized roofing on one end of his bench top as shown. Steel shavings and abrasive particles from other work fall to the bottom of the corrugations, leaving only clean ridges to come in contact with the soft aluminum.

G. E. Hendrickson, Argyle, Wis.

## Wetting Agent Added to Water Aids Removal of Wallpaper

Wallpaper can be removed quickly and with little effort when a commercial wetting agent or a detergent is mixed with the water used for soaking it. This additive permits the water to penetrate the paper more readily to dissolve the adhesive. About 1 teaspoon of wetting agent per gal. of warm water is sufficient. Apply the solution with a sponge and let it soak a few minutes before removing the paper. Wet the paper a second time, if necessary.

J. B. Mullen, Barrington, Ill.

## Backflushing With Solution Stops Leak in Heating System

If it becomes necessary to use a preparation to stop a leak in a hot-water heating system, the preparation may be applied without draining the system by backflushing. Normally, the entire system down to the boiler level has to be drained before applying the preparation, a 4 to 5-hr. job. To do the job by the backflushing method, simply mix a solution of preparation and water and pour it into a length of garden hose with female fittings on both ends, after having fitted a cork in one end. Next, remove the cork and turn the hose fitting on the drain cock at the base of the boiler water jacket. If the hose is tightly clamped with a C-clamp, or collapsed by other

means, very little of the solution will be lost when doing this. Then, screw the other end of the hose to the nearest threaded water tap, turn on the water and open the drain cock on the boiler. The water pressure will force the solution out of the hose and into the heating system. As the solution passes through the crack in the pipe, radiator or boiler, particles are deposited on the sides of it until the opening is filled and the leak is stopped. After disconnecting the hose, the excess water in the system merely passes out the overflow pipe. If one preparation doesn't completely stop the leak, apply a second one in the same manner.—Henry K. Fitts, Winchester, Mass.

## Tighten Water-Tap Handle

For temporary repair of a water-tap handle that slips on the splined stem to which it is attached, insert a short length of fine steel wire in one of the grooves of the spline as indicated in the detail. Of course, it is necessary to remove and replace the handle to do this.

C. H. Hardy, Whittier, Calif.

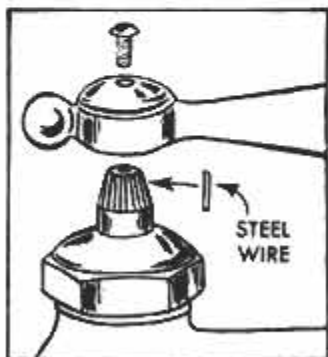

## Remove Cork With Nail

When a corkscrew is needed for opening a bottle and you have none, try using a nail to remove the cork in the manner shown in the detail. Be sure to push the nail through most of the cork at the angle shown before twisting to prevent breaking off the upper part.—Deoshankar Ajodah, Curepipe, Mauritius.





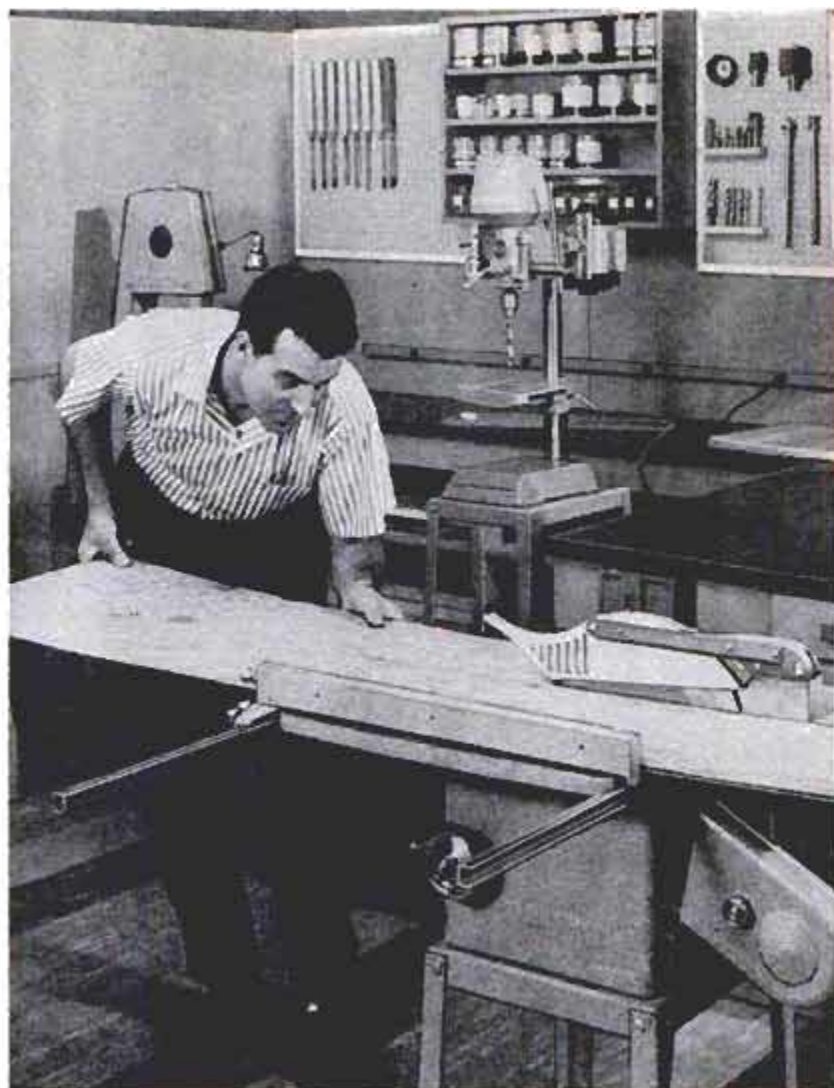

# SHOWCASE OF TOOLS



This is the first of a series of articles to aid readers in determining sizes and types of tools best suited to their needs. Tools shown are intended to give readers a "showcase" view of various units available in workshop sizes. Picturing tools in this series does not constitute approval or disapproval of them by *Popular Mechanics*.

## CIRCULAR SAWS

By E. R. Haan

**T**O MANY home-shop owners, purchase of a power tool represents a sizeable sum they will invest perhaps only once in a lifetime. For this reason the size, type and quality of tools purchased should be carefully considered beforehand.

Feeling that many readers interested in power tools do not have an opportunity of viewing all workshop power units available, such as circular saws in the bench and floor types, portable electric handsaws, drill presses, portable electric drills, etc., *Popular Mechanics* will, from time to time, present a cross section of these tools in the various groups.

If you're considering purchase of your first power unit, such as a circular saw for example, or adding to your present shop equipment, a look at all the tools in that group in which you are interested not only can save you money, but can assure that you get the right tool for your purpose. In suiting the tool to the work there are several basic factors to think about, such as its work capacity, the shop space it will occupy and the range of operations that can be performed on it with and without accessories.

You will require only a few accessories for a circular saw to do a wide range of work. The combination blade, Fig. 12, will do crosscutting, ripping, beveling



Bench saws usually are best suited to shops where space is limited



Wide range of accessories is available for all types of table saws



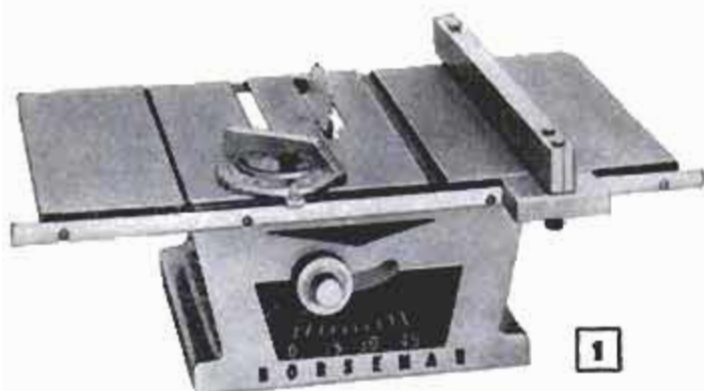

**TILTING-ARBOR BENCH SAW** takes 6½-in. blade, cuts full 2 in. deep. Takes a 5½-in. dado head. Table measures 12 x 13 in. without extensions, is made from steel plate ground smooth on top surface. Rip fence is double-locking type. Handwheel adjusts blade for tilt angle, depth of cut. Requires ½-hp., 1750 r.p.m. motor for average work, ½ hp. for heavy duty  
Rocco Products, Inc., 2916-4th Avenue S., Minneapolis, Minn.

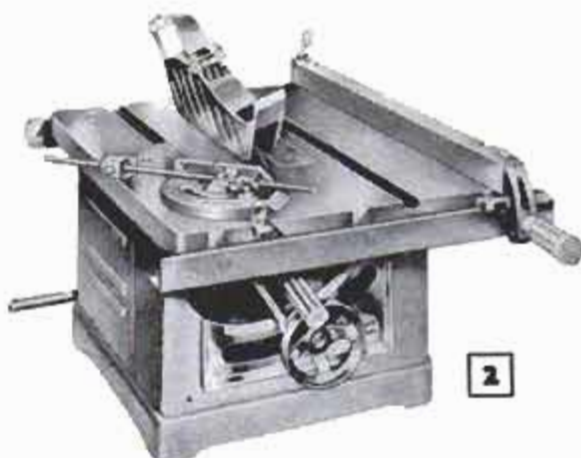

**BENCH SAW** makes cut 3-3/16 in. deep with a 10-in. blade. Tilting arbor is mounted on ball bearings. Table is cast iron, 15 x 19¼ in., and base is made from heavy sheet metal. Rip fence locks front and rear. Lever adjusts depth of cut, locks automatically. Handwheel controls degree of tilt for angle cuts. Requires ¾-hp., 1750 r.p.m. motor for average work  
American Machine & Tool Co., Inc., Royersford 1, Pa.



**8-IN. TILTING-ARBOR SAW**, above, cuts to 2¾-in. depth. Table size is 13 x 17 in. without extensions. Lever locks fence at ends. Has floating mount for ½-hp., 3450 r.p.m. motor. Handwheel controls tilt, depth  
Duro Metal Products Co., 2649 N. Kildare Ave., Chicago 39

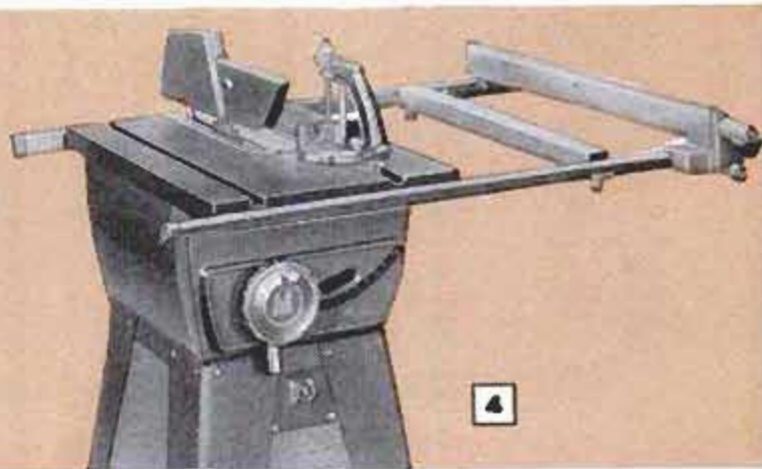

**9-IN. TILTING-ARBOR SAW**, above, comes with a 16 x 24-in. table, is regularly supplied with stand. Cuts 2¾ in. deep with 9-in. blade. Handwheel controls depth and tilt. Requires ¾-hp., 3450 r.p.m. motor  
Magna Power Tool Corp., Menlo Park, Calif.

**10-IN. TILTING-ARBOR SAW**, below, is designed for heavy duty. Cuts 3½ in. deep, requires ¾-hp., 3450 r.p.m. motor. Table is 20 x 27 in. without extensions. Fence has fine adjustment, locks at both ends  
Montgomery Ward & Co., 618 W. Chicago Ave., Chicago 10

**8-IN. TILTING-ARBOR SAW, 4-IN. JOINTER**, below, come as a combination unit mounted on floor stand and operated by ½-hp., 1750 r.p.m. motor. Joints bolts to table. Jigsaw attachment is also available  
Sears, Roebuck & Co., 925 S. Homan Ave., Chicago 7







**8-IN. TILTING-ARBOR SAW** comes with or without steel floor stand. Maximum depth of cut is 2¼ in. Machine features a one-piece steel base. Cast-iron table is 17 x 22½ in. without extensions and top surface is ground smooth. Lever at front locks both ends of ripping fence simultaneously. Dual-control handwheel adjusts blade for depth of cut, tilt angle. Requires ½-hp., 3450 r.p.m. motor; ¾ hp. for heavy duty

Atlas Press Co., 1015 N. Pitcher St., Kalamazoo, Mich.



**9-IN TILTING-ARBOR SAW** also comes with or without steel stand. Latter can be fitted with treadle-operated casters as pictured. Table measures 22 x 25 in. with extensions, is made from smoothly finished cast iron. Base and stand are of steel. Blade cuts 2¼ in. deep. This unit has two controlling handwheels. Wheel at front of base raises and lowers arbor; handwheel at side of base controls the tilt angle. Requires ¾-hp., 3450 r.p.m. motor for average work

Delta Power Tool Div., Rockwell Mfg. Co., 502E N. Lexington Ave., Pittsburgh 8, Pa.

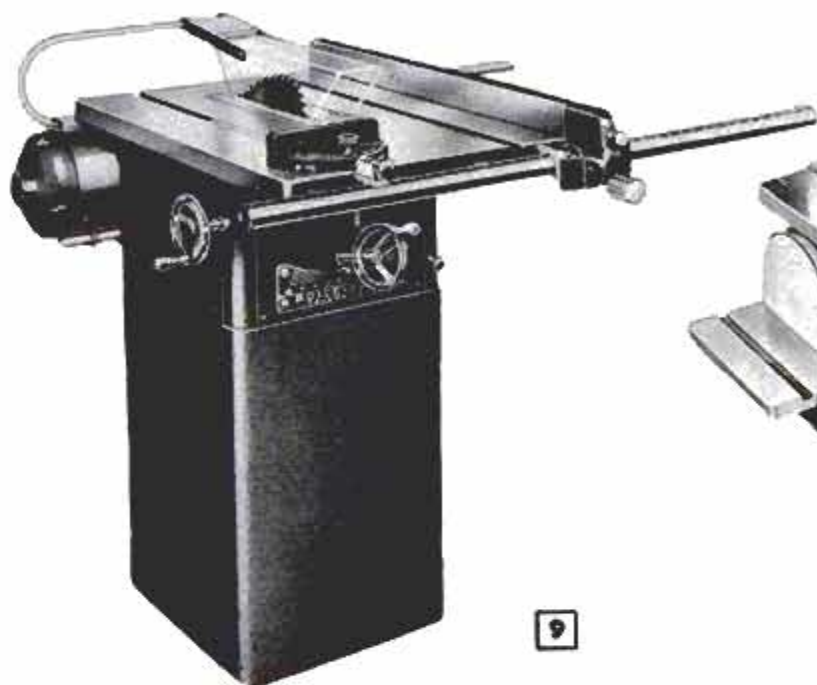

**10-IN. TILTING-ARBOR BENCH SAW** is available with an enclosed-type floor stand as pictured. This is a somewhat heavier machine than those preceding. Has a 20 x 27½-in. cast-iron table, smoothly finished, 36 in. wide with extensions. Rip fence also is cast iron, finished on both sides. Locks at the front. Blade cut 3-1/16 in. deep. Has separate handwheel controls for depth and tilt. Requires 1-hp., 1750 r.p.m. motor

Boice-Crane Co., 930 W. Central Ave., Toledo 6, Ohio

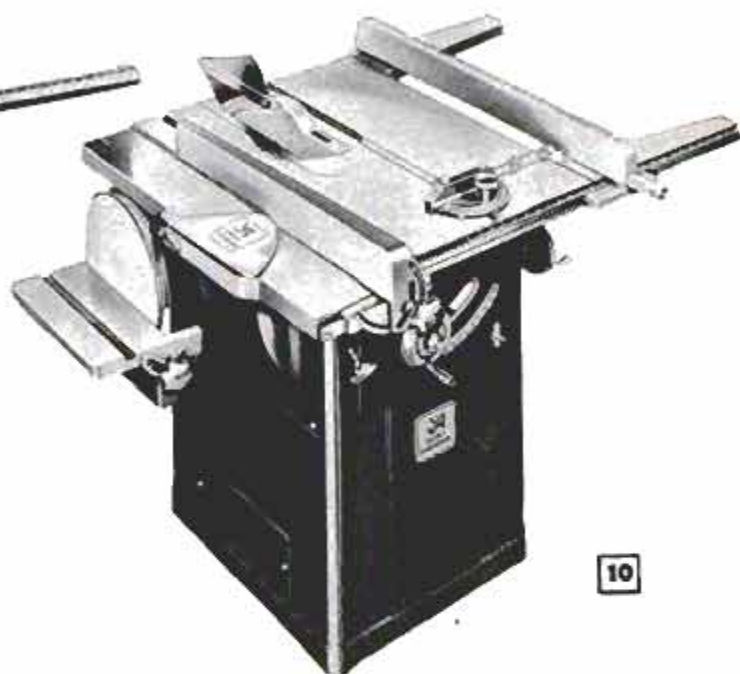

**THIS COMBINATION UNIT** is a true floor-type machine, has no subbase as do all bench saws. Combines an 8-in. circular saw, a 4-in. jointer and a 10-in. disk sander, all three units being driven by one motor housed in the base. Has separate handwheels for controlling depth and tilt angle. Pivoted yoke controlled by depth handwheel permits swinging saw blade or jointer alternately into working position

Yates-American Machine Co., 701 4th St., Beloit, Wis.



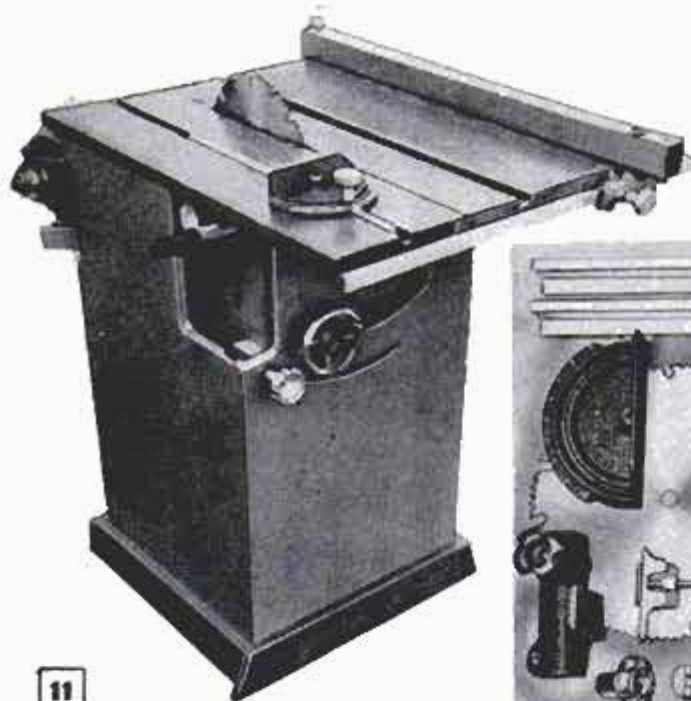

11

**10-IN. TILTING ARBOR SAW** comes to you as a kit with complete instructions. You make the floor stand and table, using hardwood and plywood and the kit which includes all necessary parts of steel and cast iron, to make complete unit pictured, less motor. Cuts  $\frac{3}{4}$  in. deep. Has separate controls for depth, tilt

Gilliom Power Tools, Lambert Field, St. Louis 21, Mo.

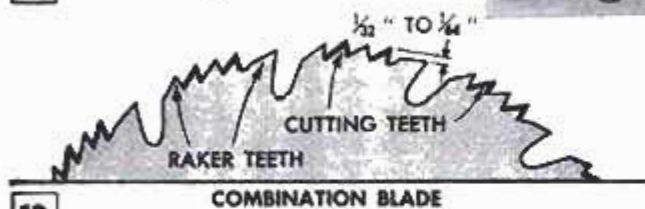
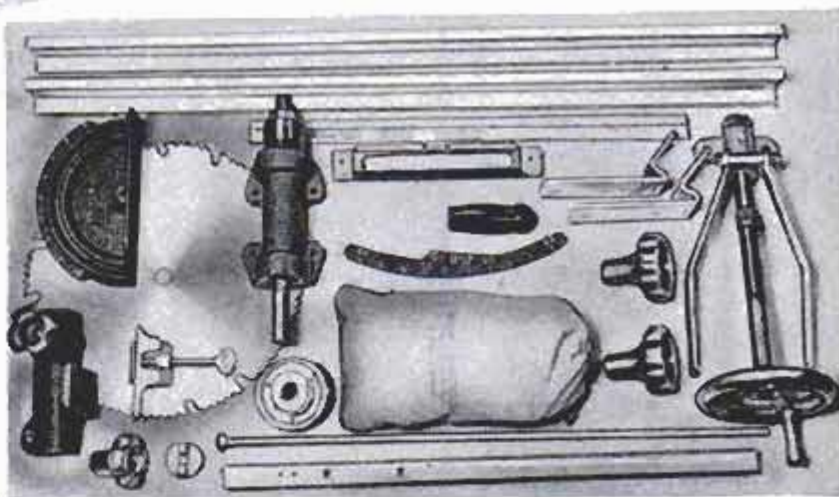

12

COMBINATION BLADE



13

CARBIDE-TIPPED BLADE

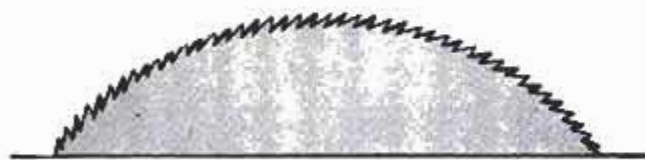

14

FINE-TOOTH CROSSCUT BLADE



15

RIPPING BLADE



16

DADO CUTTERS



17

ABRASIVE WHEEL

and mitering. You also can cut rabbets of almost any size required by making two passes of the stock. Grooves can be made with the saw blade by running adjacent cuts to give the width required. The circular blades detailed in Figs. 13, 14 and 15 are more or less classed as special-purpose blades.

Dado cutters, Fig. 16, consist of two outside cutters, or saws, and three or more inside cutters, or chippers. In the regular size the outside and inside cutters and the chippers are 6 in. in diameter, although smaller and larger sizes are available. The outside cutters can be used on the saw arbor individually, as a pair, or in combination with the chippers to cut grooves varying in width from  $\frac{1}{8}$  to  $\frac{13}{16}$  in., the widths rising from  $\frac{1}{8}$  in. by 16ths. The maximum depth of cut on the average saw table is about 1 in.

Abrasive wheels, Fig. 17, of the common types made for use on the saw arbor will cut nearly all metals but will not cut wood. Another type consists of a steel disk to which grains of tungsten carbide are bonded, a coarse grade on one side and a fine grade on the other. This wheel will cut either wood or metal. Wheels of both types are used to cut through materials and also as abrasive disks (the rigid wheels) for squaring ends of material.

Straight moldings of many different shapes and sectional sizes can be run on a table saw by using a three-knife molding head on the arbor. Only the head with several standard sets of knives, or cutters, and a special table insert are necessary to convert your saw into an efficient straight shaper. The ripping fence and miter gauge with which every table saw comes equipped serve as guides.



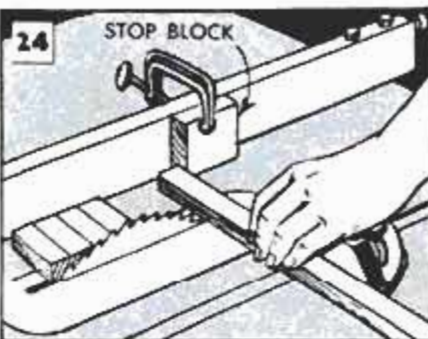
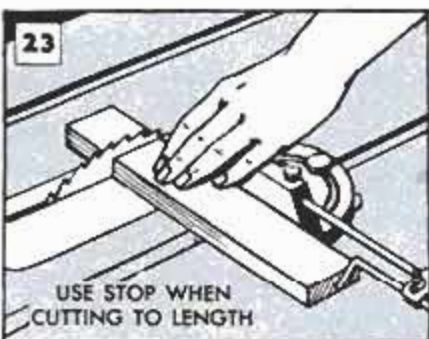
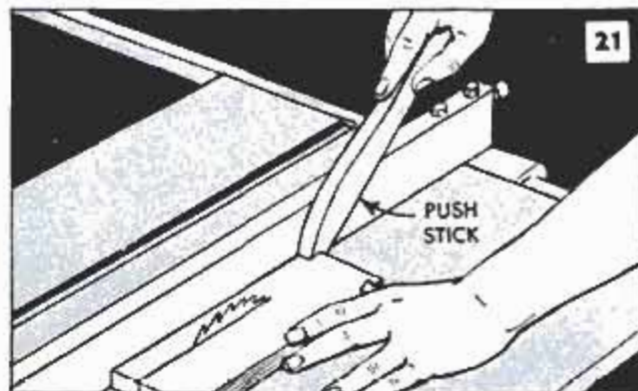
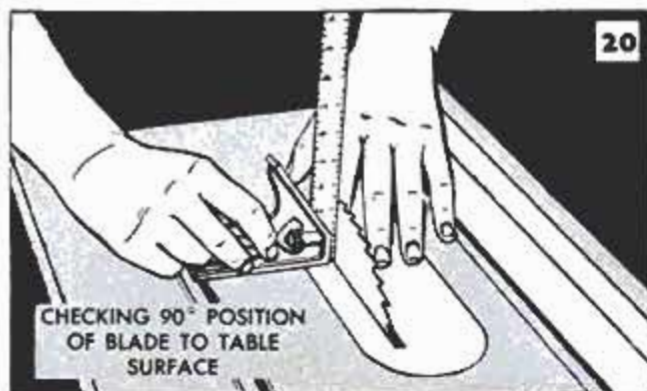
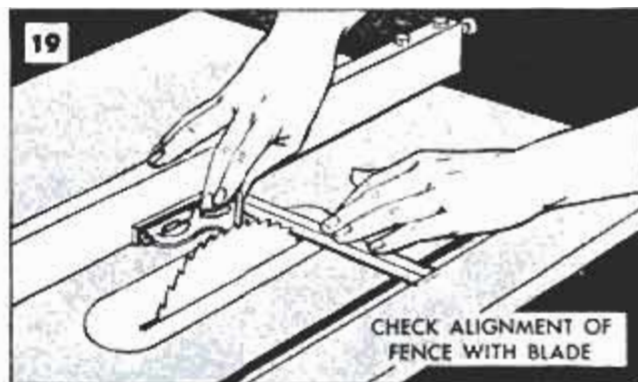
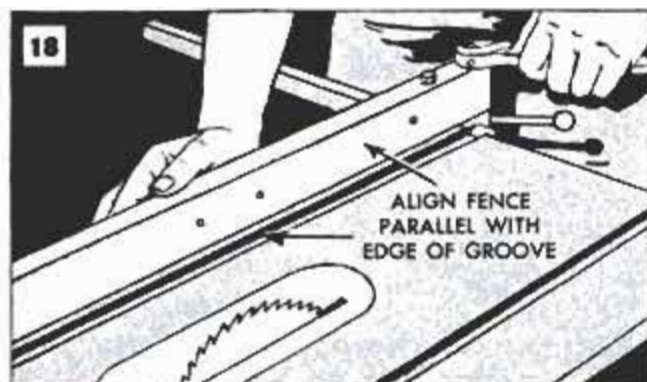

Figs. 1 to 11 inclusive picture table saws of both the bench and floor types and the specifications give you a general idea of the capacity of each unit, the construction and the size motor required for average work. Craftsmen and nearly all manufacturers refer to a table saw as a "6-in. tilting-arbor saw" or a "10-in. tilting-arbor saw", meaning that the machine comes equipped with a 6 or 10-in.-diam. blade. Thus the blade size determines to some extent the table size, the weight and general construction of the machine. Of course, the 10-in. saw will take a 6-in. blade but the maximum depth of cut will be reduced. For example, if the 10-in. blade with which the machine comes equipped gives a maximum depth of cut of, say,  $3\frac{1}{4}$  in. then the maximum cut of the 6-in. blade on the same arbor would be about  $1\frac{1}{4}$  in.

All the various makes of saw tables pictured in Figs. 1 to 9 inclusive are bench type machines. Only those shown in Figs. 10 and 11 are true floor-type machines. All others are simply bench-type machines that come with and without floor stands. However, some manufacturers do supply the bench machines with floor stands regularly.

All machines shown are of the tilting-arbor type, that is, the arbor tilts for angle cuts while the table remains level. Figs. 3, 5 and 8 picture machines with table wings, or extensions, which are supplied as extras. The wings add to the working width of the tables. Rip-fence extension bars are regularly furnished with many units, those pictured in Figs. 4, 8, 9 and 10 being examples.

Figs. 18, 19 and 20 show three steps in checking alignment of ripping fence with the blade, also the 90-deg. position of the blade with the table. These checks should be made periodically, especially if the machine gets rather hard use. If the table has never been removed from the base, you can usually rely on the grooves being in line with the blade, Fig. 18. But it's well to make a second check as in Fig. 19. Then set the blade at 90 deg. as in Fig. 20 and reset the pointer on the tilt scale to 0 deg.

Figs. 21 to 24 inclusive show methods used by experienced craftsmen when cutting narrow and wide stock to dimension. In all illustrations the blade guard has been purposely omitted for clarity. Always use the guard when it is necessary to work with your hands close to the blade. ★ ★ ★



## Jig Made of Bricks Simplifies "Baling" Newspapers



Tying bundles of newspapers or magazines can be made easy by resting the bundles on two bricks placed on edge, or two blocks cut from a 2 x 4. The bricks permit the cord to be passed around the bundles without the necessity of lifting them.

John Comstock, Wellsboro, Pa.

## Method of Removing Wallpaper Utilizes Paint Roller

After trying every method except using a steamer—which he wanted to avoid because of hot, humid weather—one homeowner loosened wallpaper for removal by applying water with an ordinary paint roller. The latter was dipped in hot water, then rolled in a paint-roller tray to remove excess water. Several fairly uniform applications of water could be made, assuring thorough saturation of the paper. Because of its greater water-absorbing characteristics, a lamb's-wool roller was used.

Alfred Runyan, Los Angeles, Calif.

## Pencil Erasers in Stop Strip Silence Rattling Door

Two pencil erasers fitted in a door-stop as indicated will silence a door that rattles because the latch fits loosely in the strike plate. After the erasers have been forced into holes drilled in the stop, they are trimmed with a knife until the door closes properly with the erasers bearing against one side.

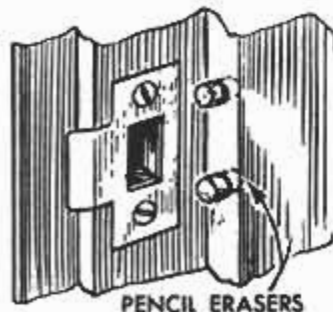

## Cork Inside Bottle Removed With Strip of Tape

Removing a cork that has been forced into a bottle can be done by dropping a strip of adhesive tape into the bottle as shown so the cork drops onto it. When the cork adheres to the tape, it is pulled into the neck of the bottle and held so a corkscrew can be inserted in it.



## Rust on Stainless Steel Caused by Improper Cleaning

Rust streaks and stains on the stainless-steel trim, hub caps and grill of an automobile are not a reaction in the metal but are due to the use of ordinary steel scouring pads. Tiny slivers break off the scouring pads and become embedded in the stainless steel, where they rust and cause the unexpected stains. To remove the discolorations caused by use of the pads, use steel-wool scouring pads made of stainless steel. Adding a small amount of scouring powder also is an aid in removing the rust from minute scratches in the stainless steel. The best method of cleaning stainless steel is the same one used to clean the painted surfaces of the car; a soap-and-water solution followed by a clear-water rinse. When caked-on dirt and stubborn

grease stains must be removed from stainless steel, use scouring powder and a damp cloth, before resorting to stainless-steel scouring pads. Rub the scouring powder and the steel-wool scouring pads in the direction of the polish marks in the stainless steel—"with the grain of the metal"—to prevent scratching and help preserve the luster of the metal. Road tar can be removed from stainless steel—and painted surfaces—by applying fuel oil to soften and dissolve the material. The residue then is washed with soap and water and rinsed with clear water. A cloth is used to wipe the metal dry to prevent water stains. No polishes, lacquers or other coatings are required to keep stainless steel shining.

Republic Steel Corp.



# LAMPS—

## *Interior and Exterior*

**B**OTH THESE LAMPS are based on antique themes, yet either will go well with the style and furnishing of a modern home. The outside lamp, Fig. 1, is built around a lantern globe, as shown in Figs. 2 and 4, that can be purchased at most hardware stores. The components of the lamp are cut and shaped from aluminum, Figs. 4, 5, 7 and 8. Brass or copper also could be used because of their weather resistance and easy workability. When aluminum is used, rivets, screws and nuts employed in the assembly also should be of aluminum. When shaping and assembling the parts for the outdoor lamp, make sure that ring D slips easily over part C. It is necessary to slide the ring upward to remove the lantern globe when the light bulb must be replaced. After disk G has been clamped between two plywood disks and the edge bent down to form a flange, right-hand detail, Fig. 8, it is riveted to ring F. This cup-shaped assembly then is

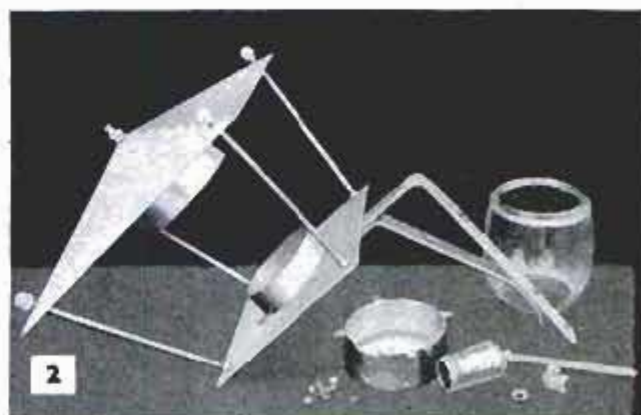
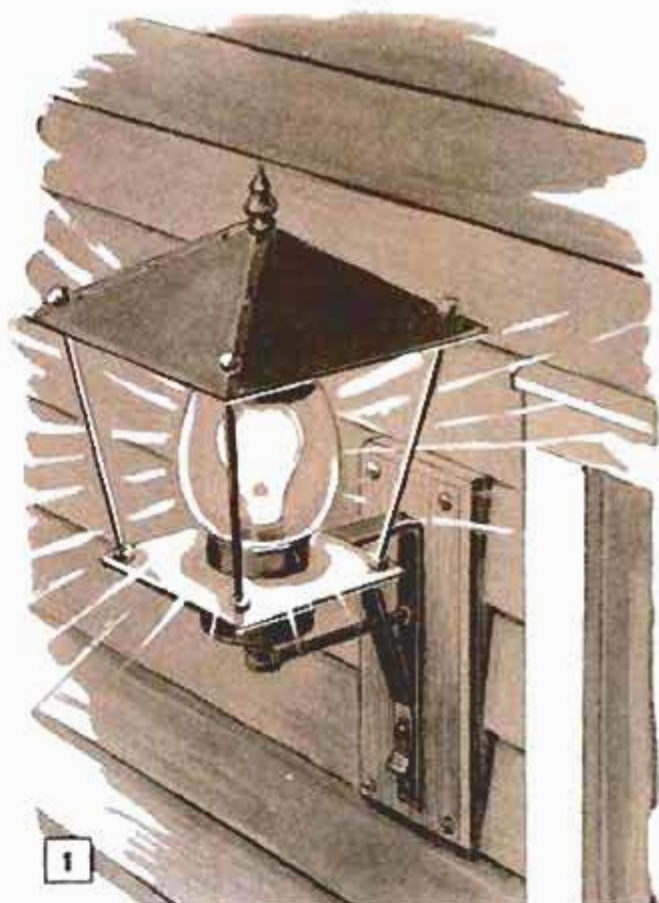

fastened to the lower surface of base B with machine screws and nuts. It is not riveted, as are the other components, because it may at some time be necessary to remove it to repair or replace the light socket. The socket is screwed to an assembly of  $\frac{1}{8}$ -in. pipe and fittings, lower detail, Fig. 4, that is used to protect the wire leading into the house wall. A brass lamp finial is screwed to the center of the lamp cap, while the four supporting rods are capped with drilled and threaded brass balls, such as can be purchased at jewelers and lamp-supply houses.

The uniquely styled table lamp, Fig. 3, has a shade that suggests a Civil War drum, the four drum sticks around its column carrying out the theme, Fig. 6. Patterned translucent plastic is cemented to a pair of embroidery hoops to form a shade, a  $\frac{1}{2}$ -in. lap being allowed on the plastic for





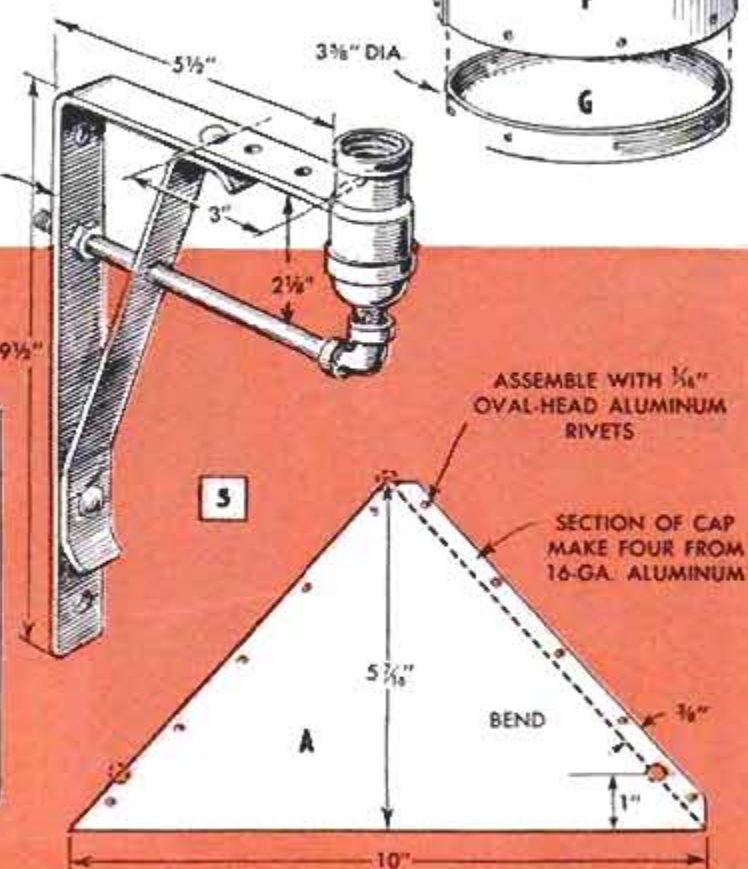
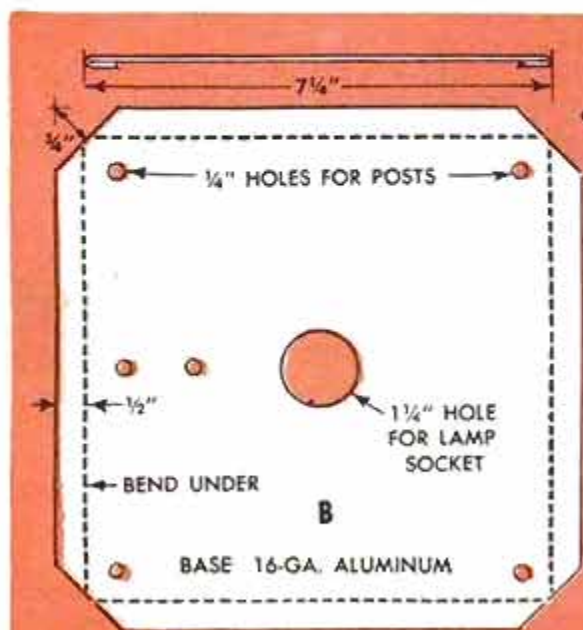
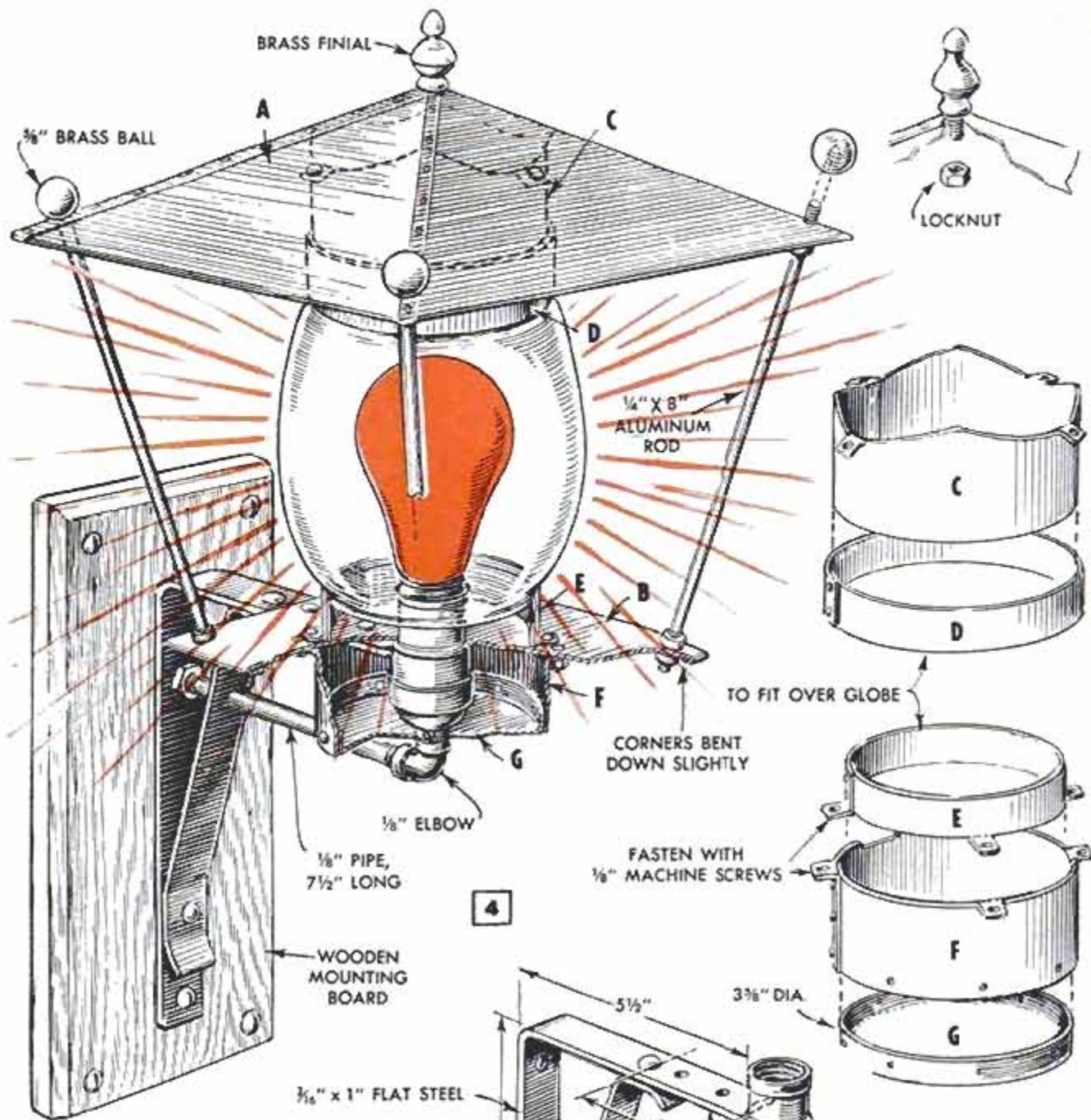



the vertical seam. The shade is supported by four lengths of wire, the ends of which are fitted through holes drilled in a washer, as shown in the upper detail, Fig. 6, then soldered in place. The opposite ends of the wires then are bent at right angles, flattened slightly and drilled to accommodate small nails or screws that are driven into the wooden embroidery hoop of the shade. A cardboard or metal tube is used for the lamp column, being plugged at the upper end with a wooden turning. This turning is drilled to receive a length of  $\frac{1}{8}$ -in. pipe. As shown in Fig. 6, the lower surface of the lamp base is counterbored to receive a locknut that is fitted on the lower end of the pipe. A locknut also is fitted on the upper end of the pipe. A lamp harp and socket also are fitted on the upper end of the pipe, the former supporting the shade. Drumsticks used on the lamp column can be purchased or turned from dowels. They are cemented in blind holes drilled in the base as indicated in Fig. 6. Sheet copper is used to make the hooks that hold the "tuning cords" on the drum. Wooden blocks, squared pattern, Fig. 6, are fitted on the cords. ★ ★ ★

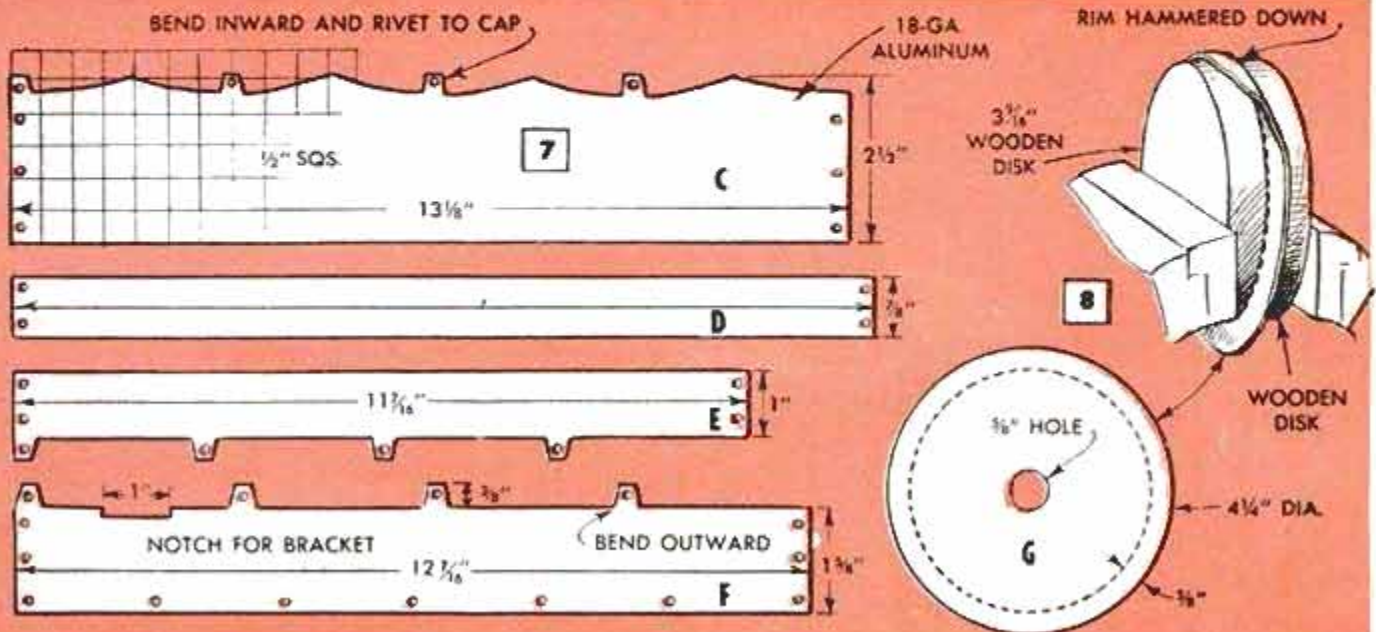
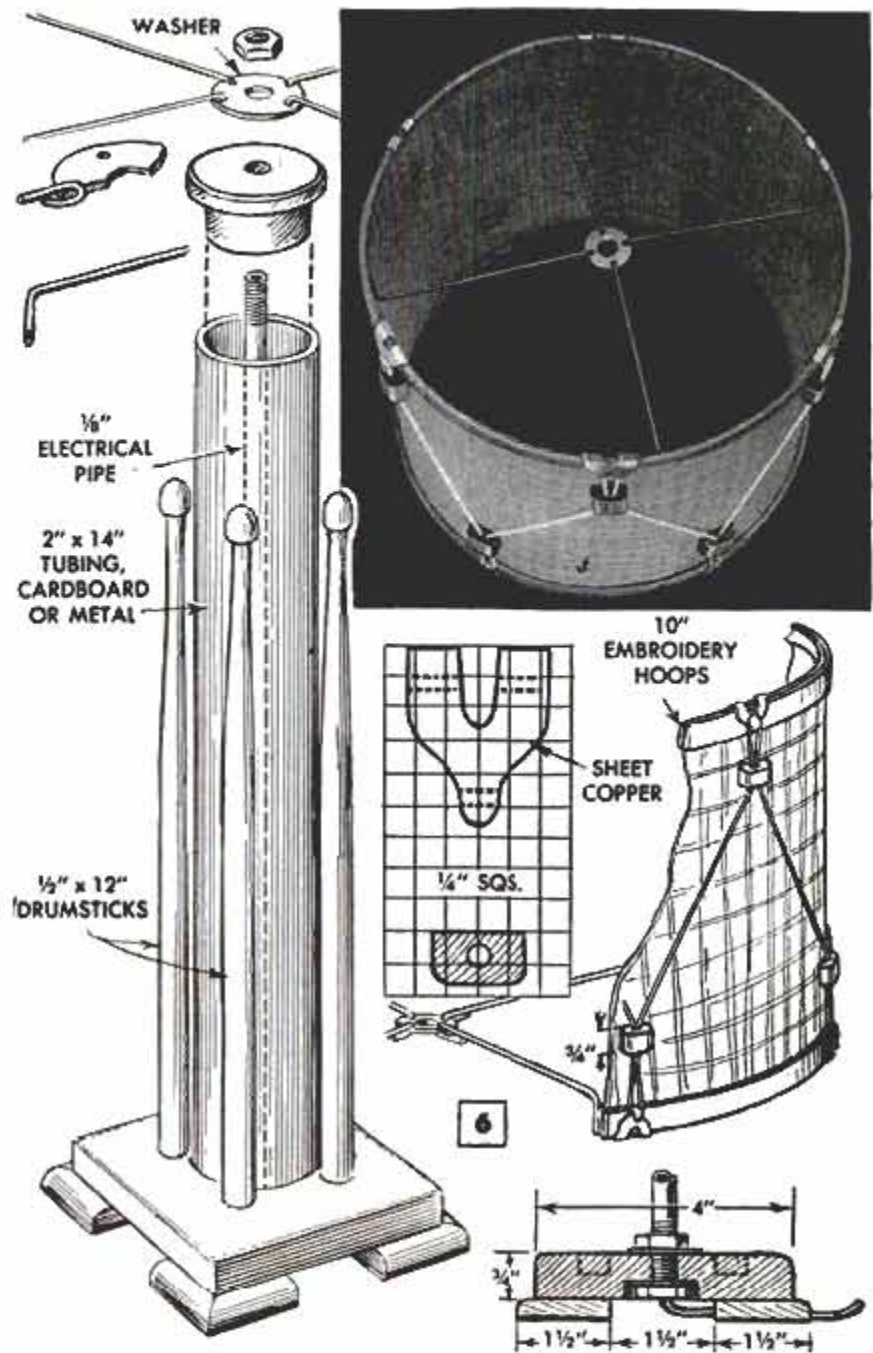



## Labor-saving Leaf Carrier



Both time and labor are saved by this 10 x 10-ft. piece of canvas with rope handles sewed to the corners. Leaves are raked onto it, then it is folded over and dragged to the street to await the city leaf-disposal truck, or to a suitable area for burning.

Marcus L. Mulkey, Chattanooga, Tenn.

## Amplify Door Chime Sound

If a door chime, bell or buzzer is not easily heard throughout a home equipped with forced-air heat, mount the chime on a cold or hot-air duct with two small sheet-metal screws. The reverberating sheet metal serves as a sounding board to amplify the sound which is sent through the ducts to all the rooms.

Fred Haitz, Sioux City, Iowa.



## Low-Cost "Storm Shutter" Awning

By Wyatt M. Wayne

**U**NDER normal circumstances this awning is an attractive means of sheltering a window from sun and rain. During a hurricane or high wind, a hidden flap drops down and the complete assembly fastens firmly to the wall. Wind-blown objects then strike it and are deflected, rather than shattering the window glass. Low cost, as well as adequate strength are built into the awning by using screw eyes and eyebolts rather than hinges, see details at right. Maximum strength in attachment to the house wall is assured by using lag screws to fasten a  $\frac{1}{4}$  x 2 x 2-in. steel angle to the wall, then suspending the awning from the angle. In the original installation, this angle support was located 10 in. above a standard 38 x 51-in. steel casement window, which allowed room for the windows to be cranked open. On other types of windows the point of attachment for the angle would be different, as would the over-all dimensions of the awning itself. Covering for the storm awning is  $\frac{1}{4}$ -in. hardboard. For the awning described, a piece of hardboard measuring 4 x 6 ft. is enough for the complete job. Note in the right-hand detail that the  $\frac{1}{4}$ -in.-pipe support must have its pivot point on the wall arranged so that it supports the awning at the proper angle in the "up" position, yet must also pivot down to allow the flap and awning to be positioned flatly against the wall. When the dimensions are changed, this pivot point may require some adjustment to be correct. When the awning is in the "down" position, two lag screws, of the type shown in the lower right-hand detail that have a bolt end, are used to secure the flap against the wall. Wing nuts are turned on the projecting bolt ends. Originally designed for use in the hurricane area of the Southeast, this storm awning would be equally useful in areas of high winter winds. ★ ★ ★



## Antifreeze Is Not Reusable

Because the rust inhibitor in antifreeze is dissipated during a season of use, the antifreeze becomes highly corrosive and should never be saved and reused the following year. Adding fresh rust inhibitor to the antifreeze seldom will eliminate the corrosion-causing factors in the solution.



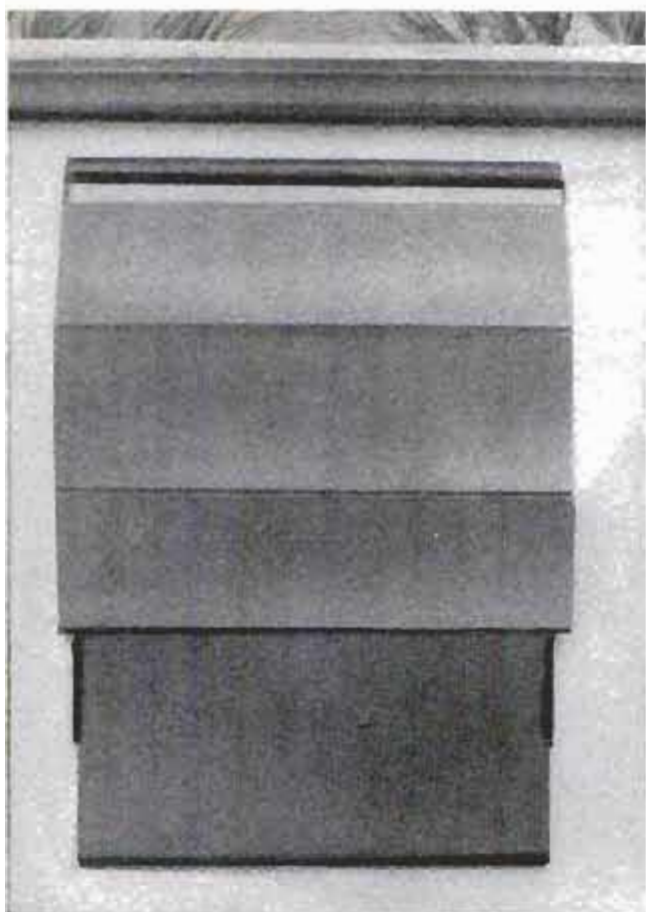

In "down" position, as shown above, normally hidden flap is dropped down and bolted to the wall with wing nuts. Method of pivoting keeps edges of flap and awning aligned when they are bolted down



Above is shown the storm-shutter awning in the "up" position. The supporting braces for the awning part of the assembly are pivoted on the storm flap that swings up inside when the unit is held in this position

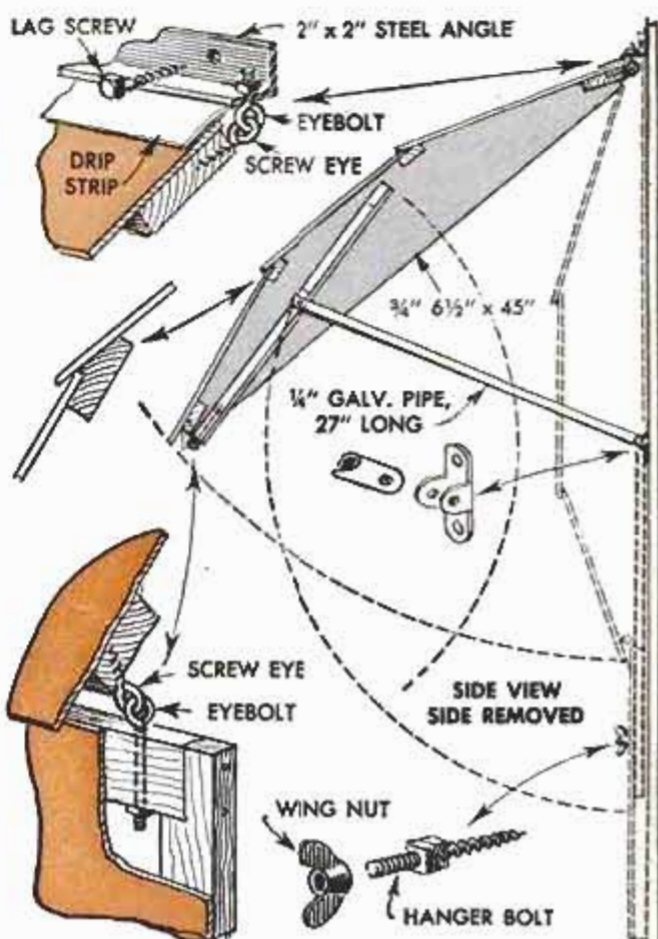
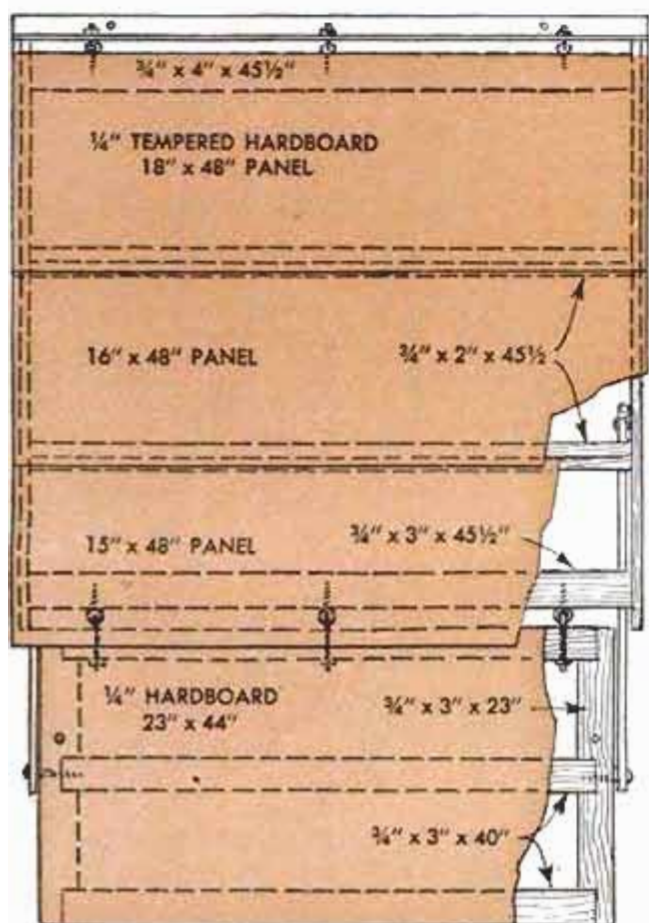



## Yarn Used to Make Pictures on Sandpaper Drawing Board



Mother will have no worries about spilled paints or crayon marks on walls or floors when the children use this sandpaper "drawing board" with colored-yarn "paints." The board is made by cementing one or more sheets of coarse sandpaper to a piece of  $\frac{1}{4}$ -in. plywood. Colored yarn, cut to lengths easily handled by youngsters, provides the drawing material. The loose weave of the yarn causes it to cling to the sandpaper to form outline sketches, and simply, removing it will "erase" any picture. — Leonard W. Mitchell, Detroit, Mich.

## Simulated Wrought-Iron Items Cut From Tempered Hardboard

Simulated wrought iron or hammered-brass hinges, house numbers, monograms and other items can be cut from tempered hardboard. The pieces are cut to shape with a jigsaw or other power tool, then the edges are gouged with a sander or half-round file to simulate the appearance of hammered metal. The surfaces can be dimpled by using a ball-peen hammer to simulate wrought iron or hammered brass. Flat-black paint is applied to complete the project.—Masonite Corporation.

## Rubber Tiles Are "Place Mats" On Barber-Shop Work Counter

Colorful mats on the work counter under the mirrors in one barber shop are not only attractive, but useful. The mats are squares of rubber tile purchased at a nearby tile store. The nonskid surfaces of the tiles prevent barber tools and bottles from sliding off the counter should someone accidentally brush against them, and the cutting edges of scissors and razors are not damaged by the resilient surfaces of the rubber tile.

A. R. Tanner, Jr., Poughkeepsie, N. Y.

## Dulled Razor-Blade Corners "Sharpened" With Pliers

When the corners of a razor blade, used for cutting paper or cardboard, become dulled, they can be "sharpened" by breaking off the blade corners with a pair of pliers, as indicated by the dotted lines.



## Rubber Band on Gummed Labels Eliminates Curling Problem

Shipping labels tend to curl toward the glued side, making it difficult to address them in a typewriter or by hand. To overcome this, curl the pack in the opposite direction and snap a rubber band around it.

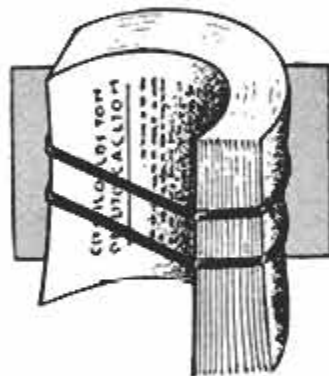

## Initials Identify Overshoes

Your children will have little trouble finding their rubbers and galoshes in the school cloak room, or hall closet at home if initials cut from tire patches are cemented to the footwear. The cement provided with the patching material will keep the initials firmly attached.

## Magnet Holds Baby Pins

You can eliminate the need for searching for lost pins which present a hazard to a baby, by fastening a small magnet to the bathinette to hold the pins. Inexpensive magnets are available drilled and with screws for easy attachment. — Charles V. Mathis, Wildwood-By-The-Sea, N. J.



# BULLDOZER BLADE

Designed for use on a tractor that has a drawbar with 3-point suspension, this bulldozer blade has a feature not usually found on such blades. Besides being adjustable to various angles, and being reversible, the blade can be offset to either side so it extends beyond the wheels. This feature makes the blade ideal for working close to buildings and foundations, and for filling ditches. Two steel angles welded to the back of the blade form a slot in which two drilled and tapped blocks of steel can be moved, as shown in the detail. Lock bolts keep the blade in position when it is adjusted. The vertical member of the blade support is a length of steel pipe welded to the horizontal bar as shown. A drilled and tapped disk is screwed to the upper end of the pipe.

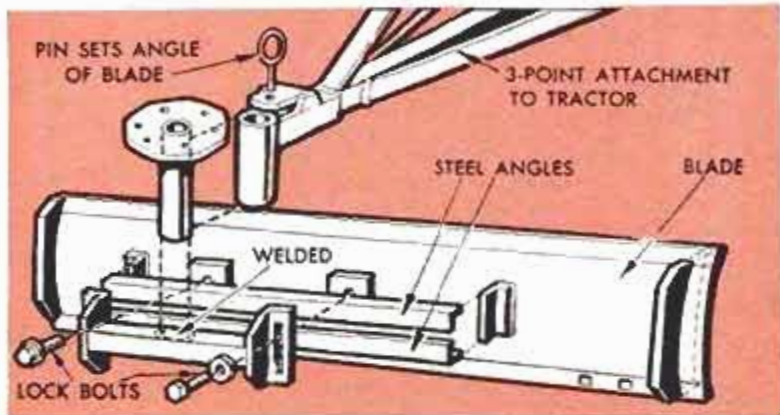
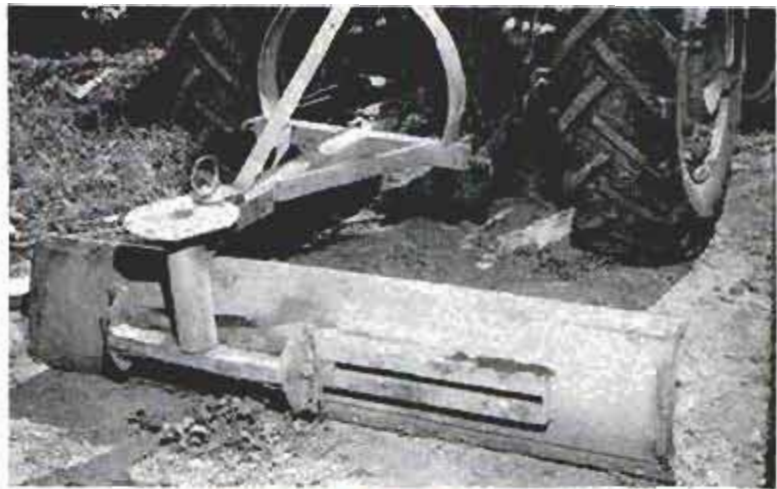

## Chute Above Rack Simplifies Feeding Baled Hay

Feeding baled hay to the livestock is much less work in this barn where a chute and a number of doors leading from the hay mow open directly above the feed rack. Baled hay dropped through the chute and doors lands in the rack, where the ties are cut and the hay scattered. The rack is located so that stock can feed from both sides, and it also can be used to keep beef cattle separated from milk cows.

A. M. Wettach, Mt. Pleasant, Iowa.

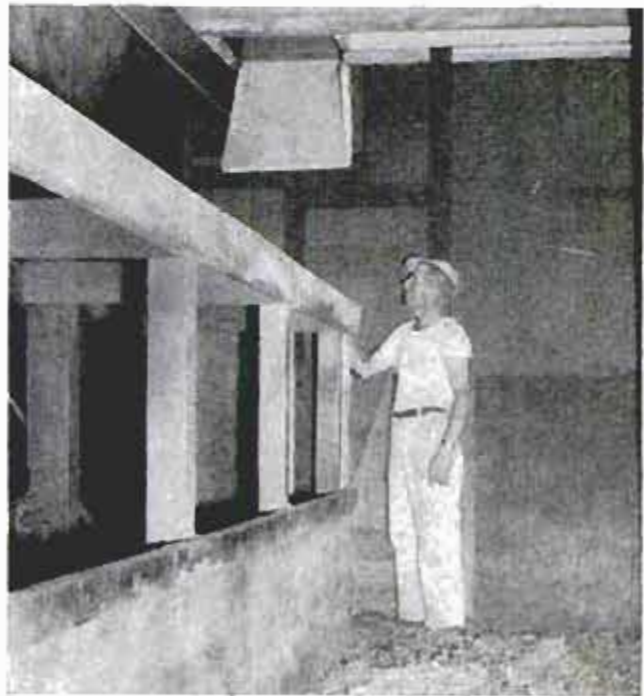

## Attaching Rural Mailbox

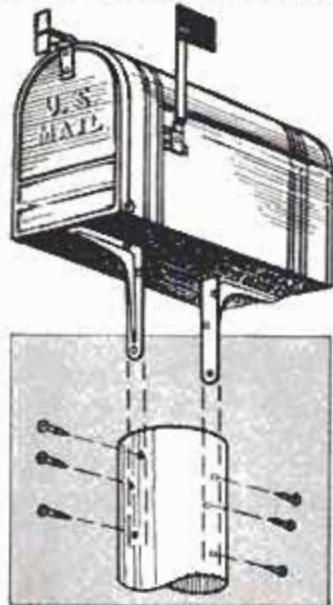

One of the simplest ways of attaching a rural mailbox to a suitable post so it is anchored securely against wind and weather is to use two shelf brackets. Small stove bolts are used to fasten the brackets to the bottom of the mailbox, and long wood screws then are fitted in the other legs of the brackets and driven into the post.

## Light Denies Corn to Raccoons

Randy Currens of Traer, Iowa, solved the raccoon problem in his sweet-corn patch by burning a road flare on a 6-ft. post every night for three weeks before harvest. Corn in the lighted area was untouched by the animals whose appetites were not as strong as their aversion to the light, even though it was not exceptionally bright.



# WORK SAVING

By A. M. Wettach

**T**O MAKE livestock feeding easier and quicker, here are several handy feeders that can be made on the farm using common materials and tools. Bunks that are used for dispensing feed in large quantity are attached to the building in which the feed is stored or prepared for use, while other feeders are mounted on skids or runners for convenient moving to pasture or feedlot. A few of the feeders are provided with some type of shelter, such as the novel but useful salt rack shown on the opposite page. A vane bolted to the top of it enables the revolving feeder to point into the wind so that rain and dust do not blow into the opening on one side.

Upper left, no supporting legs are in way of cattle feeding at this bunk which is attached to inside wall of cattle shed. Front and bottom of bunk are made of 2 x 10 planks nailed to heavy wooden braces that are nailed to sill and upright-framing timbers

Center left, stanchion-style feed bunk in cattle shed keeps feed waste to minimum by preventing cattle from dragging hay out of bunk and trampling it. Baled hay is dropped through mow-floor openings directly overhead for convenient scattering in bunk

Below left, minerals and salt are kept dry, yet accessible to cattle at all times, in sheltered feeder made of rough-sawed pine lumber cut to size and bolted together throughout for sturdiness. The 4-ft.-sq. box has separate compartments for minerals, salt

Below, heavy-duty feed bunk for cattle is made from large boiler cut in half. Sturdy legs cut from 2-in. steel pipe and welded to tank sides at each end provide support for bunk at desired height. Bunk is ideal for grain, ground feed, silage or water

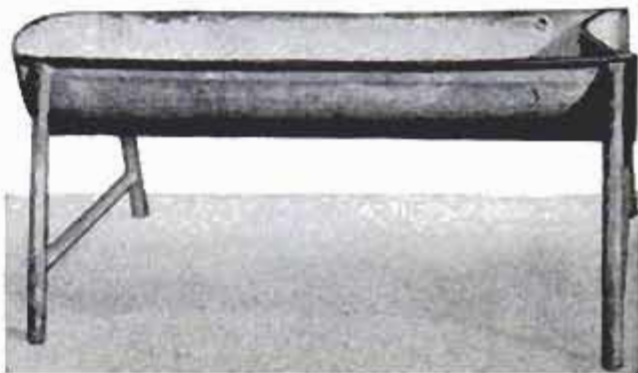
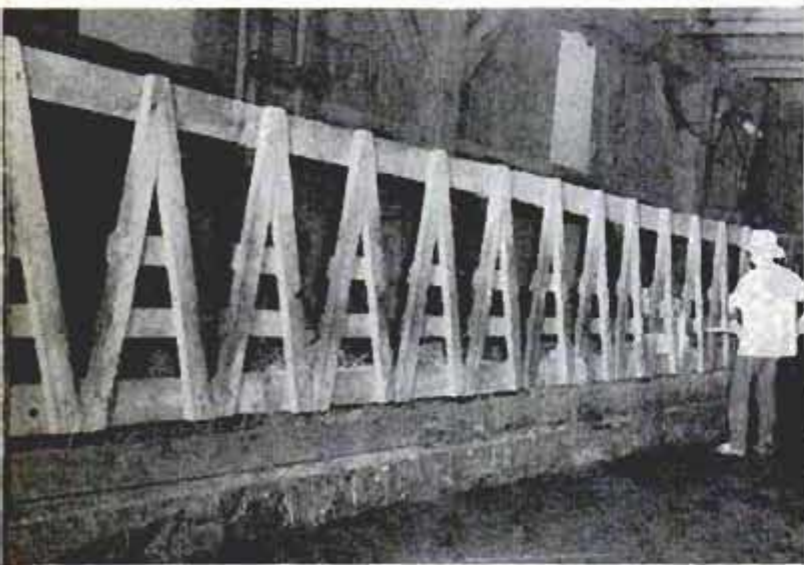
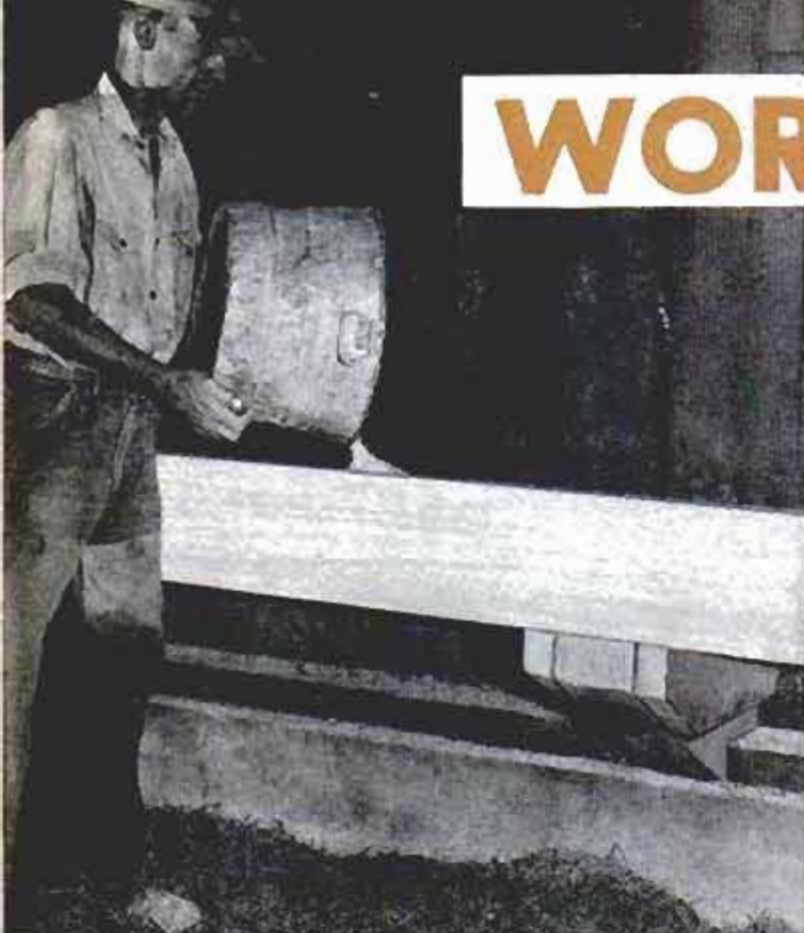



# LIVESTOCK FEEDERS

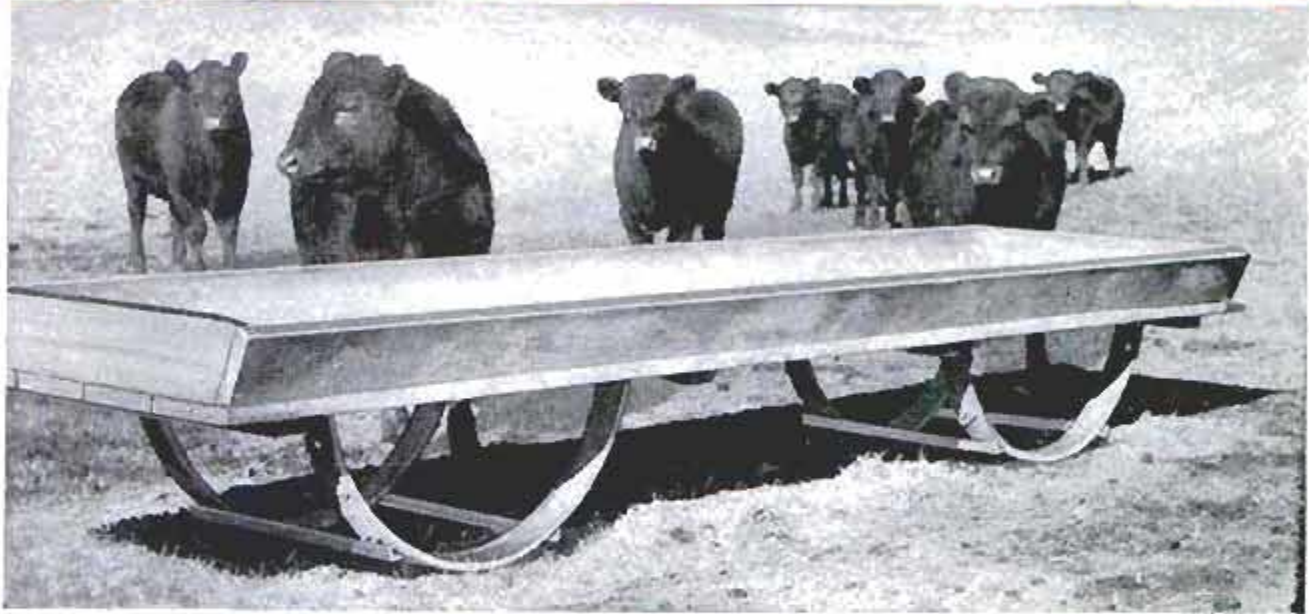

Above, rims from two discarded manure-spreader wheels cut in half and bolted to underside of feed bunk, provide sturdy legs and serve as runners for easy moving to new location. Lengths of steel angles welded to rims, prevent them from spreading

Right, vane on revolving salt rack for sheep permits rack to head into wind to protect salt from rain. Metal basket is nailed to platform on which pipe flange and length of pipe are screwed. Latter turns in larger pipe and flange assembly bolted to wheel

Below left, poured-concrete bunk for feeding ground feed and grain to cattle is attached to granary to save work. Sliding door permits direct access to bunk from granary. Framework at top consists of a channel-steel rail that is bolted to steel posts

Below right, 9 x 16-ft. self-feeder for livestock holds 100 bales of chopped hay and has 2-ft. side manger on each side. Uprights are 4 x 4s to which 2-in. planks are bolted to height of 18 in. for sturdy base. Note substantial overhangs on roof

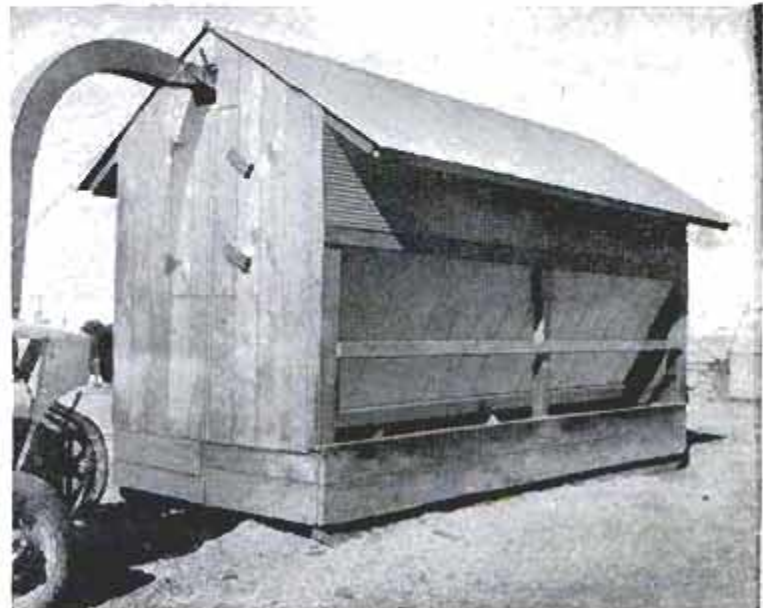
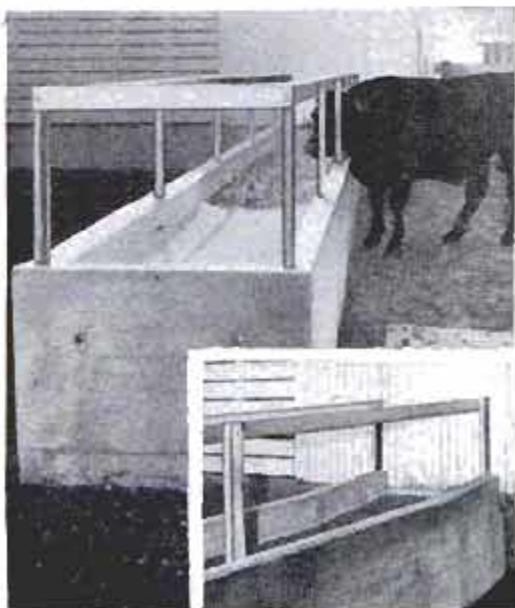





## Cleaning Solution Fed to Brush From Attached Plastic Bottle

You can avoid the time-consuming job of constantly dipping a brush in cleaning solution when removing soil from clothing, by attaching the brush to a plastic squeeze bottle in the manner shown in the detail at left. To do this, drill a  $\frac{1}{16}$ -in.-dia. hole through the back of the brush. Then counterbore this hole to take a screw-type cap that can be turned on the plastic bottle as shown. Next, the cap is permanently secured in the counterbore with waterproof plastic cement. A  $\frac{1}{16}$ -in.-dia. hole is also drilled in the cap. This should be done after cementing it in place, to assure proper alignment with the small hole drilled in the brush, for proper passage of cleaning fluid to the bristles. When cleaning solutions that evaporate quickly are used, the brush is removed from the bottle after each use and a tight-fitting cap is screwed on in its place.

## Tire Sections on Sawhorses Protect Work From Damage

To prevent marring woodwork that is being sanded or sawed on sawhorses, nail short tire sections to the top of each sawhorse stringer as indicated in the accompanying detail.—Harry J. Miller, Sarasota, Fla.

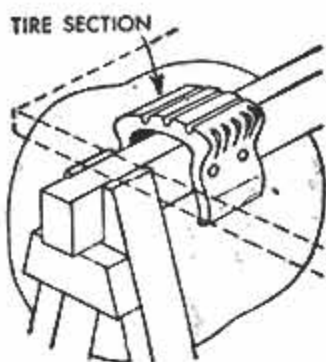

## Wood Screw Securely Anchored With Small Finishing Nail

Wood screws can be prevented from working loose by "locking" them in place with small finishing nails. There are two ways of doing this as detailed at right. One method is to file a sharply angled notch in one end of the slot to accommodate a nail as indicated. This is most easily done when the screw has been driven deep enough to remain upright while filing. If it becomes necessary to remove the screw, the nail is merely driven all the way into the wood. A second method consists of drilling a small hole through the screwhead to take a nail as shown.

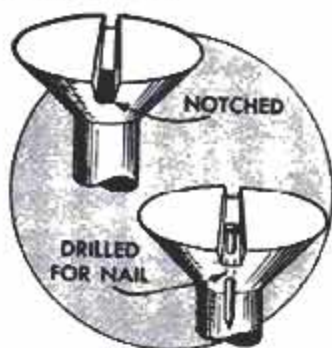

## Magnet "Spots" Brass Plate

When shopping for door locks, drawer pulls or other hardware, a good way of determining whether you are paying for solid brass or only plated items, is to test them with a small pocket magnet. Brass or aluminum will not be attracted to the magnet whereas brass-plated steel will.

## Crosswise Dowel in Plywood Holds Screw Securely

Holding power of a screw driven in the edge of plywood can be greatly increased if a dowel is glued in a hole drilled at right angles to the plies as shown.—Frank A. Javor, Newark, N. J.

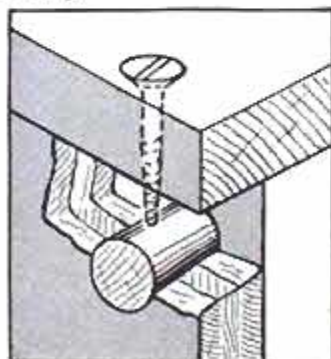

## One-Man Handling of Joist Aided by Bent Nail

Where you have no help to lift the end of a long joist and hold it in place, try a heavy nail as a substitute. Drive the nail into the joist as indicated, and bend it to form a supporting hook to hold the member in position.





*On the*  
**MARKET**  
*for Do-It-Yourselfers*



**1. SPECIAL CLEANER** for aluminum removes accumulations of grime and oxidation from aluminum storm doors and windows, household utensils and appliances. Comes as a kit with two fine steel-wool pads for application  
Corky, 337 Washington Ave., Newport, Ky.

**2. PLASTIC CEILING TILES** are designed for easy application with adhesive or staples. The tiles are washable, waterproof, fire-resistant. They come in a variety of 3-dimensional patterns, 6 tiles to a panel, in white and color  
Hallmark Plastics Corp., 151 Division St., South Hackensack, N. J.

**3. NONFLAMMABLE PAINT REMOVER** of the wipe-away type will remove several coats of paint, enamel or varnish in one application. Comes as a dry powder in 1½-lb. cans. Contents mixed with water makes 3 qt. remover  
Antique Corner, South Bend 24, Ind.

**4. CERAMIC CABINET HARDWARE** combines the texture of ceramics with the appeal of polished metal, bringing a new concept of color and dimension to modern cabinet work. Presently offered in two sizes and three colors  
Stanley Hardware, Div. of Stanley Works, New Britain, Conn.

**5. WINDOW-WALL UNIT** makes possible substantial savings in labor and time for builders and do-it-yourselfers. Eliminates over half the steps involved in framing conventional rough opening for regular window unit  
Anderson Corp., Bayport, Minn.





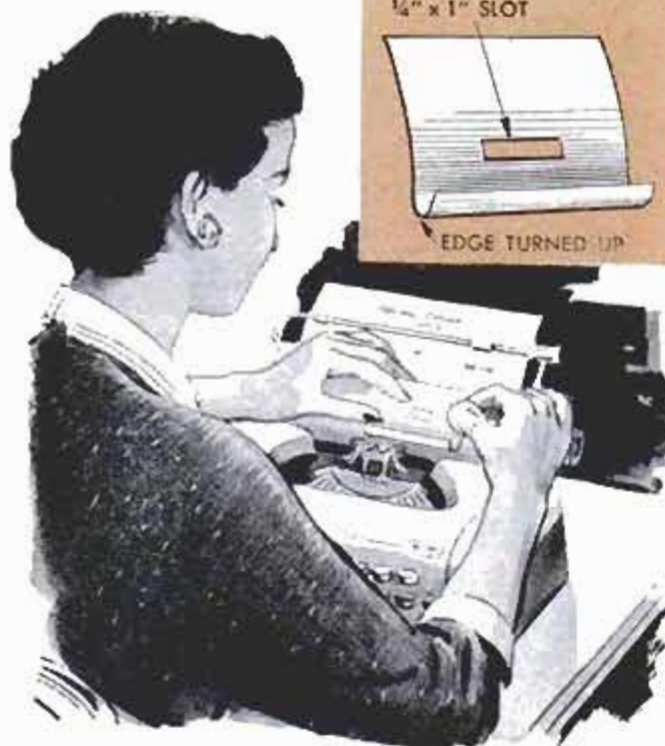

## Eraser Shield for Typewriter Protects Key Mechanism

To prevent an accumulation of eraser fragments from fouling the key levers of a typewriter, use this simple but effective shield. It is held with one hand, while the other hand is used to do the erasing. The shield is made from very thin sheet metal, such as half-hard brass, that will not bend out of shape easily when handled. A cut-out about  $\frac{1}{4} \times 1$  in. is ground at the approximate center of the shield. Grinding is suggested, rather than either cutting with hammer and chisel, or punching out the opening, to avoid distorting the thin sheet metal. Round all four corners of the sheet with a file, then bend one edge to form a trough. Bend the metal to the same curvature as the surface of the typewriter platen for a short distance above the trough. The rest of the metal is left straight. Remove all burrs on the edges and smooth with emery cloth. Shellac to prevent tarnish.

## Magnet Holds Shopping List

If you have steel cabinets in your kitchen, a small magnet makes an ideal "nail" for attaching messages, shopping lists, and notes to the doors.

## Radio Heat Softens Polish

If paste shoe polish has become hard and lumpy in the can, set it on top of your small bedroom radio, and the heat from the radio will soften the polish.

# FIX-IT-YOURSELF TELEVISION MANUAL

*For less than the cost of most new parts,  
you can learn how to maintain your TV  
set — and make many repairs yourself!*

**INCLUDES LATEST DATA ON COLOR AND  
ULTRA-HIGH-FREQUENCY TELEVISION**

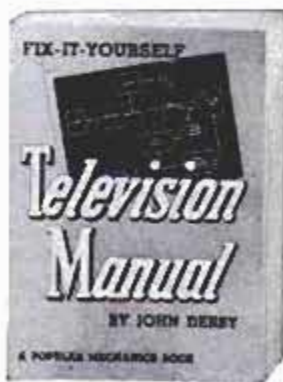

### Complete, Reliable, Authoritative

John Derby, famous electronics engineer, has written another fact-filled, money-saving book. **ALL ABOUT TELEVISION** was bought by 200,000 savings-minded people, and the demand for it is larger than ever. But, with so many new developments in the field, Mr. Derby and Popular Mechanics Press realized a completely new book should be published. One aimed directly at the man who wants to make his own repairs.

### Covers the Entire Subject

**TELEVISION MANUAL** will tell you, with no technical doubletalk, *everything* about television transmission and reception. It will expand your knowledge and enable you to handle 3 out of 4 TV repairs. Never again will you not understand what you're doing with a TV set. You'll know whether to call a professional or do the job yourself.

### All the Latest Information

Now you can learn how color TV works, how to care for, and how to enjoy most fully that color set when you get it. **TELEVISION MANUAL** will show you how to take advantage of the new UHF networks and how to convert your present set to ultra-high-frequency. It will answer almost any question you may have about television.

### MONEY-BACK GUARANTEE

**TELEVISION MANUAL** is guaranteed to satisfy you, to save you money—if not, you can return it within ten days for a full refund of the purchase price. So send your order, with a remittance of only \$3.50, today!

### Popular Mechanics Bookshop

208 East Ontario Street  
Chicago 11, Illinois



2 10-60

# GRINDING WITH SOUND

By Richard F. Dempewolff

**S**OUND WAVES, pitched so high they cannot be heard by the human ear, now are being utilized as "hammers" to drive abrasives through the hardest substances. The process is known as ultrasonic impact grinding and is made possible by a distinctive property of certain metals — notably nickel. The impact grinder employs a coil having a core, or stack, built up of nickel laminations. Electrical current is passed through the coil at an ultrasonic frequency of 27,000 cycles per second. Directional forces in the electromagnetic field thus set up cause the nickel laminations to expand and contract over a microscopic distance of about .0004. This movement, or vibration, of the coil core, taking place in the ultrasonic frequency range, is amplified first by a bank of vacuum tubes, then mechanically transmitted by a metal cone to which the die, or tool, is brazed. The cones are shown in various common shapes

## SHOP NOTES



Relief work cut into glass with ultrasonic impact grinder. Note accuracy of extremely intricate detail

in Fig. 4, A to F inclusive. In practice the work is located directly under the tool which is lowered until the point, or face, is very near the work surface, but never in actual contact with it as is a conventional cutting tool or grinding wheel. The relationship of the tool and work are shown in

Floor-type impact grinder closely resembles a vertical milling machine when set up for operation

Photos courtesy Raytheon Co.

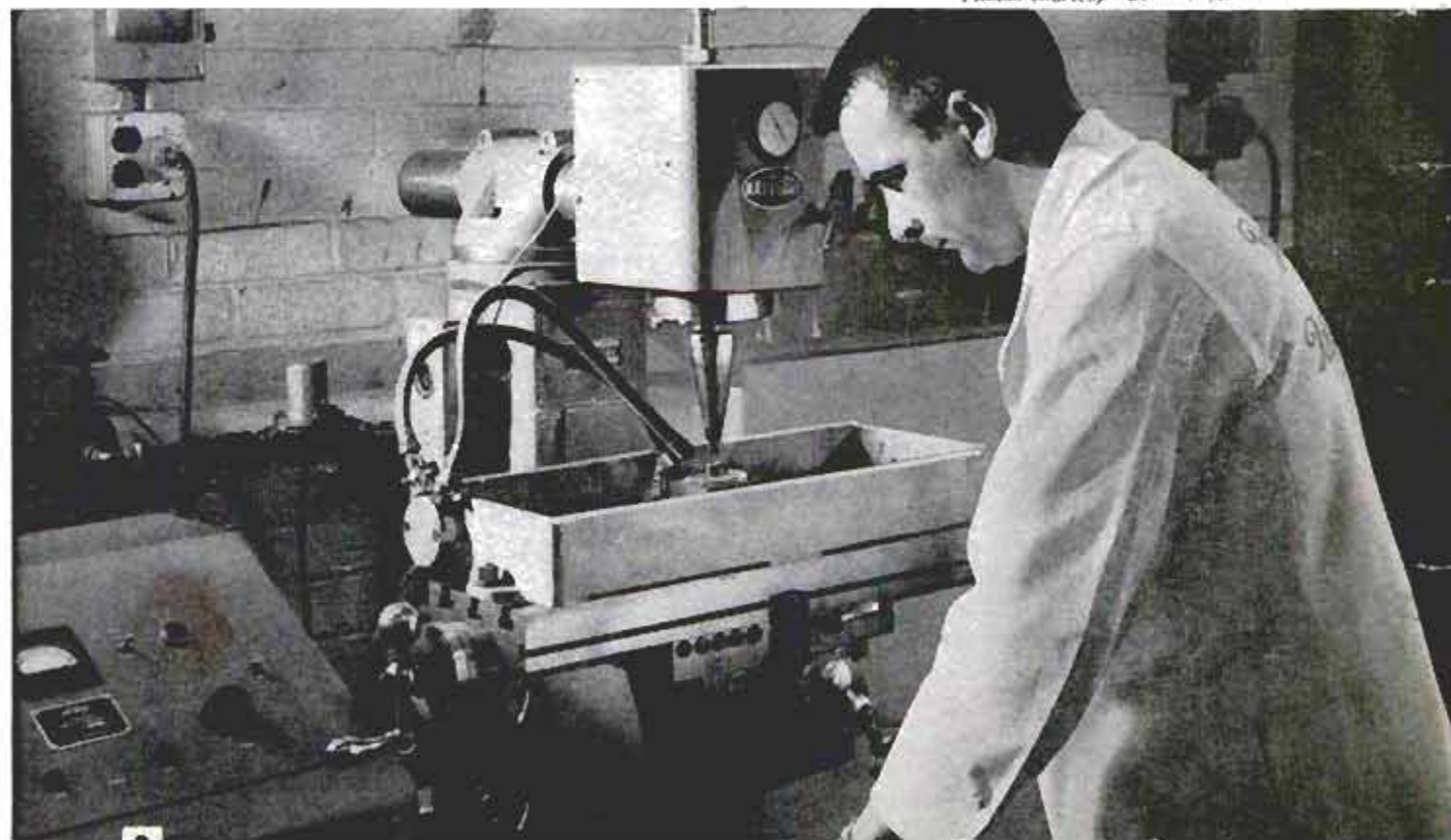





4

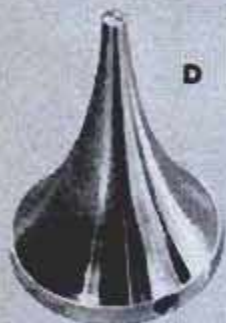
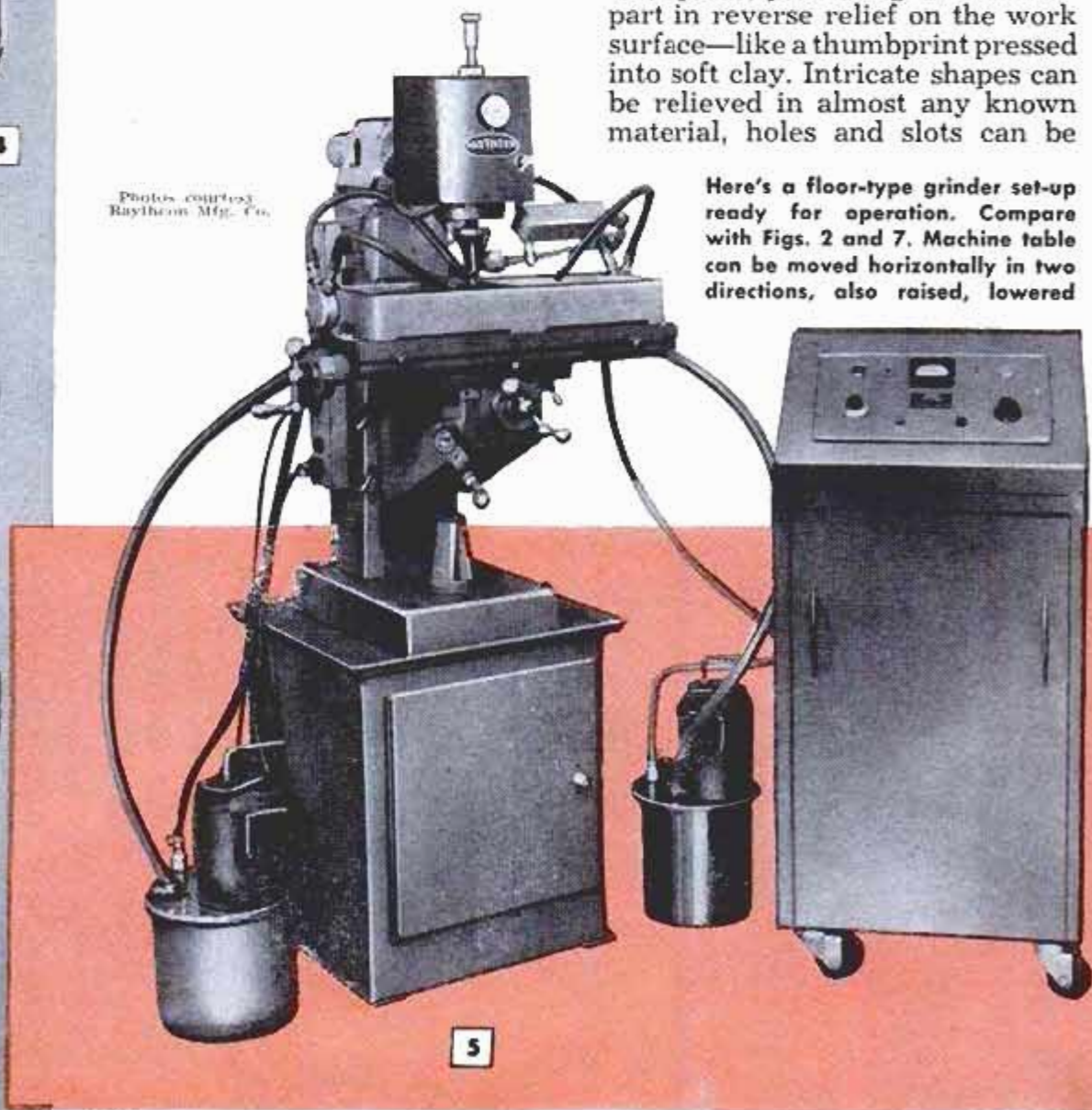

Photo courtesy Vibro-Ceramics Corp.

Above, bench-type impact grinder is designed for light work on small parts. Left, transducer cones of various shapes carry the tools, which are brazed to the tips. Note in Fig. 6 how tool cone is attached to the transmitting cone with threaded stud

Photos courtesy Raytheon Mfg. Co.



Here's a floor-type grinder set-up ready for operation. Compare with Figs. 2 and 7. Machine table can be moved horizontally in two directions, also raised, lowered

Fig. 6, the details being greatly exaggerated, of course, for purposes of clarity. When the unit is in operation an abrasive mud, or slurry, flows across the work in a steady stream. As the abrasive grains pass between the tool and the work surface, vibration of the tool causes the abrasive to cut into the material. Striking the surface of the work with terrific impact (up to 150,000 times the weight of the individual grains) the particles chip, or grind, an exact counterpart of the tool face into the work surface—hence the name impact grinding.

For drilling a straight, round hole a flat-faced cylindrical tool is brazed to the bottom of the cone-shaped toolholder. For working more intricate shapes any relieved more intricate shapes any relieved pattern that can be engraved or stamped on brass or mild steel becomes a tool for transmitting the forces that drive abrasive into the workpiece, producing its counterpart in reverse relief on the work surface—like a thumbprint pressed into soft clay. Intricate shapes can be relieved in almost any known material, holes and slots can be



drilled through, and many materials can be sliced down to only a few thousandths of an inch in thickness. An example is the slicing of delicate quartz radio crystals, the actual operation being shown in Fig. 10. Fig. 1 pictures a relief engraving in glass, while Figs. 11 and 12 show how complex patterns can be drilled into and through various materials. In addition to engraving, jewelry and diemaking, the impact-grinding unit also performs such common shop operations as drilling, reaming and broaching. Experimental work now being carried out will, of course, widen the field of application to include many operations now done by contact cutting tools of conventional types.

In present practice, impact grinding is carried out on areas up to about 3 sq. in., depending on the type of material being worked. Larger areas can be handled if the desired shape is of such a nature that it can be roughed out or partially completed beforehand by conventional methods. Where the type of work will permit, successive cuts often are used to work large areas. Finish on the workpiece is controlled by the grade of abrasive used. Fine abrasives produce a finer surface finish and generally permit holding of closer tolerances than do the coarser abrasives. Of course, where cutting speed is among the first requirements, a coarse abrasive generally is used.

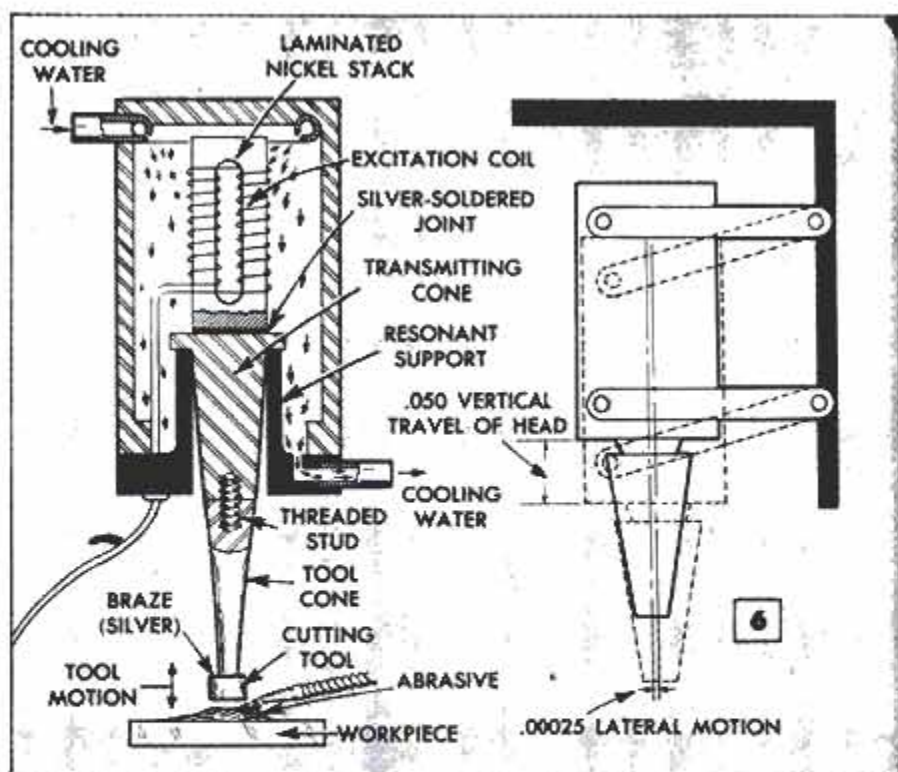

"It normally is not necessary to clamp the work," explains Patrick Duran, application engineer for Raytheon, manufacturer of impact grinders. "There is no tendency for the tool to wander. The absence of direct tool-to-work contact and the presence of cool abrasive mean that impact grinding is a cold-cutting process. Work material is not stressed or distorted in any way and, of course, is not raised in temperature."

The only appreciable heat generated in the operation is in the wire coil through which current passes at an ultrasonic frequency. The coil is water-cooled as will be noted from Fig. 7. In general appearance and size impact grinders of the floor type closely resemble a vertical milling machine, Figs. 2 and 5, also Fig. 7, the latter showing

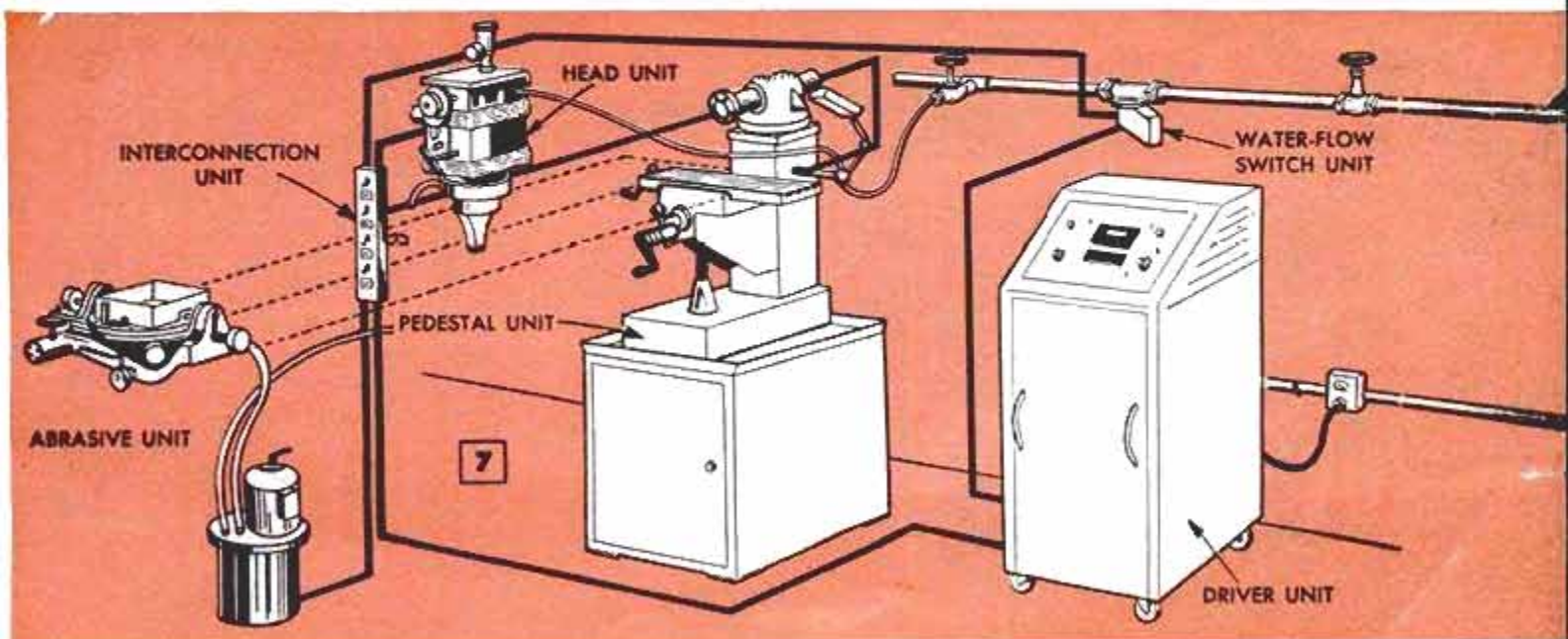



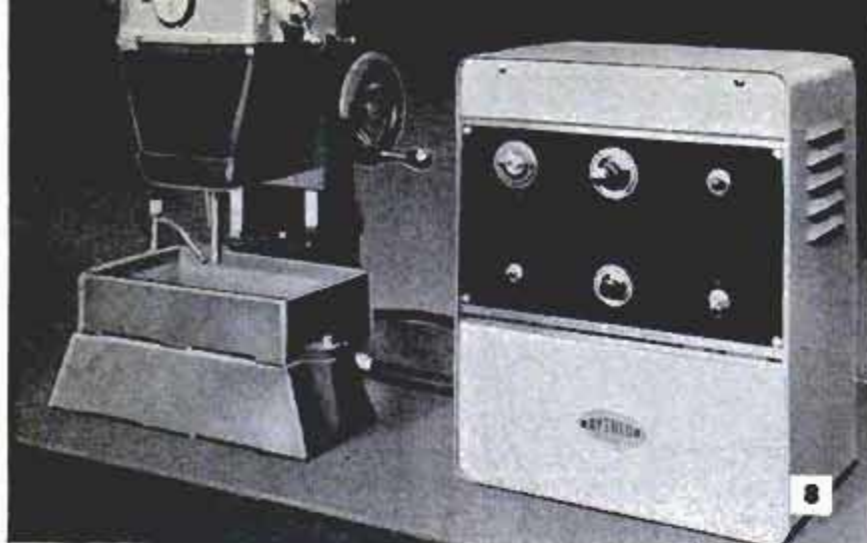

Photos courtesy Raytheon Mfg. Co.

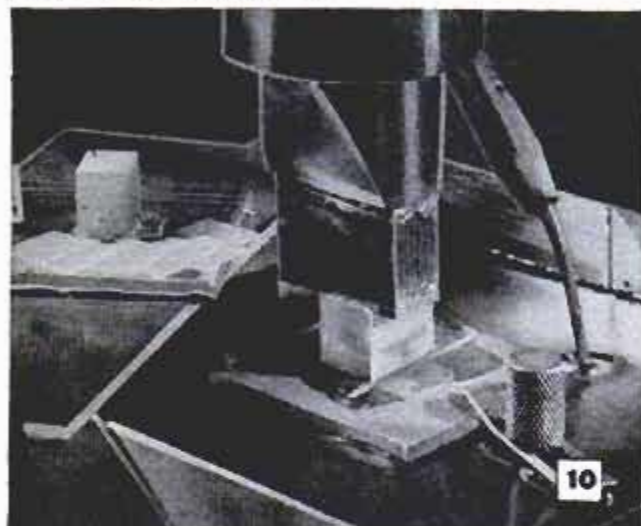

Above, actual operation of slicing radio crystals from quartz. Tool consists of laminations spaced .012 apart. Below, Figs. 11 and 12, picture intricate patterns cut into and through various kinds of materials

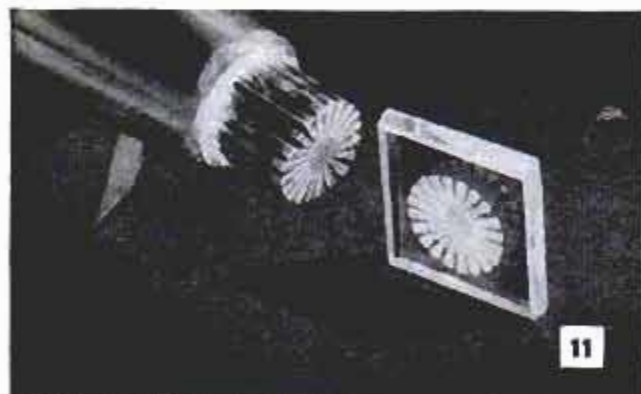

Photos courtesy Raytheon Mfg. Co.

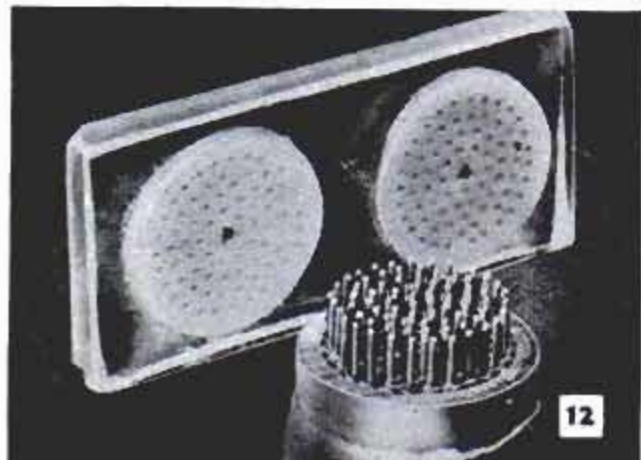

the floor-machine assembly. When machined, or ground, on these units the work usually is fed upward to the tool. On smaller bench-type units, Figs. 3 and 8, the tool generally is fed downward into the work, which is stationary. The workpiece usually is placed on a suitable mounting pad, Figs. 2, 9 and 10, and both the pad and work are then placed in a retaining tray, or pan, which is attached to the machine table as pictured. In some instances this unit is held in an adjustable subbase which is provided with a fine adjustment for positioning the work under the tool, Fig. 7. The abrasive slurry is pumped through tubes to directional nozzles, the overflow being caught in the tray and returned to the pumping units, Figs. 5 and 7.

Cutting speeds are governed by several factors such as the type of material, the quality of finish required and, of course, the grade of abrasive used. As examples, the average cutting rate in a hard material such as tungsten carbide will run about .009 inch per minute. In glass the cut progresses at a rate of about .100 inch per minute. On the very hard materials, each "traverse" of the tool may cause the abrasive grains to cut into the surface to microscopic depths only. It is the extremely rapid rate of the abrasive action that makes possible the comparatively fast cutting speeds. The tool usually is made from softer material than the workpiece, tools of brass or cold-rolled steel commonly being used to work such materials as tungsten, glass and ceramic. Although the action of the abrasive wears away the tool, the wear is at a slow rate and is always uniform. For this reason the accuracy of the tool is not impaired by the abrading action. ★ ★ ★

### How to Test a Paintbrush

A certain amount of spring in the bristles is a feature of a good paintbrush. Bristle elasticity is easily tested by stroking the brush across the back of your hand.



## Concrete Base for Shop Anvil Serves as Pipe Bender

Ideal for bending pipe and tubing is the setup shown, which consists of a block of concrete in which lengths of pipe are embedded both vertically and horizontally. The lower end of the vertical pipe fits in a length of clay tile that provides for additional length. Gravel is placed under the end of the tile for drainage. The concrete block can double as a support for an anvil or steel block on which metal work can be done. An anvil can be used in conjunction with the vertical pipe for making bends.

Mrs. T. F. Watts, Charlotte, N. C.

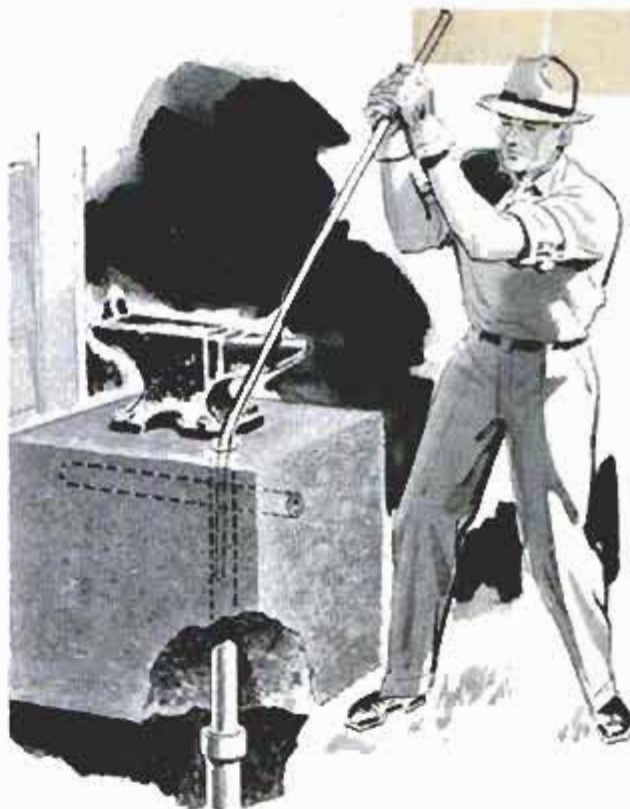

## Spark-Deflecting "Sleeves" Cut From Inner Tube

Protection for your arms against hot sparks when welding or cutting metal may be provided by "sleeves" cut from lengths of inner tube. A strap riveted to the upper ends of the sleeves fits across the back of the neck to hold them in place.

## Milk Room Warmed by Heater Taken From Automobile

The milk room on one Iowa dairy farm is warmed in winter by an automobile hot-water heater. Hot water for the heater is furnished by the automatic hot-water tank in the milk room which normally heats water for washing equipment. A thermostat, located at a distance from the heater, controls the fan motor of the heater.

O. V. Gordon, Des Moines, Iowa.



## Hinges Lubricated With Soap

To avoid the problem of stains caused by oil, use ordinary bar soap to lubricate squeaking hinges on interior doors. Pull the hinge pin, wipe it with soap and reinsert it. The soap lubrication will last a considerable length of time.

## Sliding Latch on Farm Gate Is "Livestock Resistant"

Easily opened by a man wearing mittens, yet resistant to being opened by livestock, this gate latch consists of a length of flat steel that slides in notches cut in vertical wooden members bolted to the gate. Welded to each side of the flat is a U-shaped handle bent from  $\frac{3}{8}$ -in. steel rod. These handles also limit the travel of the flat. When the latch is in the "locked" position, the handle on the outside surface of the gate engages a notch cut in the corner of a 2 x 2-in. piece of steel plate bolted to the gate as shown in the left-hand detail. Thus, opening the gate requires that the latch be lifted, then slid back the limit of travel.

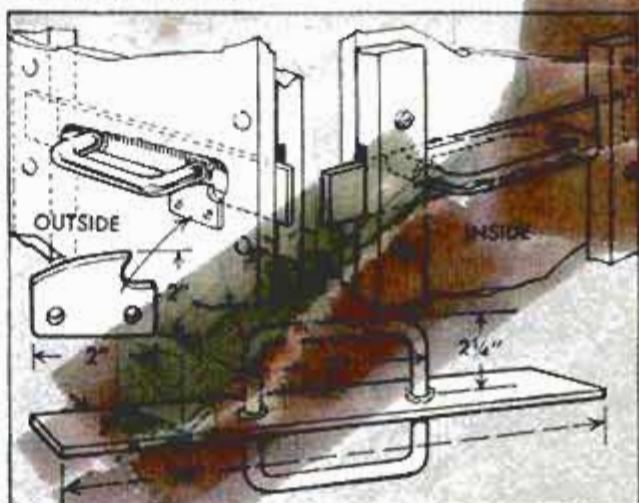







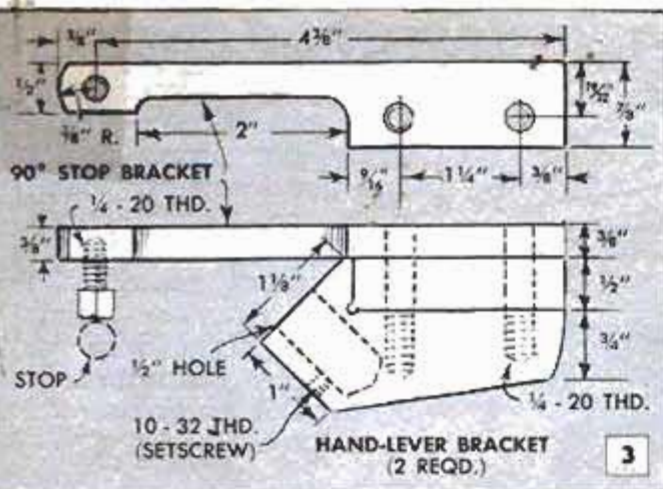

## FOR YOUR SHOP

By Ferd C. Iglehart

**T**HIS BRAKE is small-shop size, makes those clean, sharp bends in sheet metal that will delight the eye of a craftsman who has had to improvise methods of bending. It takes light sheet metals up to 17 in. wide. The hold-down blade moves at an angle of 45 deg. to the bed and adjusts automatically to the thickness of the materials to be bent. The blade is slotted to provide the clearances necessary to permit raising, in successive steps, 1/2-in. flanges on the four sides of the work, as in forming a box or tray, radio chassis, motor base, or similar work. A retractable stop at the 90-deg. position permits the operator to make repetitive right-angle bends. The throat opens to 5/4 in. to admit flanged parts.

All main parts except the table, or base, are made from cold-rolled stock. These include the parts detailed in Figs. 1 and 3 and parts A to E inclusive in Fig. 2. Note that parts A, B and C are shown assembled in the upper left-hand sectional view in Fig. 2. See also Figs. 4 and 5. Stock 3/8 and 1/2 in. in thickness is used for the right and left end plates and the hold-down supports and guides. The bending-bar brackets also are of 1/2-in. stock. Note in the right-hand detail, Fig. 2, showing end plate and hold-down support assembled, that the right end plate is a duplicate of the left plate with the exception of the lug formed on the lower edge of the latter. Note also that screw holes are counterbored to take socket-head screws flush. The hole pattern for 5/32-in. steel dowels is not dimensioned; only the approximate positions are shown. Where a lathe is not available use a straight 3/8-in. rod for the stop and substitute 5/16-in. cap-screws for the spring-tensioning screws. This will simplify construction without affecting operation of the brake.

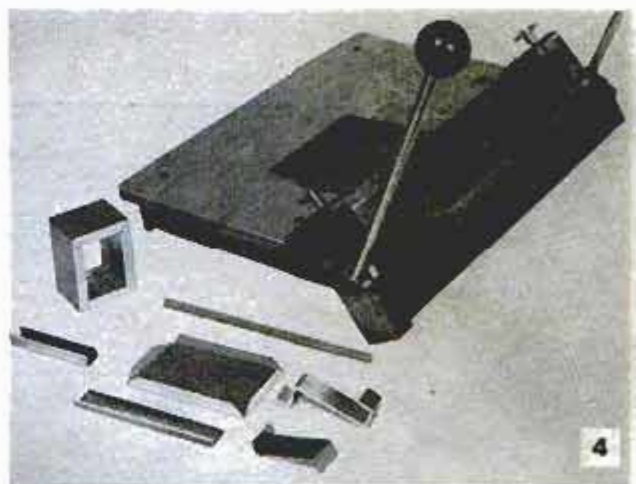

Above, brake and examples of flanged work done in light sheet metals. Below, brake assembly with left end plate, handle and 90-deg. stop removed to show hold-down support and spring-tension device

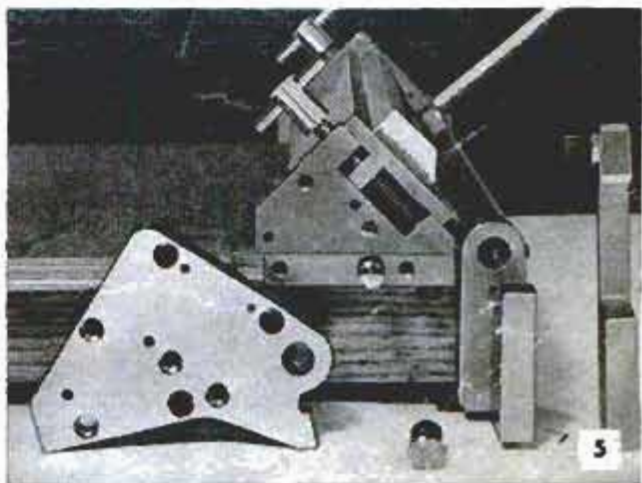



## Plug of Power Tool Is Locked in Workbench Drawer

To prevent youngsters from operating a potentially dangerous power tool that frequently is left on a workbench, cut a notch in the front of a drawer that is fitted with a lock. When the tool is not being used, drop the plug inside, with the cord in the slot, and close and lock the drawer.

## Washer Storage

To store nuts, washers or bushings neatly, use a metal disk about 12 in. in diameter to which are welded or soldered lengths of steel rod. The various items then are fitted over the steel "pegs" that are spaced 3 in. apart around the disk edge.

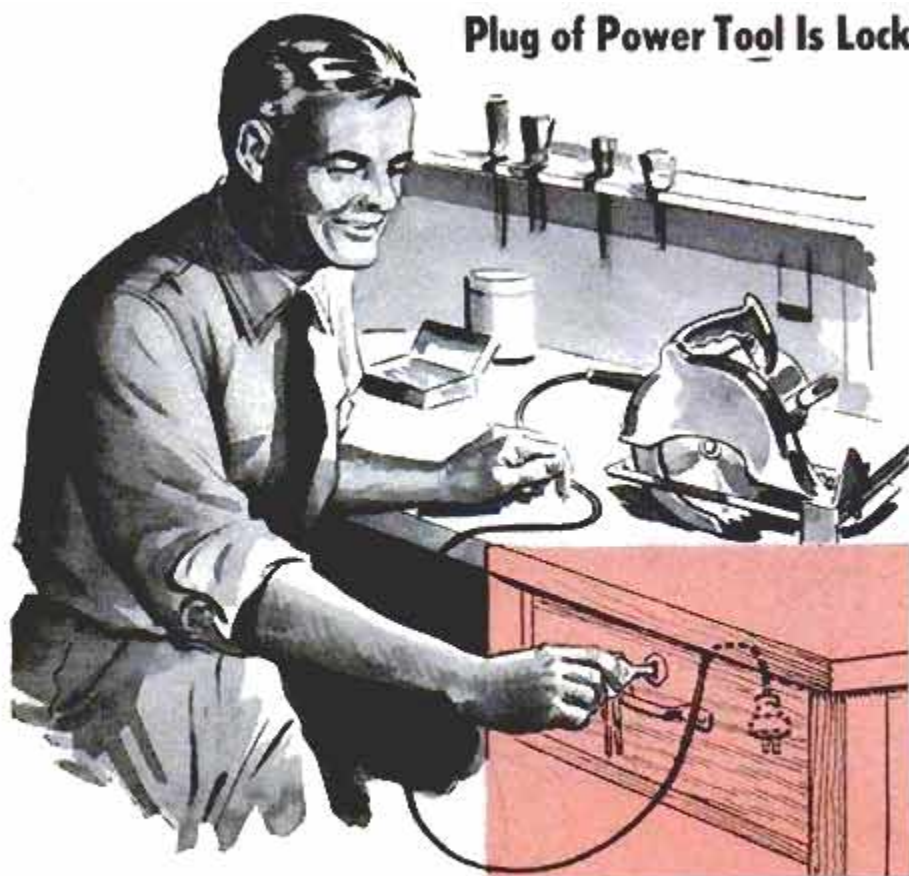

## Chuck Jaw Drives Lathe Dog In Emergency Setup

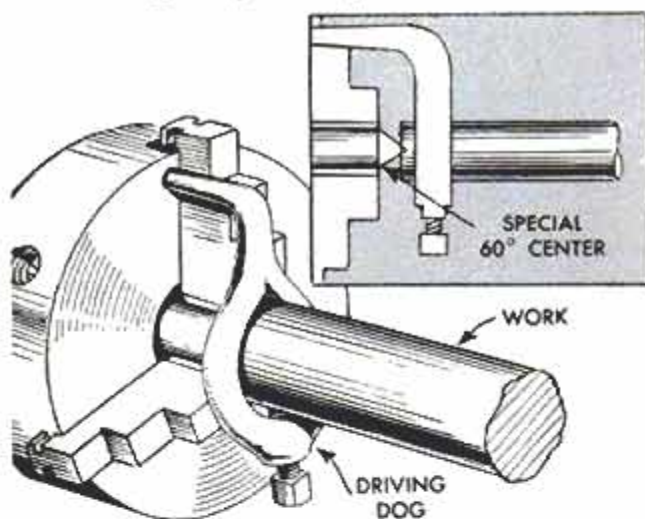

There is no need to remove the chuck from a lathe and replace it with a driving plate to turn work between centers, if the setup used by one machinist is employed. A piece of round stock is chucked in the lathe and a 60-deg. point is turned on it. The workpiece, which previously has been center-drilled at each end, then is mounted between this special center and the tail-stock center. A dog is used to drive the work, being driven itself by one chuck jaw as indicated. When the special center is re-used, it is centered as close as possible, then a finish cut is taken to assure absolutely accurate centering.

Frank L. Rush, Columbus, Ohio.

## Auxiliary Table on Bandsaw Accommodates Miter Gauge

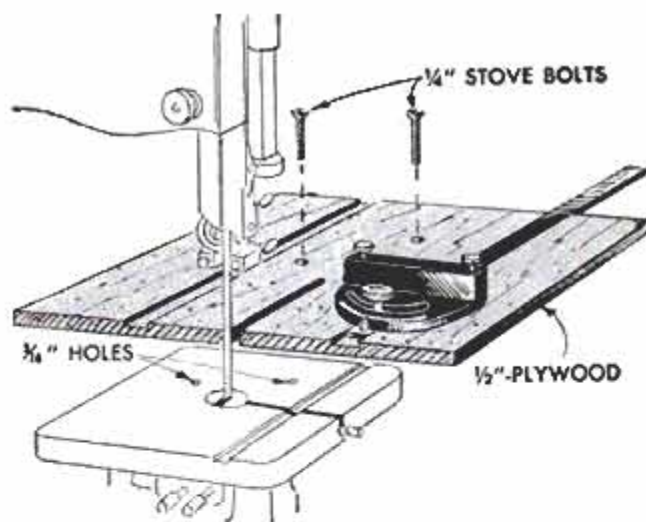

When attached to a bandsaw table, this table of 1/2 or 3/4-in. plywood accommodates a miter gauge, and does not interfere with the usefulness of the bandsaw for most jobs. Width of the plywood should be about 1 in. more than twice the width of the miter-gauge head. First, make a cut centrally and halfway across the table to take the bandsaw blade. Then, cut two parallel grooves, one on either side of the cut, and equidistant from it, for the miter gauge. Position the table so the miter gauge is at right angles to the line of the bandsaw cut, then attach it to the table of the bandsaw with two 1/4-20 stove bolts. Counter-sink the bolt heads in the plywood.



# SHOPPING FOR TOOLS



**1. ROLL-UP LADDER** comes in 10 and 12-ft. lengths and rolls up into a bundle about 21 in. in diameter, just as you see it in the photo above, showing it placed in a car trunk. The rails consist of wooden blocks 4 in. long,  $1\frac{1}{4}$  in. thick and  $2\frac{3}{8}$  in. wide. When ladder is unrolled the blocks are clamped end-to-end by lengths of aircraft cable, resulting in rigid units that will support more than 1000 lb. The rungs are of oak and are of the step type,  $1\frac{1}{16}$  in. thick and  $1\frac{3}{4}$  in. wide. Average weight is about 25 lb.

Dick Blick Co., Galesburg, Ill.

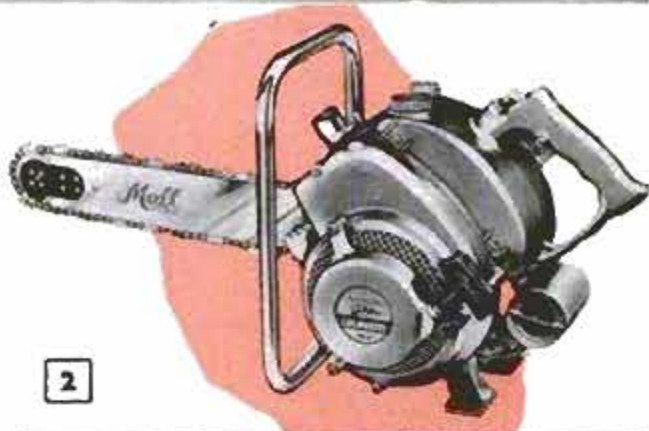

**2. DIRECT-DRIVE CHAIN SAW** is available in 18, 24 and 30-in. bar lengths. Has a specially designed, self-feeding chain, permitting freer, faster cutting with a minimum of pressure. A roller-bearing nose sprocket has been found by tests to produce at least 20 percent more cutting power by reducing friction at this heavily loaded point. A diaphragm carburetor permits operation at all work angles. Mall Tool Co., Div. of Remington Arms Co., Inc., Bridgeport, Conn.

**3. PAD SANDER AND JIGSAW ATTACHMENT** for  $\frac{1}{4}$ -in. portable drill are interchangeable on the same portable drill, which has been designed especially for mounting the two attachments. The drill housing immediately back of the chuck is squared, permitting rigid mounting of the accessory jigsaw and sander. Only pad-sander unit is pictured. Jigsaw is quite similar, employing same direct drive from drill chuck.

Thor Power Tool Co., Prudential Plaza, Chicago 1



(Continued on next page)



# SHOPPING FOR TOOLS

(Continued from preceding page)

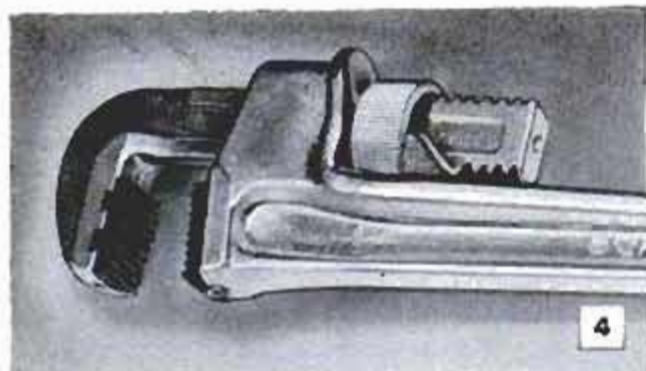

**4. ALUMINUM PIPE WRENCH** is 60 percent lighter than conventional pipe wrenches but is capable of same working loads due to use of high-strength aluminum alloys for all parts except hardened-steel jaws. Sparkproof beryllium-copper jaws are available. Made in 6 sizes from 10 to 48 in. over-all length  
Schick Products, Inc., P.O. Box 867, Belmont, Calif.

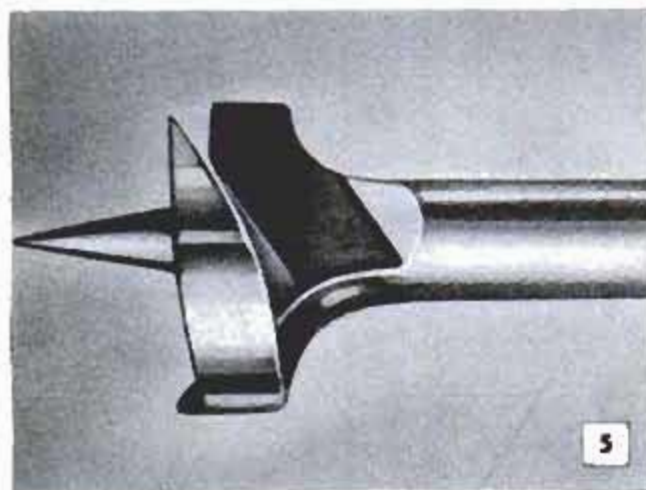

**5. POWER BITS** for boring holes in wood, plastic and laminates from  $\frac{3}{8}$  to 1 in. are designed for high-speed work when used with  $\frac{1}{4}$ -in. and larger portable electric drills. Holes in all sizes are exceptionally smooth; no scoring due to clogging with chips. Brad point maintains stability and accuracy at high speeds  
Stanley Tools, 111 Elm St., New Britain, Conn.

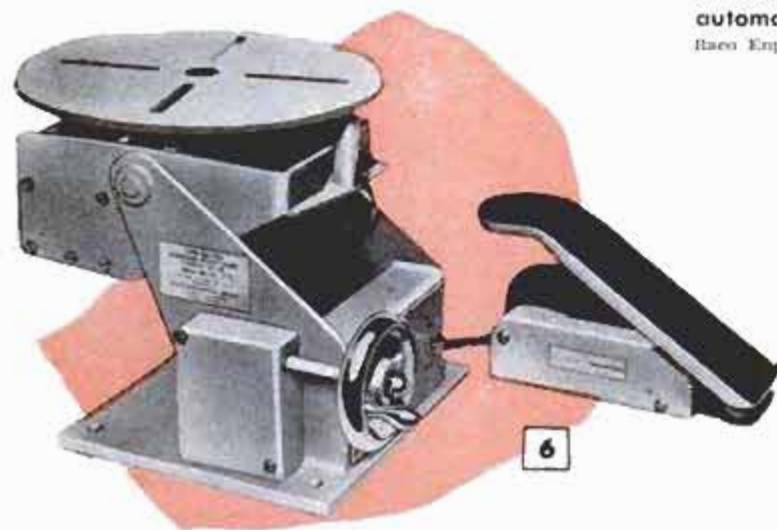

**6. POSITIONER** is adaptable to either manual or automatic welding. Will handle fabrications weighing up to 100 lb. The 12-in.-dia. turntable is fitted with a manual tilting device. Five speed ranges are available, 0 to 1.41 for manual welding, 0 to 10.5 for automatic. It is available with foot-control switch  
Raco Engineering Service, 2116 Chestnut Ave., Alhambra, Calif.

**7. TORQUE WASHER** prevents a carriage bolt from turning in wood. Fits over the square section beneath the head of the carriage bolt and when bolt is tightened the lugs embed themselves in wood. Bolt cannot turn clockwise or counterclockwise. Washers are available in several sizes  
Frank L. Robinson Co., Latham Square Bldg., Oakland 12, Calif.

**8. MEASURING MACHINE** consists of a fixed saddle with measuring anvil, a micrometer-spindle slide and a manually operated support which is connected electrically to fixed saddle. Can be set up to take measurements within close limits internally and externally on large parts  
Rupert & Co., Ltd., Chapel St., Stockport Rd., Levenshulme, Manchester 19, England

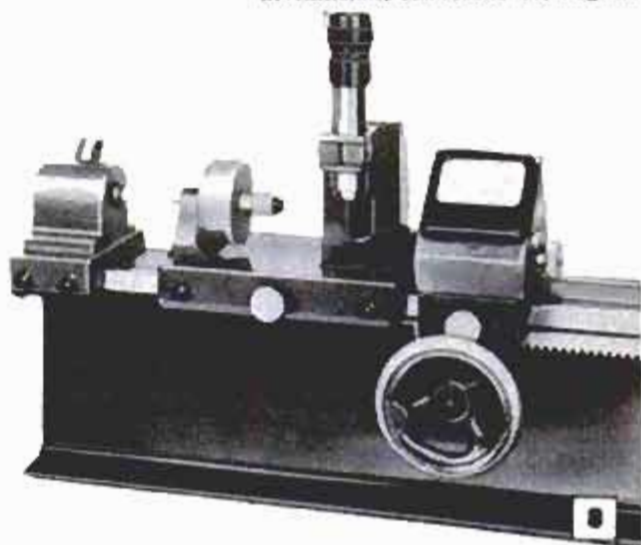
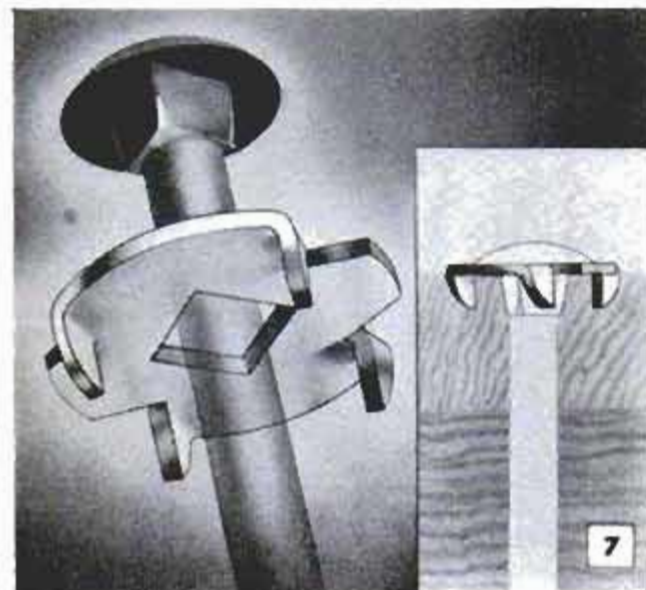



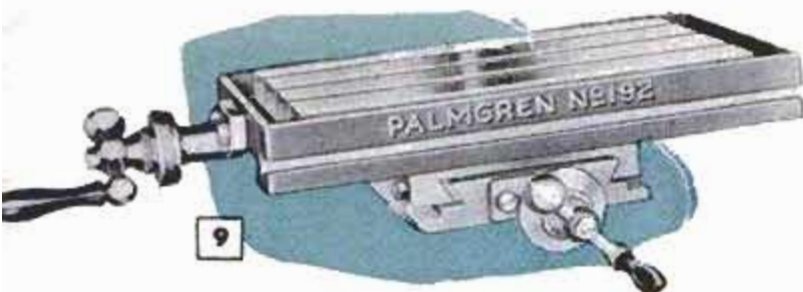

9

**9. CROSS-SLIDE MILLING TABLE** converts a drill press into a milling machine. Table has longitudinal travel of 11 in. and an infeed, or crossfeed, of 6½ in. It is 18 in. long and 9¾ in. wide. Has center keyway and two T-slots. Extra T-slot on side of table can be used to make angle plate. Weighs 133 lb.

Chicago Tool & Engineering Co.,  
8383 South Chicago Ave., Chicago 17

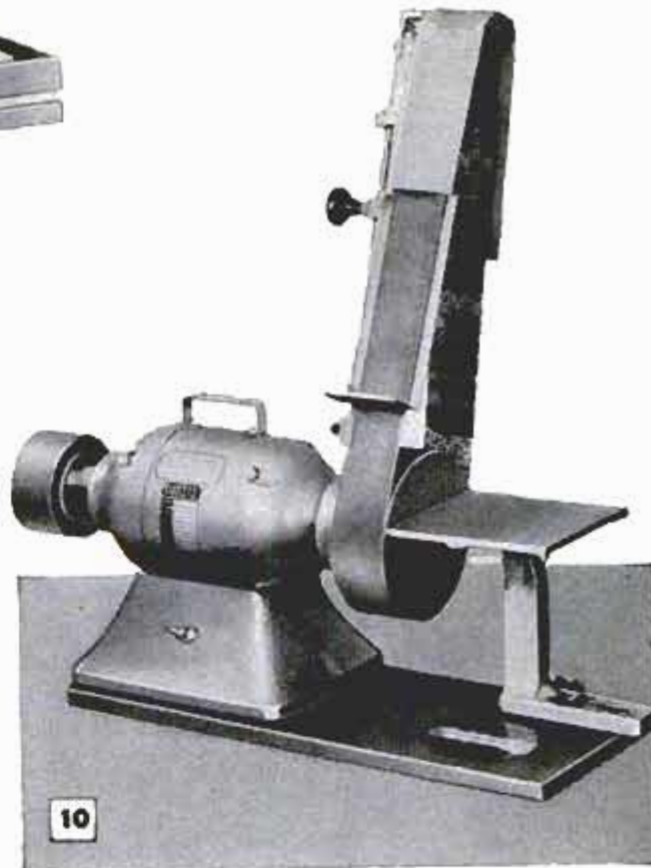

10

**10. GRINDING AND DEBURRING MACHINE** can be set up to perform several operations. Abrasive-belt extensions can be mounted on both sides of motor for roughing and finishing in one handling of material. Or machine can be set up as pictured, with one abrasive belt, contact wheel and tilting table

Curtis Machine Div., The Carborundum Co., Jamestown, N. Y.

**11. ALUMINUM SNIPS** feature replaceable steel blades and are lightweight, reducing hand fatigue. Fingergrrips are designed to give maximum leverage and protection to operator's hands. Snips are 14 in. long with a length of cut of 3¼ in. Cut 22-ga. sheet steel and somewhat heavier gauges in softer metals

Anderson Tool & Mfg. Co., 3454 N. Kostner Ave., Chicago 41

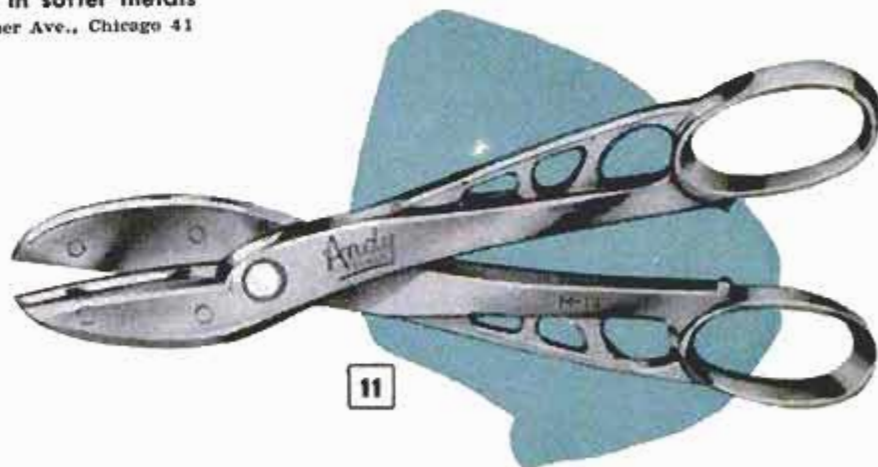

11

**12. LIGHT-STAPLE GUN** takes ¼ and 5/16-in. staples. It's made for those light-nailing, or stapling, jobs such as fastening upholstery materials, closet linings, garbage-bag holders, shelving ruffles, etc. Has built-in lifter for extracting staples

Arrow Fastener Co., Inc., 1 Junius St.,  
Brooklyn 12, N. Y.

**13. LIQUID "LOCKWASHER"** prevents nuts and screws from loosening on lawn mowers, household appliances and small power tools. Drop forms a bond that locks metal to metal, shake-proofs nuts and capscrews subjected to quite severe vibration

American Sealants Co.,  
103 Woodbine St., Hartford 6, Conn.



12

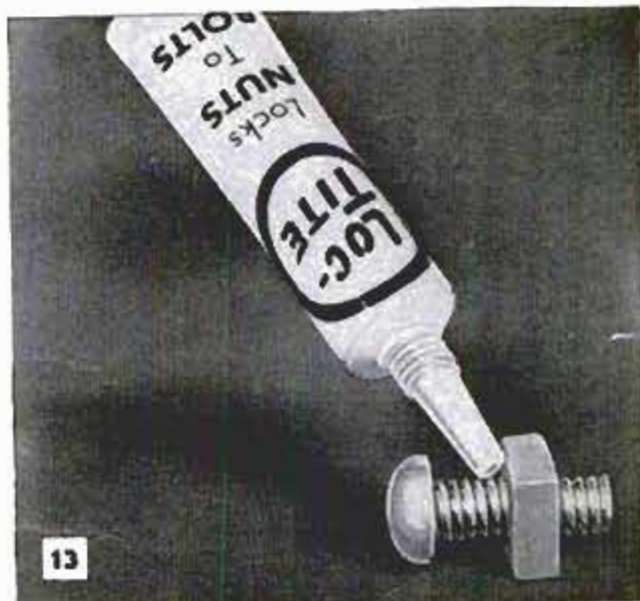

13



## Modified Measuring Tape Has "Self Marking" Feature

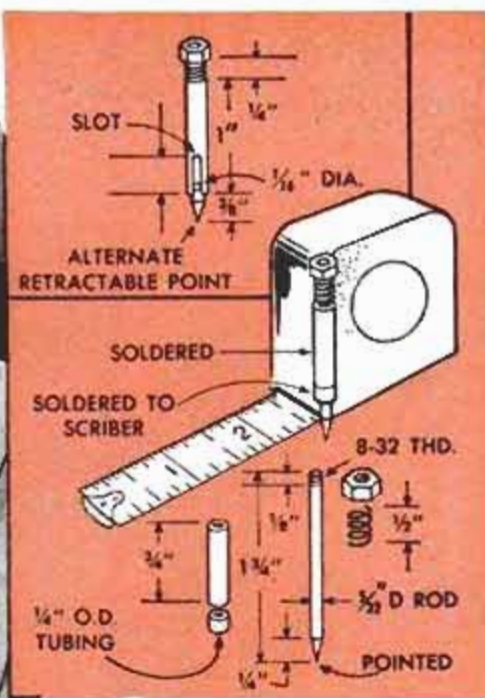

Your steel measuring tape becomes even more useful when this "self marking" feature is added. The marker itself is a 1 $\frac{3}{4}$ -in. length of  $\frac{5}{32}$ -in. drill rod with a point ground on one end. Threads are cut on the opposite end to receive an 8-32 nut. Just above the point of the marker a short length of  $\frac{1}{4}$ -in. copper tubing is soldered to act as a stop when the marker is fitted in a slightly longer piece of the tubing that is soldered to the corner of the tape case as indicated. A spring to hold up the marker is a length of spring of the type used to hang curtains.

It is stretched so it becomes a compression-type spring, holding up the marker when it is assembled in the tube. The upper detail shows an alternate marker having a slotted tube which permits the sharp point to retract fully into the lower end.

Russell J. Love, San Francisco, Calif.  
24 CALIFORNIA ST.

## Trouser-Cuff Nail "Pockets"

When driving many nails from a kneeling position, make extra-deep cuffs on your trousers for nail aprons. Large safety pins will hold the cuffs temporarily.

S. Clark, East Bradenton, Fla.

## Adjustable Stop on Drill Press Modified for Easier Action

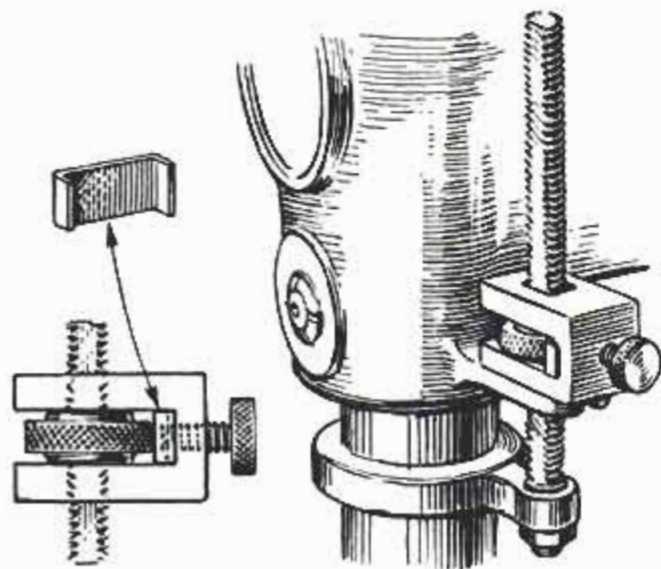

Because the two knurled nuts on the depth stop of his drill press often became jammed and difficult to turn, one man modified the stop as indicated. One nut is removed and replaced with a U-shaped block that slides over the depth stop. A knurled thumbscrew in the block bears against a U-shaped piece of metal that locks the knurled nut.

## V-Block on Magnetic Chuck Adds Extra Holding Power

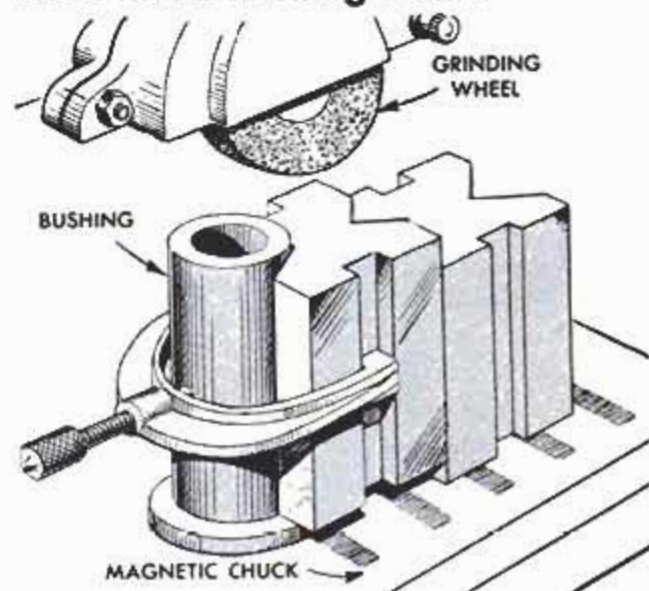

To reduce the chances of smaller workpieces being knocked over by the grinding wheel, or breaking the wheel, on a surface grinder, remember that larger items are held more firmly on a magnetic chuck than small ones. Clamp the work to a V-block which is held more firmly. On work with a flange, clamp the work to one block, and use a second block as a backup.



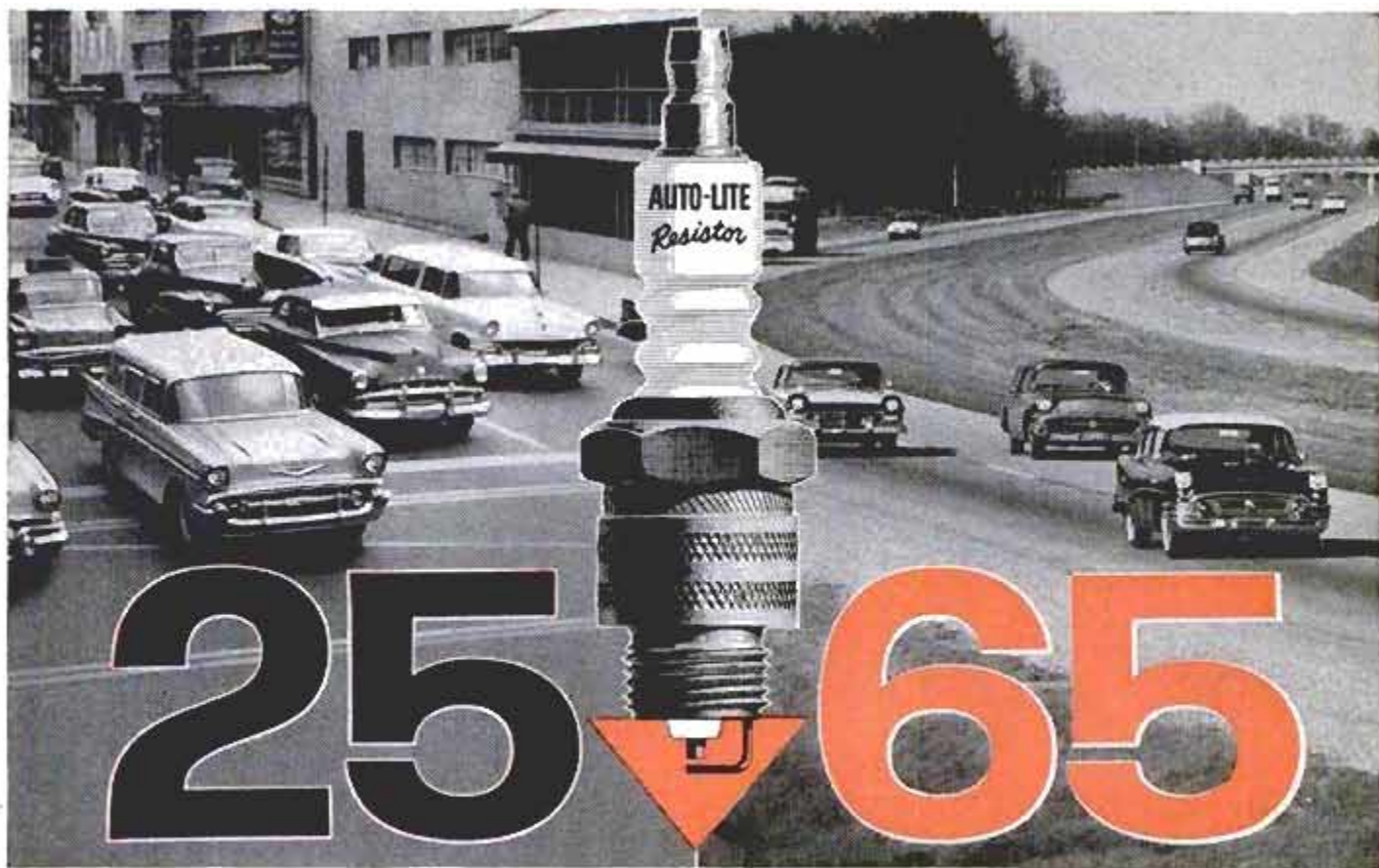

**IN TOWN TRAFFIC . . .** some spark plugs, designed for high speeds, become fouled and cause misfiring and loss of power when driven at low speeds.

**ON THE HIGHWAY . . .** some spark plugs, designed for low speeds, misfire causing power loss and invite destructive pre-ignition when driven at high speeds. Why gamble when . . .

## Auto-Lite Resistor Spark Plugs with **POWER TIP** "Fire Up" your engine\* at all speeds!



If you drive at both town-traffic and highway speeds, here's why you should use Power Tip . . . the first spark plug ignition-engineered for today's engines and today's driving.

YOU CAN SEE  
 THE BIG NEW  
 DIFFERENCE IN  
 SPARK PLUGS!



At low speeds, the projecting Power Tip is in the thick of combustion where it gets hot quicker and stays hot to burn fouling deposits away *clean*. At higher speeds, the projecting tip is in the path of the incoming air-fuel mixture where it stays cooler to effectively *check* power-robbing pre-ignition. Ask your garage or service station to install Auto-Lite . . . the *only* spark plugs with Power Tip . . . and start enjoying top performance and economy from your car at *all speeds*.

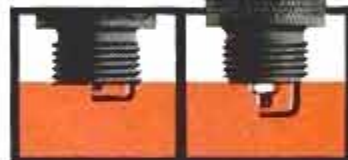

Ordinary Tip      Power Tip

\*Power Tip, with or without Resistor, is ignition-engineered for overhead-valve V-8 engines and for most overhead-valve 6-cylinder engines in all these cars—Buick, Cadillac, Chevrolet, Chrysler, De Soto, Dodge, Edsel, Ford, Hudson, Imperial, Lincoln, Mercury, Oldsmobile, Nash, Packard, Plymouth, Pontiac, Rambler, Studebaker.

Power Tip protrudes farther into the combustion chamber for better ignition. Fuel burns more evenly and completely to give top performance and economy at *all speeds*.

# AUTO-LITE RESISTOR SPARK PLUGS WITH **POWER TIP**

Auto-Lite makes a complete line of spark plugs, including Standard, Resistor, Marine, Small-Engine, Transport, and Aircraft.



LOOK, MISTER!

No Hands

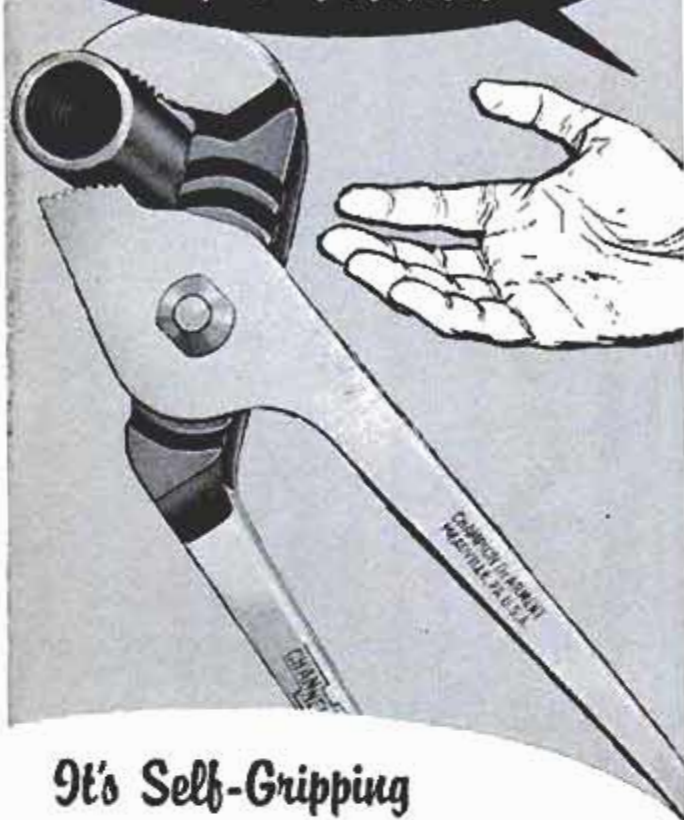

It's Self-Gripping

CHANNEL LOCK

No. 410

HEAVY-DUTY PLIER

How's this for gripping power? You won't know your own strength 'til you grab hold with this heavy-duty self-gripping plier. The Channellock No. 410 HEAVY-DUTY is actually a combination plier-wrench... and it will get into tight places you can't reach with a pipe wrench. A mighty handy, multi-purpose tool with four jaw adjustments up to 1-1/8".

ASK YOUR TOOL SUPPLIER FOR A  
CHANNELLOCK No. 410 HEAVY-DUTY PLIER

BE SURE IT'S  
A GENUINE  
CHANNELLOCK



LOOK FOR THE  
TRADEMARK  
ON THE HANDLE

CHAMPION DEARMENT TOOL COMPANY  
MEADVILLE, PENNSYLVANIA

## Clinic for Homemakers



As a service to our readers in solving the hundreds of problems pertaining to a home—inside or out—the editors of *Popular Mechanics* invite you to present your problems to The Clinic Editor for help and advice. Address your questions to The Clinic Editor, *Popular Mechanics Magazine*, 200 East Ontario Street, Chicago 11, Ill.



### Paint Peels From Putty

Q—My home is about one year old and has steel casement sash throughout. Lately I have noticed that paint is peeling from the putty in two places on one of the sashes. Moisture appears to be working out from under the paint in the immediate area and the putty appears to be soft. The defect

appears only on the lower horizontal members of the sashes. What is the cause of this failure of the putty?—S. H., Del.

A—It is difficult to say with certainty, as there are a number of probable causes. The sashes were undoubtedly glazed after installation and it is quite possible that the one affected was spotted with oil at those points where failure of the putty is occurring or that water or ice was present at the time this particular sash was glazed. One or the other of these, it would seem, is the most likely cause. At any rate, the putty has failed and must be replaced. This should be done immediately. After the putty has been removed from the affected areas, clean thoroughly with a solvent and allow to dry. Then apply a coat of paint to the sash at those points where putty has been removed. This must be allowed to dry thoroughly. Then apply new putty, taking care to force it into contact with the old and also into close contact with the glass pane. Allow the new putty to harden before painting.

### Sawdust Insulation



Q—I have just learned that the walls of the older home I recently purchased are insulated with sawdust. The house has a full basement with sills at the grade level.

The floor joists are supported on a ribband about 30 in. above the sills. Studs are covered with wood lath and plaster. I removed this at two points and out came the sawdust. It seemed to be dry, but—how do I get rid of it?—D. S., Ia.

A—Sawdust is not recommended as insulation due to the danger of insect infestation, moisture condensation and also the fact that it tends to settle and pack tightly, thus losing much of its insulating properties. But if it is dry as you say, why worry, at least at the present? If no trouble

(Continued to page 216)



# Now! New wood finishing beauty for your wood paneling and furniture

*New Weldwood Satinlac Lightener and new, improved Weldwood Satinlac give you easier, more lustrous natural wood finishes than ever before possible.*



To retain the true native wood color, use new Weldwood Satinlac Lightener as a first coat on unfinished wood.

- makes "invisible" protection possible, prevents the darkening or "wetting" look that usually occurs when conventional finishes are applied to virgin wood.

- preserves the color of freshly cut and sanded wood, and at the same time prepares the surface for subsequent luster-giving coats of Weldwood Satinlac.



For special effects, use Weldwood Firzite.

- **WHITE** for blond or pickled effects with a clear "woody" finish. Also as prime coat under paint—prevents checking, grain raise.

- **CLEAR** as a pre-sealer to assure even absorption of stain, prevent wild grain in softwood growth. Also, a perfect stain when tinted with colors-in-oil.



To get glowing, soft-sheen woodbeauty, use new, improved Weldwood Satinlac.

- brings out, preserves wood's natural beauty without the "built up" look of ordinary finishes; resists alcohol, water staining.

- resists fading or yellowing with age; new Satinlac contains an exclusive Ultra-violet ray screen that inhibits the effect of light on the wood's color.

- goes farther, works easier, has less odor; new Satinlac's improved formula contains twice as much solids as formerly; greatly superior solvents give better flow.



**CHOOSE THE FINISH YOU WANT** from this helpful display with 27 real wood samples, now at leading paint, hardware, and lumber dealers'. Shows you many of the beautiful wood finish effects you can obtain with new Weldwood Wood Finishes.

## **Weldwood**® WOOD FINISHES

**SATINLAC® • SATINLAC LIGHTENER® • FIRZITE®**

*And other products for home and industry*



Send for new Weldwood Paneling Family Room Booklet. Shows how you can build fun-giving, space-giving new value into your home.

There's a Weldwood Adhesive for every purpose



**United States Plywood Corporation**  
**Box 61, New York 46, N. Y.**

PM-9-58

Please send me:

- Information on Weldwood Wood Finishes,
- New full-color booklet, "Family Rooms In Beautiful Weldwood—100 Interesting Ideas For The Room Your Family Lives In." I enclose 10¢.

NAME.....

STREET.....

CITY.....ZONE.....STATE.....



(Continued from page 214)

is observable, such as peeling of the paint on the exterior walls, or loose, damp plaster on those plastered areas in the basement then in your case the sawdust may be serving a better purpose in the walls than out of them. However, even though the sawdust insulation may have been in place for some years, one cannot rule out the possibility of insects, such as termites and powder-post beetles (the latter are a lesser possibility), invading the walls. If the sawdust remains dry, then this would seem to be the principal danger of future trouble. It should be a comparatively simple job to remove the sawdust at any time and replace it at a nominal cost with a pour-type insulating material.

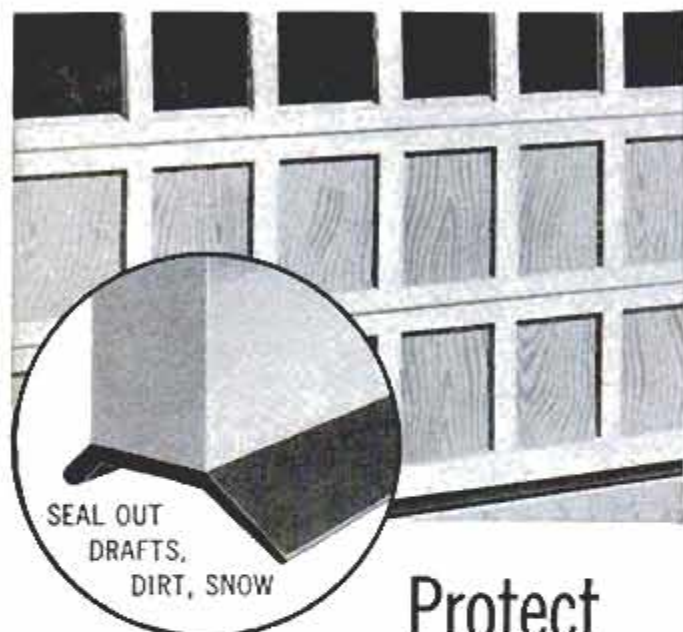

## Protect costly garage doors with **StanStrip**\*

Now . . . for less than \$3.00 . . . in less than 10 minutes . . . you can put StanStrip on an 8-foot overhead garage door. And what a difference it makes!

The thick, rubber "pad" cushions the shock of closing . . . prevents damage to doors, spares the windows, ends the crash of closing.

And, just as important, the double lips of StanStrip flex to follow every irregularity in the floor . . . seal the opening completely against dust and dirt, rain and snow. Your garage stays cleaner, drier, warmer. Your car starts easier in winter.

And does it last! You just can't hurt StanStrip. The special rubber compound was developed from hundreds of formulas tested for this purpose. Stays flexible even in coldest weather. Get StanStrip now at hardware and building supply stores.



### SEAL HOUSE DOORS, TOO

Ask for DraftTite\* . . . an exclusive combination of silicone-treated wool-pile fibers and aluminum. It's the most effective house-door weatherstrip on the market.

\*Trademark

*The Standard Products Co.*  
LEXINGTON, KENTUCKY

### Refinishing Old Piano



**Q**—I have an old piano I'd like to refinish. I don't know what kind of wood it is, but some parts are veneered as veneer is chipped at the corners. There is a lot of carving to be refinished. Finish is badly checked and the whole thing is coated with dust and grime. Can you tell me where and how to begin?

—L. E., N. Y.

**A**—Many old pianos were made from several woods, certain of the exterior parts from woods that carve easily such as gumwood, mahogany and tulipwood. Flat and curved parts usually are built up from several thicknesses of softwood and veneered with walnut, mahogany or rosewood, the latter being a favorite veneer with some makers of old pianos. As the first step, experienced refinishers usually build a mild soapsuds in soft water and give the whole thing a thorough washing, taking care not to wet the surfaces unduly. This removes the dust and grime. Then the flat surfaces are sanded lightly and the turnings or carvings are gone over with a stiff-bristle brush or steel wool. This cuts off the roughness and reduces the checks. Next, a paste is made using raw linseed oil, fine pumice stone and turpentine. This is applied to a small area at first, using a pad made by folding a soft cloth to several thicknesses. The area is then rubbed with a circular motion, a few drops of oil being added occasionally to prevent the pad from sticking. The rubbing is continued until the surface is smooth to fingertip touch. At this stage, if the first coats of the old finish are still in good condition, the grain of the wood will show quite clearly. It's at this point that refinishers of old pieces decide whether to continue the rubbing-down process or remove the old finish to the wood. If the rubbed-down finish is smooth to the touch and the grain shows the original "fire" and detail the refinisher continues the process he has started, working over the entire piece. On turnings and carvings a stiff-bristle brush or a gather of medium steel wool is used to apply the abrasive paste. All surfaces are wiped clean as the work progresses; the oil is never allowed to set on the finish. In this process no new finishing materials are applied. The process simply brightens the undercoats of the old finish, preserves it and also the desirable aged coloring, or patina, of the wood.

### Painting Stone Foundation

**Q**—My basement walls are of natural stone and the inside surface is quite irregular. Both mortar and stones appear to be in good shape and I'd like to finish the walls in some way to make them more attractive. Will an ordinary paint adhere to the stones, or is there some special paint that must be used?—I. H., R. I.

**A**—By ordinary paint we assume you mean a house paint, either interior or exterior. Such paints are not suitable for application to stone, especially below grade. We hesitate to recommend painting or otherwise coating natural stone as the texture of a wall built from stone is attractive in itself. But if painting the walls is a part of your decorative scheme then we would recommend that you use a water-soluble masonry paint.



There's an  
Elmer's Glue for  
every job you do!



#### FOR WATERPROOF GLUING

Completely waterproof two-component resorcin glue forms a bond stronger than the wood itself. Resists continuous outdoor exposure, cold and boiling water, moist and dry heat, mold and fungus, solvents, acids and alkalis. Unbeatable for boats, outdoor furniture, sports equipment. Comes in 1/4 pint and pint cans.



#### FOR NO CLAMP GLUING

Regular or nonflammable cements that bond on contact. Strong, water-resistant and heat-resistant. Best you can use for plastic laminates, plywood wall panels, leather, linoleum, synthetic rubber, thin gauge metal and all dissimilar materials. Can sizes in pints and quarts.



#### FOR HIGH SPEED GLUING

A modern, ready-to-use polyvinyl resin glue for general interior use. Perfect for gluing dowels, paneling, inlays, marquetry, cloth, paper and all porous materials. Fast setting, dries clear. Available in refillable plastic squeeze bottles, tubes and jars in a wide variety of sizes.



#### FOR GENERAL WOOD GLUING

This powdered casein glue makes strong, water-resistant joints. Works fine on hard or soft woods and many other materials. Mixes easily in cold water and can be used anywhere, even in cold outdoor temperatures. Ideal for laminating beams . . . gluing tables and counter tops, sashes and doors, molding and fixtures. 1 and 5 pound can sizes.



#### FOR STAINPROOF WOOD GLUING

Chemically neutral, this powdered urea resin glue does not stain acid woods like oak or mahogany. It is highly water resistant and mixes easily in cold water. The perfect glue for fine furniture panels, cabinet work, veneering . . . any job where a clean glue line is important. Available in 1 and 5 pound cans.



Buy where you see  
this emblem . . .



Borden Glues are available at hardware, variety, paint and lumber supply stores everywhere. For a free chart which shows the right glue to use for every job, print your name and address on a post card and mail to: Elmer's Glue Chart, The Borden Company, 350 Madison Avenue, New York 17, N. Y.

IF IT'S *Borden's* IT'S GOT TO BE GOOD!



## Festival of the Iron Men

(Continued from page 110)

up when those corncobs wouldn't catch fire. . . ." "Flew in from Montana yesterday. . . ." "Chain drive is all right going up, but coming down the other side the chain flies off. . . ." "Hauled water for Grandpa Beane at thrashin' time, and I bet I never forget the handle of that bucket. . . ." "Paid \$1200 for it, and the farmer tried to get still more. . . ." "That Russell 20-60 couldn't pull a bushel of manure. . . ."

Many of these now-shaky old threshermen can't remember anything that happened last week, but will never forget something that happened 60 years ago.

The people, of course, are even more interesting than the steamers. Dressed-up city dwellers look bewildered. Farm folk greet the old machines like long-lost friends. Over there strolls a blanket-clad family of Indians from the nearby Tama reservation. Here is a group of somber Mennonites, dressed in black from hats to boots, sunbonnets to high-laced shoes.

At noon you drift toward one of the big church tents, "The Old Threshers' Dining Hall." Inside you get a true threshers' meal, a tray piled high with fried chicken and a dozen other home-cooked foods, topped with a generous slab of mince pie. Despite the low price of the meal, the church will net \$2000 during the reunion.

Later you wander over to the grandstand for the annual "Cavalcade of Power" around the racetrack. There's standing room only as the parade begins. Each engine jerks down the track under its own power, sparks flying, and gives a triumphant "toot toot" as it passes the reviewing stand. It's an unwritten rule—but a rule seldom broken—that the honor of driving the engines goes to the indestructible iron men. And obviously this is one of the biggest moments of their long lives.

Perhaps the strangest vehicle in the parade is a 1916 LaCrosse, a combination of a buggy and a farm tractor. The driver sits in the buggy, which is pulled by the tractor. He controls the machine with reins, just as he would a horse. To go forward he lets out the lines. To reverse, he pulls back. To stop, he keeps the reins taut. A jerk on one rein will turn the gas tractor right or left.

### Engine on a Teeterboard

One of the annual features of the parade is a demonstration of balancing skill on a teeterboard by Peter Bucher. It requires a feather touch on the throttle. First the

(Continued to page 220)

## Anchor wood or metal to concrete or steel with one light tap!

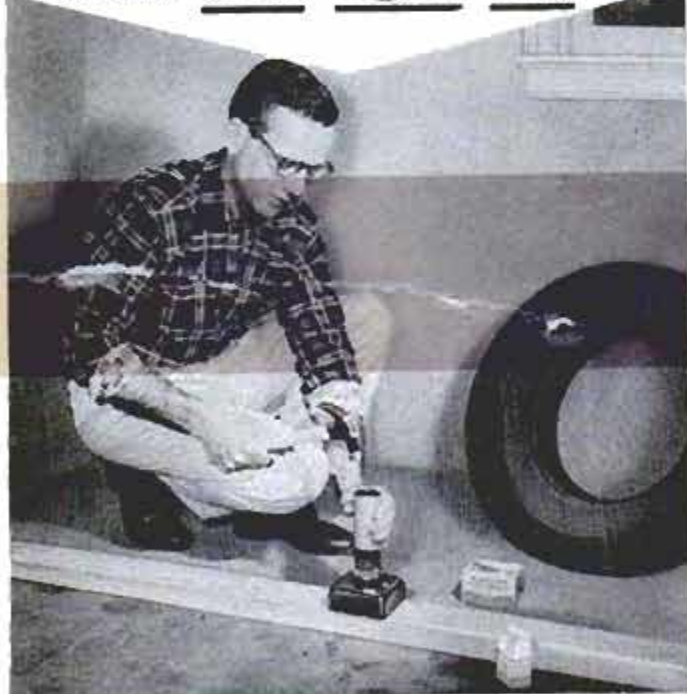

Anchoring 2 x 4 car stop to garage floor.

**Remington Mighty-Mite® Stud Driver** is a cost- and time-saving fastening tool with a hundred uses! One light hammer tap on firing pin permanently anchors furring strips, partition plates, electrical outlets to concrete or steel with special Remington Studs. Scientifically graded 22 caliber Power Loads furnish exact driving force needed. No pre-drilling. See your dealer today or send coupon for full details. **Only \$39.95**

Most dealers also have a tool-rental plan.

### HERE'S HOW THE "MIGHTY-MITE" WORKS



**UNSCREW** upper assembly, drop a Remington "Power-Guide" Stud into barrel, insert chamber bushing and proper 22 caliber Power Load.



**REPLACE** handle-grip assembly, position tool and press firmly over work. Tap firing pin with a light hammer and the job's done!

**Remington®**

**DUPONT**  
THE U.S. MADE ONE



Remington Arms Company, Inc.  
Industrial Sales Division, Box PM-9  
Bridgeport 2, Connecticut

Please send full information about the cost- and time-saving "Mighty-Mite" Stud Driver.

Name \_\_\_\_\_

Address \_\_\_\_\_

City \_\_\_\_\_ State \_\_\_\_\_



*These men chose  
from 127 courses—  
so can you!*



**Pvt. Ted W. Gill**  
Comstock, Texas  
Graduate,  
Comstock High School

"I'm getting the engineering training I wanted, thanks to the Army's technical

training program for high school graduates. My Army Recruiter showed me all the different courses I could pick from. I chose Construction Surveying. The course was even better than I thought it would be. If you'd like to pick just the training you want, the Army sure offers you the best deal."

**Pvt. Kenichi Isagawa**  
Maul, Territory of Hawaii  
Graduate,  
Baldwin High School



"If you're not going to college, the best way for a high school graduate to get just the training he wants is to enlist for the Army's technical training program. I picked a Metal-working course and learned the trade I wanted. Now I'm working right in my field. Only the Army offers you choice of schooling, so find out about it from your Army Recruiter."

Seniors—get all the details on how high school graduates can choose their technical training before enlistment from 127 modern courses. Mail this coupon for your free booklet today. Or for immediate counseling visit your local Army Recruiter. He's listed in the phone book and will give you all the facts—at no obligation!

THE ADJUTANT GENERAL  
Department of the Army  
Washington 25, D. C.  
Attn: AGSN

PM-9-58

Please send me the free Army booklet telling how high school graduates can choose their technical training before enlistment in Modern Army Green.

Name.....  
Address.....  
City..... State.....  
Date of Graduation.....

*Ready for you!  
America's Choicest Uniform!*

Only in **MODERN**  
**ARMY GREEN** is your  
Trade Schooling  
Guaranteed

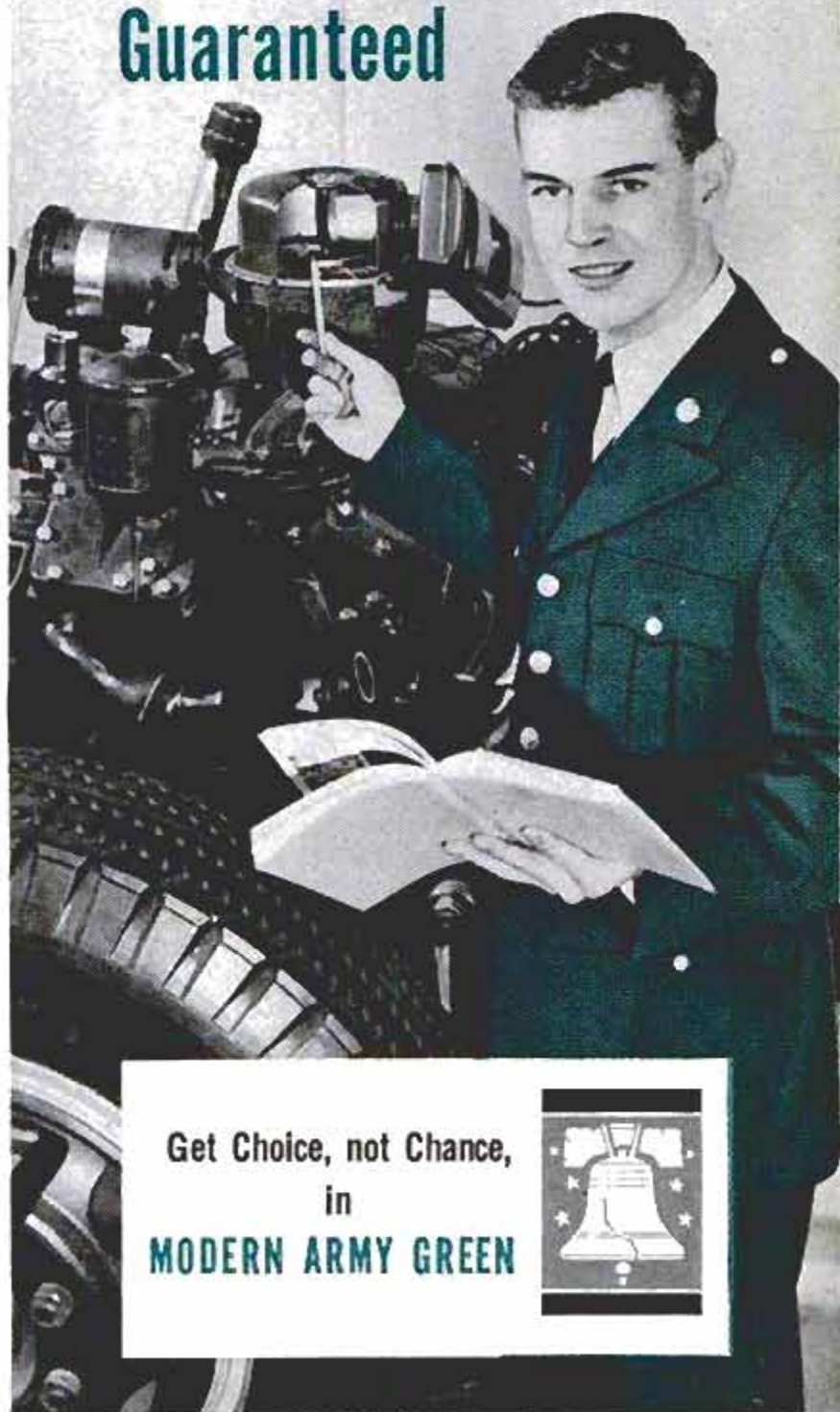

Get Choice, not Chance,  
in  
**MODERN ARMY GREEN**





More Jobs, Faster Set-ups with

## **SOUTH BEND Vertical Spindle Milling Machine**

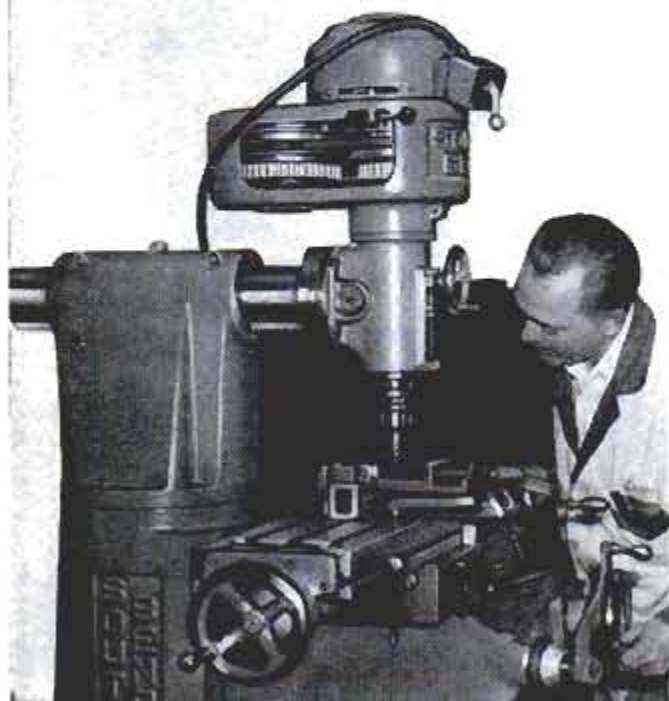

- Mills—bores—drills—reams at any angle. Head rotates 360° vertically.
- Easy accessibility simplifies job set-ups and tooling changes.
- Fast—positive head indexing and table positioning. Easy-to-read dials.
- Rugged, heavy ribbed column, knee and table.
- 32" or 42" table with 20" or 30" travel.
- Prices start at \$1829 f.o.b. factory.

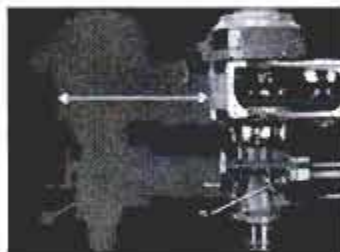

### **In or Out Ram Travel Without Re-setting Head Angle**

Head swivels on ram flange. Ram has a large key sliding in a keyway with an adjustable tapered gib. No side play or canting when ram is moved—always in alignment.

**WRITE** for complete information on milling machines. Also lathes, turret lathes, shapers, drill presses and pedestal grinders.

**SOUTH BEND LATHE**  
**SOUTH BEND 22, INDIANA**  
*Building Better Tools Since 1906*



Up to 24  
months to pay.

huge teeterboard is dragged onto the track and placed across a 10 by 10-inch timber. Out comes Bucher in his nine-ton behemoth. He runs the engine up the board and stops, just a mite short the first time. He backs off and tries again. If he overshoots by so much as an inch, 300 gallons of water will go sloshing forward in the boiler to carry him across the pivot point and plunging down the other side. This time he eases forward to precisely the right point, the board groans upward, and the huge engine stands balanced on the platform. The applause of the crowd is answered by a triumphant toot on the whistle.

And these drivers know when to pull a whistle cord. A politician approaches the microphone to make a speech, and immediately all the whistles blast forth to drown his voice. Finally he retires, defeated, and the victorious steamers head back toward the demonstration area.

### **Old-Time Songs**

As night falls you put away another tremendous thresher's dinner and wonder how the old-timers could stoke up on that much food, day after day. Then, hearing a mighty chorus from one of the buildings, you head inside. Gathered around an organ are hundreds of people singing the favorites of yesteryear. Later, along with the buffs, you listen to the tape-recorded wheezes, coughs, sputterings and toots of all the old engines. Some of these experts can tell the year and model of the engine from the sounds on the tape.

A. M. Wettach, one of the directors of the reunion and the professional photographer who took the pictures for this article, fills you in on what happens if it rains. "Hundreds of people gather in the buildings

(Continued to page 222)

In a display of driving skill, an old engineman balances a nine-ton behemoth on a teeterboard

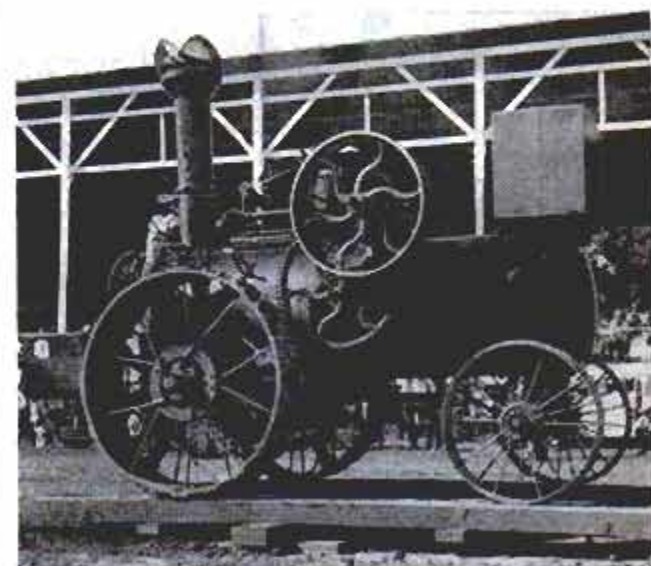



# Auto Care

starts with



Watch Walt Disney  
Studios' ZORRO  
every week on ABC-TV

Auto Care can prevent costly engine repair!

If the spark plugs in your car have gone 10,000 miles, they're due for a change. A new set of AC Hot Tip Spark Plugs can start you out again with like-new performance. That's because AC's exclusive Hot Tip

burns away carbon and oil deposits, keeps them clean-burning to assure efficient fuel combustion.

ACs are factory-installed on more new cars than any other make. Have an AC dealer install a new set in your car. Remember — Auto Care starts with AC.

AC SPARK PLUG  THE ELECTRONICS DIVISION OF GENERAL MOTORS



Sparky Says:

**"GET A NEW SET EVERY 10,000 MILES!"**



# NEW midget pliers added to KLEIN line

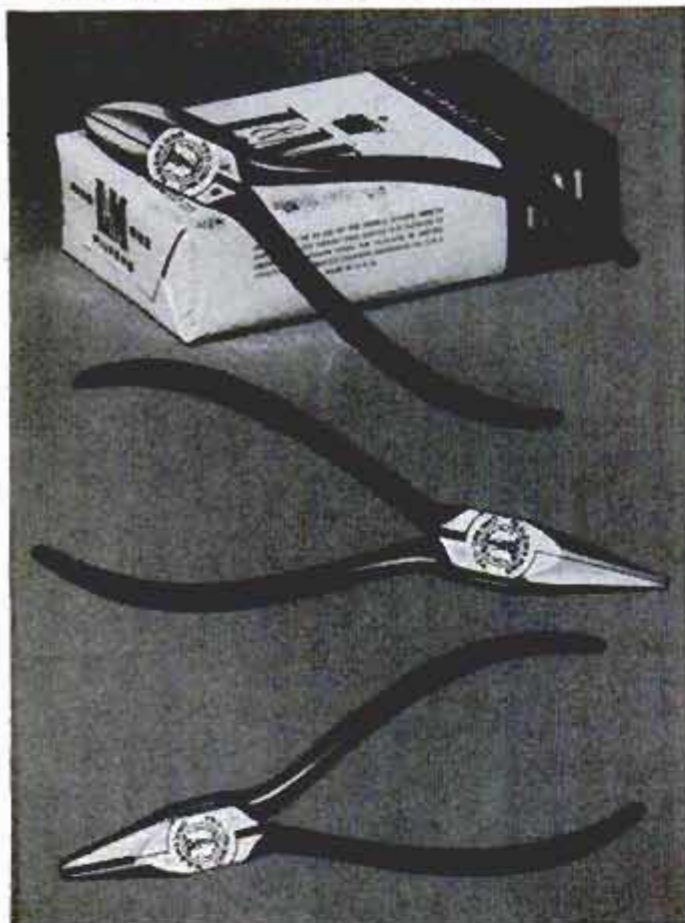

Hardly larger than a package of your favorite cigarettes, these new Klein Midget Pliers will simplify many of those small jobs where space is confined.

Midgets in size but giants in performance, they solve major problems when wiring up electronic assemblies; making model trains, airplanes, automobiles, or in any extremely small or confined work.

These new midgets are additions to the famous Klein line of high-quality pliers that are backed by over a century of manufacturing experience. See your hardware dealer.

No. 257-4 Oblique Cutting Plier	Size 4 in.
321-4½ Long Nose Plier	4½ in.
322-4½ (Without Knurl)	4½ in.
224-4½ End Cutting Plier	4½ in.



**Free Bulletin on Klein Pliers**  
Bulletin 758 lists the many various pliers in the Klein line. A copy is yours for the asking. Write for it today.

**Mathias KLEIN & Sons**  
Established 1857  
7200 McCORMICK ROAD • CHICAGO 4, ILLINOIS



and tents to sing songs or just plain visit. It's about like it was of a rainy day on the farm, when the neighbors came over to help with a small job and hung around till chore time."

Now another big reunion day is over. Gradually the crowd files off into the darkness, some going home, others to motels and hotels (this is just a stop to them as they make the reunion circuit), still others to tents where they can sleep within earshot of their beloved engines.

Ahead as you pass through the gate is the same farm family you followed this morning. The old man's bandanna is soot-stained now, and he isn't standing quite as straight. His voice quavers a little as he talks about tomorrow's parade.

In many of these old men of iron, you realize, the fires are burning low. These old-timers, both men and machines, have been passed by in a new world of satellites and jangled nerves. But hundreds of thousands of ordinary folk feel nostalgia for the old-time steamer and the men it bred.

It's a feeling you can't explain to anyone else. You just sense it as you climb into your car. In the distance, some gnarled hand pulls the whistle cord for a final good-night blast, and you can't help answering with a toot of your car horn. ★ ★ ★

## Rust-Resistant Wheat of Future Developed by Atomic Scientists

Atomic-energy scientists at Brookhaven National Laboratory, by first developing possible future wheat-rust diseases, have created wheat seeds able to resist the types of rust that could attack wheat for the next 100 years.

## Do You Know This Old-Timer?

(answer to quiz, page 22)



## 1917 Reo Flying Cloud

(4-cylinder)



Change  
For The Better  
Change To  
**V-M STEREO!**



V-M  
'Stere-O-Matic'  
Model 1201

**NOW . . . TRANSCRIPTION-TURNTABLE  
PERFORMANCE AT A POPULAR PRICE!  
The All-New V-M 'Stere-O-Matic'®  
4-Speed Stereo Record Changer**

- NEW CONVENIENCE!
- NEW VERSATILITY!
- NEW FEATURES!

Your high-fidelity system begins with your record changer. This is the one automatic 4-speed changer that matches all other changers feature for feature *and then some!* The all-new V-M Model 1201 comes wired for stereo with *stereo-cartridge* installed! Complete with dual output jacks and stereo/monaural switch.

**SEE IT! COMPARE IT! TEST IT!**

Model 1201 . . . \$50.00\* Model 1202 . . . \$50.00\*  
\*Slightly higher in the West.

BEFORE YOU BUY ANY RECORD CHANGER —  
BE SURE TO TEST V-M!

See Your Nearest V-M Dealer TODAY!

the **Voice**  of **Music**®

V-M CORPORATION • BENTON HARBOR, MICHIGAN

**Here's What Makes The 'Stere-O-Matic'  
So Completely Dependable . . .**

**RUMBLE:** — 48 db for 120 cycle rumble when tested on XLP414 test record (recorded velocity approximately 3.4 cm/sec. at 1,000 cycles.)

**WOW AND FLUTTER:** ¼ RMS.

**TURNTABLE:** Balanced to assure constant speed. Spindle bearing area centerless ground to reduce frictional drag.

**MOTOR SPEED:** Constant, positive for permanent true pitch.

**TONE ARM:** Resonance-free. Easily adjustable for any cartridge weight. Compensated to eliminate variation from bottom-to-top of record stack. Jewel-type anti-friction. Stereo cartridge installed. Will accept all popular stereo or monaural cartridges *without alteration.*

**TRACKING ANGLE:** Variation reduced to a maximum of 2°

**AUTOMATIC SHUT-OFF:** Unit shuts off automatically after last record plays.

**RECORD INTERMIX:** Will intermix 10" and 12" records of same speed. V-M "45" spindle fits easily over Tri-O-Matic spindle for 45 rpm records.

**ELECTRICAL SPECIFICATIONS:** 110-120 V; 60 cycles A.C. Special voltages and frequencies upon request.

**ALSO AVAILABLE:** Model 1202 with four-pole motor and plug-in head for GE and other magnetic stereo and monaural cartridges. All V-M models available with matching metal base-pan or pre-cut mounting board.



# How to select a paintbrush

A good brush performs better... wears longer... saves you money



Check these points when buying your next paintbrush.

First, look for a full stock of bristles in a firm, strong setting (1). Avoid brushes with loose bristles. Then inspect the individual bristles closely (2). They should be finely tapered, with slightly curled

tips. Look again and be certain a generous portion (at least 10 to 20 per cent)



of the bristles have tips which are split or "flagged" (3).

Your final assurance of a brush which will give the best painting performance is bristles of varying lengths (4),



but with a high proportion of longer lengths.

If the brush you look at passes all these tests, it will have a greater



working and paint-holding capacity and eliminate excessive dipping. It will (5) release any type finish smoothly and evenly on any surface.

One short cut to selecting a good brush is to look for the black and yellow tag, signifying a brush with TYNEX nylon bristles

(6). Properly made paintbrushes with tapered bristles of improved Du Pont TYNEX nylon give you better painting performance. They pick up a full paint load at every dip and give velvet-smooth paint-out. With proper care, brushes with durable bristles of TYNEX clean easily... rinse thoroughly... are quickly ready for another job.



**FREE**—"How to Choose and Use a Paintbrush." This booklet tells how to paint walls, ceilings, trim, furniture, radiators and do other special jobs. Gives tips on the correct painting stroke, how to hold a paintbrush, how master painters dip their brushes, how they clean them. Tells what kind of paintbrush to use for each painting job. Write to E. I. du Pont de Nemours & Co. (Inc.), Polychemicals Dept., Room 539 Du Pont Building, Wilmington 98, Delaware.



TYNEX is the registered trademark for Du Pont nylon bristles.



**TYNEX**  
NYLON BRISTLES

BETTER THINGS FOR BETTER LIVING... THROUGH CHEMISTRY

## Improve Your Wing Shooting

(Continued from page 149)

a lot of his effort gaining altitude. Once he levels off, his speed picks up and you have to allow more lead.

Of all the wing-shooting targets there's none trickier than the ruffed grouse. When you can bag this bird a fair portion of the time, you've arrived among wing shots. His flight is fast and he's an artist at getting trees between himself and your gun. Many a woodland wing shot has put a load of shot into a tree instead of the grouse that darted behind it. And in grouse hunting you have to expect the bird to take off with a roar. You need calm nerves and the ability to point your gun quickly. A light gun, especially a 20-gauge loaded with No. 7½ shot, is fine for grouse shooting.

Many wing shots insist, however, that the toughest bird of all is the dove, which has a fast erratic flight. Dove shooting is often open-country shooting. Hunters station themselves between fields where the birds fly to and from feeding or watering areas, and shoot at the birds as they pass. The pattern of shot should be tight, for this is a small bird and shot size No. 7½ or 8 will do well.

The confirmed waterfowl gunner braves all manner of weather. When he brings down a bird he feels considerable satisfaction, for shooting ducks calls for fine shooting. When you get a shot, take time to line up the gun behind the bird, move through him, pull the trigger as you get the right lead, and follow through. Get on your target early. Duck shooting should usually be done at 40 yards or less. Long shots often mean more cripples as well as fewer shots, for you simply frighten ducks out of the neighborhood. The 12-gauge shotgun is almost standard for duck shooting, although some gunners manage quite well with 16-gauge guns. No. 4 shot is probably the best.

But whatever the target, a little practice and study can go a long way toward providing a better day's wing shooting in the woods, field or blind. ★ ★ ★

## Infrared Defense Weapon "Too Good" to Be Used

Army Signal Corps scientists are trying to reduce the sensitivity of an infrared-ray device which could detect the launching of a missile thousands of miles away. Because it is extremely sensitive, the device also could spot a bonfire on the other side of the world. However, in its present form, the detector couldn't distinguish between a missile and a bonfire.



**KEEP YOUR  
WORKSHOP TOOLS  
SAFE AND ORDERLY**



This 7-drawer machinist's chest has a place for every tool. Extra durable heavy gauge steel. Felt lined drawers protect delicate edges... operate easily. Size: 8½" x 13½" x 20¼". \$27.95 at leading hardware stores. Slightly higher west. Other home workshop models from \$1.25 up.

**WATERLOO VALVE SPRING COMPRESSOR CO.**  
Waterloo, Iowa



**GENUINE ALNICO  
MAGNETS**

AMAZING, PERMANENT, NON-ELECTRIC, HIGHLY PRACTICAL. Conduct interesting experiments. Hundreds of uses. Retrieve valuable steel items such as guns, tackle from fresh or salt water; tools from tanks & drains. **GUARANTEED.** Try any magnet one week. Money back if you are not well-pleased.

No. M-710 (Wt. 53 oz.) Has pull of 225 lbs. on steel block... \$18.00  
No. M-625 (Wt. 70 oz.) Has pull of 125 lbs. on steel block... \$10.00  
No. M-575 (Wt. 18 oz.) Has pull of 75 lbs. on steel block... \$7.00  
No. M-500 (Wt. 13 oz.) Has pull of 50 lbs. on steel block... \$5.00  
No. M-300 Kit of Flat Bars 5 Pairs (10 Magnets)... \$3.00  
No. M-250 Kit of Round Rods 5 Pairs (10 Magnets)... \$2.50  
No. M-47 Hot Pad Magnets, 10 for \$1.00... 50 for \$4.87  
No. M-35 Hobbyist assortment of 8 small magnets... \$1.50

Send M.O. or check. We pay postage. Sorry no C.O.D.'s.  
**MIAMI MAGNET COMPANY, 3240 N.W. 27th Ave., Miami 42, Fla.**

**DRAINS** cellars, cisterns, wash tubs; **\$7.95**  
**IRRIGATES - CIRCULATES - SPRAYS**



1,001 uses. Stainless shaft. Won't rust or clog! Use 1/8 HP motor or larger... 3/4 HP for up to 3000 GPH; 450 GPH 80' high; or 1800 GPH from 25' well. 1" inlet; 3/4" outlet. Complete included free... \$7.95.  
**HEAVY DUTY BALL-BEARING PUMP.** Up to 7,500 GPH; or 3,000 GPH from 25' well. 1 1/4" inlet; 1" outlet. \$12.95  
Postpaid if cash with order. **MONEY BACK GUARANTEE**  
Centrifugal and Gear Pumps in All Sizes  
**LABAWCO PUMPS, Belle Mead 7, New Jersey**

**FREE THE HISTORY OF  
THE COMPASS  
SEND FOR YOUR COPY**

**New DINSMORE  
Celebrity  
COMPASSES**

in Beautiful **GOLD OR SILVER**

A jeweled, precision instrument—designed for modern cars. Full, indirect illumination. Sharp, clear letters. Silver or gold Celebrity models \$6.95, standard models \$5.45, illuminated \$6.45  
**APPROVED BY AUTO MAKERS**  
Fine Quality Compasses for over 31 Years

**DINSMORE INSTRUMENT CO.**  
1802 Kelso St., Flint 1, Michigan



Write for Folder

**STOP**

**ENGINE STALLS-VAPOR LOCK-LOW MILEAGE**

**INSTALL A MILESMASTER®**

**FUEL PRESSURE REGULATOR**



Let Milesmaster help you enjoy better, more economical motoring. Sold everywhere... only \$6.95, plus installation.

**Money Back Guarantee**  
Dept. K

**MILESMASTER, INC.** Exeland, Wisconsin

**You can buy a  
LUMINALL  
miracle paint  
for every purpose**



**FREE  
PAINTING PACK**  
SELECT ITEMS  
OF INTEREST  
TO YOU



**1. Famous  
Satin Luminall**  
The concentrated interior paint with bonus quart per gal.



**2. Exterior  
House Paint**  
Durable, high-gloss beauty for all wood exterior surfaces.



**3. Outside  
Luminall**  
For brick, concrete, masonry, asbestos shingles—all climates.



**4. Luminall  
Satin Enamel**  
Applies like paint, dries flawlessly to hand-rubbed finish.



**5. Alkyd Flat  
Wall Enamel**  
Rich, smooth enamel that applies easily on all interiors.



**6. Ready-To-Use  
Luminall**  
Easiest paint to use on all interiors. Washable. Durable!



**7. Alkyd Non-Fade  
Trim Colors**  
Hard gloss for all wood or metal sash, doors, shutters.



**8. Luminall Parch  
& Floor Enamel**  
High gloss for all floors, inside or outside, heavy duty.



**9. Concrete  
Floor Paint**  
Quick-dry, tough finish for floors, patios. Easy to use!



**10. Luminall  
Dri-Rite Enamel**  
Interior & exterior luster for yachts, machinery, furniture.



**11. Semi-Gloss  
Wall Finish**  
Kitchen-bath-trim enamel to match alkyd flat colors.

Millions of happy users know Luminall Paints apply easier, look better, last longer, cost less per square foot. That's why they're called "Miracles"!



**'HIS & HERS' PAINTING PACK**  
Great idea! Real color chips for her selection. Practical how-to-paint-it suggestions for him. A free Painting Pack.

Circle for color card on above paints

1	2	3
4	5	6
7	8	9
10	11	

Luminall Paints, Dept. K, Chicago 9, Ill.  
Please send free painting packs on items I have circled, with no obligation to me.

Name \_\_\_\_\_

Address \_\_\_\_\_

City \_\_\_\_\_ Zone \_\_\_\_\_ State \_\_\_\_\_



**LUMINALL PAINTS**  
Finest in Finishes





A-FRAME  
MOUNTAIN CABIN

## vacation cabin IDEAS



WEEKEND  
BEACH COTTAGE

### NEW full-color booklet shows 20 easy-to-build fir plywood cabins

HERE'S the perfect source of ideas for anyone planning to build a vacation cabin. Smart, modern designs by leading architects for cabins of every type and size, complete with pictures in natural settings, floor plans and building tips. Plans call for simple, straight-forward construction with light, strong fir plywood to save you time, money and trouble when you build.



complete plans  
available for all  
20 cabins

Send 10c to cover mailing costs to:

DOUGLAS FIR PLYWOOD ASSOCIATION  
Dept. Tacoma 2, Wash. Offer good USA only

## Treasure Hunt in Navajo Land

(Continued from page 92)

tires is high. In the basin, however, you lower the pressure—or you are likely to be a long time getting any place, because you will become stuck in the sand. Truck transmissions are installed in automobiles. Seat belts are almost a must. And, when drifting snows obliterate roads in the winter, the cars are put away. Jeeps and half-tracks are necessary to get you there.

Before the oil boom came to their reservation, the Navajo Indians had a per capita income of only \$420 a year. There are about 80,000 Navajos, but already their average income has more than doubled.

"Water for the land is what we want," explained a Navajo. "Our people have wanted water for a long time, and now we may get it with oil money for irrigation. The reservation needs many other things—better roads, hospitals, schools."

### Primitive Patterns Persist

There may be better Navajo homes and there may not. A good share of the Indians today still live in mud hogans with windows that have no panes, doorways that have no doors. But finer homes may not be desired by many Navajos who still follow the practice of abandoning their home after someone has died in it.

Farmington, N. Mex., is about 90 miles from the Aneth-Isma. It has seen boom possibilities throughout the years with such varied activities as cattle raising, fruit growing, brick manufacturing and flour milling, but now, with oil flowing off in the distance, the boom has really arrived. Three years ago the population of Farmington was about 3500. Today, it is 15,000 and still climbing.

### Commuting Is Real Problem

Many suburbanites think they spend quite a bit of time commuting. But commuting for oilmen in the basin is really on the rugged side. A typical foreman travels by car 175 miles per day, sometimes covers up to 300. And the traveling is lonely. Company cars are equipped with radios—but they are short-wave sets to keep in touch with their headquarters. Meeting a Navajo sheepherder is a welcome diversion. For the Navajo, meeting a tourist usually calls for the providing of detailed directions, because the chances are the tourist is lost.

Water is scarce. Wells are drilled for artesian water, but it's a standing joke that they "may produce only oil." Too often water must be trucked in. As for space, there is plenty of it. But, paradoxically, it is getting crowded with oil wells. ★ ★ ★



# Cuts Without CHIPPING\*

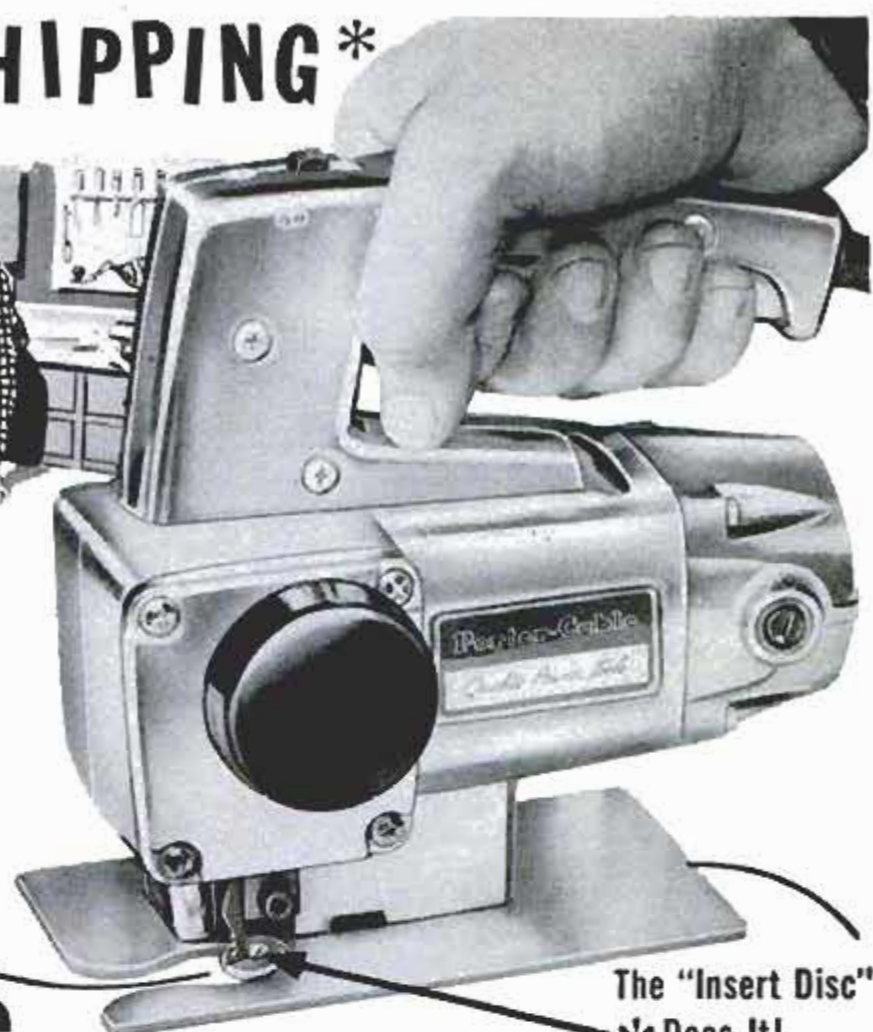
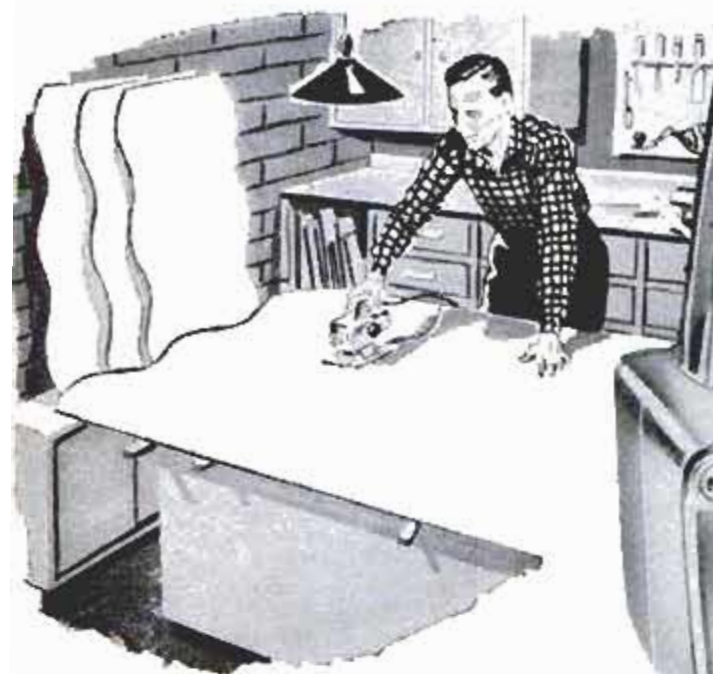

## A Genuine Porter-Cable

## Electric Hand Saw Loaded with Exclusive Features!

The "Insert Disc" \* Does It!

The Porter-Cable #52 Hand Saw is the only saw with the patented insert disc which virtually eliminates chipping and insures a smooth, even cut on plywood, plastic laminates and other materials. It's the all-purpose saw for home or workshop - hack saw, scroll-saw, cross-cut saw, jig saw, keyhole saw, coping saw and rip saw.

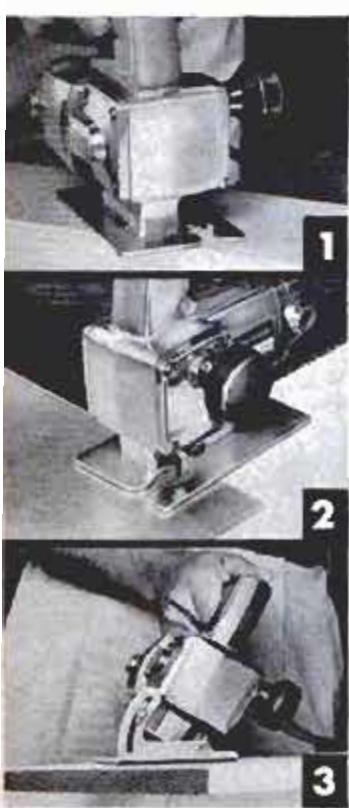

**1 SLICES 2x4's in 8 SECONDS.** Use it as cross-cut or rip saw. Handles full 2" dressed lumber, plywood, other materials.

**2 CUTS METALS, TOO - 1/4" aluminum, 1/8" steel!** Sheet metal, fittings, bar stock, and pipe are cut quickly and cleanly.

**3 CUTS ANGLES...accurately!** Accessory base allows precise angle cuts up to 45°. Easily and quickly adjusted.



**EXCLUSIVE ORBITAL ACTION** Blade moves ahead on upward stroke - backs away from work on down stroke. Eliminates drag and excess heat. Cuts 3 times faster. Blade life up to 30 times longer.

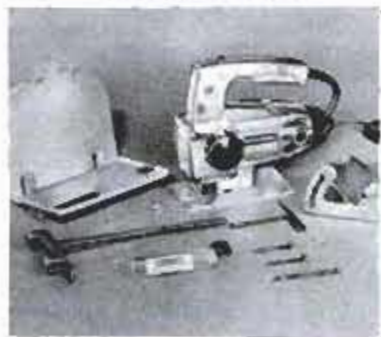

### SAVE \$10 on SAW and Special Kit

Saw complete with package of 3 assorted blades, patented "Insert Disc," allen wrench and tube of grease. Kit contains handy wall bracket, angle base, rip guide, and extra blade assortment.

Regularly \$59.95 | **SPECIAL at \$49.95**



**PORTER-CABLE MACHINE COMPANY**  
8149 Marcellus St., Syracuse 4, New York



## The Big Switch to Stereo

(Continued from page 155)

reproduction. Motion in a vertical direction, however, is often severely limited. It is conceivable, therefore, that such cartridges would cause the stylus to gouge out the vertical portion of a recorded stereo signal and would ruin the record for future stereo purposes. Obviously, the use of a monaural cartridge for playing stereo records is not recommended, but this is only a minor disadvantage. Good monaural records are very plentiful and there seems to be little reason for anyone to invest in stereo discs unless stereo reproducing equipment is already on hand. The major problem, that of playing monaural records with stereo equipment, is satisfactorily resolved.

### Looking Ahead

The switch to stereo is on! Already, only a few months after initial test demonstrations, a good selection of popular and classical stereo discs is on the market. Stereo cartridges, both ceramic and magnetic, can be purchased from distributors and most major manufacturers of hi-fi systems are including these in their new models. There is no doubt that the stereo record is here to stay.

The only question concerns the coexistence of stereo and monaural records. In view of stereo compatibility, it does not seem likely that record companies will publish the same selections in both stereo and monaural form for any length of time. It's a good bet, therefore, that in the future most new records will have STEREO on the label. But, by that time, most new phono systems will be able to handle these discs and most present hi-fi systems will have been converted for stereo reproduction. For stereo is, after all, one of the final and most dramatic steps toward true high fidelity.

### HOW YOU CAN SWITCH TO STEREO

Your present phono system can serve as the nucleus for stereo. The additional requirements, as well as the methods employed for stereo in the home, will be discussed in next month's issue.

### Vibrator for Driver Fatigue

For people who like vibrations, there are electrically operated vibrators that can be installed in bed, chair or wherever you need a restful vibratory massage. The latest is a vibrating pad "to end driver fatigue," which plugs into the cigarette lighter of automobile or truck.

# BEST AIR FILTER BUY!

RP

# EZ KLEEN

## WASHABLE FURNACE FILTER

**WASHABLE**—for constant peak efficiency, more heat from your furnace.

**ECONOMICAL**—last season after season.

**ALUMINUM**—light, strong, easy and safe to handle. Won't rust.

**CONVENIENT**—wash, re-coat, replace. Eliminate shopping for proper filter sizes.

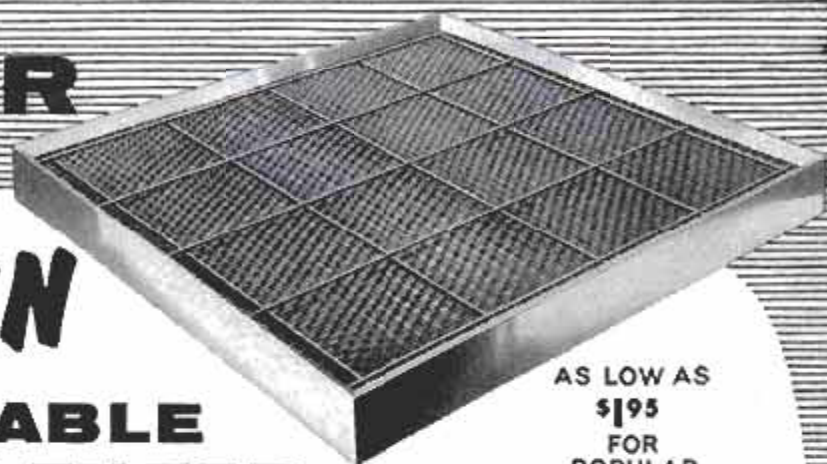

AS LOW AS  
\$1.95  
FOR  
POPULAR  
SIZES

### REMOVE ODORS, TOO

Convenient Super Handi-Koter, with sprayer, contains exclusive dirt AND ODOR removing adhesive. Has built-in detergent to simplify washing. Flush filter, re-coat with adhesive, reinstall for automatic dirt and odor removal.



AT YOUR DEALER,  
OR CONSULT YOUR CLASSIFIED TELEPHONE DIRECTORY

**RESEARCH PRODUCTS Corporation**  
Dept. 227, MADISON 10, WIS.

IN CANADA: HICKS-BAKER Ltd., Winnipeg • SPALL-BOWMAN Ltd., Guelph



**New Valuable Guide for Men**

# "HOW TO MAKE WOOD A BEAUTIFUL PART OF YOUR HOME"

Wood grains, patterns, textures you can choose! Striking effects you can create! Practical new designs, plans and ideas! Hundreds of the things you want to know about natural wood finishing, decorating and building . . . yours for just 50c in one 56-page booklet . . . by Monsanto, makers of REZ—world's most colorfully complete line of natural wood finishes!

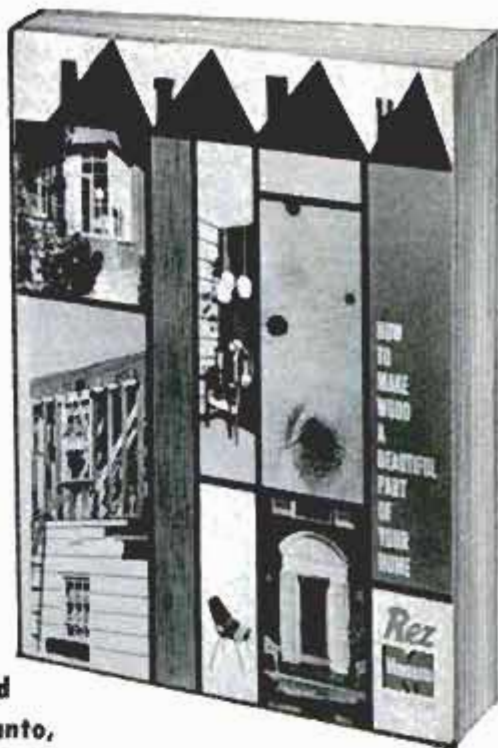

Monsanto has prepared a wonderfully helpful booklet for you — a complete how-to-do-it guide for decorating with wood and REZ natural grain sealer-finishes. Now you can choose from hundreds of wood grains and patterns, textures, colors and finishes

and achieve exactly the results you want every time.

See the woods you want for your home . . . Woods—light, sun-warm and refreshing. Woods — of rich dark tones. Woods—with dramatic whorls and patterns. Woods—with subdued grain tracings of quiet charm. Compare the most popular practical woods and plywoods. You actually see how their nature-grown beauty is enriched with a colorful variety of REZ grain-revealing finishes.

New booklet shows how natural wood becomes part of your color scheme with Color-Toned REZ. Outside, you can capture the charm and "feel" of forest, desert, mountain, seacoast or country landscape on your siding, carport, fence, trim or patio . . . inside, you can follow the same color scheme on paneling, cabinets, doors, valances, woodwork — coordinate wood color with carpeting, draperies and upholstery.

Saves you money . . . helps you select your favorite wood in the least expensive grade for your use—buy lumber, paneling, unfinished furniture and finish it easily in a few hours—enjoy all the luxury of good wood at low cost.

Easily adaptable ideas — illustrated ways to make home improvements you've always wanted — get more living space with built-ins, add on a family patio-porch, convert your basement into an activity room or rathskellar. 35 new designs. Guide plans. Easy to build.

New ideas in wall paneling . . . money-saving suggestions. How you can install and finish paneling yourself—save 25% to 60% of total cost you pay for wood.

Built-in, multipurpose cabinets you can custom-build to save space, make better use of existing storage area and open up more floor space for active use.

Different fence designs for beauty, privacy, sun screen, wind protection.

A treasure-chest of valuable additions to your home. Ways to make old rooms into new rooms with storage walls, book shelves, room dividers, closet stretchers.

Professional wood finishing made easy! Amazingly simple, sure ways to create a satiny, hand-rubbed look without rubbing or waxing . . . any color effect on any wood and enrich the natural beauty of the grain . . . a "bleached" or blond look without chemically bleaching. Tricks by master craftsmen you can use to bring out the distinctive best of redwood, pine, gum, fir, cedar, oak, birch and others.

REZ solves every wood-finishing problem for you: no cracking or peeling, controls grain raise, ends mottled and uneven colors, protects against spotting from alcohol and water, defies stains and abuse. Brush it on as easily as water . . . REZ penetrates, seals, finishes — lasts for years — will not peel or blister — guards woods from sun and weather outside — gives lasting beauty inside.

REZ—T.M. Monsanto Chemical Company

## USE HANDY COUPON



Monsanto Chemical Company  
P.O. Box 643, Dept. PM  
St. Louis 1, Missouri

Send me the color-filled, 56-page guide, "How to make wood a beautiful part of your home." I enclose 50c.

Name \_\_\_\_\_

Address \_\_\_\_\_

City \_\_\_\_\_ Zone \_\_\_\_\_ State \_\_\_\_\_



# grownup gun for younger shooters

the **Stevens 94Y**

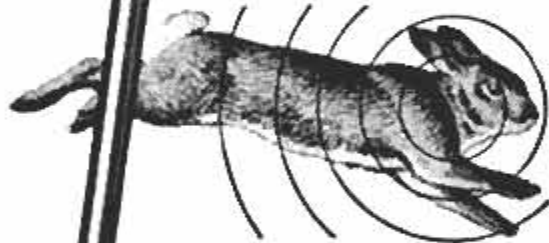

A LIGHT, SAFE AND STURDY SHOTGUN that lets your youngster share the fun of sport shooting with you . . . gives him experience in gun handling while he's young.

DESIGNED AND PROPORTIONED for younger shooters, the 94Y weighs about 5½ lbs. Its 26" barrel gives ideal balance. Shorter stock and recoil pad assure comfort and perfect fit . . . mean real shooting pleasure for the beginner.

SAME DESIGN AS THE STEVENS 94—most popular single barrel shotgun ever made—the 94Y is dependable and safe. Ejects fired shells automatically. And it's equally convenient for right- and left-handed shooters. The action opens easily by swinging lever in either direction.

YOUR CHOICE OF TWO POPULAR GAUGES—20 gauge modified or .410 gauge full choke—both effective and highly recommended for beginners. See the Stevens 94Y at your dealer's soon.

There are Savage, Stevens and Fox shotguns and rifles for every shooter and every kind of shooting. Write for free rifle or shotgun catalog. Savage Arms, Chicopee Falls 76, Mass.

**Stevens**  
SAVAGE • STEVENS • FOX FIREARMS

\$30.95

ALL PRICES SUBJECT TO CHANGE . . . SLIGHTLY HIGHER IN CANADA.



## How We'll Steer in Space

(Continued from page 139)

of power plants) is the problem of guiding a spaceship to its destination. Because we'll expend most of the ship's energy for the trip, little will remain to correct the guidance of the craft. Thus the initial "aim" of the craft must be extremely accurate; the more precise the guidance, the less fuel we'll waste.

### Navigation Is Really Important

Let's look at the guidance problem for a moment. Guidance depends upon navigation, which is simply the art of going from point A to point B. On the earth's surface, both A and B (for example, New York and Chicago) are determined by two things: Latitude and longitude. When you navigate on earth, you simply determine the latitude and longitude of your vehicle (be it plane, ship or even car), and you can easily calculate the direction you must travel to arrive at the longitude and latitude of your point of destination. You can even become temporarily lost and still reach your destination, because A and B do not move with respect to each other.

Not so in space. Both A and B move because all planetary bodies move with respect to each other. Therefore your destination doesn't stand still. It's as though you were on a motor trip to Chicago, and Chicago kept moving all the time you were on the road.

In addition to this difficulty of a moving destination, travel in space occurs in three dimensions instead of the two (latitude and longitude) of your travel on earth. Actually, we can say that navigation in space is four-dimensional: Three space dimensions and one time dimension. Because the speed of planets is very great (67,000 miles per hour for earth, 54,000 for Mars and 79,000 for Venus), even a slight error in timing and speed may cause a complete miss. And if you miss, you very likely will wander through space forever.

### Two Methods of Guidance

That's the problem. Now there are two methods we can use to guide a ship through space. We can give it precise speed and direction initially, as if it were shot from a gun. Or we can launch it with a reasonable degree of accuracy, and correct the course subsequently during the flight. The first is called the "ballistic" method. Hitting Mars ballistically is about as easy as shooting a swallow from half a mile away with an arrow.

The second method, known as midcourse

(Continued to page 232)



ADD PERMANENCE  
TO YOUR PROJECTS  
with QUALITY SCREWS and BOLTS  
by *Southern*

Remember! Only a Screw  
Holds Like a Screw!

Buy Southern by Name . .  
Buy 'em by the box, and save!  
IN ALL LEADING HARDWARE  
AND BUILDING  
SUPPLY STORES.



WOOD SCREWS  
TAPPING SCREWS  
STOVE BOLTS  
MACHINE SCREWS  
DRIVE SCREWS  
DOWEL SCREWS  
CARRIAGE BOLTS  
HANGER BOLTS

Works in seconds!

Loosens Rusted Bolts  
nuts, screws, "frozen" parts!

**LIQUID  
WRENCH**

The super-penetrating rust  
solvent that quickly loosens  
rust and corrosion.

AT HARDWARE STORES, GARAGES  
SERVICE STATIONS, EVERYWHERE  
**RADIATOR SPECIALTY CO.**  
Charlotte, N. C.



3 oz. CAN  
35c

BUILD FINE **GRANDFATHER** CLOCK NOW

The simple sensible **SPEEDE Red-i-Kut** way as thousands have—FOR YOURSELF OR SELL AT A GOOD PROFIT. SAVE HUNDREDS OF DOLLARS. SHOP TESTED PLANS "SPIRIT OF THE CENTURY" Narrow waist 83" tall or stately straight side "SPIRIT OF AMERICA." EASY-TO-FOLLOW photopack PLANS & LIFE SIZE PATTERNS tell all—plus MOVEMENT BROCHURE \$40 up, of heavy brass weight (Kuempel original) Westminster, tube BELL chime, movements, gorgeous bronze-silver MOVING MOON dials, 3/4" solid-mahogany Jiffy Joint-Kwik-Bilt case kits. Send \$1.00 today—Both plans RUSH \$1.50 as folks have for over forty years.

Kuempel Chime Clock Works, #14 Kuempel Bldg., Minneapolis 16, Minn.

**10" TILT/ARBOR SAW**  
BUILD-IT-YOURSELF  
from GIL-BILT KITS-PLANS

Sturdy wood, steel, and aluminum construction, NEW DEPARTURE ball bearings. Capacity and performance of floor saws selling for \$150.00 and up. Plans, all metal parts in kit with 10" comb. blade \$23.90, less blade \$22.95. F.O.B. St. Louis. Detail PLANS-PATTERNS only \$1.00 postpaid.

Build-it-yourself 12" and 18" Bandsaws, 6" Belt Sander, Shaper. Simplified plans, build easily with hand tools only. Advertised and sold for 11 years, over 23,000 units in use. Money back guarantee. FREE CATALOG.

GILLION POWER TOOLS, Dept. 80-J, Lambert Field, St. Louis 21, Mo.

**KING  
MIDGET**



More power, beautiful styling. New Features. Still World's Lowest Priced Car. Drive it for 75c a week. Rider agents wanted. Earn your own car. If no dealer near you send 25c for 32 page picture book with full details and dealer price. Or send \$1 (refunded first order) for this and Service Manual, plus Repair Manual, plus 15 5x7 photos of car and factory.

MIDGET MOTORS CORPORATION, ATHENS 1, OHIO

ON ANY  
DIRTY JOB



PAINTING

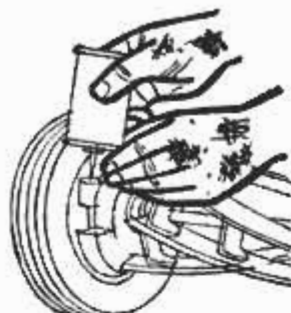

HOME REPAIRS

ENGINE JOBS

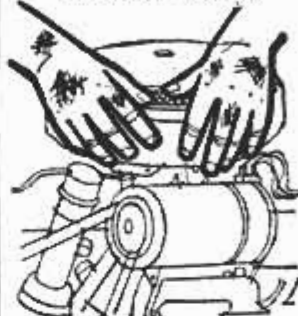

GARDENING



PROTECT  
HANDS WITH  
DU PONT PRO-TEK<sup>®</sup>

THE INVISIBLE GLOVE

Plain tap water washes off grease, grime, paint and oil when you wear Du Pont "Pro-Tek" hand cream, "the invisible glove." So stop using solvents that are irritating and inflammable. Just rub on "Pro-Tek" before tackling any dirty job. At drug, hardware, paint and auto supply stores.



Better Things for Better Living . . . through Chemistry





"Most  
useful tool  
in  
my kit"

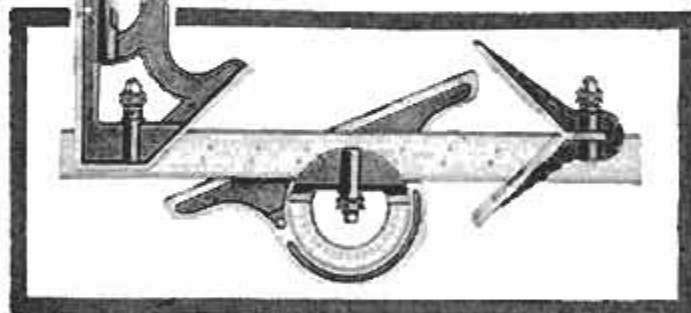

## Starrett<sup>®</sup> NO. 9 COMBINATION SET

"Seems like I use a combination set more than any other tool — so naturally I want the best. In the Starrett No. 9, you get features you don't find in other makes — patented reversible lock bolt that lets you change heads fast or reverse the blade without removing the bolt . . . smooth fitting parts with precision ground faces . . . protractor head with direct reading double graduations to save calculations . . . square and protractor heads with accurate, built-in spirit levels — and a scriber right in the square head.

"Another big Starrett feature . . . you can get the type of blade you need on your job — tempered steel, Satin Chrome Finish or rustproof Stainless Steel — also English, Metric, English-Metric or Decimal graduations."

Starrett Combination Sets are available in 12, 18 and 24-inch sizes. Shown is Starrett No. 9-12" Combination Set with square head, center head and protractor head. Blade shown has No. 16R quick-reading graduations in 32nds, 64ths, 50ths and 100ths.

### BIG NEW CATALOG—FREE

Describes and illustrates over 3000 Starrett Tools. Send the coupon.

STARRETT TOOLS are carried by leading Industrial Supply Distributors and Hardware Tool Stores.

THE L. S. STARRETT COMPANY  
Dept. AP, Athol, Mass., U. S. A.

Please send my free copy of the big new Starrett Catalog No. 27.

Name.....

Occupation.....

Address.....

City.....Zone.....State.....

guidance, is the most practical and also the most reliable because it allows for continuous correction of errors in the trajectory.

In order to use midcourse guidance, we must know certain facts: The ship's position, the ship's speed, the ship's direction of travel and the "future position" of the destination at the expected moment of arrival.

The last of these facts—the position of a planet at a given moment—we know very accurately from astronomical tables.

### Open Field for Inventors

Two of the remaining facts—the ship's position and speed — can be determined from within the ship, or by observing the ship from the earth and relaying the information to the ship. (This is an excellent field for inventors who can offer sound and simple solutions.) One practical solution is shown in Figure 2. In this solution, the ship is tracked by radar on earth. Each radar impulse from earth triggers a "transponder" on the ship, which answers with a powerful radio impulse. The time interval between the radar pulse and its echo can be used to determine the distance of the ship from earth.

Using the same system, we can measure the speed of the ship. Have you ever waited for a train at a crossing and listened to its whistle? Just as the train passes, the sound seems to drop in pitch. This is known as the "Doppler effect." Here's what happens: Because the train is moving, you in effect are "running away" from the train's whistle and its sound waves. Therefore you receive fewer waves, and the pitch of the whistle seems to drop. The same phenomenon applies to radio waves. The frequency drops as the receiver moves away from the transmitter, and increases as it moves toward the transmitter. By measuring this change in frequency we can determine the ship's speed.

### Three "Speed Fixes"

Actually, for a really accurate speed measurement we need three different "speed fixes" from three different radars on the earth's surface.

We can determine the ship's direction by measuring the angles as shown in Figure 2. One angle is the latitude of the transmitter itself. The other two show the azimuth and elevation with respect to the earth's surface.

Thus the radar-beacon system will yield three facts: The ship's distance, its direction and its speed.

Another method is for the crew of the ship itself to determine its position. All it

(Continued to page 234)





*Change it  
any way,  
any time*



*to match  
your room's  
decor!*



**T**HE TRANSPARENT decorator plate on the new Honeywell TAP-LITE\* snaps off for easy decorating, cleans easily. Just wipe with a damp cloth. Simple to install. TAP-LITE has screwless terminals. Easy to operate. Tap, it's on. Tap, it's off! Switch and plate \$1.95 at all leading retail stores.

**MINNEAPOLIS  
Honeywell**



\*Trademark

*First in Control*

**SAVE MONEY ON YOUR  
COMPRESSED AIR**

buy this complete  
SMITH 45-P air compressor



Right for spray painters, plumbers, contractors, monument shops, tire changing trucks, maintenance shops, quarries, utilities, many other users. Delivers 45 plus cu. ft. per minute; pressure up to 150 P.S.I. Powered by Wisconsin 4-cyl. air-cooled engine; uses less than 1 gal. gasoline an hour! Most compact, biggest-value compressor for its capacity anywhere! Other models to 230 cfm.

write for  
**FREE**  
brochure

**GORDON SMITH & COMPANY, Inc.**  
411 College Street, Bowling Green, Ky.

**NOW, AIM TO DO DOZENS OF  
HOUSEHOLD AND WORKSHOP JOBS  
EASIER AND BETTER  
BECKER  
SPRAY GUN**

No hoses, no cords, no attachments necessary. Inexpensive CO2 cartridge supplies all the power needed to spray paints, insecticides, stains, liquid fertilizers, and more. Nozzle adjusts from mist to stream. Container holds 21 ounces. Ask your dealer, or order direct. Remit in full, and we pay postage. Or send \$2. and pay post-man balance plus COD fee.



**ONLY  
\$19.95**  
Complete  
with 10  
cartridges

**SULLIVAN BECKER CO., Dept. 118-J, Kenosha, Wis.**

**Be Your Own Boss in the Profitable Excavating Business!**

**EARN UP TO \$1,000  
AND MORE PER MONTH**

Wherever you live, you'll find plenty of profitable work the whole year 'round for this versatile outfit . . . not just a "trencher" but an all-purpose excavating machine! Custom operators everywhere are making big money with Sherman Power Diggers. **ONE BOUGHT A FARM WITH JUST THREE YEARS' PROFITS!** Work for builders, contractors, utilities, and municipalities on such jobs as septic tanks and drainfields, sewer lines, fuel tank installations, foundations and footings, gas and water lines, field tilling and many others. The Sherman Power Digger mounted on a Ford Tractor travels quickly from job to job, digs at a fraction of the cost of manual labor. It's simple to operate, easy to maintain, built to last.

Send now for information about the easy-to-get jobs for your Sherman Power Digger. Let us tell you—without obligation—how you can go into business for yourself with an investment of less than \$5000. Or make a small down payment and pay the balance from earnings.

**SHERMAN PRODUCTS, Inc.**  
Dept. 1736 Royal Oak, Michigan



**Send Now for FREE LITERATURE!**

**Sherman Products, Inc.**  
Dept. 1736 — Royal Oak, Michigan

Send me information on how I can get into the excavation business on my own.

NAME \_\_\_\_\_

ADDRESS \_\_\_\_\_

CITY \_\_\_\_\_ STATE \_\_\_\_\_



## HOME FREEZER TIP NO.47



Wrap poultry or meat for freezing with paper molded closely to shape. Seal dependably with "SCOTCH" Brand Freezer Tape. This special moisture-resistant tape sticks tight in sub-zero cold to paper, foil, saran and other films. And you can write the date and label right on it! Get "SCOTCH" Freezer Tape in the handy cutter-edge carton, 35¢ or 98¢ rolls, at your favorite store now.

**BETTER BUY TWO!**

Made by  
Minnesota Mining & Mfg. Co.  
St. Paul 6, Minn. ©3M Co., 1958



needs is a "frame of reference." Such a method is shown in Figure 3. In this case we select the sun as the basis of the frame of reference, and also three stars. The navigator draws a line from each star to the center of the sun. His fourth line is from the ship's position to the sun, and he determines this by measuring the angles from the other three lines. So far, all he knows is that the ship lies somewhere along this fourth line. Now he measures the apparent diameter of the sun, and he can determine his distance from it, thus completely fixing his position. The only remaining fact he needs is his speed and he can determine this, once again, by the Doppler effect, which causes the shift of certain components of the stars' light.

### Computers Calculate Errors

So far we have been concerned with the precise position of the ship in space, its speed and course. Now that we have this information, what do we do with it? We feed it into computers to calculate whether there are any errors in the "orbit" or course of the ship and, if so, what corrections we must make.

Now we transmit these corrections to the ship for action. But here we face even further difficulties. We can't turn the ship like we do an airplane, simply because there is no air to act upon control surfaces. We can alter direction only by firing side rockets. We can alter speed only by firing tail or nose rockets. In Figure 4 the ship is proceeding along its course as indicated. A correction must be made, so a side rocket is fired. The new course of the ship is indicated by the second arrow, and is determined by the amount of thrust imparted by the side rocket.

### Solve One Problem, Get Another

But in doing this, still another difficulty arises. How can you impart a precise amount of side thrust when the ship itself may be moving backward, sideways or even tumbling and spinning along its course? Obviously to perform any correction you must first straighten out the ship along the ship-radar line of sight.

Again there are numerous ways we can solve the problem. One rather simple method is to use the radar pulse itself. If you dip your finger in a tub of water, you cause circular ripples to expand outward across the two-dimensional surface. Similarly, if you send a radar wave through three-dimensional space, the wave travels outward in an ever-expanding sphere. Figure 5 shows how we can take advantage

(Continued to page 236)

**SAVE STRAIN  
SAVE SKIN**

WITH  
**Bridgeport  
NEOPRENE  
CUSHION  
GRIP**

**SCREWDRIVERS**

**50%  
GREATER TURNING  
POWER**

- SUPER COMFORTABLE
- NON-SLIP GRIP
- UNBREAKABLE HANDLE
- FULLY GUARANTEED
- ALLOY STEEL BLADE

Resilient Neoprene CUSHION GRIP lets you turn screws tighter with less work—and you don't hurt your hands. Tested and approved by Mechanics

16 sizes and styles—Regular and Phillips.  
\$1.00 and \$2.70  
At your hardware store.

GEPORT HARDWARE MFG. CORP., BRIDGEPORT, CONN., U.S.A.

PATENT APPLIED FOR



Storage space and a desk, too!

## Build it yourself with Western Pine Region woods



This built-in offers plenty of storage space, plus a handy bookshelf-desk. Built of Western Pine Region woods, it's an economical way to turn wasted space into an attractive, useful area.

Straight-grained, soft-textured Western Pine Region woods come in knotty or clear patterns. You can be sure they're always thoroughly dried and seasoned. They take any paint or stain with ease, or can be waxed and rubbed to a natural glow.

For your next project choose Western Pine Region woods. Your lumber dealer can give you an estimate.

**FREE! "Friendly Home Ideas"** — 85 photographs, many in color, feature traditional and contemporary ideas for building, decorating and remodeling with Western Pine Region woods. Write for your copy to WESTERN PINE ASSOCIATION, Dept. 312-N, Yeon Bldg., Portland 4, Ore.



### Western Pine Association

member mills manufacture these woods to high standards of seasoning, grading and measurement  
 Idaho White Pine • Ponderosa Pine • Sugar Pine  
 White Fir • Incense Cedar • Douglas Fir • Larch  
 Red Cedar • Lodgepole Pine • Engelmann Spruce

Today's Western Pine Tree Farming Guarantees Lumber Tomorrow



The Modern PLASTIC  
 for lasting Home Repairs

PERMANENTLY mends cracks or holes in wood, tile, stone or plaster. Sticks and stays put—Does not chip, shrink or fall out. Easy to use. Economical. Mold it, chisel it, polish or paint it. The big 4-lb. can is obtainable from your lumber, paint or hardware dealer at \$1.40; or will be shipped direct postpaid (in U. S.) for \$1.75. Complete satisfaction guaranteed or your money refunded.

**DONALD DURHAM CO.**  
 Box 804-T Des Moines, Iowa

### HITCHING AND PARKING

a one man job with  
**BULLDOG JACKS**

- Adaptable to channel, angle or wood tongues up to 4" thick.
- Install and move from one piece of equipment to another easily.
- Both screw type and gear type models to fit any requirement.

Write for FREE descriptive folder 13M

**HAMMER BLOW TOOL CO.**  
 WAUSAU • WISCONSIN

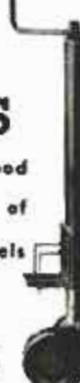

MAN-O-MAN  
 NEW

# PECOS

RED WING  
 SHOES



SIZES  
 6-13  
 WIDTHS  
 A-E

A complete line of new "Pecos" pull-on boots by Red Wing Shoes... "WORK SHOE WEAR—YET DRESSY"...

Choose from six styles—dress black or brown or tough out uppers, either 8 or 11 inches, and soles of leather, cushion crepe or oil resistant cork.

For complete information see your Red Wing Dealer or Write

**RED WING SHOE COMPANY**

195 MAIN STREET • RED WING, MINNESOTA



**More cutting power** ✓  
for 1/4" electric drills

### Irwin Speedbor "88"

most revolutionary bit in years

→ Irwin's Exclusive Hollow Ground Point and spade-type cutters bore faster, deeper, cleaner with less power. Try the Speedbor "88" in your small 1/4" electric drill or drill press and see. Get smooth, effortless cutting action in hard or soft woods, plaster, plywood, plastics — even hardrock maple! Forged in one piece from solid bar of high carbon steel, hardened full length to stay sharp. And remember . . . the hollow ground point is exclusive with Irwin's Speedbor "88". Buy individual sizes or sets from your independent hardware dealer.

No. 886-R plastic roll set of 6, sizes 3/8" to 1", only \$4.50



75¢  
each  
1/4" to 1"  
\$1.25  
each  
1 1/8" to 1 1/2"

**IRWIN**  
Wilmington, Ohio

• the original solid center auger bit  
• screw drivers • screw driver bits

## PAINTING'S A BREEZE WITH THE NEW POWER AIRE

New Power Aire takes the drudgery out of painting furniture, fences, siding! Cuts painting time up to 85% or more! Assures perfect results every time!

Perfect, too, for insecticide fogging, garden sprays, waxing, greasing, inflating, cleaning — has 101 uses around home, shop and farm!

Outperforms Them All — even many large

1/2 hp units! Power Aire compressor is the most efficient ever built! Delivers clean, oil-free air at 3.5 cfm and 30 psi pressure! Plenty of power even for heavy porch and deck enamels and multi-color paints! Portable, compact — only 10" high, weighs only 23 lbs.!

Write Today for Catalog and Introductory Offer!  
37 other models, from \$30.

**JOHNSON SERVICE CO.**  
DEPT. G, MILWAUKEE 1, WISCONSIN

Johnson  
POWER AIRE  
SPRAYER  
See Your Dealer

\$67.50  
complete kit  
including motor



of this. We mount four different antennas, which pick up the signals in phase, on the rear of the ship. When all four are equal, the ship is oriented on a direct line from the radar. If the phases are unequal, the ship can be straightened out by spinning masses, much like flywheels, inside the vessel.

Next the ship is rotated around its axis to bring the correcting side rocket into the proper position. Then the rocket is fired for the proper length of time. Subsequently other checks of the ship's position and trajectory must be made, and other corrections ordered if necessary, throughout the trip.

### Delayed Phone Calls

One of the big difficulties of such trips will be the effect of the enormous distances on communications. You can't pick up a radio telephone, say "Hello," and expect to get a prompt answer. Radio waves travel at a speed of 186,000 miles per second. Even at this speed, communicating with a spaceship in an orbit around Mars will be time consuming. For example, when Mars is at its closest approach to earth, it will still take a good 4 1/2 minutes for a message to be received after it has been transmitted. Obviously there seems little point in a telephone conversation in which the initial "Hello" is answered nine minutes or even nine hours later. It is a fair bet that interplanetary messages will be telegraphic rather than voice, and that great emphasis will be placed on condensing the "message" into as few words as possible.

It is obvious that great problems must be overcome if we are not only to "reach for the stars" but actually reach them—or at least the planets in our own solar system. But it is equally obvious that answers exist to each of these problems.

There is little doubt in my mind that man, now that he has succeeded in attaining escape velocities with his rockets, will himself escape from his mother planet and, using the immutable forces of nature to control and guide him, set off to explore his solar system. ★ ★ ★

### Mechanized Cheese Plant Uses Fast Cheddar Process

Australian scientists have developed a completely mechanized system for producing cheddar cheese. The pilot plant, which can handle about 3000 gallons of milk a day, uses a high-temperature process that cuts curd-fusing time from 90 minutes to 30 minutes.





STICKS ALMOST  
ANYTHING TO  
ANYTHING

WEATHERSTRIPPING  
REPAIRED IN A JIFFY!  
WITH

**TUFF-BOND** QUIK-SET ADHESIVE

GOODLOE E. MOORE Incorporated, Danville 14, Illinois



## Wood Carvers!

"HERE'S THE  
NEWEST  
IN THE  
CARVING FIELD!  
\$10.95 PER SET!  
OVERALL LENGTH OF  
EACH TOOL 6 1/2".  
PLASTIC HANDLES



6 PIECE CARVING SET

Most Complete Line of Chisels and Gouges  
CATALOG  
AVAILABLE!"

**BUCK & BROS. INC.**  
RIVERLIN WORKS MILLBURY, MASS.

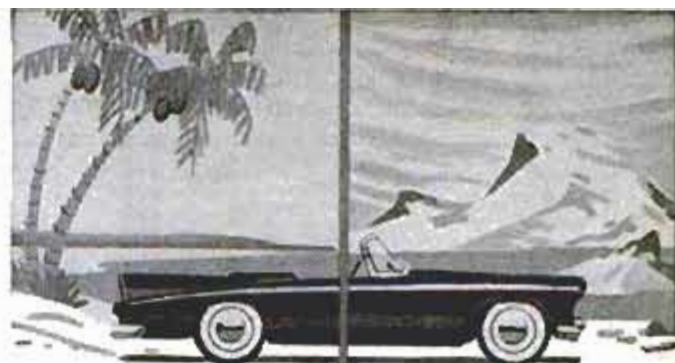

TROPIC HEAT OR ARCTIC COLD  
YOU'LL START AND YOU'LL GO!

When a fuel pump has been tested under strict government supervision and found to work perfectly at 114 degrees above zero and at 76 degrees below zero, we think it has proved itself the best on the market. That's what the Bendix® Electric Fuel Pump did. Positively eliminates vapor lock. No other pump even close to its price class could match it. Better get one for your car. (Send for free illustrated folder.)

\*REG. U.S. PAT. OFF.



**Bendix**  
ELECTRIC FUEL PUMP

BENDIX AVIATION CORP. • (Eclipse Machine Div.), Elmira, N. Y.

# "WE PAID FOR OUR HOME with a Foley Saw Filer"



Here is the true story of Leslie Patrick—as told by his wife, who wrote us about their success in a town of 12,000.

"I can truthfully say that when Mr. Patrick got his Foley, he made a good and wonderful investment. When we moved here in March, 1946, we had only a Model A Pickup and all our belongings were in it. Since then, my husband has done so well with his Foley Saw Filing Machine and repair shop that we bought a house and paid for it and have two nice boys; bought a new car and built an addition to our house; and he has got a lot of new machines in the shop that a person needs in business. Nicest of all, it is all paid for."

**Make from \$3 to \$6 an hour**

With the Foley Automatic Saw Filer you can sharpen hand, band, and circular saws just like new. Start in spare time, in your garage or basement. No experience needed. Build

up a steady, repeat CASH business which will buy YOU a home or new car. Send coupon for FREE BOOK—"Money Making Facts." Time Payments available. No salesman will call.



FOLEY MFG. CO., 916-8 Foley Bldg., Minneapolis 18, Minn.

Send Free Book "Money Making Facts" and Time Payment Plan.

Name \_\_\_\_\_

Address \_\_\_\_\_

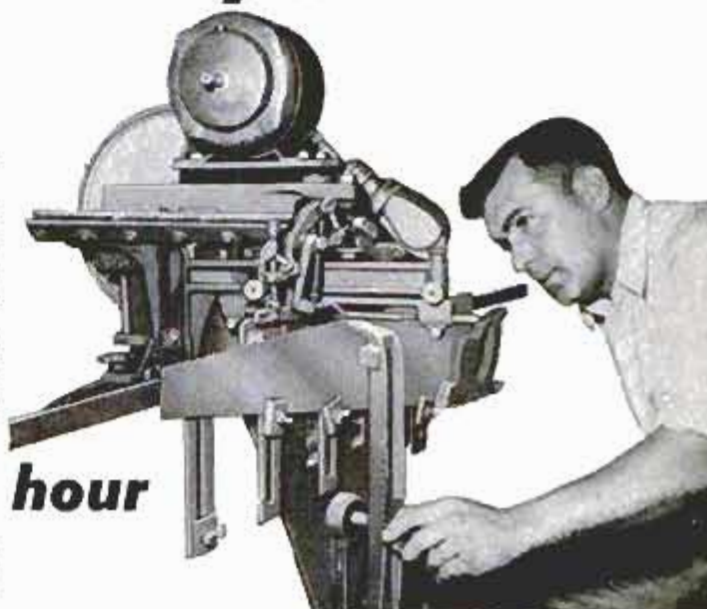





# Marlin <sup>G-98</sup>

Marlin Firearms Company, P.O. Box 995, New York 17, N. Y.

Please send me Marlin Catalog showing complete line of Marlin rifles and shotguns with color illustrations—plus 16-page Target and Game Record Book—plus sample tube of Marlin RUSTOPPER, the "miracle powder" that prevents rust and corrosion. I enclose 25¢ to cover handling.

Name.....Age.....

Address.....

City.....Zone.....State.....

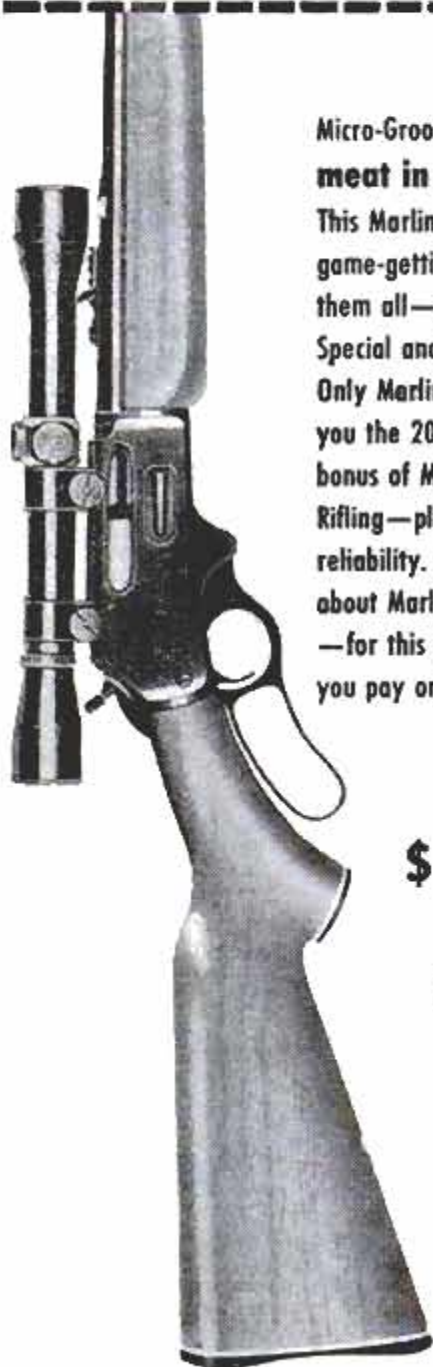

## Micro-Groove Rifling puts meat in the freezer!

This Marlin Model 336 is the game-gettin'est carbine of them all—in .30-30, .32 Special and .35 calibers. Only Marlin high-powers give you the 20-25% accuracy bonus of Micro-Groove\* Rifling—plus sturdy Marlin reliability. Ask your dealer about Marlin's Pay-Later Plan—for this great carbine, you pay only

\$ **7**<sup>95</sup>  
**DOWN\*\***

\* Patent applied for.

\*\*Retail price \$78.95 does not include scope. Prices slightly higher west of the Rockies—subject to change without notice. Also available in Canada.

## Everybody Is an Inventor

(Continued from page 103)

he'll get right to work. He learned how in school. But if you ask him to devise a way to keep air circulating in a refrigerator, he'll come back in a day or so asking, "How do you mean? With a fan?"

Purdy shrugged. "And we don't know how we mean. We hired him to tell us."

Part of this hesitancy to step over the frontier of facts and to do a little exploring can be chalked up to fear of making mistakes. Teachers and most employers take a dim view of repeated errors, but any inventor will tell you he is wrong 100 times for every time he clicks. That's the only way he can come up with anything new. But fear of failing isn't the only block to invention. Many youngsters seem unwilling to show what they can do—or unaware that they can do it.

### Inquiring Spirit Being Lost

Somewhere along the line so much of the inquiring spirit in American youth has been drowned that both government and industry have been forced to run employees through "creativity seminars" now and then. These courses are little more than pep rallies, designed to convince lazy thinkers that they were born with imaginations after all.

If I have suggested in this article that I do not believe in the efficacy of higher education, I have been misleading. It is unlikely that you can conjure with atoms until you have studied advanced nuclear physics. But the lack of formal education need not be a barrier to one's creative impulses. The fuel of creative intelligence is knowledge, which may be acquired in many ways—through formal education, listening to well-informed persons, through experiment and reading. There is always a library just around the corner.

The chairman of our council, Dr. Charles F. Kettering, of General Motors Corporation, once observed that "inventing is a combination of brains and materials. The more brains you use, the less material you need." ★ ★ ★

### Ultrasonic Waves Show Inside of Eye

Doctors using a new ultrasonic technique can diagnose ailments within the eye that cannot be seen by the use of conventional instruments. The echoes of high-frequency sound waves transmitted into the eye are converted into electrical energy on a radar receiver. The receiver displays the interior of the eye and the orbit.





Hand-rubbed finish  
without rubbing

## MCCLOSKEY HEIRLOOM®

The specially developed finish for antiques,  
furniture, wall cabinets and paneling

Flows on silken smooth, leaves no brush marks,  
never a sheen variation. Heirloom is extremely  
pale, nonyellowing, nonstaining—sets up dust-  
free in 1 to 2 hours, hardens overnight.

Send for free booklet, "How  
to Finish Furniture, Wall Cab-  
inets and Paneling with HEIR-  
LOOM Varnishes."



**MCCLOSKEY VARNISH CO.**

Dept. 213, 7600 State Rd.  
Philadelphia 36, Pa.



**BUILD THIS HOUSE YOURSELF!**  
**SAVE 65% EASILY!**

Here is the newest PM "Build-It-Yourself" house. You can build it in three stages: a shell, that you can live in while finishing the house, for only \$1800; a summer home with gas heat and all kitchen and plumbing facilities for \$2800; and a year-round luxury home with redwood paneling and dry-wall construction for only \$3800!

**Features of Expensive Homes Flexible Floor Plan**  
The Precut House adapts to many different interior designs and materials; is designed especially for amateur builders; is ideal for city, country, or resort. Book shows many variations of floor-plan: 5 or 6 rooms, 2 or 3 bedrooms, porch, carport, utility room, and bath.

**Simplified How-To-Do-It Instructions — Hundreds Of Pictures — Working Blueprint Plans!**

You can build the house with the book alone. The plans make it easier. The book gives lists of the materials required, all measurements and dimensions, suggestions for financing, and tells in words and shows in pictures every detail of construction. The Precut House Book is \$2.95; the set of 10 easy-to-read builder's blueprints is \$12.50 (duplicate sets \$5.00 each). Both book and plans are offered on a money-back guarantee. For further information or to place your order, write

**POPULAR MECHANICS PRESS,** Dept. 958, 200 E. Ontario St., Chicago, Ill.

*the drill attachment that  
doubles usefulness  
of any portable drill*

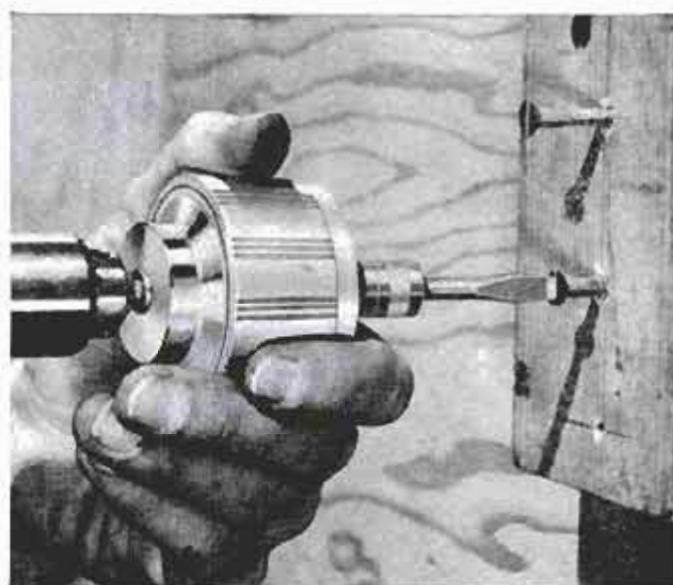

*Supreme Products' New*

## VERSAMATE®

POWER DRILL SPEED REDUCER

10 reasons why Versamate is the  
new 'must' tool for your shop:

- |                                       |   |
|---------------------------------------|---|
| 1. Gives drill seven times more power | 2. Fits all makes of power drills         |
| 3. Reduces drill speed seven-to-one   | 4. Drives screws of all sizes... easily   |
| 5. Fast, safe, easy to operate        | 6. Enough power for 1/2" masonry drilling |
| 7. Precision cut gear transmission    | 8. Yankee-style quick-change bits         |
| 9. Industrial tool quality throughout | 10. Low price... just \$9.95              |



ASK YOUR TOOL DEALER FOR

**VERSAMATE**

BY THE MAKERS OF VERSAMATIC  
AND SUPREME BRAND CHUCKS

SUPREME PRODUCTS CORP. CHICAGO 16



# 3 TERRIFIC DO-IT-YOURSELF HOME KITS THAT ELIMINATE MESSY PREPARATION WORK

## Camp's WaterShield DRY BASEMENTS GUARANTEED



- Waterproofs masonry without messy pre-wetting or curing.
- Made with Rubber-Silicone Liquid.
- Apply indoors or out.
- Resists over 50 lbs. water-head pressure.
- Available in six colors.



### hydro-plug

Stops active leaks instantly. Easy to use. No need to chip or chisel. Qt., 1/2 gal. & gal. units available.

The Original

## Latex Concrete

REPAIRS and SMOOTHS CONCRETE, BRICK, STONE, STUCCO, ETC.



- Eliminates chipping, roughening, priming and curing.
- Apply any thickness—thin as 1/16" or more than 1".
- Use indoors or out. Concrete color.
- Repairs broken step edges, cracks, holes in driveways, walls, etc.

- SMALL KIT repairs 50-150 ft. average cracks.
- LARGE KIT, double size.

Available at Leading Hardware, Lumber or Bldg. Supply dealers, or write

**The CAMP COMPANY, Inc.** Dept. PM-9  
6958 S. State St., Chicago 21, Ill.

## These Rocketeers Play Safe

(Continued from page 77)

to the lower desert floor on the other. A 10-foot launching stand and an even more elaborate static-test stand have been set up in the center of the site. The launcher, constructed of heavy-grade steel tubing, pivots on a concrete base and can be adjusted to varying angles. By changing the "pitch" of the launcher, and computing expected thrust of a rocket and its fuel, the landing area of a missile can be pinpointed to within a few feet.

But because a rocket upon launching can suddenly become a wild, uncontrollable weapon, due to wind drift, uneven fuel charge or for many other reasons, additional protective steps are taken.

Spectators are confined to slit trenches, fronted by earth mounds. Actual triggering is done by remote control from a concrete blockhouse 60 feet away. A system of green, yellow and red flags—visible anywhere in the firing area—signifies whether a rocket is fueled, armed or in storage.

### Visitors Given Instruction

Visitors to the area are given detailed instruction sheets and must sign waivers of liability. A strict firing procedure goes into operation 15 minutes before a rocket is triggered, ending with a siren's wail and a 10-second countdown.

Only at the conclusion of a day's firing, when rockets have been retrieved and volatile materials locked up, are spectators permitted in the rocket compound area to inspect the amateur missiles, take pictures and ask questions.

The average RRS rocket is three to four feet long, constructed of steel or aluminum tubing 2½ to 3 inches in diameter and carrying either three or four fins. Most nose cones are machined steel, although some made of cork or other experimental materials have worked successfully.

The average rocket, powered with a properly tamped fuel, propels itself to an altitude of between 2000 and 5000 feet. Highest altitude an RRS missile has reached is approximately 20,000 feet and the record for amateurs, set a year ago by a group in Inglewood, Calif., is 22,500 feet.

### Tamping Fuel Is a Skill

Though solid propellants are actually rapid-burning fuels, they appear to be explosive. Packed too loosely in a rocket shell, they fizzle. Tamped too tightly, they explode. Finding the right firmness between these extremes is a skill which RRS members strive for.

(Continued to page 242)





# We're Giving \$4200

## TO FOLKS WHO KNOW HOW MANY JOBS VISE-GRIP CAN DO

**SAYS BILL PETERSEN,**  
PRESIDENT, PETERSEN MFG. CO.



HOME REPAIRS WORKSHOP AT POWER TOOLS EVERYWHERE



Imagine asking *you* how many jobs Vise-Grip can do! But here's a tool so handy, even *we* don't know all its uses. So in monthly contests (ending in October) we are awarding prizes of \$200, \$100, and \$50 for the longest, practical list of uses. (And the winners' favorite tool dealers win the same amount!)

If you don't yet own one, try the new Vise-Grip with Easy Release at your hardware store. See how it locks onto work—by a hand squeeze—with 2,000 lbs. pressure! Releases with push-button ease. A whole tool kit by itself: Wrench, pliers, clamp, vise, wire cutter. A whiz for home repairs, workshop, car, hunting, boating! 7" and 10", \$2.15 - \$2.95.

Simply write your list on a plain sheet of paper with your name and address, and mail to address below.

**NOTE:** Decision of judges is final. Winners announced on request. All entries become property of Petersen Mfg. Co., Inc. In event of tie, full amount of prize tied for will be awarded each tying contestant. This contest open only to residents of U.S.A. and territorial possessions. Subject to federal, state and local regulations.

PETERSEN MFG. CO., Dept. PM-9, DeWitt, Nebr.

Products Advertised in  
PM Are Guaranteed



### NEW DELTAGRAM YEARBOOK

All of 1957's top-flight issues of this popular home workshop magazine handsomely bound in durable, hard covers. Fully illustrated and packed with helpful ideas. Features "how to" projects complete with detailed drawings, step by step instructions and bills of materials. Only \$1.50—write: Rockwell Manufacturing Co., Delta Power Tool Division, 502J N. Lexington Ave., Pittsburgh 8, Pa.

### SAVE TIME, MONEY, MILES

#### OPERATING YOUR CAR

HULL AUTO COMPASS cuts time on the road to a minimum, saves wrong turns, wasted gas, car and tire maintenance. Economical, smart. \$5.50 to \$7.95. At your dealer's or write for literature.

World's most widely used auto compass and small boat accessory.

HULL MFG. CO., P. O. Box 246-D-9, Warren, Ohio

### Find HIDDEN TREASURES

GOLD, SILVER, PRECIOUS METALS with the Famous Model 27 Metal Detector. Lightweight, ultra-sensitive, low cost. None finer. Also GEIGER COUNTERS for uranium and the VIOLITE for tungsten. INFORMATION FREE

THE *Detectron* CORP.  
5528 Vineland Ave., No. Hollywood, Calif.



## NOW Multi-Color Painting is easy for anyone!



• Low-cost PRESSURE MAID Paint Sprayer with special spray cap for MULTI-COLOR paints is ideal for do-it-yourself projects. Rugged, portable, trouble-free. Complete—ready to spray. Piston-type, direct-drive, single cylinder compressor. 1/3 h.p. 110 Volt AC motor.

Write for details and name of your nearest dealer.

The Campbell-Hausfeld Co.

1046 Railroad Ave., Harrison, Ohio



CAMPBELL-HAUSFELD

### NOW! HOME CRAFTSMEN CAN OWN THIS PROFESSIONAL ARC WELDER

EASY TERMS  
ONLY \$98<sup>50</sup>  
F. O. B.

Now you can own a Trindl full 125 amp Industrial Welder at a price far less than smaller machines. With a Trindl 125A you can weld metals up to 1/2 inch thick. Operates off either 110 or 220 volt line, properly wired. 16 heat stages from 20 to 125 amps. Make and repair anything of metal around the home, garage, farm or shop, like a professional. No previous experience or training needed. Full "do-it-yourself" instructions with each machine. Complete only \$98.50 f.o.b. factory, or write for details. Trindl manufactures a complete line of heavy duty welding machines. Dealer inquiries invited.

TRINDL PRODUCTS Ltd., Dept. T2-J  
1807 So. Clark St., Chicago 16, Ill.



**FREE**  
WRITE FOR COMPLETE DETAILS AND EASY PAY PLAN



**Guaranteed**  
12 MONTHS IN CONTINUOUS OPERATION



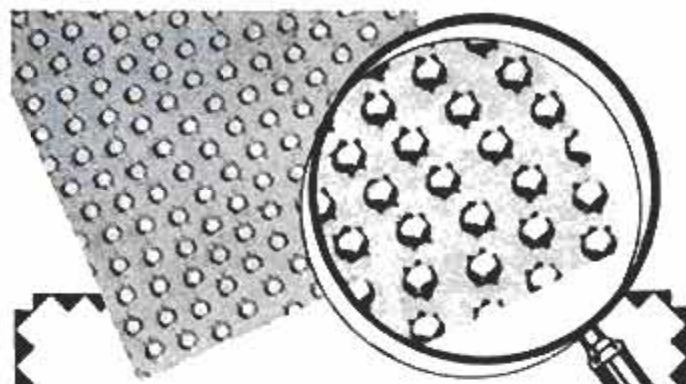

YOU'RE LOOKING AT A PIECE OF

## Dragon-Skin

Not one of St. George's souvenirs, but an amazing new cutting tool. A "steel sandpaper" that sands, rasps, smooths.



Use Less "Elbow Grease" when shaping, smoothing, rounding, or cutting slots, because Dragon-Skin cuts fast. New principle: steel sheet is punched to form special cutters—thousands of 'em—to carve away at the work. Cut is smooth and even. No rough sand "grits," no gouging.

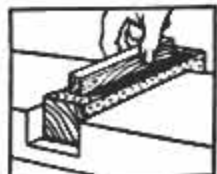

Dragon-Skin Can't Clog like sandpaper, even when you're smoothing softest wood. Chips and dust fall right through the holes. Slap the sheet once and it's clear!



Makes Hundreds of Jobs Easier, and outlasts sandpaper by far. Shapes hard or soft woods, plastics, soft metals... removes paint... at home or at work... on hand or electric sanders. Cut with scissors and wrap around sticks or dowels to make special tools.

1390

LOOK FOR THIS  
**Dragon  
Skin**  
DISPLAY  
AT YOUR  
Red Devil Dealer



75¢  
complete  
with holder  
25¢ for  
single sheets  
Also  
available in  
full sheets  
and 1/2-sheets



## Red Devil Tools.

Union, N. J., U.S.A.

World's Largest Manufacturer of Painters' and Glaziers' Tools

MAKES A HARD RUBBER  
MALLET IN A MINUTE!

## SLIP-ON<sup>TM</sup> HAMMERHEAD

- ★ 3 SIZES FOR ALL HAMMERS
- ★ GRIPS HAMMERHEAD FIRMLY
- ★ CONTOUR FIT FOR ALL BALL-PEEN AND CLAW HAMMERS!
- ★ REMOVABLE
- ★ AT HARDWARE AND AUTO STORES OR WRITE:



98¢  
EACH

**W. J. RUSCOE COMPANY**  
483 KENMORE BLVD AKRON 1, OHIO

Powdered fuel burns at the rate of one foot every tenth of a second in the rocket tube; the average rocket is spent in less than one second. It is the thrill of achieving this split-second of perfection, watching his rocket *whoosh* gracefully from the launching pad without wavering, toward which an amateur rocketeer of the RRS often works for weeks, even months.

Sometimes the work is in vain.

At a recent Mojave RRS launching, the most elaborate homemade missile of the day was a 16-foot, three-stage affair carrying a miniature camera and a parachute. Its builder spent more than two months in planning and building.

In less than 17 seconds, the rocket smashed into oblivion when the parachute failed to open and the rig crashed into the desert soil at more than 500 miles per hour.

Most of the RRS rockets are recoverable, and the total losses are rare. Tracking teams stationed in trenches around the impact area follow the airborne missile with special instruments which automatically record its compass bearing upon landing. The rocket can be located by triangulation.

Whether the RRS and its sister societies can maintain their excellent safety record depends, of course, on enforcement of its safety rules.

Some rocket experts, such as Capt. Robert C. Truax, of the Department of Defense's Advance Research Project Agency, think such precautions are adequate but recommend even safer rockets in the hands of amateurs. Truax, in fact, has designed a steam-propelled rocket which he says would be safer.

Equipped with a safety valve, Truax's missile is capable of hurling itself to altitudes of more than 10 miles—more than five times the present amateur record.

While the RRS hasn't yet tried steam, it's hard to predict what may be on the drawing boards of its young members. Meanwhile, it's a job of experiment and fail, try again and succeed.

### Successes and Fizzles

On a typical RRS launching day, only about half of the 10 to 15 missiles launched can be rated as complete successes. Some smoke awkwardly on the launching pad. Others fizzle a few feet from the stand and occasionally one explodes in mid-air.

But if only one goes off perfectly all day—and it's a rare occasion when the record is that bad—the young scientists of the RRS are happy.

Parents and friends, watching from the protective cover of slit trenches and barricades a thousand feet away, get a kick out of it, too!

★★★



## WHY DEPEND ON SOCIAL SECURITY!



**ADD TO YOUR INCOME • UP TO \$5.00/HR. SHARPENING ALL TYPES OF LAWN MOWERS**



Modern Manufacturing's precision Lawn Mower Sharpener and Bed Knife Grinder makes it easy for you to earn extra cash on a full or part time basis. Many mowers need sharpening. Do it in your basement or garage. Anyone can learn to operate this sharpener. Write today for free brochure. Dept. 10

**MODERN MFG. CO.**

160 N. Fair Oaks Ave.  
Pasadena, Calif.

**\$275.00**

F.O.B. Pasadena

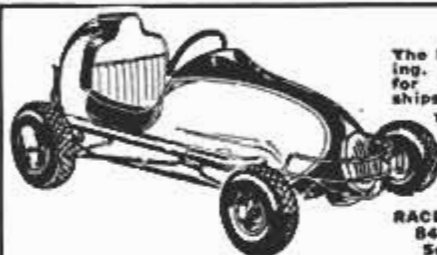

### 1/4 MIDGETS

The little league of family racing. \$449.00 complete. Write for free literature. Dealerships now available.



**RACE-CRAFT MIDGET CARS**  
8476 E. Garvey Boulevard  
South San Gabriel, Calif.

## MONEY for MEN ALL FREE

THE PLASTEX Industry needs manufacturers on small scale and for big production of Lamp and Clock Stands, Art Goods and Novelties in Plastex and Marble imitation. Experience unnecessary. 1/2c material makes regular 10c store sellers. Rubber moulds furnished for speed production. Small investment brings good returns. We are now placing big Chain Store Orders with manufacturers. Ambitious men have chance for real prosperity. Our Free booklet will interest and benefit you.

**PLASTEX INDUSTRIES, Dept. A**  
3400 Third Ave. New York 56, N. Y.

## make your own Gems 36.50

The Gem Maker comes complete with all necessary equipment, including a super-charged diamond blade for sawing, and all the wheels for grinding, shaping and polishing; also complete instructions. The complete equipment as shown, less motor and belt for only \$36.50. f.o.b. Burlington, Wisconsin. Write today for information and literature.

**B&I MANUFACTURING CO.**  
Dept. P. Burlington, Wis.



## MODEL CHANGEOVER SALE SAVE \$15.00 ON THIS TILT ARBOR SAW



**NOW \$9.95**  
Less Blade

All year a great buy at regular price of \$24.95 — this 8-inch Plana Centric Tilt Arbor Power Saw is a spectacular bargain at \$9.95 during model changeover period. This big saving is possible by our patented construction, our manufacturing facilities, and our distribution methods. Top-quality saw features the original Plana Centric Patented Ball-Bearing Floating Drive, Patented Plana Centric Cradle Suspension, and Plana Centric Patented Rip Fence that locks front and rear against the table surface. Every part in this fine saw is manufactured in our own factories. All cast iron and steel construction. Crosscuts, rips, bevels, mitres, dados, cuts compound angles. Massive cast mitre gauge. Heavy steel base fastens to any workbench. Uses any standard 1/4 or 1/2 h.p. motor. We start soon on 1959 models. During model changeover you can have this fine 1958 at a saving of \$15. Send check, M.O. or sent C.O.D. with \$2 deposit.

### LOOK AT ALL THESE SPECIAL FEATURES:

- Blade tilts, table stays level. Blade adjusts to any angle up to 50°.
- Single Hand Wheel Control. Tilts and tightens blade with a twist of the wrist. Blade rises and lowers; cuts from 0" to 2 1/4".
- Precision-ground cast iron table. Perfect flatness resists nicking and wear.
- Self-aligning rip fence. Adjustable to lie parallel to blade or give clearance either way.
- Patented Motor Mount takes any standard 1/4 or 1/2 h.p. motor. Motor rides on ball bearing rollers. Keeps belt tight, transmits full power.
- Heavy long-lasting, all-metal construction. Built for a lifetime. Shipping weight 25 lbs.

### FAMOUS AMERICAN IRONCLAD GUARANTEE

Try any Plana Centric power tool for ten days. If, for any reason, you are dissatisfied, return the merchandise for full and complete refund—no questions asked. This famous guarantee has been offered on sales of more than 3 1/2 million power tools, and it has never been violated.

**WRITE FOR FREE CATALOG**  
Big bargains in home workshop power tools

All power tools sent express collect

**AMERICAN MACHINE & TOOL COMPANY**  
ROYERSFORD 23, PA.

## ELECTRIC WELD - BRAZE & CUT

### REPAIR MOST EVERYTHING MADE OF METAL

Home Appliances, Auto parts, Farm-garden equipment, toys. Make and repair playground equipment, lawn chairs, tables, ornamental iron work gates, wagons, etc. Solder, heat, bend, and straighten, with terrific heat from arc torch. Cut and weld up to 1/4" steel plate. A million uses for Home, auto, farm, inventors, factories, etc. Works from any home 110 volt plug-in. Complete with

dark welders mask, arc torch, supply of carbon welding and brazing rods, Solder, flux, and complete Welding Instruction Book. Attractive—portable—efficient—durable—1 year guarantee. Wt. only 8 lbs. (cash, ex. mo) and pay postman \$6.95 plus C.O.D. **SEND ONLY \$3.00** postage on arrival or send \$9.95 plus \$1.50 postage and we will send postpaid. Ideal gift for mechanically minded home owners, relatives, friends. Order now for early delivery. Available only from: **MIDWAY WELDER Dept. DPM-9 Kearney, Nebraska**

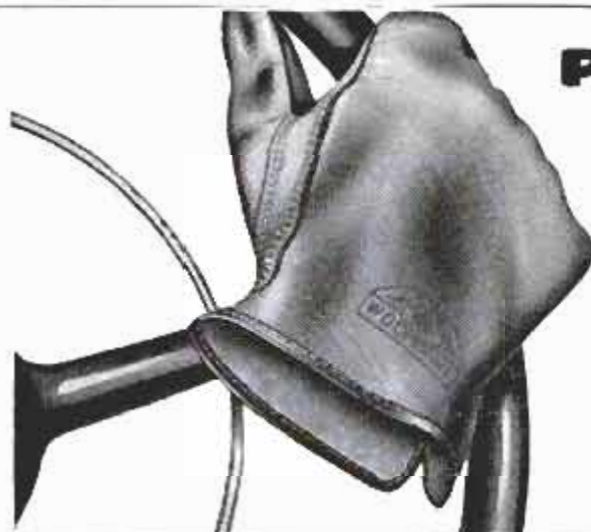

## PERFECT FEEL THROUGH SOFT LEATHER

Stay flexible always! Wear like iron. Super-soft leather — lockstitch seaming. Hands never slip, never chafe! Cost less because they wear longer. Triple-tanned to dry out soft forever. Full grain horsehide and pigskin styles. Perfect fit and feel for every job — every day.

**WOLVERINE GLOVES** Rockford, Michigan  
MASTER TANNERS OF UNUSUAL LEATHERS — horsehide — buckskin — pigskin — goatskin



## Everything for the Craftsman!



WRITE FOR NEW 132 PAGE

# WOOD AND HOME WORKSHOP CATALOG

Finest Domestic and Imported Woods  
... Mouldings, Hardware, Tools ...  
ALL AT LOW MONEY-SAVING PRICES!

Your complete wood buying guide and project book. Craftsman is your best, most complete source of finest kiln-dried domestic and rare imported woods, beautiful wood inlays, colorful bandings, matched plywoods, embossed mouldings, carved ornaments, newest woodworking tools, "hard to find" cabinet hardware and fittings... more than 1500 items! Packed with newest scroll saw patterns, project ideas and money making plans. Enclose 25c (refunded with first order) to help pay mailing, handling cost. Write:

Upholstery Materials;  
New Tools; Lamp Parts;  
Metal and Wood Legs;  
Cabinet Hardware;  
Music Boxes; Archery  
and Water Ski Kits.  
Over 1500 Items

CRAFTSMAN WOOD SERVICE COMPANY, Dept. A-9  
2729 SOUTH MARY STREET - CHICAGO 8, ILLINOIS

## "SWISH" PLANS

### PATTERNS FRAME KITS

#### BUILD THE "SWISH"

(As it appeared in Popular Mechanics)

PLANS ONLY ..... \$9.00

PLANS & PATTERNS... \$19.00

FRAME KIT (includes

plans) ..... \$100.00

Send 50c NOW for COMPLETE

CATALOG listing all of our designs.

GLEN L.

9152T Rosecrans, Bellflower, Calif.



## MAKE YOUR OWN BOLTS, BRACES, HANGERS!



now available  
GALVANIZED!

## REDI-BOLT® THREADED STEEL RODS

Save repair and construction time. Just cut to length; heat and bend; add std. nuts. Seven sizes: 1/4", 5/16", 3/8", 7/16", 1/2", 5/8", and 3/4". Handy lengths of 24" and 36". Available in galvanized or blue rust-resistant finish.

Sold in Leading Hardware Stores

**REDI-BOLT, Inc.**

5330 Indianapolis Blvd., East Chicago, Indiana

## The 1901 Olds Is Booming

(Continued from page 95)

wheels (20 x 2½ tires) employs ball bearings that need never be lubricated.

Sealed-beam electric headlamps, and the taillight are accurately modeled after the original kerosene lights. And the manufacturer claims 100 miles to the gallon gas economy.

Starts was driving his quaint gas buggy on Fort Lauderdale beach one day when he spotted a man ogling it. The man seemed a likely prospect, so Starts pulled to a halt at the curb before him.

### Has Real Pickup

After enumerating the finer points of his handmade car, Starts concluded daringly with, "... And it's got more 'pickup' than the most expensive modern car. I mean girl pickup. No female can resist, should you offer her a ride."

The man didn't seem impressed, so Starts pointed to a pretty girl approaching a block away. "You want me to show you how it works?" he challenged.

The man nodded.

Starts putt-putted off, slid his Merry Olds to a halt beside the surprised girl. Smiling, he asked courteously if she liked his little car. She did; she thought it was "cute." Would she care to go for a ride—just once around the block? She smiled and agreed.

The ride over, Starts stopped with the girl before the man at the curb. "You see how easy it is?" he asked. He turned to the girl. Had she enjoyed the ride? Yes. Had she ever seen him before? No. Would she have gone riding with the man at the curb, had he been the driver?

She laughed. "Yes—he's my husband."

\*\*\*

## Are There Millions Of Inhabited Planets?

At least a hundred million planetary systems in the universe are capable of supporting life. That is the conclusion of Dr. Harlow Shapley, retired director of Harvard College Observatory in his book, *Of Stars and Man*. The earth's sun is quite an ordinary star, and there are more than one hundred thousand million billion stars throughout the universe. Life could occur wherever a planet was located the right distance from one of these stars to provide the water and warmth that living organisms require. Thus other planets are likely to be inhabited by living, thinking beings equal or superior to man, Dr. Shapley concludes.



# SURPLUS SALE

WAR SURPLUS  
EXCESS INVENTORY  
BANKRUPT STOCK

## AIR COMPRESSOR BARGAINS

For painting, cleaning, tires, control terminals. Assemble your own outfit and save money. Lowest prices in U. S.

• Deluxe Kit. Compressor, tank, gauge, regulator, paint gun, relief valve, fittings, hose, instructions. List \$52.  
SALE ..... \$39.49 FOB

• Air Components. Compressor 1-cyl. \$19.95; Air tank. \$8.79; Regulator \$3.95; Pop-off \$1.95; Press. Gauge \$1.89; Finest Paint Gun \$11.95; Auto Switch \$4.75. All Ppd. in U. S.

## STORAGE BATTERY WINCH

• Powerful fully reversible, ball-bearing gear reduction winch. 1000-2000 lb. pull. Use on 6 or 12-v battery. Holds 40' of 1/4" cable. For trucks, docks, boats. Govt. cost \$280 ..... \$46.75 FOB



## ELECTRIC CAR MOTOR



• Runs on 6 or 12 volt batt. Powerful gear reduction. Reversible. Cost \$295.  
SALE ..... \$19.72 FOB

## SPEED REDUCER

• 80-to-1 gear reduction unit. 8 roller bearings, multiple gears. Reduces standard motor to 21 rpm - increases torque. Shafts 3/8" input, 1/4" output. Power winches, revolving signs, door openings, etc. Govt. cost \$66. SALE ..... \$8.49 Ppd.

## HYDRAULIC SPEED REDUCER

• Variable hydraulic speed reducer. Any speed from 0 to 750 rpm by simply throwing a lever. Handle up to 1 1/2 h.p. Instant reverse at any speed. Use for midget cars, shop band saws, etc. 12"x8"x9". Govt. cost \$400. SALE ..... \$49.50 FOB



## SPECIAL OF THE MONTH!

### ELECTRIC INTERVAL TIMER

• Brand new 115-v 60-c motor timer. Will sound built-in alarm at end of any pre-set period. Range 1 min. to 4 hrs. Shows remaining time on moving hand. Useful cooking, factory, photography, etc. Attractive chrome 3 1/2" dial. Easily mounted. List \$8.50. SALE ..... \$2.39 Ppd.



### DIAL PHONE

• Modern hi-efficiency attractive dial phone. Use for extension to main line on private system. Use several for complete private system, etc. Complete with ringer, dial, etc. Work on any system. Govt. cost \$25.50. SALE ..... \$9.95 Ppd.



Close-outs in pumps, hydraulics, electronics, miscellaneous. Write for catalog.

ORDER FROM AD or get free catalog.

**BURDEN SALES COMPANY**

811 West 'O' St., LINCOLN, NEBR.

*Your Contribution Helped!*



## SISTER KENNY FOUNDATION

RESEARCH • REHABILITATION • POLIO  
NEUROMUSCULAR

NATIONAL HEADQUARTERS • MINNEAPOLIS 2, MINNESOTA

## Shop PM Ads for Exciting Direct-Mail Offers

*New!  
Battery  
Powered!*



# JABSCO "WATER PUPPY" PUMP



**SELF-PRIMING!  
LOW  
COST**

*Easy  
to install...*

- BOATS —**
  - Bait Tanks
  - Water Systems
  - Wash Downs
  - Bilge Pumping
- TRAILERS —**
  - Sinks or Wash Basins
  - Car and Trailer Washing
- CAMPERS —**
  - Running Water
  - Washing Gear
  - Boats & Motors
  - Boat Pumping
- DO-IT-YOURSELFERS —**
  - Projects Galore!

JabSCO's self-priming "Water-Puppy" D. C. Pump makes outdoor life more fun, more practical. The compact "Water-Puppy" is easy to install, powered by any storage battery. Connections for 3/4" garden hose or standard pipe fitting. Dependable, maintenance and service free.

6 v. \$26.50, 12 v. \$27.00, 24 v. \$28.00, 32 v. \$28.50.

See your dealer or write direct. Specify battery voltage when ordering.

### JABSCO PUMP COMPANY

2031 N. Lincoln St., Burbank, Calif.

## Brand New! Portable Light Plants

Push Button Start! Available from 700 to 3500 watts (continuous duty) 115 volt AC power for trailers, camps, etc. CD approved. 12 volts DC (or 6 volts small units) for battery charging. No surplus parts used. New long life engines, fiber glass insulated generators. Other features available - Remote control, fully automatic, and "No Load Idling." Order today or write for details. COD order 25% deposit.

700 watts (A712) 77 lbs. .... \$143.50  
1000/1200 watts (A1012) 90 lbs. \$195.50  
Easy Terms Available



**General Electronic Service Corp.**  
PM-9 Burlington, Wisconsin



200 amp. aircooled  
"Husky Boy"

295 amp. Triple Utility  
Transformer Welder

**Make Big MONEY**



100 amp.  
"Handy Andy"



You can start your own profitable business with a minimum investment. Many opportunities exist in the ever expanding arc welding field. Cash in on the constant demand for emergency repair work and construction projects - get a low cost Hobart.

with these **LOW COST** arc welders

It's easy to weld with these new Hobart Arc welders. Built-in convenience features, at no extra cost, enable you to turn out top-notch professional work. Other models available let you weld and furnish power for running lights, tools, pumps, etc.

Write today to: **NOBART BROTHERS COMPANY, BOX M-98, TROY, OHIO, phone FE 2-1223**



## Vauxhall Owners Praise Handling and Economy

(Continued from page 86)

**The British have a word for the type of design he's talking about: Brummagem.**

**Depreciation costs can really kick you in the wallet. On many domestic cars it amounts to over \$20 a week, while the gas bill is a piddling \$4 a week. Obviously, it's not enough merely to save money on gasoline.**

**Ride is good. Driver's seat doesn't seem to fit properly, however. Rear-seat ride and rebound control are good also.**

**Trunk is more than adequate for most requirements. Of course, some people insist on taking everything they own on vacation trips. No trunk is big enough for this type.**

**It is 167 inches long or 3½ feet shorter than the 1958 Chevy. It's more than a foot narrower as well.**

**Glass is plentiful, vision excellent. Rear-view mirror is too small, its field of view too restricted. One of the few imports with a wrap-around windshield—the Detroit influence.**

→ "Manufacturers have entirely overlooked the fact that there are still some conservative people in the U.S.A. who like moderate cars that do not look like circus wagons."—Tennessee retired owner.

"Competition in American cars for excessive horsepower and extreme length may appeal to the ego, but the average driver is not physically, emotionally or psychologically equipped to handle the power sensibly."—Massachusetts banker.

→ "The high rate of depreciation is my biggest complaint about American cars—in other words, economy."—Oregon clergyman.

"One main reason I bought a foreign car is that I am tired of American manufacturers' claims about each car being cheapest in the low-price bracket. These cars lose almost a third of their value in the first year. These so-called American economy cars are keeping the gas and oil companies rich."—Illinois diesel mechanic.

### More Best-Liked Features

The following quotations describe, in order of frequency of mention, additional best-liked features:

→ "Rides well. Takes the bumps without jarring the passengers."—Wisconsin physician.

"American cars have a hump in front and rear so can only seat four comfortably. The Vauxhall is roomy for four persons and has a good ride for a small car."—Indiana powerhouse operator.

"Parking in town is no problem at all."—Illinois miner.

"It fits the garage. Easy to park."—New York bookkeeper.

→ "It isn't small or large, but medium size. On a trip there is plenty of room for luggage in the trunk, and ample room for two adults and three children. We will not go back to a larger car."—Pennsylvania manufacturer.

"Just finished a 1300-mile trip through desert, mountains and cities. Averaged 28.9 miles per gallon, cruising between 65 and 70. Experienced no driver fatigue at all. Engine temperature below normal even though outside air was 105 degrees. Burned no oil. In my American car last year on same trip I burned three quarts of oil, boiled over twice and averaged 16 miles per gallon while traveling at same speeds."—Arizona auto mechanic.

"I may not be typical, but I just returned from a trip of over 300 miles and my Vauxhall breezed along with the best of them and a lot more cheaply."—New Jersey mayor.

"At first I thought perhaps it wasn't quite powerful enough. However, after adjustments to timing, carburetor, and adjusting myself to its capabilities, I find it very responsive and a delight to drive."—Pennsylvania owner.

→ "I like its size. I have a regular-size two-car garage. With one small car and one big car in it, there is about four extra feet for storage."—Indiana dentist.

"I am a woman, only 5 feet tall, weigh 98 pounds. I like its size. Also we have a narrow driveway that can be enlarged only at great cost."—Ohio housewife.

→ "Back window is large enough so you can see both fenders. I like the wrap-around windshield too."—Ohio barber.

"Much better road vision."—Illinois principal.

"Has a good-size trunk."—Maryland foreman.

"I go over a very rough road every day and I haven't a

(Continued to page 248)



## "ARCO SCREW-MATIC"

CONVERTS EVERY ELECTRIC DRILL into a  
**POWER SCREW DRIVER!**

**EXCLUSIVE!**

- Drives biggest screws perfectly everytime because of powerful **Industrial-type Clutch**. Cannot slip, as often happens with friction-type clutches. Clutch disengages automatically when screw is driven home.
- Bit cannot slip off screw head to damage work or hurt operator's hand because of **Special Bit Holder**.

**NO ATTACHMENT UNDER \$10.00 HAS THESE 2 FEATURES!**

Includes Phillips Head Bit, 1/4" Bit for slotted screws & instructions ... **\$5.95**

At Your Dealer or order direct - we pay post. No C.O.D. 20-day Money Back Guarantee.

**ARROW METAL PRODUCTS CO.**

Dept. PM-9, 421 W. 203 St., N.Y. 34, N.Y.



*Whoosh!*

It's an  
**"MFG"**  
Corry Utility



12 1/2 feet of tough **MOLDED FIBER GLASS**... fast, smooth, highly maneuverable... built to perform! (Note reverse lap between keel and chine.)

Other "MFG" models in 12 1/2 and 15-foot sizes at \$375, \$495, \$525 and \$565 f.o.b. factory.

**MOLDED FIBER GLASS BOAT COMPANY**  
71 Fourth Avenue, Union City, Pennsylvania

And it costs only

**\$325**

f.o.b. factory  
Write today for  
colorful literature

**LONGER  
LIFE**



Gerstner Chests are built to last — to give years of satisfaction. Free Catalog to Machinists and Toolmakers.

**GERSTNER TOOL CHESTS**  
458 Columbia St., Dayton 7, Ohio

**1** You can turn  
one tool into  
twenty-four  
with  
**Black & Decker** **MAGIC SWITCH  
ATTACHMENTS**

**EASIER  
FASTER  
BETTER!**



**KESTER SOLDER**

FREE: "Soldering Simplified"  
16-page booklet — Send for  
your copy today.

For General Soldering

**KESTER SOLDER COMPANY**

4251 Wrightwood Avenue • Chicago 39, Illinois, U.S.A.



**CASITE** gives your car

**NEW PEP  
NEW POWER**

**Frees sticky rings and valves**

Get increased pick-up and improved engine performance! Casite—the "tune-up in a can"—through the air intake or added to gasoline, restores split-second valve timing and full compression.

**Prevents hydraulic lifter trouble**

Casite keeps valve lifters clean and free-working. Just put a pint in the crankcase every 1,000 miles, and with every oil change.

**Assures safe, smooth break-in**

New and rebuilt engines wear-in smoothly and safely with Casite in the oil. Penetrates tight spots—eliminates overheating, scoring.

**Cuts start-up wear**

Speeds oil flow—protects closely-fitted parts during warm-up periods. Almost doubles engine life.

**Gets rid of sludge and gum**

Casite removes gum and goo—KEEPS the engine clean—increases power, improves performance, saves gas and repairs, too.

**Results guaranteed,  
or double-your-money-back!**

Get Casite at your service station, garage or accessory store.

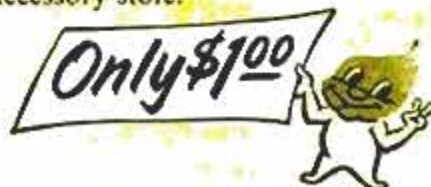

**HASTINGS MFG. CO., HASTINGS, MICH.**  
Piston Rings, Oil Filters, Spark Plugs



**Toolkit, what's that?  
With an American car,  
you're lucky to get  
a jack handle.**

**Shifting is laborious.  
Another case of taking  
the long way around.  
The shift lever should  
be on the floor so its  
action is direct, effortless.  
A backward step? Perhaps.  
But progress nonetheless.**

**Compression ratio is  
7.8 to 1. No need for  
high-test gas here.  
Car simply needs its  
timing reset.**

**Vauxhall is very, very  
British. It lacks the  
great-to-be-alive feeling  
of continental small cars.  
Solid but stodgy, sort of  
old-maidish. Could stand  
a little crossbreeding  
with the sporty type.  
Brakes are excellent.  
Clutch pedal is hydraulic,  
but heavy nonetheless.  
Would be improved by a  
four-speed transmission for  
traffic flexibility, although  
it lugs well in high.  
Instruments clear and  
accurate. Glovebox is  
elbow-deep. Rear-seat  
legroom restricted. Rear-  
wheel traction suffers on  
washboard corners.**

rattle or squeak any place on the car. They are very well made."—California warehouseman.

"I like its standard shift pattern."—New York teacher.

"Has a good heating system."—Pennsylvania trainman.

"Average owner can make most minor repairs and adjustments himself. Excellent luggage space for a small car."—Illinois superintendent.

→ "Owner's manual is clearly written even with the English phrasing. I like the little toolkit and the can of touch-up paint."—Missouri gauge maker.

#### And Additional Complaints

Fourth on the list of complaints is the difficulty of shifting, say Vauxhall owners. Here, in order of frequency of mention, are quotations on this and other complaints:

→ "My main complaint is that the gearshift seems rather tight. It's hard to shift some of the time."—Ohio nurse.

"Back cushion of the front seat is not too comfortable."—New Jersey sales supervisor.

"Both my wife and I get a cramp in the hip after driving. The front seat should be changed."—Florida repairman.

"I have talked to six Pontiac-Vauxhall dealers and none could give trained service."—Ohio office manager.

"Gas mileage is not what we were told we would get. The salesman guaranteed us 30 miles per gallon. We get 24 to 26."—Vermont secretary.

"My monthly gas bill is \$16. It used to be \$28 with my American V8. But this may not be much gain when maintenance is considered. An oil-filter element for the American car is 98 cents, for the Vauxhall it's \$3.15."—Michigan mechanical engineer.

→ "Tappets a bit noisy. Spark knock is very bad unless high-test gas is used."—Virginia owner.

"During a trip to New Mexico a noise developed and we were told it was the result of a faulty ring-and-pinion gear in the rear end. They did not have replacements available. The car was out of service for six weeks while parts were obtained."—Illinois housewife.

"Differential has a howl in it. I have waited for two months for parts."—California merchant.

"Unit body has not eliminated rattles to the extent I had expected."—Texas engineer.

"Oil consumption is high because of a leaking oil seal at the rear bearing."—New York designer.

"Oil sprays over the engine from breather cap. Uses about a quart in 1000 miles."—Pennsylvania owner.

"Wipers give trouble. At first they moved so fast they didn't even touch the glass. Now they don't work at all."—Massachusetts foundry worker.

"Steering remains stiff after almost 5000 miles."—Missouri salesman.

"Company says to use regular gas. But I have to use very high-octane gas to get good results."—Indiana nurse.

"Taillight and reflector are too far out. They have both been broken twice. Bumper doesn't protect them."—Illinois teacher.

"The heater should be moved under the hood."—New Mexico air force member.

"My wife says it is hard to clean the floor because it is sunk down."—Vermont customs inspector.

There you have it—the good and bad points about the 1958 Vauxhall as described by the owners themselves in our coast-to-coast survey. For an engineer's story on the car, turn to page 84. ★ ★ ★



**New PAINT SPRAY UNIT** Including Spray Gun  
**APPROX. ORIGINAL COST \$325**  
**OUR LOW PRICE... \$34.50**



Heavy duty compressor for continuous operation, with G.E. or equal B.B. Motor, 110 V., A.C. Develops over 1/4 h.p. 1-Quart Pressure type gun with round, fan and ceiling spray nozzles. Line filter, air drier, air gauge, 20 ft. cord & plug, 20 ft. air hose. Sprays paint, lacquer, enamel, insecticides, etc. Paints house, auto, ANYTHING. Instructions furnished. NOTHING ELSE TO BUY. Wt. 65 lbs. Tire chuck for inflating tires. 75c extra.

U. S. GOV. SURPLUS F.O.B. Chicago

ORDER FROM THIS AD.  
 Money Back Guarantee. Send check or money order.  
**ILLINOIS MFG. & SUPPLY CO.**  
 1829 S. State Street, Dept. PM9, Chicago 16, Ill.

**RETAIL PRICE \$125.00**  
**FACTORY TO YOU \$79.95**



**SUPERSHOP** includes precision-built 8" tilting table saw, vertical and horizontal drill press, 30" lathe, sander, grinder. 100% BALL BEARING. Write for FREE catalog, full details, trial plan. Easy Pay Plan.

**POWER TOOLS, INC.** 111 YATES AVENUE  
 BELoit, WIS.

**SPARE-TIME MONEYMAKING OPPORTUNITIES**  
**READ OUR CLASSIFIED ADS**  
**HUNDREDS OF BARGAINS AMAZING OFFERS**

**Onan Emergency Electric Plants**

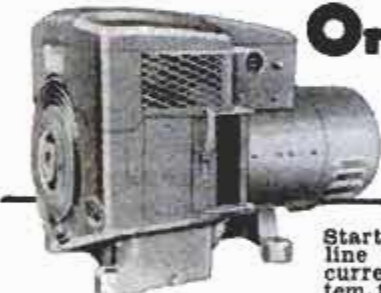

Start automatically when high-line power is cut off. supply current for lights, heating system, freezer, water pump, stove, all appliances and machines. Prevents losses and hardships. Plant stops automatically when power is restored. Compact, easy to install. 500 to 200,000 watts A.C. Priced from \$319.00.

**PORTABLE MODELS**  
 500 to 10,000 watts. Supply plug-in power anywhere!

Write for Free Folder

**D. W. ONAN & SONS INC.**  
 3586A UNIVERSITY AVE. S.E. • MINNEAPOLIS 14, MINN.

**BOAT KITS**

8'-18': 50 Models  
 \$41.75 up: Frt. pd.  
 Money-back guarantee.  
 Write now.



**FREE COLOR CATALOG**  
 Cruisers, convertibles, runabouts, fishing. Easily assembled by anyone. FREE Catalog has natural color photos, complete details, Fiberglass, accessories hardware, paint. Write Today.

**LUGER INDUSTRIES, I/IC., Dept. D-9**  
 9200 Access Road, Minneapolis 20, Minnesota

# Cut it with WISS

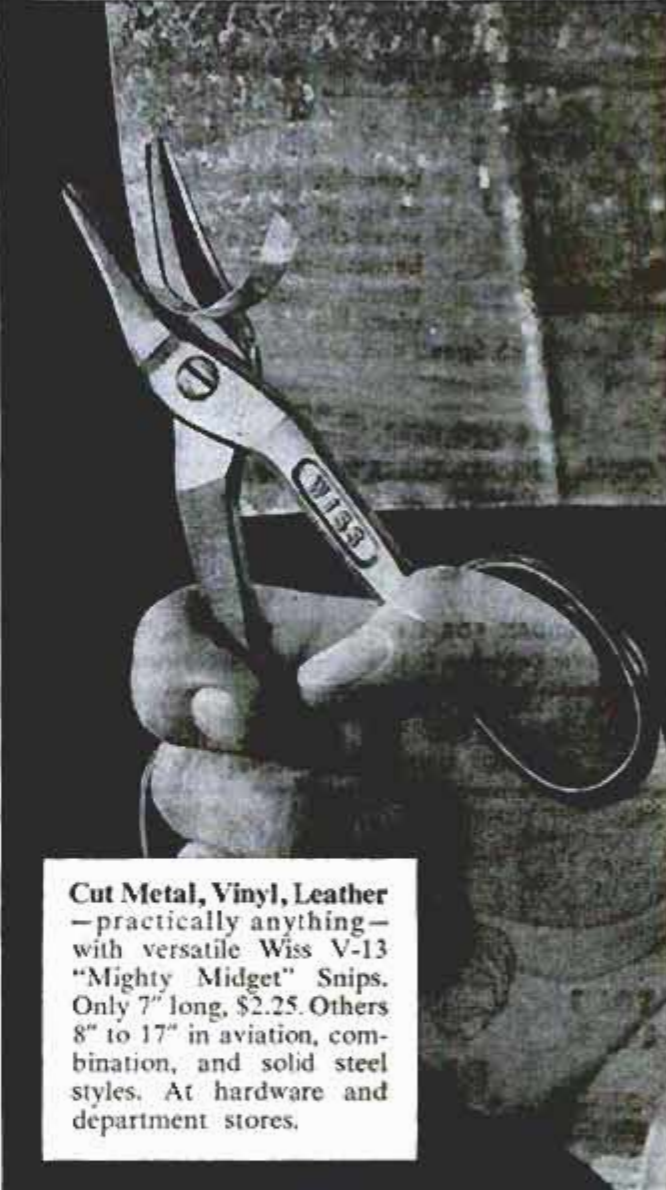

Cut Metal, Vinyl, Leather —practically anything— with versatile Wiss V-13 "Mighty Midget" Snips. Only 7" long, \$2.25. Others 8" to 17" in aviation, combination, and solid steel styles. At hardware and department stores.

## OTHER FINE WISS CUTTING TOOLS

**HEDGE SHEARS**  
 No. 8 1/2-E  
 \$5.75



"English Pattern" Hedge Shears with Cushion-cut shock absorber. Lightweight, perfect adjustment. One edge serrated and notched to prevent slipping.

**TREE PRUNERS**  
 No. 19-BF  
 \$4.95



Used by experts in vineyards and orchards. Extra lightweight, with new long steel ferrules. Hot drop forged, hardened, tempered and ground to keen edge.

**J. WISS & SONS CO., NEWARK 7, N. J.**  
 World's Largest Manufacturer of Shears, Scissors, Pinking Shears, Skalloping Shears, Metal Cutting Snips and Garden Shears



# COLUMBIA®

MADE IN U.S.A.

HIGH SPEED STEEL  
**TWIST DRILLS**  
SOLD INDIVIDUALLY  
AND IN AMERICA'S WIDEST  
ASSORTMENT OF SETS



Columbia's exclusive plastic cases easily fit the palm of your hand when closed... when opened they become unusually handy bench stands. Made in 7, 10, 13, 15, 29 piece High Speed Drill Sets. Also 1/4" Shank High Speed and Carbide Tipped Drills to 1/2".



ONLY COLUMBIA HIGH SPEED DRILLS  
OFFER YOU ALL THESE HIGH QUALITY FEATURES  
AT LOWEST AMERICAN MADE PRICES

- Easier to guide
- Less vibration
- Less trouble starting holes
- Minimum breakage
- Little tendency to "walk"
- Increased accuracy
- Greater rigidity
- Withstand heavier feed pressure

WRITE TODAY FOR ILLUSTRATED FOLDER AND PRICES  
Ask for Columbia Drills at your local Hardware Store

**COLUMBIA DRILL COMPANY**  
463 WEST ONTARIO ST., CHICAGO 10, ILL.

## NEW! amazing metal mender

1001  
USES



### Magic

### PLASTIC ALUMINUM



**REAL METAL  
in PASTE form!**

- Repairs all Metal • Easy to Use • No Heat or Tools Needed • Dries Metal-Hard in 3 Hours • Waterproof, Gasolineproof & Heatproof up to 600" • Can be Drilled, Filed, Tapped, Threaded when Dry • Solders, Seals, Repairs • Saves Time and Money • For Home, Industry, Autos, Boats, Plumbing
- Magic Plastic Aluminum is the most amazing repair product since the invention of the nail! It is real metal in paste form and has most of the properties of metal. Easy to use by anyone—no tools or heat needed.

At all Hardware, Paint, Department and Auto Supply Stores,  
\$1.00 — or send \$1.00 direct to: Dept. M-9

**MAGIC IRON CEMENT CO.** 5400 Bower Avenue  
Cleveland 27, Ohio

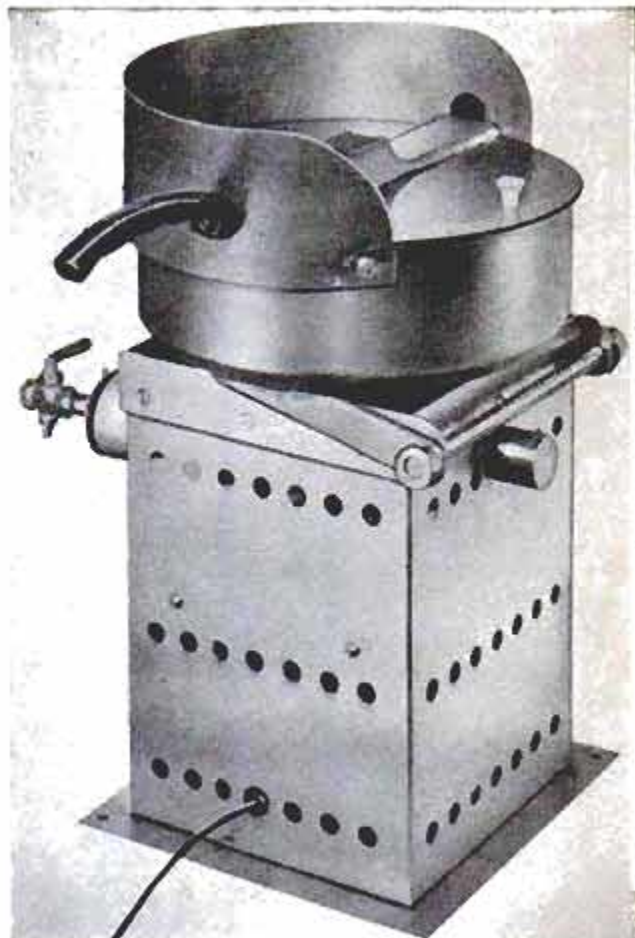

Concession Supply Co., 3918 Secor Rd., Toledo 13, Ohio

### Small Popper Has Big Production

You can make popcorn on a production-line basis with a machine weighing just 21 pounds. It pops one pound of kernels every charge. The small machine uses gas as fuel, but the kettle is stirred electrically by a 115-volt, 60-cycle motor.

### Swinging Tray Holds Tools

Automobile mechanics don't have to strain and waste motion getting tools if they use a movable steel tray to hold hand tools and parts. The tray is attached to the radiator's filler neck. It can be swung 360 degrees to any desired position.

Badger Mfg. Corp., Chicago 7

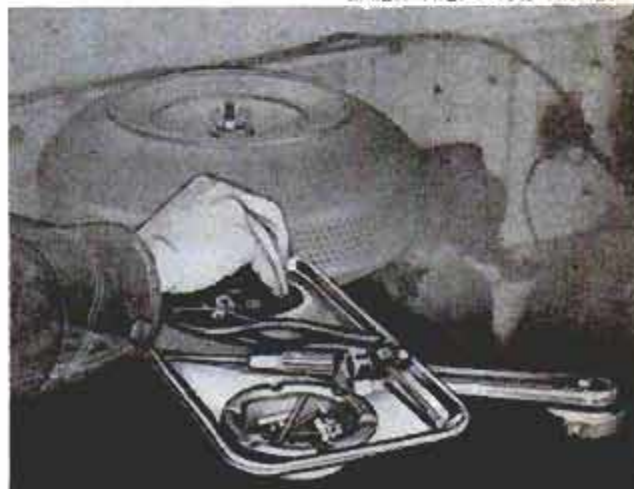



**General SALVAGE CO. SALE**

**BUILD WELDER OR LIGHT PLANT**

G-1160-250 amp, 30V, New \$15.50 used \$9.95  
 G.E. 200 amp, 30V, New \$17.50 used \$12.95  
 R-1 J. & Heintz, G.E. or Ford 300 amps \$16.95

**V-BELT PULLEY KIT.** Fits R-1, P-1, G-1 & AC-DC generators; has 2 ball bearing blocks with high speed bearings, three groove V-pulley, Dr. shaft 8" long & flex coupling \$17.50

**AC-DC WELDER KIT** = 511 G.E. Generators  
 Makes A.C. light plant & D.C. welder & battery charger, 1250 Watts A.C., & 200 Amps, 30V, D.C. incl., 1 Volt reg. 1 R.C. relay, 1 Voltmeter, 1 electrode holder, 1 switch, 1 helmet, 1 rheostat & inspr. \$33.50.

Kit with above R-1 J. & Heintz or G.E. 300 amp, gen. \$37.50. Kit with new 180-250 amp. \$25.50. Kit with G.E. 200 amp, gen. \$29.50.

**New Reactor Coil Arc Stabilizer** with 24 S. Copper wire, for R-1, P-1, G-1 & AC-DC, gen. 7"x5"x4" wt. 11 lbs. \$10.95.

**New Throttle Control Solenoid & Idling Device** for all welder engine control, 1" travel, shaft is 6" long, threaded end = SC-11 wt. 4 lbs. \$6.95.

**WATER PUMP WITH MOTOR** 1/8 H.P. 2 1/2 V. D.C. runs on 6 or 12V. D.C. Adj. 500 G.P.H. Electric pump with rheostat 12 or 24VDC water or fuel \$7.50.

**New 1/8 H.P. 7500 R.P.M. D.C. 9 Amps. Electric Actuator.** Adj. travel 5/16" either direction; tension load 850 lbs.; static 1, 2800 lbs. \$8.50. 2 / \$15.00.

**New Weaver Hydraulic Hand pump.** Heavy duty, 2000 P.S.I. including built in Pressure relief. Handle adjustable from 12"-20". Wt. 10 lbs. \$7.95

**SPEED REDUCER** 5:1 or 10:1 ratio. 2 H.P. \$5.95

**GEAR REDUCTION MOTOR BARGAIN** 42:1 ratio, reversible 24V. D.C. 200 RPM, runs on 6- or 12V D.C. & Appl. for 110V/A.C. \$4.89, 2 / \$8.95.

**ROMEC HYD. PUMP & Motor.** Positive displacement, 900 G.P.H. 28 H.P. 2500 RPM for 12- or 24V. D.C. 3 1/2" ports. New \$8.95.

**NEW Four Way Open Center Control Valve** with built in adj. relief for 1 to 4 D.A. cylinders. 3/8" ports = 10080 \$14.50. #4811 four way with 2 handles for 1 S.A. cylinder. New \$8.95

**NEW HYDRAULIC CYLINDERS**

Air or Oil Bore	Stroke	Shaft	D. Action	Price
#11 1 1/2"	6"	3/8"	3"	\$6.50
#12 2 1/2"	6"	3/8"	3"	\$5.50
#24 3 1/2"	2 1/2"	1 1/2"	3"	\$27.50
#511 3 1/2"	2 1/2"	1 1/2"	3"	\$22.50
#131 3"	2 1/2"	1 1/2"	3"	\$25.50

**NEW HYDRAULIC SYSTEM KIT**

#400 A. heavy duty Power Driven, Rated 14,000 lbs. lift. Consists of 2 D.A. hyd. cylinders, 3" bore x 24" stroke, each rated 7000 lbs. with 1000 P.S.I. in. 4 way hyd. control valve with built in relief = \$21. 1 Vickers hyd. pump, 400 G.P.H., 1500 P.S.I., 3750 RPM. 1 hyd. 2 gal. reservoir. 1 Purolator hyd. filter, 1 gauge 0-2000 P.S.I. all hose, & fittings. Value \$184.10, save \$90.00. Kit price \$94.10. Kit with two #511 cyl. \$79.95.

**HYDRAULIC PUMP BARGAINS** 1500 P.S.I.

MFG. TYPE	R.P.M.	G.P.H.	Price
Pesco Gear	1500	198	\$ 8.95
Pesco Gear	4300	360	\$12.95
7" Pesco Gear	447	cu. in. 270	\$14.50
Stratopower	450	cu. in. 3750	\$15.50
Vickers	410	cu. in. 375	\$15.50
Vickers	507	cu. in. 400	\$15.50

**GENERAL SALVAGE CO. CHECK OR M.O.**  
 2922 E. 27 St., Dept. 97, Kansas City 27, Mo.

**2 WAY PORTABLE RADIO SET**

**SENDS - RECEIVES UP TO 10 MILES AS SHOWN** with built-in antenna or hundreds of miles with outside antenna. Works on 80 and 40 meter (Novice) amateur radio-bands—also Aircraft and overseas broadcast (3 to 8 mc). **PORTABLE SELF-CONTAINED POWERED WITH STANDARD PORTABLE RADIO BATTERIES. NO AC PLUG-INS NEEDED!** Take it with you everywhere you go—on trips, vacations, camping—Keep in contact with home, friends. Has 5 watt crystal controlled transmitter—Sensitive Regenerative Receiver, Send-Receive switch, Wt. only 3 lbs. Size, only 6"x4"x4". **TESTED - PROVEN - SIMPLIFIED - PRACTICAL** - Full information given on quick easy to get license.

**SEND ONLY \$3.00** (bill, ck, mo) and pay post-man \$12.95 COD postage on arrival or send \$15.95 for postpaid delivery. Complete kit includes all parts, tube, coils, plastoid cabinet, easy instructions. (Set of batteries \$3.49; crystal \$1.49.) **COMPLETELY WIRED AND TESTED POSTPAID \$10.95.** A regular \$19.95 value—Order now before price goes up. **GUARANTEED - AVAILABLE ONLY FROM:**

**WESTERN RADIO DEPT. 8NM-9 KEARNEY, NEBR.**

**NEW, IMPROVED CALCULATOR FOR WOODWORKERS only 25c**

Instantly gives information on lumber, nails, concrete mixes, painting materials, etc. Convenient, simple to read. Just set dial for nail specifications, to convert linear to board feet, find bit sizes for screws, compare characteristics of woods. 6" diameter heavily varnished cardboard. Send 25c, no stamps, please to Greenlee Tool Co., 2109 Columbia Avenue, Rockford, Illinois.

**CUT ANY SIZE - ANY SHAPE WITH Spearhead Cutter**

Handy pocket size - cuts leather, asbestos, rubber, cork, etc. - round 1/4" to 6" - any size straight and odd shapes.

**935 POSTPAID**

**ZIMMERMAN PACKING - NORWOOD 12, OHIO**

**SAW SHARPENING IS EASY**

Super Filer No. 11 joints and sharpens hand and circular saws 6" to 10" with all teeth correct in height, depth, pitch, bevel. When file hits steel roller, teeth are finished. Saw runs true with no side pull. **\$9.95 PPD.** Includes 8" file.

**"TRU-CIRCLE"** saw set automatically sets teeth at 10° or more. **\$2.95 PPD.**

**SUPER SAW FILER No. 6**

Automatically controls depth, angle, pitch for all saws. Precision made and calibrated. Use in any vise or clamp. Includes file. **\$6.50 PPD.**

**DOWEL CENTERS** Centers inscribe exact location for opposite holes. Pairs for 1/4", 3/8", 1/2" holes. **\$1.00 PPD.**

**MONEY BACK GUARANTEE**  
**A. D. McBURNEY, 5908 Hollywood Blvd., Hollywood 28, Cal., Dept. A-98**

**Refinishing's EASIER WITH Heavy-Bodied KLEAN-STRIP**

**LOWEST PRICED WATER-WASHABLE PAINT REMOVER**

Peels off paint and all other finishes quickly, easily. Non-inflammable and needs no neutralizing. Use for either wash-off or scrape-off removal. Write for free folder describing a professional's way to remove old finishes. **The Klean-Strip Co., Inc., P. O. Box 10083A, Memphis 6, Tenn.**

**THIS CHRISTMAS Santa waves your greetings**

**FOR YOUR HOME, STORE OR COMMUNITY PROJECT**

Santa waves his welcome... His reindeer romps under a twinkling sky. These and other exciting new Christmas decorations "come alive" to greet friends, customers, community. Big 4"x6" motion displays are yours for less than \$20.00 complete—with East-Bild\* Patterns.

You buy the pattern for \$3.00; the electric motor and linkage kit for \$9.50; the materials for about \$7.00—all from your lumber dealer. Now you have everything you need to make—by yourself—professional-looking outdoor decorations. (Every year East-Bild decorations win prizes in community competitions.)

East-Bild Pattern No. 762 (Santa) and No. 764 (Reindeer) feature Homasote Board—the weatherproof, outdoor material that's easy to work and handle. Your lumber dealer stocks Homasote and East-Bild Patterns. See him today—or use the coupon.

\*T. M. Reg. East-Bild Pattern Company

**HOMASOTE COMPANY, Trenton 3, N. J.**

I enclose \_\_\_\_\_ for which send the following patterns:

Santa (Motion)—\$3.00  Madonna—50¢  Choir Boys—50¢  
 Jolly Snowmen—50¢  Sleigh—50¢  Nativity Scene—\$5.00  
 Reindeer (Motion)—\$3.00  Send name of Homasote Dealer

Name \_\_\_\_\_  
 Address \_\_\_\_\_  
 City \_\_\_\_\_ Zone \_\_\_\_\_ State \_\_\_\_\_ J-1

**IN CANADA: TORONTO, ONT.—P.O. Box 35, Station K—MONTREAL, P.Q.—P.O. Box 20, Station K**



**WELD, BRAZE****SOLDER, CUT****ANYONE CAN WELD AT HOME**

Homeowners, mechanics, farmers, hobbyists! Make repairs at home, farm or shop on fenders, bodies, bicycles, machinery—almost anything of metal. No experience needed. Welder comes complete with twin carbon arc-torch and accessories at low, low price. Operates from any properly wired 110 V. A.C. or D.C. line. Order from this ad. 10 day money back guarantee. Literature on larger equipment—FREE.

FOUR-WAY WELDER CO., Dept. F2-J 1810 S. Federal St., Chicago 16

**FOUR-WAY**

**WELDER**  
of 1001 uses  
only \$1475

F.O.B. FACTORY

**WELDER**

**CHECK YOUR TIRES . . . YOUR LIFE DEPENDS ON THEM!**

## ROCKET MASONRY DRILLS

For Drilling Hard, Reinforced Concrete & Other Masonry

Core Drills with Multiple Cutters of Tungsten Carbide — with Patented Core Slot for Efficient Removal of Core & Cuttings. 1/2" through 6" Diameter.

**Rocket's Professional Tools Will Do A Professional Job For You**

The Most Economical Rotary Drill You Can Buy — For 1 or 1,000 Holes

Ask Your Hardware Dealer, or Write for Brochure: **ROCKET CONCRETE DRILL CO., San Clemente, California**



ADDED FEATURES AT NO ADDED COST

In Sizes  
5/32" - 1 1/2" Dia.  
Centerlocked  
Molded Carbide Cutter  
Keyed to Drill Body—  
Eliminates Breakage Due to  
Melting of Solder Used in Ordinary Drills—

Enjoy The Eager Bite Of  
**SANDVIK** Swedish Steel  
**HAND SAWS**



FREE

Send for  
16-page booklet  
on How to Choose  
and Use Hand  
Saws.

The wood hungry edge of a Sandvik saw gives you extra woodworking pleasure. High crowned tooth line cuts deeper with each stroke.

Made of specially hardened, stubborn Swedish steel for lasting sharpness.

**SANDVIK STEEL, INC.**

Saw & Tool Division  
1700 Nevins Road  
Fair Lawn, N. J.

In Canada: P.O. Drawer 1335, Station "O," Montreal 9, P.Q.

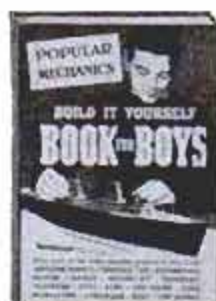

Every Boy Should Have  
This Build-It-Yourself  
**Book for Boys!**

It's natural for boys to want to make things—to fuss with tools—to fashion the kind of things "kids" want. So give boys the Build-It-Yourself Book for Boys. Encourage a youngster to express himself through the sensational new Popular Mechanics book that shows how to make 56 different things every boy dreams about. It covers science, mechanics, electricity, modeling and other fields. 192 pages of easy-to-follow instruction and 469 how-to-do-it pictures.

**56 Toys, Games, Gadgets, Models, Boats, Electrical Devices, Cars and Other Things Boys Can Make at Home**

How to make—Airplane Models, Aquaplane, Archery Kit, Bird Houses and Shelter, Boats, Bobsleds, Boomerangs, Cannon Toy, Electric game, Electric Motors, Garage Toy, Helicopter Toy, Hunting Knife, Hydroplane Model, Kites, Log Cabins, Marble Game, Microscope, Printing Press, Radio Sets, Rafts, Railroad Modeling, Shooter, Scooter, Sidewalk Cars, Sprinkler

Truck, Squirt Gun, SS United States Model, Surfboard, Tank Toy, Taxidermy, Telegraph Set, Telephone, Tree House, Water Skis, Weather Instruments, Toggan, Worktable. Build-It-Yourself for Boys sent postpaid for \$2.95 or COD, charges additional. Money refunded if you are not pleased after 5 days' use. Mail order to address below.

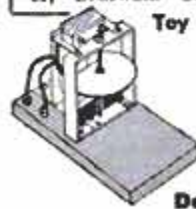

Toy motor



Boomerangs



"Ju-be"—the punt.

**POPULAR MECHANICS PRESS**  
Dept. 958, 200 E. Ontario St., Chicago 11

POPULAR MECHANICS



**WAR SURPLUS** AND MORE **SAVE UP TO 90%**



**FAMOUS NAVY MK14 AIR COMPRESSOR**

Great for tree, termite, airbrush & paint spraying; filling tires, aquariums, etc. Dual & remote control electric receptacles. 115v 60 cycle AC, heavy duty HP. Westinghouse Motor. Direct drive. Water & explosion-proof. Built-in air filter, adjustable pressure setting up to 47 lbs. 3 cu. ft. per min. Self-contained switch. Mounting brackets. These units made under license of Sperry Gyroscope Co. Wt. 66 lbs. gross. Approx. GOVT. COST \$585. Like NEW. \$21.95.

With portable steel hand cart (shown), rubber wheels, specially constructed for mounting this unit. Incl. 25' rubber air hose. 6' extension cord with plug & fittings. Wt. 76 lbs. Complete with cart—\$28.95.

With new internal-pressure spray gun with 3 adjustable spray tips. 1 qt. cap. \$35.95 complete.



**MICROMETERS** Black crackle finish frame. Easy-to-read graduations in .001. NEW. 0-1" cap. \$2.69 ppd. 1-2" cap. \$3.79 ppd.

**BENDIX GEROTOR PUMP & MOTOR**

Use wherever fluid pumping required. Excellent for hydraulic installations. Has 3/4" pipe connections, built-in relief valve adjustable up to 1500 lbs. Max. cap. 6 GPM. 1 1/2 H.P., 24 V. motor. Use on 12 to 36 V. Approx. GOVT. COST \$350. NEW \$10.95.



**ELECTRIC PUMP WITH CONTROL UNIT**

Runs on 12 or 24 V. Centrifugal type. Draws 5.2 AMPN. Has built-in removable filtering screen. Great for fudge, circulating or sump pump...bat tanks, etc. Pumps 500 GPH. Complete with on and off switch rheostat, 2 speeds (hi & lo). Mfd. by Ingersoll-Rand, Shipp. Wt. 7 lbs. Approx. GOVT. COST \$195. NEW \$8.95.



**140-1 REDUCTION GEAR**

For beaching boats, winches, hoists. Ideal for motor in golf or boy's electric car. DC motor & clutch. Easily reversible wiring diagram furnished. Hi torque, 1" speed. Runs on 6-12 or 24 V. Wt. 85 lbs. gross. Approx. GOVT. COST \$300. Like NEW. \$12.00. Matched splined gear for above—\$3.00 ea. \*225-1 Reduction Gear—\$13.50



**11 PIECE CROWFOOT WRENCH SETS**

Wrenches snap onto T-bar in 3 different positions. The only wrenches for hard-to-get-to places. Mfd. by Plomb Tool Co. for U.S. Armed Forces. Finest case hardened tool steel. No shop mechanic should be without this set. Approx. GOVT. COST \$47. NEW. \$8.95 ppd.



**SENSITIVE ALTIMETER**

In 50' increments. 0 to 35,000 ft. (inches of Mercury). Famous Pioneer. Tested & inspected in our own instrument lab. Guaranteed perfect. Approx. GOVT. COST \$150. Wt. 2 lbs. \$15.95.



**WOOD PROPELLER**

Genuine rock maple radio drone "prop." perfect for den, trophy room, boy's room. Smooth, highly varnished, 30" tip to tip. Clock, barometer or photo can be inserted easily into center (mounting holes provided). Can use to operate ice sleds, etc. Approx. GOVT. COST \$57. NEW. \$4.95 ppd.



**NEW! 1959 CATALOG! BIGGER & BETTER THAN EVER...**

971 price cuts. 1000's of bargains in war surplus & other items! 100's of pictures! Send 25c in coin for your copy today! Ppd. prices USA only. Other prices FOB Culver City, Calif. Send cash, check or money order. 50% deposit on COD.



**AIRBORNE SALES CO., INC. DEPT. PM 958**  
8501 Stellar Drive, Culver City, Calif.

**NEW PISTON RINGS CUT OIL WASTE**



**For Many Uses!**

**Metal Turning Lathe**

Only **\$49.95**

F.O.B. Lansing, Ill.

15 1/2" bed with 4 3/8" swing.

7" between centers.

Satisfaction Guaranteed.

**FREE FOLDER**

Write for it today!

Rosemoor Manufacturing Co.  
Box 147J, Lansing, Ill.

**Print Your Own**



Cards, Stationery, Advertising, Circulars, labels, photo and movie titles, church work, tags, etc. Save money. Sold direct from factory only. Raised printing like engraving, too.

**Own a Printing Business**

Print for Others, Good Profit. Have home shop. Junior press \$15; Senior \$29 up. We supply everything. Easy rules. Pays for self in short time. Write for free catalog of outfits and all details. **KELSEY PRESSES, C-37 Meriden, Conn.**

**Guaranteed BAND SAW BLADES**

Order bandsaw blades direct from manufacturer at low factory prices. **Tru-Craft blades** are custom-made to fit all bandsaw makes. Fabricated of superior Swedish steel, teeth precision sharpened and set, welded and finished to exact length, ready for installation. Warranted against faulty materials and workmanship... satisfaction or your money back! Send for price list and order form.

**TRU-CRAFT BLADES**

P. O. Box 126 Chicago 90, Ill.

**NEW! LAYTRAC RIDING CRAWLER**  
OUTWORKS ANY TRACTOR ITS SIZE



**LOWEST COST FOR 9.2 H.P.!**  
Laytrac works where others bog down! No slipping, drifting, tipping on slopes. Ideal for dozing, plowing, field work. Rugged, easy to operate. Big tractor quality! Borg-Warner 3-speed and reverse trans., cone clutch steering, 925 lbs., including blade, floating drawbar, PTO. Guaranteed. Accessories available. At dealers or direct. Write for literature. **LAYTRAC**  
2548-M9 Airport Way, Seattle 4, Wash.

Tractor less blade, \$895  
(Includes PTO and floating drawbar. Blade \$65.)

**ORIGINAL ISSUE! PORTABLE HEATING-COOKING UNIT**



Original Cost Was \$80.00

**F.O.B. Memphis, Tenn.**  
Send check with order (no C.O.D.'s, please)

- Built to U. S. Army Specifications
- Burns Gasoline — Approximately 50,000 B.T.U.'s
- Size: 21 1/2" long x 19" wide x 9 1/2" high; 55 lbs.



Fine for heating cabins... extra rooms... barns... coops... or for outdoor heating or cooking.

**ARMY SURPLUS OUTLET**

91 No. Second St. Memphis, Tenn.



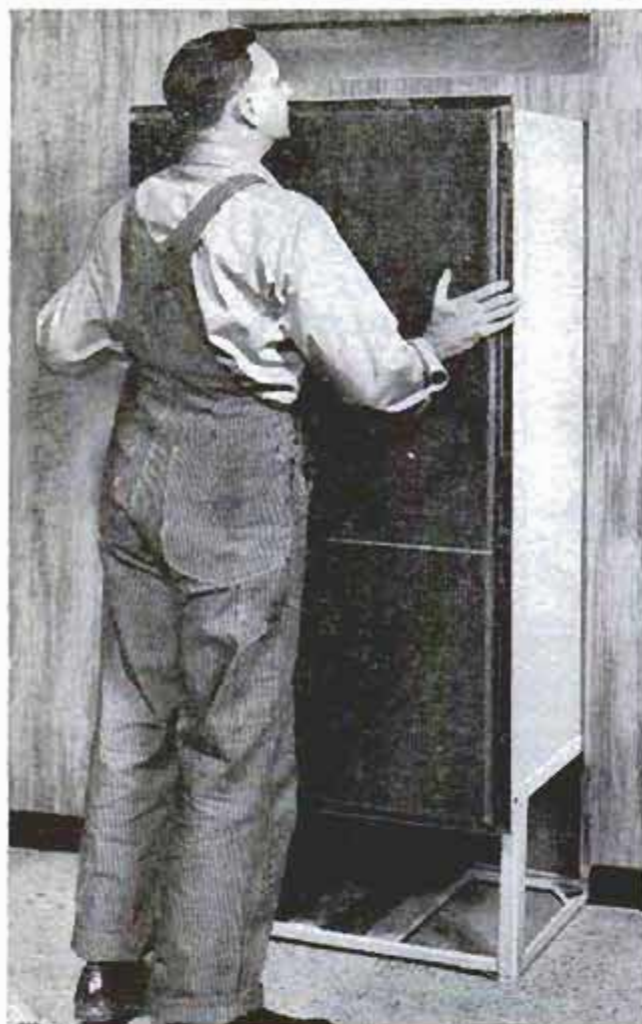

## Freezer-Refrigerator Made to Be Built-In

**F**REEZER-REFRIGERATOR combinations now can be installed as built-in units flush-mounted to paneling of the homeowner's choice. Each unit is welded to a rigid steel supporting frame which protects the tubing and holds the box at a proper height. This system permits the homeowner to select lightweight cabinet sides or panels not previously thought practicable. The refrigerator has 14 square feet of shelf area and a net capacity of eight cubic feet. The freezer has a capacity of 4.6 cubic feet and can hold 156 pounds of food and ice cubes. The refrigerator-freezer-compressor unit, weighing about 435 pounds, occupies a space 33 inches wide by 26 $\frac{5}{8}$  inches deep by 68 $\frac{3}{4}$  inches high. The air-outlet grille at the top of the box is 33 inches wide by 6 $\frac{1}{8}$  inches high.

After openings for the main units and top grille have been cut in the paneling, an outlet box is installed in the wall to the lower rear of the larger opening. The top grille is set in place, and the combination unit is pushed into the main opening until the front doors are flush with the paneling.

**NOW!** a hi-compression staple gun  
for only  
**\$4.95**



With Exclusive Push-button Loading and Built-In Staple Extractor.

Indispensable for home use...and never before priced so low! This compact, all steel, powerful SWINGLINE 101 staple gun is ideal for insulation, carpentry, upholstery, screening, wire fencing, plus thousands of other uses. Handle locks to fit pocket. Lightweight, maneuverable, jam-proof! Staple sizes  $\frac{1}{4}$ " ,  $\frac{5}{16}$ ". Send for FREE book—"Tips for Tacking".

**Swingline® INC.**

Dept. M98 Long Island City 1, New York

## REWORK YOUR BOAT TRAILER . . .



**BUILD AND ADD A TILTING RACK** for quick, easy one man dry shod launching or loading at low cost. Send \$1.00 for illustrated instructions on how to rework your present trailer or build a new one. Satisfaction guaranteed or money refunded.

**EAST PEORIA INDUSTRIES**

203 KEIL AVENUE  
EAST PEORIA, ILLINOIS

## GENERAL ELECTRIC HIGH PRESSURE AIR COMPRESSORS

Output — 1000 Lbs. per Sq. In. • For filling aqua-lung tanks • For air brush work • Filling accumulator and air-oil shock struts • Cleaning and testing spark plugs • Hundreds of other uses.

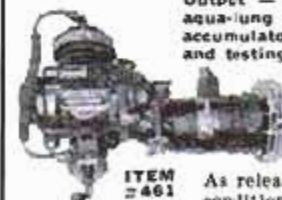

ITEM #461

Built by General Electric to exacting U. S. Air Force standards. This two cylinder, two stage air compressor rated 1000 P.S.I. output. Driven by  $\frac{1}{2}$  H.P., 27 volt D.C., 17 amp. motor.

As released from U.S.A.F. in used, serviceable condition. (Covered by our 30-day guarantee.)

14" L x 9 $\frac{1}{2}$ " H. Shpg. Wt. 15 Lbs. F.O.B. Chicago  
U.S. Gov't paid \$296.00. **OUR PRICE... 15.00**  
High pressure air receiver tank for G.E. compressor. Shpg. Wt. 2 Lbs. **4.00**  
**PRESSURE GAUGE 0 TO 2500 P.S.I. 1.50 EA.**

## STAINLESS STEEL TANK

ITEM #63—For Compressors, Tire Inflators, Floats, Buoys, Fluid containers, etc., type G-1. 2100 cu. in. capacity (9 Gals.) 450 P.S.I. Used as Aviators Oxygen Bottles. Strong, but light weight. 24" Long x 12" Dia.  $\frac{1}{4}$ " port at each end. Wgt.—19 lbs. F.O.B. **13.50** ea. **2 for 25.00**  
CHGO.



## FREE! NEW, BIG CATALOG

VALUE-PACKED PAGES GALORE. Unsurpassed War Surplus and newly manufactured Equipment. Bargains for farm, home, factory, workshop. Write today.

**GROBAN SUPPLY CO.** (Dept. 1139 S. WABASH AVE. PM-9) CHICAGO 5, ILLINOIS

POPULAR MECHANICS



Framing for the freezer-refrigerator combination provides correct airspace around the hermetically sealed compressor which is plugged or wired into the outlet. The defrost pan is clipped into position beneath the refrigerator, and the electric defrost heater placed in the defrost pan. A removable panel, which can be of the same material and finish as the surrounding panels, is inserted in place below the refrigerator-freezer unit. This panel is installed so free-flowing air moves from the floor around the compressor upward along the refrigerator's exterior walls and out through the top grille.

Self-defrosting and insulated with glass fiber, these combinations are available in antique copper enamel, stainless steel, and flat finishes (for painting). Separate dial-type controls permit the refrigerator to be turned off during vacation without impairing operation of the freezer. The refrigerator reportedly has the same shelf room as that in 11-cubic-foot models. The compressor is 1/4-horsepower, 115-volt, 60-cycle.



## P & C CLIK-STOP WRENCH

holds exact jaw openings automatically . . .

### won't work loose

P&C's amazing new Clik-Stop wrench works like an ordinary adjustable. Just turn the patented Golden Knurl, jaw locks automatically at any opening. Pick it up, drop it, kick it . . . jaw won't work loose or "creep." Chrome plated, backed by famous P&C guarantee. Ask your dealer today about P&C Clik-Stop.

Shop from the colorful P&C tool merchandisers in more than 12,000 stores coast to coast. Send 10c for catalog.



**P & C TOOL COMPANY**

Box 5926, Portland 22, Oregon  
Chicago Warehouse, Box 89, Schiller Park, Ill.

Subsidiary  
Pendleton  
Tool  
Industries

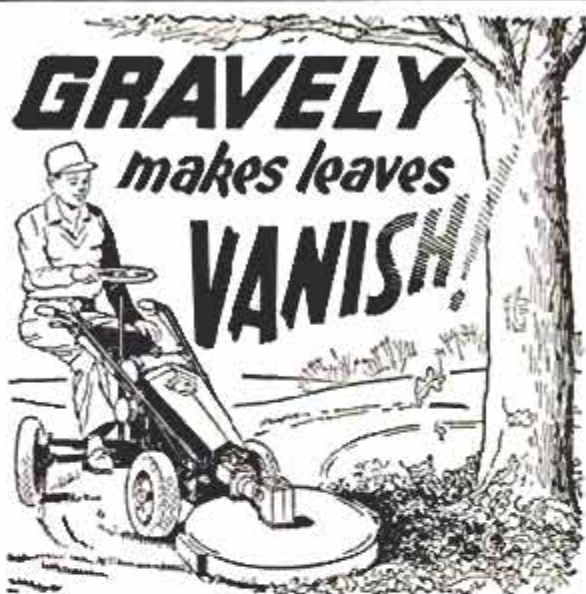

### ROTARY MOWER—LEAF MULCHER

- Mulches 30" width! . . . Twice the power of ordinary mulchers . . . gets rid of leaves fast! 6.6 HP at 2600 r.p.m.
- New Steering Sulky, New Optional Starter, New Rotary Cultivator—30 attachments for year-round work. Snowblower, Snow Plow, Chain and Circular Saws for Fall and Winter jobs . . . Finance Plan available!

Write today for FREE 24-page "Power vs Drudgery" Booklet!



**GRAVELY TRACTORS, INC.**  
BOX 963 DUNBAR, W. VA.

**FIELD-TESTED SINCE 1922**



pull the trigger...  
**spray paint**

7 times faster than brushing!



**Speedy Sprayer** ONLY \$32.00 less motor

Paints anything from a house to a toy. Saves its cost on the first major job! Speedy Sprayer does in minutes what brushing takes hours. Finish is smooth, flawless. Uses any 1/4 h.p. motor with 1/2" shaft. No. 780 *Outfit*—10 ft. air hose, tire chuck, quart gun, less motor, only \$32.00. Every workshop should have it. At leading stores.

Free! Write for "How To Spray" Booklet and folder.

**W. R. BROWN CORPORATION**

Specialists in Portable Paint Sprayers for Over 37 Years  
2635 N. NORMANDY AVENUE, CHICAGO 35, ILL.

do-2



**DIAL ANY DADO WIDTH...IN SECONDS**

FOR PROFESSIONAL PRECISION...only with a COMET QUICK-SET DADO! Cut to a maximum depth of 3/4". Dial the exact width (from 1/4" to 1 3/8"), without removing the tool from the arbor. Watch the balanced, tool-steel COMET blades cut perfect dados, rabbets and ploughs...on any table or radial arm saw. Use COMET for quick, professional precision... stays sharp 5 times longer! If not at your local dealer, order direct by check or money order. 19.95 PREPAID

**COMET MANUFACTURING CO., Dept. PM 9**

2033 Santa Fe Avenue, Los Angeles 21, California  
a division of The Siegler Corporation

**NEW BELSAW MULTI-DUTY POWER TOOL**  
SAWS—PLANES—MOLDS



Now you can use this ONE power-feed shop to turn rough lumber into moldings, trim, flooring, furniture...ALL popular patterns. RIP... PLANE... MOLD... separately or all at once with a one HP motor. Use 3 to 5 HP for high speed output. Fully Safe-guarded. Low Cost...You can own this power tool for only \$30.00 down payment. Write TODAY for Free Catalog  
**BELSAW POWER TOOLS, 909 Field Bldg., Kansas City 11, Mo.**

NEW 1958 CATALOG 200 MODELS—SAVE 2/3  
**BOAT KITS** EASY TO BUILD—Designed for the amateur. Over 200 Models. Prams to Cruisers, 8 to 21 ft. Formed hulls Semi and Custom finished. Save 50%... Now NEW

Sea Ray Molded FIBERGLAS BOAT KITS. Truly professional results. NO upkeep. SAVE 2/3 assembly time. 12 to 16 ft. Utilities and Runabouts. SEND 35c for 64 page Boat Kit & 24 page Sea Ray Catalogs. SEND \$1.00 for both plus "Boating Handbook". Dealers inquire for franchise.

**BOAT PLANS & PATTERNS** World's largest selection: over 200 plans, full-size patterns, frame-pac kits! Designed strictly for amateurs! All types: prams, kayaks, racers, runabouts, catamarans, houseboats, cruisers - inboard-outboard 6-40' wood-plywood-steel!  
**Frame-Pac Kits** Send 35c for PLAN CATALOG Catalog PLUS "Boatbuilding Handbook" \$1.00  
WRITE NOW! CUSTOM CRAFT, BUFFALO 7L, N. Y.

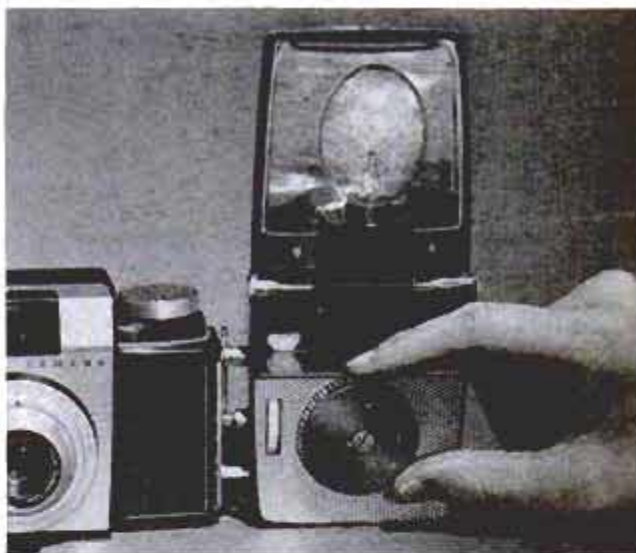

**Flash Holder Provides Own Power With Built-in Generator**

Camera owners can now buy a compact flash holder that provides its own power. The flash holder has a built-in generator that fires the lamp. A half turn of a nylon handwheel stores enough electricity in a capacitor to fire any one of the popular M-2, No. 5 or M-25 flash bulbs.

☞ Potash added to the diet of carnations causes them to perk up and sell for more.



# SPECIAL FALL HYDRAULIC SALE SAVE UP TO 85% TODAY



**No. H-24D - Double Action Cyl.**  
2000 PSI Steel barrel. Ideal for hydraulic press work. Has 2-1/2" bore, 7" stroke, 1-5/8" shaft, 19" length.

Approx. Gov't Cost . . . \$270.00  
Palley Cat. Price \$12.75

**SALE PRICE 9.95**



**No. H-56 - 1500 PSI CYL.**  
Parts are so arranged to allow these cylinders to be used singly or in series. Ideal for production line equip. Bore 1 1/2", shaft is 1-1/8", stroke 4-7/8".

Approx. Gov't Cost . . . \$70  
Reg. Palley Cat. Price \$4.25

**2.95**

**H-14 SALE NOW 7.95**

**1500 PSI Double Action HYDRAULIC CYLINDER** - Has bore of 1-3/8" Shaft 1" diameter, Stroke 15-5/8", O/A lgth. 22". Cost Gov't approx. \$90?



**No. H-35 - For long stroke operation up to 1500 PSI. Stroke is 26-3/8", Bore 1 1/2", Shaft 1", Length 32-3/4". Cost Gov't approx. \$116. Cat. Price \$16.50**

**SALE PRICE 7.95**



**4-WAY HYD. VALVE**  
Made to rigid Gov't specs. Poppet type. Spring loaded. Pressure balanced. Valve is closed in neutral. Has 1/4" internal tube ports. **SAVE!**

**H-V7A-1**  
Gov't Cost approximately \$30.00  
Regular Palley Catalog Price \$6.75

**3.95**

**SPECIAL HP-3 HYDRAULIC HAND PUMP**

Reg. Palley Price \$17.50 **ONLY 6.95**

Operates at 1500 PSI. Displaces 0.19 GPM at 30 cycles per minute. Capacity 1.5 cubic inches per cycle. Has built-in check valve. Cost gov't approx. \$80.00

**SPECIAL 4-WAY HYDRAULIC VALVE**

**H-V135U** **7.88**

Open center in neutral. Piston type with built-in relief valve. 5/8" AC tube ports. Another Surplus Bargain. Reg. Cat. price \$12.75.

## 396 PAGE CATALOG! PACKED WITH HYDRAULIC BARGAINS SEND 50¢ FOR HANDLING & MAILING SAVE!

**55 TO 1 GEAR BOX** **5.95 USED**

For use where tremendous power at a low take-off speed is desired. Drives thru a train of 6 gears rotating on self-lubricating, hi-speed roller bearings. Take-off shafts are 1/4" and 3/8".

**NEW! excellent condition 8.95**

**4-SPEED HOBBY MOTOR** **8.88**

A rugged, precision built electric motor for use on Barbecue, in home workshop, etc. Uses 110 volt, 60 cycle current. Has four take-off shafts turning at separate speeds of - 5, 25, 150 and 4000 RPM. **SAVE!**

**HIGH TORQUE HYDRAULIC MOTORS** **62.50 EACH**

**HMP-10B - Gear type. Displaces 6 cu. inches per rev. Capacity 16 GPM at 1000 PSI at 600 RPM. 3/4" shaft.**

**HMP-10C - Gear type, low speed. 12 cu. in. displacement per rev. Capacity: 16 GPM at 300 RPM at 1000 PSI. Shaft diameter is 3/4".**

**MOTOR DRIVEN GEAR PUMP** **29.75**

Has a capacity of 4.5 GPM at 2300 RPM or 1000 PSI. Integral by-pass valve returns oil to input side of pump at 1200 PSI. Has intermittent duty. 3.75 HP motor - 24 VDC, 250 amps at 2300 RPM.

**SPECIAL R-1 GENERATOR** **SAVE**

Gov't cost approx. \$200  
Palley Reg. Price \$27.95

Gov't Surplus Bargain. Designed for use on Aircraft but easy to convert for use as Arc Welder, battery charging and electro plating. Compound wound for heavy duty use. Rated 300 Amps. 24-32 Volt D.C. Has an RPM of 3750 to 4000. Rotation is counterclockwise. 3/4" spline shaft. Made by General Electric.

**NOTE: Conversion instructions to make Arc Welder are FREE on request!**

**NOW 16.95**

**WELDING REACTOR** - Has iron core wound with No. 4 wire. Will stand load of 400 Amps. Use with generators shown here . . . . . **ONLY 10.95**

**THROTTLE CONTROL SOLENOID** - Use as welder or motor control. Has 5" shaft, 1" travel. Specially priced **7.95**

**"V" BELT PULLEY ADAPTER** to adapt V-Belts to use on generators. . . . \$27.50

**24 Volt RHEOSTAT** for use as welder output control. 5 variable outputs. Only \$2.95

**04 TYPE GENERATOR** **14.95**

Another fabulous Gov't Surplus Buy! Designed for use on military aircraft. Compound wound. Adaptable for portable light and power plants or as a power supply for boats. Rated at 100 Amps, 24 V DC. Operating speed 5000 to 10,000 RPM.

**STEEL AIR TANKS**

Pressure tested to 400 PSI. Originally used as oxygen tanks. Have ports in both ends topped for 1/4" standard pipe thread. Capacity 500 cu. in. Size: 6-1/2" x 24".

No. D2-C Carbon Steel . . . **NEW 5.95 USED 4.95**

No. D2-S Stainless Steel . . . . . **9.95**

**F-2 STEEL TANKS** - Same as above except 1000 cu. inch capacity. Size: 6" x 45".

No. F-2C Carbon Steel \$6.95 F-2S Stainless . . \$10.95

**LARGE VOLUME AIR or CHEMICAL STORAGE TANKS**

**TYPE J-1**

Pressure tested to 400 PSI. Has 18,000 cubic inch capacity (77 gallons). Of stainless steel construction. Size: 24" diam. x 45" lgth. Worth \$150. . . **NOW ONLY 99.50**

**SURPLUS Stainless Steel G-1 Type AIR TANKS**

Pressure tested to 400 PSI. Ideal for air, acids, chemicals, experimental uses, etc. Has 1/4" pipe ports. Size: 12-1/2" x 24" long. **12.95**

No G-1U - Used **14.95**

No. G-1N - NEW . . . \$16.95

**CENTRIFUGAL WATER PUMP** **19.95**

Ideal for draining basements, sumps, flooded areas. Must be primed. Has brass body and rotor. Stainless steel shaft, bearing mounted. 1-1/2" pipe thread inlet, 1-3/4" hose outlet. Delivers 6000 GPM at 1 ft. head at 1800 RPM with a 1/3 HP motor. . . .

**MOUNT BASE** for above pump \$4.25

**1-1/4" Bronze Foot VALVE** for above pump to hold prime & filter. . . \$3.98

**2500 lb. BOMB HOIST** **29.95**

Ideal for garage, boat, jeep, truck, shop, etc. Has bronze worm gear drive with 24 to 1 ratio and 3-speed crank. Comes with 18 ft. of 3/16" high tensile steel cable and crank, and free-spool, pull-out clutch. . .

**MOUNTING FRAME** for Hoist \$5.00

**GOOSE NECK HOIST** **22.50**

Lifts 1000 lbs. with ease through a 21 to 1 gear ratio. Has automatic ratchet brake. The 40" long arm has a 3" pulley at the end. Ideal for "swing-about" truck or platform hoist. Comes with 12 ft. of high tensile strength cable. . . .

**HYDRAULIC REMOTE CONTROL MASTER & SLAVE** **27.50**

When connected with 1/4" tubing and filled with oil they act as a precision, remote power transmission unit. Moving Master handle causes Slave arm to respond in exact motion from 0 to 90°. Ideal for remote machinery controls, etc.

No. H-FX-1S11 **NOW 27.50**

Both units used

**palley/s**

2263 east vernon ave. dept. PM-98  
LOS ANGELES 58, CALIF.

TO ORDER: Send check or money order. All items sent freight collect. 1/2 deposit with C.O.D.s. Calif. residence add 4% state tax.



## FREE Tyler SPYRAL HACKSAW BLADE!

Demonstrate for yourself why Tyler SPYRAL Hack-saw & Coping Saw Blades are America's number 1 choice for making precision & intricate CLEAN cuts of wood, metal, plastic, tubing etc. Saw in circles, right or left, up or down. Available at your dealer. **OFFER LIMITED!** Since you will receive your FREE blade from your local dealer, you must fill out the coupon to the right & mail it to us. Offer is not valid unless you give us your name & address as well as that of your dealer. When dealer receives your FREE Tyler Blade, he will notify you by postcard.

**MAIL COUPON FOR FREE BLADE!**

**TYLER MFG. CO., INC., Dept. PM-9**  
1005 W. Arbor Vitae Ave., Inglewood, Calif.

Your Name \_\_\_\_\_  
Address \_\_\_\_\_  
City & State \_\_\_\_\_  
Name & address of my Saw Dealer is: \_\_\_\_\_



## MODERNIZING?



### ...do it yourself with Beautiful Marlite paneling

Marlite paneling in large sheets, 16" x 8' Planks, and 16" square Blocks goes up fast over old walls or new with just ordinary carpenter tools. The durable baked melamine plastic finish (wide variety of colors and patterns) cleans with a damp cloth; stays like new for years... resists heat, moisture, grease, household acids and stains. Look for the Marlite name on the back of every panel, it's your guarantee of satisfaction. For complete details on Marlite and the new \$125,000 Home Improvement Contest, see your building materials dealer. For free decorating book, write Marlite Division of Masonite Corporation, Dept. 942, Dover, Ohio.



5829

**Marlite** plastic-finished paneling



ANOTHER QUALITY PRODUCT OF MASONITE® RESEARCH

**MEASURES UP!**  
ONLY **\$2.49**  
(10 FT.)  
the *Evans*  
**KING-SIZE TAPE**  
IT STANDS UP STRAIGHT  
6-8-10-12 FOOT LENGTHS

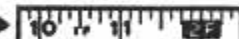

Long upright measuring jobs are easy with Evans King Size. Blade is a full 3/4" wide... 33% wider than ordinary tapes. Stands straight up or lays down flat - won't bend or buckle. Easier to read, too. Free belt clip, Tenite utility case. Sliding end hook - for 100% accurate inside-outside measuring.

**Exclusive! NO FIGURING!**

Work in feet & inches? Read here   
Work in inches? Read here 

ALSO... get *Evans* Regular White-Tapes

- 6 Ft. only \$1.09      50 Ft. only \$5.29
- FREE Tenite utility case      ● All Evans quality features ● 6-8-10-12-50-100 foot lengths

Ask your hardware dealer - Today!

**Evans RULE CO.**

Elizabeth, N. J.

Montreal, Que.



### Machine Produces Tire's Noise Even Before Tire Is Made

Through sensitive earphones, technicians listen to the high-speed whine of tires that haven't been made yet. Crayon markings on a whirling Lucite disk simulate the tread design of hypothetical tires. The disk rotates between a photocell and a light beam that is interrupted by the marks. The photocell actuates a generator, and the machine produces the electrical equivalent of the noise a tire with this tread pattern would make on a smooth road.



**POPULAR MECHANICS**  
*How to Build a Home*  
HOME • FAMILY • BETTER LIVING

# FREE!\*

## POPULAR MECHANICS BIG BOOK CATALOG

**Pictures and Describes**

**95 Different Books to Help Save Time and Money on**

- home improvement and maintenance
- workshop planning and projects
- new homes and garages
- hi-fi, television, radio, other equipment
- automobile repair and purchase
- crafts and hobbies of all kinds
- tool purchases, use, upkeep
- farm equipment and animals

**PLUS** Books of fun and education for Boys and Girls, Sport Books, Books of activities and enjoyment for the Entire Family — and many, many more!

28 large pages, beautifully illustrated and printed in two-colors, fully indexed by subject and title for fast, easy reference.

**MAIL TODAY** \* Catalog is free of charge. However, please enclose 10c to cover forwarding costs.

Popular Mechanics Press, Dept. 958, 200 E. Ontario St., Chicago 11, Ill.

RUSH big PM Book Catalog. I enclose 10c in coin to cover all handling, addressing and postage charges.

Name \_\_\_\_\_

Address \_\_\_\_\_

City \_\_\_\_\_ Zone \_\_\_\_\_ State \_\_\_\_\_



## AMERICA'S BEST JET STEAM MASTER

Now, a super efficient portable steam generator that produces live steam at 100 lbs. pressure in 60 seconds from a cold start! Produces large volume of high pressure steam on 2 pints of fuel oil. Instantly cleans sticky grease, dirt, rust, old paint, etc. off implements and farm machinery. Pays for itself in a few weeks. Sterilizes soil. Sterilizes as it cleans—milk equipment, etc. Fully automatic—oil fired with new, built-in lifetime bronze water circulating pump. Draws water from faucet or bucket. Simple and safe—anyone can use it; built-in safety valve. Complete with 12 ft. of hi-pressure steam hose and new triple efficiency steam gun that automatically mixes in soap solution if desired. Wt. 250 lbs. Item 463. **\$349.50** Special factory price.



## ELECTRIC HOIST

**2000 lb. CAPACITY.** A fortunate purchase from the Air Force enables us to offer these powerful 2000 lb. electric cable hoists at a fraction of their value. Perfect for material handling, boat hoists, elevators, lifts on assembly lines, etc. Two separate 22 ft. lift cables with independent controls permit leveling the load and controlling it perfectly. Rugged ball bearing motors of geared down design 110 volts. Available for A.C. or D.C. Please specify. Makes a terrific portable hoist with our #273 D.C. light plant at \$69.75. Offered at less than 33% of regular cost (Hook not included). Wt. 145 lbs. A.C. Model, Item 847A. **\$149.50** D.C. Model, Item 847. **\$129.50**

## Rugged, ball bearing WINCH

Sturdy ball bearing winch—super tough aluminum alloy construction. Powered by an easy starting 2 1/2 HP Briggs gas engine thru gear reduction drive—it exerts up to 3000 lbs. of terrific force for hoisting materials or pulling. Combination gear and pulley reduction results in tremendous multiplication of engine power. Lateral pulley clutch arrangement and built-in drum brake (with ratchet hand lever) enables operator to ease loads down gently and lock at any point desired. Drum handles 400 ft. of 3/4" cable or 600 ft. of 1/2" cable. Ideal for contractors, farm implement trailers and unlimited other uses! (Item 795) Wt. 125 lbs. Only **\$149.50** **HAND WINCH**—Same winch with large crank handle for extra leverage and 2 speed drive. (Item 794) Wt. 60 lbs. **\$59.50**



## Variable Speed Selector

Heavy duty, made by B. F. GOODRICH for industrial use. Provides instant speed changes for any drive. For machine tools, dryers, printing, conveyors, production lines, hoists—any operation requiring variable speed. Employs reliable "trouble free" planetary system. No hydraulic power losses. Infinite range, smooth operation, easy installation. 3 sizes: 1/2 hp., 3/4 hp., 1-2 hp. wt. 55 lbs.; 2-3 hp. wt. 105 lbs.; Reg. list \$228, \$252 and \$352. Our prices **\$79.50, \$89.50 and \$114.50**



## HEATING & VENTILATING FAN

Item 101 Easily installed in furnace pipes. Forces even heat to all rooms. Over range removes kitchen smoke and odors. Powerful, continuous duty motor, 110-120v. AC. Mount in wall or ceiling to ventilate any area. Quiet, super-efficient fan moves huge volume of air. (400 to 600 CFM.)  
8" Pipe, wt. 5 lb. **\$6.85**  
9" Pipe, wt. 6 lb. **\$7.85**  
10" Pipe, wt. 7 lb. **\$8.85**  
12" Pipe, wt. 8 lb. **\$9.85**  
**HEAVY DUTY FAN.** Semi-enclosed motor, suitable for spray booths, restaurant exhausts, poultry houses, etc. 10" Fan, wt. 8 lbs. (Item 10E). **\$11.95**  
12" Fan, wt. 10 lbs. (Item 10D). **\$12.95**  
**HIGH SPEED BARN FAN** similar to above, but larger, high speed motor moves huge volume of air.  
12" Fan (Item 10F). **\$14.95**  
14" Fan (Item 10G). **\$17.95**



## GET MASTER MECHANIC'S BEDROCK FACTORY PRICES



**700 WATT PLANT**

**PUSH BUTTON START**

115 v. 60 cyc. AC Powered by a rugged 2.2 HP. easy starting Briggs engine. No wiring necessary; just plug in and operate. Plenty of current for any oil burner, freezer, brooder, emergency lights, etc. which require up to 700 watts. Ideal for television and radios. Complete with voltmeter and built-in winding to charge 6 v. auto batteries. (Item 24) Wt. 75 lbs. Easily fits in car trunk. Be prepared if storm knocks out power lines. **\$143.50**  
1200 Watt Plant (Item 43) same as Item 24 but larger generator and engine **\$199.50** with 50% greater output.  
We make every type and size of light plants. — Write giving us your requirements!

## Double Acting Hydraulic Cylinder

A powerful cylinder mfr'd. by Massey Harris which develops both a pushing and a pulling action. Will push 8,100 lbs., with a 1000 PSI pump pressure. Cylinder is 3 3/4" O.D. with 6 1/2" stroke—standard heavy duty clevises on both ends. Has standard 1 1/2" pipe thread openings. Can be used for tilting buckets or blades, raising or lowering implements, hydraulic presses, etc. Can also be used as an air cylinder (Item 802) Wt. 17 lbs. Reg. \$68 value. Special. **\$14.95**

**OTHER DOUBLE ACTING CYLINDERS**

6" stroke — 1 1/2" bore	\$ 8.95
8" stroke — 3" bore	34.00
10" stroke — 3" bore	34.80
16" stroke — 3" bore	43.00
24" stroke — 3" bore	47.50
42" stroke — 5" bore	75.00
60" stroke — 5" bore	125.00

We have all sizes of cylinders available.  
**HYDRAULIC CONTROL VALVE** — 4 way open center valve with built-in adjustable relief. Controls 1 double, or 2 single acting cylinders. Equalizing feature permits easy control even under heavy loads. 3/4" pipe thread on inlet & outlet, — on cylinder outlets. Easily mounted, finger tip control. Wt. 16 lbs. (Item 822). **\$21.95**



**HYDRAULIC KIT**  
Complete Hydraulic Kit consists of hydraulic hand pump with built-in 2 gal. reservoir and item 802 hydraulic cylinder described above. Pump has a built in relief valve and is rated at 10 tons. Kit is ideal for presses, jacks, snow-plows, etc. Pump is 29" long—6" diam. with 3/4" ports. A terrific value! **\$39.50** (Item 836). Wt. 50 lbs. **\$23.50** Pump only (Item 836a) only.  
**HYDRAULIC HOSE COUPLERS** Connect or disconnect hydraulic lines without loss of oil. 1 1/2" pipe threads. (Item 819) per set **\$3.95**

## AIR HAMMER

**SAME HAMMER, OTHERWISE DESIGNED WITHOUT ARM** to hammer dents out of auto bodies, fenders, etc. Complete with 2 different shaped arms, a set of 5 bumping gollies, and 20 ft. of heavy duty air hose. Hammer can also be used without arm. Uses 4 CFM at 60-100 PSI. **\$173.00** **SPECIAL \$39.50**



## EXCLUSIVE! NEW LIGHTWEIGHT WATER COOLED DIESEL GENERATOR PLANT

Never before available! Now offered exclusively by Master Mechanic. A low priced, lightweight, continuous duty, Diesel generator set. Powered by a super rugged, exceptionally smooth running, one cylinder Diesel engine. Operates at conservative 1750 r.p.m. and delivers full 1750-2000 watts of power. Operates on low cost fuel oil. Wt. only 240 lbs. — representing a triumph of Diesel Engineering. Complete with fuel filter, oil pressure gauge, control box with duplex receptacle and voltmeter. (Item 830) **\$429.50** Special factory price.

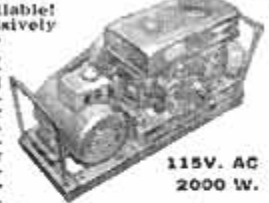

## HI-FLO Centrifugal PUMP

Completely self-priming! No foot valve required. Tremendous capacity—100 gal. per min. ! . . . Special impeller enables pump to handle muddy or sandy water. Simple to operate—simply start engine and watch the water go. Powered by a rugged, easy starting 2 HP Briggs engine. Pre-lubricated sealed bearings for years of heavy low-cost service. **Big 1 1/2" Model, Item 502. Wt. 70 lbs. Factory price. \$134.50**  
**2" Model (150 gal. per min.) with 3.6 hp engine. Item 502B—80 lbs. Special. \$169.50**

**RUBBER HOSE**  
Genuine Neoprene Hose — outlasts ordinary rubber 3 to 1. Reinforced with super tough cotton cord plies—yet completely flexible. Equipped with standard thread male and female fittings. Pump water for irrigation, stock tanks, home, barn, fire fighting, etc.—or pump gas and fuel oil. Volume factory prices—save more than 60%.



**TERRIFIC VALUES!**

Size	Price	Size	Price
1"x10'	5.95	1 1/2"x50'	29.50
1 1/4"x10'	7.95	2"x10'	16.50
1 1/4"x20'	10.95	2"x14'	9.50*
1 1/2"x25'	13.95	2"x18'	21.50
1 1/2"x50'	24.95	2 1/2"x10'	18.50
1 1/2"x100'	49.95	2 1/2"x14'	21.75*
1 1/2"x10'	10.95	3 1/2"x17'	37.50
1 1/2"x25'	14.75	3"x10'	25.50*
*Discharge Hose		4"x15'	44.95

## MINE DETECTOR

**1. MINE DETECTORS:** Used by plumbers, contractors, water dept., etc. for detecting buried metallic or non-metallic objects. Finds buried sewers, water pipes, wires, etc. Complete in carrying case. Batteries \$10.00 extra. **\$39.50** Gov't Cost \$600. Our price.

## MASTER D.C. ARC WELDER

**Easy To Use**  
Now! a portable rugged, industrial type welder with terrific performance, yet at a price hundreds of dollars less than you'd expect. Senior model made for years of trouble-free, continuous service. High capacity DC welding unit enables you to tackle any job with confidence—easily welds anything up to 2" plate using from 1/16" to 1/4" rods. Built-in stabilizer and cooling system makes arc easy to strike and hold. Dual control rheostat provides low heat soldering, brazing and welding from 30 to 300 amps. Complete with instructions, guarantee and triple V-belt or flat pulley. Easy to hook up and easy to operate. **WELDER ONLY — DUAL CONTROL MODEL.** Same as above, but drive with your tractor, jeep or gas engine of 14 HP or more. (Item 38a.) Wt. 110 lbs. \$450 value **\$119.50**  
**WELDER ONLY—INDUSTRIAL MODEL** same as above but with ceramic rotary type rheostat providing 74 different heat settings for all types of welding (Item 38b) **\$139.50** \$500.00 value.  
**COMPLETE POWER MASTER** (Illustrated above) powered by a 16 hp., air cooled Wisconsin engine. Wt. 480 lbs. (Item 28c) Compare with welder costing \$1200. **\$449.50** Factory Special.

**WELDING KIT** Two 10 ft. leads, welding helmet, electrode holder, ground clamp. Sold only with welder at **\$10.50**

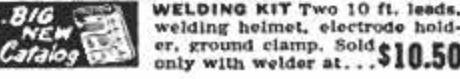

Send check or M.O. Prices f.o.b. Factory. 10 day Money back guarantee. SEND 10c for . . . **BIG NEW CATALOG**  
**MASTER MECHANIC MFG. CO., DEPT. A-98 Burlington, Wis.**



ballot for a successful future!

# 256 I.C.S. COURSES



Whether you stand at a machine or sit at a desk . . . whether you're making \$75 a week or \$75 hundred a year . . . whether your interest is Power Plants or Paper Pulp, Advertising or Electronics . . . chances are I.C.S. has exactly the course you need to get ahead.

I.C.S. is not only the oldest and largest correspondence school. It also offers the most courses. 256 in all. Each one success-proved by graduates who rose to top technical and administrative positions. Chief engineers. Superintendents. Foremen. Managers. Executive assistants.

I.C.S. Courses cover bedrock facts and theory plus practical, on-the-job applications. No skimping. Texts

are prepared by leading business and industrial authorities working with I.C.S. editors and educators. They are constantly being reviewed and revised in line with current developments.

As an I.C.S. student, you study in your spare time, set your own pace. No time lost getting to class or waiting for slower students to catch up. If you wish, I.C.S. will make progress reports to your employer. You win recognition as a "comer," one who is ready to move ahead. Thousands of students report pay increases and promotions within a few months of enrollment. All graduates win the coveted, approved I.C.S. diploma.

**3 FREE BOOKS!** Check the subject that interests you in the coupon below. I.C.S. will rush you (1) a special book outlining your opportunities in this field, (2) the 32-page gold mine of career tips, "How to Succeed," (3) a sample I.C.S. lesson (Math.) demonstrating the famous "I.C.S. Method." "X" MARKS OPPORTUNITY.



For Real Job Security—Get an I.C.S. Diploma! I.C.S., Scranton 15, Penna. Accredited Member, National Home Study Council

## INTERNATIONAL CORRESPONDENCE SCHOOLS



BOX 23299J, SCRANTON 15, PENNA.

(Partial list of 259 courses)

Without cost or obligation, send me "HOW to SUCCEED" and the opportunity booklet about the field BEFORE which I have marked X (plus sample lesson):

**ARCHITECTURE and BUILDING CONSTRUCTION**

- Air Conditioning
- Architecture
- Arch. Drawing and Designing
- Building Contractor
- Building Estimator
- Carpentry and Millwork
- Carpenter Foreman
- Heating
- Interior Decoration
- Painting Contractor
- Plumbing
- Reading Arch. Blueprints

**ART**

- Commercial Art
- Magazine & Book Illus.
- Show Card and Sign Lettering
- Sketching and Painting

**AUTOMOTIVE**

- Automobiles
- Auto Body Rebuilding and Refinishing
- Auto Engine Tuneup
- Auto Technician

**AVIATION**

- Aero-Engineering Technology
- Aircraft & Engine Mechanic

**BUSINESS**

- Accounting
- Advertising
- Business Administration
- Business Management
- Cost Accounting
- Creative Salesmanship
- Managing a Small Business
- Professional Secretary
- Public Accounting
- Purchasing Agent
- Salesmanship
- Salesmanship and Management
- Traffic Management

**CHEMICAL**

- Analytical Chemistry
- Chemical Engineering
- Chem. Lab. Technician
- Elements of Nuclear Energy
- General Chemistry
- Natural Gas Prod. and Trans.
- Petroleum Prod. and Engr.
- Professional Engineer (Chem)
- Pulp and Paper Making

**CIVIL ENGINEERING**

- Civil Engineering
- Construction Engineering
- Highway Engineering
- Professional Engineer (Civil)
- Reading Struc. Blueprints
- Structural Engineering
- Surveying and Mapping

**DRAFTING**

- Aircraft Drafting
- Architectural Drafting
- Drafting Machine Design
- Electrical Drafting
- Mechanical Drafting
- Sheet Metal Drafting
- Structural Drafting

**ELECTRICAL**

- Electrical Engineering
- Elec. Engr. Technician
- Elec. Light and Power
- Practical Electrician
- Practical Lineman
- Professional Engineer (Elec)

**HIGH SCHOOL**

- High School Diploma

- Good English
- High School Mathematics
- Short Story Writing

**LEADERSHIP**

- Industrial Foremanship
- Industrial Supervision
- Personnel-Labor Relations
- Supervision

**MECHANICAL and SHOP**

- Diesel Engines
- Gas-Elec. Welding
- Industrial Engineering
- Industrial Instrumentation
- Industrial Metallurgy
- Industrial Safety
- Machine Design
- Machine Shop Practice
- Mechanical Engineering
- Professional Engineer (Mech)
- Quality Control
- Reading Shop Blueprints
- Refrigeration and Air Conditioning
- Tool Design
- Tool Making

**RADIO, TELEVISION**

- General Electronics Tech.

- Industrial Electronics
- Practical Radio-TV Eng'g
- Practical Telephony
- Radio-TV Servicing

**RAILROAD**

- Car Inspector and Air Brake
- Diesel Electrician
- Diesel Engr. and Fireman
- Diesel Locomotive

**STEAM and DIESEL POWER**

- Combustion Engineering
- Power Plant Engineer
- Stationary Diesel Engr.
- Stationary Fireman

**TEXTILE**

- Carding and Spinning
- Cotton Manufacture
- Cotton Warming and Weaving
- Loom Fixing Technician
- Textile Designing
- Textile Finishing & Dyeing
- Throwing
- Warming and Weaving
- Worsted Manufacturing

Name \_\_\_\_\_ Age \_\_\_\_\_ Home Address \_\_\_\_\_  
 City \_\_\_\_\_ Zone \_\_\_\_\_ State \_\_\_\_\_ Working Hours \_\_\_\_\_ A.M. to P.M. \_\_\_\_\_  
 Occupation \_\_\_\_\_

Canadian residents send coupon to International Correspondence Schools, Canadian, Ltd., Montreal, Canada. . . . Special tuition rates to members of the U. S. Armed Forces.



To Introduce You to the  
**RCA VICTOR POPULAR ALBUM CLUB**

THESE FIVE OR **ANY FIVE** OF THE  
 24 ALBUMS LISTED BELOW FOR  
 ONLY \$3.98 [RETAIL VALUE AS HIGH AS \$24.90]

...if you agree to buy five albums from the Club during  
 the next twelve months from at least 100 available

THIS exciting new plan, under the direction  
 of the Book-of-the-Month Club, enables you  
 to have on tap a variety of popular music for  
 family fun and happier parties . . . and at an  
 immense saving. Moreover, once and for all, it  
 takes bewilderment out of building such a well-  
 balanced collection. **You pay far less for albums  
 this way** than if you buy them haphazardly.  
 For example, the extraordinary introductory  
 offer described above can represent as much as a  
 40% saving in your first year of membership.  
**Thereafter you save almost 33 1/3%.** After buy-  
 ing the five albums called for in this offer, you  
 will receive a *free* 12-inch 33 1/2 R.P.M. album,  
 with a nationally advertised price of at least \$3.98,  
 for every two albums purchased from the Club.  
**A wide choice of RCA VICTOR albums** will be  
 described each month. One will be singled out as  
 the *album-of-the-month*. If you want it, you do  
 nothing; it will come to you automatically. If you  
 prefer one of the alternates—or *nothing at all in  
 any month*—you can make your wishes known on  
 a simple form always provided. You pay the  
 nationally advertised price—usually \$3.98, at  
 times \$4.98 (plus a small mailing charge).



ALL ALBUMS ARE  
 12-INCH 33 1/2 R.P.M.  
 LONG-PLAYING



**SINGING STARS • BROADWAY MUSICALS • JAZZ  
 DANCE MUSIC • MOOD MUSIC • COLLECTOR'S ITEMS**

**CHECK THE FIVE ALBUMS YOU WANT  
 DO NOT DETACH FROM THE COUPON**

- |  |   |
|--|---|
| <input type="checkbox"/> WE GET LETTERS.....Perry Como             | <input type="checkbox"/> FAMILY ALL TOGETHER<br>Boston Pops       |
| <input type="checkbox"/> BELAFONTE                                 | <input type="checkbox"/> PORGY AND BESS...Merrill & Stevens       |
| <input type="checkbox"/> FRANKIE CARLE'S SWEETHEARTS               | <input type="checkbox"/> MUSIC FOR DINING<br>Melachrino Orchestra |
| <input type="checkbox"/> NEW GLENN MILLER ORCH. IN HI FI           | <input type="checkbox"/> BOUQUET OF BLUES...Dinah Shore           |
| <input type="checkbox"/> BRASS AND PERCUSSION<br>Morton Gould      | <input type="checkbox"/> SWEET 17.....Ames Brothers               |
| <input type="checkbox"/> JAMAICA.....Original Cast                 | <input type="checkbox"/> LET'S CHA CHA WITH PUENTE                |
| <input type="checkbox"/> STUDENT PRINCE.....Mario Lanza            | <input type="checkbox"/> EYES OF LOVE...Hugo Winterhalter         |
| <input type="checkbox"/> BING WITH A BEAT...Bing Crosby            | <input type="checkbox"/> THINKING OF YOU...Eddie Fisher           |
| <input type="checkbox"/> TOWN HALL CONCERT PLUS<br>Louis Armstrong | <input type="checkbox"/> MOONGLOW.....Artie Shaw                  |
| <input type="checkbox"/> LET'S DANCE with the THREE SUNS           | <input type="checkbox"/> IN A MELLOTONE...Duke Ellington          |
| <input type="checkbox"/> SOUTH PACIFIC<br>Original Sound Track     | <input type="checkbox"/> VICTORY AT SEA...Rodgers' TV Score       |
|  | <input type="checkbox"/> YES INDEED!.....Tommy Dorsey             |
|  | <input type="checkbox"/> BLUE STARR.....Kay Starr                 |

**THE RCA VICTOR POPULAR ALBUM CLUB P149-9**  
 c/o Book-of-the-Month Club, Inc., 345 Hudson St., N. Y. 14, N. Y.

Please register me as a member of The RCA VICTOR Popular Album Club and send me the five albums I have checked at left, for which I will pay \$3.98, plus a small mailing charge. I agree to buy five other albums offered by the Club within the next twelve months, for each of which I will be billed at the nationally advertised price: usually \$3.98, occasionally \$4.98 (plus mailing charge). After my fifth purchase, if I continue, for every two albums I buy I may choose a third album free. After the first year, I need buy only four albums from the Club in any twelve-month period to maintain membership. I may cancel my membership any time after buying five albums from the Club (in addition to those included in this introductory offer).

Name \_\_\_\_\_

Address \_\_\_\_\_

City \_\_\_\_\_ Zone \_\_\_\_\_ State \_\_\_\_\_

NOTE: If you wish to enroll through an authorized RCA VICTOR dealer, fill in here:

Dealer's Name \_\_\_\_\_

Address \_\_\_\_\_

PLEASE NOTE: Send no money. A bill will be sent. Albums can be sent only to residents of the U. S., its territories and Canada. Albums for Canadian members are made in Canada and shipped duty-free from Ontario.





"Bright, clean flavor...pure, snow-white filter...that's **WINSTON**"

*SAYS Bob Cummings* "I go right along with the majority," says the star of The Bob Cummings Show on NBC. "It's America's favorite filter cigarette—and mine!" To a rich, bright blend, Winston adds its own specially designed, pure white filter. The result is an unusually clean, fresh taste—the Winston taste! You'll like it, too!



© 1954 W. T. BATES TOBACCO CO., WINSTON-SALEM, N. C.

Smoke **WINSTON** America's best-selling, best-tasting filter cigarette!