

# POPULAR MECHANICS MAGAZINE

WRITTEN SO YOU CAN UNDERSTAND IT

REG. U.S. PAT. OFF. TRADE MARK, GPO: 1957 O-562,281

REG. U.S. PAT. OFF.



**Build This  
All-Purpose  
Electric Cart  
—Page 166**

Read What the Owners Report About  
**CHEVROLET, FORD  
and PLYMOUTH**  
*15 Pages on Outdoor Living*



*stop dreaming...*



*price it at  
your Evinrude  
dealer*

You can buy this dream! If you doubt it—look out across the sparkling blue water any golden day this spring. See the “Evinrude-powered” families at play. They’re no richer than you—except in living life to the fullest!

Boys and dads by the millions—and mothers and daughters, too—are finding a deeper source of companionship, sharing the fun of cruising, fishing, skiing, exploring a new world of adventure afloat.

Dreaming won't do it... but your Evinrude dealer will. He'll show you how easy it is to own the boating outfit of your dreams. Furthermore, he'll gladly take you and your family for a “Revelation Ride”... let you try, first hand, Evinrude's mighty Starflite V-4, the low-priced, high-powered Four-Fifty, the brilliant new Lark (all with Starflite sound-sealed quiet, Starflite floating-power smoothness)... or any of 8 other dashing new Evinrudes in a size and price to match your needs and budget.

See your Evinrude dealer *now*. His name is listed under “Outboard Motors” in the yellow pages of your phone book. For complete catalog in full color, write Evinrude Motors, 4236 N. 27th Street, Milwaukee 16, Wisconsin.

*A Division of Outboard Marine Corporation  
In Canada: Mfd. by Evinrude Motors, Peterborough*

**EVINRUDE**

*quiet outboard motors*





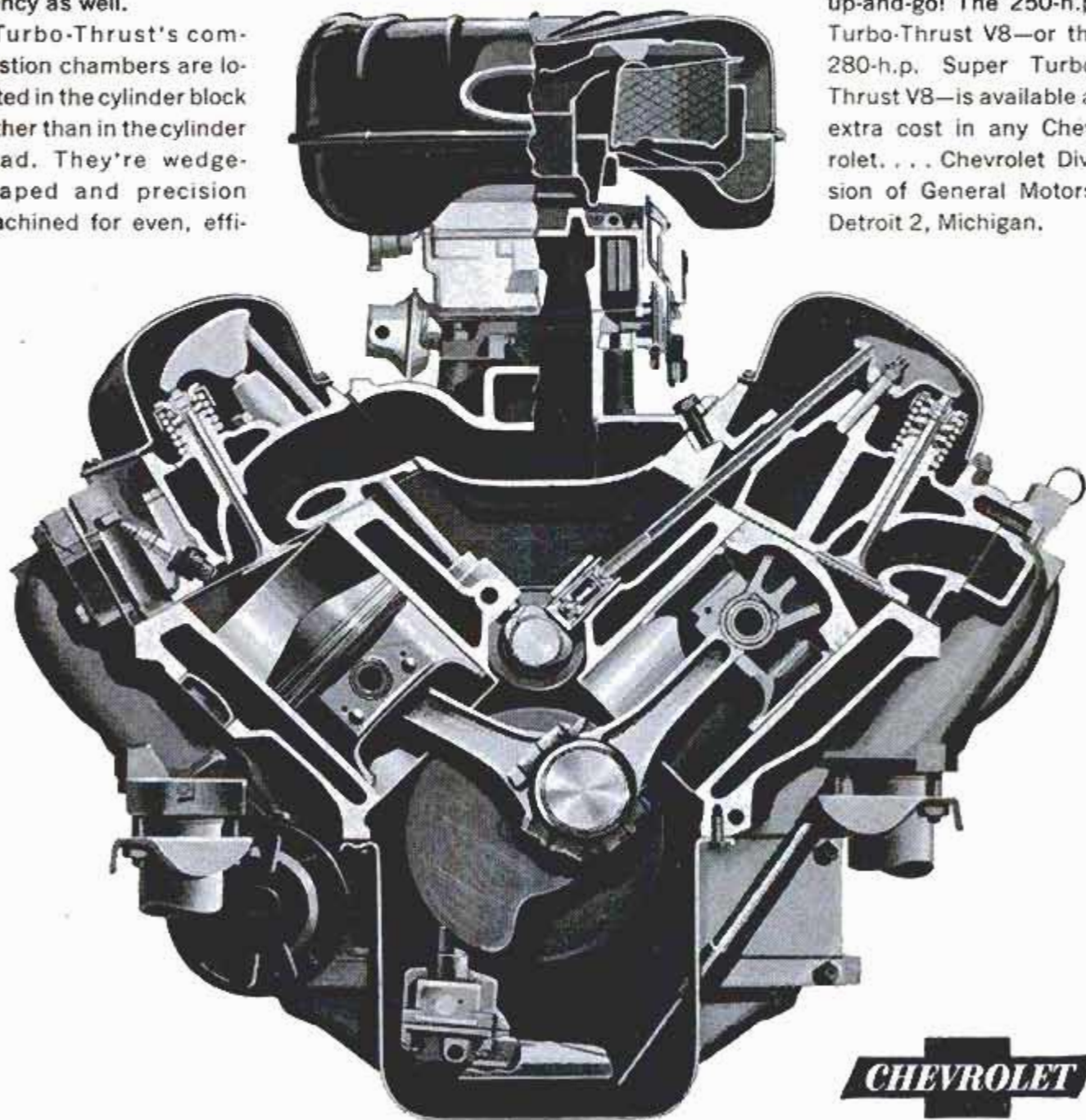
# New in the way it looks . . . in the way it feels —Chevy's Turbo-Thrust V8!

Here's an engineering achievement you can feel the instant your toe touches the treadle. You feel a new kind of response—an ultra-smooth pickup. And when you lift that Chevrolet hood you'll see why. You'll see an engine so radical it even looks different. It's the Turbo-Thrust V8. It's built around a revolutionary design that contributes to constant smoothness at all engine speeds and to exceptional efficiency as well.

Turbo-Thrust's combustion chambers are located in the cylinder block rather than in the cylinder head. They're wedge-shaped and precision machined for even, effi-

cient combustion. Since each chamber is precisely the same size, each piston does the same work. The result is a velvet-smooth flow of power from idling speed right on up. A whopping 348 cubic inches of displacement gives you power when you need it—with plenty in reserve. Visit your Chevrolet dealer today. Lift the hood and see the difference . . . take a drive and you'll feel it!

Here's a new kind of get-up-and-go! The 250-h.p. Turbo-Thrust V8—or the 280-h.p. Super Turbo-Thrust V8—is available at extra cost in any Chevrolet. . . . Chevrolet Division of General Motors, Detroit 2, Michigan.



**CHEVROLET**

APRIL 1958

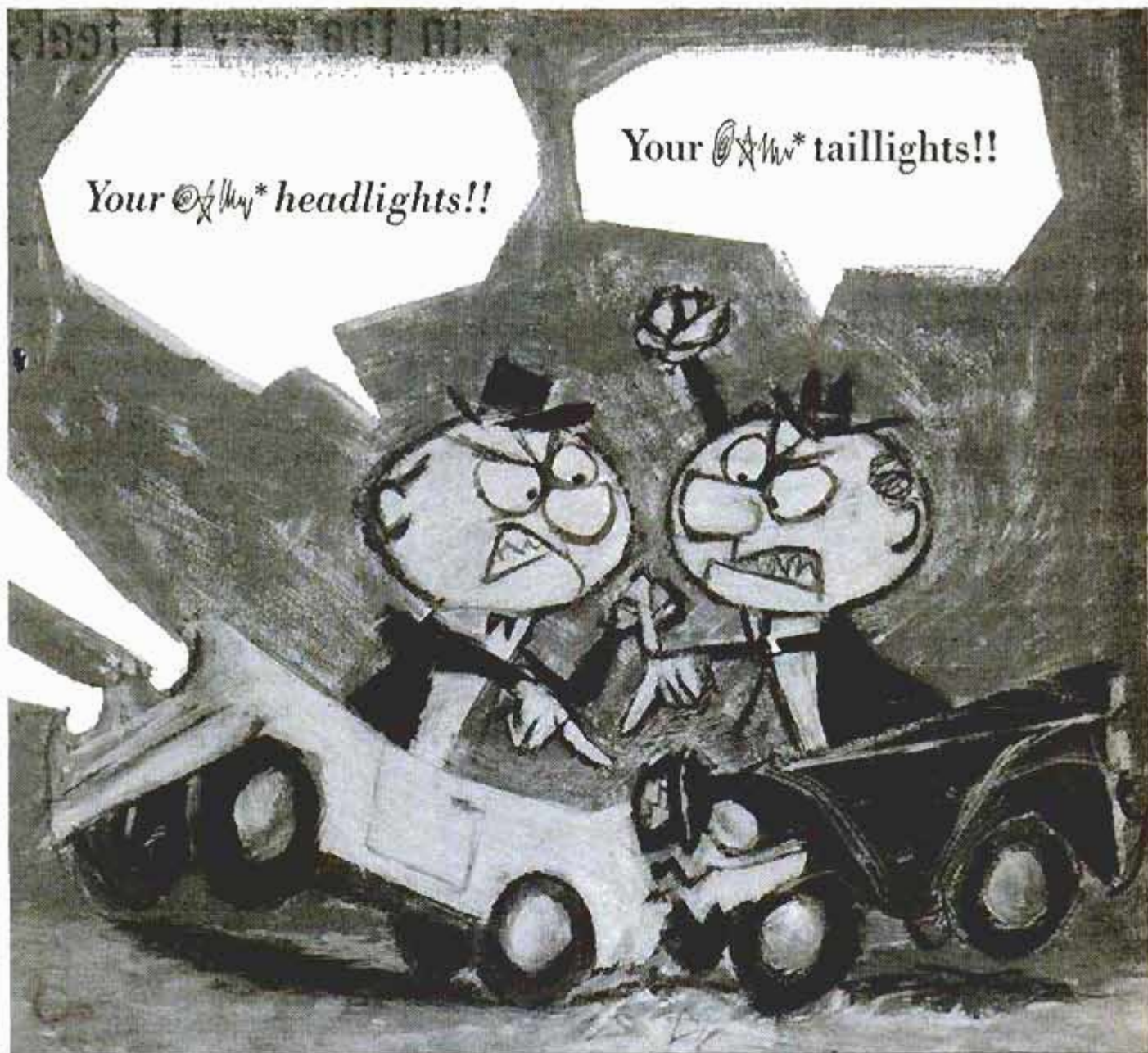
This One



E9B0-F4J-NZ75

1





## Before this happens to you:



**LOOK AT YOUR HEADLAMPS in the daytime!** If you see discolored reflectors, or blackened bulbs or droplets of moisture inside the lenses, *you've already lost much needed light.* G-E *All-Weather* Headlamps will give you a lot more light immediately and maintain it throughout the long life of the lamps. The reflectors stay bright, moisture can't get inside, they have no inner bulbs to blacken. You see better in rain, fog or snow.

maintain it throughout the long life of the lamps. The reflectors stay bright, moisture can't get inside, they have no inner bulbs to blacken. You see better in rain, fog or snow.

### **MAKE SURE YOUR HEADLAMPS ARE PROPERLY AIMED!**

Headlamps are removable parts, subject to road shock and vibration that can cause them to become misaimed. Aimed too low, you can't see far enough ahead. Aimed too high, the lights glare at on-coming drivers. Your dealer should re-aim your headlamps at least twice a year.



**CHECK FOR BURNED OUT REAR LIGHTS!** To be seen, make sure your taillights, stop lights, turn signal and license plate bulbs are working. Next time you drive in for gas or a lube job, ask your dealer to check rear lights and replace those that may have burned out with new G-E bulbs. General Electric Company, Miniature Lamp Dept. PM-48, Nela Park, Cleveland 12, Ohio.

ask your dealer to check rear lights and replace those that may have burned out with new G-E bulbs. General Electric Company, Miniature Lamp Dept. PM-48, Nela Park, Cleveland 12, Ohio.

*\*Blankety-blank, that is!*

*Progress Is Our Most Important Product*

**GENERAL  ELECTRIC**

POPULAR MECHANICS



# Popular Mechanics Magazine

Registered in U. S. Patent Office and Canada

H. H. WINDSOR, Founder

H. H. WINDSOR, JR., Editor and Publisher

Managing Editor

RODERICK M. GRANT

Assistant Managing Editor

WAYNE WHITTAKER

Shop Notes and Crafts Editor

JAMES R. WARD

Associate Editors, General Features

CLIFFORD B. HICKS

ARTHUR R. RAILTON, Automotive

KENNETH N. ANDERSON

Associate Editors, Shop Notes and Crafts

WAYNE C. LECKEY W. CLYDE LAMMEY

Radio-Television, Electronics Editor

LOTHAR STERN

Assistant Editors

SHELDON MIX, General Features

JAY W. HEDDEN, EARL WOBEC, Crafts

JOHN DALEN, ARLENE HORNICK, Makeup

Art Staff

FRANK BEATTY, Director

HENRY NEHRBASS, Assistant Director

RALPH LINNENBURGER, Art Editor

Eastern Editor

RICHARD F. DEMPEWOLFF

Empire State Bldg., New York City 1

Western Editor

THOMAS E. STIMSON, JR.

Suite 1010, 3460 Wilshire Blvd.,  
Los Angeles 5, Calif.

London Manager

DOUGLAS W. WEDDERSPOON

Eagle House, Jermyn St.,  
London S.W. 1, England

Director, Bureau of Information

ALLAN CARPENTER

Advertising Offices

Chicago: 200 E. Ontario St., Whitehall 4-0100;  
New York: Empire State Bldg., 350 Fifth Ave.,  
Longacre 5-7580; Detroit: General Motors  
Bldg., TRinity 5-8711; Cleveland: Hanna  
Bldg., 1422 Euclid Ave., PRospect 1-0456; Los  
Angeles: 3460 Wilshire, DUnkirk 2-8458; San  
Francisco: Russ Bldg., 235 Montgomery St.,  
Yukon 2-0823.

Published monthly by Popular Mechanics Company,  
200 E. Ontario St., Chicago 11, Ill. H. H. Wind-  
sor, Jr., President; Wm. Harrison Ferridge, exec.  
vice-pres.; Franklin S. Forsberg, operations vice-  
pres.; D. F. Windsor, vice-president and secretary-  
treasurer; H. H. Windsor III, vice-president; W. T.  
Windsor, vice-president; Joseph R. Buell, Jr., ad-  
vertising manager; Alan M. Deyoe, circulation  
manager. Single copy in the United States and  
Canada, 35 cents; subscription rates in the United  
States and possessions, Canada and countries of  
the Pan-American Postal Union, 1 year \$3.50; 2  
years, \$6.00; 3 years, \$8.00. To all other coun-  
tries add \$1.00 a year over United States prices  
for overseas postage. If you plan to move, notify us  
at least 30 days in advance so you will not miss  
an issue. Give both your old and new addresses.  
Entered as Second Class Matter, September 15,  
1903, at the Post Office at Chicago, Illinois, under  
Act of March 3, 1879. Entered as Second Class  
Matter at Post Office Dept., Canada. Registered  
as Second Class Matter at the Post Office at  
Mexico, D.F., Mexico, June 20, 1950.  
Copyright 1958 by Popular Mechanics Company,  
Copyright under International Copyright Union.  
Copyright in France. All rights reserved under  
Pan-American Copyright Union. Printed in the  
United States of America.

FOREIGN EDITIONS:	MECANIQUE POPULAIRE (French)	MECANICA POPULAR (Spanish)	POPULAER MEKANIK (Danish)	POPULAR MEKANIK (Swedish)	POPULARE MECHANIK (German)
Volume 109	APRIL 1958			Number 4	

Address all communications to: 200 E. Ontario St., Chicago 11, Ill.

## In This Issue...

Our Spy in Outer Space	81
How to Stay Alive on Mountain Highways	88
The Jet Stream Is the Villain	96
Owners Report on Ford, Chevrolet and Plymouth	102
Quick Power When Disaster Strikes	109
It's Moving Day!	121
Push a Button and You Make Beef	134
"K" Rations for the Zoo	140

## OUTDOOR-LIVING SECTION—

We Built a Family Room Outdoors	144
Patios in the Sky	150
Outdoor Living on a 20-Foot Lot	152
Three Pools for Small Lots	154
A Yard Is for Fun	156
Radio, TV and Electronics	159

## For the Craftsman...

Attracting Songbirds to Your Garden	163
Golf Cart—or Family Runabout—Part I	166
Bozo, the Puppet—Part I	178
Swish—a 15-ft. Sports Runabout—Part I	188
Buying a Used Camera	200
How to Cut Lap Joints	207

## Regular Departments...

Detroit Listening Post	100	On the Market	199
What's New for Your Home	126	Shopping for Tools	218
Solving Home Problems	176	Clinic for Homemakers	228

Turn to detailed index on page 74. Sources of additional information on items in this issue are shown on the Where-to-Find-It List, available without charge by writing the Bureau of Information, Popular Mechanics, 200 E. Ontario St., Chicago 11, Ill.

## Next Month...

CAMPERS ARE taking to the by-ways by the millions these days. Can an average family have fun camping? How much will it cost? What equipment is required? To learn the answers to these questions, we sent a family on a 7500-mile camping tour. The first of two articles on their joys and headaches will appear in May





# Impartial X-Ray\* Shows **RAMBLER** Leads All Low-Price Cars

**IN PERFORMANCE—HANDLING EASE  
ECONOMY—SAFETY  
COMFORT—TRADE-IN VALUE!**

All cars look good on the showroom floor. But beneath the paint and chrome are enormous differences. Some cars are gas hogs. Some are cumbersome, hard to handle and park. Some develop rattles and squeaks almost before you get them to your driveway.

Before you buy any car, it pays to get the straight, unbiased facts on room—performance—construction—economy—parking ease—safety and trade-in value.



You Get The Straight Facts  
On All Low-Price Cars In The  
*Revealing 32 Page*  
**1958 X-RAY**

Page after page compares them all—point-by-point. You will learn exactly what you get for your motor car dollar. All data is taken directly from the official literature of automotive manufacturers and from automotive engineering publications. It is compiled in easy-to-read and easy-to-understand style. The few minutes you spend reading the 1958 X-Ray can well be the most valuable time you spend all year . . . time that can save you hundreds of dollars.



*Before You Buy Any New Car—*

**\*SEE YOUR RAMBLER DEALER  
FOR YOUR FREE COPY OF  
THE FACTUAL 1958 X-RAY!**

The profusely illustrated X-Ray is yours for the asking at your Rambler dealer's. Get your copy now. And while you're there, guest-drive a new 1958 Rambler 6 or V-8. Learn for yourself why Rambler rates tops under the discerning eyes of the X-Ray.

AMERICAN MOTORS CORPORATION



14250 Plymouth Road, Detroit 32, Michigan





# ALL NEW SUPER GRAPHIC® 4x5

One look at the Super Graphic 45 will tell you that this brand new camera means business! Though smaller than its predecessor, the Pacemaker Graphic, it has even greater versatility while maintaining the 4x5 format. Size and shape have been designed for utmost user convenience. All locks and releases are convenient to adjust, large enough and properly shaped for easy operation. Swings, tilts and shifts have "click stop" neutral positions. An electric tripping button for shutter and flash is located convenient to the left hand. Focusing scale and automatic flash calculator are on top of the camera. All flash and shutter connections are internally wired, eliminating dangling cords. Revolving back lets you take horizontally or vertically composed pictures with equal ease. See this advanced new camera at your Graflex dealer's or write Dept. PM-48, Graflex, Inc., Rochester 3, N. Y., for further information.

## More Features...

- Automatic flash setting calculator.
- Front standard swings horizontally, tilts forward or backward, rises and shifts.
- New focusing hood for quiet, one-handed operation.
- Large, easy-to-handle coupled rangefinder cam and simplified mechanism for easy changing of cams.
- Integral rangefinder works even with wide angle lenses.
- Revolving back accepts all Graflex-made film accessories.
- Polarized 3-pin cord outlet in camera body connects to Grafite and Stroboflash and eliminates cords dangling from shutter.



Revolving back turns 360° in either direction. Click stops at horizontal and vertical positions.



Front standard swings horizontally, tilts forward or backward, rises and shifts.



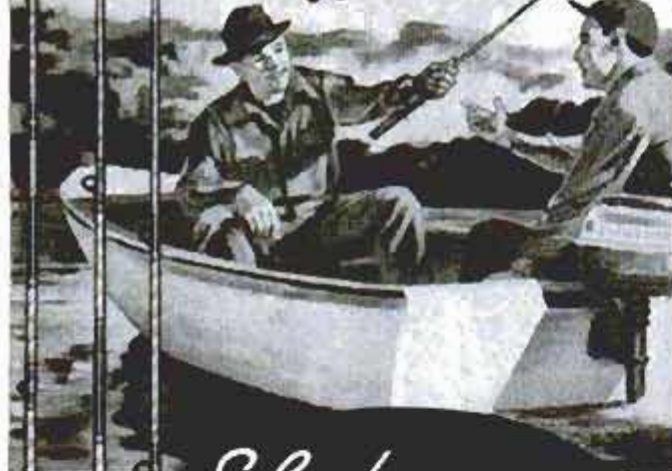
Electrical body release for tripping shutter, Stroboflash and Grafite. Internal power supply and wiring.

**GRAFLEX** • *Price-Winning Camera*  
A PRODUCT OF GENERAL PICTURES DEVELOPMENT CORPORATION





"Feel the Difference"



Shakespeare  
**WONDEROD**

THE STRAIGHT-FIBER TUBULAR GLASS ROD  
WITH THE SPIRAL MARKINGS

**Instantly you know  
it's the rod for you!**

Pick up a Wonderod, you'll thrill to the superb action, pin-point accuracy and fish-fighting power of exclusive Shakespeare straight-fiber, tubular glass construction. So light — slim — strong! For bait casting, spinning, fly-fishing, salt water or exciting new push-button fishing, there's a new Shakespeare Wonderod just waiting for you... Go pick it out, you'll be satisfied with nothing less!

Left to Right No. 1252T Fly \$22.95—No. 1463 Spinning \$18.95—No. 1577 Spin'R Cast \$16.95



**FREE! 5 COLORFUL NEW  
FISHING BOOKLETS & CALENDAR**

Write today for latest in fishing ideas and equipment on salt water, bait casting, spinning, fly and push-button fishing.

**SHAKESPEARE CO., Dept. PM-4, Kalamazoo, Mich.**  
Please send me absolutely free your 5 new fishing booklets and calendar.

Name \_\_\_\_\_

Address \_\_\_\_\_

City \_\_\_\_\_ State \_\_\_\_\_

## ACROSS THE DESK



### Avalanche of Letters

Letters by the thousands have poured in to our Bureau of Information requesting reprints of the "Significant Sixteen" autos reproduced in color in the special automotive section of the February issue. The



letters came from every state in the union and from many foreign countries. Additional reprints are now off the press and available. Requests should be accompanied by 25 cents in coin and addressed to Bureau of Information, *Popular Mechanics*, 200 East Ontario St., Chicago 11.

Here are samplings from the letters:

How could your experts overlook the Duesenberg? Four-wheel hydraulic brakes alone make it significant. . . .

Calvin D. Morehart,  
Columbus, Ohio

☆

As a collector of antique automobiles and an officer (Ed. NOTE: *He's president.*) of the Minneapolis Region of the Horseless Carriage Club of America, I would like to submit my own list of great automobiles: 1893 Duryea, 1896 Ford, 1901 Oldsmobile, 1903 Ford, 1904 Buick, 1905 Packard, 1906 Orient Buckboard, 1908 Thomas Flyer, 1909 Ford Model T, 1912 Cadillac, 1912 Locomobile, 1915 Cadillac, 1915 Dodge, 1919 Ford, 1925 Chrysler, 1926 Chevrolet, 1928 Ford, 1929 Cadillac, 1930 Packard, 1932 Lincoln, 1932 Ford Model 18, 1933 Chevrolet, 1934 Chrysler Airflow, 1935 Ford, 1937 Oldsmobile, 1939 Lincoln Continental, 1941 Packard, 1944 Willys Jeep, 1947 Studebaker, 1948 Tucker, 1949 Ford, 1955

(Continued to page 8)



**A  
BETTER  
JOB  
MORE MONEY**



**LEARN ACCOUNTING...**

**SEND FOR FREE SAMPLE LESSON**

You need no special talents to be a success in Accounting. You do not even need a preliminary knowledge of bookkeeping. All you need is the will to win—the will to work—and if you apply yourself you, too, can get into the bigger-money class.

Demand for Accountants far exceeds the supply—and this demand is increasing every day. A capable accountant should never have any trouble getting a job—and at better than average earnings.

We train you from the ground up—Basic Accounting right through Accounting Systems and Federal Income Tax. Then CPA Training to prepare for the CPA examinations.

**Why Be Satisfied with Your Present Job?**  
Why accept mediocre pay when right in your own home you can acquire the necessary training to advance rapidly in the profitable, growing field of Accounting.

**Take the Short Cut  
The LaSalle Problem Method**  
Under the LaSalle Problem Method you can acquire a thorough knowledge of Accounting—you can master its fundamental principles—and become

**OVER 4,500 CPAs HAVE BEEN  
TRAINED BY THE FAMOUS LASALLE  
PROBLEM METHOD**

expert in the application of those principles. You learn by doing—and without losing any time from your present work.

Your training is directly under the supervision of a competent staff of Certified Public Accountants and accounting experts—and you can master Accounting as rapidly as your time and ability permit.

**Free Sample Lesson**

Send the coupon today—our FREE booklet "Opportunities in Accounting" will be sent promptly along with a sample lesson. It explains fully how we train you from the ground up—or from where you are now—according to your individual needs.

Get all the facts. The cost is low—terms easy. Don't pass this page without tearing out the coupon and mailing it promptly. It can be the means of your success—more money—a better job. Get our FREE booklets and judge for yourself.

**ACCREDITED MEMBER,  
NATIONAL HOME STUDY COUNCIL**

**FIFTY YEARS OF  
QUALITY TRAINING**

**LEU**

**SEND FOR FREE BOOK**



**LaSalle Extension University**

**A Correspondence Institution**  
Dept. 464H, 417 S. Dearborn St., Chicago 5, Ill.

Please send me, free of all cost or obligation, a sample lesson in Accounting... also, your latest illustrated book, "Opportunities in Accounting."

Name..... Age.....

Address.....

City, Zone, State.....



# OPTICAL BARGAINS

## 3" ASTRONOMICAL REFLECTING TELESCOPE

(Famous Mt. Palomar type)  
See the Stars, Moon, Planets Close Up!  
60 & 120 Power — An Unusual Buy!  
Assembled and Ready to Use! You'll see the Rings of Saturn, the fascinating planet Mars, huge craters on the Moon. Aluminized and overcoated 3" diameter high-speed f/10 astronomical mirror. Telescope comes equipped with a 60X eyepiece and a mounted Barlow Lens, giving you 60 & 120 power. Optical Finder Telescope, included. Sturdy, hardwood, portable tripod. Free with scope! Valuable STAR CHART and 272 page "Astronomy Book." Stock No. 85,080-H.....\$29.50 f.o.b. Barrington, N. J. (Shipping wt. 10 lbs.)

Be Ready to See Rockets Land on the Moon!  
Order an EDMUND TELESCOPE Now!

## 4 1/4" ASTRONOMICAL TELESCOPE

Mt. Palomar type! Up to 270 Power. A fine Reflector Telescope complete with real Equatorial Mount and Tripod and 6X Finder. Aluminum tube, 4 1/4" dia. mirror, rack and pinion focusing eye-piece holder, 2 eyepieces and mounted Barlow Lens for 40X, 90X, 120X and 270X. Shipping weight approx. 25 lbs. Stock No. 85,008-H.....complete. \$74.50 f.o.b. Barrington, N. J.

## MAKE YOUR OWN ASTRONOMICAL TELESCOPE

See December, 1957 issue of POPULAR MECHANICS—Pages 188-192.  
4 1/2" MIRROR KIT—Contains ready-to-use 4 1/2" diameter concave, aluminized objective mirror, lenses for 1" focal length eyepiece, and aluminized first surface diagonal mirror.  
Order Price  
Stock No. 50,074-H.....\$16.25 postpaid  
4 1/2" Mirror only — \$15.00 postpaid  
Stock No. 50,051-H.....  
We have additional eyepieces, tubes, tripods, in fact everything you need to build telescopes.

## New! 2 in 1 Combination! Pocket-Size

### 50 Power MICROSCOPE and 10 Power TELESCOPE

Useful Telescope and Microscope combined in one amazing, precision instrument. Imported! No larger than a fountain pen. Telescope is 10 Power. Microscope magnifies 50 Times Sharp focus at any range. Handy for sports, looking at small objects, just plain snooping. Send Check or M.O. Satisfaction Guaranteed. Order Stock No. 30,059-H.....\$4.50 Pstpd.

## REAL 150 POWER ASTRONOMICAL TELESCOPE

ONLY \$16.95 Postpaid  
A good value at this price though not the equal of our Reflecting scopes above. Refractor type! Clear, razor-sharp viewing of stars, planets, craters on moon, etc. 32mm achromatic objective lens! First surface mirror diagonal lends "stoop" viewing. Removable eyepiece—interchangeable, 50, 75, and 150 power! Tube length 27 1/2". Special attachment clamp for vibrationless viewing. Money back guarantee. Included free! 272 page "Handbook of the Heavens," Star Chart and 16 page Star Booklet. Stock No. 80,060-H.....\$16.95 Postpaid

Larger 42mm objective model—67, 100, 200 power—same features as above, with 38" tube length—(included free: "Handbook of the Heavens," Star Chart and 16 page Star Booklet).  
Stock No. 80,061-H.....\$19.95 Postpaid

## See The Satellites

### NEW, LOW PRICE "SATELLITER" TELESCOPE

Get ready for a terrific sky show as more Satellites are vaulted into space. See thrilling sights with our amazing Satellite Scope at unheard of low cost. Also view comets—use as a Rich-field Scope for viewing star clusters. 5 power—wide 12° field. Use of high quality war surplus optics makes possible this bargain.  
Stock No. 70,150-H.....\$9.95 Postpaid  
We are the mfr. of the Famous "Moonwatch" Satellite Telescope!

## BUILD A SOLAR ENERGY FURNACE

A fascinating new field. Build your own Solar Furnace for experimentation—many practical uses. Easy! Inexpensive! Use scrapwood! We furnish instructions. This sun powered furnace will generate terrific heat—2000° to 3000°. Fuses enamel to metal. Sets paper aflame in seconds. Use our Fresnel Lens—14 3/4" diameter... f.l. 14".  
Stock No. 70,130-H—package of 1.....\$ 6.00 Pstpd.

## INFRARED SNIPERSCOPE TELESCOPE & PARTS

See in the dark—without being observed. War Surplus Sniperscope M-2, Gov't. cost about \$1200. Instrument complete, ready to use. Includes Power Pack, infrared light source. Will operate from 6 V auto battery. Battery or transformer available. Stock No. 85,053-H.....\$150.00 f.o.b. Save still more money! Build your own Sniperscope! We will furnish instructions—parts, including: Power Packs, 1P25A image tubes, light units, filters, etc. For details—request FREE Catalog "H."

## WRITE FOR FREE CATALOG "H"!

Complete Line of Astronomical Telescope Parts and Assembled Telescopes. Also huge selection of lenses, prisms, war surplus optical instruments, parts and accessories. Telescopes, microscopes, satellite telescopes, binoculars, etc. Request Catalog "H"!

ORDER BY STOCK NUMBER. SEND CHECK OR MONEY ORDER. SATISFACTION GUARANTEED!  
EDMUND SCIENTIFIC CO., BARRINGTON, N. J.

(Continued from page 6)

Chevrolet, 1956 Continental, 1958 Rambler American.

David J. Leipold,  
Minneapolis, Minn.

Especially would I like the reprints since my brother was the artist. . . .

Mrs. William Lowell White,  
Camp Verde, Ariz.

As a collector of old cars I would like to frame the reprints to hang in our small museum. . . .

G. Nelson Pfundt,  
Georgana Farms,  
Bucks County, Pa.

Auto issue this year is outstanding. . . .  
Harley D. Mitchell,  
Temple, Tex.

Haven't missed an issue in many years.  
John H. Heintz,  
City Manager,  
Franklin, Ohio

Too many of our youth of today fail to realize the struggle of the early automobile men to produce and market a car. Perhaps this will show them that nothing really new and startling has been accomplished in quite a few years in the auto business.

Mark Williams,  
Henderson County High School,  
Henderson, Ky.

Thought the cars were beautiful but should have included the Stutz and Mercer.  
Michael Radakovich,  
Huntington Park, Calif.

A salute to you for the accuracy of the color illustrations of early model cars, February number. Only one slight oversight: the dos-a-dos seat of 1902 Oldsmobile should have two rods supporting footrest.  
Hi Sibley,  
Nuevo, Calif.

... concerning one car not listed—Maxwell by Brisco . . . was the first with thermosiphon cooling for water and three-point motor suspension. . . .

George A. Ferrell,  
Binghamton, N. Y.

... bring back a lot of memories. I started as a driver in New York in 1907.

William G. Strawbridge,  
Boca Raton, Fla.

(Continued to page 10)





**You Can**

# Train at Home in Spare Time for Good Jobs - Better Pay

Today, choose the career you want and take the first step toward that goal. Training plus opportunity is the perfect combination for success. NRI has trained thousands of men at home, in their spare time. NRI is the oldest, largest home study Radio-TV school . . . our 40 years' experience in training men can be your doorway to success.

## Be a Radio-TV Technician

Radio-Television is America's fast growing industry. That's why it has special appeal to ambitious men not satisfied with their job and earnings. 4,000 Radio and TV stations on the air. 150 million home radios, 40 million TV sets. Plan now to get into Radio-TV. NRI can supply training quickly. Keep your job while learning. Soon after enrolling many students start to earn \$10, \$15 a week extra in spare time fixing sets for neighbors, pay for their course this way. Multi-tester you build helps make spare time earning.

### NRI Sends You Equipment for Practical Experience

NRI training is learn-by-doing. You get easy to understand lessons. NRI sends you kits of parts to build equipment for practical experience. Find out now what NRI Radio-TV Servicing or Communications training offers you. Check and mail the coupon below.



## Fix Electrical Appliances

Electric Appliance Repair offers you good pay, SECURITY. Every wired home averages 8 electrical appliances. Up to 10 million more sold every year. Owners pay well to keep them in repair. Train now to earn more in a good job or step up your income with a business of your own. As an Appliance Service Technician your opportunities are broad — your services wanted, highly regarded in your community.

### Start Soon to Make \$10 to \$15 a Week Extra in Your Spare Time

NRI training is practical, thorough. NRI supplies parts to build professional type Multi-tester. You can use it to earn extra money fixing appliances soon after starting course. Find out today about NRI Electric Appliance Service Training. Cost of course is low. Easy terms. NATIONAL RADIO INSTITUTE, Dept. 8DA, Washington 16, D.C.



## Sample Lesson and Catalog FREE

NATIONAL RADIO INSTITUTE, Dept. 8DA, Washington 16, D.C.

(CHECK ONE PLEASE—NO SALESMAN WILL CALL)

**Radio-Television**—Please send me FREE Sample Lesson and 64 Page Catalog on Radio-Television Servicing and Communications.

**Electric Appliance**—Please send me FREE Sample Lesson and Catalog on your Electric Appliance Servicing Training.

Name \_\_\_\_\_ Age \_\_\_\_\_ Address \_\_\_\_\_

City \_\_\_\_\_ Zone \_\_\_\_\_ State \_\_\_\_\_

ACCREDITED MEMBER, NATIONAL HOME STUDY COUNCIL





(Continued from page 8)

The pupils in my class at the Rawson School are studying the development of the automobile. I am sure they will benefit from the pictures. . . .

Yvonne M. Bellerose,  
Hartford, Conn.

☆

I am a high school auto-mechanics instructor and will use these in discussing the history of our American automobiles.

Jack A. De Angelis,  
Los Angeles, Calif.

☆

I happen to own one of the Chrysler Airflows 1934 and its cruising speed of 90 m.p.h. or better with gas consumption of 19 m.p.g. leaves one to wonder where the improvements are in today's crazy wrap-around sweat boxes. . . .

O. L. Hinger,  
El Paso, Tex.

☆☆☆

### Award Winner

One of the houses featured in the PM Parade of Homes (*Popular Mechanics*, October 1957) won a coveted National Association of Home Builders' 1958 Design Merit Award. The house was designed by Francis D. Lethbridge, A.I.A., of Keyes and Lethbridge, Washington, D.C., and was

built by the Bennett Construction Company in a suburb of Bethesda, Md.

☆

### Hitting Below the Beltline

After studying your "Dictionary of the Automobile Stylist" I believe I am now tuned in to give my opinion of the 1958 products of the Ivory Towers, who have been striving so hard for ipsipipsi and spooky automobiles.

In their attempts to design something gutty and gasarooney, they have pizazzed the whole thing and made it hairy, goo-goo and gorped up.

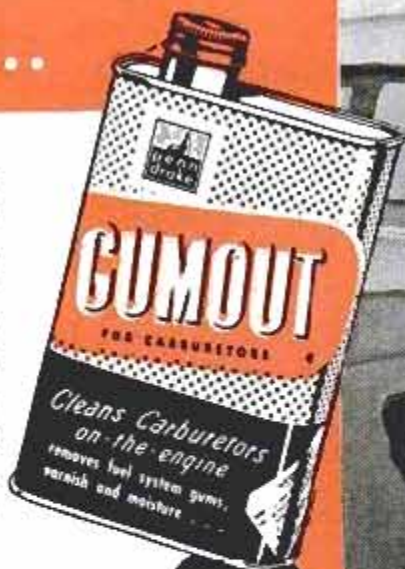
Much as I need a new car, I refuse to trade my '51 model for one of these gorky things with spaghetti from fireplace to telephone pole. Let's hope the stylists sweeten their designs and leave off the stinkles.

Bob Ingle, Jr.,  
Macon, Ga.

ED. NOTE: For those of you who missed the dictionary (Feb. 172-3) here are a few definitions to help you translate the above: Ipsipipsi, correct proportions; spooky, futuristic; gutty, powerful; gasarooney, terrific; pizazz, give it everything; hairy and goo-goo, overdone; gorped up and gorky, out of shape; spaghetti, too many moldings; fireplace, grille; telephone pole, molding below taillight; stinkles, glitter.

## CLEANS YOUR CARBURETOR while you drive...

Hard starting, stalling, high gas consumption and poor performance all come from a dirty, gummed-up carburetor. And every carburetor gets dirty—inside. GUMOUT dissolves gum and varnish deposits quickly and completely. You just add GUMOUT to your gas tank every two or three months. It cleans as you drive! There's nothing like GUMOUT. Available at all auto supply stores, or wherever automotive products are sold.



8-OZ.  
89c



GUMOUT is great for power mowers, too. Insures trouble-free operation, full power.

PINT  
\$1.50

Write for FREE 46-page Carburetor Handbook.

GUMOUT DIVISION • Pennsylvania Refining Co., 2671 Lisbon Road, Cleveland 4, Ohio





# INVENTORS

**L**earn how to protect your invention. The U. S. Patent Laws provide that any new and useful art, machine, article of manufacture, or composition of matter, or any new and useful improvement thereof, may be patented if the act of invention is involved. Therefore, every inventor with a valuable invention should take advantage of the Patent Laws and proceed for patent protection in order to safeguard his rights.

A patent gives the inventor the exclusive right to prevent others from making, using, or selling the invention claimed in the patent for a period of seventeen years.

The Patent Laws were enacted for the benefit of the inventor to give him protection for the features of his invention which are patentable. These features must be properly and concisely set forth and claimed in a formal application for patent, in order to comply with the requirements of the Patent Laws. For that reason, unless the inventor is familiar with patent matters, he should engage a competent registered patent attorney or agent to represent him. We are registered to practice before the U. S. Patent Office and are prepared to serve you in the handling of your patent matters.

A specially prepared booklet entitled "Patent Guide for the Inventor", containing detailed information with respect to patent protection and procedure, together with a "Record of Invention" form will be promptly forwarded to you without obligation upon request.

**CLARENCE A. O'BRIEN & HARVEY JACOBSON**

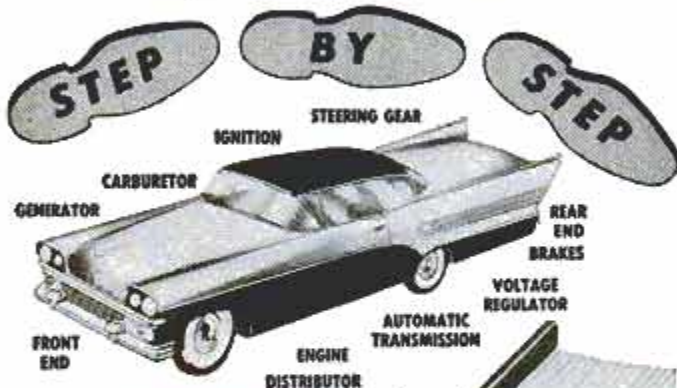
*Registered Patent Attorneys*

**81-D DISTRICT NATIONAL BUILDING**

**WASHINGTON 5, D. C.**



# HOW TO FIX ANY CAR



**FREE 7-DAY TRIAL**

**MOTOR'S AUTO REPAIR MANUAL**

ANY tune-up, service or repair job on ANY car can be as easy as A-B-C when factory experts show you how-to-do-it one step at a time. That's why no job's too tough to handle when you've got MOTOR'S brand-new AUTO REPAIR MANUAL at your elbow!

Book "starts from scratch" — tells you WHERE to start, what TOOLS to use. Whether you're a beginner or an expert mechanic—you can "breeze through" ANY repair on ANY make or model car built from 1949 through 1958!

Everything You Need to Know in 1000 Big ILLUSTRATED Pages!

NEW, REVISED, 1000-Page Edition contains the "meat" from 176 OFFICIAL shop manuals — simplified for YOU. 23,436 essential repair specifications on 24 different makes. More than 2,900 "this-is-how" pictures. 225,000 service and repair facts. Leads beginners every step of the way. Time-saving factory repair procedures for experts. Instructions and pictures so clear you CAN'T go wrong. Used by U. S. Army and Navy. 2,500,000 COPIES SOLD!

Try Book FREE 7 Days

Just mail coupon. (Attach it to postcard if you wish.) Make Manual PROVE what it's got. Unless you agree this is the greatest time and work saver you've ever seen—return book in 7 days, pay nothing. Mail coupon to: MOTOR BOOK Dept., Desk 1D, 250 W. 53 St., N. Y. 19.

Same FREE offer on MOTOR'S New Truck Repair Manual

Brand new! Covers EVERY job on EVERY popular make gasoline and Diesel truck made since 1949. FREE 7-Day Trial. Check proper box in coupon

Covers All Models — 1949 thru 1958

Buick	Jeep
Cadillac	Lincoln
Chevrolet	Mercury
Chrysler	Nash
Clipper	Oldsmobile
Continental	Packard
De Soto	Plymouth
Dodge	Pontiac
Edsel	Rambler
Ford	Studebaker
Hudson	Thunderbird
Imperial	Willys



## BVI Painting is Easy! Electric PAINT SPRAYER

with built-in motor  
only \$1295 complete  
Fully Guaranteed



Just plug in, pull trigger and spray paint, varnish, enamel, garden sprays and insecticides. 3 to 7 times faster than painting with a brush! Features sapphire nozzle, instant adjustment for heavy or light spray. Foolproof and trouble-free! Available now at dealers everywhere!

Burgess Vibrocrafters Inc. Grayslake, Illinois

## CABINET MAKING

LOW COST HOME TRAINING COURSE FOR BEGINNERS & ADVANCED CRAFTSMEN

Make money. Learn skills and secrets of fine woodworking and tool use. Professionally prepared shop method training tells and shows how. Covers everything. Easy to master.

Write for Free Booklet INTERSTATE TRAINING SERVICE DEPT. F3, PORTLAND 13, OREGON

## Print Your Own

Cards, Stationery, Advertising, Circulars, labels, photo and movie titles, church work, tags, etc. Save money. Sold direct from factory only. Raised printing like engraving, too.

Own a Printing Business

Print for Others, Good Profit. Have home shop. Junior press \$15; Senior \$29 up. We supply everything. Easy rules. Pays for self in short time. Write for free catalog of outfits and all details. KELSEY PRESSES, C-37 Meriden, Conn.

Kelsey Presses

## STUDY TO BE A DOCTOR

of Psychology or Metaphysics

Obtain a Ph.D., M.S.D., or Ph.D. Be a Teacher, Lecturer or Accredited Practitioner. Teach others how to achieve Health, Happiness and Contentment. Chartered by State. Correspondence Courses only. Write for FREE book telling how.

THE NEOTARIAN FELLOWSHIP  
Desk B, Pickwick Building Kansas City 6, Missouri

## SAVE \$10.00

NORELCO "Speedshaver" Men's Electric Shaver. Latest model, brand new and fully guaranteed.

Complete with case, cord and cleaning brush. Regularly retails at \$24.95.

Our price \$14.95 postage pd. All orders filled within 24 hrs. Your money back if you are not fully satisfied. Send check or M.O. to: JOHN BROOKS, Dept. 984, Box 212, St. Louis 3, Mo.

JOHN BROOKS, Dept. 984, Box 212, St. Louis 3, Mo.

## RUPTURED

BE FREE FROM TRUSS SLAVERY

Surely you want to THROW AWAY TRUSSES FOREVER, be rid of Rupture Worries. Then Why put up with wearing a griping, chafing and unsanitary truss. For there is now a new modern Non-Surgical treatment that is designed to permanently correct rupture. These Non-Surgical treatments are so certain, that a Lifetime Certificate of Assurance is given.

Write today for our New FREE Book that gives facts that may save you painful, expensive surgery. Tells how non-surgically you may gain work, live, play, love and enjoy life in the manner you desire. There is no obligation. Excelsior Hernia Clinic, Dept. 8305, Excelsior Spgs., Mo.

MAIL COUPON NOW FOR 7-DAY FREE TRIAL (Attach to Postcard if More Convenient)

MOTOR BOOK DEPT.  
Desk 1D, 250 W. 53th St., New York 19, N. Y.

Rush to me at once (check box opposite book you want):

MOTOR'S New AUTO REPAIR MANUAL. If O.K. I will remit \$2 in 7 days, \$2 monthly for 2 months and a final payment of \$1.95 (plus 35¢ delivery charges) one month after that. Otherwise I will return the book postpaid in 7 days. (Foreign price, remit \$10 cash with order.)

MOTOR'S New TRUCK REPAIR MANUAL. If O.K., I will remit \$3 in 7 days and \$2 monthly for 3 months, plus 35¢ delivery charges with final payment. Otherwise I will return book postpaid in 7 days. (Foreign price, remit \$11 cash with order.)

Print Name..... Age.....

Address .....

City..... State.....

Check box and save 35¢ delivery charge by enclosing WITH coupon entire payment of \$7.95 for Auto Repair Manual (or \$9 for Truck Repair Manual.) Same return-refund privilege.



# Get "The Most" in Pay and Job Security— LEARN AIR CONDITIONING

## MAKE HOME YOUR TRAINING SHOP

## & REFRIGERATION



**BUILD A REFRIGERATOR,  
AIR CONDITIONER,  
FREEZER or  
MILK COOLER**

### You Practice with 23 Kits

You learn fast because CTI sends you 23 kits. Illustration shows heavy-duty ¼ h.p. refrigeration high-side which you will build—and keep. Only CTI sends these kits.



### You Get Professional Tools

Here are tools included in just one kit. You get other tools, tubing, much equipment. Tools develop your interest and skill, speed up training.



### You Learn in Easy Stages

Another kit, which includes motor, fan, pulley, service tools. Kits are sent on a planned schedule to help you learn in easy stages. There's no other training like this!

### A GOOD JOB, MORE MONEY, BRIGHT FUTURE

—all three can be yours in the Air Conditioning & Refrigeration field! Thousands of mechanics are needed to repair and service the 150 million units in use—and the six million air conditioners, freezers and refrigerators that are produced each year. You can earn more money in a better job—if you are trained. For information on how to get this training, just fill out and mail coupon below. No obligation!



R. C. Anderson  
President CTI

### A New, Easy Way to Learn in Months

CTI training is quick and effective because it is practical. You learn by doing. During the course of your training, you receive 23 big kits, including tools. You practice with these kits, get valuable experience. For instance, you do 10 complete service and trouble-shooting jobs with CTI kits. You assemble a heavy-duty, commercial type, ¼ h.p. high side (illustrated at left). You build an air conditioner, refrigerator, freezer or milk cooler—and you keep and use this valuable unit! Only CTI sends you these fine tools and kits—helps you get real on-the-job training! And all this fine equipment is yours at no extra cost! With CTI training you can start out as a mechanic and avoid years of work as a lower-paid apprentice.

### Earn Good Income as You Train, too

CTI training is so practical that students often work in spare time repairing air conditioners and refrigerators. They add to their income this way. Some get jobs with local dealers; others work on their own. Many students go in business on graduation. A number get full-time jobs while they're students.

### A Wonderful Opportunity to Be the Boss

If you want to own a business, Refrigeration offers you opportunity for success. Since most jobs are service calls, you can build up a list of potential customers. Very little capital is needed to start.



### Mail Coupon For Two FREE Books

Mail coupon below for two books which give you complete information. One is entitled *Success in Air Conditioning and Refrigeration*. The other is a *Lesson Sample*. Both FREE.

#### DO NOT DELAY—MAIL THIS TODAY

Mr. R. C. Anderson, President  
COMMERCIAL TRADES INSTITUTE  
1400 Greenleaf Ave., Chicago 26, Ill.

Dept. R-469

Mail me SUCCESS BOOK and LESSON SAMPLE. No cost or obligation.

Name \_\_\_\_\_ Age \_\_\_\_\_

Address \_\_\_\_\_

City \_\_\_\_\_ Zone \_\_\_\_\_ State \_\_\_\_\_





# DRAFTSMEN



## CASH BIG PAY CHECKS!

Train Now for more success, greater security

LEARN AT HOME IN SPARE TIME (or at college in Chicago)

Check the want ads in any newspaper—SEE the big-pay opportunities open to you as a draftsman. What's more, you can learn this well-paid, prestige profession at home — quickly, easily! No special talent needed. Get complete, step-by-step Chicago Tech lessons in the mail, spend a few pleasant hours studying each week. In a short time you'll be a well-trained draftsman, ready to take your pick of many good jobs. Act now!



Free Information—Mail Coupon Today!

Get FREE TRIAL LESSON plus information about C.T.C. practical training. Learn what successful Chicago Tech graduates say about high pay and opportunities in drafting. No charge, or obligation.

## CHICAGO TECHNICAL COLLEGE

D-216 Tech Bldg., 2000 So. Michigan Ave. Chicago 16, Illinois

Mail me FREE lesson with facts about big opportunities in DRAFTING.

Name \_\_\_\_\_ Age \_\_\_\_\_  
 Address \_\_\_\_\_  
 City \_\_\_\_\_ Zone \_\_\_\_\_ State \_\_\_\_\_



## INSURED TIRE SERVICE POPULAR BRANDS

FREE INSURANCE POLICY given with each used tire sold. We guarantee the amount of service you pay for.

NOWHERE CAN SUCH QUALITY BE FOUND AT SUCH LOW PRICE!

SPECIAL! Deduct 10% on orders for two or more used tires

YOU CAN'T LOSE!

Super Quality — Rugged Performance — 6 Months Insured Service	
600x16 \$3.65 670x15	\$3.95 700x16 \$4.45 760x16 \$4.78
650x15 3.85 670x15	4.05 710x15 4.35 820x15 4.95
650x16 4.25 700x15	3.95 760x15 4.45 850x17 4.68

Supreme Quality — Nothing Finer — 12 Months Insured Service	
600x16 \$5.25 475x19	\$5.45 700x15 (6) \$10.45 700x20 \$12.50
600x16 (6) 6.75 640x15	4.95 750x16 (8) 15.95 750x20 (8) 18.50
650x16 5.75 670x15	5.35 700x17 11.95 750x20 (10) 17.50
650x16 (6) 7.25 710x15	5.45 750x17 16.45 825x20 21.50
700x16 6.35 760x15	5.95 750x15 10.95 900x20 19.95
750x16 (A) 8.45 800x15	6.35 30x5 11.25 1000x20 20.45
850x15 4.95 820x15	6.35 600x20 10.95 1000x20 21.25
850x17 4.75 550x15	5.35 650x20 11.75 1000x22 21.95
850x15 5.25 670x16	5.15 32x6 (8) 11.95 1100x22 22.75
700x15 5.35 700x16 (6)	10.25 32x6 (10) 12.75 1100x24 25.95

Whitewalls \$1.00 extra.

## MIDLAND TIRE SALES

Speedy shipments on Mail Orders. F.O.B. Chicago. Insurance policy sent with each order. Deduct 10% on orders for 2 or more used tires. Send CHECK or MONEY ORDER.—No COD's. 3701 S. Normal, Dept. PM-69, Chicago 9, Ill.



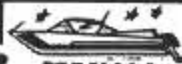
## WORLD'S LOWEST PRICED ADDING MACHINE

Counts up to 999,999,999 IDEAL FOR BUSINESS AND PERSONAL USE—GUARANTEED ACCURATE. Not a toy. Operates with only a finger flick. Adds, subtracts, multiplies, divides. Counts up to one billion. Pays for itself over and over. Ideal Gift—for Business, Income Tax and School use. MONEY BACK GUARANTEE. Send name and address. Pay postman only \$2.95 plus postage. Beautiful rich-looking leatherette Case included at no extra cost. Money back in 10 days if not delighted. AGENTS WANTED.

CALCULATOR MACHINE COMPANY P.O. Box 126, Dept. A-81, Huntingdon Valley, Penna.

## PLANS · PATTERNS · FRAME PACS

World's Largest Selection, Over 200 new plans, Full Size patterns, frame pacs. Designed for the amateur. Plans, racers, cruisers, utilities, inboards, outboards, in wood, plywood, steel. New longitudinal stressed models with revolutionary bulkhead construction. Light, super strong. Send 35c for 120 pg. PLAN CATALOG Catalog plus Boat Building Handbook.....\$1.00 SPECIAL OFFER... Plan Catalog... plus Hardware and Accessories catalog.....\$1.00



## SPECIAL I

- 120 PAGE PLAN CATALOG PLUS
- 200 PAGE "BOAT BUILDING FOR THE AMATEUR" COVERS
- BOAT BUILDING
- FIBER-GLASSING
- OUTFITTING, ETC.

CUSTOM-CRAFT-BUFFALO 7 NEW YORK

Only \$2.50

# INVESTIGATE ACCIDENTS

Train quickly in your own home for repeat income in the exciting, secure Claim Investigation and Claim Adjusting field. Our students and graduates are already earning \$4, \$5, \$6 an hour extra SPARE TIME — and up to \$10,000 a year Full Time. You need NO prior experience or higher education. Your age does NOT matter.

## HERE IS YOUR CHANCE FOR ACTION AND REAL JOB SECURITY

As a trained Claim Investigator you will (1) INVESTIGATE FACTS and (2) DISTRIBUTE MONEY as the representative of wealthy organizations.

No other business offers you greater opportunities for success and security. Here's why: The huge, rapidly expanding Claim Investigation and Adjusting Profession right now distributes more money than any other service industry. And it's growing fast. Over 200 MILLION ACCIDENTS must be investigated this year for Insurance Companies, Airlines, Railroads, Steamship Lines, and Government Offices.

MAIL NOW for FREE BOOK ➔

SEND TODAY for Big, FREE, Illustrated Catalog. Learn the exciting facts about Universal Schools' low cost training. No obligation. No salesman will call. GI APPROVED.



## UNIVERSAL SCHOOLS

6801 Hillcrest Ave. Dept. PM-4, Dallas 5, Texas

Please rush me your FREE book on Claim Investigation. This does not obligate me and no salesman will call.

Name \_\_\_\_\_ Age \_\_\_\_\_  
 Address \_\_\_\_\_  
 City \_\_\_\_\_ Zone \_\_\_\_\_ State \_\_\_\_\_

Approved by Government for Korean Veterans



**NOW!**  
at a price  
you can afford!

# MAKE MORE MONEY in TELEVISION RADIO-ELECTRONICS

**BETTER...MORE COMPLETE...LOWER COST...  
WITH NATIONAL SCHOOLS SHOP-METHOD  
HOME TRAINING!**

**BETTER...** Training that is proved and tested in Resident School shops and laboratories, by a School that is the **OLDEST** and **LARGEST** of its kind in the world.

**MORE COMPLETE...** You learn **ALL PHASES** of *Television-Radio-Electronics*.

**LOWER COST...** Other schools make several courses out of the material in our **ONE MASTER COURSE**... and you pay more for less training than you get in our course at **ONE LOW TUITION!**



These two **FREE** books will show you how!

You get all information by mail... You make your own decision... at home! **NO SALESMAN WILL CALL**

## TOP PAY... UNLIMITED OPPORTUNITIES LIFETIME SECURITY CAN BE YOURS!

You are needed in the Television, Radio, and Electronics industry! Trained technicians are in growing demand at excellent pay—in **ALL PHASES**, including Servicing, Manufacturing, Broadcasting and Communications, Automation, Radar, Government Missile Projects.

**NATIONAL SCHOOLS SHOP-METHOD HOME TRAINING**, with newly added lessons and equipment, trains you in your spare time at home, for these unlimited opportunities, including many technical jobs leading to supervisory positions.

**YOU LEARN BY BUILDING EQUIPMENT WITH KITS AND PARTS WE SEND YOU.** Your National Schools course includes thorough *Practical training—YOU LEARN BY DOING!* We send you complete standard equipment of professional quality for building various experimental and test units. You advance step by step, perform more than 100 experiments, and you build a complete TV set from the ground up, that is yours to keep! A big, new TV picture tube is included at no extra charge.

**EARN AS YOU LEARN.** We'll show you how to earn extra money right from the start. Many of our students pay for their course—and more—while studying. So can you!

### RESIDENT TRAINING AT LOS ANGELES

If you wish to take your training in our Resident School at Los Angeles, the world's TV capital, start **NOW** in our big, modern Shops, Labs and Radio-TV Studios. Here you work with latest Electronic equipment - professionally installed - finest, most complete facilities offered by any school. Expert, friendly instructors. Personal attention. Graduate Employment Service. Help in finding home near school - and part time job while you learn. Check box in coupon for full information.

**LESSONS AND INSTRUCTION MATERIAL ARE UP-TO-DATE, PRACTICAL, INTERESTING.** Every National Schools Shop-Method lesson is made easy to understand by numerous illustrations and diagrams. All instruction material has been developed and tested in our own Resident School Shops, Laboratories and Studios.

**SEND FOR INFORMATION TODAY...** it can mean the difference between **SUCCESS** and failure for you! Send for your **FREE BOOK** "Your Future in Television-Radio-Electronics" and **FREE Sample Lesson**. Do it **TODAY**, while you are thinking about your future. It doesn't cost you anything to investigate!

### GET THE BENEFITS OF OUR OVER 50 YEARS EXPERIENCE

Approved for  
GI Training



**NATIONAL SCHOOLS**

Los Angeles 37, Calif.

### YOU GET...

- 19 Big Kits—**YOURS TO KEEP!**
- Friendly Instruction and Guidance
- Job Placement Service
- Unlimited Consultation
- Diploma—Recognized by Industry
- **EVERYTHING YOU NEED FOR SUCCESS!**

### SHOP-METHOD HOME TRAINING COVERS ALL PHASES OF INDUSTRY

1. Television, including Color TV
2. Radio AM & FM
3. Electronics for Guided Missiles
4. Sound Recording and Hi-Fidelity
5. FCC License
6. Automation and Computers
7. Radar & Micro-Waves
8. Broadcasting and Communications

## NATIONAL TECHNICAL SCHOOLS

WORLD-WIDE TRAINING SINCE 1903

**MAIL NOW TO**  
**NATIONAL SCHOOLS, Dept. RB-48**  
4000 S. FIGUEROA ST., LOS ANGELES 37, CALIF.

Rush free TV-Radio "Opportunity" Book and sample lesson. No salesman will call.

NAME \_\_\_\_\_ AGE \_\_\_\_\_  
ADDRESS \_\_\_\_\_  
CITY \_\_\_\_\_ ZONE \_\_\_\_\_ STATE \_\_\_\_\_

Check if interested ONLY in Resident School training at Los Angeles.  
VETERANS: Give date of Discharge \_\_\_\_\_





# FEET HURT? YOU MAY HAVE WEAK ARCHES!

If you suffer from tired, aching feet, rheumatic-like foot and leg pains, sore heels or callouses—it's most likely due to weak or fallen arch. Dr. Scholl's Arch Supports and exercise quickly relieve these conditions. Light, flexible, adjustable. \$1.50 pair, up. Expertly fitted at selected Shoe, Department Stores and Dr. Scholl's Foot Comfort® Shops. For booklet and address of local dealer, write DR. SCHOLL'S, Chicago 10, Illinois.



## Dr. Scholl's ARCH SUPPORTS

There is a Dr. Scholl Foot Comfort® Appliance or Remedy for Every Common Foot Trouble

### MAKE STRIPES with new PAINT PEN

**Straight, curved, single or double**  
With any color paint, stripe furniture, bikes, autos, model planes, toys, linoleum, wall-board. Clean, crisp decorative lines. Can't clog or smear. Also use with glue, tempera, textile paint or underglaze... on wood, glass, plastic, ceramics, metals, fabrics and paper. Ask your dealer or order direct.

DEALERS	HOBBY	MFRS
Master paint striping tool in display carton. Write for discounts.	"Professional" results every time. Simple, easy to use. Order now.	Ask about heavy duty industrial striping tools.

**DOUBLE STRIPE MODEL \$3.25**  
5 COMBINATIONS.

Single 1/16" stripe model \$1.25

Other single stripe models 1 ea  
1/64", 1/32", 3/64", 5/64", 3/32" & 1/8"

Complete Kit \$5.00 (all 7 tips)

Extra tips 90c ea.

Extra 1/4" tip..\$1.20

**WENDELL MFG. CO.** 4234 LINCOLN AVE., Dept. 339 CHICAGO 18, ILLINOIS

**Makes \$216.00 A MONTH IN SPARE TIME!**



**M. M. REARICK SAYS: "I AVERAGE UP TO \$216.00 A MONTH OPERATING MY BELSAW SHARP-ALL AFTER WORK AND ON SATURDAYS"**

YOU can start your own spare-time business in your own home. With the new Belsaw Sharp-All you can sharpen all knives, scissors, shears, snips, ice skates, mower blades, hedge trimmers, grass whips, axes, chisels, screw drivers, scrapers and saws... just about any household, garden and shop tool. Your own CASH business with no inventory. No calls to make. No experience needed.

Learn how easily you can start your own spare-time business. Amazing low cost, easy-payment plan. Send postcard for FREE BOOK.



**BELSAW SHARP-ALL CO**  
718 Field Building • Kansas City 11, Missouri

### REAL ESTATE BE A BROKER

**PAYS BIG! SEND FOR FREE, BIG, ILLUSTRATED CATALOG NOW!** Graduates report making substantial incomes. Start and run your own business quickly. Men, women of all ages, learn easily. Course covers Sales, Property Management, Appraising, Loans, Mortgages, and related subjects. **STUDY AT HOME** or in classrooms in leading cities. Diploma awarded. Write TODAY for free book! No obligation. Approved for World War II and Korean Veterans. **WEAVER SCHOOL OF REAL ESTATE (Est. 1936)** 2020R Grand Avenue Kansas City, Mo.



EARN WHILE YOU LEARN  
SEND FOR FREE BOOKLET



### Be a LOCKSMITH

Learn fascinating, profitable trade from experts in spare time at home! Age no disadvantage. Year 'round, steady income. Full or part time. Practical, illustrated lessons. Make money even while learning! All materials and special tools supplied.

**INSTITUTE OF LOCKSMITHING, Dept. P-101**  
150 Park Ave. East Rutherford, N. J.

Lit. by N. J. State Board of Ed. Apprvd. for Vets



**Mr. "N" Made \$9,700 Last Year By Selling Just 20 KEEP/SAFEs a Month!**

Like Mr. "N" you can profit with KEEP/SAFE—the fine personal safe that undersells all others. Only safe sold direct. 95% of homes, farms and small businesses are prospects. \$30 to \$71 profit per sale, plus bonuses up to \$12 a safe. Choice territory, chance to become district agent. **FREE DEMONSTRATOR!** Get details, giving address including county.

**JOHN D. BRUSH & CO., INC.**  
575 West Ave. Rochester 11, N. Y.

### FIX OUTBOARD MOTORS

**POWERMOWERS, AND ALL SMALL 2 & 4-CYCLE GASOLINE ENGINES**

Repair your own equipment or MAKE EXTRA MONEY in this growing field. Fully illustrated, easy-to-understand. Home Study Course. Write for FREE information.

**LINCOLN TECHNICAL INSTITUTE**  
SUITE 4-E, 472 MARKET STREET, NEWARK 5, N. J.

### TELEPHONES and ALL SUPPLIES

Room to room, house to garage, private telephone service. **HANDSET CRADLE TELEPHONES (2)** Complete outfit with 100' wire, battery, staples, diagram CD-2 \$17.25 **WORM HARVESTER**—Dan Mac Magneto—gathers fish-worms by electricity. Complete with instructions. \$6.50 **FREE illustrated bulletin**



**TELEPHONE REPAIR & SUPPLY CO.**  
Dept. AA-114 • 1760 Lunt Ave., Chicago 26, Ill.



Cast your ballot for a successful future!

# 257 I.C.S. COURSES



Whether you stand at a machine or sit at a desk . . . whether you're making \$75 a week or \$75 hundred a year . . . whether your interest is Power Plants or Paper Pulp, Advertising or Electronics . . . chances are I.C.S. has exactly the course you need to get ahead.

I.C.S. is not only the oldest and largest correspondence school. It also offers the most courses, 257 in all. Each one success-proved by graduates who rose to top technical and administrative positions. Chief engineers. Superintendents. Foremen. Managers. Executive assistants.

I.C.S. Courses cover bedrock facts and theory plus practical, on-the-job applications. No skimping. Texts

are prepared by leading business and industrial authorities working with I.C.S. editors and educators. They are constantly being reviewed and revised in line with current developments.

As an I.C.S. student, you study in your spare time, set your own pace. No time lost getting to class or waiting for slower students to catch up. If you wish, I.C.S. will make progress reports to your employer. You win recognition as a "comer," one who is ready to move ahead. Thousands of students report pay increases and promotions within a few months of enrollment. All graduates win the coveted, approved I.C.S. diploma.

**3 FREE BOOKS!** Check the subject that interests you in the coupon below. I. C. S. will rush you (1) a special book outlining your opportunities in this field, (2) the 32-page gold mine of career tips, "How to Succeed," (3) a sample I. C. S. lesson (Math.) demonstrating the famous "I. C. S. Method." "X" MARKS OPPORTUNITY.



For Real Job Security—Get an I. C. S. Diploma! I. C. S., Scranton 15, Penna. Accredited Member, National Home Study Council

INTERNATIONAL CORRESPONDENCE SCHOOLS



BOX 78299D, SCRANTON 15, PENNA.

Without cost or obligation, send me "HOW TO SUCCEED" and the opportunity booklet about the field BEFORE which I have marked X (plus sample lesson):

- |  |  |  |  |  |
|--|--|--|--|--|
| <p><b>ARCHITECTURE and BUILDING CONSTRUCTION</b></p> <input type="checkbox"/> Air Conditioning<br><input type="checkbox"/> Architecture<br><input type="checkbox"/> Arch. Drawing and Designing<br><input type="checkbox"/> Building Contractor<br><input type="checkbox"/> Building Estimator<br><input type="checkbox"/> Carpentry and Millwork<br><input type="checkbox"/> Carpenter Foreman<br><input type="checkbox"/> Heating<br><input type="checkbox"/> Interior Decoration<br><input type="checkbox"/> Painting Contractor<br><input type="checkbox"/> Plumbing<br><input type="checkbox"/> Reading Arch. Blueprints <p><b>ART</b></p> <input type="checkbox"/> Commercial Art<br><input type="checkbox"/> Magazine & Book Illus.<br><input type="checkbox"/> Show Card and Sign Lettering<br><input type="checkbox"/> Sketching and Painting <p><b>AUTOMOTIVE</b></p> <input type="checkbox"/> Automobiles<br><input type="checkbox"/> Auto Body Rebuilding and Refinishing<br><input type="checkbox"/> Auto Engine Tuneup<br><input type="checkbox"/> Auto Technician | <p><b>AVIATION</b></p> <input type="checkbox"/> Aero-Engineering Technology<br><input type="checkbox"/> Aircraft & Engine Mechanic <p><b>BUSINESS</b></p> <input type="checkbox"/> Accounting<br><input type="checkbox"/> Advertising<br><input type="checkbox"/> Business Administration<br><input type="checkbox"/> Business Management<br><input type="checkbox"/> Cost Accounting<br><input type="checkbox"/> Creative Salesmanship<br><input type="checkbox"/> Managing a Small Business<br><input type="checkbox"/> Professional Secretary<br><input type="checkbox"/> Public Accounting<br><input type="checkbox"/> Purchasing Agent<br><input type="checkbox"/> Salesmanship<br><input type="checkbox"/> Salesmanship and Management<br><input type="checkbox"/> Traffic Management <p><b>CHEMICAL</b></p> <input type="checkbox"/> Analytical Chemistry<br><input type="checkbox"/> Chemical Engineering<br><input type="checkbox"/> Chem. Lab. Technician<br><input type="checkbox"/> Elements of Nuclear Energy<br><input type="checkbox"/> General Chemistry<br><input type="checkbox"/> Natural Gas Prod. and Trans.<br><input type="checkbox"/> Petroleum Prod. and Engr.<br><input type="checkbox"/> Professional Engineer (Chem)<br><input type="checkbox"/> Pulp and Paper Making | <p><b>CIVIL ENGINEERING</b></p> <input type="checkbox"/> Civil Engineering<br><input type="checkbox"/> Construction Engineering<br><input type="checkbox"/> Highway Engineering<br><input type="checkbox"/> Professional Engineer (Civil)<br><input type="checkbox"/> Reading Struc. Blueprints<br><input type="checkbox"/> Structural Engineering<br><input type="checkbox"/> Surveying and Mapping <p><b>DRAFTING</b></p> <input type="checkbox"/> Aircraft Drafting<br><input type="checkbox"/> Architectural Drafting<br><input type="checkbox"/> Drafting Machine Design<br><input type="checkbox"/> Electrical Drafting<br><input type="checkbox"/> Mechanical Drafting<br><input type="checkbox"/> Sheet Metal Drafting<br><input type="checkbox"/> Structural Drafting <p><b>ELECTRICAL</b></p> <input type="checkbox"/> Electrical Engineering<br><input type="checkbox"/> Elec. Engr. Technician<br><input type="checkbox"/> Elec. Light and Power<br><input type="checkbox"/> Practical Electrician<br><input type="checkbox"/> Practical Lineman<br><input type="checkbox"/> Professional Engineer (Elec) <p><b>HIGH SCHOOL</b></p> <input type="checkbox"/> High School Diploma | <p>(Partial list of 257 courses)</p> <input type="checkbox"/> Good English<br><input type="checkbox"/> High School Mathematics<br><input type="checkbox"/> Short Story Writing <p><b>LEADERSHIP</b></p> <input type="checkbox"/> Industrial Foremanship<br><input type="checkbox"/> Industrial Supervision<br><input type="checkbox"/> Personnel-Labor Relations<br><input type="checkbox"/> Supervision <p><b>MECHANICAL and SHOP</b></p> <input type="checkbox"/> Diesel Engines<br><input type="checkbox"/> Gas-Elec. Welding<br><input type="checkbox"/> Industrial Engineering<br><input type="checkbox"/> Industrial Instrumentation<br><input type="checkbox"/> Industrial Metallurgy<br><input type="checkbox"/> Industrial Safety<br><input type="checkbox"/> Machine Design<br><input type="checkbox"/> Machine Shop Practice<br><input type="checkbox"/> Mechanical Engineering<br><input type="checkbox"/> Professional Engineer (Mech)<br><input type="checkbox"/> Quality Control<br><input type="checkbox"/> Reading Shop Blueprints<br><input type="checkbox"/> Refrigeration and Air Conditioning<br><input type="checkbox"/> Tool Design <input type="checkbox"/> Tool Making <p><b>RADIO, TELEVISION</b></p> <input type="checkbox"/> General Electronics Tech. | <input type="checkbox"/> Industrial Electronics<br><input type="checkbox"/> Practical Radio-TV Eng'g<br><input type="checkbox"/> Practical Telephony<br><input type="checkbox"/> Radio-TV Servicing <p><b>RAILROAD</b></p> <input type="checkbox"/> Car Inspector and Air Brake<br><input type="checkbox"/> Diesel Electrician<br><input type="checkbox"/> Diesel Engr. and Fireman<br><input type="checkbox"/> Diesel Locomotive <p><b>STEAM and DIESEL POWER</b></p> <input type="checkbox"/> Combustion Engineering<br><input type="checkbox"/> Power Plant Engineer<br><input type="checkbox"/> Stationary Diesel Eng.<br><input type="checkbox"/> Stationary Fireman <p><b>TEXTILE</b></p> <input type="checkbox"/> Carding and Spinning<br><input type="checkbox"/> Cotton Manufacture<br><input type="checkbox"/> Cotton Warping and Weaving<br><input type="checkbox"/> Loom Fixing Technician<br><input type="checkbox"/> Textile Designing<br><input type="checkbox"/> Textile Finishing & Dyeing<br><input type="checkbox"/> Throwing<br><input type="checkbox"/> Warping and Weaving<br><input type="checkbox"/> Worsted Manufacturing |
|--|--|--|--|--|

Name \_\_\_\_\_ Age \_\_\_\_\_ Home Address \_\_\_\_\_

City \_\_\_\_\_ Zone \_\_\_\_\_ State \_\_\_\_\_ Working Hours \_\_\_\_\_ A.M. to P.M. \_\_\_\_\_

Occupation \_\_\_\_\_

Canadian residents send coupon to International Correspondence Schools, Canadian, Ltd., Montreal, Canada. . . . Special tuition rates to members of the U. S. Armed Forces.



# THE FREE MAILING CARD BELOW CAN HELP WRITE YOUR SUCCESS STORY

In the famous I.C.S. system of home study, students become trained, successful leaders—men who can analyze a situation—make right decisions—command the respect and confidence of their superiors. They become geared for success. No other school has so many of its former students in supervisory and management positions.

*Terrific prospects for the future*

"My enrollment in the I.C.S. Certified Public Accounting Course has opened up another world of business. My salary is almost doubled, and it's changed the whole pattern of my life. I have terrific prospects for the future." JOHN R. FORREST, JR.

*Earnings increased to \$8,705*

In the I.C.S. method you study in your spare time—earn as you learn. Easy-to-follow texts are prepared by business and industry leaders who know what you need to know to go places.

"When I began the study of my I.C.S. Diesel-Electric Locomotive Course, my yearly wage was \$5,741. At the end of 18 months' time it was raised to \$7,656 per year, and exactly a year later I was promoted and my earnings increased to \$8,705 a year or an increase of \$2,964 in two and a half years after I began my study." JEROME R. PETERSON

*Salary has doubled*

"I have advanced to highest position in my organization and my salary has doubled as a direct result of having taken an I.C.S. Course in Sanitary Engineering." JOHN H. BRAWLEY

**Cast Your Ballot for Success!**

**MAIL THIS CARD TODAY!**

Postage  
Will Be Paid  
by  
Addressee

No  
Postage Stamp  
Necessary  
If Mailed in the  
United States

**BUSINESS REPLY CARD**

FIRST CLASS PERMIT No. 1000, Sec. 34.9 P. L. & R. 1 : SCRANTON, PA.

INTERNATIONAL CORRESPONDENCE SCHOOLS  
SCRANTON 15, PA.





# INVENTORS

If you believe that you have an invention, you should find out how to protect it. The first step is to have a search made of the prior pertinent U. S. patents. If a report on this search indicates that the invention appears patentable you can apply for a patent, and the specifications and claims should be prepared.

The firm of McMorrow, Berman & Davidson, with offices in Washington, D. C., is qualified to take the necessary steps for you. We can make a preliminary search on your invention, advise you whether we think it can be patented, and prepare your application for patent.

Unless you are fully familiar with the U. S. Patent Laws, we recommend that you engage the services of a Registered Patent Attorney to protect your interests. The patent laws are *your* laws. A patent gives you the right to prevent others from making, using or selling the invention claimed in your patent for a period of 17 years.

Use these patent laws for your protection. Investigate whether your invention can be patented. If you have what you believe to be an invention, we suggest that you have this firm make a search for you.

*Send for a copy of our Patent Booklet entitled "How To Protect Your Invention," containing information about patent protection and patent procedure. Along with this we will also send you an "Invention Record" form, for your use in writing down and sketching details of your invention. We will mail them promptly. No obligation. They are yours for the asking.*

## McMORROW, BERMAN & DAVIDSON

*Registered Patent Attorneys*

**PATENTS • COPYRIGHTS • PATENTS**

**135-V VICTOR BUILDING, WASHINGTON 1, D.C.**



# YOU CAN SUCCEED IN BUSINESS THROUGH SPARE TIME HOME TRAINING

A better position—a higher salary—can be yours IF you can do the work. Business is always willing to pay the man who knows—and pay him well.

You don't have to be satisfied with a mediocre job at low pay when in your spare time at home you can quickly, and without interference with your present work, prepare for a brighter and happier future.

For nearly 50 years ambitious men and women have turned to LaSalle for greater ability and larger success. So decide today to take the first step to better your own future.

Check the career of your choice in the coupon below and we'll send you by return mail, without obligation, full information on that field—the opportunities, and what you must know to be successful.

You can win Success if you train for Success.

Mail the Coupon Today

## LASALLE EXTENSION UNIVERSITY A Correspondence Institution

417 So. Dearborn St. Dept. 464R, Chicago 5, Ill.

Please send me, without obligation, full information on the field I have checked below:

- LASALLE ACCOUNTING:** Training for position as Accountant, Auditor, Controller, Cost Accountant, Public Accountant, etc.
- LAW:** Training in Law as a foundation for business or professional success. Degree of LL.B.
- TRAFFIC & TRANSPORTATION:** Training for position as Motor Truck or Industrial Traffic Manager, Railroad; Rate Expert, Freight Solicitor, etc.
- CPA TRAINING:** Advanced training in preparation for the Uniform CPA examination.
- BUSINESS MANAGEMENT:** Training for Managerial, Sales and Department Executive positions.
- STENOTYPE:** Training for position as Stenographer, Secretary or Executive Secretary using Stenotype Machine.
- STENOGRAPHIC-SECRETARIAL:** Training for position as Stenographer, Secretary or Executive Secretary using Gregg Shorthand System.

Name.....Age.....

Address.....


City, Zone & State.....



**Nutria... NEWEST OPPORTUNITY**

New fur-bearing animal now being bred in U. S. Offers huge profits to breeders. This fur is next to Mink NOW in price and will soon surpass it. 15 to 20 young per year. Most easily and economically raised animal known. 1 1/2¢ per day to feed. ANY CLIMATE. disease resistant. The Cabana Marrone strain is obtainable ONLY through Cabana Nutria, Inc. and its authorized dealers and distributors. For free booklet and address of Cabana ranch nearest you write:

**CABANA NUTRIA, INC.**  
Dept. 28, 636 W. Lemon Ave., Arcadia, Calif.



**"I Made \$14,839 in 1 Year SERVICING RADIATORS!"**

Are you earning under \$8,000 a year? Hundreds now making \$10,000-\$12,000-\$15,000 a year servicing auto-truck-tractor radiators the inland way. Easy to learn. Inland, largest radiator equipment mfr., offers complete package—equipment, merchandising. "Pays-for-itself" financing, free training. \$305 down for equipment starts you. Profitable dept. for garage or service station. Write to

**INLAND MFG. CO., Dept. PM-4, 1108 Jackson St., Omaha 2, Nebr.**

**Now! TEST YOUR OWN TV & RADIO TUBES**  
for filament breaks ALL OF THEM—EVEN PICTURE TUBE



Nearly half of TV service calls are due to defective filaments. Tester shows if filaments are good. Insert tube in tester. Light shows if tube is burned out. Easy, safe. One service call saved pays for tester. Metal case. AC or DC. Checks fuses, appliances, etc. Only \$3.95 ppd. or C.O.D. plus charges. Deluxe Model \$4.95. Instructions. Guaranteed.

**GEIGER ENGINEERING CORP., Dept. AG-10P**  
3738 West Lawrence Avenue, Chicago 25, Ill.

## DO FALSE TEETH Rock, Slide or Slip?

**FASTEETH**, an improved powder to be sprinkled on upper or lower plates, holds false teeth more firmly in place. Do not slide, slip or rock. No gummy, gooey, pasty taste or feeling. **FASTEETH** is alkaline (non-acid). Does not sour. Checks "plate odor" (denture breath). Get **FASTEETH** at any drug counter.

**Own and Play the ACCORDION**

for fun...for popularity...for profit!

Buy direct at amazing savings from America's biggest importer of fine Italian made accordions, **5 DAY FREE TRIAL!** Easy Terms. Free Lessons—Easy to learn. Personalized selection service. Trade-ins accepted. Write today for big Color Catalog and our low wholesale prices. **FREE!** Accordion Manufacturers & Wholesalers Outlet

**SAVE UP TO 50% on famous ITALIAN MAKES**

**5 DAY FREE TRIAL**

2003 West Chicago Avenue • Dept. R-48 • Chicago 22, Illinois

**BIG \$\$\$ CAKE DECORATING CANDY MAKING**

**HUSBANDS — WIVES or Work as Team — AT HOME**

Make your kitchen pay off BIG \$\$\$. Cash in on huge demand for lovely Cake Decorations and luscious professional Candy. **FULL OR PART TIME**. Do like others, build your own business, earn big money from clubs, churches, year round parties, weddings, birthdays, Xmas, Easter, all Holidays. No Experience Necessary.

**SEND FOR FREE INFORMATION**

Men, women, ANY AGE or education welcome. No capital required — start small, grow big. Our responsibility to train and show you how to start... learn in your own kitchen. Follow easy to understand, illustrated instruction. No obligation for **FREE FACTS** write: Candy & Cake Craft, Dept. 82, 3209 W. Olympic, Los Angeles, Calif.





**MEN 17 to 55**



# DeVry Tech's Electronic Training

*has helped Men like these Get Better Jobs or Shops of their own...*

# How about YOU?



**No Advanced  
Education  
Required**

## NO PREVIOUS TECHNICAL EXPERIENCE NEEDED

Men from practically every walk of life have won better jobs or businesses of their own through DeVry Tech's program. Many of these men, like thousands of others, had no previous technical experience. They prepared either in our well-equipped Toronto or Chicago laboratories, or at home in their spare time without interfering with their regular jobs.

The "Electronic Age" is here! Opportunities for men 17 to 55 are great! Fill in coupon below for FREE details! Act now!

## Get **FREE** Facts!

Here are some of the many Electronic opportunities DeVry Tech's program will fit you for:

- Communications • Television • Radio
- Guided Missile Control • Computers •
- Radar • Micro-Waves • Instrumentation
- Automation Electronics

## Sample Booklet **FREE!**

We'll give you a free copy of an interesting booklet, "Electronics and YOU." See for yourself how you may take advantage of the opportunities in this growing field.

## LIVE-WIRE EMPLOYMENT SERVICE

DeVry Tech's Placement Department is in contact with some of the best-known employers in the Electronics field. The service is free to all graduates—and DeVry Tech's record in helping to place men has been outstanding.

**DRAFT AGE?** We have valuable information for every man of draft age; so if you are subject to military service, be sure to check the coupon.

**DEVRY** Technical INSTITUTE  
Chicago 41, Illinois  
Formerly DeForest's Training, Inc.

"One of North America's Foremost Electronics Training Centers"



## MAIL COUPON TODAY!

DeVry Technical Institute  
4141 Belmont Ave., Chicago 41, Ill., Dept. PM-4-0  
Please give me your FREE booklet, "Electronics and YOU," and tell me how I may prepare to enter one or more branches of Electronics as listed above.

Name \_\_\_\_\_ Age \_\_\_\_\_  
(PLEASE PRINT)

Street \_\_\_\_\_ Apt. \_\_\_\_\_

City \_\_\_\_\_ Zone \_\_\_\_\_ State \_\_\_\_\_

Check here if subject to Military Training.

2036 DeVry Tech's Canadian Training Center is located at  
626 Roselawn Avenue, Toronto 12, Ontario.

Accredited Member of National Home Study Council





# PLAY RIGHT AWAY ANY INSTRUMENT

—even if you don't know a single note now!

**N**OW it's EASY to learn ANY instrument. No boring exercises. Even if you don't know a single note now you can play delightful pieces—from your FIRST lesson! BY NOTE. Make amazing progress. No special "talent" needed. Learn at home in spare time. Without a teacher. Low cost! Soon you can play popular music, hymns, classical and any other music. Over 900,000 students, including Lawrence Welk.



**FREE BOOK.** Send this ad with your name and address filled in below, to: **U. S. SCHOOL OF MUSIC, Studio 304, PORT WASHINGTON, N. Y.** (No obligation, no salesman will call.)

Name \_\_\_\_\_

Address \_\_\_\_\_



**SALE 20 X 50**  
REGULARLY \$74.50  
SAVE \$44.55!

High powered, whisperweight (27 oz.) color corrected, Achromatic Binoculars. 7" high! EZ to hold. EZ to focus. Instant finger-tip adjustment. Made in Japan. **USE 30 DAYS.** If not satisfied return for refund. Add \$1 postage, handling.

**SALE PRICE ONLY \$29.95**

including case and straps! Add 10% Tax

UNITED BINOCULAR CO., 9043 S. Western, CRE-2108, Chicago 20. DEALERS WANTED



c.o.d.'s require \$2 deposit.

## EARN \$100 A WEEK AND UP

### BE AN AUTO-DIESEL MECHANIC — EARN WHILE YOU LEARN

Many of our graduates earn \$100 a week and up. You learn fast in our school and shops because you learn with tools on real equipment. Experienced instructors explain WHY and show you HOW, then you DO IT YOURSELF. One of the best equipped technical schools in the United States. Thirty-nine years' experience training men. Successful graduates in 48 states and many foreign countries. Approved for veterans. Day and evening classes. Free bulletin—write today.

**NASHVILLE AUTO-DIESEL COLLEGE**  
226 7th Ave. N., Dept. 86, Nashville, Tenn.

## NEW GRIPSO TOOL KIT

Save Time, Work, Money—4 new Power Action tools do the work of dozens of tools. In handy vinyl holder.



### WISE PLIERS

5 Tools in 1 — 1 ton grip gentle release. One hand adjustment.

### PIPE WRENCH

Press—pull it's open. Push—it's closed. Ratchet action adjustment.

### MULTI-DUTY PLIERS

Multiplies grip 10 times.

### GEAR LOCK PLIERS

Patented power gear grip.

See Your Dealer or Write  
**H. R. BASFORD CO., 235 15th St.  
San Francisco 3, California**

## TASOPE PHOTO-ENGRAVING PLANTS



Material Cost  
Of This Cut 3/4c  
Selling Price  
\$1.00 And Up

Establish your own profitable PHOTO-ENGRAVING business. Make cuts for newspapers, printers, and advertisers. Make etched name plates, plaques, etc. Instructions furnished, no experience necessary. Sold direct from factory since 1931. First five hundred cuts sold locally or by mail will pay for plant and pay you well for your time. Write for FREE catalog.

TASOPE, DEPT. PM4, AURORA, MO.

## GET INTO ELECTRONICS

V.T.I. training leads to success as technicians, field engineers, specialists in communications, guided missiles, computers, radar, automation. Basic & advanced courses in theory & laboratory. Assoc. degree in 29 mos. H.S. obtainable. RECPD accredited, G.I. approved. Graduates with major companies. Start Sept., Feb. Dorms. campus. H. S. graduate or equivalent. Catalog.

**VALPARAISO TECHNICAL INSTITUTE**  
DEPT. D VALPARAISO, INDIANA



## HIGH SCHOOL DIPLOMA

Earn a High School Diploma at home! Prepare for better job, more pay. Study in spare time. No classes. Materials furnished. Certified teachers. Valuable diploma awarded.

Write Today for Complete Information  
**SOUTHERN STATES ACADEMY**  
Box 5344-A Sta. E Atlanta, Georgia



## make your own Gems 3650

The Gem Maker comes complete with all necessary equipment, including a super-charged diamond blade for sawing, and all the wheels for grinding, shaping and polishing; also complete instructions. The complete equipment as shown, less motor and belt for only \$36.50, c.o.b. Burlington, Wisconsin. Write today for information and literature.

**B&I MANUFACTURING CO.**  
Dept. P, Burlington, Wis.



Better Than  
Your Own

## SHOE STORE AT HOME



No investment, no experience needed. Just show magic cushion comfort to friends, neighbors, co-workers. Advance commissions to \$4.00 a pair, plus Cash Bonus, Paid Vacation, \$25.00 Reward Offer. Outstanding values for men, women, children. Money back guarantee. Shoe samples supplied without cost. Write TODAY for FREE new 84 page catalog and full details.

TANNERS SHOE CO., 680 BROCKTON, MASS.

Two-  
Eyelet  
Hit With  
Cushioned  
Comfort

POPULAR MECHANICS



# WHAT ALL AUTO MECHANICS WANT TO KNOW



This Big Practical Book gives full information, with working diagrams, covering the principles, construction, ignition, service and repair of modern cars, trucks and buses.

**Diesel Engines, Hydromatic and Fluid Drives Fully Explained.**

A complete guide of 1696 Pages, with over 1500 Illustrations showing inside views of working parts, with instructions for service jobs. Completely up-to-the-minute! Priced at only \$8.



CIRCLE No. 1 IN COUPON

## HOW TO FIX HOME APPLIANCES

REFRIGERATORS WASHERS TOASTERS DRYERS IRONERS RANGES VACUUMS FREEZERS

Many other GAS AND ELECTRIC APPLIANCES Handy Reference for Electric & Gas Servicemen, Mechanics, Dealers and Homeowners. Explains clearly and simply how to locate troubles, how to test, reassemble and connect. Wiring diagrams, 1000 Facts. Easy to read. Answers ALL your questions. 864 Pages. Illustrated. Only \$6.

CIRCLE No. 2 IN COUPON



**TV TELLS HOW TO ANSWER RADIO RADIO TV QUESTIONS SERVICE LIBRARY**

HERE IS LATEST INFORMATION IN A HANDY FORM FOR RADIO AND TELEVISION REPAIRMEN, SERVICEMEN AND STUDENTS

TWO COMPLETE VOLUMES - 1568 Pages - 1083 Illustrations and Diagrams. 1001 Important Facts and Figures on Modern T.V., Radio, Electronic Devices, INCLUDES TRANSISTORS & Transistor Circuits, Rectifiers, Reged Changers, P.A. Systems, Phonograph Pick-ups, P.M., Auto Radio, Short Wave,

Basic principles, Construction, Installation, Operation, Troubleshooting. How to get Sharp, Clear T.V. Pictures. Install Aerials, How to Test, Explains COLOR SYSTEMS, Methods of Conversion, Terms, etc. Includes Ultra High Frequency. Quick ready reference or use as a home study course. Only \$8 for BOTH volumes.

CIRCLE No. 3 IN COUPON

## KNOW YOUR TRUCK

THE TRUCK & TRACTOR GUIDE for Mechanics & Drivers, Foremen, Garagemen, Helpers, Owners, Truck Shooters, Farmers, etc. Covering Gas & Diesel Motor Principles - Construction - Operation - Maintenance - Repair - Brakes - Service of all Parts. 1376 Pages. FULLY ILLUSTRATED. Index. Only \$5.

CIRCLE No. 5 IN COUPON

## PLUMBERS AND STEAMFITTERS GUIDES



Practical Trade Assistant & Reference Set. Explains in plain language and by clear illustrations, diagrams, charts, graphs and pictures the principles of modern plumbing practice including Pipe Fitting and Air Conditioning. 4 Vols. - 2624 Pages - 3642 Diagrams & Illustrations. Only \$8 for the complete set of 4 vols.

CIRCLE No. 6 IN COUPON

## PAINTING & DECORATING MANUAL

Inside Trade information on outside and inside work; how to mix paints, preparation of surfaces, paper hanging, wood finishes, tools, synthetic paints, color (with color chart), spray equipment, costs, estimating, etc. A COMPLETE guide to easier, better painting and decorating. 464 Pages. Fully Illustrated. Only \$2.

CIRCLE No. 7 IN COUPON

## 7-DAY FREE EXAMINATION

SEND NO MONEY - Pay the postman nothing! We are glad to send you any of the Audel Guides for absolutely FREE examination in your own home. We take all the risks and leave all the decisions up to YOU. There is no obligation! If you decide to keep the books of your choice you may pay for them under our astounding easy-pay plan of only \$2 a month.

### HERE IS ALL YOU DO

IT'S EASY TO ORDER: In the No-Risk Mail Order Coupon at the right just draw a circle around the number of Audel Guides you want us to send you for FREE EXAMINATION. We will send them to you at once to help you build a brighter future by increasing your SKILL. If for any reason at all you are not COMPLETELY satisfied, return the books to us, and that will end the matter! NO STRINGS OR CATCHES TO THIS OFFER.

**THEO. AUDEL & CO.**  
49 West 23rd Street, New York 10, N.Y.  
APRIL 1958

# CARPENTERS AND BUILDERS GUIDES



PRACTICAL STOREHOUSE OF MODERN CONSTRUCTION INFORMATION (4 vol. set) for carpenters and all woodworkers. Explains in easy language and by profuse illustration principles, advances, short cuts, trade secrets, all based on the NEWEST information.

Vol. 1 - Tools, steel square, saw filing, joinery, furniture, etc. Vol. 2 - Builders' mathematics, drawing plans, specifications, estimates, etc. Vol. 3 - Floors and roof framing, laying out, foundations, etc. Vol. 4 - Doors, windows, stair building, millwork, painting, etc. 4 vols. 1904 Pages. 3700 Illustrations. Whole set only \$8.

CIRCLE No. 8 IN COUPON

## PRACTICAL ELECTRICITY

A COMPLETE HANDBOOK - Quick, simplified, ready reference. Complete instruction and practical information on the rules and laws of electricity - Maintenance of Machinery - A.C. and D.C. Motors - Armatures - Wiring Diagrams - House Lighting - Power Wiring - Motors - Batteries - Transformers - etc. Simple to understand. 1520 Pages. 2600 Illustrations. Priced at \$5.

CIRCLE No. 4 IN COUPON

## DIESEL

ALL THERE IS TO KNOW ABOUT MODERN DIESEL ENGINES - Basic principles, starting valves, timing, fuel pumps, fuel injection compressor, air compressors, pistons, cylinders, lubrication, cooling systems, etc. Answers on operation, calculations. 640 Pages. Fully Illustrated. Priced at \$3.

CIRCLE No. 9 IN COUPON

## WELDERS GUIDE

Covers Electric, Oxy-acetylene, Thermit, Unionmelt welding for sheet metal, spot and pipe welds, pressure vessels and aluminum, copper, brass, bronze and other metals. Airplane work, surface hardening, hard facing, cutting, brazing, etc. 608 Pages. Fully Illustrated. Only \$3.

CIRCLE No. 10 IN COUPON

## MATHEMATICS MADE EASY

A COMPLETE HOME STUDY COURSE - Starting with the first principles of arithmetic, advancing step by step through the various stages of mathematics, including the rules and calculations for mechanical and electrical problems. New EASY correct methods. Includes plane and solid geometry, trigonometry, algebra, calculus, etc. Practical tests, reference tables and data. How to use slide rule. 752 Pages. 550 Illustrations. Priced at only \$3.

CIRCLE No. 11 IN COUPON

## NEW MACHINISTS AND TOOLMAKERS HANDBOOK

MODERN MACHINE SHOP PRACTICE - 5 PRACTICAL BOOKS IN ONE. New from cover to cover. Tells how to set up and operate lathes, screw and milling machines, shapers, drill presses and all other machine tools. A COMPLETE INSTRUCTOR AND REFERENCE BOOK. 1728 Pages. Fully Illustrated. Priced at only \$6.

CIRCLE No. 12 IN COUPON

## WIRING DIAGRAMS

This book gives the practical facts on wiring of electrical apparatus. It explains clearly and SIMPLY how to wire apparatus for all fields of electricity. Each diagram is complete and self-explaining. Know your HOOK-UPS! 304 Pages. Illustrated. Only \$2.

CIRCLE No. 13 IN COUPON

## REFRIGERATION & AIR CONDITIONING

FOUR BOOKS IN ONE - basic principles, servicing, operation, repair of: 1. Household Refrigeration. 2. Special Refrigeration Units. 3. Commercial & Industrial Refrigeration. 4. Air Conditioning Systems. A GOLD MINE of essential information. Completely up-to-date. 1360 Pages. Fully Illustrated and Indexed. Priced at only \$6.

CIRCLE No. 14 IN COUPON

# THE NEW ELECTRIC LIBRARY

A COMPLETE ENCYCLOPEDIA explaining in the simplest terms the fundamental principles, rules and applications of applied electricity.

A COMPLETE COLLEGE EDUCATION! Fully illustrated with diagrams and sketches, calculations and tables for ready reference. Questions and answers. Trial tests for practice study and review. All based on the most modern theory.

- Vol. 1 - Principles and rules of electricity, magnetism, armatures, repairs. No. 15
- Vol. 2 - Dynamos, DC Motors, construction, installation, maintenance, etc. No. 16
- Vol. 3 - Testing instruments and tests, storage battery constr. and repairs. No. 17
- Vol. 4 - Alternating current, power factor, alternators, transformers. No. 18
- Vol. 5 - A.C. Motors, windings, maintenance, converters, switches, fuses, etc. No. 19
- Vol. 6 - Relays, condensers, regulators, rectifiers, meters, switchboards, etc. No. 20
- Vol. 7 - Wiring, house light and power, circuits, high tension, plans, code, etc. No. 21
- Vol. 8 - Railways, signals, elevators, ignition, etc. No. 22
- Vol. 9 - Radio, telephone, telegraph, television, motion pictures. No. 23
- Vol. 10 - Refrigeration, illumination, welding, x-ray, electrical appliances, Index. No. 24

7,000 fully illustrated pages. Priced at only \$20 for the ENTIRE SET. Also sold individually for \$2 each.



## ALL TYPES OF BLUEPRINT READING

How to read scales, the standard symbols, detail and assembly prints, working drawings, short cuts, hints and suggestions. THE MAN WHO CAN READ BLUEPRINTS IS IN LINE FOR A BETTER JOB. This book gives you the secret language, step by step in easy stages. 448 Pages, Very Fully Illustrated. Priced at \$3.

CIRCLE No. 25 IN COUPON

## MASONS & BUILDERS GUIDES

A PRACTICAL ILLUSTRATED 4 VOL. SET - Explaining in clear, simple language and profuse illustration, principles, advances, short cuts, trade secrets, based on modern practice - including how to figure and calculate various jobs. Vol. 1 - Brick work, bricklaying, bonding, designs. Vol. 2 - Brick foundations, arches, life setting, estimating. Vol. 3 - Concrete mixing, placing forms, reinforced stucco. Vol. 4 - Plastering, stone masonry, steel construction, blueprints. 4 Vols. 1440 Pages. 2067 Illustrations. Complete Set only \$8.

CIRCLE No. 26 IN COUPON

## ELECTRIC MOTORS

THIS GUIDE covers the construction, hook-up, control, maintenance and trouble shooting of all types of motors. Includes armature winding. Explains entire subject in great detail in simple language. Over 1056 Pages of information. 617 Diagrams. All types of motors fully illustrated and indexed for ready reference. Priced at only \$5.

CIRCLE No. 27 IN COUPON

## OIL BURNERS

New, complete, explaining in detail both domestic and industrial oil burners. Includes electrical hook-ups and wiring diagrams. Fully covering the theory, construction, installation, operation, testing, servicing and repair of all equipment. Indexed for ready reference. Over 416 Pages. 320 Illustrations and Diagrams. Only \$2.

CIRCLE No. 28 IN COUPON

## ADDITIONAL IMPORTANT TITLES

- The following Audel Guides are all the best in their fields, written in clear simple fashion, all lavishly illustrated. Circle the numbers wanted in the MAIL ORDER COUPON below. All books are sent for FREE EXAMINATION.
- No. 29 SHEET METAL PATTERN LAYOUTS. 1152 Pages. \$7.50
  - No. 30 SHEET METAL WORKERS HANDBOOK. 448 Pages. 2.00
  - No. 31 MECHANICAL DRAWING GUIDE. 192 Pages. 2.00
  - No. 32 MECHANICAL DRAWING AND DESIGN. 480 Pages. 3.00
  - No. 33 ELECTRONIC DEVICES. 304 Pages. 3.00
  - No. 34 ELECTRICIANS EXAMINATIONS. 272 Pages. 2.00
  - No. 35 ELECTRIC POWER CALCULATIONS. Page 480. 3.00
  - No. 36 ELECTRIC DICTIONARY. 9000 Terms. 3.00
  - No. 37 POWER PLANT ENGINEERS GUIDE. 1568 Pages. 5.00
  - No. 38 ENGINEERS AND FIREMANS EXAMS. 544 Pages. 2.00
  - No. 39 OPERATING ENGINEERS LIBRARY. 3 Book Set. 12.00
  - No. 40 PUMPS, HYDRAULICS AND AIR COMPRESSORS. 1760 Pages. 4.00
  - No. 41 HOUSE HEATING GUIDE. 1608 Pages. 5.00

# MAIL THIS NO-RISK COUPON TODAY!

THEO. AUDEL & CO. - Self Improvement Publishers Since 1879 - P-4

49 W. 23rd Street, New York 10, N.Y.

Please mail me for 7 days' FREE EXAMINATION the books I have circled at right. I agree to mail \$2 in 7 days on each book or set ordered, and to further mail \$2 a month on each book or set ordered until I have paid the purchase price, plus shipping costs. If I am not completely satisfied with my Audel Guides I may return them.

NAME _____	17	18	19	20	21
ADDRESS _____	22	23	24	25	26
OCCUPATION _____	27	28	29	30	31
	32	33	34	35	36
<input type="checkbox"/> SAVE SHIPPING COSTS! Check here if you enclose complete payment with order. We pay postage charges. You have same return privilege.	37	38	39	40	41



# Check the Kind of Body You Want



Charles Atlas

... and I'll Show You How EASILY You Can Have It!

Just tell me, in coupon below, the kind of body you want—and I'll give it to you SO FAST your friends will be amazed! "Dynamic Tension," my easy, 15-minutes-a-day method, will make your chest and shoulders bulge... arms and legs surge with power... your whole body feel "alive!"

**FREE BOOK** Learn how I became "World's Most Perfectly Developed Man"—Mail coupon! CHARLES ATLAS, Dept. 84, 115 East 23 Street, New York City 10, N. Y.

CHARLES ATLAS, Dept. 84, 115 East 23rd St., New York 10, N. Y.

Dear Charles Atlas: Here's the Kind of Body I want: (Check as many as you like)

- More Weight—Solid—in The Right Places  
 Broader Chest, Shoulders  
 Powerful Arms, Legs, Grip  
 Slimmer Waist, Hips  
 Better Sleep. More Energy

Send me absolutely FREE a copy of your famous book showing how "Dynamic Tension" can make me a new man—32 pages, crammed with photographs, answers to vital questions, and valuable advice. No obligation.

NAME \_\_\_\_\_ AGE \_\_\_\_\_  
 (please print or write plainly)  
 ADDRESS \_\_\_\_\_  
 CITY \_\_\_\_\_ STATE \_\_\_\_\_

## SAVE 40% 4 Wheel Drive Hubs

WITH Dualmatic Hubs Economical Operation! Only Wheels Move  
 WITHOUT Dualmatic Hubs Costly Operation! Wheels Move



All Parts Stop All These Parts Move

- Stop Front End Wear • Steering Becomes Easier • Makes Tires Last Longer • Cut Costly Repair Bills • Reduce Engine Wear • More Power — Save Gasoline

### FLEET COST PRICES

Make and Model	Set. No.	Net Price
Willy's Jeeps All Models	J-5	\$47.50
Chev. 1/2 Ton 3100 Series	C-75	\$49.50
Chev. 3/4 & 1 Ton 3600 & 3800 Series	C-85	\$49.50
Dodge Power Wagons Prior 1957	D-10	\$49.50
Dodge W 100 and W 200 Series	D-95	\$49.50
GMC 1/2 Ton 100 Series	G-15	\$49.50
GMC 3/4 Ton 150 Series	G-20	\$49.50
IHC A & S 120 Series	I-25	\$49.50

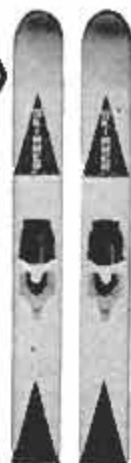
Save \$2.50 per set by ordering 3 sets or \$5.00 per set by ordering 6 sets. Only a partial listing shown above. Available for all 4-wheel drives. Catalogues, Folders, Prices on request.

Order from your local Automotive Jobber or write direct to:

**DUALMATIC**  
 PRODUCTS CO., LONGMONT, COLO.

HERE'S THE GREATEST OF ALL SKI BARGAINS!

No. 90 only \$23.00



An exceedingly fine set of skis, full size, light weight, tough, fast buoyant. Seven-ply moulded plywood with waterproof adhesive, adjustable bindings to fit any foot. Each pair carefully matched and balanced, complete satisfaction absolutely guaranteed. At your MICHIGAN WHEEL dealer or order direct — C.O.D. if you wish. Send card for FREE catalog of boating accessories, propellers for better skiing, top speed or fun.

MICHIGAN WHEEL COMPANY  
 DEPT. PM-4 — GRAND RAPIDS 3, MICH.



## MAKE BEGINNERS BIG PROFITS

Many men and women making big money on imports by mail order from home. No investment in merchandise or ads. We tell you where to get low cost products from abroad and supply list of magazines that run no-cost ads. Write for Free details. MELLINGER CO. Dept. P254, 1717 Westwood, Los Angeles 24, Calif.



## SPUTNIK Stamp - Free!

PLUS MANY OTHERS — Big, Exciting, Historic Earth-Satellite Issue Complete included in German Set Collection! New Multi-Colored Cpl. Set showing Revolution, Schumann-Schubert Music Error, Plants & Flowers Issue, Cycle Races, Nazi Airplane, etc. All this is yours FREE, to introduce our bargain approval offers. EXTRA: 48 Page Stamp Dictionary also included. Send 10c to cover mailing costs.

STAMPEX CO. BOX 47-SM WHITE PLAINS, N.Y.

## SIGHTING SCOPE

Gov't Surplus — Guaranteed Perfect.

- Built-in light for night sighting. (Takes 2 ordinary flashlight batt.)
- Built-in mountings. • 5 1/2" long.
- Weight 1 lb. • Solid brass, 1.44x used mainly for sighting. Objective lens is at small end.

Achromatic coated prismatic lenses ideal for: Telescopes, Target spotting, Hunting, Surveying. Convert to erect microscope.



\$4.98 ppd. No COD's Gov't Cost \$70

JOB LOT TRADING CO., 53 Vesey St., New York 7, N. Y.

## BECOME AN EXPERT IN

# TRAFFIC

Traffic men earn \$4,000 to \$10,000 and up. Thousands of firms need experts on rates, tariffs, regulations. We train you thoroughly in spare time at home for executive traffic jobs. Personal training under traffic authorities. Placement counsel and help. Write for free 48-page book "Traffic Management—the Fast Growing Profession."

LASALLE Extension University, 417 So. Dearborn St. A Correspondence Institution Dept. 464T, Chicago 8, Ill.



## HANDS TIED?

—because you lack a HIGH SCHOOL DIPLOMA

### Many Finish in Spare Time at Home

If you did not finish high school, here is your opportunity. Go as fast as your time and abilities permit. Course equivalent to resident school work. Prepares for college exams. Standard texts supplied. Single subjects if desired. Diploma awarded. Write now for FREE 61st Year Booklet. Get important facts at once.

American School, Dpt. H445, Drexel at 58th, Chicago 37



---

# INVENTORS

The preparation of an application for patent and the conducting of the proceedings in the Patent Office to obtain the patent is an undertaking requiring knowledge of patent law and Patent Office practice as well as knowledge of the scientific or technical matters involved in the particular invention.

Unless you are familiar with these matters, you are advised to call upon the knowledge, experience and skill available to you from a registered patent attorney or agent in order that the patent, if obtained, will adequately protect your invention.

The firm of Victor J. Evans & Co. is registered to practice before the United States Patent Office and is available to advise and assist you in all steps necessary to the preparation and prosecution of patent applications.

Let us send you a copy of our instructive booklet "Patent Protection for Inventors" which explains pertinent points concerning procedures which must be followed and how this firm acts in your behalf. We also will send "Evidence of Invention" disclosure form (with instructions for proper use) to help you take the first step toward securing a patent—a search among previously granted U. S. patents for similar types of inventions to determine probable patentability. Booklet and form sent without obligation.

VICTOR J.  
**EVANS & Co.** *Merlin M. Evans*  
REGISTERED PATENT ATTORNEY

430-D MERLIN BUILDING

WASHINGTON 6, D. C.





# DRAFTING *pays* BIG MONEY!

Draftsmen earn more, enjoy pleasanter working conditions. Get into DRAFTING and Blue-Printing, the starting point of all production. Trained Draftsmen are needed everywhere. Machines can never replace the draftsman.

## LEARN AT HOME IN SPARE TIME

Revolutionary new method teaches you quickly the hows and whys of Mechanical, Structural, Machine, Architectural, etc. Drafting. You are sent professional drafting instruments, drafting equipment, portable drafting table, etc., at no extra cost. You learn by making actual drawings.

**BIG MONEY... ADVANCEMENT OPPORTUNITIES** offered trained draftsmen. Drafting is light, pleasant work, paying big salaries. Is a stepping stone to top managerial jobs. The draftsman plans the World of Tomorrow. That is why drafting is such interesting work.

## OWN YOUR OWN DRAFTING FIRM

The investment requirement is small, the earning possibilities great. Many draftsmen eventually branch out into manufacturing the products they created. Learn of the opportunities in Drafting.

## MAIL THIS COUPON TODAY!

CHRISTY TRADES SCHOOL, Dept. DB-4103  
3214-16 W. Lawrence Ave., Chicago 25

Mail at once your big FREE book on Drafting and Blue-Printing. Tell me how your Home Training and Professional Drafting Instruments, Portable Drafting Table, Drafting Equipment, etc. can be had on a **PAY AS YOU LEARN** plan.

NAME \_\_\_\_\_ Age \_\_\_\_\_  
ADDRESS \_\_\_\_\_ CITY \_\_\_\_\_ STATE \_\_\_\_\_

*not everyone does as well, but E. O. Lockin, who started a business of his own, reports...*

for 12 months I've averaged  
**\$800 PER MONTH**  
**INCOME -**  
most of it clear profit for me!

Many men have discovered how to be independent, to be free of bosses and layoffs. L. A. Eagles grossed more than \$200 his first week. Others report gross up to \$12,000 per year. How much you make depends largely on you. You need no special skill, no large investment.

**No shop necessary.** Our ELECTRIC RUG WASHER cleans rugs, carpets right on floor... helps to show their natural color, beauty. So efficient and safe, used by large hotels and railroads.

You take no risk. Machines fully guaranteed. Write for full information including how to make big profits in **YOUR OWN BUSINESS.**



### MAIL COUPON TODAY FOR FREE BOOK

VON SCHRADER MFG. CO., 410 "R" PL., Racine, Wis.

Without obligation, send your FREE booklet containing information about your ELECTRIC RUG WASHER and how I can start my own permanent, profitable business.

Name \_\_\_\_\_  
Address \_\_\_\_\_  
City \_\_\_\_\_ Zone \_\_\_\_\_ State \_\_\_\_\_



C. KAMA

# "I'M MAKING MORE THAN \$1000 a Month

## Haven't Touched Bottom Yet!



—reports Chas. Kama, Texas, one of many who are "cleaning up" with orders for PRESTO. Science's New Midget Miracle Fire Extinguisher. So can you! Amazing new kind of fire extinguisher. Tiny "Presto" does job of bulky extinguishers that cost 4 times as much, and are 8 times as heavy. Ends fires fast as 2 seconds. Never corrodes. **GUARANTEED for 20 years!** Over 3 million sold! Sells for only \$4.95.

Show it to civil defense workers, owners of homes, cars, boats, farms, etc. and to stores for re-sale—make good income. H. J. Kerr reports \$20 a day. Wm. Wydallis, \$15.50 an hour. Write for FREE Sales Kit. No obligation. **MERLITE INDUSTRIES, Dept. P15H, Presto Div., 114 East 32nd Street, New York 16, New York** IN CANADA: Mops Co., Ltd., 371 Dowd Street, Montreal 1, P. Q.

## LAW FREE BOOK THE LAW TRAINED MAN

Write today for a FREE copy of illustrated law book, "THE LAW-TRAINED MAN," which shows how to earn the professional Bachelor of Laws (LL.B.) degree through home study of the famous Blackstone Law Course. All necessary books and lessons provided. Moderate cost; convenient monthly terms. Write for FREE law training book today.

**Blackstone School of Law, 307 N. Michigan Ave.**  
Founded 1899 Dept. 54, Chicago 1, Illinois



## MECHANICAL DENTISTRY

A profession offering unlimited opportunities. Most modern and complete course embracing every branch from Plate to Porcelain Work, which prepares you to work for Dentists or start your own business. Individual instruction—practical training in day or night school. No books—no classes. Catalog upon request.

**MCCARRIE SCHOOL OF MECHANICAL DENTISTRY**  
207 N. Broad Street Dept. 75 Philadelphia 7, Penna.

## MEN WANTED Earn \$100 Per Week and up

Master a trade with a future—learn Auto-Diesel mechanics in our shops. You learn with tools on real equipment. Earn while you learn. Many of our graduates earn \$100 per week and up. No previous experience necessary. Day and night courses. Approved for veterans. Write for free bulletin.

### NASHVILLE AUTO-DIESEL COLLEGE

226 7th Ave., N., Dept. 73 Nashville 3, Tenn.

## Shrinks Hemorrhoids New Way Without Surgery

### Science Finds Healing Substance That Relieves Pain—Shrinks Hemorrhoids

For the first time science has found a new healing substance with the astonishing ability to shrink hemorrhoids and to relieve pain—without surgery.

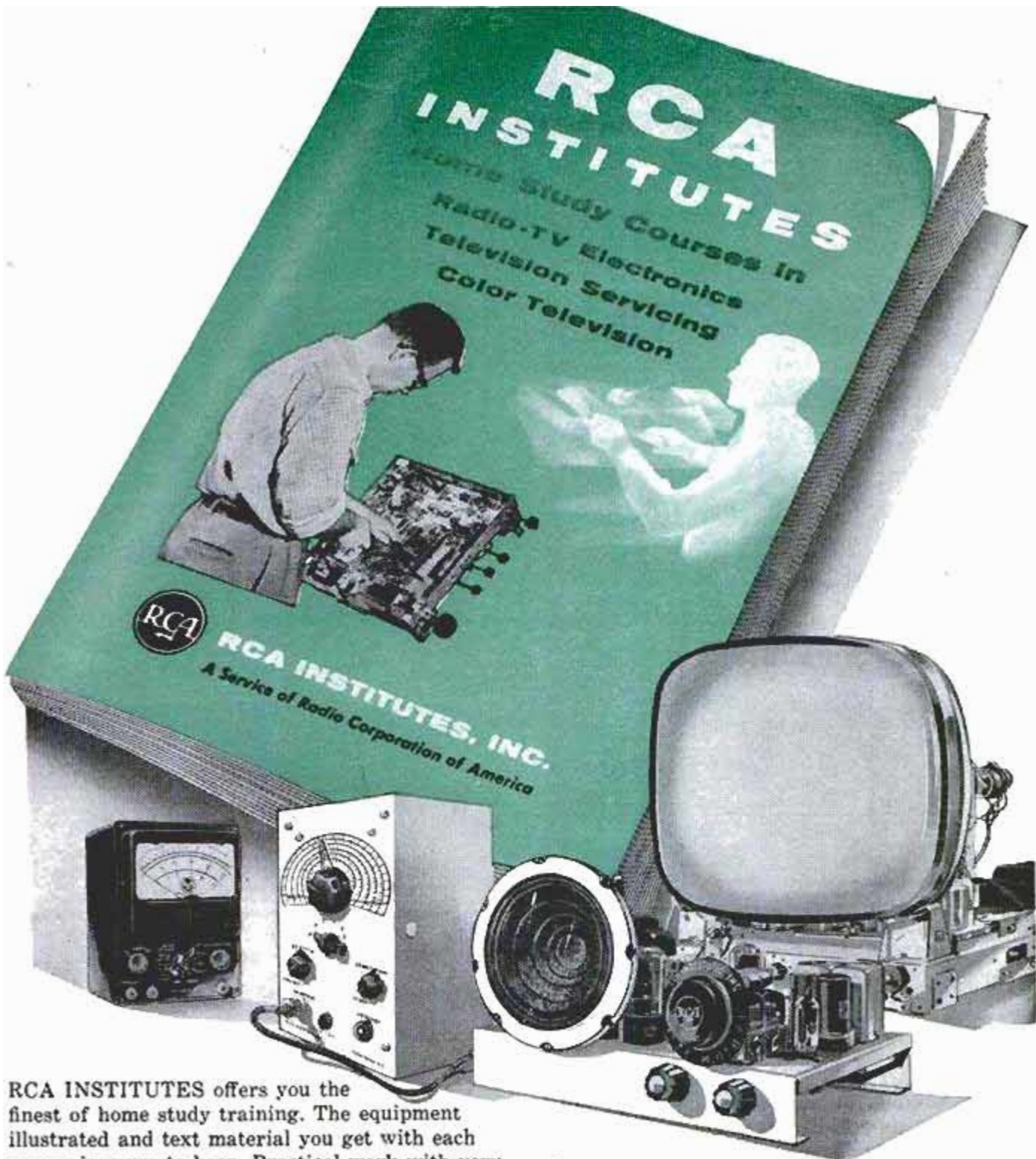
In case after case, while gently relieving pain, actual reduction (shrinkage) took place.

Most amazing of all—results were so thorough that sufferers made astonishing statements like "Piles have ceased to be a problem!"

The secret is a new healing substance (Bio-Dyne®)—discovery of a world-famous research institute.

This substance is now available in suppository or ointment form under the name Preparation H.® Ask for it at all drug counters—money back guarantee. \*Reg. U. S. Pat. Off.





RCA INSTITUTES offers you the finest of home study training. The equipment illustrated and text material you get with each course is yours to keep. Practical work with very first lesson. Courses for the beginner and the advanced student. Pay-as-you-learn. You need pay for only one study group at a time.

**Send for this  
FREE Book Now** 

[ RESIDENT SCHOOL courses in New York City offer comprehensive training in Television and Electronics. Day and evening classes start four times each year. Detailed information on request. ]

**RCA INSTITUTES, Inc.** Home Study Dept. PM-48  
350 West Fourth Street, New York 14, N. Y.

Without obligation, send me FREE 52 page CATALOG on Home Study Courses in Radio, Television and Color TV. No salesman will call.

Name ..... please print

Address.....

City.....Zone.....State.....

Korean Vets! Enter discharge date.....

In Canada — RCA Victor Co., Ltd.  
5001 Cote de Liesse Rd., Montreal 9, Que.

To save time, paste coupon on postcard.



# YOU MAKE 'EM WE SELL 'EM!



Let me show you how to build a big pay business of your own without canvassing, without house-to-house selling!



I'll show you a simple easy way to make dozens of "Made-to-Order" cases for musicians, salesmen, hunters, manufacturers, fishermen, gun collectors, photographers and 1001 other portables. I'll supply instructions, tools, materials—everything you need. My plan is absolutely safe! You risk nothing! Keep your present job and work sparetime until you decide to devote full time to this big pay work that is so fascinating. Set up your shop wherever you have

## MY NATIONWIDE SALES ORGANIZATION WANTS TO WORK FOR YOU!



a few spare feet. With my plan anyone can have his own business without a big investment and without previous experience, and remember you don't have to worry about sales because my National Sales Staff sells for you.

I am very satisfied to make a small profit because I can count on big volume on the supplies I sell to Casecrafters, yet home workers make a big profit because the finished cases sell for up to ten times the cost of materials... Write for full, FREE, details today.

**ABARSI CASECRAFT** 807 SUNSET BOULEVARD  
Dept. DD Los Angeles, Calif.



**JACK STEARNS**  
made \$450.00 on his first order for cases.  
**SO CAN YOU!**  
POSITIVE PROOF SENT TO YOU FREE!!!

## MONEY-BACK GUARANTEE



Rewind  
Movie Film  
Automatically  
as you show it!

with the new  
Performance Proved  
**O'Dell-o-matic**

## AUTOMATIC FILM REWINDER

- \* Approved by thousands of O'Dell-o-matic owners across the nation
- \* Fits quickly and easily on YOUR PROJECTOR without use of tools!
- \* Protects precious film from scratches and re-winding breakage!
- \* There's an O'Dell-o-matic Rewinder to fit all projectors—order now!
- \* "No-Risk" Guarantee... Money back if you're not completely satisfied!

O'DELL-O-MATIC ORDER FORM DEPT. N		FILM SIZE	YOU GET ADAPTER
<input type="checkbox"/> Send me an AUTOMATIC REWINDER KIT	<input type="checkbox"/> 8 mm	PLATE THREE	PLATE THREE
<input type="checkbox"/> Send me INFORMATION LITERATURE	<input type="checkbox"/> 16 mm	REELS TWO HURS.	REELS TWO HURS.
NAME _____	<input type="checkbox"/> Brownie	THREE CANS, Shipped	THREE CANS, Shipped
ADDRESS _____	REEL SIZE	postpaid BROWNIE SIZE	postpaid BROWNIE SIZE
CITY _____ STATE _____	<input type="checkbox"/> 200-ft.	at \$14.95	at \$12.95
ENCLOSED FUND <input type="checkbox"/> \$14.95 <input type="checkbox"/> \$12.95	<input type="checkbox"/> 400-ft.	plus 50¢	plus 50¢

WEST MICHIGAN DISTRIBUTING CO. 44 IONIA, S.W. GRAND RAPIDS MICHIGAN

## "MINIATURE MACHINE SHOP

No Bigger Than A Typewriter, Outperforms Machines Many Times its Size!"



That's what a popular publication says about UNIMAT in their 3 page feature story in the May issue. If you want a reprint of this story plus complete information about this amazing 10 in 1 combination precision tool write to:

AMERICAN EDELSTAAL, INC., UNIMAT DIV., Dept. 348, 350 B'way., N.Y. 13



## SEND FOR THIS FREE!

Make money. Know how to break and train horses. Write today for this book FREE, together with special offer of a course in Animal Breeding. If you are interested in Galting and Riding the saddle horse, check here ( ) Do it today—now.

**BEERY SCHOOL OF HORSEMANSHIP**  
Dept. 1104 Pleasant Hill, Ohio

## SCIENTIFIC CRIME DETECTION



### IT'S EASY TO LEARN

Let us teach you in your own home. Learn Finger Printing, Firearms Identification, Police Photography, Criminal Investigation Methods thoroughly, quickly, at small cost. Over 800 Bureaus of Identification in the U. S. employ I. A. S. students or graduates. Write today, stating age.

**INSTITUTE OF APPLIED SCIENCE, 1920 Sunnyside Ave., Dept. 1354**  
(A Correspondence School Since 1916) Chicago 40, Ill.

## NEW ARMY MINE DETECTOR

Model SCR625. A portable device for detecting metallic and nonmetallic objects. Find buried pipe lines, cables, wires, hidden jewelry, coins, sewer tile, etc.

Send for circular

Shipping weight  
appr. 85 lbs.  
F.O.B. N. Y.  
No C.O.D.'s.  
Send order to:



**COLUMBO TRADING CO., INC.**

395 Canal St., Dept. PM, New York 13, N. Y.

## Learn ACCOUNTING

Business Administration  
Bookkeeping, secretarial and allied subjects at home in your spare time or attend nationally approved resident school. Write for FREE Success Book giving complete details on courses, plans, rates and employment opportunities. G.I. approved. Write Dept. A.

**Hills BUSINESS UNIVERSITY AND EXTENSION SCHOOL**  
619 W. MAIN ST. OKLAHOMA CITY 2, OKLAHOMA

## TRUE SIGHT HAND LEVEL

only \$295



- Do your own grading, building, leveling, fencing
- Precision made. Easy to use. Saves time. Accurate up to 100 yards.
- Helps you avoid costly errors in setting up fencing, landscaping, grading, paving, laying out foundations, pools, orchards—for drainage, tiling, contouring. Made of tough phenolic plastic. Glass front hardened steel cross hair. Unbreakable mirror. Slotted eyepiece for maximum visibility. Built-in lens shade. Sensitive level vial. Only \$2.95! Get your 5556 True Sight Hand Level of your lumber or building supply dealer, who stocks the T8025 Farm and Light Construction Level and other David White medium and low-priced surveying instruments.

**DAVID WHITE INSTRUMENT COMPANY**  
Dept. G, 2051 N. 19th St., Milwaukee 5, Wisc.

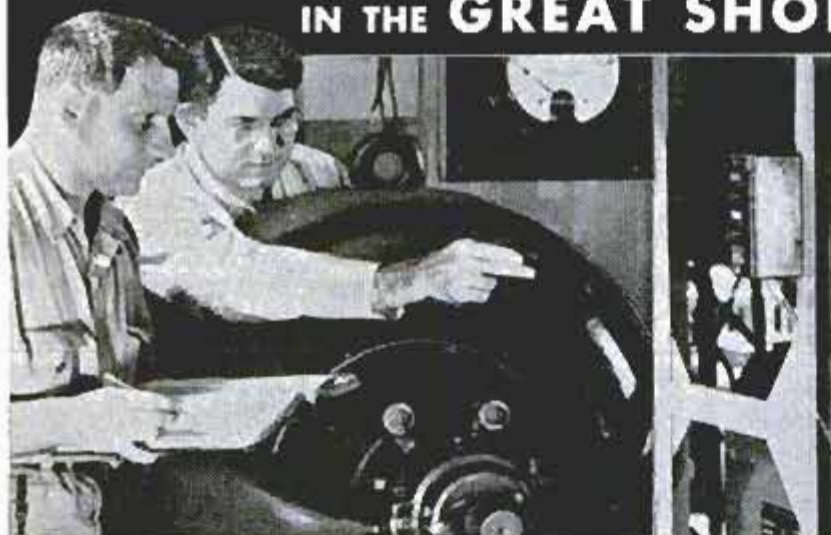


TRAIN FOR OPPORTUNITY FIELD OF

# ELECTRONICS

ON REAL EQUIPMENT  
IN THE GREAT SHOPS

OF **COYNE**



**LARGEST, OLDEST AND BEST EQUIPPED  
SCHOOL OF ITS KIND IN U.S.**

This five story Chicago building is occupied entirely by Coyne. Five big floors of Classrooms and over a quarter of a million dollars worth of Equipment. Thousands of successful men have trained at Coyne. There is no substitute for Coyne's wealth of experience.



## OPPORTUNITIES IN ELECTRICITY-ELECTRONICS

Train the Coyne way for a better job in *Electricity-Electronics*—a field that offers a world of opportunities now and in the years ahead. In industry—in the home—Electricity and Electronics are playing a vastly greater role than ever before. New developments and rapid growth are creating increasing job opportunities. Automation Electronics—one of the more recent applications of Industrial Electronics to manufacturing processes—promises to create additional demands for trained Electrical-Electronics men such as we have never seen. Electrical Training can be taken separately or combined with Television-Radio. Send coupon for more information.

*Training in Refrigeration and Electric Appliances can be included.*

**YOU TRAIN IN CHICAGO**—Learn the easier practical way in shops of Coyne in Chicago. Shop work plus technical training. No advanced education or previous experience needed. Lifetime Employment Service to Coyne Graduates.

### START NOW—PAY LATER

New liberalized credit terms and Finance Plans. Part-time employment service to students. Help in making housing arrangements.

### VETERANS OR NON-VETERANS

Coyne training is offered to Veterans and Non-Veterans alike. We'll send Bulletin giving full information. Send coupon for details.



## TELEVISION—RADIO ELECTRONICS

Great opportunity for a good job or your own business in one of America's fastest growing branches of Electronics! New stations by the hundreds . . . new sets by the millions . . . and now Color TV . . . all means greater opportunities in Sales and Service. Separate courses in Radio-Television or in combination with Electricity-Electronics available. Coupon brings details.

*Mail coupon for big free book!*

48 Page Illustrated Book, "Guide to Careers" gives you all the facts. Whether you prefer Electricity-Television-Radio or Combined Electronics Training this book describes all training offered.

**Information comes by mail. No obligation and no salesman will call.**



1. You are told the how and why of each job. 2. You're shown how to do it by trained instructors. 3. You do the jobs yourself on finest equipment.

**D. W. COOKE JR., President** **COYNE** FOUNDED 1899  
**ELECTRICAL SCHOOL**  
A Technical Trade Institute Operated Not For Profit  
500 S. Paulina Street, Chicago, Dept. 48-3C  
ELECTRICITY • RADIO • TELEVISION • REFRIGERATION • ELECTRONICS

Coyne Electrical School, Dept. 48-3C  
500 S. Paulina St., Chicago 12, Ill.  
Send **BIG FREE BOOK** and details of all training you offer. However, I am especially interested in  
 Electricity-Electronics     Television-Radio  
 Combined Electronics Training  
Name \_\_\_\_\_  
Address \_\_\_\_\_  
City \_\_\_\_\_ State \_\_\_\_\_  
*(I understand no Salesman will call.)*



**GENUINE  
360 POWER  
3" REFLECTING  
TELESCOPE**



**COMPLETE WITH  
50X, 120X, 150X, 360X  
magnifications. 4X finder scope,  
folding tripod, plus "Handbook  
of Heavens" & Magic Star Finder**

Only  
**\$26.95**

Never before a precision reflecting telescope sold with all these features, for anywhere near this low price. Professional observations guaranteed with this powerful astronomical telescope. Equipped with special WIDE-ANGLE lens for observing satellites, stars, nebulae, comets, Saturn's rings, Jupiter, Mars, Moon's detail, other celestial phenomena with observatory clearness, amazing closeups guaranteed on all objects. Will "split" close double stars. Acclaimed by experts. Optically & scientifically correct, for serious astronomical work. Comes completely assembled ready to use. Eyepieces give full range of powers, 50X, 120X, 150X, 360X. 3 inch f12.5 mirror aluminized & overcoated, guaranteed to resolve to Dawes limit. Special ventilated aluminum mirror housing for use in all climates. 3 foot hardwood folding tripod. Equatorial, alt-azimuth mount. Aluminum head compensates for earth's rotation & permits automatic tracking of astronomical objects. 36" Bakelite phenolic tube. 4X finder scope sights target fast. Completely portable; scope instantly removable from tripod for easy storage & carrying to remote areas. Also included with this amazing precision instrument, 270 page book "Handbook of the Heavens," Magic Star Finder. Satisfaction completely guaranteed or money refunded. Sent complete, nothing else to buy at the amazing low price of only \$26.95. Send cash, check, or money order. Shipped by express F.O.B. Shipping weight 10 lbs. Dept. DPM 4, OPTIK INSTRUMENTS CO., 509 Fifth Ave., N. Y. 17, N. Y.

## LEARN AT HOME TO MOUNT BIRDS



**Animals, Heads, Fishes, Pets; to TAN.  
Be a Taxidermist. Profit and FUN.**

Hunters, save your valuable TROPHIES. Mount ducks, squirrels, everything. Learn to TAN for leather and furs. Wonderful HOBBY Have a HOME MUSEUM—BIG PROFITS mounting for others. INVESTIGATE NOW.

**FREE BOOK** With 100 fine game pictures. NOW absolutely FREE. Write TODAY.

Send Postal TODAY for FREE BOOK. State AGE. N.W. SCHOOL OF TAXIDERMISTRY, Dept. 2504, Omaha, Neb.



## KASENIT COMPOUND

**FOR CASE HARDENING OF TOOLS  
GUN PARTS, MACHINERY, etc.**

Easy to Use — Needs No Special Equipment —  
NON-Poisonous — NON-Explosive — NON-In-  
flammable. SPECIAL OFFER 1 LB. CAN \$2.50  
POSTPAID with Complete Instructions.

**KASENIT CO.** (EST. 1912), 4-6 KING ST.  
MAHWAH, N. J.  
MONEY BACK GUARANTEED — (FOLDER FREE)



## REPAIR ANY WATCH



**... Swiss or American**

No previous experience needed to learn modern watch repair. An enjoyable hobby or profitable career. Unique Sweazey System starts you making repairs right away. Develops your skill step by step. Teaches you modern shop methods . . . professional short cuts . . . mistakes to avoid. Learn by personal attendance or spare time home study. Free sample lesson. No obligation. Write today!

**FREE  
SAMPLE  
LESSON**

**CHICAGO SCHOOL OF WATCHMAKING**  
2330 N. Milwaukee, Dept. 148, Chicago 47, Illinois

## GIANT 6 FOOTERS 59c



Wow! Genuine Neoprene government surplus (never used) . . . giant 6 ft. across, 21 ft. around . . . at a fraction of original cost. Durable. Can paint on advertising message. Inflate and fly. Visible for miles. Great for attracting crowds to fairs, openings, school proms, gas stations. Fun for young and old in backyards or picnics, at the beach, etc. use as water markers & buoys. Order today—59c. 2 for \$1.  
**Special 13' — \$1.95 ea.**

**FRANK SALES** 3930 SUNSET BLVD., DEPT. PM458  
LOS ANGELES 26, CALIF.

## "How to Make Money with Simple Cartoons"



A book everyone who likes to draw should have. It is free; no obligation. Simply address

**FREE  
BOOK**

**CARTOONISTS' EXCHANGE**  
Dept. 94-D Pleasant Hill, Ohio

## Secrets of VENTRILOQUISM Now Revealed!



Easy to learn in 60 to 90 days with our Home Study Course. RESULTS GUARANTEED. Make Money! Be Popular! Have Fun! Big Opportunity! Radio, Television, Stage Appearances! For FREE Information regarding price and terms WRITE. You must state your age. Dummy Catalog 25c.  
**MANER HOME COURSE OF VENTRILOQUISM**  
Box 36, Studio E, PM-4, Kensington Station  
Detroit 24, Michigan

**PLEASE  
SEND ME**



for the  
time checked.  
I am enclosing . . .

- 1 year \$3.50  
 2 years \$6.00

name \_\_\_\_\_

address \_\_\_\_\_

city \_\_\_\_\_

zone \_\_\_\_\_

state \_\_\_\_\_

Hand this order to your newdealer or send it to  
**POPULAR MECHANICS**  
200 East Ontario St. Chicago 11, Ill.



# Everything YOU WANT TO KNOW ABOUT Fireplaces AND BARBECUES

INDOOR & OUTDOOR

76 PAGES — 220 ILLUSTRATIONS

A complete handbook of designs, layouts, plans, equipment... everything in indoor and outdoor fireplaces and barbecues. Only \$1 ppd. Send for yours now!

The **Majestic Co., Inc.**  
527 Erie St., Huntington, Indiana



## Train at Home for a Top-Pay Job in **AUTO MECHANICS**

Skill adds many extra dollars to your pay check. This is especially true in the auto field, where 100,000 mechanics are needed. Average pay in some areas is \$3 per hour. It's easy to train at home in spare time for a secure job with a bright future, in America's No. 1 industry. *Mail coupon for full details.* No cost nor obligation.

### Get Experience Using Tune-Up Kit & Tools

(included with training)



CTI sends you a Tune-Up Kit, the kind that skilled mechanics use to locate engine troubles. You receive a compression Tester; Vacuum Gauge & Fuel Pump Tester; Ignition Timing Light; portable steel case. You also get mechanic's tools, including socket set. You acquire *experience* using kits.

**DIESEL MECHANICS OR BODY-FENDER REBUILDING** is yours at no extra cost. Only CTI offers this *extra* choice. You get fully-rounded training in all phases of mechanics.

### Many Students Earn Money as They Train

by taking part-time jobs in local shops or fixing cars "on their own." Many make enough to pay all tuition and buy extra equipment. Some open shops, become independent.

### Get Facts Now—Decide Later

Your future is worth looking into. Get facts on job and business opportunities. Mail coupon today—Commercial Trades Institute, Chicago 26, Ill.

**MAIL TODAY  
FREE  
BOOKLETS**

## COMMERCIAL TRADES INSTITUTE

1400 GREENLEAF AVENUE  
CHICAGO 26, ILLINOIS DEPT. A-783

Send booklet, *Big Money in Auto Mechanics*, and *Sample Lesson*. Both are FREE.

Name \_\_\_\_\_ Age \_\_\_\_\_

Address \_\_\_\_\_

City \_\_\_\_\_ Zone \_\_\_\_\_ State \_\_\_\_\_



## LEARN MEAT CUTTING



Train quickly in 8 short weeks at Toledo for a bright future with security in the vital meat business. Big pay, full-time jobs—**HAVE A PROFITABLE MARKET OF YOUR OWN!** Pay after graduation. Diploma given. Job help. Thousands of successful graduates. Our 35th year! Send NOW for FREE catalog. No obligation. GI approved. NATIONAL SCHOOL OF MEAT CUTTING, Dept. 50-C, Toledo 4, Ohio

### EXCLUSIVE! PRE-ASSEMBLED KITS! FREE CATALOG... SEND TODAY!



Now! Pre-assembled kits save up to 2/3 assembly time. Send for Free Catalog Now! Cruisers, Runabouts. 12 NEW Models 12-18'. Supermart selection of Fiberglass & Accessories.

## BOAT KITS INC.

1415 W. 92nd St., Dept. B-4 Bloomington 20, Minn.

## TERMITES IN YOUR HOUSE? GET RID OF THEM YOURSELF!

Don't pay \$300 and up to eradicate termites from your home or prevent infestation. Do it yourself in one afternoon. Easily! Quickly! Inexpensively with "TERM-OUT"! Send stamp for handbook.



**COMPASS RESEARCH**  
701-A INVESTMENT BLDG., PITTSBURGH 22, PA.

A POSTCARD

### CAN PUT YOU IN A FINE BUSINESS!

#### Rush Card TODAY for FREE OUTFIT!

Get into highly profitable, repeat-order shoe business! Sell new line of Air-Cushion comfort shoes to friends, neighbors, folks at work! Over 210 dress, sport, work, safety shoe styles for men, women. Never sold by stores. Just 2 easy orders a day—in spare time—bring you \$217 extra income a month! No investment. Rush name and address TODAY for FREE SELLING OUTFIT.

MASON SHOE, Dept. A138, Chippewa Falls, Wis.



### Million Dollar Inventory — All Famous Brands



SAVINGS NEVER LESS THAN 50% UP TO 70% OFF REGULAR PRICES  
HEADQUARTERS FOR ALL SPORTS CAR TIRE SIZES  
SEND FOR YOUR FREE CATALOG!

**RELIABLE TIRE CO.** 728 MORGAN BLVD. CAMDEN 4, N. J.



GENUINE

LONGHORNS

TO MOUNT

For over a century, magnificent spans of Longhorns have adorned ranch homes, clubs, hotel lobbies, banks and gaming houses. Longhorns have become a legendary symbol of the Old West, an era when huge fortunes and vast holdings were made and lost. Many a set of Longhorns has been silent witness to historic meetings, phenomenally large transac-

tions, even financial tragedies in offices of cattle barons of the past. For the first time, you are in position to command ownership of a mounted trophy of exquisite Longhorns.

We are offering limited numbers of ready-to-mount sets of Genuine Steer Horns in 3 to 5 foot spreads at a fraction of the price demanded by collectors,

antique dealers. Matched sets shipped in semi-polished kits, complete with hardware, mounting instructions. Appropriate decor for your mantle, rec room, den, boy's room, bar, office, cafe, motel, etc. Wonderful gifts. Mount and sell Longhorns as a profitable hobby. Priced from \$9.98. Write today for information, best selection. Lamme Co., Laclede 1, Mo.

## HOTTEST THING ON Jeep FRONT WHEELS



### STOP FRONT END DRAG IN 2 W. D.

Warn Hubs on your 4 w. d. give double-duty value—economical, free-wheeling 2 w. d. (with added pep!), normal 4 w. d. —automatically with Lock-O-Matics, manually with Warn Locking Hubs. See your 4 w. d. dealer!

## WARN HUBS

WARN MFG. CO., Inc.  
Riverton Bx 6064-A4,  
Seattle 68, Wn.

"We Have No Rent to Pay." That is Why We Can Sell For Less.

24 YEARS IN BUSINESS AT THE SAME ADDRESS

## FREE

GUARANTEE BOND given with each used tire sold. We guarantee the amount of service you pay for. SEND AD.

EVERYBODY 10% off ON EVERY TIRE MAY DEDUCT

PRICES SHAVED TO THE BONE — 6 Months Guar. W.W. \$1.00 EX.			
300x16	\$3.62	670x15	\$3.82
650x15	3.72	800x15	4.82
650x16	4.22	700x15	3.85
		700x16	\$4.42
		710x15	4.32
		760x15	4.32
		760x16	\$4.72
		820x15	4.82
		820x17	4.62
12 MOS. WRITTEN GUARANTEE. WHITE WALLS \$1.00 EACH.			
600-16	\$5.22	675-19	\$5.32
600-16(6)	6.42	640-15	4.92
650-16	5.42	670-15	5.22
650-16(6)	6.42	710-15	5.32
700-16	6.22	760-15	5.42
750-16(6)	7.42	800-15	5.72
550-18	4.82	820-15	5.72
550-17	4.72	670-16	5.15
650-15	5.22	760-16	7.72
700-15	5.32	700-16(6)	7.72
		750-15	11.92
		700-20	\$11.92
		750-20(8)	9.92
		750-20(10)	14.72
		700-17	10.92
		750-20(8)	10.92
		825-20	18.52
		900-20	18.72
		1000-20	19.72
		1100-20	19.72
		1000-22	20.92
		1100-24	23.72
		1100-22	20.02

Thousands of tires shipped all over the U.S.A. All tires shipped F.O.B. Phila. Send Check or M.O. with this ad. Dept. 2. No C.O.D. **STANDARD** 834 N. Broad St., Philadelphia 30, Pa.

## MAKE GARDENCRETE

G-4

### A Spare-Time Activity Can Lead to a Full-Time Business

On one compact, low price, easy-to-operate machine you can make 24 different kinds or sizes of Gardencrete for patios, walks, planters, barbecues, terraces, etc. Easily set up in shed or garage. With small investment, you can turn idle hours into profit and build into a full-time operation. Gardencrete enables you to cash in on large, growing demand for garden masonry in color.



\$1.00 worth of materials can be turned into \$5.00 to \$8.00 worth of Gardencrete. A cash-and-carry business. We supply full instructions. Complete information in full-color brochure. Write today.

COLORCRETE INDUSTRIES, INC.  
704 Ottawa Ave., Holland, Mich.



Patio Stones  
Flag Stones  
Solid Brick  
Hollow Brick  
Roman Brick  
Slump Brick  
Cap Stones  
Curb Stone  
etc., etc.

## JEEP OWNERS

RE-POWER NOW WITH A V-8 ENGINE — Use

FORD • CHEVROLET • MERCURY

in 2 or 4 Whl-Dr. Jeeps, Jeepsters, Sta-Wgn, Trucks, M. J. and Kaiser cars. Conversion Kits \$43.25 to \$59.85. If you want fast action tell us which engine you wish to use, give us year, Model (2 or 4 Whl-Dr) of your vehicle. Send Min. \$15.00 Dep. and we will ship correct kit, Bal. COD. Send full amt. for Prepaid shipment. Wire, phone or write for free details. Also Kits for FORD 6 engine.

HOOSIER MACHINE PRODUCTS CO.

312 S.E. 6th St. Phone CR 6-3442 Pendleton, Oregon, U.S.A.

## MONEY for MEN ALL DATA FREE

THE PLASTEX Industry needs manufacturers on small scale and for big production of Lamp and Clock Stands, Art Goods and Novelties in Plastex and Marble imitation. Experience unnecessary. Lge material makes regular 10¢ store sellers. Rubber moulds furnished for speed production. Small investment brings good returns. We are now placing big Chain Store Orders with manufacturers. Ambitious men have chance for real prosperity. Our Free booklet will interest and benefit you.

PLASTEX INDUSTRIES, Dept. A

3400 Third Ave. New York 56, N. Y.



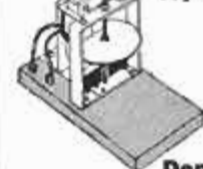
## Every Boy Should Have This Build-It-Yourself Book for Boys!

It's natural for boys to want to make things—to fuss with tools—to fashion the kind of things "kids" want. So give boys the Build-It-Yourself Book for Boys. Encourage a youngster to express himself through the sensational new Popular Mechanics book that shows how to make 56 different things every boy dreams about. It covers science, mechanics, electricity, modeling and other fields. 192 pages of easy-to-follow instruction and 469 how-to-do-it pictures.

### 56 Toys, Games, Gadgets, Models, Boats, Electrical Devices, Cars and Other Things Boys Can Make at Home

How to make—Airplane Models, Truck, Squirt Gun, SS United States Model, Surfboard, Tank Toy, Taxidermy, Telegraph Set, Telephone, Tree House, Water Skis, Weather Instruments, Toggan, Worktable. Build-It-Yourself for Boys sent postpaid for \$2.50 or COD, charges additional. Money refunded if you are not pleased after 5 days' use. Mail order to address below.

Toy motors



Boomerangs



"Ju-be"—the punt.

POPULAR MECHANICS PRESS  
Dept. 458, 200 E. Ontario St., Chicago 11



**BIGGER! BETTER! FINER! FASTER!**

**PENN  
YAN  
boats**

... this year's line of leaders includes luxury outboard runabouts, Trailboats, Cartops® and canoes. Types for cruising, fishing, skiing, racing. New clinker models, superior in tightness, laps bonded by exclusive Vulcanite process. *Bond is stronger than the wood itself.*

**FREE  
CATALOG:**  
44 pages, color  
illustrations.

**Write Today!**

**PENN YAN BOATS, Inc.**  
34th St., Penn Yan, N.Y.



**Sapphire**  
—also in  
Clinker-built

**EARN BIG \$\$\$  
LEARN LAPIDARY**  
GEM CUTTING & JEWELRY ARTS

**MAKE JEWELRY PIECES  
FOR FUN — FOR PROFIT**

Now you can make amazing, professional-looking items in your own home. Write for outstanding bible of the industry... Grieger's Encyclopedia of Lapidary. Now... over 320 pages... 2000 pictures... 30 articles... source data for everything you need. Send for **FREE INFORMATION TODAY**... at no obligation. **ACT NOW.**

**GRIEGER'S INC.** Dept. 253, 1633 E. Walnut  
Pasadena 4, Calif.



**DeLuxe METAL Pocket Rubber Stamp**

**\$2**

Custom Made. Chrome Plated. Indestructible. "Finger-Tip" Control. Self-locking case. 3-line text 1/2" x 2" area. Inked pad. Our regular, popular Nickel Plated Stamp, without DeLuxe Features, still only **\$1**



Send Check or Money Order. Mailed **POSTPAID**  
**SAMUEL H. MOSS, Inc., 36 E. 23rd St., N.Y.C. 10 Dept. MEC-4**

**\$2.95 OR 2 FOR \$5.00!**

**TESTED AND GUARANTEED**

Write for free list on all types of telephones.  
Shipments F.O.B. Simpson, Pa.

**TELEPHONE ENGINEERING CO., Dept. 4B8, Simpson, Pa.**

**250 POWER.....**



**Complete Telescope Lens Kit** only **\$3.49** postpaid

Conquer Space, Explore the Universe, Planets, Moon Craters, New Stars, etc. Complete Lens Kit consists of 80 inch focal length ground and polished objective lens, eyepiece lenses for 50 POWER, 100 POWER, 150 POWER, 200 POWER, 250 POWER, and all necessary lens fittings. Easy to make from simple step by step instructions. (Tripod and mount not included.) Money back guarantee.

**BUSSE SALES CO., Hartford, Conn., Dept. PM 68**

**ENGINES "Sing"!**

WITH **MILESMASTER®**



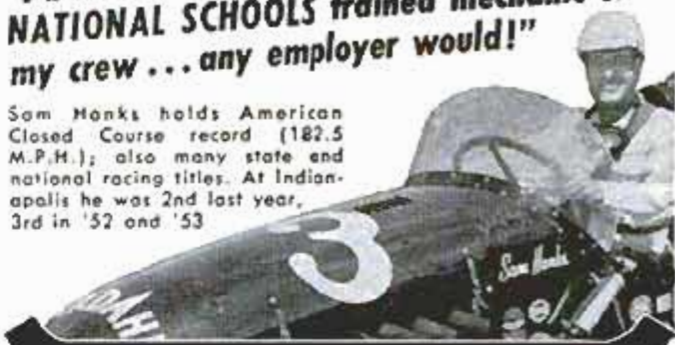
**FUEL  
PRESSURE  
REGULATOR**

For smooth running, quick starting, better mileage... install a genuine MILESMaster. Prevents flooding. Only \$6.95

**MILESMaster, Inc., Dept. K, Exeland, Wisconsin**

**SAM HANKS, 1957 "INDY 500" winner says:**  
**"I'd like a  
NATIONAL SCHOOLS trained mechanic on  
my crew... any employer would!"**

Sam Hanks holds American Closed Course record (182.5 M.P.H.); also many state and national racing titles. At Indianapolis he was 2nd last year, 3rd in '52 and '53



**MASTER ALL ENGINES  
AT HOME IN YOUR SPARE TIME  
NATIONAL SCHOOLS  
AUTO MECHANICS & DIESEL  
COURSE**  
INCLUDING FUEL INJECTION

**YOU GET AND KEEP ALL THIS EQUIPMENT**



Complete set of professional tools and All-Metal Tool Box. Same top-quality equipment used by expert mechanics everywhere. Use them, display them proudly.



"Motor Analyzing Set" contains Standard Engine Vacuum Fuel Pump Tester, Remote Starter Switch, Modern Timing Light, Standard Compression Tester. Plus compact carrying case & instructions.



Top-quality Socket Wrench with Fittings. Real professional tools you'll use during your lifetime career in repairing all types of engines, from foreign cars to big diesel jobs.

"I've worked alongside National Schools-trained mechanics," reports Sam Hanks. "They're tops, because they get all-around training, and they know how to repair fast and right the first time. No wonder National Schools graduates command top pay."

Earn as you learn men! We'll show you how. Streamlined lessons, diagrams, manuals, latest equipment, practical methods prepare you for hundreds of jobs in scores of industries. Free Placement Assistance.

Approved for GI Training

**FREE!  
VALUABLE BOOK  
& SAMPLE LESSON  
JUST SEND COUPON**



Resident Training at Los Angeles  
If you wish to take your Auto-Diesel training in our famous Resident School at Los Angeles, check special box in coupon for full information.

**NATIONAL SCHOOLS**  
Los Angeles 37, California

**NATIONAL SCHOOLS**

TECHNICAL TRADE TRAINING SINCE 1905  
LOS ANGELES 37, CALIFORNIA

**MAIL NOW**  
**NATIONAL SCHOOLS, Dept. DB-48**

**4000 S. FIGUEROA ST.  
LOS ANGELES 37, CALIF.**

Send for **FREE** Auto-Diesel Opportunity Book and Sample Lesson.

NAME \_\_\_\_\_ AGE \_\_\_\_\_

ADDRESS \_\_\_\_\_

CITY \_\_\_\_\_ ZONE \_\_\_\_\_ STATE \_\_\_\_\_

Check if interested **ONLY** in Resident School Training at Los Angeles  
**VETERANS.** Give date of discharge \_\_\_\_\_



World  
Wide



# OWN a Business!

Even if now employed, we'll personally train you, furnish all equipment & supplies, and show you how to clear **\$8,750** the first year on **2 jobs a day.**

- NATIONALLY ADVERTISED
- NO SHOP NEEDED

Enjoy the prestige and financial independence of your OWN business. You will be locally trained to help you get quickly established. Just 2 average jobs a day earns **\$8,750 NET** profit first year. Employ others. **MULTIPLY** profits. You become an expert in the care of rugs and upholstery. Easy to learn. Start part-time from home. We provide 25 regular benefits. **National Advertising, Publicity Program, Conventions, Monthly Magazine, Insurance, Advertising Kit.** Many others. You offer 5 different services: 1. **Duraclean:** Famous ABSORPTION process for cleaning rugs, upholstery. Commended by Parents'. NO scrubbing, soaking, shrinkage. Aerated foam removes dirt, grease. 2. **Durashield:** Soil-retarding treatment **KEEPS** furnishings clean MONTHS longer. 3. **Duraproof:** Protects against damage by moths. 4. **Duraguard:** Flameproofing to reduce fire damage. 5. **Spotcraft:** For removing stubborn spots and stains. Moderate payment establishes your business . . . pay balance from sales. We furnish portable machines, complete sales material, enough supplies to return **TOTAL** investment. Send for **FREE** booklets explaining Dealership Program today.

## "OWN a Business" Coupon

**DURACLEAN CO., 8-164 Duraclean Bldg., Deerfield, Ill.**  
Please rush free booklets with full details of how I may OWN a growing, lifetime business.

Name \_\_\_\_\_  
Address \_\_\_\_\_ County \_\_\_\_\_  
City \_\_\_\_\_ State \_\_\_\_\_

## STOP RUPTURE SUFFERING!

**WEB GUARANTEES LASTING RELIEF  
—OR YOUR MONEY BACK!**



Thousands have overcome disabling ruptures with the *natural* support of Web's patented design. Satisfaction—or full price refunded. Write for free book!

**WEB TRUSS CO., Dept. M-4, HAGERSTOWN, MD.**

**YOU CAN MAKE  
AS MUCH AS  
\$20,000 A YEAR  
WITH YOUR OWN BUSINESS!**

Here's your opportunity to make big money on a small investment! Open your own **RICHARDSON** Roadside Stand, backed by our proven formula and franchise plan. Our 35 years of experience in merchandising root beer at stands, parks, fountains and two world fairs is passed on to you. Let us show you—without obligation—how you can go into business for yourself with a minimum investment and join the successful franchised **RICHARDSON** Roadside Stand operators earning up to \$20,000 and more a year! A **RICHARDSON** franchise permits you to build a modern, nationally advertised **RICHARDSON** patented stand. Here's your chance to set up a nice business that's easy to operate, simple to maintain, designed to give you big seasonal profits or income all year 'round. Write for further information, now!

**RICHARDSON Corp.** Box 790 Dept. P. M.—1  
Rochester 3, New York

# \$1 BRINGS YOU \$18

Discover Flek-Kraft and Earn \$\$\$\$ AT HOME

Earn up to \$15.00 per hour spare time. Amazing new Velvet-fiber spray instantly makes any object (Lamps, Radio & TV Cabinets, Figurines, Signs, Auto dash boards, toys, furniture, draperies—anything) worth expensive \$\$\$\$ Prices. Like magic, you can spray anything with this beautiful new suede-like finish that feels like rich Velvet.

**EARN UP TO \$300.00 PER WEEK SPARE TIME**

Imagine, materials cost only 3¢ per square foot. (Average TV or radio cabinet can be beautifully sprayed with this startling new 3-dimensional Velvet finish in 15 minutes at a cost of only 34¢ in materials. Your charge for this job is at least \$10.00.)

**REPRESENTATIVES IN YOUR AREA URGENTLY NEEDED**

Own your own business. Work at home in your spare time. Help fill the huge growing demand for this amazing new beautiful Velvet-fiber finish. Orders come from stores, offices, homes, architects, auto dealers—everywhere. Possible \$20,000,000.00 worth of jobs to be done. Investigate today—be first in your area! Actual samples in 10 Radiant Colors. Booklet of 50 Home Business Opportunities and Confidential Details all sent free! Write: **Coast Industries, Los Angeles 61, Calif., Dept. B-4.**

## YOUR OWN PRINTING BUSINESS



Start in spare time at home. Everyone uses printing. Print cards, letterheads, circulars, Mail Order Advertising etc. Do hundreds of jobs, quickly and easily, with an **ADANA** world-famous, low-cost machine using standard printer's type. Follow simple instructions—produce professional work. Write for **FREE** literature.

**ADANA, 693 Seneca St., Buffalo 10, N. Y.**  
in Canada: 8 Cumberland St., Toronto.

## ARBO-GASTER GETS BIG BASS WAY DOWN DEEP



**DEADLY NEW  
DEEP-DIVING  
FLOATER**

for BAIT CASTING  
for SPINNING  
for SPIN-CASTING

Amazingly weedless, rolls over deep-water snags. Perfect control, casting or trolling. Won't twist or turn over. 3 SIZES—1/8 oz.—1/4 oz.—5/8 oz.—\$1.35 ea. Choice of 6 flashy Reflector Finishes and 9 Standard Colors.

**FRED ARBOGAST CO., INC.**  
2224 W. North Street, Akron 3, Ohio

**FREE! WRITE FOR BIG COLOR CATALOG**

## MONEY in WORMS

Big money made raising crickets, hybrid red wigglers and 12 inch African fishworms—Sell by mail—We teach you how to raise and where to sell. Free Literature. Start now for big season beginning next spring. **CARTER WORM RANCH, PLAINS, GEORGIA**

## SIGN PAINTING

Home-Study Course — Only \$5.95

Teaches you commercial sign painting and sign building as it is being done TODAY in leading shops all over the country. Complete practical course for self-instruction. Shows latest methods of truck lettering, office doors, wood letters, reflecting signs, plastic, sprayed signs, gold leaf, silk screen process, up-to-date alphabets, money-making business information, etc.

**SATISFACTION GUARANTEED OR REFUND!**  
Contains all the instruction of a high-priced correspondence course. Full price, only \$5.95, postpaid. Or C.O.D. plus postage. No risk—order today. Satisfaction or money back! Order "Sign Painting Course." **NELSON-HALL CO., 210 S. Clinton St., Dept. DS-2, Chicago 6, Ill.**



**\$500,000.00 INVENTORY  
for QUICK LIQUIDATION**

Surplus items—hundreds of them for home, shop, factory, farm and outdoor use. New items, used items, reconditioned items—all at tremendous savings—all priced for quick sale.

Page After Page of Values

This big catalog shows page after page of amazing money saving values. Write for your copy today. Send 13¢ to cover postage, mailing, etc. Write today! **SEND TODAY FOR YOUR COPY**

**STARK'S** 212 W. Madison St.  
Dept. PM-584  
CHICAGO 6, ILL.

**10c**





## college graduates get ahead faster!

You see it in your own city. They have higher incomes . . . advance more rapidly. Grasp your chance for a better life. Industrial growth . . . automation . . . technical advances create career opportunities for engineers, accountants, management experts. Share rewards awaiting college men. Important firms visit campus regularly to employ Tri-State College graduates. Start any quarter in this world-famed college. Approved for veterans.

### Bachelor of Science degree in 27 months

In Mechanical, Civil, Electrical, Chemical, Aeronautical, Radio (TV-Electronics) Engineering. In 36 months a B.S. in Business Administration (General Business, Accounting, Motor Transport Management Majors). Superior students may accelerate. 36-weeks course in Drafting. Intensive program: technical fundamentals stressed; comprehensive courses with more professional class hours. Small classes: personalized instruction. Enrollment limited. Preparatory courses. Beautiful campus. Well-equipped, new and modernized buildings and laboratories. Enter June, Sept., Jan., Mar. Earnest, capable students (whose time and budget require accelerated courses and modest costs) are invited to write Jean McCarthy, Director of Admissions, for catalog and book "Your Career in Engineering and Commerce."



## TRI-STATE COLLEGE

448 College Avenue • • • Angola, Indiana

## SHORTHAND IN

Famous SPEEDWRITING shorthand. 120 words per minute. No symbols; no machines; uses ABC's. Easiest to learn, write and transcribe. Low cost. For business and Civil Service. Over 350,000 graduates. Typing available. 35th Year. Schools in over 400 cities. Write for FREE booklet to:

**Speedwriting**  
Dept. 1504-B  
55 W. 42 St., N. Y. 36, N. Y.

**6**  
WEEKS

## MONEY... IN HIDDEN TREASURES

Find it... with a **GOLDAK Treasure Finder**. Send for FREE literature on complete line of mineral & metal locators, underwater detectors, etc., priced as low as \$64.50.

In celebration of its 25th year, **GOLDAK CO.** introduces new transistor instruments for greater sensitivity — less weight — low cost flashlight batteries. Write for information today!

**GOLDAK CO.** 1542-4 GLENOAKS BLVD., GLENDALE, CALIFORNIA

### Be an industrial designer

Combine your design abilities with technical aptitudes in Industrial Design training at Art Center School in California. Work under practicing professionals for upper level jobs as automotive stylists, product and package designers. Design offices, stores, motels, showrooms, shopping centers. Constant demand for graduates. Recent placements with Ford, G.M., Kaiser Aluminum, G.E., Raymond Loewy and other leading design studios. 700 students. Co-ed. Accredited. B.P.A. Degree. Four-year course can be completed in 2 yrs. 8 mos. by year-round training. New terms Feb., June, Sept. Enroll early. Write Mr. Mace for new catalog. 5353 West 3rd St., Los Angeles 5, California.

## ART CENTER SCHOOL

## NEW MODEL 400 SIMPLEX LAWNMOWER SHARPENER

Offers These Big Advantages:

- Grinds All Types of Mowers
- No Dis-assembly Needed
- Feeds Horizontally—Vertically
- Head Turns 90° for Bed Knives
- Fast, Positive Adjustment
- Rugged-duty Construction



Small investment returns big profits!

Send For Free Brochure Today

The Fate-Root-Heath Company • Dept. PM-4 • Plymouth, Ohio

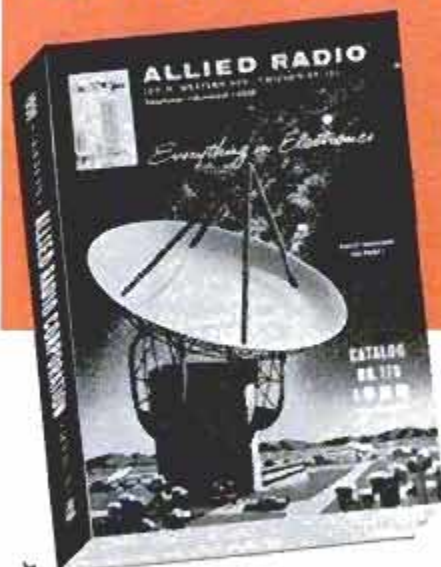
Free!

# ALLIED'S 1958

## ELECTRONIC SUPPLY CATALOG

404 value-packed pages

Send for it!



SAVE on everything in electronics

EASY TERMS AVAILABLE

### WORLD'S LARGEST STOCKS

Here's everything in Electronics for Experimenters, Builders, Amateurs, Servicemen, Engineers and Hi-Fi Hobbyists:

- Amazing Build-Your-Own KNIGHT-KITS
- Hi-Fi Music Systems & Components
- Recorders & Phono Equipment
- TV Tubes, Antennas, Accessories
- Public Address Systems
- Amateur Station Equipment
- Latest Test Instruments
- Industrial Electronic Supplies
- Parts, Tubes, Transistors, Tools and Books

SAVE on everything in Electronics — get fast, dependable service — send today for your FREE 1958 ALLIED Catalog.

Everything is Electronics From One Reliable Source

our 37th year

send for FREE Catalog

## ALLIED RADIO

ALLIED RADIO CORP., Dept. 5-D8  
100 N. Western Ave., Chicago 80, Ill.

Rush FREE 1958 ALLIED 404-Page Catalog

Name \_\_\_\_\_

Address \_\_\_\_\_

City \_\_\_\_\_ Zone \_\_\_\_\_ State \_\_\_\_\_



## Free! SCARCE "TRIANGLE" COLLECTION



Start TODAY to enjoy an exciting new hobby! Get this big, valuable collection of gorgeous, multi-colored triangle shaped postage stamps . . . brought to you from strange and mysterious lands in the wilds of Africa, enchanting Europe, exotic Latin America, etc. All genuine, all different—picturing man-eating reptiles, jungle birds, action-packed sports, ancient clipper ships; PLUS scarce airmails, fabulous commemoratives, giant and midget-sized stamps. EXTRA! Bargain Catalog, "Collector's Manual" plus other exciting offers for your inspection. Enclose 10c for mailing costs. Supplies limited. ACT NOW!

JAMESTOWN STAMP CO. DEPT. H48PM JAMESTOWN, N. Y.

RUSH my Free "Triangle" Collection and other offers. I enclose 10c for mailing costs.

Name \_\_\_\_\_  
Street \_\_\_\_\_  
City \_\_\_\_\_ State \_\_\_\_\_



## on any object ELECTROPLATE

ANY OBJECT IN HOME SHOP, GARAGE.



NOW with our NEW ELECTROCHEMICAL outfit, you can easily do your own plating. Not a mint. But a hard durable metal plate, equal to commercial plating. Get your own plating kit with instructions on plating metal and non-metal objects as Tools, Auto Parts, Silverware, Jewelry, Baby Shoes and 1001 other articles with Chrome, Copper, Gold, etc. SEND NO MONEY. Everything sent C.O.D. for the low price of ONLY \$5.95 or send \$5.95 now and receive it postpaid. Money back in 30 days if not satisfied. M. Z. SALES CO., Dept. G-20, 113 West 42nd St., New York 36, N. Y.

## EAT ANYTHING WITH FALSE TEETH



EASY TO USE STRIPS

Trouble with loose plates that slip, rock or cause sore gums? Try Brimms Plasti-Liner. One application makes plates fit snugly without powder, paste or cushions. Brimms Plasti-Liner adheres permanently to your plate; ends the bother of temporary applications. With plates held firmly by Plasti-Liner, YOU CAN EAT ANYTHING! Simply lay soft strip of Plasti-Liner on troublesome upper or lower. Bite and it molds perfectly. Easy to use, tasteless, odorless, harmless to you and your plates. Removable as directed. Money-back guarantee. At your drug counter. \$1.50 reliner for one plate; \$2.50, two plates.

Special Offer! Free 35¢ package of Tri-Dent Brushless Denture Cleaner. Send only 10¢ for postage and handling. Offer expires May 31, 1958. Plasti-Liner, Inc., Dept. AY, 1075 Main St., Buffalo 9, N. Y.

**BRIMMS PLASTI-LINER**  
THE PERMANENT DENTURE RELINER

## HUNT-MASTER RIFLESCOPES



\$9.95 INCL. MOUNT

- 1 highest luminosity, color corrected
- 2 cushioned lenses, fluoride coated
- 3 positive adjustments, precise zeroing
- 4 long eye relief (2 1/2" - 4 1/4")
- 5 easy installation
- 6 rugged, durable, DEPENDABLE

10-day money back guarantee  
Mounts to fit any make rifle, INCLUDING PELLET RIFLES. When ordering, specify type gun, model, brand, TARGET, BENCH-REST OR HUNTING

All Types of Amateur

ASTRONOMICAL

Supplies: Complete telescopes, mounts—mirror grinding supplies, misc. parts; write for FREE CATALOGUE. No C.O.D.'s please.



As power! PENSOPES \$9.95

A precision telescope that clips in your pocket like a fountain pen. For HUNTERS, SPORTS FANS, SIGHTSEERS, HOBBYISTS. NOW IN USE BY THE F. B. I. Dept. PM4

COAST INSTRUMENT, INC. 4811 Long Beach Blvd. Long Beach, Calif

## MAKE UP TO \$20 A DAY WITH

## EASISHARP



MONEY MAKING SALES PLAN FREE

Big profits in your spare time sharpening scissors. We show you how to start making money immediately. This is your chance now to have your own business and a steady income. Sharpen a pair of scissors in less than two minutes. A child can operate it. Weighs only 10 lbs. Every home, barber, tailor, dressmaker—everybody uses scissors and all need sharpening two to four times a year. Don't let some one else beat you to this opportunity. Write immediately to

SERR-EDGE MACHINE CO., 9731 Lorain Ave., Cleveland, Ohio

## Finish HIGH SCHOOL AT HOME

Complete 4 Yrs. in 12 Months

Learn More! Earn More! Enter professional or technical schools. Advance Socially. Live a Happier, Fuller Life. Individual Courses or complete schedule. WRITE FOR SCHOOL BULLETIN.

ACADEMY FOR ADULTS

30 W. Washington, Dept. PM-48, Chicago, Ill.

## BARBELLS

100 POUND SET \$11.80

Extra Plates Only 10c Pound

140-Pound, CHROME DELUXE Barbell-Dumbbell set only \$18.80. This is our feature set and is the finest ever manufactured.

Training with adjustable weight is the BEST way to keep fit; the ONLY way to develop great strength and a perfect body. As the oldest and best equipped barbell company, BUR gives value and prices no one can equal.

SEND FOR FREE CATALOG.

BUR BARBELL CO. Lyndhurst 9, New Jersey

## SEWS LEATHER

AND TOUGH TEXTILES LIKE A MACHINE

With SPEEDY STITCHER Automatic Sewing Awl, anyone can quickly and skillfully sew or repair anything made of LEATHER, CANVAS, NYLON, PLASTIC, or other heavy materials. Sews firm, even lock-stitches like a machine. Gets into hard-to-reach places. Specially made for heavy duty sewing on LUGGAGE, FOOTWEAR, BUGS, AWNINGS, SAILS, SADDLERY, UPHOLSTERY, OVERALLS, AUTO-TOPS, SPORTS GEAR, and other tough sewing jobs. Here's the handiest tool you'd ever own. Will save you many times its small cost. Comes ready for instant use . . . complete with bobbin of waxed thread and 2 different types of diamond-pointed needles. Easy-to-follow directions will make you an expert in minutes. Extra needles and waxed-thread always available. Save money, send \$1.98 for post-paid delivery. If C.O.D., \$1.98 plus postage. MONEY BACK GUARANTEE.



SPORTSMAN'S POST 366 Madison Ave., Dept. A-84, New York 17

ONLY 1.98



**Choose the Allied Way for Best Pay**

**TRAIN AT HOME**

**in Your Spare Time  
or in the Great  
Allied School**



**Drafting—All Branches**  
**Tool & Machine Design**  
**Tool Engineering (Bachelor Degree TE)**  
**Mech. Engineering (Bachelor Degree ME)**  
**Master Machinist**  
**Tool & Die Making**  
**Auto Mechanics**  
**Air Conditioning**  
**Refrigeration**

Prepare for the best jobs in your spare time at home. With ALLIED'S practical Home Study program you can progress so rapidly that big new opportunities will soon be open to you. Soon after starting many ALLIED students begin to make good extra money in their spare time. ALLIED'S Home Training methods are the finest ever designed for they are based on the successful programs developed in the ALLIED resident school for more than a quarter of a century. Your Home Training may entitle you to two weeks of training at the great ALLIED shops at no additional tuition cost, should you desire it. You get many advantages and additional services when you enroll for ALLIED training.

**More Jobs Than Graduates**

Students planning a career in engineering, can begin their training in short courses at Home or at Allied Institute, and continue progressively toward an Engineering Degree in 31 months.

Allied is approved by Industry, National Home Study Council, Department of Education, Office of Public Instruction, State of Illinois, U. S. Department of Justice. **BE AN ALLIED TRAINED MAN — GET THE FACTS — MAIL COUPON TODAY.**

**Mail Coupon for Free Sample Lesson**

**ALLIED INSTITUTE of TECHNOLOGY**

1338-42 South Michigan Avenue, Dept. PM-48, Chicago 5, Illinois

Gentlemen:

Mail me FREE BOOKS explaining ALLIED'S courses of instruction and FREE SAMPLE lesson. Vets write date of discharge \_\_\_\_\_

I am interested in the training I have checked below:  Resident  Home Study

- |  |   |   |
|--|---|---|
| <input type="checkbox"/> DRAFTING—All Branches                 | <input type="checkbox"/> MECH. ENGINEERING (Bachelor Degree—ME) | <input type="checkbox"/> AUTO MECHANICS   |
| <input type="checkbox"/> TOOL & MACHINE DESIGN                 | <input type="checkbox"/> MASTER MACHINIST                       | <input type="checkbox"/> AIR CONDITIONING |
| <input type="checkbox"/> TOOL ENGINEERING (Bachelor Degree—TE) | <input type="checkbox"/> TOOL & DIE MAKING                      | <input type="checkbox"/> REFRIGERATION    |

NAME \_\_\_\_\_

ADDRESS \_\_\_\_\_

CITY \_\_\_\_\_ COUNTY \_\_\_\_\_ STATE \_\_\_\_\_



**FREE BOOKS**

tell how YOU can become an ALLIED TRAINED MAN. Write TODAY!

**ALLIED INSTITUTE OF TECHNOLOGY, DIV.**  
**ALLIED School of Mechanical Trades**  
 1338-42 South Michigan Avenue  
 Dept. PM-48, Chicago 5, Illinois



EARN MORE—LEARN TO BE AN

# AUTO MECHANIC

OR TRAIN WITH OTHER GREER DIPLOMA COURSES

- AUTO MECHANICS
- DIESEL MECHANICS
- BODY & FENDER REPAIR
- GAS-ARC WELDING
- REFRIGERATION
- AIR CONDITIONING
- MACHINIST TRADE
- ADVANCED MACHINIST
- PIANO TUNING & REPAIR

Skilled men are needed in every part of the country. Earn top pay in established shops or start your own business. Greer's expert instruction and actual shop training teaches you how. You learn by doing—quick, easy courses using the latest tools and equipment. Day, evening and part time instructions available.

Job placement and convenient living accommodations are yours while training. Contact GREER'S FREE JOB PLACEMENT SERVICE when you enroll if you wish part time or full time employment.

## ENGINEERING DEGREE COURSES

- DIESEL AUTOMOTIVE ENGINEERING 27 MOS.
- REFRIGERATION & AIR COND. ENGINEERING 18 MOS.
- WELDING ENGINEERING 18 MOS.

All Courses Approved  Civ. or  G.I.

Please rush me free literature on Auto Mechanics, or on the trade indicated, at no obligation.

NAME \_\_\_\_\_ AGE \_\_\_\_\_

STREET \_\_\_\_\_

TOWN \_\_\_\_\_ ZONE \_\_\_\_\_ STATE \_\_\_\_\_

Established 1902

## GREER SHOP TRAINING

Box D, 2236 S. Michigan Ave.  
Chicago 16, Illinois

**BOOST**  
MILEAGE  
**ADD**  
POWER



PAT. PEND.

## with a TURBO POWER-BOOSTER

EASY TO INSTALL ON ANY CAR

Just remove carburetor and install Turbo Power-Booster for better gas mileage, smoother and more power, higher cruising speed, easier starts. **GUARANTEED TO IMPROVE PERFORMANCE AND INCREASE GAS MILEAGE.**

Dealerships Still Available in Some Areas

**RELIABLE** MACHINE & MANUFACTURING CO.  
415 H. Ave., N.W., Cedar Rapids, Iowa

SINGLE BARREL \$4.95  
DOUBLE BARREL \$8.95  
FOUR BARREL \$11.95  
All Prices p. pd.

Be Sure to State Car Model and Year

MAKES A HARD RUBBER Mallet in a Minute!

## SLIP-ON HAMMERHEAD

- ★ 3 SIZES FOR ALL HAMMERS
- ★ GRIPS HAMMERHEAD FIRMLY
- ★ CONTOUR FIT FOR ALL BALL-PEN AND CLAW HAMMERS!
- ★ REMOVABLE
- ★ AT HARDWARE AND AUTO STORES OR WRITE:



**98¢** EACH

**W. J. RUSCOE COMPANY**  
483 KENMORE BLVD AKRON 1, OHIO

# INVENTORS

PROTECT YOUR INVENTION BY A U. S. PATENT. SEND FOR FREE "INVENTION RECORD" FORM AND "PATENT INFORMATION EVERY INVENTOR SHOULD HAVE."

**CARL MILLER**

REGISTERED PATENT ATTORNEY  
WOOLWORTH BLDG., 36th FLOOR, 48A  
NEW YORK CITY

# INVENTORS

Whether an invention is patentable can be substantially determined by a search of the U. S. Patent records. Without obligation, write for information explaining the steps you should take to secure a patent.

**JOHN N. RANDOLPH**

Registered Patent Attorney  
801 Victor Building, Washington 1, D.C.

# INVENTORS

Send for **REGISTERED PATENT PATENT INFORMATION** **ASSOCIATE EXAMINER**  
Book and **INVENTOR'S RECORD** U.S. PAT. OFF. 1922-1929  
without obligation  
**GUSTAVE MILLER** Patent Attorney & Advisor  
48-PM WARNER BUILDING U. S. NAVY DEPT. 1930-4947  
WASHINGTON 4, D.C. **PATENT LAWYER**

# A NEW complete SERVICE for INVENTORS

If you have a patented or patentable item write for free information on securing a working model, manufacturing, sales or distribution for your product.

**KIP COMPANY**

P.O. BOX 235 • RESEARCH DEPT. • LIVINGSTON, N.J.

# GET THE HABIT OF OUR CLASSIFIED ADS.

Wonderful Opportunities Amazing Bargains



# INVENTORS

U. S. Patents protect your inventions. Our free book of "Instructions on Patent Procedure for Inventors," also "Certificate of Invention" form sent without obligation.

**C. A. SNOW & CO.**

REGISTERED PATENT ATTORNEYS  
428 SNOW BUILDING WASHINGTON 1, D. C.

# INVENTORS

I shall be pleased to furnish you, upon request, with full information relative to patent procedure—without any obligation on your part.

**PATRICK D. BEAVERS**

Registered Patent Attorney  
934 Columbian Building Washington 1, D. C.





## TRAIN TO OPERATE HEAVY EQUIPMENT CONTRACTORS NEED MEN NOW

The big federal and state super highways program is now in progress. Train to operate bulldozers, shovel, motor-grader, scrapers, etc. YOU can make big pay in the construction industry if you learn these skills. NOW contractors WANT our graduates.

Write or call TODAY for full information.

**THE MIDDLE-WEST SCHOOL OF HEAVY EQUIPMENT OPERATION**  
SAXTON, KENTUCKY  
(Phone Jellico, Kentucky—Harrison 4-6653)

ALSO  
Eshelman  
Gasoline  
or  
Electric  
GOLF  
CARS

## ESHELMAN ROCKET BOAT



### NEW JET PLANE DESIGN

- 14 ft. Holds Four adults.
- Leakproof Fibreglass
- Operates with any outboard motor.

Write for FREE literature.

Dept. 405  
ESHELMAN  
Baito. 2, Md.

Dealers: write for wholesale prices.

ENGINEERING  
DEGREE IN  
27 MONTHS

B.S. Degree, Aero., Chem., Civil, Elec., Mech. & Electronic Engineering (inc. Radio, TV), 36 mo. B.S. degree in Math., Chem., Physics. Prep courses. Demand for grads. Spacious campus, 20 bldgs.; dorms, auditorium, gym. Low rate. Earn board. G.I. approved. Enter June, Sept., Dec., March Catalog.  
1648 E. Washington Blvd.  
Fort Wayne 2, Indiana  
Keeping pace with progress

INDIANA TECHNICAL COLLEGE



# 1000 AND 1 USES!

Pliobond by  
**GOOD YEAR**

Super-glues "anything to anything" — super-quick!

At chain, hardware and hobby stores everywhere.

Pliobond—T.M. The Goodyear Tire & Rubber Company, Akron, Ohio

Superior's New  
Model TD-55

# TUBE TESTER

Quickly and Efficiently Tests Radio and TV Tubes Including: Seven Pin Miniatures; Eight Pin Sub-Minors, Octals and Locals; Nine Pin Novals.

Speedy, yet efficient operation is accomplished by:

1. Simplification of all switching and controls.
2. Elimination of old style sockets used for testing obsolete tubes (26, 27, 57, 59, etc.) and providing sockets and circuits for efficiently testing the new Novel and Sub-Minor types.

You can't insert tube in wrong socket. It is impossible to insert the tube in the wrong socket when using the new Model TD-55. Separate sockets are used, one for each type of tube base. If the tube fits in the socket it can be tested.

"Free-point" element switching system. The Model TD-55 incorporates a newly designed element selector switch system which reduces the possibility of obsolescence to an absolute minimum. Any pin may be used as a filament pin and the voltage applied between that pin and any other pin, or even the "top-cap."

Checks for shorts and leakages between all elements. The Model TD-55 provides a super sensitive method of checking for shorts

and leakages up to 5 Megohms between any and all of the terminals. Continuity between various sections is individually indicated. This is important, especially in the case of an element terminating at more than one pin. In such cases the element or internal connection often completes a circuit.

Elemental switches are numbered in strict accordance with R.M.A. specification.

One of the most important improvements, we believe, is the fact that the 4 position fast-action snap switches are all numbered in exact accordance with the standard R.M.A. numbering system. Thus, if the element terminating in pin No. 7 of a tube is under test, button No. 7 is used for that test.

The Model TD-55 comes complete with operating instructions and charts. Housed in rugged steel cabinet. Use it on the bench—use it for field calls. A streamlined carrying case, included at no extra charge, accommodates the tester and book of instructions.

**\$26<sup>95</sup>**  
NET



**SHIPPED ON APPROVAL  
NO MONEY WITH ORDER — NO C.O.D.**

Try it for 10 days before you buy. If completely satisfied then send \$6.95 and pay balance at rate of \$5.00 per month for 4 months—No Interest or Finance Charges Added. If not completely satisfied, return to us, no explanation necessary.

MOSS ELECTRONIC DIST. CO., INC.

Dept. D-449, 3489 Tenth Ave., New York 34, N. Y.

Please rush one Model TD-55. If satisfactory I agree to pay \$6.95 within 10 days and balance at rate of \$5 per month. If not satisfactory, I may return for cancellation of account.

Name \_\_\_\_\_

Address \_\_\_\_\_

City \_\_\_\_\_ Zone \_\_\_\_\_ State \_\_\_\_\_

All prices net. P.O.B., N.Y.C.



# How to get into the BIG PROFIT, fast-growing MAIL ORDER PLASTICS BUSINESS

**FREE!** MAIL THIS COUPON

**WARNER ELECTRIC CO., 1512 Jarvis Ave. Dept. L-2-D, Chicago 26, Ill.**  
Please rush me free and without obligation complete information, postage paid.

NAME \_\_\_\_\_  
ADDRESS \_\_\_\_\_  
CITY \_\_\_\_\_ ZONE \_\_\_\_\_ STATE \_\_\_\_\_

**on a shoe string!**

Write today for free facts about the newest and most fascinating of all home operated businesses. For the first time, a simplified machine brings the fabulous profits of Plastic Sealing and Plastic Laminating within reach of the small operator. Anyone can operate the machine with a few minutes practice. Then — with our **MAGIC MAIL PLAN** — can get mail orders pouring in daily with cash in every envelope.

**No Canvassing or Selling**

Fill orders at home in spare time to start. Then expand to full-time business. We even supply circulars to bring back cash and orders. Rush coupon for all the facts you need to start or a card will do. No charge. Write today.

**WARNER ELECTRIC CO.**

1512 Jarvis Ave., Dept. L-2-D, Chicago 26, Ill.



**SEND NAME TODAY!**

**"TI-NEE" BATTERYLESS TUBELESS LIFETIME RADIO**

"TI-NEE" RADIO IS GUARANTEED TO WORK FOR YOUR LIFETIME! USES NO TUBES, BATTERIES OR ELECTRICAL PLUG-INS. Never runs down! SMALLER THAN A PACK OF CIGARETTES! RECEIVES LOCAL RADIO STATIONS MOST ANYTIME, ANYWHERE WITHOUT EXTRA ANTENNA. Uses semi-conductor crystal diode Hi-Q Tuner. Beautiful black gold plastic cabinet. Built-in Speakerphone.



**SEND ONLY \$2.00** (bill, ck. mo. and pay postman \$4.99 COD on arrival or send \$6.99 for postpaid delivery. SENT COMPLETE READY TO LISTEN—NOTHING EXTRA TO BUY EVER! Extra long distance Aerial kit included free to receive stations up to 1,000 miles away. Available only from: **MIDWAY COMPANY, Dept. GPM-4, Kearney, Nebraska**

**TV DAN, THE MUSCLE MAN SAYS**



**I'LL GUARANTEE YOU RIPPLING MUSCLES**

**IN 6 WEEKS OR MONEY BACK**  
You can have tremendous power, look bigger, have more confidence this tested way. Revolutionary new "Body Mold" course builds your body in a way no other method can match. Get course FREE with order. Lowest factory price.  
**DAN LURIE BARBELLS**  
50 lb. set \$ 8.98 • 100 lb. set \$14.98  
150 lb. set \$21.98 • 200 lb. set \$27.98  
Extra wts. — 145 per lb. 50% cash, balance C.O.D. FOR FIRM  
**DAN LURIE BARBELL CO.**  
52-M-4 Bristol St., Dept. 250-D, Bklyn 12, N.Y.

**FREE! SEND FOR NEW SPORTS & HEALTH CATALOG**

**FREE COLOR CATALOG TAFT KIT BOATS**

17 models from \$42, frt. inc. World's finest boat kit line at mass production prices.



**only \$399**

FRT. INC. IS IN OFFSHORE CRUISER KIT

**TAFT MARINE WOODCRAFT**  
Dept. PM-458, 636-39th Ave. N.E., Minneapolis, Minn

**...TURN CONCRETE INTO GOLD!**



**MAKE UP TO \$75 A DAY IN YOUR OWN BUSINESS**

If you want to have your own business — to start a business on your own — here's your big opportunity! New high speed, low cost General block machine produces up to 1,000 concrete blocks a day. Sell all you make to builders, supply houses, and others for homes, factories, buildings, garages. Cash in on the building boom! You can make profits of 100% to 150% — up to \$75 a day! General block machine equipped with 1/2 h.p. electric motor — or can be supplied with gasoline engine — works anywhere. In little space, indoors or out. Operates from ordinary house light socket. Simple, foolproof 3 step operation — so easy a child can do it. Makes superior 3 core blocks any size from 4" to 12". Also makes chimney, sash, corner and other types. Blocks meet any building code anywhere in the country. Materials — sand, water, cement, available anywhere. Simple illustrated operating instructions and mixing formulas for cement and cinder blocks supplied with each machine. Write for FREE folder with full information.

**MOTOR DRIVEN**

R.L.T. of New York City reports: "MY GENERAL BLOCK MACHINE PAID FOR ITSELF IN FIRST 2 WEEKS!"

Hundreds now in use the world over! Write for FREE details today!

**EXTRA**

Amazing illustrated book gives floor plans for 6 sensational concrete block bungalows. Tells how to lay blocks, lay out building lines, mix concrete, build steps, porch and concrete floors all at great savings. Written by experts. Can save many times the cost of the machine! Get it now! No strings attached. Send \$1.

BOOK SENT FREE IF YOU BUY MACHINE. \$1 REFUNDED IF YOU BUY LATER.

**GENERAL ENGINES CO.**

DEPT. M-46, ROUTE 130, THOROFARE, N. J.

**HOW TO BUILD YOUR OWN CONCRETE BLOCK HOME**  
Only \$1 Prepaid

**EXPLORE FOR TREASURE!**



Find gold, silver, coins, jewelry, battle relics! M-SCOPE Treasure-Metal Locators. Used World-wide. Guaranteed Proven Performance. Transistors, Fiberglass cases, lightweight. Also Geiger, Scintillation Counters, Minerals. FREE Detailed Catalog. Easy Terms. **FISHER RESEARCH LAB., INC.**, Dept. PM-2, Palo Alto, Calif.



American citizens are better informed — thanks to Advertising!



# WANT MORE MONEY? GET INTO PHOTOGRAPHY

You can become a skilled photographer by training at home in your spare time. With the NYI Home Study Course, backed by our 50 years experience, you'll learn quickly and easily with our famous **Learn-by-Doing** Method. You get personal, helpful criticism, advice and loads of ideas from our teaching staff—who are as close to you as your mailbox. Do what hundreds of others are doing—**Earn While You Learn!** Opportunities are tremendous in Advertising, Portraits, News, Fashion, Commercial, Industrial, Color Photography, Weddings, etc.

**No previous experience necessary. Enroll anytime.** Big FREE Illustrated Book gives you all the facts and it's yours for the asking. Resident Training (Personal Attendance) is also available in our New York Studios. All Courses Approved for Veterans.

**NEW YORK INSTITUTE OF PHOTOGRAPHY**  
Dept. 49, 10 West 33 Street, New York 1, New York

## Build a SKYHOPPER Detailed Plans—\$50.00 per set (plus 4% sales tax in Calif.)

Build the world known "SKYHOPPER" from clear, simplified and easy to read drawings. All ribs and fittings are drawn full size and may be used directly as templates in fabricating parts. Approximately 260 sq. ft. of drawings supplied. Planes built from these plans are eligible for CAA license. **SPECIAL OFFER . . . Inboard Profile and Three-View Drawing . . . \$2.00 plus 4% sales tax in Calif.** Send 10c for descriptive literature. **MONEY BACK GUARANTEE.**  
**SALVAY-STARK AIRCRAFT CO.** 8296 POPPY WAY, BUENA PARK, CALIF.



## Catalog of 3100 Novelties 10c

Send 10c for amazing catalog of novelties, live animals, scientific supplies, hobbies, funmakers, planes & boats, toms, magic tricks, joke articles, unusual seeds, gadget time-savers, cameras, optical goods, projectors, movies, lucky jewelry, religious novelties, disguises, musical instruments, stamps, coins, puzzles, fortune tellers, radios, auto & bike accessories, telescopes, magnifiers, compasses, banks, smokers' gadgets, artists' supplies, printing sets, engines, motors, shockers, knives, billfolds, guns, rifles, sports, books, games, plants, etc. Send 10c (3 for 25c—get for friend!).  
**JOHNSON SMITH & CO.** Dept. 442 Detroit 7, Michigan

**WHOLESALE Electric Guitars - Parts - Factory to You**  
Solid-body Spanish, amplifiers, tone changer guitars, double-necks, single-necks, triple necks, solid-body mandolin, pickup mikes, non-electric instruments, etc. 1958 Models wholesale. **FREE CATALOG.** Free home study course with instruments. Parts & plans available to build your own.  
**CARVIN CO.,** Box 287, PM-4, Covina, Calif.

**For Many Uses!**  
**Metal Turning Lathe**  
Only **\$49.95**  
F.O.B. Lansing, Ill.  
15 1/4" bed with 4 1/2" swing.  
7" between centers.  
Satisfaction Guaranteed.  
**FREE FOLDER**  
Write for it today!  
**Rosemoor Manufacturing Co.**  
Box 147J, Lansing, Ill.

**CHROME VANADIUM 29 Pc. DRILL SET**  
Specialty made for speed drilling. In sturdy plastic tool roll. Finest alloy steel drills hardened and precision ground to the sharpest, longest lasting cutting edge obtainable; will easily and cleanly bite through hardwoods, plastics, aluminum, iron and the toughest steels. Unconditionally guaranteed for thousands of drillings. Full jobber length. Sizes by 64ths from 1/16" to 1 1/2". **NOW \$6.49 ppd.** Also available with Turned Down Shanks to fit all 1/4" drills. In individual pocket roll. **\$8.95 ppd.**  
Send Check or M.O. C.O.D. fee extra. **MONEY BACK GUARANTEE**  
**SCOTT-MITCHELL HOUSE, INC.** DEPT. F-4, 611 BROADWAY, NEW YORK 12, N. Y.

**60 Pc. Set WIRE GAUGE CHROME VANADIUM DRILLS**  
Top quality German import high test Chrome Vanadium Drills designed for speed drilling through toughest steels, woods, plastic, iron and aluminum. Precision ground, long-lasting cutting edges. Guaranteed to give years of satisfaction. A full 60 pc. set, Nos. 1 through 60. A \$14.95 value—**NOW ONLY \$5.40**  
PLUS 35c PP. & HDLG.  
Same set above with Huot Metal Index. **\$6.65**  
PLUS 35c PP. & HDLG.  
Also Available  
**20 Pc. Set - Nos. 61-80**  
**WIRE GAUGE DRILLS**  
In plastic kit with marked pocket for each drill. **ONLY \$2.50 ppd.**

# EARN WHILE YOU LEARN

# RADIO-TELEVISION

my new, faster way!

**Frank L. Sprayberry**  
Educational Director

Let me prove to you . . . without cost or obligation . . . that I can prepare you to be a Radio-Television Serviceman in 10 Months or Less

Let the true facts speak for themselves! That's why I want you to have my big new catalog and an actual sample lesson of Sprayberry Training—both FREE! **READ**—then make up your own mind! Train at home in spare hours for the best jobs and the biggest pay in Radio-Television. Easy payment terms suited to your budget. I will help you earn extra money doing radio service jobs while you learn!



**Get Practical Experience with 25 Kits of Radio-TV Parts**  
Practical experience counts most. In addition to modern lessons, you train with actual parts and equipment. Build the famous Sprayberry Training Television Set, Multi-Range Tester, 2-Band Radio, other Test Equipment—all yours to keep. Get latest training

on Color TV, Transistors, Hi-Fi and UHF Conversions . . . included to make your training more valuable.

You owe it to yourself to get all the facts . . . Mail coupon for catalog and sample lesson—FREE  
See for yourself . . . in actual pictures and descriptions . . . why Sprayberry Radio-Television Training offers more. Backed by almost 25 years of training experience. Three training plans to suit your exact needs. Rush coupon today for big new catalog and sample lesson. No obligation; no salesman will call.

**TWO BIG FREE BOOKS**

**SPRAYBERRY ACADEMY OF RADIO-TV**  
1512 Jarvis Ave., Dept. 10-F, Chicago 26, Ill.

**Mail Coupon Today!**

**SPRAYBERRY ACADEMY OF RADIO-TELEVISION**  
1512 Jarvis Ave., Dept. 10-F, Chicago 26, Ill.

Please rush catalog on your ALL-NEW Radio-Television Training Plans. I understand this does not obligate me and that no salesman will call. Include Sample Lesson FREE.

Name \_\_\_\_\_ Age \_\_\_\_\_  
Address \_\_\_\_\_  
City \_\_\_\_\_ Zone \_\_\_\_\_ State \_\_\_\_\_



# LUBRIPLATE LUBRICANTS



## Make Outboard Motors Run Better—Last Longer!

LUBRIPLATE 2-C MOTOR OIL mixes easily and stays mixed. Lubricates better, burns completely. Keeps spark plugs clean for faster, surer starting. LUBRIPLATE OUTBOARD GREASES make under-water gears run smoother. They are waterproof, won't wash off or leak out. LUBRIPLATE 105 (Grease type) for non-gear shift types, Hypoid 90 (Fluid type) for gear shift types.



YOUR OUTBOARD DESERVES  
THE BEST—USE LUBRIPLATE.  
YOU'LL SEE THE DIFFERENCE  
IMMEDIATELY!

At Marine, Sporting Goods and Hardware Stores.

### OTHER LUBRIPLATE PRODUCTS

**LUBRIPLATE  
M.D.S. MOTOR OIL**  
for cars, trucks  
and tractors

**LUBRIPLATE  
AUTO-LUBE "A"**  
for general  
automotive lubrication

**LUBRIPLATE  
IN HANDY TUBES**  
for sports and  
household uses

**LUBRIPLATE  
INDUSTRIAL LUBRICANTS**  
for every application.

LUBRIPLATE DIVISION, Fiske Brothers Refining Co.  
Newark 5, N. J., Toledo 5, Ohio.

## TEST TV & RADIO TUBES Yourself Safely in Seconds!



with New 1958  
**ELECTRONIC  
DETECTOR!**

**3<sup>98</sup>**

- ★ Checks BIG Picture Tube too!
- ★ Localizes Broken Filaments!
- ★ Pays for Itself First Time Used!
- ★ Safe! Quick! Easy! Foolproof!

Most TV failures are due to burned out tubes. Save repair calls! Check tubes yourself with Electronic Detector. Safe! Easy! No technical knowledge needed. Check motors, appliances, etc. AC & DC. Reg. model \$3.98; DeLuxe (with cover) \$4.98. Money back guarantee. Order direct:

THORESEN, INC., DEPT. 6-D-124, 585 WATER ST., NEW YORK 2, N.Y.

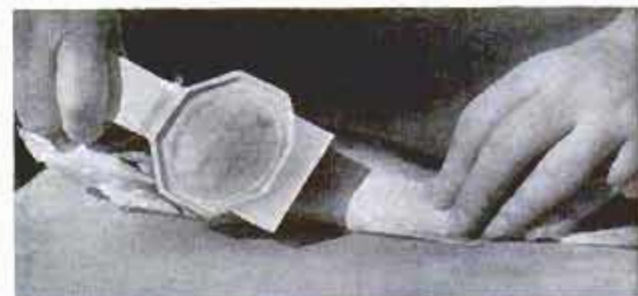


## British Record Cabinet Has Finger-Tip Selector

Up to 100 phonograph records can be stored on the cushioned rack of a British-designed cabinet. The desired disk is moved out when a sliding key is placed opposite the index number of the record. When closed, the cabinet gives air-tight protection. Both 10 and 12-inch records can be stored in the cabinet.

## Studs on Plastic Tool Scale Fish, Clean Windshield

You can clean ice from a windshield or scales from a fish with a new plastic tool. Nineteen studs are built into the head of the tool, and each stud moves in an individual socket. Thus the studs, under pressure, will adjust themselves to the curved surface of the fish or the windshield.



It takes 5000 gallons of water to bathe the half acre of exposed surface on a B-52 Stratofortress.



AMERICA'S  
LARGEST STOCKS  
of JEEP PARTS

LOWEST PRICES!  
SATISFACTION  
GUARANTEED!

The King of Jeeps



## BIG 1958 JEEP CATALOG FREE

WRITE FOR IT TODAY!



**NEW JEEP "L" HEAD MOTORS**  
FITS ALL ARMY AND CIVILIAN  
"L" HEAD 4 CYLINDER JEEPS  
Loss electrical parts, head, pan and water pump  
IN KIT FORM —

ASSEMBLE YOURSELF \$175.00  
EXCHANGE

FACTORY ASSEMBLED \$198.50  
EXCHANGE

NEW FACTORY  
GUARANTEE

FOB Chgo.—Old block must be sent prepaid

SPECIAL SERVICE TO GARAGES AND SERVICE STATIONS

Thousands of other Jeep parts and accessories available. SHOP BY MAIL—Order Direct From This Today. TERMS: Net cash with order. Open account to rated firms only. C.O.D. shipments should have 25% deposit with order. Minimum order \$3.00. Inquiries invited from dealers, exporters and quantity buyers.

**BERG TRUCK & PARTS CO., INC.**

1608 S. WABASH AVE., DEPT. 20, CHICAGO 16, ILLINOIS

## \$40 for 1½ DAY'S SPARE TIME WORK GRINDING LAWNMOWERS

Yes, J. H. B. writes, "not bad for a 76 year old young fellow earning \$40 for a day and a half's work" . . . and others are making even bigger money with the Universal Model B Lawnmower Grinder. You, too can make good spare or full time profits in your own business in your garage or basement. We furnish everything you need. Write today. No cost or obligation. Dept. M-48



**ROGERS**  
MANUFACTURING CO.  
LINDSEY, OHIO

## LEARN UPHOLSTERY

in your spare time  
run your own  
business AT HOME

FREE BOOK  
SAMPLE  
LESSON

WITH COURSE  
YOU MAKE

SLEEPER  
CHAIR

CLUB  
CHAIR

OTTOMAN

PLUS  
SLIP COVERS

### BE YOUR OWN BOSS

Earn more from the start while learning! Set up your own profitable business at home, enjoy steady income, independence — in the booming field of Custom Furniture Upholstery.

**EARN WHILE YOU LEARN . . . the easy UTS way.** Right off you start with tools, complete frames, fabrics, materials, included FREE with your practical, N. Y. State-approved UTS course. You learn skilled professional custom upholstery, reupholstery, furniture finishing, repairs; to make slip covers, window cornices, cushions, draperies in your spare time. Send for FREE Illustrated Book, Sample Lesson. Get ready for well-paid job, steady work and big profits as your own boss. Also Training in N.Y. School. APPROVED FOR VETERANS.

MAIL COUPON TODAY. No obligation.

UPHOLSTERY TRADES SCHOOL  
Dept. GD-310, 721 Broadway, N. Y. 3

Please send me FREE book with FREE Sample Lesson. No obligation—no salesman will call.  Home Study  In N.Y. School

Name \_\_\_\_\_

Address \_\_\_\_\_

City \_\_\_\_\_ Zone \_\_\_\_\_ State \_\_\_\_\_

Check if Korean Veteran

## 94.6% OF BAILEY GRADUATES ARE EMPLOYED AT TOP PAY IN THE FIELDS WHICH THEY WERE TRAINED!



### DIESEL-AUTO MECHANICS DESPERATELY NEEDED!

We have a far greater demand for our students than we can fill!

We can show you an actual waiting list of leading companies throughout the world who have tried Bailey graduates — found them outstanding, and are coming back for more!

Bailey Graduates are Successful . . . RECEIVE  
BIG PAY — HAVE SECURE FUTURE!

The Famous Bailey Course prepares you  
for BOTH Diesel and Gasoline Mechanics.

This is a must—due to the advent of using Diesel principles, such as 'Fuel Injection' on passenger cars . . . use of gasoline engines for starting Diesel engines, etc. You learn all this at Bailey in the amount of time ordinarily required to learn just one of these subjects, ALL FOR THE PRICE OF ONE.

Don't be satisfied with a 'futureless', one-type job — learn how you can make big money now!

Write today for Free Booklet that takes you on a step-by-step camera tour through our spacious, modern shops — See Bailey students in action as they Learn-by-doing with the Famous Bailey Method of training!

We provide you with housing and part time jobs while in school, plus nation-wide placement service for graduates.

## BAILEY Technical SCHOOLS

1634 S. GRAND

ST. LOUIS 4, MO.

### MAIL TODAY!

Please mail immediately this  
free booklet without obligation.

FREE BOOKLET



Name \_\_\_\_\_

Address \_\_\_\_\_

City \_\_\_\_\_ State \_\_\_\_\_

APPROVED FOR VETERAN . . . NON-VETERAN



# ENGINEERING



Photo of Heald Student in Electrical Laboratory

American Industry Steps Up Its Demand for Trained Engineers. Train Now at Healds

## BACHELOR OF SCIENCE DEGREE, 27 MONTHS

### Degree Courses:

- Electronic Engineering
- Electrical Engineering
- Highway Engineering
- Mechanical Engineering
- Structural Engineering
- Civil Engineering
- Architecture

### Diploma Courses:

- TELEVISION  Color TV
- Electronic Technician
- Industrial Electronic Tech.
- Tool & Die Design
- Architectural Drafting
- Mechanical Drafting
- Structural Drafting

Approved for Veterans

Heald College Ranks **FIRST** West of the Mississippi in "Who's Who in America"

Send for **FREE** Information Heald Engineering College

Est. 1883

Van Ness at Post, Dept. P.M. San Francisco, California

Enroll Now for New Term

NAME \_\_\_\_\_  
STREET \_\_\_\_\_  
CITY \_\_\_\_\_  
STATE \_\_\_\_\_

# Save UP TO 200%

on CONCRETE or Cinder Block Construction!

## DANDY BOY BLOCK MAKER

\$109.50

- ★ Make 6 types of blocks with standard equipment.
- ★ Perfect Blocks everytime for as low as 5¢ each.
- ★ Sturdy Construction — Advance design guarantees trouble-free performance.

★ Unmatched for quality at a low-low price. Pays for itself on one small job.

★ Makes 8x8x16 inch blocks with ROCK, BRICK or PLAIN face.

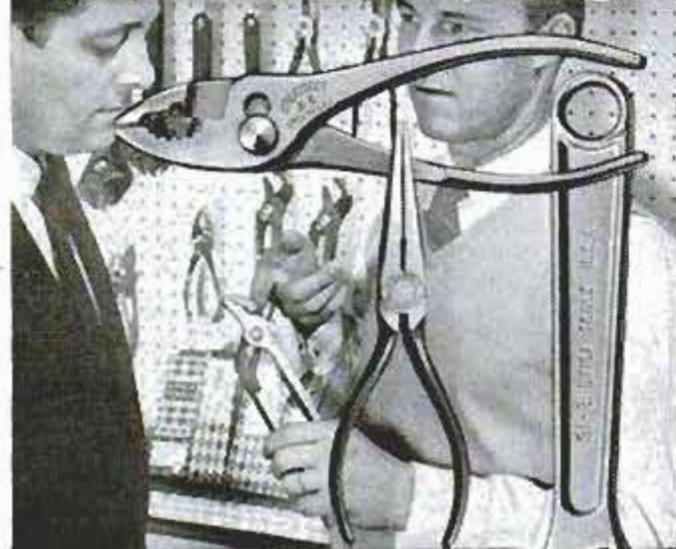


Write for detailed literature and simple operating instructions.

**GILSON MFG. CO.**  
Oostburg - Wisconsin

# UTICA

world's finest quality!



For the hobbyist, expert do-it-yourselfer and mechanic! A full line of finely balanced, nimble action pliers, wrenches and other hand tools. Drop forged, induction hardened and backed by full guarantee. At leading hardware stores.

**USE UTICA...the tools the experts use!**  
Hallmark of Quality since 1888



UTICA DROP FORGE & TOOL DIVISION  
KELSEY-NAYES CO., UTICA 4, NEW YORK

Take Correspondence Courses For a Better Education

**FOR AUTOS, TRUCKS, BOATS**

**CUTS GAS WASTE!**  
Sensational, New!  
**FILT-O-REG** with Magnet  
FUEL PRESSURE REGULATOR - FILTER

FILT-O-REG will make your engine run smoother. Saves Gas. Gives quicker starts and re-starts. Prevents flooding, stalling, and vapor lock. Lengthens carburetor and fuel pump life. Filters fuel completely. Magnetically traps harmful iron oxide that may clog carburetor needle valve. TRY FILT-O-REG on your auto, truck, boat engine! Satisfaction Guaranteed. Only \$7.95

SEND for technical bulletin 302-M  
Featured by your motor tune-up specialist!

Alondra Inc., Los Angeles 19



**Makes Gasoline Engines Run Better!**



# SPEEDPLATER AUTO CHROME

## REPLATES with PERMANENT PLATING MAKE MONEY! SAVE MONEY!

### FACTORY-NEW BRILLIANCE FOR CAR CHROME

Here at last is the car-owner's answer to all chrome problems . . . a dramatic new invention —SPEEDPLATER. It actually plates NEW METAL as you brush. And the plating you apply becomes an INDESTRUCTIBLE part of the bumper, grille or trim itself. How your car will shine! You'll be mighty proud when you remove ugly rust spots and replat metal to a NEW SPARKLE . . . when you bring new, gleaming beauty to worn, dull, even blistered chrome areas of your car. This fast sensational method of brush-plating gives FACTORY-NEW BRILLIANCE that bonds itself onto your car. It forms a hard, sparkling surface that defies all elements!

#### BUMPERS—GRILLWORK—ALL CAR TRIM RESTORED TO NEW BRILLIANCE!

Here is how easily you replat your car . . . You simply attach SPEEDPLATER'S clamps to your car's battery, then dip SPEEDPLATE Brush into miracle solution. You PLATE WITHOUT REMOVING PARTS FROM YOUR CAR. Works Fast — yet uses less battery juice than the tiniest light on your car.

#### CAR DEALERS & SERVICE STATIONS— Make BIG Profits with Special HEAVY-DUTY OUTFIT!

FACTORY RESULTS and Big Volume Business can make Terrific Profits For You with this Heavy-Duty Outfit. Do your own replating without removing bumpers or grillwork! Increase the value of used cars! Heavy-Duty Outfit Electroplates on current from standard 12 volt storage battery. ENTIRE KIT COMPLETE—Only \$34.95 with enough material to plate dozens of cars! You quickly make back cost on your very first job! Re-order solutions always available from us at rock-bottom cost to you. MONEY-BACK GUARANTEE. Order Now—If C.O.D. send \$5 deposit.



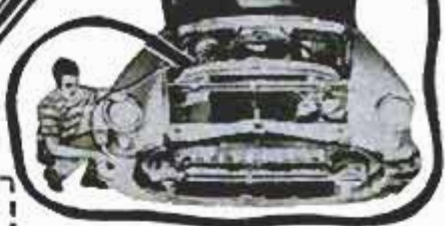
**TRY AT OUR RISK**  
If you want to put a new permanent gloss on YOUR CAR'S CHROME—you can do it right away and not risk a dime. If you are not satisfied with great results it doesn't cost you a penny! Just mail coupon with only \$1 deposit—then pay postman \$13.95 plus postage when your kit arrives. If you send \$14.95 we ship prepaid. Either way you must be COMPLETELY SATISFIED or you may return all in 10 days for FULL CASH REFUND. ACT NOW—Here's What You Get: SPEED-PLATER Brush with Permanent Anode; Wires and Clamps for battery hook-up; Special Buffs and Buffing Compound; Special Metal Polish; Full, Simple Instructions.

Quickly Builds-up a Thick, New, Plating With Each Application



SPEED PLATES YOUR CAR!

Enough Solution to plate 3 entire cars



#### Make Big Money Plating Other Cars!

Now you can add to your income during spare time . . . because 8 out of 10 cars on the road today NEED REPLATING. You can charge from \$5 for touching-up to \$50 for replating an entire car. It's easy and there's good money in it for you. When your neighbors see the brilliant plating on your car, they'll surely want you to do the job for them! Replate other things for profit too—faucets, tools, home appliances, cutlery, doctor's and dentist's instruments.

EMPIRE MERCHANDISING CO.,  
4 North 3rd Ave., Mt. Vernon, N. Y. Dept. P-48

Please rush the electroplating kit I have checked  
 Regular Kit, \$14.95 (If C.O.D. send \$1 deposit)  
 Heavy-Duty Service Station Outfit, \$34.95 (If C.O.D. send \$5 deposit)

I enclose full price, send postpaid.  
 I understand that I must be COMPLETELY SATISFIED or I may return kit in 10 days for immediate CASH REFUND.

Name \_\_\_\_\_  
 Address \_\_\_\_\_  
 City \_\_\_\_\_ State \_\_\_\_\_

### ROAD TO RICHES

You can be the next uranium millionaire! Government guarantees huge bonus! PRI instruments from \$29.95. See your local dealer today! FREE CATALOG!

Write PRI, 4223 PM W. Jefferson  
 Los Angeles 16, California

**DEALERS WANTED**

### MECHANICAL PENCIL CALCULATOR

NEW INVENTION

MATH-WIZ pencil calculator gives answers automatically to addition, multiplication and square root problems. (Indirect subtraction and division.) Easy to operate, comes in gold anodized aluminum casing. Useful gift for students, engineers, draftsmen and in all industry. Only \$2.25 postpaid. No C.O.D.

Not a Slide Rule

JACK WEISER, Dept. 1, 1233 S. Fairfax Ave., Los Angeles 19, Calif.

## FEATHER CRAFT aluminum or fiber glass...

*La Sirena*  
fiberglass runabout

*Hawk II*  
aluminum runabout

Write for brochure.

Also manufactured-distributed in Canada and Latin America

**Feather Craft, Inc.** 445 Bishop St., N. W., Atlanta 13, Ga.





Drill concrete  
**WITHOUT**  
a drill!

**PHILLIPS  
RED HEAD**

A concrete anchor that cuts its own hole, then expands to become threaded anchor for any standard 1/4" bolt. Holds hundreds of pounds. Can't come out. Install by hand in 2 minutes or with impact hammer in 22 seconds.

**HOME DRILL AND  
ANCHOR KIT \$1.85**

Driver and 4 Red Heads.  
\$2.00 (postpaid) by mail  
if your dealer cannot  
supply you.

**PHILLIPS DRILL CO.**  
Dept. H-8904  
Michigan City, Indiana



## Multi-Million Dollar Business Now Being Split Up Among Home Operators in Small Communities

### Inexpensive Table Top Machine Pays Profits UP TO \$9.20 AN HOUR

The multi-million dollar Rubber Stamp Business is now being taken over by small home operators throughout the U.S. Men and Women who operate this inexpensive machine can turn out large numbers of Rubber Stamps with special wording of all kinds. Only 27c worth of material makes a stamp that sells for \$1.80. The machine is easy for anyone to operate. It molds as many as six Rubber Stamps at a time, each with different wording such as names, addresses, notices, stock numbers, prices and other 'copy' needed by offices, factories and individuals. At full capacity, it can earn as much as \$9.20 an hour for the operator! You don't need experience to get into this big profit business at home. We supply everything, including complete instructions and eight ways to get orders for stamps coming in fast. Start making up to \$9.20 in one hour right away. We'll mail full particulars FREE; no salesman will call. Be first in your locality. Rush coupon.

**RUBBER STAMP DIV., 1512 Jarvis Avenue,  
Dept. R-2-D, Chicago 26, Ill.**

**RUBBER STAMP DIV., Dept. R-2-D  
1512 Jarvis Ave., Chicago 26, Ill.**

Please mail all facts showing how I can get started in the profitable Rubber Stamp business at home in spare time. Everything you mail me is FREE and no salesman will call.

NAME.....  
ADDRESS.....  
CITY..... Zone..... STATE.....

## Absorbs Moisture! SPECO H<sub>2</sub>O-I-DRI

removes dampness . . . stops mildew in closets,  
basements, tool rooms, storerooms, laundries,  
recreation rooms, enclosed porches . . .



HUM-I-DRI eliminates rust and moisture damage. Just place it in any wet location. It will remove up to 10 times its weight in moisture from the air. Ready for use. No "baking" or drying. Low cost refills available. See your dealer.

**Write for free bulletin!**

Standard H-5 Unit . . . . . **\$1.95**

Large H-10 Size . . . . . **\$3.95**

**SPECO INC.**

Cleveland 9, Ohio  
Dept. PM-4



Here's looking at you through rare-earth glass. Lens at right has 50 percent greater magnifying power

### "Rare Earth" Camera Lens

Some medium-priced cameras now have lenses made of a high-quality glass that formerly was used only for precision aerial cameras and telescopes. The glass has some unusual optical properties because it is made from boric oxide and rare-earth elements. The rare-element glass has almost 50-percent-greater magnifying power.



# New 1958 POWERHOUSE German TELESCOPE!



**FREE**

Our \$4.98  
German  
BINOCULARS



Famous Powerhouse '77' model. Thousands sold in U.S. & Canada for \$4.98—now yours FREE! Keep FREE even if you return Telescope for refund. Offer limited. Order today!

New model best yet! Most low cost telescopes use 2 lenses—but this new Powerhouse uses 5 — yes FIVE genuine synchronized Rothlar lenses—all ground and polished and ANCHORED in sturdy STEEL RINGS! Draw tubes are heavy-duty METAL. Contoured eyepiece for fast, easy focusing day or night. Now 225 times BIGGER AREA! What power! What range! What clarity! This new model is the crowning achievement of the renowned 102-year-old Rothlar plant in Bavarian Alps of Western Germany. Frankly, if produced here we would have to charge about \$10.00, but since we import by BOATLOADS and sell direct (no needless distribution costs or middlemen's profits tacked on) we are able to SLASH that price RIGHT IN HALF—way down to only \$4.98! Seeing is believing! You must be entirely sold on this new Telescope or your money back promptly—no questions asked! But you keep our famous Companion Powerhouse '77'

225  
Times Bigger Area!  
5 Synchronized  
Lens System!

\$4.98

German Binoculars FREE! That's our good will gift to you for just examining the telescope for 10 days. You can't lose in a deal like this. No wonder, we've already distributed 50,000 Telescopes. 50,000 people can't be wrong! But this FREE-GIFT offer will expire as soon as stock of binoculars is gone. Hurry! Next week may be too late. Rush \$4.98 check, cash or money order for prompt FREE delivery anywhere in the U.S.A. COD's plus COD fee and postage. Order direct from importer: THORESEN, Inc., Dept. 6-D-40 585 Water Street New York 2, N. Y.

## ELECTRIC WELD - BRAZE & CUT

REPAIR MOST EVERYTHING MADE OF METAL

Home Appliances, Auto parts, Farm-garden equipment, toys. Make and repair playground equipment, lawn chairs, tables, ornamental iron work gates, wagons, etc.



Solder, heat, bend, and straighten, with terrific heat from arc torch. Cut and weld up to 1/4" steel plate. A million uses for Home, auto, farm, inventors, factories, etc. Works from any home 110 volt plug-in. Complete with

dark welders mask, arc torch, supply of carbon welding and brazing rods. Solder, flux, and complete Welding Instruction Book. Attractive—portable—efficient—durable—1 year guarantee. Wt. only 8 lbs. SEND ONLY \$3.00 (cash, ck, mo) and pay postman \$6.95 plus COD postage on arrival or send \$9.95 plus \$1.50 postage and we will send postpaid. Ideal gift for mechanically minded home owners, relatives, friends. Order now for early delivery. Available only from: MIDWAY WELDER Dept. DPM-4 Kearney, Nebraska

## EARN UP TO \$500 A WEEK with your own parking lot service!



Big parking problems in towns, cities & industrial areas can mean thousands of dollars for you. Our factory trained men will show you how to make real money with your nationally known LINE-O-MATIC stripe painting machine. Get into your own business! Only \$99 F.O.B. New York for a high profit super six LINE-O-MATIC. Write today for full information!

CONSOLIDATED EQUIPMENT CO.  
5852 W. Division Street  
Chicago 51, Illinois

HOW TO GROW

## ORCHIDS AT HOME

"Most enjoyable hobby I know. People drive 100 miles to see this plant ... 10 flowers 8 1/2 inches across."  
THOS. MURST, Utah

Learn Special Conditions of Light, Temperature & Humidity Needed

WORLD'S MOST THRILLING HOBBY — SUCCESSFUL HOME GROWER offers COMPLETE illustrated instructions. Tells HOW TO START. Explains everything you need to know about growing Cattleyas, Cymbidiums, Odontoglossums and others. Many Orchids GROW WITHOUT SOIL, get food from the air. Instructions include real BLOOMING-SIZE ORCHID PLANT. FREE — full details. WRITE TODAY! TROPICAL FLOWERLAND, Dept. 34A, 100 S. Vermont, Los Angeles 4, Cal.



## PREPARE FOR BETTER JOB, BIGGER PAY IN SPARE TIME AT HOME

Today, choose the job you want—and prepare for it in time you might otherwise waste. Or if you are already in the work you like best, start training now for quicker promotion and increased pay. During the past 61 years AMERICAN SCHOOL has helped ambitious people to reach higher goals. Check subject that interests you and mail coupon for full information.

AMERICAN SCHOOL, Dept. G445, Drexel at 58th, Chicago 37, Ill.

Without obligation, please send FREE and postpaid, full particulars about the subject checked below.

- |  |  |   |
|--|--|---|
| <input type="checkbox"/> Accounting              | <input type="checkbox"/> Contracting             | <input type="checkbox"/> Mechanical Engineering |
| <input type="checkbox"/> Apprenticeship Courses  | <input type="checkbox"/> Diesel Technician       | <input type="checkbox"/> Mechanical Technology  |
| <input type="checkbox"/> Architecture & Building | <input type="checkbox"/> Drafting—Building       | <input type="checkbox"/> Metalworking Courses   |
| <input type="checkbox"/> Automotive Technician   | <input type="checkbox"/> Drafting—Machine Trades | <input type="checkbox"/> Plumbing—Practical     |
| <input type="checkbox"/> Better Foremanship      | <input type="checkbox"/> Electrical Engineering  | <input type="checkbox"/> Private Secretary      |
| <input type="checkbox"/> Blueprint Reading       | <input type="checkbox"/> Electricity—Practical   | <input type="checkbox"/> Retail Merchandising   |
| <input type="checkbox"/> Bookkeeping             | <input type="checkbox"/> Electronics—Industrial  | <input type="checkbox"/> Salesmanship—Outside   |
| <input type="checkbox"/> Business Management     | <input type="checkbox"/> HIGH SCHOOL COURSES     | <input type="checkbox"/> Sheet Metal Work       |
| <input type="checkbox"/> Civil Engineering       | <input type="checkbox"/> Mechanists              | <input type="checkbox"/> Tool Making            |

NAME \_\_\_\_\_ OCCUPATION \_\_\_\_\_ AGE \_\_\_\_\_

HOME ADDRESS \_\_\_\_\_ STATE \_\_\_\_\_

CITY \_\_\_\_\_

MAIL COUPON NOW



Learn BAKING At Home  
Baking is one of America's high industries in wages. Nearly depression-proof. Thorough basic home course lays sound foundation. If you have aptitude, write for FREE BOOKLET, "Opportunities in Commercial Baking." National Baking School, 835 Diversy Pkwy., Dept. 1354, Chicago 14, Illinois







LEARN TO

# OPERATE EARTH MOVING EQUIPMENT

Men who "boss" crawler tractors, front end loaders, motor graders, cranes, etc., earn top pay on construction, road building, excavating & other jobs. 4 week courses on motor graders and compactors \$295; bulldozers, trucks, loaders & scrapers \$375; backhoe & dragline operation \$320; dump, trailer dump & off-highway truck course \$180; 7 week combination course \$560—All courses include preventive maintenance—Special weekend instruction available—50 miles from Chicago—Economical housing & board—Write for details NOW.



## OR LEARN TO BE A CONSTRUCTION EQUIPMENT MECHANIC

Greer also teaches a complete, separate Mechanics Training Course covering Diesel engine transmissions; torque converters; fuel injection systems; track assemblies; final drive assemblies; steering systems; idlers; rollers; power transfer systems; cable control systems; hydraulic control cylinders & welding pertaining to heavy equipment such as bulldozers, scrapers, loaders, off-highway trucks, etc. Course time — 540 hours — 18 weeks — \$540. Write for details.

Please send **FREE** information on

- HEAVY EQUIPMENT OPERATORS TRAINING**
- CONSTRUCTION EQUIPMENT MECHANICS TRAINING**

Name \_\_\_\_\_ Age \_\_\_\_\_

Address \_\_\_\_\_ Phone \_\_\_\_\_

City \_\_\_\_\_ State \_\_\_\_\_



**Greer TECHNICAL INSTITUTE**  
ATT. M. D. Hutchison, Box 278, Braidwood, Ill.

## TROUBLESOME WOOD HATCHWAY?



### REPLACE IT!

With a modern Bilco Basement Door.  
All-steel, weathertight, spring-operated.  
Do it yourself in just 3 to 4 hours.

# Bilco

AMERICA'S FINEST  
BASEMENT DOOR

Write today for  
**FREE** illustrated  
replacement folder.

THE BILCO CO., Dept. 125  
NEW HAVEN 5, CONN.

Please send me complete information.

NAME .....

ADDRESS .....

CITY ..... STATE .....



### WOOD FINISHING made easy

**INTERIOR WOOD PROJECTS** Seals, primes, finishes. Nothing else to use from raw wood to bar-top finish. Dries in 30 minutes.

### MORE THAN A WOOD FINISH



**PROTECTS TOOLS FROM RUST**  
Coat tools with Deft. Non-Sticky.  
Makes table-saw tops smoother.

**DRAWERS, WINDOWS**  
will not stick. Coat runners  
& slides for smooth operation.



**PROTECTS NEW WOOD**  
against warping, darkening,  
grime, fingerprints, pencil marks.

See your dealer or write for free Deft booklet.

DESMOND's, 1826 W. 54th St., Los Angeles 62, Calif.



### Electrical Slide Rule Maneuvered by Push Button

This jumbo-size slide rule was constructed so that intricate mathematical problems could be worked out with push-button ease. An electric motor triggered by a small electronic "brain" maneuvers the slide rule into calculating position at the touch of a few buttons.





# PAY 1¢ on the DOLLAR for 1000's of Useful Items U.S. GOV'T SURPLUS

## LOOK AT THESE LOW PRICES

Jeeps... \$223 Tractors... \$68  
Trucks... \$212 Motors... 29c  
Boats... \$5.90 Airplanes... \$366  
Fork-lifts, \$197 Typewriters, \$6.80  
Hydraulic cylinders \$1.01 \* Gear  
Reducers 97c \* Transmissions \$7.80  
Billions worth sold every year

Eliminate the middleman—Save big money! Buy direct from U. S. Government at TREMENDOUS savings. Pay as low as 1c on the dollar or less. Our Directory Govt. Surplus Sales lists 100's of Army, Navy, Air Force, and other government surplus depots. Many of them right in your own back yard. Buy sports equipment, hunting, fishing and photographic equipment and supplies, radio, electronic and electrical equipment, trucks, boats, jeeps, airplanes. Plumbing, hardware, office equipment supplies. Power tools, machinery, furniture. Directory is indexed for quick information. Answers your questions. Tells you how to buy. Get on the gravy train while you can. Send \$1 for "Govt. Surplus Directory" to— Aviation Surplus Center, Dept. PM-4, Eters, Pa.

## 5 "MFG" beauties for '58 three sleek 15-footers two frisky 12 1/2-footers

All featuring the famous, tough MOLDED FIBER GLASS hull with MOLDED-in lapstrake design... trimmed with handsome mahogany... fast, smooth, easy to handle. Priced from only \$295 and \$495 f.o.b. factory. Write for literature.

MOLDED FIBER GLASS BOAT COMPANY 71 Fourth Ave. Union City, Pa.

## MAKE TREMENDOUS PROFITS

Have fun! Earn Big Money! Cast plaster figurines, bookends, plaques, novelties at home in your spare time with X.L. rubber molds! NO EXPERIENCE NEEDED! Models and rubber for 3 molds, only \$1.50 ppd. Send 25c (refunded with order) for 40 page catalog now!  
**PLASTIC ARTS STUDIO 3403 S. MADISON, DEPT. PM2 MUNCIE, INDIANA**

## AUTOMATIC STORAGE CASE HOLDS and DIALS COMPLETE SET of 29 DRILL BITS 9 DRILL BITS FREE WITH EACH CASE \$3.95

Dial-A-Drill 1/16" to 1/2" by 64ths jiffy fast. All steel circular case. Easy to store and carry. Self-locking. Also available for number drills 1 to 60. State choice No. 29 or No. 60 and send \$3.95 plus 55c for shipping (total \$4.50). Or Both cases \$6.90 plus 75c (total \$7.65). Money back guarantee.

6 3/8" x 3 1/4" KEYSTONE FERRULE & NUT CO., Dept. A, Box 11, Burlington, Wis.

## KEEP YOUR... on BENJAMIN for HIGH H.P. COMP AIR GUNS & CO2 GAS GUNS—Top Quality at LOWEST PRICES!

BB or 177 or 22  
**BENJAMIN SUPER**  
Single Shot CO2 Carbine \$14.95  
Gas Rifle (BB) with Reg. Stock  
Deluxe (BB) Model with Custom Stock (Shown) \$17.95

All Models Benjamin CO2 Carbine Gas Rifles and Benjamin CO2 Rocket Gas Pistols Use Standard Size CO2 (Soda) Cartridges (available everywhere). 2-Stage Hi-Lo Jet Power—High for Small Game—Low for Target—Up to 50 Shots from Each Cartridge. No Pumping—Safe—Accurate—Economical—Non-Toxic—12 Models—BB or 177 or 22.

Benjamin Air Rifles and Benjamin Air Pistols are Recognized All Over the World for Finest Workmanship and Highest Quality at Lowest Prices. Adjustable Power with Amazing Optimum Force. Fully Guaranteed—Safe—Accurate—Economical. Easy to Use Anywhere—12 Models for Target and Small Game 22 or 177 or BB from \$18.50.

Send Gun Catalog and Special Knife Offer!

**BENJAMIN AIR RIFLE CO., MAIL TODAY!**  
808 MARION ST., ST. LOUIS 4, MO., U.S.A.

Name \_\_\_\_\_  
Address \_\_\_\_\_  
City \_\_\_\_\_ State \_\_\_\_\_

## Become A --- BUILDING CONTRACTOR! MAIL COUPON for FREE BROCHURE

Simplified home study training program. Learn every phase of building, estimating, contracting. Fortunes are made in this line of work every year. Use spare hours—no interference with present work. Diploma awarded. Low tuition rates.

**AMERICAN TECHNICAL SOCIETY**  
Dept. PM-458, 850 E. 58th Street, Chicago 37, Ill.

Please send me your FREE Brochure and full details of your building, estimating and contracting training program.

Name \_\_\_\_\_  
Address \_\_\_\_\_  
City \_\_\_\_\_ State \_\_\_\_\_

## MANUFACTURE THIS BEAUTIFUL CONCRETE OUTDOOR FIREPLACE

Right In Your Own Backyard  
\$4.00 Worth of Sand & Cement produces this Attractive Fireplace.



Sells on Sight from \$60. to \$80. Easy to start your own Profitable Business.  
The General Fireplace Molds and Process are the most amazing and foolproof ever invented. Simple to operate. Two men can produce five fireplaces a day.

**BIG DEMAND!!**  
Sell all you produce to Department Stores, Homeowners, Parks, Nurseries and Picnic Groves. Fireplaces sell on sight. No experience necessary. We supply full operating instructions and equipment plus the know-how that spells BIG PROFITS. This is an outstanding opportunity for men of vision and small capital to get into a busy rich paying field. Don't delay, be the only exclusive manufacturer in your own home town. Mail coupon at once for full details as to how you can reserve your territory. Molds sold only on exclusive franchise.

**GENERAL ENGINES CO., Inc., Dept. MF-48**  
ROUTE 130, THORFARE, N. J.

Mr. Tor of Philadelphia writes: Sold 250 in first 4 months. Selling to Sears Roebuck, John Wanamaker, and Gimbel Bros. in Philadelphia area.

Name \_\_\_\_\_  
Address \_\_\_\_\_  
City \_\_\_\_\_ Zone \_\_\_\_\_  
State \_\_\_\_\_

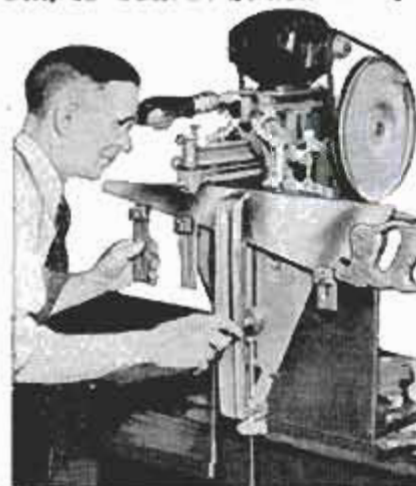


# FREE PLAN

tells how to start your own business

# FILING SAWS

Here is a steady repeat CASH business you can start in your own basement or garage in your spare time and make up to \$3 or \$5 an hour. You can file hand, band and cross-cut circular saws on the Foley Saw Filer. No eyestrain—no experience needed. "The first



saw I sharpened with my Foley Filer came out 100%—writes Clarence E. Parsons.

Every saw you sharpen with the Foley Saw Filer brings you more customers. "I rented a two-car garage and have all the work I can do"—Charles H. Smith.

**FREE BOOK**  
Shows How to Start Foley Price Guide gives saw sharpening charges. Send coupon today. No salesman will call.



**SEND COUPON FOR FREE BOOKS**  
FOLEY MFG. CO., 416-B Foley Bldg.  
Minneapolis 18, Minn.

Send me free book "Money Making Facts" and Foley Price Guide of saw sharpening charges.

Name \_\_\_\_\_

Address \_\_\_\_\_

The fun  
never  
ends



with a **Cushman**  
**ROAD KING**

Worlds of fun and excitement wrapped up in this sleek package—the leader in its field. Sturdily built for safety and service... modernly designed in two-tone colors for sharp appearance. The famous Cushman Husky 4-cycle engine delivers up to 50 miles per hour, up to 100 miles per gallon.

SOLD AND SERVICED NATIONALLY  
Replacement parts immediately available

Dealer inquiries invited

Ask your dealer for a **FREE** demonstration ride  
Write for new **FREE** Booklet today

**CUSHMAN MOTOR WORKS, INC.**

A subsidiary of Outboard Marine Corporation  
970 NO. 21st, LINCOLN, NEBRASKA

## ASK FOR

SEND 25¢ FOR  
GENEROUS SAMPLE...

**Evans'**



**ADHESIVES!**

If your dealer doesn't carry Evans Glue Products, send 25¢ (to cover mailing and handling) with dealer's name and address for generous sample of Evans Welsh Glue.

**DUX BAK** . . . waterproof linoleum cement • **LINHOLD** . . . for linoleum and tile • **QUICK STICK AND STAZ-IT** . . . wall sizing • **WELSH GLUE** . . . All purpose glue in handy squeeze bottle. • More than 100 quality adhesive products.

**THE COMMERCIAL PASTE CO.**  
520 Buttes Ave. • Columbus 15, Ohio • Since 1902

## 2 WAY PORTABLE RADIO SET

**SENDS - RECEIVES UP TO 10 MILES AS SHOWN**  
with built-in antenna or hundreds of miles with outside antennal Works on 80 and 40 meter (Novice) amateur radio bands—also Aircraft and overseas broadcast (3 to 8 mc). **PORTABLE SELF-CONTAINED POWERED WITH STANDARD PORTABLE RADIO BATTERIES. NO AC PLUG-INS NEEDED!** Take it with you everywhere you go—on trips, vacations, camping—Keep in contact with home, friends. Has 5 watt crystal controlled transmitter—Sensitive Regenerative Receiver. Send-Receive switch. Wt. only 3 lbs. Size, only 6"x4"x4". **TESTED - PROVEN - SIMPLIFIED - PRACTICAL**—Full information given on quick easy to get license. (bill, ck. inv. and pay postman \$11.95 COD postage on arrival or send \$14.95 for postpaid delivery. Complete kit includes all parts, tube, coils, plastoid cabinet, easy instructions. (Set of batteries \$2.95; crystal \$1.25.) **COMPLETELY WIRED AND TESTED POSTPAID \$19.95.** A regular \$49.95 value—Order now before price goes up. **GUARANTEED—AVAILABLE ONLY FROM:**



WESTERN RADIO

DEPT. BNM-4 KEARNEY, NEBR.

### Exclusive Double-Bearing HEAVY-DUTY PUMPS



**IRRIGATE • DRAIN • CIRCULATE • SPRAY**  
Use 1/4 HP motor or larger . . . 1 HP for up to 7,500  
GPH; 1,000 GPH 60' high; or 3,000 GPH from 25' well.  
1 1/4" inlet; 1" outlet. Stainless shaft.  
**TYPE X-2 oil-less bronze bearings. Won't rust. . . . \$10.95**  
Postpaid if cash with order. Rush your order today  
**MONEY BACK GUARANTEE**  
Centrifugal and Gear Pumps in All Sizes  
**LABAWCO PUMPS, Belle Mead 2, N. J.**

## HULL AUTO COMPASS

### SILVER ANNIVERSARY MODEL

Case in gleaming, shiny silver finish. See it, along with regular 5-color selection, at your dealers.



For 25 Years,  
America's Favorite  
Motoring and  
Boating Guides

\$5.50 to \$7.95

Write for  
Literature

**HULL MFG. CO. P.O. Box 246-D-4, Warren, Ohio**

**FREE** If you buy 2 or more Passenger 4-ply tires, we GIVE ONE tire FREE, on each order. Does not include W.W. or Truck Tires. Send Ad.



We try to Ship Your Favorite Brand (not recaps)  
**GOOD YEAR** GOODRICH, U. S., General, Firestone & others, worn slightly.  
**12 MONTH GUARANTEE** I replace FAST any defective tire, Frt. Excl.

Everybody  
Take 20%  
Off

**FREE** This pictured Tire  
Ash Tray given with  
2 or more tires

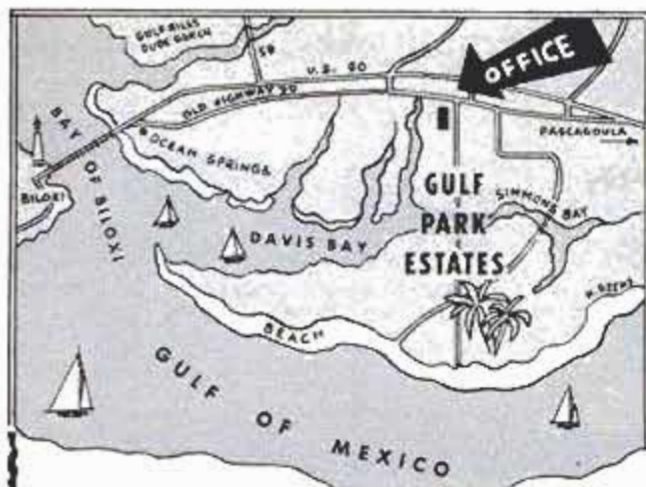
600-16(6)	\$6.25	700-17	\$10.25	750-20	\$11.25	1000-20	\$17.95
650-16(6)	6.65	700-20	10.35	700-15(6)	7.65	1100-20	17.95
700-16(6)	7.75	750-16	7.75	825-20	18.45	1000-22	20.85
		750-17	11.25	900-20	18.45	1100-22	21.15

QUANTITIES LIMITED ANY CAR TIRE & TUBE, \$5.50 Whitewalls  
SOME SIZES. BLACK 4-PLY \$1. Extra

**GENUINE STANDARD BRAND Plus FREE \$9.95 NEW TIRE**  
FACTORY ADJUSTED TIRES Innertube any car GUAR.

MARVIN **BLATT** 6th & Spring Garden Philadelphia, Pa. Send check or M.O. & this ad for fast shipment. FOB Phila. I personally select your tires as if my future depended on it. **BLATT NAME famous for 42 years in TIRES**





## GULF PARK ESTATES WHERE THE LIVING IS EASY

**\$8 buys a share in the future of  
Mississippi's Fabulous Gulf Coast**

**Multi-million dollar development  
10,000 homesites for**

**VACATION — RETIREMENT HOME — INVESTMENT**

All homesites: ¼ acre (75' x 150') — \$8 down; \$8 monthly

**Total Costs: \$895 in \$6,000 restricted area or  
\$695 in \$3,000 restricted area or Mobile homes.**

**Orders from this ad will be assigned corner lots if desired.**

**LOCATED:** On the Mississippi Gulf Coast, where white beaches extend 60 miles. Bays, bayous, rivers, offer fresh and salt water fishing, every water sport, in Gulf Park Estates; golf, riding, hunting, nearby. Entrance: 3 Miles East of Ocean Springs on Old Highway 90. Just across the Bay from Biloxi and Ocean Springs.

**IDEAL CLIMATE YEAR 'ROUND:** Comfortably cool summers, rarely any chilly days; excellent climate for asthma, sinus, arthritis sufferers. Grows citrus fruits, vegetables, abundantly.

**PLANNED COMMUNITY:** Gulf Park Estates will have shopping centers, churches, schools, parks, Country Club, Yacht Club. All property owners have privilege of entire beach and inland boat harbor. Many roads already paved. Guarantee with each purchase that fronting street will be paved or suitable lot exchanged. Electricity, telephone lines, flowing water already in. Bottled gas available until nearby natural gas is piped in. Many beautiful homes now exist in Gulf Park Estates area.

The Mississippi Gulf Coast is 1,000 Miles—2 days driving time—NEARER than Southern Florida. Gulf Park Estates offers highest elevation on the Gulf Coast, every homesite high and dry. Gulf Park Estates offers you easy, delightful living; friendly, interesting neighbors, low living costs.

**START PLANNING YOUR FUTURE TODAY!** Send \$8 deposit, and we will mail you complete descriptive literature and plat (map) showing location. You may move on property or sell, once deposit is made. If you decide to cancel your contract within 90 days, deposit and all payments will be refunded.

**INVEST SMALL AMOUNT NOW** and count your profits tomorrow. We expect to sell 75% of the lots in 12 months. Come choose your lots personally if you wish, or you may exchange assigned lots any time for any available lots at printed prevailing prices. Buy NOW and get in on ground floor. Write for colorful brochure.

**WE MAKE IT EASY FOR YOU TO BUILD,** as prices include: Artesian deep well flowing water piped to your property; road paving; taxes and interest while paying; all deed costs, title guarantee policy; land cleared with our bulldozer, if desired; 100 shrubs and palms for landscaping. You may choose your contractor from many competitive firms available, or we will assist you; also in financing.

**PROPERTY VALUE** is adequately protected by reasonable restrictions of our property-owned committee.

**FOR REFERENCE,** contact Peoples Bank, Biloxi, Miss.

**Send coupon Plus \$8 Deposit on each lot Today!**  
GULF PARK ESTATES, Dept. PM4, Biloxi, Miss.

Reserve for me \_\_\_\_\_ homesites \$895. Enclosed is \_\_\_\_\_ deposit on each homesite. Send contract, and map showing location.

Are corner lots desired? \_\_\_\_\_. It is understood my deposit and payments will be returned without question if requested in 90 days.

Name \_\_\_\_\_

Address \_\_\_\_\_

City \_\_\_\_\_ Zone \_\_\_\_\_ State \_\_\_\_\_

# BALKO TOOLS

## SEND FOR BALKO'S BIG 1958 CATALOG

Covers best lines of woodworking and metalworking tools and accessories. Precision tools—portable electric saws, drills, routers, sanders, grinders, flexible shaft equipment—lathes, drill presses, mills, power saws, sheet metal forming and cutting machinery. Contains hundreds of unique tools and attachments—flanges, shaft collars, pulleys, etc. You get fastest service, lowest prices from Balko. To get this great new catalog, send 25¢ to cover cost of mailing, to:

**BALKO, 6666 N. Western Ave., Chicago 45, Ill.**

## "SWISH" PLANS



### PATTERNS FRAME KITS

**BUILD THE "SWISH"**  
(as featured in this issue)

**PLANS ONLY .....\$9.00**

**PLANS & PATTERNS...\$19.00**

**FRAME KIT (includes**

**plans) .....\$100.00**

Send 50¢ NOW for COMPLETE

CATALOG listing all of our designs.

**GLEN L.**

9152T Rosecrans, Bellflower, Calif.

## ATTENTION: Distributors - Salesmen — Full or Part-Time

### SAFE-T-BLOK

Trade Mark ® Pend.  
Pat. 2,461,248  
Other Pat. Pending

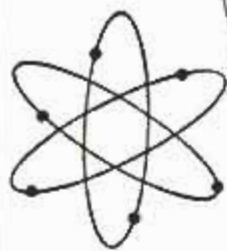


**SAFE:** At last the hazard of the bumper jack has been **ELIMINATED.** No falling or moving of car even on the steepest hill. You are safe with Safe-T-Blok, a safety device every car owner cannot afford to be without. Use for blocking cars, house trailers, boat trailers, small aircraft, when rotating tires, has many uses. **BIG PROFITS** proven sales plan, sales unlimited. Sell direct or through service stations. Up to \$20.00 a day part-time. Retail price \$6.95. Don't wait. For a complete Safe-T-Blok demonstrator for your car with full information on this wonderful

fast selling safety device, send only \$3.95, postpaid. Mail today to **SAFE-T-BLOK, DEPT. S-2, P. O. BOX 453, FORT WORTH, TEXAS.** *FREE freight to all 48 states.*



Interesting, Pictorial  
**FREE  
BOOKLET**



to help you decide on  
**YOUR CAREER  
IN ENGINEERING**

Here is a graphic story about dynamic careers as engineers and engineering technicians. Booklet covers such subjects as:

- Wide variety of job opportunities.
- The courses offered, degrees you can earn, and what you are qualified to do.
- Pictures of the Milwaukee School of Engineering, its facilities, plus Milwaukee scenes.
- Recreation, student organizations, fraternities.
- Scholarships, part-time work, admission requirements.

— and many other important and interesting facts to help you understand and decide on your career in engineering. Send for your free copy today — no obligation whatsoever.

MS-73

**Milwaukee School of Engineering**  
— dedicated to serving young men and industry

**SEND COUPON**

**Milwaukee School of Engineering**  
Dept. PM-456, 1025 N. Milwaukee St., Milwaukee, Wis.

Please send me free the new booklet  
"Prepare for Your Career in Engineering"  
I am interested in \_\_\_\_\_

Name \_\_\_\_\_ (COURSE) \_\_\_\_\_ Age \_\_\_\_\_

Address \_\_\_\_\_

City \_\_\_\_\_ Zone \_\_\_\_\_ State \_\_\_\_\_

I'm eligible for veteran's education benefits.

Yes  No  Discharge date \_\_\_\_\_

**10" Slide Rule**



**ONLY 98¢** postpaid

**ANYONE WHO UNDERSTANDS SIMPLE 7TH GRADE ARITHMETIC CAN USE THIS STANDARD SLIDE RULE!** Be modern — use this quick easy way of figuring. For business men, students, carpenters, machinists, salesmen, printers and engravers, office workers, farmers, merchants, time keepers, plumbers, electricians—everyone who does figuring can save time and labor with this slide rule.

**FREE** Illustrated instruction book shows you how to get correct answers instantly without pencil and paper. (You get BOTH slide rule and instruction book for only 98¢ postpaid. Satisfaction guaranteed or refund.)

**NELSON-HALL CO., 210 S. Clinton, Dept. 2DS-2, Chicago 6**

**BOAT KITS** 50 Models  
8' to 18'

Free Catalog in Full Color



Runabouts, cruisers, convertibles, fishing: \$41.75 and up, Freight pd. Luger boats equal factory built; yet save you to 2/3 cost. Methods assure a perfect assembly by anyone. FREE color catalog includes: Fiberglass, trailers, paints, hardware, accessories. Write now.

**LUGER INDUSTRIES, INC. Dept. B-4**  
9200 Access Rd. Minneapolis 20, Minn.

**75 POWER TELESCOPE \$3.98**  
25X-45X-75X

**NEW** 3 in one telescope, 3 variable 25X-45X-75X magnification. Brass bound, 25 power for ultra bright images 45 & 75 power for long range. Guaranteed to bring distant stars, moons, objects, sports 75 times closer. Most powerful scope sold anywhere near this amazing low price. American made, 5 sections. Opens 36", closes 1 ft.; contains 4 ground & polished lenses. Can also be used as powerful compound microscope. Mass production enables us to offer telescope complete at \$3.98 postpaid. Money back guarantee.

**CRITERION CO., Dept. PMB 56, 331 Church St., Hartford, Conn.**

**BRONZE FOUNDRY**



Schools • Home Workshops • Inventors

Make your own castings of aluminum, copper, bronze, silver. Foundry sets are available in three sizes including 2400 Deg. F. blast Furnaces. \$26.50; \$33.50; and \$46.00 f.o.b. Marysville or Lakewood. Free Circular.

**KANSAS CITY SPECIALTIES CO. (Dept. B) Box 6022, Marysville, Kans. P-4** or Box 7543, Lakewood, Colo.

**FREE LAFAYETTE CATALOG**  
JUST OFF THE PRESS!  
NEW 180 PAGE ELECTRONIC CATALOG FEATURING  
THE BEST BUYS IN THE BUSINESS

Packed with the largest selection of Electronic, Radio and T.V. Parts, and equipment, PA, Hi-Fi systems, tubes, antennas, Transistor Kits, parts and components, Test Equipment, new build your own kits, tools, books, Microscope, drafting equipment, Binoculars, Telescopes, All Radio, TV and Ham supplies—ALL AT GREAT SAVINGS —For the economy minded servicemen, dealer, engineer and technician. **CHUCK FULL OF BUYS! SEND FOR YOUR FREE COPY TO-DAY.**



Name \_\_\_\_\_

Address \_\_\_\_\_

City \_\_\_\_\_ Zone \_\_\_\_\_ State \_\_\_\_\_

**Lafayette Radio** 165-08 LIBERTY AVE. JAMAICA 33, N. Y.



**WORLD'S  
BEST  
WANT-AD  
MEDIUM**

# CLASSIFIED ADVERTISEMENTS



Advertisements in this section \$1.25 per word, each insertion, minimum 10 words, payable in advance.

To be inserted under proper classification, copy must be in our office the  
20th of the second month preceding date of issue  
F. W. Johnson, Manager, Classified Advertising  
Popular Mechanics Magazine, 200 East Ontario Street, Chicago 11, Illinois

## YOU'LL PROFIT

By reading and answering the classified ads in this section. Hundreds of opportunities for you to make and save money

### AUTOMOBILES, MIDGET CARS

**NON-Profit** organization offers automobile literature. Old, modern and foreign; dealer books, service manuals, glossy photographs; free motor magazines. Write to get on free mailing list. Auto Maniacs, Inc., Stockbridge, Mich.

**1958 SUPERIGNITIONER.** Starting, pep, mileage, \$4.50; Kaisers, Varitypers, IBM's. Courses, Barbells, EG, Elmsford, N. Y.

### AUTO SUPPLIES AND EQUIPMENT

**CRANKSHAFT Grinder,** hand operated. Makes bearings fit without taking engine apart. \$3.75. Literature. L. D. McGee, 719 Cascade St., Wenatchee, Wash.

**RING-Valve job** while driving. \$6.00. Literature. Motaloy, Grantham, Penna.

**NEW** And used parts at savings. Complete guaranteed parts service for all models cars and trucks, 1924 and later. Largest in the West. Jeep and army parts specialists. Newest type shifting hubs for all Jeep and all military and latest production front end drive vehicles. \$27.50 and up. Write. Pioneer Auto and Truck Parts Co., 734 W. 13th Avenue, Denver 17, Colo.

**DO-It-Yourself** booklets. 24 different booklets each covering an interesting subject. Free catalog. Popular Mechanics Press, 631 N. St. Clair St., Chicago 11.

**SAVE Money** on Jeep and army truck parts. Large inventory. Catalogs for Jeep or G.M.C. owners. American Auto Parts Co., 1830 Locust, Kansas City, Mo.

**JEOP Owners—V-8 conversions.** Read Jeep Owners ad, page 30.

**FREE!** New catalog. Speed, power, mileage increasing equipment. Discounts! Almqvist Engineering, Milford PM5, Penna.

**AUTO Emblems — T-shirts, jackets, trophies.** Free literature. Spot Enterprises, P.O. Box 66, Culver City 1, Calif.

**AUTOMOTIVE Books.** Free catalog. Popular Mechanics Press, 631 N. St. Clair St., Chicago 11.

**SENSATIONAL** invention reduces driver fatigue. A must for hot weather driving. Every driver a prospect. Quick sales, big profits. Portable Breeze-Thru spring cushion with patented Bak-Ade support. Protected springs will not rip upholstery. Convince yourself, send for facts. Protek-Bak Corp., Dept. PM1, 113 S. Hanover St., Baltimore 1, Md.

**FREE Giant 1958 parts catalog.** Thousands scarce accessories stores don't have. Gadgets, custom equipment. Send 25¢ postage (refundable). Newhouse Automotive Industries, 5805-PM-4 Beverly, Los Angeles 22, Calif.

**DUAL Beam safety headlight system** for 1957 and older automobiles. Puts 50% more light on the highway. Many safety factors. Can be installed in 20 minutes. All parts and complete instructions \$2.00 postpaid. F-M Industries, 107 S.E. 11th Ave., Forest Lake, Minnesota.

**FREE!** 1958 Automotive catalog. 244 pages, 75,000 items. Parts of every description for stock cars, hot rods, custom cars, trucks, and station wagons. Save up to 50%. Same day service. Quality guaranteed or money back. Send 25¢ (refundable, first order). J. C. Whitney, 1919 PM-4, Archer, Chicago 16, Ill.

**AMAZING** Compression seal. Saves costly repairs, gives added miles, power, better performance and longer life to car, truck or tractor. Same as a new ring job. 10,000 miles one treatment \$3.95 postpaid. Guaranteed. Details free. Charles Soles Motor Service, Windsor, Missouri.

**FOUR** New auto products improve performance, economy, safety. Free literature write Comet, Box 327, Riverside, Miami 35, Fla.

**STOP** Expensive replacement of parts with easy-to-install Davis Ball Boot. Protects drive shaft coupling and ball housing on Chevrolets and Fords, 1941 through 1957, all models. Prevents wear of metal parts, stops lubricant losses, keeps dirt and grit out of transmission. Write for free literature. Davis Ball Boot Company, Inc., 2301 Yale Street, Houston, Tex.

**NEW** Do it yourself paint spray kit. Repair, customize your car, ideal hobbies. Lasts lifetime. Guaranteed, \$3.95. Information. Kits, 1047 Belvedere, North Vancouver, Canada.

**STUCK?** \$4.95 Delivers 15 feet 3 ton nylon tow and emergency rope. Ruggles, 436 Arnold, New Bedford, Mass.

**FOREIGN** Auto parts, body part, accessories. All cars. Prices discounted. Free catalog. Box 199, Manhasset, N. Y.

**BEAUTIFUL** St. Christopher car medals. \$2. Box 504, Nyack, New York.

**JEOP** Tops \$7.50, door curtain \$3.50, side curtain \$2.00. Prices f.o.b.: Jacksonville, Texas; Surplus Sales.

**RECHROMING** Kit for automobiles. \$2.98. Details. Fairmount Chemical, East Syracuse, New York.

**REPLATES** Bumpers and chrome parts in minutes. Not a paint or polish. Works magical. Guaranteed refund, \$1.50 postpaid. Re-Nu Co., Box 147M, Hamtramck 12, Mich.

### AUTO TRAILERS

**EVERSILENT** — Patented, ball joint, trailer couplers. Self adjusting, spring action. Free specifications, prices. Mobile Wheel Products, 1510 McClellan Ave., Detroit 14, Michigan.

**BUILD** Expanding eight foot trailer. Accommodates five. Literature 10¢. Fram-A-Cor Company, Wilmington, Mass.

**TRAILER** Building manual \$1.00. Booklet 30¢. Kamcraft, Box 1153, Milwaukee 1, Wis.

**CABIN** Trailer kits. Pleasure or business. Write Burlington Manufacturing Company, Burlington, Iowa.

**DON'T** Buy anything until you've seen the "new look" in camping. New camp trailer, a new cartop camper, new camp kitchen. Free illustrated brochure. Write: Hellite Trailers, Inc., Dept. P.M., Lodi, California.

**ALUMINUM** Pickup coach kits. Literature 10¢. Comstock Trailers, Parsons, Kansas.

### MOTORCYCLES, BICYCLES, MOTORSCOOTERS AND SUPPLIES

**NSU** Scooters and motorcycles. BMW motorcycles, 2 to 35 h.p., shaftdrive and chaindrive. Butler & Smith, P.O.B. 45, New York City 24.

**WHIZZER** Motors, \$20.00; midget race car reasonable; motorscooter \$6.00; Cushman two-speed \$20.00. Send 25¢ (35¢ first class mail) for catalog #32 jammed with sensational bargains in wheels, motors, motorscooters, midget cars, motorbikes, construction plans, etc. Gall, 1313 Jefferson, Toledo, Ohio.

**SAVE 20%** On genuine H.D. parts. Used parts for Harley, Indian, Cushman, Whizzer, Servicycles. Used outboard parts. Est. 32 yrs. Bill's Cycle Shop, 1005 S. State, Syracuse 3, N. Y.

**HARLEY - Davidsons** — Used bargains. New, used parts, accessories for all models. Bulletin, catalog 25¢. Knuth's (Factory Dealer), 1753 Muskego, Milwaukee, Wis.

**DOODLEBUG** Motorscooter \$15, Cushman \$20, less engines. Doodlebug engine \$5, Whizzer \$5. Midget car with motorcycle engine \$75, Indian engine and transmission \$15. (Mailorder only). Send 25¢ (35¢ for first class mailing) for directory-catalogue number 82, just out, listing these and hundreds of other bargains, home-builders parts, plans, etc. Midget Motors Directory, Athens, Ohio.

**PARTS** New, used. List 10¢. Ballak, 811 N. 9th, St. Louis 1, Mo.

**RECONDITIONED** Motorcycles and motors. Chromium accessories. Complete stock Indian parts. Expert rebuilding. Fast service. Indian Motorcycle Sales, Kansas City 27, Missouri.

### AVIATION

**BUILDING** Your own airplane is easy with our new simplified "Stits Playboy" and "Flut-R-Bug" construction blueprints. For details (with photographs, 3-view and cut-away drawings). Mail \$1.00 to Stits Aircraft, Box 3084M, Riverside, California.

**AIRPLANE** Recognition poster 18"x25". U.S.A. and foreign. Decorative. Instructive. 120 assorted \$4.97. 30 assorted \$1.98. 10 for \$1.00. 3 samples 50¢. Postpaid. Karl Ort, Box 21M, Thomasville, Penna.

**BUY** Surplus aircraft; engines; fuselages; radios; cameras; instruments; helicopters; misc., direct from gov't depot. List, procedure \$1.00. Royal, Box 155C, Cliffside, N. J.



**SMALL Helicopters** theory and guide manual. Drawings. Construction data. \$2.00. Sandhill Aircraft, Box 336, Atkinson, Nebraska.

**PROPELLERS.** Plans, supplies for airboats and snowplanes. Latest designs, prompt delivery. Catalog 25¢. Banks-Maxwell, Box 3301E, Ft. Worth 5, Texas.

**BUY Direct** now from U. S. government depots, surplus aircrafts; fuselages; assemblies; aircraft engines; helicopters; instruments; electronics; radiotelephones; Misc. Send for bulletin "Depot List and Procedure" \$1.00. Box 8-PM, Sunnyside 4, New York.

**BUILD Your own plane!** Complete plans, instructions \$1.00. Flying course included. ABC Publications, Box 849-AR, San Francisco 1, California.

#### ELECTRICAL SUPPLIES

**ELECTRIC Pencil:** Engraves all metals \$2.00. Beyer Mfg., 10511-H Springfield, Chicago 43.

**LAMPS—Parts** catalog containing wiring instructions, 25¢. Gyro Lamps, 3436P N.W. 54 Street, Miami, Fla.

**LAMP.** Electrical parts, wholesale. Thousands of items for repairing, converting. Catalog 25¢. Brown Lamp, Box 305, Clayton 5, Mo.

**LEARN Electric** wiring, repairing. Beginner's handbook \$1.00. Craftsmen, 1919 Lawrence, Houston 8, Texas.

#### WELDING, SOLDERING, PLATING

**WELDERS,** 110/220, \$39.50. Morris, 1070 Inner Drive, Schenectady 3, New York.

**ACETYLENE** Welding outfits, new \$24.50, arcwelders \$56.50. Eagle Welding, Dept. P.M., 5085 Broadway, Chicago 40, Ill.

**FREE Catalog,** welders, welder kits. Build 300-ampere welder using aircraft generator, plans 25¢. Dunbar Manufacturing, Houston 23, Texas.

**BUILD—Your own** welder or welder and power combination. Low cost unit connected to used engine lets you weld anywhere. Free booklet tells how. Get into profitable welding business. Write Hobart-weld, Box M-482, Troy, Ohio.

**BUFFS—Set of 6", 4", 3".** Specify arbor or we ship 1/2". Sent post paid for \$1.00 bill, check or m.o. Maumee Buff Company, 830 1/2 Summit St., Toledo 4, Ohio.

**NEW And different** oxy-acetylene outfit welds, cuts, heats, brazes, with interchangeable tips. No attachments needed. Light, portable. Complete outfit, full instructions, only \$84.50. Special money-saving plan for oxygen and acetylene supply. Write for free literature today. Dept. M, Linde Company, 30 East 42nd Street, New York 17, N. Y.

**100 SURPLUS** Welding outfits, welding and cutting torches, regulator hoses, welding wire, goggles, etc. Welding Headquarters, 2425 Milwaukee Ave., Chicago 47, Ill.

**WELDING—Now** you can get professional results with this new streamlined, portable oxy-acetylene welding-cutting kits from one of the country's leading manufacturers of welding equipment. You get everything you need for welding up to 1/4" steel, for cutting up to 2" plate. Kit includes welding and cutting attachment, two welding tips, cutting head, regulators, hose, spark lighter, safety goggles, wrench. Ideal for light auto and body repair, plumbing, brazing, bicycle work, metal hobbyists, and all light-weight metal fabrication. Bargain price, whole kit: \$113.00. Send check or money order to: Air Reduction Sales Co., Dept. W.E. 150 E. 42nd St., New York 17, New York. Or send for further information.

**BUILD 350 Ampere** d.c. welder from aircraft generator. Dime brings plans and manufacturer's welding supply catalog. LeJay Manufacturing Co., Inc., 2927 Emerson So., Minneapolis, Minnesota.

#### MACHINERY, TOOLS, SUPPLIES

**HYDRAULIC** Cylinders, standard and special sizes up to 6" diameter. Pumps, valves available. Unit Mfg. Co., 18 West 26 Street, Minneapolis 4, Minnesota.

**NEW Surplus—H.S. milling** cutters, tools. Save to 90%. Sample \$1.00. Dosem \$6.00. Free list. Salmie Enterprises, 40 Greendale Avenue, Worcester 6, Mass.

**MAKE Concrete** drain tile. Simple, inexpensive machine. Write: Ceeten Products, Cornelia, Georgia.

**SMALL Screw** assortment. For precision repair, model-making. 210 screws, nuts, washers 0-80, 1-72, 2-64, 2-56, 3-56, 39 lengths and heads, \$3.90 postpaid check or money order. Catalog screws, taps and dies. Ferner, Box 55, Malden, Mass.

**MINIATURE** Taps, dies, screws, tools. Free folder. Morris, Southbridge, Mass.

**SURPLUS** Socket wrenches, half price. Davis, 3606-A Lakeland, Shreveport, La.

**OIL Drum** cement mixer assembly kit. Circular. Nu-Way-Do Co., Newaygo, Mich.

#### ENGINES, MOTORS, DYNAMOS

**ALTERNATING** Current generators, 750 watt \$42.50, twincylinder compressors with 1/2 horse \$22.00, motors 1 horse \$38.50. Butler, 1885 Milwaukee, Chicago.

**DIESEL** Injector parts wanted. GM51-71-110. Bares, 7120 Carnegie, Cleveland 3, Ohio.

**REWIND** Motors yourself. Complete instructions \$1.00. Lewis Mfg., Howell, Michigan.

**WINDING** Data. 275 motors, single and three phase, \$1.10. Data Company, Box 7631, Kansas City 28, Mo.

**GAS Engines:** Briggs Stratton, 2-2 1/4 h.p.; recoil starter; cast iron; horizontal shaft. Brand new; factory fresh; latest (model-6). Were priced \$64.80; special price \$44.50 freight paid. (Special price 10 or more.) Money back guarantee. Details free. Northern, 172-M Merrimac Street, Boston 14, Mass.

**AIR Compressors,** light plants, half price. Free folder. IMSCO, 1829 South State, Chicago 16.

#### BOATS, OUTBOARD MOTORS

**KITS—Build, sell.** Water skis, boats and accessories. Make money at home. Send for free catalogue and tips. Hill Mfg. Co., 1901 So. 75 St., West Allis 19, Wis.

**SAVE Money.** New, used outboard motor parts. Send wants. Stamp appreciated. Outboard Motor Mart, 229-M State, Boston 9, Mass.

**MARINE** Conversions for Ford and Jeep engines. Catalog 25¢. Lehman Manufacturing Company, 972D Broad Street, Newark 2, New Jersey.

**FULL Size, cut-to-shape** boat patterns, blueprints, 7 1/2-38 feet. Big new 88 pg. illustrated "Build a Boat" catalog of naval architect-designed cruisers, runabouts, skiffs, outboard boats, sailing, racing, houseboats, 50¢. "How to Build a Boat" booklet, \$2.50. Hardware and equipment catalog, \$2.00. Cleveland Boat Blueprint Co., Dept. A-66, Box 1651, Cleveland, Ohio.

**PERMANENT** Lettering for boats, vehicles, homes, businesses, cast bronze, polished natural or chrome. Three sizes in script and three in block letters. Write for circular. Boat Names Company, 426 West 5th St., Kansas City, Mo.

**FORDS And Jeeps** 100% marine engines with famous Convo-Kits. Deluxe catalogue 25c coin. Oscometers, 3627B Lawrence, Philadelphia 40, Penna.

**NEW, Used, rebuilt** marine motors. Marine conversions, fittings. Free catalog. Stokes Marine Supply, Dept. 24, Coldwater, Michigan.

**NEW Revolutionary** Core-Glass and aluminum boats. 21 models 12 to 18 ft. for inland and sea coast waters. Boat trailers from 12 to 20 ft. to 1100 lbs. capacity. Fiberglass boat covering kits. Mahogany water skis. Write for free wholesale catalog. Buy direct from: Osage Manufacturing Co., Osage, Minn.

**PROPELLERS.** Plans, supplies for airboats, snowplanes. Catalog 25¢. Banks-Maxwell, Box 3301F, Ft. Worth 5, Texas.

**FIBERGLASS** Your boat! Wholesale prices. Send for information, sample. Aqua Glas, Box 99, Altadena, Calif.

**FIBERGLAS** Polyester bonding kit. Strong, durable, light. Illinois Blow Pipe, 2800 Halfday Rd., Deerfield, Ill.

**BRASS** Vents stop dry rot. 4 samples 25¢. Blaco Mfg. Co., Cleveland 3, Ohio.

**FIBERGLAS** Permanent boat waterproofing. Special 25% discount. Complete kits, \$9.45 up. Guaranteed materials. Easy application. Full instructions. Free literature. Ajax Plastics, Dept. PM, P.O. Box 1323, Port Worth, Texas.

**FREE Catalog** boat covers, motor covers, fenders, life jackets, life cushions, marine hardware, rope, anchors, water skis. Mantowoc Awning & Cotton Goods Products Co., Dept. MC, Box 261, Mantowoc, Wis.

**PREFORMED,** Fiberglass-plywood pram hulls. Tremendous savings! Free catalog. Wetherfield Marine, Box 63-MA, Wetherfield, Connecticut.

**BOAT Plans—Full size** patterns, frame kits. Modern inboards and outboards for amateur builders. Complete new catalog 50¢ or specify requirements. New speed-boat inboard hardware catalog 25¢. Glen Designs, 9152 Rosecrans, Bellflower, Calif.

**FREE Catalog!** Boat kits, trailers, fiberglass, marine hardware. Luger Industries, Dept. M-4, 9200 Access Rd., Minneapolis 20, Minnesota.

**FIBERGLAS** Boat covering, wholesale prices. Seifert's, Box 31M, DePere, Wis.

**FREE Catalogue.** Rubber boats, life vests, tents. Box 22PMB, Thomasville, Penna.

**GOVERNMENT** Sells—Surplus boats; LST's; LCVP's; aircrafts; helicopters; jeeps; trucks; tractors; radiotelephones; misc. Buy direct now from U. S. government. "Depot List and Procedure," \$1.00. Brody, Box 8-PBM, Sunnyside 4, New York.

**ROPE,** Nylon, dacron, polyethylene. John Ruggles, 436 Arnold, New Bedford, Mass.

**WATER** Ski kits, laminated, save 50%. Quammen's, Route 4A, Stillwater, Minn.

**MARINE** Conversion, Willys to Cadillac, engines, kits and parts. Catalogue and conversion hints free. Barr Marine, 2706 Castor Avenue, Philadelphia 34, Penna.

**MOLDED** Boats; inboard, outboard, sail \$139.50! Marinecraft, Box 161-M, Brighton, Mass.

**MARINE** Tool kits. World-famous Ampco safety tools. "Golden" lifetime bronze. Rustproof, nonmagnetic, spark-resistant. Popular "Tarpon" kit, screw-driver, pliers, adjustable wrench, only \$12.95. Cash with order. Free bulletin describes other kits. Ampco Metal, Inc., Milwaukee 46, Wisconsin.

**BUILD** Small boats. Booklet 25¢. Catalog free. Popular Mechanics Press, 633 N. St. Clair St., Chicago 11.

#### ATHLETIC EQUIPMENT, BODY BUILDING COURSES

**OUTSTANDING** Physical development! Any age. New guaranteed discovery uses only a rope! Strength, health, muscles. Gain-reduce. Free details. Ropercise, 4834-A Art. San Diego 15, California.

**BARBELLS.** Dumbbells. Courses. Free catalogue. Good Barbell Co., Siloam Springs, Arkansas.

**JUDO** Defeat bullies—36 lessons \$1.00. 1112 Tipton St., High Point, N. Car.

**4 MUSCLE** Courses 25¢. Fully guaranteed. Sids System, South Gate, California.

**BE Taller!** Coach's "Inch-At-A-Time" system. \$1.00 complete. Satisfaction guaranteed. Marty Snyder, Box 195-EX, Union City, New Jersey.

**JUDO.** 125 Pages, 186 illustrating photographs, \$2.00. Marshall Mail Merchandising, Dept. 2B, Payne Road, Bethel, Connecticut.

**BE Taller!** Amazing guaranteed instructions \$1.00. ABC, Box 849-tr, San Francisco 1, California.

**KARATE** System splits planks, masonry, barehanded. Absolutely no armlocks, chokes, throws. Enlarged edition \$3.98 postpaid. Jim Lee, P.O. Box 245, Oakland 4, Calif.

**SLOWING** Down? Legs and feet muscles cramp and ache? Active men and women know you are only as young as your feet and legs. Amazing Perrin Method activate stimulates and intensifies circulation and nervous force. Basic and organic. No expensive equipment. Quick and lasting benefit. One small cost cover life benefits. Why an inferior life? Information free. Ornin Company, 1017 13th St., Des Moines, Iowa.



## SPORTING GOODS, GUNS, FISHING TACKLE, ARCHERY, TRAPPING

FREE 152 Page fishing catalog—Includes latest "do it yourself" kits. Netcraft Company, Dept. B4, Toledo 13, Ohio.

TACKLE Box—Beautiful waterproof plywood. Rustproof brass fixtures. Home workshop plans. \$1.00. Sportsman, Box 859, Milwaukee, Wisconsin.

BUY Wholesale! 25,000 nationally advertised products. Get amazing dealer catalogs. Complete details free. American Wholesalers, 1841-A Levee, Dallas 7, Tex.

HOOP Scoot, the fastest team game for small areas. Windows need not be safeguarded. \$2.00 postpaid. No c.o.d. Refundable in 5 days. Hoop Scoot, 220-59 73rd Avenue, Bayside 64, N. Y.

BARREL Knot tying vise. Makes tapered leaders, snells hooks, splices, line, ties leader to line. \$2.50 postpaid. Satisfaction guaranteed. Send cash, check or money order to Anglers' Knot Tying Vise, P.O. Box 173, Wichita 1, Kansas.

BARBFREE Guaranteed shakeproof chromed sample hook, literature and prices 25¢. X Seamco, Rt. 18, Pottstown, Penna.

FREE Catalogue. Tents, rubber boats, life vests. Box 22PM4, Thomasville, Penna.

PATENTED Tubular cricket container, \$1.00, postpaid. Satisfaction guaranteed. Armstrong's Cricket Farms, Glennville, Georgia, or West Monroe, Louisiana.

FREE Below wholesale fishing catalog. Fishing Tackle Mart, Dept. 54, Box 6737, Chicago 80, Illinois.

FISHERMAN, Golfers, photographers. Caddy Towel by Cannon. Keychain type attachment. 14"x18". Snaps easily to clothing and equipment. Keeps gear clean, dry. Perfect gift. Green or brown \$1.00. High Road, P.O. Box 685, Los Gatos, Calif.

FREE—Giant 1958 wholesale sporting goods catalog. Lowest wholesale prices. Complete line of fishing tackle, cameras, sporting goods, appliances, outdoor items. Write today. Santa Fe Distributing Co., 1321 Main St., Dept. 800, Kansas City, Missouri.

SPORTING Goods. Free wholesale list. Sports, 1556 Main St., Rahway, N. J.

MOLDS For fisherman's sinkers, jigs, squids, casting and spinning lures. Free catalog. Sweet's Molds, Tonawanda 1, New York.

HOW To catch fish with smell. Secret recipes, formulas, methods, 25¢. Johnson's, 312 Lake Avenue, Ithaca, New York.

LUGERS! Mausers! Colts! P-38s! Kentuckies! Weatherbys! Antique-modern guns, accessories! Super bargain catalog only 50¢. Agramonte's, Yonkers 20, N. Y.

BIG Money raising crickets and 12 inch African fishworms. Free literature. Carter Ranch, Plains, Georgia.

5000 BARGAINS, Firearms, binoculars, war relics. Catalog 50¢. Smith Firearms, Runnede, N. J.

FREE Sporting goods catalogs! Save 70%. Econ-O-Mart, Whippany 2, New Jersey.

JAP Rifle altering to 30-06, \$6.00. Japshells, \$3.95. Catalog 5¢. T. P. Shop, West Branch 11, Mich.

BUILD Barbecue. Complete plans. Booklet 25¢. Free catalog. Popular Mechanics Press, 633 N. St. Clair St., Chicago 11.

CAMPING Equipment, world's largest selection, low prices. Send 25¢ (print name-address) for 160 page complete catalogue of tents, camping equipment, national camp sites guide and camping handbook. Morsan, 10-21R 50th Avenue, Long Island City 1, New York.

## EARTHWORMS—CRICKETS

FREE Literature—Amazing profits raising giant fishworms and crickets. Carter Redworms, Plains, Georgia.

\$1000 MONTHLY Possible, raising earthworms—African Giants! Backyard, garage, basement. Complete illustrated booklet, explains raising, feeding, packing, marketing. Only 25¢! Ozark Worm Farm-J, Willow Springs, Missouri.

JUMBO Meal worms, supreme ice, pan-fish bait, 300, \$1.00; 1000, \$3.00; 5000, \$10.75; how raise, prepaid. Muckett's, 113, N. Paca, Baltimore, Maryland.

FREE Picture folder, "How to Make \$3,000 Yearly Sparetime, Backyard, Raising Earthworms!" Oakhaven 56, Cedar Hill, Texas.

GRAY Crickets scientifically raised, vitamin fed, larger, livelier, live longer. 1000, \$7.50; 500, \$5.00; 125, \$2.00 postpaid. Orders filled same day received. Satisfaction guaranteed. Write for catalog of cricket supplies. Selph's Cricket Ranch, "Mid-south's Oldest and Largest," Box 2123, Memphis 2, Tenn.

RAISE And sell earthworms: Pleasant profitable home industry. Instruction booklet 35¢. Frank H. Barnhart, 209 Lamont, San Antonio, Texas.

GRAY Crickets our specialty: Millions ready for immediate shipment. They're larger, livelier. 1000, \$7.50; 500, \$5.00; 125, \$2.00, postpaid. Live delivery guaranteed. All associated supplies available. Write closest farm for 1958 catalog. Armstrong's Cricket Farms, "World's Largest," West Monroe, Louisiana or Glennville, Georgia.

FREE List: Earthworm raising books and manuals; instruction folder. Earl Shields, Box 358-A, Mountain Home, Arkansas.

FISHERMEN—West Coast: 250 "select" breeders, instructions for own supply all summer, \$3.00. Earthworms, Box 834, San Luis Obispo, California.

## TAXIDERMY

FREE Book tells how you can learn taxidermy and tanning. Fascinating, profitable hobby. Send postal. No obligation. State age. Northwestern School, Dept. 2533, Omaha 2, Nebr.

## BINOCULARS, TELESCOPES, MICROSCOPES, MAGNIFIERS

REFRACTOR And reflector telescopes. Also mirrors, lenses, tripods, etc., for making your own telescope. Free illustrated catalog. Suffolk Science, Mattituck, N. Y.

REFLECTING Telescope, 60X, completely assembled \$29.75. Guaranteed observatory clearness. Free information. Skyscope, 475 Fifth Avenue, New York City 17.

WAR Surplus bargains: Millions of lenses, instruments, telescopes, binoculars, components and complete line of astronomical telescope items. World's greatest optical market-place! Send only \$1.00 for beginner's 10-lens kit and big instruction booklet Stock 2-CH. Write for catalog "CH," free! Edmund Scientific Co., Barrington, New Jersey.

BUILD Astronomical telescope. 35 page illustrated book. \$1.00 postpaid. Coast Industries, El Campo, Texas.

MICROSCOPES, Binoculars, 6X telescope \$2.75. Free information. Hughes Mailorder Service, Box 45, Jeffersonville, Indiana.

BINOCULARS, Telescopes, microscopes. Terrific values \$3.98 up. Request free money-saving catalog. Criterion, Dept. P 65, Hartford, Conn.

SATELLITE Telescope. Complete plans, instructions. \$1.00. Blakeslee, Center Road, Avon, Ohio.

BUILD Your own reflector telescope. Complete kit: Mirrors, eyepieces, tripod, all other accessories. Request free illustrated literature. Criterion Manufacturing, Dept. DPM 40, Hartford, Conn.

MICROSCOPE Catalog 25¢. Research Scientific Supplies, 126 West 23rd Street, New York 11, N. Y.

ANOTHER First—The Escape 5" reflector completely assembled, 115X \$59.95. Free information. Esco Products, Oakridge, N. J.

BINOCULARS, 6X30, \$16.49 and tax. Manhattan Surplus, Manhattan Beach, Calif.

AMAZING Prices, precision binoculars. Folder "Binocular Selecting," catalog free. Dealers also write. Prentiss Importers, Mercury Bldg., West Los Angeles 25, Calif.

REFLECTOR Telescope kits \$7.25 (3") to \$175. (12"). Mirrors, cells, focusing mounts, tripods, eye systems. Anything, everything in telescopes. Optics, also binoculars, microscopes, optical instruments. Free catalog. Also ready to use telescopes from \$25. Esco Products, Oakridge, N. J.

DYNASCOPE—Sensational new reflector telescope. Send for details. Criterion Co., Dept. DP 43, Hartford, Conn.

BUY Direct from manufacturer. Mirrors, kits, lenses, parts for astronomical telescopes. Mirrors, lenses repolished. Price list on request. Kistner, Box 74, Wakefield, New York 66, New York.

## PLANTS, SEEDS, BULBS, NURSERY AND GARDEN SUPPLIES

BARREL Cactus seed, 12 for 25¢ cash. 1624 E. 1 St., Tucson, Ariz.

WORLD'S Greatest cash crop. Free information. Write Ginseng Gardens, Asheville, N. C.

RAISE Your shrubs, trees from seed. Free planting guide, price list. Woodlot Seed Co., Norway 9, Michigan.

GINSENG, Goldenseal roots bring up to \$14 pound. Full information. F. M. Collins, Viola, Iowa.

BABY Evergreens, seedlings, ornamental stock. List free. Neuner's Nursery, 368 Eicher Road, Pittsburgh 2, Penna.

EVERGREENS From seed. Free descriptive folder. 1500 blue or Norway spruce seeds \$1.00. Others. Strom's, Bellaire 23, Michigan.

GROW From seeds—Big profits with our instructions. Evergreens, shrubs, Christmas trees. Large packet, 15 varieties \$1. Complete catalog free. PMM Mellinger's, North Lima, Ohio.

GROW Dwarf trees! Pot, sell. Instructions and seeds, 25¢. Mail Order Specialties, 1439 PM-3 Sabraton Ave., Morgantown, W. Va.

## PETS—DOGS, BIRDS, RABBITS, HAMSTERS, ETC.

BEAUTIFUL Pure white pedigreed police puppies. Also bred females \$100 to \$150. Ansonia Kennels, McHenry, N. Dak.

RAISE Rabbits successfully by knowing facts. 48 page illustrated book describing 25 breeds. Housing, feeding, breeding, marketing, etc. Plus bulletin. 25 cents. American Rabbit Association, 36 Arba Building, Pittsburgh, Penna.

MAKE Money raising chinchillas, mink, nutria, rabbits, cavies for us. Free catalog. Keeney Brothers, New Freedom 2, Penna.

DESCENDED Skunks, monkeys, hawks, reptiles. Illustrated catalogue, 25¢. Trails End Zoo, St. Stephen, S. C.

HAMSTERS—Ideal pets. \$2.95 pair. Free booklet. Jer-Fre's Hamstery, 2425 Hoyt, Siskiyew Heights 13, Michigan.

WE Pay \$3.50 lb. dried. Grow mushrooms, cellar, shed and outdoors. Spare, full time, year round. We have 25,000 customers. Free book. Washington Mushroom Ind., Dept. 171, 2954 Admiral Way, Seattle, Wash.

PUGS (Like toy boxes). Free pictures. Herb Miller, 513 Kent, Lubbock, Texas.

HAMSTERS—Golden: Young, \$3.00 pair, breeders, \$4.00 pair. New mutation, \$5.00 pair. Adirondack Hamstery, Prospect 10-D, New York.

BABY Raccoons, skunks. Drastically reduced. Catalog 25¢. Shady Fur Farm, Springfield, Minnesota.

RAISE Rabbits on \$500 month plan. Plenty markets. Free details. White's Rabbitry, Delaware, Ohio.

CROWS, Magpies, ravens, skunks, prairie dogs, raccoons, ringtail cats, hawks, owls, horned larks, squirrels. Free list. Antilley's, Route 2, Abilene, Texas.

TROPICAL Fish—Color pictures of 55 species swimming in their natural habitat. Send 10¢. Miracle Filter Co., Dept. W, Box 9128, Long Beach, California.

## FUR BEARING ANIMALS

MONEYMAKING Opportunities producing mink or nutria. Easy. 21st year. Voight Farms, Atlanta 2, Texas.

BIG Profits with colored nutria. Free information. Organic Nutria Farms, Atlanta, Texas.

MINK Raising information free. Complete. Lake Superior Mink Farm, Superior, Eel, Wisconsin.



**MARCH Sale**—Guaranteed outstanding quality bred mink. Also nutria. Voight Farms, Atlanta 2, Texas.

**1000 BRED Mink**—Booklet, plans 25¢. Lake Ontario Ranch, Gravel Road, Webster, N. Y.

### FARMS, FARM LANDS, REAL ESTATE

**FLORIDA** Lot: \$5 down. Full price only \$133. High, dry, adjoining city. Near Daytona Beach. Streets, electricity, phones, churches, schools, shopping. Near ocean and St. Johns river. World's best fishing! Write for free photos. Amos Huysman, Box 826, Orange City, Florida.

**FLORIDA**—Half acre tracts, high-dry. Near Gulf beaches. Raise your own fruits and vegetables. Only \$795.00, \$10.00 down, \$10.00 month. Information: G. B. Potterfield, Owner, Dept. AA, Union Building, Charleston, West Virginia.

**FLORIDA** Security campsites \$30. \$5 monthly, warranty deeds. Thompson, Sandisfield, Mass.

**MOUNTAIN** Lots near lakes. \$147.50, \$5.00 monthly. Evelyn Pratt, Box 6331, Greensboro, N. C.

**FLORIDA** Winter garden farms. 10 acres at \$25 monthly. Beautifully wooded. Popular golf resort area. Wonderful fishing, hunting. Grow fruits, berries, vegetables, poultry. Money-back guarantee. Booklet free. Wendell Wood, Fountain, Florida.

**\$5.00 MONTHLY** Buys 40 acres productive land: near town. Price \$290.00. Free list. Box 425-P, Carthage, Mo.

**OZARK** Specialty farms. Terms. Description mailed free. 20 years service. Armstrongs, Shook, Missouri.

**TEXAS** Resort and retirement property at 5 beautiful lakes. Perfect climate year round. Finest of hunting, fishing, boating. Healthy area, good schools, excellent towns nearby. Electricity, phones, good roads. Write today for photos, maps, etc., on 4 adjoining lots \$290.00, \$10.00 down, \$10.00 monthly. This is the best spot in the United States. Dept. GS-22, Box 50, Kingsland, Texas.

**SAVE!** Free government land, inexpensive farms, homes. Aurepa, Central Valley, New York.

**OPPORTUNITIES!** Government land. U. S. Alaska, Canada. Sledge Surveys, Macon, Mississippi.

**CANADIAN** Tax sale lands for three dollars an acre and up. Small monthly payments. Farms, timber, hunting and fishing camps, mineral. Limited number of properties. Write at once for free catalogue. Tax Sale Service, Room 105, 170 Bloor St. W., Toronto 5, Canada.

**FLORIDA**—2½ Acres: \$15 down, \$15 monthly; full price, \$695. High elevation, near Gulf of Mexico. Suitable farming, citrus, poultry. Free information, Florida Sunshine Coast Development Co., Brooksville, Florida, Dept. PM-1.

**FLORIDA** Trailer homesites. Water system. \$495.00, \$10.00 monthly. Lake privileges. Box 2005, Deland, Florida.

**FREE** Strout catalog! Farms, homes, businesses, resorts, retirement properties. Over 2900 values in 34 states. 57 years' service. World's largest! Write Strout Realty, 7-MP So. Dearborn, Chicago 3, Ill.

**HOMESITES** \$15 Monthly—California's finest garden section. Morro Bay's scenic shores. Wonderful fishing, boating. Fertile soil, softest water, temperate climate, congenial community. Free literature. Richard Otto, Department M, San Luis Obispo, California.

**FLORIDA** Nice homesites, \$345 at \$10 monthly. Folder free. Howard Vernor, Deland, Florida.

**FLORIDA** Homesites, new lakeside development. Moderate prices, monthly payments. Fine hunting, fishing. Adjoins Ocala National Forest. Literature. Grace Parker, Paisley, Florida.

**OWN** California land. \$2 acre minimum buys state, government lands. 500,000 acres, 40 to 640 acre tracts. 10¢ brings brochure. Pioneer Ranches, 8228-PM Sunset, Hollywood 46, California.

### FARM MACHINERY AND SUPPLIES

**SENSATIONAL** Garden tractor. Hoes between plants and rows, including strawberries. Eliminates hand hoeing. Nothing else like this. Patent 2742840. Also tills. Fantastic offer to first few inquiries. Auto Hoe, DePere 68, Wisconsin.

### POULTRY, FARM SUPPLIES

**RAISE** Baby chicks. Two hundred \$5.95 c.o.d. Plus postage. Diamond Chickery, Newfield, N. J.

### PROFITABLE OCCUPATIONS

**MONEY** Plans! "Secret Journal." Grandpa, two daughters made \$2500 first month! Work home. Publiccos, Oceanside, Calif.

**CHARACTER** Analysis. Free brochure. Lucas System, 2419 Sunset, Los Angeles 26, California.

**HOME** Mailorder beginner's manual, sources, methods, opportunities, 25¢. Carahan Bros., 9610 Acacia, Fontana, Calif.

**\$60.00 WEEKLY**, Sparetime—Easy! Home Venetian blind laundry. Free book. Burt, 2434ES, Wichita 13, Kansas.

**FREE** Book "990 Successful, Little-Known Businesses." Work home. Plymouth, 1610-43 Street, Brooklyn 4, N. Y.

**WE** Pay \$3.50 lb. dried. Grow mushrooms. Cellar, shed and outdoors. Spare, full time, year round. We have over 25,000 customers. Free book, Washington Mushroom Ind., Dept. 99, 2954 Admiral Way, Seattle, Wash.

**BE** The Popular Mechanics representative in your neighborhood and earn big profits in your spare time. Write Popular Mechanics Magazine, Room 305M, 200 E. Ontario St., Chicago 11.

**SAVE** Money! Buy wholesale! Free catalog general merchandise. Norris, 487-M Broadway, New York City.

**SPARETIME** Repeat profits taking magazine subscriptions. Special offers. Cassell Agency, Boynton Beach, Florida.

**BIG** Money raising fishworms and crickets. Free literature. Carter Wormery, Plains, Georgia.

**BAKE** New greaseless doughnuts in kitchen. Sell stores. Free recipes. Michael Ray, 3605 South 15th, Minneapolis 7, Minn.

**FREE** Book "505 Odd, Successful Businesses." Work home. Pacific, Oceanside, Calif.

**MAKE** Money writing short paragraphs. Information free. Barrett, Dept. CX-27, 7464 No. Clark, Chicago 26.

**MUSIC ROOMS** Quicker, easier, cheaper. Newest, etc free. Spawm \$1.00. Luxur, 641 South 19th, Newark 3, N. J.

**MAILORDER!** Easy way. Professional, inexpensive. Write Box 8382-B, Albuquerque, New Mexico.

**MAKE** Flexible molds. Cast plaques, figurines. Free sample. Tooker, 1045-M Fairview, Hamilton, Ohio.

**VENDING** Machines—No selling. Operate a route of coin machines and earn amazing profits. 32-page catalog free. Parkway Machine Corporation, Dept. 25, 715 Ensor Street, Baltimore 2, Maryland.

**AUCTIONEERING**—Home study course. Diploma granted. Auction School, Ft. Smith, Ark.

**AMERICA'S** Largest wholesale supply. Buy, sell. Amazing profits. New free plan. Associated Wholesalers, Box 52-DX, Burlington, Iowa.

**BUY** Wholesale! 25,000 nationally advertised products. Get amazing dealer catalogs. Complete details free. American Wholesalers, 1841-B Levee, Dallas 7, Tex.

**WHOLESALE** Price list free! Save 50%! Appliances, cameras, sporting goods, housewares, hardware, jewelry, clothing, gifts, etc. Buy-Rite, Hawthorne 60, New Jersey.

**BIG** Profits in welding. Easy to learn. Low cost training in completely equipped non-profit school. GI approved. Write for free booklet. Hobart Trade School, Box M-483, Troy, Ohio.

**BECOME** A surplus merchandise broker. Unlimited opportunities. Eagle Co., 17579 Ohio, Detroit 21, Michigan.

**REPAIR** Bicycles in spare time. Information. Albert Lamborn, Box 271, West Chester, Penna.

**"HOW To Win Prize Contests," "Type-writer Profits"** booklets, mailorder, drop-shipped. No inventory investment. Samples, information \$1.00. Bayer, 938P Betty Avenue, Neenah, Wisconsin.

**\$400.00 DAY** in aviation. Secrets money making methods \$2.00. Aero Advertising, 3030 W. Pierce, Milwaukee 15, Wis.

**MAKE** Money collecting names! Postcard will bring details. W. K. Hillhouse, Box 179, Syracuse 1, N. Y.

**RAISE** Minnows for steady income. Instructions only \$2.00. Chippewa Sales, Box 391, Mt. Pleasant, Mich.

**WANTED**, Men, women, raise bait for us at home. Full, spare time. Doesn't take up space. We furnish everything. Write Bait Associates, Dept. PM-4, Stetson, Maine.

**TREMENDOUS** Profits. Raise fabulous Nutria fur animal, easily, economically. Sunset Ranch, R3, Waterloo, Ontario, Canada.

**MAGAZINE** Subscriptions—Largest commissions. Bonus. Qualified Agency, 451GA Kingston, Brooklyn 25, N. Y.

**YOUR** Own business! Our literature. Profits! Lowilco, Box 9031, Chicago 90.

**FREE** Details. Work home. Stout Company, Box 9215, Washington 23, D. C.

**\$50.00 WEEKLY**, Sparetime—Easy! Repairing electric motors. Free details, Lincoln, Box 52, Hempstead, N. Y.

**RAISE** Pheasants on \$100 week plan. Little capital and space can make you independent. Free details. Great Central System, Columbus 6, Kansas.

**WE** Get \$13.50 per thousand for addressing. How? Further details for stamp. Jackson's, 37215, Los Angeles 37.

**MAILORDER** Opportunities, offers, plans. Price \$2.00 postpaid. Mail Service, Dept. B, Box 313, Whitehall, Michigan.

**FREE!** Exciting catalog packed with books covering most everything. Think of it—From cover to cover you will find described and illustrated hundreds of books telling how to fix and how to build almost anything. How to remodel your home; do your own decorating, plumbing, electrical work. Simplified books covering concrete work, carpentry, painting, furniture making and refinishing. How to build your own boat, home workshop tools. Best books on photography, welding, hobbies, homecraft. How to make a home freezer. Send for your free copy now. Popular Mechanics Press, 200-BO East Ontario St., Chicago 11, Ill.

### BOOKS, PERIODICALS, PICTURES, POSTCARDS

**SHIPS**, Photographs, lists 10¢. Scozzafava, 1648 59th Street, Brooklyn 4, N. Y.

**OUT-Of-print** books at lowest prices! You name it, we find it! Fast service. No obligation. International Bookfinders, Box 3003-PM, Beverly Hills, Calif.

**SCIENCE**, Mathematics, language booklets! Literature free. Franks, 3121 South Racine, Chicago 8.

**JOHN** Friend, bookfinder, can get the books you want. Free search service. Box 2570PM, Long Beach 1, California.

**NATIONAL** Geographic Magazines, 1888-1956. Periodical Service, Box 465-PM, Wilmington, Delaware.

**RARE** Magazines, catalog 10¢. Nationwide Exchange, Box 1375-P, San Antonio 6, Texas.

**BOOKFINDERS!** All subjects. Send wants! Jaher Book Service, 183 Hazelwood Drive, Westbury, N. Y.

**BRITISH** Book bargains—Any subject. Catalog free. Transbooks, Box 1-PMV, Wantagh, N. Y.

**POCKET** Novels, comics, magazines, wholesale, retail. List free. Backdates, 1181 E. Lombard St., Baltimore 2, Md.

**AMAZING** New plan free! "How To Retire at Age 21." Men or women over 21 can retire now. Shows how you can prepare for life of leisure if you're under 21. Bob Belmont, Box 258, Hawthorne 4, N. J.

**TRADE** Pocket novels with others. Details. Satellite Books, Box 1522, Ft. Worth, Tex.

**CRAZY** Book titles. Embalming Can Be Fun. Raising Children for Profit. 8 others. Free literature. Lynch, 402-4 Hazlett, Baltimore 29, Md.



**BECOME** The most successful organic gardener in your neighborhood! Free book, "Make Compost in 10 Days," shows you step-by-step how to turn waste products into life-giving soil. Yours free as a new reader of "Organic Gardening & Farming Magazine." Special introductory offer, 5 months for \$1.00. Your dollar cheerfully refunded if you aren't completely satisfied. Or we will bill you, if you prefer. Organic Gardening & Farming, Dept. PM-1, Emmaus, Penna.

**FREE** Catalog, 80 money-saving "How To" books. Bailey, Box 115-P, Cressona, Penna.

**BOOKHUNTERS!** Send wants! Atlantic Book Service, Cedar Street, Charleston 29, Mass.

### GAMES, TOYS, NOVELTIES

**HOP** A snail or hopscotch law. As it's played in Scandinavian countries. Full instructions. 25¢ postpaid. C. W. Co., 228 Coatsville Ave., Salt Lake City 15, Utah.

### MAGIC TRICKS, PUZZLES, JOKER NOVELTIES

**MAGIC** As a hobby. Miser's dream explained. One dollar. Woolf, 844 W. 80 St., Los Angeles 44, Calif.

**ONLY** 10¢ Brings unique bird warbler and catalog. Over 200 magic, tricks and jokes. Penn. Box 303, Philadelphia 5, Penna.

**MAGIC** "Anyone" can do! Big catalog, fun packed. Bulletins with mystifying routines, like professionals! 50¢ (worth more!). Santer, 1159, New York City 8.

**VANISHING** Cards with magic catalog, 35¢. Box 391-P, Jackson Heights, New York.

**DOLLAR** Magic set free with catalog 25¢. 4462-PM Germantown, Philadelphia.

**ONLY** 10¢ Brings you magic's greatest value, Douglas famous catalog, 500 tricks. Tricks for amateur and professional, for pocket, parlor, club, stage, with balls, coins, cards, cigarettes, silks, apparatus. Fastest service to magicians everywhere for over 30 years. Amaze your friends, send 10¢ today. Douglas Magicland, Dept. 10, Dallas, Texas.

**SMOKEBOMBS** 25¢. 7 For \$1.00. Terrific! 4463-PM Greene, Philadelphia 44.

**PROFESSIONAL** Catalog, 175 pages, 25¢. Williams, 900 Plymouth, Ellwood City, Penna.

**WHOLESALE!** Thirty 10¢ trick novelties \$1.00! Profits! 1746-W Market, Philadelphia 3.

**WORLD'S** Finest professional magic. Joker novelties. Giant illustrated catalog 10¢. Top Hat, Evanston 12, Illinois.

**BE** A magician! Large professional catalog of latest tricks, 35¢. Ireland, C-109 North Dearborn, Chicago 2, Illinois.

**STINKBOMBS.** Potent aroma! 12/\$1. Kits. 1452 Drake, San Pablo 10, California.

**3100 NOVELTIES.** Jokes, tricks, gadgets, funmakers, hobbies. Big catalog 10¢. Johnson-Smith, D-424, Detroit 7.

**VENTRILOQUISM.** easiest method. Details free. Smith, 2125 N. Bigelow, Peoria, Ill.

**"VENTRILLO."** Professional voice-thriller 25¢. Ventriloquist puppet 75¢. Box 971-PM, Philadelphia 5.

### COINS, TOKENS, CURRENCY

**12 DIFFERENT** Barber dimes \$2.00. Bargain lists free. Sayers, 1000 Unaka, Johnson City, Tennessee.

**MEXICAN** Money, list, coin, 10¢. Kosan Service, 142-Friant, Calif.

**1958 GIANT** U.S. coin catalogue 25¢. Acc. 314 S. Clark, Chicago 4.

**COINS** Wanted! United States rare coin value catalogue. Prices we pay, illustrated 1793 to 1954, 50¢. Indians, Lincolns wanted! Guaranteed buying list 25¢. Bourne Coins, 1436 Maumee, Fort Wayne, Ind.

**BRILLIANTIZE**—Safe for proof coins \$1.00 prepaid. Stephenson's, Inc., Ames, Iowa.

**32 PAGE** Informative U.S. illustrated coin list 10¢. Stoney, 192 Washington, Boston 8, Mass.

**NEW!** 1958 Canadian commemorative silver dollar uncirculated plus current "Canadian Bulletin" \$1.50. Marles, Box 833, Calgary, Canada.

**RAREST** Carson City mint dollar 1885. Uncirculated, \$3.00. Illustrated coin catalogue 25¢. Shultz, Salt Lake City 10, Utah.

**SAN** Francisco mint closed! Made only cents and dimes in 1955. In short supply and great demand. One each, brilliant uncirculated, for 25¢. Free coin lists with order. Bryson Stamp & Coin Company, 612 White, Toledo 5, Ohio.

**BARGAINS.** U.S. coins: 1893 Columbian world's fair half dollar, \$1.00. Ten different Indian pennies, 75¢. Two-cent piece, and 3-cent piece, \$1.00. Gold 1/4 eagle, \$9.00. Gold 1/2 eagle, \$12.50. Beautiful coin bracelet, \$1.00. Many coins available. What do you need? Rare Coin Company, 31 North Clark, Chicago 2.

**LARGEST** Coin magazine, 180 pages, 35¢. Scrapbook, 7320-J Milwaukee, Chicago 31.

**COINS** From Formosa, Vatican, etc., plus foreign banknote, 10¢ with coin approvals. Littleton Coin Co., Littleton 81, New Hampshire.

**GET** Profit and pleasure in collecting old coins. Send 10¢ for 56-page illustrated coin catalog. You'll be delighted with it. Send for it now. B. Max Mehl, 370 Mehl Building, Fort Worth, Texas. Largest rare coin establishment in U. S. Established 40 years.

**COMPLETE** United States coin bargain lists, Indianhead cent, 10¢. Economy Sales, 156-A Dean, Mansfield, Mass.

**INDIAN** Cent plus Bargain Lists 10¢. Hutchinson's, Box 4747, Philadelphia 34, Penna.

**FOREIGN** Coin, banknote and large illustrated coin list for 3¢ postage. Bargains: Indian head cent, 10¢; wooden nickel, 10¢; Chinese dollar, 53¢. Approvals included with every order. Tatham Coin Company, Springfield 30, Massachusetts.

**1955 MINT** Set brilliant uncirculated select P-D-S, 11 pieces \$2.95. 1956 proof set \$3.60. 1957 proof set \$2.80. 1958 proof set \$2.50. Thomas Lavin, 6751 Paschall Ave., Philadelphia 42, Penna.

**BEGIN** A coin collection, the most interesting hobby. Send for our book "Collecting U. S. Coins for Pleasure and Profit." Pages of interesting suggestions and pictures tells how and what to collect, sell, trade, store. Many items of interest. Cash or stamps \$1.50. Texas Coin Exchange, Inc., 2017 Cedar Springs, Dallas 1, Texas.

**SAVE!** Private collector forced to sell. High grade coins and currency from the United States and foreign countries. Send for free price list. Arthur Timko, 5407 Cullom Ave., Chicago, Illinois.

**WANTED** 1909-S, 1914-D, 1931-D-S cents. White, Box 201, Racine, Wisconsin.

**OLD** Gold coins wanted, United States and Mexico. John Wood, Box 9522, Dallas, Texas.

**"VALU-Packed"** American coin catalog, 10¢! Sullivan's, Pioneer Building, St. Paul 1, Minn.

**HONG** Kong, Japan, Germany, China's bills. All 10¢. Jolie, Roslyn Height, N. Y.

**BUYING** Many different Lincoln cents over \$15.00 each, list 35¢. Hock, 2510 South California, Chicago 8.

**LARGEST** Lincoln cent dealer. Singles, rolls. List 6¢ stamps. Gem Coin, Box 476, Fort Wayne, Indiana.

**OLD** Money wanted. Will pay fifty dollars for nickel of 1913 with liberty head (no buffalo). We pay cash premiums for all rare coins. Send 5¢ for large coin folder. May mean much profit to you. Numismatic Co., Dept. 20, Fort Worth, Texas.

**THREE** Different Indian cents 25¢; list. Collector's Bargains, New Hope, Penna.

**44** DIFFERENT Coins, \$1.00. 44 different bills, \$1.00. Oddehon, Box 482, St. Louis, Mo.

**ILLUSTRATED** Foreign coin catalogues. Gold coins, 24 pages. Silver, copper coins, 60 pages. 50¢ each. James Randall, Box 2205, Ft. Lauderdale, Florida.

**WANTED!** Coins! List 25¢. Hugh's, 522 Second Avenue, N. W., Hickory, N. C.

**CANADIAN** 1958 Uncirculated silver dollar, \$2.00. Crown Hobbies, 167, Codsell, Downsview, Ontario, Canada.

**COIN** Collectors supplies! Large illustrated catalog 10¢. Coin Care Corp., 1627-A West Anaheim, Long Beach 13, Calif.

**WANTED!** Coins! Highest prices paid, confidential buying list, 25¢. Hartford, 5345 Halsted, Chicago 9, Illinois.

**WANTED** — 1822 \$5.00 Gold, pay \$10.-000.00. 1913 liberty head nickel \$4,000.00. 1894-S dime \$2,000.00. 1876-C.C. 20¢ piece \$1,000.00. 1901-S quarter \$60.00-\$500.00. 1922 50¢, \$6.00-\$80.00. 1885 trade dollar \$1,000.00. Uncirculated dollars 1804-1839, 1893-S, 1895-P, 1903-O \$100.00-\$5,000.00. Certain dates Lincoln cents before 1932, \$100.00; flying eagle cents, \$500.00; Indian cents, \$140.00; dimes before 1943, \$300.00; quarters before 1924, \$1,000.00; half dollars before 1905, \$1,000.00; halfcents, \$500.00; 2¢ pieces, \$100.00; 3¢ pieces, \$130.00; half-dimes, \$500.00. Hundreds of others worth \$10.00-\$1,000.00. Canadian coins: 1921 5¢ silver, \$100.00. 1889 dimes, \$50.00. 1875 quarters, \$75.00. 1921 50¢, \$500.00. Wanted: Large cents, gold coins, paper money, etc. Know their true value. Our large illustrated guarantee buying-selling catalogue, send \$1.00. Purchase catalogue giving complete allcoin information before sending coins. Catalogue dollar refunded on \$20.00 sale. Thousands of persons have sold us coins. Worthycoin Corporation Incorporated 1938. Leaders Numismatic Quotations, K-412-C, Boston 8, Mass.

**FREE!** Fsbulous newspaper for coin collectors. First edition. Coins, 33 East Congress, Chicago 5, Illinois.

**1943 STEEL** Cents, P-D-S, set extra fine \$1. Brilliant uncirculated gems, set \$2.00. Van Riesch, Slinger, Wis.

**\$50 PAID** To fill album with 89 pennies before 1940. Album, details, \$1. "Pennies." Box 1512, Grand Central, New York City 17.

**LARGE** Cent, white cent and bargain list, only \$1. Delmaco, Box 1123, Wilmington 99, Delaware.

**PROOF**-Sets. 1958 set only \$2.50; 1957, \$3.00; 1956, \$4.00; 1955, \$6.00; 1954, \$7.00; 1953, \$12.00; 1952, \$18.00; 1951, \$29.00; 1950, \$47.00. Complete set 1950-1958 inclusive, \$120.00. Postpaid. Prompt shipment. Money-back guarantee. Dan Morafka, A.M.A., 432-P 23rd Ave., San Francisco 21, California.

**SILVER** Dollars. Beautiful. Brilliant, uncirculated, San Francisco mint—78-S, 79-S, 80-S, 81-S, 82-S, 87-S, 89-S, 90-S, 91-S, 97-S, 21-S, 22-S, 23-S, 25-S, only \$2.00 each. Carson City Mint: 80-CC, 81-CC, 82-CC, 83-CC, 84-CC, 85-CC, 90-CC, 91-CC, only \$3.00 each. Postpaid. 10 day money-back guarantee of satisfaction. Thousands of other coins. Proof sets. Gold. Silver dollars. Cents, etc. Free price list. Send your want lists. We also buy coins. What do you have? And please name your price. Postal Products Company, Post Mail Order, Joe Gordon, A.N.A., 5614-MC California Street, San Francisco 21, California.

**AROUND** The world there's nothing else like Bebee's 82-page gigantic bargain catalogue. Only \$1.00 (deductible on \$10.00 order). Rare Indians: 1877, \$27.50; 1908-S, \$8.95; 1909-S, \$39.50. Lincolns: 1909-S, \$6.45; 1914-D, \$16.50; 1931-S, \$7.50. 1916-D dime \$19.50. \$5 gold \$11.95. 1958 proof set \$2.50; 1958 Canadian totem-pole dollar \$1.75. Highest prices paid gold (any quantity), rare coins, currency. Describe fully for amazing offer. Bebee's, 4514 North 30th, Omaha 11, Nebraska.

**LINCOLN**, Indian cents, all dates. 1909-VDB cent and complete pricelist 50¢. Penny Mart, PL-11, Box 629, Chicago 90.

**SAVE** Old U. S. coins for pleasure and profit. 10 different dates of Indian cents (1899-1908) in folder for all Indian cents \$1.00; one thick white Indian cent, one two-cent piece, one three-cent nickel, all dated before 1866, all 3 coins for \$2.00. Coins have clear dates. Empire State Coin & Stamp Co., Empire State Building, New York 1, N. Y.

**10 "NEW"** Lincoln cents (different) and coin album, \$2. Paying \$35.00 complete sets. (139 pennies). \$4.50 hundred Indianheads. MacDonalds, 316-B Hobart, Grand Rapids 7, Mich.

**SILVER** Dollars: Uncirculated, 1879p through 1891p, 1897p \$2.00 each. 1893cc \$15.00. Retail lists 10¢. Holden's, Garwin, Iowa.



## STAMP COLLECTING

FIRST Day cover approvals! Artercraft; Artmaster. Included free: Valuable airmail flight cover. Myers, Coopersburg, Penna.

SPEND Pennies, not dollars. Stamps. 43 Castle Blvd., Akron 13, Ohio.

FREE 10 Japan war stamps. Approvals. Schroeder, 1486 1/2 Sherburne, St. Paul 4, Minn.

CUBANS Approvals, set free. Alfredo Otero, Box 431, Havana, Cuba.

HYDERABAD, Nyassaland, Pakistan, Selangor, Singapore, free! Unusual, inexpensive approvals accompany. Nade's, Box 2116, Philadelphia 3, Pennsylvania.

TUYA International philatelic dictionary, containing over 7,500 surcharges, philatelic terms in 11 languages, countries, capitals, areas, population, currencies, condensed biographies and names and addresses of principal clubs and philatelic societies throughout the world, for sale at all philatelic supply houses or will be sent registered postpaid upon receipt of \$3.50. Tuya International Philatelic Dictionary, P. O. Box 268, Havana SX, Cuba.

JUMBO Assortment. 10¢ with fine bargain approvals. Pfeleiderer, Joppa, Maryland.

100 DIFFERENT Belgium free. UPU world's fair rotary hi value railroad stamps free to approval applicants. Trylon, Box 179-P, Forest Hills 75, N. Y.

ADVANCED Collector approvals. Ormonde Doyle, 3115 South Forest, Independence, Missouri.

WOW! 110 All different Germany 10¢. Zeppelins, semi-postals, airmails, high values, etc. Giant catalog, bargain lists included with beautiful approvals. Jamestown Stamp, Dept. A48PM, Jamestown, N. Y.

GIGANTIC Collection free. Includes triangles, early United States, animals, commemoratives, British Colonies, high value pictorials, etc. Complete collection plus big illustrated magazine all free. Send 5¢ for postage. Gray Stamp Company, Dept. PM, Ontario, California.

90,000 STAMPS Sale! Big lot better stamps \$1. Extra special \$2. Giant assortments \$5 and \$10. Persil, 436 N. Y. Ave., Brooklyn 25, N. Y.

77 DIFFERENT U. S.—25¢. Approvals. Utechts, 1134D North Keeler, Chicago 51.

AUSTRALIA—Fifty different exciting commemoratives, animals, kings, queens. This valuable Australian collection only 10¢ with approvals. Viking, Great Neck 8, New York.

FREE! Giant bargain catalog—New edition listing thousands of bargains including U. S. and B. N. A. stamps, packets, mixtures, albums, accessories and supplies; sent with beautiful approvals. Jamestown Stamp, Dept. E48PM, Jamestown, N. Y.

GIANT Stamp zoo free! Snakes, leopards, rhinoceros, zebu, koalabear and other fierce jungle beasts. Approvals. Send 10¢ for handling. Free stamp magazine. Lincoln Stamp Co., St. Catharine's 118, Ontario.

25¢ REFUNDABLE. Brings catalogue, free pictorials cataloguing \$1.45. Warden. 68, Sierra Madre, Calif.

100 DIFFERENT Mexico, \$1.00. Gray's. 108 West Elm, Phoenix, Arizona.

FREE Gigantic worldwide list of guaranteed stamp packets at discount. Plus practical way of earning same. Walt's Discount Sales, P.O. Box 1002, Clearwater, Florida.

SELECTED Stamps. Assortment free with approvals. D. J. Stamps, 5951 Benner, Los Angeles 42, Calif.

100 SIAM \$3.00. Approvals on request. Salsman, Box 702, Berkeley, California.

GIANT Approvals, thousands different, 1¢ and 2¢ each. Wahl's Stamp Exchange, 7008P Farragut, Chicago 31, Ill.

HARD To get China packet 10¢ to new customers. Tru-Value, P.O. Box 2098, Santa Ana, Calif.

SENSATIONAL Penny approvals! Hugh's, 522 Second Avenue, N.W., Hickory, N. C.

1000 DIFFERENT Worldwide stamps \$1.00. Valued over \$20.00. Universal, Box 6, Kenosha 5, Wisconsin.

GIANT Diamond, midget triangle, Timor, 26 others, 3¢, approvals. Carpenter, P.O. Box 310, Claremont, Calif.

101 ALL Different. 10¢ with approvals. Smith, 6 Greencroft, Champaign, Illinois.

OLD U. S. Flags, famous Americans, commemoratives, approvals, surprise packet, 10¢ handling. Metropolitan Stamps, Box 312UC, Jackson Heights, N. Y.

PACKETS; Satisfaction or refund. \$1.00 each specified country. Cochran Company, 1814 West Corona, Phoenix, Arizona.

COLORFUL Pictorial collection free, with approvals. Variety Stamps, Box 98-M, Newton Highlands 61, Mass.

50 BRITISH Colonials 10¢ with approvals. Brandon, 819 3rd Ave., Altoona, Penna.

POLAND: General foreign; U. S. plate blocks; approvals. Chas. Alexander, Rockford R3, Mich.

FREE Stamps with approvals. Mitchell Cohen, 5337 Monroe, Hollywood 38, Calif.

"SPUTNIK" Stamp (guaranteed genuine), plus pictorials, bicolors, etc., only 10¢ with nice approvals. Shoaps, 7504 Briarcliff, Cleveland 30, Ohio.

UNITED States price list free. Stamp-land, Box 2003, Miami 11, Fla.

JAPAN Highest value, scarce No. 605. 500 yen, catalogs \$1.25. Only 10¢. Burns, Box 3761, Honolulu 11, Hawaii.

1000 MIXED. Includes pictorials, 50¢. Knopp, Box 1381, Bristol, Conn.

100 ALL Different mint United States commemoratives \$6.75 includes bicentennials, parks, famous Americans. No approvals. Gil's, Box M12, Brooklyn 29, New York.

FREE U. S. stamps. 1943 flag, commemoratives included in collection of 25 different, plus valuable \$5.00 stamp. All for 10¢ mailing charge. Approvals. Willett Co., Box 338-A, Yorktown Heights, N. Y.

FREE! Egypt, Iran, Iraq, Israel, Lebanon, Syria. Excellent approvals. Panorama, Box 229, Miami 2, Florida.

500 MIXED Worldwide 25¢. Brookside Stamps, Box 133, Mendon, Mass.

U. S. Classics. Over 50 yrs. old. 15 selected old-timers. Missing in biggest collections. All 15 at less than 1¢ each. 10¢ with approvals. Jaro, Box 246-T, New York City 8.

U. S. Stamps. Giant bargain catalog—10¢. Raymax, 35-VZ Maidenlane, New York City 38.

50 DIFFERENT China 10¢ with approvals. Plymouth, Department A-10, Bell, California.

100 DIFFERENT 10¢ With approvals. Roger Davis, 525 Main St., New York Mills, N. Y.

FREE 50 Worldwide introducing inexpensive approvals. University Stamps, P.O. Box 95, Tamiami Station, Miami 44, Florida.

1000 DIFFERENT With approvals. Jacobson, 4395-C Broadway, New York 40, N. Y.

UNITED States approvals, including rare old issues. Credit references required. Merritt Brundige, Cambridge, N. Y.

FREE! Over 100 different, \$2.50 value, including space satellite, Israel, British, U. S., first U. N., Siberia. Approvals, catalogue. Send 10¢ for mailing. Gatewood, Box 346, Winston-Salem, N. C.

PENNY Approvals! Regardless catalogue! Kloster, 4164 52nd St., San Diego 5, Calif.

500 U. S. stamps 25¢; 100 pictorials 25¢. Carlton's, 10243 Silverton, Tujunga, Calif.

WORLDWIDE, 50 All different, absolutely free, just to introduce our incomparable approvals. Kent Stamp Company, GPO Box 87, Brooklyn, N. Y.

RUSSIA, 25 Exciting gems or 50 fascinating Bulgaria 10¢. Approvals. Belmont Stamps, Washington 15, D. C.

64 PAGE U. S. catalog free. Stone, 192 Washington, Boston 8, Mass.

FREE—Valuable U.S.A.! (1) Scarce genuine postage stamp picturing first U.S.A., issued in 1847! (2) Big collection 30 all-different United States; ancient 19th century, valuable \$1 stamp, etc. (3) Collection beautiful commemoratives. (4) Collectors guide; big 64-page bargain catalog including all U.S. postage issues; other exciting offers! Send 10¢ for mailing expenses. Harrisco, 4165 Transit Bldg., Boston 17, Mass.

PRE 1894—United States, three copies free to approval applicants. Collier, Chamblee, Ga.

50,000 STAMP Grab-bags. 25¢ each. Anderson, P.O. Box 1, Reading, Penna.

CHINA, 5 Different airmail only 5¢, to approval buyers. Coast, P.O. 2187C, Santa Ana, California.

FREE—Airmails, commemoratives, pictorials. Approvals. H. P. Wischart, Frankfort, Ohio.

FREE United States commemorative list. H & S, 45 Bromfield, Boston, Mass.

FIRST U. N. set. Among world's prettiest. Only 10¢. Approvals. Welles, Box 1246-R, New York City 8.

7 CANAL Zone 10¢. Approvals. Merkel Stamps, 30 Grandview, South Hadley Falls, Mass.

SUPERIOR Worldwide mission mixture. Amazing variety! Half pound \$1.60 postpaid. Bay Nielsen, 4545B Harvard, Montreal 28, Canada.

60 DIFFERENT U. S., included 30 commemoratives 25¢. No approvals. Seidenberg, Appleton, Wisconsin.

FREE! Amazing list! Alphabetical! Two feet long! Stampmart, Hartford 1, Conn.

14,000 DIFFERENT! Amazing new plan builds your collection systematically, country by country. Only 50¢ weekly. Free details. L. G. Ware, Stepney 75, Conn.

INTRODUCING Our better United States approvals, we offer 15 United States stamps including Columbian, Pan-Pacific, famous American, airs, others; only 10¢. Ocean Stamps, Box 64-PM, Brooklyn 29, New York.

UNITED States price list, 116 pages, price 25¢. Mark Hanna, 335 Fifth Ave., Pittsburgh 22, Penna.

U. S. Mint flag set, complete, \$1.00. Free list. Brooks, 2323 Avenue X, Brooklyn 35, New York.

SPACEPHOBIA? Our 1¢-2¢ approvals cure quickly. BKJ, Astor, Boston 23, Mass.

"ABE Lincoln" giant diamond, rainbow colored flag set, Israel, South Korea, 50 others different only 10¢. Approvals. Champlain, Isle La Motte, Vermont.

FREE United States illustrated catalog. Bailey, 45 Bromfield, Boston, Mass.

U. S. approvals. Low prices. Eagle Stamps, Romine Ave., Pittsburgh 26, Penna.

ECONOMICAL 1/2¢-3¢ Approvals. 33,000 varieties. Dresel, Box 128-N, West Englewood, New Jersey.

TWO \$5.00 U.S. stamps plus 20 different, 10¢ with U.S. approvals. Irwin, Box 1105, Brooklyn 30, N. Y.

FREE! 107 British Colony stamps. All different, from Britain's farflung colonial empire. Catalog value \$2.50. Free stamp magazine, approvals. Send 10¢ for handling. Act now! Niagara Stamp Co., St. Catherine's 71, Ontario.

UNITED States commemorative collection containing 33 different—10¢. Approvals. White, 516-A Avenue L, Brooklyn 30, New York.

SELL Your surplus good grade stamps. Write, describing fully what you have. Vanroy Shirk, Lebanon, Pennsylvania.

AMAZING Offer! 200 United States stamps—including commemoratives, airmails, high denominations to \$1.00. Only 10¢ to approval applicants! Illustrated bargain lists free. Mystic Stamp Co., Dept. 80, Camden, New York.

100 STAMPS, 10¢ With approvals. Smith, 508A Brooks, College Station, Texas.

OLD Scarce U.S. seconds on approvals. Slight imperfections, lowest prices. Herfield, Clintonhill Sta., Newark 8, N. J.

100 OLD United States between 1861 and 1935, \$1.00. Roush Stamps, 51 Chestnut, Mansfield, Ohio.

UNITED States approvals. Select copies, used—mint. Kingsbury, Fairfax, Vermont.

ICELAND 10 Different beautiful stamps for only 10 cents to applicants for our good old fashioned approvals. Old Colony Stamp Co., Dept. A, Milford, Connecticut.

1-2¢ EACH! Thousands of exciting worldwide stamps. Free examination. Cole, Box 223-A, Buffalo 21, N. Y.

225 STAMPS For only 10¢! This mammoth value includes airmails, pictorials; stamps from strange countries cataloguing up to 25¢ each! Also approvals. Mystic Stamp Company, Camden 80, New York.



100 DIFFERENT Austria, 10¢. Approvals. Aronson, Box P, Newton Centre 59, Mass.

WEIRD Diamond shape coffee stamps. Lovely flower triangle! First American big commemorative. Greenland, idol dancer, etc. Free with approvals. Capital Stamp Co., Ferrysburg 2, Mich.

25 DIFFERENT Commemoratives 1893 up 10¢. U. S. approvals. K&B, Box 70, Brooklyn 23, N. Y.

MINT U. S. at face! Older commemoratives only in 25¢ packet. Limit one with request for mint U. S. approvals. Western, Box 1669P, Salinas, California.

136 DIFFERENT U. S. commemoratives \$1.00, 50-25¢. Request approvals. Harold Holub, 18 East 198th Street, New York 68, N. Y.

CANADA, 100 Different 35¢ with bargain approvals. K. S. Holmes, London, Canada.

FREE Sample! Interesting, informative, illustrated. National Stamp News, Anderson, South Carolina.

FREE! 15 Mint French Colonies; interesting approvals accompany. Tropicana, Box 624-M, Oakland Park, Fla.

1250 STAMPS \$1.00. World wide. Good variety, off paper. Many pictorials and commemoratives. No approvals follow. Harrison's Stamps, 1435 1st Ave., Oakland 6, Calif.

FREE Stamp wallet, perforation gauge sent to new approval customers. Robert J. Clark, Box 728-P, Evanston, Ill.

EXCITING Strange countries packet. Free with approvals; Saxon, Orange, California.

STAMP Collecting outfit, includes packet worldwide stamps, package hinges, watermark detector, millimeter gauge. Everything 10¢ with approvals. Lorain Brown, Marion, Michigan.

PENNY Approvals. Thousands. Bargains for pennies. Gifts with purchases. Penny Stamps, Orange 1, California.

FREE 60 Different stamps. Request approvals. Stanley Zajac, 159 Emerson Ave., Toronto, Canada.

FREE Stamp collection, 100 different stamps from Europe, Africa, Asia, Scandinavia, Balkans, etc. 3¢ to approval applicants. Tatham Stamp Company, Springfield 30, Massachusetts.

FREE. Everything free—Mammoth collection cataloguing \$20.00 also 50 valuable complete sets. 54 gigantic multicolor commemoratives. All volumes Scott's International albums, catalogues, even Master Global albums. Free when you buy our sensational foreign approvals. Bargain Stamps, Redlands, California.

FREE Packet! Angola, Azores, Mongolia, Nepal, Palestine. Fascinating approvals. Coral, Box 7095 (Ludlum), Miami 55, Fla.

SEND Two dimes for the best U. S. catalogue you have ever received. New-Way Stamp, Lawrence, Mass.

WANTED—Stamp collections, accumulations. Murray Gold, 62-95p Saunders, Rego Park 74, N. Y.

25 DIFFERENT Luxembourg 5¢, approvals. Neal, 5950 Tower, Riverside, Calif.

U. S., British Colonial and foreign approvals. Hill Company, Box 51, Defiance, Ohio.

EGYPT 25 Different 3¢ postage. Approvals. Bellet, Mapleleaf, Hazel Park, Mich.

LAOS, 25 Different mint pictorials \$1.25. CK Stamps, 6912 Sheridan Road, Kenosha, Wisconsin.

101 DIFFERENT Free; send postage. Martin, 2102 Bentley, Los Angeles 25, Calif.

FREE! "Packet stamps"—With approvals. Steele, Box 451-PM, Long Beach, California.

FREE San Marino, Mozambique, Czechoslovakia, Australia, Argentina. Approvals. May, Box 988-B, Coral Gables 34, Florida.

U. S. 19th Century special 12 different 10¢, approvals. Margas, 1173b East 51st St., Brooklyn 34, N. Y.

LIBERIA, Bicolored bird triangles—Free! Approvals. William Deems, 226 Race, Ravenswood, West Virginia.

RUSSIA, 50 Different 25¢ with approvals. Eby, 3026 Waterloo Court, Chicago 14, Ill.

FREE Classic airmail, approvals, references. Pickford, Box 208, Bradley Beach, New Jersey.

UNITED States, \$1.00 buys 7 fine unused. #643, #645, #646, #651, #657, #680, #688. Approvals accompany. Whitton Paine, Westport 11, Connecticut.

SPUTNIK. World's first space satellite stamp, plus 50 different free with interesting approvals. Stamp Imports, Peterborough, Ontario, Canada.

U. S. commemorative stamps—Mint, unused; army-navy heroes set of 1936, 10 stamps; armed service set of 1945, 5 stamps (includes flag raising at Iwa Jima); Roosevelt set of 4, all 19 stamps \$1.00. U. S. price list free on request. Empire State Coin & Stamp Co., Empire State Building, New York 1, N. Y.

THIRTY Years stockpiling! United States, Canada, British; collection approvals. Enclose 10¢. Peterson, 405 Empire Bank, St. Paul 1, Minn.

WE Have just the approvals you want. U. S. and foreign. LaCede Stamps, 4973A Columbia Ave., St. Louis 9, Mo.

100 WORLD-Wide 10¢. Approvals. Box 642, No. Attleboro, Mass.

BAHAWALPUR UPU complete set free with approvals. Taconic Stamps, Box 1370, Anram, New York.

ITALY—100 Different 10¢ with approvals. DeRespinis, G.P.O. Box 771A, New York 1, N. Y.

ISRAEL, 10 Distinctive, different 10¢ Approvals accompany. Rocket Valley Dept. M, Box 328, Canoga Park, Calif.

SETS, Packets, surprises, with purchases. Approvals. Stamp Farm, P1, Oxford, Wis.

#### ANTIQUES, RELICS, INDIAN GOOD: CURIOS

SELECTED War arrowhead \$1.00. L1 5¢. H. Talburt, Calico Rock, Ark.

INDIAN Relics, baskets, weapons. L1 10¢. Rush, 34, Belvidere, N. J.

SCALPING Knife, spearhead, thunde bird \$4.00. Catalog free. Arrowhead Glenwood, Arkansas.

ARROWHEAD, Drill, scraper, stunner \$1.00. Smith, 841 N. Tacoma, Indianapolis 1, Indiana.

STONE Arrowhead making instructions, illustrated, complete, \$1.00. Chief Blackhawk, Box 564-N, Kennewick, Wash.

#### PRECIOUS STONES, MINERALS

CUT Gems, make jewelry—For profit or fun. 100 page magazine tells how: where to get supplies. Sample 25¢ or request free literature. Lapidary Journal, Del Mar 2, Calif.

EARTH Science, the rockhounds national magazine. Subscription \$2.00. Sample 35¢. Box 1357-PM, Chicago 90, Ill.

AGATES, Gems, machines. Free list. Northwest Gems, 2819 North Warner, Tacoma 7, Washington.

LARGEST Gem and mineral magazine tells how to have profitable fun with rocks, gems, jewelry. Monthly, \$3.00 year. Sample 25¢. Gems & Minerals, Dept. A1, Mentone, California.

SEMI-Precious uncut gems. Ten different for \$1.00. Request list 26. Prospectors Shop, 201 San Francisco, Santa Fe, New Mexico.

TEN Polished gems, baroque shaped, only \$1.00. Bargain lists, gems, jewelry mountings, 25¢. Gem cutting equipment, 25¢. O'Brien's, 1116N Wilcox, Hollywood 38, Calif.

#### HOBBIES AND COLLECTIONS

NAZI Collectors. Large list 10¢. Holmers, 13503 Lakewood, Paramount, California.

COLLECT Medals! Nazi badge 50¢; embroidered swastika and catalog, 25¢; 35 American emblems, 50¢. Hobbies, Box 71, Rockaway Park B-94, N. Y.

100 NEW U. S. military insignias including purple heart ribbon. Postpaid \$2.00. N. Kimmel, 10436 Cheviot Dr., Los Angeles 64, Calif.

EXCITING New hobby with micro organic crystals. Catalog 10¢ or send \$1.00 for samples. Riklin Research Laboratories, Box 3295-P, Seattle, Wash.

NAZI Insignia, 12 different \$1.00. Medals, patches, armbands, flags, daggers. Illustrated lists, 15¢. Hobbyland, 1207 1st St., W., Calgary, Canada.

100  
25¢  
1311-C  
mist.  
35¢  
Incy

free  
of  
chater  
27. Co  
S. Say  
&w  
ment.  
No. Wel  
RS. Hi-F  
J E. 88 St.  
6MM. Mov  
International  
Blackhawk's  
new and used  
color slides  
ators! Biggest at  
accessories, sup  
as. Davenport 14.  
6MM. Sound. pro  
ntal exchange. V  
atalog. National Cir  
York City.  
16MM. Film bou  
\$5. Bryant Supply C  
6MM. Movies. 50  
Animals, cartoons,  
\$1.00. MovieLand  
Sherman Way, Van

#### MUSIC AND MUS

ACCORDION M  
rangements, folios  
Bleecker, New Yor

COMPLETE Mu  
ers. Jerry Colonn

SONGS, Poems  
basis. Songwriter  
Broad St., Newar

POEMS W  
\$1.45; 30  
for complete price list  
mailers. Photo-Mail, Box 216M,  
Square Station, New York City 10.

FREE! Color snapshot folder. Offers,  
lists, mailers. Houghton's, Erving, Mass.

PARTICULAR? 8 Jumbos—40¢, 12—50¢.  
Special; 35 mm., 36 exposures \$1.25. Intro-  
ductory offer. Flash Foto, Box 36M,  
Brooklyn 4, N. Y.

8-HOUR Service on deluxe jumbo prints.  
8-exposure roll developed and 8 jumbo  
prints 40¢, 12 exposure 55¢, 16 exposure  
70¢; 35mm. 20 exposure 75¢, 36 exposure  
\$1.25. Jumbo deckle-edge reprints 4¢ each.  
Contact prints made if specified. Bay  
Photo Service, P.O. Box 210, Oakland,  
California.

KODACHROME Processing 20 exposure,  
8mm. roll movie \$1.00. 36 exposure \$1.75.  
Ansochrome, Ektachrome \$1.00. Koda-  
color developing \$1.65, \$1.25 per print. Free  
mailers and price list. Nu-Color Labora-  
tories, Box 191, Hartford 1, Connecticut.

ENLARGEMENTS, Heavyweight seven  
5x7's or four 8x10's \$1.00. Jack Koons,  
Huntington Mills, Luzerne County, Penna.

FAST Film service. Black and white:  
6 exposure 40¢; 12 exposure 60¢; 20 ex-  
posure \$1.00. Reprints 5¢. Kodacolor: Pro-  
cessing 90¢. Prints 32¢ each. Ansochrome,  
Ektachrome \$1.40; Kodachrome \$1.50.  
Mounted. Finest quality over 40 years.  
Mailers. Mail Order Photo Service, Box  
297, Watertown, Wisconsin.

TRIAL—8 Jumbo, 35¢; 12, 50¢. Limit 3  
rolls. Western Photo, PM46, Box 298, San  
Francisco 1.

3 8x10 \$1.00. Your negatives. Cooke  
Foto Lab., 1547 Cahuenga, Hollywood 28,  
Calif.

SUPERIOR Quality. Prompt service. 8  
jumbos in album 40¢. 16 contacts 50¢.  
Jumbo reprints 5¢. Satisfaction guaran-  
teed. Also complete color film finishing  
service. Write for free circulars and mail-  
ers. Fast-X-Foto, Box A, Jersey City,  
N. J.

REPRINTS 30 For \$1.00 through May  
31. Twelve exp. 39¢. Wallets 20 for \$1.00.  
Lincoln Studios, Dept. K, Box 13, Lincoln,  
Nebr.



## AND SOUND IT

8mm. roll \$1.50. Processing. Better Brooklyn, N. Y.

Need-fresh color. 16mm. Free copy. Kansas City

Send 25¢ for 16mm. Get slash-2424 Entrance California.

Free dollars. Fresh color film. Home Superior Bulk Film Co., Chicago 10.

Free catalogue. New York City 28.

Free catalogue. Greenvale, N. Y.

Big new 1958 sale 16mm. 8mm. movies; used 16mm. sound track in U.S.A. Cam-erolies. tool! Blackhawk Iowa.

Directors. films. Sale. Hit store or write for drama, 71 Dey St., New York City.

Light, sold, exchanged. Co., Emporia, Va.

1. \$1.00—Special offer. Travel, comedies. Send Films, Inc., 16121-M Nuys, Calif.

## MUSICAL INSTRUMENTS

Music catalog—3000 articles free. Pagani, PM-289, New York 14.

Music service for songwriters. Box 888-M, Burbank, Calif.

Promoted. 15% royalty Cooperative Assoc., 972 N. J.

Five Star Music Masters, 650 Beacon Building, Boston, Mass.

SWISS Musical movements. \$1.90. Helax, 218 W. 72nd St., New York City 23.

SONG Poems wanted. Free examination. Send poems. McNeil, Master of Music, 1112 PM Wilshire, Santa Monica, Calif.

VIOLIN Makers supplies. Free catalog. 369 W. Fourth, Los Angeles 13.

YOUR Songs arranged and recorded for publisher's presentation. For information write: Vance Studios, 3409 Grand Ave., Oakland, Calif.

POEMS, Lyrics, songs wanted! Cleveland Music, 162 Boylston St., Boston 16, Mass.

POEMS Wanted for new songs. Send poems. Immediate consideration. Crown Music Company, 49-C West 32 Street, New York City.

ELECTRIC Guitars, amplifiers, wholesale. Free catalog. Carvin P.M.M. Covina, California.

ACCORDIONS, Wholesale to everyone. Save up to 60%. All national known brands. Free catalogue. Del Principe, 29 South Cicero, Chicago 44.

SONG Request guarantees royalties. Instructions two dollars. Howard Olenik, Mt. Morris, Mich.

VIOLINMAKERS, Repairers. Fine tone wood, and all violin supplies. Send for free wholesale new price list. International Sales, 414-MPM E. Baltimore St., Baltimore 2, Maryland.

WRITE Songs. Big money and reputation. Write for information. J. Gordon Pub. Co., 4700 South California Avenue, Chicago.

SONGS Into dollars. Share \$29 million dollars yearly for new songwriters, song-poets. Songs composed, published, promoted by famous firm. Information, appraisal free. Send to Nordyke Publishing, 6000 Sunset, Hollywood 28PM, California.

SONGPOEMS And lyrics wanted. Mail to: TinPan Alley, Inc., 1650 Broadway, New York 19, N. Y.

WANTED! Poems, lyrics, songs, ideas. Bengol, 93 Jefferson, Chelsea 50, Mass.

ACCORDIONS—Direct from importer. Save 50% and more! Free trial. Lifetime guarantee. Trades accepted. Free catalog. Write Accordion Manufacturers Outlet, Dept. 148-R, 2003 Chicago, Chicago 22.

POEMS Wanted for new songs and recording. Immediate consideration. Send poems. Songcrafters, Box 6145, Acklen Station, Nashville, Tenn.

1958 ACCORDIONS Wholesale—10 day trial. Free catalog. American Accordion Center, 5329 PM-4 Belmont, Chicago.

PUNCH Line—The booklet that packs a punch. 25¢. Adams Music, Van Wert, Ohio.

FABULOUS Ukulele deal \$3.00. Von Scherb, 307 Robinson Avenue, Marrero, Louisiana.

TUNE Your own piano. Tuning wrench, tools and instructions \$9.75. Nelson Co., Box 707, Gilroy, California.

ACCORDION Repairs made easy. Step by step instructions. Write Pagani, Circular PM-289, Bleecker, New York 14, N. Y.

## RADIO, TELEVISION AND ELECTRONICS

RADIO Course only \$22.95. Includes all tubes, parts, tools, instructions. Write for full information. Progressive "Edu-Kits" Inc., Dept. 553-B, 497 Union Ave., Brooklyn 11, N. Y.

EVERYBODY'S Tube and set tester, complete ten dollars. Literature free. Stegotronics, Colchester, Connecticut.

GOVERNMENT Surplus radios, parabolic reflectors, snooperscopes, mine detectors, parts. Catalog 10¢. Meshna, Malden 48, Mass.

CRYSTAL Radio experimenters write to Hulet, 305 Hope, Lakewood, N. J.

CRYSTAL Radio kit \$1.00, preassembled \$1.25, phone \$1.75; catalogue. Clearco Crystal Company, 2968 North 4th, Milwaukee 12, Wisconsin.

TAPE Recorders, hi fi components, tapes. Unusual values. Free catalog. Dressner, 69-02M 174 St., Flushing 65, N. Y.

MISSILE Electronics: Uses magnetic amplifiers and transistors. Send \$1.00 for theory of operation. Box 8087, Long Beach 8, Calif.

REMOTE Speaker 4x4x2, television, radio, phonograph. "Money Maker," Box 1142, Lancaster, Penna.

## BUSINESS OPPORTUNITIES

FREE Picture folder, "How to Make \$3,000 Yearly Sparetime. Backyard, Raising Earthworms!" Oakhaven 38, Cedar Hill, Texas.

FORTUNES Raising redworms. Instructions free. Three Oaks Ranch, Dresden, Tenn.

"MAILORDER Laws and Regulations" and "Mailorder Rules for Beginners." Learn about necessary licenses, different taxes, legal requirements, etc. Both books, \$2.00. Tasker, Box 3131, Alexandria, Va.

MAKE \$200.00 Monthly spare time with jigsaw. Free details. Elkman, 346F North Summit, Sioux Falls, South Dakota.

INCOME From local information. No selling. Write Neherco, La Verne, Calif.

MAILORDER. Free book. Shrager Advertising, 2 W. 46, New York City 36.

LEARN Mailorder selling. Pays big! Free Colliers' reprint! Elliott, 216-A W. Jackson, Chicago 6.

MUSHROOMS Quicker, easier, cheaper. Newest facts free. Spawn \$1.00. Luxur, 641 South 19th, Newark 3, N. J.

"EVERYBODY Likes candy" — Make professionally home. (Our 47th Year.) Ragsdale Candies, B107, East Orange, New Jersey.

MAKE Money, address and mail new self-selling catalog; we fill orders for you; big profits; many repeats. Send 35¢ for sample and complete details! Tri-States, Box 8008, Huntington, W. Va.

\$600.00 PROFIT. Mailing 100 catalogs! Catalogs feature items paying you up to 85¢ profit on \$1 items. Work from your home or office. No need to carry stock. We drop ship. Start immediately! Send only \$1 (cash, check, money order or stamps) for 10 catalogs, or 25¢ for sample. Free instructions included. Costar's, G.P.O. Box 972-PM, New York 1.

MONEY Plans! "Secret Journal." Grandpa, two daughters made \$2500 first month! Work home. Publicco, Oceanside, Calif.

SELL By mail. Book 25¢. Berryman, 153 Victoria, Northlake, Illinois.

SHARPEN Scissors, pinkers, knives. Inexpensive, precision outfit. Blackhawks, Sheldahl, Iowa.

OPERATE Profitable home business. Free details. Service, Box 636PM, Newport News, Virginia.

REBUILD Batteries; repair dolls; make rubber stamps, "75 ideas" free. Universal, Box 1076-A, Peoria, Ill.

BIGGEST Money makers in the field; Acme saw and lawnmower sharpeners. Free literature. Max Mfg. Co., 138 Stockton Ave., San Jose 26, Calif.

FREE "Franchise Profit Letter," describes nationwide opportunities. Exclusive distributorships, dealerships, agency operations. Write today. National Franchise Reports, 333 North Michigan, Chicago 1.

TO \$100.00 Weekly. Sparetime, home operated mailorder business. Successful beginner's plan. Everything supplied. Lynn, 10420-M National, Los Angeles 34.

LEARN Real estate by listening to records. Lee Institute, Brookline 46, Mass.

CAMERA Owners! Earn \$50.00 week-ends! Instructions \$1.00, information free! Kline, 935-PM North Austin, Chicago 51, Illinois.

COLORGLAZED Concrete pottery made without molds. Patented method. Cemetery products, novelties, tiles. Basement leak-sealing. Money-making projects. Booklet, details free. Men only. National Potteries Company, Grand Rapids, Minnesota.

PIANO Tuning learned quickly at home. Tremendous field! Musical knowledge unnecessary. Information free. Empire School of Piano Tuning, Champaign, Ill. (Founded 1935).

BUY Direct from factories—Appliances, cameras, watches! Free details! Cam Company, 6810PM-20th Ave., Brooklyn 4, N. Y.

MIMEOGRAPHING Services pay sensational local profits. Exciting secret plans exposed! Write: Moele Mimeo Shop, Bonham 7, Texas.

BRUSH Plating outfits for plating articles in the home and shop. No tanks necessary. Silvering mirrors, spare or full time. Free particulars. Gunmetal Co., Ave. H, Decatur, Illinois.

WANT To make big money at home? \$10.00 profit in an hour possible with invisible mending. Make tears, holes, disappear from clothing, fabrics. Steady year-round demand from cleaners, laundries, homes. Details free. Fabricon, 6234 Broadway, Chicago 40, Illinois.

WHOLESALE—Thousands nationally advertised products. Buy, sell. Amazing profits. New, free plan. Associated Wholesalers, 1016-D Starr, Burlington, Iowa.

OPERATE Mailorder folio business! Free details. Ballard's, 425 East Catherine, Louisville 3, Ky.

MAKE Flexible molds. Cast plaques, figurines. Free sample. Tooker, 1045-R Fairview, Hamilton, Ohio.

NATURAL Molding rubber, extra thick. Free sample. W. Wooley, 1016-A Donald, Peoria, Illinois.

BIG Money raising fishworms and crickets. Free literature. Carter Farms, Plains, Georgia.

VENDING Machines—No selling. Operate a route of coin machines and earn amazing profits. 32-page catalog free. Parkway Machine Corporation, Dept. 26, 715 Ensor Street, Baltimore 2, Maryland.

\$70 WEEKLY—Home, spare time. Simplified mail bookkeeping. Immediate income—easy! Auditax, 34757A, Los Angeles 34.

WANT More business? Here's an amazing opportunity to increase your sales. Talk to thousands of interested readers of "Mechanica Popular." Our Spanish Edition covers the Latin American countries like a blanket. They're real mailorder buyers. Classified rate 75¢ per word. Try an ad in our next issue. Classified Advertising Department, Popular Mechanics Magazine, 200 East Ontario Street, Chicago 11, Ill.

MINK Raising information free. Complete. Lake Superior Mink Farm, Superior, E.E.1, Wisconsin.

100 JOBS. Details free. Business 60, des Ormes, Quebec 3, P.Q., Canada.



**START** Home business making statuary, plaques, novelties, garden furniture, artificial marble flooring, liquid marble. Make your own flexible molds. Amazing profits. Only \$1.98. Free literature. Popular Mechanics Press, 631 No. St. Clair St., Chicago 11.

**COPUBLISH** Mail Sale Advertiser, leading mail order paper. Details, latest copy, dime. Vanroy Shirk, Lebanon, Penna.

**LEARN** Photo-negative portrait retouching. Men, women. \$5 hour possible spare or full time at home. Easy, glamorous. Work for photographers by mail order. Full details sent free. Duval, 100 So. Vermont, Los Angeles 4.

**YOUR** Own name brand business. No investment; no inventory. Part time or full time. Sell famous brands of appliances, housewares, silverware, radios, vacuum cleaners, lamps, tools, clocks, watches, jewelry, etc., etc., over 1000 items. Join thousands of successful independent dealers. Send for free catalog and dealer price list. H. B. Davis Corp., Dept. 11, 145 W. 15 St., New York City.

**11,000 NEW** Prospects daily. Baby record books, shoes, albums. Sell mailorder. Use our literature. Write: No-Co-Ro, Capitola, California.

**BAKE** New greaseless doughnuts in kitchen. Sell stores. Free recipes. M. Ray, 3605 South 15th, Minneapolis 7, Minnesota.

**FIX** Typewriters. Inexpensive home course teaches factory secrets. Free booklet. Athey, Tarentum, Penna.

**PLATE** Baby shoes, jewelry, gifts, bronze and colored pearl. Free booklet. Platex, 11029 South Vermont, Los Angeles 44.

**FREE** Catalog. Contains hundreds of businesses, farms and income properties throughout U.S., Canada. Specify type and location desired. Deal direct with owners. U. I. Buyers Digest, 1608 Hillhurst, Dept. PM-3, Los Angeles 27, Calif.

**LIQUID** Rubber. Make flexible molds. Free sample. Chaney, 1907-A East Road, Jacksonville 11, Florida.

**BOOKKEEPERS**, Accountants. Operate a bookkeeping service. Part or full time. Amazing simplified system. Wonderful money-making opportunities. Complete information free. National Bookkeeping Publishing Co., Suite 307, 3435 Broadway, Kansas City 11, Mo.

**WE** Pay \$3.50 lb. dried. Grow mushrooms. Cellar, shed and outdoors. Spare, full time, year round. We have 25,000 customers. Free book. Washington Mushroom Ind., Dept. 172, 2954 Admiral Way, Seattle, Wash.

**FREE** Book "505 Odd, Successful Businesses." Work home, Pacific, Oceanside, Calif.

I want to send you proof of the wonderful pulling power of Popular Mechanics classified pages. What's your proposition? Write me today. Include literature if possible. F. W. Johnson, Manager Classified Advertising, Popular Mechanics Magazine, 200 E. Ontario St., Chicago 11, Ill.

**INTERNATIONAL** Mailorder business. Complete setup service—Not just instructions. Hermes, 152 West 42, New York City 36.

**PLASTERCRAFT** Molds, liquid rubber, plasters, flocks, candle supplies. Catalog and manual free. Blue Rapids Supply, Blue Rapids, Kansas.

**MARY-Mac** agency—motorized vibrator. Cushions, chairs, tables, belts. Mary-Mac Factory, 1012 Powhattan, Dallas, Texas.

**FREE** Folio "\$5,000-\$45,000. Unlimited Vacations." No merchandise. Unknown! Work home, sparetime! Haylings, Carlsbad, Calif.

**MAKE** \$46 From square foot plywood; jig saw necessary. Free details. Woodart, Bridgewater, Mass.

**OPERATE** Profitable mailorder business! Write: Thomas Bond, 1637H West Vernon, Phoenix, Arizona.

**OPERATE** Mail-order printing brokerage. Details free. Advisory Service, Hartsdale, N. Y.

**QUICK** Profits, with no capital! Take orders for magazines your neighbors like, want. Make cash on the spot! We show how with free kit. Get yours now. Write McGregor Magazine Agency, Dept. 310, Mount Morris, Ill.

**\$5,000 YEARLY**, Spare time at home. Nothing to buy. No local selling. Dignified. Guaranteed. Home Harvest, Rt. 3, Box 3491-A, Albuquerque, New Mexico.

**WE** Love our mailman—He leaves over \$1000.00 monthly in our rural mailbox. My college professor husband drafted a scientific home mailorder method. We bought a Texas ranch, live as we always wanted. Now we sell the Ranch Mailorder Method. Operates anywhere. Inquire: Eveningshade Ranch, Boerne, Texas.

**BE** Appointed state notary public now. Write, Stationers, Boerne, Texas.

**GROW** Orchids at home. Profitable, fascinating. Successful home grower explains special light, temperature and humidity conditions orchids need. Free: Full details, Orchids, 100 S. Vermont, Los Angeles 4.

**EARN** \$10,000 Yearly raising Angora rabbit wool for us. Information 25¢ coin. American Angora Company, Malta 12, Montana.

**IMPORTING**, Modern dropship method. Details free. The Hazen Company, 6601M—8th Avenue N. St. Petersburg 10, Florida.

**DOLLARS** In every mail. Profitable mail order operates in your home, farm, or office. Send for free details. Webb Imports, 8729 1/2 Warvale, Rivera, Calif.

**\$100.00 WEEKLY** Spare room. Raise redworms soilless way. Odorless. Charlie Morgan, Box 116E, Bushnell, Florida.

**TYPIST** Operate profitable mail-order business. Stamp brings details. General Sales, 336 Roosevelt St., Creve Coeur, Ill.

**SELLING** By mail fascinating. Profitable. Free information. Alfano, 19 Pine, Closter, New Jersey.

**EARN** \$50 To \$60 daily repairing typewriters, write New England Training Service, Carmel 2, Maine.

**GROW** A living miniature forest or orchard (only inches high), that bears tasty tiny fruit at home. Learn amazing dwarfing secrets! Fascinating hobby. Profitable home-business opportunity. Free seeds and plan. (State your age.) Miniature Nurseries, Dept. AL, Gardena, California.

**MONEY** Making manuals. Free list. Harold Hamm, Route 5, Penwick, Ontario, Canada.

**START** Home mailorder business! We supply everything, fill your orders, guide you. Write: Rogers, 2954A, Pennsylvania Ave., Charleston, W. Va.

**WANT** Salaried, executive position? Our course teaches qualified men how to get it! Thomas Surface, Director, Roanoke, Virginia.

**INVISIBLE** Reweaving: \$5 in one hour possible reweaving burns, tears, moth-holes. Spare-full time. Free details. Skill-Weave, Dept. C-164, 335 W. Madison, Chicago 6.

**START** Your own business on credit (U.S. and Canada). Be your own boss. 1425 dealers sold \$5,000 to \$32,000 in 1957. We supply stocks, equipment on credit. 200 home necessities. Sales experience unnecessary. Pleasant profitable business backed by world-wide industry. Write Rawleigh's, Dept. D-U-PPM, Freeport, Ill.

**WANTED**—Limited number intelligent men and women to work at home on exclusive mail order business proposition. No selling, we furnish everything including literature, names, addresses, stock and ship items for you. Free details. Mail Order Distributors (Franchise Division), AL, Los Angeles 61.

**ENTER** The drain and sewer cleaning business. Free catalog. Electric Cleaning Co., Box 224, Boston 34, Mass.

**"COOLIE-Grinderlap"** with Re-Lod-Able diamond wheel sharpens carbide tools and drills to keenest edge. Cheapest and best. Home-shop or factory. Terms like rent. Instructions free. Write D T Co., Sheldon M. Booth, Box 32, South Haven, Michigan.

**"50 NEW** Home-Business Ideas" booklet, sample free. Spray exotic velvet-suede on anything. Flockcraft-AL, Los Angeles 61.

**LET** Me sell your products nationally. I'll send you free information on how to establish spare time-full time Cascraft business. You build! We sell! Everything supplied. Abarsl, 807-SK Sunset, Los Angeles 12, Calif.

**HOME-Import** mail order business—Import profitable items below wholesale. Experience and product investment unnecessary. Full, spare time. Famous world trader guides you. Free list "157 Imports," details, Mellinger, P704, Los Angeles 24.

**BECOME** Tax consultant. Grad earn to \$3,000 every tax season prep returns evenings. State approved. U Institute, Hoboken 2K, N. J.

**MAKE** Extra money. Cash commission. Everybody buys easy-to-sell advertising book matches. Union label. All sizes. Cut for all businesses. Powerhouse selling kit free. Steady repeat business. No experience necessary. Superior Match Co., Dept. MX-458, 7528 S. Greenwood, Chicago 19.

**OPERATE** Profitable mail order business. Write Walter Service, 4159A East 112th, Cleveland 5, Ohio.

**\$250.00 WEEK** Spare time profit possible. Earn at home with new fascinating printing method. \$5 starts you. Send no money now. Free confidential facts and valuable samples. Screen-Print, AL, Los Angeles 61.

**MAIL** Dealers—Home workers. Get \$25 orders, all yours. Details 25¢. Gray Company, 136J Virginia, Vallejo, Calif.

**WHY** Not make and sell your own product? Make all the profit. Our book "Home Factory" tells how to make 101 different products and articles. Tells where to buy all ingredients and materials necessary. Price 50¢ postpaid. H. H. Patterson, A.D.D., 2011 E. 32nd St., Chattanooga 7, Tenn.

**\$25.00 ONE** Hour! "Caging" water wells. Build own inexpensive instrument. Write: Carter, Box 713, Lubbock, Texas.

**WANTED:** Home producers, to be subcontractors. Cast plastic products for manufacturers in our clearing house service. Thousands of easily made items required. Cash in at home, without previous experience. Plastic Service Associates, Dept. 4-PM, East Boston 28, Massachusetts.

**SPARETIME** Cash at home filing saws by machine. Free plan tells how. Victor E. Foley Co., Columbia Heights, Minn.

**FREE** Book "990 Successful, Little-Known Businesses." Work home. Plymouth, 1610-43 Street, Brooklyn 4, N. Y.

**SELL** Books by mail. 400% profit. Royal, Box 368-X, Cleveland 27, Ohio.

**WHOLESALE!** Thousands name brand products. Free catalogs! United Wholesalers, 1265-G Broadway, New York 1, N. Y.

**LEARN** Netting and cord hammock making. Instruction \$2. H. Kask, Box 1072, Toronto 3, Ontario, Canada.

**PROVEN** Mail dealer setup. Products, prospects supplied. Stamp brings details. Benefit, 817 Taylor, Fort Worth, Texas.

**MAILORDER** Opportunity! Outstanding books shipped under your label. Had-don House, Box 55-M, New York City 62.

**MAKE** 100% Profit every time you push a button! Quickie Spray shines all shoes instantly without daubing, brushing, buffing. Be first! Rush refundable dollar for demonstrator, selling kit. Franchises available. James R. Barnett Co., Dept. PM-488, Wellesley Hills 81, Mass.

**ABUNDAVITA** Means better living, bigger bank balances! Campo, 391(A) Grand, Long Beach 14, California.

**LADIES'** Hosiery wholesale. Sample 49¢. Cross, 2411 5th Avenue, Altoona, Penna.

**SPECIALIZED** Magazines—Free list. Over 5,100 publications, current copies, over 1,100 self-help books. All trades, businesses, vocations, hobbies, sports. Commercial Publications, Box 44C, Franklin, Indiana.

**AMAZING** Profits: Make stucco walls that look like rock. Build concrete-rock waterfalls. Hollywood Cementcraft, 8527-B Wonderland, Hollywood 46, California.

**BUY** Wholesale! Get up to 80% off on nationally known brands. Start a discount buying service at home. Catalog \$1 (refundable). Robert Carr, 8118-A Lexington, Philadelphia 15, Penna.

**YOUR** Chemical product idea developed for you by manufacturing chemist, Ph.D. Research, development, samples, trial lots, production runs. Ekra Laboratories, Inc., 39 E. 20th St., New York City Tel.: AL 4-3860.

**GROW** Expensive herbs for us! Big profits home-business of your own. Year around profitability! We supply everything necessary! Send for free rare seeds and revealing plan. (State your age.) National Herb Exchange, Dept. AL, Gardena, Calif.



in-cans, news-  
Ads. Instructions  
J, 12-XAE, Nor-

self Mailorder Busi-  
ness money-making op-  
portunity. Tasker, Box  
Virginia.

profit selling Liquid Fish  
emission, full or part time.  
sample and full informa-  
tion. Mon Products, Inc., Seneca 3.

Opportunity for sound, exclusive  
business. Proved, time-tested,  
details successful. Moderate capital.  
details, proof, write Erol Slater, 305  
Eighth, Los Angeles 14, Calif.

HOME Business ideas. Book 25¢. Jef-  
fries, 12596 Market, Redding, Calif.

PROFITABLE Mail order business, ex-  
pactly prepared tested method. Completely  
demonstrated. Particulars 10¢. Business  
Consultants, Box 322, Bayonne, N. J.

LEARN Pest control! \$1000.00 monthly  
proved. Rid homes, farms, businesses of  
termites, rodents, pests. New short-cut  
methods! It's easy, fascinating. Huge demand.  
Free details. AFCAA, Dept. 1H,  
15015 Ventura Blvd., Sherman Oaks, Calif.

MAKE Big money. Work from home.  
Ground floor opportunity. Booming busi-  
ness. Art-Stone, Box 856-A, St. Louis, Mo.

SELL Real Estate. \$1.00 brings some  
basic facts, what to study. Endsley, 46  
Whittier, Indianapolis 19, Indiana.

MEN! If you are seeking financial se-  
curity, if you want to be your own boss, if  
you want to get into a year-in, year-out  
service business that can make you finan-  
cially independent and take you out of the  
"expendable employee" category, read on  
about Martinizing! Martinizing is the  
most outstanding dry cleaning process  
known today! Martinizing is a complete,  
self-contained dry cleaning plant and store  
which requires very little space and can  
be located almost anywhere. It will be  
completely planned and installed for you.  
Requires only a nominal cash outlay, with  
the balance easily financed! Complete  
training in Martinizing methods provided.  
A Martinizing franchise can pay back your  
investment in a few years—furnish you a  
good income! Profit from your own ef-  
forts! No worries about lay-offs, strikes,  
job-politics! It costs nothing to get all  
the details on how you can get into busi-  
ness for yourself now! Write today to:  
Martin Equipment Company, Dept. PMC-4,  
5000 Section Ave., Cincinnati 12, Ohio.

MAKE Money selling ball point pens.  
List free. Miller, 205 20th Street, Brook-  
lyn 32, New York.

FREE. How to make fast, easy double  
profits with wonderful foreign imports and  
nationally advertised merchandise. Spare,  
full time. Terrific bargains. SM Products,  
7401 Woolston, Philadelphia 38-M, Penna.

\$34.70 TWO Hours. Manufacturing. No  
selling. Carlayne Castings, 1803 Premont,  
Rapid City, South Dakota.

MAKE Strange plastic building material  
of waste, easily. Water, fire, wear and ter-  
mite resistant. Bays Laboratory, Arkansas  
City, Kansas.

FREE! Regular \$3.00 world drop-ship  
directory. Tells how to operate mail order  
business at home without capital. Gives  
all necessary information. Limited quan-  
tity available. Write today. Glass, Ell-  
wood City, Penna.

BEGINNER'S Mail-order fundamentals.  
A. Nelson, 40-66 Ithaca, Elmhurst, New  
York.

HAVE Pleasant, profitable home-oper-  
ated mail business. 300 new products  
yearly. Learn how to make money part  
time. Rush 35¢ for sample and details.  
Louis Arango, 137-H Kensington Avenue,  
Jersey City 4, N. J.

BUILD Fascinating hobby-business en-  
graving plastics! Profits to \$5 hour! Sam-  
ple, details 25¢. Personal engraved em-  
blems \$1.95. Desco Distr's., 5262-A Van  
Nuys, Van Nuys, Calif.

100 NYLON Hose rejects \$2.00. Allsheer  
Mills, 21831 Cloverlawn, Oak Park, Mich.

"MAIL Order Business" magazine. Most  
comprehensive mail trade journal in the  
world! 2 sample issues \$1. Refunded if  
unsatisfactory. Tower Press, Inc., Lynn  
891, Mass.

\$60.00 WEEKLY. Sparetime — Easy!  
Home Venetian blind laundry. Free book.  
Burt, 2434EP, Wichita 13, Kansas.

PLASTIC Business of your own. Ten  
items. Start at home; minimum capital.  
Send \$1.00. Dewhurst, Lockhart, Florida.

MAKE Money selling recipes and house-  
hold hints by mail. Information free. Bar-  
rett, Dept. CA-27, 7464 No. Clark, Chicago  
26.

AMAZING Profits making concrete drain  
tile. Simple machine can pay for itself  
first day. Write: Ceeten Products, Cor-  
nelia, Ga.

FLEXIBLE Rubber molds for plaster  
and Marble figurines. Sample and large  
illustrated catalog 25¢, refunded on first  
order. K-C Novelty, Dept. 81, Easthamp-  
ton, Mass.

OPERATE Profitable repeat business  
from your home. Franchise option. Full  
instructions, \$1.00. Refund privilege.  
Reber, Box 51, York, Penna.

\$1000 NET A month easy, and be your  
own boss. Have a route of book racks in  
drugstores. We show you exactly how.  
We've sold over 300,000,000 books. Write  
for free information to Little Blue Books,  
Dept. RD, Girard, Kansas.

GET Your vitamins free! Your own  
private labels. Buy direct. By-pass the  
middleman. Make all the profit. We sup-  
ply product, plan, advertising. No invest-  
ment. VitaMins, 4801 PM Cedardale,  
Wichita, Kans.

TRAVEL Winter south, summer north.  
Your own outdoor business. Send \$1.00.  
Climatic Enterprises, Box 129, Sebring,  
Florida.

MAKE \$50,000.00 Yearly from home. In-  
formative plans free. Fortune Enterprises.  
Addison, Illinois.

SENSATIONAL Opportunity! Co-publish  
"Mail Order Bulletin." Amazing details,  
literature, latest copy, 10¢. Glenn Mc-  
Elhannon, Cos Cob, Connecticut.

#### MONEYMAKING OPPORTUNITIES

SNAKES, Lizards, turtles, frogs bring  
good prices for full or part-time collectors.  
We buy and sell all kinds, all sizes, any  
quantities. Collectors brochure, complete  
details, 25¢. Biological Exchange, 1211B  
Wagner Lane, El Paso, Texas.

RECEIVE Big mails, samples, offers,  
catalogs, one whole year 25¢. Martain  
Company, 5345 South Halsted, Chicago 9,  
Ill.

MAKE Big easy profits making costume  
jewelry at home in spare time! Quick,  
easy to make; easier to sell! Details free!  
Don-Bar, 3511 W. Armitage, Dept. D-192,  
Chicago 47, Ill.

MAKE \$5,000 Yearly sparetime raising  
mink, chinchillas, nutria, etc. Free booklet  
reveals proved plans. Write Furs, 588  
Mt. Pleasant Road, Toronto 1, Canada.

START Big-pay business at home in  
spare time. No experience needed to op-  
erate little table-top machine for bronzing  
baby shoes. Make \$5.46 profit on every  
pair. Full particulars free. Send postcard  
to Mason, 1512 Jarvis, Room CM-3-D,  
Chicago 26, Ill.

MAKE Money writing short paragraphs!  
No tedious study. I tell you what to write,  
where and how to sell; and supply list of  
editors buying from beginners. Many  
small checks add up quickly. Write to  
sell, right away. Send for free facts.  
Benson Barrett, Dept. C 27-R, 7464 Clark,  
Chicago 26.

POSITIVELY No selling. I made \$20,000  
in one year without any selling whatever.  
I bought up junk jewelry. Uncle Sam paid  
me \$35 an ounce for the gold in it, less  
small refining charge. Get my "\$20,000  
a Year Secret" free. Leslie Patton, 335  
W. Madison, Dept. C9-C, Chicago 6.

MEN — Women! Start money-making  
plastic laminating business at home in  
spare time. Material that costs 11¢ brings  
back \$2.50. No canvassing or selling but  
mail orders bring in \$20 a day. Write for  
full particulars free. Rush name on post-  
card to Warner, Room CL-2-D, 1512 Jarvis,  
Chicago 26, Ill.

WIN Contest money. General Contest  
Bulletin gives hundreds of tips. Lists cur-  
rent contests, rules. Sample magazine 25¢.  
General Contests, 1609½ East 5th, Duluth,  
Minnesota.

CIGARETTES — Improved roller makes  
20 for 9¢. Facts free. Moberly, Box 821,  
Owensboro, Kentucky.

\$1 TO \$20 Checks daily! Write simple  
sentences, paragraphs, poetry for pay! No  
experience necessary. I tell you what to  
write, how to write, supply large list of  
buying editors. Begin writing for pay,  
today! Will Herman, 1726 W. 25th St.,  
Cleveland 13, Ohio.

\$36-\$200 WEEKLY Plating baby shoes,  
making jewelry, novelties, etc. at home.  
Details free. JO-CA Electroplater, 7840-D  
Northwest Sixth Court, Miami 50, Florida.

MAKE Money mailing sample business  
cards. Vosacek Printing, 4444A Ute, San  
Diego 17, Calif.

"NEWEST Products Report," popular  
mail order magazines, interesting mails  
25¢. Burke & Brown, 61 Haven, New York  
City 32.

MEN And women wanted to start home  
business in spare time with little table-  
top rubber stamp machine. Easy to earn  
up to \$9.80 an hour without previous ex-  
perience. Full particulars free by mail.  
Send postcard to Roberts, 1512 Jarvis,  
Room CR-2-D, Chicago 26, Ill.

EARN Cash at once, sending us easy  
orders for magazines your friends, neigh-  
bors want. Instant profits! We show how.  
For free kit, everything you need, write  
McGregor Magazine Agency, Dept. 320,  
Mount Morris, Ill.

START Home mail order business. I  
made enough money to retire. Now own  
\$18,000 home, Cadillac car, have money in  
bank. Amazing facts free. Norris Cole, 217  
4th Street West, Bradenton, Florida.

AMAZING Successes through franchises!  
Become exclusive franchise holder your  
territory. Information rushed. National  
Franchise Reports, 333 North Michigan,  
Chicago 1.

ESTABLISH Your own business. Simpli-  
fied instruction qualifies you to prepare  
income tax forms for others. No experi-  
ence. Unlimited income. Full time or part  
time. Full details free. International Tax  
Institute, 524-28th Avenue, San Fran-  
cisco 21.

\$15,000 PROFIT In one year possible, on  
\$5.00 cash and just 3 hours attention  
weekly! Experience unnecessary! Fabu-  
lous but true! Proof, complete detailed  
plan, only \$1.00. Satisfaction or refund!  
Columbia Enterprises, 8203-P, Grubb  
Road, Silver Spring, Maryland.

"HOME Business Digest" has money-  
making opportunities galore. Sample 25¢.  
Donovan, 79-PM Greenbelt, Levittown,  
New York.

ATTENTION Typewriter owners. Make  
handsome profits. Write today. Groves  
Company, 682, Hastings 8, Nebraska.

DO It yourself. What? Repair TV,  
build furniture, make barbecue, plumbing  
repairs, build boats, do house wiring, re-  
model home, lay tile, modernize kitchen,  
repair home, and scores of other things  
you can do yourself. Books covering each  
subject, only 25¢. Send for descriptive list.  
It's free. Popular Mechanics Press, 200-LB  
East Ontario St., Chicago 11, Ill.

BUY Wholesale! 30-80% discounts! Ap-  
pliances, gifts, typewriters, tools, watches,  
sporting goods, jewelry, cameras, house-  
wares, etc. Consolidated Distributors,  
Clifton 28, New Jersey.

FREE Fello "\$5,000-\$45,000. Unlimited  
Vacations." No merchandise. Unknown!  
Work home, sparetime! Haylings, Carls-  
bad, Calif.

READ Progressive Mailtrade, the maga-  
zine that tells how to make money by mail.  
Dime brings sample and special offer.  
Progressive Mailtrade, Box 357, Sheboygan,  
Wisconsin.

BIG Money raising, fishworms and  
crickets. Free literature. Carter Hatchery,  
Plains, Georgia.

EARN Money evenings copying and du-  
plicating comic cartoons for advertisers.  
Adservice, Argyle 1, Wisconsin.

SELL Titania gems. Far more brilliant  
than diamonds. Catalog 10¢. Diamonite,  
2420-M 77th, Oakland 5, California.

VENDING Machines—No selling. Oper-  
ate a route of coin machines and earn  
amazing profits. 32-page catalog free.  
Parkway Machine Corporation, Dept. 27,  
715 Ensor Street, Baltimore 2, Maryland.

DOLLARS Every day! It's magical—  
You keep all the dollars. Setup free. Otto  
Miller, Box 588-W, Oshkosh, Wis.

JOIN The prosperity parade with a mail  
order bookshop in your own home. Valu-  
able information free. Practical Publica-  
tions, 3974-F Milwaukee, Chicago 41, Ill.



WE Pay \$3.50 lb. dried. Grow mushrooms. Cellar, shed and outdoors. Spare, full time, year round. We have 25,000 customers. Free book. Washington Mushroom Ind., Dept. 173, 2954 Admiral Way, Seattle, Wash.

**HOMEWORKER** Magazine, published continuously since 1940, brings you profit and pleasure ideas. Sample 10¢. Homeworker, 20 East Delaware, Chicago 11, Ill.

**MUSHROOMS** Quicker, easier, cheaper. Newest facts free. Spawn \$1.00. Luxur, 641 South 19th, Newark 3, N. J.

"**TIMELY Tips Magazine**," Paulding, Ohio, publishes moneymaking opportunities, ideas, promotional plans, monthly, 25¢. 32nd year, \$2.00.

**TURN** Your snapshots, photographs into money! Send \$1.00 for "How and Where." Donovan, 10524 Tantau, Cupertino 1, Calif.

**FAST** Profits the easy way! Make and sell costume jewelry. Details free! Write Modern Craft, Box 11088-PM, St. Petersburg 33, Florida.

**ATTENTION** Florists, novelty, souvenir shops. Longleaf pine cones for sale. Dried, about 8" high, 10" circumference. \$12.00 per 100. Sample carton 10 cones \$2.00 postpaid U.S.A. Hallsboro Mfg. Co., Inc., Hallsboro, North Carolina.

**JOIN** Cooperative moneymaking mail opportunities service. Bayou Enterprises, 119 North Sterling, Lafayette, Louisiana.

**HOTTEST** Mail order plan ever! Sell photos, films, art novelties. Huge proven profits! Free details! Profits Unlimited, Dept. 1H, 15015 Ventura Blvd., Sherman Oaks, California.

**TRUE** Wholesale! No service charge. No minimum. Name brands! Big stock. Catalog \$1, refundable. House of Better Buys, Mail Dept., 722 East Silver Spring, Milwaukee 17, Wisconsin.

**BIG** Money earned while asleep! Neighbors think I struck oil! Unbelievably easy. Details \$1.00 (refundable). Grant, Grant-ham, Penna.

**SELL** Snowballs. You make them. 400% profits. Outfits \$5.00 up. Postpaid. Catalog. Snowball, 9534-P Lemturner, Jacksonville 8, Florida.

**AMAZING** Offer: Send 10 cent stamp. Jack Bester, deDeur, Transvaal, South Africa.

**HAME** More money without extra work, by preventing common losses, avoiding hidden costs in daily living. New guidebook tells how. 14 sections; 200 practical pointers. Only \$1.00. Information free. Visor Publications, 19-A Brooks Bldg., Ann Arbor, Mich.

**RECEIVE** More money by mail. Our mailorder idea kit shows you how. It's jam-packed with moneymaking opportunities. Only 25¢ postpaid. Payne's, 162-P McKittrick, Kentville, N. S., Canada.

**NEW** 7"x11" Signs. Comedy, religious, general, 7¢, sell 50¢. Catalog free. 15 samples, \$1.00. Lowy, 812 Broadway, Dept. 971, New York City 3.

**IF** You need additional income, then you need this book. "How You Can Make More Money by Mail." Price \$1.50 ppd. Satisfaction guaranteed. Or send 10¢ for complete information. The Carlsons, 10701 S. Central Park Ave., Dept. PM, Chicago 43, Illinois.

**MAKE** Money! Read "53 Money Making Ideas" and "Ways to Success." Both \$1. Jones, 4331 Talofa, N. Hollywood, Calif.

**30 PROFITABLE** Publications; books, \$1.00. Big mail listing 25¢. Lewis, 8 Scott, Utica, N. Y.

**FREE** "4000 Word Report" on new depression-proof business opportunities. Fortune Enterprises, Addison, Illinois.

#### EXPORT — IMPORT

**IMPORTS.** Hunting knives, cuckoo clocks. Free list. Virginia World Trade Co., Centerville, Virginia.

#### FORMULAS. PLANS. ETC.

**FORMULAS** For latest money-making discoveries. New! Good! Valuable literature free! Miller, Chemist, 1517-D, Tampa, Florida.

**FORMULAS:** All kinds, latest, best. Literature free. Kemixal, Park Ridge, Ill.

**FREE** Large formula catalog. Big surprise. Western Chemical, Salem, Oregon.

**10,000 AUTHENTIC** Formulas. Lists, valuable information free. Brockway, Gage Building, Topeka, Kansas.

**PRACTICAL** Formulas. Lists free. Cummings, Chemist, Gordon Ave., Syracuse 4, N. Y.

**LATE,** Modern manufacturing formulas. List free. Moon Chemical, Martville, New York.

#### PLASTICS

**PLEXIGLAS.** Square foot cost, 1/16", \$1.20; 1/8", \$1.52; 3/16", \$1.86; 1/4", \$2.21; 3/8", \$3.23; 1/2", \$4.36. Colors add 10%. Send 15¢ for postage. Artistocrat Plastics, 23 Sussex Avenue, Newark, N. J.

**LEARN** Plastics fabrication for spare time income. Low cost home training now available. Write for free booklet. Interstate Training Service, Dept. D-3, Portland 13, Ore.

**LAMINATING** Supplies. Free price list. Solomonson, 46 Cornhill, Boston 8, Mass.

**BOXES,** Plastic. Free list. Althor, 170 Bay 23 Street, Brooklyn, N. Y.

**PLEXIGLAS.** Acetate, vinylite, polyester, fiberglass, epoxy, styrofoam, mold materials. 28 page instructive, informative wholesale-retail catalog. 25¢. Gem-O-Lite, 5527 Cahuenga Blvd., North Hollywood, California.

**NEW** Liquid casting plastic, clear, colors. Embed real flowers, coins, photos. New Manual shows fine things you can make at home and sell at big profit. Send 25¢. Castolite, Dept. D-101, Woodstock, Illinois.

**SIMPLE** Instructions. Casting beautiful plastic sign letters. Bunsey, 1920 Warren, Davenport, Iowa.

**PLASTICS!** Casting, molding and modeling. Complete outfits, molds, jewelry, accessories. Send 25¢ for catalog and beautiful plastic novelty. Castacraft Corp., Dept. M480, P.O. Box 555, Palo Alto, Calif.

**PLASTIC** Sealing cards, etc., by machine. Permanize, 330 East Center St., Kalamazoo, Mich.

**CAST.** Embed, laminate, your ideas into dollars. Thousands of products easily made. Over 70 materials, liquid foam, rubber, aluminum, ivory, glass. Formulas, manufacturing methods, mold construction included in catalog. Send 25¢. Gel, Box 261, Union, N. J.

#### CHEMISTRY

**CHEMICALS** And apparatus for industrial, analytical, and private laboratories. Catalog 25¢. Dept. M-50, Biological Supply Co., 1176 Mt. Hope Ave., Rochester 20, N. Y.

**EXPERIMENTERS:** Bargains catalog, 25¢ (refundable). Hagenow Laboratories, 2414 Clark, Manitowoc, Wisconsin.

**ILLUSTRATED** Catalog: Chemistry, mineralogy, biology 25¢. Tracey Laboratories, Evanston, Illinois.

**APPARATUS** Bargains. Timers, pressure gauges, stainless steel vessels, hygrometers, magnifiers, others. Free list. Andrew Tech, 7068 N. Clark, Chicago 26, Ill.

**ROCKETS!** Large, comprehensive volume, color illustrated; \$1.95. Fabian's, 4370-P Clark, Montreal 18.

**CHEMICALS** In small quantities. Chemistry and apparatus sets. 28th year. Catalog 25¢. John H. Winn, 124M West 23 Street, New York 11, N. Y.

**CHEMISTRY-Science** magazines. Literature free. Lankton, Box 5126-C10, Lansing 6, Michigan.

**CHEMICALS.** Glassware catalog. 25¢. Laboratory Sales, Box 161-A, Brighton, Mass.

#### HELP WANTED

**SMALL** Southwest college with excellent research facilities is seeking the services of experienced research scientists and engineers. Salary competitive. Excellent climate for health seekers, outdoor recreation, including hunting, fishing, swimming, rock hunting, and golf. Direct letter of application to Arthur P. Stanton, Personnel Manager, Campus Station, Socorro, New Mexico, describing qualifications and salary requirements. Include recent photograph.

#### AGENTS WANTED

**BIG** Profits. Stamp social security plates, key protectors. Sample 50¢. Catalog free. General Products, 188-PM State, Albany 10, N. Y.

**CASH** Commissions at once, taking orders for magazines every family wants! No experience needed. For free moneymaking kit, with everything you need, write McGregor Magazine Agency, Dept. 300, Mount Morris, Ill.

**FREE** Sample! Beautiful feather pictures. Siviak, Apartado 9036, Mexico 1, D. F.

**AGENTS** — 300% Profit selling genuine gold window letters; stores and offices. Free samples. Metallic Sign Letter Co., 1217-D West Newport, Chicago.

**YOUR** Ad in this space will get some good agents for you. Yes, I'll prove it. Write for Folder "A" right now. F. W. Johnson, Classified Advertising Manager, Popular Mechanics Magazine, 200 E. Ontario St., Chicago 11, Ill.

**GOLD** Or silver letters, numbers. Windows, doors, trucks. 1" to 6". 500% profits. Free samples. Atlas-T, 544 West 79th, Chicago 20.

**PRINTING.** Advertising salesmen—Excellent moneymaking sideline selling decalcomania name plates, small quantities. Automobile initials, sign letters. Free samples. Ralco, XL, Boston 19, Mass.

**EASY** Handwork makes fast-selling useful articles. Sample free. Sunmade Company, Brockton 64, Massachusetts.

**GOLDMINE** Of 600 money makers. Free copy. Specialty Salesman Magazine, Desk 5B, 307 North Michigan, Chicago 1, Ill.

**IT'S** Easy to sell our big line business printing, calendars, advertising specialties and political advertising. Big cash commission each sale, even first day. Full or part time. Experience unnecessary. Prospects unlimited. Big sales kit free. National Press, Dept. 6, North Chicago, Illinois.

**RUN** A spare-time greeting card and gift shop at home. Show friends samples of our wonderful new 1958 all-occasion greeting cards and gifts. Take their orders and earn up to 100% profit. No experience necessary. Costs nothing to try. Write today for samples on approval. Regal Greetings, Dept. 42, Ferndale, Michigan.

**\$13.50 HOURLY** Profits possible, introducing 5 valuable farm books your area. Published by Popular Mechanics. Farmers buy on sight. Details free. Popular Mechanics Press, 200 E. Ontario, Dept. 64-B, Chicago.

**SELL** Key-Back, recolling key chain. Particulars free. Weinberger, Columbus, Wisconsin.

**MEN-Women** agents: Sensational new moneymakers — Beautifully hand-painted, plastic personalized photo enlargements, compacts, rings, bracelets, lockets, etc. Simply take orders, pocket 40% commission. We deliver and collect. Sales outfit free. Novelco, 3343 North Ave., Chicago 47.

**MEN, Women,** make money spare time plus new car given to producers as bonus. Amazing hosiery guaranteed to wear without holes, snags and runs, or replaced free. For example, lovely 60 gauge nylons, guaranteed for as long as 1 1/2 years, or replaced free. Write Wilknit, 1784 Wash., Greenfield, Ohio.

**YOUR** Own business — Used suits \$1.50, overcoats 65¢, mackinaws 35¢, shoes 12 1/2¢, ladies coats 30¢, dresses 15¢. Enormous profits. Catalog free. Nathan Portnoy Associates, 2109-AA Roosevelt Road, Chicago 8.

**NEW** Car thief signal. Lightning seller. Samples sent on trial. Northwest Electric 2, South Dakota.

**EARN** Extra money! 16 proven plans. Free facts. DeLuxe Press, Lorain 2, Ohio.

**HAWAIIAN** Candy and gift items. Maier Products, 3109 Waialae, Honolulu.

**SEEKING** New products? Get my outfit 47 money-making specialties. Latest conveniences for home, car. Send no money. Just your name. Kristee 80, Akron, Ohio.

**60% PROFIT** On cosmetics — Famous nationally advertised Hollywood cosmetics pay 60%. Make \$25 day up. Hire others. For free samples, details, write Studio Girl, Glendale, Calif. Dept. 1284G.



**PART**, Full time or by mail. 250% mark up for \$1.00 item needed in every home. Volume Sales Co., 41 Fenway Street, Stamford, Conn.

**MAKE 100% Profit** every time you push a button! Quickie Spray shines all shoes instantly without daubing, brushing, buffing. Be first! Rush refundable dollar for demonstrator, selling kit. Franchises available. James R. Barnet Co., Dept. PM-48, Wellesley Hills 81, Mass.

**EARN \$10,000 Yearly**—Only two sales daily. World's best seller, The Holy Bible. (Illustrated) Protestant or Catholic. Margareta's, P.O. Box 92, Hazleton 7, Penna.

**CURTAIN Rod starter**. Fast seller. Advance, 2414 Woodway, Dayton 6, Ohio.

**STOP Auto thieves**. Amazing invention does it. Prevents slightest tampering with car. Autoists wild about it. Guarantees perfect safety. Sells fast. Brings big profits. Complete details free. Gregory Sales Company, 316 Marion Building, Cleveland 13, Ohio.

**DAMASCENE Earrings!** Exotic orientalism. Huge profit. Ohga, PM108, Sigakenkusatu, Japan.

**\$25 DAY**, Easy. New fire extinguisher. Retail \$2.95. Profit \$2.00. Free sales kit. Edconco, 155 East 44th Street, Dept. P4, New York 17, New York.

**MAKE \$100** And more a week easily with new office and home necessity. 110% profit! Free details and sample offer. Amberland, 277 W. 2nd, S. Boston, Mass.

**MOTION Maps**. Action, color, real attention getters! Everybody wants one. Triple mark-up. Retail 25¢. Send 25¢ for samples, etc. Dept. 8, H and K Co., 4505 State Line, Kansas City, Mo.

**SENSATIONAL!** Make \$50.00 day. Write for details. National Distributing, 1751 W. Flagler St., Miami 35, Fla.

**1500% PAID** For introducing amazing Octa-Powr. Carburetor bolt-out. Materials and instructions only \$1.00. No inventory. Beach, 16220 Benwick, PM4, LaPuente, Calif.

**EZY Clothesline reel**. Easily demonstrated. Delights women. Quick sales. Distributors goldmine. Free details. Reel Engineering, 1830 19th St., Wyandotte, Mich.

**NEW Upholstery cleaner**. Wipe on, wipe off. Free literature. Star Upholstering, 934 Braddock Avenue, Braddock, Penna.

**SELL Retailers and distributors** fantastic new toy rocket. Shoots 85 to 100 feet up. 100% safe. Three feet tall. Performs three amazing feats. Destined to sweep the country. For complete sales plan and sample (postg. pd.) send \$3.50 to M.C.B. Products, 1214 S. Sheppard St., Indianapolis, Indiana.

#### BUY IT WHOLESALE

**MY Six 80% money-saving catalogues**. Amos Mail Order, Yountville, Calif.

**NEW Wholesale buyers guide**, \$1.00. King, 393 Strasser, Nashville 11, Tenn.

**BUY Wholesale!** Discounts to 80%! Gifts, appliances, housewares, tools, watches, etc. Midwest, IMP-156, Pontiac, Illinois.

**USED** And new watches \$2 up. Free list. Southern Watches, 5-PM So. Wabash, Chicago 3.

**ELECTRIC Guitars, amplifiers**. Wholesale. Free catalog. Carvin PMW, Covina, Calif.

**5 WHOLESALE Bargain price catalogs**: During the year, clothing for entire family, sheets, blankets, towels, kitchenware, drug sundries, jewelry, notions, appliances, luggage, vitamins, toys, novelties, fans, gift items, watches, clocks, school supplies, tools, color television screens, cushion vibrators, televisions, radios, high-fidelity phonographs, specials, close outs. (Over 1500 items). Discounts to 75%. Rush \$1.00 deposit, refundable. Broehm Products, M-2569 North 12th Street, Milwaukee 6, Wisconsin.

**RAZOR Blades**, double edge, packaged individually in 100 blade display boxes. 1 box \$1.00. Home Ideas, 204-M, Short Hills, N. J.

**FREE Wholesale price catalog**. Swiss watches at Swiss prices. Appliances, books, jewelry, cookwares, tableware, cutlery, etc. Discounts to 80%. Tony Distributing Co., 135-P So. 13 St., San Jose, California.

**BIG Multicolor wholesale catalog!** Housewares, appliances, clothing, silverware, cookware, luggage, binoculars, radios, phonographs, cameras, recorders, projectors, typewriters, shavers, sporting goods, toys, tools, sewing machines, watches, jewelry. Name brands. Huge discounts. Postcard: Selbyco, Decatur 155, Illinois.

**BUY Wholesale!** 25,000 nationally advertised products. Get amazing dealer catalogs. Complete details free. American Wholesalers, 1841-C Levee, Dallas 7, Texas.

**WHOLESALE Price list free!** Save 50%! Appliances, cameras, sporting goods, housewares, hardware, jewelry, clothing, gifts, etc. Buy-Rite, Hawthorne 61, New Jersey.

**WHOLESALE!** Appliances, tools, clothing, etc. Free catalogs! United Wholesalers, 1265-M Broadway, New York 1, N. Y.

**HANDMADE Cowboy boots**. Free catalog. 40 styles. Hall Boots, Box 7302, El Paso 5, Texas.

**DIRECTORY** Of wholesale printing and office supplies, \$2.00. King, 393 Strasser, Nashville 11, Tenn.

**DIAMOND Rings wholesale**. Write Midtown Distributors, Box 1656, Worcester 7, Mass.

**BULOVA**, Benrus watches, like new. \$4.95 up. Illustrated folder, 200 illustrations free. Dept. 116, Cosmos, 81 E. 125th St., New York City.

#### SALESMEN—DISTRIBUTORS

**AD Matches!** Sell amazing designs—10, 20, 30, 40 and 240-light book matches. Bigger spot cash commissions; every business a prospect. Low prices for high quality. Repeats. Start without experience; men, women; full, part time. Buy nothing! Sales kit furnished. Match Corp., Dept. PM-100, Chicago 32, Illinois.

**SELL: Sing Sing bug chairs**. Effective, harmless, electric insect control. No gasses. Three daily sales, \$300.00 weekly. Good Harbor Pursuits, Lake Leelanau, Michigan.

**CALLING** On businessmen? Low-priced printed envelope line can pay you \$67.50 extra profit weekly without extra calls! Free sample outfit. M. P. Brown, Inc., 424 N. Third, Burlington 30, Iowa.

**FAST Money-maker**—New development. Uniforms advertise 24 hours a day. Exclusive with Master. Name, emblem glow in dark. Free outfit. Master, P-19 Water, Ligonier, Indiana.

**BUSINESS Kit free!** Postcard puts you in business! Complete line 230 shoe styles, also jackets! New discoveries pay big commissions. No investment. Send for free kit. Mason, Chippewa Falls 71, Wis.

**MAKE Extra money**. Cash commissions. Everybody buys easy-to-sell advertising book matches. Union label. All sizes. Cuts for all businesses. Powerhouse selling kit free. Steady repeat business. No experience necessary. Superior Match Co., Dept. M-458, 7528 S. Greenwood, Chicago 19.

**SIMPLE** Demonstration of our new invention amazes business and professional men. Write to Frank Brown, Jr., Dept. P-1, Box 97, Milan, Missouri.

**IF You're interested** in making money in selling, see the hundreds of exceptional opportunities in Salesmen's Opportunity Magazine. Send name for your copy, absolutely free. Tell us what you're selling now. Opportunity, 848 N. Dearborn, Dept. 17, Chicago 10, Illinois.

**WHOLESALE Distributors and wagon jobbers** wanted. Call on automotive and service garages and stations. A line that you can sell on every stop. For information write Continental Mechanics Research Corporation, Box 175, Madison, Indiana.

**AUTOMOTIVE** And plumbing jobbers, salesmen, distributors—Fantastic profits with 8 revolutionary new products. Tremendous market. High repeat. Nonseasonal. Free details of factory distributorship. Conklin, Inc., Box 5628, Nokomis Station, Minneapolis, Minn.

**SELL New Squeezit paint roller, scraper, cleaners**, to paint and hardware dealers. Write: Basala Products, 3213 Bagley Ave., Detroit 16, Mich.

**MAKE Big money** selling the Security hand pressure dry chemical fire extinguisher. Information free. Hurry. Hudson Mfg. Co., Sheridan 6, Michigan.

**200 LAZY Salesmen** wanted. Terrific deal. Ohfoco, No. Madison 5, Ohio.

**MANUFACTURER** Wants distributors for body shop supplies. Repeats weekly. Universal Products, 11709 Nebraska Ave., Tampa, Florida.

**10¢ COMIC Books** 1¢ each. Regular newsstand approved titles. Publishers surplus, coverless. Packed 100 assorted titles in counter display box. Retail 5¢ a book. Minimum shipment 20 boxes, f.o.b. Sample box \$3.00 prepaid. Payment with all orders. Build route business selling stores. Comic Books, Box 49M, Shamokin Dam, Penna.

**TREMENDOUS Profits!** Amazing new "Wonder Shoe Shine Spray." Send for sample \$1.00, dozen \$9.85. Protected territories. Details free. Princeton, 300P Northern Boulevard, Great Neck, N. Y.

**TAKE** Over your area as a service distributor keeping retail stores supplied. Our nationally advertised 27-year old line gives you 66 $\frac{2}{3}$ % mark-up. Tremendously successful money-making plan. Write G. U. Harris, c/o Novo, 1166 Milwaukee, Chicago 22, Ill.

#### EMPLOYMENT INFORMATION

**CALIFORNIA** Employment information free. Letters remailed 25¢. Rains, 5621 Gracewood, Arcadia, California.

**DETROIT** Help wanted mailed \$1.00. Letters remailed, 25¢ each. Neubauer, 37550—31 Mile, Richmond, Mich.

**HIGH** Paying jobs, opportunities, foreign, U.S.A. All trades. Companies pay fare. For information write Dept. 573, National Employment Information, 1020 Broad, Newark, New Jersey.

**AMAZING** New plan free! "How To Retire at Age 21." Men or women over 21 can retire now. Shows how you can prepare for life of leisure if you're under 21. Bob Belmont, Box 258, Hawthorne 6, N. J.

**GOLDRUSH!** Jobs unlimited. High pay. Romantic, booming San Francisco area. Classifieds, map, \$1.00. Bonanza, Canyon, California.

**PACIFIC Northwest**—America's last employment frontier. Earn good pay; healthy climate. \$1 rushes you 100% bona fide employment opportunities. Advancement, 218 Builders Exchange Building, Portland, Oregon.

**JOBS** Aplenty, highest pay, greater Chicago classified listings, \$1. Hartford, 5345 Halsted, Chicago 9, Illinois.

**JOBS** In California. All ages! Need hundreds of guards, unskilled laborers, mechanics, drivers, clerks, draftsmen, salesmen, and many others. Name your job! \$300 to \$900 per month. Rush \$2.00. Satisfaction guaranteed or money refunded. Personnel Consultants, 2018C Channing Way, Berkeley, California.

**FOREIGN** Jobs—Latin America, Alaska, Canada, up to \$1500 monthly. Up-to-date 1958 foreign service directory gives complete information; hot list of firms hiring for military and civilian construction, aircraft, oil, exporters-importers, mining. How-when-where to apply. 11th successful year. \$1.00. Global Reports, Box 8873-S, Los Angeles 8, Calif.

**JOBS** On merchant ships. Big pay. Box 4092, Jacksonville, Florida.

**JOBS** Overseas! Janeczek Development Co., 1090 Hub Station, New York 55, N. Y.

**FOREIGN, Domestic jobs!** Big money! Men and women. Skilled and unskilled. Latest dependable information from one who has actually worked many years abroad \$2.00 (Airmailed \$2.25). Parks, Box 1665, Lake City Station, Seattle 55, Wash.

**FLORIDA'S** Booming. Hundreds big pay jobs. Copyrighted statewide analysis, free contacts, airmailed \$2.00. Sun-Glo Service, Perry 5, Florida.

**CALIFORNIA** Employment lists. Los Angeles, San Diego. \$1.00 each. Special "non-skilled" lists and California map included. Calemployment, 844 Oaklawn, Chula Vista 2, California.

**CALIFORNIA**—Jobs, opportunities. Interested? For details—write Chesley, 3977 $\frac{1}{2}$  Texas Street, San Diego 4, California.

**CONSTRUCTION** Workers, truck drivers, tradesmen, equipment operators, business workers, professionals, others: British Columbia, North America's last great frontier, is under major development and expansion. For latest pertinent information write Opportunity News Service, Dept. M, Drawer 1509, Kelowna, B. C., Canada.



**COPYRIGHTED Reports on best paying jobs with travel, adventure, promotions. Construction, aviation, shipping, laborers, clerical, trades, supervisory, factory, unusual opportunities. Many types of work. Skilled and unskilled. Foreign and state-side openings for men and women. Only \$2.00 (\$2.25 airmail), including registration-advisory service. Satisfaction guaranteed. Included absolutely free: Special reports on Alaska, Spanish airbase construction, South American opportunities and husband-wife foreign jobs. Research Services, Suite 514-PMB Meramec Building, St. Louis 5, Missouri.**

**REAL Job opportunities—Texas and Southwest. Latest weekly reports on jobs for mechanics, machinists, technicians, engineers, trades, sales, office. Satisfaction guaranteed. Airmailed \$3.00. Rhines, 11337 Flamingo, Dallas 18, Texas.**

**AMERICAN Overseas jobs. High pay, men, women. Transportation paid. Free information. Transworld, Dept. D, 200 West 34th St., New York City 1.**

**LATIN American employment and investment opportunities. Have a job or business in South America or Mexico. \$3.00 for airmail details. Latin American Trade Consultants, Box 5273, Guayaquil, Ecuador.**

**ALASKA Bound? Don't be deceived! Resident 8 years, many locations. Living costs, all questions. \$2.00. Bill McKay, Box 539, East Falmouth, Massachusetts.**

**TO Construction men: Extensive, detailed project report now available for U.S.A., Canada, Alaska, in the following fields. Refinery, chemical, petro-chemical, mining, oilfield, pipeline construction. \$5.00. Comet Publishing Co., Box 1351, New York 1, N. Y.**

#### SPECIAL SERVICES

**BOOKKEEPING, Taxes by mail. Free information. Write "Mail-Me-Monday," 920 Van Buren, Milwaukee 2, Wis.**

**INFORMATION On anything. Ferguson Research Specialists, 116-14 141 St., South Ozone Park 36, N. Y.**

**INFORMATION Secured, papers prepared, addressing. Burton, 509 West Pointsett, Greer, South Carolina.**

**TRANSLATIONS Made—Accurate, fast, reasonable. Translations, 44 Thirteenth, Paterson 4, New Jersey.**

#### EDUCATIONAL AND INSTRUCTION

**LEARN By ear with Dormiphone. While you sleep, amazing new scientific invention works for you. Revolutionary Dormiphonic tools give you a shortcut to learning languages, correct speech; memorizing facts, figures; ideal for self-improvement, relaxation, habit training. Saves time, effort. So simple to use, children benefit. Used by educators, psychologists. Write for fascinating free book. No obligation. Modernophone, Inc., 320-048 Mezz., Radio City, New York City 20.**

**MEN Wanted age 19 to 45 to train as builders, estimators and contractors at home in spare time. Big pay opportunities. Write for free brochure. American Technical Society, 850 E. 58th St., Dept. PM-584, Chicago 37, Illinois.**

**LEARN Arc, gas, heliarc welding spare time at home. Big pay trade. Easy practical training covers metallurgy, latest techniques, short cuts, metal repairs, etc. Free booklet. Write Utilities Engineering Institute, Dept. WC-17, 2523 Sheffield, Chicago 14.**

**LEARN Civil and criminal investigation at home. Earn steady good pay. Institute Applied Science, 1920 Sunnyside, Dept. 164, Chicago 40, Ill.**

**NEED Educational or vocational help? Free questionnaire. Educational Advisors, 227 Sweetbriar, Paramus, N. J.**

**STUDY To be a doctor of psychology, metaphysics, divinity or philosophy. Correspondence courses only. The Neotarian Fellowship, Desk 9, Kansas City 6, Mo.**

**COMPLETE Your high school at home in spare time with 61-year-old school. Texts furnished. No classes. Diploma. Information booklet free. American School, Dept. X445, Drexel at 58th, Chicago 37, Illinois.**

**AMAZING New plan free! "How To Retire at Age 21." Men or women over 21 can retire now. Shows how you can prepare for life of leisure if you're under 21. Bob Belmont, Box 258, Hawthorne 7, N. J.**

**IT'S Fun learning a language by Lingua-phone, world's standard conversational method. At home, quickly, easily learn to speak French, Spanish, German, Japanese, Russian, Icelandic, Modern Greek—your choice of 34 languages. It's like living in another country. Complete recorded courses on free trial. Send for free book and details. No obligation. Try, don't buy! Linguaphone Institute, T-83-048 Radio City, New York 20.**

**LEARN Mineralogy and lapidary art at home. Diploma course. Earn big profits making costume jewelry. Free catalogue. Mineral Science Institute, Desk 2, 159 East Ontario, Chicago 11.**

**WELDERS Earn big money. Easy to learn arc, gas, automatic welding. New equipment, low cost training in non-profit school. GI approved, free booklet. Hobart Welding School, Box M-481, Troy, Ohio.**

**PIANO Lesson taught by tape recorder. Write: Ray Ellerman, Box 452, Weillston Station, St. Louis 12, Mo.**

**EARN Degree. Free bulletin. Home-study only. Midwestern Bible School, 1060 Broadripple, Indianapolis.**

**MASTER Watchmaking at home. Free sample lesson. Chicago School, 2328-YD Milwaukee, Chicago 47.**

**BECOME An efficiency expert. Learn what to do. Seven papers \$19.00. Personal advise. Free literature. Box 9-A, Baldwin Park, Calif.**

**PIANO Tuning pays. Big money in spare time. Learn at home in 30 days. No musical knowledge necessary. Phonograph, records, tools and instructions furnished. Personal instructions available. Free catalog. Capital Piano Tuning School, 3100 S.W. 18th Court, Fort Lauderdale, Fla.**

**LEARN Mail order publishing. Free details. Rainone Printer, Middle Village 79, New York.**

**ENGINEERING Degrees earned through home study. Residence courses also available. Pacific International University, (operating as a College of Engineering only at present), 5719-B Santa Monica Boulevard, Hollywood 38, California.**

**HIGH School diploma at home. Licensed teachers—Approved materials. Southern States Academy, Box 5344-MX, Station E, Atlanta, Georgia.**

**WE Pay \$3.50 lb. dried. Grow mushrooms. Cellar, shed and outdoors. Spare, full time, year round. We have 25,000 customers. Free book. Washington Mushroom Ind., Dept. 174, 2954 Admiral Way, Seattle, Wash.**

**BOOKKEEPERS! Increase your earnings! Operate your own simplified "Dollar-A-Week" bookkeeping and tax service. Full or spare time. Details free. No obligation. Ellis, Box 200, Cedar Grove, North Carolina.**

**BE A real estate broker. Study at home. Send for free catalogue. Midwest School of Real Estate, 68 North Chicago Street, Joliet, Illinois.**

**TIMESTUDY—Your key to positive personal profits. Associated Techniques, Box 235, Hollidaysburg, Penna.**

**LEARN Appliance service and repair. Motors, washers, refrigeration, cleaners, everything. Free booklet. Armstrong, 11027-A South Vermont, Los Angeles 44.**

**STUDY For Doctor's degree of psychology, metaphysics and divinity. Correspondence courses only. College of Divine Metaphysics, Dept. P-M, 2811 North Illinois, Indianapolis 8, Indiana.**

**BE A real estate broker. Study at home. Write for free book today. GI approved. Weaver School of Real Estate, 2018P Grand, Kansas City, Missouri.**

**USED Correspondence courses and books sold and rented. Money back guarantee. Catalog free. (Courses bought.) Lee Mountain, Pisgah, Alabama.**

**EARN While you learn. Auto and diesel mechanics master this top paying trade. Many graduates earn \$100 a week and up. Approved for Korean veterans. For free information write Dept. No. 256, Nashville Auto-Diesel College, Nashville 3, Tenn.**

**WANT A diesel job? New opportunities to increase income. Higher pay. More money. We can help you qualify. Tools. Shop method home training. Write today! Diesel, Tractor, Heavy Equipment Division. Interstate Training Service, Dept. B-3, Portland 13, Oregon.**

**PIANO Tuning pays. Learned easily at home. GI approved. 59th year. Free booklet. Niles Bryant School, Dept. P, 3731 Stockton, Sacramento 20, Calif.**

**INVESTIGATOR Training. Secret Service System. 1917-B Weth, Chicago 39.**

**SECRET Investigation. Experience necessary. Investigators particulars. George Wagner, M125 West 86th, New York 24.**

**SING, Speak, with power, personality. Self-training records. Amazing details. Canfield, 2018-A 5th Ave., South, Minneapolis 4, Minn.**

**PHYSICAL Therapy and massage. Home training. Practice privately or work with doctors and hospitals. Free catalogue. National Institute, Desk 4, 159 E. Ontario, Chicago, Ill.**

**HANDWRITING Analysis now accepted in college, business, industry. Our men, women who use grapho analysis spare, full time earning more money, getting prestige, success, happiness. Uncrowded, fascinating field for intelligent men, women anxious to get ahead. We need more members. Investigate this growing field where you give a real service to your fellow man. Opportunities unlimited. Free sample lesson and information to all over 21. Write today! IGAS, 2307 National Station, Dept. 1014, Springfield, Missouri.**

**EARN College degrees, correspondence. Metropolitan University, Box 86-M, Glendale 5, California.**

**ENGINEERING. Home study. Midwest Engineering School, 10923 Hillcrest, Hickman Mills 34, Missouri.**

**BE An investigator. Write for free details. State age. National Detective Academy, Dept. P, P.O. Box 1082, Scottsdale, Arizona.**

**ANALYZE Handwriting for profit! Complete outfit \$1.00. Box 1352-G, Philadelphia 5.**

**\$1,000 MONTHLY Possible in collection agency business. Write Cole Associates, Sak Bldg., Syracuse 2, N. Y.**

**TYPING Learned in 90 minutes! Complete course \$4.95. Tuch-Rite, 37 South 13th, Philadelphia 7, Penna.**

**BOOKS. Free general catalog, 100 pages. Text, vocational, educational, instructional subjects. Millions of volumes, new and used. Bargain prices. Books bought. Est. 1902. Long's College Book Co., Dept. PM, Columbus 1, Ohio.**

**LEARN The Bible—Self training records. Free literature. Album Sales, Box 121, Cincinnati 24, Ohio.**

**FREE. Schooling, lodging, meals. Write Robbins, 1565—24th N.W., Canton 9, Ohio.**

**AIR Conditioning and refrigeration servicing made easy; simple instructions show you how. Auto air conditioning also covered. Send \$3.00 today. Paul Connolly, 919 S.W. 23rd Road, Miami, Fla.**

**"HOW To Read Blueprints With Estimating." Six day home study course. Gassin, Box 20591, Los Angeles 6, Calif.**

**HELP Wanted—Dental technicians. Simplified home study course. Work with a dentist, or have own laboratory, earn up to \$500.00, per week. Send for free booklet. The Denshire School for Dental Technicians, Box #762, Boston 2, Mass.**

**FIND, Organize, and direct your abilities for success via new, effective straight-line method, with creative personal collaboration. D. A. Wing, Croton Road, Newaygo, Michigan.**

**USED Correspondence courses, educational books. Money-back guarantee. Catalog 10¢. (Courses bought.) Bayles, 78 Courtright, Wilkes-Barre, Penna.**

**SWEDISH Massage, learn at home. Diploma. Dr. Swanson School Swedish Massage, Illinois licensed vocational school, 3809 Alta Vista Terrace, Chicago, Ill.**

**SPEECH Correction course—Proved method overcomes stammering. Send \$1.00 to Quimplan, 1034 Briarwood, Northbrook, Ill.**

**DRAFTING-Design: Architectural, mechanical, electrical, structural, aircraft, surveying. Mathematics-physics. Veteran approved. Mondell Institute, 230 West 41st, New York City.**

**BE An auctioneer. Home study course. Auctioneering, 103 N. 2nd, River Falls, Wis.**

**JET Pumps. Ten simple rules how to become a jet pump expert. Details \$1.00. Paylor, Water Consultant, 790 College Street, Jackson, Tennessee.**



\$150 WEEKLY Earned by advertising copywriters. Positions plentiful. Home study course guaranteed. Weekly payments. Ad-Writers Guild, Chester Springs 1, Pennsylvania.

### PLAYS, STORIES, MANUSCRIPTS

**WANT** Your book published? Learn how we publish, advertise, promote, distribute. Many successes. Free booklet P.M. Vantage, 120 West 31, New York City. Midwest office: 220 S. Michigan Ave., Chicago, Ill.

**AUTHORS**—Free brochure tells how your book can be published, nationally promoted, advertised. Write today! Bardley Hall Press, Dept. PM, 363 Lexington Ave., New York City 17.

**WANTED:** Book manuscripts, all subjects considered. Greenwich Book Pub., Attn. Mr. Zealand, 489 Fifth Ave., New York City.

### CARTOONING, COMMERCIAL ART, SHOWCARD & SIGN PAINTING, TATTOOING

**"HOW To Make Money With Simple Cartoons"**—A book everyone who likes to draw should have. It is free; no obligation. Simply address Cartoonists' Exchange, Dept. 94-C, Pleasant Hill, Ohio.

**PAINT Signs.** Use letter patterns and stencils. Many styles and sizes. Catalog 10¢. Berge Company, Gonvick, Minn.

**PAINT Signs**—Master die cut, outline letter patterns. Complete assortment 1½" to 12" high, prepaid \$2.00. Eyerly, 583, Newton, Iowa.

**LEARN Sign painting at home.** Free talent test. Ben Kerns, Box 813-PM, Greenville, S.C.

**YOU Can entertain with chalk talks.** Catalog 10¢. Balda The Cartoonist, Oshkosh, Wis.

**LEARN Sign painting with fascinating system.** Straley, 410 S. Western, Springfield, Ohio.

**COURSE In art and drawing, 46 lessons, \$2.00.** Free literature. Kamm Printing, Oshkosh, Wis.

**FREE Facts about our famous cartooning course.** No obligation. Cartoons-of-the-Month, Roslyn, New York.

**CARTOON Your way to success!** Internationally known instructor, Raye Burns, will personally teach you to create original, salable cartoons at home. Cost of course is very low. Write for free details. Raye Burns School, Box 3583-P, Cleveland 18, Ohio.

**LEARN Profitable, fascinating tattooing.** Free illustrated information. Zeis, 728-C Leslie, Rockford, Illinois.

**ANIMATION—How and why.** Commercial television needs animators. Earn \$10,000-\$15,000 yearly. Illustrated book shows how. Only \$1.98. Ross Enterprises, 3297 Bayfront Drive, Baldwin, New York.

### ADVERTISING AGENCIES, LETTER WRITERS, FOR ADVERTISERS

**ADVERTISE:** 24 Words, 100 Canadian newspapers \$5.50. Lists free. Advertising Bureau, 10511-C Springfield, Chicago 43.

**ADVERTISING.** Result-getting ads prepared, placed newspapers, magazines, radio, anywhere! Lowest rates. Catalogue free. Baker Advertising Agency, 189 W. Madison, Chicago 2.

**MAILING Lists** most any classification \$5.00 1000. Your circulars mailed with ours \$4.00 1000. Write for our literature. Dixie Mailers, King, N. C.

**WANT More business?** Here's an amazing opportunity to increase your sales. Talk to thousands of interested readers of "Mechanica Popular." Our Spanish Edition covers the Latin American countries like a blanket. They're real mailorder buyers. Classified rate 75¢ per word. Try an ad in our next issue. Classified Advertising Department, Popular Mechanics Magazine, 200 East Ontario Street, Chicago 11, Ill.

**SALESMEN:** Agents: Known mailorder buying consumers (men, women) gummed labels, \$9.00 thousand. Other classifications. Free folder. Brunell, 241 Grove, Montclair, N. J.

**WOMEN Mail buyers, 1000, \$2.00.** Other lists. Northwest, Medina 1, Washington.

**BEFORE Advertising**—Get instructive Ad-Guide and newspaper-magazine rate-book, free. Chicago Advertising Agency, Chicago 4.

**ADVERTISERS**—Your 25 inch ad in 300,000 circulation \$5.50. Webber, Box 321, West Palm Beach, Florida.

### RUBBER STAMPS AND OFFICE SUPPLIES

**8 HOUR Service, 3 lines \$1.00.** Guaranteed. Bassler, Ludlow, Mass.

**QUALITY Rubber stamps!** 3 lines \$1.00. Signature stamp \$3.50. Prompt service. Satisfaction guaranteed. Campfield, 14 Beaufort Circle, Springfield 4, Mass.

**GOOD Impressions pay, 3 lines \$1.00.** Guaranteed. Boardman, Houghton, N. Y.

**THREE Line office type or pocket case rubber stamp, \$1.00.** W. S. Atherton, Box 61, Randolph, Massachusetts.

**NEW 4 Pen Desk Master.** Same color ink as barrel. Red, green, blue, black. Gift, home or office. \$1.50 postpaid. Duffey Sales, Box 201, Mishawaka, Ind.

### TYPEWRITERS, DUPLICATORS, OFFICE DEVICES

**CHECK Protector, guaranteed—\$1.** I. R. Parsons, Riverside Drive, Huntington, W. Va.

**RECONDITIONED Typewriters, duplicating, printing devices, \$25.00 up.** Supplies. Appliances, DixieGraph, King, N. C.

### PRINTING, MULTIGRAPHING, MIMEOGRAPHING, GUMMED LABELS

**MIMEOGRAPHING**—New method, details free. Mary's, 1126 10th St., Des Moines 14, Iowa.

**BUSINESS Printing.** Top quality. Wholesale prices. A. Hanlon, Malvern, Penna.

**MIMEOGRAPHING.** Printing. Best quality, reasonable rates. Frajmdot (formerly Currier), New Lebanon Center, N. Y.

**PRINTING That makes an impression.** Hamel-Printer, 210 Fifth Ave., Suite 1102G, New York 10, N. Y.

**FREE Catalog, postpaid printing.** D M Press, Sebastopol, California.

**BUSINESS, Personal printing—Labels, rubber stamps, accessories.** Illustrated catalog, free! Brose, 196-A, Clerk, Jersey City 5, N. J.

**MIMEOGRAPHING—Letters, pricelists, formulas, instructions.** Lowest prices. Lem's Letter Shop, 5710 Stanton, Detroit 8.

**1500 PERSONALIZED 5/8"x1 1/2" Labels \$1.00.** Your 3 line name and address printed with blue ink on fine quality white gummed paper. Money back guarantee. Hamilton-Ward, Dept. 10B, Westfield, Mass.

**ADS Running under this heading sell printing.** Ask me for proof. I'll gladly send you amazing facts. Ask for Folder "P." F. W. Johnson, 200 E. Ontario St., Chicago 11, Ill.

**CIRCULARS! 1000 6x9 \$6.50.** Estimates anything, price list. Valaitis, Inc., 1705 South 2nd, Philadelphia 11.

**BUSINESS Cards, 1000 flat black \$2.75, engraved \$3.50.** Samples, Sales, 1333 Orchid Ave., Winter Park, Fla.

**1000 8 1/2"x5 1/2" LETTERHEADS or 2000 labels \$5.45.** Decco, Box 3315-M, St. Louis 3.

**UNIQUE Printing catalog, free.** Klifford, 545 North Oakland, Pasadena 4, California.

**OFFSET Printing, 24 hour service—\$6.75 1000 8 1/2"x11 National Letter, 251 W. 42 St., New York City 36.**

**500 6 3/4 ENVELOPES, Printed, \$3.50 postpaid.** Hickman Company, Coalgate, Oklahoma.

**500—6 3/4 ENVELOPES \$3.50 Postpaid;** statements same. Stanley Press, Lake Katrine, New York.

**OFFSET Printing, \$5.95—1000, 8 1/2"x11.** Demis Printing, 740 N. Long, Chicago 44, Illinois.

**5000 CIRCULARS Printed and mailed—\$9.50.** Heyer, 36-11 Raven, Levittown 33, New York.

**1000 PERSONAL Printed name and address labels in plastic container, only \$1.00 postpaid.** Travis Jackson, Box 87, Washington, Ga.

**ARTWORK, Trademarks, letterheads** professionally designed. Graphic, 726 Cedar Terrace, Columbia, S. C.

**150 SHEETS, 100 Envelopes, 50 correspondence cards** beautifully printed, 50 stickers. Everything \$2.98, guaranteed! Hildreth Industries, 1047 Inner, Schenectady 3, New York.

**SELL It by postcard—250 cards mimeographed one side, 80 words your copy, white or green stock \$3.75 postpaid.** Additional 100's 75¢. For printing address side, add \$1.50. Royal Trading Company, Box 821, Chicago, Ill.

**YOUR Name and address printed on gummed labels, 1000-3 lines \$1.00.** 15¢ each extra line. 1/2 x 1 1/2. Print clearly. No c.o.d.'s. Addison Mail Order, PMA-4, 1840 Addison, Chicago 13.

**1000 EMBOSSED Business cards \$2.99 postpaid.** Universal Arts, Scotch Plains, New Jersey.

**100 LETTERHEADS, 8 1/2"x11.** Watermarked, and 100 6 3/4 envelopes, carefully printed. \$2.00. Postpaid. Race Printers, Hudson, New York.

**1,000 BUSINESS Cards.** Raised letters, \$3.50. Samples. Pioneer, Island Park 12-PM, New York.

**SPECIALIZED Mimeographing—Letters, price list, samples.** A. M. Letter Shop, 2190 Harkins, Menlo Park, Calif.

### PRINTING OUTFITS AND SUPPLIES

**DO Your own printing. Save money.** Simple rules. We supply everything. Print for others; good profit. Raised printing like engraving too. Have home shop. Details free. Kelsey Presses, V-11, Meriden, Connecticut.

**PRINTING Presses, type, supplies, lists 3¢.** Turnbaugh Service, Mechanicsburg, Penna.

**MAKE Your own self-molding rubber stamps and printing cuts.** Flexirubber, Argyle 1, Wisconsin.

**RUBBER Stamp making presses, hydraulic operated, electrically heated.** Sizes 5"x8", 8"x12", 10"x15" starting outfits. All kinds supplies. Custom Manufacturing, 601 N. Jefferson, Springfield, Missouri.

**TYPE Cases, cabinets, from manufacturer.** Free catalog. King McKay Company, 23179 Telegraph Road, Detroit 41, Michigan.

### PATENT ATTORNEYS

**C. A. Snow & Co.—M427, Snow Building, Washington 1, D. C.** Registered Patent Attorneys. Write for information.

**CANADA—Ramsay Company Registered, 273 Bank Street, Ottawa, Canada.**

**INVENTORS:** Without obligation, write for information explaining the steps you should take to secure a patent. John Randolph, Registered Patent Attorney, 803 Victor Bldg., Washington 1, D. C.

**PATENTS, "Proof of Invention" free.** E. E. Vrooman, Registered Patent Attorney, 507 McKim Building, Washington 5, D. C.

**"INVENTOR'S Guide" and "Record of Invention" free on request.** Frank P. Ledermann, Registered Patent Attorney, 154 Nassau Street, New York City.

**INVENTION Record form free and "Patent Information Every Inventor Should Have."** Carl Miller, Registered Patent Attorney, Woolworth Building, New York.

**INVENTORS:** Learn how to protect your invention. Unless the inventor is familiar with patent matters, he should engage a competent registered patent attorney or agent to represent him. We are registered to practice before the U. S. patent office and prepared to serve you in handling your patent matters. "Patent Guide for the Inventor" containing detailed information concerning patent protection and procedure with "Record of Invention" form will be forwarded to you upon request—without obligation. Clarence A. O'Brien & Harvey Jacobson, Registered Patent Attorneys, 81B-D District National Building, Washington, D. C.

**INVENTORS—Take these preliminary steps toward patent protection.** Sketch and describe your invention. Sign, date and have this disclosure witnessed by two people who understand your invention. Have us make a preliminary search among U.S. patents already granted for similar types of invention. We report on the probable patentability of your invention and recommend your further course of action. Write for our instructive booklet, "Patent Protection for Inventors" and convenient "Evidence of Invention" disclosure form. Victor J. Evans & Co., 431-D Merlin Building, Washington 5, D. C.



**INVENTORS**—If you believe you have an invention, you should find out how to protect it. The firm of McMorrow, Berman & Davidson with offices in Washington, D. C., is qualified to take the necessary steps for you. Send for copy of our Patent Booklet "How to Protect Your Invention." We will also send you an "Invention Record" form. No obligation. They are yours for the asking. McMorrow, Berman & Davidson, Registered Patent Attorneys, 134-H Victor Building, Washington 1, D. C.

#### FOR INVENTORS

**INVENTORS!** Have you good patentable ideas? Write Mr. Metzler, 11 West 42nd, New York.

**INVENTIONS** Wanted now by my manufacturer-clients. Patented, unpatented. Write Gilbert Adams, Patent Broker, 80-A Wall Street, Financial District, New York City.

**INVENTORS:** Information on patent procedure furnished on request, without obligation. John Randolph, Registered Patent Attorney, 802 Victor Bldg., Washington 1, D. C.

**INVENTIONS** Wanted—27 years experience promoting patented, patent pending inventions. National Service Bureau, 3130 Meramec, St. Louis 18, Mo.

"**INVENTOR'S** Guide" and "Record of Invention" free on request. Frank P. Ledermann, 154 Nassau Street, New York 38, N. Y.

**PATENT** Searches \$5.00. 48-hour air-mail service. Invention protection forms free. Write Patent Engineering Service, 711 14th Street N. W., Washington 5, D. C.

**INVENTORS.** Don't sell your invention patented or unpatented until you receive our offer. Write Cowgill, Box 298, Marion, Ohio.

**PATENT** Searches \$5.00. 48-hour service. Free invention protection forms. Write Raymond L. Smith, Patent Searcher, 620 Sheraton Building, Washington 5, D. C.

**PATENT** Searches, including copies of nearest patents, \$6.00. Reports airmailed within 48 hours. More than 100 registered patent attorneys use my service. For free invention protection forms, write Miss Ann Hastings, P.O. Box 176, Washington 4, D. C.

**INVENTION** Record form free and "Patent Information Every Inventor Should Have." Carl Miller, Registered Patent Attorney, Woolworth Building, New York.

**GERMAN** Inventors' Post, monthly. Subscription rate \$6.00 yearly. Specimen copy \$1.00. Leibnizstr. 58, Berlin-West/Germany.

**INVENTORS:** Learn how to protect your invention. Unless the inventor is familiar with patent matters, he should engage a competent registered patent attorney or agent to represent him. We are registered to practice before the U. S. Patent Office and prepared to serve you in handling your patent matters. "Patent Guide for the Inventor" containing detailed information concerning patent protection and procedure with "Record of Invention" form will be forwarded to you upon request—without obligation. Clarence A. O'Brien & Harvey Jacobson, Registered Patent Attorneys, 81A-D District National Building, Washington, D. C.

**INVENTORS**—This firm is registered to practice before the United States Patent Office and available to assist you in the preparation and prosecution of your patent application. "Patent Protection for Inventors" booklet containing detailed information and steps to take toward patent protection sent promptly upon request. No obligation. Victor J. Evans & Co., 432-D Merlin Building, Washington 6, D. C.

**DEAL** Direct with manufacturers. Names furnished. Instructions, valuable information. Incline quarter. Standifer, 2645 Bartlett, Oakland 2, Calif.

**INVENTORS**—If you believe you have an invention, you should find out how to protect it. The firm of McMorrow, Berman & Davidson with offices in Washington, D. C., is qualified to take the necessary steps for you. Send for copy of our Patent Booklet "How to Protect Your Invention." We will also send you an "Invention Record" form. No obligation. They are yours for the asking. McMorrow, Berman & Davidson, Registered Patent Attorneys, 134-K Victor Building, Washington 1, D. C.

**IDEAS** Wanted for mail order business. Will produce, advertise and sell your invention. Reply Box 553, Pomona, Calif.

**INVENTORS**—Send for free Patent Information book and Inventor's Record. Registered Patent Attorney, Associate Examiner, Patent Office 1922-29, Patent Attorney & Advisor, Navy Department 1930-47. Gustave Miller, 48A Warner Building, Washington 4, D. C.

**FOUND.** 200 Wanted inventions that fill a need. How to invent them. Right one could make your fortune. Free details. Woodward, 1221 Edgewood, Havertown, 3-E, Penna.

#### INVENTIONS WANTED

**INVENTIONS** And ideas designed for your profit and patented for your best protection at low definite fees. Thirty years experience in developing and patenting invention in U. S. and foreign countries. Patent searches with valuable report \$15.00. Joseph O'Brien, 132 Nassau Street, New York 38, N. Y.

**CASH** Or royalty settlements for new unusual products with mass market appeal. Royal-T Products Div., 811 Wyandotte, Kansas City, Mo.

**INVENTIONS** Wanted immediately for promoting on cash or royalty. Patented, unpatented. Free booklet outlines royalty rates, requirements. Write Kessler Corporation, 541W, Fremont, Ohio.

**WANTED** Inventions and how to sell. Information free. Research Surveys, Box 3891, Columbus 13, Ohio.

**NEW** Ideas, inventions wanted. Write: Berger-Young Company, Rittman, Ohio.

**AA-1** Manufacturer wants proven items. Complete steel fabrication, machine shops. Royalty or negotiated. Valley Manufacturing Co., Valley, Nebraska.

**INVENTIONS** Wanted now by my manufacturer-clients. Patented, unpatented. Write Gilbert Adams, Patent Broker, 80-S Wall Street, Financial District, New York City.

**INVENTORS.** Don't sell your invention patented or unpatented until you receive our offer. Write Cowgill, Box 298, Marion, Ohio.

**INVENTIONS** Wanted: Patented, patent pending. 27 years experience promoting inventions. National Service Bureau, 3130 Meramec, St. Louis 18, Mo.

**INVENTIONS** Wanted. Patented; unpatented. Tremendous manufacturers lists. Global Marketing Service, 3420 77th, Oakland 5, California.

**ARE** You interested in offers from reliable manufacturers for your invention? Patented, unpatented. Harvey Engineers, Cambridge, Maryland.

**FREE** Sales and marketing analysis of your invention. Patented or unpatented. Write: Inventions, Box 292, Kansas City 41, Missouri.

#### PATENTS FOR SALE

**PORTABLE** Mechanical device. No serious competition. Should retail at \$35. Prospects, every carpenter, every do-it-yourselfer. Cash and royalty with production guarantee. Barnes Tool Service, Box 135, Pulaski, Tenn.

**TWO-Way** tractor, swivel seat, 4-wheel drive, circle turn, centrally mounted operating features. John A. Johnson, Route 2, Zebulon, North Carolina.

#### MANUFACTURING

**MODELS**—Small lot manufacturing. Metals, plastics, etc. Milburn, Burlington, Kentucky.

#### MODELS, MODEL SUPPLIES

**SHIP** Model kits, fittings and plans including clippers, trawler, fishermen, frigates, privateer, etc. Towboat of 1900 for HO gauge \$3.95. 1958 catalog 25¢. Model Shipways, Box 85, Bogota, N. J.

**BUILD** Miniature passenger hauling live steam locomotive, with file and drillpress. We do machine work, you bolt it together. Catalog 50¢. Little Engines, Lomita, Calif.

**SHIP** Models. Most complete line in New England. Kits, fittings, plans, books, tools, engines, motors. 1958 illustrated catalog 35¢. James Bliss & Co., Inc., Dept. SM, 342 Atlantic Ave., Boston 10, Mass.

**BALSA** Wood and model aircraft. 40-page catalog 25¢. Sig Co., Montezuma, Iowa.

**SHIP** And yacht model fittings; blueprints. Send 35¢ for illustrated catalog listing hundreds of items. A. J. Fisher, 102-1 Etowah Ave., Royal Oak, Mich.

**SHIP** Models and yacht supplies complete. Large 68 page catalogue 50¢. Bill Wild's, 510 East 11 St., New York City 9.

**MODEL** railroading is easy with Model Trains, the simple how-to-do-it magazine. Send 25¢ now for sample magazine and booklet. Model Trains Magazine, Dept. 540PM, Milwaukee 3, Wisconsin.

**ROCKETS.** 4 Different plans. \$1. Rocketry, Box 964, Spencer, Iowa.

**POWER** Models. Unusual steam, gasoline and traction engines, fittings, metals. 32 books on model engineering. New comprehensive catalog \$1.00. Chas. Cole, Ventura, Calif.

#### HOME CRAFTSMEN

**MAKE** \$200.00 Monthly spare time with jigsaw. Free details. Elkman, 346P North Summit, Sioux Falls, South Dakota.

**PATTERNS** Flying ducks, man sawing wood. Dutch maid churning butter, and 30 lawn ornaments, only \$1.00. Lincolns Studio, Columbia, Conn.

**FREE** Seashells catalog. Instruction book 35¢. Secor's, Bradenton, Florida W.

**LEATHERCRAFT.** Imported and domestic leather, tools, kits, complete catalog. 25¢ refundable. Midas, Box 1255, Dept. 38, Huntington Park, California.

**FREE** Catalog. 2150 artist-drawn patterns, designs. Craftplans, 1322-A Wabash, Chicago 5.

**AMERICA'S** Most complete home craft supply company. Send 10¢ for big colored catalog. Giles & Kendall Co., Huntsville, Alabama.

**LEARN** Art metalcraft and jewelry making. Complete, inexpensive, home training course now available. Special tools and materials furnished. Write for free booklet. Interstate Training Service, Dept. L-3, Portland 13, Oregon.

**KNOCKDOWN** Cedar chests and lumber. Free price list. Bedford Lumber Company, Shelbyville, Tennessee.

**STYLECRAFT** "Pretraced" leather kits. Handbags, billfolds, filligree belts. Patterns on leather. Just carve, assemble and lace. "Pre-carved" kits also available. Send 25¢ for catalog, free folder. Refunded first order. Apache Leather Company, 2804 E. Washington St., Phoenix, Arizona.

**BRASS** Ventilators stop rot, mildew, paint peeling. 4 samples 25¢. Blaco Mfg. Co., Cleveland 3, Ohio.

**WOODWORKING** And cabinetmaking course for beginning and advanced home craftsmen. Only complete low-cost home training program available. Write for free booklet. Interstate Training Service, Dept. G-3, Portland 13, Ore.

**LEATHERCRAFT.** Send 10¢ for new 76-page catalog of tools, supplies, kits, including metalcrafts, enameling, ceramics, all other crafts. Complete stock. Reasonable. Since 1910. Sax Bros., Dept. PM-4, 1111 N. 3rd, Milwaukee, Wis.

I want to send you proof of the wonderful pulling power of Popular Mechanics classified pages. What's your proposition? Write me today. Include literature if possible. F. W. Johnson, Manager Classified Advertising, Popular Mechanics Magazine, 200 E. Ontario St., Chicago 11, Ill.

50¢ **COIN** Will bring you complete plans for making a good rotary power mower. No power tools needed. Hancock, Box 754, Springdale, Conn.

101 **PATTERNS** Of smart gifts, novelties, shelves, action windmills, plus, "Make Money Jig Sawing" \$1.00. Mastercraft, 45M, 7041 Olcott, Chicago 31, Illinois.

**FREE** "Do-it-yourself" leathercraft catalog. Tandy Leather Company, Box 791 P25, Fort Worth, Texas.

**STEEL**—You can do it yourself. Harden, soften, temper steel. Complete information \$1.00 postpaid. Precision Specialties, Inc., 1342 East 58th Street, Kansas City 10, Missouri.

**PANCY** Walnut squares cut 12-15-18, etc. to 36 inches long. Midland Lumber Co., P.O. Box 124, St. Joseph, Mo.



NEW Patented lifetime tile cutter. Cuts asphalt, asbestos, vinyl, etc. Saves time. Eliminates breakage. Only \$3.95. Guaranty Sales Co., Box 55M, Grosse Ile, Mich.

FREE—Tool holder price list. Marra, 1337 Kenilworth, Lakewood 7, Ohio.

SAKI Cocktail table. Long, low, beautiful. Plans \$1.00. Designer, 2225 Oriole, Long Beach, Michigan City, Indiana.

VIOLIN Making supplies. Free catalog. Fred Artindale, Box 71992, Los Angeles 1, Calif.

LEATHERCRAFT, Enameling, mosaics, shellcraft, metal tooling, many more crafts. Free big illustrated catalog. Kit Kraft, 284, Studio City, Calif.

### DO IT YOURSELF

MOWER Kits complete, easy to assemble. Write for free literature. Triangle (PM) 185, Fort Scott, Kansas.

CABINET Plans drawn to fit your special requirements. Write: Cabinet Planning Service, Box 73, Sta. B, Evansville, Ind.

NOW Available! Nationally known power lawn-edger, hedge-trimmer in kit form. Build your own with our parts, plans; save up to 70% of retail value. For details, write: Powur-Trim, Box 8826, Fort Worth, Tex.

GRANDFATHER Clock movements, barometers, blueprints, kits. Wholesale catalog 25¢. Mason-Sullivan, Noroton, Conn.

18 FULL-Size patterns. Save money with easy-to-use, professionally designed full-size patterns. Make money selling beautiful, useful furniture. Make modern step and cocktail tables; metal lamps; cupola; 12-foot outboard. All patterns test-built; sold with money-back guarantee. Get your free list of these convenient, economical patterns today. Popular Mechanics Press, 200-HH E. Ontario Street, Chicago 11, Ill.

CREATE Big United States map, 6 ft. x 4 ft. Use 9x9 tile or paint on play room floor. Complete patterns \$2.98. Sigl Mfg. Co., 430 Delaware Ave., Buffalo 2, New York.

SAVE \$100.00. Beautiful plastic tile for your bathroom and kitchen 3 3/4¢ each. Free color charts. Miles Tile Co., P.O. Box 17026, San Diego 17, California.

BUILD Rotary tiller and mower combined or separate. Ride or walk. Kits complete. Mass production low prices. 2 1/2 and 3 h.p. engines \$35.00 and \$38.00. Literature free. Shaw Du-All (PM), Galesburg, Kansas.

LAZY-Suzan ideas. Hardware circular free. Endema, Box 6155, Bridgeport, Conn.

LAY Bricks like an expert with Sigl's Masonry Spacers, 2¢ each, 2 for each brick. Quantity discounts. Sigl Mfg. Co., 430 Delaware Ave., Buffalo 2, New York.

ROCKETS. Do it yourself. Complete description \$1.00. Kallai, P.O. Box 425, Akron 9, Ohio.

REMODEL Your own home. Save hundreds of dollars. New, amazing book shows you how. Written so you can understand it. Step by step instructions make it easy. Fully illustrated, 400 photographs, hundreds of diagrams, 160 pages, \$2.95. Literature free. Popular Mechanics Press, 200-RH East Ontario St., Chicago 11, Ill.

PORCELAIN Chips repaired permanently. Stays white. Satisfaction guaranteed. Not a paint. Easy. Complete kit only \$3.95. Appre, 1644 Venice, Granite City, Illinois.

DRAFTING Board, professional, adjustable. Easy plans complete \$1.00. Designer, 2225 Oriole, L. B., Michigan City, Indiana.

BUY Picture frames from us in mitered pieces, you do gluing and nailing yourself. Save big money on frames, also get free delivery. Chesapeake Picture Frame Co., Box 533, Baltimore 3, Maryland.

INSTALL 5-Gal. disposal can in your kitchen sink cabinet. Opens and closes automatically. \$4.50. Sigl Mfg. Co., 430 Delaware Ave., Buffalo 2, New York.

BUILD Real refrigerated room air conditioner from refrigerator parts. Plans \$1.00. T. B. Fairry, 1484 Virginia Avenue, Orangeburg, South Carolina.

STEEL Towel holders, 4 for \$1.00. 5" triangle. Screws on wall or vacuum cup. Sigl Mfg. Co., 430 Delaware Ave., Buffalo 2, New York.

### WATCHES, OLD GOLD, JEWELRY

10 SWISS Watches \$18.00. Catalog 25¢. Berkowitz, 1150 Castle Hill, New York City 62.

WATCHMAKERS'-Jewelers' supplies. Largest encyclopedic catalog 25¢. Bengal Wholesalers, Culver City, California.

COSTUME Jewelry supplies, settings, rhinestones, etc. 88 page illustrated catalog. 25¢. Milady, Box 1328, G.P.O., New York City.

HIGHEST Cash for old gold, broken jewelry, gold teeth, watches, diamonds, silverware, spectacles, platinum, mercury. Free information. Rose Refiners, Heyworth Building, Chicago 2.

GOLD, Silver, platinum, old jewelry, diamonds, watches, spectacle frames wanted. Highest prices paid, satisfaction guaranteed. Information sent free. Wilmut's, 1067 Bridge St., Grand Rapids 4, Mich.

MAKE Big easy profits making costume jewelry at home in spare time! Quick, easy to make; easier to sell! Details free! Don-Bar, 3511 W. Armitage, Dept. D-452, Chicago 47, Ill.

HIGHEST Cash paid for old gold, jewelry, watches, diamonds, silver, gold teeth. 100% full value paid immediately. Satisfaction guaranteed. Mail articles today. Information free. Established 1900. Chicago Gold Smelting Co., 6 E. Monroe St., Dept. 458, Chicago 3, Ill.

WATCH And clock repairing books. Free catalog. North American, 2320-AR Milwaukee, Chicago 47, Illinois.

EXPERT Watch repairing. Watch Rebuilding Service, Alvin Baggett, Palmyra, Tenn.

EASY To make costume jewelry at home. Catalog 10¢. Introductory kit including catalog \$1.00. J & M Novelties, Dept. CD-3, Box 173, Broadview, Illinois.

WATCHMAKERS Journal for watchmakers, students, hobbyists, collectors. Sample copy 25¢. Dean Co., Box 3218-M, Daytona Beach, Fla.

### TOBACCO, SMOKERS' SUPPLIES

PIPES—Imported. Four per year. Free details. Pipes-of-the-World, 3827 Jay Avenue, Alexandria, Virginia.

BUY Direct. (Free sample) chewing, pipe or cigarette tobacco. Write Jolley Farms, Dresden, Tenn.

### RAZORS, BLADES, SHARPENING

GUARANTEED. Men's, ladies' electric shaver. \$4.98 postpaid. V-Strunk, Soddy, Tenn.

### FOR THE HOME

VENETIAN Blinds. Order by mail. Save time and money. Write for free booklet. Kazmack Venetian Blind Co., 477-7th Ave., Brooklyn 15, N. Y.

DURABLE Plastic utility apron. Transparent, resists water, oils, grease, acids, soaps, etc. Wonderful for home or workshop. Protects clothes. \$1.50 postpaid. Money back guarantee. Alessi Sales, 229 Riverdale Ave., Yonkers, N. Y.

PICTURES Crooked? Keep them straight with "Everstraight" hangers. Six pairs \$1.00. P.O. Box 147a, Hampton, Va.

CAST Aluminum weathervane. High quality, adjustable base, flat black, 27" x 20 1/4". Horse, rooster, tandem bike. Please specify. \$6.95 prepaid. Home Industries, Box 107, Jackson, Ohio.

"HOME Improvement Guide." New, amazing 192 page volume. Packed with ideas, plans for remodeling, decorating, landscaping, built-in projects. \$2.50 prepaid. Popular Mechanics Press, 200-HG East Ontario St., Chicago 11.

### OF INTEREST TO WOMEN

60% PROFIT On cosmetics — Famous nationally advertised Hollywood cosmetics pay 60%. Make \$25 day up. Hire others. For free samples, details, write Studio Girl, Glendale, Calif. Dept. 1284G.

"8 MISTAKES Parents Make." Every parent should have this new book about child training. It is free; no obligation. Simply address Parents Association, Dept. 674, Pleasant Hill, Ohio.

FUN! Profitable too. Learn photograph coloring. Details. Weirich, 7553 Giarndon Circle, El Paso, Texas.

WE Pay \$3.50 lb. dried. Grow mushrooms. Cellar, shed and outdoors. Spare, full time, year round. We have 25,000 customers. Free book. Washington Mushroom Ind., Dept. 176, 2954 Admiral Way, Seattle, Wash.

SELL Fine fabrics. Get yours wholesale. Box 863, Norwalk, Conn.

COLGATE'S Lustre-Creme shampoo, 4 lbs., \$4.85 postpaid. Geller, 2089P Matthews, 62, New York City.

DRESSES 24¢; Shoes 39¢; men's suits \$4.95; trousers \$1.20. Better used clothing. Free catalog. Transworld 164-S Christopher, Brooklyn 12, N. Y.

### PERSONAL

RESEARCH Typist. Personal attention. Every field of knowledge. V. Schaut, 619 Kamms, Mishawaka, Indiana.

VITAMINS—Save 45%. Buy direct. All formulas. Free catalogue. Vitaspec, Box 4433P, Philadelphia 40, Penna.

ENJOY Health. Free booklet. Ruth's Nutrition, 152 Kearny, PM, San Francisco, Calif.

BIBLE Questions answered. Stamped envelope. Bylon, 17187 Bentler, Detroit 19, Michigan.

PAY Your bills now. Borrow \$100 to \$600 cash by mail. Easy, quick, private. Repay in small monthly installments over 20 months. Your payments may run 1/2 less than now; have money left over to spend. Loan order blank mailed free in plain envelope. Advise amount needed. State Finance Co., 323 Securities Bldg., Dept. D-227, Omaha 2, Nebr.

PHILIPPINE Information, \$1.00. O. Villasis, 762 Gen. Luna, Manila, Philippines.

"SCIENCE Milestones." Records march of science starting 400 years before Christ, right up to date. Amazing facts revealed. 312 pages packed with startling information that will thrill you. A real history of science. \$5.00. Literature free. Popular Mechanics Press, 200-SM East Ontario St., Chicago 11, Ill.

"HOW Can I find out?" You can! Information confidentially developed. Any matter, person, problem. Worldwide. Officially licensed. Established 1922. William Herman, 15 Maiden Lane, New York 38.

AMAZING New plan free! "How To Retire at Age 21." Men or women over 21 can retire now. Shows how you can prepare for life of leisure if you're under 21. Bob Belmont, Box 258, Hawthorne 2, N. J.

BORROW Money by mail. \$100-\$600. Anywhere. Air mail service. Postal Finance, 200 Keeline Building, Dept. 658E, Omaha 2, Nebraska.

HANDWRITING Analyzed, personality development, vocational guidance. Write Schreiber, P.O. Box 343, Birmingham, Michigan.

COBRA. Self-defense street-fighting tricks. Designed to help peaceful adults. \$2. Gaucho, 846-S7 Sunnyside, Chicago 40.

LOANS By mail. Borrow \$50 to \$500. Employed men and women over 25, eligible. Confidential, no co-signers, no inquiries of employers or friends. Up to 2 years to repay, monthly payments. Supervised by State of Nebraska. Loan application sent free in plain envelope. Give occupation. American Loan Plan, City National Bank, Dept. PM-4, Omaha, Nebraska.

I want to send you proof of the wonderful pulling power of Popular Mechanics classified pages. What's your proposition? Write me today. Include literature if possible. F. W. Johnson, Manager Classified Advertising, Popular Mechanics Magazine, 200 E. Ontario St., Chicago 11, Ill.

### REMAILING SERVICE

REMAINS 25¢. Monthly \$3.00. Confidential. Zurga, 1455 Meridian, Miami Beach 39, Florida.

COLUMBUS Mail forwarding-receiving address for rent. Details free. William McLaughlin, 800 Stewart, Columbus 6, Ohio.

SECRET Mail forwarding. \$3 month. Hedgpath, Box 830, Alhambra 23, Calif.

REMAINS, 25¢. Receiving, forwarding, \$3.00 monthly. Hale, Box 1, Glenmont, N. Y.



CONFIDENTIAL Remailings 25¢. \$3.00 monthly. Blace, Box 24, Geauga Lake, Ohio.

LAS Vegas, Nevada. Confidential remailings 25¢, \$3.00 month, classifieds \$1.00. Unique, Box 1376.

TACOMA, Remailing 25¢: Receiving, forwarding. Monthly rates. Sund, 3602 Ferdinand St., Tacoma 7, Washington.

MAIL Received and forwarded — \$2.00 month. Remails 25¢. Mailed from Houston, Galveston, Baytown. Newspapers, weekly 20¢; Sunday 75¢. Less for steadies. Kemco, Box 3545, Baytown, Texas.

CLEVELAND Receiving-forwarding. \$3 month. Gordon, 12201-D Miles, Cleveland, Ohio.

LETTERS Retailed 25¢. Monthly rates. Confidential handling. Martin Dale, Box 293, Jackson, Michigan.

REMAILS, Panoramic postals, classifieds, 25¢. Wilson, Box 2309, San Diego 12, Calif.

NEW York City remails 25¢. d'Martinis, 8375 Woodhaven Blvd., New York City 21.

CALIFORNIA Remails 25¢. \$2.00 monthly. Employment information free. Rains, 5621 Gracewood, Arcadia, California.

ANNAPOLIS—Home of Navy. Remails 25¢. Scenic postcards, dozen \$1.00. Lee Pine, Box 162R1, Glenburnie, Maryland.

LETTERS Retailed 25¢. Jerry Love, 1419 E. 83rd, Los Angeles 1, Calif.

LOVELAND Remails are uniquely sincere. Specially marked 25¢. Konrad, Box 144, Route 3, Loveland, Ohio.

HAWAII—Waikiki remails 25¢. International, Box 8132, Honolulu 15, Hawaii.

BRITAIN. Air remails. Two for \$1.00. Reliable. J. Smith, 3 Tavistock Road, Harlesden, London N.W. 10, England.

JUAREZ, Mexico or El Paso, Texas. Remails 25¢ or \$3 month. Taylor, Box 1176, El Paso.

REMAILING 25¢. \$3.00 month. Box 135, White Bear Lake, Minn.

#### TREASURE FINDERS

GOLD, Silver metal detectors. Geiger counters for uranium. Violites. Sensational new fully guaranteed models. None finer. Information free. Detectron Corp., 5528 Vineland Ave., North Hollywood, Calif.

FIND Buried treasure, gold and silver, with Goldak's sensational 3½ lb. "find-it" locator, only \$64.50. Write for free literature on complete line of mineral, metal locators; Geiger and scintillation counters. Goldak, 1541 W. Glenoaks Blvd., Glendale, Calif.

FREE Literature—Light weight, guaranteed metal detectors, Geiger counters and mineralights. Kits and assembled models. Electronic Applications. Dept. M, Box 8, Arlington 10, Virginia.

TREASURE Map of United States. War loot, lost mines, sunken ships, pirate gold, etc. Hundreds of locations. Big 28x44 only \$1.00 postpaid. Free literature. Tom Gambrel, Box 872, San Francisco 1, Calif.

HIDDEN Gold veins lie throughout the country waiting discovery. Could you recognize gold? Sample of raw gold plus comprehensive recognition data, \$2.00. McDowell, 5860 McBryde, Richmond, Calif.

TREASURE Book 25¢. Locators, maps. Howe, 811 Kansas, Atchison, Kansas.

TREASURE! Coins, bullion, cannon balls, silverware, M-scope locators find them. Newest features. Terms. Catalog. Fisher Research, Dept. C-1, Palo Alto, Calif.

#### FOR SALE—MISCELLANEOUS

USED Juke boxes, pool games \$100. Hit records 30¢. Catalog free. Wickens, 1139-P W. Summer, Appleton, Wis.

SHOP On wheels. Inexpensive wheel kit. Free catalog. Ripplingers, 1926 Gravois, St. Louis 4, Mo.

RUBBER Tired disc wheels. All sizes. For home, farm, industry. Ball, roller, oilite bearings. For wheelbarrows, shop, farm, machinery. Coaster wagons, market carts, lawn furniture, etc. Hand trucks. Axles. Free specifications, prices. Mobile Wheel Products, 1510 McClellan Ave., Detroit 14, Michigan.

8 PIECE Ball pen explorer. 5 year guarantee. \$1.50. United States Pen Service, B. 495, Atlanta 1, Ga.

HEARING Aid batteries, wholesale. Free list. Habs, Box 51, York, Penna.

#### WANTED—MISCELLANEOUS

SCRAP Mercury (quicksilver) containers supplied — Tantalum, tungsten, silver, platinum. Metallurgical Products Company, Established 1909, 35th & Moore Sts., Philadelphia 45, Penna.

QUICKSILVER, Platinum, silver, gold. Ores analyzed. Wholesale Terminal, Norwood, Mass.

OLD Toy trains—Catalogs, (before 1940). Howell Day, New Market, New Jersey.

NEW Products and gadgets wanted. Rich, 24 Burlington, Springfield, Mass.

#### MISCELLANEOUS

BUY Wholesale! 25,000 nationally advertised products. Get amazing dealer catalogs. Complete details free. American Wholesalers, 1841-D Levee, Dallas 7, Tex.

ROCKETS. How to build successful flying models. Complete instructions \$1.00. Greiner Enterprises, Box 3579, Hamilton Station, Baltimore 14, Maryland.

ROCKET Makers kit. Body parts, orifice material, parachute, safety fuse, instructions \$2.00. Central Rocket Co., Box 221 PM, Waupaca, Wis.

LEGITIMATE Big mail 25¢. John Butterworth, 489 Henry, Detroit 1, Mich.

UNBEATABLE Discounts on watches, repairs, accessories. Surprising allowances trading old watches for new. Free information. Watch Owners'-Buyers' Club, 580A-2 Fifth Avenue, New York City 36.

RECEIVE Magazine samples, mails, catalogues, offers from everywhere. Get listed 25¢. Rorick, Cincinnati 26, Ohio.

RECEIVE Mails, magazine samples, offers, opportunities. Get listed 25¢. Ed. Polaski, Box 272, Miami 47, Fla.

SELL! Buy! Trade! Anything. Read, "Trading Post Magazine," 10¢. Thorne's, 525 Dewey, Jackson 30, Michigan.

70 BIBLE Lessons 25¢. Bulletin, Box 87, Cathedral Station, New York 25, N. Y.

ORNAMENTAL Iron designs. Book of 1700 beautiful, practical designs for railings, columns, etc. Free literature. Cunningham, 3881 South 3200 West, Salt Lake City, Utah.

CIGARETTES—Perfect Draw. Make for 1/4¢. Details free. Mac Products, 1249 Mason Rd., Akron, Ohio.

WANT More business? Here's an amazing opportunity to increase your sales. Talk to thousands of interested readers of "Mechanica Popular." Our Spanish Edition covers the Latin American countries like a blanket. They're real mailorder buyers. Classified rate 75¢ per word. Try an ad in our next issue. Classified Advertising Department, Popular Mechanics Magazine, 200 East Ontario Street, Chicago 11, Ill.

NEW Snow Cone machines. All prices. P.O. Box 7803, Dallas, Texas.

AZTEC Plumage—Art pictures. Exciting free information. Jurczuk, Box 6, Kalamazoo, Michigan.

"HOME Improvement Guide." New, amazing 192 page volume. Packed with ideas, plans for remodeling, decorating, landscaping, built-in projects. \$2.50 prepaid. Popular Mechanics Press, 200-HG East Ontario St., Chicago 11.

IT'S Magic! Rechargeable pocket flashlight. No batteries to replace. Recharge from AC outlet. Satisfaction guaranteed. Only \$7.65 postpaid. Ted Weems Enterprises, 3202 A Kings Road, Dallas, Texas.

100,000 PRODUCTS Wholesale—Free catalog! Send postcard. Econ-O-Mart, Whippany 15, New Jersey.

YOUR Name wanted. We'll send 1000 publishers, mailers, wholesalers your name, on our list one year 25¢. Dixie Mailers, King, N. C.

BOOKS On antiques and their prices. Free circular! P. Warman Publishers, Uniontown, Penna.

CIGARETTES—Make 20 for 9¢. Facts free. Moberly, Box 810, Owensboro, Kentucky.

WE Pay \$3.50 lb. dried. Grow mushrooms. Cellar, shed and outdoors. Spare, full time, year round. We have 25,000 customers. Free book. Washington Mushroom Ind., Dept. 175, 2954 Admiral Way, Seattle, Wash.

CESSPOOLS. Septic tanks, clogged drains. How they function and how to keep them working. Free literature. Chemical Cesspool & Drain Cleaning Co., Boston 34, Mass.

STUPENDOUS Mental power. Adults. Details—3¢. Wisdom, 846 Sunnyside, Chicago 40.

MEXICAN Food recipes \$1.00. Chef Paul, 1307½ N. 4th Pl., Lamesa, Texas.

JAPAN: Buy gifts, novelties air-mail, drop-ship; 24 page catalog, manufacturers' names addresses, business information. Send \$1.00. Clarence Yamagata, 302 Naka 7 Bldg., Marunouchi, Tokyo.

ASTONISH Your friends. Bewilder your enemies. Startle even yourself, with an easily acquired "Personal Power" that none can ignore. Amazing factual control! Postcard brings free details. Dimensional Enterprises, Sedona 3, Arizona.

PERMANENT Match, world's smallest novelty lighter with key chain, power-packed of flame. \$1.00. Green Star Trading Co., 2910 S. E. 136, Portland 66, Ore.

SEND 50 Cents for your authentic piece of coral or driftwood from fabulous Pirate's Cove to Wally, Key Largo, Florida.

HOME Shoe repairing the revolutionary new way. Simply spread it on soles and heels like butter. Will dry into a long wearing, non-slip composition. Send for trial offer. An amazing, mouldable plastic sole saver. Money back guarantee. Rush \$2.00 to: Instant Cobbler, Box 2061, Trenton, New Jersey.

WIN Your company "suggestion award." Design, production and electrical engineers. Revolutionary new product will save up to 52% wiring time in the manufacture of products using extensive cable runs. Write today for complete information. P.O. Box 808, Grand Central Station, New York 17, New York.

GENUINE Stuffed alligators 24", \$3.00; 30", \$3.50. Special 15" alligator, bushy fox tail, raccoon tail, with surprise gift \$3.00 postpaid. Live baby alligators \$3.50. Key's, Box 703, Logansport, La.

10 ALL Different mail order magazines plus our 4 page list of unique, imported, fast-selling items. All for 25¢. Emerson Trading, Pompton Plains 39, New Jersey.

BIG Science mails! Lifetime listing, 25¢. Fabian's, 4370-B Clark, Montreal 18.

GET Ready for summer. Cleanable air filters fit all window air conditioners, last for years, cut to size with scissors \$1.50. Crescent Sales, 1132 N. Dorgenois St., New Orleans 19, La.

SEAT Belts—Pull 2" nylon, aircraft steel chrome buckles. 4500-pound test, fingertip release. Easy installation instructions. All colors, 42", 48" or 56". Check or money order, \$7.95 ppd., \$15 for two. Best available. Safety Engineered Products Co., Dept. H, 7829 W. Greenfield Ave., Milwaukee 14, Wis.

NEW, Clear plastic sofa, chair, sectional protective covers. Free literature. Star Upholstering, 934 Braddock Avenue, Braddock, Penna.

REGENCY Transistor radios. Ninety day factory warranty! 2½x3x1¼"! 1000 hours three, included, penlight cells! Sample: \$18 postpaid. Lange's, 2107 Oak, Los Angeles 7, Calif.

CALIFORNIA Calls—Get facts. 8 pages \$2.00. Langdon, 526 Alande, Los Angeles 36.

HOME Work business supplies. Write Schulthels, Box 449, Irwin, Penna.

OPPORTUNITIES, Offers, plans, samples, 25¢. Jones, 8448 Kavanagh, Baltimore 22, Maryland.

HOW To secure better paying jobs! Proven successful. \$2.00. Aldco, 3930 Wenonah Lane, Ft. Wayne, Ind.

I want to send you proof of the wonderful pulling power of Popular Mechanics classified pages. What's your proposition? Write me today. Include literature if possible. P. W. Johnson, Manager Classified Advertising, Popular Mechanics Magazine, 200 E. Ontario St., Chicago 11, Ill.



Furniture  
Falling  
Apart?



DON'T THROW IT AWAY — FIX IT WITH

## Plastic Steel<sup>®</sup> 80% STEEL

AS EASY TO USE AS MODELING CLAY. Hardens in two hours — holds permanently. Can be filed, sanded and painted. PLASTIC STEEL bonds iron, steel, brass, aluminum, wood, concrete, etc., to itself or each other.

LEAKING RADIATOR? — PLASTIC STEEL mends radiators, pipes, tanks and appliances in minutes. No special tools needed. Requires no heat or pressure — will harden under water.

CAR REPAIRS — Save money on auto repairs with PLASTIC STEEL. Fix torn fenders, cracked engine blocks, leaking gas tanks.

PLASTIC STEEL has a million uses around the home, garage or farm. 3 convenient home kits — 98c, \$1.89 and \$3.95 AT LEADING HARDWARE STORES.

DEVCON CORPORATION

175 ENDICOTT STREET, DANVERS, MASS.

Make with \$7 worth of materials . . .

## SELL FOR \$125!

Every Home with Yard a "Hot" Prospect for  
Colorful Cobbled

## CONCRETE BARBECUE

Get in on BIG PROFITS—up to \$20 an hour—by making these handsome sectional outdoor barbecues right in your back yard or garage . . . in 5 hours spare time! Cash in now on the national rage for outdoor eating. 3 units fully repay your small investment. All equipment and easy, step-by-step instructions supplied. You buy only sand, cement and flue lining from your building supply dealer. Thousands of prospects all around you . . . so get started now. For full information just fill in and mail the coupon. No obligation.

CASH COMES  
ROLLING IN!

Demand for outdoor barbecues now growing by leaps and bounds . . . and the BIG PROFITS are yours for the asking. Act now. Get full information. Fill in and mail the coupon!



H. SOKOLIS, Dept. PM-458  
928 Cherry Lane, Southampton, Pa.

Gentlemen: Rush complete details re your equipment for producing high-profit Cobbled Concrete Barbecues.

Name \_\_\_\_\_  
Street or R. D. \_\_\_\_\_  
Town \_\_\_\_\_ Zone \_\_\_\_\_ State \_\_\_\_\_



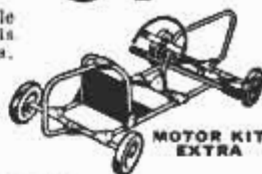
## 24 in. RIDING MOWER

Full 3½ hp., 4 cycle, cast iron heavy duty engine on a riding mower with forward, neutral and reverse a \$229.00 value for just \$149.95.

# Only \$34.95

Here it is . . . a strong durable little car that can be motorized. Chassis of steel tubing and torque roll wheels. Sled runners available for snow.

Write for free literature. All prices F.O.B. St. Louis. Send check or M.O. Include 10% with all C.O.D. orders. Missouri residents add 2% sales tax.



Baleco

Dealers write for folder M.

EQUIPMENT COMPANY - ST. LOUIS 5, MO.

## LIMITED SUPPLY! BRAND-NEW, BALL BEARING SINGLE PHASE ELECTRIC MOTORS



FAMOUS BRAND! SAVE WAY OVER HALF

Powerful CAPACITOR MOTORS with heavy starting torques to handle every heavy-duty job. NEW, ball bearing models that mount IN ANY POSITION. 230-Volts, 60 cycle, single phase, standard mounting and shaft size. PERFECT FOR: refrigeration, saws, machine tools, blowers, grain elevators, wood-working tools, pumps and farm equipment. FULLY GUARANTEED! Save \$\$\$\$.

ORDER DIRECT FROM THIS AD TODAY!

1½ HP (Reg. \$172.00) 1750 RPM, Ball Bearing only \$57.50 fob

2 HP (Reg. \$231.00) 1750 RPM, Ball Bearing only \$79.50 fob

3 HP (Reg. \$292.00) 1750 RPM, Ball Bearing only \$105 fob

FREE CATALOG of Machinery Wholesale Buys Phone Taylor 9-1365

ROBERTS ELECTRIC CO., Dept. PM-776, 849 W. Grand, Chicago 22

## HYDRAULIC JACK REPAIRS

Earn While You Learn at Home



Millions of jacks in gas & auto-service stations, truckers, body-shops, riggers, factories, farms need servicing. We show you HOW — easy step by step directions—what tools to use. EARN UP TO \$5 an hour, in spare time, in your own basement or garage. Start your own business NOW. Write for folder #PM-4 & free bonus offer.

Institute of Hydraulic Jack Repair

P.O. Box 50, Bloomfield, N. J.

## NEW - MIDGET SHORT WAVE RADIO



GETS STATIONS 12,000 MILES AWAY!

Tunes ALL foreign short wave bands. London, Paris, Moscow, Australia, ALL Amateur bands 160 to 10 meters! ALL long distance Air Force and Air Line aircraft, Ships at Sea, AF overseas broadcasts, State-County Police, Industrial bands—U.S. Radio broadcasts. Tunes 500 KC. to 40 mc.—600 to 7 meters! NOTHING LIKE IT ON THE MARKET ANYWHERE AT ANY PRICE. Super-regenerative Receiver. Short antenna included—Hook up in 1 second! PORTABLE SELF-CONTAINED—POWERED WITH RADIO BATTERIES SOLD EVERYWHERE. NO AC PLUG.

INS! Size only 4½" x 6" x 4". Wt. complete

—3 lbs. Calibrated hi-ratio easy tuning dial. Wonderful for Boy Scouts, tourists, vacations, amateurs, short wave listeners. EVERYONE CAN NOW HEAR THE WHOLE WORLD TALKING!

SEND ONLY \$4.00 (bill, ck, mo) and pay postman \$12.95 COD postage on arrival or send \$16.95 for post-paid delivery. Complete easy to wire kit includes all parts, tubes, broadcast coil, plastoid cabinet, instructions—(set of long life batteries \$2.99 extra). COMPLETELY WIRED AND TESTED —

POSTPAID IN USA \$21.95. Easily a \$49.95 value. Order now before price goes up — GUARANTEED — AVAILABLE ONLY FROM:

WESTERN RADIO Dept. BRM-4 KEARNEY, NEBR.

## PROTECT YOUR CAR WITH

Latest and best automotive products  
—you'll find them advertised in PM.



# Now . . . FASTEST POCKET ADDING MACHINE

## Dial Your Number — Read Your Answer!

★ Add, Subtract, Calculate!

★ Truly Automatic—It Never Makes a Mistake!

AMAZING NEW "Tom Thumb" Home Adding Machine guaranteed as accurate as office machines costing \$100.00, yet all you pay is \$1.98. Not a toy, not a gadget, but a precision-engineered American-made machine that NEVER MAKES A MISTAKE! You dial your number—and read your answer instantly, automatically! Add mountains of numbers, page after page of figures in mere MINUTES while others take HOURS! No guesswork, no double-checking, no pencil-chewing, no erasures, no "starting all over," no costly human mistakes that may mean MONEY OUT OF YOUR POCKET! This machine is 100% accurate—and it's guaranteed accurate for 10 years or FREE replacement! It saves you time, work, money and needless mental aggravation and frazzled nerves! Use this amazing machine day after day: Check bills, statements, purchases. Use for INCOME TAX RETURNS! Keep running tab of food purchases at super-markets (You always know how much you've spent—before you reach check-out counter!). Keep score in card games, golf, all sports. Check children's homework. Indispensable for fast, fingertip computing! Machine is UNBREAKABLE in normal use. Never needs repairs, adjustments or lubrication. No loose parts. Fits pocket or purse. Comes complete with stylus—ready to use. Handsomely boxed. No. 116, \$1.98.

DE LUXE MODEL: Calculates to 100,000. Only \$2.98. No. 116-D.

DELUXE OFFICE-TYPE DESK MODEL. Calculates to One Million. Has Clearing Lever that clears machine in split-second. Used by offices, small business, etc. Only \$3.98. Order by No. 116-F. SPECIAL! FREE \$1.25 Slide Rule with \$3.98 Adding Machine. See coupon for details!



We sell only by mail — NOT thru stores. Order now!

### Gear Operated Like \$100.00 Office Machines!

This "Tom Thumb" model is completely different from old-style, long-column type adding machines that require complicated, time-consuming "over-loop" action everytime you go over "9". Those machines are NOT gear-operated; therefore not fully automatic! This model has synchronized meshing gears that automatically turn digits to right totals with lightning speed! No pushing up or down, no searching for figures! No wonder independent Consumer Testing proves this model "A-1"—the BEST! THORESEN'S, 585 Water Street, New York 2, N. Y.

THORESEN, Inc., Dept. 6-D-116  
585 Water Street, New York 2, N. Y.

Rush Adding Machine checked below. My money back if I'm not satisfied.

- No. 116 Reg. Model \$1.98
- No. 116-D DeLuxe Model \$2.98
- No. 116-F DeLuxe Desk Model \$3.98

FREE! Our \$1.25 Slide Rule & Book FREE on prepaid order for our \$3.98 Adding Machine. Keep Slide Rule FREE in any Case!

- Payment enclosed. Send postage-paid.
- Send COD plus COD fee & Postage.

PRINT NAME \_\_\_\_\_

ADDRESS \_\_\_\_\_

# HAYES GARDEN HOSE SPRAYERS

The new, scientific way to kill insect pests and fertilize lawns



Easy as watering — no tank to lug, no lifting, no pumping — water pressure does the work. Does any garden or lawn spraying in 1/4 the time as compared with old-fashioned methods

Patented internal metering jets in Hayes spray guns automatically mix and accurately proportion garden chemicals and water in the exact ratio recommended by chemical manufacturers for killing insects, fertilizing lawns

That's why the Hayes — and only the Hayes — carries the approval of leading manufacturers of garden chemicals for use with their products including these well-known nationally advertised brands

Acme • Black Leaf • Bonide • Chlordane • Crag • End-O-Weed • Foliun • Gaviota • Geigy • Gro-Stuf • 3-in-One •

Instant Vigoro • Northrup-King • Ortho • Pmas • Pratt • Ra-pid-gro • Weedone  
Models for every spraying need At your hardware and nursery dealer



Hayes Garden Sprayers. For insecticides, fungicides, crabgrass killers, fly, ant and termite control. In 1 1/2, 3, 4, 6 & 12 gallon sizes. From \$2.95.

Hayes Lawn Sprayers. For fertilizers, lawn moth solutions, fungicides, weed killers, herbicides, etc. in 3 models. From \$2.95.

FREE! 20-page booklet on garden and lawn care. Write Dept. M.

World's Largest Manufacturer of Garden Hose Sprayers

Hayes Spray Gun Co. 98 N. San Gabriel Blvd., Pasadena, Calif.



Draweracks can be stacked in many ways

## PUT **stock your SHOP** IN YOUR SHOP!

EASY TO GET AT!

With ONE HAND you can reach and get . . . instantly . . . exactly the size and type of screw you want. "STOCK your SHOP" is a smart, new, convenient, and economical way to buy and store screws. Try a few boxes. You'll like them!

**SCREWS IN NEW CLEAR PLASTIC BOXES**

**FOR EASY DRIVING, ALL WOOD SCREWS ARE SPEEDIZED**

An invisible lubricating film on "STOCK your SHOP" Wood Screws makes them easy to drive in even the hardest woods! This free extra feature eliminates bent and broken screws, prevents sore and aching hands. Ask for "STOCK your SHOP" the next time you buy screws.

ELCO TOOL & SCREW CORP., ROCKFORD, ILL.



EASY TO GET OUT!

59¢ PER BOX



LOOK FOR THIS SELF-SERVE DISPLAY AT YOUR STORE



**Anchor wood or metal  
to concrete or steel  
with one light tap!**



Anchoring 2 x 4 partition plate to basement floor.

**Remington Mighty-Mite® Stud Driver** is a cost- and time-saving fastening tool with a hundred uses! One light hammer tap on firing pin permanently anchors furring strips, partition plates, electrical outlets to concrete or steel with special Remington Studs. Scientifically graded 22 caliber Power Loads furnish exact driving force needed. No pre-drilling. See your dealer today or send coupon for full details. **Only \$39.95**

*Most dealers also have a tool-rental plan.*

**HERE'S HOW THE "MIGHTY-MITE" WORKS**



**UNSCREW** upper assembly, drop a Remington "Power-Guide" Stud into barrel, insert chamber bushing and proper 22 caliber Power Load.



**REPLACE** handle-grip assembly, position tool and press firmly over work. Tap firing pin with a light hammer and the job's done!

**Remington** 

Remington Arms Company, Inc.  
Industrial Sales Division, Box PM-4  
Bridgeport 2, Connecticut

Please send full information about the cost- and time-saving "Mighty-Mite" Stud Driver.

Name \_\_\_\_\_

Address \_\_\_\_\_

City \_\_\_\_\_ State \_\_\_\_\_



# STOP OIL BURNING

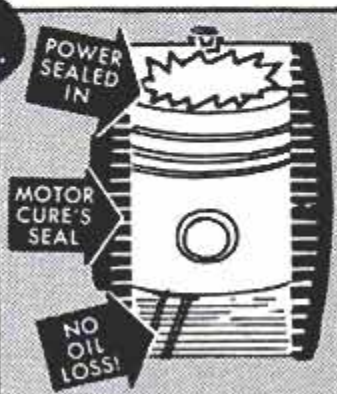
**INSTANTLY!**



**\$1.95**  
16 fl. ozs.

MOTOR CURE, the safe, pure petroleum base sealant, fills in, plates, tightens and seals in and around the rings and cylinder bores. Compression is restored . . . oil cannot bypass the rings and OIL BURNING STOPS!

It's a promise! Pour MOTOR CURE in the engine oil and STOP OIL BURNING! Raise Compression, Increase Oil Pressure, quiet noisy tappets, valves and lifters . . . feel new power . . . hear new smoothness . . . see new performance.



At service stations, garages, accessory stores.  
Write for full details. **THE KAPRO CORPORATION**  
2329 S. Michigan Ave., Chicago 10, Ill.



Give your home that *Special* look with a **TRADITIONAL LANTERN AND POST** (ALL METAL) *only*

**\$19.95**

This beautiful lantern unit is adjustable to heights up to 7' 4". Comes in complete package with adjustable steel lamp post; name plate arm; black painted aluminum lantern with glass windows and solid brass top ornament.

Delivered Railway Express prepaid as a complete unit ready for installation.

Send check or money order for \$19.95 (West of the Mississippi) \$20.45

**NORTHWOOD PRODUCTS**  
P.O. BOX 591  
WARREN, OHIO





## New car pick-up gone?...call for HASTINGS

That loss of pep and power is one of the first signs of worn-out piston rings. Costly wastage of oil and gas starts mounting up... and ends up with costly repairs later on.

See your motor specialist the minute oil-pumping warns you there's trouble ahead. When he recommends new piston rings, ask for Hastings. They're engineered exclusively

for replacement service... to stop oil-pumping, save gasoline, restore lost performance. Get new car performance from your present car—with Hastings. Truly your best investment for thousands of extra miles of trouble-free driving. Hastings Manufacturing Company, Hastings, Mich. Piston Rings, Casite, Wear Reducer, Oil Filters, Spark Plugs

U. S. PATENT NOS. 2614809, 2712971

TOUGH ON OIL-PUMPING  
GENTLE ON CYLINDER WALLS

# HASTINGS

PISTON RINGS



## OUTWORKS THEM ALL

Prepares the toughest soils in one operation. All-purpose tiller-tractor tills to 12" deep—12" to 40" wide. 3 models; 7 rotor styles including mulchers. 40 attachments include all tractor tools, mowers, snow plow. Tough chain-gear drive. Send for details.



Pat'd. Also Patts. Pend.

## MERRY TILLER

Northern Life Building, Box 1835, Seattle 4, Wash.

You can rely on products advertised in PM



## NOW a hand TOOL-BENDER



at a HAND-TOOL PRICE!

Now, at last you can get a hand tool bender at a new low hand-tool price. No shop room required to use it—just use in a vise. A must for plumbers, electricians, tanners, welders and home handy men.

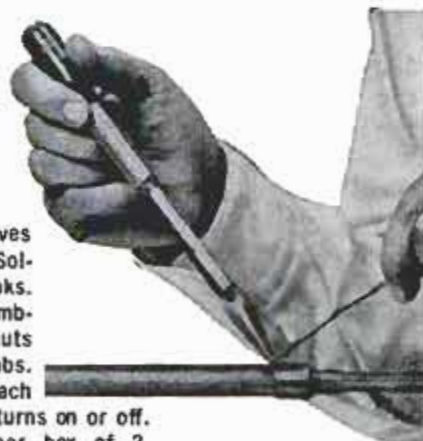
No maintenance department is complete without a Reliable Tool Kit Bender. Send for yours today!

**\$19.95**  
p. pd.

**RELIABLE** MACHINE & MANUFACTURING CO.  
415 H. Ave., N.W., Cedar Rapids, Iowa

## POCKET SIZE BLOW TORCH

only  
**\$1.95**  
with charger



Butane gas blow torch gives intense 3500° flame. Solders, brazes, fixes leaks. Perfect for wiring, plumbing, loosening frozen nuts and bolts, 1001 odd jobs. Carry in your pocket. Each charger lasts 1/2 hour, turns on or off.

Extra chargers, 49¢ per box of 2.

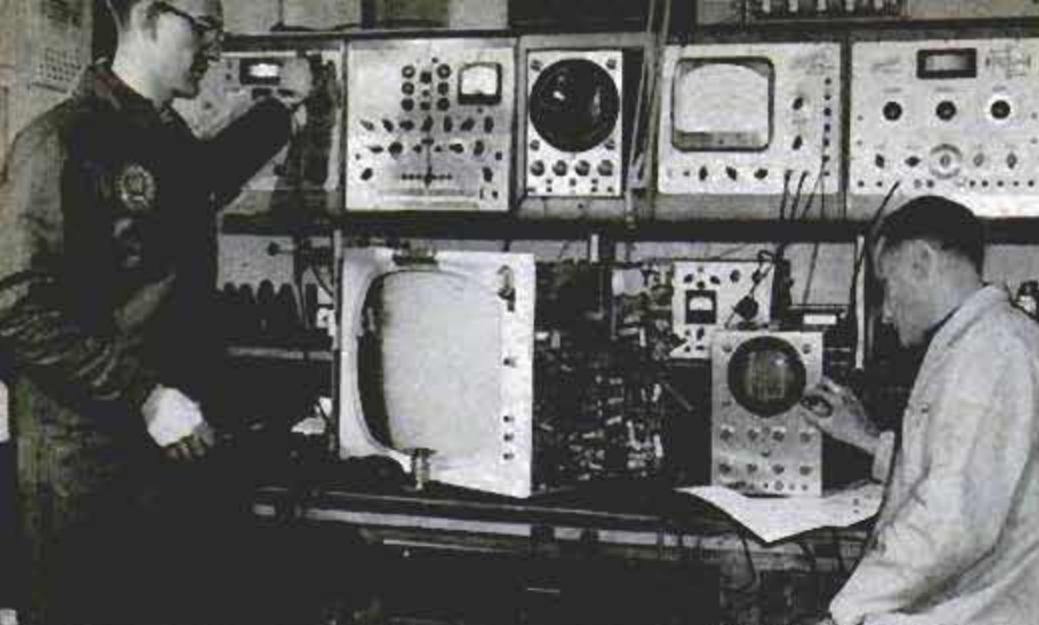
Get Jet King Butane Blow Torch at hardware stores. Or, send check or money order, we pay postage. For \$1 more (total \$2.95), get Soldering Kit; torch, tip, 3 feet cored solder, extra charger. Good for TV, radio, jewelry.

KIDDE MANUFACTURING CO., INC., Dept. PM-44  
42 FARRAND ST., BLOOMFIELD, N. J.

Send me \_\_\_\_\_ JET KING BLOW TORCHES @ 1.95 ea.  
Send me \_\_\_\_\_ JET KING SOLDER KITS @ 2.95 ea.  
Send me \_\_\_\_\_ Boxes of Extra Chargers @ .49 per box.  
My check, \_\_\_\_\_ money order \_\_\_\_\_ for \$ \_\_\_\_\_ is enclosed

NAME \_\_\_\_\_  
STREET \_\_\_\_\_  
CITY \_\_\_\_\_ STATE \_\_\_\_\_





J.N.E. Television, E. Chicago, Ind.

Analyze, locate, repair and adjust are the steps followed in television servicing. The tools of this trade are instruments such as oscilloscope, signal generator, vacuum tube ohmmeter, tube tester and sweep generator. Here, technicians are checking the alignment of a set using some of this equipment.

### CAREER SERIES THREE

**SKILLS  
for  
AMERICA**

# TELEVISION — RADIO — ELECTRONICS

## Field of Skill and Opportunity

Today, the interest of the entire world is focused upon this great industry. It is the basis of entertainment in our homes; it is vital in advertising, public relations and the split-second communication of news and current events. In community service: Police and fire, traffic control, dial and long-distance telephone, and a host of other similar applications, it has become essential.

Then, on a larger scale, you might say the very peace of the world hinges on electronics. Radar was one of the deciding factors in the outcome of World War II. The first atomic explosion was seen on an oscilloscope screen. In man's conquest of space, electronics is undoubtedly the most important factor.

The potential for the further development and application of electronics is tremendous! This is one of the fastest growing, most dynamic of all industries and should be considered by every young man when planning his career. The opportunities for interesting, good paying jobs with real advancement possibilities in sales and service, in manufacturing, and in research are as unlimited as the future of electronics itself!

### Radio-Television Repairmen Are Wanted!

Due to the universal use of radio and television, and the phenomenal rate of manufacture and sales of new sets, the number of qualified radio-TV repairmen available today has fallen behind the volume of repair work required to keep millions of sets in good working order. This shortage of repairmen has created un-

matched opportunities for men interested in becoming radio-TV technicians.

In the opinion of educators and businessmen, the opportunities that exist today for technicians will continue far into the future. And for the man who will really make the effort to qualify himself, they exist regardless of general employment conditions. The qualified technician is needed now—and will be needed for unpredictable years ahead.

The earning possibilities for technicians depend upon the individual. Those interested in making a living, and a little more, can do so without difficulty. Those determined to rise higher to succeed can. A radio-TV repair business of your own is well within the reach of the qualified technician, and for little more than \$1500. The opportunity is there for those having the ambition and drive to take advantage of it. However, success depends on you, your training, your service, and customer relations.

### Training and Education a First Essential

Radio-TV servicemen are highly skilled specialists. They must be thoroughly familiar with the theory of reception. They must analyze circuit malfunctions by use of electronic test instruments, and must make necessary component replacement and repairs. To service color television, the printed circuit-transistor receiver and other advanced applications of electronics requires specialized knowledge. Careful technical training and education are fundamental to success in the exciting field of electronics.





"As distributors of electronic supplies, we deal with service technicians, engineers, ham operators, hi-fi enthusiasts, experimenters, and hobbyists. To service these customers to their satisfaction, our parts salesmen, countermen and store managers must have a broad understanding of radio, television and electronics. Our company recommends that all sales personnel have technical training. I am manager of three Olson stores in the Chicago-Milwaukee area. The trade school education I received has been one of the greatest aids in my work. Without it, I wouldn't be in my position of responsibility!" Charles F. Kellner, Chicago Manager, Olson Radio Warehouse.

"The television repairman has to know almost as much as the designer to service sets properly. This takes study! Our requirements for new men are 2-4 years of trade school training. Our experienced technicians spend one to two weeks each year taking trade courses to keep abreast of electronic improvements. Trade schools have certainly earned my respect! I'm a graduate of one, so are my son and son-in-law. Fact is, the success of our business is due to our trade school background." J. N. Eismin, Owner (right); J. N. Eismin, Jr., J.N.E. Television, East Chicago, Ind.

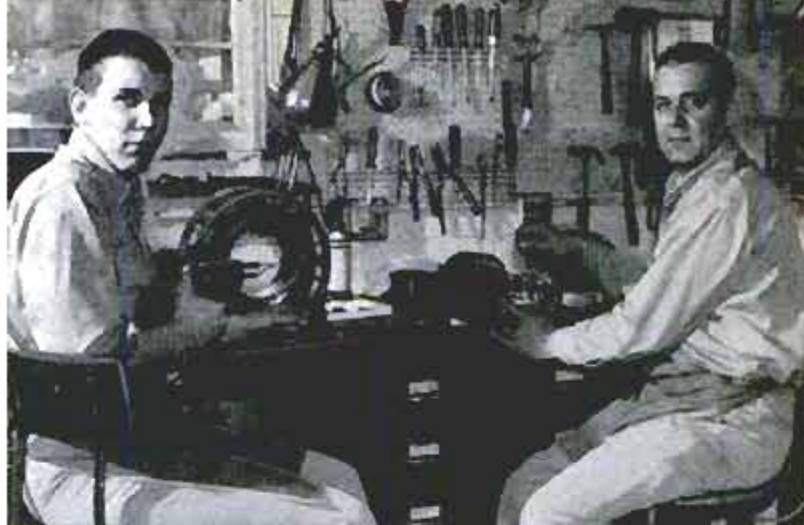
### Required Training Available

The means of securing the training necessary to qualify as a top rate technician is readily at hand. No man who is willing to work hard need pass up his opportunity because of lack of training. There are many excellent resident technical schools and home study schools that will provide you with the authoritative training you must have for a technical career.

Many of these technical schools may be found in the pages of *Popular Mechanics*. The training they give will enable you to rise, with a little experience, to the supervisory level. Then, with continued study and application, you should be able to reach almost any goal you set for yourself.

Throughout the width and breadth of modern industry are men in all types of positions—executive and administrative as well as shop and laboratory—who got their start through technical and trade schools. The electronic field is gigantic in size and manifold in application; it is expanding to unimaginable horizons. The opportunity is there—the training is available. Take advantage of it, and develop for yourself a skill and a future in television, radio and electronics. Do your part to develop

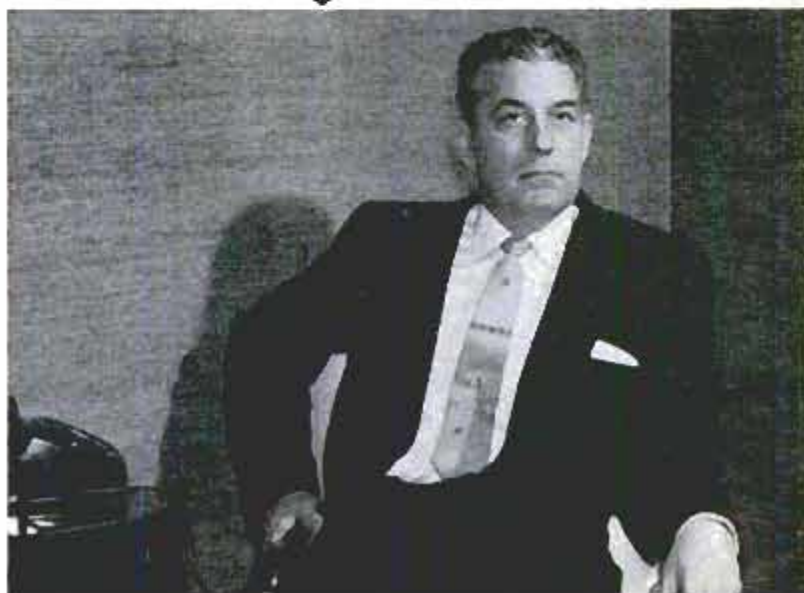
**SKILLS for AMERICA**



"No man can be truly competent in technical fields without thorough training—the kind you get through trade courses. My son and I both graduated from an electronic trade school. The thorough instruction I received made it possible for me to start my own business. The technical education my son received gave him an immediate advantage when he joined the Marine Reserve. Our firm rebuilds and repairs electric motors, generators and appliances. There is a lot of business in this field—but only for the skilled and trained." Alfred H. Laseke, Owner (right); Alfred H. Laseke, Jr., Laseke Electric Co., Palatine, Ill.



"Electronics is a growing, thriving industry with a great future. Men with technical ability are in demand. We are employing twice the number of technicians today as in 1950. Most of these have come from trade schools. The graduate of a good trade school has the training necessary to get a rewarding job in electronics. Thereafter, advancement will come according to his ambition and energy. I must emphasize the need for technical education. It's fundamental to success. For instance, without my trade school education, I'm sure I wouldn't have my present job." Roy S. Laird, Vice President, Ohmite Mfg. Co.





# Cut it with WISS



Cut Metal, Vinyl, Leather —practically anything— with versatile WISS V-13 "Mighty Midget" Snips. Only 7" long, \$2.25. Others 8" to 17" in aviation, combination, and solid steel styles. At hardware and department stores.

## OTHER FINE WISS CUTTING TOOLS

### GRASS SHEARS

No. 701  
\$2.75



Easiest cutting, fastest cutting grass shears you've ever used, with molded vinyl handle grips and special closing latch. Others from \$1.29 to \$4.95.

### PRUNERS

No. 908  
\$3.25



WISS Hy-Power Pruners cut the toughest limbs with ease. No. 908 (illustrated) 8" long, \$3.25. No. 907, 7" long, \$2.95. Wherever garden tools are sold.

## J. WISS & SONS CO., NEWARK 7, N. J.

World's Largest Manufacturer of Shears, Scissors, Pinking Shears, Skalloping Shears, Metal Cutting Snips and Garden Shears

## WHERE-TO-BUY-IT INDEX

Source of supply appears after items commercially available

### AUTOMOTIVE

Here it is—T.V. for cars.....	93
Detroit Listening Post.....	100
Car tent (Camp Craft Corp., Melvindale, Mich.).....	113
French-built coupe has Chrysler V8 engine (The Hoffman Motor Car Co., 443 Park Ave., New York City).....	117
Berkley sports car row has hardtop model (B.C.S. Corp., 566 Whalley Ave., New Haven, Conn.).....	120
Car-engine tool becomes supersensitive heart-murmur detector.....	125
Briton solves parking problem by moving big car sideways.....	132
Italian solution is pint-size car.....	132
Mobile overpass speeds servicing.....	132
Junker made into inexpensive weather-tight camping trailer.....	133
Finns' small car weighs 620 pounds.....	133
Tiny German car goes together like a frankfurter roll.....	133

### AVIATION

Amphibious helicopter rides outrigger floats.....	101
Swedish air force has rocket-powered missiles.....	112
Do-it-yourself airplane carries six passengers.....	117
Builer flies full-scale model of 1917 German fighter.....	120
Copters retrieve targets (Ryan Aeronautical Co., Lindbergh Field, San Diego 12, Calif.).....	124
Pilots watch blind spots with TV.....	139

### BOATING AND FISHING

Barnacles get the heave ho.....	124
Landing craft pushes self off beach.....	125
Skin diver-miners vacuum for gold.....	138

### CONSTRUCTION

Zurich plans parking lot for 500 cars under Limmat River... 94	94
They built a dam like a road.....	116
French town builds city hall with ice-cream-cone design.....	117
Berlin's open-air restaurant heated for year-round use.....	138

### HOUSE AND HOME

Portable aluminum torches make patio parties brighter (John Charles Copperware, John Charles Building, Torrance, Calif.).....	129
Patios in the sky.....	150
Outdoor living on a 20-foot lot.....	153
Three pools for small lots.....	154
A yard is for fun.....	156
Screens for pools or patios.....	158

### MISCELLANEOUS

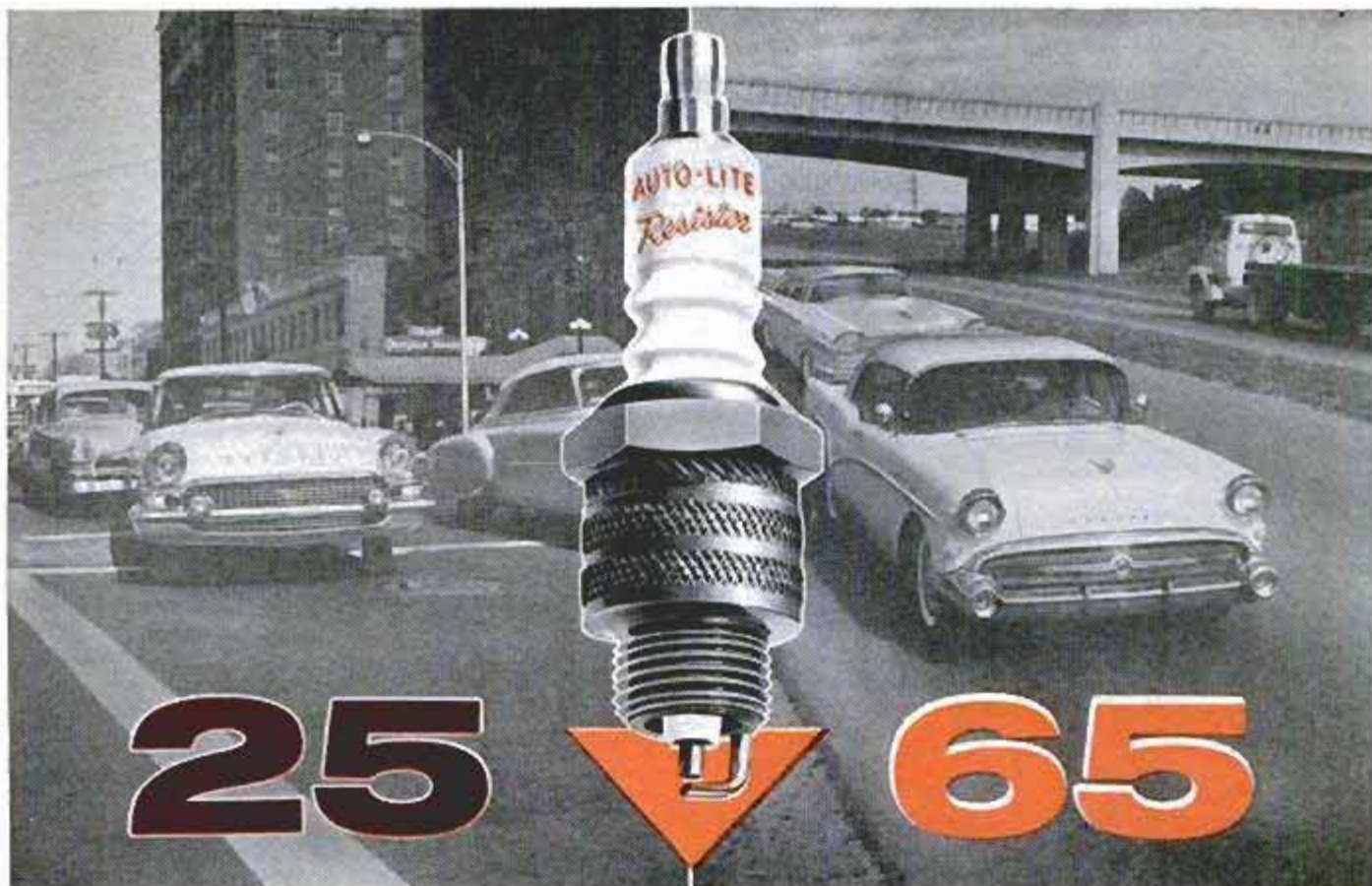
Trampoline diving board suits big or small pools (Nissen Trampoline Co., 215 A Avenue N.W., Cedar Rapids, Iowa).....	95
California race track uses big blower to dry up muddy spots.....	101
Stretchable paper prevents tearing of bags when under strain.....	112
Roll of punched tape runs automatic welder.....	120
They see drive-in movies from their own home.....	128
Stream of air powers electrostatic filter in air conditioner.....	129
Milk by the chunk served Canadian army.....	129
Sportsman's cabin.....	137
Teen-agers set up a phone system.....	143
All-transistor metal detector uses 1500-hour batteries (Fisher Research Lab. Inc., 1961 University Ave., Palo Alto, Calif.).....	272

### SCIENCE

Chemical protects bees from insecticide poisoning.....	78
Dustfree workers make missile "brains".....	93
All-transistor portable TV.....	112
Army's giant "power drill" uses nine-foot-wide bits.....	112
Magnets can cook food without direct heat.....	138
Wire coated with aluminum promises longer service.....	138

(Continued to page 76)





**IN TOWN TRAFFIC . . .** some spark plugs, designed for high speeds, become fouled and cause misfiring and loss of power when driven at low speeds.

**ON THE HIGHWAY . . .** some spark plugs, designed for low speeds, misfire causing power loss and invite destructive pre-ignition when driven at high speeds. Why gamble when . . .

## Auto-Lite Resistor Spark Plugs with **POWER TIP** "Fire Up" your engine\* at all speeds!



If you drive at both town-traffic and highway speeds, here's why you should use Power Tip . . . the first spark plug ignition-engineered for today's engines and today's driving.

At low speeds, the projecting Power Tip is in the thick of combustion where it gets hot quicker and stays hot to burn fouling deposits away clean. At higher speeds, the projecting tip is in the path of the incoming air-fuel mixture where it stays cooler to effectively check power-robbing pre-ignition. Ask your garage or service station to install Auto-Lite . . . the *only* spark plugs with Power Tip . . . and start enjoying top performance and economy from your car at *all speeds*.

\*Power Tip, with or without Resistor, is ignition-engineered for overhead-valve V-8 engines and for most overhead-valve 6-cylinder engines in all these cars—Buick, Cadillac, Chevrolet, Chrysler, De Soto, Dodge, Edsel, Ford, Hudson, Imperial, Lincoln, Mercury, Oldsmobile, Nash, Packard, Plymouth, Pontiac, Rambler, Studebaker.

YOU CAN SEE  
 THE SEE  
 THE BIG NEW  
 DIFFERENCE IN  
 SPARK PLUGS!



Ordinary Tip      Power Tip

Power Tip protrudes farther into the combustion chamber for better ignition. Fuel burns more evenly and completely to give top performance and economy at *all speeds*.

# AUTO-LITE RESISTOR SPARK PLUGS WITH **POWER TIP**

Auto-Lite makes a complete line of spark plugs, including Standard, Resistor, Small-Engine, Transport, Aircraft, and Diesel-Starting.



# IT'S TRUE

**THE ORIGINAL**  
**DURO**  
**PLASTIC ALUMINUM**  
 in the big 5 1/2 oz. Tube

**SAVE MONEY... FIX IT YOURSELF**  
**DURO** The Original **PLASTIC ALUMINUM**  
 HUNDREDS OF WAYS FOR THIS AMAZING METAL IN PUTTY FORM  
*The Family Handyman*  
 MARKED 2000, APPROVED, RECOMMENDED

**\$1.00**

**SMALL JOBS—REPAIRS**  
 Repair Automobiles—Carpenter Work—Auto Body—Auto Glass—Auto Tires—Auto Radios—Auto Engines—Auto Brakes—Auto Lights—Auto Horns—Auto Bells—Auto Bumpers—Auto Fenders—Auto Grilles—Auto Hoods—Auto Trunks—Auto Seats—Auto Carpets—Auto Mats—Auto Floorboards—Auto Dashboards—Auto Steering Wheels—Auto Shift Knobs—Auto Gear Shifts—Auto Clutch Pedals—Auto Brake Pedals—Auto Accelerator Pedals—Auto Horn Buttons—Auto Light Switches—Auto Door Locks—Auto Door Handles—Auto Window Cranks—Auto Window Rollers—Auto Window Guides—Auto Window Seals—Auto Window Gaskets—Auto Window Channels—Auto Window Frames—Auto Window Sills—Auto Window Heads—Auto Window Casings—Auto Window Frames—Auto Window Sills—Auto Window Heads—Auto Window Casings

## Is Wonderful!

Testimonials from all over the country prove DURO Plastic Aluminum's ability to perform hundreds of fix-it wonders. Use it in your home, auto, boat and shop. DURO Plastic Aluminum, the original metal in putty form, in the big 5 1/2 oz. tube, only

**\$1.00**



**HOME • AUTO • BOAT**

Be Sure You ask for DURO, the Original Plastic Aluminum Pigmented with ALCOA aluminum

USE **DURO** handy-patch

**THE SELF-SOLDERING PATCH**

For Repairing Large Rusted Out Areas  
**COMPLETE KIT**.....



EASY TO USE CUT DIP PATCH



**NEW!** from the originators of **DURO PLASTIC ALUMINUM**  
**DURO PLASTIC RUBBER**

Chemically vulcanizes without tools, heat or flame to repair most ANYTHING made of rubber or canvas. Molds to any shape. Waterproofs, rustproofs, insulates, repairs and caulks.

Large 4 fld. oz. tube in black or white.... **\$1.00**

Buy these 3 fine DURO products at all better hardware, auto accessory, paint and variety stores, if not available, write

**WOODHILL CHEMICAL MFG. CO.**  
 1395 EAST 33rd STREET CLEVELAND 14, OHIO  
 "Originators and World's Largest Mfrs. of Plastic Aluminum"

(Continued from page 74)

### WHAT'S NEW FOR YOUR HOME

Portable water softener attached to any faucet.....	126
Stepladder grips guard against accidents.....	126
Serving frame stretches to fit dishes.....	126
Electric griddle.....	127
Spring door electrical box protects outlet from elements.....	127
Spillproof plastic cup for children.....	127
Home barbering aid fastens to scissors.....	127
Electric door mat brushes dirt from shoe soles.....	127

### Craftsman and Shop Notes Index

#### LAWN AND GARDEN

Protect plants from cutworms.....	174
Old farm milk cart serves as portable garden planter.....	174
Store garden hose in basket.....	174
Temporary fences held against stakes by staples and wire.....	196
Carpeting used as tree mulch.....	206

#### HOUSE AND HOME

Tinted calking compound.....	174
Plant rack clamps on porch rail.....	174
Home target range.....	175
Repairing cracks in plaster.....	196
Sticking sash easily removed.....	214

#### MISCELLANEOUS

Insulated home for your dog.....	172
Aluminum-foil lining in grill fire pan reflects heat to grid.....	174
Drawer serves as writing desk.....	185
Sharpen sewing-machine needle.....	185
Portable sunshade for dog.....	196
Garden hose on wire fence eliminates need for gate.....	198
Flameless charcoal igniter made from range element.....	198
Coupling implement from tractor seat.....	212
Pickup box mounts on tractor.....	212
Watch and matches kept dry in jar while boating.....	213
Preventing spilled water from staining rug.....	213
Handy lifter for pickup arm.....	214
Rubber bands save old broom.....	214

#### ON THE MARKET

Plastic forms for casting building stone.....	199
Flexible doorstep.....	199
Waterproof compound.....	199
Roll-on adhesive.....	199

#### OFFICE, SHOP AND STORE

Bracket keeps ink bottle level.....	171
Cards duplicated on stamp pad.....	193
Washing of store windows simplified by perforated tubing.....	197
Handy memo pad attached to wall-mounted telephone.....	206

#### PHOTOGRAPHY

Sponge keeps print paper flat.....	193
Bracket holds extra lights for shadow-free photographs.....	197
Camera tripod hung on eyebolt.....	198

#### SHOPPING FOR TOOLS

Adjustable stop for repeat cuts on radial saw.....	218
One-piece anchor for masonry.....	218

(Continued on page 78)

**NOTICE**—It is the intention of this magazine to provide its readers with information regarding the latest developments in the mechanical arts. Except where otherwise indicated, this magazine has no information as to any unexpired patents in respect of the developments reported herein. In the event that commercial use is to be made of any of the developments reported herein, it is suggested that legal counsel be consulted to avoid liability for patent infringement. It is not the purpose of this magazine to encourage patent infringement but, as indicated, it is the intention of this magazine to report on the latest developments in the mechanical arts.



Read what users say about

# DURO<sup>®</sup> PLASTIC ALUMINUM

Here's a home repair kit in a tube

What do fix-it-yourself people have to say about Duro Plastic Aluminum? According to the mail, it's like having a handyman around the house. Metal in putty form, Duro Aluminum seals, solders, repairs—adheres to virtually any surface.

Made with ALCOA<sup>®</sup> Aluminum Powders by Woodhill Chemical Co., Cleveland, Ohio, Duro Plastic Aluminum is applied like paste, dries metal-hard in three hours. Users write that it fixes anything. Here's a sampling from their letters:

**WISCONSIN MOTORIST:** "... fender had rusted through ... used Duro Plastic Aluminum ... worked perfectly ... can't see where the hole was."

**NEW YORK HOMEOWNER:** "... fixed all my gutters and leaders with no effort ... just spread it on and let dry ... Duro is wonderful."

**WISCONSIN MAN:** "... repaired storm windows, toys; patched screens; filled in counter-sunk screws in a boat ... I'll never be without Duro Plastic Aluminum."

**NEW JERSEY MOTHER:** "No amount of glue or even nails would hold my 3-year-old's playpen together ... Duro made it good as new."

**SEATTLE NOMAD:** "... waterproofed the seams of our house trailer ... very easy to apply ... not a leak since."

**NEW YORK HOUSEWIFE:** "I have an antique pewter-and-brass urn that no fix-it shop could repair ... Duro did the trick."

**CALIFORNIA MOTORIST:** "Duro sealed my radiator after a fan blade went through it ... saved a \$15-\$20 charge at a radiator shop."

**SAVE MONEY... FIX IT YOURSELF**  
**DURO<sup>®</sup>** The Original  
**PLASTIC ALUMINUM**

HUNDREDS OF USES FOR THIS AMAZING METAL IN PUTTY FORM!

"The Family Handyman"  
 Applied Cold, Hardens into Metal

**\$1.00** LARGE 3/4 OZ. TUBE

**SEALS • SOLDERS • REPAIRS**  
 Not a Cement—Not a Glue  
**ANYONE CAN USE IT!**

ALCOA ALUMINUM

Adheres to metal, Wood, Concrete, Glass and Most Plastics

• SATISFACTORY GUARANTEED

REPAIR Holes and Leaks in Laundry Equipment

SEAL Plumbing Leaks

REPAIR Holes and Cracks in Auto Bodies

SEAL and SOLDER Leaky Gutters and Downspouts

REPAIR Holes and Leaks in Pans, Pots, and Pails

REPAIR Holes and Leaks in Wood and Metal Boats

**ALCOA does not make aluminum putties, but ALCOA Aluminum Powders are used in all the best brands. Cold solders are easy to use, require no tools, heat or flame. They adhere to metal, wood, plastic, glass or concrete ... are not affected by water, oil or gasoline ... can be burnished to a high luster or even painted. Write today for more information. Use the coupon.**



"ALCOA THEATRE"  
 Exciting Adventure  
 ALTERNATE MONDAY EVENINGS

Aluminum Company of America  
 1718-D Alcoa Building, Pittsburgh 19, Pa.

Please send me more information on cold solders made with Alcoa Aluminum Powders.

Name \_\_\_\_\_

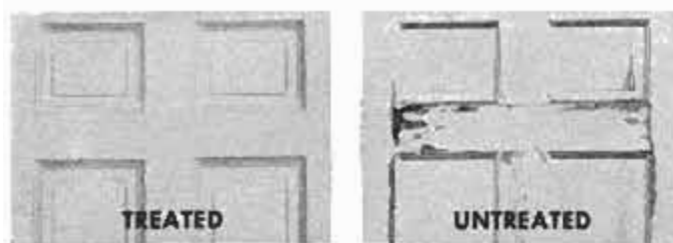
Address \_\_\_\_\_

City \_\_\_\_\_ Zone \_\_\_\_\_ State \_\_\_\_\_



# WOODLIFE

## GUARDS AGAINST



### PAINT PEELING

... also against wood rotting, warping and cracking — doors swelling, windows sticking, etc. Get WOODLIFE, the original water repellent preservative, at paint, hardware or lumber dealers.

For "natural grain" siding, panelling, trim, etc. — get P.A.R., the water repellent finish.

**PROTECTION PRODUCTS COMPANY**  
Kalamazoo, Michigan

# TRIUMPH

**GIVES YOU  
EXTRA POWER  
AND  
ECONOMY!**



You step right into the lead with Triumph — America's top-selling OHV motorcycle. Here's a fun-machine that is specially engineered for maximum performance, highest economy. Triumph is tops in every department . . . speed, maneuverability, handling ease and economy. Averages from 75 to over 100 m.p.g. Available in a wide range of models and brilliant color combinations. See your nearest Triumph dealer now for free demonstration ride.

SEND COUPON TO NEAREST ADDRESS

JOHNSON MOTORS, INC., 267 W. Colorado St., Pasadena 1, Cal.  
THE TRIUMPH CORPORATION, Towson, Baltimore 4, Maryland

**FREE!** — Please send me without obligation a copy of the new, full color 1958 Triumph catalog.

Check here for name, address and telephone number of nearest Triumph dealer, Dept. K-1

NAME:.....AOE:.....  
STREET:.....  
CITY:.....STATE:.....  
TELEPHONE NUMBER:.....

(Continued from page 76)

Portable jigsaw .....	218
Two-line striping tool.....	218
Electrothermal unit .....	219
Hydraulic scaffold .....	219
Mason's line clip.....	219
Power hacksaw blade.....	219
Air-current direction finder.....	220
Pistol-grip handle .....	220
Plunger-actuated oiler .....	220
Pneumatic oiler .....	220
Selflocking clamp .....	220

### SOLVING HOME PROBLEMS

Two-vegetable "double boiler".....	176
Center support for clothesline.....	176
Pair of embroidery hoops hold bag open.....	176
Dents in inlaid lindeum.....	176
Hang miscellaneous kitchen items.....	177
Cabinet for canned goods.....	177
"Sprinkling can" for house plants.....	177
Lift-out partitions in cabinet drawers.....	177
Premium stamps won't stick together.....	177

### WORKSHOP HINTS

"Marproofing" pliers jaws.....	171
Jig for straightening tubing.....	171
Loose bristles easily removed from paintbrush.....	185
Locking worn nut on bolt .....	198
Panels "jointed" with saw.....	198
Steel wool reinforces cement.....	198
Straw sections mark wires.....	206
"Haircut" for paintbrushes.....	206
Sponge oils overhead pulley.....	206
"Custom made" wrecking bar.....	206
Steel ball sets hollow rivet.....	211
Thumbtack tightens cover.....	211
Keep soldering iron clean.....	211
Thin splines for miter joints.....	211
Emergency door bolt from leaves of butt hinge.....	213
Screw-hole plugs made from dowels.....	217

### Beware of Lunar Uranium Stock

Don't buy stock in a uranium mine on the moon. That's the advice of Dr. Lyle B. Borst of New York University, whose studies indicate there is about one percent as much uranium on the moon as on earth. He also reports that there's "air" on the moon, but the atmosphere is so thin it is about equivalent to the best laboratory vacuum. The air contains only two heavy gases, krypton and xenon.

### Chemical Protects Bees From Insecticide Poisoning

Bees are being kept away from insecticide-sprayed fields by a chemical called hydroxyethyl-tetroctyl sulfide. The new repellent acts 8 to 48 hours after a field has been sprayed. Tests show that the repellent does not injure either cotton or cantaloupe plants; further tests are being made to see if it affects seed or fruit production. Protecting bees is important for crops that depend on good pollination for proper seed development.



## U-MAK-IT BOAT KITS



### NEW

### LAPSTRAKE SKIFF KITS

Now added to our great line of kits, new easy to assemble Lapstrake Skiffs.

30 years of boat kit pioneering. 30 models. Prams, Rowboats, Outboards, Cabin Cruisers and Skiffs.

#### SEND FOR ILLUS. CATALOG

Showing all models from 8' to 23'. Const. details, paints, access., etc. All you need to build your own.

MAIL 35c (coin) for Postage & Handling.



**U-MAK-IT** products

DELAND, FLORIDA — DEPT. 12

BUY DIRECT  
• SAVE ON •  
TILLERS • TRACTORS

Full line of attachments for mowing, gardening, farming  
2-3-4 H.P. TILLERS 12"-16" CUT.

FREE CATALOG  
& PRICE LIST

5-6-7-9 H.P.  
2 wheel &



4 wheel tractors  
**RED-E TRACTOR CO.**

4 FOURTH STREET  
RICHFIELD, WISCONSIN



Send For Free  
"How To Use"  
Booklet

SEE THEM AT  
YOUR DEALER

SANDVIK STEEL, INC.  
1704 Nevins Road  
Fairlawn, N. J.

## ENGINEERING

DEGREE IN  
27 MONTHS

### B. S. DEGREE IN

**Aeronautical, Chemical, Civil, Electrical, Mechanical and Electronic Engineering (inc. Radio and TV)**

Also B.S. DEGREE in 36 mo. in Mathematics, Chemistry, Physics (inc. Nuclear Physics), Engineering Science prep. courses. Thorough, practical program. Individualized instruction emphasized. Government approved for G.I.'s.

#### Keeping pace with progress in science and engineering

Spacious campus; 20 bldgs.; dorms, gym, Playing field. Modern, well-equipped labs including new physics lab and wind tunnel. Low tuition. New terms start quarterly. Enter June, September, December or March. Big demand for graduates. Students from 48 states and 40 foreign countries. Many earn a major part of their college expenses in this large industrial center. Send coupon for free catalog and full information. Enroll now!

## INDIANA TECHNICAL COLLEGE

548 E. Washington Boulevard, Fort Wayne 2, Indiana

Please send me free information on 27 MO. B.S. DEGREES in:

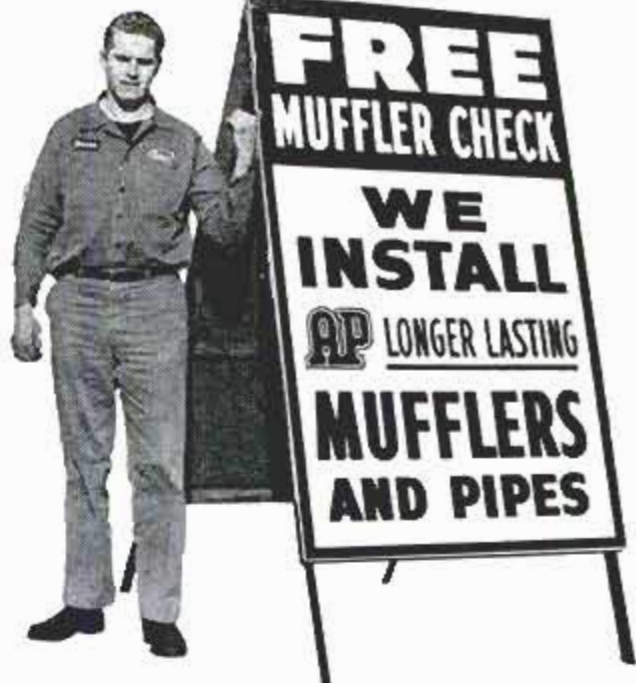
Aeronautical  Chemical  Civil  Electrical   
Mechanical  Electronics

on 36 MONTH B.S. DEGREES in:

Mathematics  Chemistry  Physics

Name \_\_\_\_\_

Address \_\_\_\_\_



This sign tells you  
where to buy  
your longer lasting  
AP "DRI-FLOW" MUFFLER

If your car is 18 months old, it is a good bet that you will need a new muffler soon. Make that muffler an AP "Dri-Flow" for extra service and greater protection from deadly carbon monoxide fumes. "Dri-Flow" design causes the muffler to heat up evenly—there are no cold spots to cause corrosive condensation (the major cause of quick rustout). Also AP mufflers are built of thicker steel—have up to 1/3 heavier outer shells and up to 2/3 heavier ends. Remember, AP costs no more than quick-rusting mufflers!



## THE AP PARTS CORPORATION

14-Q AP BLDG., TOLEDO 1, OHIO Mufflers and Pipes



Longer lasting mufflers—Designed for today's high-compression engines



# NON-TIRING ACTION! BY SARGENT



**PARROT-HEAD PRUNER**  
Pistol grip . . . with exclusive hooked nose and split anvil for clean cuts, no slipping, plus . . . Thumb-flip safety lock . . . \$3.25. Save money, buy both the pruner and self-adjusting Grass Shears — only \$5.85 for "SMART SET"!



Also heavy duty long handled Loppers. From \$3.25.



**HEDGE & SHRUB SHEAR**  
Exclusive double-spring bumper action absorbs shock . . . helps you make that next cut! Serrated, hollow-ground steel blade for clean cuts, includes notch for heavy growth . . . it's only \$4.95.

BRIGHT YELLOW TRIM PREVENTS LOSS!



**LAWN EDGER** . . . with exclusive foot pedal and constant height wheel guide for effortless, look-right kind of job. Self-sharpening steel blade takes on toughest grasses . . . just \$3.95!

**GRASS WHIP.** You swing . . . serrated steel blade does the cutting! No bending, no stooping . . . just stand 'n trim! Perfectly balanced . . . and it's yours for only \$1.95!



ASK DEALER FOR "DIAL-IT" PRUNING GUIDE (or send 25¢)

**SARGENT**  
HAND TOOL DIVISION • NEW HAVEN 9, CONNECTICUT



## Bank Gives Big Lift To Small Depositors

Designed to encourage youngsters to keep their money in a bank account, a hydraulic lift has been installed at the First National Bank of Geneva, Ill. The elevator retracts flush with the floor when adults are using the counter. But the lift adds 12 inches to the height of young depositors.

## Control Device Aids Eye Surgery

Delicate eye operations with electro-surgical equipment can be performed with less chance of tissue burning with a new control device. The instrument permits the surgeon to control both voltage and frequency of the "electrical knife" which cauterizes as it cuts. The instrument will aid surgeons in operations to correct detached retinas and similar eye defects.

## Scientists Seek Computer To Design and Make Parts

Electronic "brains" may soon be part of an automatic tool system that designs an item and then produces it. Massachusetts Institute of Technology is now engaged in research leading to such an automatic "design machine." The major obstacle has been that of working out proper instructions.



\* Best reasons in the world  
for MORE LIGHT...AIMED RIGHT!



"AIM TO LIVE" has an especially deep significance to the family man. He seeks every protection for himself and them. And one of the simplest for him to provide is the extra margin of night driving safety available through new Guide T-3 Headlamps.

These new Guides are the latest industry-approved sealed-beam type, with stepped-up power and the new light pattern which gives you more light on the right—where you need it most. They can be aimed without even turning them on because Guide precision-grinds three "Guide Points" on the face of each lens so that the aiming plane is accurate to within one ten-thousandth of an inch. Such precision, plus the simplicity and speed of aiming the T-3 way, means MORE LIGHT—AIMED RIGHT! That means extra safety for your family.

If your present headlamps are more than two years old have them replaced now with new Guide T-3s. And make it a practice to have your headlights aimed at least twice a year.

Guide  
**T-3**  
SAFETY-AIM  
HEADLAMPS  
Buy in pairs  
where you see  
**AC**

AC SPARK PLUG  THE ELECTRONICS DIVISION OF GENERAL MOTORS

Watch Walt Disney Studios' ZORRO  
every week on ABC-TV





**no drag  
on the rag**



**shine faster with  
all-new Carnu**

**Shines the deep-down color back better than ever before!**

New Johnson's Wax formula wipes off as easy as it wipes on. Actually cleans with less friction—speeds up the shine. All-new Carnu is easier on the finish, easier on you. Cleans as it shines—in one easy go!





# EXPLORER III

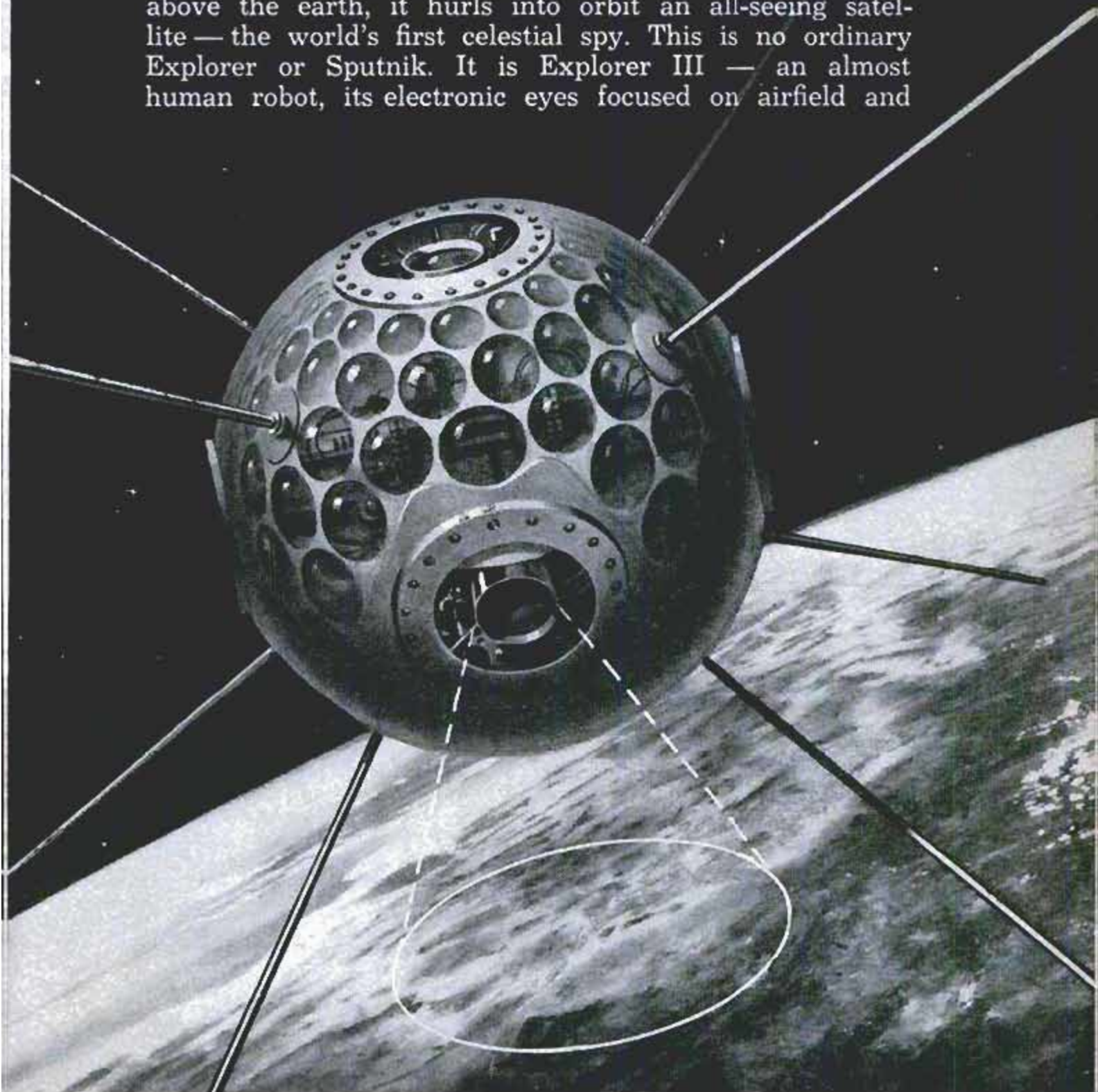
**POPULAR** APRIL  
1958  
**MECHANICS**

WRITTEN SO YOU CAN UNDERSTAND IT  
VOL. 109 NO. 4

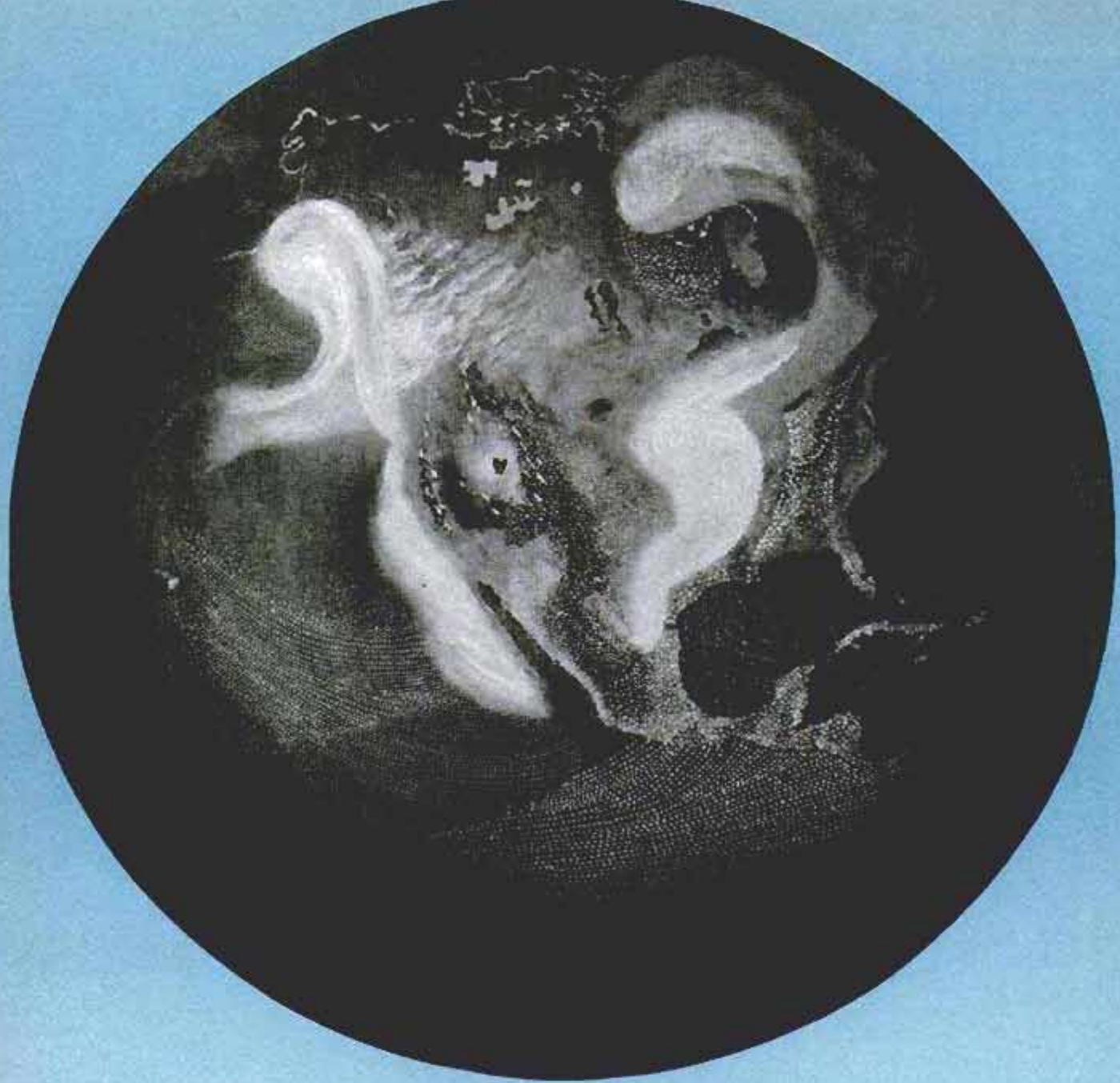
## OUR SPY IN OUTER SPACE

*By James Joseph*

**F**ROM ITS SECRET launching pad, a multistage rocket screams toward space. Minutes later and 1000 miles above the earth, it hurls into orbit an all-seeing satellite—the world's first celestial spy. This is no ordinary Explorer or Sputnik. It is Explorer III — an almost human robot, its electronic eyes focused on airfield and







This is how the earth and cloud systems might appear in TV picture from satellite 4000 miles above Texas

factory—and perhaps, on your own backyard. It is a spy, moreover, scheduled for launching within the next 24 months—sometime before 1960.

Orbiting at 16,000 miles per hour, Explorer III swings high above the pole, its course—a north-to-south polar path—calculated to carry it once around the world every 105 minutes. And with each circling it surveys yet another earth sector, thus keeping the whole world under daily surveillance.

According to present plans, the Army will launch Explorer III with a ballistic missile the same as the Redstone used to launch Explorer I on January 31, and the predicted Explorer II. These “moons” are expected to pave the way to manned space stations. The Explorer III will weigh

about 300 pounds and will be equipped with television cameras. Also in the planning stage is Explorer IV which will carry elaborate electronic equipment in addition to the cameras. The primary purpose of Explorer IV will be to gather detailed data needed for the construction of a space station. In order to launch the heavier satellites, it may be necessary to add a fifth solid-fuel stage.

The superspy's brain is a complex of solenoids and transistors. Its spatial voice—a ground-beamed transmitter; its eyes—heat-sensing infrared detectors, terrain-probing radar and high-speed aerial cameras. And deep within the diabolical sphere beats an electronic heart—a delicate timing device.

As Explorer III arcs toward enemy ter-



ritory—sprawling there a thousand miles below—the timer trips a solenoid. Automatically, a half dozen camera ports slide open, revealing long-focal length lenses. Solar-powered, an image orthicon—akin to a television's picture tube—comes suddenly alive. With a whine, a radar's transmitter is actuated, its rays straight-aimed at enemy soil and enemy secrets.

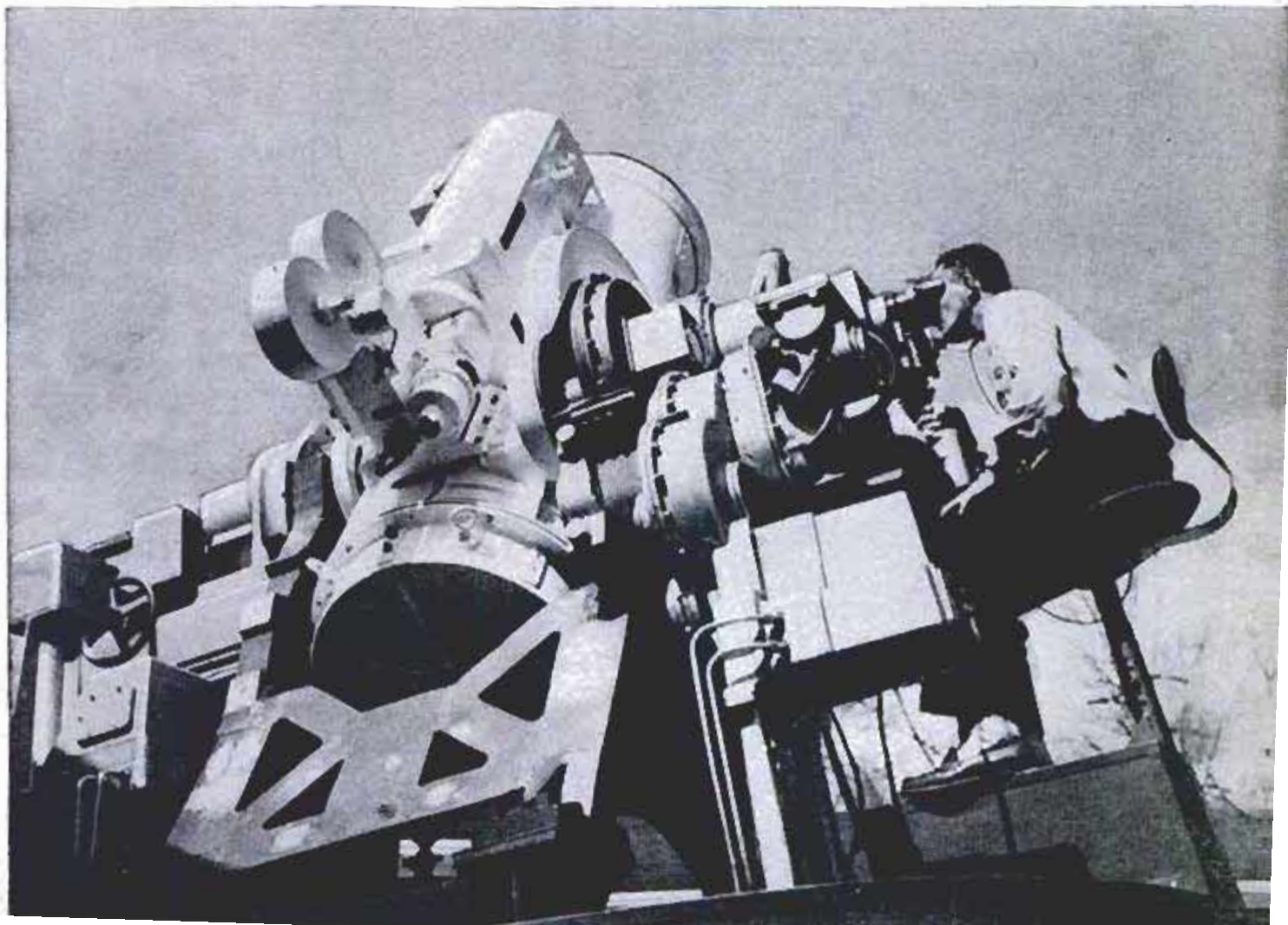
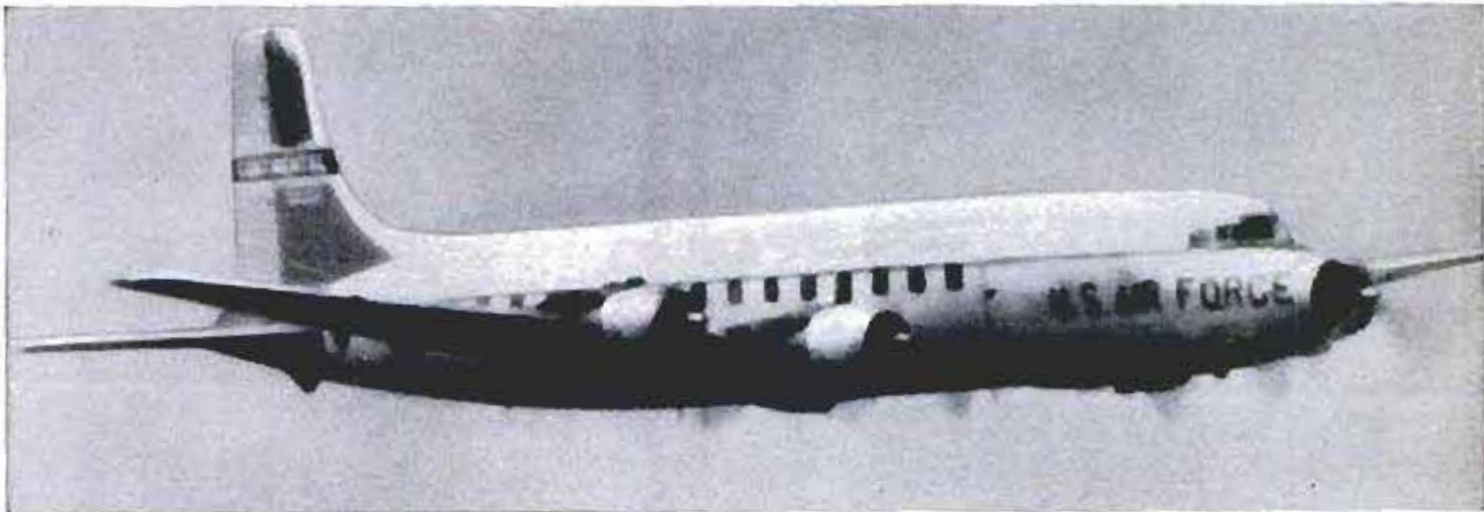
Radar reaches through miles of atmosphere and murk—to map an industrial city with better-than-atlas accuracy. Moments later, through a hole in the overcast, the orthicon tube's flat face unmasks an airfield and the fuzzy, yet discernible, out-

lines of its hundred atomic bombers. Farther on, the infrared detectors strip a steel mill bare of camouflage, as the telltale heat from its blast furnace burns indelibly into the detectors' film-strip memories.

Mission accomplished, the timer clicks again—closing the lens ports, dimming the orthicon, depowering the radar. Locked inside the demon spy, magnetic tape and film, are enemy secrets.

Forty-five minutes later—and on the other side of the earth—the satellite orbits over friendly territory. Once more its timer clicks, energizing powerful transmitters. Far below, complex recorders receive the

**Air Force plane 10 miles away was photographed with 500-inch focal-length tracking camera, shown below**







Photos above and below show accuracy of infrared reconnaissance. Bright spots in bottom photo, taken at night, pinpoint the areas of greatest activity

Photos courtesy Servo Corporation of America



SHOULD BE FAIRCHILD CAMERA & INSTRUMENT CORP. (SEE JUNE 58 PAGE 8)

intelligence report not even one hour old.

Spy satellites are well past the design stage on both sides of the Iron Curtain, their missions already set—and likewise their launching dates.

Russia, by party boss Khrushchev's own admission, has been six years at work on a celestial spy (likely Sputnik VI or VII). Last October, at the International Astronautical Federation conclave in Barcelona, a top Soviet space scientist conceded that Russia's spy satellite will be capable of "keeping constant watch on the activities of the entire world."

Less vocal are spokesmen for Lockheed Aircraft's Missiles Systems Division on the Stanford University campus where, since early 1956, our scientists have been engaged in putting together "Pied Piper," official name for the United States' hush-hush spy satellite. The project is also nicknamed "Big Brother."

It's an open secret that at least \$12,000,000 have already gone into the project, officially coded Weapon System 117-L. Pied Piper's launching date, like that of its Russian counterpart, is already set for sometime next year.

The problems, basically, boil down to adapting proven techniques in aerial photography, telemetering (robot air-to-ground communications) and tracking—to space.

Typical is the problem of "resolution"—a television or film camera's ability to record detail from high altitudes. Will Explorer III be able to peer into your backyard? And, having turned spatial Peeping Tom, will its electronic eyes be capable of differentiating between objects as small, let's say, as your car? Or, of more concern to military men, between a tank, warship or bomber?

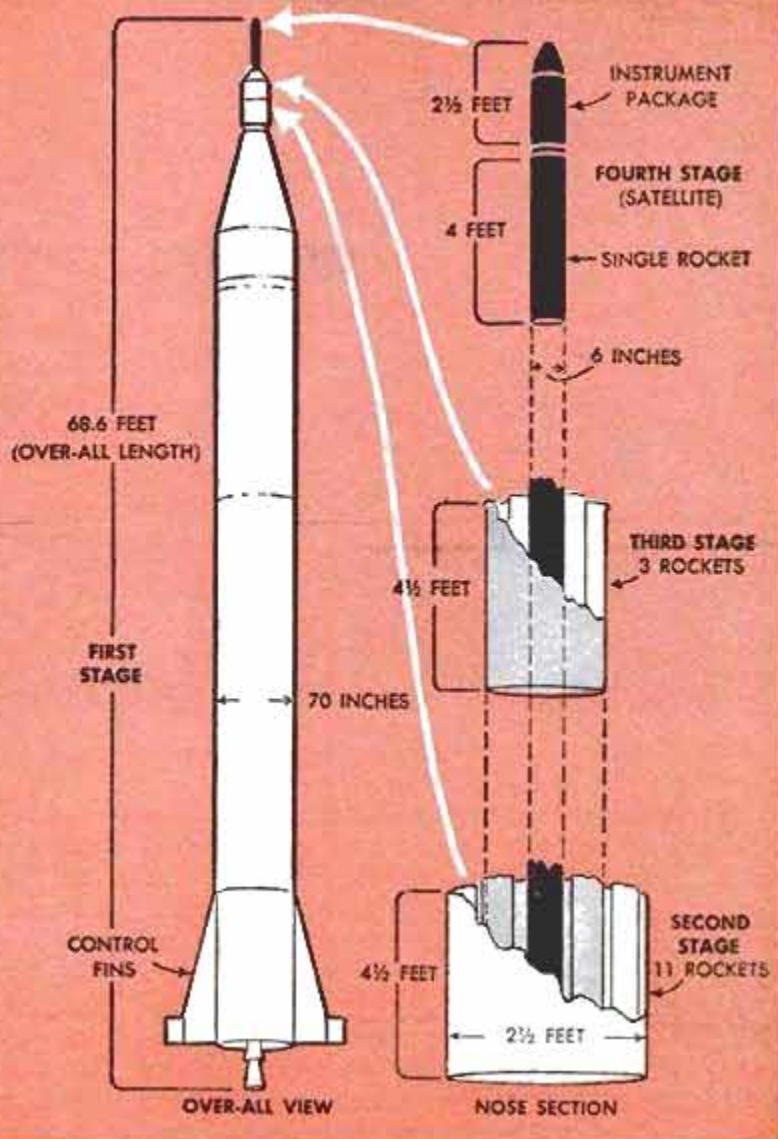
Today's best aerial cameras (including the still-secret system installed in the new B-58) reportedly can peek into your backyard from 50,000 feet and clearly detail everything over one foot square.

The same camera installed in a spy-satellite orbiting 100 times higher would do well to define the outline of a ground-tethered B-52. It might even have trouble pinpointing the runways. And as for your car? The camera wouldn't see it at all.

But the B-58's aerial eye, with its 36-inch focal length, is puny compared to cameras now under development, their focal lengths nearly three times as long, their magnification and resolution far higher. What's more, their lenses are "folded"—through a series of mirrors—into an all-seeing package no larger than the B-58 camera.

The real problem, however, is transmission. Ground-stationed intelligence ex-





perts won't have at hand the original negative. That'll remain in space. What they will have is a facsimile of the original.

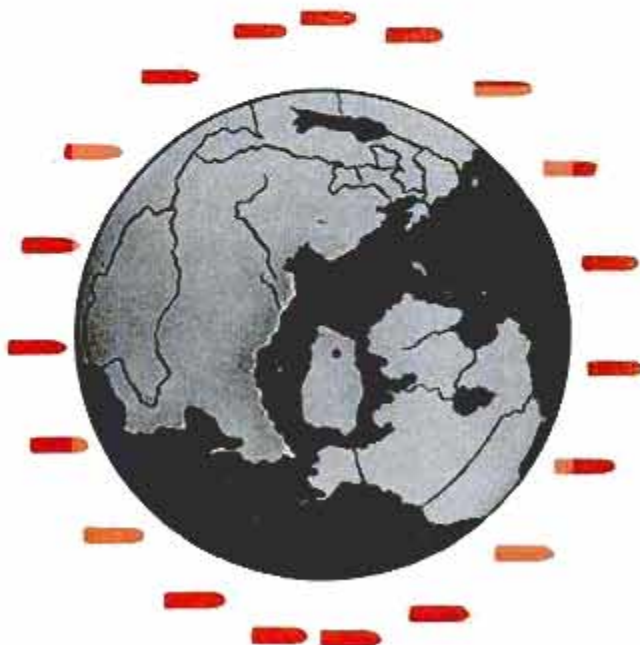
To understand the difference—and how it will dim Pied Piper's perception—let's study a hypothetical spy camera. The camera's "resolution" is rated at 40 lines per millimeter. This means that along every millimeter of negative, the lens implants 40 dabs or "bits" of image. Thus, one million "image bits" will be compacted into every square inch of negative. And the greater the number of "bits," the better a camera's ability to separate and define small objects.

A good example is a photo in your daily paper. Examine a newspaper photo under a magnifying glass and you'll observe that what seems to be a sharp picture (at a distance) is really composed of hundreds of little dots and dabs. The more dots, the sharper the picture.

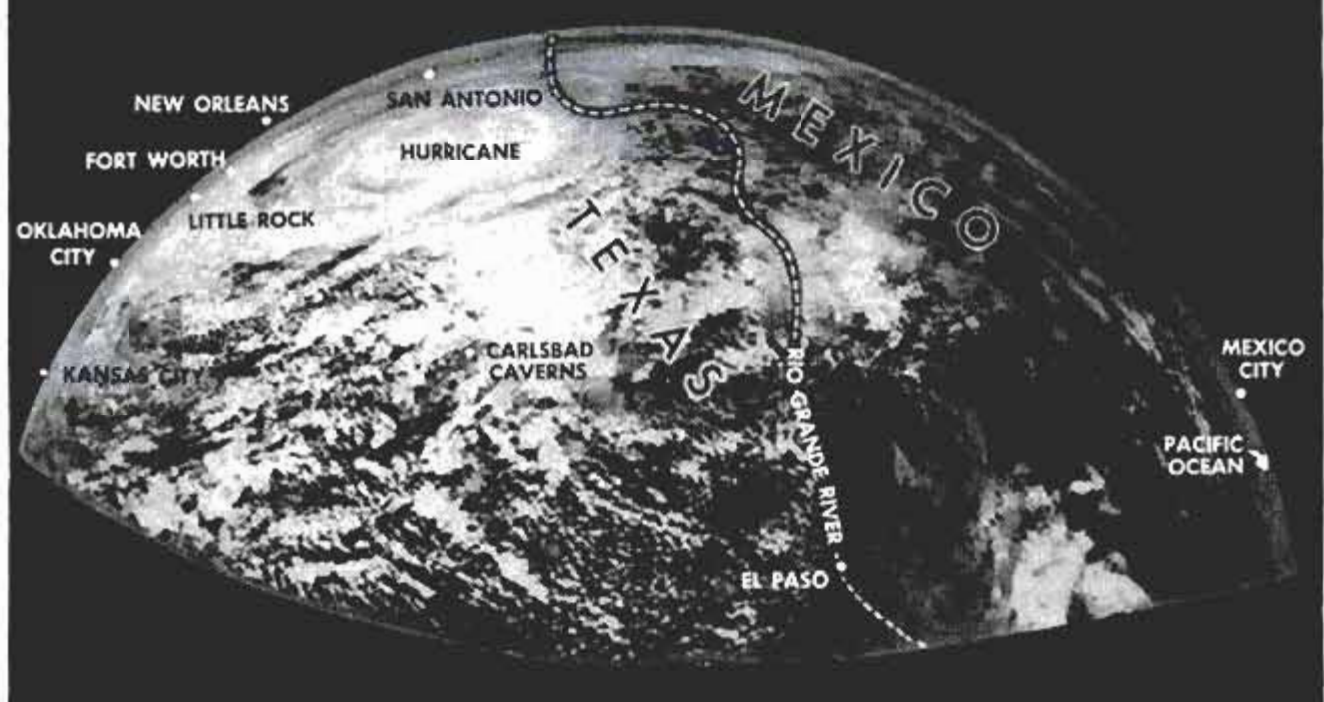
The same applies to aerial cameras and their films. And the camera we're talking about records one million bits of image to each square inch of film. Since a standard aerial negative is nine inches square, a little multiplication shows that 81 million bits of image can be implanted on this single negative.

America's first artificial satellite, Explorer I, was carried into orbit as the needle-nose of the Army's Jupiter-C rocket, shown in photo and diagrams

Orbiting around the earth at a speed of approximately 18,000 miles per hour, the Explorer satellite always "points" in the same direction. It moves headfirst, sideways and tailfirst—like a pencil you move in a circle but always hold parallel to the floor







From 100 miles up, a camera in a Navy Aerobee rocket photographed over a million square miles of earth

### Transmission Problem Being Licked

But to relay this image to a ground station, it must be transmitted. Suppose the transmitter's frequency is 10 megacycles, or 10,000,000 cycles per second. Now, for every cycle only *one* bit of image can be transmitted. Thus, you're limited to 10,000,000 bits of image per second. What happens to those other 71,000,000 image bits still on the film? Well, unless you concoct some pretty tricky circuits, you lose them. They're still on the film, of course. But the film's in the satellite. And you're on the ground. In short, all-seeing as may be your spy-camera, it's limited in transmission.

Actually, the transmission problem is close to being licked. Still, the illustration explains not only the difficulties, but why ground-bound intelligence agents may have only a reasonable facsimile of what the spatial spy sees.

Pied Piper, though, will have other eyes.

Right now in development, for example, is Servo Corporation of America's infrared sensors, capable of "thermally" mapping enemy terrain.

Explains a Servo spokesman, "every object emits infrared radiation. And the hotter an object, the greater its infrared radiation.

### Detects One Degree Difference

So heat-sensitive is Servo's newest and still secret airborne infrared detector that it'll differentiate between objects one degree warmer (or cooler) than their surroundings. Infrared sensitizers can strip camouflage from major areas of military importance—especially cities, secluded industrial hubs, perhaps even airfields.

Infrared detectors thus far declassified can, from operational heights of 50,000

feet, spot roads (which absorb heat, thus stand out from bordering terrain), trucks and tanks (revealed by their hot engines), cities and factories (exposed because the air above them is warmer than surrounding air) and ships (whose props, mixing warm surface water with the colder below, inevitably trail a cooler-than-surface-water wake).

Recently released by the Air Force were infrared photos taken at night, which clearly show not only a road, but a tank and its tracks. Another nighttime exposure pinpoints an airfield's runways, moving planes and fueling trucks, all detected thermally.

### TV Tube Films Heat

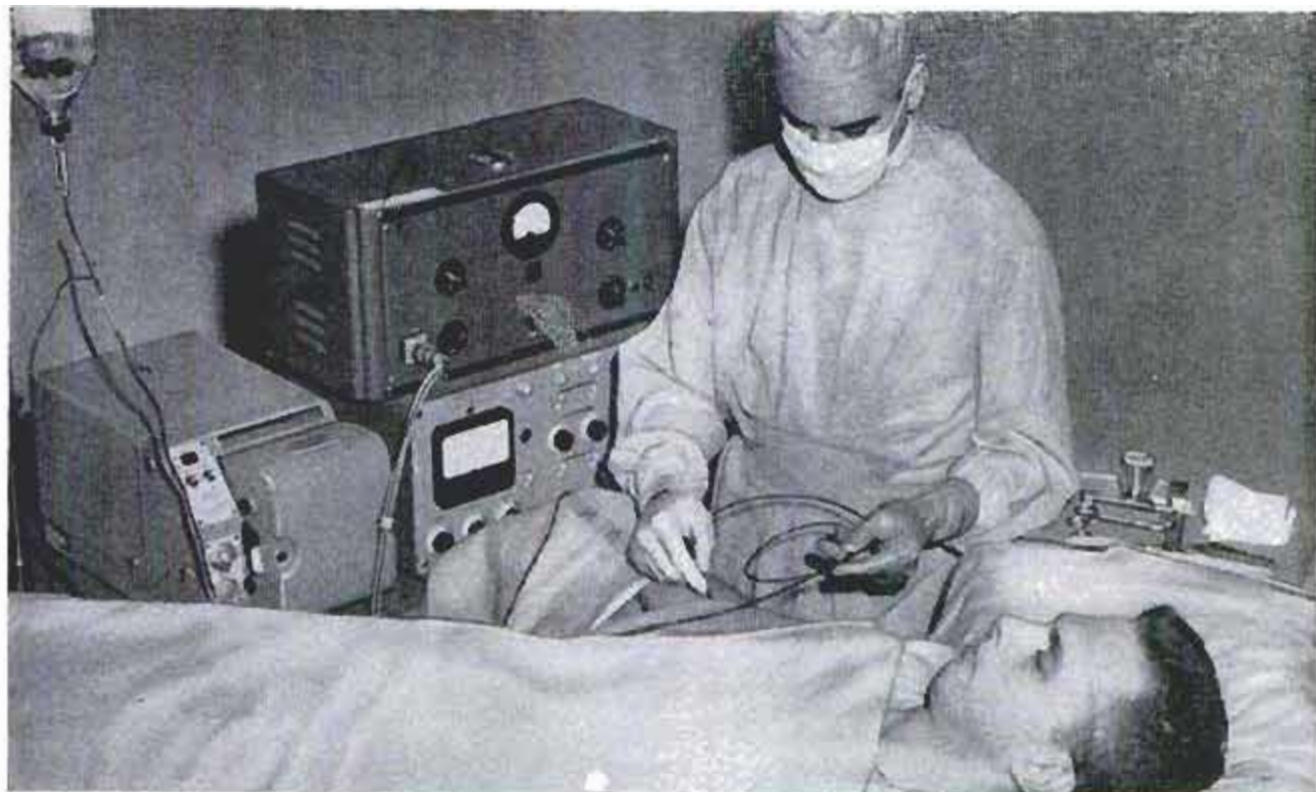
Says a military expert, "If infrared told us nothing more than when an enemy's strategic far-northern port was iced in, and shipping tied up, that might in a given situation be enough."

Servo's system is built around a camera lens or TV tube which translates a heat image into a light image—exposing infrared film. The film, automatically developed as the aerial spy hurtles through space, is "scanned" by special electronic devices, the light image translated into electrical impulses and these transmitted to ground receivers.

Ground receivers are not only in the works, but have successfully passed field tests. One of these, by Hycon Manufacturing Company of Pasadena, Calif., was originally designed for front-line combat surveillance from low-flying drone planes rigged with aerial cameras. A newer, TV version was recently tested by the U.S. Signal Corps' Combat Surveillance Department at its proving grounds.

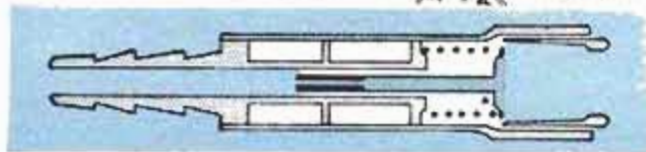
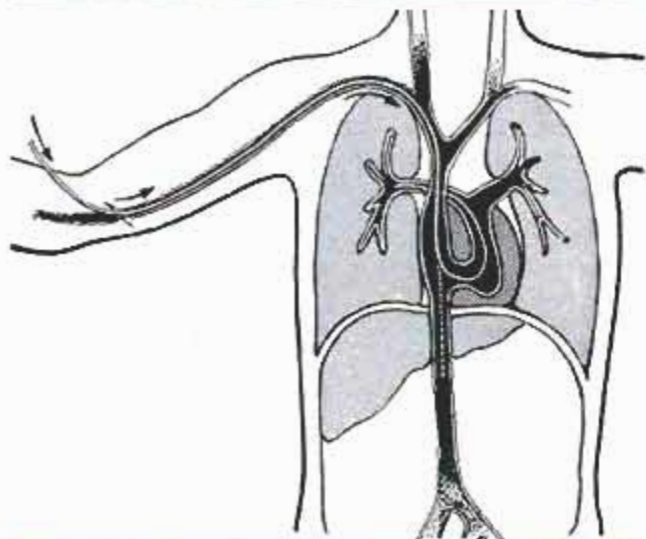
(Continued to page 248)





## Tiny Meter Moves in Veins To Record Blood Pressure

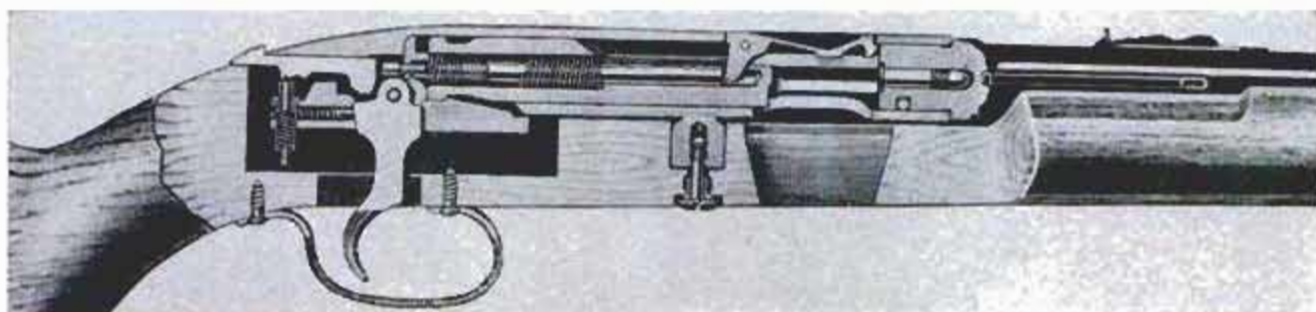
With a tiny meter about the size of the head of a match, doctors can measure blood pressure in the veins. Although doctors have long been able to measure the pressure of blood in the arteries, the blood pressure in the veins has been difficult to measure. In experiments by Dr. Herbert O. Sieker of the Veterans Administration, the little meter is fastened to the end of plastic wire and inserted in a vein. It then may be gently pushed into the chambers of the heart and blood vessels of the lungs. Slight variations in the blood pressure are sensed by the meter and transmitted as electrical impulses to an amplifier and a recorder. The meter itself was developed by Dr. Otto H. Gauer and E. Gienapp.



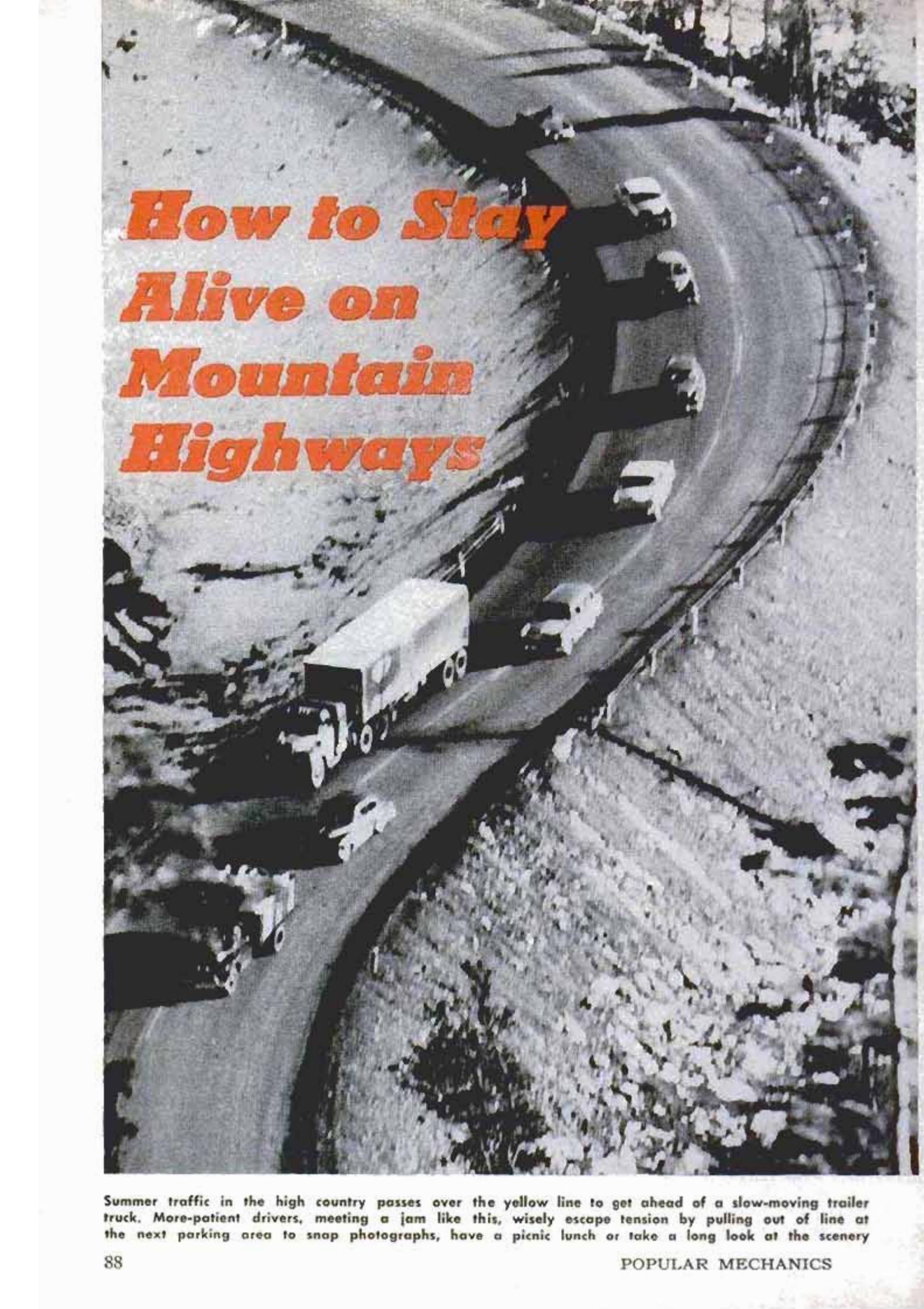
## Single-Shot .22-Caliber Rifle Has Features of Automatic

Dubbed an "automatic single shot," the new .22-caliber Winchester Model 55 rifle is loaded through the top of the chamber. Loading the rifle automatically puts it on

safety. Once it has been fired, it's unnecessary to cock again unless the trigger has been snapped on an empty case or without a round in the chamber.





An aerial photograph of a winding mountain highway. A large white trailer truck is stuck in a traffic jam, with several cars behind it. The road curves through a rocky, mountainous landscape. The text 'How to Stay Alive on Mountain Highways' is overlaid in red, bold, italicized font on the left side of the image.

# *How to Stay Alive on Mountain Highways*

Summer traffic in the high country passes over the yellow line to get ahead of a slow-moving trailer truck. More-patient drivers, meeting a jam like this, wisely escape tension by pulling out of line at the next parking area to snap photographs, have a picnic lunch or take a long look at the scenery





By **Gilbert R. Carrel**  
CHIEF, COLORADO STATE PATROL

**I**N THE WEST this summer, a record eight million vacationing motorists will travel high, weather-swept passes and deep, twisting canyons for the first time. A few will die for their mistakes. The tense majority will drive ineptly, to their own and others' discomfort.

This needn't happen. Despite steep grades, hairpin switchbacks and terrifying (to the uninitiated) drop-offs, major mountain highways aren't the treacherous shoot-the-chutes that flatland drivers picture. Normally, they're smooth, wide, safely engineered highroads to relaxation and sensational scenery. With caution, a well-maintained auto and rudimentary driving knowledge, practically no one need fear high-country driving.

Here are easy, common-sense tips to make your Western vacation the safe, pleasant idyl you envision:

**Preventive Maintenance:** Too often, a driver killed in the mountains is the vic-

tim of neglected equipment. He noses down a grade at 60. When he stabs the brake for a curve, nothing happens—a brake line has ruptured. Or a tie rod snaps, or a bald tire blows. The result is the same. He crashes through the guard rail and flips into a river or plunges down a steep slope.

The condition of brakes, steering and tires is a life-and-death matter in the mountains. So are lights—at night and in bad weather. Engine failure, if it won't kill, can leave you stranded for the night on a high, desolate pass. So before taking your mountain vacation, insure safety with a thorough checkup of your car.

When you hit the foothills, have your carburetor adjusted for high altitude; it saves gas and insures pep. Make sure you



have enough oil and water. Service stations may be few and widely spaced; at night, many will be closed. Inflate your tires (including the spare). Carry tire tools and a good jack. Put some heavy jackets, blankets and food in the rear seat. In winter, early spring and late fall, tire chains are a must.

Speeding on icy pavement, this driver skidded and hit a truck. The crash killed one and injured four







Crossing the center line, above, courts head-ons and sideswipes. The auto, below, sped around a curve, sideswiped an oncoming car, hurtled through the guard rail and plunged down a cliff. Fortunately the driver escaped without injuries



**The Uphill Grind:** When entering that first canyon, slow down. You may have been rolling at high speed on the plains, but you can't do it in the mountains. Mountain driving isn't more dangerous than the flatland variety, but it's different. Until you get the feel, be conservative. Ease into the turns, observe posted speeds and yellow, no-passing lines. Stay alert. Many canyon accidents happen in those first unfamiliar miles.

Passing uphill takes judgment. After an hour in a canyon, a steep upgrade may seem level. So be sure you have plenty of power and clear highway ahead before you swing out. Always use the gear that gives you the best speed-power ratio. Often you'll get stuck behind a slow-moving truck. Be patient. He's doing his best and



will let you pass at the first pull-out or passing strip.

If you feel nervous at the posted speed, take it easy. But watch your rear-view mirror. Most mountain states have no minimum speed laws but make it a violation to "impede the normal flow of traffic." When a half dozen cars line up behind you, pull out and let them by. It eases tension, forestalls traffic tickets, prevents "exasperation passing."

Above 8000 feet or so, overheating can be a hazard. But no stock auto should overheat if properly driven. At low speeds, shift down. Don't labor along at 20 miles per hour in third gear. This heats your engine and subjects it to unnecessary wear. Second gear may burn more fuel, but it gives you better circulation and cooling plus a comfortable feeling of power and control.

Keep an eye on the temperature gauge; remember, the boiling





When parking on a grade, it pays to block a wheel. The driver of the car in water failed to do this

point is lower at high altitude. If your car does boil over, don't scald yourself removing the radiator cap. If you can't restart, the trouble may be vapor lock, caused by overheating of your gas line or fuel pump. Pouring cold water on the pump may help; so may blowing in the gas tank. Otherwise, try opening the hood for better air circulation and wait a few minutes. Getting a push isn't advisable except on the straight and level.

**Driving the High Country:** Statistics show that most mountain collisions are caused by improper passing and following too close. Speed is the Number One killer. Not long ago, four GIs from Camp Hale, Colo., roared down a straightaway south of Leadville, Colo., doing 75. Rounding a curve four feet over the center line, they rammed a truck head-on. The impact pulverized their automobile and killed all four.

Drinking is another killer in the high country. Not only are sharp reflexes at a premium on mountain highways, but alcohol has harsher, quicker effects at high altitudes.

Rubbernecking causes its share of alpine accidents. Flatlanders find it a startling experience to see high mountains close at hand. But stop to enjoy the scenery. All mountain highways provide parking areas.

Make sure your emergency brake is set, your engine in gear, your wheels turned to prevent a roll. If necessary, block a wheel with a rock—a good idea, too, when changing a tire.

Climbing the passes, you'll meet switchbacks and breathtaking drop-offs—often with no guard rails. You'll experience at



least mild acrophobia—fear of high places. But relax. The peril is mostly psychological, and tension can cause mountain sickness. Don't overexert if unaccustomed to high altitude. If you have heart trouble or similar disability, seek your doctor's advice about mountain driving.

Watch for deer and other animals crossing mountain highways, especially at dusk. A 700-pound black bear can fold your front





In tunnels, turn on your dim lights, slow down and watch out for water, ice, sudden change in light

end like an accordion. Even porcupines have been known to cause accidents. Also, there is much open range in Western states, and sheep, cattle and horses are likely to wander onto highways.

But camera-toting tourists are probably a worse hazard. So approach turnouts and parking areas cautiously, expecting congestion. If you park, don't wander thoughtlessly onto the highway.

Above all, don't straddle the center line when driving in the high country. In "bad" places the tendency to shy away from the edge is almost irresistible. But with rock walls crowding the inside lane, you leave no room for the other guy. Straddling causes far more mountain accidents than it prevents. Typically, near Idaho Springs recently, four teen-agers rounded a curve in the wrong lane and were killed in a collision with a truck.

**About Weather:** On the plains, in summer, weather is normally a minor driving hazard. Not so in the mountains. On high, exposed highways like Trail Ridge Road in Rocky Mountain National Park, winter can come anytime. Snow squalls in July are by no means unheard of. Fog, sleet, freezing rain and wet snow can turn normally safe pavement into a slick, treacherous deathtrap for the unwary.

Clouds are the tip-off—not the fluffy white cumulus ones normal to summer afternoons, but the dark, boiling sentinels

of warm or cold fronts. Check with a ranger in advance, or catch a report on your car radio. Watch the passes and avoid storms.

If you do get caught "on top" in bad weather, stay calm. Keep moving, if it's safe. But go slow, and test your braking ability often. In rain, fog or snow, turn on your lights. Low beams will give you best visibility; at night in these conditions, high beams only reflect back in your face.

If visibility becomes too bad, stop and wait it out. Don't try to walk out you'll only get lost or hurt in a fall. If it's cold, wrap up in blankets or extra clothing. Run your engine for heat only if your exhaust system is perfect. Don't let wind blow fumes under the car. Don't let snow drift over your exhaust pipe. Carbon monoxide has killed hundreds of stalled motorists in the mountains. Beware of drowsiness; it may be a warning.

In the canyons, weather poses many hazards that flatland drivers rarely anticipate. For instance, during cloudbursts, rivers may boil up and wash out bridges and even highway sections. During freezing weather, in shady patches or on bridges, pavement otherwise clear for miles may be icy.

Anytime it rains, water washes mud from under rocks on the hillsides, thereby loosening them. Even where canyon walls aren't steep, a murderous barrage may be in prospect. Again, stay calm. Your chances



of getting hit are small. But you might crash into rocks lying on the highway, so guard against that.

Don't park. Keep moving at maximum speed and don't block traffic. Last summer, during a rainstorm in Clear Creek Canyon, Colo., a 200-pound rock slammed into an auto. The impact spun the car around, killing a youngster in the back seat. The accident was bad enough. But well-intentioned motorists who stopped to help stalled Sunday traffic five miles up and down the canyon.

**Rolling Downhill:** No single failing causes more mountain accidents than faulty downhill technique. The cause is obvious: The



combination of steep grades, gravity and hurtling two-ton autos.

Incredibly, many motorists still coast downhill. Others ride their brakes, causing the bands to heat up, expand and lose contact with the drums. Patrolmen stop hundreds of motorists each year with the dreary warning, "Your brakes are smoking; you're heading for a crash."

Prevent such a disaster by keeping your engine in gear, letting compression hold you back. You needn't fear reasonable speed on the downgrade. On steeper grades, shift down to the same gear you'd need coming up the hill.

**It's Your Responsibility:** Armed with these tips, any motorist can drive the high country with the assurance of a veteran. The prospect shouldn't unnerve you.

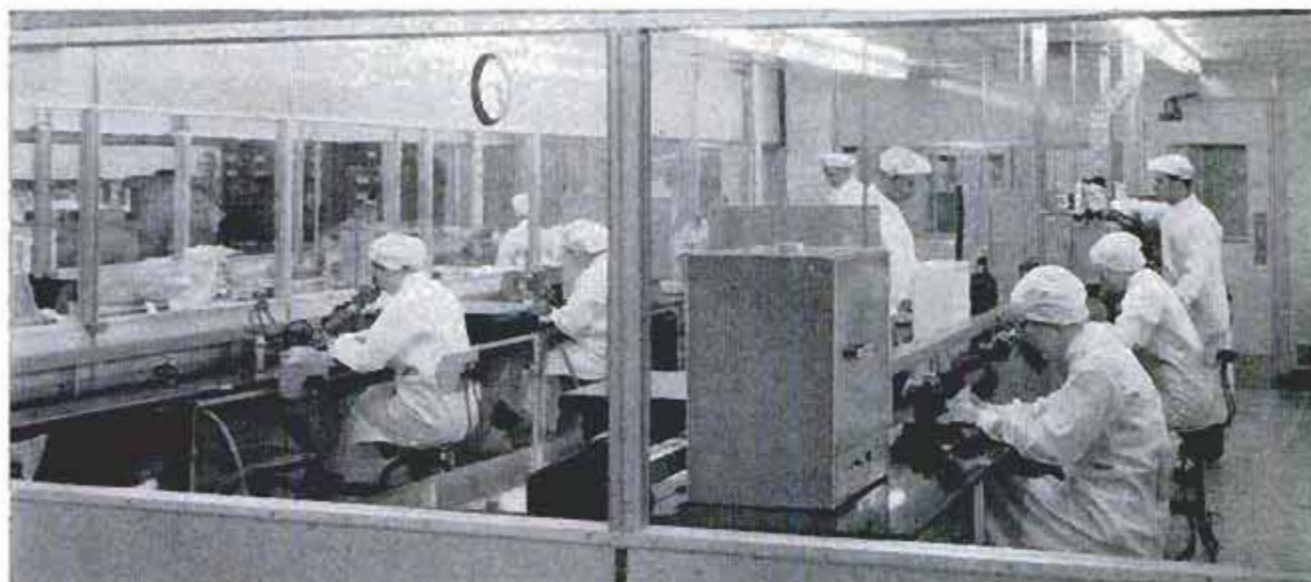
With the vast, monotonous distances in the West, drowsy motorists are one of our worst headaches. To remain alert, you just

stop and rest. Walk around, drink coffee, sleep. Fresh air alone doesn't help much.

Unfortunately, some tourists try to drive from Los Angeles to Denver (1500 miles), stopping only for food and gasoline. Recently, a motorist left Yakima, Wash., bound for Denver, intending to drive it in one 24-hour belt. He dozed once in Utah and hit the ditch. But he went on. Near Rangely, Colo., he fell asleep again. This time he slammed into a rock wall, caromed across the highway and rolled down the slope, killing himself and his daughter.

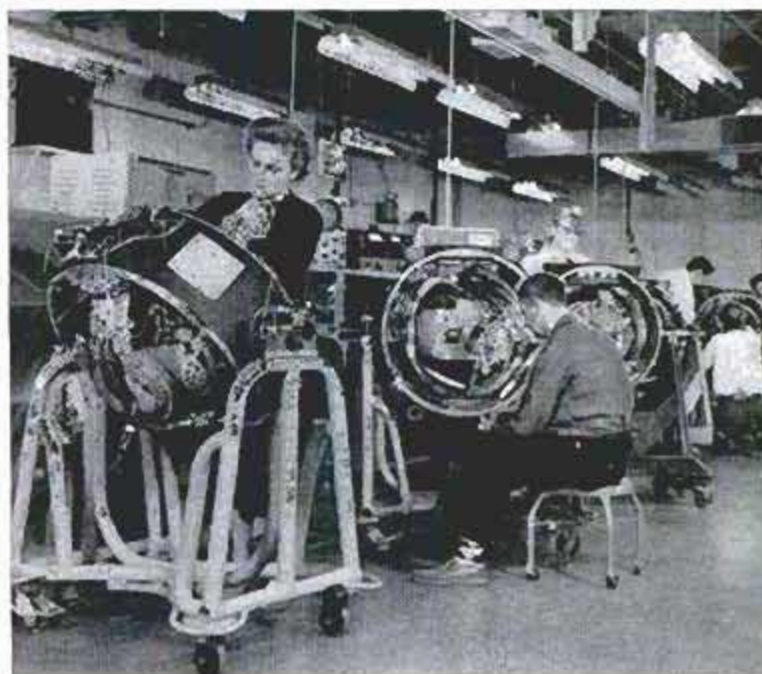
Such rashness may be hard to conceive. But Dr. Leon Brady, director of research for safety education at New York University, explains: "The problem of safe, lawful, courteous driving is primarily one of emotional make-up and social adequacy."

That goes double in the mountains. If your attitude is wrong, confine your driving to the golf course. ★ ★ ★

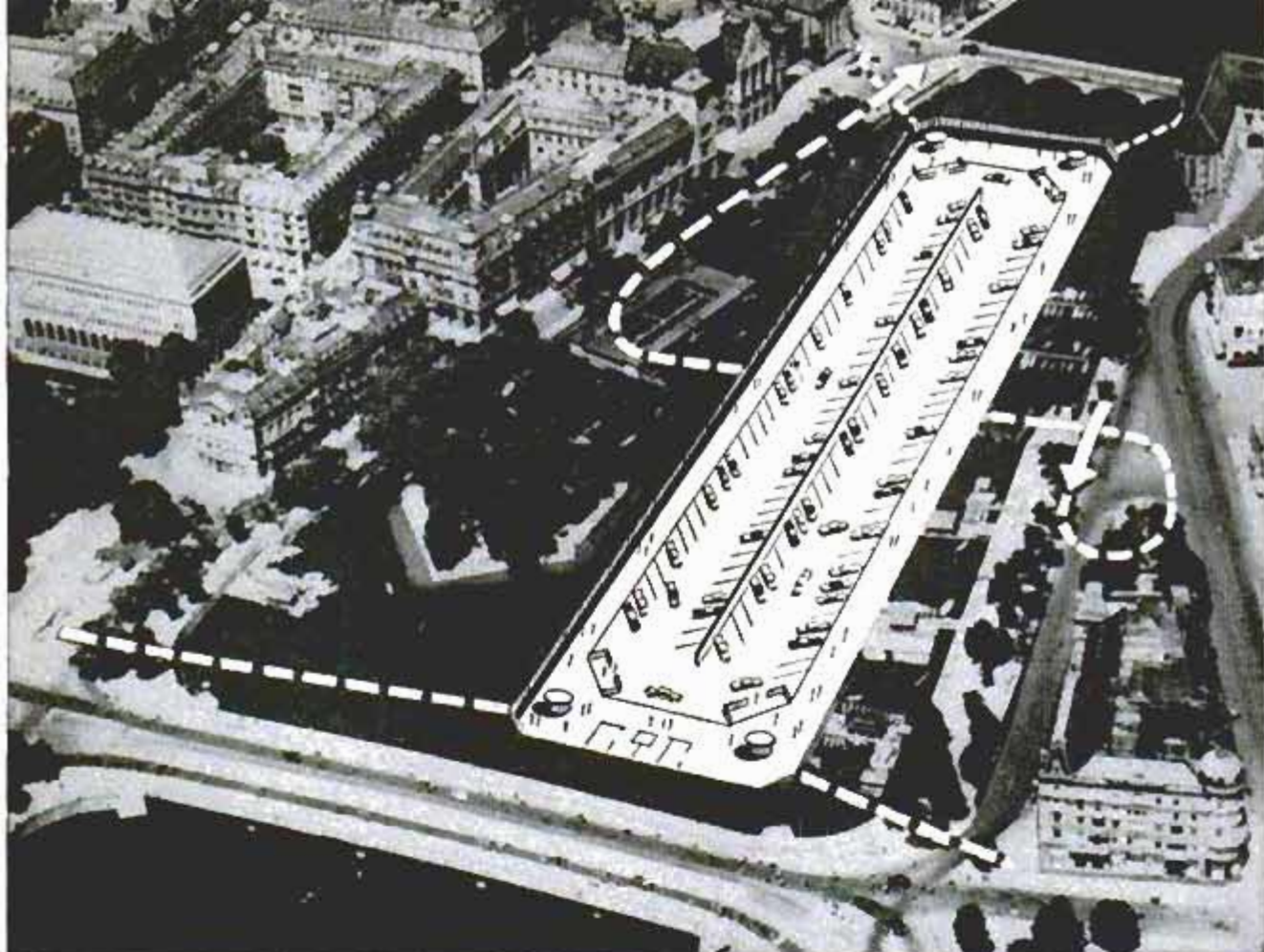


## Dustfree Workers Make Missile "Brains"

Automatic "brains" to guide ballistic missiles are now being manufactured under the sterile conditions of a surgical room. The inertial-guidance system for the Thor intermediate-range missile is in production by AC Spark Plug. The parts are made to tolerances as high as  $\frac{1}{25,000,000}$  inch. Even a speck of dust could alter the course of the missile, so production workers wear nylon hats, smocks and shoe covers at all times. The guidance system detects changes in the missile's course, computes corrections and feeds the answers to the missile with the speed of light.







Dotted lines at corners of underwater garage indicate pedestrian tunnels. Cars would enter, leave at middle

## Zurich Plans Parking Lot for 500 Cars Under Limmat River

SWITZERLAND'S LARGEST city, Zurich, hopes to solve part of its traffic problems by building a 500-car parking garage at the bottom of the Limmat River. The river bed will be dredged from its present depth of 13 feet to 39 feet. Four concrete

pontoons will be towed to the garage site. Then two parking levels will be built on the pontoon raft which will sink gradually into the dredged cavity. Pedestrian tunnels will run to the four corners of the underwater garage.

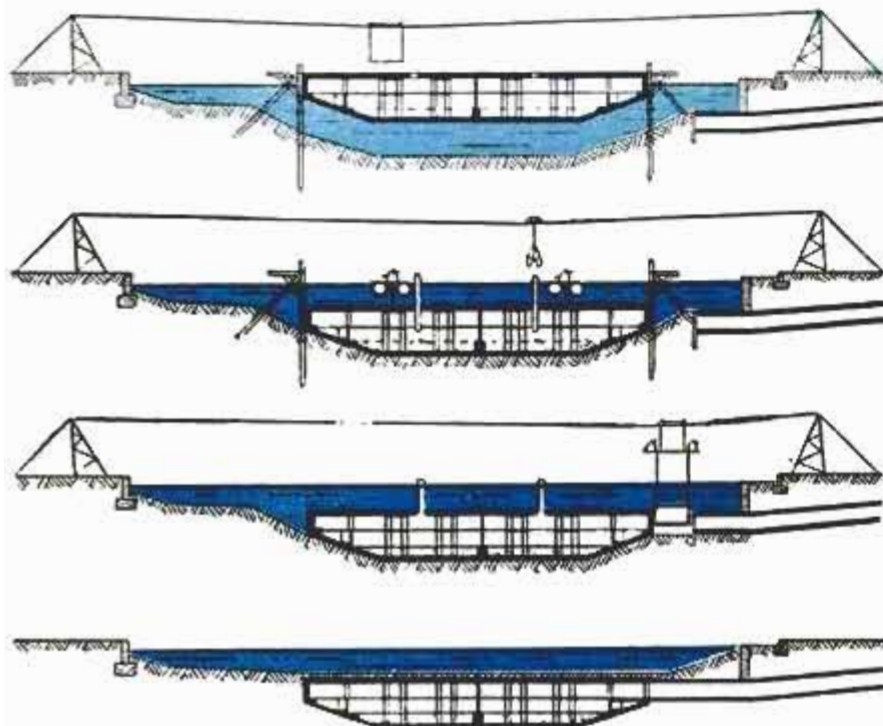


Diagram shows how two-level parking garage would be erected on series of pontoons anchored above dredged area of Limmat

To help sink concrete structure, loads of gravel ballast would be dumped on the roof. Workmen could enter through "chimneys"

Tunnels for cars and pedestrians, previously built to edge of garage, would be connected and internal construction would be finished

River bed finally would be leveled with gravel and sand to provide anchorage for boats. Shops are planned along outside walls





Photo by Nissen Trampoline Co., Cedar Rapids, Iowa

Trampoline diving is just a matter of jumping feet first into springy nylon. Unit can be located anywhere

## Trampoline Diving Board Suits Big or Small Pools

HOMEOWNERS with big or small back-yard swimming pools can make a big splash this year with a portable trampoline diving board. Even an inexperienced diver can perform tricks on a trampoline. He simply climbs to a low platform and jumps feet first onto the trampoline bed. The nylon bed, attached to the frame by springs or cables, bounces the diver into the air and over the water with little exertion on his part.

Trampolines put as much bounce in your dive as any of the wooden springboards

Photo by E. P. Fintgan Co., San Francisco, Calif.



Here's a jackknife dive from a trampoline diving board. Springs help such tricks







When the jet stream prowls south of its normal course across the country, tornadoes may strike by the dozens

## *The Jet Stream Is the Villain*

*—They're blaming tornadoes, hurricanes, floods on the vagaries of these high-flying rivers of wind. But the hitchhiking airliners like them.*

**By Frank J. Taylor**

THE PHONE JINGLED in the office of Don C. House, Supervising Forecaster of the SELS (Severe Local Storm) Forecast Center in Kansas City, Mo. On the long-distance line was a New York reporter who had an assignment to do an eye-witness story on tornadoes. "When can you guarantee me some tornadoes out there?" he asked.

"Wait a minute," said House, shuffling his weather maps. "I can't guarantee them, but if you'll be here tomorrow I think we'll have some for you."

Catching a plane, the newsman arrived in Kansas City just in time. A series of storms swirled up in the predicted area. The SELS forecasters even pinpointed one of them in advance so accurately that the reporter was on hand when the twister spiraled into the sky.

The astonished visitor wanted to know how House could tell in advance where and when the tornadoes would be born. For although the area within 500 miles of

Kansas City is the tornado incubator of the country—last year it gave birth to 900 of them—the average life of a tornado is only 10 minutes. Pinpointing them in advance calls for some meteorological wizardry.

House spread out a sequence of weather maps. Across each of them was a wide, black band, which had shifted south as each new chart was drawn, at 12-hour intervals. The dark, curving line across the country indicated the meanderings of the polar jet stream, a swift, high-altitude torrent of wind that whips eastward around the Northern Hemisphere between the 30th and 50th parallels.

This polar jet stream is the villain to blame for much of the country's disaster weather. In the six years since they established the SELS Forecast Center in Kansas City, Don House and his team of advanced weather experts have learned much about the affinity of the polar jet stream for severe storms—tornadoes, hail-



storms, cloudbursts. Whenever the polar jet veers south at the same time that moist, low-level tropical air masses are moving north from the Gulf of Mexico, the tornado spotters can expect trouble on the weather front.

A dramatic example occurred last spring. On May 19, the polar jet stream whipped in from the Pacific about halfway between San Francisco and Los Angeles, was tracked over Phoenix, Denver, Sioux City, after which it blew across the Great Lakes, New England and out into the Atlantic, causing no weather disturbance. But by May 20, at 9 a.m., it had detoured south and was checked over Albuquerque and Amarillo, after which it veered north. That afternoon, another shift brought it over Kansas City and St. Louis at an altitude of 30,000 feet, just as a mass of moist tropical air moved north up the Mississippi Valley. Recognizing the makings of catastrophic weather, the SELS Forecast Center alerted the threatened area over a network of radio stations.

During the late afternoon and evening, 50 tornadoes kicked up in Kansas and Oklahoma. In three days, there were 160 tornadoes in the area, accompanied by cloudbursts over the Kansas City environs. What happened, according to House, was that the atmosphere over the area was thrown off balance by the polar jet's shift. It took about five days of severe weather to restore equilibrium in the skies, just as it takes several days for the waters to recede after a river goes on a rampage during a flood.

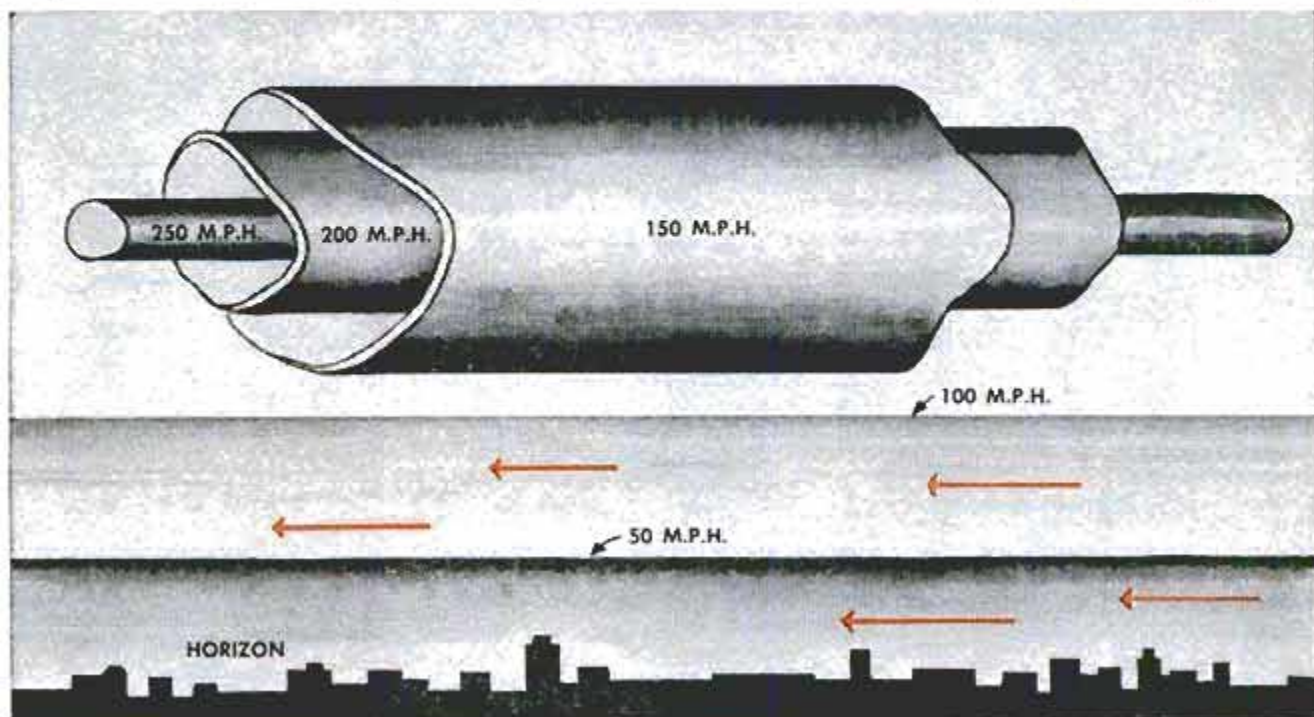
The polar jet stream was to blame for the Kansas weather binge mainly because

it triggered the cloudbursts that followed the tornadoes. Unlike low-level air mass movements, the big wind aloft carries little moisture. But often it does whip along cirrus banners of powdery ice particles which seed the clouds below. This kicks off a chain reaction of precipitation, such as the one that deluged Kansas, Missouri and Oklahoma in May, and one earlier that had drenched Texas last April, ending a five-year drought.

Airmen have known about the mighty wind upstairs since late in World War II, when B-29 bombers based in the Marianas encountered it over Japan. Often it blew so hard that bomber crews bucking it found themselves pinned motionless in the sky. To cope with it, they were obliged to overfly Japan at low levels, climb into the jet stream, make their bomb runs flying eastward, then ride the tailwind home. Pan American World Airways pilots have been riding the big wind eastward across the Pacific during the winter months for the past five years.

After the war the airlines, the Air Force and the Navy assigned teams of meteorologists to research the fantastic river of wind and find out how to put it to work. They soon concluded that planes could safely ride the jet stream nonstop from Tokyo to Honolulu, bypassing the refueling station on Wake Island entirely. At first, pilots were reluctant to try it, but in November 1952 Pan American's Capt. Logan D. Scott clipped seven hours off the Tokyo-Honolulu schedule and made the 3908-mile trip in 11 hours, 30 minutes. Since then Pan Am pilots have made hundreds of Tokyo-Honolulu nonstop flights during the winter

Diagram (not to scale) shows speeds of typical winds above surface, including the cylindrical jet stream







This man can blame jet stream for his loss. Weather Bureau now uses jet-stream studies to predict tornadoes

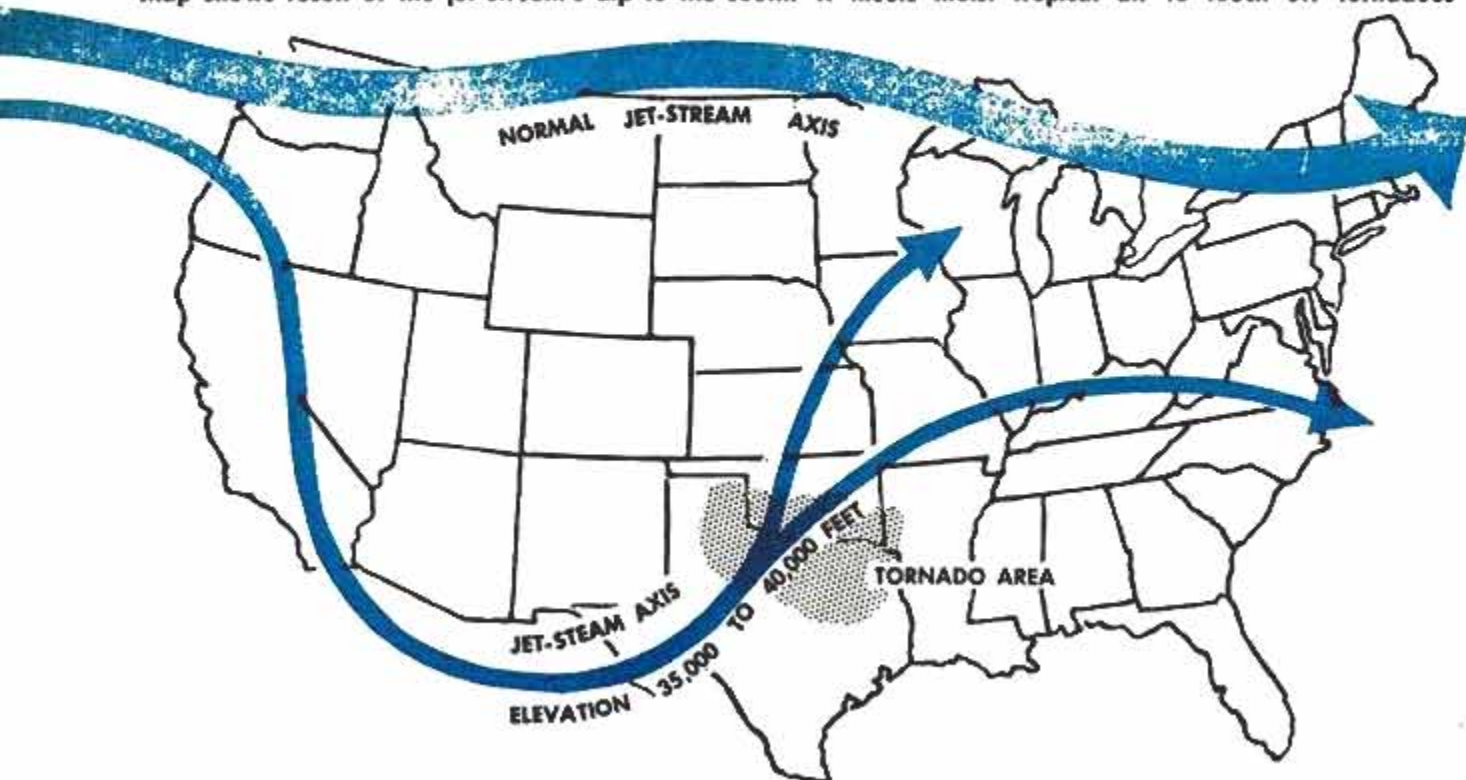
months, November to March, when the polar jet stream shifts southward to the Japan-Hawaii track across the Pacific. The record flight was made by Capt. John H. Kelly, who brought a Stratocruiser with a full load into Honolulu 9 hours, 18 minutes out of Tokyo. On that single flight, Pilot Kelly saved his company \$3000 in fuel and airplane time.

According to Kelly, "Inside the jet stream there's no weather at all. There are no clouds. You do not sense the extra

speed. It is smooth flying unless you drift too close to the north edge, where there is sharp turbulence."

Kelly and other pilots have discovered a trick for staying in the invisible, meandering jet stream. The center of the great wind river is 10 to 15 degrees warmer than its northern edge. By keeping an eye on the thermometer recording the temperature outside the plane (usually around 30 degrees below zero C.) they can hold a course in midstream. And garner the max-

Map shows result of the jet stream's dip to the south. It meets moist tropical air to touch off tornadoes





imum free ride, because the big wind's velocity is greatest at its center.

Though the jet stream was discovered and first put to work by airmen, it now looms even more important in the daily lives of the millions on the ground who are affected by the great wind's deviations from normal. Thus, tracking its willy-nilly meanderings from day to day and season to season has become a routine operation for a U.S. Weather Bureau-Air Force-Navy task force. Every day, for example, an Air Force weather-reconnaissance plane, jammed with instruments, takes off from Honolulu, flies north half way to Alaska, then returns via a dogleg that makes a 3700-mile overseas triangle. On two legs of the triangle, the flying weathermen usually pick up "the global wind band," as the Air Force calls it. If the Honolulu-based airmen don't find the big wind, another daily weather plane out of Fairbanks, Alaska, picks it up. A third triangle over the Pacific is flown out of Sacramento, Calif. The Navy operates weather planes out of Guam. The Air Force scouts the sky from Okinawa and Japan.

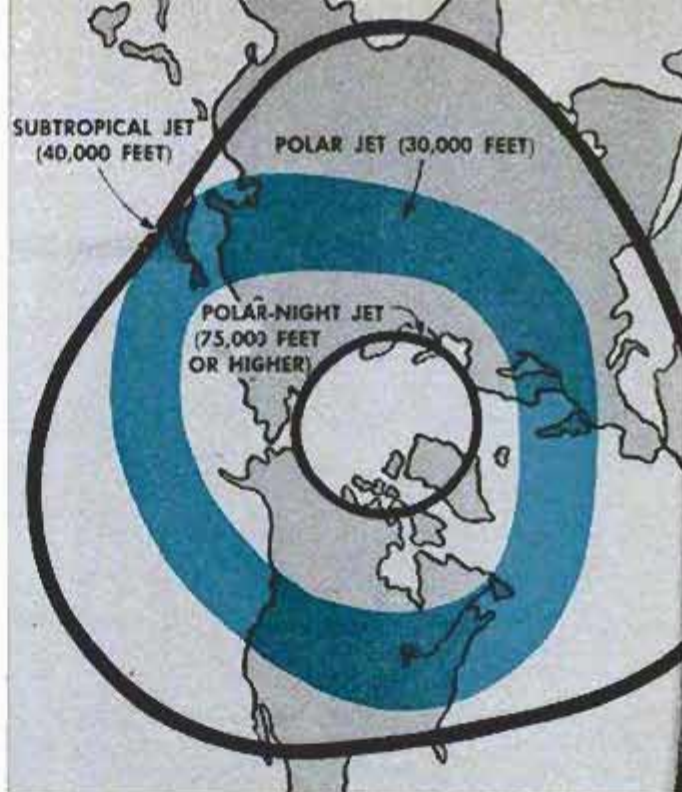
### Planes Drop Dropsondes

The weather planes release ingenious expendable mechanisms known as dropsondes, which are attached to small parachutes. As they float slowly down to the sea, tiny transmitters in the dropsondes report temperature, barometric pressure and humidity. On the weather planes, outside thermometers and wind indicators tell the airmen when they have cut across the jet stream. This and other weather information is relayed immediately to land stations which feed the facts into a vast international network.

"Each reconnaissance flight is like having 20 weather stations in the Pacific," explained Dean Parry, the Weather Bureau's jet-stream expert in Honolulu. "There's nothing more perishable than the weather, so in a matter of minutes the information is in the mainland forecast centers.

### Mistaken for Flying Saucers

On the continent the detecting is taken over by 100 U.S. Weather Bureau stations, each of which releases similar reporting mechanisms known as radiosondes, two to four times daily. The featherweight radiosondes are carried aloft by helium-inflated balloons—often mistaken for flying saucers as they glisten in the sky. As they rise, the radiosonde transmitters beam back a steady stream of reports on atmospheric pressure, humidity and temperature. In addition, the radiosondes, tracked by radio direction-finding equipment, reveal the



Map by H. Riehl, University of Chicago

Here are normal courses of three jet streams over Northern Hemisphere. Polar jet causes most trouble

wind direction and velocity at all levels up to around 60,000 feet, where the balloons explode. Other radiosondes are sent up and tracked by ships at sea. Meteorologists in Japan, Canada and European countries are checking, too. Even Soviet Russia and Red China broadcast limited reports. Tracking the polar jet stream has become a global operation.

### Four Rivers of Wind?

The concept of a single invisible global river of wind has changed to a possible four in the Northern Hemisphere. Another stream has been identified in the Southern Hemisphere, and meteorologists think there may be more. Some meteorologists consider the name "jet stream"—which was coined by the late Dr. C. G. A. Rossby, meteorologist from the University of Chicago—an unfortunate choice, because "it's neither a jet, nor a stream, but a meandering global band of wind, often a hundred miles wide and two to five miles deep."

Over the Northern Hemisphere, the southernmost of these rivers of wind is the subtropical jet stream, usually 40,000 to 45,000 feet aloft, which whips over Texas and the Carolinas at such lofty altitude that it apparently has little effect on surface weather. The arctic jet, in the far north, cuts across northern Alaska and Canada, at lower altitude, around 25,000 feet. The most recently discovered "planetary wind band," dubbed the polar night jet, flows around the earth 80,000 feet above the Arctic Circle.

The stream which wanders across the

(Continued to page 238)





**By Art Railton**

**WHAT HAPPENED?** That's the question Detroit keeps asking itself. It just can't be—this sudden reversal of the American collective mind. It never happened before.

The public has suddenly become big-car conscious—conscious that its cars are too big, and getting bigger. It's not so much that the small car has won converts as that the big car has lost them.

Everybody's picking on Detroit these days. Everybody from a Senate investigating committee to the Mayor of New York and a Bishop of the Methodist Church. The charge: Cars are too big, too pretentious, too wasteful.

Perhaps the public finally discovered it has been oversold. A new car may not be worth what it costs to buy and operate. It's cheaper to spend some money putting the old car in good shape. At least, by this time you've got the "bugs" out of it!

Just a year ago, American Motors was virtually out on its feet. The financial pages were filled with sad stories about plans to liquidate the auto division.

Today, American Motors is making money on cars for the first time in years. Yet it's not doing a thing differently from what it did a year ago. It hasn't changed, the public has.

But this is no time for complacency. Once the Big Three bring out their small cars (as they must) the rat race will begin. American Motors may have the field to itself today, but its advantage is temporary.

#### **Chrysler Still Looking?**

Success of the reincarnated 1955 Rambler astounds the industry (1000 Americans are being built and sold each week).

So panicky is Detroit becoming that usually reliable trade magazines print unfounded small-car rumors. One such rumor is that Chrysler will soon resurrect the 1955 Aero Willys (an excellent small car, by the way). Some time ago, Chrysler did consider producing this car in Australia, but that's been dropped and there is no

truth to the story of domestic production. Chrysler says it is still looking at the small-car picture. It had better stop looking and start working or the picture will be over, leaving nothing to watch but competitors' commercials.

Air suspension is certainly laying an egg as of the moment. The manufacturers aren't building it very fast and the public isn't demanding it at all.

The fact seems to be that the industry scared itself into the air-bag race. Everybody thought everybody else had it, so all rushed through their own versions, perfected or not. Sub-zero weather and air suspension don't go well together. Valve freeze-ups result. Anyway it takes an expert to tell the difference in ride.

Who will spend \$150 for something you can't feel and the neighbors can't see?

#### **Revived "T"?**

Bill Ford broke the no-talk-about-the-small-car rule and mentioned that Ford has clay work done on the new "small Ford" which, he stated, would not look like the British Ford ("it has to be more streamlined than that"). He wouldn't say any more about the car but it is generally assumed to have a 102-inch wheelbase. This is the same wheelbase as the original Ford Thunderbird. It may be mere coincidence, but it could mean that Ford is saving time by using some engineering work from the old T-Bird. Close your eyes and visualize a thin-roofed four-door body on the basic Thunderbird shape and you've got yourself a right smart-looking buggy, Mister!

Whatever it looks like, it will have no spaceship tendencies in its styling. Experience with Mercury convinced Ford that the public is not as ready to accept advanced design as some stylists think. There's still a lot of folks who like a car to look like a car.

Vauxhall sales are better than expected, says Pontiac. Can't ship them over here fast enough. This month they begin importing the new Vauxhall Cresta. It is larger than the Victor and has a six-cylinder engine. It's real deluxe all the way.

If this Cresta catches fire over here at about \$2600, Detroit will have more adjusting to do. It would prove that the public will pay extra for a well-finished "small" car and that everybody who wants a smaller car is not a penny pincher.

Citroen hopes to sell 10,000 of its 2CV models in this country in 1958. The 2CV is the utterly ugly, virtually indestructible favorite of the French farmer. Price is about \$1200. It has a one-year guarantee—parts and labor free! If they sell 10,000 of these corrugated boxes here, stylists will jump out windows all over Detroit. ★ ★ ★





## Amphibious Helicopter Rides Outrigger Floats

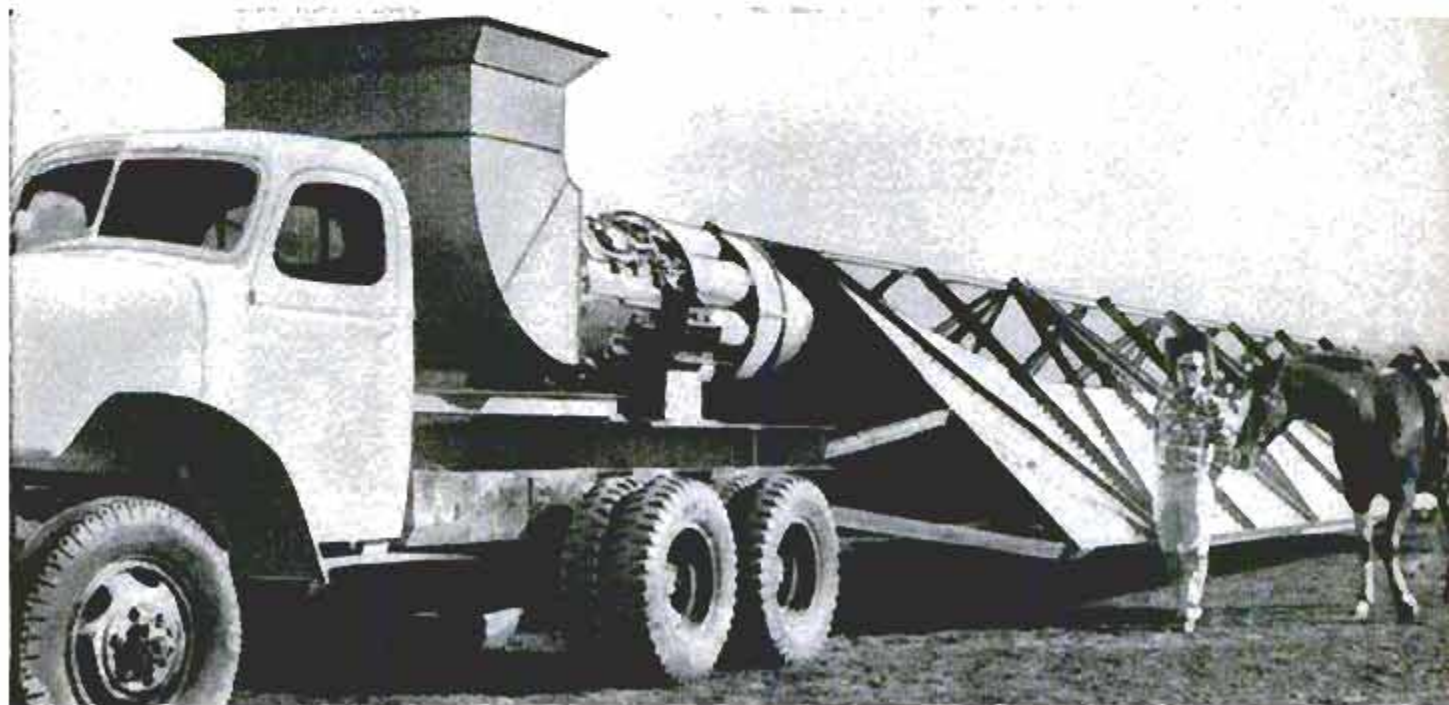
With the addition of two floats, a Vertol HUP-2 helicopter has been made amphibious. This makes the craft safer for over-water operations such as carrier duty and antisubmarine warfare. The bottom of the fuselage was reinforced to withstand landing impact, and the lower nose window was replaced with aluminum plates. The floats are outboard of the center of the helicopter. Tests show the craft can taxi forward or backward, regardless of wind direction.



## California Race Track Uses Big Blower to Dry up Muddy Spots

Horses at Santa Anita race track will find more solid footing on wet days because of a huge machine called a "jet blower." The powerful machine is driven onto the track

where it forces a blast of warm, dry air into soft spots left by the rain. The device to end muddy tracks got its first test during the recent winter season.





## CHEVROLET Owners Rate



### Three Peas in a Pod?

It's amazing how similar are the opinions of owners of each of the three makes surveyed.

Such similarity shows that the companies have reached a common ground. Most differences seem to be in styling.

Blindfold test rides in the three makes prove how slight the differences really are.

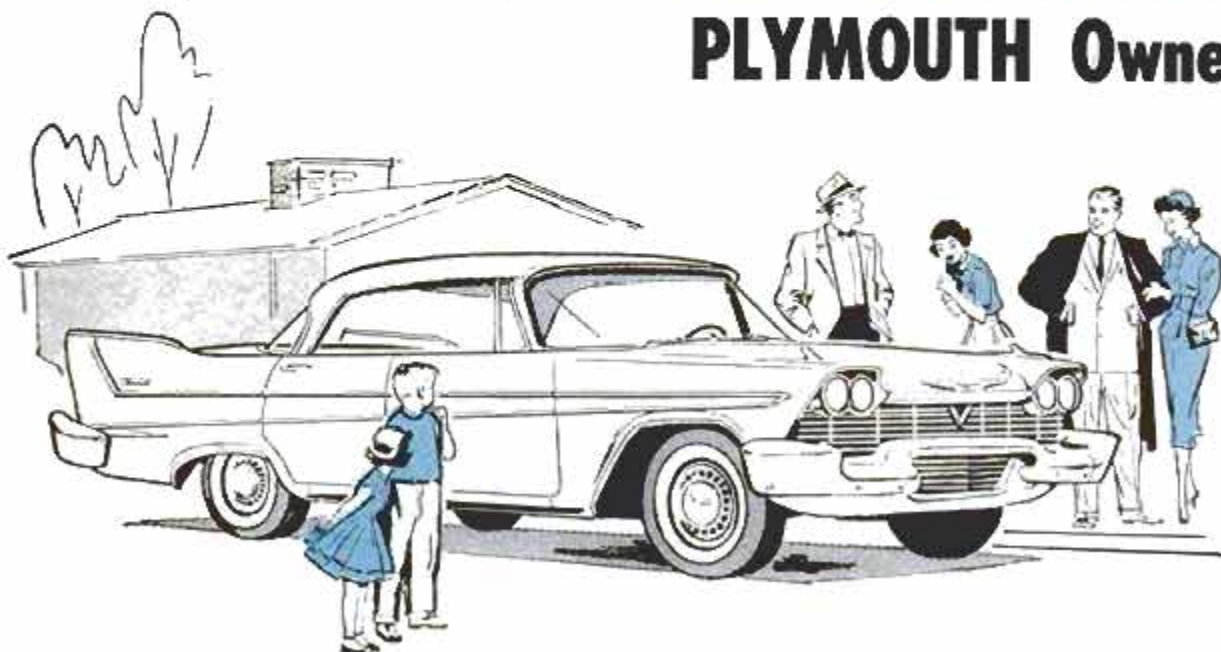
Not only are the best-liked features similar, but the complaints are also.

What about owner loyalty? Ford wins out here, although more Plymouth and Chevrolet owners plan to move up to bigger cars in the same family.

## FORD Owners Rate



## PLYMOUTH Owners Rate









# CHEVROLET

*Biggest improvement in Chevy is ride, especially on rough, undulating pavement.*

*It took the middle road: From the rear, Ford is horizontal, Plymouth is vertical, Chevrolet is diagonal.*

"I like its handling. Driving is so smooth and easy."—North Carolina bookkeeper.

▶ "Handles beautifully on curves. Rides nearly as well as a Mark VII Jaguar on rough roads."—Illinois manufacturers representative.

"I like the easy ride on long trips. I ride to college 1300 miles per week and I need comfort."—Louisiana minister.

"More comfortable riding than in previous years although the rear seat of the station wagon rides hard."—New York rural mail carrier.

"An attractive car. Does not look like a rolling chrome factory."—Washington real-estate man.

▶ "Clean lines. No fins to follow you."—Illinois accountant.

"They didn't go to extremes in styling. Didn't go out of this world and beyond, but just enough to keep Chevrolet owners satisfied."—Wisconsin draftsman.

"Has lots of acceleration."—Idaho contractor.

"Quick pickup. And it will make a U-turn on most any street."—Illinois laborer.

---

# FORD

*Disagree. Last year's Ford was a mighty handsome package. The facelift lost a little something.*

*It's refreshing to have a few owners praise economy.*

"Handles easy. I'm a rural mail carrier with an average of 300 stops per day. The car is easy to guide up to each mailbox."—Georgia mail carrier.

"Unusually good lines. Best styled car of the low-price three. Neat, streamlined front end."—North Carolina insurance salesman.

"Terrific styling. Long, even lines. Dual taillights."—New York janitor.

"Rides like sitting in a club chair."—New York owner.

"If you ever need the power to pass, it is there. You just press down and go. It has too much power, if anything."—Georgia clerk.

▶ "I like the economy, especially the first cost. I traded a big car that was putting me in the poorhouse."—Illinois contractor.

"I like the miles per gallon. My V8 gets 14.6 miles per gallon in the city and 21 on long trips."—Texas soldier.

"Roadability. Good safe solid feel on the highway and on curves."—Illinois parts manager.

---

# PLYMOUTH

*Plymouth excels here. It takes corners like a sports car. Has a "just right" feeling about its balance.*

*He's the fellow Detroit is trying to please. It forgot the sensible guy who insists that comfort come first.*

owned. Excellent control at high speeds in gusty winds."—Oregon advertising man.

"It handles real easy. Ideal woman's car."—Ohio welder.

▶ "Torsionaire ride is comfortable, driving is relaxed."—Delaware teacher.

"Low center of gravity gives outstanding ride. Smooth on straightaway, excellent around curves."—Illinois engineer.

"Lovely lines showing power, expressing personality without being too showy."—Rhode Island jeweler.

▶ "I, like thousands of others, am willing to sacrifice some comfort for style. In my opinion, all cars were more comfortable in 1953 and 1954, but they were not as good looking."—Colorado cartographer.

"Plenty of pep from 30 miles per hour up."—New York insurance agent.

"More power than I can use. Gives a feeling of security when driving fast."—California foreign representative.

"Plenty of room in the car. Everybody can relax, not feel poured in."—Ohio salesman.



"Low operating cost with the six-cylinder engine. I use regular gas, average 19 miles per gallon on long trips."—New Jersey store owner.

"I got 23 miles per gallon on a long trip in this six-cylinder job."—Illinois archival assistant.

"Very spacious. Three ride very comfortably in the front or rear seat."—Florida civil servant.

"I am over six feet tall and it sits very good. I have plenty of legroom."—Oregon sales manager.

"Visibility is excellent, making it easy to park in back-in spaces."—Oklahoma soldier.

"Plenty of vision in all weather."—Florida contractor.

"Smooth transmission. Powerglide is the best for driving on ice and snow."—Wisconsin owner.

"Roadability is what I like most. But headlights and taillights plug with snow in a storm, especially the taillights, creating a rear-end hazard."—Wisconsin semi-truck driver.

"It's a good road car. It handles like the old Hudson. Very good on curves."—Idaho soldier.

Here's how to beat the high-cost of motoring. But don't expect such economy around town with automatic transmission (even on the Six).

Except that the wipers don't wipe the sharp curve of faddish wrap-arounds.

"Spacious view. Excellent for driver."—Illinois salesman.

"Automatic transmission is really smooth. You can hardly tell when it kicks over."—New York farmer.

"Inside color combinations and excellent material are what I like."—Wisconsin high-school teacher.

"Dual headlights help night driving and the four taillights make it safer."—Illinois truck driver.

Ford's automatic is best of the three in judgment of this editor, all things considered.

### And They Complain

But the Ford is not perfect. The owners have some things they don't like (although 35.7 percent did not list a single complaint on the questionnaire).

Here, in order of frequency of mention, are the complaints.

"Many body rattles."—North Carolina technician.

"I get 17 miles per gallon on trips with this Six. I expected better mileage."—Wisconsin forester.

"This 300-horsepower engine needs high-test gas."—New York insurance salesman.

"I am very disappointed in the economy of this Ford,

Best of the three in this department.

What did he expect? He got power, didn't he?

"This station wagon has all the room to be desired and more."—Illinois engraver.

"Roominess of trunk and interior."—New Jersey agent.

"Excellent visibility in all directions. Dual headlights improve night vision."—Kansas farmer.

"Large, wide, one-piece windshield."—Texas soldier.

"Very low upkeep. I just drove 3130 miles with three persons, a 14-foot boat, motor and trailer and luggage. It performed beautifully. Averaged 13.6 miles per gallon on the trip."—New Jersey superintendent.

"I have a six and get 22 miles per gallon on trips."—Florida salesman.

"I like the push-button shift which the children can't play with while I'm driving."—Virginia sailor.

"Corners like a sports car, yet the ride is soft as in previous years."—Maryland salesman.

It's not all gain. Distortion and annoying reflections at night are some debits.

This editor doesn't feel push buttons are more convenient, but does agree they're out of the kids' way (and, unfortunately, out of the driver's way, too).

### And There Are Complaints

Not everybody is completely happy with the 1958 Plym-



# CHEVROLET

*Test car had squeaks in steering column. Hood and steering wheel shook noticeably on rough roads.*

*Big men shouldn't try to get into the back seat of an Impala.*

## Next, the Complaints

Chevrolet owners have some gripes, too. Here, in order of frequency of mention are the items most complained about by owners of the 1958 Chevrolet. (Of course, 35.4% of the owners make no complaints at all.)

"There are a lot of rattles in the dash and doors. No way to tighten the gear-selector lever or the collar around the steering post."—Wisconsin seaman.

"I bought one of the first Chevrolets sold. It appears to me that it was rushed through the factory. Minor body defects were overlooked. Right front door had to be refitted. Hood fits poorly. Dealer has tried to correct most defects, but sloppy assembly hard to overcome. I blame the factory, not the dealer."—Illinois owner.

"Minor troubles due to faulty assembly cause great inconvenience and humiliation."—Wisconsin insurance man.

"Car too low to get in and out. It is next to impossible for a big man to get in and out of the back seat of this Impala."—Georgia salesman.

(Text continued on page 244)

# FORD

*It's good to see someone take the heat off the dealer. He's expected to correct every mistake — and usually can't.*

*Owners have been saying this for years and going right out to buy the newest, lowest models.*

since that was a factor in my changing cars. Unless the mileage improves, I will pay more for another car next time to get better than 10 miles per gallon."—Illinois teacher.

"This car, like all my postwar cars, had a series of minor faults that could almost drive a guy out of his mind. It puts a terrific load on the dealer's servicing facilities and accounts for the service that is sometimes called 'bad.' Manufacturers would have more efficient dealers and happier customers if they would do a thorough job of inspection before sending the car to the dealer."—Illinois salesman.

"Poor dealer service. In six weeks they cannot seem to find the time to repair leaky oil pan, leak in vacuum line, leak in transmission case."—Wisconsin sales representative.

"Engine runs too loud."—Illinois owner.

"All new cars are too low. Not convenient to get in and out. On unpaved roads there are ruts the car drags on."—Georgia school superintendent.

"Front seats are not comfortable. Steering wheel is too

(Text continued on page 252)

# PLYMOUTH

*Common complaint on all makes today. There is no excuse for it except poor quality control at the factory.*

*Apparently it never, never rains at a proving ground.*

outh although 27.7 percent register no complaints at all.

Here are the not-so-good things that the owners complain about, listed in order of frequency of mention.

"Despite factory inspection stickers, many small things were wrong. Rear deck partially unpainted. Seat bracket missing. Folding seat in wagon did not fold."—Maryland Federal employee.

"I was amazed to find so many bolts and metal screws that were not fastened securely. Some fell out as I was driving along. You begin to wonder if the motor will fall out."—Maryland supervisor.

"It has too many rattles, especially the doors. Seem to have a spring in them that vibrates and nothing can cure it. More rattles than in my 1951 model certainly."—Illinois telephone man.

"Water leaks around doors and the ventilator."—Maryland owner.

"When it's raining and you open a door, all the water pours in."—Maryland clerk.

(Text continued on page 254)



## SUMMARY OF CHEVROLET OWNERS' OPINIONS:

OVER-ALL RATING: Excellent 67.6% Average 27.0% Poor 5.4%

### Best-liked features

Handling ease	40.2%
Riding comfort	33.7%
Exterior styling	32.6%
Power, performance	31.0%
Economy of operation	13.0%
Roominess	8.7%
Visibility	7.6%
Auto. transmission	7.6%
Roadability	5.4%

### Most-frequent complaints

None at all	35.4%
Body squeaks, rattles	16.8%
Poor workmanship	11.4%
Hard to get in, out	11.4%
Poor gas economy	10.9%
Water leaks	7.1%
Poor ride	6.0%
Poor paint, chrome	4.9%
Steering trouble	3.3%

### Had trouble with engine?

No trouble	84.2%
Some trouble	12.0%
Considerable trouble	3.8%

### What was engine trouble?

Carburetor	5.4%
Valves, tappets	2.2%
Oil leaks	2.2%

### How is dealer service?

Excellent	55.1%
Average	38.4%
Poor	6.5%

### Would buy from him again?

Yes, would	70.3%
Undecided	21.6%
No, would not	8.1%

### Have air suspension?

Yes, do have	17.8%
No, do not have	77.9%
No answer	4.3%

### Is the air suspension you have worth the added cost?

Yes, it's worth it	33.3%
No, it isn't	18.2%
No answer, don't know	48.5%

### What make car was traded?

Chevrolet	66.0%
Another GM car	7.6%
Ford product	12.4%
Chrysler product	4.3%
All others	0.5%
No trade, no answer	9.2%

### What make will buy next time?

Chevrolet	63.8%
Another GM product	7.0%
Ford product	1.6%
Chrysler product	1.6%
All others	1.1%
Undecided, no answer	24.9%



## SUMMARY OF FORD OWNERS' OPINIONS:

OVER-ALL RATING: Excellent 68.9% Average 26.4% Poor 4.7%

### Best-liked features

Handling ease	50.2%
Exterior styling	37.3%
Riding comfort	31.1%
Power, performance	30.1%
Economy of operation	8.8%
Roadability	8.3%
Visibility	6.2%
Auto. transmission	5.2%
Interior styling	5.2%

### Most-frequent complaints

None at all	35.7%
Body squeaks, rattles	15.0%
Poor gas economy	12.4%
Poor workmanship	8.8%
Poor dealer service	6.2%
Noisy engine	5.2%
Not roomy enough	4.1%
Uncomfortable seats	3.6%
Car is too low	3.6%

### Had trouble with engine?

No trouble	79.3%
Some trouble	17.6%
Considerable trouble	3.1%

### What was engine trouble?

Valves, tappets	4.7%
Carburetor	4.1%
Timing	2.1%

### How is dealer service?

Excellent	54.4%
Average	33.7%
Poor	11.9%

### Would buy from him again?

Yes, would	67.9%
Undecided	23.3%
No, would not	8.8%

### What safety features in car?

Padded visor	54.9%
Padded dash	53.9%
Seat belts	6.2%

### What make car was traded?

Ford	65.8%
Another Ford product	1.6%
General Motors make	15.5%
Chrysler Corp. make	5.7%
All others	1.6%
No trade, no answer	9.8%

### What make will buy next time?

Ford	72.5%
Another Ford product	0.5%
General Motors make	7.3%
Chrysler Corp. make	2.1%
All others	1.0%
Undecided, no answer	16.6%



## SUMMARY OF PLYMOUTH OWNERS' OPINIONS:

OVER-ALL RATING: Excellent 73.6% Average 22.3% Poor 4.1%

### Best-liked features

Handling ease	50.8%
Riding comfort	39.7%
Exterior styling	31.8%
Power, performance	14.9%
Roominess	14.4%
Visibility	11.2%
Economy of operation	10.3%
Auto. transmission	8.7%
Roadability	7.9%

### Most-frequent complaints

None at all	27.7%
Poor workmanship	14.4%
Body squeaks, rattles	11.6%
Water leaks	10.7%
Poor gas economy	6.6%
Poor ride, low seats	5.8%
Poor dealer service	5.0%
Rear-view mirror	4.5%
Lack of rear legroom	4.5%

### Had trouble with engine?

No trouble	84.3%
Some trouble	14.0%
Considerable trouble	1.7%

### What was engine trouble?

Carburetor	3.3%
Oil leaks	2.1%
Water pump	1.6%

### How is dealer service?

Excellent	54.3%
Average	35.5%
Poor	10.3%

### Would buy from him again?

Yes, would	64.5%
Undecided	24.3%
No, would not	11.2%

### Exterior feature liked most

Low, long look	19.0%
Tailfins	11.6%

### Exterior feature liked least

Tailfins	14.0%
----------	-------

### Fragile front grille

Fragile front grille	3.3%
----------------------	------

### Interior feature liked most

Dash arrangement	14.9%
Upholstery	14.0%

### Interior feature liked least

Seat design, lowness	7.8%
Rear-view mirror	6.2%

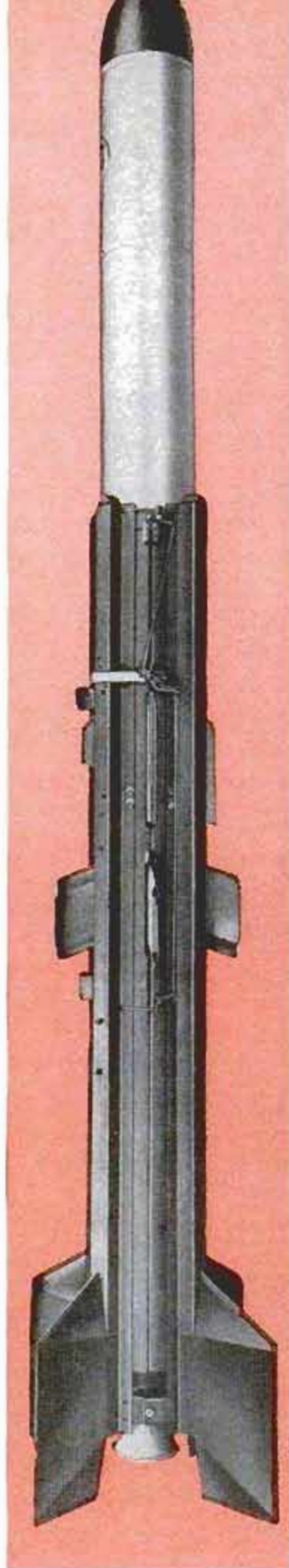
### What make car was traded?

Plymouth	36.4%
Another Chrysler make	12.0%
Ford product	15.3%
GM product	15.3%
All others	7.0%
No trade, no answer	14.0%

### What make will buy next time?

Plymouth	57.8%
Another Chrysler make	11.2%
GM product	3.7%
Ford product	2.5%
All others	2.5%
Undecided, no answer	22.3%



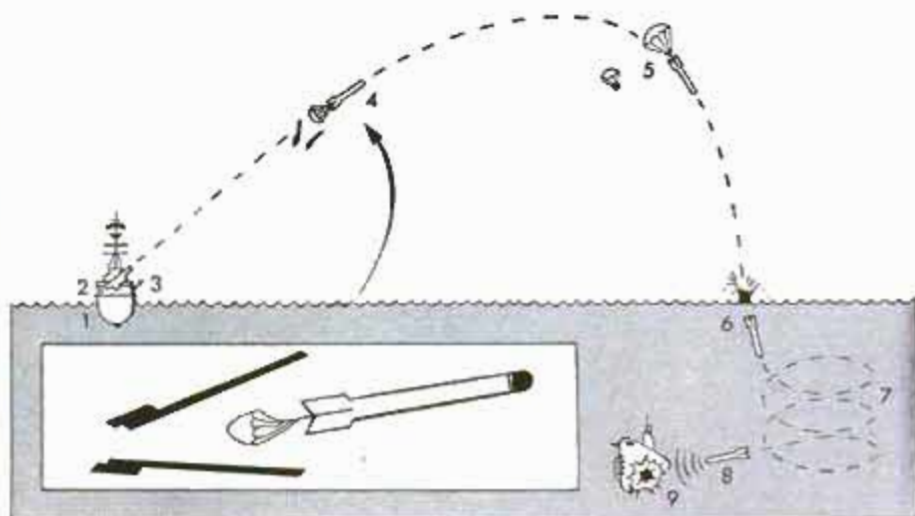


Navy's new RAT (rocket-assisted-torpedo) is launched skyward in pursuit of enemy submarine. Parachute lowers torpedo to the surface of ocean

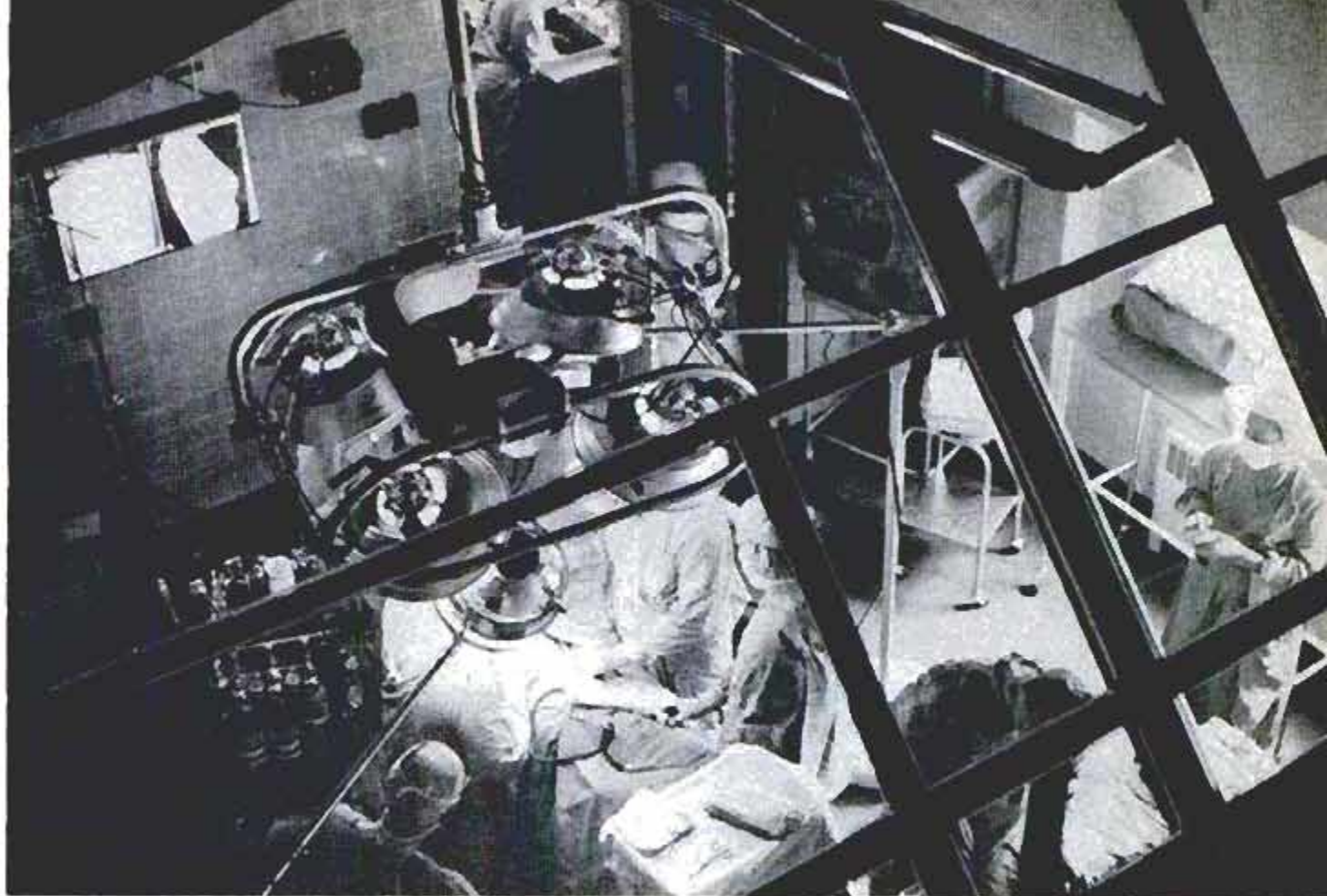
## Navy Homing Torpedoes Fight Subs

AVAILABLE TO THE U. S. FLEET THIS YEAR and described by the navy as the "greatest advancement in antisubmarine warfare since World War II," the rocket-assisted-torpedo. The weapon, called RAT for short, is 16 feet long and weighs 450 pounds. It's launched skyward but parachutes open to stabilize its flight and slow the torpedo before it hits the water. The RAT was developed by the Naval Ordnance Test Station at China Lake, Calif., which also developed the Sidewinder air-to-air missile. Since the first announcement of the RAT (*Popular Mechanics*, Feb. 1958), the Navy has revealed that RAT missile systems can be added to most U. S. destroyers without major alterations. The launching device, complete with automatic-loading magazine, can be built onto existing five-inch gun mounts. Present search and fire-control equipment can be converted for rocket-assisted-torpedo use.

**Diagram:** Ship (1) detects sub, fire control (2) prepares to launch RAT (3). Airframe drops and first chute opens (4). Second chute opens (5) before torpedo hits water (6). Torpedo searches (7), then "homes" (8) and hits sub (9)







If commercial power fails during this operation, emergency generator will go into action automatically

# QUICK POWER WHEN **DISASTER** STRIKES

**F**LYING LOW through a canyon near San Francisco last year, a Navy attack bomber cut with guillotine efficiency two 220,000-volt power lines. Immediately, as power sagged or failed throughout San Francisco and as far south as San Jose, Calif., 1,100,000 persons got a jolt of confusion. This confusion was compounded by the minute as the dim-out lasted in some areas for more than an hour.

Radio stations broadcast slow squawks that sounded as if they came from an aged Donald Duck; TV stations went off the air; elevators stopped between floors; dentists' drills slowed; the motors of electric appliances in thousands of homes started smoking, and traffic signals blinked off, causing vehicle jams until police could be rushed to busy intersections.

"We live by electric power today," commented one writer, "and San Francisco was

*225 Cherry St.  
Moose, Idaho*  
By Rafe Gibbs

This stand-by gasoline-powered electric unit in a nursing home can be started like an outboard motor







Caterpillar Tractor Co., photo

Mobile electric unit provides emergency power so contents of footwear factory can be salvaged after flood

Besides providing power for industrial equipment, some mobile units carry big floodlighting systems

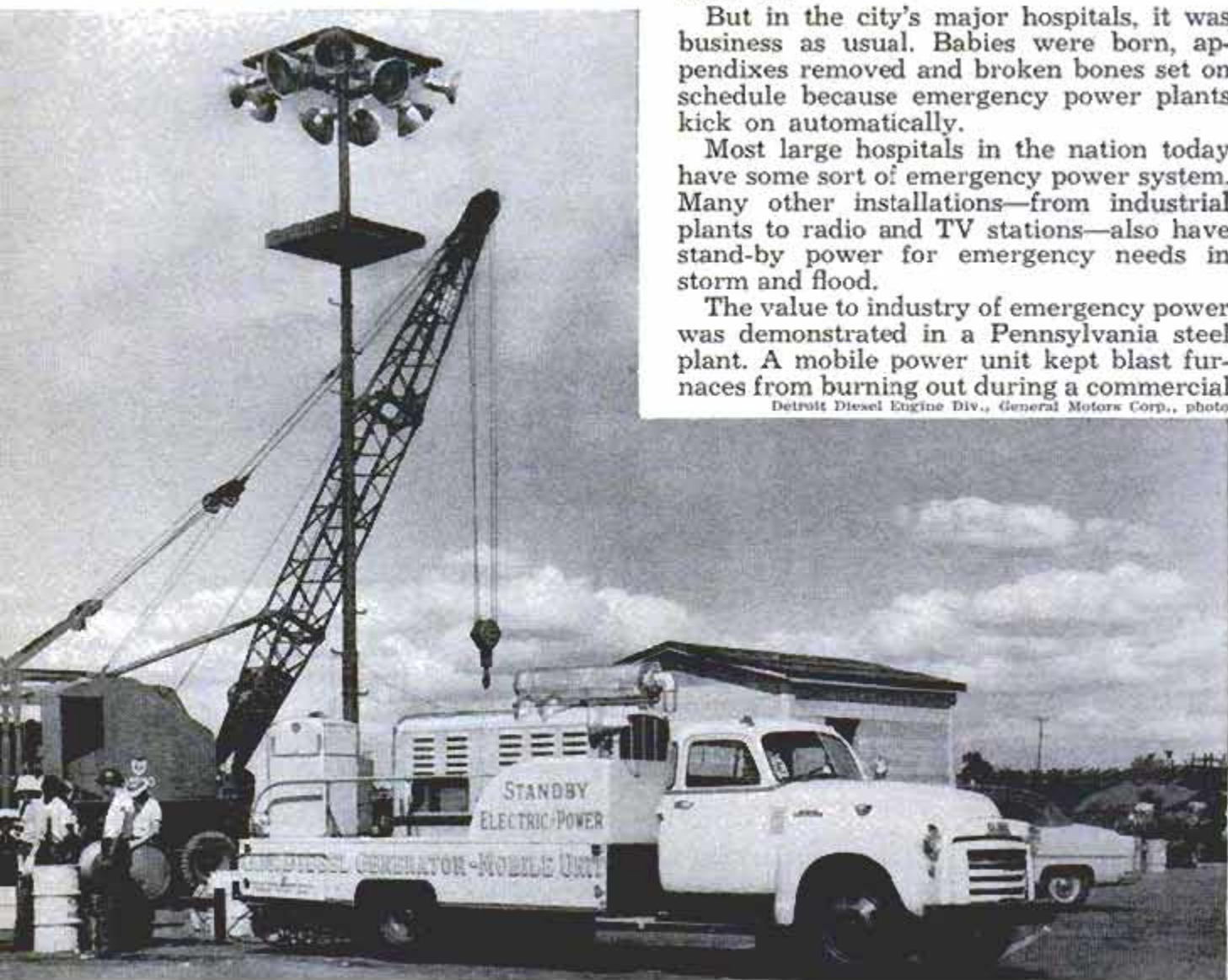
dying on the vine until the power came back on."

But in the city's major hospitals, it was business as usual. Babies were born, appendixes removed and broken bones set on schedule because emergency power plants kick on automatically.

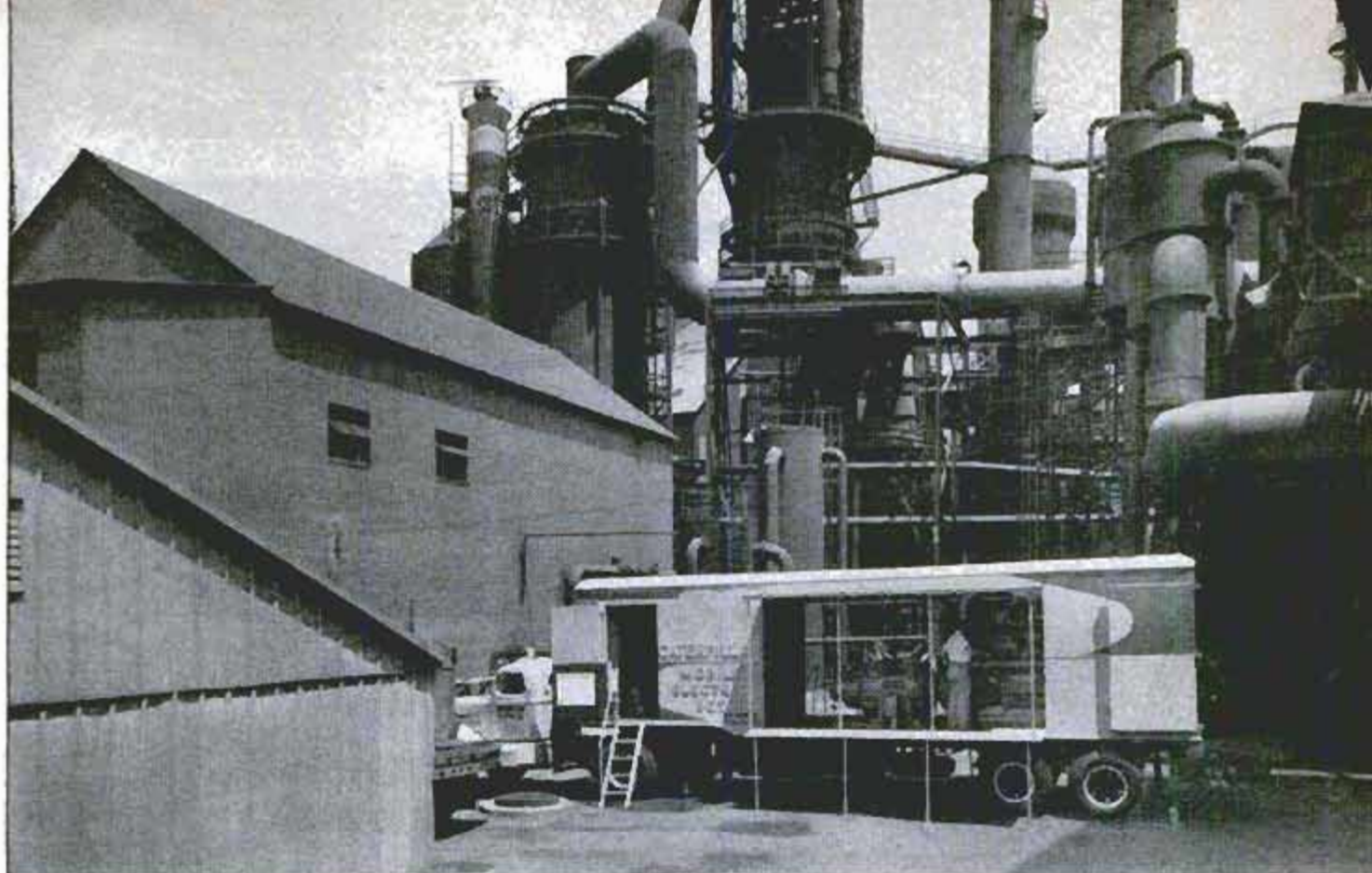
Most large hospitals in the nation today have some sort of emergency power system. Many other installations—from industrial plants to radio and TV stations—also have stand-by power for emergency needs in storm and flood.

The value to industry of emergency power was demonstrated in a Pennsylvania steel plant. A mobile power unit kept blast furnaces from burning out during a commercial

Detroit Diesel Engine Div., General Motors Corp., photo







**Auxiliary power at this plant operates water-cooling pumps to prevent the blast furnaces from burning out**

power shutoff—and from doing a possible million dollars' worth of damage.

Emergency power units have been constructed on truck trailers and on railroad cars for shifting to disaster scenes. Some of these mobile plants can develop up to 10,000 kilowatts of electrical power.

"But the point is," commented a Civil Defense official, "we just wish there were more emergency power on tap."

On a wintry day in Albany, N. Y., Robert Burdick and Marion Breen were sipping coffee in a cafe. They were en route to Vermont with a mobile diesel-power unit. That is, they were until the telephone rang.

Disaster had struck in the city of Rimouski, Province of Quebec, Can. An explosion in the city's utility plant had reduced power to nearly one half its normal capacity. Without any heat or light was 300-bed St. Joseph Hospital.

Burdick and Breen checked maps. "Seven hundred miles away," said Burdick. "Power may be restored by the time we get there, but we have orders to roll."

And roll they did, without stopping except for gas and oil. When they arrived in Rimouski they were needed—immediately.

Not only did they bring heat and light

(Continued to page 232)

**Massive 1000-kilowatt mobile generator of the West Texas Utilities Company can relieve a central station**

Electro-Motive Div., General Motors Corp., photo







## Swedish Air Force Has Rocket-Powered Missiles

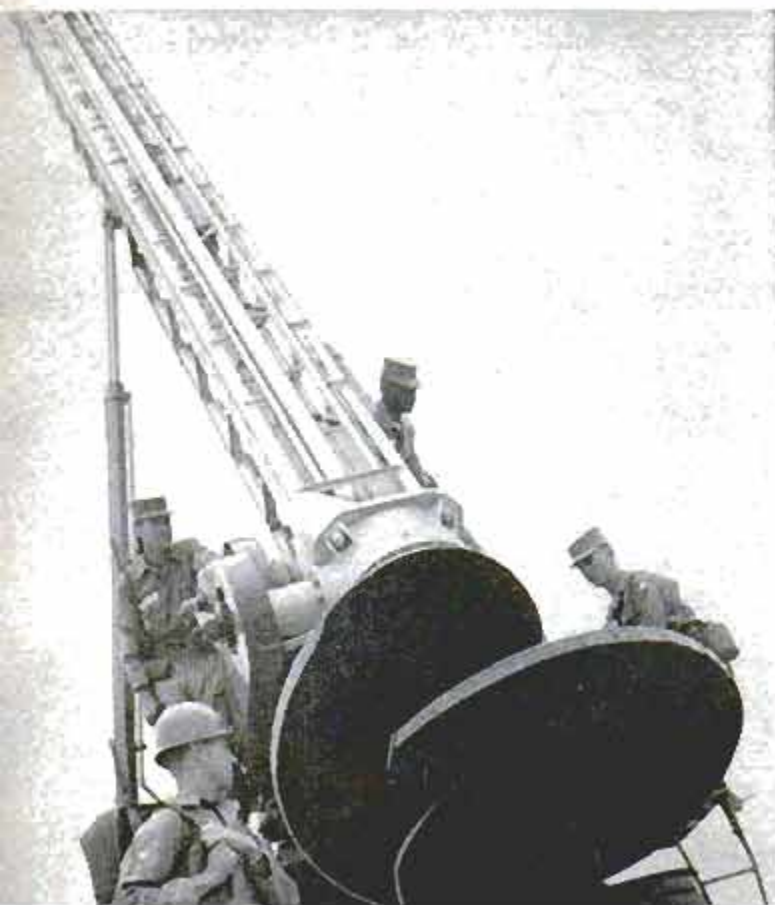
Sweden, historically a neutral nation, still keeps its arsenal ready. Its newest weapon is a rocket-powered anti-aircraft

missile that is fired from jet airplanes. Other new Swedish rockets are launched from land or sea to destroy surface targets.



## All-Transistor Portable TV

Every tube except the picture tube has been replaced by transistors in a television set described as the first truly portable "portable." In addition to the 31 transistors, the set contains two six-volt nickel-cadmium batteries which can be recharged 2000 times. The set can be operated during the charging cycle and will play six hours without recharging. The batteries can be recharged from a regular alternating-current outlet or any 12-volt direct-current source. Because low-cost transistors necessary for the portable TV are not yet available, the set is not expected to be seen in retail stores before 1960.



## Army's Giant "Power Drill" Uses Nine-Foot-Wide Bits

Holes up to nine feet in diameter can be drilled in the earth with a huge experimental auger developed by Army engineers at Fort Belvoir, Va. The big drill is used in the construction of gun emplacements, fortifications, wells and disposal pits. It's powered by a 192-horsepower gasoline engine and will cut a hole 25 feet deep at the rate of a half-foot a minute. Drills of various sizes are interchangeable.

## Stretchable Paper Prevents Tearing Of Bags When Under Strain

Grocery bags, cement sacks and heavy-duty wrappings can now be made of paper that stretches instead of tears when under strain. A bag made of the high-strength paper, called Clupak, has been filled with groceries and dropped more than 20 times without breaking.





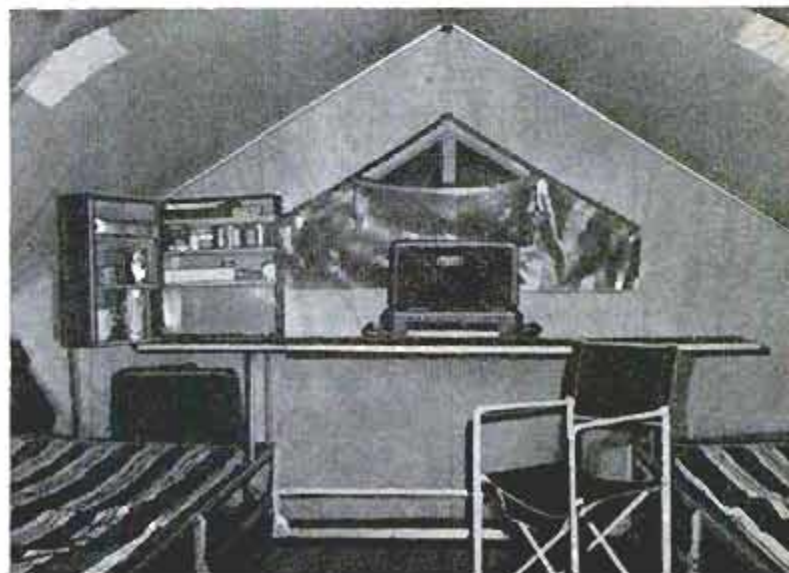
## Car Tent

CAMPERS SIMPLY DRIVE out from under a new tent, then erect it ready for occupancy in 10 minutes. The complete tent, including two double beds, is carried in a box atop the car. Stilllike legs support the box during loading and unloading. When the tent is to be erected, the box is lowered to the ground. The frame then is swung into place and the canvas of the eight by thirteen-foot tent follows. The two beds swing up from the bottom of the box into the tent sides.

From bottom of the box, bed is swung up and into side of tent. Plastic covers protect pre-made beds



Tent can be erected in 10 minutes, has strong laminated-plastic floor. Below, long work shelf along back wall helps in kitchen duties, other camp chores







## *Carving a Bowl From Plywood*

By Bonnie Peplow

**C**OMBINING THE ANCIENT art of his ancestors with modern materials and tools, Hawaiian-born Ben Goo of Arizona creates decorative bowls of various shapes and designs from nothing more than pieces of scrap plywood.

He bonds the pieces together, then carves the block with wood chisels. A beautiful blending of the practical with the true art form, the bowls are used to hold dry foods, as centerpieces and other ornaments.

Goo's idea won't stop with this, however.

He plans to expand the project and carve sculptural forms using the discarded plywood. The art will be modern, he says. One type will be representational, sculpture intended to look like objects. For example, Goo reports the plywood would lend itself to sculptural forms of clamshells. The material already suggests the layers seen in clamshells. Another form is nonobjective, sculpture not associated with anything in particular, where the possibilities are unlimited, Goo says.



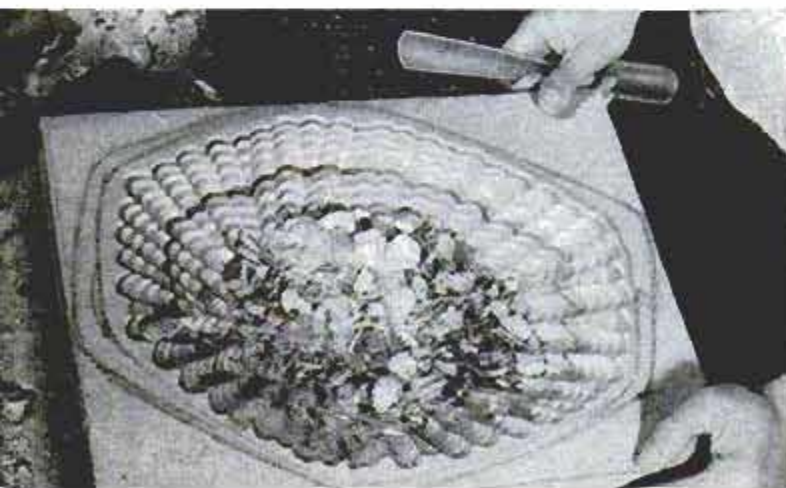
Ben Goo's first step in making plywood bowl is clamping pieces of scrap together as the glue hardens

Now the bowl is in the roughing-out stage. Goo says the plywood is easy to carve with sharp chisels



After drawing the dimensions of the bowl's exterior, he begins carving the inside with a wood chisel

He then smooths the interior with a flat chisel. Goo is an art instructor at Arizona State College





He points out that contrary to popular opinion, plywood is easy to carve with sharp chisels. Once he has carved a bowl to the desired size and shape, the first part of the finishing process is to sand it smooth. Then he raises the grain by soaking the piece in water to avoid this effect if it should come into contact with moisture later. Sanding it smooth again, Goo then saturates it with a mixture of tung oil and lemon oil. The tung is used for its penetration qualities, the lemon both for penetration and its aroma.

When the oil has dried several days, Goo covers the bowl with a wax made of 50 percent Brazilian carnauba. Pure carnauba is so hard, Goo says, that it is difficult to cut with a knife. Thus the wax provides a hard finish on the bowl.

As an art instructor at Arizona State College at Tempe, Goo has the opportunity to develop his philosophy of art. "An artist," he says, "should be able to express himself in terms of any given material. The creative use of materials which an artist meets finally leads to the art form.

"In other words," he continues, "thorough integration between the material and the

art form is necessary. The artist should learn to express the art forms without destroying the natural beauty and inherent character of the material."

This philosophy has been worked out through the years. Goo started work part-time at the age of 10 in his father's wood-working plant in Honolulu. There he had the opportunity to work with some of the finest craftsmen in the world.

He earned his bachelor of fine arts degree at the University of Iowa, majoring in sculpture and minoring in industrial design. His master of fine arts degree was earned at Cranbrook Academy of Arts, Bloomfield Hills, Mich., where he majored in sculpture and minored in ceramics.

On a nine-month Fulbright grant in Milan, Italy, he studied under world-famous masters including Marino Marini, noted Italian sculptor, who schooled Goo in the fine art of bronze casting.

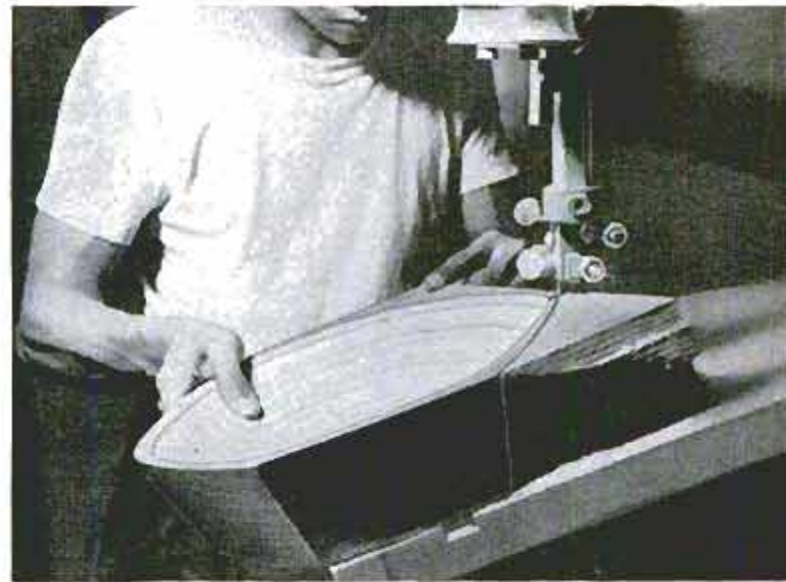
Also in Italy, Goo worked with the architectural firm of Studio Architetti BBPR, under Ernesto Rogers, Enrico Perisutti and Count Lodovico Belgioso.

The teaching post at Arizona State College followed Goo's stay in Italy. ★ ★ ★



Next he sands it smooth. Later, he raises the grain by soaking the bowl in water and sands it again

Then he roughs out the underside. Bowls are used as centerpieces and for other ornamental purposes



Bowl begins to take shape as he saws unwanted exterior. Goo also plans to use this process in sculpturing

Last stage is smoothing and sanding. Finishing is with oil mixture, covered by a coat of hard wax







Loaded asphalt truck hangs precariously on the steep slope as it is lowered by cable to the lay-down machine. Spreader lays down a strip 12 feet wide as it moves up dam. Four layers of asphalt were applied



Dam's steep slope and narrow top created problems. There was not enough room for machinery to turn around. Below, the lay-down machine is pulled on turntable and moved along dam to lay next strip



## THEY BUILT A DAM LIKE A ROAD

By K. E. Althoff

HIGH IN THE Colorado Rockies a unique dam has just been completed — but not without troubles!

This was a new challenge to the dam-construction business. Montgomery Dam was to be faced with asphalt and built with regular road-surfacing equipment. Plans called for the dam to be 113 feet high and 1900 feet long. It was to have an upstream slope of more than 30 degrees.

In the surfacing process, more than 19,000 tons of asphalt were spread on the face of the dam with a regular asphalt spreader, and faced with a road-surfacing roller. Hot asphalt, at a temperature of 303 to 332 degrees, was hauled to the top of the dam from a hot-mix plant at the base. During the quarter-mile haul the asphalt cooled about 10 degrees.

Because the top of the dam was only 20 feet wide, trucks were unable to turn around. To solve this problem the construction company built a 20-foot turntable. Trucks drove along the top of the dam to the turntable, were given a quarter turn and let down the face of the dam to deliver asphalt to the laying machine. Winches and steel cables raised and lowered the trucks and spreader.

Safety was a major consideration. In the event of mechanical failure of the cable, a driver would not have time to jump clear of the truck. For that reason all left-hand truck doors were removed. Only one failure occurred, and the driver escaped injury by immediately jumping clear.

Extensive experiments had to be made to determine the proper asphalt mix to withstand the climatic changes at the 10,000-foot elevation of the dam.

Held by a steel cable, a three-ton truck empties its load of hot asphalt mix into the lay-down machine 100 feet up from base of dam. Truck will be hauled up steep slope by winch, turned on turntable at top







## French Town Builds City Hall With Ice-Cream Cone Design

Caen, France, battered during the Normandy landings 14 years ago, is rebuilding with a "new look" in architecture. One of

the structures, resembling an ice-cream cone, will contain city municipal offices, water tower, market place and dispensary.

## French-Built Coupe Has Chrysler V8 Engine

Auto fanciers with bulging wallets will like the elegant Facel Vega, a sports coupe powered by a 360-horsepower Chrysler V8 engine. The price of the custom-built beauty is \$9750, delivered in New York City. Built in France, the car has a frame of welded steel tubing, coil springs in front and leaf springs in the rear. There are four separate leather seats. Although it is luxuriously roomy, the coupe is only 15 feet long.



## Do-It-Yourself Airplane Carries Six Passengers

Intended for short-field operations, a plane designed and built by Alvin Ray Johns, with the help of friends, has a top speed of 140 miles per hour and climbs at a rate of 1000 feet per minute. Called the Ra-son "Warrior" X-3, it can carry up to six passengers or 1000 pounds of cargo. It's powered by a 185-horsepower Lycoming engine, has a fabric-covered steel-tube fuselage, fabric-covered wood wings.



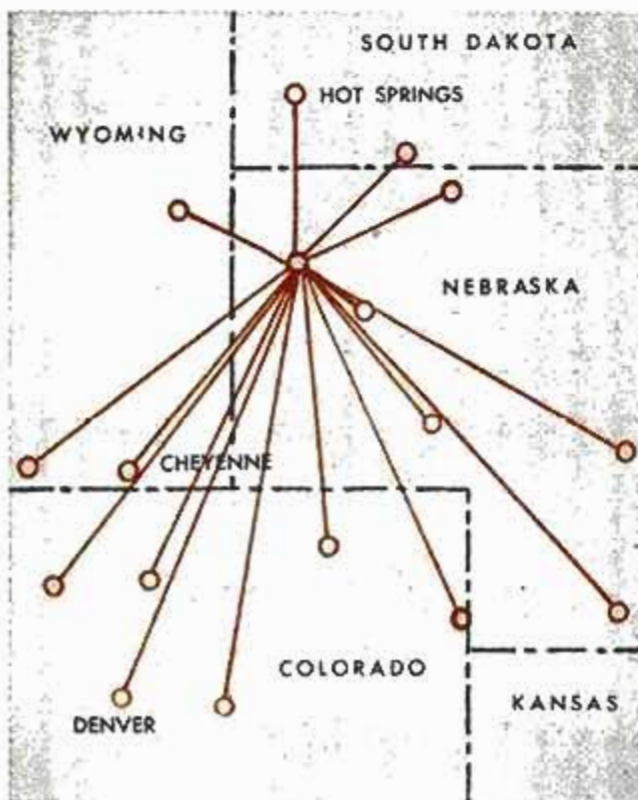




Dr. Howard H. Niningger and his wife, who literally follow flaming meteorites to the ends of the earth

## On the Trail of Meteorites

Map of one of Dr. Niningger's meteorite searches. Each of the small circles represents an interview with persons who observed a flaming object in the sky on a certain night. By plotting the reported paths of the meteorite on a map of the region, the search was narrowed to an area in western Nebraska



By George Worts

**M**ETEORITES GO FLAMING across the night sky. Somewhere they fall to earth. Hunting them down might seem as hopeless a task as trying to find the pot of gold at the end of a rainbow. Often it is. A Southwestern meteorist has spent the best years of his life tracking down these heavenly fireballs—and sometimes finding them. His tireless detective methods would win him the respect of Scotland Yard.

Since 1923, Dr. Howard H. Niningger, director of the Meteorite Museum at Sedona, Ariz., and an authority on meteorites, has closed in on 841 of these fragments from outer space. Because of his knowledge of meteorites and their habits, Dr. Niningger is now in consultation with the scientists who are working out the problems of missiles and manmade satellites.

### Metals for Missiles?

The missile men hope that a study of what happens to meteorites will be useful in deciding what metals will be most suitable for missiles. Most meteorites are composed of stone. Some are made of iron, nickel and cobalt. One million meteorites an hour—24 million a day—are plunging into our atmospheric envelope. Only one





Closing in on elusive particles from outer space. Dr. Nininger uses a mine detector to find meteorites

or two per day, weighing from two to four pounds, survive the passage toward earth. The others burn away their entire substance or turn to dust, creating dust trails 30 to 40 miles long.

Not only is the surface burned and worn off but the material itself changes. The missile scientists are experimenting with a variety of alloys to determine what combination of metals will stand up best in this enormous heat.

#### Atmosphere Brakes Meteor's Speed

The ordinary small meteorite, Dr. Nininger says, after hitting the earth's atmosphere at 26.5 miles per second, is quickly slowed down to the speed it would have if dropped from an airplane. Big meteors similar to the one that created a crater near Winslow, Ariz., thousands of years ago—Smithsonian Institution scientists recently declared that it was as large as a large house—are not slowed down so much and hit the earth at perhaps 10 miles per second.

#### Meteors Land Cold

When a meteorite approaches our atmosphere its temperature is close to that of outer space itself—459 degrees below zero Fahrenheit. During the final few seconds of its fall, it becomes invisible, its surface coated with black slag. If the fragment is large enough, its surface heating may not have neutralized all its interior stored-up outer-space cold. Meteorites have been

found, shortly after their fall, covered with frost. Some have landed in hay and straw and others have pierced houses and barns, but there is no record of one ever having started a fire. Dried grass driven into the

(Continued to page 240)

Jewelry that's really "out of this world." Bracelet and necklace are cut from cobalt-steel meteorites



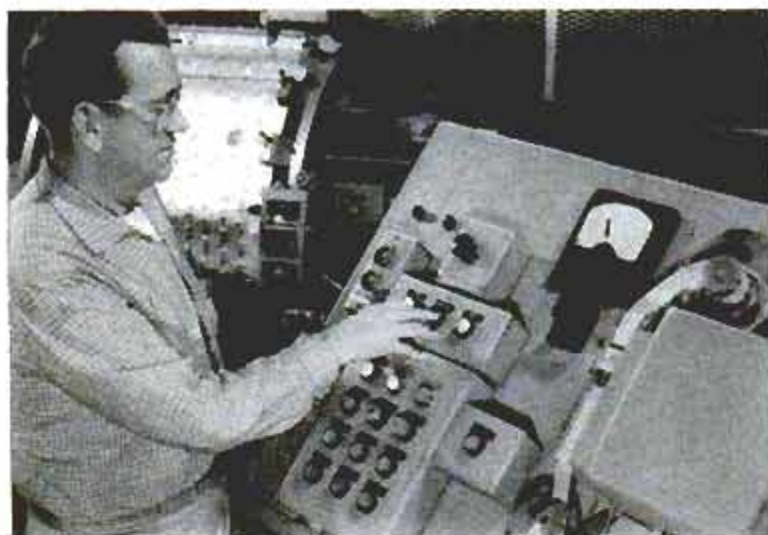




## Builder Flies Full-Scale Model of 1917 German Fighter

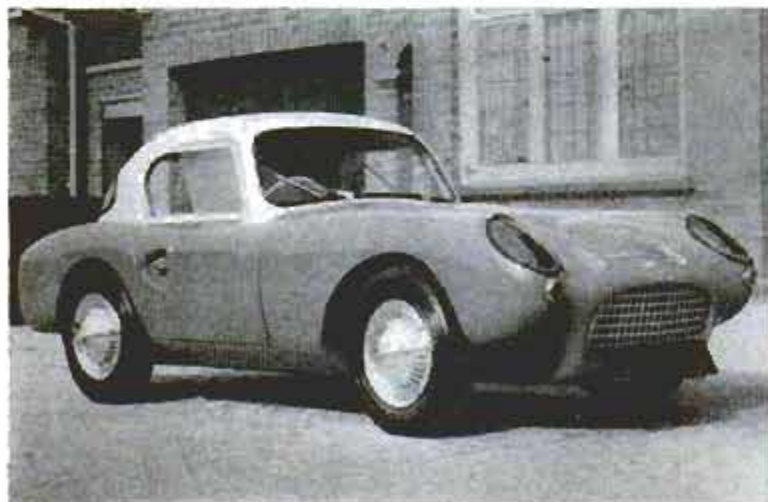
Following the original plans, obtained from the British Admiralty, Edward Brennan of Fairview Park, Ohio, has assembled a full-scale model of a Fokker D-7. The replica of the famed German fighter plane of World War I has been flown several times by Brennan and, he reports, it per-

forms admirably. The power plant is a 175-horsepower Ranger engine from a Fairchild PT-19 trainer, instead of the original 160 to 180-horsepower Mercedes. A modern fuel system was installed to conform with current regulations. Otherwise, the plane is as primitive as the 1917 version.



## Roll of Punched Tape Runs Automatic Welder

In the same way a player piano makes music from the holes in a roll of paper, an automatic welding machine at the General Electric plant in Everett, Mass., is operated by a roll of punched tape. The holes in the tape form a code which gives the machine all the directions and positions for welding up to 1600 spots in less than 90 minutes. The automatic welder is expected to save \$26,000 a year in the manufacture of jet engines for the armed forces.



## Berkeley Sports Car Now Has Hardtop Model

Tiny and simple, the British Berkeley continues its original design with a more powerful model. It comes as a hardtop or convertible. New is the three-cylinder two-stroke engine of 30-cubic-inch displacement. Top speed is 80 miles per hour. Front-wheel drive, four-wheel independent suspension and a four-speed transmission are other features. It's a favorite with members of the sports-car crowd who watch their pennies.



# It's Moving Day!

By F. Leland Elam

**WE ARE A NATION** on the go. The United States Bureau of Census reveals that one out of every five Americans changes his address each year. This means that 34,000,000 people move from one home to another taking their household goods with them or storing them.

When people move they see the things closest to their hearts, the things they live with every day—the tables they eat from, the beds they sleep in, the clothes they wear—disappear down the highway and they wonder if they will ever again see their possessions in good condition.

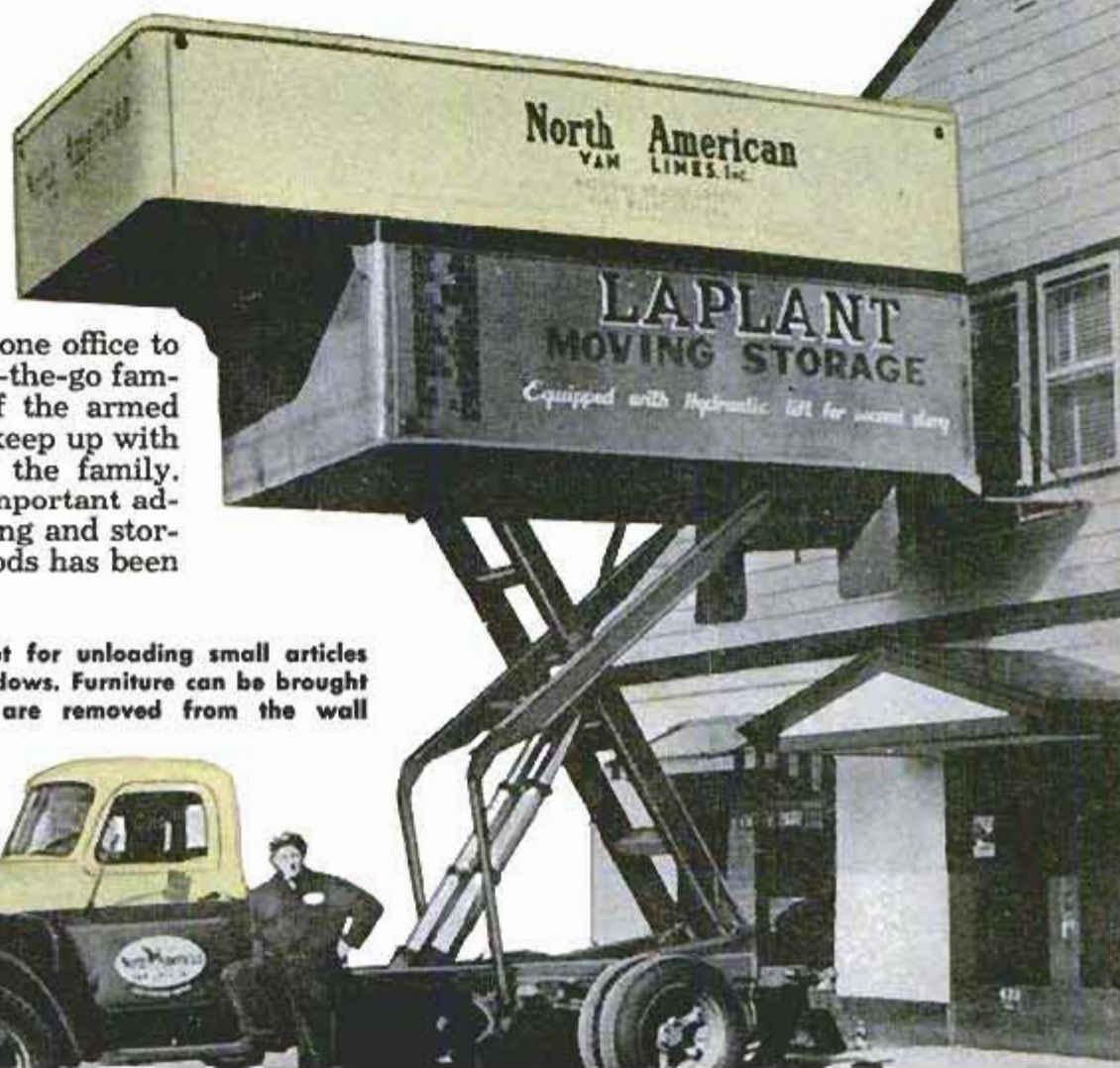
Today they need not worry. The development of "good housekeeping" practices in the moving industry, which annually receives \$204,000,000 from "people on the go," assures that household goods will reach their destination or be stored under conditions that protect them from harm.

The great demand for a mover's services is attributed to four reasons, all of which have pushed the industry into putting science to work to figure out proper-handling means: The increased availability of new homes, continued decentralization of industry, an expanding executive-training program in many fields which results in the shifting of key personnel from one office to another, and the "on-the-go families" of the men of the armed services who try to keep up with the breadwinner of the family.

One of the most important advances in the handling and storage of household goods has been

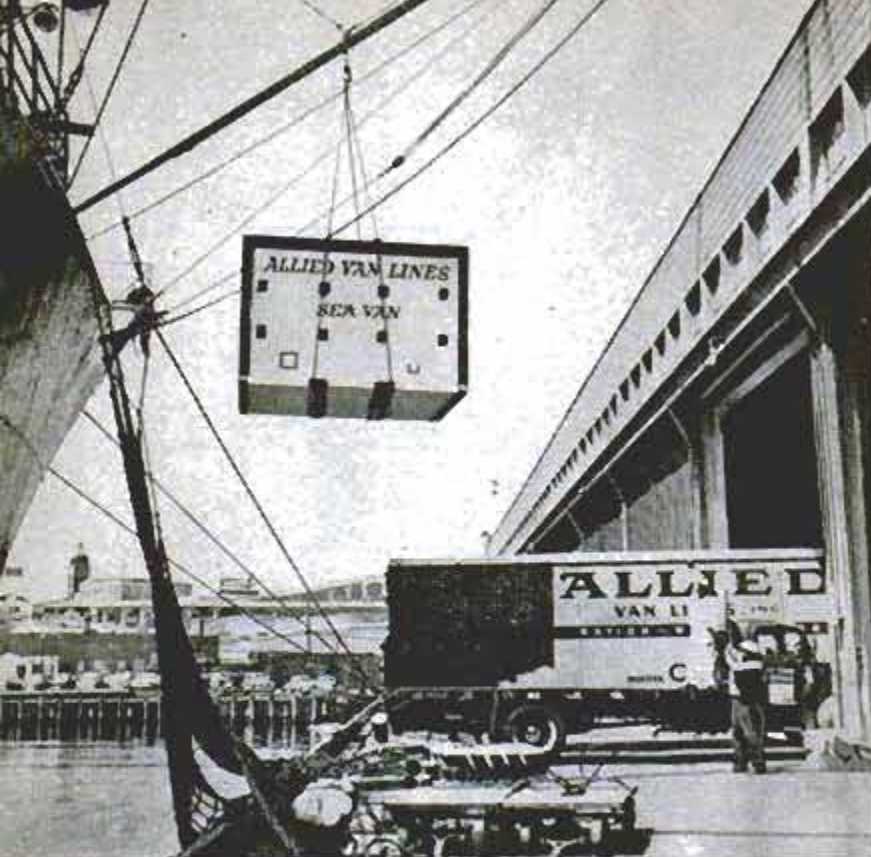


Piggyback Sea Van rides flat-bed truck and will be deposited in hold of a ship for trip overseas. One van can hold contents of a four-room home. Exterior is plywood



High-lift van lifts 14 feet for unloading small articles through second-floor windows. Furniture can be brought in if window sections are removed from the wall





Sturdy Sea Van is loaded easily and without damage onto a ship with big lifting boom. Here goes one family's possessions



This single van will hold 23 rooms of furniture. All five side doors have been removed to show portable vaults set inside

the adoption of portable vaults in which two to three rooms of furniture can be placed. Vault floors are made like pallets and this allows them to be moved about easily by fork lifts.

Important developments include a vault that can be used over and over, and one that has to be rebuilt for each user. The former offers maximum protection, its walls are solid, the door locks to keep out intruders. The latter is made of cardboard fitted to storage-load size.

The permanent vault's plywood or hard-board walls are completely smooth on the inside to eliminate any projections that might damage the contents. Framework is on the outside. The rigidity of the vaults allows storage to a height of two or three.

Cardboard vaults are patterned to the load. Furniture and other goods are placed in position with well-fitted vertical walls.

Giant pieces of cardboard are then squared around two thirds of the height of the goods and taped tight at the open end. A cap of cardboard is then slipped over the top to give a tight seal. Comparatively dustproof, it protects the load and keeps one person's household goods where it will not become mixed with that of another person. The average vault will hold furniture from two rooms.

This lighter-type vault permits an attractive and a clean-line appearance. It offers access to the goods without cumbersome handling. Its ready access appeals to the people who live in hotels, clubs or apartments and need extra space for their personal belongings.

Vaults are moved at floor level by short-lift forks. Latest models of such lifts have a foot-pedal lifting mechanism which requires only a few strokes to raise the forks to a maximum height of 5½ inches. The load is raised to a level position by the use of six lifting cams. Four-point suspension moves high loads without swaying while tandem rear wheels prevent sticking in floor cracks or elevator crevices and minimize swaying on rough floors. A rigid upright handle increases operator vision and reduces necessary aisle space.

The piggyback van has been introduced into two phases of moving. The demand of people for fast moving has brought it to air transportation. It has also met the demands for safety at a reasonable cost. It has overcome major problems in the moving of civilians to

other countries to participate in overseas governmental work and families of the armed-forces personnel.

Shipping household goods by sea used to be a major task as each piece of furniture had to be strongly crated so that it would arrive in one piece. Poor crating often resulted in major damage.

Today, however, goods receive maximum safety. An effective palletized piggyback van without wheels that fits onto a flat-bed truck and into the hold of a ship, has been developed. The Sea Van is capable of carrying furniture from the normal four-room home. It is made of the thickest waterproofed plywood. Inside walls, floor and ceiling are smooth to assure there is nothing to scar the furniture. The outside is strengthened by sealing all edges with three-inch angle iron. The van is packed solidly so no item will move about. The



door tightly recesses into the box, and is locked. This van can take a beating and still protect the furniture. Also no one can get into it except persons having keys for the lock.

Movement of household goods by airplane has been eyed by air-freight lines for some time. Only recently have economical and safe-handling methods been developed.

Slick Airways of Dallas, Tex., has developed a piggyback Sky Van. The key to this new moving operation is a lightweight, roomy aluminum container measuring 8 feet long, 5 feet wide, and 5½ feet high. Its base is palletted for easy fork-lift handling. Four of the containers can handle an average household, or about 6000 pounds.

Flat-bed trucks take them to the home where they are loaded while still on the truck. At the airport they are fork-lifted into the plane's cargo bay. To keep down shipping weight, lightweight furniture pads, and form-fitting refrigerator, stove, washing-machine and piano covers are used. The company requires a minimum of 2000 pounds per shipment, and a mini-

imum distance of 1000 miles. The householder can get coast-to-coast delivery in four or five days, and up to 2000 miles in three days. Overnight service to any city in the United States can be had by paying a special rate.

Aluminum sky vans give a minimum of vibration, loss, weather damage, and discourage pilferage. They accommodate huge pieces, yet fit snugly into a plane. They assure from 8 to 10 days faster delivery than by truck.

Two problems that have always plagued householders when they unpack their dishes were the shredded packing paper and the barrels. If you have never had to save a bunch of barrels for the moving concern until they came for them, you cannot realize how much of an annoyance they can become. These problems are now a thing of the past. Technology has developed the "clean pack" and containers that can be disposed of.

Clean pack is created by the use of corrugated cardboard and waffle cardboard. Squares of waffle cardboard are placed



Sky Vans are packed on flat-bed truck at home of family (left) then taken to airport and loaded by fork lift to freighter







Movers bring portable packing tables into the home equipped with racks that hold corrugated cardboard

between dishes, and corrugated cardboard is wrapped around a stack of five or six dishes and then stapled at the ends. The solid package fits neatly into a packing box along with others. Wrapping such large flat pieces as pictures has been simplified by using spongelike paper and burlap. They give excellent protection.

What is claimed as the largest moving van in existence was built for the Market Street Van & Storage Company of San Francisco, Calif. It will transport 23 rooms of furniture. Its over-all length is 50 feet—the box is 40 feet with a height of 9½ feet inside, and 9 feet wide. There are two skylights in the roof. Furniture can be stored as in normal-sized vans or in portable vaults. Five doors along one side can be completely removed to open up most of the side so vaults can be set in or removed by fork lifts.

Moving goods into a second-floor apartment takes a lot of back-breaking labor. Merrill J. Laplant, of Keene, N. H., built a moving van on which the box can be lifted to a height of 14 feet, allowing it to be placed at second-story windows in a position for unloading small articles. By removing window sections furniture can be taken in at second-floor level.

### Copters Retrieve Targets

Helicopters are used by the Air Force and the Navy to recover downed jet-target "drone" missiles in remote areas of both land and water. Previously, they used crane-equipped trucks and patrol boats. The Air Force carries the drones underneath their helicopters in a special cable-harness device. The Navy picks them out of the water with a hook.



A new spongelike soft paper eliminates bulky packing quilts and is ideal for wrapping framed pictures

A new palletized trilevel vault for upholstered goods has been developed by the General Van and Storage Company of St. Louis, Mo. This vault is used both for unit moving and for storage. The upholstery container enables the operator to eliminate old-fashioned, space-wasting stationary rack structures. It takes but a few minutes to move one container to the loading area and place it on the van. The heart of the new container is a three-level rack attached to a 7½-foot by 42-inch pallet base. It is open at both ends, so workmen may enter to place upholstered goods on the rack.

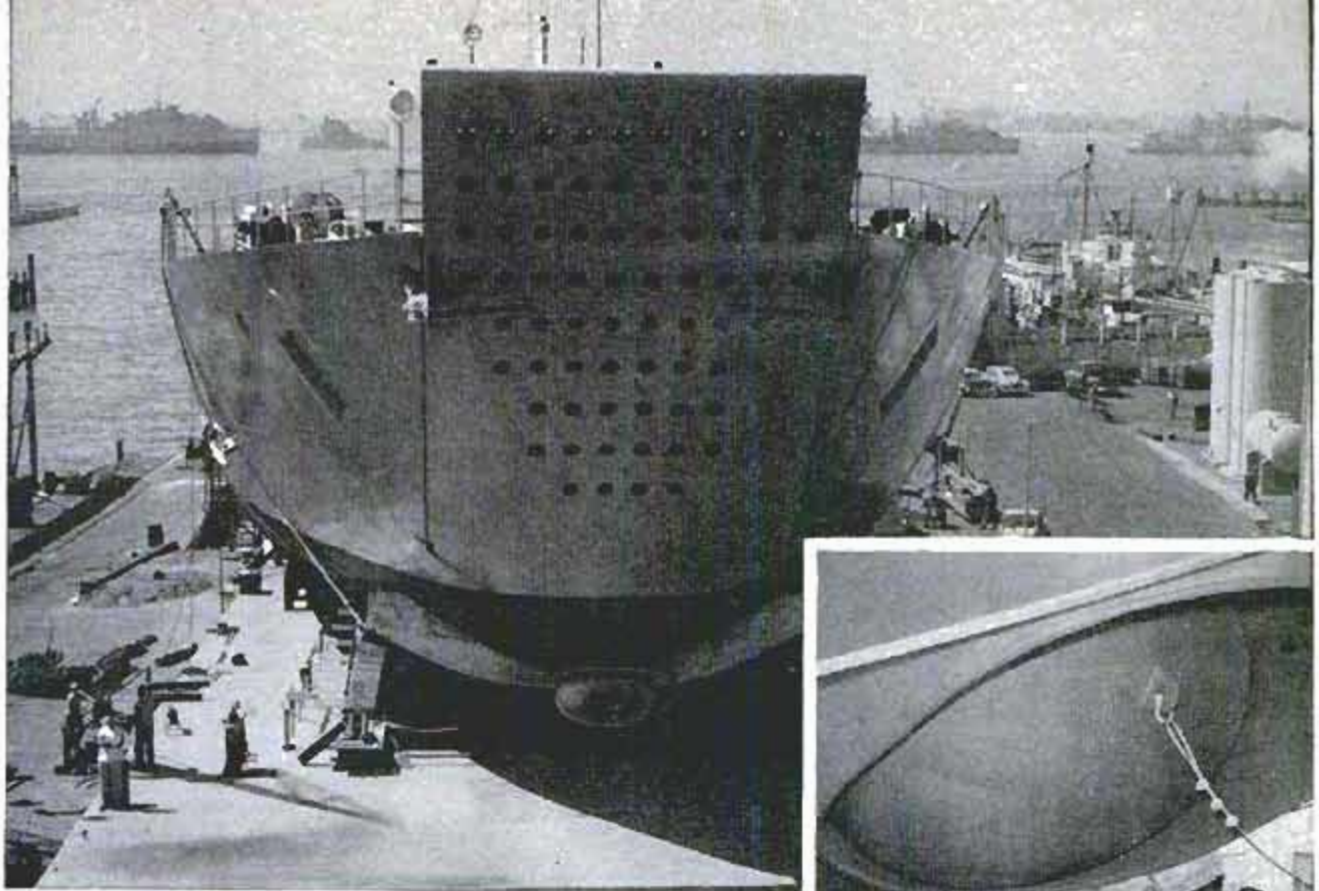
It takes a lot of work to keep 34,000,000 people on the move each year. The Census of Business reports there are 1828 establishments primarily engaged in moving and warehousing household goods for the public in the United States. It takes 27,616 persons to handle the work load of these firms which have available 51 million square feet of dry floor space, and two million cubic feet of refrigerated space.

The last 65 years have seen more development and change in man's living conditions than the previous 20 centuries. Modern phases of this development are bringing assurances of the safe keeping of nomadic man's prized possessions. ★ ★ ★

### Barnacles Get the Heave Ho

Shipowners in Sydney, Australia, will score big savings through an electronic device that prevents barnacle growth on steel-hulled vessels. The device does the job by sending supersonic waves through the hull. It has been tested successfully for a year on a vessel whose owners saved at least \$500 in docking and fuel costs each time she hit dry dock.





### Landing Craft Pushes Self off Beach

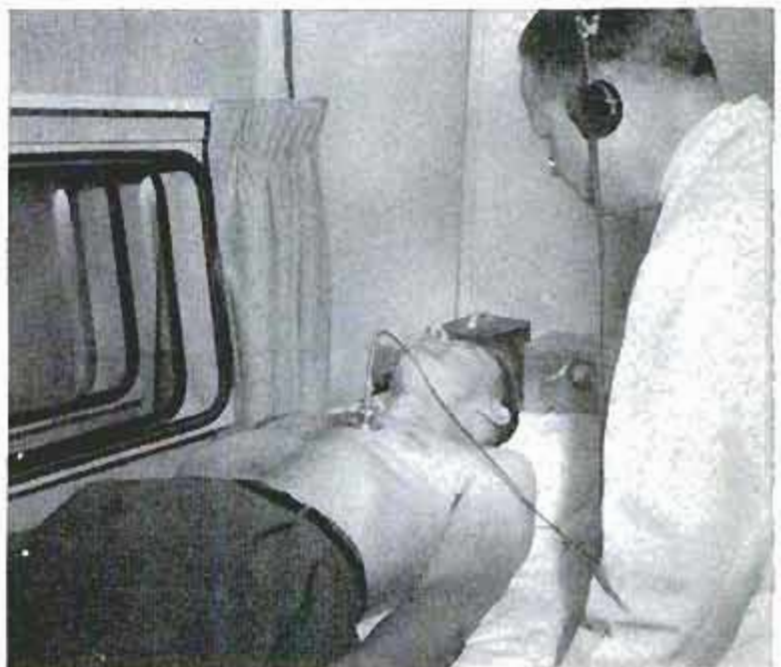
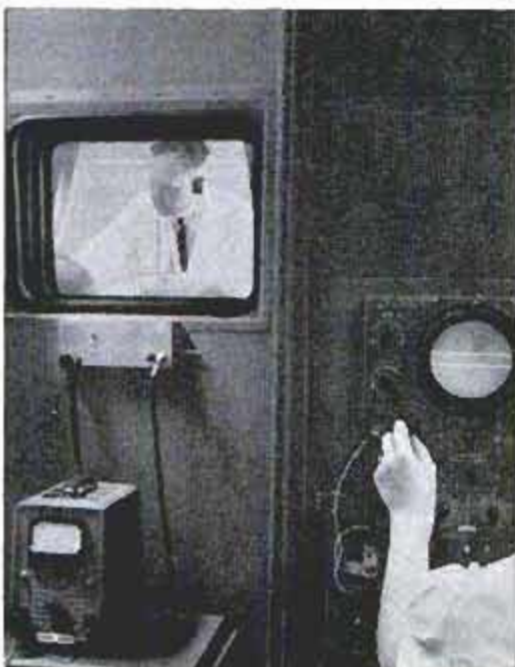
Mounted at a 45-degree angle to the deck of a new type of rudderless Army landing craft is a four-ton hydraulic ram which enables the ship literally to beat its way off an enemy shore. The ram rains fast and powerful blows on the beach, breaking the suction of sand and mud on the hull.



### Car-Engine Tool Becomes Supersensitive Heart-Murmur Detector

From a sensitive device used to measure automobile-engine pressure, doctors and General Motors technicians have developed an instrument to aid heart patients. It can detect and record heart murmurs so faint

that they are inaudible to conventional recording instruments. The patient is placed in a soundproof room when the instrument is used. It can detect chest-wall movements as small as one-half billionth inch.







# VII

## WHAT'S NEW FOR

# Your Home

**PORTABLE WATER SOFTENER** can be attached to any faucet. It weighs 10 pounds when loaded with 8 pounds of water-softening chemicals, sufficient to process 576 gallons of 10-grain hard water. The softener can be regenerated by pouring a gallon of water containing 2½ pounds of salt through the top

Atlas Distributing Co., Inc., 3723 Wilshire Blvd., Los Angeles 5, Calif.

**STEPLADDER GRIPS** put you within reach of the higher places around your house. Made of strong, rustproof tubing, the grips add 14 inches to the height of your ladder and guard against accidents caused by loss of balance. The grips fit every type of stepladder—large or small, wood or aluminum

Fred J. Chiapp Associates, Inc., 606 W. Wisconsin Ave., Milwaukee 3, Wis.



**SERVING FRAME** made with spiral spring stretches to fit hot dishes of many sizes and shapes. The spring dissipates heat rapidly, insulating the dish from the table. Used to hold a planter, the frame eliminates damp spots. It has a hammered-copper finish and comes with polished hardwood handles





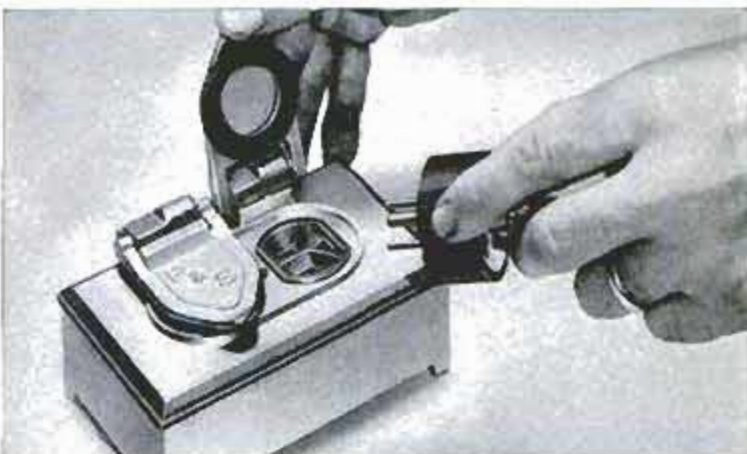
**ELECTRIC GRIDDLE** can cook food and be used as a table server and food warmer. Operating on a 110-120-volt alternating current, the griddle has a surface of 200 square inches, enabling a housewife to cook two or three foods simultaneously. It can grill 15 hamburgers at one time

West Bend Aluminum Co., West Bend, Wis.



**SPRING DOOR ELECTRICAL BOX** designed for surface mounting provides safe, simple duplex outlet operation in any area exposed to the elements. Electrical wires enter the box through a rubber grommet. The box, made of aluminum, can be quickly and easily mounted on any flat surface

Pass & Seymour, Inc., Solvay Station, Syracuse, N.Y.



**SPILLPROOF PLASTIC CUP** helps children bridge the gap between nursery bottles and open drinking containers. This tough, flexible tumbler has a snap-on lid with a spout through which the liquid is sipped. Perforations in the mouthpiece are small enough to prevent free flow of liquids, but they will pass them when slight pressure or sipping action begins

Pastry Corp., Fisher Bldg., Detroit 2, Mich.

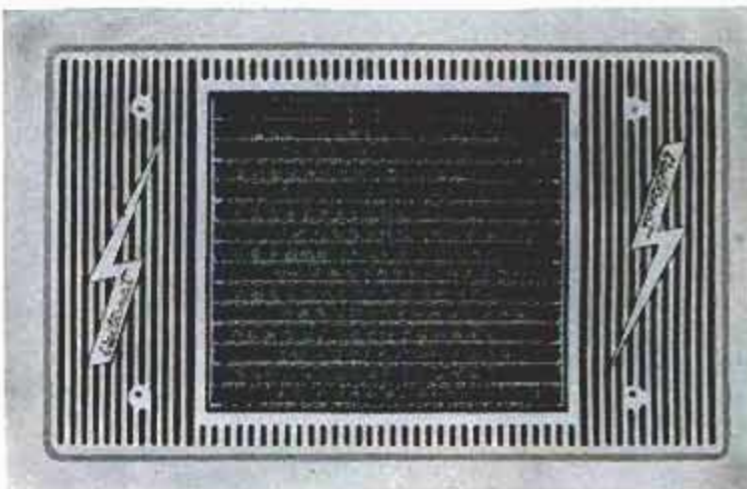


**HOME BARBERING AID** fastened onto scissors combs the hair and holds it between the blades for easy snipping. The device enables home barbers to have one hand free to hold child's head. It comes together with shears, plastic cape, and an illustrated booklet on home barbering

Ray Products, 259 Strader Ave., Cincinnati 26, Ohio

**ELECTRIC DOOR MAT** automatically brushes dirt from soles of shoes. As mat is stepped on, 15 brushes go into action in opposite directions. A 1/8-horsepower motor powers mat on 110-volt, 60-cycle alternating current. Mat is installed flush with floor, in well 29 inches deep

Electromat Co., 222 Charles St.,  
River Rouge 18, Mich.







Intercom system linking house with movie-viewing room lets Basches monitor children's room while watching film. It also lets family know when movie is about to start. Car-type speaker, below, has been replaced with an 18-inch hi-fi speaker



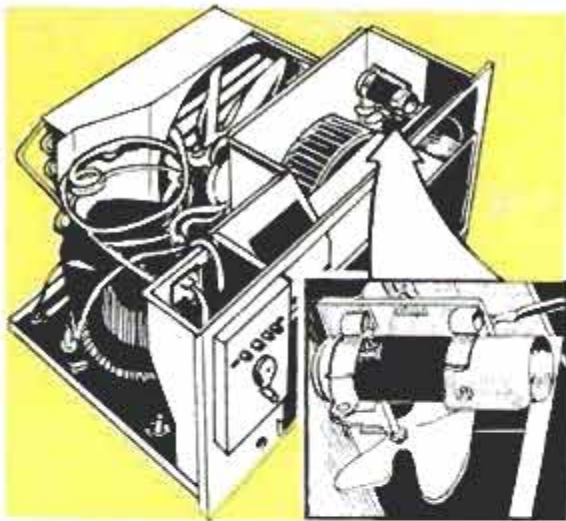
## They See Drive-in Movies From Their Own Home

HOW WOULD YOU like to have a drive-in movie theater in your back yard? Bill and Rose Basch of Los Angeles love it. When they bought their bungalow and found 1000 cars on the other side of their patio every night, they thought they had blundered. The neighbors had planted tall hedges along the back of their lots. But Basch decided to turn a potential nightmare into a dream. He asked and received permission from the theater manager to tap the sound cable. The theater sent its own technicians over to install an audio cable in the Basch's back yard and charged only for the cost of materials. Basch then built a six-seat family theater on one end of the garage. The private movie viewing room, which cost about \$500, is pine-paneled and has an acoustical ceiling. To minimize reflection, Basch installed thick, polished plate glass that's crystal clear. He bought a half-dozen used theater seats and installed an 18-inch hi-fi speaker. Now the Basches can watch two first-run movies each week without leaving home.

Drapes pull across big windows when Basches want privacy. Popcorn source is drive-in stand on other side of fence







## Stream of Air Powers Electrostatic Filter in Air Conditioner

Dust, pollen and smoke particles are removed from the air by a small electrostatic filter concealed in one of the new air-conditioning units. The filter, according to the manufacturer, attracts tiny particles like a magnet rather than merely trapping those large enough to be caught in holes. The air stream turns a fan which, in turn,

powers the filter's own generator. The filter can be cleaned by washing it, and it reportedly does not produce ozone. Another of the newly introduced air conditioners is a room-size model of the reverse-cycle heat-pump type. It has an automatic defrost device which permits it to be used even in winter temperatures.

## Milk by the Chunk Served Canadian Army

"Eight inches of milk coming up!" That could be the way an order is filled at the Canadian army's station at Fort Churchill, Man. Milk to be shipped to the post is quick-frozen at  $-45$  degrees F. The solid blocks of ice then are sent to the post in refrigerator cars. There the camp cooks saw the blocks into pieces of the desired length. Thawed for a few days at room temperature, the milk tastes as fresh as the day it came from the dairy.

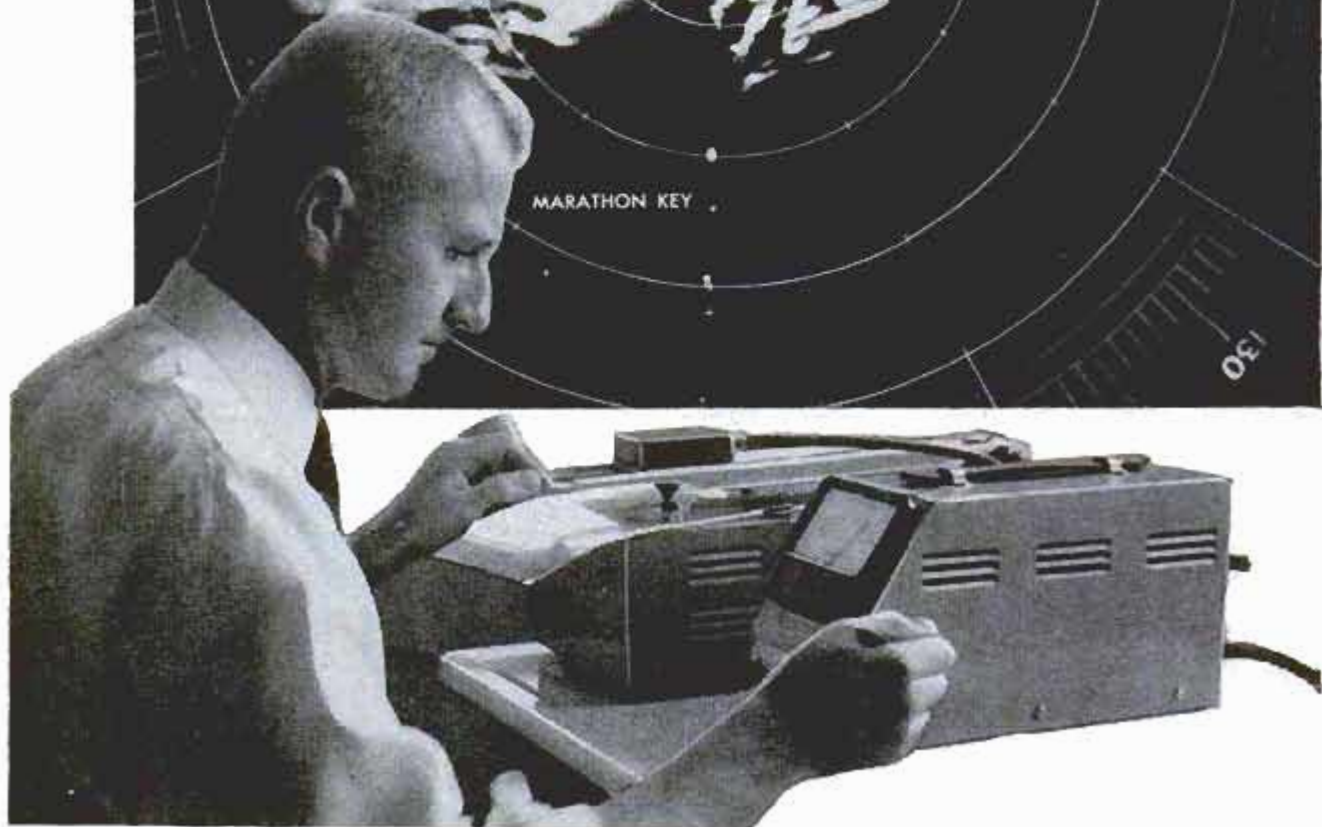
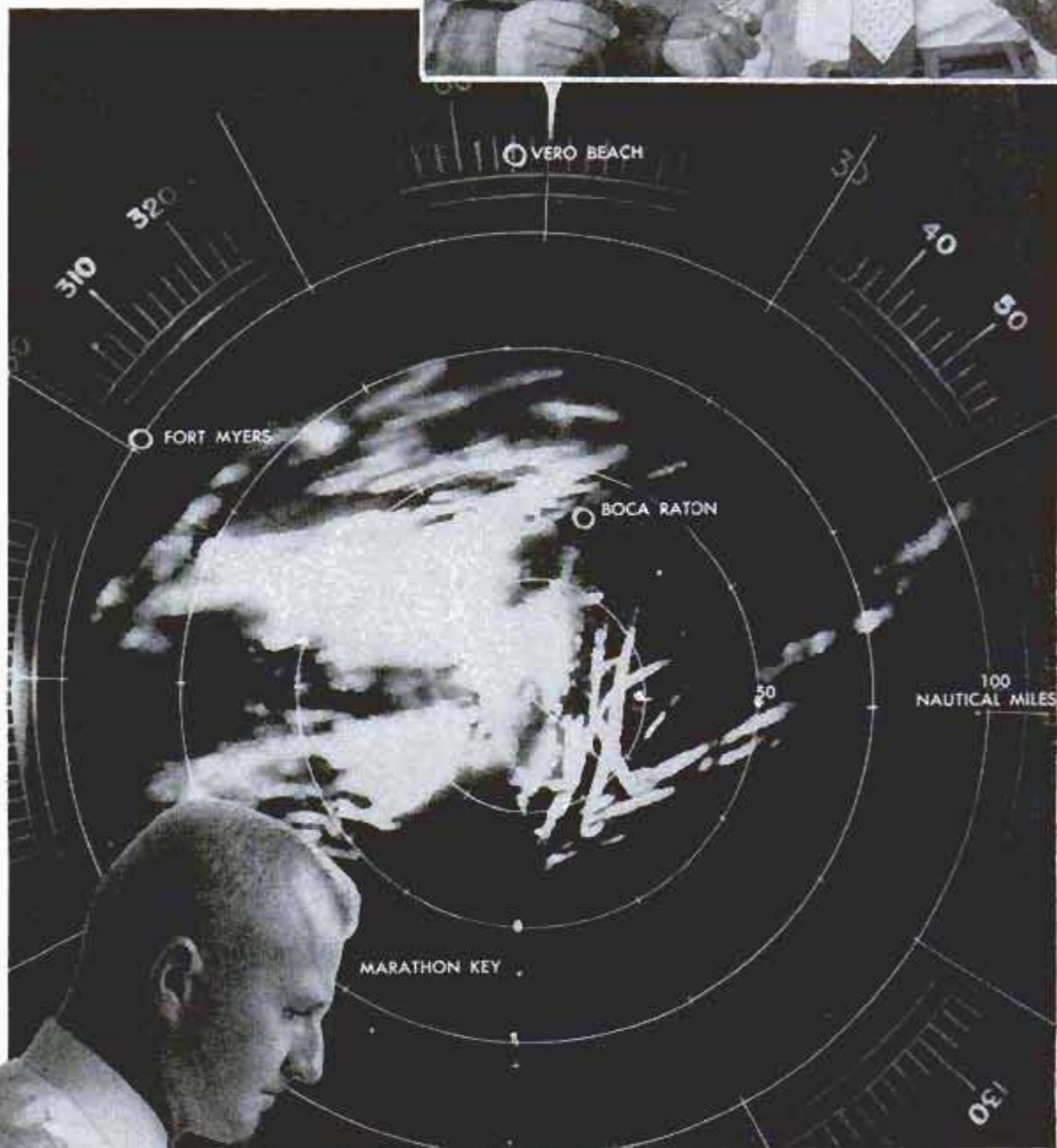
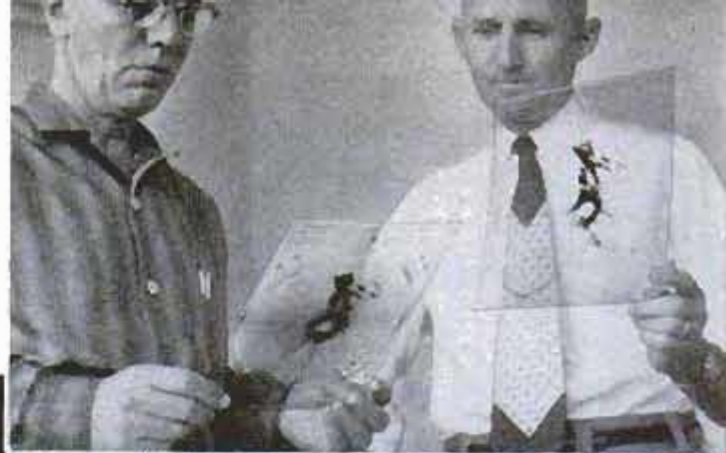
## Portable Aluminum Torches Make Patio Parties Brighter

For beach or patio parties, camping or just as a yard decoration, the new outdoor torches do a double job of providing portable lights and repelling insects. A special safety fuel contains an insect repellent. It also produces an extra-bright orange light and gives off what is described as a "scented South Seas aroma." The torches are made of aluminum with a finish that needs no polishing. Three-foot lengths of metal poles are supplied with the torches.





L. F. Conover, left, and H. W. Hiser, right, examine photographic negatives of rainfall recorded by radarscopes at University of Miami laboratory. Center photo of radarscope print shows storm over Florida Everglades that would miss most rain-gauge stations in area. Hiser, at bottom, uses densitometer to measure intensity of rainfall indicated by negative





# Forecasting Floods by Radar

By Edward Dickson and Max Hunn

**B**ECAUSE RADAR CAN "SEE" rainstorms which otherwise might be unobserved, it can become the instrument for warning communities of flash floods. And it can be harnessed as an aid to flood forecasters along the nation's major river systems to enable them to make quicker and more precise predictions of flood stages.

Those peacetime uses for the war-born magic of radar are being explored by a team of researchers at the University of Miami in Coral Gables, Fla., through a study of rainfall measurement by radar and photography. Now in its third year, the project is being conducted by the university's Marine Laboratory and Radar Research Laboratory for the U.S. Weather Bureau.

By photographing what the radar sees, the researchers have found they can obtain a fast, accurate record of rainfall occurring at any point within 100 miles of the radar station and for any given period.

A graphic example of the radar's reporting ability was related by H. W. Hiser, research associate professor who heads the project, and L. F. Conover, research meteorologist who represents the weather bureau in the experiments. During one observation of the 30,000 square miles of the research territory, the photographic negative of the radar observation showed widespread rainfall in varying degrees through much of a 6000-square-mile area. But, despite the location of 75 rain gauges in that area, rain actually fell at only one such recording station. This was an extreme comparison between a dense rain-gauge reporting network and the radar observation of rainfall. But it illustrates the more complete coverage possible by radar observations, researchers pointed out.

Rainfall can be located by radar in much the same manner that radar can find aircraft in flight. High-frequency radio waves transmitted by the radar unit are bounced back to the radar receiving unit after they encounter raindrops in the air. These echoes form a pattern on the radarscope. The greater the rainstorm, the greater the intensity of the echo and the greater the reaction on the viewing scope.

Rainfall can be located by radar in much the same manner that radar can find aircraft in flight. High-frequency radio waves transmitted by the radar unit are bounced back to the radar receiving unit after they encounter raindrops in the air. These echoes form a pattern on the radarscope. The greater the rainstorm, the greater the intensity of the echo and the greater the reaction on the viewing scope.

The researchers have put this capability of radar to work by time-exposure photographs of the echoes registered on the scope. And from the density of the rainfall echo pattern on the photograph, the researchers can determine approximate amount of rainfall at any point in the area.

Hiser and Conover believe radar can give fast and accurate rainfall measurements within its range of observation. Radar would be of particular value in detecting the dangers of flash floods. A flash flood may originate with a cloud-burst in a sparsely populated area or in a section where communications are poor. A few hours later, a community is flooded without warning when a usually peaceful stream rages over its banks. Interpretation of the radarscope can alert forecasters to the development of any rainstorms which cause these floods.

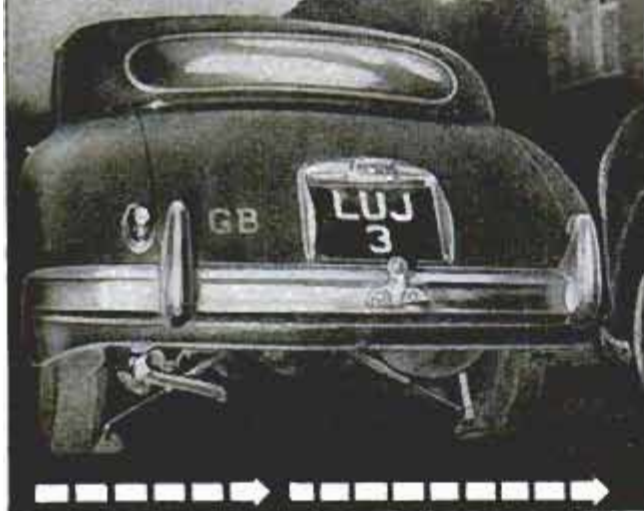
Conover, a 22-year veteran in flood forecasting, believes rainfall detection and estimation by radar will be immensely valuable to hydrologists in calculating flood conditions along the major river systems by providing faster and more complete information than is now available.

The researchers use two 8 by 10 plate-back cameras mounted on radar repeaters. The photographic film can be used to record all rainfall echoes during periods ranging from one to six hours. After a photo is developed, it is examined with a densitometer. ★ ★ ★

Cameras supplied by weather bureau are mounted on radarscopes to make a photo record of any rainfall within 100 miles



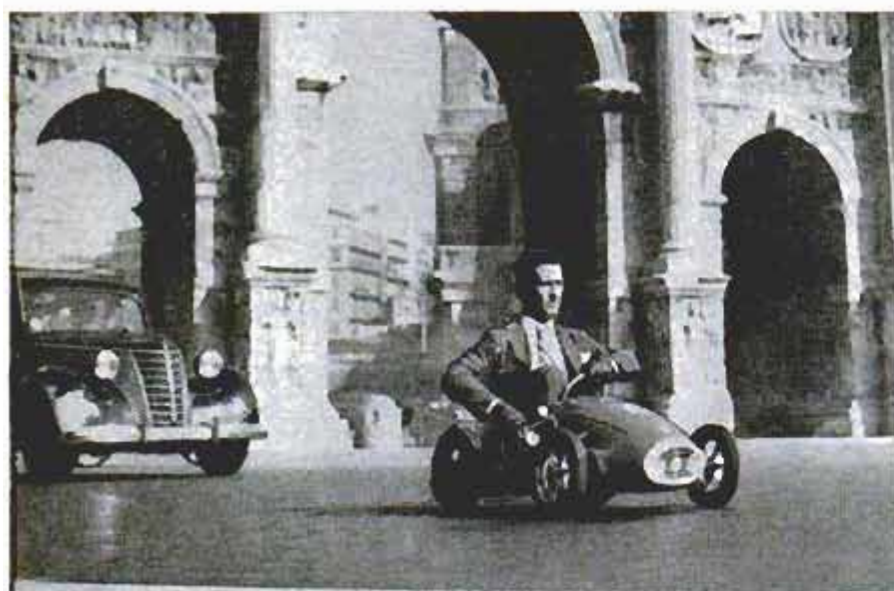




## Briton Solves Parking Problem by Moving Big Car Sideways

Parking is a problem in England and one Britisher has invented a device to move a car sideways into tight parking spaces. Hydraulic jacks raise the rear wheels off the ground. With the engine running, the

rear wheels rub against the rubber disks that form the base of each jack, rotating them and moving the rear end sideways. To swing back out of the space, the transmission is put into reverse gear.



## Italian Solution Is Pint-Size Car

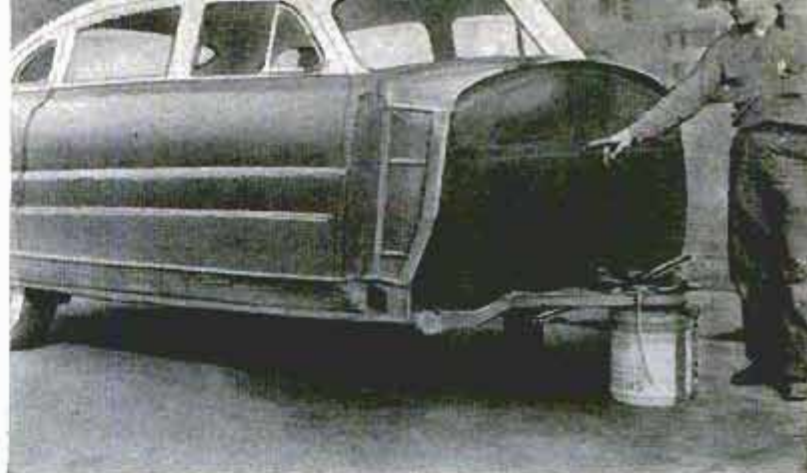
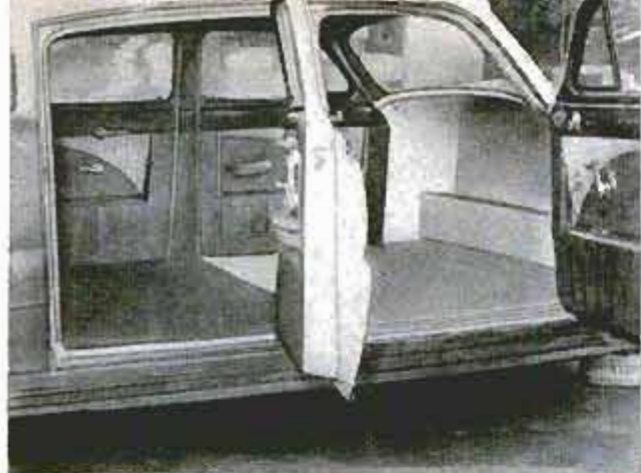
Italy has its parking problem, too, but it's no problem for Vito Pecori of Rome. He built himself a pocket-size car that he can park just about anywhere. It makes the normal small car in Italy (which is a nation of small cars) look huge. The engine is a 49-cubic-centimeter scooter power plant (about  $\frac{1}{100}$  as big as an average American engine).



## Mobile Overpass Speeds Servicing

Riding high is what the driver does when he operates a servicing unit designed and built in the shops of Fruit Industries, Bradenton, Fla. The mobile ramp is used to speed the servicing of refrigerator equipment mounted above the cab of semi-trailers. The driver sits on the working platform over the vehicle's engine and controls the unit by vertical extensions. Completely self-contained, the service vehicle carries engine-powered grease, air and fuel lines.

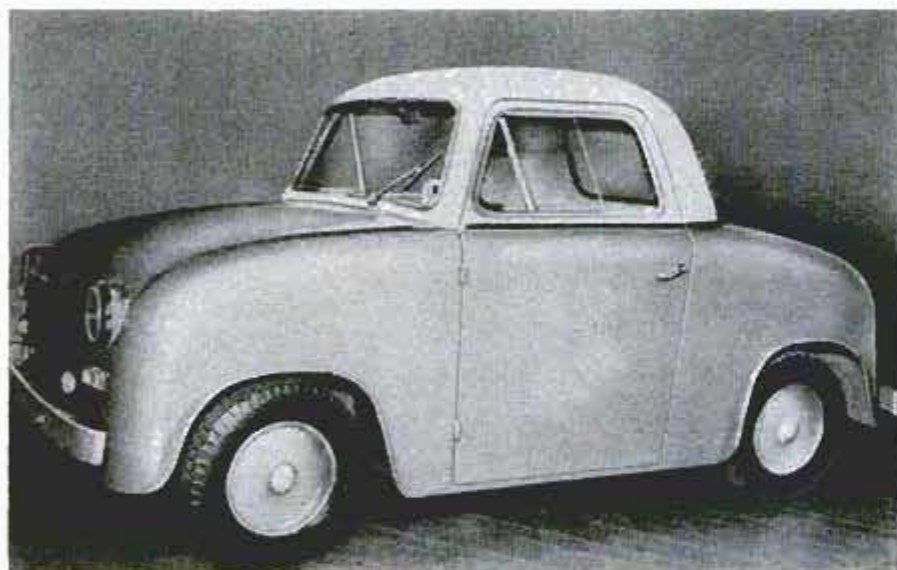




## Junker Made Into Inexpensive Weather-Tight Camping Trailer

By using a wrecked Hudson sedan, Ervin Padilla of Denver, Colo., built a lightweight, weather-tight camping trailer at a fraction of the usual cost. And, in addition, eliminated a lot of work. He paid \$20 for the body and removed everything from the

interior. A double floor of wood was laid with three inches of insulation between the layers. The bulkhead behind the rear seat was removed to provide a 10-foot-long interior. A stove mounted on the rear-window shelf is vented through a side window.



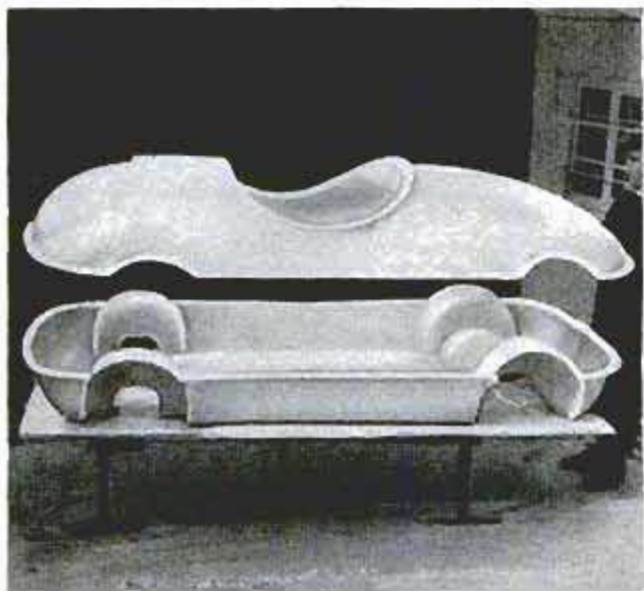
## Finns' Small Car Weighs 620 Pounds

Although it won't win any prize for styling, a new small car, the first to be made in Finland, is certainly one of the smallest. It is said to weigh about 620 pounds and to have a top speed of almost 50 miles per hour. Its engine, imported from Germany, is mounted in the rear. The car is called the "Wiima" and will sell for about \$940.

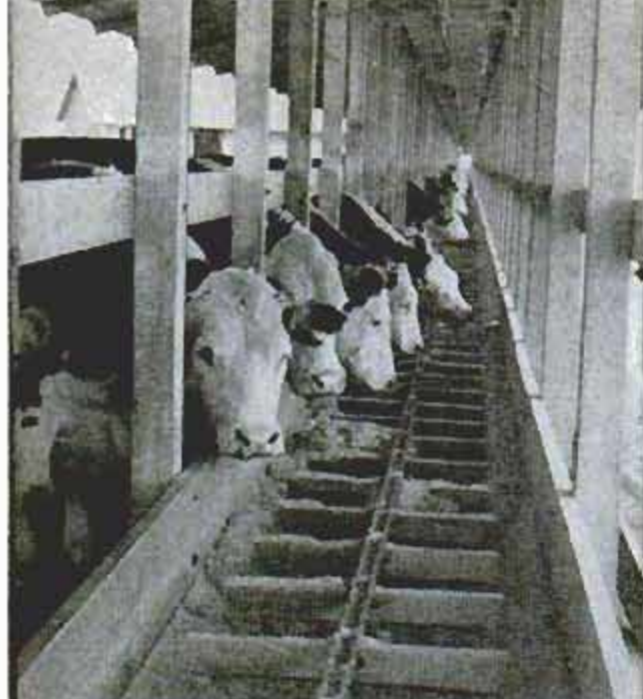
## Tiny German Car Goes Together Like a Frankfurter Roll

Although it is not yet in production, the German Mopetta has attracted considerable attention due to its plastic body that can be manufactured in two halves. Because of the ease of assembly, the cost will

be low. The small engine will be mounted in the rear and will give a top speed of about 50 miles per hour. The roadster-type body seats two persons and is said to have a comfortable suspension system.





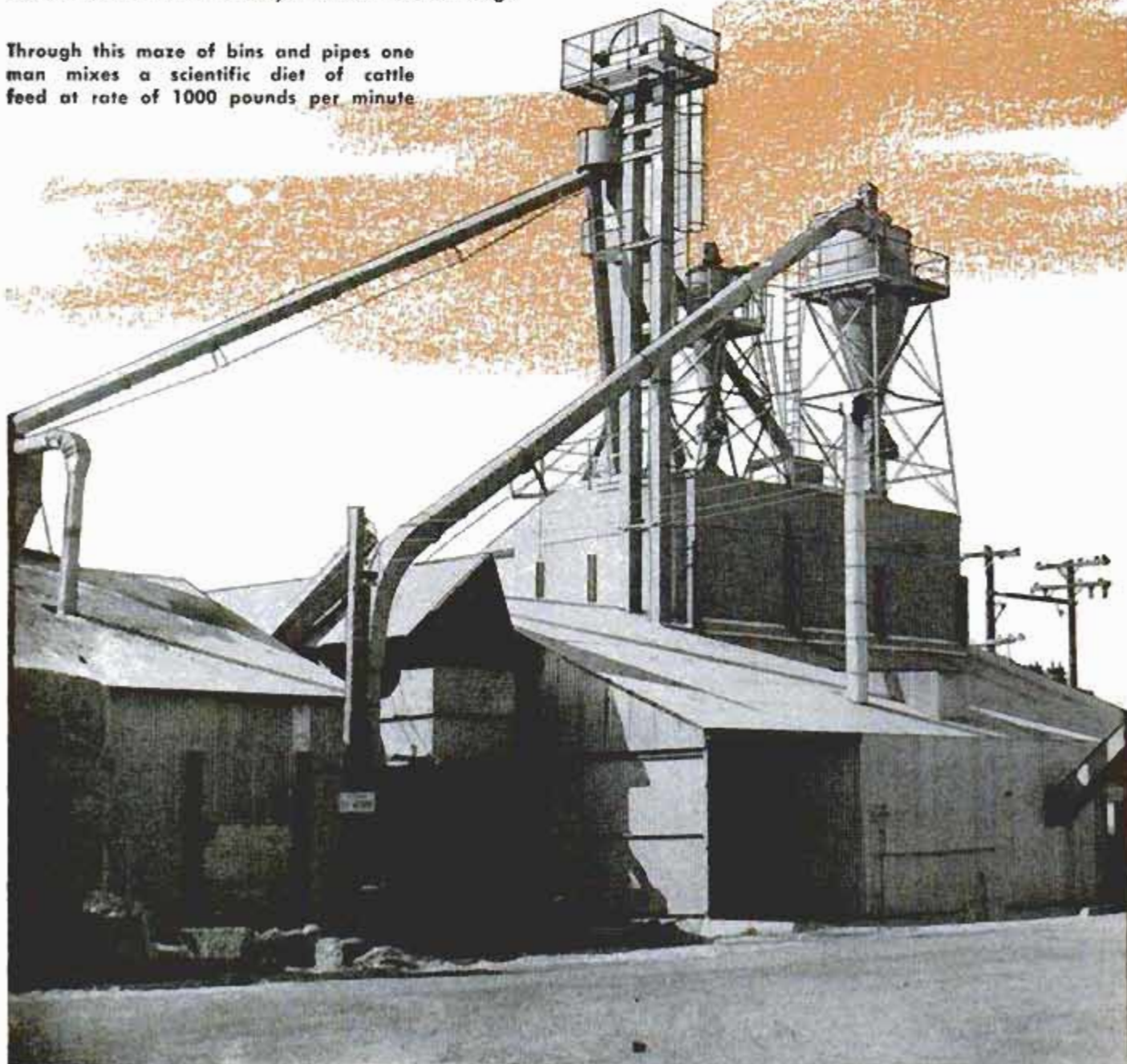


# Push a Button and You Make Beef

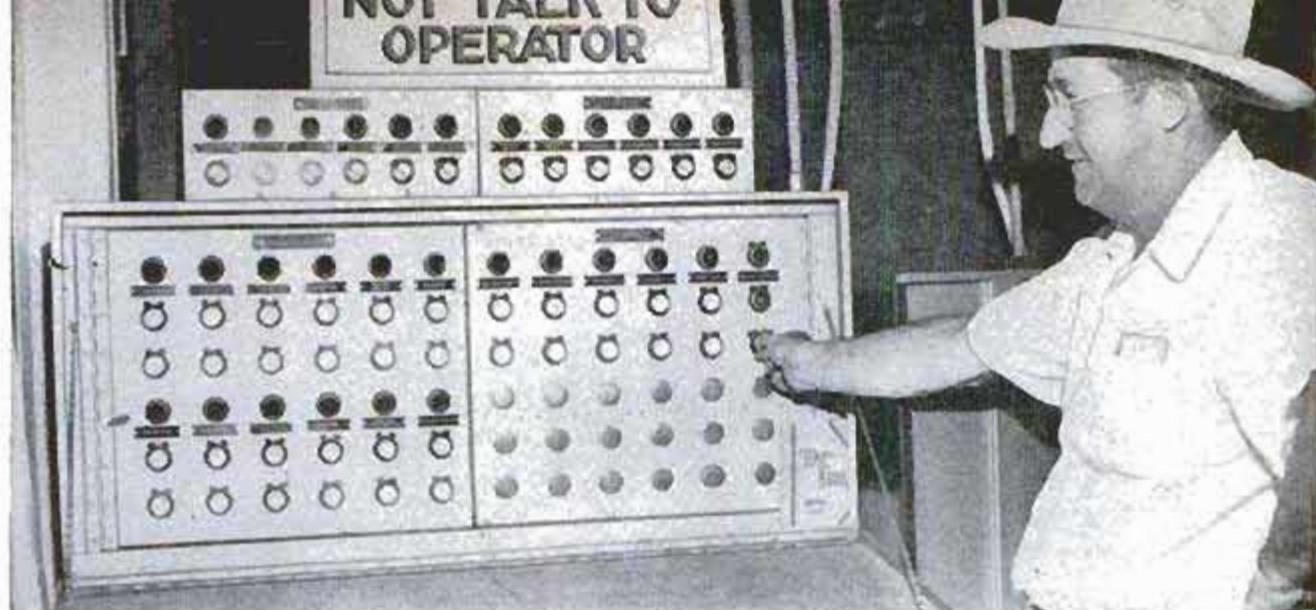
*By F. Leland Elam*

Dinner table as long as a city block serves 500 steers. Chain and bar conveyor moves feed in trough

Through this maze of bins and pipes one man mixes a scientific diet of cattle feed at rate of 1000 pounds per minute







Panel of push buttons controls all conveying systems that move feed to and from storage bins and mixers

**T**HE AGE OF AUTOMATION has arrived in the cattle industry and is turning out "push-button beef." The way it operates and the kind of beef it turns out are examples of a thorough application of modern technical knowledge. Beef today is raised to eat—not to double as shoe leather or armor plate as it often seemed to be in the past century.

Proper feeding of cattle by automation enables the cattleman to control the grains he feeds. Thus he controls the texture of the meat, its vitamin content, the color and amount of fat, and its tenderness.

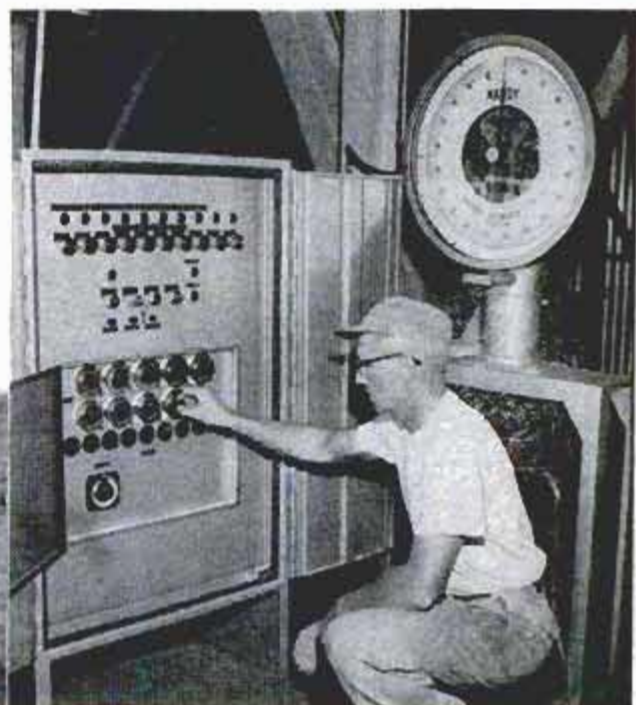
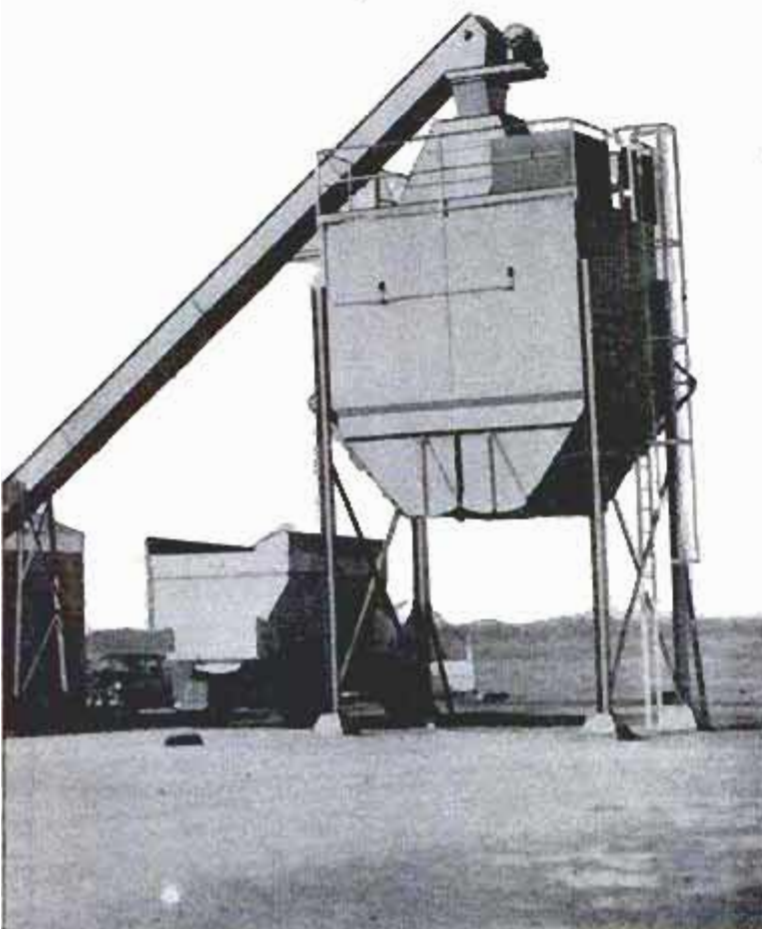
Back in the six-gun days of the 1800s and

the first half of the 20th century, if a man could ride a horse, rope a steer and pitch a lot of hay he had little trouble getting a job as a wrangler on a cattle ranch.

But as we advanced into the start of the second half of this century the picture changed. Today most cattle wranglers must learn a new language. They must know about proteins, total digestible nutrients, carbohydrates and concentrates, for they hold the secrets of making choice beef. Cattlemen must know how to figure out feeding formulas, and how to push a flock of electronic buttons to mix and feed those formulas. They are replacing spurs with throttles because they must handle big automatic feed-delivery trucks. They are turning from horses to horsepower.

Garrett Beckley of Linden, Calif., is one

Two sets of dials on panel below control the exact weight of each type of feed to be blended in mixer







Another method of feed delivery makes use of trucks equipped with augers that empty feed into yard troughs

of many cattlemen who have brought automation to cattle feeding. Under his system, three men feed 10,000 cattle faster than it formerly took 30 men to do the same job.

The operation is divided into two parts: Preparation of the feed, and presenting it to the animals. Feed preparation is handled by one man at the rate of 1000 pounds per minute—fast enough to produce in four hours enough feed for 10,000 cattle. The delivery of this feed to the animals is handled by two men.

Before automation it took a lot of men pitching hay and grain through 14 dusty and dirty hours each day just to feed a small herd of cattle. Automation cuts the required feeding time and the labor down to about one tenth and makes the old

Each batch of scientifically mixed feed is automatically weighed and recorded as it's loaded into truck



136

“shovel-and-fork method” as obsolete as a crystal-radio set.

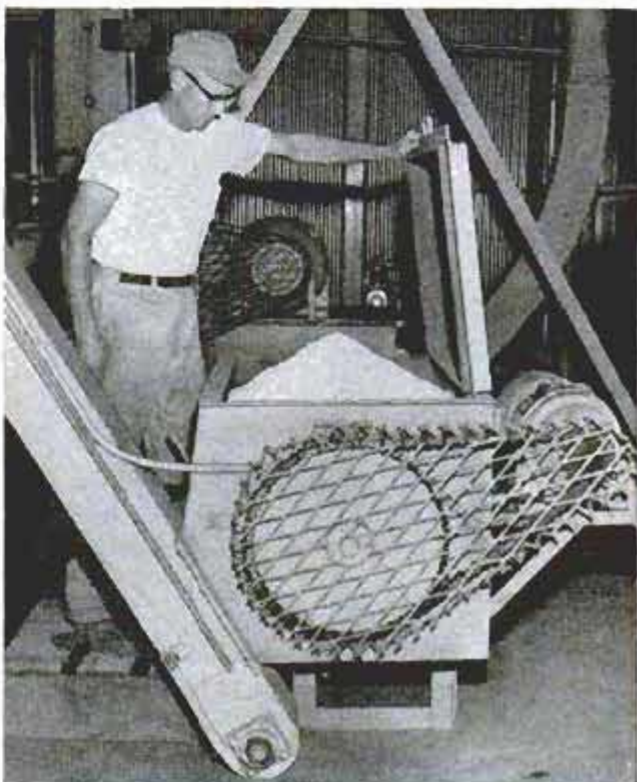
The modern mechanical way produces a fattened animal 90 to 120 days after he is brought in from pasture, where he has spent the first 18 months of his life. It raises him from about 600 pounds to a 1000-pound weight, ready for market.

“Our meals to hungry cattle are always on time,” Beckley says. “There is never any delay due to the slowing up of workers. The tons of necessary feed are mixed by one man pushing buttons and turning dials on two electronic control panels. Automation is as complete as we can make it.”

There are 30 push-button stations on one panel. These buttons control electronically all the conveyor and elevator systems that

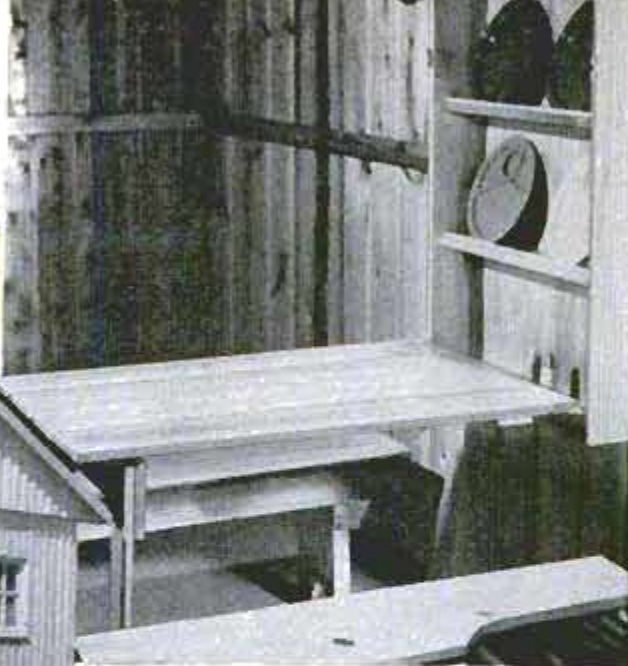
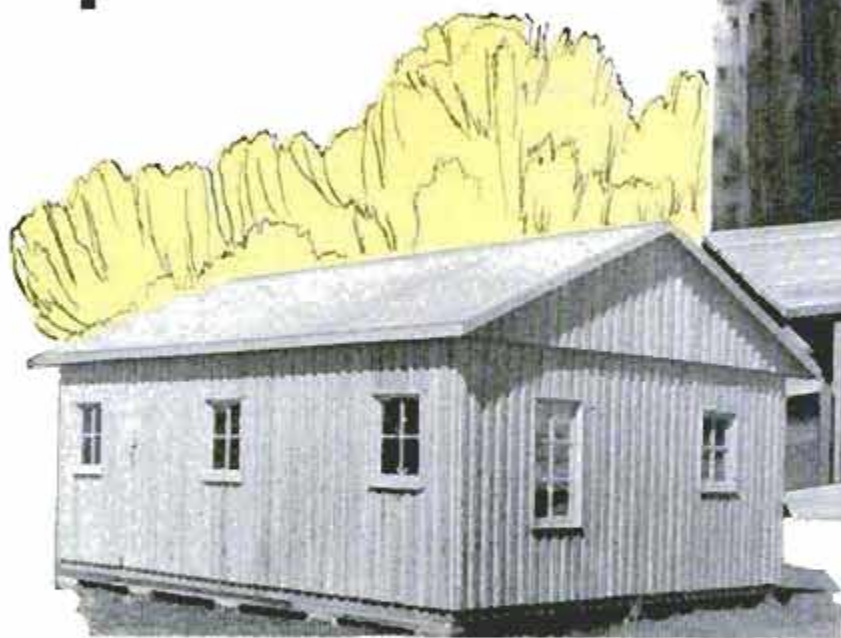
(Continued to page 228)

Trace minerals, salt, stilbestrol and antibiotics are mixed in this hopper and metered onto conveyor





# Sportsman's Cabin



Designed for a sportsman and his family, this low-cost, three-room cabin can be erected in two days by two men

**YOU'VE JUST BOUGHT** a piece of land near your favorite fishing spot, and now you're going to fulfill the dream of your life: Retire, sell the house, leave town and spend all your time satisfying a mighty appetite for the sportsman's life.

"But what are we going to live in?" asks your wife.

One answer might be this economical, easy-to-build cabin, designed especially for hunters and fishermen and their families. Two men can build it in two days, at a cost as low as \$980. Measuring 16 by 20 feet, it's ideal for four or five men, an average-size family or two couples. The suggested floor plan provides for two bedrooms size 8 by 8 feet, a 20 by 8-foot dining and living area, and a 4 by 5-foot bath, utility or storage room.

One of the best-liked features of the cabin

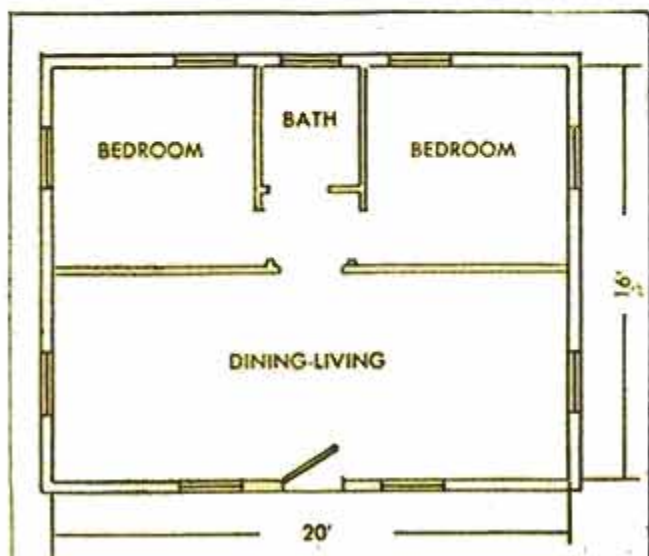
Since window and door panels are interchangeable, the cabin's suggested floor plan can be altered

is its vertical log cabin construction. Made of Michigan cedar on the outside, it blends picturesquely into any woodland or lake setting. Inside the cabin, partitions are of knotty pine.

The cabin can be erected simply and quickly because every part of it, from floor to roof, is supplied by the manufacturer and marked to coincide with panel layout, instructions and blueprints. The panels are tongued and grooved for fast, airtight assembly, and the window and door panels are complete with glass. Even without insulation the cabin is draft proof because of the precise fit of the panels.

After spending a few days putting up his cabin, the sportsman can finish off the interior at his leisure. Materials for the partitions can be bought with the cabin or separately after it has been erected.

Material used is factory engineered and soaked with wood preservatives. The cabin is draft proof







### Magnets Can Cook Food Without Direct Heat

Cooking time may be cut in half by a kitchen range developed in Germany that produces heat from magnetic eddy currents. The heat is not directly transmitted to the cooking vessel. A paper napkin can be placed between the pan and the heating surface and it will not burn or char. The range works only with pots and skillets made of a magnetic metal, and a copper coating makes them heat faster. The amount of heat is controlled by turning a knob which raises or lowers the surface on which the pan rests. The eddy currents generated by magnets also can be used to mix a milk shake on the range while other food is being cooked. A simple magnetic motor operates the mixer.



### Berlin's Open-Air Restaurant Heated for Year-Round Use

Attached to the main railway station in West Berlin is a second-story sidewalk cafe. Diners who want a view with their meal can eat on either of two balconies on the front of the station. The 300-foot-long open terrace is equipped with special heaters so that patrons of the restaurant can eat on the balcony most of the year.

### Wire Coated With Aluminum Promises Longer Service

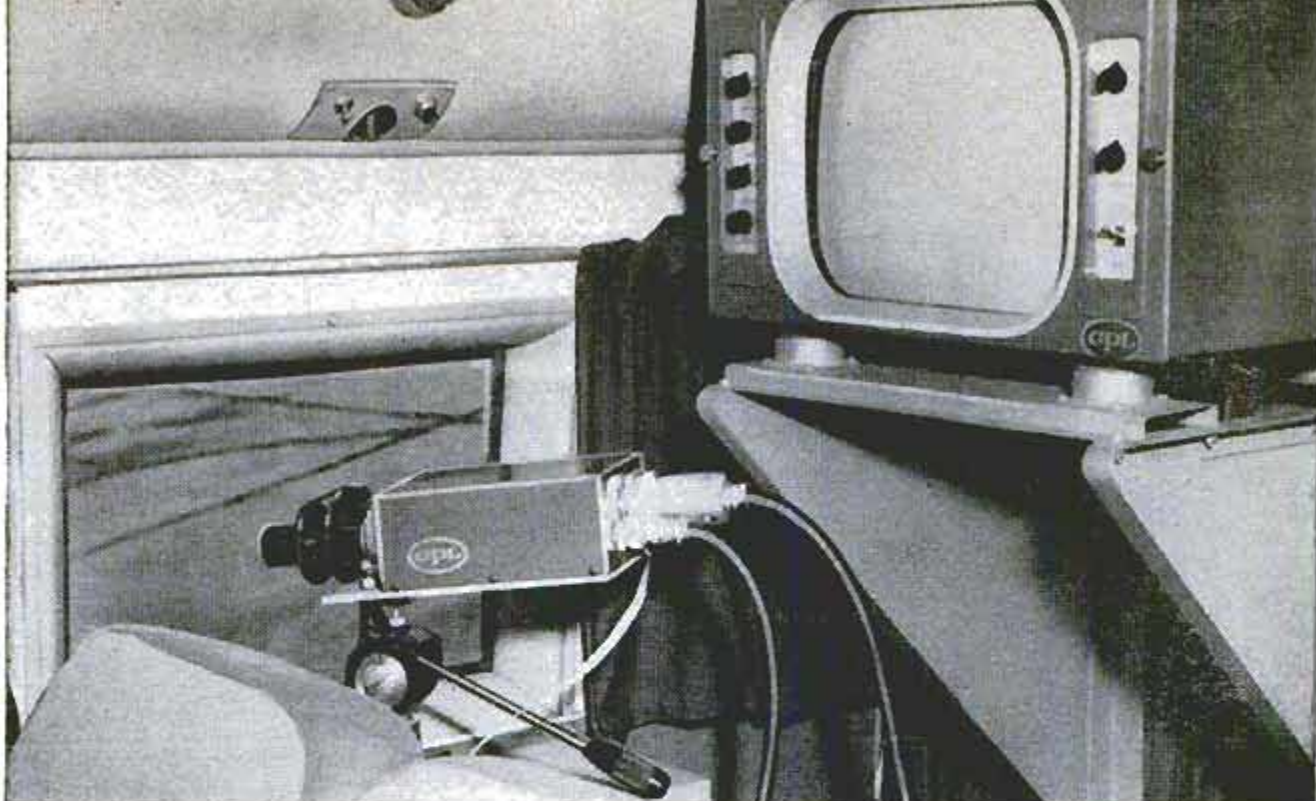
Aluminum-coated barbed wire and farm fence, promising considerably longer service than conventional zinc-coated wire, is approaching the commercial stage after five years of field testing.



### Skin Diver-Miners Vacuum for Gold

Old-time gold prospectors would be startled by the techniques of a crew of modern California miners. Business-end of their gold dredge is a vacuum cleaner head, similar to those used in most American homes. The vacuum head is attached to a 40-foot length of two-inch hose. Gold-bearing sand is sucked into a steel drum containing mercury which separates the gold from the sand. The vacuum head is moved around the river bottom by a pair of skin divers.





Television camera in the body of the plane monitors wing-control surfaces, engine and flaps for pilots

## ***Pilots Watch Blind Spots With TV***

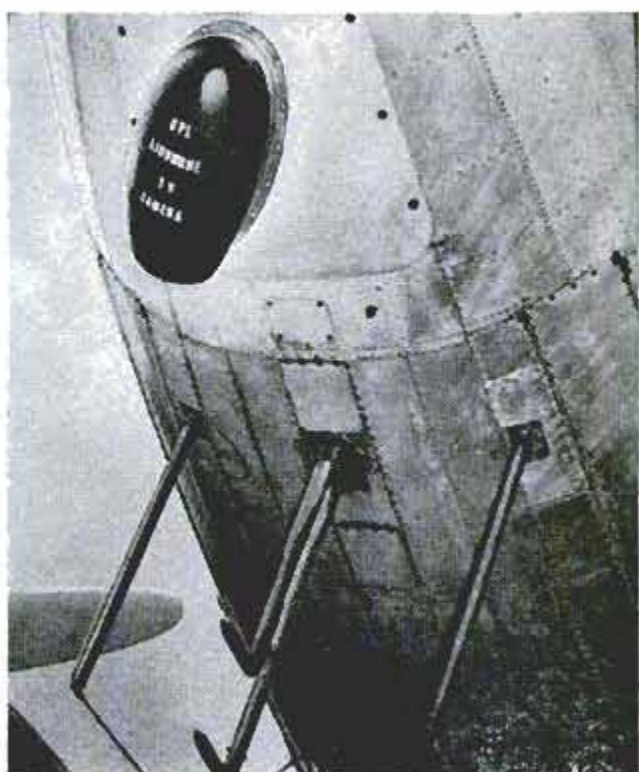
AIRBORNE TELEVISION is helping pilots to keep watch on their plane's troublesome blind spots. For example, a TV camera mounted under the plane's nose flashes a picture of the landing gear to the pilots. Viewing the wheels' position in relation to the runway helps the pilots, in cross-wind landings, to hold a low-wing attitude

Receiver shows relation of landing gear to runway. Coaxial cables connect remote cameras to receiver

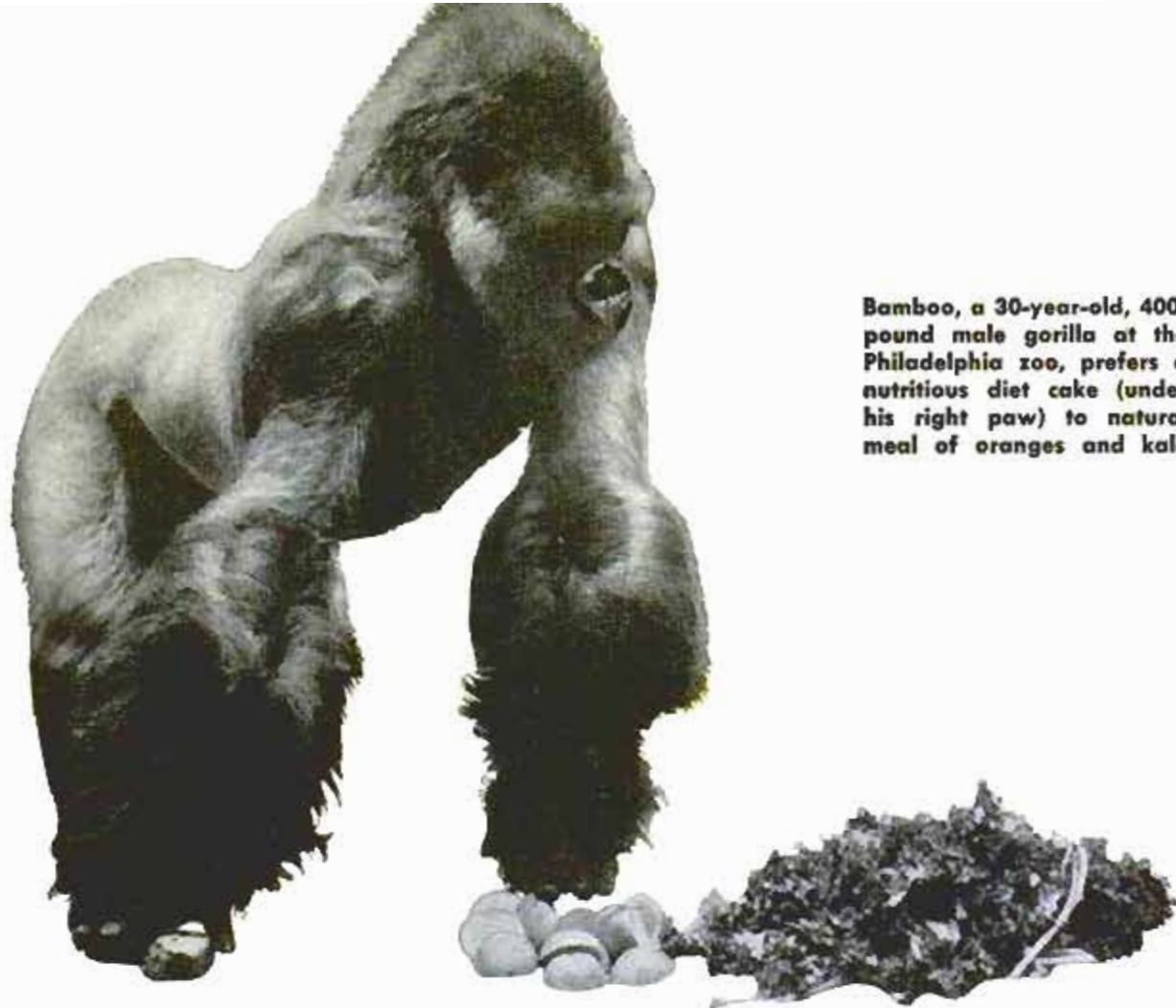
until just a moment before touchdown.

Other cameras keep a close watch on tail and wing surfaces for icing, and on engines for fuel leaks, fires or unusual vibration. Airborne TV can withstand constant vibration and temperatures down to 65 degrees below zero. Camera focus is remotely controlled.

Protective plastic bonnet encloses TV camera on nose, which is focused on plane's landing gear







Bambo, a 30-year-old, 400-pound male gorilla at the Philadelphia zoo, prefers a nutritious diet cake (under his right paw) to natural meal of oranges and kale

# "K"

## RATIONS FOR THE ZOO

*Photos by Don Honick*

The animals eat cake made of grains, flour, yeast, oils, salt, meal, and milk. Each square weighs 25 pounds. Humans say the cake tastes like grass



**B**ANANAS and oranges and kale may be fine for some gorillas. As for Bambo, the 30-year-old patriarch of the Philadelphia Zoological Garden—give him a choice and he'll pass up those "natural" foods any time for the zoo's Diet A.

The recipe? Whole grain and legume meals, milk proteins, brewer's yeast, meat, minerals and vitamins.

### Pioneer in Animal Diets

For 22 years the Philadelphia zoo—oldest in the nation, founded in 1874—has pioneered a study of nutritional diets for its residents. Under the direction of Dr. Herbert L. Ratcliffe, who is also a professor at the University of Pennsylvania School of Medicine, the zoo's Penrose Research Laboratory has worked out a series of recipes—like the GI's K ration—that keep the birds and beasts and reptiles in finer





fettle than the natural foods they might import from the jungles of Malaya and the African veldt. Result: the animals live longer—like Bamboo, the gorilla, and Queen Bess, a dowager flamingo who's been around since 1914; and they raise more and healthier young.

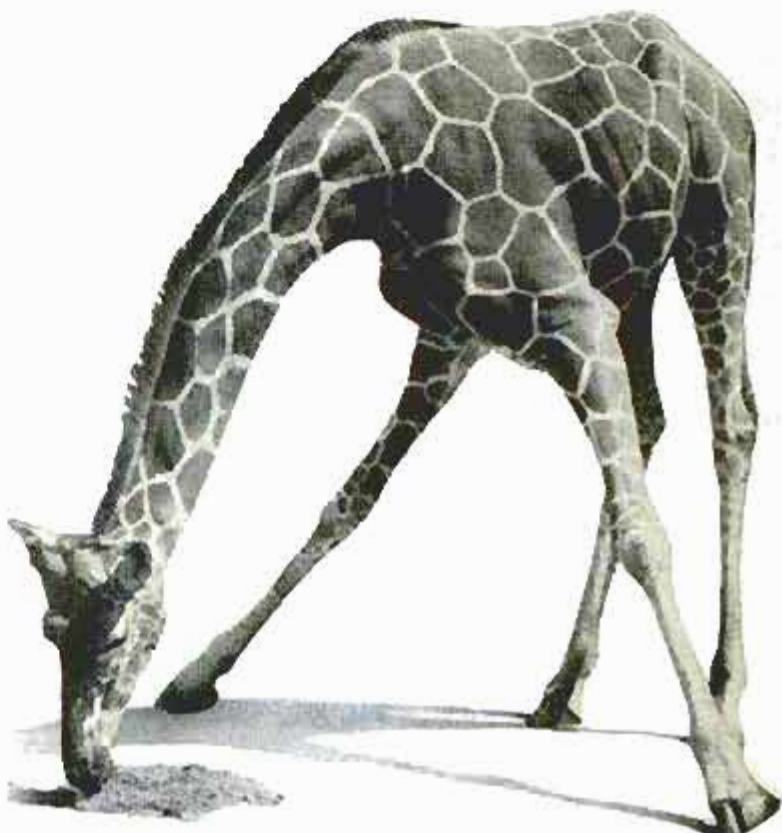
#### Eight Composite Diets

Naturally they don't all like the same menu, and at least eight composite diets have been evolved for various groups of animals. But a hummingbird will thrive on the same basic food elements as a bear, although its appetite is different. The cockatoos and parrots won't touch a "K ration" meal without some whole-seed additions. The big cats relish a slab of horse meat dredged with a mixture of milk powder, minerals and vitamins. Diet A, locally known as "monkey cake," is fine for a long list of zoo residents but the fellow with the big bill, the toucan, likes his better garnished with some finely ground carrots and hardboiled eggs—with the shells. The one group you can't sell on these newfangled cake rations is the fish-eaters. For them, it's fresh fish or nothin'.

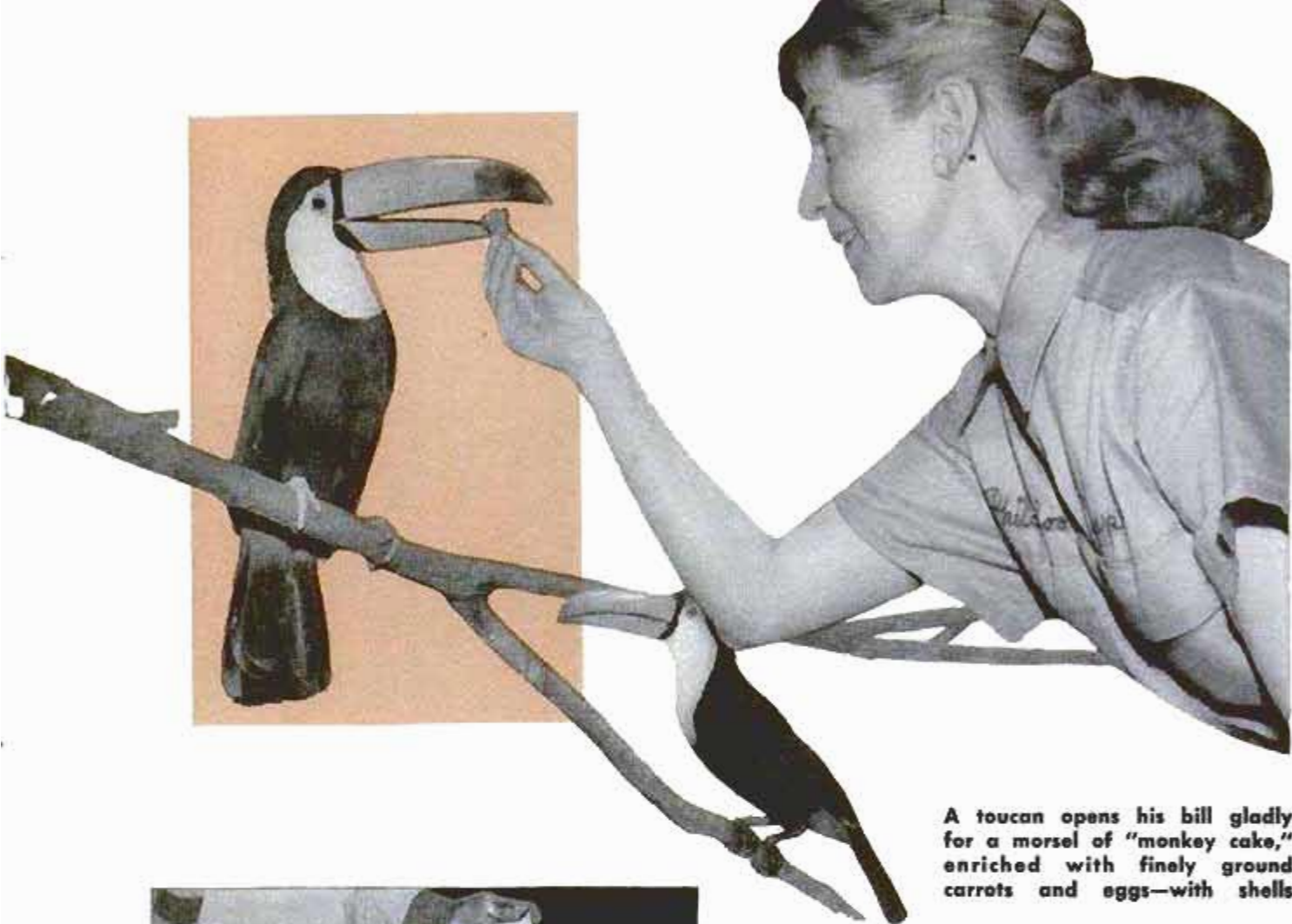
"Our diet system has its basis in the established fact that all species of higher animals must have protein, fat, carbohydrates, minerals and vitamins if they are to

Only bars can keep this jaguar from going 100 percent of the way for a tasty feast of horse meat dredged with milk powder, minerals and vitamins

This male giraffe eats a modified ration suitable also for dairy cows. The diets mean longer, healthier lives and better offspring for the zoo animals







A toucan opens his bill gladly for a morsel of "monkey cake," enriched with finely ground carrots and eggs—with shells



An employee at the zoo bags a mixture of carrots, beet pulp, and kale for the diets of plant-eaters

live and reproduce," says Dr. Ratcliffe.

#### Mortality Rate Reduced

So successful has been the Philadelphia study of nutrition that the annual mortality rate among mammals, for example, has been reduced from 18.8 percent in the 20 years prior to 1935 to 11.0 percent since 1935. And the Philadelphia zoo methods have recently been adopted by the zoo at Basel, Switzerland, and are being studied at Antwerp, Belgium and Frankfurt am Main, Germany. ★ ★ ★

The rhinoceros feeds on Diet B, a modified dairy ration. The animals relish their special diets





# Teen-Agers Set up a Phone System

HERE'S ONE SOLUTION to that age-old battle between teen-agers and parents over use of the telephone. Three enterprising youngsters of Berkeley, Calif. — John Davis, Tom Voorhies and Preston Thompson — set up their own phone system. The three lads provide service to 18 subscribers who think it's a fine idea — they pay nothing for it!

With equipment financed from their allowances, the boys worked in their spare time to set up the telephone network. Lines were strung from trees to poles to roofs. A switchboard was installed in one of the homes. Soon the service was a going concern, with all the problems of a public utility except taxes, which the boys don't have to pay since they charge no fee.

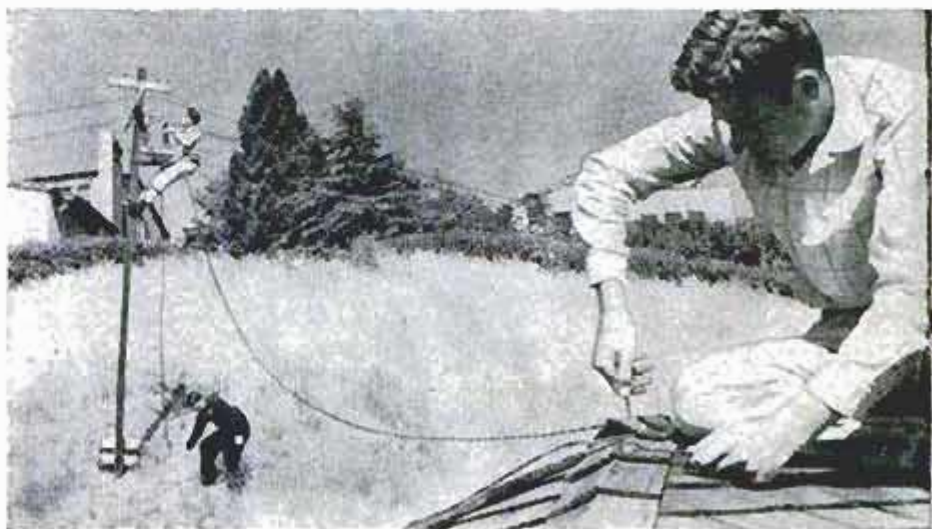
Contrary to most utilities, though, the boys hope for trouble in their system. When something goes wrong, they have an opportunity not only to run down the trouble but visit their friends while they're making repairs.

Today the company is a member of the California Independent Telephone Association. More important, the parents like the arrangement because it keeps the boys off the regular phone system.

Repairmen look forward to troubleshooting visit to home of this subscriber



Growing pains: Circuits in switchboard must be rewired to handle a new subscriber. Switchboard limits number of phones



Young linemen run line from a subscriber's home to main pole. Below, only chore they dislike is manning the switchboard. Someday they hope to convert to dial telephones







The next 15 pages are devoted to an informal way of life that started on the West Coast a number of years ago and has now swept across the entire country—outdoor living. It has affected the lives of millions of people as well as their homes and yards. It seems to us that the ideal space for outdoor living should adjoin the home and afford pleasure for the whole family—an outdoor family room. As a model for our readers, we asked Tom Riley to build such a room which is featured on the first six pages of this outdoor-living section.

## We Built a

By Tom Riley

**O**FTEN, my wife and I (and our small son, too) looked out on our rear yard and wished we knew what to do about it. Like so many California homes, ours had an open patio or terrace in back. And like so many such slabs, it baked you in the summer and in the winter it was soggy and cold.

Then *Popular Mechanics* asked me to test-build a good example of an outdoor room. It would have to be adaptable to most any home and climate. It would have to answer most any problems and desires.

My family leaped into this. (Wasn't our own rear yard an example of the need?)

We started looking at outdoor rooms in earnest and literally saw hundreds. Finally, we found one outdoor room which was good. It was far too expensive—on a home that most of us could never afford—but somehow it was practical and right. It was designed by Rosalind Wheeler, a San Francisco landscape architect.

We asked Miss Wheeler if she would design the adaptable and inexpensive outdoor room we needed. Her answer was an enthusiastic "Yes!" She agreed that construction of an outdoor room was easy but that far too often it didn't accomplish what it should. She mentioned that she had been

Before the outdoor room was added, the rear of the Riley house had a sun-baked and seldom-used patio

**BEFORE**







Jaunty roof of the outdoor room was designed to let in more light; it protects grill, tables, even the TV

# *Family Room Outdoors*

Strategically placed lights glamorize room at night as guests sit around fire in "wishing well" grill

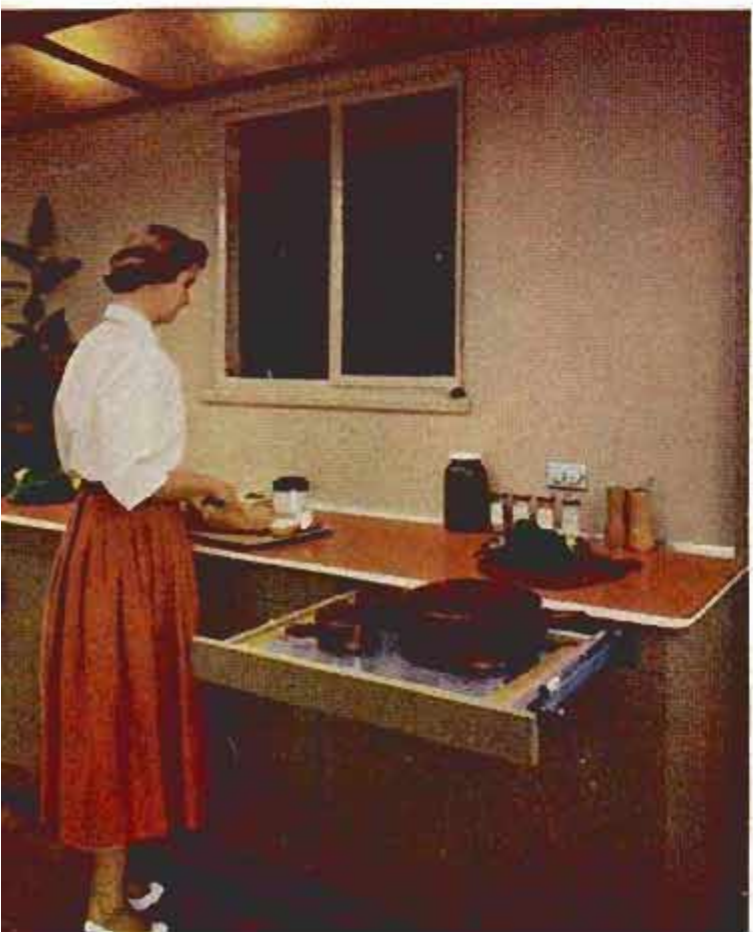






Crank at side of circular barbecue raises or lowers grill. Bricks were built up around portable grill. Attractive metal hood and stack carry smoke away

Special feature of barbecue cabinet and counter is the warming shelf which pulls out like a drawer. It was made from tray with glass heating panel in top



working on the answer for years and believed she already had it on paper.

These pages show the results. In one month, with a neighbor helping on the framing, I built the outdoor family room to Miss Wheeler's specifications. It adapted perfectly to our house and our desires, as it can to yours.

Your house influences the exact size. We made ours 14 by 29 feet, not counting its roof overhang. Miss Wheeler advises: "Don't be afraid to make the room big!"

The house also influences the location. We decided to build ours in front of the sliding glass doors of our dining room. With those doors wide open, the outdoor room becomes fully a part of the house. We also extended the outdoor room to the left to protect an entranceway from the rain, and past the kitchen window on the right so the window could be used for a pass-through.

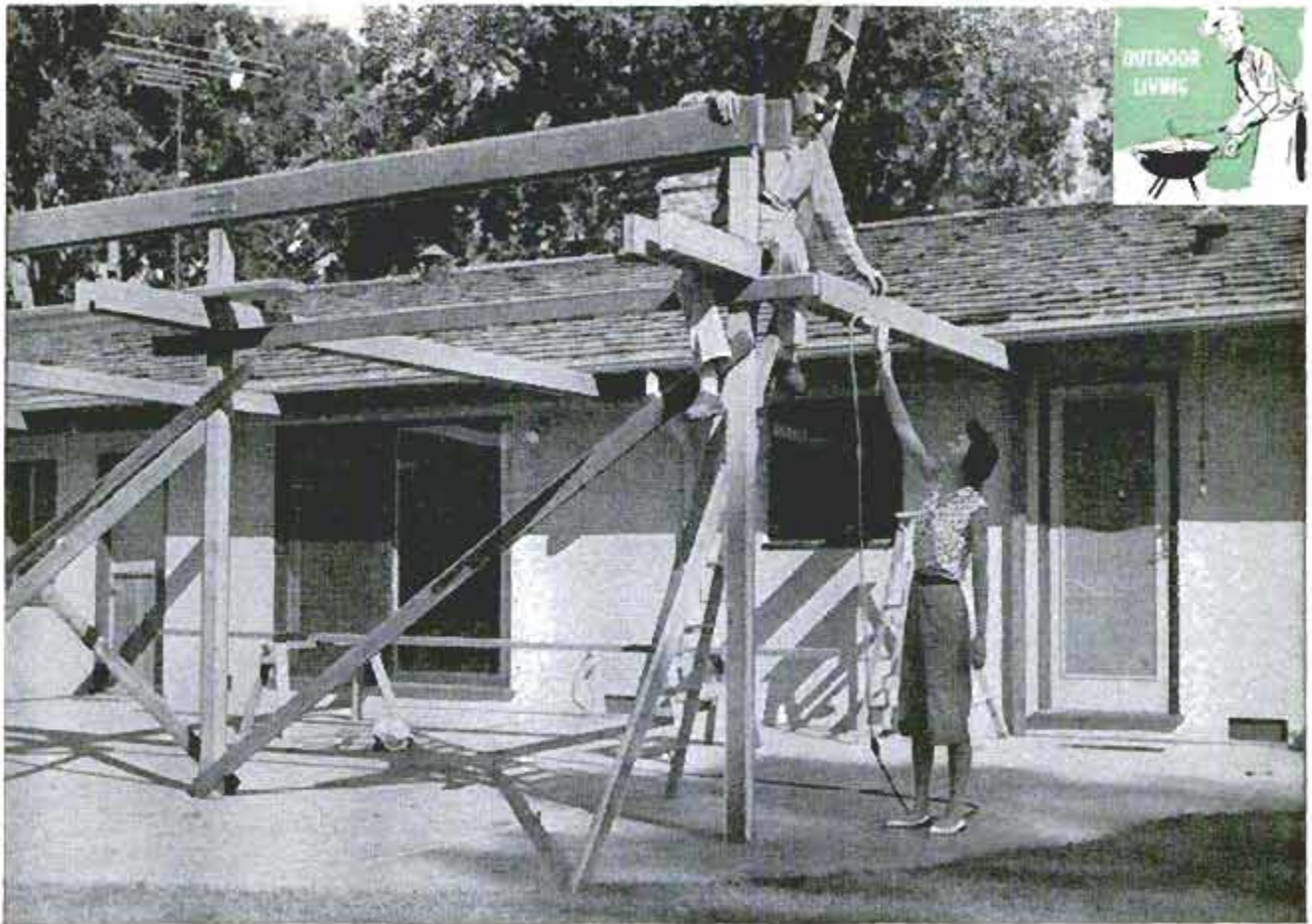
The framing of this outdoor room allows you to run a flat, narrow roof out to either side—for protection of other doorways or for architecturally tying in the room to the rest of the house. We took advantage of this possibility to run such a soffit extension off the left side to our garage.

The major part of any outdoor room is its roof. Our roof is a butterfly design and slants up from the house. This has several advantages. It attaches easily and looks better on most houses. It extends just slightly over the house gutters and drains into them, which means no extra gutters or flashing into the house roof. And you can build it high! Ours is 10 feet high at the top of the front posts. The important



Corrugated Flexboard roofing was easy to nail down. Lighter section nearest house is translucent glass fiber which helps light interior of house as well as the outdoor room. Riley used 12-foot lengths of the Flexboard and 3-foot lengths of skylight paneling





During framing operation, Riley (sitting on double two-by-six joist) reaches for drill hoisted by his wife

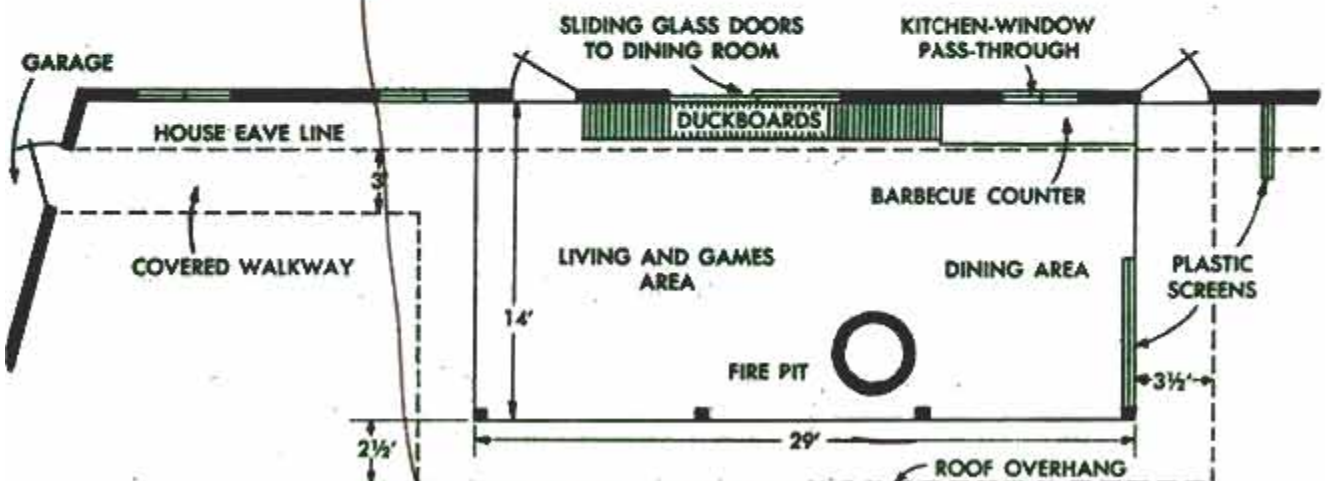
thing is to be able to see the horizon and a little of the sky when looking out the windows. Then your room will not take all the light from the house. Also, it seems to bring the outdoors into the home.

The roofing is made of Flexboard, a lightweight corrugated-asbestos-cement panel. I'd never heard of it but found out that this material has been used on the roofs of commercial buildings for almost 50 years. It is as easy to nail down as glass fiber, yet is strong enough to walk on. It's insulating, fireproof and, best of all, costs only about one third as much as many good-quality roofing materials.

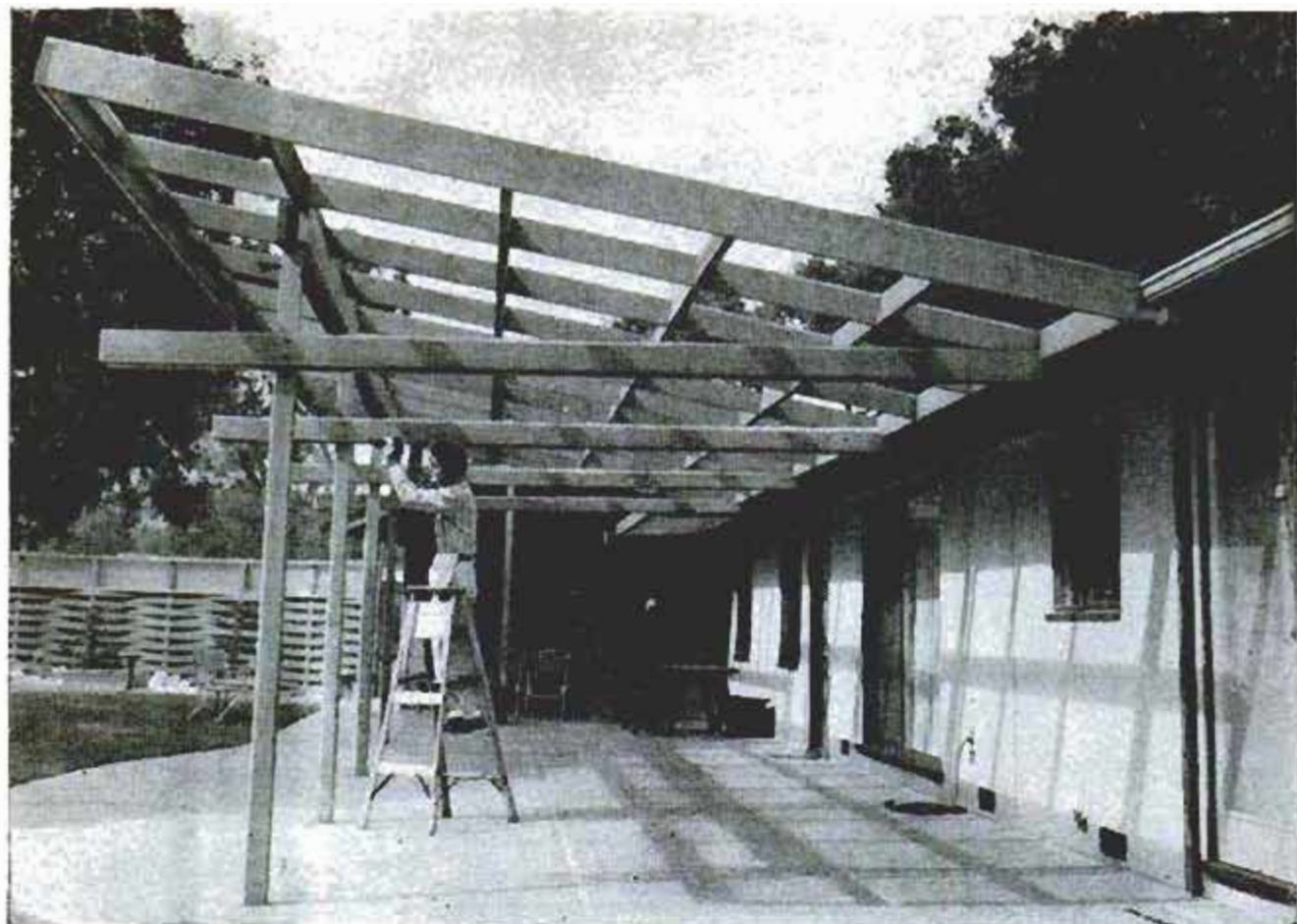
On most houses, and ours was no exception, even a butterfly roof would darken the house to some degree. So we included a skylight strip. The roof framing of the room is a conventional egg-crating of two by sixes. Over the last section adjoining the house, clear corrugated glass fiber of the same-size corrugations as the Flexboard was laid. The plastic is not as clear as glass and we've found that this gives an excellent, soft lighting to both the house and the rear of the outdoor room.

In the suburbs of San Francisco we have no insect problem so we built the outdoor room without screening. But what our

General plan of the outdoor room shows how it connects to dining room, kitchen and with walkway to garage



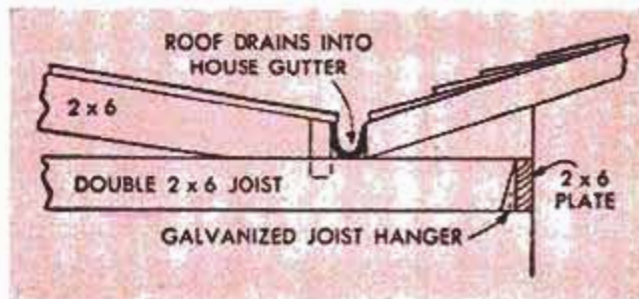
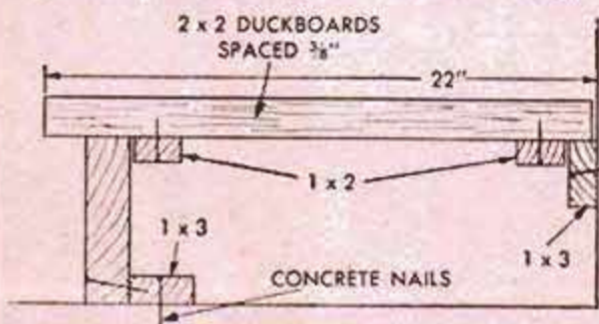




Riley puts finishing touches (trimming off and smoothing) to the completed roof frame—biggest part of job



Duckboards provide out-of-the-way seating for guests as well as space below for storage



room did need—a fairly typical case—was to be closed off at one end for privacy and wind protection. We erected a screen directly behind the barbecue table, a two-by-four frame containing two 3-foot panels of clear, flat glass fiber. A similar screen containing one panel of the plastic was attached to the side of the house beyond the outdoor room just past the kitchen door. Thus, a baffle was formed which did the job perfectly, yet in no way blocked off or enclosed the outdoor room. In the same way, if you are screening the room, you might substitute the glass fiber, or inexpensive plastic-coated fly screen, at one end for more privacy or a wind baffle. If you leave the room open and have young toddlers, you can attach accordion-type gates to the posts and house and have a huge playpen.

One possibility my wife hoped for was an outdoor room which would furnish seating and entertainment for a sizable crowd without expensive furniture and built-ins.





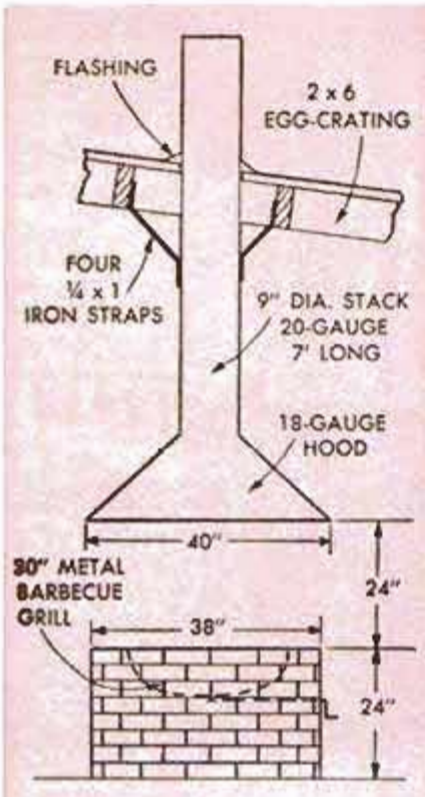
On a summer night the outdoor room can be quickly converted into a theater for viewing slides or movies

We'd seen too many examples of outdoor rooms cluttered with expensive chairs and lounges and no elbow room. We decided on duckboards made into a long, low bench extending the length of the room against the house wall. The bench's height is the

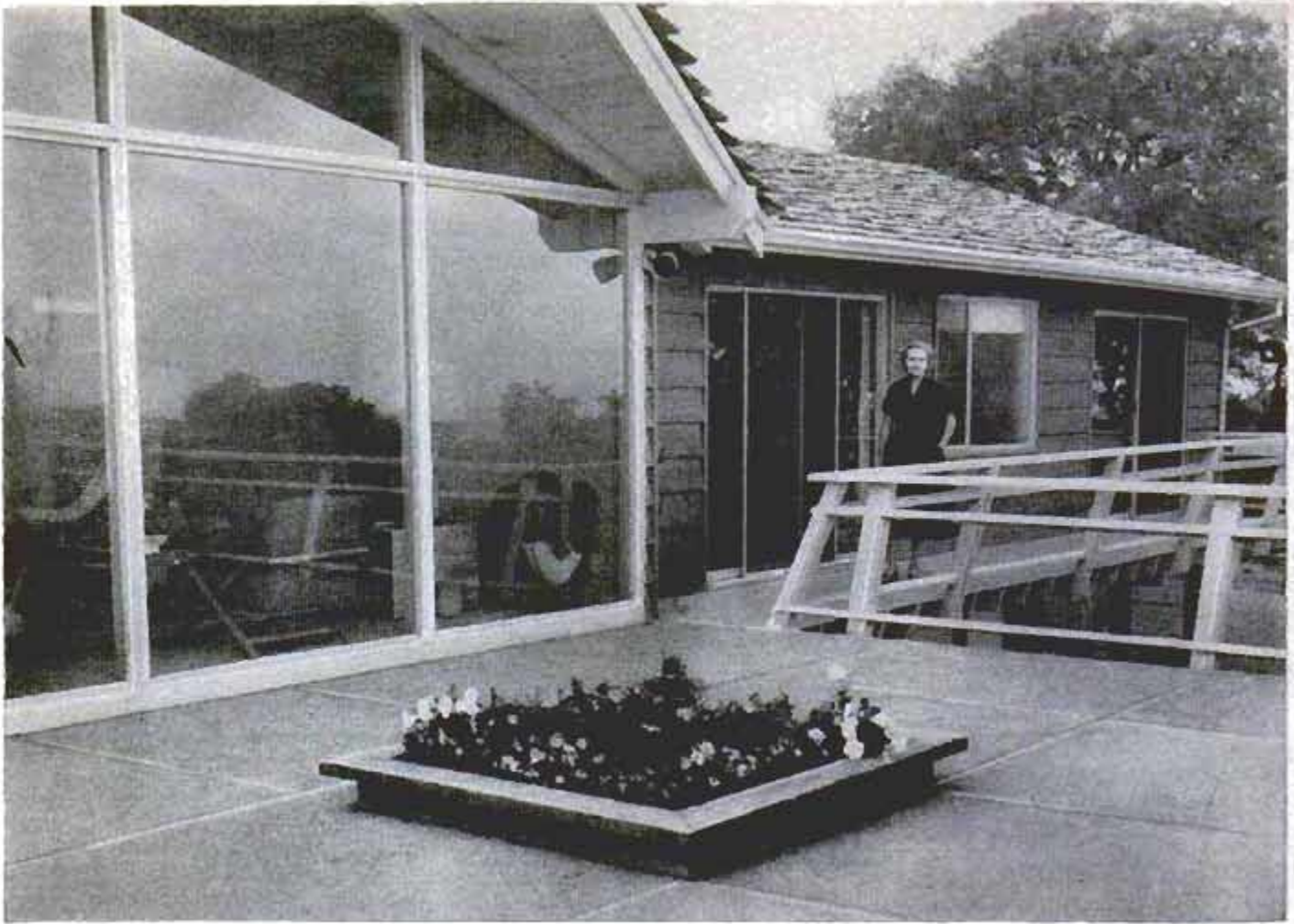
same as the doorsills of the house. On one end we placed the barbecue cabinet. Adding a few inexpensive pillows to the bench provides seating for a good number of people. The duckboards also are a safe place

(Continued to page 234)

Detail at left shows how barbecue stack was suspended from roof and fireplace built; right, grill is guide







**Roof-top patio of Jack Lind home has area of 24 by 27 feet plus deck walk. The floor is one-inch-thick concrete poured on  $\frac{3}{8}$ -inch exterior-grade plywood. Ground-level view, below, shows carport beneath patio**



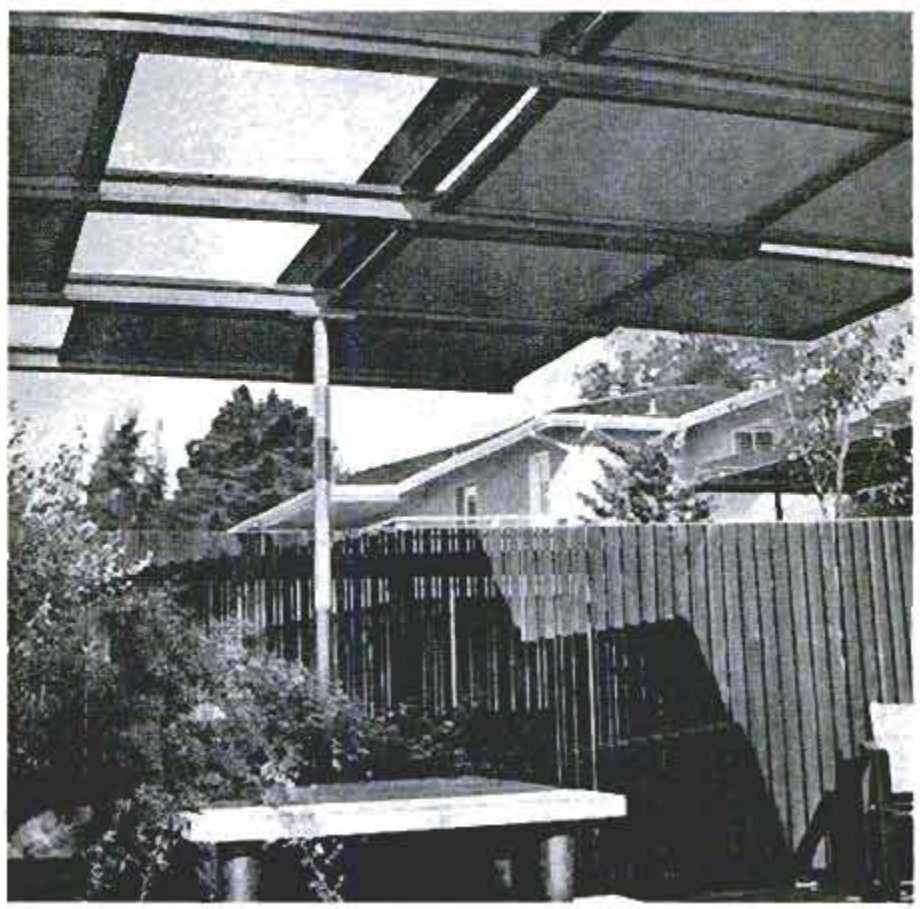


4726 22nd St  
SACRAMENTO,  
CALIF.

## OUTDOOR LIVING

on a garage or carport roof can solve the patio problem for many people with small yard space. Roof patios are gaining in popularity in California where many homes are built on steep hills, which further limits the amount of outdoor-living space. The addition of a roof-top patio to an older house often calls for a bold manner of execution. The Hugh Henes family, of Piedmont, Calif., had a small lot on a hill. The only rear-yard area was used as a driveway to the garage, which was under the house, and as a turning area to get into and out of the garage. To get the outdoor-living area, they built a two-car port out from the rear of the house with a garden deck on the roof of the carport. An entry was made to the deck from the main living area and a stairway was built at the other end of the port. Besides gaining a roof patio, the Henes family now has more room for their cars. The original garage has been converted into a storage area. Although the patio is 12 feet above the ground, a fence, partly covered by vines, eliminates the feeling of height and gives added privacy. A roof-top outdoor living area was included in the original plans of the Jack Lind home in Los Altos, Calif. The split-level hillside home has a two-car port extending from the recreation room. The carport roof, at the upper level, is covered with concrete.

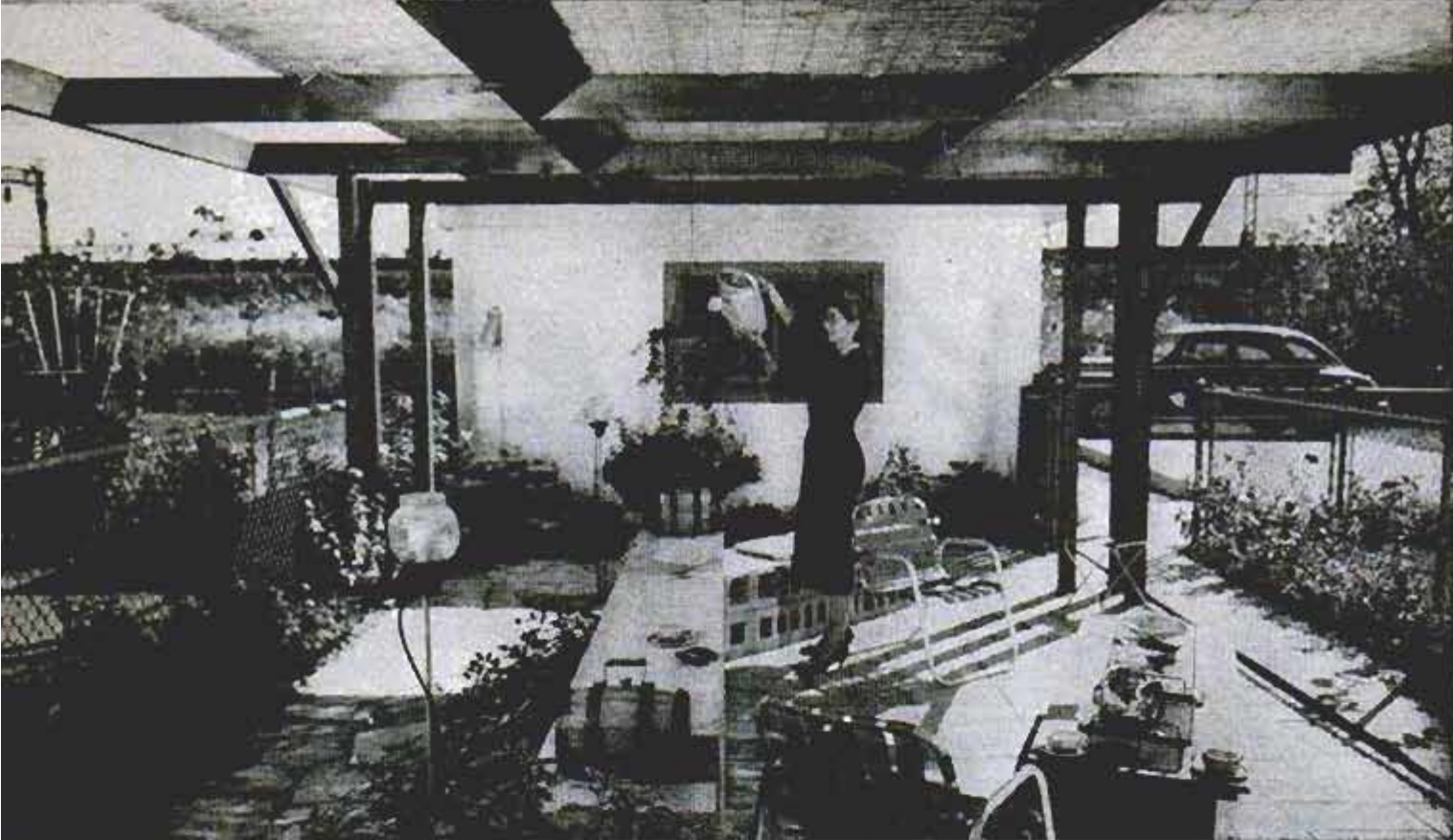
★ ★ ★



Outdoor-living area on roof of Hugh Henes carport is 12 feet above ground but gets garden look from vines on fence and tubs of flowers and shrubs. Patio floor is concrete panels with two-inch redwood dividing strips. Sunlight and shade are controlled by overhead canvas panels



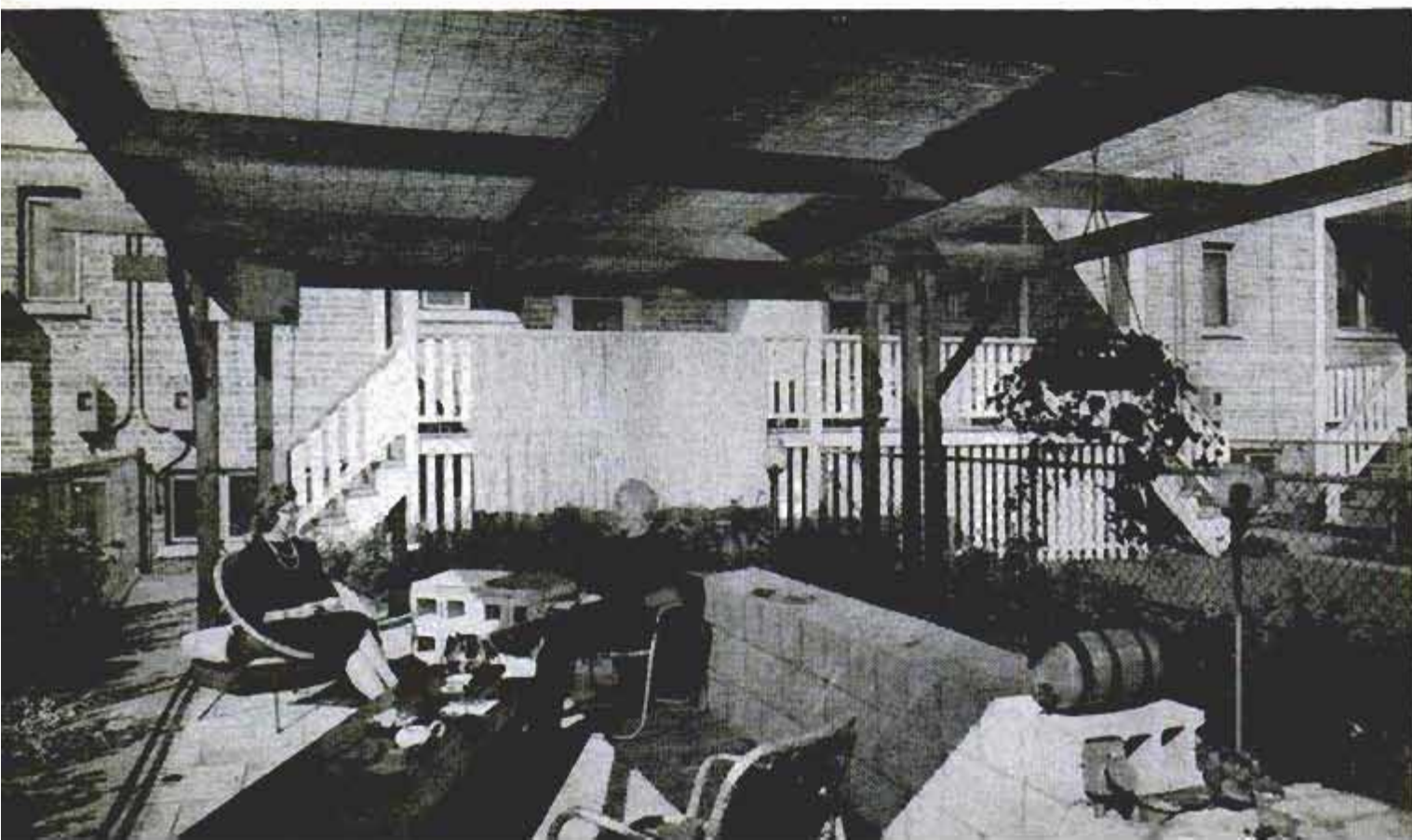




Working evenings and week ends, with a budget of \$175, the Warren Morrisons built this compact patio on a lot 20 feet wide and 30 feet long. The roof framing is construction-grade redwood finished with sealer

## OUTDOOR LIVING ON A

Cinder-block center island is arranged in angular U-pattern. The middle section is used as a buffet and the lower, end sections are used as extra seats. The coffee table was made from scrap pieces of redwood





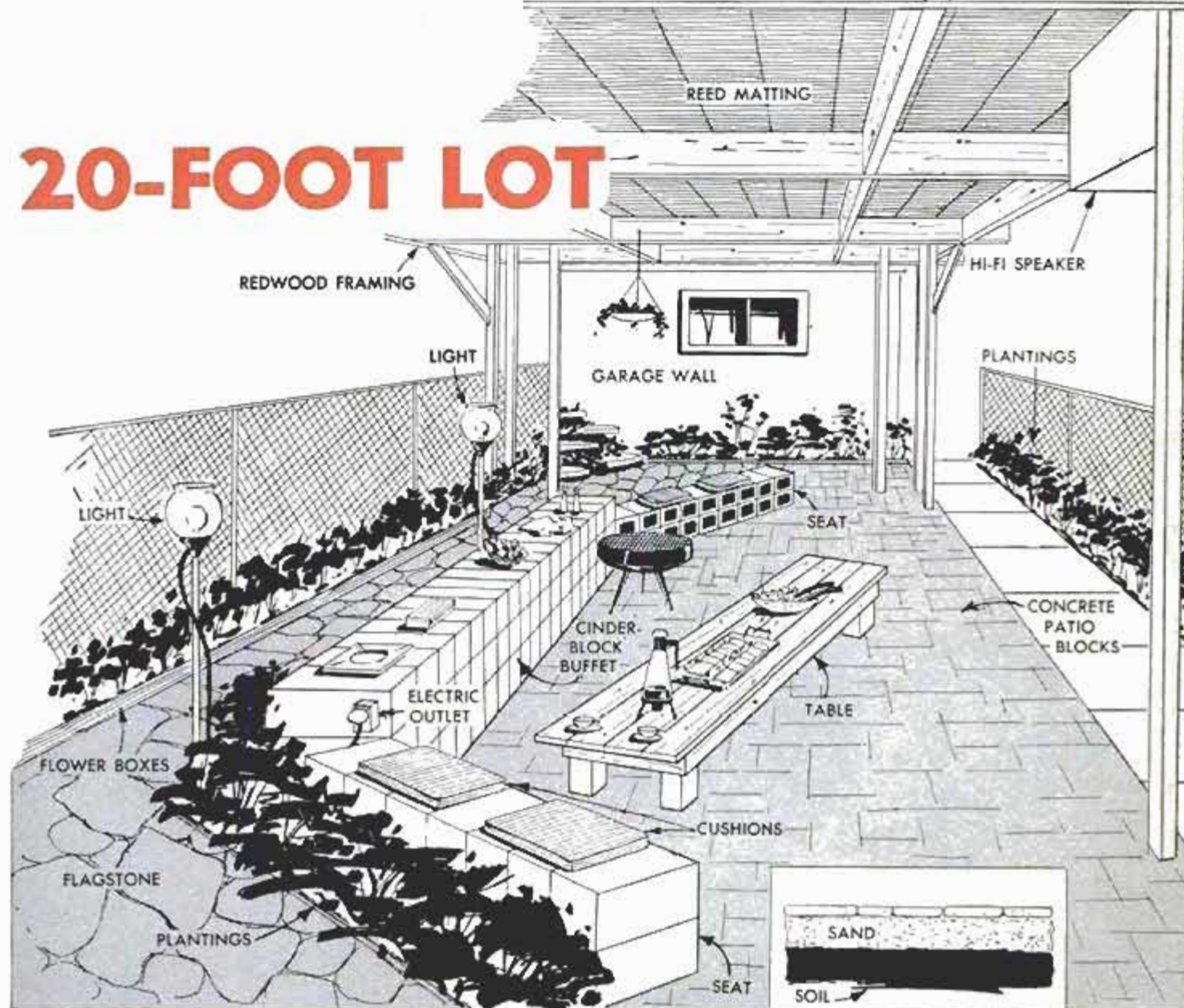
**WHAT CAN YOU DO** with a small city lot? When Mr. and Mrs. Warren Morrison finished building a garage behind their town house in Chicago, they found the back-yard had been whittled down to an area of 20 by 30 feet—about the size of a large living room. The yard was carpeted with a fine growth of bluegrass but the Morrises wanted an outdoor-living area where they could relax at the end of a warm day, barbecue a steak, entertain friends or just listen to hi-fi records. They decided to dig up the grass and convert the entire yard into a patio. The Morrises donated most of the sod to a friend, saving a couple of tiny patches for outdoor "decor." Part of the topsoil went into wooden flower boxes built along the fence. The rest was saved to nourish plants later set around the center island of the patio. The "scalped" yard was covered with a four-inch layer of sand, rolled and graded so water would drain into the alley. Next came the foundation for the cinder-block

center island, built in an angular U-pattern. Flagstone and concrete blocks were laid on the sand and the cracks between were filled with dry mortar mix. The patio roof was built of construction-grade redwood, with corner posts set in concrete two feet deep. Morrison later leveled the post tops with a power saw. The roof is covered with strips of German water-grown rush stitched together with stainless-steel wire. It can be rolled up and stored during the winter. Electric outlets on the island are wired to the garage circuit and the hi-fi speaker is connected to a player inside the house. The Morrises did all the work themselves, using evenings and week ends over a period of five weeks. Materials cost \$175. ★ ★ ★

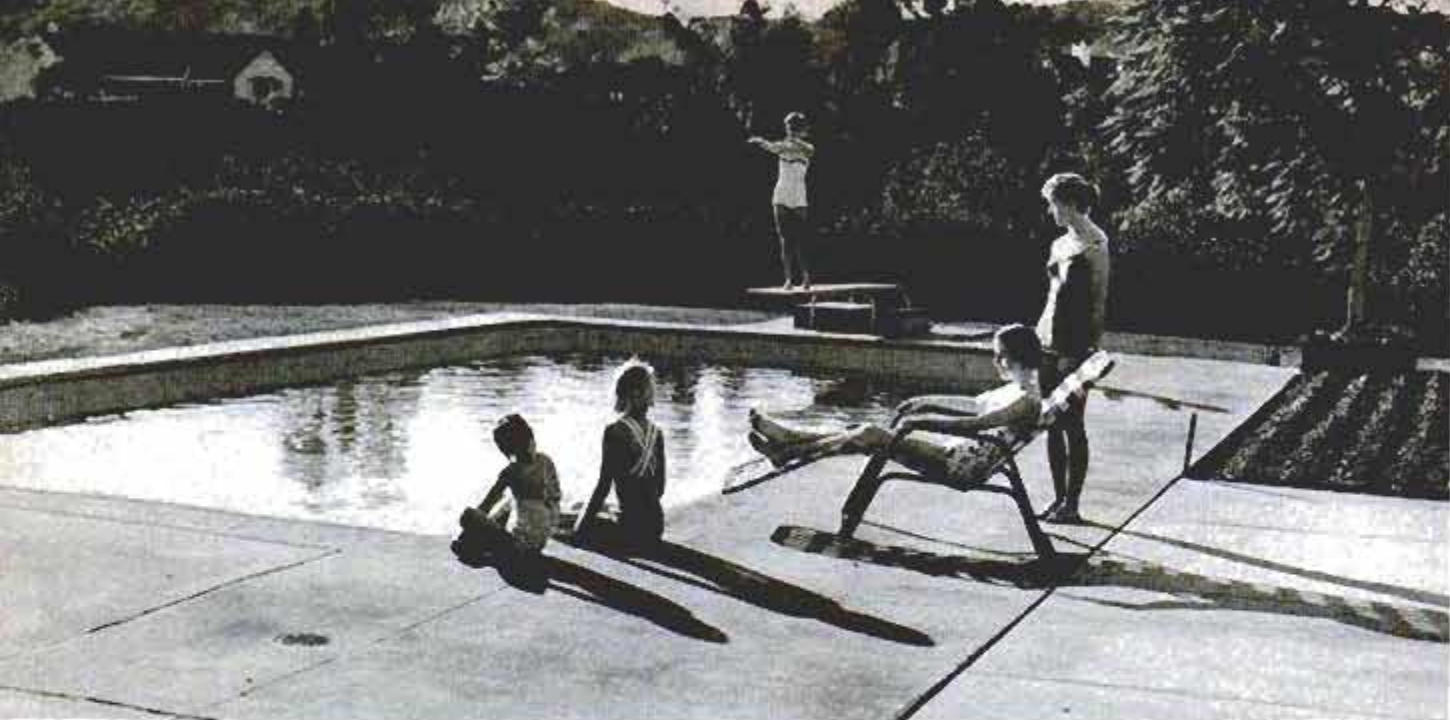


Diagram shows plan of the patio. Flagstone and concrete patio blocks were laid on four-inch sand layer

# 20-FOOT LOT

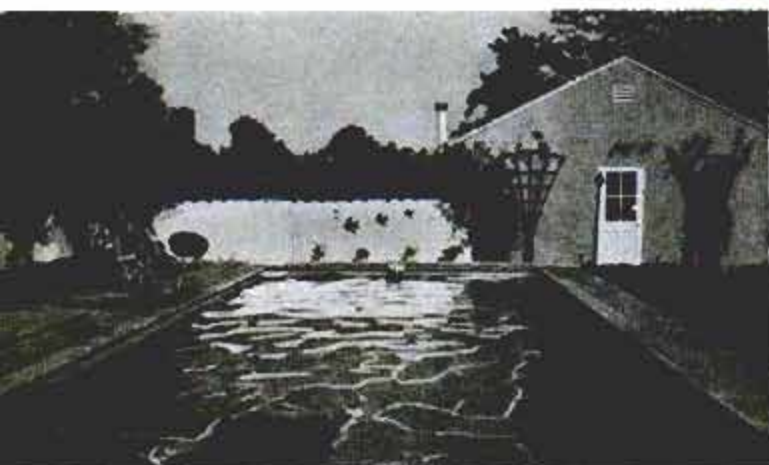






Hillside pool in Los Angeles measures 18 by 30 feet and takes up most of yard. Steep cliff is behind shrubs

## Three Pools for Small Lots



This pool was built at the rear of a yard in a modest neighborhood. It is 16 by 32 feet. The yard is fenced

LUXURY? Sure. But so is that second car and that new TV set. It all depends on how you want to spend those extra dollars for recreation and just plain fun. More and more families with small lots are installing swimming pools every year. Some of them are do-it-yourself projects but most are professional jobs. Yards with pools require enclosures or natural barriers of some kind to protect them from trespassing children. The enclosures also provide privacy. The small-yard pool with its surrounding patio is not only a delight to every member of the family but reduces yard maintenance to a minimum. If the pool patios are close enough to the house they can also be outdoor-dining areas.

Kidney-shaped swimming pool 16 by 30 feet set in tiny yard made this house a hit at Houston Home Show





# TOOLS FOR YOUR YARD AND GARDEN



## Power Mowers

Rotary or reel, both save work. Reel shears, makes smooth lawn; rotary cuts weeds, tough grass



## Round-Point Shovel

Helpful for digging in hard or clay soils. Blade should be made of tough and tempered steel



## Spading Fork

Sharp tines penetrate soil easily; more efficient than spade except in soils that are sandy



## Rakes

Garden rakes spread fertilizer, soil. Lawn rakes need flexible teeth that won't harm roots



## Narrow Trowel

Makes rows for seeds, small holes for small plants; can be used as weeder in flower beds



## Lawn Roller

Helps you maintain a smooth lawn, levels frost upheavals, improves germination, rooting



## Aerator

Permits moisture, air, nutrients to penetrate soil freely by making soil porous and loose



## Power Tiller

Prepares soil for lawn seeding or gardening. Pulverizes old plants and soil into fine mulch



## Lawn Sweeper

Removes sticks, stones before mowing, stands grass shoots up for even cut, gathers clippings



## Garden Cart

Moves small loads of soil, sand or fertilizer. Dip front down and scoop leaves into hopper



## Wide Trowel

Helpful for taking up and planting larger bulbs, potted plants. Proper handle is very important



## Hand Cultivator

Lightweight, about 18 inches long, for close work in weeding and tilling soil around plants



## Weed Knife

Also called dandelion knife. Blade slides under plant crown to remove weeds or wild grass



## Hose

Larger diameter moves water faster. Some plastic hose sensitive to sunrays, temperature



## Sprinklers

Consider water pressure, land contour, soil type. New lawns, some flowers require fine spray



## Wheelbarrow

For heavy duty hauling jobs around yard. Usually has more capacity than a garden cart



## Lawn Spreader

Distributes commercial fertilizer, grass seed or top dressing on lawn quickly and accurately



## Pressure Sprayer

Holds several gallons of spray to control weeds, insects and plant diseases in your yard



## Hedge Trimmer

Cuts woody growth, controls shape and size of shrubs. Also trims grass missed by mower



## Pruners

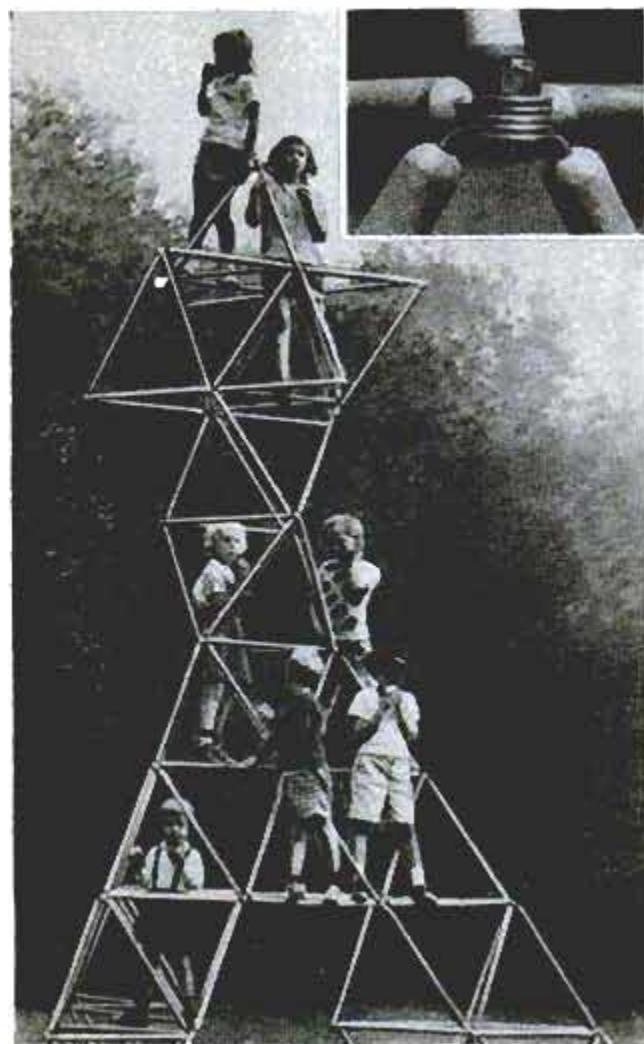
Cut back stems of tender flowers as well as tree branches. Long pole type is for tree tops



# A YARD is FOR FUN

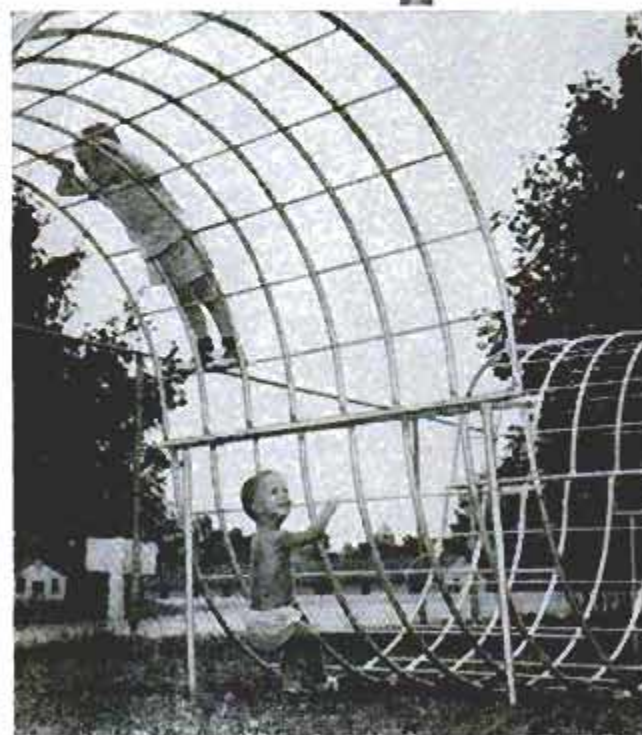
ONE OF THE MOST popular reasons for living in a house with a yard is, "so the children will have room to play." But, too frequently, the yard is a well-manicured plot of grass and flowers and the children do most of their playing on the sidewalks and streets. You don't need a lot of yard space for a playground. A big swing set requires about 70 square feet of area. Some playground items will fit into a corner of 50 square feet or less. So you can still have your roses and blue grass and the youngsters can learn that "a yard is for fun." In fact, a yard today can be more fun than ever before because of the imaginative types of apparatus available. New this year, for example, is a giant jungle gym made from 150 one-inch dowels. There's equipment for lazy-day play and some that will absorb all the energy a child can exert. ★ ★ ★

All the youngsters in the neighborhood will fit on a jungle gym that gets its strength from the geometric arrangement of dowels. Inset shows how they lock



It's a tree, the mast of a pirate ship, or maybe a pole fireman slide down. It's called a Poplar Tree and is designed to meet the climbing demands of boys and girls

Also for small "muscle men" is a Playweb Magic Carpet which allows a child to climb freely in any direction and at any angle on metal rungs

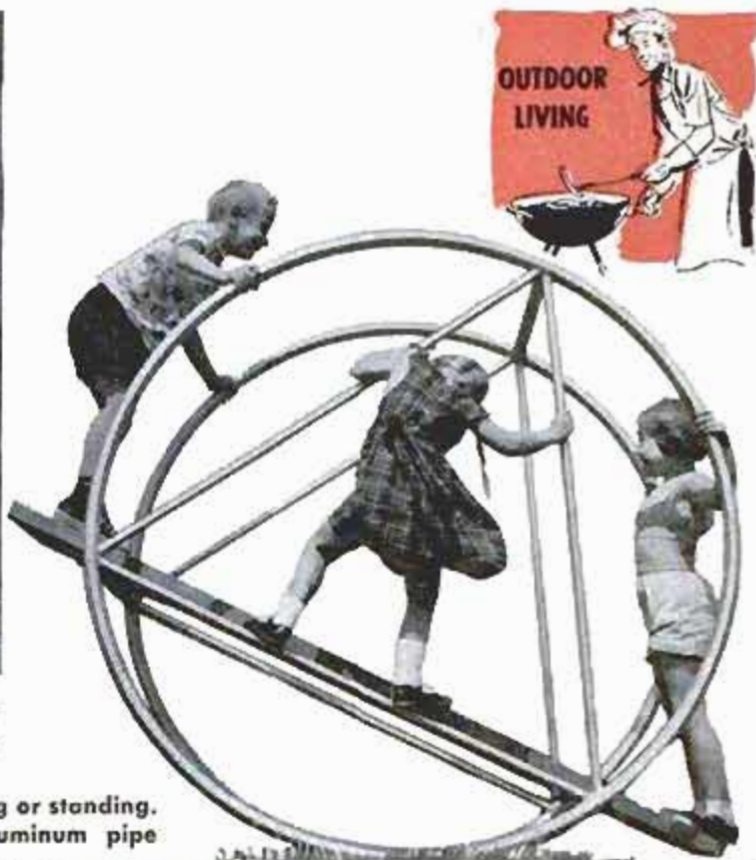




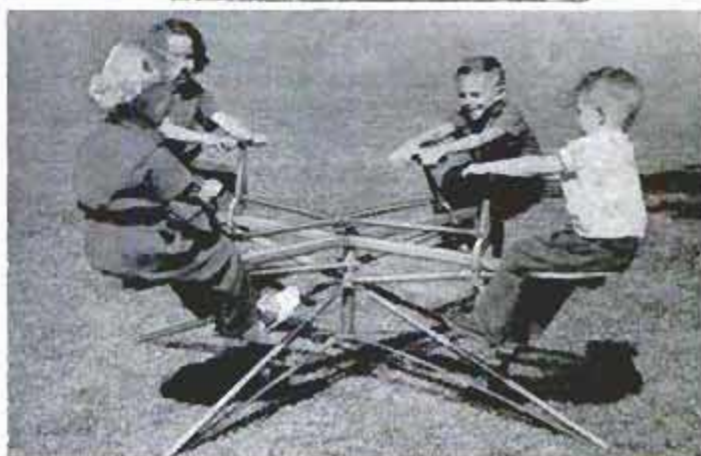


Aluminum-and-plywood Playframe is easily adaptable as a playhouse, spaceship or office

One or more can play on this teeterboard, sitting or standing. Five-foot wheels are made of enameled aluminum pipe



This is called a Rock-It and that's what you do with it. It's the right size for small yards



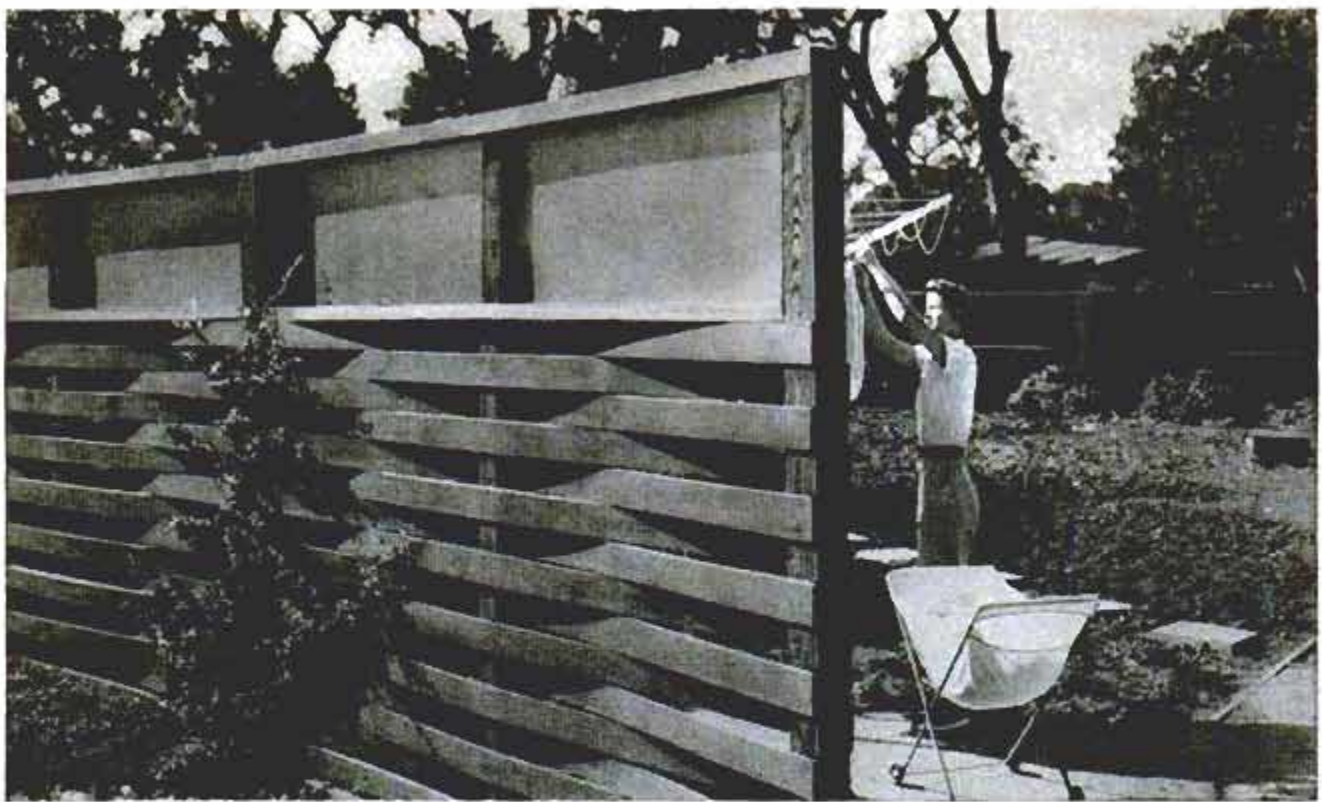
By pushing and pulling the handles, two to four children can have hours of fun on this pint-sized merry-go-round

There's plenty of rock and roll on a giant bowl made of aluminum pipe. You also can turn it upside down and climb all over it

Photos by  
Low Merrim, Barbara Paine,  
Universal Mfg. Co.

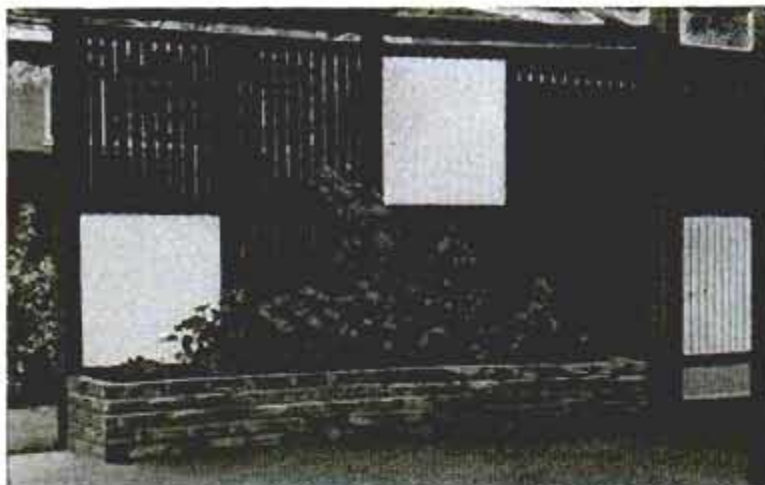




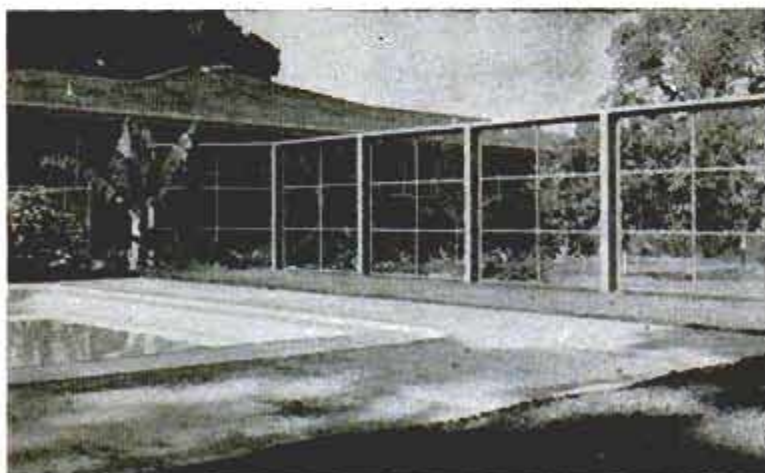


Clotheslines, trash burners and other utility items can be hidden from patio view by an attractive screen

## Screens for Pools or Patios



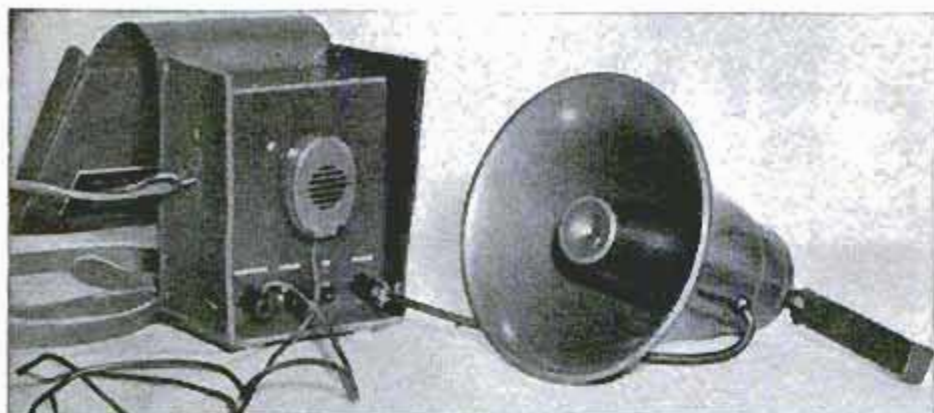
Do-it-yourself patio screen, above, was built with rough redwood at a cost of about \$34. Panels are opaque glass fiber or stained lath. Pool screen, below, uses "reject" picture windows



WHETHER YOU WANT privacy, a windbreak or an outdoor-area divider, you can make an attractive addition to your yard with one of the new patio screens. They're simple to construct and generally much less expensive than they look. The large screen shown at the top of the page was built at a cost of \$42. It's 28 feet long, 7 feet high and its purpose is to hide the utility area of the yard. Except for cellulose-acetate-coated panels at the top, redwood is used throughout. The vertical posts are, alternately, 4 by 4s and 2 by 4s. The basket weave is made from 1/2 by 2-inch redwood strips. The 12-foot privacy screen, in the center photo, was built around a brick patio planter for \$34. All the lumber is rough redwood. The framing consists of alternate 4 by 4s and 2 by 4s vertically and 2 by 4s horizontally. The light-colored panels are corrugated glass fiber. The dark panels are made of two-inch lath. The more ambitious windscreen around the pool, bottom photo, was built by the homeowner from "reject" picture windows sold by a manufacturer at a fraction of their regular cost. The frames were fastened to posts.



# Radio TELEVISION Electronics



## Build-Your-Own PORTABLE PA SYSTEM

By Thor Goodman

Battery-operated, portable, this low-power PA system is rugged, dependable

HERE IS THE do-it-yourself version of a commercial outdoor PA system which is easy to build and proven in performance. Originally designed by Dorsett Labs.\* for the University of Oklahoma, the unit was first used by field parties studying geology and proved to be highly efficient even over rough terrain and in rainy weather—the poorest operating conditions.

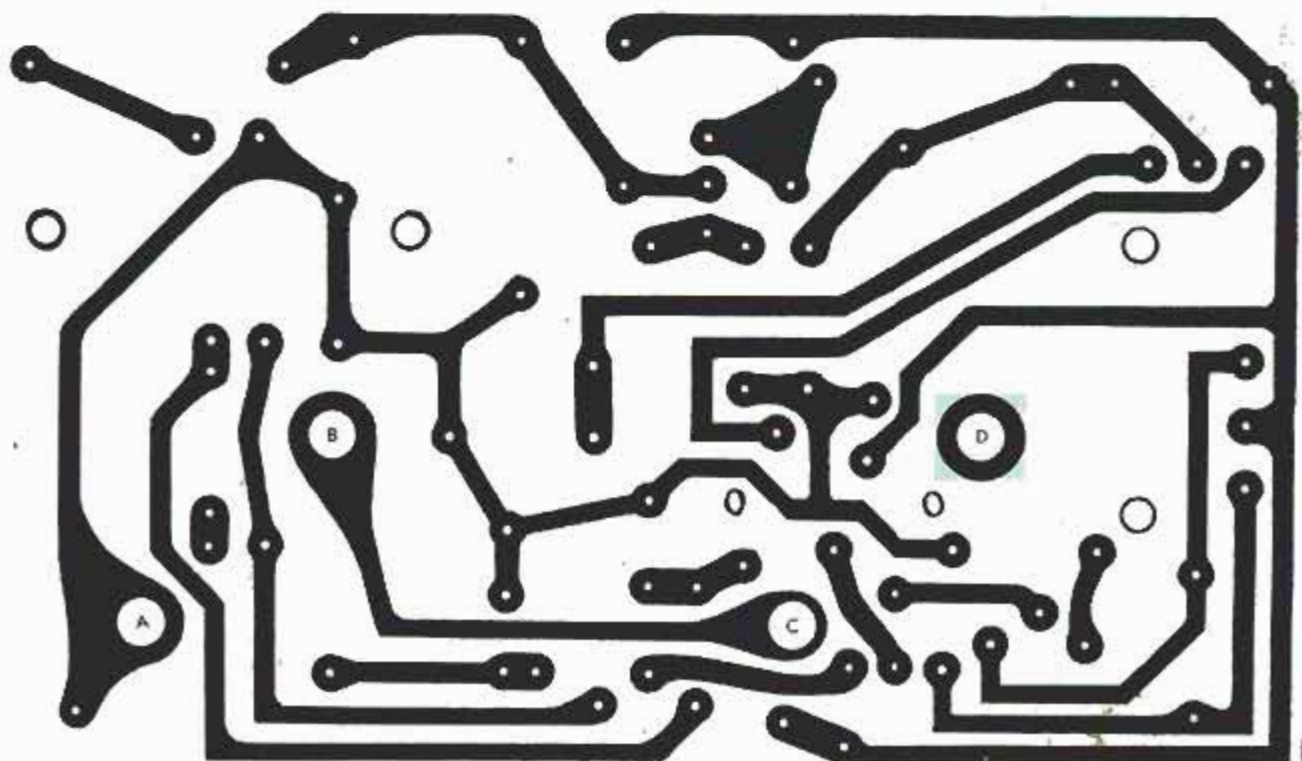
Containing a transistorized amplifier, this PA system offers greater power and intelligibility than previously available low-cost “power megaphones.” Its rated power output of approximately 500 milliwatts, driving a highly efficient trumpet

speaker, permits ordinary speech to be heard clearly over 500 feet away.

Construction is simplified through the use of a commercially available printed-circuit board (Model 50, Dorsett Labs., Norman, Okla.) which eliminates most of the tedious point-to-point wiring of conventional circuits. A full-scale drawing of this board appears in Fig. 1 for the more experimentally inclined hobbyist who may wish to make this himself from materials available from leading radio parts distributors. Alternately, standard wiring procedures may be used by mounting the small

\* Dorsett Laboratories is primarily a producer of telemetering and control equipment for aircraft, guided missiles, petroleum industries

Fig. 1. Full-scale drawing of commercial printed-circuit board on which all small parts will be mounted





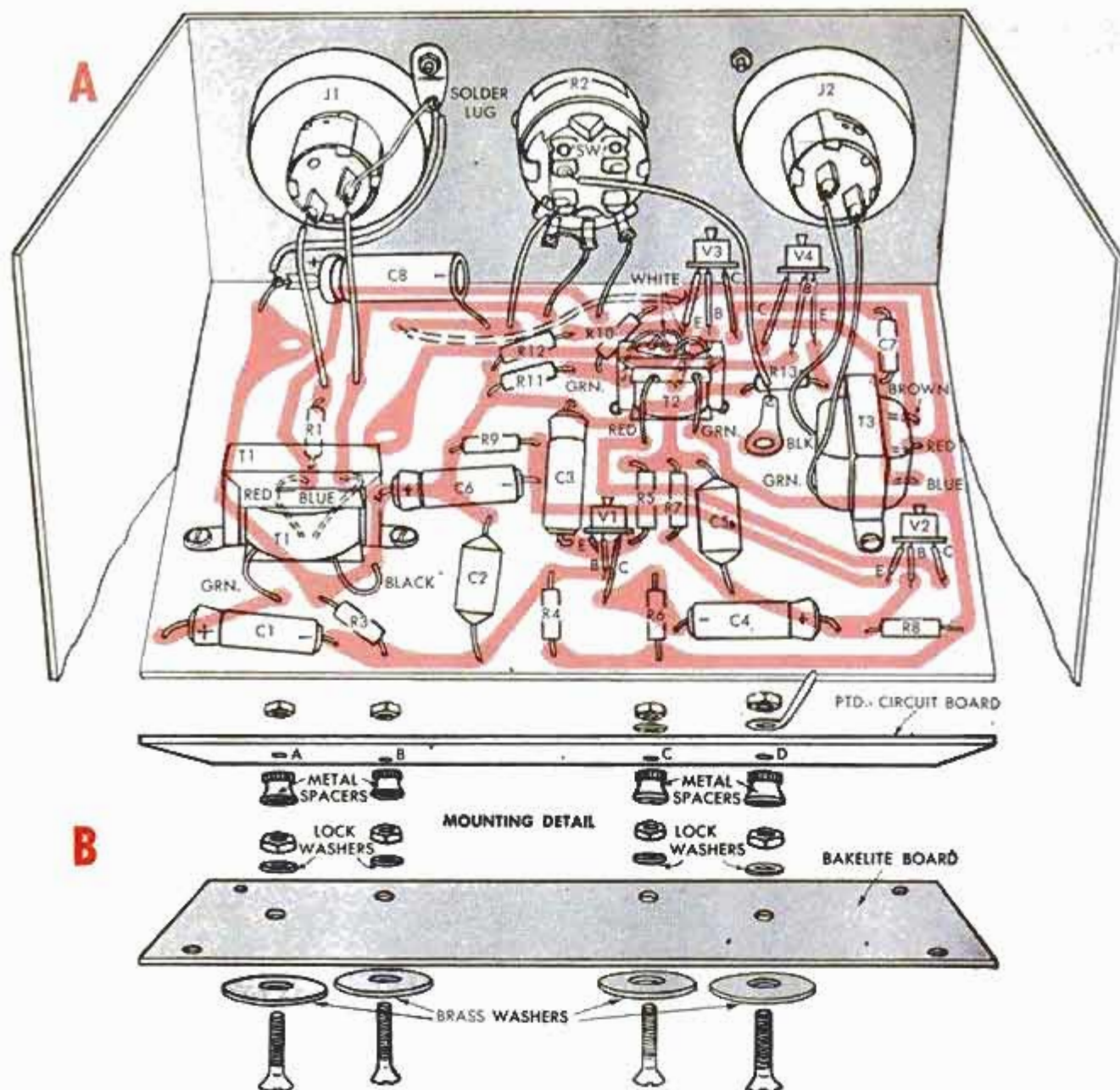


Fig. 2. A—Pictorial wiring diagram shows parts placement on printed-circuit board and aluminum case. B—Exploded view shows mounting of wired printed-circuit board to previously installed Bakelite board

parts on a perforated Bakelite board and following the schematic wiring diagram shown in Fig. 5.

Begin the construction by punching and drilling the necessary holes in an aluminum panel as illustrated in Fig. 3. Then bend the two sides of the panel to form an open-end case, or chassis, (Fig. 4) and mount receptacles J1 and J2, and the volume-control potentiometer, R2, in the proper holes (Fig. 2A). In bending the sides of the panel, special care must be used so that the battery-spacer mounting holes in one side of the case line up perfectly with the similarly spaced holes in the opposite side.

The battery spacers are made next, using  $\frac{1}{2} \times \frac{1}{4}$ -in. aluminum stock. The lengths of these may be changed slightly to obtain a flush fit in the case as illustrated in Fig. 4. Use the mounting holes in the case as

templates for drilling the holes in the ends of the spacers, to make sure that these correspond. After the drilled-and-tapped battery spacers have been fastened to the case, the latter may be painted, if desired, by first applying a primer coat of zinc chromate.

Now study the drawing of the printed-circuit board and note the four holes labeled A, B, C and D. These must line up with similarly spaced holes in a  $5\frac{1}{4} \times 3\frac{1}{16}$ -in. Bakelite board, as shown in the mounting detail of Fig. 2B. To assure proper alignment, place the printed board on top of the Bakelite one, printed side down, and carefully mark the location of these holes on the Bakelite board. The remaining four holes in the Bakelite board must be aligned with the tapped holes in the battery spacers to which the Bakelite board will be fastened.



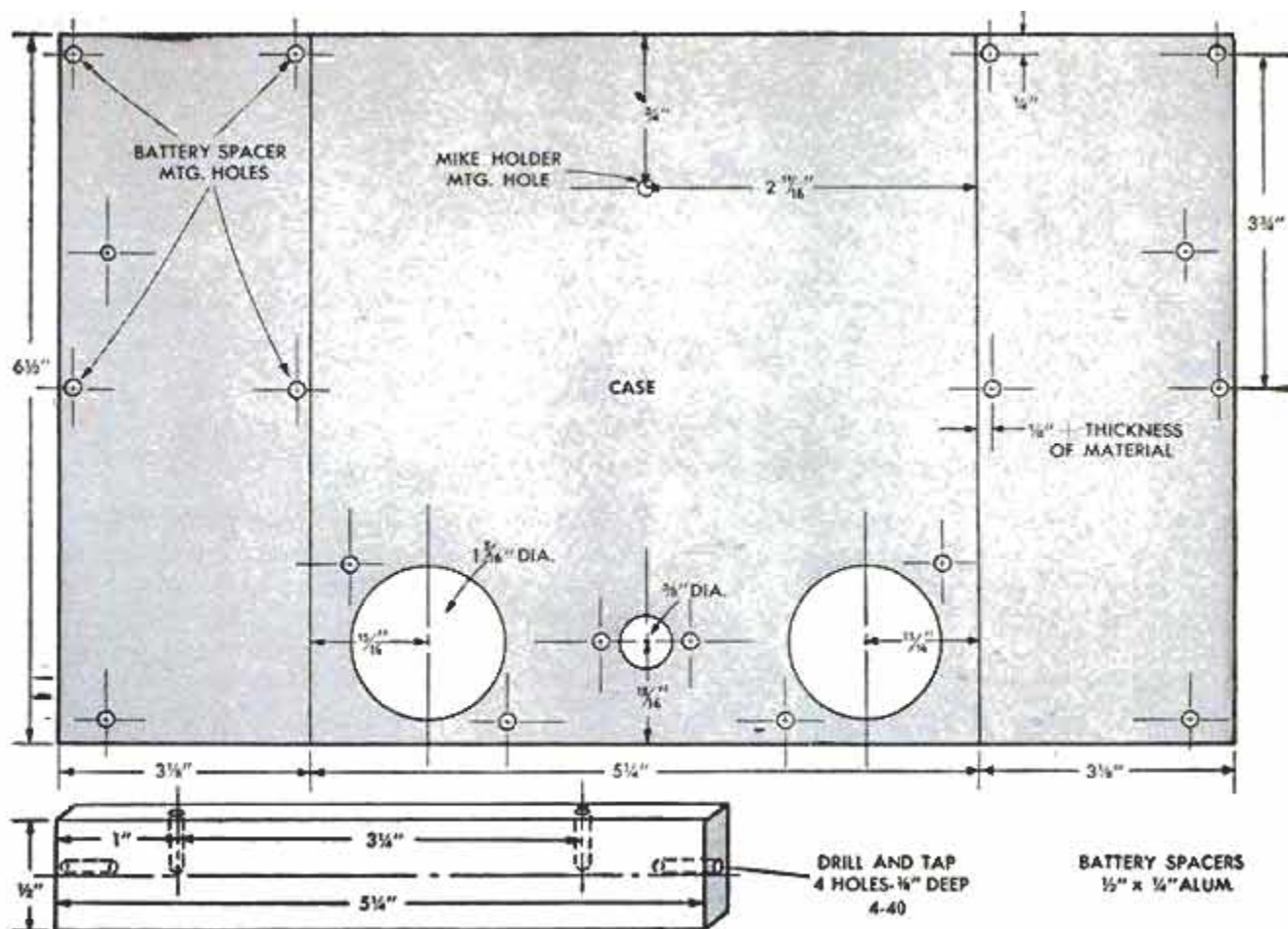


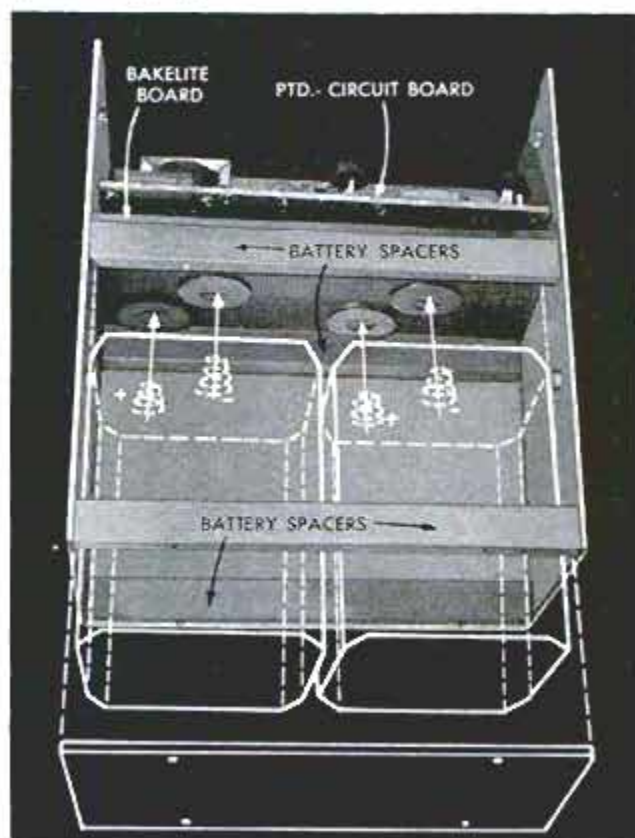
Fig. 3. Case layout and construction details for battery spacers. See text for special instructions

Soldering the small parts to the printed-circuit board is the next step. The parts must be placed on the plain side of this board and their leads soldered to the printed foil underneath. Since this board is semitransparent, the foil pattern can be seen through the top, as in Fig. 2A, by holding the board to a light. This will help you to thread the component leads through the correct holes. Use a small-tipped soldering iron, or gun, in soldering the connections and carefully avoid solder shorts between adjacent foil strips. After soldering, any excess lead lengths may be trimmed off.

The transistors are the last parts to be soldered in place, and special care should be used in their installation. The transistor leads should be left long and covered with "spaghetti" so that only the ends of the leads protrude through the bottom of the board. Soldering should be done as quickly as possible to prevent excessive heat from damaging these units. Make sure, also, that the transistor leads are inserted in the correct holes. Note the close spacing between the emitter (E) and base (B) leads and the greater separation between the base and collector (C) leads in the pictorial diagram and install these units exactly as shown.

Finally, be sure to install the wires which eventually will be connected to the

Fig. 4. Final assembly. Batteries fit snugly between spacers. Spring-connectors contact brass washers





parts on the case (J1, J2, R2 and SW).

After the printed-circuit board is completely wired, fasten the previously drilled Bakelite board to the battery spacers and mount the components board above the Bakelite one as shown in the mounting detail of Fig. 2B. The two boards should be approximately  $\frac{3}{8}$  in. apart and the height of the metal spacers separating them should be chosen accordingly. A portion of the brass washers underneath the Bakelite board may be cut off, if necessary, to prevent these from touching the aluminum battery spacer. Contact between one of the washers and the spacer could result in short-circuiting the batteries.

When installing the batteries, battery polarity must be carefully observed. Incorrect battery insertion would apply improper voltages to the transistors and could result in their destruction. If the case has been properly constructed and the battery spacers correctly installed, the batteries will fit snugly between the spacers. The bottom edges of the batteries will extend slightly below the aluminum case. Because of the spring contacts, however, the batteries may be pushed upward so that the Bakelite bottom plate may be fastened to the lower set of battery spacers. This compresses the springs and assures positive contact between the batteries and the circuit.

A readily obtainable, low-cost leather carrying case houses the completed assembly. This case was originally intended

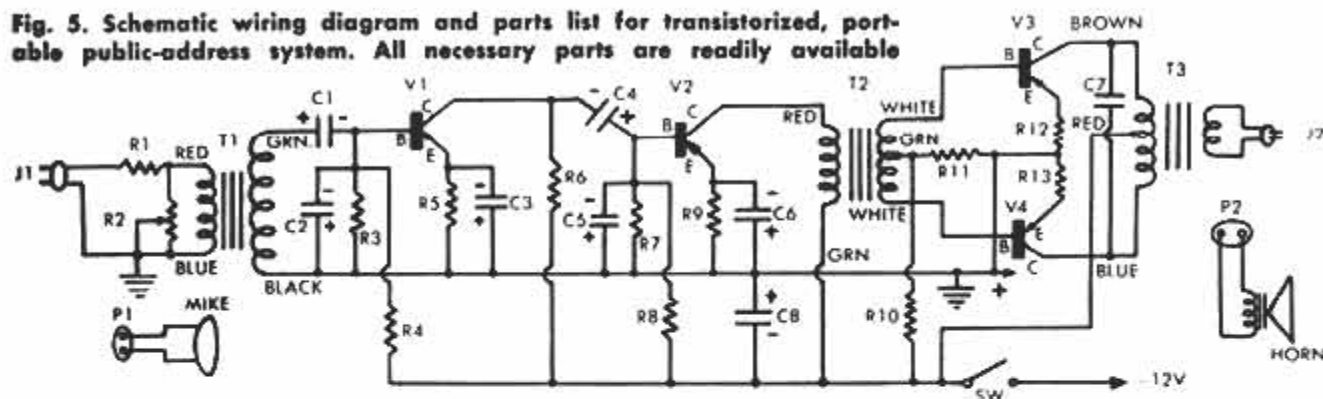
for a commercial multimeter and includes some wood support pieces which must be removed for this application. The PA assembly can then be fastened to the leather case by using the rivet holes through which the wooden supports were originally secured. A long shoulder strap can easily be added.

In use, the lightweight loudspeaker may be hand-held by means of a handle made of 1-in. hollow aluminum stock, or it may be mounted to a post or other fixed installation at a considerable distance from the amplifier. Weatherproof two-conductor cable should be employed between the speaker and amplifier for outdoor use.

When used indoors, a loud howl will be heard through the speaker at advanced volume-control settings. This is due to acoustical feedback and can be eliminated by increasing the distance between the speaker and microphone.

The size and weight of this PA amplifier could be greatly reduced through the use of smaller, lighter batteries. Such a modification would require a different method for holding the batteries in place and connecting them to the circuit. The lantern batteries originally used were selected because they are readily available and will last a year or longer under normal operation. Smaller batteries require more frequent replacement but, due to the efficiency of the amplifier circuit, even such units will provide reliable performance over a relatively long period of time. ★ ★ ★

Fig. 5. Schematic wiring diagram and parts list for transistorized, portable public-address system. All necessary parts are readily available



## LIST OF MATERIALS

**TRANSISTORS:** V1, V2—GE 2N190, V3, V4—GE 2N188A

**CONTROLS:** R2—1 meg pot with switch (SW) audio taper

**RESISTORS:** (All  $\frac{1}{2}$ -watt carbon) R1—330,000 ohms; R3—10,000 ohms; R4—100,000 ohms; R5—1000 ohms; R6, R7—15,000 ohms; R8—82,000 ohms; R9—6800 ohms; R10—4700 ohms; R11—47 ohms; R12, R13—10 ohms

**CAPACITORS:** (All 25 volt or greater) C1, C3, C4, C6—15 mfd. sub miniature electrolytic; C2, C5—.1 mfd. miniature tubular; C7—01 mfd miniature tubular; C8—50 mfd. miniature electrolytic

**TRANSFORMERS:** T1—200,000:1000-ohm input, Argonne AR 100; T2—10,000:2000-ohm driver Radio Shack No. 9969C, T3—400-ohm C.T.; 11-ohm output, Argonne AR 120

**MISCELLANEOUS:** University model MIL speaker; Astatic M101 ceram-

ic mike; 2 Eveready No. 509 6-volt lantern batteries with spring contacts, carrying case—Simpson 4136 multimeter case with center supports removed and carrying strap added; 2 Bakelite or phenolic boards (5 1/4 x 3 1/8 in. and 5-3/8 x 3-1/8 in.); printed-circuit board (see text)

**HARDWARE:** 16-gauge aluminum panel, 6 1/2 x 11 1/2 in. (panel with all holes marked and large holes punched is obtainable from Dorsett Labs, Norman, Oklahoma); 5-in. length of inch-square hollow aluminum stock, for horn holder; J1, J2—Cinch-Jones 5-302-AB sockets; P1, P2—Cinch-Jones P-302-CCT plugs with cable clamps; 1 black painter knob, assorted screws and nuts (4-40s and 10-32s); 4-1/2-in. brass washers, 4—metal spacers, 3/8-in. high, to fit No. 10 screws, 4—10-28 flathead brass screws; 4—4-40 cinch nuts; 4 pieces aluminum stock 1/4 x 1/4 in., Austin Craft battery box 2D, cut to size for mike clip



# The CRAFTSMAN X62



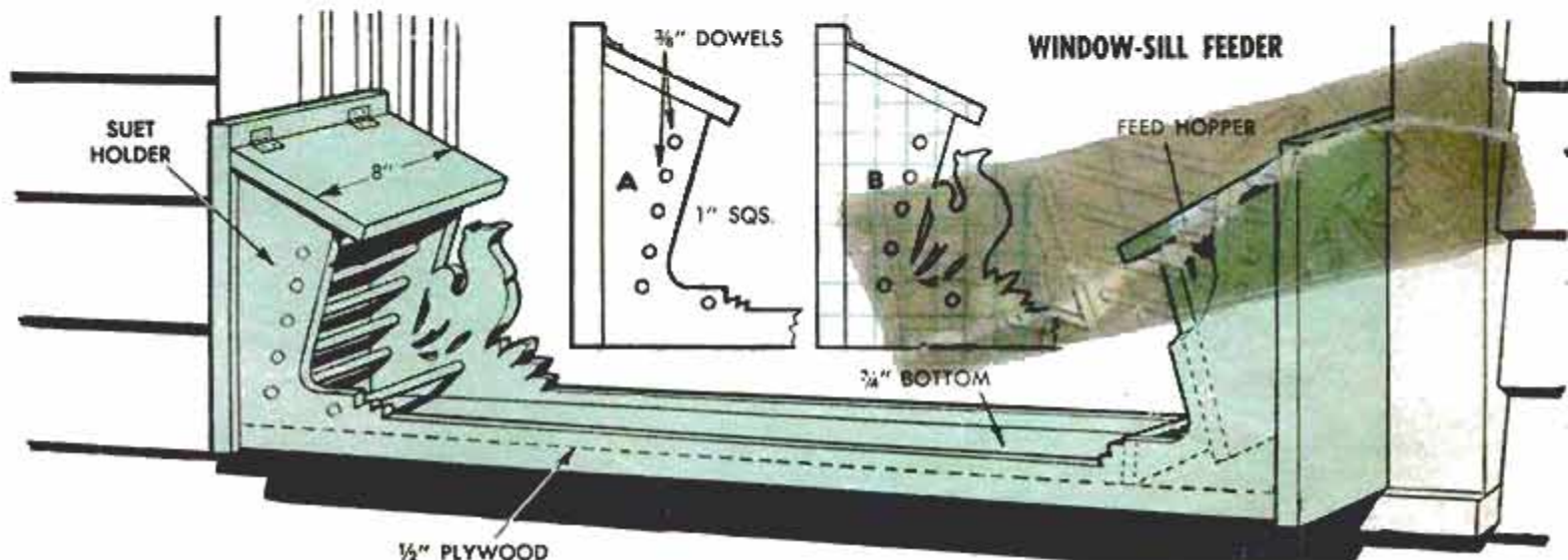
## Attracting SONGBIRDS TO YOUR GARDEN

By C. W. Woodson

SONGBIRDS WILL FIND the trees and shrubs in your back yard an ideal place in which to live if feeding stations, bird-houses and shelters, such as the ones illustrated, are made available for their use and enjoyment. Many of the desirable species will spend only the summer months with you, but some of the hardier ones may stay on to become permanent guests. The cost of food and materials required to build and provision these facilities is small compared to the number of benefits derived from the birds. They feed on insects and destructive worms and are a good source of entertainment and interest with their

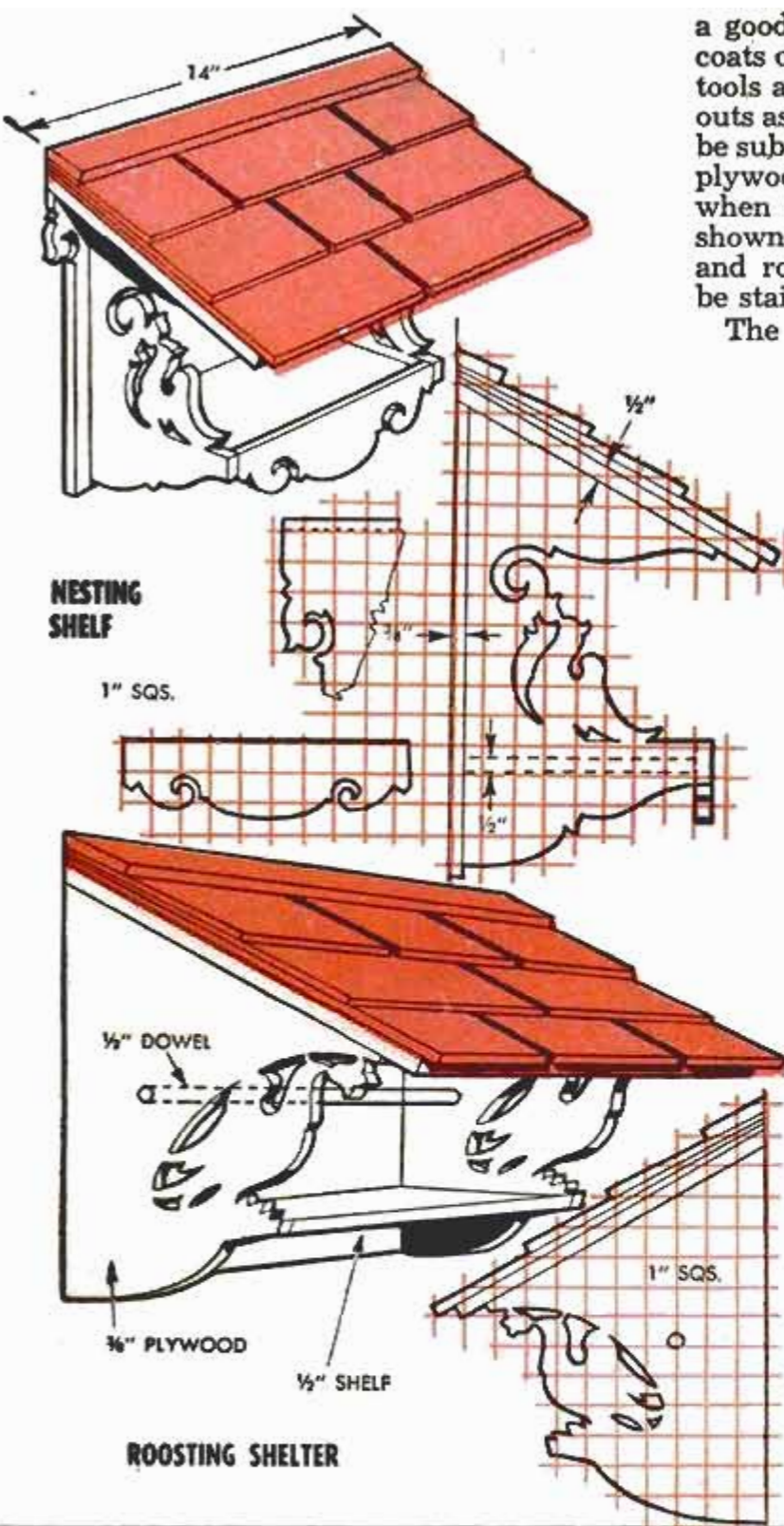
amusing antics, variety of songs and colorful plumage.

The most practical way of getting started with your back-yard bird haven is to build and install these facilities singly over a period of time starting with a feeding station. Where parts of houses or feeders are cut from plywood, the exterior type should be used to avoid deterioration from the weather. For the decorative parts, first make full-size patterns of them from the squared drawings and then make the cut-outs with a jigsaw. All of the structures are assembled with glue and finishing nails. Exposed surfaces are given two coats of



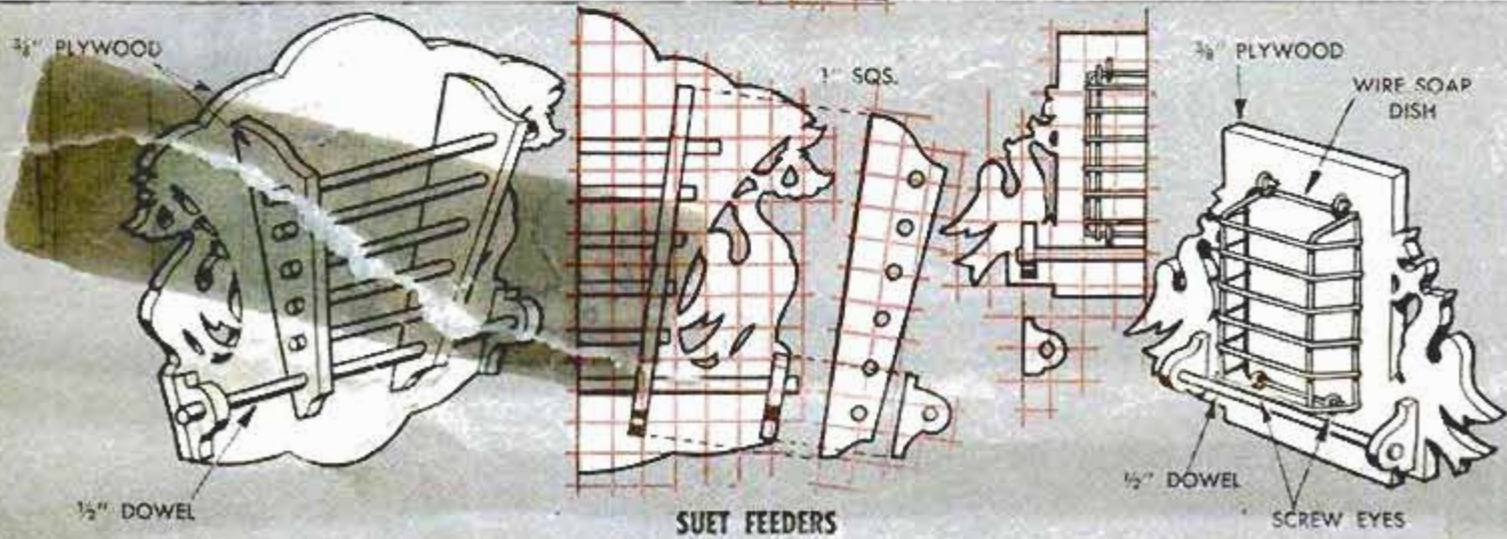


a good grade of exterior paint with three coats on the plywood edges. If the required tools are not available for making the cut-outs as shown, straightedged members may be substituted as necessary. Exterior-grade plywood need not be used for roof boards when they are covered with shingles as shown on the flicker house, nesting shelf and roosting shelter. Cedar shingles may be stained or left unfinished as desired.



The pivoting feeding station, shown at the bottom of page 165, is easy to make and is the best type of feeder for all seasons because its weather-vane design permits the feeder to head into the wind. This helps to keep the food placed in it dry, free of snow in winter, easily accessible to birds and out of reach of cats. After the parts are cut to shape and contacting edges are coated with glue, they are assembled with finishing nails. Then, exposed edges are sanded smooth and given several coats of exterior paint, two coats on the rest of the outside surfaces for complete protection from the weather. For the pivot, a pipe flange is screwed to a crossbar on the underside of the feeder and a short length of pipe turned into it as shown. The short length of pipe is then inserted in the end of a larger steel pipe that is first driven into the ground for a post. Grease should be applied to the pivot periodically to reduce friction and prevent noise that might scare birds away.

For a suet feeder, you can make one of the single-unit types as shown at the bottom of this page, or the multiple purpose window-sill feeder shown at the bottom of the first page of this article. Other than making the decorative cut-outs for the backs of the single-unit feeders, they are very easy to construct as shown. The window



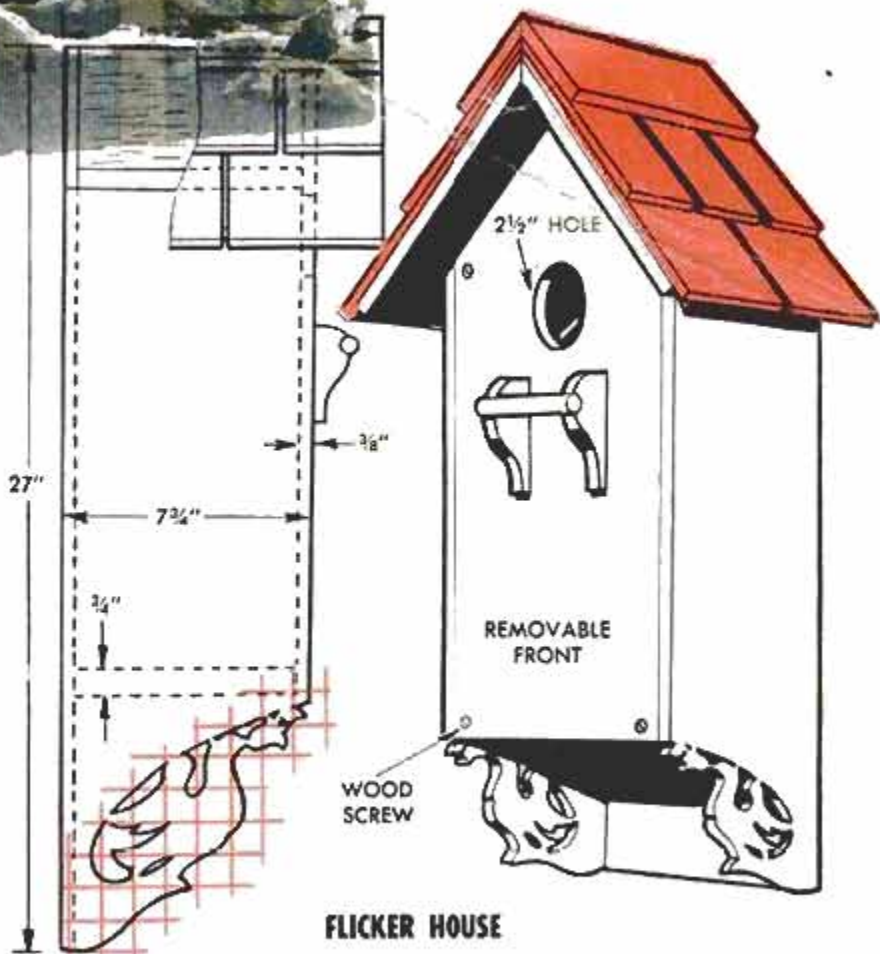


feeder has a hopper for seeds at one end, a suet holder at the other end and a large shelf between for dishes of water and bread crumbs. With this feeder mounted on a window sill you can observe birds at close range from within the house. The length of the feeder is determined by the width of the window sill on which it is placed and is assembled in the same manner as the feeding station.

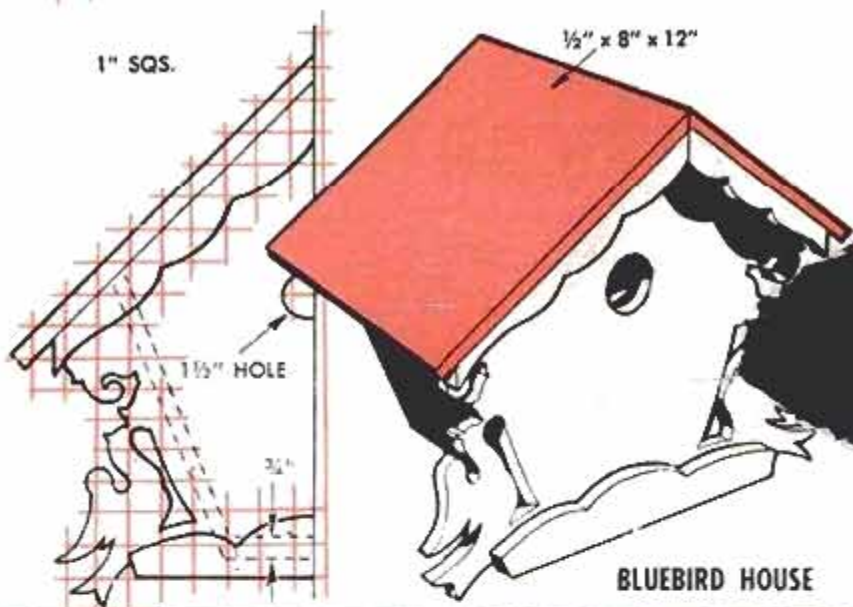
The flicker house and bluebird house are also assembled and finished as described, except that the front panel on the flicker house is screwed in place to allow it to be removed for easy cleaning of the interior. In addition, the inside surface of the front panel is scored with a series of saw cuts from the bottom to the hole to make it easier for fledglings to claw their way to the opening when it is time for them to leave the nest.

Robins, barn swallows and phoebes build their nests in open-type shelters, such as the nesting shelf shown. It is designed to be hung from the eaves of a building and should be placed from 7 to 14 ft. above the ground. If desired, this shelter may be treated with a preservative and allowed to acquire a natural weathered look.

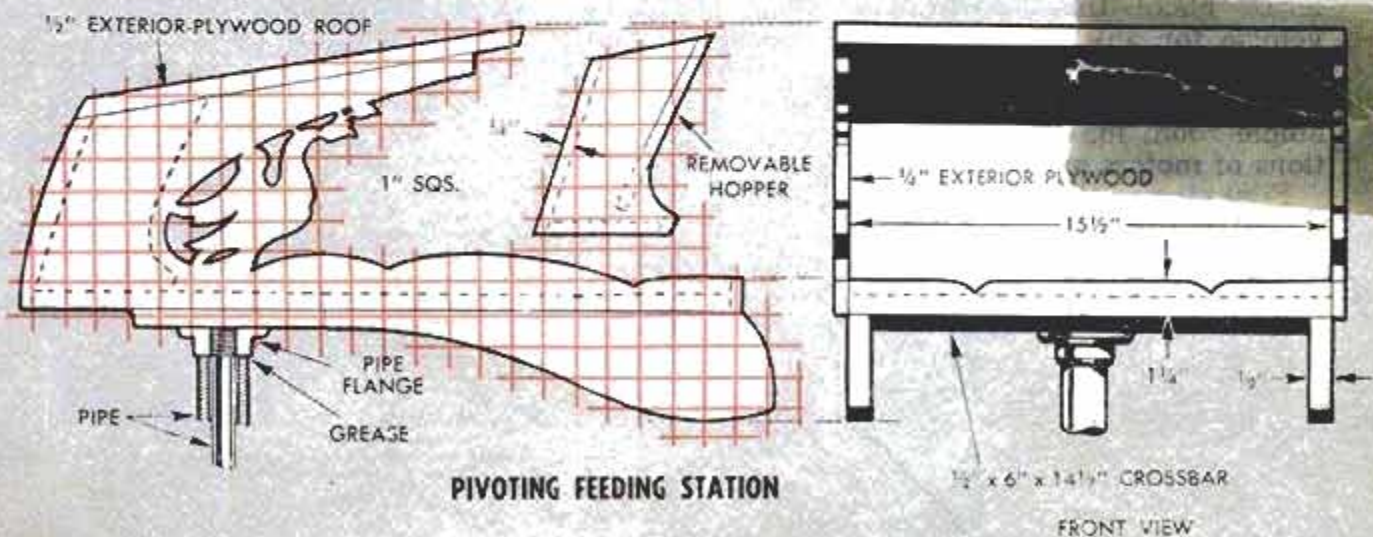
If your back yard lacks trees that are large enough to safely accommodate roosting birds, a roosting shelter can be made as shown, and hung from an eave on the house. The length of this one is 24 in., but this dimension can be increased to 30 or 36 in. depending upon the anticipated popularity of the shelter. Also, some type of bird bath should be provided in addition to the facilities illustrated in this article. ★ ★ ★



Flicker House



Bluebird House



Pivoting Feeding Station

1/2" x 6" x 1 1/2" CROSSBAR  
FRONT VIEW





Versatile is the word for this golf-cart-runabout. Grandmother, Mother, Dad and the kids all find use for it



# GOLF CART—OR FAMILY RUNABOUT

*First, it's a golf cart powerful enough to carry two adults and equipment up steep slopes. But it's also a heart-saver for the aged, "legs" for an invalid, and a "school bus" or shopping "car" for Mom. It features twin-motor drive, four speeds forward and reverse, coil-spring suspension, 2-wheel brakes and tricycle steering, plus a built-in battery charger*

## PART I

By Tom Riley

**S**PEEDS UP TO 20 m.p.h. and 30 to 40 miles on a single charging of the batteries make this cart an ideal utility vehicle for any home, farm or business. The cart is wide and low, both to assure stability on any terrain and to provide ample room for any of several combinations of motors and batteries.

First step in the construction is to make the main frame, Figs. 7 and 10, of steel channels and angles. Arc welding is required in this assembly. The next step after the main frame is assembled is to assemble the drive-unit frame, Figs. 7 through 11. The rear cross member of this frame is a length of  $\frac{3}{4}$ -in. pipe that pivots

in two U-shaped brackets bolted to plates that are welded to the rear cross member of the main frame. The brackets are a loose fit on the pipe. Strips of inner-tube rubber then are wrapped on the pipe under the brackets to provide a "snubbing" pivot. Stub axles for the rear wheels are welded to a length of pipe to produce a complete axle, that will give a width of  $41\frac{1}{2}$  in. between the outer sides of the tires. This leaves a clearance of  $\frac{3}{4}$  in. between the tires and the outer edges of the cart's main frame. The drive-unit frame is made narrow enough to clear the brake drums on the wheels. Coil springs used in the rear suspension are kept aligned by  $\frac{3}{4}$ -in.



pipe caps bolted to spring plates at the front of the drive-unit frame and to the 2-in. cross member of the main frame. A long  $\frac{3}{8}$ -in. bolt with fuller balls at each end is used to "snub" the frames together and to prevent sideways of the drive-unit frame. The lower right-hand detail in Fig. 7 shows the snubber bolt, springs and pivot-bracket setups. A piece of  $\frac{3}{4}$ -in. plywood is bolted to the drive-unit frame to support the motors. Slotted holes in the plywood permit the motors to be moved to allow adjustment of chain tension. Heavy turnbuckles are attached to the frame and to the motors near the shaft ends to "hold" this adjustment.

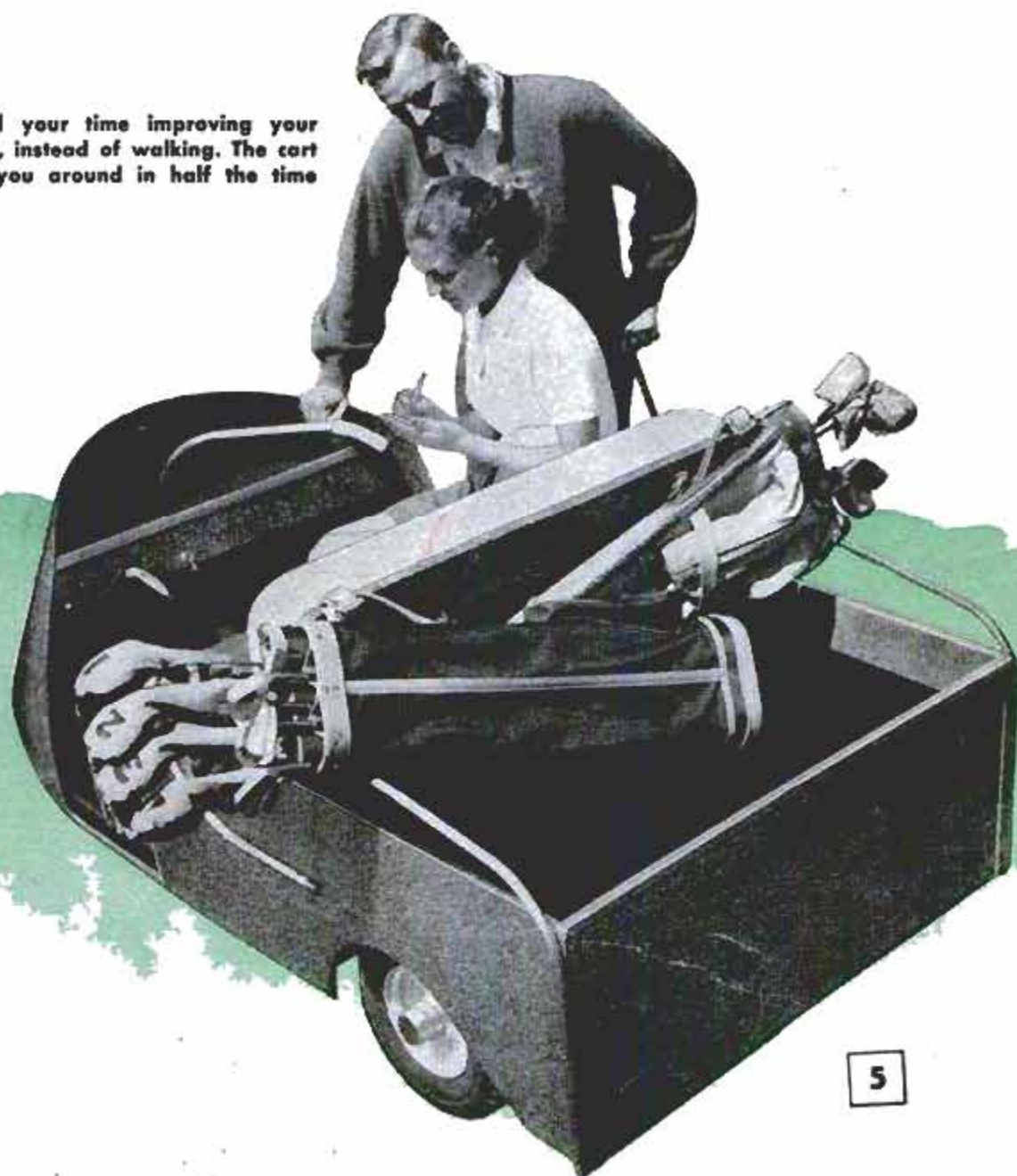
Wheels, which should be purchased before assembling the drive-unit frame because of the need for measurements, can be of several types. For the rear, the wheels should have 4.80 or 5.50 x 8 turf-type tires, such as used on most golf carts. A less ex-

pensive substitute are wheels from light aircraft, which are available as war surplus. These have tires with a channel tread, and are complete with bearings, hubs, and spindles. Also available are 6-in. brake drums and sprockets drilled to fit the wheels. For the front wheel of the cart a rounded tire is best. A  $14\frac{1}{2}$ -in. balloon aircraft tire or a 16-in. standard industrial tire should be used.

The fork assembly is made as shown in the left-hand detail, Fig. 7. Either turned brass bushings or ball bearings can be used, pressed into a counterbored length of pipe or tubing. The latter then is welded over a hole drilled in the 3-in. frame channel, Figs. 6 and 10.

Three types of d.c. electric motors can be used for the cart. Sprockets and chains from light motorcycles are used with each to deliver a speed of from 350 to 400 r.p.m. to the rear wheels. Aircraft starter motors,

Spend your time improving your game, instead of walking. The cart gets you around in half the time





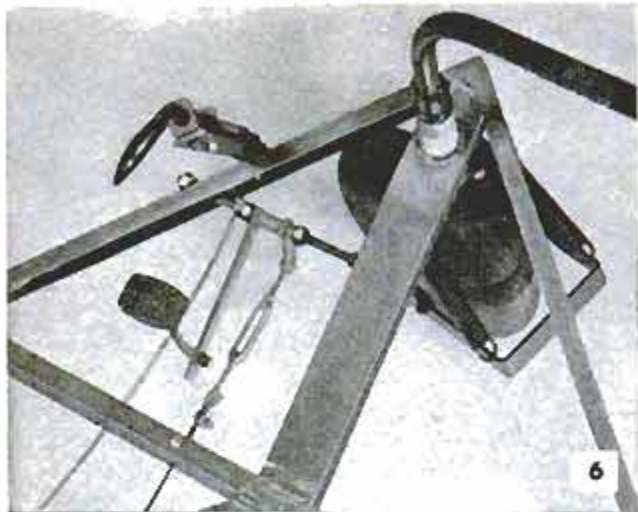
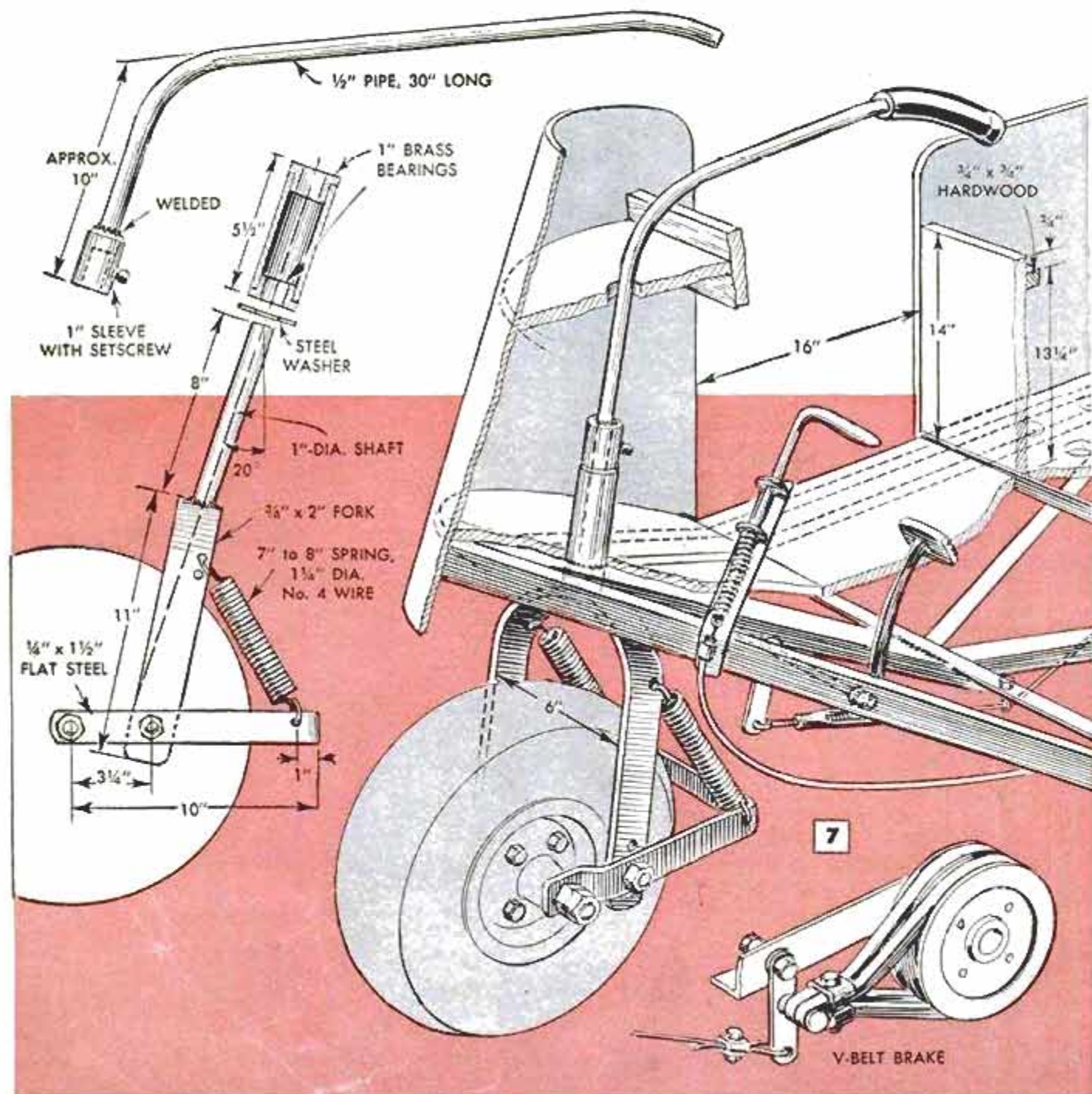
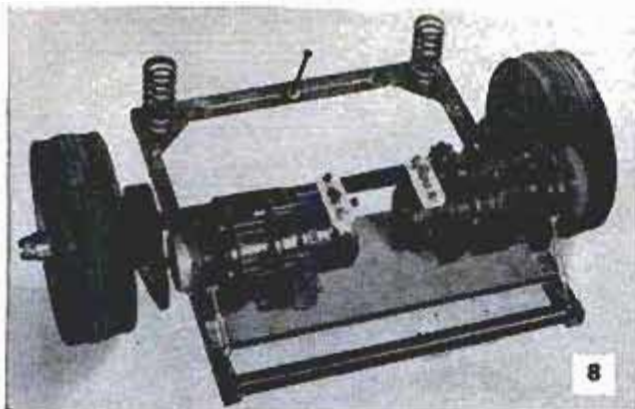


Photo of frame front end shows location of fork, foot and hand brakes, extreme turning angle possible

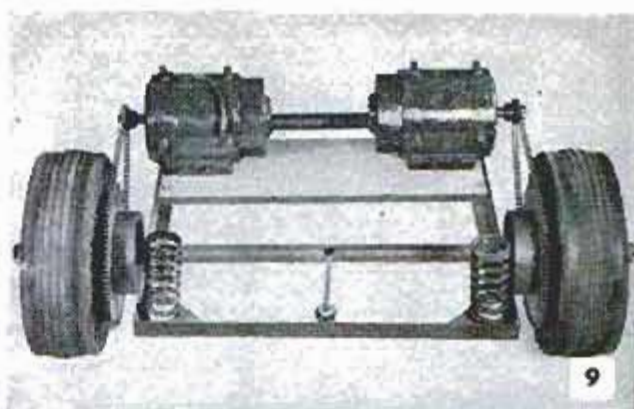
Fig. 8, available as war surplus, can be used if only moderate power is required. Although rated at 24 volts, they are designed for intermittent service and should be run with four batteries producing 12 volts, or three batteries that will provide 18 volts. Most of these motors turn only about 100 r.p.m., so a large sprocket is fitted on the motor and a smaller one on the wheel. Check the r.p.m. rating of any type motor before obtaining sprockets. A second type aircraft motor, also available as surplus, is a high-speed unit that rotates at about 5000 r.p.m., which makes it necessary to use a gear reducer of from 5-to-1 or 10-to-1 to reduce the speed to a point where chains and sprockets can handle it. A third type motor, the most expensive, is a propulsion or traction motor, Fig. 9, such



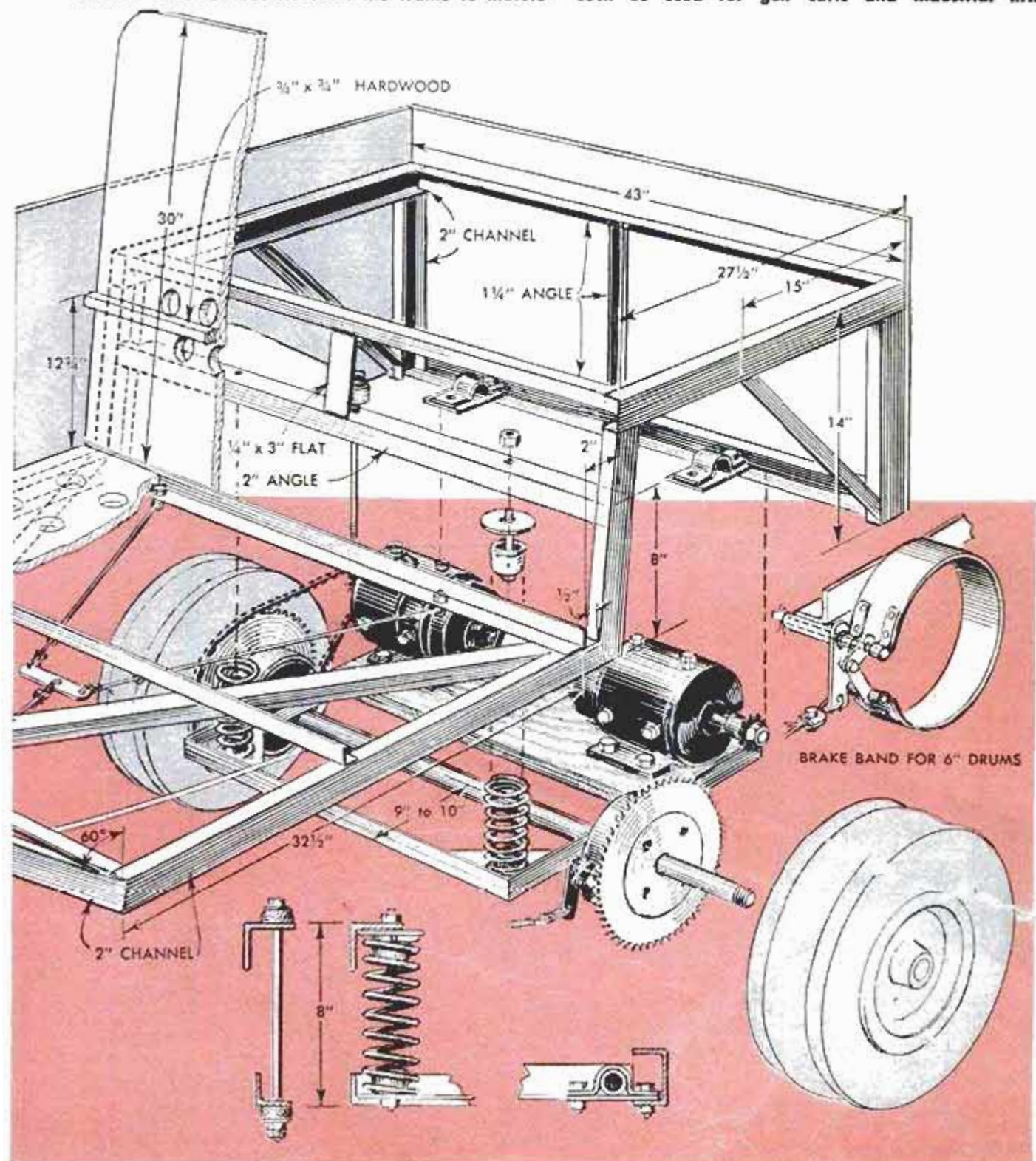




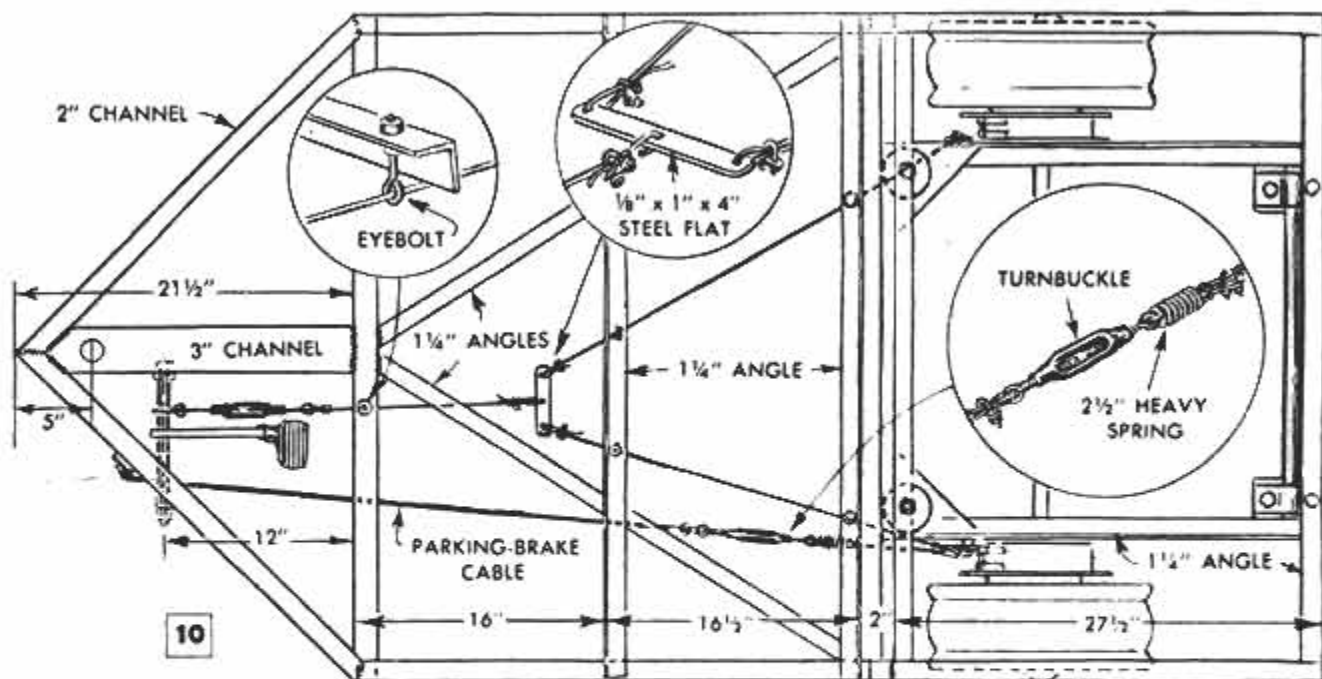
Drive-unit frame with aircraft starter motors installed. Note turnbuckles from the frame to motors



Here drive unit is fitted with propulsion motors, such as used for golf carts and industrial lifts







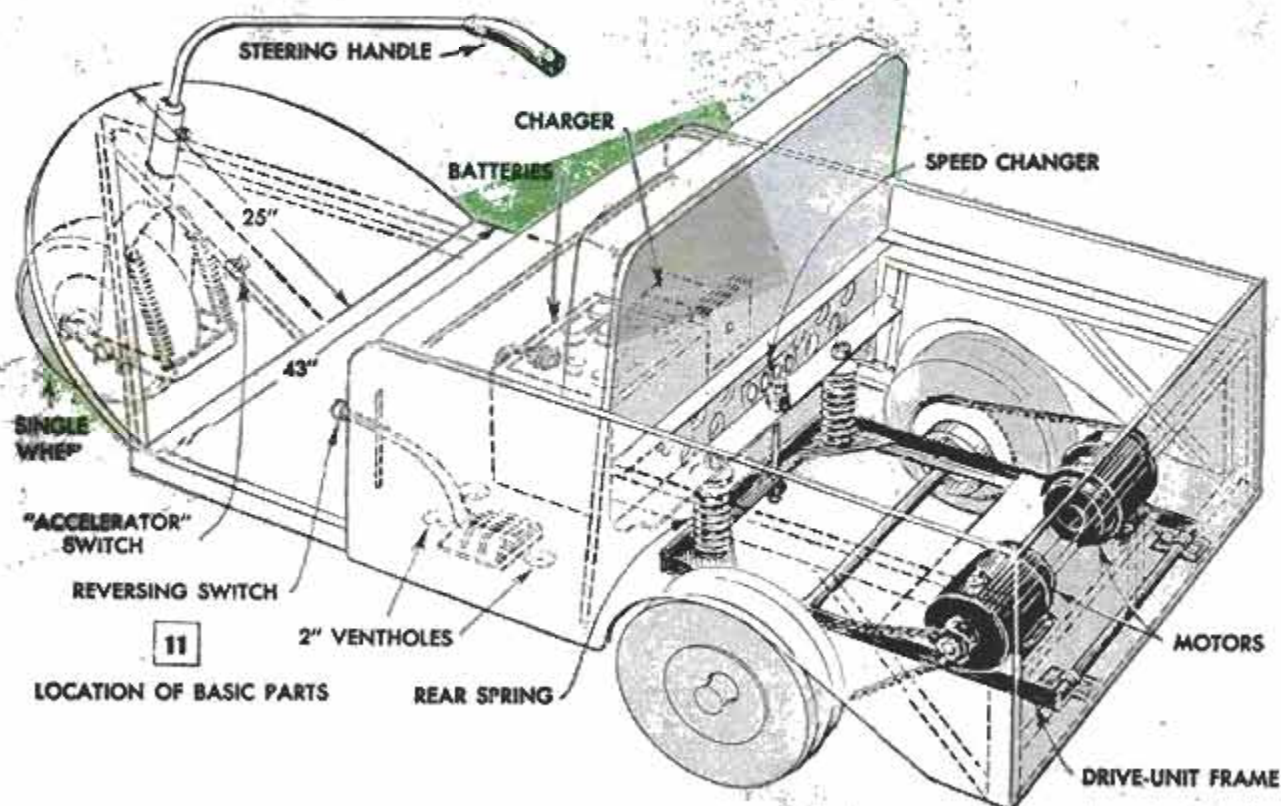
as is used for golf carts, electric lifts and the like. They are available from the larger motor manufacturers.

Brakes for the rear wheels of the cart can be made in two ways. If you purchase wheels with 6-in. drums, parking brakes of the external-contracting type, used on the drive shaft of Plymouth cars, can be modified for use as shown in the right-hand detail, Fig. 7. A second type of brake is to bolt a double V-pulley to each wheel and use two V-belts as "brake bands." The latter brake is efficient, but wears rapidly. Arrangement of the cables for both the

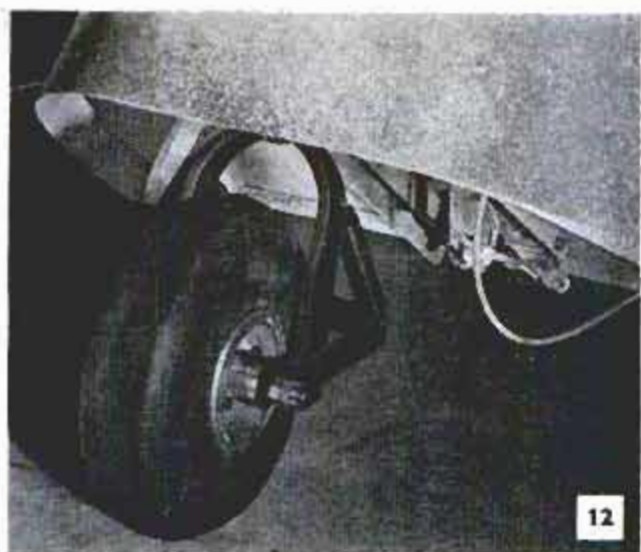
hand and foot brakes is shown in Fig. 10. The parking-brake handle can be one picked up in an auto-wrecking yard.

The seat back and three floorboards now are cut from 3/4-in., exterior-grade plywood. Ten 2-in.-dia. holes in the back are located toward the center so mud from the tires will not spatter through. These, and nine holes in the seat floorboard ventilate the charger and batteries. The seat front, cut from 1/2-in. plywood also is attached, after being slotted for the reversing switch, Figs. 11 and 13.

Figs. 1 through 5 show just a few of the



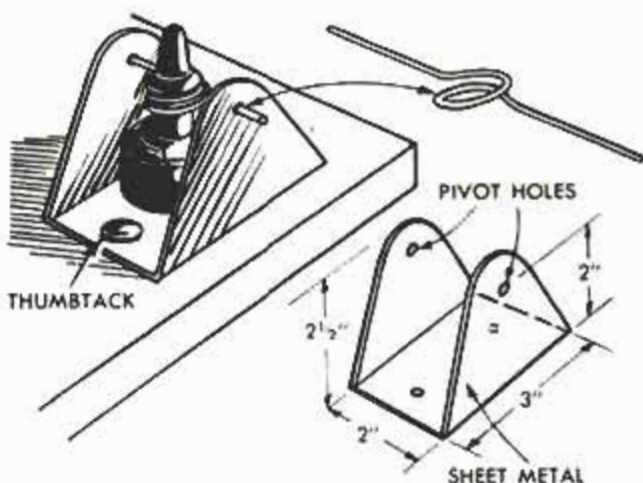
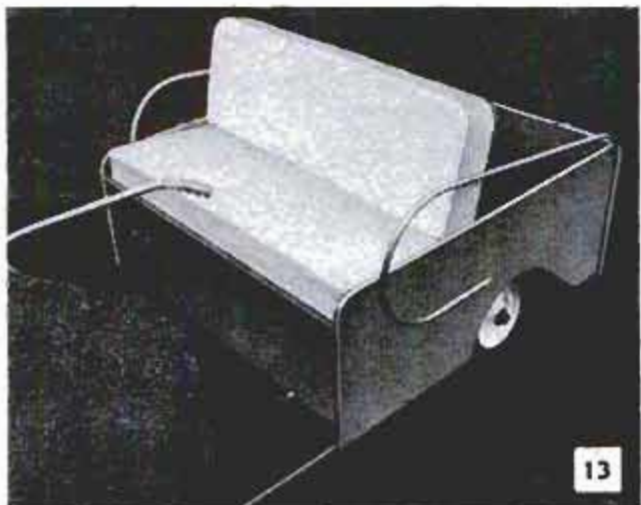




Springs used to counterbalance the hoods of some automobiles are strong enough for the fork assembly

many uses for this versatile golf cart-run-about. If it is to be used by an invalid, the cart should be fitted with hand, rather than foot controls. The "accelerator" pedal can be replaced with a lever-controlled switch on the instrument panel or glove shelf. Brakes also can be operated by a long lever projecting upward through the floorboard and positioned for the driver to grasp it easily. An upward-projecting extension handle also will have to be fitted on the reversing-switch. It is important that this switch be handy for any driver, as it can be used to brake the cart in an emergency. If the cart is to be driven on streets or highways, check with city and state officials for types of licenses required before constructing the cart. You may find that your state or city does not permit a vehicle of this type to be driven on the streets or on the highways. Next month will be shown the installation of wiring, battery hook-up and attachment of the body sides, front and seat.

This view of cart shows neat appearance of seat and rear deck. Note reverse lever at front of the seat



### Bracket Keeps Ink Bottle Level

This ink-bottle holder is intended for use on drafting tables when their entire surface is not utilized for drawing. The base of the holder is a U-shaped piece of sheet metal, drilled to accommodate the ends of a length of stiff wire that is wrapped around the neck of the bottle. Thumbtacks are used to hold bracket on the table.

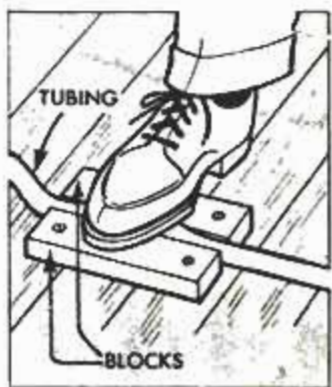
### "Marproofing" Pliers Jaws

When handling chrome-plated metal parts or other materials that must not be marred or scratched when gripped with pliers, fit the jaws with protective leather sleeves, made by cutting the fingers from an old leather glove. This method is quicker than wrapping cloth, leather or rubber strips around the jaws and makes them less bulky.



### Jig for Straightening Tubing

Two wooden blocks cut from 1-in. stock and nailed to the floor provide a simple but efficient means of straightening bent copper tubing. The blocks are spaced the diameter of the tubing, so it can be pulled through between them. Bends that are at right angles to the floor are straightened by pressing down on them with your foot. Work the tubing through slowly, to prevent kinking it.





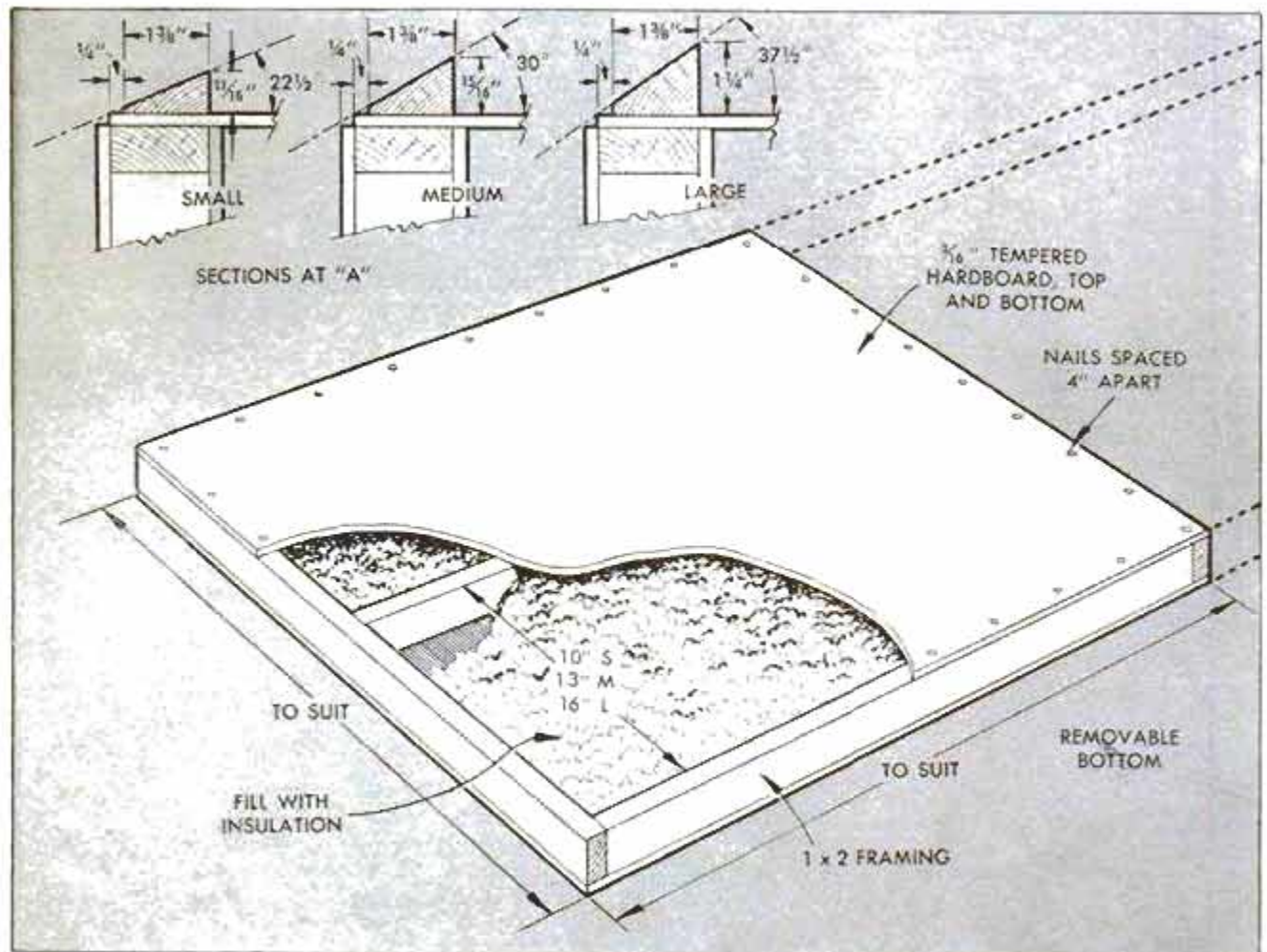
WTM 59 X232



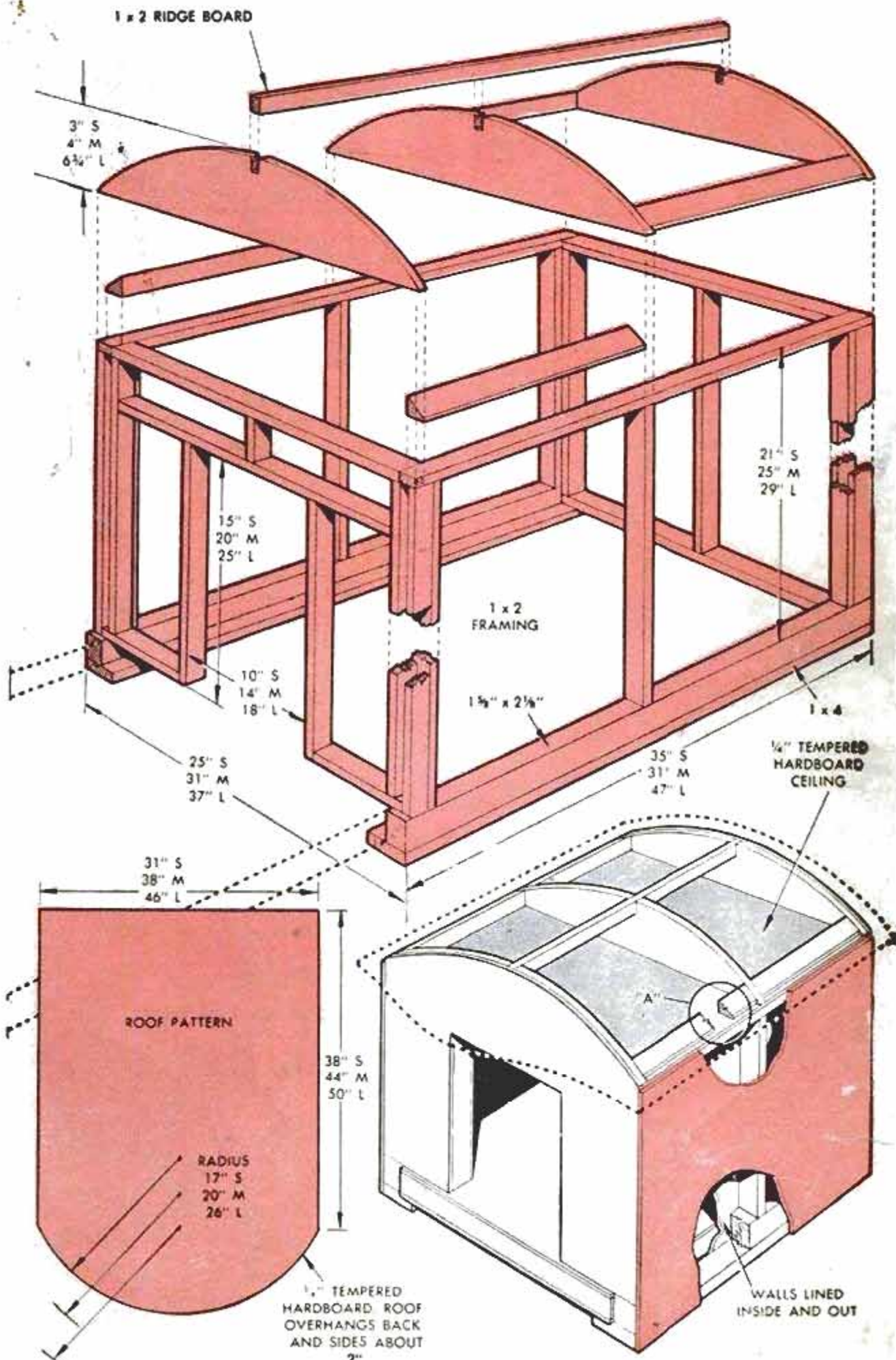
# INSULATED HOME FOR YOUR DOG

WHETHER YOUR DOG IS small, medium or large, this insulated house is designed to accommodate him in year-round comfort. Three figures are given for each dimension, being marked S, M and L, indicating small, medium and large, so that you can build any of three sizes of house to match the size of your dog. The smooth, one-piece roof is cut from a piece of tempered hardboard and is completely waterproof. The floor, which is built as a separate unit and slides out like a drawer

for easy cleaning, is filled with loose insulation. The "attic" formed between the roof and ceiling also has a layer of loose insulation on the upper side of the ceiling. To vent the attic space, drill a number of holes in the front wall, just beneath the projecting canopy formed by the roof. A vent at the rear of the house will require a weatherproof louver. The double walls of the house are insulated by stapling batt-type insulation to the framework before the hardboard covering is nailed in place. Lumber used on the lower edges of the house should be treated with creosote to provide moisture resistance, and the house should be supported above the ground to allow air circulation beneath it. When the house is completed, apply a coat of sealer, and at least two coats of quality, exterior-grade paint. ★ ★ ★









## Aluminum-Foil Lining in Grill Fire Pan Reflects Heat to Grid



Lining the fire pan of a portable charcoal grill with aluminum foil serves to reflect most of the heat produced by the coals to the cooking grid as shown in the photo. Also, the foil tends to provide more uniform distribution of heat for faster and better cooking of hamburgers, steaks and other foods. Heat rays that normally are absorbed by the bottom and sides of the fire pan are reflected back at all angles thus reaching the edges as well as the center of the cooking grid.

### Tinted Calking Compound

When calking joints and cracks on a house with redwood siding or trim, tint the compound with jeweler's rouge or iron-oxide paint pigment to blend it with the natural finish of the redwood. Use of untinted commercial compounds for this work results in an unsightly appearance.

John G. Premo, La Grange, Ill.

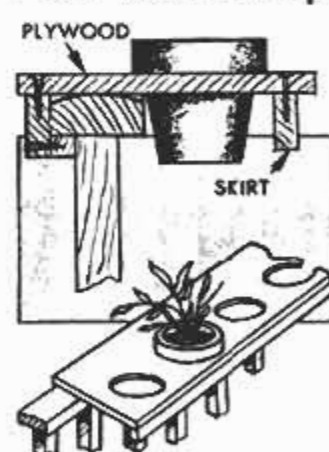
### Protect Plants From Cutworms



Here is an easy way of protecting newly planted tomato plants from cutworms that sever the tender stems immediately above the surface of the ground. Simply slit short lengths of garden hose and enclose each stem as shown in the

drawing. The hose lengths are easily removed when the plants begin to mature and no longer are endangered by these worms.

### Plant Rack Clamps on Porch Rail



This easily made flowerpot rack can be clamped on a porch rail of the type shown at almost any location desired. The weight of the potted plants placed in holes cut in the horizontal member holds the rack in place. A skirt is provided on one side of the rack to

conceal the lower portions of the pots. No fasteners are required to secure the rack to the rail, it simply hooks in place.

### Old Farm Milk Cart Serves as Portable Garden Planter



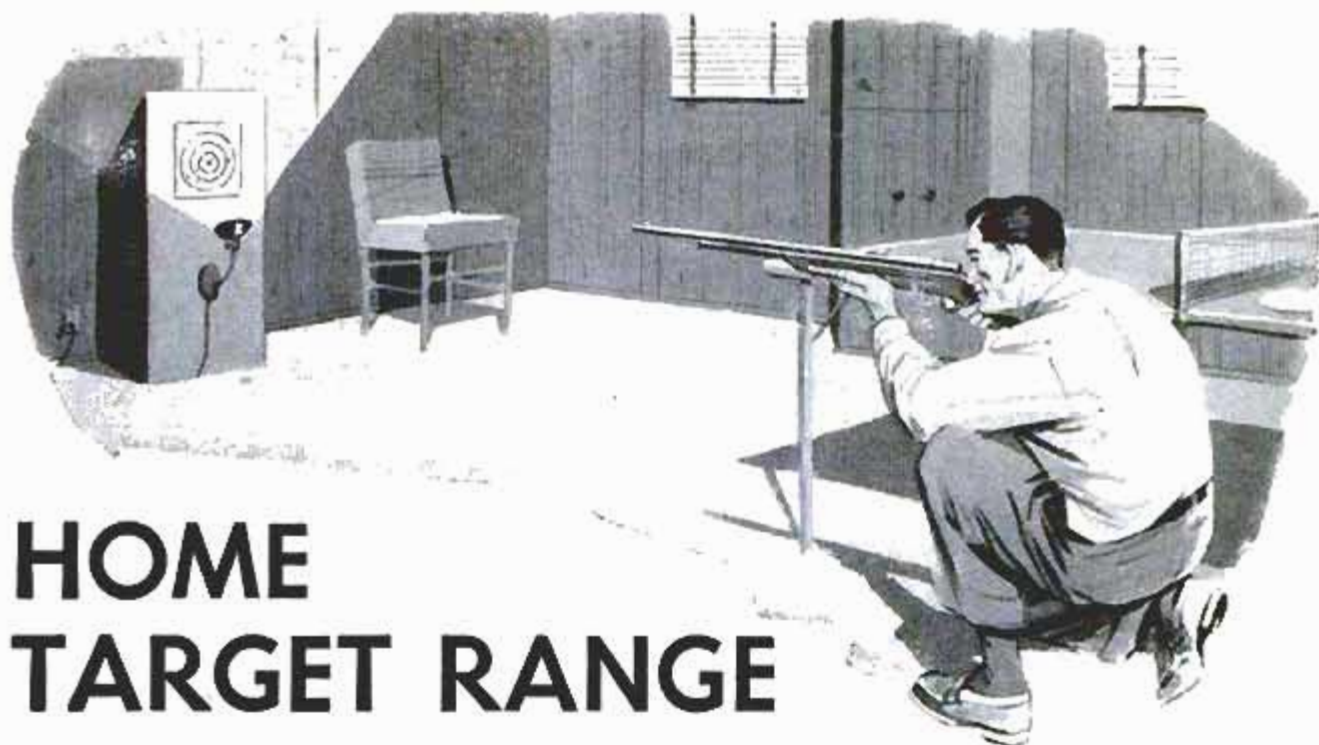
A fresh coat of paint, a pair of cow bells and a length of logging chain have made this retired farm milk cart a handy portable planter. The decorative planter can easily be moved about to add a desired touch of color anywhere in the garden. Also, it does double duty when used for hauling heavy garden material.

### Store Garden Hose in Basket

An ideal receptacle for storing a garden hose is a bushel basket. The wide diameter of the basket will permit the hose to be neatly coiled without kinks or bends for easy handling and compact storing.

M. Robert Beasley, Jackson, Mich.





# HOME TARGET RANGE

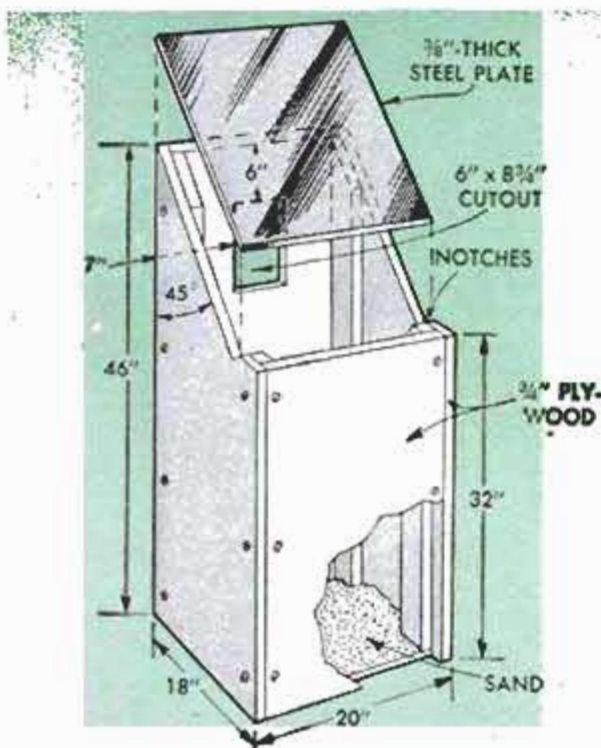
IF INDOOR public or club target ranges are too expensive or inconvenient for frequent rifle target practice, here is a rugged target cabinet that you can make and set up for a range of your own in the basement. Of course, you should first check on local ordinances governing the use of firearms in the home. Also, an unobstructed area about 40 ft. in length and a door leading to the target range that can be locked from the inside for safety are needed.

To make the target cabinet, first cut the sides, front, back and bottom panels from  $\frac{3}{4}$ -in. plywood and screw them to corner

uprights cut from 1 x 3-in. lumber as shown in the drawing. Before the front panel is attached, the target cutout is made in it and heavy-gauge galvanized sheet metal is nailed to all inside surfaces except the front panel. The steel plate for the top that deflects bullets into sand at the bottom of the cabinet can be obtained, cut to size, from a steel supply company. A paper clip screwed to the front panel above the cutout holds the paper targets in place. Illumination is provided by a desk lamp screwed to the front of the cabinet as shown in the photo below.

Ralph Treves, Flushing, N. Y.

Geoseneck desk lamp attached to front of plywood target cabinet provides nonglare illumination for target



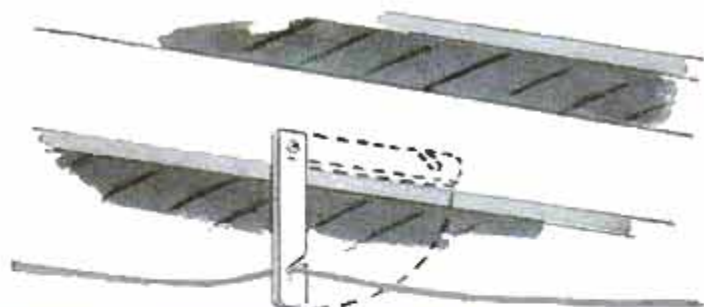


# Solving HOME PROBLEMS

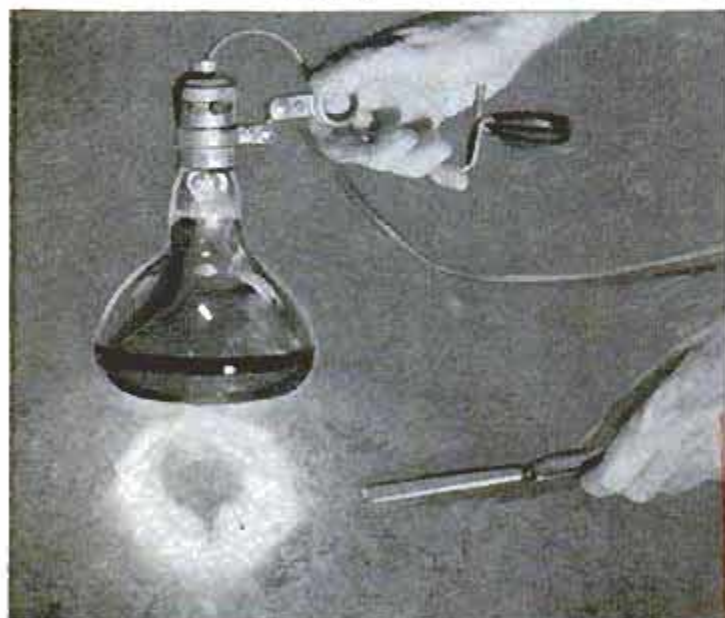


**TWO-VEGETABLE "DOUBLE BOILER,"** left, is drip coffeemaker with strainer removed. One vegetable is cooked in water in lower half, steam rises to cook food in upper half

**CENTER SUPPORT FOR CLOTHESLINE** in basement, below, is notched length of 1 x 2 or other stock, screwed to floor joist so it pivots up out of way when not used



**PAIR OF EMBROIDERY HOOPS** fitted in top of mesh vegetable bag, above, that is used to store toys, provides hand grip, keeps mouth of bag open so it is easy to toss in articles as they are picked up from floor

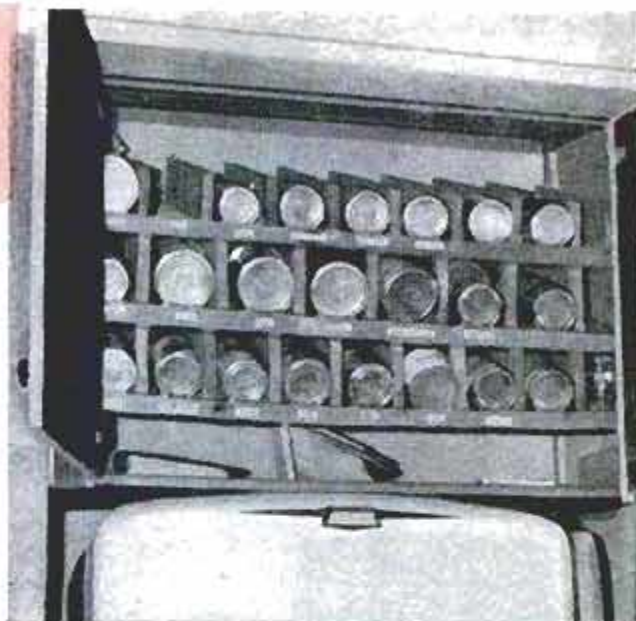


**DENTS IN INLAID LINOLEUM,** left, are reduced with aid of 250-watt heat lamp that softens material. Handle of table knife is used to "burnish" edges of dents to make them less noticeable. Avoid overheating with lamp





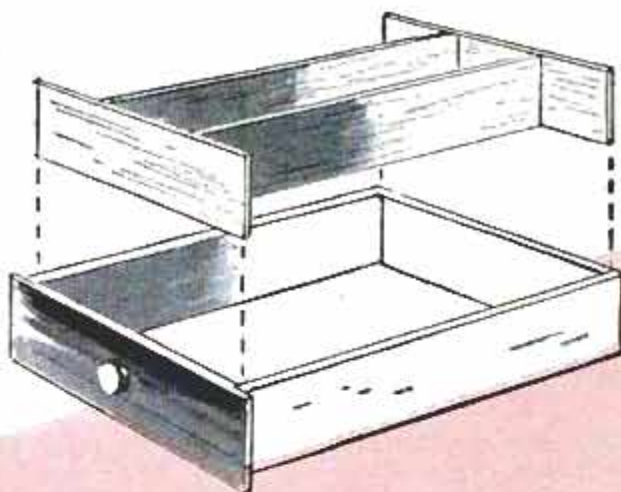
**HANG MISCELLANEOUS KITCHEN ITEMS** on "ready-made rack," above, that consists of unit taken from discarded loose-leaf notebook. Unit is screwed to wall in convenient location, items "locked" in rings



**CABINET FOR CANNED GOODS** is over refrigerator, above, has inclined racks rather than shelves. Cans slide down as lower one is removed. Strip across bottom holds in cans, has identifying labels on it

**"SPRINKLING CAN"** FOR HOUSE PLANTS is another adaptation of versatile, plastic squeeze bottle, below. For a number of plants, larger bottles, such as those in which glue is packaged, should be used

**LIFT-OUT PARTITIONS** IN CABINET DRAWERS, below, simplify the task of cleaning and lining them. In some instances, where partitions are fastened, they can be cut loose and made removable



**PREMIUM STAMPS WON'T STICK TOGETHER** while waiting to be pasted in a book, right, if they are slipped between sheets of wax paper kept handy to store them until you have time to sort them and place in the right book





# X515



# BOZO

## THE PUPPET

**PART  
I**

When it comes to size, Bozo is a large puppet and if carved from wood, he'd "weigh a ton." Actually, he's a "featherweight," for he is hollow. In this two-part story Dorothy Rankin, professional puppeteer, shows *Popular Mechanics* readers how they can mold large-size but lightweight puppets from a plastic cloth called Celastic



Notice that Bozo's hat is modeled separately in clay and that mouth outline is drawn in clay with nail

Sheet-metal shims pressed in clay at center of face serve as parting line for plaster-of-paris castings

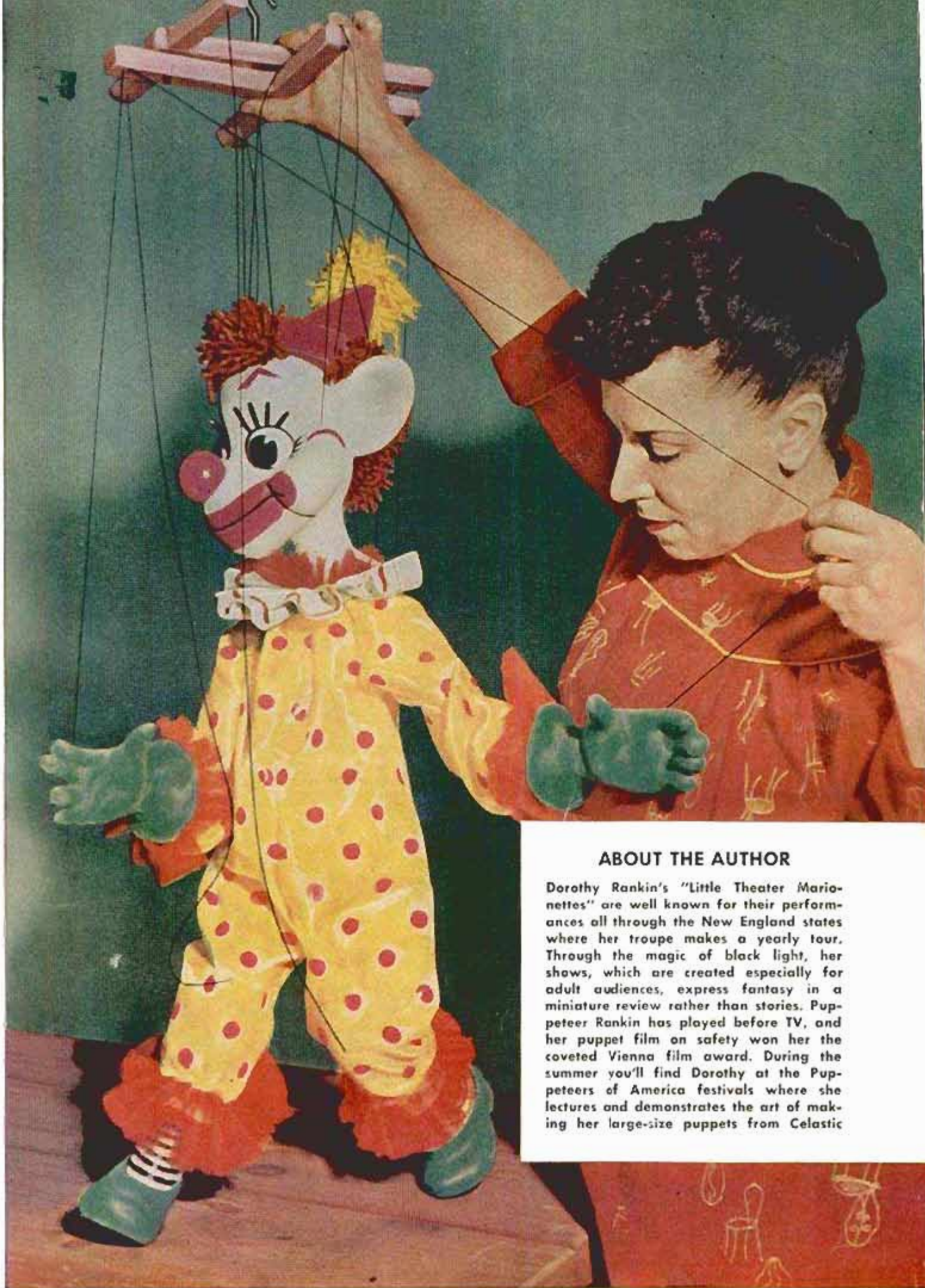
**PUPPETEERS** have to watch their weight — the weight of their puppets, that is. Holding one at the end of a string for hours at a time will tire the huskiest of troupers. That's why most puppets are small and why most puppet audiences wind up with strained necks. Now, thanks to plastic cloth, large-size puppets are practical since this new modeling material keeps the weight to a minimum. Bozo stands nearly 3 ft. tall and yet he weighs less than 5 lb.

Not only does plastic cloth produce a puppet far lighter than wood, but it simplifies puppet making to the point where almost anyone can qualify. In the process to be described, the puppet is made hollow throughout from a material called Celastic, which is a plastic cloth that comes by the yard. You work with it by cutting it up in small pieces and then dipping it in a special welding solution which makes it very limp and self-conforming. The pieces are applied wet, one at a time like patches, to plaster-

Each side of clay face is cast separately. Enough plaster of paris is added to form 2-in.-thick layer







#### ABOUT THE AUTHOR

Dorothy Rankin's "Little Theater Marionettes" are well known for their performances all through the New England states where her troupe makes a yearly tour. Through the magic of black light, her shows, which are created especially for adult audiences, express fantasy in a miniature review rather than stories. Puppeteer Rankin has played before TV, and her puppet film on safety won her the coveted Vienna film award. During the summer you'll find Dorothy at the Puppeteers of America festivals where she lectures and demonstrates the art of making her large-size puppets from Celastic

DOROTHY RANKIN  
67 LAKE SHORE RD.  
MIDDLEBURY, MASS.

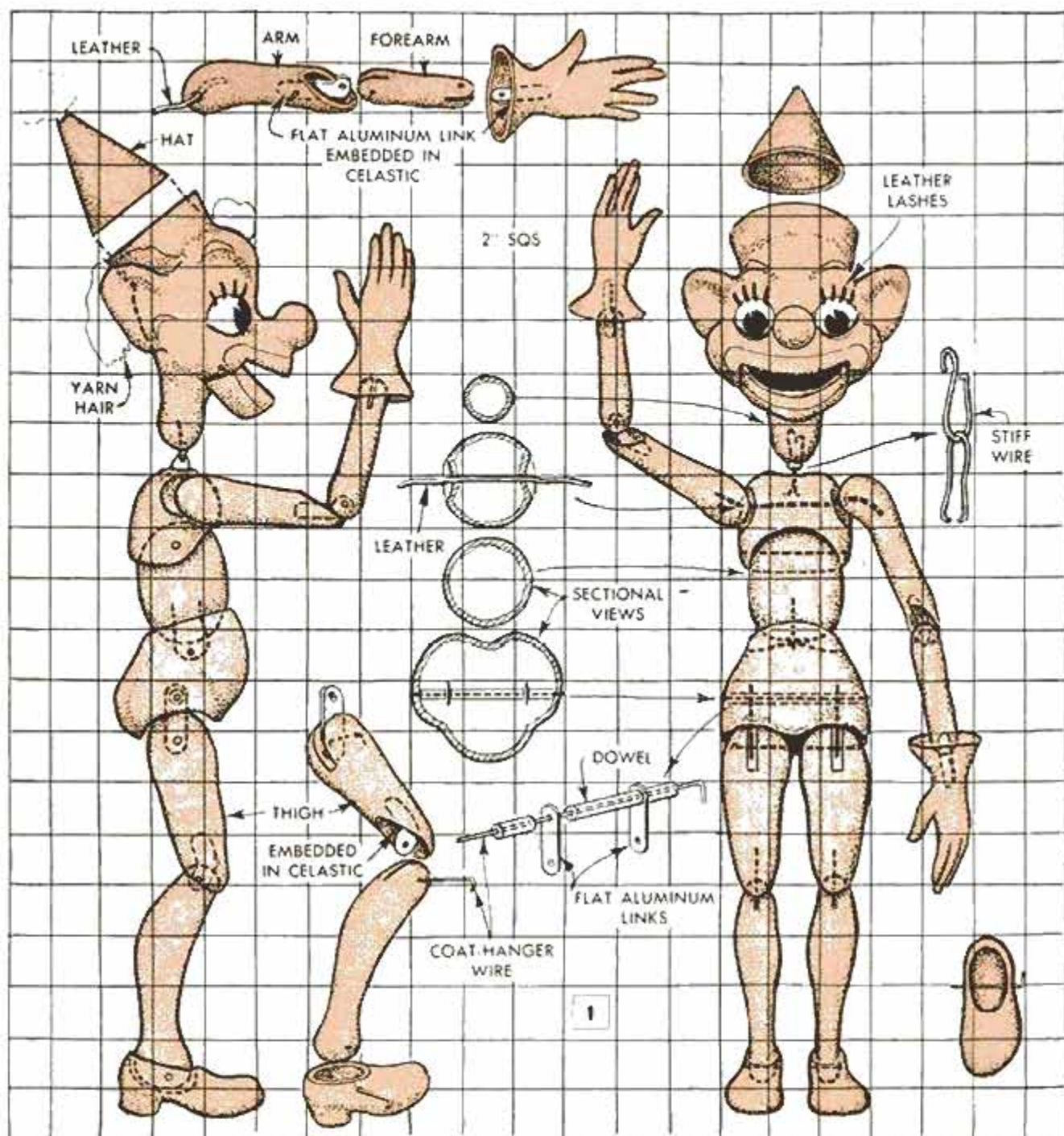




Above, a puppet's personality is largely conveyed through his face. Here puppeteer Rankin holds clay model of Bozo's head. Lower left, clown magician, another of Rankin's creations, is loaded with gimmicks. Below, Bozo's lifelike movements come from ball-and-socket joints which make him extra limber







Full-size patterns enlarged from these squared drawings give size and shape of body members for modeling in clay. Sculpturing of head is most important of all since rest of body, except hands and feet, is covered

of-paris molds. When dry, the resulting  $\frac{1}{16}$ -in.-thick shell is extremely strong, smooth and lightweight.

The most painstaking part of copying Bozo, or making a figure of your own, is molding the parts of his body in clay which must be done first so that plaster-of-paris molds can be made from them. While this requires a certain amount of sculpturing ability, you'll find that if front and profile patterns of the various parts are made and used as a guide, you'll be able to model Bozo quite closely without too much difficulty. Such patterns are easily made by ruling off on paper the same number of 2-in. squares as given in Fig. 1 and tracing the outline in corresponding squares. Plas-

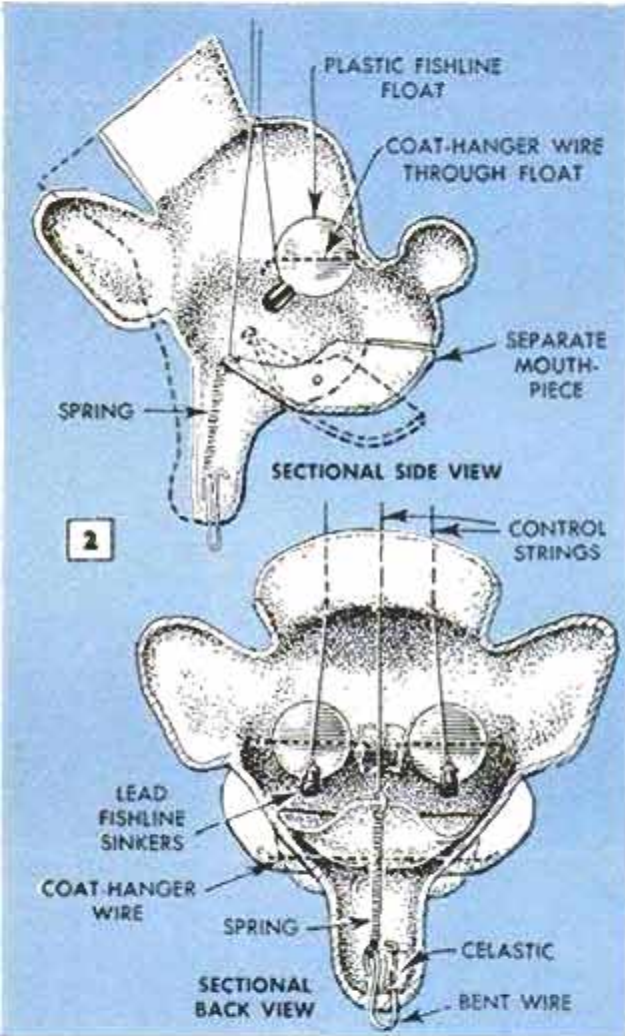
tic ball-type fishing floats are pressed in the clay to form eyeball sockets. These same floats serve later as Bozo's eyeballs. Most of your sculpturing efforts should be spent on the head since the rest of Bozo is covered by his suit. Hands and feet, as well as arms and legs, must be modeled right and left-hand. In modeling the face, strive for a balanced contour. The mouth is a part of the clay mass but is outlined in the clay to later serve as a guide in cutting out the mouth in the plastic-cloth shell. Note that the top part of the hat is sculptured and cast separately.

To conserve on clay, sculpture the front, or face, of the head first, leaving a base of clay to support it horizontally. The plaster





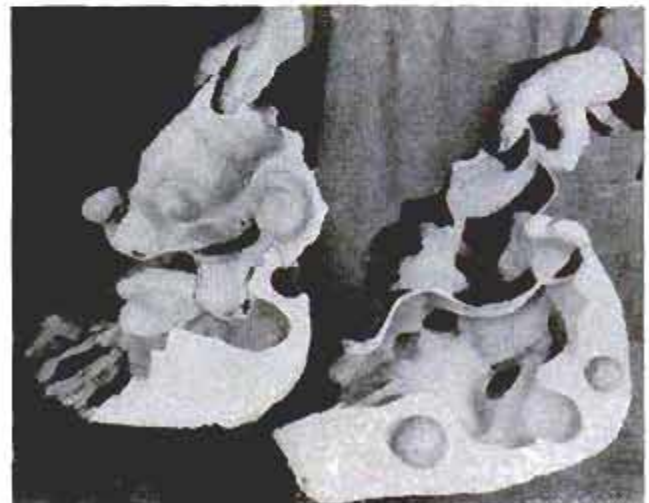
Left, plaster molds of head are cast in three parts. Above, Celastic parting agent is applied to molds to keep the mask sections from adhering to plaster



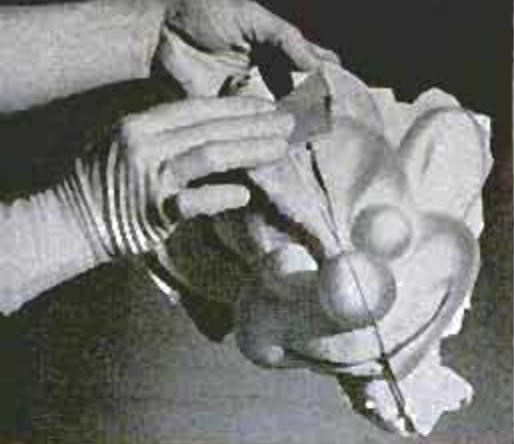
mold for the head is cast in three sections, two front sections and a back one and in order to register the back one with the others, half-round balls of clay are stuck to the clay base to form registering sockets, or keys, in the plaster molds. Similar balls are stuck to one side of the metal shims to be described. Before the molding plaster is poured over the clay, sheet-metal shims are pressed edgewise into the clay to form a parting line in the casting. The shims are flat pieces of metal about  $1\frac{1}{2}$  in. square and are inserted on a line splitting the nose from the neck to the top of the head. From this point the shims are pressed in the clay along lines just behind the ears. These particular shims will provide a flat surface for the back mold section.

The next step is to pour the plaster. This is done on one section of the face at a time. The molding plaster consists of plaster of paris, two parts, and water, one part which are stirred to a smooth, creamy consistency. Build up a layer about 2 in. thick and work fairly fast, since once the plaster begins to set, it hardens quickly. After about

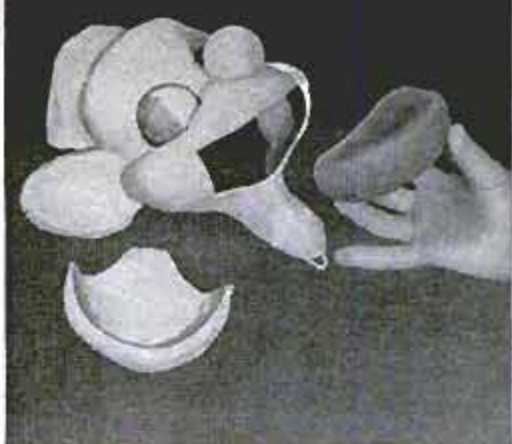
Lower left, here plaster mold is being lined with layers of Celastic which is applied in patches. Below, the completed shells being lifted from molds







Halves of face mask are joined at center with bits of Celastic



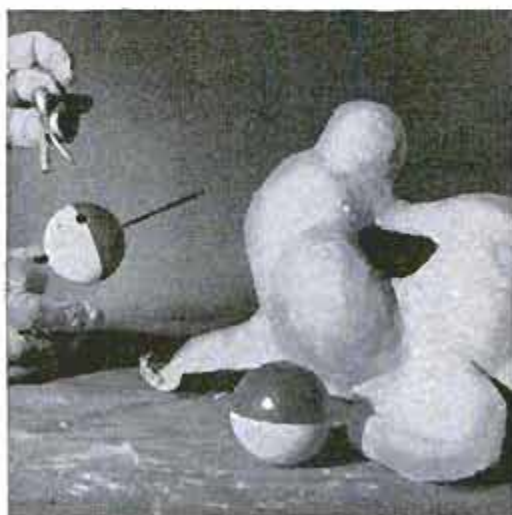
Mouth section is cut out of mask with a sharp knife, new mouth modeled in clay



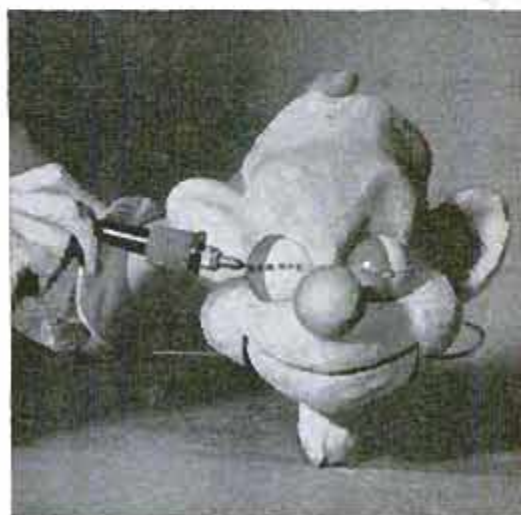
Here separate mouth section of Celastic is fitted in opening



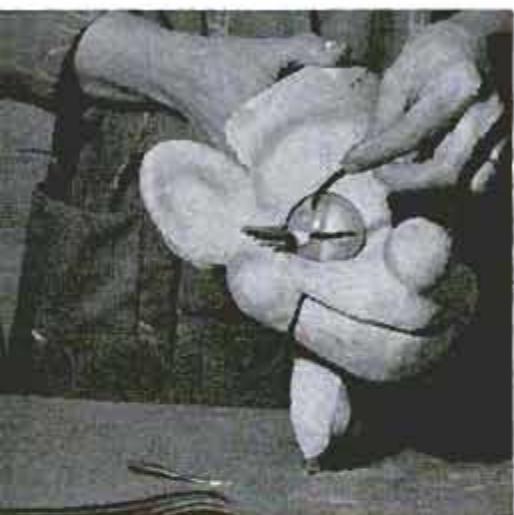
As done with mouth, eyeball openings are neatly cut in mask



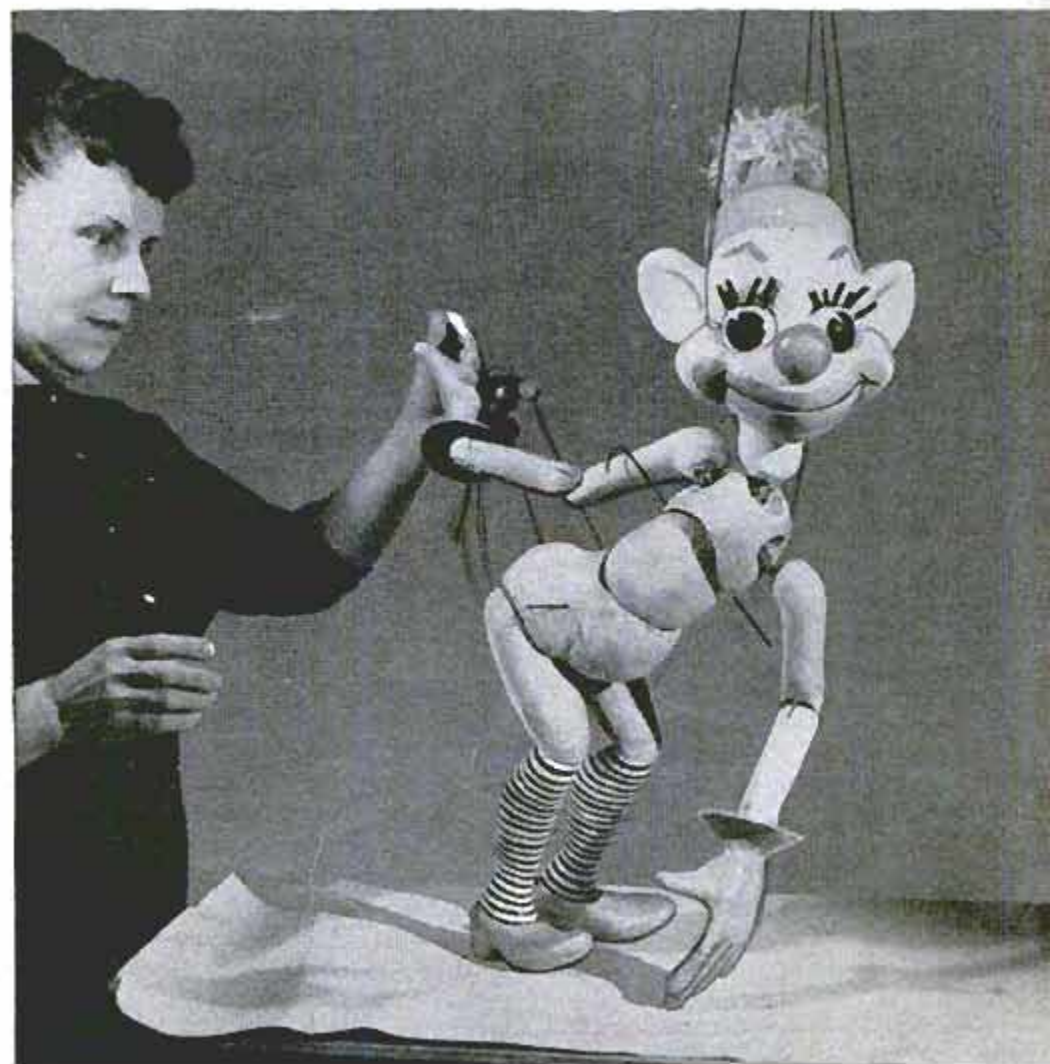
Bozo's eyes are plastic fishline floats counterweighted with fishline sinkers



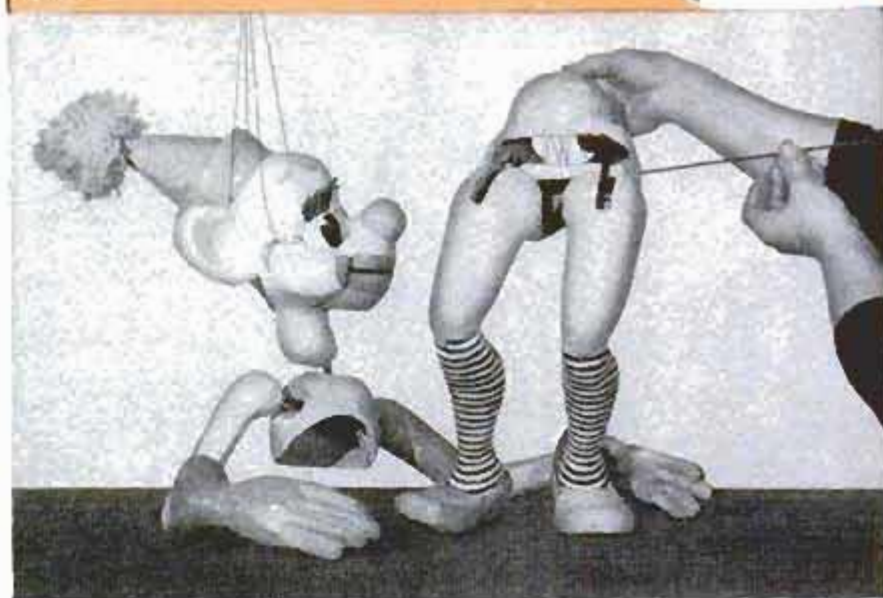
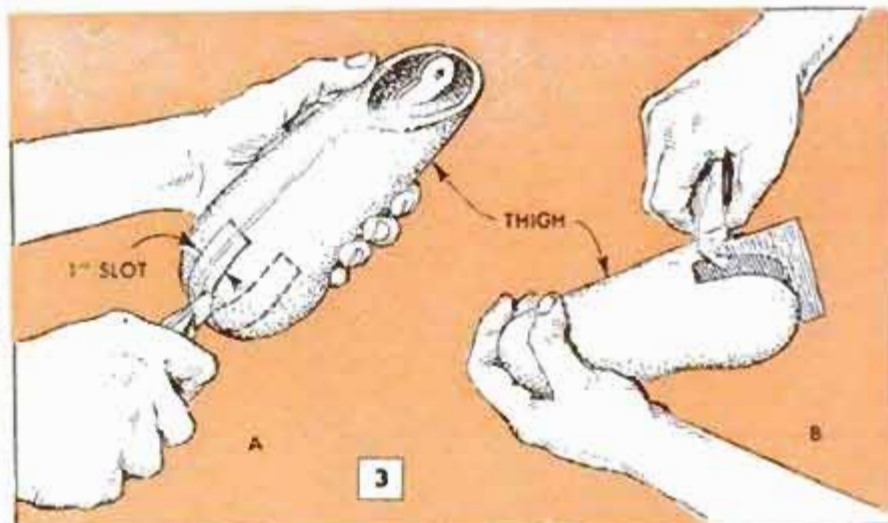
Slits for leather eyelashes are formed with wood-burning tool



Above, Celastic cement is used to glue the eyelashes. Below, thigh members sit astraddle drying jig for filling end cavity







20 min. remove the parting shims and coat the edge of the plaster mold with grease. Then continue to pour the other section of the face. The grease will keep the two from sticking together. Before the rear section can be cast, the back of the head must be completed in clay. When this is done, the parting lines of the two plaster casts just made are greased and the rear section is poured. The last steps in making the plaster casts are to soak them in water for about 1 hr., let drip dry and then quickly brush Celastic parting agent on the inside surfaces. This will keep the plastic cloth from sticking to the molds.

At this point you actually start making your puppet. Take your plastic cloth and tear it into strips about  $1\frac{1}{2}$  in. wide and then cut the strips into pieces 2 or 3 in. long. Now, wearing rubber gloves, dip about a dozen of the pieces in acetone and place them on a rack, such as a baking grill. The acetone will soften the plastic cloth and make it very limp and pliable. Start applying the patches to the mold impressions one at a time, pressing them carefully into all the nooks and crannies of the face. Let them overhang the edges of the plaster

cast a little. Add one layer, then a second and a third in succession. Don't rush the job. Each section of the mold is handled separately, but in the very same manner. It will take about 6 hr. for the plastic cloth to dry thoroughly. When removed from the plaster-of-paris molds, the thin built-up face sections not only will be extremely lightweight but surprisingly strong.

The two face shells are trimmed of excess around the edges and are fused together down the middle by bridging the joint with bits of acetone-soaked plastic cloth. By smoothing with the fingers, the patches will flatten out to paper thinness so that no ridge lines will show on the completed face. Any unevenness in the face contour, such as wrinkles or seams, may be smoothed over with Celastic mastic compound or with wood putty thinned with acetone. Touch up just where needed—the less the better since lightness and thinness are important in making large-size puppets.

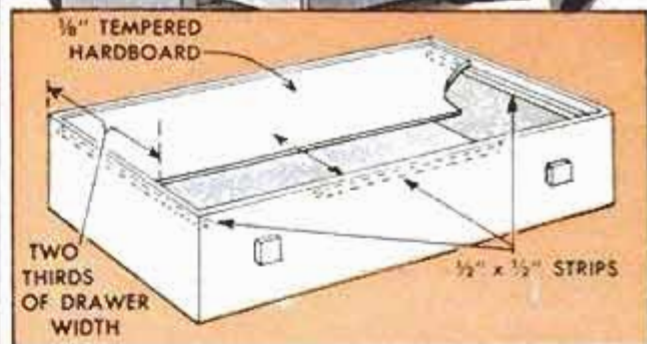
Since the clown's mouth is designed to open and close the entire mouth and chin section in the shell is cut away with a sharp knife, following the guide-line impression, and a new jaw is molded of clay. A plaster



cast is made of the new jaw and from it a plastic-cloth shell. The drawings in Fig. 2 show the shape of the separate mouth piece and how it is actuated by a spring attached to a wire in the neck. The jaw pivots on a length of coat-hanger wire which passes through the cheeks. The ends are bent downward and anchored, and smoothed over with bits of plastic cloth. Next, the eyes are cut out of the shell to form sockets for the fishing-float eyeballs. Like the jaw piece, each eyeball is pivoted with a length of wire, the ends of which are bent downward and secured on the inside of the shell with bits of plastic cloth. Pieces of leather shoelace are used for eyelashes and are cemented in holes burned in the eyeballs with a wood-burning tool. Cut the eyelashes about 1 in. long. Now, working from the inside of the shell, hold the eyes in a closed position and burn a hole in each eye near the top and cement a lead fishline sinker in each hole. The sinkers are used to counterweight the eyes and keep them normally open. A second hole is burned in the back of each eye to admit air so the Celastic cement will dry. This is important. The best way to anchor the sinkers is to insert a piece of plastic cloth crosswise through the eye of the sinker before coating with cement and inserting through the hole in the float. You'll notice in Fig. 2 that a wire loop is cemented in the lower end of the neck and left protruding for attaching the head to the body. Fishline, 12-lb.-test, is used for the strings and lengths should be tied at this time to the base of the sinkers and to the end of the movable mouth piece before the back section of the head is cemented to the front. Now go over the entire head and give it a light sanding, then a coat of flat white paint.

Making the limbs and body is done in much the same manner, first in clay, then in plaster and finally in Celastic. Ball-and-socket-type joints give a lifelike action to Bozo and Fig. 3 shows how slots are formed in the upper ends of the thighs to receive flat links which pivot them to the hips. First a slot is cut as in detail A. Then the slot is lined with plastic cloth by placing the thigh astraddle a forming jig. Finally, the excess cloth is trimmed off evenly as in detail B. Any  $\frac{3}{4}$ -in. board will serve as a jig which is covered with aluminum foil to prevent sticking. Two thicknesses of plastic cloth are dipped in acetone and placed over the aluminum-covered board. Then the thigh is pressed down over the jig and left to dry. Similar slots are made in both ends of the forearms and the upper ends of the legs. Here, the slots are made much narrower, about  $\frac{1}{8}$  in. wide, to provide less play in the joints.

(To be continued)

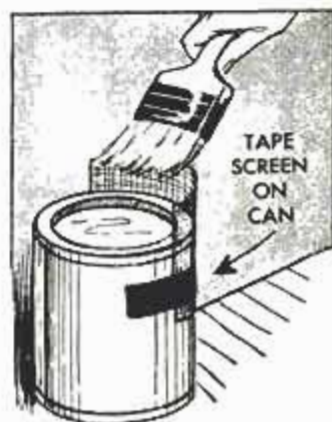


### Drawer Serves as Writing Desk

If you live in cramped quarters where there is not enough space for a small writing desk, a chest drawer can be converted for writing by fitting a piece of tempered hardboard to the top of the drawer. This should be wide enough to cover about two thirds the width of the drawer, and is held in place by cleats screwed to the inside surface of the drawer as indicated. Mount the cleats so that the hardboard is flush with the drawer top. The "desk" may be moved back to get at the contents of the drawer, or it may be removed entirely.

### Loose Bristles Easily Removed From Paintbrush

If loose bristles spoil your paint or varnish job, wipe the brush across the end of a piece of screen wire occasionally to remove them. If the wire is taped to the side of the paint can as indicated, it always will be at hand.



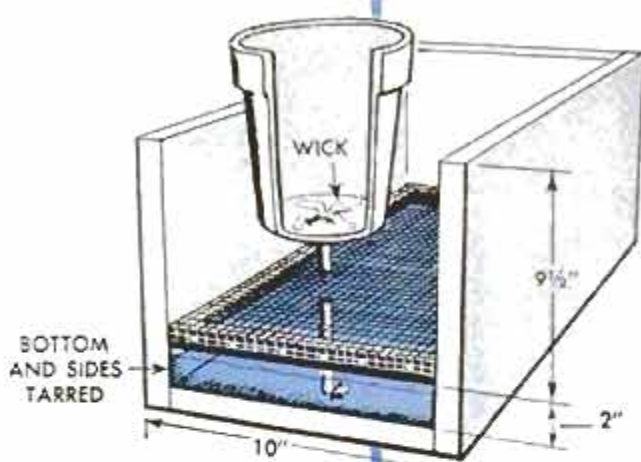
### Sharpen Sewing-Machine Needle

A quick way to sharpen a dull sewing-machine needle without removing it from the machine is to "sew" a sheet of emery cloth. Needle will sharpen itself.





**HANGING PLANTER** is coconut half-shell with bottle cap over drain hole drilled in bottom

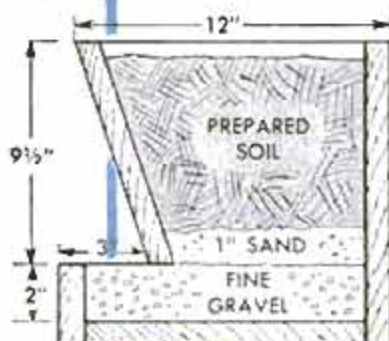


**SELF-WATERING PLANTER** made by nailing hardware cloth to cleats inside box and tarring

bottom. Wick nailed to bottom and inserted in pot carries water to plants by capillary action



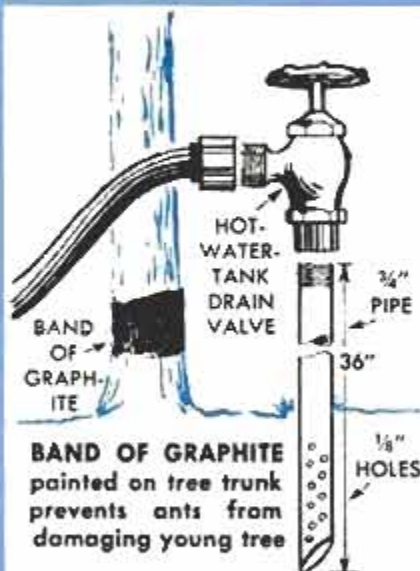
# Gardening



**SUB-IRRIGATED PLANTER** is assembled with marine glue and screws. Inner surfaces are coated with tar to seal the joints



**WATER PISTOL** is handy for spraying insecticide on undersides of plant leaves. Thoroughly rinse inside of pistol with water immediately after using



**BAND OF GRAPHITE** painted on tree trunk prevents ants from damaging young tree

**TREE-ROOT IRRIGATOR** permits watering of root system for fast growth. It is made of galvanized steel pipe, coupling and hot-water tank drain valve



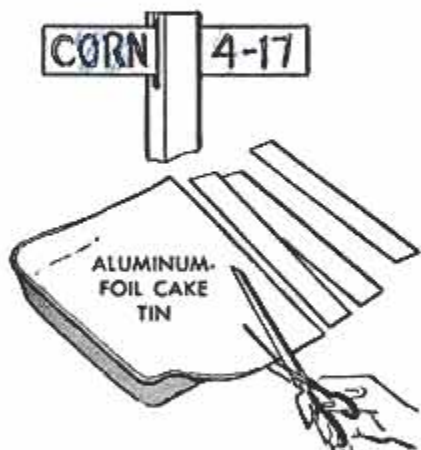
**FLOWERPOT** placed on coffee can for painting, can be rotated without touching pot for fast smudge-free paint job



**PARCEL-SIZE RURAL MAILBOX**  
 mounted on post in garden provides convenient storage for frequently used garden tools



# Hints

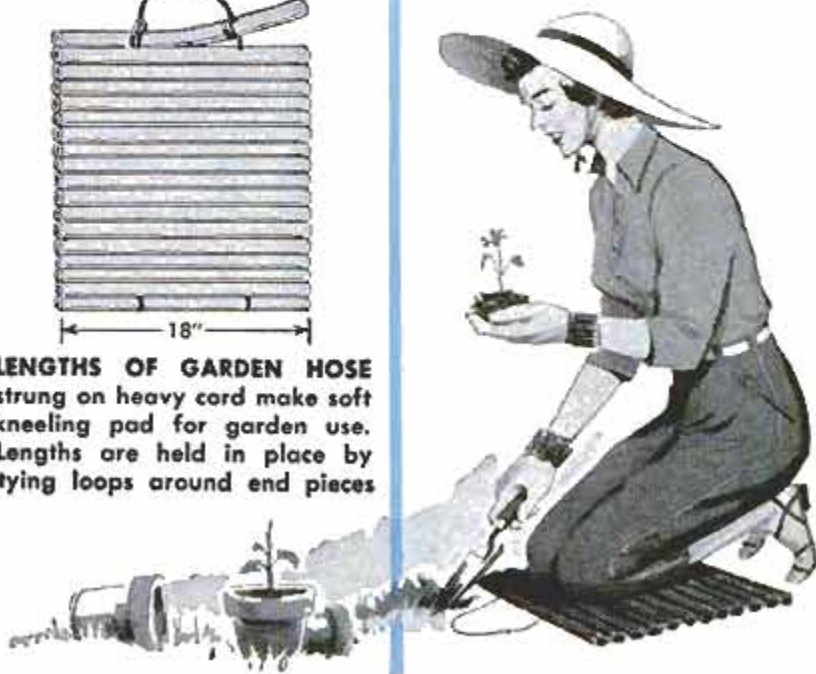


**PERMANENT PLANT MARKERS** can be made by cutting strips from aluminum pan of type used for frozen foods. Plant names and dates planted are lettered on with ball-point pen

APRIL 1958



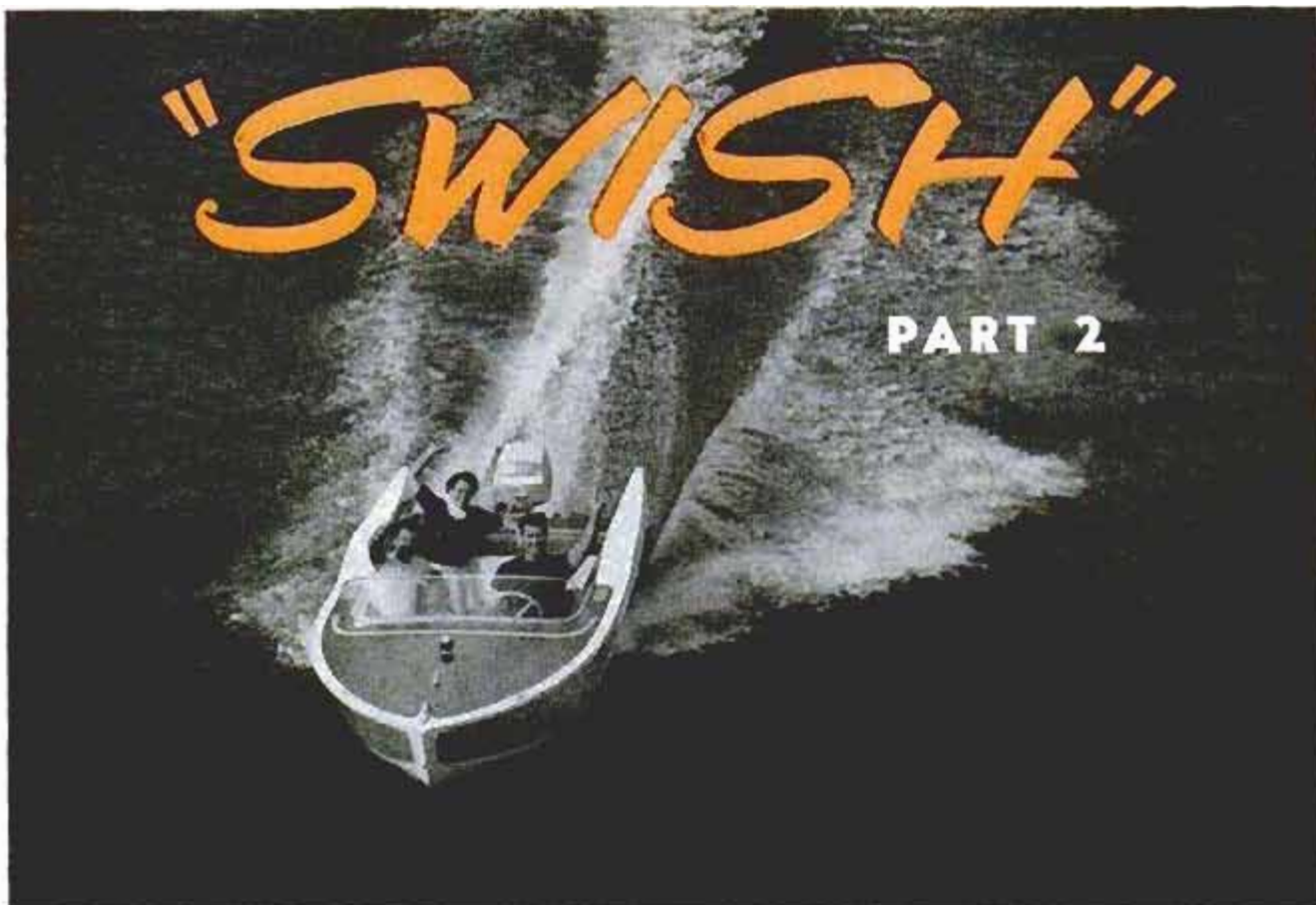
**LENGTHS OF GARDEN HOSE** strung on heavy cord make soft kneeling pad for garden use. Lengths are held in place by tying loops around end pieces





# "SWISH"

## PART 2



By Glen L. Witt, Naval Architect

**H**AVING COMPLETED the hull framing described in Part I, the next step is to fair (bevel and contour) all members according to the drawings of the transom and frames, and the lines and contours given in the plan, Fig. 24. In fairing, the most difficult part to comprehend is in the forward sections. A wood rasp is handy for fairing the stem and roughing in, but a plane should be used on the relatively flat after sections and final finishing to avoid dips and hollows. The keel should be absolutely straight and parallel to the building form from the transom to frame 3 and be faired to accept the bottom planking at the required angle as in Fig. 30. Also, the chine log should be faired as should each frame, so that each point parallel to the keel and outward from it to the chine is in a perfectly straight line longitudinally from the transom to frame 3.

Proper fairing is of the utmost importance if you want to get the most speed out of your boat. To simplify checking the fairing in the after sections, use a straight-edge. For the curved sections, a length of plywood can be used as in Fig. 13.

**Bottom Battens:** It is much easier to install the battens after all fairing of the hull framework has been completed since the notches for them are made from the faired lines of the frames. Allow the battens to extend forward approximately as shown in

Fig. 22. Forward ends of the battens may be kerfed to permit easy bending of them to the contour of the bottom planking at the bow, Fig. 28. If the battens are kerfed, the inside surfaces of each kerf are coated with glue and the kerfed end secured to the planking by a 1/4-in. brass bolt placed in a hole drilled through the planking and the batten. After the battens are fastened to the frames, fairing should again be checked to be sure the bottom planking will lie flat to all members. Note that limbers (drains that permit bilge water to flow to the lowest part of the boat) are cut in each frame on the outboard side of battens and keel as in Fig. 18.

**Side Planking:** Again, the importance of accurate fairing cannot be overstressed. At this time you should recheck all members using the methods described. Each side of the hull is planked with a single length of 1/4 x 36-in. plywood 16 ft. long. This should be of marine grade and edge-stamped EXT DFPA A-A. If two panels less than 16 ft. in length are used for a side, they must be butt joined as in Fig. 26. When this is done, the joint should occur between frames preferably in the after part of the hull where the lines are relatively straight.

When working alone, the best way to determine the required shape of the planking, is to make a template by stretching wrapping paper around one side of the hull

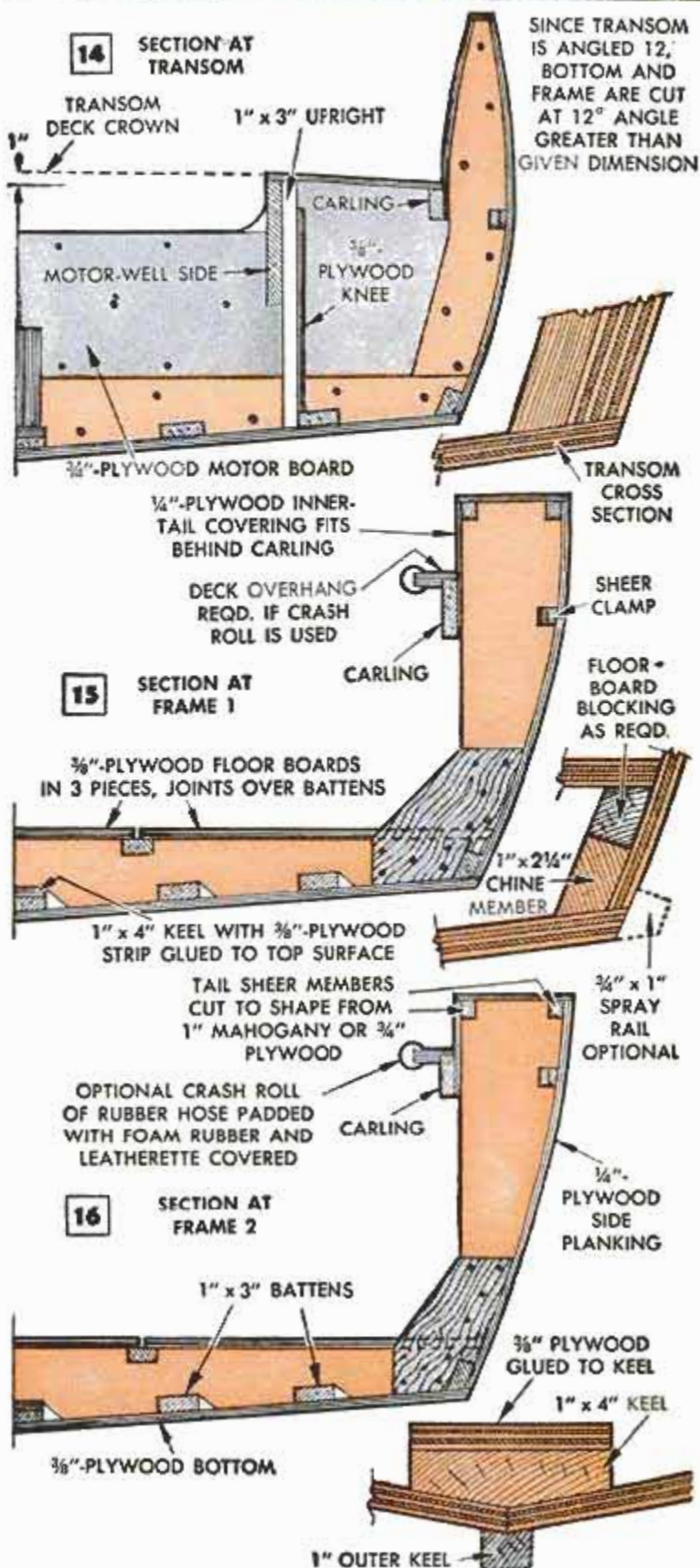


Fig. 13, thin plywood strip is pressed against each member in curved sections of hull framing that is to receive planking to check on fairing of these members

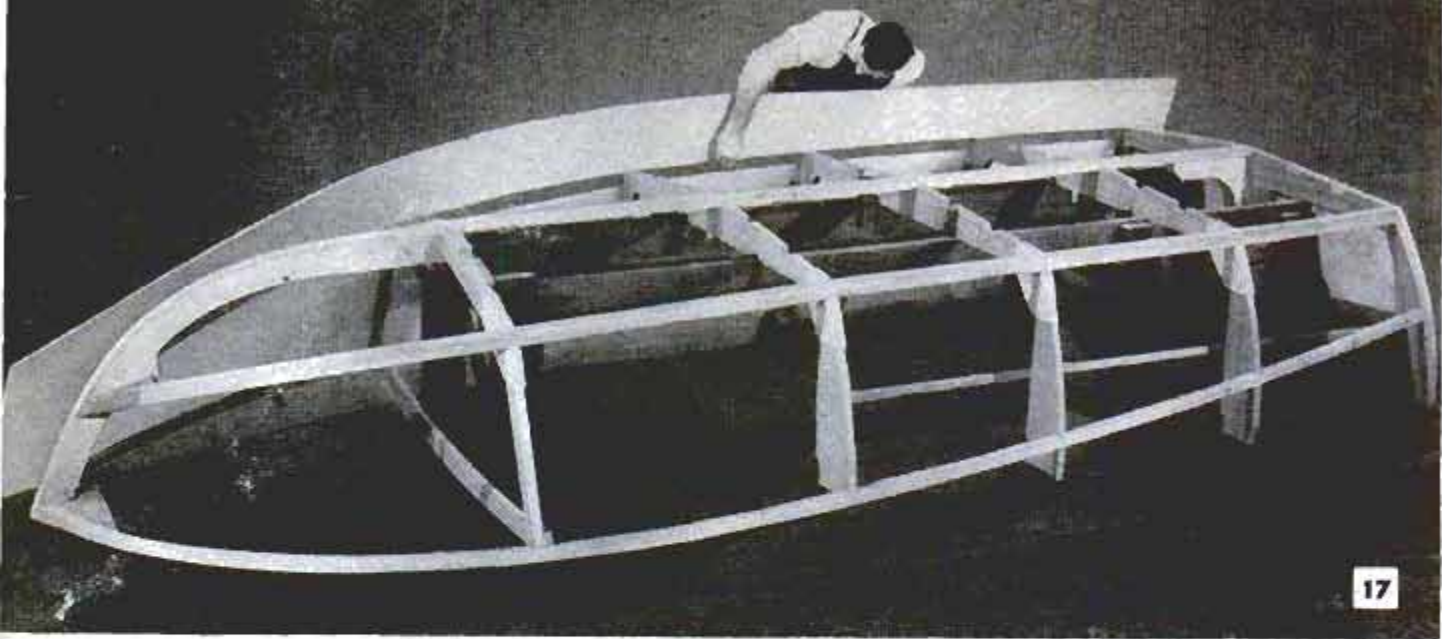


and marking it accordingly. This is then cut out and traced on the plywood. About  $\frac{1}{2}$ -in. excess should be allowed on all sides to allow for error. Another way of doing this, is to outline the shape of the planking directly on the plywood as in Fig. 17. First the planking is cut slightly oversize and then clamped and temporarily screwed in place at several points for the final fitting. The fitting at the transition joint must be made at the very edge of the chine log as in Figs. 25 and 27. This is the most important joint in the planking. Planking at the sheer, transom, stem and chine aft of frame 4, may be left  $\frac{1}{4}$  in. long for final fitting after it is permanently fastened in place. When the trial fitting meets your satisfaction, the planking is removed and used as a pattern for marking the planking for the opposite side. If the hull is to be coated with glass fiber, a hard-setting glue should be used when applying the planking. If the hull is not to be covered with glass fiber, a soft-setting or mastic-type glue should be used on all underwater joints to prevent leaks. All contacting surfaces are coated with glue and the planking relocated by the trial screw holes and fastened permanently. Screw the planking to the sheer clamp with 1-in. No. 8 screws spaced 4 in. apart. Space them 3 in. apart at the chine and stagger them as much as possible. At the transom and stem, the screws should be spaced 2 in. apart. The planking may be screwed to the frames if desired, but it is not necessary.

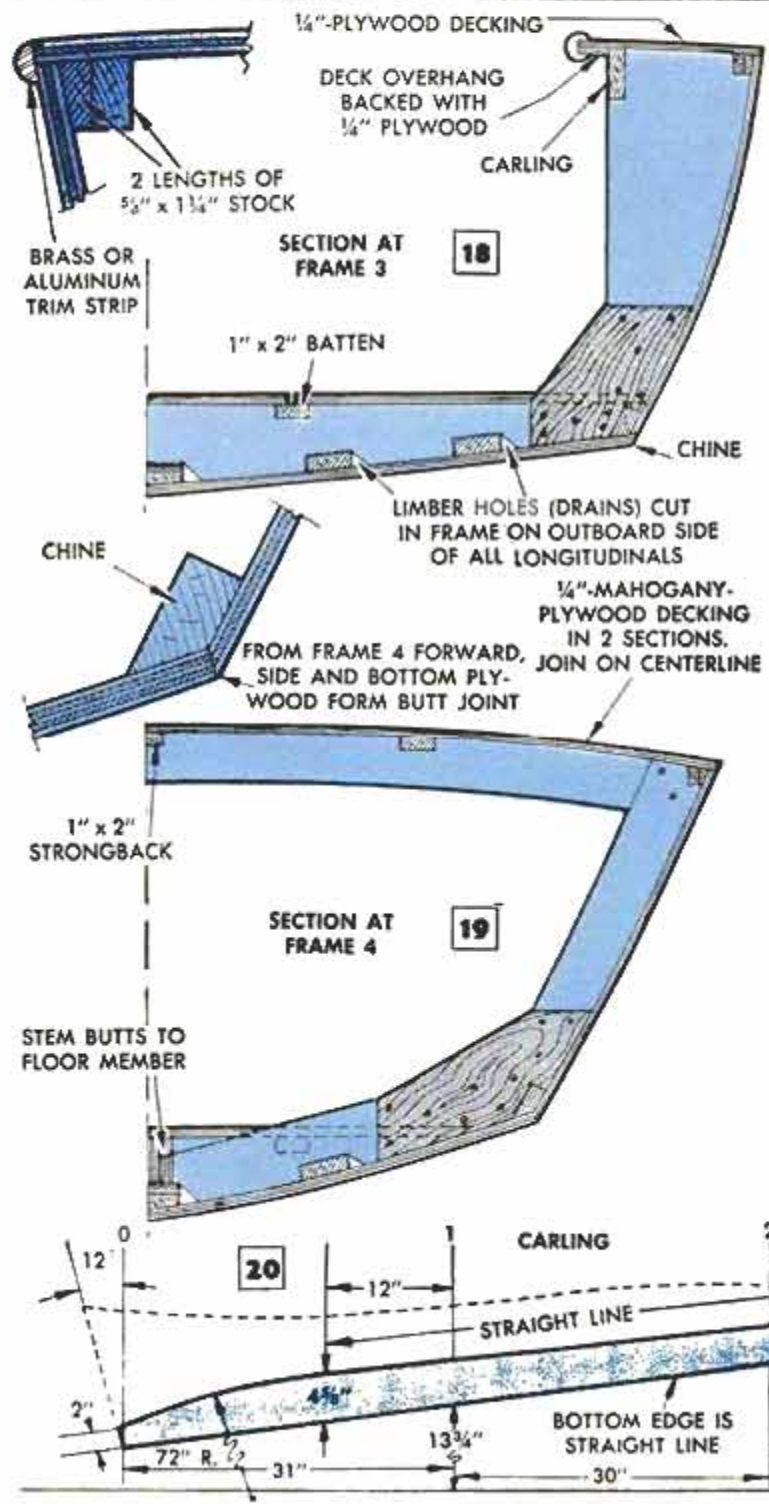
The planking for the opposite side is then applied in the same manner. Before doing this, it is advisable to fair the planking on the first side at the stem to obtain a good fit. The planking on both sides is now trimmed even with the chine-log member. Do this carefully and check the fairing as you proceed with a straightedge as before. Again, note the change in type of joint required at the transition joint. From frame 4 forward the side and bottom







17



Above, plywood panel for side planking is placed next to framework and chine and sheer lines roughly outlined on it for cutting. Excess is removed later

planking are beveled to form a butt joint. Use the same care in beveling these two members as you did when fairing the side planking from frame 4 aft.

**Bottom Planking:** The bottom planking is cut from 3/8-in. plywood of the same type and grade as the side planking and, like the latter, it is preferred in full-length panels. It is applied in two sections with the joint falling on the centerline of the keel. Fitting the butt joint with the side planking from frame 4 forward is difficult. Do this carefully, first rough marking and cutting it to shape and then trimming the beveled portion until it makes full contact with the opposing bevel on the side planking as in Fig. 23. When springing in the forward end of the bottom section, you will find the material fairly stiff. To make this job easier, cover the area with a few burlap bags and saturate them with boiling water. Also, do the same when fastening the panel permanently in place. When in place, the bow end of the first half of the bottom planking is cut off flush with the bevel on the stem



opposite it as in Fig. 29. The bow end of the second half is trimmed in the same manner, except that it is cut off flush with the outside surface of the first side as shown. Before fastening the first half of the bottom planking, it should be used as a pattern for making the opposite one.

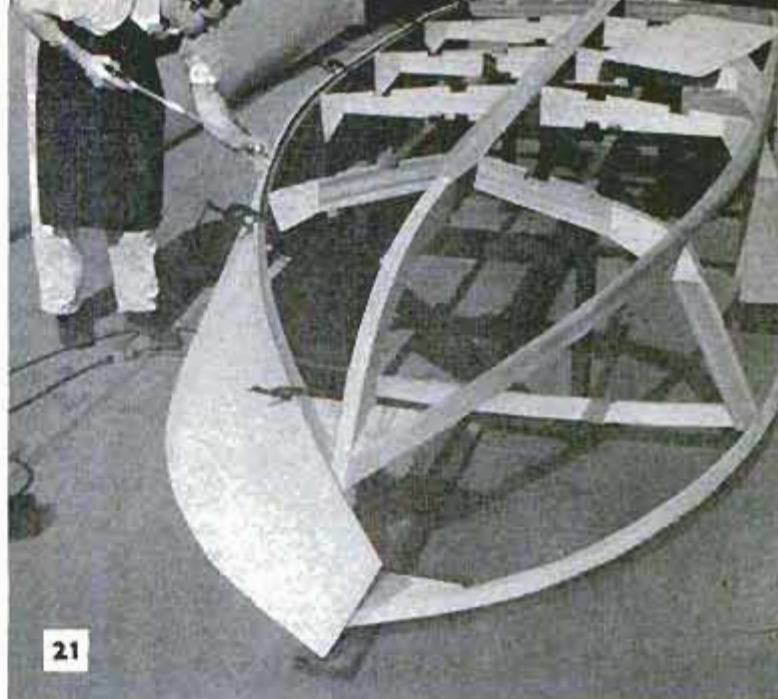
When installing the bottom planking, coat all contacting surfaces as before and fasten each section into position, working from the transom forward. Use 1-in. No. 8 screws spaced 3 in. apart along the chine and keel and 4 in. apart along the battens. The planking may be screwed to the frames but it isn't necessary. A slight overhang from frame 4 aft is planed flush with the side planking, after fastening it, Fig. 27.

**Outer Keel:** The outer keel, or skeg, covers the planking joint at the bottom centerline as shown in Figs. 16 and 24. It may be cut from 1-in. oak or mahogany stock and is set in a bed of mastic and fastened to the planking and keel with 2-in. No. 10 screws spaced 6 in. apart. If the hull is to be covered with glass fiber, the outer keel must be installed over it and bedded in resin of the same type used for applying the glass-fiber cloth.

**Stem Cap:** If the hull is not to be covered with glass fiber, a stem-cap strip of oak stock is recommended for covering the exposed plywood edge at the bow. To provide a surface for fastening the stem cap, a flat area the same width as the cap is cut on the leading edge of the planking as in Fig. 29. This protective cap strip extends from the deck to the forward end of the outer keel and is embedded in mastic and screwed to the stem and keel with 1½-in. No. 8 screws spaced 12 in. apart.

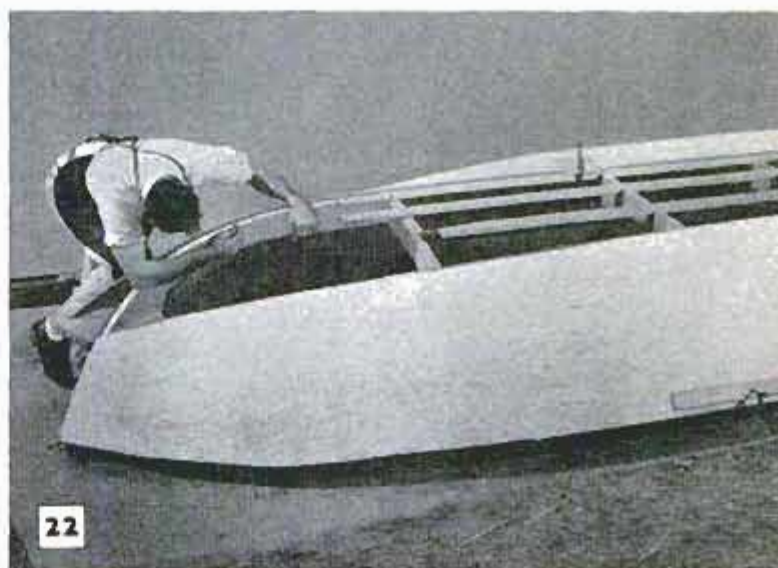
**Spray Rail:** In addition to the stem cap, a spray rail should be provided to cover the joint of the side and bottom planking at each chine as in Fig. 15. If the hull is covered with glass fiber, these members still can be used, but they must be added after the protective material is applied. The spray rail is cut to the size and shape indicated from a single length of oak or mahogany to extend from the stem to the transom parallel with the chine. It is embedded in mastic and screwed to the side planking and chine log with 2-in. No. 10 screws spaced 12 in. apart. In the after portion, from approximately amidships of the hull aft, the spray rail should be trimmed flush with the bottom planking. Up forward, the outer edge may be left at a 90-deg angle for a spray deflector.

**Applying Glass Fiber:** Any hull that is properly covered with glass fiber will last longer, practically eliminate the need for ever refinishing the boat, reduce maintenance costs to a minimum and be much stronger as a result of it. There is nothing



21

Above, side planking is clamped and screwed into position after it is recut to allow excess of ½ in. on all sides and glue applied to all facing members



22

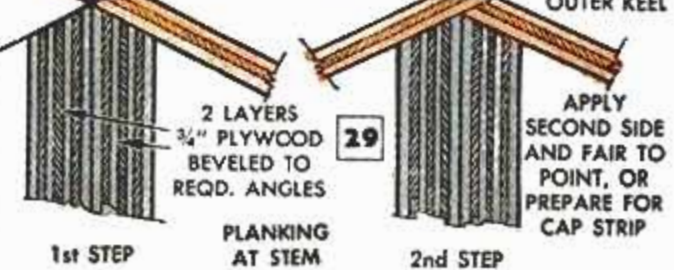
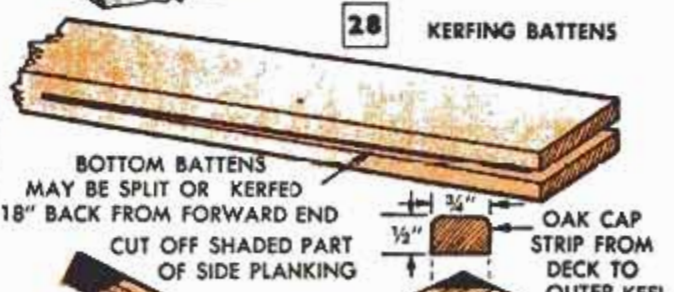
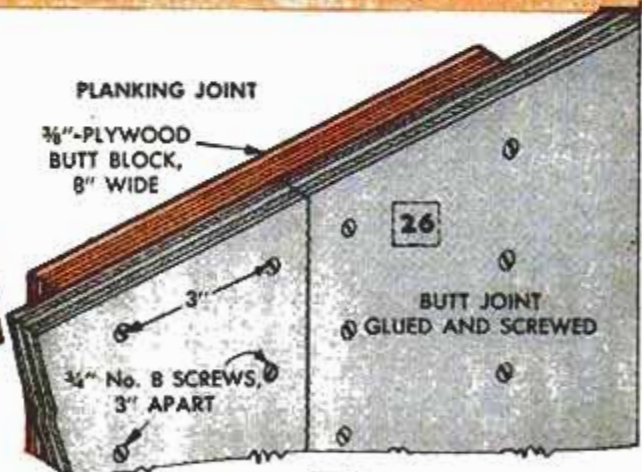
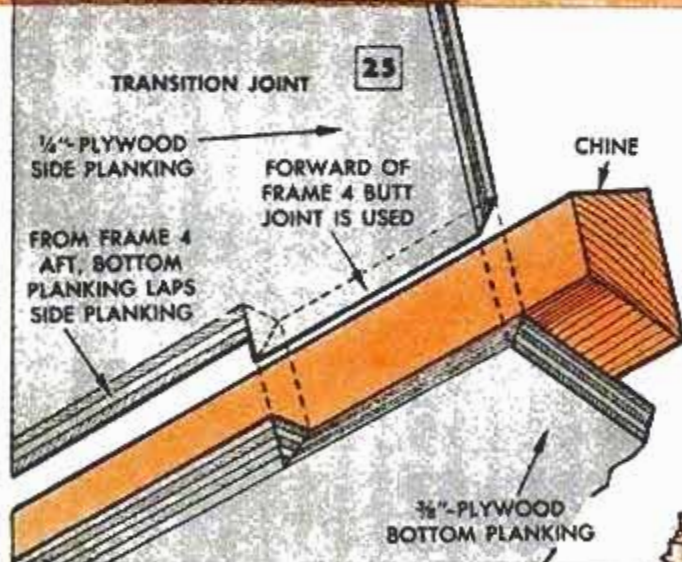
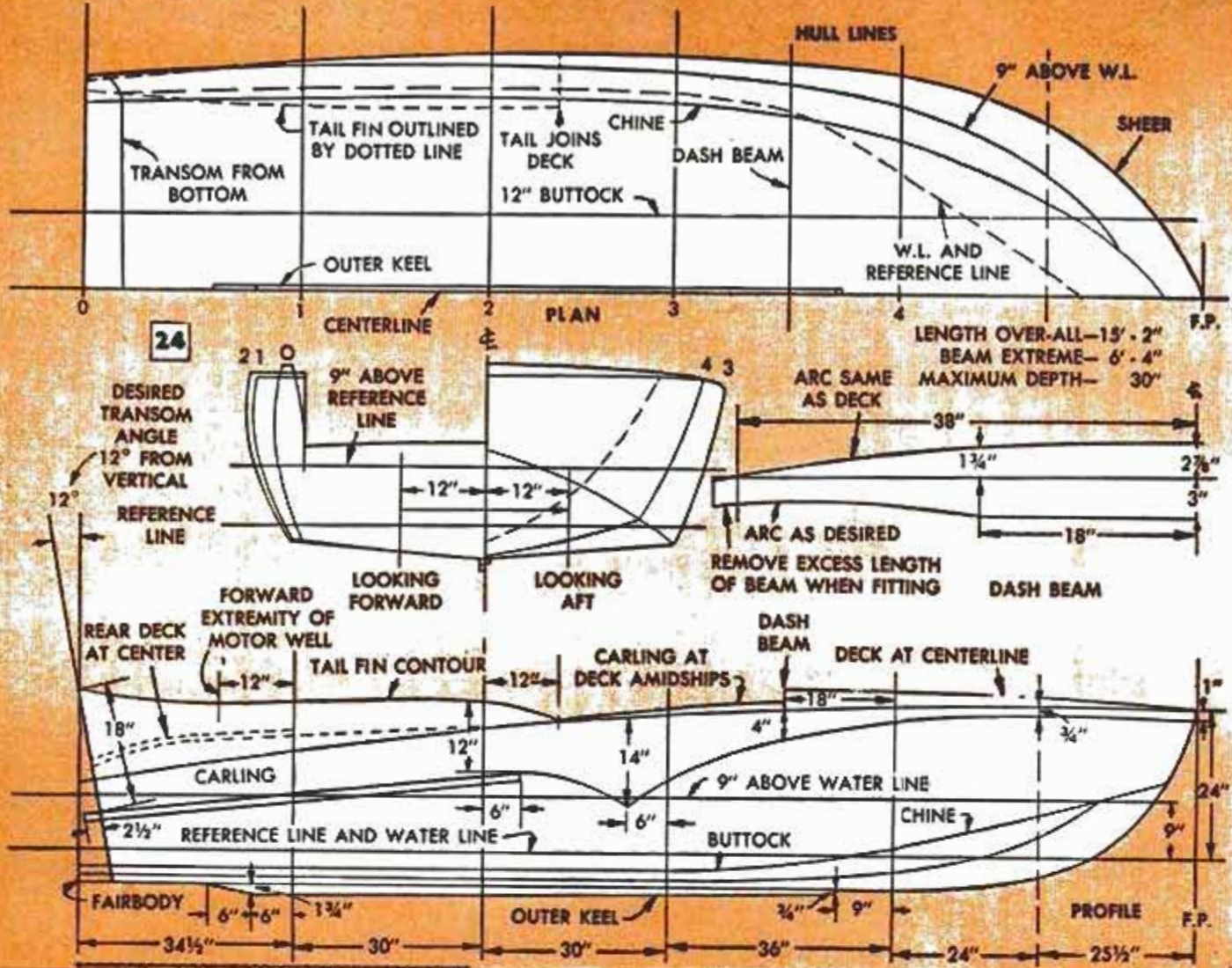
Inboard side of bottom planking is clamped to keel and accurately marked and cut for butt joint on keel. Builder forces planking against stem with knee

Outboard side of bottom planking is allowed to overlap side slightly from frame 4 aft. Forward of frame 4 it is planed to form butt joint with side planking

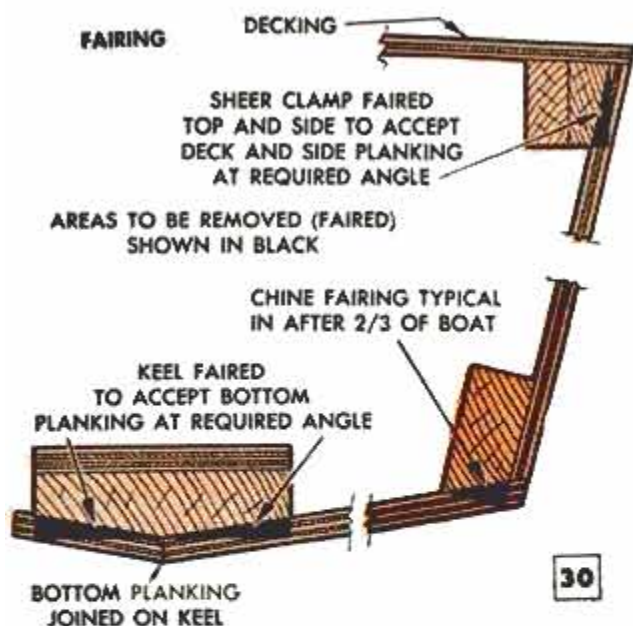


23









particularly difficult about applying the material but it is important that the manufacturer's instructions be followed to the letter. Proper proportions in mixing the catalyst with the resin are most important as is the correct temperature for applying and curing it. The usual procedure for applying glass-fiber cloth is to first apply the bonding agent with a brush or roller and then position the cloth on it, carefully removing all wrinkles and bubbles. Finally, a second coat of the resin-catalyst mixture is applied and allowed to harden.

Before painting the glass-fiber covering, sand lightly to remove rough edges, fill holes with wood putty.

**Painting:** Several coats of primer paint are applied to the hull while it is still upside down on the building form. Before doing this be sure all parts of the hull are completely trimmed and screw holes and other cavities or imperfections are filled with a hard-setting type of wood putty and the entire surface sanded smooth. (Do not sand plywood heavily or use coarse sandpaper.) For the undercoat, use a flat resin-type primer, sanding each coat when dry before adding another. It may take several coats to conceal the fir grain in the plywood and build up a smooth surface. Finish coats of paint should be applied after all construction on the boat is completed.

(To be continued)

### Blueprints Available

Those who prefer to build *Swish* from plans larger than the ones presented in the magazine may purchase a set of blueprints, 21x28 in., by writing Blueprint Department, *Popular Mechanics Magazine*, 200 E. Ontario Street, Chicago 11.

### To Save Both Time and Work

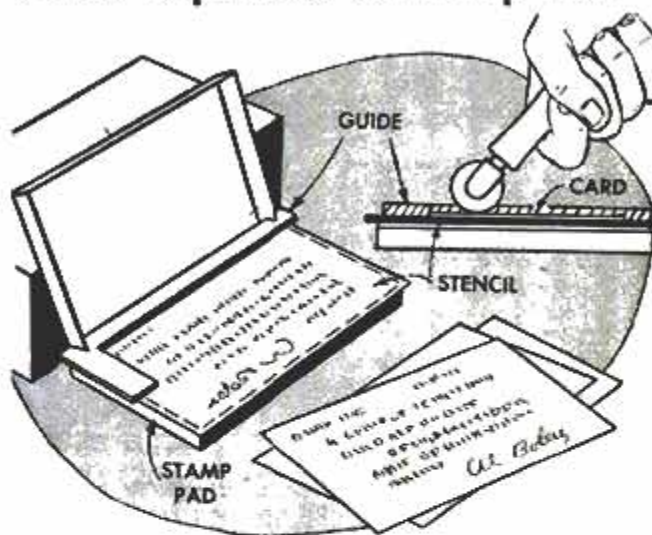
If you wish, you can buy the patterns for the stem, frames, transom, breasthook and chine blocking already drawn full size. And, to further simplify construction, you can buy these parts in kit form accurately cut in mahogany from Glen-L Marine Designs, 9152 E. Rosecrans, Bellflower, Calif.

### Sponge Keeps Print Paper Flat



Unexposed photographic print paper that is stored in the cardboard box in which it is purchased will remain flat for easy handling, if a damp sponge is kept in the box on top of the paper. To prevent drops of moisture from coming into direct contact with the paper, the sponge is placed on a sheet of aluminum foil that is formed around it to expose only the top of the sponge as shown in the photo. Be sure to keep the box closed at all times and re-moisten the sponge when necessary.

### Cards Duplicated on Stamp Pad

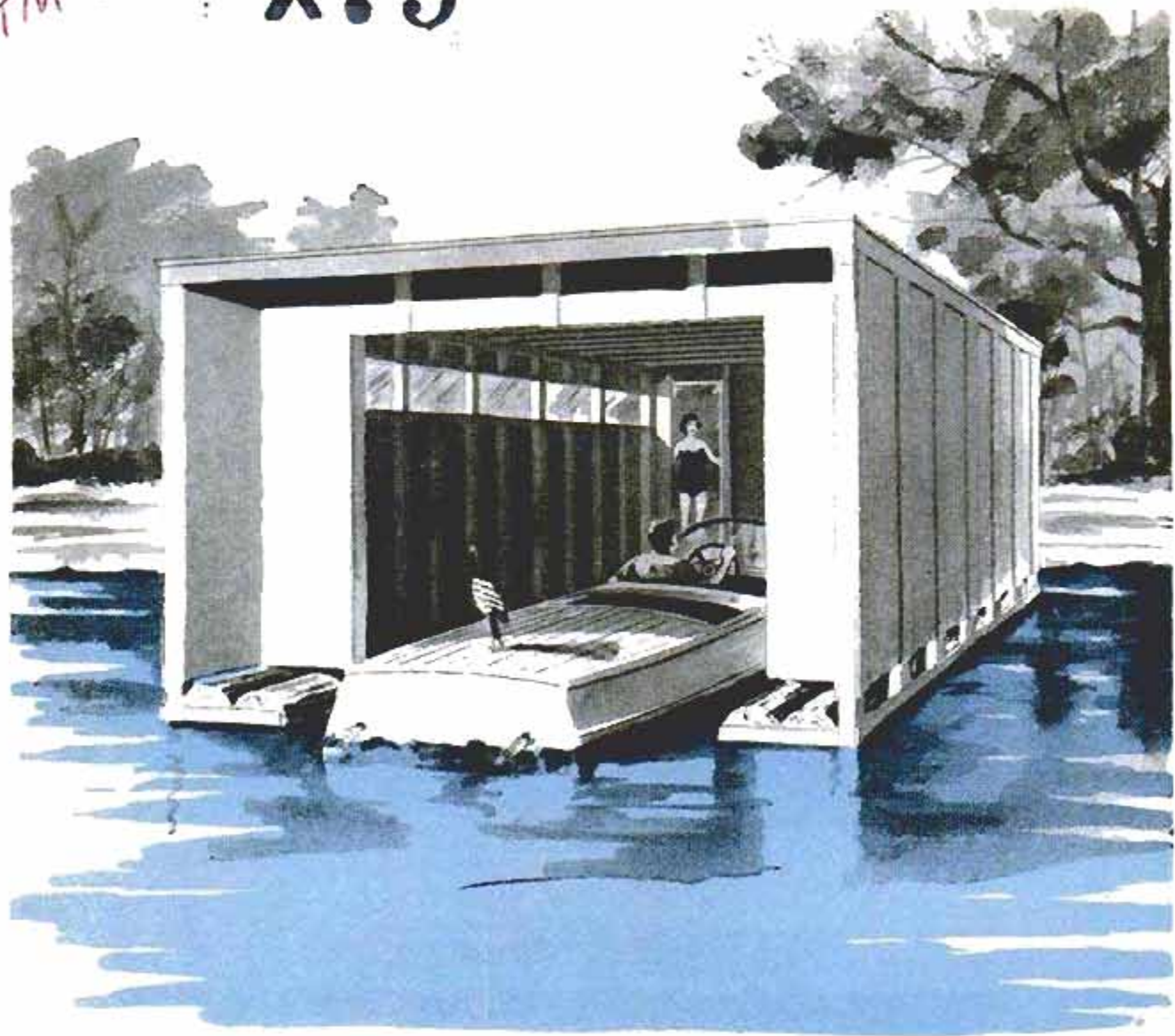


With a stamp pad, small hand roller, stencil and L-shaped guide cut from heavy cardboard, you can "Mimeograph" meeting announcements or other information on post cards quickly and easily as shown. Uniform borders on all sides of the mimeographed message are assured for all cards once the stencil is centered under the guide. The latter has slits cut in the outside edge of its longest leg to accept the ends of the stamp-pad lid for proper positioning of the guide on the pad.



W.T.M. 59

X75

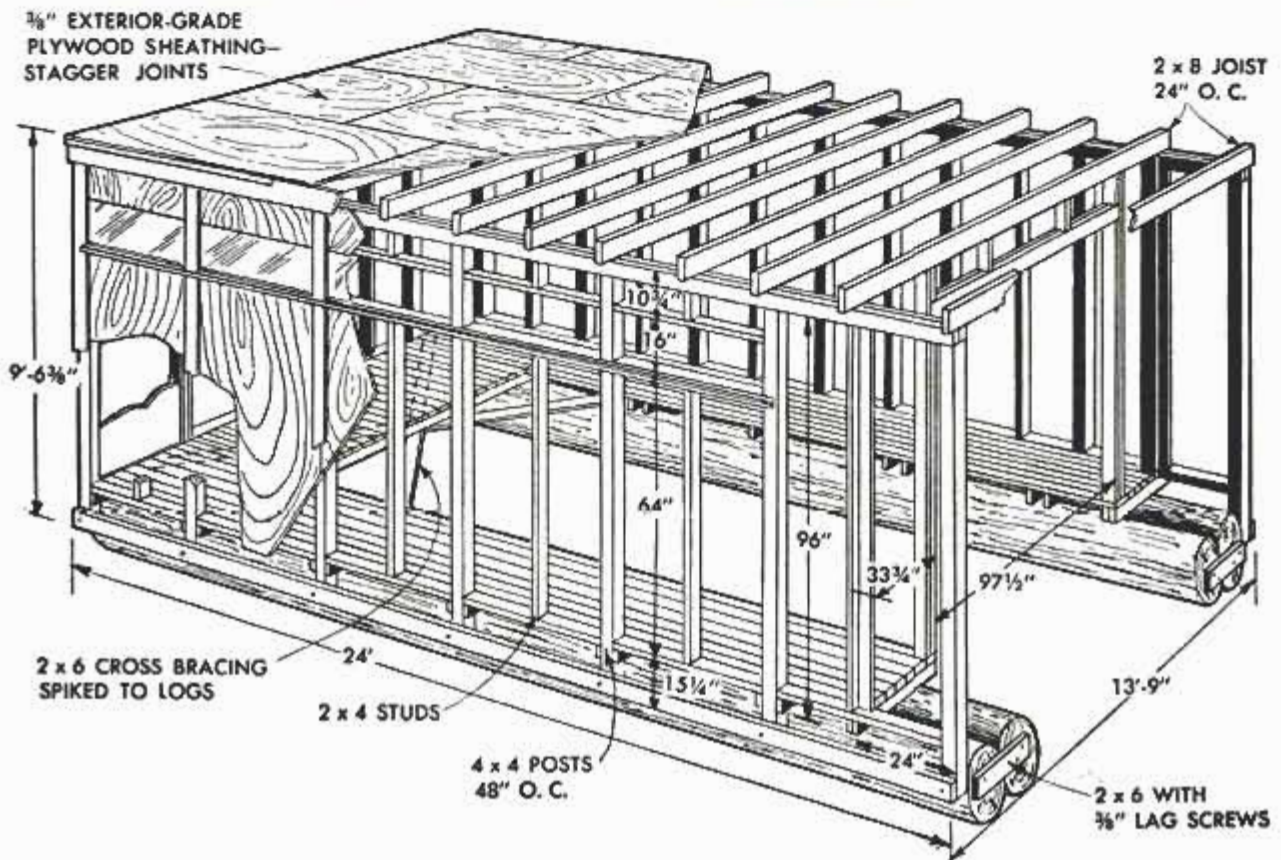
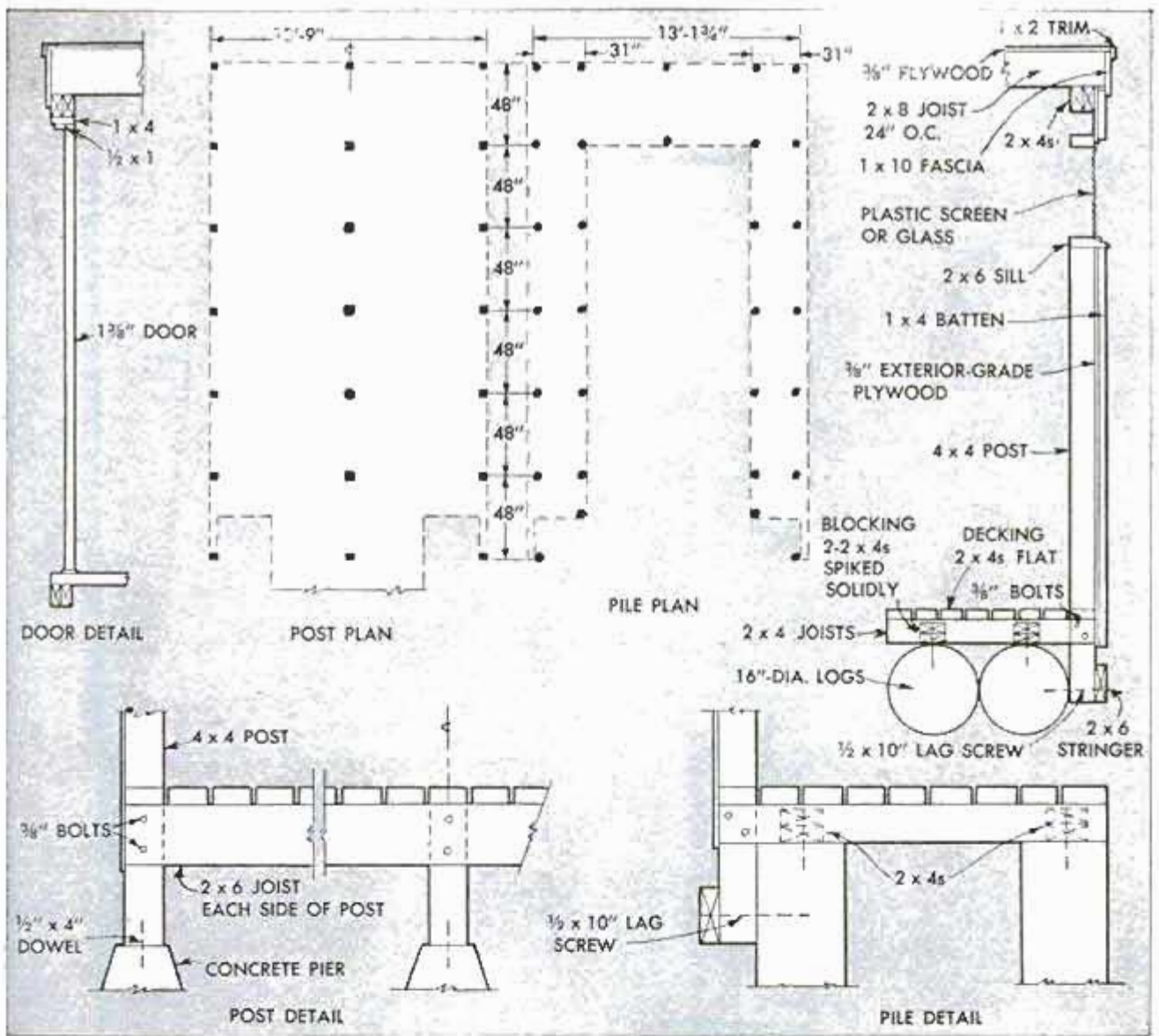


## Build a Plywood-Sheathed Boathouse

**P**ROTECT YOUR BOAT from weather, theft and vandalism by keeping it in this boathouse that is designed to be built by the home craftsman. Great strength and ease of construction are assured by the use of sheets of  $\frac{3}{8}$ -in., exterior-grade, fir plywood. The building may be floated on logs, steel drums or plywood pontoons. Logs are used on the plan shown, but only slight modifications are required to use other means of flotation. If you prefer to have your boat out of the water, the boathouse can be set on posts that are anchored in concrete piers. In the latter case, a 2 x 6 floor joist is spiked or bolted to each side of the posts, the width of the building. Decking, run lengthwise the full width of the boat house, consists of 2 x 4s nailed flat to the joists. The winch used to pull the boat out of the water should be suitably braced. An extra post might be required for some winch installations. Dimensions of a ramp to the water will depend on the boat size, height of the boathouse and other in-

dividual factors. Also, whether the boathouse is built to float, or placed on posts, a short ramp is required leading from the door at the rear of the building down to the beach. A ramp is preferred to a stairway, because motors and other gear can be carried or dragged up a ramp more easily. The door at the rear is an exterior-type door and can be purchased at most lumberyards. Battens used to cover the joints in the walls are either 1 x 4 stock, or 4-in. strips cut from sheets of 1-in. exterior-grade plywood. Sheathing for the open end of the building is formed of two L-shaped pieces cut from plywood. The L-shapes help strengthen the building, preventing it from being twisted or racked by wind and waves. A garage overhead door can be used at the boat entrance, or a drop curtain of canvas may be used, to be rolled up out of the way when entering or leaving with a boat. The roof of the boathouse is covered with roll roofing, all joints heavily tarred. \* \* \*







## Temporary Fences Held Against Stakes by Staples and Wire



Temporary wire-mesh fences, such as are used to keep pets out of flower gardens, can be set up quickly if the method shown is used. Pointed wooden stakes of a suitable length each have three or four staples driven into one side in a line. After driving the stakes in place and holding the wire mesh alongside so the staples project through the mesh, a length of heavy wire, doubled as shown, is slipped through the staples. The wire should be long enough to permit pushing the ends into the ground. This eliminates exposed wire ends.



### Portable Sunshade for Dog

This portable sunshade-shelter for a dog consists of a piece of  $\frac{1}{4}$ -in. plywood nailed to a frame assembled from scrap lengths of 1 and 2-in. stock. It can be moved easily, being lightweight, so the dog can be kept in the shade, and to prevent the animal from damaging a small area of a yard. Because the lawn or earth provides a floor, there is no cleaning problem, as there is with a doghouse. The open construction of the shelter assures adequate ventilation even on the hottest days.



### Fitting Flag on Tent Pole

Boy scouts and other campers who wish to display a flag on their tent will find that fitting a short length of copper tubing over the end of the flagstaff will permit it to be slipped over the projecting spike of the tent pole. It can be removed easily when the tent is taken down. If the staff of the flag is too large to accept the tubing, tape the latter to the side of the staff for the same result.

### Repairing Cracks in Plaster

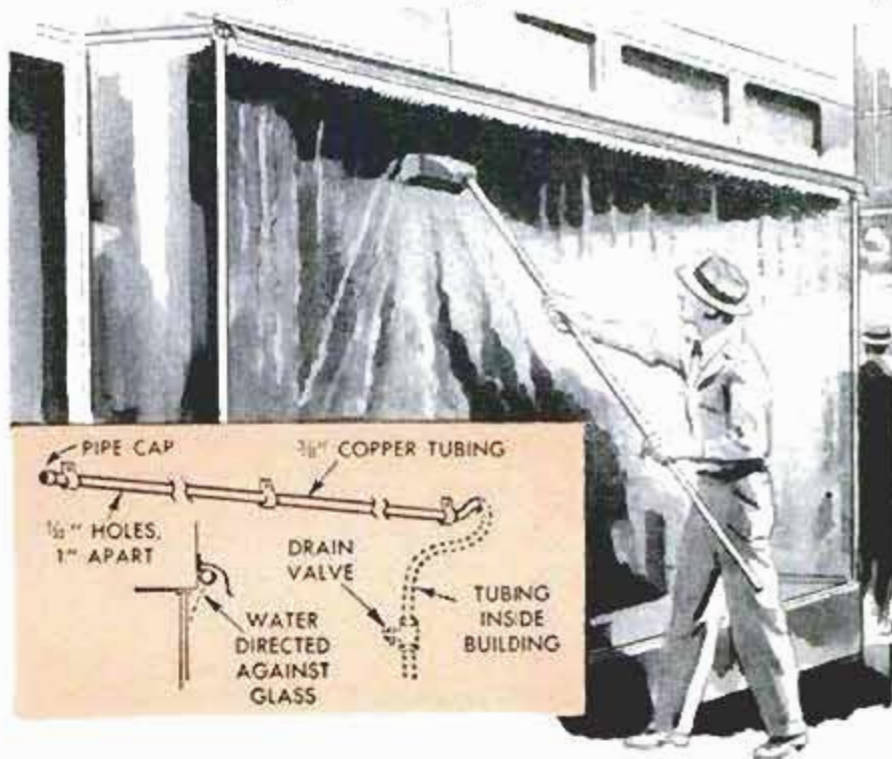
Cracks in plaster, caused by the settling of a new house, should not be repaired until settling is complete. Mark the ends of cracks with a pencil, re-marking them each time they lengthen. When the cracks no longer increase in length beyond the pencil marks, widen them slightly, then fill with spackling compound. Allow it to set thoroughly, then paint or paper.

Sam Fenn, Skokie, Ill.



## Washing of Store Windows Simplified by Perforated Tubing

For store windows that are washed daily, much time and labor can be saved by installing a perforated copper tubing along the top outside edge of the window. The tubing passes through the wall above the window and down to a drain-type valve. When the valve is opened, tiny streams of water are directed on the glass at a 45-deg. angle through  $\frac{1}{32}$ -in. holes spaced 1 in. apart. Removal of dirt and grime is aided by using a brush or rubber wiper while the water is flowing. It is necessary only occasionally to use glass-cleaning detergent.

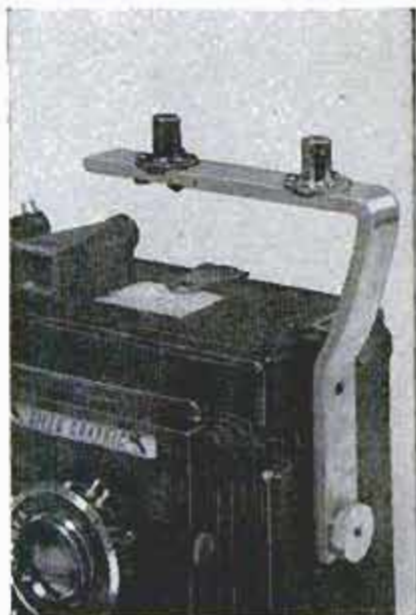


## Bracket Holds Extra Lights for Shadow-Free Photographs

When a single flash gun is located at the side of a camera, it causes harsh shadows to appear beside any subject photographed. One photographer who had this problem with his press-type camera eliminated it by attaching a bracket to the camera that permitted using two additional lights to assure a complete fill-in of light above and on both sides of any subject. The extra lights are fitted with swivel clamps so they can be adjusted to face in any direction. This setup is especially good for taking color shots where lighting is more critical than for black-and-white. The swiveling clamps also permit "bounce light" effects by aiming the auxiliary lights at the ceil-

ing or an adjacent wall. The bracket consists of a length of  $\frac{1}{4}$  x 1-in. aluminum bar, bent as indicated, to pass through the eye and over the clamp of the camera carrying strap. It does not prevent carrying the camera in the usual manner. A hole drilled near the lower end of the bracket is located so that a  $\frac{1}{4}$ -20 thumbscrew can be used to attach the bracket in place of the tripod. Permanent camera mounts on which the lights are clamped—right-hand photo—can be purchased at most photo-supply stores. They are fastened to the upper arm of the bracket with 8-32 screws in holes through the arm.

Frank Fritz, Bensenville, Ill.







### Garden Hose on Wire Fence Eliminates Need for Gate

To prevent youngsters from tearing their clothes or injuring themselves when passing through a barbed-wire fence on the way to a favorite playground, one farmer fitted spirally cut lengths of garden hose over the lower strands of wire. This eliminated the need for a special gate.

### Locking Worn Nut on Bolt



To lock a nut securely on a bolt, even when one or the other is badly worn, slot the bolt end after the nut has been tightened firmly. Spread the slotted bolt slightly with a chisel as indicated. The advantage of this method of locking a nut on a bolt is that simply

squeezing the bolt halves together again will permit removing the nut without filing or cutting.

### Panels "Jointed" With Saw

Instead of planing the edges of plywood panels before butting them, try squaring the edges in the following manner. Lay the panels edge to edge on a flat surface, and temporarily tack or clamp them in position. Then run a power handsaw through the joint, and you will have a better job than if you had taken the time to plane them.

M. Robert Beasley, Jackson, Mich.



### Flameless Charcoal Igniter Made From Range Element

Consisting of a heating element from an electric range fitted with a tubing handle, this device permits igniting the charcoal in a barbecue pit without fuel or flame. The element simply is buried in the charcoal for immediate ignition. An insulated cord runs through the tubing handle.

### Camera Tripod Hung on Eyebolt



A camera tripod can be stored out of the way suspended from a hook in the dark-room when a 1/4-in. eyebolt and two nuts are used. The lower of the two nuts is backed off halfway to form a socket and then the second nut is turned down against it to lock it

in place. The tripod screw is turned into the threads of the lower nut.

Walter Gottlieb, New York City.

### Steel Wool Reinforces Cement

An efficient way to keep furnace cement from crumbling after it hardens is to reinforce it with coarse steel wool. First form the wool in the approximate size and shape of the crack, and thoroughly work the cement into it. Then press the combination cement-steel wool into the crack with a putty knife or screwdriver, and seal with a small amount of cement. Use your finger to smooth the joint.



# On the MARKET

for Do-It-Yourselfers

**1. PLASTIC FORMS** for casting building stone simulating the naturalness and rugged strength of the finest quarried pieces is now available to the building trades and do-it-yourselfers. Each form will produce six pieces, or panels, in these sizes: Two  $1\frac{1}{2} \times 15\frac{7}{8} \times \frac{1}{2}$  in., two  $2\frac{3}{8} \times 15\frac{7}{8} \times \frac{1}{2}$ , one  $3\frac{1}{2} \times 15\frac{7}{8} \times \frac{1}{2}$  and one  $5\frac{1}{2} \times 15\frac{7}{8} \times \frac{1}{2}$  in. The six panels will cover  $2\frac{1}{2}$  sq. ft. Stone can be cast in various colors

Forms, Inc., 4040 W. Lawrence Park Rd., Chicago 48

554 W. ADAMS  
CHICAGO

**2. FLEXIBLE DOORSTOP** screws to baseboard, provides a rigid stop for door, yet bends sidewise or downward at a light touch. Prevents foot or ankle injury, does not interfere with cleaning operations. Rubber bumper will not dent or scratch finish on door. Flanged hex section has wood-screw thread which is turned into small hole drilled in baseboard. Each stop is brass plated and lacquer finished

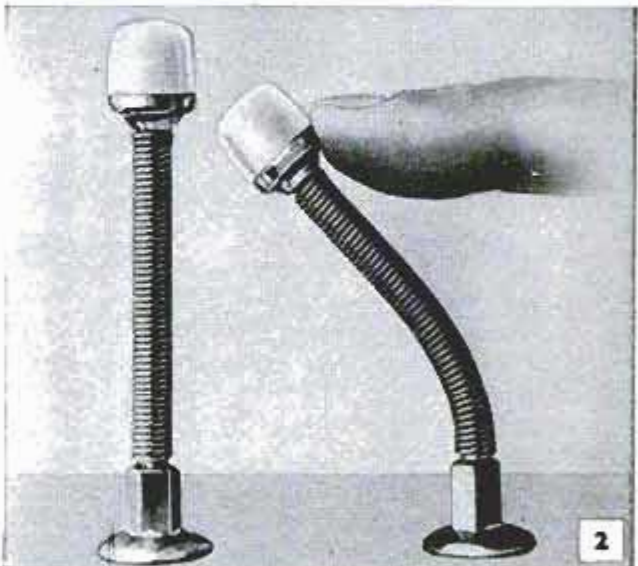
Sherwood Sales Co., 4710 Crenshaw Blvd., Los Angeles 43, Calif.

**3. WATERPROOF COMPOUND** comes in a collapsible tube with a specially designed nozzle for applying the sealer around bathtubs, lavatories, kitchen sinks and for pointing damaged or open joints in plastic or metal tiles. Material flows smoothly under light pressure from tube, making it easy to apply a uniform fillet in a corner where sink or tub joins the wall. Also used for filling cracks, nail holes

Dicks-Armstrong-Pontius, Inc., Dayton, Ohio

**4. ROLL-ON ADHESIVE**, or cement, for installing asphalt and plastic tile on floors, is applied with a long-handled paint roller from a comfortable standing position. Can be used over any floor, hardwood or concrete and over any underlayment. Rolls on in a smooth, uniform coating

Milmark Laboratories, Div. of Mastic Tile Corp., of America, Newburgh, N. Y.







# Buying a Used Camera

By Paul O. Schmidt

**I**F YOU HAVE GRADUATED from the box camera and are considering joining the more advanced group of "shutterbugs," you can find exceptional values in the used-camera market. There's no need to get a dud or be disappointed in the performance of the camera, if the following simple precautions are taken: First, and most important, decide upon the type of camera most suitable for your needs and capabilities. Anyone can take reasonably good snapshots for the family album with an ordinary box camera, a roll of film and a little enthusiasm for photography. However, for negatives that must be exposed under varying light and weather conditions and then enlarged, a camera is needed that has a fast lens, a good range of shutter speeds and accurately synchronized flash. Secondly, study buyers' guides, photo magazines and catalogues to learn what is available in the type of camera you want. Make special note of important characteristics featured in each camera, such as lens speed, shutter speeds, automatically actuated components, coupled range finder, etc. Also, check accessories included and

price of each camera, information you will need to know later when comparing prices of new cameras with used ones. Finally, unless you are buying a camera from a reputable dealer, someone should accompany you who has sufficient knowledge of camera mechanics to spot common defects and can judge its value. If such a person cannot be present to advise you, it's best to take the word of a reputable dealer.

When deciding upon the type of camera to purchase, it is important to consider the type and size of pictures you want. There is no camera that is suitable for all purposes, regardless of price. For example, you may want a camera that takes a film size that is suitable for making big enlargements without grain effect. Or, you may want one that will enable you to take single shots on sheet film instead of using an entire roll of film before developing it; one that is especially suited for taking color transparencies of economical size, or one that will produce a finished picture seconds after it is snapped. Also, you may want a camera with synchronized flash for night pictures or fill-in lighting.



### Popular Types of Cameras

The basic types of cameras beyond the box type are: (1) folding cameras, (2) 35-mm. miniatures, (3) reflex cameras, (4) press and view cameras, which really are modified folding and box cameras respectively, and (5) specialized cameras. Cameras in each of these groups are further divided into three price ranges—low cost, intermediate and premium, the latter including cameras having the most refinements. Most cameras use roll film. Many of them have mechanisms that control shutter cocking to prevent double exposures, have delayed shutter action and exposure counters. Some have coupled range finders that focus the cameras as the range finders are focused. A few of the 35-mm. "automatics" have a single control that releases the shutter, advances the film, counts the exposure and cocks the shutter for the next shot, permitting pictures to be taken in rapid sequence.

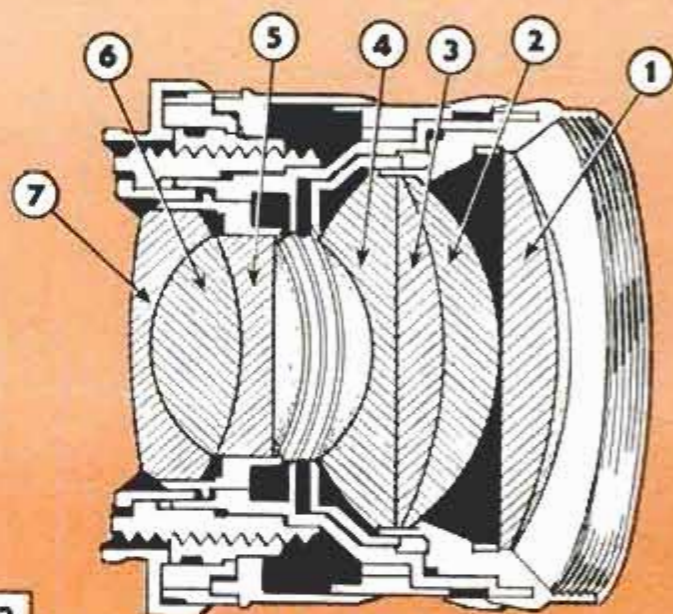
The bellows of folding-type cameras make them more compact than the box camera for convenient carrying. Inexpensive models are as simple to operate and as limited in picture-making potential as the box camera. More expensive ones have lenses, shutters and accessories which greatly increase their picture-taking ability. This type also takes album-sized negatives, an important advantage over 35-mm. miniatures.

Miniature cameras also are compact and use economical 35-mm. film. Usually they feature fast lenses and rapid shooting. A very wide variety of lenses, shutter-speed ranges and accessory combinations are available with this type of camera. They make sharp black-and-white negatives or the popular color transparencies approximately 1 x 1½-in. size. These cameras are not difficult to master but require precision use because the small picture size makes projection or enlargement imperative.

Perhaps you desire a reflex-type camera having a horizontal, waist-level ground-glass viewer the same size as the negative. Some models of this type are now equipped with prismatic viewers for easier, eye-level viewing and focusing. Most reflex cameras are available in negative sizes of 35-mm. or 2¼ x 2¼ in. There are single and twin-lens subtypes. The first has one lens for viewing and exposing, which avoids parallax—the difference in fields of view when separate taking and viewing lenses are employed. A single-lens reflex often is preferred for exacting close-up work, particularly when using interchangeable or auxiliary lenses. If you anticipate a need for multiple lenses, be sure the desired lenses are available for the camera. A twin-lens reflex camera has matched lenses



Above, condition of focusing mechanism of twin-lens reflex camera is determined by noting amount of play found in members of movable lensboard



MULTIPLE-ELEMENT LENS

Fig. 2, expensive lens is composed of several optical elements, some of which are cemented together to form cells as elements 2-3-4 and 5-6-7 of lens shown

Below, worn bracket pivots or bent brackets that hold lensboard in required position may cause lens misalignment and make accurate focusing impossible







Above, this camera has been dropped on hard surface, resulting in severe damage to shutter housing and attached mechanisms making the shutter inoperative

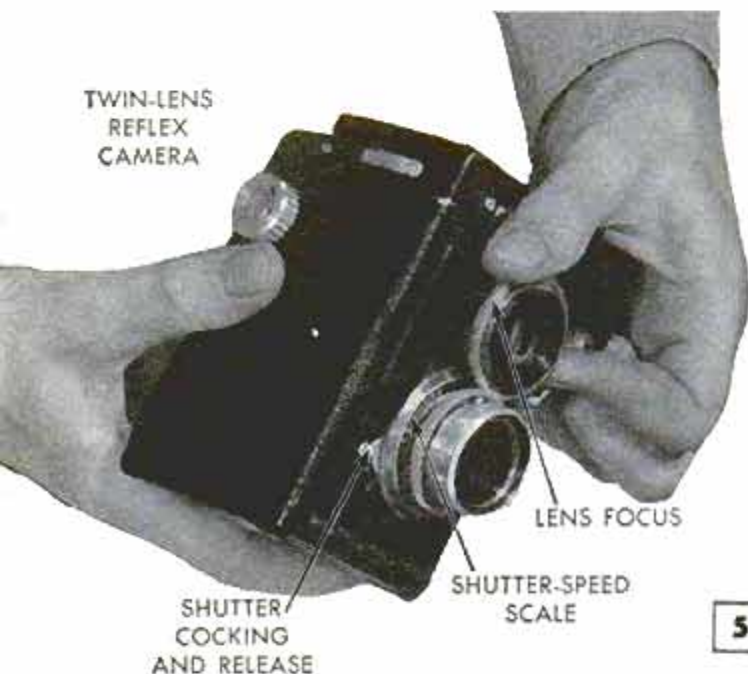
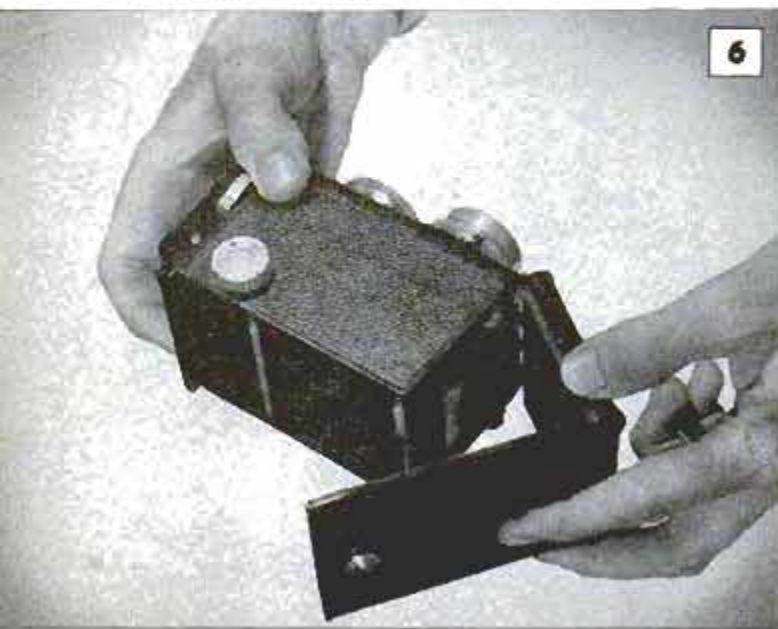


Fig. 5, lens-focus mechanism of reflex camera (also, cameras with coupled range finders) should operate smoothly without excessive play or gritty feeling

Fig. 6, chipped edges on sides of plastic reflex-camera body, or warped or bent back may result in improper closing of camera to cause light leaks



that move in unison when focusing. Some have automatic parallax correction but most do not. The amount of correction for the latter must be estimated or calculated by the photographer.

Press-type cameras, which are larger and heavier than most others, are highly versatile and use sheet film, although adapters for roll-film use are available. The 4 x 5-in. negative size is the most popular because it permits making large size fine-grain enlargements without loss of detail or sharpness. The field of view can be seen in miniature through an eye-level view finder, or negative size on a ground glass at the back. Many have adjustable lensboards to control perspective, and some have double extension bellows for extreme close-up work. Because of its bulk and relatively expensive film and print costs, the press camera is suitable only for serious amateurs and professionals.

In the specialized class are subminiature cameras that are easily concealed in the photographer's hand or clothing when taking pictures. The tiny negatives can be enlarged to album-size prints but a high degree of skill is required to produce acceptable prints. This is a limited-use camera. "One minute" cameras have many specific applications where immediate prints are desired. Duplicate prints and enlargements can be made by copying the original. Stereoscopic cameras are equipped with two taking lenses that simultaneously take two pictures of the same subject from which color transparencies are made and mounted in pairs on a slide for viewing. When viewed together, the two nearly identical pictures present a lifelike third-dimensional effect.

An experienced camera enthusiast may find a used-camera bargain in an unknown second-hand store or elsewhere, but the average camera buyer's greatest assurance of good value lies in buying from a reliable dealer. Remember that when he takes a camera in trade for resale, the dealer protects himself by fully evaluating its condition. If needed, the camera is cleaned and reconditioned in his shop or by a reliable repairman. Further, a dealer usually gives some type of guarantee. This may be in the form of money refunded, exchange privilege, or repair or replacement. A dealer cannot be expected to give an unconditional free-trial period since careless customers may damage cameras.

#### External Inspection of Camera

When checking the condition of a camera, first inspect the outside, then the inside. Finally, load the camera with film and make a few exacting tests of its performance for each photographic situation.





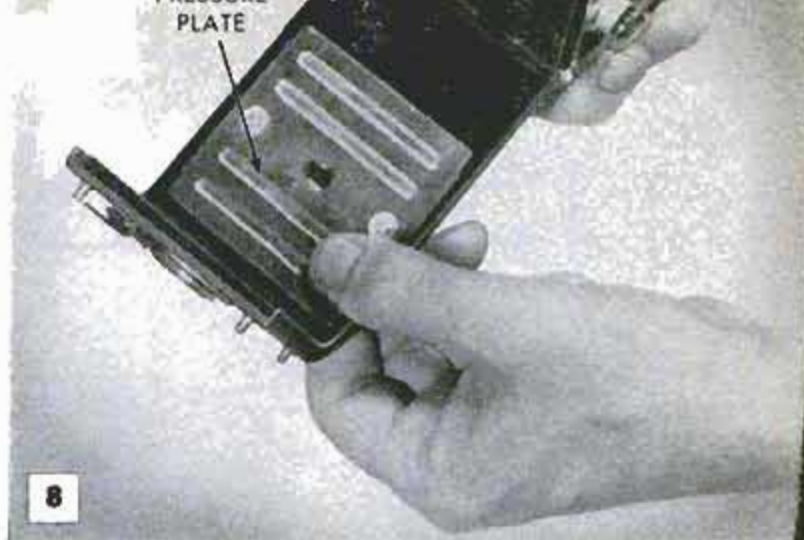
Loose-fitting camera back should be checked for light leaks that may be caused by missing or tightly compacted yarn packing in grooves in camera body

Honest wear on the outside may detract from a camera's appearance but does not impair its picture-taking qualities. However, look for obvious signs of abuse, such as deep scratches, gouges, cracks, bent or dented parts resulting from careless handling, Fig. 4. If rust is found on exposed metal parts, the camera may have been stored in a damp place and may have rust-damaged parts inside also.

Lenses help make a picture look the same to your film as it does to your eye. They differ in quality, in the amount of light they can transmit and in the size of picture image they focus on the film. Speed, or light-passing ability is rated in f-numbers. The lower a lens' f-number, the greater its light-passing ability. Lenses with considerable light-passing ability have diaphragms over them (usually between lens cells) for use at less-than-maximum opening when desired. Most box-camera lenses are of the fixed-focus type, in one piece and are usually rated at f:11. More powerful complex lenses rated at f:4.5 to f:1.1 consist of many elements of glass, Fig. 2. This is one reason why cameras in which they are used are more costly than box cameras.

If a lens is coated, generally blue but sometimes amber, see if it is intact. If not, it can be recoated at little cost. However, a yellowing appearance in a lens other than a coating likely is the result of disintegrating balsam cement used to hold the elements together. This does not affect the lens quality at first, but as the condition advances it will reduce picture quality. Such a lens can be recemented at considerable cost.

A few tiny scratches on a lens or small bubbles inside do not affect its optical quality, but large ones do. It is important to note that cheaper cameras equipped with high-speed lenses may produce bad picture definition and lack brilliance at



Pressure plate that holds film against retaining frame surrounding exposure area should be smooth and exert uniformly light pressure against film

full or near-full diaphragm opening. Thus, the lens may not be usable for photographic situations requiring such lens openings due to defective optical elements or inferior workmanship in assembly. Also, it is essential that a fast lens be fitted to the camera body with more exactness than a slower one.

A lens on its mount or lensboard, when set in its normal position (some are adjustable for height and tilt), should be parallel to the film plane, Fig. 1. Check on the focusing track or tracks on most bellows-type cameras to see that they are tightly attached to the bed and at right angles to the back. On folding cameras usually the lens mount is held by pivoted arms, Fig. 3. If these are bent they may interfere with smoothness of focusing, with opening and closing the camera and may hold the lens out of alignment.

If a camera has a focusing knob, turn it to move the lens completely forward, then backward to check for ease and smoothness of focusing. A bent shutter housing, Fig. 4, or defective gear linkage can cause binding and uneven movement. On cameras that are focused by rotating the lens on a spiral thread, the action should be smooth, without binding or gritty feeling.

On a folding camera examine the bellows to note its general condition. If brittle or patched, chances are that it leaks light or soon will. Also, check the back of the camera for proper opening, closing and locking. A bent or sprung back can cause light leaks, Fig. 6. Also, light leaks may be caused by compacted or worn yarn packing in the grooves in the camera body that receive the cover, Fig. 7.

#### General Inside Check

The entire inside surfaces of the camera body should be flat black. Bare or shiny spots on wood or metal may reflect light and ruin good pictures. Such spots can be





Above, film-wind knob should move forward only without binding or excessive play. Parts that come in contact with film must be smooth and free of rust

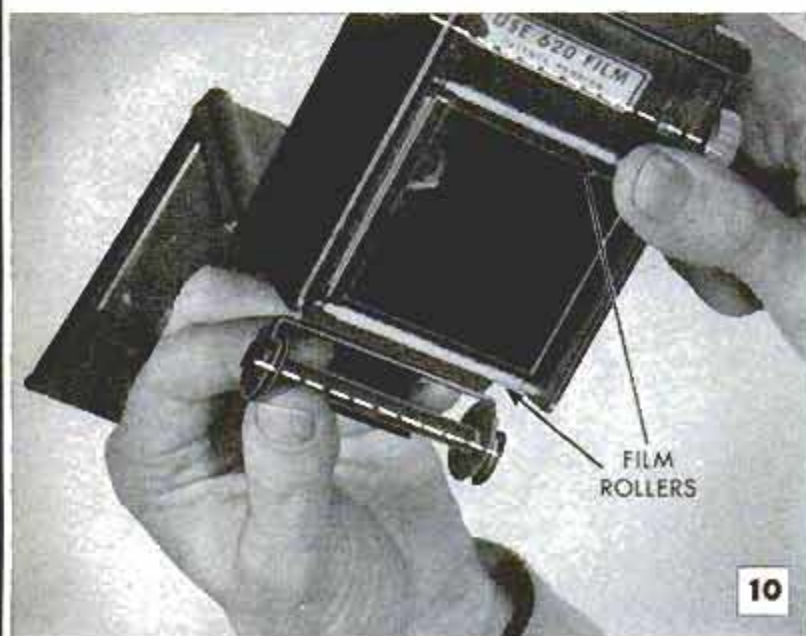


Fig. 10, film spools must be held parallel to each other in camera and film rollers turn freely to permit smooth operation of control for film advance

Fig. 11, film pack must fit snugly in adapter on camera and accept and permit withdrawal of slide without entry of light that would damage film



touched up with a coat of flat-black paint.

On roll-film cameras, the parts on which the film slides must be absolutely smooth and rustfree to prevent scratching the film. The pressure plate that holds the film against the retaining frame also should be smooth and exert uniform but rather light pressure, Fig. 8. The film-advance knob should turn forward only without binding and without excessive play. The film should move easily without strain. This you can check by loading the camera with an exposed film. The spools should be parallel so that the film will move straight and under uniform tension on both edges. Otherwise it will go on the takeup spool unevenly or loosely, permitting it to become light-struck when the roll is removed from the camera.

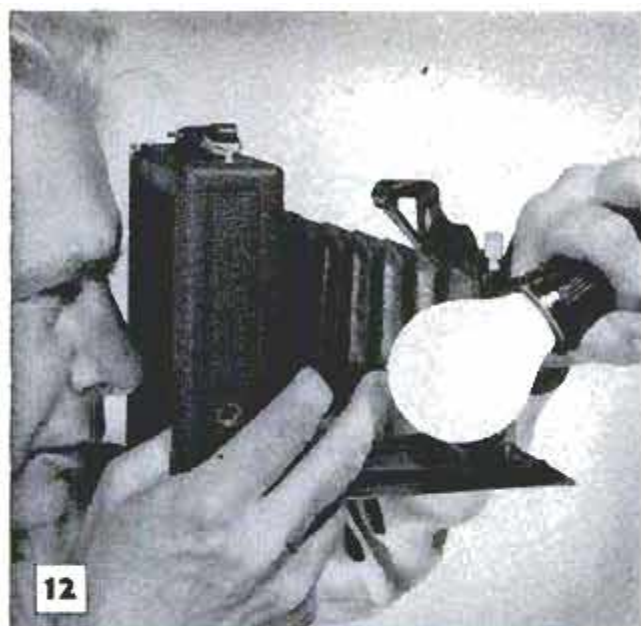
Cameras on which the film transport also controls the shutter cocking, the mechanism for prevention of double exposures, exposure counting, etc., should be checked with a test film to be sure all the features work properly. On cameras using sheet film, the film holder or film pack should slide in and out freely, yet clamp snugly into position. With the camera back open, inspect the surface of the lens element facing you. Then, open the shutter and lens diaphragm and look for deep scratches and bubble clusters. Next, close the diaphragm slowly while looking through it. The opening should remain nearly circular at all openings which indicates that the diaphragm leaves are working properly. If the aperture assumes an irregular outline at any opening, the leaves may be loose on their pivots.

When checking a bellows for light leaks, look inside while holding a lighted electric lamp next to it as in Fig. 12. Close and extend the bellows during this test.

Erratic shutter speed is a common fault of many old or dirty cameras. The shutter blades may be worn, bent, scratched or dirty, any one of which may interfere with its smooth action. Oil causes shutter blades to stick and collect dust. It should never be applied. To detect shutter inaccuracy for obvious faults, operate it a dozen times or more at each speed marked on the camera, carefully observing its speed by ear and visually. Not the slightest trace of light should be seen through the shutter when it is closed.

A flash attachment can be tested for continuity of wiring as follows: Place a flash-light bulb of proper voltage in an adapter that fits the flash socket. Then, momentarily short the two contacts in the attachment plug, which should cause the bulb to light. Precision checking of flash synchronization is a job for an expert camera repairman who has equipment to check the





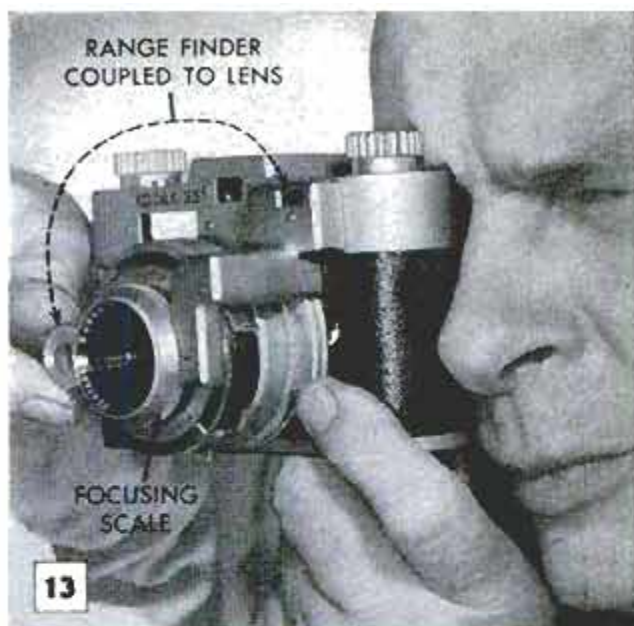
12 Electric light is held close to camera to locate light leaks that are most likely to develop at sharp bends and points of attachment of bellows

millisecond delay. About the only way you can discover error in timing is to shoot a roll of film and observe whether flash pictures taken at recommended settings are properly exposed.

To check a coupled range finder, simply mount the camera on a tripod and set the aperture at its maximum opening. Then, remove the back of the camera and tape a square of ground glass or wax paper over the film plane, the area normally occupied by film when exposed. An image produced on the film plane should have maximum sharpness when the lens setting on the focusing scale corresponds to the measured distance between the camera and subject.

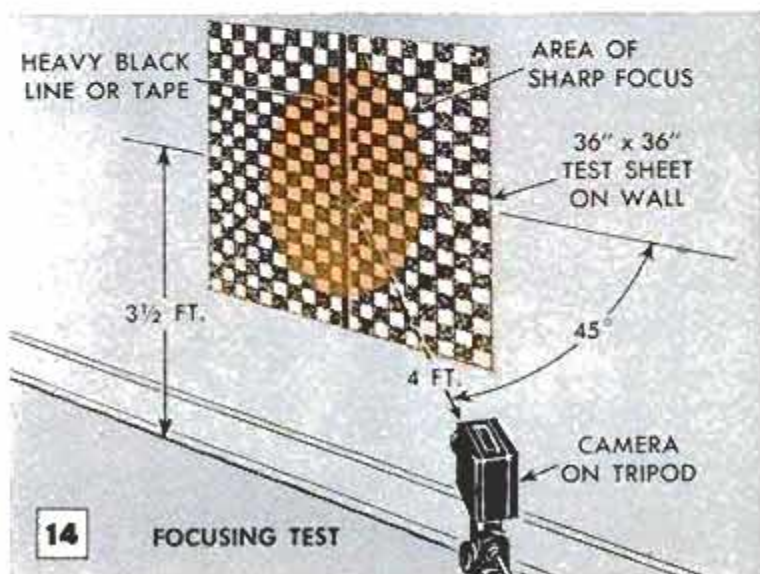
A test to determine accuracy of lens alignment in the camera is made as follows: A 3-ft.-square test sheet of white wallpaper or dull-finished oilcloth having a very distinct pattern is taped to a wall as in Fig. 14. The sheet should be perfectly flat and centered about 3½ ft. above the floor. A length of black tape or heavy black line is applied to the test sheet vertically over its center. Then, the camera is positioned at a 45-deg. angle from the wall exactly 4 ft. from the lens to the tape. The test sheet should be illuminated uniformly as determined by a light meter. "Bounce" lighting is best for this purpose.

Next, with the lens aperture fully open, photograph the test sheet, and repeat from a distance of 10 ft. at the same angle. Underexpose the negative slightly so that it will be relatively "thin." If this is carefully done, the tape and a small area on either side of it



13 When range finder is coupled to lens, distance from camera to subject focused upon should be same as that which is indicated on focusing scale

should show up in very sharp focus. If the area of sharp focus centers on either side of the tape, the distance between the lens and the film plane is incorrect in relation to the readings on the focusing scale. Many cameras have adjustments to correct such errors. A misaligned lens mount also can cause either end of the tape to be out of focus. After taking such close-up photos, make a head-on exposure of a contrasty building with the camera set at infinity. This should produce an image of uniform sharpness over the entire negative. If it does not, some type of repair may be necessary the extent of which can be determined only by a competent repairman. Never buy a camera that does not operate properly, even when allowance is made for necessary repairs. Until repaired, an inoperable camera can't be given the various checks necessary to determine its mechanical condition and quality of the lens. ★ ★ ★





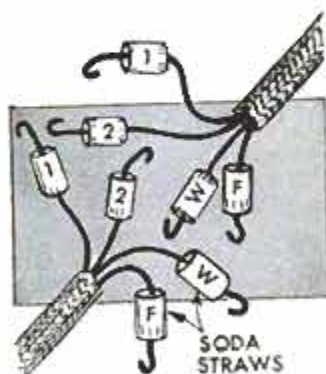
## Handy Memo Pad Attached to Wall-Mounted Telephone



Writing on a memo pad while using a wall-mounted telephone is no problem when this simple accessory is fitted to the board on which the phone is mounted. A length of copper or brass flat stock is bent as indicated to support a piece of 1-in. pine measuring about 5 x 7 in. The bracket is drilled and attached to the phone board with wood screws. The memo pad is thumbtacked to the board as shown.

## Straw Sections Mark Wires

There will be no confusion as to which wire connects to which when reassembling an electrical hookup if the corresponding wires are marked with numbered sections of soda straws when parted.



## "Haircut" for Paintbrushes

If the outside bristles of paintbrushes become frayed and worn, they may be removed easily. Using a hacksaw blade as a guide, insert it between the good bristles and the unruly ones. Then with shears or snips merely trim the frayed bristles, without danger of cutting the good ones.

## Carpeting Used as Tree Mulch

Pieces of discarded carpeting are used by one homeowner as "mulch" around young fruit trees. A hole is cut in the center of the carpeting, which then is slit and fitted around the tree trunk. Rocks are used to keep the carpeting in place.

Bil Toman, Palatine, Ill.



## Sponge Oils Overhead Pulley

An overhead pulley that is difficult to reach may be lubricated with an oil-soaked sponge tied to the rope or cable. The sponge should be large enough so that it will be squeezed as it passes through the pulley, which will cause the oil to run down onto the pulley shaft.

## "Custom Made" Wrecking Bar

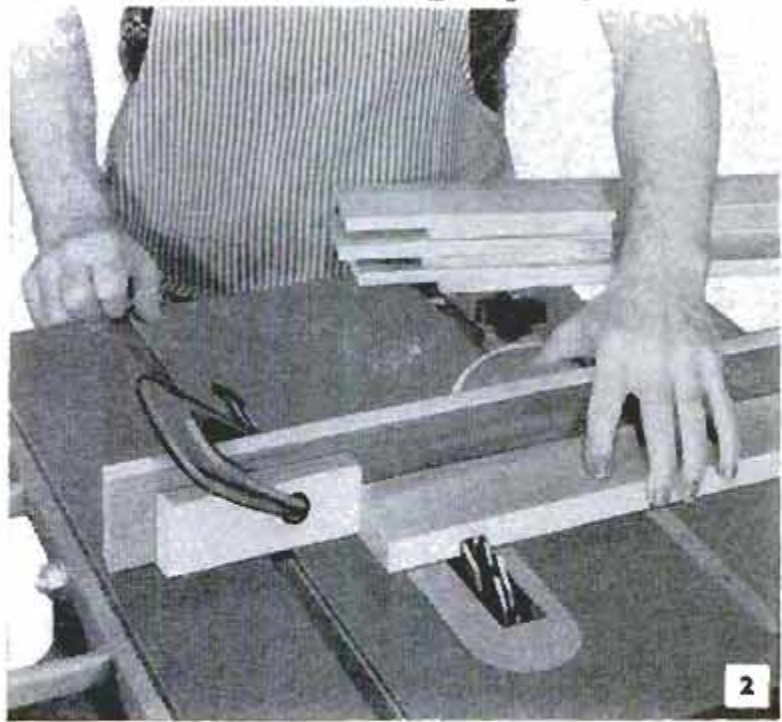
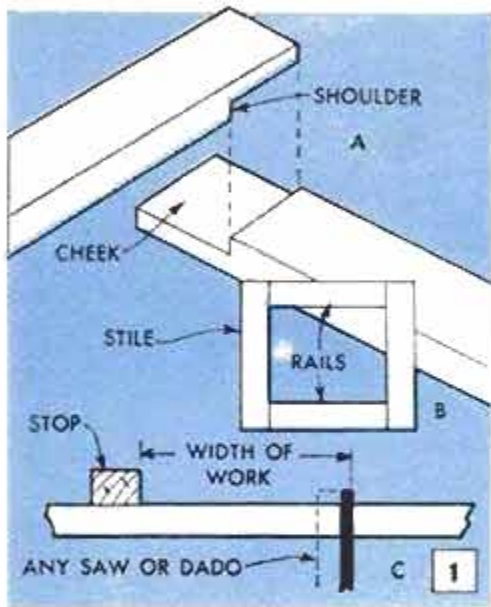
To extend the "reach" of a wrecking bar, and to reduce the chances of splitting lumber being pried, one farmer modified the bar as shown. It first was bent as indicated, then an angle and brace were welded to the lower end. The bar was extended by welding on a length of pipe.





# SHOP NOTES

X379



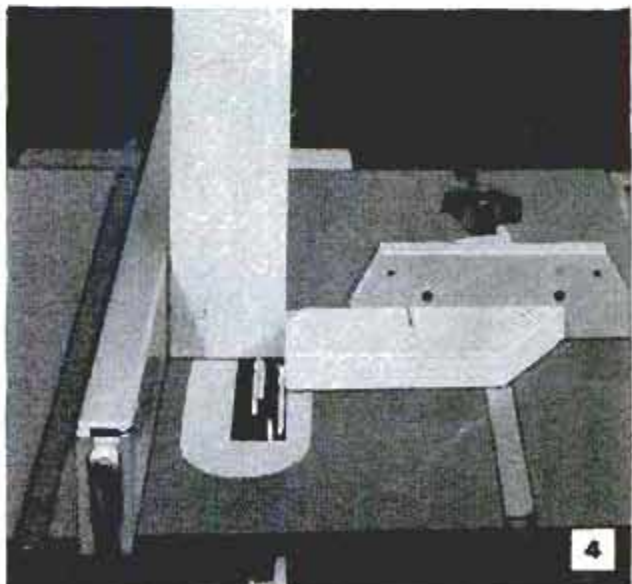
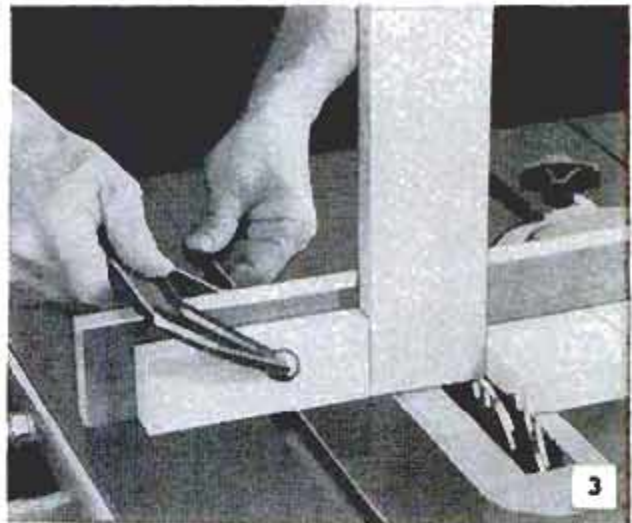
## How to Cut Lap Joints

SN  
10/11/59

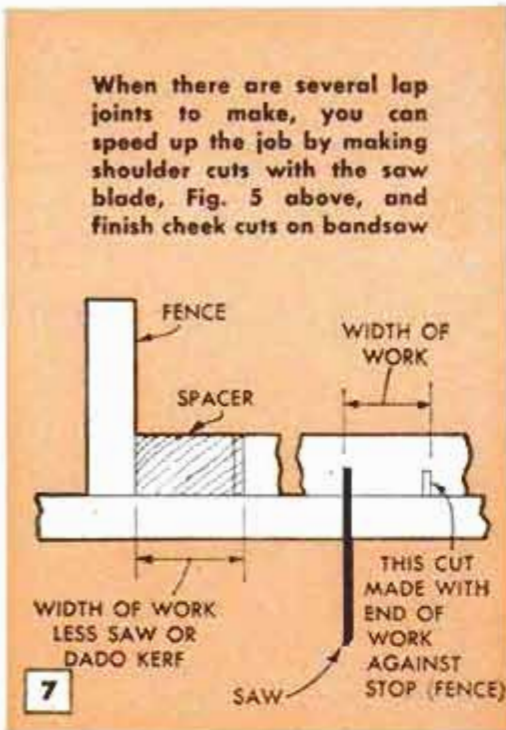
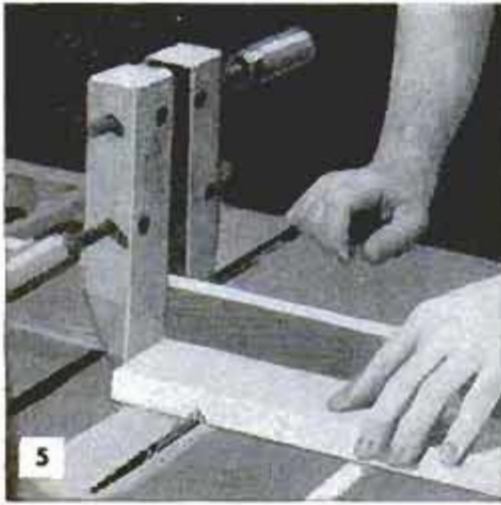
By Sam Brown

**I**F YOU MAKE your own screen frames or storm sash, frame hardboard panels or build a sawbuck table, you will need to make very accurate lap joints. The end lap is the simplest to make, either by hand methods or complete on the circular saw. The cross lap, or middle lap, requires a bit more care when making the setup. The same is true of the oblique lap, or angle lap, as it is sometimes called. When made accurately and then joined with glue and wooden pins, the end lap makes a strong, serviceable joint for the four corners of a frame such as that for a storm sash or screen. Where appearance of the finished job is of some importance it should be remembered that a frame assembled with lap joints at the corners generally looks best with the stiles unbroken as in Fig. 1, detail B. The assembly should be planned and the joints cut accordingly.

When making the end lap on a circular saw the stiles (vertical members) and the rails should be cut to final, or net, length. The shoulder cut is made with the saw blade or dado set to cut half the thickness of the stock. Be sure that this setting is accurate, then locate the stop block (a clamp also can be used, Fig. 5) and clamp it in position. Note that the stop is located from the far side of the dado head (or saw blade) and that the distance is equal to the width of the stock, Fig. 1, detail C, and also Fig. 3. If you use the miter gauge without a facing board, then the ripping fence





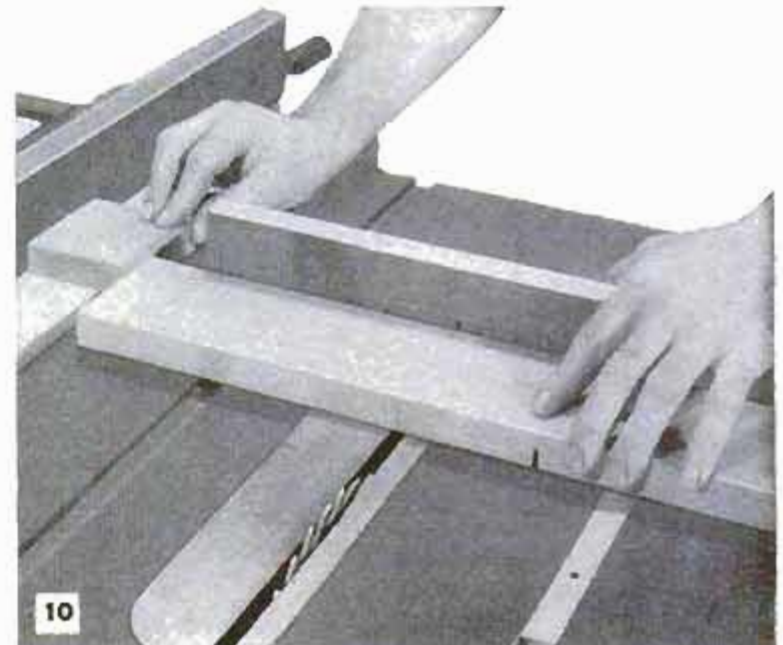
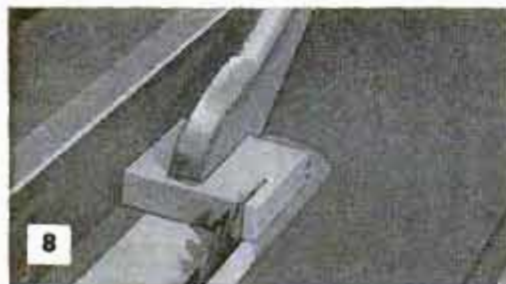


can be used as a stop, Fig. 4. The initial, or shoulder cut, then is made as in Fig. 2. When running the end lap on the power saw there are two ways of removing the waste. The first is by repeated passes over the dado head, shifting the stock after each pass, or by running the shoulder out first as in Fig. 5 and finishing with the cheek cut made on the bandsaw as in Fig. 6. The former method is perhaps the most accurate.

The cross or middle-lap joint is generally used to join two pieces of stock at the center to form a cross. When accurately made it's a strong, durable joint. Although the shoulder cuts can be made to pencil marks alone with reasonable accuracy, it's better to make the setup with a stop (the saw fence) and a spacer block. The spacer should be of a length equal to the width of the work less the width of the saw or dado kerf, Fig. 7. The best way to make a stop block is to remove the kerf width from a scrap piece of the work stock as in Fig. 8 and then nail the two pieces together as in Fig. 9. Fig. 10 pictures a block made in this manner being used to set the second shoulder cut, the first shoulder cut having been made with the fence used as a stop.

When making cross lap, an accurate spacer block is essential. Make one as in Figs. 8, 9

Cutting the oblique cross lap, Fig. 12, requires careful attention to detail when making the setup.

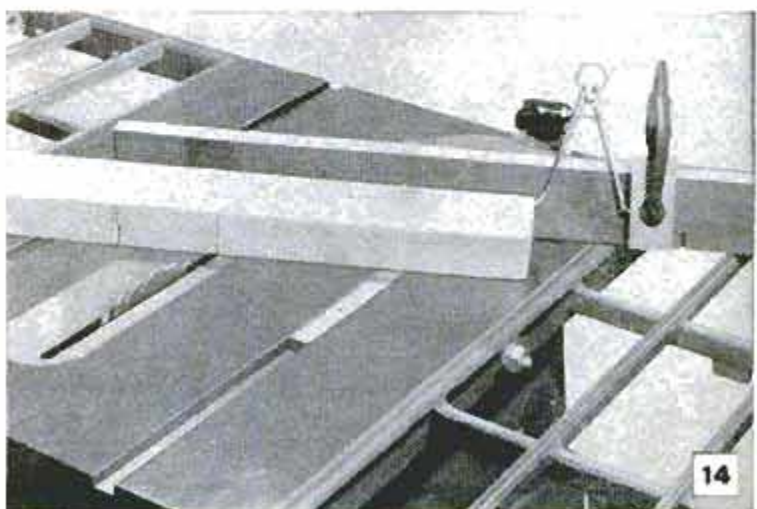
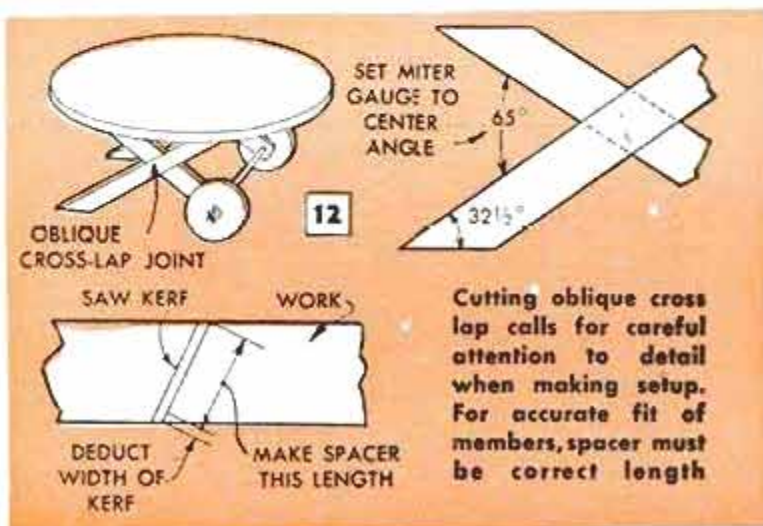
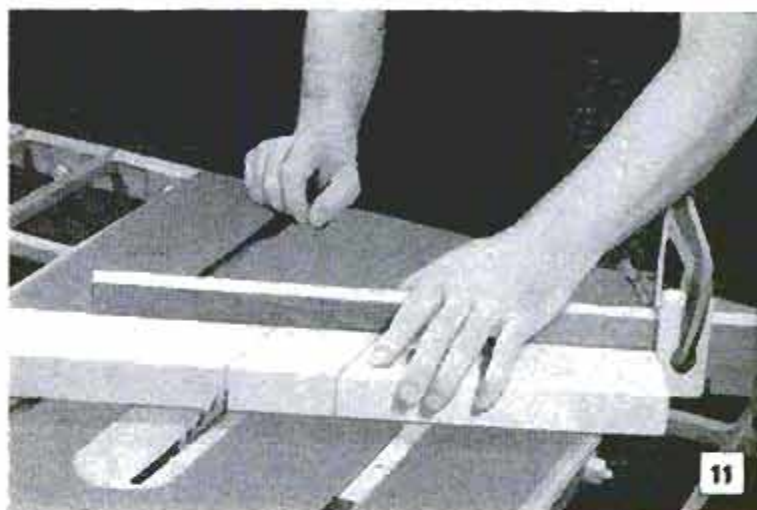




Both members of the joint are cut in the same way with the miter gauge at the same angle and on the same side of the saw table. Cut the stock to the net length and square across the ends. Do any additional cutting after the lap cuts have been made. Pencil the position of the joint on one member and mark the ends that are to be placed against the stop with the letter "S" for easy identification. The miter-gauge setting is the same as the angle of the work, Figs. 11 and 12. Note that the angle cuts to level the assembly, that is, the cuts made on the ends of the stock, are half that of the center angle, Fig. 12. If a spacer block is used, its length must equal that of the angle cut across the work less the width of the saw kerf, lower detail, Fig. 12. However, a somewhat better way is to pick off the spacing distance with inside calipers as in Fig. 13, and then use the caliper setting to space the cuts, one leg of the caliper bearing against the stop block as in Fig. 14.

Figs. 15 to 18 inclusive show how to cut an end lap with rabbet. When cutting this joint keep one rule in mind: the rabbet depth must always be one half the thickness of the workpiece. Note the upper detail, Fig. 16, also Figs. 17 and 18. One good way to assure an accurate setting of the saw or dado for cutting the rabbet is pictured in Fig. 15. Make two cuts, one on each side of a piece of scrap stock of the same sectional dimension as the material to be joined. If the cuts are even as shown, the setting is correct. For convenience, the width of the rabbet is made the same as the depth as this permits sawing it with the same fence setting, Fig. 16. Otherwise cutting the end lap with rabbet is much the same procedure as cutting the ordinary end lap except, of course, the length of the cut portion on the rails is shorter by the width of the rabbet, Fig. 16, lower detail. Note also the cut pictured in Fig. 18.

Some forms of the lap joint require right and left-hand cutting. An example is the mitered end lap, Fig. 19. Figs. 20 to 24 inclusive picture the procedure. First, you cut the stock square and to the net length. Next, you cut a plain miter on the rails as in Fig. 20. When

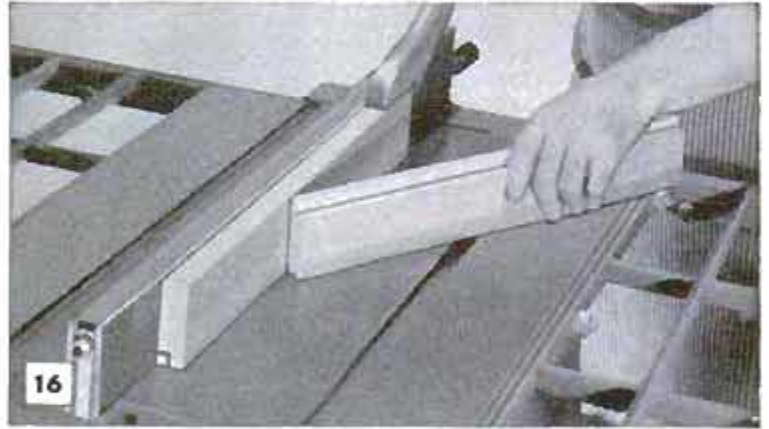
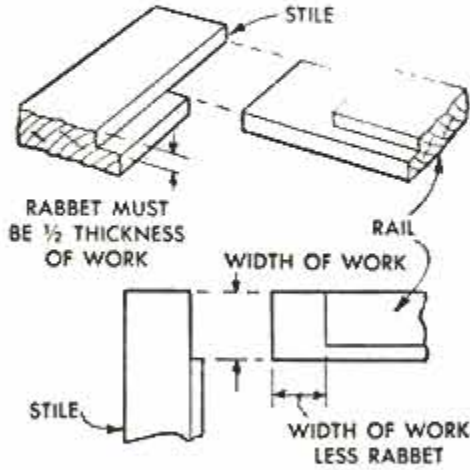




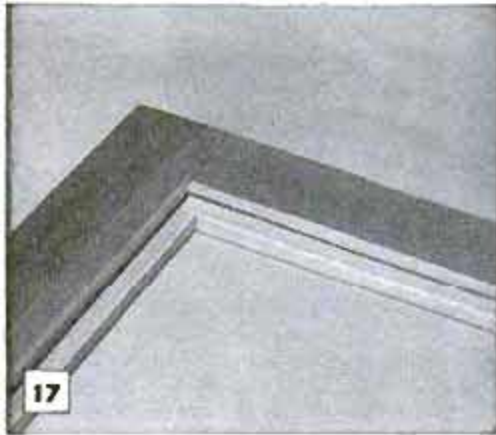


15

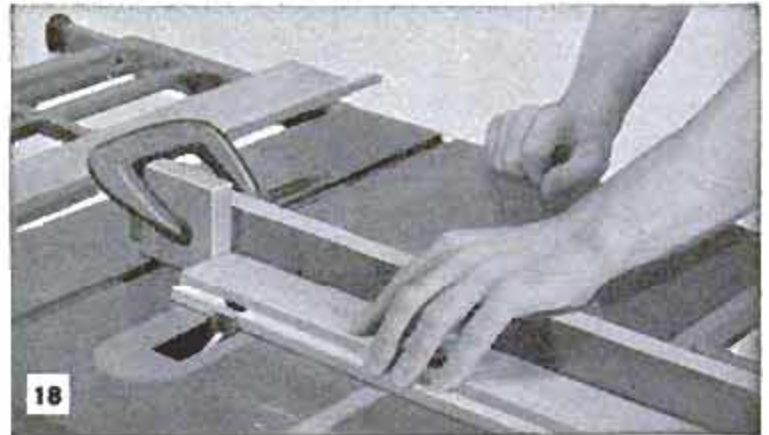
cutting the miters make sure that the stock does not creep along the miter gauge as the cuts are made. Then, with the saw blade set to cut only half the thickness of the stock, run a mitering cut on one end of all the stiles, Fig. 21. Now, with the blade at the same setting, swing the miter gauge to the opposite side of center and cut the miter on the opposite end of each of the stiles, Fig. 22. This requires resetting the end stop. As the final step in this series of operations you run a shoulder cut on



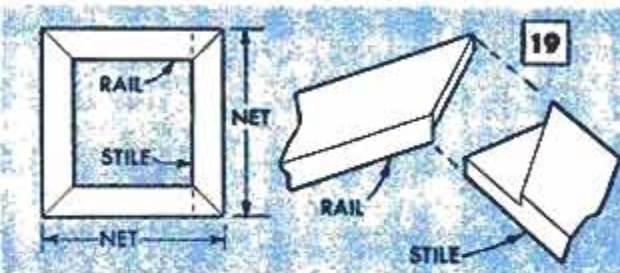
16



17

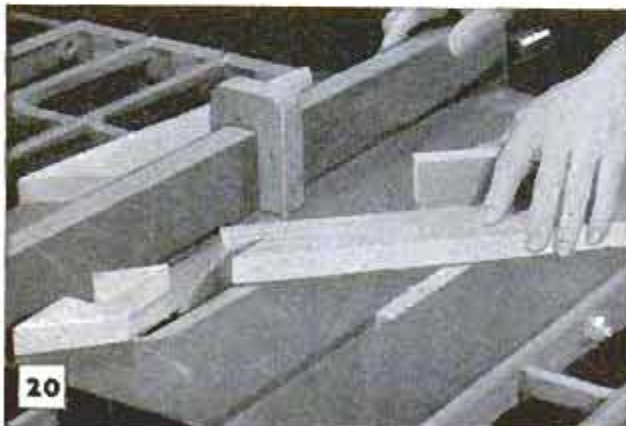


18



19

Mitered end lap is best of all lap joints appearancewise. When joined, stiles and rails appear as plain mitered at the corners. Care in making the setup on circular saw will assure accurate fit. Photos below and on opposite page picture the procedure

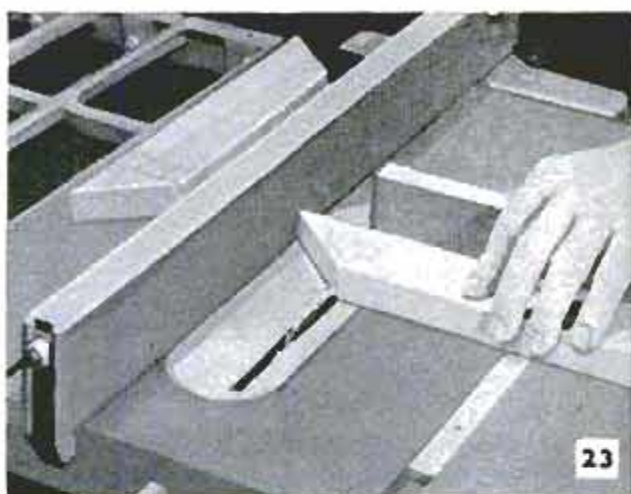


20

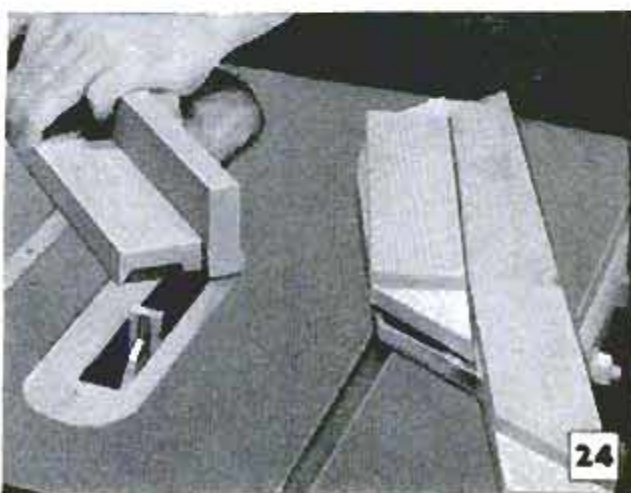


21

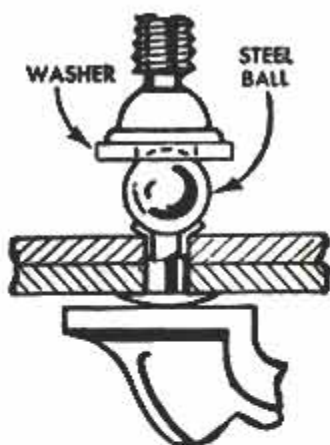




each of the rails as in Fig. 23, making sure that the stop (in this case the fence) is set to locate the cut at the precise corner of the miter. It's important to make sure of this setting; otherwise the joint will not fit properly. The last step is removing the waste from the shoulder cuts and this can be done with the dado, or faster still, with a molding head fitted with square cutters as in Fig. 24. The mitered end lap makes the neatest joint of all as the joints appear as regular miters when placed with the face side out as in the left-hand detail in Fig. 19. Before cutting any end lap, cross lap or mitered end lap be sure that all pieces are of uniform width and thickness. ★ ★ ★



### Steel Ball Sets Hollow Rivet



In an emergency, when no conventional rivet set is at hand, you still can set a hollow rivet perfectly simply by using a C-clamp and a steel ball. Drill holes in the joining parts, insert the rivet and then locate the ball and C-clamp as detailed. It is necessary to place a washer on top of the ball as indicated in order to obtain straight-line pressure.

necessary to place a washer on top of the ball as indicated in order to obtain straight-line pressure.

### Keep Soldering Iron Clean

A steel-wool pad pressed loosely into a small can makes an efficient cleaner for the soldering-iron tip. Use a medium steel wool, No. 1 or 2. Attach the can to the bench or to the wall over the bench so that it is within easy reach. Clean the iron while it is hot by pressing the tip into the wool pad and turning right and left.

### Thumbtack Tightens Cover

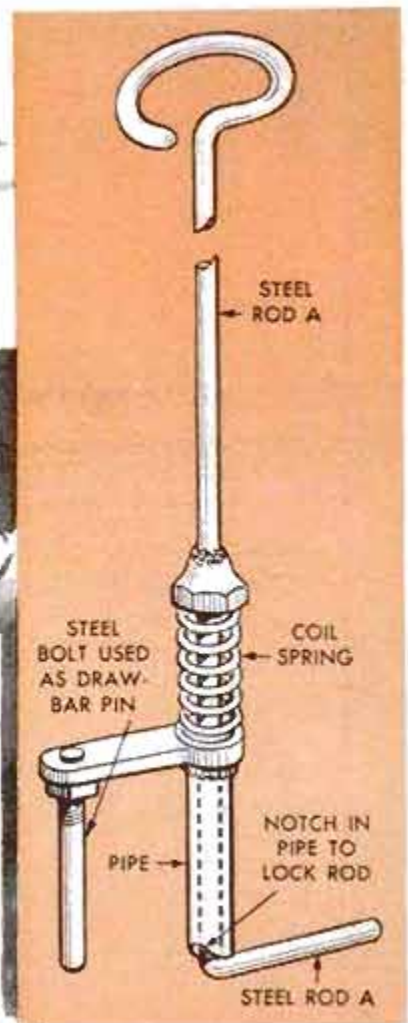
Friction covers on wooden drill cases, also those for letter and number stamps, often become loose due to hard usage. The cover can be made a tight fit again by driving a small tack in the position shown in the detail. On larger wooden cases, such as those supplied with sets of letter and number stamps, a thumbtack is suitable for the purpose.



### Thin Splines for Miter Joints

Thin stock salvaged from fruit crates makes excellent splines for mitered joints when cut into strips across the grain. Usually it's just the right thickness to fit snugly into a 1/8-in. groove which you run with the outside cutter of the dado head. For mitered joints on narrow stock, cut splines from hardwood veneers.





## Coupling Implement From Tractor Seat

When every minute counts in getting field work done, this handy coupler can save both time and steps. After a glance at the detail you'll know how it's made. A few minutes spent in the farm workshop with the welder and you have it ready to use. It combines a lifter and clevis pin. The rod A, bent at right angles near the lower end serves as the lifter. The rod carries the spring-loaded clevis-pin assembly. As you inch the tractor back you pick up the im-

plement drawbar as pictured. When the clevis-pin holes line up, you swing the pin into position and drop it into the holes, thus coupling the implement to the tractor drawbar. Then you lock the pin in place by turning the handle of the lifter until the bend at the lower end springs into the notch filed into the lower end of the pipe sleeve which is welded to the arm carrying the pin. Once the handle is turned to this position the pin cannot come out.



## Pickup Box Mounts on Tractor

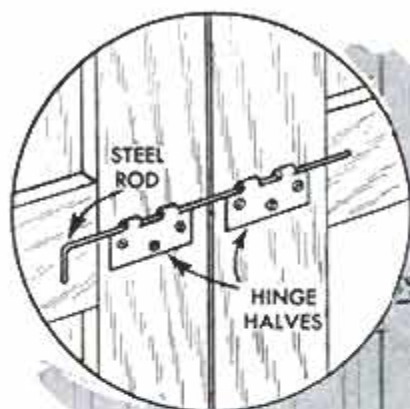
This pickup box mounts on the three-point hitch of the tractor and can be raised and lowered as desired. It's 72 in. long, 28 in. wide and 36 in. high, including the rack sides. It will handle two barrels of water or six to eight sacks of ground feed for a quick run to a self-feeder in field or pasture. With the rack sides, or open extensions, the box is suitable for transporting sheep or hogs. It is built of pine 1 x 4s, matched flooring and is braced with lengths of  $\frac{1}{4}$  x 2-in. flat steel.

A. M. Wettach, Mt. Pleasant, Iowa.



## Emergency Door Bolt From Leaves of Butt Hinge

Leaves of a discarded butt hinge can be utilized to make an emergency door bolt for a garage, shop or other outbuilding having a door or doors that swing out. Remove the hinge pin and, where double doors are to be bolted, attach the leaves as pictured, with the barrels in line. Use a length of steel rod, bent at right angles near one end, as a bolt. To bolt a single door use one leaf of the hinge and a shorter bolt. Drill a hole in the jamb to take the end of the bolt when in the closed position. — Victor H. Lamoy, Upper Jay, N. Y.



## Watch and Matches Kept Dry In Jar While Boating



A widemouthed jar wired to a shelf fastened inside the boat will protect your watch, matches and cigarettes from spray and dampness. Place a handkerchief or cotton behind the watch to hold it erect so the dial can be read.

## Preventing Spilled Water From Staining Rug

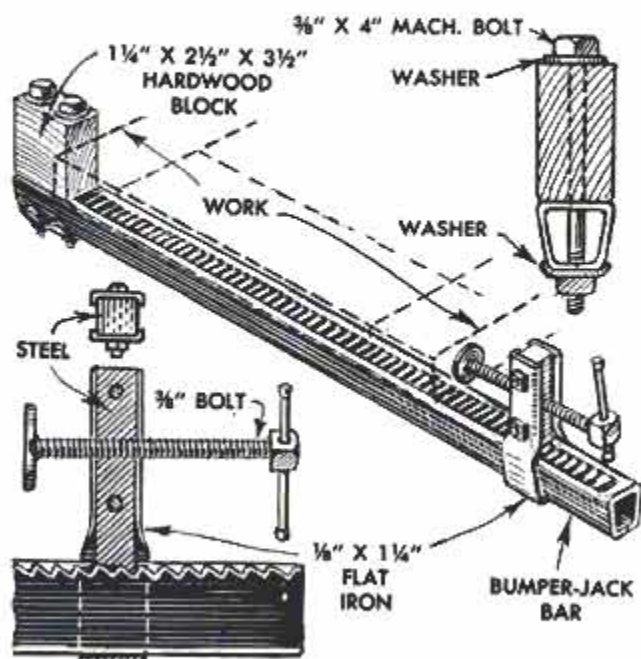
To prevent stains when water is spilled on a rug, immediately blot up all the water possible with a clean, white, unstarched terry cloth, white absorbent tissues or white paper towels. When the spot has been dried as much as possible, place fresh towels or tissues on the wet area and add weights on them to assure close contact between the blotters and the rug. The towels must remain in place until the spot has dried completely.

National Institute of Rug Cleaning, Inc.

## Adjustable Bar Clamp Made From Auto-Bumper Jack

An inexpensive bar clamp can be made by using the standard from an automobile bumper jack. A hardwood block is bolted to one end of the standard to provide a

fixed jaw. A movable jaw is made by bending a length of  $\frac{1}{8}$  x  $1\frac{1}{4}$ -in. flat iron in a squared-U-shape to fit around the bar. A steel block, the lower end of which is filed to a pawl shape to engage the rack on the column, is bolted in the U-shaped jaw. The steel block is positioned so the jaw can be moved in either direction along the rack when it is held upright, but will engage the rack when tipped slightly. The steel block is drilled and tapped to receive a  $\frac{5}{8}$ -in. bolt which serves as the clamp screw. A short length of  $\frac{1}{4}$ -in. rod fitted in a hole cross-drilled in the bolt head provides a sliding handle. A disk welded to the opposite end of the bolt forms the clamp-screw pad. — Charles A. Churnblom, Minneapolis, Minn.



☐ Curtains or garments that are to be dyed can be given a more even color if two spring-type clothespins are fastened at suitable places on the article and used as hand-grips to swish the material up and down in the dye bath. This distributes dye evenly and keeps hands out of the solution.

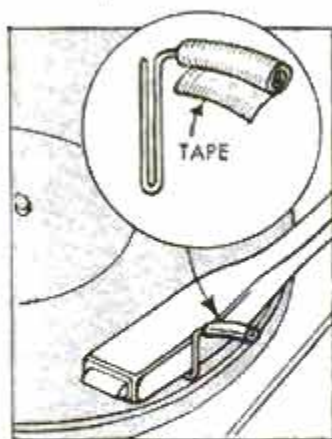




### Sticking Sash Easily Removed

Removing a storm sash that sticks may take some doing by ordinary methods, and even then you'll be lucky if you can turn the trick without damaging the sash frame. Pictured is a method that usually works, and the only damage to the sash frame are the two screw holes, which are easily filled with putty. Use round-headed screws and turn them in about  $\frac{3}{4}$  in. A light pull on each screw usually loosens the sash.

### Handy Lifter for Pickup Arm



A lifter on the pickup arm of the record player can save a lot of wear on the records. Make the lifter from a short length of fine wire, bending it so that it will snap onto the edge of the arm. — Steve Ackermann, Mead-owbrook, Pa.

### Rubber Bands Save Old Broom

Don't throw away that old broom with frayed and spreading bristles. Just soak the bristles in water for a few minutes and then snap a couple of heavy rubber bands around them below the stitching. Remove the bands after the bristles are dry, and the broom will be nearly as good as ever.

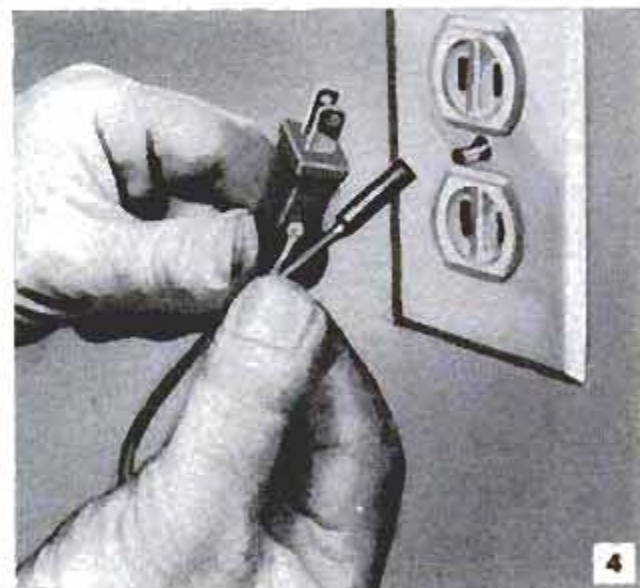
# THAT THIRD

can reduce electrical-shock hazard in older home appliances and portable power tools

**I**N NEW HOMES wired with electrical systems of the continuous-ground type, which requires that appliances be equipped with three-prong plugs, the shock hazard is reduced to the minimum. On the other hand, in older homes having two-wire electrical systems there is always the possibility that defects in appliances and portable power tools due to wear, deterioration of insulation or other causes, can create a serious, if not dangerous, shock hazard. Any hazard that may exist due to these causes is increased in the presence of dampness, as in a basement where humidity is high during summer months.

Older appliances such as wringer-type washers and any motor-driven tools having two-wire power cords, A in Figs. 1 and 2, can be grounded with a third wire, B in Figs. 1 and 2. One end of the third wire, or ground wire, should be attached to bared metal on the appliance or tool as in the inset detail, Fig. 1. The other end should be attached to a water pipe with a suitable ground clamp as in Fig. 5. In this procedure it should be understood that you are not necessarily guarding against a defect in manufacture, but against the outside chance that an electrical defect may exist in the tool or appliance due to hard usage, undue wear or other causes of which you may not be aware.

Some tools and appliances made in later years come with a three-wire power cord having a two-prong plug and a pigtail (green ground wire) leading out from the



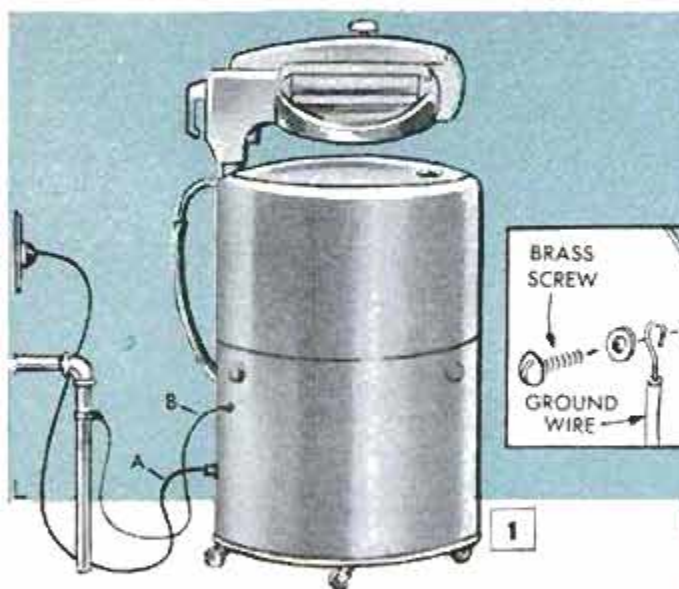
4



SN 177M 51

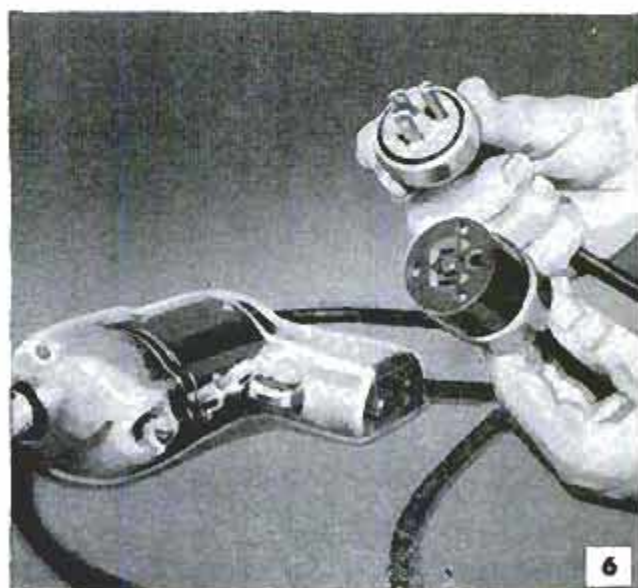
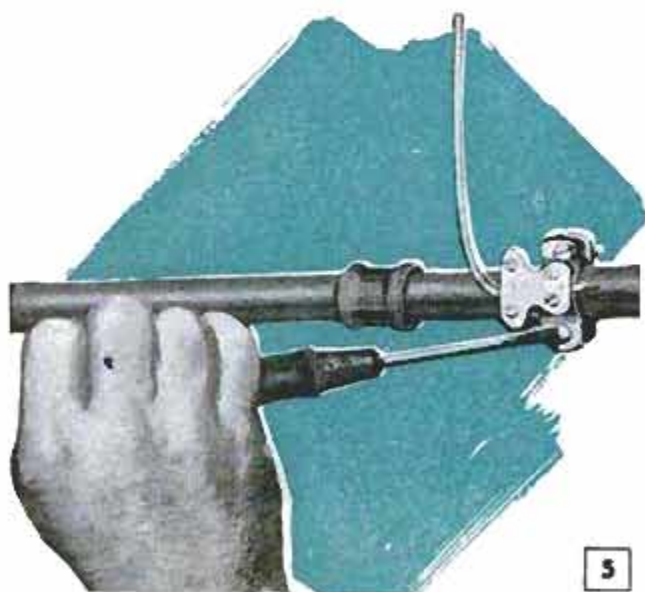
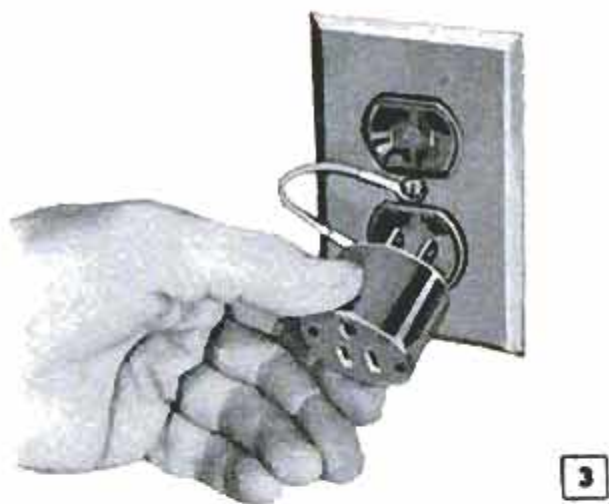
# WIRE

By Ralph Treves



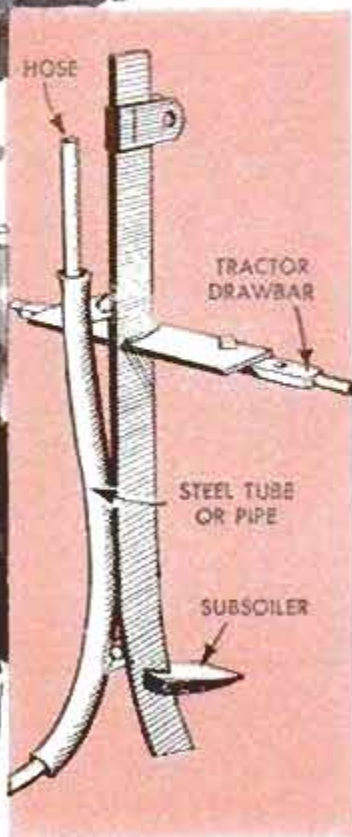
side of the plug, Fig. 4. Often this is fitted with a special screw which replaces the screw holding the cover plate of the receptacle. This is an effective ground on systems installed in BX, rigid conduit or thin-wall conduit. Late-model equipment comes with a three-wire power cord, a three-prong plug and an auxiliary plug, or jack, having a two-prong end and a pigtail for attaching the ground to the receptacle as in Fig. 3. Be sure the screw is tight.

When a portable electric drill, saw or other power tool must be operated at a distance from an outlet which is beyond the reach of the regular power cord, an extension must be used. When the tool is equipped with a three-wire cord, always use a three-wire extension having plugs as in Fig. 6. Use of such an extension will assure that the tool is properly grounded to insure working safety. ★ ★ ★





## Subsoiler Lays Hose Underground to Watering Tank



This shop-made subsoiler is designed to double as an underground hose layer. It consists of a conventional unit with a vertical beam to which is welded a bent steel tube to carry the hose down to the level of the subsoiler blade. It will lay hose to a distant water tank or poultry waterer in a few minutes' time.

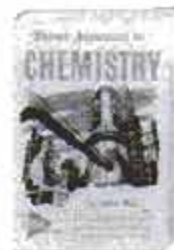
## Tiny Saw Blades From Clock Gears

An escapement wheel or the solid wheels from gear trains of an old clock movement make excellent circular saw blades for model work in balsa and other soft woods. The saws can be driven in the drill press or by means of a flexible shaft. File and set the teeth as you would a conventional blade.

## Molding Scientists Today — for America Tomorrow



Popular Mechanics is proud to announce to parents with an active interest in their son's future, a revolutionary new science career series



## "There's Adventure In" Science Career Books for Boys 11-17

Presenting a unique series of career books for the boy of today who needs and wants to know more about the scientific world we live in . . . and his place in the technical world of the future. Each story is told as exciting fiction and high adventure through the eyes of two teen-age boys, Randy and Sam Morrow. But skillfully woven throughout the fascinating stories are the even bigger, even more startling facts about the career opportunities in the sciences. The books suggest the kind of educational preparation needed in each, types of occupations that are now open and will be opening in forthcoming years. Moreover, in the telling the boy in your life learns a host of scientific and technical facts of lasting value. He also discovers in each story simple experiments he can do himself with common materials, and aptitude charts against which to pit his ability and talents.

**Prefaces by Outstanding Authorities**  
 "There's Adventure in CHEMISTRY" has a preface by Dr. Harid C. Urey, Nobel Prize-winner in this field; "ELECTRONICS" is prefaced by Dr. Lee de Forest, father of the vacuum tube. These names will further thrill and encourage boys in their great new adventure into the sciences. Well researched and completely authentic, full of fun and facts, the "Adventure" books are a source of practical information and inspiration that can help shape your boy's entire life. Years from now, your scientist son or nephew may remember them as the decisive influence that started him on a vitally important, high-paying career. Order the CHEMISTRY, ELECTRONICS and ATOMIC ENERGY books for the boy in your life now. They'll be sent postage prepaid. Your money back **\$2.50** if not pleased. **Each only**.....

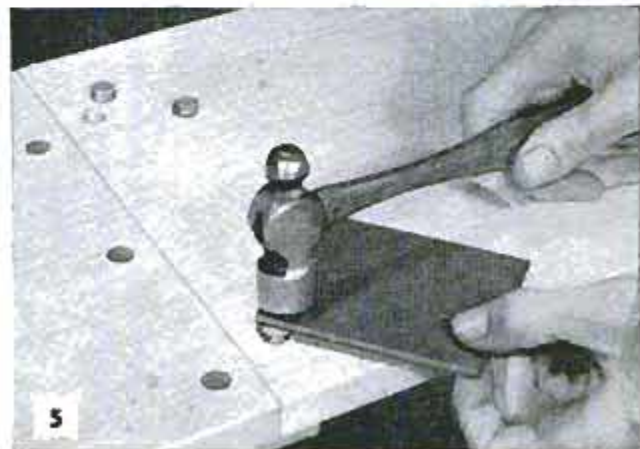
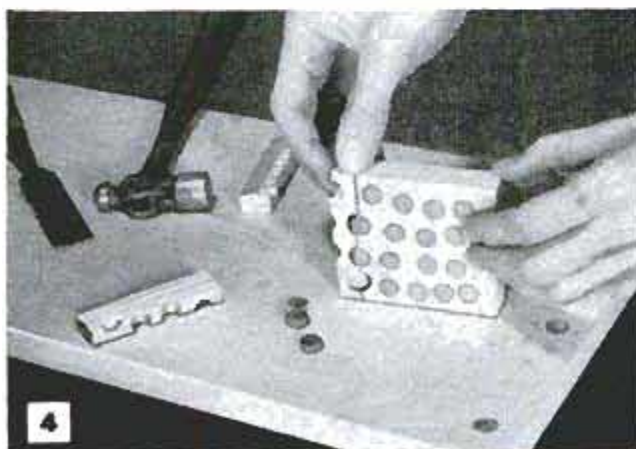
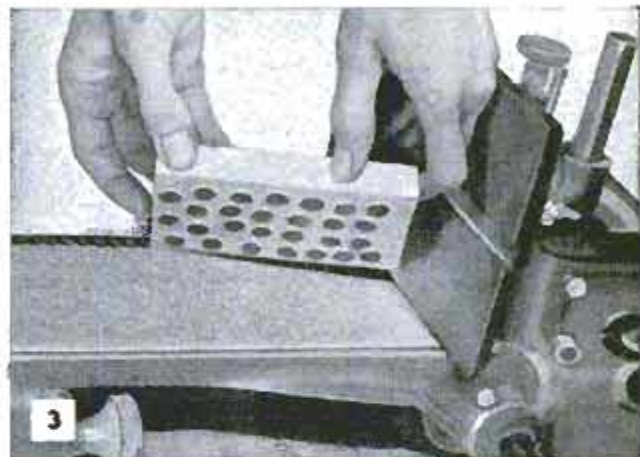
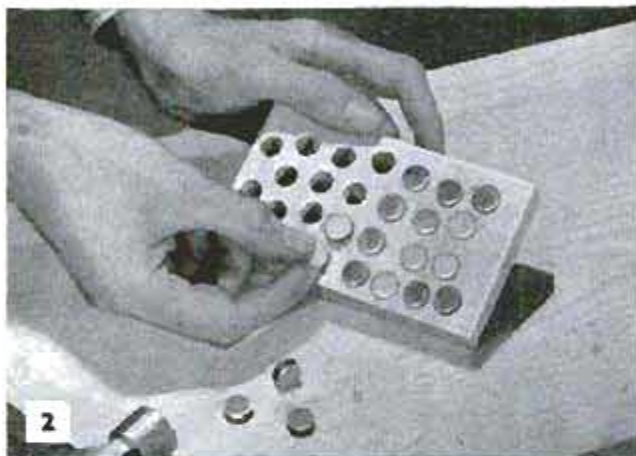
Order Today from: POPULAR MECHANICS PRESS, Dept. 458, 200 E. Ontario St., Chicago 11, Illinois



# SCREW-HOLE PLUGS MADE FROM DOWELS

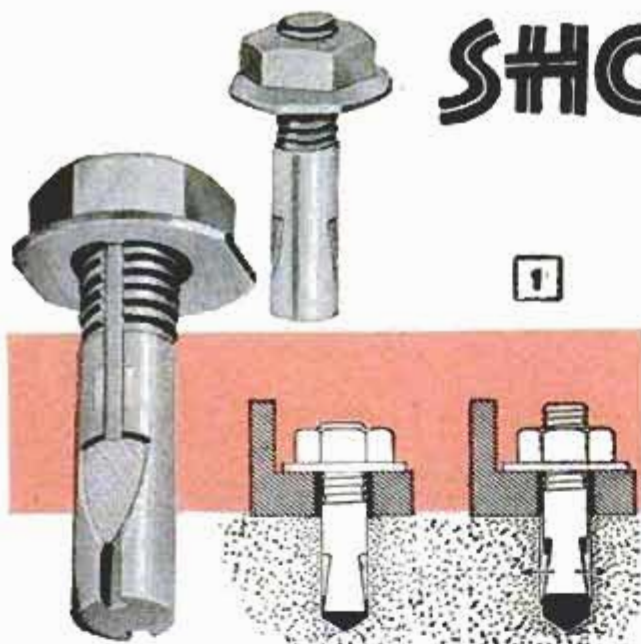
HERE'S A METHOD of making screw-hole plugs fast and in quantity. First, you drill blind holes to a uniform depth in a piece of waste stock. As will be seen, the depth of the holes determines the length of the plugs. Of course, the holes must be the same diameter as the dowel. Cut the latter into short lengths, each length slightly greater than the depth of the holes in the waste piece. Press the rough plugs thus made into the holes in the waste piece as in Fig. 2 and sand flush as in Fig. 3. Then split the waste piece into sections to release the plugs as in Fig. 4. To avoid damaging the ends of the plugs use a leather or soft-metal pad when tapping them into counterbored screw holes as in Figs. 1 and 5. Plugs made in this way are used to conceal screw and nail heads in boat construction, ranch-type flooring and cabinetwork. When plugs are used to conceal screwheads in ranch-type flooring they can be made from a contrasting wood, such as walnut or birch. Make them full length with a plug cutter, then finish to size as in Figs. 2 to 5 inclusive.

R. Hanscom, Elmhurst, Ill.





# SHOPPING FOR

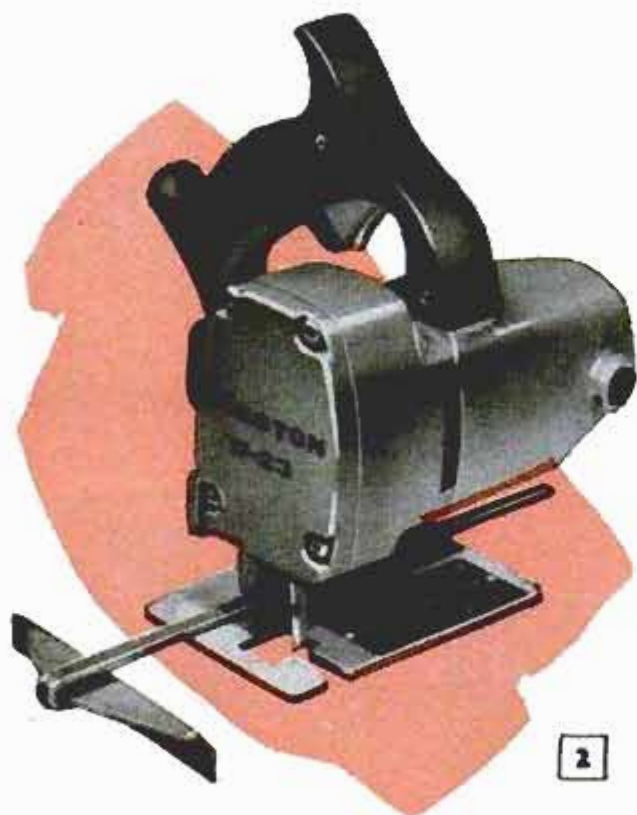


**1. ONE-PIECE ANCHOR** for masonry eliminates use of expansion sleeve. In place of sleeve a U-shaped wedge expands when the nut is tightened. The wedge fits flush in a groove and heart-shaped recesses cut in opposite sides of the stud or bolt. In use, anchor unit is passed through hole in bracket, machine base or whatever is to be fastened, inserted in hole, drilled in masonry and nut tightened

Kirel, Inc., 322 E. 28th St., New York City 16.

**2. PORTABLE JIGSAW** has motor at right angles to blade, rather than parallel with it. Driving mechanism is designed to give blade an orbital motion, moving blade away from material on down, or idle, stroke and forcing it into material on upstroke. This movement of blade results in faster cutting and cleaner work in wood, plastic and the softer metals. Blade is driven at 3800 strokes per min. Tool weighs 5¼ lb.

H. K. Porter Co., Inc., Henry Disston Div.,  
610 Tacoma, Philadelphia 35, Pa.

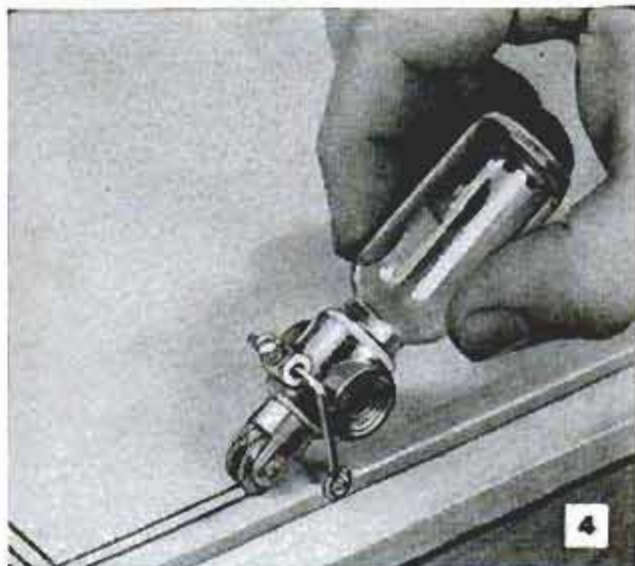
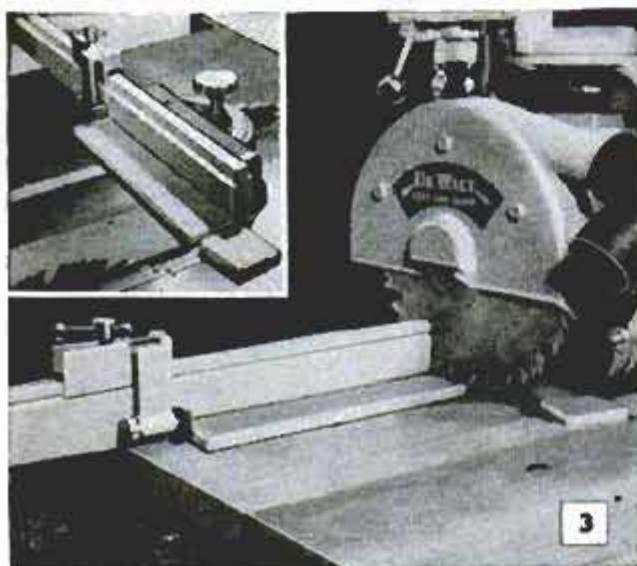


**3. ADJUSTABLE STOP** for repeat cuts on radial saw or table saw has pivoted arm which permits stop to swing upward to clear face of fence or miter gauge for cutting longer stock. This can be done without changing original setting of stop. Unit slides on grooved hardwood strip attached to miter gauge or to grooved strip which is made to replace fence on radial saw table, allowing a wide range of adjustment

R. W. Anderson Co., 1110 W. 68th St., Los Angeles 44, Calif.

**4. TWO-LINE STRIPING TOOL** comes with interchangeable striping wheels and spacers which can be assembled to run a single line, double lines of equal width, two narrow lines or two wide lines, or one wide and one narrow line in one pass. Works with enamel, lacquer, tempera, bronzing paint or any oil-base paint. Guide is adjustable and is designed to follow beads, moldings, straightedge or template

Wendell Mfg. Co., 4234 N. Lincoln Ave., Chicago 18.





# TOOLS

**5. HYDRAULIC SCAFFOLD** is operated by a control unit located on the platform. It will rise to a total height of 10 ft. and can be locked securely at any point. Designed for use by painters, carpenters and masons, and also is used by orchardists when tree pruning. Working area of platform is 2½ x 8 ft. Guard rail is standard equipment

Grell Enterprises, Galva, Iowa.

**6. POWER HACKSAW BLADE** has teeth set to a graduated width along the full length of the blade. The purpose of this graduation of the set is to lessen blade shock at start of cutting stroke, also to reduce wear on points of entering teeth. Set widens uniformly from the entering end to the finishing end of the blade as detailed

E. H. Wachs Co., 1525 N. Dryton St., Chicago 22.

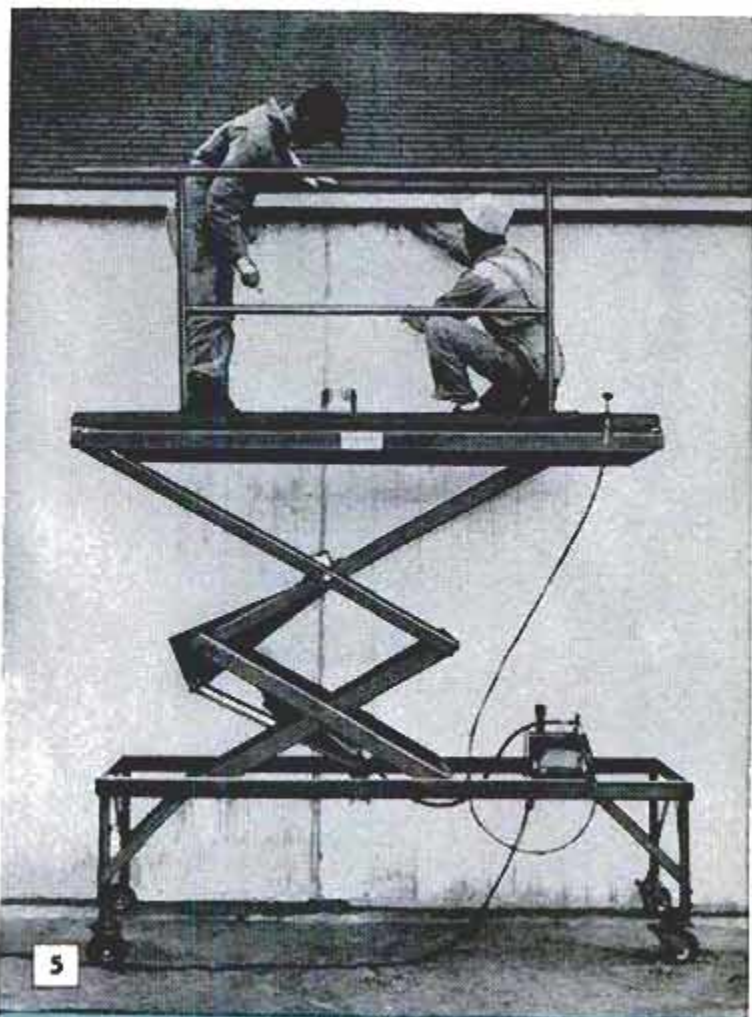
**7. ELECTROTHERMAL UNIT** replaces Bunsen burner in laboratories and in industrial research where clean, controlled heat is essential for experimental work. Heating element is mounted in a conical casing, or housing, of refractory aluminum oxide, designed so that heat is concentrated in the same manner as that from Bunsen burner

Gardner Laboratory, Inc., 5521 Landy Lane, Bethesda, Md.

**8. MASON'S LINE CLIP** holds the line in place on all types of masonry walls. No nails or other fasteners are necessary to attach clip to brick, block or stone walls. It is designed to span the width of a standard brick as pictured. It also will hold on a corner or when dropped over the web of a concrete block. Will not slip out of place

Retco Mfg. Co., Brazil, Ind.

(Continued on next page)



5

ENTERING TEETH,  
NARROW SET

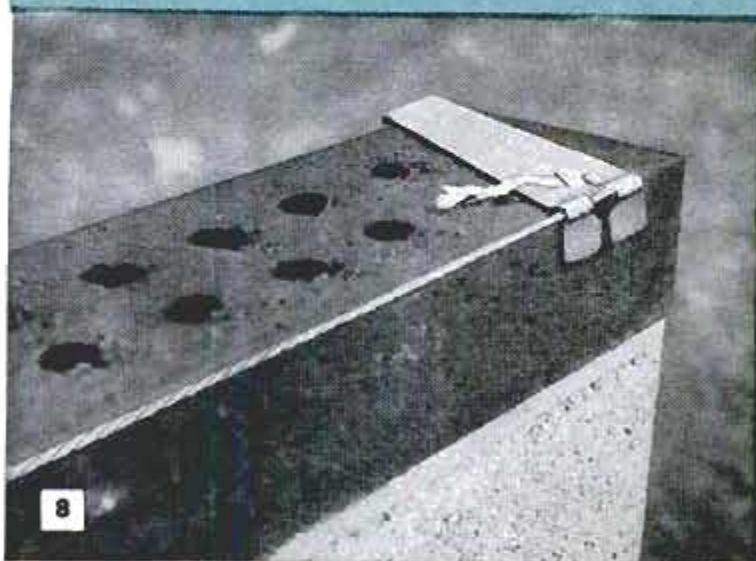
FINISHING TEETH,  
HEAVY SET



6



7



8



# SHOPPING FOR TOOLS

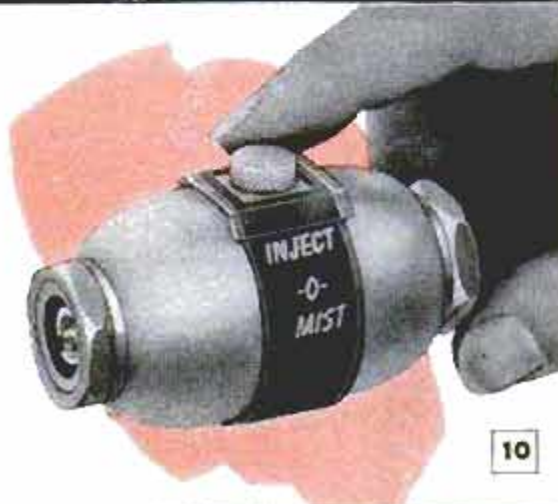
(Continued from preceding page)



9

**9. AIR-CURRENT DIRECTION FINDER** uses ordinary cigarette, regular or king size, for determining with certainty the direction of air currents either in a building, or other enclosure, or outdoors. In use, cigarette is lighted, inserted in holder and nozzle is screwed in place. Then bulb attached to holder is pressed lightly to force smoke through nozzle

Design Engineers, 214 S. Church St., Rockford, Ill.



10

**10. PNEUMATIC OILER** for air-driven tools such as staplers, wrenches, drills and riveters assures controlled lubrication to all parts of tool during long periods of operation. Unit is of injector type, made from lightweight metals with brass and stainless-steel operating parts, and is fitted with direct-reading oil gauge. Unit is 3¼ in. long, 1¾ in. in dia.

Carlson Products, Inc., 5309 N. 24th St., Omaha 10, Nebr.

**11. PISTOL-GRIP HANDLE** converts any pressurized spray can into a professional-type spray gun. Fits any pressurized can containing enamel, insecticide, deodorants or other sprays. Pressure on trigger of attachment actuates an arm which bears on spray cap of can. Pistol-grip handle provides comfortable handhold, enables user to direct spray with accuracy

Alfo, Inc., 2031 Granville Ave., Los Angeles 25, Calif.



11

**12. SELFLOCKING CLAMP** has a 5-position cam which locks the padded jaws at any one of the 5 positions desired. Easily set and locked on the work with one hand, leaving other hand free to hold parts in position. Especially useful for light assembly as rubber-faced jaws will not score finished surfaces. Jaws are replaceable. Length 4¾ in. Jaws open 2 in.

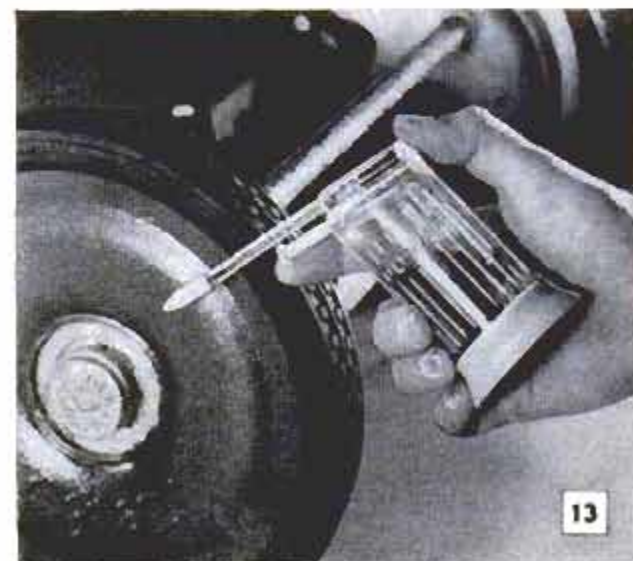
Wedgelock Corp., 5446 Satsuma Ave., North Hollywood, Calif.

**13. PLUNGER-ACTUATED OILER** has many applications in the home and workshop. Nozzle is designed to direct a very fine stream of light oil into hard to reach bearings such as those on lawn mowers, motors and household electrical appliances. Container holds up to 4 oz. of light lubricating oil and is made from transparent plastic. Base unscrews for easy filling

Plewex Oiler, Inc., 701 S. 7th St., Minneapolis 15, Minn.



12

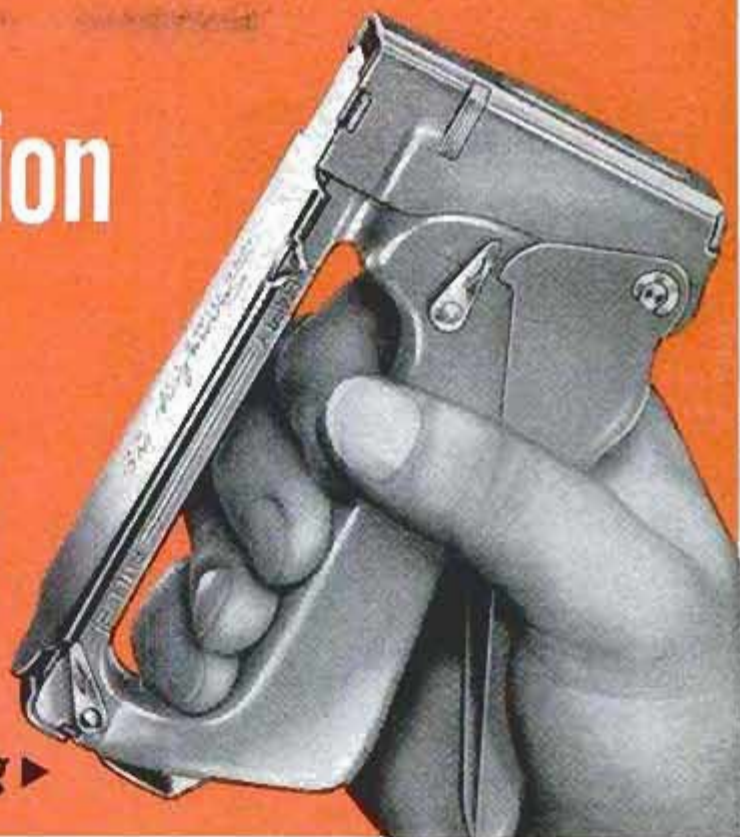


13



# NOW! a Hi-Compression Staple Gun for \$4.95

With built-in staple extractor  
and exclusive push-button loading ▶



Never before has such an indispensable tool for the home been priced so low. If your tool chest includes a hammer and a screwdriver, then you should also have this basic tool...one that automatically drives two-legged staple-nails flush with a powerful thrust and *holds tight*. This precision tool delivers as much driving power as machines twice its size and weight. Handle locks to fit pocket...is easy to load with Swingline's patented *push-button* open channel that eliminates jamming. Extremely light weight, maneuverable, balanced for tireless use. Choice of Gray, Red or Green. Takes 2 staple sizes, 1/4" and 5/16".

1. **SWINGLINE 200**—Speedmatic staple gun for professional use. Non-glare gray finish. 3 staple sizes: 3/16" to 5/16". \$10.50
2. **SWINGLINE 900**—Super-drive Tacker for ceiling tile installations, etc. Gray or chrome finish. 6 staple sizes: 3/16" to 9/16". \$12.50
3. **SWINGLINE Household Stapler**...complete with wall bracket...fastens, tacks. 4 decorator colors. \$2.95
4. **SWINGLINE CUB Stapler**. For home, school and work. It staples, mends and tacks. Red, green and gray. \$1.29



#### HANDIEST TOOL IN THE HOME!

- INSULATING
- UPHOLSTERING
- SCREENING
- CARPENTRY
- DRAPERIES
- WINDOW SHADES
- CARPETING
- WIRE FENCING



**FREE!**  
Send for  
informative,  
12-page booklet  
"Tips For Tacking"



**Swingline**® INC. LONG ISLAND CITY 1, N. Y.

World's largest manufacturer of staplers for home and office



# Kodak Camera Carnival

...at your Kodak  
dealer's now!

See "The Ed Sullivan Show," CBS-TV, Sunday nights.



New Brownie Starflash Camera takes color slides as well as black-and-white and color snapshots. Built-in flashholder. Double exposure prevention. Brownie Starflash Camera, \$8.95 or \$1 down.

New Brownie Starflex Camera has hooded viewfinder, takes color slides and snaps. Brownie Starflex Camera, \$10.75. Kodak Rotary Flashholder shoots six bulbs without reloading, from \$10.95.

See your shot big and clear before you snap it with hooded viewfinder on Kodak's Duaflex IV Camera. Fast, pre-focused Kodet lens. Kodak Duaflex IV Camera, \$17.95 or \$2 down.

New Kodak Pony II Camera for 35mm color slides. Just dial for picture you want. Make one setting, shoot. Kodak Pony II Camera, \$26.75 or \$2.75 down. New Kodak Generator Flashholder works without batteries! At your photo dealer's soon.

New Kodak Signet 50 Camera for precision photography has built-in photoelectric exposure meter. Extremely fine  $f/2.8$  lens. Flashholder, two reflectors. Kodak Signet 50 Camera, complete, \$82.50 or \$8.50 down.



Prices are list, include Federal Tax and are subject to change without notice.



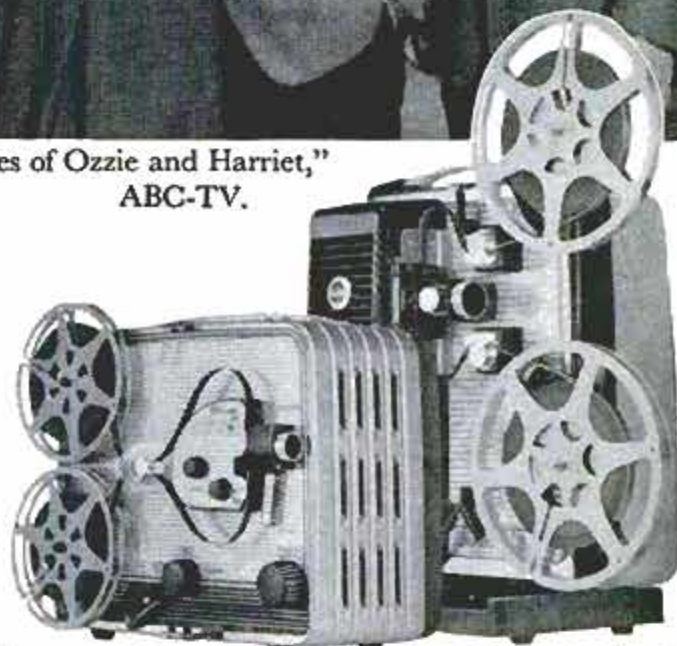
**Kodak TV stars  
invite you to the  
most exciting  
photo show  
ever...**



See "The Adventures of Ozzie and Harriet,"  
ABC-TV.



Brownie Movie Camera,  $f/2.3$  (left), takes color movies with snapshot ease. Just make one setting . . . aim . . . and shoot! Brownie Movie Camera, Turret  $f/1.9$  (right), gives you 3-lens range at 1-lens price —takes normal, wide-angle, telephoto shots. Brownie Movie Cameras from \$29.95 or \$3 down.



Big screen 8mm movies. You show 8mm movies 3 feet wide with Brownie 300 Movie Projector (left). Shows single frames, reverse-action. \$6.50 down. Brownie 300 Movie Projector, \$64.95. For extra-large-screen movies 5 feet wide, the Cine-Kodak Showtime 8 Projector (right), \$123.50 or \$12.50 down.



New Kodak Medallion 8 Movie Camera,  $f/1.9$ , loads in 3 seconds with film magazine, weighs only 23 ounces. Kodak Medallion 8 Movie Camera,  $f/1.9$ , \$106.50.

Shows color slides big-as-life. Kodak 300 Projector is only 5 inches high, easy to carry as a portable radio. Kodak 300 Projector, \$64.50 or \$6.50 down. New Kodak Cavalcade Projector shows slides *automatically!* You turn it on . . . it does the rest. At your dealer's soon!

**EASTMAN KODAK COMPANY, Rochester 4, N.Y.**

**Kodak**



New

EASY-TO-LAY

## Bruce Crestwood Floor



It's PREFINISHED Oak!

All you do is nail it down

Now you can have beautiful new oak floors in less than a day. Crestwood is a modern prefinished flooring in a special size (2" wide by only  $\frac{3}{8}$ " thick) designed to be laid over your old wood floor or subfloor.

**Completely finished**—even waxed—at the factory, Crestwood requires no sanding or finishing. It's ready for use as soon as it's laid, and will give your home rich style and beauty.

**Crestwood is packaged** in an easy-to-handle carton containing enough flooring (with proper nails) to cover 25 sq. ft. of floor area. Flooring strips have tongues and grooves for blind nailing, with nail positions marked on tongues for your convenience and to assure adequate nailing.

A new Bruce Crestwood Floor will cost you less than a good rug or carpet . . . and will last the life of your home. Sold by leading lumber dealers. Mail coupon below for colorful literature.

## MAIL FOR LITERATURE

E. L. Bruce Co.,  
Box 397-O, Memphis 1, Tenn.  
Send literature on Bruce Crestwood  
Floors to:

Name \_\_\_\_\_

Address \_\_\_\_\_

**BRUCE CRESTWOOD FLOOR**

Product of world's largest hardwood flooring maker

Clinic for  
Homemakers

As a service to our readers in solving the hundreds of problems pertaining to a home—inside or out—the editors of *Popular Mechanics* invite you to present your problems to The Clinic Editor for help and advice. Address your questions to The Clinic Editor, *Popular Mechanics Magazine*, 200 East Ontario Street, Chicago 11, Ill.



## Spackle Over Paint

**Q**—Walls in my living room are rough-textured plaster from the baseboard to the picture molding which forms the lower edge of the drop ceiling. It's an old house and I want to enlarge the living room, and in doing this I will have to lower the picture molding, thus exposing about 4 in. of the rough texture. The walls have been painted. Can I smooth these rough-textured portions with spackling compound?—R.D., Del.

**A**—We do not know that every manufacturer of spackling compound would recommend this procedure but, of course, it is done. As we understand your problem you wish to smooth a strip about 4 in. wide around the room just above the lowered molding in order to match that portion of the drop ceiling which was originally above the molding and is smooth plastered. This means that there will be an offset at the point where the spackling compound is feathered onto the smooth plaster. Question that comes to mind is, can this be satisfactorily concealed by subsequent wall decoration such as paint or wallpaper? We're rather doubtful. We think it worthwhile to think about removing the rough texture above the molding by sanding. You can do it by hand, using a coarse, open-coat sandpaper or with a portable belt sander. It is likely you can rent the latter from your local paint dealer for a nominal hourly charge. It's a tedious, messy job at best and the fine plaster dust is difficult to clean up but we think this is the most satisfactory solution to the problem as you outline it.

## Moisture Condenses on Walls



**Q**—The walls of our home are of concrete blocks and the floor is a concrete slab. Other than that we do not know the details of construction. Last winter the walls sweat badly, especially the north outside wall from the ceiling to a point about 2 ft. down. Heating is forced warm air with ducts in the floor. All windows are aluminum sashes with storm inserts. These also sweat. Are there any preventive steps we can take before the next heating season?—E. C., Ohio.

**A**—The most likely moisture source is, of course, the high humidity of the air in the rooms. Moisture from the preparation of meals, laundering, from

(Continued to page 226)



# NOW! A SHOPSMITH<sup>®</sup> FOR ONLY \$179.<sup>90</sup>



INTRODUCING THE

## **ALL NEW SHOPSMITH MARK 2**



It's an 8" SAW • It's a 12" SANDER • It's a 28" LATHE • It's a HORIZONTAL DRILL — 16½" VERTICAL DRILL

### **Companion to the Incomparable Shopsmith Mark 5!**

Here's the new SHOPSMITH everyone can afford! The all-new MARK 2 is still the famous 5-in-1 power shop that has made SHOPSMITH the most wanted power tool in America. It gives you *all* the big capacity power tools you need to build your woodworking projects from *start to finish*—does hundreds of operations! See this rugged, all-new SHOPSMITH demonstrated at your leading hardware or department store, lumber yard, or Montgomery Ward. (Price does not include motor and bench.)

©T. M. REG.

**FREE Catalog!**  
mail coupon today  
to plant nearest you!



MAGNA POWER TOOL CORP.  
Dept. 104M, Box 2808, Ft. Wayne, Ind. OR  
Dept. 104M, Menlo Park, Calif.

Please mail me your FREE catalog on the all-new SHOPSMITH Mark 2.

NAME \_\_\_\_\_

ADDRESS \_\_\_\_\_

CITY \_\_\_\_\_ ZONE \_\_\_\_\_ STATE \_\_\_\_\_

If you now own a SHOPSMITH—is it a 10ER—or Mark 5—



# This time she didn't need oil!



Most likely your wife wouldn't react this way. But if oil consumption has been a problem in your car, the results with Sealed Power's new stainless steel\* oil ring have been so phenomenal she might be tempted. Even under high vacuum conditions such as deceleration, even when cylinder condition is poor, KromeX ring sets with this new oil ring deliver absolute oil control . . . immediately save you money you've been spending for oil.

## UNIQUE FEATURES

This oil ring resists sludging and clogging because of the unique characteristics of stainless steel. And Sealed Power's stainless steel oil ring has chrome-plated steel side rails for more than double the life you'd expect. You can't do more for your car at less cost to yourself. Ask for Sealed Power.

## FREE OFFER

If you're interested in how to maintain your car properly, write for our illustrated manual, "Care and Feeding of Engines." It's yours for the asking. You'll find its illustrated pages informative, helpful, crammed with tips which may save you money. For your free copy, write Sealed Power, Dept. G-4, Muskegon, Michigan.



\*U. S. Pat. No. 2,789,872

# Sealed Power

## PISTON RINGS

BEST IN NEW CARS! • BEST IN OLD CARS!

(Continued from page 224)

the shower and possibly the furnace humidifier contribute regularly to the relatively high humidity level in the house. The walls and metal window sashes and the glass panes are colder than the air in the rooms, causing the moisture to condense on these surfaces. It's difficult to eliminate the trouble entirely in a home already built, especially one of masonry construction, but there are ways to minimize condensation. Just what is best to do is the problem, but usually a considerable reduction of the indoor humidity can be brought about by bringing in outside air to the furnace by installation of an additional cold-air duct.



## Control Wild Onion

**Q**—My lawn is infested with wild onion; at least that is what the plant is called in this locality. I have various suggestions for getting rid of the plants, but I've only been here one year and none has been carried out. Is it possible to eradicate the pest without rebuilding the lawn?—D.O., Miss.

**A**—Wild onion, as it is known in the South, usually starts growth in the fall from old plants as well as from the bulblets. The time depends largely on the amount of rainfall but usually ranges from September to November. By early spring, aerial bulblets begin to form. These drop during the late spring and early summer and sprout in the fall, thus completing the cycle. Because of this peculiarity of the growth cycle it's late in the season for you to obtain maximum results from application of a weed killer, or herbicide. Usually a complete, or near-complete kill can be obtained by applying a suitable herbicide (formulated with 2,4-D) during midwinter when the growth is most susceptible to the weed killers. However, we do think it a good idea to build up the lawn, starting immediately with periodic applications of lawn fertilizer, new grass seed and, if you wish, an application of weed killer, although as has been pointed out, you cannot expect good results so late in the season from the latter.

## Paint Chips From Woodwork

**Q**—The woodwork in my older home was stained dark oak. Last fall I painted it with two coats of semigloss paint. Now the paint is checking and peeling, exposing the dark finish underneath. What's wrong?—W. H., Conn.

**A**—You did not say where the paint is peeling and checking. Usually this trouble develops at points where hands may touch the woodwork for support, as with small children or elderly grown-ups. However, it is possible that a high-gloss varnish was used either in finishing the woodwork originally or as a refinishing coat. As a rule, interior paints do not bond well to a high-gloss finish. This is likely to be your trouble, especially if the present paint job shows defects over all the woodwork more or less uniformly. With the paint on all the woodwork, probably the best thing to do in your case is to sand it thoroughly with a fairly coarse sandpaper to remove all loose material. Then apply an undercoater which is prepared for the purpose.

## New Basement Floor Over Old

**Q**—My basement floor is quite old but is still in good condition. However, the fall to the drains is much more than necessary, being about 5 in. and resulting in depressions in the floor with rather steep slopes around each drain. I'm thinking of leveling the floor to give a fall of about 1 in. to the drains. Can I do this by filling the depressions with new concrete?—L.E., Mich.

**A**—You can, of course, do the job as you suggest, but the problem is the necessary feathering of the new concrete at the point where the floor levels at the edges of the depressions. The new concrete may fail to bond to the old at these points. It's better, we think, to break up the old concrete in the depressions, removing it entirely back to the points where the floor levels and then filling to the desired level around the drains with new concrete.



Get your choice in the smart, new  
uniform of choice — **MODERN ARMY GREEN**



**"CHOOSE YOUR TRAINING—I DID!"**

"I found only the Army guarantees high school graduates their exact job training. There's a course for every need, and it's reserved for you before you enlist, so you're sure to get the training you want. I picked Diesel Mechanics. It was a great course that I could never have afforded otherwise. Your Army Recruiter can show you how to get the training you want, too."

*Victor R. Jones*

● Pvt. Victor R. Jones, Miller, Ohio



**"CHOOSE YOUR TRAVEL—I DID!"**

"I wanted to see Europe, and I found only the Army lets you choose your own foreign travel. I picked my exact overseas assignment, and it was even guaranteed before I enlisted. What's more, I enlisted with my brother and we'll stay together all the time we're overseas. You and your buddies can plan your foreign travel just like I did. Your Army Recruiter can show you how."

*Charles R. Carrico*

● Pvt. Charles R. Carrico, Springfield, Ky.



**"CHOOSE YOUR BRANCH—I DID!"**

"I'm serving the way I wanted to, because I found the Army would let me pick the branch that interested me most. I chose Anti-Aircraft, and I'm getting top leadership training in electronics and guided missiles—a really important field of the future. You can pick the Army branch you like the best, too. Just name it and it's yours—guaranteed before you enlist."

*John D. Finley*

● Pvt. John D. Finley, Colebrook, N. H.

Only in **MODERN ARMY GREEN** can you choose  
your **JOB TRAINING • TRAVEL • BRANCH**



For details on how to choose before enlistment, send for your free booklets today. Or for immediate counseling visit your local Army Recruiter. He's listed in the phone book and will give you all the facts—at no obligation!

THE ADJUTANT GENERAL PM-4-58  
Department of the Army  
Washington 25, D.C.  
Attn: AGSN

Please send me the free Army booklets describing special opportunities that only come with Modern Army Green.

Name \_\_\_\_\_

Address \_\_\_\_\_

City \_\_\_\_\_ State \_\_\_\_\_

Date of Graduation \_\_\_\_\_



# MAKE MINE KLEINS



Your skill—the quality of work you do—is controlled in no small measure by the quality of the tools you use.

That's why electricians and good workmen everywhere insist on Klein Pliers—standard of quality by which others are judged "since 1857."

In the complete Klein line you will find pliers exactly suited for every job you do. See your hardware store or Klein distributor for the Klein Pliers you need.



Your hardware store has Kleins in stock or can get them for you quickly. Look for this new display board. It shows the most popular items in the Klein line.

Mathias **KLEIN** & Sons  
Established 1857 Chicago, Ill., U.S.A.  
7200 McCORMICK ROAD • CHICAGO 45, ILLINOIS

## Push a Button and You Make Beef

(Continued from page 136)

have to do with storage bins, batch-mixing system, haymill airlift, barley roller, molasses spray-mix system, and the moving of prepared feed storage.

The other panel has two sets of control dials. One group is for setting the amount of feed by exact weight that will come out of the feed-storage bins and be mixed into each batch of finished feed. The second set makes possible the delivery of batch after batch of feed while the operator goes about other chores.

Each of the control buttons and dials has a connecting red light to warn that the unit controlled by that button has completed its work. If the operator has to be away from the control panel he sets a dial that causes a horn to blow each time a unit has completed its task.

In the feed building, near the panels, there are a mineral mixer and storage hopper for salt, trace minerals and special chemical foods, a barley steamer and roller, and a molasses-control unit. Above these are four large feed bins, one each for eight tons of chopped hay, 35 tons of ground grain, 30 tons of rolled barley and 15 tons of whole barley. Adjacent to them are four small bins, each with a seven to eight-ton capacity, for such concentrates as cottonseed meal, sugar-beet pulp, almond-hull meal and ground dried beans.

### Dial the Formula

Each of these units, with the exception of the molasses-introduction machine, is connected to a combination batch scale-mixer by elevators, augers or airlifts.

When feed is mixed, the operator selects the desired formula, then sets the electronic dials on one panel so that the correct weight of feed will move to the scale-mixer from each storage unit. He then pushes in a proper sequence the buttons on the other panel that control the conveying devices and the feed begins to arrive at the mixer.

When mixing is complete, the scale-mixer automatically empties into an auger that lifts the feed to the molasses-introduction machine. As the feed is taken through this machine by a paddle mixer-conveyor, molasses is sprayed on it. Coming out of the machine the feed drops onto another conveyor which lifts it to four big finished-feed bins outside the building.

Feed is taken from the bins by two five-ton delivery trucks that are driven along beside 10,000 feet of corral mangers. They deposit feed via augers.

(Continued to page 230)



# Which Springfield Tiller do you prefer?

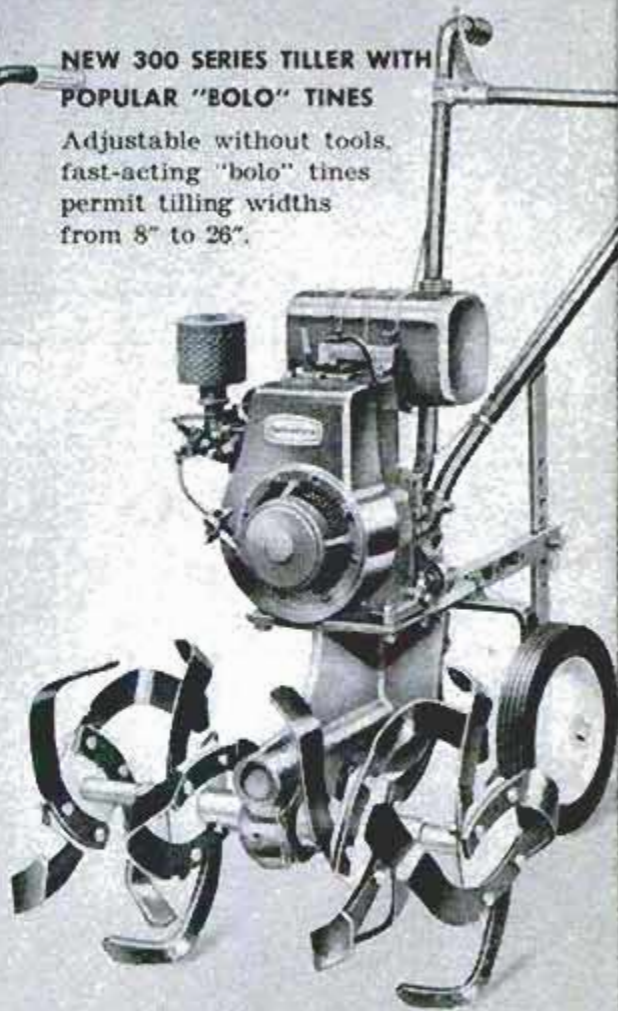
## NEW 200 SERIES TILLER WITH EXCLUSIVE SPRINGTIL TINES

Vari-width Tines, individually  
removable without tools,  
permit tilling widths  
from 7½" to 21½".



## NEW 300 SERIES TILLER WITH POPULAR "BOLO" TINES

Adjustable without tools,  
fast-acting "bolo" tines  
permit tilling widths  
from 8" to 26".



Here are two sturdy "little giants" built to plow, weed, cultivate and pulverize in any man's garden. Featuring self-sharpening tines that are guaranteed for life against breakage, both models offer Springfield's exclusive Quick-Lok Clutch on the handle bar to eliminate unnecessary armwork. Tines and transport wheels are easily adjusted to till wide or narrow rows. Depth bar permits tilling of shallow or deep furrows. Powerful 4 cycle engine "works" the garden, not the gardener.



Quick Manufacturing, Inc.  
3310 East Main St., Springfield, Ohio  
"THE HOUSE OF POWER"  
Designers and builders of the  
Springfield line of walking and riding lawn mowers



Keep your rotary mower  
blade sharp all summer  
long for only **98¢**



Rotary Mower file by Nicholson lets you sharpen your blade easily. If your machine is engine-operated, disconnect the spark; if electric, unplug cord.

It's a nuisance to drag your rotary mower off to be sharpened several times a season. The grass doesn't stop growing while your machine is away from home. But a new product by Nicholson solves the problem. Our Rotary Mower file is the first tool ever designed specifically for sharpening rotary blades. Best news of all: it sells for only 98¢, and pays for itself the first time you use it.

The Nicholson or Black Diamond Rotary Mower file comes with a handy hang-up hole for easy storage in your shop or garage. And every file comes with its own protective plastic sheath.



Look for it in its colorful display. It's at your hardware dealer's now—the biggest tool bargain you ever came across.



**NICHOLSON**  
U.S.A.

**NICHOLSON FILE COMPANY**

Providence 1, R. I.

**BLACK DIAMOND**  
U.S.A.

(In Canada: Nicholson File Company of Canada Ltd., Port Hope, Ontario)

**NICHOLSON FILES**  
A FILE FOR EVERY PURPOSE

### Cattle Can Be Finicky

One of the old systems used by cattlemen to fatten out was to chop hay and mix grain with it. Herbert Meyer, a Texas cattleman, was following this procedure when he noticed a few of his animals were getting fat faster than the others. He watched these fast gainers and found they would grab the feed, shake out the grains and eat them only, leaving the hay for the other animals.

"I investigated new mechanical-feeding methods and found that through automation," he says, "I could mix up a formula of hay, grain, concentrates and minerals that would be held together by the highly desirable ingredient, molasses, and that the animals would not shake apart."

He settled for a new feeding arrangement known as the "one-man feed lot." This is a combination of the automatic feed-mixing plant and an automatic feed chain-delivery system that eliminates trucks. The man who operates it stands in one room before a panel of switches and mixes as well as delivers the feed to his stock without even bothering to look out a window.

The inventor of the one-man feed lot is Clay Thompson of Madera, Calif., who for many years was a cowboy on the open ranges of the west. The robot system is so efficient that one man can mix and deliver feed to 500 steers in a half hour.

### Delivers Exact Amount

After feed has been electronically mixed it leaves the mixing room by auger and is dumped onto the dining table. As the first reaches the table, a chain and wooden-bar conveyor is automatically started and the feed is moved along. A preset time schedule determines when the first feed reaches the other end of the table, and the conveyor is automatically shut off. The conveyor courses upward at the end of the table and comes back to its starting point under the roof and out of reach of the stock. The system delivers just enough feed for the number of cattle that are in the feeding corral.

A quarter century ago a steer was all stomach by the time he reached a marketable weight. The beefman was lucky if the carcass yielded as much as 50 percent of its weight in marketable meat, and the housewife was lucky if she got meat that was less tough than leather.

Today the yield, well distributed over the animal under the scientific and automatic feeding, produces a carcass that yields from 55 to 65 percent, and the quality is such that it is rare that a tough cut of meat is found on the dining table. ★ ★ ★





## All you need for Spring Spruce-up... all in one handy *MoPAR* kit...all for \$2.25\*!

**Special package price!** For sparkling "new car" beauty, here's what you get in one easy-to-take-with-you, easy-to-use car care kit:

1. MoPar Automobile Polish. Fast-acting. Just apply, let dry, wipe clean.
2. MoPar Liquid Chrome Polish. Quickly removes tarnish, restores original brilliance.
3. MoPar Glass Cleaner. Spray on, wipe off. Leaves no streaks or blurs.
4. MoPar lint-free Polishing Cloth.

Pick up your kit today from your Plymouth, Dodge, De Soto, Chrysler or Imperial dealer, or independent repair shop featuring quality MoPar products. And while you're there, remember he's the man to see for *all* your car care needs. MoPar means genuine Chrysler Corporation products, made to highest quality standards.

MoPar Division, Chrysler Motors Corporation, Detroit 31, Michigan



\* factory retail price, at factory

**MoPAR**  
PARTS & ACCESSORIES



# EXTRA FUN



*a cinch for you to run!*

Relax . . . and really enjoy fishing . . . with a 1958 Oliver 6 hp motor! Rely on an Oliver for easy starting, smooth running and simple operation. It's an unbelievably slow-trotter with plenty of "zip" when you call for it. Want that "forward-thrust" look? Oliver has it! And colors are new too . . . rich Marlin Grey and Beach White. Be distinctive! Be smart! Buy Oliver in '58.

**OLIVER'S  
TILT-A-MATIC**

*Just twist the dial when you decide,  
to change your ride from rough to glide!*



**OLIVER FOR '58—6, 16, 35 HP OLYMPUS**

*Write for full-color literature*



**OLIVER OUTBOARD MOTORS**

*Division of the Oliver Corp., Mfgs. of the  
finest Farm and Industrial Equipment*

452 EAST MICHIGAN, BATTLE CREEK, MICH.

## Quick Power When Disaster Strikes

(Continued from page 111)

back to the hospital, but they kept classroom and living facilities for more than 2000 students and instructors in the city's school system operating, and serviced the main telephone exchange.

Emergency power equipment is required in the plans for new hospitals in this country if Burton-Hill federal funds are granted to aid in the building. This is even true of nursing homes for the elderly.

"It is contemplated that in case of an enemy attack on this country, the old folks could be moved to private residences, and the nursing home used as a hospital for the injured," explained Merle Denevan, manager of one of the nation's newest nursing homes in Latah County, Idaho.

Currently, Civil Defense officials are campaigning to encourage farmers to equip their tractors with electric generators. In case of attack, stand-by power would be just as important on the farm as in the city.

But, even without major disaster, the generators attached to tractors would pay dividends to the farmer. They can provide power for portable tools used away from buildings normally served by commercial power. Saws, posthole diggers and welders can all be operated by tractor power.

Also developed has been a new lightweight alternating-current power generator that can be mounted on a truck or auto. It will produce 10 kilowatts at 110-120 volts anywhere the vehicle can travel.

### Stand-by Power Can Be Lethal

Utility concerns go all out to cooperate with anybody installing a stand-by unit—for more reasons than one. Officials say:

"If electricity from a stand-by plant feeds into the utility lines it can bring sudden death to a lineman who thinks the line he is working on is dead. The transformer on the pole outside your place reduces the line voltage from 1200 to 120. But, if energy is fed into it from the house side at 120 volts, it is transformed to 7200 volts as it goes out over the line.

"This situation makes it extremely important that a switch be installed with stand-by plants which will make it impossible for both sources of supply to be connected to the home wiring at the same time, and impossible for the stand-by generator to feed into the utility lines."

Many cities today have set up stand-by power units for their police radio. Typical is that at Erie, Pa. Erie has a stand-by electric plant at its central police station and another at the transmitter several miles away. ★ ★ ★





### FOR WATERPROOF GLUING

Completely waterproof two-component resorcin resin glue forms a bond stronger than the wood itself. Resists continuous outdoor exposure, cold and boiling water, moist and dry heat, mold and fungus, solvents, acids and alkalis. Unbeatable for boats, outdoor furniture, sports equipment. Comes in 1/4 pint and pint cans.



### FOR NO CLAMP GLUING

Regular or nonflammable cements that bond on contact. Strong, water-resistant and heat-resistant. Best you can use for plastic laminates, plywood wall panels, leather, linoleum, synthetic rubber, thin gauge metal and all dissimilar materials. Can sizes in pints and quarts.



### FOR GENERAL WOOD GLUING

This powdered casein glue makes strong, water-resistant joints. Works fine on hard or soft woods and many other materials. Mixes easily in cold water and can be used anywhere, even in cold outdoor temperatures. Ideal for laminating beams . . . gluing tables and counter tops, sashes and doors, molding and fixtures. 1 and 5 pound can sizes.



Buy where you see this emblem . . .



# There's an Elmer's Glue for every job you do!



### FOR HIGH SPEED GLUING

A modern, ready-to-use polyvinyl resin glue for general interior use. Perfect for gluing dowels, paneling, inlays, marquetry, cloth, paper and all porous materials. Fast setting, dries clear. Available in refillable plastic squeeze bottles, tubes and jars in a wide variety of sizes.



### FOR STAINPROOF WOOD GLUING

Chemically neutral, this powdered urea resin glue does not stain acid woods like oak or mahogany. It is highly water resistant and mixes easily in cold water. The perfect glue for fine furniture panels, cabinet work, veneering . . . any job where a clean glue line is important. Available in 1 and 5 pound cans.

Borden Glues are available at hardware, variety, paint and lumber supply stores everywhere. For a free chart which shows the right glue to use for every job, print your name and address on a post card and mail to: Elmer's Glue Chart, The Borden Company, 350 Madison Avenue, New York 17, N. Y.

IF IT'S *Borden's* IT'S GOT TO BE GOOD!



## We Built a Family Room Outdoors

(Continued from page 149)

to leave a portable TV or hi-fi unit (above any dampness of the floor). The duckboards are in four-foot sections so they can be lifted out for storing fuel below.

Almost any barbecue fireplace becomes complicated and expensive when you place it under a roof, but you do want it inside the outdoor room to have its warmth and its barbecuing for all seasons. The answer was very simple. We purchased a 30-inch-diameter portable grill of the common metal-bowl type. With the legs removed, we turned the bowl upside down for a guide and mortared a circle of brick up around it. We made this 24 inches high and it actually resembles a wishing well. Then we mortared three columns of brick up on the inside to support the bowl and mortared it in place. A length of iron rod was welded to the crank which raises and lowers the bowl's grill. At a local sheet-metal shop, we ordered a 40-inch-diameter hood made of 18-gauge galvanized iron, along with a 9-inch-diameter, 7-foot stack or flue to fit.

This fireplace, or fire pit, should be placed where it will not block off the view, interrupt the traffic flow or reduce play and lounging areas. Any outdoor fire-

place will smoke occasionally, so it is best located near the outer side of the room. The weight of the brick and bowl is not enough to require any more foundation than the usual four-inch floor slab. The stack can pass through the asbestos roof anywhere it is four inches from the wood framing, and the hood and stack simply are supported from above by four 1/4 by 1-inch iron straps screwed to the egg-crating and stack.

Good lighting practically doubles the use and glamour of your outdoor room. We used the new Remcon low-voltage system. Any low-voltage wiring system allows you to use nonshocking, small "doorbell" wiring to all switches, but the new Remcon relays do not require a master system or that the entire house be wired with low voltage. In other words, it is a low-voltage system which can be added inexpensively to any house. On the roof of the outdoor room, I located two 150-watt floodlights to outline a large oak tree and to give some lighting throughout the rear yard. On three of the four posts of the room, I placed glass-fiber bullet lamps with 75-watt bulbs, for lighting the barbecue and the barbecue table. You do need bright lights when barbecuing. Walkway lights were placed at various points in the yard.

(Continued to page 236)



POWER CULTIVATE YOUR GARDEN

MOW TALL GRASS, WEEDS, CROPS

MOW GRASS, WEEDS, MULCH LEAVES

BLOW SNOW AWAY

HAUL HALF-TON LOADS

# GRAVELLY

offers  
**NEW EASE**  
for  
**Country Living!**



## An Amazing New Experience Awaits You!

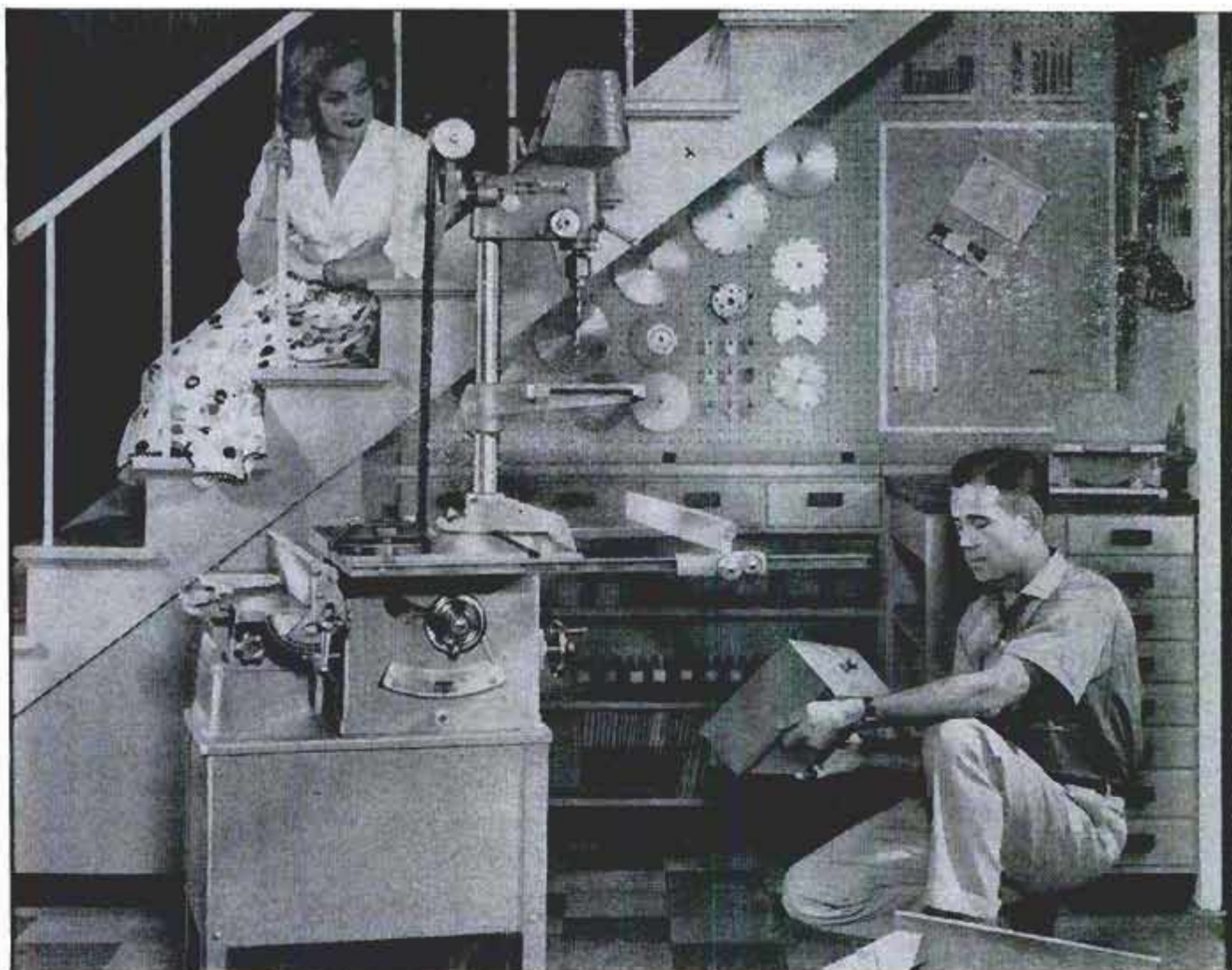
You, too, will be mighty proud when everyone marvels at the beauty of your Gravelly-kept place! . . . (If they but knew the *ease* and *speed* with which you do every lawn and garden job with your versatile Gravelly! . . .) Whatever the job, summer or winter, your Gravelly turns in a perfect performance, *with power to spare!*

## Now! 30 Tools for Every Year-Round Job!

Unmatched versatility! . . . 30 performance-proved attachments to choose from. Plus All-Gear Drive, Power Reverse, Push-Button Starter. Don't be satisfied with less than Gravelly offers!

Write today for FREE Booklet, **GRAVELLY TRACTORS, INC.**  
"Power vs Drudgery!" **BOX 463 DUNBAR, W. VA.** **EASY PAY PLAN**





## **BIG IDEA FOR SMALL SPACE**

### ***New Advanced Design*** **DELTA'SHOP**

Combination of 4 full size tools does 95% of all workshop jobs—yet takes space only 3 feet square!

If you want a *real* shop, but don't have a lot of space, the DELTASHOP is for you. It's the most *practical* all-purpose combination tool built!

Here's why: In a space just 3 feet square it puts at your finger tips a powerful 9" tilting arbor circular saw, a 4" jointer, an 11" drill press, and an 8½" disk sander—all mounted on one stand and powered by one motor. And because Delta-Shop is a combination of *full size* tools (not attachments) you can buy it all at once (as little as 10% down), or the easy Tool-At-A-Time way.

#### **IT'S SO EASY TO OWN THE BEST!**

Because Delta makes the world's most *complete* line of combination, all-purpose and individual power tools, you can choose tools exactly right for you. And you'll have the "newest look" in the world's finest power tools.

#### **BUILD THIS SPACE-SAVER SHOP**

Delta experts designed this shop so that you can build it. Easy-to-follow plans and the New Delta Reference Guide are yours—**FREE**—just send a post card with your name and address to: Delta Power Tool Division, Rockwell Mfg. Co., 502D N. Lexington Ave., Pittsburgh 8, Pa.

*Do it now*—then see *all* the *New Advanced Design Delta Tools* at your *Delta Dealer*. (He's listed under "TOOLS" in the *Yellow Pages*.) Or at leading *Department, Hardware, and Building Supply Stores*.

DELTA POWER TOOLS

another fine product by

**ROCKWELL**





The best lighting of all, a soft indirect illumination the length of the room, was placed in the house soffit. The roof overhang of our house is the usual—a two-foot overhang with the rafters exposed below. Those rafters looked raw, unfinished, when inside the outdoor room. To cover them, we placed panels of flat, clear glass fiber on the underside. The plastic matches the skylight and simply lies loose on strips of wood molding. A socket for a common 40-watt bulb was centered over each of the nine plastic panels on the underside of the roof. The result, inexpensively, was truly glamorous lighting for the room. If the soffit of your house is already enclosed, or the roof has no overhang, you can obtain a similar effect by mounting a few small floodlights on the roof to shine down through the glass-fiber skylight.

Each of the above groups of lights was controlled by a Remcon low-voltage relay. The wall outlets also were wired to relays. Thus, one button on a master panel inside the house can be touched at bedtime and you know that everything electrical outside the house is turned off. The small switch wiring is inexpensive and easy to install, so I ran it into the garage and buried it in shallow ditches in the yard, to have switches at various points outside to con-

trol floodlights, walkway lights and others.

The barbecue cabinet, like the room, can vary to fit your house and desires. It is built the same as any kitchen base cabinet, of exterior plywood, and the base is the same frame of the duckboard bench. We used 3/4-inch GPX-Yellow, the plastic-coated exterior plywood, to eliminate any chance of deterioration or weather checking. The new plastic-surfaced plywood takes paint and stain the same as wood. The cabinet top is of hard laminated plastic, practically indestructible and easy to clean. A handy feature is the warming tray on the right side of the cabinet. For this, I simply purchased one of the new serving trays which have a glass heating panel in the top. A thin drawer almost like a breadboard was built into the cabinet top to fit the tray (with its handles removed).

Constructionwise, I first had the plans okayed by our local building inspector. The only tough job I encountered was breaking four holes through the patio floor and digging down two feet below to pour concrete foundations for the four posts. To frame the room, a two-by-six plate was anchored along the side of the house above the windows to receive doubled joists from each post. The four doubled two-by-six joists from the posts were secured to the

**SAVE \$10 ON THIS SPECIAL DURING HARDWARE WEEK**



NOW  
**\$44.50**

Thru Hardware Week only

## *Black & Decker* **U-10 JIG SAW**

For *Hardware Week*, in April, Black & Decker is reducing the price of the famous B & D U-10 Jig Saw from \$54.50 to \$44.50. This versatile tool does the work of a jig saw, sabre saw, keyhole saw plus most band saw operations! It cuts straight, curved and intricate designs in practically any building material and makes pocket cuts without a "lead" hole. Fast, easy to handle . . . and powered by a B & D-built motor. Ask your B & D dealer now about the "Special" on U-10 Jig Saws.



# *Black & Decker*®

Towson 4, Md. World's Largest Maker of Electric Tools



wall plate with metal joist hangers (much stronger than toenailing) and with half-inch bolts to the posts. A doubled two-by-eight beam was placed along the top of the posts to carry the roof, and it was notched into and bolted to each post. This was not as fast as nailing, but it used less lumber and gave a stronger, cleaner design.

Most house-roof overhangs are weak and will carry little extra weight without sagging. Ours was no exception. The eggcrate frame of the roof proper was blocked and nailed to the ends of the house rafters, but the weight is actually carried by the four doubled joists underneath. The eggcrating was spaced to fit the room in approximately three-foot squares (anything from 30 to 40 inches will give good support for this type of roofing). The corrugated Flexboard roofing is available in 8, 10 and 12-foot lengths. We used 12-foot lengths and made the total roof 14½ feet wide—to use three-foot lengths of corrugated glass fiber on the skylight and have a six-inch overlap where the plastic and asbestos join. Where the plastic and asbestos rested over the house gutter, no attempt was made to have a waterproof seal. This is a safety factor—if ice or leaves should block the gutter, the water will spill down on our patio floor rather than seep through the house shingles onto ceilings.

The flat walkway roof to the garage was framed with two by sixes, spaced to match the rafters of the house overhang. It extends under the butterfly roof and ties to the doubled two-by-six joist at the end of the outdoor room. Any conventional framing of two-by-four stock can be used to enclose the sides of the room for fly screening. Concrete nails will secure the two-by-four sills of the framing to the floor and the screen frames will slip between the doubled two-by-six joists of each end of the room for good support at the top. Across the front of the room, similar two by sixes at the same level should be secured to the posts, to support the screens there.

My wife and I have found this outdoor family room to be the most usable and pleasurable part of our house. Our young son and his friends play in it, good weather and bad—and so the rest of the house has it easy. Come nightfall and the grownups take over, and when guests arrive everyone gravitates to the outdoor room. Realtors tell us the room adds a good \$2000 to the value of our house, though the material costs were less than \$600. It's hard to explain, but the room is truly an indoor-outdoor area—a transition space that makes our entire rear yard a part of our living area. We find only one problem—we now wonder why we have a living room. ★ ★ ★



## Black & Decker

# MAGIC SWITCH

—24 tools in one!

That's what you get when you start with a Black & Decker ¼" Utility Drill . . . the drill with extra power. Then switch it to any of 24 other tools just by slipping on Black & Decker Attachments!

Only quality B&D Drills . . . with the B&D-built motor—have the *power* necessary to drive attachments in a variety of continuous, demanding operations. And B&D Attachments are engineered for B&D Drills . . . to work as a team. Ask your B&D dealer about making the Magic Switch!

Turn your B&D Utility Drill into any of these 24 tools:

Saw	Roto-Hone	Orbital Sander	Furniture Polisher
Jig Saw	Wood Auger	Screw Driver	Disc Sanding Table
Twist Drill	Paint Mixer	Car Polisher	Abrasive Shapers
Drill Press	Countersink	Metal Buffer	Wire Cup Brush
Hole Saw	Cotton Buff	Floor Polisher	Wire Wheel Brush
Grinder	Disc Sander	Masonry Drill	Hedge Trimmer



# Black & Decker

Towson 4, Md. World's Largest Maker of Electric Tools



# How to select a paintbrush

A good brush performs better... wears longer... saves you money



Check these points when buying your next paintbrush.

First, look for a full stock of bristles in a firm, strong setting (1). Avoid brushes with loose bristles. Then inspect the individual bristles closely (2). They should be finely tapered, with slightly curled



tips. Look again and be certain a generous portion (at least 10 to 20 per cent) of the bristles have tips which are split or "flagged" (3).



Your final assurance of a brush which will give the best painting performance is bristles of varying lengths (4),

but with a high proportion of longer lengths.



If the brush you look at passes all these tests, it will have a greater working and paint-holding capacity and eliminate excessive dipping. It will (5) release any type finish smoothly and evenly on any surface.



One short cut to selecting a good brush is to look for the black and yellow tag, signifying a brush with TYNEX nylon bristles

(6). Properly made paintbrushes with tapered bristles of improved Du Pont TYNEX nylon give you better painting performance. They pick up a full paint load at every dip and give velvet-smooth paint-out. With proper care, brushes with durable bristles of TYNEX clean easily... rinse thoroughly... are quickly ready for another job.



**FREE**—"How to Choose and Use a Paintbrush." This booklet tells how to paint walls, ceilings, trim, furniture, radiators and do other special jobs. Gives tips on the correct painting stroke, how to hold a paintbrush, how master painters dip their brushes, how they clean them. Tells what kind of paintbrush to use for each painting job. Write to E. I. du Pont de Nemours & Co. (Inc.), Polychemicals Dept., Room 534, Du Pont Building, Wilmington 98, Delaware.



TYNEX is the registered trademark for Du Pont nylon bristles.

**DU PONT**  
REG. U. S. PAT. OFF.  
**TYNEX**<sup>®</sup>  
NYLON BRISTLES  
BETTER THINGS FOR BETTER LIVING . . . THROUGH CHEMISTRY

## The Jet Stream Is the Villain

(Continued from page 99)

temperate latitudes in which live close to a billion Americans, Europeans and Orientals boasts the full name of polar front jet; it meanders above the ever-changing weather front where the cold polar fronts from the arctic meet the warm air masses from the equator. A curious habit is that of splitting unexpectedly into two or more rivers of wind, with vast islands of comparatively still air in between. A few hundred or few thousand miles beyond these forks, the branches may merge again, for this temperamental stream shifts not only north and south, but up and down in elevation. Generally it flows between the 30,000 and 40,000-foot levels. But now and then it suddenly drops, as it did over northern California late in December of 1955, to 10,000 feet, accompanying cloud-bursts that inundated several communities, among them Yuba City, which spent Christmas under water.

### Big Winds Blow Fast

The big wind has been clocked blowing 200 miles per hour 40,000 feet above Philadelphia when the surface winds were but breezes. It was once tagged above Spokane blowing a 480-mile gale when the ground winds were gentle zephyrs blowing west. High-flying airmen have reported that above the furious global wind band the atmosphere is almost still.

The jet stream's affinity for forest fires has been revealed by Dr. Vincent Schaefer, General Electric's weather wizard, who traced 21 major "blow-up wildfires" which devastated 365,000 acres of timber in 1955, to the proximity of the big wind. Meteorologist Jerome Namias, of the Extended Forecast Section of the U.S. Weather Bureau cites convincing evidence that the destructive hurricanes of recent years—Ione, Diane, Hazel, Carol and others—swung inland over the Atlantic Coast states because the polar jet stream had shifted its course north and west instead of heading out to sea in the vicinity of the Carolinas.

### What Makes Them Blow?

What makes these violent rivers of air swirl around the earth is good for a debate any time two or more meteorologists get together. There is agreement on this much: the jet streams are cradled in the sky layers where the heavier lower atmosphere, known as the troposphere, meets the lighter, thinner upper atmosphere, the stratosphere. This layer slopes from about 60,000 feet above the equator to around 30,000

(Continued to page 242)





## "SEE-ABILITY" UNLIMITED



**Only the Advance Design of Chrysler Corporation cars  
gives you such all-around viewing**

Wherever you look, a '58 car of The *Forward Look* lets you see all outdoors! For no other design gives you so much glass to look out of.

Enormous Control Tower windshields curve around and sweep back and over—letting you see *up* as well as forward and to the side. Rear windows, too, are largest ever—up to 13 square feet of glistening wraparound glass for greater safety on the road and when you park. And of course, every window is clear vision safety-glass.

It's all part of our Advance Design. For our flowing, low dart-shape is *more* than America's favorite look. It makes possible America's most advanced ride—

Torsion-Aire—at no extra cost. This new, proved, trouble-free system of suspension stops dip when you brake, ends squat when you start and keeps you on an even keel on turns.

Advance Design goes even further in the '58 cars of The *Forward Look*: Mechanical Pushbutton Torque-Flite controls—first in the industry—Fuel-Saver chokes that give our new engines economy to match their new smoothness and performance.

But see for yourself—look into and *out* of a new '58 *Forward Look* car! A trip to a nearby dealer will convince you it's the best value on the road today.

**CHRYSLER CORPORATION**  **THE FORWARD LOOK**  
**PLYMOUTH • DODGE • DESOTO • CHRYSLER • IMPERIAL**





## "Pedigreed" Parts FOR YOUR

# CARTER



## CARBURETOR

Today's CARTER Carburetor is a precision instrument. Each part is designed to exacting tolerances to give you the performance you need for modern fuels and high-compression engines.

No wonder, then, that it's so important to insist that *only genuine CARTER Repair Parts* should be used whenever your carburetor needs overhauling. Ask your service man to overhaul your carburetor using a genuine CARTER Repair Parts Kit... look under **CARBURETOR** in the classified section of your phone book for Carter parts and service.

**CARTER CARBURETOR**  
DIVISION OF **OCF INDUSTRIES**  
INCORPORATED  
ST. LOUIS 7, MISSOURI

## On the Trail of Meteorites

(Continued from page 119)

ground by a meteorite was not even burned by the once-fiery chunk of metal.

In the Meteorite Museum are more than 10,000 meteorite specimens found in 38 states and 49 foreign countries. Many of these Dr. Nininger has acquired by trading. Others he has been called in to identify. These he buys if the owners will sell, paying one dollar an ounce and up for the smaller ones, one dollar a pound and up for the larger ones. But the gems of the collection are the shooting stars he has found himself.

### Narrowing the Search

The pursuit often ends in frustration, just as it does for the police hunting down a wanted criminal. And it calls for the same bulldog tenacity. One summer he was driving through the West when he heard of a farmer who had seen a meteorite go scorching across the night sky over his hay barn.

He found the farmer, obtained from him the meteorite's compass course and drew a corresponding line on a map of the area. The hunt was on. He drove in a great circle, stopping frequently to make inquiries, adding new lines to his map until they began to converge on one small area. It took him a week of questioning people who had seen the meteorite, or who vowed they had seen a flying saucer or an airplane in flames, to narrow the area to an ellipse containing about 15 square miles.

### Doorstops From Outer Space

He now entered the bracketed area and tried to pinpoint the exact spot where the meteorite had plunged to earth. It had fallen in a fairly well-populated farming area, but no one had seen or heard it fall. He could only conclude that it was the stony type, that it may have weighed tons as it traveled through space but had ended up as dust. If it had been metallic and had landed intact—or in fragments—he would have continued his pinpointing, finally using a modified land-mine detector.

The layman rarely recognizes a meteorite when he finds one. One meteorite that Dr. Nininger found was being used as an anvil on a ranch. Another had been forged into a crowbar by a Mexican blacksmith. He has found others built into stone walls, serving as doorstops and as weights on the lids of pickle, pork and sauerkraut barrels. Their owners are quite surprised when they learn that these handy little rocks have traveled to them through millions of miles of space. ★ ★ ★



# WOODWORKERS! DIAL-A-CUT!

Look what you can do on your power saw with the

## Comet QUICK-SET DADO MULTI-TOOL

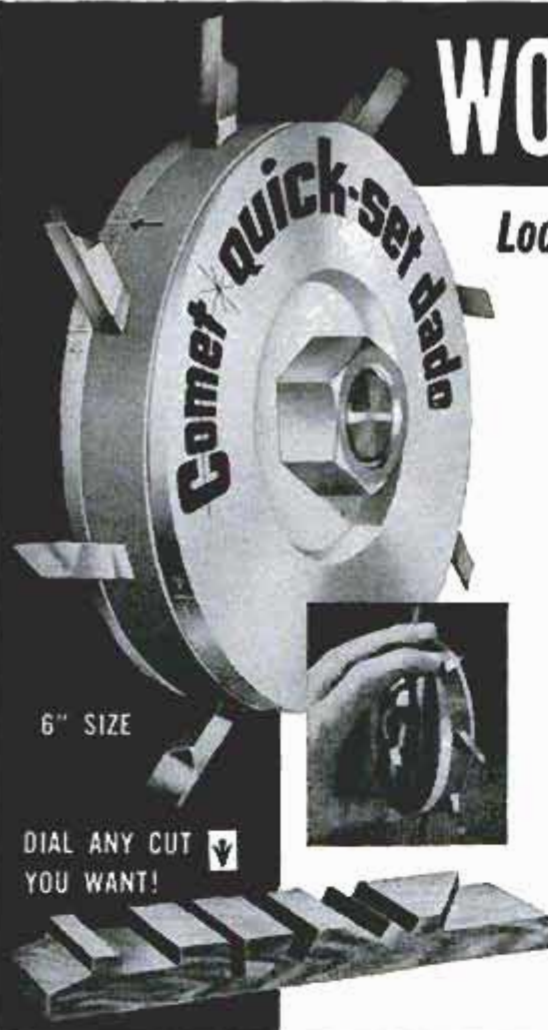
JUST "DIAL-A-CUT." This versatile, precision tool cuts perfect dado grooves, rabbets, panels, bevels, miters and ploughs, with more accuracy and speed than any tool you've ever used. Without removing it from the arbor you can set it for any cut up to  $\frac{3}{4}$ " deep and  $\frac{1}{4}$ " to  $\frac{13}{16}$ " wide, or any hairwidth between! You can make tighter fitting shelves and joints, stronger furniture, easier and quicker.

### FAMOUS WITH PROFESSIONAL WOODWORKERS

The COMET is perfectly balanced, runs true, smooth, no wobble, vibration, burning or chewing. High speed, self-cooling, tool-steel blades stay sharp 5 times longer than ordinary dados. It fits any table or radial arm saw, has bushings to fit shafts  $\frac{1}{2}$ ",  $\frac{5}{8}$ " or  $\frac{3}{4}$ ", adaptable for right or left hand rotation. See your dealer or order direct with check, money-order or C.O.D. Now available at greatly reduced price because of vast demand and volume production.

CONSOLIDATED MACHINERY & SUPPLY CO., LTD. Dept 4M  
2033 Santa Fe Ave., Los Angeles 21, California  
A DIVISION OF THE SIEGLER CORPORATION

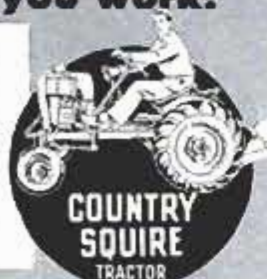
**\$19.95**  
PREPAID



## Ride while you work!

Plow, cultivate, mow, rake, harrow, till, plant, bulldoze, plow snow, spray, saw, maintain beautiful lawns. 8.4 hp. All-gear drive. B-W 4 speed trans., clutch, diff. 770 lbs. Low cost. Ready to run. Quick-change implements. 100% satisfaction guaranteed.

Write for FREE CATALOG  
COUNTRY SQUIRE TRACTOR CO.  
P.O. Box 107-K-4  
Muskego, Wis.



Do it now with

# DAP



Use DAP Kwik-Seal® for water-tight joints around bathtub, sink, tiling, baseboards. A wonder-white sealer. Long-lasting. Get handy tubes and free do-it-yourself booklet at hardware, paint and building supply dealers.

**DICKS-ARMSTRONG-PONTIUS, Inc.**  
General Offices: Dayton, Ohio

## READY CUT HOMES

**\$2150 AND UP DIRECT FROM MILL**

YOU SAVE the items which help make today's building cost expensive: high labor cost, contractor's profit and overhead, insurance, architect's fees. Cut-to-Fit eliminates usual lumber and material waste, also costly mistakes. Anyone can assemble. Simple, easy-to-follow plans furnished and each part numbered. Complete with all lumber, roofing, nails, glass, hardware, paint, doors, windows. Freight paid. Low-cost building plans sold separately if desired. 57 Homes and Floor Plans.



5 EASY PAY PLANS  
COLOR CATALOG

Send **25c**

INTERNATIONAL MILL & TIMBER CO.  
Dept. PM-48 Bay City, Mich.



# GET YOUR COPY



**FORTY PAGES.  
PROFUSELY  
ILLUSTRATED.  
JUST OFF  
THE PRESS.**

A new, revised and expanded edition of a practical booklet that amateur and professional mechanics and industrial arts teachers by the tens of thousands have used and endorsed. Illustrates scores of ways for doing it better and easier with thirty different hand tools. Tips on proper care and maintenance of tools along with other useful information for the mechanic and hobbyist. The coupon will bring your copy by return mail.

**SEND A DIME OR GET YOUR COPY  
FREE WITH THE PURCHASE OF  
ANY CRESCENT TOOL.**

**Ask Your Hardware Dealer.**

**CRESCENT TOOLS**

*Give Wings to Work*

*Sign of the Artisan  
Symbol of Excellence*

To Crescent Tool Co., Jamestown, N. Y.

Enclosed find 10¢ for my copy of  
"HOW TO USE HAND TOOLS."

Name .....

Address .....

feet above the poles. Along the northern edge of the polar jet stream, there is usually an invisible atmospheric cliff in the troposphere falling off one or two miles like the land cliffs of the Grand Canyon. Dr. Namias and P. F. Clapp of the U.S. Weather Bureau advanced another explanation, namely that "the jet stream is due to the confluence of vast streams of [warm] equatorial air and [cold] polar air at great heights. When these warm and cold masses are brought side by side, the resulting pressure differences set up a strong circulation which may develop the strength of a jet." SELS Forecaster Don House says that the jet stream is "the result of kinetic energy, the transformation of energy of position to energy of motion."

Whatever their cause, the jet streams play havoc with the weather unexpectedly. But, as forecaster House says, "By watching the jet stream, with good analysis, we can pick out the three or four danger spots across the country where trouble might occur, in time to warn people and save life. Four years ago, our chances of spotting tornadoes before they occurred were 20 in 100. Now they have improved to 65 in 100. Severe storms may not always occur when and where we forecast them, but at least we know we should be on the alert." ★ ★ ★

## pull the trigger... spray paint

7 times faster than brushing!



*Speedy Sprayer*

**ONLY  
\$32.00**  
less motor

Paints anything from a house to a toy. Saves its cost on the first major job! Speedy Sprayer does in minutes what brushing takes hours. Finish is smooth, flawless. Uses any ¼ h.p. motor with ½" shaft. No. 780 *Outfit*—10 ft. air hose, tire chuck, quart gun, less motor, only \$32.00. Every workshop should have it. At leading stores.

Free! Write for "How To Spray" Booklet and folder.

**W. R. BROWN CORPORATION**  
Specialists in Portable Paint Sprayers for Over 37 Years  
2635 N. NORMANDY AVENUE, CHICAGO 35, ILL.



Put up shelves the easy way



**Use McKINNEY  
Closet Shelf  
and Rod Supports**

These steel brackets support both closet shelf and rod. Eliminate hanging strip. A real time saver. Special price during Hardware Week only 98¢ each. Get them at your neighborhood hardware store, or write us for literature.

**McKINNEY Manufacturing Co.**  
1715 Liverpool Street • Pittsburgh 33, Penna.

A screen so fine it "holds" water can't stop the flow of this metal powder for bearings.

Yet each dust-like powder particle is a carefully proportioned alloy of copper (for strength) and lead (for softness) . . . for fine performance!



Another reason why

**FEDERAL-MOGUL** means  
**FINE PERFORMANCE!**

We make millions of copper-alloy and other types of bearings each year for the engines of new cars, trucks, buses, farm, industrial and commercial equipment. We make additional millions each year to supply the nation's mechanics with the replacement bearings they PREFER to use to restore like-new power, pep and economy. If your engine needs reconditioning, remember Federal-Mogul bearings are *engineered* for the job. Ask your mechanic!



**FEDERAL-MOGUL SERVICE**  
Division of Federal-Mogul-Bower Bearings, Inc.



Works in seconds!

**Loosens Rusted Bolts  
nuts, screws, "frozen" parts!**

**LIQUID  
WRENCH**

The super-penetrating rust solvent that quickly loosens rust and corrosion.  
AT HARDWARE STORES, GARAGES  
SERVICE STATIONS, EVERYWHERE  
**RADIATOR SPECIALTY CO.**  
Charlotte, N. C.

ALSO NEW  
**ESHELMAN  
JET DESIGN  
FIBERGLAS  
ROCKET  
BOAT**  
Write for  
**FREE  
Literature**

**ESHELMAN GOLF CARS COST FAR LESS**

**CHOICE! ELECTRIC OR GASOLINE POWER**

Both at same low price! Both feature new extra power, dependability, enjoyment! Handles like big car. Holds 2 adults and 3 bags comfortably. Also ideal cars for sport use. Write for FREE Literature.

Dept. 525  
**ESHELMAN**  
Balto. 2, Md.



Patented

**THE ORIGINAL  
PACKAGED  
BOAT KITS**

NEW FOR 1958! CATALOG FOR  
SEA-RAY FIBERGLASS PLASTIC  
BOATS, BOAT KITS AND HULLS  
CLOTH RESIN  
FIBERGLASS  
ETC.



Constructed in one day. 12 models  
from 10 ft. built in performance  
Utilities and Runabouts. No Uphoof  
Professional Results

MADE ONLY BY *Custom-Craft*  
NEW 1958 CATALOG  
70 MODELS

WORLD'S  
LARGEST  
LINE ...

DESIGNED FOR AMATEURS!

Over 200 Boats, Kits, Frame kits  
8' - 21' All Types: Run, Skiff,  
Cruiser, Etc. No lift required.  
Finest Materials Available. Easy To Build!  
Also Sewn & Custom Finished Boats at new LOW prices

EASY MONTHLY  
FINANCE PLAN  
AVAILABLE

SEND 35¢ FOR 64 PG. CATALOG AND 24 PG. "SEA-RAY"  
Fiberglass Kit Catalog. Contents include hardware, paint  
fiberglass materials. Send \$1.00 for both catalogs plus  
"BOATING HANDBOOK." DEALERS-AGENTS INQUIRE

**CUSTOM-CRAFT · BUFFALO 7L NEW YORK**



# CHEVROLET

PM's test car leaked badly in high-pressure water test.

Chevrolet is best of three, due to spare-tire position.

Wheel is nearly vertical. Has a "let's go" feeling when you slip under it.

High rear ends become low rear ends when you load the trunk — often so low they drag on ramps.

Stylists seem to pay less attention to such details than to the hood-ornament shape.

Here's a fellow who will complain about poor gas mileage next year. How can the industry satisfy guys like this?

"Step down in entering rear seat makes it hard to clean and hard for rear-seat passengers to enter."—Texas soldier.

"Too expensive to drive. Not enough miles per gallon. I get 10 miles per gallon in city."—New Jersey V8 owner.

"Water leaks in trunk, around back window and doors. Floor mats wet."—North Carolina Marine.

"It rides awful hard. Have had three sets of springs and it still rides worse than any car I've owned."—Ohio owner.

"Very poor chrome. It pitted in less than two months."—Illinois railroad clerk.

"Paint not holding up."—North Carolina farmer.

## More Best-Liked Features

"I like the multiple head and tail lights."—Illinois owner.

"It feels like a big car when behind the wheel or just riding in it."—Wisconsin rural mailman.

"Lots of room in the trunk."—Idaho floor layer.

"Strong body."—Idaho implement dealer.

"Dependable. My car has to go 365 days a year and Chevy has never let me down yet."—Wisconsin worker.

"I like the steering-wheel angle. Very easy to control."—Illinois photographer.

## More Complaints

"Turns hard when parking."—Ohio engineer.

"On Powerglide, Reverse is between Neutral and Park. I think it should be below Low. When you start the car in Park you have to go through Reverse to get into Drive."—Illinois assembler.

"Powerglide can be put into Reverse too easily. Should have a stop of some kind."—Illinois salesman.

"If there is something wrong with a new car, you take it back to the dealer. They stall you around, ask you to leave it for a day. When you go to get it, they may have fixed it or may not even have touched it."—Ohio bakery supervisor.

"All '58 Chevrolets except the Impala seem to have a high rear end. Why? Styling requires a graceful dip to the rear."—Florida television executive.

"Oil pan leaks. Can't tell if I'm burning oil or just losing it."—Ohio merchant.

"Brakes fade after several stops from high speed."—New York Army officer.

"Gas tank leaked."—Illinois welder.

"They placed all the controls, such as key switch, windshield-wiper switch, under the steering wheel. They are not handy at all."—North Carolina Marine.

"Chevy should move the inside door handles farther toward the front of the car and higher. A tall man bumps the handle with his knee and the door comes open while the car's moving."—Illinois electrician.

"Rear seat of the Impala hardtop won't sit three in comfort. The center armrest is not easy to sit on."—Illinois housewife.

"I wanted the economy of the Six, but there's not enough power. I will sacrifice economy for an eight-cylinder engine with automatic transmission in my next car. It's too hard to keep up with traffic in this one."—Illinois salesman.

## What About Air Suspension?

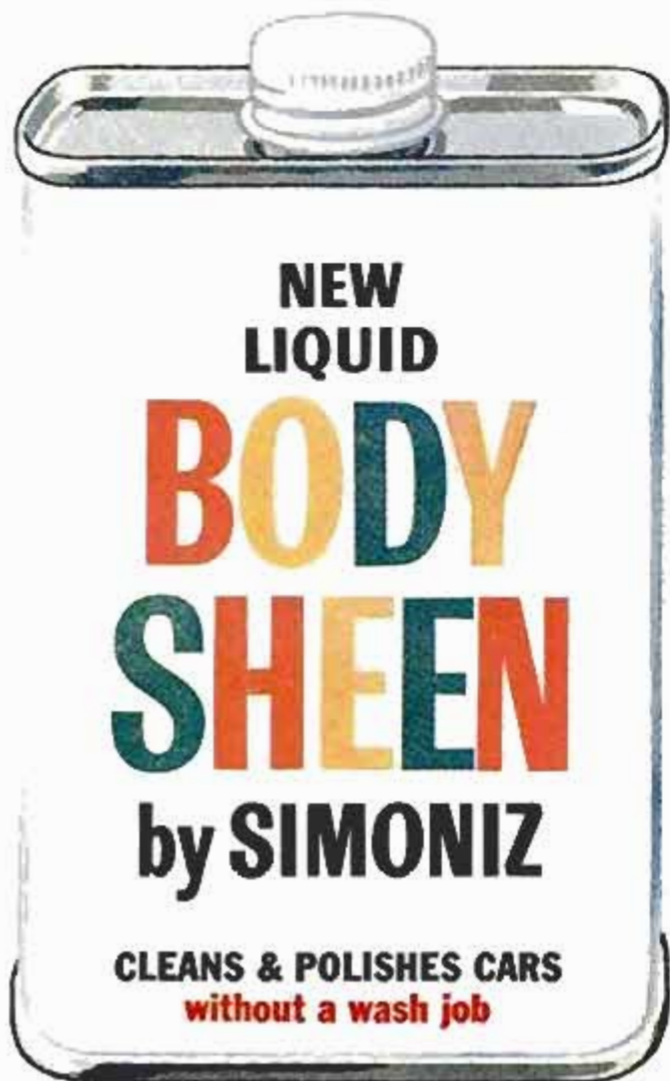
A very small percentage of the Chevrolet owners have air suspension on their cars. Those who do, however, are not as enthusiastic about the device as you would expect. Here are some quotations:

(Continued to page 258)



**SIMONIZ MAKES IT**

# A TERRIFIC NEW CAR POLISH!



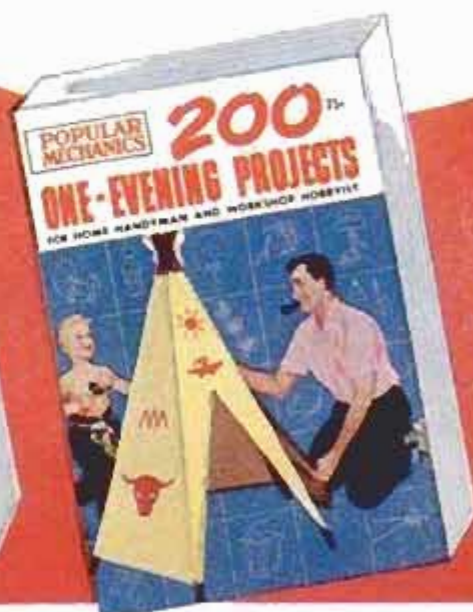
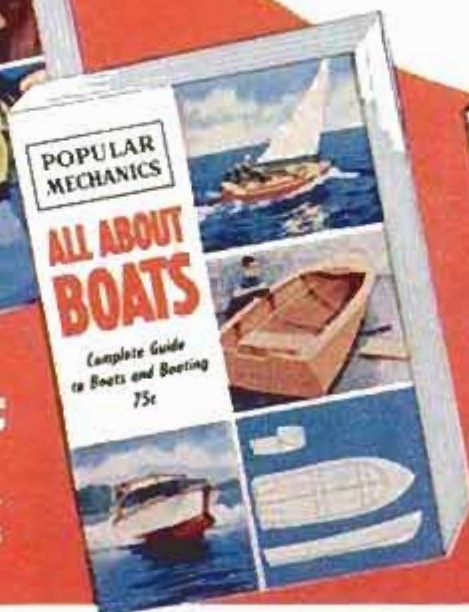
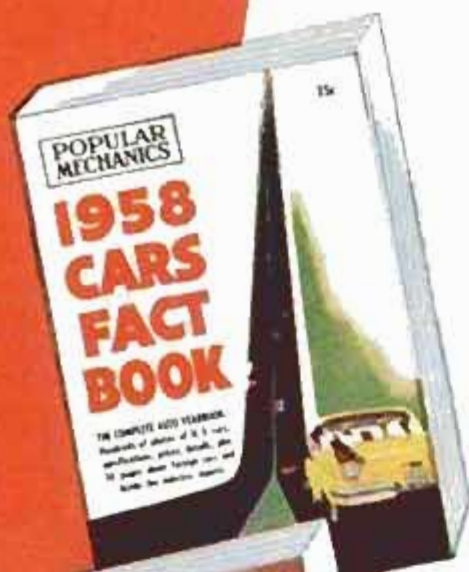
**NOW — \$1.49**



# Get these BIG NEW

POPULAR  
MECHANICS

# BOOKS at your newsstand



EACH ONLY **75c**

Worth Many Times Their Price . . .  
in fun . . . in money-saving ideas

**1958 CARS FACT BOOK.** Want to know all about the revolutionary new cars—price, styles, mechanical performance, innovations? Then this is the book for you! Describes all the domestic and many of the foreign models, with scores of photographs and construction details. If you're planning on buying a new car, or they hold great interest for you, here's a complete, informative one-source reference that's the finest on the newsstand.

**AUTO REPAIR MANUAL.** Prepared by a panel of experts to apply to every make, model and year of car. With hundreds of photos and diagrams it explains exactly how your car is supposed to run, just why it breaks down, how to repair it and how to prevent breakdowns in the future. Also covers how to buy a used car and how to save money on auto vacations. Put a copy in your glove compartment today. Refer to it for any type of car repair and be money and time ahead!

**ALL ABOUT BOATS.** Enjoy the pleasures of hunting, fishing, swimming and skin diving as never before—complete with your own beautiful boat! This book makes it possible to build the boat of your choice easily, accurately and quickly, even with few tools and little experience. Contains tested boat designs with complete step-by-step instructions, full materials list, helpful building hints. Makes you a real sailor, too; covers boat styles, maintenance, seamanship, safety and weather.

**200 ONE-EVENING PROJECTS.** Here, with many diagrams and easy to follow text, are home and hobby projects you can make in just one evening! By morning, when the paint will have dried, your handiwork will be put into admiring use by the family or friends. Projects range from a handy spice rack to a garden wishing well, with ideas for mother, sister, brother—and dad, too. Each is completely illustrated with materials list, and they're fun for all.

If no longer available at your newsstand, order direct for only 85c each (additional 10c to cover addressing, postage and handling costs). Send order, with remittance, to: **POPULAR MECHANICS PRESS, Dept. 458, 200 E. Ontario St., Chicago 11, Illinois.**

## ASK FOR THEM TODAY!



# ACCEPT NO IMITATIONS — BE SURE IT'S A

**KING O'LAWN**  
18" Homeowner  
Model Shown  
**\$149.50**

F.O.B. South Gate  
California

Total weight of  
power mower  
115 lbs.



**KING O'LAWN,**

1958 Model Briggs Stratton  
lightweight 4-cycle  
engines used.

Dual Automotive  
Clutch Control

Mows within 5/8"  
of wall, tree, etc.

All chain drive

This mower will  
give your lawn that  
golf-green carpet look.

That Forward Throw  
All cuttings are  
delivered forward.

**KING O'LAWN**  
Junior model  
power edger  
trimmer shown.

For edging and  
trimming along  
sidewalks, curbs  
and flower beds.

**\$79.50**

F.O.B. South Gate  
California

Total weight  
of power edger  
49 lbs.



Edges 5 feet  
per second  
and trims in  
the hard to  
get places.

Changes  
from edger  
to trimmer  
in just 3  
seconds

4 Models of Power Mowers and 4 Models of Power Edgers from which to choose.  
Over 2000 Dealers to serve you. A few choice dealer territories are still available. Please write

**KING O'LAWN Inc.**

P.O. BOX 1068 TWEEDY STATION  
SOUTH GATE, CALIFORNIA

Takes the **PAIN** out  
of **PAINT REMOVAL**

**KWIK** ALL-PURPOSE  
Non-Flammable  
PAINT & VARNISH REMOVER

Enables you to remove all types of paint,  
varnish, lacquer in just 5 to 15 minutes  
... from the old paints of Colonial  
Williamsburg to the new synthetic  
enamels and fiberglass finishes of  
today. Yes, Kwik's that quick! Try  
Kwik and see. Complete line of Kwik  
paint removal products at good hard-  
ware, paint and marine dealers.

Chemical Products Co., Inc., Aberdeen, Md.



Fast cutting  
Top quality

**GENSCO**

**SWEDISH WOOD CHISELS**

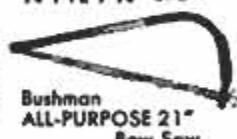
Woodworking projects have that  
little extra professional touch  
when Gensco Swedish Wood  
Chisels are used. They're tops:  
hand ground, razor sharp blades,  
Tenite II handles are unbreakable  
and fire resistant ... won't pull  
loose, sizes from 1/4" to 2".

Buy these accurate cutting, easier  
to use Gensco Wood Chisels at all  
leading hardware stores today.  
Available in sets of 4, 6 or 11 chisels  
in vinyl coated canvas rolls.



Set 300-4

1/4", 1/2", 3/4" and 1"



Bushman  
ALL-PURPOSE 21"  
Bow Saw

**POWERFUL!**

Man, here's  
light! 1/4-mile beam —  
15,000 beam candle  
power. Compact, easy to  
carry, built to last! Uses two 6-volt  
batteries. See your dealer. **\$7.50**  
less battery.

DELTA ELECTRIC CO., Marlon, Ind.



**Delta POWER-KING** ELECTRIC  
LANTERN

**GENSCO**

**GENSCO TOOLS**

A DIVISION OF

GENERAL STEEL WAREHOUSE CO., INC.  
1832 N. Kostner Ave., Chicago 39, Illinois



## Fast, easy new way to pine plank walls, built-ins, and dados



Old Craftsman's two seam-concealing joint patterns give genuine plank effect.

### WELDWOOD OLD CRAFTSMAN Pine Paneling

Here are two new Weldwood Paneling firsts that make it easier than ever for you to give your home the charm and beauty of pine planking. Old Craftsman Pine Paneling is genuine clear pine in big easy-to-install plywood panels, precision-grooved to look like real planks.

#### Two authentic joint patterns

**Cape Cod**—traditional butterfly joint

**Plank**—deep, broad V-groove

Paint it or stain it, Old Craftsman offers you countless new decorating possibilities. You can install it yourself—and it's guaranteed for the life of your home!

Free folder in full color gives specifications and decorating ideas for Old Craftsman applications in your home. Mail the coupon today.

# Weldwood®



old craftsman  
PINE PANELING

United States Plywood Corporation  
Box 61, New York 46, N. Y. PM-4-58

Please send me the full-color folder, "Weldwood Old Craftsman Pine Paneling."

Name.....

Street.....

City.....Zone.....State.....

## Explorer III Our Spy in Outer Space

(Continued from page 86)

The television camera is carried by the airborne spy and its output, a television signal, is relayed to a ground station. Picked up by sensitive antennas, the signal becomes a picture on a cathode ray tube (much like your own TV set's). A film is moved continuously across the tube's face, the film's rate-of-movement compensating for the spy craft's speed.

### Pictures in 20 Seconds

The system is called "Image Motion Compensation." Moving the film in synchronization with the aerial spy's own relative ground speed eliminates image blur. It's a nice trick, but basically no different than when you "compensate" for a fast-moving object by "following" it with your home movie or still camera.

The ground station cathode-ray receiving tube's flat face is coated with a special phosphor so that, unlike your own TV, only blue light in a very narrow spectrum is emitted. This narrow light band aims at maximizing response, thus wringing greatest detail from even a weak signal. As a matter of fact, for highest resolution a cathode-ray tube must operate at low intensity—its picture far less bright than would satisfy most home viewers.

Low light intensity produces a relatively faint image on the recording film, one reason why the developing-fixing solution (termed "monobath" because a single solution develops, stops and fixes) must be superfast. And it is. Highly acidic and warmed to about 120 degrees Fahrenheit, the monobath solution gets the entire job done in 10 seconds. Another 10 seconds and the film is squeegeed, air-dried and ready for viewing by intelligence officers.

Involved, as you might suspect, is some chemical sleight-of-hand. The monobath's developer chemicals do their job in the first two to three seconds, before the slower stopping-fixing chemicals have even begun to work. So there's no fogging.

### Electric Picture Erasers

"But film," explains one researcher, "will have only limited application in the spy-satellite camera. For once exposed and developed, the negative is dead weight and useless."

What will take over film's major recording job? Likely it will be RCA's radical new development called Electrofax. It employs a kind of electric blackboard which

(Continued to page 250)





The Dial-a-rain and Capri are available at leading hardware, garden supply and department stores or you may write direct to...

## It's fun to sprinkle... with a Nelson dial-a-rain®

Enjoy carefree sprinkling with a Dial-a-rain. Just set the dial to select the area, up to 43' x 51', to be covered with a beautiful, rainlike spray that soaks in instead of running off. Performance has been accurately measured to permit proper, controlled watering—and a handy chart tells you just how much to water.

A trouble-free water motor drives the oscillating bar steadily, even with low water pressures. Sled mounting makes moving easy. Rustproof throughout, the Dial-a-rain is guaranteed!

Only \$13.95

## See the new Nelson CAPRI

The quality-built CAPRI covers dial selected areas up to 38' x 45' with a gentle, soaking spray. Colorful drive gears of nylon are visible through plastic side in motor housing. Fully guaranteed.

Just \$9.95



L. R. NELSON MFG. CO., INC.  
PEORIA, ILLINOIS

## KING MIDGET



FOR 1958

More power, beautiful styling. New Features. Still World's Lowest Priced Car. Drive it for 75c a week. Rider agents wanted. Earn your own car. If no dealer near you send 25c for 32 page picture book with full details and dealer price. Or send \$1 (refunded first order) for this and Service Manual, plus Repair Manual, plus 15 5x7 photos of car and factory.

**MIDGET MOTORS CORPORATION**

Athens 1, Ohio

America's Finest Cultivator  
at anywhere near its small price!

Hummin'bird  
**ROTO-HOE**

only \$109.50  
complete



Now you can no longer afford to do hard spade and hoe work. This powerful (2½ h.p.) self-propelled tiller-cultivator makes gardening a pleasure! Has a beautiful self-propelled 22" twin-spindle rotary mower attachment you can hook on in seconds—for just \$44.50; and the Safe-Speed Edger for only \$27.50. Write today for free folder and nearest dealer's name.

**ROTO-HOE, Dept. P-19, Newbury, Ohio**

## NEW AND EASIER FOR EVERYONE TO USE

FOR THE MAN WHO WANTS THE BEST

**TURNER**  
Propane Gas  
TORCH

FOR:

- Soldering
- Removing Paint
- Laying Tile
- Sweating Copper Tubing
- Thawing Pipes
- Removing Putty



The instant lighting torch that burns in any position. No pumping—no priming—for refueling just unscrew the disposable tank, discard, and replace with a new full tank available everywhere. Complete with fuel.

Other TURNER Propane GAS APPLIANCES include

**CAMP STOVES**

AND  
**LANTERNS**

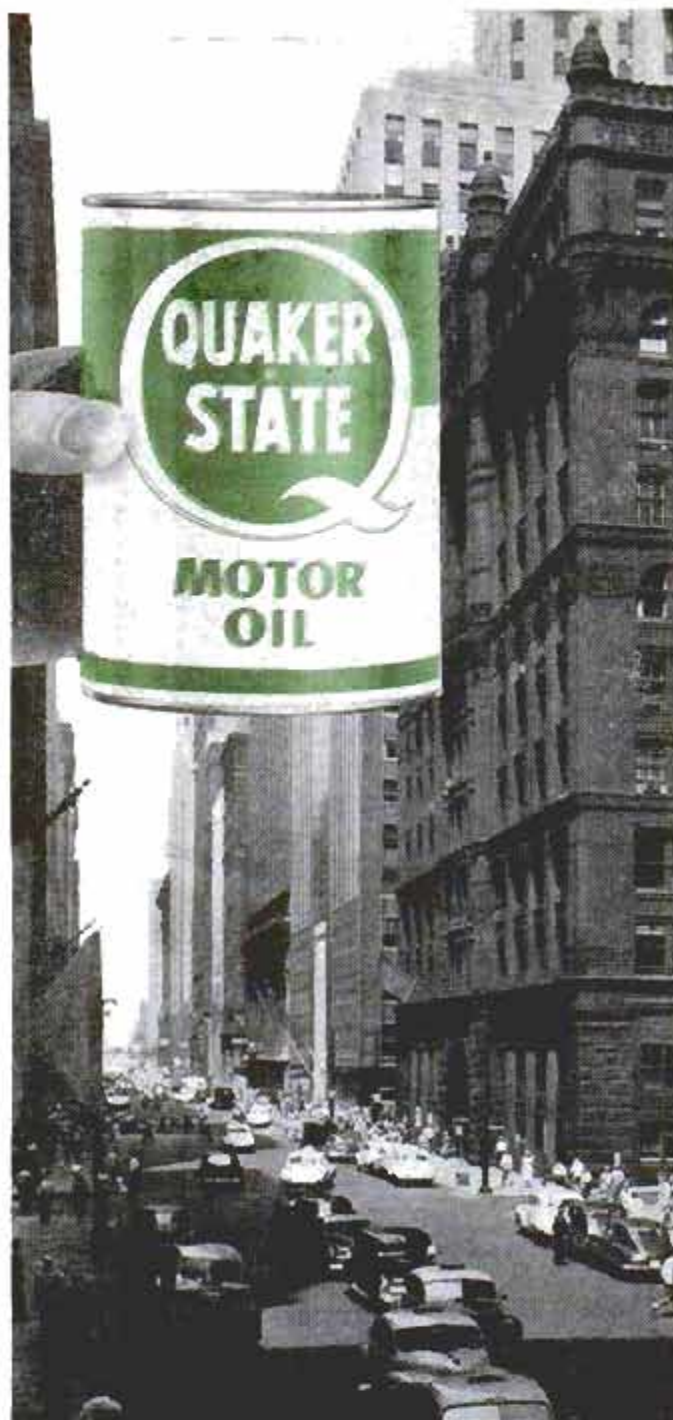
FREE Folder • WRITE TODAY!

**TURNER BRASS WORKS**

SYCAMORE, ILLINOIS







CHICAGO, ILLINOIS

Big news on the road today is Quaker State. More and more car owners are changing to this years-ahead pure Pennsylvania oil that keeps car engines cleaner and lubricates better. It's more economical, too—because it lasts longer! Always ask for **Quaker State** . . . *it's the best motor oil money can buy!*

**QUAKER STATE OIL REFINING CORPORATION, OIL CITY, PA.**  
Member Pennsylvania Grade Crude Oil Association

can be wiped clean after each exposure and used over and over again.

The principle behind the Electrofax is what researchers tab the "photoconductive effect" which is another way of reciting an age-old electrical truism that like charges repel, while unlike charges attract.

Electrically charged, a sheet of paper coated with zinc oxide acts as a kind of permanent film, receiving the image picked up by the farsighted aerial camera. Formed is an invisible electrostatic "picture"—composed of positive, negative and neutral charges. Across this invisible picture is rolled an emulsionlike dye, its particles charged. The electrostatic picture's positive areas repel the dye's positive particles, while the negative charges attract the positive—physically forming the dye into a visible picture.

### TV in Reverse

Once this picture has been transmitted to ground or stored in memory devices, the visual image is erased electrically, and the "film" is ready for another electrostatic image.

Even more advanced is a television-reconnaissance system devised by Fairchild Camera and Instrument Corporation.

Stripped to essentials, Fairchild's television-spy system involves a powerful lens which, from miles high, surveys the terrain, focusing what it sees on the flat face of an image orthicon tube.

The image orthicon is a kind of TV receiving tube—in reverse. In your home set, a telecast signal energizes the coating on the receiving tube's face, creating a picture. In the orthicon the picture produces electrical impulses which can be stored and later transmitted to ground receivers. Result: A TV-clear picture of the terrain.

Explains a Fairchild researcher, "both the image orthicon and its less-sensitive electronic brother, the vidicon, change light into electrical current. What you get is an 'electrical picture'."

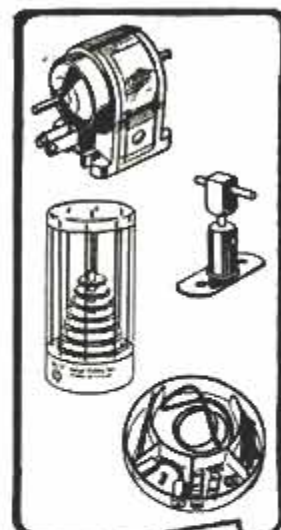
Feed the signal to a ground receiver's cathode-ray tube and the picture you see is what Explorer III saw minutes before, over enemy soil.

Here, however, interposes another problem: Ground-recording *all* that the satellite sees and transmits. Until recently there seemed no solution. The best earth-bound receivers and their cathode-ray tubes could record only about 500,000 bits of information at one time, although millions of bits could be transmitted every second. Ironically, it was a reversal of the image-transmission problem. There, you'll recall, the spy's film carried many more bits of

(Continued to page 266)



## "TINY ATOM" ELECTRIC MOTORS for HOBBY—RESEARCH—INDUSTRY



Thousands of these tiny motors now in use on hobby, research and industrial devices. Tell us your needs or order from the list below for prompt delivery.

- No. 8-100 Hi-Drive Motor, 3-6V. \$2.50
- No. 9-100 Same for 12V. . . . . \$3.00
- \*No. 3-100 Tiny Atom Motor, 1 1/2-3V. . . . . \$2.00
- For 6V. . . \$2.50 For 12V. . . \$3.00
- \*No. 26 Couplings kit . . . . . \$1.50
- No. 12 Solid shaft supports kit \$2.50
- \*No. 14 Adjustable shaft supports kit. . . . . \$3.00
- \*No. 77 Set of 7 large pulleys. \$3.00
- No. 88 Kit of 8 pulleys—2 belts \$2.00
- No. 4000 Deluxe accessories kit with motor. . . . . \$5.00
- No. 3000 Vari-speed gear unit. \$4.00
- No. 1049 Gear train with Hi-Drive motor No. 8-100. \$5.95
- Same with No. 9-100 Motor. \$6.45

\* Item illustrated. Ask for FREE Cat. All motors have ALNICO magnets

Remit with order and we pay postage in U.S.A. No C.O.D. Add 3% Sales Tax for delivery in Ohio. Write Dept. PM

For quick delivery see your local dealer — or order direct

**WILSON'S OF CLEVELAND**

425 Lakeside Ave., N.W. • Cleveland 13, Ohio



### 10" TILT/ARBOR SAW BUILD-IT-YOURSELF from GIL-BILT KITS-PLANS

Sturdy wood, steel, and aluminum construction, NEW DEPARTMENTS ball bearings. Capacity and performance of floor saws selling for \$150.00 and up. Plans, all metal parts in kit with 10" comb. blade \$25.90, less blade \$22.95. F.O.B. St. Louis. Detail PLANS-PATTERNS only \$1.00 postpaid.

Build-it-yourself 12" and 18" Bandsaws, 6" Belt Sander, Shaper. Simplified plans, build easily with hand tools only. Advertised and sold for 11 years, over 33,000 units in use. Money back guarantee. FREE CATALOG.

GILLIOM POWER TOOLS, Dept. 80-D, Lambert Field, St. Louis 21, Mo.



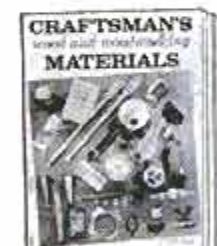
## GENUINE ALNICO MAGNETS

AMAZING, PERMANENT, NON-ELECTRIC, HIGHLY PRACTICAL. Conduct interesting experiments. Hundreds of uses. Retrieve vital steel items such as guns, tackle from fresh or salt water; tools from tanks & drains. GUARANTEED. Try any magnet one week. Money back if you are not well-pleased.

- No. M-710 (Wt. 53 oz.) Has pull of 225 lbs. on steel block. . . \$16.50
- No. M-625 (Wt. 70 oz.) Has pull of 125 lbs. on steel block. . . \$9.50
- No. M-575 (Wt. 18 oz.) Has pull of 75 lbs. on steel block. . . \$6.50
- No. M-500 (Wt. 13 oz.) Has pull of 50 lbs. on steel block. . . \$4.50
- No. M-300 Kit of Flat Bars 5 Pairs (10 Magnets). . . . . \$3.00
- No. M-250 Kit of Round Rods 5 Pairs (10 Magnets). . . . . \$2.50
- No. M-47 Hot Pad Magnets, 10 for \$1.00. . . . . \$1.00 for \$4.87
- No. M-35 Hobbyist assortment of 8 small magnets. . . . . \$1.50

Send M.O. or check. We pay postage. Sorry no C.O.D.'s.

MIAMI MAGNET COMPANY, 3240 N.W. 27th Ave., Miami 42, Fla.



### Get This NEW Catalog of WOOD & WOODWORKING EQUIPMENT

WORLD'S LARGEST SELECTION OF FINEST DOMESTIC AND IMPORTED WOODS . . . MOULDINGS, HARDWARE, TOOLS, —ALL AT LOW MONEY SAVING PRICES!

Your complete wood buying guide and project book. Craftsman is your best, most complete source of finest kiln-dried domestic and rare imported woods, beautiful wood inlays, colorful bandings, matched plywoods, embossed mouldings, carved ornaments, newest woodworking tools, "hard to find" cabinet hardware and fittings. . . more than 1,500 items! Packed with newest scroll saw patterns, project ideas & money making plans. Enclose 25c (refunded with first order) to help pay mailing, handling cost. Write now! Craftsman Wood Service Co., Dept. A-4 2729 S. Mary Street - Chicago 8, Ill.

**132 PAGES**  
Many in full color

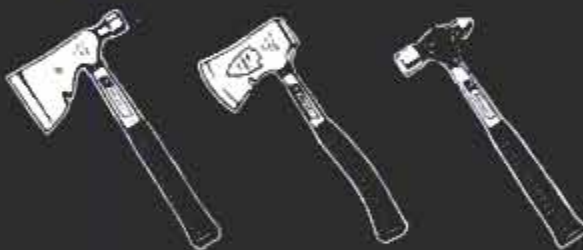
packed with rare, fancy & imported woods . . . veneers, plywoods, patterns, tools, ornaments, hardware . . . everything for the woodworker.



## Shock-absorbing handle won't loosen

\$5.25

Here's the finest hammer made. Shaft is gleaming, chrome-plated tube of boron alloy steel. Strongest ever made. Polished head is locked permanently to shaft. Tough neoprene-fiber cushion grip absorbs shock, won't slip wet or dry or in gloved hand. See ROCKET tools at your hardware store. True Temper, Cleveland 15, Ohio.



Hatchet, belt axe and ball peen, too, in famous ROCKET design that has proved its worth in the hands of over 1,000,000 proud users. Ask a carpenter!

# TRUE TEMPER.

THE RIGHT TOOL FOR THE RIGHT JOB



# FORD

Several Ford owners report serious engine failures like this.

He's talking about the new, extra-cost V8. Standard V8 is no mechanic's dream for servicing.

Right. Mirror is useless in rain or snow when you need it most. Real fault here, though, is with the wrap-around glass — one of the fictitious "advances" by the industry.

Other comments on PM's test car: Dash numerals easy to read in daylight, poor at night. But knobs well marked, day or night. Hard to get in, out of front seat due to windshield dogleg. Rear-floor topography judged poorest of three. Wells too small for comfort. Driver has a secure, detached feeling at high speed. Could be dangerous should he forget how fast the car can go (and probably is).

low. With seat close up, you bump your knees."—Wisconsin stenographer.

"Somewhat cramped inside. Seats are too low and also too flimsy."—North Carolina farmer.

"Engine trouble. At 2020 miles the oil pump locked and burned out the main bearing, burned and cracked the block and burst three pistons. Ford replaced the engine at no cost to me."—Illinois foreman.

## More Best-Liked Features

"The solidness of the body is a big improvement over the 1957 I owned."—Illinois insurance adjuster.

"I belong to a car pool and there is plenty of room for six men."—Illinois machine operator.

"I sure like the retractable hardtop. But should have a separate key switch to operate it. Too many people play with top while it is parked in garage."—North Carolina salesman.

"The 1958 engine is a mechanic's dream. Everything is where it can be reached."—Georgia auto mechanic.

"Two weeks ago I had an accident with another make a lot heavier than Ford. My Ford took it a lot better than the heavier car. No one was injured as a result of the padded dash and safety locks. There were six in my car at the time."—Illinois painter.

"I think my Ranchero fills a need which hasn't been supplied in any other model. It rides and drives like a fine car yet has excellent light-hauling capacity. By removing the shelf back of the front seat and putting a couple of folding camp stools we can provide riding space for a couple of small youngsters."—Minnesota retailer.

## More Complaints

"Just yesterday the transmission went out on my new Ranchero. I have the new Cruise-A-Matic Drive."—Idaho salesman.

"Drafty. Leaks cold air."—Wisconsin contractor.

"Outside rear-view mirror on fender is in line of maximum distortion so is of little value, especially at night when double image of headlights is seen. Vent wing windows too small, too hard to open."—Illinois pilot.

"Need improvement on shocks. Hit bottom on hard bumps."—Georgia businessman.

"Do not like the way the upper tailgate closes on this station wagon. Would prefer a handle. You have to put your hands on the glass to close it and you get your gloves or hands dirty every time."—New York engineer.

"When the road is wet, water sprays on the windshield from the crack between the hood and the front fenders near the headlights. Very bad when road is muddy. After a mile or so you can hardly see out."—Wisconsin owner.

"Very poor on ice and wet pavement. Rear end slides. Will not pull."—Illinois carpenter.

## They, Too, Want Economy

Asked to make one suggestion to the auto industry, the Ford owners came up with a wealth of ideas. But, as in the other makes surveyed, economy is the most-wanted feature.

"Better gas mileage. You get me a car that will average 80 miles per gallon and I will pay \$1000 more for it."—Wisconsin assembler.

"Let the driver feel the road he's driving on. Less spongy cars."—New York musician.

"Specialize on safety. Design trend is fine. Please don't make them any smaller."—Texas serviceman.

"Exterior styling is becoming much too flashy."—Illinois Anglican priest.

\*\*\*





## "You need special spark plugs, too"

*Always use the spark plugs specially designed for outboards—*

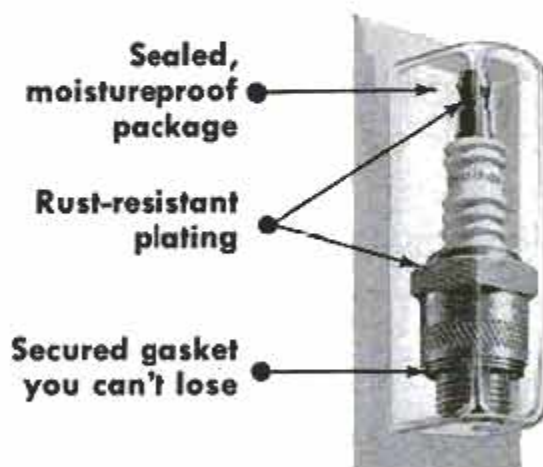
# CHAMPIONS!

You need a *special* trailer for boats. And you need special spark plugs for your outboard—Champions.

New Champion marine spark plugs are protected by a sealed, moistureproof pack. The gasket is secured so it can't be lost. And the exposed metal surfaces of this new Champion are guarded by rust-resistant plating.

This new marine plug has Champion's special "J-gap" electrode design . . . needed for easy starts . . . smooth idle . . . and full power in outboard engines. This "J-gap" is one reason why *every major outboard manufacturer uses Champions as original equipment.*

Choose either the *new* marine Champions or the *regular* marine Champions. But always choose CHAMPIONS—the spark plugs specially designed for outboard motors.



CHAMPION SPARK PLUG COMPANY • TOLEDO 1, OHIO

Every major outboard manufacturer approves — and uses **CHAMPION** Spark Plugs



# PLYMOUTH

*A lack of will power that Detroit dearly loves.*

"Ours is a gas hog. Getting 11.5 miles per gallon in the city."—New Jersey V8 owner.

"Cars are too expensive. The markup is too high for an article that loses its value so fast. If I had will power I would run the car into the ground before buying a new one."—New York fireman.

"Seats are too low. Nothing to support your legs and they become tired on long trips."—Illinois airline pilot.

"Back of front seat presses into small of the driver's back."—Alabama Army officer.

"My complaints are with dealer, not with the car. I was charged for antifreeze, but didn't get it and the engine froze. Not enough to really hurt, but I'll never feel right about it. Whatever happened when the motor overheated has left a peculiar odor in the car, especially when motor warms up. It has spoiled the car for me."—Maryland businessman.

*Absolutely right. Plymouth gets demerits on both its inside and outside mirrors.*

"Side-view mirror on left front fender is ridiculous because it is too far from the driver for quick, easy adjustment and it is virtually useless when you need it most in snow or rain."—New York teacher.

"Position of rear-view mirror is too close to the second-gear position in handshift model."—Illinois repairman.

"Back seat may be short of legroom with the front seat pushed back."—Arizona housewife.

*Plymouth's rear seat most awkward to get in, out. Door doesn't seem to open wide enough.*

"Very hard to get behind steering wheel. Knees keep hitting the wheel getting into the car."—New Jersey foreman.

"Car is built so low it is difficult to get in and out, even after several months' practice."—New Jersey secretary.

"When starting out, car jerks terrifically when Reverse or Drive button is pushed."—New Jersey owner.

"Still can't shift without looking at the buttons, especially into Reverse."—Florida photographer.

## More Good Points

"I like its easy and sure braking."—Illinois diemaker.

"Excellent trunk space. We go camping a good deal so I tried out the trunk to see if it would hold all the gear. In our old 1953 car we filled the trunk and an auto-top carrier as well. In the new Plymouth everything went into the trunk with room to spare. You may wonder why we don't have a station wagon. I dislike wagons. They are noisy and ride less comfortably. We can carry more in our trunk than a friend can in his wagon and have a comfortable ride besides."—Maryland mechanical engineer.

*No complaints about room in trunk of any car today. As cars get longer, trunks get bigger. You may have less headroom, but your bags have more.*

"Has heavy feel. Rides like it weighs 10 tons."—Arizona housewife.

"Dependable. Can take abuse. Plymouths are best for cabs."—Florida taxi owner.

"Heater on the Six works real fast."—New York student.

"I like the wind-down window in back of wagon instead of upper tailgate."—Florida painter.

*Like the wrap-around, the bubble glass is of no practical value.*

## And More Complaints

"Door handles break too easily. They should be solid metal."—Maryland cab driver.

"Bubble window is definitely not a good point. No protection from sun and it takes on too many reflections."—Wisconsin mason.

"Should use better materials, especially in the trim."—Kansas secretary.

"It is 6 inches too wide and 12 to 24 inches too long, making it difficult in traffic and impossible to park in short spaces."—Virginia engineer.

(Continued to page 274)





**NEW!**



ADJUSTABLE WRENCHES

**PROTO'S**

**GOLDEN KNURL HOLDS  
EXACT JAW OPENINGS  
AUTOMATICALLY!**

**NO BUTTONS ... NO LEVERS ... NO GADGETS**

Available in FIVE popular sizes

**4", 6", 8", 10" & 12"**

ANOTHER REASON YOU'LL

**PREFER**

**PROTO**



2209 Santa Fe Avenue



*New! . . . and available now!*

# PROTO'S **CLIK-STOP** ADJUSTABLE

*. . . the amazing wrench with the Golden Knurl that holds exact jaw openings . . .*

## **AUTOMATICALLY**

**NO BUTTONS . . . NO LEVERS . . . NO GADGETS**

Colorful display makes it easy to select Click-Stop wrenches. No increase over regular prices. Now available in 4", 6", 8", 10", and 12" sizes. (16" and 20" sizes later) Look for them at your dealers.

The Click-Stop handles like an ordinary adjustable. Merely turning the Golden Knurl clicks jaw automatically into any opening wanted . . . even non-standard or foreign sizes. Won't work loose.

Drop-forged from fine Protoloy steel. Thin head design for hard-to-get-at jobs. Highly polished, chrome plated.



Adaptable for wall or counter

700L



**Proved Rugged by Field and Laboratory Tests.** Professional mechanics across the nation job-tested the Proto Clik-Stop wrench. 98.1% acclaimed it a major improvement in adjustable wrench design.

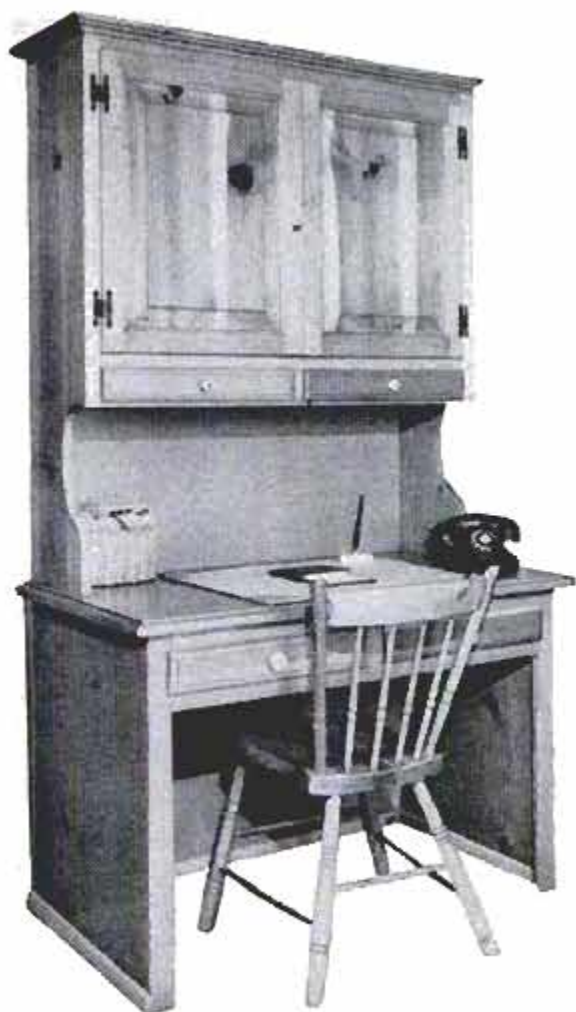
In laboratory tests, the Golden Knurl was clicked through 1,969,640 positions with no appreciable wear. Try one yourself at your quality tool store.



PENDELTON  
DIVISION OF TOOL INDUSTRIES  
INC.

2209 Santa Fe Ave., Los Angeles 54, Calif.  
583 Allen St., Jamestown, N. Y.  
P. O. Box 366, London, Ont., Canada





## Western Pine Region woods . . . help you build big, spend little, look professional

Your own skill, a few tools, and a modestly priced supply of Western Pine Region woods are all you need to turn out a job like this.

The straight-grained Western Pine Region woods make home carpentry a pleasure. That's because these carefully dried woods work so easily, take any finish without losing their natural beauty.

Your lumber dealer can suggest a Western Pine Region wood for your furniture or remodeling job.

### FREE! "Friendly Home Ideas"

— 85 photographs, many in color, feature traditional and contemporary ideas for building, decorating and remodeling with cheerful Western Pines. Write for your FREE copy to WESTERN PINE ASSOCIATION, Dept. 300-N, Yeon Bldg., Portland 4, Oregon.



### Western Pine Association

member mills manufacture these woods to high standards of seasoning, grading and measurement  
Idaho White Pine · Ponderosa Pine · Sugar Pine  
White Fir · Incense Cedar · Douglas Fir · Larch  
Red Cedar · Lodgepole Pine · Engelmann Spruce

Today's Western Pine Tree Farming Guarantees Lumber Tomorrow

**NEW! Evans**  
**POWER-TAPE**

**No More Pushing Blade Back Into Case!**

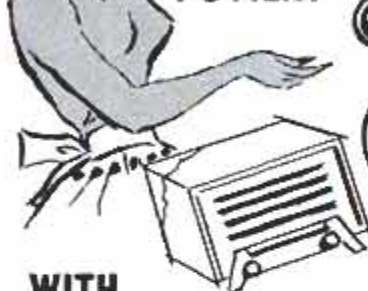
Here's the greatest single mechanical advance in steel tape history! Press the button gently with your thumb — blade returns smoothly. You control the speed. Release the button — blade stops instantly. No "creep," no lost measurements. Chrome-plated case, GIANT sliding end hook — for inside-outside measuring. White steel blade, marked in inches and feet-and-inches—no figuring! Free Tenite carrying case with magnifying lens.

**Only \$1.89 (10 ft.)**  
**Unconditionally Guaranteed**  
6, 8, 10, or 12 ft. lengths  
Get POWER-TAPE today!  
Available only at hardware stores

**Evans** RULE CO. Elizabeth, N. J.  
Montreal, Que.

## It's Easy To Repair

JEWELRY—CHINA—PLASTICS  
CERAMICS—KNICK-KNACKS  
POTTERY



### WITH TUFF-BOND QUICK-SET ADHESIVE

Keep a tube of this waterproof neoprene adhesive around the house to fix most anything. Easy to use. Sets quickly for strong, yet flexible bond. At better dealers everywhere. *Goodloe E. Moore, Incorporated, Danville 10, Ill.*



**STICKS ALMOST ANYTHING TO ANYTHING**



# CHEVROLET

In a blindfold test, four riders were not certain which car had air bags, so minor is the difference.

Other comments on PM's test car: Extremely maneuverable, turn circle reduced sharply. Biggest of the three, it feels smallest due to nimbleness. Door operation excellent. Rear floor topography most comfortable. Rear seat easiest to get in, out. Test car had optional locking differential: Great on gravel roads. Dashboard-dial legibility excellent.

"I have air suspension. I don't think it's worth the added cost because it's troublesome. Maybe it will be okay when it gets straightened out."—Florida owner.

"I am undecided right now as to whether this air suspension is worthwhile. I've had trouble and it has some good points, too."—Idaho teacher.

"Don't seem to get a smooth ride from air. I don't think it's worth the cost."—Illinois mechanic.

"Level-air feature highly undependable. Poor check valves and filtering system. Small road shocks not dampened out sufficiently."—Florida airline pilot.

## Public Wants Economy

When asked to make one suggestion to the industry, the Chevrolet owners (like other owners as well) want more economy. This seems to be the feeling of the entire public. Whether an economy car would sell in volume is a question, but the public insists it wants it.

"The industry should concentrate on producing a power plant which would significantly reduce the operating cost of cars."—Florida civil engineer.

"Improve economy of the automatic transmission. I may return to the standard-shift Six."—Wisconsin field man.

Other suggestions commonly made are:

"Slow down the assembly line just a bit so they could do a little better finishing work."—Wisconsin oil worker.

"More headroom. So a hat can be worn in the car."—Illinois professional baseball player.

"Build a small car, but dress it up so you will be proud to ride down the street in it."—Tennessee accountant.

"Bring back the trunk handle. Lid is hard to open and close with no grip on it."—Wisconsin owner. ★ ★ ★

# Faster, safer way to wash your car



Du Pont Car Wash gets your car so clean it drains dry, without *wiping*. Unlike ordinary detergents, it's safe for wax and it doesn't streak! At service stations and auto supply stores— $\frac{1}{2}$ -lb. can only 75¢.



BETTER THINGS FOR BETTER LIVING  
... THROUGH CHEMISTRY

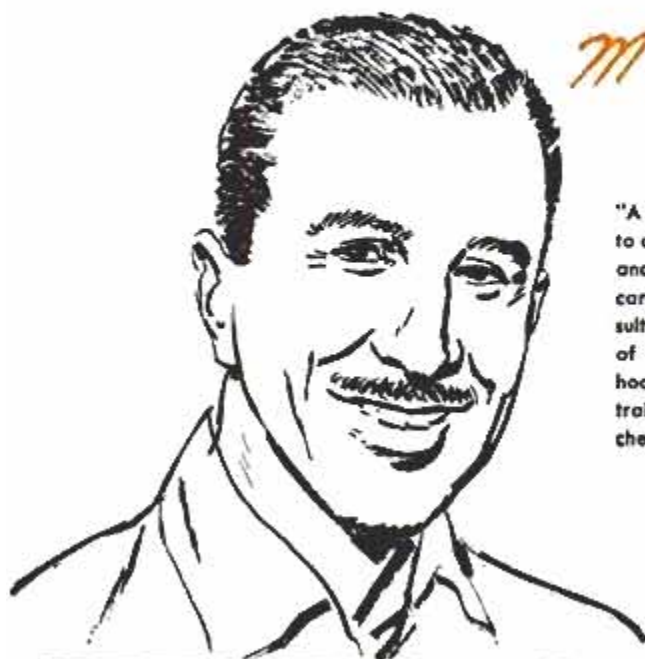


# DU PONT CAR WASH



# "There's more than one way to improve your gas mileage"

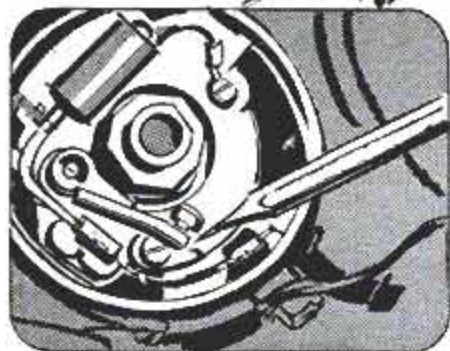
*Mauri' Rose* —experimental test driver and automotive engineer.



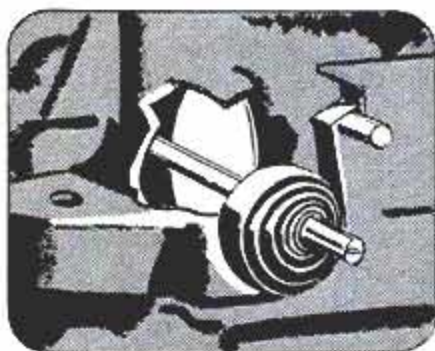
"A professional driver has a lot to do with getting top performance and economy from new cars he tests. But, the best results also depend on a number of intricate systems under the hood. That's why he relies on trained mechanics for needed checks and adjustments."



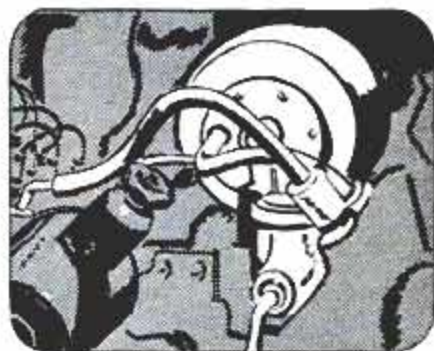
"Worn spark plugs could be a source of power and fuel loss. Electrodes must be clean, properly gapped and free from corrosion. New plugs at least every 10,000 miles is best."



"A pro always makes sure distributor points are clean and set at the proper distance for best performance. Arcing or cracks in the cap may develop to further decrease gas mileage."



"A trained mechanic checks the manifold heat control valve for possible trouble. A valve that's stuck open delays proper vaporization, a closed valve creates a loss of power."



"The vacuum system must be examined and connections tightened. Air filters should be cleaned. Clogged filters or air leaks upset mixture ratio and cause rough idle and fuel loss."



"Your carburetor should also receive a thorough check for any signs of needed adjustment, repair or cleaning. Proper care assures precision operation and maximum fuel economy."

*Specified as original equipment on more new cars than any other carburetor.*

Make sure you're taking advantage of the many ways to improve your gas mileage. See your Rochester Carburetor Specialist. He can properly diagnose your engine and make the necessary adjustments to give you the best possible performance and economy. And he's factory-trained to keep your precision-built Rochester Carburetor in top condition to deliver maximum mileage.



## ROCHESTER CARBURETORS

ROCHESTER PRODUCTS DIVISION OF  
GENERAL MOTORS, ROCHESTER, N. Y.



**POPULAR  
MECHANICS**  
MAGAZINE

Sponsored by leading manufacturers,  
dealers, contractors, builders, lending in-  
stitutions and Popular Mechanics Magazine

# Enter the \$125,000 Home Improvement CONTEST



NOTHING TO BUY—JUST FILL IN THE ENTRY FORM!



## A Sign, A Symbol, An Entry Form ... Guideposts to \$125,000

Prizes totaling \$125,000 are the incentive for the Home Improvement Council's "How's Your Home" contest. There's nothing to buy—just fill in the entry form available at any dealer displaying the Popular Mechanics' sign or HIC emblem, or use the coupon provided. The Home Improvement Council is a non-profit organization of manufacturers,

dealers, contractors, builders and lending institutions, and is subscribed to by Popular Mechanics. Its purpose is to help you **BETTER YOUR LIVING** through planned improvement projects from redecorating to complete home remodeling. Your local member stands ready to help you—ask him for information and assistance.





Check this list, and others in May and June, for the name of your local Home Improvement Dealer featuring Popular Mechanics Window Displays. He'll have information and entry forms for the \$125,000 contest

**CALIFORNIA**

Anaheim  
Martenetis Hdw.  
Nadorff Hdw.  
Arcadia  
Bob's Hdw.  
Hage Hdw.  
Arlington  
Arlington Hdw.  
La Sierra Hdw.  
Azusa  
Getts Hdw.  
Baldwin Park  
Baldwin Park Hdw.  
Banning  
Banning Hdw.  
Bellflower  
Chambers Hdw. & Bldg.  
Sup.  
Bell Gardens  
Eastern Hdw.  
Biff  
Allied Hdw.  
Brea  
Brea Hdw.  
Buena Park  
Buena Park Hdw.  
Southland Hdw.  
Canoga Park  
Wayne-Davis Hdw.  
Chatsworth  
Chatsworth Lbr. Co.  
Chino  
Center Hdw.  
Herbs Hdw.  
Chula Vista  
Peters Home & Garden  
Center  
Compton  
Compton Hdw.  
Thompson Hdw.  
Costa Mesa  
Carney Hdw.  
Nelsons Hdw.  
Covina  
Covina Hdw.  
Culver City  
Helman's Hdw.  
Steller & Stogg  
Downey  
Downey Lumber  
Fontana  
Harris Bros.  
National Hdw. & Bldg.  
Sup.  
Fullerton  
Bowen Hdw.  
Fullerton Hdw.  
Gardena  
Gardena Hdw.  
Garden Grove  
Garden Grove Hdw.  
Hawthorne  
Schlimmer's Hdw.  
Hermosa Beach  
Hughes Hdw.  
Reynolds Hdw.  
Hollywood  
Smith Hdw. Co.  
Muntington Beach  
Jones Hdw.  
Toratt's Hdw.  
Muntington Park  
James Hdw.  
Indio  
Imperial Hdw.  
Inglewood  
Balam's Hdw.  
Brizzolara Hdw.  
Van Tines Hdw.  
La Canada  
La Canada Hdw.  
La Habra  
Lahabra Hdw.  
La Puente  
Fred Lund Hdw.  
Lawndale  
Cook Lbr. Co.  
Long Beach  
Bayshore Hdw.  
Circle Hdw.  
Evans Hdw.  
Howard's Hdw.  
Norwalk Hdw.  
Raber Hdw.  
Wardlow Hdw.  
Los Angeles  
Ayres Hdw.  
Callahan Hdw.  
Cherry Co., Inc.  
Clifford's Hdw.  
Gerald's Hdw.

Koontz Hdw.  
Paulus Hdw.  
Tritch Hdw.  
Lynwood  
Abco Hdw.  
Maywood  
Canning's Hdw.  
Monrovia  
Bunker's Hdw.  
Newport Beach  
Bay Hdw.  
Northridge  
Handy Hdw.  
North Hollywood  
Whitsett Hdw.  
Norwalk  
Harold's Hdw.  
Morres Hdw.  
Ontario  
Adams Hdw.  
Orange  
Camp Hdw.  
Orange Hdw.  
Paramount  
Paramount Hdw.  
Pasadena  
Colorado Hdw.  
Pedley  
Pedley Hdw.  
Pomona  
Huntington Hdw.  
Westmont Hdw.  
Redlands  
Bates-Carlson  
Redondo Beach  
Anza Hdw.  
Pickins Hdw.  
Reseda  
Whitmire Hdw.  
Rialto  
Johnson & Son  
Rubidoux  
Rubidoux Hdw.  
San Bernardino  
Bud's Hdw.  
Lumbattis Hdw.  
Sierra Hdw.  
San Diego  
A. A. Hdw.  
Bakers Hdw.  
San Fernando  
Empire Hdw.  
San Gabriel  
Mission Hdw.  
Smith Hdw.  
Village Hdw.  
San Marino  
San Marino Hdw.  
San Pedro  
Kormak Hdw.  
Santa Ana  
Griffin Hdw.  
Knox Hdw.  
Washington Hdw.  
Sherman Oaks  
Sherman Oaks Hdw.  
Sierra Madre  
Sierra Madre Hdw.  
South Gate  
A.B.C. Hdw.  
Stanton  
Chambers Hdw.  
Temple  
Heale Hdw.  
Torrence  
Handyman Hdw.  
Las Palmas  
Torrence Hdw.  
Tustin  
Foothille Hdw.  
Tustin Hdw.  
Van Nuys  
John's Hdw.  
Vista  
Jones Hdw.  
Westminster  
Chets Paint & Hdw.  
Westminster Hdw.  
Whittier  
Coffman Hdw.  
Kieta's Hdw.  
Wilmington  
Wilmington Hdw.  
Yorba Linda  
Yorba Linda Hdw.  
**CONNECTICUT**  
Bristol  
Bristol Store  
City Hdw.  
Lee Hdw.

Canaan  
C. A. Lindell & Son  
Collinsville  
Eaton Hdw. Co.  
Danbury  
Heyman Hdw.  
Danielson  
D. Blumenthal  
East Hartford  
Main Hdw.  
Superior Hdw.  
Elmwood  
Elmwood Hdw. & Sup.  
Granby  
Beman Hdw.  
Hartford  
Capitol Hdw.  
Euclid Hdw.  
Hurwits Hdw.  
Harwinton  
Harwinton Hdw.  
Manchester  
W. G. Glenney Co.  
Moosup  
Salisbury's Hdw.  
New Milford  
Village Hdw.  
Putnam  
Trudeau & Roy Inc.  
Rockville  
Liebe's Hdw. & Paint  
Simsbury  
Welden's Hdw.  
Southington  
Neal's Hdw.  
Stafford Springs  
Marty's Hdw.  
Stafford Hdw.  
Storrs  
Mansfield Sup.  
Terryville  
Terryville Hdw.  
Thomaston  
Shearer's Hdw.  
Torrington  
Burritts Hdw.  
Unionville  
Parson Hdw.  
Washington Depot  
Washington Sup. Co.  
Watertown  
Kay's Hdw.  
West Hartford  
Anderson & Hammerlind  
Inc.  
Oakwood Hdw.  
Willimantic  
Morris Hdw. & Sup. Co.  
Windsor Locks  
F. S. Bidwell Co.  
Winsted  
Highland Hdw.  
Park Place Hdw.  
Woodbury  
P. F. Hitchcock Co.  
**DELAWARE**  
Clayton  
Slaughter's Hdw.  
Delmar  
Dashiell Hdw.  
Dover  
Dover Hdw. Co.  
Frederica  
Wilson & Gerow Hdw.  
Georgetown  
H. W. Purnell & Co.  
Greenwood  
Meredith Hdw.  
Harrington  
Taylor's Hdw.  
Laurel  
Laurel Home & Auto Store  
Taylor Hdw.  
Middletown  
Buckworth's Hdw.  
Milford  
Humes Hdw.  
Millsboro  
Boulevard Hdw. Co.  
Millville  
Millville Hdw.  
Newark  
Jackson Hdw.  
Newark Lbr.  
Rehoboth Beach  
Rehoboth Hdw.  
Seaford  
Sussex Hdw.

Wilmington  
Avenue Hdw.  
Thomas Cardwell Co.  
Highpoint Hdw.

**FLORIDA**

Dania  
Griffey Hdw.  
Fort Lauderdale  
McCann Hdw. Co.  
Hollywood  
Barry-James Hdw.  
Hardware Inc.  
Shopper's Hdw.  
Miami  
Cutler Ridge Hdw.  
Miami Shores  
National Hdw.  
N. Miami  
Nails & Pails Hdw.  
Smitty's Hdw.  
N. Miami Beach  
Dell Padely's Hdw.  
Pompano Beach  
McCann Hdw. Co.

**ILLINOIS**

Antioch  
Antioch Lbr. Co.  
Argo  
Jolovec Hdw.  
Arlington Heights  
Ace Hdw.  
Bowen Hdw.  
Freitag Hdw.  
Aurora  
Ace Hdw.  
Kelleys Hdw.  
Barrington  
Ace Hdw.  
Batavia  
Swanson Hdw.  
Bellvidere  
Brooks Heating & Hdw.  
Bensenville  
Laho's Hdw.  
Blue Island  
Schreiber Bros. Hdw.  
Broadview  
Broadview Hdw.  
West Suburban Hdw. &  
Sup.  
Byron  
S. F. Piper & Sons  
Carpenterville  
Western Hdw. & Sup.  
Cary  
Serres Hdw.  
Chicago  
Ace Hdw., Belmont St.  
Ace Hdw., Broadway  
Ace Hdw., N. Harlem  
Ace Hdw., W. North Ave.  
Arlington Hdw.  
Arnoff Hdw.  
Barnes Paint & Hdw.  
Bryn Mawr Fair & Hdw.  
Calumet Hdw.  
Carl's Hdw.  
Clark-Devon Hdw.  
Eden Best Hdw.  
Hanks Hdw.  
Hoffman Hdw.  
Jefferson Park Hdw.  
King Hdw.  
Lundins Ace Hdw.  
Midwest Hdw.  
Newport Hdw.  
O'Flara & Son Hdw.  
Paulius Hdw.  
Recks Hdw.  
Ruby's Ace Hdw.  
Schultz Hdw.  
Steve's Hdw.  
Sundberg Hdw.  
Vincennes Ace Hdw.  
Wilson Hdw.  
Chicago Heights  
Jays Hdw.  
Chicago Ridge  
Schaal Hdw.  
Cicero  
Boker Hdw.  
Vondrak's Hdw.  
Deerfield  
Deerfield Hdw.  
De Kalb  
Gustafson & Steele  
Des Plaines  
Golf Quality Hdw.  
Dixon  
Fairfax Hdw.

Visit the dealers with the Popular Mechanics' displays . . .



**Downers Grove**  
 Matias Hdw.  
 Soukup Hdw.  
**Elgin**  
 Ace Hdw.  
**Elmhurst**  
 Soukup Hdw.  
**El Paso**  
 Burton Bailly Hdw.  
**Evanston**  
 Ace Hdw.  
 Lemoi Hdw.  
**Evergreen Park**  
 Boyd Hdw.  
**Forest Park**  
 Peaslee Hdw.  
**Fox Lake**  
 Ace Hdw.  
**Fox River Grove**  
 Leader Hdw.  
**Franklin Park**  
 Killinger Ace Hdw.  
**Geneeo**  
 Ace Hdw.  
**Geneva**  
 Ace Hdw.  
 Geneva Hdw.  
**Glenn Ellyn**  
 Soukups Hdw.  
**Glenview**  
 Vaughn & Wilde Hdw.  
**Half Day**  
 Wm. R. Herrick & Son  
**Harvard**  
 Coast to Coast Hdw.  
**Harvey**  
 Sibley Lumber Co.  
**Highwood**  
 Sherony Hdw.  
**Millside**  
 Merchants Hdw.  
**Minsdale**  
 Soukups Hdw.  
**Hubbard Woods**  
 Ace Hdw.  
**Itasca**  
 Bunge Hdw.  
**Kewanee**  
 Black & Fletcher Hdw.  
**La Grange**  
 Glaser Hdw.  
 La Grange Hdw.  
**Lake Forest**  
 Coast to Coast Store  
 O'Neils Hdw.  
**Lake Zurich**  
 Keers Hdw.  
**Lansing**  
 Gus Bock Hdw.  
 Lansing Hdw.  
**Libertyville**  
 Schanck Hdw.  
**Lisle**  
 Hankinson Lbr. & Sup.  
 Albert Riedy Co.  
**Lockport**  
 Miller Ace Hdw.  
**Lombard**  
 Ratke Hdw.  
 Westmore Hdw.  
**Lyons**  
 Frank's Hdw.  
 Tower Hdw.  
**Marengo**  
 Coast to Coast Store  
**Markham**  
 Markham Hdw.  
**Mason City**  
 Brinner Bros. Hdw.  
**Matteson**  
 Hi-Low Hdw.  
**Maywood**  
 Silverman's Hdw.  
**McHenry**  
 Ace Hdw.  
 Althoff's Hdw.  
**Melrose Park**  
 Leyden True Value Hdw.  
 Seegers Hdw.  
**Milledgeville**  
 Gable Hdw.  
**Monmouth**  
 Pattons Seed & Hdw.  
**Morrison**  
 Stralow Hdw.  
**Morton Grove**  
 Jack's Hdw.  
**Mt. Prospect**  
 Busse-Berman Hdw.  
**Mundelein**  
 Mundelein Hdw.  
**Naperville**  
 Soukup Hdw.  
**Niles**  
 Niles Hdw.  
 Spee-Dee Hdw.  
**Northbrook**  
 Melser Hdw.  
 Northbrook Lbr. Co.  
**Oak Lawn**  
 Dukes Ace Hdw.  
 Hi-Low Hdw.  
 Southwest Hdw.  
**Oak Park**  
 Dressell Hdw.  
**Oregon**  
 Gilbert Hdw.  
**Ottawa**  
 Jordan Hdw. Co.  
**Palatine**  
 Hansen Hdw.  
 Zimmer Hdw.  
**Pekin**  
 Pekin Hdw. Co.  
**Peoria**  
 Millers Hdw.  
 Stein Hdw. & Sup. Co.  
**Peru**  
 Harry Debo Hdw.  
**Polo**  
 Hough's Hdw.  
**Prophetstown**  
 Ace Hdw.  
**Roanoke**  
 Roanoke Hdw.  
**Rochelle**  
 Moore Bros. Hdw.  
**Rockford**  
 Black & Co.  
 Nicholson Hdw.  
 Thorne's Hdw.  
 Tobinsons Hdw.  
**Rockton**  
 Rockton Hdw.  
**Rolling Meadows**  
 Ace Hdw.  
**Roselle**  
 Town Hdw.  
**St. Charles**  
 A. H. Borman & Co.  
 Essig Hdw.  
**Schiller Park**  
 Rudy's Hdw.  
**Skokie**  
 Becker & Young Hdw.  
**Sterling**  
 Ace Hdw.  
 Benters Hdw.  
 Fairfax Hdw.  
**Sycamore**  
 Sycamore Hdw. Co.  
**Tampico**  
 Tampico Hdw.  
**Villa Park**  
 Marchants Hdw.  
**Washington**  
 Herbst Hdw.  
**Wauconda**  
 Wauconda Hdw.  
**Waukegan**  
 Economy Builders Hdw.  
 Sup.  
**Westchester**  
 Chabot Hdw.  
**West Chicago**  
 West Chicago Hdw.  
**Western Springs**  
 Village Hdw.  
**Westmont**  
 Ogden Hdw.  
 Wavak Hdw.  
**Wheaton**  
 Hawthorne Hdw.  
 Soukup Hdw.  
**Wheeling**  
 Schuler's Hdw.  
**Wilmette**  
 Hoffman Hdw.  
**Winnebago**  
 George McGee & Sons  
**Winnetka**  
 Golden Hdw.  
**Worth**  
 Ridgeworth Hdw.  
 Tool Chest Hdw.  
**INDIANA**  
**Griffith**  
 Christenson Hdw.  
**Hammond**  
 Joe's Hdw.  
 Stern's Wood Mar Hdw.  
**MARYLAND**  
**Centreville**  
 Bartlett Hdw.  
**Chesapeake City**  
 Poard's Hdw.  
**Chesterdown**  
 Davis Hdw.  
 Stenger Hdw.  
**Crisfield**  
 Bradshaw Hdw.  
**Easton**  
 Shannon & Wrightson  
**Elkton**  
 Davis Sup. Co.  
**Federalburg**  
 Covey & Williams  
**Frederica**  
 J. W. Conley Hdw.  
**Greensboro**  
 James T. Butler Hdw.  
**Millsboro**  
 Hillsboro Hdw.  
**Northeast**  
 Homeowners Sup. Co.  
**Ocean City**  
 Byrd's Hdw.  
**Perryville**  
 Perryville Sup. Co.  
**Pocomoke City**  
 Lankford & Cutler  
**Port Deposit**  
 Bond Hdw.  
**Princess Anne**  
 Warwicks Store  
**Rising Sun**  
 Rising Sun Hdw.  
**Rock Hall**  
 Stenger Hdw.  
**Snow Hill**  
 Cherrix Hdw.  
**Stevensville**  
 Hoyt's Hdw.  
**MASSACHUSETTS**  
**Agawan**  
 Agawan Lbr. Co.  
**Athol**  
 W. E. Aubuchon Co., Inc.  
 Paige Hdw.  
**Attleboro**  
 J. F. Ashley Hdw.  
 Flynn Hdw.  
**Auburn**  
 John's Hdw. Inc.  
**Brookton**  
 Alden Hdw.  
 Grossman Bldg. & Sup.  
**Clinton**  
 W. E. Aubuchon Co., Inc.  
 Felix's Hdw.  
**Dighton**  
 Dighton Grain & Hdw.  
**Fairhaven**  
 C. F. Delano Inc.  
**Fall River**  
 Bedford Hdw.  
 Krupa Hdw.  
**Fitchburg**  
 Central Hdw.  
**Framingham**  
 South Middlesex Sup.  
 White's Hdw.  
**Gardner**  
 W. E. Aubuchon Co., Inc.  
**Groton**  
 Geo. L. Moison Co., Inc.  
**Holliston**  
 Condon Hdw.  
**Leominster**  
 Pauls Hdw.  
**Mansfield**  
 W. C. Fuller Co.  
**Marshfield**  
 Marshfield Hdw.  
**Milford**  
 W. E. Aubuchon Co., Inc.  
 Milford Hdw.  
**New Bedford**  
 Bellenoit's Hdw.  
 Lemlin Hdw.  
 Roberts Hdw. Co.  
**North Agawan**  
 Agawan Paint & Hdw.  
**North Attleboro**  
 Franklin Hdw.  
**Northboro**  
 Northboro Hdw.  
**Northbridge**  
 W. E. Aubuchon Co., Inc.  
**Oxford**  
 Chaffee Bros. Co.  
**Palmer**  
 Palmer Hdw.  
**Putnam**  
 Chandler & Morse Inc.  
**Rockland**  
 F. G. Hale & Sons  
**Saxtonville**  
 State Lbr. Co.  
**Scituate**  
 Max's Scituate Sup. Co.  
**Seekonk**  
 Oscar's Hdw.  
 Wayside Hdw.  
**South Dartmouth**  
 Bliss Corner Hdw.  
 W. T. King Lbr. Co.  
 P. S. Manchester Sons  
 Marvin Grain & Hdw.  
**Southwick**  
 Battistoni Lbr. Co.  
**Spencer**  
 W. E. Aubuchon Co., Inc.  
**Springfield**  
 Belmont Hdw.  
**Stockbridge**  
 W. J. Buckler Hdw.  
**Taunton**  
 Manny's Hdw.  
**Three Rivers**  
 Chudy's Oil Co.  
**Warren**  
 Tuckers Hdw.  
**Webster**  
 W. E. Aubuchon Co., Inc.  
 Waite Hdw.  
**Wellesley Hills**  
 Kidston Hdw.  
**Westboro**  
 Swan Hdw.  
**Westfield**  
 Scanlon & Kane Inc.  
**Westminster**  
 Allard Hdw.  
**Westport**  
 Albert E. Lees  
**West Springfield**  
 West Springfield Hdw.  
**Whitinsville**  
 W. E. Aubuchon Co., Inc.  
**Whitman**  
 A. C. Freeman, Inc.  
**Willanansett**  
 Riopel Hdw.  
**Worcester**  
 Alan Barry Corp.  
 Levesque Hdw.  
**MICHIGAN**  
**Adrian**  
 Smith Hdw.  
**Allegan**  
 Lovett Hdw.  
**Allen Park**  
 Anderson-Huebner Lbr. &  
 Sup. Co.  
**Battle Creek**  
 Mix Hdw.  
 Snyder's Hdw.  
**Belding**  
 Belding Hdw.  
**Berkley**  
 Durst Lbr. Co.  
**Birmingham**  
 A. L. Dammann Hdw.  
 Southfield Lbr. Co.  
**Bryon Center**  
 Rynbrant Hdw. & Lbr.  
**Cedar Springs**  
 Cedar Springs Hdw.  
**Dearborn**  
 Cherry Hill Hdw.  
 Do-Mor Hdw.  
 Liberty Lbr. Co.  
**Decatur**  
 Slack's Hdw.  
**Detroit**  
 Ace Hdw.  
 Roy F. Bushie & Sons Hdw.  
 Dewey's Lumberville  
 Penkell Lbr. Co.  
 Hamilton Hdw. & Electric  
 Service  
 J. & R. Hdw.  
 Kenney Lbr. Co.  
 McNichols Hdw.  
 Power Bros. Hdw.  
 Restrict Lbr. Co.  
 Don Womack Hdw.  
**East Lansing**  
 John Hicks Hdw.  
**Farmington**  
 Smith & Tupper Lbr. Co.  
**Fenville**  
 Dickinsons Hdw.  
**Fruitport**  
 Lappo Lbr. Co.  
**Garden City**  
 H. & R. Hdw.  
 Town & Country Hdw.  
**Grand Haven**  
 Van Tol Hdw.  
**Grand Rapids**  
 Alger Heights Hdw.  
 Alpine Hdw.  
 Brunsink Hdw.  
 Godwin Heights Hdw.  
 Kett Hdw.  
 Madison Square Hdw.  
 Suburban Hdw.  
 Van's Electric & Hdw.  
**Grandville**  
 Grandville Hdw.  
**Greenville**  
 Greenville Hdw.  
**Highland Park**  
 Highland Park Lbr. Co.  
**Holland**  
 Maplewood Hdw.  
 Van Klinte Hdw.  
**Ida**  
 Ida Hdw. Co.  
**Kalamazoo**  
 Curry Hdw.  
 Thomas Hdw. Co.  
**Lincoln Park**  
 Renier Co.  
**Livonia**  
 Brady's Hdw.  
 Loeffler Hdw.

Get your contest entry form from these dealers . . . OR



- Lowell**  
Hahn Hdw.  
**Madison Heights**  
Prudential Lbr. Co.  
**Middleville**  
Norman's Hdw. & Sup.  
**Muskegon**  
Gallups Hdw. & Feed  
**Muskegon Heights**  
Peck Street Hdw.  
**Royal Oak**  
Naskill Hdw.  
**Saranac**  
Chads Hdw.  
**Sparta**  
Johnson Hdw.  
**Trenton**  
Cass Hdw.  
**Wayland**  
Thomas F. Brooks Hdw.  
**Wayne**  
Howard Hdw.  
**Zeeland**  
Zeeland Hdw.
- MINNESOTA**  
**Bloomington**  
McConnell & Blomberg Hdw.  
**Edina**  
Town & Country Hdw.  
**Hastings**  
Ace Hdw.  
**Minneapolis**  
Bonkers Hdw.  
Engberg Inc.  
Fourth Avenue Hdw.  
Gardner Hdw. Co.  
Lyndale Hdw.  
Olson-Kaibel Hdw.  
Town & Country Hdw.  
**St. Louis Park**  
Meyers Hdw.  
**St. Paul**  
Bartl's Ace Hdw.  
Grand Ave. Hdw.  
Henderson Ace Hdw.  
Twin City Hdw.  
**N. St. Paul**  
Henderson Ace Hdw.  
**W. St. Paul**  
Marshall Well Store  
**Wayzata**  
Navarre Hdw.
- NEW JERSEY**  
**Belvidere**  
L. E. Ritter Lbr. Co.  
**Berkeley Heights**  
Schlechter's Berkley Inc.  
**Cranford**  
Cranford Paint & Hdw.  
**Mackensack**  
Comfort Coal & Lbr. Co.  
**Hackettstown**  
Hackettstown Hdw.  
**Irvington**  
Stuyvesant Hdw.  
**Linden**  
Wood Avenue Hdw.  
**Midland Park**  
Zegels Hdw.  
**Milford**  
Kinney Hdw.  
**Paramus**  
Brody Bros.  
**Plainfield**  
J. D. Lolzeau Lbr.  
**Ridgewood**  
Village Hdw.  
**River Edge**  
Comfort Coal & Lbr. Co.  
**Upper Montclair**  
Mocklers Hdw.  
**Washington**  
Washington Hdw. Co.  
**Westfield**  
Taylor Hdw.
- NEW YORK**  
**Baldwin**  
Josh Wolln Hdw.  
**Baldwinsville**  
Schencks Hdw.  
**Brooklyn**  
Berkoff Hdw.  
Marino Hdw.  
Michelson Bros.  
**Camillus**  
Camillus Hdw.  
**Canastota**  
Canastota Hdw.  
**Cazenovia**  
Alkman Hdw. Inc.  
**Cedarhurst**  
Simons Hdw.  
**Central Square**  
Goettles Hdw.  
**DeRuyter**  
H. W. Cook Farm Service  
**Dewitt**  
Boast Hdw.
- Earlville**  
Conklin-Rogers Hdw.  
**E. Syracuse**  
Lawless Bros. Hdw.  
**Fayetteville**  
Norton Hdw. Inc.  
**Fulton**  
Johnston's Hdw.  
West Side Hdw.  
**Hamilton**  
Eccleston Hdw.  
**Long Beach**  
F. M. O'Rourke Inc.  
**Liverpool**  
Liverpool Hdw.  
**Lynbrook**  
Lynbrook Hdw.  
**Manlius**  
Manlius Hdw.  
**Marydale**  
J & J Hdw.  
**Merrick**  
Home Hdw.  
**New Hyde Park**  
Barlow Hdw.  
**N. Syracuse**  
Bersani Hdw.  
**Nyack**  
Comfort Coal & Lbr. Co.  
**Oneida**  
Oneida Hdw.  
**Solvay**  
Nicolini Hdw.  
**Syracuse**  
Calley's Hdw.  
Chapman Lbr. Co.  
Elmwood Hdw.  
Heaphy Hdw.  
House Sheet Metal  
L & L Hdw.  
Miller Hdw. Co.  
Scharf's Hdw.  
Maurice H. Schwartz Hdw.  
Tennants Inc.
- Tully**  
Donald M. Cardner Hdw.  
**Valley Stream**  
Central Hdw.  
**Williston**  
Williston Hdw.  
**Woodmere**  
B. B. Hdw.
- OHIO**  
**Akron**  
Carlton Sup. Co.  
Carter-Jones Hdw. Co.  
Lockwood Hdw. & Sup.  
Marsh Hdw.  
Richard's General Hdw.  
Swan Hdw.  
**Ashland**  
Ashland Hdw.  
Union Hdw.  
**Barberton**  
Paul Dunn Pibg. & Hdw.  
C. E. Saurer Hdw.  
Stuyver Bros. Co.  
**Bedford**  
Bedford Hdw. & Sup. Co.  
**Bellville**  
Stevens's Hdw.  
**Berea**  
Brown Hdw.  
**Brunswick**  
Hinckley Hdw.  
**Bucyrus**  
Fischer's Hdw.  
Walther Hdw.  
**Butler**  
Reeder Hdw.  
**Carey**  
Houks Hdw.  
**Centerburg**  
Wlard Hdw.  
**Cleveland**  
Louis Eisenberg Hdw.  
E. J. Hdw.  
Huntley Hdw.  
**Copley**  
Gamauf Hdw. & Sup. Co.  
**Crestline**  
Holcker Hdw.  
**Cuyahoga Falls**  
Hibbard Hdw.  
**Findlay**  
Findlay Hdw.  
**Galion**  
Allen Hdw.  
Thomas Hdw.  
**Genoa**  
Skilliter & Sons Hdw.  
**Lakewood**  
Belle Hdw.  
Bobson Hdw.  
**Lexington**  
A. C. Kell Hdw.  
**Loudonville**  
Raby Hdw.  
**Mansfield**  
Baker Hdw.  
Fox Hdw.
- Mansfield Lbr. Inc.**  
McNeal  
Peats Home Hdw.  
**Mantua**  
Weber Hdw.  
**Marblehead**  
Merckens Bros.  
**Marysville**  
Marysville Hdw.  
**Medina**  
Medina Hdw.  
**Milford Center**  
Brake Hdw.  
**Mt. Gilead**  
Nelson's Hdw.  
**Mt. Vernon**  
G. R. Smith & Co.  
**N. Baltimore**  
Siegel Hdw.  
**Oak Harbor**  
Oak Harbor Hdw. Co.  
**Orrville**  
Rimer's Hdw.  
**Parma**  
Parma Hdw.  
**Perrysburg**  
Service Hdw. & Repair Co.  
**Plymouth**  
Miller's Hdw.  
**Ravenna**  
Hamilton Hdw.  
**Richwood**  
Davis-Hughes  
**Rossford**  
Frautschi Bros. Hdw.  
**Shelby**  
Robinson Hdw.  
**Stow**  
J. R. Anderson Inc.  
**Sunbury**  
Ward's Hdw.  
**Swanton**  
Joahow Hdw.  
**Sycamore**  
Valentine Hdw.  
**Toledo**  
Bauer's Hdw.  
Doriot Bros. Hdw.  
Hampton Hdw.  
Hill Ave. Hdw.  
Lueli Hdw.  
Ohio Hdw. Co.  
**Twinsburg**  
Richner Hdw.  
**Upper Sandusky**  
Schultz Hdw.  
**Wadsworth**  
Houglan Hdw.  
Wadsworth Sup. Co.  
**Wooster**  
Imhoff & Long Co.  
Wayne Hdw.  
Wooster Hdw.
- PENNSYLVANIA**  
**Allentown**  
Handyman's Shop  
Young's Hdw.  
**Bally**  
Eddinger Hdw.  
**Bangor**  
Bangor Hdw.  
**Bath**  
Bath Hdw.  
**Bethlehem**  
Aykroyd Hdw.  
Cantelmi Hdw.  
Fink's Hdw.  
Laufer's Hdw.  
Merit Hdw.  
**Birdsboro**  
Happel Lbr. & Sup. Co.  
**Butztown**  
Capp's on 22  
**Catasaugua**  
Hubers Hdw.  
**Easton**  
H. H. Bennett Hdw.  
Kiefer Hdw.  
W. C. Miller Hdw.  
Seiple Hdw.  
**Fullerton**  
Talotta Hdw.  
**Hamburg**  
Moyer's Hdw.  
**Hellertown**  
Brown & Borher Lbr. Co.  
Miller Bros.  
**Kutztown**  
W. Theo Miller & Son  
**Lehighton**  
Lehighton Hdw.  
**Macungie**  
Aten Hdw.  
**Mt. Penn**  
J. N. Leinbach Hdw.  
**Nazareth**  
Nazareth Hdw.  
Nazareth Tool & Sup.  
**Neffs**  
Arthur J. Henry Hdw.
- Palmerton**  
Gruber Hdw.  
Shipe's Hdw.  
**Pottstown**  
Van Buskirk & Bros.  
**Reading**  
Zerbe Hdw.  
**Statington**  
Boyer Hdw.  
**Stiles**  
Whithall Bldg. & Sup.  
**Topton**  
Schappell & Sons Hdw.  
**Wind Gap**  
Lemley's Hdw.
- RHODE ISLAND**  
**Barrington**  
Barrington Hdw.  
Maple Ave. Hdw.  
**Bristol**  
Hope Hdw.  
**Middletown**  
Sullivan Hdw.  
**Newport**  
Broadway Hdw. Co.  
J. I. O'Connell Inc.  
**Tiverton**  
Humphrey Co.  
**Warren**  
Four Corners Hdw.  
**West Barrington**  
West Barrington Hdw.  
**Woonsocket**  
Mulvey Co.  
Pinault Hdw.
- WISCONSIN**  
**Appleton**  
North Side Hdw.  
**Beloit**  
Ace Hdw.  
**Big Bend**  
R. Holtz Millwork & Hdw.  
**Brillion**  
Brillion Hdw.  
**Brookfield**  
Brookfield Hdw. & Paint  
**Brownsville**  
Bloohm & Rousseau Hdw.  
**Burlington**  
Consumer's Cooperative  
Reineman Hdw.  
**Cascade**  
Ninnemann Hdw.  
**Cedarburg**  
Baumann Hoffman Hdw.  
**Cudahy**  
Valuch Bros. Inc.  
**Delavan**  
Delavan Hdw. Co.  
**Durham**  
Busch Hdw.  
**Elkhart Lake**  
Nametz Hdw.  
**Eikhorn**  
Eikhorn Hdw.  
**Fond du Lac**  
Lange's Hdw.  
N. H. Moses  
**Grafton**  
Wegner-Hinz Hdw.  
**Green Bay**  
Lin-Mor, Inc.  
Martin Hdw.  
South Side Hdw.  
**Hales Corners**  
Marzinski Hdw.  
**Hartford**  
Leach & Christenson  
**Horicon**  
H. H. Wilke Hdw.  
**Kaukauna**  
Haas Hdw.  
Kaukauna Hdw.  
Service Hdw.  
**Kenosha**  
Isermann Hdw.  
Jornt Bros.  
Josephson & Thomey  
Loeffler Hdw.  
**Kimberly**  
Verhagen & Sons  
**Knowles**  
Czoschke Hdw.  
**Lake Geneva**  
Moore Hdw.  
**Lannon**  
Beckers Hdw.  
**Little Chute**  
Look Hdw.  
**Manitowoc**  
Palk's Ace Hdw.  
**Mayville**  
Main Hdw. & Machine  
**Menominee Falls**  
Thomas Hdw.  
**Milwaukee**  
Ace Hdw.  
Blue J Hdw.  
Buetow Hdw.

**WRITE Popular Mechanics using this coupon. ENTER TODAY.**



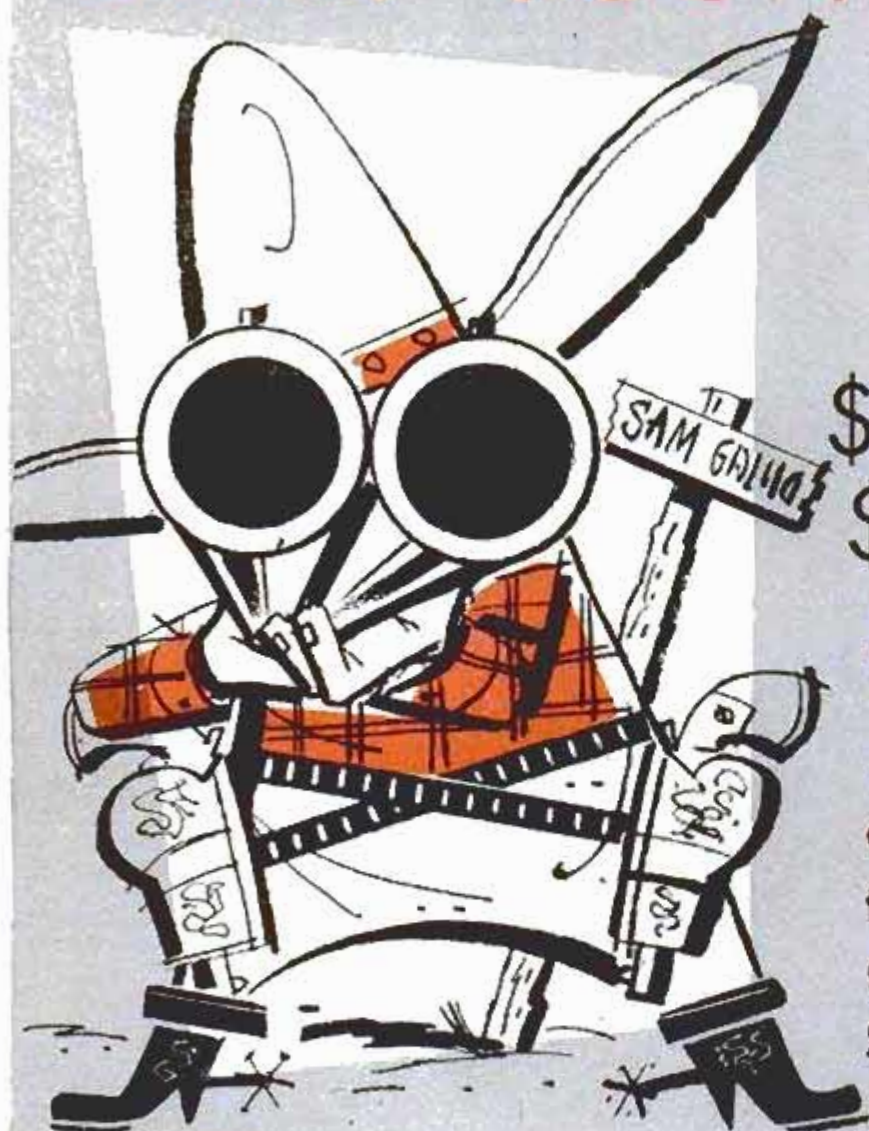
# DON'T LET ANYONE JUMP YOUR CLAIM!

Enter the  
"How's Your Home?" Contest  
sponsored by the  
Home Improvement Council

— today!

\$25,000 first prize  
\$10,000 second prize  
\$3,000 third prize

and 1,000  
other awards  
for a  
grand total of  
\$125,000



HOME IMPROVEMENT COUNCIL  
c/o POPULAR MECHANICS  
200 E. Ontario  
Chicago 11, Illinois

Gentlemen:

Please send me full particulars on the "How's Your Home?"  
contest sponsored by the HOME IMPROVEMENT COUNCIL

Name \_\_\_\_\_

Address \_\_\_\_\_

City \_\_\_\_\_ State \_\_\_\_\_

Get full details from the  
dealer who displays this  
Home Improvement Council  
emblem . . . or send the  
coupon to  
**POPULAR MECHANICS.**



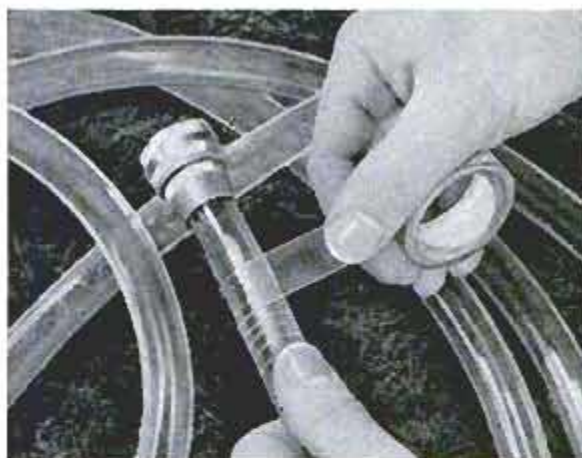


Burnham Hdw.  
 Downer Hdw.  
 Highway Hdw.  
 Layton Park Hdw.  
 Milwaukee Tile & Sup. Co.  
 Reliable Sheet Metal &  
 Hdw.  
 Sittler Paint & Hdw.  
 Strehlow Paint & Hdw.  
 West End Hdw.  
 Wisconsin Rock Wool Co.  
 Wolfenden's Hdw.  
**Mukwonago**  
 Horn Stoecker Hdw.  
**Muskego**  
 Muskego Hdw.  
**New Holstein**  
 Schilling Hdw.  
**Oconomowoc**  
 H. Lorelberg Co.  
**Oostburg**  
 Daane Hdw.  
**Oshkosh**  
 Kitz & Phell Hdw.  
 Mueller's Paint & Hdw.  
 Stillman Hdw.  
**Pewaukee**  
 Corlett Hdw.  
**Plymouth**  
 Hoffman Hdw.  
**Port Washington**  
 Fiederspiel Hdw.  
 Paul Bros. Hdw.  
**Racine**  
 Belle City Hdw.  
 Builders Hdw.  
 Kortendick Hdw.  
 Kroupa Hdw.  
 Lathrop Hdw.  
 Mohr-Jones  
**Ripon**  
 Ace Hdw.  
**Sheboygan**  
 North Gate True Valve  
 Prange-Geussanhainer Co.  
 Trilling Hdw.

**Sheboygan Falls**  
 Brill Hdw.  
 G. H. Ebbers & Sons  
 Ronsen's Inc.  
**South Milwaukee**  
 Ace Hdw.  
 Morisse Hdw.  
**St. Cloud**  
 Kees Hdw.  
**Two Rivers**  
 Two Rivers Hdw.  
**Union Grove**  
 Swantz Hdw.  
**Watertown**  
 Ace Hdw.  
 D. F. Kusel Hdw.  
**Waubesa**  
 Muehlberg Hdw.  
**Waukesha**  
 Ace Hdw.  
**Waupun**  
 Blow Hdw.  
 Buteyne Hdw.  
**Wauwatosa**  
 Gilbert Hdw.  
**West Allis**  
 Ace Hdw.  
 Kiefert's Hdw.  
 Neis Ace Hdw.  
 Pickart Hdw.  
 Weitzer Bros.  
**West Bend**  
 Walter K. Smith  
**W. De Pere**  
 Lin-Mor, Inc.  
**Williams Bay**  
 Bay Hdw.  
**VIRGINIA**  
**Chincoteague**  
 Showard Bros.  
**Onley**  
 Onley Hdw.  
**Parksley**  
 Jacks Hdw.

Be sure to check additional retailer lists  
 in May and June for your nearest  
 PM-HIC dealer!

## HOME REPAIR TIP NO. 44



Mend leaky plastic hose with tough, waterproof, "SCOTCH" Colored Plastic Tape. Stretchy tape sticks tight, resists wear, sunlight, corrosion. New clear plastic blends invisibly with any color. Also available in white, red, yellow, green, brown, blue, black. 3/4" width, 25¢; 1 1/2" width 50¢ at stores everywhere.

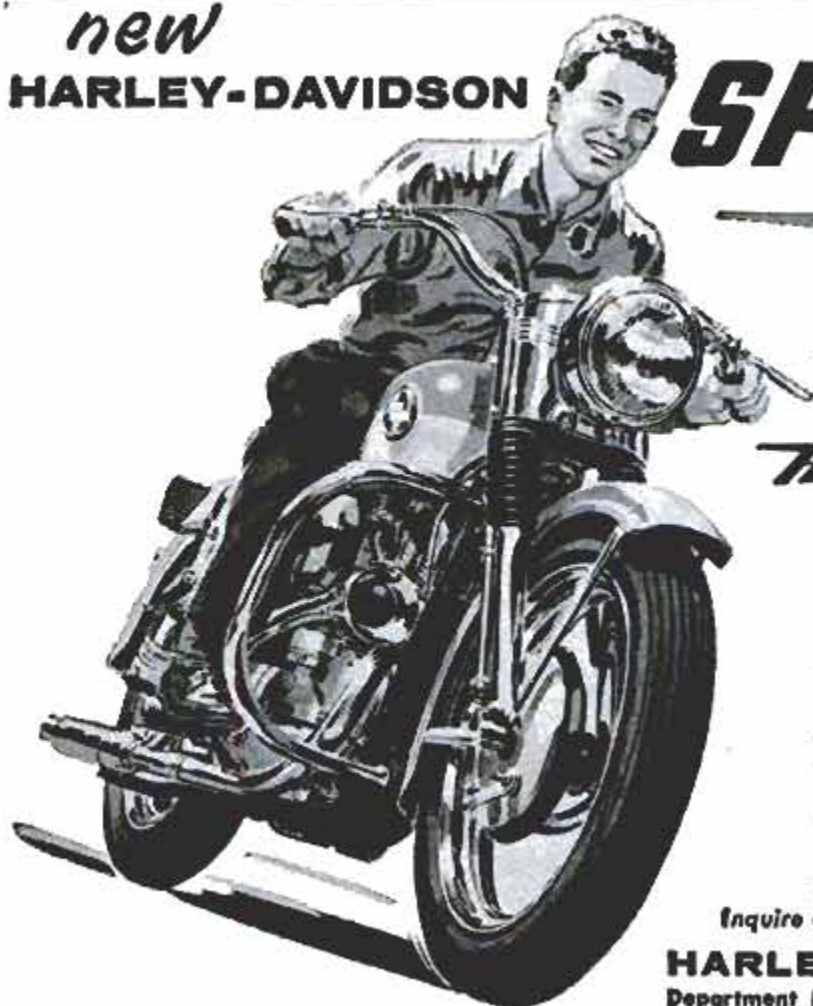
Don't run short...  
**NEXT TIME BUY TWO!**

Made by  
 Minnesota Mining & Mfg. Co.  
 St. Paul 6, Minn. ©3M Co., 1958



*new*  
**HARLEY-DAVIDSON**

# SPORTSTER



## H MODEL

*Hot - Husky - Handsome*  
**handles like the  
 thoroughbred it is!**

New bolt from the blue! . . .  
 Harley-Davidson's Sportster H means  
 extra smooth and action-packed power.

Get 12% more brake hp. with 9 to 1  
 compression ratio — a cyclonic  
 combination of special high dome  
 pistons, larger intake ports and valves,  
 and racing type tappets.

Visit your Harley-Davidson dealer  
 and test ride a Sportster H.

*Inquire about his liberal trade-in and convenient terms.*

**HARLEY-DAVIDSON MOTOR CO.**  
 Department P • MILWAUKEE 1, WISCONSIN



# Looking for Something?



LUMBER



lumber, plastics, grinding wheel,  
paint, insurance, roofers, steel  
**whatever you need—**

Find It Fast  
In The  
**Yellow Pages**



Advertisers displaying this emblem  
make your shopping easy.

intelligence than could be telemetered to ground. Here, it was the cathode-ray tube's inability to receive even this limited amount of transmission.

Happily, solution is at hand. A complex device called an ultrasonic light modulator acts like a battery of cathode-ray tubes and converts the transmitted signal into a light image. The image then exposes a film that contains every dab of transmitted image.

## Radio Signals Make Photos

The same modulator, moreover, can convert the orthicon's electrical image into a light image, exposing film in the satellite. Automatically developed, the film is stored. Later, when the spy satellite is ready to disgorge its intelligence, a scanning device reconverts the filmed image into electrical impulses—which are transmitted to the ground.

Basically, the ultrasonic cell consists of a piezoelectric crystal in contact with a container filled with alcohol and water. A piezoelectric crystal has the property of expanding or contracting when an electrical potential is applied across it. Fed the signal from Explorer III's transmitter, the crystal vibrates. These vibrations set up corresponding vibrations, or pressure waves, in the liquid. Now, if the liquid is bathed in a light source, the pressure waves—exactly duplicating the amplitude and frequency of the electrical image—will interrupt the light. This will produce a visual image identical to that picked up by the satellite. Recorded on film for analysis by military experts, the image may not mirror every detail seen by Explorer III. But at least—thanks to ultrasonic light modulation—it contains everything transmitted.

## Radar Has Drawbacks

Probably about now you're saying, "seems pretty complex." And it is. Even more complex will be Pied Piper's radar eyes.

Visually, radar trails a poor third compared either to television or aerial photography. Radar's special advantage, of course, is its ability to reach through miles of atmosphere—to "see" when clouds blind television and aerial cameras.

For greatest effectiveness, radar's beam must be focused—by parabolic antennas. So its vision is restricted to a smaller hunk of terrain.

One researcher has estimated radar's vision as "about 30,000 feet from 240 miles." That is, a target would have to measure nearly six miles to be clearly imaged by a radar orbiting at 240 miles. And perception would be less at four times the altitude.

(Continued to page 268)





Model  
S3

## The Secret of Scratch-free Sanding!

Ask any expert—the secret of a perfect finish is to sand with the wood grain! That's what the old-time craftsman did when he sanded by hand. And so do you, when you use a Dremel Straight-Line Action Sander—except that a powerful motor does all the work.

With Dremel Straight-Line Action, you leave no cross-grain scratches or orbital swirl marks to mar the finish of your project.

Dremel sanders are compact, lightweight, and easy to grip and handle. Don't be fooled by "look-alikes" or "looks" alone. Ask your dealer for a demonstration. Then compare their price, performance, and ease of handling. You're sure to pick a Dremel — and you'll be glad you did.

See Your Power Tool Dealer Today

Dremel Straight-Line-Action Power Sanders  
3 popular models — \$14.85 to \$37.50

**FREE** Power Tool Catalog on the Complete Dremel Line. Write today!

Quality Power Tools Since 1934

**DREMEL MFG. CO.**

DEPT. 118D

RACINE, WIS.



## G E A R S

**In Stock — Immediate Delivery**  
Gears, speed reducers, sprockets, thrust bearings, flexible couplings, pulleys, etc. A complete line is carried in our Chicago stock. Can also quote on special gears of any kind. Send in your blueprints and inquiries.

Send for Complete Catalog No. 10

**CHICAGO GEAR WORKS**  
440-50 N. Oakley Blvd., CHICAGO 12, ILL.



3/4" Super Mezurall®

**Here's how professionals** rate a steel tape rule. They make this buckling test before they buy . . . and so should you.

Do it, and you'll join the "pros" who insist on Lufkin quality—yet you'll pay no more for it. Because Lufkin is *the* quality tape rule at a popular price.

You'll find dozens of uses for it in your house and workshop. Look for the yellow and green box at your hardware store.



THE

**LUFKIN**

RULE COMPANY

TAPES • RULES • PRECISION TOOLS

APRIL 1958

267

## Jiffy SAWHORSE BRACKETS

NO NAILS NO SCREWS NO BOLTS

Now a sawhorse in a jiffy! Just use Jiffy Brackets and 2x4s. Sold by hdw. and bldg. supply stores everywhere, or order direct. \$1.95 A pair. *Higher W. Coast*

**GRAND HAVEN STAMPED PRODUCTS CO.**  
Grand Haven, Mich.



## WHATEVER YOU'RE MAKING

save hours of time with



**WILHOLD  
WHITE  
GLUE**

with  
Orthanol

Quicker to work: less clamping. Colorless, permanent. Leaves the work clean, the shop clean and your hands clean.

Write for **FREE BOOKLET**

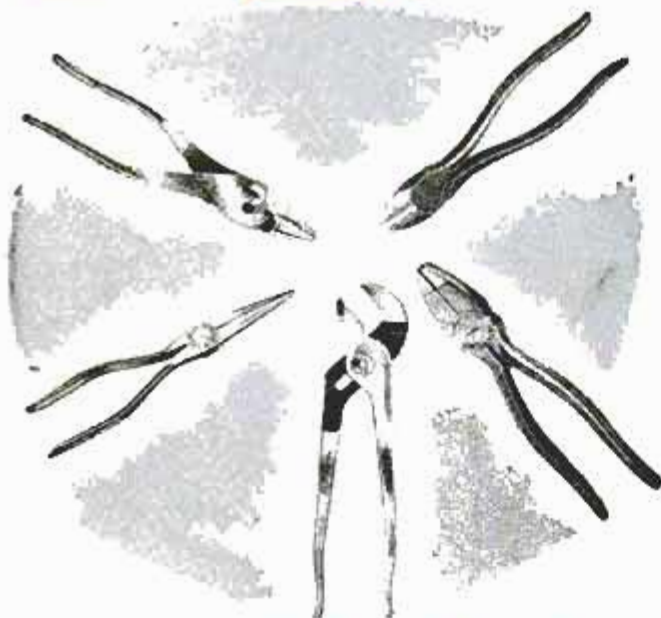
**WILHOLD PRODUCTS** Los Angeles 31, Calif.; Chicago 44, Ill.



# You'll

## DO THE JOB EASIER WITH THE RIGHT PLIER

CHAN NEL LOCK



*Full Polish Finish  
Quality Pliers*

Any job is a hard job without the right tools. These special purpose Channellock quality pliers will help you do hundreds of jobs easier, faster. They're precision-built of high grade drop forged steel to last longer, work better. And you'll like the gleaming, full-polished finish at no extra cost.

Ask for Genuine Channellock pliers by name.  
Look for the trademark on the handle.

**CHAMPION DEARMENT TOOL COMPANY**  
MEADVILLE, PENNSYLVANIA

Says one scientist, "For really good results you'd need a 50-foot antenna and we're a long way from a satellite that large."

Of course, umbrellalike antennas, spring-tensioned to unfold when Explorer III wrenches free of the atmosphere, would add more weight than Explorer III, already crammed with other sensing and seeing devices, could afford.

### Plenty of Power Needed

Even so, radar could probably pinpoint lakes, some rivers, coastlines, general terrain, weather and our largest cities. Smaller towns might show as definable blurs.

All these—aerial cameras, radar, storage devices, timers and transmitters—require power. Where's it coming from? The answer: From the sun. Unless, of course, a really pint-sized, lightweight nuclear reactor is devised before Pied Piper's scheduled launching.

Pied Piper's spherical outer skin will likely be a mosaic of glasslike, wafer-thin silicon solar cells. A square meter of what researchers call "choice cells" (hand-picked for efficiency) would, each hour, wring from the sun some 140 watts of storable energy.

"Actually," points out Norman Regnier, chief of solar equipment design, Hoffman Electronics Corporation (which supplied Vanguard's solar cells), "we're counting on 150, even 160 watts per hour there in space where, unattenuated by air and atmosphere, sunlight is far more intense."

Even so, to charge its batteries to operational levels, Pied Piper might have to take a spy's holiday—every 24 hours or so.

### Sunny Side Recharge

That is, with its timing device set to operate only when enough solar energy had been collected, Pied Piper would cease to spy while it orbited in quest of energy. Twelve of any given celestial 24 hours would likely produce 1200 to 1800 watts of power. This relatively slow recharge is easily explained; during half of its globe-girdling, Pied Piper will be in the earth's shadow. And at other times only about half of the cells will be in sunlight.

However, Pied Piper might scrupulously conserve its power, expend it only briefly over enemy territory and briefly again, over friendly terrain.

Short of low-level aerial reconnaissance (by plane or missile), spatial spies should prove our best intelligence agents, their electronic eyes focused on airfield and factory. And perhaps, on your own back yard. ★ ★ ★



# SPRAY

Professional results  
everytime with  
**PRESSURE QUEEN**  
the only 4 cyl.  
portable  
air compressor



# PAINT

Non-pulsating, continuous air flow for fine finishes...  
spraying house or barn...fast...easy...sprays paint  
undiluted, 4-5 times faster than brush—better too!

Write for details and name of your nearest dealer.



The Campbell-Hausfeld Co.  
1046 Railroad Ave., Harrison, Ohio

**CAMPBELL-HAUSFELD**

## Automatic Saw Set...

### MAKE EXTRA PROFITS!

Set 400 teeth per minute on hand or  
band saws, 4 to 16 point, with the BeMaCo  
Automatic Saw Set. Fast,  
accurate, true hammer-  
anvil action sets teeth uni-  
formly, eliminates tooth breakage.  
Used profitably by saw shops and  
manufacturers everywhere. Every  
machine positively guaranteed!  
Write for details—today!



Saw  
Machine  
Division  
33-C

## BEAVER MFG. CO.

PO Box 434  
800 ISIS AVENUE • INGLEWOOD, CALIF.

**2-SPEED, 2-DIRECTION  
OPERATION TO SAVE  
TIME AND MONEY!**

### ARIENS DE LUXE MULTIMATIC ROTARY TILLER

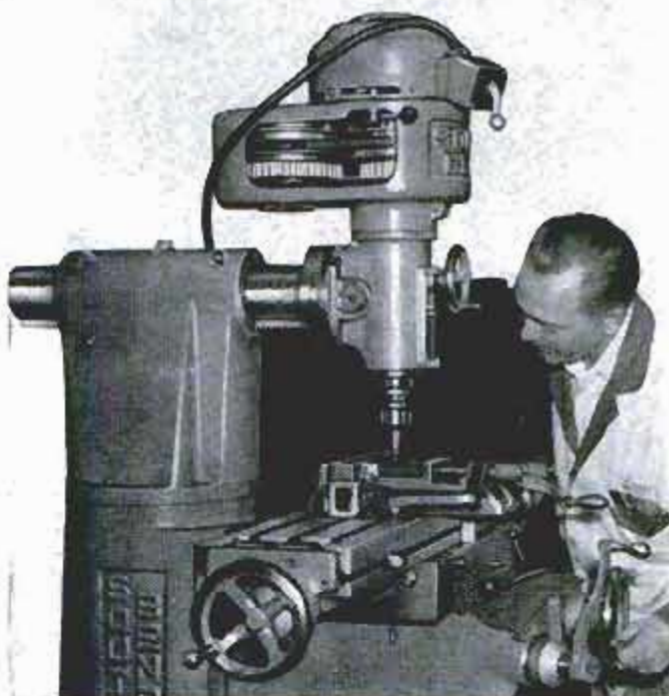


Reversible handle and Insta-Hitch attach-  
ments make this 16-inch tiller the most  
versatile, easiest operating, best balanced  
tiller made! Kohler 3.6 h.p. engine. Save  
time—save work with Ariens Multimatic!  
Write for folder. Dealer inquiries invited.

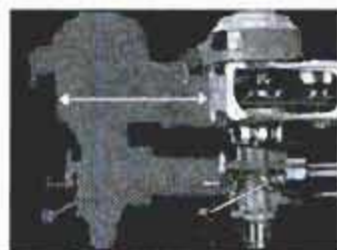
*Ariens* / 161 Coluget Street  
BRILLION,  
WISCONSIN

More Jobs, Faster Set-ups with

## SOUTH BEND Vertical Spindle Milling Machine



- Mills—bores—drills—reams at any angle. Head rotates 360° vertically.
- Easy accessibility simplifies job set-ups and tooling changes.
- Fast—positive head indexing and table positioning. Easy-to-read dials.
- Rugged, heavy ribbed column, knee and table.
- 32" or 42" table with 20" or 30" travel.
- Prices start at \$1829 f.o.b. factory.



### In or Out Ram Travel Without Re-setting Head Angle

Head swivels on ram flange. Ram has a large key sliding in a keyway with an adjustable tapered gib. No side play or canting when ram is moved—always in alignment.

WRITE for complete information on milling machines. Also lathes, turret lathes, shapers, drill presses and pedestal grinders.

**SOUTH BEND LATHE**  
SOUTH BEND 22, INDIANA

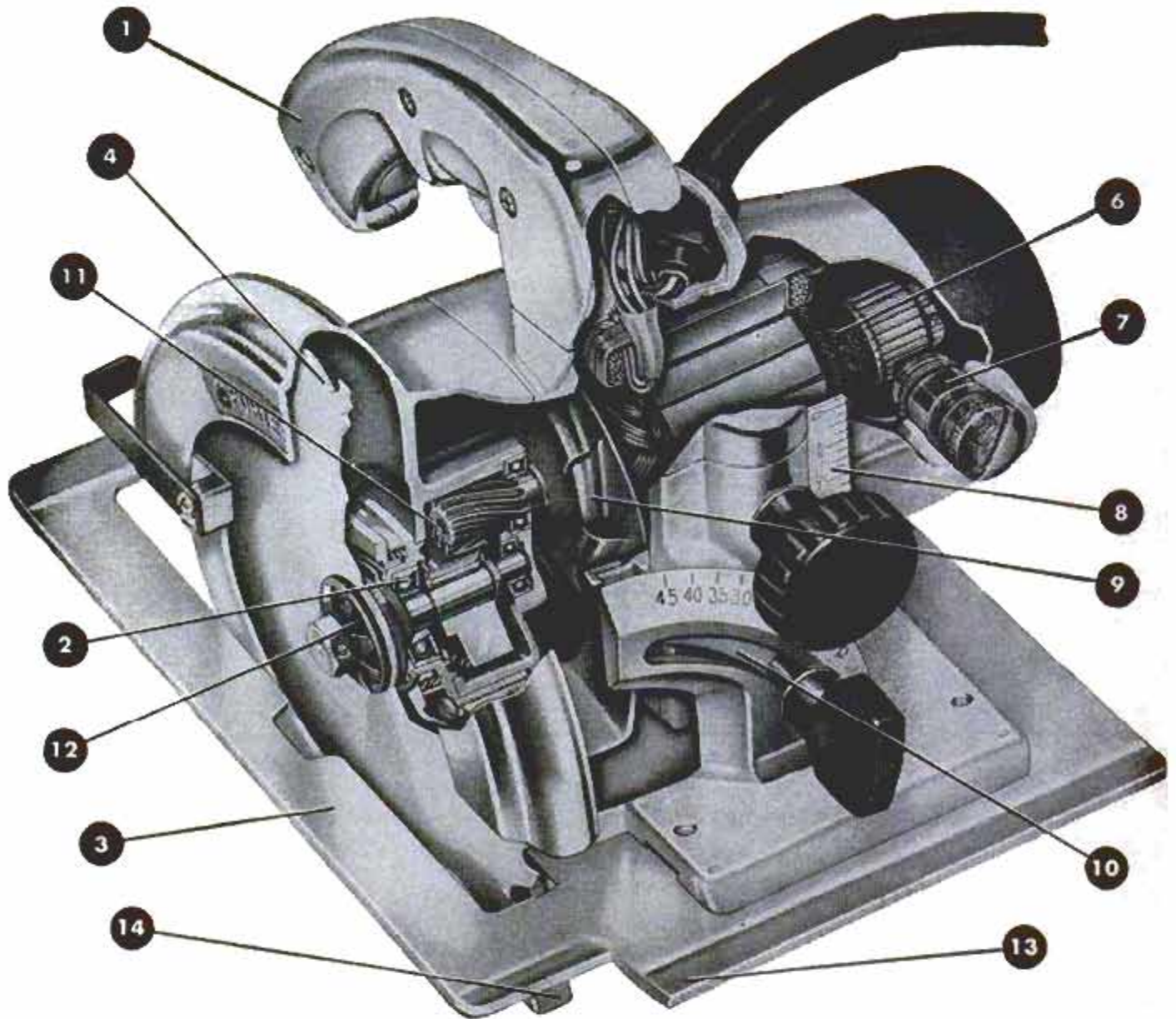
Building Better Tools Since 1906



Up to 24  
months to pay.



# PORTER-CABLE



**1 BALANCE**—Comfortable, contoured handle is specially designed and located for easy one-hand operation and for operator comfort on every cut... in any position!

**2 PRECISION BALL BEARINGS**—Heavy-duty, oversize ball bearings are used THROUGHOUT; grease packed at factory for life time trouble-free service.

**3 WIDE WRAP-AROUND BASE**—Heavy-duty machined base projects on both sides of blade to provide full support and greater stability on cuts from either direction.

**4 CHROME-PLATED BLADE**—Chrome plating gives blade extra-hard

cutting edge for longer life. Standard equipment on all new models.

**5 GEAR LUBRICATOR**—Keeps gear chamber well lubricated without having to dismantle saw. Simple twist of cup ring injects grease onto gear and pinion. (Not shown on drawing.)

**6 PRECISION MACHINE-WOUND ARMATURE**—Features a newly-developed winding technique which assures identical electrical and physical characteristics of the coils. Coils are nylon-clad and insulated for maximum power and top performance.

**7 HEAVY-DUTY BRUSHES AND BRUSH MECHANISM**—Spring-loaded car-

tridge type brushes are self-adjusting. Specially designed for better commutation and peak performance.

**8 CALIBRATED DEPTH SCALE**—Eliminates guesswork. Simply loosen depth adjustment knob and instantly raise or lower saw to desired depth as indicated on the scale.

**9 DUST BLOWER**—Specially designed to maintain high efficiency of motor and keep cutting line clear.

**10 PRECISION ANGLE SEGMENT**—Quick and easy to set for accurate bevel cutting from 0° to 45°. Weight of saw is held by heavy die castings at any depth or angle setting.

**11 PRECISION MACHINED GEARS**—Hardened for greater tooth strength, larger contact area, peak performance and longer life.

**12 KICKPROOF CLUTCH**—Eliminates kickback. Protects operator. Prevents motor and switch burnout.

**13 SINGLE LINE OF CUT**—Only one sighting line to follow on any cut—whether straight, angle or bevel.

**14 SAFETY "NO-DRAG" GUARD**—Patented miterlip on leading edge prevents jamming at start of any cut, and eliminates "drag" during the cut. Positive action of new coil spring returns guard immediately after cut is completed.



# SAWS

## are the world's finest...

**HERE'S WHY:** When it comes to designing a better saw — you can depend on Porter-Cable to do it—and do it first! Typical of Porter-Cable's fifty years of leadership are these three models—the newest additions to the famous line of Porter-Cable saws. Today, more than ever, it pays to see these quality saws at your Porter-Cable dealer. You'll get more cutting power... more satisfactory use... more professional features... more lasting value... at special low introductory prices!



### LIGHTWEIGHT 6 1/2" SAW

A 6 1/2" lightweight saw with full professional construction. 10-amp. motor for rugged cutting jobs. Perfect for all framing and roughing cuts.

**Model 146A \$69.50**

146A Saw, in handy Builder Kit, with rip guide for fast, accurate ripping and steel carrying case. **Model 146Ak Saw Kit \$83.50**

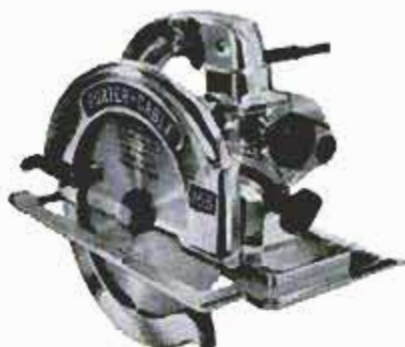


### RUGGED 7" SAW

A rugged 7" all-purpose saw with a full 12-amp. motor to give you power and speed usually found only in higher priced saws. Provides trouble-free, dependable service on every type of cutting job.

**Model 115A \$79.50**

115A Saw, in handy Builder Kit, with rip guide for fast, accurate ripping and steel carrying case. **Model 115Ak Saw Kit \$93.50**



### HEAVY-DUTY 8 1/4" SAW

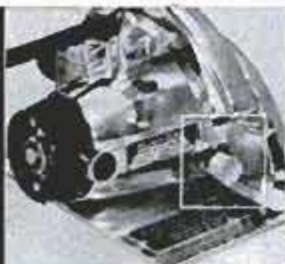
A low-priced, heavy-duty 8 1/4" saw with rugged 13-amp. motor. Designed especially for the builder who wants added power with big cutting capacity. Safety features include auxiliary front blade guard.

**Model 168 \$99.50**

168 Saw, in handy Builder Kit, with rip guide for fast, accurate ripping and steel carrying case. **Model 168K Saw Kit \$113.50**



**PATENTED DESIGN** of telescoping guard eliminates jamming and "drag" during any cut, even compound miter.



**HANDY GEAR LUBRICATOR** keeps gear and pinion well lubricated without having to take saw apart.



**EASY TO HANDLE** on any cut — because of light weight and balance. Ideal for cut-off and trimming operations.



**EXCLUSIVE auxiliary front blade guard**, on Model 168 only, covers saw teeth even on shallow cuts.



**ABRASIVE BLADES** are available for cutting metal, stone, masonry, plastics and other problem materials.

**SEE YOUR DEALER — OR MAIL COUPON TODAY!**

**Porter-Cable**  
*Quality Power Tools*

SAWS • BELT SANDERS • FINISHING SANDERS  
DRILLS • ROUTERS • PLANES

In Canada: write Porter-Cable, Ltd., Box 5019, Ontario.  
Canadian prices slightly higher.

PORTER-CABLE MACHINE CO.  
8144 Marcellus St., Syracuse 4, N. Y.

Please send me complete information on your new Saws and name of my nearest dealer.

Name \_\_\_\_\_

Address \_\_\_\_\_

City \_\_\_\_\_ Zone \_\_\_\_\_ State \_\_\_\_\_



**More Than  
Just a  
Pipe Vise**



Yoke or Chain Vises  
1/8" to 6" capacities  
Bench, Stand, Post  
or Kit

## **RIDGID** **Pipe Vises**

**...give you most  
utility for your money**

**RIDGID** LonGrip jaws take a firmer grip on pipe—and without chewing it up. Most of these vises have handy work-tray bases, pipe rests and pipe benders, doing more for you than merely holding pipe. It pays you to ask for **RIDGID** at your Hardware Dealers.

The Ridge Tool Company • Elyria, Ohio, U. S. A.



### **All-Transistor Metal Detector Uses 1500-Hour Batteries**

Now available for prospectors is an all-transistor metal detector that weighs only 12 pounds. It's powered by batteries which have an estimated life of 1500 hours of continuous operation. The detector also features printed circuits, single-turn aluminum detecting loops and a glass-fiber case. The unit is designed to detect all metals and conductive minerals.

### **Boats Made of Rubber-Plastic Will Be Unsinkable**

Small boats will soon be made of a tough blend of rubber and plastic called Royalite. With a five-ply construction built around a cellular center, its advantages include an impact strength three to five times greater than all other boat materials, and an imperviousness to rot, rust, worms or corrosion. Because of the material's cellular construction, a boat made from it cannot sink when swamped.

### **Instant Bread**

Scientists at Florida State University report they have developed a bread that can be stored dry for several months yet looks and feels like fresh bread when moisture is added. However, the experimental bread is "short on taste." The goal is a dehydrated bread that can be stored for several years and still taste like fresh bread when its normal water content is restored.



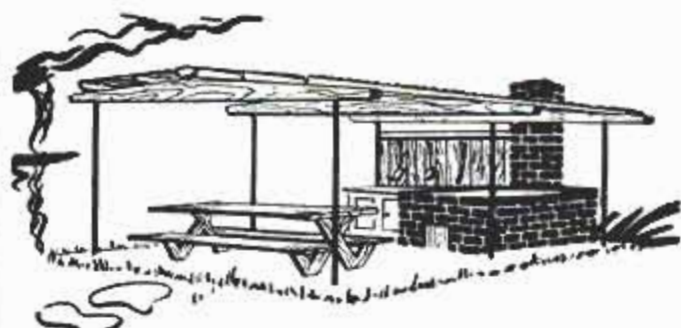
**Drill and  
Countersink  
Holes for  
Wood Screws  
in ONE  
Operation!**

**4 Bits —  
24 Combinations**

**\$1.70**  
per set

Manufacturers of World-Famous Trojan Saw Blades and Frames

Buy the **Parker** Line  
**PARKER MANUFACTURING CO.**  
WORCESTER 1, MASS., U. S. A.



**Build a SUMMER HOUSE  
with *Corrulux*®**

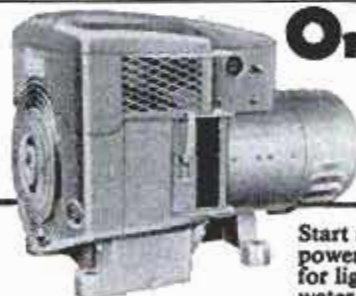
Outdoor living can be gracious and convenient with this modern adaptation of an old Southern idea. Build it for your own use or for profit, using Corrulux—the shatterproof translucent panel that reduces glare, adds colorful beauty.

Send 10 cents for complete construction details on Summer House (Plan 2) and/or 10 cents for our booklet "30 Ways to Build" showing new, practical building ideas. Dept. 41

**LOF**  
GLASS FIBERS  
**Corrulux**®

L·O·F Glass Fibers Company  
P. O. Box 20026, Houston, Texas

CORRUGATED SHEETS • FLAT PANES • PYROPANL  
DOUBLE DOME SKYLIGHTS



**Onan Emergency  
Electric  
Plants**

Start automatically when highline power is cut off, supply current for lights, heating system, freezer, water pump, stove, all appliances and machines. Prevents losses and hardships. Plant stops automatically when power is restored. Compact, easy to install. 500 to 75,000 watts A.C. Priced from \$319.00.

Write for Free Folder

**PORTABLE  
MODELS**  
500 to 10,000  
watts. Supply  
plug-in power  
anywhere!

**D. W. ONAN & SONS INC.**  
3576A UNIVERSITY AVE. S.E. • MINNEAPOLIS 14, MINN.

**NEW HONEYWELL DECORATOR LIGHT SWITCH!**



*Change it  
any way,  
any time*



*to match  
your room's  
decor!*



**T**HE TRANSPARENT decorator plate on the new Honeywell TAP-LITE\* snaps off for easy decorating, cleans easily. Just wipe with a damp cloth. Simple to install. TAP-LITE has screwless terminals. Easy to operate. Tap, it's on. Tap, it's off! Switch and plate \$1.95 at hardware stores.

MINNEAPOLIS  
**Honeywell**



\*Trademark

*First in Controls*



# PLYMOUTH

**A fault of all three cars. What happened to that wonderful under-the-seat heater, the industry's gift to rear-seat passengers?**

**Other comments on PM's test car: Windshield reflections bad at night. Dash dials excellent, day or night. Rotary headlight switch is too easy to leave on when parking on a foggy morning. Pull-out switch is more obvious, tells you it's on. Base of front-seat back had uncomfortable ridge that bothered driver. Doors hardest to operate. Glove compartment inconvenient. Wonderful (best of the three) car to drive, due to precise power steering with its fast steering ratio.**

"Can't find a garage big enough for my station wagon. After all, 214 inches is long."—New Jersey businessman.

"Paint too thin. Base coat shows through in spots."—Virginia government employee.

"Poor circulation from heater beyond front seat."—Wisconsin social worker.

"Should have handle on trunk. Always leave fingerprints where trunk is pushed down."—Wisconsin owner.

"Dimmer button hard to reach for short person."—Wisconsin design engineer.

"Location of glove compartment is inconvenient. It's far to the right and the contents fall out when it is opened."—Washington, D.C., retired Naval officer.

In each survey we ask the owners to make one suggestion to the industry as a whole, not just to the company making their car. Here are some of the most interesting suggestions:

"I believe the modern low-price American car has about reached the optimum size in relation to riding comfort. The small foreign cars which operate more economically do so with a sacrifice in comfort. I prefer the somewhat more expensive comfort. My principal gripe is directed at shoddy workmanship."—Maryland physical chemist.

"If your survey helps to restore normalcy in length of cars, reduction in claptrap, a better placement of mirrors and a correction of the fish-bowl glass arrangement which permits the sun to pour in on the helpless driver, I shall be grateful."—New York assistant principal.

"They should make a car where the driver sits a few inches ahead of other passengers, also a few inches higher. At least give the driver's seat the most consideration."—Colorado stationary engineer. ★ ★ ★

# NEW!

THE MOST REVOLUTIONARY ADVANCE  
IN PELLET GUN SHOOTING IN A DECADE!

## Crosman

.22 CALIBER PELLGUN RIFLE

# "400" REPEATER

featuring

Exclusive Patented SWING-FEED® LOADING  
with Load Indicator, and TRU-FLYTE® BARREL

Another first by Crosman—a Repeater Rifle! No more manual loading. Crosman SWING-FEED LOADING feeds and loads ten pellets automatically as you slide the bolt! Crosman Load Indicator pops out to show when chamber is loaded. Absolutely trouble-free. TRU-FLYTE Barrel delivers amazing new accuracy in pellet shooting. WRITE for colorful, new shooting booklet, Crosman Arms Co., Dept. PM-16, Fairport, New York.

NOW STOCKED BY CROSMAN SELECT DEALERS

Shooting is 3 Times MORE FUN with

## Crosman

Power  
Without Powder®

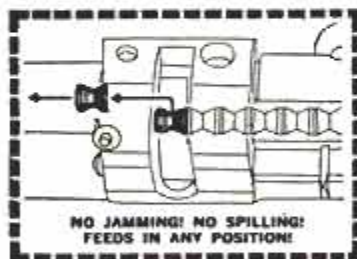
# PELLGUNS®

Available in Canada

World's Largest Manufacturer of Pellet Rifles and Pistols



AMERICA'S FIRST PERFECTED PELLET FEEDING AND LOADING ACTION



NO JAMMING! NO SPILLING! FEEDS IN ANY POSITION!





**Good  
Craftsmanship**  
starts with a

# COLUMBIAN VISE



You can't really do any job well without a dependable vise. Columbian D43 1/2 Workshop Vise is guaranteed by the world's largest vise builder. Channel steel beam, cold-rolled steel screw, replaceable heat-treated steel jaw faces, permanent pipe jaws... many more features.

Jaw Width... 3 1/2 in. Pipe Capacity... 1/8- 1 1/4 in.  
Jaw Opening... 4 in. Weight... 16 lbs.

Vises are also available with 4-inch jaws (D44) and 5-inch jaws (D45). See your Dealer.  
**WRITE FOR FREE CATALOG**  
\*add \$1 west of Rockies.

**\$11.90\***  
delivered

**COLUMBIAN VISE & MFG. CO.**  
DEPT. PM43 • CLEVELAND 4, OHIO

**KEEP YOUR  
WORKSHOP TOOLS  
SAFE AND ORDERLY**



This 7-drawer machinist's chest has a place for every tool. Extra durable heavy gauge steel. Felt lined drawers protect delicate edges... operate easily. Size: 8 1/2" x 13 1/2" x 20 1/4". \$27.95 at leading hardware stores. Slightly higher west. Other home workshop models from \$1.25 up.

**WATERLOO VALVE SPRING COMPRESSOR CO.**  
Waterloo, Iowa

**1/2 PRICE SALE**  
REGULAR 50c WOODWORKING  
PROJECT BOOKS  
NOW 4 FOR **\$1.00**

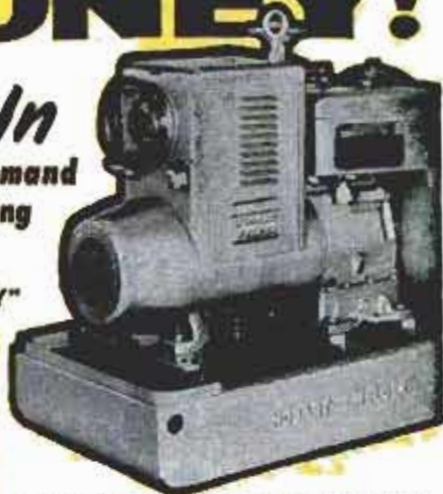
Especially prepared for the home shop owner by leading furniture designers, these four Atlas books include: 20 practical plans with items for everyone in the family, 18 outdoor equipment and garden furniture plans, 16 Modern furniture plans and 20 useful small item plans. Order today! Enclose cash, money order or check — No c.o.d.'s or stamps, please.

**Atlas Press Company**  
4-24 N. PITCHER ST. • KALAMAZOO, MICH.

arc welding  
**Pays Big  
MONEY!**

**Cash In**  
on the big demand  
for arc welding

200 Ampere  
"HUSKY BOY"



AC Transformer  
Shop Type Welder



AC Welder  
AC Power  
Combination

Every day more and more opportunities for big profits arise in arc welding. Why not cash in, especially when it's so easy to do—with a low cost, high efficiency Hobart welder. Any one of these easy-to-use models puts you in business immediately.

200 amp. "HUSKY BOY" welds anywhere. Light, rugged, compact—easily mounts on your tractor or trailer to go to those emergency repair jobs. Portable mountings also available.

AC TRANSFORMER is a popular model for small shops, auto service shops, plumbing and heating contractors, farm welding, etc. Economical to operate, yet has big industrial model features.

AC WELDER/AC POWER 200 amp. combination furnishes current for welding and power for running tools, lights, etc. Simply connect it to your own power source or to portable gas engine. WELDING LESSONS BOOK, 200 pages, fully illustrated. Self teaching, \$1.00

**HOBART BROS. CO.,** BOX M-48, TROY, OHIO, FE 2-1223  
"One of the world's largest builders of arc welding equipment"

**"BUILD-YOUR-OWN" GAS DRIVE  
WELDER**

Save \$200 to \$300 using this Hobart DC Welding Generator that gives you the opportunity to build your own efficient portable gasoline driven arc welder, at low cost.

These generators come equipped with all the features that are standard with Hobart factory-built engine driven models. Write for free booklet—"How To Build Your Own Arc Welder"



Some typical  
home-built  
welders

HOBART BROTHERS CO., Box M-48, TROY, OHIO, U.S.A.  
Please rush me complete information on:

- "Husky Boy"  AC Welder/AC Power  
 AC Transformer  Build-Your-Own  
 Send Welding Lessons Book I enclose \$1.00.  
 Booklet—"How To Build Your Own Arc Welder"

Name \_\_\_\_\_

Address \_\_\_\_\_

City \_\_\_\_\_ State \_\_\_\_\_



**The NEW  
Plus + Hammer You Want**



16 oz. head  
**\$5<sup>35</sup>**

**"3 in One"  
UNBREAKABLE  
Hammer**

**Forged One-Piece** head-handle  
Strongest Construction Known

**Everlasting Cushion Grip**  
Lasts for Life of Head

**Whip** that Gives Smooth, Effective Drive  
Marks You As a Master Craftsman

At Leading Hardware Dealers

ESTWING MFG. CO., Dept. PM-3, Rockford, Illinois  
Inventors and World's only Specialists in Unbreakable Hammers

**HUOT ROLLING TOOL CHEST**  
PROTECTS YOUR VALUABLE TOOLS



Goes where your work is! It's a handsome professional piece of equipment!

This complete rolling cabinet is ruggedly built of heavy formed and welded steel for permanent service on the job or in your home workshop. Three top drawers are cork-lined for precision tools—two heavy duty bottom drawers are extra deep for power tools. Complete with built-in lock.

MODEL 250 **HUOT** Rhymes With Do-It!

Write for free bulletin showing this and 12 other models!  
HUOT MFG. CO., 555 N. Wheeler St., St. Paul 4, Minn.



**Ceiling Tile Conceals Door  
With Access to Wiring**

Made of sheet steel with a continuous hinge on one edge, a door opening to electrical wiring in the ceiling can be concealed by a matching tile. The face of the door is cupped so that a tile will fit into it. The door catch is on the topside and only the hinge barrel is visible when the door is closed. It's opened by inserting a screwdriver into a hole in the tile.

**ADD PERMANENCE  
TO YOUR PROJECTS**

WITH SCREWS and BOLTS

by *Southern*

Buy Southern by Name . .  
Buy 'em by the box, and save!

IN ALL LEADING HARDWARE  
AND BUILDING SUPPLY STORES



WOOD SCREWS  
TAPPING SCREWS  
STOVE BOLTS  
MACHINE SCREWS  
DRIVE SCREWS  
DOWEL SCREWS  
CARRIAGE BOLTS  
HANGER BOLTS



*Cadillac*  
*Sleek, swift  
and mighty safe!*



More fun on the water, less work out of water—that's the Cadillac story for '58. Plenty of room for friends and fishing gear. Light but mighty seaworthy. The

perfect answer to all-'round water fun. H.P. ratings up to 75. Write for free folder on Cadillac aluminum, molded plywood and ply-lap\* models.

\*Pat. Pend.

CADILLAC MARINE & BOAT COMPANY • Cadillac, Michigan  
276 POPULAR MECHANICS



GIGANTIC  
SAVE-TO-70%

# MAIL SALE

WAR SURPLUS  
EXCESS INVENTORY  
BANKRUPT STOCK

## CONTRACTOR—BUILDER—FARMER LEVEL

● Precision quality level by leading mfr. Excellent for setting foundations, grading, farm contouring, surveying, etc. Powerful optically true telescope, finely graduated azimuth scale, sensitive level adjustment, polished oak tripod, 8 1/2 ft. 3-section rod, fine case, instructions, etc. A wonderful buy. SALE.....\$42.95 Ppd.

## STORAGE BATTERY WINCH

● Powerful fully reversible, ball-bearing gear reduction winch, 1000-2000 lb. pull. Use on 6 or 12-v battery. Holds 40' of 1/4" cable. For trucks, docks, boats. Govt. cost \$280. \$46.75 FOB

## AIR COMPRESSOR BARGAINS

For painting, cleaning, tires, control termite. Assemble your own outfit and save money. Lowest prices in U. S.

● Deluxe Kit. Compressor, tank, gauge, regulator, paint gun, relief valve, fittings, hose, instructions. List \$52. SALE.....\$39.49 FOB

● Air Components. Compressor 1-cyl. \$19.95; Air tank, \$8.79; Regulator \$3.95; Pop-off \$1.05; Press. Gauge \$1.89; Finest Paint Gun \$11.95; Auto Switch \$4.75. All Ppd. in U. S.

## HYDRAULIC SPEED REDUCER

● Variable hydraulic speed reducer. Any speed from 50 to 750 rpm by simply throwing a lever. Handle up to 1 1/2 h.p. Use for midget cars, shop hand saws, etc. Instant reverse. Govt. cost \$400. SPECIAL \$47.81 FOB

## HAND HYDRAULIC SYSTEM

● Brand new Blackhawk hand hydraulic pump. Complete with oil reservoir control valve, built-in relief valve. Pressures to 5000 lbs. Use for wagon unloader, lift truck, shop press, etc. Govt. cost over \$100. SALE.....\$23.95 FOB

## POWER PLANTS & GENERATORS

● Marvelous buys in new condition Govt. and factory surplus plants and generators. Write for catalog.

● 2500-w 115-v 60-c \$239.50  
● 3000-w 115-v 60-c \$299.50  
● 5000-w 115-v 60-c \$497.50  
● 3 KW 115-v DC Generator \$49.50

## OTHER OUTSTANDING SURPLUS BUYS

● 12"x24" Stainless Stl Air Tank \$16.95 FOB  
● Boat & Truck Hand Winch... 8.95 Ppd.  
● Hand Crank Fish-Worm Shocker 3.89 Ppd.  
● 12-v D-C Bilge Pump..... 9.95 Ppd.  
● Modern Dial Telephone..... 9.95 Ppd.  
● Govt. Jungle Hammock-Tent.. 6.95 Ppd.  
● 300 Amp Welding Generator... 23.95 FOB

## SPECIAL OF THE MONTH!

### FARMER-CONTRACTOR CENT. PUMP

1 1/2" Size, 8400 gph  
● Brand new, high capacity, all bronze ball bearing centrifugal pump. Wonderful for irrigation, dewatering and industrial uses.  
● 1 1/2" inlet, capacity to 140 gals. per min. Pressure to 70-ft. Speed 3000-3600 rpm. Complete with pulley. Diam. 7"x9"x6". Wt. 18 lbs. List price \$62. SALE, \$21.95 FOB  
● Hose Special. 20 ft. 1 1/4 in. with threaded fittings. Pressures to 75 lbs. List \$16.50. SALE.....\$6.29 FOB

## ELECTRIC CAR MOTOR

● Use golf or boys electric car. Geared 140 to 1. Run 6 or 12 volt auto storage battery. Easily reversible. Full instr. Wt. 34 lbs. Govt. cost \$250... \$18.95 FOB

## MISC. HYDRAULIC BARGAINS

● Tractor Pump 1000 psi 12 gpm Ppd \$45.50  
● Gauges 1000, 1500, 3000 psi (Specify) Ppd 3.49  
● Control Valve, 1 & 2 way cyl. Ppd 12.95  
● 2-Way Cyl. 3" bore, 6" stroke Ppd 14.95  
Many Hyd. items. Send for catalog.

## ORDER FROM AD or write for catalog.

Hundreds marvelous mechanical, electronic bargains.

## BURDEN SALES COMPANY

806 West "O" St., LINCOLN, NEBRASKA

## NEW, IMPROVED CALCULATOR FOR WOODWORKERS only 25c

Instantly gives information on lumber, nails, concrete mixes, painting materials, etc. Convenient, simple to read. Just set dial for nail specifications, to convert linear to board feet, find bit sizes for screws, compare characteristics of woods. 6" diameter heavily varnished cardboard. Send 25c, 00 stamps, please to Greenlee Tool Co., 2104 Columbia Avenue, Rockford, Illinois.

**WELD** **BRAZE** **4WAY**  
**SOLDER** **CUT** **ONLY \$14.75**  
I.o.b. factory

Acclaimed by thousands of Homeowners, Mechanics and Hobbyists as the welder of 1001 uses. Easily operated from properly wired 116 volt AC or DC line. The ideal gift with a life-long use... Order today on 10 day money back guarantee.  
**FOUR-WAY WELDER CO., Dept. F2-D**  
1810 S. Federal St. • Chicago 16, Ill.

# New Dexall Brush Cleaner



**Works Like Magic!**

- Cleans hardened paint brushes . . . easily and thoroughly!
- Cleans all types of bristles
- Nonflammable . . . re-usable

At Paint and Hardware Stores Everywhere

DESHLER PRODUCTS INC. • Deshler, Ohio

**More cutting power**  
for 1/4" electric drills

## Irwin Speedbor "88" most revolutionary bit in years

Irwin's Exclusive Hollow Ground Point and spade-type cutters bore faster, deeper, cleaner with less power. Try the Speedbor "88" in your small 1/4" electric drill or drill press and see. Get smooth, effortless cutting action in hard or soft woods, plaster, plywood, plastics — even hardrock maple! Forged in one piece from solid bar of high carbon steel, hardened full length to stay sharp. And remember . . . the hollow ground point is exclusive with Irwin's Speedbor "88". Buy individual sizes or sets from your independent hardware dealer.



No. 886-R plastic roll set of 6, sizes 3/8" to 1", only \$4.50



only 75¢ each any size, 1/4" to 1"

**IRWIN** • the original solid center auger bit  
Wilmington, Ohio • screw drivers • screw driver bits



**BUILD WELDER OR LIGHT PLANT** **General SALE** **NEW HYDRAULIC CYLINDERS**

G-1 160-250 amp, 30V, New \$12.95 used \$9.95  
 G.E. 200 amp, 30V, New \$14.95 used \$12.95  
 R-1 J. & Heintz, G.K. or Ford 300 amps \$16.95

**V-BELT PULLEY KIT**, File R-1, P-1, G-1 & AC-DC generators; has 2 ball bearing blocks with high speed bearings, three groove V-pulley, Dr. shaft 8" long & flex coupling \$17.50

**AC-DC WELDER KIT** #511 G.E. Generators Makes A.C. light plant & D.C. welder & battery charger, 1250 Watts A.C., & 200 Amps, 30V, D.C. incl., 2 Volt reg., 1 R.C. relay, 1 R.P.M. indicator, 1 electrode holder, 1 switch, 1 helmet, 1 rheostat & instr. \$25.50

Kit as above with R-1 J. & Heintz or G.E. 300 amp \$35.50. Kit with new 160-250 amp, gen. \$21.50. Kit with new G.E. 200 amp, gen. \$25.50.

**New Reactor Coil Arc Stabilizer** with #4 S. Copper wire, for R-1, P-1, G-1 & AC-DC, gen., 7"x5"x4" wt. 11 lbs. \$10.95.

**New Throttle Control Solenoid & Idling Device** for all welder engine control, 1" travel, shaft is 6" long, threaded end #SC-11. \$6.95.

**WATER PUMP WITH MOTOR** 1 1/2 H.P. 2 1/4" V. D.C. runs on 6 or 12V. D.C. Adj. press., 1" ports, 400 G.P.H. \$12.95 (pump minus motor \$7.95) with 900 G.P.H. pump, 1/4" H.P. motor, 3/4" ports. \$14.95.

**New 1/2 H.P. 7500 R.P.M. D.C. 9 Amps. Electric Actuator**, Adj. travel 5 1/4" either direction; tension load 850 lbs.; static 1. 2800 lbs. \$8.50. 2/\$15.00.

**New Weaver Hydraulic Hand pump**, Heavy duty, 2000 P.S.I. including built in Pressure relief. Handle adjustable from 12"-20". Wt. 10 lbs. \$7.95

**SPEED REDUCER** 5:1 or 10:1 ratio, 2 H.P. \$5.50

**GEAR REDUCTION MOTOR BARGAIN** 42:1 ratio, reversible 24V. D.C. 200 RPM, runs on 6- or 12V D.C. & Appl. for 110V/A.C. \$4.69, 2/\$8.50.

**ROMEC HYD. PUMP & Motor**, Positive displacement, 900 G.P.H. 28 H.P. 2500 RPM for 12- or 24V. D.C. 3/4" ports. New \$8.95.

**NEW Four Way Open Center Control Valve** with built in adj. relief for 1 to 4 D.A. cylinders. 3/8" ports #10060 \$14.50. #4811 four way with 2 handles for 18 A. cylinder. New \$8.95

**Air or Oil Bore Stroke Shaft D. Action**

#11	1 1/4"	6"	5/8"	\$8.50
#512	2 1/4"	4"	3/4"	\$5.50
#24	3 1/4"	2 3/4"	1 1/4"	\$27.50
#511	3 1/2"	2 1/2"	1 1/4"	\$22.50
#111	3"	2 1/4"	1-3/16"	\$25.50

**NEW HYDRAULIC SYSTEM KIT**

#400 K. Heavy duty Power Driven, rated 14,000 lbs. lift. Consists of 2 D.A. hyd. cylinders, 3" bore x 24" stroke, each rated 7000 lbs. with 1000 P.S.I., 1 four way hyd. control valve with built in relief #821, 1 Vickers hyd. pump, 400 G.P.H., 1500 P.S.I., 3750 RPM, 1 hyd. 2 gal. reservoir, 1 Purolator hyd. filter, 1 gauge 0-2000 P.S.I. all hose & fittings. Value \$184.10, save \$90.00. Kit price \$94.10. Kit with two #511 cyl. \$79.95.

**HYDRAULIC PUMP BARGAINS 1500 P.S.I.**

MFG. TYPE	R.P.M.	G.P.H.	Price	
Pesco Gear	1500	198	\$ 8.95	
Pesco Gear	4300	360	\$12.95	
7 *Pesco Gear	447 cu. in.	270	\$14.50	
*Stratopower	450 cu. in.	3750	400	\$15.50
Vickers	410 cu. in.	375	G.P.H.	\$15.50
Vickers	507 cu. in.	400	G.P.H.	\$17.50

**GENERAL SALVAGE CO.** CHECK OR M.O. 2722 E. 27 St., Dept. 94, Kansas City 27, Mo.

**4-HR. DIVING LUNG**

Send for Free Literature **49.50**  
 DEPT. PM-4

**DIVING INDUSTRIES WILMERDING, PA.**



**MAKE YOUR OWN BOLTS, BRACES, HANGERS!**

**now available GALVANIZED!**



**REDI-BOLT®**  
**THREADED STEEL RODS**

Save repair and construction time. Just cut to length; heat and bend; add std. nuts. Seven sizes: 1/4", 5/16", 3/8", 7/16", 1/2", 5/8", and 3/4". Handy lengths of 24" and 36". Available in galvanized or blue rust-resistant finish.

Sold in Leading Hardware Stores

**REDI-BOLT, Inc.**

5330 Indianapolis Blvd., East Chicago, Indiana

**Writes on Anything**

**DRIES BEFORE I can say**

**HOCUS POCUS**  
 and does **77 MARKING JOBS**  
 IN THE HOME, OFFICE, SHOP

address packets mark frozen foods

**magic marker®** Colors **77¢**

Waterproof • Can't Spill • Dries Instantly

Guaranteed by Good Housekeeping

At All Better Stationers  
 Write for Free Booklet "77 Ways to Make Life Easy."  
 Dept. E, SPEEDY PRODUCTS, INC., Richmond Hill 18, N. Y.



**Sharpen YOUR SAWS**  
 with **QUICK-WAY®**

Now you can sharpen, joint, gum and re-tooth all circular saws to 12" dia. Precision results. Safety Guide, Mounting Block and Grinding Wheel included. Model PG-12 \$19.95 Postage Paid. Send for Circular FREE! Special Saw Set with each QUICK-WAY unit purchased. (\$2.75 if ordered separately).

**QUICK-WAY SAW CO.** 236 Tompkins St. Cortland, N. Y.



**HOLD-F-ZEE®**  
 the Original **AUTOMATIC GRIP**  
**SCREWDRIVERS**

**FINEST MATERIALS AND WORKMANSHIP**

**LOK-BLOK®** makes blade twist and impact proof.  
**GRIPPER** recedes deep into handle, giving full blade use.  
**SPECIAL BIT** fits both types cross-point screws.

**—YET COST NO MORE THAN ORDINARY SCREWDRIVERS!**  
 At Leading Dealers Everywhere

**UPSON BROS., INC., ROCHESTER 14, N. Y.**





# HUNTERS! SALE MK 7 PANTHER

7.62MM (.30) CALIBER MILITARY SURPLUS RIFLES FOR DEER HUNTERS

6-SHOT BOLT ACTION  
REPEATING RIFLE SALE!



**\$13.85**

PLUS FREE AMMO

Includes 12 rds. free target  
ammo for testing

**STOCK #ER5C - The Elmer MARR VII PANTHER SPECIFICATIONS:** 6-shot bolt action repeating rifle Caliber 7.62mm (.30). Calibrated, adjustable sights, windage Rapid action, ideal light trigger pull Flat trajectory, 2820 F.P.S. Muzzle velocity Precision milled parts. Our own gunsmiths completely check and pass on every rifle Guaranteed mechanically perfect or your money back. They are test-fired, cleaned and degreased, then oiled lightly Stocks are top grade select European wood We do not refinish stocks at this price, but if you will use a little sandpaper and varnish you will have yourself a beautiful gun **THESE ARE USED EUROPEAN GUNS** specially selected from pre-World War II period You will never buy a top grade deer and bear rifle for this price again. These guns are available solely because modern armies are being equipped with new automatic weapons Softnose hunting ammo, 20 rds. \$2.95; Target Ammo 100 rds. \$7.50

**FIREARMS CLEARANCE SALE - HUNTERS NOTE!**

## HUNTERS! 30/06 SPRINGFIELD SALE!

**\$29.95**



STRAIGHT OUT OF GOVERNMENT BOXES

**STOCK #ER22A.** Original low serial number U.S. Gov't Springfield. 30/06 caliber This is the best deer gun you will ever buy. You can get hunting softnose cartridges for this gun in every gunstore or hardware store in the country. Bore is top-top and sharp. Single Springfields have sold recently for as much as \$45 to \$60. They have been stored in Cosmozine in U.S. Gov't boxes. We clean grease off and oil lightly **GUARANTEED.** Shoot it, try it. If you don't think this is a fantastic buy send it back (inside 10 days) for full refund. You'll never see them at this price again. Bolt action, 6-shot repeater, famous calibrated sights. **EXTRAS FOR SALE:** New sling, leather, \$1.95; G.I. cleaning rod, \$1.95; G.I. case with zipper, \$1.95; G.I. cowhide leather saddle case, \$4.95.

## HIGH POWER MANNLICHER DEER CARBINE WITH 4X BEAUTIFUL SPORTER STOCK COMPLETE AS YOU SEE IT HERE! SCOPE

**\$26.75**



**STOCK #ER4D.** All work guaranteed by our own gunsmithing department. This is a beautiful conversion of a powerful Mannlicher Carcano precision military carbine. Our gunsmiths contour the European premium hardwood mid-rifery stock to perfect sporting lines. Remount and rebed the superb Mannlicher rifle check headspace, trigger pull. Mount a 4X Pan-Tech telescopic sight with windage and elevation. You will never buy yourself a custom sporter complete and ready to go in this price range again. **\$55 VALUE.** Special Purchase of Guns and Scopes - 30 Day Supply - Our Once-in-a-lifetime April Bargain.

**TO ORDER RIFLES, ETC. ORDER BY STOCK NUMBER FOR FASTER SERVICE.** Send check, cash or money order for C.O.D. send by or more deposit. All items shipped F.O.B. Los Angeles. Expr. charges collect. Calif. resid. add 4% state tax. 10-day money-back guar. on all items.

**THE ELMER COMPANY**

Dept. 12, 1206 Maple Ave., Los Angeles 15, Calif.

## Remington INDIAN WAR Rolling Block Rifles

For **\$9.95** Good **\$11.95**  
- STOCK #ER10C - STOCK #ER10D

Here's a beautiful gift for someone's dad. A **\$18.95** value. These are original Remington's pride of Americana. High power single shot rifle Mod. 1900 excellent for hunting and target use. 30" nitro-proof, high-carbon steel barrel, caliber 7MM Mauser. Lots of target ammo, \$7.50 per 100 rds.

## GUNSMITH TO YOU \$19.95

POWERIZED, ACCURIZED  
30Cal. (7.5MM) Big Game Sporter

**STOCK #ER21B.** Starting with a beautiful surplus Swiss army rifle in absolute excellent condition, our own gunsmith machines and precision crowns barrel to 22" sporter length. Remounts zerues in sights, alters the hard mountain (real) walnut stock to sporter contours, rebeds barreled action perfectly, checks headspace, trigger pull (guar. light, crisp). Please return this gun for full refund if it is not perfect in every respect. Bore is perfect. A sporter for all big game. 12-shot bolt action repeater. Ammo: softnose hunting, 20 rds. \$3.25.

## 8MM MANNLICHER RIFLE

**\$19.95**

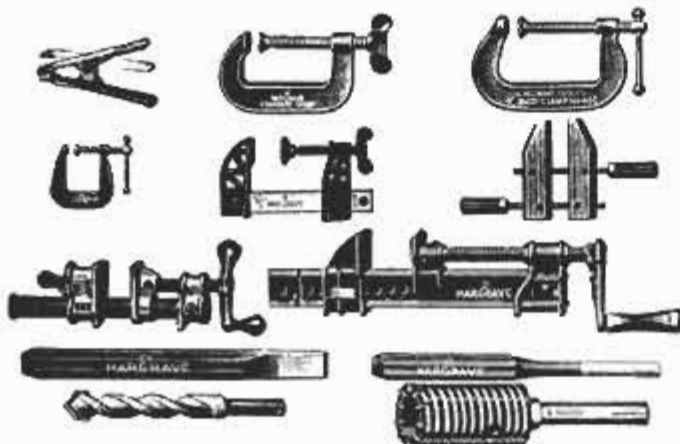
**STOCK #ER3C.** 8mm Mannlicher straight pull action shot rifle modified at European armaments to handle the standard 8mm Mauser rimless (.70x57) Mauser cartridge as loaded by all American cartridge factories. 24" barrel, 5 shot magazine, re-designed so that separate loading clips are no longer necessary. Bore good to very good, \$19.95. Target ammo, \$5.95 per 100 rds.



# HARGRAVE

The Complete Line of Tested  
**TOOLS**

**INDUSTRIAL QUALITY TOOLS  
FOR EVERY WORKSHOP**



### WRITE FOR FREE CATALOG

Showing a complete line of Clamps for all purposes, openings from 3/4" to 12" and depths from 11/16" to 16", also Chisels, Punches, Masonry Drills for hand and power hammers, Carbide Rotary Drills, Gasket Cutters, File Cleaners, etc.

See Your Local Hardware Dealer

**THE CINCINNATI TOOL CO.**

1987 WAVERLY AVE.

CINCINNATI 12, OHIO

Now **YOU** can buy  
super-tough, super-gloss

## MAN O'WAR® MARINE VARNISH

Get **FREE** facts booklet

Once sold only for marine use, sensational Man O'War Ultra Spar Marine Varnish is now available to you! The finest all-purpose varnish you've ever seen. Unusually full-bodied, pale and clear. Dries dustfree in 1 hr., hard in 4-6 hr. Tests prove salt water, boiling water, ammonia and even acid and caustic soda won't affect it. Buy it from your nearest McCloskey dealer. Send for all the facts on Man O'War Marine Varnish today!

### McCLOSKEY VARNISH CO.

Dept. 215, 7600 State Rd., Phila. 36, Pa.

Name \_\_\_\_\_

Street & No \_\_\_\_\_

City & State \_\_\_\_\_

My paint dealer \_\_\_\_\_

Dealer's address \_\_\_\_\_

MAIL COUPON FOR FREE BOOKLET





## Wash off old paint with water!

Amazing how easy it is to use this miracle new WASH-AWAY Paint Remover. Just brush it on . . . wait a few minutes . . . wash off with water — your surface is clean, ready to refinish. Ideal for removing old finish from delicate antiques. Fine for outside use . . . siding, shutters, porches, boats. No scraping! Nonflammable!

**AT SHERWIN-WILLIAMS DEALERS EVERYWHERE!**

*listed in yellow pages of phone directories*

**SAW SHARPENING IS EASY**  
 Super Filer No. 11 joints and sharpens hand and circular saws 6" to 10" with all teeth correct in height, depth, pitch, bevel. When file hits steel roller, teeth are finished. Saw runs true with no side pull. Includes 8" file. **\$9.95** PPD.

**SUPER SAW FILER No. 6—\$6.50** PPD.  
 Automatically controls depth, angle, pitch for all saws. Precision made and calibrated. Use in any vise or clamp. Includes file.

**FREE CATALOG — Dept. A-48**  
 A. D. McBURNEY, 5908 Hollywood Blvd., Hollywood 28, Cal.

**SAVE STRAIN—  
SAVE SKIN**

WITH  
**Bridgeport  
NEOPRENE  
CUSHION  
GRIP**

**SCREWDRIVERS**

**50%  
GREATER TURNING  
POWER**

16 sizes and styles—Regular and Phillips.  
 \$1.00 and \$2.70  
 At your hardware store.

- SUPER COMFORTABLE
- NON-SLIP GRIP
- UNBREAKABLE HANDLE
- FULLY GUARANTEED
- ALLOY STEEL BLADE

Resilient Neoprene CUSHION GRIP lets you turn screws tighter with less work—and you don't hurt your hands. Tested and approved by Mechanics

THE BRIDGEPORT HARDWARE MFG. CORP., BRIDGEPORT 5, CONN., U. S. A.

PATENT APPLIED FOR

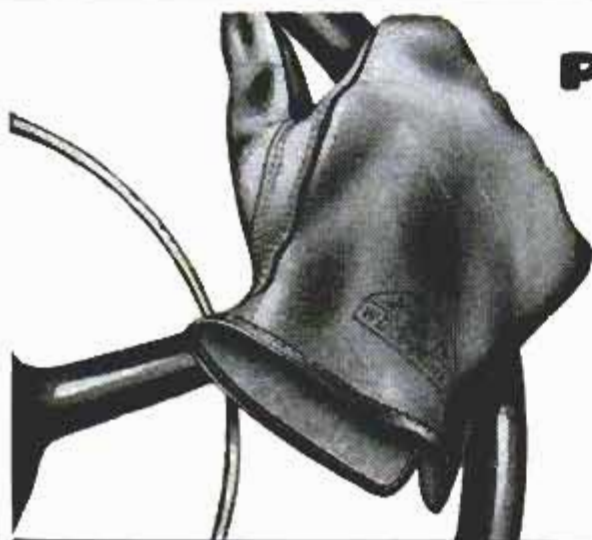
**GOT PAINTING PROBLEMS?**

**A WILGRIF PAINT BRUSH HOLDER WILL SAVE YOU TIME, TROUBLE AND TEMPER.**  
 Simply snap holder on side of any paint can. Keeps brush clean and handy at all times. Made to last indefinitely under normal usage. Unconditionally guaranteed. Don't delay—Order today.

Holder to fit both pt. and qt. cans . . . . . **50c**  
 Holder to fit gallon can . . . . . **70c**

Postage paid. Cash, check or M.O. No C.O.D.

**THE WILSON GRIFFITH BRUSH HOLDER CO., INC.**  
 78 Carolyn Drive Dept. C Marion, Ohio



## PERFECT FEEL THROUGH SOFT LEATHER

Stay flexible always! Wear like iron. Super-soft leather — lockstitch seaming. Hands never slip, never chafe! Cost less because they wear longer. Triple-tanned to dry out soft forever. Full grain horsehide and pigskin styles. Perfect fit and feel for every job — every day.

**WOLVERINE GLOVES** Rockford, Michigan  
 MASTER TANNERS OF UNUSUAL LEATHERS — horsehide — buckskin — pigskin — goatskin



**WAR SURPLUS AND OTHER BARGAINS SAVE UP TO 90%**

**BUILD YOUR OWN ARC WELDER, LIGHT PLANT OR BATTERY CHARGER \$37.50**  
 Kit incl. 1 Navy NEA-5 Gen. combination AC-DC type. AC 115 V. DC 24 V., 200-300 Amps. 2 complete generators in 1, yet no larger than reg. gen. Ideal for home, shop and farm lighting plants. Delivers 1200 Watts AC. DC side for charging batteries, welding and operating war surplus motors. Also in kit: 2 Voltage Regs., AC & DC. Reverse Current Relay, 1 Ammeter, Rheostat, Electrode Holder, Toggle Switch, Welder's Shield, Wiring Diagram for kit. Wt. under 100 lbs. Approx. GOVT. COST \$650. Kit—\$37.50. Navy NEA-5 Gen. as above, purchased separately, \$23.50.

**ARC WELDER KIT—\$26.00** Build your own complete make-up package incl. 1 Aircraft DC Gen. 200 Amps. 24 V. Rheostat, Toggle Switch, 1 Ammeter, Electrode Holder, Welder's Shield, Voltage Reg. Simple instruction wiring diagram. Wt. under 100 lbs. Approx. GOVT. COST \$475. Like new, perfect. All units guaranteed pre-tested. \$26.

**R1 GENERATOR KIT** Jack & Heints or GE. Rated 300 Amps. 24-32 V. With same items as above. Approx. GOVT. COST \$600. Complete 60 lb. kit—\$36.

**FAMOUS NAVY MK14 AIR COMPRESSOR**  
 Great for tree, termite, airbrush & paint spraying: filling tires, aquariums, etc. Dual & remote control electric receptacles, 115v 60 cycle AC. heavy duty HP. Westinghouse Motor. Direct drive. Water & explosion-proof. Built-in air filter, adjustable pressure setting up to 47 lbs. Built-in pressure gauge. Self-contained switch. Mounting brackets. These units made under license of Sperry Gyroscope Co. Wt. 66 lbs. gross. Approx. GOVT. COST \$585. Like NEW. \$21.95.  
 With portable steel hand cart (shown), rubber wheels, specially constructed for mounting this unit. Incl. 25' rubber air hose. 6' extension cord with plug & fittings. Wt. 76 lbs. Complete with cart—\$26.95.  
 With new internal-pressure spray gun with 3 adjustable spray tips, 1 qt. cap. \$35.95 complete.

**EXPLOSIVE RIVET & BLOW TORCH KIT**  
 Contains 300 assorted Dupont Explosive Rivets, 1 set of 9 fractional drills, 1 Butane Blow Torch with extra cartridge—everything needed for blind riveting. Torch can also be used for precision soldering, brazing, etc. 3500° pinpoint flame. Approx. GOVT. COST on rivets alone, \$90. Complete kit \$5.95 ppd.

**DUPONT EXPLOSIVE RIVETS** Essential wherever blind riveting required. 1/8", 5/32", 3/16". Round & flat heads. Approx. GOVT. COST 32c ea. 1,000 assorted for only \$8.00 ppd.

**BENDIX AIRCRAFT COMPASS** For boats, trucks, cars. Pioneer Instrument Co., div. Bendix. Mark VIII. Increments of 1°; 360°. Major graduations every 5°. Magnetic. Can be lighted with 6, 12 or 24 volt standard bulb. Flush panel mounting. Floating card. Tested in our own inst. lab. Approx. GOVT. COST \$250. Perfect. \$10.95 ppd.

**ASTRO COMPASS MARK II** Used by UNAF & commercial airlines. Makes pelorus & azimuth circle for air or marine navigators. Great for astronomers. Incl. carrying case. Tested for accuracy in our own lab. Approx. GOVT. COST \$400. Now \$10.95.

**BENDIX GEROTOR PUMP & MOTOR**  
 Use wherever fluid pumping required. Excellent for hydraulic installations. Has 3/4" pipe connections, built-in relief valve adjustable up to 1500 lbs. Max. cap. 6 GPM. 1 1/2 H.P., 24 V. motor. Use on 12 to 36 V. Approx. GOVT. COST \$350. NEW. \$10.95.

**140-1 REDUCTION GEAR** For beaching boats, winches, hoists. Ideal for motor in golf or boy's electric car. Built-in (removable) DC motor & clutch. Hi torque, 10 speed. Runs on 6-12 or 24 V. Wt. 65 lbs. gross. Approximate GOVT. COST \$300. Like NEW. \$12.00. Matched splined gear for above—\$3.00 ea.  
 \*225-1 REDUCTION GEAR—\$13.50.

**REVERSIBLE RATCHET WRENCH**  
 Hi torque. Delivers tremendous leverage. 4" handle with reversible ratchet. 4 hexagon nut sockets, 2 3/8", 2 9/16" & 3 1/8". Mfd. by Lowell. Approx. GOVT. COST \$215 per set. Wt. 50 lbs. NEW. Only \$9.95 per set.

**WOOD PROPELLER** Genuine rock maple radio drone "prop." perfect for den, trophy room, boy's room. Smooth, highly varnished. 30" tip to tip. Clock, barometer or photo can be inserted easily into center (mounting holes provided). Can use to operate ice sleds, etc. Approx. GOVT. COST \$57. NEW. \$4.95 ppd.

**ELECTRIC PUMP WITH CONTROL UNIT**  
 Runs on 12 or 24 V. Centrifugal type. Pumps 500 GPH. Complete with on and off switch rheostat, 2 speeds (hi & lo). Mfd. by Ingersoll-Rand. Shpg. Wt. 7 lbs. Approx. GOVT. COST \$195. NEW. \$8.95.

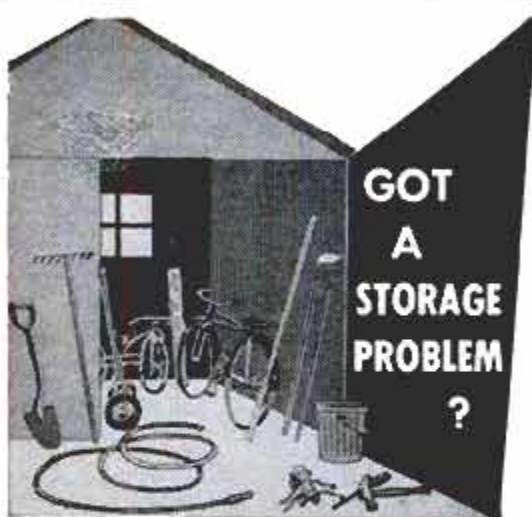
**HEAVY-DUTY RHEOSTAT** Ideal for regulating voltage on electric welders. Rated 5.75 Ohms, 100 Watts with double windings & dual female 25 amp., 125 V. receptacles. 7" h x 5 1/4" D. Shpg. wt. 2 1/2 lbs. Approx. GOVT. COST \$25. Brand New. \$2.25 ppd.

**CHRONOMETRIC TACHOMETER** Built to U.S. Navy & Air Force specs. Standard brand. For counting revolutions per min. for any rotating shaft. Can be used on speeds up to 10,000 RPM. Accuracy to 1/10 of 1%. Complete with male & female tips & shock-proof case. GOVT. COST \$87.50. NEW. Only \$19.95 ppd.

**MICROMETERS** Black crackle finish frame. Easy-to-read graduations in .001, N.W., 0-1" cap. \$2.89 ppd. 1-2" cap. \$3.79 ppd.

**NEW! TERRIFIC 1958 CATALOG!** Thousands of bargains in war surplus & other items. Hundreds of pictures. Send 25c for your copy today! Ppd. prices in USA only. Other prices FOB Culver City, Calif. Send cash, check or money order. 50% deposit on COD.

**AIRBORNE SALES CO., INC. DEPT. PM458**  
 8501 Stellar Drive, Culver City, Calif.



**GOT A STORAGE PROBLEM?**



Then you need **TURNBUCKLES** Perforated Board fixtures to end space-wasting clutter and to keep everything neatly in place until needed.

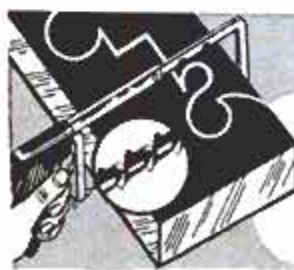
**TURNBUCKLES** do-it-yourself fixtures come in a wide variety of shapes and sizes... fit easily into any wall-hung perforated board... and hold everything from clothing and kitchen utensils to hand tools and garden equipment.

Send for your free copy of space-saving suggestions for home, farm and workshop.



**TURNBUCKLES, Inc.**  
 BOX 333, MICHIGAN CITY, INDIANA

NAME \_\_\_\_\_  
 ADDRESS \_\_\_\_\_  
 CITY \_\_\_\_\_ STATE \_\_\_\_\_



**FREE Tyler SPYRAL HACKSAW BLADE!**

Demonstrate for yourself why Tyler SPYRAL Hack-saw & Coping Saw Blades are America's number 1 choice for making precision & intricate CLEAN cuts of wood, metal, plastic, tubing, etc. Saw in circles, right or left, up or down. Available at your dealer. OFFER LIMITED! Since you will receive your FREE blade from your local dealer, you must fill out the coupon to the right & mail it to us. Offer is not valid unless you give us your name & address as well as that of your dealer. When dealer receives your FREE Tyler Blade, he will notify you by postcard.

**MAIL COUPON FOR FREE BLADE!**

**TYLER MFG. CO., INC., Dept. PM-4**  
 1005 W. Arbor Vitae Ave., Inglewood, Calif.  
 Your Name \_\_\_\_\_  
 Address \_\_\_\_\_  
 City & State \_\_\_\_\_  
 Name & address of my Saw Dealer is: \_\_\_\_\_



# Smooth lawns everywhere begin at drafting boards in Lamar, Mo.!

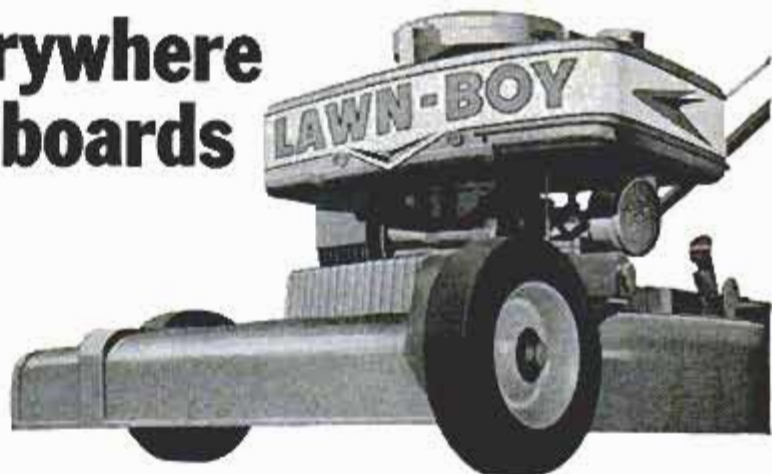
Engine design becomes more and more important to lawn care—as the sound of the power mower is heard throughout the land in ever-increasing numbers. Both the 2-cycle and the 4-cycle gasoline engines have their adherents.

Let's take a look at a specific 2-cycle gasoline engine—made by LAWN-BOY for its line of power mowers. Let's look at the reasoning behind a 2-cycle engine.

**Delivers maximum cutting power to blade.** LAWN-BOY's 2-cycle gasoline engine operates at the ideal rotary mowing speed. In addition, it provides more power per pound because it utilizes fewer parts than conventional engines.

**Maintains perfect lubrication without oil changing.** In the LAWN-BOY 2-cycle engine, gas and oil are pre-mixed before pouring into the fuel tank. Lubrication is the pressure type. You never have to worry about proper lubrication. There's

Lawn-Boy Dealers are listed in the Yellow Pages under "Lawn-Mowers", or call Western Union by number and ask for Operator 25.



no messy crankcase draining or refill to waste your time.

**Starts instantly.** Firing occurs at every stroke in the LAWN-BOY 2-cycle engine. The engine also produces the hottest spark of any lawn mower. There's no continued tugging at the cord . . . no strain . . . no wasted time.

**Reduces power losses, friction and wear.** The LAWN-BOY 2-cycle engine runs 100° cooler than other power engines. Long, thin air cooling fins get rid of heat faster. Lengthen engine life. Fewer parts cut down wear.

**Recovers quickly under changing loads.** Fly wheel governor reacts

instantly to changing power needs. Keeps engine turning at perfect rpm for most efficient grass cutting. Power on every stroke aids fast recovery.

At the LAWN-BOY drafting boards at Lamar, Mo., engine design is one of many phases of power mower engineering under constant study and improvement. Why? To make your lawn look smoother and more parklike. To make lawn care a pleasure instead of a chore for you.

## LAWN-BOY

Lawn-Boy, Lamar, Missouri. Division Outboard Marine Corporation, Makers of Johnson and Evinrude Outboard Motors. In Canada: Lawn-Boy, Peterborough, Ontario.

**HAVE FUN!**

**SAVE MONEY**

**TRY SUPERSHOP FREE**  
Factory To You — \$79.95

Think of the fun you'll have and the money you'll save with your own big capacity workshop. Picture yourself sawing with the 8" ball bearing saw. Or drilling in steel with the vertical drill press. You bore with the horizontal drill — exclusive with SUPERSHOP. You sand with the 8" disc sander. You turn with the 30" lathe. You sharpen tools on the 5" grinder.



You are invited to TRY SUPERSHOP FREE. We will pay all shipping expense. Write for full details of this amazing FREE TRIAL PLAN. Mail postcard now.

**POWER TOOLS INC.**

106 Yates Ave.  
Beloit, Wisc.

## I'll Send You This Famous TRAVIS BIKE MOTOR AT TREMENDOUS 30% SAVING



**IF YOU'LL AGREE TO DEMONSTRATE TO YOUR BIKE-RIDING FRIENDS**



**AMAZING NEW RIDER-DEMONSTRATOR PLAN CAN PAY FOR YOUR MOTOR... AND BRING YOU EXTRA CASH, TOO!**

If you'll agree to demonstrate to friends, we'll sell you a rugged, powerful 1½ H.P. world-famous Travis Motor for your own bike at amazing low Demonstrator Price of 30% off! Just ride around town and see how everyone wants a Bike Motor like yours. Only 3 orders and your own Travis is paid for—costs you nothing. Then you keep on making wonderful profits in your spare time!

### World's Lowest-Priced Bike Motor . . . Unequaled Features!

**SAFE . . .** mounts on front fork away from rider, always under control of bike brakes. **POWERFUL . . .** climbs hills, carries heavy loads. **SMOOTH-RIDING . . .** 2-cycle airplane-type multi-finned air cooled engine, ball bearing construction, direct drive to front wheel (no belts or pulleys to break). **LIGHT-WEIGHT . . .** only 17 lbs., perfectly balanced. **MOUNT IN LESS THAN 30 MINUTES . . .** anybody can do it with just pliers and screwdriver. **FITS ALL BIKES . . .** boys' or girls', balloon or lightweight. Motorcycle-type control. Unconditionally guaranteed . . . carries unique LIFE-TIME Factory Rebuilding Policy.

**FREE!** Rush name, address NOW for complete details of amazing Rider-Demonstrator Plan that saves you 30% and shows you how Travis pays for itself, makes EXTRA MONEY for you. Everything FREE. No obligation. Write:



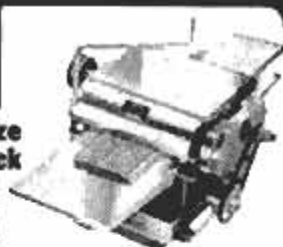
**TRAVIS PRODUCTS CO.** 224 W. HURON, DEPT. F-3 CHICAGO 10, ILL.

POPULAR MECHANICS



## SAVE MONEY on LUMBER

with the **LOW-COST BELSAW PLANER**



### Convert Rough and Random Size Lumber into Cabinet Finished Stock

Now anyone can make perfect cabinet finished stock from low-cost rough lumber... any size up to 12 1/4 inches wide and 6 inches thick. Turn out high grade finished material at a fraction of the cost you pay lumber yards. Big 42-inch-long bed makes it easy to plane heavy, wide and long pieces... BELSAW self-feeds at 14 to 34 feet per minute.

**USE THIS ONE LOW-COST MACHINE for Planing, Jointing, Sawing, Milling, Tongue and Groove.**

You can easily make flooring, siding and many other popular patterns with your Belsaw. Your Belsaw quickly pays for itself with savings on raw materials and profits on finished stock... a highly profitable machine for custom work. Compare Belsaw with any 12-inch planer on the market... Belsaw gives you more essential features—yet costs you \$50 to \$125 less than others.

Send Today for Free Literature on the Belsaw Multi-Duty Planer.

**BELSAW MACHINERY CO 2058 Field Bldg. Kansas City 11, Mo.**

### BUY GREAT NECK HAND TOOLS ... for long-lasting performance



**Precision Balanced NAIL HAMMER**

One-piece, forged steel, rubber-cushioned, no-slip grip

## GREAT NECK SAW MFRS., Inc.

MINEOLA, N. Y. — SEE YOUR LOCAL STORE

	<p><b>PAGE</b> FOR TILLING PLOWING MOWING</p>	<p>Free Catalog <b>LOW PRICES</b> EASY TERMS Over 30 Years Experience</p>	<p><b>FULLY GUARANTEED!</b> Over 60 attachments available!</p>
<p><b>PAGE</b> 1904-A S. 81st STREET MILWAUKEE, WIS.</p>			

## ETCHMO PIPE LAYOUT GAUGE



Takes the guess out of guesswork in angular pipe cutting. For use on 3", 3 1/2", 4" pipe. Accurate from zero to 45 degrees for scribing an initial line to be cut. All steel zinc plated stamping—rustproof. Assemble right on pipe—lower half of scribing panel separates from upper half for easy quick positioning on pipe. Lightweight, sturdy. Satisfaction guaranteed. Complete, prepaid \$8.95. Agents wanted.

**ETCHMO CO., 474 Nowell St., Painesville, Ohio**

## MODERN IMPROVED LAWN MOWER SHARPENER AND BED KNIFE GRINDER

Sharpen any mower in 10 to 20 minutes. Hand—Power—Reel or Rotary. Modern is actually two machines in one: a Precision Bed Knife Sharpener and a Precision Reel Sharpener. Extra Bed Knife Grinder is Absolutely Unnecessary. New Mower Support makes it possible to sharpen reel without removing bed knife. The fastest precision lawn mower sharpener on the market. Costs Less. Compare Modern's Many Exclusive Features Before Buying. Send for Free Brochure No. 10 SN



**MODERN MANUFACTURING CO.**  
160 North Fair Oaks Ave., Pasadena, California

## TOP VALUE SPECIALS!

SURPLUS ITEMS AT FRACTION OF ORIGINAL GOV'T. COST

### BOLT & WIRE CUTTER

Exclusive: Extendable Handles for Extra Leverage

Center cut type bolt cutter for soft or medium hard rods and bolts, alloy wire, and other metals. Cutting edge has equal bevel on each side for extra strength.

**FOLDED**—It fits into your pocket or tool box—safety latch locks closed when not in use. Capacities: medium hard bolts in thread 3/8"; medium hard metals 5/16". Length closed: 10 3/4"; extended 15 3/4".

A \$9.95 NOW 3.95 2 FOR VALUE ONLY 3.95 PPD. \$7.00



ITEM #478

EXTRA RUGGED

### BRAND NEW



ITEM #KW-116

### WALKER 5-TON HYDRAULIC LIFT KIT

FOR — • SNOW PLOWS • TO DUMP FARM WAGONS • ADJUST DEPTH OF PLOWS • HYDRAULIC PRESS • HYDRAULIC JACK.

**THE COMPLETE KIT CONSISTS OF:** 1—Walker Hydraulic Hand Pump—Rated 1500 lbs. per sq. inch with 2 gal. hydraulic reservoir • Release valve • Filler plug and air vent

• 28" steel handle. Fine for hydraulic presses; snow plows, jacks. Dimensions: 6" Diameter, 20" long with 3/4" pipe thread port. Pump Assembly Item #P449..... **23.50**

1—8 Ft. length double wire braid rubber covered hydraulic hose—tested to 20,000 lbs.! Item #27B4... **3.95**

1—Hydraulic Cylinder, 3" bore, 6" stroke. Husky 3/4" solid steel shaft. Will lift 10,000 lbs. using 1500 lbs. of pump pressure. Clevis mountings that take 3/4" diameter pins. May be used for single or double action service. Overall length 17 1/4"—retracted. Item #C419..... **12.50**

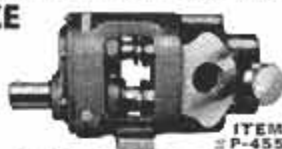
1-Gallon hydraulic fluid furnished free with each kit. Plus all necessary hydraulic fittings. Total ship. wt.—40 lbs.

**COMPLETE KIT PRICE 38.95** F.O.B. CHICAGO (ALL OF ABOVE INCLUDED).....

### BRAND NEW! U. S. NAVY COST \$92.00

### SELF-PRIMING — BRONZE 1" GEAR PUMP

FOR — • Sprinkling • Basement Draining • Fuel Transfer • Insecticide Spraying



ITEM #P-455

BUILT TO EXACTING U. S. NAVY STANDARDS

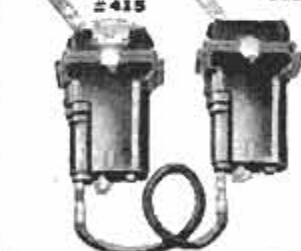
**FEATURES:** • Ball bearing construction • NEOPRENE Pump Gears • Monel Shaft—1" Dia., 2" long • Sealed steel idler gears.

**OUTPUT:** 20 Gal. per Min. 100 lbs. per Sq. In. at 1500 R.P.M.—8 Gal. per Min. at 550 R.P.M. • Standard Base Mounting — 3/8" bolt holes • Grease cup included.

• 1" Pipe Thread Ports. • Dim. 11" L. x 5" H. x 4 1/4" W. Ship. Wt. 16 lbs..... **26.50 EA.**

Limited Quantity Order Direct 2 for 50.00 F.O.B. Chicago

### MASTER & SLAVE HYDRAULIC REMOTE CONTROL SET



ITEM #413

Designed for remote operation of controls on engines, boats, special machinery, etc. Eliminates complicated mechanical linkages, cables, pulleys, etc. The master unit connects to the slave unit with a single 1/4" tube.

When master control lever is moved, slave lever follows exactly. Light, compact, aluminum alloy construction. Dim. of both units: 5 1/4" W. 9" H. 1 3/4" D. (exclusive of handle). Ship. Wt. 8 lbs. per pair. F.O.B. Chicago **27.50** pair

(Note—tubing not supplied)

**FREE — NEW SUMMER 1958 CATALOG**  
60 PAGES of unsurpassed War Surplus and new Equipment Bargains for farm, home, factory, workshop. Write today.

**GROBAN SUPPLY CO.** Dept PM-4  
1139 S. WABASH AVE., CHICAGO 5, ILL.





In just  
10 minutes  
your dealer  
can prove...

## The AMF DeWalt® Power Shop makes woodworking easy for you



**SEE** Safer, easier  
top-side cutting



**SEE** Direct-drive power,  
no belts, no pulleys



**SEE** DeWalt's exclusive  
safety features



**SEE** Layout marks visible  
every cut, no mistakes



**SEE** Work moves straight—  
saves 75% floor space



**SEE** DeWalt becomes 12  
professional tools in 1

See for yourself why DeWalt's original radial arm design, big capacity, and unsurpassed accuracy make it the finest, most valuable all-purpose power tool you can own.

Your dealer will quickly show you how a DeWalt saves the cost of a shop full of tools—makes all home woodworking fast, easy, safe... fun! How you can make furniture, build in cabinets, finish off the attic or basement, make home repairs... do all those things you've always wanted, *even if you've never used a power tool before!*

See your Franchised DeWalt Dealer for a Free, *convincing* demonstration today! Easi-Budget Terms—10% down. 2 years to pay!

Owners! Send for valuable new DeWalt Woodworking Manual, just \$3.95 pp.

Another **Amf** Product

Send the coupon for free booklet and name of nearest DeWalt dealer.

DeWalt, Dept. PM-804, Lancaster, Pennsylvania  
Division of AMERICAN MACHINE & FOUNDRY COMPANY

Send FREE colorful 20-page Booklet and name of dealer.

I enclose \$3.95 (check or m.o.) for DeWalt woodworking manual.

Name \_\_\_\_\_

Address \_\_\_\_\_

City \_\_\_\_\_ Zone \_\_\_\_\_ State \_\_\_\_\_



# GIGANTIC HYDRAULIC SALE

## SAVE! OVER 50,000 HYDRAULIC CYLINDERS at DISCOUNT PRICES

1500 PSI DOUBLE ACTION Hydraulic Cylinder Bargain  
Another Special Palley Valve, Has a Bore of 1-3/8", Shaft is 1" diameter, Stroke 15-5/8", Overall length is 22", No. H-14

Cost Gov't approx \$390  
Palley Cat. Price \$11.75

**NOW 795**

No. H-24D - Double Action Cyl. 3000 PSI. Steel barrel. Ideal for hydraulic press work. Has 2-5/8" bore, 7" stroke, 1-5/8" shaft, 19" length.

Approx. Gov't Cost . . . \$270.00  
Regular Palley Cat. Price \$12.75

**SALE PRICE 995**

No. H-84 - Double Action Cyl. 1500 PSI. Bore 1-1/2", shaft 9/16", adjustable stroke, 1-3/16" to 4-3/8". Length 14-1/2".

Approx. Gov't Cost . . . \$68.00  
Regular Palley Cat. Price . . \$7.25

**SALE PRICE 395**

Special DOUBLE ACTION Hydraulic Cylinder ideal for use where a long stroke is desired. Operates on continuous duty up to 1500 PSI. Stroke is 2-6-3/8". Bore is 1-1/2" - Shaft 1" - Length 32-3/4".

No. H-33 Cost Gov't approx. \$116.00 Regular Palley Catalog Price \$16.50

**SALE PRICE 795**

No. H-48 - Double Action 1500 PSI Cylinder. Has 2" bore, 9" stroke, 7/8" shaft, 14 1/4" lgh. Top government quality.

Approx. Gov't Cost . . . \$76.00  
Regular Palley Cat. Price . . \$10.25

**SALE PRICE 595**

No. H-54 - 1500 PSI CYL. Ports are so arranged to allow these cylinders to be used singly or in series. Ideal for production line equip. Bore 1 1/2", shaft is 1-1/8", stroke 4-7/8".

Approx. Gov't Cost . . \$70  
Reg. Palley Cat. Price \$4.25

**NOW 295**

1500 PSI DOUBLE ACTION HYDRAULIC CYLINDER Has a long stroke of 21-1/2" with a bore of 2". Shaft is 1" diameter. Overall length 28".

No. H-35

Cost Gov't approx. \$140  
Palley Cat. Price . \$17.75

**SALE PRICE 995**

**HYD. HAND PUMP**

Has capacity of 1.5 cubic inches per cycle. Operating pressure 1500 PSI. Displacement 0.19 GPM at 30 cycles per minute. Has built-in check valve.

No. HP-3

Cost Gov't approx \$80.  
Reg. Palley price \$17.50

**ONLY 695**

**SAVE UP TO 85%**

Famous "CROSLEY" AIR COMPRESSOR

Gov't cost approx. \$300  
Reg. Palley price. \$77.95

**1695**

**MOTOR DRIVEN PUMP**

Has 2 1/2 HP, 20-29 V. DC, continuous duty motor. Pump displaces .172 cu. inches per revolution. The capacity is 3 GPM at 1000 PSI discharge pressure. Rated at 1000 PSI continuous.

Gov't Cost approx. . . \$350  
Regular Palley Cat. Price \$22.50

**995**

**FOUR-WAY HYD. VALVE**

Made to rigid government specs. Popper type. Spring loaded. Pressure balanced. Valve is closed in neutral position. Has 1/4" internal tube ports. Threaded 7/16" x 20 thread. Original Gov't Cost approximately \$30.00

Regular Palley Catalog Price \$6.75

**395**

Now you can have your own convenient air supply in home, garage, shop, or studio. Ideal for paint spraying, free spray, air brush, tire inflating. Has dual and remote control electric receptacles, pressure adjustment up to 45 lbs., self contained switch, regulating wrench & mount bracket. Has 1/8 HP, 115 V, 60C, AC West-Indohouse motor. Draws 10" of vacuum. Has built-in air filter & pres. gauge.

**COMPRESSOR ACCESSORIES**  
6 ft. Elect. Cord & spec. plug \$6  
25 ft. Air Hose w/1/4" fitting \$2.95  
50 ft. Air Hose w/1/4" fitting \$4.45

**85 TO 1 GEAR BOX**

85 to 1 GEAR RATIO

For use where tremendous power at a low take-off speed is desired. Drives thru a train of 6 gears rotating on self-lubricating, hi-speed roller bearings. Take-off shafts are 1 1/4" and 3/8".

**595 USED 895**

NEW in excellent condition.

**BUILD A SATELLITE CAMERA**

**7" f2.5 EASTMAN AERO LENS**

Of the first four photos of the Russian Sputniks, three were shot by a U.C.L.A. student with this lens in a home made camera. We furnish these plans FREE to adapt the lens. It has a 178mm focal length with stops from f/2.5 to f/16. Also makes an excellent telephoto lens when used on 35mm or Speed Graphic Cameras. Glass is coated and fully color corrected.

Cost Gov't REG. 69.95  
approx. \$200.00  
**NOW 39.95**

**SPECIAL R-1 GENERATOR**

Compound wound for heavy duty. Can be easily converted for use in an Arc Welder or for boars as power supply. R-1 type. Rated 300 Amps, 24-32 V. RPM 4400 to 10,000.

Gov't cost approx. \$200  
Palley Reg. Price \$27.95

**1695**

**2500 lb. WINCH HOIST**

A small, compact winch hoist. Ideal for garage, shop, boiler, jerr, etc. Has bronze, worm-gear drive with a 24 to 1 gear ratio and a 3-speed crank. Equipped with a free-spool, pull-out clutch & 1 lb. of cable.

**2995**

**MOUNTING FRAME for Hoist Only \$5.00**

**The LARGEST COLLECTION of BARGAINS ever assembled in one catalog!**

From EVERYWHERE PALLEY'S now bring you items of every description! This fabulous catalog contains Hand & Power Tools, Microscopes, Binoculars, Industrial and Building Materials, Housewares, Office Equipment, Sport & Outdoor Equipment, Cameras, Photo Supplies, Hobby Kits & "Gadgets", Electrical & Radio Supplies, Motors & Generators and a HUGE selection of Surplus Hydraulic Cylinders, Pumps, Valves, etc. So many items it's impossible to list them all.

**WORLD'S MOST AMAZING CATALOG**

**396 PAGES**

**Send 50¢**

Your 50¢ will be refunded with your first order of \$1.00 or more

Order from this Ad. Pay by Money Order or Check, P.O.s accepted from D&B firms, 1/2 deposit with C.O.D.s. Prices FOB, Los Angeles.

**Palley's** 2263 E. VERNON AVE., DEPT. PM-48 LOS ANGELES 58, CALIF.

**TOOL CARE**

Give precision tools the kind of care that only a Gerstner Chest can provide. Free Catalog to Machinists and Toolmakers.

**GERSTNER TOOL CHESTS**  
458 Columbia St., Dayton 7, Ohio

**DRAINS** cellars, cisterns, wash tubs; **\$7.95**

**IRRIGATES - CIRCULATES - SPRAYS**

1,001 uses. Stainless shaft. Won't rust or clog! Use 1/2 HP motor or larger . . . 3/4 HP for up to 3000 GPM; 450 GPM 80' high or 1800 GPM from 25' well, 1" inlet; 3/4" outlet. Coupling included free. \$7.95.

**CELLAR DRAINER KITS (less motor)**  
"Low Boy" - 15" high, 1500 GPM . . . \$12.95  
"High Boy" - 32" high, 3,000 GPM . . . \$15.95

Postpaid if cash with order. **MONEY BACK GUARANTEE**  
LABAWCO PUMPS, Belle Mead 7A, N. J.

**WELD IT YOURSELF IN A JIFFY!**

Weld, Cut, Brazed, Solder; Iron, Steel, Brass, Bronze, Aluminum and other metals safely and easily. Make your wrought iron furniture, porch railings, fences, knick-knacks and other metal specialties. With this fine equipment anyone can do professional-like work with little practice. Tool and equipment breakdowns are annoying and costly. Don't let them bother you. The Dynamic will pay for itself quickly in both time and money and is designed to operate from any properly wired 110 volt AC line.

Order your Dynamic Industrial type transformer Arc Welder for Workshop or Industrial use today. Order from this ad.

Literature on larger equipment available on request.

**DYNAMIC WELDER COMPANY, 1808 S. Federal Street, Dept. D2-D, Chicago 16, Illinois**

**EASY PAY PLAN**

Low down-payment. Pay as you weld. Money back guarantee. Send for details. Complete outfit.

**Only \$38.50**  
F.O.B. Factory





# STAR

## HACK SAW BLADES with New "Handy-Pak" convenience

Now precision-made STAR Blades are mounted on special "Handy-Pak" cards. Makes storing and handling easier and safer. Cards also give helpful working tips... show the best blade for each job.

### STAR "LEVER-LOCK" FRAMES



- Patented "Lever-Lock" positions and tensions blade automatically.
- Handle molded for comfort.
- High-strength tempered steel back, perfectly balanced.

AT ALL LEADING HARDWARE STORES

For fact-filled booklet on metal cutting, send 10¢ in coin. 4808

**CLEMSON BROS., INC.** MIDDLETOWN, N. Y., U.S.A.

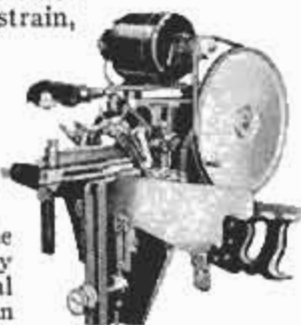
# Made \$900 IN SPARE TIME

"I did very well last year with my Foley equipment, about 950 saws in my spare time. About \$900 for me."—Leo H. Mix.

You can make up to \$3 or \$5 an hour in Spare Time. With a Foley Automatic Saw Filer you can file hand, band and circular saws better than the most expert hand filer. Cash business—no canvassing. No eyestrain, no experience needed.

### FREE BOOK "MONEY MAKING FACTS"

shows just how you can start at home in spare time, with small investment, no overhead—and develop into a full-time repair shop. Send coupon today for this practical plan. No salesman will call.



Send Coupon for **FREE BOOK**

**FOLEY MFG. CO.** 443-B FOLEY BLDG. MINNEAPOLIS 18, MINN.

Send **FREE BOOK**—  
"Money Making Facts."

Name \_\_\_\_\_

Address \_\_\_\_\_

# BEAVER riding tractor

## HALF THE WORK... TWICE THE PLEASURE



Comfort, convenience, power-packed ability of finest farm equipment are yours in America's PROVED best small tractor. Mows, plows, tills, hauls, clears snow, etc. Full 7 h.p. Wide selection of models. Write Dept. PM.

**THE BAIRD MACHINE COMPANY**

Builders of High Production Machinery Since 1846

STRAFORD • CONNECTICUT

## NEW MAGIC RADIO WALKIE TALKIE!

YOUR OWN POCKET SIZE RADIO STATION!

BROADCASTS TO ANY HOME OR CAR RADIO WITHOUT WIRES OR HOOKUPS! Wt. only 5 oz. Size, 1 1/2" x 4 1/2". Built-in telescoping antenna. Powerful Transistor-sensitive microphone, frequency setter, break-in switch! Runs for weeks on self-contained flashlight batteries. Durable plastic case. With this Radio Talkie you CAN TALK TO YOUR FRIENDS UP TO A BLOCK OR MORE AWAY! Talk up to 1 mile or more between two automobiles. INSTANT OPERATION! Just push button to talk! No license needed. Uses inductive field magnetic radiation. Useful and real fun in a million ways! GUARANTEED TO WORK. 1 YEAR SERVICE GUARANTEE.

SEND ONLY \$3.00. (cash, ck, mo) and pay postman \$9.98 COD postage or send \$12.99 for prepaid delivery. COMPLETE READY TO OPERATE with instructions and hundreds of ways and tricks for broadcasts thru any radio you desire. Price may go up soon, so get your NEW POWERFUL RADIO WALKIE TALKIE NOW. Available only from: WESTERN RADIO, Dept. RPM-4, KEARNEY, NEBR.

## Find HIDDEN TREASURES

GOLD, SILVER, PRECIOUS METALS with the Famous Model 27 Metal Detector. Lightweight, ultra-sensitive, low cost. None finer. Also GEIGER COUNTERS for uranium and the VIOLITE for tungsten. INFORMATION FREE

THE *Detector* CORP.  
5528 Vineland Ave., No. Hollywood, Calif.



## CONCRETE FLOOR PAINTER and VERSATILE TOOL

A truly remarkable patented tool. Paints in 15" swaths. 54" handle lets you paint standing up! Paints average cellar floor in less than one hour with no fatigue. (Garage 10 min.) Has other uses, such as, stripping old wax from linoleum floors, sweeping, squeegeeing, etc. Full instructions and positive guarantee. Formerly sold for \$3.95. Improved production methods allows us to reduce it to \$2.95 postpaid in continental U.S.

**MICO PRODUCTS CO., 170 Gorham Ave., Hamden 14, Conn.**



Carry Your Keys On a

## KEY-BAK Key Reel



Your keys are SAFE when you carry them on a KEY-BAK Key Reel. KEY-BAK is pocket-watch size, sturdily constructed. 24" long steel chain; Swedish clock spring reels in keys, keeps them safe and handy at your side. Wear it on the belt! Get KEY-BAK Key Reels from your hardware or key shop.

OVER A MILLION KEY-BAKS SOLD!

WEST OF MISSISSIPPI  
Lummis Mfg. Co.  
2242 E. Foothill Blvd.  
Pasadena, California

EAST OF MISSISSIPPI  
CTL Company  
1710 W. Stewart Ave.  
Wausau, Wisconsin

**ONLY  
\$2.95**



## AMERICA'S BEST

**1500 WATT PLANT**  
115v. 60 cyc. AC Push Button Start. Powered by a 3 1/2 HP. Clinton engine. Combines big output with easy portability. Provides emergency power for operating any oil burner, sump pump, freezer, television, lights, communications systems, etc. which require up to 1500 watts. (Item 22). Wt. 110 lbs. Reg. \$475 value. Factory price... **\$239.50**



**1750 Watt Plant** Powered by 4.5 HP. Electric starting & battery charging built-in. Factory price... **\$279.50**

**2500 WATT PLANT—Push Button Start** (Item 23) 110/120 v. 60 cyc. A.C. A rugged powerful plant. Reg. \$545. Special... **\$329.50**

**3500 Watt Plant Push Button Start** (Item 23) 115 v. 60 cyc. A.C. Similar to above, but larger and 33% more capacity. Wt. 270 lbs. Reg. \$760. Factory Price... **\$379.50**

**DUAL VOLTAGE 110/220 for Item 21 or 23**—\$30 additional.

## 9 TON HYDRAULIC PRESS

A tremendously powerful hydraulic press, capable of exerting 18,000 lbs. pressure. Pays for itself many times over—straightening bent connecting rods, king pins, crank shafts, axles, link pins and bars—or pushing out frozen bearings and bushings. Developed pressure under precise control and visible at all times on accurate gauge. Complete with both large and small anvils and jigs to straighten any kind of curve or bend. (Item 484). Wt. 110 lb. Actual list price \$365. Our special close-out price... **\$69.50**



**SCREW TYPE PRESS.** Nine ton capacity. See Jan. Pop. Mech's. ad for details—or write. Complete. Wt. 150 lbs. (Item 797)... **\$49.50**

## Double Acting Hydraulic Cylinder

A powerful cylinder mfr'd. by Massey Harris which develops both a pushing and a pulling action. Will push 8,100 lbs., with a 1000 PSI pump pressure. Cylinder is 3 3/4" O.D. with 8 1/2" stroke—standard heavy duty clevises on both ends. Has standard 1 1/2" pipe thread openings. Can be used for tilting buckets or blades, raising or lowering implements, hydraulic presses, etc. Can also be used as an air cylinder. (Item 802) Wt. 17 lbs. Reg. \$68 value. Special... **\$14.95**

**OTHER DOUBLE ACTING CYLINDERS**  
8" stroke — 3" bore... **\$34.00**  
10" stroke — 3" bore... **34.80**  
16" stroke — 3" bore... **43.00**  
24" stroke — 3" bore... **47.50**  
58" stroke — 5" bore... **125.00**

We have all sizes of cylinders available.

**HYDRAULIC CONTROL VALVE**—4 way open center valve with built-in adjustable relief. Controls 1 double, or 2 single acting cylinders. Equalizing feature permits easy control even under heavy loads. 3/4" pipe thread on inlet & outlet. 1/2" on cylinder outlets. Easily mounted, finger tip control. Wt. 16 lbs. (Item 822)... **\$21.95**



**HYDRAULIC KIT**  
Complete Hydraulic Kit consists of hydraulic hand pump with built-in 2 gal. reservoir and item 802 hydraulic cylinder described above. Pump has a built in relief valve and is rated at 20 tons. Kit is ideal for presses, jacks, snow-plows, etc. Pump is 2 1/2" long—6" diam. with 3/4" ports. A terrific value! (Item 836). Wt. 50 lbs. only... **\$23.50**  
Pump only (Item 836)... **\$9.50**

**HYDRAULIC HOSE COUPLERS** Connect or disconnect hydraulic lines without loss of oil. 1/2" pipe threads. (Item 819) per set **\$3.95**

## HI-FLO Centrifugal PUMP

Completely self-priming! No foot valve required. Tremendous capacity—100 gal. per min. ! Special impeller enables pump to handle muddy or sandy water. Simple to operate—simply start engine and watch the water go.

Powered by a rugged, easy-starting 2 HP Briggs engine. Pre-lubricated sealed bearings for years of heavy low-cost service. Big 1 1/2" Model. Item 502. Wt. 70 lbs. Factory price... **\$134.50**

2" Model (150 gal. per min.) with 2 1/2 HP engine. Item 502a. 90 lbs. Fact. Spec. **\$154.50**

Send check or M.O. Prices f.o.b. Factory. 10 day Money back guarantee. SEND 10c for... **MASTER MECHANIC MFG. CO.,** DEPT. A-23 Burlington, Wis.

## BUY direct from MASTER MECHANIC'S factory

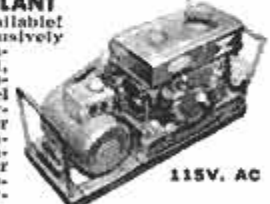
**700 WATTS PUSH BUTTON START**  
115 v. 60 cyc. AC Powered by a rugged 2.2 HP easy starting Briggs engine. No wiring necessary! Just plug in and operate. Plenty of current for any oil burner, freezer, brooder, emergency lights, etc. which require up to 700 watts. Ideal for television and radios. Complete with Voltmeter and built-in winding to charge 6 v. auto batteries. (Item 24). Wt. 75 lbs. Easily fits in car trunk. Be prepared if storm knocks out power lines. Reg. \$275 value... **\$143.50**

**1200 Watt Plant (Item 45) same as Item 23** but larger generator and engine **\$199.50**

## EXCLUSIVE! NEW!

### LIGHTWEIGHT WATER COOLED DIESEL GENERATOR PLANT

Never before available! Now offered exclusively by Master Mechanic. A low priced, lightweight, continuous duty, Diesel generator set. Powered by a super rugged, exceptionally smooth running, one cylinder Diesel engine. Operates at conservative 1750 r.p.m., and delivers full 1750-2000 watts of power. Operates on low cost fuel oil. Wt. only 240 lbs. representing a triumph of Diesel Engineering. Complete with fuel filter, oil pressure gauge, control box with duplex receptacle and voltmeter. (Item 830) Special factory price... **\$399.50**



## JET STEAM MASTER

Now, a super efficient portable steam generator that produces live steam at 100 lbs. pressure in 60 seconds from a cold start! Produces large volume of high pressure steam on 2 pints of fuel oil. Instantly cleans sticky grease, dirt, rust, old paint, etc. off implements and road machinery. Pays for itself in a few weeks. Sterilizes soil. Kills weeds as it cleans—milk equipment, etc. Fully automatic—oil fired with new, built-in lifting bronze water circulating pump. Draws water from faucet or bucket. Simple and safe—anyone can use it; built-in safety valve. Complete with 12 ft. of hi-pressure steam hose and new triple efficiency steam gun that automatically mixes in soap solution if desired. Wt. 250 lbs. Item 463. Special factory price... **\$349.50**



## RUBBER HOSE

Genuine Neoprene Hose—outlasts ordinary rubber 3 to 1. Reinforced with super tough cotton cord plies—yet completely flexible. Equipped with standard thread male and female fittings. Pump water for irrigation, stock tanks, home, barn, fire fighting, etc.—or pump gas and fuel oil. Volume factory prices—save more than 60%.

Size	Price	Size	Price
1 1/2"x10'	5.95	1 1/2"x50'	26.50
1 1/2"x10'	7.95	2"x10'	16.50
1 1/2"x20'	10.95	2"x10'	9.50*
1 1/2"x25'	13.95	2"x14'	11.50
1 1/2"x50'	24.95	2"x50'	47.50
1 1/2"x100'	49.95	2 1/2"x10'	21.75*
1 1/2"x10'	10.95	2 1/2"x15'	25.00
1 1/2"x25'	14.75	3"x10'	25.50*

\*—Discharge Hose.

## GIANT METAL SHEARS

Nine inch cutting blade made of special high carbon alloy steel, perfectly aligned and ground. Easily cuts steel plate up to 12 gauge or 3/4" thick. Overall length 40". Wt. 23 lbs. (Item 156) Regular **\$49.50**. While they last... **\$14.95**



## PORTABLE LIGHT PLANTS

**GIANT 2500 WATT PLANT**  
110-120 v. 60 cyc. AC, absolutely the best made—exclusive dynamic balanced armature; heavy windings develop up to 3000 watt overload for motor starting. Skid mounted—portable. Powered by an easy starting Briggs Wisconsin 6 HP engine—complete with all accessories; engine easily disconnected for other uses. Big outlet box, voltmeter, no wiring necessary. Ample current for all purposes. Factory warranty. (Item 31) Wt. 210 lb. Reg. price \$585. Special at... **\$299.50**

Same plant with electric self starter (Item 31a)... **\$359.50**

**Generator only and control box... \$169.50**

**DUAL VOLTAGE 110-220 available on any of above models for \$28.00 additional.**



## MASTER AIR COMPRESSOR

**COMPARE!** This is the only compressor built with a NO RUST stainless steel tank. Safe up to 500 lbs. (Item 200) High pressure type (4 c.f.m.) large volume of air for heavy duty service. For painting, spraying, inflating tires & auto tires, cleaning, blasting, etc. Piston type 2" bore compressor with built-in air filler. Master built with high strength alloy and precision bearings. Tank, 12"x24", 2100 cu. in. cap. Equipped with automatic switch that starts and stops motor to maintain desired pressure (up to 150 lbs.) and check valve, safety valve, gauge, shut-off valve, 20 ft. air hose and tire chuck. Beautifully balanced on ball bearing wheels and rubber tires. Don't take chances with used or surplus equipment. Our compressors are factory new and are guaranteed SAFE. 1/2 H.P. heavy duty model, rep. incl. motor and unloader switch. (Item 200A, low factory price)... **\$129.50**

1 1/2 H.P. model, cap. 3 c.f.m.— **\$109.50**



## CABLE HOIST

**2000 lb. CAPACITY.** A four ton purchase from the Air Force enables us to offer these powerful 2000 lb. electric cable hoists at a fraction of their value. Perfect for material handling, boat hoists, elevators, lifts on assembly lines, etc. Two separate 22 ft. lift cables with independent controls permit leveling the load and controlling it perfectly. Rugged ball bearing motors of geared down design 110 volts. Available for A.C. or D.C. Please specify. Makes a terrific portable hoist with our ±273 D.C. light plant at \$99.75. Offered at less than 33% of regular cost (hook not included). Wt. 145 lbs. A.C. Model, Item 847A... **\$149.50**  
D.C. Model, Item 847... **\$129.50**



## MASTER D.C. ARC WELDER

**Easy To Use**  
Now! a portable rugged, industrial type welder with terrific performance, yet at a price hundreds of dollars less than you'd expect. Senior model made for years of trouble-free, continuous service. High capacity DC welding unit enables you to tackle any job with confidence—easily welds anything up to 2" plate using from 1/16" to 3/4" rods. Built-in stabilizer and cooling system makes arc easy to strike and hold. Dual control rheostat provides low heat soldering, brazing and welding from 30 to 300 amps. Complete with instructions, guarantee and triple V-belt or flat pulley. Easy to hook up and easy to operate. **WELDER ONLY — DUAL CONTROL MODEL.** Same as above, but drive with your tractor, jeep or gas engine of 14 HP or more. (Item 38a.) Wt. 110 lbs. \$450 value... **\$119.50**



**WELDER ONLY—INDUSTRIAL MODEL** same as above but with ceramic rotary type rheostat providing 74 different heat settings for all types of welding (Item 38b)... **\$139.50**

**COMPLETE POWER MASTER** (illustrated above) powered by a 16 hp. air cooled Wisconsin engine. Wt. 480 lbs. Item 280) Complete with welder costing \$1200. **\$449.50** Factory Special.

**WELDING KIT** Two 10 ft. leads, welding helmet, electrode holder, ground clamp. Sold only with welder at... **\$10.50**



# FOR REAL JOB SECURITY —GET AN I.C.S. DIPLOMA



"You can stop worrying, Jane. My job's secure now! And here's the insurance policy to prove it—my I.C.S. diploma!"

This feeling of security is probably typical of every I.C.S. graduate. Because—as the job situation gets tighter, the man with I.C.S. training has the advantage.

Why? Your I.C.S. diploma tells your present employer three important things: (1) You want to make the most of your present job.

(2) You have the training you need for advancement. (3) You look for better ways of doing things on your own.

What you do about your future is up to you. Do nothing and stay at your present job at the same old pay. Or earn an I.C.S. diploma in your spare time for security, promotions, more pay! Your first step is to mark the course that interests you in the coupon below, and mail it to us.

### Three Free Books

We'll send you three interesting books. The first, "How to Succeed," is a gold mine of helpful tips. Points out many small things in your personality and behavior that can make the difference between success and failure. The second tells about the opportunities in the field of your choice. The third is a sample lesson (Math).

### Costs pennies a day

Many an I.C.S. student has made up the cost of his course in one month with the salary increase his I.C.S. training earned for him. By studying at home in your spare time, you pay yourself many times an hour more than you're now making. (One student reports—"My I.C.S. course was worth \$95 an hour to me.")

The security of your present job—or success in finding the new job you've always wanted—is in your hands. Move ahead with I. C. S. training while others stay behind on the routine, small-pay jobs.

Remember, your first step to security is to mail this coupon. Take a few minutes and do it now. If you put it off, it can cost you your future.

For Real Job Security—Get an I. C. S. Diploma! I. C. S., Scranton 15, Penna. Accredited Member, National Home Study Council

## INTERNATIONAL CORRESPONDENCE SCHOOLS



BOX 81299D, SCRANTON 15, PENNA.

(Partial list of 257 courses)

Without cost or obligation, send me "HOW TO SUCCEED" and the opportunity booklet about the field

BEFORE which I have marked X (plus sample lesson):

- ARCHITECTURE and BUILDING CONSTRUCTION**
- Air Conditioning
  - Architecture
  - Arch. Drawing and Designing
  - Building Contractor
  - Building Estimator
  - Carpentry and Millwork
  - Carpenter Foreman
  - Heating
  - Interior Decoration
  - Painting Contractor
  - Plumbing
  - Reading Arch. Blueprints
- ART**
- Commercial Art
  - Magazine & Book Illus.
  - Show Card and Sign Lettering
  - Sketching and Painting
- AUTOMOTIVE**
- Automobiles
  - Auto Body Rebuilding and Refinishing
  - Auto Engine Tuneup
  - Auto Technician

- AVIATION**
- Aero-Engineering Technology
  - Aircraft & Engine Mechanic
- BUSINESS**
- Accounting
  - Advertising
  - Business Administration
  - Business Management
  - Cost Accounting
  - Creative Salesmanship
  - Managing a Small Business
  - Professional Secretary
  - Public Accounting
  - Purchasing Agent
  - Salesmanship
  - Salesmanship and Management
  - Traffic Management
- CHEMICAL**
- Analytical Chemistry
  - Chemical Engineering
  - Chem. Lab. Technician
  - Elements of Nuclear Energy
  - General Chemistry
  - Natural Gas Prod. and Trans.
  - Petroleum Prod. and Engr.
  - Professional Engineer (Chem)
  - Pulp and Paper Making

- CIVIL ENGINEERING**
- Civil Engineering
  - Construction Engineering
  - Highway Engineering
  - Professional Engineer (Civil)
  - Reading Struc. Blueprints
  - Structural Engineering
  - Surveying and Mapping
- DRAFTING**
- Aircraft Drafting
  - Architectural Drafting
  - Drafting Machine Design
  - Electrical Drafting
  - Mechanical Drafting
  - Sheet Metal Drafting
  - Structural Drafting
- ELECTRICAL**
- Electrical Engineering
  - Elec. Engr. Technician
  - Elec. Light and Power
  - Practical Electrician
  - Practical Lineman
  - Professional Engineer (Elec)
- HIGH SCHOOL**
- High School Diploma

- Good English
  - High School Mathematics
  - Short Story Writing
- LEADERSHIP**
- Industrial Foremanship
  - Industrial Supervision
  - Personnel-Labor Relations
  - Supervision
- MECHANICAL and SHOP**
- Diesel Engines
  - Gas-Elec. Welding
  - Industrial Engineering
  - Industrial Instrumentation
  - Industrial Metallurgy
  - Industrial Safety
  - Machine Design
  - Machine Shop Practice
  - Mechanical Engineering
  - Professional Engineer (Mech)
  - Quality Control
  - Reading Shop Blueprints
  - Refrigerator and Air Conditioning
  - Tool Design
  - Tool Making
- RADIO, TELEVISION**
- General Electronics Tech.

- Industrial Electronics
  - Practical Radio-TV Eng'g
  - Practical Telephony
  - Radio-TV Servicing
- RAILROAD**
- Car Inspector and Air Brake
  - Diesel Electrician
  - Diesel Engr. and Fireman
  - Diesel Locomotive
- STEAM and DIESEL POWER**
- Combustion Engineering
  - Power Plant Engineer
  - Stationary Diesel Engr.
  - Stationary Fireman
- TEXTILE**
- Carding and Spinning
  - Cotton Manufacture
  - Cotton Warping and Weaving
  - Loom Fixing Technician
  - Textile Designing
  - Textile Finishing & Dyeing
  - Throwing
  - Warping and Weaving
  - Worsted Manufacturing

Name \_\_\_\_\_ Age \_\_\_\_\_ Home Address \_\_\_\_\_  
 City \_\_\_\_\_ Zone \_\_\_\_\_ State \_\_\_\_\_ Working Hours \_\_\_\_\_ A.M. to P.M. \_\_\_\_\_  
 Occupation \_\_\_\_\_

Canadian residents send coupon to International Correspondence Schools, Canadian, Ltd., Montreal, Canada. . . . Special tuition rates to members of the U. S. Armed Forces.



# THE ONLY COMPLETE ELECTRONIC COURSE

# Learn TELEVISION, RADIO, RADAR, SONAR, ELECTRONICS

Only CTS offers you *COMPLETE* training in all phases of Electronics. Why be satisfied with less? The new Christy Shop-Method Home Training makes learning interesting and easy. You learn Radar, Sonar, Electronics, Radio, Television. No previous experience needed. You learn by working with actual equipment. Makes learning fun. Speeds your progress. Helps you understand quicker and remember longer.

You get comprehensive training starting with your first CTS lesson! The complete knowledge CTS provides you with, gives you a broader knowledge, a greater understanding which will mean more jobs and a higher income for you for the rest of your life.

## HOME LABORATORY SENT! 19 TRAINING INSTRUMENTS INCLUDED

With CTS *COMPLETE* Home Training Course, you receive a Home Laboratory to assemble, use and keep for years of peak performance. You receive a Multi-Tester, Oscillator, Signal Tracer, Oscilloscope, Signal Generator, Electronic Timer, Regenerative Radio, Giant-size Television Receiver (optional) as well as many other valuable electronic devices. With these you will be able to make hundreds upon hundreds of exciting experiments.

## EARN WHILE YOU LEARN! EARN \$5.00—\$6.00 PER HOUR

Or *MORE* while still studying! Almost from the very first you receive training that enables you to repair radios and television sets for friends and neighbors. To install and service electronic computers, communication equipment, protective equipment for police and fire departments, etc., etc.

## FREE BOOK—SAMPLE LESSONS SENT

Get all there is to know about the Christy *COMPLETE* Electronic Course in Radio-Television-Radar-Sonar, etc. A complete, colorful, illustrated book on Electronics sent without obligation.

Also, we will send you Two sample lessons showing how the new CTS Shop-Method Home Training Course will train you for making big money in your spare time and for building a bright future for yourself.

CHRISTY TRADES SCHOOL, Dept. T-1703, 3214-16 W. Lawrence Ave., Chicago 25

## SIGN, MAIL FOR THREE BOOKS

CHRISTY TRADES SCHOOL, Dept. T-1703 3214-16 W. Lawrence Ave. Chicago 25, Ill.

Gentlemen:  
Please send me, without cost or obligation, two *FREE* lessons and the new 24-Page illustrated book telling all about the CTS Master Shop Method Home Training Course in Radar, Sonar, Television, Radio and Electronics, and the many opportunities this new field offers.

Name..... Age.....

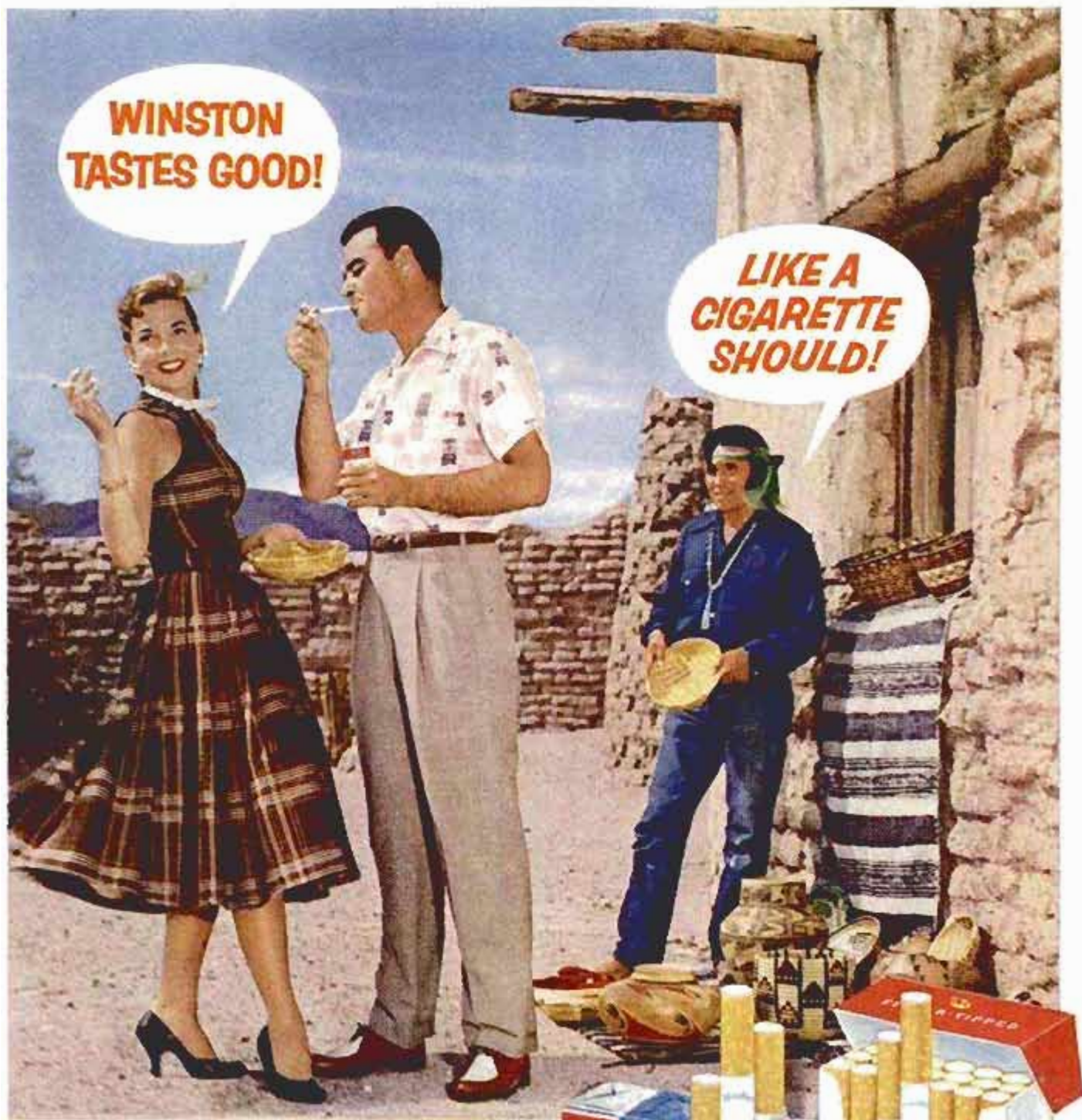
Address .....

City..... Zone.... State.....



**MAIL COUPON  
TODAY FOR  
CATALOG !**





R. J. REYNOLDS TOBACCO CO., WINSTON-SALEM, N. C.

For bright, clear flavor—  
switch to **WINSTON**

Wherever you go, folks go for Winston! You will, too. You'll like the full, rich flavor of fine tobacco. And you'll like Winston's exclusive filter, too—the pure, snow-white filter in the smart, cork-smooth tip. It's a great cigarette in every way!



Now available  
in crush-proof box, too!

Smoke **WINSTON** America's best-selling, best-tasting filter cigarette!