

SPECIAL 20 PAGES ON BOATING

# POPULAR MECHANICS

## MAGAZINE

WRITTEN SO YOU CAN UNDERSTAND IT

MOOD TRADE MARK, GREAT BRITAIN, NO.

U.S. PAT. OFF.

MARCH 1958  
35 CENTS

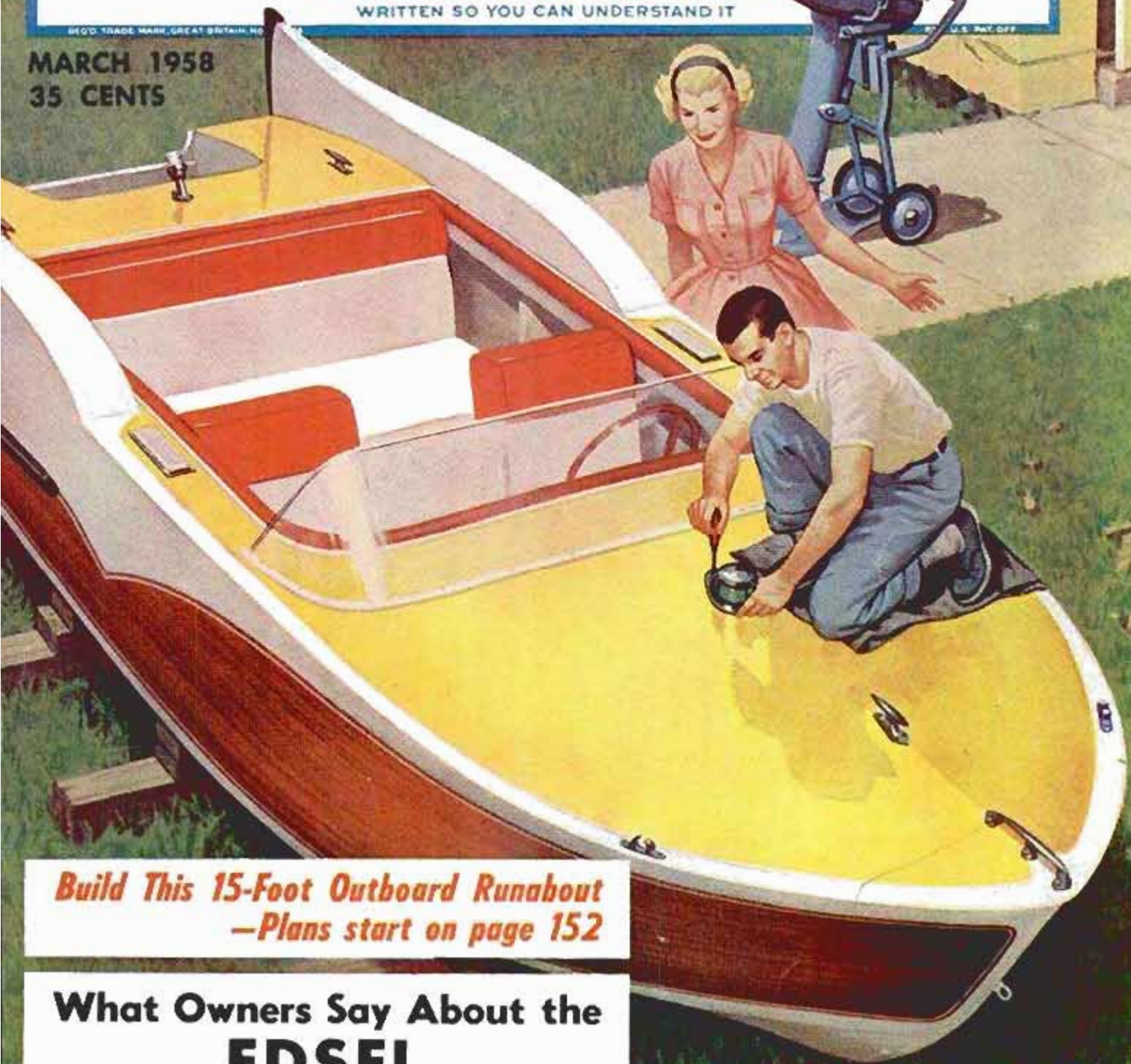

*Build This 15-Foot Outboard Runabout  
—Plans start on page 152*

**What Owners Say About the  
EDSEL**

8 Pages of Full-Color Paintings by Eric Sloane tell you  
**HOW TO FORECAST**





**1st  
PRIZE**

**WIN**

*the boat and motor of your dreams  
in Evinrude's*

# **dreamboat contest**

**FEB. 22 - MAR. 23**



**2nd  
PRIZE**



**next 16  
PRIZES**

*choose from the boats and motors on display at your*

## **EVINRUDE DEALER'S BOAT SHOW**

One look at the new Evinrudes—and the latest boats now on display at your Evinrude dealer's—and you'll know you're in "dreamboat" land.

See them now. Choose the outfit you'd like to win. Get your Contest Entry Form and fill it in. You may win a family cruiser, powered with Evinrude's revolutionary 50 hp Starflite V-4—a smart runabout, powered with Evinrude's magnificent Lark—or one of 16 other Evinrude-powered boating outfits.

Whether you win or not, a sightseeing visit to your Evinrude dealer's will be reward enough. Take the family. They'll share the fun—and they can help you win!

*A Division of Outboard Marine Corporation  
In Canada: Mfd. by Evinrude Motors, Peterborough*

# **EVINRUDE**

*quiet outboard motors*

**FIRST PRIZE—Family Cruiser Outfit.**  
Evinrude 50 hp Starflite V-4 motor plus \$3,000 in credit at your dealer for the dreamboat of your choice and accessories up to that amount.

**SECOND PRIZE—Family Runabout Outfit.**  
Evinrude 35 hp Lark motor plus \$1,200 in credit at your dealer for the family runabout of your choice and accessories up to that amount.

**NEXT 16 PRIZES—4 each Week.**  
Evinrude 7½ hp Fleetwin motor plus \$400 in credit at your dealer for the boat of your choice and accessories up to that amount.

**GO TO YOUR EVINRUDE DEALER TODAY!**  
**Here's all you do to enter!**

1. Go to your Evinrude dealer (look for his name under "Outboard Motors" in the yellow pages).
2. Pick up official rules and entry blank.
3. Look at the boating outfits he has on display. Pick the one you'd like to win, and . . .
4. Say in 50 words or less why you'd like to win it.
5. Mail official entry blank to "Evinrude Contest."



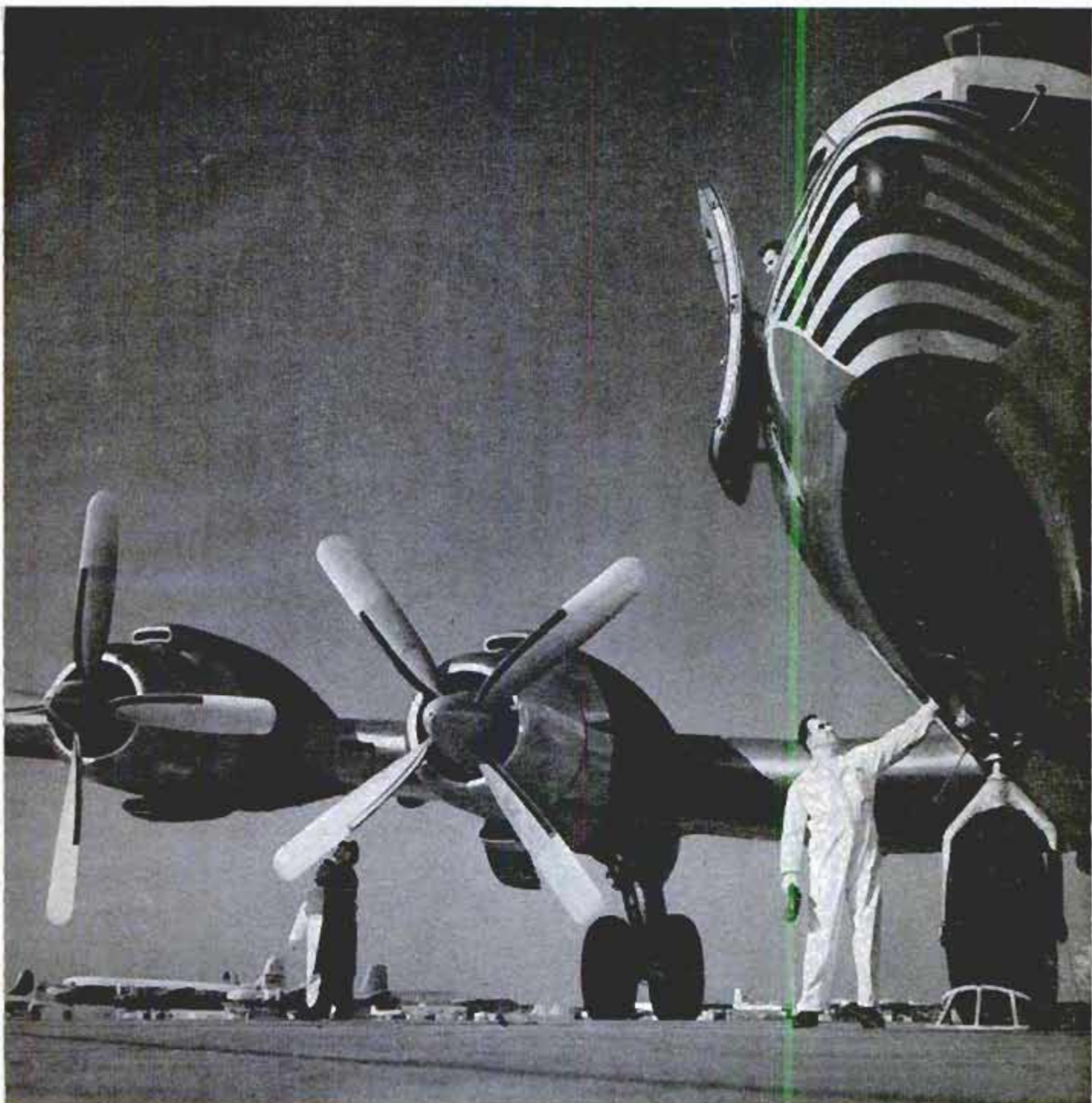

In planes as in passenger cars, Champions deliver full-firing power.  
Above: DC-7 gets set for flight from Idlewild to Paris.

Q. Why do all the world's major airlines use Champion spark plugs?

A. Champions give full-firing power  
Put new Champions in your car every 10,000 miles. You'll get an *immediate* boost in horsepower...and save gasoline, too!



*World's favorite spark plug on land, on sea, and in the air*

**CHAMPION**

This One





# THE ADVANCE DESIGN OF THE *FORWARD* LOOK

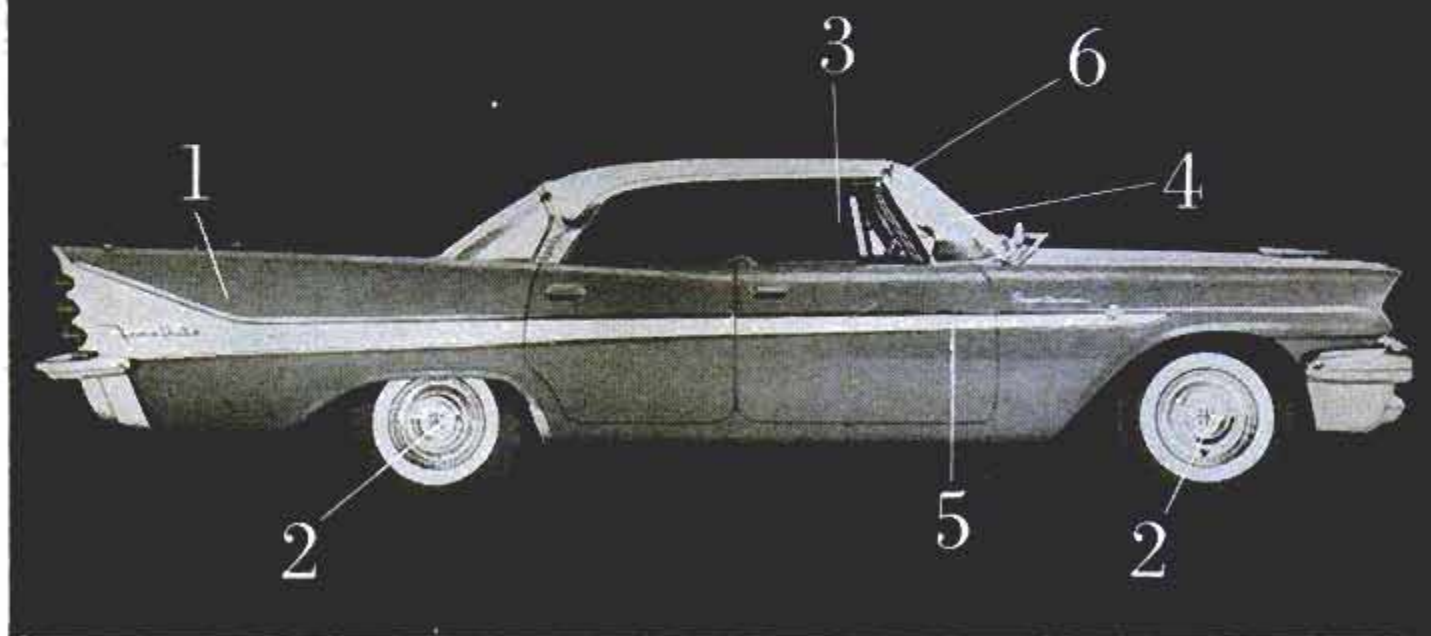

## WHY IT IS SO RIGHT • WHY IT MEANS SUCH VALUE FOR YOU

In just 12 months more than one million people bought new cars of The *Forward* Look. And nearly half a million switched to them from other makes of car. Their reasons? They're finding more that's new . . . more that's right . . . than they find anywhere else.

**1** Take, for example, the rightness of style—the dart-shape of motion. No other design contributes so much to performance. Even cuts steering corrections in cross-winds as much as 20%!

**2** There's the wonderful difference of Torsion-Aire Ride. It's America's one new completely different, completely proved system of suspension. So right it prevents starting squat, braking dip, lean on curves. *Yours at no extra cost* in every Plymouth, Dodge, De Soto, Chrysler, Imperial.

**3** Pushbutton TorqueFlite — A "first" and so right — found only in cars of The *Forward* Look. Reliable, mechanically-linked control buttons, placed safely at the driver's left. Plus full control of automatic transmission with two extra selector buttons for such conditions as mud or snow, for downhill engine braking, for flexibility in traffic and up steep hills.

**4** New Constant-Control Power Steering makes a wonderful difference, too. It works the right way—full time, not part time. Pioneered by Chrysler Corporation, it takes the work out of steering, yet gives you full control, wonderful new "feel" of the road.

**5** Your toe works less, the brakes do more, with Total-Contact braking. The difference here is big and right: quicker straight-line stops with up to 25% less pedal pressure; longer lining life, and only cars of The *Forward* Look have two cylinders working each front brake.

**6** You see up to 50% better with Control Tower windshields that sweep back into the roofline to let you look up as well as out. With safety glass all around, of course. The "all outdoors" feeling comes true again in the roominess we give you inside. More, model for model, than any other makes of car!

But the rightness goes further! In every great engineering achievement, in every fine detail of styling, in the total design and total value of these cars. It's simply a matter of giving you more for what you pay. But don't just look at a great '58 of The *Forward* Look—drive around, and discover the rightness for yourself!

**CHRYSLER CORPORATION** ➤ **THE *FORWARD* LOOK**  
**PLYMOUTH • DODGE • DESOTO • CHRYSLER • IMPERIAL**



# Popular Mechanics Magazine

Registered in U. S. Patent Office and Canada

H. H. WINDSOR, Founder

H. H. WINDSOR, JR., Editor and Publisher

Managing Editor

RODERICK M. GRANT

Assistant Managing Editor

WAYNE WHITTAKER

Shop Notes and Crafts Editor

JAMES R. WARD

Associate Editors, General Features

CLIFFORD B. HICKS

KENNETH N. ANDERSON

ARTHUR R. RAILTON, Automotive

Associate Editors, Shop Notes and Crafts

WAYNE C. LECKEY W. CLYDE LAMMEY

Radio-Television, Electronics Editor

LOTHAR STERN

Assistant Editors

SHELDON MIX, General Features

JAY W. HEDDEN, EARL WOBECK, Crafts

JOHN DALEN, DICK ZYLSTRA, Makeup

Art Staff

FRANK BEATTY, Director

HENRY NEHRBASS, Assistant Director

RALPH LINNENBURGER, Art Editor

Eastern Editor

RICHARD F. DEMPEWOLFF

Empire State Bldg., Room 2906, N.Y.C. 1

Western Editor

THOMAS E. STIMSON, JR.

Suite 1010, 3460 Wilshire Blvd.,  
Los Angeles 5, Calif.

London Manager

DOUGLAS W. WEDDERSPOON

Eagle House, Jermyn St.,  
London S.W. 1, England

Director, Bureau of Information

ALLAN CARPENTER

Advertising Offices

Chicago: 200 E. Ontario St., Whitehall 4-0100;  
New York: Empire State Bldg., 350 Fifth Ave.,  
LOngacre 5-7580; Detroit: General Motors  
Bldg., Room 5-116, TRinity 5-8711; Cleveland:  
Hanna Bldg., 1422 Euclid Ave., PRespect  
1-0456; Los Angeles: 3460 Wilshire, DUnkirk  
2-8458; San Francisco: Russ Bldg., Room  
408, 235 Montgomery St., YUKon 2-0823.

Published monthly by Popular Mechanics Company,  
200 E. Ontario St., Chicago 11, Ill. H. H. Wind-  
sor, Jr., president; Wm. Harrison Petridge, exec.  
vice-pres.; Franklin S. Forsberg, operations vice-  
pres.; D. F. Windsor, vice-president and secretary-  
treasurer; H. H. Windsor III, vice-president; W. T.  
Windsor, vice-president; Joseph H. Buell, Jr., ad-  
vertising manager; Alan M. Deyoe, circulation  
manager. Single copy in the United States and  
Canada, 35 cents; subscription rates in the United  
States and possessions, Canada and countries of  
the Pan-American Postal Union, 1 year \$3.50; 2  
years, \$6.00; 3 years, \$8.00. To all other coun-  
tries add \$1.00 a year over United States prices  
for overseas postage. If you plan to move, notify us  
at least 30 days in advance so you will not miss  
an issue. Give both your old and new addresses.  
Entered as Second Class Matter, September 15,  
1903, at the Post Office at Chicago, Illinois, under  
Act of March 3, 1879. Entered as Second Class  
Matter at Post Office Dept., Canada. Registered  
as Second Class Matter at the Post Office at  
Mexico, D.F., Mexico, June 20, 1950.  
Copyright 1958 by Popular Mechanics Company.  
Copyright under International Copyright Union.  
Copyright in France. All rights reserved under  
Pan-American Copyright Union. Printed in the  
United States of America.

FOREIGN EDITIONS:	MECANIQUE POPULAIRE (French)	MECANICA POPULAR (Spanish)	POPULAER MEKANIK (Danish)	POPULAR MEKANIK (Swedish)	POPULARE MECHANIK (German)
-------------------	------------------------------	----------------------------	---------------------------	---------------------------	----------------------------

Volume 109

MARCH 1958

Number 3

Address all communications to: 200 E. Ontario St., Chicago 11, Ill.

## In This Issue...

He Flies Kites for Love or Money	- - - -	81
The Owners Report on the Edsel	- - - -	90
Sub Tracker - Nemesis of the Submarine	- - - -	102
Watch Them Build Those New Superhighways	- - - -	107
You Can Forecast Weather by the Clouds	- - - -	112
Growing More Meat With Antibiotics	- - - -	123
Mystery of the Red Tide	- - - -	130
More Power Lights "Darkest Africa"	- - - -	136
Atomic Hideouts	- - - -	146

## SPECIAL SECTION ON BOATING -

Swish—a 15-ft. Sports Runabout—Part I	- - - -	152
What's New in Boating	- - - -	157
Cruising Down the River	- - - -	160
Do Motorboats Scare Fish?	- - - -	166
How to Buy a Used Boat	- - - -	172

Plus Other Boating Features

## For the Craftsman...

Sidewalk Jeep Has Coil-Spring Suspension	- - - -	177
The New Mark 2 Shopsmith	- - - -	180
Highflying Light Kites From Japan	- - - -	189
Do's and Don'ts of Power-Steering Repairs	- - - -	204
How to Use a Level	- - - -	209
Radio, TV and Electronics	- - - -	220

## Regular Departments...

Space—Down to Earth, by Willy Ley	89	On the Market	207
Detroit Listening Post	100	How Would You Do It?	214
What's New for Your Home	150	Shopping for Tools	218
Solving Home Problems	186	Clinic for Homemakers	228

Turn to detailed index on page 74. Sources of additional information on items in this issue are shown on the Where-to-Find-It List, available without charge by writing the Bureau of Information, Popular Mechanics, 200 E. Ontario St., Chicago 11, Ill.

## Next Month...

ALL-PURPOSE CART for golf on week ends, for errands and "school bus" during the week, for the aged or invalids or just for fun for the young members of the family is a do-it-yourself feature for April. Also, an outdoor-living section with a smart patio-family room





**FORMER SERVICEMEN**

**IF YOU  
HAVE A  
TECHNICAL  
SPECIALTY**

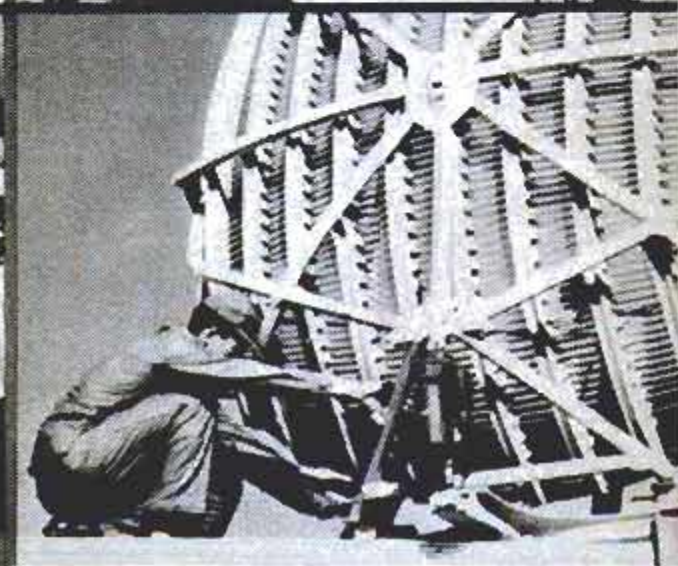
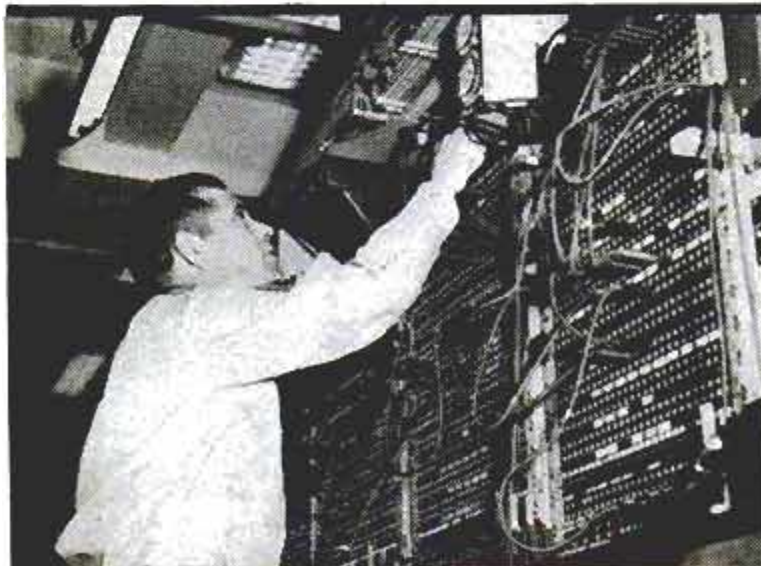

**There's an important job and a guaranteed future for you...in the U.S. Air Force**

• There is no more important job than being an Air Force specialist. For  
• he is not only a fine technician, but also a man of responsibility. On his  
• shoulders rests the vital assignment of maintaining and operating the  
• increasingly complex equipment that makes his Service the world's  
• most efficient striking force. But with this responsibility, he also knows  
• great pride...and a future that's *guaranteed*. As a technician, you, too,  
• can have this same satisfaction and assurance—in the U.S. Air Force.  
• See your Air Force Recruiter, or mail the coupon.

**The Future Belongs to the Airman**

**Today and  
Tomorrow,  
you're better off  
in the  
U. S. AIR FORCE**

**PASTE ON POSTCARD AND MAIL TO:**

Prior Service Information, Dept. PM-5321  
Box 7608, Washington 4, D.C.

Please send me more information on the Air Force Prior Service Program.

Name \_\_\_\_\_

Address \_\_\_\_\_ Age \_\_\_\_\_

City \_\_\_\_\_ Zone \_\_\_\_\_ State \_\_\_\_\_





**Brand new... and bred for action!**

This is a very special car for special people with very particular requirements. We'll grant you it is as sleekly handsome a machine as ever whispered down a boulevard, with an individual flair that is shared by no other. And we'll also concede that its road manners are impeccable, that it moves with a glove-leather suppleness that is obedience personified.

But the real difference between the 1958 Corvette and any other American car is this: It is an authentic sports car. Under that wind-sculptured

# corvette for '58

**CORVETTE**  
by Chevrolet

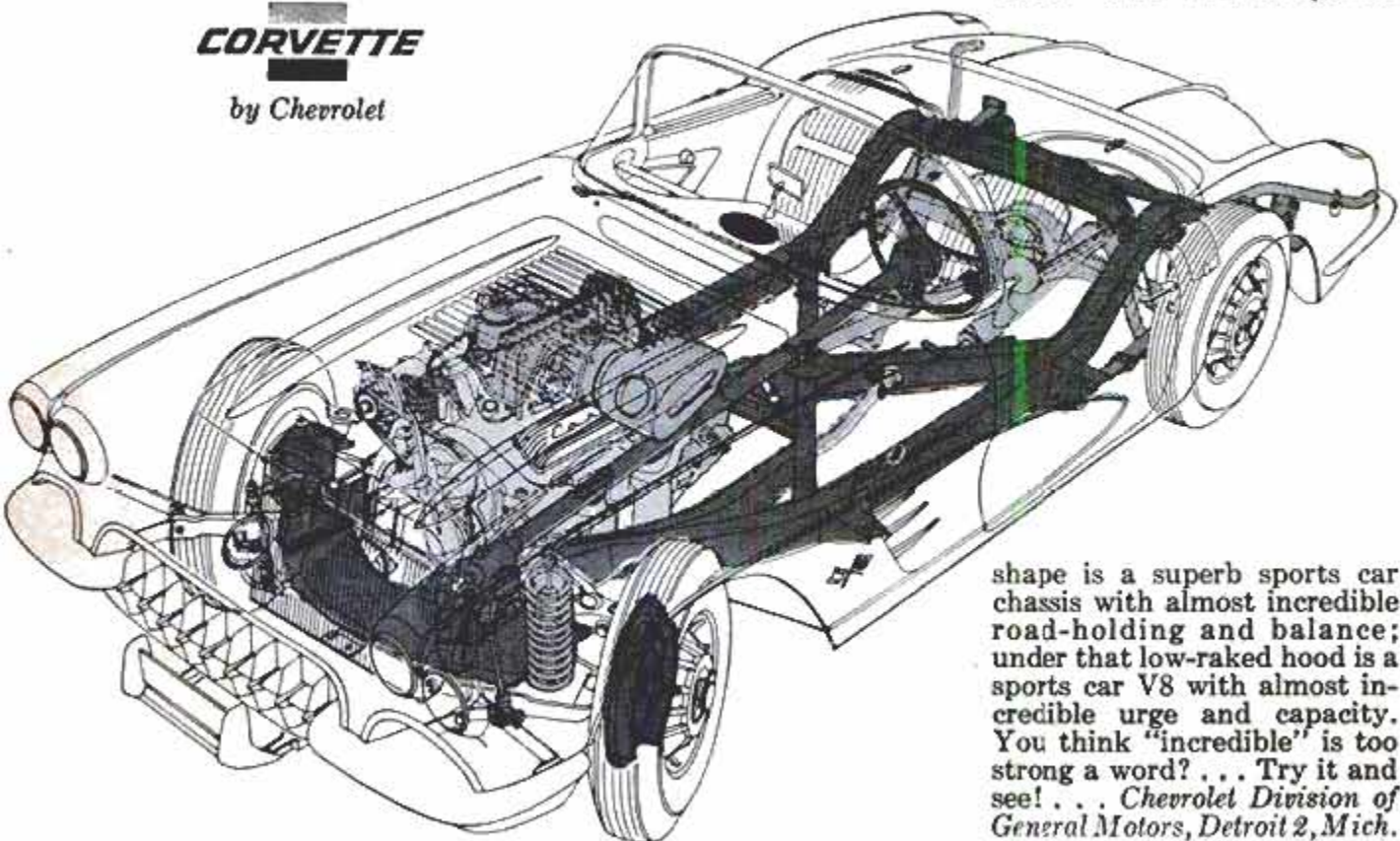

shape is a superb sports car chassis with almost incredible road-holding and balance; under that low-raked hood is a sports car V8 with almost incredible urge and capacity. You think "incredible" is too strong a word? . . . Try it and see! . . . *Chevrolet Division of General Motors, Detroit 2, Mich.*



# EASIER, QUICKER BAND ADJUSTING

with Proto professional tools

Proto's simplified set makes factory recommended band adjustments on all automatic transmissions with fewer tools . . . less cost



PART NO.	DESCRIPTION
1. 9973	Partitioned Metal Box (10-11/16"x8"x1 1/2")
2. 2356	Wrench—open end (3/8")
3. 6061F	Torque Wrench (1/4" drive)
4. 2357	Band Adjuster
5. 4742	Allen Hex Socket (1/4" hex, 1/4" drive)
6. 4710S	Socket—8 point (5/16" op., 1/4" drive)
7. 4710	Socket—6 point (5/16" op., 1/4" drive)
8. 4743	Screwdriver bit (3/8" bit, 1/4" drive)
9. 5324	Socket—12 point (3/4" op., 1/2" drive)
10. 5322	Socket—12 point (11/16" op., 1/2" drive)
11. 2359	Handle and gage (1/4" drive, 1/4" gage)
12. 2354	Servo Gage—Front
13. 2355	Servo Gage—Rear
14. 2360	Manual
15. 2361	Chart

ANOTHER REASON YOU'LL

**PREFER  
PROTO**  
PROFESSIONAL  
TOOLS



Precision band adjustments easy and profitable for any mechanic. Fully illustrated Manual #2360 shows you how. Chart #2361 gives factory specifications. Both included in this great, new Proto Set #2350.

Write Proto for details. **DEPT. A.T.**



2209 Santa Fe Avenue, Los Angeles, Calif. • 583 Allen Street, Jamestown, N.Y. • P. O. Box 366, London, Ontario, Canada

## ACROSS THE DESK



### To the Editor:

This is in reference to an article which appeared in *Popular Mechanics*, April 1957, entitled "Wooden Lung Saves Lives In India."

At the World Congress of Junior Chamber International in Tokyo, Japan, the International Council directed that literature concerning the wooden lung be distributed to Junior Chambers throughout the world. This is done with a view to assisting lesser developed countries provide more adequate medical equipment for their citizens.

I have the six-page mimeograph directions on building wooden lungs (and) six sheet directions produced by *Popular Mechanics*. We would like to publish a project digest, directions on how-to and whom to contact for assistance.

John A. Nesbitt,  
Program Director,  
Editor, JCI WORLD

**EDITOR'S NOTE:** *Permission is gladly granted. Plans for the mechanical "lung" for paralysis victims were first published in PM for January 1952. Leaflets describing its construction may be obtained by writing the Book Dept., Popular Mechanics.*

### To the Editor:

I am a regular reader of *Popular Mechanics* and have been for 10 years. I enjoy seeing pictures and accomplishments of others. I am enclosing a snapshot of myself

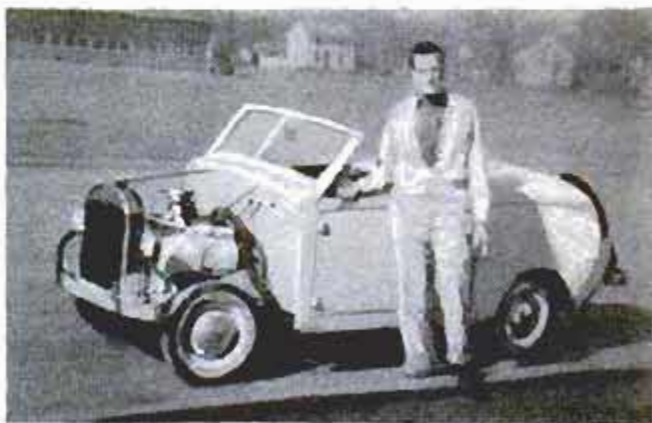

and a roadster I remodeled in spare time.

I am a manager of an alfalfa-dehydrating plant. This is a process whereby green alfalfa is cut from the field and manufactured into pellet form for livestock.

I started with a two-door Crosley coach. I altered the body considerably, replaced the original engine and transmission with

(Continued to page 8)



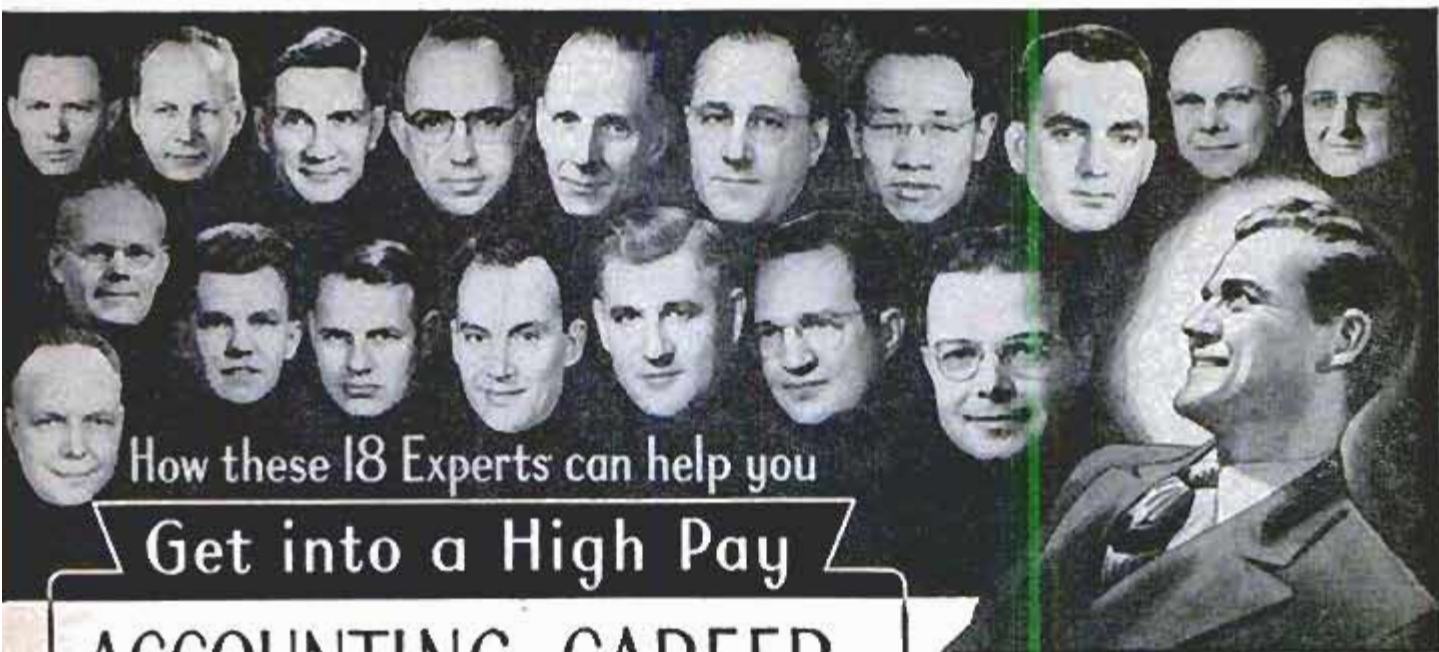

How these 18 Experts can help you

Get into a High Pay

# ACCOUNTING CAREER

LaSalle's famous staff of Accounting authorities are helping thousands prepare for fast promotions and bigger pay. They can do the same for you!

## SAMPLE LESSON SENT FREE MAIL COUPON BELOW

You don't have to wonder what LaSalle's Accounting plan is like. You will be sent a free sample lesson, which does not obligate you in any way. Study it—keep it—see for yourself how simple, clear, and easy it is to master. This is an actual lesson right out of the regular training—to show you exactly how LaSalle's Problem Method has trained more than 1,400,000 men and women from all walks of life.

Also...the latest book, "Opportunities in Accounting," gives all the latest facts about the new and growing opportunities in several different fields of profitable employment.

This can be an important day in your life. A coupon like the one below has started hundreds of thousands of men and women toward a bigger job, a larger income. It can do the same for you.

Accredited Member, National Home Study Council

**Mail the Coupon Today!**

FREE BOOKS

## LA SALLE EXTENSION UNIVERSITY

A Correspondence Institution

417 S. Dearborn Street Dept. 364H Chicago 5, Ill.

Send me free Sample Lesson in Accounting—also, latest free book, "Opportunities in Accounting," and "Success Reports"...all without cost or obligation.

Name..... Age.....

Address.....

City & Zone..... State.....



If your heart is set on a larger income and all that it means... better home—fine car—larger bank account—more of the good things of life....

If that's your ambition and you are really serious about it, then you owe it to yourself to get the REAL FACTS about LaSalle Accounting, and the many good-pay opportunities that can be YOURS through LaSalle's famous Problem Method plan.

It matters not whether you've had a single day of experience in this field—or whether you have already started but want to climb higher. LaSalle's expert training is designed to take you from where you are... to where you want to be... in higher positions and a lifetime career of security and good income.

### WHY YOU CAN'T FAIL TO GAIN

You see on this page a panel of experts who know Accounting from A to Z... all the way from Basic Accounting on up through Accounting Systems, Cost Accounting, Auditing, Federal Income Tax, and training for the CPA certificate. These are only part of our instruction staff. But what is most important to you... These CPAs and Expert Accountants know how to impart their knowledge to others... how to help you prepare quickly yet thoroughly for success in this lucrative field.

The proof? What stronger proof could there



(Continued from page 6)

a V4 Wisconsin air-cooled motor and a Chevrolet transmission. This car has a maximum speed of 70 miles per hour and is very economical on gas, using about one gallon of gas for 38 miles. It weighs 995 pounds.

Dwayne L. Green,  
Lexington, Neb.

### To the Editor:

Your article in the December issue ("What Makes a Driver Tired") was of particular interest to me. In 1929 I bought a De Soto roadster. It was beautiful and I felt like a queen driving along. We still have it and use it. I have had a De Soto sedan, two Plymouth sedans, and am now driving a 1948 Dodge. The De Soto is in the garage and the Dodge is out in all kinds of weather. That is for two reasons: The Dodge is too wide for the doors, and there is always someone wanting to buy the De Soto. About six people will stop on a Sunday to see if it is for sale. The most we've been offered is \$600. My husband likes to drive it as it takes up so little room when parking. We have found it is just as good in many ways as the Dodge. It will always draw a crowd, too. Thanks for the article.

Mrs. S. C. Wardwell,  
Bristol, R. I.

### To the Editor:

After completing a millwright apprenticeship in 1908, *Popular Mechanics* became my "bible."

At an Alaskan salmon cannery the stovepipes in all of the fishermen's cabins had to be renewed each season. The foreman berated me for cutting short lengths of pipe out of square, until I read in *Popular Mechanics* that if you wrap a piece of light cardboard around the pipe until the ends meet, mark around with a pencil, then make a hacksaw cut on the seam, insert tin snips and cut to the line, you will always have square-cut pipe sections, or 45-degree angles may also be made in this way.

After cutting timbers incorrectly because of measuring with a long linen tape, which of course stretches, I mended my ways by learning from *Popular Mechanics* always to use a steel tape to lay out such work.

Tools and supplies are not so readily available in far-flung Alaskan points as in the city where you can drop into the corner hardware store. We were running short of hacksaw blades while cutting short lengths of water and steampipe. This was until the mail arrived with *Popular Mechanics*. Here I learned that if you reverse the blade in the frame, so reversing the pitch of the teeth, you will not strip the teeth.

(Continued to page 10)



### Man with a tough hair problem

Bill Flick of New Orleans captains a 45-foot cruiser for fishing parties. His hair takes a beating from sun, wind and spray.

### He licks it with Vitalis

When he's having dinner out with friends, Bill's hair looks great because he uses Vitalis with V-7.



## New greaseless way to keep your hair neat all day...and prevent dryness

Whether your hair takes a beating from the great outdoors or morning showers, you, too, will like the way Vitalis keeps it in condition... prevents dryness. And you never have a greasy look because Vitalis grooms with greaseless V-7. Use Vitalis every day.

**New VITALIS® Hair Tonic with V-7.**



ANOTHER FINE PRODUCT OF BRISTOL-MYERS



# PICK YOUR OWN SUCCESS STORY FROM THIS PAGE

These are the true stories of people who seemed trapped in routine, low-pay shaky jobs. Handicapped by lack of proper training, they couldn't get the things they wanted out of life—more money, a job they liked, security and happiness.

They are a small sample of the thousands of men and women—young and old—who turn to I. C. S. for help. Their will-to-learn plus I. C. S. training have changed the course of their lives.

Are you discouraged with your job and pay and feel you can't improve yourself because of lack of specialized education? Well, these men and women were in the same boat. With I. C. S. training, one of these success stories could be about *you*.

**I. C. S.** is the oldest and largest correspondence school. 257 courses. Business, industrial, engineering, academic, high school. One for you. Direct, job-related. Bedrock facts and theory plus practical application. Complete lesson and answer service. No skimping. Diploma to graduates.

**For Real Job Security—Get an I. C. S. Diploma! I. C. S., Scranton 15, Penna.** Accredited Member, National Home Study Council



**Wins \$3000 contest**—"After my I. C. S. courses I secured a new position," says Mr. Cecil Rhodes. "My income has more than doubled and I recently won a \$3000 sales contest."



**From clerk to Assistant Estimator, thanks to I.C.S.** "Any way you look at it," writes Mrs. Edna James, "the time and money one spends for I. C. S. Courses will be repaid a thousandfold."



**As a college graduate, I found I.C.S. very valuable.** Robert Lee took the I. C. S. Course in Advertising, is now Promotion Manager for a large corporation. "I. C. S. got me started on the way up," he says.



**From \$152 to \$395 a month**—"I.C.S. made my engineering work more interesting," Frank Bachtik tells us. "I was a Jr. Draftsman making \$152 a month. My present income is \$395.25 a month."

**3 FREE BOOKS**—a 36-page pocket-size guide to advancement, a gold mine of tips on "How to Succeed." Also a big catalog outlining opportunities in your field of interest and a sample I.C.S. lesson (Math.).

## INTERNATIONAL CORRESPONDENCE SCHOOLS



**BOX 92299C, SCRANTON 15, PENNA.**

Without cost or obligation, send me "HOW TO SUCCEED" and the opportunity booklet about the field BEFORE which I have marked X (plus sample lesson):

- ARCHITECTURE and BUILDING CONSTRUCTION**
- Air Conditioning
  - Architecture
  - Arch. Drawing and Designing
  - Building Contractor
  - Building Estimator
  - Carpentry and Millwork
  - Carpenter Foreman
  - Heating
  - Interior Decoration
  - Painting Contractor
  - Plumbing
  - Reading Arch. Blueprints
- ART**
- Commercial Art
  - Magazines & Book Illus.
  - Show Card and Sign Lettering
  - Sketching and Painting
- AUTOMOTIVE**
- Automobiles
  - Auto Body Rebuilding and Refinishing
  - Auto Engine Tuneup
  - Auto Technician

- AVIATION**
- Aero-Engineering Technology
  - Aircraft & Engine Mechanic
- BUSINESS**
- Accounting
  - Advertising
  - Business Administration
  - Business Management
  - Cost Accounting
  - Creative Salesmanship
  - Managing a Small Business
  - Professional Secretary
  - Public Accounting
  - Purchasing Agent
  - Salesmanship
  - Salesmanship and Management
  - Traffic Management
- CHEMICAL**
- Analytical Chemistry
  - Chemical Engineering
  - Chem. Lab. Technician
  - Elements of Nuclear Energy
  - General Chemistry
  - Natural Gas Prod. and Trans.
  - Petroleum Prod. and Engr.
  - Professional Engineer (Chem)
  - Pulp and Paper Making

- CIVIL ENGINEERING**
- Civil Engineering
  - Construction Engineering
  - Highway Engineering
  - Professional Engineer (Civil)
  - Reading Struc. Blueprints
  - Structural Engineering
  - Surveying and Mapping
- DRAFTING**
- Aircraft Drafting
  - Architectural Drafting
  - Drafting Machine Design
  - Electrical Drafting
  - Mechanical Drafting
  - Sheet Metal Drafting
  - Structural Drafting
- ELECTRICAL**
- Electrical Engineering
  - Elec. Engr. Technician
  - Elec. Light and Power
  - Practical Electrician
  - Practical Lineman
  - Professional Engineer (Elec)
- HIGH SCHOOL**
- High School Diploma

- (Partial list of 257 courses)
- Good English
  - High School Mathematics
  - Short Story Writing
- LEADERSHIP**
- Industrial Foremanship
  - Industrial Supervision
  - Personnel-Labor Relations
  - Supervision
- MECHANICAL and SHOP**
- Diesel Engines
  - Gas-Elec. Welding
  - Industrial Engineering
  - Industrial Instrumentation
  - Industrial Metallurgy
  - Industrial Safety
  - Machine Design
  - Machine Shop Practice
  - Mechanical Engineering
  - Professional Engineer (Mech)
  - Quality Control
  - Reading Shop Blueprints
  - Refrigeration and Air Conditioning
  - Tool Design
  - Tool Making
- RADIO, TELEVISION**
- General Electronics Tech.
  - Industrial Electronics
  - Practical Radio-TV Engr'g
  - Practical Telephony
  - Radio-TV Servicing
- RAILROAD**
- Car Inspector and Air Brake
  - Diesel Electrician
  - Diesel Engr. and Fireman
  - Diesel Locomotive
- STEAM and DIESEL POWER**
- Combustion Engineering
  - Power Plant Engineer
  - Stationary Diesel Engr.
  - Stationary Fireman
- TEXTILE**
- Carding and Spinning
  - Cotton Manufacture
  - Cotton Warming and Weaving
  - Loom Fixing Technician
  - Textile Designing
  - Textile Finishing & Dyeing
  - Throwing
  - Warming and Weaving
  - Worsted Manufacturing

Name \_\_\_\_\_ Age \_\_\_\_\_ Home Address \_\_\_\_\_  
 City \_\_\_\_\_ Zone \_\_\_\_\_ State \_\_\_\_\_ Working Hours \_\_\_\_\_ A.M. to P.M. \_\_\_\_\_  
 Occupation \_\_\_\_\_

Canadian residents send coupon to International Correspondence Schools, Canadian, Ltd., Montreal, Canada. . . . Special tuition rates to members of the U. S. Armed Forces.



# Complete Training

... AT ONLY A FRACTION OF THE PRICE YOU MIGHT EXPECT TO PAY



Only \$10.95

for the complete 2-volume home training course (or buy books separately if you prefer)

## LEARN ELECTRIC MOTOR REPAIR (INCLUDING COMPLETE REWINDING)

Train for good pay in this uncrowded field! Learn at home to service and rewind practically any electric motor—from home appliance motors to big industrial motors and generators and their control equipment. This 560-page **ELECTRIC MOTOR REPAIR** guide explains every step by text and ALSO by more than 900 how-to-do-it pictures.

Quick guides show how to handle specific jobs. When a certain motor comes for repair, just look it up. **ELECTRIC MOTOR REPAIR** shows you exactly what to do. Right down the line, it explains troubleshooting, repair, rewinding and other maintenance in a way you can understand even without a lot of previous electrical training. Price only \$6.95 separately, but see money-saving offer in coupon. Money-back guarantee.

## LEARN ELECTRIC APPLIANCE REPAIR (ANY MAKE OR MODEL)

This 370-page Rinehart **ELECTRICAL APPLIANCE SERVICE MANUAL** shows you how to do the toughest repair jobs as well the easy ones—even if you've never fixed an appliance before. Gives specific instructions on every modern appliance. Includes refinishing methods. Handy charts help you locate troubles fast. Simple test instruments you can make yourself are explained. Tools, wiring problems and electrical principles are fully described. Gives you the "know how" you need to earn spare-time money fixing appliances—or, to build a full-time repair business. Only \$5.00 separately—or see money-saving offer in coupon.

### SPECIAL OFFER . . . you save \$1.00!

If written in "lesson" form and sold as a course, you'd regard these two great books as a bargain at \$100 or more! Together, they form a 930-page electrical repair library that makes it easy to train for this good-paying modern profession. Under this new offer, you save \$1.00 on the regular price of the two books. And you can pay in easy installments!

### EARN WHILE YOU LEARN!

Dept. PM-38, RINEHART & COMPANY, INC.  
232 Madison Ave., New York 16, N. Y.

**ELECTRIC MOTOR REPAIR (\$6.95)**       **ELECTRICAL APPLIANCE SERVICE MANUAL (\$5.00)**

**MONEY-SAVING OFFER — Save \$1.00**

Send both books at special price of only \$10.95 (regular price \$11.95). Payable at rate \$4.95 after 10 days if you decide to keep books and \$3 per month for 2 months. (SAVE! Remit price with order and we pay postage. Same 10-day return privilege with money refunded.)

Name \_\_\_\_\_

Address \_\_\_\_\_

City, Zone, State \_\_\_\_\_

(Continued from page 8)

*Popular Mechanics* aided in speeding up construction work when we had to drive 400 piles on the waterfront for a plant addition. Instead of using a cumbersome 20-foot 2 by 6 as a straightedge-level for cutoff marks, we used a length of hose with a glass tube inserted in each end. When the water level showed equal in each tube, we drove a nail on the mark and the crew following cut off the pile ends at that point.

We learned how to make machine and engine cams from *Popular Mechanics* and so cut down plant-operating costs. Cam rolls were cut off of short ends of cold-rolled steel and lathed down to size. These would be brought up to a blood-red heat and soaked in molten cyanide (using muffler or gas mask), which penetrates and casehardens the cam bearing surface.

Our foreman was not too impressed with *Popular Mechanics* until he insisted on pouring molten Babbitt metal in the wet bearings of the elevator transmission down at low-tide mark. It of course exploded in his face; we fortunately saved his sight. I told him that I had learned not to do this in *Popular Mechanics* and from then on he became a *PM* fan.

Then I began to help *Popular Mechanics*. A follower nut worked loose from a steam piston and blew off the cylinder head. I drilled out and put in extended studs and made a new head out of a two-inch oak plank and the engine functioned to put up the balance of the season salmon pack, otherwise we would have had to close down the plant. This magazine published this factual incident.

So if you become a reader of *Popular Mechanics* you may be sending in similar factual episodes half a century from now. We'll look forward to reading about them.

Sydney Cook,  
Vancouver, B.C., Can.

"FOR A BETTER-READ, BETTER-INFORMED AMERICA"



NATIONAL LIBRARY WEEK — MARCH 16-22, 1958



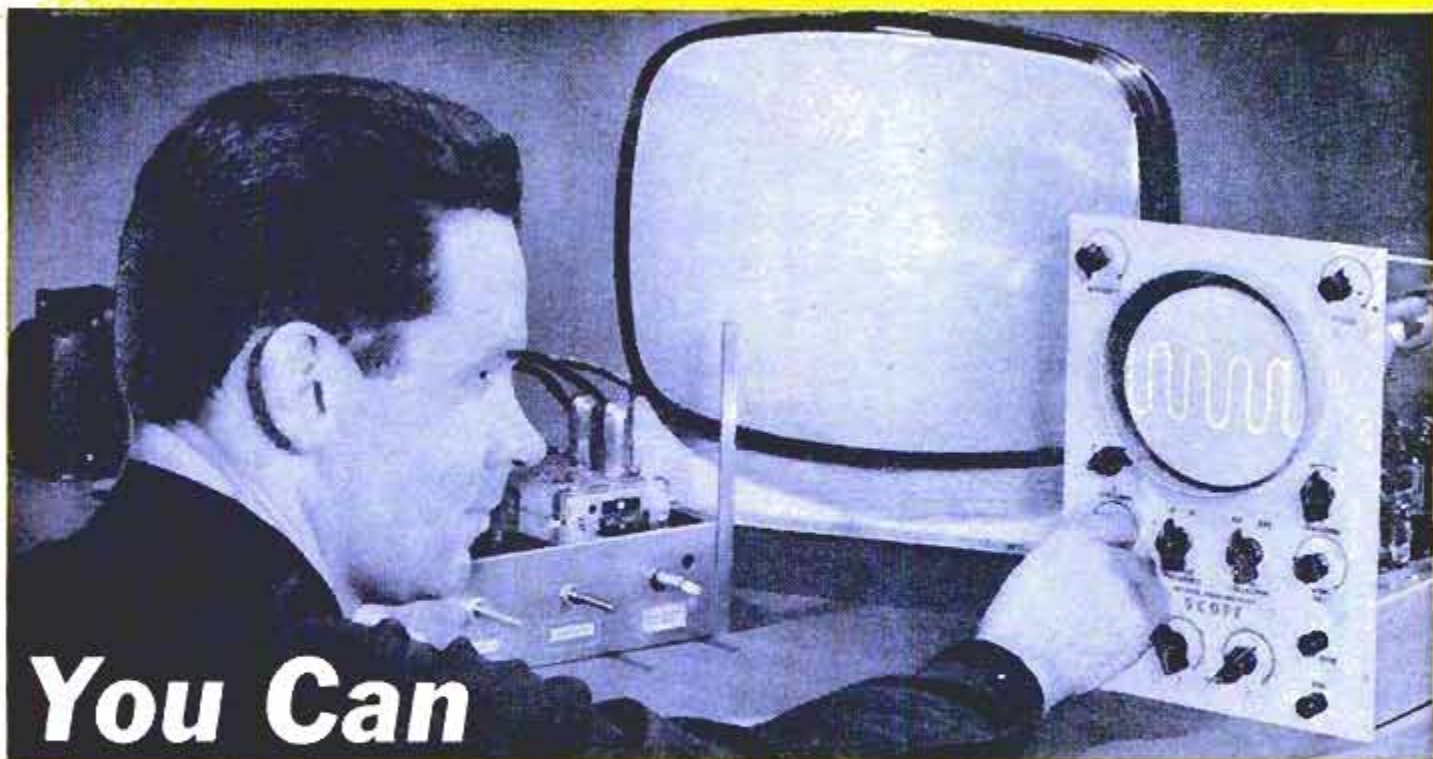

**You Can**

# Train at Home in Spare Time for Good Jobs - Better Pay

Today, choose the career you want and take the first step toward that goal. Training plus opportunity is the perfect combination for success. NRI has trained thousands of men at home, in their spare time. NRI is the oldest, largest home study Radio-TV school . . . our 40 years' experience in training men can be your doorway to success.

## Be a Radio-TV Technician

Radio-Television is America's fast growing industry. That's why it has special appeal to ambitious men not satisfied with their job and earnings. 4,000 Radio and TV stations on the air. 150 million home radios, 40 million TV sets. Plan now to get into Radio-TV. NRI can supply training quickly. Keep your job while learning. Soon after enrolling many students start to earn \$10, \$15 a week extra in spare time fixing sets for neighbors, pay for their course this way. Multi-tester you build helps make spare time earning.

### NRI Sends You Equipment for Practical Experience

NRI training is learn-by-doing. You get easy to understand lessons. NRI sends you kits of parts to build equipment for practical experience. Find out now what NRI Radio-TV Servicing or Communications training offers you. Check and mail the coupon below.



## Fix Electrical Appliances

Electric Appliance Repair offers you good pay, SECURITY. Every wired home averages 8 electrical appliances. Up to 10 million more sold every year. Owners pay well to keep them in repair. Train now to earn more in a good job or step up your income with a business of your own. As an Appliance Service Technician your opportunities are broad — your services wanted, highly regarded in your community.

### Start Soon to Make \$10 to \$15 a Week Extra in Your Spare Time

NRI training is practical, thorough. NRI supplies parts to build professional type Multi-tester. You can use it to earn extra money fixing appliances soon after starting course. Find out today about NRI Electric Appliance Service Training. Cost of course is low. Easy terms. NATIONAL RADIO INSTITUTE, Dept. 8CA, Washington 16, D.C.



## Sample Lesson and Catalog FREE

NATIONAL RADIO INSTITUTE, Dept. 8CA, Washington 16, D.C.

(CHECK ONE PLEASE—NO SALESMAN WILL CALL)

**Radio-Television**—Please send me FREE Sample Lesson and 64 Page Catalog on Radio-Television Servicing and Communications.

**Electric Appliance**—Please send me FREE Sample Lesson and Catalog on your Electric Appliance Servicing Training.

Name \_\_\_\_\_ Age \_\_\_\_\_ Address \_\_\_\_\_

City \_\_\_\_\_ Zone \_\_\_\_\_ State \_\_\_\_\_

ACCREDITED MEMBER, NATIONAL HOME STUDY COUNCIL





# YOU CAN SUCCEED IN BUSINESS THROUGH SPARE TIME HOME TRAINING

A better position—a higher salary—can be yours IF you can do the work. Business is always willing to pay the man who knows—and pay him well.

You don't have to be satisfied with a mediocre job at low pay when in your spare time at home you can quickly, and without interference with your present work, prepare for a brighter and happier future.

For nearly 50 years ambitious men and women have turned to LaSalle for greater ability and larger success. So decide today to take the first step to better your own future.

Check the career of your choice in the coupon below and we'll send you by return mail, without obligation, full information on that field—the opportunities, and what you must know to be successful.

You can win Success if you train for Success.

Mail the Coupon Today

## LASALLE EXTENSION UNIVERSITY A Correspondence Institution

417 So. Dearborn St. Dept. 364R, Chicago 5, Ill.

Please send me, without obligation, full information on the field I have checked below:

- LASALLE ACCOUNTING:** Training for position as Accountant, Auditor, Controller, Cost Accountant, Public Accountant, etc.
- LAW:** Training in Law as a foundation for business or professional success. Degree of LL.B.
- TRAFFIC & TRANSPORTATION:** Training for position as Motor Truck or Industrial Traffic Manager, Railroad; Rate Expert, Freight Solicitor, etc.
- CPA TRAINING:** Advanced training in preparation for the Uniform CPA examination.
- BUSINESS MANAGEMENT:** Training for Managerial, Sales and Department Executive positions.
- STENOTYPE:** Training for position as Stenographer, Secretary or Executive Secretary using Stenotype Machine.
- STENOGRAPHIC-SECRETARIAL:** Training for position as Stenographer, Secretary or Executive Secretary using Gregg Shorthand System.

Name.....Age.....

Address.....

City, Zone & State.....



## Manufacturing Rights Now Available in 427 Territories

CaviteX offers building owners the ultimate in masonry at sensationally low costs. Designed in line with today's architecture. Long and low. Large color range. Modular in all dimensions. Strong—safe—enduring. Suited to all types of wall construction—8" solid, cavity, partition, veneer.

As a local manufacturing opportunity, CaviteX has tremendous potentials. Local materials are processed by local labor for local consumption. Vast economies effected. That's why CaviteX has price-appeal to buyers and profit-appeal to producers. Hundreds of territories are open.



CaviteX manufacturers operate in franchise-protected territories and with exclusive privileges. Extensive sponsor cooperation. Basic machinery available on 5-year-payment plan. Write or wire for book "Opportunity, Unlimited" and tentative reservation of territory.

W. E. DUNN MFG. CO.  
409 W. 24th St., Holland, Mich.

## FREE OUTFIT STARTS YOU IN BIG MONEY SHOE BUSINESS!

We furnish everything FREE to set you up in your own profitable full or spare time shoe business. Just 3 easy sales a day brings up to \$84 a week EXTRA! Repeat orders mean big, steady profits. No experience or investment needed. You feature over 150 fast-selling styles in dress, sport, work shoes for men, including beautiful Nylon mesh shoes with Air Cushion innersoles. Also special kinds of shoes for different occupations. Amazing range of sizes and widths. Fit customers stores are unable to take care of. Start now by selling to friends, neighbors, relatives. Everyone is your prospect. Send postcard Today for FREE Selling Outfit!



WRITE TODAY!

Mason Shoe Mfg. Co., Dept. A-137, Chippewa Falls, Wis.

## How to Make Money with Simple Cartoons



A book everyone who likes to draw should have. It is free; no obligation. Simply address

FREE BOOK

CARTOONISTS' EXCHANGE  
Dept. 93-D Pleasant Hill, Ohio



## LEFAX TECHNICAL DATA BOOKS POCKET SIZE • LOOSE LEAF

Printed on loose leaf, 6 hole, 6 1/4" x 3 3/4" bond paper, each book contains about 140 pages of technical data, condensed, accurate, essential, for engineer, technical worker, teacher, student, business man

- |                    |                  |                             |                               |
|--------------------|------------------|-----------------------------|-------------------------------|
| Architecture       | Surveying Tables | Machine Design              | Radio                         |
| Home Heating       | Highway Eng'g    | Machinist's Data            | Television & FM               |
| Illumination       | General Math     | Mech. of Materials          | Electricity, AC               |
| Electrician's Data | Math Tables      | Pwr. Trans. Mach.           | Electricity, DC               |
| Builder's Data     | Physics          | Thermo. Tbls. & Charts      | AC Motors and Generators      |
| Lumber Data        | Trig-Log Tables  | Phys. & Thermo-dynamic Data | Conversion Tabl.              |
| Air Conditioning   | Gen'l Chemistry  | Metallurgy                  | Steel Forms                   |
| Building Constr.   | Chemical Tables  | Hydraulics                  | Welding Data                  |
| Reinf. Concrete    | Analytic Chem.   | Metals                      | Transformers, Relays & Motors |
| Piping Data        | Mech'l Drawing   |                             |                               |
| Surveying          |                  |                             |                               |

Write for FREE catalogs (2000 listings). See how helpful LEFAX can be to you. Send \$1.25 book, or \$6 for any five books to  
LEFAX PUBLISHERS, Dept. PM-38, PHILADELPHIA 7, PA.



# INVENTORS

**L**earn how to protect your invention. The U. S. Patent Laws provide that any new and useful art, machine, article of manufacture, or composition of matter, or any new and useful improvement thereof, may be patented if the act of invention is involved. Therefore, every inventor with a valuable invention should take advantage of the Patent Laws and proceed for patent protection in order to safeguard his rights.

A patent gives the inventor the exclusive right to prevent others from making, using, or selling the invention claimed in the patent for a period of seventeen years.

The Patent Laws were enacted for the benefit of the inventor to give him protection for the features of his invention which are patentable. These features must be properly and concisely set forth and claimed in a formal application for patent, in order to comply with the requirements of the Patent Laws. For that reason, unless the inventor is familiar with patent matters, he should engage a competent registered patent attorney or agent to represent him. We are registered to practice before the U. S. Patent Office and are prepared to serve you in the handling of your patent matters.

A specially prepared booklet entitled "Patent Guide for the Inventor", containing detailed information with respect to patent protection and procedure, together with a "Record of Invention" form will be promptly forwarded to you without obligation upon request.

---

**CLARENCE A. O'BRIEN & HARVEY JACOBSON**

*Registered Patent Attorneys*

**81-C DISTRICT NATIONAL BUILDING**

**WASHINGTON 5, D. C.**



# OPTICAL BARGAINS

## 3" ASTRONOMICAL REFLECTING TELESCOPE

(Famous Mt. Palomar type)

See the Stars, Moon, Planets Close Up!  
60 & 120 Power — An Unusual Buy!

Assembled and Ready to Use! You'll see the Rings of Saturn, the fascinating planet Mars, huge craters on the Moon. Aluminized and overcoated 3" diameter high-speed 1/10 astronomical mirror. Telescope comes equipped with a 60X eyepiece and a mounted Barlow Lens, giving you 60 & 120 power. Optical Finder Telescope, included. Sturdy, hardwood, portable tripod. Free with scope: Valuable STAR CHART and 272 page "Astronomy Book." Stock No. 85,050-H. . . . \$29.50 f.o.b. (Shipping wt. 10 lbs.) Barrington, N. J.

Be Ready to See Rockets Land on the Moon!  
Order an EDMUND TELESCOPE NOW!

## 4 1/4" ASTRONOMICAL TELESCOPE

Mt. Palomar type! Up to 270 Power. A fine Reflector Telescope complete with real Equatorial Mount and Tripod and 6X Finder. Aluminum tube, 4 1/4" dia. mirror, rack and pinion focusing eye-piece holder, 2 eyepieces and mounted Barlow Lens for 40X, 60X, 120X and 270X. Shipping weight approx. 25 lbs. Stock No. 85,006-H . . . complete. \$74.50 f.o.b. Barrington, N. J.

## MAKE YOUR OWN ASTRONOMICAL TELESCOPE

See December, 1957 issue of POPULAR MECHANICS—Pages 188-192. 4 1/4" MIRROR KIT—Contains ready-to-use 4 1/4" diameter concave, aluminized objective mirror, lenses for 1" focal length eyepiece, and aluminized first surface diagonal mirror.

Order Stock No. 50,074-H . . . . .	Price
4 1/4" Mirror only — . . . . .	\$16.25 postpaid
Stock No. 50,051-H . . . . .	\$15.00 postpaid

We have additional eyepieces, tubes, tripods, in fact everything you need to build telescopes.

## New! 2 in 1 Combination! Pocket-Size

### 50 Power MICROSCOPE and 10 Power TELESCOPE

Useful Telescope and Microscope combined in one amazing, precision instrument. Imported! No larger than a fountain pen. Telescope is 10 Power. Microscope magnifies 50 Times. Sharp focus at any range. Handy for sports, looking at small objects, just plain snooping. Send Check or M.O. Satisfaction Guaranteed. Order Stock No. 30,059-H. . . . \$4.50 Postpd.

## REAL 150 POWER ASTRONOMICAL TELESCOPE

ONLY \$16.95 Postpaid

Reflector type! Clear, razor-sharp viewing of stars, planets, craters on moon, etc. 32mm achromatic objective lens! First surface mirror diagonal lends "stoop" viewing. Removable eye-piece—interchangeable. 50, 75, and 150 power! Tube length 27 1/2".

Special attachment clamp for vibration-free viewing. Money back guarantee. Included free: 273 page "Handbook of the Heavens", Star Chart and 16 page Star Booklet. Stock No. 80,080-H. . . . \$16.95 Postpaid

Larger 42mm objective model—67, 100, 200 power—same features as above, with 38" tube length—Included free: "Handbook of the Heavens", Star Chart and 16 page Star Booklet. Stock No. 80,061-H. . . . \$19.95 Postpaid

## See The Satellites

### NEW, LOW PRICE "SATELLITER" TELESCOPE

Get ready for a terrific sky show as more Satellites are vaulted into space. See thrilling sights with our amazing Satellite Scope at unheard of low cost. Also view comets—use as a Richfield Scope for viewing star clusters, 5 power—wide 12° field. Use of high quality war surplus optics makes possible this bargain. Stock No. 70,150-H. . . . \$9.95 Postpaid

We are the mfr. of the Famous "Moonwatch" Satellite Telescope!

## BUILD A SOLAR ENERGY FURNACE

A fascinating new field. Build your own Solar Furnace for experimentation—many practical uses. Easy! Inexpensive! We furnish instructions. This sun powered furnace will generate terrific heat—2000° to 3000°. Fuses enamel to metal. Sets paper aflame in seconds. Use our Fresnel Lens—1 1/4" diameter . . . f.l. 14". Stock No. 70,130-H—package of 1 . . . . \$ 6.00 Postpd.

## INFRARED SNIPERSCOPE TELESCOPE & PARTS

See in the dark—without being observed. War Surplus Sniperscope M-2, Gov't. cost about \$1200. Instrument complete, ready to use. Includes Power Pack, Infrared light source. Will operate from 6 V auto battery. Battery or transformer available. Stock No. 85,053-H. . . \$150.00 f.o.b.

Save still more money! Build your own Sniperscope! We will furnish instructions—parts, including: Power Packs, 1P25A image tubes, light units, filters, etc. For details—request FREE Catalog "H."

## WRITE FOR FREE CATALOG "H"!

Complete Line of Astronomical Telescope Parts and Assembled Telescopes. Also huge selection of lenses, prisms, war surplus optical instruments, parts and accessories. Telescopes, microscopes, satellite telescopes, binoculars, etc. Request Catalog "H"!

ORDER BY STOCK NUMBER. SEND CHECK OR MONEY ORDER. SATISFACTION GUARANTEED!  
**EDMUND SCIENTIFIC CO., BARRINGTON, N. J.**

# Would YOU Like to Make \$1,000 A MONTH?

That's what Stanley Hyman made selling the amazing new **PRESTO Fire Extinguisher!**



Amazing new kind of fire extinguisher. Tiny "Presto" does job of bulky extinguishers that cost 4 times as much, are 8 times as heavy. Ends fires fast as 2 seconds. Fits in palm of hand. Never corrodes. Guaranteed for 20 years! Sells for only \$4.95! Over Two Million Sold!



Show it to civil defense **STANLEY HYMAN** workers, owners of homes, cars, boats, farms, etc. and to stores for resale—make good income. H. J. Kerr reported \$20 a day. C. Kama, \$1,000 a month. Write for FREE Sales Kit. No obligation. **MERLITE INDUSTRIES, Dept. P-156** 114 East 32nd Street, New York 16, New York IN CANADA: Mopa Co., Ltd., 371 Dowd Street, Montreal 1, P. Q.

## REFILLS 13 for \$1

Value 49c Each

(\$1.79 Value Each)

To Fit Every Retractable Pen

Made, including: "Scripto" "Eversharp" "Paper Mate" "Sheaffer" "Waterman" "Wearver." Over 200 others (except Parker Jotter)

One make per \$1 order. Choice of Red, Blue, Black, Green or Brown Ink.



Retractable

## PENS

6 for \$1  
100 for \$16.50

Choice of Red, Blue, Black or Green Ink! Add 10c shipping charge. Money back guarantee. Quantity and imprint prices on request.

## BARCLAY DISTRIBUTORS

DEPT. 59-C

86-24 PARSONS BLVD.

JAMAICA, N. Y.

## LEARN MEAT CUTTING



Train quickly in 8 short weeks at Toledo for a bright future with security in the vital meat business. Big pay, full-time jobs—HAVE A PROFITABLE MARKET OF YOUR OWN! Pay after graduation. Diploma given. Job help. Thousands of successful graduates. Our 35th year! Send NOW for FREE catalog. No obligation. GI approved. NATIONAL SCHOOL OF MEAT CUTTING, Dept. 50-B, Toledo 4, Ohio

## SAVE \$10.00



NORELCO "Speedshaver" Men's Electric Shaver. Latest model, brand new and fully guaranteed.

Complete with case, cord and cleaning brush. Regularly retails at \$24.95.

Our price \$14.95 postage pd. All orders filled within 24 hrs. Your money back if you are not fully satisfied. Send check or M.O. to:

JOHN BROOKS, Dept. 945, Box 212, St. Louis 3, Mo.

## Gypsy Bait Oil MAKES FISH BITE OR NO COST

Mysterious aroma of Gypsy Fish Bait Oil Compound makes smell feeding fish wild through thousands of small organs covering their bodies. One potent drop on artificial or live bait draws in fresh or salt water whether you still fish with pole, cast, spin or troll. Really works. Only \$1.98 (3 for \$4.98). Cash orders postpaid. If C.O.D. postage extra. Draws fish to your bait or money back. FREE. Handy large water resistant pouch with every bottle. Order from:



**WALLING KEITH CHEMICALS, Inc.**  
Dept. 49-C Birmingham 1, Alabama



# GOOD NEWS for men who need GOOD JOBS!

R. C. ANDERSON,  
President  
COMMERCIAL TRADES  
INSTITUTE

## BE A TRAINED MECHANIC IN AIR CONDITIONING AND REFRIGERATION

Why let the high cost of living get you down when there's such good money to be made in the Air Conditioning and Refrigeration field! Yes, this old, established, but fast-growing industry *needs thousands of trained mechanics* to install, repair and service the 150 million refrigeration units in use today. And the industry is growing! Last year, over 3 million refrigerators, 1 million freezers and 2 million air conditioners were sold. Small wonder there's a shortage of trained men! And those who *are* in the field earn top wages, work steady, put money in the bank!

Train at home in spare time for a better job in this uncrowded industry. For complete information, fill out and mail coupon. Do this today.

**23**  
BIG KITS  
to build  
AIR CONDITIONER  
REFRIGERATOR  
FREEZER or  
MILK COOLER

**Great new way to learn  
by practicing at home  
with real equipment!**

At left, Mr. Anderson demonstrates the commercial type, heavy-duty, 1/4 h.p. refrigeration high-side which you build as part of your training.

### You get sound experience by training with CTI kits

Why leave home or give up your job to attend a resident school? Train at home in spare time! CTI sends you easy-to-understand instruction and 23 training kits. You get all parts and tools to build a 1/4 h.p. refrigeration condenser. You do 10 service and trouble-shooting jobs—build a freezer, refrigerator, air conditioner or milk cooler. You get practical training—intensive experience. (Two of the 23 kits are shown at left.) Act now: Mail coupon! No obligation.



### Many students earn cash as they train

Many students, soon after they start training, do repairing in spare time. They work with local dealers evenings and week-ends. Others go "on their own." They earn extra cash, get added experience. Some land full-time jobs while students, and quite a number open shops. All this is possible because CTI training is so practical.

### An opportunity for a business of your own!

Students often build up a list of customers which includes not just homes, but office buildings, shops, food stores and industrial plants. They contract to do servicing on a fee basis, or simply answer calls. The Air Conditioning and Refrigeration field offers plenty of opportunity for independence. Own a shop—Be the boss!



### COMMERCIAL TRADES INSTITUTE

1400 GREENLEAF AVENUE DEPT. R-461  
CHICAGO 26, ILLINOIS

Rush me your booklet, Success in Air Conditioning & Refrigeration, and Sample Lesson. Both FREE.

Name \_\_\_\_\_ Age \_\_\_\_\_

Address \_\_\_\_\_

City \_\_\_\_\_ Zone \_\_\_\_\_ State \_\_\_\_\_



**MAIL COUPON TODAY FOR 2 FREE BOOKS**

"TRAINING YOU CAN TRUST"



# DRAFTSMEN



**CASH BIG  
PAY CHECKS!**

Train Now for  
more success,  
greater security

**LEARN AT HOME IN SPARE TIME**  
(or at college in Chicago)

Check the want ads in any newspaper—SEE the big-pay opportunities open to you as a draftsman. What's more, you can learn this well-paid, prestige profession at home—quickly, easily! No special talent needed. Get complete, step-by-step Chicago Tech lessons in the mail, spend a few pleasant hours studying each week. In a short time you'll be a well-trained draftsman, ready to take your pick of many good jobs. Act now!



**Free Information—Mail Coupon Today!**

Get **FREE TRIAL LESSON** plus information about C.T.C. practical training. Learn what successful Chicago Tech graduates say about high pay and opportunities in drafting. No charge, or obligation.

## CHICAGO TECHNICAL COLLEGE

C-216 Tech Bldg., 2000 So. Michigan Ave.  
Chicago 16, Illinois

Mail me **FREE** lesson with facts about big opportunities in **DRAFTING**.

Name \_\_\_\_\_ Age \_\_\_\_\_

Address \_\_\_\_\_

City \_\_\_\_\_ Zone \_\_\_\_\_ State \_\_\_\_\_

## LET US TEACH YOU TO Mount Birds



**Animals, Fish, Heads; to TAN. Hunters, Trappers, be a Taxidermist.** Let this old reliable school teach you—at home, in spare time. Our school has over 300,000 students. Save your fine trophies. Mount and keep ducks, deer, ALL wild-game. Tan skins, make robes and rugs, double your interest in **HUNTING AND FISHING**. Have a home museum.

### Free Book

Yes, **FREE**, this great strange book, with 100 fine wild-game pictures. Tells how **YOU** can become a real **TAXIDERMIST**, easily and quickly. It is amazing, thrilling, and may bring you a lifetime of **PLEASURE and PROFIT**. **SPORTSMEN**, grasp this opportunity. **SEND NOW**. A postal will do. But **WRITE TODAY**—don't fail. State your age.

**N. W. SCHOOL OF TAXIDERMIST**  
DEPT. 2503, OMAHA 2, NEBR., U. S. A.



## ROOT YOUR OWN CUTTINGS IN SAND

in a box, greenhouse, or hotbed. Scientific Instructions copyrighted, \$1.00. It is easy in an amazingly short time to root cuttings of Camellias, Azaleas, Gardenias, Roses, Evergreens and other plants in sand, any time of the year, with our Instructions. This information cost us thousands of dollars, and years of experience and costs you only \$1.00 Postpaid.

**SPURGEON PICKERING** DEPT. PMB-3,  
BILOXI, MISS.

## TELEPHONES

and ALL SUPPLIES

Room to room, house to garage, private telephone service.

**HANDSET CRADLE TELEPHONES** (2) Complete outfit with 100' wire, 2 dry cells, instructions. \$14.95

**WORM HARVESTER**—Dan Mac Magneto—gathers fish-worms by electricity. Complete with instructions. \$6.50

**FREE** illustrated bulletin



**TELEPHONE REPAIR & SUPPLY CO.**  
Dept. AA-113 1760 Lunt Ave., Chicago 26, Ill.

## LEARN PLASTICS



**COMPLETE LOW COST SHOP METHOD HOME TRAINING NOW AVAILABLE**

Get in on Big Money opportunities in Plastic molding, casting, forming, carving, etc. Earn as you learn with Interstate's professionally prepared course. All plastic materials furnished.

**WRITE FOR  
FREE  
BOOKLET**

**INTERSTATE TRAINING SERVICE**

DEPT. C-3, PORTLAND 13, OREGON

Better Than  
Your Own

**SHOE STORE  
AT HOME**



**Two-  
Eyelet  
Hit With  
Cushioned  
Comfort**

No investment, no experience needed. Just show magic cushion comfort to friends, neighbors, co-workers. Advance commissions to \$4.00 a pair, plus Cash Bonus, Paid Vacation, \$25.00 Reward Offer. Outstanding values for men, women, children. Money back guarantee. Shoe samples supplied without cost. Write **TODAY** for **FREE** new 84 page catalog and full details.

**TANNERS SHOE CO., 659 BROCKTON, MASS.**

## FALSE TEETH That Loosen Need Not Embarrass

Many wearers of false teeth have suffered real embarrassment because their plate dropped, slipped or wobbled at just the wrong time. Do not live in fear of this happening to you. Just sprinkle a little **FASTEETH**, the alkaline (non-acid) powder, on your plates. Holds false teeth more firmly, so they feel more comfortable. Does not sour. Checks "plate odor" (denture breath). Get **FASTEETH** at drug counters everywhere.



# INVENTORS

If you believe that you have an invention, you should find out how to protect it. The first step is to have a search made of the prior pertinent U. S. patents. If a report on this search indicates that the invention appears patentable you can apply for a patent, and the specifications and claims should be prepared.

The firm of McMorrow, Berman & Davidson, with offices in Washington, D. C., is qualified to take the necessary steps for you. We can make a preliminary search on your invention, advise you whether we think it can be patented, and prepare your application for patent.

Unless you are fully familiar with the U. S. Patent Laws, we recommend that you engage the services of a Registered Patent Attorney to protect your interests. The patent laws are *your* laws. A patent gives you the right to prevent others from making, using or selling the invention claimed in your patent for a period of 17 years.

Use these patent laws for your protection. Investigate whether your invention can be patented. If you have what you believe to be an invention, we suggest that you have this firm make a search for you.

*Send for a copy of our Patent Booklet entitled "How To Protect Your Invention," containing information about patent protection and patent procedure. Along with this we will also send you an "Invention Record" form, for your use in writing down and sketching details of your invention. We will mail them promptly. No obligation. They are yours for the asking.*

**McMORROW, BERMAN & DAVIDSON**

*Registered Patent Attorneys*

**PATENTS • COPYRIGHTS • PATENTS**

**135-T VICTOR BUILDING, WASHINGTON 1, D. C.**



# Home Operators Take Over Huge Rubber Stamp Profits

Men and Women Everywhere Now Can Start in a Big-Pay Business at Home in Spare Time

The multi-million dollar Rubber Stamp business is now being taken over by small, home operators throughout the U.S. Men and Women who operate this inexpensive machine can turn out large numbers of Rubber Stamps with special wording of all kinds. Material costing only 27c makes a stamp that sells for \$1.80. The machine is easy for anyone to operate. It molds as many as six Rubber Stamps at a time, each with different wording such as names, addresses, notices, stock numbers, prices and other "copy" needed by offices, factories and individuals. At full capacity, it can earn as much as **\$9.20 an hour for the operator!** You don't need experience to get into this big profit business at home. We supply everything, including complete instructions and eight ways to get orders for stamps coming in fast. Start making up to \$9.20 in one hour right away. We'll mail full particulars **FREE** and no salesman will call. Be first in your locality. Rush coupon today to **Rubber Stamp Div., 1512 Jarvis Ave., Dept. R-2-C, Chicago 26, Ill.**



This Little Table Top Machine pays Home Workers up to \$9.20 AN HOUR.

**Rubber Stamp Div., Dept. R-2-C FREE!**  
1512 Jarvis, Chicago 26, Ill.

Please rush full particulars about the little machine that can get me started in the profitable Rubber Stamp business at home in spare time. Everything you send me is **FREE** and no salesman will call.

Name \_\_\_\_\_  
Address \_\_\_\_\_  
City \_\_\_\_\_ Zone \_\_\_\_\_ State \_\_\_\_\_

## FREE! U.S. STAMPS PLUS COMPLETE U.S. CATALOG



**Sensational Get-Acquainted Offer — From World's Largest Stamp Firm! FREE** . . . scarce genuine postage stamp, as illustrated, picturing first U.S.A. (issued in 1847) **PLUS** Big collection of 30 all-different United States-19th century, valuable \$1 stamp, etc. **PLUS** collection beautiful Commemorative including American Revolution, Wild West, 1893 Columbian, many others. **EXTRA:** Big Bargain Catalog of all U.S. Postage issues; other exciting offers; Stamp Collector's Guide. Send 10c to help cover mailing costs. **Mail Coupon Today!**

**H. E. HARRIS & CO.**

4135 Transit Building, Boston 17, Mass.  
Rush my United States stamps and other offers. I enclose 10c for mailing expenses.

Name \_\_\_\_\_  
Address \_\_\_\_\_  
City & State \_\_\_\_\_

## "BE BOSS" of your own \$10,000 A YEAR SHOE BUSINESS!



New Comfort Discovery! "Foot-Shaped" Shoes

**EMPLOYED MEN! START IN YOUR SPARE TIME**

No investment required. Take orders from friends for new Work, Dress and Casual shoes with patented Air Cushion comfort. **Simple 2-finger demonstration makes**



Ordinary Sole is stiff as a board, feet take a beating.



Chester Air Cushion Sole: soft, comfortable, flexible.

**shoe selling a snap. Advance commissions to \$5.00 a pair. Cash bonus. Samples supplied. Write NOW for FREE Outfit. CHARLES CHESTER SHOE CO., Dept. C-583, Brockton, Mass.**

## SAVE GAS, GEARS, TIRES ON YOUR 4-WHEEL DRIVE!



**Stop Front End Drag in 2 W. D.**

Get maximum use of your vehicle with these famous hubs! They "take out" the front end in 2-wheel drive, give your vehicle "pick-up" economy, pep, speed, power, handling ease; stop front end gear whine, shimmy—4-wheel drive as usual, when you need it—automatically, as you shift, with Warn Lock-o-matics, manually with Locking hubs. Models for all makes 4 w.d.s. to 1 1/2 tons at truck dealers everywhere, or write:

WARN MFG. CO., Riverton Box 6064-A3, Seattle 88, Wn.



**WARN HUBS**

## JEEP OWNERS

RE-POWER NOW WITH A V-8 ENGINE — Use

**FORD • CHEVROLET • MERCURY**  
in 2 or 4 Whi-Dr. Jeeps, Jeepsters, Sta-Wgn, Trucks, H. J. and Kaiser cars. Conversion Kits \$43.25 to \$59.85. If you want fast action tell us which engine you wish to use, give us year, Model (2 or 4 Whi-Dr) of your vehicle. Send Min. \$15.00 Dep. and we will ship correct kit, Bal. COD. Send full amt. for Prepaid shipment. Wire, phone or write for free details. Also Kits for FORD 6 engine.

**HOOSIER MACHINE PRODUCTS CO.**

312 S.E. 6th St. Phone CR 6-3442 Pendleton, Oregon, U.S.A.



## HIGH SCHOOL DIPLOMA

Earn a High School Diploma at home! Prepare for better job, more pay. Study in spare time. No classes. Materials furnished. Certified teachers. Valuable diploma awarded.

Write Today for Complete Information

**SOUTHERN STATES ACADEMY**  
Box 5344-A Sta. E Atlanta, Georgia

## 10" Slide Rule



**ONLY 98¢** postpaid

**ANYONE WHO UNDERSTANDS SIMPLE 7TH GRADE ARITHMETIC CAN USE THIS STANDARD SLIDE RULE!**

Be modern — use this quick easy way of figuring. For business men, students, carpenters, machinists, salesmen, printers and engravers, office workers, farmers, merchants, time keepers, plumbers, electricians—everyone who does figuring can save time and labor with this slide rule.

**FREE** Illustrated instruction book shows you how to get correct answers instantly without pencil and paper. (You get BOTH slide rule and instruction book for only 98c postpaid. Satisfaction guaranteed or refund.)  
**NELSON-HALL CO., 210 S. Clinton, Dept. CS-2, Chicago 6**



DeVry Tech CAN PREPARE YOU IN SPARE TIME AT HOME...

for a Profitable Future in

# Electronics

as used in

## Guided Missiles

ETC.



**No Previous Technical Experience  
or Advanced Education Needed!**

If you think you need a "pull", advanced education or previous technical experience to prepare for a profitable career in the fast-growing, big opportunity field of Electronics—you're mistaken. The most important thing is a sincere desire to be somebody and to get somewhere.

During the past 27 years we have successfully trained farmers, store clerks, factory hands and men of practically every calling from 17 to 55. If these men can do it in their spare time, why can't you?

Regardless of your experience, we urge you to fill in coupon below for full FREE facts about our modern training that follows the same basic method used in our Chicago and Toronto Laboratories. It will cost you nothing for information that may prove to be the turning point in your career. Act now! Send coupon TODAY!

An **INDEX** to a Better Job,  
a Brighter Future

Communications • Radar • Television

Micro-Waves • Radio • Computers • Indus-

trial Electronics • Automation Electronics

### Draft Age?

We have valuable information for every man of draft age; so if you are subject to military service, be sure to check the coupon.

### Live-Wire Employment Service

DeVry Tech's Placement Department is in contact with some of the best-known employers in the Electronics field. The service is free to all graduates—and DeVry Tech's record in helping to place men has been outstanding.

### FREE BOOKLET!

We'll give you a free copy of an interesting booklet, "Electronics and YOU."

See for yourself how you may take advantage of the opportunities in this fast-growing field.



"One of North America's Foremost Electronics Training Centers"



Accredited Member  
of National  
Home Study Council

**DEVRY TECHNICAL INSTITUTE**

CHICAGO 41, ILLINOIS

FORMERLY

DEFOREST'S TRAINING, INC.



### MAIL COUPON TODAY!

DeVry Technical Institute

4141 Belmont Ave., Chicago 41, Ill., Dept. PM-3-0

Please give me your FREE booklet, "Electronics and YOU," and tell me how I may prepare to enter one or more branches of Electronics as listed above.

Name \_\_\_\_\_ Age \_\_\_\_\_

Please Print

Street \_\_\_\_\_ Apt. \_\_\_\_\_

City \_\_\_\_\_ Zone \_\_\_\_\_ State \_\_\_\_\_

Check here if subject to military training.

DeVry Tech's Canadian Training Center is located  
at 626 Roselawn Avenue, Toronto 12, Ontario

2019



# Just Pick the Kind of Body YOU Want

## CHECK THE COUPON BELOW

... Prove to Yourself How EASILY You Can Have It... Almost Overnight!



body feel "alive!"

### FREE 32-page Illustrated Book

32 pages on how "Dynamic Tension" changed me from a 97-lb. weakling into "World's Most Perfectly Developed Man"—and what it has done for others. Mail coupon NOW! Charles Atlas, Dept. 83, 115 E. 23rd St., N. Y. City 10.



CHARLES ATLAS, Dept. 83, 115 East 23rd St., New York 10, N. Y.

Dear Charles Atlas—Here's the Kind of Body I Want:

(Check as many as you like)

- |   |   |
|---|---|
| <input type="checkbox"/> Slimmer Waist, Hips      | <input type="checkbox"/> More Powerful Arms, Grip |
| <input type="checkbox"/> Broader Chest, Shoulders | <input type="checkbox"/> More Powerful Legs       |
| <input type="checkbox"/> More Weight, Solid       | <input type="checkbox"/> Better Energy, Sleep     |

Send me, absolutely FREE, a copy of your famous book showing how "Dynamic Tension" can make me a new man. 32 pages, crammed with photographs, answers to vital questions, and valuable advice. No obligation.

Name \_\_\_\_\_ Age \_\_\_\_\_  
Address \_\_\_\_\_ (Please Print or write plainly)  
City \_\_\_\_\_ State \_\_\_\_\_

## MAKE STRIPES with new PAINT PEN

**Straight, curved, single or double**  
With any color paint, stripe furniture, bikes, autos, model planes, toys, linoleum, wall-board. Clean, crisp decorative lines. Can't clog or smear. Also use with glue, tempera, textile paint or underglaze... on wood, glass plastic, ceramics, metals, fabrics and paper. Ask your dealer or order direct.

**DEALERS** Master paint stripping tool in display carton. Write for discounts.  
**HOBBY** "Professional" results every time. Simple, easy to use. Order now.  
**MFRS** Ask about heavy duty industrial, stripping tools.

**DOUBLE STRIPE MODEL \$3.25**  
**5 COMBINATIONS.**

**WENDELL MFG. CO.** 4234 LINCOLN AVE., Dept. 338 CHICAGO 18, ILLINOIS

## WANT MORE MONEY? GET INTO PHOTOGRAPHY

You can become a skilled photographer by training at home in your spare time! With the NYI Home Study Course, backed by our 50 years experience, you'll learn quickly and easily with our famous Learn-by-Doing Method. You get personal, helpful criticism, advice and loads of ideas from our teaching staff—who are as close to you as your mailbox. Do what hundreds of others are doing—Earn While You Learn! Opportunities are tremendous in Advertising, Portraits, News, Fashion, Commercial, Industrial, Color Photography, Weddings, etc.

No previous experience necessary. Enroll anytime. Big FREE Illustrated Book gives you all the facts and it's yours for the asking. Resident Training (Personal Attendance) is also available in our New York Studios. All Courses Approved for Veterans.

**NEW YORK INSTITUTE OF PHOTOGRAPHY**  
Dept. 49, 10 West 33 Street, New York 1, New York

### INSURED TIRE SERVICE

## POPULAR BRANDS

**SPECIAL!**  
Deduct 10% on orders for two or more used tires

**FREE** INSURANCE POLICY given with each used tire sold. We guarantee the amount of service you pay for.

**NOWHERE CAN SUCH QUALITY BE FOUND AT SUCH LOW PRICE!**

**YOU CAN'T LOSE!**

Super Quality — Rugged Performance — 6 Months Insured Service	
600x16 \$3.65	670x16 \$3.95
650x16 3.85	670x16 4.05
650x16 4.25	700x16 3.95
700x16 4.45	760x16 4.35
700x16 4.65	820x16 4.95
700x16 4.85	850x16 4.65
Supreme Quality — Nothing Finer — 12 Months Insured Service	
600x16 \$5.25	475x19 \$5.45
600x16 (6) 6.75	640x18 4.95
680x16 5.75	670x15 5.35
680x16 (6) 7.25	710x15 5.45
700x16 6.35	760x15 5.95
750x16 (6) 8.45	800x15 6.35
550x18 4.95	820x15 6.35
550x17 4.75	550x15 5.35
650x15 5.25	670x16 5.15
700x15 5.35	700x16 (6) 10.25
700x15 5.35	700x16 (6) 10.25
Whitewalls \$1.00	extra.

**MIDLAND TIRE SALES** Speedy shipments on Mail Orders. F.O.B. Chicago. Insurance policy sent with each order. Deduct 10% on orders for 2 or more used tires. Send CHECK or MONEY ORDER.—No COD's.  
3701 S. Normal, Dept. PM-68, Chicago 9, Ill.

## SEND FOR THIS FREE!

**HOW TO BREAK AND TRAIN HORSES**

Make money. Know how to break and train horses. Write today for this book FREE, together with special offer of a course in Animal Breeding. If you are interested in Gaiting and Riding the saddle horse, check here ( ) Do it today—now.

**BEERY SCHOOL OF HORSEMANSHIP**  
Dept. 1103 Pleasant Hill, Ohio

## LAW FREE BOOK

**THE LAW TRAINED MAN**

Write today for a FREE copy of illustrated law book, "THE LAW TRAINED MAN," which shows how to earn the professional Bachelor of Laws (LL.B.) degree through home study of the famous Blackstone Law Course. All necessary books and lessons provided. Moderate cost; convenient monthly terms. Write for FREE law training book today.

**Blackstone School of Law, 307 N. Michigan Ave.**  
Founded 1890 Dept. 53, Chicago 1, Illinois

## MECHANICAL DENTISTRY

To make Crowns, Plates, Bridgework, etc., for Dentists. Easy practical way to learn mechanical dentistry at home in spare time. FULL EQUIPMENT OF TOOLS AND MATERIALS INCLUDED WITH COURSE. Low tuition. Easy terms. Write for FREE BOOK about this money making profession that is not affected by machine age.

**MCCARRIE SCHOOL OF MECHANICAL DENTISTRY**  
207 N. Broad St., Dept. 74, Philadelphia 7, Pa.

## REAL ESTATE BE A BROKER

**FREE BOOK TELLS NOW**

**PAYS BIG! SEND FOR FREE, BIG, ILLUSTRATED CATALOG NOW!** Graduates report making substantial incomes. Start and run your own business quickly. Men, women of all ages, learn easily. Course covers Sales, Property Management, Appraising, Loans, Mortgages, and related subjects. **STUDY AT HOME** or in classrooms in leading cities. Diploma awarded. Write TODAY for free book! No obligation. Approved for World War II and Korean Veterans.

**WEAVER SCHOOL OF REAL ESTATE (Est. 1936)**  
2020R Grand Avenue Kansas City, Mo.

## FREE GERMAN HUNTING KNIFE

**4-INCH BLADE**

We give you handiest hunting and fishing knife you've ever had! Has 4-INCH LONG highly tempered steel blade—VERY SHARP! Attractive handle. We send knife FREE to acquaint you with our below-wholesale bargains. Please send 25c for handling. NO LIMIT—but send 25c handling for each knife. Order TODAY!

**HUNTING KNIFE, Dept. K-298, Box 881, St. Louis, Mo.**

## Learn BAKING At Home

Baking is one of America's high industries in wages. Nearly depression-proof. Thorough basic home course lays sound foundation. If you have aptitude, write for FREE BOOKLET. "Opportunities in Commercial Baking." National Baking School, 835 Diversy Pkwy., Dept. 1353, Chicago 14, Illinois



Get into

# TELEVISION RADIO-ELECTRONICS

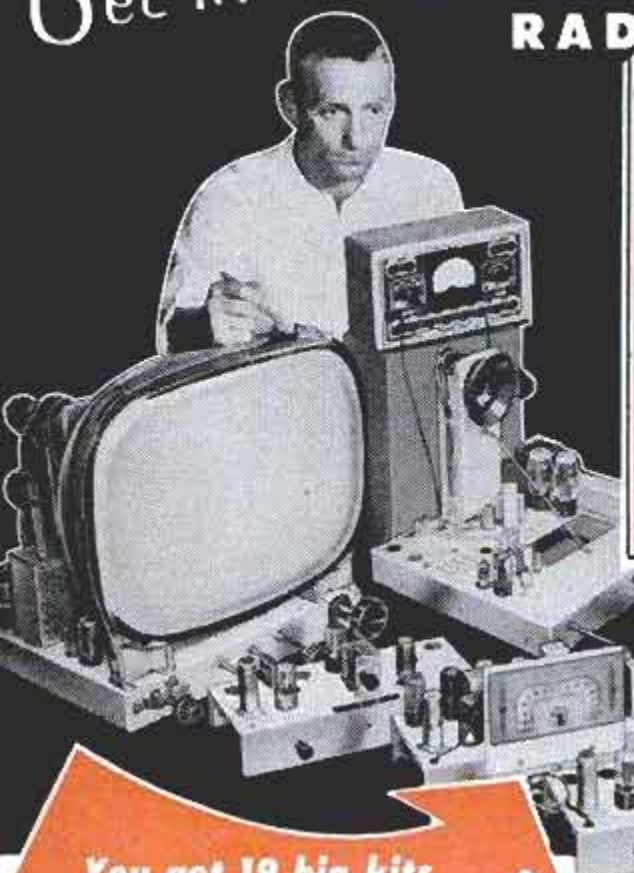

## LEARN ALL 8 PHASES BY SHOP METHOD

1. Television . . . including Color TV
2. Radio . . . AM, FM
3. Industrial Electronics
4. Communications

## OF THE INDUSTRY HOME TRAINING

5. Sound Recording & Hi-Fidelity
6. Automation
7. FCC License Preparation
8. Radar & Micro Waves

Let National Schools of Los Angeles, a Practical Resident Technical School for over 50 years, train you at home by Shop Method for unlimited opportunities in All phases of TV, Electronics, Radio.

You get 19 big kits of equipment!

### GOOD JOBS . . . MORE MONEY SECURITY . . . ALL CAN BE YOURS

YOU are needed in the great modern Television-Electronics industry. Trained technicians are in growing demand, at excellent pay, in sales and service, manufacturing, broadcasting, telecasting, communications, research, and many other important branches of the field. National Schools Master Shop-Method Training, with newly added lessons and equipment prepares you in your spare time right in your own home for these fascinating opportunities. **OUR OUTSTANDING METHOD IS PROVED BY THE SUCCESS OF GRADUATES ALL OVER THE WORLD!**

#### YOUR TRAINING IS ALL INCLUSIVE

We prepare you for a long list of job opportunities. Thousands of TV and Radio receivers are being sold every day—more than ever before. And, now, Color TV is here. Applications of Electronics in industry—**AUTOMATION**—are growing in tremendous strides. The whole field is alive—opening up new, important jobs rapidly. National Schools complete training program qualifies you in all phases of the industry.

#### YOU EARN WHILE YOU LEARN

Many students pay for their entire training—and more—with spare time earning. We'll show you how you can, too! Early in your course you receive material that shows you how to earn extra money servicing TV and Radio receivers, appliances, etc., for friends and acquaintances.

#### YOU GET EVERYTHING YOU NEED

Clear, profusely illustrated lessons, shop-tested manuals, modern circuit diagrams, practical job projects—all the valuable equipment shown above—many other materials and services—consultation privilege with our qualified staff, and Graduate Employment Service. **EVERYTHING YOU NEED** for outstanding success in Electronics.

**INDUSTRY NEEDS YOU. NATIONAL SCHOOLS WILL TRAIN YOU. SEND FOR FACTS TODAY NO OBLIGATION.**

**YOU LEARN BY SHOP METHOD . . .** you do servicing, circuit analysis, and do over 100 down-to-earth experiments. You build a Superhet Receiver and a modern TV Receiver, from the ground up, including a new, big screen picture tube. You also receive a professional, factory-made **MULTI-TESTER**. All of this standard equipment is yours to keep . . . at just one low tuition.

#### RESIDENT TRAINING AT LOS ANGELES

If you wish to take your training in our Resident School at Los Angeles, the world's TV capital, start NOW in our big, modern Shops, Labs and Radio-TV Studios. Here you work with latest Electronic equipment—professionally installed—finest, most complete facilities offered by any school. Expert, friendly instructors. Personal attention. Graduate Employment Service. Help in finding home near school—and part time job while you learn. Check box in coupon for full information.

Approved for  
GI Training

**NATIONAL SCHOOLS**

LOS ANGELES 37, CALIF

FREE!  
VALUABLE BOOK  
& SAMPLE LESSON  
—Just Send  
Coupon!



### NATIONAL SCHOOLS

TECHNICAL TRADE TRAINING SINCE 1905  
LOS ANGELES 37, CALIFORNIA

**GET FAST SERVICE—MAIL NOW TO  
NATIONAL SCHOOLS, DEPT. RB-38  
4000 S. Figueroa St., Los Angeles 37, Calif.**

Rush free TV-Radio "Opportunity" Book and sample lesson. No salesman will call.

NAME \_\_\_\_\_ AGE \_\_\_\_\_

ADDRESS \_\_\_\_\_

CITY \_\_\_\_\_ ZONE \_\_\_\_\_ STATE \_\_\_\_\_

Check if interested ONLY in Resident School training at Los Angeles, VETERANS, O've date of Discharge





Draftsmen earn more, enjoy pleasanter working conditions. Get into DRAFTING and Blue-Printing, the starting point of all production. Trained Draftsmen are needed everywhere. Machines can never replace the draftsman.

### LEARN AT HOME IN SPARE TIME

Revolutionary new method teaches you quickly the hows and whys of Mechanical, Structural, Machine, Architectural, etc. Drafting. You are sent professional drafting instruments, drafting equipment, portable drafting table, etc., at no extra cost. You learn by making actual drawings.

**BIG MONEY... ADVANCEMENT OPPORTUNITIES** offered trained draftsmen. Drafting is light, pleasant work, paying big salaries. Is a stepping stone to top managerial jobs. The draftsman plans the World of Tomorrow. That is why drafting is such interesting work.

### OWN YOUR OWN DRAFTING FIRM

The investment requirement is small, the earning possibilities great. Many draftsmen eventually branch out into manufacturing the products they created. Learn of the opportunities in Drafting.

## MAIL THIS COUPON TODAY!

CHRISTY TRADES SCHOOL, Dept. DB-4003  
4804 N. Kedzie Ave., Chicago 25

Mail at once your big FREE book on Drafting and Blue-Printing. Tell me how your Home Training and Professional Drafting Instruments, Portable Drafting Table, Drafting Equipment, etc. can be had on a PAY AS YOU LEARN plan.

NAME \_\_\_\_\_ Age \_\_\_\_\_

ADDRESS \_\_\_\_\_ CITY \_\_\_\_\_ STATE \_\_\_\_\_

Design and finish to high-lustre own Nickel-Chromium (stainless) steel ring. Bored stock has extra large flat head. Instructions and polishing papers included. State hole size: 1/2" — 9/16" — 5/8" — 11/16" — 3/4" — 13/16". \$1 postpaid. No C.O.D.

SOLAR MASTER PRODUCTS, BOX 94-S, Midland Park, N. J.



## Colorcretors are Needed Everywhere

C-9



More Colorcretors are needed to supply growing demand for the enduring, colorful beauty possible only from Colorcrete. Time-worn concrete, stucco and other old or new masonry walls are quickly transformed into clean freshness from a selection of 30 tints, tones and shades. Cementitious base—tough, tenacious, enduring. Colorcrete is applied under pneumatic air pressure by authorized Colorcretors. Machine is easy to operate and readily mobile. Opens up opportunities for men of modest capital. Broad markets with high income potentials. Write for Opportunity Book.

## COLORCRETE

COLORCRETE INDUSTRIES, INC.  
570 Ottawa Ave., Holland, Mich.

"We Have No Rent to Pay." That is Why We Can Sell For Less.

24 YEARS IN BUSINESS AT THE SAME ADDRESS

**FREE** EVERYBODY MAY DEDUCT 10% off ON EVERY TIRE

EVERYBODY MAY DEDUCT 10% off ON EVERY TIRE

600x16	\$3.62	670x15	\$3.82	700x16	\$4.42	760x16	\$4.72
650x15	3.72	800x15	4.82	710x15	4.32	820x15	4.82
650x16	4.22	700x15	3.85	760x15	4.32	850x17	4.62

12 MOS. WRITTEN GUARANTEE. WHITE WALLS \$1.00 EACH.

600-16	\$5.22	475-19	\$5.32	700-15(6)	\$8.72	700-20	\$11.92
600-16(6)	6.32	640-15	4.92	750-16(8)	9.92	750-20(10)	14.72
650-16	5.42	670-15	5.22	700-17	10.92	750-20(8)	10.92
650-16(6)	6.42	710-15	5.32	750-17	12.92	825-20	18.52
700-16	6.22	760-15	5.42	825-15	15.92	900-20	18.72
750-16(6)	7.42	800-15	5.72	600-20	9.62	1000-20	19.72
850-17	4.82	820-15	5.72	650-20	10.72	1100-20	19.72
850-17	4.72	670-16	5.15	32x6(8)	10.32	1000-22	20.92
850-15	5.22	760-16	7.72	32x6(10)	12.32	1100-24	23.72
700-15	5.32	700-16(6)	7.72	750-15	11.92	1100-22	20.02

Thousands of tires shipped all over the U.S.A. All tires shipped F.O.B. Phila. Send Check or M.O. with this ad. Dept. 2. No C.O.D.

STANDARD 834 N. Broad St., Philadelphia 30, Pa.

## SHORTHAND in 6 WEEKS

Famous SPEEDWRITING shorthand. 120 words per minute. No symbols; no machines; uses ABC's. Easiest to learn, write and transcribe. Lowest cost. For business and Civil Service. 350,000 graduates. Typing available. 35th year. Write for FREE booklet to: SCHOOL OF

6 WEEKS

© 1957

# Speedwriting

Dept. 1503-8, 55 W. 42 St., New York 36

## Learn ACCOUNTING Business Administration

Bookkeeping, secretarial and allied subjects at home in your spare time or attend nationally approved resident school. Write for FREE Success Book giving complete details on courses, plans, rates and employment opportunities. O.I. approved. Write Dept. A.

**Hills BUSINESS UNIVERSITY AND EXTENSION SCHOOL**  
619 W. MAIN ST. OKLAHOMA CITY 2, OKLAHOMA

## Now! TEST YOUR OWN TV & RADIO TUBES

ALL OF THEM—EVEN PICTURE TUBE

Nearly half of TV service calls are due to defective filaments. Tester shows if filaments are good. Insert tube in tester. Light shows if tube is burned out. Easy, safe. One service call saved pays for tester. Metal case. AC or DC. Checks fuses, appliances, etc. Only \$3.95 ppd. or C.O.D. plus charges. Deluxe Model \$4.95. Instructions. Guaranteed.

GEIGER ENGINEERING CORP., Dept. AB-107  
3738 West Lawrence Avenue, Chicago 28, Ill.

## Hotels Call for Trained Men

Record-breaking travel means nation-wide opportunities and a sound substantial future for trained men in hotels, motels, clubs, apartment house positions. Fascinating field; fine living; quick advancement. You can qualify at home or through resident classes in Washington. Previous experience proved unnecessary. Placement Service FREE. Write for FREE Book. Course approved for ALL Veteran Training. 42nd Year. LEWIS HOTEL TRAINING SCHOOL, Room DC-312, Wash. 7, D.C.

## RUPTURED

### BE FREE FROM TRUSS SLAVERY

Now there is a new modern Non-Surgical treatment designed to permanently correct rupture. These Non-Surgical treatments are so certain, that a Lifetime Certificate of Assurance is given.

Write today for our New FREE Book that gives facts that may save you painful and expensive surgery, and tells how non-surgically you may again work, live, play and love and enjoy life in the manner you desire. There is no obligation. Excelsior Hernia Clinic, Dept. 8305, Excelsior Spgs., Mo.



COVERS ALL THESE MAKES  
— ALL MODELS, 1949 THRU 1958

Buick	De Soto	Jaguar	Plymouth
Cadillac	Dodge	Lincain	Pontiac
Chevrolet	Edsel	Mercury	Rambler
Chrysler	Ford	Nash	Studebaker
Clipper	Hudson	Oldsmobile	Thunderbird
Continental	Imperial	Peckard	Willlys

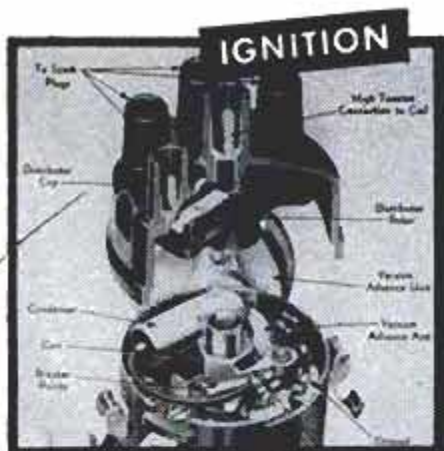

Clear photos, cutaway drawings and diagrams, plus know-how directions make every part of any ignition system crystal-clear.

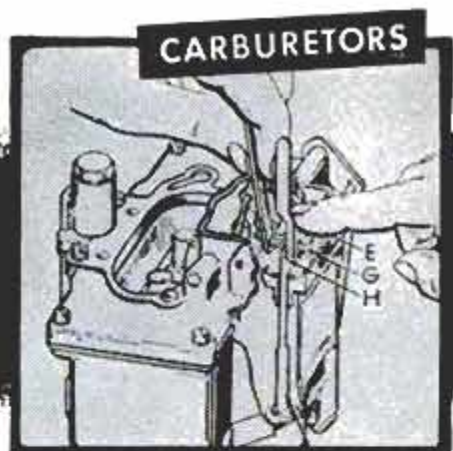

No more guesswork. You get illustrated, step-by-step procedures for all types of carburetors.

# Let Factory Experts Show You HOW TO FIX ANY PART OF ANY CAR

OVER 2 1/2 MILLION COPIES SOLD!  
USED BY U.S. ARMED FORCES

**This Famous "Auto Repair Bible" Turns Beginner Mechanics Into Experts—Saves Experts Time, Trouble, Money**

**S**UPPOSE crews of trained factory experts were ready to guide your hands as you start to fix any part of any car. If they told you **EXACTLY WHAT TO DO**, couldn't you "wrap up" any repair job—quickly, easily, right? That's exactly the kind of expert guidance you get in **MOTOR'S** new **AUTO REPAIR MANUAL!**

**YOU CAN'T GO WRONG!**

With clear illustrations and step-by-step instructions, these experts show you how to "breeze through" any job on any car listed—1949 thru 1958. Even if you're a beginner, this famous Manual can show you how to fix cars the way the **EXPERTS** do. Tells you **WHERE** to start, what **TOOLS** to use, guides you every **STEP** of the way!

You get practical how-to-do-it procedures—worked out by **AUTOMOTIVE ENGINEERS**—from 176 official Shop Manuals, hundreds of factory bulletins, boiled down in simple, easy-to-follow language. Over **ONE THOUSAND** giant pages, 2,900 "This-is-How" pictures. 291 Quick-Check Charts—23,436 essential repair specifications. Over 225,000 service and repair facts. Instructions and pictures are so clear you can't go wrong!

**3 BOOKS IN 1**

You actually get three complete "show-how" books in one giant handy, indexed volume:

**1. Complete TROUBLE-SHOOTER SECTION** spots more than 2,300 car troubles, helps you find the "bugs" fast.

**2. HOW TO SERVICE, REPAIR ALL CAR PARTS**—Transmissions, Air Suspension Systems, Rear Ends, Generators and Regulators, Fuel Pumps, Ignition Systems, Overdrives, Automatic Transmissions, Brakes, Rings, Water Pumps, Distributors, Dash Gauges, Power Steering, Power Brakes, etc., etc.

**3. STEP-BY-STEP INSTRUCTIONS AND PICTURES** on each specific car make and model—covers over 600 car models—1949 thru 1958.

**PLUS** Factory Specifications and Adjustment Tables, Tune-up Charts, Overhauling and Replacement facts—and **MUCH MORE!** Used by Armed Forces, hundreds of thousands of auto service men.

**TRY BOOK FREE 7 DAYS**

Send no money! Just mail coupon (paste it to a postal card if you prefer). Use Manual for a week, free. Unless you agree that it is the greatest time and money-saver you've ever seen, return it in 7 days—and you won't owe a cent! Mail coupon today! Address: **MOTOR Book Dept., Desk 1C, 250 West 55th St., New York 19, N. Y. (SCHOOLS, BOOKSTORES: Write for discounts.)**



**FREE 7-DAY TRIAL**  
Return and Pay Nothing if Not Delighted

**MAIL COUPON NOW FOR 7-DAY FREE TRIAL**  
(Attach to postcard if more convenient)

**MOTOR BOOK DEPT.,**  
Desk 1C, 250 W. 55th St., New York 19, N. Y.

Rush to me at once (check box opposite book you want):

**MOTOR'S** New **AUTO REPAIR MANUAL**. If O.K., I will remit \$2 in 7 days, \$2 monthly for 2 months and a final payment of \$1.95 (plus 35c delivery charges) one month after that. Otherwise I will return the book postpaid in 7 days. (Foreign price, remit \$10 cash with order.)

**MOTOR'S** New **TRUCK REPAIR MANUAL**. If O.K., I will remit \$3 in 7 days, and \$3 monthly for 3 months, plus 35c delivery charges with final payment. Otherwise I will return book postpaid in 7 days. (Foreign price, remit \$11 cash with order.)

Print Name \_\_\_\_\_ Age \_\_\_\_\_

Address \_\_\_\_\_

City \_\_\_\_\_ State \_\_\_\_\_

Check box and save 35c shipping charge by enclosing **WITH** coupon in envelope entire payment of \$1.95 for **Auto Repair Manual** (or \$9 for **Truck Repair Manual**). Same 7-day return-refund privilege applies.

**Same FREE 7-Day Offer on MOTOR'S Brand-New TRUCK REPAIR MANUAL**

Covers **EVERY** job on **EVERY** gasoline-powered truck made since 1949—**PLUS** GM and Cummins Diesels. Over 2,000 illustrations; over 300,000 facts. Check proper box in coupon for **FREE 7-DAY TRIAL**.

**Amazed Self and Friends—**  
"I amazed myself and my friends, too. Now do jobs that stumped me before."—Michael Balicky, Newark, N. J.



**So Complete and Easy to Understand —** "So complete, easy to understand—have done jobs with Manual I would not have attempted without it."—C. L. Vanerstrom, Mich.







# BE YOUR OWN MUSIC TEACHER

Send for Free Book Telling How Easily You Can Learn Piano, Guitar, Accordion, ANY Instrument This EASY A-B-C Way



Now IT'S EASY to learn music at home. No tiresome "exercises." No teacher; just START RIGHT OUT playing simple pieces. Thousands now play who never thought they could. Our pictured lessons make it easy as A-B-C to learn to play popular music, hymns, classical, and any other music. Low Cost. Over 900,000 students including TV Star Lawrence Welk. (Our 60th year.)

### Mail Coupon for FREE BOOK

Find out why our method can teach you quickly, easily, inexpensively. Write for Book. No obligation. No salesman will call. Mention your favorite instrument. Mail coupon today.

U. S. SCHOOL OF MUSIC  
Studio 303,  
Port Washington, N. Y.

**FREE BOOK**



U. S. SCHOOL OF MUSIC, Studio 303, Port Washington, N. Y.

Please send me Free 36-page illustrated Book. I would like to play (Name instrument).

Instrument \_\_\_\_\_ Have you Instrument? \_\_\_\_\_

Name \_\_\_\_\_ (Please Print)

Address \_\_\_\_\_

## NEVER AT THIS LOW PRICE! GENUINE 135-POWER ACHROMATIC TELESCOPE

with Achromatic Lens and  
4-POWER FINDER attached  
**ONLY \$18.95**  
PREPAID



### EXTRA BONUS GIFTS:

- 273 page book, "Handbook of the Heavens"
- Magic Star Finder Dial
- 220X & 400X Eyepiece lenses

**5 Magnifications 18X-35X-65X-85X-135X**  
Brings the Moon, Planets, Stars, Satellites, People  
135 times Closer, Clearer, Sharper

Never before has an ACHROMATIC 135X telescope with range finder and tripod sold for anywhere near this amazing low price! Now you can not only explore the heavens and bring the moon, planets, stars, satellites 135 times closer, but you can observe all distant objects, people, ships too, because all pictures are erect, not upside down as in all astronomical telescopes. The kind of needle-sharp color-free viewing only a genuine achromatic lens can bring you. Ready for immediate use. 5 precision lenses bring you viewing at 18X-35X-65X-85X-135X. Tubes extend to 43" made of bakelite, finished in camera bellows black, trimmed with gleaming brass. 4 power finder scope (30mm Lens) mounted on main tube is feature usually found on more expensive telescopes—brings difficult objects on target before observing with main scope. For extra stability 5 ft. hardwood folding tripod is equipped with heavy cast iron head fitted with Criterion's famous 360 degree all aluminum mount that locks instantly in any position. Obtainable only from Criterion Co. shipped prepaid. 4 famous gifts—273 page book "Handbook of the Heavens," Magic star finder dial that aids in locating stars ANYWHERE at ANYTIME of the year. 220X & 400X eyepiece lenses included free for experiments. You must be completely satisfied with this super offer or your money back in full. Shipped Complete, nothing else to buy at amazingly low price of \$18.95. Without tripod \$14.95. Send Cash, Check, or Money Order today

Dept. PMA22, CRITERION CO., 331 Church St., Hartford, Conn.

## Get Your First Class Commercial F. C. C. LICENSE

The key to better jobs and higher pay in electronics is a 1st class commercial (not amateur) F.C.C. license—Federal Gov't evidence of your qualifications as an operator-technician. We train you quickly—by mail or in resident classes. Get your 1st class F.C.C. license in 12 weeks—NO previous training necessary. Our schools are located in Hollywood and Washington. Write to the school nearest you for our FREE booklet of details.

GRANTHAM SCHOOL OF ELECTRONICS, Desk 87-C  
1505 N. Western Ave. OR 821-19th Street, N.W.  
Hollywood 27, Calif. Washington 6, D.C.



## WORLD'S LOWEST PRICED ADDING MACHINE

Counts up to 999,999,999  
IDEAL FOR BUSINESS AND PERSONAL USE—GUARANTEED ACCURATE.  
Not a toy. Operates with only a finger flick. Adds, subtracts, multiplies, divides. Counts up to one billion. Pays for itself over and over. Ideal Gift—for Business, Income Tax and School use. MONEY BACK GUARANTEE. Send name and address. Pay postman only \$2.95 plus postage. Beautiful rich-looking Leatherette Case included at no extra cost. Money back in 10 days if not delighted. AGENTS WANTED.

CALCULATOR MACHINE COMPANY  
P.O. Box 126, Dept. M-81, Huntingdon Valley, Penna.

## FREE Details write today MAIL ORDER Opportunity!

**START FROM HOME... SPARE TIME**  
We want a limited number of intelligent men and women to work at home on an exclusive mail order business proposition. No selling—we furnish everything including literature, names, addresses, stock and ship items for you. All you do is mail for us and receive money coming to your own mail box. write: MAIL ORDER DISTRIBUTORS (Franchise Division)

15201 South Broadway Dept. A-3, Los Angeles 61, Calif.



## FIX home & car APPLIANCES YOURSELF NEW! EICO READI-TESTER KIT \$12.95 Factory-wired \$15.95

All-in-one MULTI-RANGE ac/dc voltmeter, ammeter, ohmmeter, wattmeter, leakage checker. Locates defects in irons, fans, refrigerators, mixers, air-conditioning, TV & radio tubes and parts, batteries, generators, etc. Easy instruction Book has introduction to electricity & procedures for common repair jobs. Examine EICO's complete line of 50 professional instruments & kits - Write for FREE Catalog P96-3

Electronic Instrument Co., Inc., 33-00 Northern Blvd., L.I.C., N.Y.

**WAR SURPLUS BARGAINS**

# WAR SURPLUS BARGAINS

**\$500,000.00 INVENTORY for QUICK LIQUIDATION**

Surplus items—hundreds of them for home, shop, factory, farm and outdoor use. New items, used items, reconditioned items—all at tremendous savings—all priced for quick sale.

Page After Page of Values

This big catalog shows page after page of amazing money saving values. Write for your copy today. Send 10c to cover postage, mailing, etc. Write today! SEND TODAY FOR YOUR COPY

## 10c

# STARK'S

212 W. Madison St.  
Dept. PM-583  
CHICAGO 6, ILL.



# **INVENTORS--PATENTS**

*I*f you consider your invention valuable — if you have invented any new and useful art, machine, manufacture or composition of matter or improvement thereof — take these necessary preliminary steps promptly to protect it by applying for a United States patent.

Sketch and describe your invention.  
(For convenience in starting action on your invention, use "Evidence of Invention" form offered below.)

Sign, date and have this invention disclosure witnessed by two people capable of understanding your invention.

Have us make a preliminary search among U. S. patents already granted for similar types of invention.

We then prepare a report for you on the probable patentability of your invention and recommend your further course of action.

This firm is registered to practice before the U. S. Patent Office. We are available to assist you in the preparation and prosecution of your application for patent.

We shall be glad to send you promptly and without obligation, an instructive booklet—"Patent Protection for Inventors"—and our convenient "Evidence of Invention" form.

VICTOR J.  
**EVANS & Co.** *Merlin M. Evans*  
REGISTERED PATENT ATTORNEY

430-C MERLIN BUILDING

WASHINGTON 6, D. C.



# ENGINEERING



Photo of Heald  
Electrical Laboratory

Heald College Ranks **FIRST**  
West of the Mississippi  
in "Who's Who" in America

Send for **FREE** Information  
Heald Engineering College

Est. 1863

Van Ness at Post, Dept. P.M.  
San Francisco, California

Enroll Now for New Term

American Industry Steps Up Its  
Demand for Trained Engineers.  
Train Now at Healds

**BACHELOR OF  
SCIENCE DEGREE,  
27 MONTHS**

Degree Courses:

- Electronic Engineering
- Electrical Engineering
- Highway Engineering
- Mechanical Engineering
- Structural Engineering
- Civil Engineering
- Architecture

Diploma Courses:

- TELEVISION  Color TV
- Electronic Technician
- Industrial Electronic Tech.
- Tool & Die Design
- Architectural Drafting
- Mechanical Drafting
- Structural Drafting
- Surveying
- Estimating
- Master Electrician

Approved for Veterans

NAME \_\_\_\_\_  
STREET \_\_\_\_\_  
CITY \_\_\_\_\_  
STATE \_\_\_\_\_

**FREE!**  
NEW ISSUE  
QUEEN ELIZABETH  
STAMPS  
and illustrated  
booklet



Rush coupon today! Exciting, generous NEW offer of beautiful, hard-to-get stamps — some not even cataloged yet. These NEW Elizabeth II stamps have never been given before, now yours FREE. From world's newest country, Ghana; Pitcairn Islands, Kenya, Cook Islands, Ascension, many others. All genuine, all different, mint and used — so new you'll add them all to your collection. Other offers for inspection plus free "Stamp Collector's Guide". Offer limited. RUSH name, 10c for postage, handling to GARCELON STAMP CO., Dept. 3PMQ, Calais, Maine.

GARCELON STAMP CO., Dept. 3PMQ

Calais, Maine. Rush FREE NEW Elizabeth Stamps, Collector's Guide, other offers. Enclosed 10c for postage, handling. (PLEASE PRINT)

# Bean's Free Catalog



Just Off the Press

Fully illustrated 108 pages, shows three hundred and seventy-five items of interest to both men and women — special fishing tackle, footwear, clothing, leather and canvas specialties, many of our own manufacture.

L. L. Bean, Inc., 238 Main St., Freeport, Maine  
Mfrs. Fishing and Camping Specialties

## Secrets of VENTRILOQUISM Now Revealed!

Easy to learn in 60 to 90 days with our Home Study Course. **RESULTS GUARANTEED.** Make Money! Be Popular! Have Fun! Big Opportunity! Radio, Television, Stage Appearances! For **FREE** Information regarding price and terms **WRITE.** You must state your age. Dummy Catalog 25c.  
**MAHER HOME COURSE OF VENTRILOQUISM**  
Box 36, Studio E, PM-3, Kensington Station  
Detroit 24, Michigan

## "MINIATURE MACHINE SHOP

No Bigger Than A Typewriter, Outperforms Machines Many Times Its Size!"  
That's what a popular publication says about UNIMAT in their 3 page feature story in the May issue. If you want a reprint of this story plus complete information about this amazing 10 in 1 combination precision tool write to:

AMERICAN EDELSTAAL, INC., UNIMAT DIV., Dept. 338, 350 B'way., N.Y. 13

## make your own Gems 36<sup>50</sup>

The Gem Maker comes complete with all necessary equipment, including a super-charged diamond blade for sawing, and all the wheels for grinding, shaping and polishing; also complete instructions. The complete equipment as shown, less motor and belt for only \$36.50, f.o.b., Burlington, Wisconsin. Write today for information and literature.

**B&I MANUFACTURING CO.**  
Dept. P, Burlington, Wis.

## TASOPE PHOTO-ENGRAVING PLANTS

Establish your own profitable PHOTO-ENGRAVING business. Make cuts for newspapers, printers, and advertisers. Make etched name plates, plaques, etc. Instructions furnished, no experience necessary. Sold direct from factory since 1931. First five hundred cuts sold locally or by mail will pay for plant and pay you well for your time. Write for **FREE** catalog.

**TASOPE, DEPT. PM-3, AURORA, MO.**

## FREE AMAZING NEW BOOK "HOW TO ANSWER ADS"

Never before have you seen anything like this. Tells you in simple language the correct way to answer ads. Gets you quicker replies—better results, and greater satisfaction. Will save you time and money and it's **ABSOLUTELY FREE.** No obligation whatever. Every reader of advertising should have this booklet. Send a postcard for your copy **NOW.** F. W. JOHNSON, Popular Mechanics Magazine, Room 600-A, 204 East Ontario Street, Chicago 11, Ill.



# WHAT ALL AUTO MECHANICS WANT TO KNOW



This Big Practical Book gives full information, with working diagrams, covering the principles, construction, ignition, service and repair of modern cars, trucks and buses.

**Diesel Engines, Hydraulic and Fluid Drives Fully Explained.**

A complete guide of 1696 Pages, with over 1500 illustrations showing inside views of working parts, with instructions for service jobs. Completely up-to-the-minute! Priced at only \$6.



# HOW TO FIX HOME APPLIANCES

REFRIGERATORS WASHERS TOASTERS DRYERS IRONERS RANGES VACUUM FREEZERS

Many other GAS AND ELECTRIC APPLIANCES

Handy Reference for Electric & Gas Servicemen, Mechanics, Dealers and Home-owners. Explains clearly and simply how to locate troubles, how to test, reassemble and connect. Wiring diagrams. 1000 Facts. Easy to read. Answers ALL your questions. 864 Pages. Illustrated. Only \$6.

CIRCLE No. 1 IN COUPON



HERE IS LATEST INFORMATION IN A HANDY FORM FOR RADIO AND TELEVISION REPAIRMEN, SERVICEMEN AND STUDENTS

TWO COMPLETE VOLUMES - 1568 Pages - 1085 Illustrations and Diagrams 1001 Important Facts and Figures on Modern T.V. Radio-Electronic Devices. INCLUDES TRANSISTORS & Transistor Circuits, Rectifiers, Record Changers, P.A. Systems, Phonograph Pick-ups, F.M., Auto Radio, Short Wave.

Basic principles, Construction, Installation, Operation, Troubleshooting. How to get Sharp, Clear T.V. Pictures. Install Aerials. How to Test. Explains COLOR SYSTEMS. Methods of Conversion, Terms, etc. Includes Ultra High Frequency. Quick ready reference or use as a home study course. Only \$8 for BOTH volumes.

CIRCLE No. 2 IN COUPON

# KNOW YOUR TRUCK

The TRUCK & TRACTOR GUIDE for Mechanics & Drivers, Foremen, Garagemen, Helpers, Owners, Trouble Shooters, Farmers, etc. Covering Gas & Diesel Motor Principles - Construction - Operation - Maintenance - Repair - Brakes - Service of all Parts. 1376 Pages. FULLY ILLUSTRATED. Index. Only \$5.

CIRCLE No. 3 IN COUPON

# PLUMBERS AND STEAMFITTERS GUIDES

Practical Trade Assistant & Reference Set. Explains in plain language and by clear illustrations, diagrams, charts, graphs and pictures the principles of modern plumbing practice including Pipe Fitting and Air Conditioning. 4 Vols. - 2624 Pages - 3642 Diagrams & Illustrations. Only \$8 for the complete set of 4 vols.

CIRCLE No. 4 IN COUPON

# PAINTING & DECORATING MANUAL

Inside Trade information on outside and inside work, how to mix paints, preparation of surfaces, paper hanging, wood finishes, tools, synthetic paints, color (with color chart), spray equipment, coats, estimating, etc. A COMPLETE guide to repair, better painting and decorating. 484 Pages. Fully Illustrated. Only \$2.

CIRCLE No. 7 IN COUPON

# 7-DAY FREE EXAMINATION

SEND NO MONEY - Pay the postman nothing! We are glad to send you any of the Audel Guides for absolutely FREE examination in your own home. We take all the risks and leave all the decisions up to YOU. There is no obligation! If you decide to keep the books of your choice you may pay for them under our astounding easy-pay plan of only \$2 a month.

HERE IS ALL YOU DO

IT'S EASY TO ORDER: In the No-Risk Mail Order Coupon at the right just draw a circle around the number of Audel Guides you want us to send you for FREE EXAMINATION. We will send them to you at once to help you build a brighter future by increasing your SKILL. If for any reason at all you are not COMPLETELY satisfied, return the books to us, and that will end the matter! NO STRINGS OR CATCHES TO THIS OFFER.

**THEO. AUDEL & CO.**  
49 West 23rd Street, New York 10, N.Y.

# CARPENTERS AND BUILDERS GUIDES



PRACTICAL STOREHOUSE OF MODERN CONSTRUCTION INFORMATION (4 vol. set) for carpenters and all woodworkers. Explains in easy language and by precise illustration principles, advances, short cuts, trade secrets, all based on the LATEST information. Vol. 1 - Tools, steel squares, saw filing, joinery, furniture, etc.; Vol. 2 - Builders' mathematics, drawing plans, specifications, estimates, etc.; Vol. 3 - House and roof framing, laying out, foundations, etc.; Vol. 4 - Doors, windows, stair building, millwork, painting, etc. 4 vols. 1904 Pages. 3700 Illustrations. Whole set only \$8.

CIRCLE No. 8 IN COUPON

# PRACTICAL ELECTRICITY

A COMPLETE HANDBOOK - Quick, simplified, ready reference. Complete instruction and practical information on the rules and laws of electricity - Maintenance of Machinery - A.C. and D.C. Motors - Armatures - Wiring Diagrams - House Lighting - Power Wiring - Meters - Batteries - Transformers - etc. Simple to understand. 1520 Pages. 2500 Illustrations. Priced at \$5.

CIRCLE No. 4 IN COUPON

# DIESEL

ALL THERE IS TO KNOW ABOUT MODERN DIESEL ENGINES - Basic principles, starting valves, timing, fuel pumps, fuel injection compressor, air compressors, pistons, cylinders, lubrication, cooling systems, etc. Answers on operation, calculations. 640 Pages. Fully Illustrated. Priced \$3.

CIRCLE No. 9 IN COUPON

# WELDERS GUIDE

Covers Electric, Oxy-acetylene, Thermit, Unionmet welding for sheet metal, spot and pipe welds, pressure vessels and aluminum, copper, brass, bronze and other metals. Airplane work, surface hardening, hard facing, cutting, brazing, etc. 608 Pages. Fully Illustrated. Only \$3.

CIRCLE No. 10 IN COUPON

# MATHEMATICS MADE EASY

A COMPLETE HOME STUDY COURSE - Starting with the first principles of arithmetic, advancing step by step through the various stages of mathematics, including the rules and calculations for mechanical and electrical problems. New EASY correct methods. Includes plane and solid geometry, trigonometry, algebra, calculus, etc. Practical tests, reference tables and data. How to use slide rule. 752 Pages. 550 Illustrations. Priced at only \$3.

CIRCLE No. 11 IN COUPON

# NEW MACHINISTS AND TOOLMAKERS HANDBOOK

MODERN MACHINE SHOP PRACTICE - 5 PRACTICAL BOOKS IN ONE. New from cover to cover. Tells how to set up and operate lathes, screw and milling machines, shapers, drill presses and all other machine tools. A COMPLETE INSTRUCTOR AND REFERENCE BOOK. 1728 Pages. Fully Illustrated. Priced at only \$6.

CIRCLE No. 12 IN COUPON

# WIRING DIAGRAMS

This book gives the practical facts on wiring of electrical apparatus. It explains clearly and SIMPLY how to wire apparatus for all fields of electricity. Each diagram is complete and self-explaining. Know your HOOK-UPS! 304 Pages. Illustrated. Only \$2.

CIRCLE No. 13 IN COUPON

# REFRIGERATION & AIR CONDITIONING

FOUR BOOKS IN ONE - basic principles, servicing, operation, repair of: 1. Household Refrigeration. 2. Special Refrigeration Units. 3. Commercial & Industrial Refrigeration. 4. Air Conditioning Systems. A GOLD MINE of essential information. Completely up-to-date. 1260 Pages. Fully Illustrated and Indexed. Priced at only \$6.

CIRCLE No. 14 IN COUPON

# THE NEW ELECTRIC LIBRARY

A COMPLETE ENCYCLOPEDIA explaining in the simplest terms the fundamental principles, rules and applications of applied electricity.

A COMPLETE COLLEGE EDUCATION! Fully illustrated with diagrams and sketches, calculations and tables for ready reference. Questions and answers. Trial tests for practice study and review. All based on the most modern theory.

- Vol. 1 - Principles and rules of electricity, magnetism, armatures repairs. No. 15
- Vol. 2 - Dynamos, DC Motors, construction, installation, maintenance, etc. No. 16
- Vol. 3 - Testing instruments and tests storage battery constr. and repairs. No. 17
- Vol. 4 - Alternating current, power factor, alternators, transformers, etc. No. 18
- Vol. 5 - A.C. Motors, windings, maintenance, converters, switches, fuses, etc. No. 19
- Vol. 6 - Relays, condensers, regulators, rectifiers, meters, switchboards, etc. No. 20
- Vol. 7 - Wiring, house light and power, circuits, high tension, plans, code, etc. No. 21
- Vol. 8 - Railways, signals, elevators, ignition, etc. No. 22
- Vol. 9 - Radio, telephones, telegraph, television, motion pictures. No. 23
- Vol. 10 - Refrigeration, illumination, welding, x-ray, electrical appliances, Index. No. 24

7,000 fully illustrated pages. Priced at only \$30 for the ENTIRE SET. Also sold individually for \$3 each.



# ALL TYPES OF BLUEPRINT READING

How to read scales, the standard symbols, detail and assembly prints, working drawings, etc. - hints, tips and suggestions. THE MAN WHO CAN READ BLUEPRINTS IS IN LINE FOR A BETTER JOB. This book gives you the secret language, step by step in easy stages. 448 Pages, Very Fully Illustrated. Priced at \$3.

CIRCLE No. 25 IN COUPON

# MASONS & BUILDERS GUIDES

A PRACTICAL ILLUSTRATED 4 VOL. SET - Explaining in clear, simple language and profuse illustration, principles, advances, short cuts, trade secrets, based on modern practice - including how to figure and calculate various jobs. Vol. 1 - Brick work, bricklaying, bonding, design. Vol. 2 - Concrete masonry, arches, tile setting, stonemasonry. Vol. 3 - Concrete masonry, placing forms, reinforced concrete. Vol. 4 - Plastering, stone masonry, steel construction, blueprints. 4 Vols. 1440 Pages. 2087 Illustrations. Complete Set only \$8.

CIRCLE No. 26 IN COUPON

# ELECTRIC MOTORS

THIS GUIDE covers the construction, hook-ups, control, maintenance and trouble shooting of all types of motors. Includes armature winding. Explains entire subject in great detail in simple language. Over 1056 Pages of information. 617 Diagrams. All types of motors fully illustrated and indexed for ready reference. Priced at only \$5.

CIRCLE No. 27 IN COUPON

# OIL BURNERS

New, complete, explaining in detail both domestic and industrial oil burners. Includes electrical hook-ups and wiring diagrams. Fully covering the theory, construction, installation, operation, testing, servicing and repair of all equipment. Indexed for ready reference. Over 416 Pages. 320 Illustrations and Diagrams. Only \$2.

CIRCLE No. 28 IN COUPON

# ADDITIONAL IMPORTANT TITLES

- The following Audel Guides are all the best in their fields, written in clear simple fashion, all lavishly illustrated. Circle the numbers wanted in the MAIL ORDER COUPON below. All books are sent for FREE EXAMINATION.
- No. 29 SHEET METAL PATTERN LAYOUTS. 1152 Pages. \$7.90
  - No. 30 SHEET METAL WORKERS HANDBOOK. 648 Pages. 2.00
  - No. 31 MECHANICAL DRAWING GUIDE. 192 Pages. 2.00
  - No. 32 MECHANICAL DRAWING AND DESIGN. 480 Pages. 3.00
  - No. 33 ELECTRONIC DEVICES. 304 Pages. 2.00
  - No. 34 ELECTRICIANS EXAMINATIONS. 277 Pages. 2.00
  - No. 35 ELECTRIC POWER CALCULATIONS. Page 480. 3.00
  - No. 36 ELECTRIC DICTIONARY. 9000 Terms. 3.00
  - No. 37 POWER PLANT ENGINEERS GUIDE. 1568 Pages. 3.00
  - No. 38 ENGINEERS AND FIREMANS EXAMS. 344 Pages. 2.00
  - No. 39 OPERATING ENGINEERS LIBRARY. 3 Book Set. 12.00
  - No. 40 PUMPS, HYDRAULICS AND AIR COMPRESSORS. 1760 Pages. 6.00
  - No. 41 HOUSE HEATING GUIDE. 1008 Pages. 3.00

# MAIL THIS NO-RISK COUPON TODAY!

THEO. AUDEL & CO. - Self Improvement Publishers Since 1879 - P3

49 W. 23rd Street, New York 10, N.Y.

Please mail me for 7 days' FREE EXAMINATION the books I have circled at right. I agree to mail \$2 in 7 days on each book or set ordered, and to (further mail) \$2 a month on each book or set ordered until I have paid the purchase price, plus shipping costs. If I am not completely satisfied with my Audel Guides I may return them.

NAME \_\_\_\_\_ ADDRESS \_\_\_\_\_ OCCUPATION \_\_\_\_\_

SAVE SHIPPING COSTS! Check here if you enclose complete payment with order. We pay postage charges. You have same return privilege.



# "Tell Me What You Want"



- Health  Strength  More Weight  
 Less Weight  Mental Control  
 Poise  Muscular Development

## I WILL SHOW YOU How To Get It"

Says Paul Anderson  
**Strongest Man in the World**

"I was thin, underweight and almost died of Bright's Disease in my youth. My parents' prayers brought me through and my determination to gain strength led to my discovery of four great secrets. This discovery explained and applied, as I show you how to do it, will give you giant strength in easy steps."

### GET FREE BOOK—MAIL COUPON

Write today and learn how vigor, health, a fine physique, the admiration of friends can be yours. Follow the simple instructions of my course—only a few minutes a day and you can build your

body as I have built mine. You can win trophies as I have won them and be in the limelight—in sports, social events, etc. Act NOW!

PAUL ANDERSON  
 World Champion,  
 Gold Medal  
 Olympic Champion,  
 Official World  
 Record Holder,  
 The Strongest  
 Man in the World

PM38

Toccoa, Ga.  
 Without obligation please send me your free book fully illustrated and describing your 4-secret body building system.

Name \_\_\_\_\_  
 (Please Print)

Address \_\_\_\_\_

City \_\_\_\_\_ Zone \_\_\_\_\_ State \_\_\_\_\_

### 250 POWER . . . .



Complete Telescope Lens Kit only \$3.49 postpaid

Conquer Space, Explore the Universe, Planets, Moon Craters, New Stars, etc. Complete Lens Kit consists of 80 inch focal length ground and polished objective lens, eyepiece lenses for 50 POWER, 100 POWER, 150 POWER, 200 POWER, 250 POWER, and all necessary lens fittings. Easy to make from simple step by step instructions. (Tripod and mount not included.) Money back guarantee.

BUSSE SALES CO., Hartford, Conn., Dept. PM 67

# EARN \$100 A WEEK AND UP

## BE AN AUTO-DIESEL MECHANIC—EARN WHILE YOU LEARN

Many of our graduates earn \$100 a week and up. You learn fast in our school and shops because you learn with tools on real equipment. Experienced instructors explain WHY and show you HOW, then you DO IT YOURSELF. One of the best equipped technical schools in the United States. Thirty-nine years' experience training men. Successful graduates in 48 states and many foreign countries. Approved for veterans. Day and evening classes. Free bulletin—write today.

**NASHVILLE AUTO-DIESEL COLLEGE**  
 226 7th Ave. N., Dept. 86, Nashville, Tenn.

# CASH IN ON WAR SURPLUS!



IMAGINE! \$100 VALUES—NOW SELLING FOR PENNIES!

Hundreds of surplus items for home, farm, garage and shop... going for pennies on the dollar! All built to the government's higher standards. Tools, machinery, gear reducers, pumps, boats, motors; page after page of tremendous bargains.

SEE FOR YOURSELF: Send for this big catalog and see for yourself! See pages of surprising bargains. See items that cost the government thousands of dollars going for pocket change. Act now. Cash in on government surplus. Send 10c for your copy.  
**KARL ORT, Dept. PM2, Thomasville, Pa.**

## BECOME AN EXPERT IN TRAFFIC and TRANSPORTATION

Traffic men earn \$4,000 to \$10,000 and up. Thousands of firms need experts on rates, tariffs, regulations. We train you thoroughly in spare time at home for executive traffic jobs. Personal training under traffic authorities. Write for free book "Traffic and Transportation."

**LASALLE Extension University, 417 So. Dearborn St.**  
 A Correspondence Institution Dept. 364T, Chicago 5, Ill.

## TERMITES IN YOUR HOUSE? GET RID OF THEM YOURSELF!

Don't pay \$300 and up to eradicate termites from your home or prevent infestation. Do it yourself in one afternoon. Easily! Quickly! Inexpensively with "TERM-OUT"! Send stamp for handbook.



**COMPASS RESEARCH**  
 701-A INVESTMENT BLDG., PITTSBURGH 22, PA.



## \$2.95 OR 2 FOR \$5.00!



TESTED AND GUARANTEED  
 Write for free list on all types of telephones. Shipments F.O.B. Simpson, Pa.  
**TELEPHONE ENGINEERING CO., Dept. 388, Simpson, Pa.**

## STUDY TO BE A DOCTOR of Psychology or Metaphysics

Obtain a Ps.D., Ms.D., or Ph.D. Be a Teacher, Lecturer or Accredited Practitioner. Teach others how to achieve Health, Happiness and Contentment. Chartered by State. Correspondence Courses only. Write for FREE book telling how.

**THE NEOTARIAN FELLOWSHIP**  
 Desk 8, Pickwick Building Kansas City 6, Missouri

## I'll Send You This Handsome SAMPLE CASE—FREE



and Show You How to Make Up to \$30.00 in a Day

Mail coupon for this Free Tailoring Sample Case packed with 100 beautiful, big-value suit and overcoat fabrics. Take orders from friends, fellow-workers, others, for fine quality, made-to-measure clothes. Pocket big cash profits in advance. Because wearing our suits and overcoats brings more orders, we make it easy for you to get your own clothes without ic cost. No experience is needed. SATISFACTION GUARANTEED. SEND NO MONEY. Just fill out and mail coupon—today!

**J. C. FIELD & SON, Harrison & Throop Streets**  
 DEPT. W-1716 CHICAGO 7, ILLINOIS

**J. C. FIELD & SON, Dept. W-1716**  
 Harrison & Throop Sts., Chicago 7, Ill.

Dear Sir: I WANT A MADE-TO-MEASURE SUIT TO WEAR AND SHOW, without paying ic for it. Rush details and Sample Kit of actual fabrics, ABSOLUTELY FREE.

NAME \_\_\_\_\_ AGE \_\_\_\_\_

ADDRESS \_\_\_\_\_

CITY \_\_\_\_\_ STATE \_\_\_\_\_



# THESE MEN ARE GETTING PRACTICAL TRAINING IN **ELECTRICITY**

—ELECTRONICS

*On Real:*

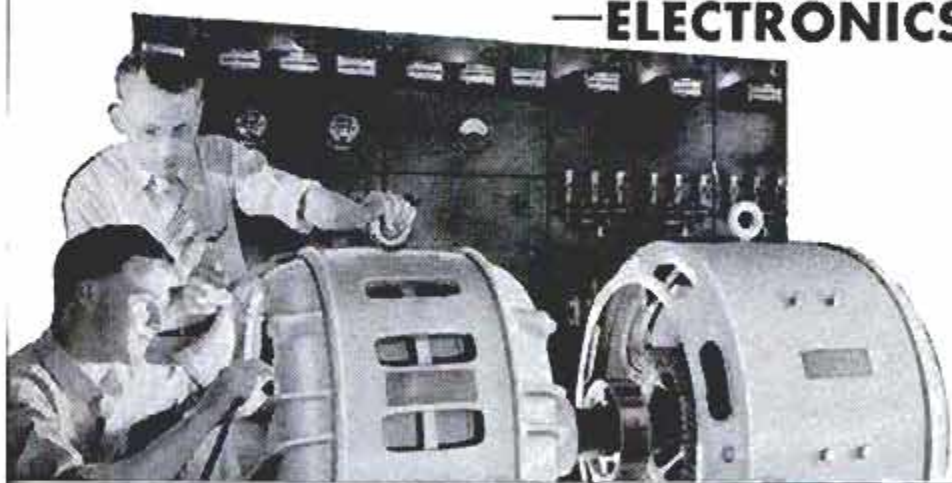

**A.C. and D.C. MOTORS  
GENERATORS  
SWITCHBOARDS  
CONTROLLERS  
WIRING JOBS  
APPLIANCES  
ELECTRONIC UNITS**

*(Shown at left—Instructor explaining operation and testing of a large Motor Generator in our A.C. Department.)*

# AND **TELEVISION-RADIO**

*On Real:*

**TELEVISION  
RECEIVING SETS  
Including Color TV  
AM and FM RADIO  
RECEIVERS including  
AUTO RADIOS  
TELEVISION TEST  
EQUIPMENT**

*(Right — Instructor helping students check the wiring and trace circuits of television receivers.)*

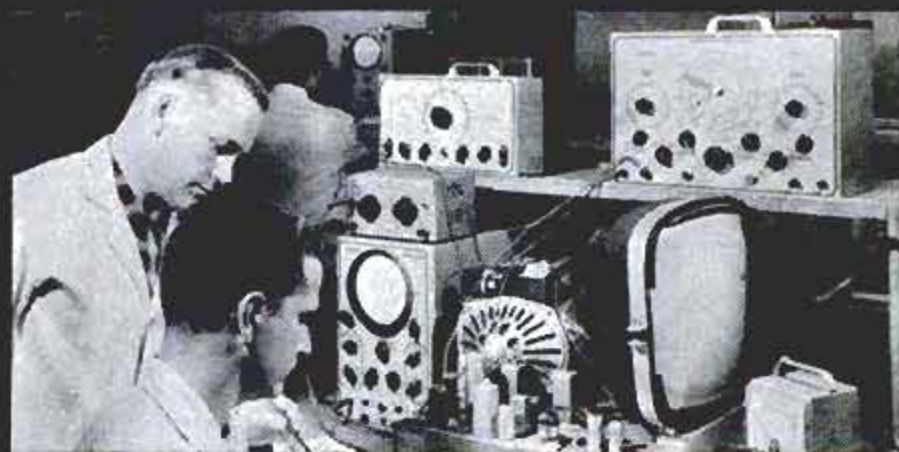

## Train in the great **SHOPS** of **COYNE**

**Largest, Oldest, Best Equipped School Of Its Kind In The U. S.**

Whether 17 or up to 45 years of age, prepare for your future now. Don't be satisfied with a "No Future" job. Train the Coyne way for a better job in a field that offers a world of opportunities in the years ahead.

**FINANCE PLAN** Enroll now, pay most of tuition later. Part-time employment help for students.

**WE TRAIN YOU IN CHICAGO** on real equipment. Trained instructors show you how, then you do practical jobs yourself. No previous experience or advanced education needed.

**CLIP COUPON NOW** for big new illustrated Coyne book "Guide to Careers in ELECTRICITY and TELEVISION-RADIO". No obligation; no salesman will call. Get vital facts now! *Training in Refrigeration and Electric Appliances can be Included.*



*Mail Coupon for  
Big Free Book*

**Training Offered  
to VETERANS  
and  
NON-VETERANS  
Alike**

**B. W. COOKE, Jr., President  
COYNE ELECTRICAL SCHOOL  
500 S. Paulina St., Chicago 12, Ill. Dept. 38-3C**

Send **FREE** book and details of all the training you offer. This does not obligate me and no salesman will call. I am especially interested in:

- ELECTRICITY-ELECTRONICS  
 TELEVISION-RADIO

NAME.....

ADDRESS.....

CITY.....STATE.....

B. W. COOKE, Jr., Pres. **COYNE** FOUNDED 1899

**ELECTRICAL SCHOOL**

**A TECHNICAL TRADE INSTITUTE OPERATED NOT FOR PROFIT  
500 S. PAULINA STREET, CHICAGO, Dept. 38-3C**

**ELECTRICITY ★ RADIO ★ TELEVISION ★ REFRIGERATION ★ ELECTRONICS**

MARCH 1958



# ENGINEERING Home Study Courses

**C**COURSES written by world authorities in all branches of engineering. Step-by-step instructions using methods proved successful by thousands of our graduates. One hour each day in your spare time will start you off to higher pay, security, prestige. Check the course you are interested in and we will send you a complete outline of the course with a booklet describing the Institute and our advanced methods of teaching. Send to: Canadian Institute of Science and Technology Ltd., 676 Century Bldg., 412, 5th St. N.W. Wash., D.C.

Civil Eng.  
Surveying  
Architecture  
Forestry  
Mining  
Structural  
Mechanical Eng.  
Industrial Eng. & Management  
Refrigeration  
Heating  
Drafting  
Plastics  
Electrical Eng.  
Radio  
Electronics  
Television  
Aeronautical Eng.  
Aircraft Engineer  
Navigation  
General  
Education  
Chemical  
Mathematics  
Journalism  
Accounting

NAME .....

ADDRESS .....

CITY ..... STATE .....

Course Interested In .....

Canadians: Send to Canadian Institute of Science & Technology Limited, 676 Garden Bldg., 263 Adelaide St. West, Toronto, Ontario.

**Exclusive Double-Bearing HEAVY-DUTY PUMPS**  
IRRIGATE • DRAIN • CIRCULATE • SPRAY  
Up to 7,500 GPH. 3,000 GPH from 25' well. Use 1/4 to 1 HP motor. 1 1/4" inlet; 1" outlet. Stainless shaft. Won't rust. **\$10.95**  
TYPE X—2 oilless bronze bearings. **\$12.95**  
TYPE XB—ball bearing model. **\$12.95**  
Postpaid if cash with order. Rush your order today  
**MONEY BACK GUARANTEE**  
Centrifugal and Gear Pumps in All Sizes  
**LABAWCO PUMPS, Belle Mead 2, N. J.**



## NEW ARMY MINE DETECTOR

Model SCR625. A portable device for detecting metallic and nonmetallic objects. Find buried pipe lines, cables, wires, hidden jewelry, coins, sewer tile, etc.

Send for circular

Shipping weight  
appr. 85 lbs.  
F.O.B. N. Y.  
No C.O.D.'s.  
Send order to:



**COLUMBO TRADING CO., INC.**

395 Canal St., Dept. PM, New York 13, N. Y.

# I'll Set You Up For Life In Your Own BIG PAY SHOE BUSINESS



**Only 8 Orders a Day Can Make You  
Up to \$32.00 a Day \$180.00 a week  
\$600.00 a month**

It's no trick at all to make big money FULL OR SPARE TIME with America's most comfortable shoes. Amazing new "Spring-Step" cushion design proves it by actual demonstration. Only ORTHO-VENT has it. No other shoe in the world like it. Profits are BIG—repeat orders are sure and easy with amazing 2-minute demonstration. No experience needed. No investment to make. Everything furnished free, including finest sales outfit and actual demonstrators! Be the big pay ORTHO-VENT man in your territory. Send Today for free outfit.

**Amazing 2-MINUTE  
DEMONSTRATION**  
Does Your Selling  
Job for You  
FAST!



I Give  
Producers  
Their Own Shoes  
AS A BONUS!

**ORTHO-VENT SHOE CO.** • 1183 BRAND ROAD SALEM, VIRGINIA

See Direct-Mail Ads in PM

**LEARN AT HOME IN SPARE HOURS** **BE A LOCKSMITH**

Learn fascinating, profitable trade from experts in spare time at home! Age or physical handicap no disadvantage. Year around, steady income. Full or part time. Practical, illustrated lessons. Make money even while learning! All materials and special tools supplied. Free Booklet.

**INSTITUTE OF LOCKSMITHING, Dept. P-100**  
150 PARK AVENUE E. RUTHERFORD, N.J.  
Lic. by N.J. State Board of Ed. Approved for Vets



**PLEASE  
SEND ME**



for the  
time checked.  
I am enclosing . . .

- 1 year \$3.50  
 2 years \$6.00

name

address

city

zone

state

Hand this order to your newsdealer or send it to  
**POPULAR MECHANICS**  
200 East Ontario St. Chicago 11, Ill.





# I'd like to give this to my fellow men... while I am still able to help!

I was young once, as you may be—today I am older. Not too old to enjoy the fruits of my work, but older in the sense of being wiser. And once I was poor, desperately poor. Today almost any man can stretch his income to make ends meet. Today, there are few who hunger for bread and shelter. But in my youth I knew the pinch of poverty; the emptiness of hunger; the cold stare of the creditor who would not take excuses for money. Today, all that is past. And behind my city house, my

summer home, my Cadillacs, my Winter-long vacations and my sense of independence—behind all the wealth of cash and deep inner satisfaction that I enjoy—there is one simple secret. It is this secret that I would like to impart to you. If you are satisfied with a humdrum life of service to another master, turn this page now—read no more. If you are interested in a fuller life, free from bosses, free from worries, free from fears, read further. This message may be meant for you.

## By Victor B. Mason

I am printing my message in a magazine. It may come to the attention of thousands of eyes. But of all those thousands, only a few will have the vision to understand. Many may read; but of a thousand only you may have the intuition, the sensitivity, to understand that what I am writing may be intended for you—may be the tide that shapes your destiny, which, taken at the crest, carries you to levels of independence beyond the dreams of avarice.

Don't misunderstand me. There is no mysticism in this. I am not speaking of occult things; of innumerable laws of nature that will sweep you to success without effort on your part. That sort of talk is *rubbish!* And anyone who tries to tell you that you can *think* your way to riches without effort is a false friend. I am too much of a realist for that. And I hope you are.

I hope you are the kind of man—if you have read this far—who knows that anything worthwhile has to be *earned!* I hope you have learned that there is no reward without effort. If you have learned this, then you may be ready to take the next step in the development of your karma—you may be ready to learn and use the secret I have to impart.

### I Have All The Money I Need

In my own life I have gone beyond the need of money. I have it. I have gone beyond the need of gain. I have two businesses that pay me an income well above any amount I have need for. And, in addition, I have the satisfaction—the deep satisfaction—of knowing that I have put more than three hundred other men in businesses of their own. Since I have no need for money, the greatest satisfaction I get from life, is sharing my secret of personal independence with others—seeing them achieve the same heights of happiness that have come into my own life.

Please don't misunderstand this statement. I am not a philanthropist. I believe that charity is something that no proud man will accept. I have never seen a man who was worth his salt who would accept

something for nothing. I have never met a highly successful man whom the world respected who did not sacrifice something to gain his position. And, unless you are willing to make at least half the effort, I'm not interested in giving you a "leg up" to the achievement of your goal. Frankly, I'm going to charge you something for the secret I give you. Not a lot—but enough to make me believe that you are a little above the fellows who merely "wish" for success and are not willing to sacrifice something to get it.

### A Fascinating and Peculiar Business

I have a business that is peculiar—one of my businesses. The unusual thing about it is that it is needed in every little community throughout this country. But it is a business that will never be invaded by the "big fellows". It has to be handled on a local basis. No giant octopus can ever gobble up the whole thing. No big combine is ever going to destroy it. It is essentially a "one man" business that can be operated without outside help. It is a business that is good summer and winter. It is a business that is growing each year. And, it is a business that can be started on an investment so small that it is within the reach of anyone who has a television set. But it has nothing to do with television.

This business has another peculiarity. It can be started at home in spare time. No risk to present job. No risk to present income. And no need to let anyone else know you are "on your own". It can be run as a spare time business for extra money. Or, as it grows to the point where it is paying more than your present salary, it can be expanded into a full time business—overnight. It can give you a sense of personal independence that will free you forever from the fear of lay-off, loss of job, depressions, or economic reverses.

### Are You Mechanically Inclined?

While the operation of this business is partly automatic, it won't run itself. If you are to use it as a stepping stone to independence, you must be able to work with your hands, use such tools as hammer and screw driver, and enjoy getting into a pair of blue jeans and rolling up your sleeves. But two hours a day of manual work will keep your "factory" running 24 hours turn-

ing out a product that has a steady and ready sale in every community. A half dollar spent for raw materials can bring you six dollars in cash—six times a day.

In this message I'm not going to try to tell you the entire story. There is not enough space on this page. And, I am not going to ask you to spend a penny now to learn the secret. I'll send you all the information, free. If you are interested in becoming independent, in becoming your own boss, in knowing the sweet fruits of success as I know them, send me your name. That's all. Just your name. I won't ask you for a penny. I'll send you all the information about one of the most fascinating businesses you can imagine. With these facts, you will make your own investigation. You will check up on conditions in your neighborhood. You will weigh and analyze the whole proposition. Then, and then only, if you decide to take the next step, I'll allow you to invest \$15.00. And even then, if you decide that your fifteen dollars has been badly invested I'll return it to you. Don't hesitate to send your name. I have no salesmen. I will merely write you a long letter and send you complete facts about the business I have found to be so successful. After that, you make the decisions.

### Does Happiness Hang on Your Decision?

Don't put this off. It may be a coincidence that you are reading these words right now. Or, it may be a matter that is more deeply connected with your destiny than either of us can say. There is only one thing certain: If you have read this far you are interested in the kind of independence I enjoy. And if that is true, then you must take the next step. No coupon on this advertisement. If you don't think enough of your future happiness and prosperity to write your name on a postcard and mail it to me, forget the whole thing. But if you think there is a destiny that shapes men's lives, send your name now. What I send you may convince you of the truth of this proverb. And what I send you will not cost a penny, now or at any other time.

**VICTOR B. MASON**  
1512 Jarvis Ave., Suite M2C  
CHICAGO 26, ILLINOIS



## Free! AIRMAIL COLLECTION



Get this spectacular collection of all-different, genuine Airmails from strange, far-away countries in Asia, Africa, Europe, the exotic Orient! World's largest airmail, scarce \$27 stamp, old Zeppelin, many, many others. A truly remarkable collection containing stamps worth up to 40c each at catalog prices! PLUS Bargain Catalog and other unusual offers. Send 10c for mailing costs. ACT NOW!

JAMESTOWN STAMP CO. Dept. F38PM, Jamestown, N. Y.

RUSH my Free Airmail Collection and other offers. I enclose 10c for mailing costs.

Name.....

Address.....

City & State.....

## There's money to be made



### IN THE ORNAMENTAL CONCRETE BUSINESS

Manufacture—and sell—Ornamental Concrete Products yourself. You can make high profit, low cost products that are easily, simply produced.

A simple do-it-yourself with ALUMINUM MOLDS

CMC light-weight, high quality Aluminum Molds bring you ease of operation and make copyrighted concrete designs with a national record of sales success. Here is a do-it-yourself project that brings not only fun but money—Big Money.



### How to turn CONCRETE into GOLD

Clear. Concise. Complete. This big, fully illustrated book gives complete, simple, easily followed "from Start-to-Finish" instructions, lists over 200 CMC Specialty Molds. Gives Valuable Sales and Production Tips. Get the complete story. Order your copy today.

Send \$2.00 for your copy—

**CMC** CONCRETE MACHINERY COMPANY, INC.  
DEPT. PM HICKORY, NORTH CAROLINA

## Shrinks Hemorrhoids New Way Without Surgery

Science Finds Healing Substance That Relieves Pain—Shrinks Hemorrhoids

For the first time science has found a new healing substance with the astonishing ability to shrink hemorrhoids and to relieve pain—without surgery.

In case after case, while gently relieving pain, actual reduction (shrinkage) took place.

Most amazing of all—results were so thorough that sufferers made astonishing statements like "Piles have ceased to be a problem!"

The secret is a new healing substance (Bio-Dyne\*)—discovery of a world-famous research institute.

This substance is now available in suppository or ointment form under the name Preparation H.\* Ask for it at all drug counters—money back guarantee. \*Reg. U. S. Pat. Off.

## SPEAK AND WRITE

... like a College Graduate!

You don't have to go back to school. I have helped thousands of men and women who have not had college training in English to become effective speakers and writers. With my new 100% self-correcting method you can stop making embarrassing mistakes, speak and write with confidence and poise. Takes only 15 minutes a day. It's fun! Send for FREE booklet. **DON BOLANDER, Career Institute, Dept. 1053, 25 E. Jackson, Chicago 4, Ill.**

## MEN WANTED

Earn \$100 Per Week and up

**AUTO DIESEL MECHANICS**

Master a trade with a future—learn Auto-Diesel mechanics in our shops. You learn with tools on real equipment. Earn while you learn. Many of our graduates earn \$100 per week and up. No previous experience necessary. Day and night courses. Approved for veterans. Write for free bulletin.

**NASHVILLE AUTO-DIESEL COLLEGE**

226 7th Ave., N., Dept. 73

Nashville 3, Tenn.



## Print Your Own

Cards, Stationery, Advertising, Circulars, labels, photo and movie titles, church work, tags, etc. Save money. Sold direct from factory only. Raised printing like engraving, too.

**Own a Printing Business**

Print for Others, Good Profit. Have home shop. Junior press \$15; Senior \$29 up. We supply everything. Easy rules. Pays for self in short time. Write for free catalog of outfits and all details. **KELSEY PRESSES, C-37 Meriden, Conn.**

## SEWS LEATHER

AND TOUGH TEXTILES LIKE A MACHINE

With **SPEEDY STITCHER** Automatic Sewing Awl, anyone can quickly and skillfully sew or repair anything made of **LEATHER, CANVAS, NYLON, PLASTIC**, or other heavy materials. Sews firm, even lock-stitches like a machine. Gets into hard-to-reach places. Specially made for heavy duty sewing on **LUGGAGE, FOOTWEAR, RUGS, AWNINGS, SAILS, SADDLERY, UPHOLSTERY, OVERALLS, AUTO-TOPS, SPORTS GEAR**, and other tough sewing jobs. Here's the handiest tool you'll ever own. Will save you many times its small cost. Comes ready for instant use... complete with bobbin of waxed thread and 3 different types of diamond-pointed needles. Easy-to-follow directions will make you an expert in minutes. Extra needles and waxed-thread always available. Save money, send \$1.98 for post-paid delivery. If C.O.D., \$1.98 plus postage. **MONEY BACK GUARANTEE.**

**SPORTSMAN'S POST**

366 Madison Ave., Dept. A-83, New York 17



198 ONLY

POPULAR MECHANICS





# RCA INSTITUTES



# OFFERS YOU THE FINEST OF HOME STUDY TRAINING



**COURSE I**  
**RADIO-TV ELECTRONICS**  
**COURSE II**  
**TV SERVICING**  
**COURSE III**  
**COLOR TV**

The equipment illustrated and text material you get with each course is yours to keep. Practical work with very first lesson. Courses for the beginner and the advanced student. Pay-as-you-learn. You need pay for only one study group at a time.



**SEND FOR THIS FREE BOOK NOW**

**RCA Institutes, Inc.** Home Study Dept. ZPM-38  
 A Service of Radio Corporation of America  
 350 West Fourth Street, New York 14, N. Y.

Without obligation, send me **FREE** 52 page CATALOG on Home Study Courses in Radio, Television and Color TV. No Salesman will call.

Name.....  
 Please print

Address.....

City..... Zone..... State.....

Korean Vets! Enter discharge date.....

**IN CANADA — RCA VICTOR COMPANY, LTD.**  
 5001 Cote de Liesse Rd., Montreal 9, Que.

**RESIDENT SCHOOL** courses in New York City offer comprehensive training in Television and Electronics. Day and evening classes start four times each year. Detailed information on request.

To save time, paste coupon on postcard



make it with 60c worth of sand & cement!

**SELL IT FOR \$2000**

every home a prospect for these "LIFETIME"

# CONCRETE INCINERATORS

Make big profits manufacturing rust proof, fire proof, almost indestructible concrete incinerators in your own backyard or garage... full or part time. Sell to home-owners, hardware, department and garden supply stores. Phila. manufacturer doing big volume with Sears, Roebuck; large department stores. Easy to follow instructions and all needed equipment supplied. Exclusive protected franchise—No competition! Territories going fast. Write immediately for full details.



Dept. PM-38, T. C. TOR  
318 Rancocas Ave., Delanco, N. J.

Gentlemen:  
Rush full information about your concrete incinerator protected franchise offer.

Name \_\_\_\_\_

Street No. or R.D. \_\_\_\_\_

City \_\_\_\_\_ Zone \_\_\_\_\_ State \_\_\_\_\_



## "I Made \$14,839 in 1 Year SERVICING RADIATORS!"

Are you earning under \$8,000 a year? Hundreds now making \$10,000 - \$12,000 - \$15,000 a year servicing auto-truck-tractor radiators the Inland way. Easy to learn. Inland, largest radiator equipment mfr., offers complete package—equipment, merchandising. "Pays-for-itself" financing, free training. \$305 down for equipment starts you. Profitable dept. for garage or service station. Write to

INLAND MFG. CO., Dept. PM-3, 1108 Jackson St., Omaha 2, Nebr.

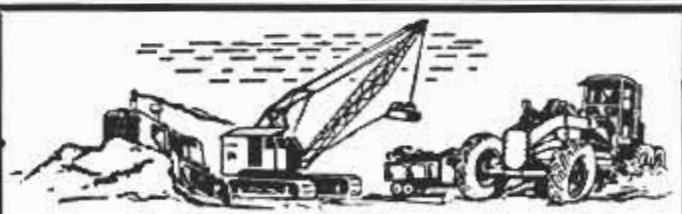

# HIGH WAGES!

Make big pay in the construction industry as an operator of Bulldozers, Draglines, Shovels, Back Hoes, Scrapers and Motor Graders. Learn these skills NOW! Machines of major manufacturers are used in our training program. Contractors need operators of earthmoving machines and pay high wages to our graduates. Don't be satisfied with just a job... learn a career!

**VETERANS: Ask about G.I. Benefits!**

Write TODAY for FREE School Catalog, no obligation, to either address

**National School of Heavy Equipment Operation**

P.O. Box 8243, Dept. D-20  
Charlotte, N. C.

**Western National School of Heavy Equipment Operation**

P.O. Box 527, Dept. D-20  
Weiser, Idaho



## Nutria... NEWEST OPPORTUNITY

New fur-bearing animal now being bred in U. S. Offers huge profits to breeders. This fur is next to Mink NOW in price and will soon surpass it. 15 to 20 young per year. Most easily and economically raised animal known. 1 1/2c per day to feed. ANY CLIMATE, disease resistant. The Cabana Marrone strain is obtainable ONLY through Cabana Nutria, Inc., and its authorized dealers and distributors. For free booklet and address of Cabana ranch nearest you write:

**CABANA NUTRIA, INC.**

Dept. 28, 636 W. Lemon Ave., Arcadio, Calif.

## You can start a \$40.00 a Day Business



**In Your Spare Time!  
Make Big Cash Profits  
In Your Own Home...  
Sharpening Household,  
Garden and Shop Tools**

Turn spare time into Big Cash Profits with new Belsaw Sharp-All. No experience needed to sharpen knives, scissors, shears, ice skates, mower blades, hedge trimmers, axes, chisels and circular saws... Learn how easily you can start your own spare time business. Amazing low cost easy-payment plan. Send Postcard for FREE BOOK. **BELSAW SHARP-ALL CO 718 Field Bldg., Kansas City 11, Mo.**

## 75 POWER TELESCOPE 25X-45X-75X \$398

NEW 3 in one telescopes, 3 variable 25X-45X-75X magnification. Brass bound. 25 power for ultra bright images 45 & 75 power for long range. Guaranteed to bring distant stars, moons, objects, sports 75 times closer.



Most powerful scope sold anywhere near this amazing low price. American made, 5 sections. Opens 36", closes 1 ft.; contains 4 ground & polished lenses. Can also be used as powerful compound microscope. Mass production enables us to offer telescope complete at \$3.98 postpaid. Money back guarantee. **CRITERION CO., Dept. PMB 55, 331 Church St., Hartford, Conn.**

## YOUR OWN PRINTING BUSINESS



Start in spare time at home. Everyone uses printing. Print cards, letterheads, circulars, Mail Order Advertising etc. Do hundreds of jobs, quickly and easily, with an ADANA world-famous, low-cost machine using standard printer's type. Follow simple instructions - produce professional work.

Write for FREE literature.

**ADANA, 693 Seneca St., Buffalo 10, N. Y.**  
in Canada: 8 Cumberland St., Toronto.

## Finish HIGH SCHOOL

**AT HOME**  
Complete 4 Years in 12 Months  
diploma



Learn More! Earn More!  
Enter College, professional or technical schools.  
Advance Socially. Live a Happier, Fuller Life. Individual Courses or complete schedule.

WRITE FOR SCHOOL BULLETIN, Dept. PM-38

**ACADEMY FOR ADULTS** 30 W. Washington  
Chicago 2, Illinois



Superior's New Model 70 UTILITY TESTER®

# FOR REPAIRING ALL ELECTRICAL APPLIANCES MOTORS • AUTOMOBILES • TV TUBES



As an electrical trouble shooter the Model 70:

- Will test Toasters, Irons, Broilers, Heating Pads, Clocks, Fans, Vacuum Cleaners, Refrigerators, Lamps, Fluorescents, Switches, Thermostats, etc.
- Will test all TV tubes for open filaments, inter-element shorts, burned out tubes, etc.
- Measures A.C. and D.C. Voltages, A.C. and D.C. Current, Resistances, Leakage, etc.
- Will measure current consumption while the appliance under test is in operation.
- Incorporates a sensitive direct-reading resistance range which will measure all resistances commonly used in electrical appliances, motors, etc.
- Leakage detecting circuit will indicate continuity from zero ohms to 5 megohms (5,000,000 ohms).

As an Automotive Tester the Model 70 will test:

- Both 6 Volt and 12 Volt Storage Batteries • Generators • Starters • Distributors • Ignition Coils • Regulators • Relays • Circuit Breakers • Cigarette Lighters • Stop Lights • Condensers • Directional Signal Systems • All Lamps and Bulbs • Fuses • Heating Systems • Horns • Also will locate poor grounds, breaks in wiring, poor connections, etc.

**IT'S SO EASY!!**



With tester's cord to outlet, current consumption of appliance to read direct on meter when line cord is connected to receptacle on panel. This typical iron takes 7 amperes (Good).



Small electric fan motor indicates 50 ohms (normal resistance).



Control circuits of most furnaces use 24 volts obtained from step-down transformer. Here's how to check room thermostat to see if wires to it are live.



Manual supplied with Model 70 shows meter needle moves to right when test leads are connected to pins 3 and 4 of this 6AU tube. Procedure for testing all tubes used in TV are detailed in manual.

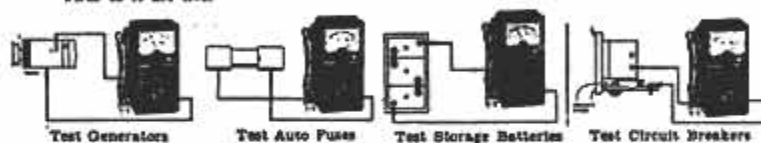

**READ THIS!**

**READ THIS!**

**READ THIS!**

You don't pay for the Model 70 until AFTER you have examined it in the privacy of your home! Model 70 is

## SHIPPED ON APPROVAL NO MONEY WITH ORDER — NO C.O.D.

Try it for 10 days before you buy. If completely satisfied then send \$3.85 and pay balance at rate of \$4.00 per month for 3 months — **No Interest or Finance Charges Added!** If not completely satisfied, return to us, no explanation necessary.

**INCLUDED FREE!!**



This 64-page book—practically a condensed course in electricity. Learn by doing.

Just read the following partial list of contents:

- What is electricity? • Simplified version of Ohms Law • What is wattage? • Simplified wattage charts • How to measure voltage, current, resistance and leakage • How to test all electrical appliances and motors using a simplified trouble-shooting technique.
- How to test all TV tubes; also simple procedure for determining which specific tube (or tubes) is causing the trouble.
- How to trace trouble in the electrical circuits and parts in automobiles and trucks.

Model 70 comes complete with above \$15<sup>85</sup> book and test leads. Only ...

MOSS ELECTRONIC DIST. CO.

Dept. D-437 3849 Tenth Ave., New York 34, N. Y.

Please rush me one Model 70. If satisfactory I agree to pay \$3.85 within 10 days and balance at rate of \$4 per month until total price of \$15.85 plus postage is paid. If not satisfactory, I may return for cancellation of account.

Name \_\_\_\_\_

Address \_\_\_\_\_

City \_\_\_\_\_ Zone \_\_\_\_\_ State \_\_\_\_\_



World  
Wide



# OWN a Business!

Even if now employed, we'll personally train you, furnish all equipment & supplies, and show you how to clear **\$8,750** the first year on **2 jobs a day.**

- **NATIONALLY ADVERTISED**
- **NO SHOP NEEDED**

Enjoy the prestige and financial independence of your OWN business. You will be locally trained to help you get quickly established. Just 2 average jobs a day earns **\$8,750 NET** profit first year. Employ others, MULTIPLY profits. You become an expert in the care of rugs and upholstery. Easy to learn. Start part-time from home. We provide 25 regular benefits. **National Advertising, Publicity Program, Conventions, Monthly Magazine, Insurance, Advertising Kit.** Many others. You offer 5 different services: 1. **Duraclean:** Famous ABSORPTION process for cleaning rugs, upholstery. Commended by Parents'. NO scrubbing, soaking, shrinkage. Aerated foam removes dirt, grease. 2. **Durashield:** Soil-retarding treatment **KEEPS** furnishings clean MONTHS longer. 3. **Duraproof:** Protects against damage by moths. 4. **Duraguard:** Flameproofing to reduce fire damage. 5. **Spotcraft:** For removing stubborn spots and stains.

Moderate payment establishes your business . . . pay balance from sales. We furnish portable machines, complete sales material, enough supplies to return **TOTAL** investment. Send for **FREE** booklets explaining Dealership Program today.

## "OWN a Business" Coupon

**DURACLEAN CO., 8-163 Duraclean Bldg., Deerfield, Ill.**

Please rush free booklets with full details of how I may OWN a growing, lifetime business.

Name \_\_\_\_\_

Address \_\_\_\_\_ County \_\_\_\_\_

City \_\_\_\_\_ State \_\_\_\_\_

## NEW - MIDGET SHORT WAVE RADIO

**GETS STATIONS 12,000 MILES AWAY!**



Tunes ALL foreign short wave bands. London, Paris, Moscow, Australia. ALL Amateur bands. 140 to 10 meters! ALL long distance Air Force and Air Line aircraft. Ships at Sea, AF overseas broadcasts. State-County Police, Industrial bands—U.S. Radio broadcasts. Tunes 500 KC to 40 mc.—600 to 7 meters! NOTHING LIKE IT ON THE MARKET ANYWHERE AT ANY PRICE. Super-regenerative Receiver. Short antenna included—Hook up in 1 second! **PORTABLE SELF-CONTAINED—POWERED WITH RADIO BATTERIES SOLD EVERYWHERE. NO AC PLUG-INS!** Size only 4 1/2" x 6" x 4". Wt. complete —3 lbs. Calibrated hi-ratio easy tuning dial. Wonders.

EVERYONE CAN NOW HEAR THE WHOLE WORLD TALKING! (bill, ck, mo) and pay postman \$12.95 COD postage on arrival or send \$16.95 for post-paid delivery. Complete easy to wire kit includes all parts, tubes, broadcast coil, plaxoid cabinet, instructions—set of long life batteries \$2.90 extra. **COMPLETELY WIRED AND TESTED — POSTPAID IN USA \$21.95. Easily a \$49.95 value. Order now before price goes up — GUARANTEED — AVAILABLE ONLY FROM:**

**WESTERN RADIO Dept. BRM-3 KEARNEY, NEBR.**

## \$1 BRINGS YOU \$18

Discover Flok-Kraft and Earn \$\$\$\$\$ AT HOME

Earn up to \$15.00 per hour spare time. Amazing new Velvet-fiber spray instantly makes any object (Lamp, Radio & TV Cabinets, Figurines, Signs, Auto dash boards, toys, furniture, draperies—anything) worth expensive \$\$\$\$\$ Prices . . . like magic, you can spray anything with this beautiful new suede-like finish that feels like rich Velvet.

**EARN UP TO \$300.00 PER WEEK SPARE TIME**

Imagine, materials cost only 3c per square foot. (Average TV or radio cabinet can be beautifully sprayed with this startling new 3-dimensional Velvet finish in 15 minutes at a cost of only 34c in materials. Your charge for this job is at least \$10.00.)

**REPRESENTATIVES IN YOUR AREA URGENTLY NEEDED**

Own your own business. Work at home in your spare time. Help fill the huge growing demand for this amazing new beautiful Velvet-fiber finish. Orders come from stores, offices, homes, architects, auto dealers, everywhere. Possible \$20,000,000.00 worth of jobs to be done. Investigate today—be first in your area! Actual samples in 16 Radiant Colors. Booklet of 50 Home Business Opportunities and Confidential Details all sent free! Write: Coast Industries, Los Angeles 61, Calif., Dept. B-3.

# INVENTORS

PROTECT YOUR INVENTION BY A U. S. PATENT. SEND FOR FREE "INVENTION RECORD" FORM AND "PATENT INFORMATION EVERY INVENTOR SHOULD HAVE."

**CARL MILLER**

REGISTERED PATENT ATTORNEY

WOOLWORTH BLDG., 36th FLOOR, 38A  
NEW YORK CITY

# INVENTORS

Whether an invention is patentable can be substantially determined by a search of the U. S. Patent records. Without obligation, write for information explaining the steps you should take to secure a patent.

**JOHN N. RANDOLPH**

Registered Patent Attorney

801 Victor Building, Washington 1, D.C.



# INVENTORS

U. S. Patents protect your inventions. Our free book of "Instructions on Patent Procedure for Inventors," also "Certificate of Invention" form sent without obligation.

**C. A. SNOW & CO.**

REGISTERED PATENT ATTORNEYS

428 SNOW BUILDING WASHINGTON 1, D. C.

Take Correspondence Courses

# INVENTORS

Send for **PATENT INFORMATION** REGISTERED PATENT ATTORNEY

Book and **INVENTOR'S RECORD** without obligation

ASSOCIATE EXAMINER  
U.S. PAT. OFF. 1922-1929

**GUSTAVE MILLER**

Patent Attorney & Advisor

38-PM WARNER BUILDING  
WASHINGTON 4, D.C.

U. S. NAVY DEPT. 1930-1947  
PATENT LAWYER

# INVENTIONS For Sale

Our clients have excellent inventions in many fields to be manufactured and marketed on a cash, royalty or license basis. Full description of clients' inventions will be sent if you state your field of interest. **INVENTORS: WE ALSO WANT INVENTIONS OF EVERY TYPE.** Write for details.

**GLOBAL MARKETING SERVICE**

2420 77th Avenue

Dept. MS

Oakland 5, Calif.

# INVENTORS

I shall be pleased to furnish you, upon request, with full information relative to patent procedure—without any obligation on your part.

**PATRICK D. BEAVERS**

Registered Patent Attorney

934 Columbian Building Washington 1, D. C.



# 1957 WINNER - INDIANAPOLIS

**SAM HANKS, famous race driver and mechanic says:**  
**"I'd like a NATIONAL SCHOOLS**  
**trained mechanic on my crew anytime!**  
**Any employer would!"**

Few racing drivers are as qualified to advise future mechanics as Sam Hanks, who builds and repairs his own racing cars. He holds the American Closed Course record (182.554 m.p.h.) and a host of state and national titles, including the National Midget Championship in '49 and the National A.A.A. crown in '53. At Indianapolis, he placed third in '52 and '53 ... last year, he was runner-up.



## MASTER ALL ENGINES IN ONE MODERN, SHOP-METHOD HOME TRAINING COURSE

# AUTO-MECHANICS & DIESEL

NUMBER ONE COURSE IN ITS FIELD," says Sam Hanks, who predicts bright future for men who clip coupon now.

"I've worked alongside National Schools Trained mechanics," reports Sam Hanks. "They're top-notch mechanics, up on the newest advances in automotive engines — even diesel jobs and fuel injection never faze them. That kind of all-around training really pays — no matter where you work. And take it from me, National Schools trained mechanics are in big demand everywhere. They command top pay, because they learned how to repair fast and right the first time. Do I recommend National Schools Home Training in Auto Mechanics & Diesel? You bet I do."

Give it to yourself, Men. National Schools of Los Angeles, a leader since 1905, brings its famous training shops to your home — gives you everything you need to make more money in today's big, opportunity filled Auto-Mechanics & Diesel industry.

Learn as you learn. We show you how. Easy to understand lessons, diagrams, manuals. Free Placement Assistance.

APPROVED FOR G. I. TRAINING



Some of National Schools' world-famous Shops

### RESIDENT TRAINING AT LOS ANGELES

If you wish to take your training in our resident School at Los Angeles, start NOW in our big, modern Shops and Labs. Work with the latest Auto and Diesel engines — all types — fuel injection, automatic transmissions, all power equipment — most complete facilities offered by any school. Expert, friendly instructors. Graduate Employment Service. Help in finding some near school—and part time job while you learn. Check coupon for information.

**YOU GET AND KEEP ALL THIS EQUIPMENT!**



Complete set of professional Tools and All-Metal Tool Box. Same top-quality equipment used by expert mechanics everywhere. Use them, display them proudly.



"Motor Analyzing Set" contains Standard Engine Vacuum Fuel Pump Tester, Remote Starter Switch, Modern Timing Light, Standard Compression Tester. Plus compact carrying case & instructions.



Top-quality Socket Wrench with Fittings. Real professional tools you'll use during your lifetime career in repairing, all types of engines, from foreign cars to big diesel jobs.

**COURSE COVERS**

- All engines
- Fuel injection
- Automatic Transmissions
- Overhauling
- Customizing
- Servicing
- Maintenance

**PREPARES YOU FOR:**

- Auto-mechanic jobs
- Airplane mechanics
- Farm machinery repair
- All diesel jobs
- Experimental Labs
- Government work
- Engine specialist
- All-around mechanic

**GET THE BENEFITS OF OUR 50 YEARS' EXPERIENCE!**



**NATIONAL SCHOOLS**  
 LOS ANGELES 37, CALIF

**FREE!**  
 VALUABLE BOOK & SAMPLE LESSON  
 —Just Send Coupon!



**NATIONAL SCHOOLS**  
 TECHNICAL TRADE TRAINING SINCE 1905  
 LOS ANGELES 37, CALIFORNIA

**MAIL NOW TO**  
**NATIONAL SCHOOLS, Dept. DB-38**  
**4000 S. FIGUEROA ST.**  
**LOS ANGELES 37, CALIF.**

Send for FREE Auto-Diesel Opportunity Book and Sample Lesson.

NAME \_\_\_\_\_ AGE \_\_\_\_\_

ADDRESS \_\_\_\_\_

CITY \_\_\_\_\_ ZONE \_\_\_\_\_ STATE \_\_\_\_\_

Check if interested ONLY in Resident School training at Los Angeles.

VETERANS: Give date of Discharge \_\_\_\_\_



**YOUR  
NEIGHBORHOOD  
NEEDS AN  
ELECTRICAL  
APPLIANCE**

# TROUBLE SHOOTER



Men needed to repair and service all kinds of Electrical Appliances—**AUTOMATIC WASHERS · DRYERS · IRONS · VACUUMS · TOASTERS · REFRIGERATORS · FANS · HOME FREEZERS · AIR CONDITIONERS**—home and industrial motors, etc.—also home and industrial wiring.

**Big, Year-'Round Profits!**  
HELP US FILL HUGE DEMAND

MODERN BIG PROFIT ONE-MAN BUSINESS YOURS AT HOME — SPARE OR FULL TIME.

No previous experience needed. New, visual "Shop-Practice" method quickly shows you how. Hundreds of plain-as-day "How to" photos and drawings make it easy. A corner of garage, porch, attic, or basement is all the space needed. No costly leases—no big overhead. We show you how to make business come to you.

**BIG MONEY, SECURE FUTURE—INDEPENDENCE.**

*P. V. in N. Y. says, "I made \$800 in 3 months while studying." T. E. H. in W. Va. says, "Made \$14 a day while learning."*

**EVERYTHING FURNISHED—Including BIG TOOL KIT** Instructions are complete and include a Tool Kit and Appliance Tester. Everything furnished to help you build your own big-profit business at home. Our new 30-day income plan shows you how to start making money almost at once. Send no money—just your name and address on coupon below. I will rush you FREE complete success plan with full details. Do it NOW—BE FIRST!

**PACIFIC TRAINING SCHOOL, Dept. PM-584**  
11029 So. Vermont Ave., Los Angeles 44, Calif.

**PACIFIC TRAINING SCHOOL, Dept. PM-584**  
11029 So. Vermont Ave., Los Angeles 44, Calif.

## NEW 30-DAY INCOME PLAN!

Shows you how to start your own Big Profit Business without investment—no big overhead

Send for this FREE BOOK! AIR MAIL COUPON NOW!



Gentlemen: Rush me postpaid your FREE plan for success in the Appliance Repair Business and the Free Book Entitled "The Appliance Repair Business and You" and remember I am under no obligation.

Name \_\_\_\_\_  
Address \_\_\_\_\_  
City \_\_\_\_\_ Zone \_\_\_\_\_ State \_\_\_\_\_

## WHOLESALE Electric Guitars - Parts - Factory to You

Solid-body Spanish, amplifiers, tone changer guitars, double-necks, single-necks, triple necks, solid-body mandolin, pickup mikes, non-electric instruments, etc. 1958 Models wholesale. FREE CATALOG. Free home study course with instruments. Parts & plans available to build your own.

**CARVIN CO., Box 287, PM-3, Covina, Calif.**

**TRANSFER LIQUIDS QUICKLY, EASILY**  
Automatically

Self-Starting

## SIPHON PUMP 7 FT. LONG

FACTORIES... CHEMISTS... LABORATORIES... PROCESSORS... DOCTORS

New large-size model with Ball Check Valves of a Polyethylene composition highly resistant to chemicals such as HYDROCHLORIC, SULPHURIC and HYDROFLUORIC acids, as well as ALCOHOLS and most SOLVENTS. Siphon or Pump liquids quickly from heavy Carboys, Drums, or Containers without lifting or moving; and with less danger of spilling.

**STANDARD MODEL**  
6 ft. long Lucite Valves for dilute acids & inorganic solutions. Empty clogged sinks, drains, traps, aquariums & inaccessible places. Carry in car & boat for emergency. Handy when closing Summer Homes for removing water from Pipes, Traps, etc.

**\$4.95** ppd.  
NO NEED TO APPLY TO MOUTH simply squeeze bulb 2 or 3 times.  
**Money Back Guarantee**

**MERIDIAN CO., 366 Madison Ave., Dept. S-171, New York 17**



**DIVING EQUIPMENT SPECIALISTS**



New catalog lists surplus bargains in diving equipment. Complete gear for commercial operators and construction work. NEW deep-water and shallow-water gear. Compressors, Telephones, Lungs, etc.

Immediate shipment from our large stocks.

Write for illustrated diving catalog—20c

**M & E MARINE SUPPLY CO.**  
P.O. Box 601-Y Camden 1, N.J., U.S.A.



**Mr. "N" Made \$9,700 Last Year B Selling Just 20 KEEP/SAFEs a Month**

Like Mr. "N" you can profit with KEEP/SAFE—the fine personal safe that undersells all others. Only safe sold direct. 95% of homes, farm and small businesses are prospects. \$30 to \$75 profit per sale, plus bonuses up to \$12 a safe. Choice territory, chance to become district agent. FREE DEMONSTRATOR! Get details giving address including county.

**JOHN D. BRUSH & CO., INC.**  
575 West Ave. Rochester 11, N. Y.

**ENGINEERING DEGREE IN 27 MONTHS**

B.S. Degree. Aero., Chem., Civil Elec. Mech. & Electronic Engineering (Inc. Radio, TV). 36 mo. B.S. degree in Math., Chem., Physics Prep courses. Demand for Grad. Spacious campus. 20 bldgs.; dorm; auditorium, gym, low rate. Ear board. G.I. approved. Enter March June, Sept., Dec. Catalog.

1638 E. Washington Blvd. Fort Wayne 2, Indiana Keeping pace with progress

## INDIANA TECHNICAL COLLEGE

**SPARE-TIME MONEYMAKING OPPORTUNITIES**  
READ OUR CLASSIFIED ADS

HUNDREDS OF BARGAINS AMAZING OFFERS

**MAKE BIG MONEY—ALL PROFIT—AT HOME!**

## INVISIBLE MENDING

Pays up to \$10 in an Hour!

Make moth holes, cigarette burns, tears, rips, disappear from all fabrics. Little-known craft pays extra spare-time profits at home. Write today for exciting details FREE!

**FABRICON, 6238 Broadway DEPT. 323. - CHICAGO 40, ILLINOIS**



## Take the ache out of GUMS RUBBED SORE BY FALSE TEETH

Get quick-soothing relief of sore, throbbing gums by applying medically-formulated NUM-ZIT Adult Strength. Thousands of false teeth wearers have already had this blessed relief. Pleasant-tasting NUM-ZIT eases discomfort while you break in new false teeth. Works wonders, too, for relief of toothache, neuralgic pains. Keep it handy for quick first aid. At all drug counters.

**Adult NUM-ZIT**

Another fine Purepac product



**Gov't Surplus** **DUPONT NYLON CORDS** **Below Mfrs. Cost**  
 Light, strong, quick-drying. Won't rot, mildew. For camping, boating, hunting, clothesline, Venetian blinds, tent ropes, light anchors, deer cords, trot lines, etc. Unused.

**OUTWEARS ORDINARY ROPE 10 to 1**  
**NYLON BRAIDED CORD**  
 1/16" dia. 100 lb. test. 1 1/2¢ per ft.  
 1/8" dia. 375 lb. test. 2¢ per ft.  
 3/16" dia. 550 lb. test. 2 1/2¢ per ft.  
 In 50, 100, 200, 300, 400, 500 ft. and over lengths.

**NYLON BRAIDED LINE**  
 1/4" dia. 1000 lb. test, olive drab, per ft. in 30, 40 and 50 ft. lengths. 3¢

**NYLON ROPE**  
 5/16" dia. 1900 lb. test. 12¢ per ft.  
 3/8" dia. 2700 lb. test. 17¢ per ft.  
 7/16" dia. 3800 lb. test. 20¢ per ft.  
 All in any length up to 1200 feet. Minimum Order \$1.00. Send check or M.O. if COD, fee extra. **MONEY BACK GUARANTEE**

**SCOTT-MITCHELL HOUSE, Inc.** DEPT. F-3, 611 BROADWAY  
 NEW YORK 12, N. Y.

**'POWER-PACK'**  
*your*  
**PAY CHECK!**

**Train at Home for a Top-Pay Job in**  
**AUTO MECHANICS**

Skill adds many extra dollars to your pay check. This is especially true in the auto field, where 100,000 mechanics are needed. Average pay in some areas is \$3 per hour. It's easy to train at home in spare time for a secure job with a bright future, in America's No. 1 industry. *Mail coupon for full details. No cost nor obligation.*

**2 WAY PORTABLE RADIO SET**  
 SENDS — RECEIVES UP TO 10 MILES AS SHOWN  
 with built-in antenna or hundreds of miles with outside antennal. Works on 80 and 40 meter (Novice) amateur radio-bands—also Aircraft and overseas broadcast (3 to 8 mci). **PORTABLE SELF-CONTAINED POWERED WITH STANDARD PORTABLE RADIO BATTERIES. NO AC PLUG-INS NEEDED!** Take it with you everywhere you go—on trips, vacations, camping—Keep in contact with home, friends. Has 5 watt crystal controlled transmitter—Sensitive Regenerative Receiver, Send-Receive switch, W.T., only 3 lbs. Size, only 6"x4"x4". **TESTED — PROVEN—SIMPLIFIED—PRACTICAL—** Full information given on quick easy to get license.

**SEND ONLY \$3.00** (bill, ck, mo) and pay postman \$11.95 COD postage on arrival or send \$14.95 for postpaid delivery. Complete kit includes all parts, tube, coil, plastoid cabinet, easy instructions. (Set of batteries \$2.95; crystal \$1.25.) **COMPLETELY WIRED AND TESTED POSTPAID \$19.95.** A regular \$49.95 value—Order now before price goes up, **GUARANTEED—AVAILABLE ONLY FROM:**

**WESTERN RADIO** DEPT. 8NM-3 KEARNEY, NEBR.

**MONEY MEN** ALL DATA **FREE**

THE PLASTEX Industry needs manufacturers on small scale and for big production of Lamp and Clock Stands, Art Goods and Novelties in Plastex and Marble imitation. Experience unnecessary. 1/2¢ material makes regular 10¢ store sellers. Rubber moulds furnished for speed production. Small investment brings good returns. We are now placing big Chain Store Orders with manufacturers. Ambitious men have chance for real prosperity. Our Free booklet will interest and benefit you.

**PLASTEX INDUSTRIES, Dept. A**  
 3400 Third Ave. New York 56, N. Y.

**FIX OUTBOARD MOTORS**  
**POWERMOWERS, AND ALL SMALL 2 & 4-CYCLE GASOLINE ENGINES**  
 Repair your own equipment or **MAKE EXTRA MONEY** in this growing field. Fully illustrated, easy-to-understand, Home Study Course. Write for **FREE** information.

**LINCOLN TECHNICAL INSTITUTE**  
 SUITE 3-E, 472 MARKET STREET, NEWARK 5, N. J.

**BUILD and FLY**  
**Bensen**  
**HELICOPTER**

Glider type 'copter—easy to build, simple to fly. Can also be mounted on floats or boat. No pilot's license required. Order 3-view drawings, specs and photo for \$1. Motor powered Gyro-Copter drawings \$2.

Send \$1 or \$2 — Ask about detailed plans and construction kits.

**BENSEN AIRCRAFT CORP., Dept. PM-38**  
 P.O. Box 2725, Raleigh, N.C.

Name \_\_\_\_\_  
 Address \_\_\_\_\_

**Get Experience Using Tune-Up Kit & Tools**  
*(included with training)*

**CTI** sends you a Tune-Up Kit, the kind that skilled mechanics use to locate engine troubles. You receive a compression Tester; Vacuum Gauge & Fuel Pump Tester; Ignition Timing Light; portable steel case. You also get mechanic's tools, including socket set. You acquire *experience* using kits.

**DIESEL MECHANICS OR BODY-FENDER REBUILDING** is yours at no extra cost. Only CTI offers this *extra* choice. You get fully-rounded training in all phases of mechanics.

**Many Students Earn Money as They Train** by taking part-time jobs in local shops or fixing cars "on their own." Many make enough to pay all tuition and buy extra equipment. Some open shops, become independent.

**Get Facts Now—Decide Later** **MAIL TODAY FREE BOOKLETS**

Your future is worth looking into. Get facts on job and business opportunities. Mail coupon today—Commercial Trades Institute, Chicago 26, Ill.

**COMMERCIAL TRADES INSTITUTE**  
 1400 GREENLEAF AVENUE  
 CHICAGO 26, ILLINOIS DEPT. A-770

Send booklet, *Big Money in Auto Mechanics*, and *Sample Lesson*. Both are **FREE**.

Name \_\_\_\_\_ Age \_\_\_\_\_  
 Address \_\_\_\_\_  
 City \_\_\_\_\_ Zone \_\_\_\_\_ State \_\_\_\_\_



**WORLD FAMOUS**  
**Black Forest**  
 FORMERLY \$3.95  
**FREE 88¢**  
 plus 12¢ postage

**10 INCHES**

**CUTS METAL**  
 Supply limited.  
 Rush today!

World's most fabulous hunting knife! Over 100,000 sold for \$3.95. Now this genuine Black Forest Knife yours for only 88 cents. Extra thick, high carbon tempered Korium Steel—can cut thru metals! Sharp enough to shave with. Gives lifetime of rugged service. Hundreds of uses: Skins moose, rabbit, deer, scales fish; cuts hemp, wire, underbrush, branches—even metals! Carves roasts, turkey, steak. Also use for impressive den decoration. 10 inches over-all. Hand forged by legendary sword makers proud of their ancient craftsmanship. Send only 88¢ plus 12¢ postage for prompt delivery. 100% satisfaction guaranteed or money back.  
**THORESEN Inc., Dept. 6-C-76**  
**585 Water Street, New York 2, N. Y.**

**FREE** If you buy 2 or more Passenger 4-ply tires, we GIVE ONE tire FREE, on each order. Does not include W.W. or Truck Tires. Send Ad.

We try to Ship Your Favorite Brand (not recaps)

**GOODRICH** U. S. General, Firestone, others, worn slightly

**GOOD YEAR** 1 replace FAST any defective tire, Fri. Ex.

**12 MONTH GUARANTEE**

Everybody Take **20% OFF** This pictured Tire FREE Ash Tray given with 2 or more tires

600-16 (G) \$6.25	700-17 \$10.25	750-20 \$11.25	1000-20 \$17.95
650-16 (G) 6.65	750-20 10.75	700-15 (H) 7.65	1100-20 17.95
700-16 (G) 7.75	750-18 7.75	825-20 18.45	1000-22 20.85
	750-17 11.25	900-20 18.45	1100-22 21.15

QUANTITIES LIMITED ANY CAR TIRE & TUBE. \$5.50 Whitewall BLACK 4-PLY \$1. Extra

**GENUINE STANDARD BRAND Plus FREE \$9.95 NEW TIRE**  
**FACTORY ADJUSTED TIRES Innertube any car GUAR.**

MARVIN **BLATT** 6th & Spring Garden Philadelphia, Pa. Send check or M.O. & this ad for immediate shipment, FOB Phila. I personally select your tires as if my future depended on it. **BLATT** NAME famous for 42 years in TIRE

**Catalog of 3100 Novelties 10¢**

Send 10¢ for amazing catalog of novelties, live animals, scientific supplies, hobbies, funmakers, planes & boats, looms, magic tricks, joke articles, unusual seeds, gadget timesavers, cameras, optical goods, projector movies, lucky jewelry, religious novelties, disguised musical instruments, stamps, coins, puzzles, fortune tellers, radios, auto & bike accessories, telescopes, magnifiers, compasses, banks, smokers' gadgets, artists' supplies, printing sets, engines, motors, shockers, knives, billfolds, guns, rifles, sports, books, games, plants, etc. Send 10¢ (3 for 25¢—get for friends!).  
**JOHNSON SMITH & CO. Dept. 440 Detroit 7, Michigan**

**Build your own JET ENGINE!**  
 Order these plans today

12. NEW JAPANESE EXPERIMENTAL Pulse Jet. Rotary drive. 5 Plans. \$8.95  
 6. RAM JET. For helicopter use. \$4.95  
 14. STOVE PIPE SIZE PULSE JET ENGINE. Includes helicopter use. \$4.95  
 9. HOT ROD BICYCLE. Compressor Jet engine. Power blower. \$1.99  
 18. DEVELOP IDEAS. How to. \$4.95

High order. Get other information, Photos, Looking-Glass Machine, Fast Art Machine, Shoe Tree Machine, New Hot Helicopter

**J. HOUSTON MAUPIN, Dept. 53, Tipp City, Ohio**

**on any object ELECTROPLATE**

ANY OBJECT IN HOME, SHOP, GARAGE. NOW with our NEW ELECTROCHEMICAL outfit. You can easily do your own plating. Not a paint. But a hard durable metal plate, equal to commercial plating. Get your own plating kit with instructions on plating metal and non-metal objects as Tools, Auto Parts, Silverware, Jewelry, Baby Shoes and 1001 other articles with Chrome, Nickel, Copper, Gold, etc. SEND NO MONEY. Everything sent C.O.D. for the low price of ONLY \$5.95 or send \$5.95 now and receive it postpaid. Money back in 7 days if not satisfied. **M. Z. SALES CO., Dept. G-19, 113 West 42nd St., New York 36, N. Y.**

**100 POUND SET \$11.80**

**BARBELLS**

140-Pound, CHROME DELUXE Barbell-Dumbbell set only \$18.80. This is our feature set and is the finest ever manufactured.

Training with adjustable weight is the BEST way to keep fit; the ONLY way to develop great strength and a perfect body. As the oldest and best equipped barbell company, BUR gives value and prices no one can equal.

**SEND FOR FREE CATALOG.**  
**BUR BARBELL CO.**  
**Lyndhurst 9, New Jersey**

Extra Plates Only 10¢ Pound

**ADD THOUSANDS OF \$ TO THE VALUE OF YOUR HOME!**

New PM Book tells and shows how to handle power tools like an expert—and make valuable property improvements

**POPULAR MECHANICS GETTING STARTED WITH POWER TOOLS**

**LEARN UPHOLSTERY**  
 in your spare time  
 run your own business AT HOME

**BE YOUR OWN BOSS**

Earn more from the start while learning! Set up your own profitable business at home, enjoy steady income, independence—in the booming field of Custom Furniture Upholstery.

**EARN WHILE YOU LEARN . . . the easy UTS way.** Right off you start with tools, complete frames, fabrics, materials, included FREE with your practical, the N. Y. State-approved UTS course. You learn skilled professional custom upholstery, reupholstery, furniture finishing, repairs; to make slip covers, window cornices, cushions, draperies in your spare time. Send for FREE Illustrated Book, Sample Lesson

Get ready for well-paid job, steady work and big profits as your own boss. Also Training in N.Y. School. APPROVED FOR VETERANS.

**MAIL COUPON TODAY. No obligation.**

**UPHOLSTERY TRADES SCHOOL**  
 Dept. GC-310, 721 Broadway, N. Y. 3

Please send me FREE book with FREE Sample Lesson. No obligation—no salesman will call.

Home Study  In N.Y. School Training

Name \_\_\_\_\_  
 Address \_\_\_\_\_  
 City \_\_\_\_\_ Zone \_\_\_\_\_ State \_\_\_\_\_  
 Check if Korean Veteran

A thorough knowledge of power tools and how to use them will enable you to perform hundreds of major and small projects around your home at tremendous savings, and increase its value significantly. Now, with the aid of "Getting Started with Power Tools," it's easy, fun, safe . . . to do more home remodeling and repair jobs, make beautiful furniture, toys and boats, or execute other more ambitious projects you have wanted to do, but never could. This remarkable book, in 160 pages of easy-to-understand text and scores of illustrations, shows you all about the interesting and profitable avocation of working with power tools. Special attention is given to the type of learning problems encountered by the novice. Each major type of power tool is illustrated with captions showing all its parts. But this book is written for the skilled craftsman as well. It tells what you should look for in planning a power tool shop, and how to lay it out for greatest efficiency. It stresses safety procedures that will benefit even the experienced workman. Various attachments are shown that will give one tool many uses, thus saving on the total investment. Never before has a book on power tools been written for the home craftsman that provides as much basic information for the novice, and as many down-to-earth work hints for the expert, as "Getting Started with Power Tools."

Order your copy today, with a money-back guarantee if not pleased. Send your check or money order to the address below in the amount of only . . . . . **\$2.50**

**POPULAR MECHANICS PRESS**  
 Dept. 358, 200 East Ontario St.  
 Chicago 11, Illinois

**CONTENTS**

Ch. 1 — Selecting power tools  
 Ch. 2 — Installing power tools  
 Ch. 3 — Portable power tools  
 Ch. 4 — Operating the circular saw  
 Ch. 5 — Dado-head techniques  
 Ch. 6 — Drill-press operations  
 Ch. 7 — Operating the bandsaw  
 Ch. 8 — How to use the jigsaw  
 Ch. 9 — Working with the wood lathe  
 Ch. 10 — Wood-shaper techniques  
 Ch. 11 — Fundamentals of the jointer



# NEW! MODEL 400 SIMPLEX Lawnmower Sharpener

## Many Exclusive Features . . .

The NEW SIMPLEX is the fastest, most accurate straight-line lawnmower grinder ever built . . . gives you all these advantages:

- Grinds all mowers—reel type, rotary, hand or power, any size.
- No dis-assembly needed, gas and oil remain in engine, support bar rotates.
- Grinding head feeds both horizontally and vertically, turns 90° for bed knives.
- Fast, positive adjustments, 4-point support on steel base with leveling screws.
- Rugged, long life construction and many other features.

## THE FATE-ROOT-HEATH COMPANY

Dept. PM-3 • Plymouth, Ohio

Small investment  
returns

**Big Profits!**



Get the facts on the new Simplex 400  
before you buy any sharpener.

**Send for free brochure today!**

### HYDRAULIC JACK REPAIRS

#### Earn While You Learn at Home

Millions of jacks in gas & auto-service stations, trucks, body-shops, riggers, factories, farms need servicing. We show you HOW—easy step by step directions—what tools to use. EARN UP TO \$5 an hour, in spare time, in your own basement or garage. Start your own business NOW. Write for folder #PM-3 & free bonus offer.

Institute of Hydraulic Jack Repair

P.O. Box 50, Bloomfield, N. J.



### CONCRETE BLOCK HOME PLANS

#### \$2500 RANCH HOME



Build your own 25' x 48' Ranch Home complete for \$2500. Forced air heating system available \$295. Contains liv. room, kit., three bedrooms, bath, utility room, fireplace, carport, or garage. Blueprints, instructions, and material list \$3.00 ppd. Money back guarantee. Other plans—\$1900 DUPLEX, \$1150 GARAGE APARTMENT, \$950 CABIN. FREE FOLDER.

MEMBER ARKANSAS HOME BUILDERS ASSOC.

BAILEY BUILDERS, 308 Hiawatha Drive, Little Rock, Ark.

## BE A COMMERCIAL

# Artist

Prepare for a fascinating, profitable Art career this easy, proven way. One "low-cost" teach yourself course covers Illustrating, Cartooning, Lettering, Oil Painting, TV Art, etc. Plus TWO ARTIST OUTFITS at no extra cost. Cash in on demand for trained artists. Be your own boss or high pay staff artist. FREE BOOK describes our easy method, opportunities in art. No obligation. No salesman will call. Just send your name, address to: WASHINGTON SCHOOL OF ART, Studio 143, Port Washington, N. Y. (Estab. 1914.)



MARCH 1958

## PREPARE FOR BETTER JOB, BIGGER PAY IN SPARE TIME AT HOME

Today, choose the job you want—and prepare for it in time you might otherwise waste. Or if you are already in the work you like best, start training now for quicker promotion and increased pay. During the past 61 years AMERICAN SCHOOL has helped ambitious people to reach higher goals. Check subject that interests you and mail coupon for full information.

AMERICAN SCHOOL, Dept. G345, Drexel at 58th, Chicago 37, Ill.

Without obligation, please send FREE and postpaid, full particulars about the subject checked below.

- |   |   |
|---|---|
| <input type="checkbox"/> Accounting               | <input type="checkbox"/> Mechanical Engineering |
| <input type="checkbox"/> Apprenticeship Courses   | <input type="checkbox"/> Mechanical Technology  |
| <input type="checkbox"/> Architecture & Building  | <input type="checkbox"/> Metalworking Courses   |
| <input type="checkbox"/> Automotive Technician    | <input type="checkbox"/> Plumbing—Practical     |
| <input type="checkbox"/> Better Foremanship       | <input type="checkbox"/> Private Secretary      |
| <input type="checkbox"/> Blueprint Reading        | <input type="checkbox"/> Retail Merchandising   |
| <input type="checkbox"/> Bookkeeping              | <input type="checkbox"/> Salesmanship—Outside   |
| <input type="checkbox"/> Business Management      | <input type="checkbox"/> Sheet Metal Work       |
| <input type="checkbox"/> Civil Engineering        | <input type="checkbox"/> Tool Making            |
| <input type="checkbox"/> Diesel Technician        | <input type="checkbox"/> Mechanists             |
| <input type="checkbox"/> Drafting—Building Trades |   |
| <input type="checkbox"/> Drafting—Machine Trades  |   |
| <input type="checkbox"/> Electrical Engineering   |   |
| <input type="checkbox"/> Electricity—Practical    |   |
| <input type="checkbox"/> Electronics—Industrial   |   |
| <input type="checkbox"/> HIGH SCHOOL COURSES      |   |

NAME \_\_\_\_\_ OCCUPATION \_\_\_\_\_  
HOME ADDRESS \_\_\_\_\_ AGE \_\_\_\_\_  
CITY \_\_\_\_\_ STATE \_\_\_\_\_

MAIL COUPON NOW



# Can you think faster than this Machine?



Be careful before you answer. GENIAC® the first electrical brain construction kit is equipped to play tic-tac-toe, cipher and encipher codes, convert from binary to decimal, reason in syllogisms, as well as add, subtract, multiply and divide. Specific problems in a variety of fields—actuarial, policy claim settlement, physics, etc., can be set up and solved with the components. Connections are solderless and are completely explained with templates in the manual. This covers 50 circuits and shows how new ones can be designed.

You will find building and using GENIACS® a wonderful experience; one kit user wrote us: "this kit has opened up a new world of thinking to me." You actually see how computing, problem solving, and game play (Tic-tac-toe, nim, etc.) can be analyzed with Boolean Algebra and the algebraic solutions transformed directly into circuit diagrams. You create from over 400 specially designed and manufactured components a machine that solves problems faster than you can express them.

Schools and colleges, teachers of science or math, engineering, philosophy or psychology will find these excellent demonstrators of circuitry, solutions in symbolic logic, theory of numbers, cybernetics, and automation.

SEND for your GENIAC® kit now. Only \$19.95 with over four hundred components and parts, fully illustrated manual and wiring diagrams. We guarantee that if you do not want to keep GENIAC® after one week you can return it for full refund. Add 80c west of Mississippi. \$2 outside U.S. Mail Name & Address with check or money order to

**OLIVER GARFIELD CO., INC., DEPT. PM-38**  
126 Lexington Avenue NEW YORK 16, N.Y.

## GIANT 6 FOOTERS 59c



Wow! Genuine Neoprene government surplus (never used) . . . giant 6 ft. across, 21 ft. around . . . at a fraction of original cost. Durable. Can paint on advertising message, inflate and fly. Visible for miles. Great for attracting crowds to fairs, openings, school proms, gas stations. Fun for young and old in backyards or picnics, at the beach, etc. use as water markers & buoys. Order today—only 59c. No C.O.D.

Special 2 for \$1.00  
13 footer . . . \$1.95

**FRANK SALES** 3930 SUNSET BLVD., DEPT. PM358  
LOS ANGELES 29, CALIF.

## EARN EXTRA MONEY IN YOUR SPARE TIME . . . AT HOME

**New Plastic-Fiberglass Process opens up excellent opportunities**

IF you have some spare time and could use extra cash, here is a new handbook you'll want to read. "How to Earn Extra Money" is full of ideas for the smaller operator with a garage or basement shop. It shows what others have done, how they started, what they make. Tells how one man earned \$1800.00 net profit in 6 weeks in his home shop, and how you can do the same. Illustrated Directions Show How to embed real flowers,

butterflies, sea shells, coins, photos in clear liquid plastics to make novelties, distinctive jewelry, advertising specialties and other fast-selling items. How the same materials are used for laminating decorative glass panels, for molding fiberglass boats and for "glass welding" wooden boats, tanks, pools. Nothing like it has ever been published before. Send 25c for manual to Commercial Craft Division, Dept. C-1.

**THE CASTOLITE COMPANY, Woodstock, Illinois**



## POPULAR MECHANICS

Books for the Farmer

- to reduce work
- protect and improve livestock
- increase profits



### New Ed. Veterinary Guide for Farmers

Written by farm expert, G. W. Stamm, this amazing book has sold more than a quarter million copies . . . now completely revised with most modern discoveries and methods fully discussed. Adopted by the U. S. Government for farm training. Used by farmers everywhere to diagnose and treat livestock diseases. Covers virtually every farm animal ailment and tells how to tell one from another; explains treatment or best procedure until the vet arrives. Includes a special, invaluable 12-page diagnostic chart that helps you locate symptoms in short order. A special chapter is devoted to artificial insemination and tells how this breeding method can improve the quality of your herd as well as increase your profits. Noted authorities proclaim this book the finest and most complete guide of its kind available to the farmer and stock raiser. . . . **\$3.95**



### New Edition Farm Manual

Helps you step up farm efficiency, improve property appearance and values, increase farm production and income. Every member of the farm family will find something in this book he or she can use to great advantage in farm operation, maintenance and improvement . . . from the building and care of equipment to painting the farm home and fast freezing of fruit and vegetables. Covers every aspect of farm machinery maintenance . . . includes detailed plans for building essential equipment from scrap and discarded materials. Even suggests how to mix and pour concrete that will last longer! Here is a book brimming with short cuts, labor-saving ideas and methods that will simplify farm chores and save you money as well. Adopted by State Farm Training Programs. Hundreds of pictures and clearly drawn diagrams. . . . **\$3.00**



### Artificial Breeding and Livestock Improvement

Now—the secrets of the key to better livestock revealed by farm editor, G. W. Stamm! The first book in ten years to cover the up-to-date principles and practices of Artificial Breeding . . . and written in words every farmer and stockman can understand easily and follow surely. This astonishing book presents the true, approved facts on inbreeding, line-breeding and cross-breeding, plus sections on timing, heat periods, how to pick a good dairy cow, how to choose a herd sire, what to do when a bull fails to perform, what's ahead in the field of frozen semen and many other topics of interest. Included is a 13-page directory of semen producers, the areas they serve and the breeds of bulls in their studs. If you are a modern livestock producer interested in the best methods and top profits, you simply cannot afford to be without this book for regular reference. . . . **\$3.50**



### Developing a Profitable Dairy Herd

Here, in a single, practically written book is everything you want and need to know about profitable dairy herd management. Written by Carnation Farms' Merton L. Moore and E. M. Gildow, D.V.M., there is complete information on feeding values, fertilization of pastures, silo practices, breeding, production, pedigrees, management problems and operating economies, vitamins and many other vitally important subjects. A most interesting chapter covers the showing and selling of cattle. Hundreds of charts, photos, drawings and diagrams leave nothing to the imagination. Whether you raise just a few cows or maintain a huge operation involving hundreds of animals—you'll profit from using this book. . . . **\$3.50**



### Hog Profits for Farmers

Hog raising can be highly profitable for the farmer . . . if proper management and feeding methods are employed. Even if you raise only a few hogs you can make a much bigger profit by applying the suggestions and ideas contained in this outstanding Popular Mechanics book. Written by Dr. W. N. McMillen, it offers down-to-earth, practical money-making information on care and management, feeds and feeding, equipment, marketing, breeds and breeding, judging, showing and sales tips. Contributors include many well-known agricultural experts and renowned college instructors. Only a mere 15 minutes of reading time will show you how to apply the six high points of profitable hog raising to improve your profits immediately. . . . **\$3.00**

Satisfaction Guaranteed or Your Money Refunded.  
Place your order now. Use coupon below.

MAIL TODAY

**POPULAR MECHANICS PRESS, Dept. 358**  
200 East Ontario St., Chicago 11, Illinois

RUSH books I have checked below. If not pleased, I can return in good order within seven days for full refund.

Remittance enclosed. Send prepaid.  Send C.O.D.; U.S.A. only

Veterinary Guide  Farm Manual  Artificial Breeding

Profitable Dairy Herd  Hog Profits

Name \_\_\_\_\_

Address \_\_\_\_\_

P.O. \_\_\_\_\_ State \_\_\_\_\_



# Choose the Allied Way for Best Pay

## TRAIN AT HOME

### in Your Spare Time or in the Great Allied School



Drafting—All Branches

Tool & Machine Design (Bachelor Degree TE)

Tool Engineering (Bachelor Degree ME)

Mech. Engineering

Master Machinist

Tool & Die Making

Auto Mechanics

Air Conditioning

Refrigeration

Prepare for the best jobs in your spare time at home. With ALLIED'S practical Home Study program you can progress so rapidly that big new opportunities will soon be open to you. Soon after starting many ALLIED students begin to make good extra money in their spare time. ALLIED'S Home Training methods are the finest ever designed for they are based on the successful programs developed in the ALLIED resident school for more than a quarter of a century. Your Home Training may entitle you to two weeks of training at the great ALLIED shops at no additional tuition cost, should you desire it. You get many advantages and additional services when you enroll for ALLIED training.

### More Jobs Than Graduates

Students planning a career in engineering, can begin their training in short courses at Home or at Allied Institute, and continue progressively toward an Engineering Degree in 31 months.

Allied is approved by Industry, National Home Study Council, Department of Education, Office of Public Instruction, State of Illinois, U. S. Department of Justice. **BE AN ALLIED TRAINED MAN — GET THE FACTS — MAIL COUPON TODAY.**

### Mail Coupon for Free Sample Lesson

#### ALLIED INSTITUTE of TECHNOLOGY

1338-42 South Michigan Avenue, Dept. PM-38, Chicago 5, Illinois

Gentlemen:

Mail me FREE BOOKS explaining ALLIED'S courses of instruction and FREE SAMPLE lesson. Vets write date of discharge.

I am interested in the training I have checked below:  Resident  Home Study

- |  |   |   |
|--|---|---|
| <input type="checkbox"/> DRAFTING—All Branches                 | <input type="checkbox"/> MECH. ENGINEERING (Bachelor Degree—ME) | <input type="checkbox"/> AUTO MECHANICS   |
| <input type="checkbox"/> TOOL & MACHINE DESIGN                 | <input type="checkbox"/> MASTER MACHINIST                       | <input type="checkbox"/> AIR CONDITIONING |
| <input type="checkbox"/> TOOL ENGINEERING (Bachelor Degree—TE) | <input type="checkbox"/> TOOL & DIE MAKING                      | <input type="checkbox"/> REFRIGERATION    |

NAME \_\_\_\_\_

ADDRESS \_\_\_\_\_

CITY \_\_\_\_\_ COUNTY \_\_\_\_\_ STATE \_\_\_\_\_



#### FREE BOOKS

tell how YOU can become an ALLIED TRAINED MAN. Write TODAY!

ALLIED INSTITUTE OF TECHNOLOGY, DIV.  
ALLIED School of Mechanical Trades  
1338-42 South Michigan Avenue  
Dept. PM-38, Chicago 5, Illinois



# OFFICIAL ELECTRICAL

Helps you do safe,  
sure installing  
and wiring jobs!

CODE RULES  
MADE PLAIN

JUST  
OUT!

NOW you can do work that fully meets latest 1953 National Electrical Code rules for correctness and safety. You can get the EXACT meaning of rules—how they apply to the electrical job you're doing—quickly and easily with this practical handbook. Explains Code rules in simple, clear language—uses diagrams, tables, and photographs so you grasp every point. Protects you against legal violations. Answers questions on materials, wiring, plans, installations.

Index lists rules applying to all types of electrical jobs, arranged under job title. You can be SURE no rule is overlooked. Complete tables give full-load current, wire size, conduit size, and branch fuse rating of all motors. Covers motor wiring, switches, generators, appliances, cable assemblies, transformers, etc.

Covers all types of jobs:

Farms, Homes, Gas stations, factories, Signal systems, Motor installation, Cranes and hoists, Alarms, many others.

FREE  
10-DAY  
TRIAL

McGraw-Hill Book Co. Inc., Dept. PM-3  
327 West 41st St., New York 36, N. Y.

Send me Abbott's National Electrical Code Handbook for 10-DAY FREE EXAMINATION. If not satisfied I will return it—pay nothing. Otherwise, I will keep it and send \$8.00, plus postage.

Name \_\_\_\_\_

Address \_\_\_\_\_

Employed by \_\_\_\_\_

City \_\_\_\_\_ Zone No. \_\_\_\_\_ State \_\_\_\_\_  
(if any)

SAVE DELIVERY COST—Check here if enclosing \$8.00 WITH coupon. Then WE prepay all handling charges. Money back if you return book. PM-3



## ABBOTT'S NATIONAL ELECTRICAL CODE HANDBOOK

New 9th edition, revised by C. L. Smith, Field Eng., Natl. Fire Protec. Assn.; brand-new arrangement, rules in same order as Code; easier-reading type; fully up to date; most improved edition in 23 years!

## NEW COLUMBIAN 'CUSTOMIZED' OUTBOARD PROPELLERS



The right propeller for every HULL-LOAD-HP combination and every USE. More propeller "bite," less vibration, big gas savings. Ask your dealer for literature with PROP SELECTOR CHART, or write COLUMBIAN BRONZE CORP., Freeport, N. Y.

TV DAN, THE  
MUSCLE MAN  
SAYS



## I'LL GUARANTEE YOU RIPPLING MUSCLES

IN 6 WEEKS OR MONEY BACK  
You can have tremendous power, look bigger, have more confidence this tested way. Revolutionary new "Body Mold" courses build your body in a way no other method can match. Get course FREE with order. Lowest factory price.

DAN LURIE BARBELLS

50 lb. set \$ 8.98 • 100 lb. set \$14.98

150 lb. set \$21.98 • 200 lb. set \$27.98

Extra sets — 1 for only \$1.25 cash.

DAN LURIE BARBELL CO.

52-N-3 Bristol St., Dept. 859-C, Bklyn 12, N.Y.

FREE! SEND FOR NEW SPORTS & HEALTH CATALOG

## New HOME-IMPORT BUSINESS!



Men — Women. We show you how to import big-profit items at amazing low foreign prices (examples at left). Your home is your office. Get list of 157 imports FREE! Full or spare time business by Mail Order. Or take volume orders from stores. Import jewelry, clothing, sporting goods, hardware, etc. NO EXPERIENCE OR INVESTMENT IN PRODUCTS NEEDED. Without obligation send today for complete details and list of 157 imports FREE! Air mail reaches us over night. THE MELLINGER CO., 1717 Westwood Boulevard, Dept. P253, Los Angeles 24, California.

Clocks 65¢  
in Germany—  
\$5 value  
in U.S.A.

You can make money in

## WATCH REPAIR



Learn at home the low cost Sweazey Way

Watch repairing pays up to \$6 an hour, part time watch makers report on survey. Unique and modern Sweazey home study System starts you making repairs right away on Swiss and American watches. Professionally prepared training. No previous experience needed. Free sample lesson and opportunity book give all facts. Write today. No obligation.

CHICAGO SCHOOL OF WATCHMAKING  
2330 N. Milwaukee Ave., Dept. 138, Chicago 47, Illinois

"JUST  
FINE,  
THANK  
YOU!"

...like 800,000 Americans who have been cured of cancer because they went to their doctors in time. To find out how to guard yourself against cancer, write to "Cancer" in care of your local Post Office.

AMERICAN CANCER SOCIETY



# SELLING OUT SALE

Thousands Camellias — Azaleas —  
Rhododendrons

Shade Trees — Flowering Shrubs  
of Every Description

We did not complete our selling out sale last season on account of enormous supply of stock, but sale will definitely end this season, which closes May 31st. Best quality stock. Rush your order now. Nothing reserved.

## FEW OF THE BARGAINS

**Camellias** — Mixed from 400 varieties of some of world's finest camellias, unlabeled. Will try to send your choice but cannot guarantee, 4 to 6 years old, mostly budded: \$3.00 each. 8 to 10 years old, extra heavy, budded: \$4.00 each.

**Sasanqua Camellias** — very hardy—2 years: 6, \$5; 12, \$9.

**Native Azaleas** — hardy, deciduous, will grow anywhere—Mixed colors, 1' to 3': 12, \$3; 24, \$5; 100, \$18.

**Rhododendrons** — grow anywhere, evergreen, unsurpassed in beauty—Mixed colors, 1' to 3': 12, \$4; 24, \$7; 100, \$25.

**Rose Bushes** — Field Grown, Assorted Varieties and Colors, 2 years old: 10, \$4.50.

**Banana Trees** — Rooted Butts, bearing size, will grow in house, shade or sun. 4 years old: each \$5.

**Privet Hedge** — 2' to 4': 50 for \$10, 100 for \$15.

**St. Augustine Lawn Grass** — it is hardy, plant anytime, evergreen, thrives in shade or sun, \$4 per bushel twigs.

**Daylilies** — Will grow anywhere. 400 varieties. Will try to send your choice, labeled, but may substitute nearest variety—6 for \$3.00; 12 for \$5.00. Mixed colors, unlabeled, 24 for \$3.00; 100 for \$10.00.

**Do Your Own Landscaping at These Give-Away Prices. All Plants Listed Below Will Grow Anywhere in U. S.**

50¢ Ea. 1 to 3'—Flowering Shrubs: Weigela, Spirea, Lilac, Snowberry, Forsythia, Dogwood, Deutzia, Mock Orange, Aithea, Redbud, Butterfly Bush, Beauty Bush, Hydrangea, Hypericum, Coral Berry, Purple Fringe, Crepe Myrtle. Trees: Weeping Willow, Pin Oak, Maple, Elm, Ash, Tulip, Birch, Red Cedar, Holly. Miscellaneous: 50¢ Ea.: Honeysuckle, Blackberries, Blueberries.

All above plants shipped prepaid. You may come to the Nursery and make your selection if desired. No time to send price lists or letters during this sale. Remittance with order. All plants sold as is on Sales Lot. On mail orders, you may return any unsatisfactory plants immediately for full refund.

**MINIMUM ORDER \$3.00! THOUSANDS OF OTHER BARGAINS! COME SEE FOR YOURSELF!**

Save enough on shrubbery to pay for a trip to Mississippi's beautiful Gulf Coast!

Highway 90, halfway between Gulfport and Biloxi. Turn at the Big Sign on the Beach. Shipped now or when desired.

Address Mail Orders to **SPURGEON PICKERING, Dept. PM3, Biloxi, Miss.**



Actual photo of evergreen English Ivy 6 foot hedge running up on parallel wire strands 12" apart. Any kind of wire will do. Will grow rapidly anywhere. Plant 6" to 12" apart. English Ivy also used to grow on walls, poles, and as ground cover, etc. It runs up on itself and rarely needs trimming. Rooted cuttings—12 for \$3.00; 100 for \$20.00.

## "TI-NEE" BATTERYLESS TUBELESS LIFETIME RADIO

"TI-NEE" RADIO IS GUARANTEED TO WORK FOR YOUR LIFETIME! USES NO TUBES, BATTERIES OR ELECTRICAL PLUG-INS. Never runs down! SMALLER THAN A PACK OF CIGARETTES! RECEIVES LOCAL RADIO STATIONS MOST ANYTIME, ANYWHERE WITHOUT EXTRA ANTENNA. Uses semi-conductor crystal diode Hi-Q Tuner. Beautiful black gold plastic cabinet. Built-in Speakerphone.

SEND ONLY \$2.00 (bill, ck, mo) and pay postman \$4.99 COD on arrival or send \$6.99 for postpaid delivery. SENT COMPLETE READY TO LISTEN—NOTHING EXTRA TO BUY EVER! Extra long distance Aerial kit included free to receive stations up to 1,000 miles away. Available only from:

MIDWAY COMPANY, Dept. GPM-3, Kearney, Nebraska



## MANUFACTURE THIS BEAUTIFUL CONCRETE OUTDOOR FIREPLACE

Right In Your Own Backyard

\$4.00 Worth of Sand & Cement produces this Attractive Fireplace.



Sells on Sight from \$60. to \$80. Easy to start your own Profitable Business.

The General Fireplace Molds and Process are the most amazing and foolproof ever invented. Simple to operate. Two men can produce five fireplaces a day.

### BIG DEMAND!!

Sell all you produce to Department Stores, Homeowners, Parks, Nurseries and Picnic Groves. Fireplaces sell on sight. No experience necessary. We supply full operating instructions and equipment plus the know-how that spells BIG PROFITS. This is an outstanding opportunity for men of vision and small capital to get into a busy rich paying field. Don't delay, be the only exclusive manufacturer in your own home town. Mail coupon at once for full details as to how you can reserve your territory. Molds sold only on exclusive franchise.

**GENERAL ENGINES CO., Inc., Dept. MF-38**  
ROUTE 130, THOROFARE, N. J.

Mr. Tor of Philadelphia writes: Sold 250 in first 4 months. Selling to Sears Roebuck, John Wanamaker, and Gimbel Bros. in Philadelphia area.

Name .....  
Address .....  
City ..... Zone .....  
State .....

## unlimited opportunity for graduate engineers

Demand for our engineering graduates exceeds supply. Important firms visit campus regularly to interview seniors. Industrial growth . . . automation . . . technical advances create career opportunities for engineers, accountants, management experts. Share rewards awaiting college men . . . higher income . . . rapid advancement. Grasp your chance for a better life now! Start any quarter in this world-famed college. Approved for veterans.

### Bachelor of Science degree in 27 months

In Mechanical, Civil, Electrical, Chemical, Aeronautical, Radio (TV-Electronics) Engineering. In 36 months a B.S. in Business Administration (General Business, Accounting, Motor Transport Management majors). Superior students may accelerate. 36-weeks course in Drafting. Intensive program: technical fundamentals stressed: comprehensive courses with more professional class hours. Small classes: personalized instruction. Enrollment limited. Preparatory courses. Beautiful campus. Well-equipped, new and modernized buildings and laboratories. Enter Mar., June, Sept., Jan. Earnest, capable students (whose time and budget require accelerated courses and modest costs) are invited to write Jean McCarthy, Director of Admissions, for catalog and book "Your Career in Engineering and Commerce."

**TRI-STATE COLLEGE**

438 College Avenue • • • Angola, Indiana



# \$ 1,000 A YEAR SPARE TIME INCOME

Spend only 1 or 2 hours a day sharpening saws, maintenance tools, knives, etc. Versatile, low-cost Foley 314 Grinder (only \$133.75) puts you in this high profit business. You can make \$3 to \$5 an hour—sharpen just 3 saws a day, for instance, and you can put over \$1,000 a year in your pocket. You clear 95¢ out of every \$1.00 you take in! Thousands of farmers, home owners, schools, industries, contractors need this service.

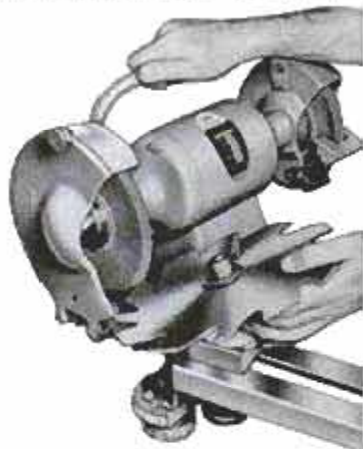

**FREE PLAN** shows how to get started, get customers, expand your business. Send coupon for information now! No obligation. No salesman will call.

**FREE PLAN** shows how to get things you want by using your spare time.



**FOLEY MFG. CO.** 373-8 Foley Bldg. Minneapolis 18, Minn.  
Send **FREE PLAN** for spare time home business with Foley 314 Grinder.

Name .....

Address .....

City ..... Zone ..... State .....

## GET INTO RADIO • TELEVISION



Prepare for Big Pay Jobs or Your Own Business  
—TRAIN AT HOME IN SPARE TIME!

### Earn While You Learn

Good pay jobs are waiting for men who know **RADIO-TELEVISION**. Learn at home, get valuable, interesting, actual, practical experience with kits and equipment we send. Earn extra cash servicing sets while learning. No previous experience needed. Rush coupon for big book and Sample Lesson . . . **FREE!** No salesman will call. Our 27th year.

**FREE!**

60 Page  
Catalog  
and  
Sample  
Lesson

**Sprayberry Academy of Radio-Television**  
1512 Jarvis Ave., Dept. 10-E, Chicago 26, Ill.  
Rush catalog and complete lesson . . . no obligation.

NAME .....

ADDRESS .....

TOWN ..... STATE .....



**A REMINDER  
CRIPPLED CHILDREN  
NEED YOUR HELP**

National Society  
for  
Crippled Children and Adults  
11 So. LaSalle Chicago 3

## YOU MAKE 'EM WE SELL 'EM!



Let me show you how to build a big pay business of your own without canvassing, without house-to-house selling!

I'll show you a simple easy way to make dozens of "Made-to-Order" cases for musicians, salesmen, hunters, manufacturers, fishermen, gun collectors, phonographs and 100! other portables. I'll supply instructions, tools, materials—everything you need. My plan is absolutely safe! You risk nothing! Keep your present job and work sparetime until you decide to devote full time to this big pay work that is so fascinating. Set up your shop wherever you have

**MY NATIONWIDE SALES ORGANIZATION WANTS TO WORK FOR YOU!**

a few spare feet. With my plan anyone can have his own business without a big investment and without previous experience, and remember you don't have to worry about sales because my National Sales Staff sells for you.

I am very satisfied to make a small profit because I can count on big volume on the supplies I sell to Casecrafters, yet home workers make a big profit because the finished cases sell for up to ten times the cost of materials . . . Write for full, FREE, details today.

**ABARSI CASECRAFT** 807 SUNSET BOULEVARD  
Dept CC Los Angeles, Calif.



**JACK STEARNS**  
made \$450.00 on  
his first order  
for cases.  
**SO CAN YOU!**  
POSITIVE PROOF SENT  
TO YOU FREE!!!



Get into..

# PLASTIC LAMINATING AT HOME!

**THIS MAN ..**  
... is taking out of the machine a Plastic Sealing Job—ordered by mail—only 11c in material cost brings back \$2.58 in cash by mail. Capacity of machine: **\$25.00 profit per hour of operation.**

Get **ORDERS** and **CASH** from your mailman—do work in **SPARE TIME** at home—or expand into **FULL TIME** business. Send coupon for Free facts about the newest and most fascinating of all home operated businesses. For the first time a simplified machine brings the fabulous profits of **Plastic Sealing** and **Plastic Laminating** within the reach of the small operator. Anyone can learn to operate the machine with a few minutes practice—then with our **Magic Mail Plan** can get mail orders pouring in daily with cash in every envelope. **No canvassing—no selling.** We even

Make \$20 to \$30 a Day by..  
**MAGIC MAIL PLAN!**

supply the circulars you mail to bring back cash and orders. Don't waste a minute. Rush your name. We'll send you **FREE** and postpaid, pictures, prices, details, and all the facts you need to start. Mail coupon or send name on postcard. No charge. Warner Electric Co., 1512 Jarvis Av., Dept. L-2-C, Chicago 26, Ill.

**Make Thousands of Beautiful Art Creations**  
COSTUME JEWELRY • CIGARETTE BOXES  
TRAYS • CANDLESTICKS • COASTERS  
LAMP BASES • BOOK ENDS...ALL IN  
SPARKLING COLORED PLASTIC



**WARNER ELECTRIC CO., 1512 Jarvis Av.**  
Dept. L-2-C, Chicago 26, Ill.  
At no cost to me, please rush complete details postage prepaid. I am under no obligation.

Name \_\_\_\_\_  
Address \_\_\_\_\_  
City \_\_\_\_\_ Zone \_\_\_\_\_ State \_\_\_\_\_

## GET INTO ELECTRONICS

V.T.I. training leads to success as technicians, field engineers, specialists in communications, guided missiles, computers, radar, automation. Basic & advanced courses in theory & laboratory. Assoc. degree in 29 mos. B.S. obtainable. ECFD accredited. G.I. approved. Graduates with major companies. Start Sept., Feb. Dorms, campus. H. S. graduate or equivalent. Catalog.

**VALPARAISO TECHNICAL INSTITUTE**  
VALPARAISO, INDIANA  
DEPT. D

## BRONZE FOUNDRY

Schools • Home Workshops • Inventors  
Make your own castings of aluminum, copper, bronze, silver. Foundry sets are available in three sizes including 2400 Deg. F. blast Furnaces. \$26.50; \$33.50; and \$46.00 f.o.b. Marysville or Lakewood. Free Circular.

**KANSAS CITY SPECIALTIES CO.** (Dept.) Box 6022, Marysville, Kans. P-3 or Box 7543, Lakewood, Colo.

## Are Those Crusts and Scales PSORIASIS?



If they are, use **Siroil**. For 25 years psoriasis sufferers have learned that **Siroil** tends to remove those unsightly crusts and scales. If lesions recur, light applications of **Siroil** help control them. **Siroil** won't stain clothing or bed linens. Offered on 2-weeks-satisfaction-or-money-refunded basis.

Write for **NEW FREE BOOKLET** written by **REGISTERED PHYSICIAN**

**NEW BOOKLET** answers 30 most-asked questions about psoriasis.

**SIROIL**

**AT ALL DRUG STORES**

**SIROIL LABORATORIES, INC.**  
Dept. PM-11 Santa Monica, Calif.  
Please send me your new **FREE** booklet on PSORIASIS.  
NAME \_\_\_\_\_ Please Print  
ADDRESS \_\_\_\_\_  
CITY \_\_\_\_\_ STATE \_\_\_\_\_

## BOAT KITS 50 Models 8' to 18'

Free Catalog in Full Color



Runabouts, cruisers, convertibles, fishing: \$41.75 and up, Freight pd. Luger boats equal factory built; yet save you to 2/3 cost. Methods assure a perfect assembly by anyone. **FREE** color catalog includes: Fiberglass, trailers, paints, hardware, accessories. Write now.

**LUGER INDUSTRIES, INC.** Dept. B-3  
9200 Access Rd. Minneapolis 20, Minn.

EARN MORE—LEARN TO BE AN

## AUTO MECHANIC

OR TRAIN WITH OTHER GREER DIPLOMA COURSES

- AUTO MECHANICS
- DIESEL MECHANICS
- BODY & FENDER REPAIR
- GAS-ARC WELDING
- REFRIGERATION
- AIR CONDITIONING
- MACHINIST TRADE
- ADVANCED MACHINIST
- PIANO TUNING & REPAIR

Skilled men are needed in every part of the country. Earn top pay in established shops or start your own business. Greer's expert instruction and actual shop training teaches you how. You learn by doing—quick, easy courses using the latest tools and equipment. Day, evening and part time instructions available.

Job placement and convenient living accommodations are yours while training. Contact **GREER'S FREE JOB PLACEMENT SERVICE** when you enroll if you wish part time or full time employment.

### ENGINEERING DEGREE COURSES

- DIESEL AUTOMOTIVE ENGINEERING 27 MOS.
- REFRIGERATION & AIR COND. ENGINEERING 18 MOS.
- WELDING ENGINEERING 18 MOS.

All Courses Approved  Civ. or  G.I.

Please rush me free literature on Auto Mechanics, or on the trade indicated, at no obligation.

NAME \_\_\_\_\_ AGE \_\_\_\_\_  
STREET \_\_\_\_\_  
TOWN \_\_\_\_\_ ZONE \_\_\_\_\_ STATE \_\_\_\_\_

Established 1902

**GREER SHOP TRAINING**  
Box C, 2236 S. Michigan Ave.  
Chicago 16, Illinois



# HOW TO GROW ORCHIDS

## AT HOME!

Learn about special conditions of light, temperature, humidity orchids need



**SUCCESSFUL HOME GROWER Says:**

"I'll Show You How Mrs. Schirmer & I Raised Orchid Plants Worth a Fortune Starting at Home in Spare Time!"



Purple — White  
Green — Yellow  
Every Rainbow Color

**THRILLING HOBBY**—Imagine the delight of watching gorgeous Orchids burst into radiant bloom—to be snipped fresh from the plant for personal corsages, for gifts, or to sell at fine profits! Big lavender or white Cattleya Orchids like those sold in every flower shop—exquisite Cymbidiums often 25 to 30 flowers on a stem. Dozens of others. Many Orchids grow without soil, getting food from the air.

**PROFITABLE HOME BUSINESS**—Schirmer Course explains how to market Orchids for profit, spare or full time—from small town, big city, even a farm. Big year-round demand from individuals, florists, hotels, etc.

Hundreds of Families Growing Orchids at Home with our help...

Millions sold by mail order. Learn how Orchids multiply—one plant may become many, each valuable as the first. No big investment. Takes only few minutes a day.



"Most enjoyable hobby I know. People drove 100 miles to see this plant—10 flowers, 8½" across.

Thomas Hurst, Utah

"I sell many blooms, and haven't really started yet. Owe my success to the Schirmers."

Mrs. Frank Harwood, Ore.

"I have standing orders for future flowers. Will always be grateful to you."

Mrs. Robert E. Lee, Ohio



**COMPLETE INSTRUCTIONS AND REAL ORCHID PLANT—YOURS TO EXAMINE AT HOME BEFORE YOU DECIDE!**

Nearly 300 pages of Instructions—the "Know-How" of the experts—in simple language, jam-packed with "show-how" drawings and photographs, many in natural color. Real blooming-size Orchid Plant included in same shipment with Course. All for you to examine at home—No obligation to buy a thing unless you wish. **FREE**—full details. **SEND NO MONEY.** Just name & address on Coupon or post card. Write today. Airmail is quickest.

**TROPICAL FLOWERLAND, Dept. 33-A**  
100 S. Vermont Ave., Los Angeles 4, Calif.

### MAIL COUPON NOW!



**TROPICAL FLOWERLAND, Dept. 33-A**  
100 S. Vermont Ave., Los Angeles 4, Calif.  
Rush me, absolutely **FREE** and postage paid, complete details on your offer of Louis & Gladys Schirmer's Instructions which show how to grow Orchids at home. The Instructions will include a real blooming-size Orchid Plant and valuable "Quick-Profit" Plan. All sent for me to examine at home before I make any decision whatever.

Name \_\_\_\_\_  
Street \_\_\_\_\_  
Town \_\_\_\_\_ Zone \_\_\_\_\_ State \_\_\_\_\_

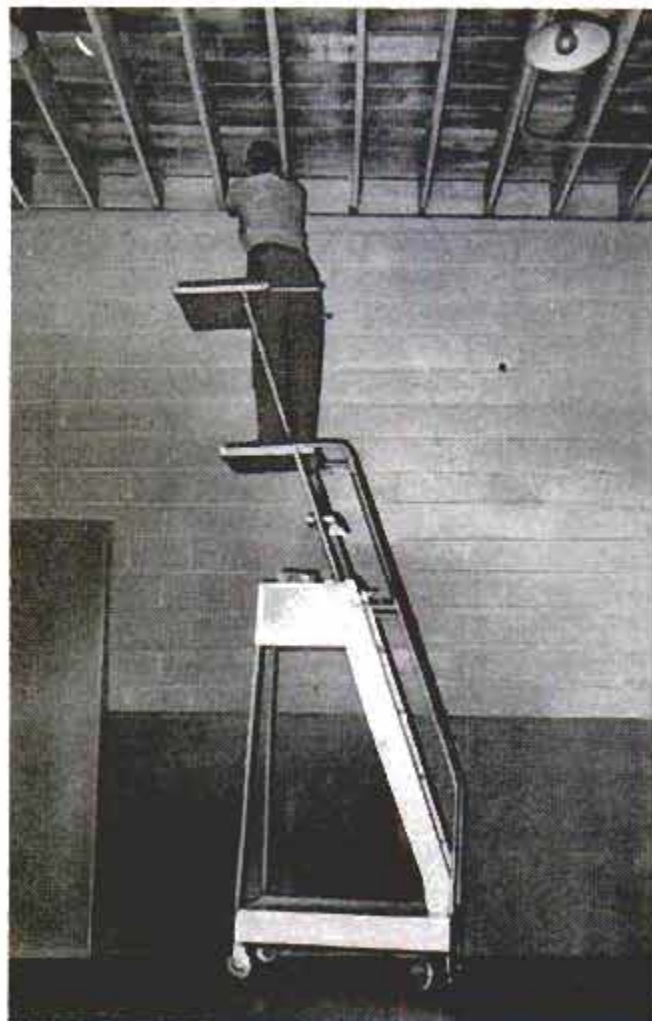

Roll-Away Truck Mfg. Co., Inc.,  
6143 S.E. Foster Rd., Portland 6, Ore.

## Telescoping-Ladder Truck Gives Worker 16-Foot Reach

Compact enough to pass through standard doorways, a four-wheeled ladder truck gives a man of average height a 16-foot reach. Fully extended, the top platform, used as a work shelf, is 11 feet 2 inches above the ground, but telescoped the unit is only 6 feet 6 inches tall. The ladder extensions are held by double independent locks and the wheels lock so the unit cannot roll accidentally. The base is only 42 inches long and 26 inches wide.

## Radio Waves Speed Healing

Faster healing of burns, ulcers and poison ivy has been accomplished with a radio-wave machine. Called the Bio-Cold-Ray, it generates the waves at a frequency of 420 kilocycles per second, just below the lowest frequencies used by commercial-broadcasting stations. The electrical energy is not the same as from a short-wave diathermy machine, but seems to have an unknown attraction to tissues that results in faster healing.

☐ Approximately 15 million pounds of coffee are consumed by the Navy each year.



# NOW! EARN GOOD MONEY IN TV REPAIR ... *within one short week!*

**ALL 3 FREE!**

COLLECT \$5 TO \$10 PER CALL—HANDLE ANY JOB, ANY SET  
Now, after 5 years research—a streamlined professional training technique that *obsoletes all others!* Within 7 days you achieve full knowledge and ability to earn \$5 to \$10 per call . . . make \$150 a week. Handle any TV set with confidence! Yes—and without paying big prices for training, or studying long months! Developed by electronics scientists in cooperation with major TV mfr's., the new *Symtronic* method is the most practical ever devised! FREE SAMPLE LESSON gives amazing proof! Use it on your set or a friend's—repair it—convince yourself you can make big money *immediately* in your own TV business! Write today for FREE LESSON and details on how to get 1000 *your-name-and-address* business stickers FREE, too! Hurry—Offer limited!

ELECTRONIC ENGINEERING, Dept. B-173, 1038 South La Brea, Los Angeles 19, California

## ELECTRIC WELD - BRAZE & CUT

REPAIR MOST EVERYTHING MADE OF METAL

Home Appliances, Auto parts, Farm-garden equipment, toys. Make and repair playground equipment, lawn chairs, tables, ornamental iron work gates, wagons, etc. Solder, heat, bend, and straighten, with terrific heat from arc torch. Cut and weld up to 1/4" steel plate. A million uses for Home, auto, farm, inventors, factories, etc. Works from any home

110 volt plug-in. Complete with dark welders mask, arc torch, supply of carbon welding and brazing rods, Solder, flux, and complete Welding Instruction Book. Attractive—portable—efficient—durable—1 year guarantee. Wt. only 8 lbs. SEND ONLY \$3.00 (cash, ck, mo) and pay postman \$6.95 plus COD postage on arrival or send \$9.95 plus \$1.50 postage and we will send postpaid. Ideal gift for mechanically minded home owners, relatives, friends. Order now for early delivery. Available only from: MIDWAY WELDER Dept. DPM-3 Kearney, Nebraska



# 94.6% OF BAILEY GRADUATES ARE EMPLOYED AT TOP PAY IN THE FIELDS WHICH THEY WERE TRAINED!



## DIESEL-AUTO MECHANICS DESPERATELY NEEDED!

We have a far greater demand for our students than we can fill!

We can show you an actual waiting list of leading companies throughout the world who have tried Bailey graduates — found them outstanding, and are coming back for more!

Bailey Graduates are Successful . . . RECEIVE BIG PAY — HAVE SECURE FUTURE!

The Famous Bailey Course prepares you for BOTH Diesel and Gasoline Mechanics.

This is a must—due to the advent of using Diesel principles, such as 'Fuel Injection' on passenger cars . . . use of gasoline engines for starting Diesel engines, etc. You learn all this at Bailey in the amount of time ordinarily required to learn just one of these subjects, ALL FOR THE PRICE OF ONE.

Don't be satisfied with a 'futureless', one-type job — learn how you can make big money now! Write today for Free Booklet that takes you on a step-by-step camera tour through our spacious, modern shops — See Bailey students in action as they Learn-by-doing with the Famous Bailey Method of training!

We provide you with housing and part time jobs while in school, plus nation-wide placement service for graduates.

## BAILEY Technical SCHOOLS

1634 S. GRAND ST. LOUIS 4, MO.

### MAIL TODAY!

Please mail immediately this free booklet without obligation.

FREE BOOKLET



Name.....  
Address.....  
City..... State.....  
APPROVED FOR VETERAN . . . NON-VETERAN

INVEST IN



KEEP YOUR... ON BENJAMIN *"First in POWER and ACCURACY"*  
for HIGH H.P. COMP  
AIR GUNS & CO<sub>2</sub> GAS GUNS—Top Quality at LOWEST PRICES!

BB or 177 or 22  
  
BENJAMIN SUPER  
Single Shot CO<sub>2</sub> Carbine \$14.95  
Gas Rifle (BB) with Reg. Stock  
Deluxe (BB) Model with Custom Stock (Shown) \$17.95

All Models Benjamin CO<sub>2</sub> Carbine Gas Rifles and Benjamin CO<sub>2</sub> Rocket Gas Pistols Use Standard Size CO<sub>2</sub> (Soda) Cartridges (available everywhere). 2-Stage Hi-LD Jet Power—High for Small Game—Low for Target—Up to 50 Shots from Each Cartridge. No Pumping—Safe—Accurate—Economic—Non-Toxic.—12 Models—BB or 177 or 22.

Benjamin Air Rifles and Benjamin Air Pistols are Recognized All Over the World for Finest Workmanship and Highest Quality at Lowest Prices. Adjustable Power with Amazing Optimum Force. Fully Guaranteed—Safe—Accurate—Economic. Easy to Use Anywhere—12 Models for Target and Small Game 22 or 177 or BB from \$18.50.

FREE! Catalog All Models Benjamin Air Guns & CO<sub>2</sub> Guns & Supplies. Also, Money-Saving Offer on Hunting & Fishing Knives, Accessories, etc.  
Send Gun Catalog and Special Knife Offer!  
BENJAMIN AIR RIFLE CO., MAIL TODAY!  
896 MARION ST., ST. LOUIS 4, MO., U.S.A.  
Name.....  
Address.....  
City..... State.....



# EDUCATION . . . Your Key to Security, Employment, Job Success



● A giant aircraft and missiles manufacturer promises new engineers . . . "Your assignment can be as big as your talents" . . .

● A major chemical company reports it must employ 20 times as many technically trained people to compete today as 10 years ago . . .

● One of the big three auto-makers is employing five times the number of college degree holders today as it did in 1947 . . .

Everyone agrees on this important principle: **knowledge is power and knowledge correctly applied is leadership.** This is true whether you are the employer vying for manufacturing prominence against competition, or employee striving for position, salary and a future. The amount of knowledge you can call on to meet and solve problems or projects spells the difference between success, failure or mediocrity.

## Industry Stresses Education

Industry is well aware of the fact that to keep ahead of competition in product development, production, and sales, its employees must be skilled and well trained. Industry recognizes also that manufacturing methods, automation, complicated production machinery, higher production quotas and daily discoveries in science and technology are increasing the amount of knowledge and technical skill it takes to understand and keep pace with the changes as they occur. As a result, employees are now being required to meet much stricter and higher educational standards in a great number of occupations.

U. S. Department of Labor surveys covering present and future employment prospects in major industries and

occupations call attention to these important points:

● New technological developments in all fields of industry and in the professions will accelerate the trend toward more jobs for the educated and skilled and fewer opportunities for the unskilled.

● Irregular employment and lower wages face the uneducated in the economy of today.

● High school graduation has become the minimum educational standard for employment in most clerical positions, apprenticeships and many other types of work. Those not completing high school will be increasingly handicapped in competing for jobs above the manual-labor or semi-skilled level.

● In many professions, the period of college education customarily required for employment 20 years ago has increased substantially and will lengthen further due to emphasis being placed on education.



It has also been pointed out by the Department of Labor that the more education a person has, the higher his income is likely to be. For instance, it is estimated that the high school graduate, during his adult years, will receive \$50,000 more than the eighth grade graduate and \$30,000 more than the student who drops out of high school.

As we come to depend more and more on machines and as our industrial society grows more complex, the need for well educated, creatively intelligent and independent thinking people will multiply. Future employers will be interviewing candidates for jobs very carefully to see if their abilities and knowledge measure up to the technical and skilled work that must be done. Employers will put a very high premium on education. Those persons who have it will be hired into responsible positions where they may expect advancement. Those persons who fail to take advantage of educational opportunities will occupy mediocre jobs with little chance for promotion. The choice between the two will be up to the individual.

Furthermore, there's the matter of job competition! The chart illustrates that by 1965 there will be approximately 700,000 fewer men aged 25-34 available to employers due to low birth rates of the Depression years than there are today. The gap in this productive age group accounts for the shortage of skilled manpower and means that those

persons who will be in the 25-34 age bracket in 1965 must be educated to the utmost now to fill the technical, and professional jobs crying for applicants.

After 1965, however, notice the millions of young men in the 14-24 age group who will then be competing for jobs. This competition will be keen because of the numbers applying. **Those men with the most education will get the best jobs and promotions!**

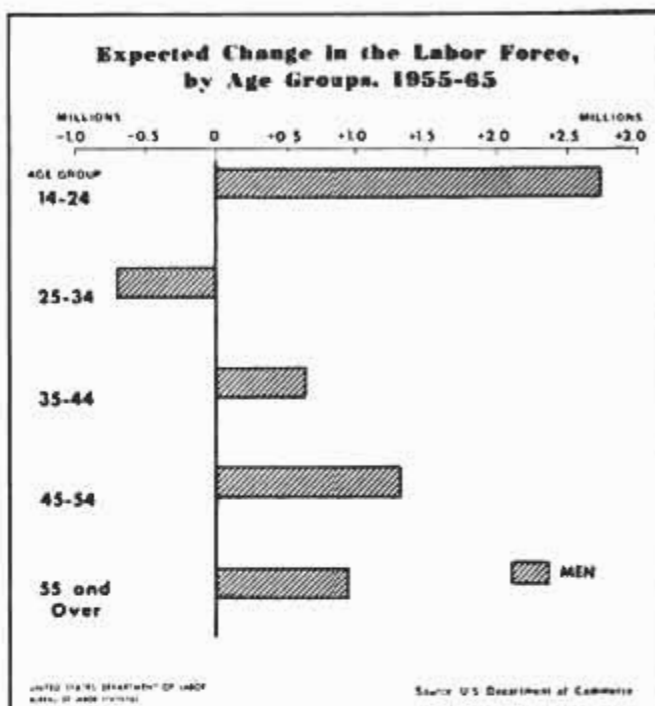

Here, then, are some of the reasons why education and training are of such importance. To have enough education is to succeed... *"Your assignment (job) can be as big as your talents."* To have too little education is to fall into mediocrity and possible unemployment. The choice is entirely up to the individual!

Popular Mechanics suggests you make every effort to continue your education, and your family's. Use every opportunity to get instruction: in high school, college — at technical institutes, through trade schools and by correspondence course. To do so is to your complete advantage for knowledge is power and in your hands will turn to leadership.

**Do Your Part to Develop**



**SKILLS  
for  
AMERICA**



Free!

# ALLIED'S 1958 ELECTRONIC SUPPLY CATALOG

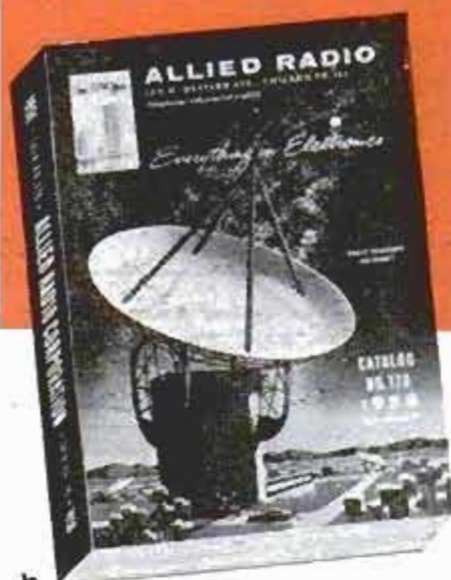

404  
value-packed  
pages

Send  
for it!

SAVE on  
everything in  
electronics

EASY TERMS  
AVAILABLE

## WORLD'S LARGEST STOCKS

Here's everything in Electronics for Experimenters, Builders, Amateurs, Servicemen, Engineers and Hi-Fi Hobbyists:

- Amazing Build-Your-Own KNIGHT-KITS
- Hi-Fi Music Systems & Components
- Recorders & Phono Equipment
- TV Tubes, Antennas, Accessories
- Public Address Systems
- Amateur Station Equipment
- Latest Test Instruments
- Industrial Electronic Supplies
- Parts, Tubes, Transistors, Tools and Books

SAVE on everything in Electronics—get fast, dependable service—send today for your FREE 1958 ALLIED Catalog.

Everything in Electronics  
From One Reliable Source

our 37th year



send for  
**FREE**  
Catalog

## ALLIED RADIO

ALLIED RADIO CORP., Dept. 5-C8  
100 N. Western Ave., Chicago 80, Ill.

Rush FREE 1958 ALLIED 404-Page Catalog

Name \_\_\_\_\_

Address \_\_\_\_\_

City \_\_\_\_\_ Zone \_\_\_\_\_ State \_\_\_\_\_

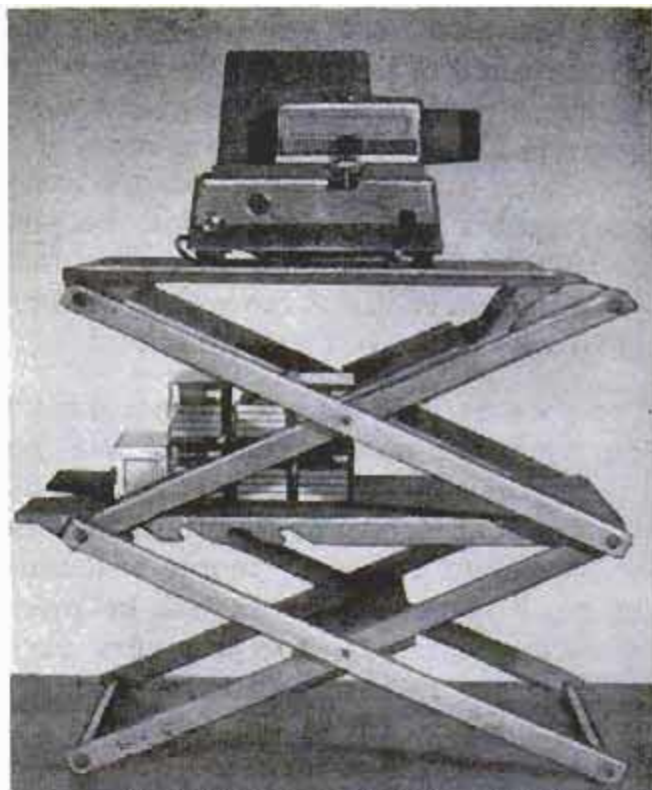

Otto Products, Inc., 376 Clay Ave., Rochester 13, N.Y.

## Adjustable Projector Stand Has Double-Tong Construction

Working like double tongs, a new projector stand opens to a height of 40 inches in a matter of seconds. When folded, the stand is only four inches high. It can be adjusted to intermediate heights by locking a dowel in a series of cutouts on the underframe of the middle shelf, which can be used to hold slides. The top table has an area of 16 by 19 inches and the middle shelf is 12 by 24 inches. The stand will support 200 pounds.

## Adhesive "Welds" Steel Rods

One drop of a new liquid adhesive will bond two two-inch steel rods together with enough strength to lift 15,000 pounds. Developed by Eastman Chemical Products, Inc., the adhesive will bond almost any type of material and sets rapidly. In five minutes the two bonded rods supported 200 pounds, in 30 minutes 5000 pounds, and in 48 hours 15,000 pounds.

## Library "Lends" Books by TV

When students at branch libraries of the University of Virginia want to study a book at the central library, they can do so by closed-circuit television. The requested book is placed under the lens of a focused TV camera at the central library and the picture of a page appears on a screen at the branch library. The student can turn the pages by operating a remote-control page-turning machine.



# HI-POWER ELECTRIC PAINT SPRAYER

with **MAGIC SWIVEL NOZZLE!**

**PRAYS UP...DOWN...SIDEWAYS!**

- Extra Powerful Motor Pump!
- Stainless Steel & Brass Parts!
- Spray Paint, Enamel, Oils, etc.

**7<sup>99</sup>**  
VALUE  
**\$19.95**



Complete Kit

## SPECIAL!

Luxury Model  
JEWELLED  
for fine, pre-  
work. Built-  
UPPER FILT-  
t. heavy-duty  
ric cord. Orig.  
price \$24.95  
w only \$9.99  
plete. Order  
No. 95-D.

Famous Hi-Power Automatic Electric Paint Sprayer Kit at our lowest price ever. New model. New powerful motor-pump. New adjustable **MAGIC SWIVEL NOZZLE**, sprays UP, DOWN, SIDEWAYS without tilting jar! **STAINLESS** Steel & Brass parts. Rustproof! 25-oz. jar. Cuts painting time up to 75%. Do average room in less than hour. Press button & spray. No stiff arms or sore muscles from carrying sloppy, dripping brushes. Paint screens, walls, ceilings, floors, cabinets; refinish furniture, etc. Gets into

cracks, rough surfaces that brush can't even reach! Completely safe—easier to clean than brush! Approved by professionals. Takes deodorants, lacquers, disinfectants, polishes, etc. Mothproof clothes, spray plants, paint car, etc. Same type formerly adv. on TV for \$19.95—now **SLASHED** to new low \$7.99. Satisfaction guaranteed or money refunded. Send check, cash or money order for prompt **FREE** delivery. COD's plus fee & postage (enclose \$1 deposit). Hi-Power Model sold only by mail, only by us. Order by No. 95.

THORESEN, Inc., Dept. 6-C-95  
585 WATER STREET  
NEW YORK 2, N. Y.

## GROW MINIATURE TREES

FREE! SEEDS & PLAN



New Fascinating HOBBY or HOME-BUSINESS OPPORTUNITY! Learn little-known techniques for growing living "Ming" Trees only inches high. Beautiful Elm, Cherry, Orange, Cypress, Peach, etc., that BLOSSOM AND BEAR TINY TASTY FRUIT. Help fill demand for these sensational dwarfed Trees. **FREE SEEDS** (8 kinds) and Plan. State your age. Write:

MINIATURE TREE NURSERIES, Dept. K-3, (Home-Growers Division) Gardena, Calif.

## WANTED FOR CASH!

Old, discarded, out of print old books, magazines, catalogues

Up to 10,000 different titles wanted weekly!

Almost a half million titles per year are wanted for Cash! Not rare, hard to find titles but many are relatively common titles, some published five years ago!

Help fill this terrific demand for old books, magazines and catalogs for good cold cash money! Work part time—choose your own time. Fascinating work, steady year round demand 52 weeks out of the year. Free information on how to start.

BOOK HUNTER, BOX 591-F, LYNN, MASS.

## ACCORDION PRICES SMASHED



**SAVE 50%**  
AND MORE DURING  
THIS GREAT SALE

### 5 Days' FREE TRIAL

Hurry! Get in on these sensational accordion values. America's largest exclusive accordion dealer selling out finest brand new accordion overstock! Fabulous savings. Leading brands in more than 30 new models. Small down payment. Easy terms. Trade-ins accepted. Chance of a lifetime.

### FREE COLOR CATALOG

Learn how easily you may own and play a fine accordion. Rush name and address for big **FREE** Color Catalog and new low wholesale price list. No obligation. **WRITE TODAY!**

ACCORDION MANUFACTURERS AND WHOLESALE OUTLET  
103 W. CHICAGO AVE., Dept. R-38, CHICAGO 22, ILLINOIS

## SAVE 50% & MORE!

# GENUINE DIAMONDS

Buy diamonds and diamond jewelry half-priced from Kaskel's, America's foremost Diamond Specialists. Every diamond is set in a luxurious new mounting... graded according to nationally accepted standard... and bonded to this effect. For over 70 years, we've served over 1,000,000 satisfied customers.

**CASH OR CREDIT**

**10 DAY UNCONDITIONAL MONEY-BACK GUARANTEE**  
References: Your bank, or any Rating Agency

**SEND FOR BIG FREE ILLUSTRATED CATALOG**

**KASKEL'S**, 41 West 57 St., N.Y. 19, N.Y. Dept. 807-C  
Send **FREE** CATALOG and Advice about **DIAMONDS** without obligation. No Salesman Will Call.

NAME.....  
ADDRESS.....  
CITY.....STATE.....

## ENGINEERING DEGREE IN 27 MONTHS

### B. S. DEGREE IN

**Aeronautical, Chemical, Civil, Electrical, Mechanical and Electronic Engineering (inc. Radio and TV)**

Also B.S. DEGREE in 36 mo. in Mathematics, Chemistry, Physics (inc. Nuclear Physics). Engineering Science prep. courses. Thorough, practical program. Individualized instruction emphasized. Government approved for G.I.'s.

**Keeping pace with progress in science and engineering**

Spacious campus, 20 bldgs.; dorms, gym, Playing field. Modern, well-equipped labs including new physics lab and wind tunnel. Low tuition. New terms start quarterly. Enter March, June, September or December. Big demand for graduates. Students from 48 states and 40 foreign countries. Many earn a major part of their college expenses in this large industrial center. Send coupon for free catalog and full information. Enroll now!

## INDIANA TECHNICAL COLLEGE

538 E. Washington Boulevard, Fort Wayne 2, Indiana

Please send me free information on 27 MO. B.S. DEGREES in:

Aeronautical  Chemical  Civil  Electrical   
Mechanical  Electronics

on 36 MONTH B.S. DEGREES in:

Mathematics  Chemistry  Physics

Name.....  
Address.....



Not everyone does as well, but C. E. Nevin,  
who started a business of his own, reports...

For 12 months I've averaged

\$1000

PER MONTH

—most of it Clear Profit for Me!



• Mr. Nevin expressed his grateful thanks for the opportunity to have a fine business of his own. Many men have discovered how to be independent, to be freed of bosses and layoffs—to build their own future on a steady, dependable foundation. G. Mundt made more than \$400 one week. **A father-son combination grossed \$33,000 their first year.** H. Lemon says, "I netted \$133 in one 8-hour day."

How much you make depends largely on you. You need no special skill, no large investment. Start part-time if you wish.

Mail coupon today for interesting

**FREE BOOK**

VON SCHRADER MFG. CO.  
310 "R" PL., Racine, Wisconsin

Send at once (no obligation) your **FREE** booklet containing information about your **ELECTRIC RUG WASHER** and how I can start my own permanent, profitable business.

Name \_\_\_\_\_

Address \_\_\_\_\_

City \_\_\_\_\_ Zone \_\_\_\_\_ State \_\_\_\_\_

**No shop necessary** • Our **ELECTRIC RUG WASHER** cleans rugs and carpets like new right on the floor...removes dirt and grime and helps to show their natural color and beauty. So efficient and safe for carpets, it is used by largest hotels and railroads.

You take no risk. Machines fully guaranteed. Don't delay. Mail coupon today for complete information including how to start making big profits in **YOUR OWN** business **BIG** opportunity.

*This is not a lease proposition. You own the machine, you are your own boss, you set your service when and where you wish and all the money you take in is your own. Cost nothing to find out—no obligation.*

**Send Coupon Now!**

**VON SCHRADER MFG. CO.**

310 "R" PL., RACINE, WISCONSIN



**WORLD'S  
BEST  
WANT-AD  
MEDIUM**

# CLASSIFIED ADVERTISEMENTS



Advertisements in this section \$1.25 per word, each insertion, minimum 10 words, payable in advance.

To be inserted under proper classification, copy must be in our office the 20th of the second month preceding date of issue  
F. W. Johnson, Manager, Classified Advertising  
Popular Mechanics Magazine, 200 East Ontario Street, Chicago 11, Illinois

## YOU'LL PROFIT

By reading and answering the classified ads in this section. Hundreds of opportunities for you to make and save money

### AUTOMOBILES, MIDGET CARS

**BUILD** Sharp 2-seater midget car at me. Plans, \$1.00. Shermans, 701 Miranda, Las Cruces, New Mexico.

**COLLECTORS** Item. Ten famous antique automobiles, prints, perfect for framing. Young, 4511 N. Woodruff Ave., Milwaukee 11, Wis.

1958 **SUPERIGNITIONITER**, Starting, 0. mileage, \$4.50. Kaisers, Varitypers, M's, barbells, courses, cat. \$1.00 refunded. EG. Elmsford, N. Y.

**AUTOMOBILES**, Wholesale prices, all 58 American made cars and equipment. Complete information for only \$1 postpaid. Harriman Books, Harriman, Tenn.

**HUNDREDS** Of automobile catalogs — all new and foreign; dealer books, glossy photographs, shop manuals; free motor magazines listed by non-profit club. Write for free mailing list. Auto Maniacs, Oakbridge, Mich.

**MIDGET** Sport car with reverse. Low cost. Powermij, 940 North 23rd St., Omaha Nebraska.

### AUTO SUPPLIES AND EQUIPMENT

**STOP** Transmission lubricant loss with easy-to-install Davis Ball Boot. Protects oil housing and drive shaft coupling; prevents wear on metal parts; saves expensive repairs. For Chevrolets, 1941 through 1954, all models, all transmissions. Write for free literature. Davis Ball Boot Company, Inc., 2301 Yale Street, Houston, Texas.

**AUTO** Emblems — T-shirts, jackets, trophies. Free literature. Spot Enterprises, O. Box 66, Culver City 1, Calif.

**FREE** Giant 1958 parts catalog. Thousands scarce accessories stores don't have. Midgets, custom equipment. Send 25¢ postage (refundable). Newhouse Automotive Industries, 5805-PM-3 Beverly, Los Angeles 22, Calif.

**AUTO** Accessory and parts catalog. 1958 edition—All new! 229 pages. Save up to 75%. 75,000 items, including Hollywood accessories, hi-speed equipment, rebuilt engines, all parts and accessories for all cars and trucks! Hard-to-get parts! Send \$2 (refundable). J. C. Whitney, 1919 M-3 Archer, Chicago 16, Ill.

**FORD** T and A parts? Try best source of model parts, all makes. Wisneski, Milwaukee 7, Wis.

**CRANKSHAFT** Grinder, hand operated. Makes bearings fit without taking engine apart. \$3.75. Literature. L. D. McGee, 719 Cascade St., Wenatchee, Wash.

**HEADLIGHT** Glare! Stop it when night living with our Glare-Bars. DuPont Distributors, Box 695, New York 1, N. Y.

**RING** Valve job while driving, \$6.00. Literature. Motaloy, Grantham, Penna.

**AUTOMOTIVE** Books. Free catalog. Popular Mechanics Press, 631 N. St. Clair St., Chicago 11.

**NEW** And used parts at savings. Complete guaranteed parts service for all models cars and trucks, 1924 and later. Largest in the West. Jeep and army parts specialists. Newest type shifting hubs for all Jeep and all military and latest production front end drive vehicles. \$27.50 and up. Write. Pioneer Auto and Truck Parts Co., 734 W. 13th Avenue, Denver 17, Colo.

**DO-It-Yourself** booklets. 24 different booklets each covering an interesting subject. Free catalog. Popular Mechanics Press, 631 N. St. Clair St., Chicago 11.

**SAVE** Money on Jeep and army truck parts. Large inventory. Catalogs for Jeep or G.M.C. owners. American Auto Parts Co., 1830 Locust, Kansas City, Mo.

**JEOP** Owners—V-8 conversions. Read Jeep Owners ad, page 18.

**REVOLUTIONARY** Gasoline saver device! Particulars, send 10¢, refundable. Grable Enterprises, 26314 Normandy, Roseville, Michigan.

**OIL** Filter refills 10¢. Free particulars. Zenick Products, Box 2461, Los Angeles 54, California.

**DUAL** Auxiliary accelerator left foot gas pedal. \$6.95. Lehner Co., Ness City, Kans.

**U-Go-Lite** signals motorists and pedestrians to go ahead. Prevents accidents. Free circular. U-Go-Lite, 1753 SE 130th, Portland 16, Ore.

**PRESTO** Midget fire extinguisher. Only \$4.95 post paid. For car, boat, and home. Guaranteed twenty years. L. & V. Sales Co., 155 Ponce de Leon Crt., Decatur, Ga.

**FREE!** New catalog. Speed, power, mileage increasing equipment. Discounts! Almqvist Engineering, Milford PM5, Penna.

### AUTO TRAILERS

**DON'T** Buy anything until you've seen the "new look" in camping. New camp trailer, a new cartop camper, new camp kitchen. Free illustrated brochure. Write: Heilite Trailers, Inc., Dept. P.M., Lodi, California.

**ALUMINUM** Pickup coach kits. Literature 10¢. Comstock Trailers, Parsons, Kansas.

**BUILD** Expanding eight foot trailer. Accommodates five. Literature 10¢. Framar Company, Wilmington, Mass.

**TRAILER** Building manual \$1.00. Booklet 30¢. Kamcraft, Box 1153, Milwaukee 1, Wis.

**CABIN** Trailer kits. Pleasure or business. Write Burlington Manufacturing Company, Burlington, Iowa.

### MOTORCYCLES, BICYCLES, MOTORSCOOTERS AND SUPPLIES

**MIDGET** Auto \$25.00; 1954 Whizzer \$20.00; Cushman motorscooter \$25.00; motorcycle \$10.00. Rush 25¢ (35¢ first class mail) for new catalog #962 listing amazing bargains in motors, midget cars, motorcycles, motorbikes, construction plans. Associated, Box 534, Toledo, Ohio.

**DOODLEBUG** Motorscooter \$15, Cushman \$20, less engines. Doodlebug engine \$5, Whizzer \$5. Midget car with motorcycle engine \$75. Indian engine and transmission \$15. (Mailorder only). Send 25¢. (35¢ for first class mailing) for directory-catalogue number 82, just out, listing these and hundreds of other bargains, home-builders parts, plans, etc. Midget Motors Directory, Athens, Ohio.

**PARTS**, New, used. List 10¢. Ballak, 811 N. 9th, St. Louis 1, Mo.

**RECONDITIONED** Motorcycles and motors. Chromium accessories. Complete stock Indian parts. Expert rebuilding. Fast service. Indian Motorcycle Sales, Kansas City 27, Missouri.

**SAVE** 20% On genuine H.D. parts. Used parts for Harley, Indian, Cushman, Whizzer, Servicycles. Used onboard parts. Est. 32 yrs. Bill's Cycle Shop, 1005 S. State, Syracuse 3, N. Y.

**50 MOTORCYCLES**, Thousands of parts. Tell us your needs. Wichita Cycle Co., 813 Ohio, Wichita Falls, Texas. Our 32nd year.

**HARLEY** - Davidsons — Used bargains. New, used parts, accessories for all models. Bulletin, catalog 25¢. Knuth's (Factory Dealer), 1753 Muskego, Milwaukee, Wis.

**RACING** Power cams for Cushman, Whizzer, Mustang, Hiawatha, Continental. Send your cam and \$10. Weber Cams, Box 33175, Los Angeles 33, Calif.

### AVIATION

**BUILD** Your own plane! Complete plans, instructions \$1.00. Flying course included. ABC Publications, Box 849-AR, San Francisco 1, California.

**BUY** Surplus aircraft; accessories; engines; instruments; electronics. Direct from U. S. government. List and procedure \$1.00. Aviation Surplus Center, Dept. 130. Etters, Penna.

**HOMEBUILT** Helicopter rotors. Picture, specs., prices 50¢. Adams, Box 6042-M, Lakewood, Calif.

**BUY** Direct now from U. S. government depots, surplus aircrafts; fuselages; assemblies; aircraft engines; helicopters; instruments; electronics; radiotelephones; Misc. Send for bulletin "Depot List and Procedure" \$1.00. Box 8-PM, Sunnyside 4, New York.

**SMALL** Helicopters theory and guide manual. Drawings. Construction data. \$2.00. Sandhill Aircraft, Box 336, Atkinson, Nebraska.

**PROPELLERS**, Plans, supplies for airboats and snowplanes. Latest designs, prompt delivery. Catalog 25¢. Banks-Maxwell, Box 3301E, Ft. Worth 5, Texas.

**AVIATION** Surplus bargain catalogue. One dime. Box 22PM3, Thomasville, Penna.



## ELECTRICAL SUPPLIES

DO It yourself for half price. Doorbell, buzzer, without transformer. Send \$1.00 for wiring diagram. O. A. Brown, Tipton, Okla.

APPLIANCE Parts, lamp parts, wiring devices, wholesale prices. Catalog 50¢ credited on first order. Lamp Specialties Co., 322 Washington St., Newark, N. J.

HOW To do it yourself—Electric wiring, repairing. Beginner's Handbook \$1.00. Craftsman, 1919 Lawrence, Houston 8, Tex.

ELECTRIC Pencil: Engraves all metals \$2.00. Beyer Mfg., 10511-H Springfield, Chicago 43.

LAMPS—Parts catalog containing wiring instructions, 25¢. Gyro Lamps, 3438P N.W. 54 Street, Miami, Fla.

MAGNETIZER—Magnetizes screwdrivers, etc., only \$1.00 postpaid. Kubiak, Huntingdon Valley, Penna.

LAMP, Electrical parts, wholesale. Thousands of items for repairing, converting. Catalog 25¢. Brown Lamp, Box 305, Clayton 5, Mo.

## WELDING, SOLDERING, PLATING

SOLDERS All! Stainless steel, copper, galvanized, etc. Eliminates precleaning. Full polyethylene dispenser 25¢. Stay-Clean Soldering Flux, 433 West 9th Street, Cincinnati, Ohio.

BUILD-Your-own welder or welder and power combination. Low cost unit connected to used engine lets you weld anywhere. Free booklet tells how. Get into profitable welding business. Write Hobart-Weld, Box M-382, Troy, Ohio.

ACETYLENE Welding outfits, new \$54.50, arc welders \$56.50, Eagle Welding, Dept. P.M., 5066 Broadway, Chicago 40, Ill.

FREE—Catalog, welders, welder kits. Build 300-ampere welder using airplane generator, plans 25¢. Dunbar Manufacturing, Houston 23, Texas.

WELDING—Now you can get professional results with this new streamlined, portable oxy-acetylene welding-cutting kits from one of the country's leading manufacturers of welding equipment. You get everything you need for welding up to 1/4" steel, for cutting up to 2" plate. Kit includes welding and cutting attachment, two welding tips, cutting head, regulators, hose, spark lighter, safety goggles, wrench. Ideal for light auto and body repair, plumbing, brazing, bicycle work, metal hobbyists, and all light-weight metal fabrication. Bargain price, whole kit: \$113.00. Send check or money order to: Air Reduction Sales Co., Dept. PM, 150 E. 42nd St., New York 17, New York. Or send for further information.

WELD, Solder, cut, braze, 1/8" welder complete \$7.95. Flame-torch \$3.95. Postage 50¢. 75 ampere transformer welder 1/2" \$24.95 complete. P.O.B. Essay Mfg. Co., Quincy 69, Mass.

WELDERS, 110/220, \$39.50. Morris, 1070 Inner Drive, Schenectady 3, New York.

## MACHINERY, TOOLS, SUPPLIES

HYDRAULIC Products Company fight weight two ton capacity household jack. Costs so little, does so much. Special \$14.95. 509 Westminster Street, Providence, Rhode Island.

SAW Scissor supplies. List 10¢. Overland Saw Service, Independence, Iowa.

SURPLUS Socket wrenches, half price. Davis, 3606-A Lakeland, Shreveport, La.

INDUSTRIAL Shop drill press from salvage. Plans \$1.00. Paul Unruh, Durham, Kansas.

OIL Drum cement mixer assembly kit. Circular, Nu-Way-Do Co., Newaygo, Mich.

NEW All bronze gear water pumps 1 1/4" connections, 56 g.p.m. @ 3000 r.p.m. Also 1" connections, 30 g.p.m. @ 3000 r.p.m., \$22.50 each, two for \$40.00. Write Sterling Engine Co., Menominee, Michigan.

MINIATURE Taps, dies, screws, tools. Free folder. Morris, Southbridge, Mass.

MCCULLOCH Chain saw parts for all model saws 1/2 price. Used but guaranteed okay. Barnett Equipment Co., So. Glens Falls, N. Y.

POWER Tools, not toys. Discounts. Factory catalogs. World Tool Supply, Box 4404, Joyfield Station, Detroit 28, Mich.

PRINTS And instructions for diemakers universal bench vise, \$1.00. Numerous others. Send for list. Cannon Tech. Enterprises, Box 504, Dayton 6, Ohio.

## SURVEYING INSTRUMENTS

NEW And guaranteed factory rebuilt transits and levels, sale or rent, with purchase option. We will repair, trade or buy old instruments. Write for list M-83. Warren-Knight Co. (Manufacturers of Surveying Instruments), 136 N. 12th St., Philadelphia 7, Penna.

## ENGINES, MOTORS, DYNAMOS

DIESEL Injector parts wanted. GM51-71-110. Bares, 7120 Carnegie, Cleveland 3, Ohio.

REWIND Motors yourself. Complete instructions \$1.00. Lewis Mfg., Howell, Michigan.

WINDING Data. 275 motors, single and three phase. \$1.10. Data Company, Box 7631, Kansas City 28, Mo.

## BOATS, OUTBOARD MOTORS

BOAT Dock—New design; adjustable, various water levels. Inexpensive, strong, portable. Plans, photographs, instructions \$3.00. Arthur Sovereign, Honey Harbour, Ontario, Canada.

NEW Revolutionary Core-Glass and aluminum boats. 21 models 12 to 18-ft. for inland and sea coast waters. Boat trailers from 12 to 20 ft. to 1100 lbs. capacity. Fiberglass boat covering kits. Mahogany water skis. Write for free wholesale catalog. Buy direct from: Osage Manufacturing Co., Osage, Minn.

FREE Catalog! Boat kits, trailers, fiberglass, marine hardware. Luger Industries, Dept. M-3, 9200 Access Rd., Minneapolis 20, Minnesota.

TILLER Pulley, nylon roller rolls on ball bearings. \$1.75. Box 66, Youngstown, Ohio.

PROPELLERS, Plans, supplies for airboats, snowplanes. Catalog 25¢. Barnes-Maxwell, Box 3301F, Ft. Worth 5, Texas.

FIBERGLASS Your boat! Wholesale prices. Send for information, sample. Aqua Glas, Box 99, Altadena, Calif.

BOAT Plans—Full size patterns, frame kits. Modern inboards and outboards for amateur-builders. Complete new catalog 50¢ or specify requirements. Glen Designs, 9152 Rosetrans, Bellflower, California.

BRASS Vents stop dry rot. 4 samples 25¢. Blazo Mfg. Co., Cleveland 3, Ohio.

FIBERGLAS Permanent boat waterproofing. Special 25% discount. Complete kits, \$9-45 up. Guaranteed materials. Easy application. Full instructions. Free literature. Ajax Plastics, Dept. PM, P.O. Box 1323, Fort Worth, Texas.

WATER Ski kits, laminated, save half. Quammen's, Rt. 4, Stillwater, Minn.

FIBERGLAS Polyester bonding kit. Strong, durable, light. Illinois Blow Pipe, 2800 Halfday Rd., Deerfield, Ill.

MOLDED Fiberglass dinghies, reasonable. Outboard, inboard or sail. Powerboat plans catalog. 50¢. Marinecraft, Box 161-M, Brighton, Mass.

KITS—Build, sell. Water skis, boats and accessories. Make money at home. Send for free catalogue and tips. Hill Mfg. Co., 1901 So. 75 St., West Alhambra 19, Wis.

SAVE Money. New, used outboard motor parts. Send wants. Stamp appreciated. Outboard Motor Mart, 229-M State, Boston 9, Mass.

MARINE Conversions for Ford and Jeep engines. Catalog 25¢. Lehman Manufacturing Company, 972D Broad Street, Newark 2, New Jersey.

FULL Size, cut-to-shape boat patterns, blueprints, 7 1/2-38 feet. Big new 88 pg. illustrated "Build a Boat" catalog of naval architect-designed cruisers, runabouts, skiffs, outboard boats, sailing, racing, houseboats, 50¢. "How to Build a Boat" booklet, \$2.50. Hardware and equipment catalog, \$2.00. Cleveland Boat Blueprint Co., Dept. A-66, Box 1651, Cleveland, Ohio.

PERMANENT Lettering for boats, vehicles, homes, businesses, cast bronze, polished natural or chrome. Three sizes in script and three in block letters. Write for circular. Boat Names Company, 426 West 5th St., Kansas City, Mo.

FORDS And Jeeps 100% marine engine with famous Convo-Kits. Deluxe catalog 25¢ coin. Oscomotors, 3627B Lawrence Philadelphia 40, Penna.

NEW, Used, rebuilt marine motors. Marine conversions, fittings. Free catalog Stokes Marine Supply, Dept. 24, Coldwater, Michigan.

BUILD Small boats. Booklet 25¢. Catalog free. Popular Mechanics Press, 6 N. St. Clair St., Chicago 11.

## ATHLETIC EQUIPMENT, BODY BUILDING COURSES

"STRETCH-To-Health." Keep in shape combination rowing machine and exercise. Complete with instructions, stores neat in drawer, take wherever you go. \$3.95. Hengrod Enterprises, 80 Larch Avenue, Jersey City 6, New Jersey.

JUDO Defeat bullies—36 lessons \$1.00. 112 Tipton St., High Point, N. Car.

SUPER Strong body! 15 proven courses \$1.00. Plans to build 20 pieces apparatus \$1.00. Both \$1.50. Stephen Kazan, 191 East 55 St., Brooklyn 3, N. Y.

BE Taller! Coach's "Inch-At-A-Time" system, \$1.00 complete. Satisfaction guaranteed. Marty Snyder, Box 195-ED, Union City, New Jersey.

KARATE—Power that splits planks, balanced. Illustrated home course \$2.00. Enlarged edition \$3.98. Jim Lee, P.O. Box 245, Oakland 4, Calif.

FEET, Leg muscles hurt? Athlete salesmen, active men and women know you're only as young as your feet and leg. Amazing Ferrin method helps activate stimulate and intensifies basic circulation without electricity or expensive equipment. Benefits are quick and lasting. Send for \$3 for full kit. Satisfaction guaranteed. Write Orin Company, 1017-13th St., D. Moines, Iowa.

OUTSTANDING Physical development. Any age. New guaranteed discovery, use only a rope! Strength, health, muscle gain—reduce. Free details. Roperco 4834-A Art, San Diego 15, California.

BARBELLS, Dumbbells, Courses. Free catalogue. Good Barbell Co., Siloas Springs, Arkansas.

## SPORTING GOODS, GUNS, FISHING TACKLE, ARCHERY, TRAPPING

MOLDS For fisherman's sinkers, jig squids, casting and spinning lures. Free catalog. Sweet's Molds, Tonawanda, New York.

FREE Catalog. Newest items. Bargain Gadgets, beads, spinners, lure part sinker molds. Finny sports MD, Toledo, Ohio.

HOW To catch fish with smell. Secret recipes, formulas, methods, 25¢. John-ton's, 312 Lake Avenue, Ithaca, New York.

LUGERS! Mousers! Colts! P-38s! Ke-tuckles! Weatherbys! Antique-modern guns, gunneries! Super bargain catalog only 50¢. Agramonte's, Yonkers 20, N. Y.

RIFLES, Shotguns, pistols, scopes, ammunition. Dealers prices. Berkshire Gun Rack, Six Lakes, Michigan.

BIG Money-raising crickets and 12 ind African fishworms. Free literature. Carter Ranch, Plains, Georgia.

5000 BAROAINS, Firearms, binocular war relics. Catalog 50¢. Smith Firearm Runemede, N. J.

FREE Sporting goods catalogs! Save 40%. Econ-O-Mart, Whippany 2, New Jersey.

JAP Rifle altering to 30-06, \$6.00. Jay shells, \$3.75. Catalog 5¢. T. P. Show West Branch 11, Mich.

BUILD Barbecue. Complete plans. Booklet 25¢. Free catalog. Popular Mechanics Press, 633 N. St. Clair St., Chicago 11.

CAMPING Equipment, world's large selection, low prices. Send 25¢ (price name-address) for 160-page complete catalogue of tents, camping equipment, national camp sites guide and camping handbook. Morsan, 10-21R 50th Avenue, Long Island City 1, New York.

FREE Below wholesale fishing catalog. Fishing Tackle Mart, Dept. 53, Box 673, Chicago 80, Illinois.

BOXING, Teaching groups. Recommended Tunney, Ross, Spike Webb. Or dollar. Max Marek, 1115 East 56 Street, Chicago.

GIRDLE Shank fishhook holds worms (M) 6 hooks, 60¢. A. S. Pinckney Mfg. Co. 1000 No. Serrano, Los Angeles 29, Calif.



**PILOT** Float trolls your lure straight out against current. Transparent scoop drives it. Perfect control from bank. Won't drift. Terrific results. Guaranteed \$2.00 p.p. S.M., Box 3104, North Sacramento, Calif.

**FREE** — Giant 1957 wholesale sporting goods catalog. Lowest wholesale prices. Complete line of cameras, sporting goods, appliances, outdoor items. Write today. Santa Fe Distributing Co., 1321 Main Street, Dept. PM, Kansas City, Mo.

**GUNSMITH.** 400 Page illustrated course \$4. Pioneer Press, Harriman, Tennessee.

### TAXIDERMY

**TAXIDERMY** Instructions complete in four volumes. \$5.00. "Amateur Tanning" \$1.50. Grantz, 322 N. 15th, Allentown, Penna.

### EARTHWORMS—CRICKETS

**JUMBO** Meal worms, supreme ice, pan-fish bait, \$30, \$1.00; 1000, \$3.00; 5000, \$10.75; how raise, prepaid. Muckett's, 113, N. Paca, Baltimore, Maryland.

**10,000 DOLLARS** Year possible raising hybrid earthworms. Information. Write Shultz's Mammoth Worm Farm, 2717 Waldren Dr., Barberton, Ohio. Good bait sold, too.

**\$800.00 MONTHLY** Raising earthworms, 32 page instruction booklet, 35¢. Mississippi Valley, PM3, Box 5913, Memphis, Tenn.

**FREE** Picture folder, "How to Make \$3,000 Yearly Sparetime. Backyard. Raising Earthworms!" Oakhaven 56, Cedar Hill, Texas.

**GRAY** Crickets; breeders our specialty. Scientifically raised, vitamin fed, heavy producers. Hard to get items now available. Measures, dispensers, graders, heating units, thermostats, rubber donuts. Write for 1958 catalog. Selph's Cricket Ranch, "Mid-south's Oldest and Largest," Box 2123, Memphis 2, Tenn.

**EARTHWORMS** Raising profitable. Literature free. Breeders and baitworms reasonable. Universal Sales, New Concord, Ky.

**FREE** Literature—Amazing profits raising giant fishworms and crickets. Carter Redworms, Plains, Georgia.

**\$10,000 YEAR** Possible, earthworms, 32 page booklet tells how 35¢. Missouri Earthworm Research, Box E-6851, Kansas City, Mo.

**\$1000 MONTHLY** Possible, raising earthworms—African Giants! Backyard, garage, basement. Complete illustrated booklet, explains raising, feeding, packing, marketing. Only 25¢! Ozark Worm Farm-J, Willow Springs, Missouri.

### BINOCULARS, TELESCOPES, MICROSCOPES, MAGNIFIERS

**BUILD** Your own reflector telescope. Complete kit; mirrors, eyepieces, tripod, all other accessories. Request free illustrated literature. Criterion Manufacturing, Dept. DPM 39, Hartford, Conn.

**REFRACTOR** And reflector telescopes. Also mirrors, lenses, tripods, etc., for making your own telescope. Free illustrated catalog, Suffolk Science, Mattituck, N. Y.

**MICROSCOPE** Catalog free. Research Scientific Supplies, 126 West 23rd Street, New York 11, N. Y.

**BINOCULARS, Telescopes, microscopes.** Terrific values \$3.98 up. Request free money-saving catalog. Criterion, Dept. P 64, Hartford, Conn.

**REFLECTING** Telescope, 60X, completely assembled \$29.75. Guaranteed observatory clearness. Free information. Skyscope, 475 Fifth Avenue, New York City 17.

**WAR** Surplus bargains: Millions of lenses, instruments, telescopes, binoculars, components and complete line of astronomical telescope items. World's greatest optical market-place! Send only \$1.00 for beginner's 10-lens kit and big instruction booklet Stock 2-CH. Write for catalog "CH," free! Edmund Scientific Co., Barrington, New Jersey.

**DYNASCOPES**—Sensational new reflector telescope. Send for details. Criterion Co., Dept. DP 42, Hartford, Conn.

**REFLECTOR** Telescope kits \$7.25 (3") to \$175 (12"). Mirrors, cells, focusing mounts, tripods, eye systems. Anything, everything in telescopes. Free catalog Also ready to use telescopes from \$25. Esco Products, Oakridge, N. J.

### PLANTS, SEEDS, BULBS, NURSERY AND GARDEN SUPPLIES

**EVERGREENS!** 2-Year plants, well-rooted. Assorted pine and spruce. Shipped postpaid at planting time; money-back guarantee. 10 for \$2; 25 for \$4; 50 for \$6; 100 for \$10. Willowcrest Nurseries, 5725 Grubb Rd., Erie, Penna.

**GINSENG,** Goldenseal roots bring up to \$14 pound. Full information. F. M. Collins, Viola, Iowa.

**EVERGREEN** Seedlings. Free catalog, planting guide. Flickingers' Nursery, Box 15, Sagamore, Penna.

**BARREL** Cactus seed, 12 for 25¢ cash. 1624 E. 7 St., Tucson, Ariz.

**WORLD'S** Greatest cash crop. Free information. Write Ginseng Gardens, Asheville, N. C.

**RAISE** Your shrubs, trees from seed. Free planting guide, price list. Woodlot Seed Co., Norway 9, Michigan.

### PETS—DOGS, BIRDS, RABBITS, HAMSTERS, ETC.

**HAMSTERS**—Golden: Young, \$3.00 pair, breeders, \$4.00 pair. New mutation, \$5.00 pair. Adirondack Hamstery, Prospect 10-C, New York.

**SCENTLESS** Skunk \$15.00. Raccoon cub \$10.00. Flying squirrel \$5.00. Reptiles, amphibians, curios. Catalog 10¢. Ray Singleton, Rattlesnake, Florida.

**FANCY** Mice, rats, 70 varieties. Free list. Great Northern, Stetson, Maine.

**WHY** Ordinary trade? Raise squabs. Thousands wanted daily. Write Ledford Farm, Box 685P, Gaffney, S. C., for free secret-revealing book.

**BEAUTIFUL** Pure white pedigreed police puppies. Also bred females \$100 to \$150. Ansonia Kennels, McHenry, N. Dak.

**RAISE** Rabbits for us—Profitable Angoras, Chinchillas, New Zealands. Particulars free. Grinsteeds, Edwardsville, Ill.

**RAISE** Rabbits successfully by knowing facts. 48 page illustrated book describing 25 breeds. Housing, feeding, breeding, marketing, etc. Plus bulletin, 25 cents. American Rabbit Association, 36 Arba Building, Pittsburgh, Penna.

**MAKE** Money raising chinchillas, mink, nutria, rabbits, cavies for us. Free catalog. Keeney Brothers, New Freedom 2, Penna.

**DESCENDED** Skunks, monkeys, hawks, reptiles. Illustrated catalogue, 25¢. Trails End Zoo, St. Stephen, S. C.

**RAISE** Rabbits or mink on \$500 month plan. Free details. White's Rabbitry, Delaware, Ohio.

**HAMSTERS**—Ideal pets. \$2.95 pair. Free booklet. Jer-Fre's Hamstery, 2425 Hoyt, Muskegon Heights 13, Michigan.

**WE** Pay \$3.50 lb. dried. Grow mushrooms, cellar, shed and outdoors. Spare, full time, year round. We have 25,000 customers. Free book. Washington Mushroom Ind., Dept. 171, 2954 Admiral Way, Seattle, Wash.

### FUR BEARING ANIMALS

**1000 BRED** Mink — Booklet, plans 25¢. Lake Ontario Ranch, Gravel Road, Webster, N.-Y.

**MINK** Raising information free. Complete. Lake Superior Mink Farm, Superior, EEl, Wisconsin.

**MARCH** Sale—Guaranteed outstanding quality bred mink. Also nutria. Voight Farms, Atlanta 2, Texas.

### FARMS, FARM LANDS, REAL ESTATE

**FARMS** \$195. \$10 Monthly. Descriptions free. Write: Armstrongs, Shook, Mo.

**OPPORTUNITIES!** Government land. U. S., Alaska, Canada. Sledge Surveys, Macon, Mississippi.

**CANADIAN** Tax sale lands for three dollars an acre and up. Small monthly payments. Farms, timber, hunting and fishing camps, minerals. Limited number of properties. Write at once for free catalogue. Tax Sale Service, Room 105, 120 Bloor St., W., Toronto 5, Canada.

**FLORIDA**—2½ Acres; \$15 down, \$15 monthly; full price, \$695. High elevation, near Gulf of Mexico. Suitable farming, citrus, poultry. Free information. Florida Sunshine Coast Development Co., Brooksville, Florida, Dept. PM-1.

**FLORIDA** Trailer homesites. Water system. \$495.00, \$10.00 monthly. Lake privileges. Box 2005, Deland, Florida.

**FREE** Strout catalog! Farms, homes, businesses, resorts, retirement properties. Over 2900 values in 34 states. 57 years' service. World's largest! Write Strout Realty, 7-MF So. Dearborn, Chicago 3, Ill.

**HOMESITES** \$15 Monthly—California's finest garden section. Morro Bay's scenic shores. Wonderful fishing, boating. Fertile soil, softest water, temperate climate, congenial community. Free literature. Richard Otto, Department M, San Luis Obispo, California.

**\$5.00 MONTHLY** Buys 40 acres productive land. Near town. Price \$250.00. Free list. Box 425-P, Carthage, Mo.

**FLORIDA.** Nice homesites, \$345 at \$10 monthly. Folder free. Howard Vernor, DeLand, Florida.

**FLORIDA** Homesites, new lakeside development. Moderate prices, monthly payments. Fine hunting, fishing. Adjoins Ocala National Forest. Literature. Grace Parker, Paisley, Florida.

**FLORIDA** Homesites \$290, payable \$10 monthly. Big 80 foot frontage. Beautifully wooded. Surrounded by lovely lakes. Gulf resort area. Splendid fishing, hunting. Booklet free. Wendell Wood, Fountain, Florida.

**LARGE** Selection farms and country homes throughout Northwest Jersey. Ask for circulars. Charles G. Ort, Box P, Racketstown, New Jersey.

**FLORIDA** Bargain homes, low taxes. Cummins Realty, Box 848, Eustis.

**ISLESBORO,** Maine, \$250,000.00 estate \$32,000. Owner, 8932—88 St., Woodhaven 21, N. Y.

**SCENIC** Homesites near state park, lake. \$5 monthly. Skyland, Box 6331, Greensboro 17, N. C.

**OWN** California land. \$2 acre minimum buys state, government lands. 500,000 acres, 40 to 640 acre tracts, 10¢ brings brochure. Pioneer Ranches, 8228-PM Sunset, Hollywood 46, California.

**TEXAS** Resort and retirement property at 5 beautiful lakes. Climate ideal year round. 2 lots adjoining total cost \$145.00, \$10.00 down, \$10.00 monthly. Folder free. GS-16, Box 50, Kingsland, Texas.

**NAPLES,** Florida homesites, 60x135, blacktop streets, 7 minutes from Naples beach, protective zoning, prices from \$399, \$10 down, \$10 month, no interest. Write for free brochure, Naples Manor, 904 5th Ave. So., Naples, Fla.

### FARM MACHINERY AND SUPPLIES

**SENSATIONAL** Garden tractor. Hoes between plants and rows, including strawberries. Eliminates hand hoeing. Nothing else like this. Patent 2742840. Also tills. Fantastic offer to first few inquiries. Auto Hoe, DePere 68, Wisconsin.

**ELECTRIC** Welders. New, heavy-duty, 180 amp. Free trial. Dealerships open. 20 year warranty. 8159 South Pleasant, Department A1, Minneapolis 20, Minnesota.

### POULTRY, FARM SUPPLIES

**RAISE** Baby chicks. Two hundred \$5.95 c.o.d. Plus postage. Diamond Chickery, Newfield, N. J.

### PROFITABLE OCCUPATIONS

**INVESTIGATE** Accidents—Earn \$750 to \$1,000 month. Thousands of airlines, insurance companies, steamship lines urgently need claim investigators. We train you home spare time. Placement counsel and help. Free book, now! No obligation. Universal Schools, T-3, Box 8202, Dallas 5, Texas.

**START** Mail order discount business at home selling gifts, appliances, books, housewares, watches, jewelry, cookware, tableware, dinnerware, cutlery, etc., at discounts to 75%! Invest nothing in stock. We ship orders under your name. Self-selling catalogs printed with your name, names of mailorder buyers supplied. Catalog, details free. Topval Corp., Lindenhurst 117, N. Y.



**BIG Profits in welding.** Easy to learn. Low cost training in completely equipped non-profit school. GI approved. Write for free booklet. Hobart Trade School, Box M-383, Troy, Ohio.

**MAKE Money** writing short paragraphs. Information free. Barrett, Dept. CX-27, 7464 No. Clark, Chicago 26.

**WHOLESALE!** Nationally advertised merchandise. Free catalogs! United Wholesalers, 1265-G Broadway, New York 1, N. Y.

**WANTED, Men, women.** Raise bait for us at home. Full, spare time. Doesn't take up space. We furnish everything. Write Bait Associates, Dept. PM2, Stetson, Maine.

**MUSHROOMS Quicker, easier, cheaper.** Newest facts free. Spawn \$1.00. Luxur, 641 South 19th, Newark 3, N. J.

**MAGAZINE Subscriptions—Largest commissions.** Bonus. Qualified Agency, 451FA Kingston, Brooklyn 25, N. Y.

**MAILORDER!** Easy way. Professional. Inexpensive. Write Box 8382-B, Albuquerque, New Mexico.

**THE Gospel versus Babylon.** A thrilling need-filling study in truth and facts. Some lost 15 centuries. Read, and enjoy my amazing little book of truth and investigation. \$1.00. Godwin, Box 592, Winterhaven, Calif.

**SAWDUST** Into dollars. Expert advice, floorsweep compounds, instructions, \$1.00. Foulball Enterprises, Box 632, Grafton, Virginia.

**RAISE Pheasants** on \$100 week plan. Little capital and space can make you independent. Free details. Great Central System, Columbus 1, Kansas.

**MAKE Flexible molds.** Cast plaques, figurines. Free sample. Tooker, 1045-M Fairview, Hamilton, Ohio.

**VENDING Machines—No selling.** Operate a route of coin machines and earn amazing profits. 32-page catalog free. Parkway Machine Corporation, Dept. 25, 715 Ensor Street, Baltimore 2, Maryland.

**AUCTIONEERING—Home study course.** Diploma granted. Auction School, Ft. Smith, Ark.

**BUY Wholesale!** Over 10,000 nationally advertised products. Appliances, cameras, sporting goods, housewares, watches, typewriters, tools, clothing, etc. Send postcard today. Buy-Rite, Box 258, Hawthorne 3, New Jersey.

**AMERICA'S Largest wholesale supply.** Buy, sell. Amazing profits. New free plan. Associated Wholesalers, Box 52-DX, Burlington, Iowa.

**EARN \$240.00** a month at home, spare time doing only two \$5.00 invisible mending jobs a day. Big money paid for service that makes cuts, tears disappear from fabrics. Steady demand. Details free. Fabricon, 6236 Broadway, Chicago 40, Ill.

**MONEY Plans!** "Secret Journal." Grandpa, two daughters made \$2500 first month! Work home. Publicoes, Oceanside, Calif.

**CHARACTER Analysis.** Free brochure. Lucas System, 2419 Sunset, Los Angeles 26, California.

**HOME Mailorder beginner's manual,** sources, methods, opportunities, 25¢. Carnahan Bros., 9610 Acacia, Fontana, Calif.

**\$60.00 WEEKLY.** Sparetime — Easy! Home Venetian blind laundry. Free book. Burti, 2434ES, Wichita 13, Kansas.

**FREE Book "990 Successful, Little-Known Businesses."** Work home. Plymouth, 1610-43 Street, Brooklyn 4, N. Y.

**WE Pay \$3.50 lb. dried.** Grow mushrooms. Cellar, shed and outdoors. Spare, full time, year round. We have over 25,000 customers. Free book. Washington Mushroom Ind., Dept. 99, 2954 Admiral Way, Seattle, Wash.

**BE The Popular Mechanics representative** in your neighborhood and earn big profits in your spare time. Write Popular Mechanics Magazine, Room 305M, 200 E. Ontario St., Chicago 11.

**SAVE Money!** Buy wholesale! Free catalog general merchandise. Norris, 487-M Broadway, New York City.

**SPARETIME Repeat profits** taking magazine subscriptions. Special offers. Cassell Agency, Boynton Beach, Florida.

**BIG Money** raising fishworms and crickets. Free literature. Carter Wormery, Plains, Georgia.

**FREE Follo "\$5,000-\$45,000: Unlimited Vacations."** No merchandise. Unknown! Work home. sparetime! Haylings, Carlsbad, Calif.

**BAKE New greaseless doughnuts** in kitchen. Sell stores. Free recipes. Michael Ray, 3605 South 15th, Minneapolis 7, Minn.

**FREE Book "505 Odd, Successful Businesses."** Work home. Pacific, Oceanside, Calif.

**FREE: Exciting catalog** packed with books covering most everything. Think of it—From cover to cover you will find described and illustrated hundreds of books telling how to fix and how to build almost anything. How to remodel your home; do your own decorating, plumbing, electrical work. Simplified books covering concrete work, carpentry, painting, furniture making and refinishing. How to build your own boat, home workshop tools. Best books on photography, welding, hobbies, homecraft. How to make a home freezer. Send for your free copy now. Popular Mechanics Press, 200-BO East Ontario St., Chicago 11, Ill.

### BOOKS, PERIODICALS, PICTURES, POSTCARDS

**FREE: Catalog!** Hundreds of subjects! Treasure-Site Book Company, 279 South Alden, Philadelphia 39.

**BRITISH Book bargains—Any subject.** Catalog free. Transbooks, Box 1-PMU, Wantagh, N. Y.

**WANTED—Locomotive and Car Builders' Encyclopedias.** Box 9522, Dallas, Texas.

**"SAUCERS" Quarterly.** Six issues, \$2.00. Flying Saucers International, Box 35034, Los Angeles 35.

**SHIPS, Photographs, lists 10¢.** Scozzafava, 1648 59th Street, Brooklyn 4, N. Y.

**OUT-Of-print books** at lowest prices! You name it, we find it! Fast service. No obligation. International Bookfinders, Box 3063-PM, Beverly Hills, Calif.

**SCIENCE, Mathematics, language booklets!** Literature free. Franks, 3121 South Racine, Chicago 8.

**JOHN Friend, bookfinder,** can get the books you want. Free search service. Box 2570PM, Long Beach 1, California.

**DISPOSAL Sale: New-used books.** List sample free. Perzil, 436 New York Ave., Brooklyn 25, N. Y.

**NATIONAL Geographic Magazines, 1888-1956.** Periodical Service, Box 465-PM, Wilmington, Delaware.

**RARE Magazines, catalog 10¢.** Nationwide Exchange, Box 1375-P, San Antonio 6, Texas.

**BOOKFINDERS! All subjects.** Send wants! Jaher Book Service, 183 Hazelwood Drive, Westbury, N. Y.

### MAGIC TRICKS, PUZZLES, JOKER NOVELTIES

**WORLD'S Finest professional magic.** Joker novelties. Giant illustrated catalog 10¢. Top Hat, Evanston 12, Illinois.

**BE A magician!** Large professional catalog of latest tricks. 35¢. Ireland, C-109 North Dearborn, Chicago 2, Illinois.

**STINKBOMBS.** Potent aroma! 12/\$1. Kits, 1452 Drake, San Pablo 10, California.

**3100 NOVELTIES, Jokes, tricks, gadgets, funmakers, hobbies.** Big catalog 10¢. Johnson-Smith, D-424, Detroit 7.

**VENTRILOQUISM, easiest method.** Details free. Smith, 2125 N. Bigelow, Peoria, Ill.

**"VENTRILLO," Professional voice-thriller 25¢.** Ventriloquist puppet 75¢. Box 971-PM, Philadelphia 5.

**MAGICIAN'S Headquarters!** Catalog 25¢. Hocus Pocus, 209 West Capitol, Jackson, Mississippi.

**ITCHING Powder, trick matches, cigarette loaders,** 13 packages \$1.00. Arlane's, Philadelphia 44.

**ONLY 10¢ Brings you magic's greatest value.** Douglas famous catalog, 500 tricks. Tricks for amateur and professional, for pocket, parlor, club, stage, with balls, coins, cards, cigarettes, silks, apparatus. Fastest service to magicians everywhere for over 30 years. Amaze your friends, send 10¢ today. Douglas Magician, Dept. 10, Dallas, Texas.

**SMOKEBOMBS 25¢, 7 For \$1.00.** Terrific! 4463-PM Greene, Philadelphia 44.

**PROFESSIONAL Catalog, 175 pages, 25¢.** Williams, 900 Plymouth, Ellwood City, Penna.

**WHOLESALE! Thirty 10¢ trick novelties \$1.00!** Profits! 1746-W Market, Philadelphia 3.

### COINS, TOKENS, CURRENCY

**AROUND The world** there's nothing else like Bebee's 82-page gigantic bargain catalogue—Only \$1.00 (deductible on \$7.50 order). Large Dollar bill (new) \$1.50; roll (50) Indian cents \$4.95; \$5 gold \$11.95. Paying positively highest prices all gold (any quantity), rare coins, currency. Describe fully for free estimate. Bebee's, 4514 North 30th, Omaha 11, Nebraska.

**WHAT Do you have** in U. S. coins to sell? Singles, lots, rolls, and collections wanted. White, Box 201, Racine, Wis.

**PUN To show your friends!** Genuine old large dollar bills \$2.98. Bash, Box 516, Champaign, Illinois.

**OLD Money wanted.** Will pay \$100.00 for 1894 dime, S. mint, \$50.00 for 1913 Liberty head nickel (not buffalo). Big premiums paid for all rare coins. Send 5¢ for large coin folder. May mean much profit to you. Numismatic Co., Dept. 20, Fort Worth, Texas.

**12 DIFFERENT Barber dimes \$2.00.** Bargain lists free. Snyers, 1000 Unaka, Johnson City, Tennessee.

**MEXICAN Money, list, coin, 10¢.** Kosan Service, 142-Friant, Calif.

**1958 GIANT U.S. coin catalogue 25¢.** Ace, 314 S. Clark, Chicago 4.

**WANTED! Coins! Highest paid!** Confidential catalog, \$1. Sullivan's, Endicott Building, St. Paul 1, Minn.

**BEGIN A coin collection,** the most interesting hobby. Send for our book "Collecting U. S. Coins for Pleasure and Profit." Pages of interesting suggestions and pictures tells how and what to collect, sell, trade, store. Many items of interest. Cash or stamps \$1.00. Texas Coin Exchange, Inc., 2017 Cedar Springs, Dallas 1, Texas.

**WANTED—1822 \$5.00 Gold** pay \$10,000.00. 1913 liberty head nickel \$4,000.00. 1894-G dime \$2,000.00. 1876 C.C. 30¢ piece \$1,000.00. 1901-S quarter \$60.00-\$500.00. 1922 50¢, \$5.00-\$80.00. 1885 trade dollar \$1,000.00. Uncirculated dollars 1804-1839, 1893-S, 1895-P, 1903-O \$100.00-\$5,000.00. Certain dates Lincoln cents before 1932, \$100.00; flying eagle cents, \$500.00; Indian cents, \$140.00; dimes before 1943, \$300.00; quarters before 1924, \$1,000.00; half dollars before 1905, \$1,000.00; halfcents, \$500.00; 2¢ pieces, \$100.00; 3¢ pieces, \$130.00; half-dimes, \$500.00. Hundreds of others worth \$10.00-\$1,000.00. Canadian coins: 1921 5¢ silver, \$100.00. 1889 dimes, \$50.00. 1875 quarters, \$75.00. 1921 50¢, \$500.00. Wanted: Large cents, gold coins, paper money, etc. Know their true value. Our large illustrated guarantee buying-selling catalogue, send \$1.00. Purchase catalogue giving complete allcoin information before sending coins. Catalogue dollar refunded on \$20.00 sale. Thousands of persons have sold us coins. Worthycoin Corporation Incorporated 1938. Leaders Numismatic Quotations, K-440-C, Boston 8, Mass.

**COINS Wanted!** United States rare coin value catalogue. Prices we pay, illustrated 1793 to 1954, 50¢. Indians, Lincolns wanted! Guaranteed buying list 25¢. Bourne Coins, 1436 Maumee, Fort Wayne, Ind.

**25 LINCOLN Pennies 1909 to 1940** or 1926S quarter \$1.00 each. Box 161, Bay Shore, New York.

**U. S. coin sellout continues!** Bargain list 25¢. Hugh's, 522 Second Ave., N.W., Hickory, N. C.

**MEXICAN Coins.** Free bargain list. Spranz, Box 168, Alamo, Texas.

**LINCOLN, Indian cents, all dates.** 1909-VDB cent and complete pricelist 50¢. Penny Mart, PL-10, Box 629, Chicago 90.

**\$20.00, \$50.00, \$100.00 CONFEDERATE Bills, \$1.00.** Approvals. Buza, Stevens Point, Wisconsin.

**BRILLIANTIZE—Safe for proof coins** \$1.00 prepaid. Stephenson's, Inc., Ames, Iowa.

**FREE: Every serious collector** wants our free circular. Write Hobbyville, Wenona, Illinois.



U. S. coins, including many found in your change, command high prices. "The Handbook of U. S. Coins," 1958 edition illustrates, describes and lists prices paid by reputable dealers for every coin ever minted by U. S. 126 pages of fascinating and valuable information. \$1.10 postpaid. Empire State Coin & Stamp Co., Suite 337, Empire State Bldg., New York City.

**LARGEST Lincoln cent dealer.** Singles, rolls. List 6¢ stamps. Gem Coin, Box 476, Fort Wayne 5, Indiana.

**FOREIGN Coins.** 10 diff., 25¢. 25 diff. from 25 diff. countries, special, \$1.00. Foreign bills, 20 diff., 25¢. Indian cents, 10 diff., 75¢. Lists. Oliver Arnold, Macon 1, Mo.

**32 PAGE Informative U.S. illustrated coin list 10¢.** Stoney, 192 Washington, Boston 8, Mass.

**10 DIFFERENT Indianhead cents, lists \$1.00.** Lists, curious coin 10¢. Elliott, 335 Juniper, Coraopolis, Penna.

**NEW! 1958 Canadian commemorative silver dollar uncirculated plus current "Canadian Bulletin" \$1.50.** Marles, Box 833, Calgary, Canada.

**U.S. large cent, 3¢ piece and bargain list, only \$1.** Delmaco, Box 1123, Wilmington 99, Delaware.

**LINCOLN, Indian and Canadian cents, buffalo nickels.** Bargain list 10¢. Hughes, 21 Ottawa, Grand Rapids, Michigan.

**44 DIFFERENT Coins, \$1.00.** 100 different coins, \$2.50. 66 coins and bills, \$1.00. Oddehon, Box 482, St. Louis, Mo.

**10 DIFFERENT Indian Cents \$1.00.** Coins, Box 6184, Albuquerque, New Mexico.

**WHAT Nickel is worth \$3,500?** Send 25¢ for latest book showing values of rare American coins. Stack's, 125 West 57 St., New York City.

**\$1,000,000.00 CASH** In honest to goodness authentic reproductions of genuine Confederate money in 10's, 20's, 50's, 100's, etc. Only \$2.98. Best Values Co., Dept. #M-252, 403 Market Street, Newark, New Jersey.

**RAREST Carson City mint dollar 1885.** Uncirculated, \$3.90. Illustrated coin catalogue 25¢. Shultz, Salt Lake City 10, Utah.

**WHOLESALE Coins for dealers, investors.** Lists 10¢. Al Johnson, Box 35, Colorado Springs, Colo.

**SAN Francisco mint closed!** Made only cents and dimes in 1955. In short supply and great demand. One each, brilliant uncirculated, for 25¢. Free coin lists with order. Bryson Stamp & Coin Company, 612 White, Toledo 5, Ohio.

**BARGAINS, U.S. coins:** 1893 Columbian world's fair half dollar, \$1.00. Ten different Indian pennies, 75¢. Two-cent piece, and 3-cent piece, \$1.00. Gold 1/2 eagle, \$9.00. Gold 1/4 eagle, \$12.50. Beautiful coin bracelet, \$1.00. Many coins available. What do you need? Rare Coin Company, 31 North Clark, Chicago 2.

**LARGEST Coin magazine, 180 pages, 35¢.** Scrapbook, 7320-J Milwaukee, Chicago 31.

**COINS From Formosa, Vatican, etc., plus foreign banknote, 10¢ with coin approvals.** Littleton Coin Co., Littleton 51, New Hampshire.

**LINCOLN Cents 1910-S, 1913-S, 1921-S, 1923-S, 1924-S, all for \$2.** Gasser's, Box 34615, Los Angeles 34, California.

**GET Profit and pleasure in collecting old coins.** Send 10¢ for 56-page illustrated coin catalog. You'll be delighted with it. Send for it now. B. Max Mehl, 370 Mehl Building, Fort Worth, Texas. Largest rare coin establishment in U. S. Established 40 years.

**OLD United States gold coins bought.** John J. Pirpo, 120 Santa Ana Ave., San Francisco 27, Calif.

**COMPLETE United States coin bargain lists, Indianhead cent, 10¢.** Economy Sales, 156-A Dean, Mansfield, Mass.

**COIN Albums and accessories.** Send dime for new 24-page illustrated catalog. Coin Care Corp., 1627 West Anaheim, Long Beach 13, Calif.

**INDIAN Cent plus Bargain Lists 10¢.** Hutchinson's, Box 4747, Philadelphia 34, Penna.

**FOREIGN Coin, banknote and large illustrated coin list for 3¢ postage.** Bargains: Indian head cent, 10¢; wooden nickel, 10¢; Chinese dollar, 53¢. Approvals included with every order. Tatham Coin Company, Springfield 30, Massachusetts.

**SILVER Dollars.** Beautiful, Brilliant, uncirculated, San Francisco mint: 78-S, 79-S, 80-S, 81-S, 82-S, 87-S, 89-S, 90-S, 91-S, 97-S, 21-S, 22-S, 23-S, 25-S, only \$2.00 each. Carson City mint: 81-CC, 82-CC, 83-CC, 84-CC, 85-CC, only \$3.00 each. Postpaid. 10 day money-back guarantee of satisfaction. Thousands of other coins. Proof sets, Gold, Silver dollars, Cents, etc. Free price list. Send your want lists. We also buy coins. What do you have? And please name your price. Postal Products Company, Fast Mail Order, Joe Gordon, A.N.A., 5614-MC California Street, San Francisco 21, California.

**PROOF-Sets.** 1958 set only \$2.50; 1957, \$3.00; 1956, \$4.00; 1955, \$6.00; 1954, \$7.00; 1953, \$12.00; 1952, \$18.00; 1951, \$29.00; 1950, \$47.00. Complete set 1950-1958 inclusive, \$120.00. Postpaid. Prompt shipment. Money-back guarantee. Dan's—Dan Morafka, A.N.A., 432-P 23rd Ave., San Francisco 21, California.

### STAMP COLLECTING

**100 ALL Different mint United States commemoratives \$6.75** includes bicentennials, parks, famous Americans. No approvals. Gil's, Box M12, Brooklyn 29, New York.

**FREE U. S. stamps.** 1943 flag, commemoratives included in collection of 25 different, plus valuable \$5.00 stamp. All for 10¢ mailing charge. Approvals. Willett Co., Box 338-A, Yorktown Heights, N. Y.

**FREE! Egypt, Iran, Iraq, Israel, Lebanon, Syria.** Excellent approvals. Panorama, Box 229, Miami 2, Florida.

**500 MIXED Worldwide 25¢.** Brookside Stamps, Box 133, Mendon, Mass.

**50 BRITISH Colonials free approval applicants.** Handling 10¢. Brandon, 819 3rd Ave., Altoona, Penna.

**500 FINE Mixed U.S. 15¢.** Wright, 201M Mealey, Hagerstown, Maryland.

**FREE! 107 British colony stamps,** all different, from Britain's farflung colonial empire. Catalog value \$2.50. Free stamp magazine. Approvals. Send 10¢ for handling. Act now! Lincoln Stamp Co., St. Catharines 418, Ontario.

**TERRIFIC Stamp bargain!** Israel, Iceland, Vatican assortment—Plus exotic triangle set. Also fabulous British Colonial accumulation. Plus large stamp book. All four offers free. Send 10¢ to cover postage. Empire Stamp Corp., Dept. PM, Toronto, Canada.

**WOW! 110 All different Germany 10¢.** Zeppelins, semi-postals, airmails, high values, etc. Giant catalog, bargain lists included with beautiful approvals. Jamestown Stamp, Dept. A38PM, Jamestown, N. Y.

**STAMP Finder, world map and encyclopedia of stamp issuing countries only 5¢.** Approvals. Goliath Company, Bethlehem K1, New Hampshire.

**"VALU-Packed" American stamp catalog, 10¢!** Sullivan, Pioneer Building, St. Paul 1, Minn.

**125 CANADIAN, Newfoundland 10¢.** Yonge Stamps, 247 Cortleigh Blvd., Toronto 12, Canada.

**1000 DIFFERENT Worldwide stamps \$2.00.** Universal, Box 6, Kenosha 5, Wis.

**U. S. Classics.** Over 50 yrs. old. 15 selected old-timers. Missing in biggest collections. All 15 at less than 1¢ each. 10¢ with approvals. Jaro, Box 246-T, New York City 8.

**JOB Lot approvals.** Postpaid both ways. 1103 South Ash, Wichita 16, Kansas.

**25 CHINA Unused, 3¢.** Approvals. Jim's, 1317 Apple, Silver Spring, Maryland.

**1030 DIFFERENT Stamps \$1.00.** Approvals. Klondike, 682 Jefferson, Elgin, Illinois.

**ON Postcard, 2 different Danish stamps.** Send 80¢. A. Reinhardt, Slagelsegade 18, II, Copenhagen, Denmark.

**40¢ SCOTT, Or less.** Fine foreign. Hummer, 4308 Allan, Burbank 1, Calif.

**U. S. Stamps.** Giant bargain catalog—10¢. Raymax, 35-VZ Maidenlane, New York City 38.

**50 DIFFERENT China 10¢ with approvals.** Plymouth, Department A-10, Bell, California.

**100 DIFFERENT 10¢ With approvals.** Roger Davis, 525 Main St., New York Mills, N. Y.

**TUYA International philatelic dictionary,** containing over 7,500 surcharges, philatelic terms in 11 languages, countries, capitals, areas, population, currencies, condensed biographies and names and addresses of principal clubs and philatelic societies throughout the world, for sale at all philatelic supply houses or will be sent registered postpaid upon receipt of \$3.50. Tuya International Philatelic Dictionary, P. O. Box 268, SX, Cuba.

**DEALERS—Wholesale list.** Postage 3¢. Frank, 5031 Queensberry, Baltimore 15, Maryland.

**750 U. S. 35¢; 2,000 Foreign \$1.00.** Yaccari, 1431-43rd, North Bergen, N. J.

**GIANT U. S. Canada price list, over 100 pages, 700 illustrations, 10¢.** Thom, 4808 15th Avenue, Minneapolis 17, Minn.

**AUSTRALIAN Price list, 3¢ postage.** Chamberlin, Box 906, Galveston 7, Texas.

**93% DISCOUNT.** \$100 Catalog value only \$7.00. \$210 only \$14.00. All undamaged Scott over 10¢. Castellan, Box 1442, Stanford, California.

**FREE! Giant bargain catalog—New edition** listing thousands of bargains including U. S. and B. N. A. stamps, packets, mixtures, albums, accessories and supplies; sent with beautiful approvals. Jamestown Stamp, Dept. E38PM, Jamestown, N. Y.

**FREE! 15 Different Manchukuo, plus world's only octagonal stamp, plus Abyssinia Red Cross set, to those requesting approvals.** C. E. Cleaveland, 806 North Humphrey, Oak Park, Illinois.

**BEAUTIFUL 2¢ Commemorative approvals by country.** James Valliere, 28 Thorncike St., Concord, N. H.

**BELOW Wholesale Germany, Saar, Switzerland.** Pricelist dime. Kaperl, P.O.B. 35175, Los Angeles, Calif.

**BULGARIA: Fifty different exciting pictorials, animals, trucks, flowers.** This valuable collection, only 15 cents with approvals. Boger, Box 152, North Wales, Penna.

**"WORLD'S Oldest man" (airmail), Katango commemoratives, Indonesia (cat. 50¢), plus famous "Piccard balloon" stamp, all, 10¢ with approvals.** Mark International, 4628 N. Hollywood, Milwaukee 11, Wisconsin.

**FREE 50 Worldwide introducing inexpensive approvals.** University, Stamps, P.O. Box 95, Tamiami Station, Miami 44, Florida.

**AMAZING! 357 World wide stamps, all different for 25¢.** Money back guarantee, with approvals. Hurry, limited supply. Veteran Stamp Co., 169 Kensington Ave. N., Hamilton, Ontario, Canada.

**1958 U. S. Price list, 25¢.** Lee's, Box 796, Rockford, Illinois.

**15 MONACO Mint beauties—Olympics, weddings, triangles, 25¢.** Attractive approvals. Matthews, 58 South Lake, Troy, New York.

**1000 DIFFERENT With approvals.** Jacobsen, 4395-C Broadway, New York 40, N. Y.

**500 FOREIGN Mixture 50¢.** Also approvals. John Hatt, Box 253, Bangor, Maine.

**100 FOREIGN, 20 U. S. commemoratives, 10¢.** Approvals. Weckerling, 1304J Choquette, Austin 5, Texas.

**SURPRISE Stamps free with United States, foreign bargain lists.** Randles, Box 1163PM, Hutchinson, Kansas.

**MIDGET Triangle, giant diamond, Timor.** 26 others 3¢. Approvals. Carpenter, Box 310, Claremont, Calif.

**U.S. Commemoratives: 145 different \$1; 210 different \$2.** Moseley, 6 Hanley Downs, St. Louis 17, Missouri.

**UNITED States approvals, including rare old issues.** Credit references required. Merritt Brundige, Cambridge, N. Y.

**50 ALL Different South American 10¢ with worldwide approvals.** Superior Stamps, Box 53A, Cathedral Station, New York 25, N. Y.

**FREE! Over 100 different, \$2.50 value, including space satellite, Israel, British, U. S., first U. N., Siberia.** Approvals, catalogue. Send 10¢ for mailing. Gatewood, Box 346, Winston-Salem, N. C.

**TEN Sports plus 50 different, 10¢ with approvals.** Bennett, Candor 3, N. Y.

**PENNY Approvals! Regardless catalogue!** Kloster, 4164 52nd St., San Diego 5, Calif.



FIRST German airpost set complete. Ten cents. European approvals. Boger, Box 152, North Wales, Penna.

AIRMAILS — Forty-four different, 10¢. Approvals. Valley's, Box 414M, Spring Valley, California.

PHILIPPINES — 25 Different 10¢. approvals. Dopko, 3482 Laura Lane, Riverside, California.

50 DIFFERENT Argentina. 10¢ with approvals. Smith, 6 Greencroft, Champaign, Illinois.

500 U. S. stamps 25¢; 100 pictorials 25¢. Carlton's, 10243 Silverton, Tujunga, Calif.

HIGH Values up to \$1.25 catalog each. Big recent commemoratives. Airmails. All included in 115 different; 16 Far East countries. \$2.00. No approvals. Burns, Box 3761, Honolulu 11, Hawaii.

WORLDWIDE, 50 All different, absolutely free. Just to introduce our incomparable approvals. Kent Stamp Company, GPO Box 87, Brooklyn, N. Y.

RUSSIA, 25 Exciting gems or 50 fascinating Bulgaria 10¢. Approvals. Belmont Stamps, Washington 15, D. C.

EARN Beautiful sets buying pictorial approvals. Stamp Farm, Oxford, Wis.

BRITISH Colonials. 105 different including Boy Scout, queens, 10¢ with approvals. Cranston, P.O. Box 3583, Cranston 10, Rhode Island.

40,000 VARIETIES Available on approvals. 1¢ upwards. Keigwin, Box 933B, Daytona, Florida.

1 AND 2 Cent approvals in envelopes. R. Schnobelen, Columbiana, Ohio.

20,000 WORLDWIDE Penny each. Surprise samples, 25¢. James Vaughn, Gulfport 7, Florida.

PRE 1894—United States, three copies free to approval applicants. Collier, Chamblee, Ga.

UNITED States commemorative and plate block price lists free. No approvals. Frank Hutter, 468—6th Street, Brooklyn 15, New York.

NEXT Ten 3¢ FD Aircraft covers, \$1. Aufderheide, Box 224, Trenton 8, N. J.

FREE Packet, used U. S. approvals. Zupancic, 2372 Mahan, Ferndale, Mich.

VERY First issues of sixteen different countries, (including scarce Greenland, Vietnam, etc.) only 25¢, with approvals. Variety Stamps, Box 98-P, Newton Highlands 61, Massachusetts.

MOZAMBIQUE Company #165-74 bicolored airplane triangles given approval buyers. William Deems, 226 Race, Ravenswood, West Virginia.

FREE! Scarce 1905 stamps (world's smallest). Approvals. Wheeler, Winona Lake, Indiana.

800 MIXED U.S., old-new, 25¢. Lists. Weatherby, Medina, Ohio.

70 OLD U.S., famous Americans, flags, commemoratives, approvals, surprise packet, 10¢ handling. Metropolitan Stamps, Box 312TF, Jackson Heights, N. Y.

SCARCE Nepal, 1890 midget, Jaipur, 203 10¢; \$9.00 value Armenia, etc., \$1. Approvals. Sands Company, 131 Burns Street, Hampton, Virginia.

64 PAGE U.S. catalog free. Stone, 192 Washington, Boston 8, Mass.

FREE! 100 British Empire, 10¢ handling. Approvals included. Kensington Stamps, Buffalo 15, N. Y.

FREE — Valuable U.S.A. (1) Scarce genuine postage stamp picturing first U.S.A., issued in 1847! (2) Big collection 30 all-different United States; ancient 19th century, valuable \$1 stamp, etc. (3) Collection beautiful commemoratives. (4) Collectors guide: big 64-page bargain catalog including all U.S. postage issues; other exciting offers! Send 10¢ for mailing expenses. Harrisco, 4165 Transit Bldg., Boston 17, Mass.

FREE San Marino, Mozambique, Czechoslovakia, Australia, Argentina, Approvals. May, Box 986-A, Coral Gables 34, Florida.

50,000 STAMP Grab-bags, 25¢ each. Anderson, P.O. Box 1, Reading, Penna.

FREE Surprise assortment, 50 different world wide. With attractive approvals, popular prices. Banner, Box 65-A, Park Forest, Illinois.

FREE! "Worldwide assortment," with approvals. Steele, Box 451-Q, Long Beach, Calif.

508 DIFFERENT Worldwide from Madagascar, Macao, Guinea, etc., catalogued over \$15 only 35¢. Approvals. Littleton Stamp Company, Littleton Q1, New Hampshire.

ONLY 10¢—Catalogued \$1.16. 4 scarce Siberia; 10 sport topicals Czechoslovakia. Approvals. Penn Stamp, Box 303, Philadelphia 5, Penna.

ADULT, Beginners; free 2 mint sets. Approvals. Madison Stamps, 27334 Brettonwoods, Madison Heights 4, Michigan.

CHINA, 5 Different airmail only 5¢, to approval buyers. Coast, P.O. 2187C, Santa Ana, California.

FREE—Airmails, commemoratives, pictorials. Approvals. H. P. Wisehart, Frankfurt, Ohio.

FREE United States commemorative list. H & S, 45 Bromfield, Boston, Mass.

FIRST U. N. set. Among world's prettiest. Only 10¢. Approvals. Welles, Box 1246-R, New York City 8.

7 CANAL Zone 10¢. Approvals. Merkel Stamps, 30 Grandview, South Hadley Falls, Mass.

SUPERIOR Worldwide mission mixture. Amazing variety! Half pound \$1.60 postpaid. Bay Nielsen, 4545B Harvard, Montreal 28, Canada.

300 DIFFERENT Given free with approvals. Particulars. Windsor Stamps, 8834 Cornell Ave., Chicago 17.

GIANT Approvals, thousands different, 1¢ and 2¢ each. Wahl's Stamp Exchange, 7008P Farragut, Chicago 31, Ill.

60 DIFFERENT U. S., included 30 commemoratives 25¢. No approvals. Seidenberg, Appleton, Wisconsin.

WONDERFUL Offer, 7 complete mint sets only 10¢ with approvals. Reich (M26), 1033 Lawrence, Chicago 40.

UNITED Nations, Five different 10¢. Approvals. Anderson, 1112 Harrison, San Francisco 3, Calif.

FREE! Amazing list! Alphabetical! Two feet long! Stampmart, Hartford 1, Conn.

14,000 DIFFERENT! Amazing new plan builds your collection systematically, country by country. Only 50¢ weekly. Free details. L. G. Ware, Stepney 75, Conn.

INTRODUCING Our better United States approvals, we offer 15 United States stamps including Columbian, Pan-Pacific, famous American, airm. others; only 10¢. Ocean Stamps, Box 64-PM, Brooklyn 29, New York.

UNITED States price list, 116 pages, price 25¢. Mark Hanna, 335 Fifth Ave., Pittsburgh 22, Penna.

U. S. Mint flag set, complete, \$1.00. Free list. Brooks, 2323 Avenue X, Brooklyn 35, New York.

SPACEPHOBIA? Our 1¢-2¢ approvals cure quickly. BKJ, Astor, Boston 23, Mass.

"ABE Lincoln" giant diamond, rainbow colored flag set, Israel, South Korea, 50 others different only 10¢. Approvals. Champlain, Isle La Motte, Vermont.

FREE United States illustrated catalog, Bailey, 45 Bromfield, Boston, Mass.

U. S. approvals. Low prices. Eagle Stamps, Romine Ave., Pittsburgh 26, Penna.

ECONOMICAL 1/2¢-3¢ Approvals, 33,000 varieties. Dresel, Box 128-N, West Englewood, New Jersey.

TWO \$5.00 U.S. stamps plus 20 different, 10¢ with U.S. approvals. Irwin, Box 1105, Brooklyn 30, N. Y.

FREE! 107 British Colony stamps. All different, from Britain's farflung colonial empire. Catalog value \$2.50. Free stamp magazine, approvals. Send 10¢ for handling. Act now! Niagara Stamp Co., St. Catherine's 71, Ontario.

UNITED States commemorative collection containing 33 different—10¢. Approvals. White, 516-A Avenue L, Brooklyn 30, New York.

SELL Your surplus good grade stamps. Write, describing fully what you have. Vanroy Shirk, Lebanon, Pennsylvania.

50 DIFFERENT Argentine 10¢. Approvals. Reuter, 611 W. 40th Pl., Los Angeles 37.

AMAZING Offer! 200 United States stamps — including commemoratives, airmails, high denominations to \$1.00. Only 10¢ to approval applicants! Illustrated bargain lists free. Mystic Stamp Co., Dept. 80, Camden, New York.

100 STAMPS, 10¢ With approvals. Smith, 508A Brooks, College Station, Texas.

OLD Scarce U.S. seconds on approvals. Slight imperfections, lowest prices. Hernefield, Clintonhill Sta., Newark 8, N. J.

100 OLD United States between 1861 and 1935, \$1.00. Roush Stamps, 51 Chestnut, Mansfield, Ohio.

UNITED States approvals. Select copies, used—mint. Kingsbury, Fairfax, Vermont.

ICELAND 10 Different beautiful stamps for only 10 cents to applicants for our good old fashioned approvals. Old Colony Stamp Co., Dept. A, Milford, Connecticut.

1-2¢ EACH! Thousands of exciting worldwide stamps. Free examination. Cole, Box 223-A, Buffalo 21, N. Y.

225 STAMPS For only 10¢! This mammoth value includes airmails, pictorials; stamps from strange countries cataloging up to 25¢ each! Also approvals. Mystic Stamp Company, Camden 80, New York.

100 DIFFERENT Austria, 10¢. Approvals. Aronson, Box F, Newton Centre 59, Mass.

WEIRD Diamond shape coffee stamps. Lovely flower triangle! First American big commemorative. Greenland, idol dancer, etc. Free with approvals. Capital Stamp Co., Ferrysburg 2, Mich.

25 DIFFERENT Commemoratives 1893 up 10¢. U. S. approvals. K&B, Box 70, Brooklyn 23, N. Y.

MINT U. S. at face! Older commemoratives only in 25¢ packet. Limit one with request for mint U.S. approvals. Western, Box 1689P, Salinas, California.

135 DIFFERENT U.S. commemoratives \$1.00. 50-25¢. Request approvals. Harold Holub, 18 East 198th Street, New York 68, N. Y.

200 WORLDWIDE 10¢ To approval applicants. Collins', P.O. Box 125, Shell Beach, Calif.

CANADA, 100 Different 35¢ with bargain approvals. K. S. Holmes, London, Canada.

FREE Sample! Interesting, informative, illustrated. National Stamp News, Anderson, South Carolina.

100 DIFFERENT, 10¢ To approval applicants. Cochran, 1814 West Corona, Phoenix, Ariz.

FREE! 15 Mint French Colonies; interesting approvals accompany. Tropicana, Box 624-M, Oakland Park, Fla.

FREE! Eight sided stamp, triangle, diamond, midget, mammoth, to approval buyers. Downey, Box 70-A, Bell, Calif.

1250 STAMPS \$1.00. World wide. Good variety, off paper. Many pictorials and commemoratives. No approvals follow. Harrison's Stamps, 1435 1st Ave., Oakland 6, Calif.

FREE Stamp wallet, perforation gauge sent to new approval customers. Robert J. Clark, Box 728-P, Evanston, Ill.

100 DIFFERENT Stamps, 10¢ with approvals. Finney, Box 89, El Monte, Calif.

EXCITING Strange countries packet, Free with approvals; Saxon, Orange, California.

12,000 PENNY Approvals waiting for you. Many from exotic countries, pictorials, airmails, new issues. Tilbury, Box 862, Newark 1, N. J.

STAMP Collecting outfit, includes packet worldwide stamps, package hinges, watermark detector, millimeter gauge. Everything 10¢ with approvals. Lorain Brown, Marion, Michigan.

PENNY Approvals. Thousands. Bargains for pennies. Gifts with purchases. Penny Stamps, Orange 1, California.

FREE 60 Different stamps. Request approvals. Stanley Zajac, 159 Emerson Ave., Toronto, Canada.

ATTRACTIVE World-wide collection 10¢, approvals. Coley, 3606 Lazywood, Houston 23, Texas.

FREE, 100 Different stamps with approvals. Jeans Stamps, 42 Evergreen Rd., North Fort Myers, Florida.

FREE Stamp collection, 100 different stamps from Europe, Africa, Asia, Scandinavia, Balkans, etc. 3¢ to approval applicants. Tatham Stamp Company, Springfield 30, Massachusetts.

FREE! Mint British Colonies from North Borneo, Caymans, Seychelles, Dominica, Papua, New Guinea, Sarawak, Brunei. Free with approvals. Viking, Great Neck 8, New York.

GIGANTIC Packet list free to approval applicants. Salsman, 1729 Milvia, Berkeley, Calif.



69 COLOMBIA. Beautiful! 25¢ with worldwide approvals. Cooper, 6018 Harcourt, Los Angeles 43, California.

FREE Mint set! Request approvals. Stampco, 5151 Princeton, Memphis 17, Tennessee.

100 DIFFERENT U.S.—50¢. Approvals. Utechs, 1134D North Keeler, Chicago 51.

FINE United States, mint and used. Illustrated price list free. Stampland, Box 2003, Miami 11, Florida.

FREE, Everything free—Mammoth collection cataloging \$20.00 also 50 valuable complete sets. 54 gigantic multicolor commemoratives. All volumes Scott's International albums, catalogues, even Master Global albums. Free when you buy our sensational foreign approvals. Bargain Stamps, Redlands, California.

MOSQUITO And Olympic stamps, plus Brazil George Washington, 10¢ with approvals. Hill Company, Box 51, Defiance, Ohio.

FREE Packet! Angola, Azores, Mongolia, Nepal, Palestine. Fascinating approvals. Coral, Box 7095 (Ludlam), Miami 55, Fla.

125 DIFFERENT Foreign, 10¢. Approvals! Connelly, 404 North Andrews, Fort Lauderdale, Florida.

SEND Two dimes for the best U. S. catalogue you have ever received. New-Way Stamp, Lawrence, Mass.

WANTED—Stamp collections, accumulations. Murray Gold, 62-95p Saunders, Rego Park 74, N. Y.

EXCEPTIONAL—125 Different including triangles, commemoratives, catalog \$3.00, dime, approvals. Reeves, Box 597, Miami 37, Florida.

FREE! Russia Sputnik, Monaco triangles. Approvals. Keating, 2520-P Boulevard, Jersey City, New Jersey.

50 BRITISH Colonies 10¢. Attractive approvals accompany. Rocket Valley, Box 328, Canoga Park, Calif.

SPUTNIK. The world's first Sputnik stamp plus 50 all different free with approvals. Stamp Imports, Peterborough, Ontario, Canada.

## ANTIQUES, RELICS, INDIAN GOODS, CURIOS

INDIANCRAFT. 40 Page illustrated catalog 15¢. Grey Owl, 4518 1/2 Seventh, Brooklyn 20, N. Y.

ANCIENT Grooved stone tomahawk \$3.00. Indian relic list free. Lear's, Glenwood, Arkansas.

ARROWHEADS Made easy! Improved professional arrowhead making kit with photos and detailed instructions only \$2.00. Lobo A.C., Box 144, Carlsbad, New Mexico.

AFRICAN Masks, shields, spears, etc. Trade new merchandise for old guns, swords, etc. Send 10¢ for list. Exotics Trading Post, 1115 East 55 Street, Chicago.

SELECTED War arrowhead \$1.00. List 5¢. H. Talburt, Calico Rock, Ark.

SPEARHEAD. Arrowhead, scraper \$1.00. Smith, 841 N. Tacoma, Indianapolis 1, Indiana.

STONE Arrowhead making instructions. Illustrated, complete, \$1.00. Chief Blackhawk, Box 564-N, Kennewick, Washington.

ANTIQUÉ Style pump lamps \$5.98. Bartol's Sales, 2229 W. Wells, Milwaukee 3, Wis.

## PRECIOUS STONES, MINERALS

10 DIFFERENT. Genuine, semi-precious stones, only \$2, including amethyst or topaz; all cut, 5 carats up, undamaged, reclaimed from old jewelry. Postpaid, moneyback. International Gem, 15A Maiden Lane, New York City 38.

FREE Examination offer. Thirty uncut gem specimens. Collectors, students, cutters write for details. Or send \$3.50. No foreign orders. Reed's 4930B, Palo Alto S.E., Albuquerque, New Mexico.

ILLINOIS—Gesundheit! Visit our rock-hound paradise. Circular free. Heike, Wenona, Illinois.

SEMI-Precious uncut gems. Ten different for \$1.00. Request list 26. Prospectors Shop, 201 San Francisco, Santa Fe, New Mexico.

TEN Polished gems, baroque shaped, only \$1.00. Bargain lists, gems, jewelry mountings, 25¢. Gem cutting equipment, 25¢. O'Brien's, 1116N Wilcox, Hollywood 38, Calif.

CUT Gems, make jewelry—For profit or fun. 100 page magazine tells how; where to get supplies. Sample 25¢ or request free literature. Lapidary Journal, Del Mar 2, Calif.

EARTH Science, the rockhounds national magazine. Subscription \$2.00. Sample 35¢. Box 1357-PM, Chicago 90, Ill.

AGATES, Gems, machines. Free list. Northwest Gems, 2819 North Warner, Tacoma 7, Washington.

LARGEST Gem and mineral magazine tells how to have profitable fun with rocks, gems, jewelry. Monthly, \$3.00 year. Sample 25¢. Gems & Minerals, Dept. A1, Mentone, California.

## HOBBIES AND COLLECTIONS

EXCITING New hobby with micro organic crystals. Catalog 10¢ or send \$1.00 for samples. Riklin Research Laboratories, Box 3295-P, Seattle, Wash.

NAZI Insignia, 12 different \$1.00. Medals, patches, armbands, flags, daggers. Illustrated lists, 15¢. Hobbyland, 1207 1st St., W., Calgary, Canada.

COLLECTORS Matchbook covers. 100 different unused, \$1.00. Catalog 25¢. Album \$3.00. Charles Edelman, 1311-C East 84, Cleveland 3, Ohio.

CIVIL War soldiers for the dioramist. 32 illustrated pages. Catalog 10-Z 35¢. Busler Miniatures, 40 Howe St., Quincy 69, Mass.

35 DIFFERENT American patches, 50¢; Nazi medals, sample 50¢; propaganda leaflet 25¢; embroidered swastika, catalog 25¢. Hobbies, Box 71, Rockaway Park B-94, N. Y.

MINIATURE Soldiers. Over 700 different sets to choose from. Catalog 10¢. Willard Snyder, 1809 Ranstead St., Philadelphia 3, Penna.

FREE—Every serious collector wants our free circular. Write Hobbycraft, Wenona, Illinois.

WANTED Cigarette, tobacco cards. Write Charles Bray, East Bangor, Penna.

## CAMERAS, PHOTO SUPPLIES

FREE! Free! Send for your new 52 page photographic bargain book. Over 5,000 new and used items at huge savings. For your free bargain book, write to Dept. 13, Central Camera Co., 230 S. Wabash, Chicago 4, Ill.

16MM. Kodachrome titles, 5 words or less 40¢. Additional words 7¢ each. Myron A. Tripp, Box 343, New Bedford, Mass.

PHOTOGRAPHY For pleasure or profit. Learn at home. Practical basic training. Long established school. Free booklet. American School of Photography, 835 Diversey Pkwy., Dept. 3441, Chicago 14.

MAKE Money coloring photographs. Instructions \$1. Gene Gruchow, Neligh, Nebraska.

PHOTOGRAPHIC Slide rule gives all data. Simplifies photography. Pocket case included. \$1.00. Guaranteed. Ed Gibson, East Aurora, N. Y.

KODAK. Bell-Howell, discounts to 40%. Photo equipment, appliances, free catalog. Mellers Mart, Box 135-PM-6, Pelham, New York.

LEICA, Contax, Nikon, Minox, Exakta. All leading brands. Trade, buy, sell. Free catalog. Write Mr. Gallagher, Wall St. Camera Exchange, 80 Wall St., New York 5, N. Y.

## PHOTO FINISHING

TRIAL Offer—8 jumbos 40¢. 12, 50¢. Thrifty Photos, PM38, Box 275, San Francisco 1, Calif.

25 WALLET-Size silk finish photos from any picture \$1.00. Original returned unharmed. Studio, Box 701G, Springfield, Missouri.

REPRINTS 30 For \$1.00 through April 30th. Twelve exp. 39¢. Wallets 20 for \$1.00. Lincoln Studios, Dept. K, Box 13, Lincoln, Nebr.

KODACHROME Processing by Kodak. 8mm. roll or 35mm., 20 exp., \$1.35. Prompt service. Write for mailers and prices. Color Pix, Dept. P, CPO Box 30, Kingston, N. Y.

KODACOLOR Reprints 25¢. 8 exposures \$2.25, 12 exposures \$3.25, failures credited. Sunflower Color, El Dorado 6, Kansas.

ANSCOCHROME Roll film processed, mounted \$1.10. Okmit Lab., 57 North Street, Johnson City, New York.

FREE Color print coupon. Professional quality Ektachrome, Anscochrome processing, \$1.00. Kodachrome, \$1.25. Write for mailers. National Color Corporation, Box 12155M, Atlanta 5, Ga.

COLOR Processing—High quality, fast service and low prices. Kodacolor developing 85¢; prints 27¢. Kodachrome: 35mm. processing, 20 exposures; \$1.45; 36 exposures, \$2.25. Send for complete price list and free mailers. Photo-Mail, Box 216M, Madison Square Station, New York City 10.

FREE! Color snapshot folder. Offers, lists, mailers. Houghton's, Irving, Mass.

PARTICULAR? 8 Jumbos—40¢. 12—50¢. Special; 35 mm., 36 exposures \$1.25. Introductory offer. Flash Foto, Box 36M, Brooklyn 4, N. Y.

8-HOUR Service on deluxe jumbo prints. 8-exposure roll developed and 8 jumbo prints 40¢, 12 exposure 55¢, 16 exposure 70¢; 35mm. 20 exposure 75¢, 36 exposure \$1.25. Jumbo decklegrade reprints 4¢ each. Contact prints made if specified. Bay Photo Service, P.O. Box 210, Oakland, California.

KODACHROME Processing 20 exposure, 8mm. roll movie \$1.00. 36 exposure \$1.75. Anscochrome, Ektachrome \$1.00. Kodacolor developing \$.65, \$.25 per print. Free mailers and price list. Nu-Color Laboratories, Box 191, Hartford 1, Connecticut.

ENLARGEMENTS. Heavyweight seven 5x7s or four 8x10s \$1.00. Jack Koons, Huntington Mills, Luzerne County, Penna.

## MOTION PICTURES AND SOUND EQUIPMENT

BMM Movies, 50 ft. \$1.00—Special offer. Animals, cartoons, travel, comedies. Send \$1.00, or \$5.00 for six assorted. Movie-land Films, Inc., 16121-M Sherman Way, Van Nuys, Calif.

FREE Catalog. Save dollars. Fresh 8mm., 16mm. b&w and color film. Home processing equipment. Superior Bulk Film Company, 448 No. Wells, Chicago 10.

RECORDERS, Hi-Fi. Free catalogue. Carstan, 215 E. 88 St., New York City 28.

5,000 8-16MM. Movie films. Free catalogues. International, Greenvale, N. Y.

FREE! Blackhawk's big new 1958 sale catalog new and used 16mm., 8mm. movies; 2" x 2" color slides; used 16mm. sound projectors! Biggest stock in U.S.A! Cameras, accessories, supplies, too! Blackhawk Films, Davenport 14, Iowa.

MOVIE Camera film: 8mm. roll \$1.50. 16mm. 100' \$3.00. Free processing. Better Films, 742 New Lots, Brooklyn, N. Y.

SAVE 50%! Guaranteed-fresh color, b&w. movie film! 8mm., 16mm. Free catalog! Eso-R, 47th Holly, Kansas City 12, Missouri.

NEW 1958 Bargain discount 8 mm catalogue also 16 mm sound. Write National Cinema, 71 Dey Street, New York City. Specify 8 or 16 mm.

16MM. Sound, silent subjects, accessories, 15 page bargain bulletin. Gaines, Box 114PM, Skokie, Illinois.

EXCITING Film free! Send 25¢ for mailing. State 8mm. or 16mm. Get slash-price listings. Richter's, 2424 Entrance Drive, Hollywood 27, California.

## MUSIC AND MUSICAL INSTRUMENTS

SONG Poems wanted. Free examination. Send poems. McNeil, Master of Music, 1112 PM Wilshire, Santa Monica, Calif.

VIOLIN Makers supplies. Free catalog. 309 W. Fourth, Los Angeles 13.

YOUR Songs arranged and recorded for publisher's presentation. For information write: Vance Studios, 3409 Grand Ave., Oakland, Calif.

POEMS. Lyrics, songs wanted! Cleveland Music, 162 Boylston St., Boston 16, Mass.

SONGWRITERS! Don't mail poems or songs anywhere! Write for safe procedure! Song Service P, 333 West 56th, New York City 19.

POEMS Wanted for new songs. Send poems. Free examination. Immediate consideration. Songcrafters, 2724 Arcade Station, Nashville, Tenn.



**POEMS** Wanted for new songs. Send poems. Immediate consideration. Crown Music Company, 49-C West 32 Street, New York City.

**ELECTRIC** Guitars, amplifiers, wholesale. Free catalog. Carvin P.M.M. Covina, California.

**ACCORDIONS**, Wholesale to everyone. Save up to 80%. All national known brands. Free catalogue. Del Principe, 29 South Cicero, Chicago 44.

**SONG** Request guarantees royalties. Instructions two dollars. Howard Olenik, Mt. Morris, Mich.

**VIOLINMAKERS**, Repairers. Fine tone wood, and all violin supplies. Send for free wholesale new price list. International Sales, 414-MPM E. Baltimore St., Baltimore 2, Maryland.

**WRITE** Songs. Big money and reputation. Write for information. J. Gordon Pub. Co., 4700 South California Avenue, Chicago.

**SONGS** Into dollars. Share \$29 million dollars yearly for new songwriters, song-poets. Songs composed, published, promoted by famous firm. Information, appraisal free. Send to Nordyke Publishing, 6000 Sunset, Hollywood 28PM, California.

**SONGPOEMS** And lyrics wanted. Mail to: TinPan Alley, Inc., 1650 Broadway, New York 19, N. Y.

**WANTED!** Poems, lyrics, songs, ideas. Bengol, 93 Jefferson, Chelsea 50, Mass.

**SONGWRITERS:** New! Use piano. Compose, write tunes to your own songs. Reading music unnecessary. Simple written instructions. \$1.00. Guaranteed. Bridgforth, 3522 Griggs Road, Houston 21, Texas.

**ACCORDIONS**, Wholesale. Free catalog. Importer, 8932-88 St., Woodhaven 21, N. Y.

1958 **ACCORDIONS** Wholesale - 10 day trial. Free catalog. American Accordion Center, 5329-PM-3 Belmont, Chicago.

**COMPLETE** Music service for songwriters. Jerry Colonna, Box 888-M, Burbank, Calif.

\$1.00 **PHOTOGRAPHIC** Guitar catalog. 1958 best buys, discounts. \$1.00 book "How to Play Any Instrument." Courses 50% off. Send 25¢. Ed Sale, Bradley Beach, New Jersey.

**SONGS**, Poems promoted. 15% royalty basis. Songwriters Cooperative Assoc., 972 Broad St., Newark, N. J.

1958 **ACCORDIONS**-Direct from importer. Save 50% and more! Free trial. Lifetime guarantee. Trades accepted. Free catalog. Write Accordion Manufacturers Outlet, Dept. 38-R, 2003 Chicago, Chicago 22.

**CLARINETS** And trumpets from factory. Save 50%. Free information. Libro's Music Center, 591 Chapel St., New Haven, Conn.

**POEMS** Wanted. Five Star Music Masters, 630 Beacon Building, Boston, Mass.

**SWISS** Musical movements, \$1.90. Helax, 218 W. 72nd St., New York City 23.

## RADIO, TELEVISION AND ELECTRONICS

**GOVERNMENT** Surplus radios, parabolic reflectors, snooperscopes, mine detectors, parts. Catalog 10¢. Meshna, Malden 48, Mass.

**CRYSTAL** Radio experimenters write to Hulet, 305 Hope, Lakewood, N. J.

**FREE!** Giant bargain catalog. Transistor, "Sun" radios, kits, portables, audio, electronics, photographic, optics, tools, household. Write Lektron, 131M Everett Ave., Chelsea, Mass.

**CRYSTAL** Radio kit \$1.00, preassembled \$1.25, phone \$1.75; catalogue. Clearco Crystal Company, 2966 North 4th, Milwaukee 12, Wisconsin.

**TAPE** Recorders, hi fi components, tapes. Unusual values. Free catalog. Dressner, 69-02M 174 St., Flushing 65, N. Y.

**FREE!** TV repair hints for your set. Noack Electronics, Box 329, Colton, Calif.

**KITS:** Shortwave radio \$3.50; crystal radio 75¢. Alliance, 2059 60th, Brooklyn 4, N. Y.

**SUN** Powered radio \$12.95. Box 412, Riv. Sta., Miami 35, Fla.

**BUILD** 12 Receivers, transmitter, signal tracer, code oscillator, signal injector. Complete home radio course only \$22.95. No need to spend hundreds of dollars for a course. For a mere fraction of its real value, our course trains you in basic radio. TV, Hi-Fi. Course includes everything you need: Tubes, parts, tools, instructions. Write for full information. Also receive free servicing literature on radio, TV, Hi-Fi worth \$1.50. Progressive "Edu-Kits" Inc., Dept. 552B, 497 Union Ave., Brooklyn 11, N. Y.

## BUSINESS OPPORTUNITIES

**MAKE** Extra money. Cash commissions. Everybody buys easy-to-sell advertising book matches. Union label. All sizes. Cuts for all businesses. Powerhouse selling kit free. Steady repeat business. No experience necessary. Superior Match Co., Dept. MX-358, 7528 S. Greenwood, Chicago 19.

**BIG** Profits in Mexican foods. \$10.00 capital starts you in business making and selling enchiladas, tamales, tacos. Information free. All America Food Service, P.O. Box 2756, San Antonio, Texas.

**EXCLUSIVE** Distr. Amazing, crushed, redwood cedar! Add water, brushed on. Cedarizes closets, attics, cupboards, cloak, storage rooms! Terrific sales stores, homes, builders, hotels, schools, trailers! Huge profits. Plant, 90-H Summit, Brookline, Mass.

**FREE** Picture folder, "How to Make \$3,000 Yearly Sparetime, Backyard, Raising Earthworms!" Oakhaven 38, Cedar Hill, Texas.

**GROW** A living miniature forest or orchard (only inches high), that bears tasty tiny fruit at home. Learn amazing dwarfing secrets! Sensational fascinating hobby, profitable home-business opportunity. Free details! Miniature Nurseries, Dept. MH, Gardena, California.

**BUY** At wholesale prices! Resell at big profits. Brand name merchandise: appliances, cookware, housewares, watches, jewelry, rings, dry goods, clothing, luggage, tools, sporting goods, toys, gifts, etc. Free 1958 color catalog. Write today. Merit Home Products, Dept. PM-3, 107 Manhattan Ave., Brooklyn 6, New York.

**HOME-Import** mail order business-Import profitable items below wholesale. Experience and product investment unnecessary. Full, spare time. Famous world trader guides you. Free list "157 Imports," details. Mellinger, P703, Los Angeles 24.

"50 **NEW** Home-Business Ideas" booklet, sample free. Spray exotic velvet-suede on anything. Plockcraft-MH, Los Angeles 61.

**WHOLESALE!** Appliances, tools, clothing, etc. Free catalogs! United Wholesalers, 1265-F Broadway, New York 1, N. Y.

**WE** Establish you in your own mail order discount business. Sell appliances, gifts, books, housewares, watches, jewelry, cookware, tableware, dinner, cutlery, etc., at discount to 75%. No stock needed. We ship orders under your name. Self-selling catalogs printed with your name, advertising postcards, circulars, names of mail order buyers supplied. Catalog, details free. Topval Corp., Lindenhurst 218, N. Y.

**FORTUNES** Raising redworms. Instructions free. Three Oaks Ranch, Dresden, Tenn.

**CLEARO** Prevents steam, fog, rain, ice on windshields, eye glasses. Prevents steam inside of windshields, mirrors, windows 15 days. Mail \$1 year's supply. Clearo, 1190 Market St., San Francisco 2, Calif.

\$250.00 **WEEK** Spare time profit possible. Earn at home with new fascinating printing method. \$5 starts you. Send no money now. Free confidential facts and valuable samples. Screen-Print, MH, Los Angeles 61.

**BREED** Rare tropical fish at home. Earn big money! Learn secrets! Help fill huge demand. Amazing opportunity! Free plan. Tropical Fish Breeders MH, Los Angeles 61, Calif.

**WANTED:** Home producers, to be subcontractors. Cast plastic products for manufacturers in our clearing house service. Thousands of easily made items required. Cash in at home, without previous experience. Plastic Service Associates, Dept. 3-PM, East Boston 28, Massachusetts.

**MOTEL-Resort** management - Qualify for hundreds fascinating, leisurely, well-paid executive openings. Learn at home. Free booklet. Motel Managers Training School P143C, 612 S. Serrano, Los Angeles 5.

**WANTED** - Limited number intelligent men and women to work at home on exclusive mail order business proposition. No selling, we furnish everything including literature, names, addresses, stock and ship items for you. Free details. Mail Order Distributors (Franchise Division), MH, Los Angeles 61.

**WIN** Fortune! Invent something! "200 Wanted Inventions and How to Invent Them." Free brochure. MCB, 1221D West Minnehaha Pkwy., Minneapolis, Minn.

**LEARN** Professional TV servicing in one week! Fabulous new simplified system. No big expense. No studying. No tools or equipment. Spare, full time. Own your own big profits business! Save! Amazing but true! Free! Write, Electronic Engineering, Dept. BC-173, 1038 So. LaBrea, Los Angeles 19, California.

"**MAILORDER** Laws and Regulations" and "Mailorder Rules for Beginners." Learn about necessary licenses, different taxes, legal requirements, etc. Both books, \$2.00. Tasker, Box 3131, Alexandria, Va.

**WAXES** Floors without wax. New invention. No more floor wax to buy. Sensational seller. Samples sent on trial. Kristee 117, Akron, Ohio.

**FREE!** Complete mail order business! Terrific profits! No investment! Vitamins, 4801PM Cedardale, Wichita, Kans.

**MAIL** Order! Succeed with your own proven mail-order business. No inventory. We drop-ship and show you how easy big profits can be made. Write Giftime, Dept. M., 919 Walnut St., Philadelphia 7, Penna.

**LET** Me sell your products nationally. I'll send you free information on how to establish spare time-full time Casecraft business. You build! We sell! Everything supplied. Abarsi, 807-SJ Sunset, Los Angeles 12, Calif.

**MAKE** Chipped glass nameplates. Resilvering mirrors. Electroplating. Outfit prices. Sprinkle, Plater V60, Marion, Ind.

**NEW** Directory of German manufacturers, \$3.00. Big import catalog, \$2.00 refundable. Schapals, 404DP Westwood, Mobile, Alabama.

**MAKE** \$200.00 Monthly spare time with Jigsaw. Free details. Elkman, 346P North Summit, Sioux Falls, South Dakota.

**EARN** Big money-Start mail order book business. No inventory. Experience unnecessary. Crown Business Service, Dept. 16, 475 Fifth Ave., New York City.

**YOUR** Photo on stamps. No investment, no stock. Big profits. Free samples. Miniature Photostamps, Box 44-S, New York City 67.

**INCOME** From local information. No selling. Write Neherco, La Verne, Calif.

**MAILORDER**. Free book. Shrager Advertising, 2 W. 46, New York City 36.

\$3 **TO** \$5 Hour sharpening saws spare-time. Ideal small town business. No selling. Customers repeat. Experience unnecessary with automatic machines. Free booklet explains. Victor D. Foley Co., Columbia Heights, Minn.

**LEARN** Mailorder selling. Phys big! Free Colliers' reprint! Elliott, 216-A W. Jackson, Chicago 6.

"**MAILORDER** Treasure Chest." Absolutely free. Tasker, Box 3131, Alexandria, Virginia.

**DOUBLE** Profits. New home merchandise business. Works anywhere. Spare, full time. Big, quick returns. Free details. SM Products, 7401 Woolston, Philadelphia 38-P, Pennsylvania.

**SUCCESS** Or failure? Get all the facts about any type of business or workshop. Free information on how to save up to 50% on all brands of shop equipment. See before you buy. Terms. If you are going into any full or part time business, this is the most important ad of your lifetime. Send addressed, stamped envelope. Advisory Associates, 4824 Templeton Street, Los Angeles 32, Calif.

\$200 **PER** Day made operating concessions at fairs and carnivals. New, illustrated book reveals how. \$1. Globe Co., Macon 14, Georgia.

**MONEY** Wants you. Tells 97 ways to "Make A Million." Others have. Why can't you? Free details. Woodward, 1221 Edgewood, Havertown, (3C), Penna.

**DIGNIFIED** Way to spare time earnings. Work from home. No selling. Not a get rich quick scheme but a dignified way to extra income. For particulars write J. and G. Enterprises, Box 784, Wilmington, Del.



**MUSHROOMS** Quicker, easier, cheaper. New facts free. Spawn \$1.00. Luxur, 641 South 19th, Newark 3, N. J.

**MADE \$10,000.00** Typing at home. Guaranteed proof. Amazing information 10¢. Lenore Felgen, Box 1125-PM, Oak Park, Ill.

**"EVERYBODY Likes candy"**—Make professionally home. (Our 47th Year.) Ragsdale Candies, B107, East Orange, New Jersey.

**GET Rich** scientifically. Amazing proven technique. Guaranteed. Free test. Frederick C. Lane and Associates, 1337 Curragh Ave., Burnaby 1, British Columbia.

**MAKE Money**, address and mail new self-selling catalog; we fill orders for you; big profits; many repeats. Send 35¢ for sample and complete details! Tri-States, Box 8008, Huntington, W. Va.

**PRINTING**, Office supplies wholesale. Save 50%. Royal, Box 368-A, Cleveland 27, Ohio.

**GROW** Expensive herbs for us! Big profits home-business of your own. Year around profitability! We supply everything necessary. Send for free rare seeds and revealing plan. National Herb Exchange, Dept. MH, Gardena, Calif.

**EARN \$10,000** Yearly—Only two sales daily. World's best seller, the Holy Bible. (Illustrated) Protestant or Catholic. Margareta's, P.O. Box 92, Hazleton 7, Penna.

**LIQUID Marble**: Colorful, glossy! Molded, brushed, sprayed! Cast novelties, statuary. Composition floors, tile. Flexible molds. Particulars free. Marbleizing Service, Edwardsville, Illinois.

**CASH** From sawdust, tin-cans, newspapers. Over 200 methods. Instructions \$1.00. Charles Company, 12-XAD, Norwood, Ohio.

**"MAIL Order Business"** magazine. Most comprehensive mail trade journal in the world! 2 sample issues \$1. Refunded if unsatisfactory. Box 591-CS, Lynn, Mass.

**\$600.00 PROFIT**. Mailing 100 catalogs! Catalogs feature items paying you up to 85¢ profit on \$1 items. Work from your home or office. No need to carry stock. We drop ship. Start immediately! Send only \$1 (cash, check, money order or stamps) for 10 catalogs, or 25¢ for sample. Free instructions included. Costar's, G.P.O. Box 972-PM, New York 1.

**START** Your own business on credit (U.S. and Canada). Be your own boss. 1527 dealers sold \$5,000 to \$32,000 in 1956. We supply stocks, equipment on credit. 200 home necessities. Sales experience unnecessary. Pleasant profitable business backed by world-wide industry. Write Rawleigh's, Dept. C-U-PPM, Freeport, Ill.

**LARSTONE**. Highest, foolproof, formulas, stucco paint, concrete floor leveler. Unlimited profits. Free information. 3419-9 East, Salt Lake City 6, Utah.

**WONDERFUL Offer!** Opportunities galore! Send 25¢ for information. W. K. Hillhouse, Box 179, Syracuse, N. Y.

**NEVER Forget** birthdays, anniversaries, important dates. Our method guaranteed. Send dollar bill. Martin Company, 5345 South Halsted, Chicago 9, Ill., Dept. "D."

**BECOME** Factory distributor of aluminum windows, doors, jalousies, awnings, etc. Sell wholesale and retail. Small investment. Starlight Mfg. Co., R. D. #1, Box 605, Lakewood, N. J.

**HOME** Mailorder business. Use our literature. Importer, Box 6642, Portland 66, Oregon.

**PICK** Your own business. "Money-Moon" bulletin 10¢. Script, Box 4076, St. Petersburg, Florida.

**NYLON** Stockings rejects. 100 for \$2.00. Allsher Mills, 21831 Cloverlawn, Oak Park 37, Michigan.

**MONEY Plans!** "Secret Journal." Grandpa, two daughters made \$2500 first month! Work home. Publicco, Oceanside, Calif.

**MAKE \$50,000** Yearly from home. Informative plans free. Fortune Enterprises, Addison, Illinois.

**OPERATE** Successful home mailorder business. Gilbert Ridsen, 2735 Grand River, Detroit 1, Mich.

**MAILMAN** Brings \$150 daily. Succeed at home with proven, tested, amazing mail order opportunities. Free profitable details, sample instructions, fast! Holiday Publications, 2801 Greysolon Road, Duluth, Minn.

**OUR Complete** plan puts you in business for yourself, part time or full time, manufacturing household necessities used by every housewife. Free details. Berto Company, 30-B Huntington Avenue, Boston 16, Mass.

**CO-PUBLISH** Rural Advertiser. Details. Buller's 7 Pearl St., Springfield, Mass.

**NEED Cash?** Send \$1 for 5-methods and 10-sources raising capital. Business Service, Cole Camp 2, Mo.

**BOOST** Your income! Build sparetime hobby-business engraving, plastics. Profits to \$5 hour! Sample, details 25¢. Engraved American eagle door emblems \$1.45. Desco Distr's., 5262-M Van Nuys, Van Nuys, Calif.

**MARKETS** Everywhere. Make artistic concrete birdbaths, pottery. Chemical coloring. Home workshop. Hundred varieties. Hollywood Cementcraft, 8527-K Wonderland, Hollywood 46, California.

**SELL** By mail. Book 25¢. Berryman, 153 Victoria, Northlake, Illinois.

**\$400.00 DAY** In aviation. Secrets money making methods \$2.00. Aero Advertising, 3030 W. Pierce, Milwaukee 15, Wis.

**SHARPEN** Scissors, pinkers, knives. Inexpensive, precision outfit. Blackhawks, Sheldahl, Iowa.

**\$34.70 TWO** Hours. Manufacturing concrete products. No selling. Carlayne Castings, 1803 Fremont, Rapid City, So. Dak.

**SELL** Merlin electronic garage door operators. Make from \$50 to \$75 on every sale. Operate from your home. M. J. Fitzgerald Co. B-1, 2815 West Vliet Street, Milwaukee 8, Wisconsin.

**OPERATE** Profitable home business. Free details. Service, Box 636PM, Newport News, Virginia.

**REBUILD** Batteries; repair dolls; make rubber stamps. "75 ideas" free. Universal, Box 1076-A, Peoria, Ill.

**MONEY** In scrap dealing. Amazing booklet \$1.00. Business, 60 Ormes, Quebec 3, P.Q., Canada.

**BIGGEST** Money makers in the field; Acme saw and lawnmower sharpeners. Free literature. Max Mfg. Co., 138 Stockton Ave., San Jose 26, Calif.

**FREE** "Franchise Profit Letter," describes nationwide opportunities. Exclusive distributorships, dealerships, agency operations. Write today. National Franchise Reports, 333 North Michigan, Chicago 1.

**EXCLUSIVE** Distributorship available in most areas for world-famous cadmium battery guaranteed to outlast your car. Tremendous profit opportunity. Investment for merchandise only. Free franchise. Cadmium Battery, Corporation Dept. 102, El Segundo, California.

**TO \$100.00** Weekly. Sparetime, home operated mailorder business. Successful beginner's plan. Everything supplied. Lynn, 10420-M National, Los Angeles 34.

**LEARN** Real estate by listening to records. Lee Institute, Brookline 46, Mass.

**CAMERA Owners!** Earn \$50.00 week-ends! Instructions \$1.00, information free! Kline, 935-PM North Austin, Chicago 51, Illinois.

**COLORGLAZED** Concrete pottery made without molds. Patented method. Cemetery products, novelties, tiles. Basement leak-sealing. Money-making projects. Booklet, details free. Men only. National Potteries Company, Grand Rapids, Minnesota.

**PIANO** Tuning learned quickly at home. Tremendous field! Musical knowledge unnecessary. Information free. Empire School of Piano Tuning, Champaign, Ill. (Founded 1935).

**BUY** Direct from factories—Appliances, cameras, watches! Free details! Cam Company, 6810PM-20th Ave., Brooklyn 4, N.Y.

**MIMEOGRAPHING** Services pay sensational local profits. Exciting secret plans exposed! Write: Mozelle Mimeo Shop, Bonham 7, Texas.

**BRUSH** Plating outfits for plating articles in the home and shop. No tanks necessary, silvering mirrors, spare or full time. Free particulars. Gunmetal Co., Ave. H, Decatur, Illinois.

**WANT** To make big money at home? \$10.00 profit in an hour possible with invisible mending. Make tears, holes, disappear from clothing, fabrics. Steady year-round demand from cleaners, laundries, homes. Details free. Fabricon, 6234 Broadway, Chicago 40, Illinois.

**BUY Wholesale!** Over 10,000 nationally advertised products. Appliances, cameras, sporting goods, housewares, watches, typewriters, tools, clothing, etc. Send postcard today. Buy-Rite, Box 258, Hawthorne 1, New Jersey.

**WHOLESALE**—Thousands nationally advertised products. Buy, sell. Amazing profits. New, free plan. Associated Wholesalers, 1016-D Starr, Burlington, Iowa.

**OPERATE** Mailorder folio business! Free details. Ballard's, 425 East Catherine, Louisville 3, Ky.

**MAKE** Flexible molds. Cast plaques, figurines. Free sample. Tooker, 1045-R Fairview, Hamilton, Ohio.

**NATURAL** Molding rubber, extra thick. Free sample. W. Wooley, 1016-A Donald, Peoria, Illinois.

**BIG** Money raising fishworms and crickets. Free literature. Carter Farms, Plains, Georgia.

**VENDING** Machines—No selling. Operate a route of coin machines and earn amazing profits. 32-page catalog free. Parkway Machine Corporation, Dept. 26, 715 Ensor Street, Baltimore 2, Maryland.

**\$70 WEEKLY**—Home, spare time. Simplified mail bookkeeping. Immediate income—easy! Auditax, 34757A, Los Angeles 34.

**WANT** More business? Here's an amazing opportunity to increase your sales. Talk to thousands of interested readers of "Mechanica Popular." Our Spanish Edition covers the Latin American countries like a blanket. They're real mailorder buyers. Classified rate 75¢ per word. Try an ad in our next issue. Classified Advertising Department, Popular Mechanics Magazine, 200 East Ontario Street, Chicago 11, Ill.

**START** Home business making statuary, plaques, novelties, garden furniture, artificial marble flooring, liquid marble. Make your own flexible molds. Amazing profits. Only \$1.98. Free literature. Popular Mechanics Press, 631 No. St. Clair St., Chicago 11.

**MINK** Raising information free. Complete. Lake Superior Mink Farm, Superior, E.E.I., Wisconsin.

**CO-PUBLISH** Mail Sale Advertiser, leading mail order paper. Details, latest copy, dime. Vanroy Shirk, Lebanon, Penna.

**LEARN** Photo-negative portrait retouching. Men, women. \$5 hour possible spare or full time at home. Easy, glamorous. Work for photographers by mail order. Full details sent free. Duval, 100 So. Vermont, Los Angeles 4.

**YOUR** Own name brand business. No investment; no inventory. Part time or full time. Sell famous brands of appliances, housewares, silverware, radios, vacuum cleaners, lamps, tools, clocks, watches, jewelry, etc., etc., over 1000 items. Join thousands of successful independent dealers. Send for free catalog and dealer price list. H. B. Davis Corp., Dept. 11, 145 W. 15 St., New York City.

**11,000 NEW** Prospects daily. Baby record books, shoes, albums. Sell mailorder. Use our literature. Write: No-Co-Ro, Capitola, California.

**BAKE** New greaseless doughnuts in kitchen. Sell stores. Free recipes. M. Ray, 3635 South 15th, Minneapolis 7, Minnesota.

**PIX** Typewriters. Inexpensive home course teaches factory secrets. Free booklet. Athey, Tarentum, Penna.

**MONEY** For you! Big profits! Cast plaster figurines, bookends, plaques at home with XL rubber molds. No experience needed! Write for illustrated, 40-page catalog, only 25¢! Plastic Arts Studios, 3433 So. Madison Street, Department 5, Muncie, Indiana.

**PLATE** Baby shoes, jewelry, gifts, bronze and colored pearl. Free booklet. Platex, 1129 South Vermont, Los Angeles 44.

**FREE** Catalog. Contains hundreds of businesses, farms and income properties throughout U.S., Canada. Specify type and location desired. Deal direct with owners. U. I. Buyers Digest, 1608 Hillhurst, Dept. PM-3, Los Angeles 27, Calif.

**LIQUID** Rubber. Make flexible molds. Free sample. Chaney, 1907-A East Road, Jacksonville 11, Florida.

**BOOKKEEPERS**, Accountants. Operate a bookkeeping service. Part or full time. Amazing simplified system. Wonderful money-making opportunities. Complete information free. National Bookkeeping Publishing Co., Suite 307, 3435 Broadway, Kansas City 11, Mo.



WE Pay \$3.50 lb. dried. Grow mushrooms. Cellar, shed and outdoors. Spare, full time, year round. We have 25,000 customers. Free book. Washington Mushroom Ind., Dept. 172, 2954 Admiral Way, Seattle, Wash.

\$250 WEEK Cleaning venetian blinds. Patented machinery. Free literature. Robinson. 7213B. Indianapolis 1, Indiana.

FREE Book "505 Odd, Successful Businesses." Work home. Pacific, Oceanside, Calif.

I Want to send you proof of the wonderful pulling power of Popular Mechanics classified pages. What's your proposition? Write me today. Include literature if possible. P. W. Johnson, Manager Classified Advertising, Popular Mechanics Magazine, 200 E. Ontario St., Chicago 11, Ill.

INTERNATIONAL Mailorder business. Complete setup service—Not just instructions. Hermes, 152 West 42, New York City 36.

PLASTERCRAFT Molds, liquid rubber, plasters, floccs, candle supplies. Catalog and manual free. Blue Rapids Supply, Blue Rapids, Kansas.

MARY-Mac agency—motorized vibrator. Cushions, chairs, tables, belts. Mary-Mac Factory, 1012 Powhattan, Dallas, Texas.

FREE Folio "\$5,000-\$45,000. Unlimited Vacations." No merchandise. Unknown! Work home, sparetime! Haylings, Carlsbad, Calif.

MAKE \$46 From square foot plywood: jig saw necessary. Free details. Woodart, Bridgewater, Mass.

OPERATE Profitable mailorder business! Write: Thomas Bond, 1637H West Vernon, Phoenix, Arizona.

RUBACREAM! Concentrated latex cream! Makes molds quicker! Thicker! Instructive literature free! Castcraft Studios, 508-PM Marion St., Brooklyn 33, N. Y.

OPERATE Mail-order printing brokerage. Details free. Advisory Service, Hartsdale, N. Y.

QUICK Profits, with no capital! Take orders for magazines your neighbors like, want. Make cash on the spot! We show how with free kit. Get yours now. Write McGregor Magazine Agency, Dept. 310, Mount Morris, Ill.

WE Love our mailman—He leaves over \$1000.00 monthly in our rural mailbox. My college professor husband drafted a scientific home mailorder method. We bought a Texas ranch, live as we always wanted. Now we sell the Ranch Mailorder Method. Operates anywhere. Inquire: Eveningshade Ranch, Boerne, Texas.

CANDIED Popcorn and potato chip equipment. Eakins, Box 933-A8, Springfield, Ohio.

BE Appointed state notary public now. Write, Stationers, Boerne, Texas.

\$5,000 YEARLY, Spare time at home. Nothing to buy. No local selling. Dignified. Guaranteed. Home Harvest, Rt. 3, Box 3491-A, Albuquerque, New Mexico.

MINIATURE Golf plans \$1.00. Lil-Putt, Box 294, Rock Island, Illinois.

GROW Orchids at home. Profitable, fascinating. Successful home grower explains special light, temperature and humidity conditions orchids need. Free: Full details, Orchids, 100 S. Vermont, Los Angeles 4.

EARN \$10,000 Yearly raising Angora rabbit wool for us. Information 25¢ coin. American Angora Company, Malta 12, Montana.

IMPORTING. Modern dropship method. Details free. The Hazen Company, 6601M—8th Avenue N. St. Petersburg 10, Florida.

DOLLARS In every mail. Profitable mail order operates in your home, farm, or office. Send for free details. Webb Imports, 8729 1/2 Warvale, Rivera, Calif.

\$100.00 WEEKLY Spare room. Raise redworms soilless way. Odorless. Charlie Morgan, Box 116E, Bushnell, Florida.

MAKE Strange plastic building material of waste, easily. Water, fire, wear and termite resistant. Bays Laboratory, Oklahoma City, 9.

TYPIST Operate profitable mail-order business. Stamp brings details. General Sales, 336 Roosevelt St., Creve Coeur, Ill.

BIG Money in mailorder. Merrill Histand, Box 182AP, Hatfield, Penna.

SELLING By mail fascinating. Profitable. Free information. Alfano, 19 Pine, Closter, New Jersey.

EARN \$50 TO \$60 daily repairing typewriters, write New England Training Service, Carmel 2, Maine.

BIG Profits possible in your own discount business. No investment in stock. Free literature. J. T. Halleck Distributing Co., 23-C Kingsland Ave., Kearny, N. J.

### MONEYMAKING OPPORTUNITIES

WIN Contest money. General Contest Bulletin gives hundreds of tips. Lists current contests, rules. Sample magazine 25¢. General Contests, 1609 1/2 East 5th, Duluth, Minnesota.

\$1 TO \$20 Checks daily! Write simple sentences, paragraphs, poetry for pay! No experience necessary. I tell you what to write, how to write, supply large list of buying editors. Begin writing for pay, today! Will Herman, 1726 W. 25th St., Cleveland 13, Ohio.

CIGARETTES—Improved roller makes 20 for 9¢. Facts free. Moberly, Box 821, Owensboro, Kentucky.

\$36-\$200 WEEKLY Plating baby shoes, making jewelry, novelties, etc. at home. Details free. JO-CA Electroplater, 7840-D Northwest Sixth Court, Miami 50, Florida.

EARN At home with your telephone. Details free. Kendon Company, 635-A Main, Hartford 3, Conn.

MAKE Money mailing sample business cards. Vossacek Printing, 4444A Ute, San Diego 17, Calif.

SPARETIME Profits, opportunities. Free information. Ed. Polaski, Box 272, Miami 47, Fla.

\$5,000.00 ANNUALLY Possible for you in mailorder. Free information. Ransie, Box 1719-A, Richmond 14, Virginia.

"NEWEST Products Report," popular mail order magazines, interesting mails 25¢. Burke & Brown, 61 Haven, New York City 32.

JOIN Cooperative moneymaking mail opportunities service. Free literature. Bayou Enterprises, 119 North Sterling, Lafayette, Louisiana.

START Big-pay business at home in spare time. No experience needed to operate little table-top machine for bronzing baby shoes. Make \$5.46 profit on every pair. Full particulars free. Send postcard to Mason, 1512 Jarvis, Room CM2A, Chicago 26, Ill.

TAPE Recording—Fabulous new business! \$500.00 monthly spare time! Entire country wide-open. Free facts. Dixieland Publishers, Asheboro 2A, N. C.

137 BUSINESS Plans collection. For home or outside, sparetime possible. Little or no capital, big profits potential, practical, diversified. Mandry and Tous, 218 West Jackson Boulevard, Chicago 6.

MAKE Money writing short paragraphs! No tedious study. I tell you what to write, where and how to sell; and supply list of editors buying from beginners. Many small checks add up quickly. Write to sell, right away. Send for free facts. Benson Barrett, Dept. C-27-N, 7464 Clark, Chicago 26.

EARN Cash at once, sending us easy orders for magazines your friends, neighbors want. Instant profits! We show how. For free kit, everything you need, write McGregor Magazine Agency, Dept. 320, Mount Morris, Ill.

START Home mail order business. I made enough money to retire. Now own \$18,000 home, Cadillac car, have money in bank. Amazing facts free. Norris Cole, 217 49th Street West, Bradenton, Florida.

MEN - Women! Start money-making plastic laminating business at home in spare time. Material that costs 11¢ brings back \$2.58. No canvassing or selling but mail orders bring in \$20 a day. Write for full particulars free. Rush name on postcard to Warner, Room CL2A, 1512 Jarvis, Chicago 26, Ill.

AMAZING Successes through franchises! Become exclusive franchise holder your territory. Information rushed. National Franchise Reports, 333 North Michigan, Chicago 1.

ESTABLISH Your own business. Simplified instruction qualifies you to prepare income tax forms for others. No experience. Unlimited income. Full time or part time. Full details free. International Tax Institute, 524—26th Avenue, San Francisco 21.

\$60.00 WEEKLY, Sparetime — Easy! Home Venetian blind laundry. Free book. Burt, 2434ER, Wichita 13, Kansas.

\$15,000 PROFIT In one year possible, on \$5.00 cash and just 3 hours attention weekly! Experience unnecessary! Fabulous but true! Proof, complete detailed plan, only \$1.00. Satisfaction or refund! Columbia Enterprises, 8203-P, Grubb Road, Silver Spring, Maryland.

"HOME Business Digest" has money-making opportunities galore. Sample 25¢. Donovan, 79-PM Greenbelt, Levittown, New York.

ATTENTION Typewriter owners. Make handsome profits. Write today. Groves Company, 682, Hastings 8, Nebraska.

DO It yourself. What? Repair TV, build furniture, make barbecue, plumbing repairs, build boats, do house wiring, remodel home, lay tile, modernize kitchen, repair home, and scores of other things you can do yourself. Books covering each subject, only 25¢. Send for descriptive list. It's free. Popular Mechanics Press, 200-LB East Ontario St., Chicago 11, Ill.

BUY Wholesale! 30-80% discounts! Appliances, gifts, typewriters, tools, watches, sporting goods, jewelry, cameras, housewares, etc. Consolidated Distributors, Clifton 28, New Jersey.

FREE Folio "\$5,000-\$45,000. Unlimited Vacations." No merchandise. Unknown! Work home, sparetime! Haylings, Carlsbad, Calif.

READ Progressive Mailtrade, the magazine that tells how to make money by mail. Dime brings sample and special offer. Progressive Mailtrade, Box 357, Sheboygan, Wisconsin.

BIG Money raising, fishworms and crickets. Free literature. Carter Hatchery, Plains, Georgia.

EARN Money evenings copying and duplicating comic cartoons for advertisers. Adservice, Argyle 1, Wisconsin.

SELL Titania gems. Far more brilliant than diamonds. Catalog 10¢. Diamonite, 2420-M 77th, Oakland 5, California.

VENDING Machines—No selling. Operate a route of coin machines and earn amazing profits. 32-page catalog free. Parkway Machine Corporation, Dept. 27, 715 Ensor Street, Baltimore 2, Maryland.

FREE Book "505 Odd, Successful Businesses." Work home. Pacific, Oceanside, Calif.

DOLLARS Every day! It's magical—You keep all the dollars. Setup free. Otto Miller, Box 588-W, Oshkosh, Wis.

JOIN The prosperity parade with a mail order bookshop in your own home. Valuable information free. Practical Publications, 3974-P Milwaukee, Chicago 41, Ill.

WE Pay \$3.50 lb. dried. Grow mushrooms. Cellar, shed and outdoors. Spare, full time, year round. We have 25,000 customers. Free book. Washington Mushroom Ind., Dept. 173, 2954 Admiral Way, Seattle, Wash.

EARN Money making ever-lasting, realistic plastic plants and flowers. Easy to make, easier to sell! Send for free illustrated catalog plus booklet "How to Make Money Selling Plastic Plants." Lady Carol, Inc., Dept. LC-70, 211 S.W. 28th St., Ft. Lauderdale, Fla.

HOMEWORKER Magazine, published continuously since 1940, brings you profit and pleasure ideas. Sample 10¢. Homeworker, 20 East Delaware, Chicago 11, Ill.

1958 WHOLESALE Directory of books that sell by mail. Details 3¢ stamp. P. Bailey, Cressona, Penna.

HOTTEST Mail order plan ever! Sell photos, films, art novelties. Huge proven profits! Free details! Profits Unlimited, Dept. 1G, 15015 Ventura Blvd., Sherman Oaks, California.

MAKE Big easy profits making costume jewelry at home in spare time! Quick, easy to make; easier to sell! Details free! Don-Bar, 3511 W. Armitage, Dept. C-192, Chicago 47, Ill.

GROW Christmas trees from seed. 1500 seed, three kinds. \$1.00 postpaid. Christmas Tree Seed Co., Sabinsville 3, Penna.

600 HOME Moneymaking secrets. Get this "know how"! Details free. Write Stanley, 258-A North Freeman, Inglewood 3, California.

KILL Pests for profit! \$1200.00 monthly proved! Rid homes, farms, business of termites, rodents, pests. New shortcut methods! Learn everything two weeks! Free success plan. APCOA, Dept. 1G, 15015 Ventura Blvd., Sherman Oaks, Calif.



**BOOKKEEPERS:** Earn up to \$600 month operating your own bookkeeping service, part or full time. Proved plan. Simplified system. Free details. Tax Saver System, Dept. X, Fort Worth 2, Texas.

**COSTUME Jewelry** from manufacturer. Sell from our free catalogue. 100 illustrated items. Packard Co., 48 West 25 St., New York 10, N. Y.

**MUSHROOMS** Quicker, easier, cheaper. Newest facts free. Spawn \$1.00. Luxur, 641 South 19th, Newark 3, N. J.

**SELL** Your neighbors aluminum awnings! Wholesale prices. Write Groff, Box 10254, Tampa, Florida.

**PROFIT** By mail. 3-way plan. Standard Supply Service, King Ferry, N. Y.

**\$100.00 WEEKLY**, Or more, selling earthworms. 30 page book tells how. 35¢. Huff's Hatchery, Buckner, Mo.

**SELL** Books by mail. 400% profit. Royal, Box 368-X, Cleveland 27, Ohio.

**SPARETIME** Cash. Eight complete plans. \$1.00. Topp, Box 7572, Casselberry, Fla.

**BRONZED** Baby shoe mountings. Immediate delivery! Foster, 1520 Ardmore, Chicago 26.

**PROFITABLE** Mailorder information. Details free. Stark, Box 9897, Houston 15, Texas.

**YOUR** Name on giant mailing list. Hundreds of opportunity offers. Send 25¢ and state offers or mdse. desired. Direct Mail Service Co., P.O. Box PM581, Bakersfield, Calif.

**BIG** Money earned while asleep! Neighbors think I struck oil! Bonafide proposition easily handled by anyone. Nothing like it! Details \$1.00 (refundable). Grant, Grantham 1, Penna.

**JOIN** Weekly big mail club. Weekly opportunity offers, etc. Three months 35¢. One year \$1. Sniezek Mail Service, 4425 South Hills Drive, Cleveland 9, Ohio.

**25¢ BRINGS** Mail-order offers. Post's Business Service, Golden, Illinois.

**MONEY** Plans! "Secret Journal." Grandpa, two daughters made \$2500 first month! Work done. Publiccos, Ocean-side, Calif.

**FABULOUS** Money-making business opportunities available immediately. Fortune Enterprises, Addison, Illinois.

**"TIMELY** Tips Magazine." Paulding, Ohio, publishes moneymaking opportunities, ideas, promotional plans, monthly, 25¢. 32nd year, \$2.00.

**TYPISTS**, Make handsome profits. Write today. Harwood, Box 1061, San Antonio, Texas.

**HERE'S** How to win contests \$1.00. Anna Minnicke, Star Route, Willow Springs, Mo.

**TURN** Your snapshots, photographs into money! Send \$1.00 for "How and Where." Donavan, 10524 Tantau, Cupertino 1, Calif.

**NATIONALLY** Known bureaus need part-time workers now! Earnings to \$100.00 monthly possible. Complete assignments at home, either typing or longhand. Enclose stamp for details. Post Service Bureau, Rice Lake, Wis.

#### EXPORT — IMPORT

**IMPORT**—Jewelry, handbags, novelties, etc. Our booklet, which may be obtained free, tells how. Thorison, 901-A Chicago Street, Manitowoc, Wisconsin.

**FREE** Information—How to start an importing business from your home. Direct Mail Service Co., P.O. Box PM581, Bakersfield, Calif.

#### FORMULAS, PLANS, ETC.

**LARGE** Formula catalog free. Analysis reasonable. Western Chemical, Salem, Oregon.

**PRACTICAL** Formulas. Lists free. Cummings, Chemist, Gordon Ave., Syracuse 4, N. Y.

**LATE**, Modern manufacturing formulas. List free. Moon Chemical, Martville, New York.

**FORMULAS** For latest money-making discoveries. New! Good! Valuable literature free! Miller, Chemist, 1517-D, Tampa, Florida.

**FORMULAS**; All kinds, latest, best. Literature free. Kemixal, Park Ridge, Ill.

#### PLASTICS

**FREE!** Beautiful plastic novelty and catalog of casting plastics, molding materials, molds, kits, jewelry and specialties. Castacraft Corp., Dept. M380, P.O. Box 555, Palo Alto, California.

**NEW** Liquid casting plastic, clear, colors. Embed real flowers, coins, photos. New Manual shows fine things you can make at home and sell at big profit. Send 25¢. Castolite, Dept. C-101, Woodstock, Illinois.

**PLASTIC** Tooling, casting, embedding, laminating and mold supplies. Catalog includes instruction and manufacturing methods. Satellite sphere, liquid glass, aluminum, ivory, rubber. Send 25¢. Gel, Box 261, Union, N. J.

**LAMINATORS**—Job out larger work. We laminate 20" x 24". Send for price list. Lieco, Box 66, College Pt. 56, N. Y.

**PLEXIGLAS**. Square foot cost, 1/16", \$1.20; 1/8", \$1.52; 3/16", \$1.86; 1/4", \$2.21; 3/8", \$3.23; 1/2", \$4.36. Colors add 10%. Send 15¢ for postage. Artistocrat Plastics, 23 Sussex Avenue, Newark, N. J.

**LEARN** Plastics fabrication for spare time income. Low cost home training now available. Write for free booklet. Interstate Training Service, Dept. D-3, Portland 13, Ore.

**LAMINATING** Supplies. Free price list. Solomson, 46 Cornhill, Boston 8, Mass.

**BOXES**, Plastic. Free list. Althor, 170 Bay 23 Street, Brooklyn, N. Y.

**PLEXIGLAS**. Acetate, vinylite, polyester, fiberglass, epoxy, styrofoam, mold materials. 28 page instructive, informative wholesale-retail catalog, 25¢. Gem-O-Lite, 5527 Cahuenga Blvd., North Hollywood, California.

#### CHEMISTRY

**CHEMISTRY**—Science magazines. Literature free. Lankton, Box 5126-C9, Lansing 6, Michigan.

**"ROCKETS!"** — Large, comprehensive volume, illustrated. \$1.95 postpaid. Fabian's, 4370-P Clark, Montreal 18.

**ROCKET** Fuel, chemicals in small quantities, laboratory apparatus and glassware. 27th year. Catalog 25¢. John H. Winn Co., Inc., 124M West 23 Street, New York 11, N. Y.

**LARGE** 48 Page supplies catalog, 25¢. Laboratory Sales, Box 161-A, Brighton, Mass.

**AMAZING** New book of science experiments, formulas, and catalogue of laboratory supplies. Only 25¢. National Scientific Co., Dept. PM-3, 500 West Road, Lombard, Illinois.

**CHEMICALS** And apparatus for industrial, analytical, and private laboratories. Catalog 25¢. Dept. M-50, Biological Supply Co., 1178 Mt. Hope Ave., Rochester 20, N. Y.

**EXPERIMENTERS**: Bargains catalog, 25¢ (refundable). Hagenow Laboratories, 2414 Clark, Manitowoc, Wisconsin.

**ILLUSTRATED** Catalog: Chemistry, mineralogy, biology 25¢. Tracey Laboratories, Evanston, Illinois.

#### AGENTS WANTED

**FREE!** Win your own shirts to display and use, as extra reward, plus advance commissions up to \$3.25 per shirt. We start you in exclusive made-to-measure shirt business with beautiful free outfit containing actual fabric samples. Write today to Bostonian, Dept. S-58-16, 1112 Boylston, Boston 15, Mass.

**60% PROFIT** On cosmetics — Famous nationally advertised Hollywood cosmetics pay 60%. Make \$25 day up. Hire others. For free samples, details, write Studio Girl, Glendale, Calif. Dept. 1283G.

**MARVELOUS** "Wonder shoe shine spray." Unusual 10 second demonstration item, retails to \$2, your cost 60¢. Send for free information or \$1 for sample. Princeton Industries, 300-M Northern Boulevard, Great Neck, New York.

**BIG** Profits. Stamp social security plates, key protectors. Sample 50¢. Catalog free. General Products, 188-PM State, Albany 10, N. Y.

**BEAUTIFUL** Feather pictures! Free details, sample 20¢ stamps, Apartado 1668, Mexico 1, D. F.

**DRYCLEANS** Clothing for only 10¢ per garment. Lightning seller. Saves dry-cleaning bills. Samples sent on trial. Kristee 79, Akron, Ohio.

**\$1,000.00** A Month for making dramatic 3-second demonstration of amazing lightweight Presto fire extinguisher. New chemical used by Airforce snuffs out fires instantly. Only \$4.95. Terrific commissions. Millions want it. Free kit. Merlite, 114 E. 32nd, Dept. P-66G, New York City 16.

**I'LL** Send you free stocking sample newest advancement in hosiery since discovery of nylon. Patented full-length; stays up without supporters, amazingly comfortable. Nationally advertised price \$1.95. Make money fast introducing to friends at \$1.00 pair. American Mills, Dept. 647, Indianapolis, Indiana.

**EARN** Big money full or part-time. Quickie Spray shines all leather instantly without buffing, brushing. Be first! Rush refundable \$1.00 for demonstrator, selling kit. Franchises available. James R. Barnett Co., Dept. PM-38, Wellesley Hills 81, Mass.

**AGENTS**—\$2000 Month. New cigarette machine. Macco, Box 6028-P, Minneapolis 10, Minn.

**CLEANS** Windows without mess. Strange "dry" cleaning-cloth. Replaces liquids. Windows gleam. Samples sent on trial. Kristee 78, Akron, Ohio.

**\$25** DAY, Easy. New fire extinguisher. Retail \$2.95. Profit \$2.00. Free sales kit. Edconco, 155 East 44th Street, Dept. P3, New York 17, New York.

**NEW** Invention, \$4.95 fire alarm, paying up to \$1,100 a month. No wiring. Unlimited market. Dramatic demonstration. Free kit. Merlite (Alarm Div.), 114 E. 32nd St., Dept. F-66G, New York 16, N. Y.

**SELL** "Blind made" ties, household items. All made by blind people. Terrific moneymakers! Blind Workers, 5535-Q Clark, Chicago 40, Illinois.

**IMPORTED** Rings and bracelets, with anyone's picture completed in our studio. Amazingly low priced. 100% profit. Write Oceanic Importing Co., Dept. PM, Hyde Park National Bank Bldg., Chicago 15, Ill.

**EVERY** Car owner, every housewife needs it. 100% profit. Foreign Products Corporation, 21 Washington, West Orange, N. J.

**AGENTS!** Big profits, full or part time, selling stores, homes and industry. Simple convincing demonstration cinches sales fast. Terrific repeat item used every day by millions. Be first in your area to enjoy success with Magic Tack Cloth. Literature and sample free! Wm. Juergens Mfg. Co., Dept. PM4, Box 143, Sta. C, Toledo, Ohio.

**WANTED**, Part-time fire extinguisher salesman. Out-O-Matic, 1737G E. 31st, Denver, Colorado.

**CASH** Commissions at once, taking orders for magazines every family wants! No experience needed. For free money-making kit, with everything you need, write McGregor Magazine Agency, Dept. 300, Mount Morris, Ill.

**FREE** Sample! Beautiful feather pictures. Sylviak, Apartado 9036, Mexico 1, D. F.

**AGENTS** — 300% Profit selling genuine gold window letters; stores and offices. Free samples. Metallic Sign Letter Co., 1217-D West Newport, Chicago.

**YOUR** Ad in this space will get some good agents for you. Yes, I'll prove it. Write for Folder "A" right now. F. W. Johnson, Classified Advertising Manager, Popular Mechanics Magazine, 200 E. Ontario St., Chicago 11, Ill.

**GOLD** Or silver letters, numbers. Windows, doors, trucks, 1" to 6". 500% profits. Free samples. Atlas-T, 544 West 79th, Chicago 20.

**PRINTING**, Advertising salesmen—Excellent moneymaking sideline selling decalcomania name plates, small quantities. Automobile initials, sign letters. Free samples. Ralco, XL, Boston 19, Mass.

**YOUR** Own business—Used suits \$1.50, overcoats 65¢, mackinaws 35¢, shoes 12½¢, ladies coats 30¢, dresses 15¢. Enormous profits. Catalog free. Nathan Portnoy Associates, 605-AA West 12th Place, Chicago 7.



**EASY Handwork** makes fast-selling useful articles. Sample free. Sunmade Company, Brockton 64, Massachusetts.

**GOLDMINE** Of 600 money makers. Free copy. Specialty Salesman Magazine, Desk 5B, 307 North Michigan, Chicago 1, Ill.

**IT'S Easy** to sell our big line business printing, calendars, advertising specialties and political advertising. Big cash commission each sale, even first day. Full or part time. Experience unnecessary. Prospects unlimited. Big sales kit free. National Press, Dept. 6, North Chicago, Illinois.

**RUN A** spare-time greeting card and gift shop at home. Show friends samples of our wonderful new 1958 all-occasion greeting cards and gifts. Take their orders and earn up to 100% profit. No experience necessary. Costs nothing to try. Write today for samples on approval. Regal Greetings, Dept. 42, Ferndale, Michigan.

**AGENTS 100%** Profit selling the only modern envelope sealer in existence. Sell offices, factories, homes direct and by mail. Free details and sample refer Amberland, 277 W. 2nd St., S. Boston, Mass.

**WHOLESALE** Clothing catalog plus real merchandise samples. Bostonian 14-B Dock Square, Boston 8, Mass.

**\$13.50 HOURLY** Profits possible, introducing 5 valuable farm books your area. Published by Popular Mechanics. Farmers buy on sight. Details free. Popular Mechanics Press, 200 E. Ontario, Dept. 64-B, Chicago.

**FREE Directory**—Tells you where to buy 800,000 articles direct from manufacturers all over the world. Up to 1000% profit! Glass, Ellwood City 15, Penna.

**SELL Key-Back**, recolling key chain. Particulars free. Weinberger, Columbus, Wisconsin.

#### BUY IT WHOLESALE

**HANDMADE** Western boots. Free catalog, price list. Hall Boots, Box 7302, El Paso, Texas.

**DISCOUNT** Household catalog 25¢. Dur Bin Enterprises, Box 388, Pekin, Ill.

**BIG Multicolor** wholesale catalog! Housewares, appliances, clothing, silverware, cookware, luggage, binoculars, radios, phonographs, cameras, recorders, projectors, typewriters, shavers, sporting goods, toys, tools, sewing machines, watches, jewelry. Name brands. Huge discounts. Postcard: Selbyco, Decatur 154, Illinois.

**WHOLESALE!** Appliances, tools, clothing, jewelry, etc. Free catalogs! United Wholesalers, 1265-M Broadway, New York 1, N. Y.

**FREE Wholesale** catalog. Gifts, appliances, books, housewares, watches, jewelry, cookware, tableware, dinnerware, cutlery, etc. Discounts to 80%. Topval Corp., Lindenhurst 124, N. Y.

**MY Six 80%** money-saving catalogues. Amos Mail Order, Yountville, Calif.

**BARGAIN** Price catalog. Appliances, books, housewares, watches, jewelry, cookware, tableware, cutlery, etc. Discounts to 80%. Rush \$1.00 deposit refundable. Tony Distributing Co., 135-C So. 13th, San Jose, California.

**NEW**, Wholesale buyers guide, \$1.00. King, 393 Strasser, Nashville 11, Tenn.

**BUY Wholesale!** Thousands nationally advertised products. Send postcard! Southland Products, Lincolnton 21, North Carolina.

**NEON** Window signs, custom made. Merchants save 50%. Neon Tube Co., 1758 S. Cleveland Ave., Canton, Ohio.

**SPONGES**, Buy direct. 12 for \$1.00 prepaid. Assorted colors, soft and durable. Sponge King, 9957 Belcher, Downey, Calif.

**BUY Wholesale!** Discounts to 80%! Gifts, appliances, housewares, tools, watches, etc. Midwest, IMP-156, Pontiac, Illinois.

**USED** And new watches \$2 up. Free list. Southern Watches, 5-PM So. Wabash, Chicago 3.

**ELECTRIC** Guitars, amplifiers, wholesale. Free catalog. Carvin PMW, Covina, Calif.

**JOIN** Catalog club. Send \$1.00 (refundable) for 8 wholesale catalogs. Stark, Box 9897, Houston 15, Texas.

**BUY Wholesale!** Over 10,000 nationally advertised products. Appliances, cameras, sporting goods, housewares, watches, typewriters, tools, clothing, etc. Send postcard today. Buy-Rite, Box 258, Hawthorne 4, New Jersey.

**WHOLESALE** Catalog clothing, shoes, linens, housewares. Bostonian 14-C Dock Square, Boston 8, Mass.

#### SALESMEN—DISTRIBUTORS

**SIMPLE** Demonstration of our new invention amazes business and professional men. Write to Frank Brown, Jr., Dept. P-1, Box 97, Milan, Missouri.

**INCREASE** Present income. Build growing sideline, fulltime business. No investment. Farmers, agents, dealers. Take orders for Campbell's Gro-Green Liquid Fertilizer Concentrates. Free sample, sales kit. Campbell Co., Rochelle 332, Illinois.

**IF You're** interested in making money in selling, see the hundreds of exceptional opportunities in Salesmen's Opportunity Magazine. Send name for your copy, absolutely free. Tell us what you're selling now. Opportunity, 848 N. Dearborn, Dept. 17, Chicago 10, Illinois.

**SALES** Agents home improvement field for unique line of prefabricated, modular room additions, screen enclosures and awnings. Nationally advertised and distributed. Liberal commissions. Panelfab Products, Inc., 2000 N. E. 146th Street, North Miami, Florida.

**WHOLESALE** Distributors and wagon jobbers wanted. Call on automotive and service garages and stations. A line that you can sell on every stop. For information write Continental Mechanics Research Corporation, Box 175, Madison, Indiana.

**WANTED:** You. If you have spare time you can make good extra money-selling specialty advertising and executive gifts to business firms in your area. You will be your own boss and can adjust your working time to fit your own needs. No pressure selling. No quotas to meet. No investment required. Write Hal Lufkin, Newton Manufacturing Company, Newton 4, Iowa.

**MAKE** Money. Sell sensational dwarf trees, bear giant-size apples, peaches, pears. Ornamental. Also Stark-Burbank standard trees, roses, shrubs, vines, etc. Outfit free. Stark, Desk 30738, Louisiana, Mo.

**BUSINESS** Kit free! Postcard puts you in business! Complete line 230 shoe styles, also jackets! New discoveries pay big commissions. No investment. Send for free kit. Mason, Chippewa Falls 70, Wis.

**CALLING** On businessmen? Low-priced printed envelope line can pay you \$67.50 extra profit weekly without extra calls! Free sample outfit. M. P. Brown, Inc., 424 N. Third, Burlington 29, Iowa.

**ANYONE** Can sell famous Hoover uniforms for beauty shops, waitresses, nurses, doctors, others. All popular miracle fabrics, nylon, dacron. Exclusive styles, top quality. Big cash income now, real future. Equipment free. Hoover, Dept. C-100, New York 11, N. Y.

**SELL** \$1.00 Item. Sample 25¢. Crane Enterprises, 369 Crane, Pittsfield, Mass.

**PENNANTS**, Tablecloths, other plastics. Best prices, top deal. Write Turk Corp., South Bend, Ind.

**MAKE** Extra money. Cash commissions. Everybody buys easy-to-sell advertising book matches. Union label. All sizes. Cuts for all businesses. Powerhouse selling kit free. Steady repeat business. No experience necessary. Superior Match Co., Dept. M-358, 7528 S. Greenwood, Chicago 19.

**EARN** \$30-\$40 Spare time! No experience needed. Sell famous-make men's shoes low-priced for fast sale. Free catalog. Write: Doublewear Shoes, 317 E. Lake, Minneapolis 8, Minn.

**AD Matches!** Sell amazing designs—10, 20, 30, 40 and 240-light book matches. Bigger spot cash commissions; every business a prospect. Low prices for high quality. Repeats. Start without experience; men, women; full, part time. Buy nothing! Sales kit furnished. Match Corp., Dept. PM-99, Chicago 32, Illinois.

**\$1,000 A Month** for making dramatic 3-second demonstration of amazing lightweight Presto fire extinguisher. New chemical used by airforce snuffs out fires instantly. Only \$4.95. Terrific commissions. Millions want it. Free kit. Merlite, 114 E. 32nd, Dept. P-66G, New York City 16.

**FAST** Money-maker—New development. Uniforms advertise 24 hours a day. Exclusive with Master. Name, emblem glow in dark. Free outfit. Master, F-18 Water, Ligonier, Indiana.

**WILL** You wear new suits and topcoats without one penny cost and agree to show them to friends? You can make up to \$30.00 in a day even in spare time, without canvassing. Progress Tailoring Co., 500 South Throop St., Dept. W-326, Chicago 7, Illinois.

**NEW** Comfort discovery! Sell "foot-shaped" shoes, other famous air cushion footwear. Saturdays, evenings. Immediate commissions, cash bonus. Samples supplied. Charles Chester Shoes, 371 Brockton, Mass.

**GET** New shirt outfit free: Make \$90.00 weekly on 5 average orders a day. Famous quality made-to-measure dress and sport shirts at \$3.95 up sell fast to all men. No experience needed. Full or part time. Write: Packard Shirt Co., Dept. 641, Terre Haute, Ind.

**MONEY** Back low priced trading stamp plan pays you bigger spot cash profits with steady year 'round income from reorder commissions. Every grocery, gas station, drug store, etc., are quick buyers. Free pocket sales kit. Worthmore, P-3, 1825 South Michigan Avenue, Chicago 16, Ill.

**CALENDARS**, Advertising novelties, matches. All styles, including religious, varnished. 12 sheet, girls. Hundreds of advertising novelties, book matches, etc. Fleming Calendar Co., Sales Division, 6539 Cottage Grove, Chicago 37, Ill.

**NEW** Invention, \$4.95 fire alarm, paying up to \$1,100 a month. No wiring. Unlimited market. Dramatic demonstration. Free kit. Merlite (Alarm Div.), 114 E. 32nd St., Dept. P-66G, New York 16, N. Y.

**HOT** Item. Millions need it. Terrific demonstrations. Big commissions. First time in direct sales. Information free. Write today. Hudson Mfg. Co., Sheridan 5, Michigan.

**AUTOMOTIVE** And plumbing jobbers, salesmen, distributors—Fantastic profits with 8 revolutionary new products. Tremendous market. High repeat. Nonseasonal. Free details of factory distributorship. Conklin, Inc., Box 5626, Nokomis Station, Minneapolis, Minn.

**SALESMEN**—Increased closures guaranteed. Write Sowle, 652 Lockhaven, Daly City, Calif.

**THIEVES**, Vandals run from automobile equipped with police auto alarm. Salesman's sample \$4.95 postpaid. Retail \$9.95. Easy to install. Guaranteed. Gregory Sales Company, 316 Marion Building, Cleveland 13, Ohio.

**DISTRIBUTORS** For best selling, repeating home and auto glaze. Exclusive sales rights. Details free. Dusing Inc., 8763 Oriole, St. Louis 15, Mo.

**IT Ain't** sellin', just servicing! Stores make money for you every open hour. Tremendously successful. Free book tells all. Write: G. M. Harris, Novo, Inc., 1166 Milwaukee, Chicago 22, Illinois.

#### EMPLOYMENT INFORMATION

**FOREIGN** Jobs—Latin America, Alaska, Canada, up to \$1500 monthly. Up-to-date 1958 foreign service directory gives complete information; hot list of firms hiring for military and civilian construction, aircraft, oil, exporters-importers, mining. How-when-where to apply. 11th successful year. \$1.00. Global Reports, Box 8873-S, Los Angeles 8, Calif.

**BOOMING** Venezuela—Only hours from the States. New data regarding jobs, opportunities, conditions, etc. Salaries to \$1650 monthly U. S. tax exempt. Bonuses, living allowances extra. First-hand information direct \$2.00 (\$2.35 air mailed) checks or money orders only. Paul B. Smith, Apartado 172, Maracaibo, Salina, Venezuela.

**JOBS** On merchant ships. Big pay. Box 4092, Jacksonville, Florida.



**AMERICAN Overseas jobs.** High pay, men, women. Transportation paid. Free information. Transworld, Dept. M, 200 West 34th St., New York City 1.

**JOBS Overseas!** Janeczek Development Co., 1090 Hub Station, New York 55, N. Y.

**HIGH Paying jobs, opportunities,** foreign, U.S.A. All trades. Companies pay fare. For information write Dept. 61J, National Employment Information, 1020 Broad, Newark, New Jersey.

**TRUCK Drivers, laborers helpers, crafts-**men over \$1000 monthly for northern bases. For information South America, Spain, Europe, Alaska, etc. Foreign job listing \$1.00. Universal, 1110 Commerce Building, St. Paul, Minn.

**FOREIGN, Domestic jobs! Big money!** Men and women. Skilled and unskilled. Latest dependable information from one who has actually worked many years abroad \$2.00 (airmailed \$2.25). Parks, Box 1665, Lake City Station, Seattle 55, Wash.

**COPYRIGHTED Reports on best paying** jobs with travel, adventure, promotions. Construction, aviation, shipping, laborers, clerical, trades, supervisory, factory, unusual opportunities. Many types of work. Skilled and unskilled. Foreign and state-side openings for men and women. Only \$2.00 (\$2.25 airmail), including registration-advisory service. Satisfaction guaranteed. Included absolutely free: Special reports on Alaska, Spanish airbase construction, South American opportunities and husband-wife foreign jobs. Research Services, Suite 514-PMA, Meramec Building, St. Louis 5, Missouri.

**FOREIGN, Alaskan, U.S.A., jobs! To** \$1500.00 monthly! Million Americans employed overseas. Copyrighted reports. Who to contact for highest paying jobs. Laborers, trades, truck drivers, office, engineers, many others. 52 countries—St. Lawrence project, Spain, Latin America, Northern project, Europe. Year registration-advisory service. Application forms. Unconditional money-back guarantee! \$2.00 (airmailed \$2.25). C.O.D.'s accepted. International Reporter, St. Louis 1-PG, Missouri.

**CALIFORNIA Employment and business** opportunity information. Accurate lists for Los Angeles, San Francisco and San Diego \$1. Letter remains 25¢. Rains, 5621 Gracewood, Arcadia, California.

**FLORIDA, West central, Fastest growing** area. Job information, business opportunities, male, female, \$1.00. English, 901 Longfellow, Lakeland, Fla.

**FLORIDA'S Booming.** Hundreds big pay jobs. Copyrighted statewide analysis, free contacts, airmailed \$2.00. Sun-Glo Service, Perry 5, Florida.

**"U.S.A., Foreign jobs." To \$1400.00** monthly. Latin America, Europa, all continents. Who to contact for specialized job-information. \$1.00 postpaid. Anton, 135-D So. 13 St., San Jose, California.

**FREE! Information for choice California** opportunities, jobs, housing. Chesley, 3977½ Texas Street, San Diego 4, Calif.

**MIAMI Beach, Miami, Hialeah.** Hundreds of jobs. Chamar Service, Box 594, Hialeah, Fla.

**FABULOUS Florida job opportunities.** St. Petersburg! Florida's booming city! Sunday classifieds airmailed \$1.00. Peter Sherman, P.O. Box 179, St. Petersburg, Fla.

### SPECIAL SERVICES

**TRANS-World import mail order club** supplies new sources, markets. Many products. Free details. Nunnally Exporters, San Angelo, Texas.

**FOR \$1.00 We will answer any three** questions about the fabulous state of Texas. W. D. Bolenbarr and Co., Navasota, Texas.

**PRIVATE Mail address—\$2 per month.** Jones, 4331 Talofa, N. Hollywood, Calif.

**PUZZLE Fans—3, 4, 5, 6 and 7-word** lists compiled alphabetically and positionally to 1st and last letters (10 lists), from Collegiate dictionary \$3.00. Thomas Word-Lists, Box 577-P, Dania, Florida.

**BOOKKEEPING, Taxes by mail.** Free information. Write "Mail-Me-Monday," 920 Van Buren, Milwaukee 2, Wis.

**INFORMATION On anything.** Ferguson Research Specialists, 116-14 141 St., South Ozone Park 36, N. Y.

### EDUCATIONAL AND INSTRUCTION

**PIANO Tuning pays.** Big money in spare time. Learn at home in 30 days. No musical knowledge necessary. Phonograph, records, tools and instructions furnished. Personal instructions available. Free catalog. Capital Piano Tuning School, 3160 S.W. 16th Court, Fort Lauderdale, Fla.

**LEARN Mail order publishing.** Free details. Rainone Printer, Middle Village 79, New York.

**ENGINEERING Degrees earned through** home study. Residence courses also available. Pacific International University, (operating as a College of Engineering only at present), 5719-B Santa Monica Boulevard, Hollywood 38, California.

**HIGH School diploma at home.** Licensed teachers—Approved materials. Southern States Academy, Box 5344-MX, Station E, Atlanta, Georgia.

**WE Pay \$3.50 lb. dried.** Grow mushrooms. Cellar, shed and outdoors. Spare full time, year round. We have 25,000 customers. Free book. Washington Mushroom Ind., Dept. 174, 2954 Admiral Way, Seattle, Wash.

**BOOKKEEPERS! Increase your earnings!** Operate your own simplified "Dollar-A-Week" bookkeeping and tax service. Full or spare time. Details free. No obligation. Ellis, Box 200, Cedar Grove, North Carolina.

**BE A real estate broker.** Study at home. Send for free catalogue. Midwest School of Real Estate, 68 North Chicago Street, Joliet, Illinois.

**TIMESTUDY—Your key to positive personal** profits. Associated Techniques, Box 235, Hollidaysburg, Penna.

**LEARN Appliance service and repair.** Motors, washers, refrigeration, cleaners, everything. Free booklet. Armstrong, 11027-A South Vermont, Los Angeles 44.

**STUDY For Doctor's degree of psychology,** metaphysics and divinity. Correspondence courses only. College of Divine Metaphysics, Dept. P-M, 2811 North Illinois, Indianapolis 8, Indiana.

**BE A real estate broker.** Study at home. Write for free book today. GI approved. Weaver School of Real Estate, 2018P Grand, Kansas City, Missouri.

**USED Correspondence courses and books** sold and rented. Money back guarantee. Catalog free. (Courses bought.) Lee Mountain, Pisgah, Alabama.

**EARN While you learn.** Auto and diesel mechanics master this top paying trade. Many graduates earn \$100 a week and up. Approved for Korean veterans. For free information write Dept. No. 256, Nashville Auto-Diesel College, Nashville 3, Tenn.

**WANT A diesel job? New opportunities to** increase income. Higher pay. More money. We can help you qualify. Tools. Shop method home training. Write today! Diesel, Tractor, Heavy Equipment Division, Interstate Training Service, Dept. B-3, Portland 13, Oregon.

**INVESTIGATOR Training.** Phillips Secret Service System, 1917-B North Kenneth, Chicago 39.

**PIANO Tuning pays.** Learned easily at home. GI approved. 59th year. Free booklet. Niles Bryant School, Dept. P, 3731 Stockton, Sacramento 20, Calif.

**SECRET Investigation.** Experience unnecessary. Investigators particulars free. George Wagner, M125 West 86th, New York 24.

**SHORTHAND In four days.** Learn at home. \$2.98 ppd. Take notes three times faster. Fineline Company, 303-PM Fifth Avenue, New York 16, N. Y. Free literature available.

**SING.** Speak, with power, personality. Self-training records. Amazing details. Canfield, 2018-A 5th Ave., South, Minneapolis 4, Minn.

**PHYSICAL Therapy and massage.** Home training. Practice privately or work with doctors and hospitals. Free catalogue. National Institute, Desk 4, 159 E. Ontario, Chicago, Ill.

**MEN Wanted, age 19 to 45, to train as** draftsmen designers at home in spare time. Big pay opportunities. Write for free brochure. American Technical Society, 850 E. 58th St., Dept. PM-583, Chicago 37, Illinois.

**COMPLETE Your high school at home** in spare time with 61-year-old school. Texts furnished. No classes. Diploma. Information booklet free. American School, Dept. X345, Drexel at 58th, Chicago 37, Illinois.

**HANDWRITING Analysis now accepted** in college, business, industry. Our men, women who use grapho analysis spare, full time earning more money, getting prestige, success, happiness. Uncrowded, fascinating field for intelligent men, women anxious to get ahead. We need more members. Investigate this growing field where you give a real service to your fellow man. Opportunities unlimited. Free sample lesson and information to all over 21. Write today! IGAS, 2307 National Station, Dept. 1014, Springfield, Missouri.

**LEARN Civil and criminal investigation** at home. Earn steady good pay. Institute Applied Science, 1920 Sunnyside, Dept. 163, Chicago 40, Ill.

**WATCH-Making, jewelry home study** courses. Greatest deal! Watchmaking Institute, Culver City, California.

**LEARN "By ear" with Dormiphone.** While you slumber, the amazing new scientific invention works for you. Revolutionary Dormiphonic tools give you a shortcut to learning languages, correct speech; memorizing facts, figures; relaxation, habit training. Saves you time, effort. So simple to use, children benefit. Used by educators, psychologists. Write today for fascinating free book. No obligation. Modernophone, Inc., 320-038 Radio City, New York City 20.

**MASTER Watchmaking at home.** Free sample lesson. Chicago School, 2328-YC Milwaukee, Chicago 47.

**EARN College degrees, correspondence.** Metropolitan University, Box 86-M, Glendale 5, California.

**FINISH High School at home, spare** time. No classes. Diploma awarded. Write for free catalog. Wayne School, Catalog HF-84, 2527 Sheffield, Chicago 14.

**LEARN Arc, gas, heliarc welding spare** time at home. Big pay trade. Easy practical training covers metallurgy, latest techniques, short cuts, metal repairs, etc. Free booklet. Write Utilities Engineering Institute, Dept. WC-16, 2523 Sheffield, Chicago 14.

**WELDERS Earn big money.** Easy to learn arc, gas, automatic welding. New equipment, low cost training in non-profit school. GI approved. Free booklet. Hobart Welding School, Box M-381, Troy, Ohio.

**IT'S Fun learning a language by Lingua-**phone, world's standard conversational method. At home, quickly, easily learn to speak French, Spanish, German, Japanese, Russian, Modern Greek—Your choice of 34 languages. It's like living in another country. Complete recorded courses on free trial. Send for free book and details. No obligation. Try, don't buy! Lingua-phone Institute, T-83-038 Radio City, New York City 20.

**ENGINEERING, Home study.** Midwest Engineering School, 10923 Hillcrest, Hickman Mills 34, Missouri.

**BE An investigator.** Write for free details. State age. National Detective Academy, Dept. P, P.O. Box 1082, Scottsdale, Arizona.

**INEXPENSIVE Correspondence courses:** science, arts, psychology, engineering. Earn diplomas, degrees, colleges abroad. Aurecas, Central Valley, New York.

**ANALYZE Handwriting for profit!** Complete outfit \$1.00. Box 1352-G, Philadelphia 5.

**LEARN International Morse code.** Elementary course on 12" microgroove record, \$3.00, postpaid. Kord-All, Box 444, Warren, Ohio.

**\$1,000 MONTHLY Possible in collection** agency business. Write Cole Associates, Sak Bldg., Syracuse 2, N. Y.

**TYPING Learned in 90 minutes!** Complete course \$4.95. Tuch-Rite, 37 South 13th, Philadelphia 7, Penna.

**DANCE! Free lesson proves you can!** Homestudies, 507 Fifth Avenue, New York City 17.

**BOOKS.** Free general catalog, 100 pages. Text, vocational, educational, instructional subjects. Millions of volumes, new and used. Bargain prices. Books bought. Est. 1902. Long's College Book Co., Dept. PM, Columbus 1, Ohio.

**LEARN Mineralogy at home.** Geologists show you how. 80 specimen collection included. Free catalogue. Mineral Science Institute, Desk 2, 159 E. Ontario, Chicago 11.



## PLAYS, STORIES, MANUSCRIPTS

**MAKE** Money writing features. Amazing book tells how. Free literature. Ben Arid, Hermosa Beach, Calif.

**WANTED:** Book manuscripts, all subjects considered. Greenwich Book Pub., Atten. Mr. Zealand, 489 Fifth Ave., New York City.

**WANT** Your book published? Learn how we publish, advertise, promote, distribute. Many successes. Free booklet PM. Vantage, 120 West 31, New York City. Midwest office: 220 S. Michigan Ave., Chicago, Ill.

## CARTOONING, COMMERCIAL ART, SHOWCARD & SIGN PAINTING, TATTOOING

**FREE** Facts about our famous cartooning course. No obligation. Cartoons-of-the-Month, Roslyn, New York.

**CARTOON** Your way to success! Internationally known instructor, Raye Burns, will personally teach you to create original, salable cartoons at home. Cost of course is very low. Write for free details, Raye Burns School, Box 3583-P, Cleveland 18, Ohio.

**LEARN** Profitable, fascinating tattooing. Free illustrated information. Zeis, 728-C Leslie, Rockford, Illinois.

**SIGN** Painting—Lessons by mail. Books on lettering, gold leaf, show cards, pictorial. Write: Sign Instruction, 4304 Virginia, Kansas City 10, Missouri.

**PAINT** Signs—Master die cut, outline letter patterns. Complete assortment 1 1/2" to 12" high, prepaid \$2.00. Eyerly, 563, Newton, Iowa.

**LEARN** Sign painting at home. Free talent test. Ben Kerns, Box 812-PM, Greenville, S.C.

**YOU** Can entertain with chalk talks. Catalog 10¢. Balda The Cartoonist, Oshkosh, Wis.

**LEARN** Sign painting with fascinating system. Straley, 410 S. Western, Springfield, Ohio.

**COURSE** In art and drawing, 46 lessons, \$2.00. Free literature. Kamm Printing, Oshkosh, Wis.

**"HOW** To Make Money With Simple Cartoons"—A book everyone who likes to draw should have. It is free; no obligation. Simply address Cartoonists' Exchange, Dept. 93-C, Pleasant Hill, Ohio.

## ADVERTISING AGENCIES, LETTER WRITERS, FOR ADVERTISERS

**ADVERTISING** Ratebook leading newspapers, magazines, free. Chicago Advertising Agency, Chicago 4.

**NEW** Mothers—Suburban Detroit 1958. 500 \$3.75 gummed labels. Vickers, 1143 E. Pearl, Hazel Park 3, Mich.

**WOMEN** Mail buyers, 1000—\$2.00. Other lists. North West, Medina 1, Washington.

**FREE!** 1958 Advertisers Rate and Data Directory. 52 pages! E. H. Brown Advertising Agency, 20 N. Wacker, Chicago 6.

**ADVERTISE:** 24 Words, 100 Canadian newspapers \$5.50. Lists free. Advertising Bureau, 10511-C Springfield, Chicago 43.

**ADVERTISING.** Result-getting ads prepared, placed newspapers, magazines, radio, anywhere! Lowest rates. Catalogue free. Baker Advertising Agency, 189 W. Madison, Chicago 2.

**MAILING** Lists most any classification \$5.00 1000. Your circulars mailed with ours \$4.00 1000. Write for our literature. Dixie Mailers, King, N. C.

**SALESMEN:** Agents: Known mailorder buying consumers (men, women) gummed labels, \$9.00 thousand. Other classifications. Free folder. Brunell, 241 Grove, Montclair, N. J.

**WANT** More business? Here's an amazing opportunity to increase your sales. Talk to thousands of interested readers of "Mechanica Popular." Our Spanish Edition covers the Latin American countries like a blanket. They're real mailorder buyers. Classified rate 75¢ per word. Try an ad in our next issue. Classified Advertising Department, Popular Mechanics Magazine, 200 East Ontario Street, Chicago 11, Ill.

## RUBBER STAMPS AND OFFICE SUPPLIES

**THREE** Line name and address metal or plastic pocket case \$1.00. Mated Mailers, P.O. Box 494-3, Buffalo 5, N. Y.

**SIGNATURE** Stamps \$2.00; 3 lines \$1.00. Boardman, Houghton, New York.

**THREE** Lines \$1.00. Rubber Stamp Service, 109 North Hyatt St., Tipp City, Ohio.

**WAY** Under \$1.00. World's sharpest, resembles printing. Engesser, Box 82, Saint Peter, Minnesota.

**8 HOUR** Service, 3 lines \$1.00. Guaranteed. Bassler, Ludlow, Mass.

**QUALITY** Rubber stamps! 3 lines \$1.00. Signature stamp \$3.50. Prompt service. Satisfaction guaranteed. Campfield, 14 Beaufort Circle, Springfield 4, Mass.

**FREE** 800-Emblem catalog. Address stamp \$1.00. Kraft, Box 2, Los Angeles 53.

## TYPEWRITERS, DUPLICATORS, OFFICE DEVICES

**RECONDITIONED** Typewriters, duplicating, printing devices. \$25.00 up. Supplies. Appliances. DixieGraph, King, N. C.

## PRINTING, MULTIGRAPHING, MIMEOGRAPHING, GUMMED LABELS

**MIMEOGRAPHING,** Printing. Best quality, reasonable rates. Frajimidot (formerly Currier), New Lebanon Center, N. Y.

**FREE!** Catalog. Printing, rubber stamps. Mel-Jac Company, Box 925, Jacksonville 1, Florida.

**225** IMPRINTED Envelopes only \$2.00. Sample free. Thomas, Box 444, Highland Station, Springfield 9, Mass.

**BUSINESS** Printing. Top quality. Wholesale prices. A. Hanlon, Malvern, Penna.

**FAST,** Guaranteed accurate, complete printing service. Catalog, 3¢ stamp. Box 1062, Albany, Georgia.

**OFFSET** Printing—24 hour service. \$6.75, 1000, 8 1/2"x11. National Letter, 251 West 42 St., New York City 36.

**PRINTING** That makes an impression. Hamel-Printer, 210 Fifth Ave., Suite 1102G, New York 10, N. Y.

**SAVE!** 1000 Business cards \$3.00. Samples. James Printery, Washington, Ga.

**YOUR** Name and address printed on gummed labels. 1000—3 lines \$1.00, 15¢ each extra line. 1/2" x 1 1/4". Print clearly. No c.o.d.'s. Addison Mail Order, PMA-3, 1840 Addison, Chicago 13.

**500** ENVELOPES 6 3/4". Printed. \$4.00 postpaid. Nu-Art, Box 154, Fayetteville, Arkansas.

**1000** EMBOSSED Business cards \$3.50. Samples. Hickman Company, Coalgate, Oklahoma.

**100** EACH—6 3/4" Envelopes, letterheads 5 1/2" x 8 1/2". \$3.85. Literature. Fred, the Printer, Dept. PM, Box 623, Independence, Mo.

**FINE** Personal stationery—Sensationally low cost. Leon's, 1065 Berne, Atlanta 16, Ga.

**MIMEOGRAPHING,** Reasonably priced! Samples free. Western, 719-M 12th, Memphis, Texas.

**1000** ENVELOPES #10 \$7.95 Postpaid. Other printing bargains! Decco, Box 3315M, St. Louis 3.

**MIMEOGRAPHING**—New method, high quality, reasonable, speedy. Mary's, 1126 10th St., Des Moines 14, Iowa.

**500** STATEMENTS \$3.50 Postpaid. 500 6 3/4" envelopes, same. Stanley Press, Lake Katrine, N. Y.

**MIMEOGRAPHING** Work on offset press. Samples and price list. Perkins Printing Service, Fremont, Nebraska.

**125** TWO Color 8 1/2"x11 letterheads or 125 6 3/4" envelopes \$2.50. Hudak Printing, 511 S. Biakely St., Dunmore, Penna.

**PHOTO** - Offset printing, letterpress, mimeographing. Free samples. Litho, Madison, Tenn.

**QUALITY** Business cards. Free samples. Gerald Porter, 123 E. Robinson, Jackson, Michigan.

**10,000** ATTRACTIVE 2 Color circulars \$20. Samples. Fame, 291 Ellis, San Francisco 2, Calif.

**FAST** Service! 100—8 1/2"x11 letterheads \$2.00. Raco Press, (PM), 818 West Gift, Peoria, Illinois.

**FREE** Catalog, postpaid printing. D M Press, Sebastopol, California.

**BUSINESS** Personal printing—Labels, rubber stamps, accessories. Illustrated catalog, free! Brose, 196-A, Clerk, Jersey City 5, N. J.

**MIMEOGRAPHING**—Letters, pricelists, formulas, instructions. Lowest prices. Lem's Letter Shop, 5710 Stanton, Detroit 2.

**1500** PERSONALIZED 3/8"x1 1/4" Labels \$1.00. Your 3 line name and address printed with blue ink on fine quality white gummed paper. Money back guarantee. Hamilton-Ward, Dept. 10B, Westfield, Mass.

**ADS** Running under this heading sell printing. Ask me for proof. I'll gladly send you amazing facts. Ask for Folder "P." F. W. Johnson, 200 E. Ontario St., Chicago 11, Ill.

**BUSINESS** Cards. Printing. Reasonable. Free catalog. Edmondson, Box 4865-P, Atlanta 2, Georgia.

**1,000** BUSINESS Cards. Raised letters. \$3.50. Samples. Pioneer, Island Park 9, New York.

**CIRCULARS!** 1000 6x9 \$6.50. Estimates anything, price list. Valaitis, Inc., 1705 South 2nd, Philadelphia 11.

**BUSINESS** Cards. 1000 flat black \$2.75, engraved \$3.50. Samples. Sales, 1333 Orchid Ave., Winter Park, Fla.

**1000** 8 1/2"x11 LETTERHEADS, \$5.00. Samples free. Country Press, New Florence, Penna.

## PRINTING OUTFITS AND SUPPLIES

**RUBBER** Stamp making presses, hydraulic operated, electrically heated. Sizes 5"x8", 8"x12", 10"x15" starting outfits. All kinds supplies. Custom Manufacturing, 601 N. Jefferson, Springfield, Missouri.

**TYPE** Cases, cabinets, from manufacturer. Free catalog. King McKay Company, 33179 Telegraph Road, Detroit 41, Michigan.

**DO** Your own printing. Save money. Simple rules. We supply everything. Print for others; good profit. Raised printing like engraving too. Have home shop. Details free. Kelsey Presses, V-11, Meriden, Connecticut.

**PRINTING** Presses, type, supplies, lists 3¢. Turnbaugh Service, Mechanicsburg, Penna.

**MAKE** Your own self-molding rubber stamps and printing cuts. Plexirubber, Argyle 1, Wisconsin.

## PATENT ATTORNEYS

**INVENTION** Record form free and "Patent Information Every Inventor Should Have." Carl Miller, Registered Patent Attorney, Woolworth Building, New York.

**INVENTORS:** Learn how to protect your invention. Unless the inventor is familiar with patent matters, he should engage a competent registered patent attorney or agent to represent him. We are registered to practice before the U. S. patent office and prepared to serve you in handling your patent matters. "Patent Guide for the Inventor" containing detailed information concerning patent protection and procedure with "Record of Invention" form will be forwarded to you upon request—without obligation. Clarence A. O'Brien & Harvey Jacobson, Registered Patent Attorneys, 81B-A District National Building, Washington, D. C.

**INVENTORS**—Take these preliminary steps toward patent protection. Sketch and describe your invention. Sign, date and have this disclosure witnessed by two people who understand your invention. Have us make a preliminary search among U.S. patents already granted for similar types of invention. We report on the probable patentability of your invention and recommend your further course of action. Write for our instructive booklet, "Patent Protection for Inventors" and convenient "Evidence of Invention" disclosure form. Victor J. Evans & Co., 431-C Merlin Building, Washington 6, D. C.



**INVENTORS**—If you believe you have an invention, you should find out how to protect it. The firm of McMorro, Berman & Davidson with offices in Washington, D. C., is qualified to take the necessary steps for you. Send for copy of our Patent Booklet "How to Protect Your Invention." We will also send you an "Invention Record" form. No obligation. They are yours for the asking. McMorro, Berman & Davidson, Registered Patent Attorneys, 134-G Victor Building, Washington 1, D. C.

C. A. Snow & Co.—M427, Snow Building, Washington 1, D. C. Registered Patent Attorneys. Write for information.

**CANADA**—Ramsay Company Registered, 273 Bank Street, Ottawa, Canada.

**INVENTORS**: Without obligation, write for information explaining the steps you should take to secure a patent. John Randolph, Registered Patent Attorney, 803 Victor Bldg., Washington 1, D. C.

**PATENTS**. "Proof of Invention" free. E. E. Vrooman, Registered Patent Attorney, 507 McKim Building, Washington 5, D. C.

"INVENTOR'S Guide" and "Record of Invention" free on request. Frank P. Ledermann, Registered Patent Attorney, 154 Nassau Street, New York City.

### FOR INVENTORS

**INVENTORS**—This firm is registered to practice before the United States Patent Office and available to assist you in the preparation and prosecution of your patent application. "Patent Protection for Inventors" booklet containing detailed information and steps to take toward patent protection sent promptly upon request. No obligation. Victor J. Evans & Co., 432-C Merlin Building, Washington 6, D. C.

**INVENTORS**—If you believe you have an invention, you should find out how to protect it. The firm of McMorro, Berman & Davidson with offices in Washington, D. C., is qualified to take the necessary steps for you. Send for copy of our Patent Booklet "How to Protect Your Invention." We will also send you an "Invention Record" form. No obligation. They are yours for the asking. McMorro, Berman & Davidson, Registered Patent Attorneys, 134-F Victor Building, Washington 1, D. C.

**INVENTORS!** Have you good patentable ideas? Write Mr. Metzler, 11 West 42nd, New York.

**INVENTORS**—Send for free Patent Information book and Inventor's Record. Registered Patent Attorney, Associate Examiner, Patent Office 1922-29, Patent Attorney & Advisor, Navy Department 1930-47. Gustave Miller, 38A Warner Building, Washington 4, D. C.

**INVENTIONS** Wanted now by my manufacturer-clients. Patented, unpatented. Write Gilbert Adams, Patent Broker, 80-A Wall Street, Financial District, New York City.

**INVENTORS**: Information on patent procedure furnished on request, without obligation. John Randolph, Registered Patent Attorney, 802 Victor Bldg., Washington 1, D. C.

**INVENTORS**: Learn how to protect your invention. Unless the inventor is familiar with patent matters, he should engage a competent registered patent attorney or agent to represent him. We are registered to practice before the U. S. Patent Office and prepared to serve you in handling your patent matters. "Patent Guide for the Inventor" containing detailed information concerning patent protection and procedure with "Record of Invention" form will be forwarded to you upon request—without obligation. Clarence A. O'Brien & Harvey Jacobson, Registered Patent Attorneys, 81A-A District National Building, Washington, D. C.

**INVENTIONS** Wanted—27 years experience promoting patented, patent pending inventions. National Service Bureau, 3130 Meramec, St. Louis 18, Mo.

"INVENTOR'S Guide" and "Record of Invention" free on request. Frank P. Ledermann, 154 Nassau Street, New York 38, N. Y.

**INVENTIONS** And ideas designed for your profit and patented for your best protection at low definite fees. Thirty years experience in developing and patenting inventions in U.S. and foreign countries. Patent searches with valuable report \$15.00. Joseph O'Brien, 132 Nassau Street, New York 38, N. Y.

**PATENT** Searches \$5.00. 48-hour airmail service. Invention protection forms free. Write Patent Engineering Service, 711 14th Street N. W., Washington 5, D. C.

**INVENTORS**. Don't sell your invention patented or unpatented until you receive our offer. Write Cowgill, Box 298, Marion, Ohio.

**PATENT** Searches \$5.00. 48-hour service. Free invention protection forms. Write Raymond L. Smith, Patent Searcher, 620 Sheraton Building, Washington 5, D. C.

**PATENT** Searches, including copies of nearest patents, \$6.00. Reports airmailed within 48 hours. More than 100 registered patent attorneys use my service. For free invention protection forms, write Miss Ann Hastings, P. O. Box 176, Washington 4, D. C.

**INVENTION** Record form free and "Patent Information Every Inventor Should Have." Carl Miller, Registered Patent Attorney, Woolworth Building, New York.

### INVENTIONS WANTED

**INVENTIONS** Wanted now by my manufacturer-clients. Patented, unpatented. Write Gilbert Adams, Patent Broker, 80-A Wall Street, Financial District, New York City.

**INVENTORS**. Don't sell your invention patented or unpatented until you receive our offer. Write Cowgill, Box 298, Marion, Ohio.

**SUPERIOR** Promotions. Patented; unpatented inventions. Information booklet, free. Superior, 338-344 North Rodeo, Beverly Hills, Calif.

**INVENTIONS** Wanted: Patented, patent pending. 27 years experience promoting inventions. National Service Bureau, 3120 Meramec, St. Louis 18, Mo.

**INVENTIONS** Wanted. Patented; unpatented. Tremendous manufacturers lists. Global Marketing Service, 2420 77th, Oakland 5, California.

**ARE** You interested in offers from reliable manufacturers for your invention? Patented, unpatented. Harvey Engineers, Cambridge, Maryland.

**FREE** Sales and marketing analysis of your invention. Patented or unpatented. Write: Inventions, Box 292, Kansas City 41, Missouri.

**INVENTORS**: If you have an invention for sale, patented or unpatented, write for free brochure outlining manufacturers' requirements, royalty rates. Kessler Corporation, 531W, Fremont, Ohio.

**INVENTORS**: Free space in America's largest invention catalogue. Write Publishers: A. J. Murphy & Associates, 681 Market Street, San Francisco 5, California.

**INVENTIONS** Wanted: Patented, unpatented. All types desired by our clients. Immediate information by airmail. Inventors Marketing Service, P.O. Box 17, Dept. M, Gonzales, Texas.

### PATENTS FOR SALE

**AUTOMATIC** Poultry waterer. Positive action. Cash and royalty. Barnes Tool Service, Box 135, Pulaski, Tenn.

**OIL** Patent #2559100. W. L. White, Rte. 5, Box 15, Natchez, Miss.

### MANUFACTURING

**DISPLAY** Models: Architectural, product design, molecular, and general technological. Free mock-up prepared with reasonable estimates. Write Tri-Dimensional, 4339 Lindell, St. Louis 8, Mo.

**MODELS**—Small lot manufacturing. Metals, plastics, etc. Milburn, Burlington, Kentucky.

### MODELS, MODEL SUPPLIES

**POWER** Models. Unusual steam, gasoline and traction engines, fittings, metals. Triple expansion marine engine. New comprehensive catalog \$1.00. Chas. Cole, Ventura, Calif.

**MODELS**, Hobbies, supplies. 270 page catalog \$1.00, refundable. Joynes, 221 N. Limestone, Lexington, Ky.

**MODEL** Builders Cyclopedic—Railroads; airplanes; ships; crafts; guns; autos; tools; engines; supplies; 310 illustrated pages. 30,000 items. World's largest hobby catalog. National Sales, Box 143, DuBois, Penna.

**MODEL** I railroads you can build. Send \$1 for detailed plans, wiring, instruction book about eight small HO railroads you can build. Model Railroader Magazine, Dept. 139PM, Milwaukee 3, Wisconsin.

**SHIP** Model kits, fittings and plans including clippers, trawler, fishermen, frigates, privateer, etc. Towboat of 1900 for HO gauge \$3.95. 1958 catalog 25¢. Model Shipways, Box 85, Bogota, N. J.

**BUILD** Miniature passenger hauling live steam locomotive, with file and drillpress. We do machine work, you bolt it together. Catalog 50¢. Little Engines, Lomita, Calif.

**LIONEL** Trains—Appliances. Big discounts. Bulletin free. Catalog 25¢. Mack Bros., 2043P Chicago Ave., Chicago 22.

**SHIP** Models. Most complete line in New England. Kits, fittings, plans, books, tools, engines, motors. 1958 illustrated catalog 35¢. James Bliss & Co., Inc., Dept. SM, 342 Atlantic Ave., Boston 10, Mass.

**BALSA** Wood and model aircraft. 40-page catalog 25¢. Sig Co., Montezuma, Iowa.

**SHIP** And yacht model fittings; blueprints. Send 35¢ for illustrated catalog listing hundreds of items. A. J. Fisher, 1002-1 Etowah Ave., Royal Oak, Mich.

**SHIP** Models and yacht supplies complete. Large 68 page catalogue 50¢. Bill Wild's, 510 East 11 St., New York City 9.

### HOME CRAFTSMEN

101 **PATTERNS** Of smart gifts, novelties, shelves, action windmills, plus, "Make Money Jig Sawing." \$1.00. Mastercraft, 35M, 7041 Olcott, Chicago 31, Illinois.

**FREE**. New big illustrated catalog, leathercraft, metalcraft, woodcraft kits and supplies. Complete stock, top values, latest ideas. Write today. J. C. Larson Co., Dept. 7927, 820 S. Tripp, Chicago 24.

**MAKE** \$200.00 Monthly spare time with jigsaw. Free details. Elkman, 346P North Summit, Sioux Falls, South Dakota.

**SHELLCRAFT** Supplies. Highest quality. Lowest prices. Large catalogue free. Pace's, Box 279, Bradenton 9, Florida.

16 **LAWN** Chairs, 22 tables, benches, trellises. Plans and necessary patterns \$1.00 Mastercraft, 33M, 7041 Olcott, Chicago 31, Illinois.

**LEATHERCRAFT**, Copper enameling, mosaic tile, metal tooling, many more crafts. Complete illustrated catalog free. Kit Kraft, 283, Studio City, Calif.

**PATTERNS** Flying ducks, man sawing wood, Dutch maid churning butter, and 30 lawn ornaments, only \$1.00. Lincoln Studio, Columbia, Conn.

129 **FULL-Size** artist drawn jigsaw patterns, \$1.00. Craftplans, 1322-A Wabash, Chicago 5.

**BUY** Picture frame moldings at wholesale, actually less than cost of raw lumber. All styles and widths. Free delivery. Write for price list. Chesapeake Picture Frame Co., Box 533, Baltimore 3, Maryland.

**LEATHERCRAFT**. Send 10¢ for new 76-page catalog of tools, supplies, kits, including metalcrafts, enameling, ceramics, all other crafts. Complete stock. Reasonable. Since 1910. Sax Bros., Dept. PM-3, 1111 N 3rd, Milwaukee, Wis.

**DELUXE** Door nameplate kit. 1" gold lacquer letters for your first, last name; black plastic base; instr. \$2. Complete satisfaction guaranteed. Bryant's Supply, Clayton 1, Oklahoma.

**FREE** Seashells catalog. Instruction book 35¢. Secor's, Bradenton, Florida W.

**SEASONED** Walnut and cherry squares, blocks, boards. Price list free. Midland Lumber Company, Dept. M, P.O. Box 124, St. Joseph, Missouri.

**LEATHERCRAFT**. Imported and domestic leather, tools, kits, complete catalog. 25¢ refundable. Midas, Box 1255, Dept. J8, Huntington Park, California.

**OVER** 900 Woodworking projects. Books and patterns. Free catalog. Craftsman, 115-C Worth Street, New York City 13.

**FREE** Catalog. 2150 artist-drawn patterns, designs. Craftplans, 1322-A Wabash, Chicago 5.



AMERICA'S Most complete home craft supply company. Send 10¢ for big colored catalog. Giles & Kendall Co., Huntsville, Alabama.

LEARN Art metalcraft and jewelry making. Complete, inexpensive, home training course now available. Special tools and materials furnished. Write for free booklet. Interstate Training Service, Dept. L-3, Portland 13, Oregon.

KNOCKDOWN Cedar chests and lumber. Free price list. Bedford Lumber Company, Shelbyville, Tennessee.

WOODWORKING And cabinetmaking course for beginning and advanced home craftsmen. Only complete low-cost home training program available. Write for free booklet. Interstate Training Service, Dept. G-3, Portland 13, Ore.

STYLECRAFT "Pretraced" leather kits. Handbags, billfolds, filigree belts. Patterns on leather. Just carve, assemble and lace. "Prepared" kits also available. Send 25¢ for catalog, free folder. Refunded first order. Apache Leather Company, 2804 E. Washington St., Phoenix, Arizona.

FREE "Do-it-yourself" leathercraft catalog. Tandy Leather Company, Box 791 F25, Fort Worth, Texas.

BRASS Ventilators stop rot, mildew, paint peeling. 4 samples 25¢. Blaco Mfg. Co., Cleveland 3, Ohio.

### DO IT YOURSELF

MAKE A fine clock in a single evening! Even clockmakers can't tell these beautiful replicas of Early American shelf clocks from factory-made. Precut solid mahogany, walnut, cherry. Guaranteed preassembled electric motor. Buy the kit—Save money. Write, Rarewood Crafts, 69 W. Washington, Chicago 2.

BUILD Rotary tiller and mower combined or separate. Ride or walk. Kits and parts. Mass production low prices. 2½ and 3 h.p. engines \$35.00 and \$38.00. Circulars free. Shaw Du-All (PM), Galesburg, Kansas.

PLAY Popular music on piano—Without teacher. Money order of \$2.50 p.p. for Kay Bruner Self-Teaching fast method, Box 581, Rockford, Ill.

MOWER Kits complete, easy to assemble. Write for free literature. Triangle (PM) 185, Fort Scott, Kansas.

MAKE Paint stick to metal with "Metal Treat." \$1.00 bottle makes one gallon. At leading hardware and paint stores or prepaid from Klean-Strip Co., P.O. Box 10083-D, Memphis, Tenn.

CABINET Plans drawn to fit your special requirements. Write: Cabinet Planning Service, Box 73, Sta. B, Evansville, Ind.

NOW Available! Nationally known power lawn-edger, hedge-trimmer in kit form. Build your own with our parts, plans; save up to 70% of retail value. For details, write: Powur-Trim, Box 8626, Fort Worth, Tex.

BUILDING Plans for block homes \$1.00. Thompson, P.O. Box 8245, Tampa 4, Fla.

SWIMMING Pool—Are you thinking of building your own swimming pool? Learn the facts first. Send \$2.00 for complete instructions on concrete pools, illustrated literature, blueprints. United Swimming Pools, Inc., 820 Taunton Avenue, Seekonk, Mass.

BE Your own plumber. You can. Few inexpensive tools and our instructive book, "Home Plumbing Guide," shows and tells you how. Hundreds of photographs and diagrams. Easy to follow. 160 pages. \$3.50. Catalog free. Popular Mechanics Press, 200PG East Ontario St., Chicago 11, Ill.

WASHING Machine parts, Bendix, Thor, others. Exchange units available. Discounts. Bendix Service of New York, 3956 Broadway, New York 32, N. Y.

ELECTRICAL Appliance factory replacement parts, every part, all makes, discounts. Consolidated Service Centers, 1115 St. Nicholas Avenue, New York 32, N. Y.

GRANDFATHER Clock movements, barometers, blueprints, kits. Wholesale catalog 25¢. Mason-Sullivan, Noroton, Conn.

AWNINGS. Build your own. Fiberglass, aluminum. Write for literature. Lusterglo, Inc., Wickliffe, Ohio.

18 FULL-Size patterns. Save money with easy-to-use, professionally designed full-size patterns. Make money selling beautiful, useful furniture. Make modern step and cocktail tables; metal lamps; cupola; 12-foot outboard. All patterns test-built; sold with money-back guarantee. Get your free list of these convenient, economical patterns today. Popular Mechanics Press, 200-HH E. Ontario Street, Chicago 11, Ill.

### WATCHES, OLD GOLD, JEWELRY

GOLD, Silver, platinum, old jewelry, diamonds, watches, spectacle frames wanted. Highest prices paid, satisfaction guaranteed. Information sent free. Wilmot's, 1067 Bridge St., Grand Rapids 4, Mich.

WATCH And clock repairing books. Free catalog. North American, 2320-AQ Milwaukee, Chicago 47, Illinois.

OLD Gold jewelry, watches, coins, etc. wanted. Any condition, top prices paid. Send by registered or insured mail. Midas Enterprises, Box 257, Frederick, Md.

WRIST Watches, genuine Swiss, air-mailed postpaid. Men's 17 jewels, automatic, \$40 value, \$16.90. Ladies' 17 jewels, \$15.84. Free catalog. Moon Company, 2333C East Cameron, West Covina, Calif.

WATCHMAKERS' Tools, materials, supplies, watches. Catalog. Gales, Box 1000, Chicago 90, Illinois.

EASY To make costume jewelry at home. Catalog 10¢. Introductory kit including catalog \$1.00. J & M Novelties, Dept. CC-3, Box 173, Broadview, Illinois.

COSTUME And shell jewelry supply catalog loaded with fast selling designs, 25¢. Modern Craft, Box 11088, St. Petersburg 33, Florida.

10 SWISS Watches \$18.00. Catalog 25¢. Berkowitz, 1150 Castle Hill, New York City 62.

COSTUME Jewelry supplies, settings, rhinestones, etc. 88 page illustrated catalog. 25¢. Milady, Box 1328, G.P.O., New York City.

HIGHEST Cash for old gold, broken jewelry, gold teeth, watches, diamonds, silverware, spectacles, platinum, mercury. Free information. Rose Refiners, Heyworth Building, Chicago 2.

### RAZORS, BLADES, SHARPENING

100 DOUBLE Edge blades \$1.00. Wandrie, 5078 Garland, Detroit 13, Mich.

### FOR THE HOME

CAST Aluminum weathervane. High quality, adjustable base, flat black. 27" x 20 1/2". Horse, rooster, tandem bike. Please specify. \$6.95 prepaid. Home Industries, Box 107, Jackson, Ohio.

"PAINT The sash; not the glass" with the amazing E-Z-Edger. Eliminate overlapping, masking, scraping. Only \$2.49 with brush, postpaid. Guaranteed. E-Z-Edger. P.O. Box 13137, Tampa 11, Florida.

OUTDOOR Fireplace plans, 15 tested designs easy to build. Send for illustrated price list. Hager Design, 3713 Halsted Road, Rockford 1, Illinois.

FREE. Discount catalog! Save on gifts, housewares, books, jewelry. Postage prepaid. Carvet Enterprises, 232 Normandy Rd., Massapequa, N. Y.

"HOME Improvement Guide." New, amazing 192 page volume. Packed with ideas, plans for remodeling, decorating, landscaping, built-in projects. \$2.50 prepaid. Popular Mechanics Press, 200-HG East Ontario St., Chicago 11.

### OF INTEREST TO WOMEN

60% PROFIT On cosmetics—Famous nationally advertised Hollywood cosmetics pay 60%. Make \$35 day up. Hire others. For free samples, details, write Studio Girl, Glendale, Calif. Dept. 1283G.

"8 MISTAKES Parents Make." Every parent should have this new book about child training. It is free; no obligation. Simply address Parents Association, Dept. 673, Pleasant Hill, Ohio.

EXTRA Money making-selling floral-craft. Flower kit and big catalog \$1.10. Hauser House, Box 624, Phoenix, Arizona.

READY To sew apron \$1.00. Ann Johnson, 212 Gulf Street, Milford, Conn.

COLGATE'S Lustre-Creme shampoo, 4 lbs., \$4.85 postpaid. Geller, 2089P Matthews, 62, New York City.

DRESSES 24¢; Shoes 39¢; men's suits \$4.95; trousers \$1.20. Better used clothing. Free catalog. Transworld 164-S Christopher, Brooklyn 12, N. Y.

WE Pay \$3.50 lb. dried. Grow mushrooms. Cellar, shed and outdoors. Spare, full time, year round. We have 25,000 customers. Free book. Washington Mushroom Ind., Dept. 176, 2954 Admiral Way, Seattle, Wash.

SELL Fine fabrics. Get yours wholesale. Box 863, Norwalk, Conn.

WANT To make big money at home? \$10.00 profit in an hour possible with invisible mending. Make tears, holes, disappear from clothing, fabrics. Steady year-round demand from cleaners, laundries, homes. Details free. Fabricon, 6270 Broadway, Chicago 40, Illinois.

### PERSONAL

VITAMINS—Save 45%. Buy direct. All formulas. Free catalogue. Vitaspac, Box 4435P, Philadelphia 40, Penna.

ENJOY Health. Free booklet. Ruth's Nutrition, 152 Kearny, PM, San Francisco, Calif.

BIBLE Questions answered. Stamped envelope. Bylon, 17167 Bentler, Detroit 19, Michigan.

"HOW Can I find out?" You can! Information confidentially developed. Any matter, person, problem. Worldwide. Officially licensed. Established 1922. William Herman, 170 Broadway, New York City.

BORROW Money—By mail. \$100 to \$600 from Postal Finance. Employed men, women easily obtain \$100 to \$600 fast, entirely by mail. Repay in small monthly payments. Friends, relatives, employer, tradespeople will not know you are applying for loan. Advise occupation, amount wanted. Postal Finance Company, 200 Keeline Bldg., Dept. 658C, Omaha, Nebr.

LOANS By mail. Borrow \$50 to \$500. Employed men and women over 25, eligible. Confidential, no co-signers, no inquiries of employers or friends. Up to 2 years to repay, monthly payments. Supervised by State of Nebraska. Loan application sent free in plain envelope. Give occupation. American Loan Plan, City National Bank, Dept. PM-3, Omaha, Nebraska.

PAY Your bills now. Borrow \$100 to \$600 cash by mail. Easy, quick, private. Repay in small monthly installments over 20 months. Your payments may run ½ less than now; have money left over to spend. Loan order blank mailed free in plain envelope. Advise amount needed. State Finance Co., 323 Securities Bldg., Dept. C-227, Omaha 2, Nebr.

PHILADELPHIA Opportunities. Sunday's classifieds \$1. Bartoli, Westville Grove, N. J.

I Want to send you proof of the wonderful pulling power of Popular Mechanics classified pages. What's your proposition? Write me today. Include literature if possible. F. W. Johnson, Manager Classified Advertising, Popular Mechanics Magazine, 200 E. Ontario St., Chicago 11, Ill.

MAKE Your own will. Order will form for \$1.00 prepaid. National Courtesy Service, Milan, Missouri.

BOLOBAM. Defensive quick-knockout street-fighting tricks. Swiftly learned. \$2. Gauch, 846-87 Sunnyside, Chicago 40.

RESEARCH Typist. Personal attention. Every field of knowledge. V. Schaut, 619 Kamms, Mishawaka, Indiana.

HANDWRITING Analyzed scientifically. Send sample, \$1. Box 56, Fairport, N. Y.

ASTONISH Your friends. Bewilder your enemies. Startle even yourself with an easily acquired "personal power" that none can ignore. Amazing control! Postcard brings free details. Dimensional Enterprises, Box 191, Sedona 3, Arizona.

"HOW To Get a Better Job." Letter-size brochure. \$2.00. Terrestrial Publications, Box 4238, Philadelphia 44, Penna.



## REMAILING SERVICE

UNALAKLEET, Alaska, remails 25¢. Albert Bell, Box 87, Unalakleet, Alaska.

LAS Vegas, Nevada, Confidential remails 25¢, \$3.00 month, classifieds \$1.00. Unique, Box 1376.

TACOMA, Remailing 25¢: Receiving, forwarding. Monthly rates. Sund, 3602 Ferdinand St., Tacoma 7, Washington.

REMAILS 25¢, Month \$3.00. Patrick Kennedy, R.F.D. #2, Box 175, St. Clair, Michigan.

LETTERS Remailed 25¢. J. Love, 1419 E. 83d, Los Angeles 1, California.

REMAILING Miami, Miami Beach, 25¢. Scenic postcards. R. Shay, 103 Marion, Hollywood, Florida.

SEATTLE Or Bremerton remails — 25¢. Dorman, Box 42, University Station, Seattle 5, Washington.

CLEVELAND Forwarding-receiving. \$3 month. Gordon, 12201-D Miles, Cleveland 5, Ohio.

CONFIDENTIAL Remailings 25¢. \$3.00 monthly. Blace, Box 24, Geauga Lake, Ohio.

N.Y.C. Remails, 25¢. Monthly, \$3.00. Edward Barron, 171 W. 81 St., New York City 24.

ALOHA! Six colored hula girl postcards — \$1.00. Remailed free. Souvenir gifts available. Surprise your friends. Now! Today! Write: Jim Fobel, 4503-HU Aukai Avenue, Honolulu.

REMAILS 25¢. Month \$3.00. Hauser, P.O. Box 624, Phoenix, Arizona.

SAN Francisco remails 25¢, receiving-forwarding, \$3.00 month. Kent, Box 4606.

REMAILS 25¢. Monthly \$3.00. Confidential. Zurga, 1455 Meridian, Miami Beach 39, Florida.

COLUMBUS Mail forwarding-receiving address for rent. Details free. William McLaughlin, 800 Stewart, Columbus 6, Ohio.

SECRET Mail forwarding. \$3 month. Hedgpath, Box 830, Alhambra 23, Calif.

RICHMOND Remails 25¢, monthly \$3.00. Reasley, 1829 Claiborne, Richmond, Va.

LETTERS Remailed from Mexico. Surprise your friends. Five, \$1.00. Air remails \$1.50. Five scenic postcards from Mazatlan, Acapulco, Mexico City, Tampico, Veracruz, return for remail, \$1.00, no checks. Or five postcards 50¢ stamps. Mexican sarapes and rebozos (stoles), Indian rugs, feathercraft pictures. Titles, colors, sizes, prices sent on request. Thrifty Remailing Service, Dept. B220, P.O. Box 1046, Nogales, Ariz.

REMAILS From fabulous Key Largo. 25¢ each. Wally, Key Largo, Florida.

REMAILS 25 Cts. Details free. Persil, 436 N. Y. Ave., Brooklyn 25, N. Y.

REMAILS, 25¢. Receiving, forwarding, \$3.00 monthly. Hale, Box 1, Glenmont, N. Y.

SECRET, Stamps provided. Typed inquiries, letters answered, telegrams sent, answered. From \$5 month. Box 232, Fredrickton, Canada.

## TREASURE FINDERS

TREASURE Locators. Newest treasure finder in 20 years. Guaranteed M-Scope. Transistorized. Proven performance. Terms. Catalog. Fisher Research, Dept. C-1, Palo Alto, Calif.

HALF Price. World famous P.R.I. instruments. Model 106C Geiger \$49.75. Model 117B scintillator \$149.75. New. Guaranteed. Free catalog. P.O. Box 8732E, Los Angeles 8, California.

GOLD, Silver metal detectors. Geiger counters for uranium. Violites. Sensational new fully guaranteed models. None finer. Information free. Detectron Corp., 5528 Vineland Ave., North Hollywood, Calif.

PIND Buried treasure, gold and silver, with Goldak's sensational 3 1/2 lb. "find-it" locator, only \$64.50. Write for free literature on complete line of mineral, metal locators; Geiger and scintillation counters, Goldak, 1541 W. Glenoaks Blvd., Glendale, Calif.

PROSPECTORS, Mineralogists, save. Build your own portable far ultra violet lamp. Detects tungsten, uranium ores, etc., where "black light" can't. Directions \$2.00. Vamadco, Box 5534, Arlington 5, Va.

FREE Literature—Light weight, guaranteed metal detectors, Geiger counters and mineralights. Kits and assembled models. Electronic Applications, Dept. M, Box 8, Arlington 10, Virginia.

## FOR SALE—MISCELLANEOUS

HEARING Aid batteries, wholesale. Free list. Habs, Box 51, York, Penna.

DISC Wheels. Semi-pneumatic rubber tired. All sizes. For home, farm, industry. Ball, oilite, roller bearing. For coaster wagons, lawn furniture, barbecues, super market carts, wheelbarrows, machinery, industrial trucks, etc. Axles, Hand trucks. Free list, prices, specifications. Write: Mobile Wheel Products, 1510 McClellan Ave., Detroit 14, Michigan.

OLD Wall telephones, working order. Oak cabinets, hand crank for ringing. \$5 each, f.o.b. Telephone Co., Turtle Lake, Wis.

## WANTED—MISCELLANEOUS

SURPLUS Calendars. We are interested in buying per weight or quantity closeouts of the present season. Our shippers will pay cash for all orders. Guillermo J. Wagner, P.O. Box 953, Guayaquil, Ecuador.

QUICKSILVER, Platinum, silver, gold. Ores analyzed. Wholesale Terminal, Norwood, Mass.

SCRAP Mercury (quicksilver) containers supplied — Tantalum, tungsten, silver, platinum. Metallurgical Products Company, Established 1909, 35th & Moore Sts., Philadelphia 45, Penna.

## MISCELLANEOUS

MICROFILM Viewer free, microfilm personal papers. Insure against loss. Details. Mermico, Merrill, Wisconsin.

100,000 PRODUCTS Wholesale — Free catalog! Send postcard. Econ-O-Mart, Whippany 15, New Jersey.

YOUR Name wanted. We'll send 1000 publishers, mailers, wholesalers your name. on our list one year 25¢. Dixie Mailers, King, N. C.

BOOKS On antiques and their prices. Free circular! P. Warman Publishers, Uniontown, Penna.

SADDLES, Boots, western wear, leather supplies. Free catalog. Silver Spur, Box 1785-N1, Ft. Worth, Texas.

WE Pay \$3.50 lb. dried. Grow mushrooms. Cellar, shed and outdoors. Spare, full time, year round. We have 25,000 customers. Free book. Washington Mushroom Ind., Dept. 175, 2954 Admiral Way, Seattle, Wash.

BUY Wholesale! Over 10,000 nationally advertised products. Appliances, cameras, sporting goods, housewares, watches, typewriters, tools, clothing, etc. Send postcard today. Buy-Rite, Box 258, Hawthorne 2, New Jersey.

CIGARETTES—Make 20 for 9¢. Facts free. Moberly, Box 810, Owensboro, Kentucky.

CESSPOOLS, Septic tanks, clogged drains. How they function and how to keep them working. Free literature. Chemical Cesspool & Drain Cleaning Co., Boston 34, Mass.

OUTDOOR Toilets, cesspools, septic tanks cleaned, deodorized with amazing new product. Safe, harmless, easy to use. 150,000 customers your guarantee of satisfaction. Money-back guarantee. Postcard brings free trial offer. Burson Laboratories, Dept. D-21, 951 Willard Ct., Chicago 22, Ill.

STUPENDOUS Mental power. Adults. Details—3¢. Wisdom, 846 Sunnyside, Chicago 40.

MEXICAN Food recipes \$1.00. Chef Paul, 1307 1/2 N. 4th Pl., Lamesa, Texas.

CASH For old books! Free details. Solle, 100 Main, Omena, Michigan.

JAPAN: Buy gifts, novelties air-mail, drop-ship; 24 page catalog, manufacturers' names addresses, business information. Send \$1.00. Clarence Yamagata, 202 Naka 7 Bldg., Marunouchi, Tokyo.

WRITE For free catalog. New government surplus—GI self-instruction books. Value over \$7 each. Mathematics, history, foreign languages, accounting, farming, auto-mechanics, establishing new business, etc. \$1.00 each postpaid. Choose from over 60 courses. Sual Co., Dept. H, Elsinore, California.

NEW Snow Cone machines. All prices. P.O. Box 7803, Dallas, Texas.

BEAUTIFUL, Imported paintings worth hundreds, only \$6.40 up. Samples, Lehmann, Box 122, Brockport, N. Y.

MANUFACTURER'S Name, address, any product; trade, brand names identified; \$1.00 each. Report, Box 655, Thomasville, Georgia.

AZTEC Plumage—Art pictures. Exciting free information. Jurczuk, Box 6, Kalamazoo, Michigan.

"BACKWOODS Journal" — \$1.00 year, sample 10¢. Cabin Life, Old Forge, New York.

"HOME Improvement Guide." New, amazing 192 page volume. Packed with ideas, plans for remodeling, decorating, landscaping, built-in projects. \$2.50 pre-paid. Popular Mechanics Press, 200-HG East Ontario St., Chicago 11.

BUY! Sell! Swap! "Nationwide Exchange Directory" 10¢. Brand's, Sycamore, Illinois.

RECEIVE — Samples, magazines, mails, offers everywhere. Get listed. 25¢. Rorick, Box 86P, Cincinnati 26, Ohio.

IT'S Magic! Rechargeable pocket flashlight. No batteries to replace. Recharge from AC outlet. Satisfaction guaranteed. Only \$7.65 postpaid. Ted Weems Enterprises, 3202 A Kings Road, Dallas, Texas.

AMUSE Friends. 15 gag cards 25¢. W. Eckberg, 1000 Jewett, Woodstock 21, Ill.

MILLIONS Of ruptured helped! Since 1880 our world-famous low-cost rupture device has helped millions of reducible rupture patients forget their rupture worries! Maybe our 77 years of rupture experience may help you. Why not see? Write Brooks Co., 373-H State St., Marshall, Michigan.

RECEIVE Opportunities, offers, plans, samples, 25¢. Jones, 8448 Kavanagh Rd., Baltimore 22, Maryland.

FREE! All about moneymaking plan to gain promotion and more money in your present job. Ern-Mar, Clermont 12, Fla.

DRAFTING Board, professional, adjustable. Easy plans complete \$1.00. Designer, 2225 Oriole, L. B. Michigan City, Ind.

AMUSE Your friends! 20 business and monkey business cards \$1.00. Bill Lewis, 1022 Eureka, Lansing, Michigan.

I Want to send you proof of the wonderful pulling power of Popular Mechanics classified pages. What's your proposition? Write me today. Include literature if possible. F. W. Johnson, Manager Classified Advertising, Popular Mechanics Magazine, 200 E. Ontario St., Chicago 11, Ill.

GENUINE Jim Richards boots. Jodhpurs, Wellingtons, engineers, paratroopers, western styles. Free catalog. Sellers Company, 8830 Alameda, Ysleta, Texas.

HEAT Your home for almost nothing. Folio free with purchase "Rainbow Fire Color." For fireplace pleasure. Generous pound box including folio \$2.00 p.p. Ottawa-quebec Products Co., Quechee, Vermont.

WANT More business? Here's an amazing opportunity to increase your sales. Talk to thousands of interested readers of "Mecanica Popular." Our Spanish Edition covers the Latin American countries like a blanket. They're real mailorder buyers. Classified rate 75¢ per word. Try an ad in our next issue. Classified Advertising Department, Popular Mechanics Magazine, 200 East Ontario Street, Chicago 11, Ill.

10 ALL Different mail order magazines plus our 4 page list of unique, imported, fast-selling items. All for 25¢. Emerson Trading Co., Pompton Plains 39, New Jersey.

IMPORTED Offertunities, catalogs, items, everything. 25¢. Hermesen, 3415 Knox, Bronx 67, N. Y.

CIGARETTES—Perfect Draw. Make for 1/2¢. Details free. Mac Products, 1249 Massillon Rd., Akron, Ohio.



# \$SAVE \$ ON U\$ GOV'T \$URPLUS\$

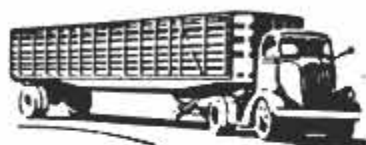

Our publication "Government Surplus Sales" lists hundreds of items for sale by the U. S. Government at tremendous savings, as low as 1c on a \$1.00.

These are samples of the savings that have been made.

LIFE BOAT ....\$12.00	GRINDER .....\$4.69	SHAPER .....\$15.00	DUMP TRUCK.....\$76.77
TRACTOR .....\$75.00	TYPEWRITER ...\$7.51	FREEZER .....\$50.00	SPRAY PAINTER.....\$15.25
	MOTOR .....\$4.00		

Hundreds others listed in our bulletin "Government Surplus Sales" and may be purchased direct from U. S. Government \*prices not listed. Hunting, Fishing, Camping, Sporting Equipment, Photographic Equipment and Supplies, Radio and Electronic Equipment, Amphibious Trucks, Jeeps, Boats, Motors, Binoculars, Plumbing, Electrical Equip., Cars, Power Tools, Machinery, Chemicals, Furniture, Office Equipment, Supplies, Scrap, Etc.

How may you receive our bulletin "Government Surplus Sales?" By sending \$1.00 to  
**GOVERNMENT SURPLUS SALES, P. O. Box 169, Department 8-5, East Hartford 8, Conn.**

## CHECK YOUR TIRES . . . YOUR LIFE DEPENDS ON THEM!

# You Can Play



## ANY INSTRUMENT

IMAGINE! Even if you never dreamed you could play . . . you can soon surprise friends with your musical ability. No special talent needed. Spend a few minutes a day at home—only a few cents per lesson. Teach yourself piano, guitar, accordion, any instrument. Play popular music, hymns, classical, any other music — by note, quickly. Over 900,000 students, including famous TV Star Lawrence Welk!



**FREE BOOK** — Read the fascinating story of this wonderful method in 36-page book. For FREE copy, fill in ad below, and mail. (No salesman will call.)



**U. S. SCHOOL OF MUSIC**  
 Studio 303A  
 Port Washington, N. Y.  
 (60th year)



Name \_\_\_\_\_  
 (please print)

Address \_\_\_\_\_



## TRAIN TO OPERATE HEAVY EQUIPMENT CONTRACTORS NEED MEN NOW

The big federal and state super highways program is now in progress. Train to operate bulldozers, shovel, motor-grader, scrapers, etc. YOU can make big pay in the construction industry if you learn these skills. NOW contractors WANT our graduates.

Write or call TODAY for full information.

**THE MIDDLE-WEST SCHOOL OF HEAVY EQUIPMENT OPERATION**  
 SAXTON, KENTUCKY  
 (Phone Jellico, Kentucky—Harrison 4-6653)



America is a Better  
 America —  
 thanks to Advertising!



# BUILD YOUR OWN HOME

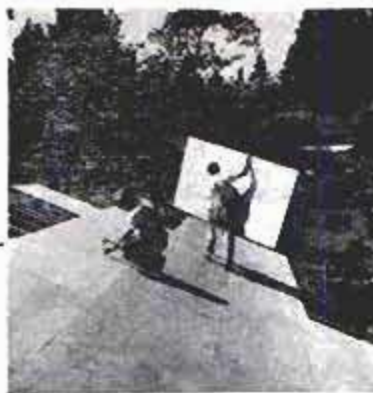

## SAVE MANY HUNDREDS OF DOLLARS

One of every five U. S. homes now being built is at least partially owner built. You can do it, too, and save big money! These PM books make it easy—with plans, ideas you can adapt anywhere and beautiful, tested designs.

### POPULAR MECHANICS PRECUT HOUSE

The small picture can only hint at the beauty of this exciting home. Best of all, you can build it yourself and save up to 65% of its market value. You can do the job in three stages: a shell using a kit of precut materials (or cut your own from stock sizes) that you can live in while finishing the house—only \$1800; then a summer house with gas heat, all kitchen and plumbing facilities—only \$2800; finally, a fine year-round home featuring luxurious redwood paneling and dry-wall construction for \$3800, complete. Basic floor plan is 24' by 46' for a 5 or 6-room house with two or three bedrooms, porch, carport, utility room and bath. Build it from the book alone . . . or buy the full size plans to make the job

**\$2.50**



### RANCH-TYPE HOUSE

The most popular of all homes today—the ranch style. You can build this beautiful home and save \$7,000 to \$10,000! It's a year-round home, a full 31' long, 29' wide. Fully insulated. Finished inside and outside with durable plywood; requires no costly plastering. Has brick "island wall" and big fireplace in living room. Heating, ventilating and wiring a stem included. Build the basic home first—living room, dining area, two bedrooms, bath, utility room and carport—all for about \$5,000. Later on, add garage, breezeway (carport becomes a third bedroom)—all for about \$2500 more. Actual pictures and carefully explained instructions cover every step in proper order. Includes notes on construction, framing, lumber list, specifications. Ten working size blueprints available to aid in construction—see coupon.

**\$3.50**



### CONCRETE BLOCK HOUSE

A project well within the reach of any handy man who can use simple tools! This unique book covers every step of building a modern five-room concrete block house that has been completed in many communities for less than \$4500, with all plumbing, heating and electrical equipment. If you can mix a batch of concrete and saw a board straight, you'll have no trouble building this attractive Popular Mechanics home. Concrete construction throughout—poured concrete floors and concrete block walls, with vapor-sealed insulation.

Walls are plastered inside and stuccoed outside. Very little carpentry required—which makes the home easy to clean and maintain at a minimum cost. Complete list of needed materials with prices and source of supply, including mill work and equipment. Blueprints also available if desired—see coupon.

**\$2.00**



### YOUR HOME and HOW TO BUILD IT YOURSELF

Here's the real answer—build it yourself! Yes, you can construct a modern, truly beautiful 1 1/2 story home with a basement, living room, kitchen, dining nook, two bedrooms, bath, plenty of closet space—plus an extra two bedrooms on the second floor, a breezeway and an attractive garage. Think the cost is beyond your pocketbook? Not if you follow the leadership and plans given here! The house is a whopping 35'-0" x 28'-11", breezeway 20'-10" x 8'; garage 20'-10" x 12'. Easy to build in most any style of architecture, traditional or modern. Book gives floor plans, elevations, construction notes, lumber list and specifications. Includes hundreds of drawings and photos to make every step of construction crystal-clear even for the amateur builder. Set of ten blueprints is available—see coupon.

**\$3.00**



Springtime is building time! Order the book of your choice now and be ready to go when the weather's right. Satisfaction guaranteed or your money back.

**MAIL COUPON TODAY**

POPULAR MECHANICS PRESS, Dept. 358  
200 E. Ontario St., Chicago 11, Illinois

RUSH book and/or blueprints I have checked below. If not pleased, I can return in good order within seven days for full refund.

- Remittance enclosed  Send C.O.D.; U.S.A. only
- PM Precut House book \$2.50  Precut House plans only \$12.50  
 Precut House book and plans \$14.00  Ranch House book \$3.50  
 Ranch House plans only \$13.50  Ranch House book, plans \$15.00  
 Concrete House book \$2.00  Concrete House plans only \$12.00  
 Concrete House book, plans \$13.00  Your Home book \$3.00  
 Your Home plans only \$12.50  Your Home book, plans \$14.00

Name \_\_\_\_\_  
Address \_\_\_\_\_  
City \_\_\_\_\_ Zone \_\_\_\_\_ State \_\_\_\_\_

# 2 YEARS OF STUDY can give you these ADVANTAGES

- Associate in Applied Science degree
- Preparation for a career as an engineering technician in

**ELECTRONICS  
ELECTRICAL POWER  
METALLURGY  
COMPUTERS  
AIR CONDITIONING**

- or you can continue without loss of credit to a 4-year Bachelor of Science degree in Mechanical or Electrical Engineering

# at MSOE in Milwaukee



**FREE** folder answers your questions about the Engineering Technician, who he is, what he does, and how to become one.  
**SEND TODAY**

## MILWAUKEE SCHOOL OF ENGINEERING

1025 N. Milwaukee St., Dept. PM-358, Milwaukee, Wisconsin

Please send free folder  
 "The Engineering Technician;"  
 Booklet "Your Career in Engineering."  
 (please print)

I'm interested in \_\_\_\_\_  
 (name of course)

Name \_\_\_\_\_ Age \_\_\_\_\_

Address \_\_\_\_\_

City \_\_\_\_\_ Zone \_\_\_\_\_ State \_\_\_\_\_

Eligible for vets. educational benefits  yes  no.

Discharge date \_\_\_\_\_

MS-85



# ARBO-GASTERS PAY OFF BIG AT LAS VEGAS



Abe Schiller, executive vice president of The Flamingo Hotel, Las Vegas, Nevada, writes: "Our cruiser always carries a full set of Arbo-gasters to insure our guests success with the big lunkers of Lake Mead." Arbo-gaster dives like a jet, runs right over stumps and rocks. Easy to control running depth. Perfect for trolling, won't twist line. NEW 1/8-oz. size, also 1/4-oz. and 5/8-oz.—all \$1.35 each. 15 Colors.

FLOATS • DIVES DEEP • RUNS DEEP



For Spinning  
For Spin-Casting  
For Bait-Casting

MAIL FOR BIG FREE CATALOG

**Fred Arbogast Co., Inc.**

2223 W. North St., Akron 3, Ohio

Please send my FREE copy of latest Arbogast color catalog of baits—full of pictures of catches.

Name \_\_\_\_\_

Address \_\_\_\_\_

City \_\_\_\_\_

State \_\_\_\_\_

## BIG PAY JOBS for men who qualify in DIESEL



**TRAIN NOW FOR A DIESEL FUTURE.** Steady, high-pay jobs await men qualified in Diesel, Tractor, and Heavy Equipment. Are you qualified for job and advancement opportunities in this fast-growing field? You can qualify!

**COMPLETE DIESEL COURSE NOW AVAILABLE.** If you are ambitious and want to get ahead in this big money field, you'll want to know about the complete Diesel home training course now offered by Interstate Training Service. Covers all phases of operation, repair, service. Easy to master in spare time. No interference with present job. Up-to-the-minute. Regularly revised to cover new developments. We invite comparison of material offered. Advisory placement service for our students.

**YOU OWE IT TO YOURSELF** to investigate Interstate Training Service Diesel Training. Thousands agree it has helped them to better jobs...better pay. It can do the same for you!

WRITE FOR FREE INFORMATION TODAY

INTERSTATE TRAINING SERVICE, Portland 13, Ore.  
Please see that I receive FREE 24-page book, "Getting Ahead in Diesel." (A-3)

NAME \_\_\_\_\_ AGE \_\_\_\_\_  
ADDRESS \_\_\_\_\_  
CITY \_\_\_\_\_ ZONE \_\_\_\_\_ STATE \_\_\_\_\_

## WHERE-TO-BUY-IT INDEX

Source of supply appears after items commercially available

### AUTOMOTIVE

Detroit listening post.....100  
Father and son build six-cylinder model-T engine.....101  
Soapbox racer becomes motorcar.....143  
Dashboard ash tray empties by vacuum into container under hood.....145

### AVIATION

Look what a jet engine can swallow..... 87  
French jet copter to be built in U.S..... 97  
British build world's first vertical-take-off airliner.....106  
Plane takes off vertically with extended wing flaps.....121  
Ejection seat fires under water.....135  
Giant snuffer to put out aircraft fire.....141  
Helicopter shakes nut trees.....145  
Weather planes fly world-wide.....247

### BOATING

Giant canoe resembles craft used by fur traders.....121  
Auto-top boat sports electric-starting engine and built-in radio.....134  
Traffic quiz for boaters.....164

### MISCELLANEOUS

Gwedish tank killer is light but powerful..... 80  
Tank pushes steel roller to explode land mines in its path.... 88  
Electronic cashier changes dollar bill (A.B.T. Mfg. Corp., 715 N. Kedzie Ave., Chicago)..... 96  
Weatherproof shelter built at low cost (Homasote Co., Trenton 3, N. J.)..... 96  
Dry-cleaned garments are sealed in plastic (Magic Seal Paper Products, P. O. Box 1766, Denver, Colo.).....106  
Six-volt flashlight uses four dry cells (Burgess Battery Co., Freeport, Ill.).....106  
Non-ferrous metals joined by heated wire flux.....121  
Braille is reproduced in quantity on modified duplicating machine.....122  
Machine speeds pipe laying (Cosom Engr. Corp., Minneapolis, Minn.).....122  
Paw-powered latch opens door for dogs that like to scratch.....122  
Propeller tows line for boatless fisherman.....128  
Red-tide organism sure death to fish.....130  
Double globe shows orbits (Farquhar Transparent Globes, 3724 Irving St., Philadelphia, Pa.).....134  
Camper's emergency kit (Safety Research and Mfg. Co., Maritime Bldg., Seattle 4, Wash.).....135  
British livestock gate opens automatically for vehicles.....143  
Electric water heater uses snap-on heating units (Fowler Mfg. Co., Portland, Ore.).....143  
Leather from salmon skin (John Metz, 13 Tarleton Rd., Newton Centre, Mass.).....145  
Numbers system helps fight fires.....149  
"Piggyback" trailer unit for standard pickup truck sleeps three.....149

### PHOTOGRAPHY

Polaroid copy stand for small objects (Polaroid Corp., Cambridge, Mass.)..... 97  
Microfilmed material reproduced in seconds (Duplicating Products Div., Minnesota Mining and Mfg. Co., 900 Bush Ave., St. Paul 6, Minn.).....101  
Fastest camera shutter records wire "explosion".....133  
Black and white prints from color negatives (Eastman Kodak Co., Rochester 4, N. Y.).....148

### SCIENCE

Huge centrifuge tests missile parts (Convair Div., General Dynamics Corp., San Diego 12, Calif.)..... 54  
Army tests portable radio station with "balloon" antenna... 88  
Auto-piston coating cuts exhaust problems..... 96  
Jato snooper missile has changeable nose..... 96

(Continued to page 76)



# Carefree Afloat



## Care Free Ashore

Carefree afloat, because Aluma Craft are beautifully designed for years of pleasurable streamlined performance with maximum stability and built-in safety.

Care free ashore, because your Aluma Craft needs neither constant upkeep nor expensive annual overhaul to keep it shipshape and ready to go.

**LIGHTFOOT ALUMINUM SKIS.** Stronger, lighter and more buoyant. Folder ready.

### ALUMA CRAFT BOAT COMPANY

1519 Central Avenue N.E., Minneapolis 13, Minnesota

WRITE FOR



THE MARK OF QUALITY

**NEWEST CATALOG.** Showing 23 models including 2 Aluma Glass runabouts and new attractively low-priced models.

**NEW!** 9.2 H.P. RIDING **\$895** (Blade \$65 extra)  
**CRAWLER only**



**OUTWORKS ANY TRACTOR ITS SIZE**  
Ideal for clearing, grading, plowing, field or row crops, yard work. Big tractor ruggedness, quality. Anyone can operate. Borg-Warner 3-speed and reverse trans., cone clutch steering. Tractor with blade, floating drawbar, PTO, and any-where in U.S., \$960. Wt. 925 lbs. Guaranteed. Accessories available. At dealers or direct.

**LAYTRAC**  
Power! Traction!

LAYTRAC, 254883 Airport Way, Seattle 4, Wn.

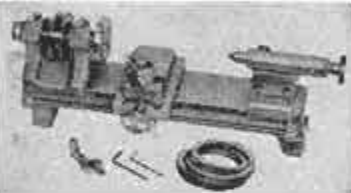

**For Many Uses!**

Metal Turning Lathe

Only **\$4995**

F.O.B. Lansing, Ill.

15-1/2" bed with 4-1/2" swing.

7" between centers.

Satisfaction Guaranteed.

**FREE FOLDER**

Write for it today!

Rosemoor Manufacturing Co.  
Box 147J, Lansing, Ill.

**BECOME A ...**  
**Machine Tool**  
**DRAFTSMAN & DESIGNER**

**Mail Coupon For Free Brochure**  
Simplified home study training program. Learn every phase of Machine Drafting and Tool Designing. Step up to a better job—big-pay. Use spare hours—no interference with present work. Diploma awarded. Low Tuition.

American Technical Society  
Dept. PM-358, 850 E. 58th St.  
Chicago 37, Ill.

Please send me your **FREE BROCHURE** and full details about Machine Draftsman and Tool Designer training program.

Name.....  
Address.....  
City..... State.....

**"I predict my earnings for 1958 will be \$20,000"**



*Clifford B. Wapp*

Toledo, Ohio

**AS A NIAGARA SALESMAN,** you enjoy almost limitless income potential . . . \$10,000 is within easy reach your first year. But *more important,* Niagara is a booming industry offering you a *satisfying* career. You'll be selling a product that is medically-proved to promote better health for your customers. Booklets describing the wonderful opportunities available in Niagara are yours for the asking. Send coupon today!

© Niagara Therapy Mfg. Corp.

**SEND FOR FREE BOOKLET**

**NIAGARA**  
Dept. PM-358  
Adamsville, Pa.

Name \_\_\_\_\_

Address \_\_\_\_\_







**CASITE gives your car**

# NEW PEP NEW POWER

## Frees sticky rings and valves

Get increased pick-up and improved engine performance! Casite—the “tune-up in a can”—through the air intake or added to gasoline, restores split-second valve timing and full compression.

## Prevents hydraulic lifter trouble

Casite keeps valve lifters clean and free-working. Just put a pint in the crankcase every 1,000 miles, and with every oil change.

## Assures safe, smooth break-in

New and rebuilt engines wear-in smoothly and safely with Casite in the oil. Penetrates tight spots—eliminates overheating, scoring.

## Cuts start-up wear

Speeds oil flow—protects closely-fitted parts during warm-up periods. Almost doubles engine life.

## Gets rid of sludge and gum

Casite removes gum and goo—KEEPS the engine clean—increases power, improves performance, saves gas and repairs, too.

## Results guaranteed, or double-your-money-back!

Get Casite at your service station, garage or accessory store.



**HASTINGS MFG. CO., HASTINGS, MICH.**  
Piston Rings, Oil Filters, Spark Plugs

(Continued from page 74)

Aim scope at moon to study earth.....	97
Battle lines on map sent by teletypewriter.....	101
Big hydroelectric dams planned in western Canada.....	128
Electronic weather computer aids aiming of missiles.....	129
Plastic cartridge case developed by Navy.....	129
Portable radar units designed for Marines.....	129
Big steel "sandwiches" for lightweight planes.....	133
Number-reading machine may translate handwriting.....	133
Heat produces electricity.....	134
Liquid-nitrogen refrigerator chills to 320 below zero (Linde Co., Div. of Union Carbide Corp., 30 East 42nd St., New York City 17).....	135
Divers can chat on "sonar" phone.....	144
Will space men mine meteors?.....	145
Science out-foxes radar.....	226
"Billion H-bomb" sun flares.....	247
Solid-boron propellant boosts rocket efficiency (Callery Chemical Co., c/o Ketchum, MacLeod and Grove, Inc., 411 Seventh Ave., Pittsburgh 19, Pa.).....	250

### WHAT'S NEW FOR YOUR HOME

Burglar alarm.....	150
Nylon hose shaker.....	150
Portable air conditioner.....	150
"Utensil wheel".....	150
Heat exchanger.....	151
Heating element.....	151
Lawn edger.....	151
Rack for iron.....	151
"Third hand" holds mirror.....	151

### WHAT'S NEW IN BOATING

Aluminum duck boat.....	157
Motor caddy.....	157
Outboard houseboat.....	157
Outboard speedboat.....	157
Day cruiser.....	158
Easy boatloading.....	158
Shallow-water boat.....	158
Big outboard cruiser.....	159
Motor stabilizer.....	159
Portable generator.....	159
Small outboard.....	159

### Radio-Television, Electronics

Radio aids to carefree cruising.....	220
--------------------------------------	-----

### Craftsman and Shop Notes Index

#### AUTOMOTIVE

Diagnosing choke trouble.....	188
Static-eliminator strap pivoted.....	192
Complete engine tune-up requires mechanical-tappet adjustment.....	196
Handle stored inside car jack.....	200

#### BOATING

Fun is the main function of this oil-drum boat.....	176
Low-cost fenders for outboard boat are easy to make.....	176
Sponge is useful boating gear.....	176
Steel cable provides useful boat-trailer accessory.....	176
Cleat controls anchor rope.....	179

#### HOUSE AND HOME

"Bow and arrow" tie rack is simple jigsaw project.....	192
Raising overhead light fixture.....	192
Adjustable bookrack for table or desk.....	193
Friendly giraffe is decorative height chart for child.....	196

(Continued to page 78)

**NOTICE**—It is the intention of this magazine to provide its readers with information regarding the latest developments in the mechanical arts. Except where otherwise indicated, this magazine has no information as to any unexpired patents in respect of the developments reported herein. In the event that commercial use is to be made of any of the developments reported herein, it is suggested that legal counsel be consulted to avoid liability for patent infringement. It is not the purpose of this magazine to encourage patent infringement but, as indicated, it is the intention of this magazine to report on the latest developments in the mechanical arts.



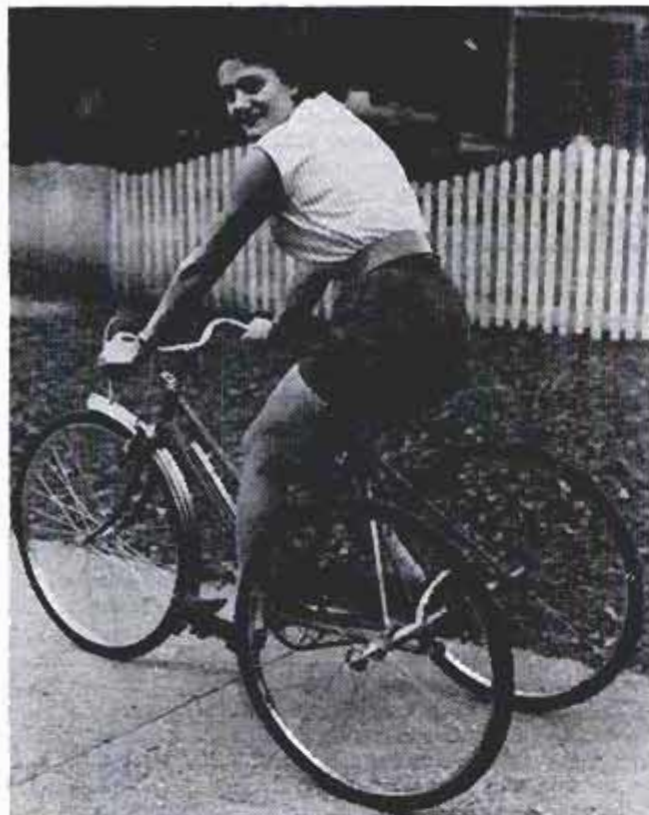

Cyclo-Pedia, 6447 Michigan Avenue, Detroit 10, Mich.

## Tricycle for Adults Weighs Less Than Bicycle

Designed for healthy or handicapped adults who like outdoor exercise, a new 26-inch tricycle weighs 10 pounds less than a standard bicycle. It has a split rear-axle unit which allows the left drive wheel to turn independently of the right. The adult-size tricycle is produced in frame styles for either male or female riders.



## LEARN TO OPERATE EARTH MOVING EQUIPMENT

Good pay for men trained to "boss" crawler tractors, front end loaders, motor graders, cranes, etc., on the 41,000 mile, road improvement program and other construction jobs; building; terracing; grading; land clearing; excavating, etc., plus comprehensive maintenance, in a 200 hour, 5 week course. . . . Special weekend instruction available. School located 50 miles from Chicago. Economical housing and boarding available. Get in on a good paying future NOW.



## OR LEARN TO BE A CONSTRUCTION EQUIPMENT MECHANIC

Greer also teaches complete, separate, Mechanics Training Course covering Diesel engine transmissions; torque converters; fuel injection systems; track assemblies; final drive assemblies; steering systems; idlers; rollers; power transfer systems; cable control systems; hydraulic control cylinders & welding pertaining to heavy equipment such as bulldozers, scrapers, loaders off highway trucks, etc. Course time—540 hours—18 weeks. Enroll today to earn top pay.

Please send FREE information on

- HEAVY EQUIPMENT OPERATORS TRAINING  
 CONSTRUCTION EQUIPMENT MECHANICS TRAINING

NAME \_\_\_\_\_ AGE \_\_\_\_\_

ADDRESS \_\_\_\_\_

CITY \_\_\_\_\_ STATE \_\_\_\_\_



**Greer TECHNICAL INSTITUTE**  
ATT. M. C. Hutchison, Box 278, Braidwood, Ill.

## SCHOOL OPPORTUNITIES

Improve your education, take advantage of school advertising.

## High School at Home

### MANY FINISH IN 2 YEARS

No classes. No time wasted going to and from school. Progress as fast as your time and abilities permit. Standard H.S. texts supplied. Thousands enroll each year in this 61-year-old school. Send for FREE descriptive booklet.

**AMERICAN SCHOOL, Dept. H-345  
Drexel at 58th St., Chicago 37, Ill.**

Without obligation, please send FREE descriptive booklet.

Name \_\_\_\_\_

Address \_\_\_\_\_

## 7 POWER ILLUMINATED MAGNIFIER

Only \$3<sup>49</sup>



POWERFUL 7X Illuminated magnifier. Lets you see smallest object large and clear. Yes, magnifies area almost 50 times—even in dimmest light. Used by machinists, inspectors, repair shops, banks, photographers, collectors, labs, etc. High quality, precision lenses, combined with rugged, thick, chromeplated steel body. Has calibrated reading surface. You could pay up to \$10 and not get a more useful and satisfying instrument. Now only \$3.49. SPECIAL 10 POWER deluxe model—magnifies area 100 times—only \$4.49. Money Back Guarantee. Please include 25¢ with each order for special packing and shipping.

**EMPIRE MDSG. CO.**  
Dept. A-94

4 N. 3rd Ave. Mt. Vernon, New York

Smallest objects  
made large—  
clear—light





# LUBRIPLATE LUBRICANTS



## Make Sports Equipment Work Better...Last Longer!

LUBRIPLATE IN HANDY TUBES is a waterproof, semi-fluid lubricant. It's white and clean, will not wash off nor run out. Reduces friction and wear, prevents rust and corrosion. Belongs in every tackle box, gun case and car glove compartment. Nothing like it... nothing as good.



**YOUR SPORTS EQUIPMENT  
DESERVES THE BEST...USE  
LUBRIPLATE...YOU'LL SEE  
THE DIFFERENCE IMMEDIATELY**

If your service man does not have LUBRIPLATE Lubricants, ask him to write us.

### OTHER LUBRIPLATE PRODUCTS

LUBRIPLATE 2-C MOTOR OIL for outboards  
LUBRIPLATE OUTBOARD GREASES for underwater gears  
LUBRIPLATE H.D.S. MOTOR OIL for cars, trucks and tractors  
LUBRIPLATE AUTO-LUBE "A" for general automotive lubrication  
LUBRIPLATE Industrial Lubricants for every application

LUBRIPLATE DIVISION, Fiske Brothers Refining Co.  
Newark 5, N. J., Toledo 5, Ohio.

**FREE LAFAYETTE CATALOG**  
JUST OFF THE PRESS!  
NEW 180 PAGE ELECTRONIC CATALOG FEATURING  
THE BEST BUYS IN THE BUSINESS

Packed with the largest selection of Electronic, Radio and T.V. Parts, and equipment, PA, Hi-Fi systems, tubes, antennas, Transistor Kits, parts and components, Test Equipment, new build your own kits, tools, books, Microscope, drafting equipment, Binoculars, Telescopes, All Radio, TV and Ham supplies—ALL AT GREAT SAVINGS! —For the economy minded servicemen, dealer, engineer and technician. **CHUCK FULL OF BUYS! SEND FOR YOUR FREE COPY TO-DAY.**

Name \_\_\_\_\_  
Address \_\_\_\_\_  
City \_\_\_\_\_ Zone \_\_\_\_\_ State \_\_\_\_\_

*Lafayette Radio* 165-08 LIBERTY AVE  
JAMAICA 33, N. Y.

(Continued from page 76)

Snack trays .....	197
Cottage "settee" made from old car seat.....	201
Solving home problems—	
Cleaning overshoes .....	186
Cutting bread slices of equal thickness.....	186
How to keep glass stoppers from freezing.....	186
To renew bristles of brushes.....	186
Double-ended hook for bedframe.....	187
Dowel in hem of cloth used for damp-pressing.....	187
Faster flush-tank float.....	187
Miniature clipboard .....	187
Spreading liquid wax.....	187
"Disposable" funnel improvised from beverage container.....	188
"Frozen" drum-trap cover loosened with hammer and punch.....	193
Improved system sterilizes and filters furnace air.....	200
Valve permits draining sink trap to prevent freezing.....	200
Paint mixed with coat hanger.....	208
Roof coating in colors.....	217

### MISCELLANEOUS

"Dodging" card for enlarging has variable hole selector.....	179
Corks in drawing board provide "renewable" surface.....	188
Fan-shaped panel "trims" fence.....	188
Ornamental flagstaff tips.....	188
Ventilator for a doghouse.....	188
Highflying light kites from Japan.....	189
Garden cart has lift-out basket.....	194
Identifying filter containers.....	196
Leader stored in film magazine.....	196
Worm used as surface bait.....	200

### ON THE MARKET

Double-channel aluminum track.....	207
Polka-dot paint .....	207
Telescoping standpipe .....	207
Weather stripping .....	207

### SHOPPING FOR TOOLS

Camper's ax .....	218
Impact-hammer unit .....	218
Reel prolongs air-hose life.....	218
Universal bending block.....	218
Vibration-dampening pads .....	218
Flexible link shaft.....	219
Metal-cutting bench lathe.....	219
Self-locking wrench .....	219
Steel-wool holder .....	219

### WORKSHOP HINTS

Easy-to-release stud driver.....	185
For accurate center-drilling.....	185
"Portable mounted" motor.....	185
Stair stringers marked accurately with square and strip.....	185
Coins used as gasket patterns.....	192
Wire covering "solder-proofed".....	192
Short cut in chair repairing.....	196
Measuring diameter of wire.....	200
Improvised bar clamp.....	208
Improvised speed wrench.....	213
Two-way cut saves blades.....	213
How would you do it?.....	214
Lathe spindle tapers cleaned safely with brass "reamer".....	216
Pointing pipe stakes makes them easier to drive.....	216
Safety-razor sanding block.....	216
V-block holds square stock when locating centers.....	216
Dual-purpose sanding block.....	217
Hammer pocket on sawhorse.....	217
Radius scribed with can lid.....	217

☐ The Trans-Australian Railway boasts the longest stretch of straight track in the world, approximately 300 miles without a curve on the 1108-mile line between Port Pirie Junction in South Australia and Kalgoorlie in Western Australia.





This is metallic green. It's actually fun to bring an old roof to life with weatherproof Al-Chroma, a product of the Al-Chroma Paint Co., Stevens Point, Wisconsin.

## MR. SOPPA BRUSHES ON A NEW GREEN METALLIC ROOF IN ONE DAY

### Now available—Aluminum Fibrated Coating in Sunproof Colors

Here's the answer to a major home maintenance problem. Faced with a dingy, worn-out roof, Mr. Soppa, of Milwaukee, Wis., reports he simply brushed on a new one in less than a day—and color-styled it to harmonize with his house.

He used Al-Chroma, a new, exclusive formulation pigmented with Alcoa® Aluminum that gives the famed protection of aluminum fibrated roof coating *plus* a choice of six sunproof colors.

It's weatherproof. An aluminum fibrated coating protects in any climate—stays firm on top, soft and pliable underneath, will not run or crack. It literally seals the surface, thus protects against surface deterioration and extends roof life. And reflective aluminum turns back part of the sun's heat, helps keep interiors cooler in summer.

**One coat hides any surface.** Aluminum fibrated coating is ideal for asphalt, slate, composition felt or concrete roofs—even well-cleaned, rusty metal. Works equally well on asphalt siding.

**Handsome metallic colors.** A good colored aluminum fibrated coating is fadeproof, stays new-looking for years. Weathering actually intensifies the colors.

**Easy to apply.** A coating like Al-Chroma comes ready mixed, requires no thinning or heating. It's easy to apply with brush, squeegee or spray gun.

**Alcoa does not make roof coatings,** but we will be happy to refer you to reputable manufacturers who do. Send today for our free booklets, *Painting With Aluminum* and *Aluminum Asphalt Roof Coatings Make Time Stand Still*.

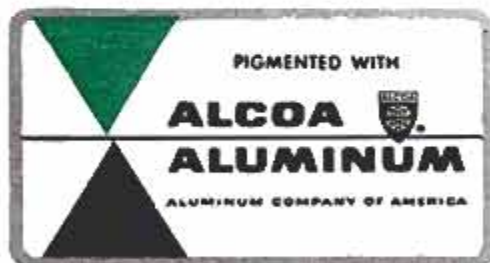

**"ALCOA THEATRE"**  
Exciting Adventure  
ALTERNATE MONDAY EVENINGS

Aluminum Company of America, Paint Service Bureau  
1718-C Alcoa Building, Pittsburgh 19, Pennsylvania

Please send your free booklets:

- Painting With Aluminum*  
 *Aluminum Asphalt Roof Coatings Make Time Stand Still*

I am interested  
in protecting \_\_\_\_\_

Name \_\_\_\_\_

Address \_\_\_\_\_

City \_\_\_\_\_ Zone \_\_\_\_\_ State \_\_\_\_\_



# Preferred

by more engine manufacturers  
for original equipment  
and replacement service  
than any other piston ring!



**INTERNATIONAL HARVESTER**—one of the leading engine manufacturers using Perfect Circle piston rings for both original equipment and replacement service.

Behind the world-wide preference for Perfect Circle is a history of more than half a century of PC engineering leadership—and more. There's a history, too, of unceasing creative research...a constant search for the new and the better...matchless manufacturing skills...and scores of contributions to the forward march of the automotive industry, year after year.

You benefit from Perfect Circle achievements every time you buy a car, truck or tractor equipped with PC piston rings or

other components that bear the mark of Perfect Circle perfection. And you're sure to benefit, too, when you ask for Perfect Circle piston rings when it's time to overhaul your car, truck or tractor. PC 2-in-1 Chrome piston rings are plated with thick, wear-resisting chrome that more than *doubles* the life of cylinders, pistons and rings, mean sustained power with lasting oil economy! Perfect Circle Corporation, Hagerstown, Ind.; The Perfect Circle Co., Ltd., 888 Don Mills Rd., Don Mills, Ont.

*Since 1903...partner in progress to the automotive industry*

**PERFECT CIRCLE**  **PISTON RINGS**





**POPULAR** MARCH 1958  
**MECHANICS**

WRITTEN SO YOU CAN UNDERSTAND IT  
VOL. 109 NO. 3



***He Flies Kites  
for Love or Money***

By George X. Sand

WHEN Rear Adm. Richard E. Byrd led his Operation Deepfreeze expedition to the Antarctic, the famed explorer knew from experience that very tall low-frequency radio antennas would be required

Developed during war, kite held communication devices 1500 feet in air





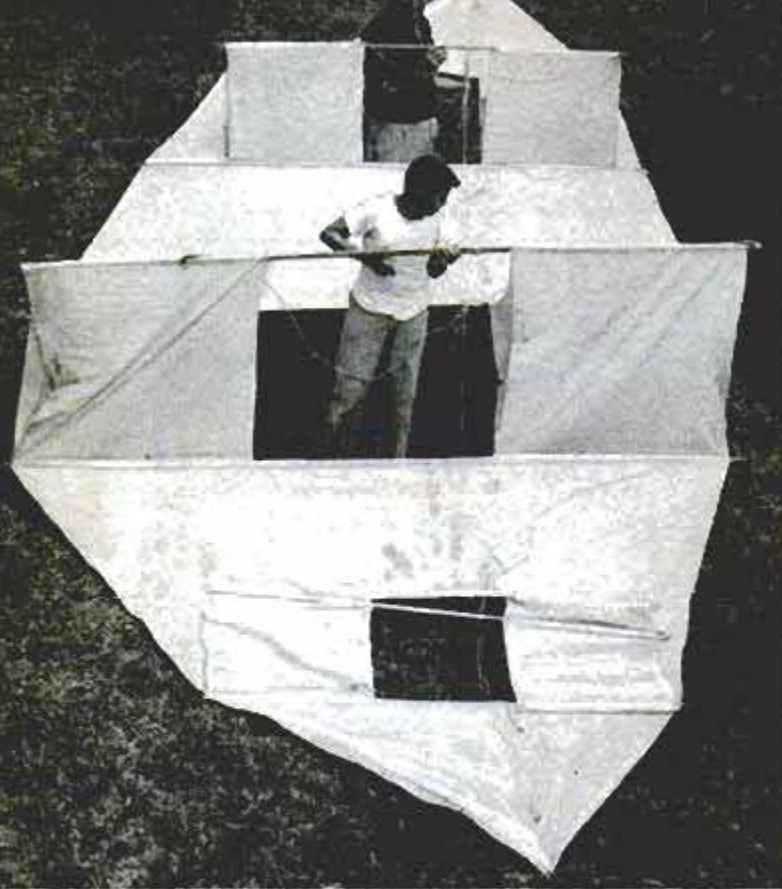

Jalbert and son display kite with 18-foot wingspread. The inventor once used it to tow an automobile

to maintain dependable communication with the outside world. The nature of the polar atmosphere was such that it hopelessly attenuated the conventional short-wave signals.

To erect huge, very costly radio masts would require transporting thousands of

tons of steel under very unfavorable circumstances. Once up, such towers would be subject to the violent storms that lash this desolate area.

Instead, Byrd decided to use captive balloons to send aloft the long antennas. However, unlike the unsteady "rubber cow" gas bags used during the last war, these balloons would have to remain practically stationary in the polar sky, regardless of the wind. A big order!

### Jalbert Knew the Answer

The Jalbert Aerology Laboratory at Boca Raton, Fla., knew the answer to Byrd's problem. The founder of this unique lab, Domina C. Jalbert, 53, is an energetic French Canadian inventor who has delighted himself by flying kites since he was four. He supplied the Deepfreeze expedition with airfoil "kite balloons" of his own origin that are part kite, part balloon, with the best features of each.

"I'd discovered that an ordinary balloon would remain stationary overhead only if there was little or no wind to blow it and its cable away from the vertical plane," explains Jalbert. "In fact, if the wind blew strongly enough it would force the gas bag right down against the ground.

"On the other hand, to remain aloft and steady, a kite required a fairly strong breeze. Without wind, the kite would dive to earth. So I compromised by putting kitelike fins and rudders on a streamlined balloon. Henceforth, the stronger the wind

Trapped air supports marker which is tossed from a ditched plane or stricken vessel to attract attention

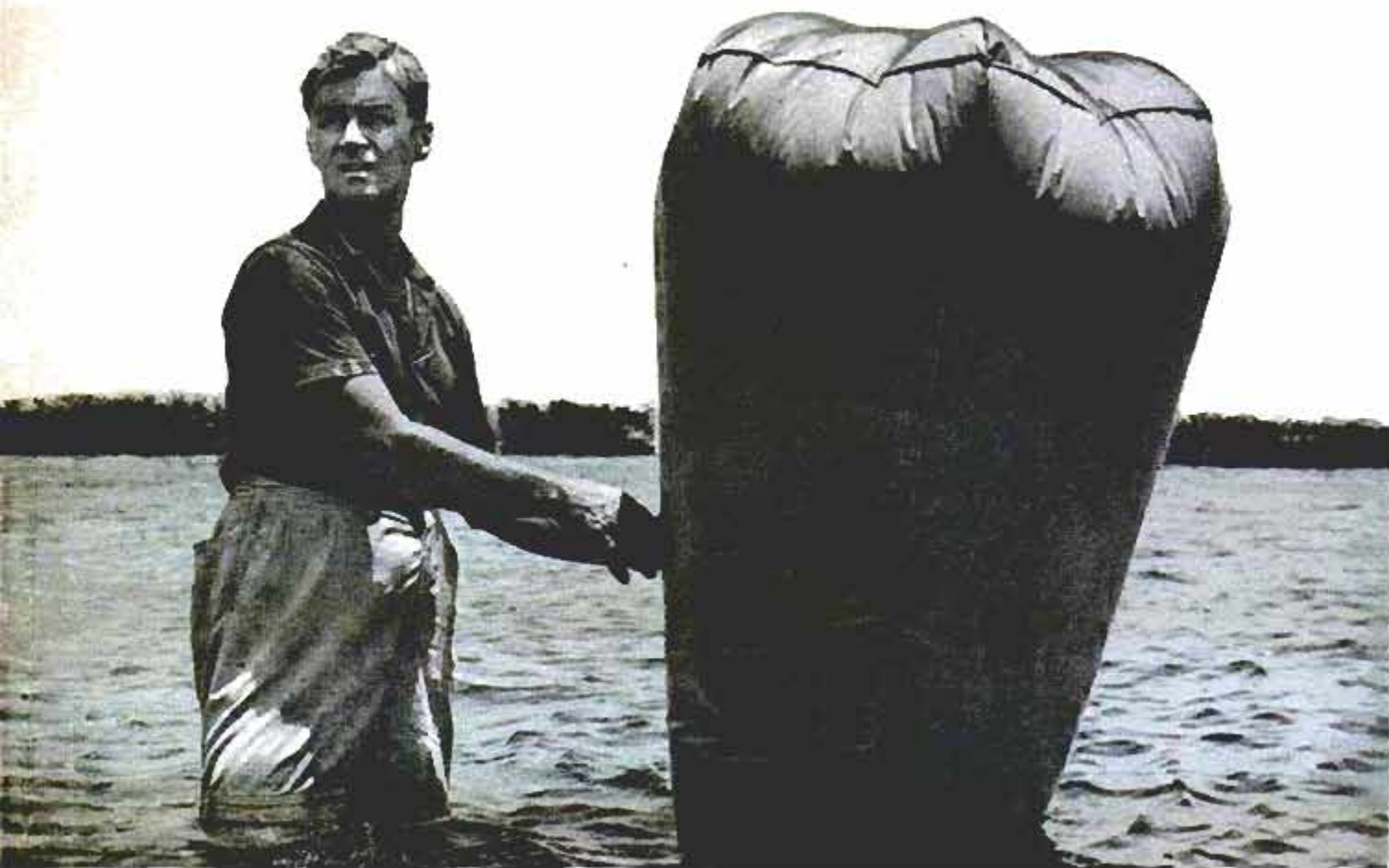



the more the kite-balloon would climb against it. And, of course, with no wind the hydrogen or helium-filled bag would remain up anyway."

Jalbert's measure of a good captive balloon is its ability to remain almost directly overhead, for days if necessary, with practically no movement. His kite-balloons have solved the problems of surveyors in rough terrain by supporting airborne sighting markers for their transits. When the Rockefeller Foundation found itself wondering how it could suspend mosquito traps above the tallest trees of the Brazilian jungle to make possible a study of malaria conditions, Jalbert's invention provided the means.

The unusual product has found application from one end of the earth to the other. Byrd used it in the Antarctic; near the North Pole, Norwegian whaling ships put it to work to mark the location of harpooned leviathans, preventing loss of the floating carcasses.

Several years ago the University of Washington wanted to record on film the activities of spawning salmon in the rivers. However, experience warned that the sound of a boat or plane motor, even the splash of a wading cameraman, would disturb the fish and defeat the purpose. You guessed it: one of Jalbert's kite-balloons was weighted down so that it floated silently over the unsuspecting salmon while an automatic camera made the pictures.

Sometimes when optimum conditions prevail, Jalbert will use a straight kite on his projects instead of the kite-balloon. Once the Woods Hole Oceanographic Institute had him make a kite for measuring

Jalbert kite is used to suspend smoke-measuring instrument above chimney in a city's antismog campaign

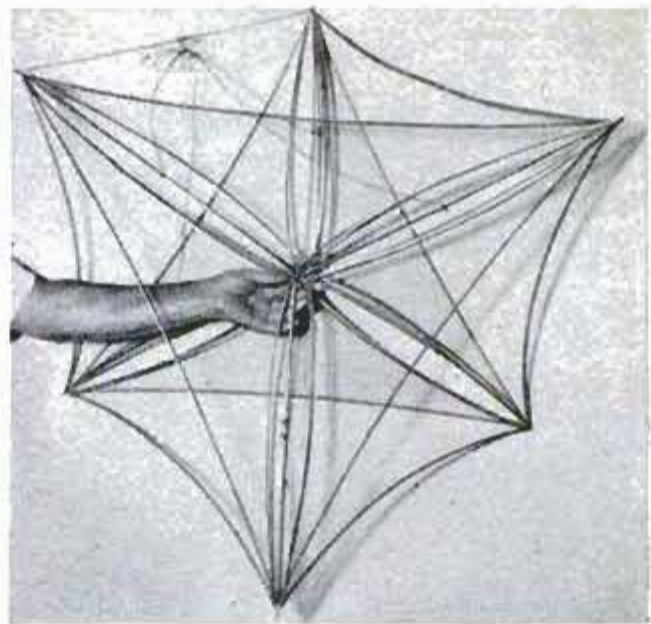
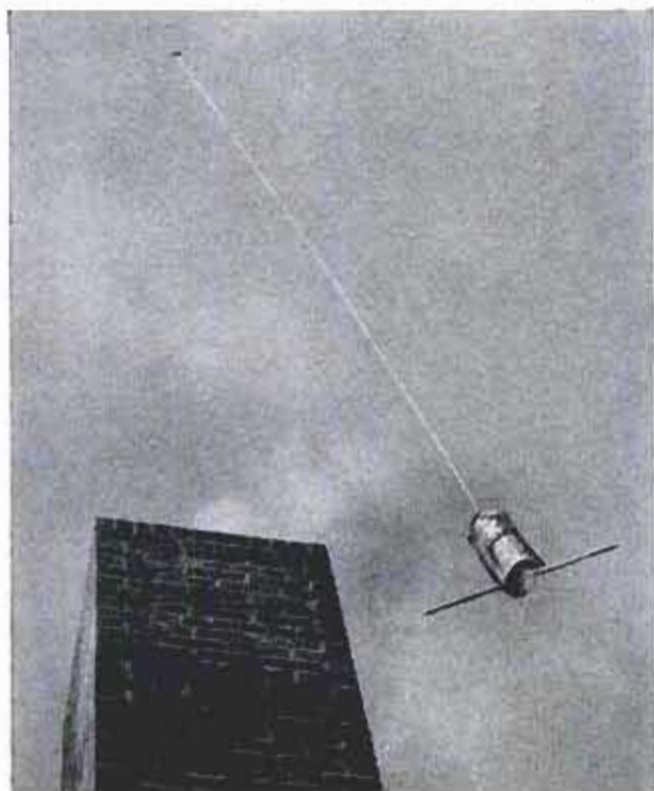

Collapsible radar reflector is stored aboard lifeboat, flown to pinpoint location of drifting boat

the depth of the Caribbean Sea in the vicinity of the Virgin Islands. "Because the southeast trade winds blew steadily in that area the kite easily held up the depth-recording instruments," he says.

He uses Egyptian cotton for the construction of his kites.

"Speaking of kites, I think I hold the world's surf-casting record—1500 feet," says the inventor with a chuckle. He'd gone fishing for striped bass at Martha's Vineyard, Mass., but the fish insisted upon remaining far offshore. So Dom rigged up a kite to fly his bait out to the stripers where it was released to fall among them.

However, the majority of the clients' letters in the files of Dom's 10,000-square-foot aerology laboratory in Florida deal with the kite-balloon. An Oregon vacation site, located deep in a wooded wilderness, flies a telltale kite-balloon directly overhead. This marker in the sky enables lost tenderfeet to find their way back to camp.

The "sky hooks" are likewise used in everyday life to hold aloft eye-catching signs that promote everything from political campaigns to fund-raising projects, fairs, carnivals and the opening of new business establishments. In Texas, cowboy residents blinked unbelievably when a huge American flag unfurled itself in the sky above a supermarket. High above the flag rode one of Jalbert's kite-balloons.

His most important customer is the U. S. Government. He is a member of the Naval Institute and has been cited by the Navy. Among the classified jobs in which he has taken part are guided-missile and earth-satellite projects.

Domina Jalbert was born in St. Michael, in northern Quebec, the 17th child of a very poor family of 21 children.



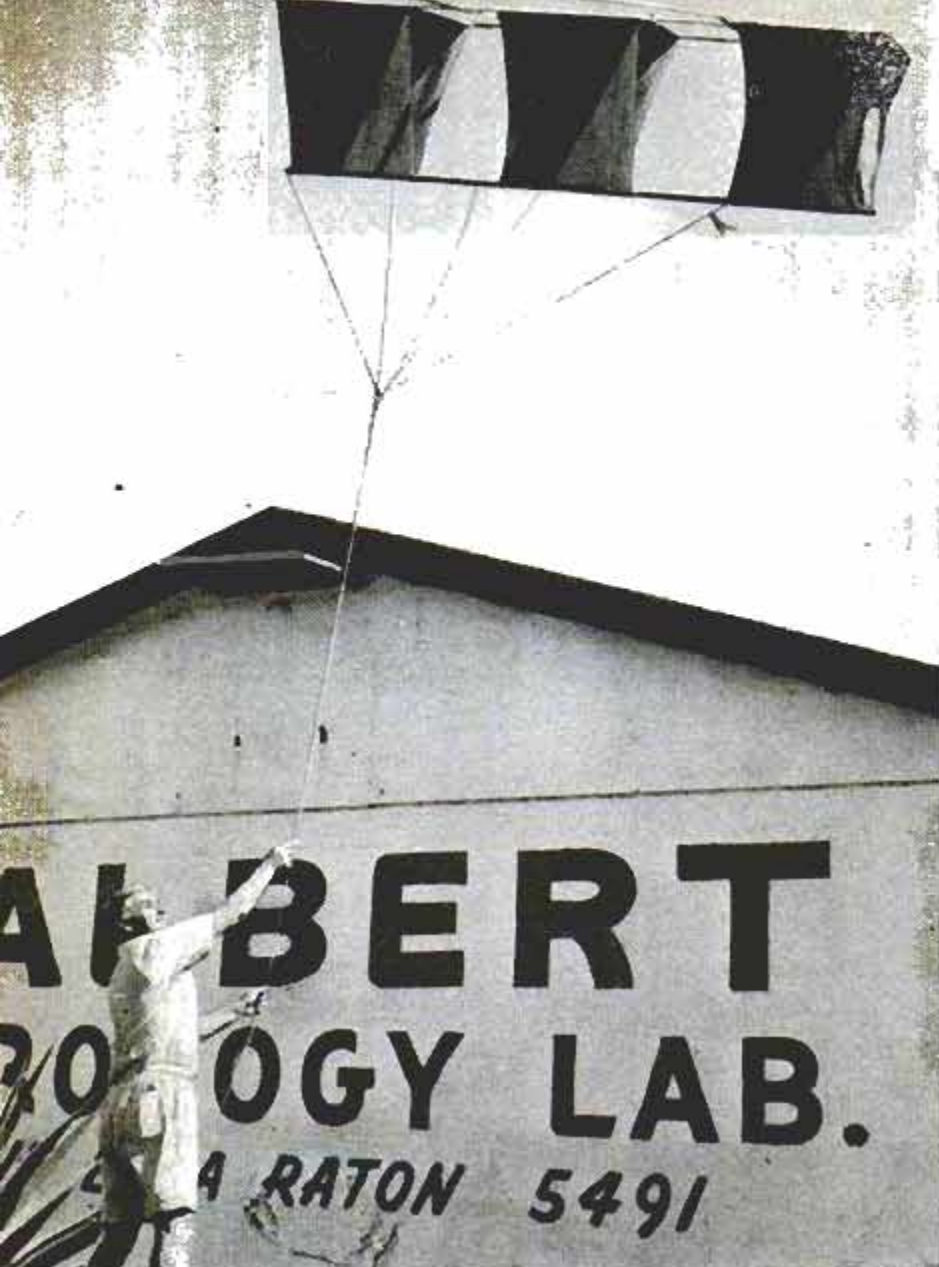

Kite six feet tall with eight-foot spread was designed to support depth-measuring devices over the surface of the Caribbean

Multicell parachute canopy developed by Jalbert will carry 35 to 40 percent greater load than a conventional parachute



"There was no railroad, no automobiles, nothing," he recalls. "There was very little money to buy clothing, none at all for toys. My mother was constantly remodeling old clothing from one child to fit the next younger.

"I used the leftover rags to make kites to play with. Kites fascinated me. I made all kinds. I even flew them in the rain. What few neighbors we had thought I was crazy."

By the time the boy was 14 his family had moved to Woonsocket, R. I. To help his struggling parents, he quit school at the sixth grade and went to work in the woolen mills. He has had no formal schooling since. Yet this self-taught inventor is often invited to lecture at large universities.

Dom continued to play and experiment with kites at every opportunity. At first puzzled why the same kite would fly perfectly one day, then badly the next, he learned how changing winds, temperatures and other factors could affect the performance of his kites.

He built a kite with an 18-foot wingspread that could tow an automobile. And he stumbled upon the advertising potential of his hobby one day when he flew a political candidate's name above the city for \$15. The man was elected—only member of his party to win.

Meanwhile, young Jalbert had become interested in foot racing, no doubt the result of running fast since childhood to launch his kites. He won several dozen trophies as a sprinter, and became national walking champion in the early '30s.

Although friends continued to ridicule him for "playing" with kites, Jalbert kept on stubbornly. By this time he'd learned that a properly rigged kite could be expected to fly almost directly overhead, with very little drag or bow (catenary) in its line. If the bow was permitted the kite would very likely end up in tree tops.

This catenary was not caused by the weight of the line; rather, by the pressure of the wind against the total area of the string, and the effect of gravity. When this combined pressure overcame the dynamic lift of the kite, down everything would come! (If you computed the area of the line by





Square chute of multicell type is more efficient than round one. With several cells ripped, chute still supports load

taking its diameter — including the “fuzz” of the weave—and multiplied this by the length, you nearly always found you had a square area almost equal to that of the kite surface which was trying to lift it.)

“By the time World War II broke in Europe my years of experimenting with kites and small balloons had taught me the art of precision rigging,” Dom recalls. “It happened that my hobby represented something for which few people had trained themselves. The U. S. Rubber Company made me chief rigger of their barrage-balloon division.”

England was in urgent need of barrage balloons for protection against Nazi dive-bombers. In Dom’s home town of Woonsocket floors and wall partitions were hastily ripped from an idle factory building to provide space for building the cumbersome gas bags. They measured 76 feet long, 28 feet high, and each one upon completion would fill most of a three-story wing of the plant.

In one 300-foot-long assembly room dozens of girls cut out the more than 100 different patterns that were required, cementing these together on the floor. These employees wore special moccasins to aid the constant battle against dirt. A single piece of grit—should it be overlooked and aggravated later by a violently tossing balloon at several thousand feet—could cut into the cotton fabric like a knife.

Collapsible rubber boats were also manufactured in this U. S. Rubber Company plant. And Dom invented a collapsible kite to be stored inside a small cylinder aboard rubber boats, to serve as a rescue signal for drifting sailors and airmen.

“The Air-Sea Rescue Service wanted other things developed,” he remembers. “I was transferred to the Dewey and Almy Chemical Company at Cambridge, Mass. There I worked with kite-balloons in various scientific fields, traveling extensively throughout the country. I made kites for the Massachusetts Institute of Technology and for the Signal Corps.”

After the war Dom decided to go into business for himself. There was a growing demand for stable balloons that could lift substantial loads. And with Neoprene and new coated fabrics available, the possibilities appeared good. He recalls with a smile the photographer who came to him with the request for “a kite for making aerial pictures.” When the inventor promptly hooked four 12-foot-tall kites in tandem and invited the cameraman to “climb aboard” a makeshift bosun’s chair, the lensman paled. He hurriedly explained it was only his camera he’d intended to fly. Dom’s 12-year-old daughter obliged, instead, by going nonchalantly aloft in her father’s husky rig to take the pictures.

Today the Aerology Laboratory provides standard models of airfoil kite-balloons



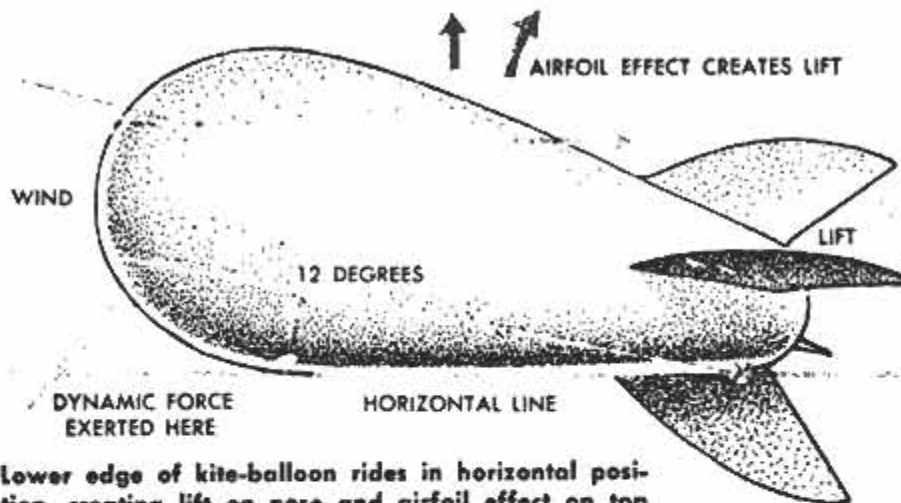

Lower edge of kite-balloon rides in horizontal position, creating lift on nose and airfoil effect on top

that meet most of the requirements of customers. Other types are available on order. The standard jobs vary in length from 16 to 30 feet, in diameters from 7½ to 12 feet, and will lift gross weights from 22 to 122 pounds, depending upon whether helium or hydrogen is used.

Jalbert is convinced that kite-balloons would be put to much greater use today had not much of his work been of a secret nature for the government.

"As a result, when you say 'balloon' today the public immediately visualizes the clumsy, old-fashioned barrage type," he says. "This is like comparing a modern car with a Model T!"

He explains the general operation of his own streamlined units thus: "The belly or bottom rides in the horizontal position. From the diameter of the nose to that of the tail you have a 12-degree 'angle of attack.' The wind shifts slightly below the nose and creates a lift, going over the top of an airfoil that provides a vacuum and lifts the balloon straight up."

Fortunately, the operators of an Ohio radio broadcasting station do not share the general public apathy concerning balloons. When a tornado hurled their steel tower to earth they phoned Jalbert to rush a kite-balloon by air. They got it next day and resumed broadcasting with a temporary antenna.

"To their surprise, they discovered they had a 50 percent greater coverage," says Jalbert. "There apparently was less grounding effect caused by the wire that replaced the tower."

In 1950 Domina Jalbert used one of his "sky anchors" to demonstrate a technique which has since revolutionized air-pollution studies. Assisted by engineers at the Columbus, Ohio, Battelle Memorial Institute, he sent aloft instruments to gather samples of gases and solid particles which pollute the air. These were collected in bottles and piped down a small rubber tube to the ground by a vacuum process.

In addition, battery-powered instruments simultaneously recorded the velocity and direction of the wind, humidity, air temperature and other weather factors.

Dom demonstrated how the kite-balloon could be used to suspend the recording gadgets in the center of gases being emitted from a factory smokestack, or fly them high above the city. Such scientific sleuthing served

a double purpose: the guilty factory operators were usually happy to cooperate by trapping the sulphur and other smog-causing waste products at the source, since to do so would represent a substantial saving for them, while helping to cleanse the city's air.

In much the same manner Dom has assisted medical researchers in making pollen counts. And his kite-balloons have been planted in the path of tornadoes to record storm turbulence and other data. More recently, the tough gas-filled kites have felt the concussion of atomic blasts in the desert.

When a customer comes to Dom he is asked three questions: (1) How high above sea level the kite will be expected to fly; (2) how much weight must be carried; (3) the duration of the flight, and under what conditions.

The energetic inventor does not limit his experimenting to kites and balloons. He flies his own plane and is a consultant for the Advisory Committee on Weather Control, a group authorized by Congress to evaluate public and private experiments in "cloud seeding." In an experiment not long ago over the Jalbert Aerology Laboratory in Florida meteorologists released plumes of silver-iodide "smoke" from propane and oxygen-fed generators. Bright yellow balloons were simultaneously released with the vapor so that 16-mm. "time lapse" cameras could track the minute particles as upper air currents carried them into cloud banks to set up the desired reaction.

In fact, anything that involves the controlling of air, gas or liquid will fire Jalbert's inventive imagination. Many airplanes and vessels have disappeared without a trace during recent years in the tropic oceans that wash the Florida shores. Thinking about one disaster, Jalbert found himself designing a self-inflating sea marker which can be tossed out by a ditching plane

(Continued to page 248)





"Everything but the kitchen sink" seems to describe the variety of objects drawn into jet-engine inlets

## Look What a Jet Engine Can Swallow!

BECAUSE OF THE "vacuum cleaner" type of inlets on jet aircraft engines, all sorts of foreign objects are drawn into the engines. The Pratt and Whitney Aircraft Company has been conducting exhaustive tests to prove the ability of its jet engines to ingest foreign objects while in full operation. For example, large ice balls have been fired into the engine compressor at speeds of up to 600 miles per hour to demonstrate the ability of the engines to withstand extreme hail conditions. Other

objects tossed into the company's twin-spool, axial-flow JT-3 and JT-4 engines include several varieties of birds, radio headphones, several kinds of caps, a jacket, a length of chain, rocks, bearings, bolts, wrenches and assorted chunks of metals and fabrics. The unusual experiments helped prove the reliability and safety of the jet-engine designs to the Civil Aeronautics Authority which, in turn, has certified the JT-3 and JT-4 engines for use in the new Douglas and Boeing transports.



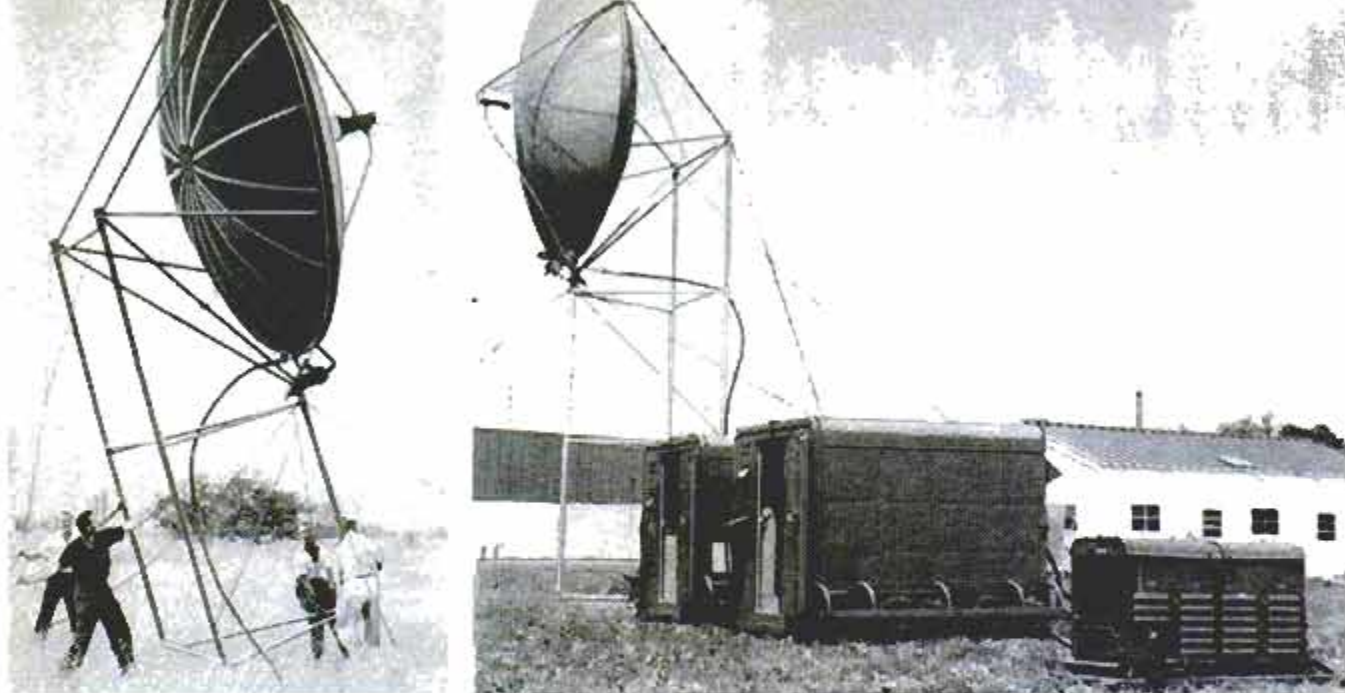

## Army Tests Portable Radio Station With "Balloon" Antenna

Capable of being packed into two metal huts and carried by transport aircraft, an Army radio terminal being tested in Arizona has an antenna that inflates like a

balloon. The plastic-fabric antenna, inflated in 12 minutes by a motor-driven blower, is a key to the portability of the unit. It reduces the weight by nearly 1000 pounds.



## Swedish Tank Killer

Being tested by the Swedish army is a new nine-centimeter antitank gun. The long-range, recoilless rifle is reported to be equivalent to a 90-millimeter gun. The weapon weighs only 176 pounds, when removed from its two-wheeled carriage. Its light weight and power are expected to make the tank killer an important weapon in Sweden's arsenal.

## Tank Pushes Steel Roller to Explode Land Mines in Its Path

Armored units can move quickly through mine fields with the help of a mine-exploding roller that travels in front of a tank. The high-strength steel roller consists of a series of 12 wheels, four feet in diameter and mounted on independent axles.

☐ Fly ash from British electric power plants is being used to increase clover and grass crops as a soil additive, to stabilize soil-cement roads, and to make bricks of 20 percent clay and 80 percent ash.





# SPACE- DOWN TO EARTH

By Willy Ley



FEW JOURNALISTS can write with the authority of Dr. Willy Ley concerning the conquest of space. One of the founders of the German Rocket Society in 1927, Dr. Ley has written hundreds of magazine articles and nearly a dozen authoritative books, two of which have become classics in this field—*The Conquest of Space and Rockets, Missiles, and Space Travel*. Starting with this issue, Dr. Ley periodically will discuss space research for *Popular Mechanics* readers.

**THE WEIGHT OF SPUTNIK NO. 1.** There has been considerable wailing by both amateur and professional hand-wringers over what these people choose to consider Russia's big lead in the missile and satellite field. No one can deny that Russia fired some big rockets and placed satellites into orbit. But there's been a deluge of poppycock about "miraculous" scientific advances that enabled them to do it. Much of this analysis reflects ignorance about rocketry. Let's consider just a few of the hard facts that the gloommongers overlook.

A little calculating sometimes can go a long way, even if it doesn't do much except lay a few rumors to rest. The planned American Vanguard satellite is to weigh 22 pounds and Sputnik No. 1 appeared in the sky with the relatively enormous weight of 184 pounds. But these two figures are literally only half of the story. The other half is in the take-off weights of the satellite-carrying rockets. The Vanguard rocket has a take-off weight of 22,000 pounds in round figures. The Russian satellite was fired with the aid of a T-2 Intermediate Range Ballistic Missile with a take-off weight of 85 metric tons. This is roughly 85,000 kilograms or 187,000 lbs. Sputnik No. 1 weighs 83.6 kilograms. Com-

pare the two figures and you'll see that in both cases the ratio between the take-off weight and the "useful payload" for the orbit is very nearly 1000 to 1.

This proves, incidentally, that the Russians did not use a "secret fuel," a fuel unknown to Western scientists. The Russians themselves say that their fuel is a highly refined kerosene burned with liquid oxygen. The 1000-to-1 weight ratio shows this to be true. They used a well-known fuel, but lots of it per second in an enormous rocket.

☆ ☆ ☆

**THE SCIENTIFIC VALUE** of a shot to the moon. It is practically certain that sometime during 1958 either the Russians or we, and most likely both, are going to shoot a rocket to the moon. Such a shot is the next spectacular event which is within reach of existing rockets. That it is not much more difficult than putting something into an orbit can be deduced from the simple fact that making something orbit requires a rocket velocity of five miles per second while the shot to the moon will require seven miles per second. This velocity can be reached by the top stage of a four-stage

(Continued to page 264)

## First U.S. Satellite

Sixteen powerful rockets were used to push the first U.S. satellite into orbit on Jan. 31. The first stage was a huge Redstone missile which normally has a range of about 200 miles. The second stage consisted of 11 special solid-propellant, 50-pound rockets. Three more rockets of this type formed the third stage, and atop the assembly was the final and "payoff" stage—a single rocket attached to the 40-inch cylindrical satellite.

In its long orbit the satellite swings out as far as 1700 miles from the earth, and comes as close as 200 miles in its nearest approach. Its speed is 18,000 miles per hour.

One little-understood feature of the satellite is its attitude or "posture" in space. It neither tumbles nor moves continually headfirst. To illustrate, hold a pencil in your thumb and forefinger and move it in a circle through the air, always keeping the pencil parallel to the floor. As the pencil "orbits" it will move headfirst, tailfirst and sideways.



# Edsel Power, Handling Are Tops, Say Owners

HOW GOOD is the Edsel? What do Edsel owners have to say about this newest member of the Ford family of cars?

*Popular Mechanics* asked 1000 Edsel owners to tell you what they think about the car. This article is their story.

Marginal comments are by Art Railton, *PM's* Automotive Editor, and are based on his test of an Edsel Pacer two-door hardtop.

Also included in the marginal notations are pertinent extracts from Dale Kelly's expert engineering analysis of the Edsel Citation four-door hardtop. Kelly's complete test report appears on page 94.

By this thorough coverage, *PM* will bring you the full story of each car it tests in this regular monthly feature to help you decide which car is best for you.

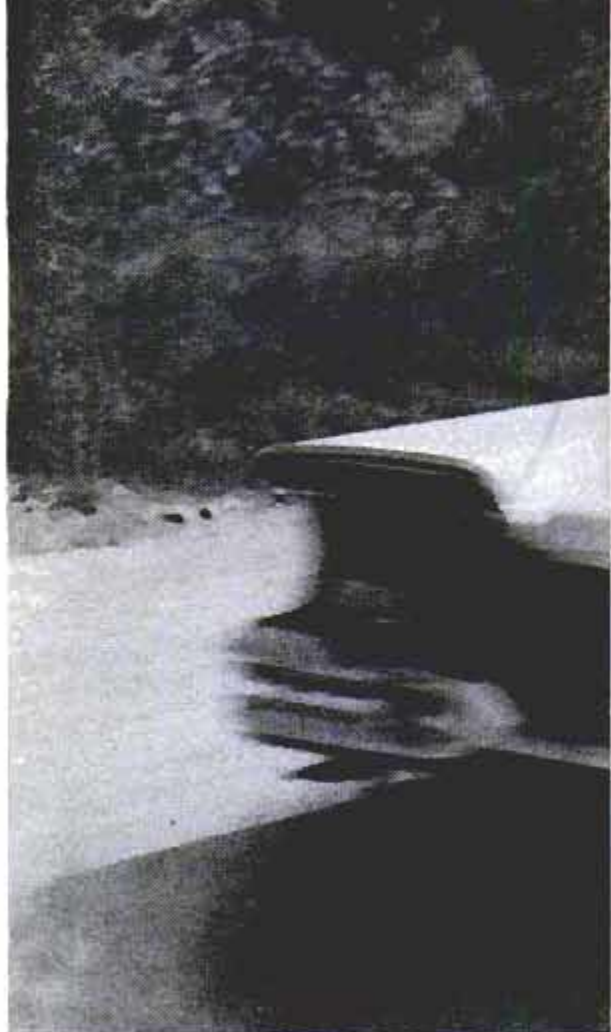

*Kelly's best 0-to-60 average was 10 seconds, not spectacular, but plenty adequate.*

*Handling was easy, but it may be a bit too much for the wheel-to-wheel ratio is too slow.*

*Riding outdoors is a pleasure in. Sprung with perhaps too soft for some but this is a good ride for the family.*

**P**ERFORMANCE is the feature Edsel owners like best, but close behind comes ease of handling. Almost half of the owners in the *PM* survey ranked one of these two items on the best-liked list.

"I like its **quick getaway**. It does 120 miles per hour (on the speedometer) easily. Its best cruising speed is 90 miles per hour."—Illinois owner.

"It has the power to get around traffic. Plenty of speed. I have had six new cars in the last two years and this Edsel has them all beat in performance."—Indiana automobile-plant employee.

"I drove from Virginia to the West Coast averaging 850 miles a day. I have never driven a car with the **handling ease** of the Edsel."—Washington serviceman.

"It seems to fit me and this makes it an easy car to handle."—Connecticut carpenter.

Third on the list of best-liked features is riding comfort with 33 percent of the owners mentioning it. Right behind it, with 31 percent, is exterior styling.

"We drove to Canada and hit some pretty bad roads on the way up. My wife was asleep in the back seat and on one of the roughest stretches of detour she didn't even wake up. This is a truly **smooth-riding car**. She even put polish on her nails in the back seat with no smears."—Texas drug salesman.

"I can say they took the driver into consideration in designing this car. He is at ease all the time."—Illinois automobile mechanic.

"Lots of station wagons ride very rough. But this Edsel wagon has a smooth, comfortable ride."—Pennsylvania self-employed owner.

"Best-riding car I've ever been in. Has heavy car comfort, light car get-up-and-go."—Maryland salesman.





**OWNERS  
REPORT**  
A NATIONWIDE SURVEY

"I like the clean cut of the Edsel. It really looks sharp."—Michigan salesman.

"I like the body style most. It is so different from any other car."—Oklahoma tile layer.

"Styling is prettiest in the industry. I am glad it does not have big, ugly tailfins. I would not have bought it if it had."—Kentucky oil-company employee.

### And They Complain, Too

More than a third (36.3 percent) of the Edsel owners have no complaints at all about their cars. In fact, there is only one complaint that can be described as frequently mentioned. It is **poor workmanship** in assembly which results in many trips to the garage for service. Slightly more than 16 percent of the owners list this fault. Some of their criticism is serious.

"This car has been in the repair shop almost every other day. The exhaust pipes rattled. The tachometer clicked. The heater did not work. The electric shift did not work properly. Rear windows do not go up and down easily (it's a convertible)."—New York owner.

"Workmanship very poor, the welding especially. After I paid for the car, the dealer took me aside and said, 'We want you to know, we only sell this car, we do not make it.'"—New York procurement representative.

"Dealer replaced at no cost to me the following parts: Automatic transmission, rear-end assembly, three windshields, speedometer."—Indiana television engineer.

"Took a 1600-mile trip. When I reached home only the motor and cigarette lighter were working. Power steering went out, radio dial jammed, vent motor failed with vents open, shift buttons failed at times."—Alabama owner.

The most frequently mentioned of the specific complaints

*One man's meat is another man's poison, and vice versa. That's the story of styling.*

*Faults like these don't show up in the usual road tests. Here the true value of the Owners' Report shows up. We are testing not just one car, but hundreds of cars with the help of owners from coast to coast.*

*The calculated risks of mechanical servants. None of these failures would have occurred with old-fashioned manual controls.*





Edsel owners don't agree about the attractiveness of the grille, but all seem to agree that it's distinctive

*No complaint of this on the test car.*

*Test car did ping slightly on hard pulls, but super-premium gas was not used, only straight premium.*

*Although it was a hardtop, the test car developed no squeaks or rattles during the 500-mile test.*

*Kelly's report shows that about 12 miles per gallon is all you can expect from the Edsel Citation for all-around driving.*

deal with power-steering trouble, the engine, dealer service, body noises, poor gas mileage (a perennial complaint of new-car owners) and sloppy paint job. Here are some of the things the owners say on these subjects:

▶ **"Power steering groans** on sharp turns. The belts have been adjusted but it still groans."—Ohio osteopath.

"Steering not up to par. There's a rattle in the hub of the steering wheel too."—New York factory worker.

▶ **"Engine appears to be building up carbon. Knocks** in spite of spark adjustment. It may be that a big engine will have this trouble as it is rarely possible to operate it at any more than a small part of its power."—Washington salesman.

"Noisy engine from the start. Rod bearings loose and replaced at 3000 miles. Knocking again at 6050 miles."—Wisconsin supervisor.

"Service is bad. I blame the factory. The people who service the car just don't know how to do so. They say they spent 250 million, they should have spent a couple of million more teaching service managers how to service the car before it was put on the market." — Pennsylvania inspector.

▶ **"Too many squeaks and rattles."**—Wisconsin owner.

"Carburetor not adjusted right. Uses a lot of gas. About 10 miles per gallon."—Massachusetts pharmacist.

"Have to use super fuel. When spark is retarded to eliminate knock, power and economy disappear. Dropped from 16 down to 13 miles per gallon."—New York salesman.

▶ **"Poor paint job. Dealer has repainted it twice. Worst paint job I ever saw on a new car."**—Montana druggist.

"Painting job is the worst I have ever seen. The fabric on the ceiling is a lousy job also. It is full of wrinkles."—Ohio painter and decorator.

### What Make Traded?

Since all Edsel sales are conquest sales (the term used in the industry to describe a change from one make to another), it is interesting to see what makes were traded.

As you might expect, more Fords were traded in on Edsels





You can put a lot of money into the dash—most everything costs extra. Cheapest item is \$2 glovebox light

than any other make, with Mercury coming in second, just a fraction of a percentage point above Chevrolet. Here are the percentages: **Ford 32.8 percent; Mercury 11.7 percent; Chevrolet 11.5 percent; Buick 7.4 percent; Pontiac 6.8 percent.**

Asked what make they will buy next time, the Edsel owners show an average amount of loyalty. Just about half (51.6 percent) say they will buy another Edsel. About 30 percent are undecided or do not answer. Of those who plan to buy some other make, the one most likely to be bought is Ford with 4.1 percent. Chevrolet is next with 3.3 percent, then Oldsmobile, Buick and Chrysler with 1.4 percent each. There is little evidence that the Edsel buyers are going to trade up in the Ford family as a mere 0.8 percent said they planned to buy Mercury next.

### What About That Grille?

The survey made clear that there is plenty of controversy about the **oval-shaped Edsel grille**, even among owners. When asked to name the exterior styling feature they like most, the owners rank the grille at the top of the best-liked list with 19.7 percent. When you add others who mentioned the "front end" as the thing they like best, the number totals a big 36.6 percent.

But the next question asks owners to name the exterior styling feature they like least. Once again, the grille gets top honors as 9.0 percent list it. When the "front end" answers are added, the total is 13.4 percent.

"At first people couldn't get used to the grille. In fact, they didn't like it, but as time goes on they are liking it more."—South Dakota hatchery operator.

"I like the front end because it is **entirely different** from any other. I advise the other companies to break up the straight hood like Edsel has done. It's beautiful."—California salesman.

"The front end looks too heavy and bulky."—Texas oil-company worker.

*Trouble here is that most Edsel sales seem to be coming from people who might have bought Fords or Mercurys—that's no way to increase business.*

*You either like or dislike the vertical grille—there is no middle ground. If they had to do it over, Edsel stylists probably would have "jazzed" up the front end more—the public seems to like jazz.*

*Agree. It is good that at least one company is trying to be different. There are too many look-alikes in this business—and even more "be-alikes" under the sheet metal.*





# 1958 EDSEL TEST DATA

**MODEL TESTED:** 1958 Edsel Citation four-door hardtop with four-barrel carburetor, single exhaust, automatic transmission, power brakes and linkage-type power steering.

Rear-axle ratio: 2.91 to 1. Wheelbase: 124 inches. Tires: 8.50 by 14. Weight: 4440 pounds with gas tank half full (56 percent on the front wheels, 44 percent on the rear).

Mileage on car at time of test: 4500 miles. Barometer: 29.52 inches. Temperature: 53 degrees F. Payload: 200 pounds.

## ACCELERATION TIME FROM STANDING START (in seconds)



Ignition timed for:	0 to 20	0 to 40	0 to 60	0 to 80	1/4 mile
Regular gasoline.....	2.8	6.4	11.0	17.2	18.2
Premium gasoline.....	2.6	6.1	10.2	15.9	17.6
Super-premium gasoline.....	2.6	6.1	10.0	15.5	17.4

(All tests in Drive range. Gasoline had the following octane ratings by Research method: Regular 90; Premium 97, Super-premium 105.)

## FUEL ECONOMY (miles per gallon)



Ignition timed for:	Steady 30 m.p.h.	Steady 50 m.p.h.	Steady 70 m.p.h.	Traffic Route
Regular gasoline.....	17.15	14.65	12.1	8.5
Premium gasoline.....	17.5	15.2	12.5	8.3

(In traffic test car makes 10 full stops per mile and is driven fast enough to average 15 miles per hour.)

Estimated average

**ANNUAL GASOLINE BILL: \$245 for 10,000 miles**

(Based on exclusive use of premium gas at 33 cents a gallon.)

## SPEEDOMETER ERROR (miles per hour)



Speedometer reading.....	20	30	40	50	60	70	80
True speed.....	21	31	41	51	61	71	81

## ODOMETER ERROR (miles traveled)

Odometer registered 91 miles for an actual distance of 100 miles (see below).



## DRIVER'S VISION

Driver could see part of road 20 feet in front of car, full width of road 29 feet in front of car.



## GROUND CLEARANCE (unloaded car)

Worst dip that could be crossed.....29-ft. radius  
 Worst hump that could be crossed...20-ft. radius  
 Deepest rut that could be negotiated.....7.5 in.  
 Curb clearance for door opening.....12 in.

## MISCELLANEOUS

### STEERING

Steering-wheel turns for 100-ft. circle 1.05 turns  
 Curb-to-curb turn-circle diameter.....43.5 feet  
 Wall-to-wall turn-circle diameter.....46.0 feet  
 Steering-wheel turns, lock-to-lock.....5.0 turns

**CENTER OF GRAVITY:** 23 inches

### TRUNK CAPACITY

14 cartons (one cubic foot each)

### WATER RESISTANCE (see Observations)

Splash-pan test: No leaks. Ignition not affected.

Brakes slightly uneven a short time after test.

High-pressure test: Very slight leaks in passenger compartment and in trunk.

## OBSERVATIONS

During a heavy rain, the trunk leaked badly and, because the drain hole in the spare-tire well was plugged with undercoating, the well filled with water and overflowed.

In place of a water-temperature indicator there are two warning lights. One (a red light) comes on when the temperature reaches 233 degrees F. the other (green) stays on until the temperature reaches 115 degrees. This range (from 115 to 233 degrees) is far too wide to ensure good engine performance. These lights, as well as the oil-pressure and generator-charge lights, are located very low on the instrument panel where they are partly obscured by the steering wheel.

The brightness control for the instrument-panel lights is separate from the headlight switch.

It is not labeled and is obscurely located under the instrument panel.

The steering wheel requires far too much "winding" to negotiate a given curve.

If battery goes dead with pushbutton transmission control in Park, the car cannot be pushed as the transmission cannot be taken out of Park when no electricity is available.

The unusual odometer error (showing fewer miles than actually traveled) appears to be due to an assembly-line blunder in the selection of speedometer gears. Another Edsel was tested and found to register a more usual 102 miles for every 100 miles traveled. Had the test car been so geared, it would have had the usual optimistic speedometer also.



"Don't like the horse collar in front, but I don't see it when I'm driving."—New York pipe fitter.

"The oval-shaped grille is extended too high to be attractive."—Ohio polisher.

"They should improve the grille although it is distinctive."—Minnesota contractor.

### More Best-Liked Features

Here, in order of frequency of mention, are more best-liked features listed by Edsel owners (for the exact percentages see table on page 95):

"I love the **handy push-button shift** on the steering wheel. It's the most handy one yet."—Ohio owner.

"Push buttons very good. Being able to shift with either hand is helpful."—Wisconsin minister.

"By using my thumb to shift, I can keep both hands on the wheel."—Colorado salesman.

"Fastest shift and handiest."—Vermont salesman.

"Solid feel. Makes me feel safe in turns at 75 miles per hour."—Georgia salesman.

"Substantial, secure feeling at 90 miles per hour."—Illinois tool designer.

"It has a **big-car feeling**."—South Dakota owner.

"Visibility. The large rear window gives more vision to the rear."—Massachusetts typist.

"My wife says it is the only car in which she is able to see the right front fender while behind the wheel. She is only five feet tall."—Massachusetts foreman.

"Enormous reserve power."—Illinois executive.

"Seats support back and shoulders. Passengers always comment favorably."—Missouri executive.

"Much more comfortable having the smaller part of the split front seat behind the driver."—Illinois saw man.

"I like the convenient controls: the flip switches on the panel, the heater control."—Illinois owner.

"Large trunk area."—New York maintenance man.

"I'm a rural letter carrier with 300 boxes on a route of 45 miles. I average 11 to 12 miles per gallon, which I think

(Continued to page 276)

*Disagree. The wheel-  
ing push buttons seem  
less convenient than  
the old lever. And  
the light behind them is  
much too bright.*

*Don't do it yet.  
I'd rather have  
over the panel design.*

*It's a real surprise  
that the car is so  
good. I'd like to  
know more about  
it.*

## HERE'S A SUMMARY OF THE EDSSEL OWNERS' OPINIONS:

**OVER-ALL RATING:**      **Excellent 72.9%**      **Average 21.6%**      **Poor 5.5%**

### Best-Liked Features

Performance, acceleration	48.6%
Ease of handling	47.5%
Riding comfort	33.3%
Exterior styling	30.9%
Push-button transmission	13.4%
Roadability	13.1%
Big-car feel	6.8%

### Most-frequent complaints

None at all	36.3%
Poor workmanship	16.1%
Power-steering trouble	7.9%
Noisy engine	7.7%
Dealer service poor	7.1%
Body noises	6.8%
Poor gas mileage	6.6%
Poor paint job	6.0%

### Best-liked styling feature?

Grille	19.7%
Front end	16.9%
Rear-end design	13.9%
Taillights	11.7%

### Least-liked styling feature?

Grille	9.0%
Front end	4.4%
Taillights	2.2%
Rear end	1.9%

### Had trouble with engine?

No trouble	69.7%
Some trouble	24.6%
Considerable trouble	5.7%

### What was engine trouble?

Carburetor, auto choke	9.9%
Valves	5.5%
Oil leaks	5.2%
Knock, ping	3.0%
Generator trouble	1.6%

### How is dealer service?

Excellent	59.9%
Average	28.3%
Poor	11.8%

### Would buy from him again?

Yes, would	58.2%
No answer, undecided	29.2%
No, would not	12.6%

### What car did dealer sell before?

Ford Motor Co. car	30.2%
Studebaker-Packard	23.5%

Chrysler Corp. car	14.7%
General Motors car	14.3%
Other	17.3%

### What make was traded?

Ford	32.8%
Mercury	11.7%
Chevrolet	11.5%
Buick	7.4%
Pontiac	6.8%
Oldsmobile	6.3%
Plymouth	4.4%
Packard	3.6%
Studebaker	2.5%
All others	11.1%
No trade, no answer	4.4%

### What make will buy next time?

Edsel	51.6%
Ford	3.3%
Chevrolet	1.4%
Oldsmobile	1.4%
Chrysler	1.4%
No answer, don't know	27.6%
All others	13.3%

### Approve industry style trends?

Yes, approve	77.8%
No, do not approve	14.5%
No answer	7.7%





## Electronic Cashier Changes Dollar Bill

Slip a one-dollar bill into a slot in a robot cashier and, in three seconds, you'll receive four nickels, three dimes and two quarters. The inventor, William A. Patzer of Chicago, says the device can be adapted to give other change combinations—from two half dollars to 100 pennies. It also can be modified to accept currency of other denominations. The one-dollar-bill changer will reject other denominations, fake or foreign currency.



## JATO Snooper Missile Has Changeable Nose

External design of the Army's new SD-3 surveillance drone is revealed by a model of the new missile. Republic Aviation Corporation has started production of the pilotless craft for the Signal Corps. The drone has interchangeable nose units which make it possible to change the drone quickly from one type of surveillance sensory device to another. The drone can be launched in short space by using jet-assisted-take-off equipment and it is recoverable.



## Weatherproof Shelter Built at Low Cost

Geodesic-dome principles are used in construction of a new kind of weatherproof shelter that costs about 50 cents per square foot of floor area. A slat frame of 1 by 4s, bolted in a series of triangles, is fastened to a base ring. Nailed to the frame are eight-foot squares of insulating board.

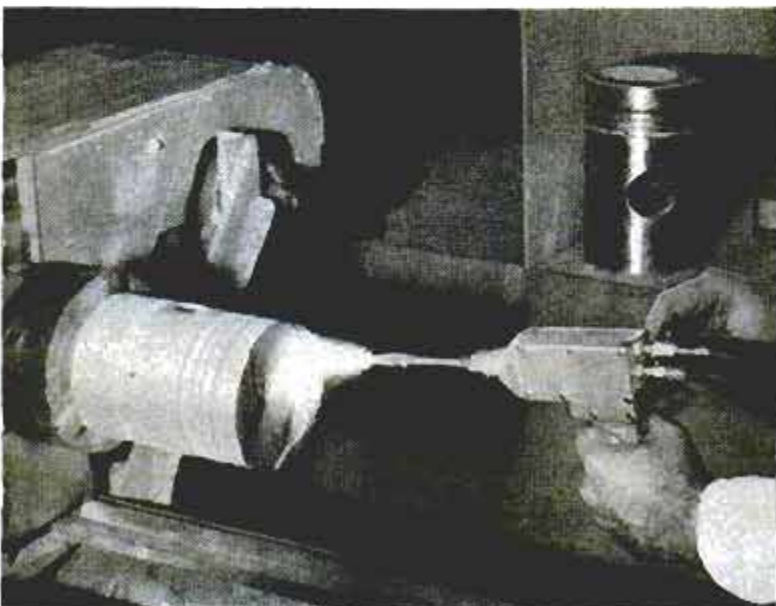

## Auto-Piston Coating Cuts Exhaust Problems

Ceramic scientists at Armour Research Foundation have developed a coating for piston heads which may eliminate some of the problems of auto-engine exhaust. The flame-sprayable coating contains rare-earth oxides that act as a catalyst in internal-combustion engines. The scientists found the coating reduced the amount of carbon monoxide and unburned carbon in auto engines during acceleration and deceleration. The coating, however, seemed to have little effect under idling conditions or at high cruising speeds.



## Look at Moon To Study Earth

Does the earth change colors during different seasons, like the planet Mars? Dr. Andre Danjon, French astronomer, has developed an "earth shine" measuring scope which may answer the question. The instrument will analyze light from the earth as it is reflected from the moon's dark side.

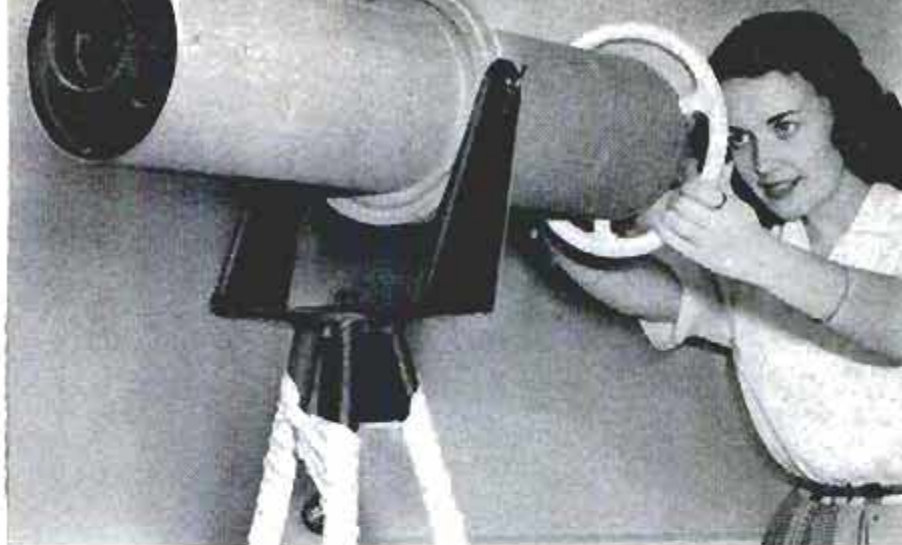

## French Jet Copter To Be Built in U.S.

Alouette II, French-designed jet helicopter which set an altitude record of 29,931 feet, will be marketed in the United States. Republic Aviation also has a licensing agreement for eventual manufacture of the five-place copter. It's powered by an Artouse gas-turbine engine which allows take-off without a long warm-up. Maintenance time reportedly is one eighth that of other copters.



## Polaroid Copy Stand For Small Objects

Photographing charts, maps, titles and small objects with a Polaroid Land camera is simplified with a new copying unit. The unit includes a camera stand, easel, timer and lights. The item to be photographed is placed on the cork easel, the fluorescent lights at the side are turned on, the timer is started and the exposure is made. The timer also can be used to time development of the picture. The 11-by-14-inch cork surface is marked off in eight sizes to conform to the shape of the film used in the camera. The fields on the easel show exactly what will appear in the picture with the camera at various heights.

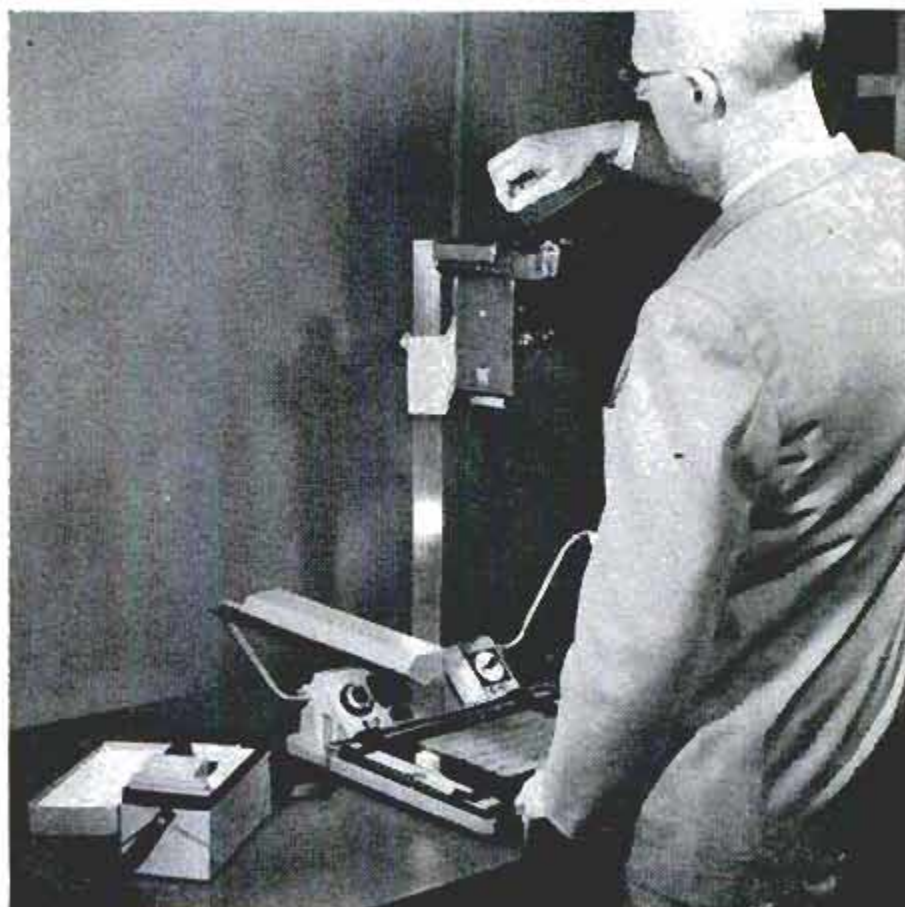



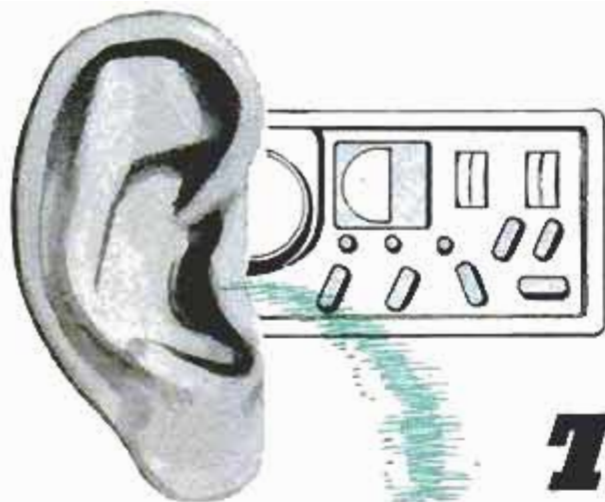

# **Electronic "Ears" Track Salmon**

By Howard E. Jackson

After sonic "fish tag," below right, is assembled it is dipped in waterproofing plastic solution. Crystal transducer at left is inserted in left half of capsule

**U**LTRASONIC TRACKING and ranging equipment has been developed for the U. S. Fish and Wildlife Service station at Seattle, Wash., to obtain information on adult salmon behavior in relation to Columbia River dams. The equipment reveals behavior patterns of salmon at fishway entrances and exits, near spillways and powerhouse sections.

It consists of a miniature underwater, ultrasonic transducer or sonic "fish tag," and a self-positioning

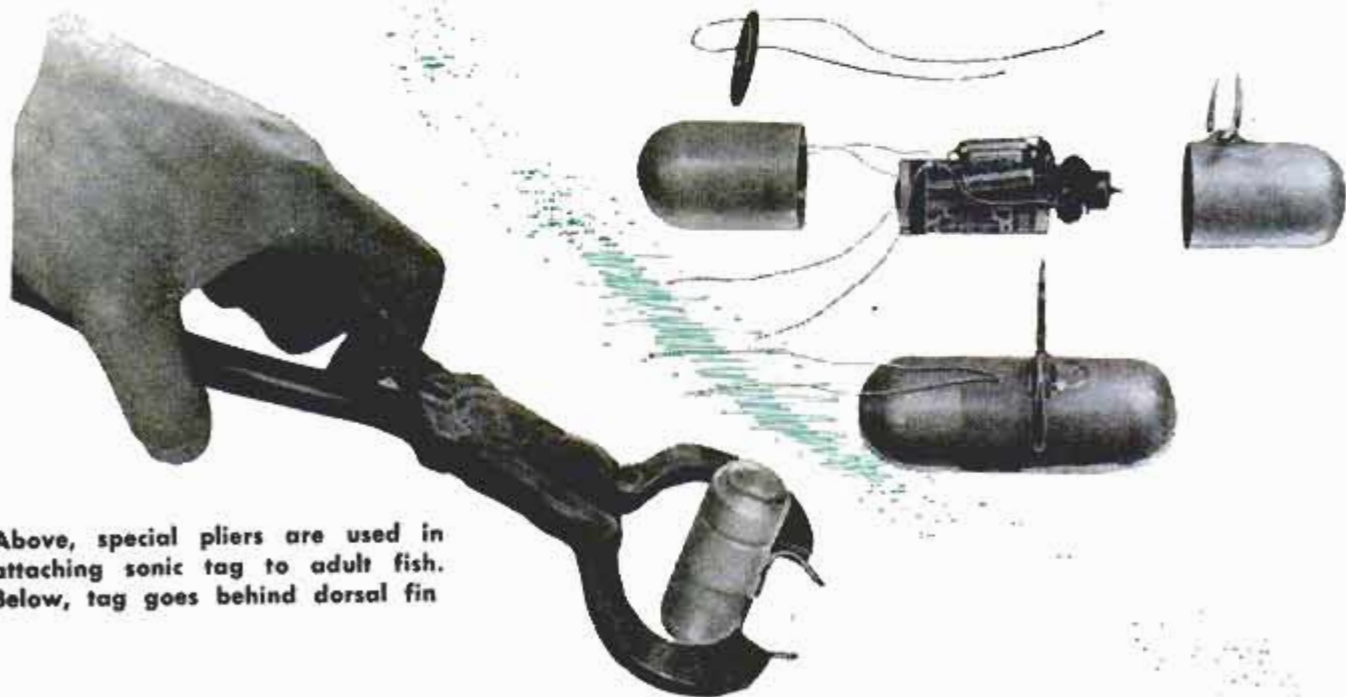

Above, special pliers are used in attaching sonic tag to adult fish. Below, tag goes behind dorsal fin





directional, echo-ranging-receiving system. After the tag is attached to a fish, the transmitted sound waves are picked up by receiving equipment on a boat. Since the receiver is calibrated in bearing, distance and angle in relation to the sonic tag, the position of the fish can be pin-pointed and its detailed movements readily plotted.

The tag is attached behind the dorsal fin of the salmon by a "hog ring" while the fish is underwater in a trap. The fish is not handled nor is it immobilized.

The transducer is an aluminum capsule  $2\frac{3}{8}$  inches long, weighing approximately 2 grams immersed. The 15-volt battery and the electronic circuits are embedded in plastic foam. The transistor is in one end, the resonating crystal in the other. The "hog ring" is soldered to the capsule.

In quiet, fresh water the sound waves can be detected up to 2000 feet. In turbulent water the distance is reduced to 65

feet. The distances in sea water are reduced by one third. Depending upon the size of the battery, the sound waves can be detected from 10 to 100 hours. Even though the fish can be detected at distances up to 2000 feet, the maximum radius within which the fish can be "tracked" is 800 feet.

The transducers' repetition rates are adjustable, allowing several tags to be used at the same time, in the same area. The position of up to 10 tags can be pin-pointed and identified with equipment that can be tuned to a desired frequency.

The automatic-tracking device "homes" on the tag and aims the echo-ranging system, which tells the movements of the tag by sending ultrasonic impulses into the water. Echoes from the fish tell its position through an indicator unit. The frequency of the sound impulses differs from that of the sonic tag, precluding interference.

The indicator unit has a viewing screen, a tilt-angle meter, a loudspeaker and a signal-level indicator, plus the operating controls. The screen, a calibrated cathode-ray



Salmon are tagged in 30 seconds inside a trap. Tag is attached by a "hog ring." Aboard boat is automatic sonic tracking-ranging receiver

tube, shows the echoes as a bright spot of light after conversion into electrical energy; the bearing and distance of the fish can be read directly. The meter shows the angle at which the sound impulses are projected into the water. With this information the depth of the fish can be calculated. The loudspeaker produces signals that help interpret the returning echoes, and the signal-level indicator shows the strength of sound waves being transmitted by the tag and indicates the distance of the fish from the echo-ranging system.

Although this equipment was developed by Minneapolis-Honeywell Regulator Company to provide data on adult salmon movements relative to dams, it can also supply information on the movements of other adult fish and aquatic animals under natural conditions. ★ ★ ★

◀ Natsyn, a new type synthetic rubber that has the molecular structure and performance characteristics of the natural, tree-grown product, has moved from laboratory scale to a tonnage-basis production.





By Art Railton

**THE GIANTS AWAKEN.** As sales of imported cars soar and domestic-car sales sag, the industry begins to move.

The big companies are involved in the race of the decade—the race for the first American small car (disregarding the Rambler American which is now being built at the rate of 40,000 a year).

As you would expect, denials are strong. The companies claim to be no more serious about the small car now than they were two years ago.

Ford has told its big boys to stop making statements on the subject. When this happens, look out. Everybody's happy to talk about the distant future, but nobody wants to talk about next year.

The small-car target is 1960, with hopes of hitting 1959. Mark it down on your calendar.

Detroit versions of the small car will range from 102 to 106-inch wheelbases. They must be a little bigger, a little more luxurious and more comfortable than the European versions.

Chevrolet seems to be ahead in the race right now, although Ford is close behind. Guesses are that designs will be conventional, sort of scaled-down American cars. This, if true, is disappointing to those who have been hoping for refreshing ideas.

Chrysler Corporation is apparently still uncertain on this subject. It might have to settle for selling a European-built car.

### What Happened to Turbines?

All the noise about small cars drowns out any talk about turbines — the much-discussed "engine of tomorrow" only a few years ago. But Chrysler continues to keep over 100 engineers on the project. There must be a future in it, that's a lot of money to invest.

Advocates say turbines will be for sale in seven years. Problems of economy and metallurgy have been licked. Even the durability angle is solved.

Of course, piston-engine men quietly laugh at such predictions. And so the battle

goes. One group minimizes the gains of the other in the big battle for budgets.

More talked about, but only a little closer to the customer is fuel injection. Much was said about this revolution, but the bloom seems to have gone. Chrysler still is not building cars with it despite the advance publicity.

Apparently, electronic fuel injection is not as foolproof as we were led to believe. It's just about as scarce an item as Mercury's 400-horsepower engine!

### Air's the Thing

Meanwhile, air suspension has become the latest engineering fad. It hasn't convinced everybody, though. One engineer describes it as a "desperate move for a sales gimmick in a softening market."

(Cadillac, however, reports a good reception by the customer and is currently fitting 22 percent of its cars with air ride.)

Air suspension has great value in load-leveling, but in comfort it's a little like the fairy tale of the Real Princess. You recall the story of how the real princess was selected from a group of imposters when she alone was able to detect a small, hard pea beneath a huge pile of mattresses. Only a real princess can detect the added comfort of air suspension.

Detroit is buzzing with rumors, if not with business these days. Ford's realignment of the Mercury-Edsel-Lincoln divisions is an indication of uncertainty. Major changes in the GM styling studios is another. The future of Detroit big wheels is more uncertain than in many years.

Rumors are that General Motors is now committed to annual style changes of major proportions. No more mild facelifts. Every division is said to be working on an all-new look for 1959 — even Chevrolet and Pontiac. Ford also may have scrapped its 1959 plans and jumped ahead to '60.

These may be just rumors, nothing more, but they indicate the uncertain air that spreads over Detroit like a fog.

Detroit has always claimed it costs as much to build a small car as a big one, hence the small car is a poor dollar value for the consumer. An engineer at a recent SAE meeting listed many areas where big money would be saved in a practical small car: Simplify grille and bumpers; use just two headlights and taillights; drop the wrap-around windshield; simplify dashboards; eliminate four cylinders, dual exhausts and four-barrel carburetors. These moves, if done, will cut prices sharply and reduce maintenance costs as well.

Somebody must make this radical move soon or it may be too late, he said. It's frightening talk, but healthy—and welcome talk to lots of consumers. ★ ★ ★



## Battle Lines on Map Sent by Teletypewriter

Teletypewriter operators can transmit "pictures" of battle lines and weather fronts through a new system devised at the University of Michigan. At the sending end, the operator scans the line through a transparent grid and sends numbers which represent segments of the line. At the receiving end, the numbers are automatically converted into the line segments on a map.



## Father and Son Build Six-Cylinder Model-T Engine

Still in good operating condition is a six-cylinder Model-T Ford constructed around 1920 from two four-cylinder blocks. It's owned by Jim DeFrango of Hayward, Calif., who helped his father, Nick, perform the "operation" with an ordinary hacksaw, a lathe and welding equipment.

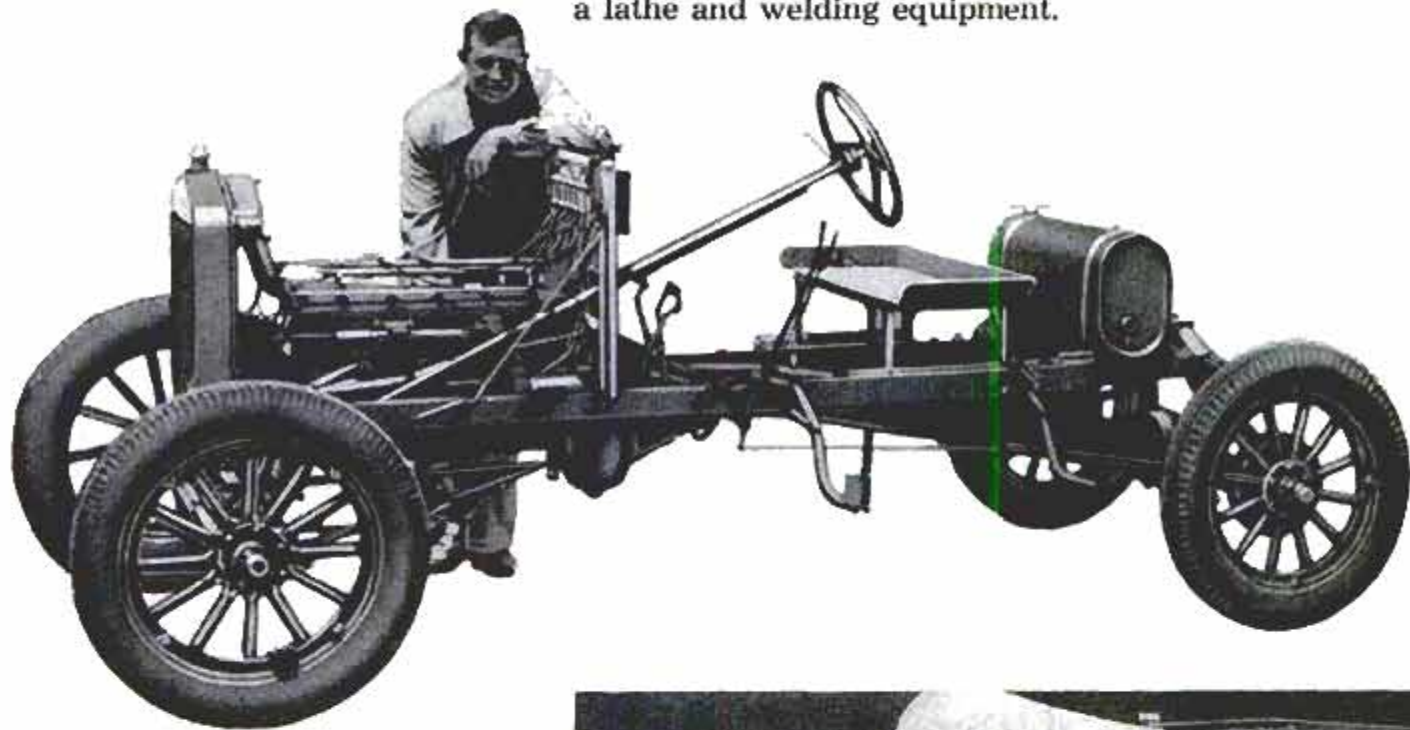

## Microfilmed Material Reproduced in Seconds

Copies of microfilmed material can be made in 10 seconds by a recently developed desk-top microfilm reader and printer. Only three controls operate the machine: One knob locates the filmed material to be copied, a dial sets the printing time and a push button makes the print. No darkroom is required; all operations can be performed in normal light. The cost per print is about eight cents.

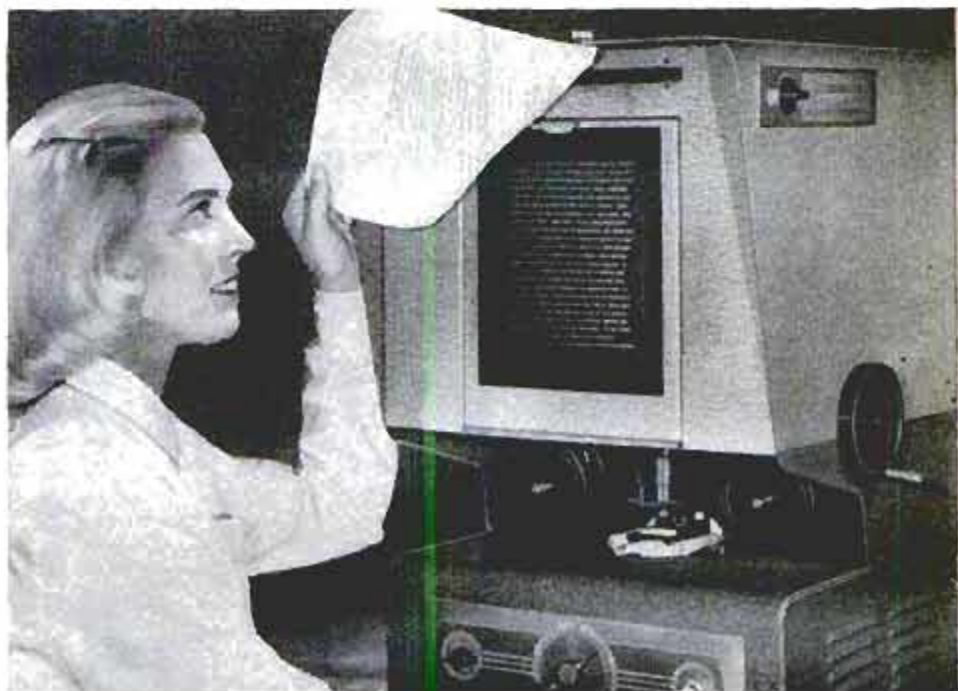



*A Killer in slow motion, the squat  
little S2F is the Navy's*

# NEMESIS OF THE SUBMARINE

*By Marvin Weisbord*

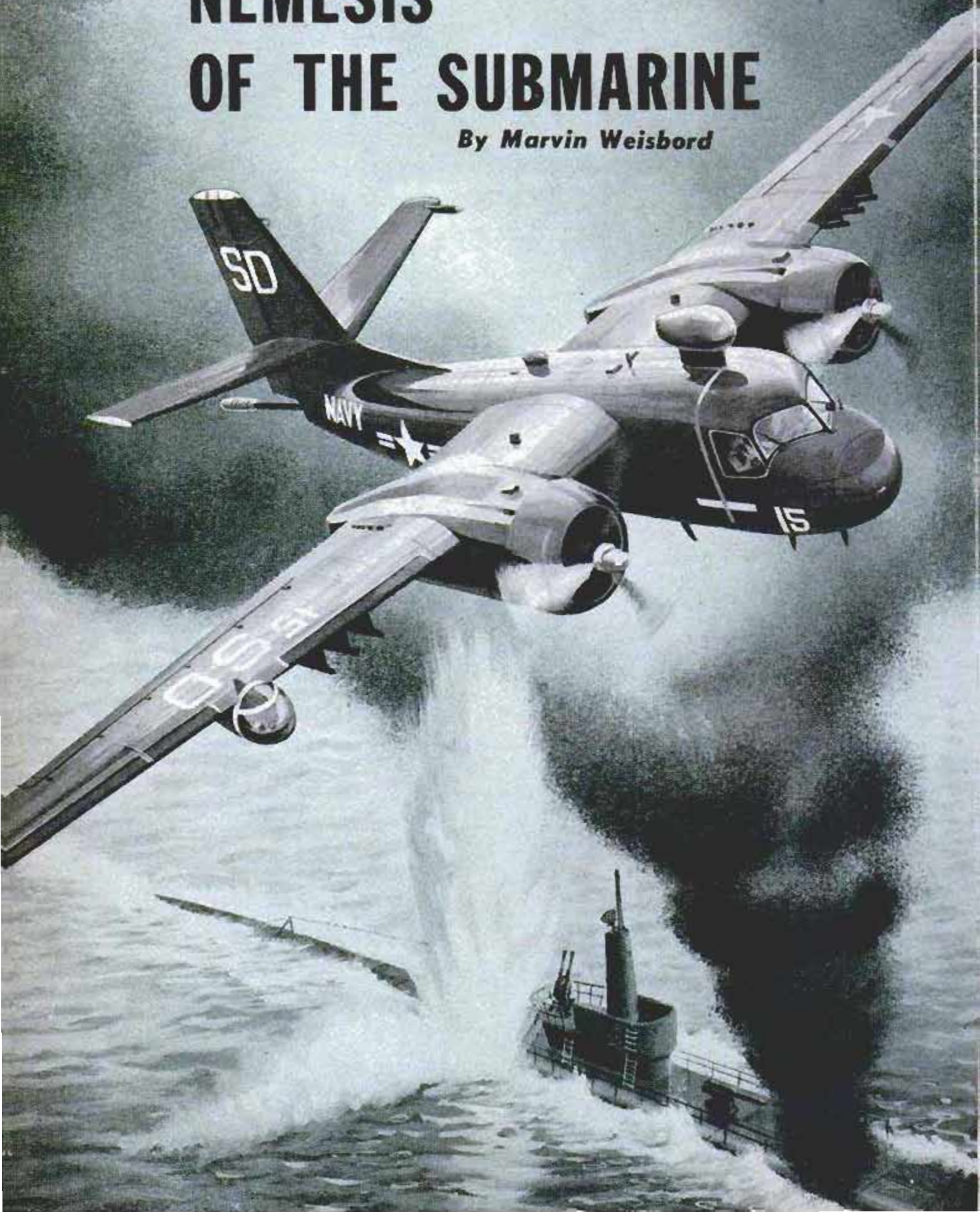





Plane director positions Tracker for take-off from a carrier. Practice rockets are visible under the wings

WHEN A NAVY PILOT landed his stubby S2F "Tracker" at an Air Force base not long ago, an Air Force pilot said, "Man, that's the oddest-looking ship I've ever seen." Two Navy destroyers, reporting the passage of S2Fs at sea, erroneously described them as obsolete World War II bombers. A Tracker pilot, folding his plane's wings after landing at another airfield, was astonished to hear the tower sending a crash truck. They thought his wings were falling off.

The obscure S2F, which baffles even veteran pilots with its small size and deceptively docile appearance, is as new and revolutionary in its field as the B-52 is in intercontinental bombing. Yet the Tracker is powered by two propeller-type engines first designed in the early 1930s. Its squat little body is barely half the size of the DC-3. It spends much of its time flying at a 140-knot crawl over open water at ridiculously low altitudes from 100 to 300 feet. Yet it is neither an observation plane nor a decoy.

Grumman Aircraft's Tracker is the first airplane ever designed from drawing board up as a carrier-based antisubmarine plane. In its field, it is the deadliest hunter-killer of submarines now flying. Indeed, it is the only carrier aircraft equipped both to find submarines and destroy them. Before the Tracker became operational in 1954, it took two powerful single-engine planes to get a sub. One large radar-equipped plane acted as "hunter"; a second AF loaded with bombs and a torpedo made the "kill."

Today a single all-weather Tracker is hunter and killer combined. Operating day and night, in fog, sleet, snow and clouds that keep their jet brethren grounded, the slow but deadly Trackers make their revealing sweeps across miles of open ocean to ferret out submarines. And pilots agree

that no sub now built can withstand a Tracker onslaught.

The Tracker pilot has a painstaking instrument job, at slow speeds and low altitudes. He is not the carefree barrel-rolling jet ace of the movies, but a methodical stalker in a mid-ocean cat-and-mouse game, and a careful, deadly killer once he has found his prey.

Three factors contribute to the Tracker's effectiveness against submarines: A wealth of electronic detecting and tracking devices including radar and MAD (Magnetic Airborne Detection); an arsenal of deadly weapons ranging from bombs and depth charges to the most advanced torpedoes and rockets; and a pair of 1525-horsepower nine-cylinder Wright engines, on either of which the Tracker can take off, fly and land if necessary.

An Air Force jet pilot, seeing an S2F for the first time, asked in perfect seriousness, "How does it fly with those things sticking out all over it?" He was referring to the

Crewmen load sonobuoys into pods located at rear of each engine nacelle. Buoys are spring-released





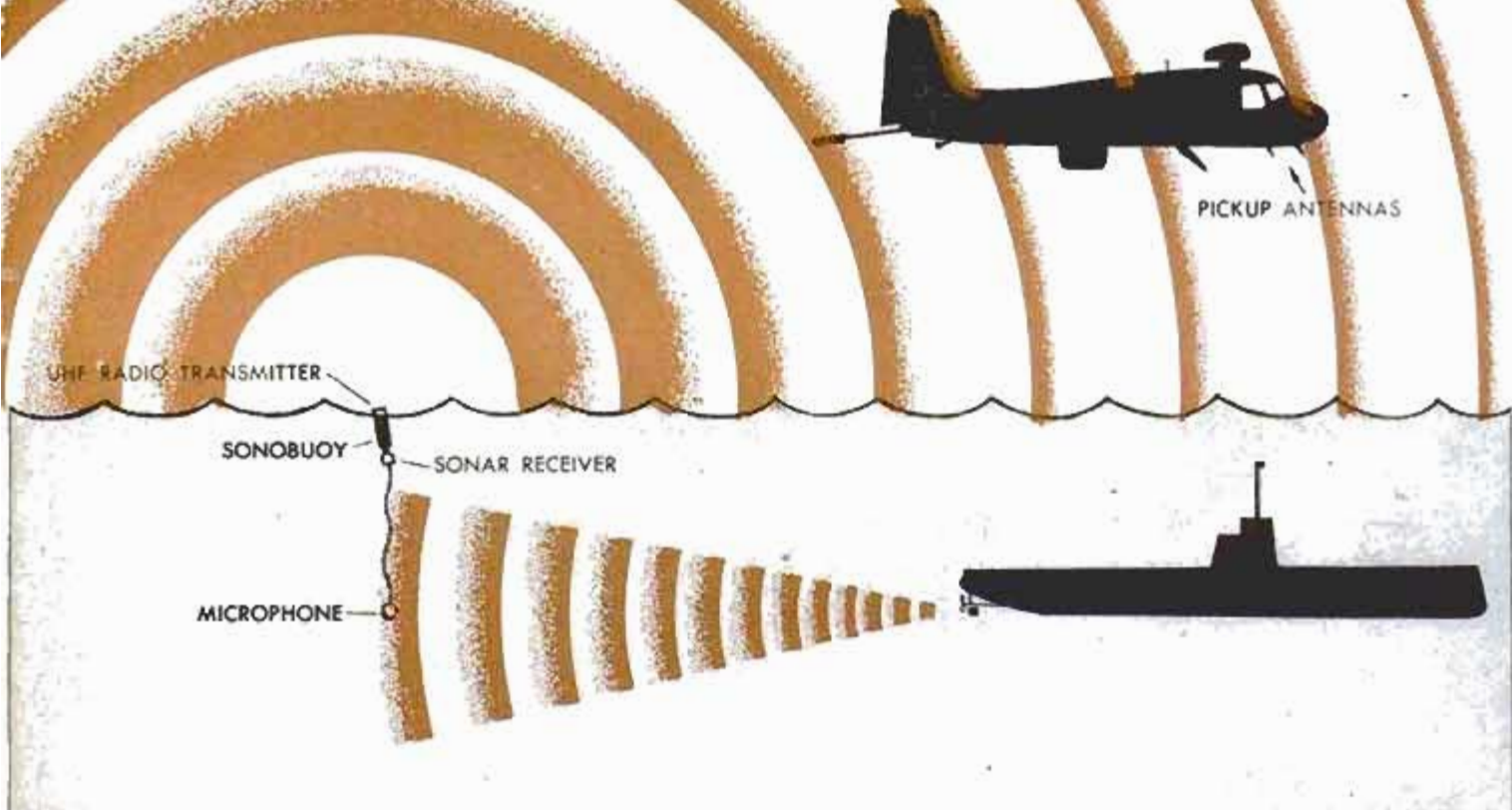

Sonobuoy picks up sound waves caused by submarine propellers. Transmitter on surface radios data to S2F

giant submarine searchlight on the right wing, the retractable radome peeking from the plane's belly, the capsule-like MAD boom tip extending just beneath the rudder, and the pod above the cockpit which houses navigation gear.

These appendages might seem strange to a man who flies smooth-skinned supersonic craft. Imagine this same Air Force pilot's surprise were he to witness a Tracker in action. On an actual mission, the radome, a radar antenna, descends four feet beneath the fuselage. The retractable MAD boom extends out 11 feet from the airplane's tail. And the Tracker sails lazily along a precise search pattern, "things sticking out all over it," its eyes and ears straining for contact with subs.

In the cockpit, each of the four hunter-killer crewmen performs specific jobs. The pilot does the actual flying and releasing of weapons and constantly checks and cross-checks both flight and tracking instruments. He must be especially precise about altitude. As one lieutenant puts it, "At 100 feet over the water there's not much difference between tracking a sub and becoming one—if you lose a little altitude." The copilot, who handles most of the navigating chores, makes the necessary voice reports to the aircraft carrier and other planes in the area. He also helps with the tracking and may spell the pilot on long, dreary searches.

Behind the pilots sit two combat aircrew men. They are enlisted men, petty officers, who work at one of naval aviation's most responsible jobs. These technicians operate the sensitive radar, MAD and other track-

ing devices. In effect they tell the pilot where to fly and when, and the exact moment to release his weapons. On the skill of these men rests much of the success of an antisub mission.

The Tracker's job is not an easy one. A submarine has the entire ocean to hide in. If the sub cuts its engines and lies quietly on the bottom, it is very difficult to detect. On the other hand, a sub that sits on the bottom doesn't sink ships. Sooner or later the undersea commander must take his vessel at least to periscope depth. If he's after a convoy, the sub makes periodic sweeps with its periscope and radar gear, then submerges again. If he's in transit, at one time or another the sub's skipper must either surface or put up a snorkel in order to recharge batteries.

During these moments when some part of the submarine sticks above water, the Tracker pilot can make contact with his radar from many miles away. Often as not a plane-crew member catches sight of a glinting periscope first and gives the alarm, "Sub!" Some pilots say that the human eye is the most reliable instrument for the detection of submarines. However, destroyers with their sonar, and helicopters, which can sweep a few feet over the surface of the water or hover motionless in one spot, aid the Tracker in its detection work.

Typical of Tracker squadron pilots in both Atlantic and Pacific fleets are the men of Air Anti-Submarine Squadron 36 based at the Norfolk, Va., Naval Air Station. Flying frequently from the aircraft carrier *USS Valley Forge*, these men train by pur-





Latest in sub-hunting equipment includes radome under S2F and magnetic airborne detection boom behind

suing and attempting to "sink" under mock battle conditions an American sub acting as enemy. They fly as much with their heads as with their hands.

"If you can narrow down a sub's position from the whole ocean to 10 square miles, you've got a reasonable chance of getting him," a pilot explained recently. Back from a practice antisub mission, he was sipping a soda in one of the *Valley Forge* ready rooms.

"You try to outfox the fox," the pilot continued. "For instance, on today's mission I knew the sub wasn't far away, but he was staying down and I couldn't pinpoint him. I'd fly in cloud cover for a while,

then dart out to check for his periscope. Turned out he wasn't biting. Sometimes we pretend to fly away in hope that he'll surface when he thinks we're gone. Next minute we come zooming over the horizon with a load of depth charges."

These ruses, however, rarely enable a Tracker pilot to make a fast kill. Usually he settles down to a slow, painstaking job of searching, making contact, tracking his quarry, and moving in for a methodical attack. Flying low with his sensitive MAD boom extended, the pilot traces a pre-arranged pattern across the water. Any disturbance in the earth's magnetic field,

(Continued to page 266)

Magnetic airborne detection gear shows sub is nearby because of disturbance of magnetic lines of force







## British Build World's First Vertical-Take-Off Airliner

Capable of transporting 48 passengers or 9000 pounds of freight at speeds up to 185 miles per hour, the British Rotodyne is

described as the world's first VTO airliner. Two Eland turboprop engines provide forward speed. Jet units move the rotor.

## Dry-Cleaned Garments Are Sealed in Plastic

Transparent plastic bags are applied to dry-cleaned garments by a new machine. The garment is hung on the machine, which forms rolled plastic into a sealed cover. After the garment is removed, the cover can be used by the housewife to store blankets or other household items.

## Six-Volt Flashlight Uses Four Dry Cells

Four dry cells fit into the barrel of a new six-volt flashlight, giving it the power of a utility lantern. The lamp weighs only 22 ounces despite its power. Its beam of light has a nighttime penetration of a quarter mile.

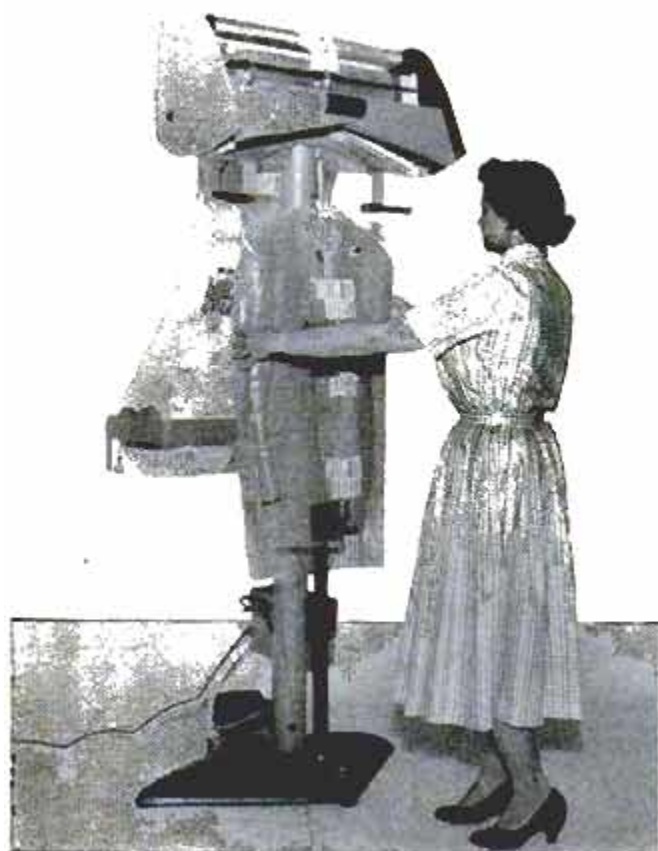



# Watch Them Build

**A**MERICA'S ROAD BUILDERS are now at work on a task that is unprecedented in the history of any nation. Some notion of its magnitude may be had from this: the plan books for one eight-mile stretch of New York superhighway contained 1200 separate maps and thousands of single-spaced pages of specifications. Now they are building 41,000 miles of superhighways and are scheduled to have the job done by 1973.

The design of some complicated structures requires 36,000 computations. The job calls for hundreds of thousands of bridges, causeways, trumpet exchanges and cloverleaves. That's a bugle blast of arithmetic such as has never been heard before. In addition, they are leveling, grading, draining, paving, shouldering, lighting, fencing and landscaping an area larger than the state of Rhode Island.

This is only for the new National System

By Ira Wolfert

*500 West End Ave  
New York City*

All photos, except as otherwise noted, courtesy American Road Builders

In the days of the five-cent cigar, highways were paved by men who loaded wheelbarrows with concrete from a steam-powered mixer. Modern equipment enabled contractors to pave the Kansas Turnpike, below, at rate of a half mile a day

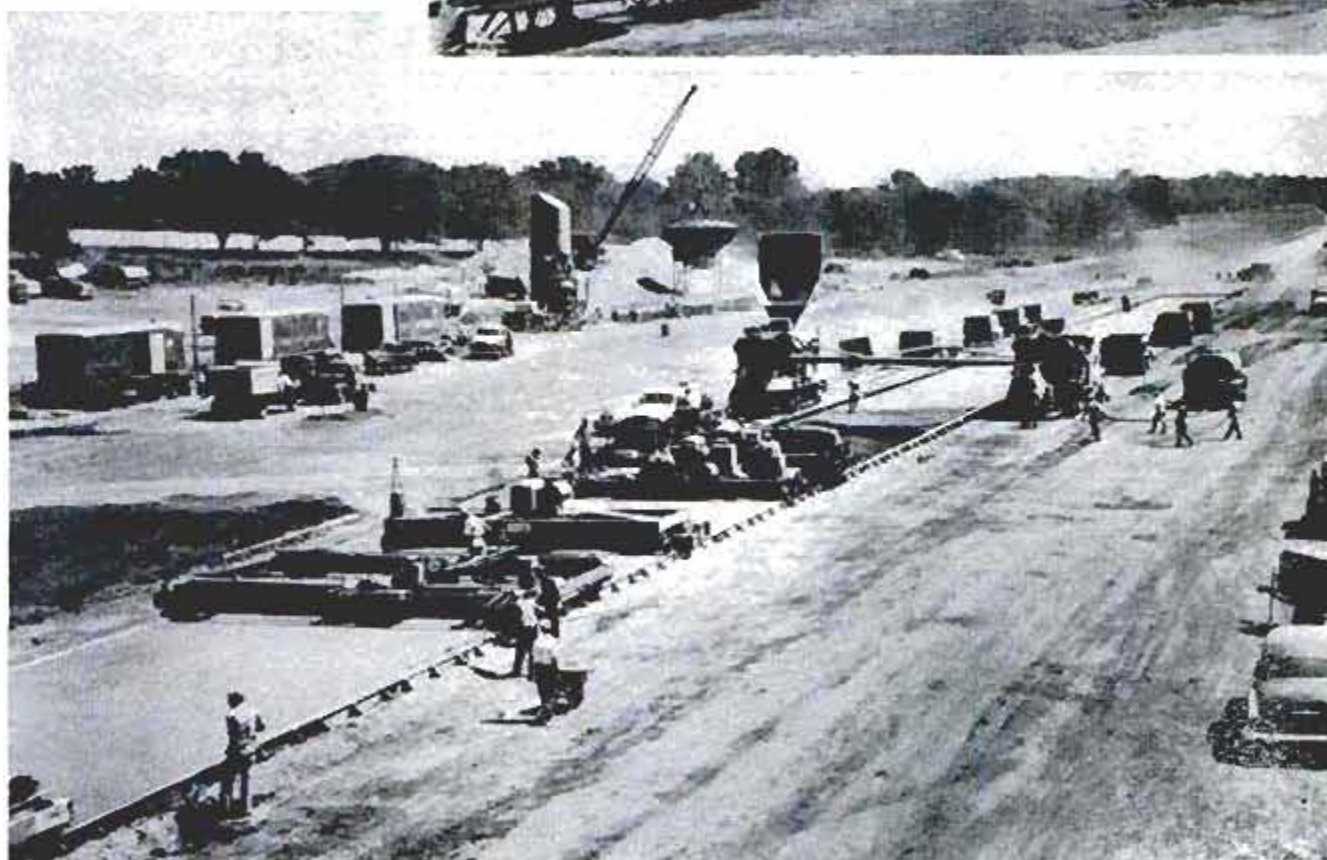
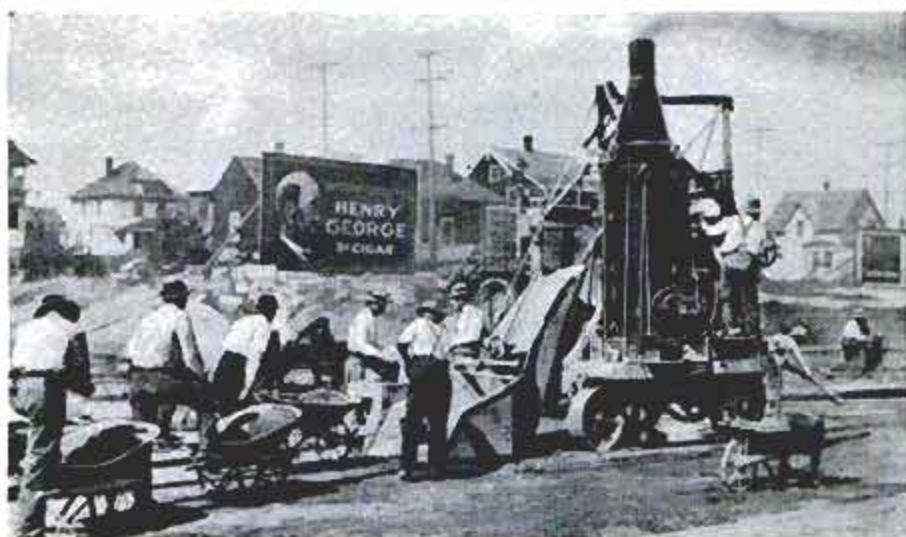





Fifty years ago, when horsepower meant horses, roads were graded with drag scrapers that moved 10 cubic yards of earth a day. Tractors today move tons in minutes

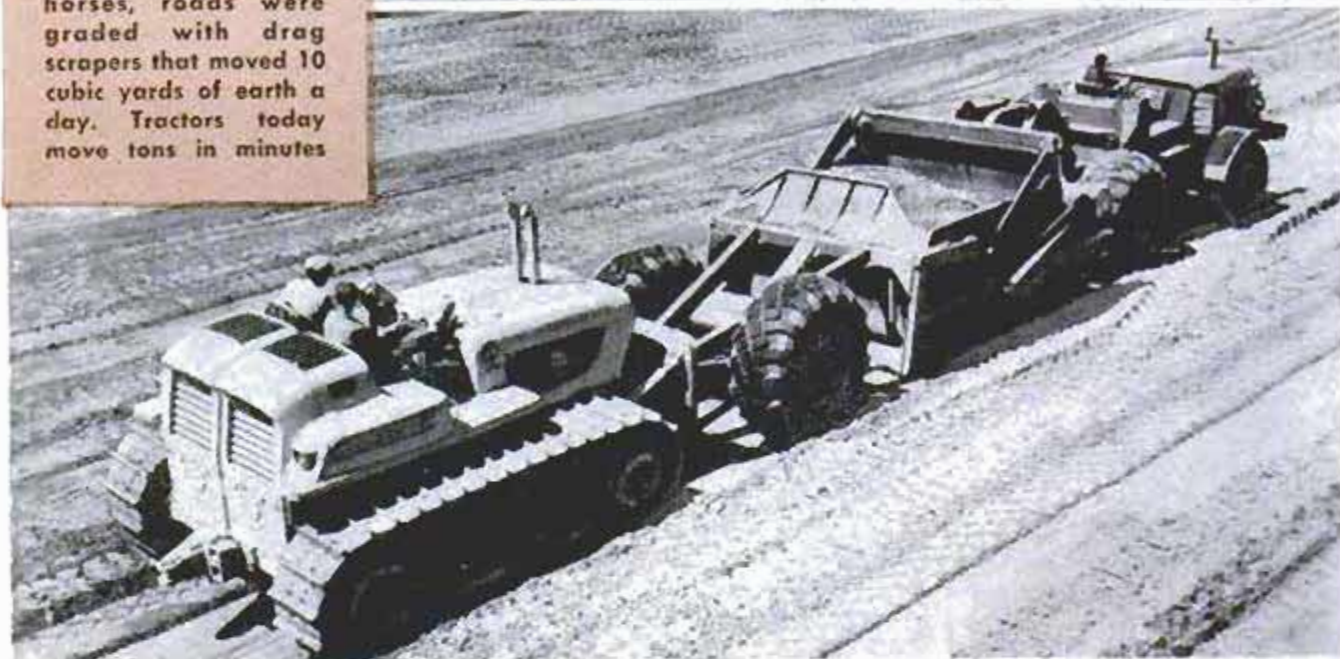

By the 1920's earth-moving had become mechanized but mule teams and wagons were still in use. The modern loader, below, shoots 15 cubic yards of dirt in 25 seconds





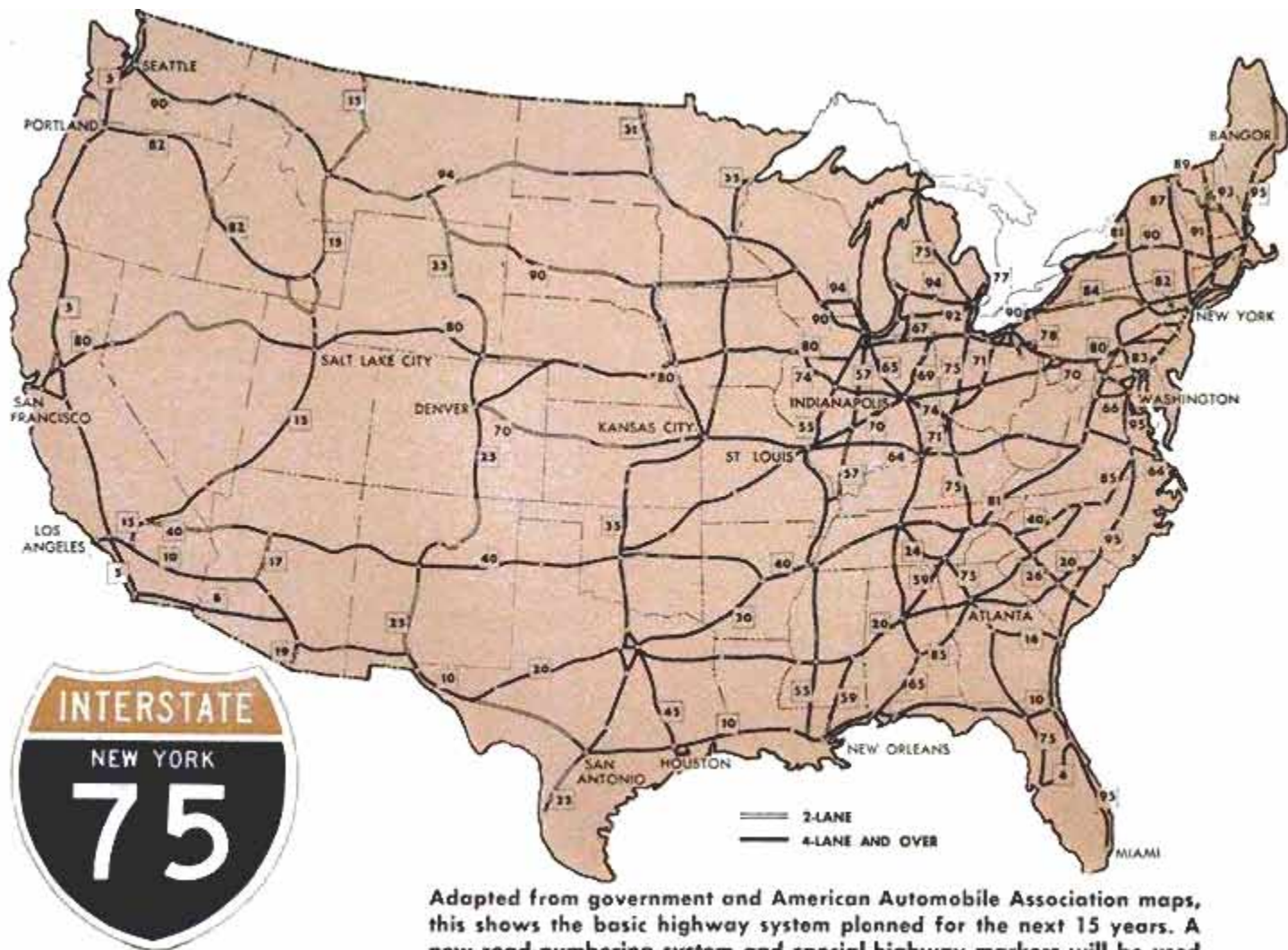

Adapted from government and American Automobile Association maps, this shows the basic highway system planned for the next 15 years. A new road-numbering system and special highway markers will be used

of Interstate and Defense Highways that will connect more than 90 percent of U.S. cities with a population of 50,000 and over. At the same time construction is under way on belt and arterial routes in all major cities, and on the elimination of bottlenecks in the existing 3,400,000-mile network of roads. Motorists began buying all this work on a pay-as-you-ride basis two years ago, paying one cent more for a gallon of gas or diesel oil. More money is being raised by increased taxes on tire rubber, trucks and buses.

What are the chances for completing so Herculean a labor on schedule? Well, after traveling around the nation to look, I can report: the things road builders can do nowadays have to be seen to be believed, and even then you have to look twice.

Last summer, where the U.S. 101 freeway was piercing the California redwood country south of Dyerville, a hill stood in the way of the approaches to a new bridge. The hill went up 500 feet at an angle steeper than a standing ladder. So they put the scrapers to work, hauling them up the slope, hooked to a tow cable.

With its rubber-tired wheels higher in some models than the driver, the modern scraper looks like a monument to a bug. But it can do the work of a thousand men

with dynamite and wheelbarrows. It took three minutes to get one of them to the top of the hill. There it unhinged its under-slung steel belly, plunking the cutting edge into the earth. Then it went plunging down. In one pass, nearly 30 tons of earth and rock slid up into the scraper's body. Then, the way ladies used to pick up their skirts to run, the scraper lifted up its belly and scooted away at 25 miles per hour to dump its load.

Where the rock was too solid for the scraper to cut with its own power, a tractor pulled it and another got behind and shoved. Over the hardest going, a ripper led the way. It had two steel teeth 30 inches long and, with tractor, weighed 28 tons. The teeth would be pulled, cracking and crunching, through the solid rock, to be followed by a tractor pulling a scraper that was being shoved by another tractor—making such a howl in the hills that even the echoes shrieked soprano.

On projects of this kind, when the hill has been scraped down enough to support trucks, loaders are brought in—a kind of scraper fitted with a conveyor belt. Now, instead of lodging in the body, the earth and rock slide up the belly onto a moving belt and are carried to the trucks alongside. I watched 22-ton trucks moving in



a steady stream, for it took only 10 seconds to load one.

On another California section of the interstate system, they are performing the greatest single excavation job in highway history plus other assorted bits of Brobdingnagias. For instance, Carquinez Strait is crossed by the seventh largest cantilever bridge in the world. By December there will be a second, even greater, bridge alongside it—each carrying traffic one way. And the highway, instead of curving around the hills as U.S. 40 does at present, will plunge through a man-dug canyon more than a quarter mile wide with walls on each side 350 feet high. The benches alone on these walls to keep them from sliding are 20 feet wide.

Dazing power, dazzling speed, amazing precision. "A lot of the work couldn't even be attempted by the old methods," Federal Highway Administrator Bertram D. Tallamy, told me. "Even if money was no object, they couldn't find room on the job to hold enough men and horses."

It's all a far cry from the way the roads we're driving on now were built in the 20s and 30s. Then they started with bushwhackers, surveyors and a man walking along with a chain to measure the land. Today's roads start in an airplane with a \$17,000 camera. While the plane travels 300 miles per hour at 2400 feet, pictures are taken every  $3\frac{1}{4}$  seconds.

To get a three-dimensional view they take two pictures of the same area from different angles. Through the airplane and its modern camera, the highway engineer looks over the ground with needle-sharp eyes set 1440 feet apart in his head. A ma-

chine called a plotter superimposes the two pictures for him. John Wolvin, manager of the Chicago Aerial Surveys Company, told me a skilled operator with a modern plotter is able to tell you from aerial snapshots even how deep a body of water is and how many gallons it contains. He can make the machine draw a contour map that will fit the earth and every bush, every tree, every boulder on it as precisely as a contact lens fits an eyeball.

Old-time surveying—the bushwhackers, the transit man, the surveyor walking along with the chain to measure the land is being supplanted by a geodimeter or, since last June when the first one arrived in the United States from South Africa, by the more portable, quicker, Tellurometer. It directs a microwave at a prominent landscape feature up to 40 miles away and tells how many thousand-millionths of a second the wave takes to bounce back. The time is translated into miles, yards, feet, inches. "We call it pretty good surveying when there is an error of only eight feet in 40 miles," said Capt. J. H. Brittain of the U.S. Coast and Geodetic Survey. "With the Tellurometer, there's a possible error of only eight inches in 40 miles."

Today we are driving six times as many automobiles twice as fast ten times as far as our roads were designed to carry. The increase in trucking alone since 1931, when our present highway system was being completed, has been overwhelming. Last year interstate trucks alone carried 240 billion ton-miles of freight—about 12 times as much as 26 years before. Yet in that time we have added comparatively little to our road system.

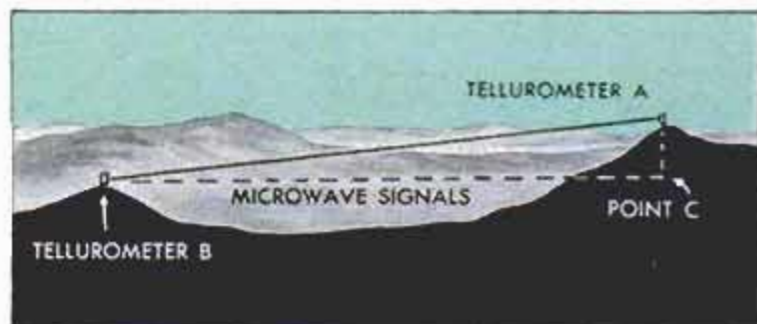

Because speed of microwaves between Tellurometer units is constant, the distance between points A and B can be measured by the time it takes signals to travel between the points. The distance between B and C can be easily calculated after the difference in altitude, between A and C, is measured





Building a paved road in 1909, above, was a slow process with only a steam-roller and a wagon load of rock. Modern pavers put down a 16-foot asphalt lane of roadway in a single pass



One reason for this inadequacy is that until recently it was impossible to make adequate surveys on which to base reasonable traffic forecasts. But now there are pressure pads built into the roadbeds, electric eyes gazing from traffic stanchions, radar in cans hanging from light poles. Even if there had been the means for collecting so voluminous a mass of information 25 years ago, there would have been no way to cope with it. A single survey made recently for one Massachusetts section of the interstate system would have taken one man with a desk calculator 10 years to make it add up to anything. An electronic computer did it in two days. A computer program in the Georgia State Highway Department makes geometric calculations for skewed bridges in 10 minutes. With old-time calculators it would have taken about a week. Now 27 state highway departments have electronic computers. At least 11 more have them on order.

The traffic survey shows where how much road should be built. But the way the road should go must be decided by the designer. His job is to draw a line, through the aerial picture, that will require the least valuable land, the least amount of earthmoving, the least amount of drainage ditches and culverts, be the shortest dis-

tance, do the minimum damage to the value of the neighboring area and provide the greatest service. One thing must always be juggled against another. If I go over this flat field instead of through this hill, how much will it cost to get dirt to fill that low spot there? If I cut through the hill, I will have a downgrade to accelerate the entering traffic, an upgrade to slow up the exiting traffic, but how much grass seed will I need to hold the embankments? At what angle will the winter sun hit the south slope? Those are questions the highway engineer must resolve before even starting to design a road.

#### Scenery Is Safety Aid

And Tallamy is exhorting him to juggle one more factor—beauty. "Open up a view," he pleads. His passion is more than aesthetic. The superhighways already in use in Texas, California and eastern states have consistently carried higher-speed traffic at less than half the national fatality rate per mile traveled. Scenery plays a part in their excellence, Tallamy says, because it snaps a driver out of the hypnotic fog that can settle on him during a long, monotonous haul.

The new Washington-Frederick, Md., highway is an example in many respects of

(Continued to page 270)



# You Can FORECAST WEATHER by the Clouds

By Eric Sloane

**T**HE WEATHERMAN who makes his maps without even looking out of the window might frown upon predictions by cloud observation. Yet there will be times outdoors when the sky is all you have to consult. Tomorrow's actual weather is over the horizon, sometimes over two or three horizons, so what you see overhead concerns the weather you already have. Yet folklore—and science, too—prove that the sky has a message, very often giving hints to the weatherwise of what tomorrow's weather will be.

Of prime importance is the direction of upper clouds. A wind driving upper clouds usually lowers and becomes a surface wind after a while. But knowing the prevailing fair-weather winds (usually west to northerly in temperate winter months and west to southerly in temperate summer months) is the basis for field observation and prediction.

The subtle coloring in clouds is often unnoticeable because the glare of the sky is too strong. By painting the underside of a pane of glass black, you may observe the sky with less strain and glare; sometimes the beauty of the reflection in your "black glass" is worth the trouble.

A hundred years ago, when every man was a farmer to some extent and his livelihood depended largely upon knowing what tomorrow's weather would be, daily weather diaries were kept. Why not try this system? By simply jotting down your observations daily for one month you can see what weather follows each sky condition. You will be well on your way to weather wisdom.

It is remarkable that we who live beneath clouds all our lives often are unaware that clouds have anatomy. Imagine yourself in a large room. The puff from a cigar or cigarette smoker would be a cumulus shape. Then observe the flat layer of smoke that settles over the whole room; that would be stratus cloud shape. Go out to the kitchen and open the refrigerator; shapeless icy wisps float out—cirrus clouds. Cloud nomenclature is that simple.

Motion pictures of clouds show they have birth, development and decay. Cumulus clouds open like giant white roses, then drop their "petals" and disappear back into the atmosphere. Even simple snapshots of a thundercloud taken at one-minute intervals will show the symphony of cloudlife.

(Continued to page 226)



Eric Sloane, famous as the "cloud man," started his career in this field by doing an Air Force manual on the effects of high altitude on the human body. After the war he designed and built the Hall of Atmosphere in the American Museum of Natural History. He has written a number of books on clouds and weather forecasting. He reports that "the rest of my life will be spent in doing murals and paintings of the sky"





Cloud forecasting begins with a knowledge of cloud shapes. Although there are many scientific names in cloud lore, there are only three basic shapes. Learn these and you have taken the first step toward becoming a cloud expert. The names of the three shapes somewhat resemble the clouds themselves: Icy

"cirrus" clouds, accumulated "cumulus" clouds and straight-ceiling "stratus" clouds.

CIRRUS wisps hover above 30,000 feet; CUMULUS ranges from fair-weather lumps at 4000 feet to cumulo-nimbus thunderheads 35,000 feet high; STRATUS ceilings are like lofty fogs. Try picking out these shapes above.

## CIRRUS



## CUMULUS



## STRATUS





# CUMULUS CLOUDS

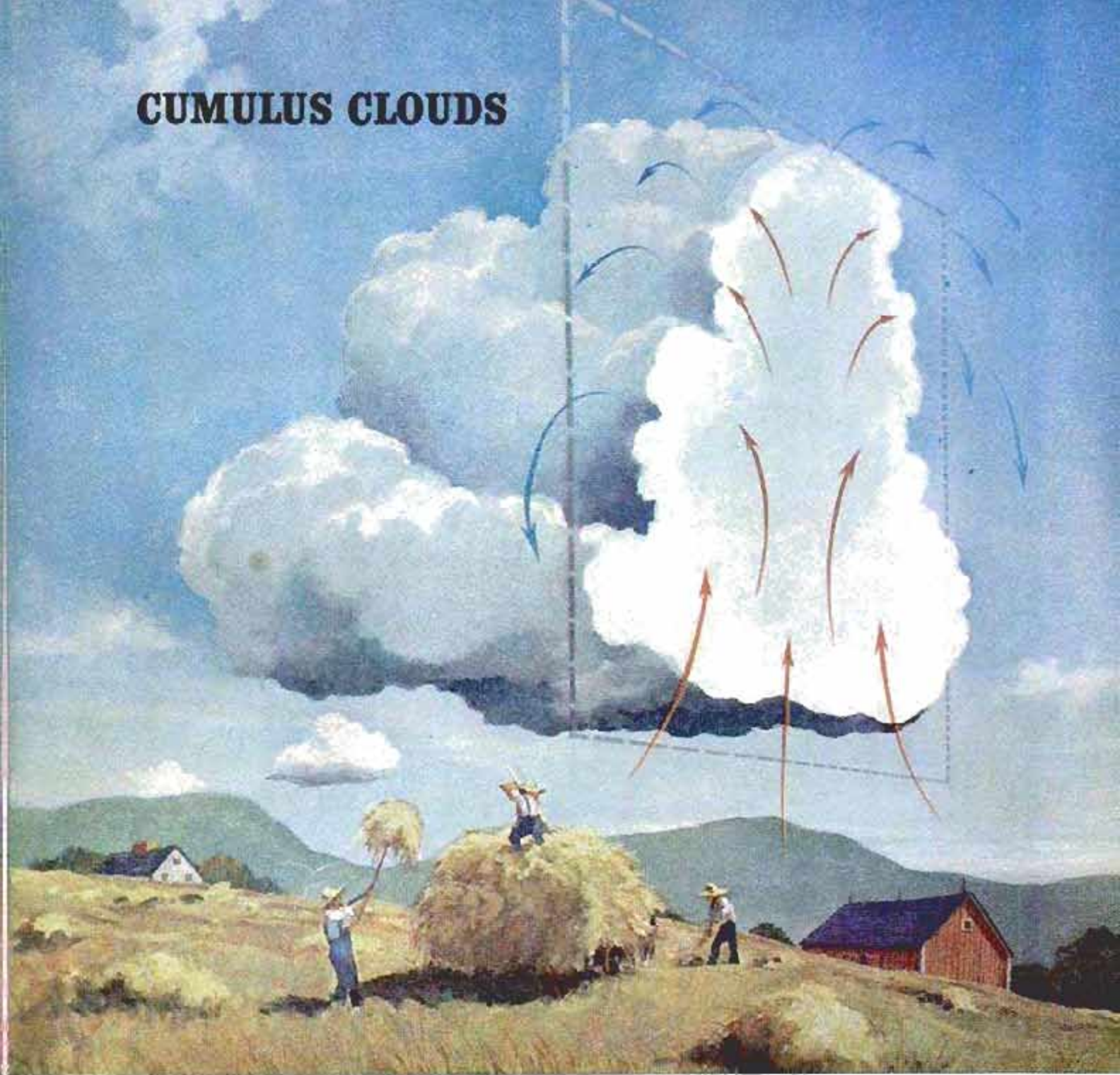

Cumulus clouds form when sun-warmed air cools. Coldness comes with altitude. Cooling shrinks (condenses the volume of) air, squeezing invisible moisture (vapor) into visible droplets (clouds). This miracle occurs at about 4000 feet.

If you wring out a wet towel, the drier the towel the more you have to squeeze to produce water. Likewise, the drier the air, the more height (chill) is needed to squeeze its vapor into a cloud. Above is a cross section through a cumulus. Red

arrows show rising thermals (warm air). Blue arrows show falling currents of cooled air. This mechanical cell might last 20 minutes or so as the cloud builds up, then disintegrates back into the air. If the air is very wet and very warm, cumulus can grow into a thermal thunderstorm.

The drawings below show sequence of a cumulus, and why it is the visible upper part of a thermal cell. Any fine white cloud may have started as swamp water or moist dirt some 50 miles away!

Sun-warmed earth forms heat-canopy aloft, which leans with wind

Heat bubble breaks from earth and rises to condensation level

Thermal over 4000-foot condensation level becomes visible cloud





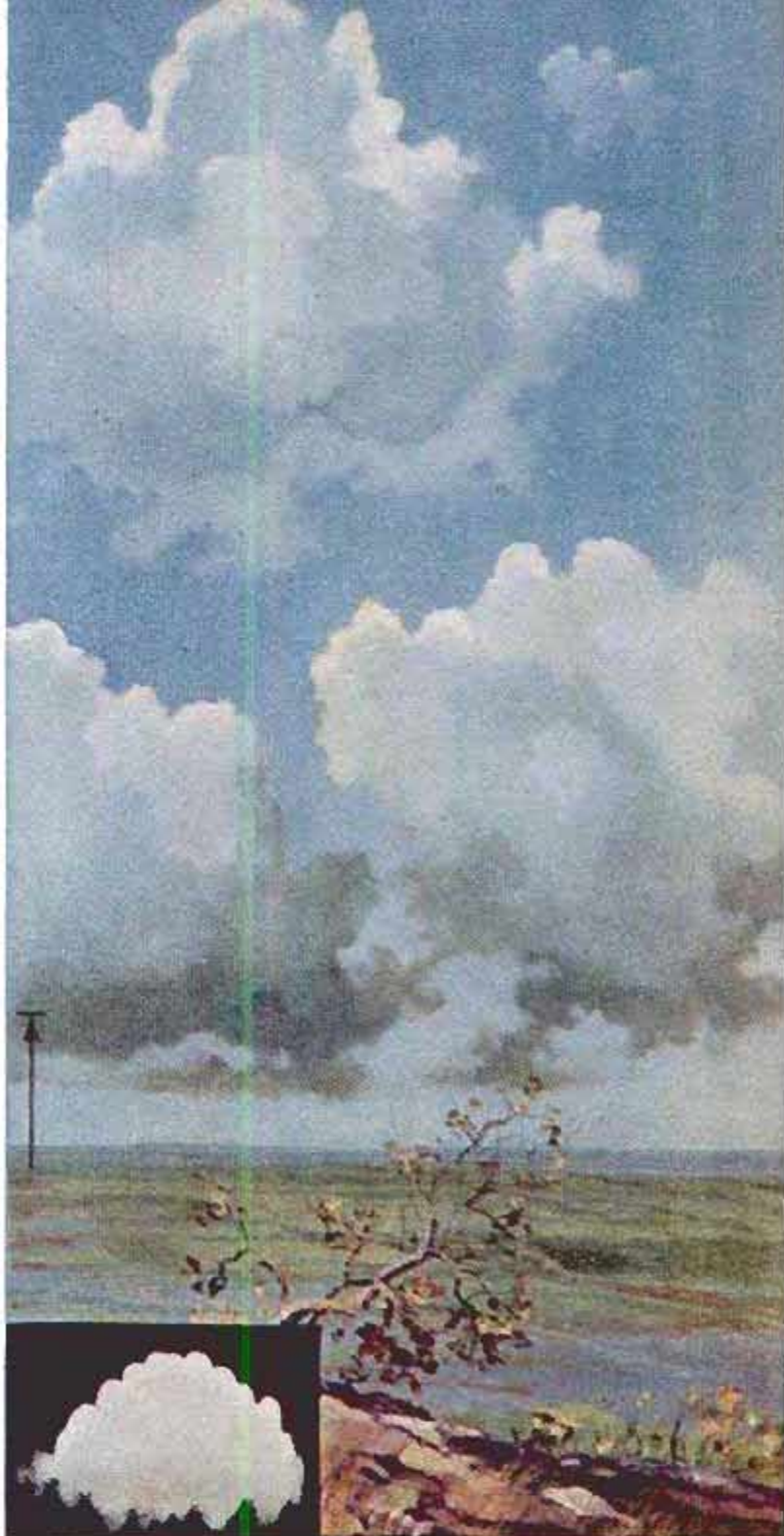

Above are two fields of cumulus clouds with different heights, shapes and colors. The clouds on the left are high, oval-shaped with flat bottoms. They indicate fair weather. The clouds on the right are chaotic and tufted, resembling shellbursts. They are lower and darker. This sky promises showers.

Darkness in clouds is no indication of rain if the clouds remain high. However, thunderstorms usually move from west to east, so darkness in the west is always a threat.

The most important thing in cloud watching is to note the direction of movement. If clouds are moving in prevailing-wind direction, fair weather is best assured.

Learn prevailing winds (usually west to northerly during winter, west to southerly during summer) and you can tell fair skies from threatening ones. Storms never come from wind direction because winds always pinwheel around low pressure; face wind and nearest storm center will be on right (opposite in southern hemisphere).

#### FRONTS

Weathermen look for rain along fronts. Fronts are merely the prows of moving air masses. Along these collision fronts storms most often occur. When weather is cool, a warm-air mass usually brings the next rain; when it is warm, a cold-air mass usually brings the next storm.

The next four pages show invading cold and

warm-air masses with their characteristic clouds. Cold air is heavy and noses downward, with its front slanting back; cold-air masses feature cumulus types, short hard rains and good visibility.

Warm air is light, slanting overhead for hours before its rain, which is slower and longer lasting; clouds are stratus, and visibility poor.



# CLOUDS OF THE COLD-FRONT STORM



FRONTAL  
LINE



When warm-weather cumulus clouds darken and lower (usually from the west) and cobweb-ceiling (anvil top) flows overhead, a cold-air-mass storm is less than an hour away



Cold air (blue arrows) plows under warm air (red arrows) pushing it up into a boiling line of squall clouds. Rain is just ahead under approaching thunderhead (cumulo-nimbus)





ANVIL TOP

CUMULO-NIMBUS

COLD AIR

↑  
Thunderhead arrives with torrent of rain. Updrafts rise to about 35,000 feet, flattening into anvil top which flows ahead of storm. Rainfall is heavy, but storm is soon over

↑  
Front passes, rain stops. You are now within the cold-air mass, with clear air, good visibility and high cumulus puffs. Note how all cold-air-mass clouds have been cumulus types





Nonprevailing wind, cirrus wisps (cobwebby ceiling) indicate tip of an approaching warm-air mass. Rain is about 800 miles away



Overcast thickens to foglike sheets (cirro-stratus). Sun or moon shines through, but a halo appears. Rain is imminent



## CLOUDS OF THE WARM-FRONT STORM

Although snowplow angle of the cold front gives little warning, warm air (red arrows) flows overhead from 10 to 40 hours before rain occurs. The sloping front may be 1000 miles long. Rain often lasts "as long as it took to come." The storm is usually sullen, less violent than a cold-front storm. Air in the wake is usually warm, hazy, moist and visibility is poor. Note the sequence of stratus-type clouds and the slant of warm air.

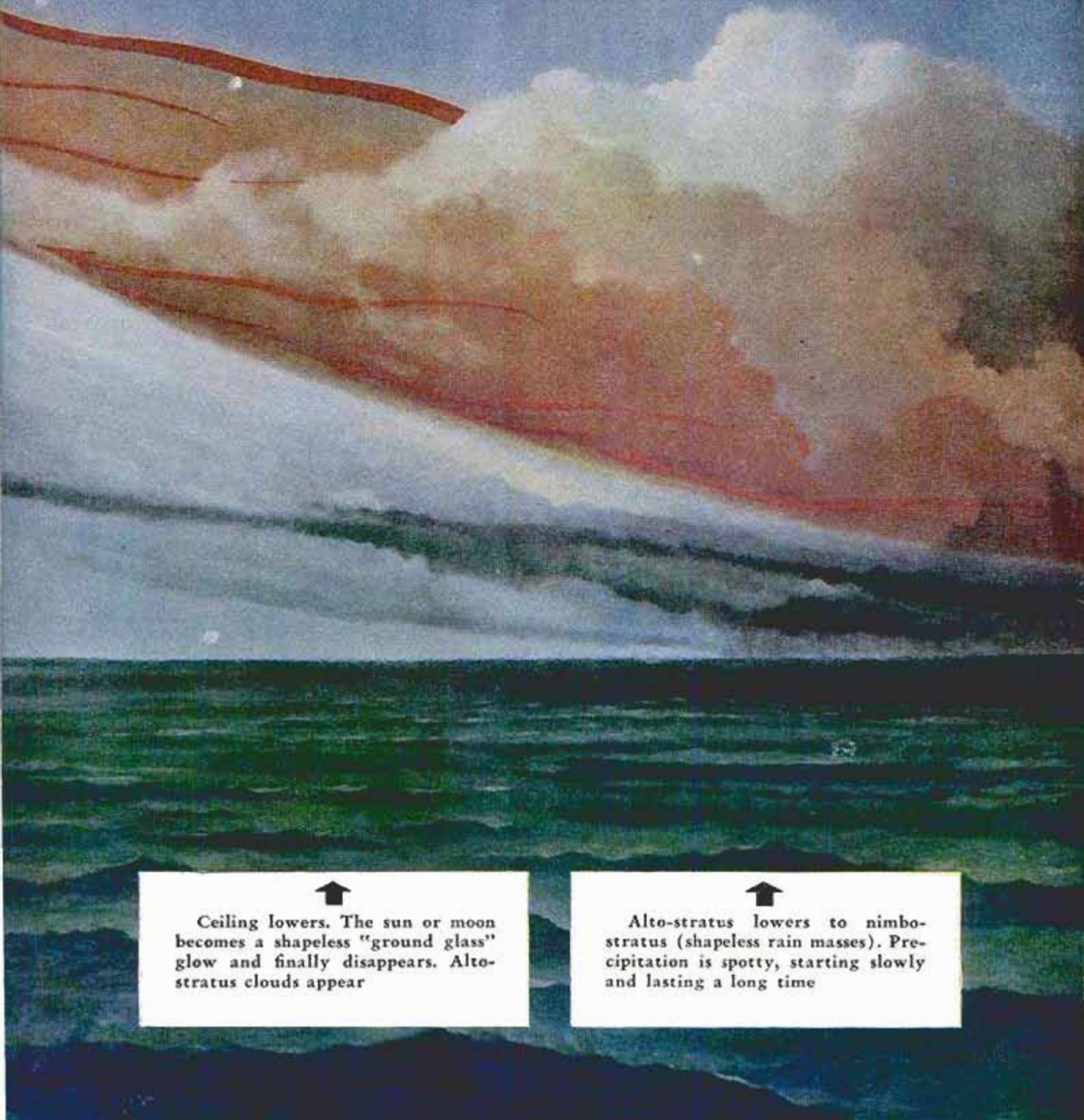

↑  
Ceiling lowers. The sun or moon becomes a shapeless "ground glass" glow and finally disappears. Alto-stratus clouds appear

↑  
Alto-stratus lowers to nimbo-stratus (shapeless rain masses). Precipitation is spotty, starting slowly and lasting a long time



The outdoorsman who can't get weather reports must depend upon his own observations. There is a good deal of superstition about the weather, but some folklore has a sound scientific basis. Below are some of the superstitions with a

strong element of truth. Remember them and you will be better able to predict tomorrow's weather. They may also be useful in predicting the weather for a specific location when reports are general and uncertain.



**SOUNDS ARE HOLLOW BEFORE RAIN:** Lowering clouds (A) make distant sounds (planes, trains, etc.) louder, with an echo effect

**DISTANT SHORES SEEM NEAR BEFORE RAIN:** Unstable air (B) removes salt haze, making the horizon clearer



**NO DEW, SURE RAIN:** Heaviest dew forms in cloudless air. Heavy dew, fair tomorrow

**DULL MOON AND STARS FORETELL RAIN:** High-altitude air inequalities cause moon and stars to appear fuzzy. Sharp moon and un-twinkling stars foretell clear weather tomorrow

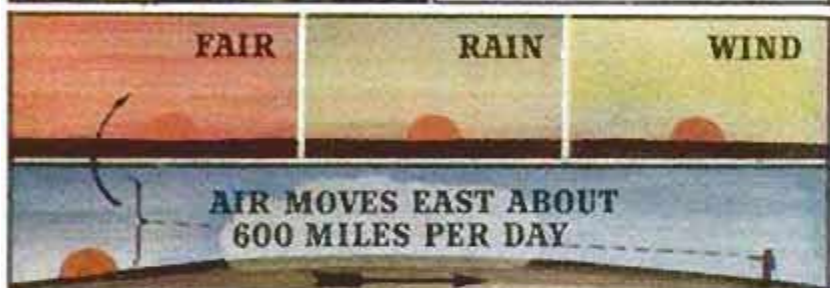

**SUNSET COLORS FORETELL WEATHER:** Moisture in western air (which will reach you tomorrow) tips off the weather. Red means fair; pale yellow-gray, rain; bright yellow, winds. Colors, remember, refer to the sky, not the actual sun



**SUN AND MOON HALOS HINT RAIN:** Halos occur in ice clouds of approaching warm-air rain

**BIGGER THE HALO, NEARER THE RAIN:** Lower clouds cause bigger halos, so rain is that much closer. Halo predictions are most accurate during warmer months



**FACING WIND NEAREST STORM IS ON RIGHT:** Counter-clockwise spin of low pressure makes this true in northern hemisphere. Just the opposite is true in southern hemisphere. This works with all low-pressure rains and will tell the location of a hurricane's eye and plot its movements

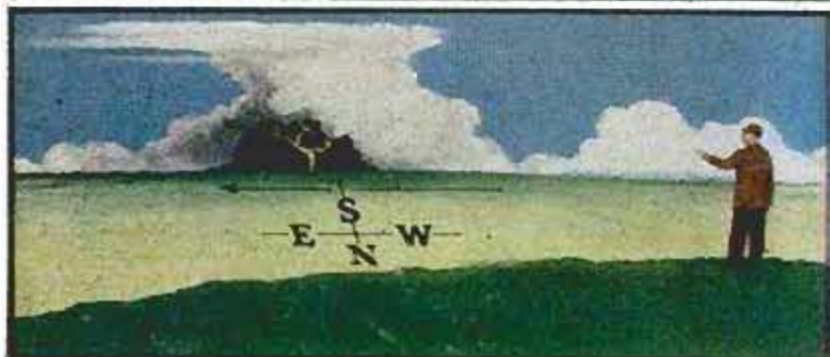

**MOST THUNDERSTORMS MOVE EASTWARD:** Lightning seen from anywhere but western sector of sky is from a storm which will pass you by. The anvil top of thunderheads flows in the direction of the storm





## Giant Canoe Resembles Craft Used by Fur Traders

Perhaps the largest birch-bark canoe ever built was recently launched at Golden Lake, Ont., Can. It measures 36½ feet

long and 6 feet wide. A giant reproduction of canoes used by early fur traders, it will be displayed at Canada's National Museum.

## Nonferrous Metals Joined By Heated Wire Flux

Any nonferrous metals can now be joined by a chemical technique said to be different from soldering, welding or brazing. Wire strips of a special material are fed into the joint as it is heated with a torch. It takes about one minute to form a joint sometimes stronger than the metals involved. Aluminum, copper, brass, zinc, gold and many other metals can be joined by the new process.

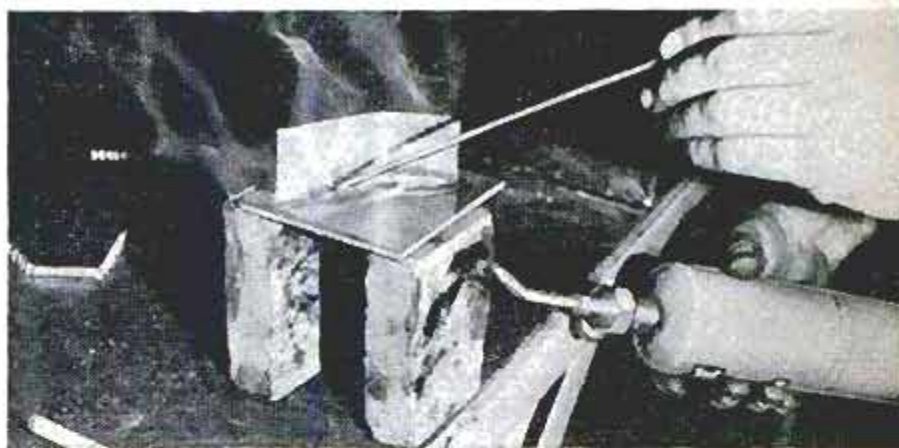

## Plane Takes Off Vertically With Extended Wing Flaps

Double-retractable wing flaps that extend below the trailing edge of the wing permit a Ryan research plane to make vertical take-offs and landings while the fuselage remains in the conventional horizontal position. The extended wing flaps form a hood that forces the propeller slipstream downward, providing vertical lift. When aloft, the flaps retract for normal forward flight.

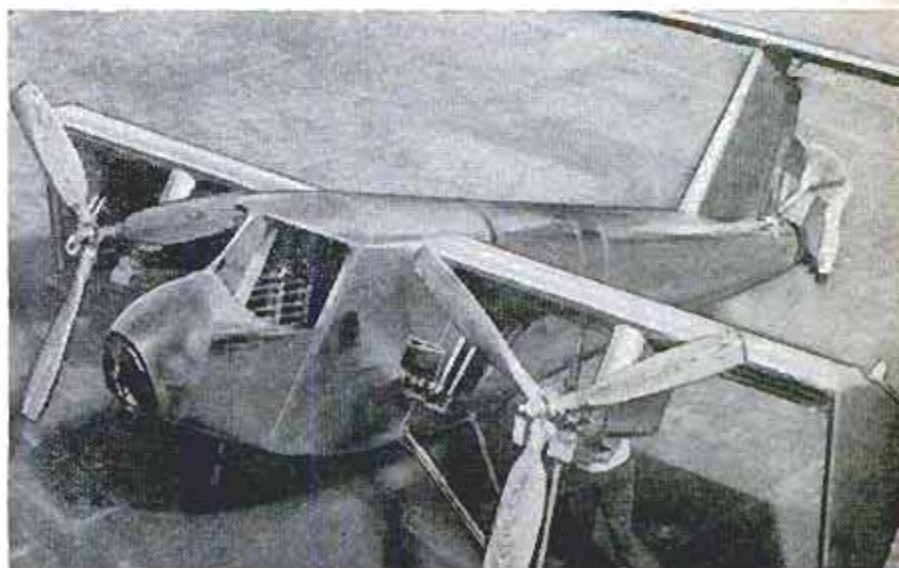



## Paw-Powered Latch Opens Door for Dogs That Like to Scratch

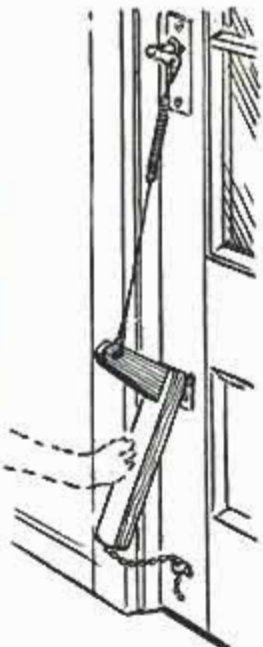

Dogs that scratch at the door to be let in will find a homemade "dog latch" to their liking. For his dog, Henry Leeb of Gladstone, N. J., built a right-angled scratch board, the top of which was attached by wire to a hole drilled in the door handle. Leeb hinged the upper part of the scratch board to the door. Now Mr. Leeb's dog presses a paw on the board to turn the handle and open the door.

☐ Fuel tanks on the Douglas DC-8 jet airliner will stretch from wing tip to wing tip and the overseas version will have a capacity of 140,500 pounds of fuel—equal to the total take-off weight of the present DC-7C airliner.

## Braille Is Reproduced in Quantity on Modified Duplicating Machine



Special Braille type has been developed for use on some standard duplicating machines which have been modified. The Braille type, which allows blind persons to "read" by feeling raised dots representing words, is set a line at a time. The lines are then set in channels cut in the drum of the duplicating machine. The new process makes it possible to produce "printed" material for the blind in quantity and at low cost.

☐ So sensitive is a new military TV camera that light from an ordinary match reveals as much to the camera as a man with 20/20 vision sees in the light of a 150-watt electric bulb.



## Machine Speeds Pipe Laying

Operating at speeds up to three feet per minute, a small automatic trenching machine makes a clean cut wide enough to lay underground electrical cable, lawn sprinkler systems or cold-water pipes. Hardened steel teeth of the saw cut through rugged soil where hand trenching would be almost impossible. Three models trench to depths of 12, 18 or 24 inches. The machine is attached to an aircraft cable which guides the saw while the operator does other tasks. The trencher stops at the end of the cable.



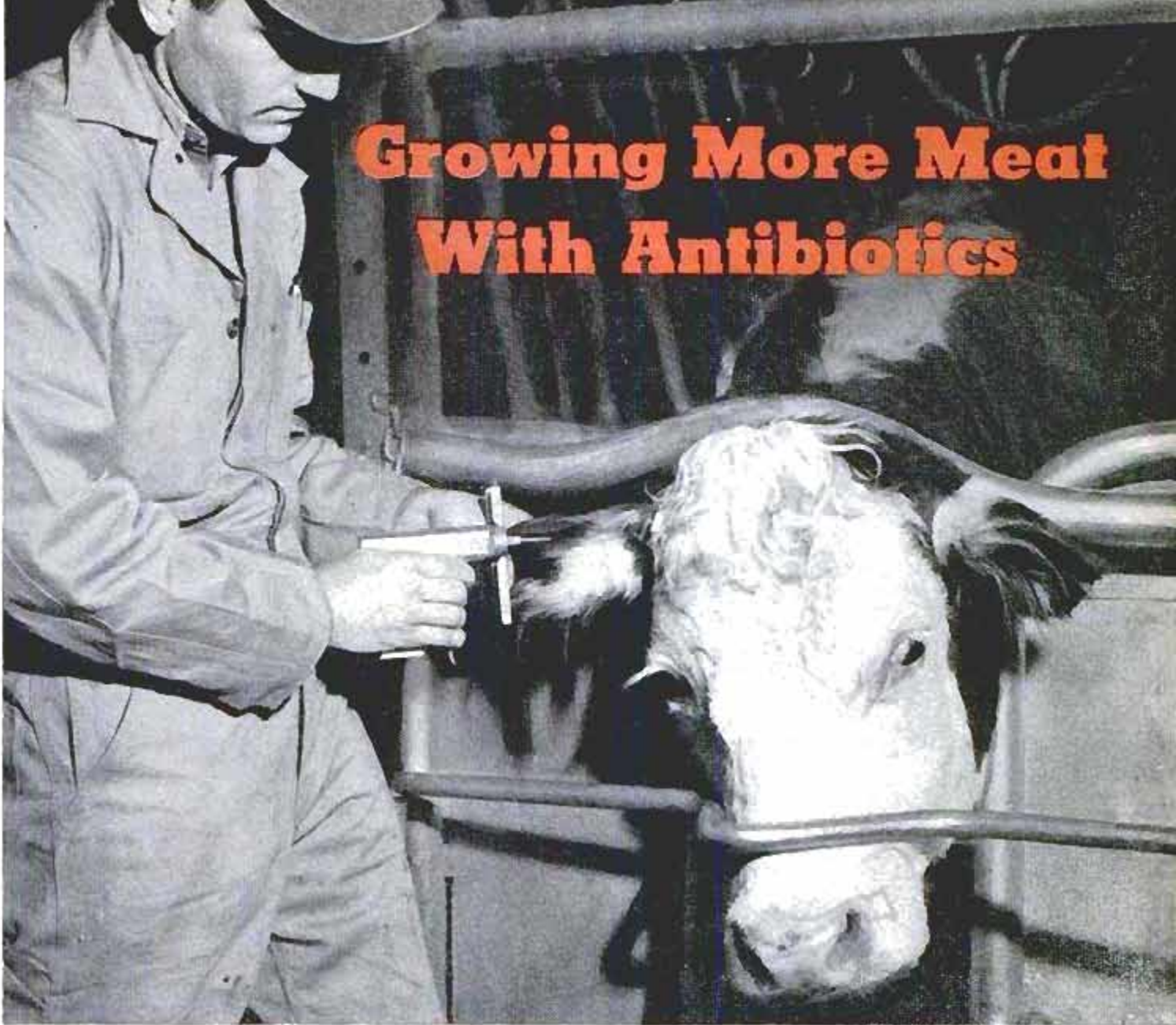

## Growing More Meat With Antibiotics

Chas. Pfizer & Co. photos

Hormone pellet, implanted in steer's ear by "gun," will increase its growth nearly 20 percent, on less feed

By Clifford B. Hicks

**T**HROUGHOUT THE WORLD there are more than 57 million square miles of land. Scoop up any single teaspoonful of this dirt—from Aachen to Zeebrugge, to your own back yard—and you will be

holding in your spoon a population of up to 300 million invisible, living creatures.

These specks of elementary life—a few of them at any rate—are science's latest gift to the farmer. Put to work on the

Pigs have eaten same feed, but middle one has an antibiotic, one on right an antibiotic plus "unidentified growth factor"

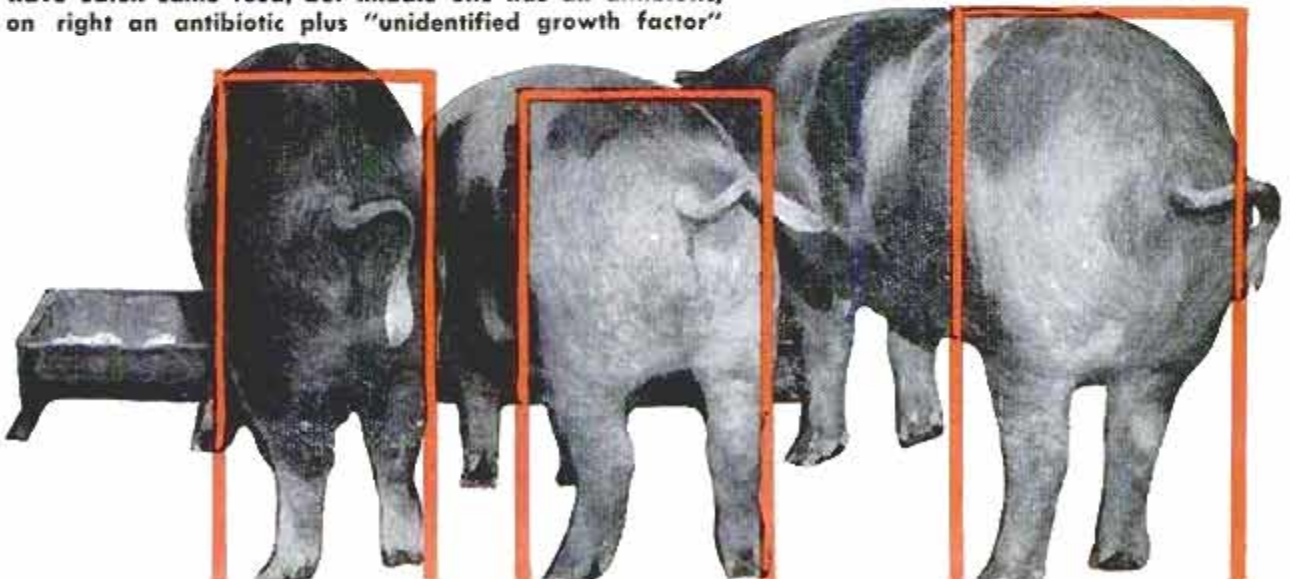





Search for new antibiotics begins with soil samples gathered by travelers in all parts of the world

farms and ranches of this country, they are producing heavier and healthier cattle and hogs. They are doing this in a shorter time and on the same amount of feed, or even less. They are bringing broilers to market weeks ahead of their normal time. And on many farms they are bringing one extra egg into existence for every four eggs of expected production.

After a culture is made of a new antibiotic, colony of bacteria is placed in it to test its lethal power

The scientists themselves admit they aren't sure how the invisible organisms do their farm chores. They're trying to find out. Meanwhile their minute little friends are going right on producing more meat and eggs, and doing it faster than ever before in history.

These invisible specks of life are the same ones that have saved countless human

This is a pure colony of the mold used in production of Terramycin, isolated after study of 100,000 cultures

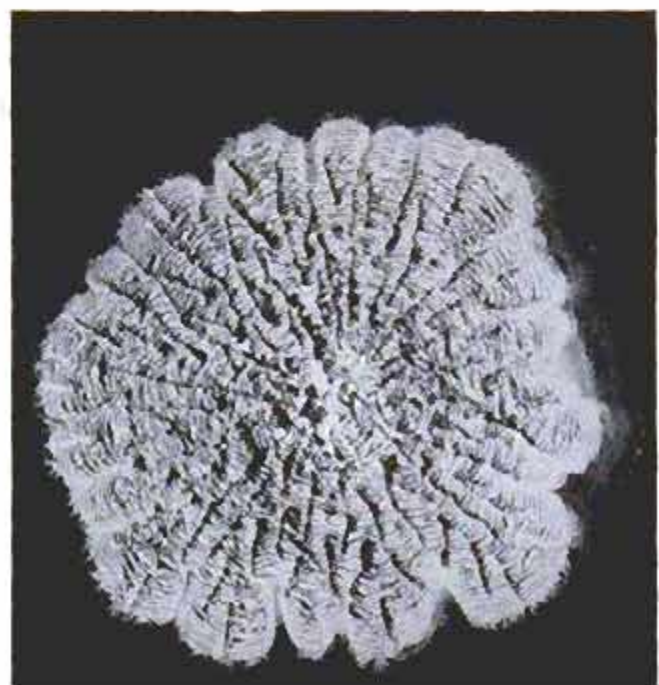



lives in the last 15 years. They are the "living factories" that turn out penicillin and aureomycin, streptomycin and Terramycin, Chloromycetin and all the other "wonder" drugs. The organisms produce chemical substances—antibiotics—which the family doctor uses as medicines. The farmer now uses them, not only as medicines, but as growth stimulators.

If you peer through a microscope at that spoonful of moist dirt you'll see a spectacularly beautiful jungle. In this lush setting, the tiny beings wage violent and relentless warfare against each other for food, for water, for living space, for survival. Their weapons are the antibiotics they produce.

These organisms are the molds and other fungi, more easily classified as plants than animals. A few are harmful to man, but most are either harmless or beneficial.

Primitive peoples long have recognized the curative ability of molds. More than a thousand years before Christ, the Chinese used a moldy soybean curd to clear up skin infections. The Indians in Central America used fungi to treat wounds long before the word penicillin ever entered our language.

Back in 1928, Alexander Fleming discovered the potent power of penicillin. Little attention was paid to his discovery until World War II, when British researchers turned to Fleming's papers as a possible source for a new drug to treat the wounded. The first human being ever treated with penicillin was a London bobby who scratched himself while shaving and developed an ultimately fatal blood infection. He was given penicillin as a last resort, and was well on his way to recovery when the test-tube supply of the precious drug was exhausted. The first life ever saved by penicillin was that of a small boy with a throat infection that would yield to no other medication.

Only a few ounces of the antibiotic had ever been produced when the British, their facilities overburdened by the war, turned to American drug companies for help in developing methods to produce thousands of pounds of it. Not long after, an alert researcher



When an antibiotic has proved effective in exhaustive studies, it is mass-produced in giant tanks for worldwide distribution

Huge rotary filters separate the molds and other materials from the fermentation liquor which contains the antibiotic

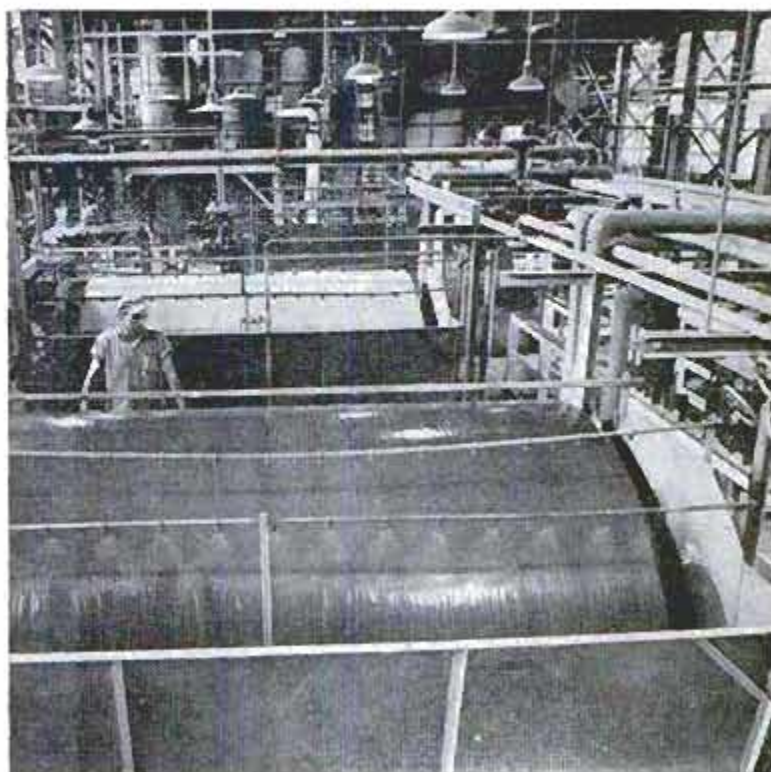





Pfizer scientist explains "picture window" in a steer. Through it, researchers can learn what happens during digestive process

Antibiotics not only stimulate growth of animals and poultry, but fight disease. Here a turkey gets Terramycin for sinusitis



in this country was shopping for groceries in a Peoria (Ill.) market when he came across a moldy cantaloupe. Testing the mold, he discovered that, sure enough, it not only produced penicillin, but produced it 200 times as fast as the older strain. This new strain not only saved thousands of lives during the war, but was the ancestor of the penicillin on your druggist's shelf at this moment.

If one mold worked such miracles, would others do still better? Drug companies began testing soil samples from all over the world. For thousands that proved harmful or weak, they found one that showed promise. Streptomycin popped up in a spadeful of New Jersey soil in 1944. This was followed in 1947 by Chloromycetin and aureomycin. Tests of another 100,000 soil samples turned up Terramycin in 1949.

"I guess we've rediscovered streptomycin hundreds of times," says a drug-company official ruefully, recalling hundreds of thousands of discarded soil samples.

When the new drugs proved so effective in guarding human health, they were tried on animals. Today a veterinarian prescribes one of the wonder drugs for an ailing animal as quickly as your family physician prescribes one for Junior's sore throat.

The age of antibiotics in feed, though, came suddenly and almost accidentally. In the late '40s, vitamin B-12 was being studied as a growth stimulant for animals. Both crude and refined forms of B-12 were fed to poultry. Both resulted in growth increases. However, the birds receiving the crude form grew more than the birds on the expensive, refined form. Tests soon showed that the crude materials actually contained small quantities of antibiotics which were not present in the refined material. And it was the antibiotics that stimulated the birds to even greater growth.

One of the finest places to see this agricultural miracle—and mystery—is the 700-acre Agricultural Research and Development Center of Chas. Pfizer & Co., Inc. The world's largest producer of antibiotics, Pfizer was quick to see the potential value of these drugs as growth stimulators. The firm





Egg-breaking machine tests shell's strength. Researchers discovered that Terramycin makes shells stronger

took over an abandoned military hospital at Terre Haute, Ind., and converted it into an experimental farm.

There you can see fat sows nursing their newborn in the comfort of private "maternity" rooms complete with tiled baths. White-robed attendants stride briskly through the corridors taking care of the animals. Each sow has a complete health record posted near the door of her room. All that's missing is the nervous father in the waiting room, and no doubt even he can be found elsewhere on the farm. At any given moment the farm's population may run to 8000 animals, each with an individual number, its own IBM card and a permanent record of what happens to it during its life on the farm.

These animals, for the most part, are used in feed experiments. Steers, for example, are divided into groups. One group is fed normal rations. The other groups are fed rations containing antibiotics, vitamins and "unidentified growth factors" in varying amounts and combinations. Pfizer scientists then interpret the results and come up with recommendations.

#### "Window" in a Steer

To aid in this research, the scientists are performing minor miracles. They have installed a "picture window" in a steer through which they not only can observe the digestive process, but can take samples at any desired moment. The material is used in another engineering triumph, an artificial rumen. This weird contraption of tubes and hoses precisely duplicates a cow's digestive process. Meanwhile the steer with the porthole continues to live a happy life, apparently quite proud that he is just a little different from the steers in the neighboring stalls.

And what results do they get? Take a look at the figures, not only from the

Pfizer tests but from agricultural colleges and farm feed lots across the country. Beef cattle, fed low levels of Terramycin, grow an average of eight percent faster than the control animals. Their "feed efficiency" (ability to convert feed into meat) also averages eight percent higher. As a result, one study shows that each Terramycin-fed animal paid the farmer \$3.15 more, on the average, than its counterpart on the same rations but without the antibiotic.

Pigs are given a similar boost up the growth ladder. They grow 10 to 20 percent faster when given a low-level antibiotic supplement, requiring less feed for the same gain. Iowa State College authorities estimate that Iowa farmers, if they properly fed antibiotics to all hogs, would pocket an extra \$20,869,000 a year.

Young calves show an average increase in rate of gain of 20.6 percent on antibiotics. The poultry business shows tremendous progress, part of which can be attributed to antibiotics. Back in 1935 it took 15 pounds of feed and 14 to 16 weeks to produce a three-pound broiler. Today the

(Continued to page 260)

Eggs at top are annual production from an average hen. At bottom are added eggs that can be expected with addition of antibiotic





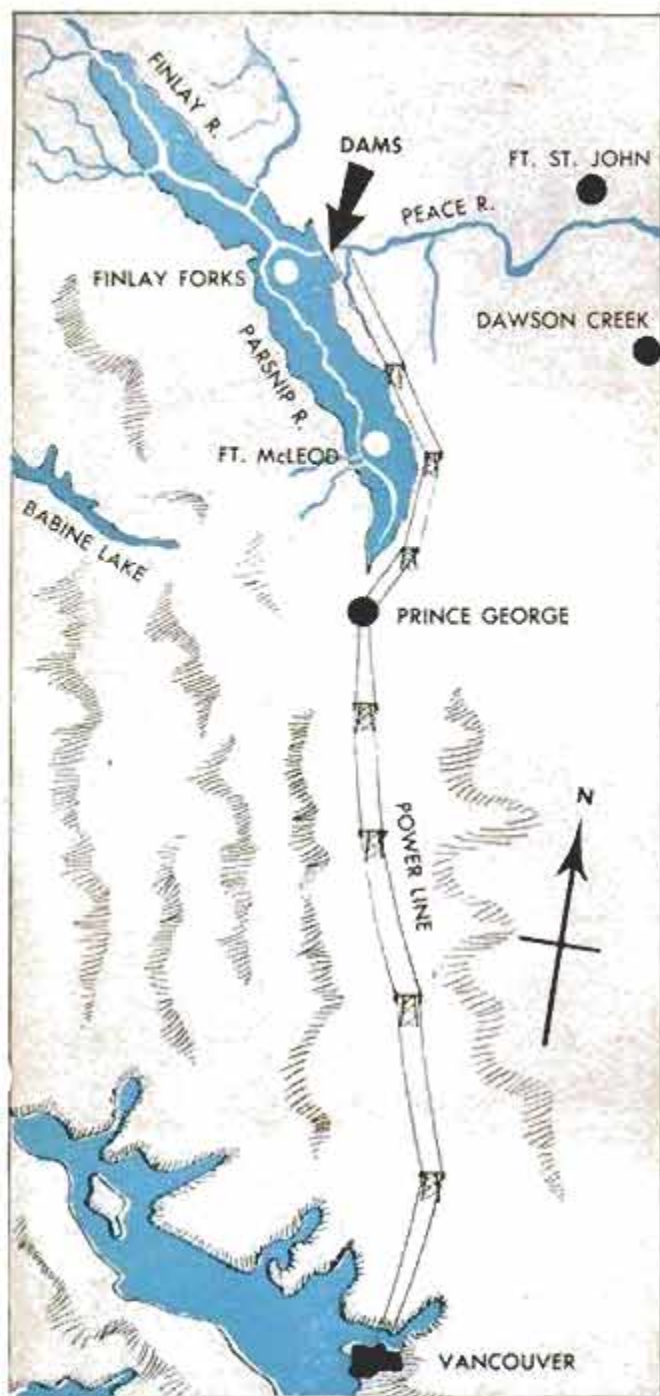

## Big Hydroelectric Dams Planned in Western Canada

Among the huge hydroelectric power systems planned in various parts of the world (See "More Power Lights Darkest Africa," page 136) is the Peace River project in western Canada. The plan, promoted by Swedish financier Axel Wenner-Gren, calls for a series of dams on the Peace River, backing up water along the Finlay and Parsnip rivers. The water would form a lake some 260 miles long and up to 15 miles wide. Hydroelectric turbines at the dams would generate nearly 40 percent more electricity than Grand Coulee can produce. The power would be transmitted to Prince George and 400 miles south to Vancouver. From Vancouver it would be distributed into the Northwest Power Pool for consumers in Seattle, Tacoma and other cities of the area.

## Propeller Tows Line For Boatless Fisherman

Now you can troll for fish while sitting on a dock. A Montana cowboy, Jacob Mandel, has patented a self-propelled fishing board that will tow one or more baited hooks 250 feet on a relatively quiet body of water. The fishing board is pushed through the water by a propeller driven by a spring-tension pulley. An occasional backward tug on the controlling line restores the pulley tension. The fish can be played "considerably," according to Mandel, although not as freely as would be possible without the fishing board. The hook and line or leader are suspended behind the fishing board so there is nothing between the fisherman and the fish except the line.

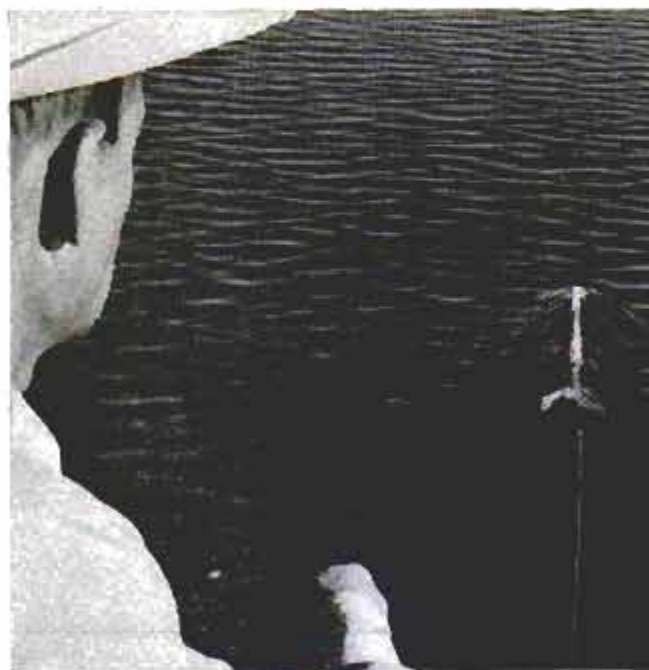



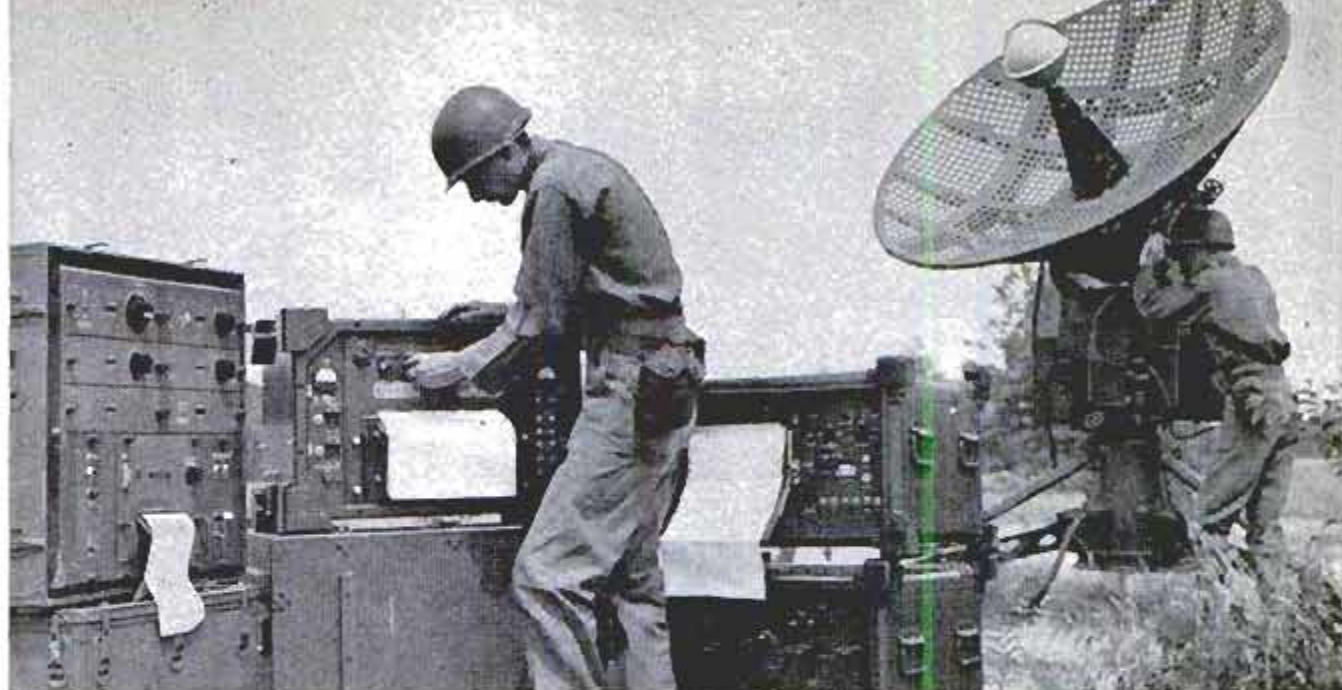

## Electronic Weather Computer Aids Aiming of Missiles

Aiming long-range artillery or missiles requires accurate information about high-altitude weather. The Army now has a

portable "electronic weatherman" to keep tab on winds and other information. Weather balloons transmit data to the computer.

## Plastic May Replace Brass In Cartridge Cases

Brass and steel cartridge cases for artillery shells may be replaced by inexpensive plastic cases. The plastic cartridge cases weigh less than half as much as the steel or brass cases, a factor which would reduce shipping weight by millions of pounds during combat. The plastic cartridges were developed by the Naval Ordnance Laboratory and will be further tested by the Army. The same plastic cartridge cases have been test-fired a half-dozen times to determine their flexibility and durability.



## Portable Radar Units Designed for Marines

High-speed enemy aircraft and missiles can be located in 10 seconds by a portable radar unit developed for the Marines. The units will be part of a TEW (tactical early warning) system extending the nation's defense perimeter. A dual-wall "air mattress" radome and equipment can be carried by helicopter, truck or amphibious vehicle and set up in two hours. Only one man is needed to monitor the radar. Miniature parts reduce size of TEW radar to one fourth that of conventional systems.







U. S. Fish and Wildlife Service photos

## Red-Tide Organism— Sure Death to Fish →

IN THE PHOTO ABOVE, taken during the 1952 outbreak, thousands of fish cover the water, mute evidence of the deadly efficiency of the red tide.

The red tide is caused by a microscopic organism called *Gymnodinium brevis*. The brevis are normally present in sea water, but sporadically they attain killing concentrations. What happens then can be seen in the photos at right. Two mullets about seven inches long are dropped into a tank containing about 21 million brevis. After a futile four-minute attempt to escape the deadly poison released by the microscopic bug, both fish are dead.

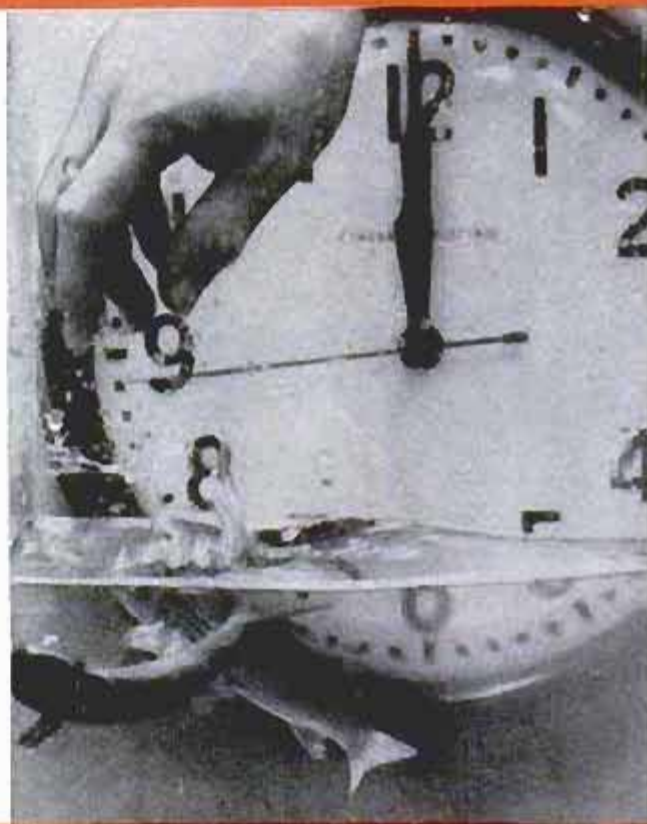



*Kingfish*, the 43-foot floating laboratory for red-tide research, gets under way on periodic patrol to check Gulf water conditions



## SEAGOING SLEUTHS PROBE THE MYSTERY OF THE RED TIDE

By Max Hunn

**S**TRANGERS VISITING the Crayton Cove docks in Naples, Fla., usually take a second and longer look at a sleek, gray 43-foot cruiser with the lines of a pleasure craft, yet carrying radar antenna and an afterdeck loaded with strange gear.

If they ask questions, they learn it's the floating laboratory of the U. S. Fish and Wildlife Service's red-tide field station in Naples. Despite its pleasure-craft exterior, it carries a variety of special equipment for "detectives" who are solving the spo-

radic fish kills in the Gulf of Mexico, popularly known as the red tide. A red-tide attack hit the Naples area recently; tons of dead fish were washed ashore.

Aboard the *Kingfish*, powered by two 150-horsepower diesel engines, is approximately \$50,000 worth of special equipment, making it one of the most unusual boats afloat. In addition to its 16-mile-range radar, the *Kingfish* carries a depth recorder, LORAN navigation equipment, a conductivity recorder, a hand anemometer, pH

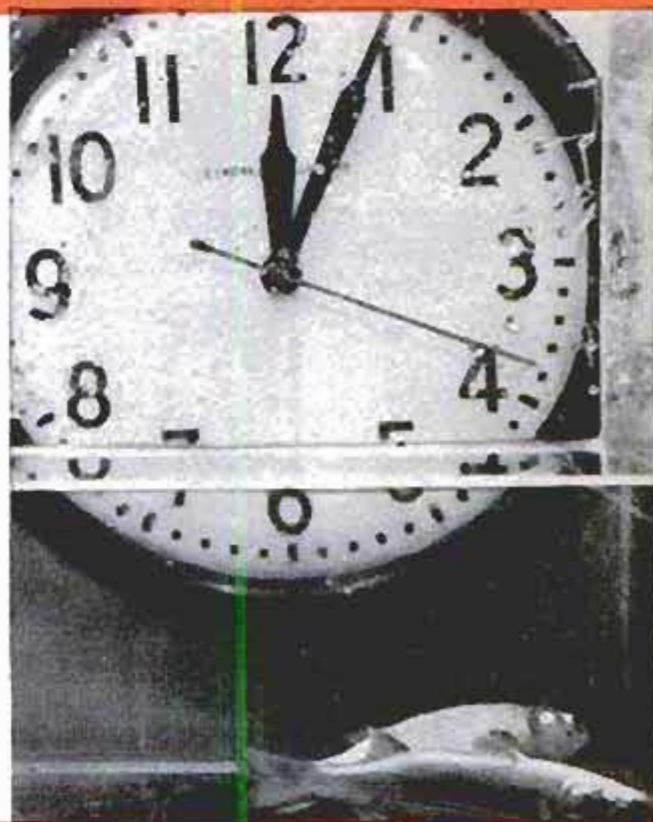
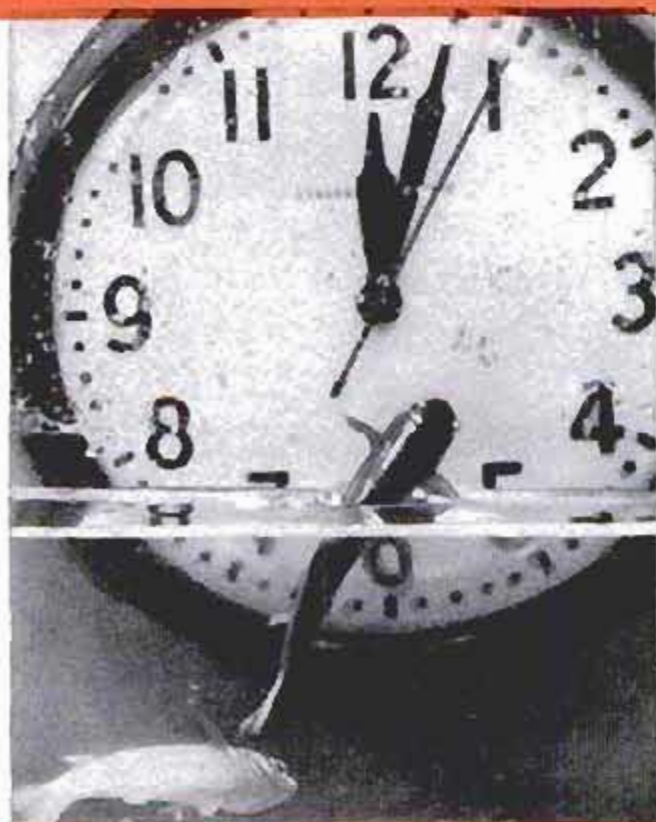





Plastic bottle goes over the side to collect water specimen for analysis in battle against the red tide



Specimens are placed in a quick-freeze unit for trip to laboratory, where they are examined for the brevis

meter for measuring the acidity of the water, thermometers, a ship-to-aircraft voice radio which also reaches the Naples shore laboratory and vessels of the cooperating State Board of Conservation, a 3000-watt diesel generator and a specially built quick-freeze unit.

The *Kingfish*, skippered by Capt. J. D. McCormick, is the major one of four means of collecting hundreds of water samples—the Naples station collects and analyzes 600 to 800 samples monthly—from the 180-mile stretch of the Florida coast between Clearwater on the north and Marathon in the Keys. The *Kingfish* collects the majority of the samples from stations inside the 10-fathom coastal curve, while others are collected by auto from inland points as far away as Lake Okeechobee, and by outboard skiff and float plane in waters too shallow for the cruiser. Although the *Kingfish* draws only 4½ feet—about a foot more

than her design, as a result of the extra equipment—there are many places too shallow for her. There are 380 water-sampling stations.

It takes two weeks to patrol the 180-mile stretch with intermittent cruising. It takes approximately five days to make the southern run from Naples to Marathon and return. The north run, Naples to Clearwater and back, takes a week.

The sampling procedure is the same at each check point. A plastic bucket is used to haul aboard surface-water samples, and an ingeniously rigged plastic jug brings up samples from the bottom. The deep-water samples are obtained by lowering the lead-weighted jug, rigged with a special cork release which opens the container at the proper depth.

Samples consigned to the Galveston laboratory are poured into glass vials

(Continued to page 240)

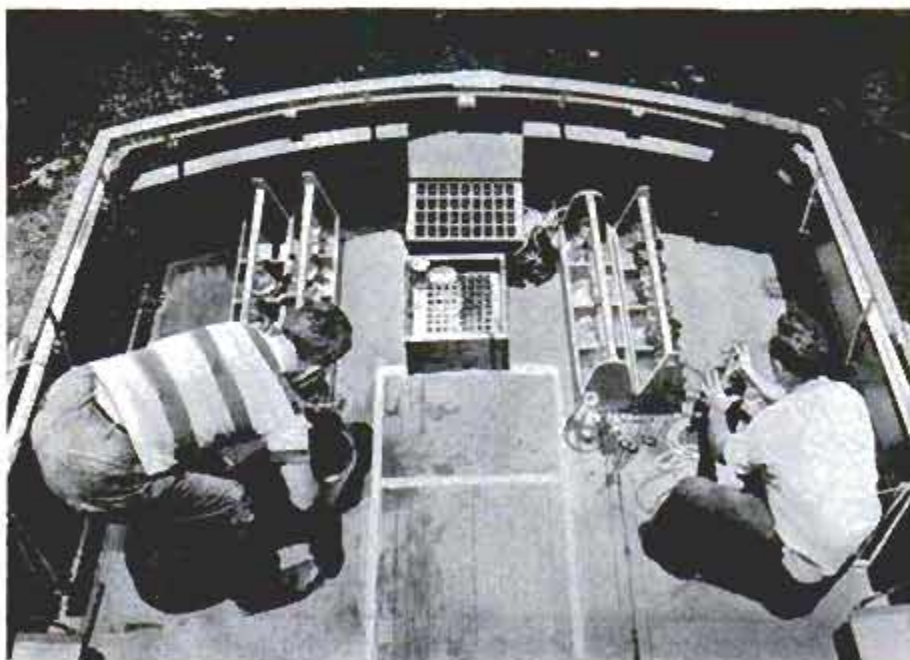

Water samples are collected in plastic buckets from 300 stations in Gulf. Temperature and acidity of the water are noted, along with wind, weather conditions



## Fastest Camera Shutter Records Wire "Explosion"

Exposures of only five billionths second are being made with a camera, claimed to be the world's fastest, which was developed for learning more about intense explosions, ultra-speed shock waves and special nuclear reactions. The accompanying picture, made with the camera, shows three stages in the disintegration of an electric wire  $\frac{1}{1000}$  inch in diameter when electric current is applied to it. The three superspeed exposures were made at intervals of 20, 30 and 40 billionths of a second after electricity was applied to the wire.

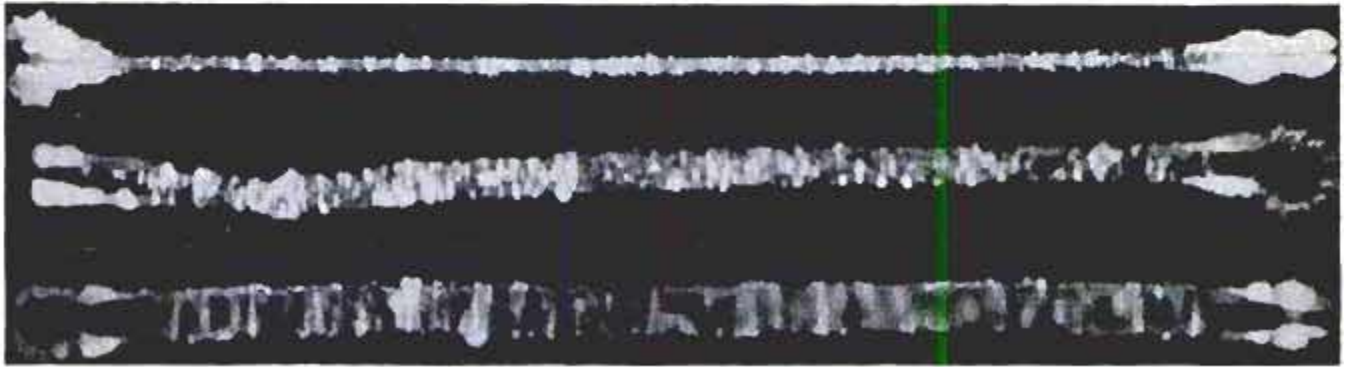
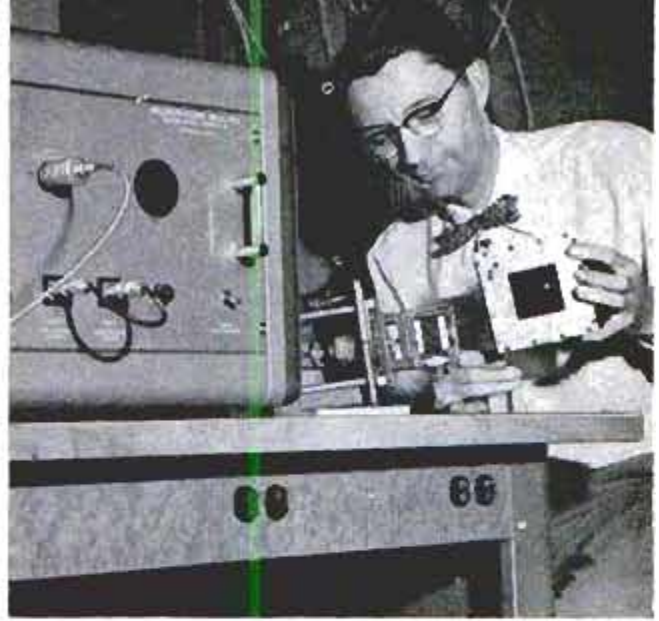

## Number-Reading Machine May Translate Handwriting

Machines that read handwriting may develop from a device built in the Bell Telephone Laboratories that can identify numbers written on it. The device has a writing surface divided by seven short lines radiating from two dots. When a numeral is written on the surface with a metal stylus, the lines of the numeral cross the vector lines in a pattern which identifies the number. Bell engineers say a four-dot system with 12 vector lines could identify handwritten letters. The machine can be connected to an electronic computer.



## Big Steel "Sandwiches" For Lightweight Planes

Large, thin sheets of stainless and alloy steel for missiles and aircraft can be manufactured by a new "sandwich" rolling process. The method consists of sandwiching stainless or alloy-steel plates between two heavier plates of ordinary carbon steel and closing the assembly with welded-in side and end bars. The sandwich is then heated and rolled. U.S. Steel reports that sandwiching can produce steel sheets nearly twice the width of those made by conventional methods. This will result in less weight in aircraft "skins."







### Double Globe Shows Orbits

Satellite orbits can be clearly demonstrated on a new earth-sky globe. The earth globe is mounted inside a clear-plastic globe imprinted with a map of the stars. Orbits can be marked on outer globe.



### Heat Produces Electricity

Changing heat into electricity has been achieved with electrodes in a gas-filled tube called a thermionic converter. When the cathode is heated, electrons "boil out" and pass to the anode, producing current.

### Auto-Top Boat Sports Electric-Starting Engine and Built-in Radio

Small enough to be carried on top of a car, a new luxury boat built in West Germany is claimed to be the world's smallest

motorboat. The little two-seater is powered by an electric-starting two-stroke engine. Equipment includes a built-in radio.





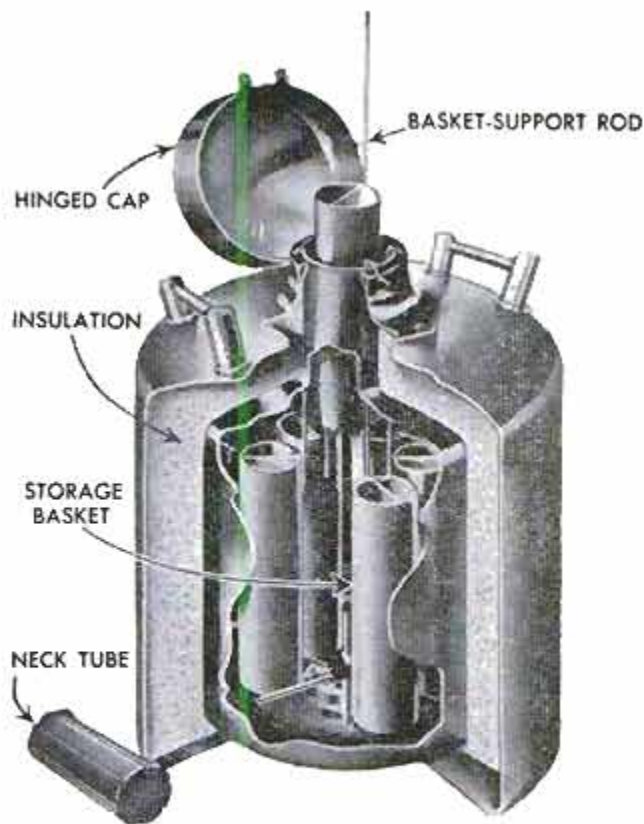

## Liquid-Nitrogen Refrigerator Chills to 320 Below Zero

Developed primarily to store and transport delicate biological materials, such as bacteria cultures and animal glands, a new portable refrigerator is cooled by liquid nitrogen. Materials for freezing or storage are placed in cylindrical baskets which are lowered into the nitrogen. The unit maintains a constant temperature of 320 degrees

F. below zero as long as liquid nitrogen is present in any quantity, and a single charge of the chemical lasts a month. Besides its value as a storage container for biological specimens, the supercool refrigerator can be used to shrink small metal production parts. The parts will expand for a tight fit at normal temperatures.



## Campers' Emergency Kit

Planning a camping or fishing trip? You may want to take along a kit that includes signal flares, fishline and hooks, water-resistant matches and other items that would be handy to have in an emergency. The flare gun, not much bigger than a cigar, can be filled, cocked and fired with one hand if necessary. It shoots a brilliant red flare 200 feet into the air. Also available is an aluminum-alloy hand ax with a hollow handle that can be used as a canteen.

## Ejection Seat Fires Under Water

Trapped in a flooded Douglas F4D-1 when it plunged into the ocean, a U.S. Navy pilot recently made the first successful underwater ejection, reaching the surface 45 seconds after firing the ejection seat.



# More Power Lights "Darkest Africa"

VOLTA RIVER  
PROPOSED AJENA DAM

PROPOSED INGA DAM

KARIBA DAM SITE

CONGO RIVER

ZAMBESI RIVER

In the valleys of the Volta, Congo and Zambesi Rivers, regions unknown a century ago, engineers are developing some of the world's biggest hydroelectric dams. Cheap electricity lures modern industries to the land of lions, elephants and primitive tribes

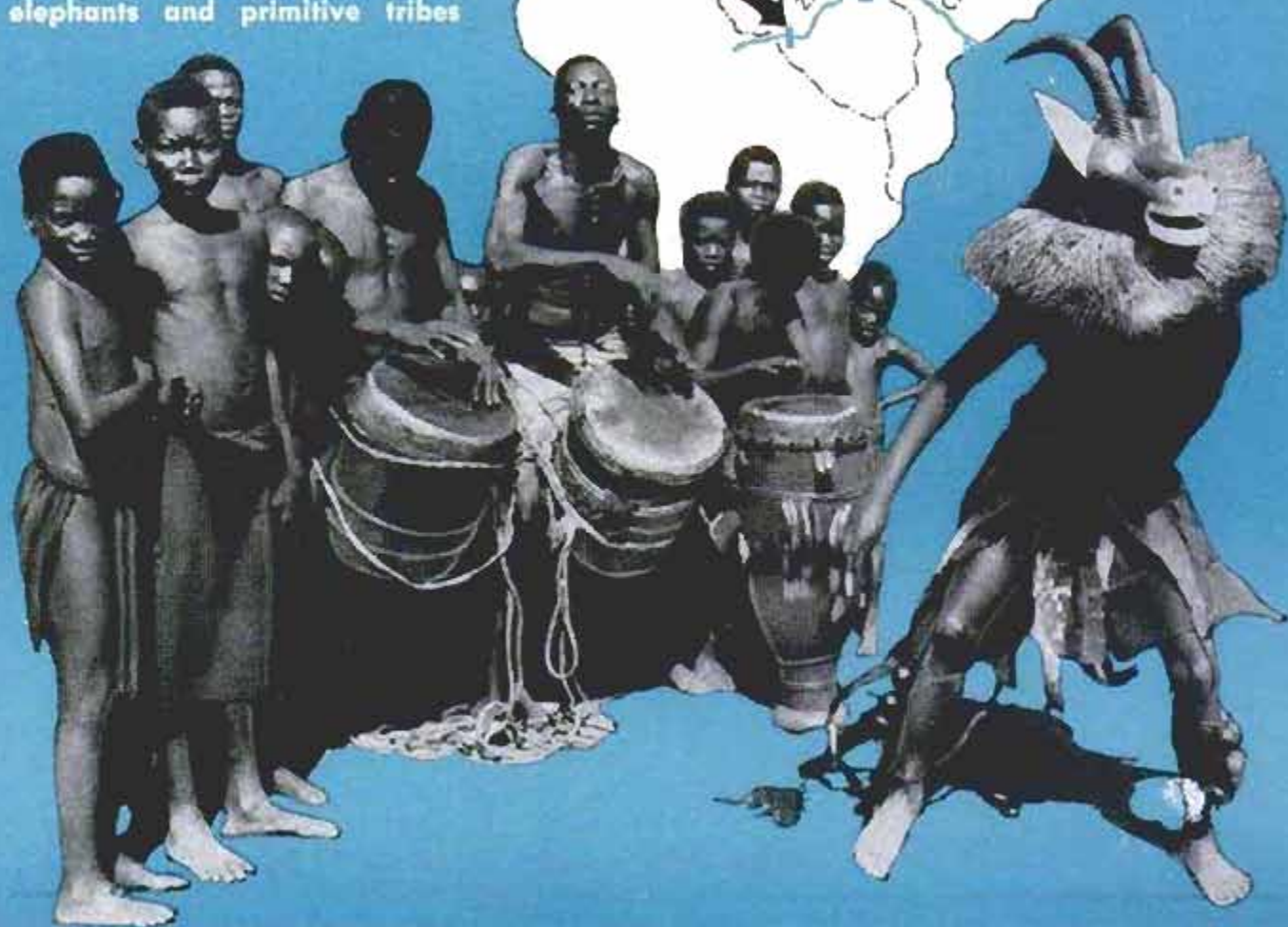





Zambesi River tumbles nearly 400 feet over Victoria Falls, about 220 miles upstream from the Kariba Dam

By Peter Holz

**E**VER-INCREASING NUMBERS of American businessmen have come to take a look at Africa and taken home the news that the once-dark continent is no longer as dark as it used to be. The bush, the lions and elephants are still there—the American businessmen saw all these, but they saw something else, too. All over Africa the search for oil and minerals is on the increase and industries both small and big are appearing all over the scene.

Unprecedented development is taking place not only in the highly industrialized Union of South Africa, which has always been considered the workshop of Africa, but also in the Central African Federation of Nyasaland and Northern and Southern Rhodesia, as well as in the Belgian Congo and the Gold Coast, now Ghana.

At the time of writing, the largest hydroelectric scheme in the world is being built on the Zambesi River in the Central African Federation. The Belgian Congo is considering an even larger scheme and in Ghana, the Volta River hydroelectric project is being given serious consideration. More and more power is planned for Africa and its 200 million Africans and five million Europeans—power for the advancement of Africa and the free world.

One hundred years ago, central Africa

Shaving away the side of a mountain in the Belgian Congo uncovers deposit of tin, one of the valuable minerals of the African colony. Engineers plan a multibillion dollar hydroelectric and industrial development project in the Belgian Congo, near Inga





**FIRST STAGE** of Kariba Dam construction shows thin arch cofferdam erected on left bank of the Zambesi River during low-water season. Dotted line indicates diversion tunnel built at the same time on right bank

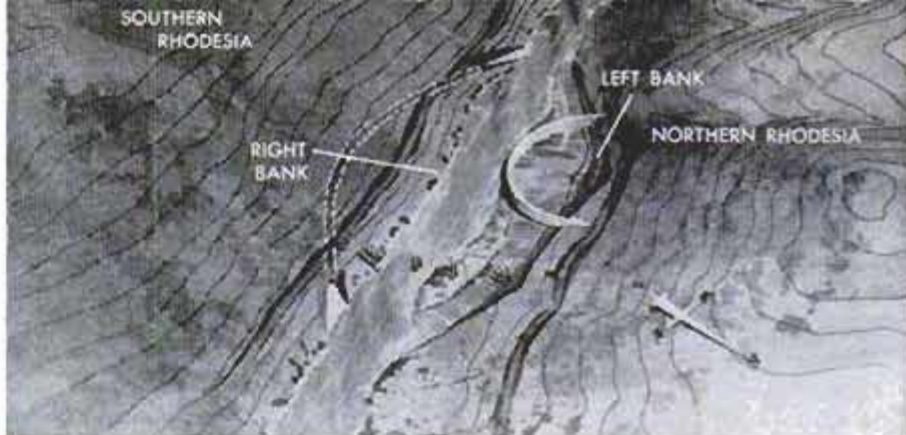

**SECOND STAGE** shows part of main dam erected within cofferdam as right flank is started above water level. Temporary bridges are built below dam. Contour lines in drawings show 50-foot differences in elevation



**THIRD STAGE**, during second low-water season, allows new cofferdams to be built around site of main dam section. Left-flank cofferdam is demolished. Water is forced through diversion tunnel as excavation is begun to extend dam into banks



**FOURTH STAGE**, scheduled for third low-water season, shows original diversion tunnel closed and dam wall rising. Power-house intakes and other facilities for first two turbines are shown in cutaway of right bank

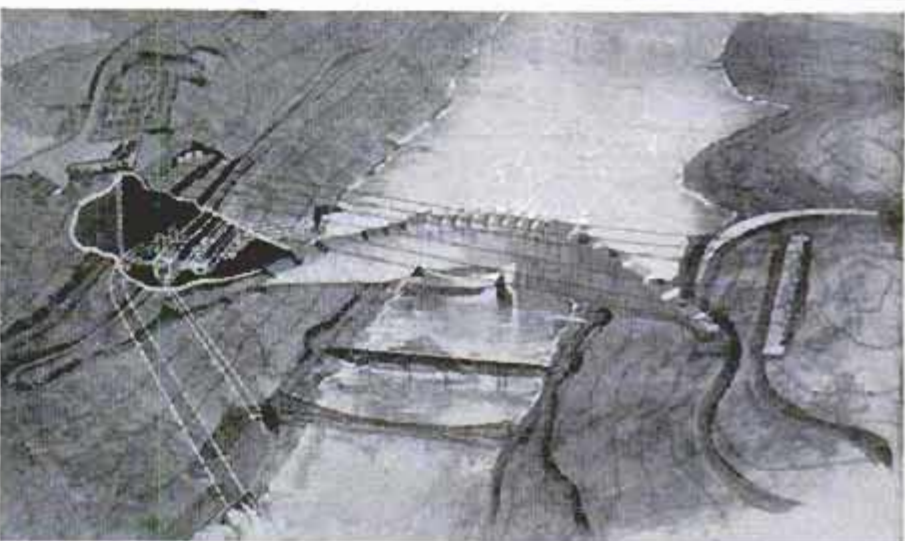





Kariba Dam as it will appear when completed. Water from Zambesi will be diverted into turbines through intakes and tailraces, indicated by dotted lines. Road crosses top of dam

was practically unknown to Europeans except a handful of explorers. Today, more than a quarter million Europeans call the Central African Federation their home. Large towns have sprung up and, with them, industries. The standard of living of the seven million Africans in the Federation has been appreciably raised by the white man's knowledge and enterprise.

Since the end of the war, production of minerals such as copper, lead, gold and chrome—as well as asbestos and zinc—has increased considerably. Coal, however, is not plentiful and to offset a future crisis in the second largest copper-mining industry in the world, the Kariba hydroelectric scheme was planned.

Thousands of Europeans and Africans are at work on this project which by 1960 will change the face of Africa. The Kariba Dam, spanning the Kariba Gorge through which the Zambesi flows, will create the largest manmade lake in the world with a shoreline of 800 miles, and a surface area

of more than 2000 square miles. The amount of water in it will be more than four times that of Hoover Dam's Lake Mead, now the largest manmade lake.

Naturally there are people, primitive Africans, who call this vast area to be inundated, their home. About 25,000 of them are being evacuated to an area specially set aside for them. As compensation for being moved from their ancient tribal lands, the whole tribe will be allowed a tax-free period of two years, a six months' supply of free food and other benefits.

Originally the total cost of the Kariba hydroelectric project was estimated to be \$240,000,000. Latest estimates put the figure at \$330,000,000. Some of the money comes from the World Bank, some from the copper mines which will use electricity generated at Kariba, and some from the Colonial Development Corporation.

Initially six generating units will be installed at Kariba, but the power will be increased by the installation of 10 more

Boiling waters of Zambesi lap at Kariba Dam bridge supports during 1957 flood that submerged cofferdam







**Copper mine in Belgian Congo would be part of hydroelectric industrial project proposed for this colony**

generating units as demand increases. Electricity will be delivered by transmission lines joining Kariba with networks in Northern and Southern Rhodesia.

Power will be transmitted at 330,000 volts through steel-cored aluminum conductors. Although the Federation is the second-largest producer of copper in the world, the use of copper for conductors was ruled out because of price.

A township for European workers and their families is springing up near the dam on an area of about 130 acres. A hotel, church, meeting hall, swimming pool, tennis courts, a primary school, shops and

other facilities are also being constructed. African quarters, too, are being built.

The concrete-arch dam which is really the kingpin of the whole project will, when complete, rise to a height of about 420 feet above the foundations. The length of the dam along the roadway will be about 1900 feet. About 1,200,000 cubic yards of concrete will be poured.

In the center of the dam wall will be a spillway 306 feet long divided into eight sections, each with a gate 38 feet long and 26 feet high. The spillway has been designed to handle 300,000 cubic feet of water

(Continued to page 232)

**Blister copper loaded on railroad cars in Northern Rhodesia, near site of the Kariba hydroelectric dam**







## ***Giant Snuffer to Put Out Aircraft Fire***

BASED on the same principle as a candle snuffer—but big as a tent—is a device proposed for dousing aircraft fires. At the sound of a crash warning, a truck bearing the collapsible snuffer is rushed onto the airfield. If fire breaks out, the snuffer is hoisted by a boom attached to the truck and dropped over the burning plane to cut off the supply of oxygen. Also helping to smother the flames are chemical sprays on the underside of the fire-resistant canopy. Asbestos-clad firemen rush in to rescue the crew. The three Spanish inventors, shown with the model at right, suggested the idea while students at the School of Aviation Medicine, Randolph Air Force Base, Tex.

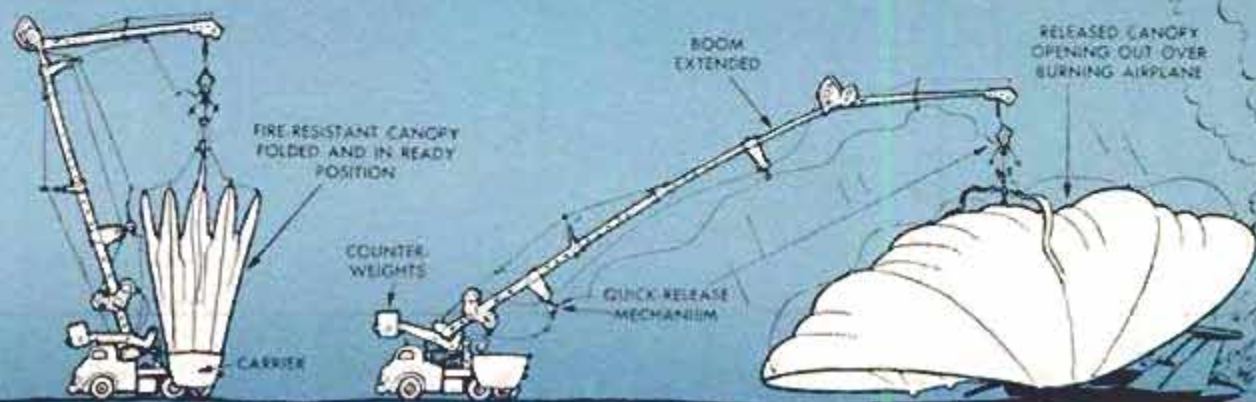



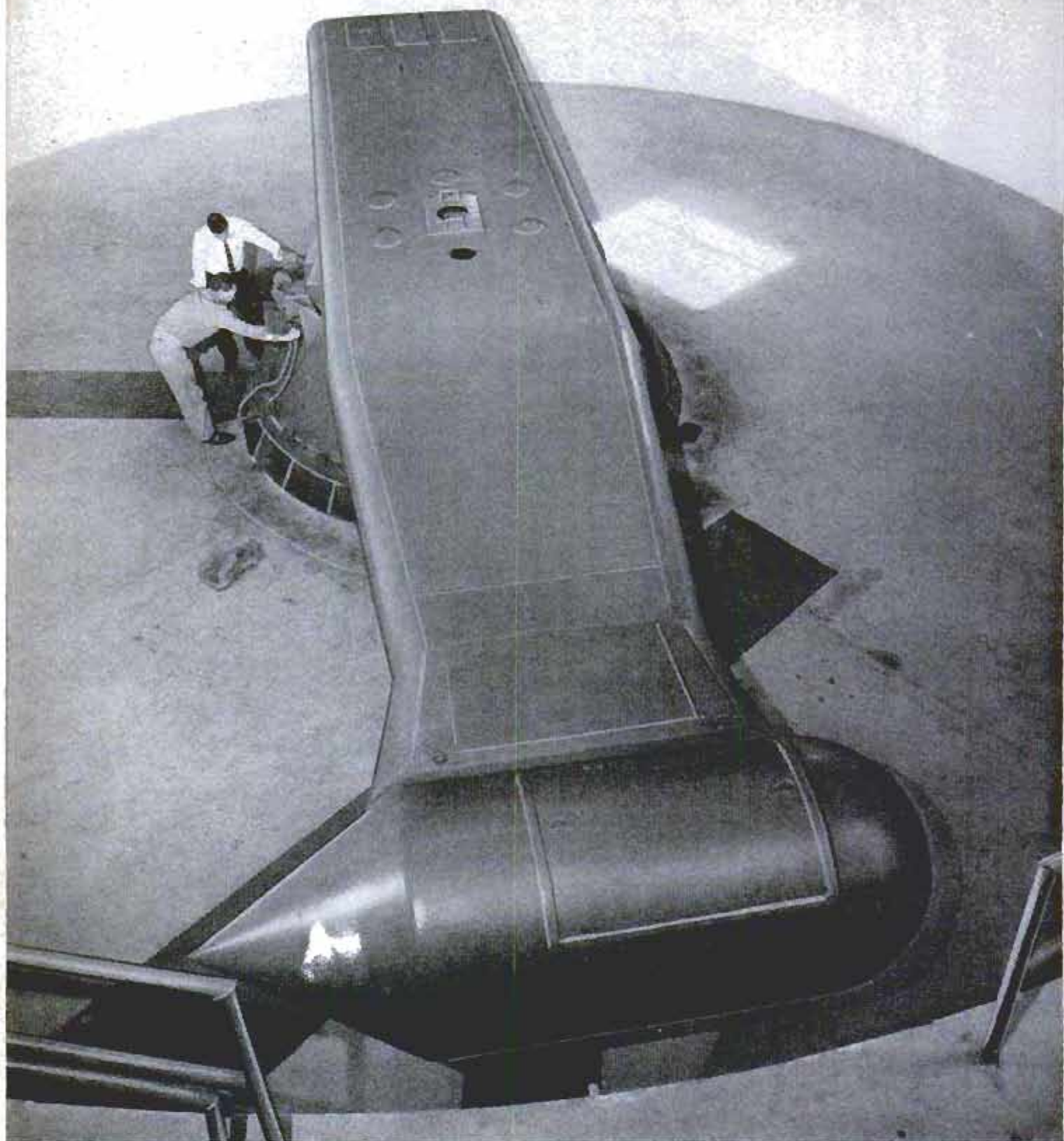

## **Huge Centrifuge Tests Missile Parts**

BUILT TO TEST components of the Atlas intercontinental ballistic missile, a big centrifuge at the Convair Astronautics test laboratories can whirl a one-ton load at

121 revolutions per minute. The machine develops enough energy to loft a golf ball from San Diego, Calif., to a point in the Atlantic Ocean 700 miles beyond New York.





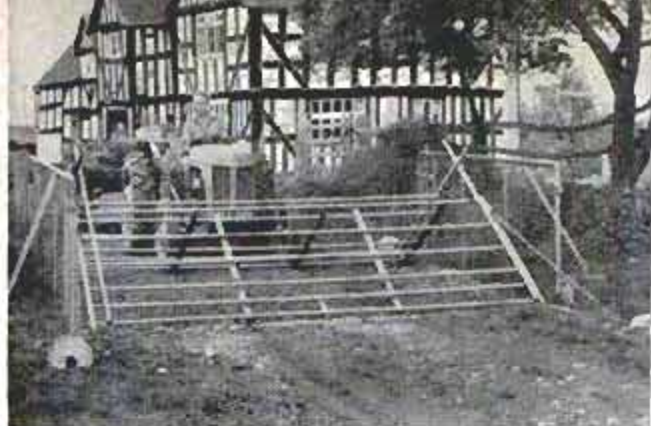

## British Livestock Gate Opens Automatically for Vehicles

There's no need to stop your tractor or truck when you approach a livestock gate used by British farmers. The grid gate

folds flat when the front wheels touch it. Counterweights raise the gate again as soon as the vehicle has passed.

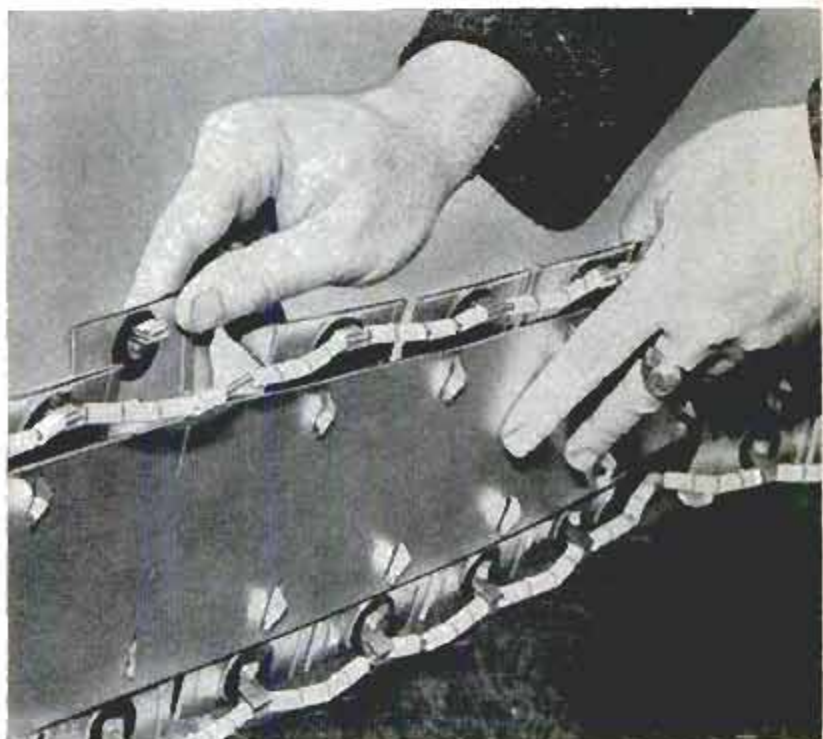

## Electric Water Heater Uses Snap-On Heating Units

Elements for a new kind of electric water heater can be replaced in a few seconds, without disconnecting the heater. The

series of individual 250-watt segments is joined to the bus bars by spring clips. Failure of one unit does not affect the others.

## Soapbox Racer Becomes Motorcar

Using a two-horsepower engine from a milking-machine compressor, Arthur T. Stultz of Burlington, Vt., has converted a soapbox racer to a motorcar that can go 20 miles per hour. A system of V-belts and an old bicycle wheel gives the vehicle a gear system with a power ratio of approximately 15 to 1.

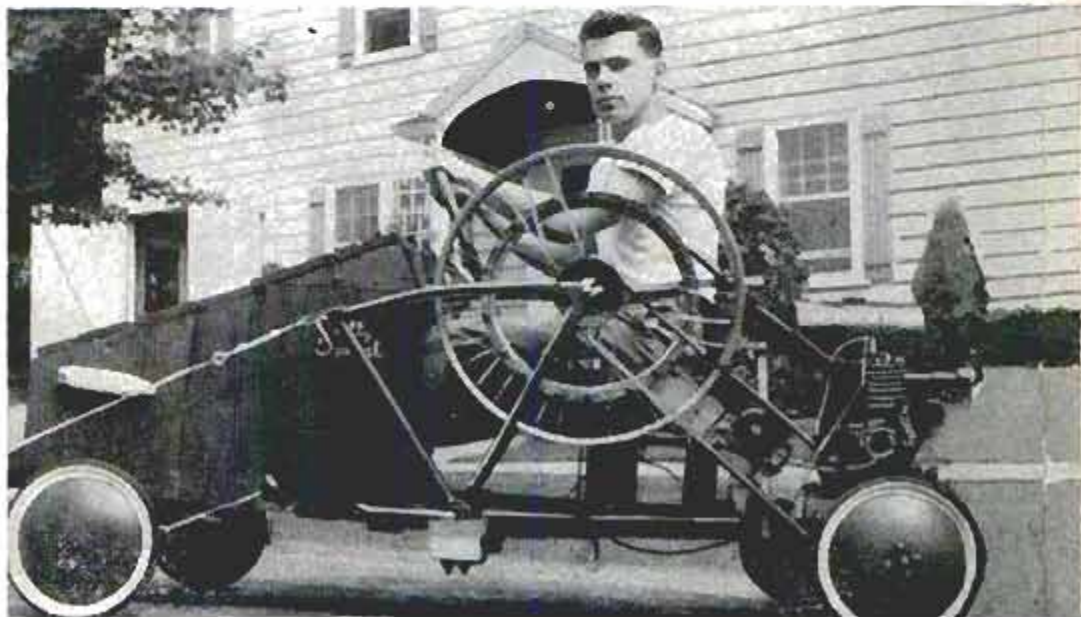





## Divers Can Chat On "Sonar" Phone

Divers are able to talk back and forth under water by using a new device that is based on the principle of sonar. Known as an underwater voice projector, it allows divers to converse almost as plainly as in the open air. The apparatus consists of a microphone that is embedded in the diver's breathing apparatus, a battery, a transistorized amplifier and a metal diaphragm that is worn on the chest. The diaphragm, actuated by a ceramic ring that changes dimensions by electrostrictive action, projects the sound waves through water. Reception is principally by bone conduction instead of by the eardrums. A diver who is listening must be bareheaded, or must wear a stethoscope type of pickup encased in a full diving suit and metal helmet. The present diver-worn projector, built by the Navy Electronics Laboratory at San Diego, Calif., has a range of 100 yards.

## Waterless Coal Washer Cleans by Air Pressure

Hailed as a waterless coal washer, a huge machine invented by Emery O. Milligan of Marion, Ill., and Ralph J. Lofquist of Chi-

cago cleans coal by air. The device forces air under pressure through the coal. It will be manufactured in southern Illinois.

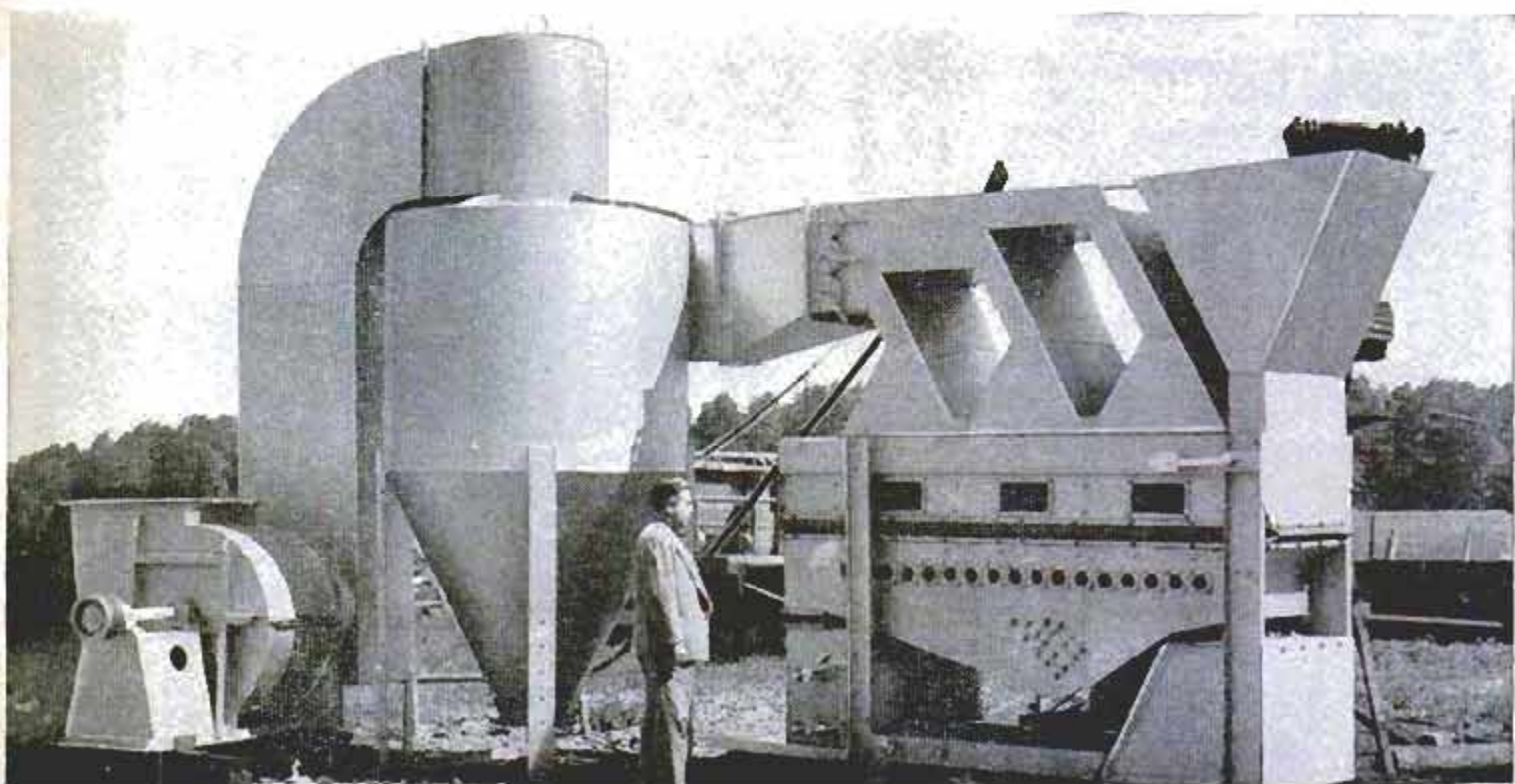





## Leather From Salmon Skin

Looking for new materials for interior decor or handicraft? Now you can buy leather made from the hides of Alaska Chinook or king salmon. The natural surface of the hide has a fish-net pattern. The processed hides are available in five colors.

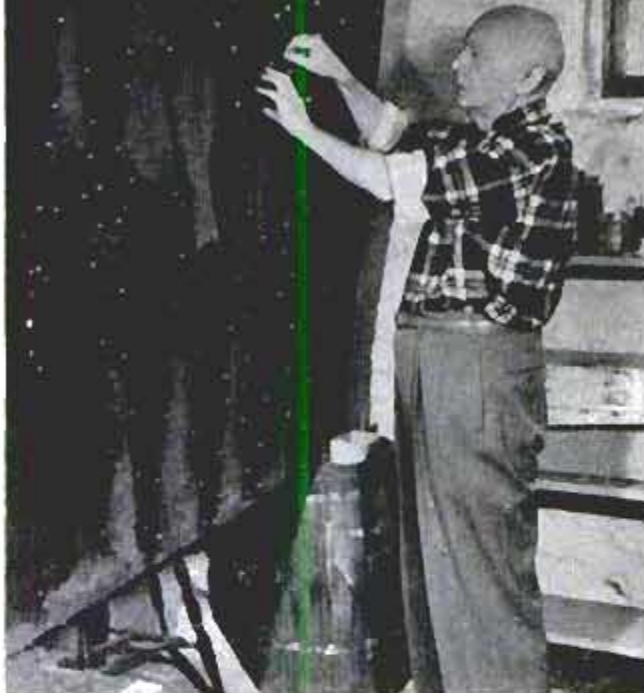

## Helicopter Shakes Nut Trees

Pecan growers in Texas and Georgia are experimenting with the use of helicopters to harvest the crop. The copter hovers over a tree for two or three minutes while the wind from the rotor blades flails the limbs, shaking the pecans onto the ground.



## Will Space Men Mine Meteors?

Prospectors in outer space may someday mine rare metals and gems from the thousands of meteors circling the earth. According to missile and space experts, including Dr. Ernest Stuhlinger, head of the U. S. Army ballistic-missile program at Huntsville, Ala., it may be possible to land on and mine a large meteor, or scoop smaller ones into a spaceship. The small meteors, which normally burn up when they enter the earth's atmosphere, are almost pure gold, silver, platinum, iron, copper and other metals. Diamonds, the purest form of carbon, are also prevalent.

## Dashboard Ash Tray Empties by Vacuum Into Container Under Hood

Touch a button on the side of a new ash tray for cars and the cigarette stub is drawn by vacuum through a tube to a glass

container under the hood. The vacuum extinguishes any sparks and the container needs to be emptied only four times a year.

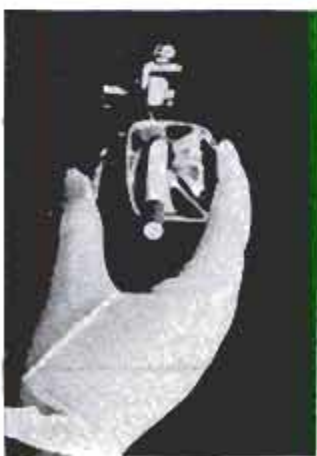
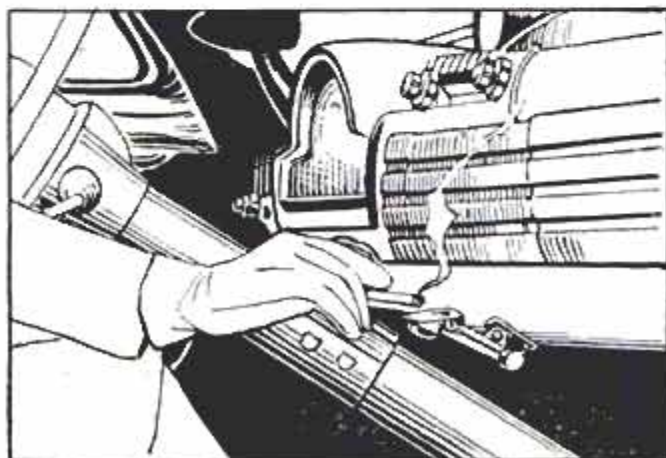





William A. Rhodes, left, demonstrates the radio transmitter in his snug underground atomic-bomb shelter

# Atomic Hideouts

Shelter has two circular rooms nine feet in diameter; one serves as storage area, the other for living

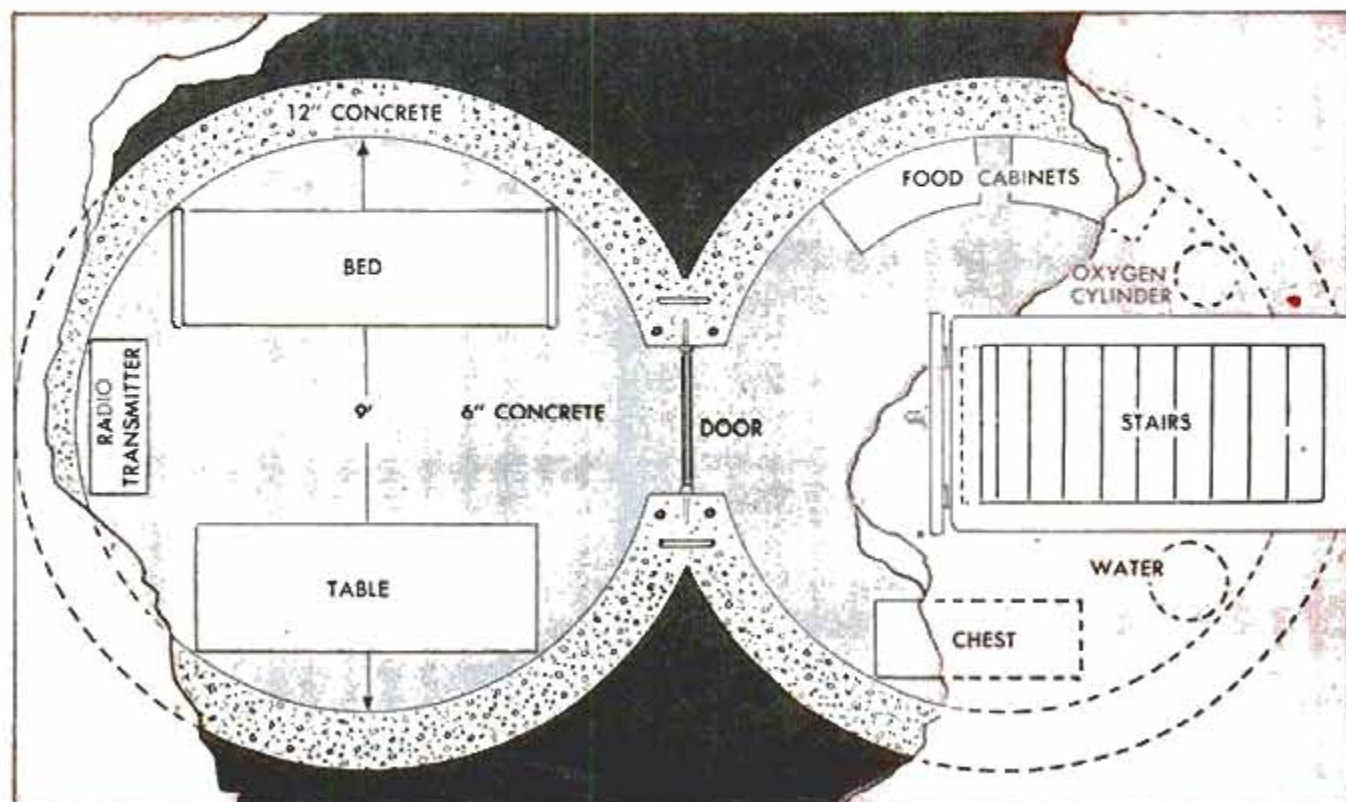



**L**IFEBOATS ON THE DECK of an ocean liner do not necessarily mean that the captain expects the ship to go down. This same reasoning, according to the builder of an atomic-bomb shelter in Phoenix, Ariz., should be applied to the building of such shelters across the nation. William A. Rhodes, research physicist, is no prophet of gloom; but he believes that an underground shelter that can be built for \$400 is pretty cheap family insurance against an H-bomb war. The concrete shelter he recently finished building has received the blessing of the Phoenix Civil Defense authorities who proclaim it to be an excellent type of family bomb shelter. In fact, they have urged others to build shelters of similar style.

The importance of some kind of shelter was stressed in the Gaither report made for the Office of Defense Mobilization and the National Security Council. Among other measures the report recommended "a Civil Defense shelter program at a cost of around \$5,000,000,000 a year for four to five years. The shelters would be designed to save lives against the perils of radioactive fallout and only incidentally to help the nation's industry to recuperate after an enemy attack."

Many Civil Defense workers and people like William Rhodes feel that it is a mistake to wait for a federal shelter-building program. After all, such shelters might be miles from your home. Also, approaches

to the shelters might be jammed after an alert that enemy bombers or an intercontinental ballistic missile was on the way.

The simple shelter built by Rhodes in his back yard was designed to afford protection for himself, his wife, and their son, for a period of two weeks. It might accommodate one or two more persons with the addition of an extra oxygen tank.

The Rhodes shelter consists of two adjoining circular rooms; each is nine feet in diameter. The reinforced-concrete floor is six inches thick and the walls are one foot thick. I-beams support the ceiling which is 6½ feet in height. The entrance is through a hatch which is slightly above ground level with wooden stairs that lead down into the shelter. The first room contains storage cabinets for food and clothing, a water tank and oxygen cylinder. In the inner room are a bed, table, chairs, lounge (which could serve as a bed for the son), a desk, cabinets, and a ham radio transmitter and receiver. A transmission antenna juts upward from the shelter and its supporting pipe provides a channel for electric lines and air intake.

Temperature in the shelter varies from 62 to 78 degrees throughout the year. High humidity from irrigation seepage requires the occasional use of a dehumidifier; a small electric heater is used sometimes for 10-minute periods. In addition to its use as a bomb shelter, the underground rooms provide the Rhodes family with a cool

Transmission antenna for radio transmitter extends through roof of shelter. Hatch is in the background



Door for hatch is made of aluminum and plywood laminated material similar to that used in airplanes

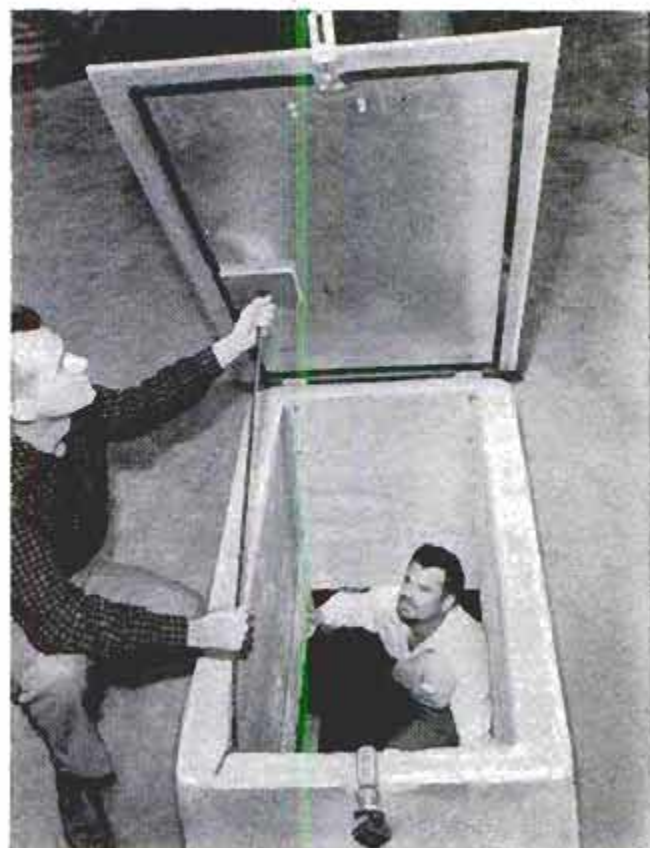



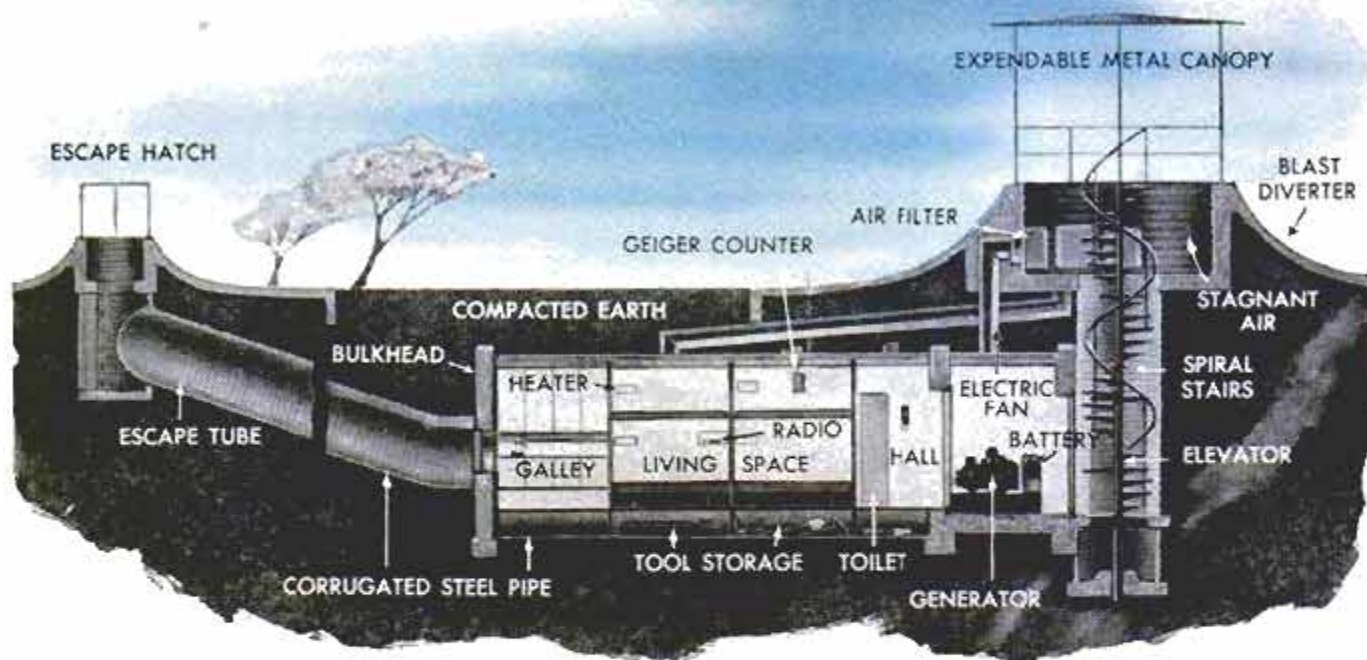

Laszlo's luxury shelter is designed for safety under all conditions except for a direct hit by an H-bomb

place in which to relax during the hot summer weather.

In contrast to the Rhodes project, a deluxe bomb shelter in Los Angeles provides comfortable quarters for eight persons for two weeks. Its maximum capacity is 14 persons. The shelter is engineered to provide safety under all conditions except for a low-altitude direct hit by a hydrogen bomb. It was designed by Paul Laszlo, industrial designer of Beverly Hills, Calif., in collaboration with authorities on blast, thermal conditions and fallout. Comfortably supplied with food, water, electricity and filtered air, shelter's occupants would be in touch with the world by short-wave radio. A Geiger counter with a protected tube located above ground would tell the occupants when surface contamination was reduced to a safe level.

The shelter consists of complete living quarters, including galley and toilet built inside a 10-foot-diameter galvanized pipe with waterproof joints. The pipe is buried under four feet of compacted earth. In addition to a main entrance with spiral staircase and elevator, a remote escape hatch is

also provided. The self-sealing entrance doors are designed to withstand pressure differentials of 30 pounds per square inch. The ground surface around the main entrance sweeps up so as to carry blast pressure past, reducing pressures inside the entrance area to subsonic velocities. A metering orifice in each ventilating duct keeps pressures inside the shelter within safe limits. Dust filters that would trap radioactive dust are contained in the ducts.

The shelter has its own electric generator that starts up automatically if city power is disrupted. In case of generator failure, the lights and ventilating system automatically switch over to batteries that could operate the equipment for a week.

A large underground emergency-water tank, connected to the city mains, is equipped with a valve that closes after an explosion to prevent the water supply for the shelter from being contaminated with radioactive water. Bottled water is stored in the galley. Storage space under the floor contains survival tools including oxygen tanks and masks and acetylene cutting equipment. ★ ★ ★

## Black-and-White Prints From Color Negatives

With the development of a panchromatic enlarging paper, photographers can make good quality black-and-white prints from color negatives. Conventional enlarging papers, due to their lack of red sensitivity, reproduce reds as black. The new paper, announced by Eastman Kodak, yields faithful black-and-white prints without using corrective filters, although filters may be used for special effects.

## Dinosaurs and Man

Dinosaurs were the dominant animals on earth for about 130,000,000 years; man and his forerunners have been here less than 2,000,000 years and all human history covers little more than 10,000 years, according to the Smithsonian Institution.

☛ Cloud-seeding on the West Coast has resulted in an average precipitation increase during seeded storms of 5 to 22 percent, according to the President's Advisory Committee on Weather Control.



# Numbers System Helps Fight Fires

Because many people panic during a fire and fail to report the exact address of the blaze, firemen of Hartford Township, Ohio, have assigned a special "fire number" to each household in the area. A copy of this number is kept at the base of the telephone and the same number

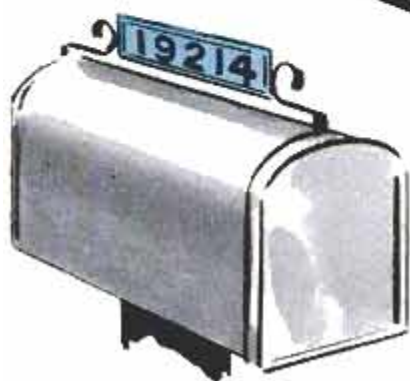

appears on the mailbox. Now, when a person reports a fire, he merely reads his fire number to the fire department. From the department's file, firemen pull a card listing the address, number of persons in the family, location of master switch, nearest water supply, hazards such as a mean dog or stored gasoline and other information helpful to fire fighters.

## "Piggyback" Trailer Unit for Standard Pickup Truck Sleeps Three

Sleeping room for three is available in a "piggyback" camping unit that weighs only 800 pounds and fits into any standard pickup truck. It provides many of the facilities of a house trailer but does not require the extra license plates, tail light and slow speed of a conventional mobile home. It

can be driven and parked anywhere you can take a passenger car. The unit is installed or removed by sliding it on pipe rollers up or down a ramp. It is completely insulated, has a birch-paneled interior and a skylight vent in the roof. A unit for the Ford Ranchero pickup sleeps four.

Interior has seats that fold into double bed, gas range, electric lights, ice box, water tank, sink

Exterior shows snug fit in pickup body, with no overhang. Third bunk is in extension over the cab





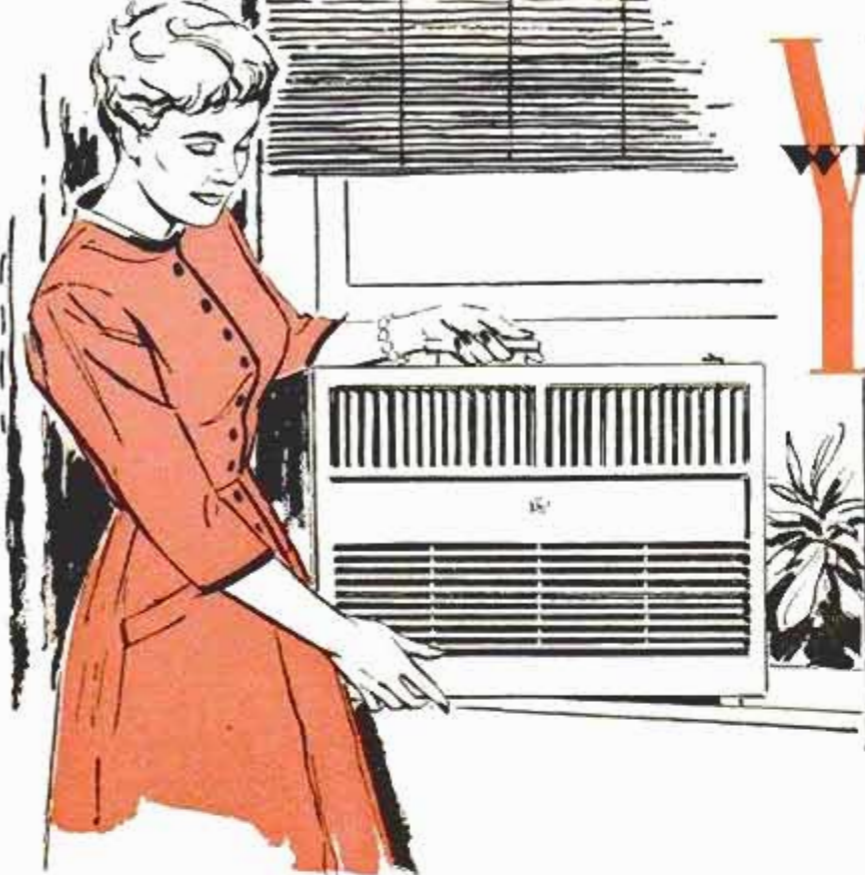

# WHAT'S NEW FOR Your Home

← **PORTABLE AIR CONDITIONER** also serves as a room heater or dehumidifier. Using the heat-pump principle, unit can be rotated, back to front, in the window to warm room air. Placed on the floor it becomes a dehumidifier. Unit weighs less than 60 pounds, fits most windows  
Carrier Corp., Syracuse 1, N.Y.

**"UTENSIL WHEEL,"** right, hangs from the ceiling to hold pots and pans over "island" working centers in modern kitchens. A push of the housewife's finger rotates wheel on ball-bearing mount to bring the desired utensil within reach  
Arch Co., 31 Milk St., Boston 9, Mass.

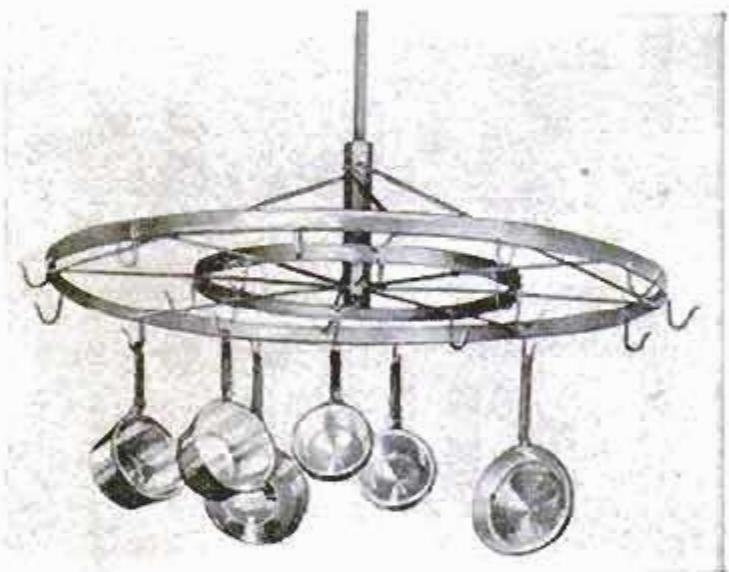

**NYLON HOSE SHAKER,** below, uses centrifugal force to wash and dry nylons within minutes. Nylons and detergent solution are placed in container, which housewife then shakes for a few moments. After rinsing the hose, she swings container at arm's length. Centrifugal force dislodges water, leaves hose virtually dry  
P. F. Fleming, 1202 Commerce Bldg., Houston 2, Tex.



**BURGLAR ALARM,** below, requires no electricity, locks partially raised windows against further opening. Bell itself is turned to wind up alarm. "Ears" fit against sash and casement. Raising the window trips trigger beneath bell  
Allied Associates, P.O. Box 48, Dexter, Me.

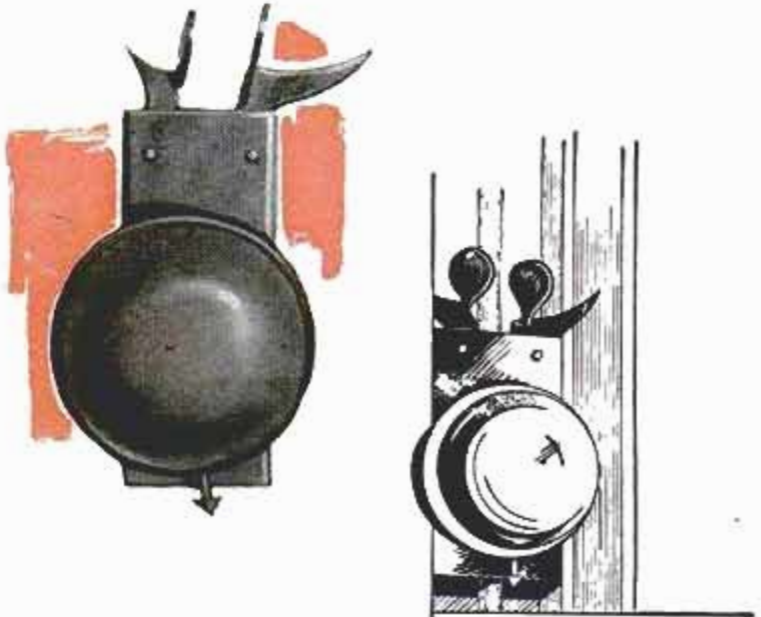





**HEAT EXCHANGER**, mounted between furnace and chimney, warms basement with heat that otherwise would escape. Thermostat controls fan which blows air through tubes to recover heat

AirLite Mfg. Co., Emporium, Pa.



**"THIRD HAND"** holds mirror while milady dresses her hair. Mirror measures seven by eight inches, has a watertight plastic frame. Flexible arm can be mounted on any wall, permitting mirror to be adjusted in height and angle

Magic Vu Inc., 1150 S. Broadway, Denver, Colo.

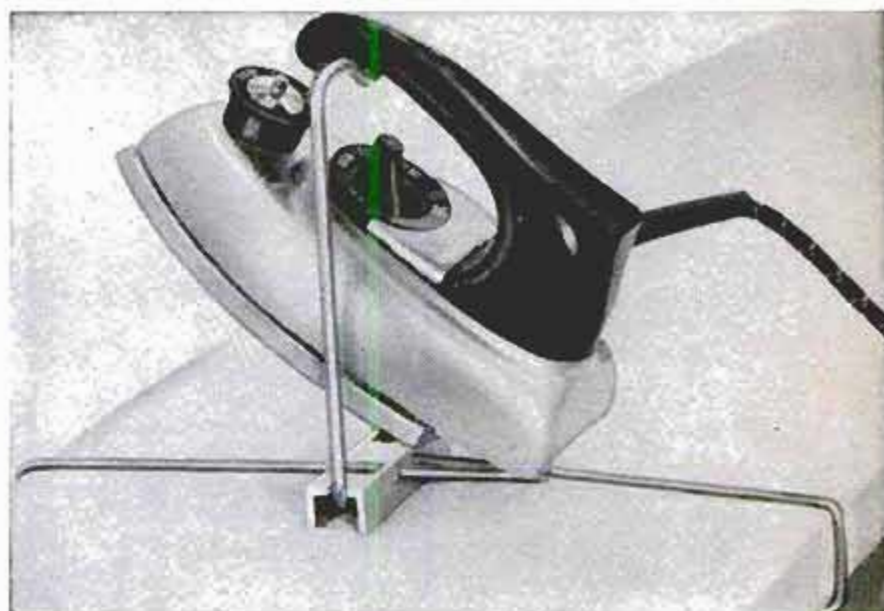

**RACK FOR IRON** holds it off the ironing board to minimize fire hazard. Adjustable clamps hold the rack to the board. Rack holds both open and closed-handle irons

Fleming Mfg. Co., 3240 N.W. 27th Ave. (Room 47), Miami, Fla.

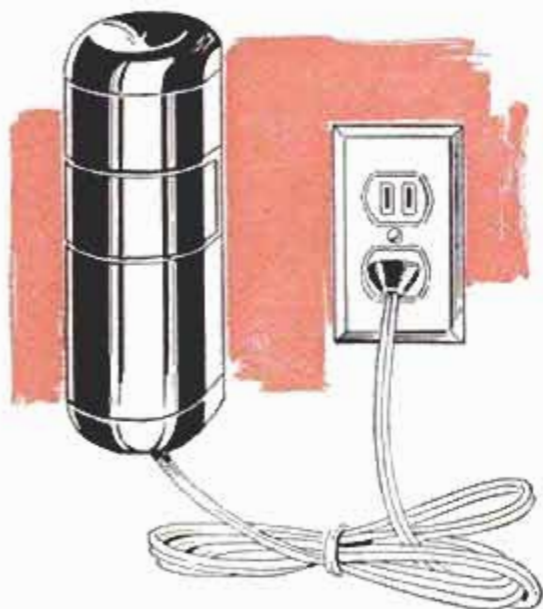

**HEATING ELEMENT**, installed in closets or cabinets, prevents mildew. The element is encased in a steel cylinder open at both ends. Damp air goes in the bottom and is dried as it moves up tube

Air Dri Associates, P.O. Box 411, Station A, St. Petersburg, Fla.

**LAWN EDGER** is really a sidewise lawn mower. Metal finger moves along the edge to lift the overhanging grass. Single wheel is geared to turn the side-revolving blades, which trim the grass wherever lawn meets sidewalk

Otcraft Products, Inc., 1307 W. 25th St., Norfolk, Va.

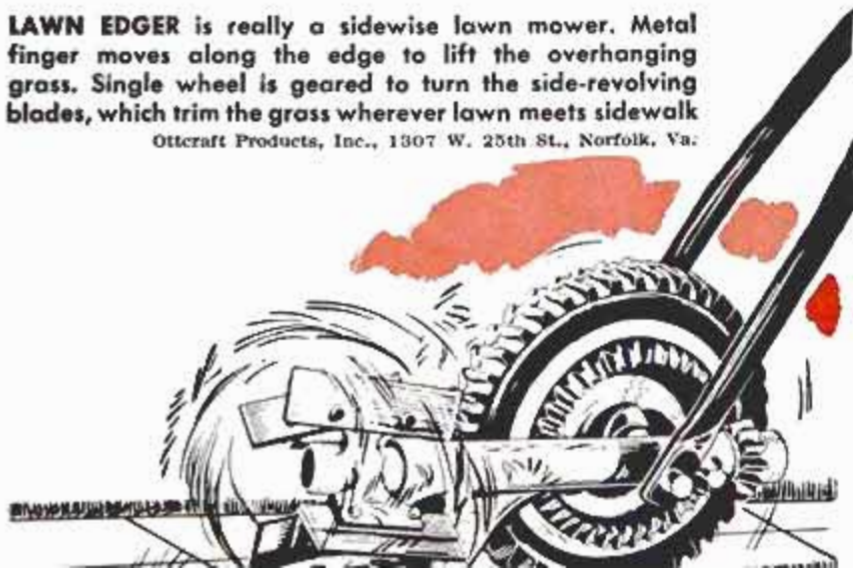



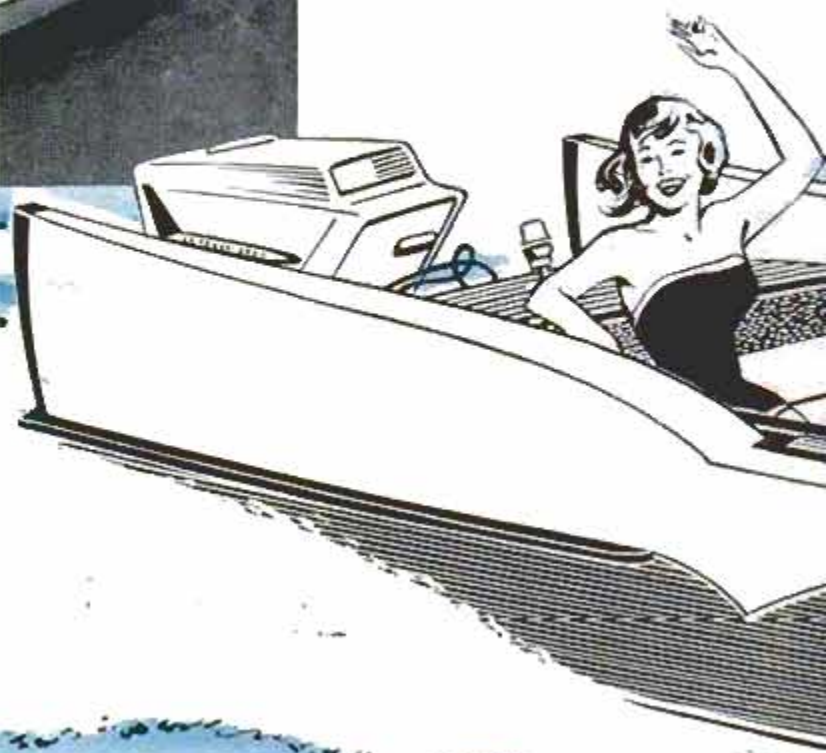

# "SWISH"

## 15-FT. SPORTS RUNABOUT

### PART I

**F**OR THE OUTBOARD ENTHUSIAST who desires a really fast boat with an ultramodern appearance, here is *Swish*, a 15-ft. 2-in. sports runabout designed especially for *PM* readers by Glen L. Witt, naval architect. Although unusual in design, construction of the boat is basically simple so that anyone familiar with a few common tools can build her with little difficulty. An extreme beam of 6 ft. 4 in. and a maximum hull depth of 30 in. provides for a roomy cockpit in which comfortable front and rear seats are installed for enjoyable riding. The rear seat is removable to accommodate fishing, water skiing or skin-diving equipment when desired. The high sweeping tailfins not only make the boat attractive but stiffen the hull and de-

flect spray to keep the motor and rear-seat passengers dry.

All materials, lumber and fittings required for construction of the boat are itemized in the materials list on page 252. Materials not listed may be substituted at the discretion of the builder, provided they are of similar quality and have about the same characteristics. Where lumber is specified, white oak, Philippine mahogany or Sitka spruce can be used as desired, keeping in mind that for strength oak is preferable, for appearance mahogany is best, and for good strength and light weight, spruce is advised. All plywood used must be intended for marine or exterior use. Plywood edge-stamped EXT-DFPA will assure the builder of guaran-



WEIGHT: Write Glen L. Witt

# BOATING . . .

*Swish*, one of the trimmest family runabouts ever designed for the craftsman, leads off our annual boating section. Among other articles in these 29 pages, boaters will find a report on new boating products, a shantyboat vacation cruise, all the 1958 motor specifications, tips on buying used boats, radio aids for boaters (page 220) and a scientist's answer to that old question, "Do Motorboats Scare Fish?"

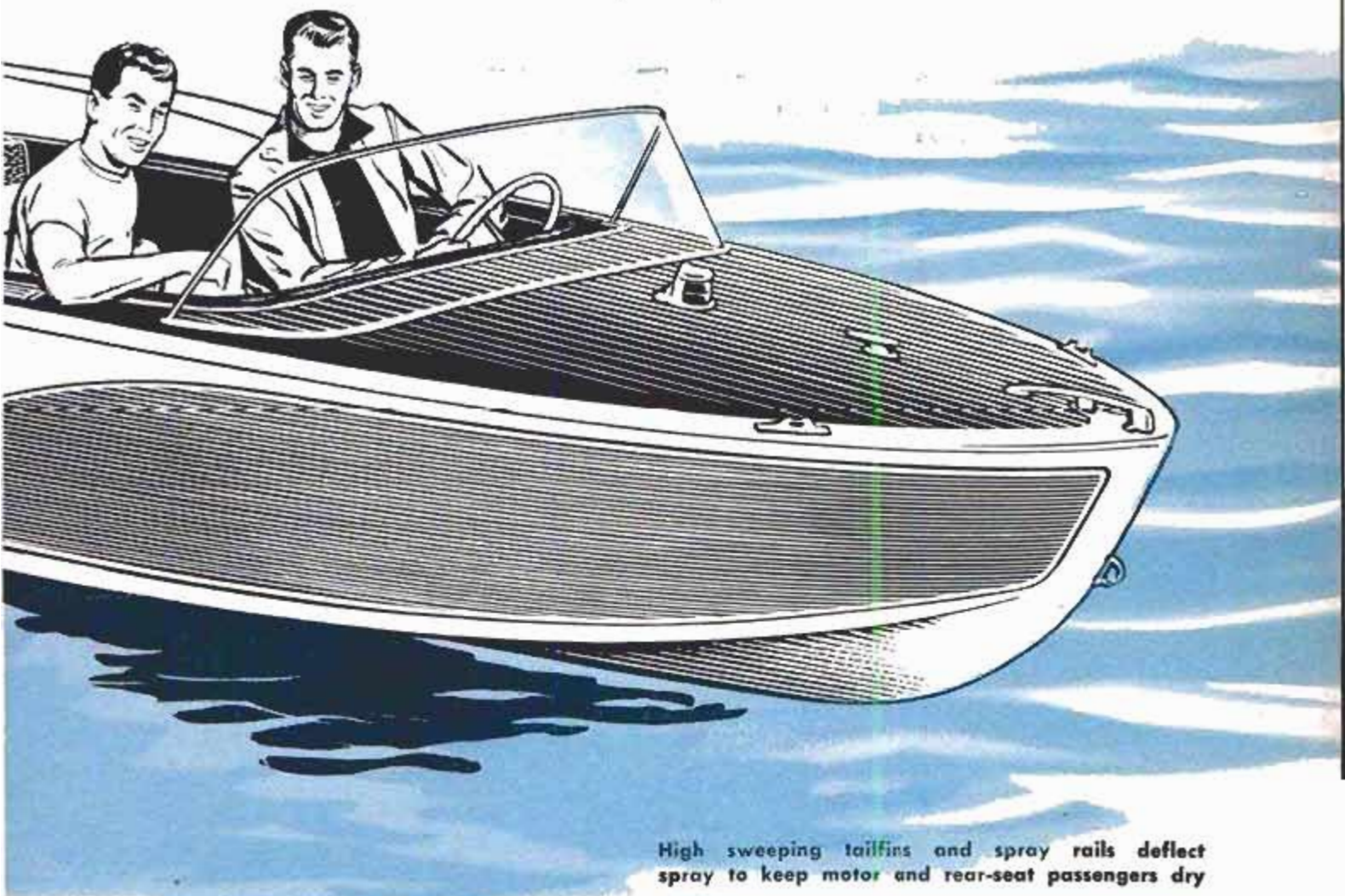

High sweeping tailfins and spray rails deflect spray to keep motor and rear-seat passengers dry

teed exterior plywood. The marine grade or solid-core type plywood is best and is strongly recommended particularly for the planking.

All joints throughout the boat should be glued. Resorcinol-type glue, a liquid and powder combination mixed at the time of use, is recommended. Urea-resin glue can be used, but not when gluing oak that is to be in contact with salt water. Where galvanized bolts are specified, use only the hot-dipped type.

**Frames:** Half patterns of the four frames are detailed in Figs. 2, 3, 4, 5 and 6. With the exception of the transom, a full-size pattern of each frame should be made on wrapping paper. Note that all width dimensions are taken from a centerline.









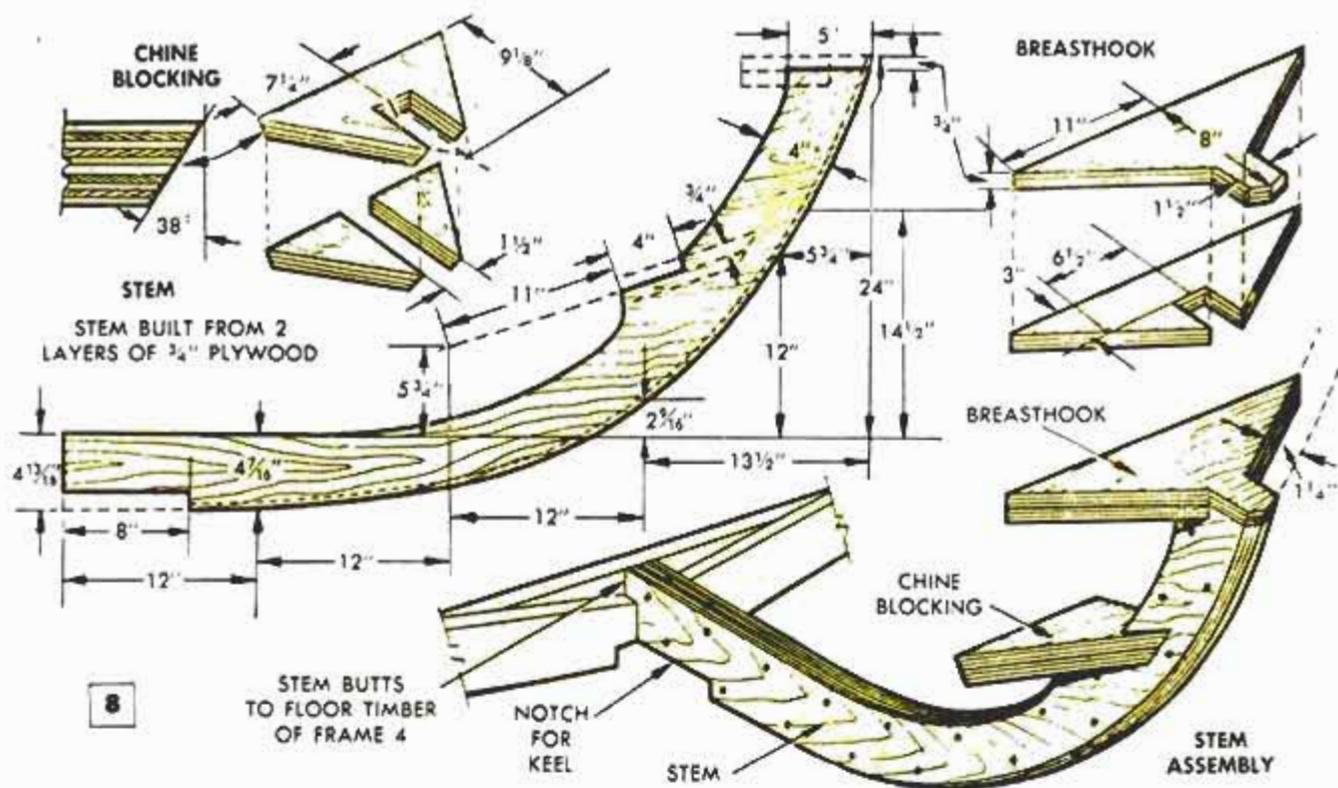

When springing-in the arcs on the side and bottom members of the frames, observe that dimensions are given at mid-points between chine and sheer, and chine and keel. To strike the bottom arcs, use a thin batten, such as a kite stick, and bow it to coincide with these three points: Chine, sheer and given mid-point. The same procedure applies for finding the arcs for the sides of the frames. The frames are fabricated from 1-in. oak or mahogany. To transfer the pattern to the wood, simply lay your pattern over the lumber and make punch marks at  $\frac{1}{2}$ -in. intervals along the lines. Carbon paper may be used for transfer of patterns if desired. At the

chine junction of the side and bottom members, a  $\frac{3}{8}$ -in.-plywood gusset is used on both sides of each frame. Note that all frames of the boat are assembled from a setup level which is the top edge of the bottom frame member. This height must be kept accurate and true. Assemble the frame parts directly over the full-size patterns. Coat the gussets liberally with glue and nail them in place with a minimum of five nails per member as specified in the fastening schedule of the materials list. On frame 4 the bottom frame member consists of three pieces, the outer pieces being joined by a backing member called the floor timber that is cut from the same

**Most important step of boat construction is accurate alignment of transom, frames and stem on strongback**

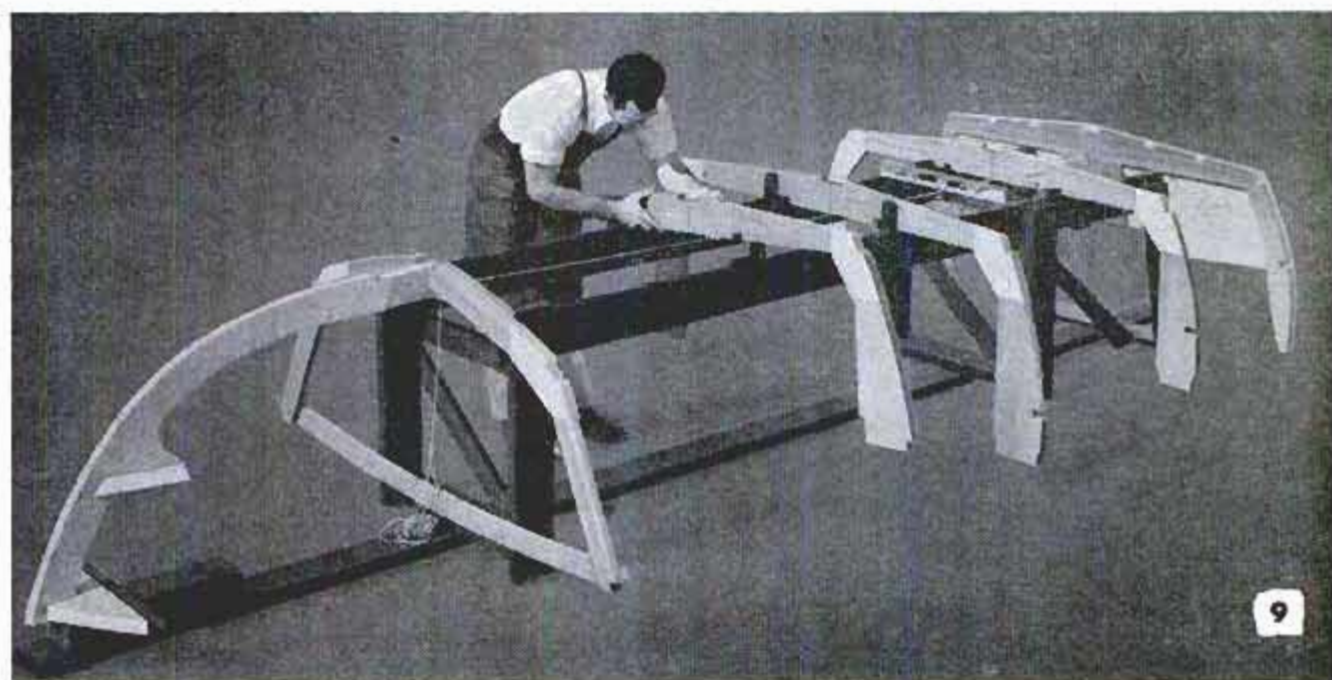



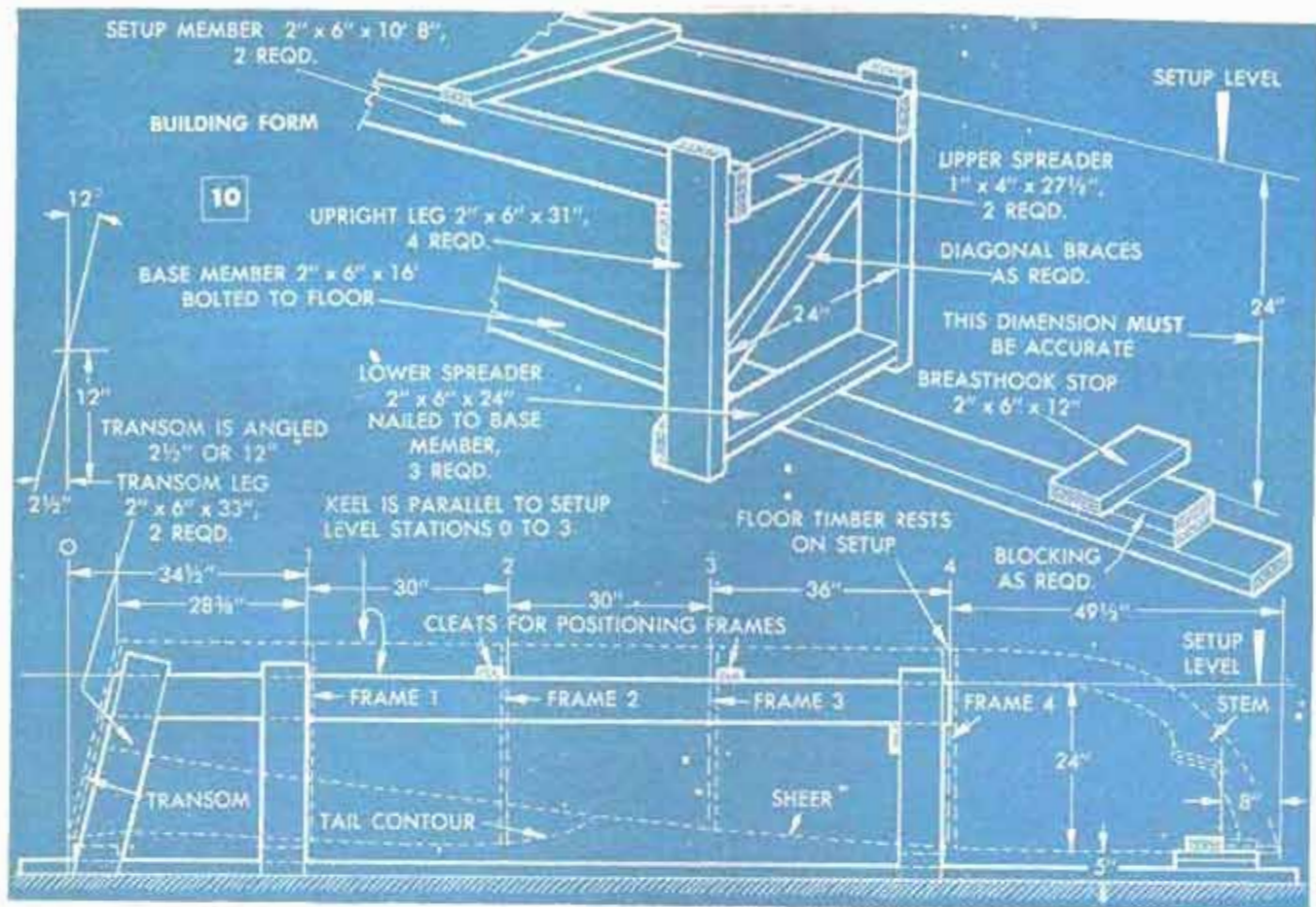

material as the frames, Fig. 1. After assembling all frames, notches for the floor battens, chine log, sheer clamp and keel are cut.

**Transom:** The transom is laid out full size too, but since the after side of the transom frame is covered with  $\frac{3}{4}$ -in. plywood, the pattern is drawn directly on the ply-

wood. Take special note that the transom is at a 12-deg. angle to conform with the keel, sheer, batten and chine notches. The transom and transom frame are assembled with glue and screws (see schedule). The transom is shown with a cutout that will accommodate a single medium-size motor.

(Continued to page 252)

**Strongback and attached members must be rigid to prevent movement when sheer clamp is sprung into position**

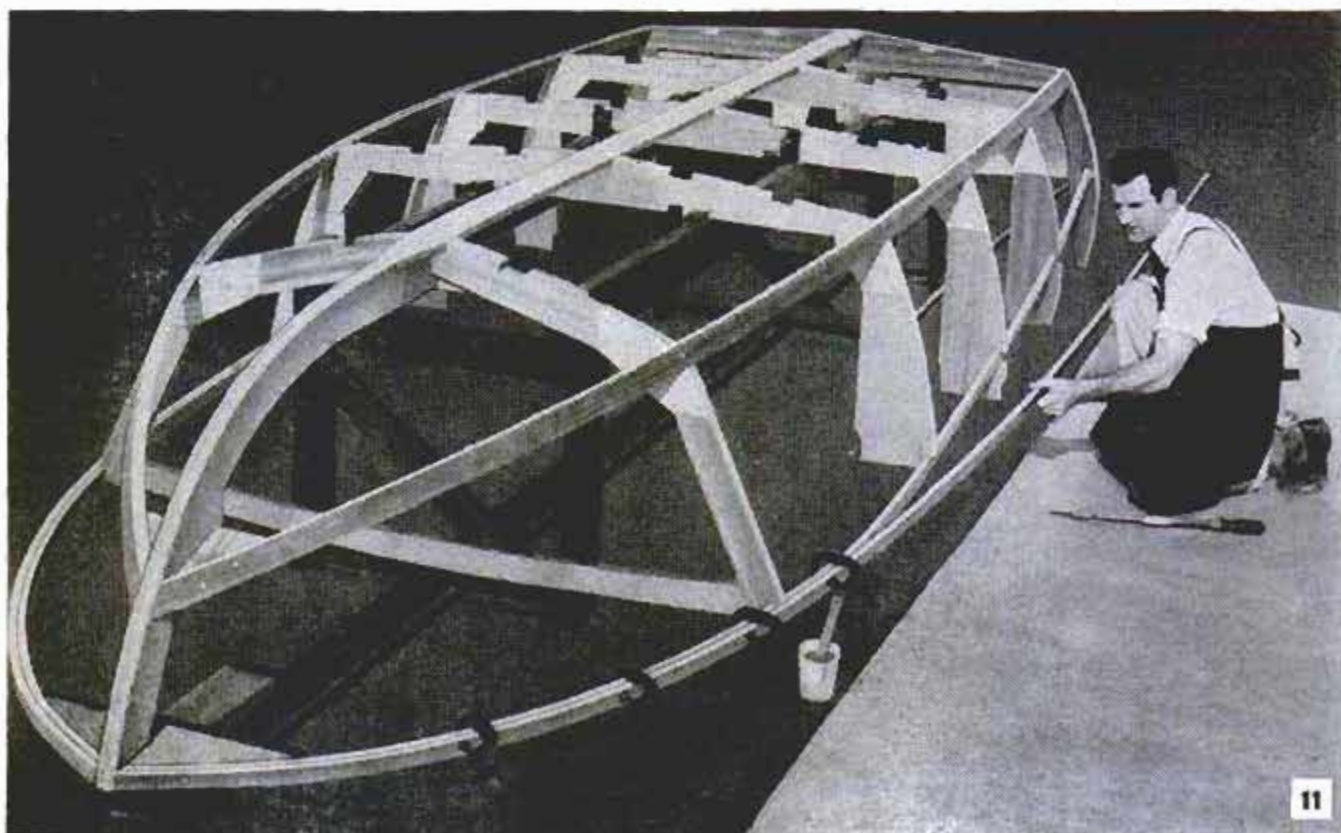



# WHAT'S NEW IN BOATING



**OUTBOARD HOUSEBOAT** is powered by three 60-horsepower motors mounted in wells. One is located forward center and the others are in the stern at the sides. The craft, 60 feet long and 28 feet wide, is claimed to be the world's largest outboard houseboat  
Larry Vita, Smithtown, Long Island, N. Y.

**ALUMINUM DUCKBOAT** weighs only 69 pounds, allowing one-man portage. The cabin-blind is weather and mildew-proof vinyl-covered nylon which rolls into a small package. Loops are provided for inserting camouflage material. Length of the boat is 11 feet  
Duratech Mfg. Corp., Route 202, East of Peekskill, N. Y.



**MOTOR CADDY** weighs only five pounds but it will carry outboard motors up to 35 horsepower. The caddy can be slipped into a wall bracket, making it a permanent storage stand

Marin-E-Products,  
9030 Bridgeway,  
Sausalito, Calif.



**OUTBOARD SPEEDBOAT** has skin-stress type of construction with all the hull weight in the skin. Speed is rated at 30 miles per hour with one outboard and 40 plus with two. Inboard models have Corvette, T-Bird, Chrysler or Cadillac engines; speed, 50 plus  
Casey-Craft, Murrenport, La.







**SHALLOW WATER** for fishing or hunting requires a nearly flat-bottom boat. One of the new models that fills the need also has a deck design that's easy to camouflage for duck hunting. It's lightweight, easy to carry and launch and moves fast with a 10 or 12-horsepower motor. About 12 feet long, it seats two persons

Glass Magic, Inc., 2759 Ludelle St.,  
Fort Worth 5, Tex.

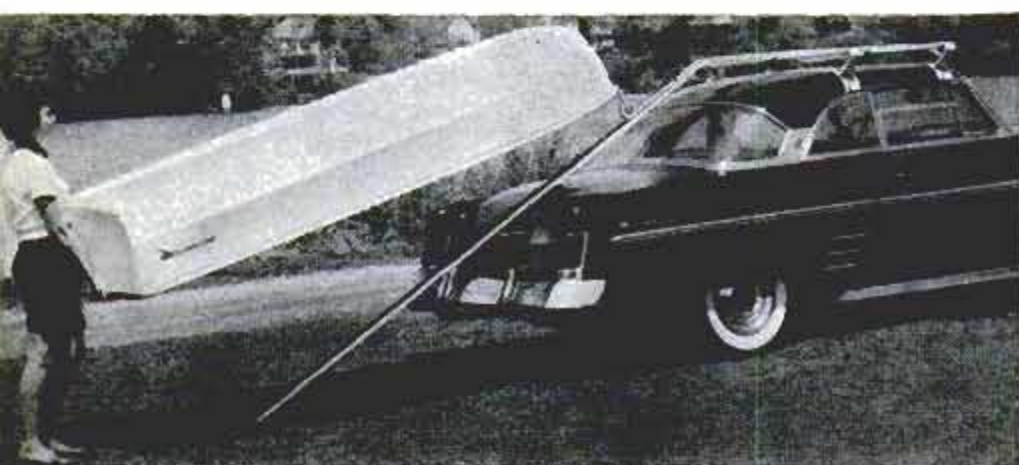

**EASY BOATLOADING** for craft too big for one man to handle but too small for a trailer. A bow wheel assembly is attached to a rubber tire that rolls on a steel ramp. The loading ramp consists of four telescoping channel sections, with the top sections curved at the ends. Roof-top bars can also be used to carry other items

Market Forge Co., Everett 4D, Mass.

**DAY CRUISER** is designed for either single or dual outboard installations. The new models are made with much heavier gauge aluminum in the hull bottoms. Some feature sleeping facilities and an optional hardtop. The aluminum hull is anodized

Feather Craft, Inc., 450 Bishop St., N.W., Atlanta 13, Ga.







**BIG OUTBOARD CRUISER** has inboard-style comforts and travels at a speed of 18 miles per hour. The 31-foot model sleeps eight and carries a galley with stove, oven and gas refrigerator. Control cables for the two 60-horsepower outboards are completely concealed

LePage Craft, Maple Grove, Que., Can.



**SMALL OUTBOARD** is equipped with a 3.6-horsepower motor but can use up to a 10. It cruises at speeds between 5 and 10 miles per hour. Built of mahogany plywood, the craft weighs 100 pounds, has only one seat

Turn-A-Craft, Marble Lake, Quincy, Mich.

**MOTOR STABILIZER** increases power and speed for outboards with 25 or more horsepower. For ski towing, it cuts drift on turns and reduces spray

Jagiel Research & Development Co., Toledo, Ohio.

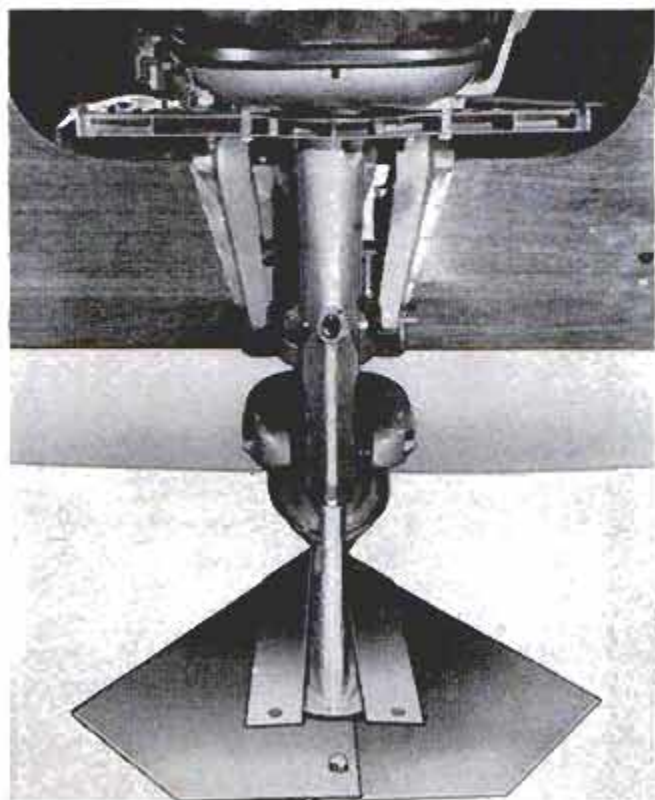

**PORTABLE GENERATOR** produces 800 watts of 115-volt alternating current. Tank holds fuel for up to three hours of operation. Muffler diverts sound

Bendix Pacific Div., 11600 Sherman Way, North Hollywood, Calif.





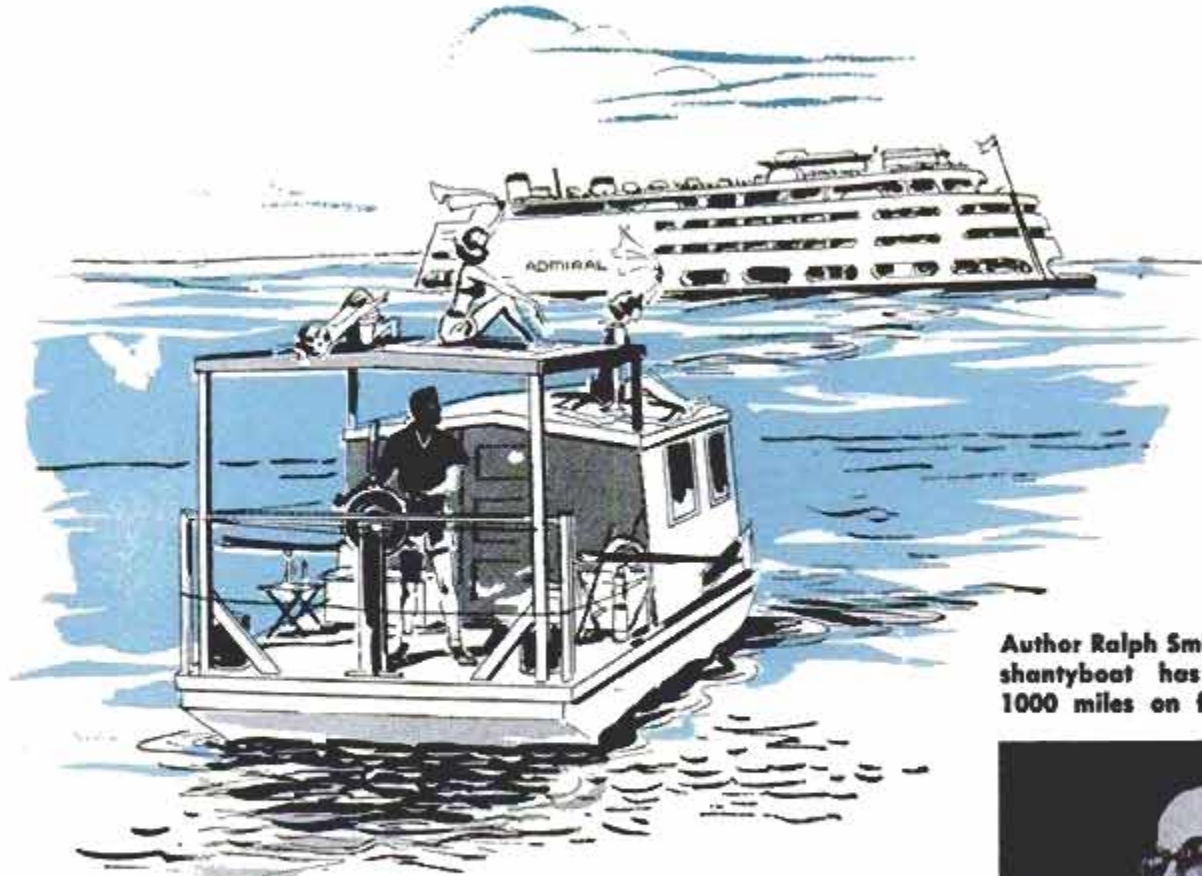

Author Ralph Smith, whose shantyboat has traveled 1000 miles on five rivers



**We're a boating family. We travel by whim, throw away the clock and calendar, always head for one destination—Fun. Our houseboat is homemade, we need no horsepower for**

# Cruising Down the River

By Ralph Smith



**O**THERS CAN HAVE their sleek cruisers and slippery runabouts. For fun on inland water, give me cruising in a shantyboat.

A shantyboat is a houseboat built to travel. Most of the time, in a shantyboat, you just drift on the current and enjoy life. Shoal of draft, easy to handle and sturdy, the shantyboat can—as our experience demonstrates—go just about anywhere on inland waters. We have logged a thousand miles on five rivers over a three-season period in our boat. On the Missouri, with only sweeps for control, we negotiated tricky currents in a river beset with pile dikes and retentions waiting to penalize error by engulfing a boat. The Gasconade,



a brawling, snaggle-toothed mountain stream in the Ozarks, was a harsh test; we found water so shallow that we had to go over the side and lift the boat across gravel bars, as well as rapids so fast that we had to drop the boat through on lines. On the Mississippi and Ohio we successfully rode towboat wakes that put solid water over the deck. On Kentucky Lake, after negotiating the Tennessee, we took open water subject to storms so severe and abrupt that safety harbors are spotted every three miles or so as refuges for the towboats, husky as they are.

Shantyboats are easy to construct, economical to build and can be made large or small, elaborate or simple according to the owner's need or whim. Since the scow hull is little more than a glorified box, any amateur can build one. Simplicity brings economy by permitting the use of dimension lumber without waste. The roominess of the square shape permits a surprising amount of livability to be built into even a small boat.

The attributes—as well as the inevitable disadvantages—of shantyboats are attested by my own craft.

### Plywood Hull and Deck

Because I planned to drift, using the current for propulsion and the oars for control, I made the boat as small and maneuverable as possible. Length is 18 feet. Beam is just under eight feet to permit it to be legally towed on a trailer. For lightness,  $\frac{3}{4}$ -inch lumber and half-inch plywood were used to sheath the hull. Hull framing con-

sists of two by two-inch lumber for the vertical pieces and two by three-inch material for the cross timbers. To hold down weight,  $\frac{3}{8}$ -inch plywood is used for the deck and  $\frac{1}{8}$ -inch hardboard for the cabin sides. The result is a 1200-pound craft that pulls no harder than a heavily loaded skiff. We traveled under oars for 700 miles before hanging a motor on the stern at St. Louis, Mo. The motor is only  $7\frac{1}{2}$  horsepower, yet so easily does the boat move that it pushed the craft upstream against the current of the Ohio and Tennessee.

Despite the small size, the boat has room equivalent to a conventional boat twice the size. It has full-size bunks for four with air mattresses and sleeping bags, a galley equal in size to the kitchen of an efficiency apartment, a table to accommodate four at meal time, a full-length clothes locker plus bins, drawers and cabinets that carry supplies for three weeks. With six windows, the cabin is so airy that even in the South we found blankets necessary.

### Initial Cost: \$400

The cost was surprisingly low. The total initial investment was around \$400. The boat went together in only six months of evening and week-end work. Every piece of wood, save for the curved roof beams, was cut on a bench saw. The precaution of backing all seams with battens and using wicking and compound in all joints and seams paid off; my only concern with the bilge is the cobwebs that form there.

This is not to say that a shantyboat is the perfect boat. There is no such thing. With

Always ready to interrupt our journey, every clear-water creek was a signal for a swim. We carried sheets of hardboard which fit over the canopy to shade deck on warm days







Each evening we headed for a river sandbar. There, as the sun went down behind the distant cottonwoods, we would eat our evening meal around a driftwood fire

a shallow bite on the water—our craft draws but three inches—and the high sides sticking like sails into the air, it is so sensitive to wind that the slightest breeze will send the boat lumbering off. When equipped with sweeps alone, shantyboats are one-way craft. Distance put behind is as impossible to recapture as time. While the scow hull has great initial stability, it lacks a conventional hull's ability to recover if rolled too far. But for places where the water shoals out, for downstream drifting and in protected waters, a shantyboat has advantages not possessed by other craft.

#### Start at St. Louis

Our pattern of journeying, which we plan to continue until we run out of river, is to drift for three weeks each summer. When we have used up our time we leave the boat on the bank until the following year brings another installment. Two years of journeying took us from Omaha, Neb., to St. Louis, where our 1957 voyage began. On hand were my wife Dorothy, my 11-year-old son John, and my 17-year-old daughter Anne.

Although we had a gleaming new motor on the stern bracket for the ascent of the Ohio and Tennessee, we put out from St. Louis under oars. Our preference is to drift. It was a novel experience to be rowing a "motorboat" downstream.

We shoved off in the grayness of first light to negotiate St. Louis harbor before the workboats began their busy shuttling of barges back and forth. In the 21 miles

from the Chain of Rocks, where we had been tied, to Jefferson Barracks, the Mississippi has a substantial drop. The resulting stiff current carried us along at high speed—at least for our craft. Breakfast time found us abreast of the old steamboat landing, paved with cobblestones, in downtown St. Louis. We pulled in to eat, making fast to the same shackle that in the days of the packets may have held the *Robert E. Lee* or the *Natchez*, the *Grand Republic* or the *J. M. White*. At noon we passed under the Jefferson Barracks highway bridge at St. Louis' southern environs and shortly thereafter found the bank flanked by the cottonwoods and willows that mark open country. After a year of urban living, we always welcome the bottomland jungle that walls off a too familiar contact with other folks.

#### Wind Helps—Sometimes

The weather, which during our fitting out had been so hot that even St. Louisans complained, gave us a break. Ordinarily on the river, wind accompanies the sun. On our first day we traveled in utter calm, which made for lazy and delightful drifting. With no breeze to blow it into shore, the boat picked its own way downstream with only an occasional wide-spaced stroke or two of the oars to keep it from sliding out of the current. The only time the man on duty had to get out of his deck chair was to pull the boat out of the way of an approaching towboat. When the wind did blow, as it did on the second day, it was a



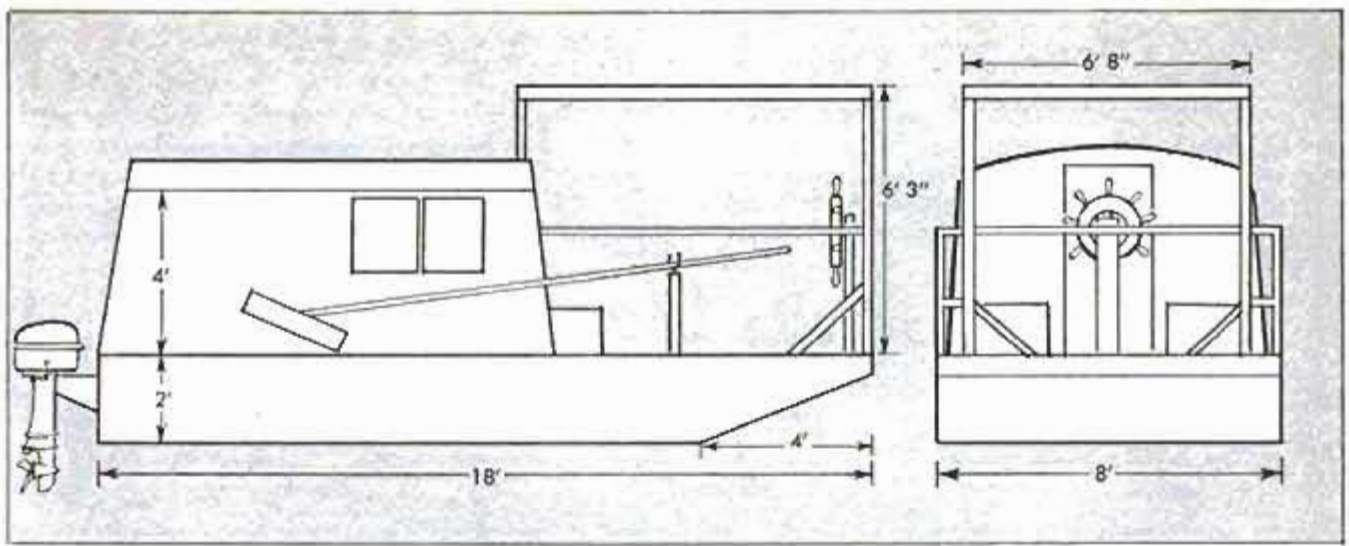

Our shantyboat is only 18 feet long. Beam is just under eight feet to permit it to be towed on a trailer

tailwind. We bowled along under its urging to rack up 49 miles—our best distance in a single day in three years of drifting!

We throw away both the clock and the calendar when we drift. Our interest is not mileage but fun; we are always ready to interrupt our journeying. Each clear-water creek was the signal to go overboard for a swim. At Ste. Genevieve, a town so old that it looks on St. Louis—itsself among the oldest of major American cities—as a Johnny-come-lately, we spent a day studying the old buildings. When we were caught upstream from the mouth of the Okaw River by a windstorm so severe that it lifted the sand off the bars into a river dust storm, we let the boat scud into shore and spent the rest of the day fitting to the canopy the sheets of hardboard I had tem-

porarily lashed in place at St. Louis. At Chester, Ill., we laid over for half a day waiting for my daughter Mary, and her college roommate, Lorraine Livingston, who were to make the balance of the trip with us.

### Acres of Barges

The motor proved itself an instrument of both safety and comfort below Chester. When the weather reverted to its usual pattern, we would drift in the morning calm until the rising breeze made it difficult to hold the boat in the river. Then we would go under power until late afternoon brought a lessening of the wind. On occasion we used the motor to get out of the path of towboats, which constitute the

(Continued to page 234)

Despite its small size, our boat has room equivalent to conventional boats twice as big. It has full-size bunks for four, a galley equal to the kitchen of an efficiency apartment, plus storage space for three weeks' supplies





# TRAFFIC QUIZ FOR BOATERS

How good a pilot are you? Here's a traffic quiz on rules of the road for boaters. The traffic laws for boats take several forms, depending upon the waters involved; there are International Rules of the Road, Inland Rules of the Road, Pilot Rules and state laws. In most basic respects the laws are similar, though

the pleasure-boat skipper should be thoroughly familiar with the rules governing his own waters. Those rules are based on marine custom and common sense. Try the quiz below. Most rules of the road, whatever the waters, agree on the correct answers. You'll find those answers on page 230



**1.** You are skipper of the powerboat at left, in a hurry to meet some friends for a picnic lunch. Already you are late, and you're afraid you'll miss the fried chicken. You want to pass the fishing vessel. Is this permitted? And what about that sailboat on your starboard bow? What should you do in this situation?

.....

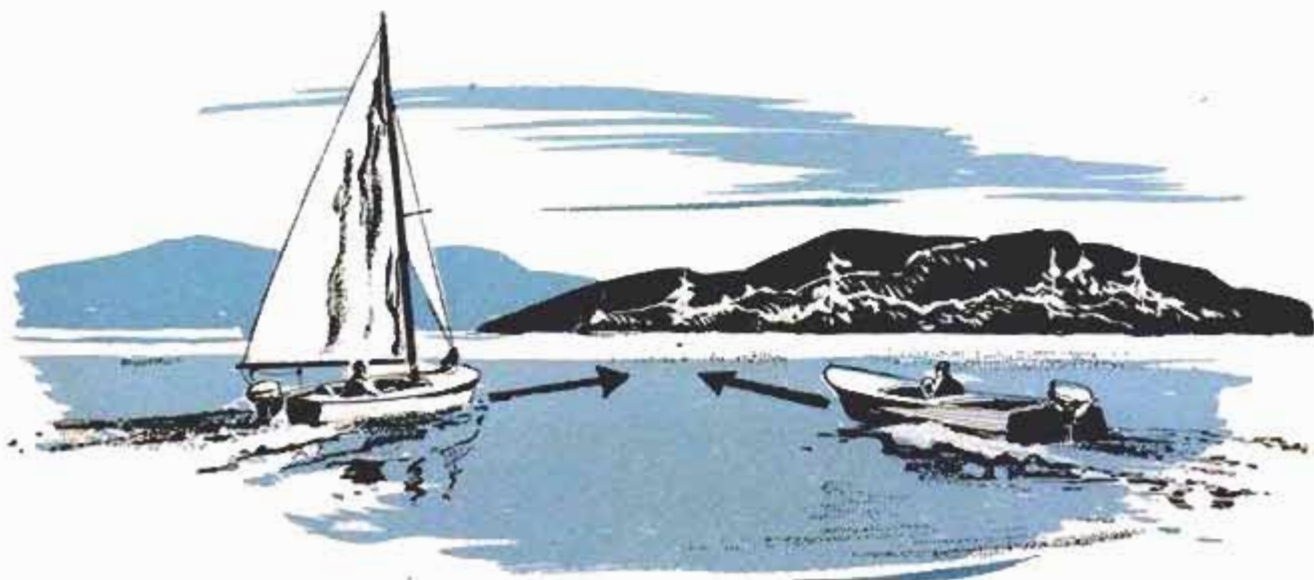

**2.** You're out for a trial run in your new runabout, shown at right. Suddenly you spot the sailboat off your port bow. Obviously the two boats are on a collision course. Who has the right of way, you or the skipper of the sailboat? And regardless of the right of way, what should you do?

.....





**3.** You're skipper of the powerboat shown in the foreground, under way and headed out toward open water. Just casting off from the slip on your port bow is a sailboat. Is there any reason why you shouldn't continue on your present course? In this case, who has the right of way?

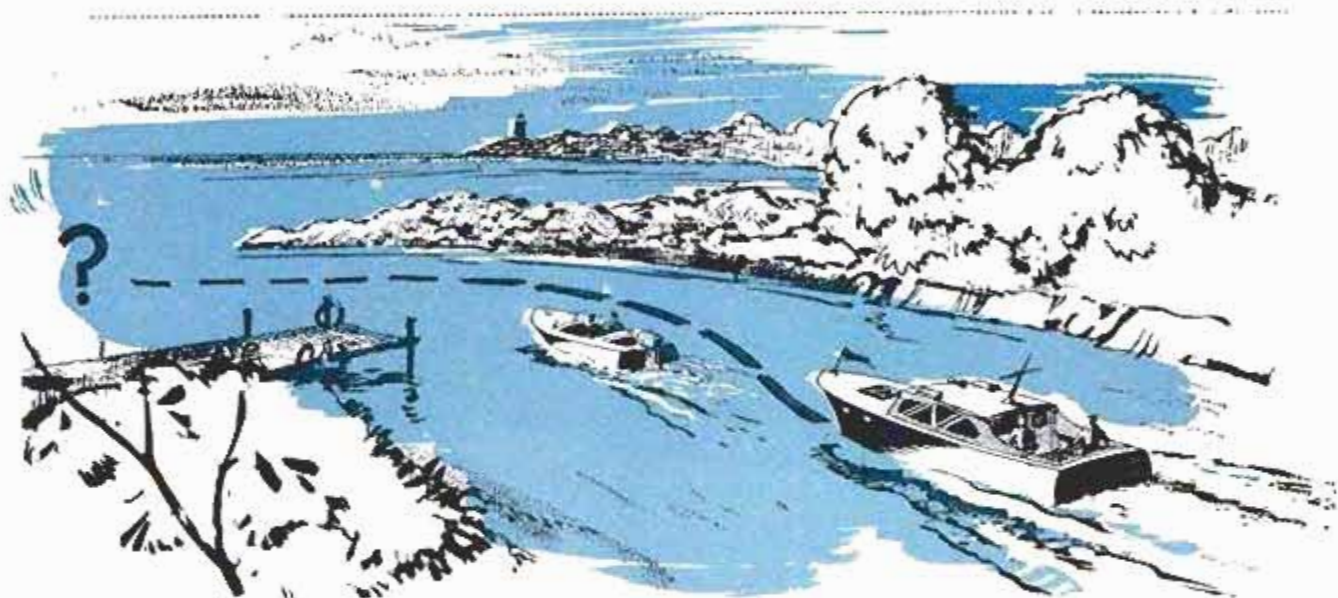

**4.** You are heading up a river channel, overtaking another boat. Ordinarily, according to custom, you would pass to port. However, in this case the dock is an obstacle to port, so you decide to pass to starboard. Is there any reason why you shouldn't? What should you do before you pass?

**5.** You are skipper of the small boat shown below. You are out for a pleasure cruise, dawdling along the canal and admiring the scenery. Astern, and overtaking you, appears a towboat pulling a string of barges. Do you have the right of way, or the towboat? What should you do?

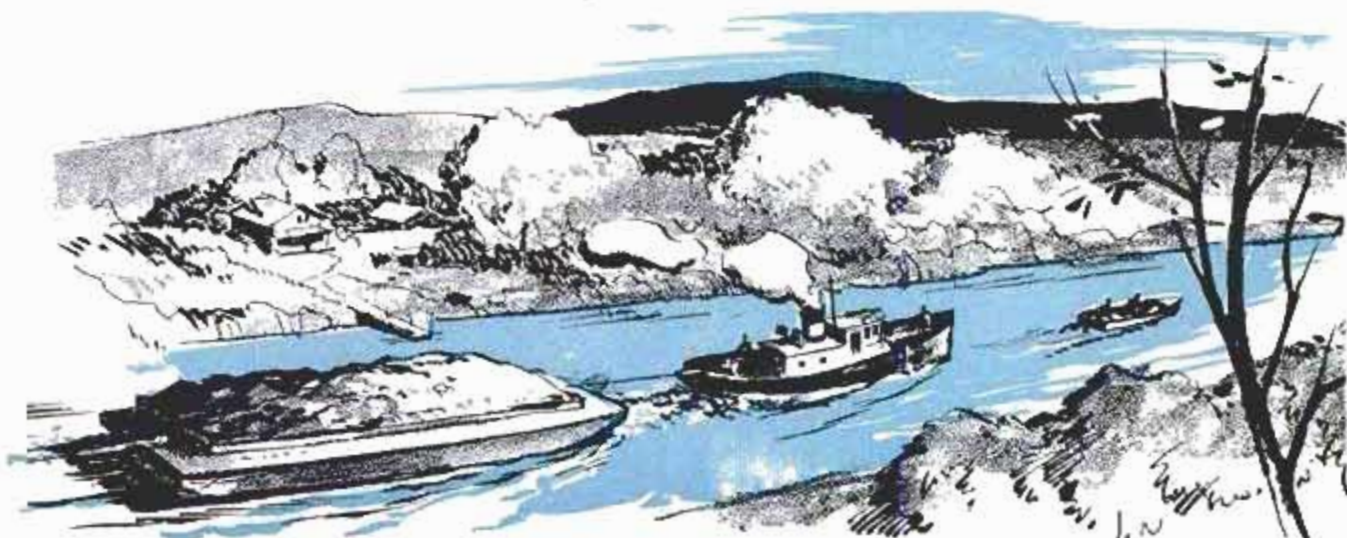



# DO MOTORBOATS SCARE FISH?

By Dr. Karl F. Lagler

CHAIRMAN, DEPARTMENT OF FISHERIES,  
SCHOOL OF NATURAL RESOURCES, UNIVERSITY OF MICHIGAN

**D**ID YOU EVER go fishing on a fine, fine day and then wonder whether motorboats were scaring all the fish away?

Both as an enthusiastic angler and an aquatic scientist, I've done my share of worrying over this problem. Then, several years back, I started doing research to find out whether motorboats affect fishing. My research, some of it scientific, some personal, has convinced me that:

- Motorboats seldom harm fish — large, small or even eggs.
- Motorboats seldom, if ever, keep fish from spawning.
- Motor noise does not appear to disturb fish.
- And—most important to the fisherman—the noise of nearby motors has not been shown to affect the rate at which fish bite!

It takes a lot of convincing for me to be convinced. Perhaps you are the same. But convinced I am, as the result of scientific and personal research stretching over 10 years.

The first thing that bothered me about motorboats was the way they rocked my boat or drowned my fly as they passed when I was fishing. I had no way of knowing whether they had anything to do with the number of fish I hooked. This set me to thinking about the ways that motorboats might be harmful to fish and to fishing. Now I've done enough research to answer some of the questions.

## **Do Motorboats Injure Fish?**

The answer to this one is: rarely. The ability of fish to avoid collision with objects

Tests by the author indicate outboards on a lake have no effect on number of fish caught

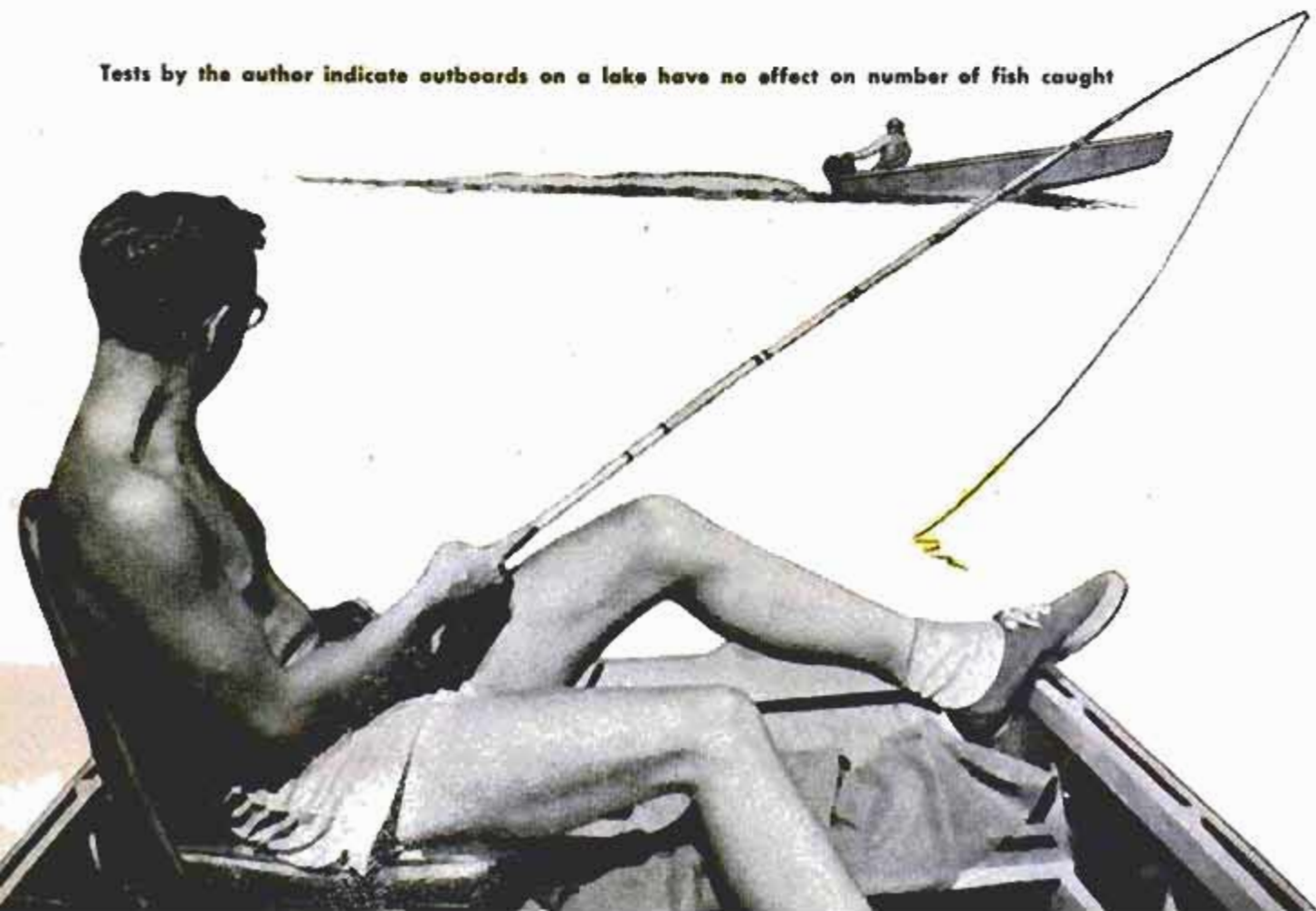





Mullet, photographed at Silver Springs, Fla., show little concern about outboard motor operating nearby

is truly remarkable. Have you ever seen two fish collide? They are protected from such mishaps by all the senses we have, plus special low-frequency-sound detectors.

Stand on a bridge or causeway in the Florida Keys, visit Marineland in Florida and watch the behavior of fish in large schools. Here great numbers of fish wheel and turn, bank and dive, and never collide.

Now come with me on a week end to my summer home on a chain of lakes 50 miles from the heart of Detroit. Here the fish are

numerous, both in kinds and numbers. The afternoons hum with speeding motorboats. In connecting channels there's often quite a traffic jam. But in all my years at these lakes I have never seen the shores littered with dead fish following a boating-filled week end, nor has anyone else reported such slaughter by boats. In fact, worm fishermen may be responsible for more deaths of fish than power-boaters. That few fish survive being hooked on live bait and then released has been proved by scientists.

Samples taken from bottoms of test ponds show that fish food organisms thrive despite use of motors

Dissolved gases in water, here being tested by author, aren't rendered lethal by intensive motor use







Robot outboard circling pond two or more hours a day didn't interfere with spawning of bass and bluegills

Occasionally, over the years, people have brought or sent me fish apparently killed by wounds. I have not always been able to identify the cause of death. However, among the culprits (in addition to hooks)

Other tests showed water did not become noticeably more cloudy than in adjacent nonmotor-use ponds

have been bears, mink, otter, herons and kingfishers. All of these make fairly characteristic marks on their prey. As I recall, I have seen only two fish, one a walleye, the other a sucker, that quite certainly had been killed by a propeller slash.

What about young fish? Can they be destroyed by props of motorboats? Certainly they can—if they are really in the way. Occasionally the eggs of sunfish, crappies, bass, perch and walleyes are in motorboat waters, yet most will be in areas too shallow to be bothered. However, eggs in direct line of propeller blasts may be dislodged and scattered, and will be ready prey for natural enemies. In actual tests, guardian-parent bass and other members of the sunfish family returned promptly to their nests when chased away by an oar or by a propeller passing very close to them. Even slow-swimming young fish, such as largemouth bass, can keep out of the way of motorboats (at least up to boat speeds of 12 miles per hour).

With my colleague, Dr. Albert S. Hazard, now research director of the Pennsylvania Fish Commission, I once stocked two similar, adjacent ponds in Michigan with the same number of fingerling largemouth bass. In one pond every morning and afternoon, a five-horsepower outboard ran out a tank full of fuel at three-quarter speed (about 12 miles per hour). The robot boat circled the pond again and again on a bridle attached to a swivel on a tall stake in the center of the pond. It ran the circular course for about an hour, morning and afternoon, all summer long. At the end of the summer, the ponds were drained and





the fish recovered and counted. The motors had not killed off the fish at all! In fact, perhaps accidentally, there was slightly better survival in the motor-use pond than in the other.

In the experimental motor-use pond the exhaust gas (carbon monoxide) did not accumulate to an amount that killed fish. The motors did not cause measurable damage to fish-food organisms. The water did not become noticeably more cloudy (turbid) than in the adjacent nonmotor-use one. And oil from repeated spillage when filling engines never became evident around the shores.

### **Do Motorboats Prevent Spawning?**

Hardly—for several reasons. First, most food and game species spawn either in the early spring or late fall outside the peak seasons of powerboating. Before the end of June, most black bass have already spawned throughout their range from the Gulf of Mexico to Canada. The same is true for walleye, perch and pike. Brook trout and brown trout are fall spawners.

In addition, most fish apparently have no more fear of motorboats than you and I, as pedestrians, have of the average automobile. Rock bass and several kinds of sunfishes are all known to nest successfully

adjacent to heavily used boating channels. Lie on a dock and watch the fish while a motorboat roars by—they hardly bat the eyelashes they don't have.

In order to see if bluegills and largemouth bass would be kept from spawning by powerboats, we performed another experiment. Four similar ponds were chosen at Michigan's Wolf Lake Fish Hatchery. One pair of ponds was stocked with bluegill, the same number to each pond. The other two ponds were stocked with identical numbers of largemouth breeders. Motors were run daily for two hours on circling robot boats in one of each pair of ponds. Judging from the numbers of young fish taken from the ponds at the end of the experiment, nesting was equally successful in the motor-use as in the nonmotor-use ponds. Later, at the end of the summer, similar numbers of fish were taken from the ponds. This showed that not only would nests be built near motorboat courses but also that the young in nests would hatch successfully and survive through a whole summer of boat activity.

### **Does Engine Noise Disturb Fish?**

Not much, if at all. Come along to a smallmouth-bass river or a trout stream.

(Continued to page 244)

Young fish survive well in motor-use waters as seen after drawing samples from nests into glass tubes

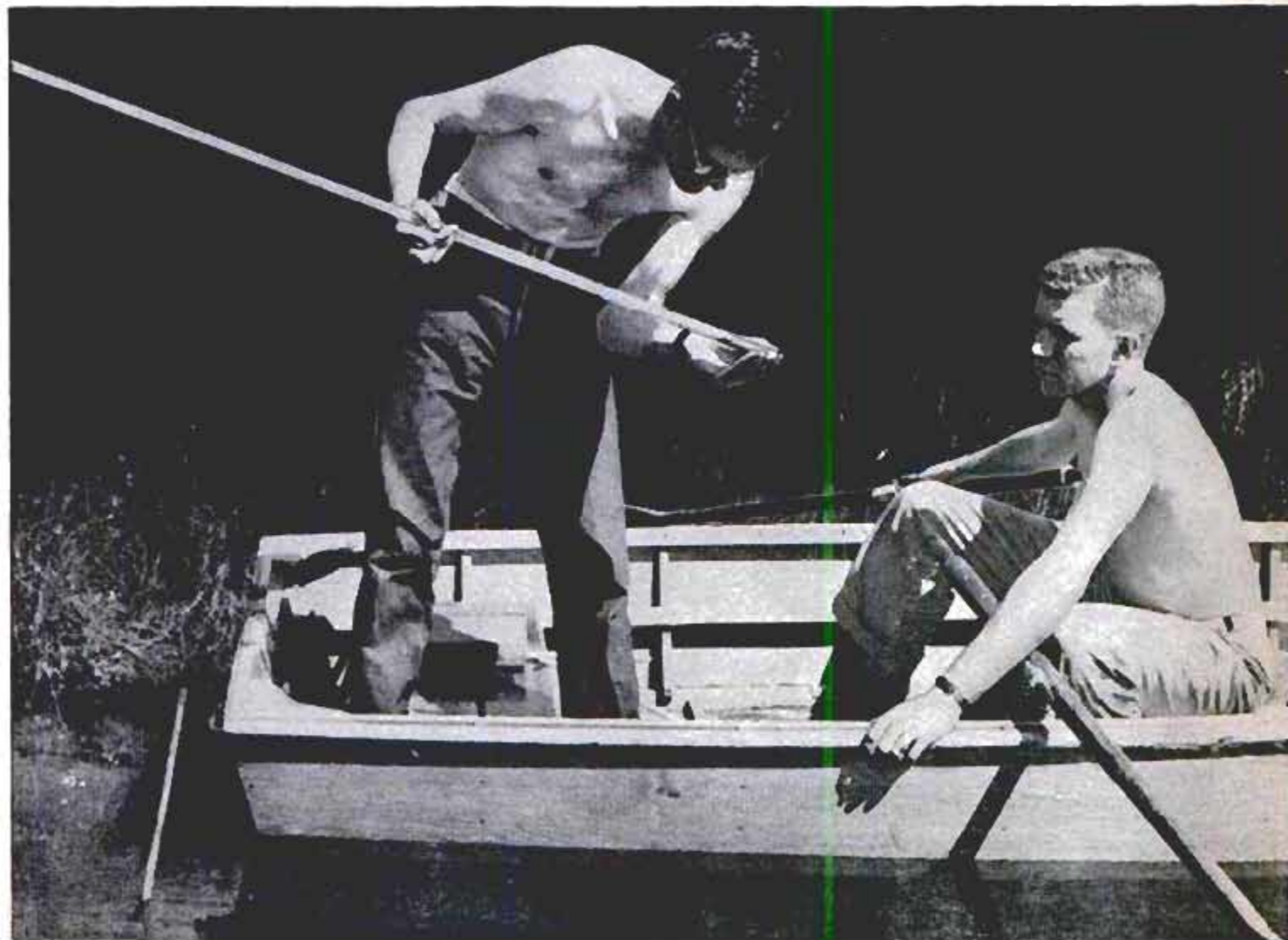



# BUYERS' GUIDE TO

Brand Name and Source, Manufacturer if Other Than Source	Model Name or Number	Horsepower (at r.p.m. rated)	Weight (pounds)	Number of Cylinders	Displacement (inches)	Bore and Stroke (inches)	Gearshift	Fuel Tank Capacity (gallons if unstated)	Starter	Price
AIRBOY (Air-drive) Airboats, Inc. St. Louis, Mo.	Model 20	2	38	1	4.7	2 x 1 1/2	None, pivot	1.5 Quarts	Manual	\$179.50
	Model 40	4	54	1	8	2 1/4 x 2	None, pivot	2 Quarts	Manual	215.00
BUCCANEER Gale Products Galesburg, Ill.	3D15B	3 at 4000	37	1	5.32	2 1/8 x 1 1/2	None, pivot	5	Manual	140.00
	5S13B	5 at 4000	46.5	2	8.84	1 15/16 x 1 1/2	None, pivot	8	Manual	185.00
	5D15B	5 at 4000	51	2	8.84	1 15/16 x 1 1/2	Yes	4.25	Manual	230.00
	12S13B	12 at 4000	69.5	2	17.89	2 1/4 x 2 1/4	Yes	2	Manual	325.00
	12D17B	12 at 4000	77.5	2	17.89	2 1/4 x 2 1/4	Yes	6	Manual	350.00
	22D15B	25 at 4000	119.5	2	35.7	2 7/8 x 2 3/4	Yes	6	Manual	465.00
	27DE15B	25 at 4000	130	2	35.7	2 7/8 x 2 3/4	Yes	6	Electric	555.00
→ 35DE10B	35 at 4500	134	2	40.5	3 1/16 x 2 3/4	Yes	6	Electric	585.00	
CHAMPION Champion Motors Co. Minneapolis, Minn.	Guide Four	4.2 at 4300	42	1	5.84	2 1/16 x 1 3/4	No	10 Pints	Manual	179.00
	Guide Six	6 at 4300	46	2	9.66	1 7/8 x 1 3/4	Yes	10 Pints	Manual	233.00
	Superior 7	7.8 at 4300	46	2	9.66	1 7/8 x 1 3/4	Yes	28 Pints	Manual	265.00
	Sweet 16	16.5 at 4300	58	2	19.94	2 1/2 x 2 1/32	Yes	6	Manual	387.00
	Sweet 16	16.5 at 4300	58	2	19.94	2 1/2 x 2 1/32	Yes	6	Manual	376.00
	Hot Rod Class B	46	2	19.94	2 1/2 x 2 1/32	No	2	Manual	475.00	
→ Tandem 33	16.5 at 4300	58	2	19.94	2 1/2 x 2 1/32	Yes	6	Manual	631.00 a per	
CONTINENTAL Continental Mfg. Co. Culver City, Calif.	Sport	2.5 at 3750	22	1	5.05	1 5/8 x 1 5/8	None, pivot	5 Pints	Manual	89.95
	Sport Deluxe	2.5 at 3750	27	1	5.05	1 5/8 x 1 5/8	None, pivot	5 Pints	Manual, recoil	99.95
DRAGONFLY (Air-drive) Robertson-Hedges, Inc. Kansas City, Mo.	87	2 at 4000	41	1	4.7	2 x 1 1/2	None	25	Manual	189.50
	81	5 at 4000	50	1	8.1	2 1/2 x 1 5/8	None	30	Manual	279.50
ELGIN Sears, Roebuck and Co. Chicago, Ill. (West Bend)	5823	2 at 4000	28	1	3.76	1 3/4 x 1 1/16	None, pivot	31	Manual	99.95
	5953	5.5 at 4000	56	2	10.6	2 x 1 11/16	Yes	4.25	Manual	209.95
	5973	7.5 at 4000	56	2	11.97	2 1/8 x 1 11/16	Yes	4.25	Manual	279.95
	5878	7.5 at 4000	50	2	11.97	2 1/8 x 1 11/16	None, pivot	5	Manual	199.95
	5896	12 at 4000	61	2	17.72	2 3/8 x 2	Yes	6	Manual	279.95
	5897	12 at 4000	61	2	17.72	2 3/8 x 2	Yes	6	Manual	289.95
	5893	12 at 4000	64	2	17.72	2 3/8 x 2	Yes	4.25	Manual	269.95
	→ 5944	35 at 4500	118	2	41.49	3 1/8 x 2 7/16	Yes	6	Manual	449.95
	→ 5945	35 at 4500	121	2	41.49	3 1/8 x 2 7/16	Yes	6	Manual	459.95
	→ 5982	35 at 4500	130	2	41.49	3 1/8 x 2 7/16	Yes	6	Electric	519.95
	→ 5983	35 at 4500	133	2	41.49	3 1/8 x 2 7/16	Yes	6	Electric	529.95
→ 5990	35 at 4500	138	2	41.49	3 1/8 x 2 7/16	Yes	6	Electric	559.95	
→ 5991	35 at 4500	141	2	41.49	3 1/8 x 2 7/16	Yes	6	Electric	569.95	
EVINRUDE Evinrude Motors Milwaukee, Wis.	Lightwin	3 at 4000	33	2	5.28	1 9/16 x 1 3/8	None, pivot	7	Manual	160.00
	Ducktwin	3 at 4000	33	2	5.28	1 9/16 x 1 3/8	None, pivot	7	Manual	160.00
	Fisherman	5.5 at 4000	56	2	8.84	1 15/16 x 1 1/2	Yes	4.25	Manual	230.00
	Fleetwin	7.5 at 4000	59	2	12.4	2 1/8 x 1 3/4	Yes	4.25	Manual	270.00
	Sportwin	10 at 4000	68	2	16.6	2 3/8 x 1 7/8	Yes	6	Manual	310.00
	Fastwin	18 at 4500	80	2	22	2 1/2 x 2 1/4	Yes	6	Manual	395.00
	Fastwin	18 at 4500	87	2	22	2 1/2 x 2 1/4	Yes	6	Electric	475.00
	Big Twin	35 at 4500	123	2	40.5	3 1/16 x 2 3/4	Yes	6	Manual	495.00
	Big Twin	35 at 4500	129	2	40.5	3 1/16 x 2 3/4	Yes	6	Electric	585.00
	Lark	35 at 4500	138	2	40.5	3 1/16 x 2 3/4	Yes	6	Electric	625.00
	→ Four Fifty	50 at 4000	197	V.4	70.7	3 x 2 1/2	Yes	6	Manual	740.00
	→ Starlite	50 at 4000	205	V.4	70.7	3 x 2 1/2	Yes	6	Electric	840.00
	FAGEOL Fageol Products Co. Kent, Ohio	44	40 at 5200	190	4	44	2 1/2 x 2 1/4	Yes	6.5	Electric
→ 60		50 at 5200	190	4	60	2 3/4 x 2 1/2	Yes	6.5	Electric	
→ Gold Cup 60		55 at 5200	190	4	60	2 3/4 x 2 1/2	Yes	6.5	Electric	
FIRESTONE Firestone Outboard Motors, Minneapolis, Minn. (Scott-Atwater)	3.6	3.6 at 4000	36	1	6.21	2 1/8 x 1 3/4	No	1	Manual	125.00
	5	5 at 4200	42	2	7.48	1 11/16 x 1 43/64	Yes	3.5	Manual	225.00
	10	10 at 4200	59	2	14.82	2 11/64 x 2	Yes	6	Manual	320.00
	16	16 at 4200	58	2	19.95	2 11/32 x 2 5/16	Yes	6	Manual	365.00
	38	38 at 4800	117	2	40.51	3 1/16 x 2 3/4	Yes	6	Electric, Optional	499.95
HIAWATHA Gamble-Skogmo, Inc. Minneapolis, Minn. (Scott-Atwater)	3.6	3.6 at 4000	36	1	6.21	2 1/8 x 1 3/4	None, pivot	1	Manual	109.95
	5	5 at 4200	45	2	7.48	1 11/16 x 1 43/64	Yes	3.5	Manual	209.95
	7.5	7.5 at 4200	59	2	11	2 x 1 3/4	Yes	6	Manual	264.95
	10	10 at 4200	66	2	14.82	2 11/64 x 2	Yes	6	Manual	319.50
	16	16 at 4200	79	2	19.95	2 11/32 x 2 5/16	Yes	6	Manual	349.95
38	38 at 4800	128	2	40.51	3 1/16 x 2 3/4	Yes	6	Electric, Optional	509.95	
JOHNSON Johnson Motors Waukegan, Ill.	Sea-Horse 3	3 at 4000	33.25	2	5.28	1 9/16 x 1 3/8	None, pivot	4.88 Pints	Manual	160.00
	Sea-Horse 5.5	5.5 at 4000	56	2	8.84	1 15/16 x 1 1/2	Yes	4.5	Manual	230.00
	Sea-Horse 7.5	7.5 at 4000	59	2	12.4	2 1/8 x 1 3/4	Yes	4.5	Manual	270.00
	Sea-Horse 10	10 at 4000	67	2	16.6	2 3/8 x 1 7/8	Yes	6	Manual	310.00
	Sea-Horse 18	18 at 4500	77	2	22	2 1/2 x 2 1/4	Yes	6	Manual	395.00
	Sea-Horse 18	18 at 4500	87	2	22	2 1/2 x 2 1/4	Yes	6	Electric	475.00
	Sea-Horse 35	35 at 4500	123	2	40.5	3 1/16 x 2 3/4	Yes	6	Manual	495.00
	Sea-Horse 35	35 at 4500	129	2	40.5	3 1/16 x 2 3/4	Yes	6	Electric	585.00
	→ Super Sea-Horse 35	35 at 4500	138	2	40.5	3 1/16 x 2 3/4	Yes	6	Electric	625.00
	→ Sea-Horse 50	50 at 4000	197	V.4	70.7	3 x 2 1/2	Yes	6	Manual	740.00
→ Super Sea-Horse 50	50 at 4000	205	V.4	70.7	3 x 2 1/2	Yes	6	Electric	840.00	
MAJESTIC Outboard Motor Brands, Inc., Minneapolis, Minn. (Champion)	Fisherman Special	4.2 at 4300	42	1	5.84	2 1/16 x 1 3/4	No	10 Pints	Manual	179.00
	M 3N GS	6 at 4300	46	2	9.66	1 7/8 x 1 3/4	Yes	10 Pints	Manual	233.00
	M 4N GS	7.8 at 4300	47	2	9.66	1 7/8 x 1 3/4	Yes	10 Pints	Manual	249.00
	M 6N GS	15 at 4300	54	2	19.94	2 1/2 x 2 1/32	Yes	6	Manual	355.00

† Data not available

→ Arrow indicates new, significant or special motors this year



# THE '58 OUTBOARDS

Brand Name and Source, Manufacturer if Other Than Source	Model Name or Number	Horsepower (at r.p.m. rated)	Weight (pounds)	Number of Cylinders	Displacement (inches)	Bore and Stroke (inches)	Gearshift	Fuel Tank Capacity (gallons if unstated)	Starter	Price
<b>MERCURY</b> Kiekhaefer Corp. Fond du Lac, Wis.	Mark 6	6	42	2	7.2	1 3/4 x 1 1/2	None; pivot	6	Manual	525.00
	Mark 10	10	66	2	18.5	2 1/2 x 2 1/8	Yes	6	Manual	330.00
	Mark 25	20	75	2	20	2 7/16 x 2 1/8	Yes	6	Manual	380.00
	Mark 28	22	75	2	22	2 9/16 x 2 1/8	Yes	6	Manual	430.00
	Mark 30	30	110	4	30	2 7/16 x 2 1/8	Yes	6	Manual	479.50
	Mark 55	40	111	4	40	2 7/16 x 2 1/8	Yes	6	Electric Optional	535.00
	Mark 58	45	127	4	44	2 9/16 x 2 1/8	Yes	6	Electric Optional	630.00
	Mark 75	60	163	6	60	2 7/16 x 2 1/8	Reversing powerhead	6	Electric Optional	730.00
<b>NEPTUNE</b> Muncie Gear Works Muncie, Ind.	Mighty Mite	17 at 4000	17	4	3.0	1 9/16 x 1 1/2	None	25	Manual	89.50
<b>OLIVER</b> Oliver Outboard Motors Battle Creek, Mich.	6	6 at 4500	50	2	9.42	2 x 1 1/2	Yes	3.5	Manual	235.00
	16	16 at 4500	79	2	19.94	2 1/2 x 2 1/32	Yes	6	Electric Optional	380.00
	35 Olympus	35 at 4500	125	2	42.35	3 1/16 x 2 7/8	Yes	6	Electric	640.00
<b>SCOTT-ATWATER</b> Scott-Atwater Mfg. Co. Minneapolis, Minn.	3.6	3.6 at 4000	36	1	6.23	2 1/8 x 1 3/4	None	8 pints	Manual	134.00
	5	5 at 4200	50	2	7.48	1 11/16 x 1 43/64	Yes	3.5	Manual	242.75
	7.5	7.5 at 4200	60	2	11	2 x 1 3/4	Yes	6	Manual	277.25
	10	10 at 4200	65	2	14.82	2 1/16 x 2	Yes	6	Manual	324.50
	16	16 at 4200	80	2	19.95	2 11/32 x 2 5/16	Yes	6	Manual	384.25
	Manual Start 27	27 at 4800	107	2	27.65	2 11/16 x 2 7/16	Yes	6	Manual	448.50
	Electric Start 27	27 at 4800	119	2	27.65	2 11/16 x 2 7/16	Yes	6	Electric with generator	563.50
	Manual Start 40	40 at 4800	130	2	42.18	3 1/8 x 2 3/4	Yes	6	Manual	538.50
	Electric Start 40	40 at 4800	142	2	42.18	3 1/8 x 2 3/4	Yes	6	Electric with generator	663.00
	Royal Scott 40	40 at 4800	142	2	42.18	3 1/8 x 2 3/4	Yes	6	Electric with generator	749.00
<b>SEA-BEE</b> Goodyear Tire and Rubber Co., Akron, Ohio (Gale Products)	3 HP Deluxe	3 at 4000	37	1	5.32	2 1/8 x 1 1/2	None; pivot	5	Manual	139.95
	5 HP Standard	5 at 4000	58	2	8.84	1 15/16 x 1 1/2	Yes	5	Manual	175.95
	5 HP Deluxe	5 at 4000	70	2	8.84	1 15/16 x 1 1/2	Yes	5	Manual	205.95
	12 HP Standard	12 at 4000	77.5	2	17.89	2 1/4 x 2 1/4	Yes	6	Manual	329.00
	12 HP Deluxe	12 at 4000	77.5	2	17.89	2 1/4 x 2 1/4	Yes	6	Manual	355.00
	25 HP Rewind Standard	25 at 4000	119.5	2	35.7	2 7/8 x 2 3/4	Yes	6	Manual	439.00
	25 HP Rewind Deluxe	25 at 4000	119.5	2	35.7	2 7/8 x 2 3/4	Yes	6	Manual	470.00
	25 HP EL Standard	25 at 4000	130	2	35.7	2 7/8 x 2 3/4	Yes	6	Electric	529.00
	25 HP EL Deluxe	25 at 4000	130	2	35.7	2 7/8 x 2 3/4	Yes	6	Electric	560.00
	35 HP Deluxe	35 at 4500	134	2	40.5	3 1/16 x 2 3/4	Yes	6	Electric	585.00
<b>SEA KING</b> Montgomery Ward and Co., Chicago (Gale Products)	60-9006	3 at 4000	37	1	5.32	2 1/8 x 1 1/2	None; pivot	5	Manual	116.00
	60-9003	5 at 4000	46.5	2	8.84	1 15/16 x 1 1/2	None; pivot	8	Manual	133.88
	60-8960	5 at 4000	57	2	8.84	1 15/16 x 1 1/2	Yes	1	Manual	184.00
	60-9016	12 at 4000	69.5	2	17.89	2 1/4 x 2 1/4	Yes	2	Manual	233.88
	60-8971	12 at 4000	77.5	2	17.89	2 1/4 x 2 1/4	Yes	6	Manual	307.00
	60-9005	12 at 4000	86.5	2	17.89	2 1/4 x 2 1/4	Yes	6	Electric	365.00
	60-9025	25 at 4000	119.5	2	35.7	2 7/8 x 2 3/4	Yes	6	Manual	410.00
	60-9026	25 at 4000	130	2	35.7	2 7/8 x 2 3/4	Yes	6	Electric	479.00
	60-8997	35 at 4500	134	2	40.5	3 1/16 x 2 3/4	Yes	6	Electric	585.00
	<b>VOYAGER</b> Outboard Motor Brands, Inc. Minneapolis, Minn. (Champion)	Fisherman Special	4.2 at 4300	42	1	5.84	2 1/16 x 1 3/4	No	10 Pints	Manual
V-3N-GS		6 at 4300	46	2	9.66	1 7/8 x 1 3/4	Yes	10 Pints	Manual	233.00
V-4N-GS		7.8 at 4300	47	2	9.66	1 7/8 x 1 3/4	Yes	10 Pints	Manual	249.00
V-6N-GS		15 at 4300	54	2	19.94	2 1/2 x 2 1/32	Yes	6	Manual	355.00
<b>WEST BEND</b> West Bend Aluminum Co., Hartford, Wis.	Shrimp	2 at 4000	28	1	3.76	1 3/4 x 1 9/16	None; pivot	5 Pints	Manual	119.95
	Pike	6 at 4500	56	2	10.60	2 x 1 11/16	Yes	4.5	Manual	249.95
	Muskie	8 at 4500	57	2	11.97	2 1/8 x 1 11/16	Yes	4.5	Manual	275.00
	Barracuda	12 at 4000	59	2	17.72	2 3/8 x 2	Yes	6	Manual	349.95
	Shark	35 at 4500	118	2	41.49	3 1/8 x 2 7/16	Yes	6	Manual	495.00
	Shark	35 at 4500	132	2	41.49	3 1/8 x 2 7/16	Yes	6	Electric	585.00
	Shark	35 at 4500	136.5	2	41.49	3 1/8 x 2 7/16	Yes	6	Electric with generator	615.00
<b>WIZARD</b> Western Auto Supply Co., Kansas City, Mo. (Oliver)	Powermatic 5.5	5.5 at 4200	55	2	9.42	2 x 1 1/2	Yes	3.5	Manual	210.00
	Powermatic 15	15 at 4200	75	2	19.94	2 1/2 x 2 1/32	Yes	6	Manual	339.50
	Powermatic 35	35 at 4500	120	2	42.35	3 1/16 x 2 7/8	Yes	6.5	Manual	495.00
	Powermatic 35	35 at 4500	125	2	42.35	3 1/16 x 2 7/8	Yes	6.5	Electric with generator	595.00





# SHOPPING FOR A USED OUTBOARD

By V. Lee Oertle *5300 Grand ave  
COVINA, CALIF.*

**B**UYING A USED BOAT can be fun, but to get a good buy, just as thorough an inspection and testing of it is required as is necessary when purchasing a used car. Time spent carefully checking the hull and equipment of the boat of your choice will pay dividends later in carefree

**Fig. 1. Make visual inspection of propellers. Nicks, dents or bent blades might cause excessive vibration**



boating with a minimum of expense for repairs, regular maintenance and fuel. Never buy a used boat without first running it to see if it handles satisfactorily. If possible, try to test run the boat with about the same passenger load and water-surface conditions prevailing as you'd expect under normal use of it. The boat should be large enough to accommodate comfortably the skipper, his crew (family) and one or two guests but not so large as to strain the recreation budget and demand too much of your free time for maintenance and operation.

Whatever the choice, you will discover that there is no boat that will perform ideally under all conditions. A fast hull on one boat may be unsafe in rough water. A deep keel on another design may handle well in rough water but would require more power and need excessive depth of water in back channels and shoals where fishing is likely to be good. If speed is of primary importance, as when towing skiers or for fast cruising, select a boat of shallow draft, moderate beam and strong construction so that it will take the strain of pounding in choppy water with powerful outboards mounted on the transom.

When buying a boat for cruising, don't



try to get the biggest thing obtainable for the outlay you expect to make. Give more consideration to design, construction and suitability than to mere size, even if it becomes necessary to sacrifice some of the accommodations you would like to have.

There are bad boats as well as good ones on the market. Some of the bad ones may be relatively young in years bedecked with fine coats of paint and varnish. If the boat is in the water, have it hauled out and check the bottom. The planking should abutt the transom and stem squarely and solidly. Sight along the keel for "hooks" (large concave indentations in the bottom caused by improper support of the hull during storage, or damaged longitudinal

**Fig. 3, right.** If boat is in good condition, bottom will appear to be flat or slightly convex when straightedge is held against hull planking next to the keel

**Fig. 4, below.** Heavy duty trailer with cradle-type hull support is needed to haul heavy boat

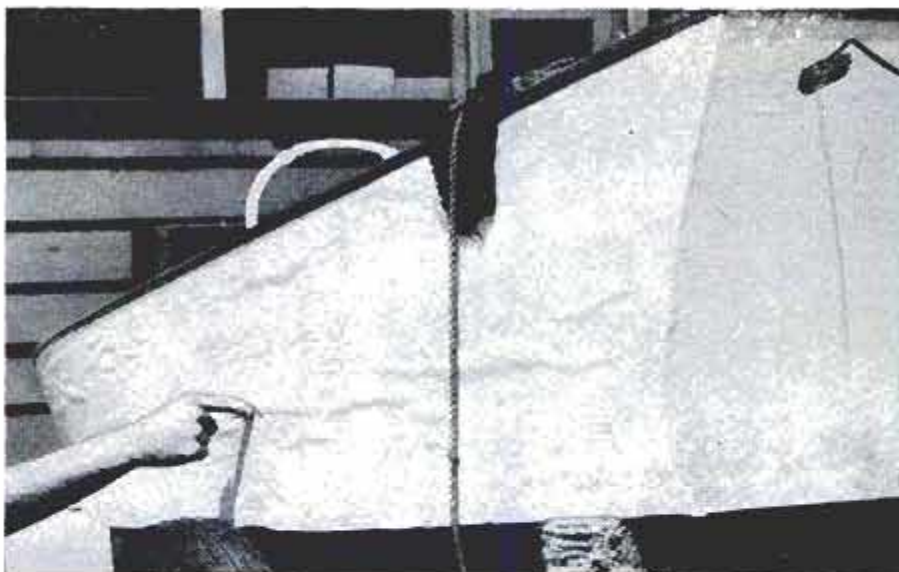

**Fig. 2, above.** Numerous air bubbles under glass fiber on hull are subject to easy puncturing, offer no reinforcement to hull and are eyesore that cannot be satisfactorily repaired except at considerable expense

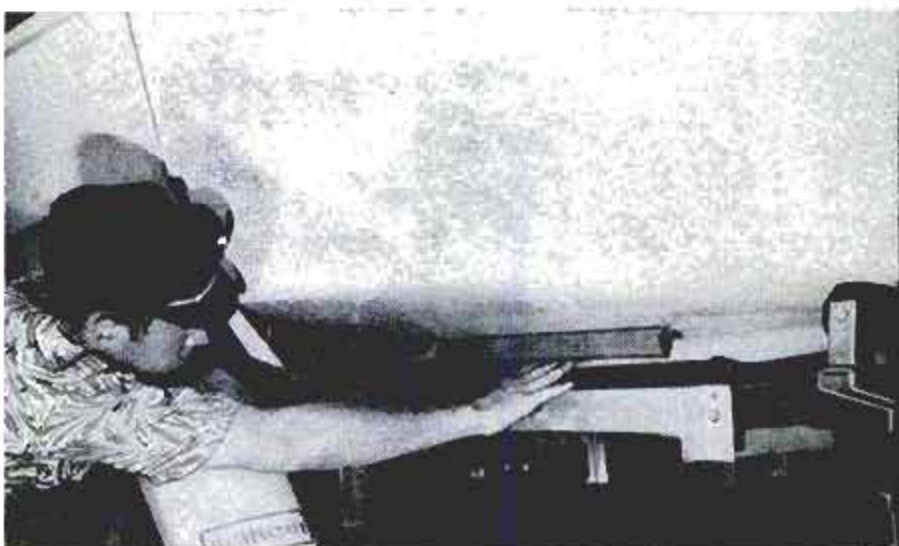



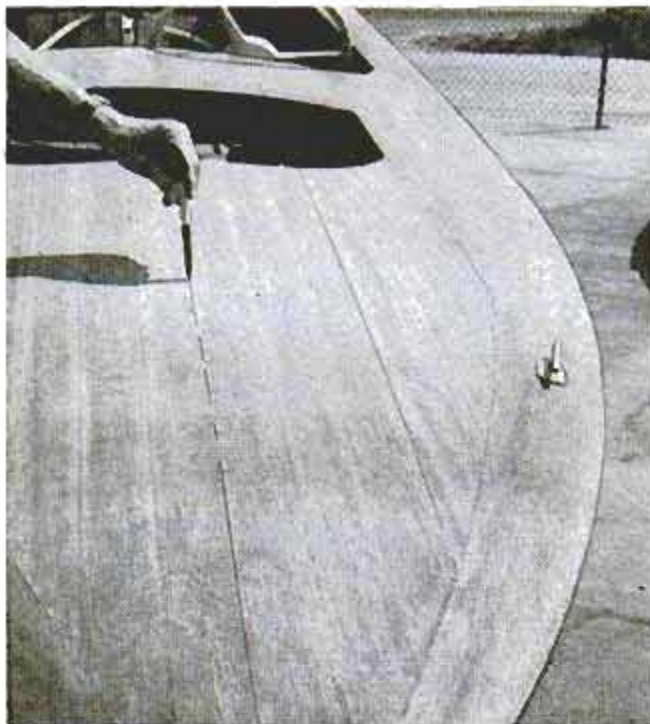

**Fig. 5. Open seams of planked boat admit rainwater that saturates unprotected wood and causes dry rot**

members). One good way to check for this is to hold a straightedge against the hull as in Fig. 3. "Hooks" cause a boat to perform improperly and act as a drag, making it impossible to attain full hull speed. Be suspicious of cracks that could develop into troublesome leaks. A glass-fiber covered hull should be free of bubbles that are easily punctured, offer no reinforcement to the hull and are an eyesore that can't be remedied without great expense, Fig. 2.

Rust spots or streaks on a painted hull usually are an indication of "nail sickness," badly corroded fastenings. This may mean that the hull is in need of a costly refastening job and should not be purchased.

Chances of finding dry rot (type of fungus) in an open hull are slight. However, inspect a boat thoroughly for rot, especially if the boat has been covered and out of use for a long time, or if it has



**Fig. 6. Fuel-tank leak can be detected by gasoline odor, or stained metal if area of leak is visible**

enclosed spaces, such as cabins and lockers. Dry rot can be detected by probing questionable members with a dull knife blade. If the blade can be pushed into a member with little effort, it is likely to be infected and may need replacing. Be sure seams in an aluminum boat are correctly joined and do not leak. Glass boats should be free of bad cracks, and flotation tanks should be provided in both metal and glass boats.

When examining the inside of the hull, see that the frames and other structural members are sound and uncracked. A badly cracked frame will cause the planks to work and the boat to leak. Permanently installed equipment, such as heads and bilge pumps, should be checked by pumping water through them. Coast Guard-required safety equipment should be accounted for and be in usable condition, especially life preservers.

**Fig. 7. Hauling heavy boat on small trailer is unsafe, may cause damage to hull**

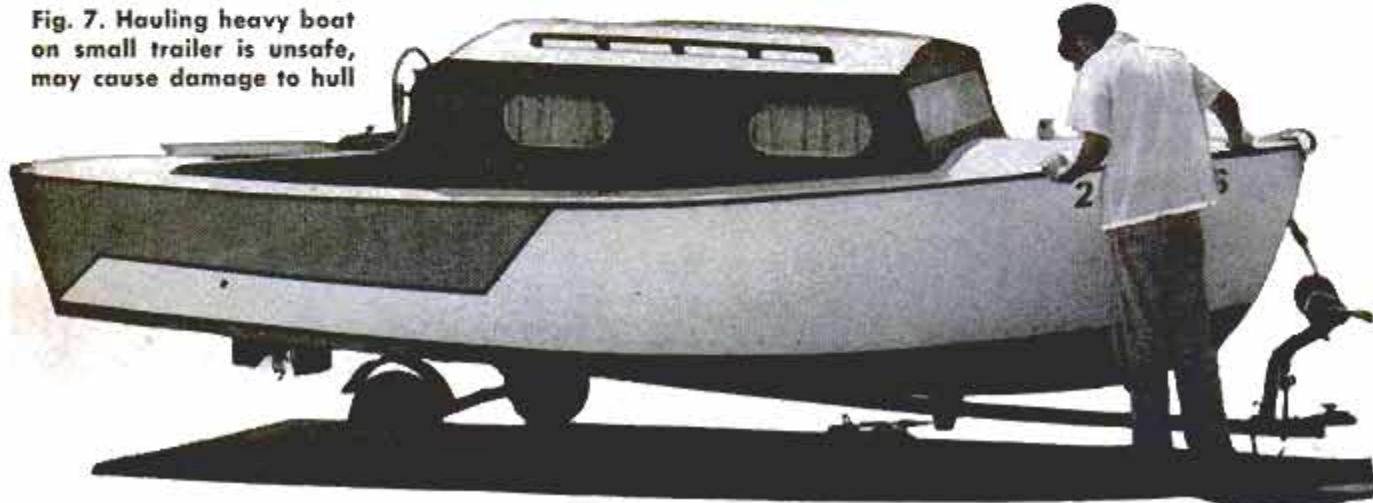





Fig. 8, above. Enclosed space below deck with clutter of damp gear is likely place to find dry rot

If one or more used out-board motors are included with the sale of the boat, test them, too. First, check the compression by pulling the starter rope and noting the amount of "pull" and "bounce" as the pistons turn through their compression strokes. Then, start the motor and note whether the slow-speed needle valves respond to adjustment. If they don't, the motor will not idle or run properly at slow speeds. Also, check the wiring, fuel connections and gasoline line for possible shorts or leaks. A careful visual check of propellers should be made noting nicks, dents or bent blades, Fig. 1. Any one of these defects may cause excessive motor vibration and power loss. Excessive vertical play of the propeller-shaft bearings or lubrication seepage are signs of worn bearings.

Many used boats are sold with trailers. To be acceptable, a trailer must be large enough for the boat, provide adequate support for the hull and have a wheel assembly in proper alignment. ★ ★ ★

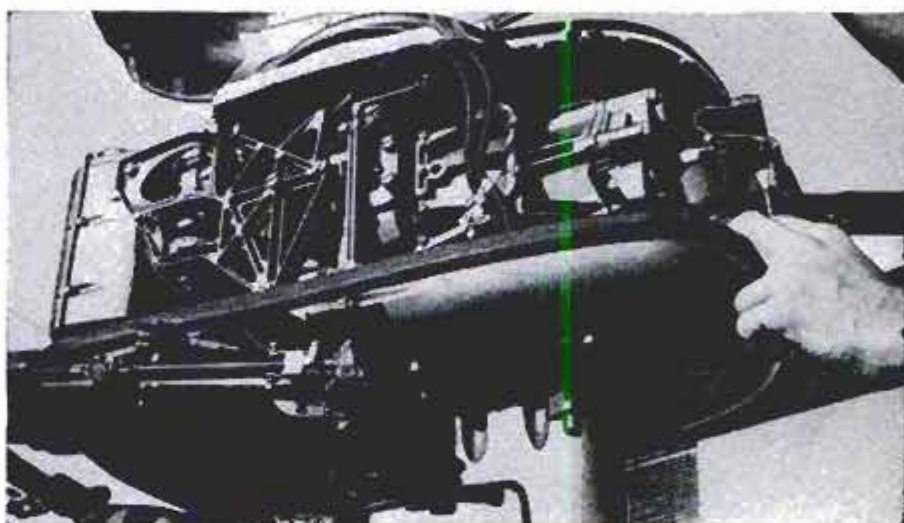
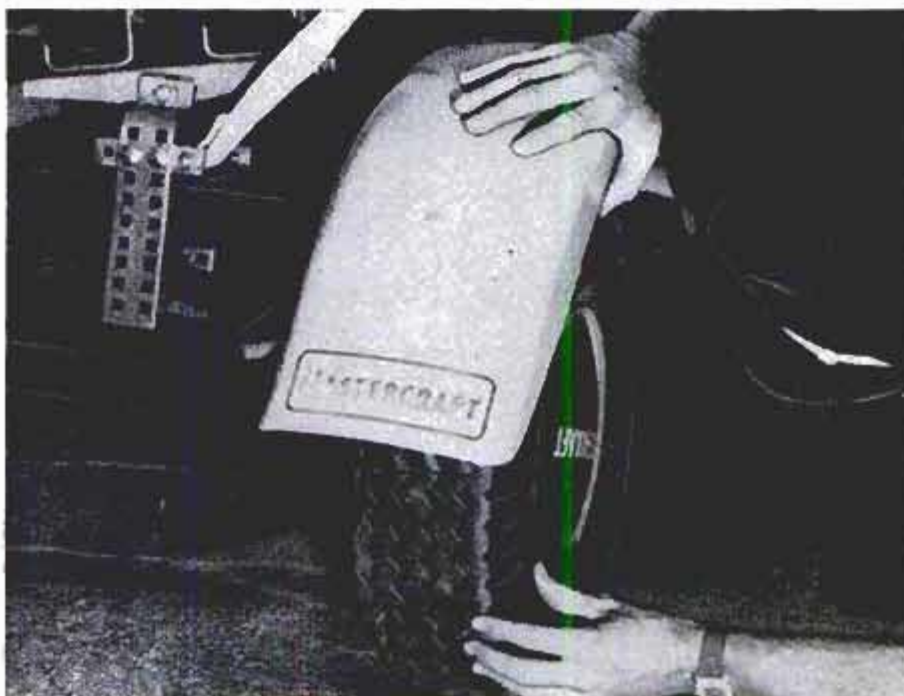

Fig. 9, above. Motor hood is removed to check fuel lines and wiring. Fig. 10, below. Trailer-tire treads badly worn at outer edges may indicate worn or loose wheel bearings, bent axles or spindles or overloading





701 St. George St. Lewisburg, Pa.

## Fun Is the Main Function of This Oil-Drum Boat

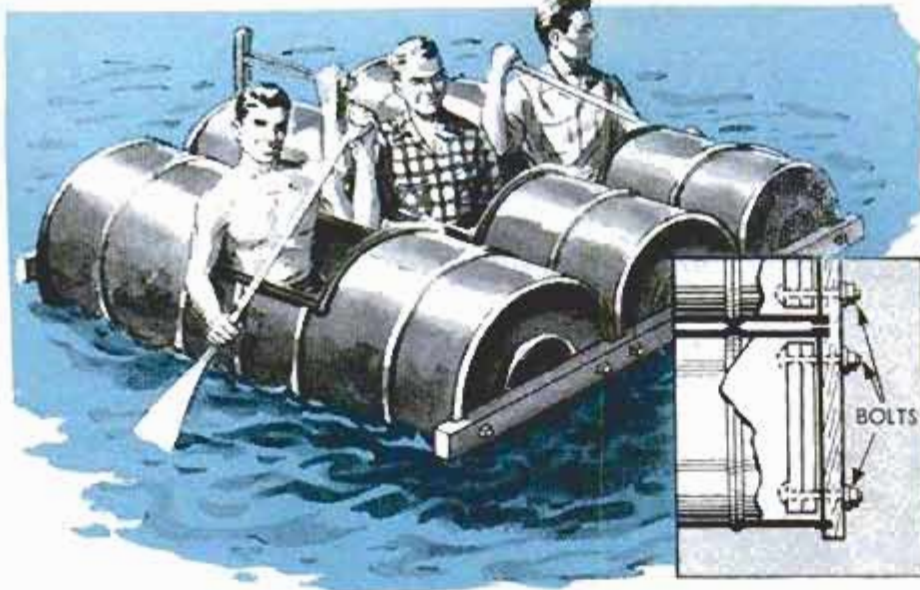

Six steel oil drums are the components of this strange craft that was designed by college students for a floating trip down the Susquehanna River. One end of each drum was removed and the drums welded end-to-end in pairs. Then an opening was cut at the center of each unit to provide a "cockpit," and rubber hose, slitted, was fitted over the sharp edges. The 3-unit assembly, bolted together on 2 x 4s, proved extremely stable.

## Steel Cable Provides Useful Boat-Trailer Accessory

Tipping and swinging a boat trailer while it is still held by an automobile is done readily with this simple accessory. It consists of a 1/4-in. steel cable clamped to the underside of the trailer just ahead of the wheels. The opposite end of the cable is formed in a loop that slips over the ball of the trailer hitch. A turnbuckle in the cable permits shortening it should it stretch through use.—Capt. Joseph L. Lyon, Camp Lejeune, N. C.



## Sponge Is Useful Boating Gear

Whether you have a small skiff or a large cruiser, a small sponge is a handy piece of gear to have aboard. It can be used to wipe up water and spray that cannot be removed by pump or bailing can, and is ideal for cleaning seats and decks.

## Low-Cost Fenders for Outboard Boat Are Easy to Make

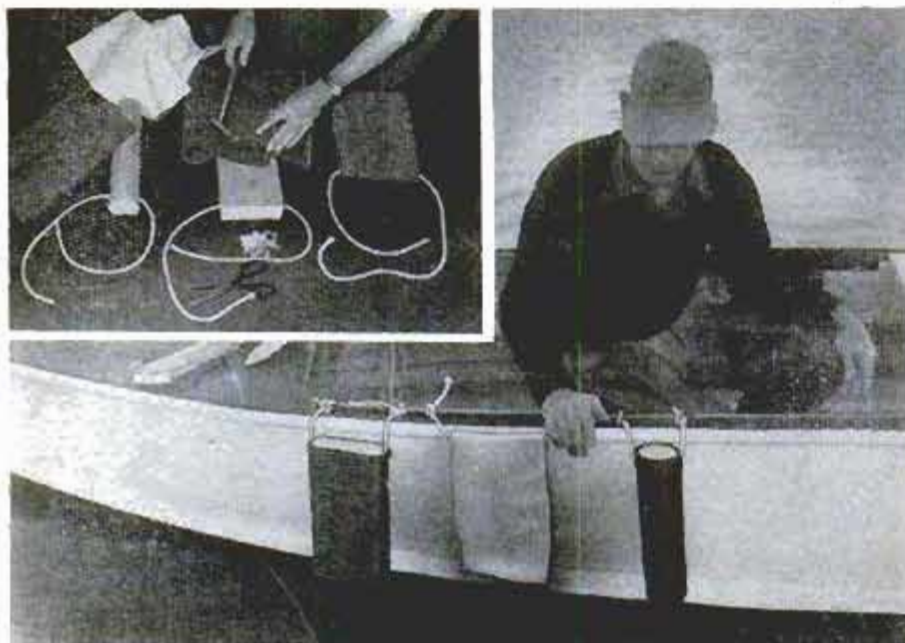

Fenders are a must to protect the paint and hull of any boat. An outboard owner can make his own, any of three types being simple to assemble. The first type is a length of 3-in.-dia. dowel over which carpeting is nailed. Of similar construction, but flat, is a fender made by covering a length of 2 x 6 with carpeting. They are suspended by a sash cord passed through holes drilled in the wood and tied to the gunwale. A soft fender is made by folding carpeting in a pad and covering with canvas.





# Sidewalk Jeep Has Coil-Spring Suspension

By M. C. Anderson *506 N. NORWOOD, ARLINGTON 3, VA.*

AS RUGGEDLY DESIGNED as its namesake, this sidewalk Jeep will last through many a campaign of rough play. To assure maximum strength, as well as ease of construction, the body and frame members of the car, Fig. 4, are cut from 3/4-in. exterior-grade fir plywood. It is important to use exterior-grade plywood, as wood intended only for inside use does not have the weather-resistance needed for a vehicle that will be outdoors most of the time. As a further guarantee of strength, all joints are made with waterproof glue and screws. Compound curves are avoided in this Jeep design and even simple curves have been kept to a minimum.

After the body and frame have been cut out, assembled and the glue allowed to set thoroughly, the running gear is constructed. Some welding is required on the front and rear axle assemblies. If you do not have welding facilities, a local welding shop should do the job for a moderate cost after you have cut and fitted the components. The rear axle is a modified "trailing link" design, Figs. 2 and 3, with the radius rods welded solidly to the axle. The coil springs used on both the front and rear suspension are auto-engine valve springs.

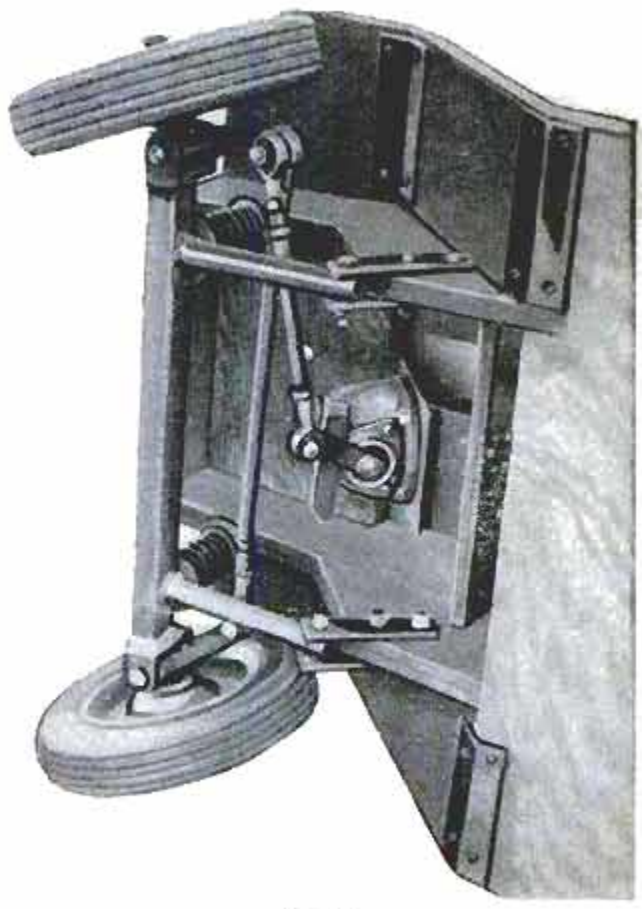

1



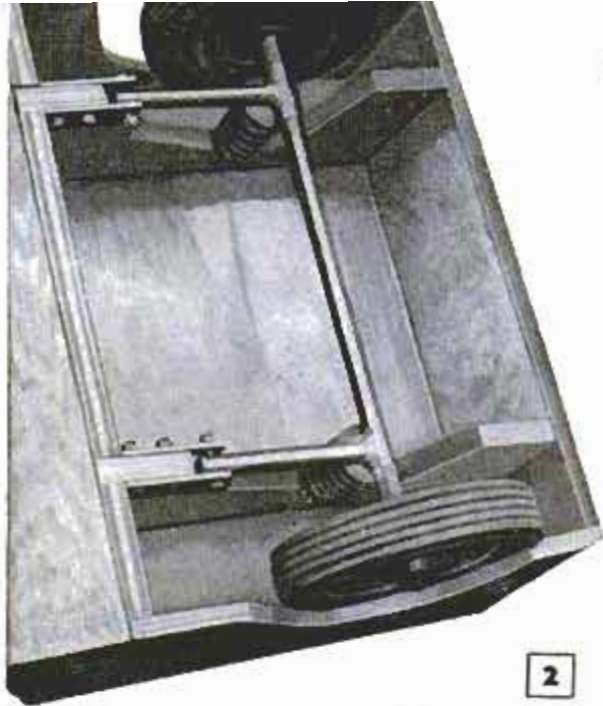

2

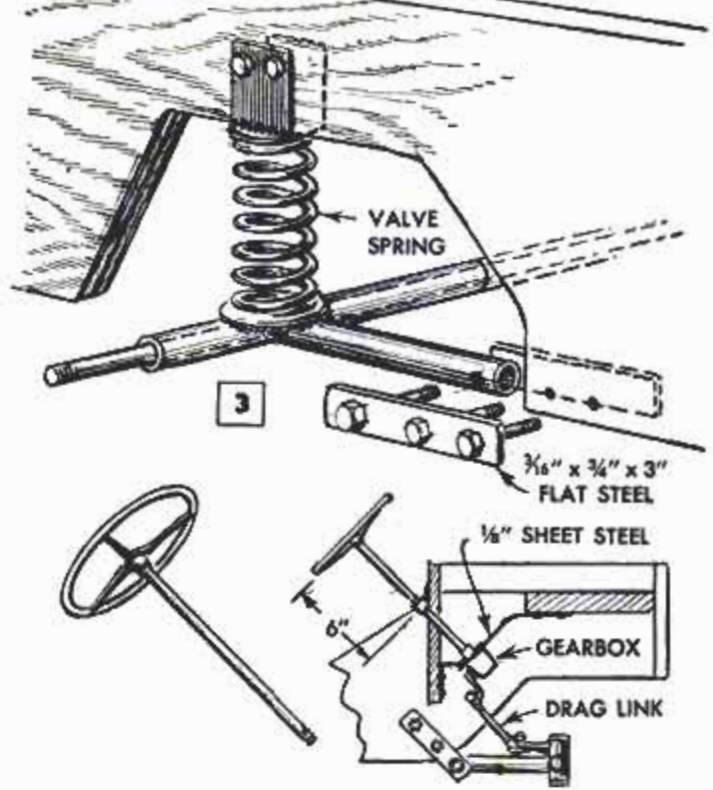

3

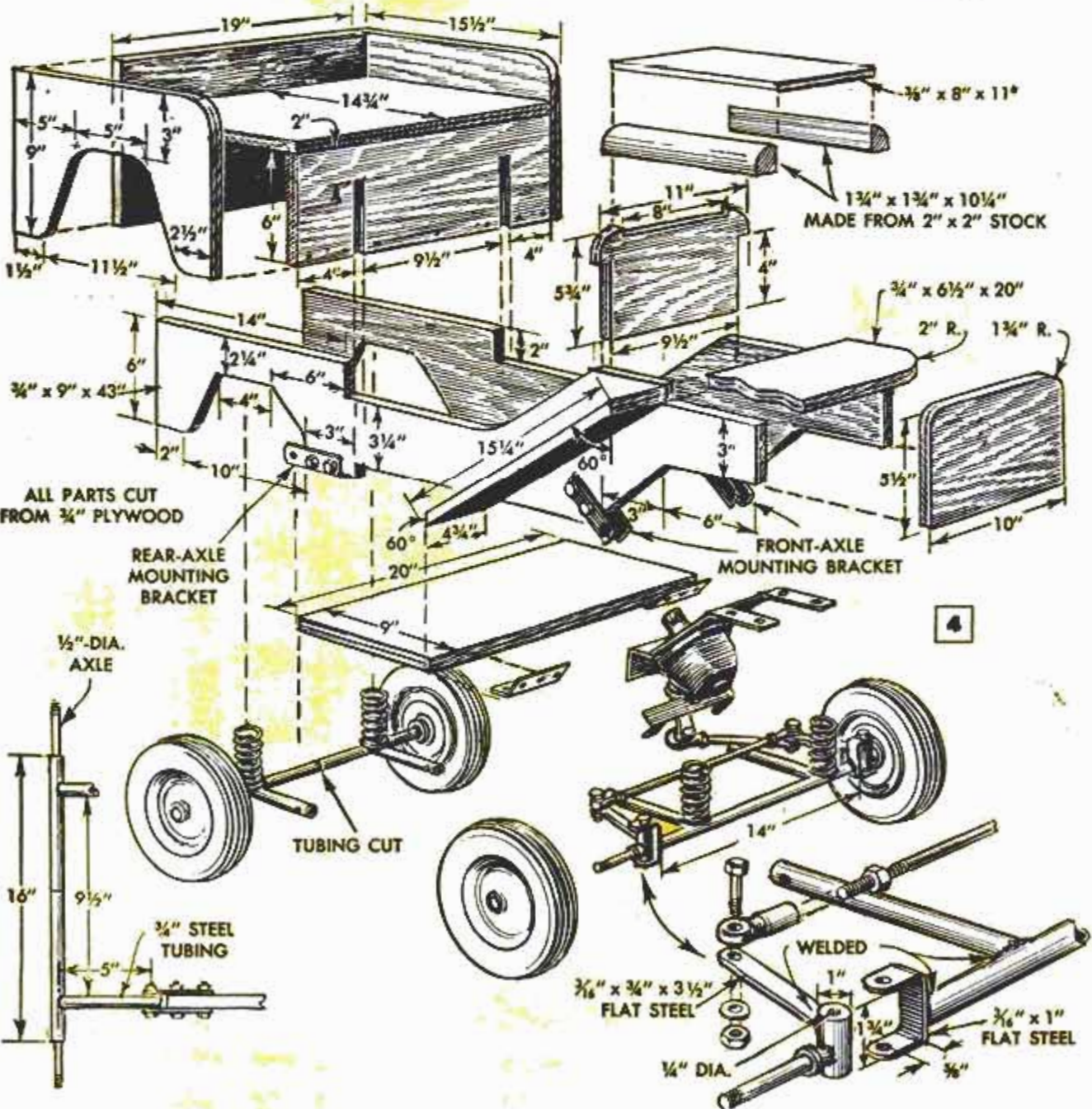

4



They usually can be purchased at an auto-wrecking yard, but even new ones are not too expensive. The upper end of each spring is brazed to a U-shaped bracket bent from flat steel and bolted to the car frame. The lower end of each spring is brazed to a steel washer that is welded to the axle assembly. A length of 1/2-in. steel rod, rotating inside the tubing assembly is the actual axle to which the rear wheels are attached. Cutting the rear-axle tubing at the center allows it to flex slightly when the Jeep is driven over rough ground.

The front-axle assembly, Fig. 1 and lower, right-hand detail Fig. 4, also is a modified trailing-link design. Either round or square tubing can be used. Square tubing, Fig. 1, makes assembly and alignment somewhat easier. Kingpin-support yokes welded to the ends of the front axle are steel flats bent to a U-shape. Each spindle assembly consists of a length of 1-in. round stock to which is welded a spindle — a length of 1/2-in. steel rod—and a steering arm. A 1/4-in. hole is drilled in the spindle to accommodate a 1/4-in. "kingpin." Aircraft control rods were used on the original car for the steering assembly, but can be replaced with cut-down auto tie rods and ends. The steering-gear box used on the original car was a reduction gear purchased at a war-surplus store. This unit can be replaced with a steel flat welded at right angles to the lower end of the steering column and coupled to the drag link. Changes in the steering assembly may require modifications in the sheet-metal support for the steering gear and column.

Wheels on the prototype Jeep were 10-in. semi-pneumatic, of the type sold as replacements for coaster-wagon wheels. However, wheels from a discarded wagon or other toy can be used just as well. If other types of wheels are used, check the required axle size before assembling the running gear for the Jeep. Some wheels may require a smaller or larger diameter axle. The steering wheel for the Jeep can be bent and welded from tubing or pipe, or a light wagon wheel may be utilized. To finish the car, apply a coat of sealer, then at least two coats of good enamel. Olive drab is the traditional color for a military Jeep, but a "civilian" model can sport any hue of the rainbow. Headlights can be wooden disks or shallow food tins nailed to the radiator. For a "deluxe" version, real lights powered by flashlight dry cells should be installed. Rubber mats on the floor and running boards will add a touch of individuality, and a plastic-covered seat cushion will provide a measure of comfort and luxury that is waterproof and easily cleaned when necessary. ★ ★ ★

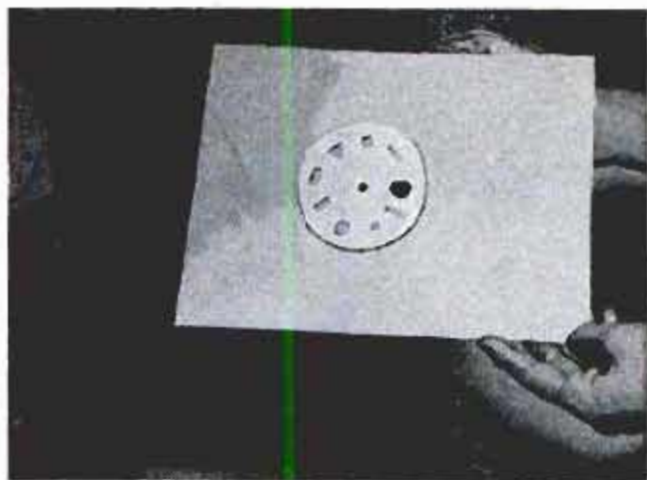

### "Dodging" Card for Enlarging Has Variable Hole Selector

This "dodging" card for use in photo enlarging can be made in a few minutes from two pieces of cardboard. For 8 x 10-in. enlargements the large backing board should be at least 9 x 11-in. to protect the print from overlapping light. Holes of various sizes and shapes are cut in a 4-in. dial which is mounted on the card with a small bolt or rivet. The edges of the holes should be uneven, to facilitate blending of "burned" areas with the surrounding image.—Clinton R. Hull, Costa Mesa, Calif.

### Cleat Controls Anchor Rope

Attached to a gunwale near the stem of a rowboat as shown, a wood or metal cleat can be used to hold the anchor above bottom temporarily to permit rowing short distances when changing fishing locations. This eliminates the need to constantly hoist the anchor in and out of the boat. The anchor rope is snubbed around the cleat a few turns, with the portion of the rope toward the anchor on top, to keep the rope tight.

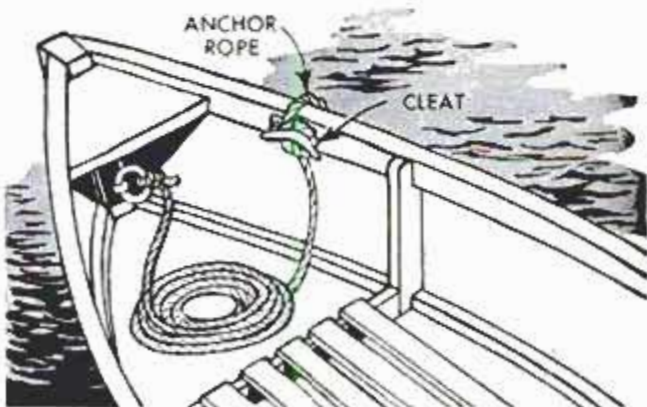

Ⓛ Before finishing hardwood flooring, sand it carefully. Start with No. 2 sandpaper for cutting high spots. Then use No. 1, and finish with No. 0. Use this procedure especially for close-grain northern hardwoods that require careful sanding.



Current Shopsmith, Mark 5, is actually many tools in one. It is a precision-built tool of which any home craftsman will be proud

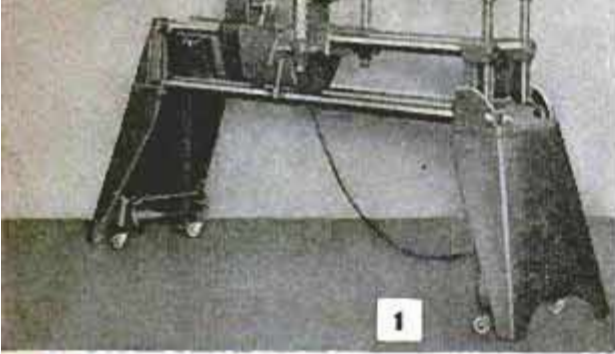

1



The new economy model Mark 2, above, is lower-priced, but will do the work of the Mark 5 model, even though it has fewer convenience features

2

## The New Mark 2 SHOPSMITH

SUCCESS OF MANY small foreign cars on the American market, as well as one or two small domestic models, has proved Americans are willing to forego some of the luxuries to save cost. It is important to note, however, that the small car was really not generally accepted until it could provide dependable transportation at practical speeds.

Now a manufacturer in an entirely different field—power tools—is following the same formula. Magna Power Tool Corporation has just announced a new economy-type Shopsmith. Like the smaller foreign cars, the new Shopsmith Mark 2 does not have all the luxuries of the Mark 5, but it does equally well the job for which it was designed.

The low price for the new Shopsmith naturally caused us to ask the question: How can so much be saved without forfeiting efficiency? So we invited the manufacturer to explain how this problem had been approached and what was accomplished.

The results are shown on this and the four pages following. Descendants of the first nonworking-model mockup pictured in Fig. 3, and later the working model shown in Fig. 4, the current, higher-priced model, Mark 5, is pictured in Fig. 1, and the new economy model, Mark 2, is shown in Fig. 2. A quick glance shows little difference in the two models, design in general as well as accuracy and

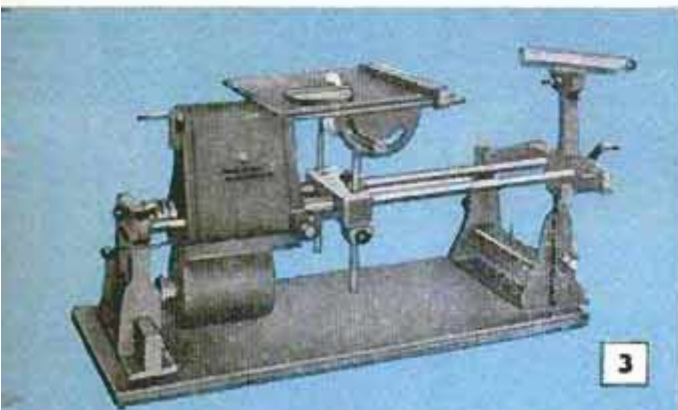

3

Above, designer's first nonworking model; the first conception of the Shopsmiths to be produced at later date

Below, the first working model and the parent of current models, Mark 5 and 2. Notice use of drill-press head in model

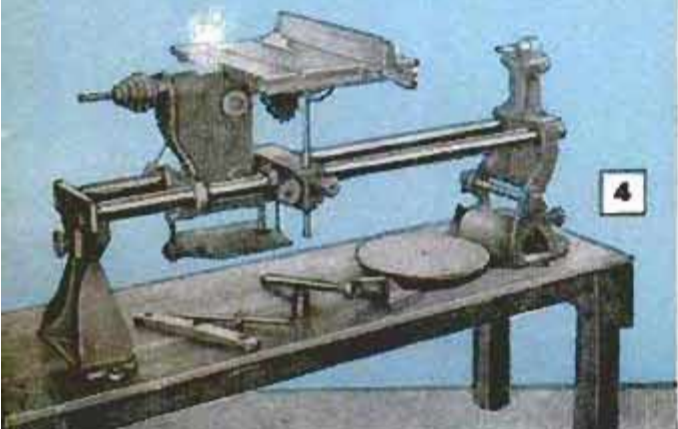

4



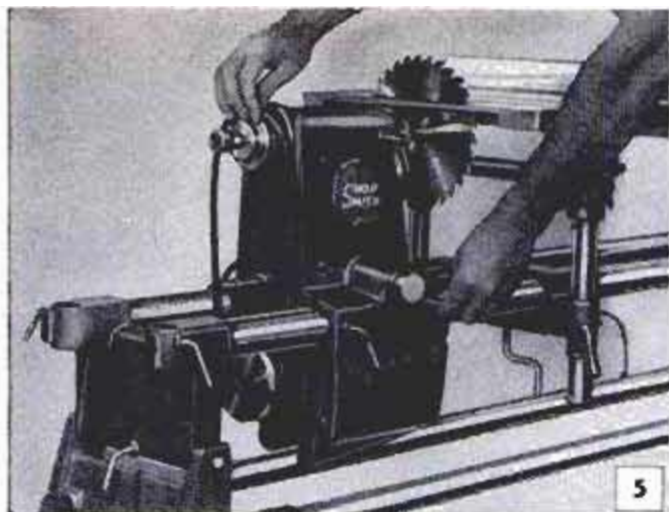

Changing speeds on Mark 2 is merely a matter of loosening belt tension and shifting belt to the various pulley combinations of two step pulleys

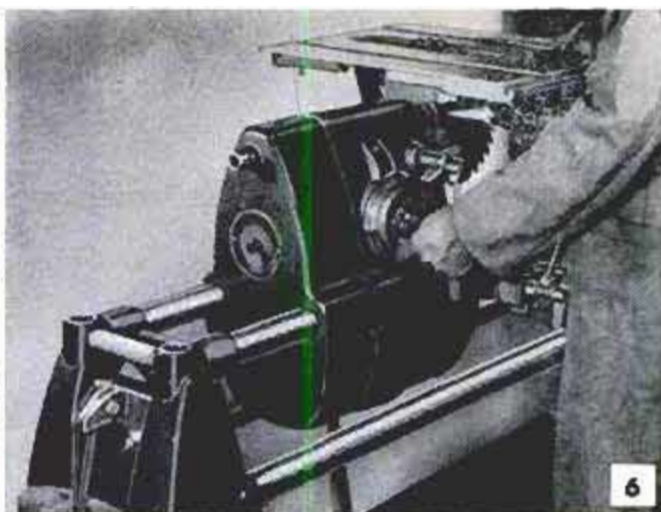

Desired speed is dialed on Mark 5. An expandable pulley on motor shaft is widened or narrowed by dial mechanism to increase or decrease pulley dia.

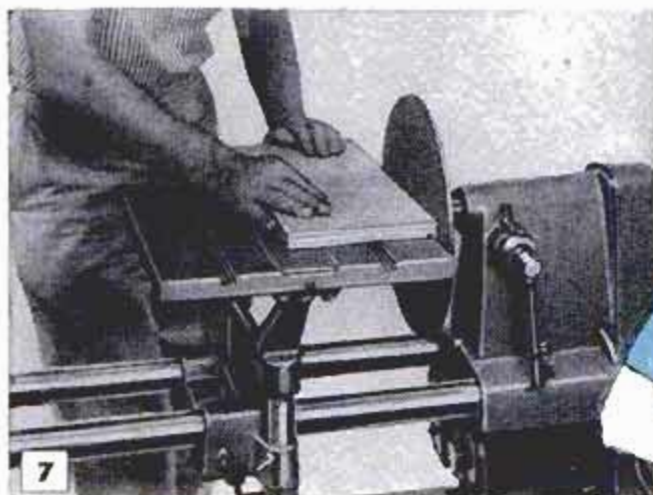

Replacing the saw blade with a sanding disk provides a disk sander which, when used in conjunction with table, does accurate edge sanding

Right, the bandsaw accessory, as do all accessories used on the Mark 5, also fits the new Mark 2. It is driven through the mandrel shaft by a coupling

rugged construction being maintained. Accessories for the higher-priced model also are used on the economy model. Close inspection shows how lower costs for the new Shopsmith were made possible without sacrificing quality. Like the small-car manufacturer who holds down costs by using a "stick shift" instead of an automatic transmission, and eliminates power assists and gadgets considered a convenience, the manufacturer of the new Shopsmith reduced costs by using a simple drive and eliminating some of the unnecessary convenience features from the tool.

Figs. 5 and 6 show the drives of the two tools. To change speeds on the Mark 2, the belt is shifted on the pulleys by hand, Figs. 5 and 17, while on the Mark 5, speeds are changed by rotating a dial as in Figs. 6 and 16.

As with the car's automatic transmission,





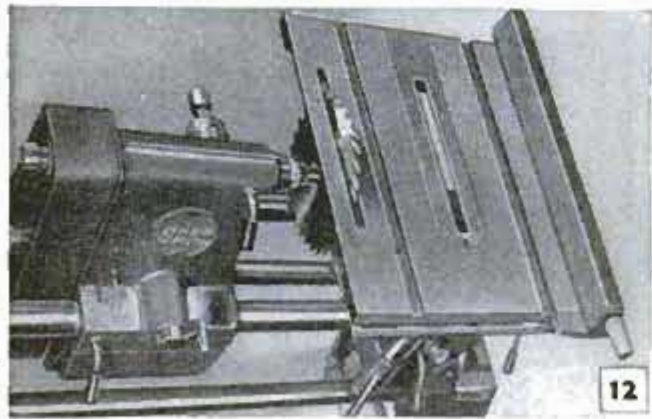
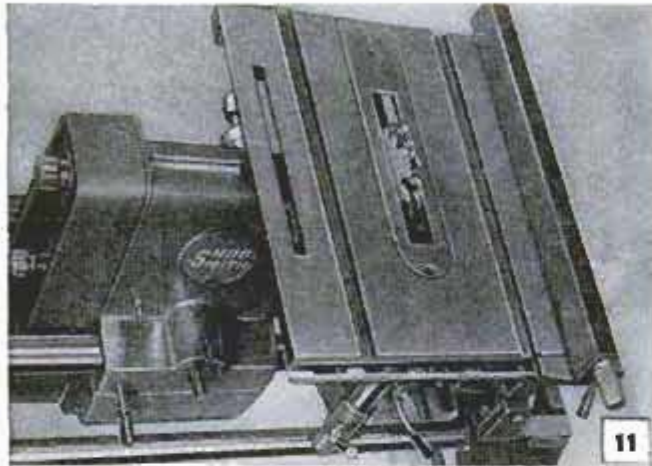
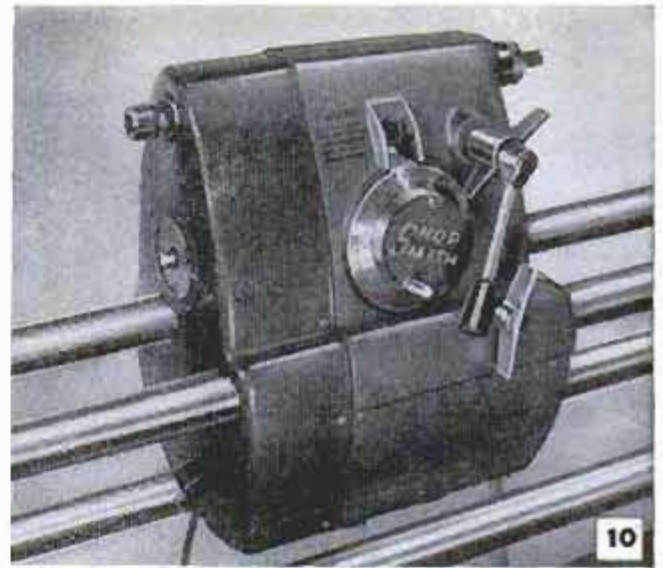
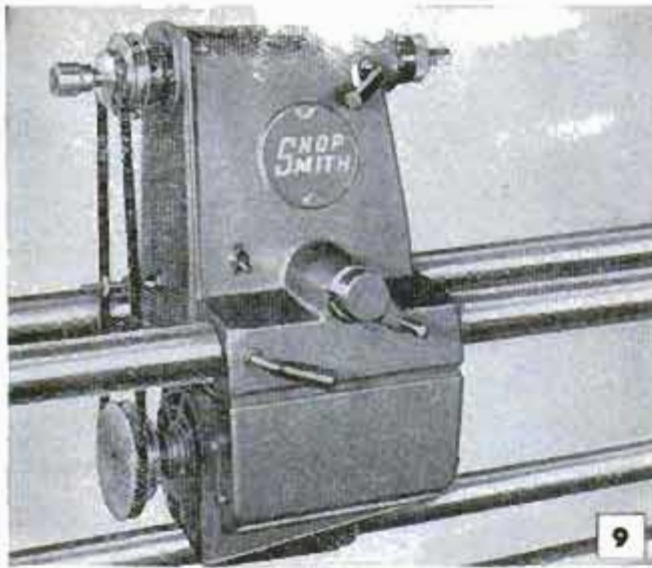

9. Step pulleys in drive permit many shaft speeds, which are obtained by shifting belt to various pulleys

10. Speeds on Mark 5 changed by calibrated dial, which actuates expandable pulley to change its dia.

11 and 12. Table on Mark 2 has two slots. One at left permits wider work on table than center slot

13. By using the auxiliary table, unusually long work can be handled on either of the Shopsmith tools

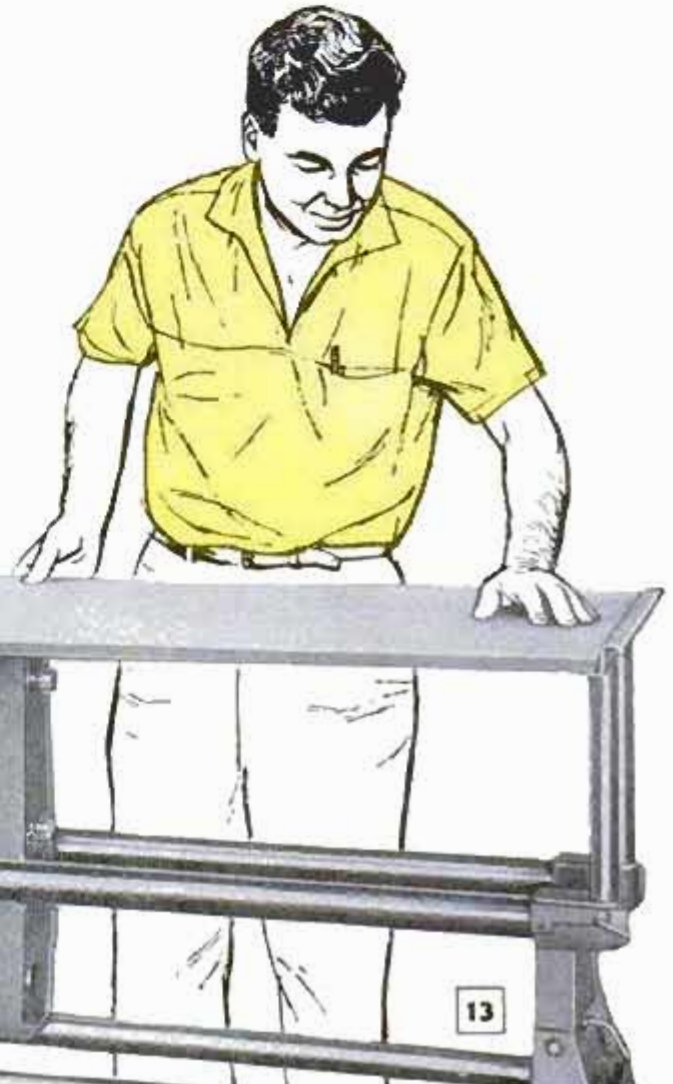



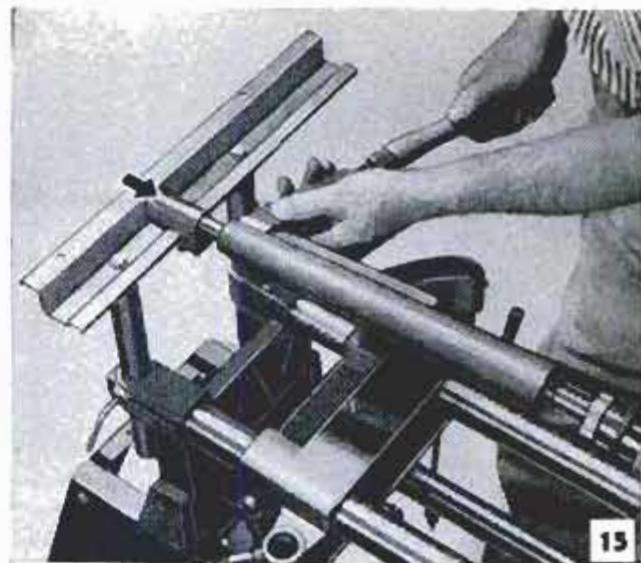
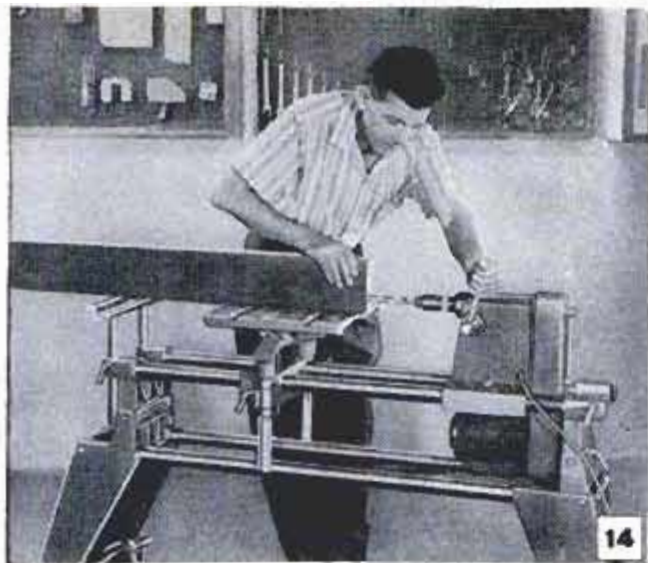

The two tables support long work for accurate horizontal drilling. Table-height adjustment makes it easy to spot the drill point exactly where desired

Tailstock center slides on support to get the necessary "setover" for taper turning. Casting holding center clamps to auxiliary table for quick adjustment

dialing the speed of the tool is a convenience, but is not necessary to doing quality work with the tool. Other cost-reducing features are shown in Figs. 9 and 10. Notice the difference in the control knobs of the two tools. Those on both tools accomplish the same purpose, but those on the Mark 5, Fig. 10, have a more deluxe appearance, and have position-locking features, while those on the Mark 2, Fig. 9, are merely screws with plastic handles.

Further cost-reducing features were effected in the table-raising mechanism on

Right, an expandable pulley on the motor shaft operated by a dial changes speeds on the Mark 5. Below, the belt-and-pulley drive used on Mark 2

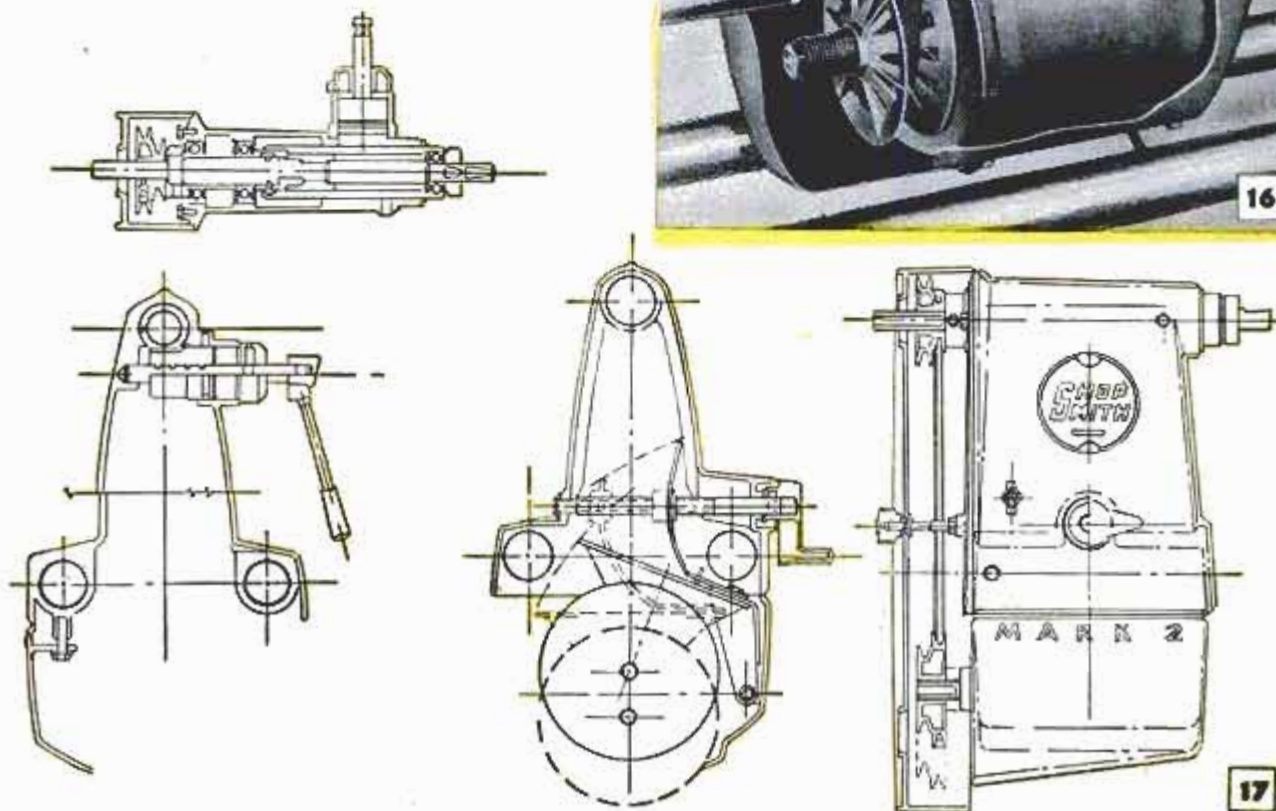
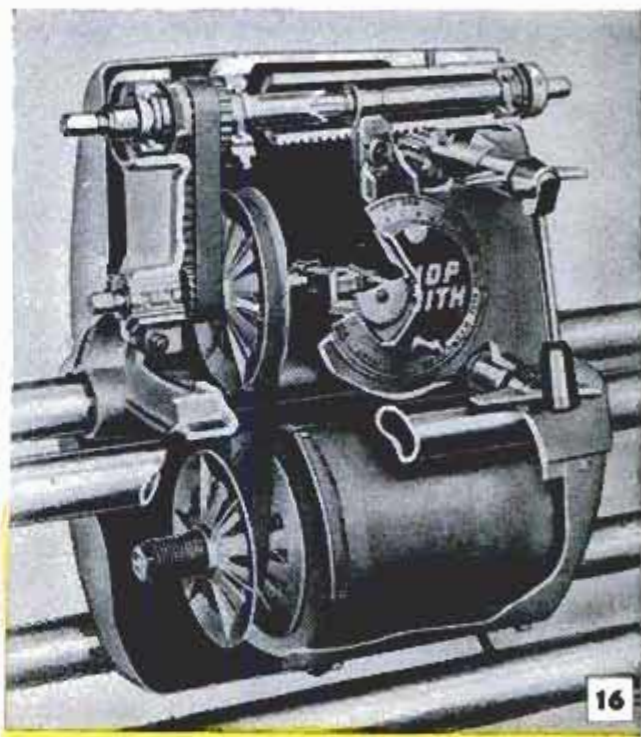



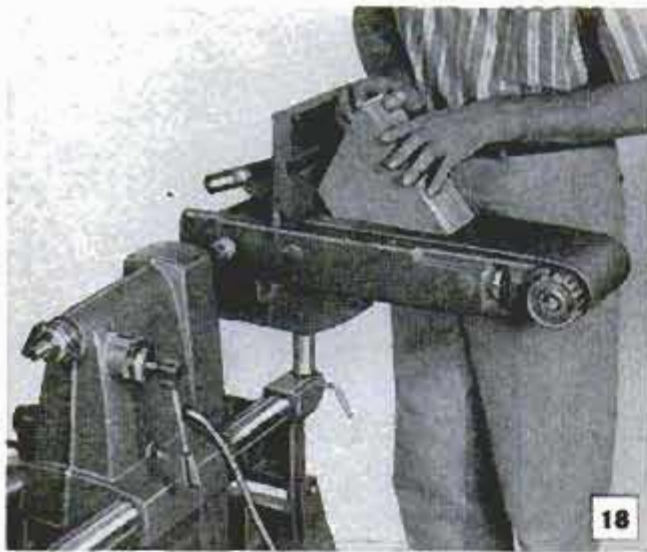

18

Belt-sander accessory, as are all accessories, is driven from end of mandrel shaft as shown above

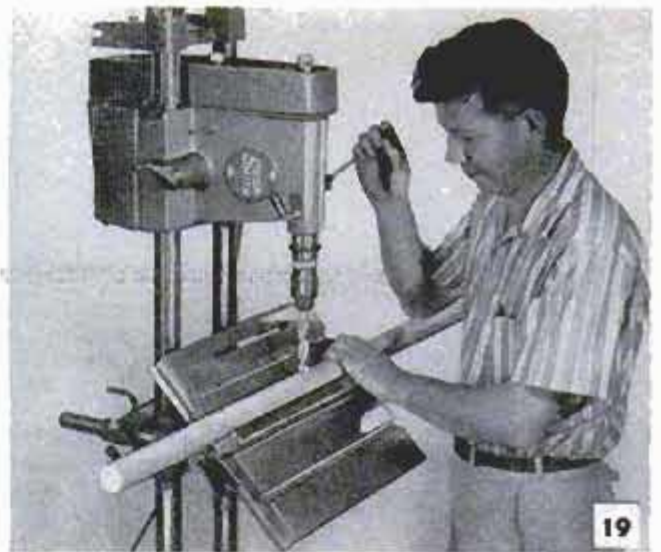

19

Both Shopsmiths convert to vertical drill presses, which provide conveniently wide tables, above

the Mark 2. The Mark 5 utilizes a rack and pinion, Fig. 21, while with the economy model, rapid raising is done by hand. Micro-adjustment of the table for critical setting is provided by a screw crank which can be seen just below the table in Fig. 22.

Although not shown for the sake of clarity, an arm clamped to one of the table standards projects out over the end of the crank, to adjust the table for height.

As indicated in Figs. 11 and 12, the table on the Mark 2 has two slots, one centered

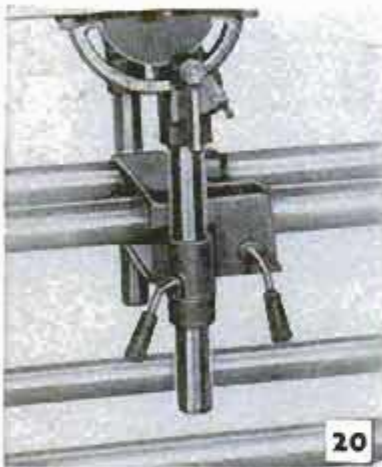

20

Mark 2 table-adjustment controls are plastic-handled screws

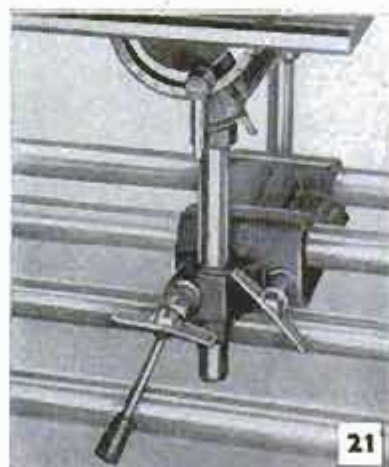

21

Table on Mark 5 is adjusted in height by rack-and-pinion gear

Below, motor on Mark 2 has plenty of power to operate all accessories used on the Mark 5

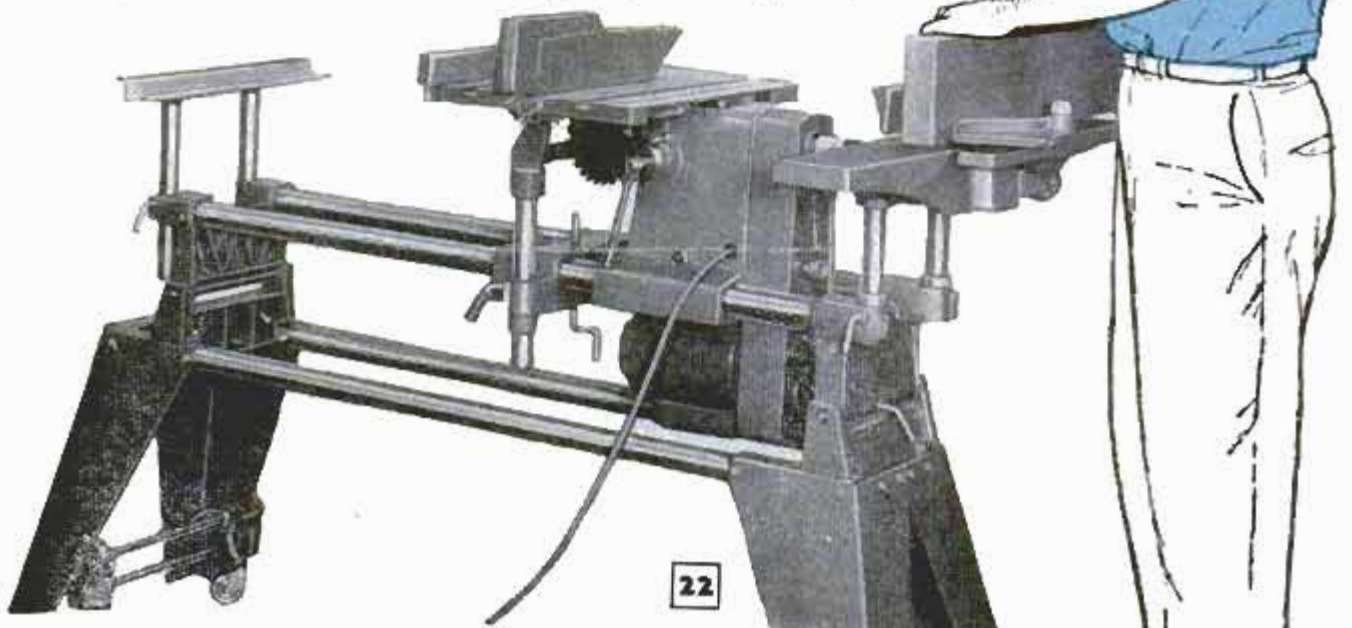

22



and one near the left edge. Use of the left slot permits wider work between saw blade and the rip fence, Fig. 12, when the fence is on the table.

Where the Mark 5 has a cast, deluxe, auxiliary table, or long-work support, on which the rip fence also may be used, the economy model has a simpler stamped one, which is shaped so it also serves as a rip fence, as in Fig. 13. When the Mark 5 is used as a wood-turning lathe, the auxiliary table is replaced with a special tailstock, which carries a fitting to hold the center. This fitting can be rotated to set the center for taper turning. On the Mark 2, the tailstock center is held in a small casting that slides on the auxiliary table as indicated by the arrow in Fig. 15.

As with the Mark 5 Shopsmith, the Mark 2 model can be used as a wood-turning lathe, Fig. 15, a horizontal drill press, Fig. 14, or a vertical drill press as in Fig. 19. The economy model also operates various accessories used on the Mark 5, such as a disk sander, Fig. 7, a bandsaw, Fig. 8, a belt sander, Fig. 18, or a jointer as in Fig. 22. ★ ★ ★

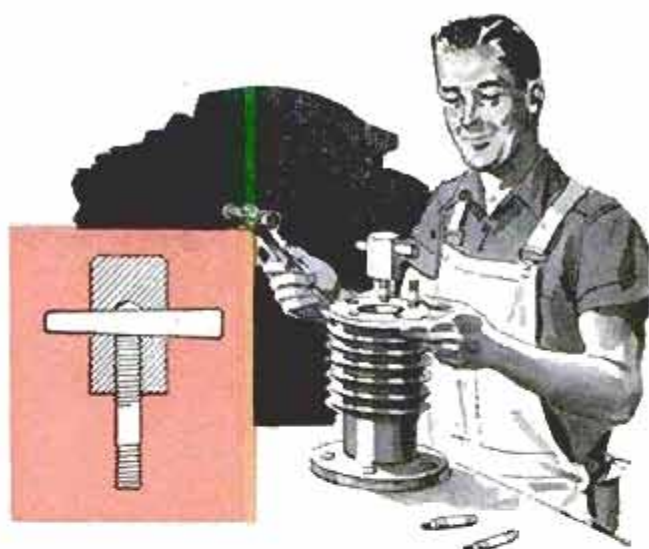

### Easy-to-Release Stud Driver

This stud driver is made by drilling and tapping a length of steel hexagon bar, then cross-drilling the bar near the upper end of the threaded hole. The latter hole is reamed with a No. 1 Morse-taper reamer. A Morse-taper shank from a discarded drill then is tapped into the hole. After a stud is driven, tapping out the shank releases the driver and stud.

C. W. Woodson, Chicago.

### Stair Stringers Marked Accurately With Square and Strip

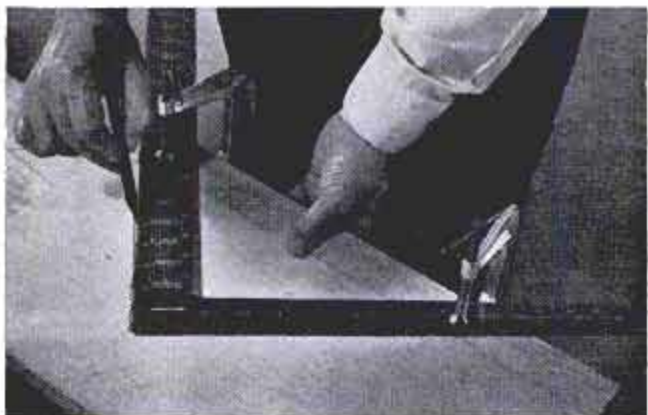

When marking stair stringers one carpenter clamps a straight strip of wood across a framing square so the distances from the corner of the square to the strip will equal the lengths of cuts to be made for treads and risers. The square is moved from one marking position to the next, with the wood strip held snugly against the edge of the stringer. For accurate results with this method, it is necessary, of course, that the edge of the stringer be perfectly straight. Both stringers are cut at the same time to assure identical units.

### For Accurate Center-Drilling

Rough forgings have a draft angle on the ends, and center drilling them without preparation will produce elongated holes that will cause the forging to run out-of-round when set up in a lathe for turning. To avoid this problem, spot-face the ends in one of several ways. The ends can be faced-off in a lathe, smoothed with a belt sander

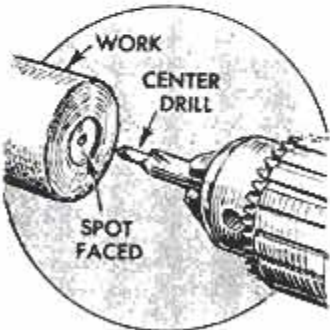

or milled, depending on the shape of the workpiece and availability of machinery.

Frank La Saracina, New York City.

### "Portable Mounted" Motor

When a small electric motor is used to drive several machines in your shop by moving it from one location to another, it can be anchored securely at any point by first mounting it on a wooden block. The block is fitted with a U-shaped hinge rod at the machine side of the motor as indicated. Holes drilled in the bench at the desired location for each machine permit the insertion of the ends of the rod. Locate the holes so the motor hangs on the belt.

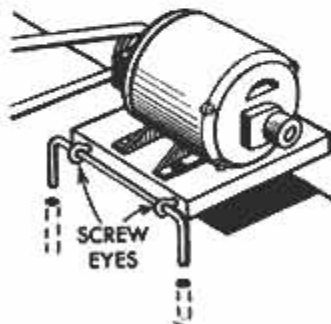





↑  
**CUTTING BREAD SLICES** of equal thickness is easy when board is ruled with guide lines

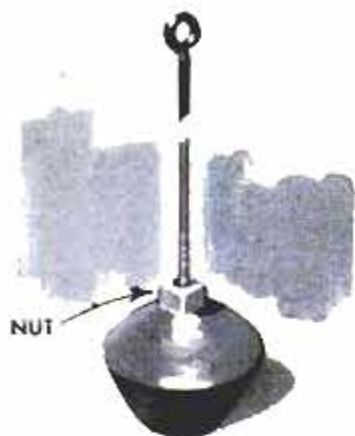

# Solving HOME PROBLEMS



↓  
**TO RENEW BRISTLES** of some types of brushes that have vegetable-fiber bristles, soak them in a saline solution, then dry thoroughly. Bristles again will be stiff

↓  
**GLASS STOPPERS** will not "freeze" in medicine bottles if they are wrapped with a strip of adhesive tape that acts as "gasket." Permits easy removal



↓  
**CLEANING OVERSHOES** with a vacuum cleaner when they are dried between wearings will remove dust and dirt that often spoils fresh shoeshines and socks

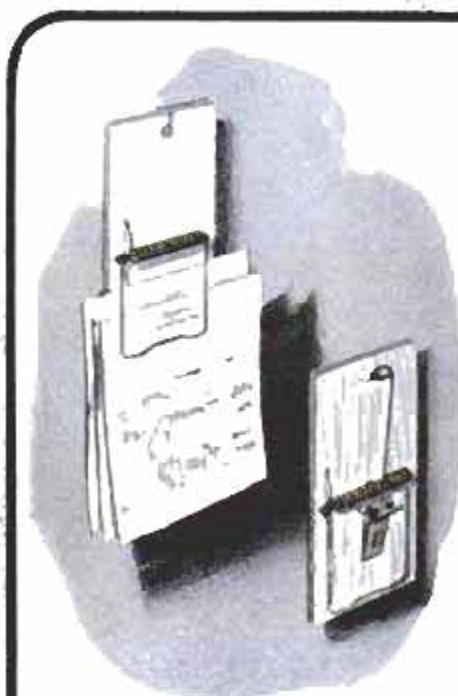



◀ **FLUSH-TANK FLOAT** will have faster, more positive action when weight is added to it. Weight consists of ½-in. nut fitted on stem of float as in the detail, left

EXTRA SCREWS FOR REINFORCEMENT

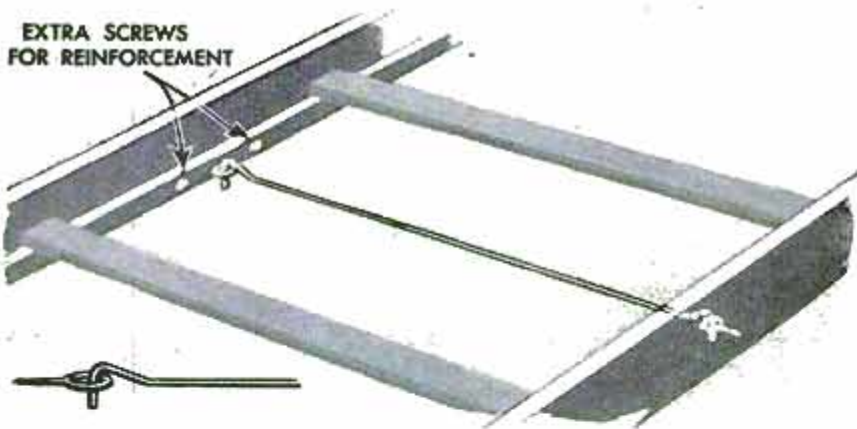

▶ **DOUBLE-ENDED HOOK** long enough to span width of bedframe and fit in screw eyes driven into rails will keep rails from bowing out and allowing slats to drop



ADHESIVE TAPE

◀ **MINIATURE CLIPBOARD** is made by removing trigger and catch from ordinary mousetrap, then painting it. Screwed to wall or door it is handy for receipts, bills

SPREADING LIQUID WAX on a floor is simpler, quicker and less wasteful when a clothes-sprinkler head is forced into neck of the can to make it into a dispenser

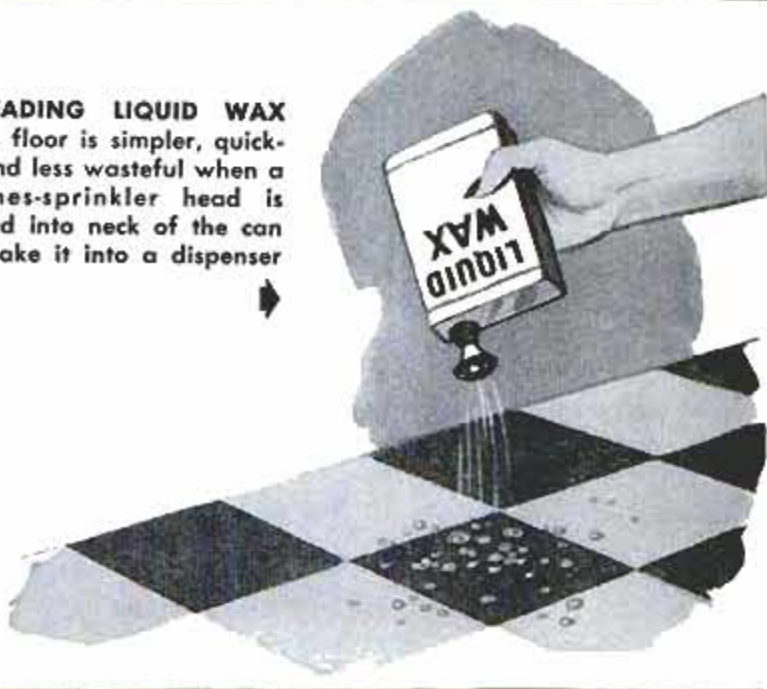

▶ **DOWEL IN HEM** of cloth used for damp-pressing garments provides means for easier handling, permits cloth to be spread smoothly over garment to be pressed





## "Disposable" Funnel Improvised From Beverage Container



When no funnel is available, one can be improvised by removing the bottom from a beverage can. The can must be of the type with a narrow mouth that is sealed with a bottle cap. Even heavy liquids, such as oil and paint, pour rapidly through this handy "disposable" funnel.

## Ventilator for a Doghouse

To provide rain-proof ventilation for a doghouse, install this "louver" made from a 1-lb. coffee can. The can is cut in half, then the edge is notched and bent as indicated to form tabs. Cut a semicircular opening in the doghouse large enough to accommodate the louver, then insert the louver from inside the house and nail it in place.

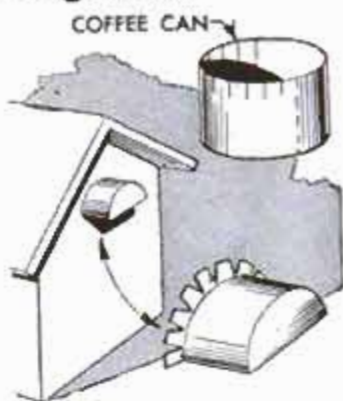

## Corks in Drawing Board Provide "Renewable" Surface

Constantly using the same size paper on a drawing board results in four small areas that become pitted and roughened from the thumbtack holes. To avoid this, drill large holes at the points where frequent perforations occur and fit fine-grained corks in the holes, sanding them level with the board. Now, when these areas become pitted, the corks are removed and new ones inserted.

ations occur and fit fine-grained corks in the holes, sanding them level with the board. Now, when these areas become pitted, the corks are removed and new ones inserted.

## Ornamental Flagstaff Tips



Fancy plastic and metal caps used on perfume, cologne and other cosmetic bottles are ideal for use as ornaments to dress up an otherwise plain flagstaff. Trim the end of the staff so the cap must be forced on, then apply waterproof cement inside cap and press over end of staff.

## Fan-Shaped Panel "Trims" Fence

Assembled from the same size pickets that are used in the fence, this fan-shaped panel is fitted at right angles to the end of the fence to eliminate a "chopped-off" look. The lower ends of the pickets were tapered to make a tight fit at the fan base.

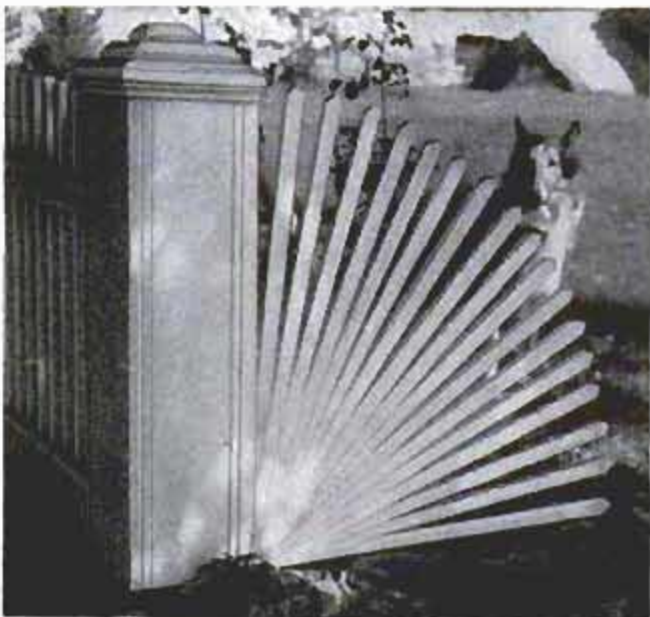

## Diagnosing Choke Trouble

Damage to the hot-air tube in an automatic choke can result in carbon building up in the mechanism and causing trouble. If a malfunctioning automatic choke shows signs of excess carbon, corrosion or burning, replace the hot-air tube.





## HIGHFLYING LIGHT KITES FROM JAPAN

By Hi Sibley

**T**RADITIONALLY EXPERT kitefliers, the Japanese have produced some interesting and unusual models. On the next two pages are plans for several of these kites, plus a fast-winding reel to keep the kites under control. With the exception of the large Daimyo kite, which requires  $\frac{1}{4}$  x  $\frac{1}{4}$ -in. spruce or pine strips, all kites are made from  $\frac{1}{16}$  x  $\frac{3}{16}$ -in. bamboo strips. Where curves are required, the bamboo first is heated over a lamp bulb or small flame, then is bent. All kites are covered with rice paper, obtainable at most hobby stores. Designs are painted on the paper with poster paint before it is applied. Cut the paper 1 in. larger, all around, than the frame, then fold it over and cement. ★ ★ ★

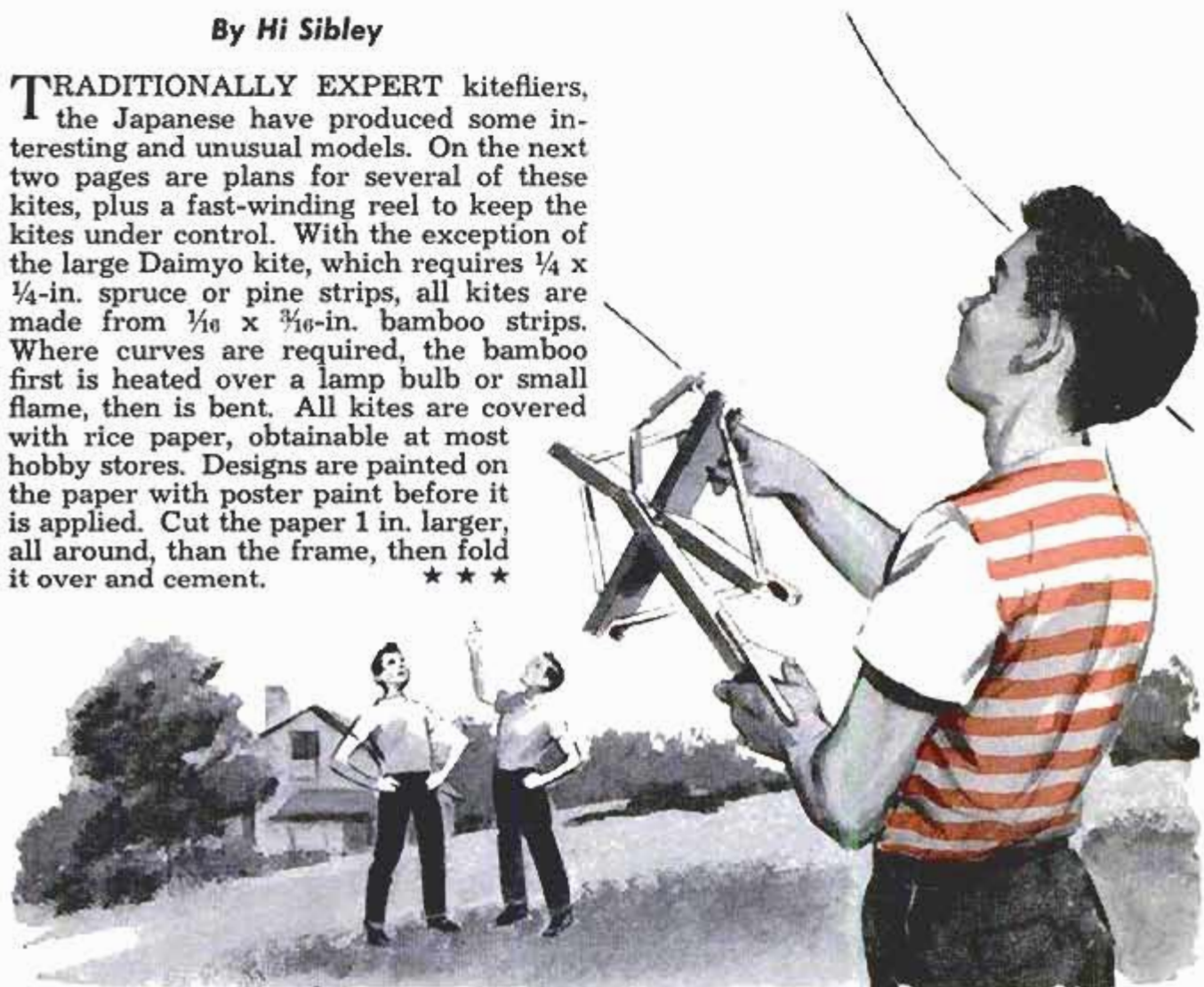





2" SQS.

**DAIMYO KITE**

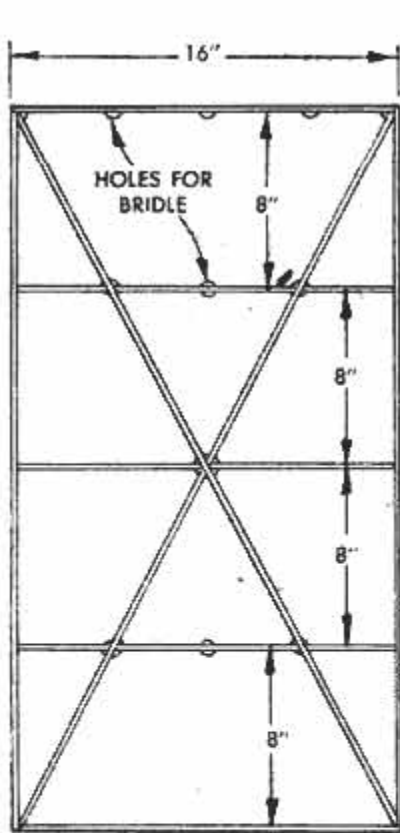
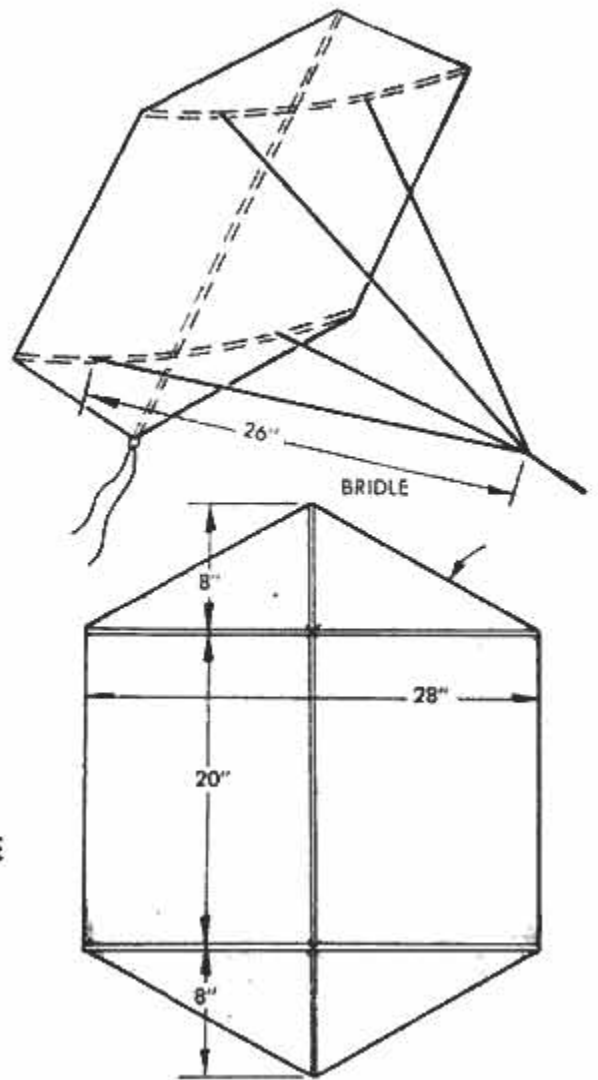

**BACK VIEW**

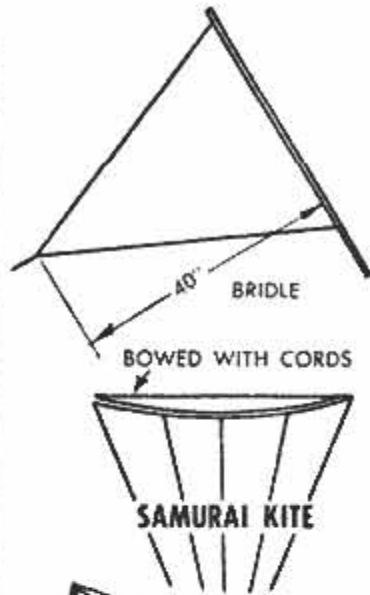

**SAMURAI KITE**



ALL FRAMES ARE MADE FROM  $\frac{1}{16}$ " x  $\frac{3}{16}$ " BAMBOO

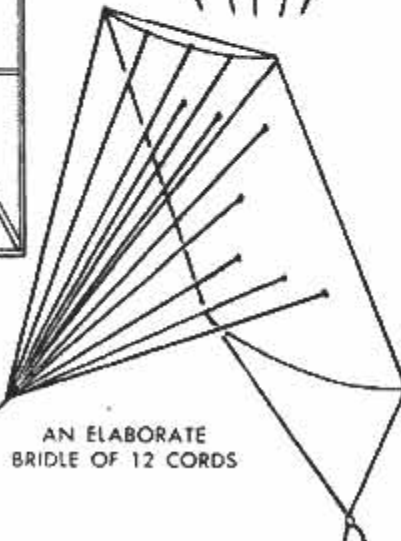

AN ELABORATE BRIDLE OF 12 CORDS



2" SQS

**POPULAR MECHANICS**



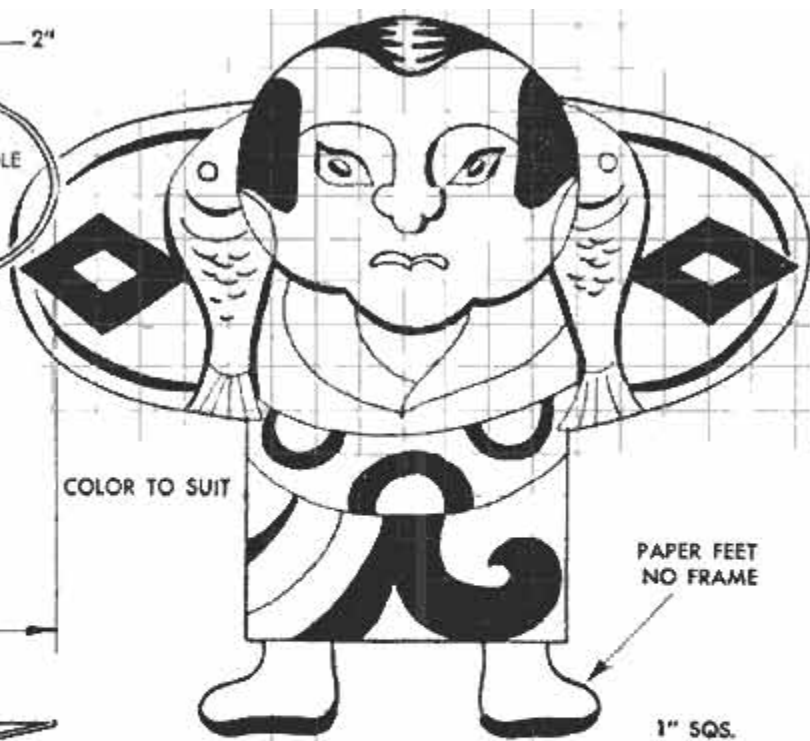
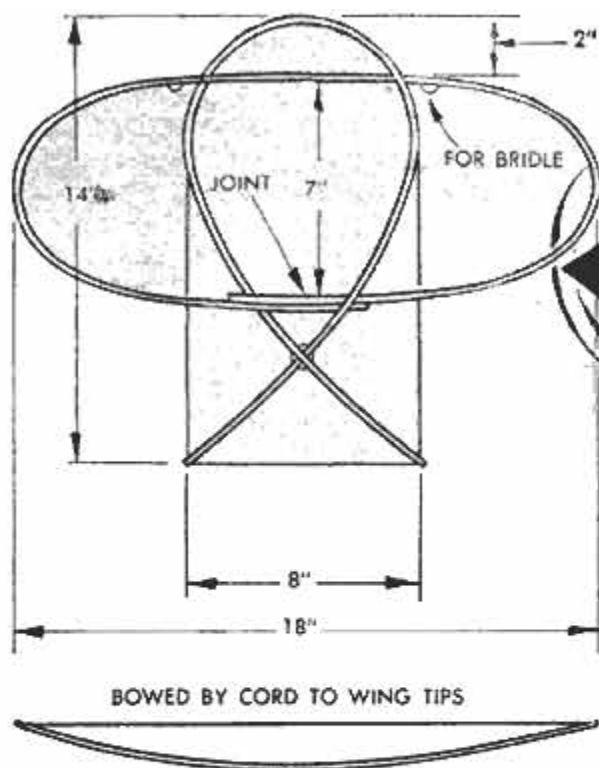

NIKKO KITE

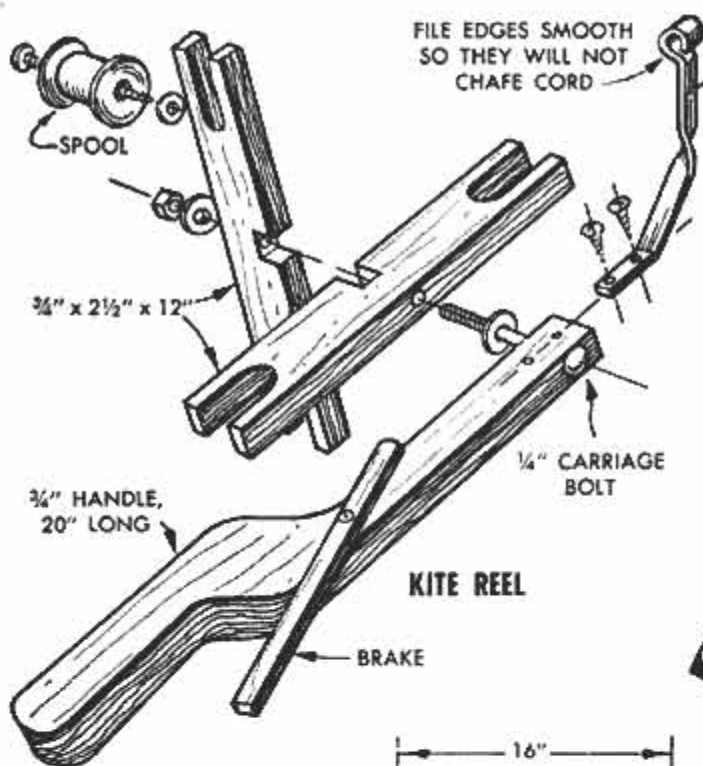

KITE REEL

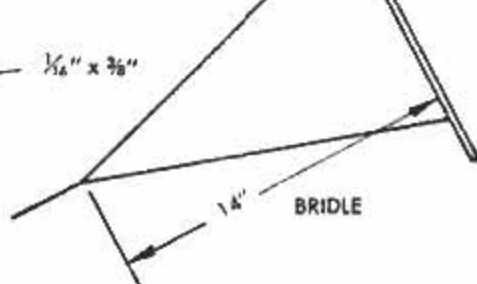

KYOTO KITE

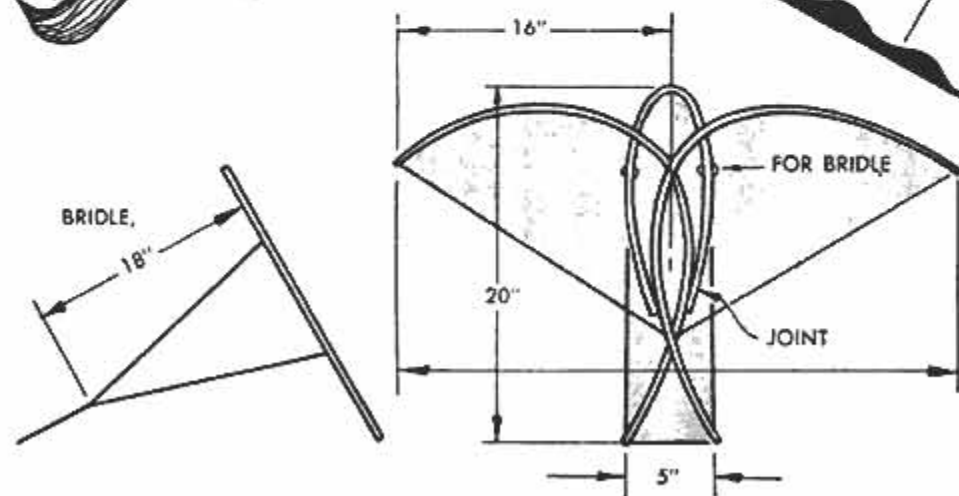
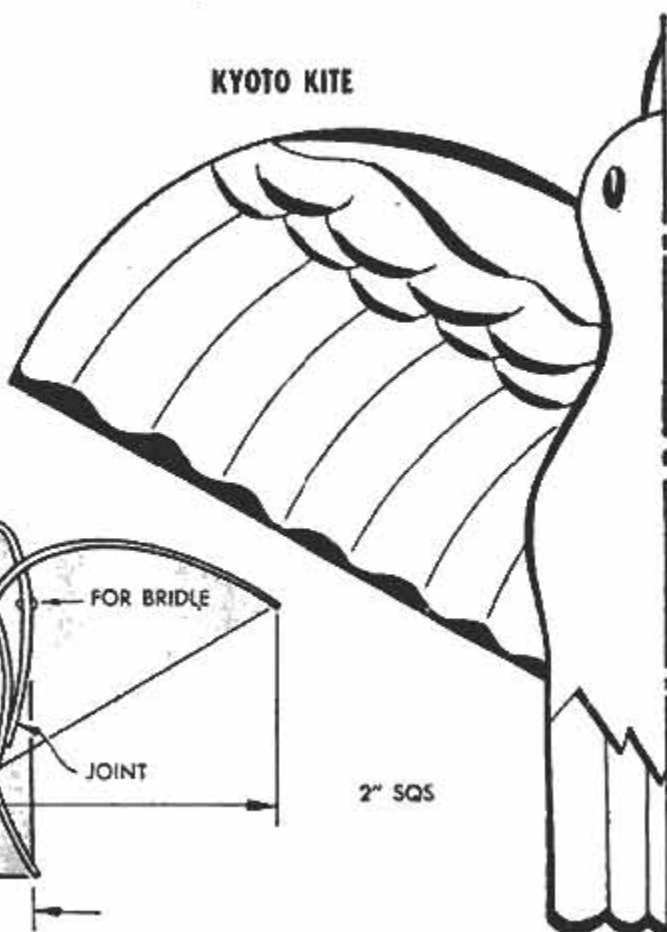



## "Bow and Arrow" Tie Rack Is Simple Jigsaw Project



Novel in appearance, this "bow and arrow" tie rack is easy to make. Power tools will permit you to "mass produce" them for gifts or sale, but single units can be made with ordinary hand tools. The bow-shaped back of the rack is cut from  $\frac{1}{4}$ -in. plywood, the arrow-head and feather are cut from  $\frac{3}{4}$ -in. stock. For an added touch, the arrow-head can be carved to appear more realistic. The shaft of the arrow is a length of  $\frac{3}{8}$ -in. dowel. Blocks used to support the arrow can be assembled from three small scrap pieces, as indicated, or a single piece of solid stock may be drilled to accommodate the arrow shaft. Head and feather are drilled and glued to the shaft last.

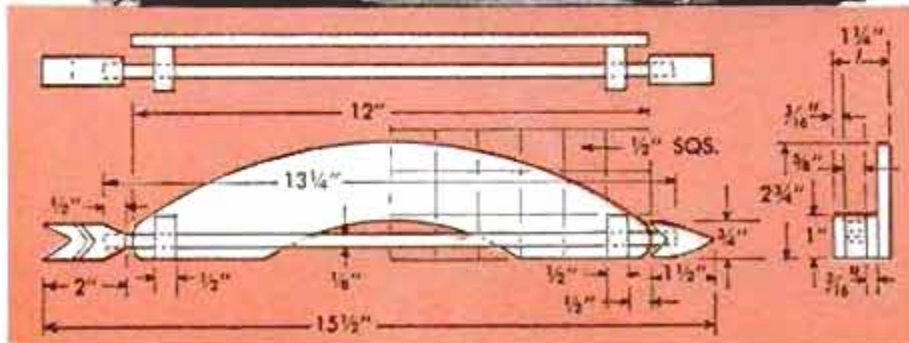

### Static-Eliminator Strap Pivoted

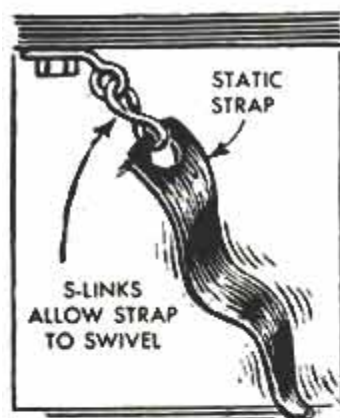

If the strap used to eliminate static electricity from your car or truck breaks off frequently, it probably is due to the fatigue induced in the material by the constant flexing at the point where it is bolted to the frame. To eliminate this

factor, attach the strap with two S-shaped chain links as indicated, using one link to bolt the strap to the frame, the other to provide a pivoting, semiswivel connector.

### Wire Covering "Solder-Proofed"

To solder terminals on electric wires without burning the insulation, wrap the latter with steel wool, held in place with a spring-type wooden clothespin. The steel wool will absorb heat from the soldering iron, thus preserving the insulation. If you solder with an open flame, do not use this method as the steel wool might ignite, but instead, use a heavy wrapping of asbestos cloth around the insulation.

### Raising Overhead Light Fixture

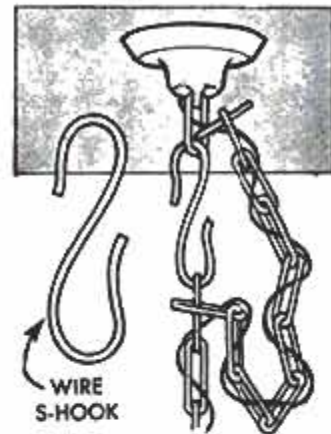

If a table is temporarily moved from beneath a low-hanging overhead light, such as when cleaning floors, the light should be raised above head level to prevent someone striking his head against it. Where the light is suspended from a

chain, as is customary with most older-type fixtures, an S-hook of heavy wire can be used to elevate the light. This method requires no alteration of the light fixture.

### Coins Used as Gasket Patterns

Coins make ideal patterns for cutting circular gaskets of rubber, leather or other soft materials. Place a piece of the gasket material between two coins of the correct size and cut around the edge with a sharp knife or razor blade. The diameters of the various coins are as follows: Penny,  $\frac{3}{4}$  in.; nickel,  $\frac{13}{16}$  in.; dime,  $\frac{11}{16}$  in.; quarter  $\frac{15}{16}$  in.; half-dollar,  $\frac{13}{16}$  in.; silver dollar,  $1\frac{1}{2}$  in.—W. R. Beasley, Jackson, Mich.



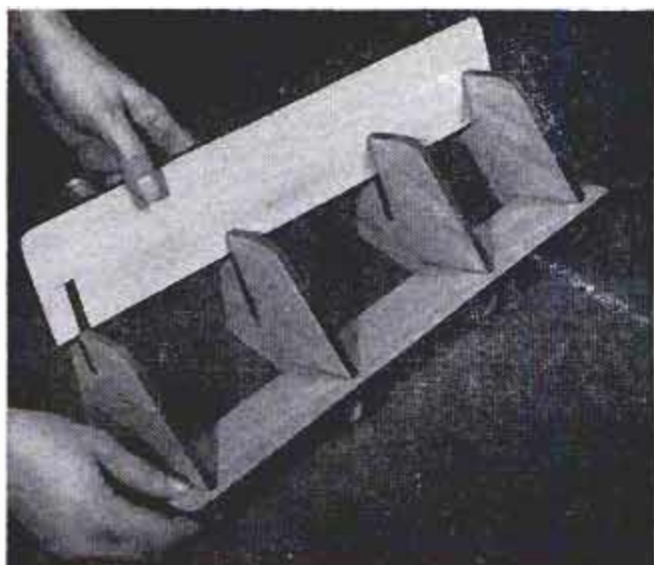

Above, adjustable bookrack consists of back, bottom and four uprights, two of which slide for adjustment

## Adjustable Bookrack For Table or Desk

This attractive little bookrack, made of six interlocking hardboard members, has space for two or three reference books and several other books that you'd like to have within easy reach on a desk or table. The movable dividers permit displaying books in separate groups for easy selection. No glue, nails or screws are necessary for assembling it since the slots permit the pieces to interlock securely. The members of the rack shown in the photos were cut from hardboard scraps with a simulated wood-grain finish on one side. The unfinished surfaces are painted a blending color. Also, plywood or any other suitable material may be used and finished as desired. The rack shown is 15 in. wide, 4½ in. high and 5 in. deep. These dimensions can be altered as desired to provide more or less space for books. Members that are to receive matching slots—back and bottom, two end pieces and two adjustable or sliding verticals should be clamped together in their respective pairs when cutting the required slots

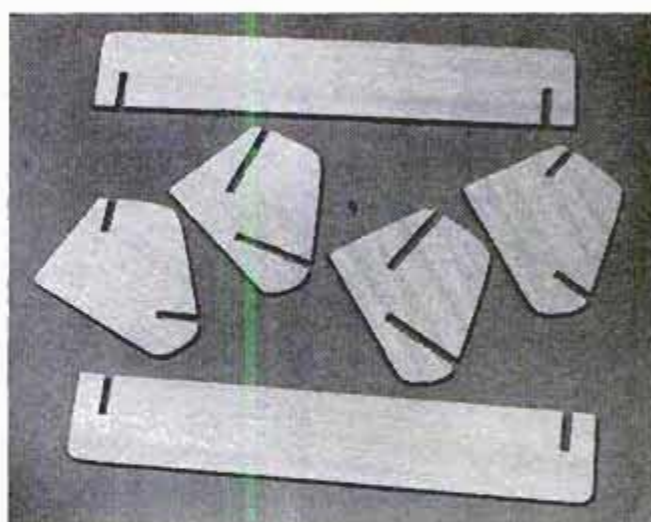

Slots that interlock at ends of rack are 1¼ in. long, slots in two sliding verticals are twice as long

for proper alignment. The width of all slots is equal to the thickness of the stock used. Slots that interlock at the ends are 1¼ in. long. Slots in the two adjustable verticals are twice as long as the slots in the end members. Edges are sanded smooth, using a fine grade of sandpaper, and painted a blending color.

Photos and information courtesy Marsh Wall Products, Inc.

## "Frozen" Drum-Trap Cover Loosened With Hammer and Punch

When attempting to remove a "frozen" drum-trap cover in a bathtub drain, try tapping it loose with a hammer and punch as shown in the drawing. The notches are cut so that the striking surfaces are 180 deg. apart and face in opposite directions. This permits tapping the cover in alternate directions for easier loosening of the frozen threads. After the cover is removed, clean the threads on it and the trap and coat them with lubricating grease to assure easier removal of the cover at some future date.

E. R. Haan, Evanston, Ill.

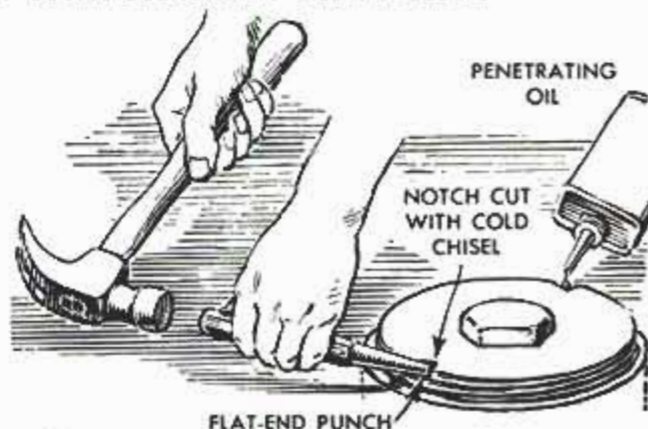



By Dick Hutchinson



## Garden Cart Has Lift-Out Basket

ANY LADY GARDENER will appreciate this carry-all garden cart that is even more useful than it is attractive. Compartments in each end of the cart permit carrying garden tools, while the center basket is removable. This latter feature permits the basket to be emptied easily when it is filled with weeds, or to be carried into the house or basement when

filled with potted plants that must be wintered indoors. Salvaged wheels from a discarded wagon, tricycle or doll carriage may be used for the cart. In the detail, a  $\frac{1}{4}$ -in. steel rod is suggested for the axle. This may vary with different sizes of wheels. The cart frame and components are cut from  $\frac{3}{4}$ -in. plywood or 1-in. solid stock ( $\frac{3}{4}$  in. when finished). Framing of the

basket is  $\frac{3}{4}$ -in. stock, the covering is  $\frac{1}{4}$ -in. plywood or hardboard. To accommodate the basket, both end compartments slant at an angle of 82 deg. The ends of the pieces used for the compartments are cut at this angle. After the compartments have been installed, draw a diagonal line from the outside upper corner to the lower inside corner of each compartment and install the vertical handle members on the lines. Other members between the handles hold the basket. ★ ★ ★



Completed cart is given coat of sealer and several coats of house paint







## Friendly Giraffe Is Decorative Height Chart for Child

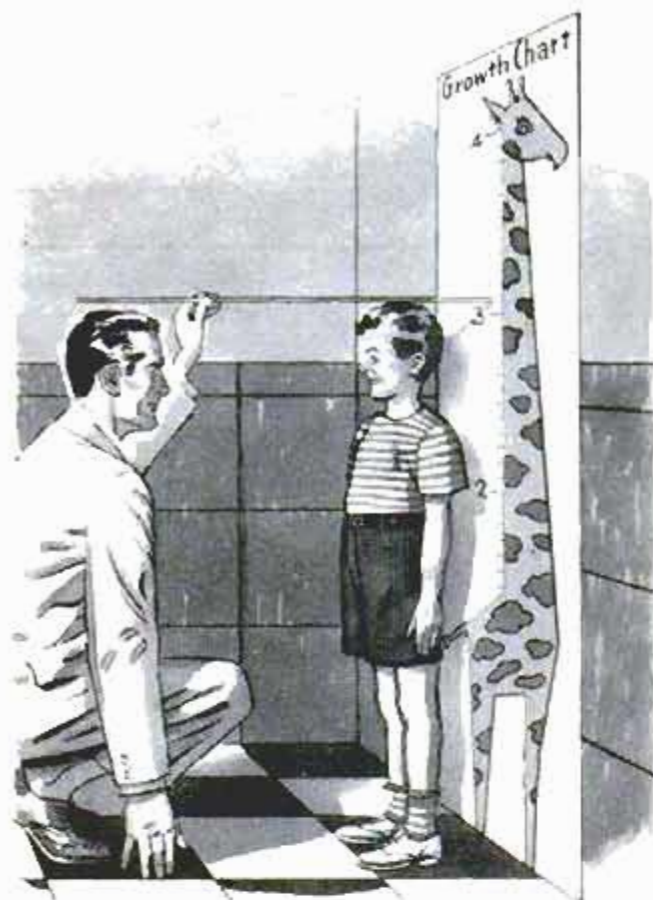

Both an attractive decoration for a child's room, as well as a useful height chart is this story-book giraffe cut from plywood, hardboard, wallboard or sheet linoleum. To make the giraffe, first cut a paper pattern slightly more than 4 ft. high, then trace it on the material to be used and saw or cut it out. Paint irregularly shaped "spots" on the giraffe, or cut them from the same material as the body and cement them on as overlays. Paint the giraffe body yellow, the spots a terra-cotta color. Cement the finished animal to the wall, then mark off feet and inch measurements to one side of the neck and paint one large, friendly eye in the head.

## Short Cut in Chair Repairing

Dried glue remaining in a hole in which a chair leg or rung is to be replaced must be removed to assure a correct fit. A quick way of doing this is to wrap sandpaper around a dowel that is slightly smaller in diameter than the hole. Chuck the dowel in a drill press, or hand brace, and rotate it in the hole. This will quickly remove dried bits of glue.

## Complete Engine Tune-Up Requires Mechanical-Tappet Adjustment

Adjustment of mechanical tappets often is overlooked during an otherwise complete engine tune-up job. Tappets that are quiet are not necessarily in proper adjustment.

Replacement of lifters, or grinding the faces of rocker arms, often is necessary to assure that quiet tappets also have the proper clearance for maximum efficiency.

## Identifying Filter Containers

For quick identification of a number of photographic filters, write or type the daylight and tungsten exposure guide numbers along with the filter type on a piece of paper and attach it to the cover of the filter container. If it is available, colored paper of a shade to match the filter color should be used for the identification label, to make selection even quicker and simpler.

Don Honick, Chicago.

## Leader Stored in Film Magazine

All the nylon or monofilament line needed by the average fisherman for making leaders can be stored neatly in his fishing kit by using a discarded 35-mm. film magazine, or cartridge. Remove the end cap from the cylinder, and take out the spool. Wind the line on the spool, then replace it, allowing an inch or two to project through the slit in the cartridge. Keep magazine in small can provided for it.

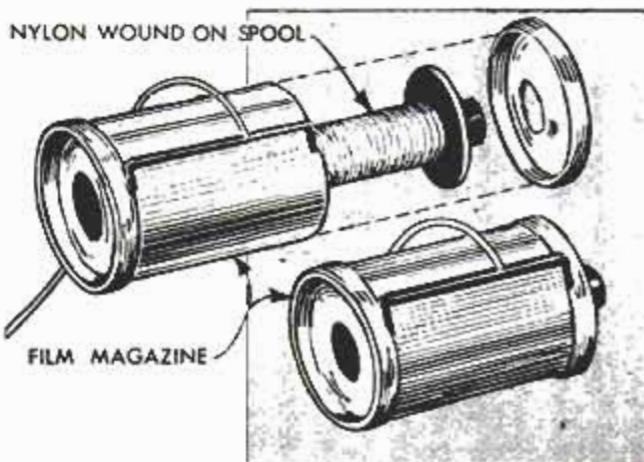



# SNACK TRAYS

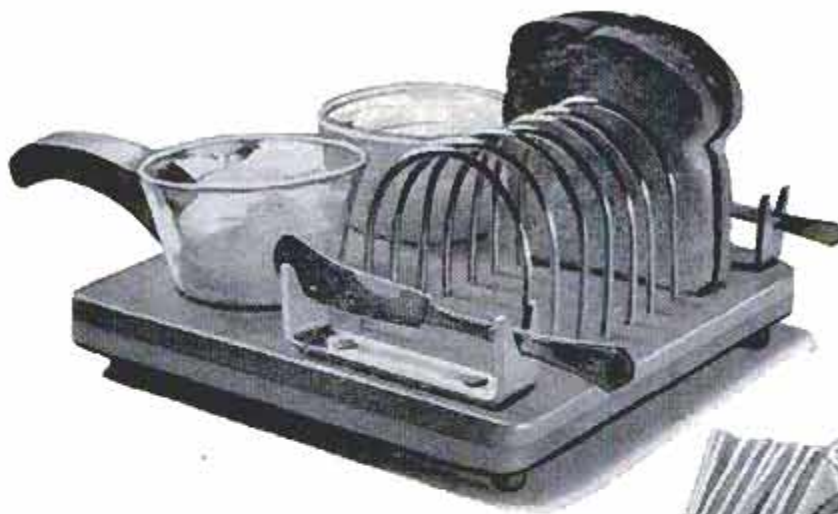

By **Bertram Brownold**

AS EASILY CARRIED by their handles as frying pans, these two snack trays are as simple to make as they are convenient to use. Both trays are identical except for the installation of aluminum-wire loops on one for holding toast, and a V-bottomed trough for cookies and crackers on the other. Custard cups are used for jellies and cheese spreads. Sheet aluminum is bent to form the cookie trough, aluminum flat bar is used for the knife holders. Rubber-headed tacks can be fitted to the dowel legs.

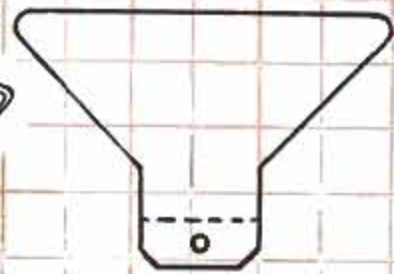

$\frac{1}{16}$ " ALUMINUM, 2 REQD.

ALUMINUM WIRE  
9 REQD.

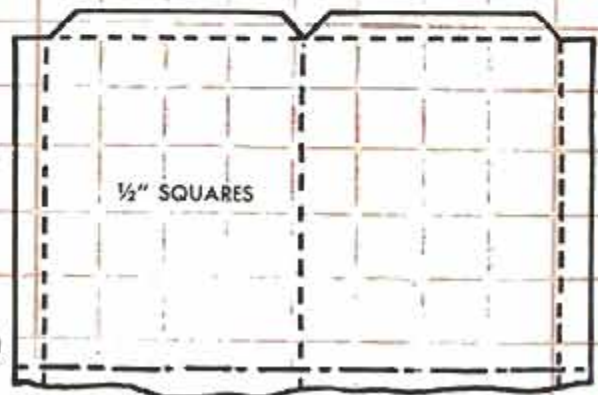
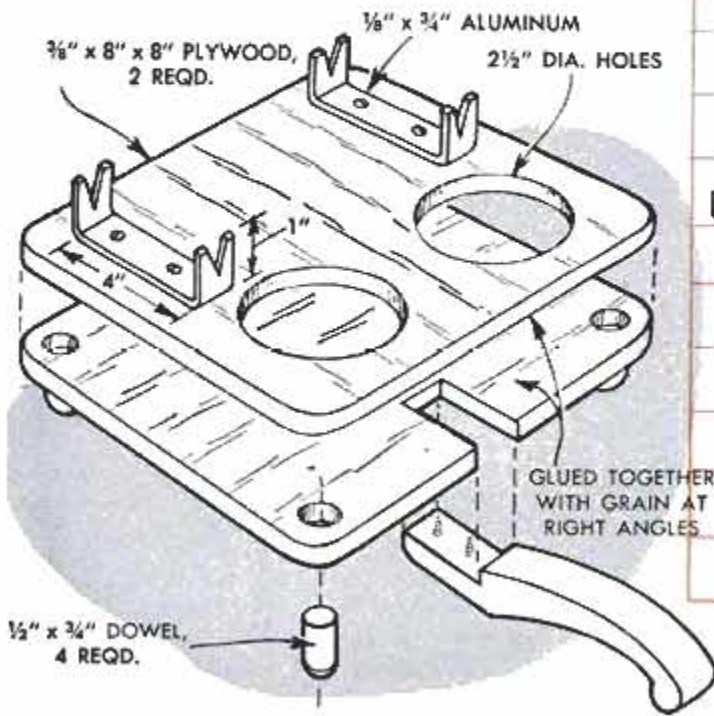
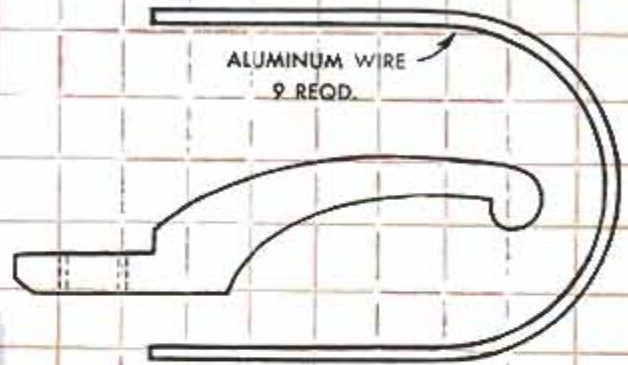



# Ornamental Wagon Wheels From

By Enno R. Haan

**I**F YOU HAVE FOUND it impossible to locate carriage or wagon wheels, such as shown in the photos, for use as gates or other decorations, you can use your workshop to solve the problem. Figs. 1 through 6 show an imitation wheel that resembles its prototype in considerable detail, while Figs. 7 and 8, plus detail A in Fig. 9, show a simplified version of such a copy. Moisture-resistant woods, such as red cedar, redwood and cypress are recommended for construction of the wheels, and should be painted to conceal the wood grain and joints.

For either type of wheel, start with the rim, or felly. This consists of band-sawed segments of solid stock or waterproof plywood, assembled with nails and waterproof glue. The plans show a rim size of 44-in. o.d., but smaller wheels can be made by reducing dimensions to suit. Figs. 2 and 3 show segments and method of assembly for the more realistic wheel; Figs. 7 and 8 show the segments and assembly method for the simpler wheel. To assemble the rims accurately, line them up on a circle drawn on a large piece of paper.

For the more authentic wheel, drill and counterbore screw holes radially in the finished rim, detail C, Fig. 9, for fastening the spokes. These are cut from 1-in.-sq. stock. Saw the hub ends to shape, Fig. 4, then round the rest of each spoke. The narrow neck of each spoke near the hub flange has an egg-shaped cross section, Fig. 4. Cut two hub blocks and two hub flanges, Fig. 6, and drill pilot holes in the flanges to receive upholsterer's roundheaded nails to imitate rivetheads, detail B, Fig. 9. Now, attach the hub blocks to the flanges.

Temporarily assemble all the spokes on a 5-in. circle to check for fit, and trim as necessary. Assemble and clamp the spokes, using waterproof glue on the inside of one hub flange. When the glue has set, glue on the other flange. Next, fit the hub-and-spoke assembly in the rim, driving screws into the spoke ends. Add a rim of  $\frac{1}{4}$ -in. tempered hardboard, smooth side out, Fig. 5, after soaking the hardboard for bending.

The simplified version of the wheel has the spokes, round or square, nailed to the sides of the rim, Fig. 8. The hub ends are nailed and glued between two disks of  $\frac{1}{2}$ -in. waterproof plywood. ★★★

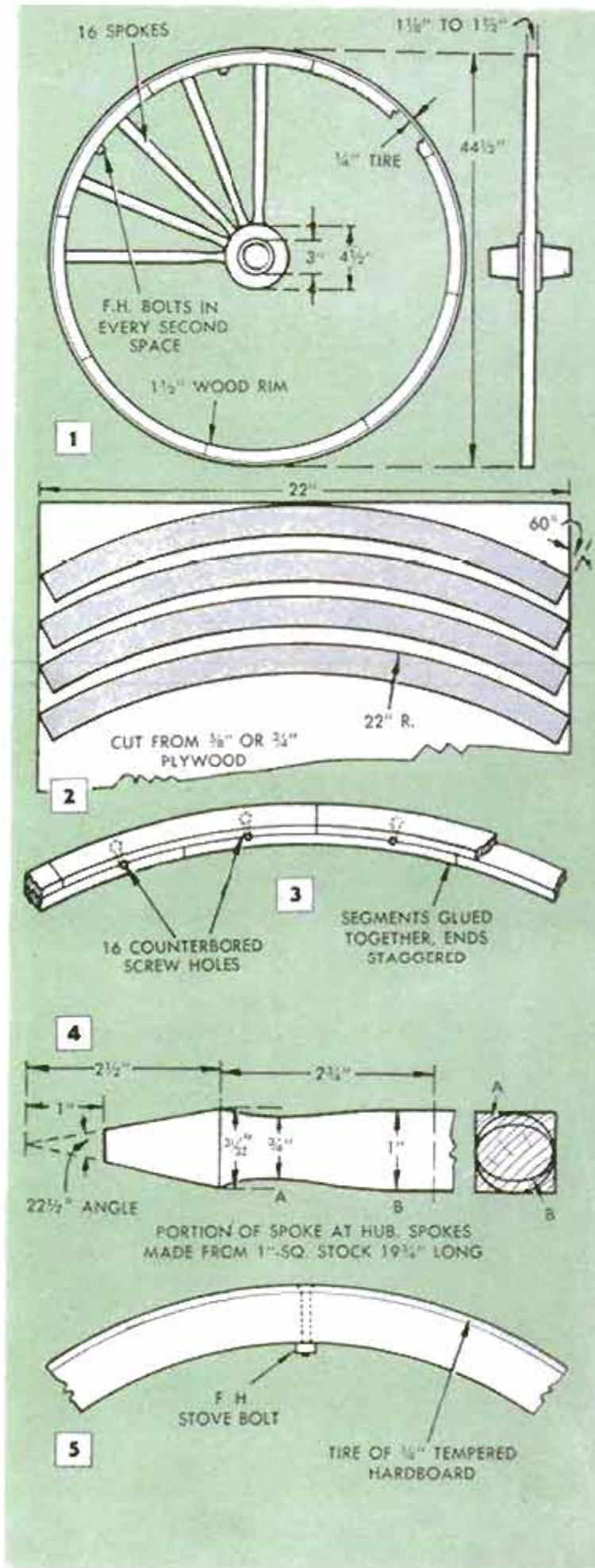



# Your Workshop

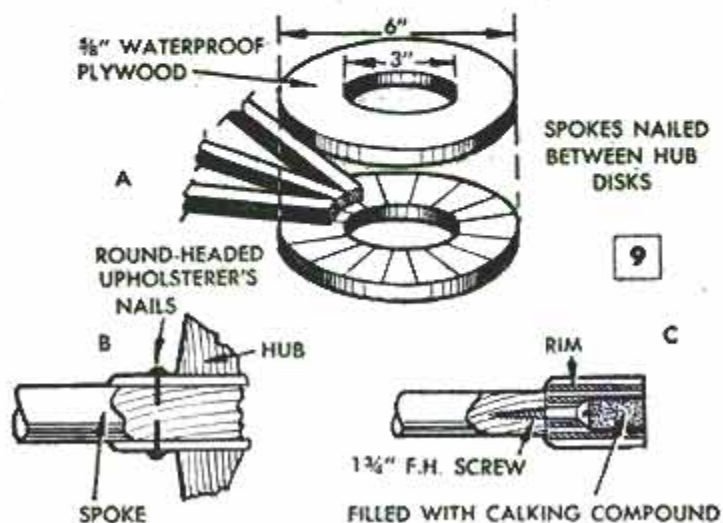
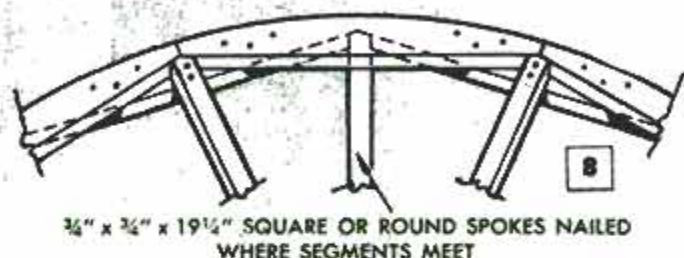
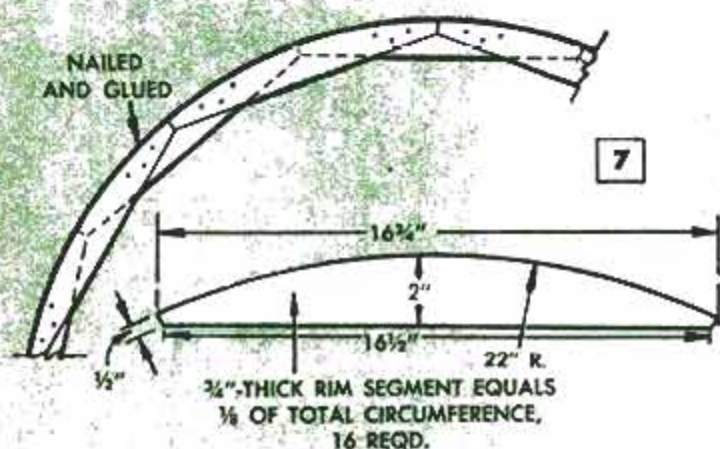
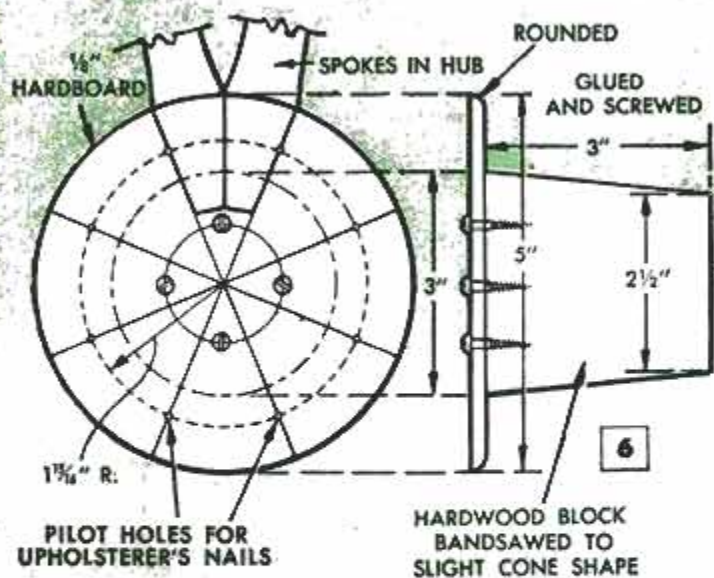

Copies of wagon and carriage wheels made in your workshop can be used for ornamental purposes, as are real wheels shown above and below

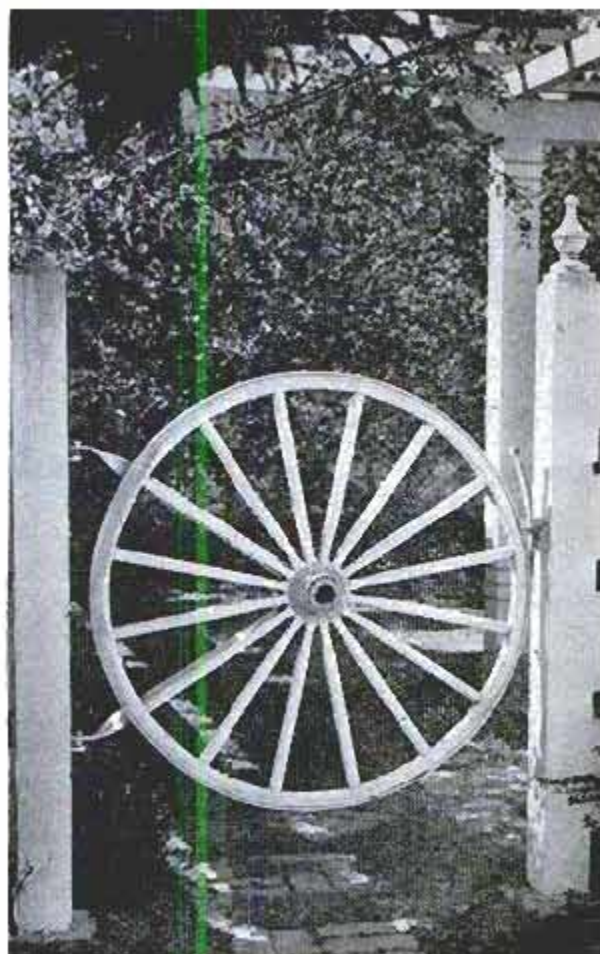



## Valve Permits Draining Sink Trap to Prevent Freezing



To simplify the job of draining the trap of a sink located in a summer cottage when this is necessary to prevent freezing during cold weather, fit a pet-cock in the trap as indicated. If there is a drain plug in the trap, the valve can be installed in its place. When there is no plug, the trap can be drilled and tapped to receive the valve. The valve will have to be soldered or brazed in place if the trap is of a material too thin to be threaded.

## Handle Stored Inside Car Jack

Stored in the hollow column of a bumper jack, the jack handle is readily available and requires almost no space in the trunk. To prevent the handle rattling, cement a rubber block inside the jack.



## Improved System Sterilizes and Filters Furnace Air

Changes in the filtering system of his forced-air furnace were used by one homeowner to alleviate hay fever and asthma suffered by members of his family. Filters in the furnace were replaced by an electrostatic type manufactured by the Goodyear Tire and Rubber Co. under the trade name *Pliotron*. The filters consist of matted polyethylene plastic fibers held in an aluminum frame by pieces of hardware cloth. When an air current passes through the filters, an electrostatic charge is generated.

Dust particles are attracted by the charge and held in the plastic. The filters are cleaned by rinsing in water, or, if especially dirty, in mild soap and water. Washing does not affect the electrostatic characteristic of the plastic. To further purify the air circulated by the furnace, the homeowner installed a germicidal light in the furnace plenum. Similar to a fluorescent lamp in appearance, and also requiring a starter and ballast, the 30-watt lamp produces ultraviolet rays.

## Measuring Diameter of Wire

One method of measuring the size of small-diameter wire, when no micrometer is available, is to wind it on a dowel to form a helix. Wrap the coils tightly so there is no space between adjacent turns. Then, count the number of turns per in. and divide this number into 1 in. Thus, if there are 16 turns per in., 16 divided into 1 equals  $\frac{1}{16}$  in., or 0.0625 in.

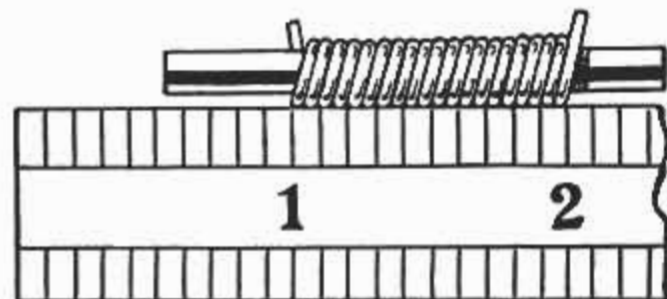

## Worm Used as Surface Bait

Used as surface bait, a night crawler will catch more fish than when it is used deep in the water. Lash the worm to a straight twig with nylon thread, then insert three No. 2 fly hooks through the body of the worm so the shanks are hidden. Run a 10-in. leader through the eyes of the three hooks and tie it to your casting line. Weighing about  $\frac{1}{4}$  oz., this "fly" will cast easily and float on the water.

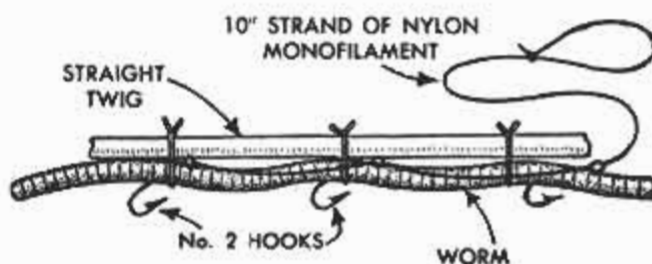



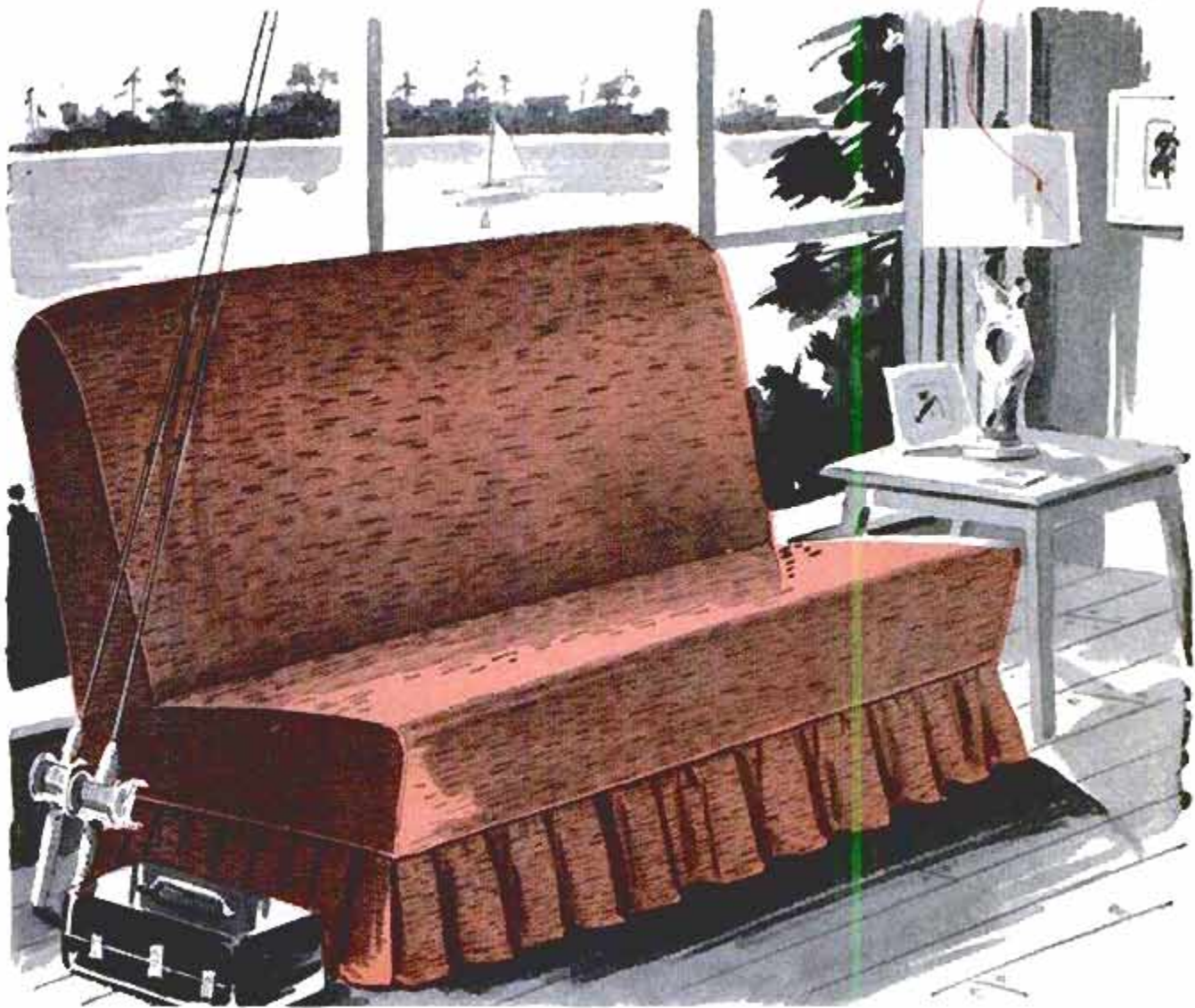

## Cottage "Settee" Made From Old Car Seat

HERE IS AN attractive and comfortable "settee" that is ideal for use in a recreation room or lake cottage. You can have one like it simply by screwing two lengths of 2 x 4 lumber to the underside of a front auto seat as shown in the lower-right photo. The 2 x 4s serve as a base to which a wooden block is screwed at each corner for

proper elevation of the seat. For a higher seat, add one or more blocks cut from stock of the desired thickness to each foot. The washable slip cover is made from several yards of inexpensive cotton material having a pattern that is suitable for the room in which the settee is used.

Edward W. Bird, Bethesda, Md.

After vacuuming cushions upholstery is cleaned with foam from detergent mixed with 2 qt. warm water

Seat base consists of two 2 x 4s, with wooden blocks for legs attached at ends, screwed to seat bottom

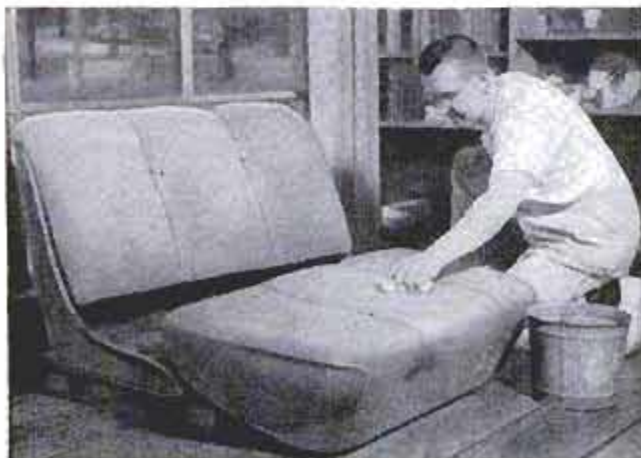



# First Aid for Furniture Legs

By Walter E. Burton



Pencil clamped to length of wood scrap is handy gauge for marking chair legs for uniform cutting

**U**NSIGHTLY SCRATCHES or other damage to the legs of your favorite chair or table needn't be the cause for discarding the piece, or paying a small fortune for refinishing it. To restore the original beauty of the damaged piece simply follow the repair suggestions illustrated in this article. Even broken legs can be made to appear like new by anyone familiar with common tools as indicated in Fig. 5.

Surface scratches can be made less noticeable by applying furniture wax or scratch remover. Another way of concealing scratches is to rub boiled linseed oil on the damaged finish with the fingers. Then,

After sanding damaged finish on furniture leg, varnish of matching color is applied with artist's paintbrush to blend touched-up areas with old finish



rub the area with a turpentine-dampened cloth and polish it with a dry cloth. To darken and refinish worn areas that appear bleached, sand the areas, and apply varnish stain to match the finish, Fig. 2. Dark spots on blond-finished wood may be lightened with dry-cleaning fluid rubbed on with a cloth. If this doesn't do the job, try rubbing the spots with tooth powder mixed with water to make a paste. After removing the abrasive material, the wood is waxed or varnished as necessary.

For accurate trimming of uneven chair legs, clamp a pencil to a length of wood and mark the legs as in Fig. 1. Then, trim each leg with a rasp. Most chairs have front legs that are of a different length than the rear ones and must be trimmed proportionately. An easy remedy for leveling uneven table legs is to place caster cups under each leg with cardboard disks inserted in each cup that requires shims, as shown in Fig. 3.

A good way of protecting legs from scratching is to install metal ferrules on each leg as in Fig. 4. The ferrules are cut from metal tubing of the desired diameter and then are driven onto the legs with a mallet. A furniture glider tapped on the end of each leg protects the floor.

Casters that drop from chair legs are repaired by replacing the worn sleeves, Figs. 7 and 8. To prevent a leg from splitting when driving in a new sleeve, the hole is enlarged and a length of copper tubing inserted to receive the sleeve. ★ ★ ★



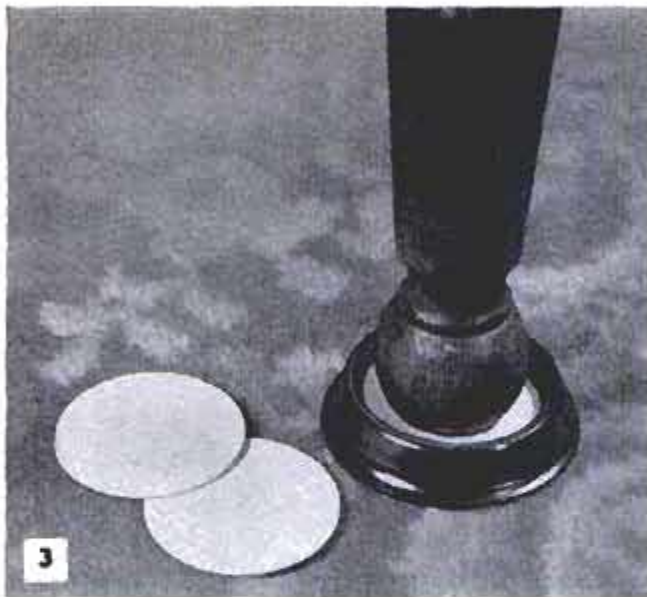

**3**  
 Disks cut from sheet of heavy cardboard are placed in caster cup to provide inconspicuous shim for furniture leg that is slightly shorter than others

To repair broken chair leg saw off damaged part and join extension piece to leg with dowel. Folded sandpaper on dowel aids dressing surfaces of joint

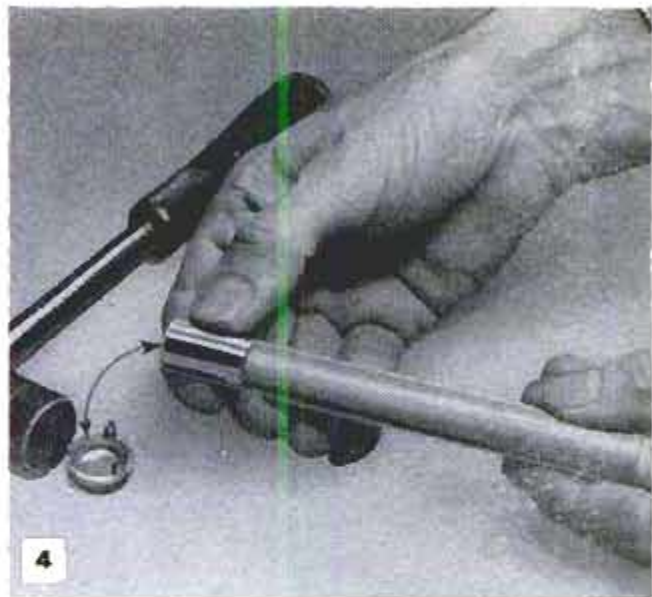

**4**  
 Ferrule for small furniture leg is cut from length of brass tubing and driven on leg. Furniture glider installed on end of leg protects floor from damage

Cracked chair leg is repaired by applying glue to contacting surfaces of break and wrapping strong rubber band around leg to clamp pieces securely

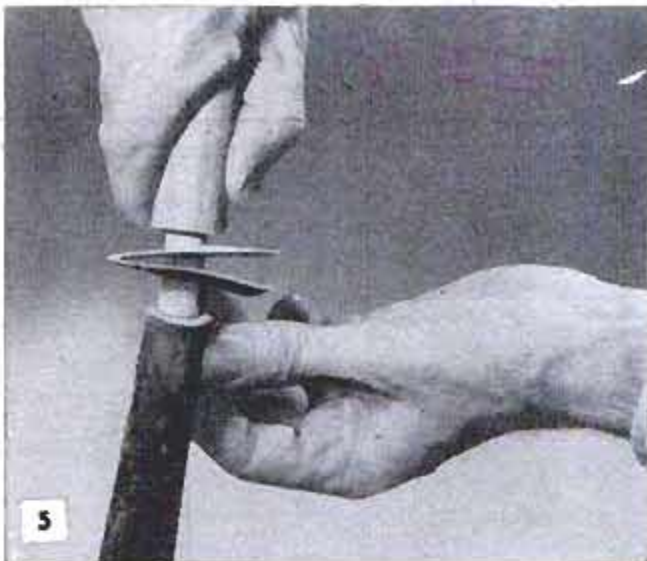

**5**  
 To prevent caster from falling out of socket, worn sleeve is replaced by new one. Length of copper tubing inserted in hole prevents leg from splitting

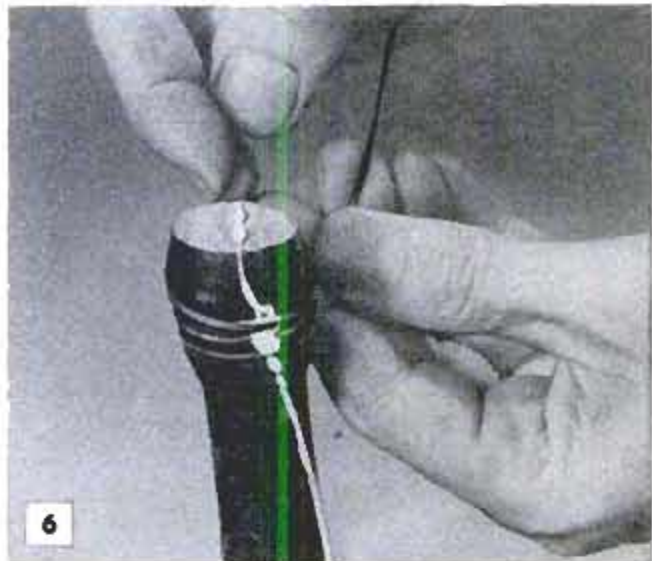

**6**  
 When installing caster in socket, center punch should be used for driving stem into sleeve. Striking caster wheel with hammer might damage the wheel

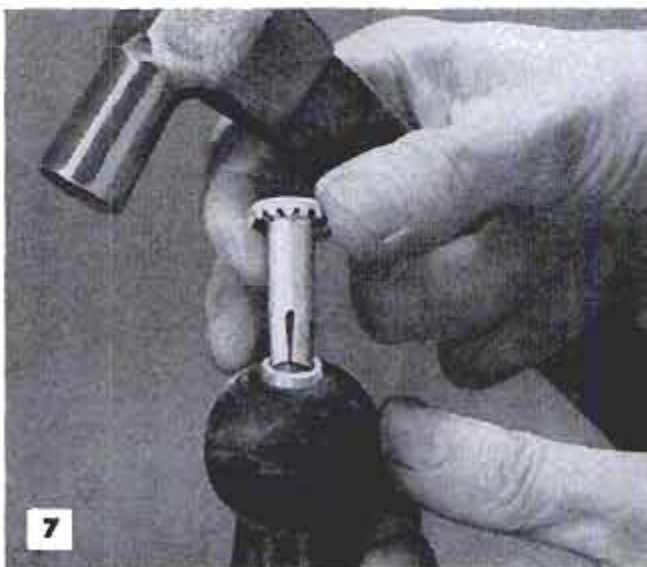



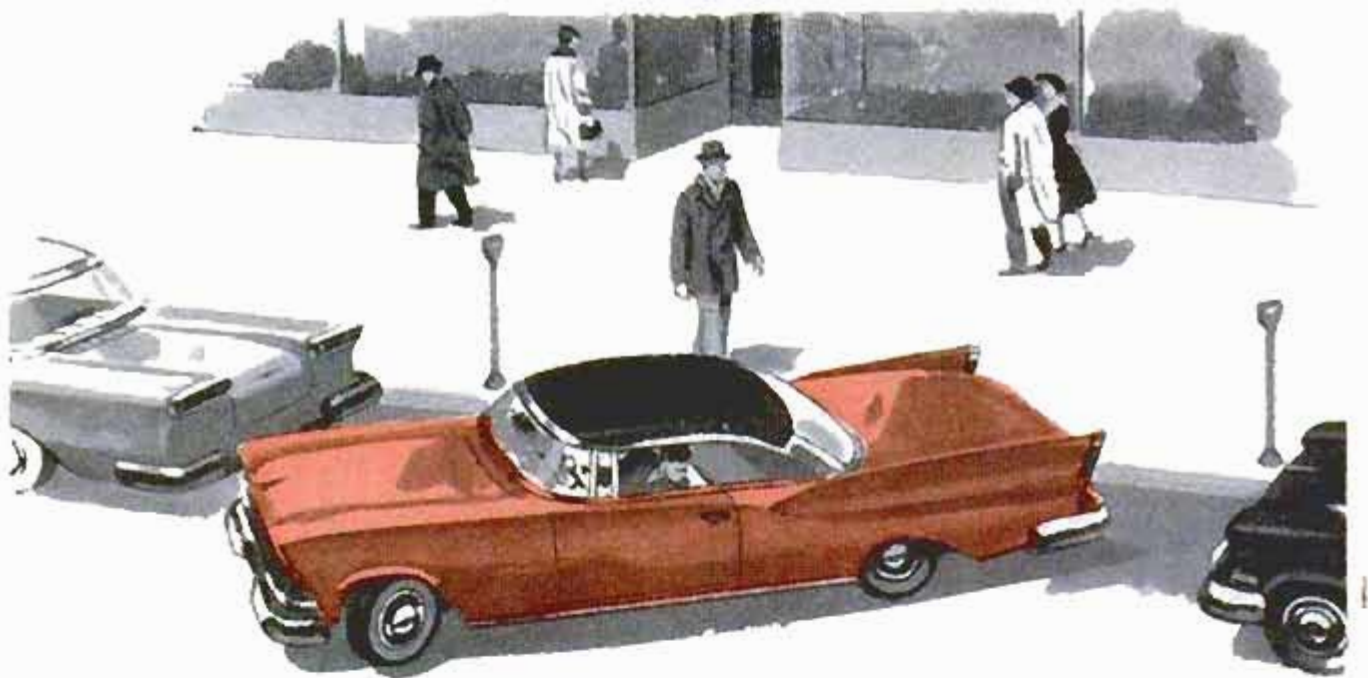

## Do's and Don'ts of Power-Steering Repairs

By John Krill

SN  
~~WFM~~ 59

**B**ECAUSE IT WORKS silently and unseen, power steering on a modern automobile is taken for granted until the day it suddenly takes extra effort to turn the steering wheel, and parking becomes a muscle-straining job. Like all things mechanical, power steering sometimes malfunctions. When this happens, there are a number of simple tests that the average car owner can make to determine how serious the trouble is, and whether or not he can fix it himself. The unit illustrated in this article, Figs. 1 through 5, is the power-steering assembly on a 1955 Chevrolet. While other makes of power steering differ somewhat, an understanding of this particular unit will provide a general understanding of all types.

Basically, a power-steering unit consists of a hydraulic pump to provide pressure, detail 1, Fig. 3, lines to deliver the fluid under pressure to a cylinder, detail 2, Fig. 3, and a valve, detail 3, Fig. 3 and detail 4, Fig. 2. The valve is operated by the pitman arm, Fig. 2, to route the fluid to the correct end of the cylinder. A piston inside the cylinder then moves the steering assembly to match the movement of the steering wheel. The hydraulic pump on the Chevrolet is driven by a splined extension of the generator shaft, Fig. 5, which means that if the fan belt is loose or worn, and the generator does not rotate properly, neither will the pump. Belt adjustments are made by pivoting the generator on its brackets, Fig. 1. Other types of power

steering have pumps driven directly by the fan by means of a pulley on the pump shaft. The first test to make is to determine whether the fan belt is adjusted to the right tension, or if it is worn and needs replacing. Adjusting or replacing a fan belt are easy jobs for the home mechanic and require only simple tools.

If the fan belt is all right, and the power steering still is inoperative, the next thing to check is the oil level in the pump reservoir. To illustrate the importance of the reservoir being full, pump pressure in the Chevrolet unit is 750 lb. per sq. in. Other units may have varying pressures, but all will be relatively high and any loss of fluid seriously reduces the efficiency of the unit. Hydraulic oil may be lost by leakage through connections in the hydraulic lines and hoses, or through a damaged oil seal in the pump itself. When checking the oil level in the pump reservoir, inspect the oil closely to see if any air bubbles are present. Bubbles mean that air is trapped in the hydraulic system, and the system must be bled to remove it. Bleeding the air is another operation the home mechanic can do himself. First, after wiping all lines and hoses clean, make sure the pump reservoir is full. If oil must be added, allow a few minutes before going to the next step in the operation. Now, jack up the car so that both front wheels are off the ground. Start the engine, let it idle for a few minutes, then accelerate it to about 1500 r.p.m., which is equivalent to about 35 m.p.h. with



the transmission in neutral and the rear wheels blocked. Slowly turn the steering wheel all the way left, then all the way right. Lower the car and remove the jack. Turn the steering wheel from full right to full left with the wheels on the ground. Inspect the cleaned lines and hoses for any leaks, then recheck the pump and add oil if necessary.

Make sure the pump assembly is bolted solidly to the back of the generator. (This refers to the Chevrolet unit. On others make sure the brackets and pump are bolted solidly together.) Be sure there are no worn bearings in either the pump or generator. Damaged bearings will cause noisy operation and possibly sluggish operation if the bearings are binding on the pump or generator shaft and causing the fan belt to slip.

If the steering still is not right after these checks, take your car to a competent mechanic. Unless you are a skilled mechanic, it is not recommended that you tear down and rebuild a power-steering hydraulic pump. If the pump is malfunctioning, remove it and have a mechanic rebuild it for you. You can save the labor costs involved in removing and replacing the pump, and be sure that the pump has

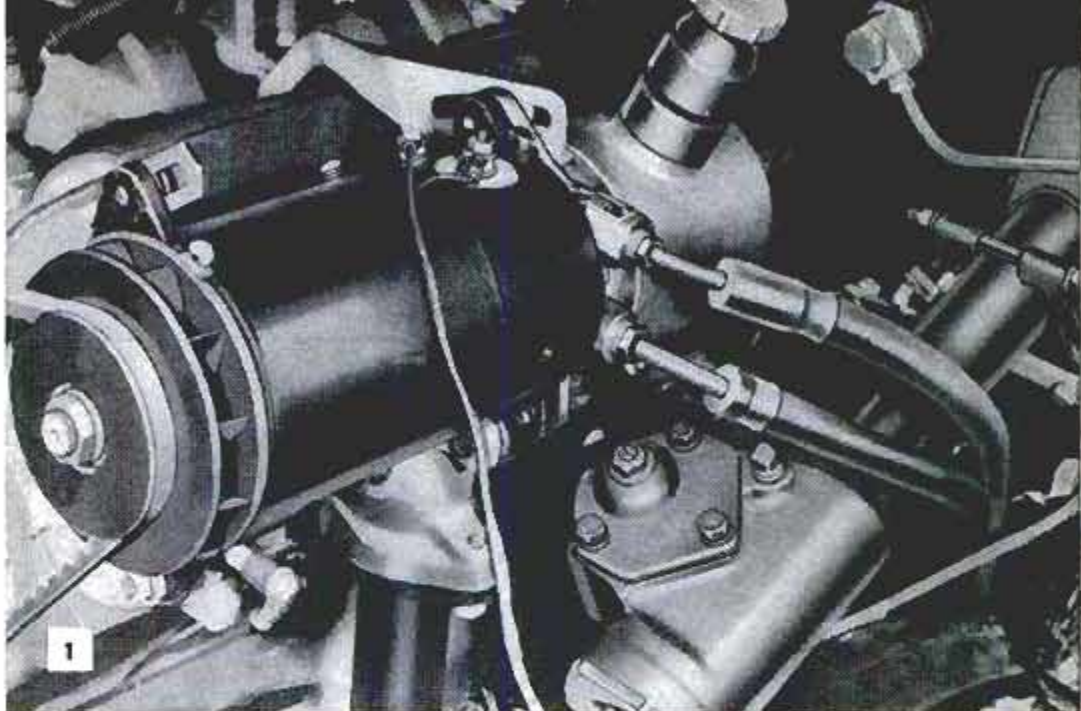

Above, power-steering hydraulic pump in place behind generator on 1955 Chevrolet. Below, Fig. 2, details 1 and 2 are heat shields, detail 3 is the pitman arm, 4 is the valve, and 5 is the adjustment clamp. Below, Fig. 3, detail 1 is pump, detail 2 is cylinder, detail 3 is the valve

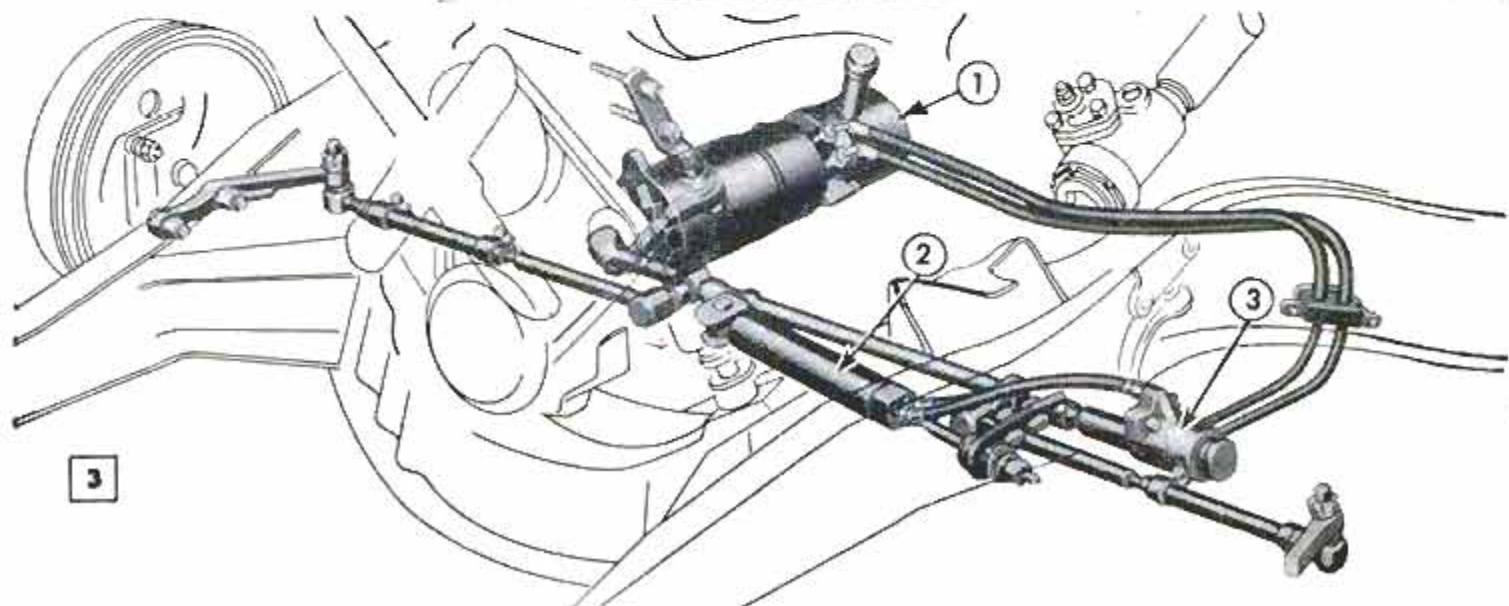
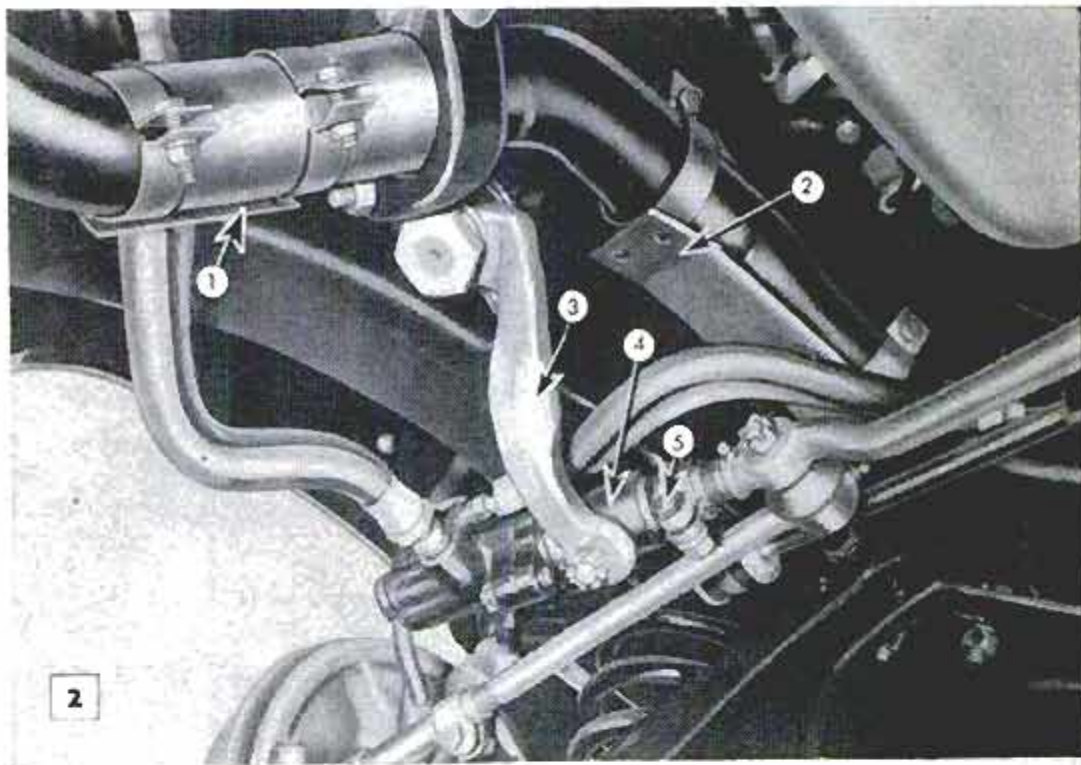



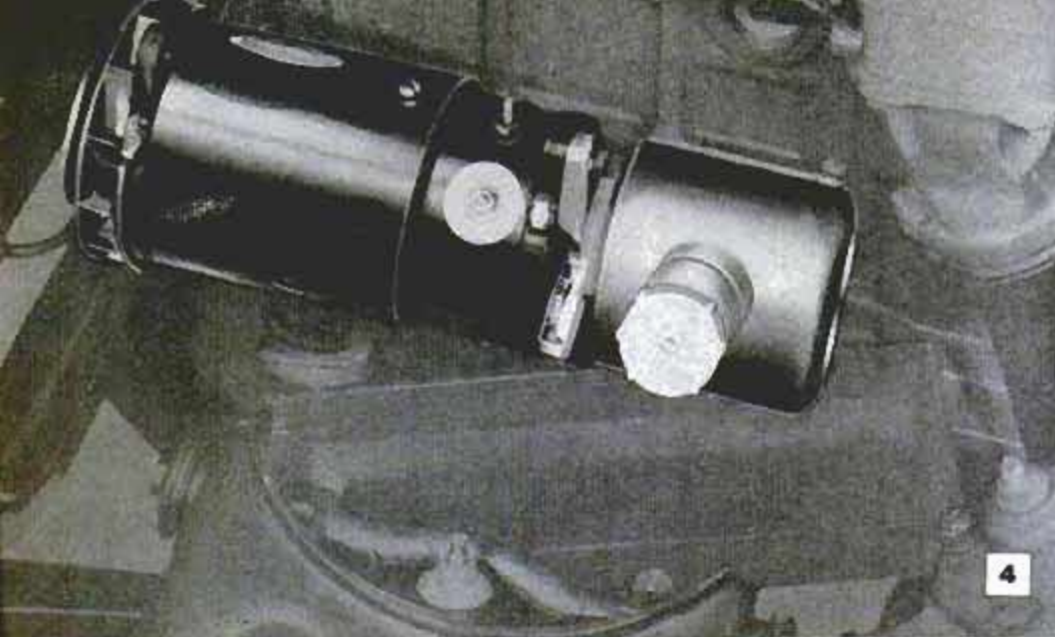

Hydraulic pump for power steering on 1955 Chevrolet is bolted to back of generator housing, unit is driven through generator by fan belt

been serviced properly. After you have replaced the pump, bleed the system in the manner already described.

Generally, the first test a mechanic will make on a complaint of power-steering trouble is to hook a special scale to the steering wheel and apply pressure to determine how much effort is required to turn the wheel. If the pressure is greater than specified by the manufacturer, the mechanic will know that something is wrong and can make further tests. If there is a buzzing sound in the power-steering system, it means that a valve is sticking. The mechanic will disconnect one of the oil lines and hook up a pressure gauge. With the gauge in place, the steering wheel will be rotated from right to full left, with the engine idling. The gauge then will show whether the pump is producing too high, or too low a pressure. Depending on

Power-steering pump positioned for installation, showing splined extension of generator shaft that fits into pump shaft and drives it

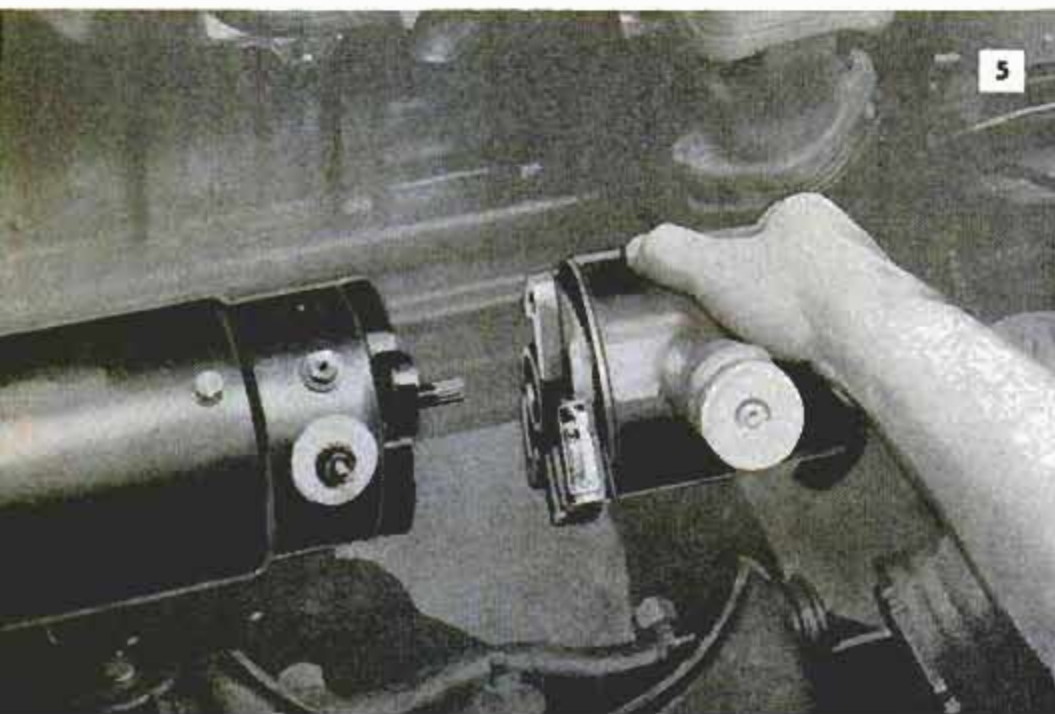

the gauge reading, the mechanic will make repairs to correct the pressure. He will, of course, bleed the system after the gauge has been removed and the lines reconnected. Front-wheel alignment also will be checked. Poor alignment will produce resistance in the steering that might seem to be a malfunction of the power steering.

In extreme cases, the steering-gear case at the lower end of the steering column might be causing resistance. Adjustments in the gear case permit reducing or increasing end play in the steering

column, and changing the "lash" or free play in the steering gears. A mechanic can quickly tell if the steering gears are in proper adjustment.

If you are a skilled mechanic, tearing down and rebuilding the hydraulic pump for a power-steering unit is not too difficult. But, the unit must be assembled on a clean workbench, and each component of the unit must be spotlessly clean. Even a small particle of grit in the hydraulic system can cause trouble by jamming a valve, cutting an oil seal or blocking an orifice. A solvent should be used to wash all parts, and they should be wiped dry with a lint-free cloth. Do not strike any parts with a steel tool. Any sharp edges or burrs on any component should be removed with a fine hone. When the reassembled pump has been installed, it will be necessary to bleed the hydraulic system of the power-

steering unit, and check all connections for leaks. Make sure that the heat shields on the exhaust pipe, details 1 and 2, Fig. 2, are in place. If the shields are removed, heat from the exhaust can cause the hydraulic oil to boil and affect the efficiency of the power steering. The boiling fluid will act much like air in the system, and bleeding the system will seem to correct the trouble. However, the moment the hydraulic oil again becomes heated by the exhaust, the trouble will return. The hydraulic lines must be kept cool. ★ ★ ★



# On the MARKET

for Do-It-Yourselfers

**1. POLKA-DOT PAINT** comes in a pressurized container, can be used to decorate any painted surface. Size of dots is determined by distance container is held from surface; the farther away the smaller the dots. Dots of various colors can be applied without waiting for those previously applied to dry thoroughly

Sapolin Paints, Inc., 205 E. 42nd St., New York City 17

**2. WEATHER STRIPPING** combines a rigid and flexible plastic in a continuous strip which can be used in place of the conventional doorstop in new construction. Keeps out rain, snow, dust, draft and insects. Comes in sets to fit all standard interior and exterior doors, also for large openings up to 6 x 7 ft.

The Duraflex Co., 3500 N.W. 42nd St., Miami 42, Fla.

**3. TELESCOPING STANDPIPE** for basement drain prevents flooding of basement floor when water backs from the storm sewers. Fits inside 4-in. drainpipe or tile, extends to about 25 in. above floor under pressure of 2 lb. per sq. in. Pressure-relief valve opens at about 6 lb. to prevent damage to floor of basement

Sewer-O-Matic, Inc., 5926 S. Racine Ave., Chicago 36

**4. DOUBLE-CHANNEL ALUMINUM TRACK** for sliding panels or doors comes in sets in two sizes. The smaller provides channels for glass or hardboard panels  $\frac{1}{8}$  in. thick. Larger set provides double-track channels  $\frac{1}{4}$  in. wide for plywood or hardboard. Standard length is 6 ft. Each set contains two tracks

Reynolds Metals Co., 2500 S. Third St., Louisville, Ky.

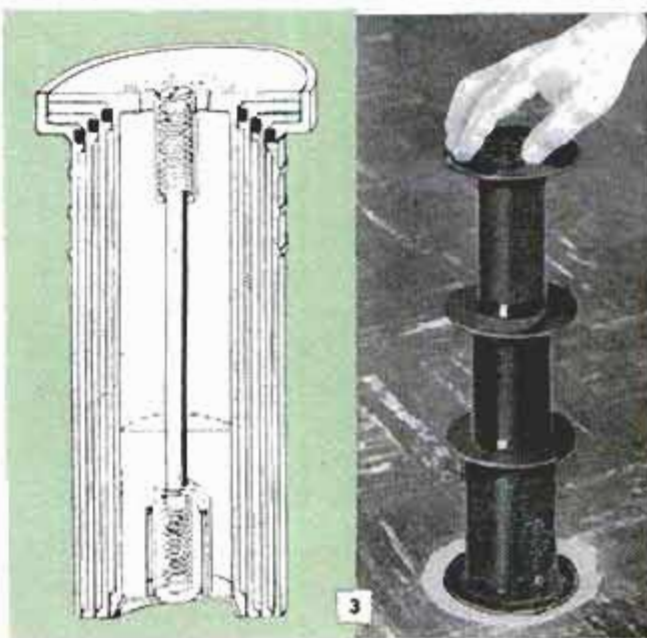
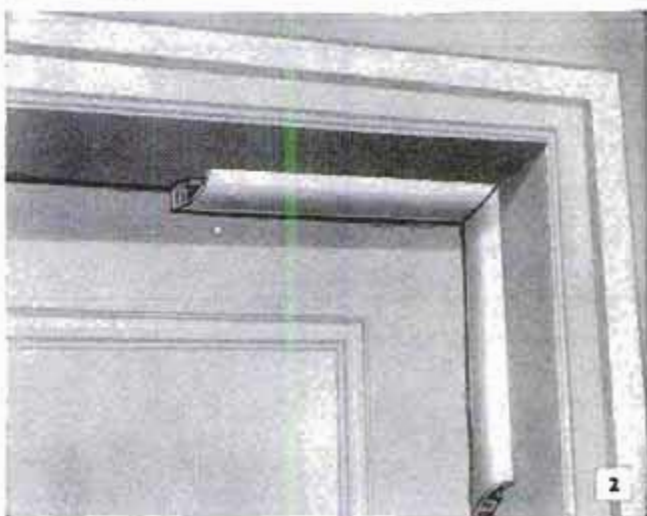
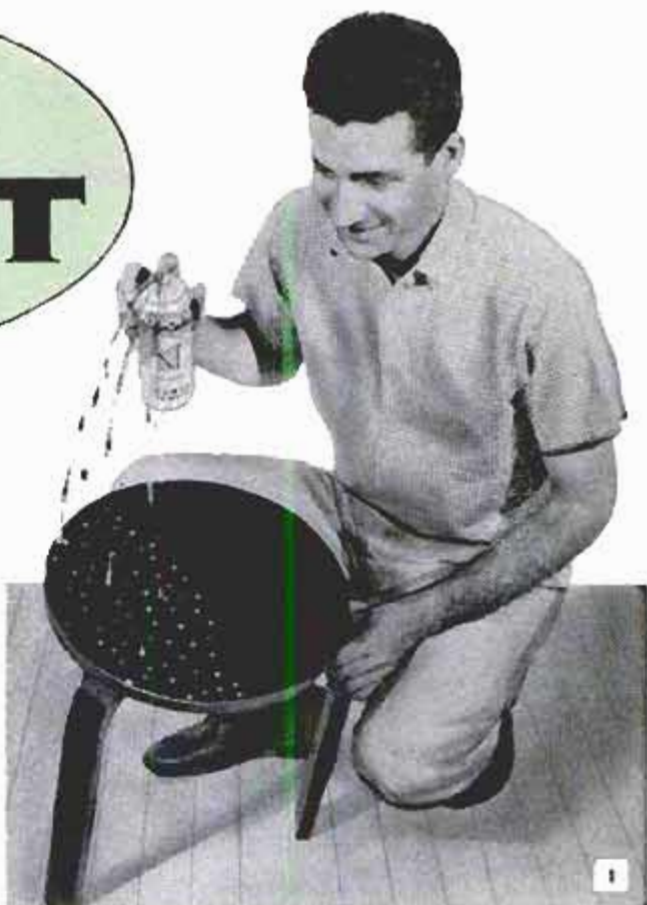





### Paint Mixed With Coat Hanger

Here is an easy way of mixing paint that has settled to the bottom of its container. Simply form two legs in a heavy-wire coat hanger and cut off the hook as shown in the detail. Then, chuck the twisted portion of the hanger in a hand drill and use it to mix the paint as shown.

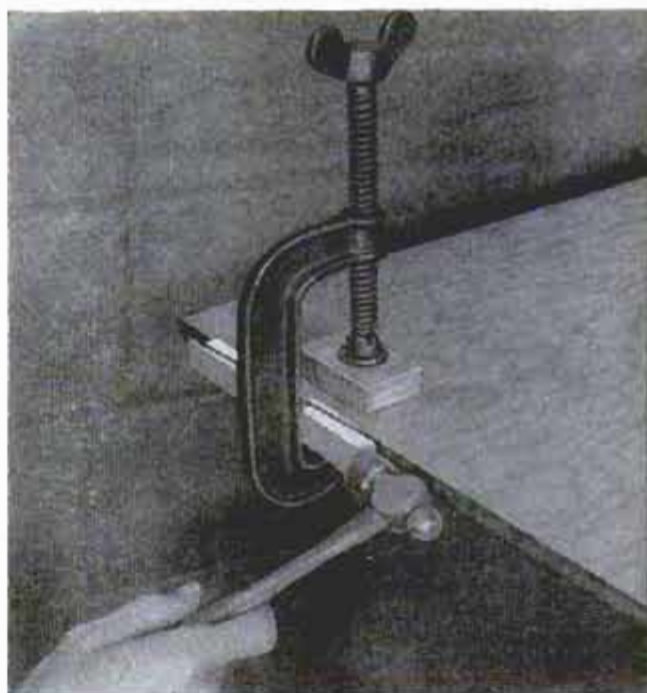

### Improved Bar Clamp

When gluing veneer strips to the edges of a plywood panel and bar clamps are unavailable for clamping the material, try using a C-clamp for this purpose as shown. Small wooden wedges forced between the clamp frame and veneer strip apply pressure as needed to secure a good bond.

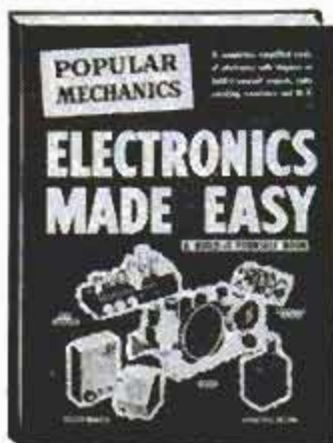

## Enrich Your Life With the Marvels of Hi-Fi! Thrill to a Pocket-Size Transistor Radio . . .

Have you been wanting a Hi-Fi set for your home . . . a portable transistor radio no bigger than your hand . . . and any of the other pieces of electronic equipment that are adding so much enjoyment to modern living? Then here's how you can have them, at merely a fraction of the usual purchase price. Using Popular Mechanics new book—*Electronics Made Easy*—

### *You Can Make These Electronic Devices Yourself!*

This unusually practical book enables you, without any previous experience, to enter the amazing field of electronics for fun or profit. In 192 pages of simple step-by-step instructions and hundreds of illustrations, you learn all about Hi-Fi—exactly what it is and how to build your own Hi-Fi system. You discover how to make the "miracle" transistor radio, how electronic tubes work, how to do radio

servicing, how to use test instruments and make your own, and how to convert old radios into inter-com systems and other devices. It's fun and easy to build your own electronic equipment with the help of this book which contains numerous do-it-yourself projects. Send for your copy of *Electronics Made Easy*. It's your key to the most fascinating hobby of these times **\$2.95** for just.....

Send your order to  
**POPULAR MECHANICS PRESS, 208 East Ontario Street, Chicago 11, Illinois**



# SHOP NOTES

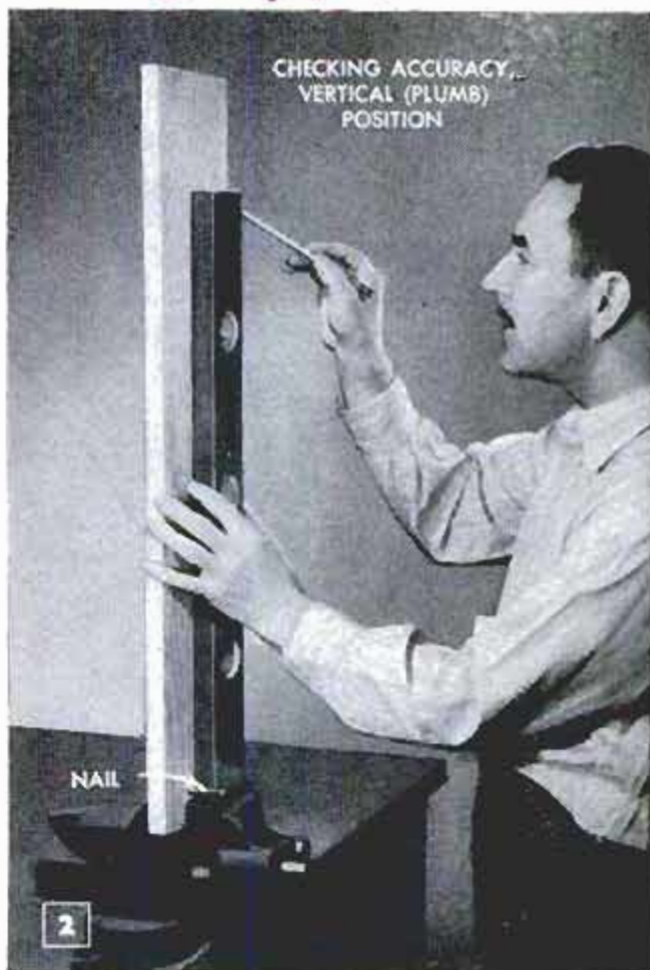
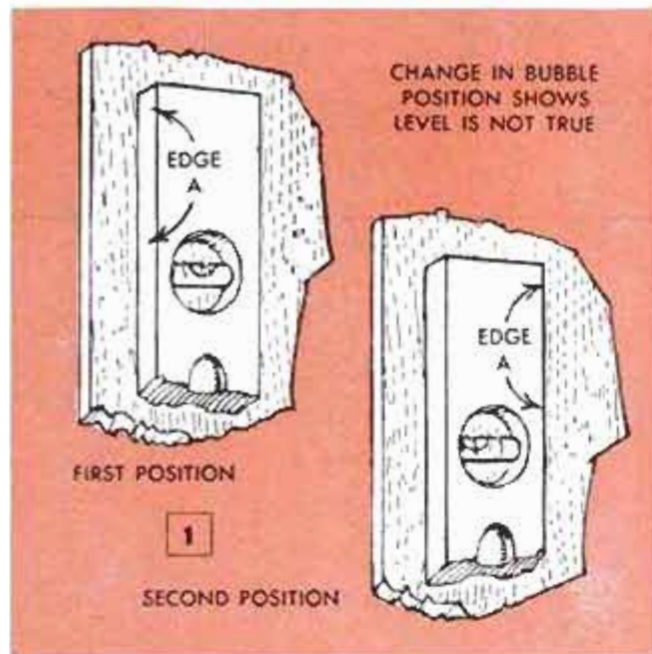

## How to USE A LEVEL

By Sam Brown

CORNERS AND WALLS of wood and masonry buildings stand straight and true because the builder used a level to plumb them at the time of construction. He very likely used a carpenter's or builder's level with fixed level tubes in a wooden frame, the simplest and probably the most useful of all the various types of levels. It's made with plain bent tubes, or vials, each containing alcohol, a bubble and two graduations, or witness marks, as in Fig. 3, the lower view. This type of level will show an error of about  $\frac{1}{8}$  in. in 10 ft., Fig. 4, the lower detail. This is considered permissible in common building construction.

Precision-level tubes are ground inside to a true radius and are graduated to  $\frac{1}{10}$  in. as in the upper view, Fig. 3. On the precision bench level each graduation can represent, for example, 10 sec. of arc, which is equal to .0006 over a span of 1 ft. Note the table, Fig. 4, which gives comparative values for various types of levels, Fig. 5. Extremely accurate, the precision level must be used correctly as otherwise much

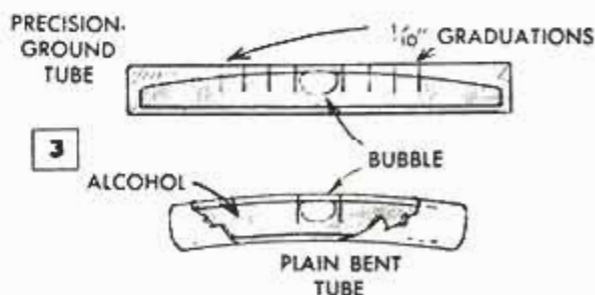

ANGLE PER GRADUATION OR $\frac{1}{10}$ " BUBBLE MOVEMENT	CHANGE FOR $\frac{1}{10}$ " BUBBLE MOVEMENT		AVERAGE WORKING ACCURACY	
	At 1 Ft.	At 60 Ft.	At 10 Ft.	At 100 Ft.
2 SEC. OF ARC	.0001"	.007"	.0001"	.001"
A 10 SEC.	.0006	.035	.001	.01
A 30 SEC.	.0017	.104	.002	$\frac{1}{64}$
1 MIN.	.003	.209	.003	$\frac{1}{32}$
5 MIN.	.017	1.04	$\frac{1}{64}$	$\frac{1}{16}$
25 MIN.	.087	5.23	$\frac{1}{16}$	$\frac{1}{4}$
B 1 DEG.	.209	12.5	$\frac{1}{8}$	$1\frac{1}{4}$

A - PRECISION BENCH LEVEL      B - CARPENTER'S LEVEL

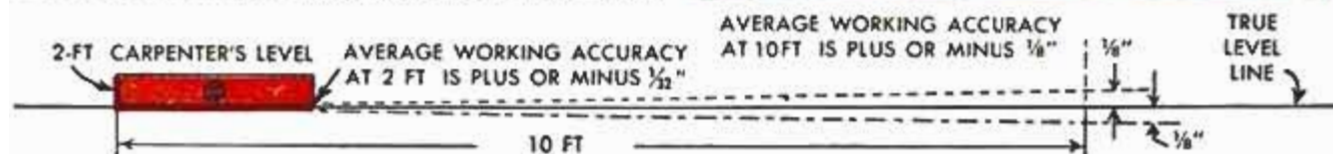



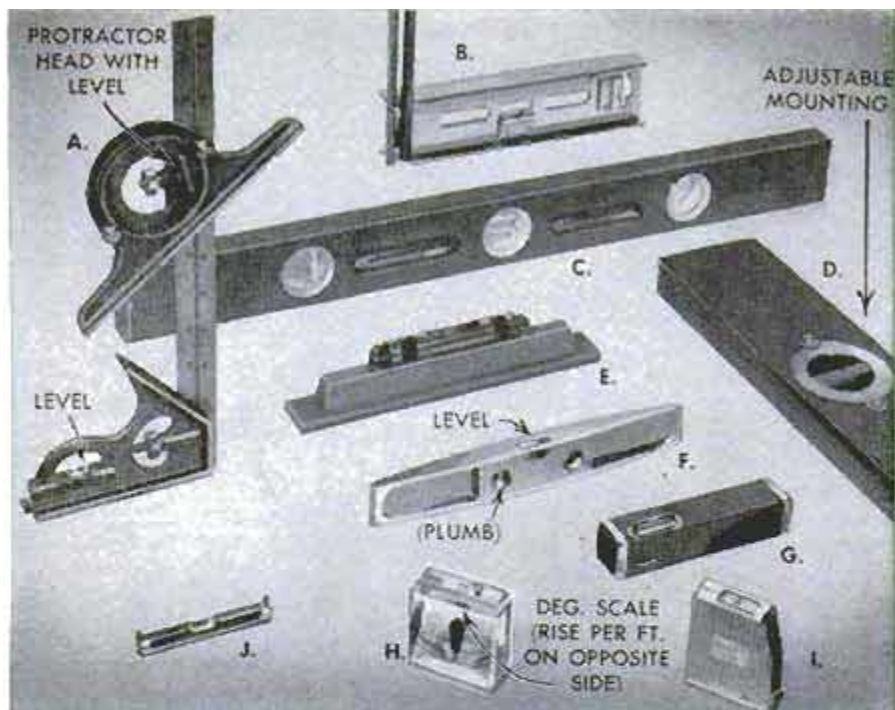

5

- A. - COMBINATION SQUARE
- B. - LEVEL AND SQUARE
- C. - CARPENTER'S LEVEL
- D. - ADJUSTABLE LEVEL
- E. - PRECISION BENCH LEVEL
- F. - 9" POCKET LEVEL
- G. - HAND SIGHTING LEVEL
- H. - FLOATING PLUMB BOB
- I. - TAPE RULE WITH LEVEL
- J. - LINE LEVEL

of the accuracy built into it will be lost. As an example, machinists, diemakers and others who use precision levels in the shop always allow at least 30 sec. for the bubble to settle, or stabilize, before taking a reading. Also, care must be taken to see that all contacting surfaces on both the level and the part, or parts, to be checked are perfectly clean. A film of oil, particles of dust or metal chips on any contacting surface will result in an inaccurate reading. Note the variations in average working accuracy of the levels A in the first column of the table, Fig. 4, and compare with B, the carpenter's level. Also note that a 25-min.-level tube has an allowable variation of  $\frac{1}{16}$  in. at 10 ft. compared with  $\frac{1}{8}$  in. for the carpenter's level. The 25-min. tube is used in some all-metal levels and also in those found on some combination squares.

Any level can be tested with reasonable accuracy simply by placing it on a flat surface, noting the exact position of the

bubble and then reversing the level and comparing the bubble positions, Fig. 9, also Figs. 11 and 12. Of course, the positions of the bubble and tube have been exaggerated in the drawings for the sake of clarity. A somewhat more accurate test of a level can be carried out as in Figs. 2 and 8. The board used for both the vertical (plumb) and the horizontal test must be flat and smooth. For making the plumb test, Fig. 2, place the board in the bench vise as pictured and drive a small nail near the lower end. Place the end of the level against the nail, center the bubble in the plumb tube and make a light pencil mark on the board along the edge of the level frame. Then reverse the level side-to-side, Fig. 1, center the bubble and make a second pencil mark on the board. Then note the variation, if any, between the two marks. If the variation is not greater than average width of a pencil line then the level usually can be considered sufficiently accurate for prac-

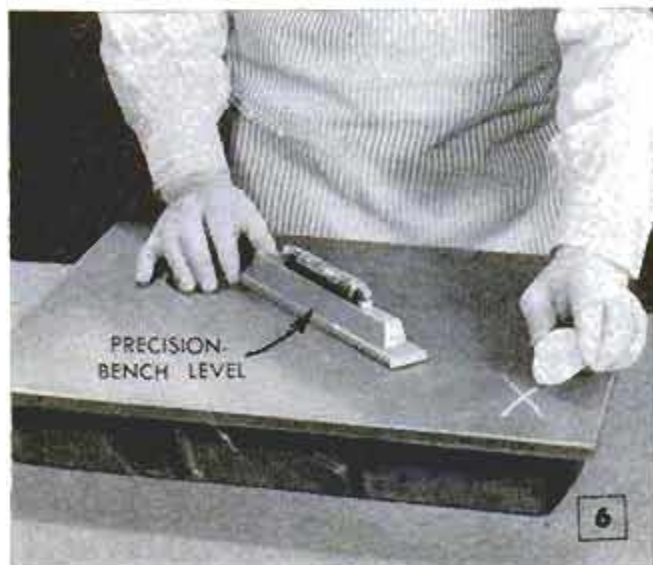

210

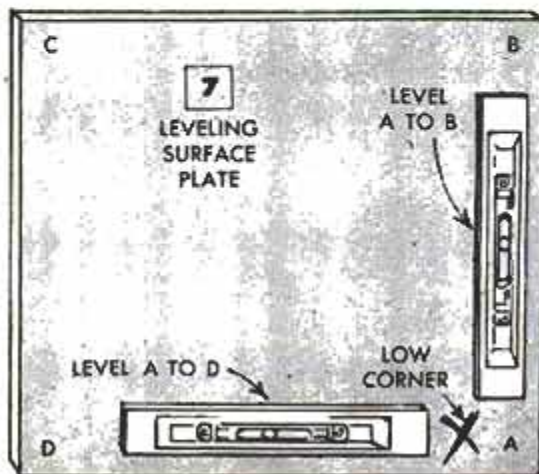



CHECKING ACCURACY,  
HORIZONTAL POSITION

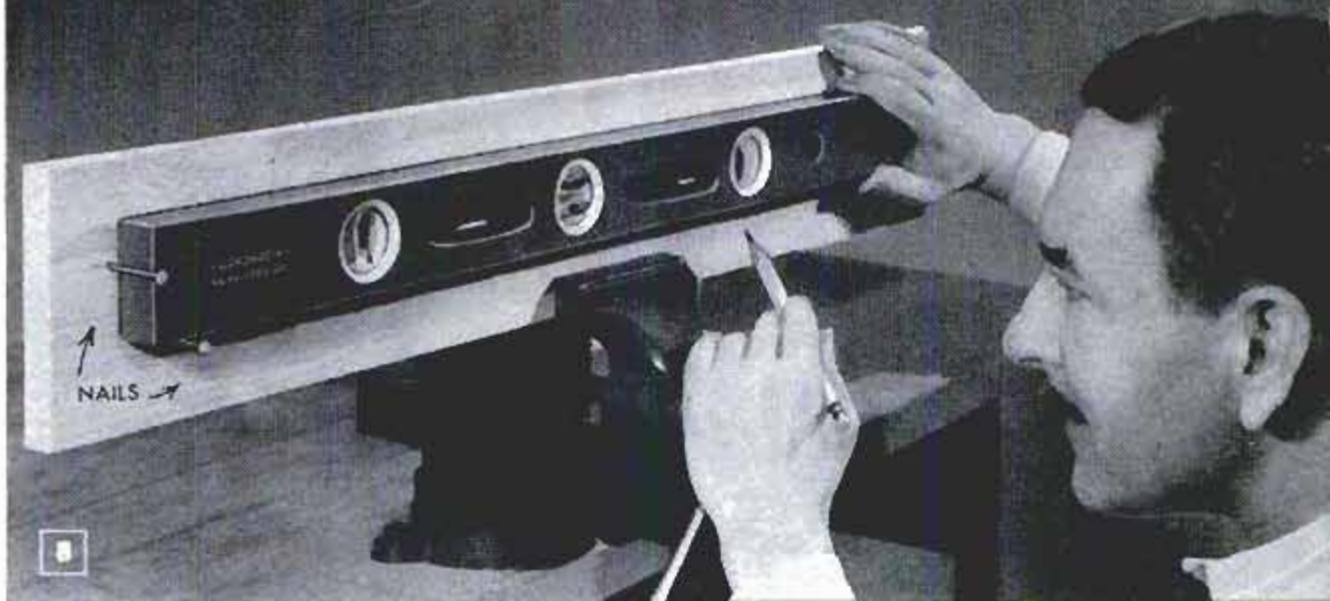

tical purposes. It should not, of course, be depended on for use on work requiring extreme accuracy. Proceed in much the same manner when making the horizontal test, using a board having two nails driven near the end to support one end of the level as in Figs. 8 and 10. When making both tests it's a good idea to repeat each test several times as there may be some slight error in reading the precise location of the bubbles in relation to the witness marks on the tubes. On nonadjustable levels having fixed tubes and wooden frames it may be possible to correct the error, if any, by planing the edges of the frame slightly. Levels having adjustable tube holders, or wells, can be adjusted to compensate for any error that may develop as a result of rough usage.

When using a level to check a horizontal surface keep in mind that the bubble moves toward the high side of the work, that is, it moves to the right or left in relation to the witness marks, or graduations, on the tube. When leveling a flat surface, such as a surface plate, Fig. 6, or a bench top or floor, first locate the low corner. A in Fig. 7. Then level the work to the two adjacent corners, B and D in Fig. 7. This is a general procedure for leveling comparatively large, flat surfaces, but when leveling a machine, such as a lathe, it is the usual practice to level first across the width and then check the length. For this work the precision level should always be used. Generally it is best to double check after leveling the machine two ways as the weight of the machine may cause it to settle on the blocking slightly. Also, make sure that the weight of the unit is evenly distributed on all bearing points, or pads, as otherwise inaccuracies may result.

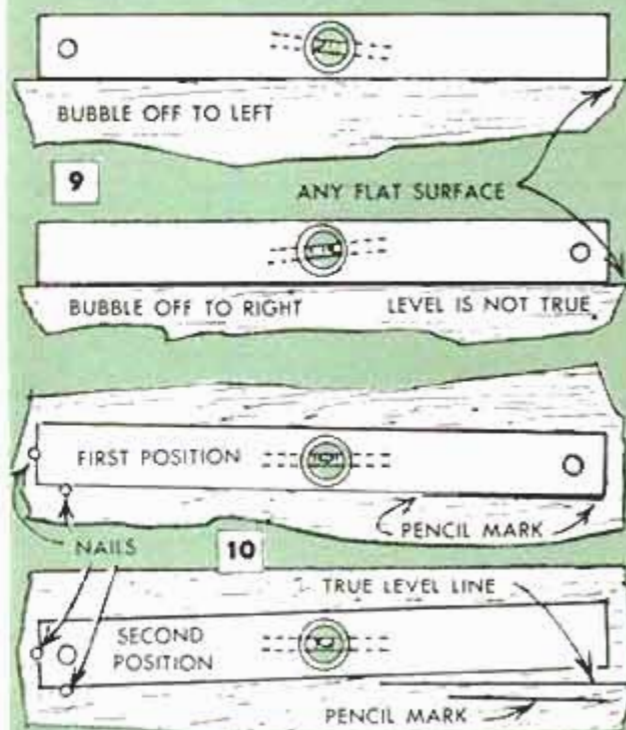



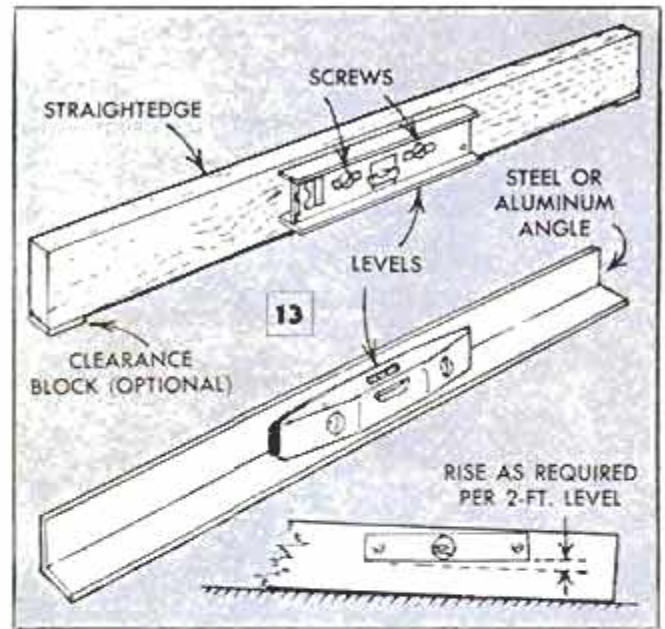

Long level frames do not necessarily add to the accuracy of the level as a unit but they do help to prevent errors resulting from poor contact. This is especially helpful in frame building construction, in laying up masonry and in setting the forms for poured concrete. Rather than use a long level, builders frequently attach a short level to a straightedge as in Fig. 13 and the photo at the left. In this way they gain the accuracy of the long level without sacrificing any of the advantages of the short level for other work. Note that clearance blocks are often nailed to the ends of the straightedge to eliminate any undue errors caused by contact with warped lumber. The level can be permanently attached to the straightedge with screws, Fig. 13, or can be placed on top of the straightedge as in the photo at the left of Fig. 13. Builders often use a level attached to a straightedge to obtain a uniform fall per ft. in a line of draitile. This is done by attaching the level to a straightedge as in the lower detail, Fig. 13.

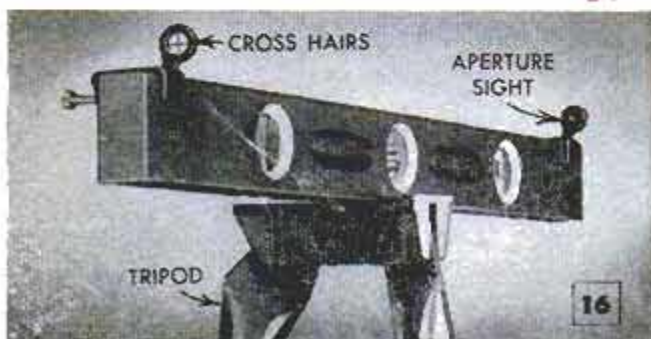
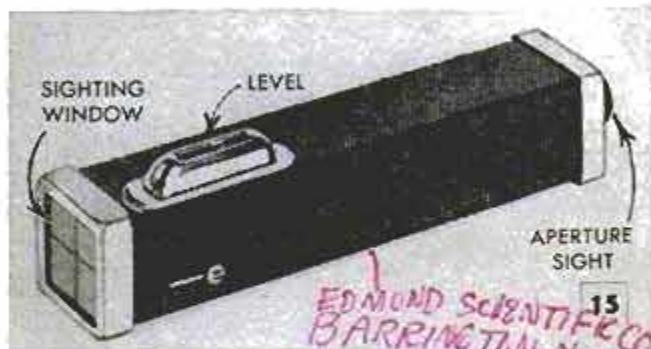
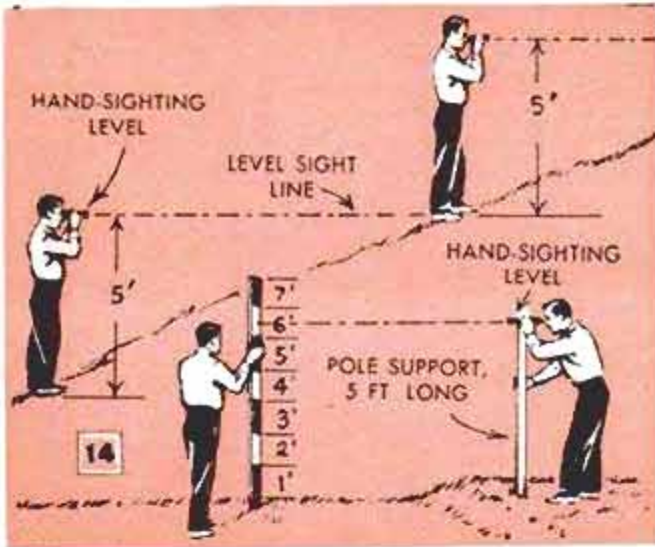

An ordinary carpenter's level can be fitted with level sights, Fig. 16, and used to project level lines for a considerable distance. When used in this manner the unit usually is attached to a tripod or other rigid support so that it is at a convenient eye level. Another unit, probably more frequently used for this special work, is the hand-sighting level, Fig. 15. In this instrument a mirror reflects the position of the bubble to the observer's eye, making it comparatively easy to run level lines on grades and on level ground as in Fig. 14. For working a slope, or grade, as in the upper detail, Fig. 14, the instrument can be hand-held with an accuracy sufficient for most practical purposes. Where greater accuracy is required, the instrument should be supported on a pole or tripod and sight-



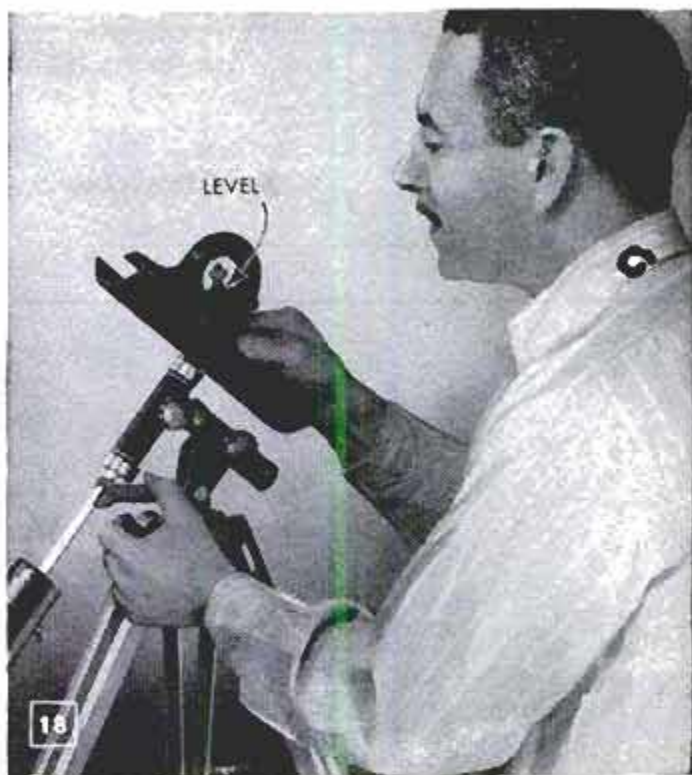
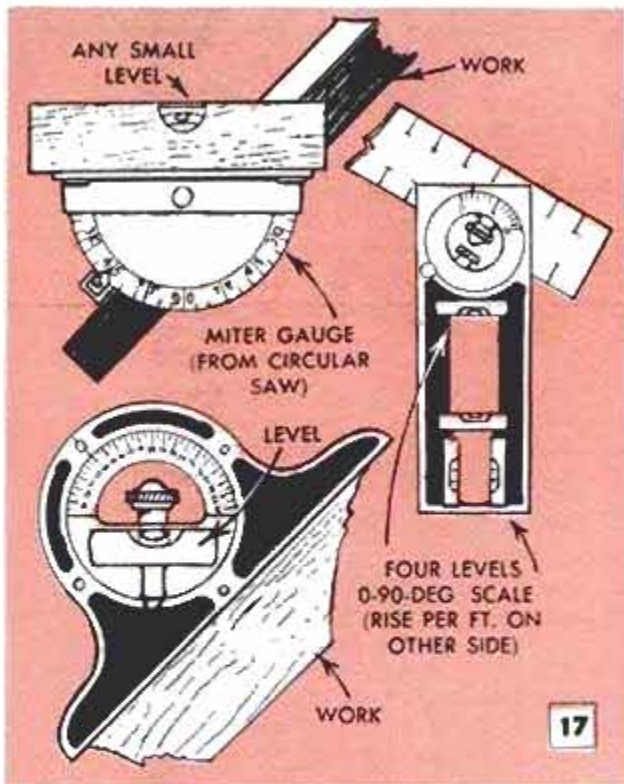

ed on a target as in the lower detail, Fig. 14.

An excellent tool, which employs four level tubes and is especially useful in checking angles in roof framing and other types of more precise work, is shown in the right-hand detail, Fig. 17. One side of the calibrated head is graduated 0 to 90 deg., while the opposite side shows rise per ft. A similar tool is the protractor head, lower left-hand detail in Fig. 17. This usually comes as an accessory to the com-

bination square, but for determining angles it is used without the blade, or scale. The built-in level provides a means of checking angles accurately, an example of its many unusual applications being shown in Fig. 18. Lacking these precise units, accurate angular checks can be made with the miter gauge from the circular saw used in combination with a small level, upper left-hand detail in Fig. 17. Very accurate work can be laid out with this simple setup. ★ ★ ★

### Two-Way Cut Saves Blades

When a hacksaw blade breaks in a cut in thin-walled tubing, steel angle or a steel round, don't start the new blade in the old cut. Always turn the work over in the vise and run the new cut down to join the old one. The reason for this precaution is that the old blade is worn and cuts a narrower slot, or kerf. The new blade will bind and may break in the old cut.

### Improvised Speed Wrench

When there's no speeder handle in the socket-wrench set you can improvise a ratchet speeder in minutes or less from an ordinary bit brace. Just cut off the handle of the L-shaped driver, insert in the chuck of the brace as pictured and there you are. Or, place the short extension in the chuck. Most bit-brace chucks will take the smaller socket-wrench extensions.

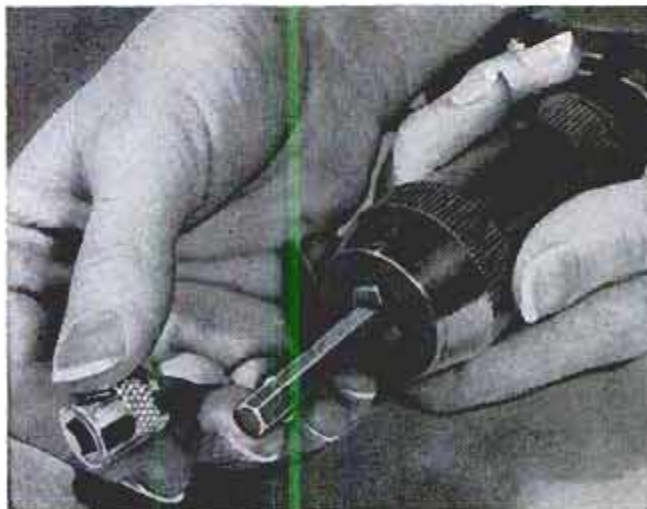
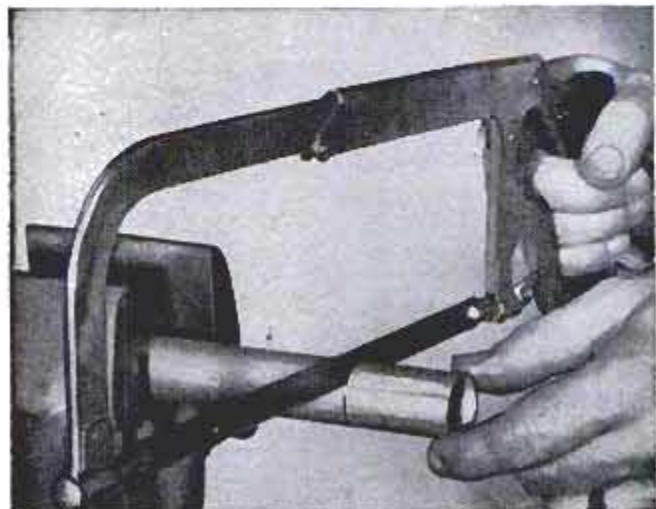



# How Would You Do It?

By Chris Nelson

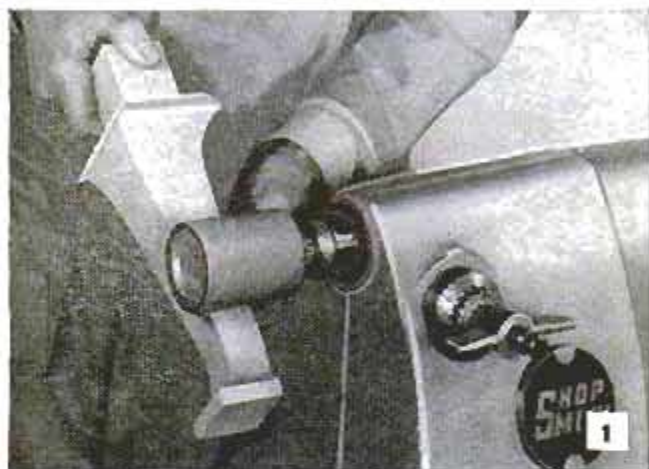

**1. Q—What is meant by freehand sanding with a drum? Which part is moved, the work or sanding drum?**

A—In freehand sanding the work is held in one or both hands and moved over the face of the rotating drum. Very accurate sanding of curved surfaces is possible when the drum is mounted on a horizontal spindle. It's best to use a medium-grade sandpaper

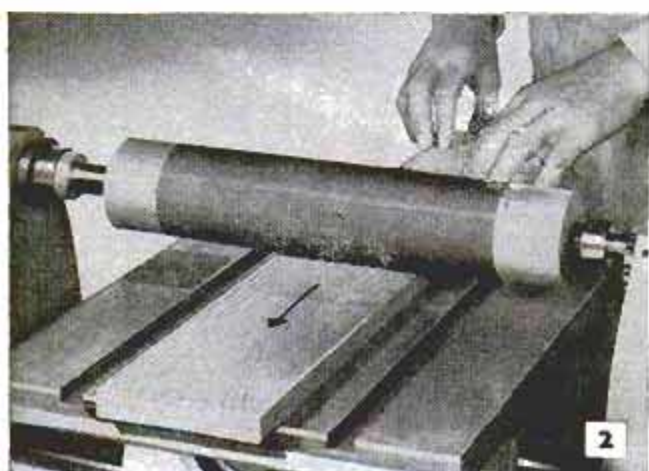

**2. Q—Can a sanding drum be set up to do thickness sanding, working on the face of a board?**

A—On a multipurpose machine like that pictured, turn a hardwood drum, attach a sheet of medium-grade sandpaper and locate the machine table under the drum. Feed the work against the rotation of the drum. Depth of cut should never exceed 1/16 in.

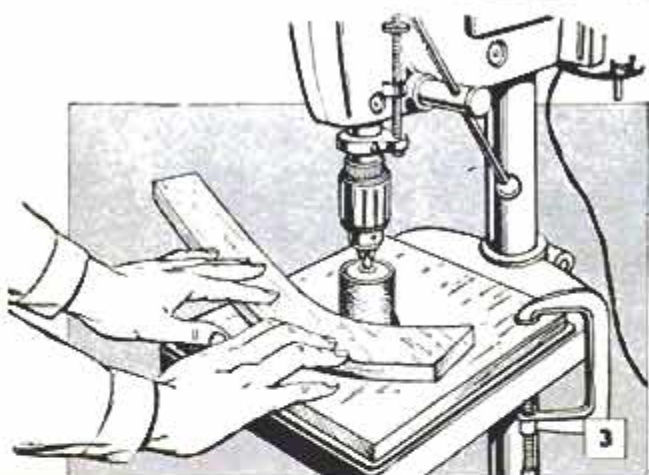

**3. Q—Is it possible to sand a curved edge perfectly square with the face of the stock?**

A—Yes. Set up the job in the drill press as shown. Make an auxiliary table of plywood, drilling a hole through the plywood at the center slightly larger than the drum. Lower the spindle so that end of the drum is about 1/2 in. below surface of auxiliary table

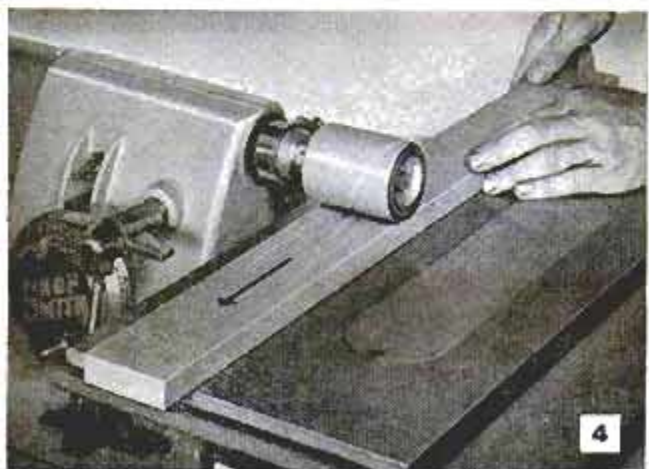

**4. Q—Can the drum sander be used to sand narrow strips to a uniform thickness?**

A—Compare the setup in Fig. 4 with that in Fig. 2. In both setups the work passes between the drum and the machine table and will be sanded to a uniform thickness determined by the table setting. Feed the work slowly and always against the rotation of drum

**5. Q—How about sanding a radius on the end of a furniture leg to fit against a round column?**

A—The radius of the sanding drum must be near that of the turned column the part is to fit. Use the machine table to support the work with its center line on the center line of the drum. Bring up the ripping fence to help support and guide one end of the leg





**6. Q—Is it practical to joint the edges of stock with a sanding drum, using a fence to guide the stock?**

A—This can be done either on the drill press or the radial saw, and is practical when no jointer is available. On the radial saw, use the regular stop as a guide, tilt motor to vertical position and set drum to cut about 1/32 in. at each pass. If drill press is used for this job, clamp guides to the long auxiliary table

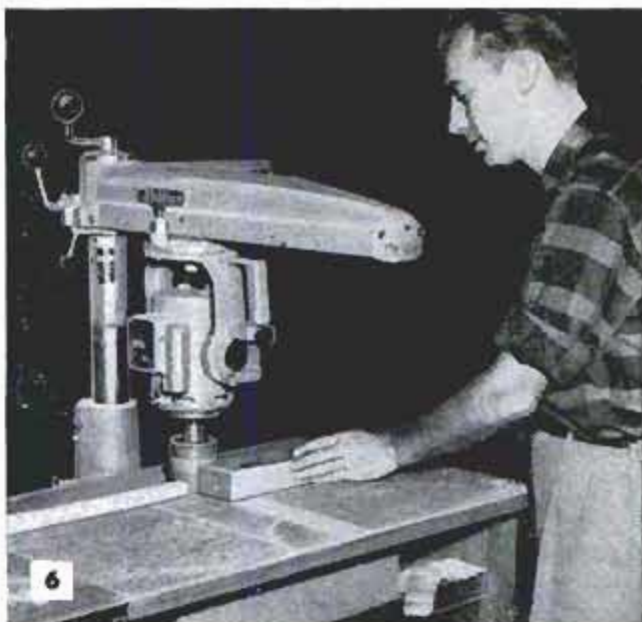

**7. Q—Can a wide rabbet, sometimes used in making raised panels, be smoothed with a sanding drum?**

A—This is a practical operation on a multipurpose machine. First, extend the sanding sleeve about 1/32 in. beyond the end of the drum so it will cut into the corner of the rabbet. Then adjust table to give a light cut and bring up the ripping fence to guide the work. Always feed against the rotation of drum

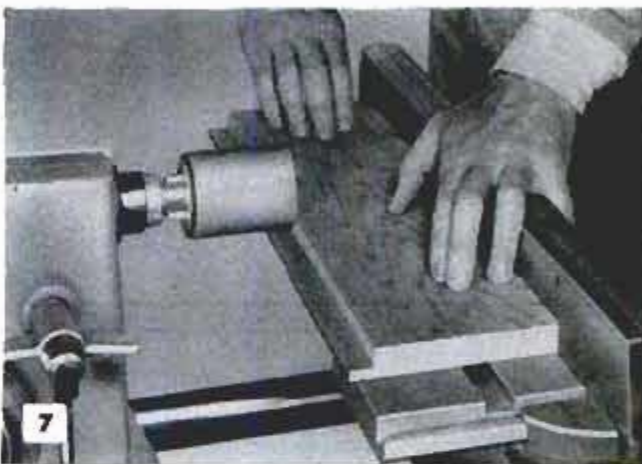

**8. Q—Are sanding drums practical for smoothing narrow slots and intricate jigsawed patterns?**

A—Drums come in sizes from 1/4 in. up and the smaller sizes are useful for working in slots or fretwork down to 1/8-in. radius. Small drums and abrasive rods work best when mounted in a drill press. An auxiliary table is unnecessary as smaller sizes of drums and rods will pass through hole in the regular machine table

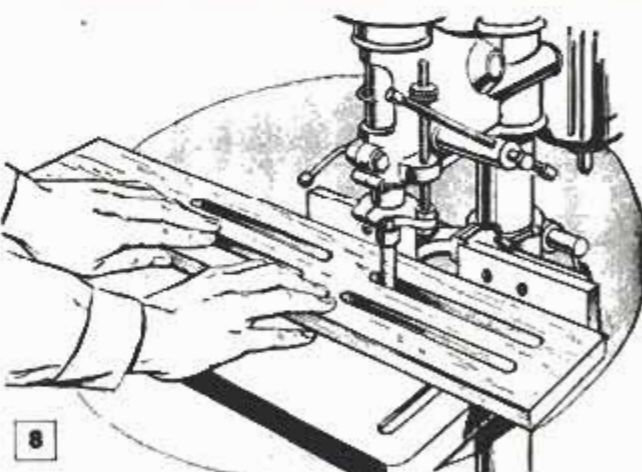

**9. Q—In some types of work rabbets are cut with a part of the shoulder curved. How is it sanded?**

A—First, adjust the sandpaper sleeve on the drum so that the edge of the sleeve extends about 1/32 in. Then chuck in the drill press and lower spindle until edge of sleeve touches cheek of the cut. A light pressure on the work is necessary to prevent scoring surface of shoulder. It's best to use fine abrasive

**10. Q—What, if any, are the advantages of using a sanding drum on a flexible shaft?**

A—By driving the flexible shaft from an individual motor as pictured, or from a drill press or multipurpose tool, you can work on large pieces that cannot be handled easily on machine tables. Using a flexible-shaft drive the drum can be operated effectively in any position. Use medium to coarse abrasive

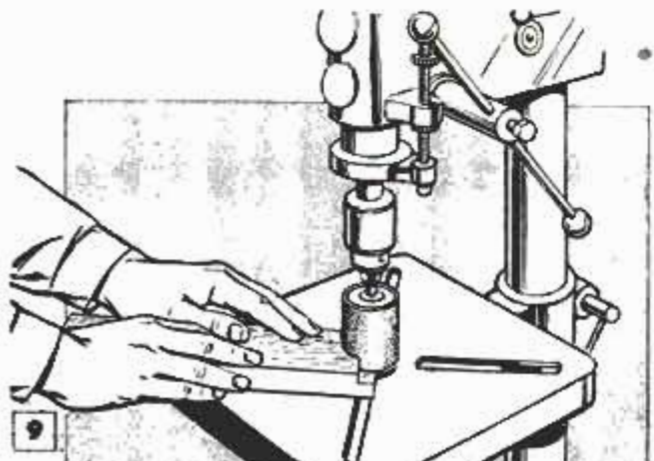



## Pointing Pipe Stakes Makes Them Easier to Drive

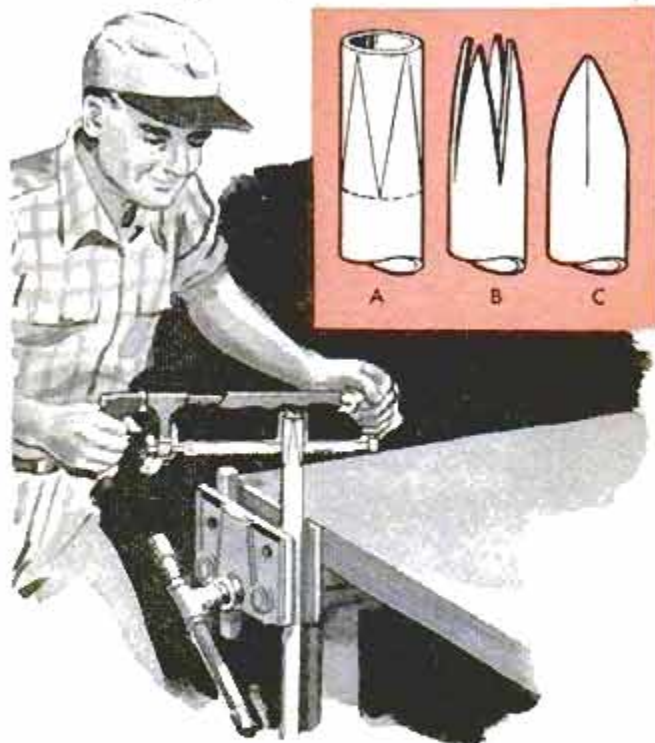

Stakes made from lengths of pipe drive much easier and more accurately in undisturbed soils if you take time to point them. Mark the end of the pipe as in detail A at four equidistant points and scribe four identical triangles, the length of each being equal to twice the outside diameter of the pipe. Then saw out waste with a hacksaw to form four points as in detail B. Bend points together as in detail C.

## Safety-Razor Sanding Block

An old safety razor, of the take-apart type, makes an excellent sanding block for small curved or recessed surfaces. The sandpaper is held in position by tucking the ends between the head and comb of the razor, and locked in place by tightening the handle. When using fine paper, several pieces can be installed and time saved by pulling the used piece away when it becomes worn.

## Lathe Spindle Tapers Cleaned Safely With Brass "Reamer"

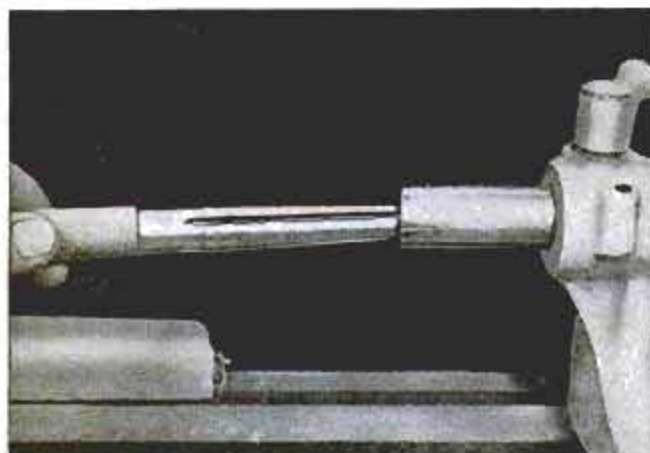

When setting up the lathe to machine stock between centers, it is essential that the spindle and tailstock tapers be cleaned before inserting the centers. Even the tiniest metal chip in one or both tapers can cause errors in machining by throwing the centers slightly out of line. Instead of relying on a cloth wiper, machinists in tool-rooms and school shops make a special cleaning tool from soft brass. One end is turned to a taper and provided with four to six grooves to serve as chip traps. The other end is knurled to provide a firm handhold.—H. J. Gerber, Stillwater, Okla.

## V-Block Holds Square Stock When Locating Centers

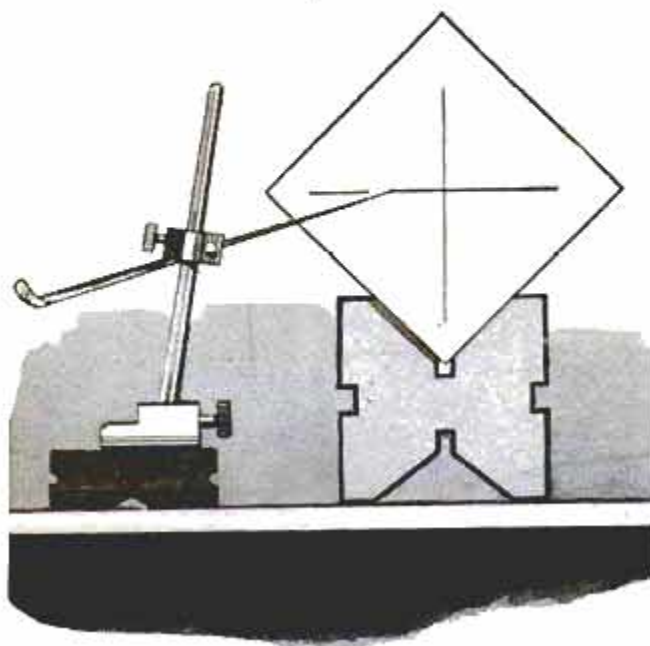

When the accuracy requirements are only average, centers can be scribed on square stock simply by using a surface gauge and V-block. Set up the job on a surface plate, place the work in the V-block and set the scribe point to one corner of the stock. Then scribe the first line. Shift the stock 90 deg. and scribe the second line to intersect the first. Two precautions are necessary: Wipe the stock with a clean cloth wiper to remove all metal chips and grime. Do the same with the V-block and make sure that the chip-clearance groove at the bottom of the vee is clean. Small metal chips on any of the milled surfaces or in the clearance groove may cause inaccuracy in the layout. Where the pieces to be center-marked are more than 5 in. in length, use a pair of matched V-blocks.  
Frank LaSaracina, New York City.





## DUAL-PURPOSE SANDING BLOCK

For sanding both old and new work it's handy to have a sanding block with one flat surface and two radii. With a block shaped to a given radius on each edge you can work concave surfaces such as those on moldings and picture frames as well as a table top or other flat surface. The block pictured above and detailed at the right combines these features and in addition provides a hinged clamp which holds the ends of the sandpaper firmly. As dimensioned in the detail, the block takes one third of a standard 9 x 12-in. sheet of sandpaper. The block proper is cut from  $\frac{7}{8}$ -in. hardwood and rounded on one edge to a  $\frac{7}{16}$ -in. radius and on the other to  $\frac{1}{8}$  in. As indicated, the hinged clamp, or leaf, is shaped to provide a comfortable palm rest. No padding is used as the block is designed for finish sanding to a true, flat surface. —J. W. Nash, Sayville, Long Island, N. Y.

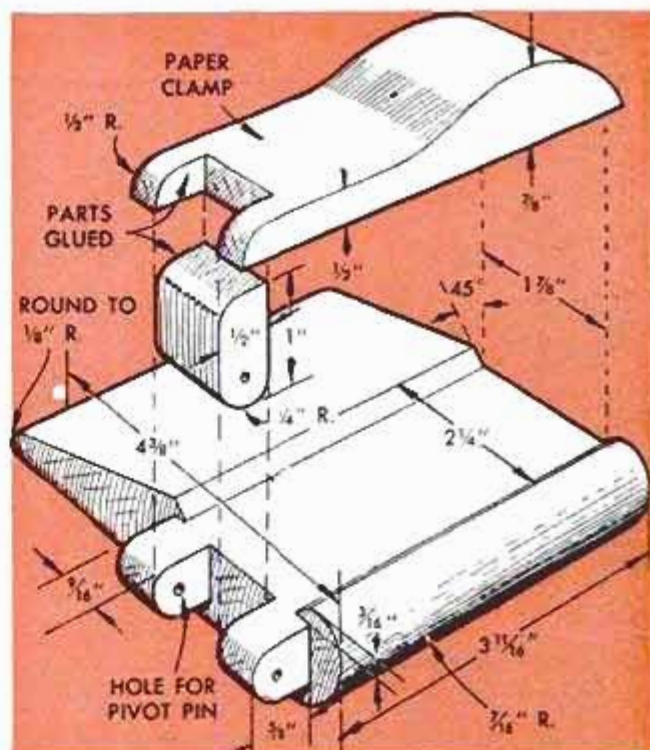
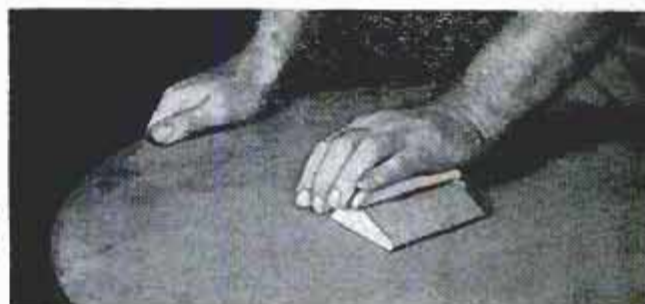

## Roof Coating in Colors

A new protective metallic finish that comes in colors makes it possible to reroof your home with a paintbrush. It waterproofs, insulates, decorates and preserves any type of roof. The finish also is suitable for use on asphalt siding, exterior metal surfaces, boats, life rafts and for waterproofing outdoor swimming pools. Comes in red, blue, green, brown, gray, colonial white and aluminum. It's formulated from refined asphalt, long-fibered asbestos, aluminum and pure color pigments.

☞ Candle wax may be removed from furniture without damaging the finish by using a piece of stiff cardboard to scrape off the wax. Then, wash the stained portion with mild soap and water, rinse, allow to dry and re wax the affected area.

## Radius Scribed With Can Lid

Scribing the guide line for rounding a corner either by sawing or rasping can be done in a jiffy with a can lid. The method is accurate enough for rounding corners on tabletops and shelves and saves minutes over conventional methods making use of a compass. Just place the lid at the corner of the work with the two sides of the lid flush with the edges. Mark with a pencil and there you are, ready for cutting with a jigsaw.

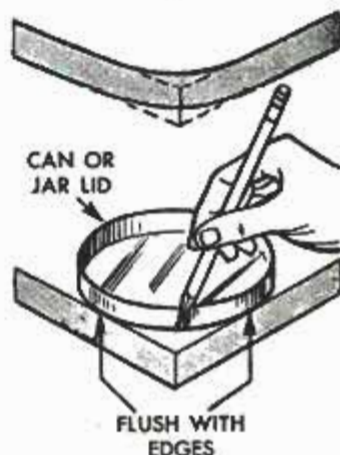



# SHOPPING FOR TOOLS

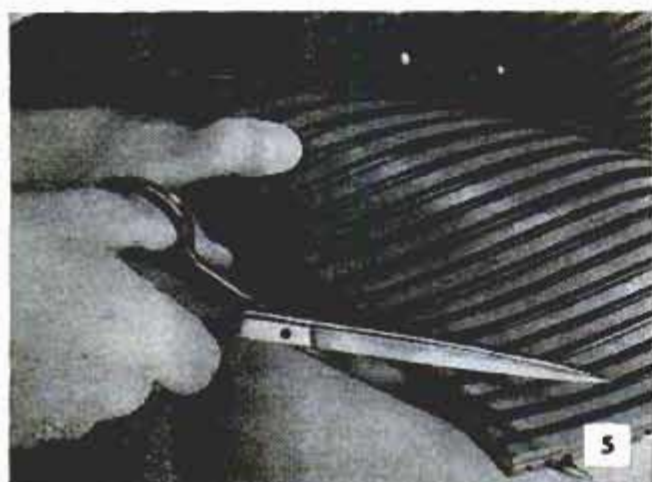
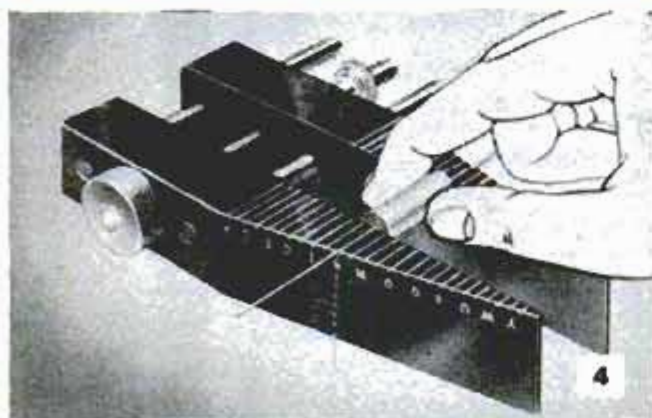

**1. IMPACT-HAMMER UNIT** can be driven by any  $\frac{1}{4}$ -in. portable electric drill on a flexible shaft. Unit is supplied with two Morse-taper adapters to use standard masonry drill bits from  $\frac{5}{32}$  to 1 in. Body of the tool serves as a convenient handle and is perforated to dissipate heat. Has a built-in shock absorber to reduce operational vibration to minimum

Hamer-Drill Co., 514 Greenwich St., New York City 13

**2. REEL** prolongs air-hose life and saves time and space in welding shops. Comes with mounting brackets for attaching to ceiling, wall or floor. Spring motor provides rewinding power. Special pawl locks hose at any desired length. Light pull on hose releases pawl, permitting hose to be rewound automatically. Models are supplied for  $\frac{3}{16}$ ,  $\frac{1}{4}$ -in. hose

United Specialties, Inc., Main and Mosby Sts., El Dorado, Ark.

**3. CAMPER'S AX** is only 12 in. long over-all and weighs just 1 lb. Head and handle are hollow, can be filled with sand when more weight is needed. Made from aluminum alloy having a fine-steel cutting edge molded into the head. Indispensable for campers, woodsmen, fishermen and hunters who must pack a minimum of weight when traveling in remote areas

Safety Research and Mfg. Co., Maritime Bldg., Seattle 4, Wash.

**4. UNIVERSAL BENDING BLOCK** eliminates plier damage and simplifies and speeds up the rather delicate operation of bending leads on resistors, capacitors and other electrical components while assembling these units according to printed circuits. Block is adjustable to accommodate any component body length from  $\frac{1}{4}$  to  $1\frac{3}{4}$  in. Weighs only 10 ounces

By-Buk Co., 4314 W. Pico Blvd., Los Angeles 19, Calif.

**5. VIBRATION-DAMPENING PADS** for light machines can be cut from this material to the required size and shape with ordinary scissors. Made from Neoprene, material comes in ribbed sheets  $\frac{3}{8}$  in. thick and 18 in. square, the ribs running in two directions on opposite sides of sheet. Recommended load on a pad cut from a single sheet is 50 lb. per sq. in.

Vibration Mountings, Inc., 98-17 50th Ave.,  
Corona 68, Long Island, N. Y.



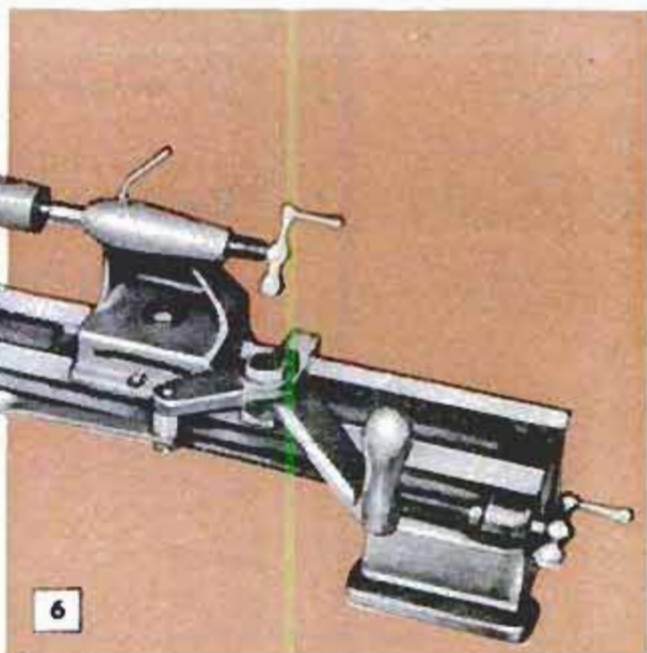
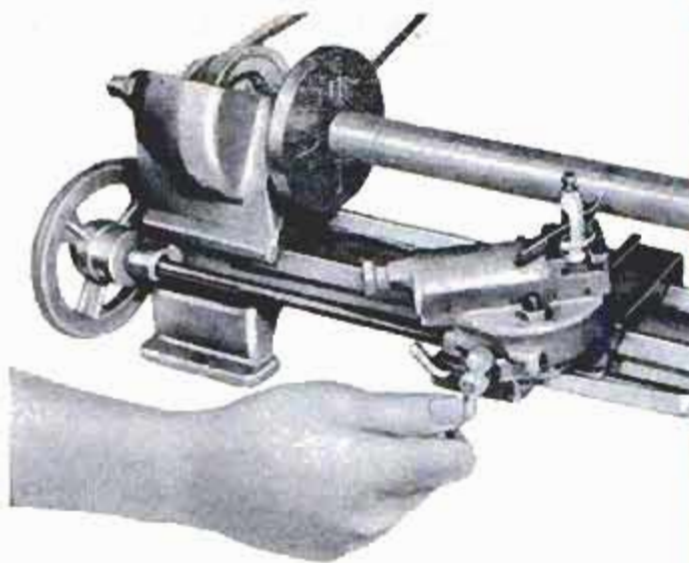

6

**6. METAL-CUTTING BENCH LATHE** is just the right size for modelmakers and others who need a small lathe for light, close work. Bed is 30 in. long, has two 60-deg. V-ways and is ribbed for extra strength and rigidity. Takes 20 in. between centers, swings work 7 in. in dia. over bed. Compound swivels through 360 deg., is locked to carriage with T-slot bolts

King Corp., 2757 Euclid Ave., Cleveland 15, Ohio

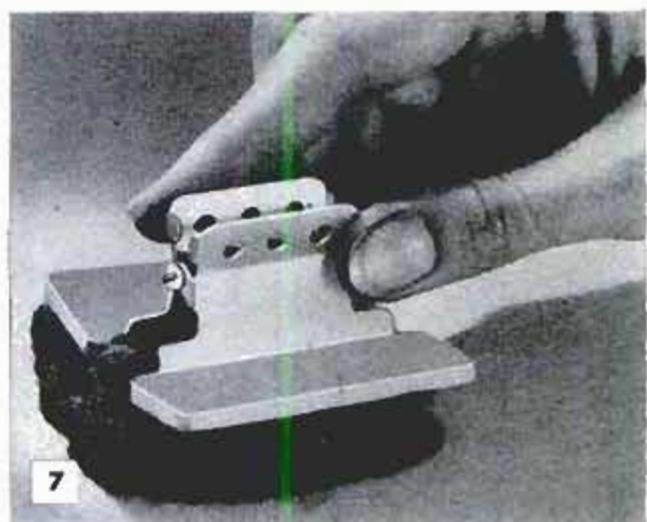

7

**7. STEEL-WOOL HOLDER** protects the hands, grips pad firmly and permits application of greater pressure when cleaning kitchen utensils, woodwork or cutting the gloss on finishing materials between coats. Made of aluminum with rubber guards to prevent fingers from coming in direct contact with the steel wool. Pad is instantly released by pressing handles

Quality Metal Products, Inc., Ozone Park, N. Y.



8

**8. FLEXIBLE LINK SHAFT** is designed to permit application of equal torque in both directions. In this it differs from flexible-shaft cores which are made from spirally wound wire, permitting torque to be applied in only one direction. Designed to operate inside various types of covers such as armored Neoprene hose, nonmetallic hose and semirigid tube Clark Flexible Link Shaft Co., Box 73, Newton Highlands 61, Mass.

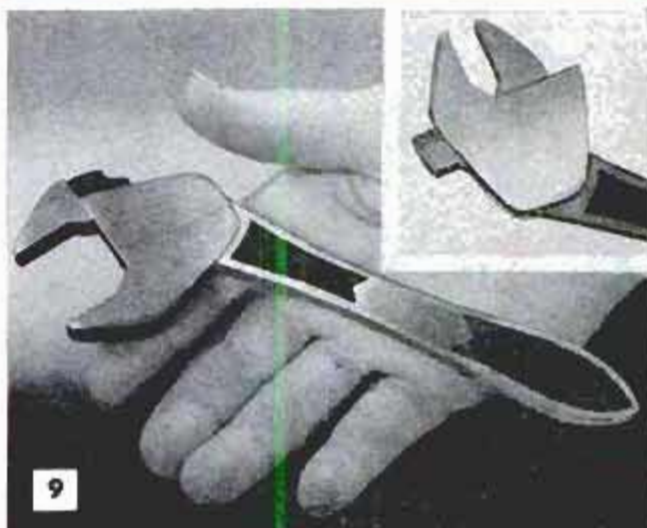

9

**9. SELF-LOCKING WRENCH** is adjusted to fit any nut within its capacity simply by placing movable jaw against nut and swinging handle. Jaws adjust automatically to nut size. Pressure on handle causes jaws to grip nut; the greater the pressure, the tighter the grip of jaws. To loosen nut, simply turn wrench over, swing handle in opposite direction

Superior Sales Enterprises, 1508 N. Vermont Ave., Los Angeles 6, Calif.





## Radio Aids to Carefree Cruising

By L. M. Dezettel

Fig. 1. Motorola's Weatherama, a transistorized portable covering beacon and standard broadcast bands



IF THERE'S ONE THING that the estimated 30 million "week-end sailors" who operate some six million pleasure boats in the U.S. have in common, it's their enthusiastic endorsement of boating as a sport and hobby. Yet, many of them, from personal experience, will agree that it can also be one of the most hazardous of pastimes. If you're out in your boat, for example, and fog starts to close in, you suddenly become the "last man on earth." It is of little comfort to know that shore is but a mile or two away, or that there's another boat almost within hailing distance. The waves lapping against the side of the hull suddenly take on an ominous tone and every sound becomes a warning of impending danger.

Situations such as these can fill even a hardened part-time mariner with apprehension unless his boat is equipped with some of the electronic instruments which guide his course and provide aid and comfort under almost any condition.



Today, boating, whether for business or pleasure, is no longer a "by guess and by golly" proposition. Electronic firms, keeping pace with the rapidly expanding boat industry, are providing sensibly priced equipment which can make cruising more enjoyable and carefree for you and your family.

Probably everyone who expects to spend more than an hour or two in a boat will equip himself with a radio. In many powerboats, salvaged automobile receivers provide an inexpensive means for excellent reception, while in other craft, battery-operated portables are employed. In addition to continuous entertainment, these radios also give intermittent weather forecasts and emergency storm warnings which are broadcast in many local areas.

Some currently available portables cover the marine and aircraft-beacon band in addition to the standard-broadcast frequencies, see Fig. 1. With these, far more frequent and detailed weather reports can be obtained. Since most portables have built-in directional antennas,

Fig. 2. Typical marine-radio direction finder and normal directional characteristics of loop-type radio receiving antennas

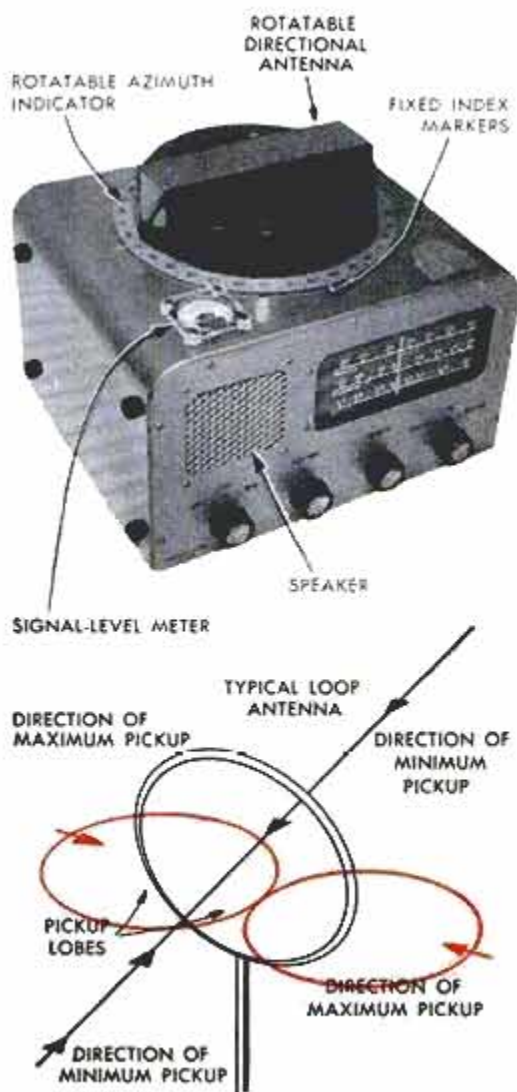

they can also serve as crude direction finders in case of emergency.

### Radio Direction Finding

One of the most useful instruments aboard pleasure boats is the radio direction finder. When cruising out of sight of familiar landmarks, or when weather conditions make visual navigation difficult, the RDF, properly calibrated, can be depended on to guide you to your destination safely and accurately.

But even the best direction finder won't stand up and shout "land five miles off the port bow." To derive maximum benefit from these versatile instruments, the operator should be aware of their capabilities and the characteristics of the marine radiobeacons.

**Marine Radiobeacons.** As an aid to safer navigation, the U.S. Coast Guard has blanketed our coastlines with a vast network of radiobeacons. Each of these transmits on its assigned radio frequency a

Fig. 3. Location and characteristics of marine radiobeacons in Lake Michigan area. Clockface shows operating-time intervals

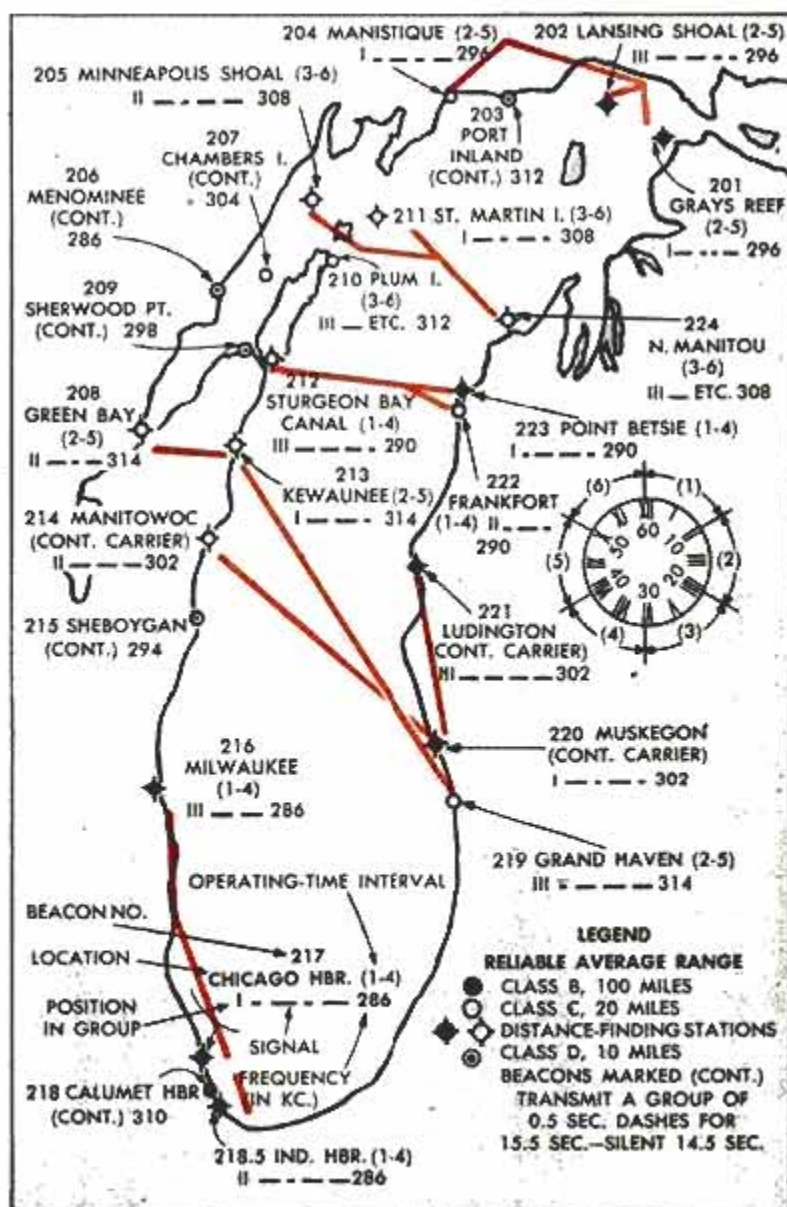



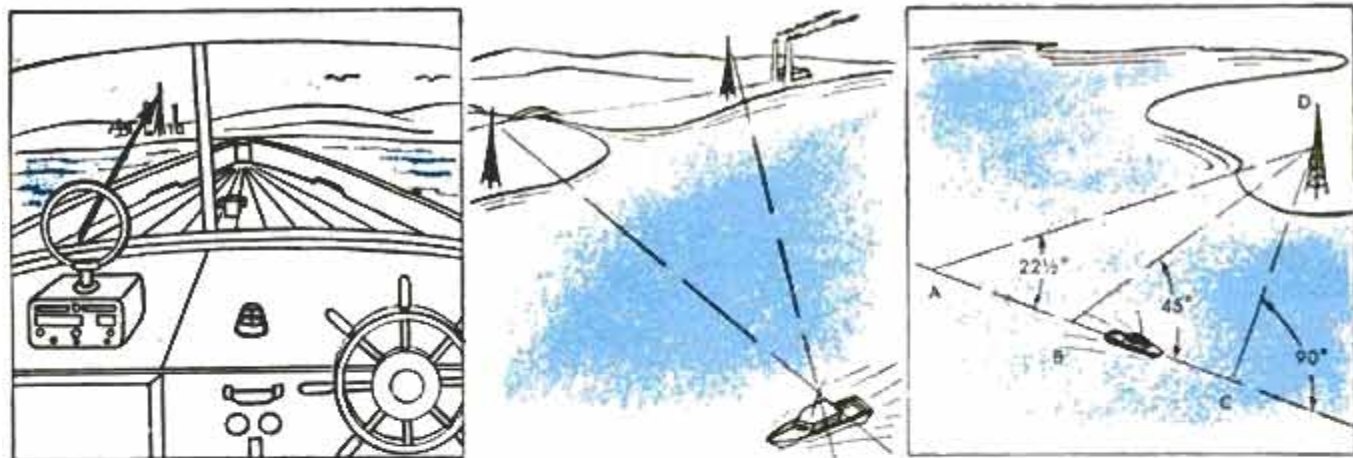

Fig. 4. Major RDF applications. Left—piloting on a beam of silence. Center—plotting position. Right—distance calculations, when bearing angle is doubled, distance run equals distance to station.  $AB=BD$ ;  $BC=CD$

series of dits and dahs which identifies its location.

Fig. 3 shows the location and characteristics of beacons in a typical area. Some of these operate in groups of two or three, as indicated by the colored connecting lines, while others operate independently. All beacons in a specific group transmit on the same frequency and broadcast in rotation, at designated times, twice every hour.

To determine how this system works, note the clockface in Fig. 3 which has been divided into six 10-minute intervals. These intervals, labeled 1, 2, 3 . . . consecutively, describe the normal operating schedule of the various beacons. For example, beacon No. 217, at Chicago Harbor, operating in time interval one and four (1-4), transmits during the first and fourth 10-minute period of every hour. This station belongs to a group comprising beacons Nos. 216, 217, and 218.5, all of which transmit during the same time interval.

Since all of these beacons operate on one frequency, simultaneous transmission would cause serious interference. To avoid this, the beacons broadcast consecutively, in the indicated I, II, III order. At the beginning of each hour, beacon No. 217 (I in the group) broadcasts its — — — — signal for one minute. This is followed for one minute by the — — — — signal from beacon No. 218.5 (II in the group), and finally by the — — signal from No. 216. This sequence is repeated three times at the beginning of each half-hour transmitting interval. (In the 2-5 interval, beacon II starts the transmitting sequence, while during the 3-6 interval transmission begins with beacon III. During fog, all beacons in the affected area operate continuously in the regular sequence.)

**Direction Finder Characteristics.** Leaving the subject of radiobeacons for the moment, let's investigate briefly the direction finder itself. A typical unit, see Fig. 2,

consists of a sensitive radio receiver, a rotatable azimuth scale, one or more fixed-index markers and a directional and rotatable loop antenna. The latter may be considered the heart of any DF equipment.

Any antenna loop, whether it consists of an actual circular configuration or simply of some wire wound around a slender ferrite core, has very definite directional characteristics, see Fig. 2. When rotated so that its plane is broadside toward a station, it picks up very little or no energy from the signal of that particular transmitter. This property of loop antennas forms the basis of all direction finders and makes the first major function of such equipment, that of "homing" on a fixed radio-signal source, readily apparent. Assuming that the direction finder is installed with its index markers parallel to the keel of the boat, it is possible to steer an unerring course toward any destination having a beacon or broadcast station simply by setting the antenna pointer to the index marker and heading the boat in the direction which gives a minimum signal indication on the direction finder's null-indicating meter or from the loudspeaker.

The ability to take a "fix" on any radio-signal source can be used to accomplish the RDF's second major function—that of plotting your own position. To do this, the azimuth scale is set so that the fixed-index marker indicates the true bearing of the boat, as shown by a compass reading corrected for local magnetic variations and compass deviation. The receiver is tuned to the frequency of the nearest beacon group. When this beacon group goes on the air, the antenna is rotated for a null indication for each beacon in turn and the bearings of these, as indicated on the azimuth scale by the antenna pointer, are jotted down. When these bearings are plotted on a chart, the intersection of the bearing lines shows the location of the boat.

A direction finder plus a knowledge of



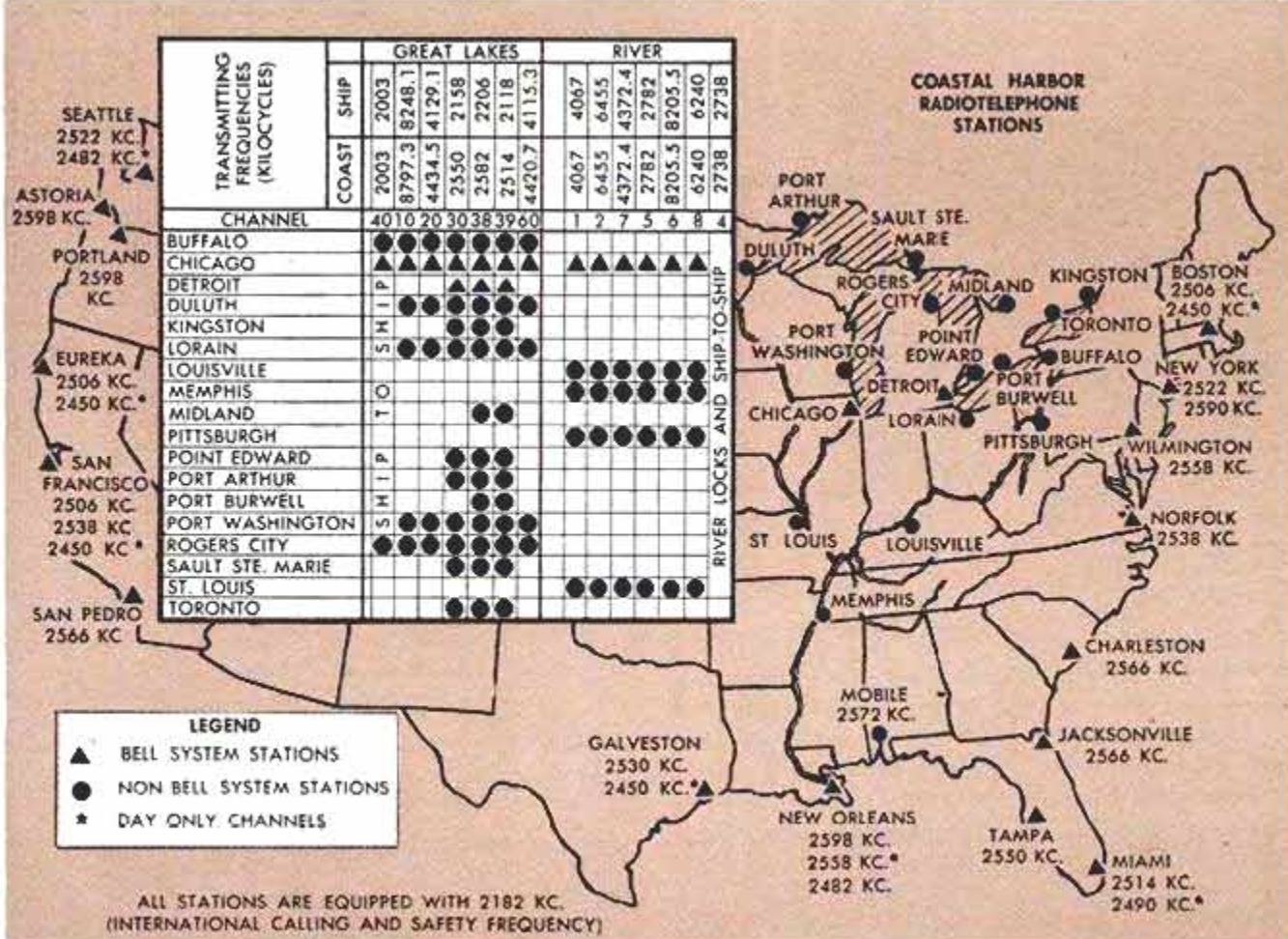

Fig. 5. Wherever you may cruise, you are almost certain to be within radio range of a harbor station

fundamental trigonometry will permit you to calculate the distance from your boat to any fixed-signal source, as illustrated in Fig. 4. Additional distance-finding possibilities are provided by many of the radiobeacons which are designated as distance-finding beacons. During a fog these beacons transmit, near the end of their regular operating minute, a one-second dash, followed by a one-second silence and a long dash of either three or five seconds duration. These two dashes are synchronized with similarly timed blasts from a sound fog signal. The number of seconds elapsing between the end of the long radio dash and the termination of the long blast

from the foghorn (as heard by the observer) will, when divided by 5.5, give your approximate distance, in nautical miles, from the light station.

Because the nearness of any large objects can affect the directional properties of loop antennas, any direction finder should be calibrated after installation. For this purpose, any radiobeacon will broadcast, on request, a continuous signal at any time other than its regularly scheduled broadcast time. Requests for calibrating signals may be made by radiotelephone or by prearranged agreement.

The ability to call for and receive aid, (Continued to page 258)

Fig. 6. Typical radiotelephones for pleasure craft. "Portable" unit, center, operates from built-in batteries

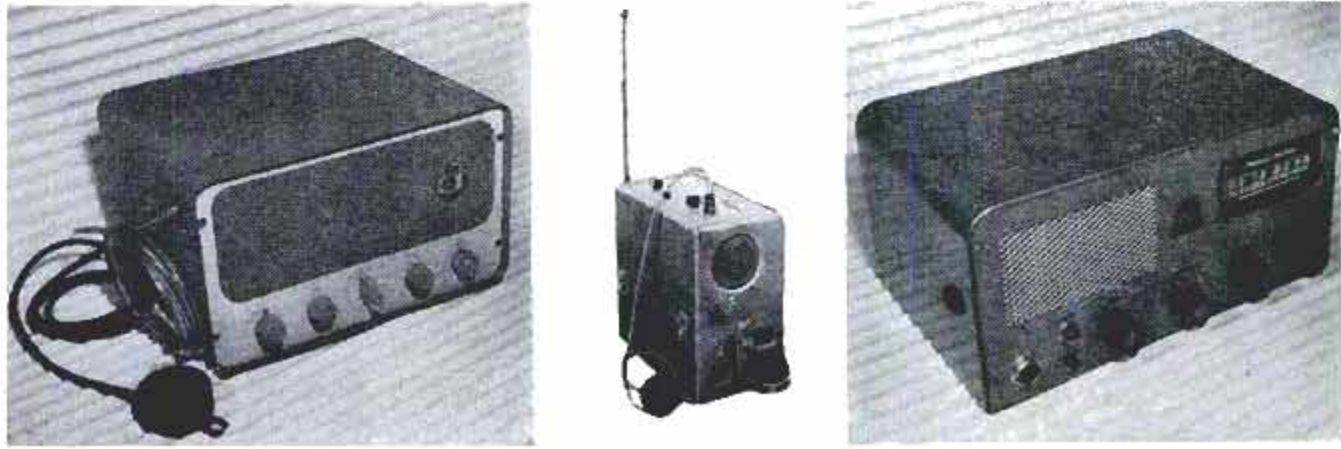



# TV TIPS



**IF YOUR TV PICTURE TUBE** picks up distracting reflections from a floor or table lamp, end this annoyance by fastening a sheet of aluminum foil inside the lamp shade (above). Properly installed, foil will not mar the appearance of the shade. G. F. STILLWELL

**FRAGILE MINIATURE TV TUBES** (below) are often damaged while being reinserted in their sockets after having been removed for checking. When socket holes are not visible, as with shielded sockets, draw a guide line along the lower portion of the tube and chassis, using a crayon or grease pencil, before removing the tube. Tube can then be easily reinserted by lining up the two marks. G. F. STILLWELL

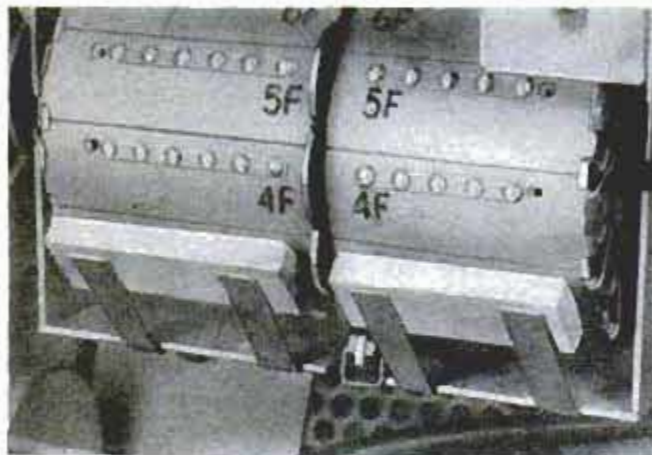
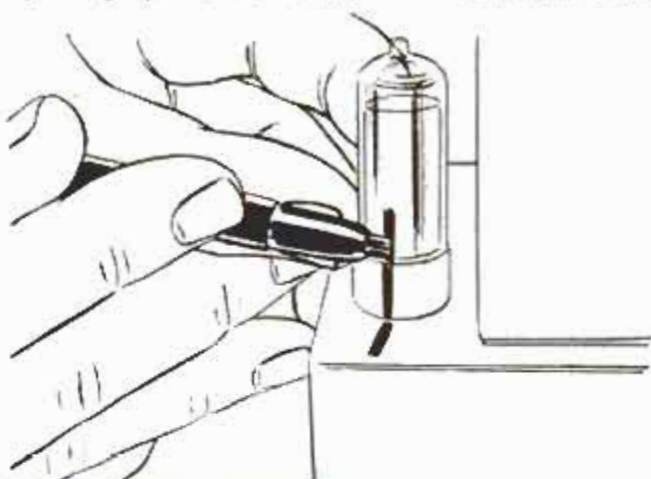

**CONTACTS OF TURRET-TYPE TV TUNERS** must be cleaned frequently to prevent noisy and spotty reception. Cleaning pads, made and mounted as shown above, reduce the frequency of this annoyance. Pads are made of hardwood, slightly curved, and faced with a hard grade of blotting paper. Spring-metal strips hold pads against turret and contacts are cleaned automatically when tuner is rotated.

H. Y. MOON

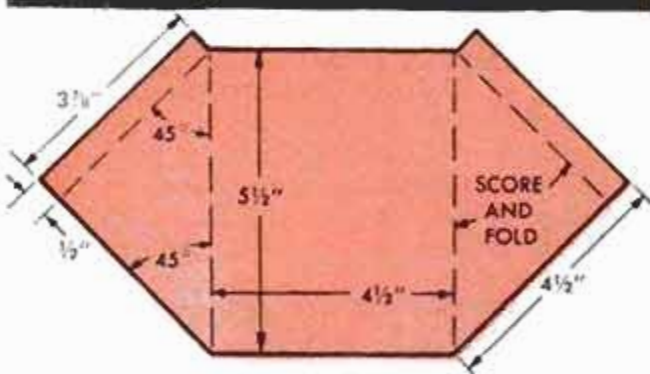
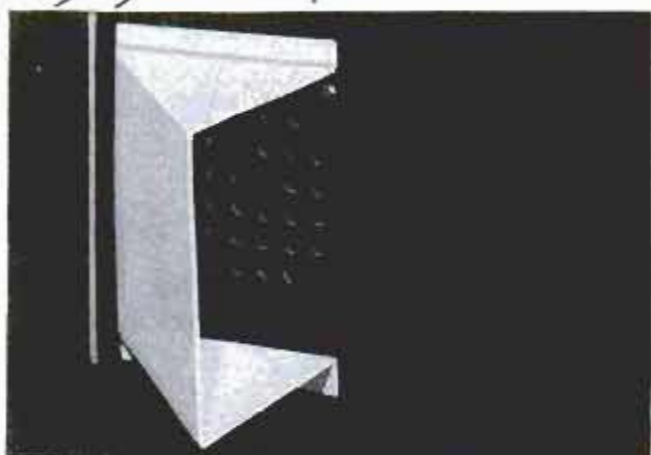

**TO SPLICE** two pieces of TV twin-line, follow the method shown below. Cut insulation along outer edges and pull wires away from ribbon. Place one piece above the other, twist the corresponding leads together and solder. Cut off superfluous insulation. Taping removes strain from soldered joints.

E. DEVORE

**TV-SOUND REDIRECTOR** (above) increases volume and improves audio quality of receivers with small side-mounted speakers. Redirector, made of heavy cardboard and fastened to cabinet with cellulose tape, effectively channels sound towards listener.

W. C. EYMANN

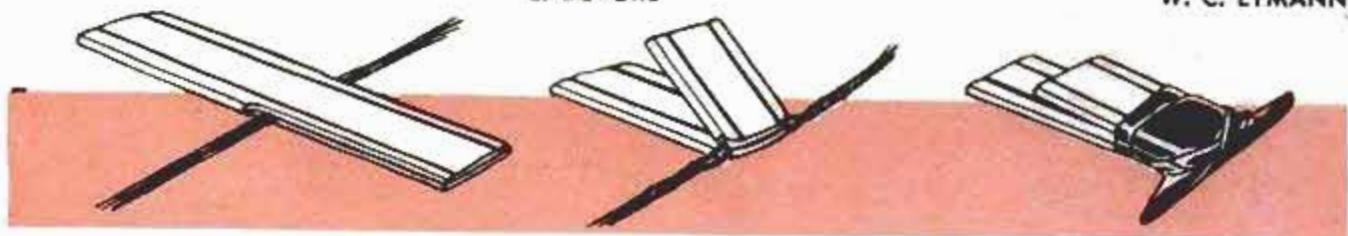



# specks the size of a micron

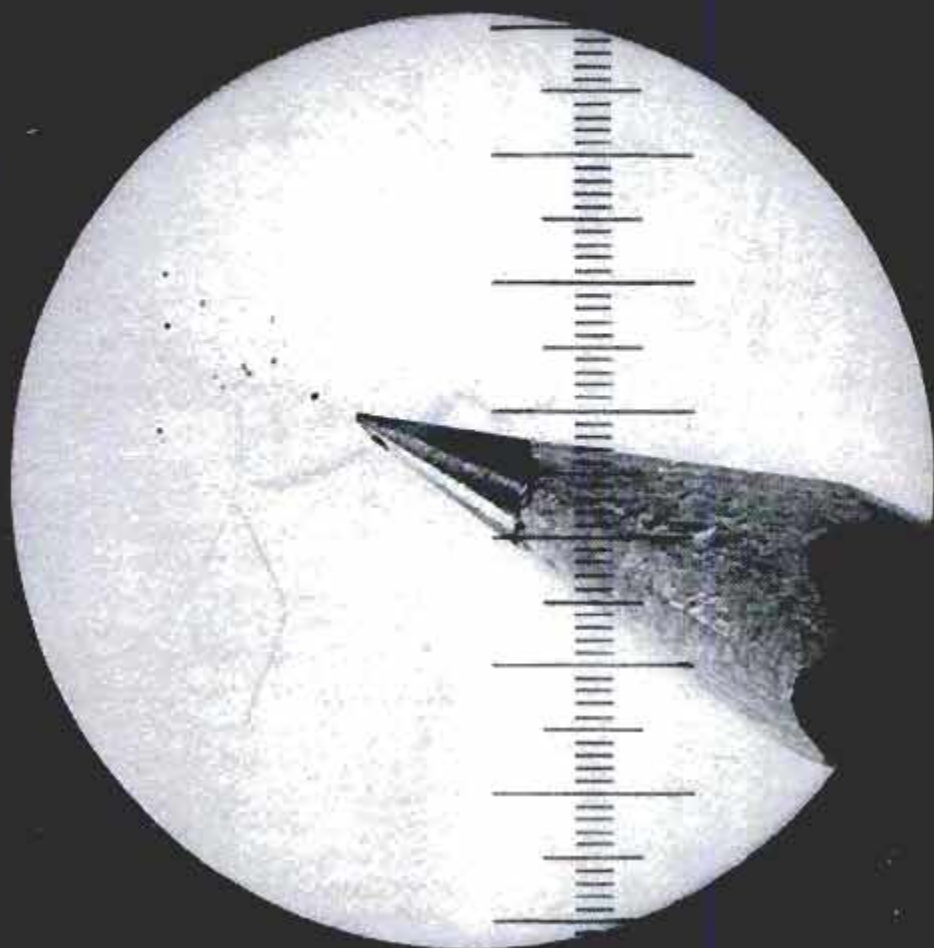

# can shorten your engine life

Waste and abrasive particles *far too small to see* with the naked eye can have a deadly effect on engine performance. That's the problem that led to the development of the MoPar Micronic Oil Filter. It eliminates even these particles from the oil system, to the size of a *micron* (.000039 of an inch).

This means that the filter catches over  $\frac{1}{3}$  more dirt per square inch than ordinary filters. Chrysler Corporation Engineers perfected the method by means of a special filter element paper. These "Forward Look" engineers also developed—

- greatly increased filtering speed—because the filter surface area is over 8 times larger than conventional types—571 inches against 69.
- far greater *capacity*—3 to 5 times the capacity of a waste-type filter of corresponding size. And there's no unloading, warping or distorting.

If you demand top engine performance and value your engine life, you'll use a MoPar Micronic Oil Filter. The name MoPar means *genuine* Chrysler Corporation parts and accessories, made to highest precision standards. Available at all Plymouth, Dodge, De Soto, Chrysler or Imperial dealers, or leading independent repair shops.

GENUINE CHRYSLER-ENGINEERED

**MoPAR**  
PARTS & ACCESSORIES

MoPar Division, Chrysler Motors Corporation  
Detroit 31, Michigan



# NEW! STOPPING POWER FOR FIGHTIN' FISH

*Shakespeare*  
PUSH-BUTTON  
WONDERCAST



CAST 10 OR 12-LB. LINES  
EASY!..QUICK AS A FLASH!  
with **PUSH-BUTTON MAGIC**



## NEW SHAKESPEARE GOLDEN BRONZE FINISH

Here is double stopping power with easy push-button operation, to hook, hold and handle the big ones. Push the button... s-w-i-s-h the rod... PRESTO—PUSH-BUTTON FISHING. Instantly adjustable super-smooth drag. Famous Shakespeare quality and engineering. No. 1777 Golden Bronze Finish, carboloy pick-up. Factory Filled approx. 100 yds. 10-lb. line... \$23.95. Also available No. 5055-12 extra spool with 75 yds. 12-lb. line \$3.50.

**Free!** 5 COLORFUL NEW FISHING BOOKLETS & CALENDAR

Write today for latest in fishing ideas and equipment on salt water, bait casting, spinning, fly and push-button fishing.



**SHAKESPEARE CO.**  
Dept. PM-3, Kalamazoo, Mich.

Please send me absolutely free your 5 new fishing booklets and calendar.

Name \_\_\_\_\_

Address \_\_\_\_\_

City \_\_\_\_\_ State \_\_\_\_\_

## You Can Forecast Weather By the Clouds

(Continued from page 112)

As you travel, you might notice that the closer you get to the equator, the higher are the clouds. This is because the earth rotates, causing centrifugal force to swing the atmosphere and its clouds outward. Weather and clouds go up about five miles near the poles, 7½ miles in the temperate zones and 10 miles at the equator. Because warm air ascends and cold air descends, winter skies are lower than summer skies.

Cloud heights are something you will be able to ascertain with a little practice. Fair-weather cumulus averages 4000 feet at the base, alto-cumulus and other middle clouds average 10,000 to 20,000 feet. From 25,000 up, clouds are composed of ice droplets instead of water droplets, so cirro-cumulus ("mackerel" sky), cirro-stratus and lofty cirrus are all ice clouds which the sun and moon can shine through without making a shadow. Cirrus scratches the floor of the stratosphere where the thin air is cloudless and weatherless, some 38,000 feet up.

It all sounds awesome and strange, yet you are making a true cloud when you breathe out winter air, condensing the warm wet air from your lungs into visible droplets. Air moves from west to east about 600 miles a day; how odd, then, to realize the air you breathe was hundreds of miles away yesterday, and the air you exhale will be abroad in a few more days.

Such simple truths are part of a weather wisdom we all should have, particularly in this age of space-travel conjecture. We suddenly find that the sky is part of the earth, a thin layer of stuff we live in just as the fish live in the sea. The surface of the earth is not beneath our feet at all—it lies overhead, just a little way beyond the clouds. ★ ★ ★

## Science Out-Foxes Radar

Radar's probing "eye" possibly has been blinded. From England comes the announcement that scientists have discovered a material that absorbs radar pulses. It is made of foam-rubber panels bonded to brass and ceramics. Successful tests already have been made. This is the first known possibility that radar warning defense can be defeated.

☐ More sunspots were observed during 1957 than at any time in recorded history, according to National Bureau of Standards.



*"like having Wings on your feet!"*



Modern Mercury! Jim Rusing,  
ski director at Florida's Sunshine Springs.  
Photographed at Sunshine Springs, Sarasota.

*(when*

# MERCURY OUTBOARDS

*pull for you)*

*It's easy to own a  
Mercury! As little as  
10% down, up to  
24 months to pay!*



© 1958 Kiekhaefer Corporation, Fond du Lac, Wis.  
WRITE FOR FREE ILLUSTRATED CATALOG



Jim Rusing says, "Skiing behind a Mercury is like having wings on your feet—like Mercury's namesake, the messenger of the gods! Nothing compares with the pure thrill a Mercury delivers, from take-off to feel-of-flight planing!"

That's Mercury—the powerful outboard that brought water-skiing within the price reach of everyone . . . the only outboard with enough thrust, enough speed and enough dependability to be the choice of top-ranking water skiers everywhere. Thousands of professional water ski shows are proof enough that Mercury is best for water skiing.

Mercury offers the most that's new for 1958, the widest choice of power on the water in twins, fours and sixes. See your Mercury dealer.



## NEW Starrett No. 167 RADIUS GAGES



### Now at NEW LOW PRICES!

- No. S167C Radius Gage Set without Holder..... \$10.35  
 No. S167C Radius Gage Set with Holder..... 12.00  
 No. S167CH with 1/64 in. Gage and with Holder. 13.55

See Your Starrett Distributor

MECHANICS, MACHINISTS, INSPECTORS... here's why you'll go big for these new Starrett No. 167 Radius Gages:

*Stainless steel* with no-glare satin finish — to make them rustproof and stainproof, easy on the eyes in any light. *Individual gages* — easier to use, less chance of errors. *Five gaging surfaces on each* — to handle any concave or convex radii. *Sizes from 1/64" to 1/2"* — in your choice of six convenient sets. Available with handy gage holder.

### BIG NEW CATALOG—FREE

Describes and illustrates over 3000 Starrett Tools. Send the coupon.



STARRETT TOOLS are carried by leading Industrial Supply Distributors and Hardware Tool Stores.

THE L. S. STARRETT COMPANY  
 Dept. AP, Athol, Mass., U. S. A.  
 Please send my free copy of the big new Starrett Catalog No. 27.

Name.....  
 Occupation.....  
 Address.....  
 City..... Zone... State.....

## Clinic for Homemakers



As a service to our readers in solving the hundreds of problems pertaining to a home—inside or out—the editors of *Popular Mechanics* invite you to present your problems to The Clinic Editor for help and advice. Address your questions to The Clinic Editor, *Popular Mechanics Magazine*, 200 East Ontario Street, Chicago 11, Ill.

### Sanding Floors

*Q—I plan to rent a floor-sanding machine for refinishing the hardwood floors in several rooms on the first floor of my older home. The finish on the floors seems to be in fair condition but is much discolored and shows wear in the traveled areas. I'm told that if I use turpentine on the floor the sander will do a much better job. Is this true?—O. M., N. Y.*



*A—Yes, but have you thought of the fire hazard? Should the sander strike a nail a shower of sparks is likely to result. The danger of igniting the turpentine film should be obvious. Because of this we could not recommend the use of any volatile solvent for the purpose that has been suggested to you. This also would be true of carbon tetrachloride, which is nonflammable but presents a health hazard due to the toxicity of the fumes. Generally it is best to use a coarse open-coat abrasive the first time over an old floor. Use a comparatively light pressure so that the open-coat abrasive only breaks the finish film but does not cut down to the bare wood. This procedure usually tends to prevent clogging of the abrasive. Go over the floor a second time, cutting a little deeper. Follow with a medium-grade open-coat abrasive, cutting through to the bare wood. Follow with a fine abrasive to remove the scratches from the surface. Usually this procedure produces good results on an old floor, but much depends on the condition and age of the original finish, of course. In some instances it will pay to remove the old finish with a paint and varnish remover before sanding. When this is done be sure to provide adequate ventilation.*

### Refinishing Leather Upholstery

*Q—I have a large leather-upholstered chair. The upholstery is rather worn at the corners of the cushion and on the tops of the armrests. There are a few small cracks at these points but they do not seem to go clear through the leather. Is there any way of refinishing leather upholstery?—R.M., N. Y.*



*A—If you are sure that your chair is upholstered in genuine leather and not the so-called imitation leather or other types of leather substitute, then the question of whether or not it can be successfully refinished depends almost entirely on the extent and nature of the wear or other defects. Special enamels and dyes are available in a wide range of colors and are easy to apply by following*

(Continued to page 230)



# GRAVELY

## More for your Money!



CULTIVATE GROWING CROPS

POWER CULTIVATE YOUR GARDEN

PERFECT SEEDBED WITH ROTARY FLOW

MOW LAWN AREAS

MOW TALL GRASS, WEEDS, CROPS

BLOW SNOW AWAY

MOVE SNOW, DIRT

HAUL HALF-TON LOADS

### GRAVELY MAKES TOUGH JOBS EASY!

Gravely does jobs other tractors won't . . . because Gravely has that *extra* power you need for the toughest lawn, garden, field and farm tasks. Does a better job everywhere, even on *steep slopes!*

With a choice of 30 attachments, you do every chore with a performance-proved tool that does it *better, faster, easier!* Because Gravely's *all muscle*—its direct engine drive puts the power where it counts— at the *working tool.* That means performance *Plus!*

#### More For Your Money!

Yes, you get *more* power, *more* performance, *more* for your money when you get Gravely. The cutaway view on the right shows you its clean, compact, power-engineered design — the reason for Gravely's remarkable performance.

Never before, in a small tractor, such remarkable *versatility*, such built-in *power*. Whatever the job, whatever the season, Gravely turns in a *real* job with unbelievable *ease* and *speed* . . . All-Gear Drive, Power Reverse, Balanced-Weight Handling. Push-Button Starter optional.

- ALL-GEAR DRIVE
- POWER REVERSE
- Power Attachments Securely Mounted by Only 4 Bolts



SINCE 1922

New 24-page "Power vs Drudgery" Booklet shows how Gravely can solve *your* upkeep and gardening problems *better, faster, easier.* Mail coupon today!

EASY PAY PLAN

**GRAVELY TRACTORS, INC.**  
**BOX 363, DUNBAR, W. VA.**

Please send me "Power vs. Drudgery" Booklet and dealer's name.

Name \_\_\_\_\_  
Address \_\_\_\_\_  
City \_\_\_\_\_ Zone \_\_\_\_\_ State \_\_\_\_\_

WRITE TODAY

**FIELD-TESTED SINCE 1922**





**particular drivers, particularly,  
need Ajustomatic Shock Absorbers**

More and more owners of late-model, high-performance automobiles are demanding what only Gabriel Ajustomatic shock absorbers offer: • Freedom to choose soft, normal or firm ride—to suit your driving habits • A new experience in superior stability, control and roadability.

Gabriel Ajustomatics are standard (export) or optional (domestic) on *nine* different makes of U. S. cars in 1958. Thousands of late-model sports cars, station wagons and other automobiles in use today attest their value. If you are dissatisfied with the conventional controls supplied on your present car, switch over.

The Gabriel Co. • Cleveland 15, Ohio



**AJUSTOMATIC SHOCK ABSORBERS**

(Continued from page 228)

the manufacturers' directions. The colored enamels are more or less opaque and are quite effective in hiding ordinary defects. The dyes color the material without entirely hiding the characteristic texture and graining of the leather. It is very important that all surfaces of the upholstery be thoroughly cleaned before either of these refinishing materials is applied.

**Picture Spots Wall**

*Q — Recently, I moved several large pictures which had been hanging for some time in the same place. Dark spots of the exact size of the frames now appear on the wall. How can I remove these unsightly spots and prevent their recurrence?—S. H. Wash.*



**A**—As a rule, it is rather difficult to remove the spot entirely by ordinary means without damaging the wall or covering, as some wall coverings fade less behind the picture. However, most of the soiling is due to a lack of air circulation, which allows dust to collect back of the frame. If the walls are painted with a washable oil paint, a household paint cleaner will remove the grime and dust, making the spot less noticeable. Clean papered walls with a wallpaper cleaner. When hanging the picture, drive a tack at each lower corner of the frame, letting the head project from  $\frac{1}{8}$  to  $\frac{1}{4}$  in. The tacks hold the picture away from the wall, permitting air to circulate freely and preventing the accumulation of dust.

**ANSWERS TO "TRAFFIC QUIZ  
FOR BOATERS," PAGES 164-165**

1. Boats of all types while under way must keep clear of boats fishing. Already you are wrong for not giving the fishing vessel a wider berth. Also, you are on a collision course with the sailboat. Under virtually all conditions, a sailboat has right of way over a motorboat. Forget about the fried chicken. Head slowly off to starboard and give both vessels plenty of leeway as you pass.

2. The boat to starboard—your craft in this case—ordinarily has the right of way, but here a sailboat is involved. Does this alter the situation? Not this time, for the sailboat is under power with an outboard motor. In such a case, the sailboat becomes a powerboat. Thus you definitely have the right of way. However, you should stay alert, making certain the other skipper gives you your rights. Better to yield the right of way than collide!

3. Unquestionably you have the right of way despite the fact that the other craft is a sailboat. Vessels coming out of a slip have no rights until they are entirely clear of the slip or pier. You should proceed cautiously though. The skipper of the sailboat doesn't have the degree of control that you have in your powerboat.

4. The overtaken vessel has all the privileges and your vessel—the overtaking one—has none. That headland to starboard is an obstacle, as the boat ahead may run close to it, cutting you off if you pass to starboard. Better wait until you are in more open waters. In any event, when you plan to pass to starboard, sound one blast of your whistle or horn and wait for his signal of recognition before proceeding.

5. Strictly speaking, you have the right of way and the towboat can't pass until you yield. In this case, common sense should prevail over the rules of the road. That towboat is a lot bigger than your craft. As a matter of courtesy, a boat with an unwieldy tow should be given the right of way. At the first opportunity, let the towboat pass.



# AMAZING NEW KIND OF POWER SAW

Reciprocating blade works back and forth like a handsaw — 166 power-strokes a second!

Only the blade moves!  
**NO WHIPPIN'  
KICKIN' CHAIN!**



## WRIGHT REBEL

**WORLD'S SAFEST  
POWER SAW!**

**USE IT FOR DOZENS  
OF DIFFERENT JOBS!**



Follow a chalkline without "wandering." You guide it and relax because the Wright Rebel feeds itself! Leaves a smooth mill-edge finish—the only power saw that does true precision-cutting!



Women or youngsters can do it! Neither strength nor skill is required to handle the lightweight, super-safe Wright Rebel. Smooth, self-feeding cutting action—with no whip, kick or grab!



Improve your property! Build a rustic fence; bridge a ravine; clear out shrubs and undergrowth; trim hedgerows; build a play house or garden "tea house." It's easy—and fun—with a Wright Rebel!

Totally *different* from any other gasoline-powered saw you've ever seen! Works on entirely different principle: reciprocating blade, *NO CHAIN!* So *SAFE*, so *EASY* to use for *EVERY* kind of outdoor sawing job—for farmers, hobbyists, outdoorsmen, nurserymen, orchard owners, right-of-way and park maintenance, pulpwood operators, etc. Drops trees up to 20" with a single cut—yet follows a chalkline and leaves a smooth mill-edge, for precision cutting. Costs less to operate and maintain. *Pays for itself* in just a few jobs!

**\$189<sup>50</sup>**

Includes 20" blade  
F.O.B. Sheboygan, Wis.  
Price applies in U.S. only  
Dealerships available!

**No other Power Saw does so MANY jobs!**

- Fells
- Limbs
- Bucks
- Undercuts
- Prunes
- Clears land
- Precision-cuts
- Leaves Mill-edge
- World's SAFEST Power Saw!

**THOMAS INDUSTRIES INC.**

**POWER SAW DIVISION**

Executive Offices: 410 S. Third St., Louisville 2, Ky.

THOMAS INDUSTRIES INC. products: Moe Light and Star Light lighting fixtures...Wright power saws...Radiant opal glass... Ideal bathroom cabinets... Electric Sprayit paint spraying equipment

**FREE DEMONSTRATION**

See your local Wright Saw Dealer!

Send 10c for illustrated "Easy Steps to Woodcutting" booklet—shows dozens of do-it-yourself projects for fun and profit!

**MAIL THIS COUPON TODAY!**

Thomas Industries Inc., Power Saw Division  
410 S. Third St., Louisville 2, Ky., Dept. 67-C

- I enclose 10c for handling and mailing illustrated "Easy Steps to Woodcutting" booklet—and full facts about the NEW Wright Rebel power saw.
- I am interested in becoming a dealer.

Name \_\_\_\_\_

Address \_\_\_\_\_

City \_\_\_\_\_ Zone \_\_\_\_\_ State \_\_\_\_\_





# SET YOUR SIGHTS ON THE SAVAGE 340

It's always "open season" with the Savage 340 . . . chambered for 2 great varmint cartridges and America's most popular deer caliber. Stock has medium-high comb and trim lines for steady handling, fine balance and streamlined appearance.

This rugged bolt action repeating rifle has a ramp front sight and rear sight with elevation adjustment . . . drilled and tapped for popular receiver sights and 'scope mounts. Available in 3 great calibers:

**.222 Remington 50 grain bullet**

The advanced design of the 340 brings out the ballistic potential of this high velocity, flat-shooting cartridge.

**.22 Hornet 45 grain bullet**

An economical cartridge that delivers peak accuracy in the Savage 340.

**.30-30, 150 and 170 grain bullets**

For more than 50 years it has proved its effectiveness on deer and medium-sized game.

The 340's exclusive head space control and specialized Savage manufacturing methods give you extreme accuracy at a price so low you can buy the 340 complete with 'scope for less than you might expect to pay for the rifle alone. See it at your dealer's now.

There is a complete line of Savage, Stevens and Fox shotguns and rifles for every shooter and every kind of shooting. Write for free rifle or shotgun catalog. Savage Arms Corp., Chicopee Falls 6, Mass.

\$57<sup>50</sup>

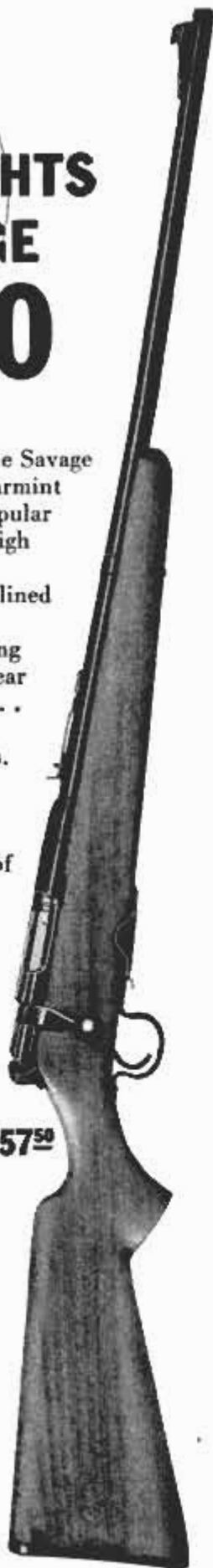

# Savage

TRADEMARK  
SAVAGE • STEVENS • FOX FIREARMS



ALL PRICES SUBJECT TO CHANGE . . . SLIGHTLY HIGHER IN CANADA

## More Power Lights "Darkest Africa"

(Continued from page 140)

per second in the event of a flood. The reservoir will be full by 1963.

Recent record floods of the Zambesi River seriously endangered the beginning of the project. The swollen river, carrying dead animals and huge trunks of trees with it, raced six feet above the 50-foot-high cofferdam in the narrow Kariba Gorge.

### Big Plans For Congo

The floods, fortunately, did little damage. The contractors removed everything that could be moved to a higher level, braced a vital road bridge with extra cables and piled 100 tons of steel girders on it to give it added stability while the Zambesi waters rose two inches per hour.

Farther north, in the Belgian Congo, blueprints are being drawn for the construction of another of the world's largest hydroelectric power plants at Inga, on the lower Congo River. The planners include Clarence E. Blee, chief engineer of the Tennessee Valley Authority. The Belgian Colonial Minister said this dam would give birth to an industrial complex which might well rival the Ruhr in Germany. This project would favor the birth of a series of new industries such as aluminum, ferro-alloys, the treatment of ores, paper and a plant for the separation of isotopes. The scheme is expected to cost about \$3,750,000,000 and take 30 years to complete.

### Ghana Needs Power For Smelting

Looking farther north to newly created Ghana, we see the investigations of yet another gigantic hydroelectric scheme, the Volta Project, in progress.

Primary object of the Volta River Project would be the production of about 210,000 tons of aluminum annually. To achieve this output, bauxite mines would have to be developed, a dam and power station would have to be built at Ajena, an aluminum smelter would have to be built, and new railway links between mines and smelters and coast considered.

In addition to these major projects, innumerable smaller hydroelectric schemes are constantly being built all over the continent from Egypt to the Cape of Good Hope. One may well wonder how long it will take Africa to catch up with the more developed areas of the world. At the present rate it should not take too long. Here, there and everywhere in Africa civilization reaches out to tame the wild rivers. And with each one tamed, it will advance on the road to a better life. ★★ ★





FROM **Aroma to Coffee**

640 MILES—31¢



***For less than 1/20th of a cent a mile, a new AC Oil Filter keeps oil clean, protects your engine!***

It's a fact . . . in the next 12 months, if you're an average driver, you'll travel over 15 times the distance from Aroma to Coffee for a total of 10,000 miles! The engine of your car will have to endure all driving extremes from hot to cold . . . crawling to cruising to climbing. All of these conditions can affect its performance and efficiency.

Your engine is the most vital unit of your car! That's why it's so important to give it the low-cost added protection of a new AC Oil Filter at least twice each year. An AC Oil Filter cleans all of the oil in the engine every 30 seconds at normal speeds . . . protects the precision parts from possible damage by dirt, dust, grit and bits of metal as small as 1/100,000th of an inch.

The next time you change the oil in your engine — change to a new AC Oil Filter, too! Your nearby AC Dealer will tell you how little it costs, how much it does for your engine.

Watch Walt Disney Studios' ZORRO every week on ABC-TV

AC  THE ELECTRONICS DIVISION OF GENERAL MOTORS



**CHANGE OIL AND FILTER, TOO!**



# 3 helpful booklets for home improvers specially priced at only 25¢

Regularly worth 85¢, these three booklets are packed with "here's how" instructions on how to add new value to your home and its furnishings.



**PROJECTS YOU CAN BUILD WITH WELDWOOD OLD CRAFTSMAN PINE PLYWOOD.** With this 96-page book and *Old Craftsman* you can make toys, furniture, home improvements, kitchen cabinets. 18 projects in all, with complete instructions, materials lists, detailed drawings. Special section tells you how to plane, nail, drill, saw, screw, sand, glue, bend, and finish *Old Craftsman Pine Plywood* for best results. Regular price, 50¢.



**FAMILY ROOMS IN BEAUTIFUL WELDWOOD**—100 interesting ideas for the room your family lives in. Brand-new 20-page booklet with full-color photographs shows how you can build fun-giving, space-giving luxury into your family-room with handsome Weldwood Paneling. All the essentials of a satisfactory family room are treated in this booklet. Regular price, 10¢.



**DO-IT-YOURSELF WITH WELDWOOD PLYWOOD.** This 40-page booklet, with photographs and detail drawings, shows you how to build room dividers, storage walls, jalousies, built-ins, even a full-sized basement playroom. Gives hints on how to make your job easier, what tools and materials you'll need. Regular price, 25¢.



## Weldwood® wood paneling

Adhesives • Firzite® • Plywood • Satinlac® • Flexible Wood-Trim®

### SPECIAL OFFER COUPON!

United States Plywood Corp., Box 61, N. Y. 46, N. Y.

Please send me your combination offer of three idea and plans books, described above, worth 85¢, at special price. Enclosed find 25¢. PM-3-58

Name.....

Street.....

City..... Zone..... State.....

## Cruising Down the River

(Continued from page 163)

greatest danger on the lower river. If a boat were to be swept beneath a tow its occupants would be carried under at least an acre of barges before they could even hope to come up for air.

We found the Mississippi a much easier river than the Missouri on which to drift. The Missouri's narrow width and snarl of whiplash currents, when combined with the limited control that oars give, make the river a dangerous one. A shantyboater isn't able to haul a boat clear after trouble develops; he has to anticipate trouble before it occurs. The Mississippi's sheer size—its width of more than half a mile contrasts with the 600-foot width of the Missouri at my home—enabled us to ride out in the stream and escape shore hazards. At the same time control was easier because of the Mississippi's fat laziness of current.

### Camping on Sandbars

Against this was arrayed the parade of the towboats, which on the Missouri are a comparative rarity. Had we not swung the shantyboat to take bow on the wake of every passing tow, I think we might have been capsized. Towboats presented a problem at night, as their wakes banged us against the shore to which we were tied.

Although our two extra guests were easily absorbed without crowding, they did overrun our sleeping capacity of four. This caused no hardship. Each evening we headed for a sandbar, motoring in as far as possible, then rowing until the oars dragged bottom. Then over the side we went, wading in with the boat until we found a tiny cove that would give a measure of protection from wave wash of the towboat. Mississippi River sandbars are beautiful, clean with hard-packed sand, and airy in their vastness. There, as the sun went down behind the distant cottonwoods, we would eat our evening meal around a driftwood fire—and water-leached driftwood has a perfume all its own. Two persons had to sleep on shore, and the beach was the preferred spot. The soft warmth of air mattresses and sleeping bags was luxurious, while the open expanse usually caught enough breeze to keep off the mosquitoes. It was wonderful to lie there, watching the stars against the black velvet of the sky while the dying embers of the fire glowed and the tiny lapping of the wavelets close at hand invited sleep.

At Cairo we turned from the Mississippi and began our 44-mile crawl up the wonderfully clear Ohio. Our speed, which had

(Continued to page 236)



# Why Magna?

— Because MAGNA's new, complete family of superior power tools incorporates the first significant design contributions in over a quarter-century!

**HERE'S WHY THE MAGNA 18-IN. JIGSAW** gives you more features than any other jigsaw: • *New Ease of Operation* — exclusive swing-down arm quickly converts jigsaw to saber saw; built-in blower keeps cutting-line free of sawdust! • *Increased Capacity* — chucks and guides pivot 90° for side or front sawing; big 11" x 11" tilting table! • *Integral Precision* — adjustable blade guides for correct blade-width and thickness! • *Rugged Durability* — ball-bearing shaft and continuous oil-bath permit speeds to 2500 rpm! Basic Jigsaw only \$58.50 delivered. (MAGNA 12½" Jigsaw only \$27.88 delivered.) Mail coupon now for full specifications in *free* Magna-Line catalog.

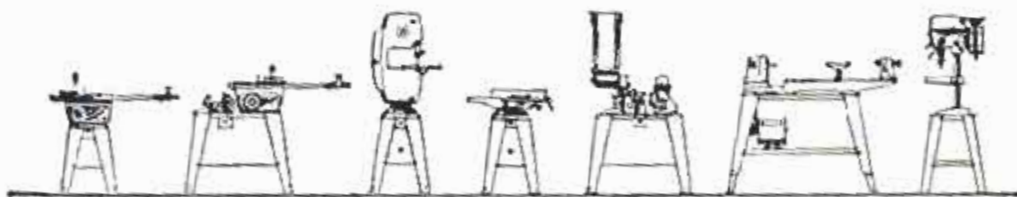

MAGNA-LINE tools for home and industry include (l to r): 9" Saw, 9" Saw-Jointer, 11" Band Saw, 4" Jointer, 6" Belt Sander, Compressor-Sprayer, 30" Lathe, 12½" Drill Press. (Also the new MAGNA Thrifty-Three: 8" T/A Saw, 12½" Jigsaw, 4" Belt Sander).



MAGNA POWER TOOL CORPORATION  
*World's largest independent  
producers of power tools*

MAGNA POWER TOOL CORPORATION  
Dept. 704-M, Menlo Park, California, OR  
Dept. 704-M, Box 2808 Fort Wayne, Indiana

Please send me your free, illustrated MAGNA-LINE catalog:

Name \_\_\_\_\_

Address \_\_\_\_\_

City \_\_\_\_\_ Zone \_\_\_\_\_ State \_\_\_\_\_

® T. M. REG.



Be sure  
it's a genuine  
**CHANNELLOCK**

Only Channellock has this reinforced edge for greater strength.

Only Channellock has undercut interlocking non-slip channels.

LOOK FOR THIS TRADE MARK

Why? Only Channellock has undercut, interlocking channels that can't slip no matter how tight you grip. Only Channellock has the reinforced tension edge to withstand maximum gripping force. These exclusive features have made the Channellock No. 420 the first choice of skilled mechanics everywhere. So be sure you get only genuine Channellock pliers. Look for the trademark on the handle.

ASK YOUR TOOL SUPPLIER FOR CHANNELLOCK PLIERS — BY NAME

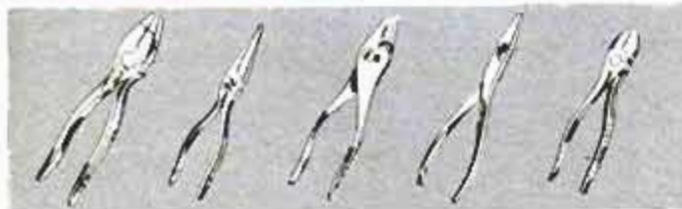

**CHAMPION DeARMENT TOOL COMPANY**  
MEADVILLE, PENNSYLVANIA

ranged between seven and eight miles per hour on the Mississippi, abruptly dropped to between three and four miles per hour. Slow as this was, we were fortunate in being able to ascend the river at all. The Ohio is a succession of dams with ingeniously designed sections that are hinged so that they can be raised or lowered. In time of high water they are folded down on the bottom and the Ohio becomes an open river with a current that would have been too swift for us to buck. Fortunately, we arrived at a time of low water when the dams, which deepen the river to navigable depth, created a stairstep succession of pools all the way to Paducah, Ky.

At Dam 53, located above Mound City, Ill., we approached our first lock with some trepidation. One problem was the fact that our boat has neither remote throttle nor reverse controls; when maneuvering is required, John's station is at the wheel while I stand at the stern to operate the motor.

### Moving Through the Locks

Actually, it was easy. We took the boat to a spot outside the lock walls and waited for a tow to clear. When the tow moved out and the green light beckoned us in. John did a nice job of piloting. He had to take the boat through the wake thrown up by the departing towboat, meanwhile navigating the narrow opening left when employees closed one of the two gates. He did it deftly and brought the boat to a halt within inches of the mooring bitt. There was no condescension in the tone of a lock employe, amused by the age of our 11-year-old pilot but impressed by his performance, as he addressed John as "captain." The experience was so smooth that our chief reaction was one of being overwhelmed by all the men and machinery working—without charge—to fill a chamber 600 feet long and 110 feet wide for the benefit of as inconsequential a craft as ours.

Though the trip up the Ohio was slow, we found it a delight. At night we gravitated to the Kentucky side which, guarded by a broad band of swamp and bottom jungle, is almost wilderness. We didn't realize how completely alone we had been until, at one landing spot, we found footprints in the sand. Somehow the evidence that another human being had been there snapped the spell and made the place less desirable.

### Our Gas-Station Guides

When we needed gas, as we did frequently in the tussle with the river, we of necessity headed for the towns along the Illinois shore. Each landing brought a covey of fishermen's children bursting out

(Continued to page 238)





# Sealed Power's NEW STAINLESS STEEL OIL RING

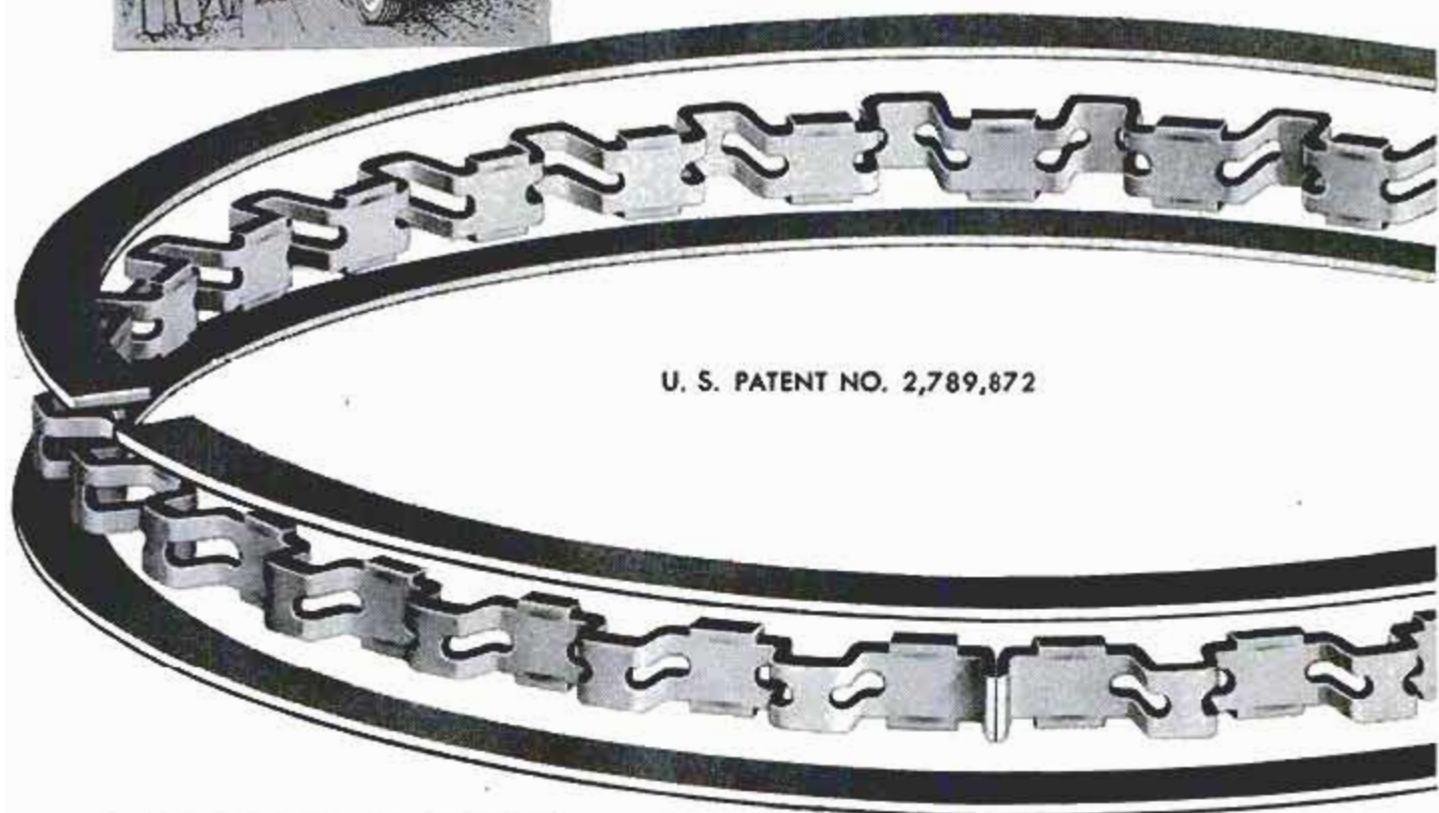

U. S. PATENT NO. 2,789,872



## WAS PROVED AND APPROVED AROUND THE WORLD WITH **FORD**

Deserts—mountains—rutted roads—sandy trails—heat—cold—great cities—tiny villages—through all these around the globe, the 1958 Ford was tested—and came through with flying colors.

Also triumphant in the Ford engine were new stainless steel oil rings and associated compression rings by Sealed Power—setting their own records for performance, reliability and economy—the SEALED POWER SS-50U does things no other ring can do.

**SEALED POWER CORPORATION**  
MUSKEGON, MICHIGAN



of the brush to greet us. Invariably they accompanied us into town to guide us to the gas station, the grocery and the ice plant. Their chatter was as artlessly pleasing as was their gratitude when we rewarded them with a soda—along the Southern rivers a soft drink inevitably is a “sody.” Always they addressed me as “sir” and my wife as “ma’am.” The river is an oasis of juvenile good manners.

At Paducah we turned into the Tennessee and picked our way through the congestion of the busy waterfront for the last 22-mile run upstream.

### Tailing a Towboat

When Kentucky Dam came into sight, it loomed up impressively. Lowermost of the 21 TVA dams, its lock is one of the tallest single lift locks in the world, just as its 184-mile-long lake is one of the biggest manmade bodies of water.

I left the boat and went up above to scout out the lock and lake. The lake, its boundary lost against the horizon, was calm in the afternoon sun; I could foresee no difficulty in traveling the three miles to where, the Coast Guard light list told us, a safety harbor lay.

At 5:30 P.M. we moved into position to enter the lock. At 9 o'clock on a moonless night we were still there. While we waited, a bustle of big commercial tows materialized to monopolize the lock. Finally the *Louise* of Louisville, upbound with four barges of coal, entered. We tailed it in.

The first time through such a lock, especially at night, is frightening. In the blackness of the lock's depths, we couldn't tell where the gates left off and the lock wall began. With visions of being caught by the gates, each as tall as an eight-story building, we snuggled alongside the *Louise* and made fast. We looked back to see the gates inching shut to commit us irrevocably to the lock. I think the gates of Hades, when they close, must look like Kentucky's. The water under us began boiling as it poured into the chamber. The *Louise* put its props in motion to ease the strain on its hawsers, and the wake added to the turbulence to bang us around. The roar of the boat's diesels reverberated deafeningly in the concrete chamber. Looking upward was like looking out of a deep well; the faces of tourists peering at us over the rim of the lock were so far away they appeared as indistinct patches of white.

### A Fast Run for Shore

The ordeal took an hour before we completed rising and the upper gates opened. The pilot of the *Louise* held his boat fast

for us to make our way out. We inched down the corridor, with only a dozen feet of clearance between the barges and the lock wall. As we came into the open we heard the roar of motors behind us as the *Louise* began moving ahead.

We came out on the lake to find that, while we had been waiting, a wind had come up. The lake was running a sea with three-foot waves that threatened to roll us if we tried to traverse the three miles to the harbor. We had to reach shore—and fast.

John held the boat straight until it cleared the last of the training piers that guard the lock, and then swung it at right angles toward shore. The pilot of the *Louise* sensed our difficulty. He turned his searchlight on and laid it ahead of us in a warning. Squarely across our path, barring the shore, was a gravel reef. We changed course and the pilot shifted his light and pinpointed a spot on shore. We followed the light in, pitching so that the prop came up into the air with a wild whir at each wave, and ended up against a little spit of gravel and rock that gave us a measure of protection against the waves.

### Came the Dawn

We sparred the boat off and, dog tired, went to sleep. At 3:45 in the morning, Dorothy shook me awake. The wind had shifted to put the waves broadside to the boat. The craft was grinding on the rocks with a violence that threatened to chew out the bottom in minutes. We got out sounding poles and held it off, hoping daylight would bring an easing of the storm.

Dawn, with the sky heavily overcast, was slow—terribly slow—in coming. When it did and we could see, we felt a little foolish.

Not 50 yards away, a haven of quiet water, was a pleasure-boat harbor.

### Store Boat for Next Summer

We moved into the harbor and tumbled into the bunks. Later, with time running out, we arranged to store the boat until next year, and another chapter of shanty-boat travel. Our craft, beaten and stained by travel on five rivers, stood in sharp contrast to the gleaming sleekness of the white and chrome cruisers moored in the harbor. As we worked to strip down and button up the boat for storage, we thought we detected amusement in some of the glances sent our way.

If so, we could return them levelly. We had experienced the sweep of the river and the vastness of the night sky. For three weeks we had moved in serenity. We felt renewed and calm and strong. We were rich. All they had was money. ★ ★ ★



# Modernize your kitchen electrically

for less than

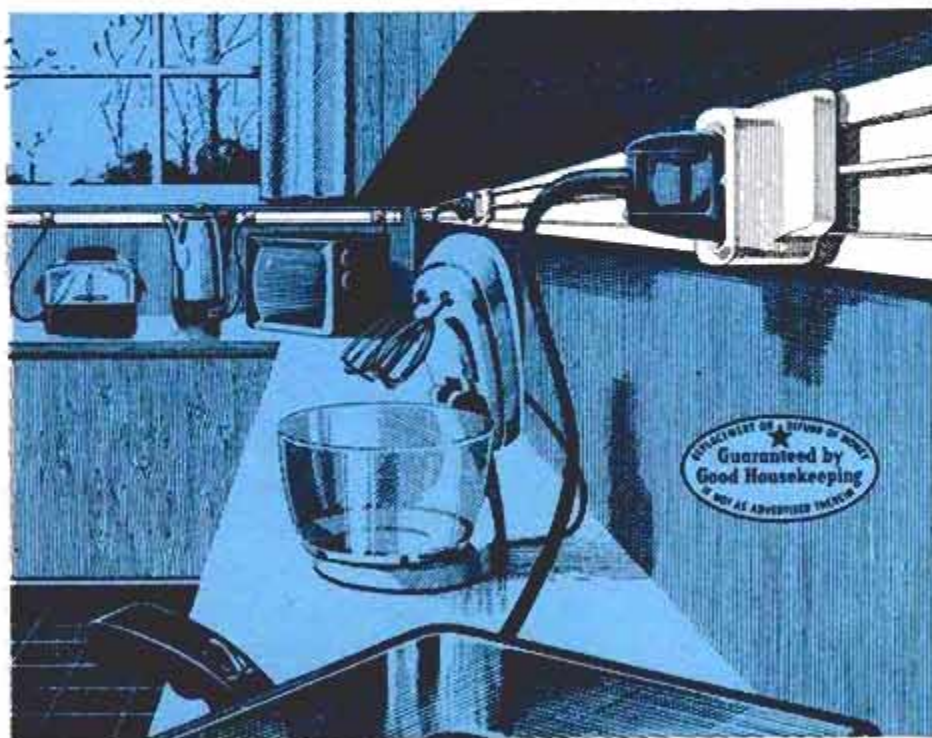

## Twist in outlets anywhere!

Install Electrostrip. It's the easy, *inexpensive* way to bring electrical efficiency and convenience to your kitchen. Electric outlets twist into the strip at any spot—*exactly* where you need them for mixers, blenders, appliances. Electrostrip is ideal in other rooms, too . . . lets you move outlets as you rearrange furniture, lamps and TV.

Available now in a new "do-it-yourself" kit, Electrostrip installs quickly. No breaking into plaster. No complicated connections. It's simple . . . safe . . . listed by Underwriters' Laboratories. Get this flexible outlet system from your hardware or building supply store. BullDog Electric Products Co., Detroit 32, Michigan. In Canada, Toronto 15, Ontario.

© BEPCO

Look for the colorful kit: 15 feet of strip, 4 outlets and fittings with detailed and easy-to-follow installation instructions—complete for only \$9.95. You'll enjoy full HOUSEPOWER with Electrostrip.



# Electrostrip

Made by BullDog Electric Products Co.,  
a division of I-T-E Circuit Breaker Co.

PATENTED

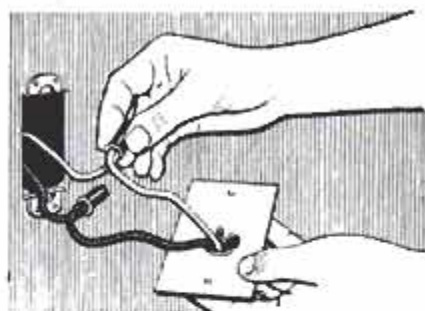

1 Make connection



2 Remove old outlet strip



3 Bend at corners



4 Affix end cap

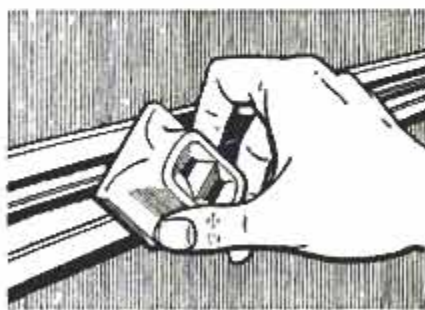

5 Twist in outlets



here's why  
**Master Padlocks**  
 are the WORLD'S  
**STRONGEST**

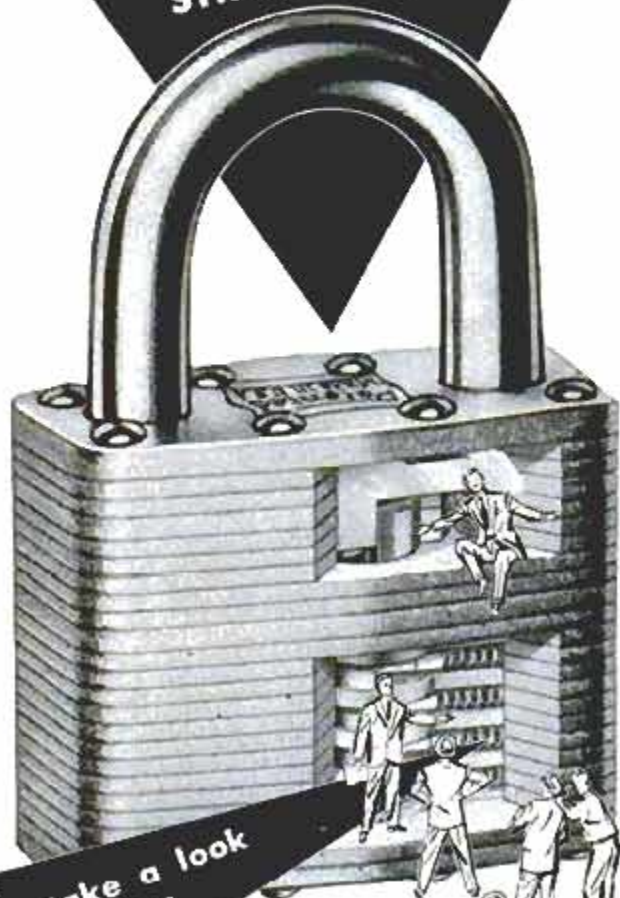

- Laminated steel case for maximum strength!
- Genuine pin tumbler security!
- Precision-built patented features!
- Available keyed-alike for all your padlock needs!

The best padlock protection you can buy for your property and valuables comes in a laminated steel case with a pin tumbler mechanism — and that's MASTER Padlocks, proved the world's strongest, the world over!

\$1.25 to \$4.00, in a variety of sizes, at hardware stores and locksmiths everywhere!



MASTER LOCK CO., Milwaukee 45, Wis.  
 World's Largest Padlock Manufacturers

## Seagoing Sleuths Probe The Mystery of the Red Tide

(Continued from page 132)

which are inserted in the specially designed quick freezer. In 10 minutes they are frozen solid. Samples to be examined at Naples are put in glass flasks but are not frozen.

The portable quick freezer is the brain child of necessity and the ingenuity of Joe Bell, veteran biologist-oceanographer in charge of the field station.

The quick freezer, built of marine plywood and powered by a ½-horsepower motor which takes the temperature down to a minus 10 degrees, will hold a maximum of 500 vials, normal production for a three-day sampling run and, if electricity should fail, will maintain the temperature for 24 hours as a result of special insulation.

### Look at Samples Under Scope

At Naples, the samples are examined under a microscope for a micro-organism, *Gymnodinium brevis*, which studies have shown to be the cause of the red tide. Actually the red tide is neither red nor a tide, but results when the brevis, which are always present and normally inoffensive, reach a concentration of 500,000 per quart of water. Then fish die in a matter of minutes.

Isolating the cause of the fish kill has been the first step in the continuing study. Now the investigation is concentrating upon determining what causes the brevis to attain killing concentrations, and how to break up such concentrations before thousands of fish litter the sea and turn beaches into foul-smelling strips of sand, endangering the tourist trade as well as commercial fishing.

### Red Is Greenish-Yellow

Research reveals that the Florida red tide—which is not red since the brevis actually are greenish-yellow in color—has occurred at infrequent intervals for many years. Extreme concentrations of the brevis can cause a reddish reflection from the sun's rays, hence the popular red label.

In the governmental archives, the red-tide detectives found one report of such a kill in the vicinity of Fort Jefferson—the island fortress on Dry Tortugas—in 1878. So bad was the outbreak that the garrison commander had to detail squads of soldiers to bury the dead fish washed ashore. A study of the logs of fishing boats reveals other outbreaks as far back as 1844.

Impetus to the present investigation was supplied by serious outbreaks in 1946 and

(Continued to page 242)



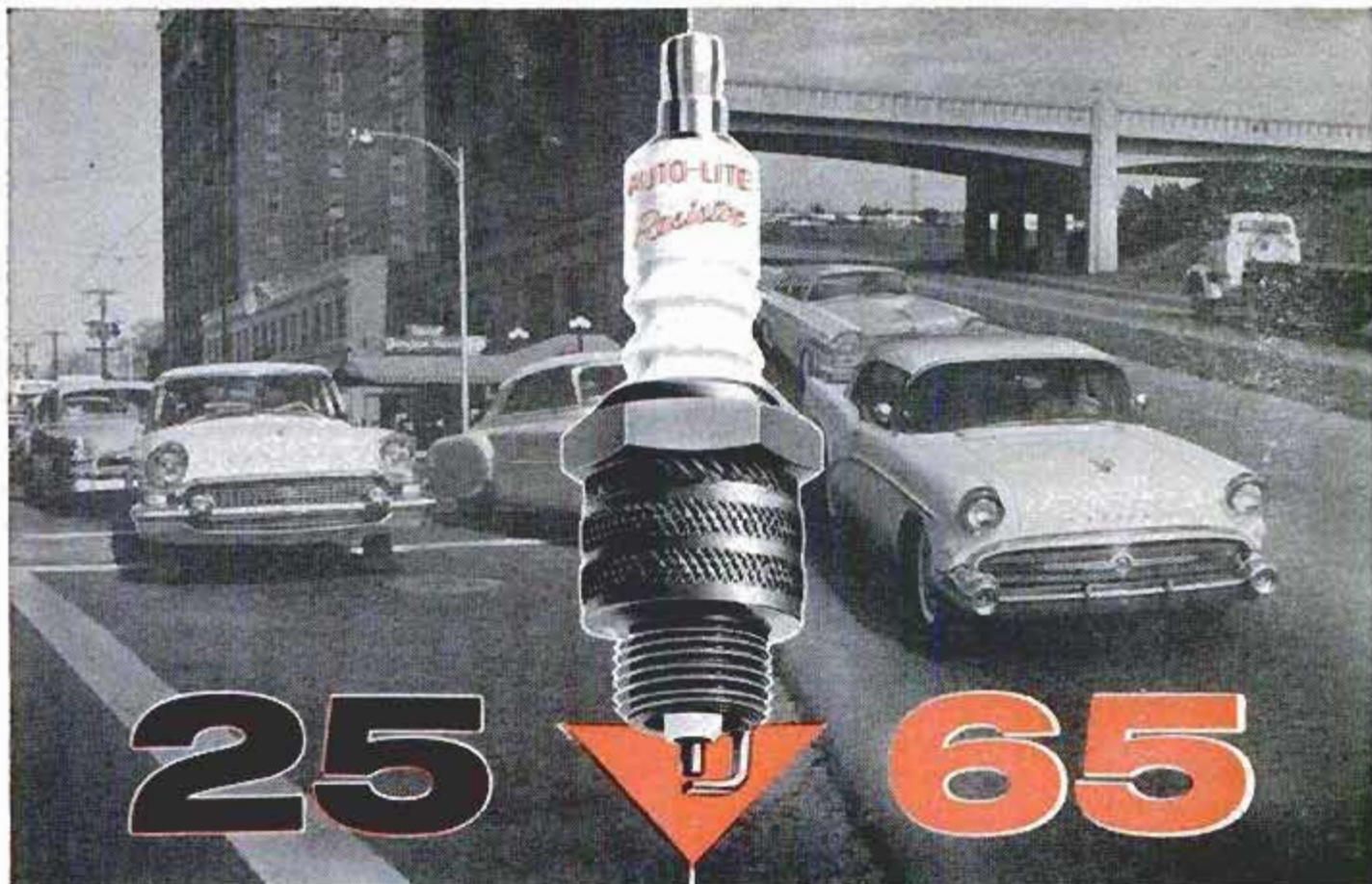

**IN TOWN TRAFFIC . . .** some spark plugs, designed for high speeds, become fouled and cause misfiring and loss of power when driven at low speeds.

**ON THE HIGHWAY . . .** some spark plugs, designed for low speeds, misfire causing power loss and invite destructive pre-ignition when driven at high speeds. Why gamble when . . .

## Auto-Lite Resistor Spark Plugs with **POWER TIP** "Fire Up" your engine\* at all speeds!



If you drive at both town-traffic and highway speeds, here's why you should use Power Tip . . . the first spark plug ignition-engineered for today's engines and today's driving.

YOU CAN SEE  
 THE BIG NEW  
 DIFFERENCE IN  
 SPARK PLUGS!



Ordinary Tip      Power Tip

At low speeds, the projecting Power Tip is in the thick of combustion where it gets hot quicker and stays hot to burn fouling deposits away *clean*. At higher speeds, the projecting tip is in the path of the incoming air-fuel mixture where it stays cool to *check* power-robbing pre-ignition. Ask your garage or service station to install Auto-Lite . . . the *only* spark plugs with Power Tip . . . and start enjoying top performance and economy from your car at *all speeds*.

\*Power Tip, with or without Resistor, is ignition-engineered for overhead-valve V-8 engines and for most overhead-valve 6-cylinder engines in all these cars—Buick, Cadillac, Chevrolet, Chrysler, De Soto, Dodge, Edsel, Ford, Hudson, Imperial, Lincoln, Mercury, Oldsmobile, Nash, Packard, Plymouth, Pontiac, Rambler, Studebaker.

Power Tip protrudes farther into the combustion chamber for better ignition. Fuel burns more evenly and completely to give top performance and economy at *all speeds*.

# AUTO-LITE RESISTOR SPARK PLUGS WITH **POWER TIP**

Auto-Lite makes a complete line of spark plugs, including Standard, Resistor, Small-Engine, Transport, Aircraft, and Diesel-Starting.



1947, when thousands of dead fish were observed floating at sea and washing ashore. Local, state and Federal agencies pooled their resources and established a systematic program to solve the red tide. Another serious outbreak occurred in 1953-54.

Slowly and painstakingly a huge amount of data concerning rainfall at sea and inland, water temperatures and conditions, tides and the intensity of the sun's rays is being collected and tabulated—all aimed at establishing a picture of conditions necessary for a red tide to form.

### Study the Tides, Too

And in such investigations, the *Kingfish* plays a vital role in addition to gathering water samples. Ascertaining the exact tidal and current movements along the coast has been one of the most perplexing problems and has caused the development of special instruments.

The *Kingfish's* radar is used to track specially made floats, so designed that they will move with the tides and currents, yet will be relatively immune to surface winds.

The cruiser is used to track these floats for specific surveys. Three of the floats are placed overboard and their movements plotted every hour by radar during a 24-hour period, thus providing the scientists

with a comprehensive record of the tides and currents in a given area.

Tracking the floats proved to be more difficult than first anticipated. The metal pole proved too small to give a good radar reading, and various devices were tried to improve the radar reception. Every scheme failed until Joe Bell thought of utilizing Christmas foil. This tinsel attached to the floats' masts proved the answer.

Other information collected by the *Kingfish* includes data on the salinity and the acidity of the water.

From laboratory experiments the scientific detectives have ascertained that the brevis will die when subjected to a small quantity of powdered copper sulphate. They feel this may be the answer to checking the red tide, but cannot be certain until a large-scale experiment can be conducted. ★ ★ ★

### Bombers to Use Chemical Fuels Now in Design Stage

Two aircraft manufacturers—North American Aviation and Boeing—are understood to be competitively designing a "heavy" bomber that will be powered by a chemical fuel such as boron, lithium, hydrogen peroxide and fluorine compounds, instead of petroleum.

## Smoothest motorcycle ever!

# NEW

## HARLEY-DAVIDSON

# DUO-GLIDE



**DUO-GLIDE —**  
absolutely the  
finest motorcycle  
ever built.

**FOR A NEW CONCEPT OF POWER AND RIDING COMFORT** swing aboard the DUO-GLIDE. Sleek and powerful, it's an engineering masterpiece.

New swinging-arm rear suspension coupled with Hydra-Glide front fork and spring-loaded seat post provides unexcelled comfort. Hydraulic rear brake is another Harley-Davidson exclusive. Loaded with other new features too!

Solo or with a buddy, you get a miracle ride on the DUO-GLIDE. Ask your dealer for a test ride and about his liberal trade-in deals, convenient new terms. Or write for free literature.

## HARLEY-DAVIDSON MOTOR CO.

Dept. P, Milwaukee 1, Wisconsin



you'll get  
more jobs done—  
and done better—  
with a



## PORTER-CABLE ROUTER

The Porter-Cable Router is one of the most useful woodworking tools you can own. With it you can do all these jobs: make decorative edges on table tops, bookcases and shelving; cut outlines for inlay jobs; grooves and rabbets for cabinet work; mortises for door hinges; circles and ovals—all with perfectly smooth edges and much more.

Illustrated here is the famous Porter-Cable

Router #100, now with full  $\frac{7}{8}$  h.p. It is quality built with a non-marking base, precision ball bearings and high-speed, interchangeable motor for Power Plane and Shaper. An outstanding value at only \$57.50. Model #162  $\frac{1}{2}$  h.p. Router, \$49.50.

See these new professional quality tools at your Porter-Cable dealer today or write for full information.



### ROUTER BIT KIT

Contains everything you'll need for hundreds of basic Router applications and jobs. Three high-speed bits and sharpening wheel come in hinged transparent case.

No. PR-138Y Bit kit. . . only \$9.95.

### PORTER-CABLE MACHINE CO.

8143 Marcellus Street  
Syracuse 4, New York

Saws, Drills, Sanders,  
Routers, Shapers, Planes.

**Porter-Cable**

*Quality Power Tools*

In Canada, write Porter-Cable Ltd., Box 5019, London, Ont. Canadian Prices Slightly Higher.



*It's like employing  
your own personal mechanic  
to keep your engine  
always at its best*



The superior lubricating qualities of Kendall SuperB mean less wear, less need of repair. Oil and gas mileage go up. Noise level goes down. Driving is more economical, more enjoyable with this All-Weather SAE 10W-30 oil refined from 100% Bradford Pennsylvania Crude Oil—richest in the world.

Ask your favorite dealer  
for it now

**KENDALL REFINING COMPANY**  
BRADFORD, PENNA.

## Do Motorboats Scare Fish?

(Continued from page 169)

Pull on a pair of waders and get ready to see more fish in a few minutes than you ever dreamed were there. We are going to use an electrical shocker to stun the fish. The stunned fish can be looked at in hand and then returned to the water. They'll recover in a few minutes and swim away. Here's how we do it. In a boat behind us we float a gasoline-engine electrical generator. Each of us holds a wire-mesh electrode mounted on the end of a rake handle. One electrode is positive, the other negative. Fish are stunned in the field between the submerged electrodes and we dip them up with landing nets as they surface during our walk upstream. With the generator whirring at 4500 revolutions per minute in the boat, we soon have a bushel of fish in our nets. All are taken despite the loud sound of the generator and the splashing and other noise we ourselves make as we move upstream.

### Can Fish Hear?

Can a fish hear the racket we made? Certainly — because fundamental hearing parts like those of the human ear are well developed in fish, too. Why didn't the fish scoot away? Why could we shock them within a few feet of our feet? Simply because the noise didn't scare them away.

Now we can go to a lake, carry the shocker in a powerboat, suspend electrodes about eight feet ahead of the bow, motor slowly along, and pick up the temporarily shocked fish. Here we add the noise of an outboard to the whir of the generator. Together, they certainly sound louder than the outboard alone.

### Noise Audible for a Mile

Want to get an idea of what a fish hears when a powerboat goes by? We'll jump into four feet of water off the end of our dock and let my son speed away from us with a 35-horsepower outboard. A loud singing sizzle will gradually fade to a whisper. The whisper will still be audible when he has gone nearly a mile away. Both propeller and underwater exhaust contribute to the sound we hear.

And while we were making this observation, with all its commotion, the neighbor kids on a dock not 20 feet away kept right on catching crappies, bluegills, pumpkin seeds and rock bass! This lack of fear of engine sounds has been witnessed on many occasions. The fish keep right on biting. Scientists working under water with diving gear have been amazed at the lack of

(Continued to page 246)



# NOW...

## Hang Fixtures Securely On Hollow-Core Flush Doors!

### MOLLY

# JACK NUT

At last you can hang mirrors, racks, shelves, kickplates, etc., securely on wood or metal hollow-core flush doors. Only  $\frac{3}{8}$ " expansion space required. And the weight Jack Nuts will hold is limited only by the strength of the door.

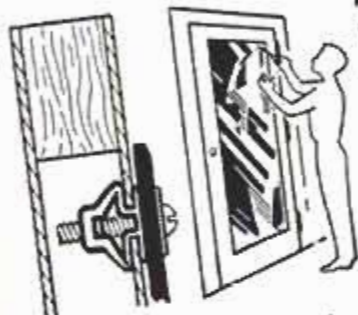

Ask Your Hardware Man for Molly JACK NUTS

WRITE FOR FREE LITERATURE



**MOLLY**  
CORP. • READING, PA.



ACTUAL  
SIZE OF 45



WORKS IN EXPANSION  
SPACE AS SMALL AS  $\frac{3}{8}$ "

...gives permanent anchorage, cannot pull through. Fixtures can be removed and replaced in same nut. Neat in appearance. Will not disfigure door or mar finish. Jack Nuts grip any material from 0" to  $\frac{3}{4}$ " thick. As easy to install as A-B-C:



**A**  
DRILL HOLE AND  
INSERT JACK NUT.



**B**  
RUN IN SCREW UNTIL  
IT TURNS FAIRLY HARD.



**C**  
FIXTURE CAN BE  
REMOVED AND REPLACED  
IN SAME NUT.

- Only  $\frac{1}{2}$  the size of the next smallest hollow wall fastener on the market.
- By the makers of famous Molly Screw Anchors.



## NEW WAY TO CUT PERFECT GROOVES WITH CIRCLE SAW!

Just dial any of 40 cuts. Parallel, clean, no sanding! Leave on saw for regular cuts. For  $\frac{1}{2}$ ,  $\frac{3}{8}$ ,  $\frac{3}{4}$  and 1" arbors. At dealer's or order direct!

Only  
**\$4.95**  
per set

Send for free booklet

**WARREN DADO WASHERS CO.**

Dept. #23 P.O. Box 98, Detroit 2, Mich.

## EXCLUSIVE! PRE-ASSEMBLED KITS! FREE CATALOG... SEND TODAY!



Now! Pre-assembled kits save up to  $\frac{2}{3}$  assembly time. Send for Free Catalog Now! Cruisers, Runabouts, 12 NEW Models 12-18". Supermart selection of Fiberglass & Accessories.

# BOAT KITS INC.

1415 W. 92nd St., Dept. B-3 Bloomington 20, Minn.

America's Finest Cultivator  
at anywhere near its small price!

**Hummin'bird**  
**ROTO-HOE**

only  
**'109.50**  
complete



Now you can no longer afford to do hard spade and hoe work. This powerful (2½ h.p.) self-propelled tiller-cultivator makes gardening a pleasure! Has a beautiful self-propelled 22" twin-spindle rotary mower attachment you can hook on in seconds—for just \$44.50; and the Safe-Speed Edger for only \$27.50. Write today for free folder and nearest dealer's name.

**ROTO-HOE, Dept. P-19, Newbury, Ohio**

## PAINTING TIP NO. 42

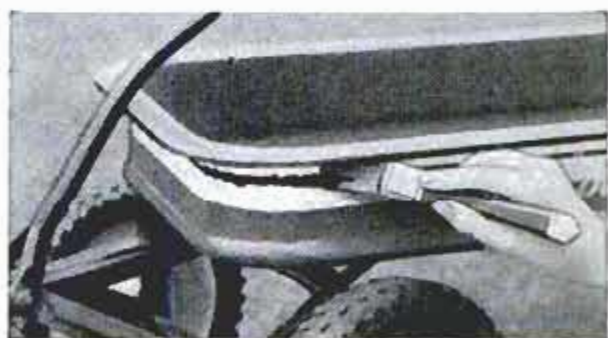

Make professional-looking stripes with "SCOTCH" Brand Masking Tape. Stretchy tape sticks tight, hugs curved surfaces. Paint will not bleed through. After paint has "set", "SCOTCH" Masking Tape strips off easily, leaving a clean, sharp edge. Makes painting quicker, neater with brush, roller or spray. Get "SCOTCH" Brand in the handy cutter-edge carton—35¢, 69¢, 98¢, \$1.69—wherever paint is sold.

Don't run short...  
**BETTER BUY TWO!**

Made by  
Minnesota Mining & Mfg. Co.  
St. Paul 6, Minn.  
© 3M Co., 1958





# Now! A lightweight chain saw for heavyweight cutting!



## New Black & Decker Chain Saw Attachment plus Black & Decker Saw brings you cleaner, faster, easier chain sawing!

Talk about versatility! With this new Black & Decker Chain Saw Attachment, you can buck, fell, limb, trim, notch quickly and easily! Quick, because this attachment is powered by the famous Black & Decker Saw motor. Easy, because it's so light.

And it's even more versatile because you can convert right back to a full-powered circular saw for dozens of other sawing jobs! Even if you only do occasional chain sawing, it will pay you to get this money-saving combination of a B&D Saw and Chain Saw Attachment. See your dealer now! The Black & Decker Mfg. Co., Dept. M-038, Towson 4, Md. (In Canada: P.O. Box 278, Brockville, Ont.)

### YOU CAN PURCHASE THE B&D CHAIN SAW ATTACHMENT:



**BY ITSELF** (for your present B&D #73 or #83 Saw)

Cast aluminum; teeth grip wood while cutting. Handles trees up to 18" diameter.

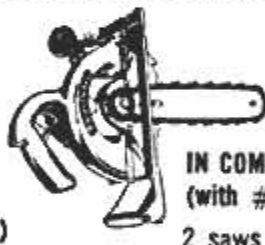

**IN COMBINATION** (with #73 Saw)

2 saws in 1, at attractive saving! Converts from saw to chain saw in minutes. Weighs 14½ lbs!

# Black & Decker®



World's Largest Maker of Electric Tools

Look under "Tools-Electric"

concern that fish show over surface sounds and motorboat noises.

Let's wigwag Karl, Jr., back to the dock and take a run with him. Now we swing out of the lake into the Huron River. Motorboat traffic picks up considerably. And there, on a river bend 50 feet from the traffic lane, is an anchored boat with two guys and a gal, still-fishing. They glower at us as our wash rocks their boat, but keep right on fishing. Two hours and a hundred boat-passes later, we stop to see if they've caught anything. The stringer comes up and on it are 37 of the nicest bluegills! The boats didn't put the fish down; the fish appear to have kept right on biting although they were never out of sound of a motor. If some were scared by the motors, it was not enough to keep our anglers from making a good catch.

### Use Motors for Trolling

Now let's get up early in the morning and troll for walleyes or for muskies. There was a day when we'd row to do this. But now we just throttle the engine down to a slow put-put-put and troll. The result: fine fishing. As a matter of fact, the only times that powerboats are not used for trolling is when trolling with power is too successful for the good of the fish stock. Only a few states have laws that prohibit the use of motors for trolling. The rest either have repealed them or never had them at all. Good and well-tried advice to fishermen is "when in doubt, troll."

On occasion, I take a short fishing holiday with my graduate students. One of them, now a fish scientist, used to be a guide in New England. He told me of a way that outboards are used to make fish bite. In some of the trout rivers of Maine, the guide will nose the motorboat into the bank and then race the engine in gear. This is a noisy procedure and churns up a great cloud of mud from the bottom. Then the boat is pushed off and trout are taken around the edge of the cloud!

### Outboard Helps Trout Fishing

On opening day of trout season one year, I fished the main stream of the Au Sable River in Michigan. Two fish doctors-to-be were with me. But even for experts, fishing was slow. Then a lad with an outboard ran up stream. "Good time to get out for a smoke," I said to my boys as I waded ashore. I'd no sooner lighted up than the boys each landed a trout. After the outboarding lad had gone upstream for the third time (after fishing back down), each time providing a little bump to the fishing, it dawned on me that here was something



that looked like a cause-and-effect relationship. This is slim evidence, I know, but the only brook and rainbow trout that we had for supper were taken in the few-minute intervals following each of the boy's upstream passes with his kicker.

Convinced by the foregoing that fish are not scared away by motor sounds, we wondered whether or not the noise would keep the fish from biting. With funds from the Outboard Boating Club of America, my colleague, Dr. Hazzard, and I hired a team of fishermen and a motorboat operator for an experiment. We found a 40-acre lake with a good population of sunfish and went to work. Daily each of the three fishermen chose a fishing spot at random. He would anchor his boat there and fish for the day, rain or shine, windy or calm, hot or cold. Worms were used as bait and all fishing was still-fishing. On alternate days a five-horsepower outboard on a 12-foot rowboat rumbled by each fisherman every 15 minutes, all day long. There was no such disturbance on alternate days. No other motorboats were allowed on the lake during the experiment. At the end of 66 days, 33 of motor use and 33 without, the catch was essentially the same for both kinds of days. The three-man crew actually caught an average of  $\frac{1}{10}$  fish more per hour on nonmotor days than on motor-use ones! Statistical treatment of the data led to the conclusion that the observed difference was not significant, and by sheer chance could have been as great or greater in the opposite direction.

Thus there is no technical evidence at hand that would condemn motorboating from the fish-eye point of view. The real concern is with the relationship of the boater and the angler. Each wants to protect his sport. They can do it in a truly democratic manner by recognizing that each has his rights. Common courtesy and consideration by all concerned will save the sports of both. ★ ★ ★

### Weather Planes Fly World-Wide

Reconnaissance airplanes of the U. S. Air Force Weather Service fly 35,000 miles each day, for a total of more than 12 million miles per year, gathering weather data in vital areas throughout the world where it is not otherwise available.

### "Billion H-Bomb" Sun Flares

Major outbursts of the sun may release in 20 minutes energy equal to the explosion of a billion of the largest known hydrogen bombs, according to Prof. John A. Simpson of the Enrico Fermi Institute for Nuclear Studies, University of Chicago.

## NEW BLACK & DECKER $\frac{3}{4}$ H.P. HEAVY DUTY ROUTER GIVES YOU MORE

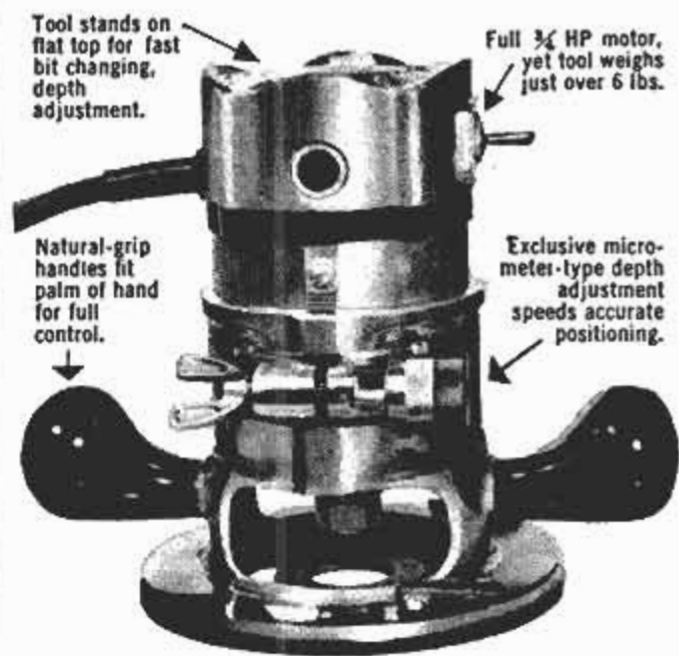

Tool stands on flat top for fast bit changing, depth adjustment.

Full  $\frac{3}{4}$  HP motor, yet tool weighs just over 6 lbs.

Natural-grip handles fit palm of hand for full control.

Exclusive micro-meter-type depth adjustment speeds accurate positioning.

A maximum of power packed into a minimum of weight! That's the new Black & Decker Router . . . one of the lightest, most compact units on the market! And it's loaded with special features for faster, easier, more precise work. This is the *complete* woodworking tool, perfect for beading, grooving, routing, fluting, etc. Compare the power and performance of the new Black & Decker Router with **Only** any other. Then compare price **\$59.50** and you'll be sold!

### ...and new B&D Router Kit!



B&D ROUTER KIT gives you Router, six popular bits, Straight and Circular Guide in handy metal kit for only \$88.00 . . . Save \$5.75.

WRITE TODAY for new B&D Router Manual—loaded with project ideas, illustrations, professional tips. Send only 50c with name and address to: The Black & Decker Mfg. Co., Dept. M-038, Towson 4, Md. (In Canada: P. O. Box 278, Brockville, Ont.)

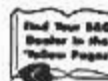

Look under "Tools-Electric"



# Black & Decker®

World's Largest Maker of Electric Tools



see the amazing new  
EASY-TO-BUILD ELECTRONIC  
**ALLIED knight-kits**

in **ALLIED'S 1958**

**ELECTRONIC SUPPLY CATALOG**

**FREE!**

**BUILD YOUR OWN!  
SAVE MONEY—HAVE FUN**



**404** value-packed pages



**HI-FI KITS**



**HOBBY KITS**



**INSTRUMENT KITS**



**HAM KITS**

**SAVE on Everything in Electronics**

**WORLD'S LARGEST STOCKS**

Everything for Experimenters, Builders, Amateurs, Servicemen, Engineers and Hi-Fi Hobbyists. Get more for your money in Hi-Fi systems and components; build-your-own KNIGHT-KITS; recorders and phono equipment; TV tubes, antennas, accessories; Amateur station equipment; test instruments; industrial electronic equipment—plus the world's largest stocks of parts, tubes, transistors, tools and books. Send today for your **FREE 1958 ALLIED Catalog!**

Everything in Electronics From One Reliable Source  
our 37th year **EASY TERMS AVAILABLE**

**ALLIED RADIO**

**ALLIED RADIO CORP., Dept. 24-C8  
100 N. Western Ave., Chicago 80, Ill.**

Rush **FREE 1958 ALLIED 404-Page Catalog**

Name \_\_\_\_\_

Address \_\_\_\_\_

City \_\_\_\_\_ Zone \_\_\_\_\_ State \_\_\_\_\_

send for  
**FREE  
Catalog**

## He Flies Kites for Love or Money

(Continued from page 86)

or boat crew and be seen for miles by searchers.

The bright-yellow cloth cylinder (nylon coated with rubber) stands eight feet high and is 3½ feet in diameter. Weighted at the open end, it traps air inside upon contact with the water's surface, then floats away gracefully before the breeze.

### Markers Could Bring Help

"In an emergency, or even should a vessel or airplane sight a floating hazard to navigation, such a marker could bring the Coast Guard quickly to the scene," Dom says. "All that the radio message to the searchers need tell would be the latitude and longitude where the marker was thrown over, the speed and direction of the surface wind. It will remain afloat for a month or more."

Circus performers and high divers place their lives in his hands when they ask him to design rubber tanks and other special equipment. He numbers among his clients Sol Solomon, acrobatic diver who has employed a Jalbert collapsible water tank made of nylon with Neoprene "welds." Only 15 feet in diameter and 7 feet deep, the tank safely stopped the daredevil aerialist's dive from 120 feet.

While the author was interviewing the inventor, a pair of California yachtsmen dropped in to inquire if Jalbert would design an ocean-racing sail which the wind could not rip. They'd already lost several sails made of three and four-ounce material.

### Designs Lightweight Sail

After studying their plans Dom startled the sportsmen by declaring he would build them a sail from one-ounce material that would have the strength of ordinary seven-ounce fabric. "What's more, if it rips you won't have to pay for it," he concluded.

Jalbert's latest invention deals with such wind-pressured cloth and promises to become one of his most important contributions. It is a "multicell" parachute, made of rip-stop nylon, and he has designed it in both circular and square form. These chutes are the first of their kind and are patented.

"They consist of many small chutes put together to form one big chute," he explains. "For the same weight in an ordinary parachute, this will carry 35 to 40 percent more load. And it will be about 40 percent safer, too. It will not rip, and it costs from 15 to 18 percent less to build than the conventional chute."

(Continued to page 250)



# ACCEPT NO IMITATIONS — BE SURE IT'S A

**KING O'LAWN**  
18" Homeowner  
Model Shown  
**\$149.50**

F.O.B. South Gate  
California

Total weight of  
power mower  
115 lbs.



**KING O'LAWN,**

1958 Model Briggs Stratton  
lightweight 4-cycle  
engines used.

Dual Automotive  
Clutch Control

Mows within 1/8"  
of wall, tree, etc.

All chain drive

This mower will  
give your lawn that  
golf-green carpet look.

That Forward Throw  
All cuttings are  
delivered forward.

**KING O'LAWN**  
Junior model  
power edger  
trimmer shown.

For edging and  
trimming along  
sidewalks, curbs  
and flower beds.

**\$79.50**

F.O.B. South Gate  
California

Total weight  
of power edger  
49 lbs.



Edges 5 feet  
per second  
and trims in  
the hard to  
get places.

Changes  
from edger  
to trimmer  
in just 3  
seconds

4 Models of Power Mowers and 4 Models of Power Edgers from which to choose.  
Over 2000 Dealers to serve you. A few choice dealer territories are still available. Please write

**KING O'LAWN Inc.**

P.O. BOX 1068 TWEEDY STATION  
SOUTH GATE, CALIFORNIA



**GENUINE ALNICO**  
**MAGNETS**

AMAZING, PERMANENT, NON-ELECTRIC, HIGHLY PRACTICAL.  
Conduct interesting experiments. Hundreds of uses. Retrieve valuable  
steel items such as guns, tackle from fresh or salt water; tools  
from tanks & drains. **GUARANTEED.** Try any magnet one week.  
Money back if you are not well-pleased.

No. M-710 (Wt. 53 oz.) Has pull of 225 lbs. on steel block... \$16.50  
No. M-625 (Wt. 70 oz.) Has pull of 125 lbs. on steel block... \$9.50  
No. M-575 (Wt. 18 oz.) Has pull of 75 lbs. on steel block... \$6.50  
No. M-500 (Wt. 13 oz.) Has pull of 50 lbs. on steel block... \$4.50  
No. M-300 Kit of Flat Bars 5 Pairs / 10 Magnets... \$3.00  
No. M-250 Kit of Round Rods 5 Pairs (10 Magnets)... \$2.50  
No. M-47 Hot Pad Magnets, 10 for \$1.00... 50 for \$4.87  
No. M-35 Hobbyist assortment of 8 small magnets... \$1.50

Send M.O. or check. We pay postage. Sorry no C.O.D.'s.

MIAMI MAGNET COMPANY, 3240 N.W. 27th Ave., Miami 42, Fla.

**SPARE TIME CAN PAY OFF!**

Turn your woodworking hobby into a profitable pastime by making knick-knacks, furniture and toys from simple, clear instructions in Rogers Project Plans, using Rogers Glue to be sure of strength and dependability. Always uniform, ready to use, chemically pure and clear, Rogers Glue baffles humidity and weather conditions, and will not streak or stain wood. To get Rogers Project Plans, Rogers Book of Woodworking Shop Notes, and a full-size jar of Rogers Glue, send just 20c with your name and address to Rogers Glue Co., Gloucester, Mass.



**ROGERS**

*the strongest glue - lasts forever*  
GLOUCESTER, MASS.



Easy to Spread —  
Ready to Use — Good  
Coverage — Just a  
Little Does a Lot —  
Asks for Rogers Glue  
at your Local Store,  
and get 25 woodwork-  
ing project plans at  
the same time.

**P&C screwdriver**  
*protects your hands!*



★ speeds work

★ lasts longer

Mechanics know there is a big difference in screwdrivers. That's why so many prefer P&C quality. U.L. Approved yellow plastic handle fits your hands perfectly, won't shock, burn or chip... resists acid and grease. Polished rugged alloy steel bit is heat treated, hardened and tempered.



Shop for  
tools from  
P&C  
merchandisers  
in more than  
12,000 stores  
coast to coast.  
Send 10c  
for catalog.

**P & C** **TOOL COMPANY**

Box 5926, Portland 22, Oregon  
Chicago Office, Box 87, Schiller Park, Ill.  
Subsidiary Pendleton Tool Industries



Remove old

# PAINT



Wash it off! Scrape it off!  
It's easy either way with

## HEAVY-BODIED KLEAN-STRIP



One application of Heavy-Bodied Klean-Strip will easily and quickly peel off several layers of paint or any other finish. Semi-paste consistency makes it ideal for use on overhead or vertical surfaces. Non-inflammable, needs no neutralizer or afterwash.

**THE KLEAN-STRIP CO., INC.**  
2340 S. Lauderdale, Memphis, Tenn.



## TROPIC HEAT OR ARCTIC COLD YOU'LL START AND YOU'LL GO!

When a fuel pump has been tested under strict government supervision and found to work perfectly at 114 degrees above zero and at 76 degrees below zero, we think it has proved itself the best on the market. That's what the Bendix® Electric Fuel Pump did. Positively eliminates vapor lock. No other pump even close to its price class could match it. Better get one for your car. (Send for free illustrated folder.) \*REG. U.S. PAT. OFF.

# Bendix

## ELECTRIC FUEL PUMP

BENDIX AVIATION CORP. • (Eclipse Machine Div.), Elmira, N. Y.



The new canopy will not "Roman candle" (split from skirt to apex, thereby spilling out its air). In fact, when the enthusiastic inventor had nationally known jumper Lew Sanborn first test the two multicell creations, the two men purposely ripped out several cells.

Sanborn jumped at 6000 feet and purposely fell free for 2000 feet before yanking the rip cord. Instead of permitting air to rush to the top of the canopy, as does the ordinary chute, the multicell design traps air at the skirt edge first, after which the rest of the area is filled.

### Jalbert Explains Square Chute

Jalbert explains the justification for the square chute in this manner: "If you put two circles side by side, with their rims together, the area where they touch will be very small. However, if you put two squares side by side, the drag coefficient of this combination is about one third more than the first. Hence, two square chutes will be as effective as three round chutes and you have thereby saved the cost of one extra chute, one extra rigging and one extra packing."

Dom Jalbert regards it a shame that today's kids "cannot buy a low-cost kite which will fly at a high angle above the horizon, with little catenary in the line to send it crashing into the trees."

To this day he is kidded for flying kites, and he shakes his head over this attitude of the average adult. "They wouldn't make fun of me if I spent my money on expensive rods and reels and traveled hundreds of miles in the hope of catching a fish," he observes, eyes twinkling. "Yet I could have every bit as exciting a battle simply by staying home and flying an inexpensive kite at the end of a fishing line from my backyard. At least, I would be sure of having something hooked!" ★ ★ ★

### Solid-Boron Propellant Boosts Rocket Efficiency

More efficient rockets are promised by development of a solid boron-carbon-hydrogen compound as a rocket fuel. Rockets using the new fuel will have less weight and be less complicated because they will not have to carry fuel-transfer pumps. The boron fuel also will permit air-breathing engines to operate at higher altitudes than would be possible with conventional fuels.

☞ Cows in the University of Wyoming dairy herd carry magnets in their stomachs as part of a study of "hardware disease," an ailment found in cattle that swallow wire, nails and other bits of metal.



**CUT THE BOLT YOU NEED  
TO ANY LENGTH**

**HEAT AND BEND  
TO ANY SHAPE**

24" and  
36" lengths

**7 SIZES**

1/4" 5/16" 3/8" 7/16"  
1/2" 5/8" 3/4"

**REDI-BOLT  
THREADED STEEL RODS**

Ask Your Hardware Dealer or Write

**REDI-BOLT, Inc., 5330 Indianapolis Blvd., East Chicago, Ind.**

**5 NEW CRUISER KITS**

Many other models.  
Best values in fiberglass  
covering kits, marine  
supplies.



18 Ft.  
Offshore Cruiser

**TAFT MARINE WOODCRAFT**

Dept. PM-358 636 39th Ave. N.E. Minneapolis 21, Minn.

LOW AS

**\$399**

Freight  
Included  
FREE  
COLOR  
CATALOG

**shaw**

shoes are designed for men whose feet  
are part of their job!

Here's a sturdy work oxford, with all the styling, fit and comfort of a dress oxford! Shaw's high value features include full cushion insole heel to toe with metatarsal pad and cushion side arch support . . . oil resistant Neoprene sole . . . steel arch . . . Nylon stitched . . . plus the finest leathers and craftsmanship, in black or Cordovan color. AT STORES EVERYWHERE, or write us for details.



**IDEAL FOR**  
mechanics, filling station men, mailmen, factory workers—anyone who wants comfort and style in a work oxford! Also available as high shoe.



Sensibly priced  
at \$10.95,  
others \$8.95  
to \$12.95.

ARCH

**M. T. SHAW, INC.**  
Coldwater, Michigan

"37 Years of Quality Shoemaking"



**engineered and designed  
with the craftsman in mind...**

**KENNEDY  
MECHANIC KITS**

A MUST for every mechanic, Kennedy Mechanic Kits are a compact, convenient method for carrying and storing tools and parts. Features hip-roof and four smooth-action trays. Durable, reinforced steel with dark brown, ripple baked enamel finish and contrasting green trays.

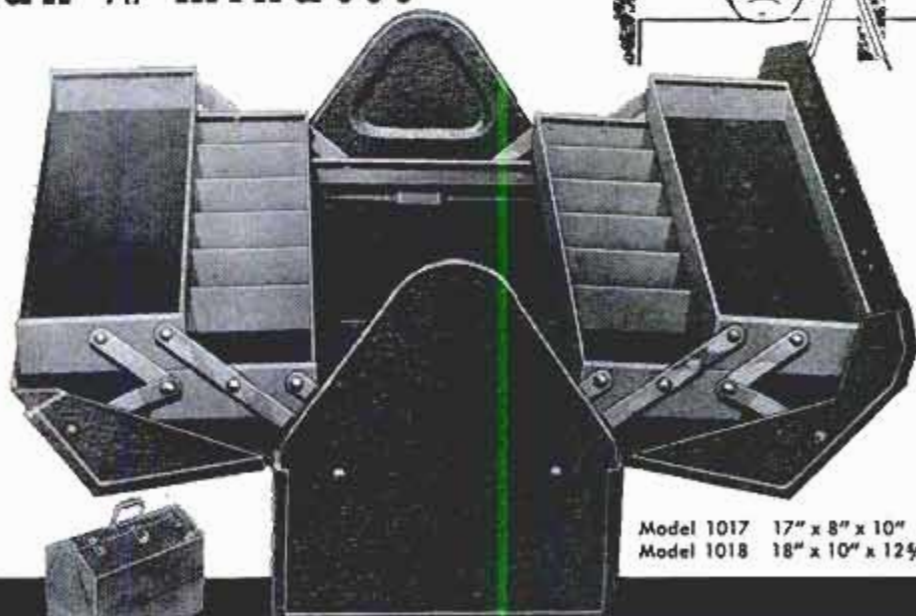

Model 1017 17" x 8" x 10"  
Model 1018 18" x 10" x 12 1/4"



Kennedy K-20 All-Purpose Kit for shop or home. Brown, ripple baked enamel finish.

KENNEDY MANUFACTURING COMPANY, VAN WERT, OHIO

WRITE, WE'LL  
TELL YOU  
WHERE!

**KENNEDY MFG. CO.**  
Van Wert, Ohio, Dept. PM-3  
Please send name and address of  
nearest Kennedy dealer.

Name \_\_\_\_\_  
Address \_\_\_\_\_  
City, Zone  
and State \_\_\_\_\_



The width of the cutout can be increased or lessened according to the size and number of outboard motors to be used. The 3/4-in. motor board is coated with glue and fastened into position with 1 1/2-in. No. 8 screws spaced 6 in. apart.

**Stem:** The stem is laid out full size directly on plywood according to the dimensions given in Fig. 8. It is fabricated from two layers of 3/4-in. plywood. Coat the mating surfaces liberally with glue and screw the pieces together.

**Breasthook:** The breasthook is made up of two layers of 3/4-in. plywood as detailed in Fig. 8. Note that a notch is provided in the bottom half to accept the stemhead.

**Chine blocking:** The chine blocking simplifies fitting of the chine to the stem at the proper point and angle. It is laid out on 3/4-in. plywood as detailed in Fig. 8. The parts are assembled with glue and

nails or screws. After assembly the forward edges are cut to 38-deg. angles as shown.

**Transom knees:** Three transom knees are required, one of which is fabricated from three layers of 3/4-in. plywood and bolted to the keel and transom, Fig. 7. The other two are cut from 3/8-in. plywood and screwed to the outer battens and transom.

**Building form:** The builder is advised not to skimp or attempt to use warped or otherwise unsuitable lumber when constructing the building form. This form will govern the entire shape of the boat. To insure an accurately built hull, the base member of the building form should be made rigidly and securely anchored to a wooden floor, concrete slab or any other fairly smooth and level surface, including the ground, Fig. 10. After the base member

(Continued to page 254)

## MATERIALS LIST

All lumber listed should be first grade free from shakes and knots. Lumber designated as 1 in. thick should be "four quarters" material finished as full as possible (3/4 in. to 7/8 in.). All other thicknesses are listed net. All widths are actual dimensions. All lengths allow material for cutting to fit. All plywood must be exterior type, marine grade, with solid core suggested for stressed areas. Plywood panels 1/4 in. thick are three ply, 3/8-in. panels 5 ply and anything over 3/8 in. a minimum of 5 plys. It is suggested that the builder group his lumber so as to obtain random width material for ripping to the desired widths, rather than obtain the exact sizes shown. This will produce a substantial saving.

Key to materials list: DFP—Douglas fir plywood, AB, exterior grade, AA, marine grade; MP—Mahogany plywood, marine or exterior grade; Oak—White oak lumber; M—Mahogany lumber; S—Spruce lumber.

Item	Material	Quan.	Size
Frames and transom frame	O, M, or S	40	random bd. ft.
Gussets and keel laminations	DFP	1	3/8"x4"x8'
Transom, stem, chine blocking, breasthook and tail-fin sheers	DFP	1	3/4"x4"x8'
Floorboards	DFP	2	3/8"x4"x8'
Seat brackets and fin sheers	DFP	1	3/4"x4"x8'
Seat backs and base	DFP	2	3/8"x3"x6'
Decking	MP	2	1/4"x4"x8'
Bottom planking	AA-DFP	2	3/8"x3"x14'
Side planking	AA-DFP	2	1/4"x3"x16'
Keel	O, M, or S	1	1"x4"x12'
Battens	O, M, or S	2	1"x3"x12'
Battens	O, M, or S	2	1"x3"x10'
Chine log	O, M, or S	2	1"x2 1/2"x15'
Sheer clamp	O, M, or S	4	3/8"x1 1/4"x16'
Carlings	O, M, or S	2	1"x5"x10'
After-deck beams	M	2	1"x6"x5'
Dash beam	M	1	1"x6"x6' 4"
Forward-deck beam	O, M, or S	1	1"x4"x4' 6"
Strongback	O, M, or S	1	1"x2"x8'
Deck battens	O, M, or S	2	1"x2"x5'
Motor-well sides	M or 3/4" P	2	1"x9"x2'
Floor battens	O, M, or S	2	1"x2"x8'
Tail-fin blocking	M	2	2"x5"x24"
Bumper rail	M	2	1"x2 1/2"x8'
Misc. blocking	O, M, or S	as reqd.	
<b>FASTENINGS:</b>			
Screws, F.H.	bronze or galv.	2 doz.	3" No. 14
Screws, F.H.	bronze or galv.	1 gross	2" No. 10
Screws, F.H.	bronze or galv.	1 gross	1 1/2" No. 8
Screws, F.H.	bronze or galv.	1 gross	1 1/2" No. 8
Screws, F.H.	bronze or galv.	6 gross	1" No. 8
Nails, annular-ring type	monel	2 lbs.	1 1/4"
Nails, annular-ring type	monel	3 lbs.	1"
Bolts, carriage with washers	galv.	6	5/8"x5 1/2"
Glue	plastic resin	7 lbs.	or equivalent amount of resorcinol glue

Members	Type	Size	Spacing
Gussets to frames	nails	1 1/4"	5 ea. member
Floor timbers to frames	screws	1 1/2" No. 8	4 ea. member
Transom frame to transom	screws	1 1/2" No. 8	6" apart
Stem laminations	screws	1 1/2" No. 8	6" apart
Breasthook laminations	screws	1 1/2" No. 8	8 reqd.
Chine-blocking laminations	screws	1 1/2" No. 8	8 reqd.
Transom-knee laminations	screws	1 1/2" No. 8	8 reqd.
Breasthook to stem	screws	2" No. 10	2 reqd.
Stem to frame	screws	2" No. 10	3 reqd.
Chine blocking to stem	screws	2" No. 10	2 reqd.
Keel to stem	bolts	5/16"	2 reqd.
Knee to keel and transom	bolts	5/16"	4 reqd.
Keel to frames	screws	2" No. 10	2 ea. joint
Plywood strip to keel	nails	1"	4" apart
Knee to transom and battens	screws	1" No. 8	3" apart
Battens to frames	screws	2" No. 10	1 ea. joint
Chine log to frames, etc.	screws	2" No. 10	1 ea. joint
Sheer clamp to frames, etc.	screws	2" No. 10	1 ea. joint
Planking to sheer clamp	screws	1" No. 8	4" apart
Planking to chine log and keel	screws	1" No. 8	3" apart
Planking to battens	screws	1" No. 8	4" apart
Planking to frames	screws	1" No. 8	4" apart
Planking to stem and transom	screws	1 1/4" No. 8	2" apart
Outer keel to hull	screws	2" No. 10	6" apart
Stem-cap strip to hull	screws	1 1/2" No. 8	12" apart
Spray rail to hull	screws	2" No. 10	12" apart
Carling to frames	screws	2" No. 10	2 ea.
Intermediate deck beam	screws	2" No. 10	2 ea. end
Deck framing	screws	2" No. 10	2 ea. joint
Deck battens to beams	screws	2" No. 10	1 ea. joint
Strongback to beams and breasthook	screws	2" No. 10	1 ea. joint
Decking all outer edges	nails	1"	2" apart
Decking all other points	nails	1"	4" apart



# NEW!

all new  
**PERMA-GRIT**  
hand sander



## REVOLUTIONARY NEW DISCOVERY ... lasts a lifetime of workshop use

### THE MIRACLE OF **PERMA-GRIT**

Tungsten carbide—industry's hardest metal—has long been used on production cutting tools. Now, SKIL has discovered a new process to manufacture abrasive tools for the handyman to use on wood, wallboard and compositions. Small particles of tungsten carbide are copper brazed under heat to steel. Keeps the particles permanently fixed in position. And each grit is a cutting edge that stays sharp for years!

Here's the sander to beat arm weariness and sanding boredom. A handyman's tool for sanding wood, wallboard, plastics or drywall joints. With a sanding surface made of particles of tungsten carbide brazed to a thin, steel sheet. When clamped to its sanding block, the sheet gives a cutting surface that removes stock twice as fast as any sandpaper! The exact spacing of the grit minimizes clogging. Deposits from gummy woods that ruin ordinary sandpaper are quickly removed with a wire brush or solvent. The Perma-Grit sander is sharp. Cuts fast all during its lifetime. Outlasts hundreds of sandpaper sheets. It's all here in one kit—1 Perma-Grit Sander, 1 Medium-Grit Shoe, 1 Fine-Grit Shoe—only \$3.45.

AVAILABLE AT YOUR HARDWARE, LUMBER OR PAINT STORE



#### PERMA-GRIT WHEEL

Most amazing accessory ever made for a table saw. Tungsten carbide particles on edge and sides of 8" wheel. Actually 5 tools in 1. Saws, sands, dadoses, shapes, notches or ploughs without changing blade. Safe—no teeth. Only \$12.95.



#### PERMA-GRIT FILE

Outperforms any other wood file or rasp ever developed. Resists loading because wide grit spacing gives self-cleaning action. Full 14" blade. Fine grit on one side with coarse on the other. Each—\$2.25.



Made only by SKIL Corporation, manufacturers of famous SKIL and SKILSAW products. 5033 N. Elston Ave., Chicago 30, Ill. In Canada: 3601 Dundas St. West, Toronto 9.



PAINT SMOOTHER, EASIER with  
**Brushes by Baker!**



**Use Baker Brushes** and paint easier, faster, better! Enjoy smoother painting, use fewer strokes, get more coverage. Next time you paint choose the right Baker Brush size most practical for the job.



learn  
to paint  
like an  
expert . . .

**Free booklet** tells "HOW TO DO A GOOD PAINT JOB." Today, send card to Baker Brush Co., Inc., 83 Grand Street, New York 13.



**BRUSHES BY  
BAKER**

AMERICA'S FINEST PAINTING TOOLS

is anchored, legs are constructed to support the longitudinal setup members which must be level lengthwise and athwartships. Also, it is very important that the height from the top of the breasthook to the setup level be exactly 24 in. The frames are mounted bottom-side-up and spaced as shown. Be sure to space the frames accurately and anchor them rigidly to the form with clamps or screws. If the setup members of the form are level, a carpenter's square and level may be used to plumb the frames.

The chine blocking and breasthook can now be assembled to the stem. The heel of the stem is then slipped into the slot between the bottom frame members of frame 4, butted to the floor timber and screwed

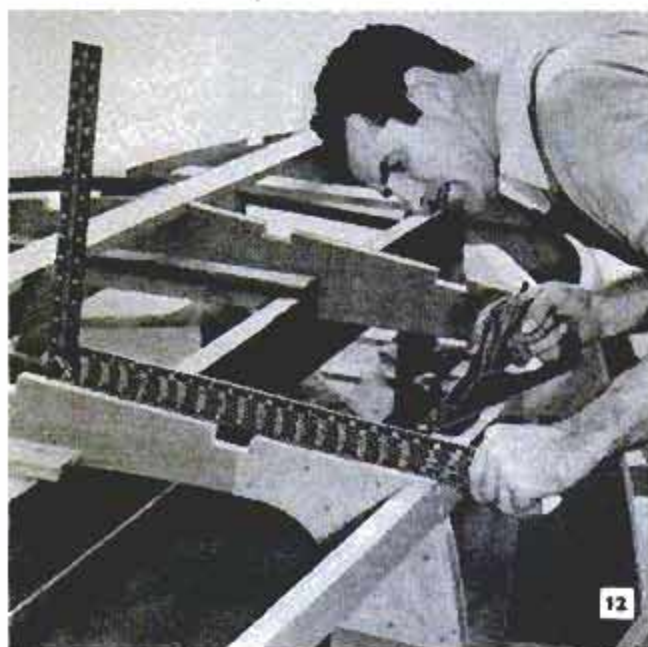

Frame members requiring flat surfaces are checked with straightedge and ridges removed with plane

to it. The breasthook should be securely fastened to the blocking to prevent movement during construction.

The transom is aligned in place and angled 12 deg. from the setup level, plus 90 deg. Simply insert shims between the building form and the transom frame until the transom has been brought to the proper height. This is to assure that the keel is straight from the transom to frame 3. After aligning the entire assembly on the form, anchor the members in position and brace them rigidly to prevent movement, especially when springing the curved longitudinals into place. Considerable stress is placed on the form when doing this.

**Keel:** The keel is a single length of 1 x 4-in. oak or mahogany with a  $\frac{3}{8}$  x 4-in. plywood strip glued and nailed to the inner face to prevent splitting of the keel. The

(Continued to page 256)



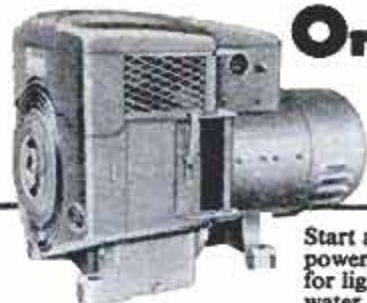

## Onan Emergency Electric Plants

Start automatically when highline power is cut off, supply current for lights, heating system, freezer, water pump, stove, all appliances and machines. Prevents losses and hardships. Plant stops automatically when power is restored. Compact, easy to install. 500 to 75,000 watts A.C. Priced from \$319.00.

Write for Free Folder

### PORTABLE MODELS

500 to 10,000 watts. Supply plug-in power anywhere!



**D. W. ONAN & SONS INC.**  
3574A UNIVERSITY AVE. S.E. • MINNEAPOLIS 14, MINN.

## FOLDING LEG BRACKETS



Amazing new design with automatic spring action push button control. Locks in both open and closed position. Lifetime heavy duty metal construction. Simple, foolproof. Can't stick or bind. Smooth action. Easy to attach. Only 1 3/4" x 2 1/2" x 2 1/2" in size—neat and strong. Perfect for ping-pong or any type table. Complete with all screws. Money back guarantee. SEND CHECK OR M. O.—NO C.O.D.

**\$3.95**  
SET OF 4  
POST PAID

**DOO-IT STORE**  
1040 N. WOODWARD  
ROYAL OAK, MICH.

### 1/4 MIDGETS

The little league of family racing. \$449.00 complete. Write for free literature. Dealerships now available.



**RACE-CRAFT MIDGET CARS**  
8476 E. Garvey Boulevard  
South San Gabriel, Calif.



BUY DIRECT  
• SAVE ON •  
TILLERS • TRACTORS

Full line of attachments for mowing, gardening, farming  
2-3-4 H.P. TILLERS 12"-16" CUT.

FREE CATALOG  
& PRICE LIST

5-6-7-9 H.P.  
2 wheel 8

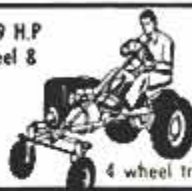

**RED-E TRACTOR CO.**

3 FOURTH STREET  
RICHFIELD, WISCONSIN

**EASIER  
FASTER  
BETTER!**



## KESTER SOLDER

FREE: "Soldering Simplified"  
16-page booklet—Send for your copy today.

For General Soldering

**KESTER SOLDER COMPANY**  
4251 Wrightwood Avenue • Chicago 39, Illinois, U.S.A.

No other power tool offers you  
so **MUCH** for so little

## DYNO-MITE POWER WORKSHOP



Start with the  
No. 888  
**POWER TOOL**  
3 Tools in 1  
• 3/8" Drill  
• 6" Disc Sander  
• 6" Polisher

1/3 h.p.

ONLY  
**\$44.95**

**THEN ADD THESE ATTACHMENTS TO  
MAKE A COMPLETE POWER WORKSHOP**

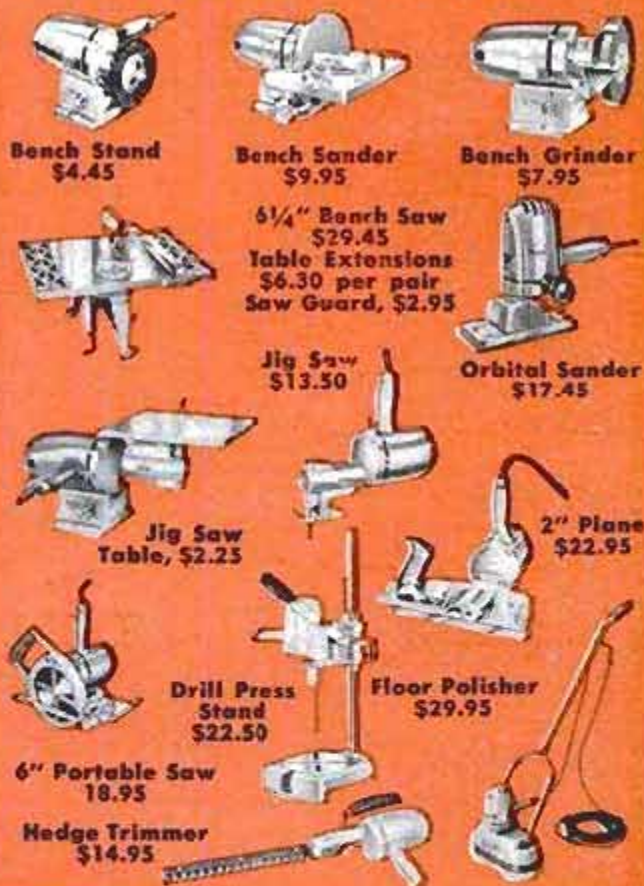

Bench Stand  
\$4.45

Bench Sander  
\$9.95

Bench Grinder  
\$7.95

6 1/4" Bench Saw  
\$29.45

Table Extensions  
\$6.30 per pair  
Saw Guard, \$2.95

Jig Saw  
\$13.50

Orbital Sander  
\$17.45

Jig Saw  
Table, \$2.25

2" Plane  
\$22.95

Drill Press  
Stand  
\$22.50

Floor Polisher  
\$29.95

6" Portable Saw  
18.95

Hedge Trimmer  
\$14.95

### FREE FOLDERS!

Ask for them at your hardware dealer's or write:

**MILLERS FALLS  
TOOLS**

**MILLERS FALLS CO., Dept. PM-23, Greenfield, Mass.**



# Looking for Something?



## CONTRACTORS



roofers, glaziers, gardeners' tools,  
shoes, dresses, swimming pools?  
whatever you need—

Find It Fast  
In The  
Yellow Pages



Advertisers displaying this emblem make your shopping easy.

keel is glued and screwed to the frames and transom. Countersink the screws  $\frac{1}{4}$  in. Also, the keel is bolted to the stem with two  $\frac{3}{16}$ -in. carriage bolts with the heads of the bolts countersunk below the surface.

**Chine log:** The junction of the side planking and bottom planking is the chine point or line and backing member is called the chine log or member. The chine log is cut in a single length from 1 x 2 $\frac{1}{4}$ -in. mahogany or oak. This is fitted into the notch at the transom and sprung around the notches in the frames. The notches in the frames must

### To Save Both Time and Work

If you wish, you can buy patterns for the stem, frames, transom, breasthook and chine blocking already drawn full size. And, to further simplify construction, you can buy these parts in kit form accurately cut in mahogany from Glen-L Marine Designs, 9152 E. Rosecrans, Bellflower, Calif.

be beveled up forward so that the chine log will lie flat against the frames. Bevel the chine log to fit against the stem at the chine blocking. Coat the notches with glue and fasten with a single 2-in. No. 10 screw at each frame and at the transom. Fasten it to the chine blocking with several 2-in. No. 10 screws. The same operation should be performed on the other side simultaneously to equalize the stress.

**Sheer clamp:** The sheer clamp is built up from two thicknesses of  $\frac{5}{8}$  x 1 $\frac{1}{4}$ -in. mahogany or spruce in single lengths. The notches for the sheer clamp must be beveled similarly to the chine log. Spring the first lamination of the sheer clamp around and nail it to each member. The second layer is then coated with glue and laminated to the first. Screw both layers to

### Blueprints Available

Those who prefer to build *Swish* from plans larger than the ones presented in the magazine may purchase a set of blueprints, 17 x 34 in., by writing Blueprint Department, *Popular Mechanics Magazine*, 200 E. Ontario St., Chicago 11.

the frames, transom and breasthook. The laminations should be held together with clamps until the glue has set as in Fig. 11. The builder will note that the sheer clamp is set in vertically from amidships forward. No attempt should be made to twist the sheer clamp to conform to the contour of the side planking.

(To be continued)



## BUILDING or REPAIRING your BOAT?

For Sturdiness, Long Life,  
and Low Upkeep...



use  
**Southern  
FASTENERS**

famous for  
Quality and Permanence

**SOUTHERN SCREWS** for Marine use in Brass,  
Chrome Plated Brass, Aluminum, Stainless, Hot  
Galvanized Steel, Everdur Silicon Bronze

AT YOUR MARINE SUPPLY or HARDWARE STORE

## NEW SPEED PROPELLERS



for JOHNSON, EVINRUDE  
18, 35, 50 HP OUTBOARDS,  
SCOTT ATWATER 22, 40, 60  
and MERCURY large motors. If you  
own one of these great motors by all  
means investigate MICHIGAN'S new, style  
SMC 3-blade, propellers engineered especially  
for them, to provide more speed, better skiing,  
more fun. Send postcard for FREE 1958 Catalog.  
Also contains outstanding bargains in skis, speed-  
ometers, boating accessories... helpful boating  
data. Dept. PM-3, Michigan Wheel Co.  
Grand Rapids 3, Mich.

## Sharpen YOUR SAWS

with QUICK-WAY\*

Now you can sharpen, joint, gum and  
retool all circular saws to 12" dia. Pre-  
cision results. Safety Guide, Mounting Block  
and Grinding Wheel included. Model PG-12  
\$19.95 Postage Paid. Send for Circular  
FREE! Special Saw Set with each QUICK-WAY  
unit purchased; (\$2.75 if ordered separately).

QUICK-WAY SAW CO. 236 Tompkins St. Corland, N. Y.

## ESHELMAN TRACTORS

LOW AS \$99

Plows-Cultivates-Saws  
Cuts-Dozer-Narrows  
Hauls-Snow Plow-  
Rolls. Eshelman  
Tractors, Tillers,  
Riding Rotary Mow-  
ers for Better Lawns  
and Gardens. Adver-  
tised in GOOD HOUSEKEEP-  
ING. Thousands of satisfied  
users. Write for Free Literature.  
Dept. 307, ESHELMAN, Balto 2, Md. \$399.00

Shipping Points: BALTIMORE •  
CHICAGO • INDO

3 PASS.  
SPORT CAR  
Ideal 2nd Car  
or Sportabout.  
Fully  
Equipped.  
Write For  
Literature.

## A BETTER DOCK

without working in water

with  
**PERMA-DOCK  
METAL  
BRACKETS**

Here's a quick, low  
cost way to erect and  
take down a stronger dock. You build wooden dock  
in sections, attach "Perma-Dock" Brackets, float into  
place on boat, drive steel pipes thru brackets, lock  
with set screws. "Perma-Dock" Mooring Bars safely  
hold boats near dock.



Write for circular on all "Perma-Dock" Marine Specialties  
**CENTRAL MACHINE WORKS CO.** 1235 Central Avenue  
Minneapolis 13, Minn.



## Shock- absorbing handle won't loosen

\$5<sup>25</sup>

Here's the finest  
hammer made.  
Shaft is gleaming,  
chrome-plated tube  
of boron alloy steel.  
Strongest ever made.  
Polished head is  
locked permanently to  
shaft. Tough neoprene-  
fiber cushion grip  
absorbs shock, won't  
slip wet or dry or  
in gloved hand. See  
ROCKET tools at your  
hardware store. True Temper,  
Cleveland 15, Ohio.



Hatchet, belt axe and ball peen, too,  
in famous ROCKET design that has  
proved its worth in the hands of over  
1,000,000 proud users. Ask a carpenter!

# TRUE TEMPER

THE RIGHT TOOL FOR THE RIGHT JOB



## Radio Aids to Carefree Cruising

(Continued from page 223)

in case of emergency, can sometimes spell the difference between just another adventure and—tragedy. To this end, nothing will do more to insure carefree cruising than a reliable radiotelephone.

Until recently, equipment of this type was priced out of reach of most pleasure-craft owners, but times have changed. Now, some radiotelephones can be purchased for less than \$300; a relatively small cost considering the peace of mind and convenience they afford. For, while safety at sea is the primary purpose of such units, they also permit instant communications with relatives, friends and business associates even though you are surrounded by miles of water.

Typical low-cost radiotelephones are illustrated in Fig. 6. Basically, these consist of a combination receiver-transmitter, an antenna and a power pack. The receiver usually covers the broadcast band plus five or more fixed marine-radio channels. The transmitter is pretuned to frequencies complementary to the receiving channels. Both units are crystal controlled to prevent frequency drift and assure reliable performance. A channel selector permits simultaneous switching of receiver and

transmitter to the desired channel. To operate, simply select the desired channel, press the button on the associated microphone, and you are ready to transmit. Release the button and the receiver is automatically placed in operation on the complementary receiving frequency.

Why five or more ship's channels? To answer this question you need only realize that radio channels, unlike land telephone lines, can handle only one conversation at a time. Now look at the map in Fig. 5, which shows the locations of shore telephone stations, and try to imagine the chaos which would result if all boats in a congested area would try to contact a land station or each other on the same frequency.

To handle the flow of communications and minimize interference, many shore stations have been assigned two or more frequencies. Furthermore, some marine band frequencies are used only for the purpose of establishing contact between stations (calling frequencies), while others are used to actually carry on the conversation (working frequencies). And, in addition, the frequencies designated to handle ship-to-ship traffic are usually different from those established for ship-to-shore messages. It is easy to see, therefore, why the radiotelephone must be able to cover



The gang's on the **GO**  
with **Cushman**

The all-new  
**ROAD KING**  
and the flashing **EAGLE**

Cushman machines are BUILT to GO for a world of fun and excitement. Powered by the famous Cushman Husky 4-cycle engine—up to 50 miles per hour, up to 100 miles per gallon. Distinctive, modern design (the Road King is finished in two-tone colors) plus rugged construction for safety, service and a smooth soaring ride.

Write for new FREE Booklet today  
Ask your dealer for FREE demonstration

**CUSHMAN MOTOR WORKS, INC.**  
A subsidiary of Outboard Marine Corporation  
969 NO. 21st, LINCOLN, NEBRASKA

SOLD AND SERVICED  
NATIONALLY  
Replacement parts  
immediately available  
Dealer inquiries invited



a number of frequencies for reliable performance in various regions. Commercial equipment is designed so that the desired channels can be obtained by selecting and installing the correct set of crystals.

### Monitor Distress Frequency

When a radiotelephone is in operation and conversation is not in progress on other frequencies, it is required by law that the international distress frequency be monitored. To make this convenient, this frequency (2182 kc.) has also been chosen as the international calling frequency. Most communications originate on this channel before being transferred to the regular working frequency of the area in question. This regulation does much to increase the speed with which aid can be rushed to an imperiled mariner. Since most radio-equipped boats will be tuned to the distress frequency, a call for help will often be answered long before the Coast Guard can arrive on the scene.

**Transmitter power.** Reliable operation of a radiotelephone depends primarily on the range of the transmitter aboard ship. It is of little use merely to be able to hear the powerful coastal stations unless these can also pick up your calls. The proper choice of transmitter power rating, therefore, is a very important one. The exact

range of a transmitter is difficult to determine because it depends on many variables such as atmospheric conditions, time of day and year, frequencies used, etc., but it is conservatively estimated at approximately 1½ miles per watt of transmitter power input for fresh-water operation. Salt-water conditions may increase this range as much as 100 percent.

FCC regulations set the minimum power limits for marine-radio transmitters at 15 watts but, beyond that, your requirements are determined by the distance you wish to cover. A good rule is—buy all the power you need, but no more than you expect to use. For, not only do costs increase proportionally to transmitter power, but excessive range can cause serious interference by tying up channels in areas far beyond your own required range.

**Licensing.** Any citizen of the U.S., over 18 years old, can obtain a station license simply by filling out forms usually supplied when the equipment is purchased. An operator's permit may be obtained after passing a brief, nontechnical written examination given at a local FCC office. ★★★

☐ Perfect reception of Australian TV programs 2000 miles away in Auckland, New Zealand, in 1957, was attributed to an upper-atmosphere effect of sunspots.

# NEW *LaHer* HOOK-LOCK OVERLOAD SPRINGS



Lift weight off rear wheel with bumper jack, align Hook-Lock spring with car spring.



Place Hook-Lock hooks over car spring, snap onto Hook-Lock spring socket; insert keeper bolts. Release jack.

-----> Any make or model **\$36<sup>50</sup>** per set

## World's Quickest Attachable and Detachable Spring

- Perfect for pulling house trailers
- Ideal for all sportsmen and salesmen carrying heavy loads
- Attach it to any car in minutes! No special tools required
- Adds up to 1000 lbs. extra capacity
- Adds new life to old, tired springs
- Foolproof engineering — No u-bolts, no gadgets
- Guaranteed by LaHer — America's leading spring manufacturer for 50 years



### LAHER SPRING & TIRE CORP.

ST. LOUIS, 2131 Locust St. • OAKLAND, 2615 Magnolia St. • PITTSBURGH, 5515 Penn. Ave. • MEMPHIS, 300 Madison Ave. • LOS ANGELES, 807 E. 8th St. • FORT WORTH, 910 Florence St. • SAN FRANCISCO, 98 - 12th St. • SALT LAKE CITY, 541 So. State St. • SEATTLE, 714 E. Pike St. • PORTLAND, N.W. 15th & Davis St. • SPOKANE, 3319 W. Second Ave. • SACRAMENTO, 1217 - 16th St.

SEE YOUR NEAREST AUTO SUPPLY OR SERVICE DEALER TODAY!

If he cannot supply you, send check or money order to address nearest you, giving us your make, model and year of car. Check above for price to fit your make and model, and we will ship direct, postage paid on money back 15 day trial guarantee.

JOBBER AND DISTRIBUTORS WRITE NOW ABOUT OPEN TERRITORIES



If it takes more  
**ACCURACY**  
 it's a job for a  
**SOUTH  
 BEND**  
 10" lathe

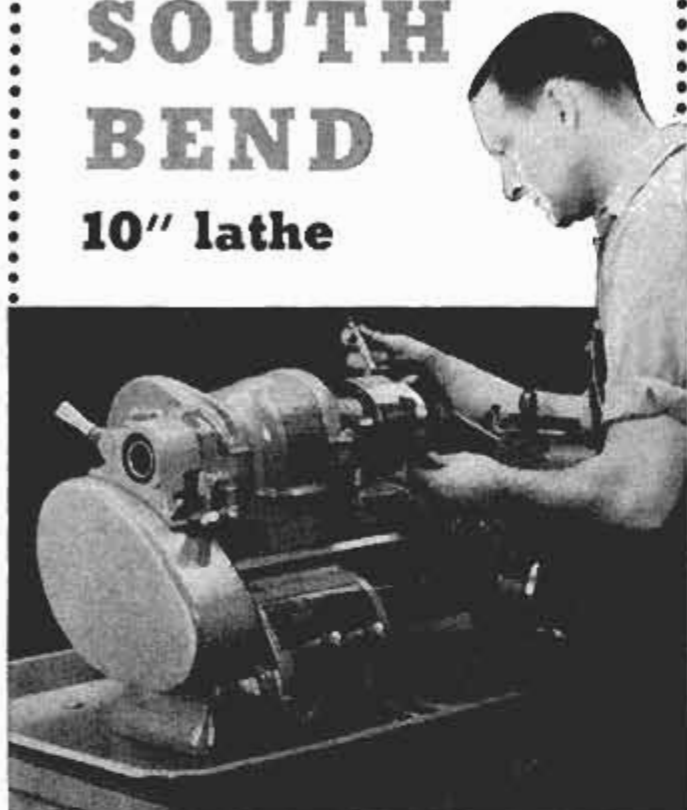

- Accuracy that's a match for any job.
- Superfinished spindles with sleeve type bearings that hold tolerances for years.
- Hardened and ground bed ways optional for extreme conditions.
- Smooth, vibration-free operation for fine finishes.
- More usable power.
- 1-1/16" collet capacity—70 threading, longitudinal and cross-feeds.
- 14 engine and toolroom models.

PRICES START AT \$1282 F.O.B. FACTORY

WRITE for complete catalog of South Bend 9" to 16-24" lathes, turret lathes, milling machines, shapers, drill presses, pedestal grinders and attachments.

**SOUTH BEND LATHE**  
**SOUTH BEND 22, INDIANA**  
*Building Better Tools Since 1906*



## Growing More Meat With Antibiotics

(Continued from page 127)

same broiler is ready in eight to nine weeks on 7½ pounds of antibiotic-supplemented, nutritionally improved feed. Turkeys average a pound heavier at 24 weeks if they are fed traces of Terramycin.

### More Eggs

The poultry industry was in for still another surprise. Dr. C. W. Carlson of the South Dakota Agricultural Experiment Station experimented with Terramycin as a supplement for laying hens. His results show that the antibiotic yields about one extra egg for each four eggs normally produced. This significant jump in production is accomplished by adding less than two ounces of Terramycin to a ton of feed!

The puzzle is fascinating because such extremely small quantities of antibiotics are producing these results. When used as a medicine, about two grams of Terramycin per day are required to treat a human being. It takes less than 1/10,000 this amount to speed the growth of a chicken. As a matter of fact, not much more Terramycin is added to the feed than there is gold in sea water!

### How Do Antibiotics Do It?

What does a trace of antibiotic do to produce this extra meat, this additional egg, this speedy growth? Pfizer scientists admit they don't know yet, though they have theories. One of the more accepted ideas is that every animal (and man, too), no matter how healthy, may be suffering continually from "subclinical" diseases caused by microorganisms in the digestive tract. These diseases are so slight in effect that they go undetected. You just can't find anything wrong with the animal. The scientists theorize that traces of antibiotic may be knocking out such microorganisms. So far, though, the microorganisms and their effects are strictly theoretical. No proof exists. Meanwhile the animals go right on growing faster.

### Lots of Proof

There's a great deal of proof, though, of this fast growth. As a result, a significant part of the 34 million tons of feed manufactured in this country last year contained traces of antibiotics.

Farm scientists aren't resting on their antibiotic laurels. Another development of the past few years is a hormone pellet that also makes livestock grow bigger and faster. And right now at the Terre Haute

(Continued to page 262)



# CUT-TO-FIT HOMES CUT BUILDING COSTS

CHOICE OF 57 DESIGNS

ORDER NOW

SAVE UP TO 1/3



Build your own home and save the builders' profit—plus savings in lumber and labor with Sterling Ready-Cut-Homes. Anyone can assemble with simple, easy to follow plans furnished. Every house complete with all lumber, roofing, nails, glass, hardware, paint, doors and windows marked ready to erect. Freight paid. Complete building plans ready for filing at low cost. Sold separately if desired. Write today!

PRICED FROM \$2150 up

Five Easy Payment Plans

Send 25c for NEW COLOR CATALOG

INTERNATIONAL MILL AND TIMBER CO.  
DEPT. PM-38 BAY CITY, MICHIGAN

## BOAT KITS BUY DIRECT... SAVE 2/3! NO DEALERS · FREE FREIGHT

SAVE... on the Finest Quality Boat Kits. Lowest Prices, Mahogany Decks, Frames, Props Racers, Cruisers, Runabouts. Over 40 Models of simple to construct boats and frame kits. SEND 10c FOR NEW COLOR CATALOG... Boats, Paints, Hardware, trailers, fiber-glass etc. Over 2000 items for your boat.

BUY ON EASY CREDIT TERMS

Boat Plans-Patterns-Frame Kits

Craig Craft  
Tonawanda, N. Y.

Build over 50 modern boats from large scale plans, available with FULL-SIZE patterns, new PRE-FAB frame kits! All types: prams to cruisers, 6 to 25 ft. Best buy for Amateurs! SEND 10c for CATALOG.



## JACOBSEN ENGINES

(SURPLUS)

USE FOR MODELS, AIR BOATS, BICYCLES, etc. \$5.95 Postpaid

Brand new 2.3 H.P. Jacobsen Basic Engines designed and built for the U.S. Government, at a cost many times this price. Engine Features: 2.3 H.P. @ 3400 RPM; 2 cycle—operates in any position (designed for horizontal mounting); Bore 2"; Stroke 1 1/2"; Crankshaft—roller bearing; Piston—aluminum. 3-ring; Weight—8 pounds. Use your own battery or glow-plug ignition. Two types of carburetors available. Optional—Single speed—\$2.25 each; Tillotson variable speed—\$5.75, either postpaid. ALL ITEMS GUARANTEED TO YOUR ENTIRE SATISFACTION OR MONEY BACK (LESS POSTAGE).

ESSE RADIO COMPANY

40 West South

Indianapolis 25, Indiana

Improve Your Home



## BIG AUTO NEWS IN SMALL AD

TRUNK HOLDS 500 LBS.



NEW 3 PASS. SPORT CAR COSTS FAR LESS TO BUY TO DRIVE

It's big inside—small outside. Ideal second car or Sportabout. Fully equipped. Written guarantee. Most big car features.

WRITE FOR FREE LITERATURE ESHELMAN CO.

Dept. 203, 109 Light St., Balto 2, Md.

Dealers Write For Distrib. Info.

## SURPLUS MAUSER BOLT ACTION RIFLES

\$9.95

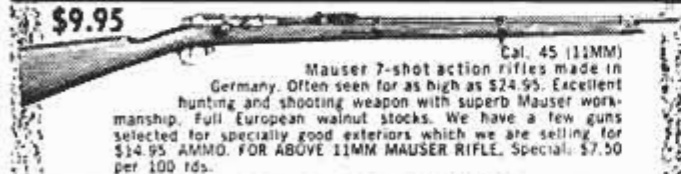

Cal. 45 (11MM) Mauser 7-shot action rifles made in Germany. Often seen for as high as \$24.95. Excellent hunting and shooting weapon with superb Mauser workmanship. Full European walnut stocks. We have a few guns selected for specially good exteriors which we are selling for \$14.95 AMMO. FOR ABOVE 11MM MAUSER RIFLE. Special: \$7.50 per 100 rds.

## JUST IN: GERMAN ARMY RIFLES

\$9.95



The famous German Army Mauser Model 88—5-shot bolt action rifle, cal. 8MM. Calibrated sights. Bore guar. good Full walnut stocks, a fine hunting weapon as is or may be easily converted to a sporter. Fine German workmanship, of course. We have a few Model 88's selected for good exteriors which we are selling for \$16.95. Ammunition for above 8MM Mauser Rifle, special: \$7.50 per 100 rds.

## SPECIAL BARGAIN OFFER: BOTH ABOVE RIFLES \$18.95

Includes one clip of free ammo for each rifle. This is a special offer to men who wish to add these two fine specimens to their collection.

TO ORDER: Send check, cash or M.O. For C.O.D. send 1/2 deposit or more. All orders shipped R.R. Express charges collect F.O.B. Pasadena, Calif. res. add 4% state tax. 30-day money back guarantee.

GOLDEN STATE ARMS CORP

386 W. Green Street, Pasadena 6, Calif.



## A PARKER HACK SAW for any day in the week

The Parker model you want, saws easier, holds blades more rigidly, and fits your pocketbook. Unconditionally Guaranteed.

Manufacturers of World-Famous Trojan Saw Blades and Frames

PARKER MANUFACTURING CO.  
WORCESTER 1, MASS., U. S. A.



the right glue  
for every job you do

# ELMER'S® GLUE-ALL!

and other  
Elmer Glues



if it's *Borden's*  
it's got to be good!

Long on Quality ... Short on Price!

## Evans L-O-N-G WHITE-TAPES

25-50-75-100 FOOT LENGTHS

**Built-In  
HANDY  
HOOK-RING  
COMBINATION**

For easy one-man measuring. Comes with every Evans Long White-Tape as a standard feature... you pay not a penny more!

**A FINE-QUALITY PRECISION  
MEASURING TOOL**

- Snow-white Bonderized steel blade
- Sharp jet-black precision markings — for clear, easy reading
- Heavy leather-grained cover... of moisture, scuff and stain-resistant DuPont Vinyl
- Stainless steel edge band
- Double roller mouthpiece, recessed crank, winding reel, all heavily chrome plated for rust resistance, handsome appearance
- FREE plastic utility case

EVANS, Elizabeth, N. J.

"hospital" researchers are feeding, of all things, tranquilizers to farm animals. No, the cows and hogs aren't wandering around in a happy daze. The dose of tranquilizer is far below the level of sedation. As a matter of fact, you can't observe any effect on the animals—except that they gain weight about 12 percent faster.

### Growth on Top of Growth

Pfizer scientists recently put steers through an 84-day trial to find out whether the gains with antibiotics, hormones and tranquilizers were cumulative, could be piled on top of each other. Apparently they can, to a great extent. The steers showed an 11-percent improvement in gain on Terramycin. Combining Terramycin with stilbestrol (the hormone) produced a 23-percent boost in rate of gain. When traces of a tranquilizer were added, there was a further 12-percent increase. Your imagination can wing off on a real flight of fancy if you use these figures as a basis for guessing the future speed-up in the growth of anything from a chick to a Brahma bull.

There has been some concern that antibiotics, hormones and tranquilizers may produce a meat that is somehow different, that it might contain significant amounts of lingering drugs, that it might be dangerous for human consumption. The Food and Drug Administration is the guardian of such worries. The agency has been extremely cautious in approving supplements for feeds. After long research, it reported that it could find no observable traces of certain antibiotics and hormones in the carcasses of animals fed these supplements. Such antibiotics and hormones have been approved. Research on tranquilizers is so recent that these drugs have not yet been approved.

### Travelers Bring Soil Samples

Meanwhile Pfizer scientists are plunging still deeper into the lush and violent jungle of antibiotics. World travelers of all types—missionaries, airplane pilots, explorers, vacationers—are commissioned to bring back soil samples from remote lands.

The goal of this global treasure hunt is the discovery of still more effective drugs, antibiotics that will wipe out diseases that present drugs can't touch, antibiotics that will produce still bigger and healthier livestock in a still shorter time. Scientists are rummaging the world for these unknown organisms. A new superdrug may not be discovered for decades, or it may turn up tomorrow.

And this speck of violent life may come from a far-off Himalayan valley, or from a pinch of soil in your own back yard. ★★★



## How to make your cabinets more convenient



**Hide-A-Shelf hardware** stores appliances, small power tools, radios, and similar items out of sight in your cabinets and easily raises them to desk height or counter height when needed. Easy to install... accommodates any width shelf... fits any cabinet with inside height of 22½" or more. Adjusts to counterbalance 6 to 30 lb.



**Easy-to-install Turn-A-Shelf hardware** eliminates groping in dark, hard-to-reach corner cabinets. Use for both full-round or corner-type revolving shelves. Economical three-piece pivot hardware... beautiful Copper-Glo steel shelves... reversible shelf brackets for wooden shelves... and sturdy center posts.

You can see Hide-A-Shelf and Turn-A-Shelf working models at your Amerock hardware dealer or lumber dealer.



Recommended for use in Home Improvement Council Remodeling Contest

Write name and address below, send to Amerock Corp., Box PM83, Rockford, Illinois

### Ride while you work!

Plow, cultivate, mow, rake, harrow, till, plant, bulldoze, plow snow, spray, saw, maintain beautiful lawns. 8.4 hp. All-gear drive. B-W 4 speed trans, clutch, diff. 770 lbs. Low cost. Ready to run. Quick-change implements 100% satisfaction guaranteed.

Write for FREE CATALOG  
COUNTRY SQUIRE TRACTOR CO.  
P.O. Box 107-K-3  
Muskego, Wis.



### BUILD FINE GRANDFATHER CLOCK NOW

The simple sensible Red-i-Kut way as thousands have — SAVE HALF. SHOP TESTED PLANS "SPIRIT OF THE CENTURY" Narrow waist, 83" tall or stately straight side "SPIRIT OF AMERICA." EASY-TO-FOLLOW photopack plans tell all—plus BROCHURE of heavy brass weight Westminster, tube chime, movements, gorgeous bronze-silver dials, 3/4" solid mahogany case kits. Send \$1.00 today—Both plans \$1.50 NOW. Kuempel Chime Clock Works, Engineering Dept., Minneapolis 16, Minn.



## NEW Penn Yan BOATS



### Further Ahead than Ever!

25 basic hull designs—models for cruising, fishing, skiing, racing. New work-free, leak-proofed constructions. New Clinker-bullets, flexibly bonded with Vulcanite. New standards of quality, performance, satisfaction. Write today for latest free catalog, full color illustrated. Penn Yan Boats, Inc., 34 th St., Penn Yan, N. Y.

## Everyone GETS TO USE...



## THE SIOUX POLISHER SANDER

The car, the floors, the furniture, everything will shine like new when this SIOUX Electric Polisher Sander joins your family. It arrives ready to work, complete with Wool Polishing Pad, Polishing Wax, and Abrasive Discs. A handle for polishing floors and a drill chuck with 7 drills are optional extras.



Look for SIOUX in the yellow pages under "Electric Tools"

Write for Free Catalog



ALBERTSON & CO. INC. SIOUX CITY, IOWA, U.S.A.



(Continued from page 89)

rocket with one of the largest missiles, such as the Atlas, as the first stage.

It is certain that a shot to the moon would have a large prestige and publicity value for the nation which makes one. But will it also have scientific value, beyond the simple demonstration that it can be done? There are two scientific aspects which come to mind at once. One has to do with the cosmic rays. Our earth has two "cosmic-ray shields." The first is the earth's magnetic field, which deflects many of them. The second shield is the atmosphere, which absorbs most of those that the magnetic field failed to deflect. For this reason a cosmic-ray count taken in a satellite orbit still does not give the figures which scientists really want. In the first place the satellite orbit is still inside the magnetic field. In the second place a satellite orbit is, relatively speaking, so close to the earth that the bulk of the earth covers very nearly half the sky and therefore intercepts all the cosmic rays that might come from the region blotted out by the earth. But a shot to the moon would climb out of the magnetic field, and earth would be so far "below" that it would not cover much of the sky.

One other possible scientific result would depend on an accident. If the rocket happened to hit one of the dark areas of the moon we would get an answer to an astronomical puzzle. The dark areas, the *mare* plains of the moon, are so incredibly smooth that the English astronomer Thomas Gold has suggested that they might really be depressions filled to the brim with dust. A rocket hit would show whether they are that or not.

☆ ☆ ☆

**THE PHOTON DRIVE.** There has been a flurry of talk recently that the Russians are working on a "photon drive," and many readers wonder just what new and wonderful invention this might be. Actually it is not of Russian origin but was first discussed by an Austrian, Dr. Eugen Saenger. The idea is that a sufficiently powerful light beam should produce a reaction. But this reaction is so weak that it will be of no practical value for a long time to come. The "ion drive" is a different story. Ions are electrically charged atoms which can be accelerated with magnetic fields. This is under investigation right now, and may become practical somewhat sooner. The reaction one can get from an ion drive is rather weak, too, and it won't work inside the atmosphere. But it could power a vehicle already in outer space. ★ ★ ★



## Wash off old paint with water!

Amazing how easy it is to use this miracle new WASH-AWAY Paint Remover. Just brush it on . . . wait a few minutes . . . wash off with water — your surface is clean, ready to refinish. Ideal for removing old finish from delicate antiques. Fine for outside use . . . siding, shutters, porches, boats. No scraping! Nonflammable!

AT SHERWIN-WILLIAMS DEALERS EVERYWHERE!

*listed in yellow pages of phone directories*

## STOP FAN DRAG!

with the NEW  
**FAN-O-MATIC**  
MODEL 200  
**Automatic  
FAN RELEASE**

Makes fan a free-wheeling unit  
at speeds over 35 MPH\*

### INCREASES

- Available Horsepower up to 20 H.P. at cruising speeds.
- Gas Mileage up to 3 miles per gallon . . . by actual road tests.
- Acceleration up to 10% . . . in official tests conducted at Indianapolis Speedway by U. S. Auto Club.

### REDUCES

- Engine Noise, Vibration for smoother, quieter riding.

Simple to install. Adaptable to most cars  
Installation instructions with every unit

\*Easily adjustable to higher or lower speeds



AVAILABLE at Auto Dealers, Garages, Service Stations  
Manufactured and Guaranteed by  
**Radiator Specialty Co., Charlotte, N. C.**

In Canada: Radiator Specialty Co., Ltd., Toronto

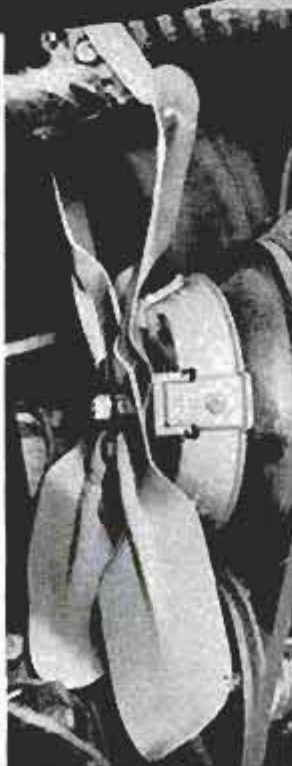

2189



## New! 1958 Low-cost Starcraft Boats



Sixteen stylish new models in aluminum and fiberglass with extra features, low price!

For fishing, for fun. Fifteen-year guarantee on aluminum models. Send for free catalog today!

## STARCRAFT BOATS

Department Q-3, Goshen, Indiana

## OUTWORKS THEM ALL

Prepares the toughest soils in one operation. All-purpose tiller-tractor tills to 12" deep - 12" to 40" wide. 3 models; 7 rotor styles including mulchers. 40 attachments include all tractor tools, mowers, snow plow. Tough chain-gear drive. Send for details.



Pat's Also Pat's, Peris.

## MERRY TILLER

Northern Life Building, Box 1835, Seattle 4, Wash.

## GLASS-BORING BIT

Glass-boring R&B BIT, 1/4" dia.; made of finest carbon steel. Fits into standard hand drill. For drilling in glass, mirrors, bottles, etc. Easy to use; instructions included.

Satisfaction guaranteed.

Send check or M.O.

One R&B BIT, prepaid . . . . . \$3<sup>85</sup>

NILBOR ENGINEERING CO.  
2303 N. Geyer Rd. • St. Louis 22, Mo.

## CRAFTSMAN'S



## 132 PAGES Many in full color

packed with rare, fancy & imported woods... veneers, plywoods, patterns, tools, ornaments, hardware... everything for the woodworker.

## Get This NEW Catalog of WOOD & WOODWORKING EQUIPMENT

WORLD'S LARGEST SELECTION OF FINEST DOMESTIC AND IMPORTED WOODS... MOULDINGS, HARDWARE, TOOLS, -ALL AT LOW MONEY SAVING PRICES!

Your complete wood buying guide and project book. Craftsman is your best, most complete source of finest kiln-dried domestic and rare imported woods, beautiful wood inlays, colorful bandings, matched plywoods, embossed mouldings, carved ornaments, newest woodworking tools, "hard to find" cabinet hardware and fittings... more than 1,500 items! Packed with newest scroll saw patterns, project ideas & money making plans. Enclose 25c (refunded with first order) to help pay mailing, handling cost. Write now! Craftsman Wood Service Co., Dept. A-3 2729 S. Mary Street • Chicago 8, Ill.

# Arc welding PAYS BIG!



"Build Your Own" gas drive welder with this HOBART generator and

**SAVE \$200 to \$300**

Just connect this low cost 250 amp.

unit to any good used auto engine and you're equipped for a highly profitable welding business. Investigate this wonderful opportunity for making more money by mailing the coupon below.

### AC welder-AC power

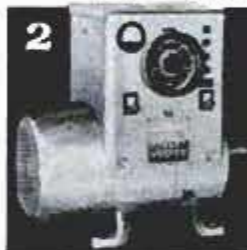

200 amp. combination that you can connect to your own power source. Lets you operate where no power lines are available. Furnishes current for welding and power for running tools, lights, motors, etc. Build your own combination welder and power unit with a good used auto engine.

### air-cooled engine driven

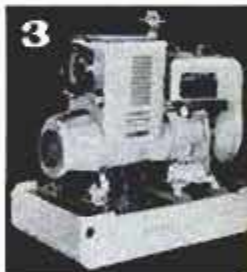

Welds anywhere. Easily mounts on truck or trailer for getting to those profitable emergency repair jobs. Light, rugged, compact and air-cooled. Fine for fabrication purposes and tough enough for continuous operation on light or medium production work.

### utility AC arc welder



Superior performance, economical operation and general serviceability make this a popular model for 200 pages small shops, implement fully shops, auto service shops, plumbing and heating con-illustrated, tractors, farm welding, self teach-etc. Has same features of the big industrial models. ing \$1.00

HOBART BROTHERS CO., BOX M-38, TROY, OHIO Phone FE 2-1223

HOBART BROS. CO., Box M-38, Troy, Ohio

Without obligation, send me complete information on:

1. "Build Your Own"     3. Air-Cooled, Engine Driven  
 2. ACWelder-ACPower     4. Utility AC Welder  
 Enclosed is \$1. Send me Welding Lessons Book

NAME \_\_\_\_\_

ADDRESS \_\_\_\_\_

CITY \_\_\_\_\_ STATE \_\_\_\_\_



## Nemesis of the Submarines

(Continued from page 105)

such as a submarine might make as it passes through the water, registers on a rotating cylinder in the aircraft. Meantime, when the submarine is definitely determined to be in a certain area, a crewman releases a pattern of "sonobuoys." These are nothing more than sensitive little microphones and transmitters. They float on the water picking up the sounds a submarine's propellers make in the water and, sometimes, it is claimed, even the conversations of the crew inside the hull. These sounds are relayed to the airplane. A trained operator can tell the speed, course and approximate position of a submarine from the sounds his sonobuoys relay.

When a sub's position is determined, a crewman fires a smokelight onto the water to mark the spot. Further sweeps back and forth across the water help pinpoint the enemy and bring the plane closer and closer to the moment of attack. The pilot must choose his tactics and weapons carefully if he is to get the sub first time around. Conditions of the sea, wind, estimated depth of the target and other factors affect his choice. Beneath each of his wings nestles a 350-pound depth charge and two powerful five-inch antisub rockets. In his bomb bay, a giant aerial torpedo, the kind that chases a sub once it hits the water, is on call at the press of a button.

S2F pilots agree that when the attack point is reached, virtually nothing can save the submarine. "If one weapon doesn't get him, another one will," one pilot comments. "Once we know where he is, he can't slip away." As the sub contact fills his detector screen, the crewman doing the tracking yells "Contact!" The pilot presses a little button on his control column, then pulls back smoothly to climb away from the coming explosion.

### Glass Bombs for Mock Raids

For practice, Tracker pilots may launch a chargeless torpedo. When the weapon makes a dull thump against the sub's side, the submarine crew knows they have been "sunk." Another practice weapon is an 18-inch glass "bomb" filled with water for ballast. Dropped on or near a submarine, the bomb explodes a small charge which does not damage but tells listeners in the sub how close the blast came and how effective a real bomb would have been. In battle, fully charged weapons would leave the sub lying somewhere on the ocean bottom, its hull ripped apart, its ship-sinking potential shattered forever.

After a successful run, it remains only for the pilot to step up his two powerful engines, climb a few hundred or a few thousand feet, and return to his home carrier. Operating far out at sea, he stands a pretty good chance of avoiding attack from enemy jet fighters. Jets consume far too much fuel at low altitudes to make a profitable attack on an S2F, climb back to efficient operating altitude, and return home.

### Stalls or Spins Are Rare

Despite his slow-flying potential, the Tracker pilot can hit a 200-knot clip when he has to. Best of all, weather doesn't bother him. With barely 200 feet of ceiling and a half-mile visibility, he can make a CCA (Carrier Controlled Approach) if he must.

When a Tracker comes in over his carrier's fantail, he's practically "hanging from the props" at just above stalling speed. Yet a stall or spin in an S2F is practically unknown. One Canadian pilot training with an American squadron had his port engine quit him during a deck-launch take-off run. Thinking quickly, he feathered his dead prop and hauled back on the stick. Observers swear he was climbing as he passed over the flight deck's edge.

Even more amazing is the tale of an S2F which became the victim of a catapult misfire. Only 125 feet from the start of its slingshotlike run, the bridle, which holds plane to catapult, snapped. "In any other carrier plane now flying, he'd have been dribbled into the sea," one watching pilot declared. Somehow the powerful Tracker stayed airborne.

### Best Bet Against Red Subs

Despite the fuss over supercarriers, jet attack planes and long-range bombers, the Tracker remains one of America's first-line defense weapons. Russia counts the submarine her best seagoing offensive weapon in case of war. The Russians have an estimated 475 tin fish, and are building more at the rate of 75 or 80 a year. The Tracker is the U.S. Navy's newest and finest "tin fisherman."

In the first two years of World War II in the Atlantic, America's major naval effort was antisubmarine warfare. German U-boats took a heart-breaking toll of allied warships and merchant shipping. Hundreds of billions of dollars were poured into the fight against a few hundred German subs.

"We hope it never comes to a showdown between our planes and the Russian subs," an S2F pilot reflected recently. "But if it does, heaven help the poor sub that crosses my search path." ★ ★ ★





## *EXTRA FUN... a cinch to run!*

Take to the water! Have fun with an Oliver . . . really new from prop to powerhead. Beautiful . . . distinctively styled in Marlin Grey and Beach White with a choice of red, blue, or yellow shrouds on the 35! Reliable . . . exclusive features to assure easy, efficient and relaxed boating. Power . . . tests prove they exceed their ratings! A full line . . . to please boating preferences and budgets: 6 HP—16 HP—35 HP Olympus. Relax and play with the Oliver of your choice, ready now! Electric starter optional on 16 HP—standard on 35 HP.

*Write for new 4-color literature*



**OLIVER OUTBOARD MOTORS 452 E. MICHIGAN, BATTLE CREEK, MICHIGAN**

*Division of the Oliver Corp., Mfgs. of the finest Farm and Industrial Equipment*



# **OLIVER**

*outboards for*

# *1958*



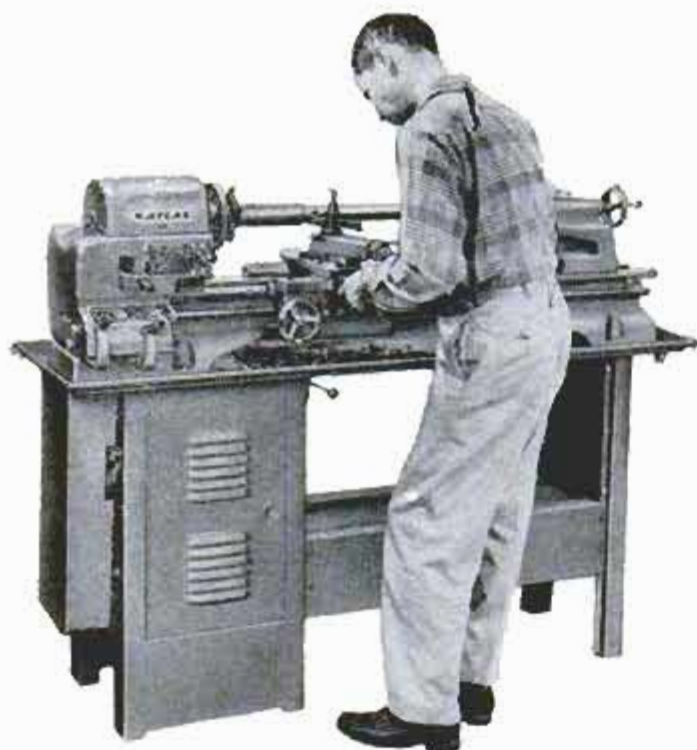

## You get SO MUCH MORE with the NEW *Atlas* 12" LATHE

- Big Capacity — 12 $\frac{1}{4}$ " swing over bed, 12" swing over saddle wings — 8" over cross slide — up to 36" between centers.
- Timken tapered roller bearings for accuracy and service.
- Heavy bed with ways precision ground to align to within .001" in all planes.
- 16 spindle speeds. Complete V-belt drive for full transmission of power.
- Reversible power cross feed and longitudinal feed. Wide thread cutting range.

These and other big-lathe features, *standard equipment* on the Atlas, give you greater capacity, versatility and performance than has ever before been available at or near this low price. The *outstanding* lathe value . . . perfect for production, experimental, service, school and home shops.

BENCH LATHE PRICES START AT **\$325<sup>00</sup>**  
F.O.B. FACTORY



Write TODAY FOR NEW ILLUSTRATED LITERATURE

### ATLAS PRESS COMPANY

3-24 N. PITCHER STREET, KALAMAZOO, MICH.



### Model Plane Sets Record

Raymond Gibbs of London claims a new world's speed record of 152 miles per hour for his five-cubic-centimeter model plane. Gibbs' previous record for a model on control lines was 146 miles per hour. The British model-plane fan also holds the International Cup for the fastest flying 2 $\frac{1}{2}$ -cubic-centimeter aircraft.

### Extension Handle for Outboard

With a new extension handle, a fisherman can control his outboard motor from the middle of the boat. The handle replaces the regular plastic grip on the motor and can be installed with one screw. It permits control of both throttle and steering from a point four feet forward of the motor.

Ritefit Mfg. Co., Inc., 2420 Hiawatha Ave., Minneapolis 4, Minn.





**GIGANTIC  
SAVE-TO-70%**

# MAIL SALE

**WAR SURPLUS  
EXCESS INVENTORY  
BANKRUPT STOCK**

## HYDRAULIC SPEED REDUCER

• Variable hydraulic speed reducer. Any speed from 0 to 750 rpm by simply throwing a lever. Handle up to 1 1/2 h.p. Use for midget cars, shop band saws, etc. Instant reverse. Govt. cost \$428.  
**SPECIAL.....\$47.81 FOB**

## AIR COMPRESSOR BARGAINS

For painting, cleaning, tires, control terminals. Assemble your own outfit. Lowest prices in U.S.  
• Deluxe Kit, Compressor, tank, gauge, regulator, paint gun, fittings. How to build instructions. List \$52. **SALE \$39.49 FOB.**  
• Compressor 1-cyl. \$19.95; 2-cyl. \$49.95; Govt. Air Tank, \$8.79; Regulators, \$3.98; Pop Off \$1.95; Pres. Gauge \$1.89. Finest paint gun \$11.95. Auto switch \$4.75. All prepaid.



## GOLF ELECTRIC CAR MOTOR

• Use golf or boys electric car. Geared 100 to 1. Run 6 or 12 volts, also on AC. Easily reversible. Full instr. Wt. 34 lbs. Govt. cost \$250.....**FOB \$19.46**



## 2500-WATT PLANT

• Brand new factory overstock 115/230-V, 60-C, 2500-W (will deliver 3000-W). 3-wire sing. ph. plants. Mod. 23 Briggs engine, ball bearing generator. Ideal for farm or city emergency or full time use, and for camping, portable tools, etc. Be prepared for power line failure. Wt. 265 lbs. Nat. Adv. List \$425.  
**SALE.....\$239.50 FOB**  
(Dozens bargains plants and generators.)



## IRRIGATION PUMPS

2 1/2" size, 16,500 gph  
• New bronze 1-bearing centrifugal 280 gal. per min. 65 ft. head. Intake 2 1/2". With 6" pulley. Wonderful unit. Govt cost \$98. **SALE.....\$49.50 FOB.**  
• Same pump in 1 1/2" size, 140 gal. 70 ft. head. Govt. cost \$62.  
**SALE.....\$24.61 Ppd.**



## AIR FORCE BOATS

• Amazing air force survival boats. Carry 1 or 2 men. Folds into compact pkg. Easily inflated. Very safe. Marvelous fishing or river floater trips. With sail mast. Govt. cost over \$100.  
**SALE.....\$27.95 Ppd.**



## SPECIAL OF THE MONTH!

### TRACTOR WEED SPRAYER

• Latest design, 5-row (14') outfit. Complete outfit using Hypro finest ball bearing high pressure roller pump, T-jet nozzles, relief valve, hoses, controls. List \$175.  
**SALE.....\$97.65 Ppd.**

### HYDRAULIC SURPLUS BARGAINS

• Save to 80%. Build loaders, lifts, presses, etc.  
• Super special cylinder. 1 1/2" bore x 4" stroke. (Precision) Govt. cost \$75. **SALE.....\$3.89 Ppd.**  
• 100s other hydraulic pumps, cylinders, hose, etc. Send for catalog.

### STORAGE BATTERY WINCH

• Powerful fully reversible, ball-bearing gear reduction winch. 1000-2000 lb. pull. Use on 6 or 12-v battery. Holds 40' of 1/4" cable. For trucks, docks, boats. Govt. cost \$280. **\$46.75 FOB**

**ORDER FROM AD or write for catalog.**  
Hundreds marvelous mechanical, electronic bargains.

**BURDEN SALES COMPANY**  
805 West 110th St., LINCOLN, NEBRASKA

**PAGE FOR TILLING PLOWING MOWING**

**FULL LINE** 2 to 6 HP with complete gear drive and reverse.

**Free Catalog** LOW PRICES EASY TERMS Over 30 Years Experience

**FULLY GUARANTEED!** Over 60 attachments available!

**PAGE 1904-A S. 81st STREET MILWAUKEE, WIS.**

## ONE BIT FOR ALL

Handiest drill bit made. Use on any electric drill, lathe, drill press, etc. Made of finest American hi-speed steel. 3 1/2" long, 1/4" diameter. Has 2" side-cutting section. Cuts steel, wood, plastic, aluminum, etc. 3 types—specify types wanted. (1) All purpose. (2) Wood. (3) Heavy metal. \$2.45 each — 3 for \$7.00 — Postpaid. Money back guaranteed. Buy from your dealer or send check or Money Order and name of favorite tool dealer TODAY. (Makes ideal gift.)

**BEAVER DRILL & TOOL CO., 3008-J McGee Trafficway, Kansas City, Mo.**

### .... DRILL SAW - REAM CUT

**BEAVER HI-SPEED SAW DRILL BITS**

Jobber & Dealer Inquiries Invited

## TROUBLESOME WOOD HATCHWAY?

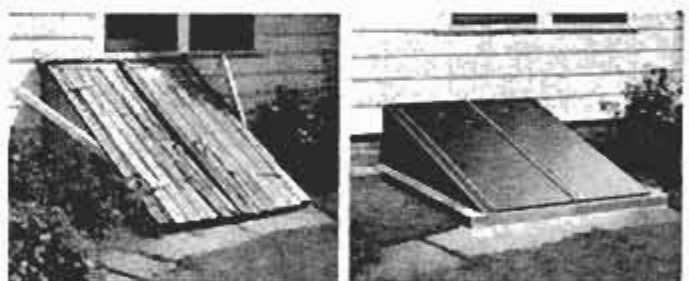

## REPLACE IT!

With a modern Bilco Basement Door. All-steel, weathertight, spring-operated. Do it yourself in just 3 to 4 hours.



AMERICA'S FINEST BASEMENT DOOR

Write today for FREE illustrated replacement folder.

THE BILCO CO., Dept. 124 NEW HAVEN 5, CONN.

Please send me complete information.

NAME .....

ADDRESS .....

CITY ..... STATE .....

## U-MAK-IT BOAT KITS

### NEW LAPSTRAKE SKIFF KITS

Now added to our great line of kits, new easy to assemble Lapstrake Skiffs.

30 years of boat kit pioneering. 30 models. Prams, Rowboats, Outboards, Cabin Cruisers and Skiffs.

**SEND FOR ILLUS. CATALOG** Showing all models from 8' to 23'. Const. details, paints, access., etc. All you need to build your own. MAIL 35c (coin) for Postage & Handling.

**U-MAK-IT products**  
DELAND, FLORIDA — DEPT. 12



# 8" TILT ARBOR SAW 1957 MODEL—BELOW COST!

## BLADE TILTS—TABLE REMAINS LEVEL

Heavy duty all cast iron and steel construction. Precision ground cast iron table. Price includes massive cast iron mitre gauge and patented motor drive that fits any motor. Cross cuts, rips, bevels,



mitres, dados, cuts compound angles — everything expected of saws costing four times as much. Depth of cut adjustable; 0" to 2 1/4" — table always level. Send check or M.O. \$1.00 deposits on C.O.D.'s.

**SPECIAL BARGAIN** — This saw is our 1957 model. Each saw is brand new — sent to you in factory sealed cartons. Sold and guaranteed direct from the factory to you at a fantastic bargain.

## FREE 10 DAY TRIAL — MONEY BACK GUARANTEE

Try this famous saw 10 days. If you are not satisfied that it does the work of any tilt arbor saw, regardless of price, return for immediate money back refund.

Sent Express Collect

We reserve right to refund money if stock is exhausted

**AMERICAN MACHINE & TOOL CO.**  
ROYERSFORD 16, PA.



## Modernize a room in a weekend with soilproof Marlite paneling!

In a few hours you can turn an out-moded room into a modern interior with Marlite paneling. Marlite Planks (16" x 8") and Blocks (16" square) go up fast over new walls or old. The soilproof plastic finish resists smudges and stains; cleans with a damp cloth. See your lumber dealer for Marlite in distinctive wood finishes, marble patterns, "Companion Colors"—or write for free decorating ideas book. Marlite Division of Masonite Corporation, Dept. 342, Dover, Ohio.



# Marlite

plastic-finished paneling

ANOTHER QUALITY PRODUCT OF MASONITE® RESEARCH

## Watch Them Build Those New Superhighways

(Continued from page 111)

the kind of designing the administrator is trying to get. "Instead of cutting away the hills," he explains, "they benched them, built the lanes on different levels and not only opened up a view but saved a considerable amount of money."

### Relaxed Riding on Thruway

The 562-mile New York Thruway is an even more extensive example. This is more than a good road. It's a great one and has come to be recognized as the very model of what the Interstate and National Defense System should be, which is chiefly why President Eisenhower appointed Tallamy, who supervised its building, to his present job. I have driven this road many times between New York and Buffalo. At every curve, up every hill you rarely see less than 1000 feet ahead. As I drove relaxed and secure at a mile a minute on a roadbed that is a contractor's poem in concrete, I felt that I was looking through the windshield at a long love letter to New York State.

Most state highway departments do have men who love their land, but it takes time to jockey with highway alignments by ordinary methods—weeks to make a single alignment, weeks more to see if the road might work out better by going a somewhat different way.

### Brains—Electronic and Human

So it is promising to learn that in Ohio, they are doing what the authoritative *Engineering News-Record* calls "breaking the sound barrier in highway engineering"—trying out different alignments on the electronic machines. E. S. Preston, who developed the system, explained it to me while his machines were gobbling punch cards and tape all around him, spitting out numbers, drawing lines, making cross sections. He left me behind at the first curve, but I came away with this much: It's been taking 54 months on an average throughout the nation to complete a superhighway—actual construction 24 months; 30 months for location studies and production of final plans. With his electronic zip-what-is-it, Preston is clipping about 60 percent from the time consumed in these preliminaries.

Road-building used to be something that college football players worked at during the summer vacation to sharpen their muscles. But now they have to bring along their brains and professors who know how

(Continued to page 272)



# stock your shop

- SCREWS
- BOLTS
- NUTS

**DraweRack**  
without boxes



**EASY TO GET AT! EASY TO GET OUT!**

Buy your screws in these handy, sparkling, clear-plastic drawer-boxes! Generous quantities of top-quality fasteners at 59c per box. Keep them in the ingenious, multi-purpose DraweRack storage system — ready for quick selection and instant use! At your hardware store . . .

ALL WOOD SCREWS ARE  
**SPEEDIZED**  
FOR EASY DRIVING INTO  
EVEN HARDEST WOODS

**59c**

PER BOX



ELCO TOOL & SCREW CORP.

ROCKFORD, ILLINOIS

## ROAD TO RICHES

You can be the next uranium millionaire! Government guarantees huge bonus! PRI instruments from \$29.95. See your local dealer today! FREE CATALOG! Write PRI, 4223 PM W. Jefferson Los Angeles 16, California



DEALERS WANTED



## GEARS

**In Stock — Immediate Delivery**  
Gears, speed reducers, sprockets, thrust bearings, flexible couplings, pulleys, etc. A complete line is carried in our Chicago stock. Can also quote on special gears of any kind. Send in your blueprints and inquiries.

Send for Complete Catalog No. 10

**CHICAGO GEAR WORKS**  
440-50 N. Oakley Blvd., CHICAGO 12, ILL.

## Takes the PAIN out of PAINT REMOVAL

**KWIK** ALL-PURPOSE  
Non-Flammable  
PAINT & VARNISH REMOVER

Enables you to remove all types of paint, varnish, lacquer in just 5 to 15 minutes . . . from the old paints of Colonial Williamsburg to the new synthetic enamels and fiberglass finishes of today. Yes, Kwik's that quick! Try Kwik and see. Complete line of Kwik paint removal products at good hardware, paint and marine dealers.

Chemical Products Co., Inc., Aberdeen, Md.



View of one of the Lawns surrounding the lovely \$200,000 home of Spurgeon Pickering, owner of Mondo Grass Co., on the beautiful beach of the Gulf of Mexico; the entire 7 lawns, sidewalks, shoulders, and neutral grounds are planted solidly in Mondo Grass, truly one of the most attractive show places of the South.

**NOW IS GOOD TIME TO PLANT**  
OR  
**CAN BE PLANTED SPRING—SUMMER—FALL—WINTER**  
(if ground is not frozen)

# BLUE-GREEN MONDO "GRASS"

TRADE MARK REGISTRATION APPLIED FOR U. S. PATENT OFFICE  
**REQUIRES NO MOWING — MAKES WORLD'S MOST BEAUTIFUL LAWN**  
Buy THE ONLY genuine Mondo Grass from us.  
Beware of imitations.

Blue-Green Mondo Grass is described by the U. S. Department of Agriculture as quote "Ophiopogon Japonicus, (formerly called Mondo Japonicus), is native to Northern China and should withstand severe degree of freezing; evergreen, commonly called Mondo Grass" unquote.

This sod-forming EVERGREEN, low-growing oriental genus is currently used by many owners of distinctive homes in America for lawn grass. Now we can offer this exclusive Blue-Green Mondo Grass at popular prices.

**SO HARDY IT CAN BE PLANTED ANYTIME.** It is recommended for beautiful lawns where mowing is not desired, Blue-Green Mondo Grass retains its color the year 'round; thrives in shade or sun; extremely hardy, rarely requires watering; fantastically beautiful, drooping low to the ground in weeping style year after year. **REQUIRES NO MOWING.**

Ideal for heavy shaded areas or sun, dry or wet. **FREE** folder of testimonials and many photos of Mondo lawns sent on request.

Mondo is resistant to diseases; insects and animals will not feed on it. Stops erosion, grows compactly, crowding out other grass and weeds; multiplies rapidly, approximately 100 times (10,000%) first year, if properly handled. Enhances property value. So sensational we expect to revolutionize lawn-making. For good coverage first year plant 2" to 6" apart. Numerous rooted blades to sprig.

Planting and culture instructions with each order. Remittance with order. Shipped prepaid. **MONEY-BACK GUARANTEE:** If not completely delighted you may return at once for refund. Open account to A-1 rated firms buying 1,000 sprigs or more, FOB Biloxi.

**ORDER TODAY** . . . Sprigs shipped in damp moss. Guaranteed to grow or we will replace.  
**25 SPRIGS \$2.98**

50 Sprigs . . . . . \$ 5.00	1,000 Sprigs . . . . . \$79.00
100 Sprigs . . . . . 9.00	5,000 Sprigs or more
500 Sprigs . . . . . 40.00	per 1,000 . . . . . 50.00

**MONDO GRASS CO., Dept. PM-3, Biloxi, Miss.**

I enclose \$ \_\_\_\_\_ for Prepaid Shipment \_\_\_\_\_ Sprigs Mondo Grass.

Name \_\_\_\_\_

Address \_\_\_\_\_

City \_\_\_\_\_ State \_\_\_\_\_



# WILLIAMS

## DROP-FORGED TOOLS

### FINEST IN FIT, FEEL AND FINISH

#### B-52 and S-52 Reversible "SUPERRATCHETS" 50% Stronger Than Government Requirements

- 41 Teeth give 82 teeth action; less than 4½° to rotate nut.
- Stresses evenly distributed throughout entire mechanism.
- Harder the pull on handle, the more teeth in contact.
- Available individually or in 2001 chest.
- Rugged construction; no one part bears bulk of stresses.

### "SUPERCHEST"

#### No. 2001

6 Drawer  
Metal Chest  
14½x12½x25"  
Chest 53 lbs.  
Tools 69 lbs.  
Total 122 lbs.



Complete 149 Piece set contains 51 "Super-sockets" with 37 attachments in ¼, ⅜, ½ and ¾" drives, 61 "Superrenches", pliers, chisels, screwdrivers, etc. All drawers lock automatically when cover is closed and locked by combination lock and hasp. Free brass, individually-engraved nameplate with each chest.

503 CATALOG shows "The Broadest Line of Its Kind". Free on request.

J. H. WILLIAMS & CO., 419 Vulcan St., Buffalo 7, N. Y.

# Taylor

tops 'em all



## with this new HOLIDAY CONVERTIBLE

When you buy a windshield, be sure it's the Taylor-Made Holiday—then you can add the Top later.



New glamour-styled VENTILATED Convertible for all-weather cruising comfort. Bold, panoramic Windshield features new Speed-Aire Wing Ventilators for complete air-draft control. Top now available in White Vinyl Nylon! Complete range of stock sizes for a perfect fit on almost every open boat. Taylor-Made—by the leader in Windshields and Convertibles.

MAIL COUPON FOR FREE 1958 FULL COLOR CATALOG

N. A. TAYLOR CO., INC., Gloversville 14, N. Y.

Please send free catalog of Taylor-Made Products.

Name.....

Address.....

to use seismographs, hydraulic hoes, diamond saws, vibrators, sheepsfoot rollers. There are machines that can remove eight truckloads of earth in a single bite, compacters swaying on wobbly wheels, paving trains smoking and snorting along on steel rails—a veritable industrial plant on wheels.

### How to Drain a Marsh

One day I accompanied Conrad Lang, chief engineer of the New York Thruway, as he inspected construction on that part of the interstate system which will connect Massachusetts and New York through the Berkshire Mountains. From a hilltop I saw, along the graded road bed, a peat marsh being drained. They had hammered hollow pipes into the muck, filled the pipes with sand, then carefully pulled the pipes out to leave the sand standing in columns. Then they had piled up on the marshy road bed enough rock to fill not only it but a quarter mile of lowland beyond. The great pile of rock was squeezing the soggy ground like a sponge, the water in the marsh bubbling up through the columns of sand. When the marsh is dry, they'll push the extra rock off into the lowland beyond.

Rolling toward the peat marsh on steel rails was a parade of monsters that looked as if they had escaped from Walt Disney's drawing board. The rails had been laid in the shape of a concrete highway. A giant paver came first. It had revolving barrels, was draped all over with tubes, hoses and valves, and had an arm sticking out in back that was longer than itself. A bucket rode busily back and forth along this arm, dropping blobs of concrete between the rails. Each blob weighed as much as an automobile.

### Assembly-Line Landscaping

Chuffing along behind the paver was an animated box that pushed a paddle from side to side, spreading the paver's droppings evenly. On the rails behind it rode a wide row of "feet" that were jiggling fantastically, stomping on the concrete 4000 times a minute to eliminate any voids. Behind that was a relatively dainty creation that moved a wand gently from side to side to smooth the concrete's surface.

Then, as in the circus after the parade of the elephants, came the men on foot. They were pushing long-handled wooden floats to level the imperfections, dragging stiff-bristled brooms to give the concrete a skid-resistant surface, spraying a membrane to protect it as it cured. Behind them were men sawing contraction joints in the hardened slab. And behind them were

(Continued to page 274)



# KING MIDGET

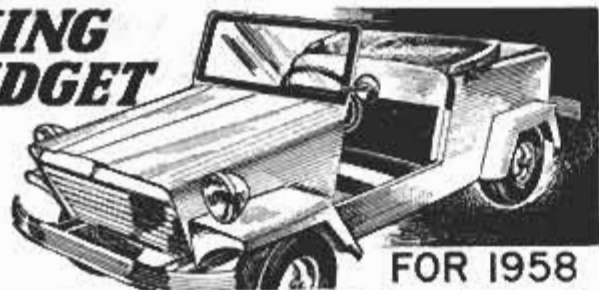

FOR 1958

More power, beautiful styling, New Features. Still World's Lowest Priced Car. Drive it for 75c a week. Rider agents wanted. Earn your own car. If no dealer near you send 25c for 32 page picture book with full details and dealer price. Or send \$1 (refunded first order) for this and Service Manual, plus Repair Manual, plus 15 5x7 photos of car and factory.

**MIDGET MOTORS CORPORATION**  
Athens 1, Ohio

## MASTERCRAFT CONSTRUCTION

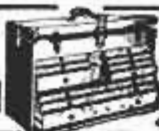

Fifty years experience in skilled woodworking is behind every Gerstner Chest. Free Catalog to Machinists and Toolmakers.  
**GERSTNER TOOL CHESTS**  
458 Columbia St., Dayton 7, Ohio

Works in seconds!

**Loosens Rusted Bolts**  
nuts, screws, "frozen" parts!

## LIQUID WRENCH

The super-penetrating rust solvent that quickly loosens rust and corrosion.

AT HARDWARE STORES, GARAGES  
SERVICE STATIONS, EVERYWHERE  
**RADIATOR SPECIALTY CO.**  
Charlotte, N. C.



# TOP VALUE SPECIALS!

SURPLUS ITEMS AT FRACTION OF ORIGINAL GOV'T. COST

**OUR SPRING SPECIAL**

**OBERDORFER BRONZE**

## CENTRIFUGAL PUMP

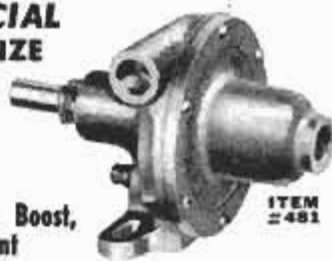

ITEM #481

For: Fluid Transfer, Sprinkler Boost, Circulating, Marine Coolant

Designed for continuous, heavy service. Carbon bearings require no lubrication. For direct or belt-drive with speeds up to 3450 RPM. All bronze housing and impeller with 1/2" stainless steel shaft. Has 3/8" inlet and outlet with 1/4 H.P. Motor delivers—Gallons Per Minute, Head in Feet

R.P.M.	0	4	6	8	12	16	20
@ 1750	3.00	2.00	1.25				
@ 3450	7.25	6.75	6.50	6.25	6.00	5.25	4.25

Regularly **OUR SPECIAL**  
**\$26.50** **SPRING OFFER, ONLY 12.50** Paid.  
2 for 23.00

**FREE! NEW 1958 CATALOG**

60 VALUE-PACKED PAGES of unsurpassed War Surplus and newly manufactured Equipment. Bargains for farm, home, factory, workshop. Write letter today.

Order Direct from Ad. Send Payment Or Purchase Order Today  
For Phone Orders Call Webster 9-3793

**GROBAN SUPPLY CO.** Dept. PM-3  
1139 S. WABASH AVE., CHICAGO 5, ILL.

# CASH FILING SAWS

Make up to \$3 or \$5 an hour spare time—or start a full time business with the



## FOLEY SAW FILER

Here is a steady repeat CASH business you can start at home in your basement or garage, while you are working at your regular job. No experience is necessary to turn out perfect cutting saws—"the first saw I sharpened came out 100%. I think the Foley Saw Filer is a marvel of perfection," writes Clarence E. Parsons. No canvassing—every saw you sharpen will bring you new customers. You will find you can make up to \$3 or \$5 an hour—\$20 to \$30 a week in your spare time as a starter. "My spare time saw filing business has made me \$952 these first ten months," says R. T. Chapman.

With a Foley Saw Filer you can file all hand saws, also band and cross-cut circular saws. It is easy to operate—simple adjustments—no eyestrain. Patented jointing principle evens up all irregular teeth and makes an old saw cut just like new.

**FACTS" Shows How To Start**

**FOLEY MFG. CO., 316-8 Foley Bldg.**  
Minneapolis 18, Minn.

Send me free book "MONEY MAKING FACTS" and Saw Sharpening Price Guide.

Name \_\_\_\_\_

Address \_\_\_\_\_

City \_\_\_\_\_

State \_\_\_\_\_



## This Free Book "MONEY MAKING

"MONEY MAKING FACTS" shows you how others have added hundreds or thousands of dollars to their incomes and how you can develop into a general repair shop that will be your own business. This is a CASH business with a small investment, no overhead, no stock of goods to carry. Mail coupon now for free book and nation-wide survey of saw sharpening charges. No salesman will call.



SAWS

PLANES

MOLDS



## NEW BELSAW MULTI-DUTY POWER TOOL

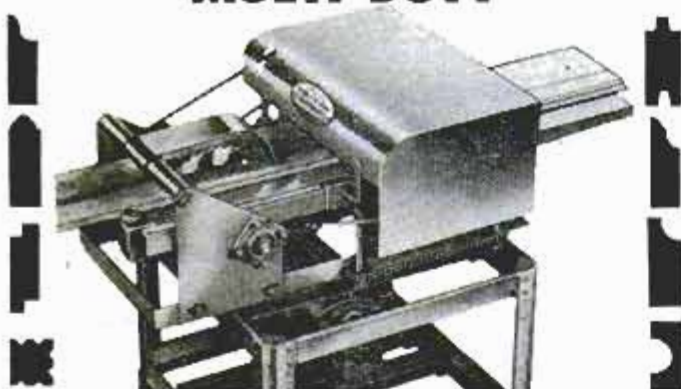

Now you can use this ONE power-feed shop to turn rough lumber into high-value moldings, trim, flooring, furniture ... ALL popular patterns.

### RIP... PLANE... MOLD...

separately or all at once by power-feed ... with a one horsepower motor. Use 3 to 5 HP for high speed commercial output.

### FULLY SAFE-GUARDED, anti-kickback design.

Low Cost ... You can own this money-making power tool for only \$30.00 down payment.

Write TODAY for free Catalog

BELSAW POWER TOOLS • 908 Field Bldg., Kansas City 11, Mo.

## FIX IT THIS SURE, EASY WAY!



Strong, flexible, waterproof, neoprene adhesive offers the sure, easy way to replace loose tile, repair loose plastic or linoleum sink and table tops. Thousands of uses. At better dealers everywhere. *Goodloe E. Moore, Incorporated, Danville, 11, Illinois.*

## TUFF-BOND QUIK-SET ADHESIVE STICKS ALMOST ANYTHING TO ANYTHING



gardeners, blowing grass seed out of huge nozzles, placing shrubs and trees carefully on the island between the lanes in just the places where they can be counted on to cut the glare of approaching headlights.

### Asphalt Plants on Wheels

That was a concrete highway. But paving with black top, too, has become a task for an assembly-line industrial plant. Asphalt plants are now built on wheels and travel hundreds of miles from job to job. Twenty-five years ago it took a gang of men to spread and level an asphalt mix. Now a two-man automatic paver with a roller following can do two miles of a 12-foot-wide road in a day, and the road can be opened to traffic minutes after they've passed.

Progress—progress all along the line. In Illinois, a car making 14.5 miles to a gallon of gas over an ordinary route suddenly averages 22 miles per gallon over a new superhighway. Lexington, N. C.; San Rafael, Calif.; Kokomo, Ind., and a hundred other communities that felt they were going to become victims of progress learn that even bypassed towns derive economic benefit from the new roads. In New York a trucking firm, by paying \$48,000 a year in Thruway tolls, is able to reduce its insurance bill \$50,000 a year. These are all studied and demonstrated effects of those superhighways already in use.

Driving on one is like driving on tracks. The superhighway—with its one-way lanes, its overpasses and underpasses at every intersection, its long unobstructed lines of sight, its accelerating and decelerating lanes acting like switch sidings for incoming and outgoing traffic—provides the automobile with the equivalent of an express train's road bed.

### Block Signals for Cars

They are even working out a way to provide the automobile driver on these concrete "tracks" with safeguards now enjoyed by locomotive engineers. At the intersection of U.S. 77 and State Highway 2 outside Lincoln, Neb., RCA and Nebraska highway engineers have sawed some wiring into the roadway and deposited small electronic control detectors on the shoulders. The detectors work signals, which warn of approaching cars at the intersection, tell a driver in any lane he is coming too close to the car ahead, tell when it is safe to pass on a curve and when it isn't.

You may yet be driving in greater safety on roads equipped with automatic block signals like a railroad's. For greater safety, in every possible way, is being built into the new superhighways. ★★★



For Complete Engine Protection, Install a

# STEWART-WARNER

## "TWIN-PANEL"

Ammeter and Oil Pressure Gauge

Car Owners:  
you need more than  
just "warning  
lights"!

COMPLETE  
"do it yourself"  
KIT

- Ammeter
- Oil Pressure Gauge
- Twin Gauge Panel for under-dash mounting
- Installation instructions

Easy to install!  
Fits all cars!

Battery and oil warning lights tell only *half* the story! They just indicate that your generator is not charging, or that your oil pressure is low. But a Stewart-Warner ammeter tells actual *RATE* of current flow—indicates when there is danger of burning out a generator—helps prevent overcharging or discharging battery. A Stewart-Warner oil pressure gauge tells *EXACT* oil pressure—helps assure safe engine operation!

Ask for it at your car dealer, service station, garage or automotive parts store or write: Dept. AM-38, 1840 Diversey Parkway, Chicago 14, Illinois.

INSTRUMENT DIVISION

**STEWART-WARNER**  
CORPORATION

Symbol of

**SW**

Excellence

KEEP DRIVING STRAIGHT IN '58



### HULL AUTO COMPASS

America's favorite motoring guide for 25 years. At your dealer's or write for literature.

Ever-Dependable Boating Guides, Too **\$6.95 and \$5.50**

HULL MFG. CO., P. O. Box 246-D3, Warren, O.

## BOAT OWNERS FREE CATALOG

boat covers, motor covers, fenders, life jackets, life cushions, marine hardware, rope, anchors, water skis

Manitowoc Awning & Cotton Goods Products Co.  
Dept. M Box 261 Manitowoc, Wis.



## NEW GRIPSO TOOL KIT

Save Time, Work, Money—4 new Power Action tools do the work of dozens of tools. In handy vinyl holder.



### WISE PLIERS

5 Tools in 1 — 1 ton grip gentle release. One hand adjustment.

### PIPE WRENCH

Press—pull it's open. Push—it's closed. Ratchet action adjustment.

### MULTI-DUTY PLIERS

Multiplies grip 10 times.

### GEAR LOCK PLIERS

Patented power gear grip.

See Your Dealer or Write  
H. R. BASFORD CO., 235 15th St.  
San Francisco 3, California

## EARN GOOD MONEY—Spare or Full Time IN A BUSINESS OF YOUR OWN...

### SMALL INVESTMENT — NO EXPERIENCE NEEDED

Thousands of men are making big money in their own business. You too, can have a fine income with an assured future in spare or full time with the Universal lawn mower grinder. Investigate our success plan now, it includes everything you need plus facts on how others have earned over \$3,600 in one season, working part time. Act now! Mail coupon today!

**ROGERS**

MANUFACTURING CO.  
Lindsey, Ohio

ROGERS MFG. CO., Dept. M38, Lindsey, Ohio  
Gentlemen: Rush me FREE details on easy inexpensive way to get into my own business.

Name \_\_\_\_\_  
Address \_\_\_\_\_  
City \_\_\_\_\_ State \_\_\_\_\_

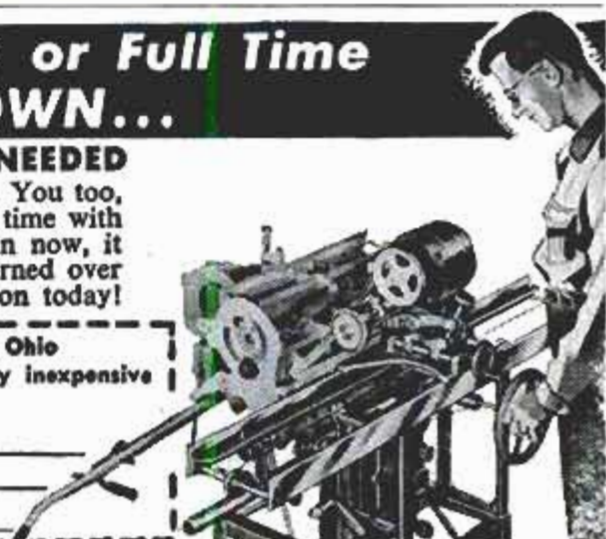



## Edsel Power, Handling Rate High With Owners

(Continued from page 95)

is good for a car this size. As I do most of my own service, I like the spark plugs being where I can change them easily and the oil filter is easy to remove also."—Illinois owner.

### And More Complaints

"The front seat back is too thin. Not enough padding."—Tennessee mine foreman.

"Piping between fabric and plastic on back of seat irritates your back when wearing a sport shirt."—New York cost engineer.

"Heater control does not work as it should. Dial must be turned to almost full otherwise you get cold air."—Ohio tire-company worker.

"Automatic transmission is very rough when shifting. When it goes from starting gear to high it slips for a few seconds then takes hold with a grab."—Maryland owner.

"Push-button shift on the steering post requires visual attention to operate. It's easy to push the wrong button."—California physician.

"My three-year-old son can reach the push buttons. What happens if he pushes one of them while I'm driving?"—Illinois businessman.

"If Park button was elsewhere than in cluster there would be less chance of pushing it by mistake. Should be on dash above parking-brake release."—Illinois designer.

"Have to bail out water from the depressed floor after the car stands out in the rain all night."—Virginia housewife.

"Rear floor mat does not stay in place. Had to have screws put into floor to hold it."—Wisconsin chemist.

"On a cold morning, the engine idles so fast it moves the car at 40 miles per hour. I have to keep my foot on the brake all the way to work to hold it down to the legal speed limit."—Ohio toolmaker.

"The glove compartment is exceptionally small."—Wisconsin brakeman.

"Station wagon looks too much like a Ford."—Massachusetts manufacturer.

"It seems as though everything on it but the body is extra, extra, extra. Costs too much. With the extras mine cost \$4088. And as far as I can see it has nothing other cars haven't had for years."—Arkansas publisher.

"Lack of instruments. I like dials because they make it easier to check on battery and engine. Lights only tell you a thing is or is not working, but not how it is working."—Michigan guard.

In each PM Owners Report survey we ask the owners to make one suggestion to the entire industry. Here are some of the more interesting suggestions:

"I see no reason for automobiles that are 18 feet long and weigh two tons and yet seat only four persons, rather uncomfortably at that. One must be a contortionist to enter and then, once inside, there is no adequate foot and head-room for the normal man, particularly in the back seat. The Edsel is as good as or better than the other medium-price cars in this respect."—Georgia professor.

"Put the headlight dimmer switch in a more convenient place. I recommend the center of the steering post."—Florida plant foreman.

"Have each maker try to be different rather than con-

(Continued to page 280)

Seemed to be very little range to heat control in test car. Had to be almost wide open to get any heat. Power assist is good, but it's another potential trouble causer.

Over 6 m.p.h., nothing happens if Reverse or Park is pushed. Below that speed, the car stops with a violent shudder.

This is due to action of automatic choke—a good argument for the old hand choke.

Can't see value of drum-type speedometer. With needle you can "sense" speed by relative position of needle on dial. With drum, you have to read the figure to know how fast you are going. As for lights versus dials: It's an old argument. Edsel lights are mounted too low.

The professor makes a lot of sense, but people still seem to buy big cars when given a choice. Guess people don't make sense.





For clean oil all the time  
call for

**HASTINGS**

Only Hastings Oil Filter Cartridges keep oil clean *all the time*, because only Hastings has Densite filtering material.

Densite is different! Millions of selected cotton fibres—pressure packed—trap even the most microscopic dirt particles. Only Densite keeps oil clean from filter change to filter change, when replaced as normally recommended.\*

Next filter change, call for Hastings—for clean oil *all the time!* Hastings Manufacturing Co., Hastings, Mich. Also makers of Piston Rings, Casite, Wear Reducer, Spark Plugs.

*\*Proved by tests conducted in accordance with U.S. Bureau of Standards procedures.*



U. S. Patent  
No. 2,797,811



**you don't have to be a**

**SHYPOKE\***



**... to take the BIG STEP**

Enter the  
**\$125,000 Home Improvement Council**  
"Better Your Living" Contest Today!

**\$25,000**  
FIRST PRIZE  
1,003 prizes in all!

*\*The tall one's the shypoke*



HOME IMPROVEMENT COUNCIL  
c/o POPULAR MECHANICS  
200 E. Ontario  
Chicago 11, Illinois

Gentlemen:

Please send me full particulars on the "Better your living"  
contest sponsored by the HOME IMPROVEMENT COUNCIL.

Name \_\_\_\_\_

Address \_\_\_\_\_

City \_\_\_\_\_ State \_\_\_\_\_

*You can be a Winner!*

Get full  
details from the dealer who  
displays the Home Improve-  
ment Council emblem, or send  
this coupon to **POPULAR  
MECHANICS. But act today!**



# NEW! DREMEL MOTO-SHOP

## Complete All-Family Power Work Shop

Dremel Moto-Shop is the first real multi-purpose workshop designed for the whole family. In one compact, portable unit you have a jig saw, disc sander, buffing wheel, bench grinder, and a flexible shaft machine. 5 power tools in 1 unit that do 1,001 jobs. For the kids it provides hours of constructive, creative recreation. It's invaluable to Dad, and even Mom, for hobby work and home maintenance. Moto-Shop is not a toy, but a professional-quality power tool with a ball bearing rotary motor. It's super-safe; cuts  $\frac{3}{4}$ " wood, metal, plastics, etc.; sets up anywhere, can be carried from room to room. Outperforms heavier, more expensive jig saws. See your power tool or hobby dealer today.

Model 571 (jig saw with disc sander attachment) .....\$33.95

Model 572 (with all attachments shown) ..\$49.95

FREE Moto-Shop Catalog. Write today!

DREMEL MFG. CO. Dept. 118C, Racine, Wis.

5  
POWER TOOLS  
IN ONE



Model  
572



WELD BRAZE  
SOLDER CUT



4WAY

ONLY  
\$14.75  
f.o.b. factory

WELDER  
Complete with  
Twin Carbon Arc  
Torch and ac-  
cessories... to  
handle all metal-  
craft work.

Acclaimed by thousands of Homeowners, Mechanics and Hobbyists as the welder of 1901 uses. Easily operated from properly wired 110 volt AC or DC line. The ideal gift with a life-long use... Order today on 10 day money back guarantee.

FOUR-WAY WELDER CO., Dept. F2-C  
1810 S. Federal St. • Chicago 16, Ill.

### NEW, IMPROVED CALCULATOR FOR WOODWORKERS only 25c

Instantly gives information on lumber, nails, concrete mixes, painting materials, etc. Convenient, simple to read. Just set dial for nail specifications, to convert linear to board feet, find bit sizes for screws, compare characteristics of woods. 6" diameter heavily varnished cardboard. Send 25c, no stamps, please to Greenlee Tool Co., 2103 Columbia Avenue, Rockford, Illinois.



### Find HIDDEN TREASURES

GOLD, SILVER, PRECIOUS METALS with the Famous Model 27 Metal Detector. Lightweight, ultra-sensitive, low cost. None finer. Also GEIGER COUNTERS for uranium and the VIOLITE for tungsten. INFORMATION FREE

THE *Detectron* CORP.  
5528 Vineland Ave., No. Hollywood, Calif.



## Short Cuts with WILHOLD WHITE GLUE



Glue joints.  
Glue glass in place.  
One 1 3/8" brad holds  
mitre while glue dries

MAKE PICTURE FRAMES  
without dowels or splines

You'll like it better. Simplifies woodworking. Sets quick, dries clear,

holds permanently. Illustrated, one of many Wilhold shortcuts. FREE BOOKLET.

Paint, Hardware, Lumber, Variety Stores. Or write  
WILHOLD PRODUCTS Los Angeles 31, Calif.; Chicago 44, Ill.

FREE THE HISTORY OF THE COMPASS SEND FOR YOUR COPY



DESIGNED for MODERN CARS!

DINSMORE AUTO COMPASS

Your best friend in strange cities and rural areas. Dinsmore compasses show you the right way—the shortcuts. Eliminates guesswork. Beautiful new Travelite models in gold or silver only \$6.95. Other models \$5.45 and \$6.45.



WRITE FOR FOLDER

DINSMORE INSTRUMENT COMPANY

1802 KELSO ST.,  
FLINT 1, MICH.

ONLY COMPASS APPROVED BY AUTO MAKERS!

pull the trigger...

## spray paint

7 times faster than brushing!



Speedy Sprayer

ONLY  
\$32.00  
less motor

Paints anything from a house to a toy. Saves its cost on the first major job! Speedy Sprayer does in minutes what brushing takes hours. Finish is smooth, flawless. Uses any 1/4 h.p. motor with 1/2" shaft. No. 780 Outfit—10 ft. air hose, tire chuck, quart gun, less motor, only \$32.00. Every workshop should have it. At leading stores.

Free! Write for "How To Spray" Booklet and folder.

W. R. BROWN CORPORATION  
Specialists in Portable Paint Sprayers for Over 37 Years  
2635 N. NORMANDY AVENUE, CHICAGO 35, ILL.



**Other comments on test car: Power is so great that driving in rain is almost as treacherous as on ice. Wheels spin on wet pavement with anything but the most delicate accelerator pressure.**

**Big windshields are fine, but in snow or rain there is a wide swath of unwiped glass blocking vision in center.**

**Wiper switch worked very poorly.**

**Excellent control of windshield reflections. None at all appeared in night driving.**

**Radio had very poor tone quality.**

**Altogether a satisfactory car, but its distinctive character seems limited to styling.**

form to a pattern. That is what I like about the Edsel."—Wisconsin minister.

"For years most cars have been misrepresented as being six-passenger models. Except for children, there is no leg-room in the center of either seat."—Texas underwriter.

"Put a decent gas-filler pipe on the cars. When gas is spilled, the filling-station attendant always gets blamed for the mistake of the engineer."—Wisconsin filling-station operator.

"Add a control that would increase or decrease the sound that signals when directional lights are blinking."—Connecticut executive.

"I believe that my Edsel is above average. But the industry trend to longer and wider cars is not in the public interest. The added width is dangerous on some of our older narrow roads and also on city streets when cars are parked on both sides. Cars have too much horsepower. I would like a somewhat plainer car and a lower price."—Oregon field auditor.

"I own four cars, three of them being big cars which are so-called gasoline hogs. If you have a good troublefree engine getting 5 or 6 miles per gallon less than other engines it isn't worth worrying about. I have known people to spend enough on their cars trying to save gas that they would have to get 50 miles per gallon to pay for the garage bills."—Indiana funeral director.

There you have it, the story of the new Edsel as told by the people who know it best—the owners themselves.

At the moment, Edsel sales are not going well, but neither are sales of most cars. As one owner says, "If there was a mistake in bringing out the Edsel, it is not in the car, but in the time it was brought out. It's a good car." ★ ★ ★

**NEW FIR PLYWOOD BOAT PLANS**

25¢ ea. ★ Designed by leading naval architects for style and top performance

★ Specially planned for "do-it-yourself" construction with fir plywood



Large, easy-to-follow scale plans have step-by-step illustrated instructions and complete material lists

**OUTBOARDS**

- 11' (Plan 35)—Fast, roomy car-top utility model.
- 13' (Plan 40)—Ideal for skiing and fishing or family fun.
- 16' (Plan 55)—Roomy deluxe runabout. Seats 6 in comfort.



**CABIN CRUISERS**

- 18' (Plan 60)—Easy-to-build family day cruiser.
- 20' (Plan 65)—Overnighter. Sleeps 2. Has galley and head.



**ROWBOATS**

- 8' (Plan 30)—Light, all-purpose pram. Takes small outboard.
- 14' (Plan 45)—Roomy, flat bottom punt for hunting and fishing.

PLANS 25¢ EACH. Order by number. Also write for free folder describing boats in detail. (Offer good USA only). Douglas Fir Plywood Association, Dept. 9, Tacoma, Washington.

Use only Exterior plywood (EXT-DFPA®) for boats. Comes in several sizes, grades—including premium quality solid-core "Marine Exterior" for hull construction.



**10" TILT/ARBOR SAW BUILD-IT-YOURSELF from GIL-BILT KITS-PLANS**



Sturdy wood, steel, and aluminum construction. NEW DEPARTURE ball bearings. Capacity and performance of floor saws selling for \$150.00 and up. Plans, all metal parts in kit with 10" comb. blade \$25.90, less blade \$22.95. F.O.B. St. Louis. Detail PLANS PATTERNS only \$1.00 postpaid.

Build-it-yourself 12" and 18" Bandsaws, 8" Belt Sander, Shaper. Simplified plans, built easily with hand tools only. Advertised and sold for 11 years, over 33,000 units in use. Money back guarantee. FREE CATALOG.

**GILLIOM POWER TOOLS**, Dept. 80-C, Lambert Field, St. Louis 21, Mo.

**DRAINS** cellars, cisterns, wash tubs; **\$7.95**

**IRRIGATES - CIRCULATES - SPRAYS**



Up to 3,000 GPH; 450 GPH 80' high; or 1800 GPH from 25' well. Use 1/4 to 3/4 HP motor. Couplings included free. 1" inlet; 3/4" outlet. Stainless steel shaft. Won't rust or clog. Type P—\$7.95

**CELLAR DRAINER KITS** (less motor) \$12.95

"Low Boy" 15" high, 1500 GPH. . . . . \$12.95

"High Boy" 32" high, 3,000 GPH. . . . . \$15.95

Postpaid if cash with order. **MONEY BACK GUARANTEE**

**LABAWCO PUMPS**, Belle Mead 7A, N. J.

**The Modern PLASTIC for lasting Home Repairs**



**DURHAM'S Rock Hard WATER PUTTY**

WILL NOT SHRINK STICKS AND STAYS PUT

PERMANENTLY mends cracks or holes in wood, tile, stone or plaster. Sticks and stays put—Does not chip, shrink or fall out. Easy to use. Economical. Mold it; chisel it, polish or paint it. The big 4-lb. can is obtainable from your lumber, paint or hardware dealer at \$1.25; or will be shipped direct postpaid (in U. S.) for \$1.50. Complete satisfaction guaranteed or your money refunded.

**DONALD DURHAM CO.**  
Box 804-T Des Moines, Iowa





## SAW SHARPENING IS EASY

Super Filer No. 11 joints and sharpens hand and circular saws 6" to 10" with all teeth correct in height, depth, pitch, level. When file hits steel roller, teeth are finished. Saw runs true with no side pull. Includes 8" file.

**\$9.95**  
PPD.

"TRU-CIRCLE" saw set automatically sets teeth at 10° or more.

**\$2.95**  
PPD.



## SUPER SAW FILER No. 6

Automatically controls depth, angle, pitch for all saws. Precision made and calibrated. Use in any vise or clamp. Includes file.

**\$6.50**  
PPD.

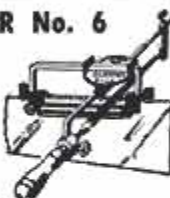

## DOWEL CENTERS

Centers inscribe exact location for opposite holes. Pairs for 1/4", 3/8", 1/2" holes.

**\$1.00**  
PPD.

MONEY BACK GUARANTEE

A. D. McBURNEY, 5908 Hollywood Blvd., Hollywood 28, Cal., Dept. A-38

# SHARK

# BRAND



Swedish Steel

## CHISELS

SEE THEM AT YOUR DEALER  
Send For Free "How To Use" Booklet

SANDVIK STEEL, INC.

1704 Nevins Road  
Fair Lawn, N. J.



**3-PASS. SPORT CAR**

Ideal 2nd Car or Sportabout. Fully Equipped. Write For Literature.

## ESHELMAN TRACTORS

LOW AS **\$99**

For Better Lawns and Gardens investigate Eshelman Riding Rotary Mowers, Tillers, Tractors. Adversely used in GOOD HOUSEKEEPING. Thousands of Satisfied Users. Write for Free Literature.

Dept. 106, ESHELMAN  
Baltimore 2, Md.



Riding Mower **\$272.25**

Shipping Points: BALTIMORE - CHICAGO - RENO

You can depend on products advertised on these pages—they all bear the . . .



## ENGINES "Sing"!

WITH **MILESMASTER**®



## FUEL PRESSURE REGULATOR

For smooth running, quick starting, better mileage . . . install a genuine MILESMASTER. Prevents flooding. Only \$6.95  
**MILESMASTER, INC., Dept. K, Exeland, Wisconsin**

## Ever do any of these jobs?



**Screw Driving . . .**

Versamatic increases power 7 times—will drive the heaviest screw with ease. It reverses for screw removal.



**Nut Running . . . On or Off . . .**

Use 1/4" adapter furnished . . . drive socket attachments. Fast, safe. Works just like a power wrench.



**Heavy-Duty Drilling . . .**

Attach 1/2" Chuck (not included) and light tools will perform heaviest drilling jobs. Drive hole saws, masonry bits, etc.

YEAR HERE—SHOW TO YOUR TOOL DEALER

do it better, faster, easier with your power drill and a **Supreme VERSAMATIC**

Give your portable drill some real authority . . . with a Supreme Versamatic . . . the reversible speed reducer that makes a drill 7 times more powerful—many times more versatile. Do the sort of jobs illustrated in the photos above. Do them easily, safely, accurately . . . with a Versamatic.

Versamatic fits any portable drill. Yankee-style bits are quick to change—replacements are available locally. Ask your dealer about Versamatic today. He either has one now or can get one for you in a hurry. Guaranteed by the makers of Supreme Brand Chucks.

SUPREME **Versamatic**

**\$14.95** complete  
at better tool  
dealers everywhere



**SUPREME PRODUCTS CORPORATION**

2222 S. Calumet, Chicago 16, Illinois  
A Division of A•S•R Products Corporation



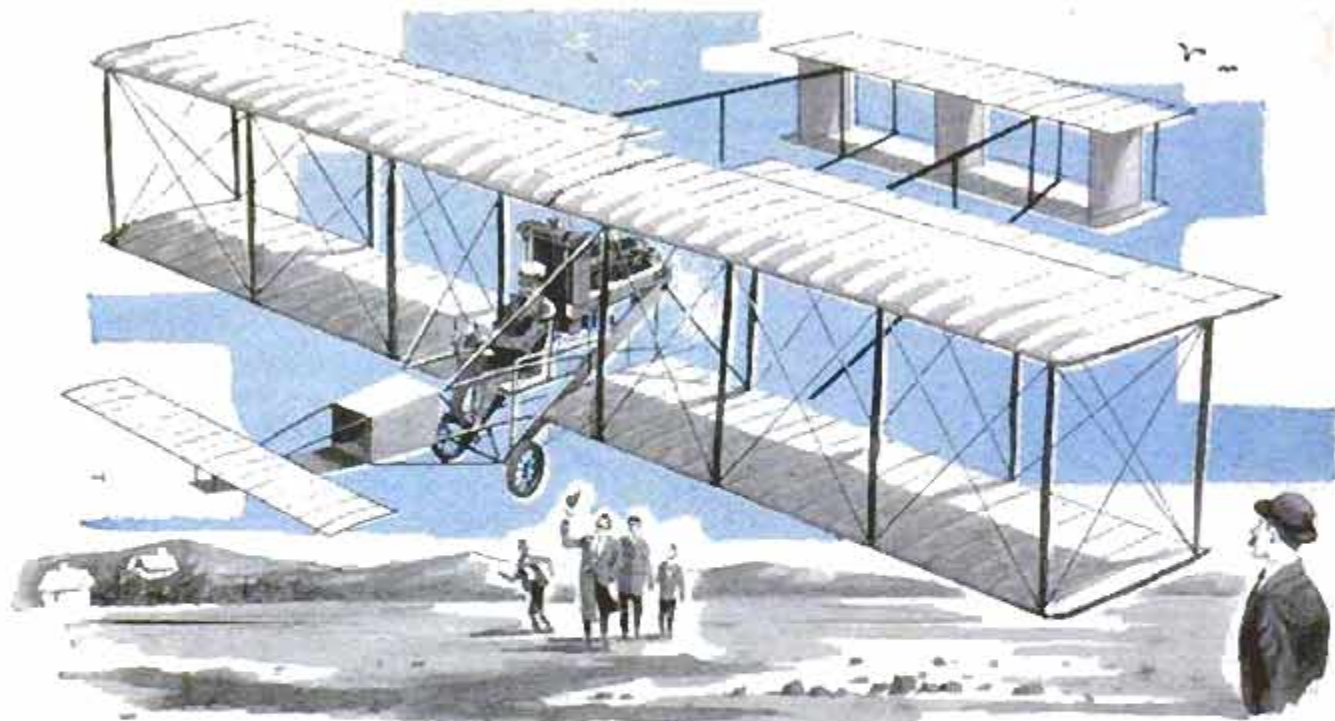

## "His Remarks Were Quite Prophetic"

POPULAR MECHANICS recently received the following letter:

"I write this letter on the Golden Anniversary of the United States Air Force. This morning a copy of your magazine, dated July 1907, was brought to my attention. It contained two articles of interest. One was entitled 'The Dangers of Flying' by L. J. Lesh, and the other, quoting Alexander Graham Bell, allowed that the problems of air navigation had been solved. . . . His remarks were quite prophetic. . . . In a release regarding the 50th anniversary of the Air Force we would like to reprint both articles. . . ."

George N. Kent, Captain, USAF, Information Officer,  
Mather Air Force Base, Calif.

*We were pleased, of course, to grant permission to reprint the two articles. In addition, we feel some of our 1958 readers would like to see the prophetic remarks written in 1907. The two articles follow.*

### THE DANGERS OF FLYING

By L. J. Lesh

How often nowadays we hear remarks such as this: "He has succeeded in flying, has he? Well, let him fly; but you can excuse me when it comes to anything as dangerous as that." Yet the same person who swears that he would not ride a flying-machine for all the money in the Bank of England does other things merely for sport that are fully as dangerous as flying (with the machines we now have at our command); things, too, that give him vastly less pleasure than he could get out of a strongly made and well tested aeroplane.

To the inexperienced aviation seems attended by dangers that loom up as almost

too great to be braved by a human being, and the would-be flying man is accordingly quite surprised when he finds that, after a little practice, a flying-machine is almost as safely and easily handled as a bicycle. In fact, he finds that about the only difference between coasting downhill on a bicycle and sliding upon the air on a gliding machine is that in the latter it is necessary to instinctively adjust the fore and aft balance, which in the bicycle is always preserved as long as the two wheels touch the ground.

The first machine to carry a man through the air for any considerable distance was the Lilienthal soarer, which, however, possessed such poor fore and aft balance that it could not be safely operated in winds of over 20 miles an hour. It was this defect,

(Continued to page 284)



# DELTA HOMECRAFT® TOOLS

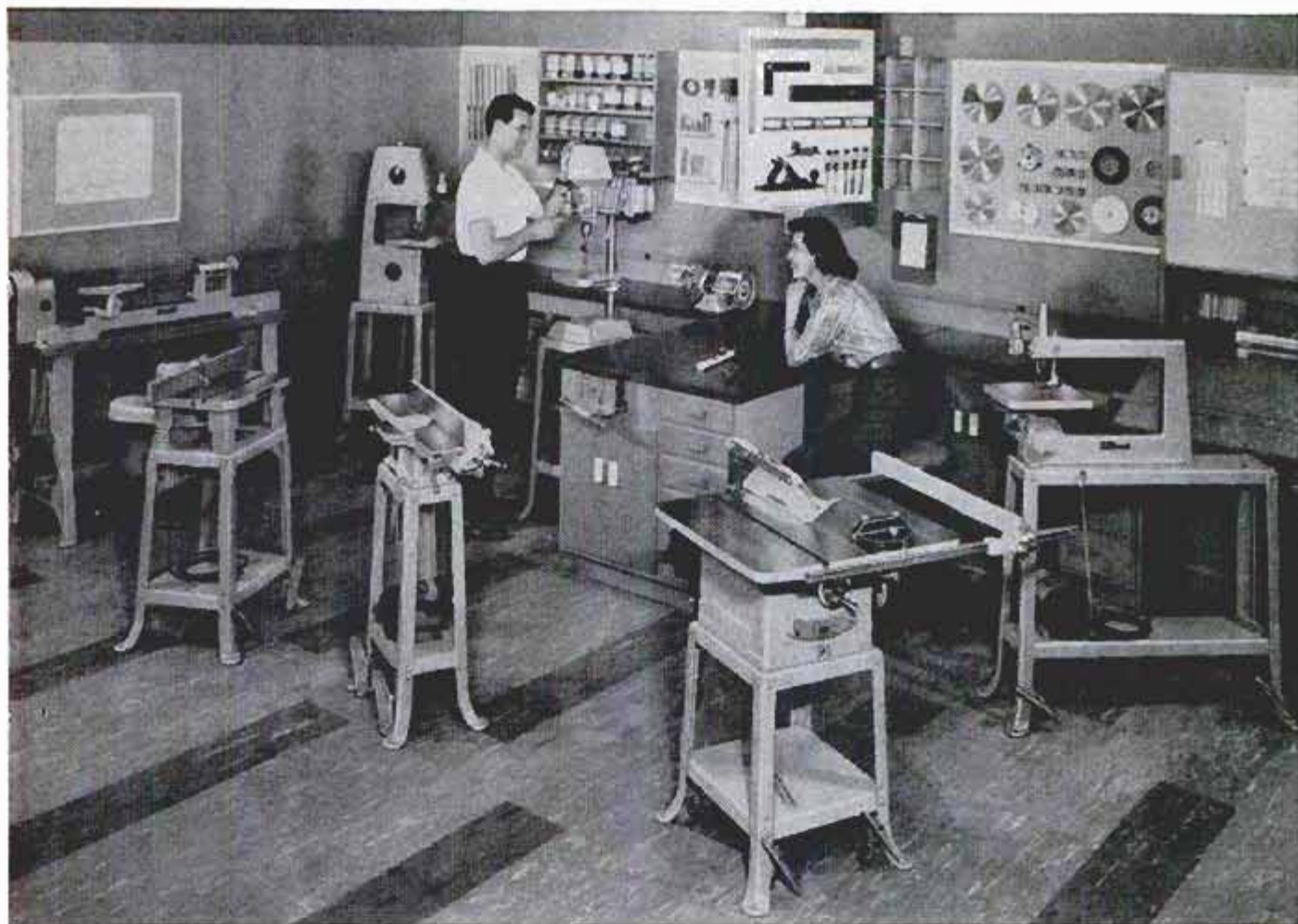

## make this "dream shop" come true in your home

You can own a shop as good looking, and good to work in as this one. Designed by Delta experts, it offers a big, T-shaped work bench, revolving tool rack, hide-away drawing board and many more unique convenience features. And New Advanced Design Delta Homecraft Tools (with exciting new styling by Raymond Loewy Associates, Inc.) give you *power* and *precision* you normally expect only in industrial tools costing twice as much!

### START THIS SHOP FOR \$17.10 DOWN

All you need to actually start building this shop is a Delta 9" Tilting Arbor Saw—basic tool of all woodworking—and you can have it delivered for as little as \$17.10 down! Later you can add other New Advanced Design Delta tools—11" Drill Press, 4" Jointer, 10" Band Saw, Shaper, 14/11

Lathe, 16" Scroll Saw, and Bench Grinder—to complete your shop.

FREE WORKSHOP PLANS are yours for the asking—complete with bills of materials and easy-to-follow instructions. Write: Rockwell Mfg. Co., Delta Power Tool Div., 502C N. Lexington Ave., Pittsburgh 8, Pa.

*Do it now—and see all the New Advanced Design Delta Homecraft Tools at your nearest Delta Dealer, (listed under "TOOLS" in the Yellow Pages) or at leading Department, Hardware and Building Supply Stores.*

DELTA POWER TOOLS

another fine product by

**ROCKWELL**





coupled with its bad condition of repair, that probably caused the death of its operator.

Since Lilienthal's death earnest attempts have been made towards producing a machine that should be structurally strong and possess good equilibrium, even though less important features had to be omitted to make these conditions possible. These efforts have produced the Chanute and Wright types of aeroplane, which are satisfactorily strong and safe to handle, and yet are quite efficient in flying qualities.

The truss construction now used by nearly all aeronautical engineers provides



such a strong and rigid framework for the aeroplane surfaces that breakage of this part of the machine seems practically impossible. The part of future dynamic aeroplanes that will undoubtedly cause the most trouble will be the motor, for as yet none has been developed that is even reasonably immune from breakage and stoppage. Of course, if the motor stopped a flier would have to come down, and if it happened to be flying over an undesirable landing place and did not possess the power of gliding flight it might come to grief when it lit.

The recent flights of the Wright brothers seem to indicate that they have found either a successful equilibrium preserving device or a vastly improved arrangement of steering surfaces, so that at last we can cease bothering about the balance and control of a machine.

The Wright flyer is capable of being steered with even greater accuracy than an automobile or bicycle, and yet the operators have spent far less time in actual practice

than is required to obtain a mastery over either of the last two conveyances.

To a person who has had considerable experience in the air the possibility of accident seldom occurs, and indeed the motion is so rapid that there is no time to think about it during a flight. People seldom think of the risks they run while riding at 100 miles an hour in a railway car, or half a mile a minute in an automobile, and it is quite probable that after the novelty of the thing wears off there will be few people afraid to experience the quick rush of the aeroplane.

---

### AERIAL NAVIGATION A SUCCESS, SAYS DR. BELL

---

"The problem of aerial navigation already is solved and America is in advance of the rest of the world in heavier-than-air flying machines." This was the emphatic statement made by Professor Alexander Graham Bell in England, recently, whither he had gone to receive the degree of doctor of science conferred upon him by Oxford. Dr. Bell declares that "there is left only the problem of improving the machine that has been invented" by the Wright brothers, and others, and that "great credit is due Mr. Octave Chanute of Chicago," who not only induced young Americans to experiment, but paid much of the expenses out of his own pocket. In regard to future developments, Dr. Bell said:

"The development of the airship, I think, will come for other than commercial reasons, for the flying machine is destined to take an important part in warfare. The war departments of different governments are watching with greatest interest whatever is being done in this direction, and once a successful airship is given to the world its growth toward perfection will be more rapid than anything ever seen.

"The airship will overturn all present methods of warfare. Then, too, wealthy men will take to airships as they have taken to automobiles, and the machines will be developed for speed. They will undoubtedly be utilized for purposes of rapid and light transportation, such as carrying the mails."



**WAR SURPLUS** AND MORE BARGAINS **SAVE UP TO 90%**

**FAMOUS NAVY MK14 AIR COMPRESSOR**



Great for tree, termite, airbrush & paint spraying; filling tires, aquariums, etc. Dual & remote control electric receptacles. 115V 60 cycle AC, 1/3 HP. Westinghouse Motor. Direct drive. Water & explosion-proof. Built-in air filter, adjustable pressure setting up to 47 lbs. Built-in pressure gauge. Self-contained switch. Mounting brackets. These units made under license of Sperry Gyroscope Co. Wt. 66 lbs. gross. Approx. GOVT. COST \$585. Like NEW. \$21.95.

With portable steel hand cart (shown), rubber wheels, specially constructed for mounting this unit. Incl. 15' rubber air hose, 6' extension cord with plug & fittings. Wt. 76 lbs. Complete with cart—\$26.95.

**ARC WELDER KIT—\$26.00** Build your own complete make-up package incl. 1 Aircraft DC Gen. 200 Amps. 24 V; Rheostat, Toggle Switch, 1 Ammeter, Electrode Holder, Welder's Shield, Voltage Reg. Simple instruction wiring diagram. Wt. under 100 lbs. Approx. GOVT. COST \$475. Like new, perfect. All units guaranteed pre-tested. \$26.



**BUILD YOUR OWN ARC WELDER, LIGHT PLANT OR BATTERY CHARGER \$37.50**

Kit incl. 1 Navy NEA-5 Gen. combination AC-DC type. AC 115 V. DC 24 V., 200-300 Amps. 2 complete generators in 1, yet no larger than reg. gen. Ideal for home, shop and farm lighting plants. Delivers 1200 Watts AC, DC side for charging batteries, welding and operating war surplus motors. Also in kit: 2 Voltage Regs., AC & DC, Reverse Current Relay, 1 Ammeter, Rheostat, Electrode Holder, Toggle Switch, Welder's Shield, Wiring Diagram for kit. Wt. under 100 lbs. Approx. GOVT. COST \$650. Kit—\$37.50. Navy NEA-5 Gen. as above, purchased separately. \$23.50.

**R1 GENERATOR KIT** Jack & Heints or GE. Rated 300 Amps. 24-32 V. With same items as above. Approx. GOVT. COST \$600. Complete 80 lb. kit—\$36.

**HEAVY-DUTY RHEOSTAT** Ideal for regulating voltage on electric welders. Rated 5.75 Ohms, 100 Watts with double windings & dual female 25 amp., 125 V. receptacles. 7" hi x 5 1/4" D. Shpg. wt. 2 1/2 lbs. Approx. GOVT. COST \$25. Brand New. \$2.25 ppd.



**BENDIX GEROTOR PUMP & MOTOR**

Use wherever fluid pumping required. Excellent for hydraulic installations. Has 3/4" pipe connections, built-in relief valve adjustable up to 1500 lbs. Max. cap. 6 GPM. 1 1/2 H.P., 24 V. motor. Use on 12 to 36 V. Approx. GOVT. COST \$350. NEW. \$10.95.



**140-1 REDUCTION GEAR** For beaching boats, winches, hoists. Ideal for motor in golf or boy's electric car. Built-in (removable) DC motor & clutch. Hi torque, 10 speed. Runs on 6-12 or 24 V. Wt. 65 lbs. gross. Approximate GOVT. COST \$300. Like NEW. \$12.00. Matched splined gear for above—\$3.00 ea.



\*225-1 REDUCTION GEAR—\$13.50.



**EXPLOSIVE RIVET & BLOW TORCH KIT**

Contains 300 assorted Dupont Explosive Rivets, 1 set of 9 fractional drills, 1 Butane Blow Torch with extra cartridge—everything needed for blind riveting. Torch can also be used for precision soldering, brazing, etc. 3500° pinpoint flame. Approx. GOVT. COST on rivets alone. \$90. Complete kit \$2.95 ppd.



**DUPONT EXPLOSIVE RIVETS**

Essential wherever blind riveting required. 1/8", 5/32", 3/16". Round & Flat heads. Approx. GOVT. COST 32c ea. 1,000 assorted for only \$5.00 ppd.



**ELECTRIC PUMP WITH CONTROL UNIT**

Runs on 12 or 24 V. Centrifugal type. Pumps 500 GPH. Complete with on and off switch rheostat, 2 speeds (hi & lo). Mfd. by Ingersoll-Rand. Shpg. Wt. 7 lbs. Approx. GOVT. COST \$195. NEW. \$6.95.



**CHRONOMETRIC TACHOMETER**

Built to U.S. Navy & Air Force specs. Standard brand. For counting revolutions per min. for any rotating shaft. Can be used on speeds up to 3000 RPM. Accuracy to 1/10 of 1%. Complete with male & female tips & shock-proof case. GOVT. COST \$87.50. NEW. Only \$19.95 ppd.



**MICROMETERS**

Black crackle finish frame. Easy-to-read graduations in .001. NEW. 0-1" cap. \$2.69 ppd. 1-2" cap. \$3.79 ppd.

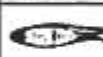

**WOOD PROPELLER**

Genuine rock maple radio drone "prop." perfect for den, trophy room, boy's room. Smooth, highly varnished. 30" tip to tip. Clock, barometer or photo can be inserted easily into center (mounting holes provided). Can use to operate ice sleds, etc. Approx. GOVT. COST \$57. NEW. \$4.95 ppd.



**B-16 KOLLSMAN AIRCRAFT COMPASS**

Ideal for boats, cars, etc. Grad. in 5° increments. Liquid-filled. Lighted. Poly-plane compensator. Panel mounting. 3 1/2" dia. face; 4 1/2" deep. Checked & tested in our own lab. Approx. GOVT. COST \$150. Like NEW. \$12.95 ppd.



**ASTRO COMPASS MARK II**

Used by USAF & commercial airlines. Makes polaris & azimuth circle for air or marine navigators. Great for astronomers. Incl. carrying case. Tested for accuracy in our own lab. Approx. GOVT. COST \$400. Now \$10.95.



**HOMELITE PORTABLE POWER PLANT**

Ideal for welding, battery charging, emergency lights for cabins, camps, aircraft, trailers or wherever power needed. Easy rope pull starting. Fully equipped, ready to start. 2000 W., 32 V., 5 H.P. Like NEW. Tested. Shock-mounted. Deluxe type. Net wt. 115 lbs. Gross wt. cased 200 lbs. Approx. GOVT. COST \$700. Now—\$65.00. 2500 W.—\$75.

**NEW! TERRIFIC! 1958 CATALOG!** Thousands of bargains in war surplus & other items. Hundreds of pictures. Send 25c for your copy today! Ppd. prices in USA only. Other prices FOB Culver City, Calif. Send cash, check or money order. 50% deposit on COD.

**AIRBORNE SALES CO., INC. DEPT. PM358**  
8501 Stellar Drive, Culver City, Calif

**WOODWORKERS!**

- Brand new 145th Anniversary Edition of Constantine's Manual for Craftsmen—126 pages, many in full color.
- Complete selection of rare and fancy imported and domestic woods, veneers, inlays, carvings, mouldings, hard-to-get items, hardware, upholstery supplies, plans, patterns and Do-It-Yourself Information. Send 50c (refunded on first order) for this big catalog and reference guide.

**ALBERT CONSTANTINE & SON, INC.**  
2056-1 Eastchester Rd., New York 61, N.Y.



**IMPROVED LAWN MOWER SHARPENER AND BED KNIFE GRINDER**

Sharpen any mower in 10 to 20 minutes. Hand—Power—Reel or Rotary. Modern is actually two machines in one, a Precision Bed Knife Sharpener and a Precision Reel Sharpener. Extra Bed Knife Grinder is Absolutely Unnecessary. New Mower Support makes it possible to sharpen reel without removing bed knife. The latest precision lawn mower sharpener on the market. Costs Less. Compare Modern's Many Exclusive Features Before Buying. Send for Free Brochure No. 10 SN



**MODERN MANUFACTURING CO.**  
160 North Fair Oaks Ave., Pasadena, California

**Paragon**  
*time is accommodation*

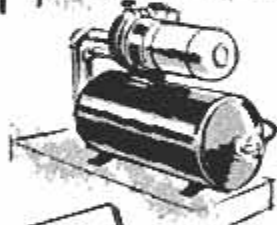

Where water supply is insufficient, Paragon Timers automatically cycle pumping operation to flow of well. Learn all about TIME in booklet offered below.



**Paragon Electric Company**  
Two Rivers, Wisconsin, Dept. 73-20

Please rush colorfully illustrated 32-pg. booklet, *TIME — Past — Present — Future*. I enclose 10c (no stamps) for postage, handling.

Name.....  
Address.....  
City.....Zone.....State.....



# Cut it with WISS



Wiss Hy-Power Pruners, with hand-honed blades, cut the toughest limbs with ease. Two sizes: No. 908, 8" long, \$3.25. No. 907, 7" long, \$2.95. At hardware, department, and garden supply stores.

## OTHER FINE WISS CUTTING TOOLS

### GRASS SHEARS

No. 701  
\$2.75



Easiest cutting, fastest cutting grass shears you've ever used, with molded vinyl handle grips and special closing latch. Others from \$1.29 to \$4.95.

### TIN SNIPS

No. V-13  
\$2.25



Only seven inches long, these "mighty midget" snips cut metal, vinyl, rubber, leather. Others 10" to 17" in aviation, combination and solid steel styles.

## J. WISS & SONS CO., NEWARK 7, N. J.

World's Largest Manufacturer of Shears, Scissors, Pinking Shears, Skalloping Shears, Metal Cutting Snips and Garden Shears



## Lightweight Plastic Harp Has Good Tone Quality

Using nylon strings, a glass-fiber body and a cast-aluminum base, Earl L. Thompson of Silver Spring, Md., has produced an inexpensive, lightweight harp with much of the tonal quality of a concert instrument. Thompson's harp has 18-inch legs which can be detached to bring the instrument down to a level more convenient for children to play it. The 31 strings have a tension of 1300 pounds, compared to about 700 pounds for a big concert harp. The harp weighs only 14 pounds.

*should be "700 POUNDS MORE"*  
**"Cooler" Lowers Temperature  
Ten Degrees in Five Minutes**

Aided by a "blood heat exchanger," surgeons performing complex heart operations can now lower their patients' body temperatures 10 degrees in as little as 5 minutes. Superseding ice packs and refrigerated blankets, the heat exchanger can lower temperature at an average rate of one degree Fahrenheit every 30 seconds, raise it with almost equal speed, and control it with an accuracy of one half degree. The device consists of a group of stainless-steel tubes enclosed by a specially constructed steel jacket. Blood pumped from the patient through a heart-lung machine returns to the patient by way of the heat exchanger. There it flows through the tubes, which are surrounded by circulating water that can be precisely controlled to either cool or warm the flowing blood.



# You Get More with Arkansas Traveler



Morquise  
15-ft. Custom  
Sportsman

Dashing performance. Beautiful lines. Perfect blending of Fiber Glass and aluminum (good-bye maintenance bother). And now a new **GUARANTEE!** See your Arkansas Traveler Dealer. Or write for free folder.

Arkansas Traveler Boats  
2006 E. 14th St., Little Rock, Ark.



## NEW MAGIC RADIO WALKIE TALKIE!

**YOUR OWN POCKET SIZE RADIO STATION!**  
BROADCASTS TO ANY HOME OR CAR RADIO WITH-  
OUT WIRES OR HOOKUPS! WL only 5 oz. Size, 1 1/2 x 2 1/2 x  
4 1/2". Built-in telescoping antenna. Powerful Transistor—  
sensitive microphone, frequency setter, break-in switch!  
Runs for weeks on self-contained flashlight batteries.  
Durable plastic case. With this Radio Talkie you CAN  
TALK TO YOUR FRIENDS UP TO A BLOCK OR  
MORE AWAY! Talk up to 1 mile or more between  
two automobiles. INSTANT OPERATION! Just push  
button to talk! No license needed. Uses inductive  
field magnetic radiation. Useful and real fun in a  
million ways! **GUARANTEED TO WORK. 1  
YEAR SERVICE GUARANTEE.**  
SEND ONLY \$3.00. (cash, ck, mo) and pay  
postman \$9.98 COD postage or send \$12.99 for  
prepaid delivery. COMPLETE READY TO OPER-  
ATE with instructions and hundreds of ways and  
tricks for broadcasts thru any radio you desire. Price  
may go up soon, so get your NEW POWERFUL RADI-  
VOX WALKIE TALKIE NOW. Available only from:  
WESTERN RADIO, Dept. RPM-3, KEARNEY, NEBR.

# Anchor wood or metal to concrete or steel with one light tap!



Anchoring 2x4 partition plate to basement floor.

**Remington Mighty-Mite® Stud Driver** is a cost-  
and time-saving fastening tool with a hundred  
uses! One light hammer tap on firing pin perma-  
nently anchors furring strips, partition plates,  
electrical outlets to concrete or steel with special  
Remington Studs. Scientifically graded 22  
caliber Power Loads furnish *exact* driving force  
needed. No pre-drilling. See your dealer today  
or send coupon for full details. **Only \$39.95**

Most dealers also have a tool-rental plan.

### HERE'S HOW THE "MIGHTY-MITE" WORKS

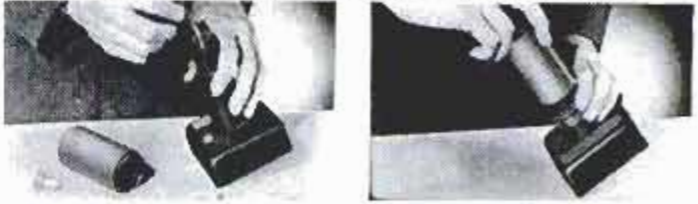

**UNSCREW** upper assembly, drop  
a Remington "Power-Guide" Stud  
into barrel, insert chamber bushing  
and proper 22 caliber Power Load.

**REPLACE** handle-grip assembly,  
position tool and press firmly over  
work. Tap firing pin with a light  
hammer and the job's done!



Remington Arms Company, Inc.  
Industrial Sales Division, Box PM-3  
Bridgeport 2, Connecticut

Please send full information about the cost- and  
time-saving "Mighty-Mite" Stud Driver.

Name \_\_\_\_\_  
Address \_\_\_\_\_  
City \_\_\_\_\_ State \_\_\_\_\_

## Hunters! 30/06 SPRINGFIELD SALE!

Straight out of  
Government  
Boxes!  
**\$2995**

Original low  
serial  
number  
U.S. Gov't  
Springfield,  
30/06 Caliber.  
This is the best  
deer gun you will  
ever buy. You can  
get hunting softnose  
cartridges for this gun  
in every gunstore or  
hardware store in the  
country. Boxes are tip-top  
and sharp. Single Spring-  
field have sold recently for  
as much as \$45 to \$50. They  
have been stored in Cosmoline  
in U.S. Gov't boxes. We clean  
grease off and oil lightly. **GUAR-  
ANTEED:** Shoot it, try it. If you  
don't think this is a fantastic buy,  
send it back (inside 10 days) for full  
refund. You'll never see them at this  
price again. Bolt action, 6-shot re-  
peater, famous calibrated sight. **EXTRAS  
FOR SALE:** New sling, leather, \$1.95,  
G.I. cleaning rod, \$1.95, O.D. G.I. case  
with zipper, \$1.95, G.I. cowhide leather  
saddle case, \$4.95.  
**ORDERING:** Check, cash or money order.  
\$10 or more deposit for C.O.D. Calif.  
resid. add 4% state tax. Shipped F.O.B.  
Los Angeles.

**THE ELLNER COMPANY**  
Dept. 2, 1208 Maple St.  
Los Angeles, Calif.



SAVE UP TO 64% • SURPLUS GOODS • HOME-SHOP and FARM

**FINEST RUBBER TIRE & TUBE**  
10x3.50, 4 ply. With rim, 3" hub & axle bearing. Ideal for wheelbarrows, boat trailers, cement mixers, compressors, generators, yard wagons, etc. Very sturdy construction.  
\$16 Val. **\$7.88 Ppd.**

**9 pc. BENCH GRINDER/ELEC. DRILL KIT**  
1 ea. Wire wheel, stone grinder, buffing wheel, & rubber backing pad. Also 2 Tampico straw wheels & 3-6" Fibre sanding discs. 12 center. Reg. \$7.50. **\$2.89 Ppd.**

**A. C. ELEC. CLOCK & TIMER**  
125V., 60 Cy. with 3 1/2" multi-color dial. Perfect time keeper. Built in buzzer sounds at pre-set timer setting. Mount in radio, TV, desk, bed, wall, etc. \$12.75 value. **\$2.98 Ppd.**

**6 pc. FINE STEEL DADO SET**  
2-5" Dado saw blades & 4 fillers. 7/8" arbor. A must for every wood worker.  
List \$22.95 **\$6.49 Ppd.**

**SPECIAL! . . . 26 pc. ALL PURPOSE ELECTRIC DRILL KIT**  
Use with any size drill. Consists of 1 ea. lamb's wool (with bonnet) buffing pad, rag wheel, Tampico straw wheel, wire wheel, stone grinder, rubber backing pad, & polishing paste. Also 6 sanding discs, 10 high grade carbon steel drill bits sized 1/16" to 1/2", adapter, washer & screw. Ready to use for every do-it-yourself chore. Has 1001 uses. Easily a \$10.00 value. . . . **\$3.89 Ppd.**

**ALL NEW PRESSURE HANDLE**  
Use on portable elec. or pneumatic drill. Simple to use. Remove standard hand handle. Screw in 7/8"-14 thread pressure handle. Fasten one end to work; other end over handle. A slight twisting pressure on handle turns worm gear and rotates sprocket. Drill with ease, safety, and complete control. Full operating instructions and pictures. Reg. \$20. **\$6.48 ppd.**

**STEEL AUGER BITS**  
3/8"-40c, 1/2"-50c, 5/8"-55c, 3/4"-70c, 1 1/8"-70c. Minimum order 5 bits

**10 ASST. GRINDING WHEELS**  
1/4" & 1/2" shanks for wood, composition, metal & plastic. Reg. \$8 value. **\$2.75 Ppd.**

3" Stainless steel Hose Clamps with screw adjustment, per doz. **\$2.50**  
24-7" Sanding Discs, (assorted grits), & Backing Pad. **\$1.95**  
1/2" capacity #338 Jacobs Geared Chuck, (5/8"-16 thread). **\$3.19**  
1/2" capacity #338 Jacobs Geared Chuck (3/8"-24 thread) **\$3.19**

Send CHECK or M. O. No C.O.D.s  
**MAELOR SALES CO.**  
FULL MONEY BACK GUARANTEE 1060 N. DAMEN, CHICAGO 22, ILL.



Zenith Radio Corporation, 6001 W. Dickens, Chicago

## Tubeless Short-Wave Radio Powered by Flashlight Batteries

Weighing less than 13 pounds, including batteries, a tubeless, portable, short-wave radio receiver operates on nine transistors. The set is powered by nine standard flashlight batteries. It has seven tuning ranges, between 2 and 22.4 megacycles, in addition to the standard-broadcast band. The handle contains a telescoping antenna that can be extended to three feet for short-wave reception.

## Living Tissue on Color TV

Invisible light and color TV have teamed up to give medical science a look at living tissue. In the past, the study of living tissue has been difficult because the light needed for illumination rapidly caused damage or death to the cells under observation. In the new system, short bursts of ultraviolet light, lasting about 1/1000 second, are used to illuminate the specimen under the microscope. The image seen by the microscope is reproduced on a color-television receiver.

## Insects Reveal Presence

Insects' presence in food stock, particularly grains, can be determined by an instrument sensitive to infrared radiation given off by the insects.

*Repair Wall Cracks fast and easy!*



## Dexall Patching Paste

- Won't sag even on vertical surfaces
- Positively shrink-proof and crack-proof
- Needs no sealer . . . paint over it in 15 minutes

At Paint and Hardware Stores Everywhere

DESHLER PRODUCTS INC. • Deshler, Ohio



**NOW CUT HOLES & DISCS IN SECONDS!**

**SLUG BEING EJECTED**



**"ARCO HOLE-SAW" with New Automatic "SLUG-EJECTOR"**  
Fits any Electric Drill, Lathe, Drill Press, Motor

Exclusive "Slug-Ejector" pops out discs immediately—therefore works 3-times faster than other hole saws selling for twice as much. 4-shatterproof blades easily exchanged to cut 1", 1 1/2", 2" & 2 1/2" holes thru any 3/4" stock. Safety-lock prevents blades from "jumping out."

**No. 650 HOLE-SAW** as above but with 7 blades to cut 1", 1 1/4", 1 1/2", 1 3/4", 2", 2 1/4" & 2 1/2" holes. . . . . **\$7.95**  
At your dealer or order direct on our **20-DAY MONEY BACK GUARANTEE**. Send check. M.O. (ppd). COD + post.  
**ARROW METAL PRODUCTS CO.**  
Dept. PM-3, 421 West 203rd St., New York 34, N. Y.



**2500 WATT A. C. ELECTRIC GENERATOR**  
115-Volt. 60-Cycle A.C. Single Phase

Government Cost \$250.00

**Brand New SURPLUS Fully GUARANTEED**

**Only \$125.00 fob**

Ideal as a permanent or stand-by unit for electricity IDENTICAL to your house current. Perfect for farms, camps, aboard ship, oil fields, mines, etc. Easily handles lights, refrigerator, deep freeze, oil burner, radio; power for saws, floodlights, drills, pumps, etc. ALL BALL BEARING! Operates at 3600 RPM. Drive with 5 HP or larger engine—or use power take off. Voltage self regulating. Standard base mtg. Two outlets. Size: 13" long, 8" dia. Wgt. 65 lbs. Delivers 2500 Watts CONTINUOUSLY!

**SUPPLY LIMITED! ORDER DIRECT FROM AD**  
Free Catalog of other Surplus, Hydraulics  
**ROBERTS ELECTRIC CO., Dept. PM-759, 849 W. Grand, Chicago 22**



**Heavy Duty Bench Type ALLEN PUNCH PRESSES**

Model B-2  
**2 ton - \$97.50**  
Tilting model  
**\$127.50**  
fob—less motor

164 Different Model Combinations  
1 to 5 ton capacities  
Moderate in price  
Fully guaranteed  
See your supply dealer or write for Free catalog giving complete information and prices on our Bench Type Punch Presses.

**ALVA ALLEN INDUSTRIES, Dept. PM, Clinton, Mo.**

*Plan your VACATION in* **TENNESSEE**



send for *Free Booklet*

Treat your family to a 3-way vacation that includes mountains, lakes, and history. They'll ride highways into the sky in the Great Smoky Mountains National Park; fish, boat and swim in Tennessee's 22 Great Lakes; see the homes of three presidents, historic battlefields, TVA dams, and the world's only Atomic Energy Museum at Oak Ridge. Yes, for three vacations in one, see Tennessee. Send now for free 40-page book.

**MAIL COUPON TODAY**

Tennessee Division of Information  
1761 Cordell Hull Bldg., Nashville, Tennessee  
Please send Free Booklet

NAME \_\_\_\_\_  
ADDRESS \_\_\_\_\_  
CITY & STATE \_\_\_\_\_

**"SWISH" PLANS PATTERNS FRAME KITS**



**BUILD THE "SWISH"**  
(as featured in this issue)

PLANS ONLY ..... **\$9.00**  
PLANS & PATTERNS... **\$19.00**  
FRAME KIT (includes plans) ..... **\$100.00**  
Send 50c NOW for COMPLETE CATALOG listing all of our designs.

**GLEN L.**  
9152T Rosecrans, Bellflower, Calif.

**WELD IT YOURSELF IN A JIFFY!**



Weld, Cut, Braze, Solder; Iron, Steel, Brass, Bronze, Aluminum and other metals safely and easily. Make your wrought iron furniture, porch railings, fences, knock-knacks and other metal specialties. With this fine equipment anyone can do professional-like work with little practice. Tool and equipment breakdowns are annoying and costly. Don't let them bother you. The Dynamic will pay for itself quickly in both time and money and is designed to operate from any properly wired 110 volt AC line.

Order your Dynamic Industrial type transformer Arc Welder for Workshop or Industrial use today. Order from this ad.  
Literature on larger equipment available on request.

**DYNAMIC WELDER COMPANY, 1808 S. Federal Street, Dept. D2-C, Chicago 16, Illinois**

**EASY PAY PLAN**

Low down-payment. Pay as you weld. Money back guarantee. Send for details. Complete outfit.

**Only \$38.50**  
F.O.B. Factory



# PM Books for Boys and Girls to help them know about Science

**MR. WIZARD'S SCIENCE SECRETS**, by Don Herbert. The star of the famous TV program seen coast-to-coast weekly on more than 60 stations has written this educational and entertaining book that will help in school and through a whole lifetime. The book is just like his unusual program and just as intriguing. It contains more than 150 of his television experiments, in word and picture. Answers thousands of "how" and "why" questions children ask on the human body, gravity, flight, heat and radiation, electricity, etc. It's facts with fun—so fascinating and interesting children never tire of learning.

264 pages. \$3.00.

**THE BOY SCIENTIST**, by John Lewellen. An up-to-the-minute introduction to the exact sciences, bursting with facts every modern boy wants to know. Written and illustrated with such clarity that even complex principles are quickly grasped by the young mind. This book won for Popular Mechanics Company the 1955 award of the Thomas Alva Edison Foundation as publisher of "The Best Children's Science Book." A truly outstanding work.

264 pages. \$3.95

**SCIENCE MILESTONES**, from the *Science Digest* series. A record of the march of science which will fire the imagination, and inspire youngsters in their pursuit of scientific knowledge. Contains dramatic revelations of 60 important individuals whose contributions, from 400 B.C. to the present, are landmarks in the history of science. This book is as fascinating as fiction, as factual and revealing as a laboratory report. Beautifully illustrated and printed.

312 pages. \$5.00

The books above are ideal as birthday gifts, Christmas presents or for general reading for the scientific-minded youngster. Each is authoritative, clearly presented and illustrated, quality printed and bound, as you would expect from the publishers of Popular Mechanics Magazine. You and your children must be pleased or your money back. Send check or money order today for the books of your choice to—

**Popular Mechanics Press, Dept. 358**

200 E. ONTARIO STREET

CHICAGO 11, ILLINOIS



## Be Your Own Boss in the Profitable Excavating Business!

### EARN UP TO \$1,000 AND MORE PER MONTH

Wherever you live, you'll find plenty of profitable work the whole year 'round for this versatile outfit . . . not just a "trencher" but an all-purpose excavating machine! Custom operators everywhere are making big money with Sherman Power Diggers. ONE BOUGHT A FARM WITH JUST THREE YEARS' PROFITS! Work for builders, contractors, utilities, and municipalities on such jobs as septic tanks and drainfields, sewer lines, fuel tank installations, foundations and footings, gas and water lines, field tilling and many others. The Sherman Power Digger mounted on a Ford Tractor travels quickly from job to job, digs at a fraction of the cost of manual labor. It's simple to operate, easy to maintain, built to last.

Send now for information about the easy-to-get jobs for your Sherman Power Digger. Let us tell you—without obligation—how you can go into business for yourself with an investment of less than \$5000. Or make a small down payment and pay the balance from earnings.

**SHERMAN PRODUCTS, Inc.**

Dept. 1736 Royal Oak, Michigan



Send Now for FREE LITERATURE!

Sherman Products, Inc.  
Dept. 1736 — Royal Oak, Michigan

Send me information on how I can get into the excavation business on my own.

NAME \_\_\_\_\_

ADDRESS \_\_\_\_\_

CITY \_\_\_\_\_ STATE \_\_\_\_\_



## THE 'POCKET' MACHINE SHOP

The all-purpose Plierench comes equipped with Universal gear-jaw. Tool made of chrome molly forged steel in gun metal finish. Form fit handle. Adjustable from 0" - 1 1/2". Thousand pound pressure grip for bench-vise jobs on the spot. For mechanics, home handymen, plumbers, electricians, farmers. Pipe gear-jaw or Wire gear-jaw extra at \$1.50 each. Carrier pouch free with purchase of Plierench and extra jaws. F.O.B. Chicago.

Two sizes:

7" 16 oz. (with Universal jaw) \$7.50  
8 1/2" 20 oz. (with Universal jaw) \$8.50

### PLIERENCH COMPANY of AMERICA

4611 N. Ravenswood Avenue, Chicago 40, Illinois Dept. P



Unconditional Guarantee

## SIMPLIFIED ENGINE TURNING TOOL

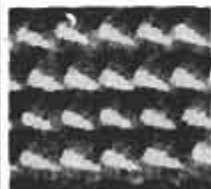

Decorate or jewel any polished metal surfaces, tools, gun parts, auto trim etc. Only a drill press needed. Requires no lubricants or compounds. Tool with 3 tips & instructions \$1.00 postpaid. Add 25c for 1/4" shank. Extra tips 4 for 25c ppd.

WORK SAMPLE R. E. HUTCHINSON SUTTON, MASSACHUSETTS

# Strip

... old paint the easy way! Use famous Savogran Strypeeze.

## PROTECT YOUR CAR WITH

Latest and best automotive products —you'll find them advertised in PM.



1958 PERKO NO 161  
SMALL BOAT  
EQUIPMENT CATALOG

Check full of NEW and MODERN items.

38 Pages full of Equipment for Small Boats, Outboards, Runabouts, etc.

SEND FOR YOUR COPY TODAY

Include 25c to cover cost of Mailing and Handling.

PERKINS MARINE  
LAMP & HARDWARE CORP.  
1952 PITKIN AVE., B'KLYN 7, N. Y.

## LOOK! All New - All Precision - All Deluxe SUPERSHOP MODEL X

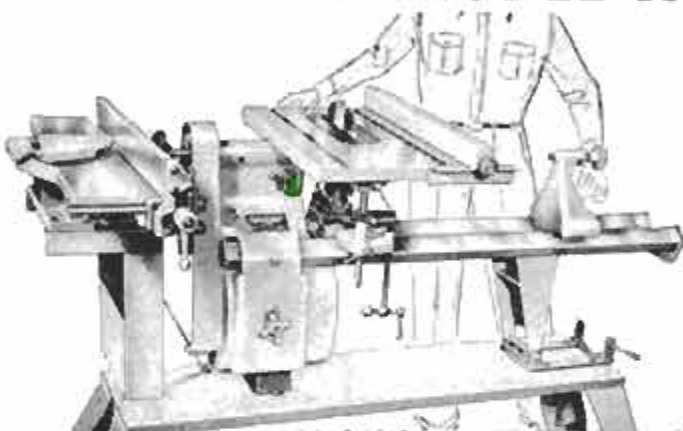

8" SAW

WE PAY ALL  
FREIGHT FOR  
YOUR FREE  
HOME TRIAL

ONLY  
\$139.50  
EASY  
PAY  
PLAN



Vert. Drill Press



Hor. Drill Press



8" Sander



30" Lathe



5" Grinder

Never before have you seen so much deluxe, precision-built power tool workshop at any price! Designed for the man who wants the best. Massive cast and precision-machined headstock, self-centering inverted "V" bedways (like precision metal lathes), exclusive non-friction speed changer, extra-large cast and precision-ground saw table. 100% ball bearing, lifetime-lubricated. You save by ordering direct from factory. You are invited to test Supershop Model X in your home FREE. Mail coupon or postcard for FREE brochures, photos, details, specifications, accessory list — and amazing freight prepaid FREE HOME TRIAL PLAN. All free.

MAIL COUPON OR  
POSTCARD TODAY

POWER TOOLS, INC. 105 Yates Avenue  
Beloit, Wisconsin

NAME \_\_\_\_\_  
ADDRESS \_\_\_\_\_  
CITY \_\_\_\_\_ STATE \_\_\_\_\_





## What on earth Is a Grady Wedge?



A Red Devil Grady Wedge driven into the end of axe or hammer handle keeps the head on tight, safe. Your hardware dealer has 8 different sizes, from 4¢ to 14¢ each—or a handy bag of 5 most-useful sizes for 28¢. Cheap life insurance!



**Nothing Sharper Than Razor Blades** for scraping stickers off windshields, paint off windows or what have you? But why shed blood when 29¢ buys you this Red Devil "Red Hed" that's easy to grasp, retracts blade with a thumbflick. Spare blades, 5 for 15¢, colored red to warn when business edge is exposed.



**Scraping Is Easier Than You Thought** when you use the right Red Devil Scraper for the job. Professionals know this, so we make 18 different sizes, shapes, and kinds to keep 'em happy. The best stores carry all, priced from 35¢ to \$4.50, and will tell you which to use.



**Linoleum Cuts Like Butter** with a Red Devil Linoleum Knife. A whiz for cardboard, opening boxes, cutting roofing material. Worth 55¢ to have one "just in case", but if you're choosy, Red Devil dealers have 7 different styles for which you can pay as much as \$1.10. 4571

*It's always best to buy where Red Devil Tools are sold, for wider choice, highest quality, and correct "how-to" advice.*

**Free booklet, "How To Prepare Surfaces For Finishing."**  
Address Dep't. B-3



### Red Devil Tools.

Union, N. J., U. S. A.

World's largest manufacturer of painters' and glaziers' tools.

HAVE ELECTRICITY ANYWHERE!

## Bendix

### PORTABLE GENERATOR

Take this lightweight 110 V, 60 cycle AC generator anywhere for full 750 watts of light and power. Small, compact, completely self-contained. Weighs only 49 lbs. 2 HP engine runs up to 3 hours on single tank-full. Rewind starter; built-in muffler. Mail coupon now.



for LIGHTS  
TV-RADIO  
CAMPING  
TRAILERS  
BOATS  
FARM  
EMERGENCY

DEALER  
INQUIRIES  
INVITED

Bendix Aviation, North Hollywood, Calif.  
Send literature on your 750 W Generator.

Name \_\_\_\_\_  
Address \_\_\_\_\_



L. G. Gildersteeve, 55 Valley St., Pasadena, Calif.

## Fun for Mom, Too!

Even mom or pop can jog along on a new pogo stick that uses compressed air instead of a spring. The air chamber is filled at a service station or by hand pump. Depending upon the air pressure, the pogo stick will bounce hard and high, or give a cushioned ride. Also, the pressure can be adjusted so the toy can be used by anyone weighing from 20 to 250 pounds.

## Indians of High Andes Have Huge Blood Supply

Heredity plus top-of-the-Andes environment have combined to adapt the body of the stocky, big-chested Indians of Peru to life two miles or more above sea level, reports Dr. Marshall T. Newman. Physical anthropologist of the Smithsonian Institution, Dr. Newman has made a study of the Indians at Hacienda Vicos, high up in the Peruvian Andes mountains. Besides their huge chests and lungs, he found the Indians have an average of two more quarts of blood in their bodies than sea-level inhabitants and their red blood cells are larger, providing more surface area for taking up oxygen. This also results in a larger heart to pump blood to the extremities. Dr. Newman found the bare feet and hands of the Indians warm even in the intense cold of the high Andean nights.



# GIGANTIC HYDRAULIC SALE

## SAVE! OVER 50,000 HYDRAULIC CYLINDERS at DISCOUNT PRICES

Take advantage of these tremendous bargains. Missiles are making manned aircraft obsolete and the Gov't is disposing of and dismantling 1000's of planes. We purchased a huge lot of Hydraulic Equipment at extra low prices and are passing the savings on to you. Never in our History have we offered these Hyd. items at such low prices. Prices good Feb & March ONLY!

No. H-24D - Double Action Cyl. 3000 PSI. Steel barrel. Ideal for hydraulic press work. Has 2-3/8" bore, 7" stroke, 1-3/8" shaft, 19" length.

Approx. Gov't Cost . . . . \$270.00  
Regular Palley Cat. Price \$172.75

**SALE PRICE 995**

No. H-24 - Double Action Cyl. 1500 PSI. Bore 1-1/2", shaft 9/16", adjustable stroke, 1-3/16" to 4-3/8". Length 14-1/2".

Approx. Gov't Cost . . . . \$68.00  
Regular Palley Cat. Price . . \$72.50

**SALE PRICE 395**



Special DOUBLE ACTION Hydraulic Cylinder  
Ideal for use where a long stroke is desired. Operates on continuous duty up to 1500 PSI. Stroke is 2-3/8". Bore is 1-1/2" - Shaft 1" - Length 32-3/4".

**SALE PRICE 795**

No. H-74 Cost Gov't approx. \$116.00 Regular Palley Catalog Price \$16.50



Cost Gov't approx. \$140  
Palley Cat. Price. \$17.75

1500 PSI DOUBLE ACTION HYDRAULIC CYLINDER  
Has a long stroke of 21-1/2" with a bore of 2". Shaft is 1" diameter. Overall length 28".

**SALE PRICE 995**

No. H-75



Cost Gov't approx. \$90  
Palley Cat. Price. \$11.75

1500 PSI DOUBLE ACTION Hydraulic Cylinder Bargain -  
Another Special Palley Value. Has a Bore of 1-3/8", Shaft is 1" diameter. Stroke 15-5/8". Overall length is 22".

**NOW 795**

No. H-73

No. H-48 - Double Action 1500 PSI Cylinder. Has 2" bore, 9" stroke, 7/8" shaft, 14 1/2" lgh. Top government quality.

Approx. Gov't Cost . . . . \$76.00  
Regular Palley Cat. Price. . \$10.25

**SALE PRICE 595**

No. H-56 - 1500 PSI CYL. Ports are so arranged to allow these cylinders to be used singly or in series. Ideal for production line equip. Bore 1 1/2", shaft is 1-1/8", stroke 4-7/8".

Approx. Gov't Cost . . \$70  
Reg. Palley Cat. Price \$4.25

**NOW 295**



### MOTOR DRIVEN PUMP

Has 2 1/2 HP, 20-29 V. DC, continuous duty motor. Pump displaces .172 cu. inches per revolution. The capacity is 3 GPM at 1000 PSI discharge pressure. Rated at 1000 PSI continuous.

Gov't Cost approx. . . . . \$350  
Regular Palley Cat. Price \$22.50

**995**



HAND PUMP WITH HANDLE  
No. HP-3

Cost Gov't approx \$80.00  
Reg. Palley price \$17.50

**NOW 695**

Has capacity of 1.5 cubic inches per cycle. Operating pressure 1500 PSI. Displacement 0.19 GPM at 30 cycles per minute. Has built-in check valve.

### FOUR-WAY HYD. VALVE

Made to rigid government specs. Poppet type. Spring loaded. Pressure balanced. Valve is closed in neutral position. Has 1/4" internal tube ports. Threaded 7/16" x 20 Thread. Original Gov't Cost approximately \$30.00  
Regular Palley Catalog Price \$6.75



**395**

## SAVE UP TO 85% ON OTHER BARGAINS

## BUILD A SATELLITE CAMERA

### COMPRESSOR

Use for paint, tree spray, oil brush, tire inflating. Has 1/8 HP, 115 V, 60C, AC Westinghouse motor. Draws 10" of vacuum. Has built-in air filter and pressure gauge. Has adjustable pressure to 35 PSI. **SAVE NOW!**

Gov't cost approx. \$300  
Reg. Palley price. \$27.95

**1695**

### GEAR BOX

B5 to 1 GEAR RATIO  
For use where tremendous power at a low take-off speed is desired. Drives thru a train of 6 gears rotating on self-lubricating, hi-speed roller bearings. Take-off shafts are 1 1/2" and 3/8". **NEW in excellent condition.**

Gov't cost approx. \$95  
Reg. Palley price. \$89.50

**595 USED 895**

### 7" f2.5 EASTMAN AERO LENS

Of the first four photos of the Russian Sputnik, three were shot by a U.C.L.A. Student with this lens in a home made camera. We furnish these plans **FREE** to adopt the lens. It has a 178mm focal length with stops from f/2.5 to f/16. Also makes an excellent telephoto lens when used on 35mm or Speed Graphic Camera. Glass is coated and fully color corrected.

Cost Gov't approx. \$200.00  
REG. 69.95  
**NOW 39.95**

### SPECIAL R-1 GENERATOR

Compound wound for heavy duty. Can be easily converted for use in an Arc Welder or for boats as power supply. R-1 type. Rated 300 Amps, 24-32 V. RPM 2450 to 10,000.

Gov't cost approx. \$200  
Palley Reg. Price \$27.95

**1695**

### 2500 lb. WINCH HOIST

A small, compact winch hoist. Ideal for garage, shop, trailer, jeep, etc. Has bronze, worm-gear drive with a 24 to 1 gear ratio and 3-speed crank. Equipped with a free-spool, pull-out clutch & 1 1/2" of cable.

Gov't cost approx. \$295  
Reg. Palley Price \$27.95

**2995**

MOUNTING FRAME for Hoist Only \$5.00

NATIONALLY ADVERTISED MERCHANDISE • NEW and USED GOVT SURPLUS • FACTORY CLOSE OUTS • EXCITING IMPORTS!

From EVERYWHERE PALLEY'S now bring you items of every description! This fabulous catalog contains Hand & Power Tools, Microscopes, Binoculars, Industrial and Building Materials, Housewares, Office Equipment, Sport & Outdoor Equipment, Cameras, Photo Supplies, Hobby Kits & "Gadgets", Electrical & Radio Supplies, Motors & Generators and a HUGE selection of Surplus Hydraulic Cylinders, Pumps, Valves, etc. So many items it's impossible to list them all.

**WORLD'S MOST AMAZING CATALOG**

**396 PAGES**

Send 50¢

Four 30¢ will be refunded with your first order of \$1.00 or more

Order from this Ad. Pay by Money Order or Check. P.O.s accepted from O&B firms. 1/2 deposit with C.O.D.s. Prices FOB, Los Angeles.

**Palley's** 2263 E. VERNON AVE., DEPT. PM-38 LOS ANGELES 58, CALIF.

Products Advertised in PM are Guaranteed

**PM TAG of INTEGRITY**

## 64" FLEXIBLE SHAFT

WOVEN WIRE CORE ONLY \$6.95  
USE AS ELECTRIC DRILL

GOVT. SURPLUS - never used - limited quantity. REAL BARGAIN. Cannot be duplicated for less than \$15.00. Coupling fits 1/2" or 3/4" motor shaft (state which); spindle and fits standard chuck. Durable, heavy Use it for grinding, polishing, buffing, drilling, etc.

Chuck for same only \$1.25. Send check or money order and we will ship P.P. prepaid or C.O.D. Plus Postage. Money refunded if not satisfied.

**L. C. DOWNNEY CO. - Dept. M**  
8004 TRAYMORE AVE., PHILA. 18, PA.

## START A BUSINESS this Quick Way

"I have taken in 100 mowers in 5 weeks since I got my Foley." says George C. Wise.

### FOLEY LAWN MOWER SHARPENER

Start in spare time and make a quick CASH PROFIT. The Foley handles up to 3 or 4 mowers per hour—prices run \$2.00 to \$3.00 for hand mowers, \$5.00 to \$8.00 for power mowers. You make 99% profit!

**FREE VALUABLE ILLUSTRATED BOOK** shows how to sharpen low-cost all leading makes of power mowers. Foley prices are low—easy payments available. **FREE PLAN** tells how to start. Write today—no salesman will call.

**FOLEY MFG. CO., 307-8 Foley Bldg., Mpls. 18, Minn.**



# Can One of These 4

## POPULAR MECHANICS

# "How-To"

# AUTO MANUALS

## Save You \$100 and More in Repair Bills in 1958?



## 7-DAY FREE TRIAL

### Will Convince You It Can!

Yes, even if you've never fixed your own car before, one of these 4 valuable Auto Manuals can show you exactly what to do to repair any part of your car and save yourself perhaps hundreds of dollars in a single year. Separate manuals for the "low-priced three" (Ford, Chevrolet, and Plymouth) and a comprehensive Auto Repair Manual for all other makes of cars. Select the Manual for your car and discover an easy-to-follow fast guide to any repair of any trouble with any part. Includes maintenance tips, too, to prevent trouble and expense.

*Written by Automotive Engineers and Authorities*

Contains latest official factory information written by long-experienced automotive engineers who know your car inside and out. Tells you how to locate source of trouble, explains step-by-step repair procedure so even the beginner can understand it. Guides you every step of the way as you put your car in perfect running condition. Tells how to prevent breakdowns and how to meet road emergencies. Ford, Chevrolet, and Plymouth Manuals are only \$3.50 each. Auto Repair Manual is only \$2.50.

## SEND NO MONEY

Just Mail Coupon NOW for 7-DAY FREE TRIAL

Send for Manual for your car. We'll rush it on approval. See if you agree it's a big time and money saver. If not, return Manual in 7 days and owe nothing. Hurry! Mail Coupon TODAY!

**POPULAR MECHANICS PRESS**  
200 East Ontario Street, Dept. 358  
CHICAGO 11, ILLINOIS

### Here Are Just a Few of the Money-Saving Chapters:

#### MANUAL FOR FORD OWNERS

367 pages—(for all models 1950-58)—Meet the Ford; Storage Battery; Ignition System; Engine Maintenance; Servicing Valves; Fordomatic Transmission; Tune-Up Specifications; 1958 Ford Developments; Safe and Thrifty Driving, etc.

#### MANUAL FOR CHEVROLET OWNERS

304 pages—(for all models 1950-58... order now, we ship immediately on publication in April)—Meet the New Chevrolet; Ignition; Fuel System; Valves; Pistons and Bearings; Tune-Up; Synchronesh Transmission; Powerglide Transmission; Steering Adjustments; Brake Adjusting, Relining, etc.

#### MANUAL FOR PLYMOUTH OWNERS

319 pages—(for all models 1950-57)—Meet Your New Plymouth; Ignition; Engine Maintenance; Tune-Up; Manual, Overdrive, Automatic Transmission; Power Brakes; Clutch Operation; Rear Axle; Trouble Shooting; Tire Care, etc.

#### AUTO REPAIR MANUAL

160 pages—Automatic Transmissions; Manual Transmissions; 12-volt Ignition; Motor Tune-Up; Brakes; Tires; Springs; Lubrication; Cooling; Battery; Carburetor; Generator; Body Care and Repair; Hill Holder; Horns, Switches, etc.

## MECHANICS! SERVICEMEN!

## Get This Book

# FREE

## When You Order the Other 3

If you're a professional repairman, all 4 books will save you a world of time, to boost your income. Order all 4 manuals for 7-DAY FREE TRIAL. If you decide to keep them, send only \$10.50 (for Ford, Chevrolet and Plymouth Manuals at \$3.50 ea.) plus shipping charges, and the valuable Auto Repair Manual is yours to keep. FREE! You save \$2.50! Mail Coupon NOW!

POPULAR MECHANICS PRESS, Dept. 358  
200 East Ontario St., Chicago 11, Illinois

Rush Manual(s) I have checked below for FREE TRIAL. If O.K., I'll remit purchase price for Manual(s) ordered, plus shipping charges. Otherwise, I agree to return Manual(s) postpaid within 7 days.

Ford (\$3.50)  Chevrolet (\$3.50)  Plymouth (\$3.50)  Auto Repair (\$2.50)

I am an auto mechanic. Rush all 4 manuals on FREE TRIAL. If O.K. I will remit \$10.50 plus shipping charges for Ford, Chevy and Plymouth Manuals, and the \$2.50 Auto Repair Manual is mine FREE. Otherwise, I'll return Manuals postpaid in 7 days.

I want to save shipping charges, so I enclose payment in full for Manual(s) checked. Rush postpaid. Same 7-day return privilege, with money refunded.

Name \_\_\_\_\_

Address \_\_\_\_\_

City \_\_\_\_\_

Zone \_\_\_\_\_ State \_\_\_\_\_



## AMERICA'S BEST

### 1500 WATT PLANT

115v. 60 cyc. AC Push Button Start. Powered by a 3 1/2 HP. Clinton engine. Combined, big output with easy portability. Provides emergency power for operating any oil burner, sump pump, freezer, television, lights, communications systems, etc. which require up to 1500 watts.

(Item 22). Wt. 110 lbs. Reg. \$475 value. Factory price... **\$239.50**

1750 Watt Plant Powered by 4.5 Briggs engine. Electric starting & battery charging built-in. Factory price... **\$279.50**

2500 WATT PLANT—Push Button Start (Item 21) 110/120 v. 60 cyc. A.C. A rugged powerful plant. Reg. \$645. Spec. **\$329.50**

3500 Watt Plant Push Button Start (Item 23) 115 v. 60 cyc. AC. Similar to above, but larger and 33% more capacity. Wt. 270 lbs. Reg. \$760. Factory Price... **\$379.50**

DUAL VOLTAGE 110/220 for Item 21 or 23 —\$30 additional.

### BATTERY CHARGING GENERATOR

#### Push Button Start

A husky, 750 watt plant (designed for battery charging only) that will charge 6 or 12 volt batteries in just minutes! When mounted with two 6 volt batteries it provides a terrific cold weather motor starting unit, as well as a fast charger! Charges all batteries anywhere—no in-line current needed. Ideal for service stations, garages and farms. Comes complete with ammeter and cutoff. (Item #21) Wt. 120 lbs. Regularly \$295. Our special, only. **\$119.50**

### MASTER AIR COMPRESSOR

COMPARE! This is the only compressor built with a NO RUST stainless steel tank. Comes up to 500 lbs.

(Item 209) High pressure type (4 c.f.m.) Large volume of air for heavy duty service. For paint spraying, inflating truck & auto tires, greasing, sand blasting, etc. Piston type 2" bore compressor with built-in air filter. Master built with high strength alloys and precision bearings. Tank, 12"x24", 2100 cu. in. cap. Equipped with automatic switch that starts and stops motor to maintain desired pressure (up to 150 lbs.) and check valve, safety valve, gauge, shut-off valve, 20 ft. air hose and tire chuck. Beautifully balanced on ball bearing wheels and rubber tires. Don't take chances with used or surplus equipment. Our compressors are factory new and are guaranteed SAFE. 1/2 H.P. heavy duty model, rpm. ind. motor and unloader switch. **\$129.50**

Item 209A, low factory price... **\$109.50**

### RUBBER HOSE

Genuine Neoprene Hose — outlasts ordinary rubber 3 to 1.

Reinforced with super tough cotton cord plies—totally completely flexible. Equipped with standard thread male and female fittings. Pump water for irrigation, stock tanks, home, barn, fire fighting, etc.—or pump gas and fuel oil. Volume factory prices—save more than 60%.

Size	Price	Size	Price
1"x10'	5.95	1 1/2"x50'	29.50
1 1/2"x10'	10.95	2"x10'	16.50
1 1/2"x20'	19.95	2"x10'	9.50*
1 1/2"x25'	13.95	2"x14'	21.50
1 1/2"x50'	24.95	2"x50'	47.50
1 1/2"x100'	49.95	2 1/2"x10'	21.75*
1 1/2"x10'	10.95	3 1/2"x15'	25.00
1 1/2"x25'	14.75	3"x10'	25.50*

\*—Discharge Hose.

### Variable Speed Selector

Heavy duty, made by B. F. GOODRICH for industrial use. Provides instant speed changes for any drive. For machine tools, dryers, printing, conveyors, production lines, hoists—any operation requiring variable speed. Employs reliable "trouble free" planetary system. No hydraulic power losses. Infinite range, smooth operation, easy installation. 3 sizes: 1/2-1 hp. 36 lbs.; 1-2 hp. wt. 55 lbs.; 2-3 hp. wt. 105 lbs.; Reg. list \$228, \$252 and \$352. Our prices **\$79.50, \$89.50 and \$114.50**

Send check or M.O. Prices f.o.b. Factory. 10 day Money back guarantee. SEND 10c for... **MASTER MECHANIC MFG. CO., DEPT. A-38 Burlington, Wis.**

## SAVE middleman profits

BUY DIRECT from

MASTER MECHANIC factory

(Item 24)

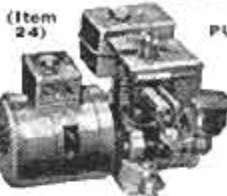

### 700 WATT PUSH BUTTON START

115 v. 60 cyc. AC Powered by a rugged 2.2 HP easy starting Briggs engine. No wiring necessary! Just plug in and operate. Plenty of current for any oil burner, freezer, brooder, emergency lights, etc. which require

up to 700 watts. Ideal for television and radios. Complete with Voltmeter and built-in winding to charge 6 v. auto batteries. (Item 24) Wt. 75 lbs. Easily fits in car trunk. Be prepared if storm knocks out power lines. Reg. \$275 value... **\$143.50**

1200 Watt Plant (Item 45) same as Item 24 but larger generator and engine with 50% greater output... **\$199.50**

## EXCLUSIVE! NEW!

### LIGHTWEIGHT WATER COOLED DIESEL GENERATOR PLANT

Never before available! Now offered exclusively

by Master Mechanic. A low priced, lightweight, Diesel

generator set. Powered by a super

rugged, exceptionally smooth running, one cylinder Diesel engine. Operates at conservative 1750 r.p.m. and delivers full 1750-2000 watts of power. Operates on low cost fuel oil. Wt. only 240 lbs. representing a triumph of Diesel Engineering. Complete with fuel filter, oil pressure gauge, control box with duplex receptacle and voltmeter. (Item 830) Special factory price... **\$399.50**

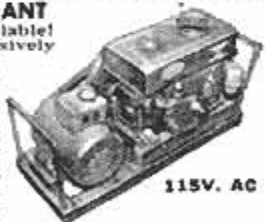

115V. AC

### MASTER D.C. ARC WELDER



Easy To Use

Now! a portable rugged, industrial type welder with terrific performance, yet at a price hundreds of dollars less than you'd expect. Senior model made for years of trouble-free continuous service. High capacity DC welding unit enables you to tackle any job with confidence—easily welds anything up to 2" plate using from 1/16" to 1/4" rods. Built-in stabilizer and cooling system makes arc easy to strike and hold. Dual control rheostat provides low heat soldering, brazing and welding from 30 to 300 amps. Complete with instructions, guarantee and triple V-belt or flat pulley. Easy to hook up and easy to operate.

WELDER ONLY — DUAL CONTROL MODEL. Same as above, but drive with your tractor, jeep or gas engine of 14 HP or more. (Item 38A) Wt. 110 lbs. \$450 value... **\$119.50**

WELDER ONLY—INDUSTRIAL MODEL same as above but with ceramic rotary type rheostat providing 74 different heat settings for all types of welding. (Item 38B) \$500.00 value... **\$139.50**

COMPLETE POWER MASTER (Illustrated above) powered by a 16 hp., air cooled Wisconsin engine. Wt. 480 lbs. (Item 280) Compares with welder costing \$1200. Factory Special... **\$449.50**

WELDING KIT. Two 10 ft. leads, welding helmet, electrode holder, ground clamp. Sold only with welder at... **\$10.50**

### FAUCET WATER HEATER



Instant hot water from any faucet for just pennies—sounds unbelievable—but it's true! You just slip MASTER MECHANIC'S new Faucet Water Heater over any water faucet, plug it in a wall outlet and you've got steaming hot running water instantly for dishes, shaving, washing baby's bottle, etc.

Simple and safe—operates on ordinary 110v. house current—costs only 2 1/2 cents per hour for hot water. Ideal for homes, barns, cabins, trailers, etc. Easily regulated from lukewarm to full hot. Fully guaranteed! (Item 408) Wt. 2 lbs. Factory price F.O.B. Burlington, only... **\$4.95**

## PORTABLE LIGHT PLANTS

### GIANT 2500 WATT PLANT

110-120 v. 60 cyc. AC. Absolutely the best made — exclusive dynamically balanced armature; heavy windings develop up to 5000 watt overload for motor starting. Skid mounted — portable. Powered by an easy starting Briggs or Wisconsin 6 HP engine—complete with all accessories: engine easily disconnected for other uses. Big outlet box, voltmeter, no wiring necessary. Ample current for all purposes. Factory warranty. (Item 31) Wt. 210 lbs. Reg. price \$585. Special at... **\$299.50**

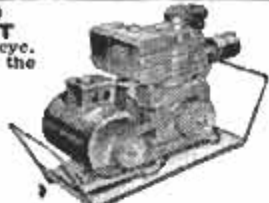

Same plant with electric self starter (Item 31A)... **\$359.50**

Generator only and control box... **\$169.50**

DUAL VOLTAGE 110-220 available on any of above models for \$28.00 additional.

### Double Acting Hydraulic Cylinder



A powerful cylinder mfr'd. by Massey Harris which develops both a pushing and a pulling action. Will push 8,100 lbs., with a 1000 P.S.I. pump pressure. Cylinder is 3 1/2" O.D. with 8 1/2" stroke—standard heavy duty clevises on both ends. Has standard 1/2" pipe thread openings. Can be used for tilting buckets or blades, raising or lowering implements, hydraulic presses, etc. Can also be used as an air cylinder. (Item 802) Wt. 17 lbs. Reg. \$68 value. Special... **\$14.95**

### OTHER DOUBLE ACTING CYLINDERS

8" stroke — 3" bore... **\$34.00**  
10" stroke — 3" bore... **\$4.80**  
16" stroke — 3" bore... **\$43.00**  
24" stroke — 3" bore... **\$47.50**

We have all sizes of cylinders available.

### HYDRAULIC CONTROL VALVE — 4 way

open center valve with built-in adjustable relief. Controls 1 double, or 2 single acting cylinders. Equalizing feature permits easy control even under heavy loads. 3/4" pipe thread on inlets & outlets. 1/2" on cylinder outlets. Easily mounted, finger tip control. Wt. 16 lbs. (Item 822)... **\$21.95**

### HYDRAULIC KIT



Complete Hydraulic Kit consists of hydraulic hand pump with built-in 2 gal. reservoir and Item 802 hydraulic cylinder described above. Pump has a built in relief valve and is rated at 20 tons. Kit is ideal for presses, jacks, snow-plows, etc. Pump is 2 1/2" long—8" diam. with 3/4" ports. A terrific value! (Item 835) Wt. 50 lbs... **\$39.50**

Pump only (Item 836) only... **\$23.50**

HYDRAULIC HOSE COUPLERS Connect or disconnect hydraulic lines without loss of oil. 1/2" pipe threads. (Item 819) per set... **\$4.95**

### CABLE HOIST

2000 lb. CAPACITY. A fortunate purchase from the Air Force enables us to offer these powerful 2000 lb. electric cable hoists at a fraction of their value. Perfect for material handling, boat hoists, elevators, lifts on assembly lines, etc. Two separate 22 ft. lift cables with independent controls permit leveling the load and controlling it perfectly. Rugged ball bearing motors of geared down design 110 volts. Available for A.C. or D.C. Please specify. Makes a terrific portable hoist with our #273 D.C. light plant at \$99.75. Offered at less than 33% of regular cost (Hook not included). Wt. 145 lbs. A.C. Model, Item 847A... **\$149.50**

D.C. Model, Item 847... **\$129.50**

### SCREW-TYPE PRESS

A tremendously powerful press capable of exerting nine tons of pressure. Pays for itself straightening bent parts, or pushing out bearings and bushings. Ideal for manufacturing and assembly operations because of precise control. Massive 1 1/4" screw permits precise control over vertical travel. Extra heavy ribbed yoke has a throat 21" high: depth capacity for working to the center of an 11 1/2" object. Includes 8" x 15 1/2" vise-type table and two pushing arbors. Wt. 150 lbs. (Item 797). Reg. **\$149.50**. Special... **\$49.50**

HYDRAULIC PRESS. Nine ton capacity. See Dec. Pop. Mech's ad for details—or write. Complete Wt. 110 lbs. (Item 464)... **\$69.50**



This Practical Self-Study Course will give you

# A COMPLETE MASTERY OF MATHEMATICS EASILY, QUICKLY



Learn Mathematics... get a **BETTER JOB!**

**N**ow you, too, can learn mathematics and get the basic training for a better job... the kind of training that is quickly recognized today and gladly paid for.

Just look at the "help wanted" ads in any big-time newspaper—look at the hundreds of wonderful opportunities for men who know mathematics: superintendents and foremen, technicians and laboratory workers, designers, draftsmen, mathematicians and engineers. Look at the huge companies—page after page of them—that are advertising for help *every day in the year!* They all need trained men, men

who know mathematics, to help them keep up with the ever-increasing demands in aviation, electronics, nuclear science, automation, jets and missiles.

Now you can learn mathematics—the foundation of all technical work—quickly, easily, inexpensively and right in your own home. A very simple and interesting course in book form has been prepared for you by an expert who has devoted a lifetime to teaching practical men the fundamentals of this important subject. Every minute you spend on this complete, practical course in mathematics will pay you big dividends.

## MATHEMATICS For Self Study

By J. E. Thompson, B.S. in E.E., A.M., Dept. of Mathematics, Pratt Institute

A COMPLETE COURSE AND REFERENCE LIBRARY

You start right from the beginning with a review of arithmetic that gives the special short cuts and trick problems that save countless hours of time. Then, step by step, you go into higher mathematics and learn how simple it all can be when an expert explains it to you.

### Get This Training in Only Ten Minutes a Day

You can gain all the benefits of a mathematical training in just a few months if you will devote only ten minutes each day to these easy, practical lessons.

Here are but a few of the hundreds of subjects simplified and explained in this complete self-study course in mathematics:

### An Expert Gives You His Simplified Methods

Prof. Thompson, the author of these books, is an expert at teaching practical Mathematics. He presents each problem in the clearest, simplest way. He gives you the kind of information you need for success!

**ARITHMETIC:** Starting with a quick review of principles, this book gives you the special calculation methods used in business and industry that every practical man should know. Above all else it shows you how to attain speed and accuracy with fractions and decimals, ratio and proportion, etc. Fundamentals in all computations in engineering—in both plant and field—and the essential methods for rapid calculation are made clear and simple.

**ALGEBRA:** This volume makes algebra a live interesting subject. The author starts with simple problems that can be solved by arithmetic and then shows you how to apply algebraic methods. Among other subjects, it teaches you all about logarithms—the method of computation that engineers use to save time. It also shows you how to solve problems which are involved in business and industrial work relating to machines, engines, ships, autos, planes, etc.

**GEOMETRY:** This book gives you the practical, common-sense method for solving all problems in both plane and solid geometry—problems ranging from the simplest distance problems to the geometry of spheres which have applications ranging all the way from the atom to the earth itself.

**TRIGONOMETRY:** Practically every problem in machine work, land surveying, mechanics, astronomy and navigation is solved by methods of trigonometry, and this interesting volume makes the methods of solving them clear and easy. These methods are explained simply with actual examples of calculations of height and distance as applied to meteorology, the position of a ship at sea, the construction of buildings, bridges and dams, the cutting of gears, etc.

**CALCULUS:** This branch of mathematics deals with rate problems and is essential in computation involving objects moving with varying rates of speed. It also enables you to find the most efficient design for any kind of mechanism, engine, or moving vehicle.

D. VAN NOSTRAND COMPANY, INC., PUBLISHERS, PRINCETON, NEW JERSEY



5 VOLUMES  
1,543 Pages  
Illustrated

### MAIL THIS COUPON

D. Van Nostrand Company, Inc., Princeton, N. J.

Send me **MATHEMATICS FOR SELF STUDY** in 5 volumes. Within 10 days I will either return the books or send you \$1.85 as first payment and \$2.00 per month for four months until the total price of \$9.85, plus a small delivery cost is paid.

(If you send \$9.85 with this coupon, we will pay the delivery. Return privilege and refund guaranteed.)

Name \_\_\_\_\_

Address \_\_\_\_\_

City \_\_\_\_\_ Zone \_\_\_\_\_ State \_\_\_\_\_

In Canada: Order from D. Van Nostrand Company Ltd.  
25 Hollinger Road, Toronto, Canada. LO 5-7580

### SEND NO MONEY

Examine These Books for  
10 Days FREE!

Send no money now, not a penny! The coupon at left will bring you the complete course in book form for 10 days' trial. Unless you are convinced that it is exactly what you need and want you may return the books and owe nothing or you may keep them by sending us the small down payment of \$1.85, balance in four monthly payments of \$2.00 each. Take advantage of this opportunity to acquire a complete training in mathematics this simple, inexpensive way.

### Thousands of Jobs Are Waiting for Trained Men

Industry is working at top capacity to meet the needs of our gigantic industrial program. Trained mechanics and technicians are in urgent demand, and in practically ALL OF THESE JOBS a knowledge of mathematics is required.

Remember, mathematics is the foundation of all technical work. Give yourself this basic preparation now by this quick, convenient, inexpensive method.



# "BLUE CHIP" TRAINING

—for the man  
who can take it  
hard and fast

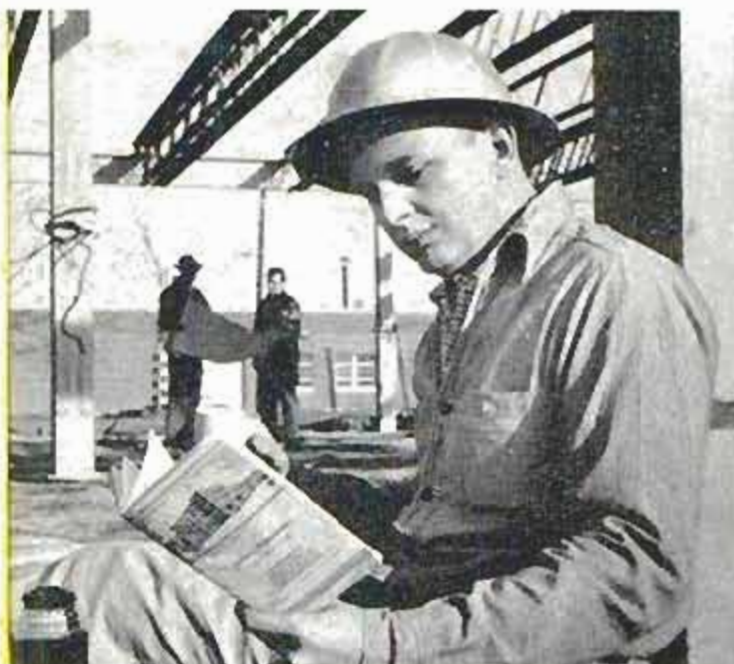

Here is a special kind of training for a special kind of man. No frills. No kidding around. No prodding or pampering. Just straight, honest, rock-solid instruction in practical subjects related to your job.

And it comes to you fast as you can take it.

This is training with a high "cash value." "Blue chip" companies by the hundreds recognize its worth, boost I.C.S.-trained men into better jobs, promote them faster, place them in positions of responsibility and prestige.

If you missed out on a college education . . . if you have money problems, a job to hold down, a family to support, then you're right to train with I.C.S. *No other school has so many of its former students now in supervisory and management positions!*

But remember—it takes a special kind of man to learn while he earns, the I.C.S. way. Don't mail the coupon below unless you're ready right now to say, "Prove to me you have what I want. I'll prove I can take it!"

For Real Job Security—Get an I. C. S. Diploma!

I. C. S., Scranton 15, Penna.

Accredited Member,  
National Home Study Council

## INTERNATIONAL CORRESPONDENCE SCHOOLS



BOX 72299C, SCRANTON 15, PENNA.

(Partial list of 257 courses)

Without cost or obligation, send me "HOW TO SUCCEED" and the opportunity booklet about the field BEFORE which I have marked X (plus sample lesson):

- |  |  |  |   |  |
|--|--|--|---|--|
| <p><b>ARCHITECTURE and BUILDING CONSTRUCTION</b></p> <input type="checkbox"/> Air Conditioning<br><input type="checkbox"/> Architecture<br><input type="checkbox"/> Arch. Drawing and Designing<br><input type="checkbox"/> Building Contractor<br><input type="checkbox"/> Building Estimator<br><input type="checkbox"/> Carpentry and Millwork<br><input type="checkbox"/> Carpenter Foreman<br><input type="checkbox"/> Heating<br><input type="checkbox"/> Interior Decoration<br><input type="checkbox"/> Painting Contractor<br><input type="checkbox"/> Plumbing<br><input type="checkbox"/> Reading Arch. Blueprints <p><b>ART</b></p> <input type="checkbox"/> Commercial Art<br><input type="checkbox"/> Magazine & Book Illus.<br><input type="checkbox"/> Show Card and Sign Lettering<br><input type="checkbox"/> Sketching and Painting <p><b>AUTOMOTIVE</b></p> <input type="checkbox"/> Automobiles<br><input type="checkbox"/> Auto Body Rebuilding and Refinishing<br><input type="checkbox"/> Auto Engine Tuneup<br><input type="checkbox"/> Auto Technician | <p><b>AVIATION</b></p> <input type="checkbox"/> Aero-Engineering Technology<br><input type="checkbox"/> Aircraft & Engine Mechanic <p><b>BUSINESS</b></p> <input type="checkbox"/> Accounting<br><input type="checkbox"/> Advertising<br><input type="checkbox"/> Business Administration<br><input type="checkbox"/> Business Management<br><input type="checkbox"/> Cost Accounting<br><input type="checkbox"/> Creative Salesmanship<br><input type="checkbox"/> Managing a Small Business<br><input type="checkbox"/> Professional Secretary<br><input type="checkbox"/> Public Accounting<br><input type="checkbox"/> Purchasing Agent<br><input type="checkbox"/> Salesmanship<br><input type="checkbox"/> Salesmanship and Management<br><input type="checkbox"/> Traffic Management <p><b>CHEMICAL</b></p> <input type="checkbox"/> Analytical Chemistry<br><input type="checkbox"/> Chemical Engineering<br><input type="checkbox"/> Chem. Lab. Technician<br><input type="checkbox"/> Elements of Nuclear Energy<br><input type="checkbox"/> General Chemistry<br><input type="checkbox"/> Natural Gas Prod. and Trans.<br><input type="checkbox"/> Petroleum Prod. and Engr.<br><input type="checkbox"/> Professional Engineer (Chem)<br><input type="checkbox"/> Pulp and Paper Making | <p><b>CIVIL ENGINEERING</b></p> <input type="checkbox"/> Civil Engineering<br><input type="checkbox"/> Construction Engineering<br><input type="checkbox"/> Highway Engineering<br><input type="checkbox"/> Professional Engineer (Civil)<br><input type="checkbox"/> Reading Struc. Blueprints<br><input type="checkbox"/> Structural Engineering<br><input type="checkbox"/> Surveying and Mapping <p><b>DRAFTING</b></p> <input type="checkbox"/> Aircraft Drafting<br><input type="checkbox"/> Architectural Drafting<br><input type="checkbox"/> Drafting Machine Design<br><input type="checkbox"/> Electrical Drafting<br><input type="checkbox"/> Mechanical Drafting<br><input type="checkbox"/> Sheet Metal Drafting<br><input type="checkbox"/> Structural Drafting <p><b>ELECTRICAL</b></p> <input type="checkbox"/> Electrical Engineering<br><input type="checkbox"/> Elec. Engr. Technician<br><input type="checkbox"/> Elec. Light and Power<br><input type="checkbox"/> Practical Electrician<br><input type="checkbox"/> Practical Lineman<br><input type="checkbox"/> Professional Engineer (Elec) <p><b>HIGH SCHOOL</b></p> <input type="checkbox"/> High School Diploma | <input type="checkbox"/> Good English<br><input type="checkbox"/> High School Mathematics<br><input type="checkbox"/> Short Story Writing <p><b>LEADERSHIP</b></p> <input type="checkbox"/> Industrial Foremanship<br><input type="checkbox"/> Industrial Supervision<br><input type="checkbox"/> Personnel-Labor Relations<br><input type="checkbox"/> Supervision <p><b>MECHANICAL and SHOP</b></p> <input type="checkbox"/> Diesel Engines<br><input type="checkbox"/> Gas-Elec. Welding<br><input type="checkbox"/> Industrial Engineering<br><input type="checkbox"/> Industrial Instrumentation<br><input type="checkbox"/> Industrial Metallurgy<br><input type="checkbox"/> Industrial Safety<br><input type="checkbox"/> Machine Design<br><input type="checkbox"/> Machine Shop Practice<br><input type="checkbox"/> Mechanical Engineering<br><input type="checkbox"/> Professional Engineer (Mech)<br><input type="checkbox"/> Quality Control<br><input type="checkbox"/> Reading Shop Blueprints<br><input type="checkbox"/> Refrigeration and Air Conditioning<br><input type="checkbox"/> Tool Design <input type="checkbox"/> Tool Making <p><b>RADIO, TELEVISION</b></p> <input type="checkbox"/> General Electronics Tech. | <input type="checkbox"/> Industrial Electronics<br><input type="checkbox"/> Practical Radio-TV Engr'g<br><input type="checkbox"/> Practical Telephony<br><input type="checkbox"/> Radio-TV Servicing <p><b>RAILROAD</b></p> <input type="checkbox"/> Car Inspector and Air Brake<br><input type="checkbox"/> Diesel Electrician<br><input type="checkbox"/> Diesel Engr. and Fireman<br><input type="checkbox"/> Diesel Locomotive <p><b>STEAM and DIESEL POWER</b></p> <input type="checkbox"/> Combustion Engineering<br><input type="checkbox"/> Power Plant Engineer<br><input type="checkbox"/> Stationary Diesel Engr.<br><input type="checkbox"/> Stationary Fireman <p><b>TEXTILE</b></p> <input type="checkbox"/> Carding and Spinning<br><input type="checkbox"/> Cotton Manufacture<br><input type="checkbox"/> Cotton Warming and Weaving<br><input type="checkbox"/> Loom Fixing Technician<br><input type="checkbox"/> Textile Designing<br><input type="checkbox"/> Textile Finishing & Dyeing<br><input type="checkbox"/> Throwing<br><input type="checkbox"/> Warming and Weaving<br><input type="checkbox"/> Worsted Manufacturing |
|--|--|--|---|--|

Name \_\_\_\_\_ Age \_\_\_\_\_ Home Address \_\_\_\_\_

City \_\_\_\_\_ Zone \_\_\_\_\_ State \_\_\_\_\_ Working Hours \_\_\_\_\_ A.M. to P.M. \_\_\_\_\_

Occupation \_\_\_\_\_

Canadian residents send coupon to International Correspondence Schools, Canadian, Ltd., Montreal, Canada. . . . Special tuition rates to members of the U. S. Armed Forces.





TIPS FROM  
TEXACO

## "WHY TIRES GET TIRED"

IT WAS 4 A.M. in the parking lot and the tires got talking.

"Boy, it's tough," said the left rear. "Carrying car tonnage at 70 M.P.H. is bad enough without the driver punishing us, too."

"Yeh, sudden starts, stops and fast, sharp turns grind off rubber," said the right rear.

"Banging and scraping against curbs and rocks is bad," added the right front. "And

under-inflation shortens our lives."

"Yes," replied the left front. "And the front wheels have excessive toe-in that's scraping us to the cords. When I blow the boss won't like it."

*Smart drivers save. They have their tires checked (and rotated) regularly by their Texaco Dealer . . . and they buy their new tires from him — and batteries, too.*



**Why smart drivers don't** get tired! A rough-riding chassis tires you, without your knowing why. It's worse if you get squeaks and rattles. That's the reason Texaco developed cushiony, smooth-riding Marfak chassis lubrication. Makes riding and handling easier and safer. Marfak seals itself in against dirt, dust and splashed water. Protects against wear. See your Texaco Dealer — *the best friend your car has ever had.*



THE TEXAS COMPANY

**TEXACO DEALERS**  
IN ALL 48 STATES

Texaco Products are also distributed in Canada, Latin America, and Africa.

TUNE IN . . . METROPOLITAN OPERA radio broadcasts Saturday afternoons, ABC.

